

Int. Cl.: 41

Prior U.S. Cls.: 100, 101 and 107

United States Patent and Trademark Office

Reg. No. 3,518,687

Registered Oct. 21, 2008

**SERVICE MARK
PRINCIPAL REGISTER**



THOMAS, CHRISTINE L. (UNITED STATES IN-
DIVIDUAL)
COLLEGE OF NATURAL RESOURCES
UNIVERSITY OF WISCONSIN-STEVENS POINT 1900
FRANKLIN ST.
STEVENS POINT, WI 54481

FOR: EDUCATIONAL SERVICES, NAMELY,
CONDUCTING WORKSHOPS AND SEMINARS IN
THE FIELD OF OUTDOOR SKILLS ASSOCIATED
WITH HUNTING, FISHING, AND WILDERNESS

SURVIVAL, IN CLASS 41 (U.S. CLS. 100, 101 AND
107).

FIRST USE 6-0-1992; IN COMMERCE 6-0-1992.

OWNER OF U.S. REG. NO. 2,085,985.

SER. NO. 75-445,789, FILED 3-6-1998.

CAROL SPILS, EXAMINING ATTORNEY

Int. Cl.: 14

Prior U.S. Cls.: 2, 27, 28 and 50

United States Patent and Trademark Office

Reg. No. 3,518,688

Registered Oct. 21, 2008

**TRADEMARK
PRINCIPAL REGISTER**

REPLICA COLLECTION ITALY

RICHMAN ASSOCIATES INC. (NEW YORK CORPORATION)
350 EAST 79TH STREET
NEW YORK, NY 10021

FOR: COSTUME JEWELRY MADE IN ITALY, IN CLASS 14 (U.S. CLS. 2, 27, 28 AND 50).

FIRST USE 12-1-1995; IN COMMERCE 12-1-1995.

NO CLAIM IS MADE TO THE EXCLUSIVE RIGHT TO USE "COLLECTION", APART FROM THE MARK AS SHOWN.

SEC. 2(F).

SER. NO. 75-455,657, FILED S.R. 3-24-1998 AM. P.R. 5-17-2007.

BONNIE LUKEN, EXAMINING ATTORNEY

Int. Cls.: 4, 7, 20, 35, 36, 37, 39, 40 and 42

Prior U.S. Cls.: 1, 2, 6, 13, 15, 19, 21, 22, 23, 25, 31, 32, 34, 35, 50, 100, 101, 102, 103, 105 and 106

Reg. No. 3,518,689

United States Patent and Trademark Office

Registered Oct. 21, 2008

**TRADEMARK
SERVICE MARK
PRINCIPAL REGISTER**

The logo for LUKOIL features the word "LUKOIL" in a bold, black, sans-serif font. The letter "O" is replaced by a stylized oil drop shape, which is also filled with black.

OPEN JOINT STOCK COMPANY "OIL COMPANY LUKOIL" (RUSSIAN FED. CORPORATION)

11, SRETENSKY BOULEVARD
MOSCOW 101000, RUSSIAN FED.

FOR: DUST LAYING AND ABSORBING COMPOSITION FOR USE ON UNPAVED ROADS, PETROLEUM BASED DUST ABSORBING COMPOSITION FOR USE IN ROAD BUILDING AND DUSTLAYING; DIESEL FUELS; FUEL FOR AIRCRAFT AND SHIPS; OIL FUEL; GASOLINE FUEL FOR MOTOR VEHICLES; FUEL WITH AN ALCOHOLIC BASE FOR USE IN AIRCRAFT AND MOTOR VEHICLES; COMBUSTIBLE CHARCOAL BRIQUETTES; GASOLINE; PETROLEUM JELLY FOR INDUSTRIAL PURPOSES; INDUSTRIAL OILS; GENERAL PURPOSE GREASES; AUTOMOTIVE GREASES; NON-CHEMICAL ADDITIVES TO MOTOR FUEL; CUTTING OILS FOR INDUSTRIAL METAL WORKING; AND LUBRICATING GREASE FOR INDUSTRIAL USE, IN CLASS 4 (U.S. CLS. 1, 6 AND 15).

FOR: OIL FIELD AND REFINERY EQUIPMENT, NAMELY, DRILLING RIG MACHINERY AND PARTS THEREFOR; PNEUMATIC TUBE CONVEYORS, IN CLASS 7 (U.S. CLS. 13, 19, 21, 23, 31, 34 AND 35).

FOR: BEDROOM FURNITURE, OFFICE FURNITURE, OUTDOOR FURNITURE AND LIVING ROOM FURNITURE; FURNITURE MIRRORS; PICTURE FRAMES; JEWELRY CASES NOT OF PRECIOUS METAL; FIGURINES AND SCULPTURES MADE OF WOOD, CORK, REED, CANE, WICKER, HORN, BONE, IVORY, PLASTIC, MOTHER OF PEARL, WHALEBONE, WAX AND PLASTERS; MATTRESSES AND PILLOWS; AIR MATTRESSES AND PILLOWS NOT FOR MEDICAL PURPOSES; SLEEPING BAGS FOR CAMPING; CURTAIN RODS;

CORKS FOR BOTTLES; PLASTIC BANNERS; PLASTIC BIBS; PLASTIC CRATES; CONTAINERS NOT OF METAL FOR COMMERCIAL USE, IN CLASS 20 (U.S. CLS. 2, 13, 22, 25, 32 AND 50).

FOR: DIRECT MAIL ADVERTISING; TELEVISION ADVERTISING AGENCIES; ADVERTISING AGENCIES, NAMELY, PROMOTING THE SERVICES OF AUTOMOBILE DEALERSHIPS THROUGH THE DISTRIBUTION OF PRINTED MATTER; CO-OPERATIVE ADVERTISING AND MARKETING; BUSINESS MARKETING CONSULTING SERVICES; PROVIDING COMMERCIAL AND STATISTICAL INFORMATION; AUCTIONEERING; IMPORT-EXPORT AGENCIES; DOCUMENT REPRODUCTIONS; COMMERCIAL AND INDUSTRIAL MANAGEMENT ASSISTANCE; COMPUTERIZED DATABASE MANAGEMENT; DATA PROCESSING SERVICES, NAMELY, SCIENTIFIC RESEARCH DATA INDEXING AND PROCESSING; RENTAL OF OFFICE MACHINES AND EQUIPMENT; ORGANIZING EXHIBITS FOR COMMERCIAL OR ADVERTISING PURPOSES; EMPLOYMENT AGENCIES; BUSINESS INVESTIGATIONS; AND EFFICIENCY EXPERTS, IN CLASS 35 (U.S. CLS. 100, 101 AND 102).

FOR: INSURANCE BROKERAGE, CAPITAL INVESTMENT CONSULTATION, EVALUATION OF CREDIT BUREAU DATA, FINANCIAL ANALYSIS AND CONSULTATION; LEASING OF REAL ESTATE, REAL ESTATE MANAGEMENT, CHARITABLE FUND RAISING, CREDIT RECOVERY AND COLLECTION; COLLECTION AGENCIES, BANKING AND COMMODITY BROKERAGE SERVICES; SAFETY DEPOSIT BOX SERVICES AND FACTORING AGENCIES, IN CLASS 36 (U.S. CLS. 100, 101 AND 102).

FOR: CONSTRUCTION OF ROADS AND ROAD PAVING; MAINTENANCE AND REPAIR OF MACHINERY, FREEZING EQUIPMENT, ELECTRIC AND ELECTRONIC APPLIANCES; CONSTRUCTION, REPAIR AND CLEANING OF BUILDINGS; CONSTRUCTION OF UTILITY FACILITIES FOR OTHERS; RENTAL OF CONSTRUCTION EQUIPMENT; QUARRY AND MINE EXTRACTION SERVICES, NAMELY, OIL AND GAS EXTRACTION; DRILLING OF WELLS AND PIPELINE CONSTRUCTION AND MAINTENANCE, IN CLASS 37 (U.S. CLS. 100, 103 AND 106).

FOR: TRANSPORT OF FUEL BY PIPELINE; TRUCK HAULING; RENTAL OF VEHICLES; RENTAL OF STORAGE CONTAINERS; CHAUFFEUR SERVICES; RENTAL OF GARAGE SPACE; PARKING PLACE RENTAL; FREIGHT FORWARDING SERVICES; ARRANGING TRAVEL TOURS EXCEPT FOR HOTEL RESERVATIONS; FREIGHT TRANSPORT BROKERAGE; PACKING ARTICLES FOR TRANSPORTATION; MESSAGE DELIVERY AND COURIER SERVICES, IN CLASS 39 (U.S. CLS. 100 AND 105).

FOR: ECOLOGICAL PURIFICATION SERVICES, NAMELY, PURIFICATION OF AIR, BODIES OF WATER, DRINKING WATER AND SEWAGE; ENVIRONMENTAL REMEDIATION SERVICES, NAMELY, SOIL, WATER AND WASTE TREATMENT SERVICES; FUR CONDITIONING, WOODWORKING; LEATHER WORKING; WOOL TREATMENT AND FINISHING; METAL TREATMENT; WASTE TREATMENT; MANUFACTURE OF

JEWELRY, ARTS AND CRAFTS OBJECTS, CLOTHS, DRAPERY, FURNITURE AND NONSTANDARD OFFICE EQUIPMENT TO THE ORDER AND SPECIFICATION OF OTHERS, IN CLASS 40 (U.S. CLS. 100, 103 AND 106).

FOR: SCIENTIFIC RESEARCH, TECHNICAL RESEARCH, ENGINEERING SERVICES; COMPUTER PROGRAMMING FOR OTHERS; LEGAL SERVICES; MASSAGE AND BEAUTY SALON; EMERGENCY MEDICAL ASSISTANCE SERVICES; HOTELS; PORTRAIT AND AERIAL PHOTOGRAPHY; INDUSTRIAL DESIGN; COMMERCIAL ART DESIGN; GRAPHIC ART DESIGN; ARCHITECTURAL DESIGN AND CONSULTATION; PROVIDING FACILITIES FOR EXHIBITIONS, MEETINGS, PRESENTATIONS; DATING SERVICES; RENTAL OF TEMPORARY ACCOMMODATIONS; ANIMAL BREEDING; CONDUCTING ECOLOGICAL RESEARCH; LICENSING OF INTELLECTUAL PROPERTY; WRITTEN TEXT EDITING; LANGUAGE TRANSLATION SERVICES; QUALITY CONTROL FOR OTHERS; TECHNICAL SUPERVISION AND INSPECTION IN THE FIELD OF FUEL OIL AND NATURAL GAS; ECOLOGICAL RESEARCH AND PROSPECTING, IN CLASS 42 (U.S. CLS. 100 AND 101).

OWNER OF RUSSIAN FED. REG. NO. 141745, DATED 5-17-1996, EXPIRES 7-20-2015.

SER. NO. 75-475,100, FILED 4-27-1998.

SHANNON TWOHIG, EXAMINING ATTORNEY

Int. Cls.: 4, 7, 20, 35, 36, 37, 39, 40 and 42

Prior U.S. Cls.: 1, 2, 6, 13, 15, 19, 21, 22, 23, 25, 31, 32, 34, 35, 50, 100, 101, 102, 103, 105 and 106

Reg. No. 3,518,690

United States Patent and Trademark Office

Registered Oct. 21, 2008

**TRADEMARK
SERVICE MARK
PRINCIPAL REGISTER**

LUKOIL

OPEN JOINT STOCK COMPANY "OIL COMPANY LUKOIL" (RUSSIAN FED. CORPORATION)

11, SRETENSKY BOULEVARD
MOSCOW 101000, RUSSIAN FED.

FOR: DUST LAYING AND ABSORBING COMPOSITION FOR USE ON UNPAVED ROADS, PETROLEUM BASED DUST ABSORBING COMPOSITION FOR USE IN ROAD BUILDING AND DUSTLAYING; DIESEL FUELS; FUEL FOR AIRCRAFT AND SHIPS; OIL FUEL; GASOLINE FUEL FOR MOTOR VEHICLES; FUEL WITH AN ALCOHOLIC BASE FOR INDUSTRIAL PURPOSES; INDUSTRIAL OILS; GENERAL PURPOSE GREASES; AUTOMOTIVE GREASES; NON-CHEMICAL ADDITIVES TO MOTOR FUEL; CUTTING OILS FOR INDUSTRIAL METAL WORKING; AND LUBRICATING GREASE FOR INDUSTRIAL USE, IN CLASS 4 (U.S. CLS. 1, 6 AND 15).

FOR: OIL FIELD AND REFINERY EQUIPMENT, NAMELY, DRILLING RIG MACHINERY AND PARTS THEREFOR; PNEUMATIC TUBE CONVEYORS, IN CLASS 7 (U.S. CLS. 13, 19, 21, 23, 31, 34 AND 35).

FOR: BEDROOM FURNITURE, OFFICE FURNITURE, OUTDOOR FURNITURE AND LIVING ROOM FURNITURE; FURNITURE MIRRORS; PICTURE FRAMES; JEWELRY CASES NOT OF PRECIOUS METAL; FIGURINES AND SCULPTURES MADE OF WOOD, CORK, REED, CANE, WICKER, HORN, BONE, IVORY, PLASTIC, MOTHER OF PEARL, WHALEBONE, WAX AND PLASTERS; MATTRESS AND PILLOW; AIR MATTRESSES AND PILLOWS NOT FOR MEDICAL PURPOSES; SLEEPING BAGS FOR CAMPING; CURTAIN RODS; CORKS FOR BOTTLES; PLASTIC BANNERS; PLASTIC BIBS; PLASTIC CRATES; CONTAINERS NOT OF METAL FOR COMMERCIAL USE, IN CLASS 20 (U.S. CLS. 2, 13, 22, 25, 32 AND 50).

FOR: DIRECT MAIL ADVERTISING; TELEVISION ADVERTISING AGENCIES; ADVERTISING AGENCIES, NAMELY, PROMOTING THE SERVICES OF AUTOMOBILE DEALERSHIPS THROUGH THE SERVICES; PROVIDING COMMERCIAL AND INDUSTRIAL MANAGEMENT ASSISTANCE; COMPUTERIZED DATABASE MANAGEMENT; DATA PROCESSING SERVICES, NAMELY, SCIENTIFIC RESEARCH DATA INDEXING AND PROCESSING; RENTAL OF OFFICE MACHINES AND EQUIPMENT; ORGANIZING EXHIBITS FOR COMMERCIAL OR ADVERTISING PURPOSES; EMPLOYMENT AGENCIES; BUSINESS INVESTIGATIONS AND EFFICIENCY EXPERTS, IN CLASS 35 (U.S. CLS. 100, 101 AND 102).

FOR: INSURANCE BROKERAGE; CAPITAL INVESTMENT CONSULTATION, EVALUATION OF CREDIT BUREAU DATA, FINANCIAL ANALYSIS AND CONSULTATION; LEASING OF REAL ESTATE, REAL ESTATE MANAGEMENT, CHARITABLE FUND RAISING, CREDIT RECOVERY AND COLLECTION; COLLECTION AGENCIES, BANKING AND COMMODITY BROKERAGE SERVICES; SAFETY DEPOSIT BOX SERVICES AND FACTORING AGENCIES, IN CLASS 36 (U.S. CLS. 100, 101 AND 102).

FOR: VEHICLE CLEANING SERVICES; CONSTRUCTION OF ROADS AND ROAD PAVING; INSTALLATION, MAINTENANCE AND REPAIR OF MACHINERY, FREEZING EQUIPMENT, ELECTRIC AND ELECTRONIC APPLIANCES; CONSTRUCTION, REPAIR AND CLEANING OF BUILDINGS; UTILITY SYSTEMS CONSTRUCTION; RENTAL OF CONSTRUCTION EQUIPMENT; BLASTING OPERATIONS; QUARRYING SERVICES AND MINE WORKINGS; MINING EXTRACTION, INCLUDING OIL AND GAS EXTRACTION; DRILLING OF WELLS; PIPELINE CONSTRUCTION AND

MAINTENANCE, IN CLASS 37 (U.S. CLS. 100, 103 AND 106).

FOR: TRANSPORT OF FUEL BY PIPELINE; TRUCK HAULING; RENTAL OF VEHICLES; RENTAL OF STORAGE CONTAINERS; CHAUFFEUR SERVICES; RENTAL OF GARAGE SPACE; PARKING PLACE RENTAL; FREIGHT FORWARDING SERVICES; ARRANGING TRAVEL TOURS EXCEPT FOR HOTEL RESERVATIONS; FREIGHT TRANSPORT BROKERAGE; PACKING ARTICLES FOR TRANSPORTATION; MESSAGE DELIVERY AND COURIER SERVICES, IN CLASS 39 (U.S. CLS. 100 AND 105).

FOR: ECOLOGICAL PURIFICATION SERVICES, NAMELY, PURIFICATION OF AIR, BODIES OF WATER, DRINKING WATER AND SEWAGE; ENVIRONMENTAL REMEDIATION SERVICES, NAMELY, SOIL, WATER AND WASTE TREATMENT SERVICES; FUR CONDITIONING, WOODWORKING; LEATHER WORKING; WOOL TREATMENT AND FINISHING; METAL TREATMENT; WASTE TREATMENT; MANUFACTURE OF JEWELRY, ARTS AND CRAFTS OBJECTS, CLOTHS, DRAPERY, FURNITURE AND NON-STANDARD OFFICE EQUIPMENT TO THE ORDER AND SPECIFICATION OF OTHERS, IN CLASS 40 (U.S. CLS. 100, 103 AND 106).

FOR: SCIENTIFIC RESEARCH, TECHNICAL RESEARCH, ENGINEERING SERVICES; COMPUTER PROGRAMMING FOR OTHERS; LEGAL SERVICES; MASSAGE AND BEAUTY SALON; EMERGENCY MEDICAL ASSISTANCE SERVICES; HOTELS; PORTRAIT AND AERIAL PHOTOGRAPHY; INDUSTRIAL DESIGN; COMMERCIAL ART DESIGN; GRAPHIC ART DESIGN; ARCHITECTURAL DESIGN AND CONSULTATION; PROVIDING FACILITIES FOR EXHIBITIONS, MEETINGS, PRESENTATIONS; DATING SERVICES; RENTAL OF TEMPORARY ACCOMMODATIONS; ANIMAL BREEDING; CONDUCTING ECOLOGICAL RESEARCH; LICENSING OF INTELLECTUAL PROPERTY; WRITTEN TEXT EDITING; LANGUAGE TRANSLATION SERVICES; QUALITY CONTROL FOR OTHERS; TECHNICAL SUPERVISION AND INSPECTION IN THE FIELD OF FUEL OIL AND NATURAL GAS; ECOLOGICAL RESEARCH AND PROSPECTING, IN CLASS 42 (U.S. CLS. 100 AND 101).

OWNER OF RUSSIAN FED. REG. NO. 141746, DATED 5-17-1996, EXPIRES 7-20-2015.

SER. NO. 75-475,106, FILED 4-27-1998.

SHANNON TWOHIG, EXAMINING ATTORNEY

Int. Cls.: 4, 7, 20, 35, 36, 37, 39, 40 and 42

Prior U.S. Cls.: 1, 2, 6, 13, 15, 19, 21, 22, 23, 25, 31, 32, 34, 35, 50, 100, 101, 102, 103, 105 and 106

Reg. No. 3,518,691

United States Patent and Trademark Office

Registered Oct. 21, 2008

**TRADEMARK
SERVICE MARK
PRINCIPAL REGISTER**



OPEN JOINT STOCK COMPANY "OIL COMPANY LUKOIL" (RUSSIAN FED. CORPORATION)

11, SRETENSKY BOULEVARD
MOSCOW 101000, RUSSIAN FED.

FOR: DUST LAYING AND ABSORBING COMPOSITION FOR USE ON UNPAVED ROADS, PETROLEUM BASED DUST ABSORBING COMPOSITION FOR USE IN ROAD BUILDING AND DUSTLAYING; DIESEL FUELS; FUEL FOR AIRCRAFT AND SHIPS; OIL FUEL; GASOLINE FUEL FOR MOTOR VEHICLES; FUEL WITH AN ALCOHOLIC BASE FOR INDUSTRIAL PURPOSES; INDUSTRIAL OILS; GENERAL PURPOSE GREASES; AUTOMOTIVE GREASES; NON-CHEMICAL ADDITIVES TO MOTOR FUEL; CUTTING OILS FOR INDUSTRIAL METAL WORKING; AND LUBRICATING GREASE FOR INDUSTRIAL USE, IN CLASS 4 (U.S. CLS. 1, 6 AND 15).

FOR: OIL FIELD AND REFINERY EQUIPMENT, NAMELY, DRILLING RIG MACHINERY AND PARTS THEREFOR; PNEUMATIC TUBE CONVEYORS, IN CLASS 7 (U.S. CLS. 13, 19, 21, 23, 31, 34 AND 35).

FOR: BEDROOM FURNITURE, OFFICE FURNITURE, OUTDOOR FURNITURE AND LIVING ROOM FURNITURE; FURNITURE MIRRORS; PIC-

TURE FRAMES; JEWELRY CASES NOT OF PRECIOUS METAL; FIGURINES AND SCULPTURES MADE OF WOOD, CORK, REED, CANE, WICKER, HORN, BONE, IVORY, PLASTIC, MOTHER OF PEARL, WHALEBONE, WAX AND PLASTERS; MATTRESS AND PILLOW; AIR MATTRESSES AND PILLOWS NOT FOR MEDICAL PURPOSES; SLEEPING BAGS FOR CAMPING; CURTAIN RODS; CORKS FOR BOTTLES; PLASTIC BANNERS; PLASTIC BIBS; PLASTIC CRATES; CONTAINERS NOT OF METAL FOR COMMERCIAL USE, IN CLASS 20 (U.S. CLS. 2, 13, 22, 25, 32 AND 50).

FOR: DIRECT MAIL ADVERTISING; TELEVISION ADVERTISING AGENCIES; ADVERTISING AGENCIES, NAMELY, PROMOTING THE SERVICES OF AUTOMOBILE DEALERSHIP THROUGH THE SERVICES; PROVIDING COMMERCIAL AND INDUSTRIAL MANAGEMENT ASSISTANCE; COMPUTERIZED DATABASE MANAGEMENT; DATA PROCESSING SERVICES, NAMELY, SCIENTIFIC RESEARCH DATA INDEXING AND PROCESSING; RENTAL OF OFFICE MACHINES AND EQUIPMENT; ORGANIZING EXHIBITS FOR COMMERCIAL OR ADVERTISING PURPOSES; EMPLOYMENT AGENCIES; BUSINESS INVESTIGATIONS AND EFFICIENCY EXPERTS, IN CLASS 35 (U.S. CLS. 100, 101 AND 102).

FOR: INSURANCE BROKERAGE; CAPITAL INVESTMENT CONSULTATION, EVALUATION OF CREDIT BUREAU DATA, FINANCIAL ANALYSIS AND CONSULTATION; LEASING OF REAL ESTATE, REAL ESTATE MANAGEMENT, CHARITABLE FUND RAISING, CREDIT RECOVERY AND COLLECTION; COLLECTION AGENCIES, BANKING AND COMMODITY BROKERAGE; SAFETY DEPOSIT BOX SERVICES AND FACTORING AGENCIES, IN CLASS 36 (U.S. CLS. 100, 101 AND 102).

FOR: VEHICLE CLEANING SERVICES; CONSTRUCTION OF ROADS AND ROAD PAVING; INSTALLATION, MAINTENANCE AND REPAIR OF MACHINERY, FREEZING EQUIPMENT, ELECTRIC AND ELECTRONIC APPLIANCES; CONSTRUCTION, REPAIR AND CLEANING OF BUILDINGS; UTILITY SYSTEMS CONSTRUCTION; RENTAL OF CONSTRUCTION EQUIPMENT; BLASTING OPERATIONS; QUARRYING SERVICES AND MINE WORKING; MINING EXTRACTION, INCLUDING OIL AND GAS EXTRACTION; DRILLING OF WELLS; PIPELINE CONSTRUCTION AND MAINTENANCE, IN CLASS 37 (U.S. CLS. 100, 103 AND 106).

FOR: TRANSPORT OF FUEL BY PIPELINE; TRUCK HAULING; RENTAL OF VEHICLES; RENTAL OF STORAGE CONTAINERS; CHAUFFEUR SERVICES; RENTAL OF GARAGE SPACE; PARKING PLACE RENTAL; FREIGHT FORWARDING SERVICES; ARRANGING TRAVEL TOURS EXCEPT FOR HOTEL RESERVATIONS; FREIGHT TRANSPORT BROKERAGE; PACKING ARTICLES FOR TRANSPORTATION; MESSAGE DELIVERY AND COURIER SERVICES, IN CLASS 39 (U.S. CLS. 100 AND 105).

FOR: ECOLOGICAL PURIFICATION SERVICES, NAMELY, PURIFICATION OF AIR, BODIES OF

WATER, DRINKING WATER AND SEWAGE; ENVIRONMENTAL REMEDIATION SERVICES, NAMELY, SOIL, WATER AND WASTE TREATMENT SERVICES; FUR CONDITIONING, WOODWORKING; LEATHER WORKING; WOOL TREATMENT AND FISHING METAL TREATMENT; WASTE TREATMENT; MANUFACTURE OF JEWELRY, ARTS AND CRAFTS OBJECTS, CLOTHS, DRAPERY, FURNITURE AND NON-STANDARD OFFICE EQUIPMENT TO THE ORDER AND SPECIFICATION OF OTHERS, IN CLASS 40 (U.S. CLS. 100, 103 AND 106).

FOR: SCIENTIFIC RESEARCH, TECHNICAL RESEARCH, ENGINEERING SERVICES; COMPUTER PROGRAMMING FOR OTHERS; LEGAL SERVICES; MASSAGE AND BEAUTY SALON; EMERGENCY MEDICAL ASSISTANCE SERVICES; HOTELS; PORTRAIT AND AERIAL PHOTOGRAPHY; INDUSTRIAL DESIGN; COMMERCIAL ART DESIGN; GRAPHIC ART DESIGN; ARCHITECTURAL DESIGN AND CONSULTATION; PROVIDING FACILITIES FOR EXHIBITIONS, MEETING, PRESENTATIONS; DATING SERVICES; RENTAL OF TEMPORARY ACCOMMODATIONS; ANIMAL BREEDING; CONDUCTING ECOLOGICAL RESEARCH; LICENSING OF INTELLECTUAL PROPERTY; WRITTEN TEXT EDITING; LANGUAGE TRANSLATION SERVICES; QUALITY CONTROL FOR OTHERS; TECHNICAL SUPERVISION AND INSPECTION IN THE FIELD OF FUEL OIL AND NATURAL GAS; ECOLOGICAL RESEARCH AND PROSPECTING, IN CLASS 42 (U.S. CLS. 100 AND 101).

OWNER OF RUSSIAN FED. REG. NO. 141747, DATED 5-17-1996, EXPIRES 7-20-2015.

SER. NO. 75-475,107, FILED 4-27-1998.

SHANNON TWOHIG, EXAMINING ATTORNEY

Int. Cl.: 36

Prior U.S. Cls.: 100, 101 and 102

United States Patent and Trademark Office

Reg. No. 3,518,692

Registered Oct. 21, 2008

**SERVICE MARK
PRINCIPAL REGISTER**

CENTURY FINANCIAL SERVICES

CENTURY BANCORP, INC. (MASSACHUSETTS
CORPORATION)
400 MYSTIC AVENUE
MEDFORD, MA 02155

NO CLAIM IS MADE TO THE EXCLUSIVE
RIGHT TO USE "FINANCIAL SERVICES", APART
FROM THE MARK AS SHOWN.

FOR: INVESTMENT SERVICES, NAMELY,
BROKERAGE AND INVESTMENT SERVICES TO
INDIVIDUAL AND COMMERCIAL CUSTOMERS,
IN CLASS 36 (U.S. CLS. 100, 101 AND 102).

SER. NO. 75-709,738, FILED 5-19-1999.

FIRST USE 9-0-1991; IN COMMERCE 9-0-1991.

INGA ERVIN, EXAMINING ATTORNEY

Int. Cl.: 36

Prior U.S. Cls.: 100, 101 and 102

United States Patent and Trademark Office

Reg. No. 3,518,693

Registered Oct. 21, 2008

**SERVICE MARK
PRINCIPAL REGISTER**

CENTURY BANK

CENTURY BANCORP, INC. (MASSACHUSETTS
CORPORATION)
400 MYSTIC AVENUE
MEDFORD, MA 021556316

NO CLAIM IS MADE TO THE EXCLUSIVE
RIGHT TO USE "BANK", APART FROM THE
MARK AS SHOWN.

FOR: BANKING SERVICES, IN CLASS 36 (U.S.
CLS. 100, 101 AND 102).

SER. NO. 75-709,833, FILED 5-19-1999.

FIRST USE 5-0-1969; IN COMMERCE 5-0-1969.

INGA ERVIN, EXAMINING ATTORNEY

Int. Cls.: 9 and 16

Prior U.S. Cls.: 2, 5, 21, 22, 23, 26, 29, 36, 37, 38 and 50

Reg. No. 3,518,694

United States Patent and Trademark Office

Registered Oct. 21, 2008

**TRADEMARK
PRINCIPAL REGISTER**

WORLD SERVICE

THE BRITISH BROADCASTING CORPORATION
(UNITED KINGDOM CORPORATION)
BROADCASTING HOUSE, PORTLAND PLACE
LONDON W1A 1AA, ENGLAND

THE AFORESAID GOODS, IN CLASS 9 (U.S. CLS. 21,
23, 26, 36 AND 38).

FOR: ELECTRICAL AND ELECTRONIC APPARATUS AND INSTRUMENTS, NAMELY, COMPUTERS; COMPUTER PERIPHERALS; COMMUNICATIONS APPARATUS, NAMELY, RADIOS AND TELEPHONES; SOUND, VIDEO AND DATA RECORDING AND REPRODUCING APPARATUS, NAMELY, AUDIO CASSETTE RECORDERS AND PLAYERS, CD PLAYERS AND VIDEO CASSETTE RECORDERS; WORD PROCESSING APPARATUS AND INSTRUMENTS, NAMELY, DEDICATED WORD PROCESSORS; AMUSEMENT APPARATUS, NAMELY, TOUCH PADS FOR USE WITH A TELEVISION SCREEN OR VIDEO MONITOR; COMPUTER GAME SOFTWARE AND REMOTE CONTROLLERS FOR USE WITH A TELEVISION SCREEN OR A VIDEO MONITOR; COMPUTER SOFTWARE FOR USE IN WORD PROCESSING; COMPUTER GAME SOFTWARE; VIDEO GAME SOFTWARE; COMPUTER GAME CARTRIDGES FOR USE WITH ELECTRONIC GAME APPARATUS; PRERECORDED SOUND AND VIDEO RECORDINGS FEATURING MUSIC; CINEMATOGRAPHIC AND PHOTOGRAPHIC FILMS FEATURING MUSIC AND MUSICAL ENTERTAINMENT; SUNGLASSES; PRERECORDED PHONOGRAPH RECORDS, COMPACT DISCS, AUDIO TAPES, VIDEO CASSETTES, MAGNETIC CARTRIDGES, SOUND CARDS ALL FEATURING MUSIC AND MUSICAL ENTERTAINMENT; COMPUTER GAME EQUIPMENT CONTAINING MEMORY DEVICES NAMELY, DISCS; ELECTRICALLY, MAGNETICALLY OR OPTICALLY RECORDED DATA FOR COMPUTERS FEATURING NEWS, ENTERTAINMENT AND MUSIC; INTERACTIVE COMPACT DISCS AND CD-ROMS FEATURING MUSIC, ENTERTAINMENT AND INFORMATION ABOUT INSTRUCTION, EDUCATION, SPORTS, AND NEWS; COMPUTER MOUSE MATS AND MOUSE PADS FOR USE WITH COMPUTERS; PARTS FOR ALL OF

FOR: ART PAPER, TYPING PAPER AND COMPUTER PAPER; PRINTED PUBLICATIONS, NAMELY, BOOKS, PAMPHLETS, PRINTED GUIDES, CATALOGS, AND PROGRAMS FEATURING ENTERTAINMENT, INFORMATION ABOUT NEWS, SPORTS, RECREATIONAL ACTIVITIES, COOKING AND EDUCATIONAL MATERIALS; A SERIES OF NON-FICTION BOOKS FEATURING BIOGRAPHIES, HISTORY AND SCIENCE BOOKLETS FEATURING FINANCIAL INFORMATION, HISTORY AND TECHNICAL INFORMATION; MAGAZINES FEATURING PERSONALITIES AND MATTERS OF CURRENT INTEREST; NEWSPAPERS OF GENERAL CIRCULATION; PRINTED GUIDES WITH THE SCHEDULES OF BROADCAST RADIO AND TELEVISION PROGRAMS; PAPER BAGS; PAMPHLETS FEATURING FICTIONAL CHARACTERS AND FINANCIAL INFORMATION; BROCHURES ABOUT TRAVEL; NEWSLETTERS ABOUT REGIONS OF THE WORLD; NEWS BULLETINS; PRINTED PROGRAMS IN RELATION TO BROADCAST RADIO AND TELEVISION PROGRAMS; STATIONERY; ARTIST MATERIALS, NAMELY, PAINT BRUSHES AND PENCILS; INSTRUCTIONAL AND TEACHING MATERIALS, NAMELY, BOOKS, WORK BOOKS IN THE FIELD OF CURRENT EVENTS, GEOGRAPHY, HISTORY, CULTURES AND LANGUAGE TEACHING; FLASH CARDS; WRITING INSTRUMENTS; PENS; PENCILS; CRAYONS; DRAFTING RULERS AND DRAWING RULERS; PENCIL SHARPENERS; PENCIL BOXES; PENCIL CASES; PENCIL HOLDERS; POSTERS; PHOTOGRAPHIC PRINTS; PHOTOGRAPH ALBUMS; BINDERS; MULTI-RING BINDERS; FOLDERS; NOTE BOOKS; NOTEPADS; DIARIES; CALENDARS; POSTCARDS; GREETING CARDS; GRAPHIC DRAWINGS; STICKERS; IRON ON TRANSFERS; STENCILS; ORDINARY PLAYING CARDS; PASSPORT CASES AND CHECKBOOK CASES; PARTS FOR THE AFORESAID GOODS, IN CLASS 16 (U.S. CLS. 2, 5, 22, 23, 29, 37, 38 AND 50).

PRIORITY CLAIMED UNDER SEC. 44(D) ON
UNITED KINGDOM APPLICATION NO. 2132534,
FILED 5-6-1997.

SER. NO. 75-983,615, FILED 8-14-1997.

OWNER OF ERPN CMNTY TM OFC REG. NO.
539130, DATED 11-8-2002, RENEWED AS REG. NO.
539130, DATED 5-7-2007, EXPIRES 5-6-2017.

BARBARA GAYNOR, EXAMINING ATTORNEY

Int. Cl.: 30

Prior U.S. Cl.: 46

United States Patent and Trademark Office

Reg. No. 3,518,695

Registered Oct. 21, 2008

**TRADEMARK
PRINCIPAL REGISTER**

CAFÉ SAN MIGUEL

LEVEL GROUND TRADING LTD. (CANADA
LIMITED LIABILITY COMPANY)
#1-6824 KIRKPATRICK CRESCENT
SAANICHTON, B.C. V8M 1Z9, CANADA

FOR: GROUND AND WHOLE BEAN COFFEE
AND RELATED COFFEE PRODUCTS MADE PRI-
MARILY OF WHOLE COFFEE BEANS, NAMELY
CHOCOLATE COVERED COFFEE BEANS , IN
CLASS 30 (U.S. CL. 46).

FIRST USE 5-1-1999; IN COMMERCE 5-1-1999.

NO CLAIM IS MADE TO THE EXCLUSIVE
RIGHT TO USE "CAFE", APART FROM THE MARK
AS SHOWN.

THE ENGLISH TRANSLATION OF CAFÉ SAN
MIGUEL IS "SAN MIGUEL COFFEE".

SER. NO. 76-193,380, FILED 1-16-2001.

INGRID C. EULIN, EXAMINING ATTORNEY

Int. Cl.: 11

Prior U.S. Cls.: 13, 21, 23, 31 and 34

United States Patent and Trademark Office

Reg. No. 3,518,696

Registered Oct. 21, 2008

**TRADEMARK
PRINCIPAL REGISTER**

MUNCHKIN

TOTAL HEAT INC. (MASSACHUSETTS COR-
PORATION)
120 BRALEY ROAD
EAST FREETOWN, MA 02717

FOR: HOT WATER HEATERS AND WATER
HEATER SYSTEMS COMPRISED OF TANKS,
THERMOSTATS, AND HEATING ELEMENTS SOLD

TOGETHER AS A UNIT, IN CLASS 11 (U.S. CLS. 13,
21, 23, 31 AND 34).

FIRST USE 6-26-1998; IN COMMERCE 6-26-1998.

SER. NO. 76-195,419, FILED 1-16-2001.

RONALD R. SUSSMAN, EXAMINING ATTORNEY

Int. Cl.: 10

Prior U.S. Cls.: 26, 39 and 44

United States Patent and Trademark Office

Reg. No. 3,518,697

Registered Oct. 21, 2008

**TRADEMARK
PRINCIPAL REGISTER**

NEUROSTEP

NEUROSTREAM TECHNOLOGIES, INC. (CANADA CORPORATION)
SUITE 301 - 2099 LOUGHEED HIGHWAY
PORT COQUITLAM, BRITISH COLUMBIA V3B 1A8,
CANADA

FOR: BIOMEDICAL DEVICES, NAMELY, NERVE CUFFS FOR STIMULATING NERVES, RECORDING NERVE ACTIVITY, MODULATING NERVE ACTIVITY, AND/OR FLUID INFUSION, IMPLANTABLE ELECTRONIC DEVICES INCLUDING BIOELECTRICAL SIGNAL PROCESSORS AND BIOELECTRIC STIMULATORS; AND SURGICAL TOOLS FOR IMPLANTING NERVE CUFFS AND

ASSOCIATED BIOMEDICAL DEVICES, IN CLASS 10 (U.S. CLS. 26, 39 AND 44).

PRIORITY CLAIMED UNDER SEC. 44(D) ON CANADA APPLICATION NO. 1101669, FILED 5-1-2001, REG. NO. TMA704558, DATED 1-11-2008, EXPIRES 1-11-2023.

SER. NO. 76-329,153, FILED 10-24-2001.

ALEXANDER L. POWERS, EXAMINING ATTORNEY

Int. Cl.: 42

Prior U.S. Cls.: 100 and 101

United States Patent and Trademark Office

Reg. No. 3,518,698

Registered Oct. 21, 2008

**SERVICE MARK
PRINCIPAL REGISTER**

i4i

INFRASTRUCTURES FOR INFORMATION INC.
(CANADA CORPORATION)
116 SPADINA AVENUE
5TH FLOOR
TORONTO, ONTARIO, M5V 2K6, CANADA M5V
2K6

FOR: DEVELOPMENT AND DESIGN OF COM-
PUTER SOFTWARE PROGRAMS FOR OTHERS, IN
CLASS 42 (U.S. CLS. 100 AND 101).

PRIORITY CLAIMED UNDER SEC. 44(D) ON
CANADA APPLICATION NO. 1100984, FILED 5-3-
2001, REG. NO. TMA593514, DATED 10-30-2003, EX-
PIRES 10-30-2018.

SER. NO. 76-333,557, FILED 11-2-2001.

RONALD MCMORROW, EXAMINING ATTORNEY

Int. Cls.: 36 and 37

Prior U.S. Cls.: 100, 101, 102, 103 and 106

United States Patent and Trademark Office

Reg. No. 3,518,699

Registered Oct. 21, 2008

SERVICE MARK
PRINCIPAL REGISTER

ALFA CORPORATION (DELAWARE CORPORATION)

2108 E. SOUTH BLVD.
MONTGOMERY, AL 36198

FOR: PROPERTY AND CASUALTY INSURANCE UNDERWRITING SERVICES; REAL ESTATE SERVICES, NAMELY, PROVISION OF COMMERCIAL AND RESIDENTIAL REAL ESTATE BROKERAGE SERVICES, IN CLASS 36 (U.S. CLS. 100, 101 AND 102).

FIRST USE 6-0-1988; IN COMMERCE 6-0-1988.

FOR: CONSTRUCTION SERVICES, NAMELY, GENERAL CONTRACTING AND BUILDING SERVICES IN THE CONSTRUCTION INDUSTRY OF NEW HOMES, RESIDENTIAL COMMUNITIES AND COMMERCIAL PROPERTIES, IN CLASS 37 (U.S. CLS. 100, 103 AND 106).

FIRST USE 6-0-1988; IN COMMERCE 6-0-1988.

OWNER OF U.S. REG. NO. 2,088,673.

SER. NO. 76-370,711, FILED 2-14-2002.

KAELIE KUNG, EXAMINING ATTORNEY

Int. Cl.: 35

Prior U.S. Cls.: 100, 101 and 102

United States Patent and Trademark Office

Reg. No. 3,518,700

Registered Oct. 21, 2008

**SERVICE MARK
PRINCIPAL REGISTER**

ASCENTI

AIR CANADA (CANADA CORPORATION)
AIR CANADA CENTRE
P.O. BOX 14000, STATION AIRPORT
ST. LAURENT, QUEBEC, CANADA H4Y 1H4

FOR: CUSTOMER LOYALTY PROGRAM IN WHICH CREDITS ARE ACCUMULATED AND REDEEMED FOR TRAVEL AND/OR OTHER SERVICES AND PRODUCTS, IN CLASS 35 (U.S. CLS. 100, 101 AND 102).

PRIORITY CLAIMED UNDER SEC. 44(D) ON CANADA APPLICATION NO. 1123016, FILED 11-22-2001, REG. NO. TMA689768, DATED 6-14-2007, EXPIRES 6-14-2022.

SER. NO. 76-412,954, FILED 5-21-2002.

ALICE SUE CARRUTHERS, EXAMINING ATTORNEY

Int. Cl.: 43

Prior U.S. Cls.: 100 and 101

United States Patent and Trademark Office

Reg. No. 3,518,701

Registered Oct. 21, 2008

**SERVICE MARK
PRINCIPAL REGISTER**

THE ASHRAM

THE ASHRAM LTD (CALIFORNIA CORPORATION)
2025 N. MCKAIN
CALABASAS, CA 91302

FIRST USE 9-1-1974; IN COMMERCE 9-1-1974.

SEC. 2(F).

FOR: HEALTH RESORT SERVICES, NAMELY,
PROVIDING FOOD AND LODGING THAT SPECIALIZE
IN PROMOTING PATRONS' GENERAL HEALTH AND
WELL BEING, IN CLASS 43 (U.S. CLS. 100 AND 101).

SER. NO. 76-468,636, FILED 11-21-2002.

KATHERINE CONNOLLY, EXAMINING ATTORNEY

Int. Cl.: 34

Prior U.S. Cls.: 2, 8, 9 and 17

United States Patent and Trademark Office

Reg. No. 3,518,702

Registered Oct. 21, 2008

TRADEMARK
PRINCIPAL REGISTER



IMPOREXPOR BALBOA, S.A. (SPAIN CORPORATION)
C/ORENSE, 51
MADRID, SPAIN 28020

FOR: TOBACCO, SMOKING ARTICLES, NAME-
LY, CIGARETTES, CIGARS, HERBS FOR SMOK-
ING, SMOKING TOBACCO; MATCHES, IN CLASS
34 (U.S. CLS. 2, 8, 9 AND 17).

OWNER OF ERPN CMNTY TM OFC REG. NO.
2468658, DATED 1-11-2008, EXPIRES 4-11-2012.

THE MARK CONSISTS OF THE WORD "BAL-
BOA" IN CAPITALIZED LETTERS IN WHICH THE
BORDERING LINES ARE IN THE COLOR WHITE,
AND THE BULK OF THE LETTERS IS IN THE
COLOR GOLD. THE MARK ALSO COMPRISES A
DESIGN ELEMENT, I.E., THE BLACK BACK-
GROUND ON WHICH THE WORD "BALBOA" IS
PLACED.

SER. NO. 76-501,581, FILED 3-10-2003.

GEORGIA CARTY, EXAMINING ATTORNEY

Int. Cl.: 33

Prior U.S. Cls.: 47 and 49

United States Patent and Trademark Office

Reg. No. 3,518,703

Registered Oct. 21, 2008

**TRADEMARK
PRINCIPAL REGISTER**

PIZZA

PIZZA WINE NOMINEES PTY LTD (AUSTRALIA
CORPORATION)
MILAWA-BOBINAWARRAH ROAD
MILAWA, VICTORIA, AUSTRALIA

PRIORITY CLAIMED UNDER SEC. 44(D) ON
AUSTRALIA APPLICATION NO. 935567, FILED 11-
26-2002.

FOR: ALCOHOLIC BEVERAGES, NAMELY,
WINE AND WINE BASED BEVERAGES, DISTILLED
SPIRIT BASED PRE-MIXED ALCOHOLIC COCK-
TAILS, IN CLASS 33 (U.S. CLS. 47 AND 49).

SER. NO. 76-504,061, FILED 4-3-2003.

FIRST USE 8-0-2004; IN COMMERCE 8-0-2004.

MARY CRAWFORD, EXAMINING ATTORNEY

Int. Cl.: 16

Prior U.S. Cls.: 2, 5, 22, 23, 29, 37, 38 and 50

United States Patent and Trademark Office

Reg. No. 3,518,704

Registered Oct. 21, 2008

**TRADEMARK
PRINCIPAL REGISTER**

REPRESENT

YOUTH COMMUNICATION (NEW YORK COR-
PORATION)
224 WEST 29TH STREET, 2ND FLOOR
NEW YORK, NY 10001

FIRST USE 7-0-2003; IN COMMERCE 7-0-2003.

SER. NO. 76-555,656, FILED 10-10-2003.

FOR: MAGAZINE WRITTEN BY AND FOR
TEENS CONCERNING FOSTER CARE LIFE, IN
CLASS 16 (U.S. CLS. 2, 5, 22, 23, 29, 37, 38 AND 50).

PATRICIA EVANKO, EXAMINING ATTORNEY

Int. Cl.: 36

Prior U.S. Cls.: 100, 101 and 102

United States Patent and Trademark Office

Reg. No. 3,518,705

Registered Oct. 21, 2008

**SERVICE MARK
PRINCIPAL REGISTER**

AEGIS VALUE FUND

BERNO, GAMBAL & BARBEE, INC. (DELA-
WARE CORPORATION)
1100 NORTH GLEBE ROAD, SUITE 1040
ARLINGTON, VA 22201

FOR: INVESTMENT SERVICES, NAMELY, FI-
NANCIAL SERVICES IN THE NATURE OF AN
INVESTMENT SECURITY, IN CLASS 36 (U.S. CLS.
100, 101 AND 102).

FIRST USE 10-22-1997; IN COMMERCE 10-22-1997.

THE MARK CONSISTS OF STANDARD CHAR-
ACTERS WITHOUT CLAIM TO ANY PARTICULAR
FONT, STYLE, SIZE, OR COLOR.

NO CLAIM IS MADE TO THE EXCLUSIVE
RIGHT TO USE "VALUE FUND", APART FROM
THE MARK AS SHOWN.

SER. NO. 76-587,806, FILED 4-21-2004.

PAULA MAHONEY, EXAMINING ATTORNEY

Int. Cls.: 2, 19 and 37

Prior U.S. Cls.: 1, 6, 11, 12, 16, 33, 50, 100, 103 and 106

Reg. No. 3,518,706

United States Patent and Trademark Office

Registered Oct. 21, 2008

**TRADEMARK
SERVICE MARK
PRINCIPAL REGISTER**

PRISMO

PRISMO LIMITED (UNITED KINGDOM COMPANY)
FROGMORE PARK, WATTON AT STONE
HERTFORD, HERTFORDSHIRE SG14 3RU, UNITED KINGDOM

FOR: PAINTS, LACQUERS; SURFACE COATINGS IN THE NATURE OF PAINTS; MARKING MATERIALS IN THE NATURE OF PAINTS; NON-METALLIC MATERIALS FOR ANTI-SKID AND COLORED SURFACE TREATMENTS OF ROADS, PATHS, RUNWAYS AND BRIDGES, NAMELY EPOXY BASED COATING COMPOSITIONS AND RESIN-BASED COMPOSITIONS, AND THERMOPLASTIC RESIN-BASED COMPOSITION INCORPORATING CALCINED BAUXITE AND MINERAL EXTENDERS, IN CLASS 2 (U.S. CLS. 6, 11 AND 16).

FOR: NON-METALLIC MATERIALS FOR REPAIRING, CONSTRUCTING, AND SURFACING ROADS, PATHS, RUNWAYS AND BRIDGES, NAMELY HOT APPLIED SYNTHETIC POLYMER MODIFIED RESIN COMPOUNDS CONTAINING CEMENT, MINERALS, FIBERS, SAND, GRAVEL AND GRANITE AGGREGATES, BITUMEN BASED ASPHALT, ASPHALT, PITCH AND AGGREGATES CONTAINING THE AFORESAID SUBSTANCES, POLYMER MODIFIED BITUMEN BASED SEALING COMPOUNDS INCORPORATING GLASS FIBERS, RUBBER GRANULES AND GRANITE AGGREGATE, POLYMERIZED, BITUMEN AND RUBBER COMPOUND; NON-METALLIC MATERIALS FOR

MAKING DECORATIVE MARKINGS, LANE MARKINGS, DIRECTION MARKINGS AND WARNING MARKINGS ON ROADS, PATHS, RUNWAYS AND BRIDGES, NAMELY THERMOSETTING BINDERS INCORPORATING AGGREGATE MATERIALS, STONE, SAND, GRAVEL, GRANITE, STONE FLINTS, BAUXITE, AND SPARS, ASPHALT COMPOUND INCORPORATING PIGMENT, RUBBER GRANULES, GRANITE AGGREGATE AND GLASS FIBERS, PREFORMED THERMOPLASTIC STRIPS, NUMBERS, LETTERS, SHAPES AND SYMBOLS AND THERMOPLASTIC COMPOSITIONS INCORPORATING PIGMENT, EXTENDERS AND BINDERS, IN CLASS 19 (U.S. CLS. 1, 12, 33 AND 50).

FOR: CONSTRUCTION, MAINTENANCE AND MARKING SERVICES; ALL FOR ROADS, PATHS, RUNWAYS AND BRIDGES, IN CLASS 37 (U.S. CLS. 100, 103 AND 106).

THE MARK CONSISTS OF STANDARD CHARACTERS WITHOUT CLAIM TO ANY PARTICULAR FONT, STYLE, SIZE, OR COLOR.

OWNER OF ERPN CMNTY TM OFC REG. NO. 000772814, DATED 9-6-1999, EXPIRES 9-6-2009.

SER. NO. 76-597,617, FILED 6-16-2004.

DOMINIC J. FERRAIUOLO, EXAMINING ATTORNEY

Int. Cl.: 10

Prior U.S. Cls.: 26, 39 and 44

United States Patent and Trademark Office

Reg. No. 3,518,707

Registered Oct. 21, 2008

**TRADEMARK
PRINCIPAL REGISTER**

SILKIDOSE

GALDERMA S.A. (SWITZERLAND CORPORATION)
ZUGERSTRASSE 8
CHAM, SWITZERLAND CH6330

FOR: RECEPTACLE IN THE NATURE OF A DRUG DELIVERY DEVICE, NAMELY, A HAND-HELD APPLICATOR FOR DELIVERING MEASURED AMOUNTS OF MEDICATION TO THE SKIN FOR THE TREATMENT OF DERMATOLOGICAL DISORDERS, IN CLASS 10 (U.S. CLS. 26, 39 AND 44).

THE MARK CONSISTS OF STANDARD CHARACTERS WITHOUT CLAIM TO ANY PARTICULAR FONT, STYLE, SIZE, OR COLOR.

OWNER OF SWITZERLAND REG. NO. 521219, DATED 5-4-2004, EXPIRES 2-27-2014.

SER. NO. 76-599,178, FILED 6-24-2004.

BRENDAN REGAN, EXAMINING ATTORNEY

Int. Cl.: 7

Prior U.S. Cls.: 13, 19, 21, 23, 31, 34 and 35

Reg. No. 3,518,708

United States Patent and Trademark Office

Registered Oct. 21, 2008

**TRADEMARK
PRINCIPAL REGISTER**



TRITEK TECHNOLOGIES, INC. (DELAWARE
CORPORATION)
103 EAST BRIDLE PATH
HOCKESSIN, PA 197079409

FIRST USE 0-0-1988; IN COMMERCE 0-0-1988.

SER. NO. 76-648,949, FILED 10-21-2005.

FOR: MAIL SORTING MACHINES, IN CLASS 7
(U.S. CLS. 13, 19, 21, 23, 31, 34 AND 35).

REBECCA POVARCHUK, EXAMINING ATTOR-
NEY

Int. Cl.: 20

Prior U.S. Cls.: 2, 13, 22, 25, 32 and 50

Reg. No. 3,518,709

United States Patent and Trademark Office

Registered Oct. 21, 2008

**TRADEMARK
PRINCIPAL REGISTER**

CHAIR SOX

THE PENCIL GRIP, INC. (CALIFORNIA S CORPORATION)

P.O. BOX 201

BRIGHTWATERS, NY 11718

FOR: CHAIR LEG END COVERS AND DESK LEG END COVERS, IN CLASS 20 (U.S. CLS. 2, 13, 22, 25, 32 AND 50).

FIRST USE 1-1-2005; IN COMMERCE 1-1-2005.

THE MARK CONSISTS OF STANDARD CHARACTERS WITHOUT CLAIM TO ANY PARTICULAR FONT, STYLE, SIZE, OR COLOR.

NO CLAIM IS MADE TO THE EXCLUSIVE RIGHT TO USE "CHAIR", APART FROM THE MARK AS SHOWN.

SER. NO. 76-650,606, FILED 11-14-2005.

CHARLOTTE CORWIN, EXAMINING ATTORNEY

Int. Cls.: 7, 11 and 17

Prior U.S. Cls.: 1, 5, 12, 13, 19, 21, 23, 31, 34, 35 and 50

Reg. No. 3,518,710

United States Patent and Trademark Office

Registered Oct. 21, 2008

**TRADEMARK
PRINCIPAL REGISTER**

POLYTECH

POLYMERS TECHNOLOGIES, INC. (DELAWARE CORPORATION)
420 CORPORATE BOULEVARD
NEWARK, DE 19702

FOR: NON-METALLIC FILTERS FOR USE WITH MACHINES FOR PURIFICATION OF GASES, OILS, NATURAL GAS, PROPANE, AIR AND SIMILAR LIQUIDS, NAMELY, GASOLINE, KEROSENE, OIL AND SIMILAR GASES AND LIQUIDS; NON-METALLIC ENGINE GASKETS, IN CLASS 7 (U.S. CLS. 13, 19, 21, 23, 31, 34 AND 35).

FIRST USE 10-1-1989; IN COMMERCE 10-1-1990.

FOR: NON-METALLIC FILTERS FOR PURIFICATION OF LIQUIDS, NAMELY, WATER AND AQUEOUS SOLUTION, NAMELY, AQUEOUS BASED PROPRIETY PROCESS SOLUTIONS, WATER

BASED SOLUTIONS CONTAINING OIL AND KEROSENE, GASOLINE AND SIMILAR LIQUIDS, IN CLASS 11 (U.S. CLS. 13, 21, 23, 31 AND 34).

FIRST USE 10-1-1989; IN COMMERCE 1-1-1990.

FOR: NON-RIGID THERMAL INSULATING LAMINATED PARTS FOR INSULATION OF ENGINES, INDUSTRIAL EQUIPMENT AND FOR ENGINE ENCLOSURES, IN CLASS 17 (U.S. CLS. 1, 5, 12, 13, 35 AND 50).

FIRST USE 10-1-1989; IN COMMERCE 1-1-1990.

SER. NO. 76-655,172, FILED 2-13-2006.

DAVID HOFFMAN, EXAMINING ATTORNEY

Int. Cls.: 3, 5 and 21

**Prior U.S. Cls.: 1, 2, 4, 6, 13, 18, 23, 29, 30, 33, 40, 44,
46, 50, 51 and 52**

Reg. No. 3,518,711

United States Patent and Trademark Office

Registered Oct. 21, 2008

**TRADEMARK
PRINCIPAL REGISTER**



AHLSTROM WINDSOR LOCKS LLC (DELA-
WARE LIMITED LIABILITY COMPANY)
TWO ELM STREET
WINDSOR LOCKS, CT 06096

FOR: NONWOVEN MATERIALS, SUBSTRATES
OR SPECIALTY PAPERS USED IN WIPING APPLI-
CATIONS, NAMELY, DISPOSABLE WIPES IM-
PREGNATED WITH CHEMICALS OR
COMPOUNDS FOR PERSONAL HYGIENE, DISPO-
SABLE WIPES IMPREGNATED WITH CHEMICALS
OR COMPOUNDS FOR HOUSEHOLD USE IN
CLEANING, DISPOSABLE WIPES IMPREGNATED
WITH CHEMICALS OR COMPOUNDS FOR INDUS-
TRIAL USE, BABY WIPES, AND DISPOSABLE
WIPES IMPREGNATED WITH CHEMICALS OR
COMPOUNDS FOR HOUSEHOLD USE, DISPOSA-
BLE WIPES IMPREGNATED WITH CHEMICALS
OR COMPOUNDS FOR HOUSEHOLD USE IN DIS-
INFECTION, IN CLASS 3 (U.S. CLS. 1, 4, 6, 50, 51 AND
52).

FIRST USE 0-0-1993; IN COMMERCE 0-0-1993.

FOR: NONWOVEN MATERIALS, SUBSTRATES
OR SPECIALTY PAPERS USED IN WIPING APPLI-
CATIONS, NAMELY, SANITIZING WIPES, IN
CLASS 5 (U.S. CLS. 6, 18, 44, 46, 51 AND 52).

FIRST USE 0-0-1993; IN COMMERCE 0-0-1993.

FOR: NONWOVEN MATERIALS, SUBSTRATES
OR SPECIALTY PAPERS USED IN WIPING APPLI-
CATIONS, NAMELY, FABRIC CLEAN ROOM
WIPES, IN CLASS 21 (U.S. CLS. 2, 13, 23, 29, 30, 33,
40 AND 50).

FIRST USE 0-0-1993; IN COMMERCE 0-0-1993.

THE MARK CONSISTS OF A FACE OF A BEAR
REPEATED AS A PATTERN ON THE SURFACE OF
THE GOODS.

SEC. 2(F).

SER. NO. 76-655,794, FILED 2-28-2006.

CARRIE GENOVESE, EXAMINING ATTORNEY

Int. Cl.: 9

Prior U.S. Cls.: 21, 23, 26, 36 and 38

Reg. No. 3,518,712

United States Patent and Trademark Office

Registered Oct. 21, 2008

**TRADEMARK
PRINCIPAL REGISTER**

IRM

ECTEL LTD. (ISRAEL COMPANY)
43 HASIVIM STREET
PETACH TIKVA 49517, ISRAEL

THE MARK CONSISTS OF STANDARD CHARACTERS WITHOUT CLAIM TO ANY PARTICULAR FONT, STYLE, SIZE, OR COLOR.

FOR: COMMUNICATION EQUIPMENT FOR USE IN COMMUNICATION NETWORKS AND DIRECTLY SOLD TO TELECOMMUNICATION SERVICE PROVIDERS, NAMELY, COMPUTER SOFTWARE AND HARDWARE, FOR BILLING VERIFICATION, FRAUD DETECTION, MONITORING, MEASURING, ANALYZING, SECURITY MANAGING, NETWORK SURVEILLANCE, AND REPORTING INFORMATION EXTRACTED FROM COMMUNICATION NETWORKS, IN CLASS 9 (U.S. CLS. 21, 23, 26, 36 AND 38).

PRIORITY CLAIMED UNDER SEC. 44(D) ON ISRAEL APPLICATION NO. 184855, FILED 11-1-2005, REG. NO. 184855, DATED 8-7-2007, EXPIRES 8-7-2017.

SER. NO. 76-658,148, FILED 4-10-2006.

CHERYL CLAYTON, EXAMINING ATTORNEY

Int. Cl.: 12

Prior U.S. Cls.: 19, 21, 23, 31, 35 and 44

United States Patent and Trademark Office

Reg. No. 3,518,713

Registered Oct. 21, 2008

**TRADEMARK
PRINCIPAL REGISTER**

GAZZA

SUOMEN RENGASTEHDAS OY (FINLAND CORPORATION)
PIRKKALAISTIE 1
37100 NOKIA, FINLAND

FOR: TIRES FOR VEHICLES AND BICYCLES, IN CLASS 12 (U.S. CLS. 19, 21, 23, 31, 35 AND 44).

PRIORITY CLAIMED UNDER SEC. 44(D) ON ERPN CMNTY TM OFC APPLICATION NO.

4699971, FILED 11-3-2005, REG. NO. 004599971, DATED 10-23-2006, EXPIRES 11-3-2015.

OWNER OF U.S. REG. NO. 2,309,195.

SER. NO. 76-658,399, FILED 4-13-2006.

DAVID HOFFMAN, EXAMINING ATTORNEY

Int. Cl.: 30

Prior U.S. Cl.: 46

United States Patent and Trademark Office

Reg. No. 3,518,714

Registered Oct. 21, 2008

**TRADEMARK
PRINCIPAL REGISTER**

THE POWER OF FRUIT

WAGNER, PAUL (UNITED STATES INDIVIDUAL)

2374 SEIPSTOWN ROAD

FOGELSVILLE, PA 18051

FOR: FROZEN FRUIT BARS CONSISTING OF WHOLE, GROUND OR PUREED FRUIT AND NATURAL JUICES THEREFROM, IN CLASS 30 (U.S. CL. 46).

FIRST USE 3-23-2006; IN COMMERCE 12-18-2006.

THE MARK CONSISTS OF STANDARD CHARACTERS WITHOUT CLAIM TO ANY PARTICULAR FONT, STYLE, SIZE, OR COLOR.

OWNER OF U.S. REG. NO. 3,325,347.

NO CLAIM IS MADE TO THE EXCLUSIVE RIGHT TO USE "FRUIT", APART FROM THE MARK AS SHOWN.

SER. NO. 76-659,681, FILED 5-8-2006.

ANNE E. GUSTASON, EXAMINING ATTORNEY

Int. Cls.: 7 and 11

Prior U.S. Cls.: 13, 19, 21, 23, 31, 34 and 35

United States Patent and Trademark Office

Reg. No. 3,518,715

Registered Oct. 21, 2008

**TRADEMARK
PRINCIPAL REGISTER**

 **WHISPERTECH**

WHISPER TECH LIMITED (NEW ZEALAND
COMPANY)
224 ARMAGH STREET
CHRISTCHURCH, NEW ZEALAND

FOR: ELECTRICAL GENERATORS, GASEOUS OR LIQUID FUEL-POWERED, ENGINE DRIVEN COGENERATION UNITS FOR USE PRIMARILY IN GENERATING ELECTRICAL POWER, AND ALSO FOR USE IN PRODUCING HEAT; ELECTRIC MOTORS AND ENGINES, NAMELY, DIRECT CURRENT AND ALTERNATING CURRENT MOTORS; ELECTRIC GENERATORS; ELECTRIC GENERATORS FOR USE WITH EXTERNAL COMBUSTION ENGINES FOR THE GENERATION OF ELECTRICITY, HEATING AND COOLING IN HOUSEHOLD AND COMMERCIAL ESTABLISHMENTS; AND PARTS AND FITTINGS FOR THE AFORESAID GOODS, IN CLASS 7 (U.S. CLS. 13, 19, 21, 23, 31, 34 AND 35).

FOR: COGENERATION UNITS FOR SIMULTANEOUS GENERATION OF HEAT AND ELECTRIC POWER FOR HOUSEHOLD AND COMMERCIAL USE COMPRISED OF A NATURAL GAS OR LIQUID FUEL ENGINE, ELECTRICAL GENERATOR, ENCLOSURE AND WATER STORAGE TANK, AND PARTS AND FITTINGS THEREFOR, IN CLASS 11 (U.S. CLS. 13, 21, 23, 31 AND 34).

PRIORITY CLAIMED UNDER SEC. 44(D) ON NEW ZEALAND APPLICATION NO. 748289, FILED 5-22-2006, REG. NO. 748289, DATED 5-22-2006, EXPIRES 5-22-2016.

SER. NO. 76-661,286, FILED 6-8-2006.

ALLISON HOLTZ, EXAMINING ATTORNEY

Int. Cl.: 9

Prior U.S. Cls.: 21, 23, 26, 36 and 38

Reg. No. 3,518,716

United States Patent and Trademark Office

Registered Oct. 21, 2008

**TRADEMARK
PRINCIPAL REGISTER**

Avisere

AVISERE, INC. (ARIZONA CORPORATION)
8560 E. 22ND STREET
TUCSON, AZ 85710

FOR: COMPUTER HARDWARE, COMPUTER PROGRAMS FOR DATA RETRIEVING DEVICES AND SOFTWARE SYSTEMS, AND PATTERN RECOGNITION THROUGH OPTICAL, ELECTROMAGNETIC, AND TACTILE DEVICES AND SOFTWARE SYSTEMS USED TO DETECT, DIFFERENTIATE, AND INTERPRET BETWEEN OR AMONG OBJECTS AND HUMANS, NON-HUMANS, AND THE OBJECTS WITH WHICH THEY INTERACT; COMPUTER HARDWARE AND SOFTWARE SYSTEMS USED FOR PROCESSING INFORMATION OBTAINED BY PATTERN RECOGNITION DEVICES USED TO DETECT, DIFFERENTIATE, AND INTERPRET BETWEEN OR AMONG OBJECTS AND HUMANS, NON-HUMANS AND THE OB-

JECTS WITH WHICH THEY INTERACT USED AS MANAGEMENT DECISION TOOLS FOR IDENTIFICATION AND OPTIMIZATION OF THE EFFICIENCY AND PROFITABILITY OF PRODUCT, USER, OR CUSTOMER THROUGHPUT, AS WELL AS THE USE OF SUCH TECHNOLOGIES AND BUSINESS MODELS IN THE DEVELOPMENT OF MARKET STRATEGIES AND BUSINESS PLANS, IN CLASS 9 (U.S. CLS. 21, 23, 26, 36 AND 38).

FIRST USE 3-0-2003; IN COMMERCE 3-0-2003.

THE MARK CONSISTS OF STANDARD CHARACTERS WITHOUT CLAIM TO ANY PARTICULAR FONT, STYLE, SIZE, OR COLOR.

SER. NO. 76-662,311, FILED 6-29-2006.

GRETTA YAO, EXAMINING ATTORNEY

Prior U.S. Cl.: B

United States Patent and Trademark Office

Reg. No. 3,518,717

Registered Oct. 21, 2008

CERTIFICATION MARK
PRINCIPAL REGISTER

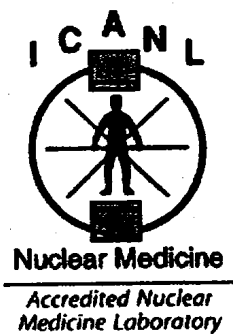

INTERSOCIETAL ACCREDITATION COMMISSION (MARYLAND CORPORATION)
8830 STANFORD BOULEVARD
SUITE 306
COLOMBIA, MD 21045

FOR: NUCLEAR MEDICINE LABORATORIES, IN CLASS B (U.S. CL. B).

FIRST USE 2-1-2006; IN COMMERCE 2-1-2006.

NO CLAIM IS MADE TO THE EXCLUSIVE RIGHT TO USE "NUCLEAR MEDICINE" AND "NUCLEAR MEDICINE LABORATORY", APART FROM THE MARK AS SHOWN.

THE CERTIFICATION MARK, AS USED BY PERSONS AUTHORIZED BY THE CERTIFIER, CERTIFIES THAT THE LABORATORY HAS UNDERGONE A QUALITY REVIEW THAT INCLUDES PERSONNEL, PHYSICAL FACILITIES, EQUIPMENT AND INSTRUMENTATION, PROTOCOLS AND PROCEDURES, AND IMAGE QUALITY AND REPORTING.

SEC. 2(F) AS TO "ACCREDITED NUCLEAR MEDICINE LABORATORY".

SER. NO. 76-663,100, FILED 7-14-2006.

MICHAEL SOUDERS, EXAMINING ATTORNEY

Int. Cl.: 42

Prior U.S. Cls.: 100 and 101

United States Patent and Trademark Office

Reg. No. 3,518,718

Registered Oct. 21, 2008

**SERVICE MARK
PRINCIPAL REGISTER**

MAKING WAVES IN POWER

OCEAN POWER TECHNOLOGIES, INC. (NEW
JERSEY CORPORATION)
1590 REED ROAD
PENNINGTON, NJ 08534

THE MARK CONSISTS OF STANDARD CHAR-
ACTERS WITHOUT CLAIM TO ANY PARTICULAR
FONT, STYLE, SIZE, OR COLOR.

FOR: DESIGN AND DEVELOPMENT OF SYS-
TEMS FOR GENERATING ELECTRICAL POWER
FROM WAVE ENERGY, IN CLASS 42 (U.S. CLS. 100
AND 101).

SER. NO. 76-664,116, FILED 8-4-2006.

FIRST USE 1-25-2005; IN COMMERCE 3-15-2005.

ARETHA SOMERVILLE, EXAMINING ATTORNEY

Int. Cl.: 20

Prior U.S. Cls.: 2, 13, 22, 25, 32 and 50

United States Patent and Trademark Office

Reg. No. 3,518,719

Registered Oct. 21, 2008

**TRADEMARK
PRINCIPAL REGISTER**

Schott PI Coating

SCHOTT AG (FED REP GERMANY JOINT
STOCK COMPANY)
HATTENBERGSTRASSE 10
D-55122 MAINZ, FED REP GERMANY

FOR: FITTED PRIMARY PACKAGING MADE OF
SPECIAL GLASS AND PLASTICS FOR PHARMA-
CEUTICAL PREPARATIONS, NAMELY, PHARMA-
CEUTICAL VIALS, CARTRIDGES, AMPOULES,
INJECTION AMPOULES, FINE TIP AND DRINK-
ING AMPOULES, AND AEROSOL CONTAINERS,
ALL SOLD EMPTY, IN CLASS 20 (U.S. CLS. 2, 13, 22,
25, 32 AND 50).

FIRST USE 9-0-2005; IN COMMERCE 9-0-2005.

THE MARK CONSISTS OF STANDARD CHAR-
ACTERS WITHOUT CLAIM TO ANY PARTICULAR
FONT, STYLE, SIZE, OR COLOR.

NO CLAIM IS MADE TO THE EXCLUSIVE
RIGHT TO USE "COATING", APART FROM THE
MARK AS SHOWN.

SER. NO. 76-666,239, FILED 9-18-2006.

ALICE BENMAMAN, EXAMINING ATTORNEY

Int. Cl.: 1

Prior U.S. Cls.: 1, 5, 6, 10, 26 and 46

Reg. No. 3,518,720

United States Patent and Trademark Office

Registered Oct. 21, 2008

**TRADEMARK
PRINCIPAL REGISTER**



MARS FISHCARE NORTH AMERICA, INC.
(PENNSYLVANIA CORPORATION)
50 E. HAMILTON STREET
CHALFONT, PA 189140218

FOR: CHEMICAL AND BACTERIA PREPARATIONS FOR THE TREATMENT, CONDITIONING, AND CLEANING OF AQUARIUMS AND AQUARIUM WATER; LIQUID PLANT FOOD FOR USE IN AQUARIUMS; WATER TREATMENT CHEMICALS IN THE NATURE OF RESINS AND MINERALS FOR THE ABSORPTION OF AMMONIA FROM AQUARIUMS, IN CLASS 1 (U.S. CLS. 1, 5, 6, 10, 26 AND 46).

FIRST USE 5-0-2005; IN COMMERCE 5-0-2005.

THE COLOR(S) BLUE IS/ARE CLAIMED AS A FEATURE OF THE MARK.

THE MARK CONSISTS OF THE COLOR BLUE AS APPLIED TO THE BOTTLE CAP FOR THE PACKAGING FOR THE OWNER'S GOODS. THE COLOR BLUE APPEARS ON THE CAP OF THE BOTTLE. THE DOTTED OUTLINE OF THE GOODS IS INTENDED TO SHOW THE POSITION OF THE MARK ON THE GOODS AND IS NOT PART OF THE MARK.

SEC. 2(F).

SER. NO. 76-667,991, FILED 10-23-2006.

MICHAEL TANNER, EXAMINING ATTORNEY

Int. Cl.: 41

Prior U.S. Cls.: 100, 101 and 107

United States Patent and Trademark Office

Reg. No. 3,518,721

Registered Oct. 21, 2008

**SERVICE MARK
PRINCIPAL REGISTER**

WESTCHESTER VIPERS

WESTCHESTER VIPERS HOCKEY ASSOCIATION (UNITED STATES CORPORATION)

91 FAIRVIEW PARK DRIVE

ELMSFORD, NY 10523

FOR: ENTERTAINMENT IN THE NATURE OF ICE HOCKEY GAMES, IN CLASS 41 (U.S. CLS. 100, 101 AND 107).

FIRST USE 0-0-1999; IN COMMERCE 0-0-1999.

THE MARK CONSISTS OF STANDARD CHARACTERS WITHOUT CLAIM TO ANY PARTICULAR FONT, STYLE, SIZE, OR COLOR.

NO CLAIM IS MADE TO THE EXCLUSIVE RIGHT TO USE "WESTCHESTER", APART FROM THE MARK AS SHOWN.

SER. NO. 76-669,373, FILED 11-22-2006.

AMOS T. MATTHEWS, JR., EXAMINING ATTORNEY

Int. Cl.: 30

Prior U.S. Cl.: 46

United States Patent and Trademark Office

Reg. No. 3,518,722

Registered Oct. 21, 2008

TRADEMARK
PRINCIPAL REGISTER



MARUKYO SEIKA KABUSHIKI KAISHA (JAPAN CORPORATION)
2002-2, HATAGASAKI, YONAGO-SHI
TOTTORI 683-0845, JAPAN

FOR: PASTRIES, IN CLASS 30 (U.S. CL. 46).

FIRST USE 10-31-2002; IN COMMERCE 10-31-2002.

NO CLAIM IS MADE TO THE EXCLUSIVE RIGHT TO USE THE NON-LATIN CHARACTERS THAT TRANSLATE TO "CONFECTIONERY", APART FROM THE MARK AS SHOWN.

THE NAME "MARUKYO" DOES NOT IDENTIFY A LIVING INDIVIDUAL.

THE FIRST CIRCULAR COMPONENT WITH THE DOT IN THE MIDDLE IS MERELY A DESIGN WITH NO MEANING. THE FIRST THREE NON-LATIN CHARACTERS ON THE MARK TRANSLITERATES INTO "KASHIAN" AND THIS MEANS CONFECTIONERY IN ENGLISH, AND THE LAST TWO NON-LATIN CHARACTERS TRANSLITERATES INTO "MARUKYO," WHICH IS PART OF OWNER'S NAME AND HAS NO ENGLISH TRANSLATION.

SER. NO. 76-670,928, FILED 12-29-2006.

ANTHONY RINKER, EXAMINING ATTORNEY

Int. Cl.: 41

Prior U.S. Cls.: 100, 101 and 107

United States Patent and Trademark Office

Reg. No. 3,518,723

Registered Oct. 21, 2008

**SERVICE MARK
PRINCIPAL REGISTER**

HRT

HRT ROCKS, LLC (MASSACHUSETTS LIMITED
LIABILITY COMPANY)
3 KNIGHT ROAD
SHARON, MA 02067

FOR: ENTERTAINMENT IN THE NATURE OF
VISUAL AND AUDIO PERFORMANCES REN-
DERED BY A VOCAL AND INSTRUMENTAL
GROUP, MUSICAL BAND OR ROCK BAND, IN
CLASS 41 (U.S. CLS. 100, 101 AND 107).

FIRST USE 5-13-2005; IN COMMERCE 9-1-2005.

THE MARK CONSISTS OF STANDARD CHAR-
ACTERS WITHOUT CLAIM TO ANY PARTICULAR
FONT, STYLE, SIZE, OR COLOR.

SER. NO. 76-672,784, FILED 2-16-2007.

JENNY PARK, EXAMINING ATTORNEY

Int. Cl.: 40

Prior U.S. Cls.: 100, 103 and 106

United States Patent and Trademark Office

Reg. No. 3,518,724

Registered Oct. 21, 2008

**SERVICE MARK
PRINCIPAL REGISTER**



BUSHELL, GARY M. (UNITED STATES INDIVIDUAL)
5607 CAMP SPRINGS AVE.
CAMP SPRINGS, MD 20748

FOR: DIGITIZED EMBROIDERY AND CUSTOM IMPRINTING OF APPAREL, TOWELS, FOOTWEAR, KEY CHAINS, CUPS, MUGS AND ACCESSORIES WITH DECORATIVE DESIGNS AND PERSONALIZED MESSAGES FOR MARKETING, ADVERTISING AND PERSONAL USE, IN CLASS 40 (U.S. CLS. 100, 103 AND 106).

FIRST USE 9-0-2005; IN COMMERCE 1-0-2006.

THE COLOR(S) BLACK, LIGHT BLUE, MEDIUM BLUE, RED, WHITE, AND YELLOW IS/ARE CLAIMED AS A FEATURE OF THE MARK.

THE MARK CONSISTS OF A BLACK EAGLE WITH A WHITE TAIL, A WHITE HEAD, AND YELLOW BEAK APPEARING TO THE RIGHT OF THE TERM "SEW" IN THE COLOR RED, "YA" IN THE COLOR MEDIUM BLUE, AND "RIGHT" IN THE COLOR RED. THE EAGLE'S FEET ARE HIDDEN BEHIND A LIGHT BLUE CREST WITH A MEDIUM BLUE BAND. THE LETTERS "S", IN THE COLOR RED, "Y", IN THE COLOR MEDIUM BLUE WITH WHITE TIPS, AND "R" IN THE COLOR RED APPEAR ON THE CREST.

SER. NO. 76-673,281, FILED 2-26-2007.

REBECCA POVARCHUK, EXAMINING ATTORNEY

Int. Cl.: 35

Prior U.S. Cls.: 100, 101 and 102

United States Patent and Trademark Office

Reg. No. 3,518,725

Registered Oct. 21, 2008

**SERVICE MARK
PRINCIPAL REGISTER**



VEGE USA, LLC (CALIFORNIA LIMITED LIABILITY COMPANY)
4257 E. LIVE OAK AVENUE
ARCADIA, CA 91006

FIRST USE 6-2-2000; IN COMMERCE 6-2-2000.

FOR: WHOLESALE DISTRIBUTORSHIPS IN THE FIELD OF FROZEN FOODS AND IMPORT AGENCIES IN THE FIELD OF FROZEN FOOD, IN CLASS 35 (U.S. CLS. 100, 101 AND 102).

SER. NO. 76-673,948, FILED 3-12-2007.

MARY CRAWFORD, EXAMINING ATTORNEY

Int. Cls.: 16, 41, 42 and 45

Prior U.S. Cls.: 2, 5, 22, 23, 29, 37, 38, 50, 100, 101 and 107

Reg. No. 3,518,726

United States Patent and Trademark Office

Registered Oct. 21, 2008

**TRADEMARK
SERVICE MARK
PRINCIPAL REGISTER**

REACHREADY

CHEMICAL INDUSTRIES ASSOCIATION LIMITED (UNITED KINGDOM LIMITED COMPANY)
KINGS BUILDING, SMITH SQUARE
LONDON, UNITED KINGDOM SW1P 3JJ

FOR: PRINTED PUBLICATIONS, NAMELY, NON-FICTION BOOKS, BROCHURES, PAMPHLETS, INFORMATION SHEETS, NEWSLETTERS, MAGAZINES, REPORTS AND GUIDES; PRINTED INSTRUCTIONAL AND TEACHING MATERIAL, ALL OF THE FOREGOING BEING IN ALL FIELDS OF THE CHEMICAL, BIOTECHNOLOGY AND PHARMACEUTICAL INDUSTRIES, IN CLASS 16 (U.S. CLS. 2, 5, 22, 23, 29, 37, 38 AND 50).

FOR: PROVIDING SEMINARS AND TRAINING, ARRANGING AND CONDUCTING OF EDUCATIONAL CONFERENCES, CONGRESSES, SEMINARS, SYMPOSIUMS AND WORKSHOPS, PUBLICATION OF BOOKS, PUBLICATION OF ELECTRONIC BOOKS AND JOURNALS ON LINE, PUBLICATION OF TEXTS, ALL OF THE FOREGOING BEING IN ALL FIELDS OF THE CHEMICAL, BIOTECHNOLOGY AND PHARMACEUTICAL INDUSTRIES, IN CLASS 41 (U.S. CLS. 100, 101 AND 107).

FOR: INDUSTRIAL ANALYSIS IN THE NATURE OF INDUSTRIAL AND SCIENTIFIC RESEARCH, ALL RELATING TO THE CHEMICAL, BIOTECHNOLOGY AND PHARMACEUTICAL INDUSTRIES;

INFORMATION, ADVISORY SERVICES, AND CONSULTANCY SERVICES IN CONNECTION WITH THE AFOREMENTIONED SERVICES AND ALL RELATING TO THE CHEMICAL, BIOTECHNOLOGY AND PHARMACEUTICAL INDUSTRIES SERVICES AND ALL RELATING TO THE CHEMICAL, BIOTECHNOLOGY AND PHARMACEUTICAL INDUSTRIES, IN CLASS 42 (U.S. CLS. 100 AND 101).

FOR: SCIENTIFIC AND TECHNOLOGICAL REGULATORY COMPLIANCE SERVICES, NAMELY, REVIEWING STANDARDS AND PRACTICES TO ASSURE COMPLIANCE WITH LEGAL REGULATIONS GOVERNING RESEARCH PRACTICES IN THE CHEMICAL, BIOTECHNOLOGY AND PHARMACEUTICAL INDUSTRIES; LEGAL SERVICES PROVIDED TO ALL SECTORS OF THE CHEMICAL, BIOTECHNOLOGY AND PHARMACEUTICAL INDUSTRIES, IN CLASS 45 (U.S. CLS. 100 AND 101).

THE MARK CONSISTS OF STANDARD CHARACTERS WITHOUT CLAIM TO ANY PARTICULAR FONT, STYLE, SIZE, OR COLOR.

OWNER OF ERPN CMNTY TM OFC REG. NO. 004946455, DATED 2-6-2007, EXPIRES 3-6-2016.

SER. NO. 76-674,232, FILED 3-16-2007.

MAUREEN DALL, EXAMINING ATTORNEY

Int. Cl.: 9

Prior U.S. Cls.: 21, 23, 26, 36 and 38

United States Patent and Trademark Office

Reg. No. 3,518,727

Registered Oct. 21, 2008

**TRADEMARK
PRINCIPAL REGISTER**

HALLO

HIRSCHMANN AUTOMOTIVE GMBH (AUSTRIA
LIMITED LIABILITY COMPANY)
OBERER PASPELSWEG 6-8
6830 RANKWEIL-BREDERIS, AUSTRIA

PRIORITY CLAIMED UNDER SEC. 44(D) ON
AUSTRIA APPLICATION NO. AM7346/2006, FILED
10-31-2006, REG. NO. 237242, DATED 3-1-2007, EX-
PIRES 10-31-2016.

FOR: ELECTRONIC INSTRUMENTS FOR AUTO-
MOBILES, NAMELY, SENSORS, SWITCHES,
TRANSFORMERS, REGULATORS AND CONTROL-
LERS, DETECTORS, AND CHECKING APPARATUS
FOR CONDUCTING, SWITCHING, TRANSFORM-
ING REGULATING OR CONTROLLING ELECTRI-
CITY, IN CLASS 9 (U.S. CLS. 21, 23, 26, 36 AND 38).

THE MARK HAS NO MEANING IN A FOREIGN
LANGUAGE.

SER. NO. 76-675,841, FILED 4-23-2007.

THE MARK CONSISTS OF STANDARD CHAR-
ACTERS WITHOUT CLAIM TO ANY PARTICULAR
FONT, STYLE, SIZE, OR COLOR.

DAWN FELDMAN, EXAMINING ATTORNEY

Int. Cl.: 35

Prior U.S. Cls.: 100, 101 and 102

United States Patent and Trademark Office

Reg. No. 3,518,728

Registered Oct. 21, 2008

**SERVICE MARK
PRINCIPAL REGISTER**



DAWSON COUNTY CHAMBER OF COMMERCE
(GEORGIA CHARITABLE, NON-PROFIT COR-
PORATION)
P.O. BOX 299
DAWSONVILLE, GA 30534

FOR: BUSINESS INFORMATION SERVICES, IN
CLASS 35 (U.S. CLS. 100, 101 AND 102).

FIRST USE 2-27-2007; IN COMMERCE 2-27-2007.

NO CLAIM IS MADE TO THE EXCLUSIVE
RIGHT TO USE "DAWSON" AND THE PICTORIAL
REPRESENTATION OF DAWSON COUNTY,
APART FROM THE MARK AS SHOWN.

THE COLOR(S) BLACK, RED, GREEN AND
WHITE IS/ARE CLAIMED AS A FEATURE OF
THE MARK.

THE MARK CONSISTS OF THE COLORS BLACK,
RED, GREEN, AND WHITE. THE COLOR BLACK
APPEAR INSIDE THE SCOTTY DOG DESIGN AND
IN THE OUTLINE OF THE PICTORIAL REPRESENTATION
OF DAWSON COUNTY, THE COLOR RED
APPEARS IN THE DOG'S BOWTIE AND THE LET-
TERING FOR THE WORDING "DAWSON SAYS...",
THE COLOR GREEN APPEARS IN THE DESIGN OF
THE MOUNTAINS, AND THE COLOR WHITE
APPEARS IN THE DESIGN OF THE MOUNTAINS,
IN THE DOG DESIGN, AND INSIDE THE PICTORIAL
REPRESENTATION OF DAWSON COUNTY.

SER. NO. 76-676,231, FILED 4-30-2007.

SETH A. RAPPAPORT, EXAMINING ATTORNEY

Int. Cl.: 25

Prior U.S. Cls.: 22 and 39

United States Patent and Trademark Office

Reg. No. 3,518,729

Registered Oct. 21, 2008

TRADEMARK
PRINCIPAL REGISTER



HILLS HATS LIMITED (NEW ZEALAND COMPANY)
30 FITZHERBERT STREET
PETONE, NEW ZEALAND

FOR: HEADWEAR, IN CLASS 25 (U.S. CLS. 22 AND 39).

PRIORITY CLAIMED UNDER SEC. 44(D) ON NEW ZEALAND APPLICATION NO. 767631, FILED

4-30-2007, REG. NO. 767621, DATED 4-30-2007, EXPIRES 4-30-2017.

NO CLAIM IS MADE TO THE EXCLUSIVE RIGHT TO USE "HATS LIMITED" AND "ESTABLISHED 1875", APART FROM THE MARK AS SHOWN.

SER. NO. 76-676,430, FILED 5-4-2007.

LESLIE RICHARDS, EXAMINING ATTORNEY

Int. Cl.: 40

Prior U.S. Cls.: 100, 103 and 106

Reg. No. 3,518,730

United States Patent and Trademark Office

Registered Oct. 21, 2008

**SERVICE MARK
PRINCIPAL REGISTER**

BERNHARD WOODWORK LTD.

BERNHARD WOODWORK LTD. (ILLINOIS CORPORATION)
3670 WOODHEAD DRIVE
NORTHBROOK, IL 60062

FOR: CUSTOM MANUFACTURE OF ARCHITECTURAL WOODWORK, CASEWORK, MILLWORK AND STORE FIXTURES FOR THE RESIDENTIAL, COMMERCIAL, AND RETAIL MARKETS, IN CLASS 40 (U.S. CLS. 100, 103 AND 106).

FIRST USE 9-1-1965; IN COMMERCE 9-1-1965.

THE MARK CONSISTS OF STANDARD CHARACTERS WITHOUT CLAIM TO ANY PARTICULAR FONT, STYLE, SIZE, OR COLOR.

NO CLAIM IS MADE TO THE EXCLUSIVE RIGHT TO USE "WOODWORK LTD.", APART FROM THE MARK AS SHOWN.

SER. NO. 76-676,647, FILED 5-10-2007.

DAVID TAYLOR, EXAMINING ATTORNEY

Int. Cl.: 39

Prior U.S. Cls.: 100 and 105

United States Patent and Trademark Office

Reg. No. 3,518,731

Registered Oct. 21, 2008

**SERVICE MARK
PRINCIPAL REGISTER**

SWAIN TOURS

SWAIN AUSTRALIAN TOURS (2003), INC.
(PENNSYLVANIA CORPORATION)
6 WEST LANCASTER AVENUE
ARDMORE, PA 19003

OWNER OF U.S. REG. NOS. 1,975,220, 3,243,305
AND OTHERS.

FOR: TRAVEL AGENCY SERVICES, NAMELY,
MAKING RESERVATIONS AND BOOKINGS FOR
TRANSPORTATION, IN CLASS 39 (U.S. CLS. 100
AND 105).

NO CLAIM IS MADE TO THE EXCLUSIVE
RIGHT TO USE "TOURS", APART FROM THE
MARK AS SHOWN.

FIRST USE 11-2-1986; IN COMMERCE 11-2-1986.

SEC. 2(F).

THE MARK CONSISTS OF STANDARD CHAR-
ACTERS WITHOUT CLAIM TO ANY PARTICULAR
FONT, STYLE, SIZE, OR COLOR.

SER. NO. 76-677,178, FILED 5-21-2007.

ELIZABETH KAJUBI, EXAMINING ATTORNEY

Int. Cl.: 41

Prior U.S. Cls.: 100, 101 and 107

United States Patent and Trademark Office

Reg. No. 3,518,732

Registered Oct. 21, 2008

**SERVICE MARK
PRINCIPAL REGISTER**

HIPPY GOURMET

ICFX, INC. (CALIFORNIA CORPORATION)
P.O. BOX 955
FAIRFAX, CA 94978

FOR: PUBLICATIONS, IN THE NATURE OF A
NEWSLETTER, FEATURING COOKING AND
FOOD CONSUMPTION, IN CLASS 41 (U.S. CLS.
100, 101 AND 107).

FIRST USE 9-1-2000; IN COMMERCE 9-1-2000.

THE MARK CONSISTS OF STANDARD CHAR-
ACTERS WITHOUT CLAIM TO ANY PARTICULAR
FONT, STYLE, SIZE, OR COLOR.

NO CLAIM IS MADE TO THE EXCLUSIVE
RIGHT TO USE "GOURMET", APART FROM THE
MARK AS SHOWN.

SER. NO. 76-677,783, FILED 6-4-2007.

CAROLYN CATALDO, EXAMINING ATTORNEY

Int. Cl.: 9

Prior U.S. Cls.: 21, 23, 26, 36 and 38

Reg. No. 3,518,733

United States Patent and Trademark Office

Registered Oct. 21, 2008

TRADEMARK
PRINCIPAL REGISTER

POLATRAK

DEEPWATER CORROSION SERVICES, INC.
(TEXAS CORPORATION)
10851 TRAIN COURT
HOUSTON, TX 77041

FOR: PERMANENT REFERENCE ELECTRODE DESIGNED TO MONITOR LEVELS OF CORROSION ON BURIED OR IMMERSSED STEEL STRUCTURES; REFERENCE ELECTRODE SYSTEM COMPRISING A PROBE FOR MEASURING LEVELS OF CORROSION ON BURIED STEEL STRUCTURES, AN ELECTRICAL CIRCUIT FOR MEASURING LEVELS OF CORROSION ON BURIED STEEL STRUCTURES, AND A METER FOR MEASURING LEVELS OF CORROSION ON BURIED STEEL STRUCTURES; ELECTRODE BASED PROBE FOR MEASURING LEVELS OF CORROSION ON BURIED STEEL STRUCTURES; ELECTRODE BASED METER FOR MEASURING LEVELS OF CORRO-

SION ON BURIED STEEL STRUCTURES; AND ELECTRODE BASED MONITORING SYSTEM COMPRISING PROBES FOR MEASURING LEVELS OF CORROSION ON BURIED STEEL STRUCTURES, AND METERS FOR MEASURING LEVELS OF CORROSION ON BURIED STEEL STRUCTURES, IN CLASS 9 (U.S. CLS. 21, 23, 26, 36 AND 38).

FIRST USE 3-1-1988; IN COMMERCE 3-1-1988.

THE MARK CONSISTS OF STANDARD CHARACTERS WITHOUT CLAIM TO ANY PARTICULAR FONT, STYLE, SIZE, OR COLOR.

SER. NO. 76-678,136, FILED 6-12-2007.

KRISTINA MORRIS, EXAMINING ATTORNEY

Int. Cls.: 9 and 16

Prior U.S. Cls.: 2, 5, 21, 22, 23, 26, 29, 36, 37, 38 and 50

Reg. No. 3,518,734

United States Patent and Trademark Office

Registered Oct. 21, 2008

TRADEMARK
PRINCIPAL REGISTER

SOUNDS GREAT!

CREATIVE PATHWAYS LTD. (OHIO LIMITED
LIABILITY COMPANY)
P.O. BOX 58011
CINCINNATI, OH 452580011

FOR: PRERECORDED CDS AND AUDIO TAPES
FEATURING ENGLISH LANGUAGE TUTORIALS
FOR YOUNG CHILDREN AGES 3-7, IN CLASS 9
(U.S. CLS. 21, 23, 26, 36 AND 38).

FIRST USE 9-0-1994; IN COMMERCE 9-0-1994.

FOR: EDUCATIONAL PUBLICATIONS, NAME-
LY, EDUCATIONAL LEARNING CARDS, FLASH

CARDS, ACTIVITY CARDS, WORKBOOKS, TEXT-
BOOKS, ACTIVITY BOOKS, TEACHER GUIDES,
MANUALS, POSTERS, AND EDUCATIONAL
BOOKLETS IN THE FIELD OF THE ENGLISH
LANGUAGE FOR YOUNG CHILDREN AGES 3-7,
IN CLASS 16 (U.S. CLS. 2, 5, 22, 23, 29, 37, 38 AND 50).

FIRST USE 9-0-1994; IN COMMERCE 9-0-1994.

SER. NO. 76-678,242, FILED 6-14-2007.

JAMES LOVELACE, EXAMINING ATTORNEY

Int. Cl.: 35

Prior U.S. Cls.: 100, 101 and 102

United States Patent and Trademark Office

Reg. No. 3,518,735

Registered Oct. 21, 2008

**SERVICE MARK
PRINCIPAL REGISTER**



SCOTT SOUTHARD TALENT, INC., (MASSACHUSETTS CORPORATION)
278 MAIN STREET
GLOUCESTER, MA 01930

FOR: TALENT AGENCY AND ARTISTS MANAGEMENT SERVICES, IN CLASS 35 (U.S. CLS. 100, 101 AND 102).

FIRST USE 7-1-2004; IN COMMERCE 7-1-2004.

NO CLAIM IS MADE TO THE EXCLUSIVE RIGHT TO USE "INTERNATIONAL MUSIC NETWORK", APART FROM THE MARK AS SHOWN.

THE COLOR(S) BLUE, WHITE, BROWN, BLACK AND GREY IS/ARE CLAIMED AS A FEATURE OF THE MARK.

THE COLOR BLUE APPEARS ON THE LETTERS "IMN", THE COLOR WHITE APPEARS IN CLOUD LIKE SMATTERINGS ON THE BLUE BACKGROUND OF THE LETTERS "IMN". THE COLOR BROWN APPEARS ON THE PLANKS AND THE COLOR BLACK APPEARS ON THE TIES IN THE DESIGN COMPONENT OF THE MARK. THE WORDING "INTERNATIONAL MUSIC NETWORK" APPEARS IN GREY.

SER. NO. 76-678,334, FILED 6-18-2007.

KATHRYN COWARD, EXAMINING ATTORNEY

Int. Cl.: 33

Prior U.S. Cls.: 47 and 49

United States Patent and Trademark Office

Reg. No. 3,518,736

Registered Oct. 21, 2008

**TRADEMARK
PRINCIPAL REGISTER**

DIPINTI

CANTINA LA VIS E VALLE DI CEMBRA SOCIE-
TA COOPERATIVA (ITALY CORPORATION)
AT VIA CARMINE
7 LAVIS (TN), ITALY

FOR: WINES, SPARKLING WINES, DISTILLED
SPIRITS AND LIQUORS, IN CLASS 33 (U.S. CLS. 47
AND 49).

THE MARK CONSISTS OF STANDARD CHAR-
ACTERS WITHOUT CLAIM TO ANY PARTICULAR
FONT, STYLE, SIZE, OR COLOR.

PRIORITY CLAIMED UNDER SEC. 44(D) ON
ITALY APPLICATION NO. RM2007C00041, FILED
1-23-2007, REG. NO. 0001107308, DATED 4-17-2008,
EXPIRES 1-21-2017.

THE FOREIGN WORDING IN THE MARK
TRANSLATES INTO ENGLISH AS PAINTINGS.

SER. NO. 76-679,831, FILED 7-23-2007.

BERYL GARDNER, EXAMINING ATTORNEY

Int. Cl.: 20

Prior U.S. Cls.: 2, 13, 22, 25, 32 and 50

United States Patent and Trademark Office

Reg. No. 3,518,737

Registered Oct. 21, 2008

**TRADEMARK
PRINCIPAL REGISTER**

SLIP-ON

KABUSHIKI KAISHA SATO CHISHIKI ZAISAN
KENKYUSHO (JAPAN CORPORATION)
9-10, EBISU 4-CHOME
SHIBUYA-KU, TOKYO 150-0013, JAPAN

FOR: BLANK OR PARTIALLY PRINTED PLAS-
TIC LABELS AND PLASTIC TAGS FOR USE IN THE
DESIGNATION OF PLANTS AND HORTICULTUR-
AL PRODUCTS , IN CLASS 20 (U.S. CLS. 2, 13, 22, 25,
32 AND 50).

FIRST USE 4-0-1954; IN COMMERCE 5-26-1954.

THE MARK CONSISTS OF STANDARD CHAR-
ACTERS WITHOUT CLAIM TO ANY PARTICULAR
FONT, STYLE, SIZE, OR COLOR.

SEC. 2(F).

SER. NO. 76-679,898, FILED 7-25-2007.

ESTHER BELENKER, EXAMINING ATTORNEY

Int. Cl.: 44

Prior U.S. Cls.: 100 and 101

United States Patent and Trademark Office

Reg. No. 3,518,738

Registered Oct. 21, 2008

**SERVICE MARK
PRINCIPAL REGISTER**

ADVANCED PLASTIC SURGERY CENTER

MUNASIFI, TALAL A. (UNITED STATES INDIVIDUAL)
1635 N. GEORGE MASON DRIVE, #380
ARLINGTON, VA 22205

FOR: MEDICAL SERVICES, NAMELY, PROVIDING COSMETIC AND PLASTIC SURGERY, IN CLASS 44 (U.S. CLS. 100 AND 101).

FIRST USE 10-0-1997; IN COMMERCE 11-0-1997.

THE MARK CONSISTS OF STANDARD CHARACTERS WITHOUT CLAIM TO ANY PARTICULAR FONT, STYLE, SIZE, OR COLOR.

OWNER OF U.S. REG. NO. 2,330,599.

NO CLAIM IS MADE TO THE EXCLUSIVE RIGHT TO USE "PLASTIC SURGERY CENTER", APART FROM THE MARK AS SHOWN.

SEC. 2(F).

SER. NO. 76-680,402, FILED 8-6-2007.

DAWN HAN, EXAMINING ATTORNEY

Int. Cls.: 16 and 20

Prior U.S. Cls.: 2, 5, 13, 22, 23, 25, 29, 32, 37, 38 and 50

United States Patent and Trademark Office

Reg. No. 3,518,739

Registered Oct. 21, 2008

**TRADEMARK
PRINCIPAL REGISTER**

TREE TRAINERS

KABUSHIKI KAISHA SATO CHISHIKI ZAISAN
KENKYUSHO (JAPAN CORPORATION)
9-10, EBISU 4-CHOME
SHIBUYA-KU TOKYO 150-0013, JAPAN

FOR: PAPER LABELS, IN CLASS 16 (U.S. CLS. 2, 5,
22, 23, 29, 37, 38 AND 50).

FIRST USE 0-0-1990; IN COMMERCE 0-0-1990.

FOR: PLASTIC LABELS, IN CLASS 20 (U.S. CLS. 2,
13, 22, 25, 32 AND 50).

FIRST USE 0-0-1990; IN COMMERCE 0-0-1990.

THE MARK CONSISTS OF STANDARD CHAR-
ACTERS WITHOUT CLAIM TO ANY PARTICULAR
FONT, STYLE, SIZE, OR COLOR.

SEC. 2(F).

SER. NO. 76-680,571, FILED 8-10-2007.

ESTHER BELENKER, EXAMINING ATTORNEY

Int. Cls.: 29 and 30

Prior U.S. Cl.: 46

United States Patent and Trademark Office

Reg. No. 3,518,740

Registered Oct. 21, 2008

TRADEMARK
PRINCIPAL REGISTER



HILL, SHEILA A. (UNITED STATES INDIVIDUAL), DBA HILL'S CHESTNUT FARM
5243 LAWNDALE ROAD
SAGINAW, MI 48604

FOR: PROCESSED NUTS, NAMELY, CHESTNUTS AS A PROCESSED FOOD PRODUCT IN CHESTNUT BUTTER, NUT FLOUR AND FRUIT CHIPS, WHICH INCLUDE CHESTNUTS AS AN INGREDIENT, IN CLASS 29 (U.S. CL. 46).

FIRST USE 5-19-2007; IN COMMERCE 5-19-2007.

FOR: SALSA AND MEAT TENDERIZER THAT INCLUDE CHESTNUTS AS AN INGREDIENT, IN CLASS 30 (U.S. CL. 46).

FIRST USE 5-19-2007; IN COMMERCE 5-19-2007.

"THE COLOR(S) BLACK, WHITE, BROWN, TAN, DARK GREEN, LIGHT GREEN IS/ARE CLAIMED AS A FEATURE OF THE MARK."

THE MARK CONSISTS OF AN ANIMATED DRAWING OF A CHESTNUT WITH A FACE, ARMS AND LEGS. THE COLOR BLACK APPEARS IN THE SHADING OF THE BODY OF THE NUT, AND IN THE EYES AND MOUTH OF THE NUT; THE COLOR WHITE APPEARS IN THE EYES AND MOUTH OF THE NUT; THE COLOR BROWN APPEARS IN THE BODY OF THE NUT WHERE THE NUT IS SPLIT IN HALF; THE COLOR TAN APPEARS IN THE ARMS AND LEGS OF THE NUT AND INSIDE THE BODY OF THE NUT; THE COLOR DARK GREEN APPEARS IN PART OF THE BODY OF THE NUT, AND THE COLOR LIGHT GREEN APPEARS IN THE RIM OF THE NUT WHERE THE NUT SPLITS IN HALF.

SER. NO. 76-680,911, FILED 8-20-2007.

CARYN GLASSER, EXAMINING ATTORNEY

Int. Cl.: 35

Prior U.S. Cls.: 100, 101 and 102

United States Patent and Trademark Office

Reg. No. 3,518,741

Registered Oct. 21, 2008

**SERVICE MARK
PRINCIPAL REGISTER**

COMFORT24-7

COMFORT24-7.COM, LLC (ILLINOIS LIMITED
LIABILITY COMPANY)
16 NORTH 9TH AVENUE
MELROSE PARK, IL 60160

FOR: BUSINESS SERVICES, NAMELY, REGIS-
TERING, SCREENING, CREDENTIALING, AND
ORGANIZING COMPANIES AND SKILLED LA-
BORERS AND INFORMATION CONCERNING
HEATING, AIR CONDITIONING, INDOOR AIR
QUALITY AND SAFETY PRODUCTS AND SERVI-
CES FOR POTENTIAL CONSUMERS ALL PROVI-

DED VIA THE INTERNET, IN CLASS 35 (U.S. CLS.
100, 101 AND 102).

FIRST USE 4-26-2007; IN COMMERCE 4-26-2007.

THE MARK CONSISTS OF STANDARD CHAR-
ACTERS WITHOUT CLAIM TO ANY PARTICULAR
FONT, STYLE, SIZE, OR COLOR.

SER. NO. 76-681,239, FILED 8-28-2007.

BENJAMIN OKEKE, EXAMINING ATTORNEY

Int. Cl.: 35

Prior U.S. Cls.: 100, 101 and 102

United States Patent and Trademark Office

Reg. No. 3,518,742

Registered Oct. 21, 2008

**SERVICE MARK
PRINCIPAL REGISTER**



TAP PUBLISHING CO. (TENNESSEE GENERAL
PARTNERSHIP)
174 FOURTH STREET
P.O. BOX 509
CROSSVILLE, TN 38557

FIRST USE 8-29-2003; IN COMMERCE 8-29-2003.

OWNER OF U.S. REG. NO. 2,456,583.

FOR: CLASSIFIED ADVERTISING SERVICES
RENDERED VIA PRINTED PUBLICATIONS AND
ELECTRONIC MEDIA ACCESSIBLE THROUGH
THE INTERNET IN THE FIELDS OF AVIATION,
HEAVY EQUIPMENT, COMMUNICATIONS EQUIP-
MENT AND OIL FIELD EQUIPMENT, IN CLASS 35
(U.S. CLS. 100, 101 AND 102).

NO CLAIM IS MADE TO THE EXCLUSIVE
RIGHT TO USE "PUBLISHING", APART FROM
THE MARK AS SHOWN.

SER. NO. 76-682,012, FILED 9-18-2007.

TINA L. SNAPP, EXAMINING ATTORNEY

Int. Cl.: 43

Prior U.S. Cls.: 100 and 101

United States Patent and Trademark Office

Reg. No. 3,518,743

Registered Oct. 21, 2008

SERVICE MARK
PRINCIPAL REGISTER

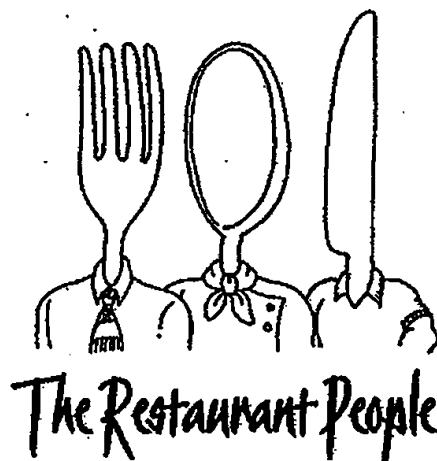

RESTAURANT PEOPLE MANAGEMENT COMPANY, LLC (FLORIDA LIMITED LIABILITY CORPORATION)

200 S.W. 2ND STREET

FORT LAUDERDALE, FL 33301

FOR: OPERATING RESTAURANTS AND BARS, IN CLASS 43 (U.S. CLS. 100 AND 101).

FIRST USE 0-0-1999; IN COMMERCE 0-0-1999.

NO CLAIM IS MADE TO THE EXCLUSIVE RIGHT TO USE "RESTAURANT", APART FROM THE MARK AS SHOWN.

THE MARK CONSISTS OF FORK, SPOON, AND KNIFE CHARACTERS POSITIONED ABOVE THE STYLIZED WORDS "THE RESTAURANT PEOPLE".

SER. NO. 76-682,019, FILED 9-18-2007.

ROBIN CHOSID, EXAMINING ATTORNEY

Int. Cl.: 36

Prior U.S. Cls.: 100, 101 and 102

United States Patent and Trademark Office

Reg. No. 3,518,744

Registered Oct. 21, 2008

**SERVICE MARK
PRINCIPAL REGISTER**

AMERICA'S INFOMART, INC.

AMERICA'S INFOMART, INC. (TEXAS CORPORATION)
P.O. BOX 63
ALLEN, TX 75002

FOR: BUILDING MANAGEMENT SERVICES
FOR RESIDENTIAL AND COMMERCIAL PROPERTIES,
IN CLASS 36 (U.S. CLS. 100, 101 AND 102).

FIRST USE 7-1-1993; IN COMMERCE 7-1-1993.

THE MARK CONSISTS OF STANDARD CHARACTERS WITHOUT CLAIM TO ANY PARTICULAR FONT, STYLE, SIZE, OR COLOR.

NO CLAIM IS MADE TO THE EXCLUSIVE RIGHT TO USE "AMERICA'S" AND "INC.", APART FROM THE MARK AS SHOWN.

SER. NO. 76-682,068, FILED 9-19-2007.

ESTHER BELENKER, EXAMINING ATTORNEY

Int. Cl.: 36

Prior U.S. Cls.: 100, 101 and 102

United States Patent and Trademark Office

Reg. No. 3,518,745

Registered Oct. 21, 2008

**SERVICE MARK
PRINCIPAL REGISTER**

**AMERICA'S
INFOMART**

AMERICA'S INFOMART, INC. (TEXAS CORPORATION)
P.O. BOX 63
ALLEN, TX 75002

FOR: BUILDING MANAGEMENT SERVICES FOR RESIDENTIAL AND COMMERCIAL PROPERTIES, IN CLASS 36 (U.S. CLS. 100, 101 AND 102).

FIRST USE 7-1-1993; IN COMMERCE 7-1-1993.

THE MARK CONSISTS OF STANDARD CHARACTERS WITHOUT CLAIM TO ANY PARTICULAR FONT, STYLE, SIZE, OR COLOR.

NO CLAIM IS MADE TO THE EXCLUSIVE RIGHT TO USE "AMERICA'S", APART FROM THE MARK AS SHOWN.

SER. NO. 76-682,088, FILED 9-19-2007.

ESTHER BELENKER, EXAMINING ATTORNEY

Int. Cl.: 9

Prior U.S. Cls.: 21, 23, 26, 36 and 38

Reg. No. 3,518,746

United States Patent and Trademark Office

Registered Oct. 21, 2008

**TRADEMARK
PRINCIPAL REGISTER**

RONAN

RONAN ENGINEERING COMPANY (CALIFORNIA CORPORATION)
21200 OXNARD STREET
WOODLAND HILLS, CA 91367

FIRST USE 7-6-1959; IN COMMERCE 7-6-1959.

FOR: PROCESS MONITORING APPARATUS, NAMELY, ANNUNCIATORS, TEMPERATURE MONITORS, RADIO TRANSMITTERS AND ALARM TRIPS; SEQUENTIAL EVENTS RECORDERS FOR DATA ACQUISITION; AND NUCLEAR MEASUREMENT INSTRUMENTATION, NAMELY, POINT LEVEL GAUGES, DENSITY GAUGES, CONTINUOUS LEVEL GAUGES, CONTINUOUS WEIGH SCALES AND MASS FLOW APPARATUS, IN CLASS 9 (U.S. CLS. 21, 23, 26, 36 AND 38).

THE MARK CONSISTS OF STANDARD CHARACTERS WITHOUT CLAIM TO ANY PARTICULAR FONT, STYLE, SIZE, OR COLOR.

SEC. 2(F).

SER. NO. 76-682,359, FILED 9-27-2007.

SHANNON TWOHIG, EXAMINING ATTORNEY

Int. Cl.: 25

Prior U.S. Cls.: 22 and 39

United States Patent and Trademark Office

Reg. No. 3,518,747

Registered Oct. 21, 2008

**TRADEMARK
PRINCIPAL REGISTER**

FINIS

FINIS, INC. (CALIFORNIA CORPORATION)
4647-B LAS POSITAS ROAD
LIVERMORE, CA 94551

FOR: SWIM WEAR; SWIM CAPS, IN CLASS 25
(U.S. CLS. 22 AND 39).

FIRST USE 9-0-2001; IN COMMERCE 9-0-2001.

THE MARK CONSISTS OF STANDARD CHAR-
ACTERS WITHOUT CLAIM TO ANY PARTICULAR
FONT, STYLE, SIZE, OR COLOR.

THE ENGLISH TRANSLATION OF THE FRENCH
WORD "FINIS" IS COMPLETE OR CONCLUDED.

SER. NO. 76-682,583, FILED 10-4-2007.

SETH A. RAPPAPORT, EXAMINING ATTORNEY

Int. Cl.: 28

Prior U.S. Cls.: 22, 23, 38 and 50

United States Patent and Trademark Office

Reg. No. 3,518,748

Registered Oct. 21, 2008

**TRADEMARK
PRINCIPAL REGISTER**

FINIS

FINIS, INC. (CALIFORNIA CORPORATION)
4647-B LAS POSITAS ROAD
LIVERMORE, CA 94551

FOR: SWIM FINS AND SWIM PADDLES, IN
CLASS 28 (U.S. CLS. 22, 23, 38 AND 50).

FIRST USE 1-8-1995; IN COMMERCE 1-8-1995.

THE MARK CONSISTS OF STANDARD CHAR-
ACTERS WITHOUT CLAIM TO ANY PARTICULAR
FONT, STYLE, SIZE, OR COLOR.

THE ENGLISH TRANSLATION OF THE FRENCH
WORD "FINIS" IS "COMPLETE" OR "CONCLU-
DED."

SER. NO. 76-682,626, FILED 10-2-2007.

SETH A. RAPPAPORT, EXAMINING ATTORNEY

Int. Cl.: 10

Prior U.S. Cls.: 26, 39 and 44

United States Patent and Trademark Office

Reg. No. 3,518,749

Registered Oct. 21, 2008

**TRADEMARK
PRINCIPAL REGISTER**

OPTISPEC

UTAH MEDICAL PRODUCTS, INC. (UTAH CORPORATION)
7043 SOUTH 300 WEST
MIDVALE, UT 84047

FOR: MEDICAL LIGHTING DEVICES, NAMELY, PORTABLE CLIP-ON LIGHTS USED FOR ILLUMINATION OF THE CERVIX DURING GYNECOLOGICAL EXAMINATIONS AND PROCEDURES, IN CLASS 10 (U.S. CLS. 26, 39 AND 44).

FIRST USE 10-1-2007; IN COMMERCE 10-1-2007.

THE MARK CONSISTS OF STANDARD CHARACTERS WITHOUT CLAIM TO ANY PARTICULAR FONT, STYLE, SIZE, OR COLOR.

SER. NO. 76-682,937, FILED 10-15-2007.

AISHA CLARKE, EXAMINING ATTORNEY

Int. Cl.: 40

Prior U.S. Cls.: 100, 103 and 106

United States Patent and Trademark Office

Reg. No. 3,518,750

Registered Oct. 21, 2008

**SERVICE MARK
PRINCIPAL REGISTER**

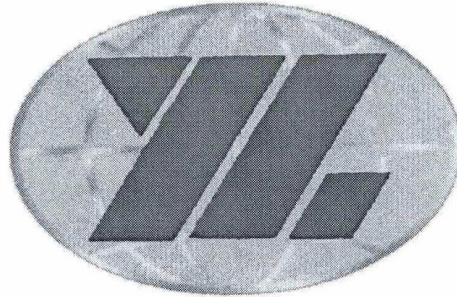

ANHUI YINGLIU ELECTROMECHANICAL INC.
(CHINA CORPORATION)
26 QIYUN ROAD
PRIVATE SCIENCE & TECH ECONOMIC PARK
HEFEI ECON & TECH DEVELOPMENT ZONE
ANHUI, CHINA

FOR: MANUFACTURE OF CASTINGS OF
VALVES, PUMPS, METERS, RAILWAY, AUTOS,
MINING AND CONSTRUCTION TOOLS AND MA-
CHINERY IN CARBON STEEL, ALLOY STEEL,
STAINLESS STEEL AND CUSTOMIZED STEEL TO
THE ORDER AND/OR SPECIFICATION OF OTH-
ERS; MACHINING SERVICES FOR OTHERS,
NAMELY, MACHINING OF CASTINGS OF

VALVES, PUMPS, METERS, RAILWAY, AUTOS,
MINING AND CONSTRUCTION TOOLS AND MA-
CHINERY IN CARBON STEEL, ALLOY STEEL,
STAINLESS STEEL AND CUSTOMIZED STEEL, IN
CLASS 40 (U.S. CLS. 100, 103 AND 106).

FIRST USE 3-1-2004; IN COMMERCE 3-1-2004.

THE MARK CONSISTS IN PART OF A STYLIZED
CAPITAL YL

SER. NO. 76-683,161, FILED 10-22-2007.

PRISCILLA MILTON, EXAMINING ATTORNEY

Int. Cl.: 43

Prior U.S. Cls.: 100 and 101

United States Patent and Trademark Office

Reg. No. 3,518,751

Registered Oct. 21, 2008

**SERVICE MARK
PRINCIPAL REGISTER**



THE CULINARY SCHOOL OF FORT WORTH,
LLC (TEXAS LIMITED LIABILITY COMPAN-
NY)
6100 CAMP BOWIE #25
FORT WORTH, TX 76116

FOR: FOOD SERVICE OPERATION, WHEREBY
CUSTOMERS PURCHASE PRE-ASSEMBLED DIN-
NERS AND SIDES TO BAKE AT HOME, IN CLASS 43
(U.S. CLS. 100 AND 101).

FIRST USE 10-26-2007; IN COMMERCE 10-26-2007.

OWNER OF U.S. REG. NOS. 3,007,122, 3,172,956
AND OTHERS.

NO CLAIM IS MADE TO THE EXCLUSIVE
RIGHT TO USE "TAKE AND BAKE" AND "SUP-
PERS", APART FROM THE MARK AS SHOWN.

SER. NO. 76-684,072, FILED 11-14-2007.

SANDRA MANIOS, EXAMINING ATTORNEY

Int. Cl.: 29

Prior U.S. Cl.: 46

United States Patent and Trademark Office

Reg. No. 3,518,752

Registered Oct. 21, 2008

**TRADEMARK
PRINCIPAL REGISTER**

TEXAS HERITAGE

HEB GROCERY COMPANY, LP (TEXAS LIMITED PARTNERSHIP)
646 SOUTH MAIN
SAN ANTONIO, TX 78204

OWNER OF U.S. REG. NO. 2,919,358.

FOR: MEAT PRODUCTS, NAMELY, HOT DOGS, JERKY, IN CLASS 29 (U.S. CL. 46).

NO CLAIM IS MADE TO THE EXCLUSIVE RIGHT TO USE "TEXAS", APART FROM THE MARK AS SHOWN.

FIRST USE 3-26-2003; IN COMMERCE 3-26-2003.

SER. NO. 76-684,093, FILED 11-16-2007.

THE MARK CONSISTS OF STANDARD CHARACTERS WITHOUT CLAIM TO ANY PARTICULAR FONT, STYLE, SIZE, OR COLOR.

G. MAYERSCHOFF, EXAMINING ATTORNEY

Int. Cl.: 31

Prior U.S. Cls.: 1 and 46

United States Patent and Trademark Office

Reg. No. 3,518,753

Registered Oct. 21, 2008

**TRADEMARK
PRINCIPAL REGISTER**

JUST FOR YOU!

HEB GROCERY COMPANY, LP (TEXAS LIMITED PARTNERSHIP)
646 SOUTH MAIN
SAN ANTONIO, TX 78204

THE MARK CONSISTS OF STANDARD CHARACTERS WITHOUT CLAIM TO ANY PARTICULAR FONT, STYLE, SIZE, OR COLOR.

FOR: LIVE FLOWERS; LIVE FLOWER ARRANGEMENTS, IN CLASS 31 (U.S. CLS. 1 AND 46).

SER. NO. 76-684,094, FILED 11-16-2007.

FIRST USE 7-30-2004; IN COMMERCE 7-30-2007.

G. MAYERSCHOFF, EXAMINING ATTORNEY

Int. Cls.: 9, 25 and 41

Prior U.S. Cls.: 21, 22, 23, 26, 36, 38, 39, 100, 101 and 107

Reg. No. 3,518,754

United States Patent and Trademark Office

Registered Oct. 21, 2008

**TRADEMARK
SERVICE MARK
PRINCIPAL REGISTER**

JC CHASEZ

CHASEZ, JOSHUA SCOTT (UNITED STATES INDIVIDUAL)
C/O HOLLAND & KNIGHT LLP
2099 PENNSYLVANIA AVENUE, N.W. SUITE 100
WASHINGTON, DC 20006

FOR: MUSICAL SOUND RECORDINGS; DOWNLOADABLE MUSICAL SOUND RECORDINGS; VIDEO RECORDINGS FEATURING MUSIC; DOWNLOADABLE VIDEO RECORDINGS FEATURING MUSIC; DOWNLOADABLE RING TONES; COMPACT DISCS FEATURING MUSIC; AND AN INTERNET WEB PAGE FEATURING DOWNLOADABLE MUSIC RECORDINGS, IN CLASS 9 (U.S. CLS. 21, 23, 26, 36 AND 38).

FIRST USE 0-0-2004; IN COMMERCE 0-0-2004.

FOR: TEE-SHIRTS, IN CLASS 25 (U.S. CLS. 22 AND 39).

FIRST USE 0-0-2004; IN COMMERCE 0-0-2004.

FOR: ENTERTAINMENT SERVICES, NAMELY, LIVE MUSIC CONCERTS; LIVE PERFORMANCES BY A MUSICAL PERFORMING ARTIST; PERSONAL APPEARANCES BY A MUSICAL PERFORMING ARTIST; TELEVISED AND MOVIE

APPEARANCES BY A MUSICAL PERFORMING ARTIST; HOSTING RADIO PROGRAMS FEATURING MUSIC; AN INTERNET WEB PAGE FEATURING NEWS AND INFORMATION CONCERNING A MUSICAL PERFORMING ARTIST, PHOTOGRAPHS OF A MUSICAL PERFORMING ARTIST, AND AN ON-LINE JOURNAL, NAMELY, A BLOG CONCERNING THE ACTIVITIES OF A MUSICAL RECORDING ARTIST; AN INTERNET WEB SITE FEATURING MUSICAL SOUND RECORDINGS AND NEWS AND INFORMATION CONCERNING A MUSICAL RECORDING ARTIST, IN CLASS 41 (U.S. CLS. 100, 101 AND 107).

FIRST USE 0-0-2004; IN COMMERCE 0-0-2004.

THE MARK CONSISTS OF STANDARD CHARACTERS WITHOUT CLAIM TO ANY PARTICULAR FONT, STYLE, SIZE, OR COLOR.

THE NAME "JOSHUA SCOTT CHASEZ" IDENTIFIES A LIVING INDIVIDUAL WHOSE CONSENT IS OF RECORD.

SER. NO. 76-684,515, FILED 11-30-2007.

GEORGE LORENZO, EXAMINING ATTORNEY

Int. Cl.: 16

Prior U.S. Cls.: 2, 5, 22, 23, 29, 37, 38 and 50

United States Patent and Trademark Office

Reg. No. 3,518,755

Registered Oct. 21, 2008

TRADEMARK
PRINCIPAL REGISTER



SAFETYTAT, LLC (MARYLAND LIMITED LIABILITY COMPANY)
15 GLEN LYON COURT
PHOENIX, MD 21131

FOR: TEMPORARY TATTOOS, NAMELY, CHILDREN'S AND ADULT'S IDENTIFICATION TATTOOS, IN CLASS 16 (U.S. CLS. 2, 5, 22, 23, 29, 37, 38 AND 50).

FIRST USE 10-30-2007; IN COMMERCE 10-30-2007.

THE MARK IS IN LOWERCASE SHOWING A DESIGN ELEMENT APPEARING ON THE LEFT OF THE MARK. THE DESIGN COMPRISES A CIRCLE INSIDE A BIGGER CIRCLE WITH A CHILD SHOWING HIS ARM WITH A TATTOO.

SER. NO. 76-684,747, FILED 12-10-2007.

ANNE E. GUSTASON, EXAMINING ATTORNEY

Int. Cl.: 28

Prior U.S. Cls.: 22, 23, 38 and 50

United States Patent and Trademark Office

Reg. No. 3,518,756

Registered Oct. 21, 2008

**TRADEMARK
PRINCIPAL REGISTER**

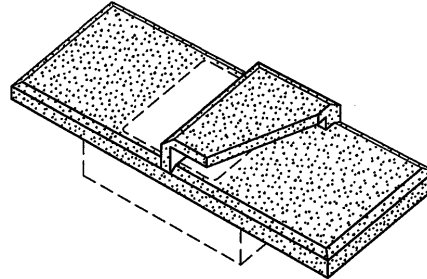

TECH ART, INC. (NEVADA CORPORATION)
4185 WEST TECO AVENUE
LAS VEGAS, NV 89118

FOR: NON-METAL, NON-ELECTRONIC PLAYING CARD HOUSING THAT ALLOWS THE USER TO READ PLAYING CARDS, IN CLASS 28 (U.S. CLS. 22, 23, 38 AND 50).

FIRST USE 4-0-1990; IN COMMERCE 4-0-1992.

OWNER OF U.S. REG. NOS. 1,762,122 AND 1,798,804.

THE STIPPLING IS FOR SHADING PURPOSES ONLY AND DOES NOT INDICATE COLOR.

THE MARK CONSISTS OF THE PRODUCT CONFIGURATION OF AN OPTICAL PLAYING CARD CHARACTER READER. THE PRODUCT CONFIGURATION INCLUDES A FLAT MEMBER TO WHICH IS ATTACHED A HOOD. THE BOTTOM HOUSING AND THE OPENING IN THE FLAT MEMBER ARE SHOWN IN PHANTOM, ARE NOT PART OF THE MARK, AND SERVE ONLY TO INDICATE THE POSITION OF THE MARK.

SEC. 2(F).

SER. NO. 76-685,325, FILED 12-27-2007.

TRACY CROSS, EXAMINING ATTORNEY

Int. Cl.: 37

Prior U.S. Cls.: 100, 103 and 106

Reg. No. 3,518,757

United States Patent and Trademark Office

Registered Oct. 21, 2008

SERVICE MARK
PRINCIPAL REGISTER

OAP
OWNER'S ADVOCATE
PROGRAM

JEK ARCHITECTURAL & ENGINEERING SERVICES, INC. (ILLINOIS CORPORATION), DBA
JEK OWNER'S ADVOCATE, INC.

1921 ROHLWING RD., SUITE A
ROLLING MEADOW, IL 60008

FOR: CONSTRUCTION CONSULTATION, IN
CLASS 37 (U.S. CLS. 100, 103 AND 106).

FIRST USE 11-0-2005; IN COMMERCE 11-0-2005.

THE MARK CONSISTS OF STANDARD CHARACTERS WITHOUT CLAIM TO ANY PARTICULAR FONT, STYLE, SIZE, OR COLOR.

NO CLAIM IS MADE TO THE EXCLUSIVE RIGHT TO USE "OWNER'S ADVOCATE PROGRAM", APART FROM THE MARK AS SHOWN.

SER. NO. 76-686,074, FILED 1-24-2008.

TINA KUAN, EXAMINING ATTORNEY

Int. Cl.: 35

Prior U.S. Cls.: 100, 101 and 102

United States Patent and Trademark Office

Reg. No. 3,518,758

Registered Oct. 21, 2008

**SERVICE MARK
PRINCIPAL REGISTER**

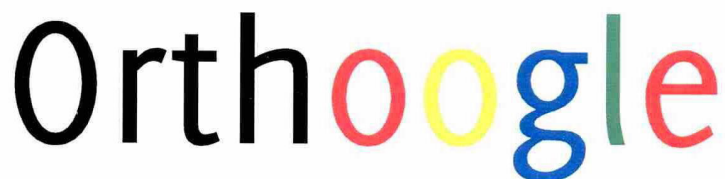

Orthoogle

DTC HEALTHCOM, LLC (NEW YORK LIMITED LIABILITY COMPANY)
244 WESTCHESTER AVENUE
WHITE PLAINS, NY 10604

FOR: CONSULTANT TO ORTHOPEDIC PRACTICES AS TO EFFICIENCY RELATED TO INTERNET ADVERTISING, IN CLASS 35 (U.S. CLS. 100, 101 AND 102).

FIRST USE 11-28-2006; IN COMMERCE 11-28-2006.

THE COLOR(S) BLACK, RED, YELLOW, BLUE, AND GREEN IS/ARE CLAIMED AS A FEATURE OF THE MARK.

THE MARK CONSISTS OF THE WORD "ORTHOOGLE" IN STYLIZED LETTERS. THE COLOR BLACK APPEARS IN THE FIRST FOUR LETTERS, "ORTH", THE COLOR RED APPEARS IN THE FIFTH LETTER, "O", AND THE NINTH LETTER, "E", THE COLOR YELLOW APPEARS IN THE SIXTH LETTER, "O", THE COLOR BLUE APPEARS IN THE SEVENTH LETTER, "G", AND THE COLOR GREEN APPEARS IN THE EIGHTH LETTER, "L".

SER. NO. 76-686,133, FILED 1-25-2008.

LIEF MARTIN, EXAMINING ATTORNEY

Int. Cl.: 45

Prior U.S. Cls.: 100 and 101

United States Patent and Trademark Office

Reg. No. 3,518,759

Registered Oct. 21, 2008

**SERVICE MARK
PRINCIPAL REGISTER**

myGoodDeed

MY GOOD DEED (CALIFORNIA PUBLIC BENEFIT CORPORATION)
19000 MACARTHUR BOULEVARD
IRVINE, CA 92612

FOR: PERSONAL AND SOCIAL SERVICES IN THE NATURE OF ENCOURAGING PEOPLE TO ENGAGE IN GOOD DEEDS, NAMELY, PERSONAL LIFESTYLE CONSULTING SERVICES FEATURING THE PROMOTION OF VOLUNTEERISM AND PARTICIPATION IN CHARITABLE SERVICES, PROVIDING INFORMATION CONCERNING CHARITABLE CAUSES AND HUMANITARIAN EFFORTS IN THE FIELD OF SOCIAL JUSTICE, AND ORGANIZING AND CONDUCTING SUPPORT GROUPS IN THE

FIELD OF VOLUNTEERISM AND CHARITABLE SERVICE PARTICIPATION, IN CLASS 45 (U.S. CLS. 100 AND 101).

FIRST USE 8-10-2006; IN COMMERCE 8-10-2006.

THE MARK CONSISTS OF STANDARD CHARACTERS WITHOUT CLAIM TO ANY PARTICULAR FONT, STYLE, SIZE, OR COLOR.

SER. NO. 76-686,462, FILED 2-4-2008.

JAY BESCH, EXAMINING ATTORNEY

Int. Cl.: 25

Prior U.S. Cls.: 22 and 39

United States Patent and Trademark Office

Reg. No. 3,518,760

Registered Oct. 21, 2008

**TRADEMARK
PRINCIPAL REGISTER**

ENCHANTED ENFANT

ENCHANTED ENFANT, LLC (PENNSYLVANIA
LIMITED LIABILITY COMPANY)
26 MEETINGHOUSE SQUARE
FALLSINGTON, PA 19054

FOR: CHILDREN'S CLOTHING, NAMELY,
DRESSES, TOPS, PANTS, COATS, JACKETS, SWEA-
TERS, BATHING SUITS, SOCKS, BELTS AND SUS-
PENDERS, IN CLASS 25 (U.S. CLS. 22 AND 39).

FIRST USE 7-29-2007; IN COMMERCE 7-29-2007.

THE MARK CONSISTS OF STANDARD CHAR-
ACTERS WITHOUT CLAIM TO ANY PARTICULAR
FONT, STYLE, SIZE, OR COLOR.

NO CLAIM IS MADE TO THE EXCLUSIVE
RIGHT TO USE "ENFANT", APART FROM THE
MARK AS SHOWN.

THE WORD "ENFANT" TRANSLATES FROM
THE FRENCH AS "CHILD".

SER. NO. 76-686,533, FILED 2-4-2008.

KIMBERLY PERRY, EXAMINING ATTORNEY

Int. Cls.: 35 and 36

Prior U.S. Cls.: 100, 101 and 102

United States Patent and Trademark Office

Reg. No. 3,518,761

Registered Oct. 21, 2008

**SERVICE MARK
PRINCIPAL REGISTER**

BUYERSCOPE

WINCHESTER CAPITAL PARTNERS, LLC (CONNECTICUT LIMITED LIABILITY COMPANY)
WINCHESTER HOUSE, 445 ORANGE STREET
NEW HAVEN, CT 065116202

FOR: MANAGERIAL RESEARCH, NAMELY, BUSINESS MANAGEMENT RESEARCH, AND MARKET RESEARCH REGARDING ACQUISITIONS AND CORPORATE DEVELOPMENT, IN CLASS 35 (U.S. CLS. 100, 101 AND 102).

FIRST USE 1-20-2008; IN COMMERCE 1-20-2008.

FOR: FINANCIAL RESEARCH REGARDING MERGERS, ACQUISITIONS, AND CORPORATE

DEVELOPMENT, IN CLASS 36 (U.S. CLS. 100, 101 AND 102).

FIRST USE 1-20-2008; IN COMMERCE 1-20-2008.

THE MARK CONSISTS OF STANDARD CHARACTERS WITHOUT CLAIM TO ANY PARTICULAR FONT, STYLE, SIZE, OR COLOR.

SER. NO. 76-686,569, FILED 2-6-2008.

EMILY CARLSEN, EXAMINING ATTORNEY

Int. Cls.: 9 and 37

Prior U.S. Cls.: 21, 23, 26, 36, 38, 100, 103 and 106

United States Patent and Trademark Office

Reg. No. 3,518,762

Registered Oct. 21, 2008

**TRADEMARK
SERVICE MARK
PRINCIPAL REGISTER**

KVAR ENERGY SAVINGS

TAYLOR, GREGORY G. (UNITED STATES IN-
DIVIDUAL)
610 MOONPENNY CIRCLE
PORT ORANGE, FL 32127

FOR: CAPACITOR BANKS FOR INSTALLATION
ON ELECTRICAL EQUIPMENT AND SIZING
EQUIPMENT FOR SAME, IN CLASS 9 (U.S. CLS.
21, 23, 26, 36 AND 38).

FIRST USE 9-30-1995; IN COMMERCE 9-30-1995.

FOR: SERVICES IN THE NATURE OF SIZING
AND INSTALLING CAPACITOR BANKS ON ELEC-
TRICAL EQUIPMENT, IN CLASS 37 (U.S. CLS. 100,
103 AND 106).

FIRST USE 9-30-1995; IN COMMERCE 9-30-1995.

THE MARK CONSISTS OF STANDARD CHAR-
ACTERS WITHOUT CLAIM TO ANY PARTICULAR
FONT, STYLE, SIZE, OR COLOR.

NO CLAIM IS MADE TO THE EXCLUSIVE
RIGHT TO USE "ENERGY SAVINGS", APART
FROM THE MARK AS SHOWN.

SER. NO. 76-686,915, FILED 2-19-2008.

JILL C. ALT, EXAMINING ATTORNEY

Int. Cl.: 36

Prior U.S. Cls.: 100, 101 and 102

United States Patent and Trademark Office

Reg. No. 3,518,763

Registered Oct. 21, 2008

**SERVICE MARK
PRINCIPAL REGISTER**



STERLING WEALTH MANAGEMENT, INC. (ILLINOIS CORPORATION)
115 NORTH NEIL STREET, SUITE 305
CHAMPAIGN, IL 61820

FOR: FINANCIAL ADMINISTRATION OF RETIREMENT PLANS; FINANCIAL ANALYSIS AND CONSULTATION; FINANCIAL CONSULTATION; FINANCIAL INVESTMENT IN THE FIELD OF SECURITIES; FINANCIAL MANAGEMENT; FINANCIAL PLANNING; FINANCIAL PLANNING CONSULTATION; FINANCIAL PLANNING FOR RETIREMENT; FINANCIAL PLANNING, NAMELY, THE CREATION OF PERSONALIZED STRATEGIES TO ACHIEVE FINANCIAL INDEPENDENCE; FINANCIAL PORTFOLIO MANAGEMENT; FINANCIAL RESEARCH; FINANCIAL SERVICES IN THE NATURE OF AN INVESTMENT SECURITY; FINANCIAL SERVICES, NAMELY, ASSISTING OTH-

ERS WITH THE COMPLETION OF FINANCIAL TRANSACTIONS FOR STOCKS, BONDS, SECURITIES AND EQUITIES, IN CLASS 36 (U.S. CLS. 100, 101 AND 102).

FIRST USE 9-1-2004; IN COMMERCE 9-1-2004.

THE COLOR(S) DARK GREEN AND WHITE IS/ARE CLAIMED AS A FEATURE OF THE MARK.

THE MARK CONSISTS OF DARK GREEN SQUARE WITH WHITE STYLIZED "S" FROM UPPER RIGHT CORNER TO LOWER LEFT CORNER.

SER. NO. 76-687,040, FILED 2-22-2008.

JULIE VEPPUMTHARA, EXAMINING ATTORNEY

Int. Cl.: 44

Prior U.S. Cls.: 100 and 101

United States Patent and Trademark Office

Reg. No. 3,518,764

Registered Oct. 21, 2008

**SERVICE MARK
PRINCIPAL REGISTER**



BORST LANDSCAPE & DESIGN INC. (NEW JERSEY CORPORATION)
260 WEST CRESCENT AVENUE, SUITE 1
ALLENDALE, NJ 07401

FOR: LANDSCAPING SERVICES NAMELY, LAWN, TREE AND SHRUB CARE, IN CLASS 44 (U.S. CLS. 100 AND 101).

FIRST USE 10-16-2006; IN COMMERCE 11-30-2006.

NO CLAIM IS MADE TO THE EXCLUSIVE RIGHT TO USE "ORGANIC", APART FROM THE MARK AS SHOWN.

THE COLOR(S) BLUE, BLACK AND GREEN IS/ ARE CLAIMED AS A FEATURE OF THE MARK.

THE MARK IS PRESENTED WITH THE WORD "BORST" ON ONE LINE IN THE COLOR BLUE, THE WORD "ORGANIC" ON A SECOND LINE AND THE PHRASE, "THE SCIENCE OF NATURE" ON A THIRD LINE ARE BOTH IN THE COLOR BLACK. A DESIGN OF SIX BLADES OF GRASS IS SET OFF TO THE RIGHT SIDE OF THE WORDS "BORST" AND "ORGANIC" AND ABOVE THE LETTERS "U, R, AND E" IN THE WORD "NATURE". THESE ARE IN VARYING SHADES OF THE COLOR GREEN.

SER. NO. 76-687,246, FILED 2-29-2008.

RON FAIRBANKS, EXAMINING ATTORNEY

Int. Cl.: 39

Prior U.S. Cls.: 100 and 105

United States Patent and Trademark Office

Reg. No. 3,518,765

Registered Oct. 21, 2008

**SERVICE MARK
PRINCIPAL REGISTER**

Manna Freight Systems, Inc.

MANNA FREIGHT SYSTEMS INC. (MINNESOTA CORPORATION)
2440 ENTERPRISE DRIVE
MENDOTA HEIGHTS, MN 55120

OWNER OF U.S. REG. NO. 3,292,635.

FOR: FREIGHT TRANSPORTATION OF GOODS BY AIR, TRAIN, OR TRUCK, IN CLASS 39 (U.S. CLS. 100 AND 105).

NO CLAIM IS MADE TO THE EXCLUSIVE RIGHT TO USE "FREIGHT SYSTEMS, INC.", APART FROM THE MARK AS SHOWN.

FIRST USE 3-14-1991; IN COMMERCE 3-14-1991.

SER. NO. 76-687,291, FILED 3-3-2008.

THE MARK CONSISTS OF STANDARD CHARACTERS WITHOUT CLAIM TO ANY PARTICULAR FONT, STYLE, SIZE, OR COLOR.

MATTHEW EINSTEIN, EXAMINING ATTORNEY

Int. Cl.: 28

Prior U.S. Cls.: 22, 23, 38 and 50

United States Patent and Trademark Office

Reg. No. 3,518,766

Registered Oct. 21, 2008

**TRADEMARK
PRINCIPAL REGISTER**

JIU LING

QUAGLIA, BRIAN (UNITED STATES INDIVIDUAL)

151 AIRPORT ROAD

WARWICK, RI 02886

FOR: A GAME, NAMELY, A BOARD AND DICE DRINKING GAME INVOLVING TRICKERY, DECEPTION AND BLUFF, IN CLASS 28 (U.S. CLS. 22, 23, 38 AND 50).

FIRST USE 2-16-2008; IN COMMERCE 2-16-2008.

THE MARK CONSISTS OF STANDARD CHARACTERS WITHOUT CLAIM TO ANY PARTICULAR FONT, STYLE, SIZE, OR COLOR.

THE NAME "JIU LING" DOES NOT IDENTIFY A LIVING INDIVIDUAL.

THE ENGLISH TRANSLATION OF THE WORD "JIU LING" IN THE MARK IS "ONLY KING."

SER. NO. 76-687,299, FILED 3-3-2008.

CARYN GLASSER, EXAMINING ATTORNEY

Int. Cl.: 11

Prior U.S. Cls.: 13, 21, 23, 31 and 34

United States Patent and Trademark Office

Reg. No. 3,518,767

Registered Oct. 21, 2008

**TRADEMARK
PRINCIPAL REGISTER**

AIRHAWK

ROSSMAN ENTERPRISES, INCORPORATED
(OHIO CORPORATION)
11449 DEERFIELD ROAD
CINCINNATI, OH 45242

THE MARK CONSISTS OF STANDARD CHAR-
ACTERS WITHOUT CLAIM TO ANY PARTICULAR
FONT, STYLE, SIZE, OR COLOR.

FOR: AIR PURIFICATION UNITS, IN CLASS 11
(U.S. CLS. 13, 21, 23, 31 AND 34).

SER. NO. 76-687,418, FILED 3-6-2008.

FIRST USE 9-15-2003; IN COMMERCE 2-15-2004.

RAMONA ORTIGA, EXAMINING ATTORNEY

Int. Cl.: 7

Prior U.S. Cls.: 13, 19, 21, 23, 31, 34 and 35

United States Patent and Trademark Office

Reg. No. 3,518,768

Registered Oct. 21, 2008

**TRADEMARK
PRINCIPAL REGISTER**

STAMPEDE

PARK INDUSTRIES, INC. (MINNESOTA CORPORATION)
6600 SAUKVIEW DRIVE
ST. CLOUD, MN 56302

FOR: MULTIPLE BLADE SAWING SYSTEM COMPOSED OF AN INFEED CONVEYOR FOR FEEDING STONE SLABS INTO A PLURALITY OF CIRCULAR SAW BLADES MOUNTED ON A COMMON, MOTOR-DRIVEN ARBOR WITH ADJUSTABLE SPACING BETWEEN ADJACENT BLADES, IN CLASS 7 (U.S. CLS. 13, 19, 21, 23, 31, 34 AND 35).

FIRST USE 1-29-2008; IN COMMERCE 1-29-2008.

THE MARK CONSISTS OF STANDARD CHARACTERS WITHOUT CLAIM TO ANY PARTICULAR FONT, STYLE, SIZE, OR COLOR.

SER. NO. 76-687,559, FILED 3-10-2008.

FRANK LATTUCA, EXAMINING ATTORNEY

Int. Cl.: 10

Prior U.S. Cls.: 26, 39 and 44

United States Patent and Trademark Office

Reg. No. 3,518,769

Registered Oct. 21, 2008

**TRADEMARK
PRINCIPAL REGISTER**



ARES TRADING S.A. (SWITZERLAND SOCIETE
ANONYME)
ZONE INDUSTRIELLE DE L'OURIETTAZ
CH-1170 AUBONNE, SWITZERLAND

OWNER OF U.S. REG. NO. 3,150,806.

FOR: MEDICAL APPARATUS AND INSTRU-
MENTS, NAMELY, INJECTOR FOR GROWTH
HORMONE, IN CLASS 10 (U.S. CLS. 26, 39 AND 44).

ANY GRAY IN THE MARK IS INTENDED TO
SHOW SHADING OR CONTRAST ONLY.

SER. NO. 76-687,637, FILED 3-12-2008.

FIRST USE 0-0-2007; IN COMMERCE 0-0-2007.

BRIAN CALLAGHAN, EXAMINING ATTORNEY

Int. Cl.: 40

Prior U.S. Cls.: 100, 103 and 106

Reg. No. 3,518,770

United States Patent and Trademark Office

Registered Oct. 21, 2008

**SERVICE MARK
PRINCIPAL REGISTER**

THERMAL BALANCE

THERMAL TECHNOLOGY SERVICES, INC.
(FLORIDA CORPORATION)
7500 ULMERTON RD - SUITE 28
LARGO, FL 33771

FOR: CRYOGENIC TREATMENT OF METAL GOODS, NAMELY, BRAKE DRUMS, ROTORS AND BRAKE PARTS, FORMED METAL PARTS INCLUDING CYLINDERS, FIREARM PARTS, CUTTING BLADES INCLUDING MOWER BLADES AND EDGING BLADES, SPORTING GOODS INCLUDING GOLF CLUBS, BASEBALL BATS, TENNIS STRINGS, ENGINE COMPONENTS, JET ENGINE PARTS, IN CLASS 40 (U.S. CLS. 100, 103 AND 106).

FIRST USE 3-21-2007; IN COMMERCE 3-21-2007.

THE MARK CONSISTS OF STANDARD CHARACTERS WITHOUT CLAIM TO ANY PARTICULAR FONT, STYLE, SIZE, OR COLOR.

NO CLAIM IS MADE TO THE EXCLUSIVE RIGHT TO USE "THERMAL", APART FROM THE MARK AS SHOWN.

SER. NO. 76-687,674, FILED 3-13-2008.

CHRISTOPHER BUONGIORNO, EXAMINING ATTORNEY

Int. Cl.: 44

Prior U.S. Cls.: 100 and 101

United States Patent and Trademark Office

Reg. No. 3,518,771

Registered Oct. 21, 2008

**SERVICE MARK
PRINCIPAL REGISTER**

MEDSHAPE

MEDSHAPE WEIGHT LOSS CLINIC, LLC (ARIZONA LIMITED LIABILITY COMPANY)
1845 SOUTH DOBSON ROAD, SUITE 202
MESA, AZ 85202

FOR: WEIGHT LOSS, DIET AND NUTRITION PLANNING AND SUPERVISION FEATURING MEDICAL, EXERCISE, BEHAVIOR MODIFICATION, AND HORMONE AND PRESCRIPTION THERAPY SERVICES, AND COUNSELING RELATED THERETO, IN CLASS 44 (U.S. CLS. 100 AND 101).

FIRST USE 2-7-2007; IN COMMERCE 2-7-2007.

THE MARK CONSISTS OF STANDARD CHARACTERS WITHOUT CLAIM TO ANY PARTICULAR FONT, STYLE, SIZE, OR COLOR.

SER. NO. 76-687,685, FILED 3-13-2008.

KARANENDRA S. CHHINA, EXAMINING ATTORNEY

Int. Cl.: 9

Prior U.S. Cls.: 21, 23, 26, 36 and 38

Reg. No. 3,518,772

United States Patent and Trademark Office

Registered Oct. 21, 2008

TRADEMARK
PRINCIPAL REGISTER



Soft Touch

CONTROLLED AIR SYSTEMS (PENNSYLVANIA
CORPORATION)
1325 MINK ROAD
PERKASIE, PA 18944

FIRST USE 1-1-2008; IN COMMERCE 1-1-2008.

SER. NO. 76-687,687, FILED 3-13-2008.

FOR: TOUCH SCREEN THERMOSTAT, IN CLASS
9 (U.S. CLS. 21, 23, 26, 36 AND 38).

KARANENDRA S. CHHINA, EXAMINING ATTOR-
NEY

Int. Cl.: 41

Prior U.S. Cls.: 100, 101 and 107

United States Patent and Trademark Office

Reg. No. 3,518,773

Registered Oct. 21, 2008

**SERVICE MARK
PRINCIPAL REGISTER**

FASTEST GUN ALIVE

COWBOY FAST DRAW ASSOCIATION, LLC
(SOUTH DAKOTA PARTNERSHIP)
PO BOX 5
FERNLEY, NV 89408

FOR: ENTERTAINMENT IN THE NATURE OF
COMPETITIONS IN THE FIELD OF SHOOTING
CONTESTS, IN CLASS 41 (U.S. CLS. 100, 101 AND
107).

FIRST USE 1-30-2008; IN COMMERCE 1-30-2008.

THE MARK CONSISTS OF STANDARD CHAR-
ACTERS WITHOUT CLAIM TO ANY PARTICULAR
FONT, STYLE, SIZE, OR COLOR.

NO CLAIM IS MADE TO THE EXCLUSIVE
RIGHT TO USE "FASTEST GUN", APART FROM
THE MARK AS SHOWN.

SER. NO. 76-687,721, FILED 3-14-2008.

JOHN GARTNER, EXAMINING ATTORNEY

Int. Cl.: 41

Prior U.S. Cls.: 100, 101 and 107

United States Patent and Trademark Office

Reg. No. 3,518,774

Registered Oct. 21, 2008

**SERVICE MARK
PRINCIPAL REGISTER**

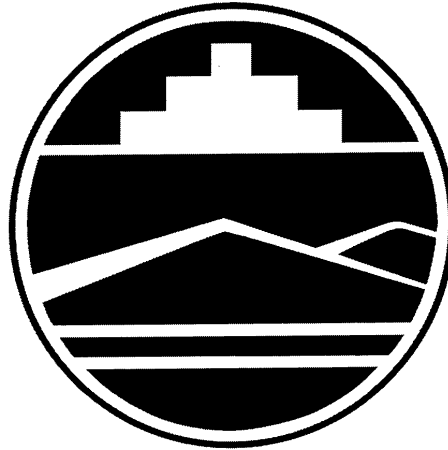

PRESCOTT COLLEGE, INC. (ARIZONA NON-
PROFIT CORPORATION)
220 GROVE AVENUE
PRESCOTT, AZ 86301

FOR: EDUCATIONAL SERVICES, NAMELY,
PROVIDING COURSES OF INSTRUCTION, AND
TRAINING AT THE COLLEGE AND POST-GRAD-
UATE LEVELS, AND THE DISTRIBUTION OF
COURSE MATERIAL IN CONNECTION THERE-
WITH, IN CLASS 41 (U.S. CLS. 100, 101 AND 107).

FIRST USE 9-6-1988; IN COMMERCE 9-6-1988.

DESIGN OF LANDSCAPE, MOUNTAINS AND
BUILDING WITHIN A CIRCLE

SER. NO. 76-687,729, FILED 3-14-2008.

ALEX KEAM, EXAMINING ATTORNEY

Int. Cl.: 37

Prior U.S. Cls.: 100, 103 and 106

United States Patent and Trademark Office

Reg. No. 3,518,775

Registered Oct. 21, 2008

**SERVICE MARK
PRINCIPAL REGISTER**



GREENWAVE ELECTRIC, INC. (KANSAS CORPORATION)
1100 SW WANAMAKER RD, SUITE 5
TOPEKA, KS 66604

FOR: ELECTRICAL CONTRACTING SERVICES,
IN CLASS 37 (U.S. CLS. 100, 103 AND 106).

FIRST USE 11-1-2007; IN COMMERCE 11-6-2007.

THE COLOR(S) DARK GREEN, LIGHT GREEN
AND WHITE IS/ARE CLAIMED AS A FEATURE OF
THE MARK.

THE MARK CONSISTS OF THREE CONCENTRIC
CIRCLES WITH THE LETTER "W" IN THE CENTER.

"W" IS ASYMMETRICAL AND HAS HORIZONTAL
LINES RUNNING FROM THE TOP LEFT AND
RIGHT ENDS OF THE "W" AND TAPERS OFF TO
THE LEFT AND TO THE RIGHT RESPECTIVELY.
THE COLOR DARK GREEN APPEARS IN THE
BACKGROUND OF THE INTERIOR CIRCLE; THE
COLOR LIGHT GREEN APPEARS IN THE OUTER
CIRCLE AND IN THE "W"; AND THE COLOR
WHITE APPEARS IN THE MIDDLE THIN CIRCLE
BETWEEN THE DARK GREEN AND LIGHT
GREEN.

SER. NO. 76-687,796, FILED 3-17-2008.

KARANENDRA S. CHHINA, EXAMINING ATTOR-
NEY

Int. Cl.: 35

Prior U.S. Cls.: 100, 101 and 102

United States Patent and Trademark Office

Reg. No. 3,518,776

Registered Oct. 21, 2008

**SERVICE MARK
PRINCIPAL REGISTER**

BEYOND FURNITURE

MISKELLY FURNITURE (MISSISSIPPI CORPORATION)

101 AIRPORT ROAD

JACKSON, MS 39208

FOR: RETAIL FURNITURE STORE, IN CLASS 35
(U.S. CLS. 100, 101 AND 102).

FIRST USE 2-24-2005; IN COMMERCE 2-24-2005.

THE MARK CONSISTS OF STANDARD CHARACTERS WITHOUT CLAIM TO ANY PARTICULAR FONT, STYLE, SIZE, OR COLOR.

NO CLAIM IS MADE TO THE EXCLUSIVE RIGHT TO USE "FURNITURE", APART FROM THE MARK AS SHOWN.

SER. NO. 76-687,806, FILED 3-17-2008.

ANGELA M. MICHELI, EXAMINING ATTORNEY

Int. Cl.: 35

Prior U.S. Cls.: 100, 101 and 102

United States Patent and Trademark Office

Reg. No. 3,518,777

Registered Oct. 21, 2008

SERVICE MARK
PRINCIPAL REGISTER

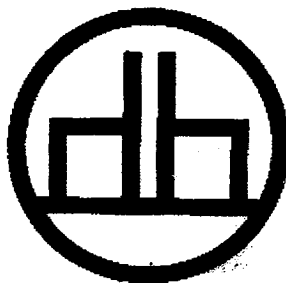

twinhouse

TWINHOUSE, L.L.C (GEORGIA LIMITED LIABILITY COMPANY)
2815 PEACHTREE ROAD
ATLANTA, GA 30305

FOR: ART GALLERY SERVICES, IN CLASS 35
(U.S. CLS. 100, 101 AND 102).

FIRST USE 9-1-1996; IN COMMERCE 9-1-1996.

THE MARK CONSISTS OF THE DESIGN REPRESENTATION OF TWO CHAIRS FACING BACK TO BACK ON A LINE INSIDE A CIRCLE WITH THE WORD "TWINHOUSE" BELOW.

SER. NO. 76-687,874, FILED 3-17-2008.

WENDY JUN, EXAMINING ATTORNEY

Int. Cl.: 36

Prior U.S. Cls.: 100, 101 and 102

United States Patent and Trademark Office

Reg. No. 3,518,778

Registered Oct. 21, 2008

**SERVICE MARK
PRINCIPAL REGISTER**

PUSH BUTTON INVESTING

DRALUCK, RON (UNITED STATES INDIVIDUAL)
270 WALHALLA COURT
ATLANTA, GA 30350

FOR: REAL ESTATE INVESTMENT SERVICES, NAMELY, REAL ESTATE ACQUISITION SERVICES, REAL ESTATE SALES BROKERAGE, AND REAL ESTATE FINANCING SERVICES, IN CLASS 36 (U.S. CLS. 100, 101 AND 102).

FIRST USE 3-1-2005; IN COMMERCE 5-12-2005.

THE MARK CONSISTS OF STANDARD CHARACTERS WITHOUT CLAIM TO ANY PARTICULAR FONT, STYLE, SIZE, OR COLOR.

NO CLAIM IS MADE TO THE EXCLUSIVE RIGHT TO USE "INVESTING", APART FROM THE MARK AS SHOWN.

SER. NO. 76-687,875, FILED 3-17-2008.

WENDY JUN, EXAMINING ATTORNEY

Int. Cl.: 35

Prior U.S. Cls.: 100, 101 and 102

United States Patent and Trademark Office

Reg. No. 3,518,779

Registered Oct. 21, 2008

**SERVICE MARK
PRINCIPAL REGISTER**



AVA, INC. (TEXAS CORPORATION)
1001 PAT BOOKER ROAD, SUITE 101
UNIVERSAL CITY, TX 78148

FOR: ASSOCIATION SERVICES, NAMELY, PROMOTING THE INTERESTS OF PERSONS INTERESTED IN PROMOTING HEALTH AND PERSONAL WELLNESS THROUGH WALKING, SWIMMING, BIKING, AND CROSS-COUNTRY SKIING, IN CLASS 35 (U.S. CLS. 100, 101 AND 102).

FIRST USE 9-0-1994; IN COMMERCE 9-0-1994.

OWNER OF U.S. REG. NOS. 1,461,433 AND 1,491,683.

THE MARK CONTAINS A TWO-DIMENSIONAL DESIGN CONSISTING OF THE LETTERS AVA. THE GRAY IS USED FOR SHADING ONLY AND IS NOT AN INDICATION OF COLOR.

SER. NO. 76-687,885, FILED 3-19-2008.

AMOS T. MATTHEWS, JR., EXAMINING ATTORNEY

Int. Cl.: 35

Prior U.S. Cls.: 100, 101 and 102

United States Patent and Trademark Office

Reg. No. 3,518,780

Registered Oct. 21, 2008

**SERVICE MARK
PRINCIPAL REGISTER**

BREAKAWAY INNOVATION

STRATEGIC MOMENTUM, INC. (CALIFORNIA CORPORATION)
645 FRONT STREET, SUITE 908
SAN DIEGO, CA 92101

FIRST USE 6-24-2007; IN COMMERCE 6-24-2007.

FOR: CONSULTING SERVICES IN THE FIELD OF HUMAN AND BUSINESS RESOURCE DEVELOPMENT, NAMELY, IMPLEMENTING PROCESSES TO ENHANCE COMMUNICATION AND INCREASE PRODUCTIVITY FOR EMPLOYEES AND EMPLOYERS, AND ENHANCE GROWTH, PROFITABILITY AND COMPETITIVENESS FOR THE BUSINESS, IN CLASS 35 (U.S. CLS. 100, 101 AND 102).

THE MARK CONSISTS OF STANDARD CHARACTERS WITHOUT CLAIM TO ANY PARTICULAR FONT, STYLE, SIZE, OR COLOR.

SER. NO. 76-687,905, FILED 3-20-2008.

DORITT L. CARROLL, EXAMINING ATTORNEY

Int. Cl.: 12

Prior U.S. Cls.: 19, 21, 23, 31, 35 and 44

Reg. No. 3,518,781

United States Patent and Trademark Office

Registered Oct. 21, 2008

**TRADEMARK
PRINCIPAL REGISTER**

SuckerPunch Sallys

SUCKERPUNCH SALLY'S, LLC (ARIZONA LIMITED LIABILITY COMPANY)
14982 NORTH 83RD PLACE, SUITE 100
SCOTTSDALE, AZ 85260

FOR: MOTORCYCLES AND STRUCTURAL PARTS THEREFOR, IN CLASS 12 (U.S. CLS. 19, 21, 23, 31, 35 AND 44).

FIRST USE 10-1-2003; IN COMMERCE 10-1-2003.

THE MARK CONSISTS OF STANDARD CHARACTERS WITHOUT CLAIM TO ANY PARTICULAR FONT, STYLE, SIZE, OR COLOR.

OWNER OF U.S. REG. NO. 3,058,678.

SER. NO. 76-687,921, FILED 3-20-2008.

MARTHA FROMM, EXAMINING ATTORNEY

Int. Cl.: 35

Prior U.S. Cls.: 100, 101 and 102

United States Patent and Trademark Office

Reg. No. 3,518,782

Registered Oct. 21, 2008

**SERVICE MARK
PRINCIPAL REGISTER**

SuckerPunch Sallys

SUCKERPUNCH SALLYs, LLC (ARIZONA LIMITED LIABILITY COMPANY)
14982 NORTH 83RD PLACE, SUITE 100
SCOTTSDALE, AZ 85260

FOR: RETAIL STORE SERVICES AND ON-LINE RETAIL STORE SERVICES FEATURING MOTORCYCLES, MOTORCYCLE KITS, MOTORCYCLE PARTS, MOTORCYCLE ACCESSORIES, APPAREL, HEADWEAR, KEY CHAINS AND BELT BUCKLES, IN CLASS 35 (U.S. CLS. 100, 101 AND 102).

FIRST USE 3-23-2006; IN COMMERCE 3-23-2006.

THE MARK CONSISTS OF STANDARD CHARACTERS WITHOUT CLAIM TO ANY PARTICULAR FONT, STYLE, SIZE, OR COLOR.

OWNER OF U.S. REG. NO. 3,058,678.

SER. NO. 76-687,922, FILED 3-20-2008.

MARTHA FROMM, EXAMINING ATTORNEY

Int. Cls.: 36 and 45

Prior U.S. Cls.: 100, 101 and 102

United States Patent and Trademark Office

Reg. No. 3,518,783

Registered Oct. 21, 2008

**SERVICE MARK
PRINCIPAL REGISTER**

VORF

VIETNAMESE ORPHANS RELIEF FUND (OHIO
501(C)(3) NON-PROFIT CORPORATION)
3784 WASHINGTON PARK BLVD.
NEWBURGH HEIGHTS, OH 44105

FOR: CHARITABLE FUNDRAISING SERVICES,
IN CLASS 36 (U.S. CLS. 100, 101 AND 102).

FIRST USE 5-12-2003; IN COMMERCE 5-12-2003.

FOR: ADOPTION AGENCY AND ADOPTION
PLACEMENT SERVICES, IN CLASS 45 (U.S. CLS.
100 AND 101).

FIRST USE 5-12-2003; IN COMMERCE 5-12-2003.

THE MARK CONSISTS OF STANDARD CHAR-
ACTERS WITHOUT CLAIM TO ANY PARTICULAR
FONT, STYLE, SIZE, OR COLOR.

SER. NO. 76-687,940, FILED 3-20-2008.

DAWN HAN, EXAMINING ATTORNEY

Int. Cls.: 18 and 35

Prior U.S. Cls.: 1, 2, 3, 22, 41, 100, 101 and 102

United States Patent and Trademark Office

Reg. No. 3,518,784

Registered Oct. 21, 2008

**TRADEMARK
SERVICE MARK
PRINCIPAL REGISTER**

STEFAN MANN

STEPHEN J. SANDERS, INC. (CALIFORNIA CORPORATION), DBA STEFAN MANN
34505 NORTH SCOTTSDALE ROAD, SUITE J-6
SCOTTSDALE, AZ 85266

FOR: MEN'S AND WOMEN'S LUGGAGE AND LEATHER GOODS, NAMELY, WALLETS, TOILETRY CASES, ATTACHE CASES, CREDIT CARD CASES, PORTFOLIOS, AGENDAS, HANDBAGS, AND LUGGAGE, IN CLASS 18 (U.S. CLS. 1, 2, 3, 22 AND 41).

FIRST USE 5-0-1980; IN COMMERCE 5-0-1980.

FOR: RETAIL STORE SERVICES FEATURING HANDBAGS, LUGGAGE, FINE LEATHER GOODS,

GIFT ITEMS, AND RELATED MERCHANDISE, IN CLASS 35 (U.S. CLS. 100, 101 AND 102).

FIRST USE 9-0-1980; IN COMMERCE 9-0-1980.

THE MARK CONSISTS OF STANDARD CHARACTERS WITHOUT CLAIM TO ANY PARTICULAR FONT, STYLE, SIZE, OR COLOR.

THE NAME "STEFAN MANN" DOES NOT IDENTIFY A LIVING INDIVIDUAL.

SER. NO. 76-687,981, FILED 3-21-2008.

DAWN FELDMAN, EXAMINING ATTORNEY

Int. Cl.: 38

Prior U.S. Cls.: 100, 101 and 104

United States Patent and Trademark Office

Reg. No. 3,518,785

Registered Oct. 21, 2008

**SERVICE MARK
PRINCIPAL REGISTER**



SELAH DEVELOPMENT S.A. (CANADA CORPORATION)
BUREAU 2900, 1000
RUE DE LA GAUCHETIÈRE OUEST
MONTREAL (QUEBEC), H3B 4W5, CANADA

FOR: PROVIDING TRANSMISSION OF ELECTRONIC MESSAGES AMONG ONLINE USERS IN THE FIELD OF SOCIAL NETWORKING AND RE-

LATIONSHIPS, IN CLASS 38 (U.S. CLS. 100, 101 AND 104).

FIRST USE 3-2-2008; IN COMMERCE 3-2-2008.

SER. NO. 76-687,992, FILED 3-24-2008.

FRED MANDIR, EXAMINING ATTORNEY

Int. Cl.: 28

Prior U.S. Cls.: 22, 23, 38 and 50

United States Patent and Trademark Office

Reg. No. 3,518,786

Registered Oct. 21, 2008

**TRADEMARK
PRINCIPAL REGISTER**

JERKY J

NATURE VISION, INC. (MINNESOTA CORPORATION)
PO BOX 641
1480 NORTHERN PACIFIC ROAD
BRAINERD, MN 56401

THE MARK CONSISTS OF STANDARD CHARACTERS WITHOUT CLAIM TO ANY PARTICULAR FONT, STYLE, SIZE, OR COLOR.

FOR: ARTIFICIAL FISHING LURES, IN CLASS 28 (U.S. CLS. 22, 23, 38 AND 50).

SER. NO. 76-688,000, FILED 3-24-2008.

FIRST USE 6-1-2007; IN COMMERCE 9-1-2007.

LINDSEY RUBIN, EXAMINING ATTORNEY

Int. Cl.: 35

Prior U.S. Cls.: 100, 101 and 102

United States Patent and Trademark Office

Reg. No. 3,518,787

Registered Oct. 21, 2008

**SERVICE MARK
PRINCIPAL REGISTER**

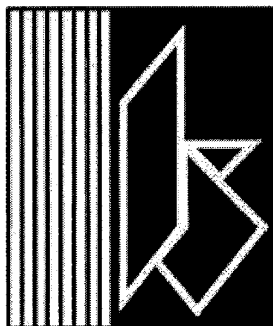

KABLE MEDIA SERVICES, INC. (DELAWARE CORPORATION)
505 PARK AVENUE - 7TH FLOOR
NEW YORK, NY 10022

FOR: ORDER FULFILLMENT SERVICES; DISTRIBUTORSHIP SERVICES FOR PUBLICATIONS OF OTHERS; RETAIL SERVICES BY DIRECT SOLICITATION BY SALES AGENTS IN THE FIELDS OF MAGAZINES, PUBLICATIONS, VIDEOS, PRE-RECORDED MUSIC AND MOVIES, COMPUTER SOFTWARE, CATALOGS, COMPACT DISCS, DVDS, BOOK CLUBS, CRAFT SUPPLIES AND CRAFT MATERIALS, BOOKS, NEWSLETTERS, NOVELTIES, CLOTHING, JEWELRY, AND TOYS; MAIL SORTING; MAIL HANDLING AND RECEIVING, MAIL LIST PREPARATION AND ENHANCING; PICKING; SORTING, PREPARING PACKING ARTICLES TO THE ORDER AND SPECIFICATION OF OTHERS; ORDER FULFILLMENT SERVICES, NAMELY, ORDER PROCESSING; CALL CENTER SERVICES, NAMELY, PROVIDING TELEPHONE ANSWERING SERVICES FOR OTHERS; MERCHANDISE PACKAGING; COMPUTERIZED

TRACKING AND TRACING OF PACKAGES IN TRANSIT; PROMOTING THE GOODS AND SERVICES OF OTHERS THROUGH ELECTRONIC AND PRINT ADVERTISING; ARRANGING FOR PICKUP, DELIVERY, STORAGE AND TRANSPORTATION OF DOCUMENTS, PACKAGES, FREIGHT AND PARCELS VIA GROUND AND AIR CARRIERS; MANAGEMENT OF COMPUTERIZED AND NON-COMPUTERIZED MARKETING DATABASES FOR OTHERS, IN CLASS 35 (U.S. CLS. 100, 101 AND 102).

FIRST USE 5-1-2003; IN COMMERCE 5-1-2003.

OWNER OF U.S. REG. NO. 2,600,264.

THE MARK CONSISTS OF QUADRILATERALS IN A RECTANGULAR BOX WITH VERTICAL LINES ON LEFT.

SER. NO. 76-688,010, FILED 3-24-2008.

LINDA ESTRADA, EXAMINING ATTORNEY

Int. Cl.: 41

Prior U.S. Cls.: 100, 101 and 107

United States Patent and Trademark Office

Reg. No. 3,518,788

Registered Oct. 21, 2008

**SERVICE MARK
PRINCIPAL REGISTER**

KIMS OF COMEDY

BYRNE, STEVEN J. (UNITED STATES INDIVIDUAL)
142 WEST END AVENUE
NEW YORK, NY 10023

FOR: ENTERTAINMENT SERVICES IN THE NATURE OF ON-GOING TELEVISION PROGRAMS IN THE FIELD OF COMEDY; ENTERTAINMENT IN THE NATURE OF VISUAL AND AUDIO PERFORMANCES, AND MUSICAL, VARIETY, NEWS AND COMEDY SHOWS, ENTERTAINMENT IN THE NATURE OF LIVE COMEDY SHOWS; ENTERTAINMENT, NAMELY, A CONTINUING COMEDY SHOW BROADCAST OVER TELEVISION, SATELLITE, AUDIO AND VIDEO MEDIA, IN CLASS 41 (U.S. CLS. 100, 101 AND 107).

FIRST USE 3-13-2003; IN COMMERCE 3-13-2003.

THE MARK CONSISTS OF STANDARD CHARACTERS WITHOUT CLAIM TO ANY PARTICULAR FONT, STYLE, SIZE, OR COLOR.

NO CLAIM IS MADE TO THE EXCLUSIVE RIGHT TO USE "COMEDY", APART FROM THE MARK AS SHOWN.

SER. NO. 76-688,016, FILED 3-24-2008.

ALEX KEAM, EXAMINING ATTORNEY

Int. Cl.: 36

Prior U.S. Cls.: 100, 101 and 102

United States Patent and Trademark Office

Reg. No. 3,518,789

Registered Oct. 21, 2008

**SERVICE MARK
PRINCIPAL REGISTER**

SERVICE THAT MAKES CENTS

TIB THE INDEPENDENT BANKERSBANK
(TEXAS BANKING ASSOCIATION)
350 PHELPS COURT, SUITE 200
IRVING, TX 75028

FOR: FINANCIAL SERVICES, NAMELY, BANKING SERVICES, MORTGAGE LENDING SERVICES, STOCK FINANCING SERVICES, CREDIT CARD SERVICES, CREDIT AND DEBIT CARD TRANSACTION PROCESSING SERVICES, ASSET/LIABILITY MANAGEMENT SERVICES, INVESTMENT SERVICES, ELECTRONIC BANKING SERVICES, CHECK PROCESSING AND ELECTRONIC WIRE TRANS-

FER SERVICES, IN CLASS 36 (U.S. CLS. 100, 101 AND 102).

FIRST USE 7-1-2004; IN COMMERCE 7-1-2004.

THE MARK CONSISTS OF STANDARD CHARACTERS WITHOUT CLAIM TO ANY PARTICULAR FONT, STYLE, SIZE, OR COLOR.

SER. NO. 76-688,062, FILED 3-26-2008.

ANNE E. GUSTASON, EXAMINING ATTORNEY

Int. Cl.: 5

Prior U.S. Cls.: 6, 18, 44, 46, 51 and 52

Reg. No. 3,518,790

United States Patent and Trademark Office

Registered Oct. 21, 2008

**TRADEMARK
PRINCIPAL REGISTER**

SkinProtek

THETA BIOMEDICAL CONSULTING AND DEVELOPMENT CO., INC. (MASSACHUSETTS CORPORATION)
14 PARKMAN STREET
BROOKLINE, MA 02446

THE MARK CONSISTS OF STANDARD CHARACTERS WITHOUT CLAIM TO ANY PARTICULAR FONT, STYLE, SIZE, OR COLOR.

FOR: DIETARY NUTRACEUTICAL FOR USE IN TREATING HUMAN SKIN WOUNDS AND BRUISES, IN CLASS 5 (U.S. CLS. 6, 18, 44, 46, 51 AND 52).

SER. NO. 76-688,107, FILED 3-27-2008.

FIRST USE 8-2-2002; IN COMMERCE 8-2-2002.

JULIE WATSON, EXAMINING ATTORNEY

Int. Cl.: 5

Prior U.S. Cls.: 6, 18, 44, 46, 51 and 52

Reg. No. 3,518,791

United States Patent and Trademark Office

Registered Oct. 21, 2008

**TRADEMARK
PRINCIPAL REGISTER**

BrainGain

THETA BIOMEDICAL CONSULTING AND DEVELOPMENT CO., INC. (MASSACHUSETTS CORPORATION)
14 PARKMAN STREET
BROOKLINE, MA 02446

FOR: DIETARY NUTRACEUTICAL FOR USE IN TREATING HUMANS WITH A POTENTIAL FOR NEUROLOGICAL DEGENERATIVE DISEASES, IN CLASS 5 (U.S. CLS. 6, 18, 44, 46, 51 AND 52).

FIRST USE 1-6-2008; IN COMMERCE 1-6-2008.

THE MARK CONSISTS OF STANDARD CHARACTERS WITHOUT CLAIM TO ANY PARTICULAR FONT, STYLE, SIZE, OR COLOR.

SER. NO. 76-688,108, FILED 3-27-2008.

JULIE WATSON, EXAMINING ATTORNEY

Int. Cl.: 9

Prior U.S. Cls.: 21, 23, 26, 36 and 38

United States Patent and Trademark Office

Reg. No. 3,518,792

Registered Oct. 21, 2008

**TRADEMARK
PRINCIPAL REGISTER**

CU ARCHIVES

MECUL SERVICES CORP. (MAINE CORPORATION)
P.O. BOX 1236
PORTLAND, ME 04104

FOR: INTERNET-BASED COMPUTER STORAGE AND RETRIEVAL SOFTWARE APPLICATION USED TO RETRIEVE, REVIEW, RESEARCH AND STORE DOCUMENTS SUCH AS REPORTS AND STATEMENTS, IN CLASS 9 (U.S. CLS. 21, 23, 26, 36 AND 38).

FIRST USE 7-1-2001; IN COMMERCE 7-1-2001.

THE MARK CONSISTS OF STANDARD CHARACTERS WITHOUT CLAIM TO ANY PARTICULAR FONT, STYLE, SIZE, OR COLOR.

OWNER OF U.S. REG. NO. 2,861,720.

SEC. 2(F).

SER. NO. 76-688,116, FILED 3-27-2008.

ESTHER BELENKER, EXAMINING ATTORNEY

Int. Cl.: 1

Prior U.S. Cls.: 1, 5, 6, 10, 26 and 46

Reg. No. 3,518,793

United States Patent and Trademark Office

Registered Oct. 21, 2008

**TRADEMARK
PRINCIPAL REGISTER**

DIACTAGEN

H & S CORPORATION. (ARKANSAS CORPORATION)
P.O. BOX 56
ALMA, AR 72921

FOR: WATER TREATMENT CHEMICALS,
NAMELY, ACIDIFIERS FOR USE IN POULTRY
AND ANIMAL DRINKING WATER, IN CLASS 1
(U.S. CLS. 1, 5, 6, 10, 26 AND 46).

FIRST USE 1-0-1991; IN COMMERCE 1-0-1991.

THE MARK CONSISTS OF STANDARD CHARACTERS WITHOUT CLAIM TO ANY PARTICULAR FONT, STYLE, SIZE, OR COLOR.

OWNER OF U.S. REG. NO. 2,961,870.

SER. NO. 76-688,529, FILED 4-11-2008.

DORITT L. CARROLL, EXAMINING ATTORNEY

Int. Cls.: 1 and 5

Prior U.S. Cls.: 1, 5, 6, 10, 18, 26, 44, 46, 51 and 52

United States Patent and Trademark Office

Reg. No. 3,518,794

Registered Oct. 21, 2008

**TRADEMARK
PRINCIPAL REGISTER**

SONOPORATION

BAYER SCHERING PHARMA AKTIENGESELL-
SCHAFT (FED REP GERMANY UNINCORPO-
RATED ASSOCIATION)

MULLERSTRASSE 178

BERLIN, FED REP GERMANY 13353

FOR: (BASED ON 44(E)) CHEMICALS USED IN
SCIENCE, NAMELY, CHEMICALS USED IN PHAR-
MACEUTICAL AND CHEMICAL MANUFACTUR-
ING, IN CLASS 1 (U.S. CLS. 1, 5, 6, 10, 26 AND 46).

FOR: (BASED ON 44(E)) PHARMACEUTICAL
PREPARATIONS, NAMELY, DIAGNOSTICS FOR

CLINICAL OR MEDICAL USE, IN CLASS 5 (U.S.
CLS. 6, 18, 44, 46, 51 AND 52).

THE MARK CONSISTS OF STANDARD CHAR-
ACTERS WITHOUT CLAIM TO ANY PARTICULAR
FONT, STYLE, SIZE, OR COLOR.

OWNER OF ERPN CMNTY TM OFC REG. NO.
1353242, DATED 2-21-2001, EXPIRES 1-22-2014.

SER. NO. 76-978,878, FILED 12-6-2004.

DOMINICK J. SALEMI, EXAMINING ATTORNEY

Int. Cls.: 35, 36, 37 and 38

Prior U.S. Cls.: 100, 101, 102, 103, 104 and 106

United States Patent and Trademark Office

Reg. No. 3,518,795

Registered Oct. 21, 2008

**SERVICE MARK
PRINCIPAL REGISTER**

GOODMAN NETWORKS

GOODMAN NETWORKS, INC. (TEXAS CORPORATION)
13835 SENLAC DRIVE
FARMERS BRANCH, TX 75234

FOR: SUPPLY CHAIN MANAGEMENT SERVICES, NAMELY, MATERIALS MANAGEMENT, PROCUREMENT, KITTING, STAGING, CONFIGURATION, AND LOGISTICS SERVICES, NAMELY, LOGISTICS MANAGEMENT; PROJECT MANAGEMENT AND STAFFING SERVICES IN THE FIELD OF TELECOMMUNICATIONS; ASSET RECOVERY, VALUE-ADDED RESELLER SERVICES, NAMELY, PROVIDING DISTRIBUTORSHIP SERVICES AND LIQUIDATION SERVICES, ALL IN THE FIELD OF TELECOMMUNICATION EQUIPMENT; PROVIDING TELECOMMUNICATIONS SITE AND PROJECT SERVICES, NAMELY, DUE DILIGENCE SERVICES, NAMELY, LEASE NEGOTIATIONS, IN CLASS 35 (U.S. CLS. 100, 101 AND 102).

FIRST USE 9-0-2000; IN COMMERCE 9-0-2000.

FOR: PROVIDING TELECOMMUNICATIONS SITE AND PROJECT SERVICES, NAMELY, REAL ESTATE SITE ACQUISITION SERVICES, IN CLASS 36 (U.S. CLS. 100, 101 AND 102).

FIRST USE 9-0-2000; IN COMMERCE 9-0-2000.

FOR: PROVIDING ADVICE IN THE INSTALLATION, NAMELY, ENGINEERING, PHYSICALLY CONNECTING AND INTEGRATING, OPERATIONS, MAINTENANCE, AND DECOMMISSIONING SERVICES FOR WIRELESS TELECOMMUNICATION NETWORKS; PROVIDING INSTALLATION, NAMELY, ENGINEERING, PHYSICALLY CONNECTING AND INTEGRATING, OPERATIONS, MAINTENANCE, AND DECOMMISSIONING SERVICES FOR WIRELESS TELECOMMUNICATION NETWORKS; PROVIDING ADVICE IN THE INSTALLATION, NAMELY, ENGINEER-

ING, PHYSICALLY CONNECTING AND INTEGRATING, SWITCHING, MAINTENANCE, AND DECOMMISSIONING OF WIRELINE TELECOMMUNICATION PRODUCTS; PROVIDING INSTALLATION, NAMELY, ENGINEERING, PHYSICALLY CONNECTING AND INTEGRATING, SWITCHING, MAINTENANCE, AND DECOMMISSIONING OF WIRELINE TELECOMMUNICATION PRODUCTS; PROVIDING INSTALLATION, NAMELY, ENGINEERING, PHYSICALLY CONNECTING AND INTEGRATING OF TELEVISION, ELECTRICAL, FIBER OPTIC, AND MARINE CABLE LINES; INSTALLATION, NAMELY, ENGINEERING, PHYSICALLY CONNECTING AND INTEGRATING OF TELEPHONE LINES; PROVIDING ADVICE IN THE INSTALLATION, NAMELY, ENGINEERING, PHYSICALLY CONNECTING AND INTEGRATING AND MAINTENANCE SERVICES OF DATA, SOUND, AND IMAGES BY SATELLITE; PROVIDING MATERIALS MANAGEMENT, INSTALLATION, NAMELY, ENGINEERING, PHYSICALLY CONNECTING AND INTEGRATING, AND MAINTENANCE SERVICES OF DATA, SOUND, AND IMAGES BY SATELLITE; PROVIDING TELECOMMUNICATIONS SITE AND PROJECT SERVICES, NAMELY, CONSTRUCTION MANAGEMENT AND PLANNING; ELECTRICAL AND CABLE TELEVISION CONTRACTING; TELECOMMUNICATIONS EQUIPMENT REFURBISHING; CONSTRUCTION OF CELLULAR PHONE TOWERS, COMMUNICATION ANTENNAE, COMMUNICATION TOWERS, TELEPHONE LINES, FIBER OPTIC TRANSMISSION LINES, AND SATELLITE RECEIVING STATIONS; WASTE DISPOSAL SERVICES FOR OTHERS IN THE FIELD OF TELECOMMUNICATION EQUIPMENT, IN CLASS 37 (U.S. CLS. 100, 103 AND 106).

FIRST USE 9-0-2000; IN COMMERCE 9-0-2000.

FOR: PROVIDING ACCESS AND RELOCATION SERVICES FOR TELECOMMUNICATION NETWORKS, NAMELY, PROVIDING UNIFIED ACCESS

TO TELECOMMUNICATION NETWORKS UTILIZING VARIOUS TECHNOLOGIES AND CHANGING LOCAL WIRELESS TELECOMMUNICATIONS SERVICES AREAS TO NEW WIRELESS TELECOMMUNICATIONS AREAS; PROVIDING WIRELESS BROADBAND, VIDEO, AND VOICE COMMUNICATION SERVICES, NAMELY, DEPLOYMENT AND MAINTENANCE OF SAID NETWORKS; PROVIDING ENHANCED 911 (E-911) SUSTAINMENT SERVICES, NAMELY, DEPLOYMENT AND MAINTENANCE OF SAID NETWORKS; TELECOMMUNICATIONS CONSULTATION; RENTAL AND CONSIGNMENT OF EQUIPMENT FOR TELECOMMUNICATIONS, IN CLASS 38 (U.S. CLS. 100, 101 AND 104).

FIRST USE 9-0-2000; IN COMMERCE 9-0-2000.

THE MARK CONSISTS OF STANDARD CHARACTERS WITHOUT CLAIM TO ANY PARTICULAR FONT, STYLE, SIZE, OR COLOR.

NO CLAIM IS MADE TO THE EXCLUSIVE RIGHT TO USE "NETWORKS", APART FROM THE MARK AS SHOWN.

SEC. 2(F).

SER. NO. 77-000,184, FILED 9-15-2006.

BRIAN NEVILLE, EXAMINING ATTORNEY

Int. Cls.: 35 and 42

Prior U.S. Cls.: 100, 101 and 102

United States Patent and Trademark Office

Reg. No. 3,518,796

Registered Oct. 21, 2008

**SERVICE MARK
PRINCIPAL REGISTER**

MOOD PORTRAITS

QUEST INTERNATIONAL SERVICES B.V.
(NETHERLANDS CORPORATION)
HUIZERSTRAATWEG 28
1411 GP NAARDEN, NETHERLANDS

FOR: MARKET RESEARCH SERVICES; CONDUCTING MARKETING STUDIES; BUSINESS RESEARCH; COMPILATION AND SYSTEMIZATION OF INFORMATION INTO COMPUTER DATABASES; OBTAINING, ANALYZING AND REPORTING CONSUMER OPINION INFORMATION, IN CLASS 35 (U.S. CLS. 100, 101 AND 102).

FOR: PRODUCT DEVELOPMENT CONSULTANCY SERVICES IN THE FIELD OF FRAGRANCE AND FLAVOR DESIGN AND DEVELOPMENT; ANALYSIS OF DATA, RESEARCH AND DEVELOPMENT SERVICES AND PROVISION OF INFORMATION AND ADVICE, ALL IN THE FIELD OF PRODUCT DEVELOPMENT RELATING TO FRAGRANCE AND FLAVOR DESIGN AND DEVELOPMENT; TECHNICAL RESEARCH RELATING TO THE FIELD OF FRAGRANCE AND FLAVOR DESIGN AND DEVELOPMENT; PROVIDING TECHNICAL

AND PRODUCT DEVELOPMENT INFORMATION VIA ELECTRONIC MEANS FROM STORED SOURCES, RELATING TO THE FIELD OF FRAGRANCE AND FLAVOR DESIGN AND DEVELOPMENT; PROVIDING AN ONLINE SEARCHABLE COMPUTER DATABASE OF INFORMATION IN THE FIELD OF FRAGRANCE AND FLAVOR DESIGN AND DEVELOPMENT, IN CLASS 42 (U.S. CLS. 100 AND 101).

THE MARK CONSISTS OF STANDARD CHARACTERS WITHOUT CLAIM TO ANY PARTICULAR FONT, STYLE, SIZE, OR COLOR.

PRIORITY CLAIMED UNDER SEC. 44(D) ON ERPN CMNTY TM OFC APPLICATION NO. 005297452, FILED 9-6-2006, REG. NO. 005297452, DATED 9-7-2007, EXPIRES 9-6-2016.

SER. NO. 77-002,389, FILED 9-19-2006.

THOMAS MANOR, EXAMINING ATTORNEY

Int. Cls.: 9, 16, 35 and 42

**Prior U.S. Cls.: 2, 5, 21, 22, 23, 26, 29, 36, 37, 38, 50,
100, 101 and 102**

Reg. No. 3,518,797

United States Patent and Trademark Office

Registered Oct. 21, 2008

**TRADEMARK
SERVICE MARK
PRINCIPAL REGISTER**

LISA

QUEST INTERNATIONAL SERVICES B.V.
(NETHERLANDS CORPORATION)
HUIZERSTRAATWEG 28
1411 GP NAARDEN, NETHERLANDS

FOR: COMPUTER SOFTWARE FOR USE IN THE DESIGN AND DEVELOPMENT OF FLAVORS AND TO PREDICT AND DESIGN CONSUMER PREFERRED FLAVORS, IN CLASS 9 (U.S. CLS. 21, 23, 26, 36 AND 38).

FOR: PRINTED MATERIAL, NAMELY, BOOKS, BROCHURES, MAGAZINES, NEWSLETTERS AND BULLETINS RELATING TO THE FIELD OF FLAVOR DESIGN AND DEVELOPMENT, IN CLASS 16 (U.S. CLS. 2, 5, 22, 23, 29, 37, 38 AND 50).

FOR: MARKET RESEARCH SERVICES; CONDUCTING MARKETING STUDIES; BUSINESS RESEARCH; COMPILATION AND SYSTEMIZATION OF INFORMATION INTO COMPUTER DATABASES; OBTAINING, ANALYZING AND REPORTING CONSUMER OPINION INFORMATION, IN CLASS 35 (U.S. CLS. 100, 101 AND 102).

FOR: PRODUCT DEVELOPMENT CONSULTANCY SERVICES IN THE FIELD OF FRAGRANCE AND FLAVOR DESIGN AND DEVELOPMENT; ANALYSIS OF DATA, RESEARCH AND DEVELOP-

MENT SERVICES AND PROVISION OF INFORMATION AND ADVICE, ALL IN THE FIELD OF PRODUCT DEVELOPMENT RELATING TO FLAVOR DESIGN AND DEVELOPMENT; TECHNICAL RESEARCH RELATING TO THE FIELD OF FLAVOR DESIGN AND DEVELOPMENT; PROVIDING TECHNICAL AND PRODUCT DEVELOPMENT INFORMATION VIA ELECTRONIC MEANS FROM STORED SOURCES, RELATING TO THE FIELD OF FLAVOR DESIGN AND DEVELOPMENT; PROVIDING AN ONLINE SEARCHABLE COMPUTER DATABASE OF INFORMATION IN THE FIELD OF FRAGRANCE AND FLAVOR DESIGN AND DEVELOPMENT, IN CLASS 42 (U.S. CLS. 100 AND 101).

THE MARK CONSISTS OF STANDARD CHARACTERS WITHOUT CLAIM TO ANY PARTICULAR FONT, STYLE, SIZE, OR COLOR.

PRIORITY CLAIMED UNDER SEC. 44(D) ON ERPNTY TM OFC APPLICATION NO. 5326641, FILED 9-20-2006, REG. NO. 5326641, DATED 12-5-2007, EXPIRES 9-20-2016.

SER. NO. 77-006,664, FILED 9-25-2006.

THOMAS MANOR, EXAMINING ATTORNEY

Int. Cls.: 9 and 41

Prior U.S. Cls.: 21, 23, 26, 36, 38, 100, 101 and 107

Reg. No. 3,518,798

United States Patent and Trademark Office

Registered Oct. 21, 2008

**TRADEMARK
SERVICE MARK
PRINCIPAL REGISTER**

ARIZONA

ANDREW DUNN (UNITED STATES INDIVIDUAL)
SUITE 755

315 W. PONCE DE LEON AVENUE
DECATUR, GA 30030 AND

JAMES DEDAKIS (UNITED STATES INDIVIDUAL)
SUITE 755

315 W. PONCE DE LEON AVENUE
DECATUR, GA 30030 AND

ALEX HORNBAKE (UNITED STATES INDIVIDUAL)
SUITE 755

315 W. PONCE DE LEON AVENUE
DECATUR, GA 30030 AND

BENJAMIN WIGLER (UNITED STATES INDIVIDUAL)
SUITE 755

315 W. PONCE DE LEON AVENUE
DECATUR, GA 30030 AND

NICHOLAS CAMPBELL (UNITED STATES INDIVIDUAL)
SUITE 755

315 W. PONCE DE LEON AVENUE
DECATUR, GA 30030

FOR: PHONOGRAPH RECORDS AND PRE-RECORDED AUDIOTAPES FEATURING CONTEMPORARY MUSIC EXCLUDING OPERATIC MUSIC; APPARATUS FOR RECORDING, TRANSMITTING, OR REPRODUCING AUDIO OR AUDIO-VISUAL RECORDINGS, IN CLASS 9 (U.S. CLS. 21, 23, 26, 36 AND 38).

FIRST USE 8-14-2005; IN COMMERCE 8-14-2005.

FOR: ENTERTAINMENT SERVICES, NAMELY, LIVE PERFORMANCES BY A VOCAL AND INSTRUMENTAL GROUP FEATURING CONTEMPORARY MUSIC, EXCLUDING OPERATIC MUSIC SERVICES, IN CLASS 41 (U.S. CLS. 100, 101 AND 107).

FIRST USE 8-14-2005; IN COMMERCE 8-14-2005.

THE MARK CONSISTS OF STANDARD CHARACTERS WITHOUT CLAIM TO ANY PARTICULAR FONT, STYLE, SIZE, OR COLOR.

SER. NO. 77-009,631, FILED 9-28-2006.

EMILY CHUO, EXAMINING ATTORNEY

Int. Cl.: 41

Prior U.S. Cls.: 100, 101 and 107

United States Patent and Trademark Office

Reg. No. 3,518,799

Registered Oct. 21, 2008

**SERVICE MARK
PRINCIPAL REGISTER**

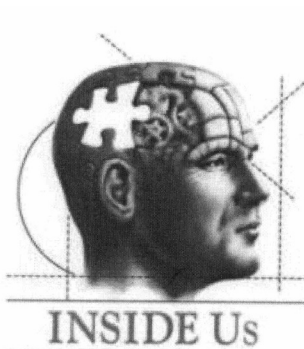

ROMELING, ANNA LOUISE (UNITED KING-
DOM INDIVIDUAL)
CHESTER, 12A WHITE FRIARS
CHESHIRE, ENGLAND CH11NZ

FOR: EDUCATION SERVICES, NAMELY, CON-
DUCTING WORKSHOPS, SEMINARS, CLASSES
AND ONE-TO-ONE SESSIONS IN THE FIELD OF
EXECUTIVE COACHING; EXECUTIVE COACHING
SERVICES IN THE FIELD OF BUSINESS MANAGE-
MENT; EDUCATION SERVICES, NAMELY, MEN-
TORING IN THE FIELD OF BUSINESS
MANAGEMENT AND PRODUCTIVITY, ONE-ON-
ONE MENTORING IN THE FIELD OF BUSINESS,
EXECUTIVE BUSINESS MENTORING; ARRAN-
GING AND CONDUCTING EDUCATIONAL SEMI-

NARS AND WORKSHOPS IN THE FIELD OF
BUSINESS MANAGEMENT AND PRODUCTIVITY,
AND EXECUTIVE COACHING; PROVISION OF
TRAINING FACILITIES; PROVIDING INFORMA-
TION IN THE FIELD OF EXECUTIVE COACHING;
ADVISORY SERVICES IN THE FIELD OF EXECU-
TIVE COACHING , IN CLASS 41 (U.S. CLS. 100, 101
AND 107).

FIRST USE 6-15-2006; IN COMMERCE 6-15-2006.

SER. NO. 77-012,680, FILED 10-3-2006.

REBECCA POVARCHUK, EXAMINING ATTOR-
NEY

Int. Cls.: 36 and 37

Prior U.S. Cls.: 100, 101, 102, 103 and 106

United States Patent and Trademark Office

Reg. No. 3,518,800

Registered Oct. 21, 2008

SERVICE MARK
PRINCIPAL REGISTER

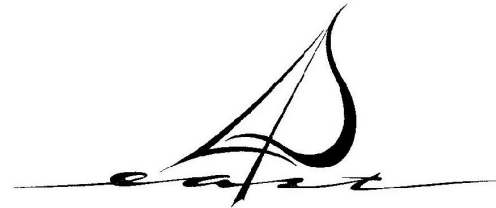

LAKESHORE EAST

MAGELLAN DEVELOPMENT GROUP, LLC (IL-
LINOIS LIMITED LIABILITY COMPANY)
303 EAST WACKER DRIVE, SUITE 2750
CHICAGO, IL 60601

FOR: REAL ESTATE SERVICES, NAMELY,
BROKERAGE OF HOMES AND CONDOMINIUMS,
IN CLASS 36 (U.S. CLS. 100, 101 AND 102).

FIRST USE 6-0-2000; IN COMMERCE 6-0-2000.

FOR: REAL ESTATE DEVELOPMENT, IN CLASS
37 (U.S. CLS. 100, 103 AND 106).

FIRST USE 6-0-2000; IN COMMERCE 6-0-2000.

THE MARK CONSISTS OF A GRAPHIC OF A
SAIL ABOVE AND INTERSECTING WAVES OF
WATER WHICH ARE MADE UP OF THE WORD
"EAST". BELOW THE WORD "EAST" IS THE
PHRASE "LAKESHORE EAST".

SER. NO. 77-013,803, FILED 10-5-2006.

ALYSSA PALADINO, EXAMINING ATTORNEY

Int. Cl.: 25

Prior U.S. Cls.: 22 and 39

United States Patent and Trademark Office

Reg. No. 3,518,801

Registered Oct. 21, 2008

TRADEMARK
PRINCIPAL REGISTER



ICECO LIMITED (HONG KONG CORPORATION)
15TH FLOOR, UNIT 1504, EASTERN CENTER
1065 KING'S ROAD
QUARRY BAY, HONG KONG

FIRST USE 5-0-2005; IN COMMERCE 5-0-2006.

PRIORITY CLAIMED UNDER SEC. 44(D) ON
HONG KONG APPLICATION NO. 300671887, FILED
7-3-2006, REG. NO. 300671887, DATED 7-3-2006, EX-
PIRES 7-3-2016.

FOR: APRONS, CLOTHING BELTS, COATS, TOP-
COATS, DRESSING GOWNS, FROCKS, GOWNS,
JACKETS, JERSEYS, JUMPERS, KNITWEAR,
NAMELY, TOPS, SWEATERS, VESTS, HATS AND
SCARVES, LEATHER AND IMITATION LEATHER
CLOTHING, NAMELY, BELTS, COATS, JACKETS
AND PANTS, OUTERWEAR, NAMELY, COATS
AND JACKETS, OVERALLS, PANTS, DRESS
SHIELDS, SHIRTS, SKIRTS, SWEATERS, T-SHIRTS,
TIGHTS, TROUSERS, SOCKS; HEADGEAR, NAME-
LY, HATS, CAPS AND HEADBANDS, IN CLASS 25
(U.S. CLS. 22 AND 39).

THE ENGLISH TRANSLATION OF "CREAZIONE
ARTISTICA DEL BALLO" IS ARTISTIC CREATION
THROUGH DANCE.

SER. NO. 77-015,992, FILED 10-6-2006.

ODESSA BIBBINS, EXAMINING ATTORNEY

Int. Cls.: 9 and 16

Prior U.S. Cls.: 2, 5, 21, 22, 23, 26, 29, 36, 37, 38 and 50

United States Patent and Trademark Office

Reg. No. 3,518,802

Registered Oct. 21, 2008

**TRADEMARK
PRINCIPAL REGISTER**

MAGNIFEYE

REDMERE TECHNOLOGY LTD. (IRELAND CORPORATION)
MILLMOUNT DEVELOPMENT CENTRE, #3
DROGHEDA, IRELAND

FOR: CONSUMER ELECTRONICS PRODUCTS, NAMELY, MIXED MEDIA ENCLOSED ELECTRONIC CHIPS, CABLES, RECEIVERS, TRANSMITTERS, REPEATERS FOR HIGH SPEED COMMUNICATIONS AND NETWORKING BETWEEN CONSUMER ELECTRONICS MULTIMEDIA PRODUCTS; SOFTWARE FOR USE IN CONSUMER ELECTRONICS PRODUCTS FOR HIGH SPEED COMMUNICATIONS AND NETWORKING BETWEEN CONSUMER ELECTRONICS MULTIMEDIA PRODUCTS, NAMELY, BETWEEN MIXED MEDIA ENCLOSED ELECTRONIC CHIPS, CABLES, RECEIVERS, TRANSMITTERS, AND REPEATERS, IN CLASS 9 (U.S. CLS. 21, 23, 26, 36 AND 38).

FOR: PRINTED MATTERS, NAMELY, NEWSLETTERS, BROCHURES AND USER MANUALS FEATURING INSTRUCTIONS AND INFORMATION IN REFERENCE TO CONSUMER ELECTRONICS MULTIMEDIA PRODUCTS, IN CLASS 16 (U.S. CLS. 2, 5, 22, 23, 29, 37, 38 AND 50).

THE MARK CONSISTS OF STANDARD CHARACTERS WITHOUT CLAIM TO ANY PARTICULAR FONT, STYLE, SIZE, OR COLOR.

OWNER OF IRELAND REG. NO. 005369608, DATED 10-31-2007, EXPIRES 10-9-2016.

SER. NO. 77-017,034, FILED 10-9-2006.

ESTHER A. BORSUK, EXAMINING ATTORNEY

Int. Cls.: 6, 7 and 11

**Prior U.S. Cls.: 2, 12, 13, 14, 19, 21, 23, 25, 31, 34, 35
and 50**

Reg. No. 3,518,803

United States Patent and Trademark Office

Registered Oct. 21, 2008

**TRADEMARK
PRINCIPAL REGISTER**



BRUNOGUIDI S.R.L. (ITALY LIMITED LIABILITY COMPANY)
ZONA INDUSTRIALE
VIA DELLE ACACIE, 2
GRIGNASCO (NOVARA), ITALY 28075

FOR: METAL PIPE JUNCTIONS FOR PLUMBING MARINE, INDUSTRIAL AND CIVIL PLANTS; METAL PIPES FOR THE FLOW OF LIQUID FLUIDS; METAL TUBES; PLUMBING FITTINGS OF METAL, NAMELY, ELBOW-SHAPED JOINT, PIPE TO PIPE CONNECTOR, T-SHAPED JOINT, CROSS-SHAPED JOINT, REDUCING STRAIGHT NIPPLE JOINT, PIPE CLOSING PLUG, PIPE TO HOSE CONNECTOR, INCOMING WATER FILTERING GRATE, WATER DISCHARGE PIPE, AIR VENTING PIPE, FLANGED METAL NUT, TANK CLOSING PLUG, IN CLASS 6 (U.S. CLS. 2, 12, 13, 14, 23, 25 AND 50).

FOR: WATER FILTERS BEING PARTS OF WATER COOLING MARINE ENGINES, IN CLASS 7 (U.S. CLS. 13, 19, 21, 23, 31, 34 AND 35).

FOR: SIPHON BREAK VALVES; WATER FILTERS FOR AIR CONDITIONER CIRCUITS; WATER FILTERS FOR DESALINATION UNITS, IN CLASS 11 (U.S. CLS. 13, 21, 23, 31 AND 34).

OWNER OF ERPN CMNTY TM OFC REG. NO. 4428405, DATED 5-6-2005, EXPIRES 5-6-2015.

THE MARK CONSISTS OF THE LETTER "R" (REVERSED IMAGE) AND THE LETTER "G".

SER. NO. 77-018,046, FILED 10-10-2006.

DAVID HOFFMAN, EXAMINING ATTORNEY

Int. Cl.: 35

Prior U.S. Cls.: 100, 101 and 102

Reg. No. 3,518,804

United States Patent and Trademark Office

Registered Oct. 21, 2008

SERVICE MARK
PRINCIPAL REGISTER

ARITAUM

AMOREPACIFIC CORPORATION (REPUBLIC OF KOREA CORPORATION)
181, 2-KA, HANGANG-RO, YONGSAN-KU
SEOUL, REPUBLIC OF KOREA 140-777

FOR: MODELING FOR ADVERTISING OR SALES PROMOTION; PREPARING ADVERTISEMENTS FOR OTHERS; ADVERTISING AGENCIES; DISSEMINATION OF ADVERTISING MATTER; PUBLISHING OF ADVERTISING TEXTS; RENTAL OF ADVERTISEMENT SPACE AND ADVERTISING MATERIAL; UPDATING OF ADVERTISING TEXTS; RENTAL OF SIGNS FOR ADVERTISING PURPOSES; ADVERTISING SERVICES OF A RADIO AND TELEVISION ADVERTISING AGENCY; ARRANGING AND CONDUCTING OF FAIRS AND EXHIBITIONS FOR BUSINESS AND ADVERTISING PURPOSES; DISTRIBUTION OF SAMPLES PUBLICITY PURPOSES; CINEMA ADVERTISING; DIRECT MAIL ADVERTISING; ONLINE ADVERTISING ON COMPUTER COMMUNICATION NETWORKS; SALES PROMOTION SERVICES; BUSINESS MANAGEMENT AND ORGANIZATION CONSULTANCY; ASSISTANCE WITH BUSINESS MANAGEMENT; PROVIDING BUSINESS INFORMATION, ALSO VIA INTERNET, THE CABLE NETWORK OR OTHER FORMS OF DATA TRANSFER; COST AND PRICE ANALYSIS; ADVISORY SERVICES RELATING TO BUSINESS MANAGEMENT AND BUSINESS OPERATIONS; BUSINESS RESEARCH; BUSINESS INVESTIGATIONS AND APPRAISALS; COMMERCIAL AND INDUSTRIAL MANAGEMENT ASSISTANCE; COMMERCIAL INFORMATION AGENCIES; PROVIDING INFORMATION ABOUT COMMERCIAL BUSINESS; WHOLESALE AND RETAIL STORE SERVICES IN THE FIELD OF COSMETICS, COSMETIC UTENSILS, SOAPS, DETERGENTS, TOOTHPASTES, PRECIOUS METALS, WATCHES, JEWELRY, PAPER, STATIONERY, FURNITURE, CUSHIONS, NON-ELECTRIC TOOTHBRUSHES, SHOES, PROCESSED VEGETABLES, FROZEN VEGETABLES, FROZEN

FRUITS, MILK PRODUCTS EXCLUDING ICE CREAM, ICE MILK AND FROZEN YOGURT, BREAD, GREEN TEA, COFFEE, FRESH VEGETABLES, FRESH FRUITS, NONALCOHOLIC BEVERAGES CONTAINING FRUIT JUICES, FRUIT DRINKS, BEER, MINERAL WATER, ALCOHOLIC BEVERAGES OF FRUIT AND TOBACCO; MEDIATION OF AGREEMENTS REGARDING THE SALE AND PURCHASE OF GOODS IN THE FIELD OF COSMETICS, COSMETIC UTENSILS, SOAPS, DETERGENTS, TOOTHPASTES, PRECIOUS METALS, WATCHES, JEWELRY, PAPER, STATIONERY, FURNITURE, CUSHIONS, NON-ELECTRIC TOOTHBRUSHES, SHOES, PROCESSED VEGETABLES, FROZEN VEGETABLES, FROZEN FRUITS, MILK PRODUCTS EXCLUDING ICE CREAM, ICE MILK AND FROZEN YOGURT, BREAD, GREEN TEA, COFFEE, FRESH VEGETABLES, FRESH FRUITS, NON-ALCOHOLIC BEVERAGES CONTAINING FRUIT JUICES, FRUIT DRINKS, BEER, MINERAL WATER, ALCOHOLIC BEVERAGES OF FRUIT AND TOBACCO; FRANCHISE SERVICES, NAMELY, OFFERING TECHNICAL AND BUSINESS MANAGEMENT ASSISTANCE IN THE ESTABLISHMENT AND OPERATION OF RETAIL STORES THAT WILL FEATURE COSMETICS, COSMETIC UTENSILS, SOAPS, DETERGENTS, TOOTHPASTES, PRECIOUS METALS, WATCHES, JEWELRY, PAPER, STATIONERY, FURNITURE, CUSHIONS, NON-ELECTRIC TOOTHBRUSHES, SHOES, PROCESSED VEGETABLES, FROZEN VEGETABLES, FROZEN FRUITS, MILK PRODUCTS EXCLUDING ICE CREAM, ICE MILK AND FROZEN YOGURT, BREAD, GREEN TEA, COFFEE, FRESH VEGETABLES, FRESH FRUITS, NONALCOHOLIC BEVERAGES CONTAINING FRUIT JUICES, FRUIT DRINKS, BEER, MINERAL WATER, ALCOHOLIC BEVERAGES OF FRUIT AND TOBACCO, IN CLASS 35 (U.S. CLS. 100, 101 AND 102).

THE MARK CONSISTS OF STANDARD CHAR-
ACTERS WITHOUT CLAIM TO ANY PARTICULAR
FONT, STYLE, SIZE, OR COLOR.

SER. NO. 77-018,663, FILED 10-11-2006.

OWNER OF REPUBLIC OF KOREA REG. NO.
0154536, DATED 9-18-2007, EXPIRES 9-18-2017.

SHAILA SETTLES, EXAMINING ATTORNEY

Int. Cl.: 9

Prior U.S. Cls.: 21, 23, 26, 36 and 38

United States Patent and Trademark Office

Reg. No. 3,518,805

Registered Oct. 21, 2008

**TRADEMARK
PRINCIPAL REGISTER**

ACCU-CAM

9141-0720 QUEBEC INC. (CANADA CORPORATION)
285 ST-GEORGES STREET
DRUMMONDVILLE - QUEBEC, CANADA J2C4H3

FOR: ACCESS SYSTEM COMPOSED OF AN ELECTRICALLY POWERED OPERATOR FOR GARAGE DOORS, IN CLASS 9 (U.S. CLS. 21, 23, 26, 36 AND 38).

THE MARK CONSISTS OF STANDARD CHARACTERS WITHOUT CLAIM TO ANY PARTICULAR FONT, STYLE, SIZE, OR COLOR.

PRIORITY CLAIMED UNDER SEC. 44(D) ON CANADA APPLICATION NO. 1298652, FILED 4-21-2006, REG. NO. TMA702129, DATED 11-30-2007, EXPIRES 11-30-2022.

SER. NO. 77-025,952, FILED 10-20-2006.

LINDA ESTRADA, EXAMINING ATTORNEY

Int. Cls.: 35, 37 and 42

Prior U.S. Cls.: 100, 101, 102, 103 and 106

United States Patent and Trademark Office

Reg. No. 3,518,806

Registered Oct. 21, 2008

**SERVICE MARK
PRINCIPAL REGISTER**



WESTERN INDUSTRIAL RESOURCES COR-
PORATION (ARIZONA CORPORATION)
3640 S. CACTUS ROAD
APACHE JUNCTION, AZ 85219

FOR: EMPLOYMENT AGENCY SERVICES,
NAMELY, PROVIDING EMPLOYEES IN THE NAT-
URE OF SUPPLEMENTAL LABOR, ON CONTRACT
TO THE PIPELINE INDUSTRY FOR MAINTAINING
EXISTING PIPELINES, IN CLASS 35 (U.S. CLS. 100,
101 AND 102).

FIRST USE 11-1-1996; IN COMMERCE 11-1-1996.

FOR: FACILITIES MAINTENANCE CONTRACT-
ING SERVICES, NAMELY, CORROSION CONTROL;
CONSTRUCTION SERVICES, NAMELY, FABRICA-
TION OF WOOD, CONCRETE AND METAL STRUC-
TURES; INSTALLATION AND REPAIR OF
MACHINERY UTILIZED IN REFINERY AND
MINING APPLICATIONS; INSTALLATION AND
REPAIR OF HVAC SYSTEMS; INSTALLATION
AND MAINTENANCE OF ELECTRICAL, LIGHT-
ING, SECURITY, COMMUNICATIONS, GROUND-
ING GRIDS, AND CONTROL SYSTEMS FOR
OTHERS, IN CLASS 37 (U.S. CLS. 100, 103 AND 106).

FIRST USE 11-1-1996; IN COMMERCE 11-1-1996.

FOR: CONDUCTING GAS MEASUREMENTS
FOR OTHERS OF EXISTING PIPELINES AND PRE-
PARING APPROPRIATE EXPERT REPORTS; DE-
SIGN OF ELECTRICAL, LIGHTING, SECURITY,
COMMUNICATIONS, GROUNDING GRIDS, AND
CONTROL SYSTEMS FOR OTHERS; AND PER-
FORMING CORROSION CONTROL SERVICES
FOR EXISTING PIPELINES, NAMELY, ENGINEER-
ING SERVICES IN THE FIELD OF CORROSION
AND PROTECTIVE COATINGS, IN CLASS 42 (U.S.
CLS. 100 AND 101).

FIRST USE 11-1-1996; IN COMMERCE 11-1-1996.

THE MARK CONSISTS OF A FANCIFUL DEPICT-
TION OF THE LETTERS "WI" IN A CIRCLE.

SER. NO. 77-029,898, FILED 10-26-2006.

WANDA KAY PRICE, EXAMINING ATTORNEY

Int. Cl.: 44

Prior U.S. Cls.: 100 and 101

United States Patent and Trademark Office

Reg. No. 3,518,807

Registered Oct. 21, 2008

**SERVICE MARK
PRINCIPAL REGISTER**



7TH STREET VILLA DAY SPA, LTD (TEXAS
LIMITED PARTNERSHIP)
8333 PATREOTA
BENBROOK, TX 76126

FOR: HEALTH SPA SERVICES, NAMELY, COS-
METIC BODY CARE SERVICES, IN CLASS 44 (U.S.
CLS. 100 AND 101).

FIRST USE 9-7-2006; IN COMMERCE 9-7-2006.

NO CLAIM IS MADE TO THE EXCLUSIVE
RIGHT TO USE "7TH STREET" AND "DAY SPA",
APART FROM THE MARK AS SHOWN.

THE MARK CONSISTS OF SCRIPT LETTERS "S"
AND "V" WITH THE NUMBER "7" IN BETWEEN,
ALL INSIDE A HORIZONTAL OVAL DESIGN,
WITH A SCROLL DESIGN BELOW, AND THE
WORDS "7TH STREET VILLA DAY SPA" BELOW
THE SCROLL DESIGN.

SER. NO. 77-030,443, FILED 10-26-2006.

BRENDAN MCCAULEY, EXAMINING ATTORNEY

Int. Cls.: 35 and 44

Prior U.S. Cls.: 100, 101 and 102

United States Patent and Trademark Office

Reg. No. 3,518,808

Registered Oct. 21, 2008

**SERVICE MARK
PRINCIPAL REGISTER**

SIGHTLIFE

NORTHWEST LIONS FOUNDATION FOR SIGHT
AND HEARING (WASHINGTON NON-PROF-
IT CORPORATION)
901 BOREN AVENUE, SUITE 810
SEATTLE, WA 98104

FOR: PROMOTING PUBLIC AWARENESS PER-
TAINING TO EYE BANKS AND THE DONATION
OF EYE TISSUE; CONSULTING SERVICES IN THE
FIELD OF ESTABLISHING, PROMOTING, AND
MAINTAINING EYE BANKS AND EYE TISSUE
DONATION, IN CLASS 35 (U.S. CLS. 100, 101 AND
102).

FIRST USE 11-0-2006; IN COMMERCE 11-0-2006.

FOR: EYE BANK SERVICES, NAMELY, RECO-
VERING, PROCESSING AND PROVIDING EYE

TISSUE FOR EYE SURGERIES, EYE RESEARCH
AND EYE EDUCATION AND EVALUATING AND
PROVIDING OCULAR TISSUE PREPARED WITH
LASER TECHNOLOGIES AND PROCESSES; PRO-
VIDING INFORMATION PERTAINING TO EYE
BANKS AND THE DONATION OF EYE TISSUE, IN
CLASS 44 (U.S. CLS. 100 AND 101).

FIRST USE 11-0-2006; IN COMMERCE 11-0-2006.

THE MARK CONSISTS OF STANDARD CHAR-
ACTERS WITHOUT CLAIM TO ANY PARTICULAR
FONT, STYLE, SIZE, OR COLOR.

SER. NO. 77-035,340, FILED 11-2-2006.

SIMON TENG, EXAMINING ATTORNEY

Int. Cl.: 41

Prior U.S. Cls.: 100, 101 and 107

United States Patent and Trademark Office

Reg. No. 3,518,809

Registered Oct. 21, 2008

**SERVICE MARK
PRINCIPAL REGISTER**

COMMODITIES 123

OPTIONSPRESS HOLDINGS, INC. (DELAWARE CORPORATION)
39 SOUTH LASALLE STREET, STE 200
CHICAGO, IL 60606

FOR: PROVIDING EDUCATIONAL SERVICES VIA AN ONLINE COMPUTER NETWORK, NAME-
LY, PROVIDING SELF-STUDY COURSES, ONLINE SEMINARS AND WORKSHOPS, ALL RELATING TO COMMODITY FUTURES AND OPTIONS, IN CLASS 41 (U.S. CLS. 100, 101 AND 107).

FIRST USE 10-10-2006; IN COMMERCE 10-10-2006.

THE MARK CONSISTS OF STANDARD CHARACTERS WITHOUT CLAIM TO ANY PARTICULAR FONT, STYLE, SIZE, OR COLOR.

NO CLAIM IS MADE TO THE EXCLUSIVE RIGHT TO USE "COMMODITIES", APART FROM THE MARK AS SHOWN.

SER. NO. 77-035,605, FILED 11-2-2006.

SOPHIA S. KIM, EXAMINING ATTORNEY

Int. Cls.: 39 and 43

Prior U.S. Cls.: 100, 101 and 105

United States Patent and Trademark Office

Reg. No. 3,518,810

Registered Oct. 21, 2008

**SERVICE MARK
PRINCIPAL REGISTER**



CAYMAN AIRWAYS LTD. (CAYMAN ISLANDS CORPORATION)
#91 OWEN ROBERTS DRIVE
P.O. BOX 10092 APO
GRAND CAYMAN, CAYMAN ISLANDS

FOR: AIR TRANSPORTATION; ARRANGING TRAVEL TOURS, IN CLASS 39 (U.S. CLS. 100 AND 105).

FIRST USE 6-0-1977; IN COMMERCE 6-0-1977.

FOR: MAKING HOTEL RESERVATIONS FOR OTHERS, IN CLASS 43 (U.S. CLS. 100 AND 101).

FIRST USE 6-0-1977; IN COMMERCE 6-0-1977.

"THE MARK CONSISTS OF A STYLIZED TURTLE WITH ONE PEG LEG; WEARING A HAT, NECKERCHIEF, SCARF, AND BOOT; AND HOLDING A SWORD."

SER. NO. 77-036,358, FILED 11-3-2006.

PAULA MAHONEY, EXAMINING ATTORNEY

Int. Cl.: 9

Prior U.S. Cls.: 21, 23, 26, 36 and 38

United States Patent and Trademark Office

Reg. No. 3,518,811

Registered Oct. 21, 2008

**TRADEMARK
PRINCIPAL REGISTER**



LIGHTSTONE IP, LLC (NEVADA LIMITED LIABILITY COMPANY)
SUITE 430
5190 NEIL ROAD
RENO, NV 89502

FOR: CD CASES; CD SLEEVES; CHILDREN'S EDUCATIONAL MUSIC CDS AND DVDS; DOWNLOADABLE FILMS AND TV PROGRAMS PROVIDED VIA A VIDEO-ON-DEMAND; DOWNLOADABLE MOTION PICTURES AND TV SHOWS ABOUT RELIGIOUS STORIES; DOWNLOADABLE MUSICAL SOUND RECORDINGS; DOWNLOADABLE RING TONES, GRAPHICS AND MUSIC VIA A GLOBAL COMPUTER NETWORK AND WIRELESS DEVICES; DOWNLOADABLE VIDEO RECORDINGS FEATURING RELIGIOUS

STORIES; DVD CASES; DVD SLEEVES; DVDS FEATURING RELIGIOUS STORIES; MOTION PICTURE FILMS ABOUT RELIGIOUS STORIES; MUSICAL SOUND RECORDINGS; MUSICAL VIDEO RECORDINGS; VIDEO RECORDINGS FEATURING RELIGIOUS STORIES, IN CLASS 9 (U.S. CLS. 21, 23, 26, 36 AND 38).

FIRST USE 6-7-2002; IN COMMERCE 6-7-2002.

THE MARK CONSISTS OF A LOWERCASE "I" WITH A FLAME ABOVE REPLACING THE DOT.

SER. NO. 77-040,223, FILED 11-9-2006.

CHARISMA HAMPTON, EXAMINING ATTORNEY

Prior U.S. Cl.: B

United States Patent and Trademark Office

Reg. No. 3,518,812

Registered Oct. 21, 2008

**CERTIFICATION MARK
PRINCIPAL REGISTER**

BRS

AMERICAN SPEECH-LANGUAGE-HEARING
ASSOCIATION (KANSAS NON-PROFIT COR-
PORATION)
10801 ROCKVILLE PIKE
ROCKVILLE, MD 20852

FOR: PREVENTION, DIAGNOSIS, HABILITA-
TION, AND REHABILITATION OF COMMUNICA-
TION, SWALLOWING, OR OTHER UPPER AERO
DIGESTIVE DISORDERS; ELECTIVE MODIFICA-
TION OF COMMUNICATION BEHAVIORS; AND
ENHANCEMENT OF COMMUNICATION, IN
CLASS B (U.S. CL. B).

FIRST USE 12-31-1999; IN COMMERCE 12-31-1999.

THE MARK CONSISTS OF STANDARD CHAR-
ACTERS WITHOUT CLAIM TO ANY PARTICULAR
FONT, STYLE, SIZE, OR COLOR.

THE CERTIFICATION MARK, AS USED BY
PERSONS AUTHORIZED BY THE CERTIFIER,
CERTIFIES THAT THE INDIVIDUAL PROVIDING
THE SERVICES HAS MET THE STANDARDS FOR
ENTRY INTO PRACTICE OF THE PROFESSION OF
SPEECH-PATHOLOGY.

SER. NO. 77-043,716, FILED 11-14-2006.

KELLY MCCOY, EXAMINING ATTORNEY

Int. Cls.: 12 and 41

Prior U.S. Cls.: 19, 21, 23, 31, 35, 44, 100, 101 and 107

United States Patent and Trademark Office

Reg. No. 3,518,813

Registered Oct. 21, 2008

**TRADEMARK
SERVICE MARK
PRINCIPAL REGISTER**

**SIMULATED IMPAIRED DRIVING
EXPERIENCE**

INNOCORP. LTD. (WISCONSIN CORPORATION)
500 SOUTH NINE MOUND ROAD
VERONA, WI 53593

FOR: MOTORIZED LAND VEHICLES, NAMELY,
VEHICLES USED FOR DEMONSTRATING THE
EFFECTS OF IMPAIRED OPERATION OF A VEHI-
CLE, IN CLASS 12 (U.S. CLS. 19, 21, 23, 31, 35 AND 44).

FIRST USE 3-13-2003; IN COMMERCE 3-13-2003.

FOR: EDUCATIONAL PROGRAMS IN THE
FIELD OF IMPAIRED OPERATION OF VEHICLES,

AND RELATED MATERIALS, IN CLASS 41 (U.S.
CLS. 100, 101 AND 107).

FIRST USE 8-0-2003; IN COMMERCE 8-0-2003.

THE MARK CONSISTS OF STANDARD CHAR-
ACTERS WITHOUT CLAIM TO ANY PARTICULAR
FONT, STYLE, SIZE, OR COLOR.

SEC. 2(F).

SER. NO. 77-045,040, FILED 11-15-2006.

JAY FLOWERS, EXAMINING ATTORNEY

Int. Cl.: 9

Prior U.S. Cls.: 21, 23, 26, 36 and 38

Reg. No. 3,518,814

United States Patent and Trademark Office

Registered Oct. 21, 2008

**TRADEMARK
PRINCIPAL REGISTER**



YOUGHIOGHENY COMMUNICATIONS-IP, LLC
(DELAWARE LIMITED LIABILITY COMPAN-
NY)

2819 NW LOOP 410
SAN ANTONIO, TX 78230

FOR: TELEPHONES, TELEPHONE ACCESSORIES
AND EQUIPMENT, NAMELY, WIRELESS TELE-
PHONES, BATTERIES; CHARGERS; TELEPHONE
CARRYING CASES, HANDS-FREE DEVICES, AND
CARRYING CLIPS FOR WIRELESS TELEPHONES
SOLD AS A UNIT IN COMBINATION WITH WIRE-
LESS TELEPHONES, IN CLASS 9 (U.S. CLS. 21, 23, 26,
36 AND 38).

FIRST USE 7-31-2006; IN COMMERCE 7-31-2006.

OWNER OF U.S. REG. NO. 3,098,763.

NO CLAIM IS MADE TO THE EXCLUSIVE
RIGHT TO USE "COMMUNICATIONS", APART
FROM THE MARK AS SHOWN.

THE MARK CONSISTS OF THE WORD "POCK-
ET" WITH SOUNDWAVES AS THE LETTER "O".

SEC. 2(F).

SER. NO. 77-045,409, FILED 11-16-2006.

BENJAMIN OKEKE, EXAMINING ATTORNEY

Int. Cl.: 35

Prior U.S. Cls.: 100, 101 and 102

Reg. No. 3,518,815

United States Patent and Trademark Office

Registered Oct. 21, 2008

SERVICE MARK
PRINCIPAL REGISTER

SOUTHDALE

SOUTHDALE LIMITED PARTNERSHIP (DELA-
WARE LIMITED PARTNERSHIP)
SUITE 500
5425 WISCONSIN AVENUE
CHEVY CHASE, MD 20815

ATING A SHOPPING MALL, IN CLASS 35 (U.S. CLS.
100, 101 AND 102).

FIRST USE 11-0-2000; IN COMMERCE 11-0-2000.

FOR: SHOPPING CENTER SERVICES, NAMELY,
BUSINESS MANAGEMENT SERVICES FOR SHOP-
PING MALLS AND PROMOTING THE GOODS
AND SERVICES OF OTHERS BY MEANS OF OPER-

SER. NO. 77-045,609, FILED 11-16-2006.

CHARLOTTE CORWIN, EXAMINING ATTORNEY

Int. Cls.: 35 and 39

Prior U.S. Cls.: 100, 101, 102 and 105

United States Patent and Trademark Office

Reg. No. 3,518,816

Registered Oct. 21, 2008

**SERVICE MARK
PRINCIPAL REGISTER**

STUDY AUSTRALIA

STUDY AUSTRALIA LLC (INDIANA LIMITED
LIABILITY COMPANY)
54515 STATE ROAD 933 N., P.O. BOX 1004
NOTRE DAME, IN 46556

FOR: ADMINISTRATION OF CULTURAL AND
EDUCATIONAL EXCHANGE PROGRAMS, NAME-
LY, STUDY ABROAD PROGRAMS, IN CLASS 35
(U.S. CLS. 100, 101 AND 102).

FIRST USE 0-0-2002; IN COMMERCE 0-0-2002.

FOR: ARRANGEMENT OF TRAVEL TOURS IN
CONNECTION WITH STUDY ABROAD PRO-
GRAMS, IN CLASS 39 (U.S. CLS. 100 AND 105).

FIRST USE 0-0-2002; IN COMMERCE 0-0-2002.

THE MARK CONSISTS OF STANDARD CHAR-
ACTERS WITHOUT CLAIM TO ANY PARTICULAR
FONT, STYLE, SIZE, OR COLOR.

NO CLAIM IS MADE TO THE EXCLUSIVE
RIGHT TO USE "STUDY", APART FROM THE
MARK AS SHOWN.

SEC. 2(F).

SER. NO. 77-045,815, FILED 11-16-2006.

FRANK LATTUCA, EXAMINING ATTORNEY

Int. Cls.: 35 and 36

Prior U.S. Cls.: 100, 101 and 102

United States Patent and Trademark Office

Reg. No. 3,518,817

Registered Oct. 21, 2008

**SERVICE MARK
PRINCIPAL REGISTER**

TMA

TMA LIST BROKERAGE & MANAGEMENT,
INC. (DELAWARE CORPORATION)

12021 SUNSET HILLS ROAD, SUITE 350

RESTON, VA 20190

FOR: MARKETING CONSULTING SERVICES,
MARKETING DATA MANAGEMENT SERVICES,
PROVIDING MAILING LISTS AND MARKETING
DATA, IN CLASS 35 (U.S. CLS. 100, 101 AND 102).

FIRST USE 5-15-1985; IN COMMERCE 5-15-1985.

FOR: MAILING LISTS AND MARKETING DATA
BROKERAGE SERVICES, IN CLASS 36 (U.S. CLS.
100, 101 AND 102).

FIRST USE 5-15-1985; IN COMMERCE 5-15-1985.

THE MARK CONSISTS OF STANDARD CHAR-
ACTERS WITHOUT CLAIM TO ANY PARTICULAR
FONT, STYLE, SIZE, OR COLOR.

SER. NO. 77-045,856, FILED 11-16-2006.

FRANK LATTUCA, EXAMINING ATTORNEY

Int. Cls.: 12, 35 and 37

Prior U.S. Cls.: 19, 21, 23, 31, 35, 44, 100, 101, 102,
103 and 106

Reg. No. 3,518,818

United States Patent and Trademark Office

Registered Oct. 21, 2008

TRADEMARK
SERVICE MARK
PRINCIPAL REGISTER



TIRE KINGDOM, INC. (FLORIDA CORPORATION)
823 DONALD ROSS ROAD
JUNO BEACH, FL 33408

THE COLOR(S) RED, GRAY, BLACK, WHITE AND BLUE IS/ARE CLAIMED AS A FEATURE OF THE MARK.

FOR: TIRES, IN CLASS 12 (U.S. CLS. 19, 21, 23, 31, 35 AND 44).

FIRST USE 1-5-2006; IN COMMERCE 1-5-2006.

FOR: RETAIL TIRE STORES, IN CLASS 35 (U.S. CLS. 100, 101 AND 102).

FIRST USE 1-5-2006; IN COMMERCE 1-5-2006.

FOR: TIRE BALANCING; TIRE ROTATING AND BALANCING, IN CLASS 37 (U.S. CLS. 100, 103 AND 106).

FIRST USE 1-5-2006; IN COMMERCE 1-5-2006.

OWNER OF U.S. REG. NOS. 1,838,215, 2,864,332 AND OTHERS.

NO CLAIM IS MADE TO THE EXCLUSIVE RIGHT TO USE "TIRES IN AN HOUR OR LESS", APART FROM THE MARK AS SHOWN.

THE COLORS RED AND WHITE AND BLUE APPEAR ON THE CROWN; THE COLORS RED AND GRAY APPEAR ON THE HANDS OF THE CLOCK; THE COLOR WHITE APPEARS ON THE FACE OF THE CLOCK; THE COLOR BLACK APPEARS ON THE NUMBERS 0, 15, 30 AND 45 ON THE FACE OF THE CLOCK; THE COLOR RED APPEARS ON THE WORDS "OR LESS . . ." AND THE OUTLINING OF THE WORDS "TIRES IN AN HOUR"; THE COLORS BLACK AND WHITE APPEAR ON THE TIRE TREAD; THE COLOR BLUE APPEARS ON THE OUTLINING OF ALL OF THE LETTERS; THE COLOR WHITE APPEARS ON THE WORDS "MERCHANT'S TIRE TIRES IN AN HOUR"; AND THE COLOR GRAY APPEARS IN THE BLOCK SHAPES IN THE BACKGROUND OF THE LOGO.

SER. NO. 77-049,273, FILED 11-21-2006.

COLLEEN DOMBROW, EXAMINING ATTORNEY

Int. Cls.: 9, 38 and 42

Prior U.S. Cls.: 21, 23, 26, 36, 38, 100, 101 and 104

Reg. No. 3,518,819

United States Patent and Trademark Office

Registered Oct. 21, 2008

**TRADEMARK
SERVICE MARK
PRINCIPAL REGISTER**

TELEOPTIX

TELEOPTIX S.R.L. (ITALY LIMITED LIABILITY COMPANY)
VIA GUIDO ROSSA, 20
CORNATE D'ADDA (MI), ITALY 20040

FOR: ELECTRONIC AND OPTICAL INSTRUMENTS, COMPONENTS, DEVICES, AND SYSTEMS FOR TELECOMMUNICATION, IN PARTICULAR IN MILITARY, ENERGY AND TRANSPORTATION INDUSTRY, NAMELY, HIGH FREQUENCY MODULES AND TRANSCEIVERS FOR WIRELESS APPLICATIONS, SYNCHRONOUS DIGITAL HIERARCHY (SDH) HIGH LINEARITY UP-AND-DOWN CONVERTERS, SYNCHRONOUS DIGITAL HIERARCHY (SDH) HIGH POWER TRANSMITTER MODULES, SYNCHRONOUS DIGITAL HIERARCHY (SDH) AND PLESIOCHRONOUS DIGITAL HIERARCHY (PDH) EQUIPMENT, NAMELY, SYNCHRONOUS DIGITAL HIERARCHY (SDH) AND PLESIOCHRONOUS DIGITAL HIERARCHY (PDH) ELECTRONIC AND OPTICAL MODULES AND TRANCEIVERS FOR WIRELESS APPLICATIONS; SYSTEMS AND COMPONENTS FOR RADIO AND OPTICAL FIBER TRANSMISSION, NAMELY, HIGH CAPACITY OPTICAL TRANSMITTERS, RECEIVERS, MODULES AND TRANSCEIVERS FOR OPTICAL FIBER TRANSMISSION SYSTEMS, ACTIVE OPTICAL COMPONENTS, PASSIVE OPTICAL COMPONENTS AND MODULES, ERBIUM DOPED FIBER AMPLIFIER (EDFA) AND OPTICAL AMPLIFIERS, FIBER OPTIC BASED COMPONENTS, IN CLASS 9 (U.S. CLS. 21, 23, 26, 36 AND 38).

FOR: TELECOMMUNICATION ACCESS SERVICES, IN CLASS 38 (U.S. CLS. 100, 101 AND 104).

FOR: ENGINEERING SERVICES, NAMELY, ENGINEERING SERVICES FOR TELECOMMUNICATION APPARATUSES AND SYSTEMS, IN

PARTICULAR IN MILITARY, ENERGY AND TRANSPORTATION INDUSTRY, DESIGN AND ENGINEERING SERVICES TO DEVELOP PROJECTS AND MANUFACTURING OF WIRELESS HIGH FREQUENCY SYSTEMS AND OPTICAL FIBER SYSTEMS; ENGINEERING SERVICES FOR DESIGNING AND MANUFACTURING OF SUBSTRATES SUCH AS CERAMICS AND HIGH FREQUENCY (HF) LAMINATES, SURFACE MOUNTING DEVICE (SMD) AND DIE ATTACHMENT, SUCH AS BRAZING, REFLOW AND ATTACHMENT TECHNOLOGIES AND MATERIALS, INTERCONNECTION TECHNOLOGIES, SUCH AS CONNECTORIZATION, SOLDERING, WIRE AND RIBBON BONDING, FIBER SPLICING AND RECOATING, PACKAGE SEALING; ENGINEERING SERVICES FOR TESTING WIRELESS HIGH FREQUENCY SYSTEMS AND COMPONENTS THEREOF; ENGINEERING SERVICES FOR TESTING OPTICAL HIGH CAPACITY FIBER OPTIC SYSTEMS AND COMPONENTS THEREOF, IN CLASS 42 (U.S. CLS. 100 AND 101).

THE MARK CONSISTS OF STANDARD CHARACTERS WITHOUT CLAIM TO ANY PARTICULAR FONT, STYLE, SIZE, OR COLOR.

PRIORITY CLAIMED UNDER SEC. 44(D) ON ERPN CMNTY TM OFC APPLICATION NO. 005489174, FILED 11-22-2006, REG. NO. 005489174, DATED 11-7-2007, EXPIRES 11-22-2016.

THE WORDING "TELEOPTIX" HAS NO MEANING IN A FOREIGN LANGUAGE.

SER. NO. 77-052,445, FILED 11-28-2006.

SUZANNE BLANE, EXAMINING ATTORNEY

Int. Cl.: 12

Prior U.S. Cls.: 19, 21, 23, 31, 35 and 44

Reg. No. 3,518,820

United States Patent and Trademark Office

Registered Oct. 21, 2008

**TRADEMARK
PRINCIPAL REGISTER**

SILENT EPS

JTEKT CORPORATION (JAPAN CORPORATION)
OSAKA-SHI
5-8, MINAMISEMBA 3-CHOME, CHUO-KU
OSAKA, JAPAN 542-8502

FOR: CABLE CARS; CAR DAMPERS; MINE-CAR PUSHERS; MINE-CAR PULLERS; TRACTION ENGINE; POWER MACHINERIES AND TOOLS FOR LAND VEHICLES, NAMELY, INTERNAL COMBUSTION ENGINES FOR LAND VEHICLES, STEAM ENGINES FOR LAND VEHICLES, JET ENGINES FOR LAND VEHICLES, TURBINES FOR LAND VEHICLES; POWER STEERING GEARS FOR AUTOMOBILES AND STRUCTURAL PARTS THEREFOR; STEERING GEARS FOR AUTOMOBILES AND STRUCTURAL PARTS THEREFOR; POWER TRAIN PARTS FOR LAND VEHICLES, NAMELY AXLES FOR LAND VEHICLES, SPINDLES, SHAFT COUPLINGS AND CONNECTORS FOR LAND VEHICLES, IDLING PULLEYS FOR LAND VEHICLES, REVERSING GEARS, REDUCTION GEARS FOR LAND VEHICLES, BELT PULLEYS FOR LAND VEHICLES, POWER TRANSMISSION BELTS FOR LAND VEHICLES, TOOTHED WHEELS AND GEARS FOR LAND VEHICLES, SPEED CHANGE GEARS FOR LAND VEHICLES, FLUID COUPLINGS FOR LAND VEHICLES, HYDRAULIC TORQUE CONVERTERS FOR LAND VEHICLES, LINKS FOR LAND VEHICLES, ROLLER CHAINS FOR LAND VEHICLES, SHOCK ABSORBERS FOR LAND VEHICLES, SPRINGS FOR LAND VEHICLES, BRAKES FOR LAND VEHICLES; PARACHUTES; BURGLAR

ALARMS FOR VEHICLES; WHEELCHAIRS; ELECTRIC MOTORS FOR LAND VEHICLES; VESSELS AND STRUCTURAL PARTS THEREFOR; AIRCRAFT AND STRUCTURAL PARTS THEREFOR; RAILCARS AND STRUCTURAL PARTS THEREFOR; AUTOMOBILES AND STRUCTURAL PARTS THEREFOR; TWO-WHEELED MOTOR VEHICLES, BICYCLES AND STRUCTURAL PARTS THEREFOR; BABY CARRIAGES; RICKSHAW; SLEIGHS; HAND CARTS FOR HANDLING GOODS; CARTS; HORSE DRAWN CARRIAGES; BICYCLE TRAILERS; ADHESIVE RUBBER PATCHES FOR REPAIRING TIRES AND TUBES, IN CLASS 12 (U.S. CLS. 19, 21, 23, 31, 35 AND 44).

THE MARK CONSISTS OF STANDARD CHARACTERS WITHOUT CLAIM TO ANY PARTICULAR FONT, STYLE, SIZE, OR COLOR.

PRIORITY CLAIMED UNDER SEC. 44(D) ON JAPAN APPLICATION NO. 2006-78999, FILED 8-24-2006, REG. NO. 5050857, DATED 6-1-2007, EXPIRES 6-1-2017.

NO CLAIM IS MADE TO THE EXCLUSIVE RIGHT TO USE "EPS", APART FROM THE MARK AS SHOWN.

SER. NO. 77-054,200, FILED 11-30-2006.

CAROLYN CATALDO, EXAMINING ATTORNEY

Int. Cl.: 12

Prior U.S. Cls.: 19, 21, 23, 31, 35 and 44

Reg. No. 3,518,821

United States Patent and Trademark Office

Registered Oct. 21, 2008

**TRADEMARK
PRINCIPAL REGISTER**

Z-30

RUPP MARINE, INC. (FLORIDA CORPORATION)
P.O. DRAWER F
4761 ANCHOR AVENUE
PORT SALERNO, FL 34992

FOR: STRUCTURAL PARTS AND ACCESSORIES FOR FISHING BOATS, NAMELY, ANTENNA MOUNTINGS, ROD AND REEL HANGERS; OUTRIGGERS AND PARTS THEREOF; ACCESSORIES FOR FISHING BOAT OUTRIGGERS, NAMELY, RELEASE CLIPS, LAY DOWN HOOKS, SPACER BLOCKS, HOLD-IN ARMS, AND CLAMP-ON FITTINGS; STRUCTURAL PARTS FOR FISHING BOATS, NAMELY, OUTRIGGER POLES, POLE BASES, POLE MOUNTINGS, TOWER MOUNTS,

ROD HOLDERS, POLE SETTERS; STRUCTURAL PARTS FOR BOATS, NAMELY, COLLAPSIBLE BACK BARS; HULL FITTINGS, NAMELY, CLEATS AND BAILERS, IN CLASS 12 (U.S. CLS. 19, 21, 23, 31, 35 AND 44).

FIRST USE 1-1-2002; IN COMMERCE 1-1-2003.

THE MARK CONSISTS OF STANDARD CHARACTERS WITHOUT CLAIM TO ANY PARTICULAR FONT, STYLE, SIZE, OR COLOR.

SER. NO. 77-055,739, FILED 12-1-2006.

SETH A. RAPPAPORT, EXAMINING ATTORNEY

Int. Cls.: 12 and 20

**Prior U.S. Cls.: 2, 13, 19, 21, 22, 23, 25, 31, 32, 35, 44
and 50**

Reg. No. 3,518,822

United States Patent and Trademark Office

Registered Oct. 21, 2008

**TRADEMARK
PRINCIPAL REGISTER**

AGILA EASYLIFT

DRÄGER MEDICAL AG & CO. KG (FED REP
GERMANY CORPORATION)
MOISLINGER ALLEE 53-55
LÜBECK, FED REP GERMANY 23558

FOR: MOBILE SUPPORTING FRAMES AND
HOLDING DEVICES FOR MEDICAL TECHNO-
LOGY APPARATUS AND INSTRUMENTS, NAMELY,
MOBILE CARTS WHICH PROVIDE PORTS AND
OUTLETS FOR POWER SUPPLY AND COMMUNI-
CATIONS LINES, FOR HOLDING SURGICAL, AN-
ESTHESIA, MONITORING, VENTILATION AND
MEDICAL DIAGNOSTIC EQUIPMENT, IN CLASS
12 (U.S. CLS. 19, 21, 23, 31, 35 AND 44).

FOR: FIXED SUPPORTING FRAMES AND
HOLDING DEVICES FOR MEDICAL TECHNO-
LOGY APPARATUS AND INSTRUMENTS, NAMELY,
NON-MOBILE CARTS WHICH PROVIDE PORTS
AND OUTLETS FOR POWER SUPPLY AND COM-
MUNICATIONS LINES, USED FOR HOLDING SUR-

GICAL, ANESTHESIA, MONITORING,
VENTILATION AND MEDICAL DIAGNOSTIC
EQUIPMENT, IN CLASS 20 (U.S. CLS. 2, 13, 22, 25,
32 AND 50).

THE MARK CONSISTS OF STANDARD CHAR-
ACTERS WITHOUT CLAIM TO ANY PARTICULAR
FONT, STYLE, SIZE, OR COLOR.

PRIORITY CLAIMED UNDER SEC. 44(D) ON
ERPNTY TM OFC APPLICATION NO.
005514419, FILED 12-1-2006, REG. NO. 005514419,
DATED 11-15-2007, EXPIRES 12-1-2016.

THE ENGLISH TRANSLATION OF THE WORD
"AGILA" IN THE MARK IS EAGLE.

SER. NO. 77-056,909, FILED 12-5-2006.

BILL DAWE, EXAMINING ATTORNEY

Int. Cl.: 41

Prior U.S. Cls.: 100, 101 and 107

United States Patent and Trademark Office

Reg. No. 3,518,823

Registered Oct. 21, 2008

**SERVICE MARK
PRINCIPAL REGISTER**

WEAPONS SPECIALISTS

WEAPONS SPECIALISTS, LTD. (NEW YORK CORPORATION)
33 GREENE STREET, LOFT #1W
NEW YORK, NY 10013

FOR: RENTAL OF THEATRICAL PROPS IN THE NATURE OF WEAPONS; PROVIDING ON-SET INSTRUCTION IN THE USE OF THEATRICAL PROPS IN THE NATURE OF WEAPONS; CONSULTING IN THE USE OF THEATRICAL PROPS IN THE NATURE OF WEAPONS, IN CLASS 41 (U.S. CLS. 100, 101 AND 107).

FIRST USE 1-1-1981; IN COMMERCE 1-1-1981.

THE MARK CONSISTS OF STANDARD CHARACTERS WITHOUT CLAIM TO ANY PARTICULAR FONT, STYLE, SIZE, OR COLOR.

NO CLAIM IS MADE TO THE EXCLUSIVE RIGHT TO USE "WEAPONS", APART FROM THE MARK AS SHOWN.

SEC. 2(F).

SER. NO. 77-057,411, FILED 12-5-2006.

LAURA HAMMEL, EXAMINING ATTORNEY

Int. Cls.: 3, 14, 18 and 25

**Prior U.S. Cls.: 1, 2, 3, 4, 6, 22, 27, 28, 39, 41, 50, 51
and 52**

Reg. No. 3,518,824

United States Patent and Trademark Office

Registered Oct. 21, 2008

**TRADEMARK
PRINCIPAL REGISTER**

BLINKY WINKY

SAZABY LEAGUE, LTD. (JAPAN CORPORATION)
NO. 49-13, MOTOYOYOGI-CHO, SHIBUYA-KU
TOKYO, JAPAN

FOR: ANTI-STATIC SPRAY FOR CLOTHING FOR DOMESTIC USE, RUST REMOVING PREPARATIONS, STAIN REMOVERS, NAMELY, BENZINE FOR REMOVING STAIN, FABRIC SOFTENERS FOR LAUNDRY USE, LAUNDRY BLEACH; ADHESIVES FOR AFFIXING FALSE HAIR, NAMELY, ADHESIVES FOR WEARING WIGS, ADHESIVES FOR AFFIXING FALSE EYELASHES; WASHING-UP LIQUIDS, NAMELY, STARCH PASTE FOR WASHING AND SEAWEED GELATINE FOR WASHING; EXFOLIATING CLEANING PREPARATIONS FOR PAINTS; SHOE CREAM, SHOE BLACKS; SHOE POLISHES; SOAPS; DENTIFRICE; COSMETICS; PERFUMERY; ABRASIVE SAND, NAMELY, SAND PAPER, ABRASIVE SAND, NAMELY, GRINDING SAND CLOTHS, ABRASIVE SAND, NAMELY, GRINDING SANDS, ARTIFICIAL PUMICE STONES FOR PERSONAL USE, CLEANING AND POLISHING PAPER, FALSE NAILS, FALSE EYELASHES, IN CLASS 3 (U.S. CLS. 1, 4, 6, 50, 51 AND 52).

FOR: PRECIOUS METALS; KEY HOLDERS OF PRECIOUS METALS; JEWEL BOXES MADE OF PRECIOUS METAL; PRECIOUS METAL TROPHIES, COMMEMORATIVE COINS WITH COMMEMORATIVE SHIELDS; EARRINGS; JEWEL CHAINS; JEWEL PENDANTS; NECKLACES; RINGS BEING JEWELRY; JEWELRY FOR THE HEAD; TIE PINS; NUTCRACKERS, PEPPER SHAKERS, SUGAR BOWLS, SALT SHAKERS, EGG STANDS, NAPKIN HOLDERS, NAPKIN RINGS, TRAY AND TOOTH-PICK STANDS, ALL MADE OF PRECIOUS METAL; NEEDLE BOXES MADE OF PRECIOUS METAL; CANDLE EXTINGUISHERS AND CANDLE STANDS MADE OF PRECIOUS METAL; VASES

AND BASINS MADE OF PRECIOUS METAL; POUCHES AND PURSES MADE OF PRECIOUS METAL; POWDER COMPACTS MADE OF PRECIOUS METAL; SHOE ORNAMENTS MADE OF PRECIOUS METAL; SMOKERS' ARTICLES MADE OF PRECIOUS METAL, NAMELY, ASHTRAYS, CIGAR AND CIGARETTE CASES, LIGHTERS AND MATCH BOXES, IN CLASS 14 (U.S. CLS. 2, 27, 28 AND 50).

FOR: METAL FITTINGS FOR BAGS, CLASPS FOR POUCHES; SHOPPING BAGS MADE OF SKIN OR LEATHER; CLOTHING FOR PETS; COLLARS FOR PETS; CARRY-ALL BAGS; BACKPACKS; BOSTON BAGS; BRIEFCASES; BUM BAGS; CARRYING CASES FOR DOCUMENTS; DUFFLE BAGS; EVENING HANDBAGS; FOLDING BRIEFCASES; GLADSTONE BAGS; HANDBAGS; KNAPSACKS; LEATHER BAGS, SUITCASES AND WALLETS; LEATHER BRIEFCASES; LEATHER CASES; LEATHER HANDBAGS; SHOULDER BAGS; SUITCASES; TOTE BAGS; TRAVELING BAGS; TRUNKS; WAIST BAGS; PURSES; WALLETS; LEATHER PURSES; KEY CASE; COIN PURSES NOT MADE OF PRECIOUS METAL; PORTABLE LEATHER CASES FOR COSMETIC UTENSILS; UMBRELLAS AND PARASOLS; WALKING STICKS, CANES, METAL FITTINGS FOR CANES, SHAFTS OF CANES; DRAWSTRING POUCHES; BUSINESS CARD CASES, IN CLASS 18 (U.S. CLS. 1, 2, 3, 22 AND 41).

FOR: CLOTHING, NAMELY, HATS AND PANTS, CAP VISORS, CAPS, FUR HATS, HEAD SCARVES, HEAD WEAR, HEADBANDS, HOODS, KNITTED CAPS, VISORS, BERMUDA SHORTS, BLAZERS, BLOUSONS, BOW TIES, BRACES IN THE NATURE OF SUSPENDERS, BRIEFS, CARDIGANS, CHEMISES, COATS, COLLARS, CORSETS, COVERALLS, CRAVATS, DOWN JACKETS, DRESSES, DUST COATS, FLEECE SHORTS, FUR COATS AND JACKETS, GREATCOAT, JERKINS, JUMPERS, LADIES' SUITS, MEN'S SUITS, MANTLES, MORNING

COATS, NEGLIGEEES, NIGHT GOWNS, NIGHT-CAPS, NIGHTDRESSES, POLO SHIRTS, RAIN TROUSERS, RAINCOATS, RAINPROOF JACKETS, SHIRTS FOR SUITS, SUEDE JACKETS, SUITS OF LEATHER, SWEAT PANTS, SWEAT SHIRTS, SWEAT SUITS, KNEE-HIGH STOCKINGS, KNICKERS, SOCKS AND STOCKINGS, TANK TOPS, TIES, T-SHIRTS, TUXEDO BELTS, TUXEDOS, TWIN SETS, WIND COATS; UNDERWEAR, LINGERIE, KNITTED UNDERWEAR, UNDER SHIRTS, UNDER-SKIRTS, BEACH WEAR, SWIMMING CAPS, SWIMWEAR, BANDANAS, BATHING COSTUMES, ANKLE SOCKS, FUR MUFFS, GLOVES, MUFFLERS, NECKERCHIEFS, SHOULDER SCARVES, SILK SCARVES, SLEEP MASKS, STOLEES, WRIST-BANDS, GARTERS; STOCKING SUSPENDERS, HAT BANDS, BELTS; SUSPENDER BELTS FOR MEN; SUSPENDER BELTS FOR WOMEN; FOOTWEAR, ANKLE BOOTS; BOOTS; CANVAS SHOES; RAIN BOOTS; SABOTS; SANDAL-CLOGS; MULES;

WINTER BOOTS; BEACH FOOTWEAR; MASQUERADE COSTUMES; SPECIAL SPORTS CLOTHING, NAMELY, SPORTS JACKETS, SPORTS JERSEYS, AND SPORT OVER UNIFORMS; SPECIAL SPORTS SHOES, IN CLASS 25 (U.S. CLS. 22 AND 39).

THE MARK CONSISTS OF STANDARD CHARACTERS WITHOUT CLAIM TO ANY PARTICULAR FONT, STYLE, SIZE, OR COLOR.

OWNER OF JAPAN REG. NO. 4868918, DATED 6-3-2005, EXPIRES 6-3-2015.

OWNER OF JAPAN REG. NO. 4903512, DATED 10-21-2005, EXPIRES 10-21-2015.

SER. NO. 77-057,498, FILED 12-5-2006.

CAROL SPILS, EXAMINING ATTORNEY

Int. Cls.: 36 and 45

Prior U.S. Cls.: 100, 101 and 102

United States Patent and Trademark Office

Reg. No. 3,518,825

Registered Oct. 21, 2008

**SERVICE MARK
PRINCIPAL REGISTER**



SUSTAINABLE WEALTH MANAGEMENT LTD.
(CANADA CORPORATION)
SUITE 1000, 888-3RD STREET S.W.
CALGARY, CANADA T2P5C5

FOR: PROVIDING FINANCIAL AND SECURITIES INFORMATION IN THE FORM OF A FINANCIAL INDEX THAT IS USED BY INSTITUTIONAL INVESTORS WISHING TO INVEST IN THE ENERGY SECTOR; CONSULTING SERVICES, NAMELY, EVALUATING THE COMPOSITION OF AND WEIGHTINGS FOR COMPANIES LISTED ON THE FINANCIAL INDEX, NAMELY FINANCIAL ANALYSIS AND CONSULTATION, IN CLASS 36 (U.S. CLS. 100, 101 AND 102).

FOR: LICENSING OF AN ENERGY SECTOR FINANCIAL INDEX, IN CLASS 45 (U.S. CLS. 100 AND 101).

PRIORITY CLAIMED UNDER SEC. 44(D) ON CANADA APPLICATION NO. 1305796, FILED 6-16-2006, REG. NO. TMA694913, DATED 8-28-2007, EXPIRES 8-28-2022.

NO CLAIM IS MADE TO THE EXCLUSIVE RIGHT TO USE "OIL SANDS SECTOR INDEX", APART FROM THE MARK AS SHOWN.

SER. NO. 77-058,278, FILED 12-6-2006.

JOHN DWYER, EXAMINING ATTORNEY

Int. Cl.: 9

Prior U.S. Cls.: 21, 23, 26, 36 and 38

Reg. No. 3,518,826

United States Patent and Trademark Office

Registered Oct. 21, 2008

**TRADEMARK
PRINCIPAL REGISTER**

The logo for HyperQAM is displayed in a large, bold, sans-serif font. The letters are black with a white outline, giving it a three-dimensional appearance. The text is centered on the page.

VECIMA NETWORKS INC. (CANADA CORPORATION)
4210 COMMERCE CIRCLE
VICTORIA, CANADA V8Z6N6

PRIORITY CLAIMED UNDER SEC. 44(D) ON
CANADA APPLICATION NO. 1326940, FILED 12-5-
2006, REG. NO. TMA702868, DATED 12-11-2007, EX-
PIRES 12-11-2022.

FOR: COMMUNICATIONS DATA EQUIPMENT
FOR USE WITH CABLE, DIGITAL VIDEO AND
BROADBAND WIRELESS APPLICATIONS, NAME-
LY, QUADRATURE AMPLITUDE MODULATORS,
IN CLASS 9 (U.S. CLS. 21, 23, 26, 36 AND 38).

SER. NO. 77-059,365, FILED 12-7-2006.

PAM WILLIS, EXAMINING ATTORNEY

Int. Cl.: 3

Prior U.S. Cls.: 1, 4, 6, 50, 51 and 52

United States Patent and Trademark Office

Reg. No. 3,518,827

Registered Oct. 21, 2008

**TRADEMARK
PRINCIPAL REGISTER**

FUEL FOR LOVE

L'OREAL (FRANCE SOCIETE ANONYME)

14 RUE ROYALE

PARIS, FRANCE 75008

FOR: PERFUMES, EAU DE TOILETTE, BODY MILK, COLOGNE, AFTER SHAVE LOTION AND BALMS; GELS AND LOTIONS FOR THE SHOWER AND THE BATH, IN CLASS 3 (U.S. CLS. 1, 4, 6, 50, 51 AND 52).

THE MARK CONSISTS OF STANDARD CHARACTERS WITHOUT CLAIM TO ANY PARTICULAR FONT, STYLE, SIZE, OR COLOR.

PRIORITY CLAIMED UNDER SEC. 44(D) ON FRANCE APPLICATION NO. 063465246, FILED 11-24-2006, REG. NO. 063465246, DATED 11-24-2006, EXPIRES 11-24-2016.

SER. NO. 77-061,016, FILED 12-11-2006.

DAVID MILLER, EXAMINING ATTORNEY

Int. Cl.: 4

Prior U.S. Cls.: 1, 6 and 15

United States Patent and Trademark Office

Reg. No. 3,518,828

Registered Oct. 21, 2008

**TRADEMARK
PRINCIPAL REGISTER**

KRYSTOL

PETRO-CANADA (CANADA CORPORATION)
150 - 6TH AVENUE S.W., P.O. BOX 2844
CALGARY, CANADA T2P3E3

FOR: TECHNICAL GRADE WHITE MINERAL
OIL, IN CLASS 4 (U.S. CLS. 1, 6 AND 15).

FIRST USE 9-0-2006; IN COMMERCE 9-0-2006.

THE MARK CONSISTS OF STANDARD CHAR-
ACTERS WITHOUT CLAIM TO ANY PARTICULAR
FONT, STYLE, SIZE, OR COLOR.

PRIORITY CLAIMED UNDER SEC. 44(D) ON
CANADA APPLICATION NO. 1327181, FILED 12-7-
2006.

OWNER OF CANADA REG. NO. 709647, DATED
3-17-2008, EXPIRES 3-17-2023.

SER. NO. 77-062,077, FILED 12-12-2006.

MELVIN AXILBUND, EXAMINING ATTORNEY

Int. Cls.: 35 and 42

Prior U.S. Cls.: 100, 101 and 102

United States Patent and Trademark Office

Reg. No. 3,518,829

Registered Oct. 21, 2008

**SERVICE MARK
PRINCIPAL REGISTER**

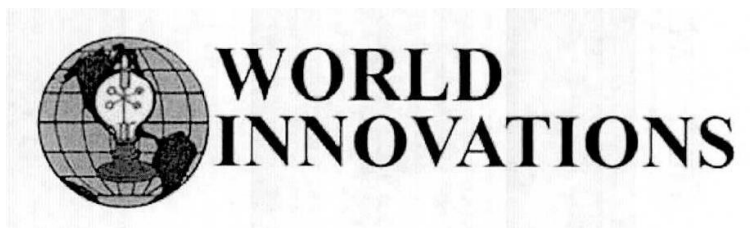

SWATZAK, CHRISTOPHER (UNITED STATES
INDIVIDUAL), DBA WORLD INNOVATIONS
1400 EAST WASHINGTON AVENUE
MADISON, WI 53703

FOR: BUSINESS MARKETING AND BUSINESS
CONSULTATION SERVICES IN THE FIELD OF
BUSINESS INNOVATIONS, IN CLASS 35 (U.S. CLS.
100, 101 AND 102).

FIRST USE 4-10-1996; IN COMMERCE 4-15-1996.

FOR: PRODUCT DEVELOPMENT, IN CLASS 42
(U.S. CLS. 100 AND 101).

FIRST USE 4-10-1996; IN COMMERCE 4-15-1996.

THE MARK CONSISTS OF A GLOBE WITH OUT-
LINES OF CONTINENTS AND A DEPICTION OF A
LIGHT BULB IN THE CENTER OF THE GLOBE,
WITH THE WORDS "WORLD INNOVATIONS" TO
THE RIGHT OF THE GLOBE.

SEC. 2(F) AS TO "WORLD INNOVATIONS".

SER. NO. 77-062,659, FILED 12-12-2006.

KATHERINE CHANG, EXAMINING ATTORNEY

Int. Cls.: 9, 16, 41 and 44

**Prior U.S. Cls.: 2, 5, 21, 22, 23, 26, 29, 36, 37, 38, 50,
100, 101 and 107**

Reg. No. 3,518,830

United States Patent and Trademark Office

Registered Oct. 21, 2008

**TRADEMARK
SERVICE MARK
PRINCIPAL REGISTER**

ALLEN CARR

ALLEN CARR'S EASYWAY (INTERNATIONAL)
LTD. (UNITED KINGDOM PRIVATE LIMITED COMPANY)
5 UPPER WIMPOLE STREET
LONDON, UNITED KINGDOM W1G6BP

FOR: VIDEO AND AUDIO TAPES, DVDS, COMPACT DISCS, AND CD-ROMS RELATING TO OVERCOMING ADDICTIONS, SUCH AS ADDICTIONS TO NICOTINE, ALCOHOL AND NARCOTICS, IN PARTICULAR NICOTINE, STOPPING SMOKING, DRINKING ALCOHOL AND TAKING NARCOTICS, OVERCOMING WEIGHT PROBLEMS, FEARS AND COMPULSIONS, AND TO DEVELOPING PERSONAL CHARACTERISTICS, IN CLASS 9 (U.S. CLS. 21, 23, 26, 36 AND 38).

FOR: PRINTED PUBLICATIONS, NAMELY, BOOKS, PERIODICALS, NEWSLETTERS, MAGAZINES, BROCHURES, PAMPHLETS AND LEAFLETS RELATING TO OVERCOMING ADDICTIONS, SUCH AS ADDICTIONS TO NICOTINE, ALCOHOL AND NARCOTICS, IN PARTICULAR NICOTINE, STOPPING SMOKING, DRINKING ALCOHOL AND TAKING NARCOTICS, OVERCOMING WEIGHT PROBLEMS, FEARS AND COMPULSIONS, AND TO DEVELOPING PERSONAL CHARACTERISTICS, IN CLASS 16 (U.S. CLS. 2, 5, 22, 23, 29, 37, 38 AND 50).

FOR: EDUCATION SERVICES, NAMELY, PROVIDING COURSES, CONFERENCES, LECTURES, SEMINARS AND WORKSHOPS RELATED TO BUSINESS FRANCHISE MANAGEMENT; EDUCATION SERVICES, NAMELY, PROVIDING SEMINARS, WORKSHOPS, CONFERENCES, COURSES, EDUCATIONAL CLINICS AND LECTURES RELATING TO OVERCOMING ADDICTIONS, SUCH AS ADDICTIONS TO NICOTINE, ALCOHOL AND NARCOTICS, IN PARTICULAR NICOTINE, STOPPING

SMOKING, DRINKING ALCOHOL AND TAKING NARCOTICS, OVERCOMING WEIGHT PROBLEMS, FEARS AND COMPULSIONS, AND TO DEVELOPING PERSONAL CHARACTERISTICS; ARRANGING, CONDUCTING, ORGANIZING AND PLANNING OF EDUCATIONAL CONFERENCES, COURSES, LECTURES AND SEMINARS RELATING TO OVERCOMING ADDICTIONS, SUCH AS ADDICTIONS TO NICOTINE, ALCOHOL AND NARCOTICS, IN PARTICULAR NICOTINE, STOPPING SMOKING, DRINKING ALCOHOL AND TAKING NARCOTICS, OVERCOMING WEIGHT PROBLEMS, FEARS AND COMPULSIONS, AND TO DEVELOPING PERSONAL CHARACTERISTICS; INCLUDING THE CONDUCTING OF SUCH CONFERENCES, COURSES, LECTURES AND SEMINARS VIA THE INTERNET; PUBLICATION OF EDUCATIONAL MATERIAL SUCH AS PRINTED BOOKS, BROCHURES, PAMPHLETS, LEAFLETS AND BROCHURES RELATING TO OVERCOMING ADDICTIONS SUCH AS ADDICTIONS TO NICOTINE, ALCOHOL AND NARCOTICS, IN PARTICULAR NICOTINE, STOPPING SMOKING, DRINKING ALCOHOL AND TAKING NARCOTICS, OVERCOMING WEIGHT PROBLEMS, FEARS AND COMPULSIONS, AND TO DEVELOPING PERSONAL CHARACTERISTICS, IN CLASS 41 (U.S. CLS. 100, 101 AND 107).

FOR: MEDICAL SERVICES; MEDICAL CLINIC SERVICES; HEALTH CLINIC SERVICES; ADVICE, COUNSELING, CONSULTANCY, INFORMATION, THERAPY AND HYPNOTHERAPY, RELATING TO OVERCOMING ADDICTIONS AND/OR DEPENDENCY, SUCH AS TO NICOTINE, ALCOHOL AND NARCOTICS, IN PARTICULAR NICOTINE, STOPPING SMOKING, DRINKING ALCOHOL AND TAKING NARCOTICS, OVERCOMING WEIGHT PROBLEMS, FEARS AND COMPULSIONS, AND

TO DEVELOPING PERSONAL CHARACTERISTICS,
IN CLASS 44 (U.S. CLS. 100 AND 101).

THE MARK CONSISTS OF STANDARD CHAR-
ACTERS WITHOUT CLAIM TO ANY PARTICULAR
FONT, STYLE, SIZE, OR COLOR.

OWNER OF ERPN CMNTY TM OFC REG. NO.
3395266, DATED 2-4-2005, EXPIRES 10-8-2013.

OWNER OF U.S. REG. NO. 3,128,479.

THE NAME "ALLEN CARR" DOES NOT IDENTI-
FY A LIVING INDIVIDUAL.

SER. NO. 77-062,688, FILED 12-12-2006.

INGRID C. EULIN, EXAMINING ATTORNEY

Int. Cl.: 9

Prior U.S. Cls.: 21, 23, 26, 36 and 38

Reg. No. 3,518,831

United States Patent and Trademark Office

Registered Oct. 21, 2008

**TRADEMARK
PRINCIPAL REGISTER**

MOVERWORX

GINGON SOLUTIONS, INC. (FLORIDA CORPORATION), DBA MOVERMAX
10940 NW 50TH STREET
FT. LAUDERDALE, FL 33351

FIRST USE 2-1-2003; IN COMMERCE 2-1-2003.

FOR: COMPUTER SOFTWARE FOR BUSINESS PROSPECT MANAGEMENT, FOR MANAGING A DATABASE OF INFORMATION PERTAINING TO INVENTORY, MILEAGE CALCULATING, COMPOSING TASKS LISTS AND CREATING REPORT SPREADSHEETS FOR USE BY MEMBERS OF THE MOVING INDUSTRY IN BUSINESS MANAGEMENT, IN CLASS 9 (U.S. CLS. 21, 23, 26, 36 AND 38).

THE MARK CONSISTS OF STANDARD CHARACTERS WITHOUT CLAIM TO ANY PARTICULAR FONT, STYLE, SIZE, OR COLOR.

SER. NO. 77-063,492, FILED 12-13-2006.

TINA BROWN, EXAMINING ATTORNEY

Int. Cls.: 36 and 42

Prior U.S. Cls.: 100, 101 and 102

United States Patent and Trademark Office

Reg. No. 3,518,832

Registered Oct. 21, 2008

**SERVICE MARK
PRINCIPAL REGISTER**

**YOUR PARTNER IN TAX-SMART
PHILANTHROPY**

CHARLES SCHWAB & CO., INC. (CALIFORNIA CORPORATION)
101 MONTGOMERY STREET
SAN FRANCISCO, CA 94104

FOR: CHARITABLE SERVICES, NAMELY, PROVIDING DONOR-ADVISED FUND AND CHARITABLE TRUST SERVICES FOR PHILANTHROPIC PURPOSES; PROVIDING CHARITABLE ACCOUNT INFORMATION AND CHARITABLE DONATION INFORMATION REGARDING FINANCIAL CONTRIBUTIONS TO THE ACCOUNT AND GRANT DISTRIBUTIONS FROM THE ACCOUNT; PROVIDING FINANCIAL INFORMATION IN THE FIELD OF CHARITABLE CONTRIBUTION AND CHARITABLE DONATION AND GRANT DISTRIBUTION PLANNING, IN CLASS 36 (U.S. CLS. 100, 101 AND 102).

FIRST USE 11-0-2005; IN COMMERCE 11-0-2005.

FOR: COMPUTER SERVICES, NAMELY, HOSTING A WEBSITE FEATURING RESEARCH AND ANALYSIS OF OTHERS IN CHARITABLE ORGANIZATIONS VIA A GLOBAL COMPUTER COMMUNICATIONS NETWORK, AND CHARITABLE DONATION INFORMATION, IN CLASS 42 (U.S. CLS. 100 AND 101).

FIRST USE 11-0-2005; IN COMMERCE 11-0-2005.

THE MARK CONSISTS OF STANDARD CHARACTERS WITHOUT CLAIM TO ANY PARTICULAR FONT, STYLE, SIZE, OR COLOR.

SER. NO. 77-063,544, FILED 12-13-2006.

GRETTA YAO, EXAMINING ATTORNEY

Int. Cls.: 36 and 42

Prior U.S. Cls.: 100, 101 and 102

United States Patent and Trademark Office

Reg. No. 3,518,833

Registered Oct. 21, 2008

**SERVICE MARK
PRINCIPAL REGISTER**



SCHWAB CHARITABLE

CHARLES SCHWAB & CO., INC. (CALIFORNIA CORPORATION)
101 MONTGOMERY STREET
SAN FRANCISCO, CA 94104

FOR: CHARITABLE SERVICES, NAMELY, PROVIDING DONOR-ADVISED FUND AND CHARITABLE TRUST SERVICES FOR PHILANTHROPIC PURPOSES; PROVIDING CHARITABLE ACCOUNT INFORMATION AND CHARITABLE DONATION INFORMATION REGARDING FINANCIAL CONTRIBUTIONS TO THE ACCOUNT AND GRANT DISTRIBUTIONS FROM THE ACCOUNT; PROVIDING FINANCIAL INFORMATION IN THE FIELD OF CHARITABLE CONTRIBUTION AND CHARITABLE DONATION AND GRANT DISTRIBUTION PLANNING, IN CLASS 36 (U.S. CLS. 100, 101 AND 102).

FIRST USE 9-0-2006; IN COMMERCE 9-0-2006.

FOR: COMPUTER SERVICES, NAMELY, HOSTING A WEBSITE FEATURING RESEARCH AND ANALYSIS OF OTHERS IN CHARITABLE ORGANIZATIONS VIA A GLOBAL COMPUTER COMMUNICATIONS NETWORK, AND CHARITABLE DONATION INFORMATION, IN CLASS 42 (U.S. CLS. 100 AND 101).

FIRST USE 9-0-2006; IN COMMERCE 9-0-2006.

OWNER OF U.S. REG. NOS. 1,516,641, 2,649,841 AND OTHERS.

NO CLAIM IS MADE TO THE EXCLUSIVE RIGHT TO USE "CHARITABLE", APART FROM THE MARK AS SHOWN.

SER. NO. 77-063,553, FILED 12-13-2006.

GRETTA YAO, EXAMINING ATTORNEY

Int. Cl.: 41

Prior U.S. Cls.: 100, 101 and 107

United States Patent and Trademark Office

Reg. No. 3,518,834

Registered Oct. 21, 2008

**SERVICE MARK
PRINCIPAL REGISTER**

MILF NEXT DOOR

RK NETMEDIA, INC. (FLORIDA CORPORATION)
3RD FLOOR
705 WASHINGTON AVENUE
MIAMI BEACH, FL 33139

FOR: ENTERTAINMENT SERVICES IN THE NATURE OF PHOTOGRAPHIC IMAGES, PICTURES, VIDEO AND AUDIO RECORDINGS, AND INFORMATION INVOLVING ADULT ORIENTED SUBJECT MATTER TRANSMITTED THROUGH A GLOBAL COMPUTER NETWORK, IN CLASS 41 (U.S. CLS. 100, 101 AND 107).

FIRST USE 12-29-2002; IN COMMERCE 12-29-2002.

THE MARK CONSISTS OF STANDARD CHARACTERS WITHOUT CLAIM TO ANY PARTICULAR FONT, STYLE, SIZE, OR COLOR.

SER. NO. 77-064,757, FILED 12-14-2006.

KATHERINE CONNOLLY, EXAMINING ATTORNEY

Int. Cl.: 9

Prior U.S. Cls.: 21, 23, 26, 36 and 38

United States Patent and Trademark Office

Reg. No. 3,518,835

Registered Oct. 21, 2008

**TRADEMARK
PRINCIPAL REGISTER**

THERMOGAZER

SUMITOMO ELECTRIC INDUSTRIES, LTD. (JAPAN CORPORATION)

5-33 KITAHAMA 4-CHOME, CHUO-KU

OSAKA-SHI, OSAKA, JAPAN 541-0041

FOR: OPTICAL FIBER TEMPERATURE SENSORS, OPTICAL FIBER STRAIN SENSORS, OPTICAL FIBERS, AND OPTICAL FIBER CABLES, IN CLASS 9 (U.S. CLS. 21, 23, 26, 36 AND 38).

THE MARK CONSISTS OF STANDARD CHARACTERS WITHOUT CLAIM TO ANY PARTICULAR FONT, STYLE, SIZE, OR COLOR.

OWNER OF JAPAN REG. NO. 5031779, DATED 3-9-2007, EXPIRES 3-9-2017.

SER. NO. 77-066,175, FILED 12-18-2006.

ARETHA SOMERVILLE, EXAMINING ATTORNEY

Int. Cls.: 30 and 35

Prior U.S. Cls.: 46, 100, 101 and 102

Reg. No. 3,518,836

United States Patent and Trademark Office

Registered Oct. 21, 2008

**TRADEMARK
SERVICE MARK
PRINCIPAL REGISTER**

Dots Cupcakes

DOTS CUPCAKES, LLC (CALIFORNIA LIMITED
LIABILITY COMPANY)
400 S. ARROYO PARKWAY
PASADENA, CA 91105

THE MARK CONSISTS OF STANDARD CHAR-
ACTERS WITHOUT CLAIM TO ANY PARTICULAR
FONT, STYLE, SIZE, OR COLOR.

FOR: BAKERY GOODS, NAMELY CUPCAKES,
IN CLASS 30 (U.S. CL. 46).

NO CLAIM IS MADE TO THE EXCLUSIVE
RIGHT TO USE "CUPCAKES", APART FROM THE
MARK AS SHOWN.

FIRST USE 11-17-2006; IN COMMERCE 11-17-2006.

FOR: RETAIL BAKERY SHOPS, IN CLASS 35 (U.S.
CLS. 100, 101 AND 102).

SER. NO. 77-068,465, FILED 12-20-2006.

FIRST USE 11-17-2006; IN COMMERCE 11-17-2006.

ERIN FALK, EXAMINING ATTORNEY

Int. Cls.: 1 and 2

Prior U.S. Cls.: 1, 5, 6, 10, 11, 16, 26 and 46

Reg. No. 3,518,837

United States Patent and Trademark Office

Registered Oct. 21, 2008

**TRADEMARK
PRINCIPAL REGISTER**

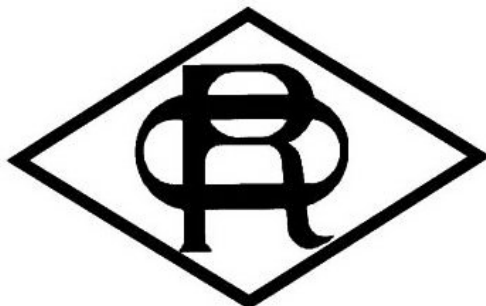

ORIENT CHEMICAL INDUSTRIES, LTD. (JAPAN
JOINT STOCK COMPANY)
7-14, SHINMORI 1-CHOME, ASAHI-KU
OSAKA-SHI, OSAKA, JAPAN

FOR: CHEMICALS, NAMELY, CHARGE CONTROL AGENTS FOR USE IN TONER FOR DEVELOPING ELECTROSTATIC IMAGES, NUCLEATING AGENTS FOR SYNTHETIC RESIN FOR USE IN THE SYNTHETIC RESIN MOULDING, CRYSTALLIZATION RETARDANTS FOR SYNTHETIC RESIN FOR USE IN THE SYNTHETIC RESIN MOULDING, ADDITIVES FOR IMPROVING INSULATION PERFORMANCE OF SYNTHETIC RESIN, LASER RAY ABSORBENTS, AND MASTERBATCH TYPE LASER RAY ABSORBENTS; PHOTOCONDUCTIVE CHEMICALS FOR USE IN MANUFACTURING PHOTORECEPTOR, PHOTOCONDUCTIVE CHARGE GENERATION CHEMICALS FOR USE IN MANUFACTURING PHOTORECEPTOR, PHOTOCONDUCTIVE CHARGE TRANSPORT CHEMICALS FOR USE IN MANUFACTURING PHOTORECEPTOR, ORGANIC CHEMICALS FOR ELECTROLUMINESCENCE, ORGANIC CHEMICALS FOR OPTICAL RECORDING MEDIA, ORGANIC CHEMICALS FOR PHOTOELECTRIC CELL OR SOLAR CELL; PLANT GROWTH REGULATING PREPARATIONS; FERTILIZERS; CERAMIC GLAZINGS; CHEMICAL TEST PAPER; ARTIFICIAL SWEETENERS; FLOUR AND STARCH FOR INDUSTRIAL PURPOSES; UNPROCESSED PLASTICS, IN CLASS 1 (U.S. CLS. 1, 5, 6, 10, 26 AND 46).

FOR: DYES, NAMELY, LASER RAY ABSORBING DYES, LASER RAY TRANSMITTING DYES, NEAR INFRARED RAY ABSORBING DYES, NEAR INFRARED RAY TRANSMITTING DYES, MASTER-

BATCH TYPE LASER RAY ABSORBING DYES, MASTERBATCH TYPE LASER RAY TRANSMITTING DYES, MASTERBATCH TYPE NEAR INFRARED RAY ABSORBING DYES, MASTERBATCH TYPE NEAR INFRARED RAY TRANSMITTING DYES, DYES FOR COLORING OF PHOTOCONDUCTIVE MATERIALS, DYES FOR COLORING PHOTOCONDUCTIVE CHARGE GENERATION MATERIALS, DYES FOR COLORING PHOTOCONDUCTIVE CHARGE TRANSPORT MATERIALS, DYES FOR COLORING ORGANIC MATERIALS FOR ELECTROLUMINESCENCE, DYES FOR COLORING ORGANIC MATERIALS FOR OPTICAL RECORDING MEDIA, DYES FOR COLORING ORGANIC MATERIALS FOR PHOTOELECTRIC CELL AND SOLAR CELL, DYES FOR USE IN THE MANUFACTURE OF COATINGS FOR OPTICAL RECORDING MEDIA, DYES FOR USE IN THE MANUFACTURE OF COATINGS FOR PHOTOELECTRIC CELL AND SOLAR CELL, AND DYE SOLUTIONS FOR USE IN MANUFACTURING INKS FOR INK JET PRINTERS, PLOTTERS, RECORDERS, INK JET PROCESS COPYING MACHINES, INK JET PROCESS FACSIMILE MACHINES AND WRITING INSTRUMENTS; PIGMENTS, NAMELY, LASER RAY ABSORBING PIGMENTS, LASER RAY TRANSMITTING PIGMENTS, NEAR INFRARED RAY ABSORBING PIGMENTS, NEAR INFRARED RAY TRANSMITTING PIGMENTS, MASTERBATCH TYPE LASER RAY ABSORBING PIGMENTS, MASTERBATCH TYPE LASER RAY TRANSMITTING PIGMENTS, MASTERBATCH TYPE NEAR INFRARED RAY ABSORBING PIGMENTS, MASTERBATCH TYPE NEAR INFRARED RAY TRANSMITTING PIGMENTS, AND PIGMENTS IN THE FORM OF DISPERSION IN LIQUID FOR USE IN

MANUFACTURING INKS FOR INK JET PRINTERS, PLOTTERS, RECORDERS, INK JET PROCESS COPYING MACHINES, INK JET PROCESS FACSIMILE MACHINES AND WRITING INSTRUMENTS, PIGMENTS FOR COLORING OF PHOTOCONDUCTIVE MATERIALS, PIGMENTS FOR COLORING OF PHOTOCONDUCTIVE CHARGE GENERATION MATERIALS, PIGMENTS FOR COLORING OF PHOTOCONDUCTIVE CHARGE TRANSPORT MATERIALS, PIGMENTS FOR COLORING OF ORGANIC MATERIALS FOR ELECTROLUMINESCENCE, PIGMENTS FOR COLORING OF ORGANIC MATERIALS FOR OPTICAL RECORDING MEDIA, AND PIGMENTS FOR COLORING OF ORGANIC MATERIALS FOR PHOTOELECTRIC CELL AND SOLAR CELL, PIGMENTS FOR USE IN THE MANUFACTURE OF COATINGS FOR OPTICAL RECORDING MEDIA, PHOTOELECTRIC CELL AND SOLAR CELL; PAINTS; PRINTING INKS FOR USE IN INK JET PRINTERS, PLOTTERS, RECORDERS, INK JET PROCESS COPYING MA-

CHINES AND INK JET PROCESS FACSIMILE MACHINES; COPAL; SANDARAC; SHELLAC; DAMMAR; MORDANTS FOR USE IN DYEING FIBERS OR FIBER PRODUCTS; WOOD PRESERVATIVES; ANTI-RUST GREASES; NONFERROUS METALS IN FOIL OR POWDER FORM FOR PAINTERS, DECORATORS, PRINTERS AND ARTISTS; PRECIOUS METALS IN FOIL OR POWDER FORM FOR PAINTERS, DECORATORS, PRINTERS AND ARTISTS, IN CLASS 2 (U.S. CLS. 6, 11 AND 16).

OWNER OF JAPAN REG. NO. 4979735, DATED 8-18-2006, EXPIRES 8-18-2016.

THE MARK CONSISTS OF A STYLIZED DEPICTION OF THE LETTERS "OR" WITHIN A DIAMOND SHAPED BORDER.

SER. NO. 77-069,199, FILED 12-21-2006.

LINDA POWELL, EXAMINING ATTORNEY

Int. Cl.: 36

Prior U.S. Cls.: 100, 101 and 102

United States Patent and Trademark Office

Reg. No. 3,518,838

Registered Oct. 21, 2008

**SERVICE MARK
PRINCIPAL REGISTER**

THE PEOPLE WHO KNOW

SECURITY FEDERAL CREDIT UNION (UNITED STATES FEDERALLY CHARTERED CREDIT UNION)

P.O. BOX 5160

3801 W. BOULEVARD DRIVE

FLINT, MI 485050160

FOR: CREDIT UNION AND BANKING SERVICES, IN CLASS 36 (U.S. CLS. 100, 101 AND 102).

FIRST USE 0-0-2001; IN COMMERCE 0-0-2001.

THE MARK CONSISTS OF STANDARD CHARACTERS WITHOUT CLAIM TO ANY PARTICULAR FONT, STYLE, SIZE, OR COLOR.

SER. NO. 77-070,677, FILED 12-22-2006.

MICHELE SWAIN, EXAMINING ATTORNEY

Int. Cls.: 9, 16 and 41

**Prior U.S. Cls.: 2, 5, 21, 22, 23, 26, 29, 36, 37, 38, 50,
100, 101 and 107**

Reg. No. 3,518,839

United States Patent and Trademark Office

Registered Oct. 21, 2008

**TRADEMARK
SERVICE MARK
PRINCIPAL REGISTER**

KOLD KARMA

A. SMITH HOLDINGS LIMITED (UNITED KINGDOM LIMITED COMPANY)
22-23 OLD BURLINGTON STREET
LONDON, UNITED KINGDOM W1S2JJ

FOR: COMPUTER PROGRAMS FOR CONTROLLING COMPUTER GAMES; PRE-RECORDED COMPACT DISCS, DVDS, VIDEO AND SOUND RECORDINGS FEATURING MUSIC AND MUSIC PERFORMANCES; CINEMATOGRAPHIC FILM AND PHOTOGRAPHIC SLIDE TRANSPARENCIES; VIDEO DISKS AND VIDEO TAPES WITH RECORDED ANIMATED CARTOONS; GAME AND AMUSEMENT APPARATUS, ALL ADAPTED FOR USE WITH TELEVISION, VIDEO OR COMPUTER RECEIVERS OR VIDEO DISPLAY UNITS, NAMELY, ELECTRONIC GAME PROGRAMS; ELECTRONIC VIDEO AND COMPUTER GAMES APPARATUS, NAMELY, COMPUTER GAMES SOFTWARE, COMPUTER GAMES CONSOLES, AND ELECTRONIC VIDEO MONITORS; PRE-RECORDED VIDEO TAPES FEATURING MUSIC AND MUSIC PERFORMANCES; COMPUTER AND VIDEO GAME, NAMELY, CASSETTES AND DISCS, IN CLASS 9 (U.S. CLS. 21, 23, 26, 36 AND 38).

FOR: PRINTED MATTER, NAMELY, BOOKS, MAGAZINES, FANZINES ALL RELATING TO A PARTICULAR MUSICAL PERFORMING GROUP; PHOTOGRAPHS; STATIONERY; COMIC STRIPS; NEWSLETTERS FEATURING A PARTICULAR MUSICAL PERFORMING GROUP; CALENDARS, DICTIONARIES; GIFT WRAPPING PAPER, GREETING CARDS, INVITATION CARDS, PICTURE CARDS, POSTCARDS; DECALCOMANIAS, PRESSURE SENSITIVE STICKERS; PAINTINGS, PRINTS; PHOTOGRAPH ALBUMS; INSTRUCTIONAL AND

TEACHING APPARATUS, NAMELY, PRINTED INSTRUCTIONAL AND TEACHING MATERIALS IN THE FIELD OF VIDEO AND COMPUTER GAMES; PLASTIC BAGS FOR GENERAL USE AND PAPER BAGS; POSTERS; PENS, PENCILS; PEN AND PENCIL CASES; PAPERWEIGHTS; ADHESIVES FOR STATIONERY AND HOUSEHOLD USE; ARTISTS MATERIALS, NAMELY, PAINT BRUSHES AND ARTS AND CRAFTS PAINT SETS, IN CLASS 16 (U.S. CLS. 2, 5, 22, 23, 29, 37, 38 AND 50).

FOR: ENTERTAINMENT SERVICES, NAMELY, LIVE MUSICAL ENTERTAINMENT PERFORMANCES, SHOWS, PRESENTATIONS AND CONCERTS BY A PARTICULAR MUSICAL PERFORMING GROUP; RECORDING STUDIO SERVICES; PRODUCTION OF ENTERTAINMENT, NAMELY, PRODUCTION OF MOTION PICTURE FILMS, TELEVISION PROGRAMS, AUDIO, VIDEO AND CINEMATOGRAPHIC RECORDINGS; MUSIC PUBLISHING SERVICES, PUBLICATION OF TEXTS, IN CLASS 41 (U.S. CLS. 100, 101 AND 107).

THE MARK CONSISTS OF STANDARD CHARACTERS WITHOUT CLAIM TO ANY PARTICULAR FONT, STYLE, SIZE, OR COLOR.

PRIORITY CLAIMED UNDER SEC. 44(D) ON ERPN CMNTY TM OFC APPLICATION NO. 005521125, FILED 12-4-2006, REG. NO. 005521125, DATED 1-4-2008, EXPIRES 12-4-2016.

SER. NO. 77-072,180, FILED 12-27-2006.

ALEX KEAM, EXAMINING ATTORNEY

Int. Cls.: 17, 20 and 27

**Prior U.S. Cls.: 1, 2, 5, 12, 13, 19, 20, 22, 25, 32, 35, 37,
42 and 50**

Reg. No. 3,518,840

United States Patent and Trademark Office

Registered Oct. 21, 2008

**TRADEMARK
PRINCIPAL REGISTER**

BIO-LUX

BARNHARDT MANUFACTURING COMPANY
(NORTH CAROLINA CORPORATION), DBA
NCFI POLYURETHANES
1515 CARTER STREET
MT. AIRY, NC 27030

FOR: POLYURETHANE FOAM FOR USE IN
MATTRESSES, FURNITURE SEAT AND BACK
CUSHIONS, IN CLASS 17 (U.S. CLS. 1, 5, 12, 13, 35
AND 50).

FIRST USE 2-28-2007; IN COMMERCE 4-2-2007.

FOR: POLYURETHANE FOAM SEAT AND BACK
FURNITURE CUSHIONS AND VISCO-ELASTIC
FOAM MATTRESSES, IN CLASS 20 (U.S. CLS. 2, 13,
22, 25, 32 AND 50).

FIRST USE 2-28-2007; IN COMMERCE 4-2-2007.

FOR: POLYURETHANE FOAM CARPET PAD-
DING, IN CLASS 27 (U.S. CLS. 19, 20, 37, 42 AND 50).

FIRST USE 2-28-2007; IN COMMERCE 4-2-2007.

THE MARK CONSISTS OF STANDARD CHAR-
ACTERS WITHOUT CLAIM TO ANY PARTICULAR
FONT, STYLE, SIZE, OR COLOR.

SER. NO. 77-072,338, FILED 12-28-2006.

ELLEN PERKINS, EXAMINING ATTORNEY

Int. Cls.: 38 and 42

Prior U.S. Cls.: 100, 101 and 104

United States Patent and Trademark Office

Reg. No. 3,518,841

Registered Oct. 21, 2008

SERVICE MARK
PRINCIPAL REGISTER

ImProve!

*Integrated multimedia Platform for remote
operations with visual engagement*

TELESIS SOLUTIONS GROUP, INC. (NEW YORK CORPORATION)
1045-A PARK BOULEVARD - SUITE 2
MASSAPEQUA PARK, NY 11762

FOR: ON-DEMAND WEB-BASED TELECOMMUNICATION SOLUTIONS, NAMELY, AUDIO AND VIDEO TELECONFERENCING; BROWSER BASED VISUAL/VIDEO TELECOMMUNICATION SOLUTIONS INTERFACING FOR MULTIPLE USERS, NAMELY, AUDIO AND VIDEO TELECONFERENCING, AND PROVISION OF ACCESS TO DATA AND DOCUMENTS STORED ELECTRONICALLY IN CENTRAL FILES FOR DOCUMENT SHARING AND DOCUMENT COLLABORATION; AND INTER-ACTIVE APPLICATIONS FOR REMOTE OPERATIONS, DISTANCE LEARNING/TRAINING, MEETINGS AND EXCHANGE OF INFORMATION, NAMELY, ELECTRONIC DELIVERY OF IMAGES AND PHOTOGRAPHS VIA GLOBAL COMPUTER NETWORK, IN CLASS 38 (U.S. CLS. 100, 101 AND 104).

FIRST USE 11-9-2006; IN COMMERCE 11-9-2006.

FOR: ON-DEMAND WEB-BASED TELECOMMUNICATION SOLUTIONS, NAMELY, PROVIDING TEMPORARY USE OF ON-LINE NON-DOWNLOADABLE SOFTWARE FOR INTEGRATING MULTI-MEDIA APPLICATIONS, VIDEO APPLICATIONS, WEBCAM AND DESKTOP VIDEO CONFERENCING; BROWSER BASED VISUAL/VIDEO

TELECOMMUNICATION SOLUTIONS, NAMELY, PROVIDING TEMPORARY USE OF ON-LINE NON-DOWNLOADABLE SOFTWARE FOR INTERFACING MULTIPLE USERS; AND INTER-ACTIVE APPLICATIONS, NAMELY, PROVIDING TEMPORARY USE OF ON-LINE NON-DOWNLOADABLE SOFTWARE FOR CONTROLLING REMOTE OPERATIONS, DISTANCE LEARNING/TRAINING, MEETINGS AND EXCHANGE OF INFORMATION, IN CLASS 42 (U.S. CLS. 100 AND 101).

FIRST USE 11-9-2006; IN COMMERCE 11-9-2006.

NO CLAIM IS MADE TO THE EXCLUSIVE RIGHT TO USE "INTEGRATED MULTIMEDIA PLATFORM FOR REMOTE OPERATIONS WITH VISUAL ENGAGEMENT", APART FROM THE MARK AS SHOWN.

THE MARK CONSISTS OF THE WORDS "IMPROVE!" STYLIZED, AND THE WORDS "INTEGRATED MULTIMEDIA PLATFORM FOR REMOTE OPERATIONS WITH VISUAL ENGAGEMENT" WITH THE FIRST LETTER OF THE WORDS BEING UNDERSCORED TO SPELL THE WORD "IMPROVE".

SER. NO. 77-072,343, FILED 12-28-2006.

ELLEN PERKINS, EXAMINING ATTORNEY

Int. Cls.: 27, 35, 37 and 42

**Prior U.S. Cls.: 19, 20, 37, 42, 50, 100, 101, 102, 103
and 106**

Reg. No. 3,518,842

United States Patent and Trademark Office

Registered Oct. 21, 2008

**TRADEMARK
SERVICE MARK
PRINCIPAL REGISTER**

GENERALSPTS VENUE

APPLEBY, ANDREW D. (UNITED STATES INDIVIDUAL)
400 WATER STREET, SUITE 250
ROCHESTER, MI 48307 AND
GENERAL SPORTS & ENTERTAINMENT, LLC
(MICHIGAN LIMITED LIABILITY COMPANY)
400 WATER STREET, SUITE 250
ROCHESTER, MI 48307

FOR: SYNTHETIC SURFACING CONSISTING OF RIBBONS OF SYNTHETIC FIBERS ADHERED TO A BACKING AND PARTIALLY COVERED WITH A PARTICULATE INFILL FOR THE PLAYING OF FOOTBALL, SOCCER, GOLF, FIELD HOCKEY, LACROSSE, BASEBALL AND OTHER ATHLETIC ACTIVITIES, IN CLASS 27 (U.S. CLS. 19, 20, 37, 42 AND 50).

FIRST USE 6-2-2006; IN COMMERCE 6-2-2006.

FOR: BUSINESS SERVICES, NAMELY, BUSINESS CONSULTATION, BUSINESS MARKETING SERVICES; OFFERING TECHNICAL ASSISTANCE IN THE ESTABLISHMENT AND/OR OPERATION OF SPORTS FACILITIES, IN CLASS 35 (U.S. CLS. 100, 101 AND 102).

FIRST USE 6-2-2006; IN COMMERCE 6-2-2006.

FOR: INSTALLATION AND MAINTENANCE OF SYNTHETIC FIBERS ADHERED TO A BACKING AND PARTIALLY COVERED WITH A PARTICULATE INFILL, IN CLASS 37 (U.S. CLS. 100, 103 AND 106).

FIRST USE 6-2-2006; IN COMMERCE 6-2-2006.

FOR: TECHNICAL ADVICE IN THE FIELD OF ENGINEERING, IN CLASS 42 (U.S. CLS. 100 AND 101).

FIRST USE 6-2-2006; IN COMMERCE 6-2-2006.

THE MARK CONSISTS OF STANDARD CHARACTERS WITHOUT CLAIM TO ANY PARTICULAR FONT, STYLE, SIZE, OR COLOR.

OWNER OF U.S. REG. NOS. 2,465,105, 2,465,107 AND OTHERS.

NO CLAIM IS MADE TO THE EXCLUSIVE RIGHT TO USE "VENUE", APART FROM THE MARK AS SHOWN.

SER. NO. 77-072,438, FILED 12-28-2006.

TEJBIR SINGH, EXAMINING ATTORNEY

Int. Cl.: 30

Prior U.S. Cl.: 46

United States Patent and Trademark Office

Reg. No. 3,518,843

Registered Oct. 21, 2008

**TRADEMARK
PRINCIPAL REGISTER**

COCKTAIL CENTRAL

NANTUCKET HARVEST CO., INC. (MASSACHU-
SETTS CORPORATION)

ONE WEST STREET

FALL RIVER, MA 02720

FOR: SALT; SPICE BLENDS; SUGAR, IN CLASS 30
(U.S. CL. 46).

FIRST USE 10-23-2006; IN COMMERCE 10-23-2006.

THE MARK CONSISTS OF STANDARD CHAR-
ACTERS WITHOUT CLAIM TO ANY PARTICULAR
FONT, STYLE, SIZE, OR COLOR.

NO CLAIM IS MADE TO THE EXCLUSIVE
RIGHT TO USE "COCKTAIL", APART FROM THE
MARK AS SHOWN.

SER. NO. 77-072,658, FILED 12-28-2006.

BONNIE LUKEN, EXAMINING ATTORNEY

Int. Cl.: 41

Prior U.S. Cls.: 100, 101 and 107

United States Patent and Trademark Office

Reg. No. 3,518,844

Registered Oct. 21, 2008

**SERVICE MARK
PRINCIPAL REGISTER**



C12 GROUP, LLC (NORTH CAROLINA LIMITED
LIABILITY COMPANY)
4101 PIEDMONT PARKWAY
GREENSBORO, NC 27410

FOR: PERSONAL COACHING SERVICES FOR
CHRISTIAN CEOs, PRESIDENTS, BUSINESS OWN-
ERS AND BUSINESS EXECUTIVES IN THE FIELD
OF LEADERSHIP, BUSINESS MANAGEMENT,
GENERAL MANAGEMENT, ORGANIZATIONAL
DEVELOPMENT, COMMUNICATION, PERFOR-
MANCE MANAGEMENT, FINANCIAL MANAGE-
MENT AND SPIRITUALITY MANAGEMENT, IN
CLASS 41 (U.S. CLS. 100, 101 AND 107).

FIRST USE 6-1-1992; IN COMMERCE 6-1-1992.

OWNER OF U.S. REG. NO. 2,720,517.

NO CLAIM IS MADE TO THE EXCLUSIVE
RIGHT TO USE "GROUP", APART FROM THE
MARK AS SHOWN.

SER. NO. 77-073,088, FILED 12-29-2006.

DANNEAN HETZEL, EXAMINING ATTORNEY

Int. Cl.: 3

Prior U.S. Cls.: 1, 4, 6, 50, 51 and 52

United States Patent and Trademark Office

Reg. No. 3,518,845

Registered Oct. 21, 2008

**TRADEMARK
PRINCIPAL REGISTER**

SPAMEDICA SKIN

SPAMEDICA INTERNATIONAL SRL (BARBADOS CORPORATION)
2ND FLOOR, INTERNATIONAL TRADING CENTRE
WARRENS, ST. MICHAEL, BARBADOS

FOR: HOUSE MARK FOR A FULL LINE OF NON-MEDICATED SKIN CARE PREPARATIONS, IN CLASS 3 (U.S. CLS. 1, 4, 6, 50, 51 AND 52).

FIRST USE 9-7-2005; IN COMMERCE 9-7-2005.

THE MARK CONSISTS OF STANDARD CHARACTERS WITHOUT CLAIM TO ANY PARTICULAR FONT, STYLE, SIZE, OR COLOR.

OWNER OF U.S. REG. NO. 2,408,973.

NO CLAIM IS MADE TO THE EXCLUSIVE RIGHT TO USE "SKIN", APART FROM THE MARK AS SHOWN.

THE WORDING "SPAMEDICA" HAS NO MEANING IN A FOREIGN LANGUAGE.

SER. NO. 77-073,660, FILED 12-29-2006.

ELISSA GARBER KON, EXAMINING ATTORNEY

Int. Cls.: 9, 18 and 25

Prior U.S. Cls.: 1, 2, 3, 21, 22, 23, 26, 36, 38, 39 and 41

Reg. No. 3,518,846

United States Patent and Trademark Office

Registered Oct. 21, 2008

**TRADEMARK
PRINCIPAL REGISTER**

JACQUES BOGART

JACQUES BOGART INTERNATIONAL BV
(NETHERLANDS CORPORATION)
WESTBLAAK 89
ROTTERDAM, NETHERLANDS 3012KG

FOR: SPECTACLES, SUNGLASSES, SPECTACLE GLASSES, SPECTACLE FRAMES, SPECTACLE CASES, CORDS AND CHAINS FOR SPECTACLES, ANTI-GLARE SPECTACLES, TELESCOPES; PHOTOGRAPHIC, CINEMATOGRAPHIC, OPTICAL AND EDUCATIONAL APPARATUS AND INSTRUMENTS, NAMELY, CAMERAS, VIDEO PROJECTORS, MOVIE PROJECTORS, COMPUTER MONITORS; APPARATUS FOR RECORDING, TRANSMISSION OR REPRODUCTION OF SOUND OR IMAGES; DATA PROCESSORS AND COMPUTERS, IN CLASS 9 (U.S. CLS. 21, 23, 26, 36 AND 38).

FOR: FANCY GOODS OF LEATHER AND IMITATIONS OF LEATHER, NAMELY, POCKET WALLETS, BUSINESS AND CREDIT CARD CASES, SCHOOL SACHELS, SCHOOL BAGS, PURSES NOT OF PRECIOUS METALS, HAND BAGS, SLING BAGS, BEACH BAGS, BRIEFCASES, TRAVELING SETS COMPRISED PRIMARILY OF LUGGAGE, GARMENT BAGS AND TRAIN CASES SOLD AS A UNIT, VANITY CASES SOLD EMPTY, KEY CASES, ATTACHÉ CASES, TRUNKS AND TRAVELING BAGS, UMBRELLAS, PARASOLS, SUNSHADES IN THE NATURE OF BEACH UMBRELLAS, IN CLASS 18 (U.S. CLS. 1, 2, 3, 22 AND 41).

FOR: GARMENTS OF ALL KINDS FOR MEN, WOMEN AND CHILDREN, NAMELY, JACKETS, THREE-QUARTER LENGTH COATS, COATS,

TROUSERS; KNITWEAR, NAMELY, SWEATERS, MITTENS AND SCARVES; SHIRTS, INCLUDING KNITTED SHIRTS, BLOUSES, RAINCOATS, OVERCOATS AND UNDERWEAR; SPORTS CLOTHING, NAMELY, JOGGING SUITS, SWEAT PANTS, SWEAT SHIRTS, T-SHIRTS; HOSIERY, NAMELY STOCKINGS AND SOCKS, PULLOVERS, KNITTED SHIRTS; LINGERIE; LINEN CLOTHING, NAMELY, LINEN TROUSERS AND SHIRTS; SHOES AND FOOTWEAR, EXCEPT ORTHOPEDIC FOOTWEAR, BOOTS, ANKLE BOOTS, HALF BOOTS, SLIPPERS, ESPADRILLES, SANDALS, SHOES FOR WEAR ON ATHLETIC COURTS, MOCCASINS; HEADWEAR; BELTS, BRACES, NECKTIES, GLOVES, HEAD-SCARVES, IN CLASS 25 (U.S. CLS. 22 AND 39).

THE MARK CONSISTS OF STANDARD CHARACTERS WITHOUT CLAIM TO ANY PARTICULAR FONT, STYLE, SIZE, OR COLOR.

OWNER OF BENELUX REG. NO. 618118, DATED 9-19-1997, RENEWED AS REG. NO. 618118, DATED 7-26-2007, EXPIRES 9-19-2017.

OWNER OF U.S. REG. NOS. 1,423,521 AND 2,411,464.

"THE NAME(S), PORTRAIT(S), AND/OR SIGNATURE(S) SHOWN IN THE MARK DOES NOT IDENTIFY A PARTICULAR LIVING INDIVIDUAL."

SER. NO. 77-073,941, FILED 12-31-2006.

MARTHA FROMM, EXAMINING ATTORNEY

Int. Cl.: 34

Prior U.S. Cls.: 2, 8, 9 and 17

United States Patent and Trademark Office

Reg. No. 3,518,847

Registered Oct. 21, 2008

TRADEMARK
PRINCIPAL REGISTER

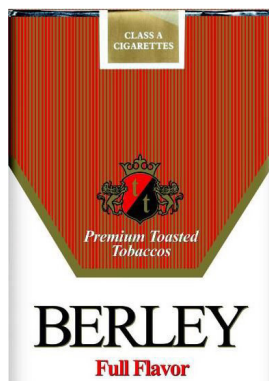

IP, LLC (KENTUCKY LIMITED LIABILITY COMPANY)
200 PROGRESS DR.
RUSSELL SPRINGS, KY 42642

FOR: CIGARETTES, IN CLASS 34 (U.S. CLS. 2, 8, 9 AND 17).

FIRST USE 8-31-2005; IN COMMERCE 8-31-2005.

NO CLAIM IS MADE TO THE EXCLUSIVE RIGHT TO USE "CLASS A CIGARETTES," "PREMIUM TOASTED TOBACCOS," "FULL FLAVOR," AND "BURLEY", APART FROM THE MARK AS SHOWN.

THE COLOR(S) RED, GOLD, BLACK AND WHITE IS/ARE CLAIMED AS A FEATURE OF THE MARK.

THE MARK CONSISTS OF THE WORD "BERLEY" IN BLACK ABOVE THE WORDING "FULL

FLAVOR" IN RED ALL SET AGAINST A WHITE BACKGROUND. ABOVE THE WORD "BERLEY" IS A SIX SIDED POLYGON WITH THE BOTTOM THREE SIDES OUTLINED IN GOLD AND FEATURING A SERIES OF RED AND GOLD VERTICAL LINES ACROSS THE DESIGN. AT THE BOTTOM OF THE RED AND GOLD IS THE WORDING "PREMIUM TOASTED TOBACCOS" IN WHITE WITH BLACK HIGHLIGHTS ABOVE WHICH IS A DESIGN OF GOLD LIONS OUTLINED IN BLACK ON EITHER SIDE OF A RED AND BLACK SHIELD FEATURING THE LETTERS "T T" IN GOLD AND BEARING A GOLD CROWN OUTLINED IN BLACK. AT THE TOP CENTER OF THE RED AND GOLD BACKGROUND IS A WHITE RECTANGLE WITHIN WHICH SITS A GOLD RECTANGLE AGAINST WHICH IS THE WORDING "CLASS A CIGARETTES" IN WHITE.

SER. NO. 77-075,278, FILED 1-3-2007.

MARCIE MILONE, EXAMINING ATTORNEY

Int. Cls.: 9, 10 and 42

Prior U.S. Cls.: 21, 23, 26, 36, 38, 39, 44, 100 and 101

Reg. No. 3,518,848

United States Patent and Trademark Office

Registered Oct. 21, 2008

**TRADEMARK
SERVICE MARK
PRINCIPAL REGISTER**

OXFORD INSTRUMENTS
The Business of Science

OXFORD INSTRUMENTS PLC (UNITED KINGDOM COMPANY)
TUBNEY WOODS
ABINGTON, OXON, UNITED KINGDOM OX13 5QX

FOR: FLEXIBLE PLASMA PROCESSING APPARATUS FOR PLASMA ETCHING AND PLASMA DEPOSITION; FLEXIBLE ION BEAM PROCESSING SYSTEMS FOR ION BEAM ETCHING AND ION BEAM DEPOSITION; HIGH PRECISION MAGNET, CRYOGENIC SYSTEMS COMPOSED OF LABORATORY CRYOSTATS, DILUTION REFRIGERATORS, SUPERCONDUCTING MAGNETS AND SUPERCONDUCTING THIN FILMS AND PARTS THEREFOR FOR NUCLEAR MAGNETIC RESONANCE, FOR ION CYCLOTRON RESONANCE, FOR MAGNETIC RESONANCE IMAGING AND FOR ASSOCIATED APPLICATIONS, NAMELY, ELEMENTAL AND COMPOUND ANALYSIS IN LIFE SCIENCES, MATERIALS, CHARACTERIZATION, CONDENSED MATTER PHYSICS, SCIENTIFIC AND INDUSTRIAL RESEARCH, AND SENSORS AND DETECTION, ALL FOR OTHER THAN MEDICAL PURPOSES; ELECTRON DETECTORS, ELECTRON MICROSCOPE CONTROLLERS; X-RAY PULSE PROCESSORS FOR OTHER THAN MEDICAL PURPOSES; MICROANALYSIS APPARATUS, NAMELY, X-RAY DETECTOR WITH ANALYZER, COMPUTER HARDWARE AND SOFTWARE THEREFOR FOR OTHER THAN MEDICAL PURPOSES; CRYSTALLOGRAPHIC ANALYSIS APPARATUS, NAMELY, X-RAY SOURCE, DETECTOR AND MULTI-AXIS GONIOMETER PARTICLE ACCELERATORS AND PARTS THEREFOR; LABORATORY CRYOSTATS; DILUTION REFRIGERATORS, SUPERCONDUCTING MAGNETS, SUPERCONDUCTING THIN FILMS, ELECTRON MICROSCOPY APPARATUS, NAMELY, ELECTRON BEAM BACKSCATTER DETECTOR, COMPUTER HARDWARE AND SOFTWARE THEREFOR; X-RAYS FLUORESCENCE (XRF) SPECTROMETERS, LOW-FIELD NUCLEAR

MAGNETIC RESONANCE (NMR) SPECTROMETERS; DETECTOR MAGNETS, IN CLASS 9 (U.S. CLS. 21, 23, 26, 36 AND 38).

FOR: APPARATUS AND INSTRUMENTS FOR USE IN ELECTROCARDIOGRAPHS, NAMELY, ELECTROCARDIOGRAM (ECG), ELECTROENCEPHALOGRAPHY (EEG), ELECTROMYOGRAPHY (EMG), EVOKED POTENTIALS (EP), INTRA OPERATIVE MONITORING (IOM), AND SLEEP-DISORDER DIAGNOSIS (SLEEP) HOLTER RECORDING APPARATUS FOR USE IN CARDIOLOGY AND MONITORS FOR FETAL HEART DETECTION; HIGH PRECISION MAGNET, CRYOGENIC SYSTEMS COMPOSED OF VACUUM CHAMBER WITH CRYOGENICALLY COOLED SAMPLE STAGE, COOLING APPARATUS BASED ON MIXED GAS CYCLE TO COOL SAMPLES, WOUND SUPERCONDUCTING WIRE TO PRODUCE HIGH MAGNETIC FIELDS, AND THIN FILMS ELECTRONIC DEVICES AND PARTS THEREFOR, ALL FOR NUCLEAR MAGNETIC RESONANCE, FOR ION CYCLOTRON RESONANCE, FOR MAGNETIC RESONANCE IMAGING AND FOR ASSOCIATED APPLICATIONS, NAMELY, MEDICAL DIAGNOSIS AND ELEMENTAL COMPOUND ANALYSIS IN LIFE SCIENCES, ALL FOR MEDICAL PURPOSES; X-RAY PULSE PROCESSORS FOR MEDICAL PURPOSES; MICROANALYSIS APPARATUS FOR MEDICAL USE, NAMELY, CLINICAL ANALYSIS OF TISSUES FOR DIAGNOSTIC PURPOSES, IN CLASS 10 (U.S. CLS. 26, 39 AND 44).

FOR: SCIENTIFIC RESEARCH, ADVISORY SERVICES RELATING TO SCIENTIFIC RESEARCH, MEDICAL RESEARCH, DESIGN OF SCIENTIFIC AND MEDICAL APPARATUS AND INSTRUMENTS, IN CLASS 42 (U.S. CLS. 100 AND 101).

OWNER OF UNITED KINGDOM REG. NO. 2432719, DATED 9-15-2006, EXPIRES 9-15-2016.

OWNER OF U.S. REG. NOS. 1,431,822 AND
2,599,958.

NO CLAIM IS MADE TO THE EXCLUSIVE
RIGHT TO USE "INSTRUMENTS", APART FROM
THE MARK AS SHOWN.

SEC. 2(F) "OXFORD".

SER. NO. 77-077,938, FILED 1-8-2007.

MARY ROSSMAN, EXAMINING ATTORNEY

Int. Cl.: 39

Prior U.S. Cls.: 100 and 105

United States Patent and Trademark Office

Reg. No. 3,518,849

Registered Oct. 21, 2008

**SERVICE MARK
PRINCIPAL REGISTER**

**THE FREEDOM TO FLY YOUR
OWN WAY**

AIR CANADA (CANADA CORPORATION)
STATION AIRPORT
AIR CANADA CENTRE, P.O. BOX 14000
ST. LAURENT, QUEBEC, CANADA H4Y1H4

FOR: AIR TRANSPORTATION SERVICES OF
PASSENGERS AND BAGGAGE, IN CLASS 39 (U.S.
CLS. 100 AND 105).

THE MARK CONSISTS OF STANDARD CHAR-
ACTERS WITHOUT CLAIM TO ANY PARTICULAR
FONT, STYLE, SIZE, OR COLOR.

OWNER OF CANADA REG. NO. TMA715136,
DATED 5-23-2008, EXPIRES 5-23-2023.

SER. NO. 77-078,595, FILED 1-9-2007.

MARCIE MILONE, EXAMINING ATTORNEY

Int. Cls.: 27, 35, 37 and 42

**Prior U.S. Cls.: 19, 20, 37, 42, 50, 100, 101, 102, 103
and 106**

Reg. No. 3,518,850

United States Patent and Trademark Office

Registered Oct. 21, 2008

**TRADEMARK
SERVICE MARK
PRINCIPAL REGISTER**



APPLEBY, ANDREW D. (UNITED STATES INDIVIDUAL)
400 WATER STREET, SUITE 250
ROCHESTER, MI 48307 AND
GENERAL SPORTS & ENTERTAINMENT, LLC
(MICHIGAN LIMITED LIABILITY COMPANY)
400 WATER STREET, SUITE 250
ROCHESTER, MI 48307

FOR: SYNTHETIC SURFACING CONSISTING OF RIBBONS OF SYNTHETIC FIBERS ADHERED TO BACKING AND PARTIALLY COVERED WITH A PARTICULATE INFILL FOR THE PLAYING OF FOOTBALL, SOCCER, GOLF, FIELD HOCKEY, LACROSSE, BASEBALL AND OTHER ATHLETIC ACTIVITIES, IN CLASS 27 (U.S. CLS. 19, 20, 37, 42 AND 50).

FIRST USE 6-2-2006; IN COMMERCE 6-2-2006.

FOR: BUSINESS SERVICES, NAMELY, BUSINESS CONSULTATION, BUSINESS MARKETING SERVICES; OFFERING TECHNICAL ASSISTANCE IN THE ESTABLISHMENT AND/OR OPERATION OF SPORTS FACILITIES, IN CLASS 35 (U.S. CLS. 100, 101 AND 102).

FIRST USE 6-2-2006; IN COMMERCE 6-2-2006.

FOR: INSTALLATION AND MAINTENANCE OF SYNTHETIC FIBERS ADHERED TO A BACKING

AND PARTIALLY COVERED WITH A PARTICULATE INFILL, IN CLASS 37 (U.S. CLS. 100, 103 AND 106).

FIRST USE 6-2-2006; IN COMMERCE 6-2-2006.

FOR: TECHNICAL ADVICE IN THE FIELD OF ENGINEERING, IN CLASS 42 (U.S. CLS. 100 AND 101).

FIRST USE 6-2-2006; IN COMMERCE 6-2-2006.

OWNER OF U.S. REG. NOS. 2,465,105, 2,465,107 AND OTHERS.

NO CLAIM IS MADE TO THE EXCLUSIVE RIGHT TO USE "VENUE", APART FROM THE MARK AS SHOWN.

THE COLOR(S) BLUE AND GRAY IS/ARE CLAIMED AS A FEATURE OF THE MARK.

THE COLORS BLUE AND GRAY APPEAR IN THE STADIUM DESIGN, AND THE COLOR BLUE APPEARS IN THE WORDING.

SER. NO. 77-080,168, FILED 1-10-2007.

TEJBIR SINGH, EXAMINING ATTORNEY

Int. Cl.: 35

Prior U.S. Cls.: 100, 101 and 102

United States Patent and Trademark Office

Reg. No. 3,518,851

Registered Oct. 21, 2008

**SERVICE MARK
PRINCIPAL REGISTER**

Guru Program

GABLE, TOM P. (CALIFORNIA INDIVIDUAL)
14947 RANCHO REAL
DEL MAR, CA 92014

FIRST USE 8-13-1998; IN COMMERCE 8-13-1998.

FOR: CONSULTING SERVICES RELATING TO PUBLICITY; PROMOTING PUBLIC AWARENESS OF PROFESSIONAL LEGAL AND ACCOUNTING SERVICES, HEALTH CARE, FINANCIAL SERVICES, REAL ESTATE, LODGING, HOSPITALITY, LIFE SCIENCES, GOLF EQUIPMENT, GOLF EVENT, INFORMATION TECHNOLOGY, WIRELESS, BIOTECHNOLOGY, EDUCATIONAL, AND NOT-FOR-PROFIT ORGANIZATIONS AND INSTITUTIONS; PUBLIC RELATIONS, IN CLASS 35 (U.S. CLS. 100, 101 AND 102).

THE MARK CONSISTS OF STANDARD CHARACTERS WITHOUT CLAIM TO ANY PARTICULAR FONT, STYLE, SIZE, OR COLOR.

NO CLAIM IS MADE TO THE EXCLUSIVE RIGHT TO USE "PROGRAM", APART FROM THE MARK AS SHOWN.

SER. NO. 77-083,326, FILED 1-15-2007.

JASON BLAIR, EXAMINING ATTORNEY

Int. Cl.: 21

Prior U.S. Cls.: 2, 13, 23, 29, 30, 33, 40 and 50

United States Patent and Trademark Office

Reg. No. 3,518,852

Registered Oct. 21, 2008

**TRADEMARK
PRINCIPAL REGISTER**

COOL RING

FLORIDA COOL RING COMPANY (FLORIDA
CORPORATION)
1964 E EDGEWOOD DR.
LAKELAND, FL 33803

THE MARK CONSISTS OF STANDARD CHAR-
ACTERS WITHOUT CLAIM TO ANY PARTICULAR
FONT, STYLE, SIZE, OR COLOR.

FOR: HOLDERS FOR PLANTS, NAMELY, PLAS-
TIC CONTAINERS FOR TREES, IN CLASS 21 (U.S.
CLS. 2, 13, 23, 29, 30, 33, 40 AND 50).

SER. NO. 77-083,634, FILED 1-16-2007.

FIRST USE 12-30-2005; IN COMMERCE 1-13-2006.

MATTHEW EINSTEIN, EXAMINING ATTORNEY

Int. Cl.: 21

Prior U.S. Cls.: 2, 13, 23, 29, 30, 33, 40 and 50

United States Patent and Trademark Office

Reg. No. 3,518,853

Registered Oct. 21, 2008

**TRADEMARK
PRINCIPAL REGISTER**



FLORIDA COOL RING COMPANY (FLORIDA CORPORATION)
1964 E EDGEWOOD DR
LAKELAND, FL 33803

THE MARK CONSISTS OF A FANCIFUL DESIGN.

FOR: HOLDERS FOR PLANTS, NAMELY, PLASTIC CONTAINERS FOR TREES, IN CLASS 21 (U.S. CLS. 2, 13, 23, 29, 30, 33, 40 AND 50).

SER. NO. 77-083,667, FILED 1-16-2007.

FIRST USE 12-30-2005; IN COMMERCE 1-13-2006.

MATTHEW EINSTEIN, EXAMINING ATTORNEY

Int. Cls.: 9, 35, 38 and 42

Prior U.S. Cls.: 21, 23, 26, 36, 38, 100, 101, 102 and 104

United States Patent and Trademark Office

Reg. No. 3,518,854

Registered Oct. 21, 2008

**TRADEMARK
SERVICE MARK
PRINCIPAL REGISTER**



DIMELO SAS (FRANCE CORPORATION)

2 RUE DES CAPUCINS

MEUDON, FRANCE 92190

FOR: COMPUTER SOFTWARE FOR USE IN CUSTOMER RELATIONSHIP MANAGEMENT (CRM), IN CLASS 9 (U.S. CLS. 21, 23, 26, 36 AND 38).

FOR: CREATION OF MARKETING TOOLS DESIGNED TO INCREASE A CLIENT COMPANY'S KNOWLEDGE OF CUSTOMER NEEDS, AND ITS COMPETITORS' PRODUCTS AND SERVICES, PRICING, ADVERTISING STRATEGY AND SALES STRATEGY; ON-LINE ADVERTISING AND MARKETING SERVICES; OPERATING ON-LINE MARKETPLACES FOR SELLERS OF GOODS AND/OR SERVICES, IN CLASS 35 (U.S. CLS. 100, 101 AND 102).

FOR: PROVIDING ON-LINE FORUMS FOR TRANSMISSION OF MESSAGES AMONG COMPUTER USERS CONCERNING BUSINESS PRODUCTS AND SERVICES, IN CLASS 38 (U.S. CLS. 100, 101 AND 104).

FOR: APPLICATION SERVICE PROVIDER (ASP) FEATURING SOFTWARE IN THE FIELD OF CUSTOMER RELATIONSHIP MANAGEMENT; COMPUTER SERVICES, NAMELY, CREATING AN ONLINE COMMUNITY FOR REGISTERED USERS TO PARTICIPATE IN COMPETITIONS, SHOWCASE THEIR SKILLS, GET FEEDBACK FROM THEIR PEERS, FORM VIRTUAL COMMUNITIES, ENGAGE IN SOCIAL NETWORKING AND IMPROVE THEIR TALENT; COMPUTER SERVICES, NAMELY, HOSTING ON-LINE WEB FACILITIES FOR OTHERS FOR ORGANIZING AND CONDUCTING ONLINE MEETINGS, GATHERINGS, AND INTERACTIVE DISCUSSIONS, IN CLASS 42 (U.S. CLS. 100 AND 101).

OWNER OF FRANCE REG. NO. 063420496, DATED 3-29-2006, EXPIRES 3-29-2016.

THE LETTERS "FEE", "ACK" AND THE NUMBER "2.0" ARE IN GRAY; THE LETTER "D" IS ORANGE, AND THE LETTER "B" IS GREEN.

SER. NO. 77-085,815, FILED 1-18-2007.

BRIAN NEVILLE, EXAMINING ATTORNEY

Int. Cls.: 9, 11 and 17

**Prior U.S. Cls.: 1, 5, 12, 13, 21, 23, 26, 31, 34, 35, 36, 38
and 50**

Reg. No. 3,518,855

United States Patent and Trademark Office

Registered Oct. 21, 2008

**TRADEMARK
PRINCIPAL REGISTER**

KURABE

KURABE INDUSTRIAL CO., LTD. (JAPAN CORPORATION)
4830 TAKATSUKA-CHO, HAMAMATSU-SHI
SHIZUOKA-KEN, JAPAN

FOR: ELECTRICAL CABLES AND ELECTRICAL WIRES; SPLICES FOR ELECTRICAL TRANSMISSION LINES, ELECTRICAL SOCKETS, ELECTRIC PLUGS, FIBER OPTIC CABLES, FUSE WIRE, PRINTED CIRCUITS, HYDROMETERS, HUMIDITY SENSORS, ANEMOMETERS, AIR FLOW SENSORS, AND THERMOSTATS, IN CLASS 9 (U.S. CLS. 21, 23, 26, 36 AND 38).

FOR: DOMESTIC HEATING DEVICES, NAMELY, ELECTRIC SPACE HEATERS; COOLING DOMES; LIGHT BULBS; CAR SEAT HEATERS, TOILET SEATS, TOILET SEAT HEATERS, ELECTRICALLY HEATED CARPETS, HOT WATER HEATING INSTALLATIONS, FLARES, LIGHT DIFFUSERS, LUMINOUS TUBES FOR LIGHTING, LIGHTING

INSTALLATIONS FOR DECORATION , IN CLASS 11 (U.S. CLS. 13, 21, 23, 31 AND 34).

FOR: PLASTIC OR RUBBER HOSES FOR ELECTRICAL INSULATION USE, INSULATORS FOR CABLES, THERMOPLASTIC FLEXIBLE TUBES FOR CARRYING FLUID TO A NOZZLE FOR WATER JETTING EQUIPMENT, RUBBER OR PLASTIC PACKING MATERIAL FOR FORMING SEALS, IN CLASS 17 (U.S. CLS. 1, 5, 12, 13, 35 AND 50).

THE MARK CONSISTS OF STANDARD CHARACTERS WITHOUT CLAIM TO ANY PARTICULAR FONT, STYLE, SIZE, OR COLOR.

OWNER OF JAPAN REG. NO. 5000436, DATED 11-2-2006, EXPIRES 11-2-2016.

SER. NO. 77-086,165, FILED 1-18-2007.

TEJBIR SINGH, EXAMINING ATTORNEY

Int. Cl.: 25

Prior U.S. Cls.: 22 and 39

United States Patent and Trademark Office

Reg. No. 3,518,856

Registered Oct. 21, 2008

TRADEMARK
PRINCIPAL REGISTER



JIMENEZ, VIRGINIA (UNITED STATES INDIVIDUAL)
P.O. BOX 20349
FOUNTAIN HILLS, AZ 85269

FOR: WOMEN'S APPAREL, NAMELY, T-SHIRTS AND HATS, IN CLASS 25 (U.S. CLS. 22 AND 39).

FIRST USE 9-15-2006; IN COMMERCE 9-15-2006.

THE MARK CONSISTS OF A CHILI PEPPER IN THE SHAPE OF A WOMAN JUXTAPOSED BETWEEN THE LITERAL TERMS OF THE MARK;

THE LETTER "I" APPEARS AS THE STEM OF THE CHILI PEPPER AND/OR THE HEAD AND NECK OF THE WOMAN.

THE FOREIGN WORDING IN THE MARK TRANSLATES INTO ENGLISH AS PRETTY WOMAN OR PRETTY MOMMA.

SER. NO. 77-086,210, FILED S.R. 1-19-2007 AM. P.R. 12-11-2007.

SAIMA MAKHDOOM, EXAMINING ATTORNEY

Int. Cls.: 35, 41 and 44

Prior U.S. Cls.: 100, 101, 102 and 107

United States Patent and Trademark Office

Reg. No. 3,518,857

Registered Oct. 21, 2008

SERVICE MARK
PRINCIPAL REGISTER



THE CHILDREN'S GARDEN CO.

CHILDREN'S GARDEN COMPANY (NEVADA CORPORATION)
862 SIR FRANCES DRAKE BLVD., NO. 298
SAN ANSELMO, CA 94960

FOR: ON-LINE RETAIL STORE SERVICES FEATURING GARDEN RELATED PRODUCTS; RETAIL STORE SERVICES FEATURING GARDEN RELATED PRODUCTS, IN CLASS 35 (U.S. CLS. 100, 101 AND 102).

FIRST USE 2-18-2005; IN COMMERCE 1-10-2006.

FOR: EDUCATIONAL SERVICES, NAMELY, PROVIDING CLASSES, SEMINARS AND WORKSHOPS IN THE FIELDS OF NATURE, GARDENING AND LANDSCAPING; ENTERTAINMENT IN THE NATURE OF CONDUCTING PARTIES FOR OTHERS AND ARRANGING AND CONDUCTING NATURE WALKS FOR OTHERS, IN CLASS 41 (U.S. CLS. 100, 101 AND 107).

FIRST USE 2-18-2005; IN COMMERCE 1-10-2006.

FOR: LANDSCAPE GARDENING DESIGN FOR OTHERS, IN CLASS 44 (U.S. CLS. 100 AND 101).

FIRST USE 2-18-2005; IN COMMERCE 1-10-2006.

NO CLAIM IS MADE TO THE EXCLUSIVE RIGHT TO USE "GARDEN CO.", APART FROM THE MARK AS SHOWN.

THE MARK CONSISTS OF THE MARK CONSISTS OF THE MARK CONSISTS OF THE DESIGN OF A BOY CHILD PUSHING A WHEEL BARROW WITH A GIRL CHILD RIDING INSIDE WITH THE WORDS THE CHILDREN'S GARDEN CO. WRITTEN BELOW.

SER. NO. 77-086,324, FILED 1-19-2007.

SETH A. RAPPAPORT, EXAMINING ATTORNEY

Int. Cl.: 9

Prior U.S. Cls.: 21, 23, 26, 36 and 38

Reg. No. 3,518,858

United States Patent and Trademark Office

Registered Oct. 21, 2008

**TRADEMARK
PRINCIPAL REGISTER**

AFFINIUM NETINSIGHT

UNICA CORPORATION (DELAWARE CORPORATION)
RESERVOIR PLACE NORTH
170 TRACER LANE
WALTHAM, MA 02451

FOR: COMPUTER SOFTWARE FOR MARKETING, CUSTOMER RELATIONSHIP MANAGEMENT, AND CUSTOMER INTERACTION MANAGEMENT PURPOSES, NAMELY, FOR USE IN CREATING AND MANAGING MARKETING CAMPAIGNS, CUSTOMER PROFILING, DATA MINING, COLLECTING DATA FOR PREDICTIVE MODELING, DATABASE CONTENT MANAGEMENT, CREATING AND MANAGING PERSONALIZED CUSTOMER RELATIONSHIP MODELS,

MARKETING REPORTS, AND E-MAIL CAMPAIGNS, IN CLASS 9 (U.S. CLS. 21, 23, 26, 36 AND 38).

FIRST USE 6-21-2006; IN COMMERCE 6-21-2006.

THE MARK CONSISTS OF STANDARD CHARACTERS WITHOUT CLAIM TO ANY PARTICULAR FONT, STYLE, SIZE, OR COLOR.

OWNER OF U.S. REG. NO. 2,942,323.

SER. NO. 77-086,341, FILED 1-19-2007.

MARK SPARACINO, EXAMINING ATTORNEY

Int. Cl.: 21

Prior U.S. Cls.: 2, 13, 23, 29, 30, 33, 40 and 50

United States Patent and Trademark Office

Reg. No. 3,518,859

Registered Oct. 21, 2008

**TRADEMARK
PRINCIPAL REGISTER**

SILVESTRI

DD TRADERS, INC. (DELAWARE CORPORATION)
7500 WEST 160TH STREET
STILLWELL, KS 66085

FOR: SMALL ORNAMENTAL DISPLAY BOXES MADE PRIMARILY OF GLASS, NAMELY, KEEPSAKE BOXES; CANDLEHOLDERS; DINNERWARE; GLASS BEVERAGE WARE; GLASS ORNAMENTS AND DECORATIONS, NAMELY, VASES, SCULPTURES, CERAMIC FIGURINES; SERVING PIECES MADE OF GLASS, NAMELY, TRAYS, PLATTERS, AND BOWLS; STEMWARE AND SERVING PIECES, NAMELY, TRAYS, BOWLS, AND PLATTERS; DECORATIVE CERAMIC KEEPSAKE BOXES, SOLD EMPTY; FIGURINES OF PORCELAIN AND CERA-

MIC, IN CLASS 21 (U.S. CLS. 2, 13, 23, 29, 30, 33, 40 AND 50).

FIRST USE 11-21-1984; IN COMMERCE 11-21-1984.

THE MARK CONSISTS OF STANDARD CHARACTERS WITHOUT CLAIM TO ANY PARTICULAR FONT, STYLE, SIZE, OR COLOR.

SEC. 2(F).

SER. NO. 77-088,435, FILED 1-22-2007.

TASHIA BUNCH, EXAMINING ATTORNEY

Int. Cls.: 16 and 43

Prior U.S. Cls.: 2, 5, 22, 23, 29, 37, 38, 50, 100 and 101

United States Patent and Trademark Office

Reg. No. 3,518,860

Registered Oct. 21, 2008

**TRADEMARK
SERVICE MARK
PRINCIPAL REGISTER**



by MELIÀ

DORPAN, S.L. (SPAIN CORPORATION)
POLIGONO SON CASTELLO
GREMIO TONELEROS, 24
PALMA DE MAJORCA, SPAIN 07009

FOR: POSTCARDS, STATIONERY; BOOKS, BROCHURES, MAGAZINES AND CATALOGS ON THE SUBJECT OF TRAVEL, TRAVEL DESTINATIONS AND INFORMATION OF INTEREST TO TRAVELERS; POSTERS, IN CLASS 16 (U.S. CLS. 2, 5, 22, 23, 29, 37, 38 AND 50).

FOR: HOTEL SERVICES, RESTAURANT SERVICES, IN CLASS 43 (U.S. CLS. 100 AND 101).

PRIORITY CLAIMED UNDER SEC. 44(D) ON SPAIN APPLICATION NO. 2725642, FILED 8-2-2006, REG. NO. 2725642, DATED 2-26-2007, EXPIRES 8-2-2016.

OWNER OF U.S. REG. NOS. 2,124,741, 3,100,367 AND OTHERS.

THE MARK CONSISTS OF THE WORDS "ME BY MELIÀ" IN STYLIZED FONT.

SER. NO. 77-088,786, FILED 1-23-2007.

MARIA-VICTORIA SUAREZ, EXAMINING ATTORNEY

Int. Cl.: 25

Prior U.S. Cls.: 22 and 39

United States Patent and Trademark Office

Reg. No. 3,518,861

Registered Oct. 21, 2008

**TRADEMARK
PRINCIPAL REGISTER**

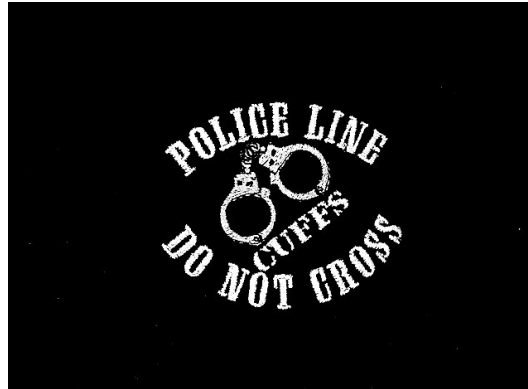

CUFFS, AN IDAHO PARTNERSHIP (IDAHO PARTNERSHIP)
1110 JEFFERSON
IDAHO FALLS, ID 83404

FOR: CLOTHING, NAMELY, T-SHIRTS, HATS, UNDERWEAR, PAJAMAS, JACKETS, AND SWEAT-SHIRTS, IN CLASS 25 (U.S. CLS. 22 AND 39).

FIRST USE 9-9-2003; IN COMMERCE 6-10-2005.

OWNER OF U.S. REG. NO. 3,216,602.

THE MARK CONSISTS OF THE WORDS "POLICE LINE" "DO NOT CROSS" AND "CUFFS," AND A DESIGN OF HANDCUFFS.

SER. NO. 77-088,795, FILED 1-23-2007.

EVELYN BRADLEY, EXAMINING ATTORNEY

Int. Cl.: 9

Prior U.S. Cls.: 21, 23, 26, 36 and 38

Reg. No. 3,518,862

United States Patent and Trademark Office

Registered Oct. 21, 2008

**TRADEMARK
PRINCIPAL REGISTER**

**TITANIUM ORE OPEN
RECEIVABLES ENVIRONMENT**

CR SOFTWARE, LLC (VIRGINIA LIMITED LIABILITY COMPANY)
4035 RIDGE TOP ROAD, SUITE 600
FAIRFAX, VA 22030

FOR: COMPUTER SOFTWARE, NAMELY, DEBT MANAGEMENT SYSTEMS FOR USE AS A COLLECTIONS RECEIVABLE TOOL, IN CLASS 9 (U.S. CLS. 21, 23, 26, 36 AND 38).

FIRST USE 10-16-2006; IN COMMERCE 10-16-2006.

THE MARK CONSISTS OF STANDARD CHARACTERS WITHOUT CLAIM TO ANY PARTICULAR FONT, STYLE, SIZE, OR COLOR.

NO CLAIM IS MADE TO THE EXCLUSIVE RIGHT TO USE "OPEN RECEIVABLES ENVIRONMENT", APART FROM THE MARK AS SHOWN.

SER. NO. 77-090,076, FILED 1-24-2007.

MARILYN IZZI, EXAMINING ATTORNEY

Int. Cls.: 9, 16 and 35

**Prior U.S. Cls.: 2, 5, 21, 22, 23, 26, 29, 36, 37, 38, 50,
100, 101 and 102**

Reg. No. 3,518,863

United States Patent and Trademark Office

Registered Oct. 21, 2008

**TRADEMARK
SERVICE MARK
PRINCIPAL REGISTER**

NATIONAL WESTMINSTER

NATIONAL WESTMINSTER BANK PLC (UNI-
TED KINGDOM PUBLIC LIMITED COMPANY
(PLC))

135 BISHOPSGATE
LONDON, UNITED KINGDOM EC2M3UR

FOR: MAGNETICALLY ENCODED CARDS FOR CARRYING DATA, NAMELY, CARDS CONTAINING DATA TO VERIFY AN INDIVIDUAL'S IDENTITY, CREDIT CARDS, DEBIT CARDS AND CARDS FOR USE WITH AUTOMATED TELLER MACHINES (ATM); MULTIFUNCTION CARDS FOR FINANCIAL SERVICES, NAMELY, MAGNETICALLY ENCODED CREDIT CARDS, MAGNETICALLY ENCODED DEBIT CARDS, MAGNETICALLY ENCODED CARDS FOR USE WITH AUTOMATED TELLER MACHINES (ATM), AND MAGNETICALLY ENCODED CARDS FOR IDENTIFYING USERS OF COMPUTERS, MOBILE PHONES AND AUTOMATED TELLER MACHINES (ATM); MAGNETICALLY ENCODED CHARGE CARDS, CASH CARDS, BANK CARDS, CHECK CARDS, CREDIT CARDS, AND DEBIT CARDS; DOWNLOADABLE COMPUTER SOFTWARE USED IN THE PROVISION OF INSURANCE, FINANCE, BANKING AND CREDIT CARD SERVICES; DOWNLOADABLE PUBLICATIONS, SUPPLIED ON-LINE FROM DATABASES OR FROM WEB PAGES AND WEB SITES ON THE INTERNET, NAMELY, DOWNLOADABLE PAMPHLETS, LEAFLETS, MAGAZINES, NEWSLETTERS, INFORMATION SHEETS AND CIRCULARS IN THE FIELD OF INSURANCE, BANKING, FINANCE AND CREDIT CARD SERVICES; COMPUTER SOFTWARE ENABLING CONNECTION TO ONLINE DATABASES, COMPUTER NETWORKS AND THE INTERNET; TELECOMMUNICATIONS APPARATUS, NAMELY, MODEMS TO ENABLE CONNECTION TO ONLINE DATABASES, COMPUTER NETWORKS AND THE INTERNET; COMPUTER SOFTWARE TO ENABLE SEARCHING OF

DATA, NAMELY, SEARCH ENGINE SOFTWARE; HAND-HELD DEVICES FOR PAYMENT AND VALUE EXCHANGE SERVICES AND FOR OTHER PERSONAL INFORMATION SERVICES, NAMELY, MAGNETIC CODED CARD READERS AND PERSONAL DIGITAL ASSISTANTS USED FOR PAYMENT AND VALUE EXCHANGE SERVICES AND FOR OTHER PERSONAL INFORMATION SERVICES; MAGNETICALLY ENCODED SECURITY ACCESS CARDS; MAGNETICALLY ENCODED IDENTIFICATION CARDS; INTEGRATED CHIP CARDS IN THE NATURE OF CARDS CONTAINING INTEGRATED CIRCUIT CHIPS USED FOR SECURITY ACCESS, BANKING, PAYMENT AND VALUE EXCHANGE, AND PERSONAL INFORMATION EXCHANGE; MAGNETICALLY ENCODED PRE-PAID TELEPHONE CALLING CARDS; ATM MACHINES; MAGNETIC POINT OF SALE ELECTRONIC CARD READERS; REMOTE ACCESS DEVICES, NAMELY, DEVICES FOR ENABLING RETAILERS TO ACCEPT AND VERIFY PAYMENT FOR GOODS BY CREDIT CARD; BLANK MAGNETIC DATA CARRIERS; BLANK ELECTRONIC DATA CARRIERS; COMPUTER HARDWARE AND SOFTWARE USED FOR THE PROVISION OF BANKING SERVICES, FINANCIAL SERVICES, BANK ACCOUNT MANAGEMENT SERVICES, MONETARY TRANSFER SERVICES, PAYMENT SERVICES, FINANCIAL ANALYSIS AND FINANCIAL REPORTS, FINANCIAL MANAGEMENT SERVICES, AND INFORMATION SERVICES RELATING TO BANKING AND FINANCE; COMPUTER SEARCH ENGINE SOFTWARE TO ENABLE THE SEARCHING OF DATA RELATING TO THE AFOREGOING; ELECTRONIC PUBLICATIONS, NAMELY, NEWSLETTERS, MAGAZINES, PERIODICALS, PAMPHLETS AND LEAFLETS ALL IN THE FIELD OF INSURANCE, BANKING, FINANCE AND CREDIT CARD SERVI-

CES ALL RECORDED ON CD-ROM OR DISKETTE, IN CLASS 9 (U.S. CLS. 21, 23, 26, 36 AND 38).

FOR: PAPER, PAPER ARTICLES, NAMELY, CARD WITHOUT MAGNETIC CODING IN THE NATURE OF BUSINESS CARDS, AND ADVERTISING MATERIALS, NAMELY, BUSINESS CARDS, POSTERS, AND PAPER BANNERS; PRINTED MATTER, NAMELY, NEWSLETTERS, BOOKS AND CIRCULARS IN THE FIELD OF INSURANCE, BANKING, FINANCE AND CREDIT CARD SERVICES; STATIONERY, NAMELY, PENS, PENCILS, PAPER WALLETS AND ENVELOPES; NEWSPAPERS, PERIODICALS IN THE FIELD OF INSURANCE, BANKING, FINANCE AND CREDIT CARD SERVICES; CHECK BOOKS; PRINTED PUBLICATIONS IN THE NATURE OF FLYERS, BROCHURES, CATALOGS, BOOKLETS, AND INSTRUCTION MANUALS, NEWSLETTERS, MAGAZINES, PAMPHLETS, LEAFLETS ALL IN THE FIELD OF INSURANCE, BANKING, FINANCE AND CREDIT CARD SERVICES; PLASTIC CARDS NOT MAGNETICALLY ENCODED FOR USE IN BUSINESS TRANSACTIONS; PLASTIC COVERED CARDS NOT MAGNETICALLY ENCODED BEARING PRINTED MATTER FOR USE AS IDENTIFY CARDS, IN CLASS 16 (U.S. CLS. 2, 5, 22, 23, 29, 37, 38 AND 50).

FOR: ACCOUNTING SERVICES; BOOK-KEEPING; SHARE REGISTRATION SERVICES, NAMELY, REGISTERING THE OWNERSHIP OF STOCKS AND BONDS; PAYROLL PREPARATIONS; BUSINESS APPRAISALS, ENQUIRIES, INVESTIGATIONS, RESEARCH AND BUSINESS MANAGEMENT ADVICE; BUSINESS MANAGEMENT CONSULTING; ADVERTISING AND PROMOTION SERVICES AND INFORMATION SERVICES RELATING THERETO; BUSINESS AND COMMERCIAL INFORMATION SERVICES, ALL PROVIDED ON-LINE FROM A COMPUTER DATABASE, COMPUTER NETWORK, GLOBAL COMPU-

TER NETWORK OR THE INTERNET; COMPILATION OF ADVERTISEMENTS FOR USE AS WEB PAGES ON THE INTERNET; BUSINESS MANAGEMENT SERVICES; BUSINESS ADVISORY SERVICES; COMPILATION OF DIRECTORIES FOR PUBLISHING ON GLOBAL COMPUTER NETWORKS OR THE INTERNET; COMPILATION OF ADVERTISEMENTS FOR USE ON OR AS WEB PAGES OR WEB SITES ON GLOBAL COMPUTER NETWORKS OR THE INTERNET; PROVISION OF SPACE ON WEB SITES FOR ADVERTISING GOODS AND SERVICES; BUSINESS ADMINISTRATION SERVICES FOR THE PROCESSING OF SALES MADE ON THE INTERNET; BUSINESS PLANNING; MARKET ANALYSIS AND RESEARCH; DATA COLLECTION, STORAGE AND PROCESSING; PERSONNEL SERVICES IN THE NATURE OF PAYROLL PREPARATION AND PAYROLL PROCESSING SERVICES; ADVISORY, CONSULTANCY AND INFORMATION SERVICES RELATING TO ALL OF THE AFORESAID SERVICES, IN CLASS 35 (U.S. CLS. 100, 101 AND 102).

THE MARK CONSISTS OF STANDARD CHARACTERS WITHOUT CLAIM TO ANY PARTICULAR FONT, STYLE, SIZE, OR COLOR.

OWNER OF ERPN CMNTY TM OFC REG. NO. 004319174, DATED 5-17-2006, EXPIRES 3-31-2015.

OWNER OF UNITED KINGDOM REG. NO. 004319174, DATED 5-17-2006, EXPIRES 5-17-2016.

OWNER OF U.S. REG. NOS. 922,574, 2,430,657 AND OTHERS.

SEC. 2(F).

SER. NO. 77-090,369, FILED 1-24-2007.

SUE LAWRENCE, EXAMINING ATTORNEY

Int. Cls.: 9, 16 and 35

**Prior U.S. Cls.: 2, 5, 21, 22, 23, 26, 29, 36, 37, 38, 50,
100, 101 and 102**

Reg. No. 3,518,864

United States Patent and Trademark Office

Registered Oct. 21, 2008

**TRADEMARK
SERVICE MARK
PRINCIPAL REGISTER**

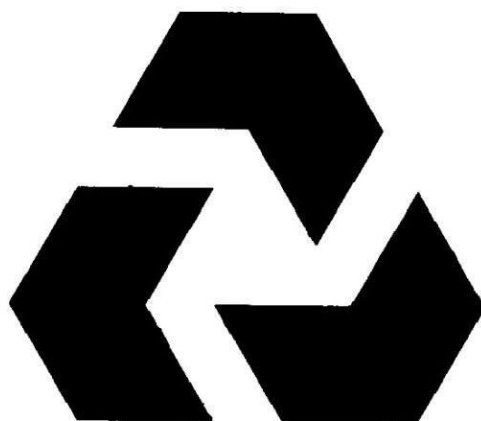

NATIONAL WESTMINSTER BANK PLC (UNI-
TED KINGDOM PUBLIC LIMITED COMPANY
(PLC))
135 BISHOPSGATE
LONDON, UNITED KINGDOM EC2M3UR

FOR: MAGNETICALLY ENCODED CARDS FOR CARRYING DATA, NAMELY, CARDS CONTAINING DATA TO VERIFY AN INDIVIDUAL'S IDENTITY, CREDIT CARDS, DEBIT CARDS AND CARDS FOR USE WITH AUTOMATED TELLER MACHINES (ATM); MULTIFUNCTION CARDS FOR FINANCIAL SERVICES, NAMELY, MAGNETICALLY ENCODED CREDIT CARDS, MAGNETICALLY ENCODED DEBIT CARDS, MAGNETICALLY ENCODED CARDS FOR USE WITH AUTOMATED TELLER MACHINES (ATM), AND MAGNETICALLY ENCODED CARDS FOR IDENTIFYING USERS OF COMPUTERS, MOBILE PHONES AND AUTOMATED TELLER MACHINES (ATM); MAGNETICALLY ENCODED CHARGE CARDS, CASH CARDS, BANK CARDS, CHECK CARDS, CREDIT CARDS, AND DEBIT CARDS; DOWNLOADABLE COMPUTER SOFTWARE USED IN THE PROVISION OF INSURANCE, FINANCE, BANKING AND CREDIT CARD SERVICES; DOWNLOADABLE ELECTRONIC PUBLICATIONS, SUPPLIED ONLINE FROM DATABASES OR FROM WEB PAGES AND WEB SITES ON THE INTERNET, NAMELY, DOWNLOADABLE PAMPHLETS, LEAFLETS, MAGAZINES, NEWSLETTERS, INFORMATION

SHEETS AND CIRCULARS IN THE FIELD OF INSURANCE, BANKING, FINANCE AND CREDIT CARD SERVICES; COMPUTER SOFTWARE ENABLING CONNECTION TO ONLINE DATABASES, COMPUTER NETWORKS AND THE INTERNET; TELECOMMUNICATIONS APPARATUS, NAMELY, MODEMS TO ENABLE CONNECTION TO ONLINE DATABASES, COMPUTER NETWORKS AND THE INTERNET; COMPUTER SOFTWARE TO ENABLE SEARCHING OF DATA, NAMELY, SEARCH ENGINE SOFTWARE; HAND-HELD DEVICES FOR PAYMENT AND VALUE EXCHANGE SERVICES AND FOR OTHER PERSONAL INFORMATION SERVICES, NAMELY, MAGNETIC CODED CARD READERS AND PERSONAL DIGITAL ASSISTANTS USED FOR PAYMENT AND VALUE EXCHANGE SERVICES AND FOR OTHER PERSONAL INFORMATION SERVICES; MAGNETICALLY ENCODED SECURITY ACCESS CARDS; MAGNETICALLY ENCODED IDENTIFICATION CARDS; INTEGRATED CHIP CARDS IN THE NATURE OF CARDS CONTAINING INTEGRATED CIRCUIT CHIPS USED FOR SECURITY ACCESS, BANKING, PAYMENT AND VALUE EXCHANGE, AND PERSONAL INFORMATION EXCHANGE; MAGNETICALLY ENCODED PRE-PAID TELEPHONE CALLING CARDS; ATM MACHINES; MAGNETIC POINT OF SALE ELECTRONIC CARD READERS; REMOTE ACCESS DEVICES, NAMELY, DEVICES FOR ENABLING RETAILERS TO ACCEPT AND VERIFY PAYMENT

FOR GOODS BY CREDIT CARD; BLANK MAGNETIC DATA CARRIERS; BLANK ELECTRONIC DATA CARRIERS; COMPUTER HARDWARE AND SOFTWARE USED FOR THE PROVISION OF BANKING SERVICES, FINANCIAL SERVICES, BANK ACCOUNT MANAGEMENT SERVICES, MONETARY TRANSFER SERVICES, PAYMENT SERVICES, FINANCIAL ANALYSIS AND FINANCIAL REPORTS, FINANCIAL MANAGEMENT SERVICES, AND INFORMATION SERVICES RELATING TO BANKING AND FINANCE; COMPUTER SEARCH ENGINE SOFTWARE TO ENABLE THE SEARCHING OF DATA RELATING TO THE AFOREGOING; ELECTRONIC PUBLICATIONS, NAMELY, NEWSLETTERS, MAGAZINES, PERIODICALS, PAMPHLETS AND LEAFLETS ALL IN THE FIELD OF INSURANCE, BANKING, FINANCE AND CREDIT CARD SERVICES ALL RECORDED ON CD-ROM OR DISKETTE, IN CLASS 9 (U.S. CLS. 21, 23, 26, 36 AND 38).

FOR: PAPER, PAPER ARTICLES, NAMELY, CARD WITHOUT MAGNETIC CODING IN THE NATURE OF BUSINESS CARDS, AND ADVERTISING MATERIALS, NAMELY, BUSINESS CARDS, POSTERS, AND PAPER BANNERS; PRINTED MATTER, NAMELY, NEWSLETTERS, BOOKS AND CIRCULARS IN THE FIELD OF INSURANCE, BANKING, FINANCE AND CREDIT CARD SERVICES; STATIONERY, NAMELY, PENS, PENCILS, PAPER WALLETS AND ENVELOPES; NEWSPAPERS, PERIODICALS IN THE FIELD OF INSURANCE, BANKING, FINANCE AND CREDIT CARD SERVICES; CHECK BOOKS; PRINTED PUBLICATIONS IN THE NATURE OF FLYERS, BROCHURES, CATALOGS, BOOKLETS, AND INSTRUCTION MANUALS, NEWSLETTERS, MAGAZINES, PAMPHLETS, LEAFLETS ALL IN THE FIELD OF INSURANCE, BANKING, FINANCE AND CREDIT CARD SERVICES; PLASTIC CARDS NOT MAGNETICALLY ENCODED FOR USE IN BUSINESS TRANSACTIONS; PLASTIC COVERED CARDS NOT MAGNETICALLY ENCODED BEARING PRINTED MATTER FOR USE AS IDENTIFY CARDS, IN CLASS 16 (U.S. CLS. 2, 5, 22, 23, 29, 37, 38 AND 50).

FOR: ACCOUNTING SERVICES; BOOK-KEEPING; SHARE REGISTRATION SERVICES, NAMELY, REGISTERING THE OWNERSHIP OF STOCKS AND BONDS; PAYROLL PREPARATIONS; BUSINESS APPRAISALS, ENQUIRIES, INVESTIGATIONS, RESEARCH AND BUSINESS MANAGEMENT ADVICE; BUSINESS MANAGEMENT CONSULTING; ADVERTISING AND PROMOTION SERVICES AND INFORMATION SERVICES RELATING THERETO; BUSINESS AND COMMERCIAL INFORMATION SERVICES, ALL PROVIDED ON-LINE FROM A COMPUTER DATABASE, COMPUTER NETWORK, GLOBAL COMPUTER NETWORK OR THE INTERNET; COMPILATION OF ADVERTISEMENTS FOR USE AS WEB PAGES ON THE INTERNET; BUSINESS MANAGEMENT SERVICES; BUSINESS ADVISORY SERVICES; COMPILATION OF DIRECTORIES FOR PUBLISHING ON GLOBAL COMPUTER NETWORKS OR THE INTERNET; COMPILATION OF ADVERTISEMENTS FOR USE ON OR AS WEB PAGES OR WEB SITES ON GLOBAL COMPUTER NETWORKS OR THE INTERNET; PROVISION OF SPACE ON WEB SITES FOR ADVERTISING GOODS AND SERVICES; BUSINESS ADMINISTRATION SERVICES FOR THE PROCESSING OF SALES MADE ON THE INTERNET; BUSINESS PLANNING; MARKET ANALYSIS AND RESEARCH; DATA COLLECTION, STORAGE AND PROCESSING; PERSONNEL SERVICES IN THE NATURE OF PAYROLL PREPARATION AND PAYROLL PROCESSING SERVICES; ADVISORY, CONSULTANCY AND INFORMATION SERVICES RELATING TO ALL OF THE AFORESAID SERVICES, IN CLASS 35 (U.S. CLS. 100, 101 AND 102).

OWNER OF ERPN CMNTY TM OFC REG. NO. 004318978, DATED 5-4-2006, EXPIRES 3-31-2015.

OWNER OF U.S. REG. NO. 922,574.

SER. NO. 77-090,379, FILED 1-24-2007.

SUE LAWRENCE, EXAMINING ATTORNEY

Int. Cl.: 35

Prior U.S. Cls.: 100, 101 and 102

United States Patent and Trademark Office

Reg. No. 3,518,865

Registered Oct. 21, 2008

**SERVICE MARK
PRINCIPAL REGISTER**

RASMUSSEN

R.C. RASMUSSEN CORPORATION (WASHING-
TON CORPORATION)
8727 5TH AVENUE SOUTH
SEATTLE, WA 98108

FOR: RETAIL STORE SERVICES AND WHOLE-
SALE DISTRIBUTORSHIP FEATURING MARINE
VESSELS, BARGES, MARINE CONSTRUCTION
EQUIPMENT, WINCHES, FAIRLEADS, SHEAVES,
MARINE HARDWARE, SHACKLES AND TOW
LINES, AND PARTS FOR ALL OF THE ABOVE, IN
CLASS 35 (U.S. CLS. 100, 101 AND 102).

FIRST USE 0-0-1981; IN COMMERCE 0-0-1981.

THE MARK CONSISTS OF STANDARD CHAR-
ACTERS WITHOUT CLAIM TO ANY PARTICULAR
FONT, STYLE, SIZE, OR COLOR.

SEC. 2(F).

SER. NO. 77-090,419, FILED 1-24-2007.

DAVID I, EXAMINING ATTORNEY

Int. Cls.: 35 and 37

Prior U.S. Cls.: 100, 101, 102, 103 and 106

United States Patent and Trademark Office

Reg. No. 3,518,866

Registered Oct. 21, 2008

**SERVICE MARK
PRINCIPAL REGISTER**



AUTONATION HOLDING CORP. (DELAWARE CORPORATION)

110 S.E. 6TH STREET, 20TH FLOOR
FT. LAUDERDALE, FL 33301

FOR: AUTOMOBILE DEALERSHIP SERVICES, IN CLASS 35 (U.S. CLS. 100, 101 AND 102).

FIRST USE 12-18-2006; IN COMMERCE 12-18-2006.

FOR: AUTOMOBILE REPAIR AND MAINTENANCE SERVICES, IN CLASS 37 (U.S. CLS. 100, 103 AND 106).

FIRST USE 12-18-2006; IN COMMERCE 12-18-2006.

OWNER OF U.S. REG. NOS. 2,568,292, 2,767,218 AND OTHERS.

THE COLOR(S) WHITE, YELLOW, AND GREEN IS/ARE CLAIMED AS A FEATURE OF THE MARK.

THE MARK CONSISTS OF A WHITE TRIANGLE LOCATED IN THE CENTER OF TWO CONCENTRIC CIRCLES WITH THE OUTER CIRCLE IN GREEN AND THE INNER CIRCLE IN YELLOW.

SER. NO. 77-091,955, FILED 1-26-2007.

WILLIAM VERHOSEK, EXAMINING ATTORNEY

Int. Cls.: 16, 35, 41, 43 and 44

**Prior U.S. Cls.: 2, 5, 22, 23, 29, 37, 38, 50, 100, 101, 102
and 107**

Reg. No. 3,518,867

United States Patent and Trademark Office

Registered Oct. 21, 2008

**TRADEMARK
SERVICE MARK
PRINCIPAL REGISTER**

DANNON CARES

THE DANNON RESEARCH INSTITUTE (DELAWARE NOT-FOR-PROFIT CORPORATION)
100 HILLSIDE AVENUE, 3RD FLOOR
WHITE PLAINS, NY 106032863

FOR: PUBLICATIONS, NAMELY, BOOKS, JOURNALS, BROCHURES AND NEWSLETTERS PERTAINING TO THE FIELD OF NUTRITION AND HEALTH, IN CLASS 16 (U.S. CLS. 2, 5, 22, 23, 29, 37, 38 AND 50).

FIRST USE 1-31-2003; IN COMMERCE 1-31-2003.

FOR: PROMOTING PUBLIC AWARENESS OF THE BENEFITS OF NUTRITION AND HEALTHY HABITS; CHARITABLE SERVICES, NAMELY, COORDINATION OF THE PROCUREMENT AND DISTRIBUTION OF FOOD DONATIONS FROM MANUFACTURERS, WHOLESALERS, RETAILERS, AND GOVERNMENT AGENCIES TO ORGANIZATIONS PROVIDING FREE FOOD TO NEEDY PEOPLE, IN CLASS 35 (U.S. CLS. 100, 101 AND 102).

FIRST USE 1-31-2003; IN COMMERCE 1-31-2003.

FOR: PROVIDING EDUCATIONAL PROGRAMS IN THE FIELDS OF NUTRITION AND HEALTH; PROVIDING ONLINE NON-DOWNLOADABLE PUBLICATIONS, NAMELY, NEWSLETTERS, BROCHURES AND JOURNALS IN THE FIELD OF NUTRITION AND HEALTH; EDUCATIONAL RESEARCH ON THE RELATIONSHIP BETWEEN NUTRITION AND HEALTH; DEVELOPMENT AND DISSEMINATION OF EDUCATIONAL MATERIALS OF OTHERS IN THE FIELD OF NUTRITION AND HEALTH; CONDUCTING AN AWARDS PROGRAM

RECOGNIZING EXCELLENCE IN COMMUNITY NUTRITION PROGRAMS; OPERATING AN AWARDS PROGRAM TO RECOGNIZE BUSINESS AND ORGANIZATIONS THAT HAVE DEMONSTRATED A COMMITMENT TO THE HEALTH AND NUTRITIONAL NEEDS OF EMPLOYEES; INFORMATION ABOUT EDUCATION, NAMELY, PROVIDING INFORMATION ABOUT NUTRITION AND HEALTH EDUCATION VIA THE INTERNET; CHARITABLE SERVICES, NAMELY, PROVIDING TRAINING IN THE FIELD OF NUTRITION AND HEALTH, IN CLASS 41 (U.S. CLS. 100, 101 AND 107).

FIRST USE 1-31-2003; IN COMMERCE 1-31-2003.

FOR: CHARITABLE SERVICES, NAMELY, PROVIDING FOOD TO NEEDY PERSONS, IN CLASS 43 (U.S. CLS. 100 AND 101).

FIRST USE 1-31-2003; IN COMMERCE 1-31-2003.

FOR: PROVIDING HEALTH INFORMATION ON A WEBSITE ON NUTRITION AND HEALTHY EATING HABITS, IN CLASS 44 (U.S. CLS. 100 AND 101).

FIRST USE 1-31-2003; IN COMMERCE 1-31-2003.

THE MARK CONSISTS OF STANDARD CHARACTERS WITHOUT CLAIM TO ANY PARTICULAR FONT, STYLE, SIZE, OR COLOR.

SER. NO. 77-092,317, FILED 1-26-2007.

B. PARADEWELAI, EXAMINING ATTORNEY

Int. Cl.: 28

Prior U.S. Cls.: 22, 23, 38 and 50

United States Patent and Trademark Office

Reg. No. 3,518,868

Registered Oct. 21, 2008

**TRADEMARK
PRINCIPAL REGISTER**

HAVOC HELI

SPIN MASTER LTD. (CANADA CORPORATION)
450 FRONT STREET WEST
TORONTO, ONTARIO, CANADA M5V1B6

FOR: FLYING TOYS, NAMELY, TOY AIRCRAFT
AND TOY HELICOPTERS, IN CLASS 28 (U.S. CLS.
22, 23, 38 AND 50).

THE MARK CONSISTS OF STANDARD CHAR-
ACTERS WITHOUT CLAIM TO ANY PARTICULAR
FONT, STYLE, SIZE, OR COLOR.

PRIORITY CLAIMED UNDER SEC. 44(D) ON
CANADA APPLICATION NO. 1328211, FILED 12-14-
2006, REG. NO. TMA713633, DATED 5-6-2008, EX-
PIRES 5-6-2023.

NO CLAIM IS MADE TO THE EXCLUSIVE
RIGHT TO USE "HELI", APART FROM THE MARK
AS SHOWN.

SER. NO. 77-093,528, FILED 1-29-2007.

AHSEN KHAN, EXAMINING ATTORNEY

Int. Cl.: 36

Prior U.S. Cls.: 100, 101 and 102

United States Patent and Trademark Office

Reg. No. 3,518,869

Registered Oct. 21, 2008

**SERVICE MARK
PRINCIPAL REGISTER**

BLUE BBVA

BANCO BILBAO VIZCAYA ARGENTARIA, S.A.
(SPAIN CORPORATION)
PLAZA SAN NICOLÁS, 4
BILBAO (VIZCAYA), SPAIN 48005

FOR: INSURANCE AGENCY SERVICES; CURRENCY EXCHANGE SERVICES; FINANCIAL CLEARINGHOUSE SERVICES; CO-OPERATIVE CREDIT SERVICES; INVESTMENT TRUST SERVICES FOR HOLDING COMPANIES; BROKERAGE SERVICES RELATING TO STOCKS, BONDS AND REAL ESTATE; REAL ESTATE TRUSTEE SERVICES AND TRUSTEESHIP REPRESENTATIVES; ISSUING OF TRAVELERS CHECKS, CREDIT CARDS AND LETTERS OF CREDIT; FINANCIAL ANALYSIS; INVESTMENT SERVICES FOR OTHERS, NAMELY, MUTUAL FUND INVESTMENT SERVICES; COLLECTION AND CREDIT AGENCIES; FIDUCIARY REPRESENTATIVE, LEASE-PURCHASE AND

LOAN FINANCING SERVICES; REAL ESTATE APPRAISAL AND MANAGEMENT; SAFE DEPOSIT BOX SERVICES, IN CLASS 36 (U.S. CLS. 100, 101 AND 102).

THE MARK CONSISTS OF STANDARD CHARACTERS WITHOUT CLAIM TO ANY PARTICULAR FONT, STYLE, SIZE, OR COLOR.

OWNER OF SPAIN REG. NO. 2065621, DATED 12-20-2004, EXPIRES 12-20-2014.

OWNER OF U.S. REG. NOS. 2,562,867, 3,012,862 AND OTHERS.

SER. NO. 77-093,712, FILED 1-29-2007.

HENRY S. ZAK, EXAMINING ATTORNEY

Int. Cls.: 18 and 25

Prior U.S. Cls.: 1, 2, 3, 22, 39 and 41

Reg. No. 3,518,870

United States Patent and Trademark Office

Registered Oct. 21, 2008

**TRADEMARK
PRINCIPAL REGISTER**

UNCONDITIONAL

PHILIP ALAN STEPHENS (UNITED KINGDOM
INDIVIDUAL)
10 RICHMOND BUILDINGS
31 SOHO LOFTS
LONDON, UNITED KINGDOM W1D3DD

FOR: LEATHER AND IMITATIONS OF LEATHER, AND GOODS MADE OF THESE MATERIALS AND NOT INCLUDED IN OTHER CLASSES, NAMELY, BRIEFCASES, SUITCASES, RUCKSACKS, WALLETS, HANDBAGS, KEY CASES, KEY CHAINS, PURSES, SHOPPING BAGS AND TRAVELING CASES; HANDBAGS, RUCKSACKS, BRIEFCASES, PURSES, WALLETS, CARD HOLDERS, KEY CASES AND HOLDERS; SUITCASES; ARTICLES OF LUGGAGE, NAMELY, CARRY-ON BAGS, SHOPPING BAGS FOR TRAVEL, TRUNKS AND TRAVELING BAGS, BAGS FOR CARRYING SPORTS IMPLEMENTS AND SPORTS CLOTHING, CARRYING CASES AND BAGS FOR TOILETRIES SOLD EMPTY, BEAUTY CASES, NAMELY, COSMETICS CASES SOLD EMPTY; SHOULDER BELTS MADE OF LEATHER AND IMITATION LEATHER; UMBRELLAS, PARASOLS AND WALKING STICKS, IN CLASS 18 (U.S. CLS. 1, 2, 3, 22 AND 41).

FOR: CLOTHING, NAMELY, WATERPROOF CLOTHING IN THE NATURE OF SHOES, JACKETS AND COATS; T-SHIRTS; SWEATSHIRTS; SWEAT PANTS; SWEATERS; SUITS; SINGLETS; VESTS; HEAD SCARVES; SHIRTS; BLOUSES; GLOVES; STOCKINGS; DRESSING GOWNS; UNDERWEAR; CAPES; SHAWLS; JEANS; PYJAMAS; CHILDREN'S CLOTHING IN THE NATURE OF JACKETS, COATS, JUMPERS, DRESSES, TROUSERS, SHIRTS, SHORTS, SKIRTS, POLO SHIRTS, VESTS, T-SHIRTS, SHOES, UNDERWEAR, SOCKS, SWIMWEAR,

WAISTCOATS, SCARVES, HATS, GLOVES, DRESSES, TROUSERS; PULLOVERS; KNITWEAR IN THE NATURE OF V-NECK SWEATERS, POLO NECK SWEATERS, JACKETS, JUMPERS, CARDIGANS, WAISTCOATS, SCARVES, HATS, GLOVES, DRESSES, TROUSERS; JOGGING SUITS; ANORAKS; BOMBER JACKETS; JACKETS; LEATHER JACKETS; DOWN-FILLED JACKETS; WIND-CHEATERS; OVERCOATS; SHORTS; SKIRTS, SOCKS, RUGBY SHIRTS; FLEECE TOPS; JUMPERS; BELTS; POLO SHIRTS; DRESSES; SWIMWEAR; BEACHWEAR; CARDIGANS; COATS; TROUSERS; MINI-SHIRTS; PINAFORES; WAISTCOATS; OVERALLS; DANCE CLOTHING IN THE NATURE OF TUTUS, TROUSERS, TOPS, T-SHIRTS AND LEOTARDS; LEOTARDS; LEGGINGS; SCARVES; TIES; FOOTWEAR; HEADGEAR, NAMELY, CAPS AND BASEBALL CAPS; BANDANNAS; RAIN HATS; KNITTED HATS; FELTS HATS; STRAW HATS; HEADBANDS; CLOTHING BELTS MADE OF LEATHER AND IMITATION LEATHER; BOOT BAGS FOR CRUISING BOOTS, ARMY BOOTS, SKI BOOTS, HIKING BOOTS, RUBBER BOOTS, HUNTING BOOTS AND LEATHER ANKLE, KNEE AND THIGH HIGH BOOTS, IN CLASS 25 (U.S. CLS. 22 AND 39).

THE MARK CONSISTS OF STANDARD CHARACTERS WITHOUT CLAIM TO ANY PARTICULAR FONT, STYLE, SIZE, OR COLOR.

OWNER OF ERPN CMNTY TM OFC REG. NO. 4086997, DATED 3-1-2006, EXPIRES 10-22-2014.

SER. NO. 77-094,276, FILED 1-30-2007.

RON FAIRBANKS, EXAMINING ATTORNEY

Int. Cl.: 27

Prior U.S. Cls.: 19, 20, 37, 42 and 50

United States Patent and Trademark Office

Reg. No. 3,518,871

Registered Oct. 21, 2008

**TRADEMARK
PRINCIPAL REGISTER**

BUILDER SELECT

COLUMBIA INSURANCE COMPANY (NEBRASKA CORPORATION)
3024 HARNEY STREET
OMAHA, NE 681313580

FOR: CARPETING, IN CLASS 27 (U.S. CLS. 19, 20, 37, 42 AND 50).

FIRST USE 7-31-2000; IN COMMERCE 7-31-2000.

THE MARK CONSISTS OF STANDARD CHARACTERS WITHOUT CLAIM TO ANY PARTICULAR FONT, STYLE, SIZE, OR COLOR.

SEC. 2(F) AS TO "BUILDER".

SER. NO. 77-094,443, FILED 1-30-2007.

SETH A. RAPPAPORT, EXAMINING ATTORNEY

Int. Cl.: 9

Prior U.S. Cls.: 21, 23, 26, 36 and 38

United States Patent and Trademark Office

Reg. No. 3,518,872

Registered Oct. 21, 2008

**TRADEMARK
PRINCIPAL REGISTER**

REJUST-IT

MICROBRIDGE TECHNOLOGIES CANADA,
INC. (CANADA CORPORATION)

1980 WEST SHERBROOKE STREET, SUITE 505

MONTREAL, QUEBEC, CANADA H3H1E8

FOR: COMPUTER SOFTWARE FOR REPEATED,
PRECISION ELECTRICAL TRIMMING OF PASSIVE
SEMICONDUCTOR CHIPS FOR DISCRETE AND
INTEGRATED CIRCUITS, IN CLASS 9 (U.S. CLS. 21,
23, 26, 36 AND 38).

THE MARK CONSISTS OF STANDARD CHAR-
ACTERS WITHOUT CLAIM TO ANY PARTICULAR
FONT, STYLE, SIZE, OR COLOR.

PRIORITY CLAIMED UNDER SEC. 44(D) ON
CANADA APPLICATION NO. 1332091, FILED 1-19-
2007, REG. NO. TMA701702, DATED 11-27-2007, EX-
PIRES 11-27-2022.

SER. NO. 77-094,479, FILED 1-30-2007.

ELIZABETH KAJUBI, EXAMINING ATTORNEY

Int. Cls.: 10, 12 and 20

Prior U.S. Cls.: 2, 13, 19, 21, 22, 23, 25, 26, 31, 32, 35,
39, 44 and 50

Reg. No. 3,518,873

United States Patent and Trademark Office

Registered Oct. 21, 2008

TRADEMARK
PRINCIPAL REGISTER

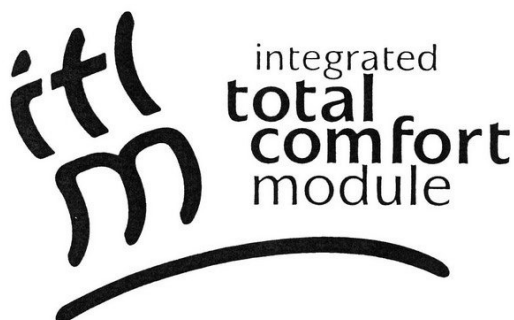

L & P SWISS HOLDING COMPANY (SWITZER-
LAND CORPORATION)
GRUNTALSTRASSE 23
WITTENBACH, SWITZERLAND 9303

FOR: SPECIALLY DESIGNED FURNITURE, NAMELY, CHAIRS FOR MEDICAL PURPOSES, NAMELY, FOR MEDICAL PATIENTS; ARMCHAIRS FOR MEDICAL PURPOSES, NAMELY, MEDICAL EXAMINATION; SEAT MODULES, NAMELY, SEAT INSERTS FOR SEAT FRAMES FOR MEDICAL PATIENTS; SEAT COMPONENTS, NAMELY, LUMBAR SUPPORTS AND CUSHIONS FOR MEDICAL PATIENTS; BACKRESTS FOR LORDOSIS PATIENTS; ERGONOMIC REST DEVICES; NAMELY, SEAT AND BACK CUSHIONS FOR LORDOSIS PATIENTS AND RESTS, NAMELY, CUSHIONS FOR LORDOSIS PATIENTS, THE AFOREMENTIONED GOODS DESTINED FOR SPECIALLY DESIGNED FURNITURE FOR MEDICAL PURPOSES, IN CLASS 10 (U.S. CLS. 26, 39 AND 44).

FOR: VEHICLE ACCESSORIES, NAMELY, AUTOMOBILE SEAT CUSHIONS, AUTOMOBILE CARGO RACKS; VEHICLE SEATS; AUTOMOBILE SEAT MODULES, NAMELY, AUTOMOBILE SEAT CUSHIONS; AUTOMOBILE SEAT COMPONENTS, NAMELY, LUMBAR SUPPORTS AND CUSHIONS; AUTOMOBILE BACKRESTS USED FOR VEHICLE SEATS; AUTOMOBILE ERGONOMIC REST DEVICES AND RESTS, NAMELY, AUTOMOBILE SEAT CUSHIONS FOR PASSENGERS TO BE USED FOR VEHICLE SEATS; THE AFOREMENTIONED

GOODS DESTINED FOR AUTOMOTIVE SEATS, IN CLASS 12 (U.S. CLS. 19, 21, 23, 31, 35 AND 44).

FOR: SITTING FURNITURE; OFFICE FURNITURE; HAIR DRESSER'S FURNITURE; BACKRESTS FOR ARMCHAIRS, SEATS, AND SITTING FURNITURE; SITTING CUSHIONS; SEAT MODULES, NAMELY, SEAT CUSHIONS; SEAT COMPONENTS, NAMELY, LUMBAR SUPPORTS FOR USE WITH CHAIRS AND SEATS; ERGONOMIC REST DEVICES AND RESTS, NAMELY, SEAT CUSHIONS AND LUMBAR SUPPORTS FOR LORDOSIS PATIENTS, DESTINED FOR SITTING FURNITURE AND OFFICE FURNITURE, IN CLASS 20 (U.S. CLS. 2, 13, 22, 25, 32 AND 50).

OWNER OF FED REP GERMANY REG. NO. 30647643, DATED 10-19-2006, EXPIRES 8-31-2016.

NO CLAIM IS MADE TO THE EXCLUSIVE RIGHT TO USE "TOTAL COMFORT MODULE", APART FROM THE MARK AS SHOWN.

THE MARK CONSISTS OF THE WORDS "INTEGRATED TOTAL COMFORT MODULE" AND THE LETTERS "I", "T", "C" AND "M" IN FANCIFUL SCRIPT, WITH AN INVERTED CURVED LINE UNDER ALL.

SER. NO. 77-094,682, FILED 1-30-2007.

LEIGH CAROLINE CASE, EXAMINING ATTORNEY

Int. Cl.: 42

Prior U.S. Cls.: 100 and 101

United States Patent and Trademark Office

Reg. No. 3,518,874

Registered Oct. 21, 2008

**SERVICE MARK
PRINCIPAL REGISTER**



EXACTCOST, INC. (DELAWARE CORPORATION)
SUITE 704
1920 E. HALLANDALE BEACH BLVD
HALLANDALE BEACH, FL 33009

FOR: APPLICATION SERVICE PROVIDER FEATURING SOFTWARE APPLICATIONS FOR DATA MANAGEMENT, ACTIVITY-BASED COST AND PERFORMANCE MANAGEMENT FOR USE IN THE HEALTHCARE FIELD, AND PROVIDING RELATED CONSULTING SERVICES, IN CLASS 42 (U.S. CLS. 100 AND 101).

FIRST USE 1-31-2007; IN COMMERCE 1-31-2007.

OWNER OF U.S. REG. NOS. 2,693,382, 2,722,880 AND OTHERS.

NO CLAIM IS MADE TO THE EXCLUSIVE RIGHT TO USE "HEALTHCARE PERFORMANCE

TECHNOLOGIES", APART FROM THE MARK AS SHOWN.

THE COLOR(S) BLACK AND BLUE IS/ARE CLAIMED AS A FEATURE OF THE MARK.

THE MARK CONSISTS OF THE WORDS "EXACTCOST" AND "HEALTHCARE PERFORMANCE TECHNOLOGIES", IN BLACK, EXCEPT FOR THE "COST" WHICH IS IN BLUE, WITH A BLUE CIRCLE AND A BLUE ARROW POINTING UPWARD AND TO THE RIGHT INTERSECTING THE CIRCLE, THE ARROW FORMED BY DOTS.

SEC. 2(F) AS TO "EXACTCOST".

SER. NO. 77-095,471, FILED 1-31-2007.

ELLEN PERKINS, EXAMINING ATTORNEY

Int. Cls.: 1 and 42

Prior U.S. Cls.: 1, 5, 6, 10, 26, 46, 100 and 101

United States Patent and Trademark Office

Reg. No. 3,518,875

Registered Oct. 21, 2008

**TRADEMARK
SERVICE MARK
PRINCIPAL REGISTER**

CLONTECH

CLONTECH LABORATORIES, INC. (CALIFORNIA CORPORATION)
1290 TERRA BELLA AVENUE
MOUNTAIN VIEW, CA 94043

FOR: REAGENTS FOR SCIENTIFIC OR MEDICAL RESEARCH USE, NAMELY, ENZYMES, NUCLEIC ACIDS, NUCLEOTIDES, PROTEINS, ANTIBODIES, BUFFER SOLUTIONS, BIOLOGICAL REAGENT OR BIOCHEMICALS AND CONJUGATES USED IN MOLECULAR BIOLOGICAL LABORATORIES; AND KITS COMPRISED OF REAGENTS FOR SCIENTIFIC OR MEDICAL RESEARCH USE, NAMELY, BUFFER SOLUTIONS, BIOLOGICAL REAGENT OR BIOCHEMICALS AND CONJUGATES USED IN MOLECULAR BIOLOGICAL LABORATORIES; AND REAGENTS, NAMELY, RESINS USED IN BIOLOGICAL OR BIOCHEMICAL LABORATORY PROCEDURES, NAMELY, CHROMATOGRAPHIC SEPARATION AND PURIFICATION, IN CLASS 1 (U.S. CLS. 1, 5, 6, 10, 26 AND 46).

FIRST USE 3-23-1984; IN COMMERCE 3-23-1984.

FOR: LABORATORY RESEARCH SERVICES IN THE FIELD OF MOLECULAR BIOLOGY, NAMELY, CUSTOMIZED CDNA LIBRARY CONSTRUCTION, CUSTOMIZED HYBRIDIZATION SERVICES, AND CUSTOMIZED ADENOVIRUS SERVICES, IN CLASS 42 (U.S. CLS. 100 AND 101).

FIRST USE 3-23-1984; IN COMMERCE 3-23-1984.

THE MARK CONSISTS OF STANDARD CHARACTERS WITHOUT CLAIM TO ANY PARTICULAR FONT, STYLE, SIZE, OR COLOR.

OWNER OF U.S. REG. NO. 2,429,360.

SER. NO. 77-096,260, FILED 1-31-2007.

SARA THOMAS, EXAMINING ATTORNEY

Int. Cl.: 41

Prior U.S. Cls.: 100, 101 and 107

United States Patent and Trademark Office

Reg. No. 3,518,876

Registered Oct. 21, 2008

SERVICE MARK
PRINCIPAL REGISTER



WILLET, INC. (MARYLAND CORPORATION)
1400 OLD TANEYTOWN RD.
WESTMINSTER, MD 21158

FOR: ENTERTAINMENT SERVICES IN THE NATURE OF VISUAL AND AUDIO PERFORMANCES, AND MUSICAL, VARIETY, NEWS AND COMEDY SHOWS; ENTERTAINMENT SERVICES IN THE NATURE OF VISUAL AND AUDIO PERFORMANCES, NAMELY, LIVE MUSIC CONCERTS, LIVE PERFORMANCES BY A MUSICAL BAND, LIVE PERFORMANCES BY A ROCK GROUP, CONTEMPORARY MUSICIANS AND MUSICAL SOLOISTS; ENTERTAINMENT SERVICES, NAMELY, PROVIDING A WEB SITE FEATURING MUSICAL PERFORMANCES, MUSICAL VIDEOS, RELATED FILM CLIPS, PHOTOGRAPHS, AND OTHER MULTIMEDIA MATERIALS; MUSIC COMPOSITION AND TRANSCRIPTION FOR OTHERS; INSTRUCTION IN THE FIELD OF MUSIC COMPOSITION, MUSIC RECORDING, INSTRUMENTAL INSTRUCTION, VOCAL TRAINING; MUSIC PRODUCTION SERVICES, NAMELY, PRODUCTION OF SOUND

AND MUSIC VIDEO AND AUDIO RECORDINGS; MUSIC PUBLISHING SERVICES, IN CLASS 41 (U.S. CLS. 100, 101 AND 107).

FIRST USE 10-1-2006; IN COMMERCE 10-1-2006.

THE MARK CONSISTS OF A BLACK BACKGROUND, AND A SMALL DASHED CIRCLE ENCLOSED BY A LARGE DASHED CIRCLE. WITHIN THE SMALL DASHED CIRCLE IS A CAPITAL LETTER "L" IN BLOCK LETTERS IN THE FORM OF A RIGHT ANGLE, DIRECTLY NEXT TO ANOTHER CAPITAL LETTER "L" WHICH FACES IN THE OPPOSITE DIRECTION; UNDERNEATH THE CIRCULAR IMAGE IN ALL CAPITAL LETTERS IS THE WORD "WILLET", WHEREIN THE LETTERS "LL" ARE ENCLOSED IN A CIRCLE. UNDERNEATH THE WORD "WILLET" IS THE WEBSITE ADDRESS, "WWW.WILLETONLINE.COM".

SER. NO. 77-097,142, FILED 2-1-2007.

SUSAN LESLIE DUBOIS, EXAMINING ATTORNEY

Int. Cls.: 18 and 25

Prior U.S. Cls.: 1, 2, 3, 22, 39 and 41

United States Patent and Trademark Office

Reg. No. 3,518,877

Registered Oct. 21, 2008

**TRADEMARK
PRINCIPAL REGISTER**

A | U | R

FLETCHER LEISURE GROUP INC. (CANADA CORPORATION)
104 RUE BARR
MONTREAL, QUEBEC, CANADA H4T1Y4

FOR: CARRY-ALL BAGS, TOTE BAGS, IN CLASS 18 (U.S. CLS. 1, 2, 3, 22 AND 41).

FOR: ATHLETIC CLOTHING, NAMELY, SHORTS, SHIRTS, PANTS, VESTS, SKIRTS, SWEATERS, JERSEYS, CASUAL CLOTHING, NAMELY, SHORTS, SHIRTS, PANTS, VESTS, SKIRTS, SWEATERS, JERSEYS, GOLF WEAR, NAMELY, SHORTS, SKIRTS, PANTS, SHIRTS, SWEATERS, VESTS, RAIN SUITS, HATS, GLOVES, IN CLASS 25 (U.S. CLS. 22 AND 39).

PRIORITY CLAIMED UNDER SEC. 44(D) ON CANADA APPLICATION NO. 1,333,478, FILED 1-31-2007, REG. NO. TMA708,006, DATED 2-21-2008, EXPIRES 2-21-2023.

THE MARK CONSISTS OF THE LETTERS "A", "U" AND "R", WITH TWO LINES, ONE BETWEEN THE "A" AND "U" AND ONE BETWEEN THE "U" AND "R".

SER. NO. 77-099,014, FILED 2-5-2007.

ELISSA GARBER KON, EXAMINING ATTORNEY

Int. Cl.: 9

Prior U.S. Cls.: 21, 23, 26, 36 and 38

Reg. No. 3,518,878

United States Patent and Trademark Office

Registered Oct. 21, 2008

**TRADEMARK
PRINCIPAL REGISTER**

chicon

SONY MANUFACTURING SYSTEMS KABUSHI-
KI KAISHA (JAPAN CORPORATION), DBA
SONY MANUFACTURING SYSTEMS COR-
PORATION

1-10 KIYOKU-CHO

KUKI-SHI, SAITAMA, JAPAN

FOR: OPTICAL APPARATUS AND INSTRU-
MENTS NOT FOR MEDICAL USE, NAMELY, LA-
SER-LIGHT GENERATORS , IN CLASS 9 (U.S. CLS.
21, 23, 26, 36 AND 38).

THE MARK CONSISTS OF STANDARD CHAR-
ACTERS WITHOUT CLAIM TO ANY PARTICULAR
FONT, STYLE, SIZE, OR COLOR.

PRIORITY CLAIMED UNDER SEC. 44(D) ON
JAPAN APPLICATION NO. 2007-007774, FILED 2-1-
2007, REG. NO. 5127821, DATED 4-11-2008, EXPIRES
4-11-2020.

SER. NO. 77-100,329, FILED 2-6-2007.

GIANCARLO CASTRO, EXAMINING ATTORNEY

Int. Cl.: 9

Prior U.S. Cls.: 21, 23, 26, 36 and 38

Reg. No. 3,518,879

United States Patent and Trademark Office

Registered Oct. 21, 2008

**TRADEMARK
PRINCIPAL REGISTER**

chicon

SONY MANUFACTURING SYSTEMS KABUSHI-
KI KAISHA (JAPAN CORPORATION), DBA
SONY MANUFACTURING SYSTEMS COR-
PORATION
1-10 KIYOKU-CHO
KUKI-SHI, SAITAMA, JAPAN

FOR: OPTICAL APPARATUS AND INSTRU-
MENTS NOT FOR MEDICAL USE, NAMELY, LA-
SER-LIGHT GENERATORS , IN CLASS 9 (U.S. CLS.
21, 23, 26, 36 AND 38).

PRIORITY CLAIMED UNDER SEC. 44(D) ON
JAPAN APPLICATION NO. 2007-007775, FILED 2-1-
2007, REG. NO. 5127822, DATED 4-11-2008, EXPIRES
4-11-2020.

SER. NO. 77-100,343, FILED 2-6-2007.

GIANCARLO CASTRO, EXAMINING ATTORNEY

Int. Cl.: 1

Prior U.S. Cls.: 1, 5, 6, 10, 26 and 46

Reg. No. 3,518,880

United States Patent and Trademark Office

Registered Oct. 21, 2008

**TRADEMARK
PRINCIPAL REGISTER**

MICROZYME

APPLIED BIOTECH INDUSTRIES, INC. (WIS-
CONSIN CORPORATION)
520 PROGRESS DRIVE
BELGUIM, WI 53004

THE MARK CONSISTS OF STANDARD CHAR-
ACTERS WITHOUT CLAIM TO ANY PARTICULAR
FONT, STYLE, SIZE, OR COLOR.

FOR: BIOTECHNOLOGY FORMED MICROBES
AND ENZYMES FOR USE IN THE BREAKDOWN
AND CONSUMPTION OF ORGANIC WASTES, IN
CLASS 1 (U.S. CLS. 1, 5, 6, 10, 26 AND 46).

SER. NO. 77-101,989, FILED 2-7-2007.

FIRST USE 1-1-1996; IN COMMERCE 1-1-1996.

BENJAMIN OKEKE, EXAMINING ATTORNEY

Int. Cl.: 33

Prior U.S. Cls.: 47 and 49

United States Patent and Trademark Office

Reg. No. 3,518,881

Registered Oct. 21, 2008

**TRADEMARK
PRINCIPAL REGISTER**

Mirrabooka

THE WINE ANGEL, INC. (NEW YORK CORPORATION)
115 W 30TH STREET, SUITE 505
NEW YORK, NY 10011

THE MARK CONSISTS OF STANDARD CHARACTERS WITHOUT CLAIM TO ANY PARTICULAR FONT, STYLE, SIZE, OR COLOR.

FOR: WINE; WINES, IN CLASS 33 (U.S. CLS. 47 AND 49).

SER. NO. 77-102,205, FILED 2-8-2007.

FIRST USE 12-28-2005; IN COMMERCE 5-1-2006.

TIMOTHY FINNEGAN, EXAMINING ATTORNEY

Int. Cl.: 41

Prior U.S. Cls.: 100, 101 and 107

United States Patent and Trademark Office

Reg. No. 3,518,882

Registered Oct. 21, 2008

**SERVICE MARK
PRINCIPAL REGISTER**



REMY BUMPPO THEATRE COMPANY (ILLI-
NOIS NON-PROFIT CORPORATION)
3717 N. RAVENSWOOD AVENUE
CHICAGO, IL 60613

FOR: ENTERTAINMENT SERVICES, NAMELY,
PRODUCTION AND PRESENTATION OF LIVE
THEATRICAL PRODUCTIONS, IN CLASS 41 (U.S.
CLS. 100, 101 AND 107).

FIRST USE 10-1-2006; IN COMMERCE 10-1-2006.

"REMY BUMPPO" DOES NOT IDENTIFY A LIV-
ING INDIVIDUAL.

SER. NO. 77-103,424, FILED 2-9-2007.

MARLENE BELL, EXAMINING ATTORNEY

Int. Cl.: 45

Prior U.S. Cls.: 100 and 101

United States Patent and Trademark Office

Reg. No. 3,518,883

Registered Oct. 21, 2008

**SERVICE MARK
PRINCIPAL REGISTER**



NEPTUNE

Shoreside Services

GENERAL STEAMSHIP AGENCIES, INC. (CALIFORNIA CORPORATION)
575 REDWOOD HIGHWAY, SUITE 200
MILL VALLEY, CA 94941

FOR: SECURITY SERVICES FOR PASSENGER AND BAGGAGE SCREENING AT CRUISE SHIP TERMINALS, IN CLASS 45 (U.S. CLS. 100 AND 101).

FIRST USE 0-0-1999; IN COMMERCE 0-0-2000.

NO CLAIM IS MADE TO THE EXCLUSIVE RIGHT TO USE "SHORESIDE SERVICES", APART FROM THE MARK AS SHOWN.

THE MARK CONSISTS OF A DEPICTION OF A MAN WITH PITCH FORK WITHIN A RECTANGLE WITH THE WORDS "NEPTUNE SHORESIDE SERVICES" TO THE RIGHT.

SER. NO. 77-104,013, FILED 2-9-2007.

JANICE L. MCMORROW, EXAMINING ATTORNEY

Int. Cl.: 4

Prior U.S. Cls.: 1, 6 and 15

United States Patent and Trademark Office

Reg. No. 3,518,884

Registered Oct. 21, 2008

**TRADEMARK
PRINCIPAL REGISTER**

**豪润驰凯
HR CHIK**

SHANDONG EASTSUN OIL CHEMISTRY COMPANY (CHINA CORPORATION)
399 JI-WEI ROAD
JINAN, CHINA 250022

FOR: ALL PURPOSE LUBRICANTS; AUTOMOBILE LUBRICANTS; AUTOMOTIVE LUBRICANTS; DRILLING LUBRICANTS; GRAPHITE AS A LUBRICANT; GRAPHITE LUBRICANTS; INDUSTRIAL LUBRICANTS; LINSEED OIL FOR USE AS A LUBRICANT; LUBRICANTS FOR AIRCRAFT ENGINES; LUBRICANTS FOR INDUSTRIAL MACHINERY; LUBRICATING GREASES; LUBRICATING OIL FOR MOTOR VEHICLE ENGINES; LUBRICATING OILS; LUBRICATION GREASE FOR VEHICLES; MARINE LUBRICANTS; SOLID FILM LUBRICANTS; VINYL WINDOW LUBRICANT, IN CLASS 4 (U.S. CLS. 1, 6 AND 15).

FIRST USE 12-10-2006; IN COMMERCE 12-10-2006.

THE FOREIGN WORDING IN THE MARK TRANSLATES INTO ENGLISH AS HEROIC SLEEK SPEED TRIUMPH.

THE NON-LATIN CHARACTER(S) IN THE MARK TRANSLITERATE INTO "HAU RUN CHI KAI".

SER. NO. 77-104,393, FILED 2-10-2007.

KHANH LE, EXAMINING ATTORNEY

Int. Cl.: 28

Prior U.S. Cls.: 22, 23, 38 and 50

United States Patent and Trademark Office

Reg. No. 3,518,885

Registered Oct. 21, 2008

**TRADEMARK
PRINCIPAL REGISTER**

SOCK ORPHANS

WEBB, QUENTIN (UNITED STATES INDIVIDUAL)
2109 BROADWAY
APT. 13-75
NEW YORK, NY 10023

FOR: PLUSH TOYS; SOFT SCULPTURE PLUSH TOYS; SOFT SCULPTURE TOYS; STUFFED TOYS, IN CLASS 28 (U.S. CLS. 22, 23, 38 AND 50).

FIRST USE 11-15-2005; IN COMMERCE 5-1-2006.

THE MARK CONSISTS OF STANDARD CHARACTERS WITHOUT CLAIM TO ANY PARTICULAR FONT, STYLE, SIZE, OR COLOR.

NO CLAIM IS MADE TO THE EXCLUSIVE RIGHT TO USE "SOCK", APART FROM THE MARK AS SHOWN.

SER. NO. 77-106,850, FILED 2-13-2007.

ANNE E. GUSTASON, EXAMINING ATTORNEY

Int. Cl.: 9

Prior U.S. Cls.: 21, 23, 26, 36 and 38

Reg. No. 3,518,886

United States Patent and Trademark Office

Registered Oct. 21, 2008

**TRADEMARK
PRINCIPAL REGISTER**

ASG-Safari.OLAP

ALLEN SYSTEMS GROUP, INC. (DELAWARE
CORPORATION)
ATTN: TIM WELSH
1333 THIRD AVENUE SOUTH
NAPLES, FL 34102

FOR: COMPUTER SOFTWARE FOR REPORTING
AND DRILL-DOWN FOR USERS OF ALL SKILL
LEVELS, FOR THE IDENTIFICATION OF RELATIONSHIP
PATTERNS, TRENDS, AND CORRELATIONS WITHIN
INFORMATION ASSETS VIA EXCEPTION HIGHLIGHTING,
IN CLASS 9 (U.S. CLS. 21, 23, 26, 36 AND 38).

FIRST USE 1-1-1997; IN COMMERCE 1-1-1997.

THE MARK CONSISTS OF STANDARD CHARACTERS
WITHOUT CLAIM TO ANY PARTICULAR FONT, STYLE,
SIZE, OR COLOR.

NO CLAIM IS MADE TO THE EXCLUSIVE RIGHT TO
USE "OLAP", APART FROM THE MARK AS SHOWN.

SER. NO. 77-107,972, FILED 2-15-2007.

ANNE E. GUSTASON, EXAMINING ATTORNEY

Int. Cl.: 44

Prior U.S. Cls.: 100 and 101

United States Patent and Trademark Office

Reg. No. 3,518,887

Registered Oct. 21, 2008

**SERVICE MARK
PRINCIPAL REGISTER**

**THE TRUSTED CHOICE FOR
WORKFORCE HEALTH MANAGEMENT**

COMPREHENSIVE HEALTH SERVICES, INC.
(MARYLAND CORPORATION)
SUITE 700
8229 BOONE BOULEVARD
VIENNA, VA 221822623

FOR: HEALTH CARE SERVICES PROVIDED AT THE WORKPLACE, NAMELY, HEALTH CARE, WELLNESS PROGRAMS, PHYSICIAN SERVICES, DISEASE MANAGEMENT PROGRAMS, MEDICAL SERVICES, AND FITNESS EVALUATION; WORKFORCE HEALTH PROGRAMS PROVIDED AT THE WORKPLACE WHICH PROVIDE ASSISTANCE, FITNESS EVALUATION AND CONSULTATION TO EMPLOYEES SO THEY MAY MAKE HEALTH, WELLNESS AND NUTRITIONAL CHANGES IN THEIR DAILY LIVING TO IMPROVE HEALTH; ONSITE HEALTH CENTERS IN THE NATURE OF MEDICAL CLINICS; MEDICAL TESTING SERVICES, NAMELY, ADMINISTERING NATIONAL FITNESS EVALUATION TESTS; HEALTH CARE SERVICES, NAMELY, WELLNESS PROGRAMS THAT PROMOTE PARTICIPANTS' HEALTH AND SAFETY; PHYSICIAN SERVICES; EMPLOYER-

SPONSORED WORKSITE AND ON-SITE HEALTH PROGRAMS, NAMELY, WELLNESS PROGRAMS AND MEDICAL CONSULTATION SERVICES; DISEASE MANAGEMENT AND HEALTH CARE SERVICES FOR EMPLOYEES AND EMPLOYEE DEPENDENTS PROVIDED BY PHYSICIANS, NURSES, AND OTHER HEALTH CARE PROVIDERS; COUNSELING SERVICES IN THE FIELDS OF HEALTH, NUTRITION AND LIFESTYLE WELLNESS WITH A FOCUS ON REDUCING ABSENTEEISM FROM WORK DUE TO SICKNESS, IN CLASS 44 (U.S. CLS. 100 AND 101).

FIRST USE 1-17-2007; IN COMMERCE 1-17-2007.

THE MARK CONSISTS OF STANDARD CHARACTERS WITHOUT CLAIM TO ANY PARTICULAR FONT, STYLE, SIZE, OR COLOR.

SER. NO. 77-108,613, FILED 2-15-2007.

TOBY BULLOFF, EXAMINING ATTORNEY

Int. Cls.: 5 and 10

Prior U.S. Cls.: 6, 18, 26, 39, 44, 46, 51 and 52

United States Patent and Trademark Office

Reg. No. 3,518,888

Registered Oct. 21, 2008

**TRADEMARK
PRINCIPAL REGISTER**

STOMA-TECH

MONTREAL OSTOMY AND HOMECARE CENTRE INC./ CENTRE D'OSTOMIE DE MONTREAL ET EQUIPEMENT POUR SOINS A DOMICILE INC. (CANADA CORPORATION)
197 JOSEPH-CARRIER, VAUDREUIL-DORION
QUEBEC, CANADA J7V5V5

FOR: OSTOMY PRODUCTS, NAMELY, STOMA PASTE AND LIQUID DEODORANT FOR OSTOMY POUCHES, IN CLASS 5 (U.S. CLS. 6, 18, 44, 46, 51 AND 52).

FIRST USE 9-0-1999; IN COMMERCE 3-17-2000.

FOR: OSTOMY PRODUCTS, NAMELY, HYDRO-COLLOID SKIN BARRIER WAFERS AND HYDRO-COLLOID OSTO SEALS FOR STOMAS AND OSTOMY POUCHES, IN CLASS 10 (U.S. CLS. 26, 39 AND 44).

FIRST USE 9-0-1999; IN COMMERCE 3-17-2000.

THE MARK CONSISTS OF STANDARD CHARACTERS WITHOUT CLAIM TO ANY PARTICULAR FONT, STYLE, SIZE, OR COLOR.

PRIORITY CLAIMED UNDER SEC. 44(D) ON CANADA APPLICATION NO. 1324764, FILED 11-7-2006, REG. NO. TMA697547, DATED 9-28-2007, EXPIRES 9-28-2022.

PRIORITY CLAIMED UNDER SEC. 44(D) ON CANADA APPLICATION NO. 1324764, FILED 11-7-2006, REG. NO. TMA697547, DATED 9-28-2007, EXPIRES 9-28-2022.

SER. NO. 77-109,686, FILED 2-16-2007.

KATHERINE CHANG, EXAMINING ATTORNEY

Int. Cl.: 9

Prior U.S. Cls.: 21, 23, 26, 36 and 38

United States Patent and Trademark Office

Reg. No. 3,518,889

Registered Oct. 21, 2008

**TRADEMARK
PRINCIPAL REGISTER**

Fashion Toolbox

WONG, GREGORY (HONG KONG INDIVIDUAL)
2314 24 AVENUE
ASTIROA, NY 11102

FOR: COMPUTER PROGRAMS FOR USE IN
FASHION DESIGN AND TEXTILE DESIGN, IN
CLASS 9 (U.S. CLS. 21, 23, 26, 36 AND 38).

FIRST USE 0-0-1998; IN COMMERCE 0-0-1998.

THE MARK CONSISTS OF STANDARD CHAR-
ACTERS WITHOUT CLAIM TO ANY PARTICULAR
FONT, STYLE, SIZE, OR COLOR.

NO CLAIM IS MADE TO THE EXCLUSIVE
RIGHT TO USE "FASHION", APART FROM THE
MARK AS SHOWN.

SER. NO. 77-110,112, FILED 2-17-2007.

INGA ERVIN, EXAMINING ATTORNEY

Int. Cl.: 37

Prior U.S. Cls.: 100, 103 and 106

United States Patent and Trademark Office

Reg. No. 3,518,890

Registered Oct. 21, 2008

**SERVICE MARK
PRINCIPAL REGISTER**

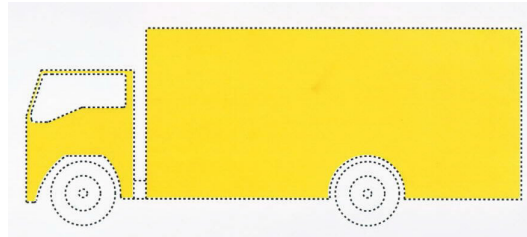

ONE HOUR AIR CONDITIONING FRANCHISING, LLC (FLORIDA LIMITED LIABILITY COMPANY)
SUITE 920
50 CENTRAL AVE.
SARASOTA, FL 34236

FOR: REPAIR, MAINTENANCE, AND INSTALLATION SERVICES IN THE FIELD OF HEATING, VENTILATION, AND AIR CONDITIONING, IN CLASS 37 (U.S. CLS. 100, 103 AND 106).

FIRST USE 12-31-2001; IN COMMERCE 12-31-2001.

THE COLOR(S) YELLOW IS/ARE CLAIMED AS A FEATURE OF THE MARK.

THE MARK CONSISTS OF THE COLOR YELLOW (PMS 109) USED OVER THE ENTIRE TRUCK. THE MATTER SHOWN IN THE DRAWING IN BROKEN LINES SERVES TO SHOW POSITIONING OF THE MARK AND IS NOT A FEATURE OF THE MARK.

SEC. 2(F).

SER. NO. 77-111,767, FILED 2-20-2007.

TERESA M. RUPP, EXAMINING ATTORNEY

Int. Cl.: 37

Prior U.S. Cls.: 100, 103 and 106

Reg. No. 3,518,891

United States Patent and Trademark Office

Registered Oct. 21, 2008

**SERVICE MARK
PRINCIPAL REGISTER**

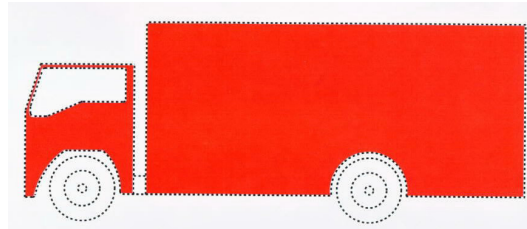

MISTER SPARKY FRANCHISING, LLC (FLORIDA LIMITED LIABILITY COMPANY)
SUITE 920
50 CENTRAL AVE.
SARASOTA, FL 34236

FOR: REPAIR, MAINTENANCE, AND INSTALLATION OF ELECTRICAL WIRING, OUTLETS, LIGHT FIXTURES, SWITCHES, AND ELECTRICAL PANELS, IN CLASS 37 (U.S. CLS. 100, 103 AND 106).

FIRST USE 0-0-1996; IN COMMERCE 0-0-1996.

THE COLOR(S) RED (PMS 485) IS/ARE CLAIMED AS A FEATURE OF THE MARK.

THE MARK CONSISTS OF THE COLOR RED (PMS 485) USED OVER THE ENTIRE TRUCK. THE MATTER SHOWN IN THE DRAWING IN BROKEN LINES SERVES TO SHOW POSITIONING OF THE MARK AND IS NOT A FEATURE OF THE MARK.

SEC. 2(F).

SER. NO. 77-111,793, FILED 2-20-2007.

TERESA M. RUPP, EXAMINING ATTORNEY

Int. Cl.: 42

Prior U.S. Cls.: 100 and 101

United States Patent and Trademark Office

Reg. No. 3,518,892

Registered Oct. 21, 2008

**SERVICE MARK
PRINCIPAL REGISTER**

AX-Solutions

BLITS, MANNY (UNITED STATES INDIVIDUAL)
3110 PARK NEWPORT, APT. 405
NEWPORT BEACH, CA 92660

FOR: CONSULTING SERVICES IN THE FIELD
OF DESIGN, SELECTION, IMPLEMENTATION
AND USE OF COMPUTER HARDWARE AND
SOFTWARE SYSTEMS FOR OTHERS, IN CLASS 42
(U.S. CLS. 100 AND 101).

FIRST USE 7-21-2006; IN COMMERCE 7-21-2006.

THE MARK CONSISTS OF STANDARD CHAR-
ACTERS WITHOUT CLAIM TO ANY PARTICULAR
FONT, STYLE, SIZE, OR COLOR.

SER. NO. 77-112,982, FILED 2-21-2007.

KEVON CHISOLM, EXAMINING ATTORNEY

Int. Cl.: 32

Prior U.S. Cls.: 45, 46 and 48

United States Patent and Trademark Office

Reg. No. 3,518,893

Registered Oct. 21, 2008

**TRADEMARK
PRINCIPAL REGISTER**

Brewer's Best

WINE-ART OF OHIO, INC. DBA L.D. CARLSON
CO. (OHIO CORPORATION)
463 PORTAGE BLVD
KENT, OH 44240

FOR: PREPARATIONS FOR MAKING BEER, IN
CLASS 32 (U.S. CLS. 45, 46 AND 48).

FIRST USE 5-1-1992; IN COMMERCE 5-1-1992.

THE MARK CONSISTS OF STANDARD CHAR-
ACTERS WITHOUT CLAIM TO ANY PARTICULAR
FONT, STYLE, SIZE, OR COLOR.

SEC. 2(F).

SER. NO. 77-113,103, FILED 2-22-2007.

TIMOTHY FINNEGAN, EXAMINING ATTORNEY

Int. Cl.: 7

Prior U.S. Cls.: 13, 19, 21, 23, 31, 34 and 35

United States Patent and Trademark Office

Reg. No. 3,518,894

Registered Oct. 21, 2008

**TRADEMARK
PRINCIPAL REGISTER**

COOL BLASTER

CITIZEN MACHINERY AMERICA, INC. (DELA-
WARE CORPORATION)
68 MOYLAN LANE
AGAWAM, MA 01001

FOR: HIGH PRESSURE COOLANT PUMP SYS-
TEM FOR MACHINE TOOLS COMPRISED PRI-
MARILY OF A HYDRAULIC PUMP, SOLENOIDS,
AN ELECTRIC MOTOR, HYDRAULIC FITTINGS
AND HOSES, AND A FILTER; AND MIST AND
SMOKE CONTROL SYSTEMS COMPRISED OF AIR
FILTERS FOR MECHANICAL PURPOSES FOR USE
WITH MACHINE TOOLS, IN CLASS 7 (U.S. CLS. 13,
19, 21, 23, 31, 34 AND 35).

FIRST USE 3-11-1997; IN COMMERCE 3-13-1997.

THE MARK CONSISTS OF STANDARD CHAR-
ACTERS WITHOUT CLAIM TO ANY PARTICULAR
FONT, STYLE, SIZE, OR COLOR.

OWNER OF U.S. REG. NO. 2,333,188.

NO CLAIM IS MADE TO THE EXCLUSIVE
RIGHT TO USE "COOL", APART FROM THE MARK
AS SHOWN.

SER. NO. 77-113,613, FILED 2-22-2007.

ALEXANDER L. POWERS, EXAMINING ATTOR-
NEY

Int. Cl.: 7

Prior U.S. Cls.: 13, 19, 21, 23, 31, 34 and 35

United States Patent and Trademark Office

Reg. No. 3,518,895

Registered Oct. 21, 2008

**TRADEMARK
PRINCIPAL REGISTER**



CITIZEN MACHINERY AMERICA, INC. (DELA-
WARE CORPORATION)
68 MOYLAN LANE
AGAWAM, MA 01001

FOR: HIGH PRESSURE COOLANT PUMP SYS-
TEM FOR MACHINE TOOLS COMPRISED PRI-
MARILY OF A HYDRAULIC PUMP, SOLENOIDS,
AN ELECTRIC MOTOR, HYDRAULIC FITTINGS
AND HOSES, AND A FILTER; AND MIST AND
SMOKE CONTROL SYSTEMS COMPRISED OF AIR
FILTERS FOR MECHANICAL PURPOSES FOR USE

WITH MACHINE TOOLS, IN CLASS 7 (U.S. CLS. 13,
19, 21, 23, 31, 34 AND 35).

FIRST USE 5-3-1999; IN COMMERCE 5-3-1999.

OWNER OF U.S. REG. NO. 2,333,188.

SER. NO. 77-113,829, FILED 2-22-2007.

ALEXANDER L. POWERS, EXAMINING ATTOR-
NEY

Int. Cl.: 7

Prior U.S. Cls.: 13, 19, 21, 23, 31, 34 and 35

United States Patent and Trademark Office

Reg. No. 3,518,896

Registered Oct. 21, 2008

TRADEMARK
PRINCIPAL REGISTER



CITIZEN MACHINERY AMERICA, INC. (DELA-
WARE CORPORATION)
68 MOYLAN LANE
AGAWAM, MA 01001

FOR: HIGH PRESSURE COOLANT PUMP SYS-
TEM FOR MACHINE TOOLS COMPRISED PRI-
MARILY OF A HYDRAULIC PUMP, SOLENOIDS,
AN ELECTRIC MOTOR, HYDRAULIC FITTINGS
AND HOSES, AND A FILTER; AND MIST AND
SMOKE CONTROL SYSTEMS COMPRISED OF AIR
FILTERS FOR MECHANICAL PURPOSES FOR USE
WITH MACHINE TOOLS, IN CLASS 7 (U.S. CLS. 13,
19, 21, 23, 31, 34 AND 35).

FIRST USE 10-0-2001; IN COMMERCE 10-0-2001.

OWNER OF U.S. REG. NO. 2,333,188.

NO CLAIM IS MADE TO THE EXCLUSIVE
RIGHT TO USE "COOL", APART FROM THE MARK
AS SHOWN.

SER. NO. 77-113,863, FILED 2-22-2007.

ALEXANDER L. POWERS, EXAMINING ATTOR-
NEY

Int. Cl.: 28

Prior U.S. Cls.: 22, 23, 38 and 50

Reg. No. 3,518,897

United States Patent and Trademark Office

Registered Oct. 21, 2008

**TRADEMARK
PRINCIPAL REGISTER**



WONDERWORX LLC (COLORADO LIMITED
LIABILITY COMPANY)
C/O SWIFT PROPERTY FUND, INC.
112 SOUTH MILL STREET, SUITE B
ASPEN, CO 81611

FOR: PLAYGROUND EQUIPMENT, NAMELY,
SEESAWS; SWINGS; TEETER-TOTTERS; AND SPIN-
NING, BOUNCING AND ROTATING CHAIRS AND
PLATFORMS, NAMELY, MERRY GO ROUNDS,
CAROUSELS, AND RIDERS, NAMELY RIDE-ON
TOYS, ROCKING HORSES, AND SPRING RIDERS,
IN CLASS 28 (U.S. CLS. 22, 23, 38 AND 50).

FIRST USE 6-29-2006; IN COMMERCE 8-29-2006.

THE MARK CONSISTS OF A MUSICAL NOTE
WITH A PERSON SHAPED AS ANOTHER MUSICAL
NOTE SWINGING FROM THE LARGER MUSICAL
NOTE.

SER. NO. 77-114,109, FILED 2-22-2007.

JENNIFER VASQUEZ, EXAMINING ATTORNEY

Int. Cl.: 28

Prior U.S. Cls.: 22, 23, 38 and 50

United States Patent and Trademark Office

Reg. No. 3,518,898

Registered Oct. 21, 2008

**TRADEMARK
PRINCIPAL REGISTER**

W o  d e r W  r x

WONDERWORX LLC (COLORADO LIMITED
LIABILITY COMPANY)

C/O SWIFT PROPERTY FUND, INC.
112 SOUTH MILL STREET, SUITE B
ASPEN, CO 81611

FIRST USE 6-29-2006; IN COMMERCE 8-29-2006.

OWNER OF U.S. REG. NO. 3,112,594.

FOR: PLAYGROUND EQUIPMENT, NAMELY,
SEESAWS; SWINGS; TEETER-TOTTERS; AND SPIN-
NING, BOUNCING AND ROTATING CHAIRS AND
PLATFORMS, NAMELY, MERRY GO ROUNDS,
CAROUSELS, AND RIDERS, NAMELY, RIDE-ON
TOYS, ROCKING HORSES, AND SPRING RIDERS,
IN CLASS 28 (U.S. CLS. 22, 23, 38 AND 50).

THE MARK CONSISTS OF THE WORD "WON-
DERWORX" WITH MUSICAL NOTES IN THE
PLACE OF THE "N" AND THE SECOND "O".

SER. NO. 77-114,113, FILED 2-22-2007.

AHSEN KHAN, EXAMINING ATTORNEY

Int. Cls.: 35 and 42

Prior U.S. Cls.: 100, 101 and 102

United States Patent and Trademark Office

Reg. No. 3,518,899

Registered Oct. 21, 2008

**SERVICE MARK
PRINCIPAL REGISTER**

TROPHY PROPERTIES

CABELA'S INCORPORATED (DELAWARE CORPORATION)
ONE CABELA DRIVE
SIDNEY, NE 69160

FOR: PROVIDING INFORMATION FOR HABITAT, LAKE AND TIMBER MANAGEMENT, IN CLASS 35 (U.S. CLS. 100, 101 AND 102).

FIRST USE 10-15-2004; IN COMMERCE 10-15-2004.

FOR: LAND AND WATER MAPPING SERVICES, IN CLASS 42 (U.S. CLS. 100 AND 101).

FIRST USE 10-15-2004; IN COMMERCE 10-15-2004.

THE MARK CONSISTS OF STANDARD CHARACTERS WITHOUT CLAIM TO ANY PARTICULAR FONT, STYLE, SIZE, OR COLOR.

NO CLAIM IS MADE TO THE EXCLUSIVE RIGHT TO USE "PROPERTIES", APART FROM THE MARK AS SHOWN.

SER. NO. 77-114,389, FILED 2-23-2007.

ROBIN CHOSID, EXAMINING ATTORNEY

Int. Cl.: 9

Prior U.S. Cls.: 21, 23, 26, 36 and 38

Reg. No. 3,518,900

United States Patent and Trademark Office

Registered Oct. 21, 2008

**TRADEMARK
PRINCIPAL REGISTER**

ROI Analyst

ALINEAN, INC. (DELAWARE CORPORATION)
SUITE 1210
201 S. ORANGE AVENUE
ORLANDO, FL 32801

FOR: COMPUTER SOFTWARE FOR MEASUREMENT OF RETURN ON INVESTMENT, INTERNAL RATES OF RETURN, NET PRESENT VALUE, AND OTHER COST/BENEFIT ANALYSIS OF THE VALUE OF INFORMATION TECHNOLOGY INVESTMENTS, IN CLASS 9 (U.S. CLS. 21, 23, 26, 36 AND 38).

FIRST USE 1-1-2001; IN COMMERCE 1-1-2001.

THE MARK CONSISTS OF STANDARD CHARACTERS WITHOUT CLAIM TO ANY PARTICULAR FONT, STYLE, SIZE, OR COLOR.

NO CLAIM IS MADE TO THE EXCLUSIVE RIGHT TO USE "ROI", APART FROM THE MARK AS SHOWN.

SEC. 2(F).

SER. NO. 77-115,860, FILED 2-26-2007.

STEVEN R. FOSTER, EXAMINING ATTORNEY

Int. Cl.: 16

Prior U.S. Cls.: 2, 5, 22, 23, 29, 37, 38 and 50

Reg. No. 3,518,901

United States Patent and Trademark Office

Registered Oct. 21, 2008

**TRADEMARK
PRINCIPAL REGISTER**

Eternal Psychology

VAN WINKLE, ERIC P. (UNITED STATES INDIVIDUAL)
21407 NE 165TH STREET
WOODINVILLE, WA 980770077

FOR: PRINTED INSTRUCTIONAL, EDUCATIONAL, AND TEACHING MATERIALS IN THE FIELD OF HEALING PSYCHOLOGY, IN CLASS 16 (U.S. CLS. 2, 5, 22, 23, 29, 37, 38 AND 50).

FIRST USE 1-6-2006; IN COMMERCE 11-25-2006.

THE MARK CONSISTS OF STANDARD CHARACTERS WITHOUT CLAIM TO ANY PARTICULAR FONT, STYLE, SIZE, OR COLOR.

NO CLAIM IS MADE TO THE EXCLUSIVE RIGHT TO USE "PSYCHOLOGY", APART FROM THE MARK AS SHOWN.

SER. NO. 77-116,661, FILED 2-26-2007.

EDWARD NELSON, EXAMINING ATTORNEY

Int. Cl.: 25

Prior U.S. Cls.: 22 and 39

United States Patent and Trademark Office

Reg. No. 3,518,902

Registered Oct. 21, 2008

**TRADEMARK
PRINCIPAL REGISTER**

BLUE PAINT

BLUE PAINT, LLC (CALIFORNIA LIMITED LIABILITY COMPANY)
1800 SOUTH ESSEX STREET
LOS ANGELES, CA 90021

THE MARK CONSISTS OF STANDARD CHARACTERS WITHOUT CLAIM TO ANY PARTICULAR FONT, STYLE, SIZE, OR COLOR.

FOR: JEANS, IN CLASS 25 (U.S. CLS. 22 AND 39).

SER. NO. 77-116,696, FILED 2-26-2007.

FIRST USE 11-2-2006; IN COMMERCE 11-2-2006.

RUDY R. SINGLETON, EXAMINING ATTORNEY

Int. Cl.: 2

Prior U.S. Cls.: 6, 11 and 16

United States Patent and Trademark Office

Reg. No. 3,518,903

Registered Oct. 21, 2008

**TRADEMARK
PRINCIPAL REGISTER**

D-TECH

IMCO TECHNOLOGIES INC. (CANADA CORPORATION)
350 WENTWORTH STREET NORTH
HAMILTON, CANADA L8L5W3

FOR: COATINGS IN THE NATURE OF INDUSTRIAL SEALANTS FOR SEALING, HARDENING, DUST PROOFING, WATERPROOFING AND WEATHERPROOFING CONCRETE, IN CLASS 2 (U.S. CLS. 6, 11 AND 16).

FIRST USE 8-1-1999; IN COMMERCE 3-1-2003.

THE MARK CONSISTS OF STANDARD CHARACTERS WITHOUT CLAIM TO ANY PARTICULAR FONT, STYLE, SIZE, OR COLOR.

SER. NO. 77-116,861, FILED 2-27-2007.

SOPHIA S. KIM, EXAMINING ATTORNEY

Int. Cl.: 38

Prior U.S. Cls.: 100, 101 and 104

United States Patent and Trademark Office

Reg. No. 3,518,904

Registered Oct. 21, 2008

**SERVICE MARK
PRINCIPAL REGISTER**

BORED@

BOREDAT, INC. (DELAWARE CORPORATION)
635 TENNESSEE STREET, APT. 404
SAN FRANCISCO, CA 94107

FOR: PROVIDING ON-LINE CHAT ROOMS AND ELECTRONIC BULLETIN BOARDS FOR TRANSMISSION OF MESSAGES AMONG USERS IN THE FIELD OF GENERAL INTEREST; PROVIDING ON-LINE CHAT ROOMS FOR TRANSMISSION OF MESSAGES AMONG COMPUTER USERS CONCERNING SOCIAL NETWORKING, COLLEGIATE LIFE; PROVIDING ON-LINE ELECTRONIC BULLETIN BOARDS FOR TRANSMISSION OF MESSAGES AMONG COMPUTER USERS CONCERNING SOCIAL NETWORKING, COLLEGIATE LIFE;

STREAMING OF AUDIO MATERIAL ON THE INTERNET; STREAMING OF VIDEO MATERIAL ON THE INTERNET; WEB MESSAGING, IN CLASS 38 (U.S. CLS. 100, 101 AND 104).

FIRST USE 2-0-2006; IN COMMERCE 2-0-2006.

THE MARK CONSISTS OF STANDARD CHARACTERS WITHOUT CLAIM TO ANY PARTICULAR FONT, STYLE, SIZE, OR COLOR.

SER. NO. 77-119,116, FILED 2-28-2007.

LINDA POWELL, EXAMINING ATTORNEY

Int. Cl.: 38

Prior U.S. Cls.: 100, 101 and 104

United States Patent and Trademark Office

Reg. No. 3,518,905

Registered Oct. 21, 2008

**SERVICE MARK
PRINCIPAL REGISTER**

BOREDAT

BOREDAT, INC. (DELAWARE CORPORATION)
635 TENNESSEE STREET, APT. 404
SAN FRANCISCO, CA 94107

FOR: PROVIDING ON-LINE CHAT ROOMS AND ELECTRONIC BULLETIN BOARDS FOR TRANSMISSION OF MESSAGES AMONG USERS IN THE FIELD OF GENERAL INTEREST; PROVIDING ON-LINE CHAT ROOMS FOR TRANSMISSION OF MESSAGES AMONG COMPUTER USERS CONCERNING SOCIAL NETWORKING, COLLEGIATE LIFE; PROVIDING ON-LINE ELECTRONIC BULLETIN BOARDS FOR TRANSMISSION OF MESSAGES AMONG COMPUTER USERS CONCERNING SOCIAL NETWORKING, COLLEGIATE LIFE;

STREAMING OF AUDIO MATERIAL ON THE INTERNET; STREAMING OF VIDEO MATERIAL ON THE INTERNET; WEB MESSAGING, IN CLASS 38 (U.S. CLS. 100, 101 AND 104).

FIRST USE 2-0-2006; IN COMMERCE 2-0-2006.

THE MARK CONSISTS OF STANDARD CHARACTERS WITHOUT CLAIM TO ANY PARTICULAR FONT, STYLE, SIZE, OR COLOR.

SER. NO. 77-119,119, FILED 2-28-2007.

LINDA POWELL, EXAMINING ATTORNEY

Int. Cl.: 25

Prior U.S. Cls.: 22 and 39

United States Patent and Trademark Office

Reg. No. 3,518,906

Registered Oct. 21, 2008

**TRADEMARK
PRINCIPAL REGISTER**

PANTHERS

PANTHERS FOOTBALL LLC (NORTH CAROLINA LIMITED LIABILITY COMPANY)
800 SOUTH MINT ROAD
CHARLOTTE, NC 28202

FOR: MEN'S, WOMEN'S AND CHILDREN'S CLOTHING, NAMELY, FLEECE TOPS AND BOTTOMS, HEADWEAR, CAPS, KNIT HATS, T-SHIRTS, SWEATSHIRTS, SHORTS, TANK TOPS, SWEATERS, PANTS, JACKETS, GOLF SHIRTS, WOMEN'S SHIRTS, KNIT SHIRTS, JERSEYS AND WRISTBANDS, ALL RELATING TO PROFESSIONAL FOOTBALL, IN CLASS 25 (U.S. CLS. 22 AND 39).

FIRST USE 9-30-1995; IN COMMERCE 9-30-1995.

THE MARK CONSISTS OF STANDARD CHARACTERS WITHOUT CLAIM TO ANY PARTICULAR FONT, STYLE, SIZE, OR COLOR.

OWNER OF U.S. REG. NO. 2,120,117.

SER. NO. 77-119,498, FILED 3-1-2007.

MAUREEN DALL, EXAMINING ATTORNEY

Int. Cl.: 35

Prior U.S. Cls.: 100, 101 and 102

United States Patent and Trademark Office

Reg. No. 3,518,907

Registered Oct. 21, 2008

**SERVICE MARK
PRINCIPAL REGISTER**

We can do that

PAPA MURPHY'S INTERNATIONAL, INC. (DE-
LAWARE CORPORATION)
SUITE 350
8000 NORTHEAST PARKWAY DRIVE
VANCOUVER, WA 98662

FOR: RETAIL STORE SERVICES FEATURING
PIZZA, IN CLASS 35 (U.S. CLS. 100, 101 AND 102).

FIRST USE 9-1-2007; IN COMMERCE 9-1-2007.

THE MARK CONSISTS OF STANDARD CHAR-
ACTERS WITHOUT CLAIM TO ANY PARTICULAR
FONT, STYLE, SIZE, OR COLOR.

SER. NO. 77-120,369, FILED 3-1-2007.

KIM SAITO, EXAMINING ATTORNEY

Int. Cl.: 45

Prior U.S. Cls.: 100 and 101

United States Patent and Trademark Office

Reg. No. 3,518,908

Registered Oct. 21, 2008

**SERVICE MARK
PRINCIPAL REGISTER**

**Protecting Assets of the
Mind**

COOPER, RODNEY A. (UNITED STATES INDIVIDUAL)
10 RIVIERA COURT
TROPHY CLUB, TX 76262

FOR: INTELLECTUAL PROPERTY CONSULTATION; LICENSING OF ARCHITECTURAL DRAWINGS TO OTHERS; LICENSING OF COMPUTER SOFTWARE; LICENSING OF INTELLECTUAL PROPERTY; LITIGATION SERVICES; PATENT AND INDUSTRIAL PROPERTY CONSULTATION; PATENT LICENSING, IN CLASS 45 (U.S. CLS. 100 AND 101).

FIRST USE 3-6-2006; IN COMMERCE 3-6-2006.

THE MARK CONSISTS OF STANDARD CHARACTERS WITHOUT CLAIM TO ANY PARTICULAR FONT, STYLE, SIZE, OR COLOR.

SER. NO. 77-121,712, FILED 3-3-2007.

JIM RINGLE, EXAMINING ATTORNEY

Int. Cl.: 41

Prior U.S. Cls.: 100, 101 and 107

United States Patent and Trademark Office

Reg. No. 3,518,909

Registered Oct. 21, 2008

**SERVICE MARK
PRINCIPAL REGISTER**

RISKY BUSINESS

NIELSEN BUSINESS MEDIA, INC. (DELAWARE
CORPORATION)
8TH FLOOR
770 BROADWAY
NEW YORK, NY 100039595

FOR: PROVIDING ONLINE NEWSLETTERS AND
ONLINE JOURNALS AND WEBLOGS FEATURING
INFORMATION REGARDING ENTERTAINMENT
AND THE ENTERTAINMENT INDUSTRY; PRO-
VIDING ONLINE MAGAZINES AND ONLINE MA-
GAZINE COLUMNS ABOUT ENTERTAINMENT

AND THE ENTERTAINMENT INDUSTRY, IN
CLASS 41 (U.S. CLS. 100, 101 AND 107).

FIRST USE 10-7-2005; IN COMMERCE 10-7-2005.

THE MARK CONSISTS OF STANDARD CHAR-
ACTERS WITHOUT CLAIM TO ANY PARTICULAR
FONT, STYLE, SIZE, OR COLOR.

SER. NO. 77-123,315, FILED 3-6-2007.

JENNIFER HETU, EXAMINING ATTORNEY

Int. Cl.: 11

Prior U.S. Cls.: 13, 21, 23, 31 and 34

United States Patent and Trademark Office

Reg. No. 3,518,910

Registered Oct. 21, 2008

**TRADEMARK
PRINCIPAL REGISTER**

Job Site

GLJ, LLC (ILLINOIS LIMITED LIABILITY COMPANY)
2ND FLOOR SOUTH
1415 N. DAYTON ST.
CHICAGO, IL 60622

FOR: PORTABLE ELECTRIC FANS, IN CLASS 11
(U.S. CLS. 13, 21, 23, 31 AND 34).

FIRST USE 12-6-2006; IN COMMERCE 12-6-2006.

THE MARK CONSISTS OF STANDARD CHARACTERS WITHOUT CLAIM TO ANY PARTICULAR FONT, STYLE, SIZE, OR COLOR.

SER. NO. 77-124,873, FILED 3-7-2007.

KEVIN DINALLO, EXAMINING ATTORNEY

Int. Cl.: 9

Prior U.S. Cls.: 21, 23, 26, 36 and 38

Reg. No. 3,518,911

United States Patent and Trademark Office

Registered Oct. 21, 2008

**TRADEMARK
PRINCIPAL REGISTER**



CABLE MANUFACTURING & ASSEMBLY, INC.
(OHIO CORPORATION)
10896 INDUSTRIAL PARKWAY, N. W.
BOLIVAR, OH 446128990

FOR: ELECTRIC CONTROL CABLES MADE PRIMARILY OF METAL FOR USE IN THE AUTOMOTIVE INDUSTRY, NAMELY, CABLES FOR USE WITH TAILGATES, ACCELERATOR CONTROLS, SHIFT CABLES, HOOD RELEASES, FUEL DOOR RELEASES, HEATER AND VENT CONTROLS; FOR USE IN THE HEAVY TRUCK INDUSTRY, NAMELY, HOOD CHECK CABLES, CABLES FOR USE WITH POWER TAKE OFF CONTROLS, CLUTCHES, ACCELERATOR CABLES, REMOTE DOOR AND LATCH RELEASES, TRAILER DOOR CABLES; FOR USE IN THE MEDICAL DEVICE INDUSTRY, NAMELY, CABLES FOR USE WITH STYLETS, SURGICAL IMPLANTS, REMOTE CONTROLS, HEART MONITOR LEADS, SUTURES, DRIVE CABLES, DISPOSABLE PRODUCTS; FOR USE IN THE FURNITURE INDUSTRY, NAMELY, HOSPITAL BED DRIVE CABLES, CABLES FOR USE WITH GAS SPRING RELEASES, RECLINER RELEASES, CRIB SIDE RELEASES, DESK AND CABINET SECURITY CABLES; FOR USE IN THE RECREATIONAL VEHICLE EQUIPMENT INDUSTRY, NAMELY, CABLES FOR USE WITH PUSH-PULL CONTROLS, HVAC CONTROLS, SAFETY AND RESTRAINT CABLES; FOR USE IN THE BOATING AND MARINE INDUSTRY, NAMELY, CABLES FOR USE WITH PUSH-PULL THROTTLE CONTROLS, GUY, RIGGING, LIFT CABLES, STEERING SYSTEMS; FOR USE IN THE SECURITY PRODUCTS INDUSTRY, NAMELY, CABLES FOR USE WITH RESTRAINTS, TIE-DOWNS, THEFT DETERRENT CABLES; FOR USE IN THE SPORTING GOODS INDUSTRY, NAMELY, WEIGHT LIFTING CABLES, RESTRAINT CABLES, CABLES FOR USE WITH SPEED AND TENSION ADJUSTMENT CONTROLS, SAFETY CABLES, BRAKE AND SHIFT CABLES,

CABLES FOR USE WITH DOWN RIGGERS; FOR USE IN THE FARM AND CONSTRUCTION EQUIPMENT INDUSTRY, NAMELY, CABLES FOR USE WITH POWER TAKE OFF CONTROLS, VERNIER THROTTLE CONTROLS, SAFETY RESTRAINT AND LIFT CABLES; FOR USE IN THE APPLIANCE INDUSTRY, NAMELY, CABLES FOR USE WITH DOOR RESTRAINTS, DRUM DRIVES, PUSH-PULL CONTROLS; FOR USE IN THE ELECTRONIC PRODUCTS INDUSTRY, NAMELY, DRIVE CABLES, CABLES FOR USE WITH DOOR RESTRAINTS, PUSH-PULL CONTROLS, LANYARDS, RIBBON DRIVES, AND SOLENOID ACTUATION; AND FOR USE IN THE AIRCRAFT AND AEROSPACE INDUSTRY, NAMELY, AIRCRAFT FLIGHT CONTROL CABLES, CABLES FOR USE WITH SEAT BACK RELEASES, SATELLITE PANEL RESTRAINTS, GROUNDING AND ENGINE CONTROL CABLES; ELECTRIC CABLE OPERATORS MADE PRIMARILY OF METAL FOR USE IN THE AUTOMOTIVE INDUSTRY, NAMELY, CABLE OPERATORS FOR USE WITH TAILGATES, ACCELERATOR CONTROLS, SHIFT CABLES, HOOD RELEASES, FUEL DOOR RELEASES, HEATER AND VENT CONTROLS; FOR USE IN THE HEAVY TRUCK INDUSTRY, NAMELY, CABLE OPERATORS FOR USE WITH HOOD CHECK CABLES, POWER TAKE OFF CONTROLS, CLUTCHES, ACCELERATOR CABLES, REMOTE DOOR AND LATCH RELEASES, TRAILER DOOR CABLES; FOR USE IN THE MEDICAL DEVICE INDUSTRY, NAMELY, CABLE OPERATORS FOR USE WITH STYLETS, SURGICAL IMPLANTS, REMOTE CONTROLS, HEART MONITOR LEADS, SUTURES, DRIVE CABLES, DISPOSABLE PRODUCTS; FOR USE IN THE FURNITURE INDUSTRY, NAMELY, CABLE OPERATORS FOR USE WITH HOSPITAL BED DRIVE CABLES, GAS SPRING RELEASES, RECLINER RELEASES, CRIB SIDE RELEASES, DESK AND CABINET SECURITY CABLES; FOR USE IN THE RECREATIONAL VEHICLE EQUIP-

MENT INDUSTRY, NAMELY, CABLE OPERATORS FOR USE WITH PUSH-PULL CONTROLS, HVAC CONTROLS, SAFETY AND RESTRAINT CABLES; FOR USE IN THE BOATING AND MARINE INDUSTRY, NAMELY, CABLE OPERATORS FOR USE WITH PUSH-PULL THROTTLE CONTROLS, GUY, RIGGING, LIFT CABLES, STEERING SYSTEMS; FOR USE IN THE SECURITY PRODUCTS INDUSTRY, NAMELY, CABLE OPERATORS FOR USE WITH RESTRAINTS, TIE-DOWNS, THEFT DETERRENT CABLES; FOR USE IN THE SPORTING GOODS INDUSTRY, NAMELY, CABLE OPERATORS FOR USE WITH WEIGHT LIFTING CABLES, RESTRAINT CABLES, SPEED AND TENSION ADJUSTMENT CONTROLS, SAFETY CABLES, BRAKE AND SHIFT CABLES, DOWN RIGGERS; FOR USE IN THE FARM AND CONSTRUCTION EQUIPMENT INDUSTRY, NAMELY, CABLE OPERATORS FOR USE WITH POWER TAKE OFF CONTROLS, VERNIER THROTTLE CONTROLS, SAFETY RESTRAINT AND LIFT CABLES; FOR USE IN THE APPLIANCE INDUSTRY, NAMELY, CABLE OPERATORS FOR USE WITH DOOR RESTRAINTS, DRUM DRIVES, PUSH-PULL CONTROLS; FOR USE IN THE ELECTRONIC PRODUCTS INDUSTRY, NAMELY, CABLE OPERATORS FOR USE WITH DRIVE CABLES, DOOR RESTRAINTS, PUSH-PULL CONTROLS, LANYARDS, RIBBON DRIVES, AND SOLENOID ACTUATION; AND FOR USE IN THE AIRCRAFT AND AEROSPACE INDUSTRY, NAMELY, CABLE OPERATORS FOR USE WITH AIRCRAFT FLIGHT CONTROL CABLES, SEAT BACK RELEASES, SATELLITE PANEL RESTRAINTS, GROUNDING AND ENGINE CONTROL CABLES; CABLE OPERATED ELECTRIC ACTUATORS MADE PRIMARILY OF METAL FOR USE IN THE AUTOMOTIVE INDUSTRY, NAMELY, ACTUATORS FOR USE WITH TAILGATES, ACCELERATOR CONTROLS, SHIFT CABLES, HOOD RELEASES, FUEL DOOR RELEASES, HEATER AND VENT CONTROLS; FOR USE IN THE HEAVY TRUCK INDUSTRY, NAMELY, ACTUATORS FOR USE WITH HOOD CHECK CABLES, POWER TAKE OFF CONTROLS, CLUTCHES, ACCELERATOR CABLES, REMOTE DOOR AND LATCH RELEASES, TRAILER DOOR CABLES; FOR USE IN THE MEDICAL DEVICE INDUSTRY, NAMELY, ACTUATORS FOR USE WITH STYLETS, SURGICAL IMPLANTS, REMOTE CONTROLS, HEART MONITOR LEADS, SUTURES, DRIVE CABLES, DISPOSABLE PRO-

DUCTS; FOR USE IN THE FURNITURE INDUSTRY, NAMELY, ACTUATORS FOR USE WITH HOSPITAL BED DRIVE CABLES, GAS SPRING RELEASES, RECLINER RELEASES, CRIB SIDE RELEASES, DESK AND CABINET SECURITY CABLES; FOR USE IN THE RECREATIONAL VEHICLE EQUIPMENT INDUSTRY, NAMELY, ACTUATORS FOR USE WITH PUSH-PULL CONTROLS, HVAC CONTROLS, SAFETY AND RESTRAINT CABLES; FOR USE IN THE BOATING AND MARINE INDUSTRY, NAMELY, ACTUATORS FOR USE WITH PUSH-PULL THROTTLE CONTROLS, GUY, RIGGING, LIFT CABLES, STEERING SYSTEMS; FOR USE IN THE SECURITY PRODUCTS INDUSTRY, NAMELY, ACTUATORS FOR USE WITH RESTRAINTS, TIE-DOWNS, THEFT DETERRENT CABLES; FOR USE IN THE SPORTING GOODS INDUSTRY, NAMELY, ACTUATORS FOR USE WITH WEIGHT LIFTING CABLES, RESTRAINT CABLES, SPEED AND TENSION ADJUSTMENT CONTROLS, SAFETY CABLES, BRAKE AND SHIFT CABLES, DOWN RIGGERS; FOR USE IN THE FARM AND CONSTRUCTION EQUIPMENT INDUSTRY, NAMELY, ACTUATORS FOR USE WITH POWER TAKE OFF CONTROLS, VERNIER THROTTLE CONTROLS, SAFETY RESTRAINT AND LIFT CABLES; FOR USE IN THE APPLIANCE INDUSTRY, NAMELY, ACTUATORS FOR USE WITH DOOR RESTRAINTS, DRUM DRIVES, PUSH-PULL CONTROLS; FOR USE IN THE ELECTRONIC PRODUCTS INDUSTRY, NAMELY, ACTUATORS FOR USE WITH DRIVE CABLES, DOOR RESTRAINTS, PUSH-PULL CONTROLS, LANYARDS, RIBBON DRIVES, AND SOLENOID ACTUATION; AND FOR USE IN THE AIRCRAFT AND AEROSPACE INDUSTRY, NAMELY, ACTUATORS FOR USE WITH AIRCRAFT FLIGHT CONTROL CABLES, SEAT BACK RELEASES, SATELLITE PANEL RESTRAINTS, GROUNDING AND ENGINE CONTROL CABLES, IN CLASS 9 (U.S. CLS. 21, 23, 26, 36 AND 38).

FIRST USE 12-31-1992; IN COMMERCE 12-31-1992.

THE MARK CONSISTS OF STYLIZED LETTERS "CMA" IN STYLIZED RECTANGULAR BOX.

SER. NO. 77-126,835, FILED 3-9-2007.

MARGARET POWER, EXAMINING ATTORNEY

Int. Cl.: 35

Prior U.S. Cls.: 100, 101 and 102

United States Patent and Trademark Office

Reg. No. 3,518,912

Registered Oct. 21, 2008

**SERVICE MARK
PRINCIPAL REGISTER**



SCOTTJOE, LLC (UNITED STATES LIMITED
LIABILITY COMPANY), DBA RED NUMBAT
547 WATTERS RD
HACKETTSTOWN, NJ 07840

THE MARK CONSISTS OF A CARTOON NUM-
BAT AND STYLIZED TEXT.

FOR: GOODS OR SERVICES PRICE QUOTA-
TIONS, IN CLASS 35 (U.S. CLS. 100, 101 AND 102).

SER. NO. 77-128,261, FILED 3-12-2007.

FIRST USE 11-12-2006; IN COMMERCE 12-1-2006.

MARILYN IZZI, EXAMINING ATTORNEY

Int. Cl.: 37

Prior U.S. Cls.: 100, 103 and 106

United States Patent and Trademark Office

Reg. No. 3,518,913

Registered Oct. 21, 2008

**SERVICE MARK
PRINCIPAL REGISTER**

ROOTER-MEDIC

GILLECE HEATING AND COOLING, INC.
(PENNSYLVANIA CORPORATION)
3347 INDUSTRIAL BOULEVARD
BETHEL PARK, PA 15102

THE MARK CONSISTS OF STANDARD CHAR-
ACTERS WITHOUT CLAIM TO ANY PARTICULAR
FONT, STYLE, SIZE, OR COLOR.

FOR: PLUMBING SERVICES, IN CLASS 37 (U.S.
CLS. 100, 103 AND 106).

SER. NO. 77-128,414, FILED 3-12-2007.

FIRST USE 3-9-2007; IN COMMERCE 3-9-2007.

AMEETA JORDAN, EXAMINING ATTORNEY

Int. Cl.: 9

Prior U.S. Cls.: 21, 23, 26, 36 and 38

Reg. No. 3,518,914

United States Patent and Trademark Office

Registered Oct. 21, 2008

**TRADEMARK
PRINCIPAL REGISTER**

DRILLINK

VARCO I/P, INC. (DELAWARE CORPORATION)
10000 RICHMOND AVENUE
HOUSTON, TX 77042

EQUIPMENT FUNCTIONS, IN CLASS 9 (U.S. CLS.
21, 23, 26, 36 AND 38).

FIRST USE 5-29-2007; IN COMMERCE 5-29-2007.

FOR: ELECTRONIC INSTRUMENTATION, COM-
PRISED OF AN ELECTRONIC INTERFACE, COM-
PUTER HARDWARE, AND COMPUTER
SOFTWARE FOR COLLECTING, RECORDING,
PROCESSING, ANALYZING, AND DISPLAYING
DATA AND INFORMATION ABOUT DRILLING
PARAMETERS AND OPERATIONS, AND FOR
MONITORING AND CONTROLLING DRILLING

THE MARK CONSISTS OF STANDARD CHAR-
ACTERS WITHOUT CLAIM TO ANY PARTICULAR
FONT, STYLE, SIZE, OR COLOR.

SER. NO. 77-129,218, FILED 3-13-2007.

BILL DAWE, EXAMINING ATTORNEY

Int. Cl.: 10

Prior U.S. Cls.: 26, 39 and 44

United States Patent and Trademark Office

Reg. No. 3,518,915

Registered Oct. 21, 2008

**TRADEMARK
PRINCIPAL REGISTER**

MICRO MOULD

OTICON A/S (DENMARK CORPORATION)
KONGEBAKKEN 9
SMORUM 2765, DENMARK

FOR: PARTS FOR HEARING AIDS, NAMELY,
EARPLUGS FOR MEDICAL PURPOSES, IN CLASS
10 (U.S. CLS. 26, 39 AND 44).

THE MARK CONSISTS OF STANDARD CHAR-
ACTERS WITHOUT CLAIM TO ANY PARTICULAR
FONT, STYLE, SIZE, OR COLOR.

PRIORITY CLAIMED UNDER SEC. 44(D) ON
DENMARK APPLICATION NO. DKVA20060, FILED
9-14-2006, REG. NO. VR200700541, DATED 3-1-2007,
EXPIRES 3-1-2017.

NO CLAIM IS MADE TO THE EXCLUSIVE
RIGHT TO USE "MOULD", APART FROM THE
MARK AS SHOWN.

SER. NO. 77-129,467, FILED 3-13-2007.

SARA THOMAS, EXAMINING ATTORNEY

Int. Cl.: 32

Prior U.S. Cls.: 45, 46 and 48

United States Patent and Trademark Office

Reg. No. 3,518,916

Registered Oct. 21, 2008

TRADEMARK
PRINCIPAL REGISTER



OWENS, BRIAN (GREAT BRITAIN INDIVIDUAL)
7, CHARLTON PLACE ISLINGTON
LONDON, GREAT BRITAIN AND
MUCCI, KARIN (GREAT BRITAIN INDIVIDUAL)
7, CHARLTON PLACE ISLINGTON
LONDON, GREAT BRITAIN

FOR: BEVERAGES BASED ON COCONUTS,
NAMELY, PASTEURIZED COCONUT JUICE , IN
CLASS 32 (U.S. CLS. 45, 46 AND 48).

PRIORITY CLAIMED UNDER SEC. 44(D) ON
ERPNTY TM OFC APPLICATION NO.
5731666, FILED 3-5-2007, REG. NO. 5731666, DATED
2-19-2008, EXPIRES 3-5-2017.

NO CLAIM IS MADE TO THE EXCLUSIVE
RIGHT TO USE "COCADA FRESCO", APART FROM
THE MARK AS SHOWN.

THE COLOR(S) GREEN, BROWN, WHITE AND
BLACK IS/ARE CLAIMED AS A FEATURE OF THE
MARK.

THE MARK CONSISTS OF AN IMAGE REPRESENTING A PALM TREE WITH THE TOP OF THE TREE BEING GREEN AND THE TRUNK OF THE TREE BEING BROWN STRIPES, THE WORDS "COCADA" AND "FRES" IN GREEN AND AN IMAGE OF A COCONUT FOLLOWING THE WORD "FRES" IN GREEN WITH THREE WHITE HOLES AND AN IMAGE OF A STRAW IN BLACK PROTRUDING FROM THE TOP WHITE HOLE.

THE ENGLISH-LANGUAGE TRANSLATION OF THE SPANISH TERM "COCADA FRESCO" IS FRESH COCONUT IN ENGLISH.

SER. NO. 77-130,393, FILED 3-14-2007.

JANICE L. MCMORROW, EXAMINING ATTORNEY

Int. Cl.: 9

Prior U.S. Cls.: 21, 23, 26, 36 and 38

Reg. No. 3,518,917

United States Patent and Trademark Office

Registered Oct. 21, 2008

**TRADEMARK
PRINCIPAL REGISTER**

**I'M NOT GAY, I JUST REALLY
LOVE RAINBOWS**

BLUE Q CORPORATION (MASSACHUSETTS
CORPORATION)
103 HAWTHORNE AVENUE
PITTSFIELD, MA 01201

THE MARK CONSISTS OF STANDARD CHAR-
ACTERS WITHOUT CLAIM TO ANY PARTICULAR
FONT, STYLE, SIZE, OR COLOR.

FOR: MAGNETS, IN CLASS 9 (U.S. CLS. 21, 23, 26,
36 AND 38).

SER. NO. 77-130,480, FILED 3-14-2007.

FIRST USE 1-10-2007; IN COMMERCE 1-10-2007.

KEVON CHISOLM, EXAMINING ATTORNEY

Int. Cl.: 41

Prior U.S. Cls.: 100, 101 and 107

United States Patent and Trademark Office

Reg. No. 3,518,918

Registered Oct. 21, 2008

**SERVICE MARK
PRINCIPAL REGISTER**

FESTIVAL DEL HUMOR

TELEVISA, S.A. DE C.V. (MEXICO CORPORATION)
EDIFICIO A, PISO 4
AVENIDA VASCO DE QUIROGA 2000
COLONIA ZEDEC SANTA FE, MEXICO 01210

FOR: ENTERTAINMENT SERVICES, NAMELY,
AN ONGOING TELEVISION PROGRAM IN THE
FIELD OF COMEDY, IN CLASS 41 (U.S. CLS. 100, 101
AND 107).

THE MARK CONSISTS OF STANDARD CHAR-
ACTERS WITHOUT CLAIM TO ANY PARTICULAR
FONT, STYLE, SIZE, OR COLOR.

OWNER OF MEXICO REG. NO. 790364, DATED 4-
30-2003, EXPIRES 3-31-2013.

THE FOREIGN WORDING IN THE MARK
TRANSLATES INTO ENGLISH AS "FESTIVAL OF
HUMOR".

SER. NO. 77-131,256, FILED 3-14-2007.

KATHRYN COWARD, EXAMINING ATTORNEY

Int. Cl.: 41

Prior U.S. Cls.: 100, 101 and 107

United States Patent and Trademark Office

Reg. No. 3,518,919

Registered Oct. 21, 2008

**SERVICE MARK
PRINCIPAL REGISTER**



THE PROFESSIONAL GOLFERS' ASSOCIATION
OF AMERICA (FLORIDA CORPORATION)
100 AVENUE OF THE CHAMPIONS
PALM BEACH GARDENS, FL 33410

FOR: ORGANIZING AND CONDUCTING GOLF
TOURNAMENTS, IN CLASS 41 (U.S. CLS. 100, 101
AND 107).

FIRST USE 3-15-2007; IN COMMERCE 3-15-2007.

OWNER OF U.S. REG. NOS. 578,653, 1,331,309 AND
OTHERS.

NO CLAIM IS MADE TO THE EXCLUSIVE
RIGHT TO USE "TEAM CHAMPIONSHIP", "1916"
OR "2007", APART FROM THE MARK AS SHOWN.

SER. NO. 77-132,269, FILED 3-15-2007.

ESTHER BELENKER, EXAMINING ATTORNEY

Int. Cl.: 35

Prior U.S. Cls.: 100, 101 and 102

United States Patent and Trademark Office

Reg. No. 3,518,920

Registered Oct. 21, 2008

**SERVICE MARK
PRINCIPAL REGISTER**

MOTORHEAD

R & D ENTERPRISES, INC. (DELAWARE CORPORATION)
20660 US HIGHWAY 31 N
VINEMONT, AL 35179

THE MARK CONSISTS OF STANDARD CHARACTERS WITHOUT CLAIM TO ANY PARTICULAR FONT, STYLE, SIZE, OR COLOR.

FOR: MARKETING OF PRODUCTS, NAMELY, MARKETING OF TRADEMARK LICENSED PRODUCTS IN THE FIELD OF NOVELTIES, IN CLASS 35 (U.S. CLS. 100, 101 AND 102).

SER. NO. 77-133,028, FILED 3-16-2007.

FIRST USE 8-1-1999; IN COMMERCE 8-1-1999.

KATHERINE CHANG, EXAMINING ATTORNEY

Int. Cls.: 9, 21, 25, 28 and 41

**Prior U.S. Cls.: 2, 13, 21, 22, 23, 26, 29, 30, 33, 36, 38,
39, 40, 50, 100, 101 and 107**

Reg. No. 3,518,921

United States Patent and Trademark Office

Registered Oct. 21, 2008

**TRADEMARK
SERVICE MARK
PRINCIPAL REGISTER**

HERO

BLACK MARKET SPORTZ LIMITED (UNITED KINGDOM LIMITED LIABILITY COMPANY)
49-61 JODRELL STREET, NUNEATON
WARWICKSHIRE, UNITED KINGDOM CV115EG

FOR: PROTECTIVE CLOTHING; PROTECTIVE HEADGEAR; PAINTBALL GOGGLES; PAINTBALL HELMETS; TELESCOPIC SIGHTS FOR PAINTBALL MARKERS; OPTICAL SIGHTS FOR PAINTBALL MARKERS; LASER SIGHTS FOR PAINTBALL MARKERS, IN CLASS 9 (U.S. CLS. 21, 23, 26, 36 AND 38).

FOR: CLEANING EQUIPMENT FOR PAINTBALL MARKERS, NAMELY, RAGS, BRUSHES AND SQUEEGEES, IN CLASS 21 (U.S. CLS. 2, 13, 23, 29, 30, 33, 40 AND 50).

FOR: HEADWEAR AND FOOTWEAR FOR PAINTBALL AND PAINTBALLERS; CLOTHING FOR PAINTBALL AND PAINTBALLERS, NAMELY, GILLIE SUITS, PANTS, SHIRTS, JACKETS, GLOVES, AND ARMBANDS; CAMOUFLAGED HEADWEAR AND FOOTWEAR FOR WEAR WHILE PLAYING OR REFEREEING PAINTBALL; CAMOUFLAGED CLOTHING, NAMELY, CAMOUFLAGED FIELD JACKETS AND CAMOUFLAGED BATTLE DRESS UNIFORMS FOR WEAR WHILE PLAYING OR REFEREEING PAINTBALL, IN CLASS 25 (U.S. CLS. 22 AND 39).

FOR: PAINTBALL MARKERS; PNEUMATICALLY OPERATED PAINTBALL MARKERS; NON-TELESCOPIC SIGHTS FOR PAINTBALL MARKERS; ROUND PODS FOR PAINTBALL PELLETS AND PROJECTILES; SPECIALLY ADAPTED PACKS AND WEBBING FOR HOLDING PAINTBALL PELLET PODS; PAINTBALL PELLET CONTAINERS; BARRELS FOR PAINTBALL MARKERS; PARTS AND FITTINGS FOR PAINTBALL MARKERS; BARREL

CONDOMS FOR PAINTBALL MARKERS; ADAPTORS FOR PAINTBALL MARKER BARRELS; COVERS AND SAFETY COVERS FOR PAINTBALL MARKERS BARRELS; PAINTBALL GRENADES; GAS FOR PAINTBALL MARKERS; GAS ADAPTORS FOR PAINTBALL MARKERS; PAINTBALL MARKERS SOLD WITH PROPELLANT; ELECTRIC PAINTBALL MARKERS; CO2 PAINTBALL MARKERS; NITROGEN GAS PAINTBALL MARKERS; MOUNTS, CRADLES, TRIPODS, BI-PODS AND SUPPORTS AND STANDS FOR PAINTBALL MARKERS; EXPANSION CHAMBERS FOR PAINTBALL MARKERS; FILL STATIONS FOR PAINTBALL MARKERS; FORE GRIPS FOR PAINTBALL MARKERS; STOCKS FOR PAINTBALL MARKERS; TRIGGERS FOR PAINTBALL MARKERS; SPRING AND LOCKING MECHANISMS FOR PAINTBALL MARKERS; LOCKING MECHANISMS FOR PAINTBALL MARKERS; RECEPTACLES FOR STORING AMMUNITION FOR PAINTBALL MARKERS; RECEPTACLES FOR CARRYING AMMUNITION FOR PAINTBALL MARKERS; APPARATUS FOR QUICK LOADING OF AMMUNITION FOR PAINTBALL MARKERS; POWER-FEEDERS, POWER-HOPPERS, ELBOW-LOADERS AND FEEDERS AND HOPPERS FOR AMMUNITION FOR PAINTBALL MARKERS; TARGETS FOR PRACTISING SHOOTING PAINTBALL MARKERS; PAINTBALL MARKERS, AMMUNITIONS, PROPELLANT, CLEANING PRODUCTS, CONTAINERS AND CARRYING ARTICLES SOLD TOGETHER AS A PACKAGE; SINGLE FIRE PAINTBALL MARKERS; RAPID FIRE PAINTBALL MARKERS; SNIPER PAINTBALL MARKERS; RIFLE PAINTBALL MARKERS, SUB MACHINE MARKER PAINTBALL MARKERS; MACHINE PISTOL PAINTBALL MARKERS; AUTOMATIC PISTOL PAINTBALL MARKERS; ASSAULT RIFLE PAINTBALL MARKERS, PISTOL PAINTBALL MARKERS; REVOLVER PAINTBALL MARKERS; PAINTBALLS;

DYED PAINTBALLS FOR USE AS PROJECTILES IN WAR GAMES; PAINTBALL MARKERS BEING SPORTING APPARATUS; MARKERS FOR FIRING PAINTBALLS; PAINTBALL BEING AMMUNITION FOR PAINTBALL MARKERS WHICH ARE SPORTING APPARATUS; PAINTBALLS BEING PROJECTILES; PROTECTIVE AND SAFETY PADDING FOR USE BY PAINTBALLERS, NAMELY, GLOVES AND CHEST, THIGH, LEG, SHOULDER, HAND, ARM, WAIST, BACK, NECK, GROIN, FOOT, ANKLE AND FACE PROTECTORS; PROTECTIVE ATHLETIC CLOTHING, NAMELY, GILLIE SUITS, ARM GUARDS, ELBOW GUARDS, KNEE GUARDS, MOUTH GUARDS AND PAINTBALL DEFLECTORS; PAINTBALL MASKS, IN CLASS 28 (U.S. CLS. 22, 23, 38 AND 50).

FOR: PAINTBALL ENTERTAINMENT AND EDUCATIONAL SERVICES, NAMELY, PROVISION

OF PAINTBALL TOURNAMENTS, PROVISION OF PAINTBALL ACTIVITY DAYS, PROVIDING INFORMATION ABOUT PLAYING PAINTBALL, ORGANISATION OF PAINTBALL GAMES, AND ORGANISATION OF PAINTBALL COMBAT GAMES, IN CLASS 41 (U.S. CLS. 100, 101 AND 107).

THE MARK CONSISTS OF STANDARD CHARACTERS WITHOUT CLAIM TO ANY PARTICULAR FONT, STYLE, SIZE, OR COLOR.

PRIORITY CLAIMED UNDER SEC. 44(D) ON UNITED KINGDOM APPLICATION NO. 2433215A, FILED 9-21-2006, REG. NO. 2433215A, DATED 9-21-2006, EXPIRES 9-21-2016.

SER. NO. 77-134,888, FILED 3-19-2007.

KIMBERLY FRYE, EXAMINING ATTORNEY

Int. Cl.: 35

Prior U.S. Cls.: 100, 101 and 102

United States Patent and Trademark Office

Reg. No. 3,518,922

Registered Oct. 21, 2008

**SERVICE MARK
PRINCIPAL REGISTER**

The Uptown Shop

UPTOWN HOUSE AND GARDEN (ILLINOIS
CORPORATION)
111 EAST 1ST ST
ELMHURST, IL 60126

FOR: RETAIL STORE SERVICES FOR WOMEN
AND TEENAGE GIRLS FEATURING LADIES
CLOTHING ACCESSORIES AND HOME DECOR,
IN CLASS 35 (U.S. CLS. 100, 101 AND 102).

FIRST USE 4-1-2004; IN COMMERCE 6-1-2004.

THE MARK CONSISTS OF STANDARD CHAR-
ACTERS WITHOUT CLAIM TO ANY PARTICULAR
FONT, STYLE, SIZE, OR COLOR.

NO CLAIM IS MADE TO THE EXCLUSIVE
RIGHT TO USE "SHOP", APART FROM THE MARK
AS SHOWN.

SER. NO. 77-138,310, FILED 3-22-2007.

EMILY CARLSEN, EXAMINING ATTORNEY

Int. Cl.: 5

Prior U.S. Cls.: 6, 18, 44, 46, 51 and 52

Reg. No. 3,518,923

United States Patent and Trademark Office

Registered Oct. 21, 2008

**TRADEMARK
PRINCIPAL REGISTER**

SOOTHING

CDJ HOLDING, INC. (CALIFORNIA CORPORATION)
1440 WASHINGTON BLVD. SUITE A-2
CONCORD, CA 94521

THE MARK CONSISTS OF STANDARD CHARACTERS WITHOUT CLAIM TO ANY PARTICULAR FONT, STYLE, SIZE, OR COLOR.

FOR: DIETARY AND NUTRITIONAL SUPPLEMENTS; HERBAL SUPPLEMENTS, IN CLASS 5 (U.S. CLS. 6, 18, 44, 46, 51 AND 52).

SER. NO. 77-140,726, FILED 3-26-2007.

FIRST USE 3-2-2007; IN COMMERCE 3-2-2007.

JANET LEE, EXAMINING ATTORNEY

Int. Cl.: 5

Prior U.S. Cls.: 6, 18, 44, 46, 51 and 52

Reg. No. 3,518,924

United States Patent and Trademark Office

Registered Oct. 21, 2008

**TRADEMARK
PRINCIPAL REGISTER**

BODY SPECIFIC

CDJ HOLDING, INC. (CALIFORNIA CORPORATION)
1440 WASHINGTON BLVD. SUITE A-2
CONCORD, CA 94521

THE MARK CONSISTS OF STANDARD CHARACTERS WITHOUT CLAIM TO ANY PARTICULAR FONT, STYLE, SIZE, OR COLOR.

FOR: DIETARY AND NUTRITIONAL SUPPLEMENTS; HERBAL SUPPLEMENTS, IN CLASS 5 (U.S. CLS. 6, 18, 44, 46, 51 AND 52).

SER. NO. 77-140,735, FILED 3-26-2007.

FIRST USE 3-2-2007; IN COMMERCE 3-2-2007.

JANET LEE, EXAMINING ATTORNEY

Int. Cls.: 9 and 45

Prior U.S. Cls.: 21, 23, 26, 36, 38, 100 and 101

United States Patent and Trademark Office

Reg. No. 3,518,925

Registered Oct. 21, 2008

**TRADEMARK
SERVICE MARK
PRINCIPAL REGISTER**

ALIVEWORLD

ALIVEWARE LIMITED (NEW ZEALAND LIMITED LIABILITY COMPANY)
95 GATLAND ROAD
PAPAKURA 2113, NEW ZEALAND

FOR: COMPUTER SOFTWARE AND DOWNLOADABLE COMPUTER SOFTWARE FEATURING INFORMATION FOR PERSONAL DEVELOPMENT, LIFESTYLE CHOICES, AND PERSONAL LIFE AND TIME MANAGEMENT, IN CLASS 9 (U.S. CLS. 21, 23, 26, 36 AND 38).

FOR: PROVIDING AN ONLINE COMPUTER DATABASE FOR INTEGRATING AND IMPLEMENTING INFORMATION IN THE FIELD OF PERSONAL DEVELOPMENT, LIFESTYLE CHOICES, AND PER-

SONAL LIFE AND TIME MANAGEMENT, IN CLASS 45 (U.S. CLS. 100 AND 101).

THE MARK CONSISTS OF STANDARD CHARACTERS WITHOUT CLAIM TO ANY PARTICULAR FONT, STYLE, SIZE, OR COLOR.

PRIORITY CLAIMED UNDER SEC. 44(D) ON NEW ZEALAND APPLICATION NO. 765578, FILED 3-22-2007, REG. NO. 765578, DATED 3-22-2007, EXPIRES 3-22-2017.

SER. NO. 77-143,926, FILED 3-29-2007.

KEVIN DINALLO, EXAMINING ATTORNEY

Int. Cl.: 5

Prior U.S. Cls.: 6, 18, 44, 46, 51 and 52

Reg. No. 3,518,926

United States Patent and Trademark Office

Registered Oct. 21, 2008

TRADEMARK
PRINCIPAL REGISTER

恒豐泰

TUNG FUNG TAI GINSENG LTD. (HONG KONG
LIMITED LIABILITY COMPANY)

G/F., 188 QUEEN'S ROAD CENTRAL

HONG KONG, HONG KONG

FOR: GINSENG AS NUTRITIONAL SUPPLE-
MENTS AND FOR MEDICINAL USE, IN CLASS 5
(U.S. CLS. 6, 18, 44, 46, 51 AND 52).

OWNER OF HONG KONG REG. NO. 19912552,
DATED 9-13-1989, EXPIRES 9-13-2010.

THE FOREIGN WORDING IN THE MARK
TRANSLATES INTO ENGLISH AS CONSTANT,
ABUNDANT, PROSPEROUS.

THE NON-LATIN CHARACTER(S) IN THE
MARK transliterate into "HANG FUNG
TAI", AND THIS MEANS "CONSTANT, ABUN-
DANT, PROSPEROUS" IN ENGLISH.

SER. NO. 77-145,822, FILED 4-2-2007.

JENNY PARK, EXAMINING ATTORNEY

Int. Cl.: 45

Prior U.S. Cls.: 100 and 101

United States Patent and Trademark Office

Reg. No. 3,518,927

Registered Oct. 21, 2008

**SERVICE MARK
PRINCIPAL REGISTER**



HODGSON LAW GROUP (CALIFORNIA SOLE
PROPRIETORSHIP)
9606 SANTA MONICA BOULEVARD, THIRD
FLOOR
BEVERLY HILLS, CA 90210

THE EGG IS GOLD, THE GOOSE BODY IS
WHITE, THE GOOSE'S LEGS ARE YELLOW, THE
LETTERING IS WHITE, ALL ON A SHADED BLUE
BACKGROUND.

FOR: LEGAL SERVICES, IN CLASS 45 (U.S. CLS.
100 AND 101).

FIRST USE 5-1-2005; IN COMMERCE 5-1-2005.

SER. NO. 77-146,803, FILED 4-2-2007.

THE COLOR(S) GOLD, WHITE, YELLOW AND
BLUE IS/ARE CLAIMED AS A FEATURE OF THE
MARK.

PAUL E. FAHRENKOPF, EXAMINING ATTORNEY

Int. Cl.: 41

Prior U.S. Cls.: 100, 101 and 107

United States Patent and Trademark Office

Reg. No. 3,518,928

Registered Oct. 21, 2008

**SERVICE MARK
PRINCIPAL REGISTER**



MOORE, RICHARD (UNITED STATES INDIVIDUAL)
182-21 AVON RD. JAMAICA ESTATES
QUEENS, NY 114322316

FOR: PROVIDES EDUCATIONAL SERVICES, NAMELY, PROVIDING TRAINING, CLASSES AND WORKSHOPS, IN THE FIELD OF STRATEGIC THINKING IN LIFE, UNDERSTANDING, FINANCE AND STRATEGIC INVESTMENTS, IN CLASS 41 (U.S. CLS. 100, 101 AND 107).

FIRST USE 2-2-2007; IN COMMERCE 2-2-2007.

THE COLOR(S) BLACK AND GRAY IS/ARE CLAIMED AS A FEATURE OF THE MARK.

THE MARK CONSISTS OF THE LETTERS "THINK B4U MOVE" ARE COLORED GRAY AND BOLD. THE CHESS PIECE IS IN BLACK, REPRESENTING A KNIGHT. THE CHESS PIECE INCLUDES A SHADOW OF GRAY AROUND IT.

SER. NO. 77-147,164, FILED 4-3-2007.

ANDREA HACK, EXAMINING ATTORNEY

Int. Cl.: 9

Prior U.S. Cls.: 21, 23, 26, 36 and 38

Reg. No. 3,518,929

United States Patent and Trademark Office

Registered Oct. 21, 2008

**TRADEMARK
PRINCIPAL REGISTER**



RICHMOND, KID (UNITED STATES INDIVIDUAL)

315 S. RANDOLPH ST.

RICHMOND, VA 23220

FOR: FLAME RESISTANT PROTECTIVE GARMENTS, NAMELY, GLOVES, BALACLAVAS, SHIRTS, PANTS, AND SOCKS THAT ARE SPECIFICALLY DESIGNED FOR STUNT PERFORMERS, IN CLASS 9 (U.S. CLS. 21, 23, 26, 36 AND 38).

FIRST USE 4-15-2006; IN COMMERCE 5-1-2006.

NO CLAIM IS MADE TO THE EXCLUSIVE RIGHT TO USE "PROTECTION GEAR", APART FROM THE MARK AS SHOWN.

THE MARK CONSISTS OF A CARTOONISH LOOKING DEVIL WITH NO FACE, ARROW POINTED TAIL, HOLDING A THREE PRONG PITCH FORK IN HIS HAND WHILE STANDING UP TO THE RIGHT OF THE TERMS "DEVIL SKIN" AND "INFERNO PROTECTION GEAR".

SER. NO. 77-147,848, FILED 4-3-2007.

ANDREA BUTLER, EXAMINING ATTORNEY

Int. Cl.: 5

Prior U.S. Cls.: 6, 18, 44, 46, 51 and 52

Reg. No. 3,518,930

United States Patent and Trademark Office

Registered Oct. 21, 2008

**TRADEMARK
PRINCIPAL REGISTER**

MF6

N.V. NUTRICIA (NETHERLANDS PUBLIC LIMITED COMPANY (PLC))
EERSTE STATIONSSTRAAT 186
ZOETERMEER, NETHERLANDS 2712HM

THE MARK CONSISTS OF STANDARD CHARACTERS WITHOUT CLAIM TO ANY PARTICULAR FONT, STYLE, SIZE, OR COLOR.

FOR: DIETETIC SUBSTANCES ADAPTED FOR MEDICAL USE, NAMELY, DIETETIC FOODS; FOOD FOR BABIES, INFANTS AND INVALIDS; FOOD SUPPLEMENTS ADAPTED FOR MEDICAL USE; DIETARY NUTRITIONAL SUPPLEMENTS; EDIBLE PLANT FIBRES FOR MEDICAL USE, NAMELY, DIETARY FIBER AS AN ADDITIVE FOR FOOD PRODUCTS, GROUND FLAXSEED FIBER FOR USE A DIETARY SUPPLEMENT, IN CLASS 5 (U.S. CLS. 6, 18, 44, 46, 51 AND 52).

OWNER OF BENELUX REG. NO. 0819350, DATED 3-14-2007, EXPIRES 2-19-2017.

OWNER OF U.S. REG. NO. 2,679,490.

SER. NO. 77-149,357, FILED 4-5-2007.

MARY CRAWFORD, EXAMINING ATTORNEY

Int. Cl.: 5

Prior U.S. Cls.: 6, 18, 44, 46, 51 and 52

United States Patent and Trademark Office

Reg. No. 3,518,931

Registered Oct. 21, 2008

**TRADEMARK
PRINCIPAL REGISTER**



N.V. NUTRICIA (NETHERLANDS PUBLIC LIMITED COMPANY (PLC))
EERSTE STATIONSSTRAAT 186
ZOETERMEER, NETHERLANDS 2712HM

FOR: DIETETIC SUBSTANCES ADAPTED FOR MEDICAL USE, NAMELY, DIETETIC FOODS; FOOD FOR BABIES, INFANTS AND INVALIDS; FOOD SUPPLEMENTS ADAPTED FOR MEDICAL USE; DIETARY NUTRITIONAL SUPPLEMENTS; EDIBLE PLANT FIBRES FOR MEDICAL USE, NAMELY, DIETARY FIBER AS AN ADDITIVE FOR FOOD PRODUCTS, GROUND FLAXSEED

FIBER FOR USE A DIETARY SUPPLEMENT, IN CLASS 5 (U.S. CLS. 6, 18, 44, 46, 51 AND 52).

OWNER OF BENELUX REG. NO. 0819357, DATED 3-14-2007, EXPIRES 2-19-2017.

OWNER OF U.S. REG. NO. 2,679,490.

SER. NO. 77-149,375, FILED 4-5-2007.

MARY CRAWFORD, EXAMINING ATTORNEY

Int. Cls.: 41 and 43

Prior U.S. Cls.: 100, 101 and 107

United States Patent and Trademark Office

Reg. No. 3,518,932

Registered Oct. 21, 2008

**SERVICE MARK
PRINCIPAL REGISTER**



APOC RESTAURANT, INC. (NEW YORK CORPORATION)
560 WEST 34TH STREET
NEW YORK, NY 10001

FOR: CABARET SERVICES, IN CLASS 41 (U.S. CLS. 100, 101 AND 107).

FIRST USE 12-31-1976; IN COMMERCE 12-31-1976.

FOR: RESTAURANT AND BAR SERVICES, IN CLASS 43 (U.S. CLS. 100 AND 101).

FIRST USE 12-31-1976; IN COMMERCE 12-31-1976.

OWNER OF U.S. REG. NOS. 1,210,093 AND 1,280,161.

THE MARK CONSISTS OF THE WORD "COPACABANA" BENEATH THE FANCIFUL IMAGE OF A WOMAN WEARING LIPSTICK, A LARGE EARRING, AND A TURBAN CONTAINING FRUITS, LEAVES AND A RIBBON.

SER. NO. 77-149,719, FILED 4-5-2007.

TAMARA FRAZIER, EXAMINING ATTORNEY

Int. Cl.: 36

Prior U.S. Cls.: 100, 101 and 102

United States Patent and Trademark Office

Reg. No. 3,518,933

Registered Oct. 21, 2008

**SERVICE MARK
PRINCIPAL REGISTER**

JEWELERS CENTER

SPECTRUM PROPERTIES GROUP, INC. (ILLINOIS CORPORATION)
SUITE 2116
5 SOUTH WABASH AVENUE
CHICAGO, IL 60603

FOR: REAL ESTATE SERVICES, NAMELY, LEASING SHOWROOMS TO TENANTS, IN CLASS 36 (U.S. CLS. 100, 101 AND 102).

FIRST USE 1-1-1992; IN COMMERCE 1-1-1992.

THE MARK CONSISTS OF STANDARD CHARACTERS WITHOUT CLAIM TO ANY PARTICULAR FONT, STYLE, SIZE, OR COLOR.

SEC. 2(F).

SER. NO. 77-150,290, FILED 4-5-2007.

LEIGH CAROLINE CASE, EXAMINING ATTORNEY

Int. Cl.: 37

Prior U.S. Cls.: 100, 103 and 106

United States Patent and Trademark Office

Reg. No. 3,518,934

Registered Oct. 21, 2008

**SERVICE MARK
PRINCIPAL REGISTER**

Fix-it Man

CLEGG, DENNIS NAKURU (UNITED STATES
INDIVIDUAL)
75 SKYVIEW ROAD
SEDONA, AZ 863363141

FOR: REPAIR OF STRUCTURES, NAMELY,
ELECTRICAL AND PLUMBING FIXTURES IN
COMMERCIAL FOOD SERVICE BUILDINGS AND
RESIDENTIAL HOMES, FOOD SERVICE PROCES-
SING EQUIPMENT, EQUIPMENT FOR COLD STO-
RAGE OF FOOD SERVICE PERISHABLES,
HEATING EQUIPMENT FOR FOOD SERVICE PRE-
PARATIONS, HEATING AND COOLING EQUIP-
MENT FOR BOTH COMMERCIAL AND

RESIDENTIAL, IN CLASS 37 (U.S. CLS. 100, 103
AND 106).

FIRST USE 4-1-2006; IN COMMERCE 4-1-2006.

THE MARK CONSISTS OF STANDARD CHAR-
ACTERS WITHOUT CLAIM TO ANY PARTICULAR
FONT, STYLE, SIZE, OR COLOR.

SER. NO. 77-152,593, FILED 4-10-2007.

JUSTINE D. PARKER, EXAMINING ATTORNEY

Int. Cls.: 3 and 5

Prior U.S. Cls.: 1, 4, 6, 18, 44, 46, 50, 51 and 52

United States Patent and Trademark Office

Reg. No. 3,518,935

Registered Oct. 21, 2008

**TRADEMARK
PRINCIPAL REGISTER**



LABORATOIRES ARKOPHARMA (FRANCE CORPORATION)
ZONE INDUSTRIELLE
CARROS CEDEX, FRANCE 06511

FOR: COSMETICS, NON-MEDICATED SKIN SOAPS, PERFUMERY AND NON-MEDICATED SKIN CARE PREPARATIONS, IN CLASS 3 (U.S. CLS. 1, 4, 6, 50, 51 AND 52).

FIRST USE 4-0-2002; IN COMMERCE 3-0-2003.

FOR: NUTRITIONAL SUPPLEMENTS; PHARMACEUTICAL PREPARATIONS, NAMELY, ANTIDEPRESSANTS, ANTITUSSIVE COLD PREPARATIONS, DIET CAPSULES, DIET PILLS, DIETARY DRINKS MIX FOR USE AS A MEAL REPLACEMENT, NUTRITIONAL DRINK MIX FOR

USE AS A MEAL REPLACEMENT, APPETITE SUPPRESSANTS; DIETARY SUPPLEMENTS, IN CLASS 5 (U.S. CLS. 6, 18, 44, 46, 51 AND 52).

FIRST USE 4-0-2002; IN COMMERCE 3-0-2003.

THE MARK CONSISTS OF THE WORDING "PLANTE SYSTEM COMPLEXE VEGETAL P.E.S" INSIDE A WHITE SQUARE. A SMALL BOX WITH LEAVES APPEARS ABOVE THE WORD "PLANTE".

THE ENGLISH TRANSLATION OF THE WORD "PLANTE SYSTEM COMPLEXE VEGETAL" IN THE MARK IS PLANT SYSTEM COMPLEX PLANT.

SER. NO. 77-152,772, FILED 4-10-2007.

HOWARD SMIGA, EXAMINING ATTORNEY

Int. Cl.: 9

Prior U.S. Cls.: 21, 23, 26, 36 and 38

United States Patent and Trademark Office

Reg. No. 3,518,936

Registered Oct. 21, 2008

TRADEMARK
PRINCIPAL REGISTER



CONSCIOUS MEDIA NETWORK INC. (WYOMING CORPORATION)
PO BOX 518
LOOMIS, CA 956500528

FOR: DOWNLOADABLE FILMS AND TV PROGRAMS FEATURING ENLIGHTENMENT, HUMAN POTENTIAL, SCIENCE AND CONSCIOUSNESS PROVIDED VIA A VIDEO-ON-DEMAND SERVICE; DOWNLOADABLE MULTIMEDIA FILE CONTAINING ARTWORK, TEXT, AUDIO, VIDEO, GAMES, AND INTERNET WEB LINKS RELATING TO ENLIGHTENMENT, HUMAN POTENTIAL, SCIENCE AND CONSCIOUSNESS; DOWNLOADABLE VIDEO RECORDINGS FEATURING ENLIGHTENMENT, HUMAN POTENTIAL, SCIENCE AND CONSCIOUSNESS, IN CLASS 9 (U.S. CLS. 21, 23, 26, 36 AND 38).

FIRST USE 4-1-2005; IN COMMERCE 4-1-2005.

NO CLAIM IS MADE TO THE EXCLUSIVE RIGHT TO USE "CONSCIOUS MEDIA NETWORK", APART FROM THE MARK AS SHOWN.

THE COLOR(S) BLACK, WHITE, GRAY, BLUE, RED, ORANGE AND YELLOW IS/ARE CLAIMED AS A FEATURE OF THE MARK.

THE MARK CONSISTS OF WHITE LETTERING ON A BLACK ROUNDEL WITH A CENTRE SECTION OF BLUE, RED, ORANGE AND YELLOW MERGING INTO THE CENTER. THE LETTERS "C", "M", AND "N" ARE IN BLACK IN THE CENTRE OF THE IMAGE. THE RIM OF THE OUTER CIRCLE IS GRAY.

SER. NO. 77-154,575, FILED 4-11-2007.

MICHAEL WEBSTER, EXAMINING ATTORNEY

Int. Cls.: 9 and 41

Prior U.S. Cls.: 21, 23, 26, 36, 38, 100, 101 and 107

United States Patent and Trademark Office

Reg. No. 3,518,937

Registered Oct. 21, 2008

**TRADEMARK
SERVICE MARK
PRINCIPAL REGISTER**

KGBEATS

MICHAEL SKLOVSKY (UNITED STATES INDIVIDUAL)

210

450 PLUMCREEK DRIVE
WHEELING, IL 60090

FOR: COMPACT DISCS FEATURING MUSIC; MUSICAL RECORDINGS DOWNLOADABLE VIA THE INTERNET; PRE-RECORDED COMPACT DISCS, RECORDS FEATURING MUSIC; SOUND RECORDINGS, IN CLASS 9 (U.S. CLS. 21, 23, 26, 36 AND 38).

FIRST USE 11-1-2001; IN COMMERCE 11-1-2001.

FOR: ENTERTAINMENT SERVICES, NAMELY, PRESENTATION OF LIVE MUSICAL PERFORMANCES BY MUSICIANS, DISC JOCKEYS; PRESENTATION OF PRE-RECORDED MUSIC VIA THE

INTERNET; PRESENTATION OF PRE-RECORDED MUSIC BY MUSICIANS, DISC JOCKEYS IN LIVE MUSIC CONCERTS AND VIA THE INTERNET; PRODUCTION OF MUSICAL RECORDINGS; MUSIC PRODUCTION SERVICES; PLANNING AND ARRANGING OF MUSICAL CONCERTS; PRODUCTION OF LIVE MUSICAL CONCERTS AND SHOWS, IN CLASS 41 (U.S. CLS. 100, 101 AND 107).

FIRST USE 5-26-1993; IN COMMERCE 5-26-1993.

THE MARK CONSISTS OF STANDARD CHARACTERS WITHOUT CLAIM TO ANY PARTICULAR FONT, STYLE, SIZE, OR COLOR.

SER. NO. 77-154,977, FILED 4-12-2007.

DANNEAN HETZEL, EXAMINING ATTORNEY

Int. Cls.: 16, 18, 25, 28, 35, 41, 43 and 44

**Prior U.S. Cls.: 1, 2, 3, 5, 22, 23, 29, 37, 38, 39, 41, 50,
100, 101, 102 and 107**

Reg. No. 3,518,938

United States Patent and Trademark Office

Registered Oct. 21, 2008

**TRADEMARK
SERVICE MARK
PRINCIPAL REGISTER**



GLENWILD COMMUNITY ASSOCIATION, INC.
(UTAH CORPORATION)
P.O. BOX 980845
PARK CITY, UT 84098

FOR: PAPER; PRINTED MATTER, NAMELY, SCORE CARDS; PRINTED PUBLICATIONS, NAMELY, GOLF COURSE GUIDES; NEWSLETTERS, CATALOGUES AND BROCHURES IN THE FIELD OF HOME BUILDING, COMMUNITY LIVING, TENNIS, GOLF AND HEALTH SPAS, IN CLASS 16 (U.S. CLS. 2, 5, 22, 23, 29, 37, 38 AND 50).

FIRST USE 8-1-2001; IN COMMERCE 8-1-2001.

FOR: TRAVEL BAGS; DUFFEL BAGS, IN CLASS 18 (U.S. CLS. 1, 2, 3, 22 AND 41).

FIRST USE 8-1-2001; IN COMMERCE 8-1-2001.

FOR: CLOTHING, NAMELY, SHIRTS, T-SHIRTS, SPORT SHIRTS, JACKETS AND LIGHTWEIGHT WIND-RESISTANT JACKETS, HATS, SWEATERS AND SWEATSHIRTS, GOLF SHOES; HEADBANDS, VISORS, WALLETS AND WATERPROOF CLOTHING, NAMELY, SHIRTS, JACKETS, HATS, AND VISORS, IN CLASS 25 (U.S. CLS. 22 AND 39).

FIRST USE 8-1-2001; IN COMMERCE 8-1-2001.

FOR: SPORTING GOODS, NAMELY, GOLF GLOVES, GOLF BALLS, GOLF BAGS, GOLF BAG COVERS, GOLF BAG TAGS, HEAD COVERS FOR GOLF CLUBS, GOLF BALL MARKERS, GOLF ACCESSORY POUCHES, GOLF FLAGS, GOLF BALL MARKERS, DIVOT REPAIR TOOLS, AND NON-MOTORIZED GOLF CLUB CARTS, IN CLASS 28 (U.S. CLS. 22, 23, 38 AND 50).

FIRST USE 8-1-2001; IN COMMERCE 8-1-2001.

FOR: ASSOCIATION SERVICES, NAMELY, PROMOTING THE INTERESTS OF HOMEOWNERS THAT RESIDE IN A COMMUNITY; RETAIL GOLF AND TENNIS STORE SERVICES, IN CLASS 35 (U.S. CLS. 100, 101 AND 102).

FIRST USE 1-1-2003; IN COMMERCE 1-1-2003.

FOR: PROVIDING TENNIS COURT FACILITIES; GOLF COURSES AND INSTRUCTIONS; HEALTH CLUBS SERVICES, NAMELY, PROVIDING INSTRUCTION AND EQUIPMENT IN THE FIELD OF PHYSICAL EXERCISE; PHYSICAL FITNESS FACILITIES AND INSTRUCTION; COUNTRY CLUBS; ENTERTAINMENT, NAMELY, PROVIDING GOLF TOURNAMENTS; COUNTRY CLUB SERVICES, NAMELY, PROVIDING FACILITIES FOR GOLF; ENTERTAINMENT SERVICES, NAMELY, ORGANIZING AND CONDUCTING GOLF TOURNAMENTS; GOLF CLUB SERVICES AND GOLF FACILITIES, NAMELY, PROVIDING GOLF COURSES; PROVIDING HEALTH CLUB FACILITIES, NAMELY, PHYSICAL FITNESS FACILITIES; PROVIDING INSTRUCTION IN THE FIELD OF PHYSICAL EXERCISE; RENTAL OF GOLF EQUIPMENT; PROVIDING RECREATIONAL FACILITIES IN THE NATURE OF CHILDREN'S PLAY AREAS AND POOLS; ARRANGING AND PROVIDING FACILITIES FOR RECREATIONAL ACTIVITIES, NAMELY, INFORMAL COMMUNITY FESTIVALS AND SPORTING TOURNAMENTS; PROVIDING RECREATIONAL OPEN SPACES; ENTERTAINMENT IN THE NATURE OF VISUAL ARTS PERFORMANCES OR LITERARY PERFORMANCES FOR EDUCATIONAL OR ENTERTAINMENT PURPOSES; HEALTH CLUB SERVICES, NAMELY, PROVIDING

INSTRUCTION AND EQUIPMENT IN THE FIELD OF PHYSICAL EXERCISE; PROVIDING FACILITIES FOR OUTDOOR RECREATIONAL ACTIVITIES, NAMELY, HIKING, BIKING, JOGGING AND FISHING; PROVIDING VARIOUS FACILITIES FOR AN ARRAY OF SPORTING EVENTS, SPORTS AND ATHLETIC COMPETITIONS; PHYSICAL FITNESS INSTRUCTION; AND PROVIDING FITNESS AND EXERCISE FACILITIES, IN CLASS 41 (U.S. CLS. 100, 101 AND 107).

FIRST USE 8-1-2001; IN COMMERCE 8-1-2001.

FOR: RESTAURANT, BAR AND COCKTAIL LOUNGE SERVICES, IN CLASS 43 (U.S. CLS. 100 AND 101).

FIRST USE 1-16-2002; IN COMMERCE 1-16-2002.

FOR: HEALTH SPA SERVICES FOR HEALTH AND WELLNESS OF BODY AND SPIRIT OFFERED AT A HEALTH RESORT; HEALTH SPA SERVICE, NAMELY, COSMETIC BODY CARE SERVICES; PROVIDING HEALTH SPA FACILITIES, NAMELY, PROVIDING MASSAGE THERAPY AND COSMETIC SKIN AND FULL BODY CARE TREATMENTS, IN CLASS 44 (U.S. CLS. 100 AND 101).

FIRST USE 1-16-2002; IN COMMERCE 1-16-2002.

OWNER OF U.S. REG. NO. 2,470,414.

THE MARK CONSISTS OF A STYLIZED VERSION OF THE MARK "GLENWILD" USING A FLOWER IN THE PLACE OF THE "L".

SER. NO. 77-156,280, FILED 4-13-2007.

BERNICE MIDDLETON, EXAMINING ATTORNEY

Int. Cls.: 16, 18, 25, 28, 35, 41, 43 and 44

**Prior U.S. Cls.: 1, 2, 3, 5, 22, 23, 29, 37, 38, 39, 41, 50,
100, 101, 102 and 107**

Reg. No. 3,518,939

United States Patent and Trademark Office

Registered Oct. 21, 2008

**TRADEMARK
SERVICE MARK
PRINCIPAL REGISTER**

GLENWILD

GLENWILD COMMUNITY ASSOCIATION, INC.
(UTAH CORPORATION)
P.O. BOX 980845
PARK CITY, UT 84098

FOR: PAPER; PRINTED MATTER, NAMELY, SCORE CARDS; PRINTED PUBLICATIONS, NAMELY, GOLF COURSE GUIDES; NEWSLETTERS, CATALOGUES AND BROCHURES IN THE FIELD OF HOME BUILDING, COMMUNITY LIVING, TENNIS, GOLF AND HEALTH SPAS, IN CLASS 16 (U.S. CLS. 2, 5, 22, 23, 29, 37, 38 AND 50).

FIRST USE 8-1-2001; IN COMMERCE 8-1-2001.

FOR: TRAVEL BAGS; DUFFEL BAGS, IN CLASS 18 (U.S. CLS. 1, 2, 3, 22 AND 41).

FIRST USE 8-1-2001; IN COMMERCE 8-1-2001.

FOR: CLOTHING, NAMELY, SHIRTS, T-SHIRTS, SPORT SHIRTS, JACKETS AND LIGHTWEIGHT WIND-RESISTANT JACKETS, HATS, SWEATERS AND SWEATSHIRTS, GOLF SHOES; HEADBANDS, VISORS, WALLETS AND WATERPROOF CLOTHING, NAMELY, SHIRTS, JACKETS, HATS, AND VISORS, IN CLASS 25 (U.S. CLS. 22 AND 39).

FIRST USE 8-1-2001; IN COMMERCE 8-1-2001.

FOR: SPORTING GOODS, NAMELY, GOLF GLOVES, GOLF BALLS, GOLF BAGS, GOLF BAG COVERS, GOLF BAG TAGS, HEAD COVERS FOR GOLF CLUBS, GOLF BALL MARKERS, GOLF ACCESSORY POUCHES, GOLF FLAGS, GOLF BALL MARKERS, DIVOT REPAIR TOOLS, AND NON-MOTORIZED GOLF CLUB CARTS, IN CLASS 28 (U.S. CLS. 22, 23, 38 AND 50).

FIRST USE 8-1-2001; IN COMMERCE 8-1-2001.

FOR: ASSOCIATION SERVICES, NAMELY, PROMOTING THE INTERESTS OF HOMEOWNERS THAT RESIDE IN A COMMUNITY; RETAIL GOLF AND TENNIS STORE SERVICES, IN CLASS 35 (U.S. CLS. 100, 101 AND 102).

FIRST USE 1-1-2003; IN COMMERCE 1-1-2003.

FOR: PROVIDING TENNIS COURT FACILITIES; GOLF COURSES AND INSTRUCTIONS; HEALTH CLUBS SERVICES, NAMELY, PROVIDING INSTRUCTION AND EQUIPMENT IN THE FIELD OF PHYSICAL EXERCISE; PHYSICAL FITNESS FACILITIES AND INSTRUCTION; COUNTRY CLUBS; ENTERTAINMENT, NAMELY, PROVIDING GOLF TOURNAMENTS; COUNTRY CLUB SERVICES, NAMELY, PROVIDING FACILITIES FOR GOLF; ENTERTAINMENT SERVICES, NAMELY, ORGANIZING AND CONDUCTING GOLF TOURNAMENTS; GOLF CLUB SERVICES AND GOLF FACILITIES, NAMELY, PROVIDING GOLF COURSES; PROVIDING HEALTH CLUB FACILITIES, NAMELY, PHYSICAL FITNESS FACILITIES; PROVIDING INSTRUCTION IN THE FIELD OF PHYSICAL EXERCISE; RENTAL OF GOLF EQUIPMENT; PROVIDING RECREATIONAL FACILITIES IN THE NATURE OF CHILDREN'S PLAY AREAS AND POOLS; ARRANGING AND PROVIDING FACILITIES FOR RECREATIONAL ACTIVITIES, NAMELY, INFORMAL COMMUNITY FESTIVALS AND SPORTING TOURNAMENTS; PROVIDING RECREATIONAL OPEN SPACES; ENTERTAINMENT IN THE NATURE OF VISUAL ARTS PERFORMANCES OR LITERARY PERFORMANCES FOR EDUCATIONAL OR ENTERTAINMENT PURPOSES; HEALTH CLUB SERVICES, NAMELY, PROVIDING INSTRUCTION AND EQUIPMENT IN THE FIELD OF PHYSICAL EXERCISE; PROVIDING FACILITIES FOR OUTDOOR RECREATIONAL ACTIV-

ITIES, NAMELY, HIKING, BIKING, JOGGING AND FISHING; PROVIDING VARIOUS FACILITIES FOR AN ARRAY OF SPORTING EVENTS, SPORTS AND ATHLETIC COMPETITIONS; PHYSICAL FITNESS INSTRUCTION; AND PROVIDING FITNESS AND EXERCISE FACILITIES, IN CLASS 41 (U.S. CLS. 100, 101 AND 107).

FIRST USE 8-1-2001; IN COMMERCE 8-1-2001.

FOR: RESTAURANT, BAR AND COCKTAIL LOUNGE SERVICES, IN CLASS 43 (U.S. CLS. 100 AND 101).

FIRST USE 1-16-2002; IN COMMERCE 1-16-2002.

FOR: HEALTH SPA SERVICES FOR HEALTH AND WELLNESS OF BODY AND SPIRIT OFFERED

AT A HEALTH RESORT; HEALTH SPA SERVICE, NAMELY, COSMETIC BODY CARE SERVICES; PROVIDING HEALTH SPA FACILITIES, NAMELY, PROVIDING MASSAGE THERAPY AND COSMETIC SKIN AND FULL BODY CARE TREATMENTS, IN CLASS 44 (U.S. CLS. 100 AND 101).

FIRST USE 1-16-2002; IN COMMERCE 1-16-2002.

THE MARK CONSISTS OF STANDARD CHARACTERS WITHOUT CLAIM TO ANY PARTICULAR FONT, STYLE, SIZE, OR COLOR.

OWNER OF U.S. REG. NO. 2,470,414.

SER. NO. 77-156,289, FILED 4-13-2007.

BERNICE MIDDLETON, EXAMINING ATTORNEY

Int. Cl.: 11

Prior U.S. Cls.: 13, 21, 23, 31 and 34

Reg. No. 3,518,940

United States Patent and Trademark Office

Registered Oct. 21, 2008

TRADEMARK
PRINCIPAL REGISTER

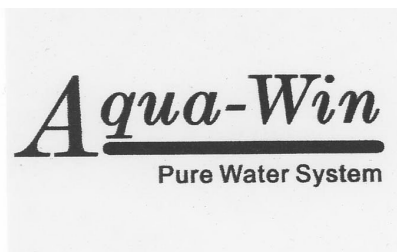

AQUA-WIN WATERTEC CO., LTD. (TAIWAN CORPORATION)
NO.668, DAFONG 2ND RD., SANMIN DISTRICT
KAOHSIUNG CITY, TAIWAN

FOR: WATER FILTERS; WATER PURIFIERS; FILTER CARTRIDGES FOR WATER FILTERS; WATER IONIZERS; OZONE GENERATORS THAT KILL MOLD AND MILDEW; WATER TREATMENT EQUIPMENT, NAMELY, REVERSE OSMOSIS FILTRATION UNITS; WATER FILTERING UNITS FOR HOUSEHOLD USE; DRINKING FOUNTAINS; DRINKING FOUNTAIN PEDESTALS; ULTRAVIOLET LAMPS NOT FOR MEDICAL PURPOSES; HOUSINGS FOR WATER FILTERS; OZONE ULTRASONIC ANION GENERATORS; WATER AND SOFT-WATER TREATMENT EQUIPMENT, NAMELY, CARTRIDGE FILTRATION, CHEMICAL STERILIZATION, ULTRAVIOLET STERILIZATION AND REVERSE OSMOSIS FILTRATION UNITS; WATER FILTERING UNITS FOR DOMESTIC, COMMERCIAL AND INDUSTRIAL USE; REFRIGERATED WATER DISPENSING UNITS; WATER SOFTENING

UNITS; DRINKING WATER DISPENSERS, NAMELY, WATER COOLERS; WATER DISPENSERS, NAMELY, WATER COOLERS WITH REVERSE OSMOSIS FILTRATION UNITS; FILTER CARTRIDGES FOR DRINKING FOUNTAINS; WATER IONIZERS; FILTER CARTRIDGES FOR WATER IONIZERS; WATER COOLERS; WATER TREATMENT EQUIPMENT, NAMELY, ULTRAVIOLET STERILIZATION UNITS; WATER TREATMENT EQUIPMENT, NAMELY, MEMBRANE FILTRATION UNITS; ALKALINE IONIC WATER GENERATORS, IN CLASS 11 (U.S. CLS. 13, 21, 23, 31 AND 34).

FIRST USE 7-31-2006; IN COMMERCE 7-31-2006.

NO CLAIM IS MADE TO THE EXCLUSIVE RIGHT TO USE "PURE WATER SYSTEM", APART FROM THE MARK AS SHOWN.

SER. NO. 77-157,258, FILED 4-16-2007.

STEVEN R. FINE, EXAMINING ATTORNEY

Int. Cl.: 36

Prior U.S. Cls.: 100, 101 and 102

United States Patent and Trademark Office

Reg. No. 3,518,941

Registered Oct. 21, 2008

**SERVICE MARK
PRINCIPAL REGISTER**

AIG AMBASSADOR

AMERICAN INTERNATIONAL GROUP, INC.
(DELAWARE CORPORATION)
70 PINE STREET
NEW YORK, NY 10270

FOR: INSURANCE UNDERWRITING SERVICES
IN THE FIELD OF ACCIDENT AND HEALTH
INSURANCE FOR BUSINESS TRAVELERS, IN
CLASS 36 (U.S. CLS. 100, 101 AND 102).

FIRST USE 2-1-2007; IN COMMERCE 2-1-2007.

THE MARK CONSISTS OF STANDARD CHAR-
ACTERS WITHOUT CLAIM TO ANY PARTICULAR
FONT, STYLE, SIZE, OR COLOR.

OWNER OF U.S. REG. NOS. 1,151,229, 1,273,845
AND OTHERS.

SER. NO. 77-157,708, FILED 4-16-2007.

KELLY MCCOY, EXAMINING ATTORNEY

Int. Cls.: 35 and 40

Prior U.S. Cls.: 100, 101, 102, 103 and 106

United States Patent and Trademark Office

Reg. No. 3,518,942

Registered Oct. 21, 2008

**SERVICE MARK
PRINCIPAL REGISTER**

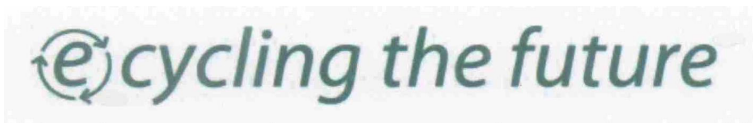

MATERIALS PROCESSING CORPORATION
(MINNESOTA CORPORATION)
2805 WEST SERVICE ROAD
EAGAN, MN 55121

FOR: REMARKETING SERVICES, NAMELY, RE-MARKETING ELECTRONIC COMPONENTS OF OTHERS, IN CLASS 35 (U.S. CLS. 100, 101 AND 102).

FIRST USE 1-18-2007; IN COMMERCE 2-15-2007.

FOR: RECYCLING SERVICES, NAMELY, ELECTRONIC EQUIPMENT RECYCLING; PRECIOUS METALS RECLAMATION SERVICES, IN CLASS 40 (U.S. CLS. 100, 103 AND 106).

FIRST USE 1-18-2007; IN COMMERCE 2-15-2007.

THE COLOR(S) GREEN IS/ARE CLAIMED AS A FEATURE OF THE MARK.

THE MARK CONSISTS OF A LOWERCASE "E" SURROUNDED BY THREE ARROWS IN THE SHAPE OF A CIRCLE FOLLOWED BY "CYCLING THE FUTURE", ALL IN THE COLOR GREEN.

SER. NO. 77-157,940, FILED 4-16-2007.

KAREN SEVERSON, EXAMINING ATTORNEY

Int. Cl.: 35

Prior U.S. Cls.: 100, 101 and 102

United States Patent and Trademark Office

Reg. No. 3,518,943

Registered Oct. 21, 2008

**SERVICE MARK
PRINCIPAL REGISTER**



MUSTARD SEED COMMUNICATIONS, LLC
(MARYLAND LIMITED LIABILITY COMPAN-
NY)

P.O. BOX 1404
BOWIE, MD 20717

FOR: ADVERTISING BY TRANSMISSION OF ON-
LINE PUBLICITY FOR THIRD PARTIES THROUGH
ELECTRONIC COMMUNICATIONS NETWORKS;
ADVERTISING SERVICES, NAMELY, PROMOTING
AND MARKETING THE GOODS AND SERVICES
OF OTHERS THROUGH ALL PUBLIC COMMUNI-
CATION MEANS; ADVERTISING THROUGH ALL
PUBLIC COMMUNICATION MEANS; DISSEMINA-
TION OF ADVERTISING FOR OTHERS VIA AN ON-
LINE COMMUNICATIONS NETWORK ON THE
INTERNET, IN CLASS 35 (U.S. CLS. 100, 101 AND
102).

FIRST USE 2-8-2006; IN COMMERCE 2-8-2006.

NO CLAIM IS MADE TO THE EXCLUSIVE
RIGHT TO USE "COMMUNICATIONS", APART
FROM THE MARK AS SHOWN.

THE MARK CONSISTS OF STYLIZED TEXT
WITH GRAPHIC REPRESENTATION OF A TREE
WITH ROOTS EMBEDDED IN THE LETTER "D" OF
THE WORD "MUSTARD".

SER. NO. 77-158,074, FILED 4-16-2007.

G. MAYERSCHOFF, EXAMINING ATTORNEY

Int. Cl.: 30

Prior U.S. Cl.: 46

United States Patent and Trademark Office

Reg. No. 3,518,944

Registered Oct. 21, 2008

**TRADEMARK
PRINCIPAL REGISTER**

NATURAL PLANET

KLN ENTERPRISES, INC. (MINNESOTA CORPORATION)
800 4TH STREET NW
PERHAM, MN 56573

FOR: CEREAL-BASED SNACK FOODS, IN CLASS
30 (U.S. CL. 46).

FIRST USE 4-19-1999; IN COMMERCE 4-19-1999.

THE MARK CONSISTS OF STANDARD CHARACTERS WITHOUT CLAIM TO ANY PARTICULAR FONT, STYLE, SIZE, OR COLOR.

OWNER OF U.S. REG. NO. 2,468,143.

NO CLAIM IS MADE TO THE EXCLUSIVE RIGHT TO USE "NATURAL", APART FROM THE MARK AS SHOWN.

SER. NO. 77-158,208, FILED 4-17-2007.

FRANK LATTUCA, EXAMINING ATTORNEY

Int. Cls.: 11 and 30

Prior U.S. Cls.: 13, 21, 23, 31, 34 and 46

United States Patent and Trademark Office

Reg. No. 3,518,945

Registered Oct. 21, 2008

**TRADEMARK
PRINCIPAL REGISTER**

ARTENSO

PETRA-ELECTRIC PETER HOHLFELDT GMBH
& CO. KG (FED REP GERMANY GMBH & CO.
KG)
GREISBACHERSTRASSE 6
BURGAU, FED REP GERMANY 89331

FOR: ELECTRIC APPARATUS FOR PREPARING
HOT DRINKS, NAMELY, COFFEE MAKING MA-
CHINES FOR USE WITH COFFEE IN FILTER
PACKS, ESPRESSO-MACHINES, COFFEE MAKING
MACHINES, IN CLASS 11 (U.S. CLS. 13, 21, 23, 31
AND 34).

FOR: COFFEE, IN PARTICULAR INCLUDING
COFFEE IN FILTER PACKS, PREPARED COFFEE-
BASED BEVERAGES, COFFEE-BASED BEVERA-
GES WITH MILK, COFFEE EXTRACTS FOR FOOD,
INSTANT COFFEE, ARTIFICIAL COFFEE, COFFEE
AND ARTIFICIAL COFFEE MIXES; COFFEE, MILK

POWDER AND ARTIFICIAL COFFEE MIXES, COF-
FEE CONTAINING CEREALS, FRUIT AND SPICES,
IN CLASS 30 (U.S. CL. 46).

THE MARK CONSISTS OF STANDARD CHAR-
ACTERS WITHOUT CLAIM TO ANY PARTICULAR
FONT, STYLE, SIZE, OR COLOR.

PRIORITY CLAIMED UNDER SEC. 44(D) ON
ERPNTY TM OFC APPLICATION NO.
005578075, FILED 12-21-2006, REG. NO. 005578075,
DATED 11-6-2007, EXPIRES 12-21-2016.

SER. NO. 77-159,329, FILED 4-18-2007.

VIVIAN MICZNIK FIRST, EXAMINING ATTOR-
NEY

Int. Cl.: 45

Prior U.S. Cls.: 100 and 101

United States Patent and Trademark Office

Reg. No. 3,518,946

Registered Oct. 21, 2008

**SERVICE MARK
PRINCIPAL REGISTER**

datinggold.com

DENIRO MARKETING, LLC. (CALIFORNIA
LIMITED LIABILITY COMPANY)
SUITE 3
6777 EMBARCADERO DRIVE
STOCKTON, CA 95219

FOR: WEB SITE SERVICES FEATURING ON-
LINE DATING CLUB, IN CLASS 45 (U.S. CLS. 100
AND 101).

FIRST USE 5-13-2002; IN COMMERCE 5-13-2002.

THE MARK CONSISTS OF STANDARD CHAR-
ACTERS WITHOUT CLAIM TO ANY PARTICULAR
FONT, STYLE, SIZE, OR COLOR.

NO CLAIM IS MADE TO THE EXCLUSIVE
RIGHT TO USE ".COM", APART FROM THE MARK
AS SHOWN.

SER. NO. 77-160,165, FILED 4-18-2007.

DEIRDRE ROBERTSON, EXAMINING ATTORNEY

Int. Cls.: 3 and 5

Prior U.S. Cls.: 1, 4, 6, 18, 44, 46, 50, 51 and 52

United States Patent and Trademark Office

Reg. No. 3,518,947

Registered Oct. 21, 2008

**TRADEMARK
PRINCIPAL REGISTER**

OENOBBIOL

LABORATOIRE OENOBBIOL (FRANCE CORPORATION)
59 BOULEVARD EXELMANS
PARIS, FRANCE 75016

FOR: COSMETICS; PREPARATIONS TO THE SKIN, EYES, OR HAIR FOR COSMETIC PURPOSES, NAMELY, SKIN LOTIONS, HAIR LOTIONS, SKIN CONDITIONERS, HAIR CONDITIONERS, HAIR SPRAY, EYELINERS, SKIN GELS AND SKIN LOTIONS FOR ACCELERATING TANS, WRINKLE-REDUCING SKIN CARE PREPARATIONS AND SKIN CREAMS FOR REDUCING WATER AND LIPIDS IN THE LIMBS, IN CLASS 3 (U.S. CLS. 1, 4, 6, 50, 51 AND 52).

FOR: NUTRITIONAL SUPPLEMENTS FOR COSMETIC, MEDICAL AND THERAPEUTIC PURPOSES; NUTRITIONAL SUPPLEMENTS INCORPORATING PROTEINS, GLUCIDS, LIPIDS AND FIBERS FOR COSMETIC, MEDICAL AND THERAPEUTIC PURPOSES; NUTRITIONAL SUP-

PLEMENTS INCORPORATING MICRONUTRIENTS, VITAMINS, MINERALS, AMINO ACIDS, FATTY ACIDS AND VEGETAL ACIDS FOR COSMETIC, MEDICAL AND THERAPEUTIC PURPOSES; DIETETIC PRODUCTS, NAMELY, DIURETIC PREPARATIONS IN LIQUID AND CAPSULE FORM; HEALTH FOOD SUPPLEMENTS; DIETARY SUPPLEMENTS FOR NON-MEDICAL USE, IN CLASS 5 (U.S. CLS. 6, 18, 44, 46, 51 AND 52).

THE MARK CONSISTS OF STANDARD CHARACTERS WITHOUT CLAIM TO ANY PARTICULAR FONT, STYLE, SIZE, OR COLOR.

OWNER OF FRANCE REG. NO. 1464375, DATED 5-10-1988, EXPIRES 12-17-2016.

SER. NO. 77-160,577, FILED 4-19-2007.

AHSEN KHAN, EXAMINING ATTORNEY

Int. Cl.: 41

Prior U.S. Cls.: 100, 101 and 107

United States Patent and Trademark Office

Reg. No. 3,518,948

Registered Oct. 21, 2008

**SERVICE MARK
PRINCIPAL REGISTER**



TCS ENTERTAINMENT, INC. (CALIFORNIA CORPORATION)
P.O. BOX 7100
LA VERNE, CA 91750

FOR: ENTERTAINMENT SERVICES, NAMELY, PROVIDING PRE-RECORDED INFORMATION IN THE FIELD OF COMEDY, COMMENTARY ABOUT COMEDY AND PRE-RECORDED COMEDY PERFORMANCES, ALL ON-LINE VIA A GLOBAL COMPUTER NETWORK; ENTERTAINMENT SERVICES, NAMELY, PROVIDING COMEDY SPOTS, NAMELY, COMEDY CLIPS AND SOUND CLIPS FOR USE IN RADIO SHOWS; ONLINE SERVICES IN THE FIELD OF RADIO SHOW PRODUCTION, NAMELY, ONLINE PRODUCTION COMPANY SERVICES IN THE FIELD OF RADIO SHOW PRODUCTION; PREPARATION SERVICES FOR RADIO PERSONALITIES IN THE NATURE OF PROVIDING PRE-RECORDED INFORMATION IN THE FIELD OF COMEDY, COMMENTARY ABOUT COMEDY AND PRE-RECORDED COMEDY PERFORMANCES ALL ON-LINE VIA A GLOBAL COMPUTER NETWORK;

ENTERTAINMENT SERVICES, NAMELY, CUSTOM WRITING SERVICES AND AUDIO RECORDING AND PRODUCTION OF SCRIPTED COMEDY SPOTS AND EDITING AND RECORDING OF SOUNDS AND IMAGES TO PROVIDE SOUND CLIPS FROM ENTERTAINMENT AND NEWS PROGRAMS FOR USE BY RADIO SHOWS; PROVIDING NEWS AND INFORMATION IN THE FIELDS OF ENTERTAINMENT AND SPORTS, AND PROVIDING NEWS IN THE NATURE OF CURRENT EVENT REPORTING FOR RADIO PERSONALITIES, IN CLASS 41 (U.S. CLS. 100, 101 AND 107).

FIRST USE 6-30-2004; IN COMMERCE 6-30-2004.

NO CLAIM IS MADE TO THE EXCLUSIVE RIGHT TO USE "AUDIO", APART FROM THE MARK AS SHOWN.

SER. NO. 77-160,990, FILED 4-19-2007.

CARYN GLASSER, EXAMINING ATTORNEY

Int. Cl.: 6

Prior U.S. Cls.: 2, 12, 13, 14, 23, 25 and 50

United States Patent and Trademark Office

Reg. No. 3,518,949

Registered Oct. 21, 2008

**TRADEMARK
PRINCIPAL REGISTER**

SECUREBOLT

CORBIN RUSSWIN, INC. (DELAWARE CORPORATION)
225 EPISCOPAL ROAD
BERLIN, CT 06037

FOR: EXIT DEVICES COMPRISED OF A METAL DOOR LATCH OPERATED BY A METAL PUSH BAR, IN CLASS 6 (U.S. CLS. 2, 12, 13, 14, 23, 25 AND 50).

FIRST USE 1-0-1998; IN COMMERCE 1-0-1998.

THE MARK CONSISTS OF STANDARD CHARACTERS WITHOUT CLAIM TO ANY PARTICULAR FONT, STYLE, SIZE, OR COLOR.

SEC. 2(F).

SER. NO. 77-162,803, FILED 4-23-2007.

REBECCA POVARCHUK, EXAMINING ATTORNEY

Int. Cl.: 9

Prior U.S. Cls.: 21, 23, 26, 36 and 38

United States Patent and Trademark Office

Reg. No. 3,518,950

Registered Oct. 21, 2008

**TRADEMARK
PRINCIPAL REGISTER**

SECUREBOLT

CORBIN RUSSWIN, INC. (DELAWARE CORPORATION)
225 EPISCOPAL ROAD
BERLIN, CT 06037

FOR: ELECTROMECHANICAL EXIT DEVICES
CONSISTING OF AN ELECTROMECHANICAL
DOOR LATCH AND PUSHBAR OPERATOR, IN
CLASS 9 (U.S. CLS. 21, 23, 26, 36 AND 38).

FIRST USE 2-27-2002; IN COMMERCE 2-27-2002.

THE MARK CONSISTS OF STANDARD CHARACTERS WITHOUT CLAIM TO ANY PARTICULAR FONT, STYLE, SIZE, OR COLOR.

SEC. 2(F).

SER. NO. 77-162,804, FILED 4-23-2007.

REBECCA POVARCHUK, EXAMINING ATTORNEY

Int. Cl.: 43

Prior U.S. Cls.: 100 and 101

United States Patent and Trademark Office

Reg. No. 3,518,951

Registered Oct. 21, 2008

**SERVICE MARK
PRINCIPAL REGISTER**

Hotel Santa Fe

SANTA FE HOTEL LIMITED PARTNERSHIP
(NEW MEXICO LIMITED PARTNERSHIP)
1501 PASEO DE PERALTA
SANTA FE, NM 87501

FOR: HOTEL SERVICES; HOTEL SERVICES FOR
PREFERRED CUSTOMERS; HOTEL, BAR AND
RESTAURANT SERVICES; HOTELS, IN CLASS 43
(U.S. CLS. 100 AND 101).

FIRST USE 3-1-1991; IN COMMERCE 3-1-1991.

THE MARK CONSISTS OF STANDARD CHAR-
ACTERS WITHOUT CLAIM TO ANY PARTICULAR
FONT, STYLE, SIZE, OR COLOR.

OWNER OF U.S. REG. NO. 1,731,817.

NO CLAIM IS MADE TO THE EXCLUSIVE
RIGHT TO USE "HOTEL", APART FROM THE
MARK AS SHOWN.

SEC. 2(F).

SER. NO. 77-164,549, FILED 4-24-2007.

MARY BOAGNI, EXAMINING ATTORNEY

Int. Cls.: 42 and 44

Prior U.S. Cls.: 100 and 101

United States Patent and Trademark Office

Reg. No. 3,518,952

Registered Oct. 21, 2008

**SERVICE MARK
PRINCIPAL REGISTER**

**ORACLE DIAGNOSTIC
LABORATORIES**

ORACLE DIAGNOSTIC LABORATORIES INC.
(FLORIDA CORPORATION)
SUITE 108
3157 N. UNIVERSITY DRIVE
DAVIE, FL 33024

FOR: MEDICAL LABORATORIES, IN CLASS 42
(U.S. CLS. 100 AND 101).

FIRST USE 1-20-2000; IN COMMERCE 1-20-2000.

FOR: MEDICAL TESTING , IN CLASS 44 (U.S.
CLS. 100 AND 101).

FIRST USE 1-20-2000; IN COMMERCE 1-20-2000.

THE MARK CONSISTS OF STANDARD CHAR-
ACTERS WITHOUT CLAIM TO ANY PARTICULAR
FONT, STYLE, SIZE, OR COLOR.

NO CLAIM IS MADE TO THE EXCLUSIVE
RIGHT TO USE "DIAGNOSTIC LABORATORIES",
APART FROM THE MARK AS SHOWN.

SER. NO. 77-168,241, FILED 4-27-2007.

BARBARA BROWN, EXAMINING ATTORNEY

Int. Cl.: 42

Prior U.S. Cls.: 100 and 101

United States Patent and Trademark Office

Reg. No. 3,518,953

Registered Oct. 21, 2008

**SERVICE MARK
PRINCIPAL REGISTER**

FISHLINK

FISH & RICHARDSON P.C. (MASSACHUSETTS
PROFESSIONAL CORPORATION)
P.O. BOX 1022
MINNEAPOLIS, MN 554401022

THE MARK CONSISTS OF STANDARD CHAR-
ACTERS WITHOUT CLAIM TO ANY PARTICULAR
FONT, STYLE, SIZE, OR COLOR.

FOR: COMPUTER SERVICES, NAMELY, AC-
CESS, STORAGE, TRANSMISSION AND DISPLAY
OF LEGAL DATA VIA A CLIENT PORTAL ACCE-
SSED OVER A GLOBAL COMMUNICATION NET-
WORK, FOR PURPOSES OF PROVIDING LEGAL
SERVICES TO CLIENTS, IN CLASS 42 (U.S. CLS. 100
AND 101).

OWNER OF U.S. REG. NOS. 3,172,398 AND
3,172,399.

SER. NO. 77-168,645, FILED 4-30-2007.

FIRST USE 3-4-2005; IN COMMERCE 3-4-2005.

KAPIL BHANOT, EXAMINING ATTORNEY

Int. Cl.: 9

Prior U.S. Cls.: 21, 23, 26, 36 and 38

United States Patent and Trademark Office

Reg. No. 3,518,954

Registered Oct. 21, 2008

**TRADEMARK
PRINCIPAL REGISTER**



WISE ON INC. (REPUBLIC OF KOREA CORPORATION)
SEYEON BLDG. 4F
115-5 SAMSUNG-DONG GANGNAM-GU
SEOUL, REPUBLIC OF KOREA

FOR: COMPUTER GAME SOFTWARE, IN CLASS
9 (U.S. CLS. 21, 23, 26, 36 AND 38).

OWNER OF REPUBLIC OF KOREA REG. NO.
0733305, DATED 1-7-2008, EXPIRES 1-7-2018.

THE COLOR(S) DARK RED IS/ARE CLAIMED AS
A FEATURE OF THE MARK.

THE MARK CONSISTS OF THE WORDS "FREE
JACK" APPEARING IN THE COLOR DARK RED.

SER. NO. 77-169,154, FILED 4-30-2007.

DAVID I, EXAMINING ATTORNEY

Int. Cls.: 16, 21, 25 and 41

**Prior U.S. Cls.: 2, 5, 13, 22, 23, 29, 30, 33, 37, 38, 39,
40, 50, 100, 101 and 107**

Reg. No. 3,518,955

United States Patent and Trademark Office

Registered Oct. 21, 2008

**TRADEMARK
SERVICE MARK
PRINCIPAL REGISTER**

InSPIRIT

WINDOM, PATRICIA T. (UNITED STATES IN-
DIVIDUAL)
BOX 1067
24 CARSON ROAD
WOODACRE, CA 94973

FOR: GREETING CARDS; CALENDARS; NOTE
BOOKS; NOTE PADS; STATIONERY; PENS; PEN-
CILS, IN CLASS 16 (U.S. CLS. 2, 5, 22, 23, 29, 37, 38
AND 50).

FIRST USE 5-1-2006; IN COMMERCE 5-1-2006.

FOR: MUGS; DRINKING CUPS; DRINKING
GLASSES, IN CLASS 21 (U.S. CLS. 2, 13, 23, 29, 30,
33, 40 AND 50).

FIRST USE 5-1-2006; IN COMMERCE 5-1-2006.

FOR: SHIRTS; T-SHIRTS; SWEAT SHIRTS; HATS;
CAPS, IN CLASS 25 (U.S. CLS. 22 AND 39).

FIRST USE 5-1-2006; IN COMMERCE 5-1-2006.

FOR: EDUCATION SERVICES, NAMELY, PRO-
VIDING CLASSES, SEMINARS, WORKSHOPS, TU-
TORING AND MENTORING IN THE FIELDS OF
INTERPERSONAL RELATIONSHIPS, CAREER,
PERSONAL GROWTH AND FAMILY, AND DIS-
TRIBUTION OF COURSE MATERIAL IN CONNEC-
TION THEREWITH, IN CLASS 41 (U.S. CLS. 100, 101
AND 107).

FIRST USE 5-1-2006; IN COMMERCE 5-1-2006.

THE MARK CONSISTS OF STANDARD CHAR-
ACTERS WITHOUT CLAIM TO ANY PARTICULAR
FONT, STYLE, SIZE, OR COLOR.

SER. NO. 77-171,064, FILED 5-2-2007.

YONG KIM, EXAMINING ATTORNEY

Int. Cl.: 41

Prior U.S. Cls.: 100, 101 and 107

United States Patent and Trademark Office

Reg. No. 3,518,956

Registered Oct. 21, 2008

**SERVICE MARK
PRINCIPAL REGISTER**

CKM

HUDSON ASSOCIATES CONSULTING, INC.
(VIRGINIA CORPORATION)
4525 E. HONEYGROVE ROAD, SUITE 205
VIRGINIA BEACH, VA 23455

FOR: EDUCATIONAL SERVICES, NAMELY,
TRAINING IN THE FIELD OF BECOMING A
CERTIFICATION INSTRUCTOR IN THE FIELD OF
KNOWLEDGE MANAGEMENT , IN CLASS 41 (U.S.
CLS. 100, 101 AND 107).

FIRST USE 1-2-1995; IN COMMERCE 1-2-1995.

THE MARK CONSISTS OF STANDARD CHAR-
ACTERS WITHOUT CLAIM TO ANY PARTICULAR
FONT, STYLE, SIZE, OR COLOR.

OWNER OF U.S. REG. NO. 3,035,023.

SEC. 2(F).

SER. NO. 77-171,318, FILED 5-2-2007.

BARNEY CHARLON, EXAMINING ATTORNEY

Int. Cls.: 35 and 36

Prior U.S. Cls.: 100, 101 and 102

United States Patent and Trademark Office

Reg. No. 3,518,957

Registered Oct. 21, 2008

**SERVICE MARK
PRINCIPAL REGISTER**

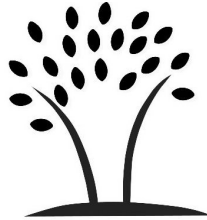

HealthCare Benefits

HEALTHCARE BENEFITS, INC. (PENNSYLVANIA CORPORATION)
1501 REEDSDALE STREET, SUITE 304
PITTSBURGH, PA 15233

FOR: HUMAN RESOURCES CONSULTATION, NAMELY, ANALYSIS OF EMPLOYEE BENEFIT AND HEALTHCARE PLANS, IN CLASS 35 (U.S. CLS. 100, 101 AND 102).

FIRST USE 6-1-2006; IN COMMERCE 6-1-2006.

FOR: ADMINISTRATION OF EMPLOYEE BENEFIT AND HEALTHCARE PLANS, IN CLASS 36 (U.S. CLS. 100, 101 AND 102).

FIRST USE 6-1-2006; IN COMMERCE 6-1-2006.

NO CLAIM IS MADE TO THE EXCLUSIVE RIGHT TO USE "HEALTHCARE BENEFITS", APART FROM THE MARK AS SHOWN.

THE MARK CONSISTS OF THE WORDING "HEALTHCARE BENEFITS" DISPLAYED BELOW A DESIGN OF A FANCIFUL TREE.

SER. NO. 77-172,281, FILED 5-3-2007.

NAKIA HENRY, EXAMINING ATTORNEY

Int. Cl.: 42

Prior U.S. Cls.: 100 and 101

United States Patent and Trademark Office

Reg. No. 3,518,958

Registered Oct. 21, 2008

**SERVICE MARK
PRINCIPAL REGISTER**

Fetish Spa

BUSCH, JAMES L (UNITED STATES INDIVIDUAL)
8126 101ST. STREET CT. E.
PUYALLUP, WA 98373

THE MARK CONSISTS OF STANDARD CHARACTERS WITHOUT CLAIM TO ANY PARTICULAR FONT, STYLE, SIZE, OR COLOR.

FOR: STOCK PHOTOGRAPHY SERVICES, NAMELY, LEASING REPRODUCTION RIGHTS OF PHOTOGRAPHS AND TRANSPARENCIES TO OTHERS, IN CLASS 42 (U.S. CLS. 100 AND 101).

SER. NO. 77-172,839, FILED 5-4-2007.

FIRST USE 6-17-2004; IN COMMERCE 6-30-2004.

JOHN E. MICHOS, EXAMINING ATTORNEY

Int. Cl.: 11

Prior U.S. Cls.: 13, 21, 23, 31 and 34

United States Patent and Trademark Office

Reg. No. 3,518,959

Registered Oct. 21, 2008

**TRADEMARK
PRINCIPAL REGISTER**

VENTAMATIC

VENTAMATIC, LTD. (TEXAS LIMITED PART-
NERSHIP)
P.O. BOX 728
MINERAL WELLS, TX 760680728

THE MARK CONSISTS OF STANDARD CHAR-
ACTERS WITHOUT CLAIM TO ANY PARTICULAR
FONT, STYLE, SIZE, OR COLOR.

FOR: POWER VENTILATORS TO EXHAUST HOT
AIR FROM ATTICS; STATIC VENTILATORS TO
EXHAUST HOT AIR FROM ATTICS; HIGH-VELO-
CITY ELECTRIC FLOOR FANS, IN CLASS 11 (U.S.
CLS. 13, 21, 23, 31 AND 34).

SER. NO. 77-173,659, FILED 5-4-2007.

FIRST USE 2-26-1949; IN COMMERCE 2-26-1949.

KATHERINE E. HALMEN, EXAMINING ATTOR-
NEY

Int. Cl.: 44

Prior U.S. Cls.: 100 and 101

United States Patent and Trademark Office

Reg. No. 3,518,960

Registered Oct. 21, 2008

SERVICE MARK
PRINCIPAL REGISTER



HENRY FORD HEALTH SYSTEM (MICHIGAN NON-PROFIT CORPORATION), DBA HENRY FORD MEDICAL GROUP

5B
ONE FORD PLACE
DETROIT, MI 482023450

FOR: HEALTH CARE, IN CLASS 44 (U.S. CLS. 100 AND 101).

FIRST USE 10-20-2005; IN COMMERCE 10-20-2005.

OWNER OF U.S. REG. NOS. 2,075,160 AND 2,077,011.

NO CLAIM IS MADE TO THE EXCLUSIVE RIGHT TO USE "MEDICAL GROUP, 1915, AND THE REPRESENTATION OF THE CADUCEUS", APART FROM THE MARK AS SHOWN.

THE NAME "HENRY FORD" DOES NOT IDENTIFY A LIVING INDIVIDUAL.

THE MARK CONSISTS OF AT THE TOP ARE THE WORDS "HENRY FORD", AN ORIGINAL CREATION RESEMBLING A SCRIPT TYPESTYLE. BELOW THESE WORDS IS A SHIELD (1-9/16" X 1-3/8") SURROUNDED BY LEAVES. THE UPPER LEFT SIDE OF THE SHIELD SHOWS A CADUCEUS. THE UPPER RIGHT SIDE OF THE SHIELD SHOWS A

MICROSCOPE. THE BOTTOM OF THE SHIELD CONSISTS OF AN OUTLINE OF A HOSPITAL BUILDING WITH AN AMBULANCE IN FRONT OF THE BUILDING. BELOW THE HOSPITAL BUILDING AND AMBULANCE ARE THE NUMBERS "1915" IN THE 8 POINT STEMPER SCHIENDLER BOLD TYPESTYLE. IN THE CENTER OF THE SHIELD IS A BANNER. THE BOTTOM LEFT OF THE BANNER CONTAINS THE LATIN WORD "INVENIO" IN THE 8 POINT STEMPER SCHIENDLER BOLD TYPESTYLE. ABOVE AND IN THE CENTER OF THE BANNER IS A STARBURST. THE CENTER OF THE BANNER CONTAINS THE WORDS "MEDICAL GROUP" IN THE 12 POINT STEMPER SCHIENDLER BOLD TYPESTYLE. THE BOTTOM RIGHT OF THE BANNER CONTAINS THE LATIN WORD "COMMITTO" IN THE 8 POINT STEMPER SCHIENDLER BOLD TYPESTYLE.

THE FOREIGN WORDING IN THE MARK TRANSLATES INTO ENGLISH AS "INVENIO: DISCOVERY AND INNOVATION; AND COMMITTO: TO UNITE, COLLABORATE AND WORK AS A TEAM".

SER. NO. 77-175,150, FILED 5-8-2007.

LOURDES AYALA, EXAMINING ATTORNEY

Int. Cl.: 14

Prior U.S. Cls.: 2, 27, 28 and 50

United States Patent and Trademark Office

Reg. No. 3,518,961

Registered Oct. 21, 2008

**TRADEMARK
PRINCIPAL REGISTER**

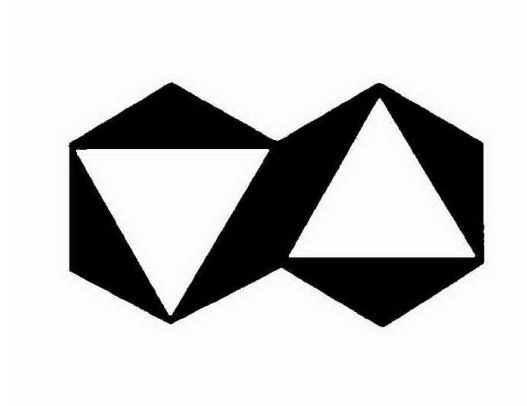

AKTSIONERNAYA KOMPANIA "ALROSA"
(ZAKRYTOE AKTSIONERNOE OBSHCHEST-
VO) (RUSSIAN FED. JOINT STOCK COMPA-
NY)

6, UL. LENINA, G. MIRNY
RESP. SAKHA (YAKUTIA), RUSSIAN FED. RU-
678170

FOR: PRECIOUS METALS AND THEIR ALLOYS;
JEWELRY; AND PRECIOUS STONES, IN CLASS 14
(U.S. CLS. 2, 27, 28 AND 50).

OWNER OF RUSSIAN FED. REG. NO. 268103,
DATED 4-29-2004, EXPIRES 4-18-2012.

SER. NO. 77-175,497, FILED 5-8-2007.

JIM RINGLE, EXAMINING ATTORNEY

Int. Cl.: 41

Prior U.S. Cls.: 100, 101 and 107

United States Patent and Trademark Office

Reg. No. 3,518,962

Registered Oct. 21, 2008

SERVICE MARK
PRINCIPAL REGISTER



THE REGENTS OF THE UNIVERSITY OF CALIFORNIA (CALIFORNIA CORPORATION)
1111 FRANKLIN STREET, 12TH FLOOR
OAKLAND, CA 946075200

FIRST USE 0-0-1868; IN COMMERCE 0-0-1868.

OWNER OF U.S. REG. NO. 2,455,006.

FOR: EDUCATIONAL SERVICES, NAMELY, CONDUCTING CLASSES, CONFERENCES, AND WORKSHOPS IN THE FIELDS OF EDUCATION, PERSONAL AND PROFESSIONAL DEVELOPMENT, PHYSICAL DEVELOPMENT, SCIENCE, ENVIRONMENT, ECOLOGY, AND RECREATION; SPORT CAMPS; ARRANGING AND CONDUCTING ATHLETIC COMPETITIONS, PROVIDING INFORMATION IN THE FIELD OF ATHLETIC COMPETITIONS, NAMELY, MEN'S BASKETBALL, WOMEN'S BASKETBALL, MEN'S CREW, WOMEN'S CREW, MEN'S CROSS COUNTRY, WOMEN'S CROSS COUNTRY, FIELD HOCKEY, FOOTBALL, MEN'S GOLF, WOMEN'S GOLF, MEN'S SOCCER, WOMEN'S SOCCER, MEN'S SWIMMING, WOMEN'S SWIMMING, MEN'S DIVING, WOMEN'S DIVING, BASEBALL, SOFTBALL, MEN'S WATER POLO, WOMEN'S WATER POLO, MEN'S GYMNASTICS, WOMEN'S GYMNASTICS, LACROSSE, RUGBY, MEN'S TRACK AND FIELD, WOMEN'S TRACK AND FIELD, WOMEN'S VOLLEYBALL, IN CLASS 41 (U.S. CLS. 100, 101 AND 107).

NO CLAIM IS MADE TO THE EXCLUSIVE RIGHT TO USE "UNIVERSITY" AND "1868", APART FROM THE MARK AS SHOWN.

THE MARK CONSISTS OF A DEPICTION OF A SEAL WITH A CIRCULAR BANNER IN THE CENTER WITH THE WORDS "THE UNIVERSITY OF CALIFORNIA BERKELEY 1868". IN THE CENTER OF THE BANNER IS A DRAWING OF AN OPEN BOOK WITH A STAR AT THE TOP RADIATING LINES AND A RIBBON WITH THE WORDS "LET THERE BE LIGHT" AT THE BOTTOM. ALL OF WHICH IS SURROUNDED BY A DOTTED CIRCLE ENCLOSED IN A SOLID CIRCLE.

SEC. 2(F) AS TO "THE UNIVERSITY OF CALIFORNIA BERKELEY".

SER. NO. 77-176,524, FILED 5-9-2007.

BARBARA GAYNOR, EXAMINING ATTORNEY

Int. Cl.: 30

Prior U.S. Cl.: 46

United States Patent and Trademark Office

Reg. No. 3,518,963

Registered Oct. 21, 2008

TRADEMARK
PRINCIPAL REGISTER



PEDRO'S TAMALES, INC. (TEXAS CORPORATION)
P.O. BOX 3571
LUBBOCK, TX 79452

FOR: TAMALES; ENCHILADAS; QUESADILLAS;
CHALUPAS; TACOS; SALSA, IN CLASS 30 (U.S. CL.
46).

FIRST USE 9-0-2001; IN COMMERCE 9-0-2001.

NO CLAIM IS MADE TO THE EXCLUSIVE
RIGHT TO USE "MARKET" , APART FROM THE
MARK AS SHOWN.

THE MARK CONSISTS OF THE WORD PEDRO'S
IN ALL LARGE CAPS CENTERED OVER THE
WORD MARKET IN SMALLER ALL CAPS. THE
WORDS ARE LOCATED ON THE LEFT SIDE AND
ON TOP OF A CHILLI PEPPER.

SER. NO. 77-180,597, FILED 5-14-2007.

TASHIA BUNCH, EXAMINING ATTORNEY

Int. Cl.: 43

Prior U.S. Cls.: 100 and 101

United States Patent and Trademark Office

Reg. No. 3,518,964

Registered Oct. 21, 2008

SERVICE MARK
PRINCIPAL REGISTER



PEDRO'S TAMALES, INC. (TEXAS CORPORATION)
P.O. BOX 3571
LUBBOCK, TX 79452

FOR: RESTAURANTS; CARRY-OUT RESTAURANTS; CATERING OF FOOD AND DRINKS, IN CLASS 43 (U.S. CLS. 100 AND 101).

FIRST USE 9-0-2001; IN COMMERCE 9-0-2001.

NO CLAIM IS MADE TO THE EXCLUSIVE RIGHT TO USE "MARKET", APART FROM THE MARK AS SHOWN.

THE MARK CONSISTS OF THE WORD PEDRO'S IN ALL LARGE CAPS CENTERED OVER THE WORD MARKET IN SMALLER ALL CAPS. THE WORDS ARE LOCATED ON THE LEFT SIDE AND ON TOP OF A CHILI PEPPER.

SER. NO. 77-180,624, FILED 5-14-2007.

TASHIA BUNCH, EXAMINING ATTORNEY

Int. Cl.: 45

Prior U.S. Cls.: 100 and 101

United States Patent and Trademark Office

Reg. No. 3,518,965

Registered Oct. 21, 2008

**SERVICE MARK
PRINCIPAL REGISTER**

SOCIAL SECURITY ADVOCATES FOR THE DISABLED

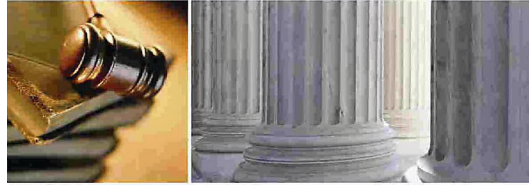

DISABILITY (SSAD) ATTORNEYS

ARRUDA & BEAUDOIN, LLP (MASSACHUSETTS LIMITED PARTNERSHIP)
SUITE 300
340 WOOD ROAD
BRAINTREE, MA 02184

FOR: LEGAL SERVICES; PROVIDING INFORMATION RELATING TO LEGAL AFFAIRS, IN CLASS 45 (U.S. CLS. 100 AND 101).

FIRST USE 5-7-2007; IN COMMERCE 5-7-2007.

NO CLAIM IS MADE TO THE EXCLUSIVE RIGHT TO USE "SOCIAL SECURITY ADVOCATES FOR THE DISABLED" AND "DISABILITY (SSAD) ATTORNEYS", APART FROM THE MARK AS SHOWN.

THE COLOR(S) BLUE, BROWN, GRAY AND WHITE IS/ARE CLAIMED AS A FEATURE OF THE MARK.

THE MARK CONSISTS OF THE WORDS "SOCIAL SECURITY ADVOCATES FOR THE DISABLED DISABILITY (SSAD) ATTORNEYS" IN THE COLOR BLUE, BROWN GAVEL AND LAW BOOKS ARE BROWN, COLUMNS ARE GRAY AND WHITE BACKGROUND.

SER. NO. 77-180,925, FILED 5-15-2007.

ARETHA SOMERVILLE, EXAMINING ATTORNEY

Int. Cl.: 41

Prior U.S. Cls.: 100, 101 and 107

United States Patent and Trademark Office

Reg. No. 3,518,966

Registered Oct. 21, 2008

**SERVICE MARK
PRINCIPAL REGISTER**

ArtVentures

ARTVENTURES STUDIO (TEXAS LIMITED LIABILITY COMPANY)
507 NORTH GOLIAD
ROCKWALL, TX 75087

FOR: EDUCATIONAL SERVICES IN THE NATURE OF FINE ARTS SCHOOLS; INSTRUCTION IN THE FIELD OF ART; WORKSHOPS AND SEMINARS IN THE FIELD OF ART; ART EXHIBITIONS, IN CLASS 41 (U.S. CLS. 100, 101 AND 107).

FIRST USE 4-1-1988; IN COMMERCE 4-1-1988.

THE MARK CONSISTS OF STANDARD CHARACTERS WITHOUT CLAIM TO ANY PARTICULAR FONT, STYLE, SIZE, OR COLOR.

SER. NO. 77-181,323, FILED 5-15-2007.

SUSAN LESLIE DUBOIS, EXAMINING ATTORNEY

Int. Cl.: 35

Prior U.S. Cls.: 100, 101 and 102

United States Patent and Trademark Office

Reg. No. 3,518,967

Registered Oct. 21, 2008

**SERVICE MARK
PRINCIPAL REGISTER**

BBRA

BIG BIKE RIDERS ASSOCIATION OF FLORIDA,
INC. (FLORIDA CORPORATION)
P.O. BOX 9663
CORAL SPRINGS, FL 33075

FOR: ASSOCIATION SERVICES, NAMELY, PROMOTING THE INTERESTS OF MOTORCYCLE RIDERS, CHILDREN AND CHILDREN'S CHARITIES; CLUB SERVICES, NAMELY, PROMOTING THE INTERESTS OF MOTORCYCLE ENTHUSIASTS, IN CLASS 35 (U.S. CLS. 100, 101 AND 102).

FIRST USE 2-0-2004; IN COMMERCE 5-0-2004.

THE MARK CONSISTS OF STANDARD CHARACTERS WITHOUT CLAIM TO ANY PARTICULAR FONT, STYLE, SIZE, OR COLOR.

SER. NO. 77-188,431, FILED 5-23-2007.

RENEE SERVANCE, EXAMINING ATTORNEY

Int. Cls.: 9 and 41

Prior U.S. Cls.: 21, 23, 26, 36, 38, 100, 101 and 107

Reg. No. 3,518,968

United States Patent and Trademark Office

Registered Oct. 21, 2008

**TRADEMARK
SERVICE MARK
PRINCIPAL REGISTER**

Piano4

PIANO PRODUCTIONS, INC. (PENNSYLVANIA
FOUNDATION)
2063 LOMBARD STREET
PHILADELPHIA, PA 19146

FIRST USE 12-1-2000; IN COMMERCE 1-1-2001.

FOR: MUSICAL SOUND RECORDINGS; MUSICAL VIDEO RECORDINGS, IN CLASS 9 (U.S. CLS. 21, 23, 26, 36 AND 38).

THE MARK CONSISTS OF STANDARD CHARACTERS WITHOUT CLAIM TO ANY PARTICULAR FONT, STYLE, SIZE, OR COLOR.

FIRST USE 12-1-2000; IN COMMERCE 1-1-2001.

SER. NO. 77-189,179, FILED 5-24-2007.

FOR: ENTERTAINMENT IN THE NATURE OF LIVE PERFORMANCES BY PIANISTS, IN CLASS 41 (U.S. CLS. 100, 101 AND 107).

REBECCA POVARCHUK, EXAMINING ATTORNEY

Int. Cl.: 21

Prior U.S. Cls.: 2, 13, 23, 29, 30, 33, 40 and 50

United States Patent and Trademark Office

Reg. No. 3,518,969

Registered Oct. 21, 2008

**TRADEMARK
PRINCIPAL REGISTER**

ALLUMINIA FUSION

BIALETTI INDUSTRIE S.P.A. (ITALY JOINT
STOCK COMPANY)
VIA FOGLIANO 1
COCCAGLIO (BS), ITALY 25030

PRIORITY CLAIMED UNDER SEC. 44(D) ON
ERPNTY TM OFC APPLICATION NO.
5934294, FILED 5-15-2007, REG. NO. 5934294, DATED
4-16-2008, EXPIRES 5-15-2017.

FOR: KITCHEN UTENSILS AND CONTAINERS
NOT OF PRECIOUS METALS OR COATED THERE-
WITH, AND NOT OF CERAMIC OR PORCELAIN,
NAMELY, LADLES AND DIPPERS, PANS, COOK-
ING PANS, KETTLES, NON-ELECTRIC KETTLES,
POTS, SAUCEPANS, NON-ELECTRIC PRESSURE
COOKERS, BAKING PANS, FRYING PANS, NON
ELECTRIC COFFEE MAKERS AND COMPONENT
PARTS THEREOF, LIDS AND HANDLES FOR POTS
AND PANS, COLANDERS, STRAINERS, IN CLASS
21 (U.S. CLS. 2, 13, 23, 29, 30, 33, 40 AND 50).

NO CLAIM IS MADE TO THE EXCLUSIVE
RIGHT TO USE "ALLUMINIA", APART FROM
THE MARK AS SHOWN.

THE FOREIGN WORDING IN THE MARK
TRANSLATES INTO ENGLISH AS ALUMINUM.

THE MARK CONSISTS OF STANDARD CHAR-
ACTERS WITHOUT CLAIM TO ANY PARTICULAR
FONT, STYLE, SIZE, OR COLOR.

SER. NO. 77-189,659, FILED 5-24-2007.

EMILY CHUO, EXAMINING ATTORNEY

Int. Cl.: 39

Prior U.S. Cls.: 100 and 105

United States Patent and Trademark Office

Reg. No. 3,518,970

Registered Oct. 21, 2008

**SERVICE MARK
PRINCIPAL REGISTER**

FlyAway

CITY OF LOS ANGELES (CALIFORNIA MUNI-
CIPAL CORPORATION)
CHE 700
200 NORTH MAIN STREET
LOS ANGELES, CA 90012

THE MARK CONSISTS OF STANDARD CHAR-
ACTERS WITHOUT CLAIM TO ANY PARTICULAR
FONT, STYLE, SIZE, OR COLOR.

FOR: TRANSPORTATION OF PASSENGERS,
GOODS, AND LUGGAGE BY MEANS OF BUS, IN
CLASS 39 (U.S. CLS. 100 AND 105).

SER. NO. 77-190,114, FILED 5-24-2007.

FIRST USE 7-10-1975; IN COMMERCE 7-10-1975.

JOHN WILKE, EXAMINING ATTORNEY

Int. Cl.: 37

Prior U.S. Cls.: 100, 103 and 106

United States Patent and Trademark Office

Reg. No. 3,518,971

Registered Oct. 21, 2008

SERVICE MARK
PRINCIPAL REGISTER



CONCEPTS SERGETTI INC. (CANADA CORPORATION)
2829 PLACE DES LISERONS
VAUDREUIL-DORION, (QC), CANADA J7V 0J4

FOR: STRINGING AND-RE-STRINGING OF RACKETS FOR RACKET SPORTS, IN CLASS 37 (U.S. CLS. 100, 103 AND 106).

PRIORITY CLAIMED UNDER SEC. 44(D) ON CANADA APPLICATION NO. 1341661, FILED 3-30-

2007, REG. NO. TMA711251, DATED 4-8-2008, EXPIRES 4-8-2023.

NO CLAIM IS MADE TO THE EXCLUSIVE RIGHT TO USE "SWEETSPOT OPTIMIZER PROCESS", APART FROM THE MARK AS SHOWN.

SER. NO. 77-190,251, FILED 5-25-2007.

SIMON TENG, EXAMINING ATTORNEY

Int. Cls.: 35 and 42

Prior U.S. Cls.: 100, 101 and 102

United States Patent and Trademark Office

Reg. No. 3,518,972

Registered Oct. 21, 2008

**SERVICE MARK
PRINCIPAL REGISTER**



THE HAVI GROUP LIMITED PARTNERSHIP
(DELAWARE LIMITED PARTNERSHIP)
SUITE 400
3010 HIGHLAND PARKWAY
DOWNERS GROVE, IL 60515

FOR: BUSINESS CONSULTING SERVICES RELATING TO PRODUCT MANAGEMENT, SUPPLY CHAIN, PRODUCTION SYSTEMS, DISTRIBUTION SOLUTIONS AND SOURCING STRATEGIES FOR OTHERS; PROCUREMENT, NAMELY, PURCHASING PACKAGING AND PACKAGING MATERIAL FOR OTHERS, IN CLASS 35 (U.S. CLS. 100, 101 AND 102).

FIRST USE 1-1-2006; IN COMMERCE 1-1-2006.

FOR: PACKAGING DESIGN FOR OTHERS; PRODUCT DEVELOPMENT FOR OTHERS; AND PRODUCT DEVELOPMENT CONSULTATION, IN CLASS 42 (U.S. CLS. 100 AND 101).

FIRST USE 1-1-2006; IN COMMERCE 1-1-2006.

NO CLAIM IS MADE TO THE EXCLUSIVE RIGHT TO USE "GLOBAL SOLUTIONS", APART FROM THE MARK AS SHOWN.

COLOR IS NOT CLAIMED AS A FEATURE OF THE MARK.

THE MARK CONSISTS OF A GLOBE THAT HAS A FRAME TO THE LEFT OF IT. THE WORD "PERSECO" APPEARS TO THE RIGHT OF THE GLOBE. THE WORDS "HAVI GLOBAL SOLUTIONS" APPEAR UNDER "PERSECO".

SER. NO. 77-190,566, FILED 5-25-2007.

ELLEN B. AWRICH, EXAMINING ATTORNEY

Int. Cl.: 24

Prior U.S. Cls.: 42 and 50

United States Patent and Trademark Office

Reg. No. 3,518,973

Registered Oct. 21, 2008

**TRADEMARK
PRINCIPAL REGISTER**

MASA

MASA S.P.A. (ITALY CORPORATION)
VIA MESTRE, 37
BOLLADELLO DI CAIRATE, ITALY

FOR: TABLE TEXTILES, LINENS AND TEXTILE GOODS, NOT INCLUDED IN OTHER CLASSES, NAMELY, TEXTILE TABLECLOTHS, TEXTILE NAPKINS, FABRIC TABLE TOPPERS; KITCHEN TEXTILES AND LINENS, NAMELY, DISH TOWELS, TEXTILE PLACE MATS; BATH TEXTILES AND LINENS, NAMELY, FACE TOWELS, HAND TOWELS, BATH TOWELS, BED TEXTILES AND LINENS, NAMELY, BED SHEETS; PILLOWCASES; TEXTILE BED COVERS, DUVET COVERS, IN CLASS 24 (U.S. CLS. 42 AND 50).

FIRST USE 4-28-1997; IN COMMERCE 4-28-1997.

THE MARK CONSISTS OF STANDARD CHARACTERS WITHOUT CLAIM TO ANY PARTICULAR FONT, STYLE, SIZE, OR COLOR.

OWNER OF U.S. REG. NO. 2,369,213.

THE TERM "MASA" HAS NO MEANING IN A FOREIGN LANGUAGE.

SER. NO. 77-190,818, FILED 5-25-2007.

MICHAEL LITZAU, EXAMINING ATTORNEY

Int. Cl.: 24

Prior U.S. Cls.: 42 and 50

United States Patent and Trademark Office

Reg. No. 3,518,974

Registered Oct. 21, 2008

**TRADEMARK
PRINCIPAL REGISTER**

FUSIONS

ROBERT KAUFMAN CO., INC. (CALIFORNIA
CORPORATION)
P.O. BOX 59266
GREENMEAD STATION
LOS ANGELES, CA 900590266

FOR: FABRICS FOR USE IN THE MANUFACTURE OF QUILTING AND CRAFTS; TEXTILE FABRICS FOR USE IN THE MANUFACTURE OF QUILTING AND CRAFTS, IN CLASS 24 (U.S. CLS. 42 AND 50).

FIRST USE 4-11-2001; IN COMMERCE 4-11-2001.

THE MARK CONSISTS OF STANDARD CHARACTERS WITHOUT CLAIM TO ANY PARTICULAR FONT, STYLE, SIZE, OR COLOR.

SER. NO. 77-191,148, FILED 5-25-2007.

JOHN KELLY, EXAMINING ATTORNEY

Int. Cl.: 35

Prior U.S. Cls.: 100, 101 and 102

United States Patent and Trademark Office

Reg. No. 3,518,975

Registered Oct. 21, 2008

**SERVICE MARK
PRINCIPAL REGISTER**



HEALTH CARE POLICY ROUNDTABLE, L.L.C.
(D.C. LIMITED LIABILITY COMPANY)
SUITE 1200
1015 15TH STREET, NW
WASHINGTON, DC 20005

FOR: PROVIDING CONSUMERS WITH REFER-
RALS IN THE FIELD OF HEALTH INSURANCE;
BUSINESS INTERMEDIARY SERVICES, NAMELY,
PROMOTING THE BROKERAGE SERVICES OF
OTHERS IN THE FIELD OF HEALTH INSURANCE;
BUSINESS MANAGEMENT CONSULTING SERVI-
CES, NAMELY, PROVIDING STRATEGIES FOR
MAKING HEALTH INSURANCE BENEFITS

AVAILABLE TO RETIRED EMPLOYEES AND
THEIR FAMILIES, IN CLASS 35 (U.S. CLS. 100, 101
AND 102).

FIRST USE 10-0-2005; IN COMMERCE 10-0-2005.

OWNER OF U.S. REG. NO. 3,440,614.

SEC. 2(F) AS TO "RETIREE HEALTH ACCESS".

SER. NO. 77-192,971, FILED 5-30-2007.

MARCIE MILONE, EXAMINING ATTORNEY

Int. Cl.: 9

Prior U.S. Cls.: 21, 23, 26, 36 and 38

United States Patent and Trademark Office

Reg. No. 3,518,976

Registered Oct. 21, 2008

**TRADEMARK
PRINCIPAL REGISTER**

Coach Dave's Hoop Count

PITCH COUNT LLC (VIRGINIA LIMITED LIABILITY COMPANY)
3824 DADE DRIVE
ANNANDALE, VA 22003

FOR: HAND HELD ELECTRONIC SPORTS COUNTER TO COUNT TOTAL ATTEMPTS, ATTEMPTS MADE, ATTEMPTS MISSED AND PERCENTAGE OF ATTEMPTS MADE TO MAKE A BASKET IN A BASKETBALL GAME OR PRACTICE AND TRACK PERFORMANCE FOR UP TO TWO BASKETBALL PLAYERS, IN CLASS 9 (U.S. CLS. 21, 23, 26, 36 AND 38).

FIRST USE 11-2-2007; IN COMMERCE 11-2-2007.

THE MARK CONSISTS OF STANDARD CHARACTERS WITHOUT CLAIM TO ANY PARTICULAR FONT, STYLE, SIZE, OR COLOR.

OWNER OF U.S. REG. NOS. 2,900,397 AND 3,259,332.

NO CLAIM IS MADE TO THE EXCLUSIVE RIGHT TO USE "HOOP COUNT", APART FROM THE MARK AS SHOWN.

SER. NO. 77-194,012, FILED 5-31-2007.

MARIA-VICTORIA SUAREZ, EXAMINING ATTORNEY

Int. Cls.: 9, 16 and 41

**Prior U.S. Cls.: 2, 5, 21, 22, 23, 26, 29, 36, 37, 38, 50,
100, 101 and 107**

Reg. No. 3,518,977

Registered Oct. 21, 2008

United States Patent and Trademark Office

**TRADEMARK
SERVICE MARK
PRINCIPAL REGISTER**



HARPERCOLLINS PUBLISHERS LIMITED (UNI-
TED KINGDOM CORPORATION)
WESTERHILL ROAD, BISHOPBRIGGS
GLASGOW, UNITED KINGDOM G642QT

FOR: ELECTRONIC PUBLICATIONS, NAMELY,
FICTION BOOKS THAT ARE DOWNLOADABLE
AND RECORDED ON COMPUTER MEDIA, IN
CLASS 9 (U.S. CLS. 21, 23, 26, 36 AND 38).

FOR: SERIES OF PRINTED FICTION BOOKS, IN
CLASS 16 (U.S. CLS. 2, 5, 22, 23, 29, 37, 38 AND 50).

FOR: ONLINE ELECTRONIC PUBLISHING OF
BOOKS, IN CLASS 41 (U.S. CLS. 100, 101 AND 107).

PRIORITY CLAIMED UNDER SEC. 44(D) ON
UNITED KINGDOM APPLICATION NO. 2445622,
FILED 2-5-2007, REG. NO. 2445622, DATED 2-5-2007,
EXPIRES 2-5-2017.

THE MARK CONSISTS OF A SKULL WEARING A
HAT WITH VINES AND THE LETTERS "S" AND "P"
IN THE BACKGROUND.

SER. NO. 77-195,810, FILED 6-1-2007.

DANNEAN HETZEL, EXAMINING ATTORNEY

Int. Cls.: 9, 16 and 41

**Prior U.S. Cls.: 2, 5, 21, 22, 23, 26, 29, 36, 37, 38, 50,
100, 101 and 107**

Reg. No. 3,518,978

United States Patent and Trademark Office

Registered Oct. 21, 2008

**TRADEMARK
SERVICE MARK
PRINCIPAL REGISTER**



HARPERCOLLINS PUBLISHERS LIMITED (UNITED KINGDOM CORPORATION)
WESTERHILL ROAD, BISHOPBRIGGS
GLASGOW, UNITED KINGDOM G642QT

PRIORITY CLAIMED UNDER SEC. 44(D) ON UNITED KINGDOM APPLICATION NO. 2445619, FILED 2-5-2007, REG. NO. 2445619, DATED 2-5-2007, EXPIRES 2-5-2017.

FOR: ELECTRONIC PUBLICATIONS, NAMELY, FICTION BOOKS THAT ARE DOWNLOADABLE AND RECORDED ON COMPUTER MEDIA, IN CLASS 9 (U.S. CLS. 21, 23, 26, 36 AND 38).

THE MARK CONSISTS OF A SKULL WEARING A HAT.

FOR: SERIES OF PRINTED FICTION BOOKS, IN CLASS 16 (U.S. CLS. 2, 5, 22, 23, 29, 37, 38 AND 50).

SER. NO. 77-195,816, FILED 6-1-2007.

FOR: ONLINE ELECTRONIC PUBLISHING OF BOOKS, IN CLASS 41 (U.S. CLS. 100, 101 AND 107).

DANNEAN HETZEL, EXAMINING ATTORNEY

Int. Cl.: 1

Prior U.S. Cls.: 1, 5, 6, 10, 26 and 46

Reg. No. 3,518,979

United States Patent and Trademark Office

Registered Oct. 21, 2008

**TRADEMARK
PRINCIPAL REGISTER**

Rheumera

ASTARTE BIOLOGICS, LLC (WASHINGTON
LIMITED LIABILITY COMPANY)
15805 NE 95TH WAY
REDMOND, WA 98052

FOR: REAGENTS FOR RESEARCH PURPOSES,
IN CLASS 1 (U.S. CLS. 1, 5, 6, 10, 26 AND 46).

FIRST USE 9-21-2006; IN COMMERCE 3-12-2007.

THE MARK CONSISTS OF STANDARD CHAR-
ACTERS WITHOUT CLAIM TO ANY PARTICULAR
FONT, STYLE, SIZE, OR COLOR.

THE WORDING "RHEUMERA" HAS NO MEAN-
ING IN A FOREIGN LANGUAGE.

SER. NO. 77-195,873, FILED 6-1-2007.

BILL DAWE, EXAMINING ATTORNEY

Int. Cl.: 25

Prior U.S. Cls.: 22 and 39

United States Patent and Trademark Office

Reg. No. 3,518,980

Registered Oct. 21, 2008

TRADEMARK
PRINCIPAL REGISTER



BLUE LINE PRODUCTIONS, INC. (GEORGIA CORPORATION)
2198 DOE COURT
SUWANNEE, GA 30174

FOR: SHIRTS, T-SHIRTS, CAPS, IN CLASS 25 (U.S. CLS. 22 AND 39).

FIRST USE 10-0-1994; IN COMMERCE 10-0-1994.

THE COLOR(S) BLACK, BLUE, YELLOW, WHITE, AND GOLD IS/ARE CLAIMED AS A FEATURE OF THE MARK.

THE MARK CONSISTS OF A GOLD BIRD WITH A WHITE HEAD, AND WITH OPEN WINGS CLUTCHING TWO BLACK BARS, WITH A BLUE BAR DISPOSED BETWEEN THE TWO BLACK BARS, A YELLOW BANNER LOCATED IN FRONT OF THE BIRD'S WINGS, AND A YELLOW BANNER LOCATED BEHIND THE BIRD'S WINGS.

SEC. 2(F).

SER. NO. 77-197,053, FILED 6-4-2007.

JAMES GRIFFIN, EXAMINING ATTORNEY

Int. Cl.: 8

Prior U.S. Cls.: 23, 28 and 44

United States Patent and Trademark Office

Reg. No. 3,518,981

Registered Oct. 21, 2008

**TRADEMARK
PRINCIPAL REGISTER**



MENARD, INC. (WISCONSIN CORPORATION)
4777 MENARD DRIVE
EAU CLAIRE, WI 54703

FOR: HAND OPERATED LAWN AND GARDEN TOOLS, NAMELY, HOES, SPADES, AERATORS, EDGERS, ICE CHOPPERS, CHISELS, WEEDERS, RAKES CULTIVATORS, TILLERS, PRUNERS, SAWS, POLE PRUNERS AND SAWS, TRANSPLANTERS, SHEARS, FRUIT PICKERS, TROWELS, GRASS WHIPS, TILLERS; LONG HANDLED ROUND POINT SHOVELS WITH FIBERGLASS HANDLES, LONG HANDLED ROUND POINT SHOVELS WITH WOOD HANDLES, D-HANDLE ROUND POINT SHOVELS WITH WOOD HANDLES, D-HANDLE SPADE POINT SHOVELS WITH WOOD HANDLES, SPECIALTY SHOVELS IN THE NATURE OF LONG HANDLE TRENCHERS WITH WOOD HANDLES, POST HOLE DIGGERS WITH FIBERGLASS HANDLES, FORKS WITH 5-TINES AND FIBERGLASS HANDLES, AND SOD LIFTERS WITH

WOOD HANDLES, IN CLASS 8 (U.S. CLS. 23, 28 AND 44).

FIRST USE 4-0-2007; IN COMMERCE 4-0-2007.

THE COLOR(S) BLACK, GREEN, WHITE AND RED IS/ARE CLAIMED AS A FEATURE OF THE MARK.

THE MARK CONSISTS OF THE WORD "MASTER" IN BLACK, THE WORD "FORCE" IN THE COLOR GREEN, WITH A RED STAR BETWEEN THE WORDS "MASTER" AND "FORCE". THE MARK IS OUTLINED IN BLACK WITH WHITE SHADING.

SER. NO. 77-197,316, FILED 6-4-2007.

KATHERINE CONNOLLY, EXAMINING ATTORNEY

Int. Cl.: 9

Prior U.S. Cls.: 21, 23, 26, 36 and 38

Reg. No. 3,518,982

United States Patent and Trademark Office

Registered Oct. 21, 2008

**TRADEMARK
PRINCIPAL REGISTER**

MAVERIC

SYNOPSYS, INC. (DELAWARE CORPORATION)
700 EAST MIDDLEFIELD ROAD
MOUNTAIN VIEW, CA 94043

FIRST USE 5-21-2007; IN COMMERCE 5-21-2007.

FOR: COMPUTER SOFTWARE FOR USE IN
MULTI-VOLTAGE VERIFICATION IN THE DE-
SIGN OF SEMICONDUCTORS DURING ELECTRO-
NIC MEMORY ANALYSIS, IN CLASS 9 (U.S. CLS. 21,
23, 26, 36 AND 38).

THE MARK CONSISTS OF STANDARD CHAR-
ACTERS WITHOUT CLAIM TO ANY PARTICULAR
FONT, STYLE, SIZE, OR COLOR.

SER. NO. 77-197,433, FILED 6-5-2007.

HANNO RITTNER, EXAMINING ATTORNEY

Int. Cls.: 35, 36, 41 and 45

Prior U.S. Cls.: 100, 101, 102 and 107

United States Patent and Trademark Office

Reg. No. 3,518,983

Registered Oct. 21, 2008

**SERVICE MARK
PRINCIPAL REGISTER**

CLYDE

CLYDE & COMPANY (UNITED KINGDOM LIMITED LIABILITY PARTNERSHIP)
BEAUFORT HOUSE, CHERTSEY STREET
GUILDFORD, UNITED KINGDOM GU14HA

FOR: BUSINESS CONSULTANCY SERVICES; BUSINESS MANAGEMENT ASSISTANCE SERVICES; PROVISION OF INFORMATION RELATING TO BUSINESS; ADVISORY SERVICES RELATING TO BUSINESS MANAGEMENT; BUSINESS ORGANIZATION CONSULTANCY; BUSINESS CONSULTING SERVICES RELATING TO ACQUISITION, MERGERS, AND FRANCHISING; ADVISING IN CONNECTION WITH TAX; PREPARATION OF BUSINESS REPORTS; ARRANGING AND CONDUCTING BUSINESS EXHIBITIONS; PROVISION OF INFORMATION OR ADVISORY SERVICES RELATING TO THE AFORESAID, IN CLASS 35 (U.S. CLS. 100, 101 AND 102).

FOR: FINANCIAL MANAGEMENT; FINANCIAL APPRAISAL OF BUSINESSES; FINANCIAL ANALYSIS; PROVISION OF INFORMATION AND ADVICE RELATING TO INSURANCE AND REINSURANCE; PROVISION OF FINANCIAL INFORMATION; PROVISION OF INSURANCE INFORMATION; FINANCIAL CONSULTANCY SERVICES; BUSINESS LIQUIDATION SERVICES, IN CLASS 36 (U.S. CLS. 100, 101 AND 102).

FOR: EDUCATION AND TRAINING SERVICES, NAMELY, ARRANGING AND CONDUCTING SEMINARS, CONFERENCES, SYMPOSIUMS AND WORKSHOPS RELATING TO BUSINESS; EDUCATION AND TRAINING SERVICES, NAMELY, ARRANGING AND CONDUCTING CONFERENCES, SEMINARS, EXHIBITIONS, WORKSHOPS, AND ONE-ON-ONE MENTORING AND TRAINING RELATING TO LAW, FINANCE, MEDIA, TELECOMMUNICATIONS, INFORMATION TECHNOLOGY, INTELLECTUAL PROPERTY, MANAGEMENT, BANKING SECURITIES, PROPERTY, TAX, INSUR-

ANCE, AVIATION, SHIPPING, AND REGULATORY AFFAIRS, IN CLASS 41 (U.S. CLS. 100, 101 AND 107).

FOR: LEGAL SERVICES; LEGAL SERVICES RELATING TO BUSINESS; LEGAL RESEARCH; PROVISION OF INFORMATION RELATING TO LEGAL SERVICES AND LEGAL RESEARCH; LEGAL SERVICES RELATING TO COMPANY FORMATION AND REGISTRATION SERVICES; LEGAL SERVICES RELATING TO CONVEYANCE OF REAL ESTATE; LEGAL SERVICES RELATING TO AVIATION, JOINT VENTURES, VENTURE CAPITAL, MERGERS AND ACQUISITIONS, CORPORATE FINANCE, ISSUANCE OF FINANCIAL INSTRUMENTS, LISTINGS IN STOCK AND EQUITY MARKETS, BANKING AND FINANCIAL SERVICES, PROPERTY, INTELLECTUAL PROPERTY, INFORMATION TECHNOLOGY, E-COMMERCE, EUROPEAN COMMISSION COMPETITION COMPLIANCE, REGULATORY AFFAIRS, EMPLOYMENT, SPORTS, CORPORATE RECOVERY, RECEIVERSHIP AND LIQUIDATION, SOLVENT AND INSOLVENT RESTRUCTURINGS, ENERGY, PRODUCT LIABILITY, PERSONAL INJURY, CLINICAL NEGLIGENCE, ENTERTAINMENT, INSURANCE AND REINSURANCE, AND INTERNATIONAL FINANCE AND TRADE; MEDIATION AND ARBITRATION SERVICES; PROFESSIONAL CONSULTATION AND ADVISORY SERVICES RELATING TO LEGAL MATTERS, IN CLASS 45 (U.S. CLS. 100 AND 101).

THE MARK CONSISTS OF STANDARD CHARACTERS WITHOUT CLAIM TO ANY PARTICULAR FONT, STYLE, SIZE, OR COLOR.

PRIORITY CLAIMED UNDER SEC. 44(D) ON ERPN CMNTY TM OFC APPLICATION NO. 005529276, FILED 12-6-2006, REG. NO. 005529276, DATED 5-2-2008, EXPIRES 12-6-2016.

SER. NO. 77-199,660, FILED 6-6-2007.

DAVID TOOLEY, EXAMINING ATTORNEY

Int. Cls.: 35, 36, 41 and 45

Prior U.S. Cls.: 100, 101, 102 and 107

United States Patent and Trademark Office

Reg. No. 3,518,984

Registered Oct. 21, 2008

**SERVICE MARK
PRINCIPAL REGISTER**

CLYDES

CLYDE & COMPANY (UNITED KINGDOM LIMITED LIABILITY PARTNERSHIP)
BEAUFORT HOUSE, CHERTSEY STREET
GUILDFORD, UNITED KINGDOM GU14HA

FOR: BUSINESS CONSULTANCY SERVICES; BUSINESS MANAGEMENT ASSISTANCE SERVICES; PROVISION OF INFORMATION RELATING TO BUSINESS; ADVISORY SERVICES RELATING TO BUSINESS MANAGEMENT; BUSINESS ORGANIZATION CONSULTANCY; BUSINESS CONSULTING SERVICES RELATING TO ACQUISITION, MERGERS, AND FRANCHISING; ADVISING IN CONNECTION WITH TAX; PREPARATION OF BUSINESS REPORTS; ARRANGING AND CONDUCTING BUSINESS EXHIBITIONS; PROVISION OF INFORMATION OR ADVISORY SERVICES RELATING TO THE AFORESAID, IN CLASS 35 (U.S. CLS. 100, 101 AND 102).

FOR: FINANCIAL MANAGEMENT; FINANCIAL APPRAISAL OF BUSINESSES; FINANCIAL ANALYSIS; PROVISION OF INFORMATION AND ADVICE RELATING TO INSURANCE AND REINSURANCE; PROVISION OF FINANCIAL INFORMATION; PROVISION OF INSURANCE INFORMATION; FINANCIAL CONSULTANCY SERVICES; BUSINESS LIQUIDATION SERVICES, IN CLASS 36 (U.S. CLS. 100, 101 AND 102).

FOR: EDUCATION AND TRAINING SERVICES, NAMELY, ARRANGING AND CONDUCTING SEMINARS, CONFERENCES, SYMPOSIUMS AND WORKSHOPS RELATING TO BUSINESS; EDUCATION AND TRAINING SERVICES, NAMELY, ARRANGING AND CONDUCTING CONFERENCES, SEMINARS, EXHIBITIONS, WORKSHOPS, AND ONE-ON-ONE MENTORING AND TRAINING RELATING TO LAW, FINANCE, MEDIA, TELECOMMUNICATIONS, INFORMATION TECHNOLOGY, INTELLECTUAL PROPERTY, MANAGEMENT, BANKING SECURITIES, PROPERTY, TAX, INSUR-

ANCE, AVIATION, SHIPPING, AND REGULATORY AFFAIRS, IN CLASS 41 (U.S. CLS. 100, 101 AND 107).

FOR: LEGAL SERVICES; LEGAL SERVICES RELATING TO BUSINESS; LEGAL RESEARCH; PROVISION OF INFORMATION RELATING TO LEGAL SERVICES AND LEGAL RESEARCH; LEGAL SERVICES RELATING TO COMPANY FORMATION AND REGISTRATION SERVICES; LEGAL SERVICES RELATING TO CONVEYANCE OF REAL ESTATE; LEGAL SERVICES RELATING TO AVIATION, JOINT VENTURES, VENTURE CAPITAL, MERGERS AND ACQUISITIONS, CORPORATE FINANCE, ISSUANCE OF FINANCIAL INSTRUMENTS, LISTINGS IN STOCK AND EQUITY MARKETS, BANKING AND FINANCIAL SERVICES, PROPERTY, INTELLECTUAL PROPERTY, INFORMATION TECHNOLOGY, E-COMMERCE, EUROPEAN COMMISSION COMPETITION COMPLIANCE, REGULATORY AFFAIRS, EMPLOYMENT, SPORTS, CORPORATE RECOVERY, RECEIVERSHIP AND LIQUIDATION, SOLVENT AND INSOLVENT RESTRUCTURINGS, ENERGY, PRODUCT LIABILITY, PERSONAL INJURY, CLINICAL NEGLIGENCE, ENTERTAINMENT, INSURANCE AND REINSURANCE, AND INTERNATIONAL FINANCE AND TRADE; MEDIATION AND ARBITRATION SERVICES; PROFESSIONAL CONSULTATION AND ADVISORY SERVICES RELATING TO LEGAL MATTERS, IN CLASS 45 (U.S. CLS. 100 AND 101).

THE MARK CONSISTS OF STANDARD CHARACTERS WITHOUT CLAIM TO ANY PARTICULAR FONT, STYLE, SIZE, OR COLOR.

PRIORITY CLAIMED UNDER SEC. 44(D) ON ERPN CMNTY TM OFC APPLICATION NO. 5529458, FILED 12-6-2006, REG. NO. 5529458, DATED 12-18-2007, EXPIRES 12-6-2016.

SER. NO. 77-199,669, FILED 6-6-2007.

DAVID TOOLEY, EXAMINING ATTORNEY

Int. Cl.: 9

Prior U.S. Cls.: 21, 23, 26, 36 and 38

Reg. No. 3,518,985

United States Patent and Trademark Office

Registered Oct. 21, 2008

**TRADEMARK
PRINCIPAL REGISTER**

NAVITWIN

NORTHROP GRUMMAN SPERRY MARINE
GMBH (FED REP GERMANY CORPORATION)
1840 CENTURY PARK EAST, 15TH FLOOR
LOS ANGELES, CA 900672199

FOR: NAUTICAL INSTRUMENTS, NAMELY, FIBEROPTIC GYROCOMPASSES BEING SPINNING TOP COMPASSES, DIGITAL GYROCOMPASSES BEING SPINNING TOP COMPASSES, SATELLITE COMPASSES, AND MAGNETIC COMPASSES; INERTIAL NAVIGATION EQUIPMENT, NAMELY, SPEED INDICATORS, POSITION INDICATORS, COURSE INDICATORS, SPEED MONITORS, POSITION MONITORS, AND COURSE MONITORS; AND OPERATED NAVIGATION SYSTEMS COMPRISED

OF USER INTERFACES, NAMELY, DATA DISPLAYS, CONTROL KEYS AND INPUT KEYS, IN CLASS 9 (U.S. CLS. 21, 23, 26, 36 AND 38).

THE MARK CONSISTS OF STANDARD CHARACTERS WITHOUT CLAIM TO ANY PARTICULAR FONT, STYLE, SIZE, OR COLOR.

OWNER OF FED REP GERMANY REG. NO. 1011241, DATED 12-4-1980, RENEWED AS REG. NO. 1011241, DATED 5-21-2000, EXPIRES 5-20-2010.

SER. NO. 77-200,548, FILED 6-7-2007.

RUDY R. SINGLETON, EXAMINING ATTORNEY

Int. Cl.: 14

Prior U.S. Cls.: 2, 27, 28 and 50

United States Patent and Trademark Office

Reg. No. 3,518,986

Registered Oct. 21, 2008

**TRADEMARK
PRINCIPAL REGISTER**

P SWISS

P SWISS, INC. (FLORIDA CORPORATION)
140 ROYAL PALM WAY, SUITE 202
PALM BEACH, FL 33480

FOR: WATCHES AND CLOCKS WHICH ARE OF SWISS ORIGIN AS DEFINED BY THE SWISS ORDINANCE GOVERNING THE USE OF THE APPELLATION "SWITZERLAND" OR "SWISS" FOR WATCHES AND JEWELRY , IN CLASS 14 (U.S. CLS. 2, 27, 28 AND 50).

FIRST USE 2-21-2007; IN COMMERCE 2-21-2007.

THE MARK CONSISTS OF STANDARD CHARACTERS WITHOUT CLAIM TO ANY PARTICULAR FONT, STYLE, SIZE, OR COLOR.

NO CLAIM IS MADE TO THE EXCLUSIVE RIGHT TO USE "SWISS", APART FROM THE MARK AS SHOWN.

SER. NO. 77-200,714, FILED 6-7-2007.

PAM WILLIS, EXAMINING ATTORNEY

Int. Cl.: 42

Prior U.S. Cls.: 100 and 101

United States Patent and Trademark Office

Reg. No. 3,518,987

Registered Oct. 21, 2008

**SERVICE MARK
PRINCIPAL REGISTER**



MULTIVIEW, INC. (TEXAS CORPORATION)
7701 LAS COLINAS RIDGE, SUITE 800
IRVING, TX 75063

FOR: COMPUTER SERVICES, NAMELY, PROVIDING SOFTWARE INTERFACES AVAILABLE OVER A NETWORK IN ORDER TO CREATE PERSONALIZED ON-LINE INFORMATION SERVICES; EXTRACTION AND RETRIEVAL OF INFORMATION AND DATA MINING BY MEANS OF GLOBAL COMPUTER NETWORKS; CREATING INDEXES OF INFORMATION, INDEXES OF WEB SITES AND INDEXES OF OTHER INFORMATION SOURCES IN CONNECTION WITH GLOBAL COMPUTER NETWORK; PROVIDING INFORMATION FROM SEARCHABLE INDEXES AND DATABASES OF INFORMATION, NAMELY, TEXT, ELECTRONIC DOCUMENTS, DATABASES, GRAPHIC AND AUDIO VISUAL INFORMATION, BY MEANS OF GLOBAL COMPUTER INFORMATION NETWORKS; PROVIDING A WEB SITE THAT FEATURES INFORMATION GATHERED FROM THE

SEARCHABLE INDEXES AND DATABASES, IN CLASS 42 (U.S. CLS. 100 AND 101).

FIRST USE 11-24-2000; IN COMMERCE 11-24-2000.

THE COLOR(S) GREEN, VIOLET, YELLOW, BLUE, BLACK AND RED IS/ARE CLAIMED AS A FEATURE OF THE MARK.

THE MARK CONSISTS OF A RECTANGLE HAVING A GREEN, VIOLET, YELLOW AND BLUE INTERIOR RECTANGLE, EACH INTERIOR RECTANGLE COMPRISING AN ILLUSTRATION OF A BLACK COLORED EYE, THE RECTANGLE DISPOSED ADJACENT TO THE WORD "MULTIVIEW", THE "MULTI" DESIGNATION IN BLACK AND THE "VIEW" DESIGNATION IN RED.

SER. NO. 77-201,568, FILED 6-8-2007.

NAPOLEON SHARMA, EXAMINING ATTORNEY

Int. Cl.: 30

Prior U.S. Cl.: 46

United States Patent and Trademark Office

Reg. No. 3,518,988

Registered Oct. 21, 2008

TRADEMARK
PRINCIPAL REGISTER



SHIROHATO FOOD INDUSTRY CORPORATION
(JAPAN CORPORATION)
1-4-10, KEIHAN HONDORI
MORIGUCHI CITY
OSAKA 570-0083, JAPAN

FOR: PASTRY, BREAD, CAKES, AND TAKOYA-
KI, NAMELY, ROUND DUMPLINGS MADE FROM
FLOUR, WATER, EGG AND OTHER INGREDI-
ENTS WITH CHOPPED OCTOPUS , IN CLASS 30
(U.S. CL. 46).

FIRST USE 4-30-2004; IN COMMERCE 4-30-2004.

NO CLAIM IS MADE TO THE EXCLUSIVE
RIGHT TO USE "TAKO YA" AND "DOTONBORI",
APART FROM THE MARK AS SHOWN.

THE THREE CHARACTERS ON THE FAR LEFT
SIDE ARE TRANSLITERATED AS "DOUTONBORI",
WHICH IS THE NAME OF A RESTAURANT DIS-
TRICT IN OSAKA. THE MIDDLE CHARACTERS
ARE TRANSLITERATED AS "KUKURU", WHICH
IS BIRD CALL. THE FAR RIGHT THREE CHAR-
ACTERS ARE TRANSLITERATED AS "TAKO YA".
"TAKO" MEANS OCTOPUS AND "YA" MEANS
SHOPS INCLUDING RESTAURANTS, CLOTH
SHOP, AND ANY KIND OF STORE.

SER. NO. 77-201,784, FILED 6-8-2007.

HOWARD SMIGA, EXAMINING ATTORNEY

Int. Cl.: 3

Prior U.S. Cls.: 1, 4, 6, 50, 51 and 52

Reg. No. 3,518,989

United States Patent and Trademark Office

Registered Oct. 21, 2008

**TRADEMARK
PRINCIPAL REGISTER**

REVITA

DIVINE SKIN, INC. (NEW YORK CORPORATION)
SUITE 11S
3000 OCEAN PARKWAY
BROOKLYN, NY 11235

THE MARK CONSISTS OF STANDARD CHARACTERS WITHOUT CLAIM TO ANY PARTICULAR FONT, STYLE, SIZE, OR COLOR.

FOR: NON-MEDICATED SHAMPOOS TO STIMULATE HAIR GROWTH, IN CLASS 3 (U.S. CLS. 1, 4, 6, 50, 51 AND 52).

SER. NO. 77-202,429, FILED 6-11-2007.

FIRST USE 2-12-2007; IN COMMERCE 2-12-2007.

ANNE FARRELL, EXAMINING ATTORNEY

Int. Cl.: 35

Prior U.S. Cls.: 100, 101 and 102

United States Patent and Trademark Office

Reg. No. 3,518,990

Registered Oct. 21, 2008

**SERVICE MARK
PRINCIPAL REGISTER**

COMPREHENSIVE ADVANTAGE

COMPREHENSIVE NETWORK, INC. (NEW
YORK CORPORATION)
1663 EAST 17TH STREET
BROOKLYN, NY 11229

FOR: PROMOTING LOYALTY AND INCREAS-
ING SERVICES THROUGH AN INCENTIVE
AWARDS PROGRAM, AVAILABLE TO PROFES-
SIONALS IN THE FIELDS OF HEALTH CARE,
PHYSICAL REHABILITATION, EDUCATION AND
BILINGUAL INTERPRETATION, WHEREBY
POINTS ARE AWARDED AND CAN THEN BE
REDEEMED FOR MERCHANDISE AND/OR GIFT
CERTIFICATES, IN CLASS 35 (U.S. CLS. 100, 101
AND 102).

FIRST USE 9-1-2005; IN COMMERCE 9-1-2005.

THE MARK CONSISTS OF STANDARD CHAR-
ACTERS WITHOUT CLAIM TO ANY PARTICULAR
FONT, STYLE, SIZE, OR COLOR.

OWNER OF U.S. REG. NO. 3,351,163.

SER. NO. 77-203,312, FILED 6-11-2007.

DOMINIC J. FERRAIUOLO, EXAMINING ATTOR-
NEY

Int. Cl.: 28

Prior U.S. Cls.: 22, 23, 38 and 50

United States Patent and Trademark Office

Reg. No. 3,518,991

Registered Oct. 21, 2008

**TRADEMARK
PRINCIPAL REGISTER**

PROHITTER

PRO HITTER CORPORATION (NEW YORK CORPORATION)
BOX 883
NEW CITY, NY 109560883

FOR: ATHLETIC SPORTING GOODS, NAMELY, BASEBALL AND SOFTBALL BATTING AIDS IN THE NATURE OF A HAND POSITIONING DEVICE WHICH FITS OVER A BATTER'S THUMB SPECIFICALLY FOR DEVELOPING GRIP TECHNIQUE, BAT POSITIONING AND FOR THUMB PROTECTION, IN CLASS 28 (U.S. CLS. 22, 23, 38 AND 50).

FIRST USE 3-10-2008; IN COMMERCE 3-10-2008.

THE MARK CONSISTS OF STANDARD CHARACTERS WITHOUT CLAIM TO ANY PARTICULAR FONT, STYLE, SIZE, OR COLOR.

SER. NO. 77-203,706, FILED 6-12-2007.

TINA BROWN, EXAMINING ATTORNEY

Int. Cl.: 16

Prior U.S. Cls.: 2, 5, 22, 23, 29, 37, 38 and 50

Reg. No. 3,518,992

United States Patent and Trademark Office

Registered Oct. 21, 2008

**TRADEMARK
PRINCIPAL REGISTER**

You've Got The Power

CRUMPTON-YOUNG, LESIA L. (UNITED STATES INDIVIDUAL)
2355 BRIXHAM AVE
ORLANDO, FL 32828

THE MARK CONSISTS OF STANDARD CHARACTERS WITHOUT CLAIM TO ANY PARTICULAR FONT, STYLE, SIZE, OR COLOR.

FOR: A SERIES OF BOOKS, WRITTEN ARTICLES, HANDOUTS AND WORKSHEETS IN THE FIELD OF SELF-IMPROVEMENT, IN CLASS 16 (U.S. CLS. 2, 5, 22, 23, 29, 37, 38 AND 50).

SER. NO. 77-205,748, FILED 6-14-2007.

FIRST USE 4-0-2004; IN COMMERCE 5-0-2004.

MARK SPARACINO, EXAMINING ATTORNEY

Int. Cl.: 9

Prior U.S. Cls.: 21, 23, 26, 36 and 38

Reg. No. 3,518,993

United States Patent and Trademark Office

Registered Oct. 21, 2008

**TRADEMARK
PRINCIPAL REGISTER**

KIRIN WARRIORS

ARISTOCRAT TECHNOLOGIES AUSTRALIA
PTY LTD (AUSTRALIA CORPORATION)
71 LONGUEVILLE ROAD
LANE COVE, NSW, AUSTRALIA 2066

PRIORITY CLAIMED UNDER SEC. 44(D) ON
AUSTRALIA APPLICATION NO. 1152084, FILED
12-14-2006, REG. NO. 1152084, DATED 12-14-2006,
EXPIRES 12-14-2016.

FOR: GAMING MACHINES; COMPUTER HARD-
WARE; DOWNLOADABLE GAME SOFTWARE;
ELECTRONIC GAME SOFTWARE, IN CLASS 9
(U.S. CLS. 21, 23, 26, 36 AND 38).

SER. NO. 77-206,089, FILED 6-14-2007.

THE MARK CONSISTS OF STANDARD CHAR-
ACTERS WITHOUT CLAIM TO ANY PARTICULAR
FONT, STYLE, SIZE, OR COLOR.

WILLIAM ROSSMAN, EXAMINING ATTORNEY

Int. Cl.: 25

Prior U.S. Cls.: 22 and 39

United States Patent and Trademark Office

Reg. No. 3,518,994

Registered Oct. 21, 2008

**TRADEMARK
PRINCIPAL REGISTER**

LA COKA NOSTRA

LA COKA NOSTRA INC. (CALIFORNIA CORPORATION)
C/O KRAMER ACCOUNTANCY CORPORATION
12300 WILSHIRE BLVD., STE 310
LOS ANGELES, CA 90025

FOR: CLOTHING, TO BE SOLD AS PROMOTIONAL MERCHANDISE FOR A MUSICAL GROUP, NAMELY, HATS, HOODED SWEATSHIRTS, JACKETS, AND T-SHIRTS, IN CLASS 25 (U.S. CLS. 22 AND 39).

FIRST USE 10-0-2006; IN COMMERCE 10-0-2006.

THE MARK CONSISTS OF STANDARD CHARACTERS WITHOUT CLAIM TO ANY PARTICULAR FONT, STYLE, SIZE, OR COLOR.

OWNER OF U.S. REG. NO. 3,388,200.

THE WORDING LA COKA NOSTRA HAS NO MEANING OTHER THAN TRADEMARK SIGNIFICANCE.

SER. NO. 77-207,562, FILED 6-15-2007.

SHARON MEIER, EXAMINING ATTORNEY

Int. Cls.: 29 and 30

Prior U.S. Cl.: 46

United States Patent and Trademark Office

Reg. No. 3,518,995

Registered Oct. 21, 2008

TRADEMARK
PRINCIPAL REGISTER



CORTES, JORGE (COLOMBIA INDIVIDUAL)
1515 WINTERBERRY LANE
WESTON, FL 33327

FOR: FROZEN FRUITS, FROZEN FRUIT CONSERVES, FROZEN FRUIT PULPS, PREPARED AND FROZEN VEGETABLES, PREPARED AND FROZEN STUFFED POTATOES, AND PREPARED AND FROZEN VEGETABLE, CHICKEN, MEAT, FISH, AND POTATO CROQUETTES, IN CLASS 29 (U.S. CL. 46).

FIRST USE 3-31-2007; IN COMMERCE 3-31-2007.

FOR: FRUIT ICE BARS, BAKERY PRODUCTS, BEVERAGES MADE OF COFFEE, COFFEE, DULCE DE LECHE, EMPANADAS, AND FROZEN BREADS, IN CLASS 30 (U.S. CL. 46).

FIRST USE 3-31-2007; IN COMMERCE 3-31-2007.

NO CLAIM IS MADE TO THE EXCLUSIVE RIGHT TO USE "PRODUCTOS", APART FROM THE MARK AS SHOWN.

"THE NAME(S), PORTRAIT(S), AND/OR SIGNATURE(S) SHOWN IN THE MARK DOES NOT IDENTIFY A PARTICULAR LIVING INDIVIDUAL."

"THE COLOR(S) RED, GOLD, SEPIA BROWN, BLACK, WHITE, AND GRAY IS/ARE CLAIMED AS A FEATURE OF THE MARK."

"THE MARK CONSISTS OF THE SEPIA BROWN TONED FACE OF A WOMAN WITH BLACK HAIR AND CLOTHING WITHIN A GRAY OVAL THAT IS OUTLINED IN GOLD WITH AN INNER BAND IN WHITE, APPEARING ABOVE A RED BANNER THAT IS OUTLINED IN GOLD WITH AN INNER BAND IN WHITE WITH THE STYLIZED WORDS "PRODUCTOS" IN BLACK AND "CHELITA" IN WHITE DISPLAYED ON THE BANNER, ON A RED DIAMOND-SHAPED BACKGROUND WITH A BAND OF GOLD WITHIN AN OUTER BAND OF RED."

THE FOREIGN WORDING IN THE MARK TRANSLATES INTO ENGLISH AS PRODUCTS.

SER. NO. 77-208,615, FILED 6-18-2007.

ALICIA COLLINS, EXAMINING ATTORNEY

Int. Cl.: 24

Prior U.S. Cls.: 42 and 50

United States Patent and Trademark Office

Reg. No. 3,518,996

Registered Oct. 21, 2008

**TRADEMARK
PRINCIPAL REGISTER**

DREAM BLANKET

BECKAN INNOVATIONS INC. (CANADA CORPORATION)
BOX 9131
SYLVAN LAKE, CANADA T4S1S8

OWNER OF CANADA REG. NO. TMA669,141,
DATED 8-2-2006, EXPIRES 8-2-2015.

FOR: UNFITTED FURNITURE COVERS MADE OF FABRIC; ANIMAL BED COVERS, NAMELY, PET BED COVERS, IN CLASS 24 (U.S. CLS. 42 AND 50).

NO CLAIM IS MADE TO THE EXCLUSIVE RIGHT TO USE "BLANKET", APART FROM THE MARK AS SHOWN.

FIRST USE 3-1-2005; IN COMMERCE 6-5-2007.

SER. NO. 77-208,668, FILED 6-18-2007.

THE MARK CONSISTS OF STANDARD CHARACTERS WITHOUT CLAIM TO ANY PARTICULAR FONT, STYLE, SIZE, OR COLOR.

SONYA STEPHENS, EXAMINING ATTORNEY

Int. Cl.: 35

Prior U.S. Cls.: 100, 101 and 102

United States Patent and Trademark Office

Reg. No. 3,518,997

Registered Oct. 21, 2008

**SERVICE MARK
PRINCIPAL REGISTER**

Manny Poppins

BASSMAN, THOMAS A. (UNITED STATES INDIVIDUAL)
2200 DIANA DRIVE #108
HALLANDALE BEACH, FL 33009

FOR: EMPLOYMENT HIRING, RECRUITING, PLACEMENT, STAFFING AND CAREER NETWORKING SERVICES, IN CLASS 35 (U.S. CLS. 100, 101 AND 102).

FIRST USE 6-1-2007; IN COMMERCE 6-1-2007.

THE MARK CONSISTS OF STANDARD CHARACTERS WITHOUT CLAIM TO ANY PARTICULAR FONT, STYLE, SIZE, OR COLOR.

THE NAME "MANNY POPPINS" DOES NOT IDENTIFY A LIVING INDIVIDUAL.

SER. NO. 77-209,269, FILED 6-19-2007.

ARETHA SOMERVILLE, EXAMINING ATTORNEY

Int. Cl.: 5

Prior U.S. Cls.: 6, 18, 44, 46, 51 and 52

Reg. No. 3,518,998

United States Patent and Trademark Office

Registered Oct. 21, 2008

**TRADEMARK
PRINCIPAL REGISTER**

DERMORBIS

ADVANCED IN VITRO CELL TECHNOLOGIES,
S.L. (SPAIN CORPORATION)
BARCELONA SCIENCE PARK
BALDIRI I REIXAC, 4-6
BARCELONA, SPAIN E-08028

PRIORITY CLAIMED UNDER SEC. 44(D) ON
ERPNTM OFC APPLICATION NO.
005970926, FILED 6-5-2007, REG. NO. 005970926,
DATED 4-25-2008, EXPIRES 6-5-2017.

FOR: MEDICINES FOR THE TREATMENT OF
PSORIASIS, ATOPIC DERMATITIS AND OTHER
DERMATOLOGIC DISEASES AND DISORDERS, IN
CLASS 5 (U.S. CLS. 6, 18, 44, 46, 51 AND 52).

SER. NO. 77-209,311, FILED 6-19-2007.

THE MARK CONSISTS OF STANDARD CHAR-
ACTERS WITHOUT CLAIM TO ANY PARTICULAR
FONT, STYLE, SIZE, OR COLOR.

KARANENDRA S. CHHINA, EXAMINING ATTOR-
NEY

Int. Cl.: 5

Prior U.S. Cls.: 6, 18, 44, 46, 51 and 52

Reg. No. 3,518,999

United States Patent and Trademark Office

Registered Oct. 21, 2008

**TRADEMARK
PRINCIPAL REGISTER**

CYCLOSTOPIC

ADVANCED IN VITRO CELL TECHNOLOGIES,
S.L. (SPAIN CORPORATION)
BARCELONA SCIENCE PARK
BALDIRI I REIXAC, 4-6
BARCELONA, SPAIN E-08028

PRIORITY CLAIMED UNDER SEC. 44(D) ON
ERPNTM OFC APPLICATION NO.
005971015, FILED 6-5-2007, REG. NO. 005971015,
DATED 4-25-2008, EXPIRES 6-5-2017.

FOR: MEDICINES FOR THE TREATMENT OF
PSORIASIS, ATOPIC DERMATITIS AND OTHER
DERMATOLOGIC DISEASES AND DISORDERS, IN
CLASS 5 (U.S. CLS. 6, 18, 44, 46, 51 AND 52).

SER. NO. 77-209,328, FILED 6-19-2007.

THE MARK CONSISTS OF STANDARD CHAR-
ACTERS WITHOUT CLAIM TO ANY PARTICULAR
FONT, STYLE, SIZE, OR COLOR.

KARANENDRA S. CHHINA, EXAMINING ATTOR-
NEY

Int. Cl.: 5

Prior U.S. Cls.: 6, 18, 44, 46, 51 and 52

Reg. No. 3,519,000

United States Patent and Trademark Office

Registered Oct. 21, 2008

**TRADEMARK
PRINCIPAL REGISTER**

SORIFREN

ADVANCED IN VITRO CELL TECHNOLOGIES,
S.L. (SPAIN CORPORATION)
BARCELONA SCIENCE PARK
BALDIRI I REIXAC, 4-6
BARCELONA, SPAIN E-08028

PRIORITY CLAIMED UNDER SEC. 44(D) ON
ERPNTM OFC APPLICATION NO.
005970967, FILED 6-5-2007, REG. NO. 005970967,
DATED 4-25-2008, EXPIRES 6-5-2017.

FOR: MEDICINES FOR THE TREATMENT OF
PSORIASIS, ATOPIC DERMATITIS AND OTHER
DERMATOLOGIC DISEASES AND DISORDERS, IN
CLASS 5 (U.S. CLS. 6, 18, 44, 46, 51 AND 52).

SER. NO. 77-209,337, FILED 6-19-2007.

THE MARK CONSISTS OF STANDARD CHAR-
ACTERS WITHOUT CLAIM TO ANY PARTICULAR
FONT, STYLE, SIZE, OR COLOR.

KARANENDRA S. CHHINA, EXAMINING ATTOR-
NEY

Int. Cl.: 33

Prior U.S. Cls.: 47 and 49

United States Patent and Trademark Office

Reg. No. 3,519,001

Registered Oct. 21, 2008

**TRADEMARK
PRINCIPAL REGISTER**

Mahogany Va La

VIETRI, ANTHONY (UNITED STATES INDIVIDUAL)
8820 GAP NEWPORT PIKE
AVONDALE, PA 19311

FOR: WINES, IN CLASS 33 (U.S. CLS. 47 AND 49).

FIRST USE 0-0-2005; IN COMMERCE 4-0-2007.

THE MARK CONSISTS OF STANDARD CHARACTERS WITHOUT CLAIM TO ANY PARTICULAR FONT, STYLE, SIZE, OR COLOR.

NO CLAIM IS MADE TO THE EXCLUSIVE RIGHT TO USE "MAHOGANY", APART FROM THE MARK AS SHOWN.

THE ENGLISH TRANSLATION OF THE WORD "VA LA" IN THE MARK IS GO THERE.

SER. NO. 77-209,958, FILED 6-19-2007.

H. M. FISHER, EXAMINING ATTORNEY

Int. Cl.: 5

Prior U.S. Cls.: 6, 18, 44, 46, 51 and 52

Reg. No. 3,519,002

United States Patent and Trademark Office

Registered Oct. 21, 2008

**TRADEMARK
PRINCIPAL REGISTER**

biossential

INDOMITUS ASSET MANAGEMENT LLC
(PENNSYLVANIA LIMITED LIABILITY COMPANY)
1579 JACK DRIVE
NORTH HUNTINGDON, PA 15642

THE MARK CONSISTS OF STANDARD CHARACTERS WITHOUT CLAIM TO ANY PARTICULAR FONT, STYLE, SIZE, OR COLOR.

FOR: DIETARY AND NUTRITIONAL SUPPLEMENTS, IN CLASS 5 (U.S. CLS. 6, 18, 44, 46, 51 AND 52).

SER. NO. 77-209,987, FILED 6-19-2007.

FIRST USE 2-2-2007; IN COMMERCE 6-19-2007.

IRA J. GOODSaid, EXAMINING ATTORNEY

Int. Cl.: 12

Prior U.S. Cls.: 19, 21, 23, 31, 35 and 44

United States Patent and Trademark Office

Reg. No. 3,519,003

Registered Oct. 21, 2008

**TRADEMARK
PRINCIPAL REGISTER**

DESIGNO

DAIMLER AG (FED REP GERMANY CORPORATION)

MERCEDESSTRASSE 137

STUTT GART, FED REP GERMANY 70327

FOR: AUTOMOTIVE INTERIOR TRIM; UPHOLSTERY, WINDSCREEN FRAMES, ROOF LINING, GEAR SHIFTS AND STEERING WHEELS, ALL FOR VEHICLES, IN CLASS 12 (U.S. CLS. 19, 21, 23, 31, 35 AND 44).

THE MARK CONSISTS OF STANDARD CHARACTERS WITHOUT CLAIM TO ANY PARTICULAR FONT, STYLE, SIZE, OR COLOR.

OWNER OF FED REP GERMANY REG. NO. 39519364.8, DATED 3-29-1996, EXPIRES 5-31-2015.

OWNER OF U.S. REG. NO. 3,037,140.

SER. NO. 77-210,568, FILED 6-20-2007.

BENJAMIN ALLEN, EXAMINING ATTORNEY

Int. Cl.: 9

Prior U.S. Cls.: 21, 23, 26, 36 and 38

Reg. No. 3,519,004

United States Patent and Trademark Office

Registered Oct. 21, 2008

**TRADEMARK
PRINCIPAL REGISTER**

**RECESSED ELECTRICAL
DESIGNS - RED**

RECESSED ELECTRICAL DESIGNS, LLC (CALIFORNIA LIMITED LIABILITY COMPANY)
P.O. BOX 530
1441 PESCADERO ROAD
PESCADERO, CA 94060

FOR: ELECTRIC CONNECTORS; ELECTRIC JUNCTION BOXES; ELECTRICAL CONNECTION BOXES; ELECTRICAL DISTRIBUTION BOXES; ELECTRICAL OUTLETS; ELECTRICAL RECEPTACLES; MULTI-OUTLET SOCKET BLOCKS; POWER ACCESS PORT FOR USE WITH ELECTRICAL CONTROL PANELS FOR CONNECTING MULTIPLE DATA AND ELECTRICAL DEVICES, IN CLASS 9 (U.S. CLS. 21, 23, 26, 36 AND 38).

FIRST USE 4-4-2007; IN COMMERCE 4-4-2007.

THE MARK CONSISTS OF STANDARD CHARACTERS WITHOUT CLAIM TO ANY PARTICULAR FONT, STYLE, SIZE, OR COLOR.

NO CLAIM IS MADE TO THE EXCLUSIVE RIGHT TO USE "RECESSED ELECTRICAL DESIGNS", APART FROM THE MARK AS SHOWN.

SER. NO. 77-213,389, FILED 6-22-2007.

SHARON MEIER, EXAMINING ATTORNEY

Int. Cl.: 25

Prior U.S. Cls.: 22 and 39

United States Patent and Trademark Office

Reg. No. 3,519,005

Registered Oct. 21, 2008

**TRADEMARK
PRINCIPAL REGISTER**

ALITTA

JACOBSON, ANITA (UNITED STATES INDIVIDUAL)
P.O. BOX 931
SANTA MONICA, CA 90406

THE MARK CONSISTS OF STANDARD CHARACTERS WITHOUT CLAIM TO ANY PARTICULAR FONT, STYLE, SIZE, OR COLOR.

FOR: JACKETS, PANTS, SHIRTS, AND SHORTS USED FOR BICYCLING, IN CLASS 25 (U.S. CLS. 22 AND 39).

SER. NO. 77-215,564, FILED 6-26-2007.

FIRST USE 6-29-1983; IN COMMERCE 8-15-1983.

BARBARA GAYNOR, EXAMINING ATTORNEY

Int. Cl.: 30

Prior U.S. Cl.: 46

United States Patent and Trademark Office

Reg. No. 3,519,006

Registered Oct. 21, 2008

TRADEMARK
PRINCIPAL REGISTER

AROMITALIA

G.E.I. GRUPPO ESSENZIERO ITALIANO SOCIETA' IN ACCOMANDITA SEMPLICE DI FERRERO E C. (ITALY PRIVATE UNLIMITED LIABILITY COMPANY)
CORSO VINZAGLIO N° 29
TORINO, ITALY 10121

FOR: BASES, CONSISTING OF MILK POWDER, VEGETABLE FAT, FRUIT, DEXTROSE STABILIZER, EMULSIFIER, FLAVOR, MILK OR VEGETABLE PROTEIN AND COLOR FOR MAKING, OR FLAVOURING OR GARNISHING OR MARBLEIZING PASTRY, ICE CREAMS, FLAVORED ICES, FRUIT ICE, ITALIAN STYLE ICE CREAMS AND ITALIAN GELATO, FROZEN CONFECTIONS, FROZEN CUSTARDS, FROZEN YOGURT, ICE MILK, PARFAITS, SHERBET AND SORBET, FLAVORING SYRUP AND TOPPING SYRUP, ALL FOR COM-

MERCIAL OR INDUSTRIAL USE, IN CLASS 30 (U.S. CL. 46).

THE MARK CONSISTS OF STANDARD CHARACTERS WITHOUT CLAIM TO ANY PARTICULAR FONT, STYLE, SIZE, OR COLOR.

OWNER OF ITALY REG. NO. 944539, DATED 11-11-2001, EXPIRES 11-11-2021.

OWNER OF U.S. REG. NOS. 2,384,544 AND 2,544,099.

SER. NO. 77-217,029, FILED 6-27-2007.

JESSICA FATHY, EXAMINING ATTORNEY

Int. Cl.: 35

Prior U.S. Cls.: 100, 101 and 102

United States Patent and Trademark Office

Reg. No. 3,519,007

Registered Oct. 21, 2008

**SERVICE MARK
PRINCIPAL REGISTER**

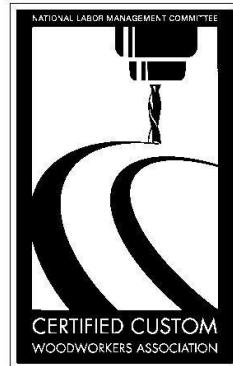

CERTIFIED CUSTOM WOODWORKERS ASSO-
CIATION (D.C. NON-PROFIT ASSOCIATION)
10TH FLOOR, WEST
101 CONSTITUTION AVENUE, NW
WASHINGTON, DC 20001

FOR: ASSOCIATION SERVICES, NAMELY, PRO-
MOTING THE INTERESTS OF ARCHITECTURAL
MILLWORK CONTRACTORS , IN CLASS 35 (U.S.
CLS. 100, 101 AND 102).

FIRST USE 10-15-2006; IN COMMERCE 10-15-2006.

NO CLAIM IS MADE TO THE EXCLUSIVE
RIGHT TO USE "NATIONAL LABOR MANAGE-

MENT COMMITTEE" AND "CERTIFIED CUSTOM
WOODWORKERS ASSOCIATION", APART FROM
THE MARK AS SHOWN.

THE MARK CONSISTS OF A VERTICAL LOGO
THAT DEPICTS A "CNC" ROUTER BIT CARVING A
ROUNDED DESIGN, WITH THE STYLIZED TEXT
"NATIONAL LABOR MANAGEMENT COMMIT-
TEE CERTIFIED CUSTOM WOODWORKERS ASSO-
CIATION".

SER. NO. 77-217,387, FILED 6-27-2007.

SALLY SHIH, EXAMINING ATTORNEY

Int. Cl.: 28

Prior U.S. Cls.: 22, 23, 38 and 50

Reg. No. 3,519,008

United States Patent and Trademark Office

Registered Oct. 21, 2008

**TRADEMARK
PRINCIPAL REGISTER**

PUSHUP PRO

ONTEL PRODUCTS CORPORATION (NEW JERSEY CORPORATION)
21 LAW DRIVE
FAIRFIELD, NJ 07004

FOR: MANUALLY-OPERATED EXERCISE EQUIPMENT FOR DOING PUSHUPS, IN CLASS 28 (U.S. CLS. 22, 23, 38 AND 50).

FIRST USE 7-21-2007; IN COMMERCE 7-21-2007.

THE MARK CONSISTS OF STANDARD CHARACTERS WITHOUT CLAIM TO ANY PARTICULAR FONT, STYLE, SIZE, OR COLOR.

NO CLAIM IS MADE TO THE EXCLUSIVE RIGHT TO USE "PUSHUP", APART FROM THE MARK AS SHOWN.

SER. NO. 77-219,182, FILED 6-29-2007.

APRIL HESIK, EXAMINING ATTORNEY

Int. Cl.: 28

Prior U.S. Cls.: 22, 23, 38 and 50

United States Patent and Trademark Office

Reg. No. 3,519,009

Registered Oct. 21, 2008

**TRADEMARK
PRINCIPAL REGISTER**



ONTEL PRODUCTS CORPORATION (NEW JERSEY CORPORATION)
21 LAW DRIVE
FAIRFIELD, NJ 07004

FOR: MANUALLY-OPERATED EXERCISE EQUIPMENT FOR DOING PUSHUPS, IN CLASS 28 (U.S. CLS. 22, 23, 38 AND 50).

FIRST USE 7-21-2007; IN COMMERCE 7-21-2007.

NO CLAIM IS MADE TO THE EXCLUSIVE RIGHT TO USE "PUSHUP", APART FROM THE MARK AS SHOWN.

THE MARK CONSISTS OF STYLIZED WORDING OF "PUSHUP PRO".

SER. NO. 77-219,201, FILED 6-29-2007.

AMY MCMENAMIN, EXAMINING ATTORNEY

Int. Cls.: 35, 36 and 41

Prior U.S. Cls.: 100, 101, 102 and 107

United States Patent and Trademark Office

Reg. No. 3,519,010

Registered Oct. 21, 2008

**SERVICE MARK
PRINCIPAL REGISTER**

**BREAKING THE CHAIN
FOUNDATION**

BREAKING THE CHAIN FOUNDATION (D.C.
NON-PROFIT CORPORATION)
BREAKING THE CHAIN FOUNDATION
4409 S. CAPITOL ST., SW
WASHINGTON, DC 20032

FOR: REFERRALS FOR AT-RISK CHILDREN IN
THE FIELD OF SOCIAL SERVICES, IN CLASS 35
(U.S. CLS. 100, 101 AND 102).

FIRST USE 7-13-2003; IN COMMERCE 7-31-2004.

FOR: CHARITABLE FUND RAISING SERVICES,
NAMELY, FUND RAISING FOR AT-RISK CHIL-
DREN AND THEIR FAMILIES; FINANCIAL SPON-
SORSHIP OF YOUTH PROGRAMS, IN CLASS 36
(U.S. CLS. 100, 101 AND 102).

FIRST USE 7-13-2003; IN COMMERCE 7-31-2004.

FOR: EDUCATIONAL AND CHARITABLE SER-
VICES, NAMELY, PROVIDING EDUCATIONAL
MENTORING AND EDUCATIONAL COUNSELING
TO AT-RISK CHILDREN, AND TUTORING AND
HOMEWORK ASSISTANCE TO AT-RISK CHIL-
DREN, IN CLASS 41 (U.S. CLS. 100, 101 AND 107).

FIRST USE 7-13-2003; IN COMMERCE 7-31-2004.

THE MARK CONSISTS OF STANDARD CHAR-
ACTERS WITHOUT CLAIM TO ANY PARTICULAR
FONT, STYLE, SIZE, OR COLOR.

NO CLAIM IS MADE TO THE EXCLUSIVE
RIGHT TO USE "FOUNDATION", APART FROM
THE MARK AS SHOWN.

SER. NO. 77-219,233, FILED 6-29-2007.

SANJEEV VOHRA, EXAMINING ATTORNEY

Int. Cl.: 16

Prior U.S. Cls.: 2, 5, 22, 23, 29, 37, 38 and 50

Reg. No. 3,519,011

United States Patent and Trademark Office

Registered Oct. 21, 2008

TRADEMARK
PRINCIPAL REGISTER



home shanti
peace in the home | peace in the world

FUCHS, JODI (UNITED STATES INDIVIDUAL)
3435 OCEAN PARK BLVD SUITE #107 PO BOX 5
SANTA MONICA, CA 90405

FOR: PAINTINGS AND THEIR REPRODUCTIONS, IN CLASS 16 (U.S. CLS. 2, 5, 22, 23, 29, 37, 38 AND 50).

FIRST USE 12-0-2003; IN COMMERCE 1-0-2006.

THE COLOR(S) PINK AND BROWN IS/ARE CLAIMED AS A FEATURE OF THE MARK.

THE COLOR PINK APPEARS IN THE WORDING "PEACE IN THE HOME / PEACE IN THE WORLD" AND IN THE ACCENT MARK LOCATED OVER THE WORD "HOME". THE COLOR BROWN APPEARS IN THE WORDING "HOME SHANTI".

THE ENGLISH TRANSLATION OF THE WORD "SHANTI" IN THE MARK IS "PEACE".

SER. NO. 77-219,596, FILED 6-29-2007.

JENNIFER VASQUEZ, EXAMINING ATTORNEY

Int. Cls.: 9, 28 and 41

Prior U.S. Cls.: 21, 22, 23, 26, 36, 38, 50, 100, 101 and 107

Reg. No. 3,519,012

United States Patent and Trademark Office

Registered Oct. 21, 2008

**TRADEMARK
SERVICE MARK
PRINCIPAL REGISTER**

SYMPHONY

OCTAVIAN INTERNATIONAL LIMITED (UNITED KINGDOM LIMITED LIABILITY COMPANY)

19-20 BOURNE COURT
UNITY TRADE ESTATE, SOUTHEND ROAD
WOODFORD GREEN, UNITED KINGDOM IG88HD

FOR: COMPUTER OPERATING PROGRAMS AND COMPUTER OPERATING SYSTEMS FOR OPERATING MACHINES DEDICATED TO ARCADE GAMES AND ELECTRONIC GAMES; COMPUTER SOFTWARE, NAMELY, OPERATING SYSTEM PROGRAMS AND UTILITIES FOR GAMES OF CHANCE, CASINO OR AMUSEMENT GAMES ADAPTED FOR USE WITH TELEVISION RECEIVERS OR ON COMPUTERIZED PLATFORMS, NAMELY, DEDICATED GAMING MACHINES, IN CLASS 9 (U.S. CLS. 21, 23, 26, 36 AND 38).

FOR: COIN-OPERATED AMUSEMENT GAME MACHINES; FLOOR-STANDING OR TABLETOP UNITS FOR PLAYING ELECTRONIC GAMES

OTHER THAN IN CONJUNCTION WITH A TELEVISION OR COMPUTER; GAMING CHIPS; ELECTRONIC ARCADE GAMES, IN CLASS 28 (U.S. CLS. 22, 23, 38 AND 50).

FOR: RENTAL OF GAMING MACHINES; CASINO SERVICES, IN CLASS 41 (U.S. CLS. 100, 101 AND 107).

THE MARK CONSISTS OF STANDARD CHARACTERS WITHOUT CLAIM TO ANY PARTICULAR FONT, STYLE, SIZE, OR COLOR.

PRIORITY CLAIMED UNDER SEC. 44(D) ON ERPN CMNTY TM OFC APPLICATION NO. 005811468, FILED 4-4-2007, REG. NO. 005811468, DATED 5-3-2008, EXPIRES 5-3-2018.

SER. NO. 77-219,787, FILED 6-30-2007.

CHRISTINE COOPER, EXAMINING ATTORNEY

Int. Cl.: 28

Prior U.S. Cls.: 22, 23, 38 and 50

United States Patent and Trademark Office

Reg. No. 3,519,013

Registered Oct. 21, 2008

**TRADEMARK
PRINCIPAL REGISTER**

THE VENETIAN LAS VEGAS

LAS VEGAS SANDS CORP. (NEVADA CORPORATION)
3355 LAS VEGAS BOULEVARD SOUTH
LAS VEGAS, NV 89109

FOR: PLUSH TOYS; PLUSH ANIMALS; STUFFED TOYS; STUFFED ANIMALS; PLAY FIGURES; PLASTIC TOY FIGURINES; SNOW GLOBES; TOY MUSIC BOXES, IN CLASS 28 (U.S. CLS. 22, 23, 38 AND 50).

FIRST USE 3-29-2007; IN COMMERCE 3-29-2007.

THE MARK CONSISTS OF STANDARD CHARACTERS WITHOUT CLAIM TO ANY PARTICULAR FONT, STYLE, SIZE, OR COLOR.

NO CLAIM IS MADE TO THE EXCLUSIVE RIGHT TO USE "LAS VEGAS", APART FROM THE MARK AS SHOWN.

SER. NO. 77-220,548, FILED 7-2-2007.

MELISSA VALLILLO, EXAMINING ATTORNEY

Int. Cl.: 44

Prior U.S. Cls.: 100 and 101

United States Patent and Trademark Office

Reg. No. 3,519,014

Registered Oct. 21, 2008

**SERVICE MARK
PRINCIPAL REGISTER**



LIFELINE INTERVENTIONS (CALIFORNIA CORPORATION)

#3

112 N. CROFT AVE
LOS ANGELES, CA 90048

FOR: ADDICTION TREATMENT SERVICES, IN CLASS 44 (U.S. CLS. 100 AND 101).

FIRST USE 1-0-2004; IN COMMERCE 3-0-2005.

NO CLAIM IS MADE TO THE EXCLUSIVE RIGHT TO USE "INTERVENTIONS", APART FROM THE MARK AS SHOWN.

THE COLOR(S) RED, BLACK, AND WHITE IS/ ARE CLAIMED AS A FEATURE OF THE MARK.

THE MARK CONSISTS OF THE WORDS "LIFELINE INTERVENTIONS" IN WHITE WITH A RED LIFELINE AND A BLACK BACKGROUND.

SER. NO. 77-223,312, FILED 7-6-2007.

KAPIL BHANOT, EXAMINING ATTORNEY

Int. Cl.: 45

Prior U.S. Cls.: 100 and 101

United States Patent and Trademark Office

Reg. No. 3,519,015

Registered Oct. 21, 2008

**SERVICE MARK
PRINCIPAL REGISTER**

RSP

OSEA, INC. (NEW YORK CORPORATION)
3748 SOUTH PARK AVE.
BLASDELL, NY 14219

THE MARK CONSISTS OF STANDARD CHAR-
ACTERS WITHOUT CLAIM TO ANY PARTICULAR
FONT, STYLE, SIZE, OR COLOR.

FOR: ANALYSIS AND CONSULTATION PER-
TAINING TO JOB SITE SAFETY, IN CLASS 45 (U.S.
CLS. 100 AND 101).

SER. NO. 77-224,602, FILED 7-9-2007.

FIRST USE 8-23-1999; IN COMMERCE 8-23-1999.

CAROLYN CATALDO, EXAMINING ATTORNEY

Int. Cl.: 11

Prior U.S. Cls.: 13, 21, 23, 31 and 34

United States Patent and Trademark Office

Reg. No. 3,519,016

Registered Oct. 21, 2008

**TRADEMARK
PRINCIPAL REGISTER**

NUDELIGHT

NUDE-LIGHT S.R.L. (ITALY SOCIETA A RE-
SPONSABILITA LIMITATA)
VIA S. AMMIRATO
FIRENZE, ITALY 10050136

FOR: LIGHTING FIXTURES, ELECTRIC LIGHT-
ING FIXTURES FOR STAGE LIGHTING, LIGHTS
FOR VEHICLES, ELECTRIC LIGHT BULBS,
FLUORESCENT TUBES FOR LIGHTING, FLUOR-
ESCENT LAMP TUBES, LAMPS, LAMP BASES,
LAMP SHADES, ARC LAMPS, LAMPS FOR OUT-
DOOR USE, SOLDERING LAMPS, GAS LAMPS,
ELECTRIC LANTERNS, OIL LAMPS, CHANDELI-
ERS, IN CLASS 11 (U.S. CLS. 13, 21, 23, 31 AND 34).

THE MARK CONSISTS OF STANDARD CHAR-
ACTERS WITHOUT CLAIM TO ANY PARTICULAR
FONT, STYLE, SIZE, OR COLOR.

PRIORITY CLAIMED UNDER SEC. 44(D) ON
ERPNTY TM OFC APPLICATION NO.
5724893, FILED 3-1-2007, REG. NO. 005724893, DATED
2-11-2008, EXPIRES 3-1-2017.

PRIORITY CLAIMED UNDER SEC. 44(D) ON
ERPNTY TM OFC APPLICATION NO.
5724893, FILED 3-1-2007, REG. NO. 005724893, DATED
2-11-2008, EXPIRES 1-3-2017.

SER. NO. 77-224,728, FILED 7-9-2007.

FRED CARL, EXAMINING ATTORNEY

Int. Cl.: 44

Prior U.S. Cls.: 100 and 101

United States Patent and Trademark Office

Reg. No. 3,519,017

Registered Oct. 21, 2008

**SERVICE MARK
PRINCIPAL REGISTER**

HEALTHWAYS

HEALTHWAYS, INC. (DELAWARE CORPORATION)
SUITE 300
3841 GREEN HILLS VILLAGE DRIVE
NASHVILLE, TN 37215

FOR: HEALTH CARE AND MEDICAL CARE MANAGEMENT SERVICES, NAMELY, COORDINATING A PATIENT'S HEALTH CARE AND MEDICAL CARE IN ORDER TO ACHIEVE A MORE SUCCESSFUL HEALTH OUTCOME, IN CLASS 44 (U.S. CLS. 100 AND 101).

FIRST USE 9-0-2005; IN COMMERCE 9-0-2005.

THE MARK CONSISTS OF STANDARD CHARACTERS WITHOUT CLAIM TO ANY PARTICULAR FONT, STYLE, SIZE, OR COLOR.

OWNER OF U.S. REG. NOS. 3,226,699 AND 3,294,917.

SER. NO. 77-224,781, FILED 7-9-2007.

DEZMONA MIZELLE, EXAMINING ATTORNEY

Int. Cl.: 35

Prior U.S. Cls.: 100, 101 and 102

United States Patent and Trademark Office

Reg. No. 3,519,018

Registered Oct. 21, 2008

**SERVICE MARK
PRINCIPAL REGISTER**

DIAORO BY GIORDANO ZANON

MIRYAZDI, ALLEN (UNITED STATES INDIVIDUAL)
627 NYES PLACE
LAGUNA BEACH, CA 92651

FOR: ON-LINE RETAIL STORE SERVICES FEATURING WALLETS, BRIEFCASES, PURSES, BACKPACKS, SUNGLASSES, PERFUME, COLOGNE, FOUNTAIN PENS, WRITING PENS, PENCILS, ALARM CLOCKS, BRACELETS, BRACELETS OF PRECIOUS METAL, CHARMS, CHOKERS, CIGARETTE HOLDERS OF PRECIOUS METAL, CLIP EARRINGS, CLOCK AND WATCH HANDS, CLOCKS, CUFF-LINKS, CUT DIAMONDS, DIAMONDS, DIVING WATCHES, EAR STUDS, EARRINGS, JEWEL PENDANTS, JEWELRY CASES OF PRECIOUS METAL, JEWELRY PINS FOR USE ON HATS, JEWELRY WATCHES, LAPEL PINS, NECKLACES, OPAL, ORNAMENTAL LAPEL PINS, PENDANTS, PINS BEING JEWELRY, PRECIOUS METAL MONEY CLIPS, PRECIOUS METALS, PRECIOUS METALS AND THEIR ALLOYS, NAMELY, GOLD, SILVER AND PLATINUM, PRECIOUS STONES, RINGS, RINGS BEING JEWELRY, RUBY, SAPPHIRE, SEMI-PRECIOUS GEMSTONES, SEMI-WROUGHT PRECIOUS STONES AND THEIR IMITATIONS, STOP WATCHES, SYNTHETIC DIAMONDS, TABLE CLOCKS, TIE CLIPS, TIE PINS, UNWROUGHT AND SEMI-WROUGHT PRECIOUS STONES AND THEIR IMITATIONS, WATCH BANDS, WATCH BRACELETS, WATCHES, WRIST WATCHES; WHOLESALE DISTRIBUTORSHIPS FEATURING WALLETS, BRIEFCASES, PURSES, BACKPACKS, SUNGLASSES, PERFUME, COLOGNE, FOUNTAIN PENS, WRITING PENS, PENCILS, ALARM CLOCKS, BRACELETS, BRACELETS OF PRECIOUS METAL, CHARMS, CHOKERS, CIGARETTE HOLDERS OF PRECIOUS METAL, CLIP EARRINGS, CLOCK AND WATCH HANDS, CLOCKS, CUFF-LINKS, CUT DIAMONDS, DIAMONDS, DIVING WATCHES, EAR STUDS, EARRINGS, JEWEL PENDANTS, JEWELRY CASES OF

PRECIOUS METAL, JEWELRY PINS FOR USE ON HATS, JEWELRY WATCHES, LAPEL PINS, NECKLACES, OPAL, ORNAMENTAL LAPEL PINS, PENDANTS, PINS BEING JEWELRY, PRECIOUS METAL MONEY CLIPS, PRECIOUS METALS, PRECIOUS METALS AND THEIR ALLOYS, NAMELY, GOLD, SILVER AND PLATINUM, PRECIOUS STONES, RINGS, RINGS BEING JEWELRY, RUBY, SAPPHIRE, SEMI-PRECIOUS GEMSTONES, SEMI-WROUGHT PRECIOUS STONES AND THEIR IMITATIONS, STOP WATCHES, SYNTHETIC DIAMONDS, TABLE CLOCKS, TIE CLIPS, TIE PINS, UNWROUGHT AND SEMI-WROUGHT PRECIOUS STONES AND THEIR IMITATIONS, WATCH BANDS, WATCH BRACELETS, WATCHES, WRIST WATCHES; MAIL ORDER CATALOG SERVICES FEATURING WALLETS, BRIEFCASES, PURSES, BACKPACKS, SUNGLASSES, PERFUME, COLOGNE, FOUNTAIN PENS, WRITING PENS, PENCILS, ALARM CLOCKS, BRACELETS, BRACELETS OF PRECIOUS METAL, CHARMS, CHOKERS, CIGARETTE HOLDERS OF PRECIOUS METAL, CLIP EARRINGS, CLOCK AND WATCH HANDS, CLOCKS, CUFF-LINKS, CUT DIAMONDS, DIAMONDS, DIVING WATCHES, EAR STUDS, EARRINGS, JEWEL PENDANTS, JEWELRY CASES OF PRECIOUS METAL, JEWELRY PINS FOR USE ON HATS, JEWELRY WATCHES, LAPEL PINS, NECKLACES, OPAL, ORNAMENTAL LAPEL PINS, PENDANTS, PINS BEING JEWELRY, PRECIOUS METAL MONEY CLIPS, PRECIOUS METALS, PRECIOUS METALS AND THEIR ALLOYS, NAMELY, GOLD, SILVER AND PLATINUM, PRECIOUS STONES, RINGS, RINGS BEING JEWELRY, RUBY, SAPPHIRE, SEMI-PRECIOUS GEMSTONES, SEMI-WROUGHT PRECIOUS STONES AND THEIR IMITATIONS, STOP WATCHES, SYNTHETIC DIAMONDS, TABLE CLOCKS, TIE CLIPS, TIE PINS, UNWROUGHT AND SEMI-WROUGHT PRECIOUS STONES AND THEIR IMITATIONS, WATCH BANDS, WATCH BRACELETS, WATCHES, WRIST WATCHES, IN CLASS 35 (U.S. CLS. 100, 101 AND 102).

FIRST USE 1-0-2007; IN COMMERCE 1-0-2007.

THE MARK CONSISTS OF STANDARD CHARACTERS WITHOUT CLAIM TO ANY PARTICULAR FONT, STYLE, SIZE, OR COLOR.

OWNER OF U.S. REG. NO. 3,295,707.

"GIORDANO ZANON" IDENTIFIES A LIVING INDIVIDUAL WHOSE CONSENT IS OF RECORD.

"DIAORO" HAS NO MEANING IN A FOREIGN LANGUAGE.

SER. NO. 77-224,916, FILED 7-9-2007.

MELISSA VALLILLO, EXAMINING ATTORNEY

Int. Cl.: 7

Prior U.S. Cls.: 13, 19, 21, 23, 31, 34 and 35

Reg. No. 3,519,019

United States Patent and Trademark Office

Registered Oct. 21, 2008

**TRADEMARK
PRINCIPAL REGISTER**



SEALTECH CORP. (ALABAMA CORPORATION)
283-D CAHABA VALLEY PKY NO.
PELHAM, AL 35124

FOR: MARINE PUMP IMPELLERS, IN CLASS 7
(U.S. CLS. 13, 19, 21, 23, 31, 34 AND 35).

FIRST USE 6-20-2007; IN COMMERCE 6-20-2007.

THE MARK CONSISTS OF AN ILLUSTRATION
OF A MARINE IMPELLER, SURROUNDED BY A
CIRCLE. THREE CIRCLES OF DECREASING SIZE
ARE LOCATED TO THE TOP RIGHT OF THE
CIRCLE. THE WORD "HYDRA" IS LOCATED BE-
LOW THE ILLUSTRATION.

SER. NO. 77-225,340, FILED 7-9-2007.

AMY MCMENAMIN, EXAMINING ATTORNEY

Int. Cl.: 35

Prior U.S. Cls.: 100, 101 and 102

United States Patent and Trademark Office

Reg. No. 3,519,020

Registered Oct. 21, 2008

**SERVICE MARK
PRINCIPAL REGISTER**

The logo for "buzzwatch" features a small yellow period followed by the word "buzzwatch" in a lowercase, sans-serif font. The text is rendered in a light gray color.

LOKION INTERACTIVE, LLC (MISSISSIPPI LIMITED LIABILITY COMPANY)
88 UNION AVENUE
MEMPHIS, TN 38103

THE COLOR(S) GRAY AND YELLOW IS/ARE CLAIMED AS A FEATURE OF THE MARK.

FOR: MONITORING AND ANALYSIS OF USER-GENERATED ONLINE CONTENT FOR OTHERS FOR MARKETING, PUBLIC RELATIONS OR CUSTOMER SERVICE PURPOSES; PROVIDING ONLINE MARKET INTELLIGENCE AND CONSUMER FEEDBACK MONITORING SERVICES FOR OTHERS, IN CLASS 35 (U.S. CLS. 100, 101 AND 102).

THE MARK CONSISTS OF A YELLOW PERIOD FOLLOWED BY THE WORD "BUZZWATCH" IN GRAY, LOWERCASE LETTERS.

SER. NO. 77-225,898, FILED 7-10-2007.

FIRST USE 10-7-2006; IN COMMERCE 4-24-2007.

CHRIS WELLS, EXAMINING ATTORNEY

Int. Cl.: 9

Prior U.S. Cls.: 21, 23, 26, 36 and 38

United States Patent and Trademark Office

Reg. No. 3,519,021

Registered Oct. 21, 2008

**TRADEMARK
PRINCIPAL REGISTER**

VICARIOUS VISIONS ALCHEMY

ACTIVISION PUBLISHING, INC. (DELAWARE
CORPORATION)
3100 OCEAN PARK BOULEVARD
SANTA MONICA, CA 90405

FOR: COMPUTER SOFTWARE FOR THE PRO-
DUCTION OF THREE-DIMENSIONAL ANIMA-
TION FOR COMPUTER-GENERATED DISPLAYS
SOLD AS A FEATURE OF COMPUTER GAME
PROGRAMS; AND COMPUTER OPERATING SYS-
TEMS, IN CLASS 9 (U.S. CLS. 21, 23, 26, 36 AND 38).

FIRST USE 11-0-2003; IN COMMERCE 11-0-2003.

THE MARK CONSISTS OF STANDARD CHAR-
ACTERS WITHOUT CLAIM TO ANY PARTICULAR
FONT, STYLE, SIZE, OR COLOR.

OWNER OF U.S. REG. NOS. 2,611,355 AND
2,611,460.

SER. NO. 77-226,304, FILED 7-10-2007.

BENJAMIN ALLEN, EXAMINING ATTORNEY

Int. Cls.: 9, 35 and 38

Prior U.S. Cls.: 21, 23, 26, 36, 38, 100, 101, 102 and 104

Reg. No. 3,519,022

United States Patent and Trademark Office

Registered Oct. 21, 2008

**TRADEMARK
SERVICE MARK
PRINCIPAL REGISTER**

ENTREPRENEUR.COM

ENTREPRENEUR MEDIA, INC. (CALIFORNIA CORPORATION)
2445 MCCABE WAY
IRVINE, CA 92614

FOR: DOWNLOADABLE PODCASTS IN THE FIELD OF BUSINESS, CURRENT EVENTS, LIFESTYLE ISSUES, AND DEVELOPMENTS IN SCIENCE AND TECHNOLOGY, IN CLASS 9 (U.S. CLS. 21, 23, 26, 36 AND 38).

FIRST USE 9-0-2002; IN COMMERCE 9-0-2002.

FOR: PROVIDING BUSINESS INFORMATION AND ADVICE VIA A WEB SITE ON A GLOBAL COMPUTER NETWORK, IN CLASS 35 (U.S. CLS. 100, 101 AND 102).

FIRST USE 9-0-2002; IN COMMERCE 9-0-2002.

FOR: BROADCASTING PROGRAMS VIA A GLOBAL COMPUTER NETWORK; AND STREAMING

OF AUDIO AND VIDEO MATERIAL VIA THE INTERNET; TELECOMMUNICATIONS SERVICES, NAMELY, TRANSMISSION OF PODCASTS, IN CLASS 38 (U.S. CLS. 100, 101 AND 104).

FIRST USE 9-0-2002; IN COMMERCE 9-0-2002.

THE MARK CONSISTS OF STANDARD CHARACTERS WITHOUT CLAIM TO ANY PARTICULAR FONT, STYLE, SIZE, OR COLOR.

OWNER OF U.S. REG. NOS. 1,453,968, 2,263,883, AND 2,502,032.

SEC. 2(F).

SER. NO. 77-226,387, FILED 7-10-2007.

PATRICIA EVANKO, EXAMINING ATTORNEY

Int. Cls.: 9 and 28

Prior U.S. Cls.: 21, 22, 23, 26, 36, 38 and 50

United States Patent and Trademark Office

Reg. No. 3,519,023

Registered Oct. 21, 2008

**TRADEMARK
PRINCIPAL REGISTER**

Nine Eagles

SHANGHAI NINE EAGLES ELECTRONIC TECHNOLOGY CO. LTD (CHINA LIMITED LIABILITY COMPANY)
ROOM 1104
HUA XIANG BUILDING, 80 MOLING RD
SHANGHAI, CHINA 200070

FOR: RADIO-CONTROLLED MODEL VEHICLE PARTS, NAMELY, BATTERIES AND REMOTE CONTROLS FOR OPERATING AND CONTROLLING RADIO-CONTROLLED MODELS, NOT USED IN CONNECTION WITH THE SPORT OF AMERICAN FOOTBALL, IN CLASS 9 (U.S. CLS. 21, 23, 26, 36 AND 38).

FIRST USE 10-1-2006; IN COMMERCE 10-1-2006.

FOR: RADIO CONTROLLED TOY VEHICLES, NOT USED IN CONNECTION WITH THE SPORT OF AMERICAN FOOTBALL, IN CLASS 28 (U.S. CLS. 22, 23, 38 AND 50).

FIRST USE 10-1-2006; IN COMMERCE 10-1-2006.

THE MARK CONSISTS OF STANDARD CHARACTERS WITHOUT CLAIM TO ANY PARTICULAR FONT, STYLE, SIZE, OR COLOR.

SER. NO. 77-227,571, FILED 7-11-2007.

MORGAN WYNNE, EXAMINING ATTORNEY

Int. Cl.: 35

Prior U.S. Cls.: 100, 101 and 102

United States Patent and Trademark Office

Reg. No. 3,519,024

Registered Oct. 21, 2008

**SERVICE MARK
PRINCIPAL REGISTER**



**B. WILLIAMS ENTERPRISE, LLC (MARYLAND
LIMITED LIABILITY COMPANY)
15601 OVERCHASE LANE
BOWIE, MD 20715**

**FOR: BUSINESS CONSULTATION SERVICES, IN
CLASS 35 (U.S. CLS. 100, 101 AND 102).**

FIRST USE 11-1-2006; IN COMMERCE 11-1-2006.

**NO CLAIM IS MADE TO THE EXCLUSIVE
RIGHT TO USE "ENTERPRISE", APART FROM
THE MARK AS SHOWN.**

**THE COLOR(S) DARK BLUE IS/ARE CLAIMED
AS A FEATURE OF THE MARK.**

**THE MARK CONSISTS OF THE COLOR DARK
BLUE APPEARS IN THE STYLIZED LETTERS "B"
AND "W" AND IN THE WORD "ENTERPRISE".**

SER. NO. 77-230,427, FILED 7-16-2007.

B. PARADEWELAI, EXAMINING ATTORNEY

Int. Cl.: 36

Prior U.S. Cls.: 100, 101 and 102

United States Patent and Trademark Office

Reg. No. 3,519,025

Registered Oct. 21, 2008

**SERVICE MARK
PRINCIPAL REGISTER**

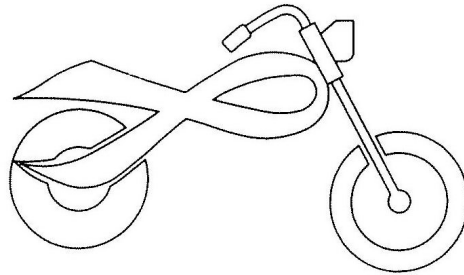

CASSIDAY, DARRIN (UNITED STATES INDIVIDUAL)
LOT A-12
2801 S. DORT HWY
FLINT, MI 48507

FIRST USE 7-0-2004; IN COMMERCE 7-0-2004.

THE MARK CONSISTS OF MOTORCYCLE WITH RIBBON AS SEAT.

FOR: CHARITABLE FUND RAISING SERVICES, NAMELY, ORGANIZING AND PROMOTING MOTORCYCLE RIDES TO RAISE FUNDS FOR CHARITABLE ORGANIZATIONS, IN CLASS 36 (U.S. CLS. 100, 101 AND 102).

SER. NO. 77-232,562, FILED 7-18-2007.

WILLIAM P. SHANAHAN, EXAMINING ATTORNEY

Int. Cl.: 30

Prior U.S. Cl.: 46

United States Patent and Trademark Office

Reg. No. 3,519,026

Registered Oct. 21, 2008

**TRADEMARK
PRINCIPAL REGISTER**

HAUTE CHOCOLATE

TEAVANA CORPORATION (GEORGIA CORPORATION)

SUITE 860

3475 LENOX ROAD

ATLANTA, GA 30326

FOR: TEA, IN CLASS 30 (U.S. CL. 46).

FIRST USE 6-0-2005; IN COMMERCE 6-0-2005.

THE MARK CONSISTS OF STANDARD CHARACTERS WITHOUT CLAIM TO ANY PARTICULAR FONT, STYLE, SIZE, OR COLOR.

NO CLAIM IS MADE TO THE EXCLUSIVE RIGHT TO USE "CHOCOLATE", APART FROM THE MARK AS SHOWN.

SER. NO. 77-233,261, FILED 7-19-2007.

DEBRA LEE, EXAMINING ATTORNEY

Int. Cl.: 41

Prior U.S. Cls.: 100, 101 and 107

United States Patent and Trademark Office

Reg. No. 3,519,027

Registered Oct. 21, 2008

**SERVICE MARK
PRINCIPAL REGISTER**

BOB WILLS' TEXAS PLAYBOYS

THE ESTATE OF BOB WILLS, INC. (TEXAS CORPORATION), DBA THE BOB WILLS ESTATE

P. O. BOX 448

C/O TWIN FIDDLE RANCH

ALVARADO, TX 760090448

FOR: ENTERTAINMENT SERVICES, NAMELY, THE LIVE RENDITION OF MUSICAL PERFORMANCES BY AN INSTRUMENTAL AND VOCAL GROUP, IN CLASS 41 (U.S. CLS. 100, 101 AND 107).

FIRST USE 9-15-1933; IN COMMERCE 9-15-1933.

THE MARK CONSISTS OF STANDARD CHARACTERS WITHOUT CLAIM TO ANY PARTICULAR FONT, STYLE, SIZE, OR COLOR.

NO CLAIM IS MADE TO THE EXCLUSIVE RIGHT TO USE "TEXAS", APART FROM THE MARK AS SHOWN.

"BOB WILLS" DOES NOT IDENTIFY A LIVING INDIVIDUAL.

SER. NO. 77-233,402, FILED 7-19-2007.

ALICIA COLLINS, EXAMINING ATTORNEY

Int. Cl.: 42

Prior U.S. Cls.: 100 and 101

United States Patent and Trademark Office

Reg. No. 3,519,028

Registered Oct. 21, 2008

**SERVICE MARK
PRINCIPAL REGISTER**



THE GENERATIONS NETWORK, INC. (DELA-
WARE CORPORATION)
360 WEST 4800 NORTH
PROVO, UT 84604

FOR: PROVIDING GENEALOGICAL AND FA-
MILY HISTORY INFORMATION SERVICES,
NAMELY, RETRIEVING, RECORDING AND RE-
VIEWING ANCESTRAL DATA VIA THE GLOBAL
COMPUTER NETWORK, IN CLASS 42 (U.S. CLS. 100
AND 101).

FIRST USE 1-7-2007; IN COMMERCE 1-7-2007.

OWNER OF U.S. REG. NO. 2,521,336.

NO CLAIM IS MADE TO THE EXCLUSIVE
RIGHT TO USE "GENEALOGY.COM", APART
FROM THE MARK AS SHOWN.

THE MARK CONSISTS OF A STYLIZED CUR-
LING LEAF ON AN ANGLE ABOVE THE LETTERS
"ALOGY" IN THE WORD "GENEALOGY.COM"
WITH THE STEM OF THE LEAF POINTING DOWN
TO THE DOT IN "GENEALOGY.COM", AND THE
CURLING POINT OF THE LEAF POINTING DOWN
TO THE LETTER "L", AND THE WORD "GENEA-
LOGY.COM" IN A LOWER-CASE STYLIZED FONT.

SER. NO. 77-235,093, FILED 7-20-2007.

RAMONA ORTIGA, EXAMINING ATTORNEY

Int. Cl.: 16

Prior U.S. Cls.: 2, 5, 22, 23, 29, 37, 38 and 50

United States Patent and Trademark Office

Reg. No. 3,519,029

Registered Oct. 21, 2008

TRADEMARK
PRINCIPAL REGISTER



운동
Efitte

PACE, KIMBERLIE A. (UNITED STATES INDIVIDUAL), DBA KIMBERLIE A. PETERSON
1016 E. HERITAGE CLUB CIRCLE
DELRAY BEACH, FL 33483

FOR: EDUCATIONAL PUBLICATIONS, NAME-
LY, TRAINING MANUALS IN THE FIELD OF
HEALTH, FITNESS, WELLNESS AND NUTRITION
, IN CLASS 16 (U.S. CLS. 2, 5, 22, 23, 29, 37, 38 AND 50).

FIRST USE 9-15-2006; IN COMMERCE 5-10-2007.

THE MARK CONSISTS OF KOREAN SCRIPT
THAT MEANS "MOVEMENT" ON EITHER SIDE

OF A CAPITAL BLOCK "E", THE WORD EFITTE IS
DIRECTLY UNDER THE KOREAN SCRIPT AND
THE LETTER "E", AND "FITTE" IS ITALICIZED..

THE NON-LATIN CHARACTERS IN THE MARK
TRANSLITERATE TO OON DOHNG AND THIS
MEANS MOVEMENT IN ENGLISH.

SER. NO. 77-235,454, FILED 7-21-2007.

REGINA DRUMMOND, EXAMINING ATTORNEY

Int. Cl.: 43

Prior U.S. Cls.: 100 and 101

United States Patent and Trademark Office

Reg. No. 3,519,030

Registered Oct. 21, 2008

**SERVICE MARK
PRINCIPAL REGISTER**

Shakes Alive! Fruit Shakes

PEAK EXPERIENCE ENTERPRISES, LLC (COL-
ORADO LIMITED LIABILITY COMPANY)

1700 WINDCLIFF DRIVE

ESTES PARK, CO 80517

FOR: RESTAURANT SERVICES, IN CLASS 43
(U.S. CLS. 100 AND 101).

FIRST USE 12-21-1999; IN COMMERCE 12-21-1999.

THE MARK CONSISTS OF STANDARD CHAR-
ACTERS WITHOUT CLAIM TO ANY PARTICULAR
FONT, STYLE, SIZE, OR COLOR.

NO CLAIM IS MADE TO THE EXCLUSIVE
RIGHT TO USE "FRUIT SHAKES", APART FROM
THE MARK AS SHOWN.

SER. NO. 77-235,851, FILED 7-23-2007.

BENJAMIN OKEKE, EXAMINING ATTORNEY

Int. Cl.: 16

Prior U.S. Cls.: 2, 5, 22, 23, 29, 37, 38 and 50

Reg. No. 3,519,031

United States Patent and Trademark Office

Registered Oct. 21, 2008

**TRADEMARK
PRINCIPAL REGISTER**

2HEADS

EGMONT UK LIMITED (GREAT BRITAIN LIMITED LIABILITY COMPANY)
239 KENSINGTON HIGH STREET
LONDON, UNITED KINGDOM W86SA

FOR: PAPER; CARDBOARD; PRINTED MATTER, NAMELY, BOOKS IN THE FIELD OF CHILDREN'S FICTION; ANNUALS IN THE FIELD OF CHILDREN'S FICTION; PUBLICATIONS, NAMELY, COMIC BOOKS; SONG BOOKS; MAGAZINES FEATURING CHILDREN'S FICTION; NEWSLETTERS IN THE FIELD OF CHILDREN'S FICTION; NEWSPAPERS; ALBUMS FOR STICKERS; PRINTED PERIODICALS IN THE FIELD OF CHILDREN'S FICTION; JOURNALS CONCERNING CHILDREN'S FICTION; CATALOGUES IN THE FIELD OF CHILDREN'S FICTION; MANUALS IN THE FIELD OF CHILDREN'S FICTION; MAPS; PAMPHLETS AND LEAFLETS IN THE FIELD OF CHILDREN'S FICTION; POSTERS; STATIONERY; PAPER LABELS; DRAWING AND PAINTING MATERIALS, NAMELY, PAINT BOXES, PAINT BRUSHES AND PENCILS; DRAWING RULERS; WRITING INSTRUMENTS; INSTRUCTIONAL AND TEACHING MATERIALS, NAMELY, EDUCATIONAL

CARD GAMES; BOOK BINDING MATERIALS; BOOK COVERS; BOOK MARKS; PRINTING SETS, NAMELY, PRINTING PAPER AND LABEL PRINTING MACHINES; DRAWINGS; PAINTINGS; PHOTOGRAPHS; PRINTS; PICTURES; CALENDARS; DIARIES; PENS; PENCILS; PENCIL BOXES; PENCIL CASES; PAPER TAGS; GIFT WRAP CARDS; WRAPPING PAPERS; NOTE PADS; DECALCOMANIAS; ERASERS; GREETING CARDS; STICKERS; TEACHING CLOCKS MADE OF PAPER; TABLE CLOTHS OF PAPER; PAPER NAPKINS; SERVIETTES MADE OF PAPER; AND TISSUE PAPER, IN CLASS 16 (U.S. CLS. 2, 5, 22, 23, 29, 37, 38 AND 50).

THE MARK CONSISTS OF STANDARD CHARACTERS WITHOUT CLAIM TO ANY PARTICULAR FONT, STYLE, SIZE, OR COLOR.

OWNER OF UNITED KINGDOM REG. NO. 2441816, DATED 7-20-2007, EXPIRES 12-19-2016.

SER. NO. 77-236,045, FILED 7-23-2007.

KAPIL BHANOT, EXAMINING ATTORNEY

Int. Cl.: 35

Prior U.S. Cls.: 100, 101 and 102

United States Patent and Trademark Office

Reg. No. 3,519,032

Registered Oct. 21, 2008

**SERVICE MARK
PRINCIPAL REGISTER**

Web 'n' Walk Express Card

DEUTSCHE TELEKOM AG (FED REP GERMA-
NY CORPORATION)
FRIEDRICH-EBERT-ALLEE 140
BONN, FED REP GERMANY 53113

FOR: ADVERTISING SERVICES, NAMELY, PRE-
PARING AND PLACING ADVERTISEMENTS FOR
OTHERS PROMOTING THE GOODS AND SERVI-
CES OF OTHERS THROUGH PRINTED ADVERTIS-
ING, PRINTED DIRECTORIES, THROUGH
ENCODED MEDIA, THROUGH THE DISSEMINA-
TION OF PROMOTIONAL MATERIALS,
THROUGH DIRECT MAIL ADVERTISING,
THROUGH ELECTRONIC BILLBOARD ADVERTIS-
ING, PREPARING AUDIO-VISUAL PRESENTA-
TIONS FOR USE IN ADVERTISING; BUSINESS
MANAGEMENT SERVICES, NAMELY, BUSINESS
APPRAISALS, BUSINESS AUDITING, PROVIDING
BUSINESS INFORMATION, NAMELY, PREPARING
BUSINESS REPORTS AND CONDUCTING BUSI-
NESS RESEARCH, ANALYSIS AND SURVEYS,
BUSINESS MANAGEMENT PLANNING, BUSINESS
MANAGEMENT CONSULTATION, BUSINESS
MANAGEMENT SUPERVISION, CONDUCTING
BUSINESS NETWORKING FOR OTHERS; BUSI-
NESS MANAGEMENT AND CONSULTING SERVI-

CES, EXCLUDING AGRICULTURAL BUSINESS
MANAGEMENT AND CONSULTING SERVICES;
PROVIDING INFORMATION VIA THE TELE-
PHONE AND THE GLOBAL COMMUNICATION
NETWORKS IN THE FIELD OF ADVERTISING
AND BUSINESS MARKETING; PROFESSIONAL
CONSULTANCY IN THE FIELD OF DATA PRO-
CESSING; ORGANIZING JOB FAIRS, IN CLASS 35
(U.S. CLS. 100, 101 AND 102).

THE MARK CONSISTS OF STANDARD CHAR-
ACTERS WITHOUT CLAIM TO ANY PARTICULAR
FONT, STYLE, SIZE, OR COLOR.

PRIORITY CLAIMED UNDER SEC. 44(D) ON FED
REP GERMANY APPLICATION NO. 3071001138,
FILED 2-12-2007, REG. NO. 30710011, DATED 3-27-
2007, EXPIRES 2-28-2017.

OWNER OF U.S. REG. NOS. 3,250,718, 3,257,839
AND OTHERS.

SER. NO. 77-237,837, FILED 7-24-2007.

STEPHEN AQUILA, EXAMINING ATTORNEY

Int. Cl.: 9

Prior U.S. Cls.: 21, 23, 26, 36 and 38

Reg. No. 3,519,033

United States Patent and Trademark Office

Registered Oct. 21, 2008

**TRADEMARK
PRINCIPAL REGISTER**

Great Day Games

ARKADIUM, INC. (NEW YORK CORPORATION)
37 W. 20TH STREET, SUITE 809
NEW YORK, NY 10011

FOR: DOWNLOADABLE MULTIMEDIA FILE
CONTAINING ARTWORK, TEXT, AUDIO, VIDEO,
GAMES, AND INTERNET WEB LINKS RELATING
TO CASUAL GAMES, IN CLASS 9 (U.S. CLS. 21, 23,
26, 36 AND 38).

FIRST USE 2-1-2006; IN COMMERCE 2-1-2006.

THE MARK CONSISTS OF STANDARD CHAR-
ACTERS WITHOUT CLAIM TO ANY PARTICULAR
FONT, STYLE, SIZE, OR COLOR.

NO CLAIM IS MADE TO THE EXCLUSIVE
RIGHT TO USE "GAMES", APART FROM THE
MARK AS SHOWN.

SER. NO. 77-238,384, FILED 7-25-2007.

JULIE WATSON, EXAMINING ATTORNEY

Int. Cl.: 43

Prior U.S. Cls.: 100 and 101

United States Patent and Trademark Office

Reg. No. 3,519,034

Registered Oct. 21, 2008

**SERVICE MARK
PRINCIPAL REGISTER**

THEO'S PIZZA & CATERING

THEO'S PIZZA & CATERING, INC. (WISCONSIN CORPORATION)

3329 SOUTH BUSINESS DRIVE

SHEBOYGAN, WI 53081

FOR: RESTAURANTS, IN CLASS 43 (U.S. CLS. 100 AND 101).

FIRST USE 4-1-2005; IN COMMERCE 4-1-2005.

THE MARK CONSISTS OF STANDARD CHARACTERS WITHOUT CLAIM TO ANY PARTICULAR FONT, STYLE, SIZE, OR COLOR.

NO CLAIM IS MADE TO THE EXCLUSIVE RIGHT TO USE "PIZZA AND CATERING", APART FROM THE MARK AS SHOWN.

SER. NO. 77-238,537, FILED 7-25-2007.

DANIEL CAPSHAW, EXAMINING ATTORNEY

Int. Cl.: 37

Prior U.S. Cls.: 100, 103 and 106

United States Patent and Trademark Office

Reg. No. 3,519,035

Registered Oct. 21, 2008

**SERVICE MARK
PRINCIPAL REGISTER**



BATHREBUILDERS, LLC (MARYLAND LIMITED LIABILITY COMPANY)
SUITE 5
2138 PRIEST BRIDGE COURT
CROFTON, MD 21114

NO CLAIM IS MADE TO THE EXCLUSIVE RIGHT TO USE "BATHREBUILDERS", APART FROM THE MARK AS SHOWN.

FOR: HOME REMODELING SERVICES, IN CLASS 37 (U.S. CLS. 100, 103 AND 106).

SER. NO. 77-238,877, FILED 7-25-2007.

FIRST USE 3-1-2005; IN COMMERCE 3-1-2005.

GEORGIA CARTY, EXAMINING ATTORNEY

Int. Cl.: 7

Prior U.S. Cls.: 13, 19, 21, 23, 31, 34 and 35

United States Patent and Trademark Office

Reg. No. 3,519,036

Registered Oct. 21, 2008

**TRADEMARK
PRINCIPAL REGISTER**



HACKETT PRECISION COMPANY, INC. (TENNESSEE CORPORATION)
1001 W. KIRKLAND AVE.
NASHVILLE, TN 37216

FOR: CUSTOM DESIGNED MACHINERY FEATURING AUTOMATION AND ROBOTICS FOR USE IN THE ASSEMBLY OR SUBASSEMBLY OF MANUFACTURED GOODS, NAMELY, EQUIPMENT THAT PERMITS CUSTOM INTEGRATION OF MANUFACTURING FACILITIES FOR ASSEMBLY OR SUBASSEMBLY OF GOODS, AUTOMATED ASSEMBLY AND TEST SYSTEMS, AUTOMATED WELDING SYSTEMS, AUTOMATED METAL REMOVAL SYSTEMS, AUTOMATED MATERIAL HANDING MACHINERY, NAMELY, PALLETIZERS, CASE ELEVATORS, AUTOMATIC PALLET DISPENSING MACHINES AND AUTOMATIC SLIP SHEET DISPENSING MACHINES, MACHINERY THAT PERMITS AUTOMATION AND INTEGRATION OF PROCESSES IN MANUFACTURING FACILITIES, ROBOTIC ASSEMBLY AND PACKAGING

MACHINERY, TOOLING MACHINERY, AND FIXTURING EQUIPMENT, NAMELY, EQUIPMENT UTILIZING CUSTOM ENGINEERED EQUIPMENT OR ROBOTICS FOR THE ASSEMBLY OR SUBASSEMBLY OF MANUFACTURE GOODS, IN CLASS 7 (U.S. CLS. 13, 19, 21, 23, 31, 34 AND 35).

FIRST USE 7-11-2007; IN COMMERCE 7-11-2007.

THE COLOR(S) BLUE, GREEN AND ORANGE IS/ARE CLAIMED AS A FEATURE OF THE MARK.

THE MARK CONSISTS OF THREE SIX SIDED POLYGONS, EACH COMPLETELY SHADED/COLORED IN BLUE, GREEN AND ORANGE.

SER. NO. 77-239,154, FILED 7-26-2007.

MARY ROSSMAN, EXAMINING ATTORNEY

Int. Cls.: 40 and 42

Prior U.S. Cls.: 100, 101, 103 and 106

United States Patent and Trademark Office

Reg. No. 3,519,037

Registered Oct. 21, 2008

**SERVICE MARK
PRINCIPAL REGISTER**



HACKETT PRECISION COMPANY, INC. (TENNESSEE CORPORATION)
1001 W. KIRKLAND AVE.
NASHVILLE, TN 37216

FOR: CUSTOM CONSTRUCTION OF MACHINERY FEATURING AUTOMATION AND ROBOTICS FOR USE IN PRODUCTION MANUFACTURING FACILITIES, NAMELY, EQUIPMENT THAT PERMITS CUSTOM INTEGRATION OF MANUFACTURING FACILITIES, AUTOMATED ASSEMBLY AND TEST SYSTEMS, AUTOMATED WELDING SYSTEMS, AUTOMATED METAL REMOVAL SYSTEMS, AUTOMATED MATERIAL HANDING MACHINERY, MACHINERY THAT PERMITS AUTOMATION AND INTEGRATION OF PROCESSES IN MANUFACTURING FACILITIES, ROBOTIC ASSEMBLY AND PACKAGING MACHINERY, TOOLING MACHINERY, AND FIXTURING EQUIPMENT, NAMELY, EQUIPMENT UTILIZING CUSTOM ENGINEERED EQUIPMENT OR ROBOTICS FOR THE ASSEMBLY OR SUBASSEMBLY OF MANUFACTURE GOODS, IN CLASS 40 (U.S. CLS. 100, 103 AND 106).

FIRST USE 7-11-2007; IN COMMERCE 7-11-2007.

FOR: CUSTOM DESIGN AND ENGINEERING OF MACHINERY FEATURING AUTOMATION AND ROBOTICS FOR USE IN PRODUCTION MANUFACTURING FACILITIES, NAMELY, EQUIPMENT

THAT PERMITS CUSTOM INTEGRATION OF MANUFACTURING FACILITIES, AUTOMATED ASSEMBLY AND TEST SYSTEMS, AUTOMATED WELDING SYSTEMS, AUTOMATED METAL REMOVAL SYSTEMS, AUTOMATED MATERIAL HANDING MACHINERY, MACHINERY THAT PERMITS AUTOMATION AND INTEGRATION OF PROCESSES IN MANUFACTURING FACILITIES, ROBOTIC ASSEMBLY AND PACKAGING MACHINERY, TOOLING MACHINERY, AND FIXTURING EQUIPMENT, NAMELY, EQUIPMENT UTILIZING CUSTOM ENGINEERED EQUIPMENT OR ROBOTICS FOR THE ASSEMBLY OR SUBASSEMBLY OF MANUFACTURE GOODS, IN CLASS 42 (U.S. CLS. 100 AND 101).

FIRST USE 7-11-2007; IN COMMERCE 7-11-2007.

THE COLOR(S) BLUE, GREEN AND ORANGE IS/ARE CLAIMED AS A FEATURE OF THE MARK.

THE MARK CONSISTS OF THREE SIX SIDED POLYGONS, EACH COMPLETELY SHADED/COLORED IN BLUE, GREEN AND ORANGE.

SER. NO. 77-239,185, FILED 7-26-2007.

MARY ROSSMAN, EXAMINING ATTORNEY

Int. Cl.: 41

Prior U.S. Cls.: 100, 101 and 107

United States Patent and Trademark Office

Reg. No. 3,519,038

Registered Oct. 21, 2008

**SERVICE MARK
PRINCIPAL REGISTER**

AppleJaxx

OWENS, ERNEST (UNITED STATES INDIVIDUAL), DBA APPLEJAXX
171 SOUTH ST. #6B
JAMAICA PLAIN, MA 02130

FOR: ENTERTAINMENT, NAMELY LIVE PERFORMANCES BY THE MUSICIAN ERNEST OWENS; ENTERTAINMENT NAMELY, PERFORMING LIVE MUSICAL CONCERTS FEATURING ERNEST OWENS , IN CLASS 41 (U.S. CLS. 100, 101 AND 107).

FIRST USE 6-0-2000; IN COMMERCE 6-0-2000.

THE MARK CONSISTS OF STANDARD CHARACTERS WITHOUT CLAIM TO ANY PARTICULAR FONT, STYLE, SIZE, OR COLOR.

SER. NO. 77-239,699, FILED 7-26-2007.

JACLYN KIDWELL, EXAMINING ATTORNEY

Int. Cl.: 45

Prior U.S. Cls.: 100 and 101

United States Patent and Trademark Office

Reg. No. 3,519,039

Registered Oct. 21, 2008

**SERVICE MARK
PRINCIPAL REGISTER**

RUNNERS' LOUNGE

SUCCESSFUL RUNNING, LLC (IOWA LIMITED
LIABILITY COMPANY)
4501 AMICK AVENUE
DES MOINES, IA 50301

FOR: ON-LINE SOCIAL NETWORKING SERVI-
CES FOR RUNNING ENTHUSIASTS, IN CLASS 45
(U.S. CLS. 100 AND 101).

FIRST USE 6-1-2007; IN COMMERCE 6-1-2007.

THE MARK CONSISTS OF STANDARD CHAR-
ACTERS WITHOUT CLAIM TO ANY PARTICULAR
FONT, STYLE, SIZE, OR COLOR.

NO CLAIM IS MADE TO THE EXCLUSIVE
RIGHT TO USE "RUNNERS", APART FROM THE
MARK AS SHOWN.

SER. NO. 77-239,837, FILED 7-26-2007.

BONNIE LUKEN, EXAMINING ATTORNEY

Int. Cl.: 39

Prior U.S. Cls.: 100 and 105

United States Patent and Trademark Office

Reg. No. 3,519,040

Registered Oct. 21, 2008

**SERVICE MARK
PRINCIPAL REGISTER**

We make sure the Boot fits
you perfectly

LEONORA M. CHIANELLO (CALIFORNIA SOLE
PROPRIETORSHIP), DBA ITALY IN STYLE
1238 12TH STREET # 5
SANTA MONICA, CA 90401

THE MARK CONSISTS OF STANDARD CHAR-
ACTERS WITHOUT CLAIM TO ANY PARTICULAR
FONT, STYLE, SIZE, OR COLOR.

FOR: COORDINATING TRAVEL ARRANGE-
MENTS FOR INDIVIDUALS AND FOR GROUPS,
IN CLASS 39 (U.S. CLS. 100 AND 105).

SER. NO. 77-240,049, FILED 7-26-2007.

FIRST USE 1-17-2007; IN COMMERCE 1-17-2007.

CYNTHIA SLOAN, EXAMINING ATTORNEY

Int. Cls.: 35 and 41

Prior U.S. Cls.: 100, 101, 102 and 107

United States Patent and Trademark Office

Reg. No. 3,519,041

Registered Oct. 21, 2008

**SERVICE MARK
PRINCIPAL REGISTER**

**Sustainable Packaging
Coalition**

GREEN BLUE INSTITUTE (DELAWARE TAX EXEMPT CORPORATION), DBA GREENBLUE
600 E. WATER STREET, SUITE C
CHARLOTTESVILLE, VA 22901

FOR: INFORMATION SERVICES IN THE FIELD OF SUSTAINABLE BUSINESS SOLUTIONS, IN CLASS 35 (U.S. CLS. 100, 101 AND 102).

FIRST USE 11-7-2003; IN COMMERCE 3-31-2004.

FOR: EDUCATION SERVICES, NAMELY, PROVIDING LIVE AND ON-LINE CONFERENCES AND SEMINARS IN THE FIELD OF SUSTAINABLE BUSINESS SOLUTIONS, AND DISTRIBUTION OF

PRINTED AND PRINTABLE MATERIAL THEREWITH, IN CLASS 41 (U.S. CLS. 100, 101 AND 107).

FIRST USE 11-7-2003; IN COMMERCE 3-31-2004.

THE MARK CONSISTS OF STANDARD CHARACTERS WITHOUT CLAIM TO ANY PARTICULAR FONT, STYLE, SIZE, OR COLOR.

SEC. 2(F).

SER. NO. 77-241,031, FILED 7-27-2007.

ANNE E. GUSTASON, EXAMINING ATTORNEY

Int. Cl.: 9

Prior U.S. Cls.: 21, 23, 26, 36 and 38

Reg. No. 3,519,042

United States Patent and Trademark Office

Registered Oct. 21, 2008

**TRADEMARK
PRINCIPAL REGISTER**

BATTERY WIZARD

LENMAR ENTERPRISES, INC. (CALIFORNIA CORPORATION)
4035 VIA PESCADOR
CAMARILLO, CA 93012

FOR: COMPUTER PROGRAMS FOR IDENTIFYING AND LINKING ELECTRONIC DEVICES WITH BATTERIES POWERING THOSE DEVICES; COMPUTER PROGRAMS FOR IDENTIFYING AND LINKING ELECTRONIC DEVICES AND BATTERIES WITH APPROPRIATE BATTERY CHARGING DEVICES, IN CLASS 9 (U.S. CLS. 21, 23, 26, 36 AND 38).

FIRST USE 6-1-2004; IN COMMERCE 6-1-2004.

THE MARK CONSISTS OF STANDARD CHARACTERS WITHOUT CLAIM TO ANY PARTICULAR FONT, STYLE, SIZE, OR COLOR.

NO CLAIM IS MADE TO THE EXCLUSIVE RIGHT TO USE "BATTERY", APART FROM THE MARK AS SHOWN.

SEC. 2(F).

SER. NO. 77-241,179, FILED 7-27-2007.

JENNIFER VASQUEZ, EXAMINING ATTORNEY

Int. Cl.: 20

Prior U.S. Cls.: 2, 13, 22, 25, 32 and 50

Reg. No. 3,519,043

United States Patent and Trademark Office

Registered Oct. 21, 2008

**TRADEMARK
PRINCIPAL REGISTER**

WineStem

KIRKENDALL, ALLAN R (UNITED STATES INDIVIDUAL)

688 EVELYN STREET
ROSEBURG, OR 97470 AND

KIRKENDALL, SHERYL L (UNITED STATES INDIVIDUAL)

688 EVELYN STREET
ROSEBURG, OR 97470 AND

DOWNING, ANDREA L (UNITED STATES INDIVIDUAL)

2232 W. LINDER AVE. #17

MESA, AZ 85202 AND

KIRKENDALL, GEOFFREY A (UNITED STATES INDIVIDUAL)

688 EVELYN STREET

ROSEBURG, OR 97470

FOR: WINE RACKS, IN CLASS 20 (U.S. CLS. 2, 13, 22, 25, 32 AND 50).

FIRST USE 3-1-2006; IN COMMERCE 3-20-2006.

THE MARK CONSISTS OF STANDARD CHARACTERS WITHOUT CLAIM TO ANY PARTICULAR FONT, STYLE, SIZE, OR COLOR.

SER. NO. 77-241,529, FILED 7-29-2007.

PAUL MORENO, EXAMINING ATTORNEY

Int. Cls.: 3 and 5

Prior U.S. Cls.: 1, 4, 6, 18, 44, 46, 50, 51 and 52

United States Patent and Trademark Office

Reg. No. 3,519,044

Registered Oct. 21, 2008

**TRADEMARK
PRINCIPAL REGISTER**

AUSTIN'S

JAMES AUSTIN COMPANY (PENNSYLVANIA CORPORATION)
P.O. BOX 827
115 DOWNIEVILLE ROAD
MARS, PA 16046

FOR: HOUSEHOLD CLEANING PREPARATIONS, NAMELY, AMMONIA, GLASS AND WINDOW CLEANER, PINE OIL CLEANER FOR GENERAL CLEANING PURPOSES, LAUNDRY DETERGENT, FABRIC SOFTENER, DISH DETERGENT, LAUNDRY AND GENERAL CLEANING BLEACH, CARPET AND UPHOLSTERY CLEANER, WINDSHIELD WASHER FLUID, DEGREASER PREPARATION NOT USED IN THE MANUFACTURING PROCESS BUT FOR USE ON KITCHEN COUNTER TOPS AND OVENS, HAND SOAP, OVEN AND GRILL CLEANER, LAUNDRY STARCH, MULTIPURPOSE CLEANER, IN CLASS 3 (U.S. CLS. 1, 4, 6, 50, 51 AND 52).

FIRST USE 1-1-1889; IN COMMERCE 1-1-1889.

FOR: SWIMMING POOL SHOCK, NAMELY, PREPARATIONS FOR DISINFECTING WATER IN SWIMMING POOLS, SPAS AND HOT TUBS, IN CLASS 5 (U.S. CLS. 6, 18, 44, 46, 51 AND 52).

FIRST USE 1-1-1889; IN COMMERCE 1-1-1889.

THE MARK CONSISTS OF STANDARD CHARACTERS WITHOUT CLAIM TO ANY PARTICULAR FONT, STYLE, SIZE, OR COLOR.

OWNER OF U.S. REG. NOS. 591,426, 728,750, AND 1,924,982.

SER. NO. 77-241,699, FILED 7-30-2007.

DAVID MURRAY, EXAMINING ATTORNEY

Int. Cls.: 35, 40 and 41

Prior U.S. Cls.: 100, 101, 102, 103, 106 and 107

United States Patent and Trademark Office

Reg. No. 3,519,045

Registered Oct. 21, 2008

**SERVICE MARK
PRINCIPAL REGISTER**

CREATESPACE

AMAZON TECHNOLOGIES, INC. (NEVADA CORPORATION)
ATTN: TRADEMARKS
PO BOX 8102
RENO, NV 89507

FOR: DISTRIBUTORSHIP SERVICES FEATURING BOOKS MUSIC, MOTION PICTURES, TELEVISION PROGRAMS AND MULTIMEDIA PRODUCTS OF OTHERS IN THE FORM OF PRINTED MATTER, AUDIO RECORDINGS, VIDEO RECORDINGS, DVDS AND COMPACT DISKS; ADVERTISING, MARKETING AND PROMOTION SERVICES; CREATIVE MARKETING DESIGN SERVICES; MERCHANDISE PACKAGING; ORDER FULFILLMENT SERVICES, IN CLASS 35 (U.S. CLS. 100, 101 AND 102).

FIRST USE 8-8-2007; IN COMMERCE 8-8-2007.

FOR: MANUFACTURE OF VIDEO AND AUDIO DISCS AND DVDS TO THE ORDER AND SPECIFICATION OF OTHERS; DUPLICATION OF VIDEO

AND AUDIO TAPES, DISCS AND DVDS TO THE ORDER AND SPECIFICATION OF OTHERS , IN CLASS 40 (U.S. CLS. 100, 103 AND 106).

FIRST USE 8-8-2007; IN COMMERCE 8-8-2007.

FOR: PUBLISHING OF BOOKS AND OTHER PRINTED MATTER; VIDEO, AUDIO AND MULTIMEDIA PUBLISHING SERVICES; PRODUCTION OF VIDEO AND AUDIO DISCS OR DVDS FOR OTHERS, IN CLASS 41 (U.S. CLS. 100, 101 AND 107).

FIRST USE 8-8-2007; IN COMMERCE 8-8-2007.

THE MARK CONSISTS OF STANDARD CHARACTERS WITHOUT CLAIM TO ANY PARTICULAR FONT, STYLE, SIZE, OR COLOR.

SER. NO. 77-242,331, FILED 7-30-2007.

DOMINIC J. FERRAIUOLO, EXAMINING ATTORNEY

Int. Cl.: 39

Prior U.S. Cls.: 100 and 105

United States Patent and Trademark Office

Reg. No. 3,519,046

Registered Oct. 21, 2008

**SERVICE MARK
PRINCIPAL REGISTER**

ECHO OFFSITE

ROVER TECHNOLOGY FUSIONS (FLORIDA
LIMITED LIABILITY COMPANY)
5115 JOANNE KEARNEY BLVD.
TAMPA, FL 33619

FOR: ELECTRONIC STORAGE OF DATA, NAME-
LY, PROVIDING A BACKUP SOLUTION WHICH
INCLUDES MULTIPLE COPIES OF DATA STORED
IN MULTIPLE LOCATIONS, LOCALLY AND IN
REMOTE SERVERS, IN CLASS 39 (U.S. CLS. 100
AND 105).

FIRST USE 6-24-2007; IN COMMERCE 6-24-2007.

THE MARK CONSISTS OF STANDARD CHAR-
ACTERS WITHOUT CLAIM TO ANY PARTICULAR
FONT, STYLE, SIZE, OR COLOR.

NO CLAIM IS MADE TO THE EXCLUSIVE
RIGHT TO USE "OFFSITE", APART FROM THE
MARK AS SHOWN.

SER. NO. 77-242,870, FILED 7-31-2007.

AISHA SALEM, EXAMINING ATTORNEY

Int. Cl.: 38

Prior U.S. Cls.: 100, 101 and 104

United States Patent and Trademark Office

Reg. No. 3,519,047

Registered Oct. 21, 2008

**SERVICE MARK
PRINCIPAL REGISTER**

Web 'n' Walk Box

DEUTSCHE TELEKOM AG (FED REP GERMA-
NY CORPORATION)
FRIEDRICH-EBERT-ALLEE 140
BONN, FED REP GERMANY 53113

FOR: TELECOMMUNICATION AND INFORMATION TECHNOLOGY SERVICES, NAMELY, ELECTRIC, DIGITAL, CELLULAR AND WIRELESS TRANSMISSION OF VOICE, DATA, INFORMATION, IMAGES, SIGNALS AND MESSAGES AND TRANSMISSION OF VOICE, DATA, IMAGES, AUDIO, VIDEO AND INFORMATION VIA TELEPHONE, TELEVISION AND GLOBAL COMMUNICATION NETWORKS; PROVIDING TELECOMMUNICATIONS CONNECTIONS OVER A GLOBAL COMMUNICATIONS NETWORK, ELECTRONIC STORE-AND-FORWARD MESSAGING; RENTAL OF TELECOMMUNICATIONS EQUIPMENT, NAMELY, EQUIPMENT FOR ELECTRONIC ACCESS TO GLOBAL TELECOMMUNICATIONS NETWORK, EQUIPMENT FOR TRANSMITTING, RECEIVING, RECORDING AND MONITORING VOICE, DATA, INFORMATION, IMAGES, SIGNALS, MESSAGES COMPRISED OF DATA AND WORD PROCESSORS, AND TELECOMMUNICATIONS HARDWARE COMPONENTS AND PERIPHERALS THEREOF FOR USE IN THE TELECOMMUNICATIONS INDUSTRY, AND RENTAL OF TELECOMMUNICATIONS EQUIPMENT FOR TRANSMITTING, RECEIVING, RECORDING AND MONITORING COMPUTER PROGRAMS FOR USE IN OPERATING AND ACCESSING TELECOMMUNICATIONS SYSTEMS; AUDIO AND VIDEO BROADCASTING; PROVIDING MULTIPLE-USER

DIAL-UP AND DEDICATED ACCESS TO THE INTERNET; PERSONAL COMMUNICATIONS SERVICES; PAGER SERVICES; TRANSMISSION AND BROADCAST OF AUDIO AND VIDEO PROGRAMMING; LEASING OF TELECOMMUNICATIONS EQUIPMENT, COMPONENTS AND SYSTEMS; PROVIDING INFORMATION VIA THE TELEPHONE AND THE GLOBAL COMMUNICATION NETWORKS IN THE FIELD OF TELECOMMUNICATIONS; CONSULTING IN THE FIELD OF TELECOMMUNICATIONS, IN CLASS 38 (U.S. CLS. 100, 101 AND 104).

THE MARK CONSISTS OF STANDARD CHARACTERS WITHOUT CLAIM TO ANY PARTICULAR FONT, STYLE, SIZE, OR COLOR.

PRIORITY CLAIMED UNDER SEC. 44(D) ON FED REP GERMANY APPLICATION NO. 30710013838, FILED 2-12-2007, REG. NO. 30710013, DATED 3-27-2007, EXPIRES 2-28-2017.

OWNER OF U.S. REG. NOS. 3,250,718, 3,257,839 AND OTHERS.

NO CLAIM IS MADE TO THE EXCLUSIVE RIGHT TO USE "BOX", APART FROM THE MARK AS SHOWN.

SER. NO. 77-243,667, FILED 7-31-2007.

STEPHEN AQUILA, EXAMINING ATTORNEY

Int. Cl.: 42

Prior U.S. Cls.: 100 and 101

United States Patent and Trademark Office

Reg. No. 3,519,048

Registered Oct. 21, 2008

**SERVICE MARK
PRINCIPAL REGISTER**

Web 'n' Walk Box

DEUTSCHE TELEKOM AG (FED REP GERMA-
NY CORPORATION)
FRIEDRICH-EBERT-ALLEE 140
BONN, FED REP GERMANY 53113

FOR: COMPUTER PROGRAMMING SERVICES FOR OTHERS; RENTAL OF COMPUTER SOFTWARE AND HARDWARE FOR ONLINE ACCESS; DATA ENCRYPTION SERVICES; APPLICATION SERVICE PROVIDER, NAMELY, HOSTING OF DIGITAL CONTENT ON THE INTERNET; HOSTING THE WEBSITES OF OTHERS ON A COMPUTER SERVER FOR A GLOBAL COMPUTER NETWORK; COMPUTER SERVICES, NAMELY, CREATING INDEXES OF INFORMATION AVAILABLE ON COMPUTER NETWORKS; PROVIDING INFORMATION VIA THE TELEPHONE AND THE GLOBAL COMMUNICATION NETWORKS IN THE FIELD OF INFORMATION TECHNOLOGY; CONSULTING SERVICES IN THE FIELD OF DESIGN, SELECTION, IMPLEMENTATION AND USE OF COMPUTER HARDWARE AND SOFTWARE SYSTEMS FOR OTHERS; INSTALLATION, MAINTENANCE AND REPAIR OF COMPUTER SOFTWARE; TECHNICAL PROJECT PLANNING SERVICES RELATED TO TELECOMMUNICATIONS EQUIPMENT; PROVID-

ING INFORMATION AT THE SPECIFIC REQUEST OF END-USERS BY MEANS OF TELEPHONE OR GLOBAL COMMUNICATIONS NETWORKS; PROVIDING TEMPORARY USE OF ONLINE NON-DOWNLOADABLE TELECOMMUNICATIONS SOFTWARE FOR PROVIDING MULTIPLE USER ACCESS TO THE GLOBAL COMPUTER NETWORK, IN CLASS 42 (U.S. CLS. 100 AND 101).

THE MARK CONSISTS OF STANDARD CHARACTERS WITHOUT CLAIM TO ANY PARTICULAR FONT, STYLE, SIZE, OR COLOR.

PRIORITY CLAIMED UNDER SEC. 44(D) ON FED REP GERMANY APPLICATION NO. 30710013.8/3, FILED 2-12-2007, REG. NO. 30710013, DATED 3-27-2007, EXPIRES 2-28-2017.

OWNER OF U.S. REG. NOS. 3,250,718, 3,257,839 AND OTHERS.

SER. NO. 77-243,675, FILED 7-31-2007.

STEPHEN AQUILA, EXAMINING ATTORNEY

Int. Cl.: 38

Prior U.S. Cls.: 100, 101 and 104

United States Patent and Trademark Office

Reg. No. 3,519,049

Registered Oct. 21, 2008

**SERVICE MARK
PRINCIPAL REGISTER**



IMPORTS & EMPORIUM, INC (OHIO CORPORATION)

P.O BOX 360734

COLUMBUS, OH 432360734

FOR: DOMESTIC ARTICLES FOR PROFIT, FEATURING ADULT VIDEO ON DEMAND, NAMELY, STREAMING OF VIDEO MATERIAL ON DEMAND; WEBCASTING SERVICES, NAMELY, ADULT LIVE VIDEO ON DEMAND , IN CLASS 38 (U.S. CLS. 100, 101 AND 104).

FIRST USE 1-1-2006; IN COMMERCE 1-1-2006.

THE COLOR(S) BLACK, WHITE, RED & GRAY IS/ ARE CLAIMED AS A FEATURE OF THE MARK.

THE MARK CONSISTS OF A WOMAN'S WHITE FACE WITH GRAY AND BLACK SHADING, HER WHITE INDEX FINGER UP TO HER RED LIP, WITH THE LITERAL ELEMENT "2TABOO4U" IN RED UNDERNEATH HER FINGER.

SER. NO. 77-243,859, FILED S.R. 8-1-2007 AM. P.R. 3-12-2008.

FRANK LATTUCA, EXAMINING ATTORNEY

Int. Cl.: 25

Prior U.S. Cls.: 22 and 39

United States Patent and Trademark Office

Reg. No. 3,519,050

Registered Oct. 21, 2008

**TRADEMARK
PRINCIPAL REGISTER**

DINA BAR-EL

DINA BAR-EL (CALIFORNIA CORPORATION)
860 S LOS ANGELES STREET
SUITE 750
LOS ANGELES, CA 90014

THE MARK CONSISTS OF THE WORDS "DINA
BAR-EL", IN STYLIZED FORM.

FOR: DRESSES, IN CLASS 25 (U.S. CLS. 22 AND
39).

SER. NO. 77-244,772, FILED 8-1-2007.

FIRST USE 1-25-1994; IN COMMERCE 1-25-1994.

BONNIE LUKEN, EXAMINING ATTORNEY

Int. Cl.: 17

Prior U.S. Cls.: 1, 5, 12, 13, 35 and 50

Reg. No. 3,519,051

United States Patent and Trademark Office

Registered Oct. 21, 2008

**TRADEMARK
PRINCIPAL REGISTER**

**International Cellulose
Corporation**

INTERNATIONAL CELLULOSE CORPORATION
(DELAWARE CORPORATION)
12315 ROBIN BLVD.
HOUSTON, TX 77045

FOR: BUILDING INSULATION, ACOUSTICAL
AND THERMAL INSULATION FOR USE IN BUILD-
INGS, SPRAY-TYPE CELLULOSE FIBER INSULA-
TION FOR BUILDINGS, ADHESIVE FOR USE WITH
CELLULOSE INSULATION, IN CLASS 17 (U.S. CLS.
1, 5, 12, 13, 35 AND 50).

FIRST USE 3-1-1987; IN COMMERCE 3-1-1987.

THE MARK CONSISTS OF STANDARD CHAR-
ACTERS WITHOUT CLAIM TO ANY PARTICULAR
FONT, STYLE, SIZE, OR COLOR.

NO CLAIM IS MADE TO THE EXCLUSIVE
RIGHT TO USE "CELLULOSE CORPORATION",
APART FROM THE MARK AS SHOWN.

SER. NO. 77-244,781, FILED 8-1-2007.

MARY BOAGNI, EXAMINING ATTORNEY

Int. Cls.: 28 and 30

Prior U.S. Cls.: 22, 23, 38, 46 and 50

United States Patent and Trademark Office

Reg. No. 3,519,052

Registered Oct. 21, 2008

TRADEMARK
PRINCIPAL REGISTER



SWEET TOYS S.L. (SPAIN CORPORATION)
POL. IND. DE LORQUÍ, SECTOR B - C/ B-2
LORQUÍ, MURCIA, SPAIN 30564

FOR: GAMES AND PLAYTHINGS, IN PARTICULAR GAMES AND TOYS IN THE NATURE OF DISPENSING CONTAINERS USED IN OR WITH BAKERY, PASTRY AND CONFECTIONERY PRODUCTS, NAMELY, CANDY OR GUM, IN CLASS 28 (U.S. CLS. 22, 23, 38 AND 50).

FOR: COFFEE, TEA, COCOA, SUGAR, RICE, TAPIOCA, SAGO, ARTIFICIAL COFFEE; CONFECTIONERY, NAMELY, CANDY, CARAMELS, GUMMIES, AND FLAVORED POWDER CANDY, IN CLASS 30 (U.S. CL. 46).

OWNER OF ERPN CMNTY TM OFC REG. NO. 004652202, DATED 10-6-2006, EXPIRES 10-13-2015.

NO CLAIM IS MADE TO THE EXCLUSIVE RIGHT TO USE "TOYS" IN CLASS 28 AND "SWEET" IN CLASS 30, APART FROM THE MARK AS SHOWN.

THE COLOR(S) MAGENTA, YELLOW, GREEN, BLUE, ORANGE, BLACK AND WHITE IS/ARE CLAIMED AS A FEATURE OF THE MARK.

THE MARK CONSISTS OF THE WORDING "SWEET TOYS" IN VARIOUS COLORS OUTLINED IN BLACK WITH A STYLIZED DESIGN ELEMENT.

THE LETTERS "E" IN THE WORDING "SWEET" FEATURE EYES IN WHITE WITH BLACK PUPILS IN THE LOOP OF EACH "E". THE LETTERS "T" AND "O" FEATURE YELLOW SCREW HEADS AND THE LETTER "Y" FEATURES AN ORANGE SCREW HEAD, GIVING THE IMPRESSION OF LETTERS BEING HELD IN PLACE BY FLAT-HEAD SCREWS. THE LETTER "O" IS IN THE SHAPE OF A GEAR. THE LETTERS "S" AND "T" IN THE WORD "SWEET" AND THE LETTER "T" IN THE WORD "TOYS" ARE COLORED MAGENTA; THE LETTERS "W" AND "Y" ARE COLORED YELLOW; THE FIRST LETTER "E" IS COLORED GREEN; THE SECOND LETTER "E" AND THE LETTER "Y" ARE COLORED BLUE; AND THE LETTER "S" IN THE WORD "TOYS" IS COLORED ORANGE. FEATURES AN ORANGE SCREW HEAD, GIVING THE IMPRESSION OF LETTERS BEING HELD IN PLACE BY FLAT-HEAD SCREWS. THE LETTER "O" IS IN THE SHAPE OF A GEAR. THE LETTERS "S" AND "T" IN THE WORD "SWEET" AND THE LETTER "T" IN THE WORD "TOYS" ARE COLORED MAGENTA; THE LETTERS "W" AND "Y" ARE COLORED YELLOW; THE FIRST LETTER "E" IS COLORED GREEN; THE SECOND LETTER "E" AND THE LETTER "Y" ARE COLORED BLUE; AND THE LETTER "S" IN THE WORD "TOYS" IS COLORED ORANGE.

SER. NO. 77-245,441, FILED 8-2-2007.

DARRYL SPRUILL, EXAMINING ATTORNEY

Int. Cl.: 10

Prior U.S. Cls.: 26, 39 and 44

United States Patent and Trademark Office

Reg. No. 3,519,053

Registered Oct. 21, 2008

**TRADEMARK
PRINCIPAL REGISTER**

FLEXPLUS

SPINEVISION, SOCIÉTÉ ANONYME (FRANCE
SOCIETE ANONYME)
180, AVENUE DAUMESNIL
PARIS, FRANCE 75012

FOR: SURGICAL IMPLANTS COMPRISING ARTIFICIAL MATERIALS, IN CLASS 10 (U.S. CLS. 26, 39 AND 44).

THE MARK CONSISTS OF STANDARD CHARACTERS WITHOUT CLAIM TO ANY PARTICULAR FONT, STYLE, SIZE, OR COLOR.

PRIORITY CLAIMED UNDER SEC. 44(D) ON ERPN CMNTY TM OFC APPLICATION NO. 005743539, FILED 2-26-2007, REG. NO. 005743539, DATED 3-12-2008, EXPIRES 2-26-2017.

SER. NO. 77-245,563, FILED 8-2-2007.

JENNIFER VASQUEZ, EXAMINING ATTORNEY

Int. Cl.: 35

Prior U.S. Cls.: 100, 101 and 102

United States Patent and Trademark Office

Reg. No. 3,519,054

Registered Oct. 21, 2008

**SERVICE MARK
PRINCIPAL REGISTER**

GOODWOOD

A.B.C. HOME FURNISHINGS, INC. (NEW YORK CORPORATION)
888 BROADWAY
NEW YORK, NY 10003

FOR: RETAIL STORE SERVICES FEATURING FURNITURE, HOME FURNISHINGS, UPHOLSTERY, ENERGY-SAVING AND ENVIRONMENTALLY-FRIENDLY PRODUCTS, IN CLASS 35 (U.S. CLS. 100, 101 AND 102).

FIRST USE 4-1-2005; IN COMMERCE 4-1-2005.

THE MARK CONSISTS OF STANDARD CHARACTERS WITHOUT CLAIM TO ANY PARTICULAR FONT, STYLE, SIZE, OR COLOR.

SER. NO. 77-245,801, FILED 8-2-2007.

MIDGE BUTLER, EXAMINING ATTORNEY

Int. Cl.: 14

Prior U.S. Cls.: 2, 27, 28 and 50

United States Patent and Trademark Office

Reg. No. 3,519,055

Registered Oct. 21, 2008

TRADEMARK
PRINCIPAL REGISTER



HUPP, ALISON L. (UNITED STATES INDIVIDUAL)
3772 E. KLEINDALE
TUCSON, AZ 85716

FOR: JEWELRY, IN CLASS 14 (U.S. CLS. 2, 27, 28 AND 50).

FIRST USE 4-25-2007; IN COMMERCE 5-1-2007.

NO CLAIM IS MADE TO THE EXCLUSIVE RIGHT TO USE "JEWELRY" , APART FROM THE MARK AS SHOWN.

THE MARK CONSISTS OF STYLIZED LETTERS SPELLING OUT AMBROSIA JEWELRY.

SER. NO. 77-245,918, FILED 8-2-2007.

KAREN BRACEY, EXAMINING ATTORNEY

Int. Cl.: 41

Prior U.S. Cls.: 100, 101 and 107

United States Patent and Trademark Office

Reg. No. 3,519,056

Registered Oct. 21, 2008

**SERVICE MARK
PRINCIPAL REGISTER**

Virginia College Online

EDUCATION CORPORATION OF AMERICA
(DELAWARE CORPORATION)
SUITE 300
300 RIVERHILLS BUSINESS PARK
BIRMINGHAM, AL 35242

FOR: EDUCATION SERVICES, NAMELY, PROVIDING ONLINE CLASSES AND GRANTING DIPLOMAS, ASSOCIATE, BACHELOR AND MASTER DEGREES IN THE FIELDS OF BUSINESS, CRIMINAL JUSTICE, INFORMATION TECHNOLOGY AND HEALTHCARE, IN CLASS 41 (U.S. CLS. 100, 101 AND 107).

FIRST USE 3-16-2004; IN COMMERCE 3-16-2004.

THE MARK CONSISTS OF STANDARD CHARACTERS WITHOUT CLAIM TO ANY PARTICULAR FONT, STYLE, SIZE, OR COLOR.

OWNER OF U.S. REG. NOS. 2,485,231 AND 2,575,830.

NO CLAIM IS MADE TO THE EXCLUSIVE RIGHT TO USE "COLLEGE ONLINE", APART FROM THE MARK AS SHOWN.

SER. NO. 77-246,197, FILED 8-3-2007.

JESSICA FATHY, EXAMINING ATTORNEY

Int. Cl.: 20

Prior U.S. Cls.: 2, 13, 22, 25, 32 and 50

Reg. No. 3,519,057

United States Patent and Trademark Office

Registered Oct. 21, 2008

**TRADEMARK
PRINCIPAL REGISTER**



LEHMANN, TAMELA (UNITED STATES INDIVIDUAL)
723 SHRIVER AVE
CUMBERLAND, MD 21502

FOR: FITTED FABRIC PET CRATES AND KENNEL COVERS THAT ARE FIVE-SIDED, MACHINE-WASHABLE, AND ARE UNIVERSAL TO FIT OVER ALL STANDARD-SIZED WIRE PET CRATES AND KENNELS REGARDLESS OF DOOR PLACEMENT, IN CLASS 20 (U.S. CLS. 2, 13, 22, 25, 32 AND 50).

FIRST USE 8-13-2007; IN COMMERCE 8-13-2007.

NO CLAIM IS MADE TO THE EXCLUSIVE RIGHT TO USE "PETCRATECOVERS.COM", APART FROM THE MARK AS SHOWN.

THE MARK CONSISTS OF THE WORDS "PETCRATECOVERS.COM" IN A STYLIZED TEXT WITH TWO PAW PRINTS.

SER. NO. 77-246,427, FILED 8-3-2007.

DANIEL BRODY, EXAMINING ATTORNEY

Int. Cl.: 35

Prior U.S. Cls.: 100, 101 and 102

United States Patent and Trademark Office

Reg. No. 3,519,058

Registered Oct. 21, 2008

**SERVICE MARK
PRINCIPAL REGISTER**

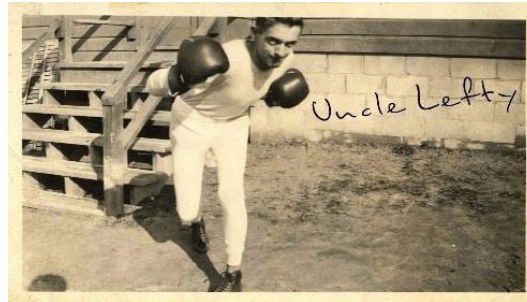

UNCLE LEFTY, INC. (NEW YORK CORPORATION)
190 SHONNARD TERRACE
YONKERS, NY 10701

FOR: TALENT AGENCIES IN THE FILM AND MUSIC INDUSTRY, IN CLASS 35 (U.S. CLS. 100, 101 AND 102).

FIRST USE 8-1-2005; IN COMMERCE 8-1-2005.

OWNER OF U.S. REG. NO. 3,425,884.

THE NAME(S), PORTRAIT(S), AND/OR SIGNATURE(S) SHOWN IN THE MARK DOES NOT IDENTIFY A PARTICULAR LIVING INDIVIDUAL.

THE MARK CONSISTS OF A PHOTO DEPICTION OF A FIGHTER IN UNDERSHIRT TOP, WITH THE WORDS "UNCLE LEFTY" IMPOSED IN SCRIPT ON THE PHOTO.

SER. NO. 77-246,571, FILED 8-3-2007.

STEVEN JACKSON, EXAMINING ATTORNEY

Int. Cl.: 11

Prior U.S. Cls.: 13, 21, 23, 31 and 34

United States Patent and Trademark Office

Reg. No. 3,519,059

Registered Oct. 21, 2008

**TRADEMARK
PRINCIPAL REGISTER**

PEGASUS ASSOCIATES LIGHTING

PEGASUS ASSOCIATES LIGHTING (PENNSYLVANIA CORPORATION)

215 GLENDA DRIVE

BEAVER FALLS, PA 150104970

FOR: LIGHTING FIXTURES, IN CLASS 11 (U.S. CLS. 13, 21, 23, 31 AND 34).

FIRST USE 9-1-2006; IN COMMERCE 9-1-2006.

THE MARK CONSISTS OF STANDARD CHARACTERS WITHOUT CLAIM TO ANY PARTICULAR FONT, STYLE, SIZE, OR COLOR.

NO CLAIM IS MADE TO THE EXCLUSIVE RIGHT TO USE "ASSOCIATES LIGHTING", APART FROM THE MARK AS SHOWN.

SER. NO. 77-246,709, FILED 8-3-2007.

DAVID I, EXAMINING ATTORNEY

Int. Cl.: 24

Prior U.S. Cls.: 42 and 50

United States Patent and Trademark Office

Reg. No. 3,519,060

Registered Oct. 21, 2008

**TRADEMARK
PRINCIPAL REGISTER**



LES LAINAGES VICTOR LTÉE (CANADA CORPORATION)

250, DE LA STATION STREET

SAINT-VICTOR, CANADA G0M2B0

FOR: BILLIARD CLOTH, IN CLASS 24 (U.S. CLS. 42 AND 50).

FIRST USE 6-30-1986; IN COMMERCE 6-30-1986.

PRIORITY CLAIMED UNDER SEC. 44(D) ON CANADA APPLICATION NO. 1348693, FILED 5-24-2007.

THE MARK CONSISTS OF A FANCIFUL DESIGN OF A BILLIARD BALL FOLLOWED BY THE WORDING "FORSTMANN".

SER. NO. 77-248,386, FILED 8-6-2007.

JAMES LOVELACE, EXAMINING ATTORNEY

Int. Cls.: 6 and 22

Prior U.S. Cls.: 1, 2, 7, 12, 13, 14, 19, 22, 23, 25, 42 and 50

Reg. No. 3,519,061

United States Patent and Trademark Office

Registered Oct. 21, 2008

**TRADEMARK
PRINCIPAL REGISTER**

The logo for "DeepRoot" features the word "Deep" in a serif font and "Root" in a larger, bold serif font. A grey triangle is positioned above the letter "R" in "Root", with its apex pointing downwards into the top of the letter.

DEEP ROOT PARTNERS, L.P. (CALIFORNIA
LIMITED PARTNERSHIP)
530 WASHINGTON STREET
SAN FRANCISCO, CA 94111

FIRST USE 7-31-2001; IN COMMERCE 7-31-2001.

FOR: TREE ANCHORING KITS CONSISTING
ESSENTIALLY OF STEEL STAKES AND POLYPRO-
PYLENE TIES FOR STAKING AND GUYING
TREES , IN CLASS 6 (U.S. CLS. 2, 12, 13, 14, 23, 25
AND 50).

OWNER OF U.S. REG. NOS. 1,849,915 AND
1,957,516.

THE MARK CONSISTS OF THE WORD "DEEP-
ROOT" WITH THE APEX OF A TRIANGLE PENE-
TRATING THE TOP OF THE "R".

FIRST USE 7-31-2001; IN COMMERCE 5-1-2007.

FOR: BULK ROLLS OF POLYPROPYLENE CORD
FOR USE IN STAKING AND GUYING TREES, IN
CLASS 22 (U.S. CLS. 1, 2, 7, 19, 22, 42 AND 50).

SER. NO. 77-248,521, FILED 8-6-2007.

JOHN E. MICHOS, EXAMINING ATTORNEY

Int. Cls.: 5, 16, 29, 35, 41 and 44

Prior U.S. Cls.: 2, 5, 6, 18, 22, 23, 29, 37, 38, 44, 46, 50, 51, 52, 100, 101, 102 and 107

Reg. No. 3,519,062

United States Patent and Trademark Office

Registered Oct. 21, 2008

TRADEMARK
SERVICE MARK
PRINCIPAL REGISTER



NS FRANCHISING, LLC (SOUTH CAROLINA
LIMITED LIABILITY COMPANY)
2104 WOODRUFF ROAD
GREENVILLE, SC 29607

FOR: VITAMINS, MINERAL SUPPLEMENTS,
NUTRITIONAL SUPPLEMENTS, PROTEIN SUP-
PLEMENTS, HERBAL SUPPLEMENTS, MEAL RE-
PLACEMENT POWDERS AND DRINKS, USED IN
CONNECTION WITH A WEIGHT MANAGEMENT
PROGRAM, IN CLASS 5 (U.S. CLS. 6, 18, 44, 46, 51
AND 52).

FIRST USE 9-1-2005; IN COMMERCE 9-1-2005.

FOR: EDUCATIONAL PUBLICATIONS, NAME-
LY, TRAINING MANUALS AND BROCHURES DE-
TAILING INSTRUCTION ON OBESITY, WEIGHT
LOSS/WEIGHT MANAGEMENT PROGRAMS, IN-
CLUDING NUTRITION AND EXERCISE, IN CLASS
16 (U.S. CLS. 2, 5, 22, 23, 29, 37, 38 AND 50).

FIRST USE 9-1-2005; IN COMMERCE 9-1-2005.

FOR: PREPARED OR PACKAGED MEALS CON-
SISTING PRIMARILY OF MEAT, FISH, POULTRY
OR VEGETABLES, IN CLASS 29 (U.S. CL. 46).

FIRST USE 9-1-2005; IN COMMERCE 9-1-2005.

FOR: RETAIL STORE SERVICES FEATURING
VITAMINS, MINERAL SUPPLEMENTS, NUTRI-
TIONAL SUPPLEMENTS, PROTEIN SUPPLE-
MENTS, HERBAL SUPPLEMENTS, MEAL
REPLACEMENT POWDERS AND DRINKS, IN
CLASS 35 (U.S. CLS. 100, 101 AND 102).

FIRST USE 9-1-2005; IN COMMERCE 9-1-2005.

FOR: EDUCATION SERVICES, NAMELY, PRO-
VIDING CLASSES, SEMINARS, WORKSHOPS IN
THE FIELDS OF OBESITY AND WEIGHT MAN-
AGEMENT, NUTRITION, AND EXERCISE AND
CONSULTATION RELATING TO PHYSICAL EXER-
CISE, IN CLASS 41 (U.S. CLS. 100, 101 AND 107).

FIRST USE 9-1-2005; IN COMMERCE 9-1-2005.

FOR: PROVIDING TREATMENT AND CONSUL-
TATION FOR WEIGHT REDUCTION, OBESITY
AND WEIGHT MANAGEMENT, NUTRITION,
NAMELY, THROUGH USE OF THE TELEPHONE,
TELEVISION, INTERNET, AND LITERATURE, IN
CLASS 44 (U.S. CLS. 100 AND 101).

FIRST USE 9-1-2005; IN COMMERCE 9-1-2005.

NO CLAIM IS MADE TO THE EXCLUSIVE
RIGHT TO USE "NUTRITION", APART FROM
THE MARK AS SHOWN.

THE COLOR(S) GREEN, ORANGE AND GRAY
IS/ARE CLAIMED AS A FEATURE OF THE MARK.

THE MARK CONSISTS OF AN ORANGE FANCI-
FUL HUMAN FIGURE COMPOSED OF A CURVED
LINE AND CIRCLE HOLDING A GRAY FORK
WITH THE UNDERLINED WORDS "NUTRITION"
AND "SOLUTIONS" IN GREEN, AND WORDING
"TAKE A BETTER BITE OUT OF LIFE." IN OR-
ANGE.

SER. NO. 77-248,644, FILED 8-7-2007.

DAVID C. REIHNER, EXAMINING ATTORNEY

Int. Cl.: 36

Prior U.S. Cls.: 100, 101 and 102

United States Patent and Trademark Office

Reg. No. 3,519,063

Registered Oct. 21, 2008

**SERVICE MARK
PRINCIPAL REGISTER**

**ENDURANCE SPECIALTY
HOLDINGS LTD.**

ENDURANCE SPECIALTY HOLDINGS LTD.
(BERMUDA COMPANY)
WELLESLEY HOUSE
90 PITTS BAY ROAD
PEMBROKE, BERMUDA HM08

FOR: REINSURANCE UNDERWRITING FOR ALL TYPES OF REINSURANCE, NAMELY, PROPERTY, CASUALTY, PROPERTY CATASTROPHE, AGRICULTURE, MARINE, AEROSPACE, SURETY AND SPECIALTY REINSURANCE; REINSURANCE UNDERWRITING ADMINISTRATION; REINSURANCE ACTUARIAL SERVICES; REINSURANCE CLAIMS ADMINISTRATION; PROCESSING OF REINSURANCE CLAIMS AND PAYMENT DATA; FINANCIAL EVALUATION FOR REINSURANCE PURPOSES; REINSURANCE CONSULTATION SERVICES; ACCIDENT INSURANCE UNDERWRITING; APPRAISALS FOR INSURANCE CLAIMS OF REAL ESTATE; CLAIMS ADJUSTMENT IN THE FIELD OF INSURANCE; ELECTRONIC PROCESSING OF INSURANCE CLAIMS AND PAYMENT DATA; FINANCIAL EVALUATION FOR INSURANCE PURPOSES; FIRE INSURANCE UNDERWRITING; INSURANCE ACTUARIAL SERVICES; INSURANCE ADMINISTRATION; INSURANCE AGENCY AND BROKERAGE; INSURANCE BROKERAGE IN THE FIELD OF PROPERTY AND CASUALTY INSURANCE; INSURANCE CARRIER SERVICES; IN-

SURANCE CLAIMS ADMINISTRATION; INSURANCE CLAIMS PROCESSING; INSURANCE CONSULTATION; INSURANCE PREMIUM RATE COMPUTING; INSURANCE SERVICES, NAMELY, WRITING PROPERTY AND CASUALTY INSURANCE; INSURANCE SUBROGATION AND SALVAGE; INSURANCE UNDERWRITING IN THE FIELD OF PROPERTY, CASUALTY, HEALTHCARE LIABILITY, WORKER'S COMPENSATION, AND PROFESSIONAL LIABILITY INSURANCE; INSURANCE UNDERWRITING CONSULTATION; PROVIDING INFORMATION IN INSURANCE MATTERS, IN CLASS 36 (U.S. CLS. 100, 101 AND 102).

FIRST USE 12-0-2001; IN COMMERCE 12-0-2001.

THE MARK CONSISTS OF STANDARD CHARACTERS WITHOUT CLAIM TO ANY PARTICULAR FONT, STYLE, SIZE, OR COLOR.

NO CLAIM IS MADE TO THE EXCLUSIVE RIGHT TO USE "SPECIALTY HOLDINGS LTD.", APART FROM THE MARK AS SHOWN.

SER. NO. 77-248,648, FILED 8-7-2007.

DEBRA LEE, EXAMINING ATTORNEY

Int. Cl.: 36

Prior U.S. Cls.: 100, 101 and 102

United States Patent and Trademark Office

Reg. No. 3,519,064

Registered Oct. 21, 2008

**SERVICE MARK
PRINCIPAL REGISTER**

**ENDURANCE REINSURANCE
CORPORATION OF AMERICA**

ENDURANCE SPECIALTY HOLDINGS LTD.
(BERMUDA COMPANY)
WELLESLEY HOUSE
90 PITTS BAY ROAD
PEMBROKE, BERMUDA HM08

FOR: REINSURANCE UNDERWRITING FOR ALL TYPES OF REINSURANCE, NAMELY, PROPERTY, CASUALTY, PROPERTY CATASTROPHE, AGRICULTURE, MARINE, AEROSPACE, SURETY AND SPECIALTY REINSURANCE; REINSURANCE UNDERWRITING ADMINISTRATION; REINSURANCE ACTUARIAL SERVICES; REINSURANCE CLAIMS ADMINISTRATION; PROCESSING OF REINSURANCE CLAIMS AND PAYMENT DATA; FINANCIAL EVALUATION FOR REINSURANCE PURPOSES; REINSURANCE CONSULTATION SERVICES, IN CLASS 36 (U.S. CLS. 100, 101 AND 102).

FIRST USE 12-0-2002; IN COMMERCE 12-0-2002.

THE MARK CONSISTS OF STANDARD CHARACTERS WITHOUT CLAIM TO ANY PARTICULAR FONT, STYLE, SIZE, OR COLOR.

NO CLAIM IS MADE TO THE EXCLUSIVE RIGHT TO USE "REINSURANCE CORPORATION OF AMERICA", APART FROM THE MARK AS SHOWN.

SER. NO. 77-248,649, FILED 8-7-2007.

DEBRA LEE, EXAMINING ATTORNEY

Int. Cl.: 9

Prior U.S. Cls.: 21, 23, 26, 36 and 38

United States Patent and Trademark Office

Reg. No. 3,519,065

Registered Oct. 21, 2008

TRADEMARK
PRINCIPAL REGISTER



EMUSE MEDIA LIMITED (IRELAND COMPANY)
UNIT 24 ENTERPRISE CENTRE
TRINITY COLLEGE, PEARSE STREET
DUBLIN, IRELAND 2

FOR: DATA PROCESSING EQUIPMENT AND COMPUTERS; COMPUTER HARDWARE; COMPUTER FIRMWARE; COMPUTER SOFTWARE TO ENABLE CONNECTION TO DATABASES AND THE INTERNET; COMPUTER SOFTWARE TO ENABLE CREATING, EDITING, UPLOADING, POSTING, DISPLAYING, TAGGING, BLOGGING, SHARING, TRADING, PARSING, OR OTHERWISE PROVIDING ELECTRONIC MEDIA, INFORMATION OR DATA INCLUDING IMAGES, GRAPHICS, SOUND, TEXT, VIDEO OR AUDIO-VISUAL INFORMATION; COMPUTER SOFTWARE AND HARDWARE FOR THE FACILITATION OF INTERACTIVE MULTI-MEDIA COMMUNICATIONS AND SOCIAL NETWORKING VIA THE INTERNET; COMPUTER SOFTWARE FOR SEARCHING AND RETRIEVING INFORMATION, SITES AND OTHER RESOURCES ON COMPUTER NETWORKS; COMPUTER SOFTWARE FOR METADATA TAGGING AND WEBSITE TAGGING; COMPUTER SOFTWARE FOR UPLOADING, MANIPULATING AND ENHANCING MEDIA OBJECTS AND OTHER DIGITAL CONTENT INCLUDING TEXTS, DOCUMENTS, PHOTOGRAPHS, IMAGES, VIDEO, AUDIO AND AUDIO-VISUAL CONTENT; COMPUTER SOFTWARE FOR USE IN CREATING AND DESIGNING WEBSITES; COMPUTER SOFTWARE FOR THE CONTEXTUALIZATION AND EDITING OF VIDEO; PRE-RECORDED DIGITAL MEDIA CARRYING ELECTRONIC RE-

CORDINGS OF DATA INCLUDING IMAGES, GRAPHICS, SOUNDS, TEXT, VIDEO OR AUDIO-VISUAL CONTENT IN THE FIELD OF ENTERTAINMENT, MUSIC, NEWS, SPORTS, CULTURE, BUSINESS, FINANCE, WEATHER, TRAVEL; APPARATUS FOR TRANSMISSION OF COMMUNICATIONS; APPARATUS FOR BROADCASTING SOUND AND IMAGES; TELEVISIONS, TELEVISION TRANSMITTERS, TELEVISION RECEIVERS, VIDEO PLAYERS, RADIO SETS; APPARATUS AND INSTRUMENTS FOR CREATING, UPLOADING, TRANSMITTING, RECEIVING, SHARING, EDITING, COMPRESSING, EXTRACTING, CODING, DECODING, PLAYING, STORING, OR ORGANIZING OF DATA INCLUDING IMAGES, GRAPHICS, SOUND, TEXTS, VIDEO OR AUDIO-VISUAL CONTENT; COMPUTER AND VIDEO GAME PROGRAMS AND SOFTWARE; VIDEO GAME MACHINES ADAPTED FOR USE WITH TELEVISION RECEIVERS OR VIDEO MONITORS; APPARATUS FOR TRANSMISSION OF DATA INCLUDING IMAGES, GRAPHICS, TEXTS, VIDEO OR AUDIO-VISUAL CONTENT; BLANK MAGNETIC DATA CARRIERS, RECORDING DISKS; CHIPS, DISKS OR TAPES BEARING OR FOR RECORDING COMPUTER PROGRAMS AND SOFTWARE; PARTS AND FITTINGS OF THE FOREGOING, IN CLASS 9 (U.S. CLS. 21, 23, 26, 36 AND 38).

OWNER OF ERPN CMNTY TM OFC REG. NO. 005887013, DATED 2-27-2008, EXPIRES 5-9-2017.

SER. NO. 77-249,140, FILED 8-7-2007.

MICHELE SWAIN, EXAMINING ATTORNEY

Int. Cls.: 35 and 41

Prior U.S. Cls.: 100, 101, 102 and 107

United States Patent and Trademark Office

Reg. No. 3,519,066

Registered Oct. 21, 2008

**SERVICE MARK
PRINCIPAL REGISTER**

TheRightsWorkshop

THE RIGHTS WORKSHOP, INC. (CALIFORNIA CORPORATION)
39 MESA ST., SUITE 112
SAN FRANCISCO, CA 94129

FOR: DEVELOPMENT OF LICENSING STRATEGY FOR THE COMMERCIAL ADMINISTRATION OF THE LICENSING OF THE GOODS AND SERVICES OF OTHERS; NEGOTIATION OF CONTRACTS FOR COPYRIGHTS OF MUSIC; INTELLECTUAL PROPERTY MANAGEMENT AGENCY INVOLVED IN THE MANAGEMENT OF COPYRIGHTS, LICENSING AND REPRESENTATION OF CONTENT CREATED BY MUSICIANS, NAMELY, CONSULTING SERVICES IN THE FIELD OF MANAGING INTELLECTUAL PROPERTIES, AND COMMERCIAL ADMINISTRATION OF LICENSES, IN CLASS 35 (U.S. CLS. 100, 101 AND 102).

FIRST USE 5-1-2002; IN COMMERCE 5-1-2002.

FOR: CONDUCTING SEMINARS AND WORKSHOPS IN THE FIELDS OF MUSIC LICENSING AND MUSIC COPYRIGHTS, IN CLASS 41 (U.S. CLS. 100, 101 AND 107).

FIRST USE 5-1-2002; IN COMMERCE 5-1-2002.

THE MARK CONSISTS OF STANDARD CHARACTERS WITHOUT CLAIM TO ANY PARTICULAR FONT, STYLE, SIZE, OR COLOR.

SEC. 2(F).

SER. NO. 77-249,456, FILED 8-7-2007.

BRIAN PINO, EXAMINING ATTORNEY

Int. Cl.: 33

Prior U.S. Cls.: 47 and 49

United States Patent and Trademark Office

Reg. No. 3,519,067

Registered Oct. 21, 2008

**TRADEMARK
PRINCIPAL REGISTER**

TALARIA

HOUDINI, INC. (CALIFORNIA CORPORATION)
4225 N. PALM STREET
FULLERTON, CA 92835

THE MARK CONSISTS OF STANDARD CHAR-
ACTERS WITHOUT CLAIM TO ANY PARTICULAR
FONT, STYLE, SIZE, OR COLOR.

FOR: WINE, IN CLASS 33 (U.S. CLS. 47 AND 49).

SER. NO. 77-250,768, FILED 8-8-2007.

FIRST USE 11-27-2007; IN COMMERCE 11-27-2007.

BERYL GARDNER, EXAMINING ATTORNEY

Int. Cl.: 3

Prior U.S. Cls.: 1, 4, 6, 50, 51 and 52

United States Patent and Trademark Office

Reg. No. 3,519,068

Registered Oct. 21, 2008

**TRADEMARK
PRINCIPAL REGISTER**



ENVIRONMENTAL BUILDING SCIENCE INC.
(CANADA CORPORATION)
100-9200 VAN HORNE WAY
RICHMOND, CANADA V6X1W3 AND
DAUM, GEORGE KEVIN (CANADA INDIVIDUAL)
305-6055 BALSAM STREET
VANCOUVER, CANADA V6M4C2

FOR: ALL-PURPOSE CLEANERS, NAMELY, ENVIRONMENTAL AND NON-TOXIC INDUSTRIAL STRENGTH CLEANERS FOR USE ON THE MOST SURFACES AND IN MULTIPLE APPLICATION, IN CLASS 3 (U.S. CLS. 1, 4, 6, 50, 51 AND 52).

FIRST USE 8-21-2000; IN COMMERCE 8-21-2000.

OWNER OF CANADA REG. NO. TMA590075,
DATED 9-17-2003, EXPIRES 9-17-2018.

NO CLAIM IS MADE TO THE EXCLUSIVE RIGHT TO USE "OIL", APART FROM THE MARK AS SHOWN.

THE COLOR(S) BLACK, YELLOW AND ORANGE IS/ARE CLAIMED AS A FEATURE OF THE MARK.

THE MARK CONSISTS OF THE WORDING "OIL LIFT" THAT APPEARS IN THE COLOR YELLOW WHICH FADES TO THE COLOR ORANGE AND A STYLIZED DESIGN OF AN OIL SPILL APPEARING IN THE COLOR BLACK.

SER. NO. 77-251,335, FILED 8-9-2007.

ALLISON HOLTZ, EXAMINING ATTORNEY

Int. Cl.: 29

Prior U.S. Cl.: 46

United States Patent and Trademark Office

Reg. No. 3,519,069

Registered Oct. 21, 2008

**TRADEMARK
PRINCIPAL REGISTER**

Tomate del Verano

STANISLAUS PARTNERS (CALIFORNIA LIMITED PARTNERSHIP)
P.O. BOX 3951
MODESTO, CA 95352

FOR: PROCESSED VEGETABLES; CANNED VEGETABLES; CANNED TOMATOES; VEGETABLE PASTE; VEGETABLE PUREE; TOMATO PASTE; TOMATO PUREE, IN CLASS 29 (U.S. CL. 46).

FIRST USE 8-25-2004; IN COMMERCE 8-25-2004.

THE MARK CONSISTS OF STANDARD CHARACTERS WITHOUT CLAIM TO ANY PARTICULAR FONT, STYLE, SIZE, OR COLOR.

OWNER OF U.S. REG. NO. 2,914,991.

NO CLAIM IS MADE TO THE EXCLUSIVE RIGHT TO USE "TOMATE", APART FROM THE MARK AS SHOWN.

THE FOREIGN WORDING IN THE MARK TRANSLATES INTO ENGLISH AS "TOMATO OF THE SUMMER".

SER. NO. 77-251,871, FILED 8-9-2007.

CHRISTINA SOBRAL, EXAMINING ATTORNEY

Int. Cl.: 20

Prior U.S. Cls.: 2, 13, 22, 25, 32 and 50

United States Patent and Trademark Office

Reg. No. 3,519,070

Registered Oct. 21, 2008

**TRADEMARK
PRINCIPAL REGISTER**

CHILL-OUT CHAIR

FREEDOM CONCEPTS INC. (CANADA CORPORATION)
1565 INKSTER BOULEVARD
WINNIPEG, MANITOBA, CANADA R2X1R2

FOR: FURNITURE, NAMELY, LIVING AND FAMILY ROOM FURNITURE; CHAIR FOR INDOOR USE, NAMELY, CHAIR WITH OTTOMAN, ARM CHAIR; CHAIR PADS; OTTOMAN , IN CLASS 20 (U.S. CLS. 2, 13, 22, 25, 32 AND 50).

FIRST USE 6-5-2005; IN COMMERCE 6-5-2005.

THE MARK CONSISTS OF STANDARD CHARACTERS WITHOUT CLAIM TO ANY PARTICULAR FONT, STYLE, SIZE, OR COLOR.

PRIORITY CLAIMED UNDER SEC. 44(D) ON CANADA APPLICATION NO. 1337458, FILED 2-21-2007.

NO CLAIM IS MADE TO THE EXCLUSIVE RIGHT TO USE "CHAIR", APART FROM THE MARK AS SHOWN.

SER. NO. 77-252,139, FILED 8-10-2007.

STEVEN R. FINE, EXAMINING ATTORNEY

Int. Cls.: 9, 35 and 36

Prior U.S. Cls.: 21, 23, 26, 36, 38, 100, 101 and 102

United States Patent and Trademark Office

Reg. No. 3,519,071

Registered Oct. 21, 2008

**TRADEMARK
SERVICE MARK
PRINCIPAL REGISTER**

ARK

ARK INNOVATIONS, LLC (ILLINOIS LIMITED
LIABILITY COMPANY)
1321 TOWER ROAD
SCHAUMBURG, IL 60173

FOR: VENDING MACHINES, IN CLASS 9 (U.S.
CLS. 21, 23, 26, 36 AND 38).

FIRST USE 12-1-2006; IN COMMERCE 12-1-2006.

FOR: VENDING IN THE FIELD OF CELLULAR
TELEPHONES, TELEPHONE ACCESSORIES, PRE-
PAID TELEPHONE CALLING CARDS, SIM CARDS,
PREPAID DEBIT CARDS AND PROVIDING AD-
VERTISING SPACE FOR OTHERS VIA DIGITAL
MONITOR DISPLAY ADVERTISING ON VENDING
MACHINES, IN CLASS 35 (U.S. CLS. 100, 101 AND
102).

FIRST USE 12-1-2006; IN COMMERCE 12-1-2006.

FOR: BILL PAYMENT SERVICES, CHECK CASH-
ING SERVICES, PREPAID DEBIT CARD SERVICES,
AND WIRE TRANSFER SERVICES RENDERED
THROUGH VENDING MACHINES, IN CLASS 36
(U.S. CLS. 100, 101 AND 102).

FIRST USE 12-1-2006; IN COMMERCE 12-1-2006.

THE MARK CONSISTS OF STANDARD CHAR-
ACTERS WITHOUT CLAIM TO ANY PARTICULAR
FONT, STYLE, SIZE, OR COLOR.

SER. NO. 77-252,257, FILED 8-10-2007.

PAULA MAHONEY, EXAMINING ATTORNEY

Int. Cl.: 9

Prior U.S. Cls.: 21, 23, 26, 36 and 38

Reg. No. 3,519,072

United States Patent and Trademark Office

Registered Oct. 21, 2008

**TRADEMARK
PRINCIPAL REGISTER**



ZHENG JASON GENG (UNITED STATES INDIVIDUAL)
11001 SUGARBUSH TERRACE
ROCKVILLE, MD 20852

FOR: MULTIPLE PURPOSE CAMERAS, IN CLASS 9 (U.S. CLS. 21, 23, 26, 36 AND 38).

FIRST USE 4-1-2006; IN COMMERCE 4-1-2006.

NO CLAIM IS MADE TO THE EXCLUSIVE RIGHT TO USE "SMART PTZ", APART FROM THE MARK AS SHOWN.

THE COLOR(S) WHITE, BLACK, GREEN AND WHITE IS/ARE CLAIMED AS A FEATURE OF THE MARK.

THE MARK CONSISTS OF A STYLIZED S IN WHITE AT TOP, GREEN IN THE MIDDLE AND BLACK ON THE BOTTOM WITH A WHITE STAR DESIGN AND THE WORD "SMART PTZ" IN GREEN, OUTLINED IN WHITE.

SER. NO. 77-253,147, FILED 8-12-2007.

BONNIE LUKEN, EXAMINING ATTORNEY

Int. Cls.: 6, 12 and 28

Prior U.S. Cls.: 2, 12, 13, 14, 19, 21, 22, 23, 25, 31, 35, 38, 44 and 50

Reg. No. 3,519,073

United States Patent and Trademark Office

Registered Oct. 21, 2008

**TRADEMARK
PRINCIPAL REGISTER**

TACO

TACO METALS, INC. (FLORIDA CORPORATION)
50 N.E. 179TH STREET
MIAMI, FL 33162

FOR: NON-STRUCTURAL METAL MARINE HARDWARE, NAMELY, HINGES, LATCHES, METAL TUBING FOR BOAT RAILS AND BIMINI TOPS; NON-STRUCTURAL PARTS OF MARINE CRAFT AND BOATS IN THE NATURE OF METAL SKI TOWER HARDWARE AND COMPONENTS, NAMELY, PINS, SWIVELS, KNOBS, BALL AND SOCKET FITTINGS, EYE ENDS, JAW SLIDES, DECK HINGES, SLIDE TRACKS, EYE STRAPS, RAIL FITTINGS, HANDRAILS, FITTINGS, GRAB RAILS, LEANING POSTS, LEANING POST BACKRESTS, POLING PLATFORMS, SEAT COLUMNS, SEAT SUPPORTS, SEAT BASES, SEAT PEDESTALS, SEATING, SEATING FEATURING A REMOVABLE STORAGE BAG AS A COMPONENT PART OF SAID SEAT, FOOT RESTS, T-TOPS, IN CLASS 6 (U.S. CLS. 2, 12, 13, 14, 23, 25 AND 50).

FIRST USE 12-7-1959; IN COMMERCE 12-7-1959.

FOR: STRUCTURAL PARTS OF MARINE CRAFT AND BOATS, NAMELY, PROTECTIVE MOLDINGS, METAL HINGES AND LATCHES, TUBING FOR BOAT RAILS AND BIMINI TOPS, MARINE PADS FOR BOAT RAILS AND BIMINI TOPS AND T-TOPS, FISHING ROD DISPLAY RACKS, FISHING ROD HANGER RACKS, FISHING ROD RACKS, FISHING TACKLE RACKS; STRUCTURAL PARTS OF MARINE CRAFT AND BOATS IN THE NATURE OF SKI TOWER HARDWARE AND COMPONENTS, NAMELY, PINS, SWIVELS, KNOBS, BALL AND SOCKET FITTINGS, EYE ENDS, JAW SLIDES, DECK HINGES, SLIDE TRACKS, EYE STRAPS, RAIL FITTINGS, HANDRAILS, FITTINGS, GRAB RAILS, LEANING POSTS, LEANING POST BACKRESTS,

POLING PLATFORMS, SEAT COLUMNS, SEAT SUPPORTS, SEAT BASES, SEAT PEDESTALS, SEATING, FOOT RESTS, T-TOPS; MARINE CRAFT AND BOAT PRODUCTS, NAMELY, OUTRIGGERS, MOUNTING PLATES FOR T-TOPS, CLAMP ON MOUNTING PLATES FOR T-TOPS, OUTRIGGER BASES AND MOUNTS, PLATES FOR RECEIVING MARINE PRODUCTS AND ATTACHMENTS TO STRUCTURAL PARTS, OUTRIGGER MOUNTS, T-TOP EXTRUSIONS, RUB RAILS, BOAT TRIMS, MARINE DRINK HOLDERS, IN CLASS 12 (U.S. CLS. 19, 21, 23, 31, 35 AND 44).

FIRST USE 12-7-1959; IN COMMERCE 12-7-1959.

FOR: HAND-HELD FISHING NETS, NAMELY, CAST NETS AND BAIT NETS; FISHING ROD RACKS, FISHING ROD HANGERS, FISHING ROD HOLDERS, CLAMP-ON FISHING ROD HOLDERS, FISHING REEL HANGERS; FISHING ROD CLUSTERS IN THE NATURE OF FISHING ROD HOLDERS; WAKEBOARD STORAGE RACKS, FISHING ROD DISPLAY RACKS, FISHING ROD HANGER RACKS, FISHING ROD RACKS, FISHING TACKLE RACKS; RIGGING KITS COMPRISED OF ROLLERS, BUNGEEES, RELEASE CLIPS, GLASS EYES, AND CORKS, IN CLASS 28 (U.S. CLS. 22, 23, 38 AND 50).

FIRST USE 12-7-1959; IN COMMERCE 12-7-1959.

THE MARK CONSISTS OF STANDARD CHARACTERS WITHOUT CLAIM TO ANY PARTICULAR FONT, STYLE, SIZE, OR COLOR.

SER. NO. 77-253,732, FILED 8-13-2007.

CHRISTINE COOPER, EXAMINING ATTORNEY

Int. Cls.: 35, 39, 40 and 42

Prior U.S. Cls.: 100, 101, 102, 103, 105 and 106

United States Patent and Trademark Office

Reg. No. 3,519,074

Registered Oct. 21, 2008

**SERVICE MARK
PRINCIPAL REGISTER**

TACO METALS

TACO METALS, INC. (FLORIDA CORPORATION)
50 N.E. 179TH STREET
MIAMI, FL 33162

FOR: ELECTRONIC CATALOGUE SERVICES FEATURING MARINE PRODUCTS; INVENTORY MANAGEMENT FOR OTHERS IN THE FIELD OF MARINE PRODUCTS; PROVIDING CONSUMER PRODUCT INFORMATION IN THE FIELD OF MARINE PRODUCTS VIA THE INTERNET, IN CLASS 35 (U.S. CLS. 100, 101 AND 102).

FIRST USE 12-7-1959; IN COMMERCE 12-7-1959.

FOR: DISTRIBUTION SERVICES, NAMELY, DELIVERY OF CUSTOM MANUFACTURED MARINE PRODUCTS FOR OTHERS, IN CLASS 39 (U.S. CLS. 100 AND 105).

FIRST USE 12-7-1959; IN COMMERCE 12-7-1959.

FOR: CUSTOM MANUFACTURING, FABRICATION AND FINISHING OF MARINE PRODUCTS FOR OTHERS, IN CLASS 40 (U.S. CLS. 100, 103 AND 106).

FIRST USE 12-7-1959; IN COMMERCE 12-7-1959.

FOR: PROVIDING TECHNOLOGICAL INFORMATION TO OTHERS IN THE FIELD OF MARINE PRODUCTS FOR THE MANUFACTURING, ENGINEERING, DESIGN, FABRICATION AND FINISHING OF MARINE PRODUCTS VIA THE GLOBAL COMPUTER NETWORK; CUSTOM DESIGN AND ENGINEERING OF MARINE PRODUCTS FOR OTHERS, IN CLASS 42 (U.S. CLS. 100 AND 101).

FIRST USE 12-7-1959; IN COMMERCE 12-7-1959.

THE MARK CONSISTS OF STANDARD CHARACTERS WITHOUT CLAIM TO ANY PARTICULAR FONT, STYLE, SIZE, OR COLOR.

NO CLAIM IS MADE TO THE EXCLUSIVE RIGHT TO USE "METALS", APART FROM THE MARK AS SHOWN.

SER. NO. 77-253,857, FILED 8-13-2007.

CHRISTINE COOPER, EXAMINING ATTORNEY

Int. Cl.: 44

Prior U.S. Cls.: 100 and 101

United States Patent and Trademark Office

Reg. No. 3,519,075

Registered Oct. 21, 2008

**SERVICE MARK
PRINCIPAL REGISTER**

ABLE TO CHANGE RECOVERY

ABLE TO CHANGE RECOVERY, INC. (CALI-
FORNIA CORPORATION)
31882 CAMINO CAPISTRANO
SUITE 220
SAN JUAN CAPISTRANO, CA 92675

FOR: ADDICTION TREATMENT SERVICES; RE-
HABILITATION OF ALCOHOL ADDICTED PA-
TIENTS; REHABILITATION OF DRUG ADDICTED
PATIENTS, IN CLASS 44 (U.S. CLS. 100 AND 101).

FIRST USE 12-31-2000; IN COMMERCE 12-31-2000.

THE MARK CONSISTS OF STANDARD CHAR-
ACTERS WITHOUT CLAIM TO ANY PARTICULAR
FONT, STYLE, SIZE, OR COLOR.

SER. NO. 77-254,036, FILED 8-13-2007.

TIMOTHY FINNEGAN, EXAMINING ATTORNEY

Int. Cl.: 28

Prior U.S. Cls.: 22, 23, 38 and 50

United States Patent and Trademark Office

Reg. No. 3,519,076

Registered Oct. 21, 2008

TRADEMARK
PRINCIPAL REGISTER



NYC TAXI

CITY OF NEW YORK BY AND THROUGH THE
NEW YORK CITY TAXI AND LIMOUSINE
COMMISSION (NEW YORK MUNICIPAL
CORPORATION)
40 RECTOR STREET
NEW YORK, NY 10007

FOR: TOY VEHICLES, IN CLASS 28 (U.S. CLS. 22,
23, 38 AND 50).

FIRST USE 8-13-2007; IN COMMERCE 8-13-2007.

NO CLAIM IS MADE TO THE EXCLUSIVE
RIGHT TO USE "NYC TAXI", APART FROM THE
MARK AS SHOWN.

THE MARK CONSISTS OF A STYLIZED CHECK-
ER DESIGN TO THE LEFT OF "7C43", OF A
RECTANGLE CONTAINING A STYLIZED DEPICT-
TION OF A MAN HAILING A CAB NEXT TO THE
WORDING "\$2.50 INITIAL FARE" AND ILLEGIBLE
TAXI FARE INFORMATION, AND OF THE WORD-
ING "NYC TAXI" IN STYLIZED FORMAT WHERE-
IN THE "T" IS ENCASED IN A CIRCLE.

SER. NO. 77-254,060, FILED 8-13-2007.

JASON LOTT, EXAMINING ATTORNEY

Int. Cls.: 9 and 42

Prior U.S. Cls.: 21, 23, 26, 36, 38, 100 and 101

Reg. No. 3,519,077

United States Patent and Trademark Office

Registered Oct. 21, 2008

**TRADEMARK
SERVICE MARK
PRINCIPAL REGISTER**

EDGEFRONTIER

AUGUSTA SYSTEMS, INC. (WEST VIRGINIA CORPORATION)
3592 COLLINS FERRY RD, STE 200
MORGANTOWN, WV 26505

FOR: COMPUTER SOFTWARE FOR DATA AGGREGATION AND CONSOLIDATION FOR USE IN THE FIELDS OF COMPUTER MONITORING, INTELLIGENCE, DEFENSE, AVIATION, ENERGY, ENVIRONMENTAL RESEARCH, COMMUNICATIONS, SOFTWARE DEVELOPMENT, APPLICATION DEVELOPMENT, ENGINEERING, INFORMATION PROCESSING, AND INFORMATION TECHNOLOGY; COMPUTER SOFTWARE FOR DATA AGGREGATION, COMPILATION, AND DISPLAY THAT INCORPORATE SENSORS OR SENSOR NETWORKS, ACCESS SENSOR OR SENSOR NETWORK DATA, PROCESS SENSOR OR SENSOR NETWORK DATA, FILTER SENSOR OR SENSOR NETWORK DATA, ALIGN SENSOR OR SENSOR NETWORK DATA, AND TRANSMIT SENSOR OR SENSOR NETWORK DATA IN THE FIELDS OF MONITORING, INTELLIGENCE, SECURITY, DEFENSE, ENERGY, ENVIRONMENTAL, COMMUNICATIONS, SOFTWARE DEVELOPMENT, APPLICATION DEVELOPMENT ENGINEERING, INFORMATION PROCESSING, AND INFORMATION TECHNOLOGY, IN CLASS 9 (U.S. CLS. 21, 23, 26, 36 AND 38).

FIRST USE 5-17-2007; IN COMMERCE 5-17-2007.

FOR: COMPUTER SYSTEMS AND SOFTWARE CONSULTATION, RESEARCH, DESIGN AND DEVELOPMENT IN THE FIELDS OF INTELLIGENCE AND SECURITY, INFORMATION PROCESSING, INFORMATION TECHNOLOGY AND SPECIALIZED TECHNOLOGY APPLICATIONS; BASIC AND APPLIED RESEARCH IN COMPUTING AND SOFTWARE PRODUCTS THAT INCORPORATE SENSORS OR SENSOR NETWORKS, PROCESS SENSOR OR SENSOR NETWORK DATA, FILTER SENSOR OR SENSOR NETWORK DATA, ALIGN SENSOR OR SENSOR NETWORK DATA AND TRANSMIT SENSOR OR SENSOR NETWORK DATA; TECHNICAL ENGINEERING AND TECHNOLOGY CONSULTATION SERVICES IN THE FIELDS OF INTELLIGENCE AND SECURITY, SOFTWARE DEVELOPMENT, APPLICATION DEVELOPMENT, INFORMATION PROCESSING AND INFORMATION TECHNOLOGY, IN CLASS 42 (U.S. CLS. 100 AND 101).

FIRST USE 5-17-2007; IN COMMERCE 5-17-2007.

THE MARK CONSISTS OF STANDARD CHARACTERS WITHOUT CLAIM TO ANY PARTICULAR FONT, STYLE, SIZE, OR COLOR.

SER. NO. 77-254,654, FILED 8-14-2007.

COLLEEN KEARNEY, EXAMINING ATTORNEY

Int. Cls.: 9 and 42

Prior U.S. Cls.: 21, 23, 26, 36, 38, 100 and 101

United States Patent and Trademark Office

Reg. No. 3,519,078

Registered Oct. 21, 2008

**TRADEMARK
SERVICE MARK
PRINCIPAL REGISTER**

**INTELLIGENT NETWORKS FROM
EDGE TO CORE**

AUGUSTA SYSTEMS, INC. (WEST VIRGINIA CORPORATION)
ATTN: PATRICK ESPOSITO II
3592 COLLINS FERRY RD, STE 200
MORGANTOWN, WV 26505

FOR: COMPUTER SOFTWARE FOR DATA AGGREGATION AND CONSOLIDATION FOR USE IN THE FIELDS OF COMPUTER MONITORING, INTELLIGENCE, DEFENSE, AVIATION, ENERGY, ENVIRONMENTAL RESEARCH, COMMUNICATIONS, SOFTWARE DEVELOPMENT, APPLICATION DEVELOPMENT, ENGINEERING, INFORMATION PROCESSING, AND INFORMATION TECHNOLOGY; COMPUTER SOFTWARE FOR DATA AGGREGATION, COMPILATION, AND DISPLAY THAT INCORPORATE SENSORS OR SENSOR NETWORKS, ACCESS SENSOR OR SENSOR NETWORK DATA, PROCESS SENSOR OR SENSOR NETWORK DATA, FILTER SENSOR OR SENSOR NETWORK DATA, ALIGN SENSOR OR SENSOR NETWORK DATA, AND TRANSMIT SENSOR OR SENSOR NETWORK DATA IN THE FIELDS OF MONITORING, INTELLIGENCE, SECURITY, DEFENSE, ENERGY, ENVIRONMENTAL, COMMUNICATIONS, SOFTWARE DEVELOPMENT, APPLICATION DEVELOPMENT ENGINEERING, INFORMATION PROCESSING, AND INFORMATION TECHNOLOGY, IN CLASS 9 (U.S. CLS. 21, 23, 26, 36 AND 38).

FIRST USE 5-17-2007; IN COMMERCE 5-17-2007.

FOR: COMPUTER SYSTEMS AND SOFTWARE CONSULTATION, RESEARCH, DESIGN AND DEVELOPMENT IN THE FIELDS OF INTELLIGENCE AND SECURITY, INFORMATION PROCESSING, INFORMATION TECHNOLOGY AND SPECIALIZED TECHNOLOGY APPLICATIONS; BASIC AND APPLIED RESEARCH IN COMPUTING AND SOFTWARE PRODUCTS THAT INCORPORATE SENSORS OR SENSOR NETWORKS, PROCESS SENSOR OR SENSOR NETWORK DATA, FILTER SENSOR OR SENSOR NETWORK DATA, ALIGN SENSOR OR SENSOR NETWORK DATA AND TRANSMIT SENSOR OR SENSOR NETWORK DATA; TECHNICAL ENGINEERING AND TECHNOLOGY CONSULTATION SERVICES IN THE FIELDS OF INTELLIGENCE AND SECURITY, SOFTWARE DEVELOPMENT, APPLICATION DEVELOPMENT, INFORMATION PROCESSING AND INFORMATION TECHNOLOGY, IN CLASS 42 (U.S. CLS. 100 AND 101).

FIRST USE 5-17-2007; IN COMMERCE 5-17-2007.

THE MARK CONSISTS OF STANDARD CHARACTERS WITHOUT CLAIM TO ANY PARTICULAR FONT, STYLE, SIZE, OR COLOR.

SER. NO. 77-254,751, FILED 8-14-2007.

COLLEEN KEARNEY, EXAMINING ATTORNEY

Int. Cl.: 35

Prior U.S. Cls.: 100, 101 and 102

United States Patent and Trademark Office

Reg. No. 3,519,079

Registered Oct. 21, 2008

**SERVICE MARK
PRINCIPAL REGISTER**



FEDERATION OF STATE MEDICAL BOARDS
OF THE UNITED STATES, INC. (NEBRASKA
NON-PROFIT CORPORATION)
400 FULLER WISER ROAD
SUITE 300
EULESS, TX 76039 AND
NATIONAL BOARD OF MEDICAL EXAMINERS
(D.C. NON-PROFIT CORPORATION)
3750 MARKET STREET
PHILADELPHIA, PA 19104

FOR: WEBSITE SERVICES IN THE NATURE OF
CONFIDENTIAL AND SECURE REAL-TIME DATA
COMPILATION FOR MEDICAL PROFESSIONALS
FOR THE PURPOSE OF COLLECTING AND RE-

PORTING DATA USEFUL FOR MEASUREMENT
AND IMPROVEMENT OF PHYSICIAN PERFOR-
MANCE AND HEALTHCARE DELIVERY, IN
CLASS 35 (U.S. CLS. 100, 101 AND 102).

FIRST USE 9-20-2006; IN COMMERCE 9-20-2006.

THE MARK CONSISTS OF THE WORDING
"TRUSTED AGENT" SITUATED TO THE RIGHT
OF A KEYHOLE DESIGN.

SER. NO. 77-254,876, FILED 8-14-2007.

RICHARD A. STRASER, EXAMINING ATTORNEY

Int. Cl.: 28

Prior U.S. Cls.: 22, 23, 38 and 50

United States Patent and Trademark Office

Reg. No. 3,519,080

Registered Oct. 21, 2008

**TRADEMARK
PRINCIPAL REGISTER**

HOTEL FITNESS

HOTEL FITNESS CLUB, INC. (GEORGIA CORPORATION)
P.O. BOX 1747
ROSWELL, GA 30077

FOR: EXERCISE EQUIPMENT, NAMELY, BENCHES, WEIGHT RACKS, EXERCISE MACHINES WITH SINGLE OR MULTIPLE STATIONS AND WEIGHT LIFTING MACHINES WITH MULTISTATIONS AND SINGLE STATIONS; EXERCISE EQUIPMENT, NAMELY, TREADMILLS, STATIONARY CYCLES, ELLIPTICAL EXERCISE MACHINES, IN CLASS 28 (U.S. CLS. 22, 23, 38 AND 50).

FIRST USE 5-0-2007; IN COMMERCE 5-0-2007.

THE MARK CONSISTS OF STANDARD CHARACTERS WITHOUT CLAIM TO ANY PARTICULAR FONT, STYLE, SIZE, OR COLOR.

OWNER OF U.S. REG. NOS. 2,369,604 AND 3,259,877.

SEC. 2(F).

SER. NO. 77-256,053, FILED 8-15-2007.

H. M. FISHER, EXAMINING ATTORNEY

Int. Cl.: 41

Prior U.S. Cls.: 100, 101 and 107

United States Patent and Trademark Office

Reg. No. 3,519,081

Registered Oct. 21, 2008

**SERVICE MARK
PRINCIPAL REGISTER**

**NORTH AMERICAN
HILLCLIMBERS ASSOCIATION
NAHA**

SMITH, JEFF W. (UNITED STATES INDIVIDUAL)
610 WEST 2200 NORTH
WEST BOUNTIFUL, UT 84087

FOR: ENTERTAINMENT SERVICES, NAMELY, PARTICIPATION IN PROFESSIONAL MOTORCYCLE HILLCLIMBING, IN CLASS 41 (U.S. CLS. 100, 101 AND 107).

FIRST USE 1-1-1996; IN COMMERCE 1-1-1996.

THE MARK CONSISTS OF STANDARD CHARACTERS WITHOUT CLAIM TO ANY PARTICULAR FONT, STYLE, SIZE, OR COLOR.

NO CLAIM IS MADE TO THE EXCLUSIVE RIGHT TO USE "NORTH AMERICAN HILLCLIMBERS ASSOCIATION", APART FROM THE MARK AS SHOWN.

SER. NO. 77-256,386, FILED 8-15-2007.

PAUL MORENO, EXAMINING ATTORNEY

Int. Cl.: 19

Prior U.S. Cls.: 1, 12, 33 and 50

United States Patent and Trademark Office

Reg. No. 3,519,082

Registered Oct. 21, 2008

**TRADEMARK
PRINCIPAL REGISTER**

GX

CARTHAGE MILLS EROSION CONTROL COM-
PANY (OHIO CORPORATION)
4243 HUNT ROAD
CINCINNATI, OH 45242

FOR: GEOSYNTHETICS, NAMELY, NON-ME-
TALLIC GEOGRIDS WITH OPEN APERTURES DE-
SIGNATED TO PROVIDE REINFORCEMENT AND
STABILIZATION OF SOIL, ROCK, GRAVEL,
EARTH AND OTHER SURROUNDING EARTHEN
AGGREGATES, IN CLASS 19 (U.S. CLS. 1, 12, 33 AND
50).

FIRST USE 11-9-2006; IN COMMERCE 11-9-2006.

THE MARK CONSISTS OF STANDARD CHAR-
ACTERS WITHOUT CLAIM TO ANY PARTICULAR
FONT, STYLE, SIZE, OR COLOR.

SER. NO. 77-258,065, FILED 8-17-2007.

DAWN FELDMAN, EXAMINING ATTORNEY

Int. Cls.: 11 and 21

Prior U.S. Cls.: 2, 13, 21, 23, 29, 30, 31, 33, 34, 40 and 50

Reg. No. 3,519,083

United States Patent and Trademark Office

Registered Oct. 21, 2008

**TRADEMARK
PRINCIPAL REGISTER**



HAWKINS COOKERS LIMITED (INDIA CORPORATION)
P.O. BOX 16083
F-101 MAKER TOWERS, CUFFE PARADE
MUMBAI, INDIA 400005

FOR: ELECTRIC PRESSURE COOKERS; ELECTRIC COOKWARE, NAMELY, BROILERS AND ROASTERS, IN CLASS 11 (U.S. CLS. 13, 21, 23, 31 AND 34).

FIRST USE 6-0-2004; IN COMMERCE 6-0-2004.

FOR: NON-ELECTRIC PRESSURE COOKERS; NON-ELECTRIC COOKWARE, NAMELY, POTS AND PANS, IN CLASS 21 (U.S. CLS. 2, 13, 23, 29, 30, 33, 40 AND 50).

FIRST USE 6-0-2004; IN COMMERCE 6-0-2004.

OWNER OF U.S. REG. NOS. 1,890,552 AND 2,337,324.

SER. NO. 77-258,259, FILED 8-17-2007.

SALLY SHIH, EXAMINING ATTORNEY

Int. Cl.: 16

Prior U.S. Cls.: 2, 5, 22, 23, 29, 37, 38 and 50

United States Patent and Trademark Office

Reg. No. 3,519,084

Registered Oct. 21, 2008

**TRADEMARK
PRINCIPAL REGISTER**

Currency Portfolio

HAUSER'S COIN COMPANY OF CLEARWATER,
INC. (FLORIDA CORPORATION)
2790 GULF-TO-BAY BLVD STE D
CLEARWATER, FL 33759

THE MARK CONSISTS OF STANDARD CHAR-
ACTERS WITHOUT CLAIM TO ANY PARTICULAR
FONT, STYLE, SIZE, OR COLOR.

FOR: ALBUMS FOR CURRENCY, IN CLASS 16
(U.S. CLS. 2, 5, 22, 23, 29, 37, 38 AND 50).

SER. NO. 77-258,539, FILED 8-17-2007.

FIRST USE 3-19-2007; IN COMMERCE 3-19-2007.

JOHN GARTNER, EXAMINING ATTORNEY

Int. Cls.: 9, 10, 12, 16, 20 and 28

Prior U.S. Cls.: 2, 5, 13, 19, 21, 22, 23, 25, 26, 29, 31, 32, 35, 36, 37, 38, 39, 44 and 50

Reg. No. 3,519,085

United States Patent and Trademark Office

Registered Oct. 21, 2008

**TRADEMARK
PRINCIPAL REGISTER**



KIDDIE'S PARADISE INC. (TAIWAN CORPORATION)
9FL, NO. 70, SEC. 5 NAN KING EAST RD.
TAIPEI, TAIWAN

FOR: DIGITAL MEDIA, NAMELY, CDS, DVDS, AND VCDs FEATURING EDUCATIONAL AND INSTRUCTIONAL MATERIALS FOR CHILDREN IN THE FIELD OF ACTIVITY GAMES, IN CLASS 9 (U.S. CLS. 21, 23, 26, 36 AND 38).

FIRST USE 1-1-2006; IN COMMERCE 1-1-2006.

FOR: THERAPY EQUIPMENT FOR PHYSICAL AND COGNITIVE PURPOSES, NAMELY, BALANCING BOARDS, BALANCING CLIMBERS, TWIN WALKERS, TACTILE PATH BLOCKS, MASSAGE ROLLS, MASSAGE RINGS, MASSAGE BALLS WITH STICK, VISUAL RINGS AND INFINITE LOOPS, IN CLASS 10 (U.S. CLS. 26, 39 AND 44).

FIRST USE 1-1-2006; IN COMMERCE 1-1-2006.

FOR: BICYCLES; TRICYCLES; BICYCLE TRAILERS; NON-MOTORIZED SCOOTERS, IN CLASS 12 (U.S. CLS. 19, 21, 23, 31, 35 AND 44).

FIRST USE 1-1-2006; IN COMMERCE 1-1-2006.

FOR: CHILDREN BOOKS; BOOKS FEATURING INFORMATION IN THE FIELDS OF EDUCATION AND ACTIVITY GAMES, IN CLASS 16 (U.S. CLS. 2, 5, 22, 23, 29, 37, 38 AND 50).

FIRST USE 1-1-2006; IN COMMERCE 1-1-2006.

FOR: FURNITURE; CUSHIONS; BALL CHAIRS, IN CLASS 20 (U.S. CLS. 2, 13, 22, 25, 32 AND 50).

FIRST USE 1-1-2006; IN COMMERCE 1-1-2006.

FOR: CHILDREN'S MULTIPLE ACTIVITY EDUCATIONAL TOYS; PLAYGROUND EQUIPMENT, NAMELY, CLIMBERS, SWINGS, SAND AND WATER TABLES ; GYM EQUIPMENT, NAMELY, GYM BALLS, GYM ROLLS, JUMPING BALLS, VAULTING BOXES AND EXERCISE MATS; TOYS; TOY SCOOTERS; TOY FURNITURE AND TOY WALKERS, IN CLASS 28 (U.S. CLS. 22, 23, 38 AND 50).

FIRST USE 1-1-2006; IN COMMERCE 1-1-2006.

THE MARK CONSISTS OF AN IRREGULAR CIRCLE.

SER. NO. 77-258,583, FILED 8-17-2007.

RONALD AIKENS, EXAMINING ATTORNEY

Int. Cl.: 25

Prior U.S. Cls.: 22 and 39

United States Patent and Trademark Office

Reg. No. 3,519,086

Registered Oct. 21, 2008

**TRADEMARK
PRINCIPAL REGISTER**



CISCO TECHNOLOGY, INC. (CALIFORNIA CORPORATION)
170 WEST TASMAN DRIVE
SAN JOSE, CA 95134

THE MARK CONSISTS OF VERICAL BARS THAT
CREATE THE APPEARANCE OF A BRIDGE.

FOR: NECKTIES, IN CLASS 25 (U.S. CLS. 22 AND 39).

SER. NO. 77-258,624, FILED 8-18-2007.

FIRST USE 10-0-2007; IN COMMERCE 10-0-2007.

JAMES GRIFFIN, EXAMINING ATTORNEY

Int. Cl.: 9

Prior U.S. Cls.: 21, 23, 26, 36 and 38

Reg. No. 3,519,087

United States Patent and Trademark Office

Registered Oct. 21, 2008

**TRADEMARK
PRINCIPAL REGISTER**

PARROT CARD

BURKE & HERBERT BANK & TRUST COMPAN-
NY (VIRGINIA CORPORATION)

100 SOUTH FAIRFAX STREET

ALEXANDRIA, VA 22314

FOR: MAGNETICALLY ENCODED BANK DEBIT
CARDS, IN CLASS 9 (U.S. CLS. 21, 23, 26, 36 AND 38).

FIRST USE 7-23-2007; IN COMMERCE 7-23-2007.

THE MARK CONSISTS OF STANDARD CHAR-
ACTERS WITHOUT CLAIM TO ANY PARTICULAR
FONT, STYLE, SIZE, OR COLOR.

NO CLAIM IS MADE TO THE EXCLUSIVE
RIGHT TO USE "CARD", APART FROM THE
MARK AS SHOWN.

SER. NO. 77-259,488, FILED 8-20-2007.

SANI KHOURI, EXAMINING ATTORNEY

Int. Cl.: 41

Prior U.S. Cls.: 100, 101 and 107

United States Patent and Trademark Office

Reg. No. 3,519,088

Registered Oct. 21, 2008

**SERVICE MARK
PRINCIPAL REGISTER**

10 THINGS YOU MUST KNOW

SCRIPPS NETWORKS, LLC (DELAWARE LIMITED LIABILITY COMPANY)
9721 SHERRILL BOULEVARD
KNOXVILLE, TN 37932

FOR: EDUCATIONAL AND ENTERTAINMENT SERVICES IN THE NATURE OF AN ON-GOING PROGRAM ABOUT HOME IMPROVEMENT, ACCESSIBLE BY RADIO, TELEVISION, CABLE, FIBER OPTIC NETWORKS, WIRELESS NETWORKS, SATELLITE, AUDIO, VIDEO, AND COMPUTER NETWORKS, IN CLASS 41 (U.S. CLS. 100, 101 AND 107).

FIRST USE 9-26-2006; IN COMMERCE 9-26-2006.

THE MARK CONSISTS OF STANDARD CHARACTERS WITHOUT CLAIM TO ANY PARTICULAR FONT, STYLE, SIZE, OR COLOR.

SER. NO. 77-259,752, FILED 8-20-2007.

CORY BOONE, EXAMINING ATTORNEY

Int. Cl.: 36

Prior U.S. Cls.: 100, 101 and 102

United States Patent and Trademark Office

Reg. No. 3,519,089

Registered Oct. 21, 2008

**SERVICE MARK
PRINCIPAL REGISTER**

FAMILY ADVANTAGE

VIRGIN MONEY USA, INC. (DELAWARE CORPORATION)
60 HICKORY DRIVE
WALTHAM, MA 02451

FOR: FINANCIAL SERVICES, NAMELY, ARRANGING OF LOANS, FINANCIAL LOAN CONSULTATION, FINANCIAL LOAN PLANNING, PROVIDING LOANS SECURED BY COMMERCIAL PAPER; ELECTRONIC FUNDS TRANSFER SERVICES VIA THE INTERNET TO ENABLE INDIVIDUALS TO ENGAGE IN LENDING AND BORROWING TRANSACTIONS WITH OTHER INDIVIDUALS, IN CLASS 36 (U.S. CLS. 100, 101 AND 102).

FIRST USE 2-1-2007; IN COMMERCE 2-1-2007.

THE MARK CONSISTS OF STANDARD CHARACTERS WITHOUT CLAIM TO ANY PARTICULAR FONT, STYLE, SIZE, OR COLOR.

NO CLAIM IS MADE TO THE EXCLUSIVE RIGHT TO USE "FAMILY", APART FROM THE MARK AS SHOWN.

SER. NO. 77-260,238, FILED 8-21-2007.

SHARON MEIER, EXAMINING ATTORNEY

Int. Cl.: 41

Prior U.S. Cls.: 100, 101 and 107

United States Patent and Trademark Office

Reg. No. 3,519,090

Registered Oct. 21, 2008

**SERVICE MARK
PRINCIPAL REGISTER**

Wings Center

WINGS, INC. (IDAHO CORPORATION)
1875 CENTURY WAY
BOISE, ID 83709

FOR: CHILDREN'S ACTIVITY AND LEARNING CENTER, NAMELY, PROVIDING FACILITIES FOR GROUP CELEBRATIONS, INDOOR PLAY, PRE-SCHOOL, AND DAY AND OVERNIGHT CAMPS; PROVIDING FACILITIES FOR GYMNASTICS, CHEER LEADING, SWIMMING, ROCK CLIMBING, MUSIC, ART, AND PHYSICAL EDUCATION; EDUCATIONAL SERVICES, NAMELY, PROVIDING CLASSES IN THE FIELD OF GYMNASTICS, CHEER LEADING, SWIMMING, ROCK CLIMBING, MUSIC, ART, AND PHYSICAL EDUCATION, IN CLASS 41 (U.S. CLS. 100, 101 AND 107).

FIRST USE 1-1-1991; IN COMMERCE 1-1-1991.

THE MARK CONSISTS OF STANDARD CHARACTERS WITHOUT CLAIM TO ANY PARTICULAR FONT, STYLE, SIZE, OR COLOR.

NO CLAIM IS MADE TO THE EXCLUSIVE RIGHT TO USE "CENTER" , APART FROM THE MARK AS SHOWN.

SER. NO. 77-260,265, FILED 8-21-2007.

MICHAEL LITZAU, EXAMINING ATTORNEY

Int. Cl.: 35

Prior U.S. Cls.: 100, 101 and 102

United States Patent and Trademark Office

Reg. No. 3,519,091

Registered Oct. 21, 2008

**SERVICE MARK
PRINCIPAL REGISTER**

FDMS

NIelsen MEDIA RESEARCH, INC. (DELA-
WARE CORPORATION)
770 BROADWAY
NEW YORK, NY 100039595

FOR: MARKET RESEARCH SERVICES; MARKET
RESEARCH SERVICES, NAMELY, COMMERCIAL
SPOT TRACKING AND ANALYSIS SERVICES;
MEDIA VIEWER DEMOGRAPHIC AND MARKET
RESEARCH AND ANALYSIS SERVICES; CON-
DUCTING MARKET AND MEDIA RESEARCH
STUDIES FOR OTHERS, IN CLASS 35 (U.S. CLS.
100, 101 AND 102).

FIRST USE 9-25-2000; IN COMMERCE 9-25-2000.

THE MARK CONSISTS OF STANDARD CHAR-
ACTERS WITHOUT CLAIM TO ANY PARTICULAR
FONT, STYLE, SIZE, OR COLOR.

SER. NO. 77-260,481, FILED 8-21-2007.

SOPHIA S. KIM, EXAMINING ATTORNEY

Int. Cl.: 35

Prior U.S. Cls.: 100, 101 and 102

United States Patent and Trademark Office

Reg. No. 3,519,092

Registered Oct. 21, 2008

**SERVICE MARK
PRINCIPAL REGISTER**

FULL DISCOVERY MARKETS

NIELSEN MEDIA RESEARCH, INC. (DELA-
WARE CORPORATION)
770 BROADWAY
NEW YORK, NY 100039595

FOR: MARKET RESEARCH SERVICES; MARKET
RESEARCH SERVICES, NAMELY, COMMERCIAL
SPOT TRACKING AND ANALYSIS SERVICES;
MEDIA VIEWER DEMOGRAPHIC AND MARKET
RESEARCH AND ANALYSIS SERVICES; CON-
DUCTING MARKET AND MEDIA RESEARCH
STUDIES FOR OTHERS, IN CLASS 35 (U.S. CLS.
100, 101 AND 102).

FIRST USE 9-25-2000; IN COMMERCE 9-25-2000.

THE MARK CONSISTS OF STANDARD CHAR-
ACTERS WITHOUT CLAIM TO ANY PARTICULAR
FONT, STYLE, SIZE, OR COLOR.

NO CLAIM IS MADE TO THE EXCLUSIVE
RIGHT TO USE "MARKETS", APART FROM THE
MARK AS SHOWN.

SER. NO. 77-260,498, FILED 8-21-2007.

SOPHIA S. KIM, EXAMINING ATTORNEY

Int. Cl.: 35

Prior U.S. Cls.: 100, 101 and 102

United States Patent and Trademark Office

Reg. No. 3,519,093

Registered Oct. 21, 2008

**SERVICE MARK
PRINCIPAL REGISTER**

AUTOMATED DISCOVERY MARKETS

NIelsen MEDIA RESEARCH, INC. (DELA-
WARE CORPORATION)
770 BROADWAY
NEW YORK, NY 100039595

FOR: MARKET RESEARCH SERVICES; MARKET
RESEARCH SERVICES, NAMELY, COMMERCIAL
SPOT TRACKING AND ANALYSIS SERVICES;
MEDIA VIEWER DEMOGRAPHIC AND MARKET
RESEARCH AND ANALYSIS SERVICES; CON-
DUCTING MARKET AND MEDIA RESEARCH
STUDIES FOR OTHERS, IN CLASS 35 (U.S. CLS.
100, 101 AND 102).

FIRST USE 9-25-2000; IN COMMERCE 9-25-2000.

THE MARK CONSISTS OF STANDARD CHAR-
ACTERS WITHOUT CLAIM TO ANY PARTICULAR
FONT, STYLE, SIZE, OR COLOR.

NO CLAIM IS MADE TO THE EXCLUSIVE
RIGHT TO USE "MARKETS", APART FROM THE
MARK AS SHOWN.

SER. NO. 77-260,501, FILED 8-21-2007.

SOPHIA S. KIM, EXAMINING ATTORNEY

Int. Cls.: 35 and 42

Prior U.S. Cls.: 100, 101 and 102

United States Patent and Trademark Office

Reg. No. 3,519,094

Registered Oct. 21, 2008

**SERVICE MARK
PRINCIPAL REGISTER**



SELECT APPOINTMENTS (HOLDINGS) LIMITED (UNITED KINGDOM CORPORATION)
2ND FLOOR CHURCHILL HOUSE
26-30 UPPER MARLBOROUGH ROAD
ST. ALBANS, UNITED KINGDOM AL13UU

FOR: EMPLOYMENT AGENCY SERVICES; EMPLOYMENT CONSULTANCY SERVICES; EMPLOYMENT COUNSELING; INFORMATION SERVICES RELATING TO JOBS AND CAREER OPPORTUNITIES; PLACING JOB ADVERTISEMENTS FOR OTHERS; PROVIDING AN ON-LINE WEBSITE FEATURING JOB ADVERTISEMENTS; PERSONNEL MANAGEMENT SERVICES; PERSONNEL RECRUITMENT; TESTING FOR THE SELECTION OF PERSONNEL; EMPLOYMENT RECRUITMENT, EMPLOYEE PLACEMENT, STAFFING AND OUTSOURCING SERVICES PRINCIPALLY FOCUSED ON LIFE SCIENCES; EMPLOYEE RECRUITMENT, EMPLOYEE PLACEMENT, STAFFING AND OUTSOURCING OF CLINICAL SERVICES FOR ORGANIZATIONS IN THE FIELDS OF PHARMACEUTICALS, BIOTECHNOLOGY, MEDICAL EQUIPMENT MANUFACTURERS, CLINICAL TRIALS AND HEALTHCARE; PROVIDING INFORMATION AND ADVISORY SERVICES IN THE AFOREMENTIONED FIELDS, IN CLASS 35 (U.S. CLS. 100, 101 AND 102).

FIRST USE 6-16-2003; IN COMMERCE 6-16-2003.

FOR: COMPUTER SERVICES, NAMELY, CREATING AND MAINTAINING INTERNET APPLICATIONS FOR OTHERS; COMPUTER SOFTWARE

DESIGN AND IMPLEMENTATION FOR OTHERS; APPLICATION SERVICE PROVIDER (ASP) FEATURING SOFTWARE FOR USE IN THE FIELD OF CONTINGENT WORKFORCE MANAGEMENT, NAMELY, SOFTWARE FOR PROCESSING INFORMATION REGARDING JOB OPPORTUNITIES, PLACEMENT OF EMPLOYEES, AND TIME ENTRY, ATTENDANCE, AND PERFORMANCE OF WORKERS, IN CLASS 42 (U.S. CLS. 100 AND 101).

FIRST USE 6-16-2003; IN COMMERCE 6-16-2003.

OWNER OF U.S. REG. NOS. 2,514,874 AND 2,514,875.

THE COLOR(S) YELLOW AND LIGHT GREEN IS/ARE CLAIMED AS A FEATURE OF THE MARK.

THE MARK CONSISTS OF A ROW OF THREE YELLOW BOXES ABOVE TWO ROWS OF FOUR BOXES AND ROW OF THREE BOXES. THE FIRST THREE BOXES OF THE SECOND LINE ARE LIGHT GREEN AND THE FOURTH BOX IS YELLOW. THE THIRD BOXES OF THE THIRD AND FOURTH ROWS ARE LIGHT GREEN AND THE OTHERS ARE YELLOW. THE WORD "DELTA" APPEARS TO THE RIGHT IN YELLOW. THE LETTER "A" IS A GREEK DELTA.

SER. NO. 77-261,255, FILED 8-22-2007.

JENNY PARK, EXAMINING ATTORNEY

Int. Cl.: 35

Prior U.S. Cls.: 100, 101 and 102

United States Patent and Trademark Office

Reg. No. 3,519,095

Registered Oct. 21, 2008

**SERVICE MARK
PRINCIPAL REGISTER**

SEQUOIA

SEQUOIA SUPPLY (PENNSYLVANIA CORPORATION)
925 EASTON ROAD
WARRINGTON, PA 18976

FOR: DISTRIBUTORSHIP SERVICES IN THE FIELD OF OUTDOOR DECK PRODUCTS, NAMELY, DECKBOARDS, RAILINGS, AND FRAMING HARDWARE, NAMELY, SCREWS, FASTENER, BOLTS AND HANGERS, IN CLASS 35 (U.S. CLS. 100, 101 AND 102).

FIRST USE 7-21-2004; IN COMMERCE 7-21-2004.

THE MARK CONSISTS OF STANDARD CHARACTERS WITHOUT CLAIM TO ANY PARTICULAR FONT, STYLE, SIZE, OR COLOR.

SER. NO. 77-261,391, FILED 8-22-2007.

JOHN DWYER, EXAMINING ATTORNEY

Int. Cl.: 9

Prior U.S. Cls.: 21, 23, 26, 36 and 38

Reg. No. 3,519,096

United States Patent and Trademark Office

Registered Oct. 21, 2008

**TRADEMARK
PRINCIPAL REGISTER**

RIOREY

RIOREY, INC. (DELAWARE CORPORATION)
7920 NORFOLK AVENUE, 10TH FLOOR
BETHESDA, MD 20814

FOR: COMPUTER HARDWARE; COMPUTER SOFTWARE, NAMELY, SOFTWARE RESTRICTING ACCESS TO AND BY COMPUTER NETWORKS TO AND OF UNDESIREED WEBSITES, MEDIA, INDIVIDUALS AND FACILITIES TO PREVENT DISTRIBUTED DENIAL (DDOS) ATTACKS ON NETWORKS AND SERVERS; COMPUTER SOFTWARE, NAMELY, SOFTWARE TO CLEANSE NETWORK INFRASTRUCTURE OF VIRUSES, NETWORK TERRORISM, DDOS ATTACKS, WORMS AND EXPLOITS; COMPUTER SOFTWARE, NAMELY, SOFTWARE FOR THE PREVENTION OF AND OR PROTECTION AGAINST BULK E-MAIL, SPAM,

DDOS ATTACKS OR OTHER INTENTIONAL MISUSE OR UNAUTHORIZED PENETRATION OF COMPUTER NETWORKS, IN CLASS 9 (U.S. CLS. 21, 23, 26, 36 AND 38).

FIRST USE 7-17-2006; IN COMMERCE 7-17-2006.

THE MARK CONSISTS OF STANDARD CHARACTERS WITHOUT CLAIM TO ANY PARTICULAR FONT, STYLE, SIZE, OR COLOR.

THE FOREIGN WORDING IN THE MARK TRANSLATES INTO ENGLISH AS RIVER KING.

SER. NO. 77-261,497, FILED 8-22-2007.

BRIAN PINO, EXAMINING ATTORNEY

Int. Cl.: 9

Prior U.S. Cls.: 21, 23, 26, 36 and 38

Reg. No. 3,519,097

United States Patent and Trademark Office

Registered Oct. 21, 2008

**TRADEMARK
PRINCIPAL REGISTER**

THE DDOS SPECIALIST

RIOREY, INC. (DELAWARE CORPORATION)
7920 NORFOLK AVENUE, 10TH FLOOR
BETHESDA, MD 20814

FOR: COMPUTER HARDWARE; COMPUTER SOFTWARE, NAMELY, SOFTWARE RESTRICTING ACCESS TO AND BY COMPUTER NETWORKS TO AND OF UNDESIREED WEBSITES, MEDIA, INDIVIDUALS AND FACILITIES TO PREVENT DISTRIBUTED DENIAL (DDOS) ATTACKS ON NETWORKS AND SERVERS; COMPUTER SOFTWARE, NAMELY, SOFTWARE TO CLEANSE NETWORK INFRASTRUCTURE OF VIRUSES, NETWORK TERRORISM, DDOS ATTACKS, WORMS AND EXPLOITS; COMPUTER SOFTWARE, NAMELY, SOFTWARE FOR THE PREVENTION OF AND OR PROTECTION AGAINST BULK E-MAIL, SPAM, DDOS ATTACKS OR OTHER INTENTIONAL MIS-

USE OR UNAUTHORIZED PENETRATION OF COMPUTER NETWORKS, IN CLASS 9 (U.S. CLS. 21, 23, 26, 36 AND 38).

FIRST USE 7-17-2006; IN COMMERCE 7-17-2006.

THE MARK CONSISTS OF STANDARD CHARACTERS WITHOUT CLAIM TO ANY PARTICULAR FONT, STYLE, SIZE, OR COLOR.

NO CLAIM IS MADE TO THE EXCLUSIVE RIGHT TO USE "DDOS", APART FROM THE MARK AS SHOWN.

SER. NO. 77-261,590, FILED 8-22-2007.

BRIAN PINO, EXAMINING ATTORNEY

Int. Cl.: 45

Prior U.S. Cls.: 100 and 101

United States Patent and Trademark Office

Reg. No. 3,519,098

Registered Oct. 21, 2008

**SERVICE MARK
PRINCIPAL REGISTER**



SWAMBLE INC. (NEVADA CORPORATION)
7160 BIRD CHERRY ST
LAS VEGAS, NV 89148

FOR: ONLINE SOCIAL NETWORKING SERVICES, IN CLASS 45 (U.S. CLS. 100 AND 101).

FIRST USE 2-1-2007; IN COMMERCE 2-1-2007.

THE COLOR(S) ORANGE, BLUE AND BLACK IS/
ARE CLAIMED AS A FEATURE OF THE MARK.

THE MARK CONSISTS OF A BLACK BACKGROUND WITH THE LOWER CASE LETTERS "S", "W", "A", "M", "B" AND "L" IN BURNT ORANGE AND A SYMBOL, WHICH APPEARS TO BE THE LOWER CASE LETTER, "E", SLANTED UP AND TO THE RIGHT, IN SKY BLUE.

SER. NO. 77-261,656, FILED 8-22-2007.

MICHELLE DUBOIS, EXAMINING ATTORNEY

Int. Cl.: 36

Prior U.S. Cls.: 100, 101 and 102

United States Patent and Trademark Office

Reg. No. 3,519,099

Registered Oct. 21, 2008

**SERVICE MARK
PRINCIPAL REGISTER**

DESERT COMMUNITY BANK

EAST WEST BANK (CALIFORNIA CORPORATION)
135 N. LOS ROBLES AVENUE, 7TH FLOOR
PASADENA, CA 91101

FOR: BANKING SERVICES, IN CLASS 36 (U.S. CLS. 100, 101 AND 102).

FIRST USE 12-16-1991; IN COMMERCE 12-16-1991.

THE MARK CONSISTS OF STANDARD CHARACTERS WITHOUT CLAIM TO ANY PARTICULAR FONT, STYLE, SIZE, OR COLOR.

OWNER OF U.S. REG. NO. 1,804,747.

NO CLAIM IS MADE TO THE EXCLUSIVE RIGHT TO USE "COMMUNITY BANK", APART FROM THE MARK AS SHOWN.

SER. NO. 77-261,685, FILED 8-22-2007.

CHRISIE B. KING, EXAMINING ATTORNEY

Int. Cl.: 36

Prior U.S. Cls.: 100, 101 and 102

United States Patent and Trademark Office

Reg. No. 3,519,100

Registered Oct. 21, 2008

SERVICE MARK
PRINCIPAL REGISTER

The logo for Tribul Cash features the word "TRIBUL" in a bold, black, sans-serif font. The letter "I" is stylized with a diamond shape above it. Below "TRIBUL", the word "Cash" is written in a black, cursive script font.

TRIBUL CASH, LLC (NEW YORK LIMITED LIABILITY COMPANY)
55 BROAD STREET, 2ND FLOOR
NEW YORK, NY 10004

FOR: PAYMENT PROCESSING SERVICES, NAMELY, CREDIT CARD AND DEBIT CARD TRANSACTION PROCESSING SERVICES, NAMELY, FINANCIAL, ELECTRONIC PAYMENT, CREDIT AND DEBIT CARD TRANSACTION PROCESSING SERVICES, NAMELY, CREDIT AND DEBIT CARD PROCESSING; CHECK VERIFICATION, CHECK GUARANTEE, AND CHECK CONVERSION, NAMELY, CHECK CASHING; ELECTRONIC FUNDS TRANSFER SERVICES; ISSUING GIFT, STORED VALUE, AND PRE-PAID CREDIT CARDS AND CREDIT CARD TRANSACTION OF GIFT, STORED VALUE, AND PRE-PAID CREDIT CARDS; PROVIDING ELECTRONIC PROCESSING OF CREDIT CARD TRANSACTIONS AND ELECTRONIC PAYMENTS VIA A GLOBAL COMPUTER NETWORK; ACCOUNTS RECEIVABLES FINANCING; CONSUMER LENDING SERVICES; FINANCIAL SERVICES IN THE FIELD OF MONEY LENDING; FINANCIAL SERVICES IN THE FIELD OF MONEY LENDING, NAMELY, MONEY LENDING; CREDIT AND CASH CARD SERVICES; ELEC-

TRONIC CREDIT CARD TRANSACTIONS; LOAN FINANCING; LOAN FINANCING AND DISCOUNT OF BILLS; PROVIDING TEMPORARY LOANS; PROVIDING LOANS SECURED BY COMMERCIAL PAPER; BUSINESS FINANCING PROCUREMENT SERVICES, IN CLASS 36 (U.S. CLS. 100, 101 AND 102).

FIRST USE 5-1-2007; IN COMMERCE 5-1-2007.

OWNER OF U.S. REG. NO. 3,336,372.

NO CLAIM IS MADE TO THE EXCLUSIVE RIGHT TO USE "CASH", APART FROM THE MARK AS SHOWN.

THE MARK CONSISTS OF THE WORD "TRIBUL" WRITTEN IN STYLIZED CAPITAL LETTERS WITH A DIAMOND DOTTING THE LETTER "I", FOLLOWED BY THE WORD "CASH" WRITTEN IN STYLIZED LETTERS WHICH APPEARS JUST UNDER AND IN FRONT OF THE LETTER "U" IN "TRIBUL".

SER. NO. 77-261,898, FILED 8-22-2007.

CHRISTINA SOBRAL, EXAMINING ATTORNEY

Int. Cl.: 41

Prior U.S. Cls.: 100, 101 and 107

United States Patent and Trademark Office

Reg. No. 3,519,101

Registered Oct. 21, 2008

**SERVICE MARK
PRINCIPAL REGISTER**



WEIHS ANGELICA R (CALIFORNIA SOLE PROPRIETORSHIP)
2820 AVENEL ST
LOS ANGELES, CA 90039

FOR: SPECIAL EVENT PLANNING AND COORDINATION, IN CLASS 41 (U.S. CLS. 100, 101 AND 107).

FIRST USE 6-6-2005; IN COMMERCE 3-5-2007.

NO CLAIM IS MADE TO THE EXCLUSIVE RIGHT TO USE "GREEN WEDDINGS & EVENTS", APART FROM THE MARK AS SHOWN.

THE COLOR(S) BEIGE, PINK AND BLACK IS/ ARE CLAIMED AS A FEATURE OF THE MARK.

THE COLOR BLACK APPEARS IN THE WORDING, "GREEN WEDDINGS & EVENTS WHAT TRACE WILL YOU LEAVE?", THE COLORS PINK AND BLACK APPEARS IN THE FLOWER DESIGN, AND THE COLOR BEIGE APPEARS IN THE FOOTPRINT AND BACKGROUND SAND DESIGN.

SER. NO. 77-262,201, FILED 8-22-2007.

KELLY CHOE, EXAMINING ATTORNEY

Int. Cl.: 42

Prior U.S. Cls.: 100 and 101

United States Patent and Trademark Office

Reg. No. 3,519,102

Registered Oct. 21, 2008

**SERVICE MARK
PRINCIPAL REGISTER**

SMART TRAC

MULTI REGIONAL MULTIPLE LISTING SERVICE, INC. (CALIFORNIA CORPORATION),
DBA MRMLS
SUITE 250
3201 W. TEMPLE AVE.
POMONA, CA 91768

FOR: PROVIDING TEMPORARY USE OF ON-LINE NON-DOWNLOADABLE SOFTWARE FOR INTEGRATED TRACKING AND MANAGEMENT OF COMMERCIAL TRANSACTIONS ON A GLOBAL COMPUTER NETWORK, IN CLASS 42 (U.S. CLS. 100 AND 101).

FIRST USE 2-21-2006; IN COMMERCE 2-21-2006.

THE MARK CONSISTS OF STANDARD CHARACTERS WITHOUT CLAIM TO ANY PARTICULAR FONT, STYLE, SIZE, OR COLOR.

NO CLAIM IS MADE TO THE EXCLUSIVE RIGHT TO USE "TRACK", APART FROM THE MARK AS SHOWN.

SER. NO. 77-262,251, FILED 8-22-2007.

KATHERINE CONNOLLY, EXAMINING ATTORNEY

Int. Cl.: 25

Prior U.S. Cls.: 22 and 39

United States Patent and Trademark Office

Reg. No. 3,519,103

Registered Oct. 21, 2008

**TRADEMARK
PRINCIPAL REGISTER**

MICROSPIKES

KAHTOOLA INC. (ARIZONA CORPORATION)
450 RIVER RUN ROAD
FLAGSTAFF, AZ 86001

FOR: ADAPTABLE FLEXIBLE FOOTWEAR
TRACTION SYSTEM, NAMELY, SLIP-ON TRAC-
TION DEVICES CONTAINING CHAINS FOR AT-
TACHMENT TO FOOTWEAR, IN CLASS 25 (U.S.
CLS. 22 AND 39).

FIRST USE 8-9-2007; IN COMMERCE 8-9-2007.

THE MARK CONSISTS OF STANDARD CHAR-
ACTERS WITHOUT CLAIM TO ANY PARTICULAR
FONT, STYLE, SIZE, OR COLOR.

SER. NO. 77-262,256, FILED 8-22-2007.

AHSEN KHAN, EXAMINING ATTORNEY

Int. Cl.: 30

Prior U.S. Cl.: 46

United States Patent and Trademark Office

Reg. No. 3,519,104

Registered Oct. 21, 2008

**TRADEMARK
PRINCIPAL REGISTER**

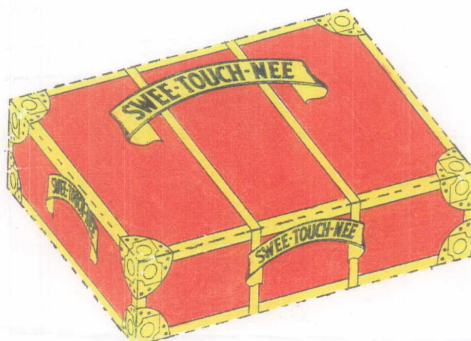

CONSOLIDATED TEA COMPANY, INC. (NEW YORK CORPORATION)
300 MERRICK ROAD
LYNBROOK, NY 11563

FOR: TEA, IN CLASS 30 (U.S. CL. 46).

FIRST USE 12-31-1950; IN COMMERCE 12-31-1950.

OWNER OF U.S. REG. NO. 2,862,785.

THE COLOR(S) RED, YELLOW-GOLD AND BLACK IS/ARE CLAIMED AS A FEATURE OF THE MARK.

THE MARK CONSISTS OF A BOX REPRESENTING A STEAMER STYLE TRUNK WITH CORNER PLATES, TOP AND SIDE VERTICAL STRAPS, EDGE

BANDING AND THE WORD "SWEE-TOUCH-NEE" WITHIN A RIBBON BANNER APPEARING ON THE TOP AND SIDES OF THE TRUNK. NO CLAIM IS MADE TO THE SHAPE OF THE BOX. THE OWNER IS NOT CLAIMING THE BOX CONFIGURATION AS A FEATURE OF ITS MARK. THE BACKGROUND OF THE STEAMER TRUNK CONFIGURATION THAT IS THE MARK IS RED IN COLOR WITH THE CORNER PLATES, STRAPS, EDGE BANDING AND BANNERS IN YELLOW-GOLD, AND THE WORDS "SWEE-TOUCH-NEE" IN BLACK.

SEC. 2(F).

SER. NO. 77-262,456, FILED 8-23-2007.

ANGELA GAW, EXAMINING ATTORNEY

Int. Cls.: 31 and 39

Prior U.S. Cls.: 1, 46, 100 and 105

United States Patent and Trademark Office

Reg. No. 3,519,105

Registered Oct. 21, 2008

**TRADEMARK
SERVICE MARK
PRINCIPAL REGISTER**



CANADIAN AGRA INC. (CANADA CORPORATION)
2091 HWY #21
KINCARDINE, ONTARIO, CANADA N2Z2Y9

FOR: ANIMAL FEED, IN CLASS 31 (U.S. CLS. 1 AND 46).

FIRST USE 5-0-1993; IN COMMERCE 5-0-1993.

FOR: DISTRIBUTION SERVICES, NAMELY, DELIVERY OF ANIMAL FEED, IN CLASS 39 (U.S. CLS. 100 AND 105).

FIRST USE 5-0-1993; IN COMMERCE 5-0-1993.

THE MARK CONSISTS OF THE STYLIZED LETTERS "CA" WITH LINES APPEARING IN THE

INTERIOR FOR THE APPEARANCE OF VISUAL DEPTH WITH PORTIONS OF A LEAF ON THE LEFT AND RIGHT SIDES, THE WORDING "CANADIAN AGRA" APPEARING BELOW IN SMALLER LETTERING, THE WORDING "BIO-CUBE" APPEARING BENEATH THIS IN VERY LARGE LETTERING AND THE PROFILE OF TWO HORSES FACING EACH OTHER ON EACH SIDE OF THE "CA CANADIAN AGRA BIO-CUBE" WORDING.

SEC. 2(F).

SER. NO. 77-262,921, FILED 8-23-2007.

GENE MACIOL, EXAMINING ATTORNEY

Int. Cls.: 35 and 44

Prior U.S. Cls.: 100, 101 and 102

United States Patent and Trademark Office

Reg. No. 3,519,106

Registered Oct. 21, 2008

**SERVICE MARK
PRINCIPAL REGISTER**

MRSI

MEDICAL REIMBURSEMENT SYSTEMS, INC.
(MASSACHUSETTS CORPORATION)
12 GILL STREET, SUITE 3000
WOBURN, MA 01801

FOR: BILLING, NAMELY, HOSPITAL EMERGENCY DEPARTMENT MEDICAL BILLING AND BILLING SUPPORT SERVICES; ADMINISTRATION, BILLING, AND RECONCILIATION OF ACCOUNTS ON BEHALF OF HOSPITAL EMERGENCY DEPARTMENTS, RECORDS MANAGEMENT SERVICES, NAMELY, DOCUMENT INDEXING FOR HOSPITAL EMERGENCY DEPARTMENTS; HOSPITAL EMERGENCY DEPARTMENT ADMINISTRATION SERVICES; HOSPITAL EMERGENCY DEPARTMENT MANAGEMENT, IN CLASS 35 (U.S. CLS. 100, 101 AND 102).

FIRST USE 9-21-2001; IN COMMERCE 9-21-2001.

FOR: MAINTAINING HOSPITAL EMERGENCY DEPARTMENT ELECTRONIC FILES AND RECORDS CONCERNING THE MEDICAL CONDITION OF INDIVIDUALS; EMERGENCY ROOM HOSPITAL SERVICES, IN CLASS 44 (U.S. CLS. 100 AND 101).

FIRST USE 9-29-2001; IN COMMERCE 9-29-2001.

THE MARK CONSISTS OF STANDARD CHARACTERS WITHOUT CLAIM TO ANY PARTICULAR FONT, STYLE, SIZE, OR COLOR.

SER. NO. 77-262,947, FILED 8-23-2007.

MARILYN IZZI, EXAMINING ATTORNEY

Int. Cl.: 43

Prior U.S. Cls.: 100 and 101

United States Patent and Trademark Office

Reg. No. 3,519,107

Registered Oct. 21, 2008

**SERVICE MARK
PRINCIPAL REGISTER**



HAZ HOLDINGS, INC. (DELAWARE CORPORATION)
34211 PACIFIC HIGHWAY S, SUITE 2
FEDERAL WAY, WA 98003

FOR: HEALTH RESORT SERVICES, NAMELY, PROVIDING FOOD AND LODGING THAT SPECIALIZE IN PROMOTING PATRONS' GENERAL HEALTH AND WELL-BEING; HOTEL SERVICES; HOTEL SERVICES FOR PREFERRED CUSTOMERS; HOTEL, BAR AND RESTAURANT SERVICES; HOTELS; MAKING HOTEL RESERVATIONS FOR OTHERS; PROVIDING ON-LINE REVIEWS OF RESTAURANTS AND HOTELS; PROVIDING TEMPORARY LODGING SERVICES IN THE NATURE OF A CONDOMINIUM HOTEL; PROVIDING TRAVEL LODGING INFORMATION SERVICES AND TRAVEL LODGING BOOKING AGENCY SERVICES FOR TRAVELERS; RESERVATION OF HOTEL ROOMS FOR TRAVELERS; RESERVATION OF

HOTEL ROOMS FOR TRAVELERS; RESORT HOTELS; RESORT LODGING SERVICES; TRAVEL AGENCY SERVICES, NAMELY, MAKING RESERVATIONS AND BOOKING FOR TEMPORARY LODGING, IN CLASS 43 (U.S. CLS. 100 AND 101).

FIRST USE 2-12-2007; IN COMMERCE 2-12-2007.

NO CLAIM IS MADE TO THE EXCLUSIVE RIGHT TO USE "HOTEL", APART FROM THE MARK AS SHOWN.

THE MARK CONSISTS OF THE LETTER "M" PARTIALLY WITHIN A CIRCLE WITH A CROWN ABOVE THE LETTER "M" AND THE WORDS "HOTEL MONARCHY" BELOW.

SER. NO. 77-262,973, FILED 8-23-2007.

GISELLE AGOSTO, EXAMINING ATTORNEY

Int. Cl.: 38

Prior U.S. Cls.: 100, 101 and 104

United States Patent and Trademark Office

Reg. No. 3,519,108

Registered Oct. 21, 2008

**SERVICE MARK
PRINCIPAL REGISTER**

**ALL REQUEST CLASSIC SOUL
LUNCH HOUR**

INNER CITY BROADCASTING CORPORATION
OF BERKELEY (CALIFORNIA CORPORATION)
SUITE 900
55 HAWTHORNE STREET
SAN FRANCISCO, CA 94105

FOR: RADIO PROGRAM BROADCASTING, IN
CLASS 38 (U.S. CLS. 100, 101 AND 104).

FIRST USE 1-6-1997; IN COMMERCE 1-6-1997.

THE MARK CONSISTS OF STANDARD CHARACTERS WITHOUT CLAIM TO ANY PARTICULAR FONT, STYLE, SIZE, OR COLOR.

OWNER OF U.S. REG. NOS. 2,481,813, 2,570,720,
AND 2,644,722.

NO CLAIM IS MADE TO THE EXCLUSIVE
RIGHT TO USE "SOUL", APART FROM THE MARK
AS SHOWN.

SEC. 2(F).

SER. NO. 77-263,462, FILED 8-24-2007.

KELLY CHOE, EXAMINING ATTORNEY

Int. Cls.: 9, 16, 25 and 28

**Prior U.S. Cls.: 2, 5, 21, 22, 23, 26, 29, 36, 37, 38, 39
and 50**

Reg. No. 3,519,109

United States Patent and Trademark Office

Registered Oct. 21, 2008

**TRADEMARK
PRINCIPAL REGISTER**

Doofuzz Dudes

MOTTER, ROSLYN J. (AUSTRALIA INDIVIDUAL)
19 CUMBERLAND STREET
EPPING 2121, AUSTRALIA

FOR: COMPUTER GAME CARTRIDGES; COMPUTER GAME CASSETTES; CHILDREN'S EDUCATIONAL SOFTWARE; COMPUTER GAME DISCS; COMPUTER GAME EQUIPMENT CONTAINING MEMORY DEVICES, NAMELY, DISCS; COMPUTER GAME JOYSTICKS; COMPUTER GAME PROGRAMS; COMPUTER GAME SOFTWARE; COMPUTER GAME SOFTWARE, NAMELY, A COMPUTER CRAPS GAME; COMPUTER GAME TAPES; COMPUTER GRAPHICS BOARDS; COMPUTER GRAPHICS SOFTWARE; COMPUTER HARDWARE AND COMPUTER SOFTWARE PROGRAMS FOR THE INTEGRATION OF TEXT, AUDIO, GRAPHICS, STILL IMAGES AND MOVING PICTURES INTO AN INTERACTIVE DELIVERY FOR MULTIMEDIA APPLICATIONS; COMPUTER JOYSTICKS; COMPUTER KEYBOARDS; COMPUTER KEYPADS; COMPUTER MOUSE; COMPUTER PROGRAMS FOR EDITING IMAGES, SOUND AND VIDEO; COMPUTER PROGRAMS FOR PRE-RECORDED GAMES; COMPUTER SOFTWARE AND FIRMWARE FOR GAMES OF CHANCE ON ANY COMPUTERIZED PLATFORM, INCLUDING DEDICATED GAMING CONSOLES, VIDEO BASED SLOT MACHINES, REEL BASED SLOT MACHINES, AND VIDEO LOTTERY TERMINALS; COMPUTER SOFTWARE TO ENHANCE THE AUDIO-VISUAL CAPABILITIES OF MULTIMEDIA APPLICATIONS, NAMELY, FOR THE INTEGRATION OF TEXT, AUDIO, GRAPHICS, STILL IMAGES AND MOVING PICTURES; COMPUTER SOFTWARE, NAMELY, SOFTWARE DEVELOPMENT TOOLS FOR THE CREATION OF MOBILE INTERNET APPLICATIONS AND CLIENT INTERFACES; ELECTRONIC COMPUTERS; ELECTRONIC GAME SOFTWARE; ELECTRONIC GAME SOFTWARE FOR CELLULAR TELEPHONES; ELEC-

TRONIC GAME SOFTWARE FOR HAND HELD ELECTRONIC DEVICES; ELECTRONIC GAME SOFTWARE FOR WIRELESS DEVICES; ELECTRONIC GAME SOFTWARE, NAMELY, AN ELECTRONIC CRAPS GAME; ELECTRONIC GAME SOFTWARE, NAMELY, AN ELECTRONIC VIDEO CRAPS GAME; ELECTRONIC PUBLICATIONS, NAMELY, BOOK, MAGAZINE FEATURING FICTIONAL STORIES FEATURING THE DOOFUZZ DUDES BOOKS RECORDED ON COMPUTER MEDIA; ENTERTAINMENT SYSTEM COMPRISING A COMPUTER, MULTIPLE DISPLAY DISPLAY SCREEN, MULTIPLE INPUT DEVICES AND A PRINTER; GAME CONTROLLERS FOR COMPUTER GAMES; GAME SOFTWARE; HAND HELD COMPUTERS; INTERACTIVE MULTIMEDIA COMPUTER GAME PROGRAM; INTERACTIVE VIDEO GAMES OF VIRTUAL REALITY COMPRISED OF COMPUTER HARDWARE AND SOFTWARE; JACKETS FOR COMPUTER DISKS; MOUSE PADS; NOTEBOOK COMPUTER COOLING PADS; POCKET COMPUTERS FOR NOTE-TAKING; TRADING CARDS RECORDED ON COMPUTER DISCS; VIDEO GAME SOFTWARE; VIDEO GAME SOFTWARE, NAMELY, A VIDEO CRAPS GAME; VIRTUAL REALITY GAME SOFTWARE; VIRTUAL REALITY SOFTWARE FOR PLAYING DOOFUZZ DUDES COMPUTER GAMES; WRIST RESTS FOR COMPUTER MOUSE USERS; WRIST RESTS FOR USE WITH COMPUTERS; WRIST SUPPORTS FOR COMPUTER MOUSE USERS, IN CLASS 9 (U.S. CLS. 21, 23, 26, 36 AND 38).

FIRST USE 6-21-2006; IN COMMERCE 6-21-2006.

FOR: WRITING PAPER PADS; XEROGRAPHIC PAPER; THERMOSENSITIVE PAPER; THICK JAPANESE PAPER; TISSUE PAPER; TISSUE PAPER FOR USE AS MATERIAL OF STENCIL PAPER (GAN-PISHI); TOILET PAPER; TOILET SEAT COVER PAPER; TRACING PAPER; TRADING CARD DISCS

OF PAPER OR CARDBOARD; TREATED PAPER FOR WRAPPING FLOWERS AND FLORAL DISPLAYS; TYPEWRITER PAPER; UNFITTED FURNITURE COVERS OF PAPER; UNPRINTED PAPER; UNSENSITIZED PHOTO PAPER; WATERPROOF PAPER; WAX BOND PAPER; WAX PAPER; WORKS OF ART MADE FROM CUSTOM MANUFACTURED PAPER; WRAPPING PAPER; WRITING PAPER; WRITING PAPER HOLDERS; RULED PAPER; SAFETY PAPER; SCENTED PAPER DRAWER LINERS; SCHOOL SUPPLY KITS CONTAINING VARIOUS COMBINATIONS OF SELECTED SCHOOL SUPPLIES, NAMELY, WRITING INSTRUMENTS, PENS, PENCILS, MECHANICAL PENCILS, ERASERS, MARKERS, CRAYONS, HIGH LIGHTERS, FOLDERS, NOTEBOOKS, PAPER, GRADUATED RULERS, PROTRACTORS, PAPER CLIPS, PENCIL SHARPENERS, WRITING GRIPS, GLUE AND BOOK MARKS; SEMI-PROCESSED PAPER; SHELF PAPER; SPECIALTY PAPERS, NAMELY, VEGETABLE PARCHMENT, FOR USE IN FOOD WRAPPING, PREPARATION, PROCESSING AND PACKAGING APPLICATIONS; STATIONERY WRITING PAPER AND ENVELOPES; STENCIL PAPER; STENCILS AND PATTERNS, BEING OF PAPER AND PLASTIC, FOR THE TRANSFERRING OF GRAPHIC DESIGNS TO PUMPKINS, MINI-PUMPKINS, GOURDS, AND OTHER FRUITS AND VEGETABLES; STORAGE CONTAINERS MADE OF PAPER; STRIPS OF FANCY PAPER (TANZAKU); SUPERCALANDERED PRINTING PAPER; SYNTHETIC BOND PAPER; SYNTHETIC PAPER; TABLE CLOTHS OF PAPER; TABLE LINENS OF PAPER; TABLE MATS OF PAPER; TABLE NAPKINS OF PAPER; PLASTIC OR PAPER BAGS FOR MERCHANDISE PACKAGING; PLASTIC-COATED COPYING PAPER; PLOTTING PAPERS; POLYESTER FILM FOR USE AS A PAPER SUBSTITUTE FOR DRY TONER XEROGRAPHIC IMAGING, NAMELY, LASER PRINTING, COLOR COPIER PRINTING, DRY TONER PRINTING, SCREEN PRINTING, AND OFFSET PRINTING; POSTCARD PAPER; POSTERS MADE OF PAPER; PRINTED PAPER LABELS; PRINTED PAPER SIGNS; PRINTED PAPER SIGNS, NAMELY, TABLE TENTS; PRINTING PAPER; PRINTING PAPERS; PROOFING PAPER; PROTECTIVE COVERS FOR SHEETS OR PAPER AND PAGES OF BOOKS AND THE LIKE; PUBLICATION PAPER; RECYCLED BOND PAPER; RECYCLED PAPER; REEL PAPER FOR PRINTERS; REPRODUCTION PAPER; RICE PAPER; RUBBISH BAGS MADE OF PAPER OR PLASTIC MATERIALS; PAPER TAPES FOR CALCULATORS; PAPER TEACHING MATERIALS IN THE FIELD OF ENGLISH LANGUAGE CLASSES; PAPER TOWELS; PAPER TRANSPARENCIES; PAPER TRAY COVERS; PAPER WASHCLOTHS; PAPER WINE GIFT BAGS; PAPER-FEEDING MACHINES FOR OFFICE USE; PAPERS FOR HOUSEHOLD AND INDUSTRIAL USE; PAPERS FOR USE IN THE GRAPHIC ARTS INDUSTRY; PARAFFINED PAPER; PARCHMENT PAPER; PARTY GOODIE BAGS OF PAPER OR PLASTIC; PARTY ORNAMENTS OF PAPER; PHOTOCOPY PAPERS; PICTURE MOUNTS OF PAPER; PLACARDS OF PAPER OR CARDBOARD; PLACE MATS OF PAPER; PLASTIC COATED COPYING PAPER; PLASTIC OR PAPER BAGS FOR HOUSE-

HOLD USE; PAPER RACKS; PAPER REFUSE BAGS; PAPER REPORT COVERS; PAPER RIBBONS; PAPER ROLLS FOR CALCULATING MACHINES; PAPER SHEETS FOR NOTE TAKING; PAPER SHOPPING BAGS; PAPER SHREDDERS; PAPER SIGN HOLDERS; PAPER STAPLERS; PAPER STAPLES; PAPER STATIONERY; PAPER STOCK; PAPER TABLE CLOTHS; PAPER TABLE LINENS; PAPER TAGS; PAPER TAKE-OUT CARTONS FOR FOOD; PAPER TAPE; PAPER TAPES; PAPER TAPES FOR CALCULATING MACHINES; PAPER NAME BADGES; PAPER NAPKINS; PAPER NOTE TABLETS; PAPER NOTEBOOKS; PAPER PACKAGING AND CONTAINERS FOR FOOD AND BEVERAGES COMPRISED OF MATERIALS DESIGNED TO LESSEN ADVERSE EFFECTS ON THE ENVIRONMENT; PAPER PADDING; PAPER PADS FOR CHANGING DIAPERS; PAPER PARTY BAGS; PAPER PARTY DECORATIONS; PAPER PARTY FAVORS; PAPER PATCHES FOR CLOTHING; PAPER PENNANTS; PAPER PET CRATE MATS; PAPER PICTURE MOUNTS; PAPER PILLOWCASES; PAPER PLACE MATS; PAPER POUCHES FOR PACKAGING; PAPER PRODUCTS, NAMELY, PAPER TUBES; PAPER PRODUCTS, NAMELY, PAPER TUBES AND PAPER CORES; PAPER GIFT WRAP BOWS; PAPER GIFT WRAPPING RIBBONS; PAPER HAND-TOWELS; PAPER HANDKERCHIEFS; PAPER HAND TOWELS; PAPER HANG TAGS; PAPER HOLE PUNCHES; PAPER IDENTIFICATION TAGS; PAPER ILLUSTRATION BOARDS; PAPER KNIVES; PAPER LABELS; PAPER LACE; PAPER LETTERS AND NUMBER FOR USE IN MAKING SIGNS, POSTERS; PAPER LINERS FOR DIAPERS; PAPER MACHE; PAPER MACHE FIGURINES; PAPER MADE FROM PAPER MULBERRY (KOHZO-GAMI); PAPER MADE FROM PAPER MULBERRY (TENGUJOSI); PAPER MAIL POUCHES; PAPER MATS; PAPER FOLDERS; PAPER FOLDING MACHINES AS OFFICE REQUISITES; PAPER FOLDING MACHINES FOR OFFICE USE; PAPER FOR JAPANESE INDOOR SLIDING PARTITIONS (FUSUMA-GAMI); PAPER FOR JAPANESE SLIDING SCREENS (SHOJI-GAMI); PAPER FOR BAGS AND SACKS; PAPER FOR PHOTOCOPIES; PAPER FOR PHOTOCOPYING; PAPER FOR RECORDING MACHINES; PAPER FOR USE AS MATERIAL OF STOCK CERTIFICATES (SHOKENSHI); PAPER FOR USE IN THE GRAPHIC ARTS INDUSTRY; PAPER FOR USE IN THE MANUFACTURE OF WALLPAPER; PAPER FOR WRAPPING AND PACKAGING; PAPER FUTON COVERS; PAPER GARBAGE BAGS; PAPER GIFT BAGS; PAPER GIFT BAGS FOR WINE; PAPER GIFT TAGS; PAPER GIFT WRAP; PAPER CONTAINERS; PAPER CONTAINING MICA; PAPER COVERS FOR TELEPHONE RECEIVERS; PAPER CUTTERS; PAPER DIAPERS; PAPER DIE CUT SHAPES; PAPER DISPLAY BOXES; PAPER DOILIES; PAPER DROP CLOTHS; PAPER EGG CARTONS; PAPER EMBLEMS; PAPER EMBOSSERS; PAPER ENVELOPES FOR PACKAGING; PAPER EXPANDING FILES; PAPER FASTENERS; PAPER FILE JACKETS; PAPER FILTERS FOR COFFEE MAKERS; PAPER FLAGS; PAPER FLOOR MATS; PAPER FLOWER POT COVERS; PAPER AND CARDBOARD; PAPER BABY BIBS; PAPER BADGES; PAPER BAGS; PAPER BAGS AND SACKS; PAPER BAGS FOR PACKA-

GING; PAPER BANNERS; PAPER BOARD; PAPER BOARDS; PAPER BOWS FOR GIFT WRAP; PAPER BOXES; PAPER BOXES FOR STORING GREETING CARDS; PAPER BUNTING; PAPER CAKE DECORATIONS; PAPER CARTON SEALING TAPE; PAPER CARTONS FOR DELIVERING GOODS; PAPER CLIP HOLDERS; PAPER CLIPS; PAPER CLOSURES FOR CONTAINERS; PAPER CLOSURES FOR SEALING CONTAINERS; MIMEOGRAPH PAPER; MODELING MATERIALS FOR USE IN MAKING CAST PAPER SCULPTURED FLOWERS; MOISTURE PROOF CELLOPHANE PAPER; MULCH PAPER; NAPKIN PAPER; NEWSPRINT PAPER; NOTE PAPER; NOTE PAPERS; NOTEBOOK PAPER; OFFICE PAPER DRILL MACHINES; OFFICE PAPER STATIONERY; OFFSET PAPER; OFFSET PRINTING PAPER FOR PAMPHLETS; OILED PAPER FOR PAPER UMBRELLAS (KASA-GAMI); OIL PROOF PAPER; ONION SKIN PAPER; OPAQUE PAPER; PACKAGING AND CONTAINERS COMPRISED OF STARCH-BASED MATERIALS IN THE NATURE OF A PAPER SUBSTITUTE FOR FOOD, BEVERAGES AND CONSUMER PRODUCTS; PACKING PAPER; PAPER; JAPANESE HANDICRAFT PAPER; JAPANESE PAPER; JAPANESE PAPER (TORINOKO-GAMI); KRAFT PAPER; LABEL PAPER; LAMINATED PAPER; LASER PRINT PAPER; LASER PRINTING PAPER; LETTER PAPER; LETTERHEAD PAPER; LINING PAPER; LOOSE LEAF PAPER; LUMINOUS PAPER; MAGAZINE PAPER; MAGNETIC PAPER; MANIFOLD PAPER; MASKING PAPER; METALLIC GIFT WRAPPING PAPER; METALLIC PAPER PARTY DECORATIONS; MILDEW PROOF PAPER; GARBAGE BAGS OF PAPER; GIFT WRAP PAPER; GIFT WRAPPING PAPER; GLASSINE PAPER; GRAPH PAPER; GROCERY PAPER; GUMMED PAPER; GUNPOWDER WRAPPING PAPER; HALLOWEEN GOODIE BAGS OF PAPER OR PLASTIC; HAND TOWELS OF PAPER; HAT BOXES OF PAPER; HEAT SENSITIVE PAPER; HEAT TRANSFER PAPER; HONEYCOMB PAPER; HYGIENIC PAPER; ILLUSTRATION PAPER; IMITATION LEATHER PAPER; INDIA PAPER; INDUSTRIAL PACKAGING CONTAINERS OF PAPER; JAPANESE CEREMONIAL PAPER STRINGS (MIZUHIKI); DIGITAL PRINTING PAPER; DIRECTORY PAPER; DISPOSABLE PAPER SHEETS FOR PERSONAL HYGIENIC USE IN THE NATURE OF DISPOSABLE HEADREST COVERS NOT FOR MEDICAL USE; DRAWING PAPER; DUPLICATING PAPER; DYE-SUBLIMATION PRINT PAPER; EKG PAPER; ELECTROCARDIOGRAPH PAPER; ELECTROSTATIC PAPER; EMBROIDERY DESIGN PATTERNS; ENVELOPE PAPER; ENVELOPE PAPERS; FACSIMILE TRANSMISSION PAPER; FIBER PAPER; FILLER PAPER; FILTER PAPER; FLUORESCENT PAPER; FLUTING PAPER; FREE-STANDING AND WALL-MOUNTED PAPER AND CARDBOARD BOXES FOR DEPOSITING A WRITTEN MESSAGE OR PRAYER WISHING A LOVED ONE WELL, FOR USE IN HOSPITALS, ELDER CARE RESIDENCES, SCHOOLS, AND INSTITUTIONS FOR CHILDREN WITH SPECIAL NEEDS; CARBON PAPER; CARDBOARD MADE FROM PAPER MULBERRY (SENKASI); CARRYING CASES MADE OF PAPER; CELLOPHANE PAPER; COASTERS MADE OF PAPER; COLLAPSIBLE BOXES OF PAPER; COMPU-

TER PAPER; CONSTRUCTION PAPER; CONTAINERS FOR ICE MADE OF PAPER OR CARDBOARD; COPIER PAPER; COPY PAPER; CORRUGATED BOARD AND PAPER CONTAINERS; CORRUGATED PAPER; COSMETIC REMOVING PAPER; CRAFT PAPER; CREPE PAPER; CREPE PAPER FOR MEDICAL, SANITARY OR DOMESTIC USE; CUSHIONING OR PADDING MADE OF PAPER FOR PACKING PURPOSES; DECORATIVE PAPER CENTERPIECES; ALUMINUM FOIL LAMINATED PAPER FOR PRINTING PURPOSES; ART PAPER; AUTOMATIC PAPER CLIP DISPENSING MACHINES FOR OFFICE OR STATIONERY USE; BABIES DIAPERS OF PAPER; BANNERS OF PAPER; BIODEGRADABLE PAPER PULP-BASED TO-GO CONTAINERS FOR FOOD; BLANK OR PARTIALLY PRINTED PAPER LABELS; BLANK PAPER COMPUTER TAPES; BLANK PAPER COMPUTER TAPES FOR RECORDING PROGRAMS; BLANK PAPER NOTEBOOKS; BLANK PAPER TAPES AND CARDS FOR THE RECORDING OF COMPUTER PROGRAMS; BLOTTING PAPER; BOND PAPER; BOOK-COVER PAPER; BOXES OF PAPER; BOXES OF PAPER OR CARDBOARD; BURP PADS OF PAPER; BUSINESS CARD PAPER; CALENDAR-FINISHED PAPER; CALLIGRAPHY PAPER; ABSORBENT PADS OF PAPER AND CELLULOSE FOR USE IN FOOD PACKAGING; ACID-RESISTANT PAPER; ADDING MACHINE PAPER; ADHESIVE NOTE PAPER; ADVERTISING BOARDS OF PAPER OR CARDBOARD; ADVERTISING SIGNS OF PAPER OR CARDBOARD, IN CLASS 16 (U.S. CLS. 2, 5, 22, 23, 29, 37, 38 AND 50).

FIRST USE 6-21-2006; IN COMMERCE 6-21-2006.

FOR: A-SHIRTS; BUTTON-FRONT ALOHA SHIRTS; CAMP SHIRTS; DRESS SHIRTS; GOLF SHIRTS; KNIT SHIRTS; LONG-SLEEVED SHIRTS; NIGHT SHIRTS; OPEN-NECKED SHIRTS; PIQUE SHIRTS; POLO SHIRTS; SHIRT FRONTS; SHIRT YOKES; SHIRTS; SHIRTS FOR SUITS; SHORT-SLEEVED OR LONG-SLEEVED T-SHIRTS; SHORT-SLEEVED SHIRTS; SLEEP SHIRTS; SPORT SHIRTS; SPORTS SHIRTS; SPORTS SHIRTS WITH SHORT SLEEVES; SWEAT SHIRTS; T-SHIRTS; TEE SHIRTS; WIND SHIRTS; YOGA SHIRTS, IN CLASS 25 (U.S. CLS. 22 AND 39).

FIRST USE 6-21-2006; IN COMMERCE 6-21-2006.

FOR: PAPER PARTY HATS; FANTASY CHARACTER TOYS; COLLECTABLE TOY FIGURES; PLASTIC CHARACTER TOYS; STUFFED DOLLS AND ANIMALS; STUFFED TOY ANIMALS; ARROWS; BABY MULTIPLE ACTIVITY TOYS; BATH TOYS; BATHTUB TOYS; BATTERY OPERATED ACTION TOYS; BENDABLE TOYS; CAPS FOR TOY PISTOLS; CASES FOR TOY STRUCTURES; CASES FOR TOY VEHICLES; CAT TOYS; CHILDREN'S ACTIVITY TABLES CONTAINING MANIPULATIVE TOYS WHICH CONVERT TO EASELS; CHILDREN'S MULTIPLE ACTIVITY TOYS; CHILDREN'S MULTIPLE ACTIVITY TOYS SOLD AS A UNIT WITH PRINTED BOOKS; CHILDREN'S WIRE CONSTRUCTION AND ART ACTIVITY TOYS; CLOCKWORK TOYS; CONSTRUCTION TOYS; CRIB TOYS; DISC TOSS

TOYS; DOG TOYS; DRAWING TOYS; EDUCATIONAL TOY FOR THE PURPOSE OF THE DEMONSTRATION OF ALTERNATIVE ENERGY SOURCES; ELECTRIC ACTION TOYS; ELECTRIC EDUCATIONAL TOY USED TO DEMONSTRATE ALTERNATIVE ENERGY SOURCES; ELECTRIC TOY TRAIN TRANSFORMERS; ELECTRONIC ACTION TOYS; ELECTRONIC LEARNING TOYS; ELECTRONIC TOY BUILDING BLOCKS THAT LIGHT UP AS A NIGHT LIGHT; ELECTRONIC TOY VEHICLES; ELECTRONICALLY OPERATED TOY MOTOR VEHICLES; FLYING SAUCERS; INFANT ACTION CRIB TOYS; INFANT DEVELOPMENT TOYS; INFANT TOYS; INFLATABLE BATH TOYS; INFLATABLE RIDE-ON TOYS; INFLATABLE THIN RUBBER TOYS; INFLATABLE TOYS; INFLATABLE TOYS SHOWING DECORATIVE PICTURES; LEVER ACTION TOYS; MECHANICAL ACTION TOYS; MECHANICAL TOYS; MINIATURE TOY HELMETS; MODEL TOY STEAM ENGINES; MODEL TOY STEAM OPERATED TRACTION ENGINES; MODELED PLASTIC TOY FIGURINES; MOLDED TOY FIGURES; MUSIC BOX TOYS; MUSICAL TOYS; NON-ELECTRONIC TOY VEHICLES; NON-RIDING TRANSPORTATION TOYS; PARTY FAVORS IN THE NATURE OF SMALL TOYS; PET TOYS; PET TOYS CONTAINING CATNIP; PET TOYS MADE OF ROPE; PLASTIC TOY HOOPS; PLAY MATS CONTAINING INFANT TOYS; PLAY MATS FOR USE WITH TOY VEHICLES; PLUSH TOYS; POP UP TOYS; POSITIONABLE PRINTED TOY FIGURES FOR USE IN GAMES; POSITIONABLE PRINTED TOY FIGURES FOR USE IN PUZZLES; POSITIONABLE THREE DIMENSIONAL TOYS FOR USE IN GAMES; POSITIONABLE TOY FIGURES; POSITIONABLE TWO DIMENSIONAL TOYS FOR USE IN GAMES; PRINTED POSITIONABLE TOYS FOR USE IN CHILDREN'S BOARD GAMES; PRINTING TOYS; PULL TOYS; PUNCHING TOYS; PUSH TOYS; RADIO CONTROLLED TOY VEHICLES; RADIO TRANSMITTERS FOR USE WITH RADIO-CONTROLLED TOYS; REMOTE CONTROL TOYS, NAMELY, CARS, RACE CARS AND BOATS; RIDE-ON TOYS; RUBBER CHARACTER TOYS; SAND TOYS; SANDBOX TOYS; SKETCHING TOYS; SOFT SCULPTURE PLUSH TOYS; SOFT SCULPTURE TOYS; SQUEEZABLE SQUEAKING TOYS; SQUEEZE TOYS; STACKING TOYS; STUFFED PUPPETS; STUFFED TOY BEARS; STUFFED TOYS; TALKING TOYS; TESSELATION TOYS; TOSSING DISC TOYS; TOY CHRISTMAS TREES; TOY ACTION FIGURES; TOY ACTION FIGURES AND ACCESSORIES THEREFOR; TOY AIRPLANES; TOY ANIMALS AND ACCESSORIES THEREFOR; TOY ARMOR; TOY ARTIFICIAL FINGERNAILS; TOY BAKE WARE AND COOKWARE; TOY BALLOONS; TOY BANKS; TOY BOWS AND ARROWS;

TOY BOXES; TOY BUILDING BLOCKS; TOY BUILDING BLOCKS CAPABLE OF INTERCONNECTION; TOY BUILDINGS AND ACCESSORIES THEREFOR; TOY BUTTERFLY NETS; TOY CAP PISTOLS; TOY CLOCKS AND WATCHES; TOY CONSTRUCTION BLOCKS; TOY CONSTRUCTION SETS; TOY FIGURES; TOY FILM CARTRIDGES AND VIEWERS; TOY FURNITURE; TOY GLIDERS; TOY GLOCKENSPIELS; TOY GUNS; TOY HARMONICAS; TOY HOLSTERS; TOY HOOP SETS; TOY HOUSES; TOY MAIL BOXES; TOY MASKS; TOY MOBILES; TOY MODEL CARS; TOY MODEL HOBBY CRAFT KITS; TOY MODEL KIT CARS; TOY MODEL TRAIN SETS; TOY MODEL VEHICLES AND RELATED ACCESSORIES SOLD AS UNITS; TOY MODELING DOUGH; TOY MUSIC BOXES; TOY NOISEMAKERS; TOY PIANOS; TOY PIANOS, SOLD AS A UNIT WITH PRINTED BOOKS IN THE FIELD OF MUSIC EDUCATION; TOY PISTOLS; TOY PRISM GLASSES; TOY PUTTY; TOY RECORD PLAYERS; TOY ROBOTS; TOY ROCKETS; TOY SCOOTERS; TOY SETS OF CARPENTERS' TOOLS; TOY SNOW GLOBES; TOY STAMPS; TOY SWORDS; TOY TRAINS AND PARTS AND ACCESSORIES THEREFOR; TOY VEHICLE TRACK SETS AND ROADWAYS AND ACCESSORIES THEREFOR; TOY VEHICLES; TOY VEHICLES AND ACCESSORIES THEREFOR; TOY VEHICLES WITH TRANSFORMING PARTS; TOY WATCHES; TOY WATER GLOBES; TOY WEAPONS; TOY WIND SOCKS; TOY XYLOPHONES; TOY ZIP GUNS; TOY, NAMELY, BATTERY-POWERED COMPUTER GAME WITH LCD SCREEN WHICH FEATURES ANIMATION AND SOUND EFFECTS; TOYS DESIGNED TO BE ATTACHED TO CAR SEATS AND HIGH CHAIRS; TOYS, NAMELY, CHILDREN'S DRESS-UP ACCESSORIES; TOYS, NAMELY, A DISK TO TOSS IN PLAYING A GAME WHEREIN OTHER DISKS ARE FLIPPED AND COLLECTED; TRANSFORMING ROBOTIC TOY VEHICLES; TRANSFORMING ROBOTIC TOYS; WATER SQUIRTING TOYS; WIND-UP TOYS; WIND-UP WALKING TOYS, IN CLASS 28 (U.S. CLS. 22, 23, 38 AND 50).

FIRST USE 6-21-2006; IN COMMERCE 6-21-2006.

THE MARK CONSISTS OF STANDARD CHARACTERS WITHOUT CLAIM TO ANY PARTICULAR FONT, STYLE, SIZE, OR COLOR.

OWNER OF AUSTRALIA REG. NO. 1119730, DATED 6-21-2006, EXPIRES 6-21-2016.

SER. NO. 77-264,238, FILED 8-24-2007.

BENJAMIN OKEKE, EXAMINING ATTORNEY

Int. Cls.: 14 and 18

Prior U.S. Cls.: 1, 2, 3, 22, 27, 28, 41 and 50

United States Patent and Trademark Office

Reg. No. 3,519,110

Registered Oct. 21, 2008

**TRADEMARK
PRINCIPAL REGISTER**



WYVERN ASSOCIATES (HONG KONG PART-
NERSHIP)
ROOM 446, NEW HENRY HOUSE
10 ICE HOUSE STREET, CENTRAL
HONG KONG, CHINA

RINGS; BEADS FOR USE IN THE MANUFACTURE
OF JEWELRY; JEWELRY ROPE CHAIN FOR NECK-
LACES, JEWELRY CHAIN OF PRECIOUS METAL
FOR NECKLACES, IN CLASS 14 (U.S. CLS. 2, 27, 28
AND 50).

FOR: PRECIOUS METALS AND THEIR ALLOYS;
GOODS IN PRECIOUS METALS OR COATED
THEREWITH, NAMELY, STERLING SILVER DOG
CHARMS, STERLING SILVER AND CRYSTAL DOG
CHARMS, PEARL NECKLACES FOR DOGS, PASTE
COSTUME JEWELRY FOR DOGS AND DOG
THEMED KEY RINGS; JEWELRY FOR ANIMALS;
PRECIOUS STONES AND ORNAMENTS OF PRE-
CIOUS METALS FOR ANIMALS; HOROLOGICAL
AND CHRONOMETRIC INSTRUMENTS; BADGES
OF PRECIOUS METAL; JEWELRY CHAINS AND
JEWELRY CHARMS; DIAMONDS; EARRINGS;
HAT ORNAMENTS OF PRECIOUS METAL; IVORY
JEWELRY; JEWEL CASES OF PRECIOUS METAL;
JEWELRY OF YELLOW AMBER; PASTE JEWELRY
AND PASTE COSTUME JEWELRY; JEWELRY ME-
DALLIONS; MEDALS; JEWELRY NECKLACES; OR-
NAMENTAL PINS; JEWELRY ORNAMENTS;
JEWELRY PEARLS; PEARLS MADE OF AMBROID,
NAMELY, PRESSED AMBER; JEWELRY PINS, PLA-
TED ARTICLES OF PRECIOUS METAL PLATING,
NAMELY, STERLING SILVER DOG CHARMS,
STERLING SILVER AND CRYSTAL DOG CHARMS,
PEARL NECKLACES FOR DOGS, PASTE COSTUME
JEWELRY FOR DOGS AND DOG THEMED KEY
RINGS; JEWELRY RINGS; JEWELRY TRINKETS,
NAMELY, STERLING SILVER DOG CHARMS,
STERLING SILVER AND CRYSTAL DOG CHARMS,
PEARL NECKLACES FOR DOGS, PASTE COSTUME
JEWELRY FOR DOGS AND DOG THEMED KEY

FOR: LEATHER AND IMITATIONS OF LEA-
THER, AND GOODS MADE OF THESE MATERI-
ALS AND NOT INCLUDED IN OTHER CLASSES,
NAMELY, DOG COLLARS, DOG LEADS/LEASHES,
DOG HARNESES AND DOG TRAVELING BAGS;
COATS FOR DOGS; ANIMAL SKINS AND HIDES;
TRUNKS AND TRAVELING BAGS; UMBRELLAS,
PARASOLS AND WALKING STICKS; WHIPS, HAR-
NESES AND SADDLERY; CLOTHING FOR DO-
MESTIC PETS; DOG SHOES, DOG COLLARS, DOG
CLOTHES; DOG CLOTHS, NAMELY, DOG BLAN-
KETS FOR COVERING A DOG AND/OR ON WHICH
A DOG CAN LIE; DOG BELLYBANDS; POUCHES
OF LEATHER; ALL-PURPOSE CARRYING BAGS,
FOLDING BRIEFCASES, SHOULDER BAGS, BRIEF-
CASES, SUITCASES, CARRY-ON BAGS, TRUNKS,
HANDBAGS, SCHOOLCHILDREN'S BACKPACKS
AND BACKPACKS; CHARM BAGS; BUSINESS
CARD CASES; TEXTILE SHOPPING BAGS AND
WHEELED SHOPPING BAGS; PURSES NOT OF
PRECIOUS METAL; KEY CASES; WALLETTS NOT
OF PRECIOUS METAL; COMMUTATION-TICKET
HOLDERS; UNFITTED VANITY CASES; UMBRELL-
AS AND THEIR PARTS; TELESCOPIC UMBRELL-
AS, RAINPROOF PARASOLS, BEACH
UMBRELLAS, BEACH PARASOLS, SUN UMBRELL-
AS AND PARASOLS; UMBRELLA COVERS, UM-
BRELLAS HANDLES, METAL PARTS OF
UMBRELLAS, FRAMES FOR UMBRELLAS AND
BAGS FOR UMBRELLAS; WALKING STICKS,

CANES, METAL PARTS OF CANES AND WALKING-STICKS, HANDLES OF CANES AND WALKING-STICKS, IN CLASS 18 (U.S. CLS. 1, 2, 3, 22 AND 41).

PRIORITY CLAIMED UNDER SEC. 44(D) ON HONG KONG APPLICATION NO. 300827523, FILED 3-8-2007, REG. NO. 300827523, DATED 3-8-2007, EXPIRES 3-7-2017.

NO CLAIM IS MADE TO THE EXCLUSIVE RIGHT TO USE "DESIGNS", APART FROM THE MARK AS SHOWN.

THE MARK CONSISTS OF THE WORDS "WAG-TRADE DESIGNS" INSIDE THE DESIGN OF A DOG'S HEAD.

SER. NO. 77-264,652, FILED 8-27-2007.

WILLIAM P. SHANAHAN, EXAMINING ATTORNEY

Int. Cl.: 42

Prior U.S. Cls.: 100 and 101

United States Patent and Trademark Office

Reg. No. 3,519,111

Registered Oct. 21, 2008

**SERVICE MARK
PRINCIPAL REGISTER**

EMPLOYEESUGGESTIONBOX

EMPLOYEESUGGESTIONBOX.COM, LLC
(FLORIDA LIMITED LIABILITY COMPANY)
SUITE 200
13502 CLUBSIDE DRIVE
TAMPA, FL 33624

FOR: APPLICATION SERVICE PROVIDER(ASP)
FEATURING SOFTWARE FOR USE IN COLLECT-
ING, STORING AND ANALYZING RECOMMEN-
DATIONS MADE BY EMPLOYEES , IN CLASS 42
(U.S. CLS. 100 AND 101).

FIRST USE 3-1-2007; IN COMMERCE 3-1-2007.

THE MARK CONSISTS OF STANDARD CHAR-
ACTERS WITHOUT CLAIM TO ANY PARTICULAR
FONT, STYLE, SIZE, OR COLOR.

SER. NO. 77-264,676, FILED 8-27-2007.

TOBY BULLOFF, EXAMINING ATTORNEY

Int. Cls.: 35 and 36

Prior U.S. Cls.: 100, 101 and 102

United States Patent and Trademark Office

Reg. No. 3,519,112

Registered Oct. 21, 2008

**SERVICE MARK
PRINCIPAL REGISTER**

PAYCARGO

COIHUE LLC (FLORIDA LIMITED LIABILITY COMPANY)
8424 NW 139 TERRACE - APT. 2702
MIAMI LAKES, FL 33016

FOR: INFORMATION MANAGEMENT IN THE NATURE OF FINANCIAL RECORDS MANAGEMENT FOR THE FREIGHT INDUSTRY THROUGH ELECTRONIC MEANS; FINANCIAL RECORDS MANAGEMENT SERVICES, NAMELY, MATCHING OF CASH AND CREDIT CARD TRANSACTION DATA WITH INVOICES AND ORDERS THROUGH ELECTRONIC MEANS; CUSTOMER SERVICE IN THE FIELD OF NON-LEGAL INVOICE AND RELATED BILLING ONLINE DISPUTE RESOLUTION, IN CLASS 35 (U.S. CLS. 100, 101 AND 102).

FIRST USE 2-2-2003; IN COMMERCE 10-18-2003.

FOR: ELECTRONIC PAYMENT, NAMELY, ELECTRONIC PROCESSING AND TRANSMISSION OF

BILL PAYMENT DATA FOR THE FREIGHT INDUSTRY; PROCESSING AND TRANSMISSION OF CASH AND CREDIT CARD TRANSACTION DATA THROUGH ELECTRONIC MEANS; PROVISION AND MANAGEMENT OF CREDIT LOANS THROUGH ELECTRONIC MEANS, IN CLASS 36 (U.S. CLS. 100, 101 AND 102).

FIRST USE 2-2-2003; IN COMMERCE 10-18-2003.

THE MARK CONSISTS OF STANDARD CHARACTERS WITHOUT CLAIM TO ANY PARTICULAR FONT, STYLE, SIZE, OR COLOR.

OWNER OF U.S. REG. NO. 3,347,315.

SER. NO. 77-264,844, FILED 8-27-2007.

JEAN IM, EXAMINING ATTORNEY

Int. Cl.: 41

Prior U.S. Cls.: 100, 101 and 107

United States Patent and Trademark Office

Reg. No. 3,519,113

Registered Oct. 21, 2008

SERVICE MARK
PRINCIPAL REGISTER



MCINTOSH, SCOTT (UNITED STATES INDIVIDUAL)
11915 GOSHEN AVENUE, SUITE 2
LOS ANGELES, CA 90049

FOR: EDUCATIONAL SERVICES, NAMELY, CONDUCTING SEMINARS, WORKSHOPS AND TRAINING COURSES IN THE HEALTHCARE INDUSTRY IN THE FIELDS OF PATIENT CARE, CUSTOMER RELATIONS, HUMAN RESOURCES, AND DOCTOR-PATIENT RELATIONSHIPS, IN CLASS 41 (U.S. CLS. 100, 101 AND 107).

FIRST USE 6-3-2005; IN COMMERCE 6-3-2005.

THE COLOR(S) GOLD, BLACK AND GREEN IS/ARE CLAIMED AS A FEATURE OF THE MARK.

THE COLOR GOLD APPEARS IN THE LETTERING OF "HOSPITALITY RX" AND IN THE PINEAPPLE AND BORDER OF THE DESIGN. THE COLOR GREEN APPEARS ON THE BRANCHES OF THE PINEAPPLE. THE COLOR BLACK APPEARS AS THE OUTLINE TO THE BORDER OF THE DESIGN AND OUTLINE OF THE PINEAPPLE DESIGN. THE COLOR WHITE APPEARS BACKGROUND AND IS NOT PART OF THE MARK.

SER. NO. 77-265,089, FILED 8-27-2007.

LINDA ESTRADA, EXAMINING ATTORNEY

Int. Cl.: 7

Prior U.S. Cls.: 13, 19, 21, 23, 31, 34 and 35

United States Patent and Trademark Office

Reg. No. 3,519,114

Registered Oct. 21, 2008

**TRADEMARK
PRINCIPAL REGISTER**

Multi-Gluer

VERMEHREN ENGINEERING CORP. (FLORIDA
CORPORATION)
3865 N. PALAFOX ST.
PENSACOLA, FL 325055238

THE MARK CONSISTS OF STANDARD CHAR-
ACTERS WITHOUT CLAIM TO ANY PARTICULAR
FONT, STYLE, SIZE, OR COLOR.

FOR: ENVELOPE-INSERTING MACHINES, IN
CLASS 7 (U.S. CLS. 13, 19, 21, 23, 31, 34 AND 35).

SER. NO. 77-265,220, FILED 8-27-2007.

FIRST USE 7-18-2007; IN COMMERCE 7-18-2007.

AHSEN KHAN, EXAMINING ATTORNEY

Int. Cl.: 11

Prior U.S. Cls.: 13, 21, 23, 31 and 34

United States Patent and Trademark Office

Reg. No. 3,519,115

Registered Oct. 21, 2008

**TRADEMARK
PRINCIPAL REGISTER**

FANWALL TECHNOLOGY

HUNTAIR INC. (DELAWARE CORPORATION)
11555 S.W. MYSLONY STREET
TUALATIN, OR 97062

OWNER OF U.S. REG. NOS. 3,236,486 AND
3,321,029.

FOR: AIR HANDLING UNITS, IN CLASS 11 (U.S.
CLS. 13, 21, 23, 31 AND 34).

NO CLAIM IS MADE TO THE EXCLUSIVE
RIGHT TO USE "TECHNOLOGY", APART FROM
THE MARK AS SHOWN.

FIRST USE 9-29-2006; IN COMMERCE 9-29-2006.

SER. NO. 77-265,334, FILED 8-27-2007.

THE MARK CONSISTS OF STANDARD CHAR-
ACTERS WITHOUT CLAIM TO ANY PARTICULAR
FONT, STYLE, SIZE, OR COLOR.

JULIE GUTTADAURO, EXAMINING ATTORNEY

Int. Cls.: 30 and 32

Prior U.S. Cls.: 45, 46 and 48

United States Patent and Trademark Office

Reg. No. 3,519,116

Registered Oct. 21, 2008

**TRADEMARK
PRINCIPAL REGISTER**



ANTHRACYTE LLC (UTAH LIMITED LIABILITY COMPANY)
SUITE 214
1338 S. FOOTHILL BLVD.
SALT LAKE CITY, UT 84108

FOR: LIQUID DRINKS, NAMELY, HERBAL TEA AND HERB TEA, IN CLASS 30 (U.S. CL. 46).

FIRST USE 5-31-2007; IN COMMERCE 6-11-2007.

FOR: LIQUID DRINKS, NAMELY, ENERGY DRINKS AND SPORTS DRINKS, IN CLASS 32 (U.S. CLS. 45, 46 AND 48).

FIRST USE 5-31-2007; IN COMMERCE 6-11-2007.

THE MARK CONSISTS OF A STYLIZATION OF THE LETTER "E" WITH A DESIGN OF A LIGHTNING BOLT..

SER. NO. 77-265,543, FILED 8-27-2007.

ALEX KEAM, EXAMINING ATTORNEY

Int. Cl.: 3

Prior U.S. Cls.: 1, 4, 6, 50, 51 and 52

Reg. No. 3,519,117

United States Patent and Trademark Office

Registered Oct. 21, 2008

**TRADEMARK
PRINCIPAL REGISTER**

Sugar Britches

HARRY WAIKART (SOUTH CAROLINA LIMITED LIABILITY COMPANY), DBA CHARLESTON CHEMIST, LLC
118 OAK TURN ROAD
CHARLESTON, SC 29412 AND
ELIN CATE-WAIKART (SOUTH CAROLINA LIMITED LIABILITY COMPANY), DBA CHARLESTON CHEMIST, LLC
118 OAK TURN ROAD
CHARLESTON, SC 29412

FOR: BATH SOAPS; BATH SOAPS IN LIQUID, SOLID OR GEL FORM; HAND SOAPS; LIQUID BATH SOAPS; LIQUID SOAP; LIQUID SOAP USED IN FOOT BATH; LIQUID SOAPS; LIQUID SOAPS FOR HANDS AND FACE; LIQUID SOAPS FOR

HANDS, FACE AND BODY; PERFUMED SOAP; PERFUMED SOAPS; SKIN SOAP; SOAPS FOR BODY CARE; SOAPS FOR PERSONAL USE, IN CLASS 3 (U.S. CLS. 1, 4, 6, 50, 51 AND 52).

FIRST USE 11-1-2006; IN COMMERCE 1-1-2007.

THE MARK CONSISTS OF STANDARD CHARACTERS WITHOUT CLAIM TO ANY PARTICULAR FONT, STYLE, SIZE, OR COLOR.

SER. NO. 77-265,790, FILED 8-28-2007.

PAULA MAHONEY, EXAMINING ATTORNEY

Int. Cl.: 42

Prior U.S. Cls.: 100 and 101

United States Patent and Trademark Office

Reg. No. 3,519,118

Registered Oct. 21, 2008

**SERVICE MARK
PRINCIPAL REGISTER**

CMSA

CANADIAN MILL SERVICES ASSOCIATION
(CANADA NON-PROFIT ASSOCIATION)
200-601-6TH STREET
NEW WESTMINSTER, CANADA V3L3C1

THE MARK CONSISTS OF STANDARD CHAR-
ACTERS WITHOUT CLAIM TO ANY PARTICULAR
FONT, STYLE, SIZE, OR COLOR.

FOR: GRADING OF LUMBER, IN CLASS 42 (U.S.
CLS. 100 AND 101).

SER. NO. 77-266,113, FILED 8-28-2007.

FIRST USE 5-16-2004; IN COMMERCE 5-16-2004.

CHERYL CLAYTON, EXAMINING ATTORNEY

Int. Cl.: 36

Prior U.S. Cls.: 100, 101 and 102

United States Patent and Trademark Office

Reg. No. 3,519,119

Registered Oct. 21, 2008

**SERVICE MARK
PRINCIPAL REGISTER**

INTER NATIONAL BANK

INTER NATIONAL BANK (TEXAS CHARTERED BANK)
1801 SOUTH 2ND STREET
MCALLEN, TX 78505

FOR: BANKING SERVICES; FINANCIAL MANAGEMENT AND CONSULTATION SERVICES; CASH MANAGEMENT SERVICES; TRUST SERVICES, NAMELY, INVESTMENT AND TRUST COMPANY SERVICES; FINANCIAL ASSET MANAGEMENT SERVICES; INVESTMENT MANAGEMENT AND CONSULTATION SERVICES; SECURITIES MANAGEMENT, NAMELY, MANAGEMENT OF PORTFOLIOS COMPRISING SECURITIES AND CONSULTATION SERVICES IN THE FIELD OF MANAGING PORTFOLIOS OF SECURITIES; INSURANCE AGENCY FOR ALL TYPES OF INSURANCE; MONEY LENDING SERVICES; COMMERCIAL LENDING SERVICES; MORTGAGE LENDING SERVICES; PERSONAL LENDING SERVICES, NAMELY, CONSUMER LENDING SERVICES; COMMERCIAL REAL ESTATE LENDING SERVICES; AND CAPITAL FUND-

ING INVESTMENT ASSISTANCE IN THE NATURE OF VENTURE CAPITAL FUNDING SERVICES TO EMERGING AND START-UP COMPANIES AND CONSULTATION SERVICES REGARDING VENTURE CAPITAL FUNDING, IN CLASS 36 (U.S. CLS. 100, 101 AND 102).

FIRST USE 3-20-1990; IN COMMERCE 3-20-1990.

THE MARK CONSISTS OF STANDARD CHARACTERS WITHOUT CLAIM TO ANY PARTICULAR FONT, STYLE, SIZE, OR COLOR.

NO CLAIM IS MADE TO THE EXCLUSIVE RIGHT TO USE "BANK", APART FROM THE MARK AS SHOWN.

SEC. 2(F).

SER. NO. 77-266,222, FILED 8-28-2007.

ALICE BENMAMAN, EXAMINING ATTORNEY

Int. Cl.: 36

Prior U.S. Cls.: 100, 101 and 102

United States Patent and Trademark Office

Reg. No. 3,519,120

Registered Oct. 21, 2008

**SERVICE MARK
PRINCIPAL REGISTER**



INTER NATIONAL BANK (TEXAS CHARTERED BANK)
1801 SOUTH 2ND STREET
MCALLEN, TX 78505

FOR: BANKING SERVICES; FINANCIAL MANAGEMENT AND CONSULTATION SERVICES; CASH MANAGEMENT SERVICES; TRUST SERVICES, NAMELY, INVESTMENT AND TRUST COMPANY SERVICES; FINANCIAL ASSET MANAGEMENT SERVICES; INVESTMENT MANAGEMENT AND CONSULTATION SERVICES; SECURITIES MANAGEMENT, NAMELY, MANAGEMENT OF PORTFOLIOS COMPRISING SECURITIES AND CONSULTATION SERVICES IN THE FIELD OF MANAGING PORTFOLIOS OF SECURITIES; INSURANCE AGENCY FOR ALL TYPES OF INSURANCE; MONEY LENDING SERVICES; COMMERCIAL LENDING SERVICES; MORTGAGE LENDING SERVICES; PERSONAL LENDING SERVICES, NAMELY, CONSUMER LENDING SERVICES; COMMERCIAL REAL ESTATE LENDING SERVICES; AND CAPITAL FUND-

ING INVESTMENT ASSISTANCE IN THE NATURE OF VENTURE CAPITAL FUNDING SERVICES TO EMERGING AND START-UP COMPANIES AND CONSULTATION SERVICES REGARDING VENTURE CAPITAL FUNDING, IN CLASS 36 (U.S. CLS. 100, 101 AND 102).

FIRST USE 8-25-2000; IN COMMERCE 8-25-2000.

NO CLAIM IS MADE TO THE EXCLUSIVE RIGHT TO USE "BANK", APART FROM THE MARK AS SHOWN.

THE MARK CONSISTS OF A LINE ABOVE EACH WORD OF THE MARK WITH AN ANGLED POINTER TO THE LEFT OF THE WORDS.

SEC. 2(F).

SER. NO. 77-266,260, FILED 8-28-2007.

ALICE BENMAMAN, EXAMINING ATTORNEY

Int. Cls.: 12 and 40

Prior U.S. Cls.: 19, 21, 23, 31, 35, 44, 100, 103 and 106

Reg. No. 3,519,121

United States Patent and Trademark Office

Registered Oct. 21, 2008

**TRADEMARK
SERVICE MARK
PRINCIPAL REGISTER**

CARY

CARY MARINE, INC. (FLORIDA CORPORATION)
SUITE 300
1250 E. HALLANDALE BEACH BLVD.
HALLANDALE BEACH, FL 33009

FOR: BOATS AND YACHTS, IN CLASS 12 (U.S. CLS. 19, 21, 23, 31, 35 AND 44).

FIRST USE 8-9-1993; IN COMMERCE 8-9-1993.

FOR: CUSTOM MANUFACTURE OF BOATS AND YACHTS, IN CLASS 40 (U.S. CLS. 100, 103 AND 106).

FIRST USE 8-9-1993; IN COMMERCE 8-9-1993.

THE MARK CONSISTS OF STANDARD CHARACTERS WITHOUT CLAIM TO ANY PARTICULAR FONT, STYLE, SIZE, OR COLOR.

OWNER OF U.S. REG. NO. 2,858,517.

SER. NO. 77-266,393, FILED 8-28-2007.

SETH A. RAPPAPORT, EXAMINING ATTORNEY

Int. Cl.: 35

Prior U.S. Cls.: 100, 101 and 102

United States Patent and Trademark Office

Reg. No. 3,519,122

Registered Oct. 21, 2008

**SERVICE MARK
PRINCIPAL REGISTER**

EXPERT

CBS PERSONNEL HOLDINGS, INC. (OHIO CORPORATION)
SUITE 300
435 ELM STREET
CINCINNATI, OH 452022644

FOR: PROVIDING RECRUITING AND CAREER PLACEMENT SERVICES TO BUSINESSES TO RECRUIT AND PLACE RETIRED OR RETIRING WORKERS BACK INTO THE WORK FORCE , IN CLASS 35 (U.S. CLS. 100, 101 AND 102).

FIRST USE 10-0-2006; IN COMMERCE 10-0-2006.

THE MARK CONSISTS OF STANDARD CHARACTERS WITHOUT CLAIM TO ANY PARTICULAR FONT, STYLE, SIZE, OR COLOR.

SER. NO. 77-267,021, FILED 8-29-2007.

MELISSA VALLILLO, EXAMINING ATTORNEY

Int. Cls.: 9, 41 and 42

Prior U.S. Cls.: 21, 23, 26, 36, 38, 100, 101 and 107

Reg. No. 3,519,123

United States Patent and Trademark Office

Registered Oct. 21, 2008

**TRADEMARK
SERVICE MARK
PRINCIPAL REGISTER**

LEARN PLAY EXPLORE SAFELY

BARTON, BENNY (UNITED STATES INDIVIDUAL)
SUITE 600
2805 NORTH DALLAS TOLLWAY
PLANO, TX 75093

FOR: CHILDREN'S EDUCATIONAL SOFTWARE; CHILDREN'S ENTERTAINMENT SOFTWARE, NAMELY, INTERACTIVE VIDEO GAME PROGRAMS, COMPUTER GAME SOFTWARE, AND INTERACTIVE SOFTWARE FEATURING ANIMATED CHARACTERS, CHILDREN'S STORIES AND EDUCATIONAL GAMES AND QUIZZES; COMPUTER HARDWARE AND COMPUTER SOFTWARE PROGRAMS FOR THE INTEGRATION OF TEXT, AUDIO, GRAPHICS, STILL IMAGES AND MOVING PICTURES INTO AN INTERACTIVE DELIVERY FOR MULTIMEDIA APPLICATIONS; COMPUTER SOFTWARE FOR THE COLLECTION, EDITING, ORGANIZING, MODIFYING, BOOK MARKING, TRANSMISSION, STORAGE AND SHARING OF DATA AND INFORMATION; EDUCATIONAL SOFTWARE FEATURING INSTRUCTION IN READING, SCIENCE, MATHEMATICS, SOCIAL STUDIES, AND LANGUAGE ARTS; DOWNLOADABLE CHILDREN'S EDUCATIONAL SOFTWARE; DOWNLOADABLE CHILDREN'S ENTERTAINMENT SOFTWARE, NAMELY, ENTERTAINMENT SOFTWARE FOR USE WITH COMPUTERS, FEATURING ANIMATED CHARACTERS, CHILDREN'S STORIES AND EDUCATIONAL GAMES AND QUIZZES, INTERACTIVE VIDEO GAME PROGRAMS, AND COMPUTER GAME SOFTWARE, IN CLASS 9 (U.S. CLS. 21, 23, 26, 36 AND 38).

FIRST USE 8-1-2007; IN COMMERCE 8-1-2007.

FOR: ENTERTAINMENT SERVICES, NAMELY, PROVIDING ON-LINE COMPUTER GAMES; PROVIDING A WEB SITE WHERE USERS CAN POST RATINGS, REVIEWS AND RECOMMENDATIONS

ON EVENTS AND ACTIVITIES IN THE FIELD OF CHILDREN'S ENTERTAINMENT AND EDUCATION; EDUCATION AND ENTERTAINMENT SERVICES, NAMELY, PROVIDING A WEBSITE FEATURING INFORMATION IN THE FIELD OF CHILDREN'S EDUCATION AND ENTERTAINMENT FEATURING AUDIO CLIPS, VIDEO CLIPS, MUSICAL VIDEOS, FILM CLIPS, PHOTOGRAPHS, AND OTHER MULTIMEDIA MATERIALS; BLOGS FEATURING INFORMATION IN THE FIELD OF CHILDREN'S EDUCATION AND ENTERTAINMENT AND WHICH MAY INCLUDE AUDIO CLIPS, VIDEO CLIPS, MUSICAL VIDEOS, FILM CLIPS, PHOTOGRAPHS, AND OTHER MULTIMEDIA MATERIALS, IN CLASS 41 (U.S. CLS. 100, 101 AND 107).

FIRST USE 8-1-2007; IN COMMERCE 8-1-2007.

FOR: COMPUTER SECURITY SERVICE, NAMELY, RESTRICTING ACCESS TO AND BY COMPUTER NETWORKS TO AND OF UNDESIRED WEBSITES, MEDIA AND INDIVIDUALS AND FACILITIES; CREATION AND PROVISION OF WEB PAGES TO AND FOR THIRD PARTIES; COMPUTER SERVICES, NAMELY, HOSTING ONLINE WEB FACILITIES FOR OTHERS FOR ORGANIZING AND CONDUCTING ONLINE MEETINGS AND INTERACTIVE DISCUSSIONS, SHARING PHOTOGRAPHS AND STORIES; COMPUTER SERVICES IN THE NATURE OF CUSTOMIZED WEB PAGES FEATURING USER-DEFINED INFORMATION, PERSONAL PROFILES AND INFORMATION; PROVIDING ONLINE NON-DOWNLOADABLE CHILDREN'S EDUCATIONAL SOFTWARE; PROVIDING ONLINE NON-DOWNLOADABLE CHILDREN'S ENTERTAINMENT SOFTWARE, NAMELY, INTERACTIVE VIDEO GAME PROGRAMS, COMPUTER GAME SOFTWARE AND ENTERTAINMENT SOFTWARE FOR USE WITH COMPUTERS, FEATURING ANIMATED CHARACTERS, CHILDREN'S STORIES

AND EDUCATIONAL GAMES AND QUIZZES, IN
CLASS 42 (U.S. CLS. 100 AND 101).

FIRST USE 8-1-2007; IN COMMERCE 8-1-2007.

THE MARK CONSISTS OF STANDARD CHAR-
ACTERS WITHOUT CLAIM TO ANY PARTICULAR
FONT, STYLE, SIZE, OR COLOR.

NO CLAIM IS MADE TO THE EXCLUSIVE
RIGHT TO USE "LEARN PLAY", APART FROM
THE MARK AS SHOWN.

SER. NO. 77-267,394, FILED 8-29-2007.

AHSEN KHAN, EXAMINING ATTORNEY

Int. Cl.: 19

Prior U.S. Cls.: 1, 12, 33 and 50

United States Patent and Trademark Office

Reg. No. 3,519,124

Registered Oct. 21, 2008

**TRADEMARK
PRINCIPAL REGISTER**

JUST BUILT BETTER

EASTERN WHOLESALE FENCE CO., INC. (NEW
YORK CORPORATION)
274 MIDDLE ISLAND ROAD
MEDFORD, NY 11763

THE MARK CONSISTS OF STANDARD CHAR-
ACTERS WITHOUT CLAIM TO ANY PARTICULAR
FONT, STYLE, SIZE, OR COLOR.

FOR: NON-METAL FENCING PANELS, POSTS,
GATES, IN CLASS 19 (U.S. CLS. 1, 12, 33 AND 50).

SER. NO. 77-267,459, FILED 8-29-2007.

FIRST USE 0-0-2003; IN COMMERCE 0-0-2003.

DANIEL CAPSHAW, EXAMINING ATTORNEY

Int. Cl.: 41

Prior U.S. Cls.: 100, 101 and 107

United States Patent and Trademark Office

Reg. No. 3,519,125

Registered Oct. 21, 2008

**SERVICE MARK
PRINCIPAL REGISTER**

GRAND SPLASH

GRAND HOSPITALITY, LLC (MINNESOTA LIMITED LIABILITY COMPANY)
973 NE 4TH STREET
GRAND RAPIDS, MN 55744

THE MARK CONSISTS OF STANDARD CHARACTERS WITHOUT CLAIM TO ANY PARTICULAR FONT, STYLE, SIZE, OR COLOR.

FOR: ENTERTAINMENT SERVICE IN THE NATURE OF AN AMUSEMENT PARK, NAMELY, A WATER PARK PROVIDED AT A HOTEL, IN CLASS 41 (U.S. CLS. 100, 101 AND 107).

SER. NO. 77-268,000, FILED 8-30-2007.

FIRST USE 8-1-2007; IN COMMERCE 8-1-2007.

DAVID TOOLEY, EXAMINING ATTORNEY

Int. Cls.: 4 and 11

Prior U.S. Cls.: 1, 6, 13, 15, 21, 23, 31 and 34

United States Patent and Trademark Office

Reg. No. 3,519,126

Registered Oct. 21, 2008

**TRADEMARK
PRINCIPAL REGISTER**

NATURAL FLAME

WEINBERGER, MICHAEL (UNITED STATES IN-
DIVIDUAL)
236 WEST 26TH STREET
NEW YORK, NY 10001

FOR: FUEL CARTRIDGES ENCLOSING ALCO-
HOL GEL FOR USE IN FIREPLACES, IN CLASS 4
(U.S. CLS. 1, 6 AND 15).

FIRST USE 5-0-2006; IN COMMERCE 5-0-2006.

FOR: FIREPLACE INSERTS IN THE NATURE OF
METAL CONVERSION STANDS TO HOLD FUEL
CARTRIDGES, IN CLASS 11 (U.S. CLS. 13, 21, 23, 31
AND 34).

FIRST USE 5-0-2006; IN COMMERCE 5-0-2006.

THE MARK CONSISTS OF STANDARD CHAR-
ACTERS WITHOUT CLAIM TO ANY PARTICULAR
FONT, STYLE, SIZE, OR COLOR.

NO CLAIM IS MADE TO THE EXCLUSIVE
RIGHT TO USE "FLAME", APART FROM THE
MARK AS SHOWN.

SER. NO. 77-268,205, FILED 8-30-2007.

CAROLYN CATALDO, EXAMINING ATTORNEY

Int. Cls.: 29 and 30

Prior U.S. Cl.: 46

United States Patent and Trademark Office

Reg. No. 3,519,127

Registered Oct. 21, 2008

**TRADEMARK
PRINCIPAL REGISTER**

JENNY'S CUISINE

SOCIETE DES PRODUITS NESTLE, S.A. (SWITZERLAND CORPORATION)
CASE POSTALE 353
1800 VEVEY, SWITZERLAND

FOR: PREPARED REDUCED CALORIE FOODS, NAMELY, PREPARED AND FROZEN ENTREES CONSISTING PRIMARILY OF POULTRY, FISH, SEAFOOD, MEATS OR VEGETABLES, TUNA SALAD, CHICKEN SALAD, SOUPS, YOGURT, PRESERVED OR STEWED FRUITS, AND CHOCOLATE FLAVORED DAIRY-BASED BEVERAGES, IN CLASS 29 (U.S. CL. 46).

FIRST USE 1-0-1988; IN COMMERCE 1-0-1988.

FOR: PREPARED REDUCED CALORIE FOODS, NAMELY, PROCESSED CEREALS, MUFFINS, PANCAKE MIX, NOODLES AND PASTA, PIZZAS, POP-

CORN, WAFFLES, FRENCH TOAST, AND RICE-BASED SNACK BARS; SALAD DRESSINGS, IN CLASS 30 (U.S. CL. 46).

FIRST USE 1-0-1988; IN COMMERCE 1-0-1988.

THE MARK CONSISTS OF STANDARD CHARACTERS WITHOUT CLAIM TO ANY PARTICULAR FONT, STYLE, SIZE, OR COLOR.

NO CLAIM IS MADE TO THE EXCLUSIVE RIGHT TO USE CUISINE, APART FROM THE MARK AS SHOWN.

SER. NO. 77-268,272, FILED 8-30-2007.

ZACHARY BELLO, EXAMINING ATTORNEY

Int. Cl.: 30

Prior U.S. Cl.: 46

United States Patent and Trademark Office

Reg. No. 3,519,128

Registered Oct. 21, 2008

**TRADEMARK
PRINCIPAL REGISTER**

JUNGLE RUMBLE LAVA FLOW

THE ALLAN CANDY COMPANY LIMITED (CANADA CORPORATION)
3 ROBERT SPECK PARKWAY, SUITE 250
MISSISSAUGA, ONTARIO L4Z2G5

OWNER OF CANADA REG. NO. TMA706473,
DATED 2-4-2008, EXPIRES 2-4-2023.

FOR: CONFECTIONERY, NAMELY, CANDY, IN
CLASS 30 (U.S. CL. 46).

SER. NO. 77-268,305, FILED 8-30-2007.

THE MARK CONSISTS OF STANDARD CHARACTERS WITHOUT CLAIM TO ANY PARTICULAR FONT, STYLE, SIZE, OR COLOR.

SANJEEV VOHRA, EXAMINING ATTORNEY

Int. Cl.: 30

Prior U.S. Cl.: 46

United States Patent and Trademark Office

Reg. No. 3,519,129

Registered Oct. 21, 2008

**TRADEMARK
PRINCIPAL REGISTER**

ALLAN PEACH SLICES

THE ALLAN CANDY COMPANY LIMITED (CANADA CORPORATION)
3 ROBERT SPECK PARKWAY, SUITE 250
MISSISSAUGA, ONTARIO L4Z2G5

FOR: CONFECTIONERY, NAMELY, CANDY, IN CLASS 30 (U.S. CL. 46).

THE MARK CONSISTS OF STANDARD CHARACTERS WITHOUT CLAIM TO ANY PARTICULAR FONT, STYLE, SIZE, OR COLOR.

OWNER OF CANADA REG. NO. TMA673299, DATED 9-25-2006, EXPIRES 9-25-2021.

OWNER OF U.S. REG. NOS. 1,708,471 AND 1,718,452.

NO CLAIM IS MADE TO THE EXCLUSIVE RIGHT TO USE "PEACH SLICES", APART FROM THE MARK AS SHOWN.

SER. NO. 77-268,316, FILED 8-30-2007.

G. MAYERSCHOFF, EXAMINING ATTORNEY

Int. Cl.: 9

Prior U.S. Cls.: 21, 23, 26, 36 and 38

United States Patent and Trademark Office

Reg. No. 3,519,130

Registered Oct. 21, 2008

**TRADEMARK
PRINCIPAL REGISTER**

T Y P E H A U S

TYPEHAUS, INC. (CALIFORNIA CORPORATION)
669 SECOND STREET
ENCINITAS, CA 92024

FOR: HARDWARE AND SOFTWARE FOR LASER AND MULTI-FUNCTION PRINTING DEVICES, NAMELY, COMPUTER HARDWARE AND SOFTWARE FOR THE CREATION AND PRINTING OF FORMS, SECURE CHECK WRITING AND BAR-

CODE PRINTING, IN CLASS 9 (U.S. CLS. 21, 23, 26, 36 AND 38).

FIRST USE 2-5-1992; IN COMMERCE 2-5-1992.

SER. NO. 77-268,492, FILED 8-30-2007.

REGINA DRUMMOND, EXAMINING ATTORNEY

Int. Cls.: 9, 41 and 42

Prior U.S. Cls.: 21, 23, 26, 36, 38, 100, 101 and 107

Reg. No. 3,519,131

United States Patent and Trademark Office

Registered Oct. 21, 2008

**TRADEMARK
SERVICE MARK
PRINCIPAL REGISTER**



BARTON, BENNY (UNITED STATES INDIVIDUAL)
SUITE 600
2805 NORTH DALLAS TOLLWAY
PLANO, TX 75093

FOR: CHILDREN'S EDUCATIONAL SOFTWARE; CHILDREN'S ENTERTAINMENT SOFTWARE, NAMELY, INTERACTIVE VIDEO GAME PROGRAMS, COMPUTER GAME SOFTWARE, AND INTERACTIVE SOFTWARE FEATURING ANIMATED CHARACTERS, CHILDREN'S STORIES AND EDUCATIONAL GAMES AND QUIZZES; COMPUTER HARDWARE AND COMPUTER SOFTWARE PROGRAMS FOR THE INTEGRATION OF TEXT, AUDIO, GRAPHICS, STILL IMAGES AND MOVING PICTURES INTO AN INTERACTIVE DELIVERY FOR MULTIMEDIA APPLICATIONS; COMPUTER SOFTWARE FOR THE COLLECTION, EDITING, ORGANIZING, MODIFYING, BOOK MARKING, TRANSMISSION, STORAGE AND SHARING OF DATA AND INFORMATION; EDUCATIONAL SOFTWARE FEATURING INSTRUCTION IN READING, SCIENCE, MATHEMATICS, SOCIAL STUDIES, AND LANGUAGE ARTS; DOWNLOADABLE CHILDREN'S EDUCATIONAL SOFTWARE; DOWNLOADABLE CHILDREN'S ENTERTAINMENT SOFTWARE, NAMELY, ENTERTAINMENT SOFTWARE FOR USE WITH COMPUTERS, FEATURING ANIMATED CHARACTERS, CHILDREN'S STORIES AND EDUCATIONAL GAMES AND QUIZZES, INTERACTIVE VIDEO GAME PROGRAMS, AND COMPUTER GAME SOFTWARE, IN CLASS 9 (U.S. CLS. 21, 23, 26, 36 AND 38).

FIRST USE 8-1-2007; IN COMMERCE 8-1-2007.

FOR: ENTERTAINMENT SERVICES, NAMELY, PROVIDING ON-LINE COMPUTER GAMES; PROVIDING A WEB SITE WHERE USERS CAN POST RATINGS, REVIEWS AND RECOMMENDATIONS

ON EVENTS AND ACTIVITIES IN THE FIELD OF CHILDREN'S ENTERTAINMENT AND EDUCATION; EDUCATION AND ENTERTAINMENT SERVICES, NAMELY, PROVIDING A WEBSITE FEATURING INFORMATION IN THE FIELD OF CHILDREN'S EDUCATION AND ENTERTAINMENT FEATURING AUDIO CLIPS, VIDEO CLIPS, MUSICAL VIDEOS, FILM CLIPS, PHOTOGRAPHS, AND OTHER MULTIMEDIA MATERIALS; BLOGS FEATURING INFORMATION IN THE FIELD OF CHILDREN'S EDUCATION AND ENTERTAINMENT AND WHICH MAY INCLUDE AUDIO CLIPS, VIDEO CLIPS, MUSICAL VIDEOS, FILM CLIPS, PHOTOGRAPHS, AND OTHER MULTIMEDIA MATERIALS, IN CLASS 41 (U.S. CLS. 100, 101 AND 107).

FIRST USE 8-1-2007; IN COMMERCE 8-1-2007.

FOR: COMPUTER SECURITY SERVICE, NAMELY, RESTRICTING ACCESS TO AND BY COMPUTER NETWORKS TO AND OF UNDESIRED WEBSITES, MEDIA AND INDIVIDUALS AND FACILITIES; CREATION AND PROVISION OF WEB PAGES TO AND FOR THIRD PARTIES; COMPUTER SERVICES, NAMELY, HOSTING ONLINE WEB FACILITIES FOR OTHERS FOR ORGANIZING AND CONDUCTING ONLINE MEETINGS AND INTERACTIVE DISCUSSIONS, SHARING PHOTOGRAPHS AND STORIES; COMPUTER SERVICES IN THE NATURE OF CUSTOMIZED WEB PAGES FEATURING USER-DEFINED INFORMATION, PERSONAL PROFILES AND INFORMATION; PROVIDING ONLINE NON-DOWNLOADABLE CHILDREN'S EDUCATIONAL SOFTWARE; PROVIDING ONLINE NON-DOWNLOADABLE CHILDREN'S ENTERTAINMENT SOFTWARE, NAMELY, INTERACTIVE VIDEO GAME PROGRAMS, COMPUTER GAME SOFTWARE AND ENTERTAINMENT SOFTWARE FOR USE WITH COMPUTERS, FEATURING ANIMATED CHARACTERS, CHILDREN'S STORIES

AND EDUCATIONAL GAMES AND QUIZZES, IN CLASS 42 (U.S. CLS. 100 AND 101).

FIRST USE 8-1-2007; IN COMMERCE 8-1-2007.

NO CLAIM IS MADE TO THE EXCLUSIVE RIGHT TO USE "LEARN PLAY", APART FROM THE MARK AS SHOWN.

THE MARK CONSISTS OF THE STYLIZED WORDS "NOODLENET" AND "LEARN PLAY EX-

PLORE SAFELY" WITH A CHILD-LIKE BALLOON CHARACTER STANDING BEHIND THE FIRST LETTER "N", ANOTHER CHILD-LIKE BALLOON CHARACTER WITH ITS ARMS RAISED BEHIND THE LETTERS "OO", AND, ANOTHER CHILD-LIKE BALLOON CHARACTER SITTING ON THE SECOND "N".

SER. NO. 77-268,605, FILED 8-30-2007.

AHSEN KHAN, EXAMINING ATTORNEY

Int. Cl.: 44

Prior U.S. Cls.: 100 and 101

United States Patent and Trademark Office

Reg. No. 3,519,132

Registered Oct. 21, 2008

**SERVICE MARK
PRINCIPAL REGISTER**

THE VILLAGE

WESTCARE FOUNDATION, INC. (NEVADA
NON-PROFIT CORPORATION)
900 GRIER DRIVE
LAS VEGAS, NV 89193

FOR: RESIDENTIAL AND OUT-PATIENT REHA-
BILITATION OF DRUG ADDICTED PATIENTS
AND SUBSTANCE ABUSE PATIENTS; MENTAL
HEALTH SERVICES, IN CLASS 44 (U.S. CLS. 100
AND 101).

FIRST USE 0-0-1973; IN COMMERCE 0-0-1973.

THE MARK CONSISTS OF STANDARD CHAR-
ACTERS WITHOUT CLAIM TO ANY PARTICULAR
FONT, STYLE, SIZE, OR COLOR.

SER. NO. 77-268,632, FILED 8-30-2007.

WANDA KAY PRICE, EXAMINING ATTORNEY

Int. Cl.: 45

Prior U.S. Cls.: 100 and 101

United States Patent and Trademark Office

Reg. No. 3,519,133

Registered Oct. 21, 2008

**SERVICE MARK
PRINCIPAL REGISTER**

nobosh

NOBOSH LLC (ARIZONA LIMITED LIABILITY
COMPANY)
SUITE 850
6900 E. CAMELBACK ROAD
SCOTTSDALE, AZ 85251

FOR: ONLINE SOCIAL NETWORKING SERVI-
CES, IN CLASS 45 (U.S. CLS. 100 AND 101).

FIRST USE 5-17-2007; IN COMMERCE 5-17-2007.

THE MARK CONSISTS OF STANDARD CHAR-
ACTERS WITHOUT CLAIM TO ANY PARTICULAR
FONT, STYLE, SIZE, OR COLOR.

THE WORDING "NOBOSH" HAS NO MEANING
IN ENGLISH

SER. NO. 77-268,950, FILED 8-30-2007.

MARY ROSSMAN, EXAMINING ATTORNEY

Int. Cl.: 42

Prior U.S. Cls.: 100 and 101

United States Patent and Trademark Office

Reg. No. 3,519,134

Registered Oct. 21, 2008

**SERVICE MARK
PRINCIPAL REGISTER**

Meet the Boneheads

ROEPER, DANIEL L. (UNITED STATES INDIVIDUAL)
9 FAIRMOUNT BLVD.
GARDEN CITY, NY 115305113

FOR: PROVIDING A WEBSITE FEATURING INFORMATION ON ENVIRONMENTAL ISSUES CONCERNING GLOBAL WARMING AND ITS EFFECT ON NATURE AND THE ENVIRONMENT, IN CLASS 42 (U.S. CLS. 100 AND 101).

FIRST USE 1-16-2006; IN COMMERCE 3-3-2006.

THE MARK CONSISTS OF STANDARD CHARACTERS WITHOUT CLAIM TO ANY PARTICULAR FONT, STYLE, SIZE, OR COLOR.

SER. NO. 77-268,996, FILED 8-31-2007.

ATTIYA MALIK, EXAMINING ATTORNEY

Int. Cl.: 42

Prior U.S. Cls.: 100 and 101

United States Patent and Trademark Office

Reg. No. 3,519,135

Registered Oct. 21, 2008

**SERVICE MARK
PRINCIPAL REGISTER**

HOPE
Help Our Planet Earth

DANIEL L. ROEPER (UNITED STATES INDIVIDUAL)
9 FAIRMOUNT BLVD.
GARDEN CITY, NY 115305113

FOR: PROVIDING A WEBSITE FEATURING INFORMATION ON ENVIRONMENTAL ISSUES CONCERNING GLOBAL WARMING AND ITS EFFECT ON NATURE AND THE ENVIRONMENT, IN CLASS 42 (U.S. CLS. 100 AND 101).

FIRST USE 1-16-2006; IN COMMERCE 3-3-2006.

THE MARK CONSISTS OF STANDARD CHARACTERS WITHOUT CLAIM TO ANY PARTICULAR FONT, STYLE, SIZE, OR COLOR.

SER. NO. 77-269,005, FILED 8-31-2007.

ATTIYA MALIK, EXAMINING ATTORNEY

Int. Cl.: 42

Prior U.S. Cls.: 100 and 101

United States Patent and Trademark Office

Reg. No. 3,519,136

Registered Oct. 21, 2008

**SERVICE MARK
PRINCIPAL REGISTER**

DATAART

DATAART ENTERPRISES, INC. (NEW YORK
CORPORATION)
475 PARK AVENUE SOUTH
NEW YORK, NY 10016

THE MARK CONSISTS OF STANDARD CHAR-
ACTERS WITHOUT CLAIM TO ANY PARTICULAR
FONT, STYLE, SIZE, OR COLOR.

FOR: DESIGN, DEVELOPMENT AND IMPLI-
MENTATION OF SOFTWARE, IN CLASS 42 (U.S.
CLS. 100 AND 101).

SER. NO. 77-269,207, FILED 8-31-2007.

FIRST USE 10-31-1997; IN COMMERCE 10-31-1997.

JESSICA A. POWERS, EXAMINING ATTORNEY

Int. Cl.: 42

Prior U.S. Cls.: 100 and 101

United States Patent and Trademark Office

Reg. No. 3,519,137

Registered Oct. 21, 2008

**SERVICE MARK
PRINCIPAL REGISTER**

DATAART

DATAART ENTERPRISES, INC. (NEW YORK CORPORATION)
475 PARK AVENUE SOUTH
NEW YORK, NY 10016

THE MARK CONSISTS OF THE WORD "DATA" IN STYLIZED LETTERING FOLLOWED BY THE WORD "ART" IN STYLIZED LETTERING. "ART" IS ENCLOSED IN A SOLID RECTANGLE.

FOR: DESIGN, DEVELOPMENT AND IMPLEMENTATION OF SOFTWARE, IN CLASS 42 (U.S. CLS. 100 AND 101).

SER. NO. 77-269,260, FILED 8-31-2007.

FIRST USE 10-31-1997; IN COMMERCE 10-31-1997.

JESSICA A. POWERS, EXAMINING ATTORNEY

Int. Cl.: 35

Prior U.S. Cls.: 100, 101 and 102

United States Patent and Trademark Office

Reg. No. 3,519,138

Registered Oct. 21, 2008

**SERVICE MARK
PRINCIPAL REGISTER**

FUTURE CARE

FUTURE CARE, INC. (NEW JERSEY CORPORATION)
200 EAST 74TH STREET
NEW YORK, NY 10021

FOR: MEDICAL COST CONTAINMENT SERVICES TO AVOID FRAUD AND ERRONEOUS BILLING IN MEDICAL TREATMENT SITUATIONS, IN CLASS 35 (U.S. CLS. 100, 101 AND 102).

FIRST USE 0-0-1986; IN COMMERCE 0-0-1986.

THE MARK CONSISTS OF STANDARD CHARACTERS WITHOUT CLAIM TO ANY PARTICULAR FONT, STYLE, SIZE, OR COLOR.

NO CLAIM IS MADE TO THE EXCLUSIVE RIGHT TO USE "CARE", APART FROM THE MARK AS SHOWN.

SER. NO. 77-269,400, FILED 8-31-2007.

MARY ROSSMAN, EXAMINING ATTORNEY

Int. Cl.: 33

Prior U.S. Cls.: 47 and 49

United States Patent and Trademark Office

Reg. No. 3,519,139

Registered Oct. 21, 2008

**TRADEMARK
PRINCIPAL REGISTER**

ADELAIDA

ADELAIDA CELLARS, INC. (CALIFORNIA CORPORATION)
5805 ADELAIDA ROAD
PASO ROBLES, CA 93446

THE MARK CONSISTS OF STANDARD CHARACTERS WITHOUT CLAIM TO ANY PARTICULAR FONT, STYLE, SIZE, OR COLOR.

FOR: WINE, IN CLASS 33 (U.S. CLS. 47 AND 49).

SER. NO. 77-269,716, FILED 8-31-2007.

FIRST USE 9-10-1984; IN COMMERCE 9-10-1984.

SHARON MEIER, EXAMINING ATTORNEY

Int. Cl.: 9

Prior U.S. Cls.: 21, 23, 26, 36 and 38

Reg. No. 3,519,140

United States Patent and Trademark Office

Registered Oct. 21, 2008

**TRADEMARK
PRINCIPAL REGISTER**

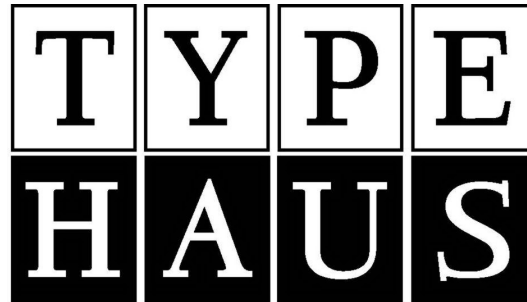

TYPEHAUS, INC. (CALIFORNIA CORPORATION)
669 SECOND STREET
ENCINITAS, CA 92024

CODE PRINTING, IN CLASS 9 (U.S. CLS. 21, 23, 26, 36 AND 38).

FIRST USE 8-23-2007; IN COMMERCE 8-23-2007.

FOR: HARDWARE AND SOFTWARE FOR LASER AND MULTI-FUNCTION PRINTING DEVICES, NAMELY, COMPUTER HARDWARE AND SOFTWARE FOR THE CREATION AND PRINTING OF FORMS, SECURE CHECK WRITING AND BAR-

SER. NO. 77-270,493, FILED 9-3-2007.

REGINA DRUMMOND, EXAMINING ATTORNEY

Int. Cls.: 37 and 40

Prior U.S. Cls.: 100, 103 and 106

United States Patent and Trademark Office

Reg. No. 3,519,141

Registered Oct. 21, 2008

**SERVICE MARK
PRINCIPAL REGISTER**

REFRIGERATOR ROUNDUP

APPLIANCE RECYCLING CENTERS OF AMERICA, INC. (MINNESOTA CORPORATION)
7400 EXCELSIOR BOULEVARD
MINNEAPOLIS, MN 55426

FOR: COLLECTION OF USED APPLIANCES FOR RECYCLING, IN CLASS 37 (U.S. CLS. 100, 103 AND 106).

FIRST USE 9-2-2007; IN COMMERCE 9-2-2007.

FOR: RECYCLING SERVICES IN THE FIELD OF USED APPLIANCES, IN CLASS 40 (U.S. CLS. 100, 103 AND 106).

FIRST USE 9-5-2007; IN COMMERCE 9-5-2007.

THE MARK CONSISTS OF STANDARD CHARACTERS WITHOUT CLAIM TO ANY PARTICULAR FONT, STYLE, SIZE, OR COLOR.

NO CLAIM IS MADE TO THE EXCLUSIVE RIGHT TO USE "REFRIGERATOR", APART FROM THE MARK AS SHOWN.

SER. NO. 77-270,596, FILED 9-4-2007.

STEPHEN AQUILA, EXAMINING ATTORNEY

Int. Cl.: 30

Prior U.S. Cl.: 46

United States Patent and Trademark Office

Reg. No. 3,519,142

Registered Oct. 21, 2008

TRADEMARK
PRINCIPAL REGISTER

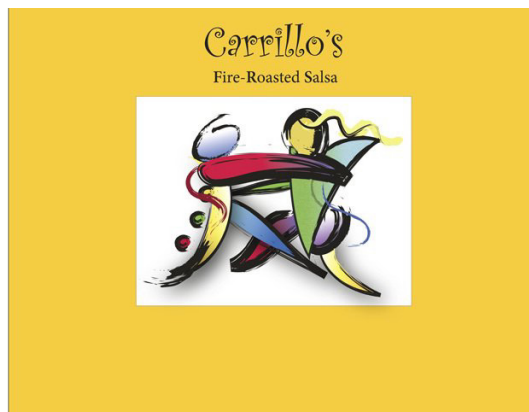

CARRILLO HOLDINGS, INC. (NEW YORK CORPORATION), DBA CARRILLO'S FIRE-ROASTED SALSA
74 PURCHASE STREET
SUITE W
RYE, NY 10580

FOR: SALSA; CONDIMENT, NAMELY, PEPPER SAUCE; SAUCES FOR BARBECUED MEAT, IN CLASS 30 (U.S. CL. 46).

FIRST USE 8-30-2007; IN COMMERCE 8-30-2007.

NO CLAIM IS MADE TO THE EXCLUSIVE RIGHT TO USE "FIRE-ROASTED SALSA", APART FROM THE MARK AS SHOWN.

THE COLOR(S) BLACK, RED, BLUE, YELLOW, GREEN, PURPLE, WHITE IS/ARE CLAIMED AS A FEATURE OF THE MARK.

THE MARK CONSISTS OF AN ABSTRACT REPRESENTATION OF TWO SALSA DANCERS DANCING TOGETHER. THE WORDING "CARRILLO'S FIRE-ROASTED SALSA" IS IN BLACK CENTERED AT THE TOP OF THE MARK. THE ART STYLE IS A PAINTBRUSH EFFECT. BLACK IS USED AS AN OUTLINE FOR MOST OF THE TWO FIGURES. BLUE IS SEEN IN THE HEAD AND LEFT LEG OF THE FIGURE ON THE LEFT, AS WELL AS LEFT PORTION OF THE UPPER TORSO AND ARM OF

THE FIGURE ON THE RIGHT. THERE IS A BLUE CURVED VERTICAL LINE EXTENDING DOWNWARD FROM THE MID-TORSO OF THE FIGURE ON THE RIGHT. THE RIGHT ARM OF THE FIGURE ON THE LEFT APPEARS IN RED AND PURPLE, OUTLINED IN BLACK. THERE IS A RED CURVED VERTICAL LINE EXTENDING DOWNWARD FROM THE FIGURE ON THE LEFT'S NECK. THERE ARE THREE DOTS EXTENDING DOWNWARD FROM THE SHOULDER OF THE FIGURE ON THE LEFT. THE FIRST DOT IS YELLOW, OUTLINED IN BLACK. THE SECOND DOT IS GREEN, OUTLINED IN BLACK AND THE THIRD DOT IS RED, OUTLINED IN BLACK. THE HEAD OF THE FIGURE ON THE RIGHT IS YELLOW WITH A YELLOW STREAM EXTENDING FROM THE HEAD, ALL OUTLINED IN BLACK. THE LEFT LEG OF THE FIGURE ON THE RIGHT IS YELLOW AND PURPLE, OUTLINED IN BLACK. THE RIGHT LEG OF THE FIGURE ON THE RIGHT IS RED AND PURPLE, OUTLINED IN BLACK. THE TORSO AND RIGHT ARM FOR THE FIGURE ON THE RIGHT IS GREEN. WHITE IS USED FOR THE RECTANGULAR FIELD BEHIND THE FIGURES. THERE IS ALSO A SUBTLE SHADOW EFFECT FOR THE FIGURES. THE BACKGROUND OF THE MARK IS A YELLOW SQUARE.

SER. NO. 77-271,515, FILED 9-5-2007.

PAULA MAHONEY, EXAMINING ATTORNEY

Int. Cls.: 38, 41, 42 and 45

Prior U.S. Cls.: 100, 101, 104 and 107

United States Patent and Trademark Office

Reg. No. 3,519,143

Registered Oct. 21, 2008

**SERVICE MARK
PRINCIPAL REGISTER**

LittleBigPlanet

SONY COMPUTER ENTERTAINMENT EUROPE
LIMITED (UNITED KINGDOM LIMITED LIABILITY COMPANY)
10 GREAT MARLBOROUGH STREET
LONDON, UNITED KINGDOM W1F7LP

FOR: PROVIDING ON-LINE CHAT ROOMS AND ELECTRONIC BULLETIN BOARDS FOR TRANSMISSION OF MESSAGES AMONG USERS IN THE FIELD OF GENERAL INTEREST; PROVIDING ON-LINE ACCESS TO COMPUTER NETWORKS, COMPUTER DATABASES, THE INTERNET, ON-LINE BULLETIN BOARDS, VIRTUAL WORLDS AND LIBRARIES OF TEXT, GRAPHICS AND AUDIO-VISUAL AND MULTIMEDIA INFORMATION AND ENTERTAINMENT, IN CLASS 38 (U.S. CLS. 100, 101 AND 104).

FOR: ENTERTAINMENT SERVICES, NAMELY, PROVIDING ELECTRONIC GAMES SERVICES PROVIDED BY MEANS OF THE INTERNET; ENTERTAINMENT SERVICES PROVIDED ONLINE AND/OR VIA A COMPUTER DATABASE FOR MATCHING USERS FOR THE TRANSFER OR SHARING OF MUSIC, VIDEO AND AUDIO RECORDINGS VIA COMMUNICATIONS NETWORKS; ENTERTAINMENT SERVICES, NAMELY, ORGANIZING, STAGING AND CONDUCTING ONLINE

ELECTRONIC GAME TOURNAMENTS; ENTERTAINMENT SERVICES, NAMELY, WIRELESS TELEVISION BROADCASTS FEATURING ONLINE ELECTRONIC GAMES, IN CLASS 41 (U.S. CLS. 100, 101 AND 107).

FOR: COMPUTER SERVICES, NAMELY, PROVIDING AN ON-LINE COMMUNITY ENABLING PHYSICALLY REMOTE PLAYERS OF AN ELECTRONIC GAME TO SEARCH ON-LINE FOR OTHER PLAYERS AND TO COMMUNICATE WITH SELECTED PLAYERS DURING THE GAME, IN CLASS 42 (U.S. CLS. 100 AND 101).

FOR: INTRODUCTION AND SOCIAL NETWORKING SERVICES, NAMELY, INTRODUCING ELECTRONIC GAME PLAYERS TO OTHER GAME PLAYERS, IN CLASS 45 (U.S. CLS. 100 AND 101).

PRIORITY CLAIMED UNDER SEC. 44(D) ON UNITED KINGDOM APPLICATION NO. 2448670B,ORI, FILED 3-7-2007, REG. NO. 2448670B, DATED 12-28-2007, EXPIRES 3-7-2017.

SER. NO. 77-272,468, FILED 9-5-2007.

JOHN E. MICHOS, EXAMINING ATTORNEY

Int. Cl.: 25

Prior U.S. Cls.: 22 and 39

United States Patent and Trademark Office

Reg. No. 3,519,144

Registered Oct. 21, 2008

**TRADEMARK
PRINCIPAL REGISTER**

INSOCK

INFINITY SPORTS, LLC (MINNESOTA LIMITED
LIABILITY COMPANY)
1264 PARK ROAD
CHANHASSEN, MN 55317

THE MARK CONSISTS OF STANDARD CHAR-
ACTERS WITHOUT CLAIM TO ANY PARTICULAR
FONT, STYLE, SIZE, OR COLOR.

FOR: ATHLETIC SOCKS, IN CLASS 25 (U.S. CLS.
22 AND 39).

SER. NO. 77-273,200, FILED 9-6-2007.

FIRST USE 1-1-2007; IN COMMERCE 1-1-2007.

BRIAN PINO, EXAMINING ATTORNEY

Int. Cls.: 4, 7, 8, 9, 11, 14 and 21

Prior U.S. Cls.: 1, 2, 6, 13, 15, 19, 21, 23, 26, 27, 28, 29, 30, 31, 33, 34, 35, 36, 38, 40, 44 and 50

Reg. No. 3,519,145

United States Patent and Trademark Office

Registered Oct. 21, 2008

**TRADEMARK
PRINCIPAL REGISTER**

BRUNTON

THE BRUNTON COMPANY (WYOMING CORPORATION)
2255 BRUNTON COURT
RIVERTON, WY 82501

FOR: CANISTERS OF FUEL, IN CLASS 4 (U.S. CLS. 1, 6 AND 15).

FIRST USE 12-31-2003; IN COMMERCE 12-31-2003.

FOR: SOLAR POWERED ELECTRICITY GENERATORS, IN CLASS 7 (U.S. CLS. 13, 19, 21, 23, 31, 34 AND 35).

FIRST USE 12-31-2002; IN COMMERCE 12-31-2002.

FOR: CUTLERY, NAMELY, FORKS, SPOONS, KNIVES, AND SPORKS, IN CLASS 8 (U.S. CLS. 23, 28 AND 44).

FIRST USE 12-31-2004; IN COMMERCE 12-31-2004.

FOR: DIRECTIONAL COMPASSES; OPTICAL INSTRUMENTS, NAMELY, BINOCULARS, MONOCULARS, SPOTTING SCOPES, POCKET SCOPES, NAMELY, POCKET-SIZED MONOCULARS; TRIPODS FOR USE WITH OPTICAL INSTRUMENTS SUCH AS SPOTTING SCOPES AND BINOCULARS; BATTERY CHARGERS; SATELLITE NAVIGATIONAL SYSTEM, NAMELY, A GLOBAL POSITIONING SYSTEM (GPS); PROTECTIVE CARRYING CASES SPECIALLY ADAPTED FOR GLOBAL POSITIONING SYSTEM (GPS) APPARATUS; COMPUTER SOFTWARE FOR USE WITH GLOBAL POSITIONING SYSTEMS (GPS) AND MAPS; ELECTRICAL CABLES FOR USE WITH GLOBAL POSITIONING SYSTEMS (GPS) APPARATUS; TWO-WAY RADIOS; ALTIMETERS, BAROMETERS; THERMOMETERS; ANEMOMETERS; PEDOMETERS; ANALOG AND DIGITAL MAP MEASURERS FOR USE IN ESTIMATING DISTANCES BETWEEN TWO POINTS ON

A MAP; POCKET TRANSITS, NAMELY, INSTRUMENTS FOR USE IN BASIC FIELD MAPPING; PROTECTIVE CARRYING CASES SPECIALLY ADAPTED FOR POCKET TRANSITS; PROTRACTORS; AND HEIGHT METERS FOR USE IN MEASURING HEIGHT DISTANCES, IN CLASS 9 (U.S. CLS. 21, 23, 26, 36 AND 38).

FIRST USE 12-31-1972; IN COMMERCE 12-31-1972.

FOR: GAS STOVES; GAS GRILLS; GAS LANTERNS; ELECTRIC LANTERNS; FLASHLIGHTS; AND ELECTRIC HEAD LAMPS, IN CLASS 11 (U.S. CLS. 13, 21, 23, 31 AND 34).

FIRST USE 12-31-2002; IN COMMERCE 12-31-2002.

FOR: STOPWATCHES, IN CLASS 14 (U.S. CLS. 2, 27, 28 AND 50).

FIRST USE 5-31-2007; IN COMMERCE 5-31-2007.

FOR: WASH BASINS; COOKWARE, NAMELY SPATULAS, LADLES, SERVING SPOONS, SERVING FORKS; SPORTS BOTTLES, SOLD EMPTY; AND CHOPSTICKS, IN CLASS 21 (U.S. CLS. 2, 13, 23, 29, 30, 33, 40 AND 50).

FIRST USE 12-31-2002; IN COMMERCE 12-31-2002.

THE MARK CONSISTS OF STANDARD CHARACTERS WITHOUT CLAIM TO ANY PARTICULAR FONT, STYLE, SIZE, OR COLOR.

SEC. 2(F).

SER. NO. 77-273,286, FILED 9-6-2007.

CHERYL CLAYTON, EXAMINING ATTORNEY

Int. Cl.: 35

Prior U.S. Cls.: 100, 101 and 102

United States Patent and Trademark Office

Reg. No. 3,519,146

Registered Oct. 21, 2008

**SERVICE MARK
PRINCIPAL REGISTER**

ReCenter

RECENTER CONSULTING, LLC (CALIFORNIA
LIMITED LIABILITY COMPANY)
PO BOX 90008
SAN DIEGO, CA 92169

FOR: BUSINESS CONSULTATION; BUSINESS
MANAGEMENT CONSULTATION IN THE FIELD
OF EXECUTIVE AND LEADERSHIP DEVELOP-
MENT; BUSINESS MANAGEMENT CONSULTING
WITH RELATION TO STRATEGY, MARKETING,
PRODUCTION, PERSONNEL AND RETAIL SALE
MATTERS; BUSINESS ORGANIZATION AND
MANAGEMENT CONSULTING; CONSULTING
SERVICES IN BUSINESS ORGANIZATION AND
MANAGEMENT; CONSULTING SERVICES IN
THE FIELD OF HIGHER EDUCATION ADMINIS-
TRATION; CONSULTING SERVICES IN THE FIELD
OF HUMAN RESOURCES DEVELOPMENT, NAME-
LY, FOR THE PROMOTION OF EMPLOYEE RE-

TENTION, CAREER GROWTH, AND INCREASED
PRODUCTIVITY FOR EMPLOYEES AND EMPLOY-
ERS; PERSONNEL MANAGEMENT CONSULTA-
TION; PROVIDING BUSINESS MANAGEMENT
INFORMATION IN CONNECTION WITH CON-
SULTING AND ADVISORY SERVICES IN THE
FIELD OF STRATEGIC PLANNING, IN CLASS 35
(U.S. CLS. 100, 101 AND 102).

FIRST USE 5-21-1999; IN COMMERCE 5-21-1999.

THE MARK CONSISTS OF STANDARD CHAR-
ACTERS WITHOUT CLAIM TO ANY PARTICULAR
FONT, STYLE, SIZE, OR COLOR.

SER. NO. 77-273,375, FILED 9-6-2007.

TRACY CROSS, EXAMINING ATTORNEY

Int. Cl.: 36

Prior U.S. Cls.: 100, 101 and 102

United States Patent and Trademark Office

Reg. No. 3,519,147

Registered Oct. 21, 2008

**SERVICE MARK
PRINCIPAL REGISTER**

SHAHIN YIELD CALC.

LODESTONE BANKING CONSULTANCY, INC.
(NEW YORK CORPORATION)
6901 HENDERSON ROAD
JAMESVILLE, NY 13078

FOR: BANKING CONSULTATION SERVICES IN
THE FIELD OF ANALYZING PROFITABILITY OF
LOAN AND CUSTOMER CRITERIA, IN CLASS 36
(U.S. CLS. 100, 101 AND 102).

FIRST USE 8-0-2007; IN COMMERCE 8-0-2007.

THE MARK CONSISTS OF STANDARD CHAR-
ACTERS WITHOUT CLAIM TO ANY PARTICULAR
FONT, STYLE, SIZE, OR COLOR.

NO CLAIM IS MADE TO THE EXCLUSIVE
RIGHT TO USE "YIELD CALC", APART FROM
THE MARK AS SHOWN.

SER. NO. 77-273,384, FILED 9-6-2007.

TRACY CROSS, EXAMINING ATTORNEY

Int. Cl.: 10

Prior U.S. Cls.: 26, 39 and 44

Reg. No. 3,519,148

United States Patent and Trademark Office

Registered Oct. 21, 2008

**TRADEMARK
PRINCIPAL REGISTER**

THE OUTPOST

SAN DIEGO SWISS MACHINING, INC. (CALI-
FORNIA CORPORATION)
SUITE A
9177 AERO DRIVE
SAN DIEGO, CA 92123

FOR: DENTAL INSTRUMENTS, NAMELY, OB-
STRUCTION REMOVAL KIT COMPOSED OF EX-
TRACTORS FOR REMOVAL OF OBSTRUCTIONS
WITHIN DENTAL STRUCTURES, DENTAL BURRS,
DENTAL DRILL BITS, DENTAL EXCAVATORS,
DENTAL PICK TIPS, FORCEPS FOR DENTAL

TECHNICAL PURPOSES, IN CLASS 10 (U.S. CLS.
26, 39 AND 44).

FIRST USE 6-28-2007; IN COMMERCE 6-28-2007.

THE MARK CONSISTS OF STANDARD CHAR-
ACTERS WITHOUT CLAIM TO ANY PARTICULAR
FONT, STYLE, SIZE, OR COLOR.

SER. NO. 77-274,560, FILED 9-7-2007.

ROBIN MITTLER, EXAMINING ATTORNEY

Int. Cl.: 41

Prior U.S. Cls.: 100, 101 and 107

United States Patent and Trademark Office

Reg. No. 3,519,149

Registered Oct. 21, 2008

**SERVICE MARK
PRINCIPAL REGISTER**

RECENTER YOUR LIFE

RECENTER CONSULTING, LLC (CALIFORNIA
LIMITED LIABILITY COMPANY)
PO BOX 90008
SAN DIEGO, CA 92169

FIRST USE 5-21-1999; IN COMMERCE 5-21-1999.

FOR: LIFE COACHING SERVICES IN THE FIELD
OF PROFESSIONAL AND PERSONAL DEVELOP-
MENT.; PERSONAL COACHING SERVICES IN THE
FIELD OF REDUCING STRESS, ENHANCING
WELL BEING, IMPROVING RELATIONSHIPS.;
PROFESSIONAL COACHING SERVICES IN THE
FIELD OF CAREER DEVELOPMENT, IN CLASS 41
(U.S. CLS. 100, 101 AND 107).

THE MARK CONSISTS OF STANDARD CHAR-
ACTERS WITHOUT CLAIM TO ANY PARTICULAR
FONT, STYLE, SIZE, OR COLOR.

SER. NO. 77-274,694, FILED 9-7-2007.

SUNG IN, EXAMINING ATTORNEY

Int. Cl.: 35

Prior U.S. Cls.: 100, 101 and 102

United States Patent and Trademark Office

Reg. No. 3,519,150

Registered Oct. 21, 2008

**SERVICE MARK
PRINCIPAL REGISTER**

ACRE

WHOLESALECRAFTS.COM, INC. (NORTH CAROLINA CORPORATION)
604 BEATEN PATH RD
MOORESVILLE, NC 28117

FOR: INFOMEDIARY SERVICES, NAMELY, FACILITATING TRANSACTIONS BETWEEN BUYERS AND SELLERS THROUGH PROVIDING BUYERS WITH INFORMATION ABOUT SELLERS, GOODS, AND/OR SERVICES; ONLINE BUSINESS NETWORKING SERVICES; OPERATING ON-LINE MARKETPLACES FOR SELLERS OF GOODS AND/OR SERVICES; PROMOTING THE GOODS AND SERVICES OF OTHERS BY PROVIDING A WEB SITE AT WHICH USERS CAN LINK TO ARTISTS AND RETAILERS; PROMOTING THE GOODS AND SERVICES OF OTHERS BY PROVIDING HYPERTEXT LINKS TO THE WEB SITES OF OTHERS; PROMOTING THE GOODS AND SERVICES OF OTHERS THROUGH ON-LINE ORDERING

AND CATALOGING OF THOSE GOODS AND SERVICES; PROVIDING A WEB SITE WHICH FEATURES ADVERTISEMENTS FOR THE GOODS AND SERVICES OF OTHERS ON A GLOBAL COMPUTER NETWORK; COMPUTERIZED ON-LINE ORDERING SERVICES IN THE FIELD OF ART; INTERNET ADVERTISING SERVICES; ON-LINE ORDERING SERVICES FEATURING ART, IN CLASS 35 (U.S. CLS. 100, 101 AND 102).

FIRST USE 12-15-1997; IN COMMERCE 12-15-1997.

THE MARK CONSISTS OF STANDARD CHARACTERS WITHOUT CLAIM TO ANY PARTICULAR FONT, STYLE, SIZE, OR COLOR.

SER. NO. 77-275,057, FILED 9-9-2007.

DAVID MURRAY, EXAMINING ATTORNEY

Int. Cl.: 38

Prior U.S. Cls.: 100, 101 and 104

United States Patent and Trademark Office

Reg. No. 3,519,151

Registered Oct. 21, 2008

**SERVICE MARK
PRINCIPAL REGISTER**

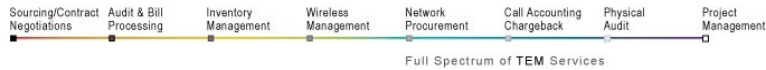

TNT EXPENSE MANAGEMENT (CONNECTICUT LIMITED LIABILITY COMPANY)
13 BERKSHIRE RD.
SANDY HOOK, CT 06482

FOR: TELECOMMUNICATIONS CONSULTATION, IN CLASS 38 (U.S. CLS. 100, 101 AND 104).

FIRST USE 6-18-2007; IN COMMERCE 7-3-2007.

NO CLAIM IS MADE TO THE EXCLUSIVE RIGHT TO USE "SOURCING/CONTRACT NEGOTIATIONS AUDIT & BILL PROCESSING INVENTORY MANAGEMENT WIRELESS MANAGEMENT NETWORK PROCUREMENT CALL ACCOUNTING CHARGEBACK PHYSICAL AUDIT PROJECT MANAGEMENT", APART FROM THE MARK AS SHOWN.

THE COLOR(S) RED, ORANGE, YELLOW, GREEN, BLUE, VIOLET, BLACK, GRAY AND WHITE IS/ARE CLAIMED AS A FEATURE OF THE MARK.

THE MARK CONSISTS OF LINEAR SPECTRUM OF COLORS THAT GO FROM RED ON THE FAR LEFT TO ORANGE TO YELLOW, TO GREEN, TO BLUE AND FINALLY TO VIOLET IN THE FAR RIGHT WITH THE WORDS "SOURCING/CONTRACT NEGOTIATIONS AUDIT & BILL PROCESSING INVENTORY MANAGEMENT WIRELESS MANAGEMENT NETWORK PROCUREMENT CALL ACCOUNTING CHARGEBACK PHYSICAL AUDIT PROJECT MANAGEMENT" ABOVE THE LINE AND A SQUARE BOX DIRECTLY UNDERNEATH EACH SEPARATE TERM. THE BOXES FADE FROM A COMPLETELY BLACK BOX ON THE LEFT TOWARDS A GREY BOX IN THE MIDDLE AND FINALLY A WHITE BOX ON THE RIGHT THE WORDS "FULL SPECTRUM OF TEM SERVICES" APPEARS UNDERNEATH THE LINE ON THE RIGHT SIDE.

SER. NO. 77-275,848, FILED 9-10-2007.

GIANCARLO CASTRO, EXAMINING ATTORNEY

Int. Cl.: 16

Prior U.S. Cls.: 2, 5, 22, 23, 29, 37, 38 and 50

United States Patent and Trademark Office

Reg. No. 3,519,152

Registered Oct. 21, 2008

**TRADEMARK
PRINCIPAL REGISTER**

**LUXE THE SOUTH FLORIDA
HOME REDEFINED**

SANDOW MEDIA, LLC (DELAWARE LIMITED
LIABILITY COMPANY)
3731 N.W. 8TH AVENUE
BOCA RATON, FL 33431

FOR: MAGAZINES FEATURING LUXURY
HOME ARCHITECTURE, DESIGN, AND FURNISH-
INGS, AND INCLUDING ART, CULINARY, AND
HOMEMAKING ARTICLES, IN CLASS 16 (U.S. CLS.
2, 5, 22, 23, 29, 37, 38 AND 50).

FIRST USE 10-1-2007; IN COMMERCE 10-1-2007.

THE MARK CONSISTS OF STANDARD CHAR-
ACTERS WITHOUT CLAIM TO ANY PARTICULAR
FONT, STYLE, SIZE, OR COLOR.

SER. NO. 77-276,642, FILED 9-11-2007.

EUGENIA MARTIN, EXAMINING ATTORNEY

Int. Cl.: 41

Prior U.S. Cls.: 100, 101 and 107

United States Patent and Trademark Office

Reg. No. 3,519,153

Registered Oct. 21, 2008

SERVICE MARK
PRINCIPAL REGISTER



CROSS COUNTRY
EDUCATION

CROSS COUNTRY EDUCATION, LLC (DELA-
WARE LIMITED LIABILITY COMPANY)
6551 PARK OF COMMERCE BLVD., NW
BOCA RATON, FL 33487

FOR: EDUCATION SERVICES, NAMELY, PRO-
VIDING PROFESSIONAL DEVELOPMENT TRAIN-
ING SEMINARS IN THE HEALTHCARE
INDUSTRY, IN CLASS 41 (U.S. CLS. 100, 101 AND
107).

FIRST USE 10-0-2005; IN COMMERCE 10-0-2005.

NO CLAIM IS MADE TO THE EXCLUSIVE
RIGHT TO USE "EDUCATION", APART FROM
THE MARK AS SHOWN.

THE MARK CONSISTS OF THE WORDS "CROSS
COUNTRY EDUCATION" DISPLAYED BELOW AN
IMAGE OF A TREE.

SER. NO. 77-276,680, FILED 9-11-2007.

VERNA BETH RIRIE, EXAMINING ATTORNEY

Int. Cl.: 25

Prior U.S. Cls.: 22 and 39

United States Patent and Trademark Office

Reg. No. 3,519,154

Registered Oct. 21, 2008

**TRADEMARK
PRINCIPAL REGISTER**

ESSENCE

ESSENCE COMMUNICATIONS INC. (DELA-
WARE CORPORATION)
135 WEST 51ST STREET
NEW YORK, NY 10020

THE MARK CONSISTS OF STANDARD CHAR-
ACTERS WITHOUT CLAIM TO ANY PARTICULAR
FONT, STYLE, SIZE, OR COLOR.

FOR: PANTYHOSE, IN CLASS 25 (U.S. CLS. 22
AND 39).

SER. NO. 77-276,838, FILED 9-11-2007.

FIRST USE 8-2-1993; IN COMMERCE 8-2-1993.

KIMBERLY FRYE, EXAMINING ATTORNEY

Int. Cls.: 16 and 39

Prior U.S. Cls.: 2, 5, 22, 23, 29, 37, 38, 50, 100 and 105

United States Patent and Trademark Office

Reg. No. 3,519,155

Registered Oct. 21, 2008

**TRADEMARK
SERVICE MARK
PRINCIPAL REGISTER**

BEYOND WHAT'S EXPECTED.

BOISE WHITE PAPER, L.L.C. (DELAWARE LIMITED LIABILITY COMPANY)
P.O. BOX 50
1111 W. JEFFERSON STREET
BOISE, ID 837280001

FOR: PAPER, IN CLASS 16 (U.S. CLS. 2, 5, 22, 23, 29, 37, 38 AND 50).

FIRST USE 1-1-2006; IN COMMERCE 1-1-2006.

FOR: DISTRIBUTION SERVICES, NAMELY, DELIVERY OF PAPER, IN CLASS 39 (U.S. CLS. 100 AND 105).

FIRST USE 1-1-2006; IN COMMERCE 1-1-2006.

THE MARK CONSISTS OF STANDARD CHARACTERS WITHOUT CLAIM TO ANY PARTICULAR FONT, STYLE, SIZE, OR COLOR.

SER. NO. 77-276,914, FILED 9-11-2007.

KATHERINE CONNOLLY, EXAMINING ATTORNEY

Int. Cl.: 16

Prior U.S. Cls.: 2, 5, 22, 23, 29, 37, 38 and 50

United States Patent and Trademark Office

Reg. No. 3,519,156

Registered Oct. 21, 2008

**TRADEMARK
PRINCIPAL REGISTER**

MI CHANGARRITO

DPE LABEL HOLDING CORP. (NEW YORK
CORPORATION)
232 BROADWAY
BROOKLYN, NY 11211

FOR: PRE-PAID TELEPHONE CALLING CARDS,
NOT MAGNETICALLY ENCODED, IN CLASS 16
(U.S. CLS. 2, 5, 22, 23, 29, 37, 38 AND 50).

FIRST USE 7-1-2007; IN COMMERCE 7-1-2007.

THE MARK CONSISTS OF STANDARD CHAR-
ACTERS WITHOUT CLAIM TO ANY PARTICULAR
FONT, STYLE, SIZE, OR COLOR.

THE FOREIGN WORDING IN THE MARK
TRANSLATES INTO ENGLISH AS MY STALL.

SER. NO. 77-277,203, FILED 9-12-2007.

STEVEN R. FOSTER, EXAMINING ATTORNEY

Int. Cls.: 35, 42 and 45

Prior U.S. Cls.: 100, 101 and 102

United States Patent and Trademark Office

Reg. No. 3,519,157

Registered Oct. 21, 2008

**SERVICE MARK
PRINCIPAL REGISTER**

WHATS IN YOUR CITY

JOHNS, DAVID (UNITED STATES INDIVIDUAL)
11759 GWEN EVANS
EL PASO, TX 79936

FOR: PROVIDING A WEBSITE FEATURING LOCAL BUSINESS INFORMATION; ADVERTISING SERVICES FOR OTHERS; MEMBERSHIP CLUB SERVICES PROVIDING DISCOUNTS AND PROCESSING REBATES FOR THE SERVICES OF OTHERS AND BUSINESS NETWORKING SERVICES, IN CLASS 35 (U.S. CLS. 100, 101 AND 102).

FIRST USE 5-1-2007; IN COMMERCE 5-20-2007.

FOR: HOSTING THE WEBSITES OF OTHERS ON A COMPUTER SERVER FOR A GLOBAL COMPUTER NETWORK, IN CLASS 42 (U.S. CLS. 100 AND 101).

FIRST USE 5-1-2007; IN COMMERCE 5-20-2007.

FOR: PROVIDING A WEBSITE FEATURING ELECTRONIC SECURITY CAMERA MONITORING SERVICES FOR SECURITY PURPOSES IN THE FIELD OF BUSINESSES AND COMMERCIAL PROPERTIES, IN CLASS 45 (U.S. CLS. 100 AND 101).

FIRST USE 3-3-2008; IN COMMERCE 6-10-2008.

THE MARK CONSISTS OF STANDARD CHARACTERS WITHOUT CLAIM TO ANY PARTICULAR FONT, STYLE, SIZE, OR COLOR.

SER. NO. 77-277,471, FILED 9-12-2007.

RENEE MCCRAY, EXAMINING ATTORNEY

Int. Cl.: 17

Prior U.S. Cls.: 1, 5, 12, 13, 35 and 50

United States Patent and Trademark Office

Reg. No. 3,519,158

Registered Oct. 21, 2008

**TRADEMARK
PRINCIPAL REGISTER**

TYTAN

SELENA USA, INC. (INDIANA CORPORATION)
21715 BECK DRIVE
ELKHART, IN 46516

FOR: SEALANTS, EXPANDING FOAM POLYUR-
ETHANE SEALANTS, CAULKING, AND EXPAND-
ING FOAM INSULATION, ALL FOR USE IN
BUILDING AND CONSTRUCTION, IN CLASS 17
(U.S. CLS. 1, 5, 12, 13, 35 AND 50).

FIRST USE 9-0-2001; IN COMMERCE 9-0-2001.

THE MARK CONSISTS OF STANDARD CHAR-
ACTERS WITHOUT CLAIM TO ANY PARTICULAR
FONT, STYLE, SIZE, OR COLOR.

SER. NO. 77-277,639, FILED 9-12-2007.

NATALIE POLZER, EXAMINING ATTORNEY

Int. Cl.: 25

Prior U.S. Cls.: 22 and 39

United States Patent and Trademark Office

Reg. No. 3,519,159

Registered Oct. 21, 2008

**TRADEMARK
PRINCIPAL REGISTER**

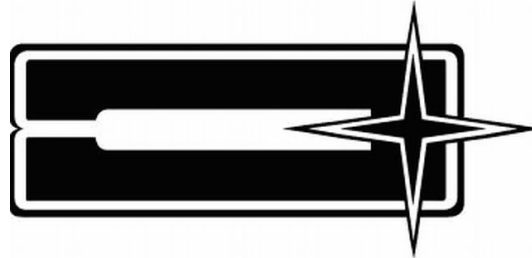

IDEMA, JOSHUA D. (UNITED STATES INDIVIDUAL)
40230 TORREY PINES RD.
MURRIETA, CA 92563 AND
IDEMA, CORRINE T. (UNITED STATES INDIVIDUAL)
40230 TORREY PINES RD.
MURRIETA, CA 92563

FOR: MEN'S SOCKS; SOCKS; T-SHIRTS; WRISTBANDS; ANKLE SOCKS; BANDANAS; HATS; SWEATSHIRTS, IN CLASS 25 (U.S. CLS. 22 AND 39).

FIRST USE 1-1-2001; IN COMMERCE 1-1-2001.

THE MARK CONSISTS OF A BACKWARDS LETTER "C" WITH A FINE OUTLINE AND AN OUTLINE STAR, OR CROSS, VERTICALLY CENTERED ON THE RIGHT SIDE OF THE LETTER "C".

SEC. 2(F).

SER. NO. 77-277,773, FILED 9-12-2007.

DARRYL SPRUILL, EXAMINING ATTORNEY

Int. Cl.: 25

Prior U.S. Cls.: 22 and 39

United States Patent and Trademark Office

Reg. No. 3,519,160

Registered Oct. 21, 2008

**TRADEMARK
PRINCIPAL REGISTER**

COMMISSIONED

IDEMA, JOSHUA D. (UNITED STATES INDIVIDUAL)
40230 TORREY PINES RD.
MURRIETA, CA 92563 AND
IDEMA, CORRINE T. (UNITED STATES INDIVIDUAL)
40230 TORREY PINES RD.
MURRIETA, CA 92563

FOR: MEN'S SOCKS; SOCKS; T-SHIRTS; WRISTBANDS; ANKLE SOCKS; BANDANAS; HATS; SWEATSHIRTS, IN CLASS 25 (U.S. CLS. 22 AND 39).

FIRST USE 1-1-2001; IN COMMERCE 1-1-2001.

THE MARK CONSISTS OF STANDARD CHARACTERS WITHOUT CLAIM TO ANY PARTICULAR FONT, STYLE, SIZE, OR COLOR.

SEC. 2(F).

SER. NO. 77-277,826, FILED 9-12-2007.

DARRYL SPRUILL, EXAMINING ATTORNEY

Int. Cls.: 29, 30 and 35

Prior U.S. Cls.: 46, 100, 101 and 102

United States Patent and Trademark Office

Reg. No. 3,519,161

Registered Oct. 21, 2008

TRADEMARK
SERVICE MARK
PRINCIPAL REGISTER



GESTION PREMIERE MOISSON INC. (CANADA CORPORATION)
189 BOULEVARD HARWOOD
DORION, CANADA J7V1Y3

FOR: DELICATESSEN ITEMS, NAMELY, PATES AND HAMS; PICKLES; SALADS, NAMELY, VEGETABLE SALADS, LEGUMINOUS SALADS, AND SALADS MADE OF MEAT, POULTRY, OR FISH; PRECOOKED DISHES, NAMELY, MEAT DISHES, FISH DISHES, SEAFOODS DISHES, GAME DISHES, SAUSAGE DISHES ALL PREPARED TOGETHER WITH RICE, VEGETABLES, POTATOES, EGGS AND/OR CHEESE; AND GROCERY ITEMS, NAMELY, JAMS, IN CLASS 29 (U.S. CL. 46).

FOR: BAKERY PRODUCTS; PASTRIES AND CAKES; DELICATESSEN ITEMS, NAMELY, MEAT PIES; CONFECTIONERY ITEMS, NAMELY, CHOCOLATES AND CANDIES; READY TO EAT ITEMS, NAMELY SANDWICHES, PRESERVED ITEMS, NAMELY, SPAGHETTI SAUCES, TOMATO SAUCES AND PASTA SAUCES; AND PASTA SALADS, IN CLASS 30 (U.S. CL. 46).

FOR: RETAIL SHOPS FEATURING DELICATESSEN ITEMS, BAKERY PRODUCTS, PASTRY ITEMS,

MEATS, PRESERVES AND GROCERY PRODUCTS, IN CLASS 35 (U.S. CLS. 100, 101 AND 102).

OWNER OF CANADA REG. NO. TMA518127, DATED 10-19-1999, EXPIRES 10-19-2014.

OWNER OF U.S. REG. NO. 2,486,492.

NO CLAIM IS MADE TO THE EXCLUSIVE RIGHT TO USE "BOULANGERIE", APART FROM THE MARK AS SHOWN.

THE MARK CONSISTS OF THE WORD "BOULANGERIE" OVER A MAN IN A WHEAT FIELD OVER THE WORDS "PREMIERE MOISSON".

THE FOREIGN WORDING IN THE MARK TRANSLATES INTO ENGLISH AS BAKERY AND FIRST HARVEST.

SER. NO. 77-277,869, FILED 9-12-2007.

DOMINIC J. FERRAIUOLO, EXAMINING ATTORNEY

Int. Cl.: 36

Prior U.S. Cls.: 100, 101 and 102

United States Patent and Trademark Office

Reg. No. 3,519,162

Registered Oct. 21, 2008

**SERVICE MARK
PRINCIPAL REGISTER**

HOPE UNLIMITED

HOPE UNLIMITED FOR CHILDREN, INC. (CALIFORNIA NON-PROFIT CORPORATION)
PO BOX 2707
LOS ALAMITOS, CA 90720

FOR: CHARITABLE SERVICES, NAMELY, PROMOTING ASSISTANCE FOR THE LIVES OF CHILDREN AT MORTAL RISK BY CHARITABLE FUNDRAISING, IN CLASS 36 (U.S. CLS. 100, 101 AND 102).

FIRST USE 1-0-1991; IN COMMERCE 1-0-1991.

THE MARK CONSISTS OF STANDARD CHARACTERS WITHOUT CLAIM TO ANY PARTICULAR FONT, STYLE, SIZE, OR COLOR.

SER. NO. 77-278,079, FILED 9-12-2007.

ZACHARY BELLO, EXAMINING ATTORNEY

Int. Cl.: 36

Prior U.S. Cls.: 100, 101 and 102

United States Patent and Trademark Office

Reg. No. 3,519,163

Registered Oct. 21, 2008

**SERVICE MARK
PRINCIPAL REGISTER**

HOPE UNLIMITED FOR CHILDREN

HOPE UNLIMITED FOR CHILDREN, INC. (CALIFORNIA NON-PROFIT CORPORATION)
PO BOX 2707
LOS ALAMITOS, CA 90720

FOR: CHARITABLE SERVICES, NAMELY, PROMOTING ASSISTANCE FOR THE LIVES OF CHILDREN AT MORTAL RISK BY CHARITABLE FUNDRAISING, IN CLASS 36 (U.S. CLS. 100, 101 AND 102).

FIRST USE 4-29-2003; IN COMMERCE 4-29-2003.

THE MARK CONSISTS OF STANDARD CHARACTERS WITHOUT CLAIM TO ANY PARTICULAR FONT, STYLE, SIZE, OR COLOR.

NO CLAIM IS MADE TO THE EXCLUSIVE RIGHT TO USE "CHILDREN", APART FROM THE MARK AS SHOWN.

SER. NO. 77-278,093, FILED 9-12-2007.

ALLISON HOLTZ, EXAMINING ATTORNEY

Int. Cl.: 35

Prior U.S. Cls.: 100, 101 and 102

United States Patent and Trademark Office

Reg. No. 3,519,164

Registered Oct. 21, 2008

**SERVICE MARK
PRINCIPAL REGISTER**



BEATYOUTHERE.COM LLP (CONNECTICUT
LIMITED PARTNERSHIP)
SUITE 10A
51 SCHUYLER AVE
STAMFORD, CT 06902

FIRST USE 8-1-2007; IN COMMERCE 8-1-2007.

THE COLOR(S) BLUE IS/ARE CLAIMED AS A
FEATURE OF THE MARK.

FOR: MATCHING CONSUMERS WITH REAL
ESTATE PROFESSIONALS IN THE FIELD OF REAL
ESTATE SERVICES VIA COMPUTER NETWORK;
PROMOTING THE GOODS AND SERVICES OF
OTHERS BY PROVIDING A WEBSITE FEATURING
COUPONS, REBATES, PRICE-COMPARISON IN-
FORMATION, PRODUCT REVIEWS, LINKS TO
THE RETAIL WEBSITES OF OTHERS, AND DIS-
COUNT INFORMATION, IN CLASS 35 (U.S. CLS.
100, 101 AND 102).

THE WORDING AND THE DESIGN OF THE
MARK ARE IN BLUE.

SER. NO. 77-278,460, FILED 9-13-2007.

DAWN FELDMAN, EXAMINING ATTORNEY

Int. Cls.: 9 and 41

Prior U.S. Cls.: 21, 23, 26, 36, 38, 100, 101 and 107

Reg. No. 3,519,165

United States Patent and Trademark Office

Registered Oct. 21, 2008

**TRADEMARK
SERVICE MARK
PRINCIPAL REGISTER**

**HARTFORD EMPLOYMENT
LIABILITY PREVENTION**

HARTFORD FIRE INSURANCE COMPANY
(CONNECTICUT CORPORATION)
LAW DEPT.-TECH/IP UNIT-HO1-09
ONE HARTFORD PLAZA
HARTFORD, CT 06155

FOR: DOWNLOADABLE MULTIMEDIA FILES, TEXT FILES, WRITTEN DOCUMENTS, AUDIO MATERIAL, AND VIDEO MATERIAL, ALL CONSTITUTING FORMS, POLICIES AND PROCEDURES RELATING TO EMPLOYMENT AND THE WORKPLACE, IN CLASS 9 (U.S. CLS. 21, 23, 26, 36 AND 38).

FIRST USE 9-23-2006; IN COMMERCE 9-23-2006.

FOR: WEB-BASED TRAINING RELATING TO EMPLOYMENT AND WORKPLACE ISSUES; PROVIDING ONLINE ARTICLES AND E-MAIL NEWSLETTERS IN THE FIELDS OF WORKPLACE ISSUES SUCH AS LEADERSHIP, HEALTH, WELLNESS,

AND SAFETY, IN CLASS 41 (U.S. CLS. 100, 101 AND 107).

FIRST USE 9-23-2006; IN COMMERCE 9-23-2006.

THE MARK CONSISTS OF STANDARD CHARACTERS WITHOUT CLAIM TO ANY PARTICULAR FONT, STYLE, SIZE, OR COLOR.

OWNER OF U.S. REG. NOS. 2,264,317, 2,495,783 AND OTHERS.

NO CLAIM IS MADE TO THE EXCLUSIVE RIGHT TO USE "EMPLOYMENT LIABILITY PREVENTION", APART FROM THE MARK AS SHOWN.

SEC. 2(F) AS TO "HARTFORD".

SER. NO. 77-278,479, FILED 9-13-2007.

BRENDAN REGAN, EXAMINING ATTORNEY

Int. Cl.: 35

Prior U.S. Cls.: 100, 101 and 102

United States Patent and Trademark Office

Reg. No. 3,519,166

Registered Oct. 21, 2008

**SERVICE MARK
PRINCIPAL REGISTER**

ESP Online

ADVERTISING SPECIALTY INSTITUTE, INC.
(PENNSYLVANIA CORPORATION)

4800 STREET ROAD

TREVOSE, PA 19053

FOR: PROVIDING AN ONLINE COMPUTER DATABASE FEATURING BUSINESS INFORMATION FOR PROMOTIONAL PRODUCTS/SPECIALTY ADVERTISING INDUSTRY , IN CLASS 35 (U.S. CLS. 100, 101 AND 102).

FIRST USE 2-18-2004; IN COMMERCE 2-18-2004.

THE MARK CONSISTS OF STANDARD CHARACTERS WITHOUT CLAIM TO ANY PARTICULAR FONT, STYLE, SIZE, OR COLOR.

OWNER OF U.S. REG. NOS. 1,595,034, 2,489,865 AND OTHERS.

NO CLAIM IS MADE TO THE EXCLUSIVE RIGHT TO USE "ONLINE", APART FROM THE MARK AS SHOWN.

SER. NO. 77-278,499, FILED 9-13-2007.

STEVEN JACKSON, EXAMINING ATTORNEY

Int. Cl.: 9

Prior U.S. Cls.: 21, 23, 26, 36 and 38

Reg. No. 3,519,167

United States Patent and Trademark Office

Registered Oct. 21, 2008

**TRADEMARK
PRINCIPAL REGISTER**

PCT

TRENCH LIMITED (CANADA CORPORATION)
71 MAYBROOK DRIVE
SCARBOROUGH, CANADA M1V4B6

FIRST USE 5-0-2007; IN COMMERCE 5-0-2007.

FOR: TELECOMMUNICATION EQUIPMENT,
NAMELY, PROGRAMMABLE POWER LINE RE-
LAY TERMINALS FOR USE BY ELECTRIC UTILI-
TIES EMPLOYING COMMUNICATION ASSISTED
HIGH VOLTAGE POWER LINE PROTECTION
SCHEMES, IN CLASS 9 (U.S. CLS. 21, 23, 26, 36 AND
38).

THE MARK CONSISTS OF STANDARD CHAR-
ACTERS WITHOUT CLAIM TO ANY PARTICULAR
FONT, STYLE, SIZE, OR COLOR.

SER. NO. 77-278,505, FILED S.R. 9-13-2007 AM. P.R.
7-2-2008.

CHARLES L. JENKINS, EXAMINING ATTORNEY

Int. Cl.: 9

Prior U.S. Cls.: 21, 23, 26, 36 and 38

Reg. No. 3,519,168

United States Patent and Trademark Office

Registered Oct. 21, 2008

**TRADEMARK
PRINCIPAL REGISTER**

JUICER

DIGITAL JUICE, INC. (FLORIDA CORPORATION)
SUITE 3001
43 SKYLINE DRIVE
LAKE MARY, FL 32746

FOR: COMPACT DISCS, DIGITAL VERSATILE DISCS, AND DIGITAL MULTIMEDIA FILE DOWNLOADS FEATURING LAYERED AND NON-LAYERED ROYALTY-FREE GRAPHICS AND BACKGROUNDS, ABSTRACT DESIGNS, PEOPLE, PLACES, AND OBJECTS FROM AROUND THE WORLD FOR USE WITH VIDEO EDITING, PRESENTATIONS, WEB, TELEVISION, FILM, GAMES,

CELL PHONES, AND ALL MULTIMEDIA APPLICATIONS AND HARDWARE, IN CLASS 9 (U.S. CLS. 21, 23, 26, 36 AND 38).

FIRST USE 4-30-2002; IN COMMERCE 4-30-2002.

THE MARK CONSISTS OF STANDARD CHARACTERS WITHOUT CLAIM TO ANY PARTICULAR FONT, STYLE, SIZE, OR COLOR.

SER. NO. 77-278,783, FILED 9-13-2007.

BENJAMIN OKEKE, EXAMINING ATTORNEY

Int. Cl.: 41

Prior U.S. Cls.: 100, 101 and 107

United States Patent and Trademark Office

Reg. No. 3,519,169

Registered Oct. 21, 2008

**SERVICE MARK
PRINCIPAL REGISTER**

GAMECHANGERS

BONIFER, MICHAEL (UNITED STATES INDIVIDUAL)
2100 GRIFFITH PARK BOULEVARD #6
LOS ANGELES, CA 90039

FOR: EDUCATIONAL SERVICES, NAMELY, PROVIDING TRAINING SERVICES, WORKSHOPS AND SEMINARS IN THE FIELD OF IMPROVISATION AND BUSINESS; CONSULTATION IN THE FIELD OF IMPROVISATION, IN CLASS 41 (U.S. CLS. 100, 101 AND 107).

FIRST USE 12-1-2006; IN COMMERCE 12-12-2006.

THE MARK CONSISTS OF STANDARD CHARACTERS WITHOUT CLAIM TO ANY PARTICULAR FONT, STYLE, SIZE, OR COLOR.

SER. NO. 77-278,859, FILED 9-13-2007.

KYLE PEETE, EXAMINING ATTORNEY

Int. Cl.: 42

Prior U.S. Cls.: 100 and 101

United States Patent and Trademark Office

Reg. No. 3,519,170

Registered Oct. 21, 2008

**SERVICE MARK
PRINCIPAL REGISTER**

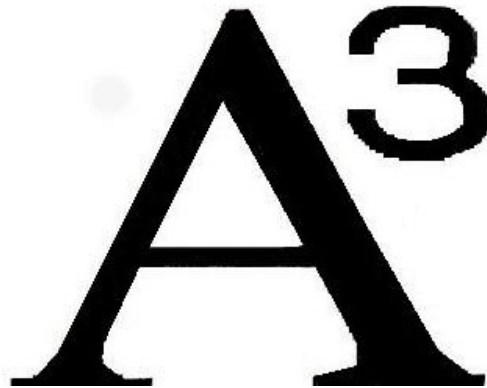

ARBOR AUDIO AND VIDEO, INC. (MICHIGAN CORPORATION), DBA ANN ARBOR AUDIO
10489 EAST GRAND RIVER AVE, SUITE I
BRIGHTON, MI 48116

FOR: DESIGN AND ENGINEERING OF AUDIO AND VIDEO SYSTEMS AND FACILITIES, COMPONENTS AND EQUIPMENT FOR OTHERS, AND CONSULTATION RELATED THERETO; ENVIRONMENTAL TESTING AND INSPECTION OF SOUND

AND AUDIO PROPERTIES, NAMELY, ACOUSTICAL MODELING AND AURALIZATION SERVICES, IN CLASS 42 (U.S. CLS. 100 AND 101).

FIRST USE 6-30-1993; IN COMMERCE 6-30-1993.

SER. NO. 77-278,880, FILED 9-13-2007.

JASON BLAIR, EXAMINING ATTORNEY

Int. Cl.: 41

Prior U.S. Cls.: 100, 101 and 107

United States Patent and Trademark Office

Reg. No. 3,519,171

Registered Oct. 21, 2008

**SERVICE MARK
PRINCIPAL REGISTER**

AMERICAN BANG

AMERICAN BANG, INC. (TENNESSEE CORPORATION)
245 3RD AVE. N
FRANKLIN, TN 37064

FOR: ENTERTAINMENT IN THE NATURE OF LIVE PERFORMANCES BY A MUSICAL GROUP; ENTERTAINMENT IN THE NATURE OF VISUAL AND AUDIO PERFORMANCES, NAMELY, MUSICAL BAND, ROCK GROUP, GYMNASIAC, DANCE, AND BALLET PERFORMANCES; ENTERTAINMENT IN THE NATURE OF LIVE PERFORMANCES BY A MUSICAL GROUP; ENTERTAINMENT, NAMELY, LIVE PERFORMANCES BY A MUSICAL BAND; ENTERTAINMENT, NAMELY, LIVE MUSIC CONCERTS; ENTERTAINMENT, NAMELY, LIVE PERFORMANCES BY MUSICAL BANDS; ENTERTAINMENT, NAMELY, LIVE PERFORMANCES BY

ROCK GROUPS, IN CLASS 41 (U.S. CLS. 100, 101 AND 107).

FIRST USE 9-7-2007; IN COMMERCE 9-7-2007.

THE MARK CONSISTS OF STANDARD CHARACTERS WITHOUT CLAIM TO ANY PARTICULAR FONT, STYLE, SIZE, OR COLOR.

NO CLAIM IS MADE TO THE EXCLUSIVE RIGHT TO USE "AMERICAN", APART FROM THE MARK AS SHOWN.

SER. NO. 77-278,928, FILED 9-13-2007.

SANDRA MANIOS, EXAMINING ATTORNEY

Int. Cls.: 42 and 45

Prior U.S. Cls.: 100 and 101

United States Patent and Trademark Office

Reg. No. 3,519,172

Registered Oct. 21, 2008

**SERVICE MARK
PRINCIPAL REGISTER**

XACT DATA DISCOVERY

XCELLENCE, INC. (MISSOURI CORPORATION),
DBA XACT DATA DISCOVERY
5800 FOXRIDGE DRIVE, SUITE 406
MISSION, KS 66202

FOR: ELECTRONIC DISCOVERY SERVICES FOR
LAWYERS, CORPORATIONS AND GOVERNMENT
AGENCIES, IN CLASS 42 (U.S. CLS. 100 AND 101).

FIRST USE 4-1-2007; IN COMMERCE 4-1-2007.

FOR: LITIGATION SUPPORT SERVICES, IN
CLASS 45 (U.S. CLS. 100 AND 101).

FIRST USE 4-1-2007; IN COMMERCE 4-1-2007.

THE MARK CONSISTS OF STANDARD CHAR-
ACTERS WITHOUT CLAIM TO ANY PARTICULAR
FONT, STYLE, SIZE, OR COLOR.

OWNER OF U.S. REG. NO. 2,894,604.

NO CLAIM IS MADE TO THE EXCLUSIVE
RIGHT TO USE "DATA DISCOVERY", APART
FROM THE MARK AS SHOWN.

SER. NO. 77-278,980, FILED 9-13-2007.

SANJEEV VOHRA, EXAMINING ATTORNEY

Int. Cls.: 42 and 45

Prior U.S. Cls.: 100 and 101

United States Patent and Trademark Office

Reg. No. 3,519,173

Registered Oct. 21, 2008

**SERVICE MARK
PRINCIPAL REGISTER**

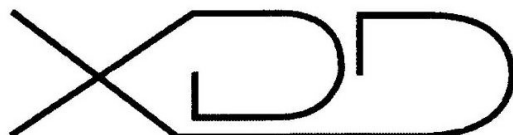

XACT DATA DISCOVERY

Because you need to know

XCELLENCE, INC. (MISSOURI CORPORATION),
DBA XACT DATA DISCOVERY
5800 FOXRIDGE DRIVE, SUITE 406
MISSION, KS 66202

FOR: ELECTRONIC DISCOVERY SERVICES FOR
LAWYERS, CORPORATIONS AND GOVERNMENT
AGENCIES, IN CLASS 42 (U.S. CLS. 100 AND 101).

FIRST USE 4-1-2007; IN COMMERCE 4-1-2007.

FOR: LITIGATION SUPPORT SERVICES, IN
CLASS 45 (U.S. CLS. 100 AND 101).

FIRST USE 4-1-2007; IN COMMERCE 4-1-2007.

OWNER OF U.S. REG. NO. 2,894,604.

NO CLAIM IS MADE TO THE EXCLUSIVE
RIGHT TO USE "DATA DISCOVERY", APART
FROM THE MARK AS SHOWN.

THE MARK CONSISTS OF THE LETTERS "X D
D" WITH THE TOP CORNER OF THE "X" MAKING
THE LETTER "D" AND THE BOTTOM CORNER OF
THE "X" MAKING THE SECOND LETTER "D", THE
WORDS "XACT DATA DISCOVERY" ABOVE THE
WORDS "BECAUSE YOU NEED TO KNOW".

SER. NO. 77-278,995, FILED 9-13-2007.

SANJEEV VOHRA, EXAMINING ATTORNEY

Int. Cl.: 36

Prior U.S. Cls.: 100, 101 and 102

United States Patent and Trademark Office

Reg. No. 3,519,174

Registered Oct. 21, 2008

**SERVICE MARK
PRINCIPAL REGISTER**

INSURING THE HEARTLAND

THE BUCKEYE STATE MUTUAL INSURANCE
COMPANY (OHIO CORPORATION), DBA
BUCKEYE INSURANCE GROUP
ONE HERITAGE PLACE
PIQUA, OH 45356

FOR: INSURANCE AGENCY AND BROKERAGE
SERVICES; INSURANCE UNDERWRITING IN THE
FIELDS OF HOME, AUTO AND FARM, IN CLASS 36
(U.S. CLS. 100, 101 AND 102).

FIRST USE 6-0-2007; IN COMMERCE 6-0-2007.

THE MARK CONSISTS OF STANDARD CHAR-
ACTERS WITHOUT CLAIM TO ANY PARTICULAR
FONT, STYLE, SIZE, OR COLOR.

SER. NO. 77-279,111, FILED 9-13-2007.

MARIA-VICTORIA SUAREZ, EXAMINING ATTOR-
NEY

Int. Cls.: 43 and 45

Prior U.S. Cls.: 100 and 101

United States Patent and Trademark Office

Reg. No. 3,519,175

Registered Oct. 21, 2008

SERVICE MARK
PRINCIPAL REGISTER



Helping to Clothe & Feed the Homeless and Impoverished.

C.U.S.H. CARIBBEAN UNITED SISTERS HELP
INC. (NEW YORK CORPORATION)
GROUND FLOOR
207 EAST 39TH STREET
BROOKLYN, NY 11203

FOR: SUPPLYING MEALS TO THE HOMELESS
OR UNDERPRIVILEGED, IN CLASS 43 (U.S. CLS.
100 AND 101).

FIRST USE 8-31-2006; IN COMMERCE 10-24-2006.

FOR: CHARITABLE SERVICES, NAMELY, PRO-
VIDING CLOTHING TO NEEDY PERSONS, IN
CLASS 45 (U.S. CLS. 100 AND 101).

FIRST USE 8-31-2006; IN COMMERCE 10-24-2006.

NO CLAIM IS MADE TO THE EXCLUSIVE
RIGHT TO USE "CARIBBEAN" AND "HELPING
TO CLOTHE & FEED THE HOMELESS AND IM-

POVERISHED", APART FROM THE MARK AS
SHOWN.

THE COLOR(S) BLACK, BROWN, ORANGE,
GOLD, GREEN AND RED. IS/ARE CLAIMED AS A
FEATURE OF THE MARK.

THE MARK CONSISTS OF THE WORDS, "CAR-
IBBEAN UNITED SISTERS HELP" AND THE TAG
LINE, "HELPING TO FEED THE HOMELESS &
IMPOVERISHED" IN BLACK TEXT. A CENTERED
TREE THAT HAS BROWN AT THE TOP WHICH
BLEEDS INTO ORANGE, THEN GOLD, AND FI-
NALLY GREEN. UNDERNEATH ALL OF WHICH IS
THE TEXT, "CUSH" IN RED.

SER. NO. 77-279,383, FILED 9-14-2007.

MARK RADEMACHER, EXAMINING ATTORNEY

Int. Cl.: 28

Prior U.S. Cls.: 22, 23, 38 and 50

United States Patent and Trademark Office

Reg. No. 3,519,176

Registered Oct. 21, 2008

**TRADEMARK
PRINCIPAL REGISTER**

HRC CRUISE CONTROL

TRUE FITNESS TECHNOLOGY, INC. (MISSOURI
CORPORATION)
865 HOFF ROAD
O'FALLON, MO 63366

FOR: EXERCISE EQUIPMENT COMPONENT
SOLD AS PART OF THE FINAL PRODUCT IN THE
NATURE OF AN AUTOMATIC VARIABLE SPEED
AND GRADE CONTROL, IN CLASS 28 (U.S. CLS. 22,
23, 38 AND 50).

FIRST USE 2-1-2007; IN COMMERCE 2-1-2007.

THE MARK CONSISTS OF STANDARD CHAR-
ACTERS WITHOUT CLAIM TO ANY PARTICULAR
FONT, STYLE, SIZE, OR COLOR.

SER. NO. 77-279,735, FILED 9-14-2007.

HEATHER SAPP, EXAMINING ATTORNEY

Int. Cls.: 44 and 45

Prior U.S. Cls.: 100 and 101

United States Patent and Trademark Office

Reg. No. 3,519,177

Registered Oct. 21, 2008

**SERVICE MARK
PRINCIPAL REGISTER**

GEL HOMECARE

GEL HOMECARE, INC. (FLORIDA CORPORATION)
SUITE 208
1280 N. CONGRESS AVENUE
WEST PALM BEACH, FL 33409

FOR: MEDICAL SERVICES, NAMELY, PHYSICAL EXAMINATION, PROVIDING MEDICAL INFORMATION; DISPENSING OF MEDICATIONS; DIETARY AND NUTRITIONAL GUIDANCE SERVICES; COORDINATION OF HOME MEDICAL EQUIPMENT, NAMELY, LEASING OF HOME MEDICAL EQUIPMENT; SKILLED NURSING AND HOME HEALTHCARE SERVICES TO MENTALLY OR PHYSICALLY CHALLENGED PEOPLE; PROVIDING HEALTH CARE SERVICES TO PATIENTS IN THEIR HOMES; OCCUPATIONAL THERAPY, RESPIRATORY THERAPY, SPEECH THERAPY AND BEHAVIORAL THERAPY, IN CLASS 44 (U.S. CLS. 100 AND 101).

FIRST USE 9-30-2001; IN COMMERCE 6-15-2008.

FOR: HOME ATTENDANT CARE, NAMELY, PERSONAL CARE ASSISTANCE FOR ACTIVITIES OF DAILY LIVING SUCH AS BATHING, GROOMING AND PERSONAL MOBILITY FOR MENTALLY OR PHYSICALLY CHALLENGED PEOPLE; PERSONAL SERVICE, NAMELY, COMPANIONSHIP SERVICES FOR ELDERLY, HANDICAPPED AND HOME-BOUND INDIVIDUALS; SERVICES PROVIDED TO INDIVIDUALS RELATING TO SOCIAL EVENTS, SUCH AS SOCIAL ESCORT SERVICES; HOMEMAKER SERVICES, NAMELY, ORGANIZATIONAL SERVICES FOR HOME OR PERSONAL PURPOSES, NAMELY, ORGANIZING CLOSET SPACE AND PERSONAL SCHEDULES, AND PERSONAL SHOPPING FOR OTHERS, IN CLASS 45 (U.S. CLS. 100 AND 101).

FIRST USE 9-30-2001; IN COMMERCE 6-15-2008.

THE MARK CONSISTS OF STANDARD CHARACTERS WITHOUT CLAIM TO ANY PARTICULAR FONT, STYLE, SIZE, OR COLOR.

NO CLAIM IS MADE TO THE EXCLUSIVE RIGHT TO USE "HOMECARE", APART FROM THE MARK AS SHOWN.

SER. NO. 77-279,942, FILED 9-14-2007.

SAMUEL E. SHARPER JR., EXAMINING ATTORNEY

Int. Cl.: 20

Prior U.S. Cls.: 2, 13, 22, 25, 32 and 50

United States Patent and Trademark Office

Reg. No. 3,519,178

Registered Oct. 21, 2008

**TRADEMARK
PRINCIPAL REGISTER**

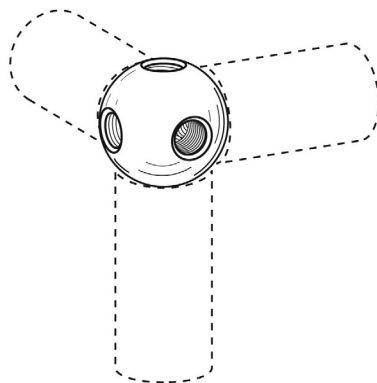

USM HOLDING AG (SWITZERLAND CORPORATION)
SCHLOSSGUTWEG 39
GUMLIGEN, SWITZERLAND CH-3073

FOR: FURNITURE, METAL FURNITURE, OFFICE FURNITURE, STORAGE CABINETS, METAL CUPBOARDS, DISPLAY CASES, SHELVING, AND PARTS FOR FURNITURE, IN CLASS 20 (U.S. CLS. 2, 13, 22, 25, 32 AND 50).

FIRST USE 8-31-1971; IN COMMERCE 8-31-1971.

PRIORITY CLAIMED UNDER SEC. 44(D) ON AUSTRALIA APPLICATION NO. 1166221, FILED 3-15-2007.

THE MARK CONSISTS OF THE DESIGN OF A CONNECTING BALL PORTION OF THE FURNITURE. THE BALL IS ROUND WITH SIX OPENINGS FOR USE IN ATTACHMENT TO THE FURNITURE. THE DOTTED LINES ARE NOT PART OF THE MARK, BUT ARE INTENDED TO SHOW THE POSITION OF THE MARK ON THE GOODS AND NO CLAIM IS MADE TO THEM.

SEC. 2(F).

SER. NO. 77-280,012, FILED 9-14-2007.

G. MAYERSCHOFF, EXAMINING ATTORNEY

Int. Cl.: 41

Prior U.S. Cls.: 100, 101 and 107

United States Patent and Trademark Office

Reg. No. 3,519,179

Registered Oct. 21, 2008

**SERVICE MARK
PRINCIPAL REGISTER**

CANCER DANCERS

CANCER DANCERS, INC. (NEW YORK CORPORATION)
C/O CROWELL & MORING, LLP
153 EAST 53RD STREET, 31ST FLOOR
NEW YORK, NY 10022

FOR: PROVIDING DANCE INSTRUCTION AND DANCE LESSONS FOR PEOPLE WITH CANCER AND CANCER SURVIVORS; ENTERTAINMENT IN THE NATURE OF DANCE PERFORMANCES BY PEOPLE WITH CANCER AND CANCER SURVIVORS; ENTERTAINMENT IN THE NATURE OF DANCE EVENTS BY PEOPLE WITH CANCER AND CANCER SURVIVORS; DANCE CAMPS FOR PEOPLE WITH CANCER AND CANCER SURVIVORS, IN CLASS 41 (U.S. CLS. 100, 101 AND 107).

FIRST USE 7-27-2007; IN COMMERCE 7-27-2007.

THE MARK CONSISTS OF STANDARD CHARACTERS WITHOUT CLAIM TO ANY PARTICULAR FONT, STYLE, SIZE, OR COLOR.

NO CLAIM IS MADE TO THE EXCLUSIVE RIGHT TO USE "CANCER", APART FROM THE MARK AS SHOWN.

SER. NO. 77-280,014, FILED 9-14-2007.

G. MAYERSCHOFF, EXAMINING ATTORNEY

Int. Cl.: 35

Prior U.S. Cls.: 100, 101 and 102

United States Patent and Trademark Office

Reg. No. 3,519,180

Registered Oct. 21, 2008

**SERVICE MARK
PRINCIPAL REGISTER**

DIRECT CONNECT

WELLBORN CABINET, INC. (ALABAMA CORPORATION)
P.O. BOX 1210
ASHLAND, AL 36251

FOR: PROVIDING AN ON-LINE INTERNET-BASED INTERACTIVE WEBSITE FOR CABINET RETAILERS TO USE FOR ORDERING, QUOTING, PRICING, ISSUING CHANGE ORDERS, CONFIRMING ORDERS, CONFIRMING SHIPPING, AND RECEIVING INVOICES FOR CUSTOM CABINETRY, IN CLASS 35 (U.S. CLS. 100, 101 AND 102).

FIRST USE 9-1-2005; IN COMMERCE 9-1-2005.

THE MARK CONSISTS OF STANDARD CHARACTERS WITHOUT CLAIM TO ANY PARTICULAR FONT, STYLE, SIZE, OR COLOR.

SER. NO. 77-280,227, FILED 9-14-2007.

JANICE KIM, EXAMINING ATTORNEY

Int. Cl.: 9

Prior U.S. Cls.: 21, 23, 26, 36 and 38

Reg. No. 3,519,181

United States Patent and Trademark Office

Registered Oct. 21, 2008

**TRADEMARK
PRINCIPAL REGISTER**

HAL

HIP, INC. (MARYLAND CORPORATION)
1049 HOOK ROAD
WESTMINSTER, MD 21157

FIRST USE 8-1-1997; IN COMMERCE 9-1-1997.

FOR: COMPUTER HARDWARE FOR INTERFACING WITH EXTERNAL ELECTRONIC DEVICES; COMPUTER SOFTWARE TO CONTROL THE COMPUTER HARDWARE INTERFACE AND THE CONNECTED EXTERNAL ELECTRONIC DEVICES, IN CLASS 9 (U.S. CLS. 21, 23, 26, 36 AND 38).

THE MARK CONSISTS OF STANDARD CHARACTERS WITHOUT CLAIM TO ANY PARTICULAR FONT, STYLE, SIZE, OR COLOR.

SER. NO. 77-280,246, FILED 9-14-2007.

KELLY MCCOY, EXAMINING ATTORNEY

Int. Cl.: 33

Prior U.S. Cls.: 47 and 49

United States Patent and Trademark Office

Reg. No. 3,519,182

Registered Oct. 21, 2008

**TRADEMARK
PRINCIPAL REGISTER**

BOTA BOX

DELICATO VINEYARDS (CALIFORNIA CORPORATION)
12001 S. HIGHWAY 99
MANTECA, CA 95336

FOR: COOKING WINE; FRUIT WINE; GRAPE WINE; KITS FOR MAKING WINE; NATURAL SPARKLING WINES; PORT WINES; RED WINE; SPARKLING FRUIT WINE; SPARKLING GRAPE WINE; SPARKLING WINES; STRAWBERRY WINE; SWEET WINES; TABLE WINES; WHITE WINE; WINE; WINE COOLERS; WINE PUNCH; WINE PUNCHES; WINES, IN CLASS 33 (U.S. CLS. 47 AND 49).

FIRST USE 7-18-2003; IN COMMERCE 9-15-2003.

THE MARK CONSISTS OF STANDARD CHARACTERS WITHOUT CLAIM TO ANY PARTICULAR FONT, STYLE, SIZE, OR COLOR.

NO CLAIM IS MADE TO THE EXCLUSIVE RIGHT TO USE "BOX", APART FROM THE MARK AS SHOWN.

THE FOREIGN WORDING IN THE MARK TRANSLATES INTO ENGLISH AS "BOOT".

SER. NO. 77-280,313, FILED 9-14-2007.

MATTHEW MCDOWELL, EXAMINING ATTORNEY

Int. Cl.: 16

Prior U.S. Cls.: 2, 5, 22, 23, 29, 37, 38 and 50

Reg. No. 3,519,183

United States Patent and Trademark Office

Registered Oct. 21, 2008

**TRADEMARK
PRINCIPAL REGISTER**

Promo Print Solutions

PROMO PRINT SOLUTIONS, INC. (WISCONSIN CORPORATION)
420 S. KOELLER STREET, SUITE 208
OSHKOSH, WI 54902

FOR: PRINTED VISUALS IN THE NATURE OF PROMOTIONAL MATERIALS AND COMMERCIAL PRINTS, IN CLASS 16 (U.S. CLS. 2, 5, 22, 23, 29, 37, 38 AND 50).

FIRST USE 9-15-2007; IN COMMERCE 9-15-2007.

THE MARK CONSISTS OF STANDARD CHARACTERS WITHOUT CLAIM TO ANY PARTICULAR FONT, STYLE, SIZE, OR COLOR.

NO CLAIM IS MADE TO THE EXCLUSIVE RIGHT TO USE "PROMO PRINT", APART FROM THE MARK AS SHOWN.

SER. NO. 77-280,621, FILED 9-16-2007.

CHARLES L. JENKINS, EXAMINING ATTORNEY

Int. Cl.: 36

Prior U.S. Cls.: 100, 101 and 102

United States Patent and Trademark Office

Reg. No. 3,519,184

Registered Oct. 21, 2008

**SERVICE MARK
PRINCIPAL REGISTER**

**REAL ESTATE WITH KNOWLEDGE
AND CARE**

MARCELLA GONZALEZ (UNITED STATES INDIVIDUAL)
78 ELM STREET
CAMARILLO, CA 93010

FOR: REAL ESTATE SERVICES, NAMELY, REAL ESTATE BROKERAGE, MORTGAGE LENDING, INVESTMENT ASSET ACQUISITION MANAGEMENT AND ESCROW SERVICES, AND ARRANGING FOR TITLE INSURANCE AND REAL ESTATE FINANCING FOR OTHERS; REAL ESTATE MANAGEMENT SERVICES ; FINANCIAL SERVICES, NAMELY, REAL ESTATE INVESTMENT BANKING, MORTGAGE BANKING AND LENDING, MANAGEMENT OF FINANCIAL AND REAL ESTATE PORTFOLIOS; VENTURE CAPITAL FUNDING SERVICES TO EMERGING AND START-UP COMPANIES; REAL ESTATE EVALUATIONS, AND APPRAISALS AGENCIES OR BROKERAGE FOR LEASING OR RENTING OF LAND; AGENCIES OR BROKERAGE FOR RENTING LAND; AGENCIES OR BROKERAGE FOR RENTING OF BUILDINGS; APPRAISAL OF REAL ESTATE; ASSESSMENT AND MANAGEMENT OF REAL ESTATE; BUSINESS BROKERAGE; EVALUATION OF REAL PROPERTY; FINANCIAL INVESTMENT IN THE FIELD OF REAL ESTATE; FINANCIAL VALUATION OF PERSONAL PROPERTY AND REAL ESTATE; INVESTMENT BROKERAGE; LAND ACQUISITION, NAMELY, REAL ESTATE BROKERAGE; LEASING OF REAL ESTATE; LEASING OF REAL PROPERTY; MORTGAGE BANKING SERVICES, NAMELY, ORIGINATION, ACQUISITION, SERVICING, SECURITIZATION AND BROKERAGE OF MORTGAGE LOANS; MORTGAGE BROKERAGE; OPERATING MARKETPLACES FOR SELLERS OF GOODS AND/OR SERVICES; PROVIDING INFORMATION IN

THE FIELD OF REAL ESTATE BY MEANS OF LINKING THE WEB SITE TO OTHER WEB SITES FEATURING REAL ESTATE INFORMATION; REAL ESTATE ACQUISITION SERVICES; REAL ESTATE AGENCIES; REAL ESTATE APPRAISAL; REAL ESTATE BROKERAGE; REAL ESTATE CONSULTANCY; REAL ESTATE CONSULTATION; REAL ESTATE EQUITY SHARING, NAMELY, MANAGING AND ARRANGING FOR CO-OWNERSHIP OF REAL ESTATE; REAL ESTATE ESCROW SERVICES; REAL ESTATE INVESTMENT; REAL ESTATE LISTING; REAL ESTATE MANAGEMENT; REAL ESTATE MANAGEMENT CONSULTATION; REAL ESTATE MULTIPLE LISTING SERVICES; REAL ESTATE PROCUREMENT FOR OTHERS; REAL ESTATE SERVICES, NAMELY, RENTAL OF VACATION HOMES, CONDOMINIUMS, CABINS, AND VILLAS USING PAY PER CLICK ADVERTISING ON A GLOBAL COMPUTER NETWORK; REAL ESTATE SYNDICATION; REAL ESTATE TIME-SHARING; REAL ESTATE TRUSTEE SERVICES; REAL ESTATE VALUATION SERVICES; REAL ESTATE VALUATIONS; VACATION REAL ESTATE TIME SHARE EXCHANGE SERVICES; VACATION REAL ESTATE TIME-SHARING, IN CLASS 36 (U.S. CLS. 100, 101 AND 102).

FIRST USE 5-31-2007; IN COMMERCE 5-31-2007.

THE MARK CONSISTS OF STANDARD CHARACTERS WITHOUT CLAIM TO ANY PARTICULAR FONT, STYLE, SIZE, OR COLOR.

SER. NO. 77-280,811, FILED 9-17-2007.

RAMONA ORTIGA, EXAMINING ATTORNEY

Int. Cl.: 28

Prior U.S. Cls.: 22, 23, 38 and 50

United States Patent and Trademark Office

Reg. No. 3,519,185

Registered Oct. 21, 2008

**TRADEMARK
PRINCIPAL REGISTER**

CLASSIC

MCPHERSON, MATHEW A. (UNITED STATES
INDIVIDUAL)
ROUTE 2, P.O. BOX 58
19055 INCLINE ROAD
NORWALK, WI 54648

THE MARK CONSISTS OF STANDARD CHAR-
ACTERS WITHOUT CLAIM TO ANY PARTICULAR
FONT, STYLE, SIZE, OR COLOR.

FOR: ARCHERY BOWS, IN CLASS 28 (U.S. CLS.
22, 23, 38 AND 50).

SER. NO. 77-281,099, FILED 9-17-2007.

FIRST USE 11-4-2005; IN COMMERCE 11-4-2005.

BARBARA BROWN, EXAMINING ATTORNEY

Int. Cl.: 9

Prior U.S. Cls.: 21, 23, 26, 36 and 38

United States Patent and Trademark Office

Reg. No. 3,519,186

Registered Oct. 21, 2008

**TRADEMARK
PRINCIPAL REGISTER**

MY CHEMICAL ROMANCE

MY CHEMICAL ROMANCE, LLC (NEW JERSEY
LIMITED LIABILITY COMPANY)
C/O FLOOD, BUMSTEAD, MCCREADY & MCCAR-
THY
387 PARK AVENUE SOUTH, 3RD FLOOR
NEW YORK, NY 10016

FOR: MUSICAL SOUND RECORDINGS; MUSI-
CAL VIDEO RECORDINGS AND OTHER AUDIO/
VISUAL RECORDINGS, NAMELY, COMPACT
DISCS FEATURING MUSICAL PERFORMANCES,
IN CLASS 9 (U.S. CLS. 21, 23, 26, 36 AND 38).

FIRST USE 7-31-2002; IN COMMERCE 7-31-2002.

THE MARK CONSISTS OF STANDARD CHAR-
ACTERS WITHOUT CLAIM TO ANY PARTICULAR
FONT, STYLE, SIZE, OR COLOR.

SER. NO. 77-281,436, FILED 9-17-2007.

EUGENIA MARTIN, EXAMINING ATTORNEY

Int. Cls.: 16 and 39

Prior U.S. Cls.: 2, 5, 22, 23, 29, 37, 38, 50, 100 and 105

United States Patent and Trademark Office

Reg. No. 3,519,187

Registered Oct. 21, 2008

**TRADEMARK
SERVICE MARK
PRINCIPAL REGISTER**



LINDA J. FORRISTAL (UNITED STATES INDIVIDUAL)
6N HILLSIDE RD.
GREENBELT, MD 20770

FOR: COOK BOOKS, IN CLASS 16 (U.S. CLS. 2, 5, 22, 23, 29, 37, 38 AND 50).

FIRST USE 0-0-1993; IN COMMERCE 0-0-1993.

FOR: PROVIDING A WEBSITE IN THE FIELD OF CULTURAL HERITAGE TOURISM, IN CLASS 39 (U.S. CLS. 100 AND 105).

FIRST USE 0-0-1998; IN COMMERCE 0-0-1998.

THE MARK CONSISTS OF A DESIGN DEPICTING, IN STYLED FORM, A WOMAN HOLDING A BOWL OF APPLES OR FRUIT STANDING AMIDST PUMPKINS AND GOURDS AND SURROUNDED BY A CIRCULAR LEAF MOTIF.

SER. NO. 77-281,493, FILED 9-17-2007.

ESTHER BELENKER, EXAMINING ATTORNEY

Int. Cls.: 9 and 12

Prior U.S. Cls.: 19, 21, 23, 26, 31, 35, 36, 38 and 44

United States Patent and Trademark Office

Reg. No. 3,519,188

Registered Oct. 21, 2008

**TRADEMARK
PRINCIPAL REGISTER**



RENTON COIL SPRING COMPANY (WASHINGTON CORPORATION)
425 S. 7TH ST.
RENTON, WA 98055

FOR: SPRINGS BEING PARTS OF VEHICLE CONTROL SYSTEMS; SPRINGS BEING PARTS OF AIRCRAFT OPERATOR CONTROLS, ACTUATOR AND AIRCRAFT CONTROL SYSTEMS; SPRINGS FOR AIRCRAFT SURFACE CONTROL ACTUATOR SYSTEMS, IN CLASS 9 (U.S. CLS. 21, 23, 26, 36 AND 38).

FIRST USE 6-30-2002; IN COMMERCE 6-30-2002.

FOR: SPRINGS FOR VEHICLES, NAMELY, SUSPENSION SPRINGS, CONTROL SPRINGS BEING

COMPONENTS PARTS, DRIVE SYSTEM SPRINGS; SPRINGS FOR AIRCRAFT LANDING GEAR AND DOORS, IN CLASS 12 (U.S. CLS. 19, 21, 23, 31, 35 AND 44).

FIRST USE 6-30-2002; IN COMMERCE 6-30-2002.

THE MARK CONSISTS OF A DEPICTION OF A COIL OVERLYING A RHOMBUS NEXT TO THE LETTERS "RCS".

SER. NO. 77-281,597, FILED 9-17-2007.

MATTHEW PAPPAS, EXAMINING ATTORNEY

Int. Cl.: 12

Prior U.S. Cls.: 19, 21, 23, 31, 35 and 44

United States Patent and Trademark Office

Reg. No. 3,519,189

Registered Oct. 21, 2008

**TRADEMARK
PRINCIPAL REGISTER**

TRIDION

DAIMLER AG (FED REP GERMANY CORPORATION)
MERCEDESSTRASSE 137
STUTTGART, FED REP GERMANY 70327

OWNER OF FED REP GERMANY REG. NO.
39640780, DATED 12-11-1996, EXPIRES 9-30-2016.

FOR: BODIES FOR PASSENGER CARS, IN CLASS
12 (U.S. CLS. 19, 21, 23, 31, 35 AND 44).

SER. NO. 77-281,848, FILED 9-18-2007.

THE MARK CONSISTS OF STANDARD CHARACTERS WITHOUT CLAIM TO ANY PARTICULAR FONT, STYLE, SIZE, OR COLOR.

RON FAIRBANKS, EXAMINING ATTORNEY

Int. Cl.: 41

Prior U.S. Cls.: 100, 101 and 107

United States Patent and Trademark Office

Reg. No. 3,519,190

Registered Oct. 21, 2008

**SERVICE MARK
PRINCIPAL REGISTER**



COUNCIL FOR RESPONSIBLE NUTRITION (D.C.
NON-PROFIT CORPORATION)
1828 L STREET, N.W., SUITE 900
WASHINGTON, DC 20036

FOR: PROVIDING ONLINE PUBLICATIONS IN
THE NATURE OF BOOKS, PAMPHLETS, AND
NEWSLETTERS IN THE FIELD OF DIETARY SUP-
PLEMENTS, IN CLASS 41 (U.S. CLS. 100, 101 AND
107).

FIRST USE 12-0-2006; IN COMMERCE 12-0-2006.

NO CLAIM IS MADE TO THE EXCLUSIVE
RIGHT TO USE "STANDARDIZED INFORMATION
ON DIETARY INGREDIENTS", APART FROM THE
MARK AS SHOWN.

THE MARK CONSISTS IN PART, OF A BOX AND
CHECKMARK DESIGN.

SER. NO. 77-281,878, FILED 9-18-2007.

ROBIN CHOSID, EXAMINING ATTORNEY

Int. Cl.: 45

Prior U.S. Cls.: 100 and 101

United States Patent and Trademark Office

Reg. No. 3,519,191

Registered Oct. 21, 2008

**SERVICE MARK
PRINCIPAL REGISTER**



BOETTCHER, BOETTCHER & LOBAUGH, INC.
(OKLAHOMA CORPORATION)
4111 S. DARLINGTON - SUITE 1075
TULSA, OK 74135

FOR: LEGAL SERVICES, IN CLASS 45 (U.S. CLS.
100 AND 101).

FIRST USE 12-31-1982; IN COMMERCE 12-31-1982.

THE COLOR(S) SILVER, BLACK, RED, BLUE
AND BROWN IS/ARE CLAIMED AS A FEATURE
OF THE MARK.

THE MARK CONSISTS OF A DENTED HARD
HAT SHOWN PREDOMINANTLY IN SILVER WITH
BLACK SHADOWS AND HINTS OF RED, BLUE
AND BROWN ON THE FRONT AND SIDE.

SER. NO. 77-282,012, FILED 9-18-2007.

DAVID YONTEF, EXAMINING ATTORNEY

Int. Cl.: 9

Prior U.S. Cls.: 21, 23, 26, 36 and 38

Reg. No. 3,519,192

United States Patent and Trademark Office

Registered Oct. 21, 2008

**TRADEMARK
PRINCIPAL REGISTER**

Envirotelligent

POWERMAND INC. (OREGON CORPORATION)
2828 SW CORBETT
SUITE 210
PORTLAND, WA 97201

FOR: COMPUTER HARDWARE AND SOFTWARE SYSTEM FOR REMOTELY MONITORING ENVIRONMENTAL CONDITIONS AND CONTROLLING DEVICES WITHIN A BUILDING, FACILITY, GROUNDS, OR DESIGNATED SPATIAL AREA, IN CLASS 9 (U.S. CLS. 21, 23, 26, 36 AND 38).

FIRST USE 0-0-2006; IN COMMERCE 0-0-2007.

THE MARK CONSISTS OF STANDARD CHARACTERS WITHOUT CLAIM TO ANY PARTICULAR FONT, STYLE, SIZE, OR COLOR.

SER. NO. 77-282,204, FILED 9-18-2007.

RENEE SERVANCE, EXAMINING ATTORNEY

Int. Cl.: 10

Prior U.S. Cls.: 26, 39 and 44

United States Patent and Trademark Office

Reg. No. 3,519,193

Registered Oct. 21, 2008

**TRADEMARK
PRINCIPAL REGISTER**

GERILINE

PREVENT PRODUCTS, INC. (MINNESOTA CORPORATION)
SUITE 210
1355 MENDOTA HEIGHTS ROAD
MENDOTA HEIGHTS, MN 55120

FOR: GERIATRIC HAND AND ARM PROTECTORS USED TO PROTECT SKIN; GERIATRIC LEG PROTECTORS USED TO PROTECT SKIN; ORTHOPEDIC ARM AND WRIST PROTECTORS USED TO PROTECT SKIN AND ENHANCE FUNCTION RECOVERY FOLLOWING SURGERY OR REMOVAL OF A CAST; ICEPACK-CONTAINING SUPPORTIVE BANDAGES USED TO RELIEVE PAIN, REDUCE SWELLING AND PROMOTE HEALING; PADDED ELBOW PROTECTORS USED TO PREVENT PRESSURE WOUNDS; PADDED HEEL PROTECTORS USED TO PREVENT PRESSURE WOUNDS; HIP

PROTECTORS USED TO HELP PROTECT THE HIP AND GREATER TROCHANTER FROM IMPACT; AND SACROCOCCYGEAL PROTECTORS USED TO HELP PREVENT PRESSURE ULCERS ON THE SACRAL AREA, IN CLASS 10 (U.S. CLS. 26, 39 AND 44).

FIRST USE 7-20-2006; IN COMMERCE 7-20-2006.

THE MARK CONSISTS OF STANDARD CHARACTERS WITHOUT CLAIM TO ANY PARTICULAR FONT, STYLE, SIZE, OR COLOR.

SER. NO. 77-282,403, FILED 9-18-2007.

JIM RINGLE, EXAMINING ATTORNEY

Int. Cl.: 13

Prior U.S. Cls.: 2 and 9

United States Patent and Trademark Office

Reg. No. 3,519,194

Registered Oct. 21, 2008

**TRADEMARK
PRINCIPAL REGISTER**

LECTRONICS LLC

LECTRONICS LLC (TEXAS LIMITED LIABILITY
COMPANY)

2420 SPRINGER DRIVE, SUITE 110

NORMAN, OK 73069

FOR: EXPLOSIVE DETONATORS, IN CLASS 13
(U.S. CLS. 2 AND 9).

FIRST USE 4-10-2007; IN COMMERCE 4-10-2007.

THE MARK CONSISTS OF STANDARD CHAR-
ACTERS WITHOUT CLAIM TO ANY PARTICULAR
FONT, STYLE, SIZE, OR COLOR.

NO CLAIM IS MADE TO THE EXCLUSIVE
RIGHT TO USE "LLC", APART FROM THE MARK
AS SHOWN.

SER. NO. 77-282,451, FILED 9-18-2007.

DAWN FELDMAN, EXAMINING ATTORNEY

Int. Cl.: 17

Prior U.S. Cls.: 1, 5, 12, 13, 35 and 50

Reg. No. 3,519,195

United States Patent and Trademark Office

Registered Oct. 21, 2008

**TRADEMARK
PRINCIPAL REGISTER**

VERISURE

WEST PHARMACEUTICAL SERVICES, INC.
(PENNSYLVANIA CORPORATION)
101 GORDON DRIVE
LIONVILLE, PA 193410645

THE MARK CONSISTS OF STANDARD CHAR-
ACTERS WITHOUT CLAIM TO ANY PARTICULAR
FONT, STYLE, SIZE, OR COLOR.

FOR: RUBBER VIAL STOPPERS, IN CLASS 17
(U.S. CLS. 1, 5, 12, 13, 35 AND 50).

SER. NO. 77-283,094, FILED 9-19-2007.

FIRST USE 11-6-2007; IN COMMERCE 11-21-2007.

MARK PILARO, EXAMINING ATTORNEY

Int. Cls.: 9 and 41

Prior U.S. Cls.: 21, 23, 26, 36, 38, 100, 101 and 107

United States Patent and Trademark Office

Reg. No. 3,519,196

Registered Oct. 21, 2008

**TRADEMARK
SERVICE MARK
PRINCIPAL REGISTER**

BLANK TAPE

LIVESAY, LENNON (UNITED STATES INDIVIDUAL)
1911 NW 106 TERRACE
PEMBROKE PINES, FL 33026

FOR: AUDIO RECORDINGS FEATURING MUSIC; MUSICAL AUDIO RECORDINGS; PRE-RECORDED CD'S FEATURING MUSIC; SOUND RECORDINGS FEATURING MUSIC; PRERECORDED COMPACT DISKS FEATURING MUSIC; PRE-RECORDED MUSICAL SOUND RECORDINGS, IN CLASS 9 (U.S. CLS. 21, 23, 26, 36 AND 38).

FIRST USE 12-31-2006; IN COMMERCE 12-31-2006.

FOR: PROVIDING ENTERTAINMENT SERVICES IN THE NATURE OF AUDIO AND VISUAL PERFORMANCES, NAMELY, MUSICAL GROUP PERFORMANCES; ENTERTAINMENT, NAMELY, LIVE PERFORMANCES BY A MUSICAL GROUP; LIVE MUSICAL PERFORMANCES BY A MUSICAL

GROUP; ENTERTAINMENT SERVICES, NAMELY, PROVIDING PRERECORDED MUSIC ONLINE VIA A GLOBAL COMPUTER NETWORK; ONLINE ENTERTAINMENT RENDERED BY A MUSICAL BAND, NAMELY, PROVIDING A WEB SITE FEATURING MUSICAL PERFORMANCES, PHOTOGRAPHS AND OTHER BAND RELATED INFORMATION, IN CLASS 41 (U.S. CLS. 100, 101 AND 107).

FIRST USE 12-10-2004; IN COMMERCE 9-30-2005.

THE MARK CONSISTS OF STANDARD CHARACTERS WITHOUT CLAIM TO ANY PARTICULAR FONT, STYLE, SIZE, OR COLOR.

SER. NO. 77-283,370, FILED 9-19-2007.

SHARON MEIER, EXAMINING ATTORNEY

Int. Cl.: 41

Prior U.S. Cls.: 100, 101 and 107

United States Patent and Trademark Office

Reg. No. 3,519,197

Registered Oct. 21, 2008

**SERVICE MARK
PRINCIPAL REGISTER**

STRIPCLUBHOUSE.COM

GALLERYGONELIVE INC. (ILLINOIS COR-
PORATION)
P.O. BOX 760
1 LEGRAND
CARBONDALE, IL 62903

FOR: ENTERTAINMENT SERVICES, NAMELY,
PROVIDING A WEB SITE FEATURING LIVE
ADULT ENTERTAINMENT PERFORMANCES, IN
CLASS 41 (U.S. CLS. 100, 101 AND 107).

FIRST USE 9-6-2007; IN COMMERCE 9-6-2007.

THE MARK CONSISTS OF STANDARD CHAR-
ACTERS WITHOUT CLAIM TO ANY PARTICULAR
FONT, STYLE, SIZE, OR COLOR.

SER. NO. 77-283,485, FILED 9-19-2007.

JENNIFER MARTIN, EXAMINING ATTORNEY

Int. Cls.: 35 and 36

Prior U.S. Cls.: 100, 101 and 102

United States Patent and Trademark Office

Reg. No. 3,519,198

Registered Oct. 21, 2008

**SERVICE MARK
PRINCIPAL REGISTER**

Wells Fargo Foundation
Connecting with community.

WELLS FARGO BANK, N.A. (UNITED STATES
NATIONAL BANKING ASSOCIATION)
MAC N9305-176 SIXTH AVENUE & MARQUETTE
1700 WELLS FARGO CENTER
MINNEAPOLIS, MN 55479

FOR: CHARITABLE SERVICES, NAMELY, ORGANIZING AND CONDUCTING VOLUNTEER PROGRAMS AND COMMUNITY SERVICE PROJECTS; CHARITABLE SERVICES, NAMELY, THE ORGANIZATION, COORDINATION AND ADMINISTRATION OF ALL VOLUNTEER EFFORT WITHIN A CORPORATION; ORGANIZATION AND SUPERVISION OF VOLUNTEERS FOR COMMUNITY SERVICE; CHARITABLE SERVICES, NAMELY, INVOLVING INDIVIDUALS AND GROUPS IN COMMUNITY-BASED SERVICE AND CHARITABLE ACTIVITIES, IN CLASS 35 (U.S. CLS. 100, 101 AND 102).

FIRST USE 9-1-2005; IN COMMERCE 9-1-2005.

FOR: PROVIDING GRANTS TO ORGANIZATIONS IN THE FIELDS OF ARTS AND CULTURE,

ECONOMIC DEVELOPMENT, FINANCIAL LITERACY AND COMMUNITY DEVELOPMENT; AND PROVIDING EDUCATIONAL SCHOLARSHIPS, IN CLASS 36 (U.S. CLS. 100, 101 AND 102).

FIRST USE 9-1-2005; IN COMMERCE 9-1-2005.

OWNER OF U.S. REG. NOS. 2,800,811, 3,320,784 AND OTHERS.

NO CLAIM IS MADE TO THE EXCLUSIVE RIGHT TO USE "FOUNDATION", APART FROM THE MARK AS SHOWN.

THE MARK CONSISTS OF BOLDED "WELLS FARGO FOUNDATION" SITTING ABOVE A LINE; AND NON-BOLDED "CONNECTING WITH COMMUNITY" BELOW THE LINE.

SER. NO. 77-283,534, FILED 9-19-2007.

LINDA ESTRADA, EXAMINING ATTORNEY

Int. Cls.: 11 and 35

Prior U.S. Cls.: 13, 21, 23, 31, 34, 100, 101 and 102

Reg. No. 3,519,199

United States Patent and Trademark Office

Registered Oct. 21, 2008

**TRADEMARK
SERVICE MARK
PRINCIPAL REGISTER**

GOLDEN LIGHTING

GOLDEN DRAGON ASSOCIATION, INC. (FLOR-
IDA CORPORATION)
2851 INDUSTRIAL PLAZA DRIVE
TALLAHASSEE, FL 32301

FOR: LIGHTING FIXTURES, IN CLASS 11 (U.S.
CLS. 13, 21, 23, 31 AND 34).

FIRST USE 0-0-1982; IN COMMERCE 0-0-1982.

FOR: WHOLESALE DISTRIBUTORSHIP FEA-
TURING LIGHTING FIXTURES, IN CLASS 35 (U.S.
CLS. 100, 101 AND 102).

FIRST USE 0-0-1982; IN COMMERCE 0-0-1982.

THE MARK CONSISTS OF STANDARD CHAR-
ACTERS WITHOUT CLAIM TO ANY PARTICULAR
FONT, STYLE, SIZE, OR COLOR.

NO CLAIM IS MADE TO THE EXCLUSIVE
RIGHT TO USE "LIGHTING", APART FROM THE
MARK AS SHOWN.

SER. NO. 77-283,563, FILED 9-19-2007.

ALEXANDER L. POWERS, EXAMINING ATTOR-
NEY

Int. Cl.: 7

Prior U.S. Cls.: 13, 19, 21, 23, 31, 34 and 35

Reg. No. 3,519,200

United States Patent and Trademark Office

Registered Oct. 21, 2008

**TRADEMARK
PRINCIPAL REGISTER**

DUAL POOL

DERRICK CORPORATION (NEW YORK CORPORATION)
590 DUKE ROAD
BUFFALO, NY 14225

FOR: VIBRATORY INDUSTRIAL SCREENING APPARATUS FOR SEPARATING MATERIALS AND PARTS THEREFOR; REPLACEMENT SCREEN CLOTHS FOR VIBRATORY SCREENING MACHINES; DRILL MUD SCREENING MACHINES; SOLIDS SEPARATION EQUIPMENT, NAMELY, MATERIAL DRYER MACHINES; ELECTRIC VIBRATORY MOTORS FOR MACHINES AND PARTS

THEREOF, IN CLASS 7 (U.S. CLS. 13, 19, 21, 23, 31, 34 AND 35).

FIRST USE 4-30-2007; IN COMMERCE 4-30-2007.

THE MARK CONSISTS OF STANDARD CHARACTERS WITHOUT CLAIM TO ANY PARTICULAR FONT, STYLE, SIZE, OR COLOR.

SER. NO. 77-283,659, FILED 9-19-2007.

CAROL SPILS, EXAMINING ATTORNEY

Int. Cls.: 9 and 42

Prior U.S. Cls.: 21, 23, 26, 36, 38, 100 and 101

United States Patent and Trademark Office

Reg. No. 3,519,201

Registered Oct. 21, 2008

**TRADEMARK
SERVICE MARK
PRINCIPAL REGISTER**

DIWA

AREVA NP GMBH (FED REP GERMANY CORPORATION)
FREYESLEBENSTRASSE 1
91058 ERLANGEN, FED REP GERMANY

FOR: DIAGNOSTIC COMPUTER SOFTWARE FOR USE IN DETECTION, LOCALIZATION AND CORRECTION OF DISTURBANCES AND POTENTIAL DISTURBANCES IN INDUSTRIAL AND POWER GENERATING PROCESSES, NAMELY, DISTURBANCES RELATING TO WATER CHEMISTRY IN WATER-STEAM CYCLES, IN CLASS 9 (U.S. CLS. 21, 23, 26, 36 AND 38).

FOR: DEVELOPMENT OF DATA PROCESSING PROGRAMS FOR OTHERS; RENTAL OF COMPU-

TER SOFTWARE FOR DATA PROCESSING, IN CLASS 42 (U.S. CLS. 100 AND 101).

THE MARK CONSISTS OF STANDARD CHARACTERS WITHOUT CLAIM TO ANY PARTICULAR FONT, STYLE, SIZE, OR COLOR.

OWNER OF FED REP GERMANY REG. NO. 1097141, DATED 10-1-1986, EXPIRES 3-31-2016.

THE MARK HAS NO MEANING IN A FOREIGN LANGUAGE.

SER. NO. 77-283,787, FILED 9-19-2007.

NAPOLEON SHARMA, EXAMINING ATTORNEY

Int. Cl.: 41

Prior U.S. Cls.: 100, 101 and 107

United States Patent and Trademark Office

Reg. No. 3,519,202

Registered Oct. 21, 2008

**SERVICE MARK
PRINCIPAL REGISTER**

**WORLD'S FIRST LIVE STRIP
CLUB**

GALLERYGONELIVE INC. (ILLINOIS COR-
PORATION)
P.O. BOX 760
1 LEGRAND
CARBONDALE, IL 62903

FOR: ENTERTAINMENT SERVICES, NAMELY,
PROVIDING A WEB SITE FEATURING LIVE
ADULT ENTERTAINMENT PERFORMANCES, IN
CLASS 41 (U.S. CLS. 100, 101 AND 107).

FIRST USE 9-6-2007; IN COMMERCE 9-6-2007.

THE MARK CONSISTS OF STANDARD CHAR-
ACTERS WITHOUT CLAIM TO ANY PARTICULAR
FONT, STYLE, SIZE, OR COLOR.

SER. NO. 77-283,823, FILED 9-19-2007.

JENNIFER MARTIN, EXAMINING ATTORNEY

Prior U.S. Cl.: 200

United States Patent and Trademark Office

Reg. No. 3,519,203

Registered Oct. 21, 2008

**COLLECTIVE MEMBERSHIP
PRINCIPAL REGISTER**

**National Reverse Mortgage
Lenders Association**

NATIONAL REVERSE MORTGAGE LENDERS
ASSOCIATION (D.C. UNINCORPORATED AS-
SOCIATION)
SUITE 420
1400 16TH STREET NW
WASHINGTON, DC 20036

FOR: INDICATING MEMBERSHIP IN AN ORGA-
NIZATION OF PROFESSIONALS IN THE REVERSE
MORTGAGE INDUSTRY, IN CLASS 200 (U.S. CL.
200).

FIRST USE 11-1-1997; IN COMMERCE 11-1-1997.

THE MARK CONSISTS OF STANDARD CHAR-
ACTERS WITHOUT CLAIM TO ANY PARTICULAR
FONT, STYLE, SIZE, OR COLOR.

NO CLAIM IS MADE TO THE EXCLUSIVE
RIGHT TO USE "ASSOCIATION", APART FROM
THE MARK AS SHOWN.

SEC. 2(F).

SER. NO. 77-284,323, FILED 9-20-2007.

DAVID MURRAY, EXAMINING ATTORNEY

Int. Cl.: 9

Prior U.S. Cls.: 21, 23, 26, 36 and 38

United States Patent and Trademark Office

Reg. No. 3,519,204

Registered Oct. 21, 2008

TRADEMARK
PRINCIPAL REGISTER



MEDICAL INTERNETICS, INC. (MICHIGAN CORPORATION)
HERBERT J. BURNS
5455 CORPORATE DRIVE, STE. 105
TROY, MI 48098

FOR: MEDICAL SOFTWARE FOR ORGANIZING AND MAINTAINING PATIENT MEDICAL INFORMATION, IN CLASS 9 (U.S. CLS. 21, 23, 26, 36 AND 38).

FIRST USE 6-1-2006; IN COMMERCE 8-1-2007.

NO CLAIM IS MADE TO THE EXCLUSIVE RIGHT TO USE "MD", APART FROM THE MARK AS SHOWN.

THE COLOR(S) GRAY, BLACK, BLUE AND RED IS/ARE CLAIMED AS A FEATURE OF THE MARK.

THE COLOR BLACK APPEARS IN THE LETTERS "G" AND "P", AND THE COLOR RED APPEARS IN THE LETTER "A" AND IN THE WORK "IT". THE COLOR BLUE APPEARS IN THE WORDING "MD". THE COLOR GRAY APPEARS IN THE TWO HALF OVALS AROUND THE LETTER "G".

SER. NO. 77-284,400, FILED 9-20-2007.

WENDY JUN, EXAMINING ATTORNEY

Int. Cl.: 25

Prior U.S. Cls.: 22 and 39

United States Patent and Trademark Office

Reg. No. 3,519,205

Registered Oct. 21, 2008

TRADEMARK
PRINCIPAL REGISTER



MILLER DESIGN INC. (DELAWARE CORPORATION), DBA ISLAND IMAGE
1122 WHITEHEAD STREET
KEY WEST, FL 33040

THE MACAW DESIGN IS IN THE COLORS RED, YELLOW AND BLUE; THE WORDING "ISLAND" IS IN SHADES OF GREEN, YELLOW AND BLUE; AND THE WORDING "IMAGE" IS IN RED.

FOR: SHIRTS, IN CLASS 25 (U.S. CLS. 22 AND 39).

FIRST USE 8-20-2003; IN COMMERCE 8-20-2003.

OWNER OF U.S. REG. NO. 3,295,435.

SER. NO. 77-284,603, FILED 9-20-2007.

THE COLOR(S) RED, YELLOW, BLUE AND GREEN IS/ARE CLAIMED AS A FEATURE OF THE MARK.

DAWN HAN, EXAMINING ATTORNEY

Int. Cls.: 9 and 16

Prior U.S. Cls.: 2, 5, 21, 22, 23, 26, 29, 36, 37, 38 and 50

Reg. No. 3,519,206

United States Patent and Trademark Office

Registered Oct. 21, 2008

**TRADEMARK
PRINCIPAL REGISTER**

HEADZONE

BEYER DYNAMIC GMBH & CO. KG (FED REP GERMANY KOMMANDITGESELLSCHAFT (KG))

THERESIENSTR. 8

HEILBRONN, FED REP GERMANY 74072

FOR: ELECTRIC AND ELECTRONIC DEVICES, EQUIPMENT AND INSTRUMENTS IN THE FIELD OF ELECTRO-ACOUSTIC TECHNOLOGY AND FOR DETECTING AUDIO SIGNALS, NAMELY, ELECTRO-ACOUSTIC TRANSDUCERS, HEADPHONES, DYNAMIC HEADPHONES, ELECTROSTATIC HEADPHONES, WIRELESS HEADPHONES, HEADPHONES FOR USE IN VEHICLES ESPECIALLY WITH INFRARED TRANSMISSION, HEADPHONES WITH ACTIVE NOISE COMPENSATION, LOUDSPEAKERS, PARTS AND ACCESSORIES FOR ELECTRO-ACOUSTIC TRANSDUCERS AND HEADPHONES, NAMELY, EAR PADS, VOLUME CONTROLS, AMPLIFIERS, ULTRASOUND HEAD TRACKING SYSTEMS COMPRISED OF HEADSETS INCORPORATING MOTION SENSORS, CONNECTING CABLES, AND RELATED OPERATING SOFTWARE, AND EARPHONE SYSTEMS COMPRISED OF EARPHONES AND RELATED SOFTWARE FOR REPRODUCING 5.1 CHANNEL STEREO SURROUND SOUND FOR STUDIO APPLICATIONS; ULTRASOUND TRANSDUCERS, ESPECIALLY FOR USE IN HEAD TRACKING SYSTEMS FOR HEADPHONES; DEVICES FOR THE TRANSMISSION OF SOUND AND VIDEO SIGNALS; DEVICES AND INSTRUMENTS IN THE FIELD OF STUDIO ENGINEERING, NAMELY, MICROPHONES, ELECTRO-ACOUSTIC TRANSDUCERS, HEADPHONES, DYNAMIC HEADPHONES, ELECTROSTATIC HEADPHONES, WIRELESS HEADPHONES, LOUDSPEAKERS, PARTS AND ACCESSORIES FOR ELECTRO-ACOUSTIC TRANSDUCERS AND HEADPHONES, NAMELY, EAR PADS, VOLUME CONTROLS, AMPLIFIERS, CONNECTING CABLES, AND RELATED OPERATING SOFTWARE, AND EARPHONE SYSTEMS COMPRISED OF EARPHONES AND RELATED SOFTWARE FOR REPRODUCING 5.1 CHANNEL STEREO SURROUND SOUND FOR STUDIO APPLICATIONS; DEVICES AND INSTRUMENTS IN THE FIELD OF CONFERENCE AND TELECOMMUNICATIONS TECHNOLOGY, NAMELY, MICROPHONES, ELECTRO-ACOUSTIC TRANSDUCERS, HEADPHONES, DYNAMIC HEADPHONES, ELECTROSTATIC HEADPHONES, WIRELESS HEADPHONES, LOUDSPEAKERS, PARTS AND ACCESSORIES FOR ELECTRO-ACOUSTIC TRANSDUCERS AND HEADPHONES, NAMELY, EAR PADS, VOLUME CONTROLS, AMPLIFIERS, CONNECTING CABLES, AND RELATED OPERATING SOFTWARE; SOUND RECORDING EQUIPMENT, ESPECIALLY FOR USE IN MOBILE UNITS; DEVICES FOR SOUND TRANSMISSION ENGINEERING, NAMELY, TRANSMITTERS, SINGLE-CHANNEL TRANSMITTERS, MULTI-CHANNEL TRANSMITTERS, INFRARED TRANSMITTERS, RECEIVERS, SINGLE-CHANNEL RECEIVERS, MULTI-CHANNEL RECEIVERS, TWO-CHANNEL RECEIVERS, INFRARED RECEIVERS, HEAD PHONE RECEIVERS AND PARTS OF SUCH GOODS, IN CLASS 9 (U.S. CLS. 21, 23, 26, 36 AND 38).

FOR: PRINT PRODUCTS, NAMELY, CATALOGUES FEATURING HEADPHONES, EARPHONES, HEAD-TRACKING, SOUND-RECORDING, SOUND-TRANSMITTING AND ACOUSTIC EQUIPMENT, INSTRUCTIONAL MANUALS FOR HEADPHONES, EARPHONES, HEAD-TRACKING, SOUND-RECORDING, SOUND-TRANSMITTING AND ACOUSTIC EQUIPMENT, PRINTED EVENT PROGRAMS, PRINTED SOUVENIR PROGRAMS, IN CLASS 16 (U.S. CLS. 2, 5, 22, 23, 29, 37, 38 AND 50).

THE MARK CONSISTS OF STANDARD CHARACTERS WITHOUT CLAIM TO ANY PARTICULAR FONT, STYLE, SIZE, OR COLOR.

OWNER OF ERPN CMNTY TM OFC REG. NO.
005308770, DATED 7-31-2007, EXPIRES 8-25-2016.

SER. NO. 77-284,804, FILED 9-20-2007.

MARY ROSSMAN, EXAMINING ATTORNEY

Int. Cl.: 3

Prior U.S. Cls.: 1, 4, 6, 50, 51 and 52

Reg. No. 3,519,207

United States Patent and Trademark Office

Registered Oct. 21, 2008

**TRADEMARK
PRINCIPAL REGISTER**

ELASTICIN

MAHJOBI, JAMIE (UNITED STATES INDIVIDUAL)
18034 VENTURA BLVD #195
ENCINO, CA 91316

FOR: AFTER SUN CREAMS; AFTER-SHAVE CREAMS; AGE SPOT REDUCING CREAMS; ANTI-AGING CREAMS; ANTI-FRECKLE CREAMS; ANTI-WRINKLE CREAMS; ANTIBACTERIAL SKIN SOAPS; AROMATHERAPY CREAMS; BEAUTY CREAMS AND POWDERS; BOOT CREAM; CLEANSING CREAMS; COLD CREAMS; CONCEALERS FOR WRINKLE, AGE SPOTS, BLEMISHES; COSMETIC CREAMS FOR SKIN CARE AND ENHANCEMENT; COSMETIC PREPARATIONS FOR SKIN RENEWAL; COSMETIC PRODUCTS IN THE FORM OF AEROSOLS FOR SKIN CARE; COSMETIC PRODUCTS TAKEN ORALLY, NAMELY, PILLS THAT INDUCE BRONZING OF THE SKIN OR ENHANCE SKIN ELASTICITY; CREAM SOAPS; CREAMS FOR CELLULITE REDUCTION; CREAMS FOR LEATHER; CUTICLE CREAM; DECORATIVE TRANSFERS AND SKIN JEWELS FOR COSMETIC PURPOSES; DEPILATORY CREAMS; EXFOLIANT CREAMS; EYE CREAM; FACE AND BODY BEAUTY CREAMS; FAIR COMPLEXION CREAM; HAIR CARE CREAMS; HAIR CREAMS; HAIR REMOVING CREAM; LOTIONS FOR SKIN, HAND AND LIP CARE; MAKE-UP REMOVING MILK, GEL, LOTIONS AND CREAMS; MOISTURIZING CREAMS; MOUSSE FOR HAIR AND SKIN CARE; NAIL CREAM; NIGHT CREAM; NON-MEDICATED FOOT CREAM; NON-MEDICATED SCALP TREATMENT CREAM; NON-MEDICATED SKIN CARE PREPARATIONS, NAMELY, CREAMS, LOTIONS, GELS, TONERS, CLEANERS AND PEELS; NON-MEDICATED STIMULATING LOTIONS FOR THE SKIN; PATCHES CONTAINING SUN SCREEN AND SUN

BLOCK FOR USE ON THE SKIN; RETINOL CREAM FOR COSMETIC PURPOSES; SCENTED BODY LOTIONS AND CREAMS; SHAVING CREAMS; SKIN ABRASIVE PREPARATIONS; SKIN BRONZING CREAMS; SKIN CARE PREPARATION, NAMELY, BODY POLISH; SKIN CARE PREPARATIONS, NAMELY, CHEMICAL PEELS FOR SKIN, NAMELY, FRUIT ACID PEELS FOR SKIN; SKIN CARE PRODUCTS, NAMELY, NON-MEDICATED SKIN SERUM, CLARIFIERS, CLEANSERS, CONDITIONERS; SKIN CREAMS IN LIQUID AND IN SOLID FORM; SKIN EMOLLIENTS; SKIN GELS FOR ACCELERATING, ENHANCING OR EXTENDING TANS; SKIN LIGHTENERS; SKIN LIGHTENING CREAMS; SKIN LOTIONS; SKIN MASKS; SKIN MOISTURIZER; SKIN MOISTURIZER MASKS; SKIN POLISHING RICE BRAN (ARAI-NUKA); SKIN SOAP; SKIN TEXTURIZERS; SKIN TONERS; SKIN WHITENING CREAMS; SKIN WHITENING PREPARATIONS; SUN CREAMS; SUNSCREEN AND TANNING CREAMS; TOPICAL HERBAL CREAM FOR FIRING AND ENHANCING BREASTS; TOPICAL SKIN SPRAYS FOR COSMETIC PURPOSES; VANISHING CREAM; WRINKLE REMOVING SKIN CARE PREPARATIONS; WRINKLE RESISTANT CREAM, IN CLASS 3 (U.S. CLS. 1, 4, 6, 50, 51 AND 52).

FIRST USE 4-20-2008; IN COMMERCE 4-20-2008.

THE MARK CONSISTS OF STANDARD CHARACTERS WITHOUT CLAIM TO ANY PARTICULAR FONT, STYLE, SIZE, OR COLOR.

SER. NO. 77-285,053, FILED 9-20-2007.

KAPIL BHANOT, EXAMINING ATTORNEY

Int. Cl.: 41

Prior U.S. Cls.: 100, 101 and 107

United States Patent and Trademark Office

Reg. No. 3,519,208

Registered Oct. 21, 2008

**SERVICE MARK
PRINCIPAL REGISTER**



OLDE TYME TUTORS, LLC (ARKANSAS LIMITED LIABILITY COMPANY)
14596 HIGHWAY 12 E.
ROGERS, AR 72756

FOR: EDUCATION SERVICES, NAMELY, CLASSES, WORKSHOPS, INDIVIDUAL GROUP INSTRUCTION AND SMALL GROUP INSTRUCTION IN THE NATURE OF COURSES AT THE GRADE SCHOOL LEVEL AND UNIVERSITY LEVEL, IN CLASS 41 (U.S. CLS. 100, 101 AND 107).

FIRST USE 3-1-2006; IN COMMERCE 3-1-2006.

NO CLAIM IS MADE TO THE EXCLUSIVE RIGHT TO USE "TUTORS", APART FROM THE MARK AS SHOWN.

THE MARK CONSISTS OF TWO LINES, THE FIRST LINE CONTAINING THE WORDS, "OLDE TYME". THE SECOND LINE HAS A DESIGN FOLLOWED BY THE WORD, "TUTORS". THE DESIGN CONTAINS THREE "V" SHAPED ELEMENTS POSITIONED BELOW A BOX THAT SURROUNDS A SQUARE WITH THE SQUARE HAVING A SOLID BACKGROUND WITH LIGHTER AREAS SHOWING A TRIANGULAR BODIED PERSON WITH AN OVAL HEAD POSITIONED WITH ARMS EXTENDING DOWNWARD TO A SMALLER TRIANGULAR BODIED PERSON WITH AN OVAL HEAD.

SER. NO. 77-285,077, FILED 9-20-2007.

ARETHA SOMERVILLE, EXAMINING ATTORNEY

Int. Cl.: 36

Prior U.S. Cls.: 100, 101 and 102

United States Patent and Trademark Office

Reg. No. 3,519,209

Registered Oct. 21, 2008

**SERVICE MARK
PRINCIPAL REGISTER**

Eagle Credit Union

EAGLE CREDIT UNION (CALIFORNIA CREDIT UNION)

4245 WEST LANE SUITE 6A

STOCKTON, CA 95208

FOR: CREDIT UNION SERVICES, IN CLASS 36 (U.S. CLS. 100, 101 AND 102).

FIRST USE 9-1-2007; IN COMMERCE 9-1-2007.

THE MARK CONSISTS OF STANDARD CHARACTERS WITHOUT CLAIM TO ANY PARTICULAR FONT, STYLE, SIZE, OR COLOR.

NO CLAIM IS MADE TO THE EXCLUSIVE RIGHT TO USE "CREDIT UNION", APART FROM THE MARK AS SHOWN.

SER. NO. 77-285,918, FILED 9-21-2007.

BARBARA GAYNOR, EXAMINING ATTORNEY

Int. Cl.: 5

Prior U.S. Cls.: 6, 18, 44, 46, 51 and 52

Reg. No. 3,519,210

United States Patent and Trademark Office

Registered Oct. 21, 2008

**TRADEMARK
PRINCIPAL REGISTER**

**EMPOWERED CHOICES. BETTER
LIVING.**

NUTRI-HEALTH SUPPLEMENTS, LLC (ARIZONA LIMITED LIABILITY COMPANY)
218 JUSTIN DRIVE
COTTONWOOD, AZ 86326

THE MARK CONSISTS OF STANDARD CHARACTERS WITHOUT CLAIM TO ANY PARTICULAR FONT, STYLE, SIZE, OR COLOR.

FOR: DIETARY AND NUTRITIONAL SUPPLEMENTS, IN CLASS 5 (U.S. CLS. 6, 18, 44, 46, 51 AND 52).

SER. NO. 77-286,122, FILED 9-21-2007.

FIRST USE 8-1-2007; IN COMMERCE 8-1-2007.

CIMMERIAN COLEMAN, EXAMINING ATTORNEY

Int. Cls.: 9, 39 and 41

Prior U.S. Cls.: 21, 23, 26, 36, 38, 100, 101, 105 and 107

Reg. No. 3,519,211

United States Patent and Trademark Office

Registered Oct. 21, 2008

**TRADEMARK
SERVICE MARK
PRINCIPAL REGISTER**

SEAVID

SILVERFLASH, INC. (CALIFORNIA CORPORATION), DBA SEAVID
P.O. BOX 2785
LA JOLLA, CA 92038

FOR: PRERECORDED MULTI-MEDIA PRODUCTS, NAMELY, DVDS, HD DVDS, MP3S, CD-ROMS, VIDEOTAPES, OPTICAL AND MAGNETO-OPTICAL DISCS, AND PORTABLE AND HANDHELD DIGITAL ELECTRONIC DEVICES FOR RECORDING, ORGANIZING, TRANSMITTING, MANIPULATING, AND REVIEWING TEXT, DATA, AUDIO AND VIDEO FILES FEATURING TRAVEL AND VACATION GUIDANCE INFORMATION FOR THE GENERAL PUBLIC, AND FEATURING MARKETING, SALES AND TRAINING INFORMATION FOR PROFESSIONALS IN THE TRAVEL INDUSTRY; COMPUTER SOFTWARE FOR USE IN ORGANIZING, TRANSMITTING, MANIPULATING, AND REVIEWING TEXT, DATA, AUDIO AND VIDEO FILES ON PORTABLE AND HAND HELD DIGITAL ELECTRONIC DEVICES, NAMELY, PORTABLE AUDIO, VIDEO, MULTIMEDIA AND DIGITAL DEVICES, FEATURING TRAVEL AND VACATION GUIDANCE INFORMATION FOR THE GENERAL PUBLIC, AND FEATURING MARKETING, SALES AND TRAINING INFORMATION FOR PROFESSIONALS IN THE TRAVEL INDUSTRY; DOWNLOADABLE TRAVEL AND VACATION GUIDANCE INFORMATION VIA THE INTERNET TO BE VIEWED VIA A PORTABLE MEDIA PLAYER, IN CLASS 9 (U.S. CLS. 21, 23, 26, 36 AND 38).

FIRST USE 8-31-1986; IN COMMERCE 6-30-1987.

FOR: PROVIDING TRAVEL INFORMATION ON A GLOBAL COMPUTER NETWORK, IN CLASS 39 (U.S. CLS. 100 AND 105).

FIRST USE 8-31-1986; IN COMMERCE 3-15-2004.

FOR: ENTERTAINMENT AND EDUCATIONAL SERVICES, NAMELY, PROVIDING VACATION GUIDANCE INFORMATION, NAMELY, ENTERTAINMENT INFORMATION AND VACATION EDUCATIONAL INFORMATION, NAMELY, LOCATION HISTORICAL INFORMATION TO BE VIEWED VIA A PORTABLE MEDIA PLAYER; VIDEOTAPING PRODUCTION SERVICES, IN CLASS 41 (U.S. CLS. 100, 101 AND 107).

FIRST USE 6-10-2006; IN COMMERCE 6-10-2006.

THE MARK CONSISTS OF STANDARD CHARACTERS WITHOUT CLAIM TO ANY PARTICULAR FONT, STYLE, SIZE, OR COLOR.

OWNER OF U.S. REG. NOS. 2,144,539, 2,335,119, AND 2,473,703.

SER. NO. 77-286,329, FILED 9-21-2007.

SHAUNIA CARLYLE, EXAMINING ATTORNEY

Int. Cl.: 35

Prior U.S. Cls.: 100, 101 and 102

United States Patent and Trademark Office

Reg. No. 3,519,212

Registered Oct. 21, 2008

**SERVICE MARK
PRINCIPAL REGISTER**

SurveySearch.net

EXPRESS INNOVATIONS, INC. (RHODE ISLAND CORPORATION)
77 ROBERT GRAY AVE
TIVERTON, RI 02878

FOR: PROVIDING AN ON-LINE COMPUTER DATABASE FEATURING CONTACT INFORMATION FOR LAND SURVEYORS FOR HIRE, IN CLASS 35 (U.S. CLS. 100, 101 AND 102).

FIRST USE 7-23-2007; IN COMMERCE 7-23-2007.

THE MARK CONSISTS OF STANDARD CHARACTERS WITHOUT CLAIM TO ANY PARTICULAR FONT, STYLE, SIZE, OR COLOR.

SER. NO. 77-286,373, FILED 9-21-2007.

BILL DAWE, EXAMINING ATTORNEY

Int. Cl.: 44

Prior U.S. Cls.: 100 and 101

United States Patent and Trademark Office

Reg. No. 3,519,213

Registered Oct. 21, 2008

**SERVICE MARK
PRINCIPAL REGISTER**

HALF THEIR SIZE!

TIME INC. (DELAWARE CORPORATION)
1271 AVENUE OF THE AMERICAS
NEW YORK, NY 10020

FOR: ONLINE INFORMATION SERVICES,
NAMELY, PROVIDING INFORMATION ON THE
SUBJECTS OF DIET, WEIGHT LOSS AND HUMAN
INTEREST STORIES RELATING TO DIET AND
WEIGHT LOSS, IN CLASS 44 (U.S. CLS. 100 AND 101).

FIRST USE 12-29-2006; IN COMMERCE 12-29-2006.

THE MARK CONSISTS OF STANDARD CHAR-
ACTERS WITHOUT CLAIM TO ANY PARTICULAR
FONT, STYLE, SIZE, OR COLOR.

SER. NO. 77-286,783, FILED 9-24-2007.

DOMINIC FATHY, EXAMINING ATTORNEY

Int. Cl.: 35

Prior U.S. Cls.: 100, 101 and 102

Reg. No. 3,519,214

United States Patent and Trademark Office

Registered Oct. 21, 2008

**SERVICE MARK
PRINCIPAL REGISTER**

The logo for Gravitant features the word "Gravitant" in a sans-serif font. The letters "G", "R", "A", "V", "I", "T", "A", "N", and "T" are colored orange. The letter "I" is stylized with a blue semi-circle above it, resembling a planet or a stylized letter.

SHEARDIGITAL INC. (TEXAS CORPORATION),
DBA GRAVITANT, INC.
SUITE 325N
11940 JOLLYVILLE ROAD
AUSTIN, TX 78759

THE MARK CONSISTS OF THE "GRAVITANT"
WORD IN ORANGE WITH A STYLIZED LETTER
"I". THE LETTER "I" HAS A SEMI-CIRCLE FACING
UPWARDS IN BLUE.

FOR: BUSINESS MANAGEMENT INTELLI-
GENCE CONSULTANCY SERVICES, IN CLASS 35
(U.S. CLS. 100, 101 AND 102).

THE FOREIGN WORDING IN THE MARK
TRANSLATES INTO ENGLISH AS "GRAVITAT-
ING" OR "REVOLVING".

FIRST USE 3-1-2004; IN COMMERCE 3-15-2004.

SER. NO. 77-286,922, FILED 9-24-2007.

THE COLOR(S) ORANGE AND BLUE IS/ARE
CLAIMED AS A FEATURE OF THE MARK.

LINDA ORNDORFF, EXAMINING ATTORNEY

Int. Cl.: 30

Prior U.S. Cl.: 46

United States Patent and Trademark Office

Reg. No. 3,519,215

Registered Oct. 21, 2008

TRADEMARK
PRINCIPAL REGISTER



NEW YASMEEN DETROIT, INC. (MICHIGAN CORPORATION)
13900 W. WARREN AVE
DEARBORN, MI 48126

FOR: BAKERY PRODUCTS, NAMELY, PITA BREAD, IN CLASS 30 (U.S. CL. 46).

FIRST USE 11-9-1985; IN COMMERCE 11-9-1985.

NO CLAIM IS MADE TO THE EXCLUSIVE RIGHT TO USE "BAKERY" AND THE NON-LATIN CHARACTERS THAT MEAN BAKERIES, APART FROM THE MARK AS SHOWN.

THE COLOR(S) GREEN, WHITE IS/ARE CLAIMED AS A FEATURE OF THE MARK.

THE MARK CONSISTS OF THE COLOR GREEN APPEARS IN THE NON-LATIN CHARACTERS, IN "YASMEEN BAKERY", IN THE FLOWER DESIGNS, AS LINING TO THE RECTANGULAR LABEL

BOXES, AND AS CIRCULAR BANDS TO THE OVERALL DESIGN. THE COLOR WHITE APPEARS IN THE FLOWER DESIGNS, IN THE RECTANGULAR LABEL BOXES, AND AS A CIRCULAR BAND. THE COLOR WHITE THAT APPEARS AS BACKGROUND OF THE ENTIRE MARK REPRESENTS TRANSPARENT AREAS AND IS NOT PART OF THE MARK.

THE FOREIGN WORDING IN THE MARK TRANSLATES INTO ENGLISH AS NEW YASMEEN BAKERIES.

THE NON-LATIN CHARACTER(S) IN THE MARK TRANSLITERATES INTO AH-FRAHN EL YAS-MEEN EL JE-DE-DA, AND THIS MEANS NEW YASMEEN BAKERIES IN ENGLISH.

SER. NO. 77-286,979, FILED 9-24-2007.

TIMOTHY FINNEGAN, EXAMINING ATTORNEY

Int. Cl.: 43

Prior U.S. Cls.: 100 and 101

United States Patent and Trademark Office

Reg. No. 3,519,216

Registered Oct. 21, 2008

**SERVICE MARK
PRINCIPAL REGISTER**



RESTAURANTS 2000, LLC (WISCONSIN LIMITED LIABILITY COMPANY)
N96 W16865 CUMBERLAND COURT
MENOMONEE FALLS, WI 53051

FOR: RESTAURANT AND TAVERN SERVICES,
IN CLASS 43 (U.S. CLS. 100 AND 101).

FIRST USE 11-30-1999; IN COMMERCE 11-30-1999.

THE MARK CONSISTS OF A SILHOUETTE OF A COWBOY COOKING OVER AN OPEN FIRE IN A DESERT-LIKE SETTING, FEATURING CACTI AND A CLEAR NIGHT SKY.

SER. NO. 77-287,107, FILED 9-24-2007.

H. M. FISHER, EXAMINING ATTORNEY

Int. Cl.: 5

Prior U.S. Cls.: 6, 18, 44, 46, 51 and 52

Reg. No. 3,519,217

United States Patent and Trademark Office

Registered Oct. 21, 2008

**TRADEMARK
PRINCIPAL REGISTER**

SECURELY YOURS

ATTENDS HEALTHCARE PRODUCTS, INC. (DE-
LAWARE CORPORATION)
1029 OLD CREEK ROAD
GREENVILLE, NC 27834

FOR: OBSTETRIC INCONTINENCE OR SANI-
TARY NAPKIN PADS AND GARMENT LINERS,
IN CLASS 5 (U.S. CLS. 6, 18, 44, 46, 51 AND 52).

FIRST USE 11-3-1986; IN COMMERCE 11-3-1986.

THE MARK CONSISTS OF STANDARD CHAR-
ACTERS WITHOUT CLAIM TO ANY PARTICULAR
FONT, STYLE, SIZE, OR COLOR.

SER. NO. 77-287,153, FILED 9-24-2007.

MARTHA SANTOMARTINO, EXAMINING ATTOR-
NEY

Int. Cl.: 3

Prior U.S. Cls.: 1, 4, 6, 50, 51 and 52

Reg. No. 3,519,218

United States Patent and Trademark Office

Registered Oct. 21, 2008

**TRADEMARK
PRINCIPAL REGISTER**



VERNAL KABUSHIKI KAISHA (JAPAN CORPORATION)
765 AMANA STREET #409
HONOLULU, HI 96814

FOR: A HOUSE MARK FOR COSMETIC SKIN CARE AND HAIR CARE PRODUCTS, NAMELY, FACIAL SOAPS, MOISTURIZERS, SKIN CONDITIONERS, MAKEUP, SHAMPOO, HAIR CONDITIONERS, AND STYLING FINISH, NAMELY, STYLING GELS; COSMETICS, HAND SOAPS,

PLANT-BASED NATURAL FRAGRANCES FOR PERSONAL USE, SYNTHETIC FRAGRANCES FOR PERSONAL USE, BLENDED FRAGRANCES FOR PERSONAL USE, IN CLASS 3 (U.S. CLS. 1, 4, 6, 50, 51 AND 52).

FIRST USE 4-11-1991; IN COMMERCE 12-27-2001.

SER. NO. 77-287,316, FILED 9-24-2007.

MARTHA FROMM, EXAMINING ATTORNEY

Int. Cl.: 9

Prior U.S. Cls.: 21, 23, 26, 36 and 38

Reg. No. 3,519,219

United States Patent and Trademark Office

Registered Oct. 21, 2008

**TRADEMARK
PRINCIPAL REGISTER**



BAKER ELECTRICAL INSTRUMENT COMPANY
(COLORADO CORPORATION)
4812 MCMURRY AVENUE
FORT COLLINS, CO 80525

OWNER OF U.S. REG. NO. 1,633,013.

FOR: SCIENTIFIC MEASURING INSTRUMENTS
IN THE NATURE OF ELECTRICAL CONDUCTIV-
ITY TESTING METERS FOR USE IN TESTING THE
CHARACTERISTICS OF WINDINGS AND PARTS
THEREOF, IN CLASS 9 (U.S. CLS. 21, 23, 26, 36 AND
38).

THE MARK CONSISTS OF THE WORD "BAKER"
AND A DESIGN OF QUADRILATERAL CONTAIN-
ING A WAVY LINE.

SER. NO. 77-287,438, FILED 9-24-2007.

FIRST USE 1-1-1966; IN COMMERCE 1-1-1966.

LAURA HAMMEL, EXAMINING ATTORNEY

Int. Cl.: 41

Prior U.S. Cls.: 100, 101 and 107

United States Patent and Trademark Office

Reg. No. 3,519,220

Registered Oct. 21, 2008

**SERVICE MARK
PRINCIPAL REGISTER**

FADED HOPE

DEITRICH, MITCHELL (UNITED STATES INDIVIDUAL)

508 B STREET

HOLMESVILLE, OH 44633 AND

CRIDER, BRIAN B. (UNITED STATES INDIVIDUAL)

508 B STREET

HOLMESVILLE, OH 44633 AND

GURR, SHANE (UNITED STATES INDIVIDUAL)

508 B STREET

HOLMESVILLE, OH 44633 AND

MOOREHOUSE II, MICHAEL R. (UNITED STATES INDIVIDUAL)

508 B STREET

HOLMESVILLE, OH 44633

FOR: ENTERTAINMENT, NAMELY, LIVE PERFORMANCES BY A MUSICAL BAND, IN CLASS 41 (U.S. CLS. 100, 101 AND 107).

FIRST USE 5-0-2004; IN COMMERCE 5-0-2004.

THE MARK CONSISTS OF STANDARD CHARACTERS WITHOUT CLAIM TO ANY PARTICULAR FONT, STYLE, SIZE, OR COLOR.

SER. NO. 77-287,718, FILED 9-24-2007.

MICHAEL KEATING, EXAMINING ATTORNEY

Int. Cl.: 30

Prior U.S. Cl.: 46

United States Patent and Trademark Office

Reg. No. 3,519,221

Registered Oct. 21, 2008

**TRADEMARK
PRINCIPAL REGISTER**

HOT TAMALES HEAVEN

WILLIE HARMON (UNITED STATES INDIVIDUAL), DBA HOT TAMALES HEAVEN
718 MAIN ST
GREENVILLE, MS 38701

NO CLAIM IS MADE TO THE EXCLUSIVE RIGHT TO USE "HOT TAMALES", APART FROM THE MARK AS SHOWN.

FOR: TAMALES, IN CLASS 30 (U.S. CL. 46).

FIRST USE 9-19-1985; IN COMMERCE 0-0-1986.

SER. NO. 77-287,942, FILED 9-25-2007.

THE MARK CONSISTS OF STANDARD CHARACTERS WITHOUT CLAIM TO ANY PARTICULAR FONT, STYLE, SIZE, OR COLOR.

PAM WILLIS, EXAMINING ATTORNEY

Int. Cls.: 35 and 37

Prior U.S. Cls.: 100, 101, 102, 103 and 106

United States Patent and Trademark Office

Reg. No. 3,519,222

Registered Oct. 21, 2008

**SERVICE MARK
PRINCIPAL REGISTER**

MANGINO

MANGINO PONTIAC-BUICK, INC. (NEW YORK CORPORATION)
1484 SARATOGA ROAD
BALLSTON SPA, NY 12020

FOR: RETAIL STORE SERVICES FEATURING AUTOMOBILES, AUTOMOBILE PARTS AND ACCESSORIES, IN CLASS 35 (U.S. CLS. 100, 101 AND 102).

FIRST USE 11-1-1978; IN COMMERCE 11-1-1978.

FOR: AUTOMOBILE MAINTENANCE AND REPAIR SERVICES, IN CLASS 37 (U.S. CLS. 100, 103 AND 106).

FIRST USE 11-1-1978; IN COMMERCE 11-1-1978.

THE MARK CONSISTS OF STANDARD CHARACTERS WITHOUT CLAIM TO ANY PARTICULAR FONT, STYLE, SIZE, OR COLOR.

SEC. 2(F).

SER. NO. 77-288,265, FILED 9-25-2007.

TRACY CROSS, EXAMINING ATTORNEY

Int. Cl.: 35

Prior U.S. Cls.: 100, 101 and 102

United States Patent and Trademark Office

Reg. No. 3,519,223

Registered Oct. 21, 2008

**SERVICE MARK
PRINCIPAL REGISTER**



AMERICAN DAIRY GOAT ASSOCIATION (MISSOURI NON-PROFIT CORPORATION)
P.O. BOX 865
SPINDALE, NC 28160

FOR: MAINTAINING A REGISTRY OF BREEDS IN THE FIELD OF DAIRY GOATS; ASSOCIATION SERVICES, NAMELY, PROMOTING THE INTERESTS OF DAIRY GOAT HERD OWNERS, IN CLASS 35 (U.S. CLS. 100, 101 AND 102).

FIRST USE 10-18-2006; IN COMMERCE 10-18-2006.

THE MARK CONSISTS OF THREE GOAT HEADS.

SER. NO. 77-288,324, FILED 9-25-2007.

CHARISMA HAMPTON, EXAMINING ATTORNEY

Int. Cl.: 21

Prior U.S. Cls.: 2, 13, 23, 29, 30, 33, 40 and 50

United States Patent and Trademark Office

Reg. No. 3,519,224

Registered Oct. 21, 2008

**TRADEMARK
PRINCIPAL REGISTER**

MABU

FAKTORIE CORPORATION (CANADA CORPORATION)
179 JOHN STREET, SUITE 404
TORONTO, ONTARIO, CANADA M5T1X4

OWNER OF CANADA REG. NO. TMA521008,
DATED 1-5-2000, EXPIRES 1-5-2015.

FOR: CLEANING CLOTHS USED FOR CLEANING, WIPING, POLISHING AND DUSTING SURFACES IN WORK PLACES, HOMES, WORKSHOPS, GARAGES AND BOATS, IN CLASS 21 (U.S. CLS. 2, 13, 23, 29, 30, 33, 40 AND 50).

THE TERM "MABU" HAS NO MEANING IN A FOREIGN LANGUAGE.

SER. NO. 77-288,429, FILED 9-25-2007.

THE MARK CONSISTS OF STANDARD CHARACTERS WITHOUT CLAIM TO ANY PARTICULAR FONT, STYLE, SIZE, OR COLOR.

KEVIN DINALLO, EXAMINING ATTORNEY

Int. Cls.: 41 and 42

Prior U.S. Cls.: 100, 101 and 107

United States Patent and Trademark Office

Reg. No. 3,519,225

Registered Oct. 21, 2008

**SERVICE MARK
PRINCIPAL REGISTER**

MJ HARDEN

ORBIMAGE SI OPCO INC. (DELAWARE CORPORATION), DBA GEOEYE
21700 ATLANTIC BOULEVARD
DULLES, VA 20166

FOR: DIGITAL AERIAL IMAGING AND PHOTOGRAPHY, IN CLASS 41 (U.S. CLS. 100, 101 AND 107).

FIRST USE 0-0-1956; IN COMMERCE 0-0-1956.

FOR: PHOTOGRAMMETRY SERVICES; GEOSPATIAL SERVICES, NAMELY, MAKING MAPS AND SCALE DRAWINGS FROM AERIAL AND SATELLITE PHOTOGRAPHS, IN CLASS 42 (U.S. CLS. 100 AND 101).

FIRST USE 0-0-1956; IN COMMERCE 0-0-1956.

THE MARK CONSISTS OF STANDARD CHARACTERS WITHOUT CLAIM TO ANY PARTICULAR FONT, STYLE, SIZE, OR COLOR.

THE NAME(S), PORTRAIT(S), AND/OR SIGNATURE(S) SHOWN IN THE MARK DOES NOT IDENTIFY A PARTICULAR LIVING INDIVIDUAL.

SER. NO. 77-288,554, FILED 9-25-2007.

JULIE WATSON, EXAMINING ATTORNEY

Int. Cl.: 35

Prior U.S. Cls.: 100, 101 and 102

United States Patent and Trademark Office

Reg. No. 3,519,226

Registered Oct. 21, 2008

**SERVICE MARK
PRINCIPAL REGISTER**

takeouttees.com

E'STEPHENIE, INC. (INDIANA CORPORATION)
315 GRADLE DRIVE
CARMEL, IN 46032

THE MARK CONSISTS OF STANDARD CHARACTERS WITHOUT CLAIM TO ANY PARTICULAR FONT, STYLE, SIZE, OR COLOR.

FOR: RETAIL INTERNET STORE SERVICES FEATURING CLOTHING, APPAREL AND ACCESSORIES, IN CLASS 35 (U.S. CLS. 100, 101 AND 102).

SER. NO. 77-288,628, FILED 9-25-2007.

FIRST USE 10-9-2006; IN COMMERCE 10-9-2006.

DEZMONA MIZELLE, EXAMINING ATTORNEY

Int. Cl.: 25

Prior U.S. Cls.: 22 and 39

United States Patent and Trademark Office

Reg. No. 3,519,227

Registered Oct. 21, 2008

**TRADEMARK
PRINCIPAL REGISTER**

**CHOPPERS ARE A LIFE
SENTENCE**

DOTSON, JR., ROBERT E. (UNITED STATES
INDIVIDUAL)
8226 E. WOODWIND AVE.
ORANGE, CA 92869

THE MARK CONSISTS OF STANDARD CHAR-
ACTERS WITHOUT CLAIM TO ANY PARTICULAR
FONT, STYLE, SIZE, OR COLOR.

FOR: FOOTWEAR; HATS; HEADWEAR; PANTS;
SHIRTS; SHOES; SHORTS; T-SHIRTS, IN CLASS 25
(U.S. CLS. 22 AND 39).

SER. NO. 77-288,817, FILED 9-25-2007.

FIRST USE 9-13-2000; IN COMMERCE 9-13-2000.

AHSEN KHAN, EXAMINING ATTORNEY

Int. Cl.: 8

Prior U.S. Cls.: 23, 28 and 44

United States Patent and Trademark Office

Reg. No. 3,519,228

Registered Oct. 21, 2008

**TRADEMARK
PRINCIPAL REGISTER**



BRONCO

C.A.S. IBERIA, INC. (TENNESSEE CORPORATION)
650 INDUSTRIAL BLVD.
SALE CREEK, TN 37373

FOR: KNIVES, NAMELY, FIXED-BLADE BOWIE
KNIVES, IN CLASS 8 (U.S. CLS. 23, 28 AND 44).

FIRST USE 9-24-2007; IN COMMERCE 9-24-2007.

THE MARK CONSISTS OF A RUNNING HORSE.

SER. NO. 77-289,075, FILED 9-26-2007.

MONIQUE MILLER, EXAMINING ATTORNEY

Int. Cl.: 16

Prior U.S. Cls.: 2, 5, 22, 23, 29, 37, 38 and 50

Reg. No. 3,519,229

United States Patent and Trademark Office

Registered Oct. 21, 2008

**TRADEMARK
PRINCIPAL REGISTER**

KOLOURBORATION

KABUSHIKI KAISHA KURETAKE (JAPAN
JOINT-STOCK COMPAY), DBA KURETAKE
CO., LTD
576, 7-CHOME, MINAMIKYOBATE-CHO
NARA-SHI, NARA-KEN, JAPAN

FOR: PAPER; PAPER RIBBONS; TRACING PA-
PER; WAXED PAPER; POLISHED PAPER; DRAW-
ING PAPER; PAPER FOR PAINTING; JAPANESE
ART PAPER; CARDBOARD ; WHITE CARDBOARD;
CRAFT CARDBOARD; PHOTOGRAPH ALBUMS;
ALBUMS FOR SCRAPBOOKING; SCRAPBOOKS;
NOTE CARDS; POSTCARDS; GREETING CARDS;
BUSINESS CARDS; PICTURE POSTCARDS; CATA-
LOGUES IN THE FIELD OF STATIONARY, ARTS
AND CRAFTS AND SCRAPBOOKING; MAGA-
ZINES FEATURING STATIONARY, ARTS AND
CRAFTS AND SCRAPBOOKING; BOOKS IN THE
FIELD OF STATIONARY, ARTS AND CRAFTS AND
SCRAPBOOKING; NEWSPAPERS IN THE FIELD OF
STATIONARY, ARTS AND CRAFTS AND SCRAP-
BOOKING; PAMPHLETS IN THE FIELD OF STA-

TIONARY, ARTS AND CRAFTS AND
SCRAPBOOKING; WRITING PAPER; PICTURES;
WATERCOLOR PICTURES; PHOTOGRAPHS; PHO-
TOGRAPH MOUNTS; GLUE FOR MOUNTING
PHOTOGRAPHS; PHOTOGRAPH STANDS; WRAP-
PING PAPER; CRAFT PAPER; PAPER KNIVES;
PUNCHES FOR CRAFT PAPER FOR SCRAPBOOK-
ING; STATIONARY; WRITING INK; WRITING IN-
STRUMENTS; STICKERS, IN CLASS 16 (U.S. CLS. 2,
5, 22, 23, 29, 37, 38 AND 50).

FIRST USE 9-1-2005; IN COMMERCE 8-1-2006.

THE MARK CONSISTS OF STANDARD CHAR-
ACTERS WITHOUT CLAIM TO ANY PARTICULAR
FONT, STYLE, SIZE, OR COLOR.

SER. NO. 77-289,143, FILED 9-26-2007.

ARETHA SOMERVILLE, EXAMINING ATTORNEY

Int. Cls.: 16, 25 and 35

Prior U.S. Cls.: 2, 5, 22, 23, 29, 37, 38, 39, 50, 100, 101 and 102

Reg. No. 3,519,230

United States Patent and Trademark Office

Registered Oct. 21, 2008

TRADEMARK
SERVICE MARK
PRINCIPAL REGISTER



CELEBRATE FREEDOM FOUNDATION (SOUTH CAROLINA NON-PROFIT ORGANIZATION), DBA CELEBRATE FREEDOM FOUNDATION
455 ST. ANDREWS ROAD, SUITE C-1
COLUMBIA, SC 29210

FOR: ENVELOPES FOR STATIONERY USE; OFFICE STATIONERY; EDUCATIONAL PUBLICATIONS, NAMELY, EDUCATIONAL LEARNING CARDS, FLASH CARDS, ACTIVITY CARDS, WORKBOOKS, TEXTBOOKS, ACTIVITY BOOKS, STORY BOOKS, PUZZLE BOOKS, PUZZLES, TEACHER GUIDES, MANUALS, POSTERS, EDUCATIONAL CARD GAMES AND EDUCATIONAL BOOKLETS IN THE FIELD OF HISTORY, MILITARY SUPPORT AND PATRIOTISM; NEWSLETTERS IN THE FIELD OF HISTORY, MILITARY SUPPORT AND PATRIOTISM; FOLDERS; PUBLICATIONS, NAMELY, BROCHURES, BOOKLETS, AND TEACHING MATERIALS IN THE FIELD OF HISTORY, MILITARY SUPPORT AND PATRIOTISM, IN CLASS 16 (U.S. CLS. 2, 5, 22, 23, 29, 37, 38 AND 50).

FIRST USE 12-31-1999; IN COMMERCE 3-31-2000.

FOR: SHORT-SLEEVED OR LONG-SLEEVED T-SHIRTS; HEADGEAR, NAMELY, BASEBALL CAPS AND/OR VISORS, IN CLASS 25 (U.S. CLS. 22 AND 39).

FIRST USE 12-31-1999; IN COMMERCE 3-31-2000.

FOR: ADVERTISING, MARKETING AND PROMOTION SERVICES, NAMELY, PROVIDING MARKETING AND PROMOTING SPECIAL EVENTS OF THE MILITARY AND OTHER ORGANIZATIONS, IN CLASS 35 (U.S. CLS. 100, 101 AND 102).

FIRST USE 3-1-2000; IN COMMERCE 3-1-2000.

NO CLAIM IS MADE TO THE EXCLUSIVE RIGHT TO USE "FOUNDATION" AND "EST. 1999", APART FROM THE MARK AS SHOWN.

THE COLOR(S) RED, WHITE AND BLUE IS/ARE CLAIMED AS A FEATURE OF THE MARK.

THE MARK CONSISTS OF A CIRCLE OUTLINED IN BLUE WITH THE WORDS "CELEBRATE FREEDOM FOUNDATION" AROUND THE INSIDE TOP EDGE OF THE CIRCLE AND CENTERED. "EST. 1999" IS CENTERED ALONG THE INSIDE BOTTOM OF THE CIRCLE WITH THREE RED STARS BEFORE AND THREE RED STARS AFTER. THE INTERIOR OF THE CIRCLE CONSISTS OF A STYLIZED UNITED STATES FLAG WITH A BLUE FIELD IN THE UPPER LEFT WITH THIRTEEN WHITE STARS; TO THE RIGHT AND BELOW THE

BLUE FIELD ARE THIRTEEN ALTERNATING RED
(7) AND WHITE (6) STRIPES.

SER. NO. 77-289,175, FILED 9-26-2007.

REGINA DRUMMOND, EXAMINING ATTORNEY

Int. Cl.: 29

Prior U.S. Cl.: 46

United States Patent and Trademark Office

Reg. No. 3,519,231

Registered Oct. 21, 2008

**TRADEMARK
PRINCIPAL REGISTER**



J&B WHOLESALE DISTRIBUTING, INC. (MINNESOTA CORPORATION)
13200 43RD STREET NE
P.O. BOX 212
ST. MICHAEL, MN 55376

FOR: MEAT; FISH; POULTRY; BEEF; PORK; PREPARED AND/OR PACKAGED ENTREES CONSISTING PRIMARILY OF MEAT, SEAFOOD, POULTRY OR VEGETABLES; FROZEN ENTREES CONSISTING OF SEASONED, MARINATED, BREADED, WRAPPED OR STUFFED MEAT, FISH, POULTRY OR SEAFOOD; MARINATED BEEF, PORK AND POULTRY, IN CLASS 29 (U.S. CL. 46).

FIRST USE 2-0-2005; IN COMMERCE 2-0-2005.

OWNER OF U.S. REG. NOS. 1,601,126, 2,164,808, AND 2,869,731.

NO CLAIM IS MADE TO THE EXCLUSIVE RIGHT TO USE "FULLY GUARANTEED BUTCHER QUALITY MEATS", APART FROM THE MARK AS SHOWN.

THE COLOR(S) WHITE, BLACK AND RED IS/ ARE CLAIMED AS A FEATURE OF THE MARK.

THE MARK CONSISTS OF A BLACK RECTANGULAR DESIGN THAT WIDENS TO A CIRCLE IN THE CENTER. THE WORDS "NO NAME" APPEAR IN LARGE WHITE LETTERS IN THE MIDDLE OF THE DESIGN, OUTLINED IN RED. THE WORDS "FULLY GUARANTEED" APPEAR IN SMALLER RED LETTERING AROUND THE TOP OF THE CIRCLE AND THE WORDS "BUTCHER QUALITY MEATS" APPEAR IN SMALLER RED LETTERING AROUND THE BOTTOM OF THE CIRCLE. A STRAIGHT RED LINE APPEARS ABOVE AND BELOW THE WORDS "NO NAME".

SER. NO. 77-289,408, FILED 9-26-2007.

MARTHA SANTOMARTINO, EXAMINING ATTORNEY

Int. Cl.: 12

Prior U.S. Cls.: 19, 21, 23, 31, 35 and 44

Reg. No. 3,519,232

United States Patent and Trademark Office

Registered Oct. 21, 2008

**TRADEMARK
PRINCIPAL REGISTER**



COMPANION TRAILERS, INC. (TEXAS CORPORATION)
10706 S PIPELINE ROAD, UNIT 140
HURST, TX 76053

FOR: CARGO CARRIER FOR VEHICLES, IN CLASS 12 (U.S. CLS. 19, 21, 23, 31, 35 AND 44).

FIRST USE 11-29-2006; IN COMMERCE 11-29-2006.

NO CLAIM IS MADE TO THE EXCLUSIVE RIGHT TO USE "TRAILERS", APART FROM THE MARK AS SHOWN.

THE MARK CONSISTS OF BANNER INCLUDING BARS OR LINES.

SER. NO. 77-289,607, FILED 9-26-2007.

DARRYL SPRUILL, EXAMINING ATTORNEY

Int. Cl.: 35

Prior U.S. Cls.: 100, 101 and 102

United States Patent and Trademark Office

Reg. No. 3,519,233

Registered Oct. 21, 2008

**SERVICE MARK
PRINCIPAL REGISTER**

PENTADIGM

DE BONIS, NICHOLAS (UNITED STATES INDIVIDUAL)
312 CROSSTOWN ROAD, #321
PEACHTREE CITY, GA 30269 AND
ALLEN, PHIL (UNITED KINGDOM INDIVIDUAL)
SEESTRASSE 103
WADENSWIL, SWITZERLAND 8820 AND
BALINSKI, ERIC (UNITED STATES INDIVIDUAL)
4 FOREST HILL DRIVE
SPARTA, NJ 07871

FIRST USE 11-0-2003; IN COMMERCE 11-0-2003.

THE MARK CONSISTS OF STANDARD CHARACTERS WITHOUT CLAIM TO ANY PARTICULAR FONT, STYLE, SIZE, OR COLOR.

SER. NO. 77-289,625, FILED 9-26-2007.

FOR: BUSINESS CONSULTING SERVICES, IN CLASS 35 (U.S. CLS. 100, 101 AND 102).

SAMUEL E. SHARPER JR., EXAMINING ATTORNEY

Int. Cl.: 14

Prior U.S. Cls.: 2, 27, 28 and 50

United States Patent and Trademark Office

Reg. No. 3,519,234

Registered Oct. 21, 2008

**TRADEMARK
PRINCIPAL REGISTER**

CAODO

NGUYEN, DO CAO (UNITED STATES INDIVIDUAL)
9200 BOLSA AVE #128
WESTMINSTER, CA 92683

FOR: COSTUME JEWELRY, IN CLASS 14 (U.S. CLS. 2, 27, 28 AND 50).

FIRST USE 1-1-2007; IN COMMERCE 1-1-2007.

THE MARK CONSISTS OF STANDARD CHARACTERS WITHOUT CLAIM TO ANY PARTICULAR FONT, STYLE, SIZE, OR COLOR.

THE ENGLISH TRANSLATION OF THE WORD CAODO IN THE MARK IS "VERY HIGH".

SER. NO. 77-290,030, FILED 9-27-2007.

EVELYN BRADLEY, EXAMINING ATTORNEY

Int. Cl.: 42

Prior U.S. Cls.: 100 and 101

United States Patent and Trademark Office

Reg. No. 3,519,235

Registered Oct. 21, 2008

**SERVICE MARK
PRINCIPAL REGISTER**

G2MQ

G2MQ CONSULTING CORP. (ARIZONA CORPORATION)
3365 WILTON CREST COURT
ALEXANDRIA, VA 22310

FOR: ACCREDITATION CONSULTING SERVICES, NAMELY, CONSULTING ON THE DEVELOPING, EVALUATING, AND TESTING STANDARDS FOR CELL PROCESSING LABORATORY SERVICES FOR THE PURPOSE OF ACCREDITATION; QUALITY MANAGEMENT CONSULTING SERVICES, NAMELY, CONSULTING ON QUALITY CONTROL MANAGEMENT SERVICES FOR THE HOSPITAL INDUSTRY; CLINICAL RESEARCH CONSULTING

IN THE FIELD OF CLINICAL TRIALS THAT FEATURE CELL PROCESSING, IN CLASS 42 (U.S. CLS. 100 AND 101).

FIRST USE 12-5-2006; IN COMMERCE 12-5-2006.

THE MARK CONSISTS OF STANDARD CHARACTERS WITHOUT CLAIM TO ANY PARTICULAR FONT, STYLE, SIZE, OR COLOR.

SER. NO. 77-290,114, FILED 9-27-2007.

KIM MONINGHOFF, EXAMINING ATTORNEY

Int. Cl.: 42

Prior U.S. Cls.: 100 and 101

United States Patent and Trademark Office

Reg. No. 3,519,236

Registered Oct. 21, 2008

**SERVICE MARK
PRINCIPAL REGISTER**

**Taking organizations above
and beyond...**

G2MQ CONSULTING CORP. (ARIZONA CORPORATION)
3365 WILTON CREST COURT
ALEXANDRIA, VA 22310

FOR: ACCREDITATION CONSULTING SERVICES, NAMELY, CONSULTING ON THE DEVELOPING, EVALUATING, AND TESTING STANDARDS FOR CELL PROCESSING LABORATORY SERVICES FOR THE PURPOSE OF ACCREDITATION; QUALITY MANAGEMENT CONSULTING SERVICES, NAMELY, CONSULTING ON QUALITY CONTROL MANAGEMENT SERVICES FOR THE HOSPITAL INDUSTRY; CLINICAL RESEARCH CONSULTING

IN THE FIELD OF CLINICAL TRIALS THAT FEATURE CELL PROCESSING, IN CLASS 42 (U.S. CLS. 100 AND 101).

FIRST USE 12-5-2006; IN COMMERCE 12-5-2006.

THE MARK CONSISTS OF STANDARD CHARACTERS WITHOUT CLAIM TO ANY PARTICULAR FONT, STYLE, SIZE, OR COLOR.

SER. NO. 77-290,150, FILED 9-27-2007.

APRIL HESIK, EXAMINING ATTORNEY

Int. Cl.: 29

Prior U.S. Cl.: 46

United States Patent and Trademark Office

Reg. No. 3,519,237

Registered Oct. 21, 2008

**TRADEMARK
PRINCIPAL REGISTER**

NATURE'S TRADITION

LEIDY'S INC. (PENNSYLVANIA CORPORATION)
266 CHERRY LANE
SOUDERTON, PA 189640257

FOR: PORK; PORK, NAMELY, TENDERLOIN,
PORK CHOPS, RIBS, PORK ROAST, IN CLASS 29
(U.S. CL. 46).

FIRST USE 10-18-2006; IN COMMERCE 10-18-2006.

THE MARK CONSISTS OF STANDARD CHARACTERS WITHOUT CLAIM TO ANY PARTICULAR FONT, STYLE, SIZE, OR COLOR.

OWNER OF U.S. REG. NO. 3,279,091.

SER. NO. 77-290,154, FILED 9-27-2007.

STEPHEN AQUILA, EXAMINING ATTORNEY

Int. Cl.: 42

Prior U.S. Cls.: 100 and 101

United States Patent and Trademark Office

Reg. No. 3,519,238

Registered Oct. 21, 2008

SERVICE MARK
PRINCIPAL REGISTER



Taking organizations above and beyond..

G2MQ CONSULTING CORP. (ARIZONA CORPORATION)
3365 WILTON CREST COURT
ALEXANDRIA, VA 22310

FOR: ACCREDITATION CONSULTING SERVICES, NAMELY, CONSULTING ON THE DEVELOPING, EVALUATING, AND TESTING STANDARDS FOR CELL PROCESSING LABORATORY SERVICES FOR THE PURPOSE OF ACCREDITATION; QUALITY MANAGEMENT CONSULTING SERVICES, NAMELY, CONSULTING ON QUALITY CONTROL

MANAGEMENT SERVICES FOR THE HOSPITAL INDUSTRY; CLINICAL RESEARCH CONSULTING IN THE FIELD OF CLINICAL TRIALS THAT FEATURE CELL PROCESSING, IN CLASS 42 (U.S. CLS. 100 AND 101).

FIRST USE 12-6-2005; IN COMMERCE 12-6-2005.

SER. NO. 77-290,191, FILED 9-27-2007.

AMY MCMENAMIN, EXAMINING ATTORNEY

Int. Cl.: 9

Prior U.S. Cls.: 21, 23, 26, 36 and 38

Reg. No. 3,519,239

United States Patent and Trademark Office

Registered Oct. 21, 2008

**TRADEMARK
PRINCIPAL REGISTER**

SUBTERRA-M8

SUBTERRACOM WIRELESS SOLUTIONS, LLC
(DELAWARE LIMITED LIABILITY COMPAN-
NY)

SUITE 1202
2 TOWER CENTER
EAST BRUNSWICK, NJ 08816

FOR: PORTABLE HANDHELD WIRELESS
TRACKING AND TWO-WAY COMMUNICATION
APPARATUS CARRIED BY MINERS OR AT-
TACHED TO EQUIPMENT FOR RECEIVING AND
TRANSMITTING SIGNALS, VOICE AND TEXT

MESSAGES, IN CLASS 9 (U.S. CLS. 21, 23, 26, 36
AND 38).

FIRST USE 7-1-2007; IN COMMERCE 7-1-2007.

THE MARK CONSISTS OF STANDARD CHAR-
ACTERS WITHOUT CLAIM TO ANY PARTICULAR
FONT, STYLE, SIZE, OR COLOR.

SER. NO. 77-290,397, FILED 9-27-2007.

JEAN IM, EXAMINING ATTORNEY

Int. Cl.: 9

Prior U.S. Cls.: 21, 23, 26, 36 and 38

Reg. No. 3,519,240

United States Patent and Trademark Office

Registered Oct. 21, 2008

**TRADEMARK
PRINCIPAL REGISTER**

SUBTERRA-ZAP

SUBTERRACOM WIRELESS SOLUTIONS, LLC
(DELAWARE LIMITED LIABILITY COMPAN-
NY)
SUITE 1202
2 TOWER CENTER
EAST BRUNSWICK, NJ 08816

FOR: WIRELESS AND WIRE LINE ACCESS
POINT COMMUNICATION DEVICE PROVIDING
REDUNDANT DATA COMMUNICATION PATHS
FROM SOURCE TO DESTINATION FOR TWO-WAY
IN-MINE VOICE AND DATA COMMUNICATIONS
TO TRACK, MONITOR AND COMMUNICATE
WITH MINERS AND EQUIPMENT UNDER-

GROUND, IN CLASS 9 (U.S. CLS. 21, 23, 26, 36 AND
38).

FIRST USE 7-1-2007; IN COMMERCE 7-1-2007.

THE MARK CONSISTS OF STANDARD CHAR-
ACTERS WITHOUT CLAIM TO ANY PARTICULAR
FONT, STYLE, SIZE, OR COLOR.

SER. NO. 77-290,405, FILED 9-27-2007.

JEAN IM, EXAMINING ATTORNEY

Int. Cls.: 2 and 40

Prior U.S. Cls.: 6, 11, 16, 100, 103 and 106

United States Patent and Trademark Office

Reg. No. 3,519,241

Registered Oct. 21, 2008

**TRADEMARK
SERVICE MARK
PRINCIPAL REGISTER**

HARDLINE

RHINO LININGS USA, INC. (CALIFORNIA CORPORATION)
9151 REHCO ROAD
SAN DIEGO, CA 92121

FOR: SPRAYABLE POLYURETHANE COATING FOR APPLICATION ON A WIDE RANGE OF COMMERCIAL, INDUSTRIAL AND CONSUMER PRODUCTS, NAMELY, VEHICLE TRAILERS, VAN FLOORS, BUILDINGS, SIDEWALKS, COMMERCIAL EQUIPMENT AND TRUCK BEDS, IN CLASS 2 (U.S. CLS. 6, 11 AND 16).

FIRST USE 10-2-2006; IN COMMERCE 10-2-2006.

FOR: APPLYING PROTECTIVE POLYURETHANE COATINGS TO A WIDE RANGE OF COM-

MERCIAL, INDUSTRIAL AND CONSUMER METAL, CONCRETE, WOOD AND FIBERGLASS SURFACES, NAMELY, VEHICLE TRAILERS, VAN FLOORS, BUILDINGS, SIDEWALKS, COMMERCIAL EQUIPMENT AND TRUCK BEDS, IN CLASS 40 (U.S. CLS. 100, 103 AND 106).

FIRST USE 10-2-2006; IN COMMERCE 10-2-2006.

THE MARK CONSISTS OF STANDARD CHARACTERS WITHOUT CLAIM TO ANY PARTICULAR FONT, STYLE, SIZE, OR COLOR.

SER. NO. 77-290,830, FILED 9-27-2007.

RENEE MCCRAY, EXAMINING ATTORNEY

Int. Cls.: 2 and 40

Prior U.S. Cls.: 6, 11, 16, 100, 103 and 106

Reg. No. 3,519,242

United States Patent and Trademark Office

Registered Oct. 21, 2008

**TRADEMARK
SERVICE MARK
PRINCIPAL REGISTER**

SOLARMAX

RHINO LININGS USA, INC. (CALIFORNIA CORPORATION)
9151 REHCO ROAD
SAN DIEGO, CA 92121

FOR: SPRAYABLE POLYURETHANE COATING FOR APPLICATION ON A WIDE RANGE OF COMMERCIAL, INDUSTRIAL AND CONSUMER PRODUCTS, NAMELY, VEHICLE TRAILERS, VAN FLOORS, BUILDINGS, SIDEWALKS, COMMERCIAL EQUIPMENT AND TRUCK BEDS, IN CLASS 2 (U.S. CLS. 6, 11 AND 16).

FIRST USE 10-2-2006; IN COMMERCE 10-2-2006.

FOR: APPLYING PROTECTIVE POLYURETHANE COATINGS TO A WIDE RANGE OF COM-

MERCIAL, INDUSTRIAL AND CONSUMER METAL, CONCRETE, WOOD AND FIBERGLASS SURFACES, NAMELY, VEHICLE TRAILERS, VAN FLOORS, BUILDINGS, SIDEWALKS, COMMERCIAL EQUIPMENT AND TRUCK BEDS, IN CLASS 40 (U.S. CLS. 100, 103 AND 106).

FIRST USE 10-2-2006; IN COMMERCE 10-2-2006.

THE MARK CONSISTS OF STANDARD CHARACTERS WITHOUT CLAIM TO ANY PARTICULAR FONT, STYLE, SIZE, OR COLOR.

SER. NO. 77-290,866, FILED 9-27-2007.

RENEE MCCRAY, EXAMINING ATTORNEY

Int. Cls.: 9, 38, 41 and 42

Prior U.S. Cls.: 21, 23, 26, 36, 38, 100, 101, 104 and 107

United States Patent and Trademark Office

Reg. No. 3,519,243

Registered Oct. 21, 2008

**TRADEMARK
SERVICE MARK
PRINCIPAL REGISTER**

Network Consciousness

STREAMCORE SYSTEM (FRANCE CORPORATION)
11/15 QUAI DE DION BOUTON
PUTEAUX, FRANCE F-92800

FOR: APPARATUS FOR TRANSMITTING, SWITCHING AND REPRODUCING SOUNDS, IMAGES AND/OR DATA; PRE-RECORDED COMPUTER PROGRAMS FOR SWITCHING AND TRANSMITTING SOUND, IMAGES AND/OR DATA, IN CLASS 9 (U.S. CLS. 21, 23, 26, 36 AND 38).

FOR: COMMUNICATION BY COMPUTER TERMINALS ON NATIONAL AND INTERNATIONAL NETWORKS; PROVIDING TELECOMMUNICATIONS INFORMATION, IN CLASS 38 (U.S. CLS. 100, 101 AND 104).

FOR: EDUCATION SERVICES, NAMELY, PROVIDING SEMINARS AND WORKSHOPS IN THE FIELD OF COMPUTER SCIENCES AND TELECOMMUNICATIONS; PUBLISHING BOOKS IN THE FIELD OF COMPUTER SCIENCES AND TELECOM-

MUNICATIONS; EDUCATION, NAMELY, PROVIDING SEMINARS AND WORKSHOPS IN COMPUTING AND TELECOMMUNICATIONS, IN CLASS 41 (U.S. CLS. 100, 101 AND 107).

FOR: PROVIDING TECHNOLOGICAL INFORMATION IN THE FIELD OF COMPUTER SCIENCE AND INFORMATION TECHNOLOGY, IN CLASS 42 (U.S. CLS. 100 AND 101).

OWNER OF FRANCE REG. NO. 073491877, DATED 3-30-2007, EXPIRES 3-30-2017.

NO CLAIM IS MADE TO THE EXCLUSIVE RIGHT TO USE "NETWORK", APART FROM THE MARK AS SHOWN.

SER. NO. 77-291,134, FILED 9-28-2007.

REBECCA POVARCHUK, EXAMINING ATTORNEY

Int. Cls.: 38, 39 and 42

Prior U.S. Cls.: 100, 101, 104 and 105

United States Patent and Trademark Office

Reg. No. 3,519,244

Registered Oct. 21, 2008

**SERVICE MARK
PRINCIPAL REGISTER**

ITOOKTHISONMYPHONE

ITOOKTHISONMYPHONE.COM, INC. (OHIO CORPORATION)
11103 DEERFIELD RD.
CINCINNATI, OH 45242

FOR: COMPUTER AIDED TRANSMISSION OF IMAGES, IN CLASS 38 (U.S. CLS. 100, 101 AND 104).

FIRST USE 10-25-2007; IN COMMERCE 10-25-2007.

FOR: STORAGE SERVICES FOR ARCHIVING DATABASES AND IMAGES, IN CLASS 39 (U.S. CLS. 100 AND 105).

FIRST USE 10-25-2007; IN COMMERCE 10-25-2007.

FOR: COMPUTER SERVICES, NAMELY, INTERACTIVE HOSTING SERVICES WHICH ALLOW THE USER TO PUBLISH AND SHARE THEIR OWN IMAGES ON-LINE, IN CLASS 42 (U.S. CLS. 100 AND 101).

FIRST USE 10-25-2007; IN COMMERCE 10-25-2007.

THE MARK CONSISTS OF STANDARD CHARACTERS WITHOUT CLAIM TO ANY PARTICULAR FONT, STYLE, SIZE, OR COLOR.

SER. NO. 77-291,196, FILED 9-28-2007.

JAMES LOVELACE, EXAMINING ATTORNEY

Int. Cl.: 36

Prior U.S. Cls.: 100, 101 and 102

United States Patent and Trademark Office

Reg. No. 3,519,245

Registered Oct. 21, 2008

**SERVICE MARK
PRINCIPAL REGISTER**



EAGLE CREDIT UNION (CALIFORNIA CREDIT UNION)
SUITE 6A
4245 WEST LANE
STOCKTON, CA 95208

FOR: CREDIT UNION SERVICES, NAMELY, PROVIDING BANKING SERVICES, SAVINGS AND CHECKING ACCOUNTS, MONEY MARKET ACCOUNTS, CERTIFICATES OF DEPOSIT, INDIVIDUAL RETIREMENT ACCOUNTS, CONSUMER AND MORTGAGE LENDING, CREDIT CARD SERVICES, DEBIT CARD SERVICES, AND ONLINE BANKING FEATURING BILL PAYMENT SERVICES, IN CLASS 36 (U.S. CLS. 100, 101 AND 102).

FIRST USE 9-1-2007; IN COMMERCE 9-1-2007.

NO CLAIM IS MADE TO THE EXCLUSIVE RIGHT TO USE "CREDIT UNION", APART FROM THE MARK AS SHOWN.

THE COLOR(S) ORANGE AND NAVY BLUE IS/ ARE CLAIMED AS A FEATURE OF THE MARK.

THE MARK CONSISTS OF AN OUTLINE DRAWING OF AN EAGLE HEAD AND WINGS IN PROFILE, ABOVE THE WORDS "EAGLE CREDIT UNION". THE OUTSTRETCHED WINGS EXTEND OVER AND THEN DOWN ALONG THE SIDES OF THE WORDS. THERE IS A BREAK IN THE LINE AT THE BOTTOM OF THE EAGLE'S BEAK. THE OUTLINE DRAWING IS IN ORANGE EXCEPT FOR THE TIPS OF THE WINGS, WHICH ARE IN NAVY BLUE. THE WORDS "EAGLE CREDIT UNION" ARE IN NAVY BLUE.

SER. NO. 77-291,314, FILED 9-28-2007.

BARBARA GAYNOR, EXAMINING ATTORNEY

Int. Cl.: 44

Prior U.S. Cls.: 100 and 101

United States Patent and Trademark Office

Reg. No. 3,519,246

Registered Oct. 21, 2008

**SERVICE MARK
PRINCIPAL REGISTER**



WOMANSAFEHEALTH, PC (MICHIGAN CORPORATION)

SUITE 8

2340 E. STADIUM BLVD.

ANN ARBOR, MI 48104

FOR: MEDICAL SERVICES, NAMELY, PROVIDING GYNECOLOGICAL SERVICES AND GENERAL HEALTH AND MEDICAL SERVICES TO WOMEN, IN CLASS 44 (U.S. CLS. 100 AND 101).

FIRST USE 8-1-2007; IN COMMERCE 8-1-2007.

THE COLOR(S) YELLOW, WHITE, GREEN AND BLACK IS/ARE CLAIMED AS A FEATURE OF THE MARK.

THE MARK CONSISTS OF A GREEN AND WHITE FLOWER WITH YELLOW BACKGROUND AND BLACK LETTERING CONTAINING THE SERVICE MARK NAME "WOMANSAFEHEALTH".

SER. NO. 77-291,439, FILED 9-28-2007.

HEATHER SAPP, EXAMINING ATTORNEY

Int. Cl.: 3

Prior U.S. Cls.: 1, 4, 6, 50, 51 and 52

United States Patent and Trademark Office

Reg. No. 3,519,247

Registered Oct. 21, 2008

TRADEMARK
PRINCIPAL REGISTER



PURI COMPANY LIMITED (THAILAND CORPORATION)
12/1 SOI PHAHOLYOTHIN 14
PHAHOLYOTHIN RD., SAMSAENNAI, PHAYATHAI
BANGKOK, THAILAND 10400

FOR: HAIR CARE PREPARATIONS, NAMELY, SHAMPOOS, HAIR CLEANSERS, HAIR WASHES, HAIR DETOXIFIERS, AND HAIR CONDITIONERS, MOISTURIZING SPRAY AND HAIR SCULPTING GELS, HAIR COLORING PREPARATIONS, AND HAIR WAVING LOTIONS; SKIN CARE PREPARATIONS, NAMELY, SOAPS, SKIN MOISTURIZERS, SKIN TONERS, SKIN CLEANSING PREPARATIONS, SKIN LOTIONS, BEAUTY MASQUES AND SKIN ASTRINGENTS FOR COSMETIC PURPOSES, SHAVING CREAMS, SHOWER GELS; PERSONAL HYGIENE PREPARATIONS, NAMELY, TOTAL BODY CLEANING PREPARATION, TOILET WATER, PERFUMES AND COLOGNES, MASSAGE OILS AND LOTIONS; ESSENTIAL OILS AND OIL MISTS FOR PERSONAL USE; SKIN CREAMS, SKIN LOTIONS, SKIN EMOLLIENTS, MOISTURIZING BODY OILS AND LOTIONS, LIP BALMS, FACE AND BODY SCRUBS, BODY WASHES, SKIN DE-

TOXIFIERS AND SKIN POLISHES; HAND LOTIONS, CREAMS AND CLEANSERS; FOOT SCRUBS, CREAMS AND BATHS, IN CLASS 3 (U.S. CLS. 1, 4, 6, 50, 51 AND 52).

FIRST USE 10-1-2003; IN COMMERCE 10-1-2003.

THE COLOR(S) GOLD IS/ARE CLAIMED AS A FEATURE OF THE MARK.

THE MARK CONSISTS OF THE WORD "PAN-PURI" BELOW A LOGO CONSISTING OF A STYLIZED IMAGE OF A PLANT IN THE SHAPE OF CURVED LINES, A PARTIAL CIRCLE, RADII AND SPHERES ALL IN GOLD.

THE FOREIGN WORDING IN THE MARK TRANSLATES INTO ENGLISH AS "PALACE OF WISDOM".

SER. NO. 77-291,482, FILED 9-28-2007.

LINDA MICKLEBURGH, EXAMINING ATTORNEY

Int. Cl.: 9

Prior U.S. Cls.: 21, 23, 26, 36 and 38

Reg. No. 3,519,248

United States Patent and Trademark Office

Registered Oct. 21, 2008

**TRADEMARK
PRINCIPAL REGISTER**

POWERGATE

LEX PRODUCTS CORP. (CONNECTICUT CORPORATION)
401 SHIPPAN AVENUE
STAMFORD, CT 06902

THE MARK CONSISTS OF STANDARD CHARACTERS WITHOUT CLAIM TO ANY PARTICULAR FONT, STYLE, SIZE, OR COLOR.

FOR: CIRCUIT BREAKERS, IN CLASS 9 (U.S. CLS. 21, 23, 26, 36 AND 38).

SER. NO. 77-291,536, FILED 9-28-2007.

FIRST USE 11-30-2002; IN COMMERCE 11-30-2002.

LINDA ORNDORFF, EXAMINING ATTORNEY

Int. Cl.: 44

Prior U.S. Cls.: 100 and 101

United States Patent and Trademark Office

Reg. No. 3,519,249

Registered Oct. 21, 2008

SERVICE MARK
PRINCIPAL REGISTER



ADVENTIST HEALTH SYSTEM/SUNBELT, INC.
(FLORIDA CORPORATION)
111 NORTH ORLANDO AVENUE
WINTER PARK, FL 327893675

FOR: MEDICAL SERVICES, IN CLASS 44 (U.S.
CLS. 100 AND 101).

FIRST USE 5-1-2007; IN COMMERCE 5-1-2007.

NO CLAIM IS MADE TO THE EXCLUSIVE
RIGHT TO USE "HOSPITAL HOME CARE SERVI-
CES", APART FROM THE MARK AS SHOWN.

THE MARK CONSISTS OF AN OVERALL HEX-
AGONAL SHAPE FORMED BY THREE INTER-
LOCKED LETTER "FS" LOCATED WITHIN A
STYLIZED REPRESENTATION OF A HOUSE, ALL
POSITIONED GENERALLY TO THE LEFT OF THE
WORDING OF THE MARK.

SEC. 2(F) AS TO "FLORIDA HOSPITAL".

SER. NO. 77-291,632, FILED 9-28-2007.

BARBARA BROWN, EXAMINING ATTORNEY

Int. Cl.: 44

Prior U.S. Cls.: 100 and 101

United States Patent and Trademark Office

Reg. No. 3,519,250

Registered Oct. 21, 2008

**SERVICE MARK
PRINCIPAL REGISTER**

**Florida Hospital Home Care
Services**

ADVENTIST HEALTH SYSTEM/SUNBELT, INC.
(FLORIDA CORPORATION)
111 NORTH ORLANDO AVENUE
WINTER PARK, FL 327893675

NO CLAIM IS MADE TO THE EXCLUSIVE
RIGHT TO USE "HOSPITAL HOME CARE SERVI-
CES", APART FROM THE MARK AS SHOWN.

FOR: MEDICAL SERVICES, IN CLASS 44 (U.S.
CLS. 100 AND 101).

SEC. 2(F) AS TO "FLORIDA HOSPITAL".

FIRST USE 5-1-2007; IN COMMERCE 5-1-2007.

SER. NO. 77-291,662, FILED 9-28-2007.

THE MARK CONSISTS OF STANDARD CHAR-
ACTERS WITHOUT CLAIM TO ANY PARTICULAR
FONT, STYLE, SIZE, OR COLOR.

BARBARA BROWN, EXAMINING ATTORNEY

Int. Cls.: 25 and 36

Prior U.S. Cls.: 22, 39, 100, 101 and 102

United States Patent and Trademark Office

Reg. No. 3,519,251

Registered Oct. 21, 2008

TRADEMARK
SERVICE MARK
PRINCIPAL REGISTER



KIDS FOR THE WORLD INC. (NEW YORK NON-
PROFIT CORPORATION)
240 EAST 90TH STREET, PHE
NEW YORK, NY 10128

FOR: CLOTHING, NAMELY, T-SHIRTS, IN
CLASS 25 (U.S. CLS. 22 AND 39).

FIRST USE 4-8-2006; IN COMMERCE 4-8-2006.

FOR: CHARITABLE FUND-RAISING SERVICES;
ELEEMOSYNARY SERVICES, NAMELY PROVID-
ING FINANCIAL AID TO IMPOVERISHED CHIL-
DREN AND THEIR FAMILIES, IN CLASS 36 (U.S.
CLS. 100, 101 AND 102).

FIRST USE 4-8-2006; IN COMMERCE 4-8-2006.

NO CLAIM IS MADE TO THE EXCLUSIVE
RIGHT TO USE "KIDS", APART FROM THE MARK
AS SHOWN.

THE STIPLING IS FOR SHADING PURPOSES
ONLY.

SER. NO. 77-291,757, FILED 9-28-2007.

ALEX KEAM, EXAMINING ATTORNEY

Int. Cl.: 44

Prior U.S. Cls.: 100 and 101

United States Patent and Trademark Office

Reg. No. 3,519,252

Registered Oct. 21, 2008

**SERVICE MARK
PRINCIPAL REGISTER**

CORE HEALTH GROUP

ROETHEL & ASSOCIATES, INC. (WISCONSIN
CORPORATION)
SUITE 220
11501 N. PORT WASHINGTON ROAD
MEQUON, WI 53092

FOR: HEALTH CARE SERVICES, NAMELY,
CREATING AND IMPLEMENTING WELLNESS
PROGRAMS FOR HEALTH ENHANCEMENT AND
DISEASE PREVENTION, IN CLASS 44 (U.S. CLS. 100
AND 101).

FIRST USE 9-20-2006; IN COMMERCE 9-20-2006.

THE MARK CONSISTS OF STANDARD CHAR-
ACTERS WITHOUT CLAIM TO ANY PARTICULAR
FONT, STYLE, SIZE, OR COLOR.

NO CLAIM IS MADE TO THE EXCLUSIVE
RIGHT TO USE "HEALTH GROUP", APART FROM
THE MARK AS SHOWN.

SER. NO. 77-293,228, FILED 10-1-2007.

TINA BROWN, EXAMINING ATTORNEY

Int. Cl.: 9

Prior U.S. Cls.: 21, 23, 26, 36 and 38

Reg. No. 3,519,253

United States Patent and Trademark Office

Registered Oct. 21, 2008

**TRADEMARK
PRINCIPAL REGISTER**

MATH DRILL EXPRESS

MATH MATTERS, LLC (FLORIDA LIMITED
LIABILITY COMPANY)
4829 BLACKACRE LANE
ORLANDO, FL 32806

FOR: COMPUTER SOFTWARE FOR CHILDREN
USED IN DEVELOPING MATHEMATICS SKILLS
AND RELATED INSTRUCTIONAL MANUALS, ALL
SOLD AS A UNIT, IN CLASS 9 (U.S. CLS. 21, 23, 26, 36
AND 38).

FIRST USE 1-4-2006; IN COMMERCE 1-4-2006.

THE MARK CONSISTS OF STANDARD CHAR-
ACTERS WITHOUT CLAIM TO ANY PARTICULAR
FONT, STYLE, SIZE, OR COLOR.

NO CLAIM IS MADE TO THE EXCLUSIVE
RIGHT TO USE "MATH DRILL", APART FROM
THE MARK AS SHOWN.

SER. NO. 77-293,994, FILED 10-2-2007.

TINA BROWN, EXAMINING ATTORNEY

Int. Cl.: 9

Prior U.S. Cls.: 21, 23, 26, 36 and 38

Reg. No. 3,519,254

United States Patent and Trademark Office

Registered Oct. 21, 2008

**TRADEMARK
PRINCIPAL REGISTER**

TECHNOMEDIA

TECHNOMEDIA LLC (SOUTH CAROLINA LIMITED LIABILITY COMPANY)
148 TAYLOR CIRCLE
GOOSE CREEK, SC 29445

THE MARK CONSISTS OF STANDARD CHARACTERS WITHOUT CLAIM TO ANY PARTICULAR FONT, STYLE, SIZE, OR COLOR.

FOR: DIGITAL MEDIA, NAMELY, DVDS, CDS, AND DOWNLOADABLE AUDIO/VIDEO/GRAPHIC FILES FEATURING INSTRUCTIONAL LECTURES, IN CLASS 9 (U.S. CLS. 21, 23, 26, 36 AND 38).

SER. NO. 77-294,158, FILED 10-2-2007.

FIRST USE 11-6-2006; IN COMMERCE 11-6-2006.

JESSICA A. POWERS, EXAMINING ATTORNEY

Int. Cl.: 41

Prior U.S. Cls.: 100, 101 and 107

United States Patent and Trademark Office

Reg. No. 3,519,255

Registered Oct. 21, 2008

**SERVICE MARK
PRINCIPAL REGISTER**

I REALLY LOVE MY...

TIME INC. (DELAWARE CORPORATION)
14-256
1271 AVENUE OF THE AMERICAS
NEW YORK, NY 10020

FOR: PROVIDING INFORMATION ONLINE IN
THE FIELD OF CELEBRITY NEWS AND CELEBRITY
FASHION, IN CLASS 41 (U.S. CLS. 100, 101
AND 107).

FIRST USE 2-1-2006; IN COMMERCE 2-1-2006.

THE MARK CONSISTS OF STANDARD CHARACTERS
WITHOUT CLAIM TO ANY PARTICULAR
FONT, STYLE, SIZE, OR COLOR.

SER. NO. 77-294,268, FILED 10-2-2007.

DOMINIC FATHY, EXAMINING ATTORNEY

Int. Cl.: 25

Prior U.S. Cls.: 22 and 39

United States Patent and Trademark Office

Reg. No. 3,519,256

Registered Oct. 21, 2008

**TRADEMARK
PRINCIPAL REGISTER**



DEUTSCHE TELEKOM AG (FED REP GERMA-
NY CORPORATION)
FRIEDRICH-EBERT-ALLEE 140
BONN 53113, FED REP GERMANY

FOR: CLOTHING, NAMELY, SHIRTS, DRESSES,
PANTS, JACKETS, COATS, T-SHIRTS, SHORTS;
HEADWEAR, NAMELY, CAPS AND HATS, IN
CLASS 25 (U.S. CLS. 22 AND 39).

PRIORITY CLAIMED UNDER SEC. 44(D) ON FED
REP GERMANY APPLICATION NO. 30722314038,
FILED 4-3-2007.

OWNER OF FED REP GERMANY REG. NO.
30722314, DATED 12-12-2007, EXPIRES 4-30-2017.

THE MARK CONSISTS OF AN INCOMPLETE
CIRCLE AND AN INCOMPLETE STAR WITHIN
THE CIRCLE.

SER. NO. 77-294,321, FILED 10-2-2007.

MARLENE BELL, EXAMINING ATTORNEY

Int. Cl.: 25

Prior U.S. Cls.: 22 and 39

United States Patent and Trademark Office

Reg. No. 3,519,257

Registered Oct. 21, 2008

**TRADEMARK
PRINCIPAL REGISTER**



DEUTSCHE TELEKOM AG (FED REP GERMA-
NY CORPORATION)
FRIEDRICH-EBERT-ALLEE 140
BONN 53113, FED REP GERMANY

FOR: CLOTHING, NAMELY, SHIRTS, DRESSES,
PANTS, JACKETS, COATS, T-SHIRTS, SHORTS;
HEADWEAR, NAMELY, CAPS AND HATS, IN
CLASS 25 (U.S. CLS. 22 AND 39).

PRIORITY CLAIMED UNDER SEC. 44(D) ON FED
REP GERMANY APPLICATION NO. 30722313.2/3,
FILED 4-3-2007, REG. NO. 30722313, DATED 12-14-
2007, EXPIRES 4-30-2017.

OWNER OF U.S. REG. NOS. 3,312,794, 3,348,739,
AND 3,348,740.

THE MARK CONSISTS OF THE TERM "CON-
GSTAR" BELOW A DESIGN OF AN INCOMPLETE
CIRCLE AND AN INCOMPLETE STAR WITHIN
THE CIRCLE.

THE TERM IN THE MARK DOES NOT HAVE
ANY MEANING IN A FOREIGN LANGUAGE.

SER. NO. 77-294,476, FILED 10-2-2007.

MARLENE BELL, EXAMINING ATTORNEY

Int. Cl.: 5

Prior U.S. Cls.: 6, 18, 44, 46, 51 and 52

Reg. No. 3,519,258

United States Patent and Trademark Office

Registered Oct. 21, 2008

**TRADEMARK
PRINCIPAL REGISTER**

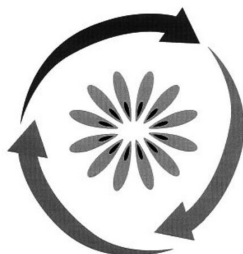

VITAL FOOD PROCESSORS LIMITED (NEW
ZEALAND LIMITED LIABILITY COMPANY)
AIRPORT OAKS
78 ASCOT ROAD
AUCKLAND, NEW ZEALAND

FOR: PHARMACEUTICAL PREPARATIONS FOR
THE TREATMENT OF DIGESTIVE DYSFUNCTION
AND RELATED CONDITIONS; VETERINARY PRE-
PARATIONS FOR THE TREATMENT OF DIGES-
TIVE DYSFUNCTION AND RELATED
CONDITIONS; PROCESSED FOODS AND BEVERA-
GES ADAPTED FOR MEDICAL PURPOSES; DIET-
ARY AND NUTRITIONAL SUPPLEMENTS;
DIETARY AND NUTRITIONAL SUPPLEMENTS
FOR USE AS A DIGESTIVE AID; PREPARATIONS

CONTAINING KIWIFRUIT ENZYMES FOR MEDI-
CAL OR PHARMACEUTICAL PURPOSES, NAME-
LY, FOR THE TREATMENT OF DIGESTIVE
DYSFUNCTION AND RELATED CONDITIONS, IN
CLASS 5 (U.S. CLS. 6, 18, 44, 46, 51 AND 52).

PRIORITY CLAIMED UNDER SEC. 44(D) ON
NEW ZEALAND APPLICATION NO. 770888, FILED
6-22-2007, REG. NO. 770888, DATED 6-22-2007, EX-
PIRES 6-22-2017.

SER. NO. 77-295,340, FILED 10-3-2007.

EDWARD NELSON, EXAMINING ATTORNEY

Int. Cl.: 41

Prior U.S. Cls.: 100, 101 and 107

United States Patent and Trademark Office

Reg. No. 3,519,259

Registered Oct. 21, 2008

**SERVICE MARK
PRINCIPAL REGISTER**

LA MANO PELUDA

GRUPO DE RADIODIFUSORAS, S.A. DE C.V.
(MEXICO CORPORATION)
PRIVADA DE HORACIO NO. 10
COL. POLANCO, MEXICO 11520

FOR: ENTERTAINMENT SERVICES, NAMELY,
CONTINUING RADIO PROGRAMS IN THE FIELD
OF TALK RADIO, IN CLASS 41 (U.S. CLS. 100, 101
AND 107).

FIRST USE 8-15-1995; IN COMMERCE 8-15-1995.

THE MARK CONSISTS OF STANDARD CHAR-
ACTERS WITHOUT CLAIM TO ANY PARTICULAR
FONT, STYLE, SIZE, OR COLOR.

THE FOREIGN WORDING IN THE MARK
TRANSLATES INTO ENGLISH AS "THE HAIRY
HAND".

SER. NO. 77-295,561, FILED 10-3-2007.

ALEX KEAM, EXAMINING ATTORNEY

Int. Cl.: 28

Prior U.S. Cls.: 22, 23, 38 and 50

United States Patent and Trademark Office

Reg. No. 3,519,260

Registered Oct. 21, 2008

**TRADEMARK
PRINCIPAL REGISTER**

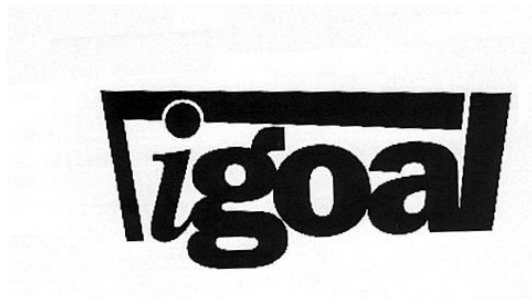

READY SET GOAL LTD. (UNITED KINGDOM
LIMITED LIABILITY COMPANY)
GALLEON HOUSE LION AND LAMB YARD FARN-
HAM
SURREY GU9 7LL, UNITED KINGDOM GU97LL

FOR: SPORTS GOALS, NAMELY, SOCCER
GOALS, HOCKEY GOALS AND LACROSSE GOALS,
IN CLASS 28 (U.S. CLS. 22, 23, 38 AND 50).

PRIORITY CLAIMED UNDER SEC. 44(D) ON
ERPNTY CMNTY TM OFC APPLICATION NO.

005825096, FILED 4-11-2007, REG. NO. 005825096,
DATED 4-24-2008, EXPIRES 4-11-2017.

THE MARK CONSISTS OF IN PART OF STY-
LIZED GOAL FORMED BY A HORIZONTAL LINE,
A VERTICAL LINE AND THE LETTER "L".

SER. NO. 77-295,722, FILED 10-4-2007.

EDWARD NELSON, EXAMINING ATTORNEY

Int. Cl.: 41

Prior U.S. Cls.: 100, 101 and 107

United States Patent and Trademark Office

Reg. No. 3,519,261

Registered Oct. 21, 2008

**SERVICE MARK
PRINCIPAL REGISTER**

AGD Briefings

ACADEMY OF GENERAL DENTISTRY (ILLINOIS NON-PROFIT CORPORATION)
SUITE 900
211 E CHICAGO AVENUE
CHICAGO, IL 606111999

FOR: PUBLICATION OF ELECTRONIC PUBLICATIONS, NAMELY, NEWSLETTERS IN THE FIELD OF DENTISTRY, IN CLASS 41 (U.S. CLS. 100, 101 AND 107).

FIRST USE 1-0-2006; IN COMMERCE 1-0-2006.

THE MARK CONSISTS OF STANDARD CHARACTERS WITHOUT CLAIM TO ANY PARTICULAR FONT, STYLE, SIZE, OR COLOR.

NO CLAIM IS MADE TO THE EXCLUSIVE RIGHT TO USE "BRIEFINGS", APART FROM THE MARK AS SHOWN.

SER. NO. 77-295,986, FILED 10-4-2007.

STEVEN JACKSON, EXAMINING ATTORNEY

Int. Cl.: 33

Prior U.S. Cls.: 47 and 49

United States Patent and Trademark Office

Reg. No. 3,519,262

Registered Oct. 21, 2008

**TRADEMARK
PRINCIPAL REGISTER**

PARADISE MANGO RUM LIQUEUR

DESTILERIA LIMTUACO & CO., INC. (PHILIPPINES CORPORATION)

1830 EPIFANIO DELOS SANTOS AVENUE

QUEZON CITY, PHILIPPINES 1106

FOR: DISTILLED SPIRITS; LIQUEURS; WINES,
IN CLASS 33 (U.S. CLS. 47 AND 49).

FIRST USE 11-19-1998; IN COMMERCE 1-15-2000.

THE MARK CONSISTS OF STANDARD CHARACTERS WITHOUT CLAIM TO ANY PARTICULAR FONT, STYLE, SIZE, OR COLOR.

NO CLAIM IS MADE TO THE EXCLUSIVE RIGHT TO USE "MANGO RUM LIQUEUR", APART FROM THE MARK AS SHOWN.

SER. NO. 77-296,002, FILED 10-4-2007.

ANNE E. GUSTASON, EXAMINING ATTORNEY

Int. Cl.: 1

Prior U.S. Cls.: 1, 5, 6, 10, 26 and 46

Reg. No. 3,519,263

United States Patent and Trademark Office

Registered Oct. 21, 2008

**TRADEMARK
PRINCIPAL REGISTER**

CLEARCOL

NANODYNAMICS, INC. (DELAWARE CORPORATION)
901 FUHRMANN BOULEVARD
BUFFALO, NY 14203

FOR: CHEMICAL PREPARATIONS, NAMELY, COLLOIDS COMPRISING UNAGGLOMEARATED NANO-PARTICLES FOR USE IN COATINGS, AS ADDITIVES TO POLYMERIC MATERIALS, AND FOR DEPOSITION ON OR INTO SUBSTRATES, IN CLASS 1 (U.S. CLS. 1, 5, 6, 10, 26 AND 46).

FIRST USE 5-1-2006; IN COMMERCE 5-1-2006.

THE MARK CONSISTS OF STANDARD CHARACTERS WITHOUT CLAIM TO ANY PARTICULAR FONT, STYLE, SIZE, OR COLOR.

SER. NO. 77-296,013, FILED 10-4-2007.

ALLISON HOLTZ, EXAMINING ATTORNEY

Int. Cl.: 3

Prior U.S. Cls.: 1, 4, 6, 50, 51 and 52

Reg. No. 3,519,264

United States Patent and Trademark Office

Registered Oct. 21, 2008

**TRADEMARK
PRINCIPAL REGISTER**

BREAKAGE DEFENSE

THE PROCTER & GAMBLE COMPANY (SOUTH
DAKOTA CORPORATION)
ONE PROCTER & GAMBLE PLAZA
CINCINNATI, OH 45202

FOR: HAIR CARE PREPARATIONS, NAMELY,
SHAMPOOS, CONDITIONERS, TREATMENTS AND
STYLING AIDS, NAMELY, HAIR CREAMS AND
HAIR LOTIONS, IN CLASS 3 (U.S. CLS. 1, 4, 6, 50, 51
AND 52).

FIRST USE 1-2-2006; IN COMMERCE 1-2-2006.

THE MARK CONSISTS OF STANDARD CHAR-
ACTERS WITHOUT CLAIM TO ANY PARTICULAR
FONT, STYLE, SIZE, OR COLOR.

NO CLAIM IS MADE TO THE EXCLUSIVE
RIGHT TO USE "BREAKAGE", APART FROM
THE MARK AS SHOWN.

SER. NO. 77-296,173, FILED 10-4-2007.

BARBARA RUTLAND, EXAMINING ATTORNEY

Int. Cls.: 35 and 36

Prior U.S. Cls.: 100, 101 and 102

United States Patent and Trademark Office

Reg. No. 3,519,265

Registered Oct. 21, 2008

**SERVICE MARK
PRINCIPAL REGISTER**

OTR

OTA FINANCIAL GROUP LP (DELAWARE LIMITED PARTNERSHIP)
ONE MANHATTANVILLE ROAD
PURCHASE, NY 10577

FOR: ANALYZING AND COMPILING DATA FOR MEASURING THE PERFORMANCE OF FINANCIAL MARKETS, NAMELY COMPILING FINANCIAL INFORMATION FROM NONTRADITIONAL SOURCES, ANALYZING FINANCIAL INFORMATION FOR DISLOCATIONS OR INFLECTION POINTS THAT PROVIDE INVESTMENT OPPORTUNITIES FOR FINANCIAL INSTITUTIONS, IN CLASS 35 (U.S. CLS. 100, 101 AND 102).

FIRST USE 1-31-1996; IN COMMERCE 1-31-1996.

FOR: FINANCIAL RESEARCH AND FINANCIAL CONSULTATION, NAMELY, PROVIDING MARKETPLACE-BASED EQUITY RESEARCH FOR FINANCIAL INSTITUTIONS, IN CLASS 36 (U.S. CLS. 100, 101 AND 102).

FIRST USE 1-31-1996; IN COMMERCE 1-31-1996.

THE MARK CONSISTS OF STANDARD CHARACTERS WITHOUT CLAIM TO ANY PARTICULAR FONT, STYLE, SIZE, OR COLOR.

OWNER OF U.S. REG. NO. 2,865,996.

SER. NO. 77-296,275, FILED 10-4-2007.

LINDA POWELL, EXAMINING ATTORNEY

Int. Cl.: 19

Prior U.S. Cls.: 1, 12, 33 and 50

United States Patent and Trademark Office

Reg. No. 3,519,266

Registered Oct. 21, 2008

**TRADEMARK
PRINCIPAL REGISTER**



PANELES ARAUCO S.A. (CHILE CORPORATION)
AVDA. EL GOLF #150, PISO 14
LAS CONDES, CASILLA
SANTIAGO, CHILE 880

FOR: NON-METAL BUILDING CONSTRUCTION MATERIALS, NAMELY, WOOD PANELS, HARDBOARD, WOOD MOLDINGS AND WOOD MATERIALS IN THE NATURE OF WOOD BEAMS, WOOD WINDOW FRAMES, WOOD DOOR FRAMES, WOOD TRIMS, WOOD POSTS, WOOD JOISTS, WOOD JOINTS, IN CLASS 19 (U.S. CLS. 1, 12, 33 AND 50).

PRIORITY CLAIMED UNDER SEC. 44(D) ON CHILE APPLICATION NO. 786.282, FILED 8-27-2007,

REG. NO. 806.972, DATED 1-25-2008, EXPIRES 1-25-2018.

THE MARK CONSISTS OF THE WORD "TRUPAN" WITH STYLIZED LINES THROUGH THE LETTERS "A" AND "N".

THE WORDING "TRUPAN" IN THE MARK HAS NO MEANING IN A FOREIGN LANGUAGE.

SER. NO. 77-296,379, FILED 10-4-2007.

TRACY WHITTAKER-BROWN, EXAMINING ATTORNEY

Int. Cl.: 41

Prior U.S. Cls.: 100, 101 and 107

United States Patent and Trademark Office

Reg. No. 3,519,267

Registered Oct. 21, 2008

**SERVICE MARK
PRINCIPAL REGISTER**

BROADWAY MEETS COUNTRY

COUNTRY MUSIC ASSOCIATION, INC. (TEN-
NESSEE CORPORATION)
ONE MUSIC CIRCLE SOUTH
NASHVILLE, TN 90405

FOR: ENTERTAINMENT, NAMELY, LIVE MU-
SIC CONCERTS, IN CLASS 41 (U.S. CLS. 100, 101
AND 107).

FIRST USE 11-12-2005; IN COMMERCE 11-12-2005.

THE MARK CONSISTS OF STANDARD CHAR-
ACTERS WITHOUT CLAIM TO ANY PARTICULAR
FONT, STYLE, SIZE, OR COLOR.

NO CLAIM IS MADE TO THE EXCLUSIVE
RIGHT TO USE "BROADWAY" AND "COUNTRY",
APART FROM THE MARK AS SHOWN.

SER. NO. 77-296,415, FILED 10-4-2007.

MICHELLE DUBOIS, EXAMINING ATTORNEY

Int. Cls.: 35, 36 and 45

Prior U.S. Cls.: 100, 101 and 102

United States Patent and Trademark Office

Reg. No. 3,519,268

Registered Oct. 21, 2008

**SERVICE MARK
PRINCIPAL REGISTER**



MEDICAL PARTNERS OF AMERICA, INC. (DELAWARE CORPORATION)
SUITE 310
822 HIGHWAY A1A NORTH
PONTE VEDRA BEACH, FL 32082

FOR: COST CONTAINMENT, REVIEW AND UTILIZATION ANALYSIS IN THE FIELD OF HEALTHCARE SERVICES; INTERACTIVE MEDICAL RECORDKEEPING SERVICES FOR USE IN RISK MANAGEMENT, CLAIMS PAYMENT, ADMINISTRATION AND REGULATORY COMPLIANCE, IN CLASS 35 (U.S. CLS. 100, 101 AND 102).

FIRST USE 7-20-2007; IN COMMERCE 7-20-2007.

FOR: MEDICAL HEALTH PLAN AND CLAIMS ADMINISTRATION; ORGANIZATION AND ADMINISTRATION OF PREFERRED PROVIDER PLANS IN THE MEDICAL FIELD, IN CLASS 36 (U.S. CLS. 100, 101 AND 102).

FIRST USE 7-20-2007; IN COMMERCE 7-20-2007.

FOR: VERIFYING AND MONITORING THE CREDENTIALS OF DOCTORS AND OTHER MEDICAL PROFESSIONALS, IN CLASS 45 (U.S. CLS. 100 AND 101).

FIRST USE 9-1-2007; IN COMMERCE 9-1-2007.

THE MARK CONSISTS OF AN EQUILINEAR CROSS DIVIDED FROM TOP RIGHT TO BOTTOM LEFT BY A CURVED LINE SEPARATING THE CROSS INTO HALVES. SUPERIMPOSED OVER THE LOWER RIGHT HALF IS A GRID THAT IS ROUNDED AS THOUGH STRETCHED ACROSS THE GLOBE IN LONGITUDINAL AND LATITUDINAL LINES.

SER. NO. 77-296,557, FILED 10-4-2007.

ESTHER BELENKER, EXAMINING ATTORNEY

Int. Cl.: 41

Prior U.S. Cls.: 100, 101 and 107

United States Patent and Trademark Office

Reg. No. 3,519,269

Registered Oct. 21, 2008

**SERVICE MARK
PRINCIPAL REGISTER**

SINGER LEARNING

SINGER LEARNING, INC. (OHIO CORPORATION)
10411 SHADYSIDE LANE
CINCINNATI, OH 45249

FOR: EDUCATION SERVICES, NAMELY, PROVIDING CLASSES, SEMINARS, WORKSHOPS, TUTORING, COACHING, AND MENTORING IN THE FIELD OF LEADERSHIP, TRAINING, PRESENTING, AND TEACHING TO BUSINESS AND TEACHING PROFESSIONALS, NOT INCLUDING COLLEGE COUNSELING, IN CLASS 41 (U.S. CLS. 100, 101 AND 107).

FIRST USE 7-0-2004; IN COMMERCE 7-0-2004.

THE MARK CONSISTS OF STANDARD CHARACTERS WITHOUT CLAIM TO ANY PARTICULAR FONT, STYLE, SIZE, OR COLOR.

NO CLAIM IS MADE TO THE EXCLUSIVE RIGHT TO USE "LEARNING", APART FROM THE MARK AS SHOWN.

SER. NO. 77-296,670, FILED 10-4-2007.

MARK PILARO, EXAMINING ATTORNEY

Int. Cl.: 39

Prior U.S. Cls.: 100 and 105

United States Patent and Trademark Office

Reg. No. 3,519,270

Registered Oct. 21, 2008

**SERVICE MARK
PRINCIPAL REGISTER**

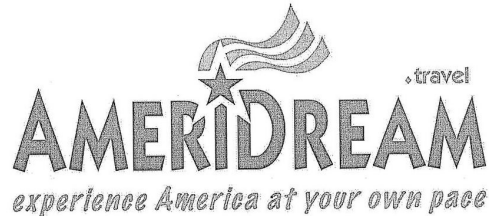

CANADREAM CORPORATION (CANADA CORPORATION)
2510 - 27TH STREET NE
CALGARY, CANADA T1Y7G1

FOR: RENTAL OF RECREATIONAL VEHICLES,
IN CLASS 39 (U.S. CLS. 100 AND 105).

OWNER OF CANADA REG. NO. TMA712906,
DATED 4-25-2008, EXPIRES 4-25-2023.

OWNER OF U.S. REG. NOS. 3,304,191 AND
3,304,193.

NO CLAIM IS MADE TO THE EXCLUSIVE
RIGHT TO USE "TRAVEL", APART FROM THE
MARK AS SHOWN.

SER. NO. 77-296,704, FILED 10-4-2007.

MICHELLE DUBOIS, EXAMINING ATTORNEY

Int. Cl.: 3

Prior U.S. Cls.: 1, 4, 6, 50, 51 and 52

United States Patent and Trademark Office

Reg. No. 3,519,271

Registered Oct. 21, 2008

**TRADEMARK
PRINCIPAL REGISTER**

Q-TICKLES

FREEMAN, GAIL (UNITED STATES INDIVIDUAL)
25040 AVE. TIBBITTS STE. D
VALENCIA, CA 91355

THE MARK CONSISTS OF STANDARD CHARACTERS WITHOUT CLAIM TO ANY PARTICULAR FONT, STYLE, SIZE, OR COLOR.

FOR: BODY AND BEAUTY CARE COSMETICS,
IN CLASS 3 (U.S. CLS. 1, 4, 6, 50, 51 AND 52).

SER. NO. 77-296,713, FILED 10-4-2007.

FIRST USE 5-21-1998; IN COMMERCE 5-21-1998.

MICHELLE DUBOIS, EXAMINING ATTORNEY

Int. Cl.: 41

Prior U.S. Cls.: 100, 101 and 107

United States Patent and Trademark Office

Reg. No. 3,519,272

Registered Oct. 21, 2008

SERVICE MARK
PRINCIPAL REGISTER



MURPHY, MICHAEL (UNITED STATES INDIVIDUAL)
324 LEE ROAD 792
SALEM, AL 36874

FOR: ENTERTAINMENT IN THE NATURE OF AN ON-GOING SPECIAL VARIETY, NEWS, MUSIC OR COMEDY SHOW FEATURING OUTDOOR ACTIVITIES SUCH AS HUNTING AND FISHING BROADCAST OVER TELEVISION, SATELLITE, AUDIO, AND VIDEO MEDIA, IN CLASS 41 (U.S. CLS. 100, 101 AND 107).

FIRST USE 7-1-2006; IN COMMERCE 7-1-2006.

THE COLOR(S) RED, BLUE, YELLOW, AQUA-BLUE, GREEN AND BEIGE IS/ARE CLAIMED AS A FEATURE OF THE MARK.

THE MARK CONSISTS OF THE WORDING "KIDS HOOKED ON THE OUTDOORS" WITH A

LARGE HOOK IN THE CENTER OF THE IMAGE AND MIXED IN WITH THE WORDING. THE COLOR RED APPEARS IN THE LETTER K IN "KIDS" AND THE LETTERS O, D AND S IN "OUTDOORS". THE COLOR BLUE APPEARS IN THE LETTER D IN "KIDS" AND THE LETTERS U AND R IN "OUTDOORS". THE COLOR YELLOW APPEARS IN THE LETTER I IN "KIDS", THE LETTER K IN "HOOKED" AND THE THIRD LETTER O IN "OUTDOORS". THE COLOR AQUA-BLUE APPEARS IN THE LETTERS H, O, O, E AND D OF "HOOKED", THE WORDS "ON THE" AND THE SECOND LETTER O IN "OUTDOORS". THE COLOR GREEN APPEARS IN THE LETTER S IN "KIDS" AND THE LETTER T IN "OUTDOORS". THE COLOR BEIGE APPEARS IN THE HOOK.

SER. NO. 77-296,751, FILED 10-4-2007.

JACQUELINE A. LAVINE, EXAMINING ATTORNEY

Int. Cl.: 37

Prior U.S. Cls.: 100, 103 and 106

United States Patent and Trademark Office

Reg. No. 3,519,273

Registered Oct. 21, 2008

**SERVICE MARK
PRINCIPAL REGISTER**

#1 VERTICAL TRANSPORTATION

J.G. ELEVATOR, LLC (NEW JERSEY LIMITED
LIABILITY COMPANY)
572 OLD YORK ROAD
BRANCHBURG, NJ 08876

FOR: INSTALLATION, MAINTENANCE AND
REPAIR OF ELEVATORS AND ASSOCIATED
EQUIPMENT, IN CLASS 37 (U.S. CLS. 100, 103 AND
106).

FIRST USE 1-1-1997; IN COMMERCE 1-1-1997.

THE MARK CONSISTS OF STANDARD CHAR-
ACTERS WITHOUT CLAIM TO ANY PARTICULAR
FONT, STYLE, SIZE, OR COLOR.

SEC. 2(F).

SER. NO. 77-296,852, FILED 10-5-2007.

SALLY SHIH, EXAMINING ATTORNEY

Int. Cls.: 14, 16, 20, 21, 25, 27, 30, 33 and 34

Prior U.S. Cls.: 2, 5, 8, 9, 13, 17, 19, 20, 22, 23, 25, 27, 28, 29, 30, 32, 33, 37, 38, 39, 40, 42, 46, 47, 49 and 50

Reg. No. 3,519,274

United States Patent and Trademark Office

Registered Oct. 21, 2008

**TRADEMARK
PRINCIPAL REGISTER**

GUY HARVEY

GUY HARVEY, INC. (FLORIDA CORPORATION)
4350 OAKES ROAD, STE. 518
DAVIE, FL 33314

FOR: CLOCKS AND WATCHES, IN CLASS 14 (U.S. CLS. 2, 27, 28 AND 50).

FIRST USE 9-1-2003; IN COMMERCE 9-1-2003.

FOR: PAINTINGS AND THEIR REPRODUCTIONS, PHOTOGRAPHIC ART PRINTS, MOUNTED POSTERS, POSTERS MADE OF PAPER, DECALS, COFFEE TABLE BOOKS FEATURING MARINE LIFE ART AND UNDERWATER PHOTOS, IN CLASS 16 (U.S. CLS. 2, 5, 22, 23, 29, 37, 38 AND 50).

FIRST USE 10-1-1985; IN COMMERCE 10-1-1985.

FOR: FURNITURE MADE OF METAL, IN CLASS 20 (U.S. CLS. 2, 13, 22, 25, 32 AND 50).

FIRST USE 11-1-2006; IN COMMERCE 11-1-2006.

FOR: HOUSEWARES AND GLASS, NAMELY, MUGS, BEVERAGE WARE, BEVERAGE GLASSWARE, DRINKING GLASSES, BEER MUGS, COASTERS NOT OF PAPER AND NOT BEING TABLE LINEN, INSULATING SLEEVE HOLDERS FOR BEVERAGE CANS, AND DINNERWARE, NAMELY, PLATES, BOWLS, CUPS AND SAUCERS, IN CLASS 21 (U.S. CLS. 2, 13, 23, 29, 30, 33, 40 AND 50).

FIRST USE 6-1-2002; IN COMMERCE 6-1-2002.

FOR: CLOTHING, NAMELY, SHORT-SLEEVED AND LONG-SLEEVED T-SHIRTS, TANK TOPS, SWEAT SHIRTS, SWEAT PANTS, SPORT SHIRTS, CAMP SHIRTS, GOLF SHIRTS, KNIT SHIRTS, OPEN-NECKED SHIRTS, POLO SHIRTS, SLEEP SHIRTS, SWEATERS, JACKETS, PANTS, CAPRI PANTS, SHORTS, DRESSES, SKIRTS, FABRIC

BELTS, LEATHER BELTS, CAPS, SUN VISORS, SCARVES, AND SWIM WEAR, IN CLASS 25 (U.S. CLS. 22 AND 39).

FIRST USE 6-15-1988; IN COMMERCE 6-15-1988.

FOR: RUGS, IN CLASS 27 (U.S. CLS. 19, 20, 37, 42 AND 50).

FIRST USE 1-2-2003; IN COMMERCE 1-2-2003.

FOR: SPICES AND SEASONINGS, IN CLASS 30 (U.S. CL. 46).

FIRST USE 1-2-2007; IN COMMERCE 1-2-2007.

FOR: WINE, IN CLASS 33 (U.S. CLS. 47 AND 49).

FIRST USE 1-2-2007; IN COMMERCE 1-2-2007.

FOR: LIGHTERS FOR SMOKERS, IN CLASS 34 (U.S. CLS. 2, 8, 9 AND 17).

FIRST USE 1-2-2002; IN COMMERCE 1-2-2002.

THE MARK CONSISTS OF STANDARD CHARACTERS WITHOUT CLAIM TO ANY PARTICULAR FONT, STYLE, SIZE, OR COLOR.

OWNER OF U.S. REG. NOS. 1,616,722, 2,582,750 AND OTHERS.

THE NAME(S), PORTRAIT(S), AND/OR SIGNATURE(S) SHOWN IN THE MARK IDENTIFIES "GUY HARVEY", WHOSE CONSENT(S) TO REGISTER IS MADE OF RECORD.

SER. NO. 77-296,946, FILED 10-5-2007.

MARIAM MAHMOUDI, EXAMINING ATTORNEY

Int. Cls.: 9 and 41

Prior U.S. Cls.: 21, 23, 26, 36, 38, 100, 101 and 107

Reg. No. 3,519,275

United States Patent and Trademark Office

Registered Oct. 21, 2008

**TRADEMARK
SERVICE MARK
PRINCIPAL REGISTER**

CREATING MEGA RESULTS

INTELLECTUAL EQUITIES, INC. (OHIO CORPORATION)
SUITE 220
16600 SPRAGUE ROAD
CLEVELAND, OH 44130

FOR: PRE-RECORDED VIDEO TAPES, COMPACT DISCS, AUDIO TAPES AND DVDS, FEATURING INSTRUCTION, DISCUSSION, INTERVIEWS AND INSTRUCTIONAL LESSONS IN THE FIELD OF BUSINESS AND PERSONAL DEVELOPMENT, IN CLASS 9 (U.S. CLS. 21, 23, 26, 36 AND 38).

FIRST USE 9-17-2007; IN COMMERCE 9-17-2007.

FOR: EDUCATIONAL SERVICES, NAMELY, CONDUCTING SEMINARS AND WORKSHOPS IN

THE FIELDS OF PERFORMANCE MOTIVATION, TEAMWORK, BUSINESS MANAGEMENT, PROBLEM SOLVING AND CREATIVE THINKING SKILLS, IN CLASS 41 (U.S. CLS. 100, 101 AND 107).

FIRST USE 9-17-2007; IN COMMERCE 9-17-2007.

THE MARK CONSISTS OF STANDARD CHARACTERS WITHOUT CLAIM TO ANY PARTICULAR FONT, STYLE, SIZE, OR COLOR.

SER. NO. 77-297,037, FILED 10-5-2007.

MICHAEL TANNER, EXAMINING ATTORNEY

Int. Cl.: 36

Prior U.S. Cls.: 100, 101 and 102

United States Patent and Trademark Office

Reg. No. 3,519,276

Registered Oct. 21, 2008

**SERVICE MARK
PRINCIPAL REGISTER**

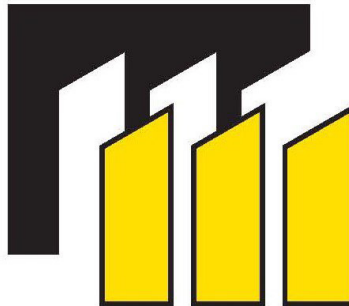

MISSOURI CREDIT UNION (MISSOURI CREDIT UNION)
111 EAST BROADWAY
COLUMBIA, MO 652034208

FOR: BANKING AND CREDIT UNION SERVICES, IN CLASS 36 (U.S. CLS. 100, 101 AND 102).

FIRST USE 3-0-1987; IN COMMERCE 3-0-1987.

THE COLOR(S) BLACK, WHITE AND GOLD IS/ARE CLAIMED AS A FEATURE OF THE MARK.

THE MARK CONSISTS OF A GRAPHIC ELEMENT OF A BLACK POLYGON WITH SUPERIMPOSED WHITE QUADRILATERALS AND GOLD QUADRILATERALS WHICH FORMS A STYLIZED LETTER "M". THE GOLD QUADRILATERALS ARE OUTLINED IN BLACK.

SER. NO. 77-297,062, FILED 10-5-2007.

JUSTINE D. PARKER, EXAMINING ATTORNEY

Int. Cl.: 9

Prior U.S. Cls.: 21, 23, 26, 36 and 38

United States Patent and Trademark Office

Reg. No. 3,519,277

Registered Oct. 21, 2008

**TRADEMARK
PRINCIPAL REGISTER**

NORTH BEAR BEAUTY SYSTEM, INC. (ILLINOIS CORPORATION)
27605 WEST FLYNN CREEK DRIVE
BARRINGTON, IL 60010

THE TERM "H2PRO" APPEARS IN THE BLUE, AS DOES THE HORIZONTAL LINE APPEARING OVER THE LETTER "O".

FOR: ELECTRIC HAIR STRAIGHTENING IRONS, IN CLASS 9 (U.S. CLS. 21, 23, 26, 36 AND 38).

SER. NO. 77-298,621, FILED 10-8-2007.

FIRST USE 10-31-2003; IN COMMERCE 10-31-2003.

THE COLOR(S) BLUE IS/ARE CLAIMED AS A FEATURE OF THE MARK.

JIM RINGLE, EXAMINING ATTORNEY

Int. Cl.: 8

Prior U.S. Cls.: 23, 28 and 44

Reg. No. 3,519,278

United States Patent and Trademark Office

Registered Oct. 21, 2008

**TRADEMARK
PRINCIPAL REGISTER**

fitupgear

ROMAR/MEC LLC (TEXAS LIMITED LIABILITY COMPANY)
218 W. RICHEY ROAD
HOUSTON, TX 77090

FOR: HAND TOOLS, NAMELY, CLAMPS, KEY PLATES, 90 DEGREE KEY PLATES, HINGED KEY PLATES, BULL PINS, U-BARS, CROWBARS, GOOSENECK STYLE CROWBARS, CONNECTING BARS, F-CLAMPS, KEY SHIMS, AND SHIM PINS, FOR STEEL PLATE AND SHEETMETAL ALIGNMENT; MANUALLY OPERATED HAND TOOLS, NAMELY, CLAMPS, KEY PLATES, 90 DEGREE KEY PLATES, HINGED KEY PLATES, BULL PINS, U-BARS, CROWBARS, GOOSENECK STYLE CROW-

BARS, CONNECTING BARS, F-CLAMPS, KEY SHIMS, AND SHIM PINS, FOR STEEL PLATE AND SHEETMETAL ALIGNMENT, IN CLASS 8 (U.S. CLS. 23, 28 AND 44).

FIRST USE 9-1-2002; IN COMMERCE 9-1-2002.

THE MARK CONSISTS OF STANDARD CHARACTERS WITHOUT CLAIM TO ANY PARTICULAR FONT, STYLE, SIZE, OR COLOR.

SER. NO. 77-298,639, FILED 10-8-2007.

LAURIE KAUFMAN, EXAMINING ATTORNEY

Int. Cl.: 41

Prior U.S. Cls.: 100, 101 and 107

United States Patent and Trademark Office

Reg. No. 3,519,279

Registered Oct. 21, 2008

**SERVICE MARK
PRINCIPAL REGISTER**

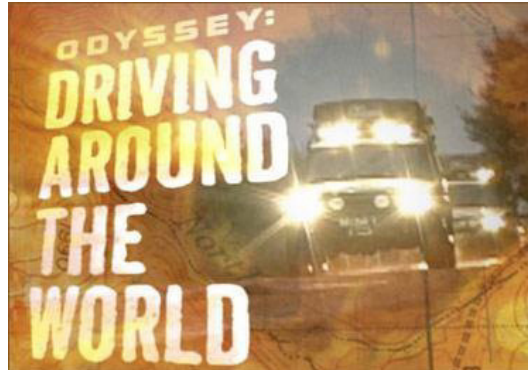

GRAPHITEX INC. (CALIFORNIA CORPORATION), DBA BURGESS PRODUCTIONS
1190 MOUNTAIN VIEW ALVISO ROAD SUITE P
SUNNYVALE, CA 94089

FOR: ENTERTAINMENT SERVICES IN THE NATURE OF AN ON-GOING REALITY BASED TELEVISION PROGRAM, IN CLASS 41 (U.S. CLS. 100, 101 AND 107).

FIRST USE 6-1-2005; IN COMMERCE 10-1-2007.

NO CLAIM IS MADE TO THE EXCLUSIVE RIGHT TO USE "DRIVING AROUND THE WORLD", APART FROM THE MARK AS SHOWN.

THE COLOR(S) ORANGE, WHITE, AND BLACK IS/ARE CLAIMED AS A FEATURE OF THE MARK.

THE MARK CONSISTS OF WHITE ALL-CAPS LETTERING OF THE WORDS "ODYSSEY: DRIVING AROUND THE WORLD"; THE LETTERING IS WHITE WITH A TEXTURIZED LAYER OF ORANGE. BLACK DETAILS OF CARS AND TEXTURE SHOW THROUGH THE ORANGE LAYER.

SER. NO. 77-298,849, FILED 10-8-2007.

DANIEL CAPSHAW, EXAMINING ATTORNEY

Int. Cl.: 37

Prior U.S. Cls.: 100, 103 and 106

United States Patent and Trademark Office

Reg. No. 3,519,280

Registered Oct. 21, 2008

**SERVICE MARK
PRINCIPAL REGISTER**

RIVERSTONE

SUGAR LAND RANCH DEVELOPMENT, L.L.C.
(TEXAS LIMITED LIABILITY COMPANY)
SUITE 500
5005 RIVERWAY
HOUSTON, TX 77056

THE MARK CONSISTS OF STANDARD CHAR-
ACTERS WITHOUT CLAIM TO ANY PARTICULAR
FONT, STYLE, SIZE, OR COLOR.

FOR: REAL ESTATE DEVELOPMENT, IN CLASS
37 (U.S. CLS. 100, 103 AND 106).

SER. NO. 77-299,195, FILED 10-9-2007.

FIRST USE 3-1-2001; IN COMMERCE 3-1-2001.

HENRY S. ZAK, EXAMINING ATTORNEY

Int. Cl.: 36

Prior U.S. Cls.: 100, 101 and 102

United States Patent and Trademark Office

Reg. No. 3,519,281

Registered Oct. 21, 2008

**SERVICE MARK
PRINCIPAL REGISTER**



BAYAT FOUNDATION (NEW JERSEY CORPORATION)
16TH FLOOR
400 KELBY STREET
FORT LEE, NJ 07024

FOR: CHARITABLE FUND RAISING SERVICES;
CHARITABLE FUND RAISING BY SPONSORSHIP
OF SPORTING EVENTS, IN CLASS 36 (U.S. CLS. 100,
101 AND 102).

FIRST USE 2-0-2004; IN COMMERCE 9-10-2005.

NO CLAIM IS MADE TO THE EXCLUSIVE
RIGHT TO USE "FOUNDATION", APART FROM
THE MARK AS SHOWN.

THE COLOR(S) BLACK AND GOLD IS/ARE
CLAIMED AS A FEATURE OF THE MARK.

THE MARK CONSISTS OF "BAYAT FOUNDATION" AND A DESIGN ALL IN GOLD AND OUTLINED IN BLACK.

THE FOREIGN WORDING IN THE MARK
TRANSLATES INTO ENGLISH AS "BAYAT FOUNDATION" .

THE NON-LATIN CHARACTER(S) IN THE
MARK TRANSLITERATES INTO "BAYAT BU-
NYAT", AND THIS MEANS "BAYAT FOUNDATION"
IN ENGLISH.

SER. NO. 77-299,199, FILED 10-9-2007.

TRACY CROSS, EXAMINING ATTORNEY

Int. Cl.: 14

Prior U.S. Cls.: 2, 27, 28 and 50

United States Patent and Trademark Office

Reg. No. 3,519,282

Registered Oct. 21, 2008

TRADEMARK
PRINCIPAL REGISTER



DESIGNS BY
LARA NOEL HILL

HILL, LARA NOEL (UNITED STATES INDIVIDUAL)

#G

15009 DICKENS STREET
SHERMAN OAKS, CA 91403

FOR: NECKLACES, BRACELETS, EARRINGS,
RINGS, BROOCHES AS JEWELRY, IN CLASS 14
(U.S. CLS. 2, 27, 28 AND 50).

FIRST USE 1-30-2002; IN COMMERCE 8-11-2002.

NO CLAIM IS MADE TO THE EXCLUSIVE
RIGHT TO USE "DESIGNS BY", APART FROM
THE MARK AS SHOWN.

THE STIPPLING IS A FEATURE OF THE MARK.

THE MARK CONSISTS IN PART OF A THUMB
PRINT ON THE BELLY OF THE ANIMATED DE-
SIGN.

SER. NO. 77-299,482, FILED 10-9-2007.

ALEX KEAM, EXAMINING ATTORNEY

Int. Cl.: 35

Prior U.S. Cls.: 100, 101 and 102

United States Patent and Trademark Office

Reg. No. 3,519,283

Registered Oct. 21, 2008

**SERVICE MARK
PRINCIPAL REGISTER**

**TRANSFORMING DATA,
DELIVERING INFORMATION**

REED TECHNOLOGY AND INFORMATION
SERVICES INC. (DELAWARE CORPORATION)
7 WALNUT GROVE DRIVE
HORSHAM, PA 19044

FOR: PROVIDING BUSINESS INFORMATION IN
THE FIELD OF MANAGING PHARMACEUTICAL
LABELING, IN CLASS 35 (U.S. CLS. 100, 101 AND
102).

FIRST USE 1-15-2003; IN COMMERCE 1-15-2003.

THE MARK CONSISTS OF STANDARD CHAR-
ACTERS WITHOUT CLAIM TO ANY PARTICULAR
FONT, STYLE, SIZE, OR COLOR.

SER. NO. 77-299,485, FILED 10-9-2007.

REBECCA GILBERT, EXAMINING ATTORNEY

Int. Cl.: 35

Prior U.S. Cls.: 100, 101 and 102

United States Patent and Trademark Office

Reg. No. 3,519,284

Registered Oct. 21, 2008

**SERVICE MARK
PRINCIPAL REGISTER**

**TRANSFORMING DATA,
DELIVERING INFORMATION**

REED TECHNOLOGY AND INFORMATION
SERVICES INC. (DELAWARE CORPORATION)
7 WALNUT GROVE DRIVE
HORSHAM, PA 19044

FOR: PROVIDING BUSINESS INFORMATION
REGARDING MANAGING INTELLECTUAL PROP-
ERTIES VIA THE INTERNET, IN CLASS 35 (U.S.
CLS. 100, 101 AND 102).

FIRST USE 1-15-2003; IN COMMERCE 1-15-2003.

THE MARK CONSISTS OF STANDARD CHAR-
ACTERS WITHOUT CLAIM TO ANY PARTICULAR
FONT, STYLE, SIZE, OR COLOR.

SER. NO. 77-299,536, FILED 10-9-2007.

REBECCA GILBERT, EXAMINING ATTORNEY

Int. Cls.: 41 and 42

Prior U.S. Cls.: 100, 101 and 107

United States Patent and Trademark Office

Reg. No. 3,519,285

Registered Oct. 21, 2008

**SERVICE MARK
PRINCIPAL REGISTER**

MCAP

THE OAK GROUP, INC. (MASSACHUSETTS
CORPORATION)
321 COMMONWEALTH ROAD
WAYLAND, MA 01778

FOR: EDUCATION AND TRAINING SERVICES,
NAMELY, PROVIDING COURSES, SEMINARS,
WORKSHOPS AND ON-LINE TRAINING PROVI-
DED VIA THE INTERNET, IN THE FIELDS OF
COMPUTER SOFTWARE USED IN THE HEALTH-
CARE INDUSTRY AND BUSINESS MANAGEMENT
AND DECISION SUPPORT IN THE HEALTHCARE
INDUSTRY, IN CLASS 41 (U.S. CLS. 100, 101 AND
107).

FIRST USE 2-16-1996; IN COMMERCE 2-16-1996.

FOR: CLINICAL AND TECHNICAL SUPPORT
SERVICES, NAMELY, TROUBLESHOOTING OF

COMPUTER SOFTWARE USED IN THE HEALTH-
CARE INDUSTRY, IN CLASS 42 (U.S. CLS. 100 AND
101).

FIRST USE 2-16-1996; IN COMMERCE 2-16-1996.

THE MARK CONSISTS OF STANDARD CHAR-
ACTERS WITHOUT CLAIM TO ANY PARTICULAR
FONT, STYLE, SIZE, OR COLOR.

OWNER OF U.S. REG. NOS. 1,919,423 AND
1,985,849.

SER. NO. 77-300,172, FILED 10-10-2007.

DOMINIC FATHY, EXAMINING ATTORNEY

Int. Cls.: 10, 12 and 20

**Prior U.S. Cls.: 2, 13, 19, 21, 22, 23, 25, 26, 31, 32, 35,
39, 44 and 50**

Reg. No. 3,519,286

United States Patent and Trademark Office

Registered Oct. 21, 2008

**TRADEMARK
PRINCIPAL REGISTER**

PX

L & P SWISS HOLDING COMPANY (SWITZER-
LAND CORPORATION)
GRUNTALSTRASSE 23
WITTENBACH, SWITZERLAND 9303

FOR: FURNITURE FOR MEDICAL AND DEN-
TAL PURPOSES, NAMELY, MEDICAL AND DEN-
TAL EXAMINATION CHAIRS; CHAIRS FOR
MEDICAL AND DENTAL PURPOSES, NAMELY,
MEDICAL AND DENTAL EXAMINATION CHAIRS,
MASSAGE CHAIRS; SPECIAL FURNITURE FOR
MEDICAL USE, NAMELY, SEAT COMPONENTS IN
THE NATURE OF BACKREST CUSHIONS, ERGO-
NOMIC REST CUSHIONS AND REST CUSHIONS
FOR LORDOSIS PATIENTS; PARTS AND FITTINGS
FOR ALL THE AFORESAID GOODS, IN CLASS 10
(U.S. CLS. 26, 39 AND 44).

FOR: SEATS FOR VEHICLES; BACK SUPPORT
CUSHIONS, BACK SUPPORTS AND BACK LEANER
CUSHIONS FOR VEHICLE SEATS; LUMBAR SUP-
PORT DEVICES FOR VEHICLE SEATS; PULL-
CABLE ARRANGEMENTS SPECIFICALLY ADAP-
TED FOR USE IN VEHICLES AND ACTUATORS
FOR ACTUATING SUCH PULL-CABLE ARRANGE-
MENTS, ALL FOR ADJUSTING VEHICLE SEATS,
HEADRESTS OF VEHICLES OR PARTS THEREOF;

PARTS AND FITTINGS FOR ALL THE AFORESAID
GOODS, IN CLASS 12 (U.S. CLS. 19, 21, 23, 31, 35 AND
44).

FOR: FURNITURE; CHAIRS AND SEATS; SEAT
FURNITURE; OFFICE FURNITURE; BACK SUP-
PORT CUSHIONS AND BACK LEANER CUSHIONS,
NOT FOR MEDICAL PURPOSES, FOR CHAIRS,
SEATS AND SEAT FURNITURE; CUSHIONS; LUM-
BAR SUPPORT CUSHIONS FOR CHAIRS, SEATS
AND SEAT FURNITURE; PARTS AND FITTINGS
FOR ALL THE AFORESAID GOODS, IN CLASS 20
(U.S. CLS. 2, 13, 22, 25, 32 AND 50).

THE MARK CONSISTS OF STANDARD CHAR-
ACTERS WITHOUT CLAIM TO ANY PARTICULAR
FONT, STYLE, SIZE, OR COLOR.

PRIORITY CLAIMED UNDER SEC. 44(D) ON
ERPNTY TM OFC APPLICATION NO.
005885231, FILED 4-24-2007, REG. NO. 005885231,
DATED 5-21-2008, EXPIRES 4-24-2017.

SER. NO. 77-300,688, FILED 10-10-2007.

KEVIN DINALLO, EXAMINING ATTORNEY

Int. Cls.: 10, 12 and 20

**Prior U.S. Cls.: 2, 13, 19, 21, 22, 23, 25, 26, 31, 32, 35,
39, 44 and 50**

Reg. No. 3,519,287

United States Patent and Trademark Office

Registered Oct. 21, 2008

**TRADEMARK
PRINCIPAL REGISTER**

P3

L & P SWISS HOLDING COMPANY (SWITZER-
LAND CORPORATION)
GRUNTALSTRASSE 23
WITTENBACH, SWITZERLAND 9303

FOR: SPECIALLY DESIGNED FURNITURE FOR MEDICAL AND DENTAL PURPOSES, NAMELY, MEDICAL AND DENTAL EXAMINATION CHAIRS; CHAIRS FOR MEDICAL AND DENTAL PURPOSES, NAMELY, MEDICAL AND DENTAL EXAMINATION CHAIRS, MASSAGE CHAIRS; SPECIALLY DESIGNED SEAT COMPONENTS FOR MEDICAL USE, NAMELY, BACKRESTS CUSHIONS, ERGONOMIC REST CUSHIONS AND REST CUSHIONS FOR LORDOSIS PATIENTS; PARTS AND FITTINGS FOR ALL THE AFORESAID GOODS, IN CLASS 10 (U.S. CLS. 26, 39 AND 44).

FOR: SEATS FOR VEHICLES; BACK SUPPORT APPARATUS, BACK SUPPORTS AND BACK LEANER CUSHIONS ALL FOR VEHICLE SEATS; LUMBAR SUPPORT DEVICES FOR VEHICLE SEATS; PULL-CABLE ARRANGEMENTS SPECIFICALLY ADAPTED FOR USE IN VEHICLES AND ACTUATORS FOR ACTUATING SUCH PULL-CABLE ARRANGEMENTS, ALL FOR ADJUSTING VEHICLE SEATS, HEADRESTS OF VEHICLES OR PARTS

THEREOF; PARTS AND FITTINGS FOR ALL THE AFORESAID GOODS, IN CLASS 12 (U.S. CLS. 19, 21, 23, 31, 35 AND 44).

FOR: FURNITURE; CHAIRS AND SEATS; SEAT FURNITURE; OFFICE FURNITURE; BACK SUPPORT CUSHIONS AND BACK LEANER CUSHIONS, NOT FOR MEDICAL PURPOSES, FOR CHAIRS, SEATS AND SEAT FURNITURE; CUSHIONS; LUMBAR SUPPORT DEVICES FOR CHAIRS, SEATS AND SEAT FURNITURE; PARTS AND FITTINGS FOR ALL THE AFORESAID GOODS, IN CLASS 20 (U.S. CLS. 2, 13, 22, 25, 32 AND 50).

THE MARK CONSISTS OF STANDARD CHARACTERS WITHOUT CLAIM TO ANY PARTICULAR FONT, STYLE, SIZE, OR COLOR.

PRIORITY CLAIMED UNDER SEC. 44(D) ON ERPNTY TM OFC APPLICATION NO. 006064356, FILED 6-26-2007, REG. NO. 006064356, DATED 5-19-2008, EXPIRES 6-26-2017.

SER. NO. 77-300,720, FILED 10-10-2007.

KEVIN DINALLO, EXAMINING ATTORNEY

Int. Cls.: 36, 41 and 45

Prior U.S. Cls.: 100, 101, 102 and 107

United States Patent and Trademark Office

Reg. No. 3,519,288

Registered Oct. 21, 2008

**SERVICE MARK
PRINCIPAL REGISTER**

Mission One

MISSION ONE, INC. (TENNESSEE CORPORATION)
P.O. BOX 5960
SCOTTSDALE, AZ 85261

FOR: MISSIONARY AND MISSION DEVELOPMENT SERVICES, NAMELY, CHARITABLE FUNDRAISING, IN CLASS 36 (U.S. CLS. 100, 101 AND 102).

FIRST USE 7-22-1991; IN COMMERCE 7-22-1991.

FOR: DEVELOPMENT SERVICES, NAMELY, TRAINING AND MENTORING RELIGIOUS MISSIONARIES AND EDUCATION SERVICES, NAMELY, PROVIDING CLASSES AND TUTORING IN THE FIELD OF BIBLICAL INSTRUCTION, CULTURES, UNDERLYING CULTURAL ASSUMPTIONS, AND THE CHRISTIAN MISSION MOVEMENT, IN CLASS 41 (U.S. CLS. 100, 101 AND 107).

FIRST USE 7-22-1991; IN COMMERCE 7-22-1991.

FOR: RELIGIOUS MINISTERIAL SERVICES, NAMELY, EVANGELISM, MISSIONARY SERVICES, AND PROVIDING INFORMATION CONCERNING MISSIONARIES, MISSIONS, AND MISSIONARY PROJECTS, IN CLASS 45 (U.S. CLS. 100 AND 101).

FIRST USE 7-22-1991; IN COMMERCE 7-22-1991.

THE MARK CONSISTS OF STANDARD CHARACTERS WITHOUT CLAIM TO ANY PARTICULAR FONT, STYLE, SIZE, OR COLOR.

NO CLAIM IS MADE TO THE EXCLUSIVE RIGHT TO USE "MISSION", APART FROM THE MARK AS SHOWN.

SER. NO. 77-300,769, FILED 10-10-2007.

KATHLEEN LORENZO, EXAMINING ATTORNEY

Int. Cl.: 30

Prior U.S. Cl.: 46

United States Patent and Trademark Office

Reg. No. 3,519,289

Registered Oct. 21, 2008

**TRADEMARK
PRINCIPAL REGISTER**

P.F. CHANG'S

PFCCB ADMINISTRATION, INC. (DELAWARE
CORPORATION)
7676 E. PINNACLE PEAK ROAD
SCOTTSDALE, AZ 85255

FOR: SPRING ROLLS, IN CLASS 30 (U.S. CL. 46).

FIRST USE 1-26-2007; IN COMMERCE 1-26-2007.

THE MARK CONSISTS OF STANDARD CHAR-
ACTERS WITHOUT CLAIM TO ANY PARTICULAR
FONT, STYLE, SIZE, OR COLOR.

OWNER OF U.S. REG. NO. 1,847,107.

THE NAME "P.F. CHANG'S" DOES NOT IDENTI-
FY A LIVING INDIVIDUAL.

SEC. 2(F).

SER. NO. 77-301,114, FILED 10-10-2007.

ALLISON HOLTZ, EXAMINING ATTORNEY

Int. Cl.: 35

Prior U.S. Cls.: 100, 101 and 102

United States Patent and Trademark Office

Reg. No. 3,519,290

Registered Oct. 21, 2008

SERVICE MARK
PRINCIPAL REGISTER



GARY KING (UNITED STATES INDIVIDUAL)
1156 N. CHURCH ST
BURLINGTON, NC 27217

NO CLAIM IS MADE TO THE EXCLUSIVE
RIGHT TO USE "FRAGRANCES", APART FROM
THE MARK AS SHOWN.

FOR: RETAIL/WHOLESALE OUTLET STORE
SPECIALIZING IN EXOTIC BODY OILS, PER-
FUMES, INCENSES, LOTIONS AND SOAPS, IN
CLASS 35 (U.S. CLS. 100, 101 AND 102).

SER. NO. 77-301,362, FILED 10-11-2007.

FIRST USE 4-1-1997; IN COMMERCE 4-1-1997.

KIMBERLY PERRY, EXAMINING ATTORNEY

Int. Cl.: 38

Prior U.S. Cls.: 100, 101 and 104

United States Patent and Trademark Office

Reg. No. 3,519,291

Registered Oct. 21, 2008

**SERVICE MARK
PRINCIPAL REGISTER**



STUMBLEUPON, INC. (DELAWARE CORPORATION)
140 SECOND STREET, THIRD FLOOR
SAN FRANCISCO, CA 94105

FOR: PROVIDING ON-LINE COMMUNICATION LINKS WHICH TRANSFER THE WEBSITE USER TO OTHER LOCAL AND GLOBAL WEB PAGES; PROVIDING ONLINE CHAT ROOMS AND AN ELECTRONIC BULLETIN BOARD FOR TRANSMISSION OF MESSAGES WHICH ALLOWS COMPUTER USERS TO DISCUSS TOPICS OF GENERAL INTEREST AND CONTENT, LINKS, AND WEB PAGES THEY HAVE SHARED WITH EACH OTHER, IN CLASS 38 (U.S. CLS. 100, 101 AND 104).

FIRST USE 4-26-2005; IN COMMERCE 4-26-2005.

THE COLOR(S) WHITE, BLUE AND GREEN IS/ ARE CLAIMED AS A FEATURE OF THE MARK.

THE COLOR WHITE APPEARS IN THE WORDING "SU"; THE COLOR BLUE APPEARS IN THE DESIGN AS THE LOWER PORTION OF THE CIRCLE; AND THE COLOR GREEN APPEARS IN THE DESIGN AS THE UPPER PORTION OF THE CIRCLE

SER. NO. 77-302,305, FILED 10-11-2007.

BENJAMIN OKEKE, EXAMINING ATTORNEY

Int. Cls.: 25 and 40

Prior U.S. Cls.: 22, 39, 100, 103 and 106

United States Patent and Trademark Office

Reg. No. 3,519,292

Registered Oct. 21, 2008

**TRADEMARK
SERVICE MARK
PRINCIPAL REGISTER**

DRESSY GIRLS

DRESSY GIRLS, INC. (NORTH CAROLINA CORPORATION)
2512 OLEANDER DRIVE
DURHAM, NC 27703

FOR: DRESSES; GIRLS FORMAL DRESSES; FLOWER GIRL DRESSES; FIRST COMMUNION DRESSES; INFANT AND TODDLER DRESSES, GIRLS PAGEANT DRESSES; DRESSING GOWNS; EVENING DRESSES AND HEAD WEAR, IN CLASS 25 (U.S. CLS. 22 AND 39).

FIRST USE 3-1-2003; IN COMMERCE 3-1-2003.

FOR: CUSTOM MANUFACTURE OF DRESSES, IN CLASS 40 (U.S. CLS. 100, 103 AND 106).

FIRST USE 6-1-2003; IN COMMERCE 6-1-2003.

THE MARK CONSISTS OF STANDARD CHARACTERS WITHOUT CLAIM TO ANY PARTICULAR FONT, STYLE, SIZE, OR COLOR.

NO CLAIM IS MADE TO THE EXCLUSIVE RIGHT TO USE "GIRLS" AS TO CLASS 25 GOODS, APART FROM THE MARK AS SHOWN.

SER. NO. 77-302,533, FILED 10-12-2007.

LINDA E. BLOHM, EXAMINING ATTORNEY

Int. Cl.: 41

Prior U.S. Cls.: 100, 101 and 107

United States Patent and Trademark Office

Reg. No. 3,519,293

Registered Oct. 21, 2008

**SERVICE MARK
PRINCIPAL REGISTER**

CHEF MONKEYS

STOUGAARD, JO (UNITED STATES INDIVIDUAL)
4228 KLUMP AVE.
NORTH HOLLYWOOD, CA 91602 AND
CUBAK, JANET (UNITED STATES INDIVIDUAL)
4228 KLUMP AVE.
NORTH HOLLYWOOD, CA 91602

FOR: TRAINING SERVICES IN THE FIELD OF
COOKING FOR CHILDREN , IN CLASS 41 (U.S. CLS.
100, 101 AND 107).

FIRST USE 6-1-2005; IN COMMERCE 6-1-2005.

THE MARK CONSISTS OF STANDARD CHARACTERS WITHOUT CLAIM TO ANY PARTICULAR FONT, STYLE, SIZE, OR COLOR.

OWNER OF U.S. REG. NO. 3,281,971.

SER. NO. 77-303,379, FILED 10-12-2007.

TIMOTHY FINNEGAN, EXAMINING ATTORNEY

Int. Cl.: 16

Prior U.S. Cls.: 2, 5, 22, 23, 29, 37, 38 and 50

United States Patent and Trademark Office

Reg. No. 3,519,294

Registered Oct. 21, 2008

**TRADEMARK
PRINCIPAL REGISTER**



PACIFIC GROUP USA, INC. (CALIFORNIA CORPORATION)
2107 ROSEMEAD BLVD
S. EL MONTE, CA 91733

FOR: GENERAL PURPOSE PLASTIC BAGS; GROCERY BAGS, LAW AND LEAF DISPOSAL BAGS; LEAF DISPOSAL BAGS; LUNCH BAGS; LUNCH BAGS MADE OF TEXTILE; MERCHANDISE BAGS; MICROWAVE COOKING BAGS; PLASTIC BAGS FOR PACKAGING; PLASTIC BAGS FOR PACKING; PLASTIC FOOD STORAGE BAGS FOR HOUSEHOLD USE; PLASTIC GARBAGE BAGS; PLASTIC OR PAPER BAGS FOR HOUSEHOLD USE; PLASTIC OVEN COOKING BAGS; PLASTIC SANDWICH BAGS; PLASTIC SHOPPING BAGS; PLASTIC TRASH BAGS; RUBBISH BAGS MADE OF PAPER OR PLASTIC MATERIALS; SANDWICH BAGS; TRASH BAGS; TRASH CAN LINERS, IN CLASS 16 (U.S. CLS. 2, 5, 22, 23, 29, 37, 38 AND 50).

FIRST USE 5-10-2007; IN COMMERCE 5-10-2007.

NO CLAIM IS MADE TO THE EXCLUSIVE RIGHT TO USE "BRAND", APART FROM THE MARK AS SHOWN.

THE COLOR(S) BLUE AND GREEN IS/ARE CLAIMED AS A FEATURE OF THE MARK.

THE MARK CONSISTS OF THE BLUE WORDING "EVER BRAND" SUPERIMPOSED ON A RECTANGULAR GREEN DESIGN ELEMENT.

SER. NO. 77-303,416, FILED 10-12-2007.

DAWN HAN, EXAMINING ATTORNEY

Int. Cl.: 35

Prior U.S. Cls.: 100, 101 and 102

United States Patent and Trademark Office

Reg. No. 3,519,295

Registered Oct. 21, 2008

**SERVICE MARK
PRINCIPAL REGISTER**



SNAXILLA, INC. (ALABAMA CORPORATION)
100 LEGACY PARC DR.
PELHAM, AL 35124

FOR: ADVERTISING BY TRANSMISSION OF ON-LINE PUBLICITY FOR THIRD PARTIES THROUGH ELECTRONIC COMMUNICATIONS NETWORKS; ADVERTISING, PROMOTION AND MARKETING SERVICES IN THE NATURE OF E-MAIL BLAST CAMPAIGNS FOR OTHERS; ADVERTISING, INCLUDING PROMOTION RELATING TO THE SALE OF ARTICLES AND SERVICES FOR THIRD PARTIES BY THE TRANSMISSION OF ADVERTISING

MATERIAL AND THE DISSEMINATION OF ADVERTISING MESSAGES ON COMPUTER NETWORKS, IN CLASS 35 (U.S. CLS. 100, 101 AND 102).

FIRST USE 4-1-2007; IN COMMERCE 4-1-2007.

THE MARK CONSISTS OF A DINOSAUR DRAWING WITHIN A CIRCULAR BOARDER.

SER. NO. 77-303,596, FILED 10-14-2007.

STEPHANIE ALI, EXAMINING ATTORNEY

Int. Cl.: 35

Prior U.S. Cls.: 100, 101 and 102

United States Patent and Trademark Office

Reg. No. 3,519,296

Registered Oct. 21, 2008

**SERVICE MARK
PRINCIPAL REGISTER**



MARIANO FERNANDEZ (UNITED STATES IN-
DIVIDUAL)

224 SYCAMORE RD APT 35

SAN YSIDRO, CA 92173

FOR: SUPERMARKETS, IN CLASS 35 (U.S. CLS.
100, 101 AND 102).

FIRST USE 9-1-2007; IN COMMERCE 9-1-2007.

NO CLAIM IS MADE TO THE EXCLUSIVE
RIGHT TO USE "SUPERMARKET" , APART FROM
THE MARK AS SHOWN.

THE MARK CONSISTS OF LOGO OF "N" WITH
LEAVES ON TOP OF "N" WITH NAME "NEIGH-
BORS SUPERMARKET" UNDER LETTER.

SER. NO. 77-303,676, FILED 10-14-2007.

NAPOLEON SHARMA, EXAMINING ATTORNEY

Int. Cl.: 1

Prior U.S. Cls.: 1, 5, 6, 10, 26 and 46

Reg. No. 3,519,297

United States Patent and Trademark Office

Registered Oct. 21, 2008

**TRADEMARK
PRINCIPAL REGISTER**

INNOBIO

INNOBIO, LLC (NORTH CAROLINA LIMITED LIABILITY COMPANY), DBA INNOBIOACTIVES, INC.

2007 YANCEYVILLE STREET, BOX 31
GREENSBORO, NC 27405

FOR: FATTY ACIDS FOR USE IN THE MANUFACTURE OF FOODS, FOOD SUPPLEMENTS, NUTRITIONAL SUPPLEMENTS, COSMETICS, AND PHARMACEUTICALS AND FATTY ACID CONCENTRATES FOR USE IN THE MANUFACTURE OF FOODS, FOOD SUPPLEMENTS, NUTRITIONAL

SUPPLEMENTS, COSMETICS, AND PHARMACEUTICALS, IN CLASS 1 (U.S. CLS. 1, 5, 6, 10, 26 AND 46).

FIRST USE 6-1-2003; IN COMMERCE 6-1-2003.

THE MARK CONSISTS OF STANDARD CHARACTERS WITHOUT CLAIM TO ANY PARTICULAR FONT, STYLE, SIZE, OR COLOR.

SER. NO. 77-303,779, FILED 10-15-2007.

JAY FLOWERS, EXAMINING ATTORNEY

Int. Cl.: 28

Prior U.S. Cls.: 22, 23, 38 and 50

United States Patent and Trademark Office

Reg. No. 3,519,298

Registered Oct. 21, 2008

**TRADEMARK
PRINCIPAL REGISTER**

BAD MUDDER

MATTEL, INC. (DELAWARE CORPORATION)
M1-1518
333 CONTINENTAL BLVD.
EL SEGUNDO, CA 90245

THE MARK CONSISTS OF STANDARD CHAR-
ACTERS WITHOUT CLAIM TO ANY PARTICULAR
FONT, STYLE, SIZE, OR COLOR.

FOR: TOYS, GAMES AND PLAYTHINGS, NAME-
LY, TOY VEHICLES AND ACCESSORIES THERE-
FOR, IN CLASS 28 (U.S. CLS. 22, 23, 38 AND 50).

SER. NO. 77-304,475, FILED 10-15-2007.

FIRST USE 6-17-2008; IN COMMERCE 6-17-2008.

MELISSA VALLILLO, EXAMINING ATTORNEY

Int. Cl.: 18

Prior U.S. Cls.: 1, 2, 3, 22 and 41

United States Patent and Trademark Office

Reg. No. 3,519,299

Registered Oct. 21, 2008

**TRADEMARK
PRINCIPAL REGISTER**

Volare

CHUN, DAVID (UNITED STATES INDIVIDUAL)
430 NORTH CANAL STREET, #21
SOUTH SAN FRANCISCO, CA 94080

FOR: BRIEFCASES; LEATHER BAGS, SUITCASES
AND WALLETS; LEATHER HANDBAGS; LEATHER
PURSES; LEATHER KEY CHAINS; SADDLES;
WHIPS; LUGGAGE, IN CLASS 18 (U.S. CLS. 1, 2, 3,
22 AND 41).

FIRST USE 9-1-2007; IN COMMERCE 9-1-2007.

"THE MARK CONSISTS OF THE WORD "VOLARE" WITH THE LETTER O CONTAINING AN ASTERISK.

"THE FOREIGN WORDING IN THE MARK TRANSLATES INTO ENGLISH AS "TO FLY"."

SER. NO. 77-304,592, FILED 10-15-2007.

ODESSA BIBBINS, EXAMINING ATTORNEY

Int. Cl.: 42

Prior U.S. Cls.: 100 and 101

United States Patent and Trademark Office

Reg. No. 3,519,300

Registered Oct. 21, 2008

**SERVICE MARK
PRINCIPAL REGISTER**

eSlide

ESLIDE, LLC (NEW YORK LIMITED LIABILITY
COMPANY)
330 MADISON AVENUE
NEW YORK, NY 10017

FOR: COMPUTER GRAPHIC DESIGN, IN CLASS
42 (U.S. CLS. 100 AND 101).

FIRST USE 12-31-2001; IN COMMERCE 12-31-2001.

THE MARK CONSISTS OF STANDARD CHAR-
ACTERS WITHOUT CLAIM TO ANY PARTICULAR
FONT, STYLE, SIZE, OR COLOR.

SEC. 2(F).

SER. NO. 77-305,285, FILED 10-16-2007.

DAWN HAN, EXAMINING ATTORNEY

Int. Cl.: 41

Prior U.S. Cls.: 100, 101 and 107

Reg. No. 3,519,301

United States Patent and Trademark Office

Registered Oct. 21, 2008

**SERVICE MARK
PRINCIPAL REGISTER**

MuNet

ORGANIZATION OF AMERICAN STATES, EXECUTIVE SECRETARIAT FOR INTEGRAL DEVELOPMENT (UNITED STATES PUBLIC INTERNATIONAL ORGANIZATION PURSUANT TO 22 U.S.C. SECTIONS 288 ET SEQ.)

ADM-203

19TH ST. & CONSTITUTION AVE., NW
WASHINGTON, DC 20006

FOR: EDUCATION SERVICES, NAMELY, PROVIDING TRAINING SEMINARS AND WORKSHOPS PROVIDED TO MUNICIPAL GOVERNMENTS IN THE FIELDS OF ELECTRONIC GOVERNMENT, CADASTRE AND GOVERNMENT PROCUREMENT

WITH CONSULTATION RELATED THERETO, IN CLASS 41 (U.S. CLS. 100, 101 AND 107).

FIRST USE 0-0-2004; IN COMMERCE 0-0-2004.

THE MARK CONSISTS OF STANDARD CHARACTERS WITHOUT CLAIM TO ANY PARTICULAR FONT, STYLE, SIZE, OR COLOR.

SER. NO. 77-305,369, FILED 10-16-2007.

JESSICA A. POWERS, EXAMINING ATTORNEY

Int. Cl.: 9

Prior U.S. Cls.: 21, 23, 26, 36 and 38

Reg. No. 3,519,302

United States Patent and Trademark Office

Registered Oct. 21, 2008

**TRADEMARK
PRINCIPAL REGISTER**

CINEGY

CINEGY LLC (DELAWARE LIMITED LIABILITY
COMPANY)
1101 PENNSYLVANIA AVENUE, 6TH FLOOR
WASHINGTON, DC 20004

THE MARK CONSISTS OF STANDARD CHAR-
ACTERS WITHOUT CLAIM TO ANY PARTICULAR
FONT, STYLE, SIZE, OR COLOR.

FOR: COMPUTER SOFTWARE FOR VIDEO AND
AUDIO PROCESSING, AUDIO AND VIDEO EDIT-
ING, AND AUDIO AND VIDEO ENCODING, IN
CLASS 9 (U.S. CLS. 21, 23, 26, 36 AND 38).

SER. NO. 77-305,956, FILED 10-17-2007.

FIRST USE 6-1-2001; IN COMMERCE 6-1-2002.

TEJBIR SINGH, EXAMINING ATTORNEY

Int. Cl.: 7

Prior U.S. Cls.: 13, 19, 21, 23, 31, 34 and 35

Reg. No. 3,519,303

United States Patent and Trademark Office

Registered Oct. 21, 2008

**TRADEMARK
PRINCIPAL REGISTER**

intellashield

ORECK HOLDINGS, LLC (DELAWARE LIMITED
LIABILITY COMPANY)
1720 CAREY AVENUE
C/O CT CORPORATION SYSTEM
CHEYENNE, WY 82001

FIRST USE 9-28-2007; IN COMMERCE 9-28-2007.

OWNER OF U.S. REG. NO. 3,450,711.

FOR: VACUUM CLEANERS AND PARTS THERE-
OF SOLD TOGETHER AS A UNIT; EXTRACTING
MACHINES FOR USE IN CLEANING CARPETS,
FABRICS AND UPHOLSTERY AND PARTS AND
FITTINGS SOLD TOGETHER AS A UNIT AND
SHAMPOO CARTRIDGES SOLD THEREWITH, IN
CLASS 7 (U.S. CLS. 13, 19, 21, 23, 31, 34 AND 35).

THE MARK CONSISTS OF THE WORD "INTEL-
LASHIELD" WITH AN ORBITING BODY.

SER. NO. 77-306,097, FILED 10-17-2007.

MARTHA FROMM, EXAMINING ATTORNEY

Prior U.S. Cl.: 200

United States Patent and Trademark Office

Reg. No. 3,519,304

Registered Oct. 21, 2008

**COLLECTIVE MEMBERSHIP
PRINCIPAL REGISTER**



NATIONAL AGING IN PLACE COUNCIL (D.C.
UNINCORPORATED ASSOCIATION)
SUITE 420
1400 16TH STREET NW
WASHINGTON, DC 20036

FOR: INDICATING MEMBERSHIP IN AN ORGA-
NIZATION OF PROFESSIONALS IN THE FIELD OF
SENIOR CITIZEN AFFAIRS, IN CLASS 200 (U.S. CL.
200).

FIRST USE 11-18-2004; IN COMMERCE 11-18-2004.

NO CLAIM IS MADE TO THE EXCLUSIVE
RIGHT TO USE "NATIONAL AGING IN PLACE
COUNCIL", APART FROM THE MARK AS SHOWN.

THE MARK CONSISTS OF A RECTANGLE WITH
THE WORDS "NATIONAL AGING IN PLACE
COUNCIL" ON INSIDE BORDER AND THE LET-
TERS "NAIPC" IN THE MIDDLE.

SER. NO. 77-306,104, FILED 10-17-2007.

CHARISMA HAMPTON, EXAMINING ATTORNEY

Int. Cl.: 39

Prior U.S. Cls.: 100 and 105

United States Patent and Trademark Office

Reg. No. 3,519,305

Registered Oct. 21, 2008

**SERVICE MARK
PRINCIPAL REGISTER**

Digitalassets

THINKING INC. (TEXAS CORPORATION)
SUITE 200
100 HIGHLAND PARK VILLAGE
DALLAS, TX 75205

FOR: DATA MANAGEMENT SERVICES, NAME-
LY, ELECTRONIC STORAGE OF GRAPHICS FILES,
ILLUSTRATIONS, BROADCAST MEDIA AND
FILES, AND PRINT AND GRAPHIC FILES, IN
CLASS 39 (U.S. CLS. 100 AND 105).

FIRST USE 11-8-2005; IN COMMERCE 11-8-2005.

THE MARK CONSISTS OF STANDARD CHAR-
ACTERS WITHOUT CLAIM TO ANY PARTICULAR
FONT, STYLE, SIZE, OR COLOR.

SER. NO. 77-306,164, FILED 10-17-2007.

ANNE E. GUSTASON, EXAMINING ATTORNEY

Int. Cl.: 11

Prior U.S. Cls.: 13, 21, 23, 31 and 34

United States Patent and Trademark Office

Reg. No. 3,519,306

Registered Oct. 21, 2008

**TRADEMARK
PRINCIPAL REGISTER**

BED EFFECTS

LULLA BEDS, L.L.C. (FLORIDA LIMITED LIABILITY COMPANY)
3718 VINELAND ROAD
ORLANDO, FL 32811

FOR: DECORATIVE ELECTRIC LIGHTS FOR BEDS, LED LIGHTS AND ELECTRIC LIGHT STRIPS, IN CLASS 11 (U.S. CLS. 13, 21, 23, 31 AND 34).

FIRST USE 6-0-2007; IN COMMERCE 6-0-2007.

THE MARK CONSISTS OF STANDARD CHARACTERS WITHOUT CLAIM TO ANY PARTICULAR FONT, STYLE, SIZE, OR COLOR.

NO CLAIM IS MADE TO THE EXCLUSIVE RIGHT TO USE "BED", APART FROM THE MARK AS SHOWN.

SER. NO. 77-306,433, FILED 10-17-2007.

MICHELE SWAIN, EXAMINING ATTORNEY

Int. Cl.: 42

Prior U.S. Cls.: 100 and 101

United States Patent and Trademark Office

Reg. No. 3,519,307

Registered Oct. 21, 2008

**SERVICE MARK
PRINCIPAL REGISTER**



ESLIDE, LLC (NEW YORK LIMITED LIABILITY
COMPANY)
330 MADISON AVENUE
NEW YORK, NY 10017

SEC. 2(F) AS TO "ESLIDE".

FOR: COMPUTER GRAPHIC DESIGN, IN CLASS
42 (U.S. CLS. 100 AND 101).

SER. NO. 77-306,960, FILED 10-18-2007.

FIRST USE 12-31-2001; IN COMMERCE 12-31-2001.

DAWN HAN, EXAMINING ATTORNEY

Int. Cl.: 9

Prior U.S. Cls.: 21, 23, 26, 36 and 38

United States Patent and Trademark Office

Reg. No. 3,519,308

Registered Oct. 21, 2008

**TRADEMARK
PRINCIPAL REGISTER**

EZ-BUILD

PDS ELECTRONICS, INC. (OHIO CORPORATION)
P.O. BOX 909
AKRON, OH 443090909

FOR: ANTENNA KITS COMPRISING STRUCTURAL ANTENNA PARTS AND RELATED HARDWARE, SOLD AS A UNIT, USED TO BUILD DIFFERENT TYPES OF ANTENNAS, NAMELY, SINGLE BAND, MULTI-BAND, MULTI-FREQUENCY AND FOLDED DIPOLE, DOUBLET AND INVERTED-VEE, OFF-CENTER FED, WINDOM, ZEPP, LONG WIRES, RHOMBIC, VEE BEAM, AND LOOP

ANTENNAS FOR AMATEUR RADIO OPERATORS, IN CLASS 9 (U.S. CLS. 21, 23, 26, 36 AND 38).

FIRST USE 9-7-2007; IN COMMERCE 9-7-2007.

THE MARK CONSISTS OF STANDARD CHARACTERS WITHOUT CLAIM TO ANY PARTICULAR FONT, STYLE, SIZE, OR COLOR.

SER. NO. 77-307,116, FILED 10-18-2007.

ELLEN B. AWRICH, EXAMINING ATTORNEY

Int. Cl.: 42

Prior U.S. Cls.: 100 and 101

United States Patent and Trademark Office

Reg. No. 3,519,309

Registered Oct. 21, 2008

**SERVICE MARK
PRINCIPAL REGISTER**



H2O INNOVATION (2000) INC. (CANADA CORPORATION)
420, BOUL.CHAREST EST, BUREAU 240
QUEBEC, CANADA G1K8M4

FOR: RESEARCH AND DEVELOPMENT SERVICES IN THE FIELD OF WATER TREATMENT; WATER TREATMENT ENGINEERING ADVISORY SERVICES, IN CLASS 42 (U.S. CLS. 100 AND 101).

FIRST USE 1-0-2000; IN COMMERCE 1-0-2000.

NO CLAIM IS MADE TO THE EXCLUSIVE RIGHT TO USE "H2O", APART FROM THE MARK AS SHOWN.

THE MARK CONSISTS OF THE NUMBER "2" AS A SUBSCRIPT BETWEEN THE "H" AND "O" WITH A HALF CIRCLE ABOVE THE "H" AND "2" WITH ONE END GOING THROUGH THE "O". A GLOBE REPLACES THE FIRST "O" IN THE WORD "INNOVATION".

SER. NO. 77-307,472, FILED 10-18-2007.

AMY GEARIN, EXAMINING ATTORNEY

Int. Cl.: 9

Prior U.S. Cls.: 21, 23, 26, 36 and 38

United States Patent and Trademark Office

Reg. No. 3,519,310

Registered Oct. 21, 2008

**TRADEMARK
PRINCIPAL REGISTER**

RAIBEAM

RAI ENTERPRISES (ARIZONA SOLE PROPRIETORSHIP), DBA RAIBEAM
5638 W. ALICE AVE.
GLENDALE, AZ 85302

FOR: ANTENNAS FOR RADIO, FOR TELEVISION, IN CLASS 9 (U.S. CLS. 21, 23, 26, 36 AND 38).

FIRST USE 2-15-1994; IN COMMERCE 5-1-1995.

THE MARK CONSISTS OF STANDARD CHARACTERS WITHOUT CLAIM TO ANY PARTICULAR FONT, STYLE, SIZE, OR COLOR.

SER. NO. 77-307,544, FILED 10-18-2007.

MARIA-VICTORIA SUAREZ, EXAMINING ATTORNEY

Int. Cl.: 28

Prior U.S. Cls.: 22, 23, 38 and 50

Reg. No. 3,519,311

United States Patent and Trademark Office

Registered Oct. 21, 2008

**TRADEMARK
PRINCIPAL REGISTER**

MINI

KEE ACTION SPORTS I LLC (DELAWARE LIMITED LIABILITY COMPANY)
570 MANTUA BOULEVARD
SEWELL, NJ 08080

THE MARK CONSISTS OF STANDARD CHARACTERS WITHOUT CLAIM TO ANY PARTICULAR FONT, STYLE, SIZE, OR COLOR.

FOR: PAINTBALL MARKERS, IN CLASS 28 (U.S. CLS. 22, 23, 38 AND 50).

SER. NO. 77-307,737, FILED 10-18-2007.

FIRST USE 12-0-2006; IN COMMERCE 12-0-2006.

JENNIFER VASQUEZ, EXAMINING ATTORNEY

Int. Cl.: 25

Prior U.S. Cls.: 22 and 39

United States Patent and Trademark Office

Reg. No. 3,519,312

Registered Oct. 21, 2008

TRADEMARK
PRINCIPAL REGISTER

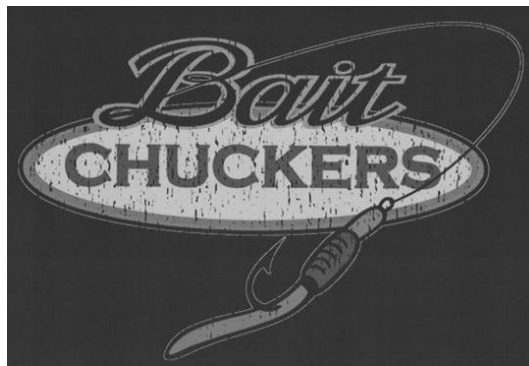

SCOTT J. MACKNEY (UNITED STATES INDIVIDUAL)
3534 GRANGER AVENUE WEST
BILLINGS, MT 59102

FOR: CAPS; TOPS; KNIT SHIRTS; LONG-SLEEVED SHIRTS; OPEN-NECKED SHIRTS; POLO SHIRTS; SHIRTS; SHORT-SLEEVED OR LONG-SLEEVED T-SHIRTS; SPORT SHIRTS; SWEAT SHIRTS; TEE SHIRTS; DENIM JACKETS; DOWN JACKETS; FISHERMEN'S JACKETS; HEAVY JACKETS; JACKETS; LEATHER JACKETS; MEN AND WOMEN JACKETS, COATS, TROUSERS, VESTS; RAIN JACKETS; WATERPROOF JACKETS AND PANTS; WIND RESISTANT JACKETS; CARGO

PANTS; DENIMS; LOUNGE PANTS; PANTS; SWEAT PANTS, IN CLASS 25 (U.S. CLS. 22 AND 39).

FIRST USE 1-1-2006; IN COMMERCE 1-1-2006.

THE MARK CONSISTS OF THE WORD "BAIT" OVER THE WORD "CHUCKERS" WHICH IS ENCLOSED IN AN OVAL DIRECTLY ABOVE A WORM ON A HOOK.

SER. NO. 77-307,836, FILED 10-18-2007.

REBECCA EISINGER, EXAMINING ATTORNEY

Int. Cls.: 24 and 25

Prior U.S. Cls.: 22, 39, 42 and 50

United States Patent and Trademark Office

Reg. No. 3,519,313

Registered Oct. 21, 2008

**TRADEMARK
PRINCIPAL REGISTER**



PUNKIN SEED, INC. (MICHIGAN CORPORATION)
7497 DOVER DR
YPSILANIT, MI 48197

FOR: EMBROIDERED FABRICS, NAMELY, BURP CLOTHS, TOWELS, HOODED TOWELS AND CHILDREN'S BLANKETS, IN CLASS 24 (U.S. CLS. 42 AND 50).

FIRST USE 7-20-2007; IN COMMERCE 7-20-2007.

FOR: CHILDREN'S CLOTHING, NAMELY, CLOTH BIBS, WITH TAGS, AS USED IN COMMERCE, IN CLASS 25 (U.S. CLS. 22 AND 39).

FIRST USE 7-20-2007; IN COMMERCE 7-20-2007.

THE MARK CONSISTS OF THREE SPACED PUMPKIN SEEDS ARRANGED ABOUT A FOCAL POINT AND HAVING AN UPPER PUMPKIN SEED ILLUSTRATED WITH A PAIR OF EYES, A CURL OF HAIR AND A PACIFIER.

SER. NO. 77-307,886, FILED 10-18-2007.

JOHN GARTNER, EXAMINING ATTORNEY

Int. Cl.: 44

Prior U.S. Cls.: 100 and 101

United States Patent and Trademark Office

Reg. No. 3,519,314

Registered Oct. 21, 2008

**SERVICE MARK
PRINCIPAL REGISTER**



MIKAN, KAREN W. (UNITED STATES INDIVIDUAL), DBA THE LEADING EDGE LASER CENTER

8407 E HIGH POINT DR
SCOTTSDALE, AZ 85266

FOR: PERMANENT HAIR REMOVAL AND REDUCTION, IN CLASS 44 (U.S. CLS. 100 AND 101).

FIRST USE 12-5-2006; IN COMMERCE 12-5-2006.

NO CLAIM IS MADE TO THE EXCLUSIVE RIGHT TO USE "HAIR", APART FROM THE MARK AS SHOWN.

THE MARK CONSISTS OF A HARE HOLDING A SUITCASE, WAVING GOODBYE WITH THE STATEMENT "GOODBYE" HARE WITH THE HARE CROSSED OUT REPLACED WITH "HAIR".

SER. NO. 77-307,962, FILED 10-18-2007.

TRACY CROSS, EXAMINING ATTORNEY

Int. Cl.: 39

Prior U.S. Cls.: 100 and 105

United States Patent and Trademark Office

Reg. No. 3,519,315

Registered Oct. 21, 2008

**SERVICE MARK
PRINCIPAL REGISTER**

TRAILER PLUS

PENSKE SYSTEM, INC. (DELAWARE CORPORATION)
SUITE 1300
1105 NORTH MARKET STREET
WILMINGTON, DE 19899

FOR: LEASING TRUCK TRAILERS, IN CLASS 39
(U.S. CLS. 100 AND 105).

FIRST USE 1-9-1995; IN COMMERCE 1-9-1995.

THE MARK CONSISTS OF STANDARD CHARACTERS WITHOUT CLAIM TO ANY PARTICULAR FONT, STYLE, SIZE, OR COLOR.

OWNER OF U.S. REG. NO. 3,142,911.

NO CLAIM IS MADE TO THE EXCLUSIVE RIGHT TO USE "TRAILER", APART FROM THE MARK AS SHOWN.

SER. NO. 77-308,177, FILED 10-19-2007.

LINDA ESTRADA, EXAMINING ATTORNEY

Int. Cl.: 3

Prior U.S. Cls.: 1, 4, 6, 50, 51 and 52

United States Patent and Trademark Office

Reg. No. 3,519,316

Registered Oct. 21, 2008

**TRADEMARK
PRINCIPAL REGISTER**

DETAILLISTE

L'OREAL (FRANCE SOCIÉTÉ ANONYME (SA))
14 RUE ROYALE
PARIS, FRANCE 75008

FOR: COSMETICS AND MAKEUP, IN CLASS 3
(U.S. CLS. 1, 4, 6, 50, 51 AND 52).

THE MARK CONSISTS OF STANDARD CHAR-
ACTERS WITHOUT CLAIM TO ANY PARTICULAR
FONT, STYLE, SIZE, OR COLOR.

PRIORITY CLAIMED UNDER SEC. 44(D) ON
FRANCE APPLICATION NO. 073496926, FILED 4-
25-2007, REG. NO. 073496926, DATED 4-25-2007, EX-
PIRES 4-25-2017.

THE WORD "DETAILLISTE" HAS NO MEANING
IN A FOREIGN LANGUAGE.

SER. NO. 77-308,241, FILED 10-19-2007.

MARK T. MULLEN, EXAMINING ATTORNEY

Int. Cl.: 29

Prior U.S. Cl.: 46

United States Patent and Trademark Office

Reg. No. 3,519,317

Registered Oct. 21, 2008

**TRADEMARK
PRINCIPAL REGISTER**

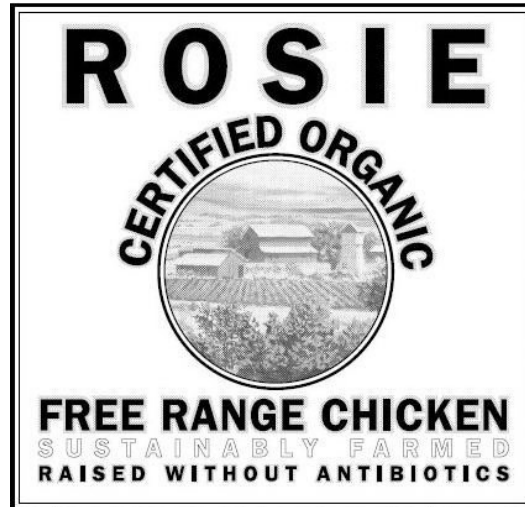

PETALUMA ACQUISITION, LLC (DELAWARE
LIMITED LIABILITY COMPANY)
2700 LAKEVILLE HIGHWAY
PETALUMA, CA 94954

FOR: ORGANIC CHICKEN AND CHICKEN
PARTS, IN CLASS 29 (U.S. CL. 46).

FIRST USE 12-31-2002; IN COMMERCE 12-31-2002.

OWNER OF U.S. REG. NOS. 2,314,594, 2,536,026,
AND 2,919,072.

NO CLAIM IS MADE TO THE EXCLUSIVE
RIGHT TO USE "CERTIFIED ORGANIC" AND
"FREE RANGE CHICKEN SUSTAINABLY
FARMED RAISED WITHOUT ANTIBIOTICS",
APART FROM THE MARK AS SHOWN.

SER. NO. 77-310,184, FILED 10-22-2007.

BRENDAN MCCAULEY, EXAMINING ATTORNEY

Int. Cl.: 29

Prior U.S. Cl.: 46

United States Patent and Trademark Office

Reg. No. 3,519,318

Registered Oct. 21, 2008

**TRADEMARK
PRINCIPAL REGISTER**



PETALUMA ACQUISITION, LLC (DELAWARE
LIMITED LIABILITY COMPANY)
2700 LAKEVILLE HIGHWAY
PETALUMA, CA 94954

NO CLAIM IS MADE TO THE EXCLUSIVE
RIGHT TO USE "CHICKEN", APART FROM THE
MARK AS SHOWN.

FOR: CHICKEN AND CHICKEN PARTS, IN
CLASS 29 (U.S. CL. 46).

SEC. 2(F) AS TO "THE RANGE CHICKEN".

FIRST USE 12-31-2002; IN COMMERCE 12-31-2002.

SER. NO. 77-310,201, FILED 10-22-2007.

OWNER OF U.S. REG. NOS. 1,493,346, 2,883,480
AND OTHERS.

BRENDAN MCCAULEY, EXAMINING ATTORNEY

Int. Cls.: 9 and 41

Prior U.S. Cls.: 21, 23, 26, 36, 38, 100, 101 and 107

Reg. No. 3,519,319

United States Patent and Trademark Office

Registered Oct. 21, 2008

**TRADEMARK
SERVICE MARK
PRINCIPAL REGISTER**

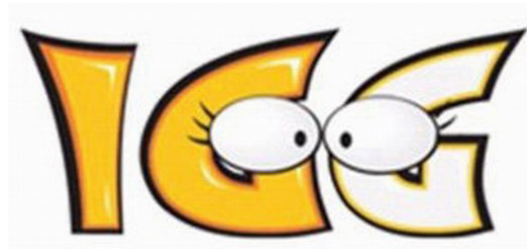

SKYUNION HONG KONG HOLDING LIMITED
(CHINA CORPORATION)
F/R 1005, WING YUE, 60-64DES VDEUX, WEST
F/R 1005, WING YUE, 60-64DES VDEUX, WEST
HONG KONG, CHINA

FOR: COMPUTER GAME CARTRIDGES; COMPUTER GAME CASSETTES; COMPUTER GAME DISCS; COMPUTER GAME EQUIPMENT CONTAINING MEMORY DEVICES NAMELY, DISCS; COMPUTER GAME JOYSTICKS; COMPUTER GAME PROGRAMS; COMPUTER GAME SOFTWARE; COMPUTER GAME SOFTWARE, NAMELY A COMPUTER CRAPS GAME; COMPUTER GAME TAPES; COMPUTER HARDWARE AND COMPUTER SOFTWARE PROGRAMS FOR THE INTEGRATION OF TEXT, AUDIO, GRAPHICS, STILL IMAGES AND MOVING PICTURES INTO AN INTERACTIVE DELIVERY FOR MULTIMEDIA APPLICATIONS; COMPUTER HARDWARE AND SOFTWARE FOR SETTING UP AND CONFIGURING LOCAL AREA NETWORKS; COMPUTER HARDWARE AND SOFTWARE FOR SETTING UP AND CONFIGURING WIDE AREA NETWORKS; COMPUTER PROGRAMS FOR PRE-RECORDED GAMES; COMPUTER PROGRAMS FOR SEARCHING THE CONTENTS OF COMPUTERS AND COMPUTER NETWORKS BY REMOTE CONTROL; COMPUTER PROGRAMS FOR THE ENABLING OF ACCESS OR ENTRANCE CONTROL; COMPUTER SOFTWARE AND FIRMWARE FOR GAMES OF CHANCE ON ANY COMPUTERIZED PLATFORM, INCLUDING DEDICATED GAMING CONSOLES, VIDEO BASED SLOT MACHINES, REEL BASED SLOT MACHINES, AND VIDEO LOTTERY TERMINALS; COMPUTER SOFTWARE FOR ACCESSING INFORMATION DIRECTORIES THAT MAY BE DOWNLOADED FROM THE GLOBAL COMPUTER NETWORK; COMPUTER SOFTWARE FOR ADMINISTRATION OF COMPUTER LOCAL

AREA NETWORKS; COMPUTER SOFTWARE FOR ADMINISTRATION OF COMPUTER NETWORKS; COMPUTER SOFTWARE FOR COMMUNICATING WITH USERS OF HAND-HELD COMPUTERS; COMPUTER SOFTWARE FOR COMPUTER SYSTEM AND APPLICATION DEVELOPMENT, DEPLOYMENT AND MANAGEMENT; COMPUTER SOFTWARE FOR CONTROLLING AND MANAGING ACCESS SERVER APPLICATIONS; COMPUTER SOFTWARE FOR CONTROLLING AND MANAGING PATIENT MEDICAL INFORMATION; COMPUTER SOFTWARE FOR REDISTRICTING, NAMELY, AGGREGATING SMALLER GEOGRAPHICAL AREAS INTO MULTIPLE LARGER AREAS; COMPUTER SOFTWARE FOR THE CREATION OF FIREWALLS; COMPUTER SOFTWARE FOR THE FIELD OF WAREHOUSING AND DISTRIBUTION, TO MANAGE TRANSACTIONAL DATA, PROVIDE STATISTICAL ANALYSIS, AND PRODUCE NOTIFICATIONS AND REPORTS; COMPUTER SOFTWARE FOR THE MANAGEMENT OF COMMERCIAL PRINTING COMPANIES IN THE FIELD OF COST ESTIMATING, PRODUCTION PLANNING, SCHEDULING PRODUCTION, BINDING, SHIPPING AND ANALYSIS OF THE PRINTING JOB, IN CLASS 9 (U.S. CLS. 21, 23, 26, 36 AND 38).

FIRST USE 5-20-2006; IN COMMERCE 5-20-2006.

FOR: ON-LINE PUBLICATION OF BOOKS; PROVIDING ON-LINE PUBLICATIONS IN THE NATURE OF NEWSLETTERS IN THE FIELD OF COMPUTER GAMES; PUBLICATION OF BOOKS; PUBLICATION OF BOOKS, MAGAZINES, ALMANACS AND JOURNALS; PUBLICATION OF BOOKS, OF MAGAZINES, OF JOURNALS, OF NEWSPAPERS, OF PERIODICALS, OF CATALOGS, OF BROCHURES; PUBLICATION OF BOOKS, REVIEWS; PUBLICATION OF BROCHURES; PUBLICATION OF ELECTRONIC MAGAZINES; PUBLICATION

OF ELECTRONIC NEWSPAPERS ACCESSIBLE VIA A GLOBAL COMPUTER NETWORK; PUBLICATION OF JOURNALS; PUBLICATION OF LEAFLETS; PUBLICATION OF MAGAZINES; PUBLICATION OF MANUALS; PUBLICATION OF MUSICAL TEXTS; PUBLICATION OF PERIODICALS; PUBLICATION OF PRINTED MATTER; PUBLICATION OF TEXT BOOKS; PUBLICATION OF TEXTS, BOOKS, JOURNALS; PUBLICATION OF TEXTS, BOOKS, MAGAZINES AND OTHER PRINTED MATTER; PUBLICATION OF TEXTS OR MAGAZINES; PUBLISHING OF ELECTRONIC PUBLICATIONS, IN CLASS 41 (U.S. CLS. 100, 101 AND 107).

FIRST USE 5-20-2006; IN COMMERCE 5-20-2006.

THE COLOR(S) YELLOW, WHITE, ORANGE AND BLACK IS/ARE CLAIMED AS A FEATURE OF THE MARK.

THE MARK CONSISTS OF THE CAPITAL LETTERS "IGG". THE "I" AND THE LETTER "G" IS YELLOW AND BORDERED IN ORANGE AND BLACK. THE LETTER "G" ON THE RIGHT IS WHITE AND BORDERED IN YELLOW AND BLACK. THERE IS A PAIR OF EYES OVERLAPPING THE TWO LETTER "G'S" THAT ARE WHITE AND BORDERED IN BLACK.

SER. NO. 77-310,552, FILED 10-23-2007.

MICHAEL KEATING, EXAMINING ATTORNEY

Int. Cl.: 29

Prior U.S. Cl.: 46

United States Patent and Trademark Office

Reg. No. 3,519,320

Registered Oct. 21, 2008

TRADEMARK
PRINCIPAL REGISTER

Nutra-Clear 

BUNGE OILS, INC. (DELAWARE CORPORATION)
11720 BORMAN DRIVE
ST. LOUIS, MO 63146

FOR: EDIBLE OILS; VEGETABLE BASED SHORTENINGS, IN CLASS 29 (U.S. CL. 46).

FIRST USE 6-22-2006; IN COMMERCE 6-22-2006.

OWNER OF U.S. REG. NOS. 1,506,176, 2,942,147, AND 3,004,135.

THE MARK CONSISTS OF THE WORDS "NUTRA-CLEAR NT" WITH THE "NT" IN AN OVAL.

SER. NO. 77-311,380, FILED 10-23-2007.

LYDIA BELZER, EXAMINING ATTORNEY

Int. Cl.: 9

Prior U.S. Cls.: 21, 23, 26, 36 and 38

United States Patent and Trademark Office

Reg. No. 3,519,321

Registered Oct. 21, 2008

**TRADEMARK
PRINCIPAL REGISTER**

CODEMINION

CODEMINION (POLAND PARTNERSHIP)
PULAWSKA 538
WARSZAWA, POLAND 02-884

THE MARK CONSISTS OF STANDARD CHAR-
ACTERS WITHOUT CLAIM TO ANY PARTICULAR
FONT, STYLE, SIZE, OR COLOR.

FOR: DOWNLOADABLE ELECTRONIC GAMES
VIA THE INTERNET AND WIRELESS DEVICES;
COMPUTER SOFTWARE, NAMELY, COMPUTER
GAME SOFTWARE, IN CLASS 9 (U.S. CLS. 21, 23, 26,
36 AND 38).

SER. NO. 77-312,553, FILED 10-24-2007.

FIRST USE 7-0-2002; IN COMMERCE 8-0-2002.

ANDREA K. NADELMAN, EXAMINING ATTOR-
NEY

Int. Cl.: 37

Prior U.S. Cls.: 100, 103 and 106

United States Patent and Trademark Office

Reg. No. 3,519,322

Registered Oct. 21, 2008

**SERVICE MARK
PRINCIPAL REGISTER**

**ElectroChemical Cleaning
(ECC)**

ULTRACLEAN ELECTROPOLISH, INC. (TEXAS CORPORATION)
WWW.ULTRACLEANEP.COM
1814 SUNNY DRIVE
HOUSTON, TX 77093

FOR: CLEANING OF INDUSTRIAL PREMISES UTILIZING A CHEMICAL CLEANING PROCESS WHICH UTILIZES VARIOUS ACIDS AND ELECTRICAL CURRENT TO REMOVE DISCOLORATION DUE TO WELDING PROCESSES AND CORROSION MECHANISMS PRIMARILY ON STAINLESS STEELS, NICKEL ALLOYS, AS WELL AS OTHER VARIOUS MATERIALS OF CONSTRUCTION, IN CLASS 37 (U.S. CLS. 100, 103 AND 106).

FIRST USE 10-1-2007; IN COMMERCE 10-1-2007.

THE MARK CONSISTS OF STANDARD CHARACTERS WITHOUT CLAIM TO ANY PARTICULAR FONT, STYLE, SIZE, OR COLOR.

NO CLAIM IS MADE TO THE EXCLUSIVE RIGHT TO USE "ELECTROCHEMICAL CLEANING", APART FROM THE MARK AS SHOWN.

SER. NO. 77-312,592, FILED 10-24-2007.

ANDREA K. NADELMAN, EXAMINING ATTORNEY

Int. Cl.: 2

Prior U.S. Cls.: 6, 11 and 16

United States Patent and Trademark Office

Reg. No. 3,519,323

Registered Oct. 21, 2008

**TRADEMARK
PRINCIPAL REGISTER**

PROMAR 200 XP

SWIMC, INC. (DELAWARE CORPORATION)
300 DELAWARE AVENUE
SUITE 522
WILMINGTON, DE 198011607

THE MARK CONSISTS OF STANDARD CHAR-
ACTERS WITHOUT CLAIM TO ANY PARTICULAR
FONT, STYLE, SIZE, OR COLOR.

FOR: PAINTS, IN CLASS 2 (U.S. CLS. 6, 11 AND 16).

SER. NO. 77-312,883, FILED 10-25-2007.

FIRST USE 11-23-2004; IN COMMERCE 11-23-2004.

MONIQUE MILLER, EXAMINING ATTORNEY

Int. Cl.: 2

Prior U.S. Cls.: 6, 11 and 16

United States Patent and Trademark Office

Reg. No. 3,519,324

Registered Oct. 21, 2008

**TRADEMARK
PRINCIPAL REGISTER**

PROCLASSIC XP

SWIMC, INC. (DELAWARE CORPORATION)
300 DELAWARE AVENUE
SUITE 522
WILMINGTON, DE 198011607

THE MARK CONSISTS OF STANDARD CHAR-
ACTERS WITHOUT CLAIM TO ANY PARTICULAR
FONT, STYLE, SIZE, OR COLOR.

FOR: PAINTS, IN CLASS 2 (U.S. CLS. 6, 11 AND 16).

SER. NO. 77-312,885, FILED 10-25-2007.

FIRST USE 6-22-2005; IN COMMERCE 6-22-2005.

MONIQUE MILLER, EXAMINING ATTORNEY

Int. Cl.: 12

Prior U.S. Cls.: 19, 21, 23, 31, 35 and 44

Reg. No. 3,519,325

United States Patent and Trademark Office

Registered Oct. 21, 2008

**TRADEMARK
PRINCIPAL REGISTER**

MIGHTY

MDSA, LLC (GEORGIA LIMITED LIABILITY COMPANY)
650 ENGINEERING DRIVE
NORCROSS, GA 30092

FOR: AUTOMOTIVE REPAIR, REPLACEMENT AND MAINTENANCE PARTS, NAMELY, AUTOMOTIVE BRAKE SYSTEMS AND PARTS THEREFOR, NAMELY, BRAKE DRUMS, BRAKE HOSES, BRAKE LINES, BRAKE LINE ADAPTER/UNION FITTINGS, BRAKE PAD SHIMS, BRAKE PADS, BRAKE ROTORS, BRAKE SHOES, BRAKE CALIPERS AND CALIPER PISTONS, BRAKE DRUM BACKING PLATES, BRAKE MASTER CYLINDERS, WHEEL CYLINDERS, AND ELECTRONIC BRAKE WEAR CYLINDERS; AUTOMOTIVE SUSPENSION, CHASSIS AND FRONT END PARTS, NAMELY, SHOCK ABSORBERS, SUSPENSION STRUTS AND ASSAYS, SUSPENSION BRACES, LIFT SUPPORTS, SUSPENSION MOUNTS, SUSPENSION SYSTEM TOOLS, WHEEL SUSPENSION AND STEERING COMPONENTS, NAMELY, ADJUSTING SLEEVES, CENTER LINKS, DRAG LINKS, AND TRACK BARS, AND CHASSIS BUSHINGS; AUTOMOTIVE ALIGNMENT PARTS, NAMELY, WHEEL WEIGHTS, ALIGNMENT BUSHINGS, ALIGNMENT

SHIMS AND SPACERS, IDLER ARM ASSEMBLIES, TIE RODS AND TIE ROD ENDS, CONTROL ARM BUSHINGS, RACK AND PINION STEERING GEAR, IDLER ARMS AND PITMAN ARMS, TORSION BARS, ADJUSTING SLEEVES, BALL JOINTS, CONTROL ARMS, SEALS AND BEARINGS; AUTOMOTIVE TRANSMISSION AND DRIVELINE PARTS, NAMELY, WHEEL BEARINGS, DRIVE SHAFTS, CV BOOTS, OIL AND GREASE SEALS, U-JOINTS, TRANSMISSION COOLER HOSES; WINDSHIELD WIPER BLADES AND REFILLS, IN CLASS 12 (U.S. CLS. 19, 21, 23, 31, 35 AND 44).

FIRST USE 6-0-1973; IN COMMERCE 6-0-1973.

THE MARK CONSISTS OF STANDARD CHARACTERS WITHOUT CLAIM TO ANY PARTICULAR FONT, STYLE, SIZE, OR COLOR.

OWNER OF U.S. REG. NOS. 2,823,994, 3,212,026 AND OTHERS.

SER. NO. 77-313,178, FILED 10-25-2007.

HEATHER THOMPSON, EXAMINING ATTORNEY

Int. Cl.: 24

Prior U.S. Cls.: 42 and 50

United States Patent and Trademark Office

Reg. No. 3,519,326

Registered Oct. 21, 2008

**TRADEMARK
PRINCIPAL REGISTER**

FORTI-BANNER

FORTI-PLAST, L.L.C. (TEXAS LIMITED LIABILITY COMPANY)
1000 POST N PADDOCK STREET
GRAND PRAIRIE, TX 75050

FOR: SYNTHETIC FIBER FABRIC WITH PRINTABLE COATING, IN CLASS 24 (U.S. CLS. 42 AND 50).

FIRST USE 10-24-2007; IN COMMERCE 10-24-2007.

THE MARK CONSISTS OF STANDARD CHARACTERS WITHOUT CLAIM TO ANY PARTICULAR FONT, STYLE, SIZE, OR COLOR.

SER. NO. 77-313,451, FILED 10-25-2007.

VIVIAN MICZNIK FIRST, EXAMINING ATTORNEY

Int. Cls.: 35 and 37

Prior U.S. Cls.: 100, 101, 102, 103 and 106

United States Patent and Trademark Office

Reg. No. 3,519,327

Registered Oct. 21, 2008

**SERVICE MARK
PRINCIPAL REGISTER**



BUNN-O-MATIC CORPORATION (DELAWARE CORPORATION)
1400 STEVENSON DRIVE
SPRINGFIELD, IL 62703

FOR: MANAGED SERVICE PROGRAM, NAME-
LY, PERFORMING INVENTORY INSPECTIONS,
SERVICE DISPATCHING, MAINTENANCE PRO-
GRAM PLANNING, EQUIPMENT LEASING PRO-
GRAMS; AND MAINTAINING RECORDS OF
PURCHASES, PRODUCTIVITY, MAINTENANCE
HISTORY, ACCOUNT HISTORY, AND LOCATION
AND DISPOSITION OF CUSTOMERS' ASSETS,
NAMELY, BEVERAGE PREPARATION AND SER-
VICE EQUIPMENT, IN CLASS 35 (U.S. CLS. 100, 101
AND 102).

FIRST USE 3-27-2006; IN COMMERCE 3-27-2006.

FOR: REPAIR, RESTORATION, MAINTENANCE
AND INSTALLATION OF BEVERAGE PREPARA-

TION AND DISPENSING EQUIPMENT, NAMELY,
ELECTRIC COFFEE MAKERS, TEA BREWERS,
WATER HEATER MACHINES, ESPRESSO MA-
CHINES, JUICE MACHINES, POWDERED BEVER-
AGE MACHINES, FROZEN AND SEMI-FROZEN
BEVERAGE MACHINES, BEVERAGE SERVERS,
HEATED AND REFRIGERATED BEVERAGE
UNITS, WATER TREATMENT EQUIPMENT, MILK
FOAMERS, MILK FROTHING UNITS, COFFEE
GRINDERS, IN CLASS 37 (U.S. CLS. 100, 103 AND
106).

FIRST USE 3-27-2006; IN COMMERCE 3-27-2006.

OWNER OF U.S. REG. NOS. 2,172,863, 3,307,727
AND OTHERS.

SER. NO. 77-314,615, FILED 10-26-2007.

KATHLEEN LORENZO, EXAMINING ATTORNEY

Int. Cls.: 37 and 40

Prior U.S. Cls.: 100, 103 and 106

United States Patent and Trademark Office

Reg. No. 3,519,328

Registered Oct. 21, 2008

**SERVICE MARK
PRINCIPAL REGISTER**



NICKEY CHICAGO, INC. (ILLINOIS CORPORATION)
1930 DEAN STREET
ST. CHARLES, IL 60174

FOR: RESTORATION AND CUSTOM REBUILDING OF EXISTING LAND VEHICLES AND PARTS THEREFOR, IN CLASS 37 (U.S. CLS. 100, 103 AND 106).

FIRST USE 9-1-2006; IN COMMERCE 9-1-2006.

FOR: CUSTOM MANUFACTURE OF AUTOMOBILES, IN CLASS 40 (U.S. CLS. 100, 103 AND 106).

FIRST USE 9-1-2006; IN COMMERCE 9-1-2006.

OWNER OF U.S. REG. NOS. 2,502,627, 2,889,108 AND OTHERS.

NO CLAIM IS MADE TO THE EXCLUSIVE RIGHT TO USE "CHICAGO", APART FROM THE MARK AS SHOWN.

THE MARK CONSISTS OF STYLIZED LETTERS SPELLING "NICKEY", IN WHICH THE LETTER "K" IS BACKWARDS; THE WORD "NICKEY" IS INSIDE A RECTANGLE DESIGN WHICH IS LONGER ON THE TOP IN RELATION TO THE BOTTOM WITH INDENTED SIDES; THE WORD "CHICAGO" IS SITUATED BELOW THE WORD "NICKEY".

SER. NO. 77-314,767, FILED 10-26-2007.

MELISSA VALLILLO, EXAMINING ATTORNEY

Int. Cl.: 25

Prior U.S. Cls.: 22 and 39

United States Patent and Trademark Office

Reg. No. 3,519,329

Registered Oct. 21, 2008

**TRADEMARK
PRINCIPAL REGISTER**



LANNER, AMY (UNITED STATES INDIVIDUAL)
P.O. BOX 4160
KINGSHILL, VI, US VIRGIN ISLANDS 008514160

FOR: MEN'S AND WOMEN'S APPAREL ACCESSORY, NAMELY, A MULTI-FUNCTIONAL OUTERWEAR ACCESSORY IN THE NATURE OF EAR MUFFS, HEADBANDS, FACE COVERINGS, NECK COVERINGS, HEAD COVERINGS, NECK GAITERS,

SCARVES, AND VISORLESS AND BRIMLESS HATS, IN CLASS 25 (U.S. CLS. 22 AND 39).

FIRST USE 6-1-2007; IN COMMERCE 7-12-2007.

SER. NO. 77-315,265, FILED 10-27-2007.

KAREN SEVERSON, EXAMINING ATTORNEY

Int. Cl.: 37

Prior U.S. Cls.: 100, 103 and 106

United States Patent and Trademark Office

Reg. No. 3,519,330

Registered Oct. 21, 2008

SERVICE MARK
PRINCIPAL REGISTER



GOLF CART DOCTOR INC. (COLORADO CORPORATION)
11774 EAST PACIFIC PLACE
AURORA, CO 80014

FOR: MAINTENANCE AND REPAIR OF ALL TYPES OF GOLF CARTS AND GOLF CARS, BOTH GAS AND ELECTRIC, IN CLASS 37 (U.S. CLS. 100, 103 AND 106).

FIRST USE 8-0-2000; IN COMMERCE 8-0-2000.

NO CLAIM IS MADE TO THE EXCLUSIVE RIGHT TO USE "GOLF CART", APART FROM THE MARK AS SHOWN.

THE STIPLING IS FOR SHADING PURPOSES ONLY.

THE MARK CONSISTS OF THE STYLIZED WORDS "GOLF CART DOCTOR GOLF CART DOCTOR". THERE IS AN IMAGE OF A GOLF CART THAT CONTAINS THE WORDS "GOLF CART DOCTOR" ON THE FRONT OF THE CART AND THE WORDS "GOLF CART DOCTOR" NEXT TO THE IMAGE OF THE GOLF CART. TO THE RIGHT OF THE CART AND UNDER THE WORD "DOCTOR" IS AN IMAGE OF VITAL SIGN.

SER. NO. 77-315,742, FILED 10-29-2007.

ELLEN PERKINS, EXAMINING ATTORNEY

Int. Cl.: 37

Prior U.S. Cls.: 100, 103 and 106

United States Patent and Trademark Office

Reg. No. 3,519,331

Registered Oct. 21, 2008

**SERVICE MARK
PRINCIPAL REGISTER**

CROWN NORTH AMERICA

L&P PROPERTY MANAGEMENT COMPANY
(DELAWARE CORPORATION)
4095 FIRESTONE BOULEVARD
SOUTHGATE, CA 90280

FOR: MOTOR VEHICLE UP-FITTING AND CUSTOMIZATION SERVICES, NAMELY, INSTALLING EQUIPMENT AND FIXTURES AND CUSTOMIZING VEHICLES TO ADAPT THE VEHICLES FOR USE IN DIFFERENT VOCATIONAL FIELDS, IN CLASS 37 (U.S. CLS. 100, 103 AND 106).

FIRST USE 0-0-2000; IN COMMERCE 0-0-2000.

THE MARK CONSISTS OF STANDARD CHARACTERS WITHOUT CLAIM TO ANY PARTICULAR FONT, STYLE, SIZE, OR COLOR.

NO CLAIM IS MADE TO THE EXCLUSIVE RIGHT TO USE "NORTH AMERICA", APART FROM THE MARK AS SHOWN.

SER. NO. 77-316,233, FILED 10-29-2007.

CHRISTOPHER BUONGIORNO, EXAMINING ATTORNEY

Int. Cl.: 9

Prior U.S. Cls.: 21, 23, 26, 36 and 38

Reg. No. 3,519,332

United States Patent and Trademark Office

Registered Oct. 21, 2008

**TRADEMARK
PRINCIPAL REGISTER**

SCENEWISE

SCENEWISE, INC. (CALIFORNIA CORPORATION)
SUITE 100
2201 PARK PLACE
EL SEGUNDO, CA 90245

FOR: DIGITAL MEDIA PRODUCTS, NAMELY, DVDS, CDS AND DIGITAL AUDIO AND VISUAL TAPES AND DISCS CONTAINING EDUCATIONAL MATERIAL IN THE FIELDS OF THE HUMANITIES, MATHEMATICS, SOCIAL SCIENCES, PHYSICAL SCIENCES, AND HEALTH SCIENCES AT THE

PRIMARY, SECONDARY OR COLLEGE LEVEL, IN CLASS 9 (U.S. CLS. 21, 23, 26, 36 AND 38).

FIRST USE 8-31-2007; IN COMMERCE 8-31-2007.

THE MARK CONSISTS OF STANDARD CHARACTERS WITHOUT CLAIM TO ANY PARTICULAR FONT, STYLE, SIZE, OR COLOR.

SER. NO. 77-316,491, FILED 10-29-2007.

GINA FINK, EXAMINING ATTORNEY

Int. Cl.: 41

Prior U.S. Cls.: 100, 101 and 107

United States Patent and Trademark Office

Reg. No. 3,519,333

Registered Oct. 21, 2008

**SERVICE MARK
PRINCIPAL REGISTER**



THE HOLE IN THE WALL GANG FUND, INC.
(CONNECTICUT CORPORATION)
555 LONG WHARF DRIVE
NEW HAVEN, CT 06511

FOR: RECREATIONAL SERVICES IN THE NATURE OF CAMPS FOR CHILDREN WITH CANCER AND OTHER LIFE-THREATENING ILLNESSES, IN CLASS 41 (U.S. CLS. 100, 101 AND 107).

FIRST USE 1-1-2007; IN COMMERCE 2-1-2007.

OWNER OF U.S. REG. NO. 2,081,582.

NO CLAIM IS MADE TO THE EXCLUSIVE RIGHT TO USE "CAMP", APART FROM THE MARK AS SHOWN.

THE COLOR(S) RED, BLUE, YELLOW, GREEN, PURPLE, LIGHT BLUE, ORANGE AND LIGHT GREEN IS/ARE CLAIMED AS A FEATURE OF THE MARK.

THE MARK CONSISTS OF VERTICAL PANELS OF RED, BLUE, YELLOW, GREEN, PURPLE, LIGHT BLUE, ORANGE AND LIGHT GREEN. THE WORD "A" IS GREEN, "HOLE" IS IN BLUE, "IN" IS IN RED, "THE" IS IN YELLOW, "WALL" IS IN PURPLE, AND "CAMP" IS IN ORANGE.

SER. NO. 77-317,321, FILED 10-30-2007.

ALEX KEAM, EXAMINING ATTORNEY

Int. Cl.: 43

Prior U.S. Cls.: 100 and 101

United States Patent and Trademark Office

Reg. No. 3,519,334

Registered Oct. 21, 2008

**SERVICE MARK
PRINCIPAL REGISTER**

MENCHIE'S

MENCHIE'S, INC. (CALIFORNIA CORPORATION)

#2
12932 MOORPARK ST.
STUDIO CITY, CA 91604

THE MARK CONSISTS OF STANDARD CHARACTERS WITHOUT CLAIM TO ANY PARTICULAR FONT, STYLE, SIZE, OR COLOR.

FOR: ICE CREAM SHOP SERVICES IN THE NATURE OF A RESTAURANT, IN CLASS 43 (U.S. CLS. 100 AND 101).

SER. NO. 77-319,626, FILED 11-2-2007.

FIRST USE 5-15-2007; IN COMMERCE 5-15-2007.

SANJEEV VOHRA, EXAMINING ATTORNEY

Int. Cl.: 45

Prior U.S. Cls.: 100 and 101

United States Patent and Trademark Office

Reg. No. 3,519,335

Registered Oct. 21, 2008

**SERVICE MARK
PRINCIPAL REGISTER**

SafeMatch

EYE CONTROLS, LLC (VIRGINIA LIMITED LIABILITY COMPANY)
14158-J WILLARD RD.
CHANTILLY, VA 20151

THE MARK CONSISTS OF STANDARD CHARACTERS WITHOUT CLAIM TO ANY PARTICULAR FONT, STYLE, SIZE, OR COLOR.

FOR: IDENTIFICATION VERIFICATION SERVICES, NAMELY, PROVIDING AUTHENTICATION OF PERSONAL IDENTIFICATION INFORMATION, IN CLASS 45 (U.S. CLS. 100 AND 101).

SER. NO. 77-319,630, FILED 11-2-2007.

FIRST USE 3-29-2007; IN COMMERCE 3-29-2007.

BONNIE LUKEN, EXAMINING ATTORNEY

Int. Cl.: 12

Prior U.S. Cls.: 19, 21, 23, 31, 35 and 44

Reg. No. 3,519,336

United States Patent and Trademark Office

Registered Oct. 21, 2008

**TRADEMARK
PRINCIPAL REGISTER**

IPJ IMPACT JACKETS

IMPACT JACKETS, LLC (MARYLAND LIMITED
LIABILITY COMPANY)
SUITE E
3420 HAMPTON HOLLOW DR.
SILVER SPRING, MD 20904

FOR: SAFETY APPAREL, NAMELY, AUTOMA-
TICALLY INFLATABLE JACKETS AND VESTS TO
ABSORB THE IMPACT CAUSED BY FALLS, IN
CLASS 12 (U.S. CLS. 19, 21, 23, 31, 35 AND 44).

FIRST USE 10-12-2005; IN COMMERCE 10-12-2005.

THE MARK CONSISTS OF STANDARD CHAR-
ACTERS WITHOUT CLAIM TO ANY PARTICULAR
FONT, STYLE, SIZE, OR COLOR.

NO CLAIM IS MADE TO THE EXCLUSIVE
RIGHT TO USE "JACKETS", APART FROM THE
MARK AS SHOWN.

SER. NO. 77-319,644, FILED 11-2-2007.

JULIE GUTTADAURO, EXAMINING ATTORNEY

Int. Cl.: 43

Prior U.S. Cls.: 100 and 101

United States Patent and Trademark Office

Reg. No. 3,519,337

Registered Oct. 21, 2008

**SERVICE MARK
PRINCIPAL REGISTER**



BONTE FRANCHISE GROUP, LLC (PENNSYLVANIA LIMITED LIABILITY COMPANY)
123 S. BROAD ST, 28TH FL
C/O ROBERT D. GREENBAUM
PHILADELPHIA, PA 19109

FOR: PROVISION OF FOOD AND DRINK IN RESTAURANTS; RESTAURANT AND BAR SERVICES; RESTAURANTS; RESTAURANTS FEATURING HOME DELIVERY; TAKE-OUT RESTAURANT SERVICES; CAFE-RESTAURANTS;

CARRY-OUT RESTAURANTS, IN CLASS 43 (U.S. CLS. 100 AND 101).

FIRST USE 6-1-2007; IN COMMERCE 6-1-2007.

THE MARK CONSISTS OF STYLIZED LETTER "B" SURROUNDED BY A CIRCLE WITH TWO BREAKS.

SER. NO. 77-319,664, FILED 11-2-2007.

KEVIN CORWIN, EXAMINING ATTORNEY

Int. Cl.: 35

Prior U.S. Cls.: 100, 101 and 102

United States Patent and Trademark Office

Reg. No. 3,519,338

Registered Oct. 21, 2008

**SERVICE MARK
PRINCIPAL REGISTER**

analyticsLife

NUMERIC ANALYTICS, LLC (PENNSYLVANIA
LIMITED LIABILITY COMPANY)
SUITE 107
5 CHRISTY DRIVE
CHADDS FORD, PA 19317

FOR: PROVIDING A BUSINESS NETWORKING
WEBSITE FOR PROFESSIONALS AND ENTHU-
SIASIS IN THE FIELD OF ANALYTICS; PROVID-
ING BUSINESS INFORMATION VIA A WEBSITE IN
THE FIELD OF WEB AND INTERNET ANALYTICS;
PROVIDING COMMERCIAL INFORMATION VIA A
WEBSITE IN THE FIELD OF WEB AND INTERNET

ANALYTICS COMPANIES, IN CLASS 35 (U.S. CLS.
100, 101 AND 102).

FIRST USE 1-10-2008; IN COMMERCE 1-10-2008.

THE MARK CONSISTS OF STANDARD CHAR-
ACTERS WITHOUT CLAIM TO ANY PARTICULAR
FONT, STYLE, SIZE, OR COLOR.

SER. NO. 77-319,845, FILED 11-2-2007.

DANIEL CAPSHAW, EXAMINING ATTORNEY

Int. Cl.: 9

Prior U.S. Cls.: 21, 23, 26, 36 and 38

Reg. No. 3,519,339

United States Patent and Trademark Office

Registered Oct. 21, 2008

**TRADEMARK
PRINCIPAL REGISTER**

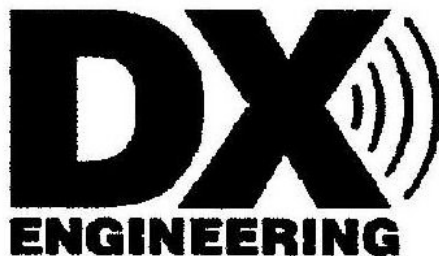

PDS ELECTRONICS, INC. (OHIO CORPORATION)
P.O. BOX 909
AKRON, OH 443090909

FOR: AMATEUR RADIO ANTENNAS, NAMELY, HIGH PERFORMANCE, LONG DISTANCE ANTENNAS USING HF, VHF OR UHF FREQUENCY BANDS TO OBTAIN OPTIMUM GAIN THROUGH CONTROL OF TAKE-OFF ANGLE, VOLTAGE STANDING WAVE RATIO AND ANTENNA PATTERN; ANTENNA PARTS THEREFOR, NAMELY, PARASITIC AND ALL-DRIVEN ARRAYS, YAGI STACKING SWITCHES AND VERTICAL ANTENNA ARRAY COMBINATIONS WHICH ALLOW INSTANT DIRECTIONAL SWITCHING AND SIMULTANEOUS COVERAGE OF TWO PATHS; AND ANTENNA PERIPHERALS, NAMELY, YAGI PHASE BOXES, VERTICAL PHASE BOXES, SIDE MOUNT PHASE BOXES AND REMOTE COAXIAL ANTENNA SWITCHES; TIME VARIABLE SEQUENCE UNITS; ACTIVE RECEIVE ANTENNAS WITH INTERNAL ANTENNA DISCONNECT RELAYS; CURRENT BALUNS AND FEEDLINE CURRENT

CHOKES; REVERSIBLE BEVERAGE ANTENNAS, AND NOISE CANCELING CONTROLLERS, IN CLASS 9 (U.S. CLS. 21, 23, 26, 36 AND 38).

FIRST USE 5-4-2004; IN COMMERCE 12-2-2005.

OWNER OF U.S. REG. NOS. 2,618,396 AND 3,071,562.

NO CLAIM IS MADE TO THE EXCLUSIVE RIGHT TO USE "DX ENGINEERING", APART FROM THE MARK AS SHOWN.

THE MARK CONSISTS OF THE LETTERS "DX" WITH CURVILINEAR LINES TO THE RIGHT THEREOF REPRESENTING SOUND WAVES AND THE WORD "ENGINEERING" UNDERNEATH SAID LETTERING.

SER. NO. 77-320,184, FILED 11-2-2007.

ELLEN B. AWRICH, EXAMINING ATTORNEY

Int. Cl.: 36

Prior U.S. Cls.: 100, 101 and 102

United States Patent and Trademark Office

Reg. No. 3,519,340

Registered Oct. 21, 2008

**SERVICE MARK
PRINCIPAL REGISTER**

CONSOLIDATED RESORTS

CONSOLIDATED RESORTS, INC. (HAWAII CORPORATION)
801 SOUTH RAMPART
LAS VEGAS, NV 89145

FOR: REAL ESTATE BROKERAGE AND LEASING; FORMATION, BROKERAGE AND MANAGEMENT OF TIME SHARE INTEREST IN VACATION PROPERTY, IN CLASS 36 (U.S. CLS. 100, 101 AND 102).

FIRST USE 4-1-1982; IN COMMERCE 4-1-1982.

THE MARK CONSISTS OF STANDARD CHARACTERS WITHOUT CLAIM TO ANY PARTICULAR FONT, STYLE, SIZE, OR COLOR.

SEC. 2(F).

SER. NO. 77-320,397, FILED 11-2-2007.

RAMONA ORTIGA, EXAMINING ATTORNEY

Int. Cl.: 42

Prior U.S. Cls.: 100 and 101

United States Patent and Trademark Office

Reg. No. 3,519,341

Registered Oct. 21, 2008

**SERVICE MARK
PRINCIPAL REGISTER**

PC SQUAD

BECKER, LAWRENCE C (UNITED STATES IN-
DIVIDUAL)

#1LL

111 S CENTRE AVE

ROCKVILLE CENTRE, NY 11570

FOR: CONSULTING SERVICES IN THE FIELD
OF DESIGN, SELECTION, IMPLEMENTATION,
SUPPORT AND USE OF COMPUTER HARDWARE
AND SOFTWARE SYSTEMS FOR OTHERS, IN
CLASS 42 (U.S. CLS. 100 AND 101).

FIRST USE 4-11-2007; IN COMMERCE 4-11-2007.

THE MARK CONSISTS OF STANDARD CHAR-
ACTERS WITHOUT CLAIM TO ANY PARTICULAR
FONT, STYLE, SIZE, OR COLOR.

NO CLAIM IS MADE TO THE EXCLUSIVE
RIGHT TO USE "PC", APART FROM THE MARK
AS SHOWN.

SER. NO. 77-320,959, FILED 11-4-2007.

LINDA ESTRADA, EXAMINING ATTORNEY

Int. Cl.: 9

Prior U.S. Cls.: 21, 23, 26, 36 and 38

Reg. No. 3,519,342

United States Patent and Trademark Office

Registered Oct. 21, 2008

**TRADEMARK
PRINCIPAL REGISTER**

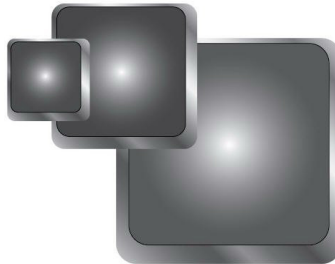

BRIGHT VIEW TECHNOLOGIES, INC. (DELA-
WARE CORPORATION)
SUITE 200
5151 MCCRIMMON PARKWAY
MORRISVILLE, NC 27560

FOR: OPTICAL FILMS, NAMELY, A MICRO-
LENS-BASED DISPLAY SURFACE, IN CLASS 9
(U.S. CLS. 21, 23, 26, 36 AND 38).

FIRST USE 11-0-2003; IN COMMERCE 11-0-2003.

THE MARK CONSISTS OF THREE-PROJECTING
SCREENS DESIGN.

SER. NO. 77-321,858, FILED 11-5-2007.

PAULA MAHONEY, EXAMINING ATTORNEY

Int. Cl.: 3

Prior U.S. Cls.: 1, 4, 6, 50, 51 and 52

United States Patent and Trademark Office

Reg. No. 3,519,343

Registered Oct. 21, 2008

**TRADEMARK
PRINCIPAL REGISTER**

DRI-BLOK

SUN PHARMACEUTICALS CORP. (DELAWARE
CORPORATION)
300 NYALA FARMS ROAD
WESTPORT, CT 06880

FOR: NON-MEDICATED SKIN CARE PREPARA-
TIONS; SUNSCREENS IN THE FORM OF LOTIONS,
CREAMS, SPRAYS AND GELS, IN CLASS 3 (U.S.
CLS. 1, 4, 6, 50, 51 AND 52).

FIRST USE 11-0-2006; IN COMMERCE 11-0-2006.

THE MARK CONSISTS OF STANDARD CHAR-
ACTERS WITHOUT CLAIM TO ANY PARTICULAR
FONT, STYLE, SIZE, OR COLOR.

SER. NO. 77-322,215, FILED 11-6-2007.

GEOFFREY FOSDICK, EXAMINING ATTORNEY

Int. Cl.: 41

Prior U.S. Cls.: 100, 101 and 107

United States Patent and Trademark Office

Reg. No. 3,519,344

Registered Oct. 21, 2008

**SERVICE MARK
PRINCIPAL REGISTER**

BLUE MAN CREATIVITY CENTER

BLUE MAN PRODUCTIONS, INC. (NEW YORK CORPORATION)
599 BROADWAY
NEW YORK, NY 10012

FOR: EDUCATIONAL SERVICES, NAMELY, PROVIDING CLASSES AND WORKSHOPS IN THE FIELDS OF LANGUAGE, SCIENCE, MATH, SOCIAL STUDIES, FINE ARTS, PERFORMING ARTS, PHYSICAL ARTS, FITNESS, TECHNOLOGY AND MEDIA LITERACY AND DISTRIBUTION OF COURSE MATERIALS IN CONNECTION THEREWITH, IN CLASS 41 (U.S. CLS. 100, 101 AND 107).

FIRST USE 8-0-2007; IN COMMERCE 8-0-2007.

THE MARK CONSISTS OF STANDARD CHARACTERS WITHOUT CLAIM TO ANY PARTICULAR FONT, STYLE, SIZE, OR COLOR.

NO CLAIM IS MADE TO THE EXCLUSIVE RIGHT TO USE "CREATIVITY CENTER", APART FROM THE MARK AS SHOWN.

SER. NO. 77-322,876, FILED 11-6-2007.

MARY CRAWFORD, EXAMINING ATTORNEY

Int. Cl.: 42

Prior U.S. Cls.: 100 and 101

United States Patent and Trademark Office

Reg. No. 3,519,345

Registered Oct. 21, 2008

**SERVICE MARK
PRINCIPAL REGISTER**

DIPITY

UNDERLYING INC. (DELAWARE CORPORATION)
1010 PENNSYLVANIA AVENUE
SAN FRANCISCO, CA 94107

FOR: COMPUTER SERVICES, NAMELY, PROVIDING ON-LINE, NON-DOWNLOADABLE SOFTWARE FOR THE CREATION OF TIMELINES BASED ON USER-SUPPLIED INFORMATION; COMPUTER SERVICES, NAMELY, HOSTING AND MAINTAINING AN ONLINE WEBSITE FOR USERS TO CREATE TIMELINES BASED ON USER-SUPPLIED INFORMATION, AS WELL AS VIEW THE

TIMELINES OF OTHERS, IN CLASS 42 (U.S. CLS. 100 AND 101).

FIRST USE 10-15-2007; IN COMMERCE 10-15-2007.

THE MARK CONSISTS OF STANDARD CHARACTERS WITHOUT CLAIM TO ANY PARTICULAR FONT, STYLE, SIZE, OR COLOR.

SER. NO. 77-324,598, FILED 11-8-2007.

JASON LOTT, EXAMINING ATTORNEY

Int. Cl.: 9

Prior U.S. Cls.: 21, 23, 26, 36 and 38

Reg. No. 3,519,346

United States Patent and Trademark Office

Registered Oct. 21, 2008

**TRADEMARK
PRINCIPAL REGISTER**

KIO YAMATO

KIO YAMATO OPTICS, INC. (NEW JERSEY
CORPORATION)
600 SYLVAN AVENUE
ENGLEWOOD CLIFFS, NJ 07632

FOR: TINTED AND UNTINTED EYEGLASSES,
EYEGLASS LENSES, EYEGLASS CASES, CLIP-ON
EYEGLASS FRAMES AND EYEGLASS FRAMES, IN
CLASS 9 (U.S. CLS. 21, 23, 26, 36 AND 38).

FIRST USE 6-15-1999; IN COMMERCE 6-15-1999.

THE MARK CONSISTS OF STANDARD CHAR-
ACTERS WITHOUT CLAIM TO ANY PARTICULAR
FONT, STYLE, SIZE, OR COLOR.

THE NAME SHOWN IN THE MARK DOES NOT
IDENTIFY A PARTICULAR LIVING INDIVIDUAL.

SER. NO. 77-324,608, FILED 11-8-2007.

BENJAMIN ALLEN, EXAMINING ATTORNEY

Int. Cl.: 37

Prior U.S. Cls.: 100, 103 and 106

United States Patent and Trademark Office

Reg. No. 3,519,347

Registered Oct. 21, 2008

**SERVICE MARK
PRINCIPAL REGISTER**

UPRIGHT REJUVENATION

SPORTS IMPORTS, INC. (OHIO CORPORATION)
P.O. BOX 21040
COLUMBUS, OH 43221

OWNER OF U.S. REG. NO. 2,637,784.

FOR: RENOVATION IN THE FIELD OF SPORTS
EQUIPMENT, NAMELY, VOLLEYBALL UP-
RIGHTS, IN CLASS 37 (U.S. CLS. 100, 103 AND 106).

NO CLAIM IS MADE TO THE EXCLUSIVE
RIGHT TO USE "UPRIGHT", APART FROM THE
MARK AS SHOWN.

FIRST USE 2-23-2000; IN COMMERCE 2-23-2000.

SEC. 2(F).

THE MARK CONSISTS OF STANDARD CHAR-
ACTERS WITHOUT CLAIM TO ANY PARTICULAR
FONT, STYLE, SIZE, OR COLOR.

SER. NO. 77-325,001, FILED 11-8-2007.

FRANK LATTUCA, EXAMINING ATTORNEY

Int. Cl.: 9

Prior U.S. Cls.: 21, 23, 26, 36 and 38

Reg. No. 3,519,348

United States Patent and Trademark Office

Registered Oct. 21, 2008

**TRADEMARK
PRINCIPAL REGISTER**

Beyond Remote Capture

OPEN SCAN TECHNOLOGIES, INC. (COLORADO CORPORATION)
1509 YORK STREET
DENVER, CO 80206

FOR: COMPUTER SOFTWARE THAT INTEGRATES ELECTRONIC CHECK DEPOSITS, WHOLESALE REMITTANCE PROCESSING, FORMS PROCESSING AND CASH APPLICATION, THAT CAN BE UTILIZED IN DISTRIBUTED AND CENTRALIZED ENVIRONMENTS, IN CLASS 9 (U.S. CLS. 21, 23, 26, 36 AND 38).

FIRST USE 8-1-2006; IN COMMERCE 10-20-2006.

THE MARK CONSISTS OF STANDARD CHARACTERS WITHOUT CLAIM TO ANY PARTICULAR FONT, STYLE, SIZE, OR COLOR.

NO CLAIM IS MADE TO THE EXCLUSIVE RIGHT TO USE "REMOTE CAPTURE", APART FROM THE MARK AS SHOWN.

SER. NO. 77-326,218, FILED 11-9-2007.

TRACY CROSS, EXAMINING ATTORNEY

Int. Cls.: 44 and 45

Prior U.S. Cls.: 100 and 101

United States Patent and Trademark Office

Reg. No. 3,519,349

Registered Oct. 21, 2008

**SERVICE MARK
PRINCIPAL REGISTER**

**It Takes Two Helping Hands
and a Golden Heart to Serve
Others**

A-1 DOMESTIC PROFESSIONAL SERVICES, INC.
(CALIFORNIA CORPORATION)
SUITE F104
12631 IMPERIAL HWY
SANTA FE SPRINGS, CA 90670

FOR: PROVIDING RESIDENTIAL HOME
HEALTH CARE SERVICES, IN CLASS 44 (U.S. CLS.
100 AND 101).

FIRST USE 9-1-1991; IN COMMERCE 9-1-1991.

FOR: SOCIAL SERVICE, NAMELY, COMPANIONSHIP SERVICES FOR ELDERLY, HANDICAP-

PED, HOME BOUND, IN CLASS 45 (U.S. CLS. 100
AND 101).

FIRST USE 9-1-1991; IN COMMERCE 9-1-1991.

THE MARK CONSISTS OF STANDARD CHARACTERS WITHOUT CLAIM TO ANY PARTICULAR FONT, STYLE, SIZE, OR COLOR.

SER. NO. 77-326,409, FILED 11-9-2007.

JOHN KELLY, EXAMINING ATTORNEY

Int. Cl.: 9

Prior U.S. Cls.: 21, 23, 26, 36 and 38

United States Patent and Trademark Office

Reg. No. 3,519,350

Registered Oct. 21, 2008

**TRADEMARK
PRINCIPAL REGISTER**

SCENEWISE 

SCENEWISE, INC. (CALIFORNIA CORPORATION)
SUITE 100
2201 PARK PLACE
EL SEGUNDO, CA 91367

FOR: DIGITAL MEDIA PRODUCTS, NAMELY, DVDS, CDS AND DIGITAL AUDIO AND VISUAL TAPES AND DISCS CONTAINING EDUCATIONAL MATERIAL IN THE FIELDS OF THE HUMANITIES, MATHEMATICS, SOCIAL SCIENCES, PHYSICAL SCIENCES, AND HEALTH SCIENCES AT THE

PRIMARY, SECONDARY OR COLLEGE LEVEL, IN CLASS 9 (U.S. CLS. 21, 23, 26, 36 AND 38).

FIRST USE 8-31-2007; IN COMMERCE 8-31-2007.

THE MARK CONSISTS OF THE WORD "SCENEWISE" AND A DEPICTION OF A COMPUTER WITH A GRADUATION CAP.

SER. NO. 77-326,445, FILED 11-9-2007.

GINA FINK, EXAMINING ATTORNEY

Int. Cls.: 9 and 16

Prior U.S. Cls.: 2, 5, 21, 22, 23, 26, 29, 36, 37, 38 and 50

Reg. No. 3,519,351

United States Patent and Trademark Office

Registered Oct. 21, 2008

**TRADEMARK
PRINCIPAL REGISTER**

FACTURES4LEARNING

WHALE WRITTEN PUBLICATIONS (WASHING-
TON SOLE PROPRIETORSHIP)
32909 188TH AVE SE
AUBURN, WA 98092

FOR: ELECTRONIC PUBLICATIONS, NAMELY,
E-BOOKS IN THE FIELD OF MATHEMATICS,
LANGUAGE ARTS, SCIENCE AND SOCIAL STU-
DIES RECORDED ON COMPUTER MEDIA; DOWN-
LOADABLE ELECTRONIC PUBLICATIONS IN THE
NATURE OF E-BOOKS IN THE FIELD OF MATHE-
MATICS, LANGUAGE ARTS, SCIENCE AND SO-
CIAL STUDIES; EDUCATION COMPUTER GAME
SOFTWARE, IN CLASS 9 (U.S. CLS. 21, 23, 26, 36 AND
38).

FIRST USE 10-18-2007; IN COMMERCE 10-18-2007.

FOR: PRINTED TEACHING AND TUTORING
MATERIALS IN THE FIELD OF MATHEMATICS,

LANGUAGE ARTS, SCIENCE AND SOCIAL STU-
DIES; EDUCATIONAL PUBLICATIONS, NAMELY,
BOOKS, HAND-OUTS, WORKBOOKS, FLASH
CARDS, ACTIVITY CARDS, LEARNING CARDS,
TEXTBOOKS, STORY BOOKS, BOOKLETS, AND
EDUCATIONAL GAMES IN THE FIELDS OF
MATHEMATICS, LANGUAGE ARTS, SCIENCE
AND SOCIAL STUDIES, IN CLASS 16 (U.S. CLS. 2,
5, 22, 23, 29, 37, 38 AND 50).

FIRST USE 10-18-2007; IN COMMERCE 10-18-2007.

THE MARK CONSISTS OF STANDARD CHAR-
ACTERS WITHOUT CLAIM TO ANY PARTICULAR
FONT, STYLE, SIZE, OR COLOR.

SER. NO. 77-326,593, FILED 11-10-2007.

AISHA CLARKE, EXAMINING ATTORNEY

Int. Cls.: 35, 36 and 39

Prior U.S. Cls.: 100, 101, 102 and 105

United States Patent and Trademark Office

Reg. No. 3,519,352

Registered Oct. 21, 2008

**SERVICE MARK
PRINCIPAL REGISTER**

LOGIS

LOGIS INC. (TEXAS CORPORATION)
4117 TRADE CENTER BLVD. ITC PARK
LAREDO, TX 78045

FOR: TRANSPORTATION LOGISTICS SERVICES,
NAMELY, ARRANGING THE TRANSPORTATION
OF GOODS FOR OTHERS, IN CLASS 35 (U.S. CLS.
100, 101 AND 102).

FIRST USE 1-1-1995; IN COMMERCE 1-1-1995.

FOR: CUSTOMS BROKERAGE, IN CLASS 36 (U.S.
CLS. 100, 101 AND 102).

FIRST USE 1-1-1995; IN COMMERCE 1-1-1995.

FOR: FREIGHT FORWARDING; WAREHOUSING
SERVICES, NAMELY, STORAGE, DISTRIBUTION,
PICK-UP, PACKING, AND SHIPPING OF
GOODS INTO MEXICO; FREIGHT BROKERAGE;
FREIGHT TRANSPORTATION BY TRACTOR-
TRAILER, IN CLASS 39 (U.S. CLS. 100 AND 105).

FIRST USE 1-1-1995; IN COMMERCE 1-1-1995.

THE MARK CONSISTS OF STANDARD CHARACTERS
WITHOUT CLAIM TO ANY PARTICULAR
FONT, STYLE, SIZE, OR COLOR.

SER. NO. 77-326,699, FILED 11-11-2007.

FRANK LATTUCA, EXAMINING ATTORNEY

Int. Cl.: 25

Prior U.S. Cls.: 22 and 39

United States Patent and Trademark Office

Reg. No. 3,519,353

Registered Oct. 21, 2008

**TRADEMARK
PRINCIPAL REGISTER**

Keymono

WINKLER, ERICH (UNITED STATES INDIVIDUAL)
296 WEST 10TH STREET, SUITE 9S
NEW YORK, NY 10014

FOR: HOODS; BELTS; CAPS; COATS FOR MEN AND WOMEN; FOOTWEAR FOR MEN AND WOMEN; JERSEYS; MEN AND WOMEN JACKETS, COATS, TROUSERS, VESTS; TOPS, IN CLASS 25 (U.S. CLS. 22 AND 39).

FIRST USE 11-1-2007; IN COMMERCE 11-1-2007.

THE MARK CONSISTS OF STANDARD CHARACTERS WITHOUT CLAIM TO ANY PARTICULAR FONT, STYLE, SIZE, OR COLOR.

SER. NO. 77-326,761, FILED 11-11-2007.

NAPOLEON SHARMA, EXAMINING ATTORNEY

Int. Cls.: 35, 36 and 42

Prior U.S. Cls.: 100, 101 and 102

United States Patent and Trademark Office

Reg. No. 3,519,354

Registered Oct. 21, 2008

**SERVICE MARK
PRINCIPAL REGISTER**



BROYHILL, J. EDGAR (UNITED STATES INDIVIDUAL)
525 N. HAWTHORNE ROAD
WINSTON-SALEM, NC 27104

FOR: PROVIDING A WEBSITE FEATURING BUSINESS MARKETING SERVICES, OFFERING PRODUCTS FOR SALE, AND INFORMATION IN THE FIELD OF AUTOMOBILES FOR SALE; ADVERTISING AND PUBLICITY SERVICES, NAMELY, PROMOTING THE GOODS, SERVICES, BRAND IDENTITY AND COMMERCIAL INFORMATION AND NEWS OF THIRD PARTIES THROUGH PRINT, AUDIO, VIDEO, DIGITAL AND ON-LINE MEDIUM, IN CLASS 35 (U.S. CLS. 100, 101 AND 102).

FIRST USE 12-1-2006; IN COMMERCE 12-1-2006.

FOR: PROVIDING A WEBSITE FEATURING FINANCIAL AND INSURANCE SERVICES AND IN-

FORMATION IN THE FIELD OF FINANCIAL AND INSURANCE SERVICES, IN CLASS 36 (U.S. CLS. 100, 101 AND 102).

FIRST USE 12-1-2006; IN COMMERCE 12-1-2006.

FOR: INSTALLATION OF COMPUTER SOFTWARE, IN CLASS 42 (U.S. CLS. 100 AND 101).

FIRST USE 12-1-2006; IN COMMERCE 12-1-2006.

THE MARK CONSISTS OF THE STYLIZED WORD "XSELLNET".

SER. NO. 77-327,444, FILED 11-12-2007.

JAMES A. RAUEN, EXAMINING ATTORNEY

Int. Cl.: 1

Prior U.S. Cls.: 1, 5, 6, 10, 26 and 46

United States Patent and Trademark Office

Reg. No. 3,519,355

Registered Oct. 21, 2008

**TRADEMARK
PRINCIPAL REGISTER**

SPILL HAND

KTK ASSOCIATES, INC. (TEXAS CORPORATION)
590 FM 1726
GOLIAD, TX 77963

FOR: A LOOSE ZEOLITE-BASED COMPOSITION SOLD IN BAGS FOR USE ON OIL SPILLS TO ABSORB THE SPILL AND PROVIDE FOR REMEDIATION OF THE SPILLED MATERIAL, IN CLASS 1 (U.S. CLS. 1, 5, 6, 10, 26 AND 46).

FIRST USE 11-10-2007; IN COMMERCE 11-10-2007.

THE MARK CONSISTS OF STANDARD CHARACTERS WITHOUT CLAIM TO ANY PARTICULAR FONT, STYLE, SIZE, OR COLOR.

SER. NO. 77-327,854, FILED 11-13-2007.

PAULA MAHONEY, EXAMINING ATTORNEY

Int. Cl.: 45

Prior U.S. Cls.: 100 and 101

United States Patent and Trademark Office

Reg. No. 3,519,356

Registered Oct. 21, 2008

**SERVICE MARK
PRINCIPAL REGISTER**

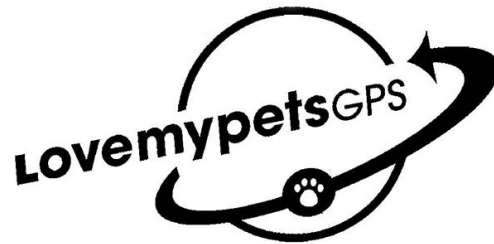

LOVEMYNETS, LLC (SOUTH CAROLINA LIMITED LIABILITY COMPANY)
2801 WADE HAMPTON BLVD., #101
TAYLORS, SC 29687

FOR: ASSISTING IN THE LOCATING OF LOST PETS; MAKING PET IDENTIFICATION TAGS AVAILABLE TO OTHERS FOR SECURITY OR LOCATION PURPOSES; MAKING PET IDENTIFICATION TRANSMITTERS AND RECEIVERS AVAILABLE TO OTHERS FOR SECURITY OR LOCATION PURPOSES; MAKING PET IDENTIFICATION COLLARS AVAILABLE TO OTHERS FOR

SECURITY OR LOCATION PURPOSES, IN CLASS 45 (U.S. CLS. 100 AND 101).

FIRST USE 9-18-2007; IN COMMERCE 9-18-2007.

OWNER OF U.S. REG. NO. 3,376,516.

THE MARK CONSISTS OF THE WORDS "LOVEMYNETSGPS" WITH STYLIZED IMAGE OF GLOBE.

SER. NO. 77-328,876, FILED 11-14-2007.

STEPHEN AQUILA, EXAMINING ATTORNEY

Int. Cl.: 5

Prior U.S. Cls.: 6, 18, 44, 46, 51 and 52

Reg. No. 3,519,357

United States Patent and Trademark Office

Registered Oct. 21, 2008

**TRADEMARK
PRINCIPAL REGISTER**

TruQ10

YOUR VITAMINS INC. (NEVADA CORPORATION), DBA PROCAPS LABORATORIES
430 PARKSON ROAD
HENDERSON, NV 89011

THE MARK CONSISTS OF STANDARD CHARACTERS WITHOUT CLAIM TO ANY PARTICULAR FONT, STYLE, SIZE, OR COLOR.

FOR: COMPLEX OF MICROORGANISMS SOLD AS AN INTEGRAL COMPONENT OF DIETARY AND NUTRITIONAL SUPPLEMENTS, IN CLASS 5 (U.S. CLS. 6, 18, 44, 46, 51 AND 52).

SER. NO. 77-329,180, FILED 11-14-2007.

FIRST USE 11-1-2006; IN COMMERCE 11-2-2007.

JIM RINGLE, EXAMINING ATTORNEY

Int. Cl.: 35

Prior U.S. Cls.: 100, 101 and 102

United States Patent and Trademark Office

Reg. No. 3,519,358

Registered Oct. 21, 2008

**SERVICE MARK
PRINCIPAL REGISTER**



MIZE, BRENDA J. (TEXAS SOLE PROPRIETORSHIP)
217 SETTLERS VALLEY DRIVE
PFLUGERVILLE, TX 78660

FOR: ON-LINE RETAIL STORE SERVICES FEATURING BABY TOYS AND GIFTS, IN CLASS 35 (U.S. CLS. 100, 101 AND 102).

FIRST USE 2-7-2007; IN COMMERCE 2-7-2007.

NO CLAIM IS MADE TO THE EXCLUSIVE RIGHT TO USE "TOY", APART FROM THE MARK AS SHOWN.

THE COLOR(S) WHITE, BLACK, GREEN, ORANGE, GREY, PINK, BROWN, LIGHT BROWN, TAN, YELLOW, PURPLE, BLUE, LIGHT BLUE AND RED IS/ARE CLAIMED AS A FEATURE OF THE MARK.

THE MARK CONSISTS OF THE COLOR GREEN THAT APPEARS IN THE WORDS "THE TOY BENCH," IN PART OF THE ONE OF THE ALPHABET BLOCKS ON THE BENCH, AND IN PART OF THE WAVY LINE UNDERLINING THE WORD "TOY"; THE COLOR WHITE APPEARS AS PART OF THE SHADOWING IN THE WORDING "THE TOY BENCH", AS THE REFLECTION OF LIGHT ON THE SQUEAKER ON THE TOY HORN, IN PART OF THE WAVY LINE UNDERLINING THE WORD "TOY"; IN THE SEAT PORTION OF THE BENCH, IN PART OF THE ALPHABET BLOCKS ON THE

BENCH, AS PART OF THE TOY BALL ON THE BENCH; THE COLOR BLACK APPEARS AS PART OF THE INSIDE OF THE BENCH, IN THE LETTERS "A" AND "B" AND "C" IN THE ALPHABET BLOCKS, AS THE OUTLINE OF THE TOY HORN AND THE TOY BALL; THE COLOR ORANGE APPEARS AS PART OF THE BABY DOLL'S HAIR AND AS ONE OF THE WAVY LINES UNDERLINING THE WORD "BENCH"; THE COLOR GREY APPEARS AS THE SIDES OF THE BENCH, AND AS PART OF THE TOY HORN; THE COLOR PINK APPEARS AS THE BACK OF THE BENCH AND AS PART OF THE WAVY LINE UNDERLINING THE WORDS "TOY" AND "BENCH"; THE COLORS BROWN AND LIGHT BROWN APPEARS AS THE COLORS OF THE TOY BEAR ON THE BENCH; THE COLOR TAN APPEARS AS THE FACE AND HANDS OF THE BABY DOLLS AND AS THE FRONT OF THE BENCH; THE COLOR YELLOW APPEARS AS PART OF THE ONE OF THE ALPHABET BLOCKS ON THE BENCH; THE COLOR PURPLE APPEARS AS THE CLOTHING ON THE BABY DOLL AND AS PART OF THE ONE OF THE ALPHABET BLOCKS; THE COLOR BLUE APPEARS AS THE SQUEAKER ON THE TOY HORN; THE COLOR LIGHT BLUE APPEARS ON PART OF THE TOY BALL, AND THE COLOR RED APPEARS AS PART OF THE TOY BALL AND IN PART OF THE WAVY LINE UNDERLINING THE WORDS "TOY" AND "BENCH".

SER. NO. 77-329,346, FILED 11-14-2007.

SALLY SHIH, EXAMINING ATTORNEY

Int. Cl.: 3

Prior U.S. Cls.: 1, 4, 6, 50, 51 and 52

United States Patent and Trademark Office

Reg. No. 3,519,359

Registered Oct. 21, 2008

**TRADEMARK
PRINCIPAL REGISTER**

Fresh Look

FRESH LOOK PRODUCTS, INC. (PENNSYLVANIA CORPORATION)
P.O. BOX 9532
WILMINGTON, DE 19809

FOR: HAIR PRODUCTS, NAMELY, SHAMPOO, HAIR CONDITIONER, HAIR TREATMENT, HAIR AND SKIN OIL AND NON MEDICATED DANDRUFF CREAM, COSMETICS AND CLEANING PREPARATIONS, IN CLASS 3 (U.S. CLS. 1, 4, 6, 50, 51 AND 52).

FIRST USE 11-21-1991; IN COMMERCE 11-21-1991.

THE MARK CONSISTS OF STANDARD CHARACTERS WITHOUT CLAIM TO ANY PARTICULAR FONT, STYLE, SIZE, OR COLOR.

SER. NO. 77-329,721, FILED 11-14-2007.

TRACY CROSS, EXAMINING ATTORNEY

Int. Cl.: 19

Prior U.S. Cls.: 1, 12, 33 and 50

United States Patent and Trademark Office

Reg. No. 3,519,360

Registered Oct. 21, 2008

**TRADEMARK
PRINCIPAL REGISTER**

FIORANO

SAROYAN LUMBER COMPANY, INC. (CALI-
FORNIA CORPORATION)
6230 SO. ALAMEDA ST.
HUNTINGTON PARK, CA 90255

THE MARK CONSISTS OF STANDARD CHAR-
ACTERS WITHOUT CLAIM TO ANY PARTICULAR
FONT, STYLE, SIZE, OR COLOR.

FOR: FLOOR BOARDS, WOODEN FLOORING,
HARDWOOD FLOORING; NON-METAL ARCHI-
TECTURAL MOULDINGS AND FINISH TRIM, IN
CLASS 19 (U.S. CLS. 1, 12, 33 AND 50).

SER. NO. 77-329,727, FILED 11-14-2007.

FIRST USE 4-18-2006; IN COMMERCE 4-18-2006.

JEAN IM, EXAMINING ATTORNEY

Int. Cl.: 39

Prior U.S. Cls.: 100 and 105

United States Patent and Trademark Office

Reg. No. 3,519,361

Registered Oct. 21, 2008

**SERVICE MARK
PRINCIPAL REGISTER**

Park 'N Go

BONA, JOHN R. (UNITED STATES INDIVIDUAL)
P.O. BOX 643804
VERO BEACH, FL 32964

FOR: CAR PARKING; PARKING LOT SERVICES; RENTAL OF CAR PARKING SPACES; RENTAL OF PARKING SPACES; RENTAL OF VEHICLE PARKING SPACES; VALET PARKING; VEHICLE PARKING, IN CLASS 39 (U.S. CLS. 100 AND 105).

FIRST USE 8-1-1984; IN COMMERCE 8-1-1984.

THE MARK CONSISTS OF STANDARD CHARACTERS WITHOUT CLAIM TO ANY PARTICULAR FONT, STYLE, SIZE, OR COLOR.

NO CLAIM IS MADE TO THE EXCLUSIVE RIGHT TO USE "PARK", APART FROM THE MARK AS SHOWN.

SER. NO. 77-330,165, FILED 11-15-2007.

ANNE MADDEN, EXAMINING ATTORNEY

Int. Cls.: 40 and 42

Prior U.S. Cls.: 100, 101, 103 and 106

United States Patent and Trademark Office

Reg. No. 3,519,362

Registered Oct. 21, 2008

**SERVICE MARK
PRINCIPAL REGISTER**

**MJS DESIGNS ELECTRONICS
SOLUTIONS ON A FAST TRACK**

MJS DESIGNS, INC. (ARIZONA CORPORATION)
SUITE 100
4130 W. WOOD ST.
PHOENIX, AZ 85040

FOR: MANUFACTURE AND ASSEMBLY OF
ELECTRONIC HARDWARE AND ELECTRONIC
CIRCUITS TO THE ORDER AND /OR SPECIFICA-
TION OF OTHERS, IN CLASS 40 (U.S. CLS. 100, 103
AND 106).

FIRST USE 2-28-2006; IN COMMERCE 2-28-2006.

FOR: DESIGN FOR OTHERS IN THE FIELD OF
ELECTRONIC HARDWARE AND ELECTRONIC
CIRCUITS; DESIGN OF COMPUTER SOFTWARE,
IN CLASS 42 (U.S. CLS. 100 AND 101).

FIRST USE 2-28-2006; IN COMMERCE 2-28-2006.

THE MARK CONSISTS OF STANDARD CHAR-
ACTERS WITHOUT CLAIM TO ANY PARTICULAR
FONT, STYLE, SIZE, OR COLOR.

NO CLAIM IS MADE TO THE EXCLUSIVE
RIGHT TO USE "DESIGNS" AND "ELECTRONICS
SOLUTIONS", APART FROM THE MARK AS
SHOWN.

SER. NO. 77-330,457, FILED 11-15-2007.

STEVEN R. FINE, EXAMINING ATTORNEY

Int. Cl.: 25

Prior U.S. Cls.: 22 and 39

United States Patent and Trademark Office

Reg. No. 3,519,363

Registered Oct. 21, 2008

**TRADEMARK
PRINCIPAL REGISTER**

empowRment panties

ADAMS, KIMBERLY M. (UNITED STATES IN-
DIVIDUAL)
P. O. BOX 1322
NORTH WALES, PA 19454

FOR: PANTIES; SHAPEWEAR, NAMELY, GIR-
DLES, BRAS; HOSIERY; LINGERIE; UNDERWEAR,
IN CLASS 25 (U.S. CLS. 22 AND 39).

FIRST USE 8-0-2007; IN COMMERCE 8-0-2007.

THE MARK CONSISTS OF STANDARD CHAR-
ACTERS WITHOUT CLAIM TO ANY PARTICULAR
FONT, STYLE, SIZE, OR COLOR.

NO CLAIM IS MADE TO THE EXCLUSIVE
RIGHT TO USE "PANTIES", APART FROM THE
MARK AS SHOWN.

SER. NO. 77-331,839, FILED 11-16-2007.

RONALD DELGIZZI, EXAMINING ATTORNEY

Int. Cl.: 35

Prior U.S. Cls.: 100, 101 and 102

United States Patent and Trademark Office

Reg. No. 3,519,364

Registered Oct. 21, 2008

**SERVICE MARK
PRINCIPAL REGISTER**

KIMBRA

MY LIFE DESIGNS, LLC (COLORADO LIMITED
LIABILITY COMPANY)
5778 S. RAPP ST.
LITTLETON, CO 80120

FOR: ON-LINE RETAIL STORES FEATURING
JEWELRY AND GIFTS, IN CLASS 35 (U.S. CLS. 100,
101 AND 102).

FIRST USE 6-0-2007; IN COMMERCE 6-0-2007.

THE MARK CONSISTS OF STANDARD CHAR-
ACTERS WITHOUT CLAIM TO ANY PARTICULAR
FONT, STYLE, SIZE, OR COLOR.

SER. NO. 77-331,892, FILED 11-16-2007.

LEIGH CAROLINE CASE, EXAMINING ATTOR-
NEY

Int. Cl.: 35

Prior U.S. Cls.: 100, 101 and 102

United States Patent and Trademark Office

Reg. No. 3,519,365

Registered Oct. 21, 2008

**SERVICE MARK
PRINCIPAL REGISTER**

KIMBRA STUDIOS

MY LIFE DESIGNS, LLC (COLORADO LIMITED
LIABILITY COMPANY)

5778 S. RAPP ST.

LITTLETON, CO 80120

FOR: ON-LINE RETAIL STORES FEATURING
JEWELRY AND GIFTS, IN CLASS 35 (U.S. CLS. 100,
101 AND 102).

FIRST USE 6-0-2007; IN COMMERCE 6-0-2007.

THE MARK CONSISTS OF STANDARD CHAR-
ACTERS WITHOUT CLAIM TO ANY PARTICULAR
FONT, STYLE, SIZE, OR COLOR.

NO CLAIM IS MADE TO THE EXCLUSIVE
RIGHT TO USE "STUDIOS", APART FROM THE
MARK AS SHOWN.

SER. NO. 77-331,918, FILED 11-16-2007.

LEIGH CAROLINE CASE, EXAMINING ATTOR-
NEY

Int. Cl.: 25

Prior U.S. Cls.: 22 and 39

United States Patent and Trademark Office

Reg. No. 3,519,366

Registered Oct. 21, 2008

**TRADEMARK
PRINCIPAL REGISTER**

HOTTROT

SCHROEDER, SHERRI (UNITED STATES INDIVIDUAL)

#139

4015 PORTE LA PAZ
SAN DIEGO, CA 92122

FOR: HATS; PANTS; SHORTS; SPORTS BRAS;
SWEAT PANTS; SWEAT SHIRTS; T-SHIRTS; TANK
TOPS; THERMAL UNDERWEAR, IN CLASS 25 (U.S.
CLS. 22 AND 39).

FIRST USE 8-10-2007; IN COMMERCE 9-9-2007.

THE MARK CONSISTS OF STANDARD CHARACTERS WITHOUT CLAIM TO ANY PARTICULAR FONT, STYLE, SIZE, OR COLOR.

SER. NO. 77-332,183, FILED 11-16-2007.

COLLEEN DOMBROW, EXAMINING ATTORNEY

Int. Cls.: 30 and 43

Prior U.S. Cls.: 46, 100 and 101

United States Patent and Trademark Office

Reg. No. 3,519,367

Registered Oct. 21, 2008

**TRADEMARK
SERVICE MARK
PRINCIPAL REGISTER**

SLOWDOWN ORGANIC

HOTEL VILLA MOZART, INC. (DELAWARE CORPORATION)

P.O. BOX 216
SHORT HILLS, NJ 07078

FOR: COFFEE; COFFEE; COFFEE BEANS; ROASTED COFFEE BEANS; COOKIES; COOKIES AND CRACKERS, IN CLASS 30 (U.S. CL. 46).

FIRST USE 9-1-2007; IN COMMERCE 9-1-2007.

FOR: COFFEE SHOPS; COFFEE-HOUSE AND SNACK-BAR SERVICES, IN CLASS 43 (U.S. CLS. 100 AND 101).

FIRST USE 11-1-2007; IN COMMERCE 11-1-2007.

THE MARK CONSISTS OF STANDARD CHARACTERS WITHOUT CLAIM TO ANY PARTICULAR FONT, STYLE, SIZE, OR COLOR.

NO CLAIM IS MADE TO THE EXCLUSIVE RIGHT TO USE "ORGANIC", APART FROM THE MARK AS SHOWN.

SER. NO. 77-332,433, FILED 11-18-2007.

SOPHIA S. KIM, EXAMINING ATTORNEY

Int. Cl.: 35

Prior U.S. Cls.: 100, 101 and 102

United States Patent and Trademark Office

Reg. No. 3,519,368

Registered Oct. 21, 2008

**SERVICE MARK
PRINCIPAL REGISTER**

CANDY HEAVEN

CANDY HEAVEN, INC. (FLORIDA CORPORATION)

17443 REAPER AVENUE

PORT CHARLOTTE, FL 33948

FOR: RETAIL CANDY STORES, IN CLASS 35 (U.S. CLS. 100, 101 AND 102).

FIRST USE 1-31-2005; IN COMMERCE 1-31-2005.

THE MARK CONSISTS OF STANDARD CHARACTERS WITHOUT CLAIM TO ANY PARTICULAR FONT, STYLE, SIZE, OR COLOR.

NO CLAIM IS MADE TO THE EXCLUSIVE RIGHT TO USE "CANDY", APART FROM THE MARK AS SHOWN.

SER. NO. 77-332,659, FILED 11-19-2007.

JENNIFER VASQUEZ, EXAMINING ATTORNEY

Int. Cl.: 35

Prior U.S. Cls.: 100, 101 and 102

United States Patent and Trademark Office

Reg. No. 3,519,369

Registered Oct. 21, 2008

**SERVICE MARK
PRINCIPAL REGISTER**

J. Michaels

J. MICHAELS CLOTHIER, LLC (NEW YORK
LIMITED LIABILITY COMPANY)
22 COOLIDGE PLACE
SMITHTOWN, NY 11787

FOR: RETAIL STORES FEATURING CLOTHING,
NAMELY, SHIRTS, DRESS SHIRTS, TIES, PANTS,
JACKETS, SUITS, UNDERWEAR, BELTS, SWEA-
TERS, SHOES , IN CLASS 35 (U.S. CLS. 100, 101
AND 102).

FIRST USE 1-1-2006; IN COMMERCE 5-1-2007.

THE MARK CONSISTS OF STANDARD CHAR-
ACTERS WITHOUT CLAIM TO ANY PARTICULAR
FONT, STYLE, SIZE, OR COLOR.

"J. MICHAELS" DOES IDENTIFY A LIVING
INDIVIDUAL WHOSE CONSENT IS OF RECORD.

SER. NO. 77-332,867, FILED 11-19-2007.

MICHELE SWAIN, EXAMINING ATTORNEY

Int. Cl.: 9

Prior U.S. Cls.: 21, 23, 26, 36 and 38

Reg. No. 3,519,370

United States Patent and Trademark Office

Registered Oct. 21, 2008

**TRADEMARK
PRINCIPAL REGISTER**

OMNI-VUE

GENESIS DIGITAL IMAGING, INC. (CALIFORNIA CORPORATION)
12921 W. WASHINGTON BLVD.
LOS ANGELES, CA 90066

THE MARK CONSISTS OF STANDARD CHARACTERS WITHOUT CLAIM TO ANY PARTICULAR FONT, STYLE, SIZE, OR COLOR.

FOR: COMPUTER SOFTWARE FOR MEDICAL IMAGING DIAGNOSTICS, IN CLASS 9 (U.S. CLS. 21, 23, 26, 36 AND 38).

SER. NO. 77-333,397, FILED 11-19-2007.

FIRST USE 9-23-2005; IN COMMERCE 9-23-2005.

HENRY S. ZAK, EXAMINING ATTORNEY

Int. Cl.: 41

Prior U.S. Cls.: 100, 101 and 107

United States Patent and Trademark Office

Reg. No. 3,519,371

Registered Oct. 21, 2008

**SERVICE MARK
PRINCIPAL REGISTER**

FISH FOR DISH

FISH FOR DISH, LLC (ARIZONA LIMITED LIABILITY COMPANY)
507 EAST DESERT HILLS ESTATES DRIVE
PHOENIX, AZ 85086

THE MARK CONSISTS OF STANDARD CHARACTERS WITHOUT CLAIM TO ANY PARTICULAR FONT, STYLE, SIZE, OR COLOR.

FOR: PROVIDING A WEBSITE THAT FEATURES INFORMAL INSTRUCTION ON COOKING, IN CLASS 41 (U.S. CLS. 100, 101 AND 107).

SER. NO. 77-333,516, FILED 11-19-2007.

FIRST USE 10-1-2007; IN COMMERCE 10-1-2007.

STEVEN PEREZ, EXAMINING ATTORNEY

Int. Cl.: 9

Prior U.S. Cls.: 21, 23, 26, 36 and 38

Reg. No. 3,519,372

United States Patent and Trademark Office

Registered Oct. 21, 2008

**TRADEMARK
PRINCIPAL REGISTER**

PGSURFER

PARETOLOGIC INC. (CANADA CORPORATION)
1827 FORT ST.
VICTORIA, CANADA V8R1J6

FIRST USE 10-28-2007; IN COMMERCE 10-28-2007.

FOR: COMPUTER SOFTWARE FOR USE IN
BLOCKING USER ACCESS TO CERTAIN INTER-
NET SITES AND CONTENT THAT MAY BE DOWN-
LOADED FROM A GLOBAL COMPUTER
NETWORK, IN CLASS 9 (U.S. CLS. 21, 23, 26, 36
AND 38).

THE MARK CONSISTS OF STANDARD CHAR-
ACTERS WITHOUT CLAIM TO ANY PARTICULAR
FONT, STYLE, SIZE, OR COLOR.

SER. NO. 77-334,177, FILED 11-20-2007.

LINDA ESTRADA, EXAMINING ATTORNEY

Int. Cl.: 44

Prior U.S. Cls.: 100 and 101

United States Patent and Trademark Office

Reg. No. 3,519,373

Registered Oct. 21, 2008

**SERVICE MARK
PRINCIPAL REGISTER**

The logo for MedExpress features the word "MedExpress" in a serif font, with a stylized cross symbol at the end of "Express". A curved line arches over the text, starting above the "M" and ending above the cross.

URGENT CARE MSO, LLC (DELAWARE LIMITED LIABILITY COMPANY)
DINSMORE & SHOHL BUILDING, SUITE 220
215 DON KNOTTS BOULEVARD
MORGANTOWN, WV 26501

FOR: MEDICAL CLINICS SPECIALIZING IN URGENT MEDICAL CARE AND TREATMENT, IN CLASS 44 (U.S. CLS. 100 AND 101).

FIRST USE 2-7-2005; IN COMMERCE 2-7-2005.

OWNER OF U.S. REG. NOS. 3,205,430 AND 3,311,726.

THE MARK CONSISTS OF A "MEDEXPRESS" LOGO INCLUDING A CROSS.

SER. NO. 77-334,306, FILED 11-20-2007.

TINA L. SNAPP, EXAMINING ATTORNEY

Int. Cl.: 28

Prior U.S. Cls.: 22, 23, 38 and 50

United States Patent and Trademark Office

Reg. No. 3,519,374

Registered Oct. 21, 2008

**TRADEMARK
PRINCIPAL REGISTER**

Romulus Extreme Gear

OLSON, KEVIN J. (UNITED STATES INDIVIDUAL)
3857 BIRCH ST. SUITE 531
NEWPORT BEACH, CA 92662

OWNER OF U.S. REG. NO. 3,321,530.

FOR: SKATEBOARD DECKS, IN CLASS 28 (U.S. CLS. 22, 23, 38 AND 50).

NO CLAIM IS MADE TO THE EXCLUSIVE RIGHT TO USE "EXTREME GEAR", APART FROM THE MARK AS SHOWN.

FIRST USE 4-13-2005; IN COMMERCE 5-13-2007.

SER. NO. 77-334,425, FILED S.R. 11-20-2007 AM.
P.R. 6-17-2008.

THE MARK CONSISTS OF STANDARD CHARACTERS WITHOUT CLAIM TO ANY PARTICULAR FONT, STYLE, SIZE, OR COLOR.

TEJBIR SINGH, EXAMINING ATTORNEY

Int. Cl.: 41

Prior U.S. Cls.: 100, 101 and 107

United States Patent and Trademark Office

Reg. No. 3,519,375

Registered Oct. 21, 2008

**SERVICE MARK
PRINCIPAL REGISTER**

Weapon-X

CLOR, DANIEL S (UNITED STATES INDIVIDUAL)
7580 MERRIMACK PLACE
RANCHO CUCAMONGA, CA 91730

FOR: ENTERTAINMENT IN THE NATURE OF VISUAL AND AUDIO PERFORMANCES, NAMELY, MUSICAL BAND, ROCK GROUP, GYMNAS TIC, DANCE, AND BALLET PERFORMANCES; ENTERTAINMENT, NAMELY, LIVE PERFORMANCES BY A MUSICAL BAND; ENTERTAINMENT, NAMELY, LIVE PERFORMANCES BY MUSICAL BANDS; ENTERTAINMENT, NAMELY, LIVE PERFORMAN-

CES BY ROCK GROUPS, IN CLASS 41 (U.S. CLS. 100, 101 AND 107).

FIRST USE 9-1-2006; IN COMMERCE 9-1-2006.

THE MARK CONSISTS OF STANDARD CHARACTERS WITHOUT CLAIM TO ANY PARTICULAR FONT, STYLE, SIZE, OR COLOR.

SER. NO. 77-334,680, FILED 11-20-2007.

KATHERINE CONNOLLY, EXAMINING ATTORNEY

Int. Cl.: 41

Prior U.S. Cls.: 100, 101 and 107

United States Patent and Trademark Office

Reg. No. 3,519,376

Registered Oct. 21, 2008

**SERVICE MARK
PRINCIPAL REGISTER**

NO HATE BUT HARMONY

PAASMAN, GERRIT (NETHERLANDS INDIVIDUAL)
78 CRICKET LANE
STAMFORD, CT 06903

FOR: NON-PROFIT ENTITY, NAMELY, PROVIDING EDUCATIONAL PROGRAMS FOR CREATING SOCIAL AWARENESS BY TEACHING IN THE FORM OF ACTING, DANCING AND STORY TELLING, IN CLASS 41 (U.S. CLS. 100, 101 AND 107).

FIRST USE 1-1-2000; IN COMMERCE 1-1-2000.

THE MARK CONSISTS OF STANDARD CHARACTERS WITHOUT CLAIM TO ANY PARTICULAR FONT, STYLE, SIZE, OR COLOR.

SER. NO. 77-334,731, FILED 11-20-2007.

NAKIA HENRY, EXAMINING ATTORNEY

Int. Cl.: 41

Prior U.S. Cls.: 100, 101 and 107

United States Patent and Trademark Office

Reg. No. 3,519,377

Registered Oct. 21, 2008

**SERVICE MARK
PRINCIPAL REGISTER**

World Wide Champ

SANSEI, INC. (NEW YORK CORPORATION)
SUITE #107
527 THIRD AVENUE
NEW YORK, NY 10016

FOR: PROVIDING A WEB SITE THAT ORGANIZES, HOSTS, AND PROMOTES SPORTING COMPETITIONS AND TRAINING, IN CLASS 41 (U.S. CLS. 100, 101 AND 107).

FIRST USE 10-22-2007; IN COMMERCE 10-22-2007.

THE MARK CONSISTS OF STANDARD CHARACTERS WITHOUT CLAIM TO ANY PARTICULAR FONT, STYLE, SIZE, OR COLOR.

SER. NO. 77-334,967, FILED 11-21-2007.

KYLE PEETE, EXAMINING ATTORNEY

Int. Cl.: 41

Prior U.S. Cls.: 100, 101 and 107

United States Patent and Trademark Office

Reg. No. 3,519,378

Registered Oct. 21, 2008

**SERVICE MARK
PRINCIPAL REGISTER**



SANSEI, INC. (NEW YORK CORPORATION)
SUITE #107
527 THIRD AVENUE
NEW YORK, NY 10016

FOR: PROVIDING A WEB SITE THAT ORGANIZES, HOSTS, AND PROMOTES SPORTING COMPETITIONS AND TRAINING, IN CLASS 41 (U.S. CLS. 100, 101 AND 107).

FIRST USE 10-22-2007; IN COMMERCE 10-22-2007.

THE COLOR(S) BLUE, WHITE, AND BLACK IS/ARE CLAIMED AS A FEATURE OF THE MARK.

THE MARK CONSISTS OF A MAN STANDING BELOW A BLUE GLOBE.

SER. NO. 77-334,992, FILED 11-21-2007.

KYLE PEETE, EXAMINING ATTORNEY

Int. Cl.: 42

Prior U.S. Cls.: 100 and 101

United States Patent and Trademark Office

Reg. No. 3,519,379

Registered Oct. 21, 2008

**SERVICE MARK
PRINCIPAL REGISTER**

LEASE CENTRAL

BUD BEHLING LEASING, INC. (PENNSYLVANIA CORPORATION)
100 OLD POND RD.
BRIDGEVILLE, PA 15107

FOR: PROVIDING TEMPORARY USE OF ON-LINE NON-DOWNLOADABLE SOFTWARE FOR MANAGEMENT OF VEHICLE FIXED AND VARIABLE COSTS, NAMELY, FINANCING, PURCHASES, FUEL MANAGEMENT, ROADSIDE ASSISTANCE, REMARKETING, ACQUISITION, REGISTRATION, TITLE TRANSFER AND MAINTENANCE, ASSOCIATED WITH VEHICLES AND VEHICLE FLEETS, IN CLASS 42 (U.S. CLS. 100 AND 101).

FIRST USE 1-1-2000; IN COMMERCE 1-1-2000.

THE MARK CONSISTS OF STANDARD CHARACTERS WITHOUT CLAIM TO ANY PARTICULAR FONT, STYLE, SIZE, OR COLOR.

NO CLAIM IS MADE TO THE EXCLUSIVE RIGHT TO USE "LEASE", APART FROM THE MARK AS SHOWN.

SER. NO. 77-335,297, FILED 11-21-2007.

KATHY DE JONGE, EXAMINING ATTORNEY

Int. Cl.: 32

Prior U.S. Cls.: 45, 46 and 48

Reg. No. 3,519,380

United States Patent and Trademark Office

Registered Oct. 21, 2008

**TRADEMARK
PRINCIPAL REGISTER**

**THE JUICE THAT MAKES YOU
GLOW**

GLOJI, INC. (CALIFORNIA CORPORATION)
937 E. ARROYO TERRACE
ALHAMBRA, CA 91801

THE MARK CONSISTS OF STANDARD CHAR-
ACTERS WITHOUT CLAIM TO ANY PARTICULAR
FONT, STYLE, SIZE, OR COLOR.

FOR: FRUIT JUICES AND FRUIT DRINKS, IN
CLASS 32 (U.S. CLS. 45, 46 AND 48).

SER. NO. 77-335,893, FILED 11-23-2007.

FIRST USE 12-6-2006; IN COMMERCE 3-8-2007.

JAMES A. RAUEN, EXAMINING ATTORNEY

Int. Cl.: 25

Prior U.S. Cls.: 22 and 39

United States Patent and Trademark Office

Reg. No. 3,519,381

Registered Oct. 21, 2008

**TRADEMARK
PRINCIPAL REGISTER**

Compass

DANIEL, SAYO ISAAC (UNITED STATES INDIVIDUAL)
848 BRICKELL KEY DRIVE, #3402
MIAMI, FL 33131

FOR: SHOES, FOOTWEAR, T-SHIRTS, SPORTS SHIRTS, SPORTS JERSEYS, SPORTS JACKETS, SPORTS PANTS, TRACK PANTS, AND SPORTS FLEECE PULLOVERS, IN CLASS 25 (U.S. CLS. 22 AND 39).

FIRST USE 11-23-2007; IN COMMERCE 11-23-2007.

THE MARK CONSISTS OF STANDARD CHARACTERS WITHOUT CLAIM TO ANY PARTICULAR FONT, STYLE, SIZE, OR COLOR.

SER. NO. 77-335,960, FILED 11-23-2007.

KIMBERLY FRYE, EXAMINING ATTORNEY

Int. Cl.: 18

Prior U.S. Cls.: 1, 2, 3, 22 and 41

United States Patent and Trademark Office

Reg. No. 3,519,382

Registered Oct. 21, 2008

**TRADEMARK
PRINCIPAL REGISTER**



MONICA RICH KOSANN PHOTOGRAPHY LLC
(CONNECTICUT LIMITED LIABILITY COM-
PANY)
97 DOGWOOD LANE
NEW CANAAN, CT 06840

FIRST USE 9-1-2006; IN COMMERCE 9-1-2006.

THE MARK CONSISTS OF THE LETTER "M".

FOR: HANDBAGS, CLUTCHES, EVENING BAGS,
AND PURSES MADE FROM PRECIOUS METALS
OR COATED THEREWITH, IN CLASS 18 (U.S. CLS.
1, 2, 3, 22 AND 41).

SER. NO. 77-336,829, FILED 11-26-2007.

STEPHANIE ALI, EXAMINING ATTORNEY

Int. Cl.: 35

Prior U.S. Cls.: 100, 101 and 102

United States Patent and Trademark Office

Reg. No. 3,519,383

Registered Oct. 21, 2008

**SERVICE MARK
PRINCIPAL REGISTER**

MYWORKVISA.US

MYWORKVISA.US, INC (NEVADA CORPORATION)
SUITE 102-103
2200 WILSON BLVD
ARLINGTON, VA 22201

FOR: PROVIDING A WEBSITE FEATURING EMPLOYMENT ADVERTISEMENTS, ADVERTISING AND SALES OF JOB VACANCIES TARGETED AT INDIVIDUALS HOLDING OR SEEKING WORK VISAS, IN CLASS 35 (U.S. CLS. 100, 101 AND 102).

FIRST USE 5-1-2007; IN COMMERCE 6-28-2007.

THE MARK CONSISTS OF STANDARD CHARACTERS WITHOUT CLAIM TO ANY PARTICULAR FONT, STYLE, SIZE, OR COLOR.

NO CLAIM IS MADE TO THE EXCLUSIVE RIGHT TO USE "VISA", APART FROM THE MARK AS SHOWN.

SER. NO. 77-337,210, FILED 11-26-2007.

DAVID C. REIHNER, EXAMINING ATTORNEY

Int. Cl.: 41

Prior U.S. Cls.: 100, 101 and 107

United States Patent and Trademark Office

Reg. No. 3,519,384

Registered Oct. 21, 2008

**SERVICE MARK
PRINCIPAL REGISTER**

CAGEPOTATO

CHICKIP, LLC (DELAWARE LIMITED LIABILITY COMPANY)
SUITE 225
8750 WILSHIRE BLVD.
BEVERLY HILLS, CA 90211

FOR: PROVIDING A WEBSITE FEATURING INFORMATION ABOUT MIXED MARTIAL ARTS; ON-LINE JOURNALS, NAMELY, BLOGS FEATURING INFORMATION ABOUT MIXED MARTIAL ARTS, IN CLASS 41 (U.S. CLS. 100, 101 AND 107).

FIRST USE 10-0-2007; IN COMMERCE 10-0-2007.

THE MARK CONSISTS OF STANDARD CHARACTERS WITHOUT CLAIM TO ANY PARTICULAR FONT, STYLE, SIZE, OR COLOR.

SER. NO. 77-337,485, FILED 11-27-2007.

STEVEN R. FOSTER, EXAMINING ATTORNEY

Int. Cls.: 36 and 42

Prior U.S. Cls.: 100, 101 and 102

United States Patent and Trademark Office

Reg. No. 3,519,385

Registered Oct. 21, 2008

**SERVICE MARK
PRINCIPAL REGISTER**

**CONNAUGHT REAL ESTATE
FINANCE LLC**

CONNAUGHT REAL ESTATE FINANCE LLC
(DELAWARE LIMITED LIABILITY COMPAN-
NY)
222 N. LASALLE STREET
CHICAGO, IL 60601

FOR: FINANCIAL SERVICES, NAMELY, HEDGE
FUND MANAGEMENT SERVICES; FINANCIAL
SERVICES, NAMELY, THE FACILITATING AND
ARRANGING OF FINANCING IN THE FIELD OF
REAL ESTATE, NAMELY, FINANCIAL REAL ES-
TATE CONSULTATION; REAL ESTATE MANAGE-
MENT, IN CLASS 36 (U.S. CLS. 100, 101 AND 102).

FIRST USE 9-1-2006; IN COMMERCE 9-1-2006.

FOR: APPLICATION SERVICE PROVIDER FEATURING
DATABASE MANAGEMENT SOFTWARE IN THE
FIELD OF REAL ESTATE FINANCE FOR

PURPOSES OF FACILITATING REAL ESTATE
TRANSACTIONS, IN CLASS 42 (U.S. CLS. 100 AND
101).

FIRST USE 11-0-2007; IN COMMERCE 11-0-2007.

THE MARK CONSISTS OF STANDARD CHAR-
ACTERS WITHOUT CLAIM TO ANY PARTICULAR
FONT, STYLE, SIZE, OR COLOR.

NO CLAIM IS MADE TO THE EXCLUSIVE
RIGHT TO USE "REAL ESTATE FINANCE LLC",
APART FROM THE MARK AS SHOWN.

SER. NO. 77-337,562, FILED 11-27-2007.

TRACY WHITTAKER-BROWN, EXAMINING AT-
TORNEY

Int. Cl.: 18

Prior U.S. Cls.: 1, 2, 3, 22 and 41

United States Patent and Trademark Office

Reg. No. 3,519,386

Registered Oct. 21, 2008

**TRADEMARK
PRINCIPAL REGISTER**

CHARMING GIRL BY CHUNMA

CHUNMA USA, INC. (CALIFORNIA CORPORATION)
2000 E. 25TH ST.
VERNON, CA 90058

THE MARK CONSISTS OF STANDARD CHARACTERS WITHOUT CLAIM TO ANY PARTICULAR FONT, STYLE, SIZE, OR COLOR.

FOR: HANDBAGS, TOTE BAGS, BACKPACKS, WALLET, LUGGAGE AND PURSES, IN CLASS 18 (U.S. CLS. 1, 2, 3, 22 AND 41).

SER. NO. 77-337,685, FILED 11-27-2007.

FIRST USE 9-1-2007; IN COMMERCE 10-15-2007.

JENNIFER MARTIN, EXAMINING ATTORNEY

Int. Cl.: 19

Prior U.S. Cls.: 1, 12, 33 and 50

United States Patent and Trademark Office

Reg. No. 3,519,387

Registered Oct. 21, 2008

**TRADEMARK
PRINCIPAL REGISTER**



EUROTEC M.F.G., INC. (CALIFORNIA CORPORATION)
84464 CABAZON CENTER DRIVE
INDIO, CA 92201

FOR: ASSEMBLY PANELS, NAMELY, WALL PANELS MADE FROM WOOD, MEDIUM DENSITY FIBERBOARD (MDF) OR HIGH DENSITY FIBERBOARD (HDF), IN CLASS 19 (U.S. CLS. 1, 12, 33 AND 50).

FIRST USE 4-29-2007; IN COMMERCE 8-2-2007.

THE MARK CONSISTS OF THE WORD "PANELMAX" WITH EACH LETTER CONTAINED IN THE OUTLINE OF A SQUARE WITH EACH SQUARE CONNECTED TO THE OTHER.

SER. NO. 77-338,052, FILED 11-27-2007.

FRED MANDIR, EXAMINING ATTORNEY

Int. Cl.: 35

Prior U.S. Cls.: 100, 101 and 102

United States Patent and Trademark Office

Reg. No. 3,519,388

Registered Oct. 21, 2008

**SERVICE MARK
PRINCIPAL REGISTER**

BackyardCity

VIMATA INTERACTIVE, INC. (TENNESSEE CORPORATION), DBA BACKYARDCITY
452 DISTRIBUTION DR.
COLLIERVILLE, TN 38017

FOR: ON-LINE RETAIL STORE SERVICES FEATURING A WIDE VARIETY OF CONSUMER GOODS OF OTHERS RELATED TO BACKYARD ENTERTAINMENT; ON-LINE RETAIL STORE SERVICES FEATURING IN-GROUND SWIMMING POOLS, ABOVE GROUND SWIMMING POOLS, SWIMMING POOL AND HOT TUB SUPPLIES, SWIMMING POOL AND HOT TUB EQUIPMENT AND SWIMMING POOL AND HOT TUB ACCESSORIES, POOL KITS, POOL SUPPLIES, POOL ACCESSORIES, CHILDREN'S POOLS, INFLATABLE POOLS, POOL COVERS, POOL EQUIPMENT, POOL CLEANERS, POOL FILTERS, POOL HEATERS, POOL PUMPS, POOL STEPS AND LADDERS, CHLORINE GENERATORS, POOL CHEMICALS AND FILTERS; POOL SLIDES, POOL FLOATS AND LOUNGES, POOL TOYS, POOL GAMES, POOL FOUNTAINS, POOL ALARMS; POND KITS, POND SUPPLIES, POND ACCESSORIES; ON-LINE RETAIL STORE SERVICES FEATURING A WIDE VARIETY OF CONSUMER GOODS OF OTHERS RELATED TO BACKYARD ENTERTAINMENT; KITS, SUPPLIES AND ACCESSORIES FOR GARDEN BUILDINGS, SHEDS AND STORAGE, GARDEN GAZEBOS, GREENHOUSES, OUTDOOR LIGHTING, LAND-

SCAPE LIGHTING, PATIO LANTERNS, GARDEN TORCHES, PATIO FURNITURE, OUTDOOR PATIO FURNITURE, OUTDOOR FURNITURE, PORCH SWINGS, HAMMOCKS, SHADES, AWNINGS, SHADE SAILS AND OUTDOOR UMBRELLAS, SWING SETS, PLAY YARDS, GAMES AND PLAYTHINGS, OUTDOOR PLAY EQUIPMENT, SWIMMING POOLS, HOT TUBS, FIREPLACES, FIRE PITS, FIRE RINGS, GAS GRILLS, PATIO HEATERS, RUGS, FANS, AND GARDEN DÉCOR; GENERAL CONSUMER MERCHANDISE; ON-LINE RETAIL DISCOUNT STORE SERVICES IN THE FIELD OF CONSUMER MERCHANDISE FOR USE ON PATIOS, PORCHES AND IN POOLS AND YARDS; COMPUTERIZED ON-LINE SERVICES FEATURING GENERAL OUTDOOR MERCHANDISE AND GENERAL OUTDOOR CONSUMER GOODS, IN CLASS 35 (U.S. CLS. 100, 101 AND 102).

FIRST USE 9-11-2001; IN COMMERCE 11-28-2001.

THE MARK CONSISTS OF STANDARD CHARACTERS WITHOUT CLAIM TO ANY PARTICULAR FONT, STYLE, SIZE, OR COLOR.

SER. NO. 77-338,057, FILED 11-27-2007.

MARY ROSSMAN, EXAMINING ATTORNEY

Int. Cl.: 36

Prior U.S. Cls.: 100, 101 and 102

United States Patent and Trademark Office

Reg. No. 3,519,389

Registered Oct. 21, 2008

**SERVICE MARK
PRINCIPAL REGISTER**

Madison & Park

MADISON & PARK, INC. (COLORADO CORPORATION)
818 GARFIELD STREET
DENVER, CO 80206

THE MARK CONSISTS OF STANDARD CHARACTERS WITHOUT CLAIM TO ANY PARTICULAR FONT, STYLE, SIZE, OR COLOR.

FOR: REAL ESTATE BROKERAGE, IN CLASS 36 (U.S. CLS. 100, 101 AND 102).

SER. NO. 77-338,215, FILED 11-27-2007.

FIRST USE 11-1-2007; IN COMMERCE 11-1-2007.

KATINA MISTER, EXAMINING ATTORNEY

Int. Cl.: 30

Prior U.S. Cl.: 46

United States Patent and Trademark Office

Reg. No. 3,519,390

Registered Oct. 21, 2008

**TRADEMARK
PRINCIPAL REGISTER**

NUTRISYSTEM

NUTRI/SYSTEM IPHC, INC. (DELAWARE CORPORATION)
SUITE 1704
300 DELAWARE AVE
WILMINGTON, DE 19801

FOR: MILKSHAKES, PUDDINGS; BREAKFAST, LUNCH, DINNER ENTREES, SNACKS AND DESERTS, NAMELY, CEREALS; CEREAL BARS, NAMELY, READY TO EAT, CEREAL DERIVED FOOD BARS, MUFFINS, BREADS, DESSERT BARS, NAMELY, BROWNIES, COFFEE FLAVORED DESSERT BARS, CHOCOLATE CRUNCH BARS, PEANUT BUTTER, CARAMEL AND MINT CHEWY CHOCOLATE BARS, FRUIT BARS, NUT BARS, RICE, SAUCES, NAMELY, SALSAS AND TOMATO SAUCES, GRAVIES, SALAD DRESSINGS, FROZEN BARS AND ICES, NAMELY, FUDGE BARS, FRO-

ZEN CONFECTIONS AND ICE POPS, FOOD BEVERAGES WITH A COFFEE, TEA OR COCOA BASE, NAMELY, COFFEE BASED BEVERAGES CONTAINING MILK, COCOA BASED BEVERAGES CONTAINING MILK, ICED TEAS, IN CLASS 30 (U.S. CL. 46).

FIRST USE 7-0-1989; IN COMMERCE 7-0-1989.

THE MARK CONSISTS OF STANDARD CHARACTERS WITHOUT CLAIM TO ANY PARTICULAR FONT, STYLE, SIZE, OR COLOR.

SER. NO. 77-338,865, FILED 11-28-2007.

BRIAN NEVILLE, EXAMINING ATTORNEY

Int. Cl.: 32

Prior U.S. Cls.: 45, 46 and 48

Reg. No. 3,519,391

United States Patent and Trademark Office

Registered Oct. 21, 2008

**TRADEMARK
PRINCIPAL REGISTER**

NUTRISYSTEM

NUTRI/SYSTEM IPHC, INC. (DELAWARE CORPORATION)
SUITE 1704
300 DELAWARE AVE
WILMINGTON, DE 19801

FOR: FRUIT DRINKS, FRUIT JUICES, AND OTHER PREPARATIONS, NAMELY, POWDER MIXES FOR MAKING LEMONADE AND CITRUS FLAVORED DRINKS, AND ORANGEADE, IN CLASS 32 (U.S. CLS. 45, 46 AND 48).

FIRST USE 5-0-1986; IN COMMERCE 5-0-1986.

THE MARK CONSISTS OF STANDARD CHARACTERS WITHOUT CLAIM TO ANY PARTICULAR FONT, STYLE, SIZE, OR COLOR.

SER. NO. 77-338,892, FILED 11-28-2007.

BRIAN NEVILLE, EXAMINING ATTORNEY

Int. Cl.: 35

Prior U.S. Cls.: 100, 101 and 102

United States Patent and Trademark Office

Reg. No. 3,519,392

Registered Oct. 21, 2008

**SERVICE MARK
PRINCIPAL REGISTER**



SAVORY CHEF, LLC (OKLAHOMA LIMITED LIABILITY COMPANY)
8283 SOUTH MEMORIAL
TULSA, OK 74133

FOR: RETAIL AND ON-LINE STORE SERVICES FEATURING CULINARY EQUIPMENT, COOKWARE, BAKEWARE, CUTLERY, KITCHEN GADGETS, UTENSILS, DINNERWARE, TABLEWARE, GLASSWARE, FLATWARE, SERVING TRAYS, CERAMIC ELECTRIC KITCHEN APPLIANCES, COOKBOOKS, RECIPES, GOURMET FOODS, MEAT, SAUCES, PREPARED FOOD MIXES, MIXES FOR BAKING GOODS, SOUP MIXES, SEASONING MIXES, DRINK MIXES, SAUCE MIXES, HOUSEWARES, INDOOR AND OUTDOOR FURNITURE, RUGS, LAMPS AND LIGHTING FIXTURES, CLOCKS, CANDLES AND CANDLE HOLDERS, CURTAINS, TABLE LINENS, KITCHEN TOWELS, BASKETS, BROOMS, BRUSHES AND DUSTERS FOR CLEANING, BARBECUES AND BARBECUE ACCESSORIES, PICNIC ACCESSORIES, SOAPS AND HAND CREAMS, IN CLASS 35 (U.S. CLS. 100, 101 AND 102).

FIRST USE 7-21-2004; IN COMMERCE 7-21-2004.

NO CLAIM IS MADE TO THE EXCLUSIVE RIGHT TO USE "CHEF" "COOKING SOLUTIONS" AND "FOOD", APART FROM THE MARK AS SHOWN.

THE MARK CONSISTS OF TWO CONCENTRIC CIRCLES; THE INNER CIRCLE CONTAINING A SHAKER, LADLE, STOCK PAN WITH STEAM ABOVE IT, TOMATO AND MUSHROOM; A HORIZONTAL BANNER BETWEEN THE CONCENTRIC CIRCLES WITH THE WORDING "FOOD" ON ONE SIDE OF THE CIRCLE AND "ARTS" ON THE OTHER; AND THE WORDING "COOKING SOLUTIONS" CONTOURED WITHIN THE TOP PORTION OF THE CONCENTRIC CIRCLES, AND THE WORDING "SAVORY CHEF" ON THE BOTTOM PORTION.

SER. NO. 77-339,238, FILED 11-28-2007.

PAULA MAHONEY, EXAMINING ATTORNEY

Int. Cl.: 39

Prior U.S. Cls.: 100 and 105

United States Patent and Trademark Office

Reg. No. 3,519,393

Registered Oct. 21, 2008

**SERVICE MARK
PRINCIPAL REGISTER**

**MCCARTNEY PRODUCE FRESH
FRUITS & VEGETABLES**

IF&P FOODS, INC. (INDIANA CORPORATION)
5941 WEST 82ND STREET
INDIANAPOLIS, IN 46268

FOR: DISTRIBUTION SERVICES, NAMELY, DELIVERY OF FRESH FRUITS AND FRESH VEGETABLES, IN CLASS 39 (U.S. CLS. 100 AND 105).

FIRST USE 0-0-1975; IN COMMERCE 0-0-1975.

THE MARK CONSISTS OF STANDARD CHARACTERS WITHOUT CLAIM TO ANY PARTICULAR FONT, STYLE, SIZE, OR COLOR.

NO CLAIM IS MADE TO THE EXCLUSIVE RIGHT TO USE "PRODUCE FRESH FRUITS & VEGETABLES", APART FROM THE MARK AS SHOWN.

SEC. 2(F).

SER. NO. 77-339,685, FILED 11-29-2007.

JIM RINGLE, EXAMINING ATTORNEY

Int. Cl.: 35

Prior U.S. Cls.: 100, 101 and 102

United States Patent and Trademark Office

Reg. No. 3,519,394

Registered Oct. 21, 2008

**SERVICE MARK
PRINCIPAL REGISTER**

CONNEXION FROM TANDUS

TANDUS US INC. (DELAWARE CORPORATION)
311 SMITH INDUSTRIAL BOULEVARD
DALTON, GA 30721

FOR: BUSINESS CONSULTING SERVICES,
NAMELY, PROVIDING INFORMATION, ADVICE
AND ASSISTANCE TO CUSTOMERS IN THE CAR-
PET AND FLOOR COVERING INDUSTRIES RELA-
TED TO PRODUCT DISTRIBUTION, OPERATIONS
MANAGEMENT SERVICES, LOGISTICS, REVERSE
LOGISTICS, SUPPLY CHAIN, AND PRODUCTION
SYSTEMS AND DISTRIBUTION SOLUTIONS, IN
CLASS 35 (U.S. CLS. 100, 101 AND 102).

FIRST USE 3-9-2006; IN COMMERCE 3-9-2006.

THE MARK CONSISTS OF STANDARD CHAR-
ACTERS WITHOUT CLAIM TO ANY PARTICULAR
FONT, STYLE, SIZE, OR COLOR.

OWNER OF U.S. REG. NOS. 2,672,859, 2,832,384
AND OTHERS.

SER. NO. 77-339,739, FILED 11-29-2007.

DOMINICK J. SALEMI, EXAMINING ATTORNEY

Int. Cl.: 37

Prior U.S. Cls.: 100, 103 and 106

United States Patent and Trademark Office

Reg. No. 3,519,395

Registered Oct. 21, 2008

**SERVICE MARK
PRINCIPAL REGISTER**

New Era Homes

NEW ERA HOMES, LLC (OREGON LIMITED
LIABILITY COMPANY)
18475 PINEHURST RD.
BEND, OR 97701

FOR: HOUSING SERVICES, NAMELY, DEVELOPMENT OF REAL PROPERTY, NAMELY, IMPROVEMENT, AND NEW CONSTRUCTION; HOUSING SERVICES, NAMELY, IMPROVEMENT, AND CONSTRUCTION OF RESIDENTIAL REAL PROPERTY; BUILDING CONSTRUCTION SERVICES, IN CLASS 37 (U.S. CLS. 100, 103 AND 106).

FIRST USE 2-12-2007; IN COMMERCE 6-15-2007.

THE MARK CONSISTS OF STANDARD CHARACTERS WITHOUT CLAIM TO ANY PARTICULAR FONT, STYLE, SIZE, OR COLOR.

NO CLAIM IS MADE TO THE EXCLUSIVE RIGHT TO USE "HOMES", APART FROM THE MARK AS SHOWN.

SER. NO. 77-340,237, FILED 11-29-2007.

DAVID COLLIER, EXAMINING ATTORNEY

Int. Cl.: 41

Prior U.S. Cls.: 100, 101 and 107

United States Patent and Trademark Office

Reg. No. 3,519,396

Registered Oct. 21, 2008

**SERVICE MARK
PRINCIPAL REGISTER**



**COVENANT
COLLEGE**

COVENANT COLLEGE, INC. (GEORGIA CORPORATION)

14049 SCENIC HIGHWAY

LOOKOUT MOUNTAIN, GA 30750

FOR: EDUCATIONAL SERVICES, NAMELY, PROVIDING COURSES OF INSTRUCTION AT THE COLLEGE AND GRADUATE LEVEL, IN CLASS 41 (U.S. CLS. 100, 101 AND 107).

FIRST USE 6-15-2004; IN COMMERCE 6-15-2004.

NO CLAIM IS MADE TO THE EXCLUSIVE RIGHT TO USE "COLLEGE", APART FROM THE MARK AS SHOWN.

THE COLOR(S) DARK BLUE, LIGHT BLUE AND WHITE IS/ARE CLAIMED AS A FEATURE OF THE MARK.

THE MARK CONSISTS OF A DARK BLUE SHIELD WITH A SCOTTISH THISTLE IN WHITE DISPOSED IN THE MIDDLE LEFT OF THE SHIELD SYMBOL AND LIGHT BLUE DIAGONAL STRIPES ON THE RIGHT SIDE OF THE SHIELD WITH THE WORDS "COVENANT COLLEGE" ON TWO SEPARATE LINES BELOW THE SHIELD.

SER. NO. 77-340,447, FILED 11-29-2007.

KATHERINE CONNOLLY, EXAMINING ATTORNEY

Int. Cl.: 35

Prior U.S. Cls.: 100, 101 and 102

United States Patent and Trademark Office

Reg. No. 3,519,397

Registered Oct. 21, 2008

**SERVICE MARK
PRINCIPAL REGISTER**



WHOLE PET CENTRAL, INC. (MARYLAND CORPORATION)
209 AMMUNITION DRIVE
ODENTON, MD 21113

NO CLAIM IS MADE TO THE EXCLUSIVE RIGHT TO USE "PET", APART FROM THE MARK AS SHOWN.

FOR: RETAIL STORE SERVICES FEATURING PET FOOD, PET SUPPLEMENTS AND PET PRODUCTS, IN CLASS 35 (U.S. CLS. 100, 101 AND 102).

SER. NO. 77-340,501, FILED 11-29-2007.

FIRST USE 4-4-2007; IN COMMERCE 5-15-2007.

PAULA MAHONEY, EXAMINING ATTORNEY

Int. Cl.: 12

Prior U.S. Cls.: 19, 21, 23, 31, 35 and 44

United States Patent and Trademark Office

Reg. No. 3,519,398

Registered Oct. 21, 2008

**TRADEMARK
PRINCIPAL REGISTER**

Surfhunter

HUNT YACHTS, INC. (MASSACHUSETTS CORPORATION)
1909 ALDEN LANDING
PORTSMOUTH, RI 02871

THE MARK CONSISTS OF STANDARD CHARACTERS WITHOUT CLAIM TO ANY PARTICULAR FONT, STYLE, SIZE, OR COLOR.

FOR: PERSONAL JET BOATS; RECREATIONAL JET BOATS; BOATS AND STRUCTURAL PARTS THEREFOR, IN CLASS 12 (U.S. CLS. 19, 21, 23, 31, 35 AND 44).

SER. NO. 77-340,755, FILED 11-30-2007.

FIRST USE 9-19-1968; IN COMMERCE 8-8-1975.

WILLIAM VERHOSEK, EXAMINING ATTORNEY

Int. Cl.: 33

Prior U.S. Cls.: 47 and 49

United States Patent and Trademark Office

Reg. No. 3,519,399

Registered Oct. 21, 2008

**TRADEMARK
PRINCIPAL REGISTER**

RIDGECREST

CHEHALEM, INC. (OREGON CORPORATION)
31190 NE VERITAS LANE
NEWBERG, OR 97132

THE MARK CONSISTS OF STANDARD CHAR-
ACTERS WITHOUT CLAIM TO ANY PARTICULAR
FONT, STYLE, SIZE, OR COLOR.

FOR: WINE, IN CLASS 33 (U.S. CLS. 47 AND 49).

SER. NO. 77-340,896, FILED 11-30-2007.

FIRST USE 12-1-1992; IN COMMERCE 12-1-1992.

MICHAEL TANNER, EXAMINING ATTORNEY

Int. Cl.: 6

Prior U.S. Cls.: 2, 12, 13, 14, 23, 25 and 50

Reg. No. 3,519,400

United States Patent and Trademark Office

Registered Oct. 21, 2008

**TRADEMARK
PRINCIPAL REGISTER**

Crazy Daisies

FAIFERLICK, LARRY R. (UNITED STATES IN-
DIVIDUAL)
8401 N 70TH
LINCOLN, NE 68517

THE MARK CONSISTS OF STANDARD CHAR-
ACTERS WITHOUT CLAIM TO ANY PARTICULAR
FONT, STYLE, SIZE, OR COLOR.

FOR: WROUGHT IRON DECORATIVE ART-
WORK, IN CLASS 6 (U.S. CLS. 2, 12, 13, 14, 23, 25
AND 50).

SER. NO. 77-341,390, FILED 11-30-2007.

FIRST USE 9-1-2006; IN COMMERCE 9-1-2006.

SOPHIA S. KIM, EXAMINING ATTORNEY

Int. Cls.: 36 and 37

Prior U.S. Cls.: 100, 101, 102, 103 and 106

United States Patent and Trademark Office

Reg. No. 3,519,401

Registered Oct. 21, 2008

**SERVICE MARK
PRINCIPAL REGISTER**



LOESS HILLS LODGE, LLC (IOWA LIMITED
LIABILITY COMPANY)
4909 PORTRAITS PLACE
LAS VEGAS, NV 89149

FOR: REAL ESTATE MANAGEMENT, IN CLASS
36 (U.S. CLS. 100, 101 AND 102).

FIRST USE 10-1-2006; IN COMMERCE 3-1-2007.

FOR: REAL ESTATE DEVELOPMENT, IN CLASS
37 (U.S. CLS. 100, 103 AND 106).

FIRST USE 10-1-2006; IN COMMERCE 3-1-2007.

NO CLAIM IS MADE TO THE EXCLUSIVE
RIGHT TO USE "LOESS HILLS LODGE", APART
FROM THE MARK AS SHOWN.

THE COLOR(S) MAROON IS/ARE CLAIMED AS
A FEATURE OF THE MARK.

THE MARK CONSISTS OF THREE ABSTRACT
DRAWINGS OF TREES IN A MAROON HUE WITH
THE NAME "LOESS HILLS LODGE" UNDER-
NEATH.

SER. NO. 77-341,396, FILED 11-30-2007.

SOPHIA S. KIM, EXAMINING ATTORNEY

Int. Cl.: 35

Prior U.S. Cls.: 100, 101 and 102

United States Patent and Trademark Office

Reg. No. 3,519,402

Registered Oct. 21, 2008

**SERVICE MARK
PRINCIPAL REGISTER**

DJ Ambassador

IMPACT MARKETING & PROMOTIONS (CALIFORNIA CORPORATION)
19236 CAMMIE LANE
TARZANA, CA 91356

FOR: ADVERTISING SERVICES, NAMELY, PROMOTING AND MARKETING THE GOODS AND SERVICES OF OTHERS THROUGH ALL PUBLIC COMMUNICATION MEANS, IN CLASS 35 (U.S. CLS. 100, 101 AND 102).

FIRST USE 6-1-2005; IN COMMERCE 6-1-2005.

THE MARK CONSISTS OF STANDARD CHARACTERS WITHOUT CLAIM TO ANY PARTICULAR FONT, STYLE, SIZE, OR COLOR.

NO CLAIM IS MADE TO THE EXCLUSIVE RIGHT TO USE "DJ", APART FROM THE MARK AS SHOWN.

SER. NO. 77-341,588, FILED 11-30-2007.

PAUL MORENO, EXAMINING ATTORNEY

Int. Cl.: 7

Prior U.S. Cls.: 13, 19, 21, 23, 31, 34 and 35

United States Patent and Trademark Office

Reg. No. 3,519,403

Registered Oct. 21, 2008

**TRADEMARK
PRINCIPAL REGISTER**

Stairs Made Easy

INNOVATIVE LIFTS, INC (MARYLAND CORPORATION)

8338 VETERANS HWY SUITE 101B

MILLERSVILLE, MD 21108

FOR: STAIR LIFTS, IN CLASS 7 (U.S. CLS. 13, 19, 21, 23, 31, 34 AND 35).

FIRST USE 1-20-2006; IN COMMERCE 7-10-2006.

THE MARK CONSISTS OF STANDARD CHARACTERS WITHOUT CLAIM TO ANY PARTICULAR FONT, STYLE, SIZE, OR COLOR.

NO CLAIM IS MADE TO THE EXCLUSIVE RIGHT TO USE "STAIRS", APART FROM THE MARK AS SHOWN.

SER. NO. 77-341,825, FILED S.R. 12-1-2007 AM. P.R. 6-30-2008.

ELISSA GARBER KON, EXAMINING ATTORNEY

Int. Cl.: 44

Prior U.S. Cls.: 100 and 101

United States Patent and Trademark Office

Reg. No. 3,519,404

Registered Oct. 21, 2008

**SERVICE MARK
PRINCIPAL REGISTER**



MEDIMIN, INC. (NEVADA CORPORATION)
PMB 1
17750 W. ELLIOT ROAD
GOODYEAR, AZ 85338

FOR: MEDICAL CLINIC AND HEALTHCARE SERVICES FEATURING NON-EMERGENCY, WALK-IN MEDICAL DIAGNOSTIC AND TREATMENT SERVICES IN CONVENIENT LOCATIONS, IN CLASS 44 (U.S. CLS. 100 AND 101).

FIRST USE 4-1-2007; IN COMMERCE 5-1-2007.

OWNER OF U.S. REG. NO. 3,392,942.

NO CLAIM IS MADE TO THE EXCLUSIVE RIGHT TO USE "CONVENIENT MEDICAL CARE", APART FROM THE MARK AS SHOWN.

THE COLOR(S) BLUE, WHITE AND GREEN IS/ ARE CLAIMED AS A FEATURE OF THE MARK.

THE COLOR(S) GREEN APPEARS IN THE MEDICAL CROSS AND THE TEXTUAL COMPONENT "MIN," THE COLOR WHITE APPEARS AS THE CLOCK HANDS DISPLAYED IN THE MEDICAL CROSS, AND THE COLOR BLUE APPEARS IN THE INCOMPLETE CIRCLE DESIGN AS WELL AS THE TEXTUAL COMPONENT "MED" AND THE TEXT "CONVENIENT MEDICAL CARE".

SER. NO. 77-342,402, FILED 12-3-2007.

RONALD AIKENS, EXAMINING ATTORNEY

Int. Cl.: 43

Prior U.S. Cls.: 100 and 101

United States Patent and Trademark Office

Reg. No. 3,519,405

Registered Oct. 21, 2008

SERVICE MARK
PRINCIPAL REGISTER



ARMADILLO PALACE, L.P. (TEXAS LIMITED PARTNERSHIP)
STE. 1
2422 BARTLETT ST.
HOUSTON, TX 77098

FOR: BAR AND RESTAURANT SERVICES, IN CLASS 43 (U.S. CLS. 100 AND 101).

FIRST USE 4-25-2005; IN COMMERCE 4-25-2005.

NO CLAIM IS MADE TO THE EXCLUSIVE RIGHT TO USE "PALACE", APART FROM THE MARK AS SHOWN.

THE STIPPLING IS FOR SHADING PURPOSES ONLY.

THE COLOR(S) YELLOW, DARK BLUE, LIGHT BLUE, RED, PINK, ORANGE, WHITE, BLACK, BROWN, TAN, GREEN AND CREAM IS/ARE CLAIMED AS A FEATURE OF THE MARK.

THE MARK CONSISTS OF "ARMADILLO" IN STYLIZED LETTERS HAVING THE COLOR YELLOW AT THE UPPER PORTION, THE COLOR GREEN IN THE MIDDLE PORTION, AND THE COLOR BLUE ON THE LOWER PORTION, FURTHER OUTLINED IN THE COLORS RED AND WHITE AND WITH SHADOWS IN THE COLOR BLACK, ON A BACKGROUND OF THE COLOR GREEN WHICH IS FURTHER OUTLINED IN THE COLOR YELLOW, FURTHER OUTLINED IN THE COLOR RED, FURTHER OUTLINED IN THE COLOR YELLOW, FURTHER OUTLINED IN THE COL-

OR BLUE; WITH THE STYLIZED REPRESENTATION OF AN ARMADILLO ON THE UPPER LEFT CORNER HAVING COLORS OF BROWN, CREAM, BLACK, WHITE AND ORANGE, OUTLINED IN BLUE; WITH "GOODE'S" APPEARING ON THE TOP CENTER OF THE MARK WITH STYLIZED LETTERS IN THE COLORS RED ON THE UPPER PORTION AND ORANGE ON THE LOWER PORTION, FURTHER OUTLINED IN THE COLOR BLUE; JUST TO THE RIGHT OF THE ARMADILLO'S NOSE IS A REPRESENTATION OF A CACTUS PLANT IN THE COLOR GREEN BEARING FLOWER BUDS IN THE COLORS RED AND CREAM AND A FLOWER IN THE COLORS RED, PINK, YELLOW, WHITE AND BLUE, OUTLINED IN YELLOW, WITH A BACKGROUND IN THE COLOR YELLOW WITH RADIATING LINES IN THE COLOR ORANGE; A FLAG POLE IN THE COLOR ORANGE AND CREAM AND WITH TASSELS IN THE COLORS ORANGE AND YELLOW; AND FINALLY, ON THE LOWER RIGHT OF THE MARK, "PALACE" IN STYLIZED LETTERS BEING BLUE OUTLINED IN THE COLORS WHITE AND RED, WITH SHADOWS IN THE COLOR BLUE, ON A BACKGROUND IN THE COLORS YELLOW AND ORANGE, WITH SMALL CIRCLES IN THE COLORS CREAM AND BLUE UNDERSCORING, AND A STAR ABOVE, THE STAR BEING IN THE COLORS CREAM, ORANGE, YELLOW AND RED, OUTLINED IN THE COLOR BLUE.

SER. NO. 77-342,763, FILED 12-3-2007.

KAELIE KUNG, EXAMINING ATTORNEY

Int. Cl.: 36

Prior U.S. Cls.: 100, 101 and 102

United States Patent and Trademark Office

Reg. No. 3,519,406

Registered Oct. 21, 2008

**SERVICE MARK
PRINCIPAL REGISTER**

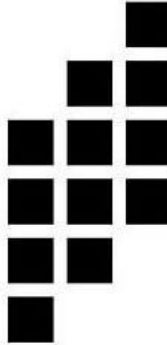

REIS SERVICES, LLC (MARYLAND LIMITED
LIABILITY COMPANY)
5TH FLOOR
530 FIFTH AVENUE
NEW YORK, NY 10036

FOR: ADVICE RELATING TO INVESTMENTS; AGENCIES FOR BROKERAGE OF SECURITIES TRADING IN OVERSEAS SECURITIES MARKETS AND OF TRANSACTIONS ON COMMISSION OF OVERSEAS MARKET SECURITIES FUTURES; AGENCIES OR BROKERAGE FOR LEASING OR RENTING OF LAND; AGENCIES OR BROKERAGE FOR RENTING OF BUILDINGS; APPRAISAL OF REAL ESTATE; APPRAISALS FOR INSURANCE CLAIMS OF PERSONAL PROPERTY; APPRAISALS FOR INSURANCE CLAIMS OF REAL ESTATE; ASSESSMENT AND MANAGEMENT OF REAL ESTATE; CAPITAL INVESTMENT CONSULTATION; CAPITAL INVESTMENT SERVICES; EQUITY CAPITAL INVESTMENT; EVALUATION OF REAL PROPERTY; FINANCIAL ADVICE; FINANCIAL ADVICE AND CONSULTANCY SERVICES; FINANCIAL ADVISORY AND CONSULTANCY SERVICES; FINANCIAL ANALYSIS AND CONSULTATION; FINANCIAL ANALYSIS AND RESEARCH SERVICES; FINANCIAL CONSULTANCY; FINANCIAL CONSULTATION; FINANCIAL CONSULTATION IN THE FIELD OF REAL ESTATE; FINANCIAL CONSULTING; FINANCIAL DUE DILIGENCE; FINANCIAL INFORMATION AND ADVISORY SERVICES; FINANCIAL INFORMATION AND EVALUATIONS; FINANCIAL INFORMATION PROVIDED BY ELECTRONIC MEANS; FINANCIAL PLANNING AND INVESTMENT ADVISORY SER-

VICES; FINANCIAL PORTFOLIO ANALYSIS SERVICES; FINANCIAL SERVICES, NAMELY, MORTGAGE PLANNING; FINANCIAL VALUATION OF PERSONAL PROPERTY AND REAL ESTATE; FISCAL ASSESSMENT AND EVALUATION; FISCAL VALUATIONS AND ASSESSMENTS; HOME APPRAISAL SERVICES; INSURANCE AND FINANCIAL INFORMATION AND CONSULTANCY SERVICES; INVESTMENT ADVICE; INVESTMENT ADVISORY SERVICES; INVESTMENT CONSULTATION; LAND ACQUISITION, NAMELY, REAL ESTATE BROKERAGE; LAND VALUATION; NEWS REPORTING SERVICES IN THE FIELD OF FINANCIAL NEWS; ONLINE FINANCIAL PLANNING SERVICES; PRIVATE EQUITY FUND INVESTMENT SERVICES; PROVIDING A WEB SITE THAT ASSISTS FINANCIAL PROFESSIONALS IN THE MANAGEMENT OF RETIREMENT ACCOUNTS; PROVIDING A WEB SITE WHERE USERS CAN POST RATINGS, REVIEWS AND RECOMMENDATIONS ON STOCKS, BONDS, MUTUAL FUNDS AND OTHER FINANCIAL INSTRUMENTS; PROVIDING A WEBSITE THAT FEATURES INFORMATION ON THE OPTIONS MARKETS; PROVIDING FINANCIAL INFORMATION; PROVIDING INFORMATION AND ADVICE IN THE FIELD OF FINANCE, FINANCIAL INVESTMENTS, FINANCIAL VALUATIONS, AND THE FINANCIAL ASPECTS OF RETIREMENT; PROVIDING INFORMATION IN INSURANCE MATTERS; PROVIDING INFORMATION IN THE FIELD OF REAL ESTATE BY MEANS OF LINKING THE WEB SITE TO OTHER WEB SITES FEATURING REAL ESTATE INFORMATION; PROVIDING INFORMATION IN THE FIELD OF REAL ESTATE VIA THE INTERNET; PROVIDING INFORMATION VIA A GLOBAL COMPUTER NETWORK

ON THE SUBJECT OF NON-RESIDENTIAL BUILDING AND FACILITIES MANAGEMENT; PROVIDING ON-LINE NEWS IN THE FIELD OF FINANCE; PROVIDING REAL ESTATE LISTINGS AND REAL ESTATE INFORMATION VIA THE INTERNET; PROVISION OF FINANCIAL INFORMATION; PUBLIC EQUITY INVESTMENT MANAGEMENT; REAL ESTATE ACQUISITION SERVICES; REAL ESTATE APPRAISAL; REAL ESTATE APPRAISAL AND VALUATION; REAL ESTATE CONSULTANCY; REAL ESTATE CONSULTATION; REAL ESTATE INVESTMENT; REAL ESTATE LISTING; REAL ESTATE

VALUATION SERVICES; REAL ESTATE VALUATIONS, IN CLASS 36 (U.S. CLS. 100, 101 AND 102).

FIRST USE 3-14-2005; IN COMMERCE 3-14-2005.

THE MARK CONSISTS OF A SERIES OF SQUARES.

SER. NO. 77-343,048, FILED 12-3-2007.

JAMES A. RAUEN, EXAMINING ATTORNEY

Int. Cl.: 15

Prior U.S. Cls.: 2, 21 and 36

United States Patent and Trademark Office

Reg. No. 3,519,407

Registered Oct. 21, 2008

**TRADEMARK
PRINCIPAL REGISTER**

**Gaston Brohan's
OAK BASS ROSIN**

GREGORIAN, ARNOLD J. (UNITED STATES
INDIVIDUAL)

109 CENTRAL AVENUE PO BOX 3618

GLYNDON, MD 21071 AND

GREGORIAN, JULIE A. (UNITED STATES INDIVI-
DUAL)

109 CENTRAL AVENUE PO BOX 3618

GLYNDON, MD 21071

FOR: ROSIN FOR STRINGED MUSICAL IN-
STRUMENTS, IN CLASS 15 (U.S. CLS. 2, 21 AND 36).

FIRST USE 4-1-2004; IN COMMERCE 5-1-2004.

THE MARK CONSISTS OF STANDARD CHAR-
ACTERS WITHOUT CLAIM TO ANY PARTICULAR
FONT, STYLE, SIZE, OR COLOR.

NO CLAIM IS MADE TO THE EXCLUSIVE
RIGHT TO USE "OAK BASS ROSIN", APART FROM
THE MARK AS SHOWN.

THE NAME(S), PORTRAIT(S), AND/OR SIGNA-
TURE(S) SHOWN IN THE MARK DOES NOT IDENTI-
FY A PARTICULAR LIVING INDIVIDUAL.

SER. NO. 77-343,054, FILED 12-3-2007.

KATHLEEN LORENZO, EXAMINING ATTORNEY

Int. Cl.: 38

Prior U.S. Cls.: 100, 101 and 104

United States Patent and Trademark Office

Reg. No. 3,519,408

Registered Oct. 21, 2008

**SERVICE MARK
PRINCIPAL REGISTER**

Linked Senior

LINKED SENIOR LLC (D.C. LIMITED LIABILITY COMPANY)
1650 FOXHALL RD NW
WASHINGTON, DC 20007

FOR: MOBILE MEDIA SERVICES IN THE NATURE OF ELECTRONIC TRANSMISSION OF ENTERTAINMENT MEDIA CONTENT, IN CLASS 38 (U.S. CLS. 100, 101 AND 104).

FIRST USE 3-1-2007; IN COMMERCE 3-1-2007.

THE MARK CONSISTS OF STANDARD CHARACTERS WITHOUT CLAIM TO ANY PARTICULAR FONT, STYLE, SIZE, OR COLOR.

NO CLAIM IS MADE TO THE EXCLUSIVE RIGHT TO USE "SENIOR", APART FROM THE MARK AS SHOWN.

SER. NO. 77-343,066, FILED 12-3-2007.

TINA KUAN, EXAMINING ATTORNEY

Int. Cl.: 44

Prior U.S. Cls.: 100 and 101

United States Patent and Trademark Office

Reg. No. 3,519,409

Registered Oct. 21, 2008

**SERVICE MARK
PRINCIPAL REGISTER**

**EAT COOKIES. LOSE WEIGHT.
IT'S THAT SIMPLE.**

LAVI ENTERPRISES, LLC (FLORIDA LIMITED
LIABILITY COMPANY)
SUITE B-38
3350 NW BOCA RATON BLVD.
BOCA RATON, FL 33431

FOR: WEIGHT LOSS SERVICES, NAMELY, CON-
SULTING TO INDIVIDUALS AND COMMUNITIES
ENGAGED IN GROUP WEIGHT LOSS PROGRAMS,
IN CLASS 44 (U.S. CLS. 100 AND 101).

FIRST USE 11-8-2007; IN COMMERCE 11-8-2007.

THE MARK CONSISTS OF STANDARD CHAR-
ACTERS WITHOUT CLAIM TO ANY PARTICULAR
FONT, STYLE, SIZE, OR COLOR.

SER. NO. 77-344,389, FILED 12-5-2007.

CHRISTINE COOPER, EXAMINING ATTORNEY

Int. Cl.: 42

Prior U.S. Cls.: 100 and 101

United States Patent and Trademark Office

Reg. No. 3,519,410

Registered Oct. 21, 2008

**SERVICE MARK
PRINCIPAL REGISTER**

WeatherVista

WEATHERVISTA, LLC (NORTH CAROLINA
LIMITED LIABILITY COMPANY)
338 MCADOO AVE
GREENSBORO, NC 27406

FOR: PROVIDING WEATHER INFORMATION;
WEATHER FORECASTING; WEATHER INFORMA-
TION SERVICES; WEATHER REPORTING; ME-
TEOROLOGICAL FORECASTING; PROVIDING
METEOROLOGICAL INFORMATION, IN CLASS 42
(U.S. CLS. 100 AND 101).

FIRST USE 8-1-2005; IN COMMERCE 12-7-2007.

THE MARK CONSISTS OF STANDARD CHAR-
ACTERS WITHOUT CLAIM TO ANY PARTICULAR
FONT, STYLE, SIZE, OR COLOR.

SER. NO. 77-347,319, FILED 12-7-2007.

HENRY S. ZAK, EXAMINING ATTORNEY

Int. Cl.: 26

Prior U.S. Cls.: 37, 39, 40, 42 and 50

United States Patent and Trademark Office

Reg. No. 3,519,411

Registered Oct. 21, 2008

**TRADEMARK
PRINCIPAL REGISTER**

Hairline Illusions

BROWN-LAWSON, EGYPT P. (UNITED STATES
INDIVIDUAL)

352 7TH AVENUE

NEW YORK, NY 10001

FOR: HAIR PIECES AND WIGS, IN CLASS 26 (U.S.
CLS. 37, 39, 40, 42 AND 50).

FIRST USE 6-30-2004; IN COMMERCE 12-1-2007.

THE MARK CONSISTS OF STANDARD CHAR-
ACTERS WITHOUT CLAIM TO ANY PARTICULAR
FONT, STYLE, SIZE, OR COLOR.

NO CLAIM IS MADE TO THE EXCLUSIVE
RIGHT TO USE "HAIRLINE", APART FROM THE
MARK AS SHOWN.

SER. NO. 77-347,476, FILED 12-9-2007.

STEPHEN AQUILA, EXAMINING ATTORNEY

Int. Cl.: 25

Prior U.S. Cls.: 22 and 39

United States Patent and Trademark Office

Reg. No. 3,519,412

Registered Oct. 21, 2008

**TRADEMARK
PRINCIPAL REGISTER**



SHO SUM, INC. (GEORGIA CORPORATION)
809 KENDALL KNOLL WAY
MABLETON, GA 30126

THE MARK CONSISTS OF A STYLIZED LETTER
"S".

FOR: T-SHIRTS AND LONG-SLEEVE T-SHIRTS,
IN CLASS 25 (U.S. CLS. 22 AND 39).

SER. NO. 77-348,057, FILED 12-10-2007.

FIRST USE 1-0-2008; IN COMMERCE 1-0-2008.

FRANK LATTUCA, EXAMINING ATTORNEY

Int. Cl.: 28

Prior U.S. Cls.: 22, 23, 38 and 50

Reg. No. 3,519,413

United States Patent and Trademark Office

Registered Oct. 21, 2008

**TRADEMARK
PRINCIPAL REGISTER**

LTX

KGR OUTDOOR AND LEISURE PRODUCTS
(TEXAS CORPORATION)
20555 FM 1488
MAGNOLIA, TX 77355

FOR: FISHING RODS AND FISHING ROD ACCESSORIES, NAMELY, FISHING LINE, FISHING TACKLE, AND FISHING REELS, IN CLASS 28 (U.S. CLS. 22, 23, 38 AND 50).

FIRST USE 7-1-2005; IN COMMERCE 7-1-2005.

THE MARK CONSISTS OF STANDARD CHARACTERS WITHOUT CLAIM TO ANY PARTICULAR FONT, STYLE, SIZE, OR COLOR.

THE WORDING "LTX" HAS NO MEANING IN A FOREIGN LANGUAGE.

SER. NO. 77-348,170, FILED 12-10-2007.

SUSAN RICHARDS, EXAMINING ATTORNEY

Int. Cls.: 36 and 37

Prior U.S. Cls.: 100, 101, 102, 103 and 106

United States Patent and Trademark Office

Reg. No. 3,519,414

Registered Oct. 21, 2008

**SERVICE MARK
PRINCIPAL REGISTER**



RETAIL PROPERTY SOLUTIONS, LLC (GEORGIA LIMITED LIABILITY COMPANY)
2145 SPALDING DRIVE
ATLANTA, GA 30350

FOR: REAL ESTATE CONSULTATION; REAL ESTATE MANAGEMENT CONSULTATION; ASSESSMENT AND MANAGEMENT OF REAL ESTATE, IN CLASS 36 (U.S. CLS. 100, 101 AND 102).

FIRST USE 9-1-2005; IN COMMERCE 9-1-2005.

FOR: REAL ESTATE DEVELOPMENT SERVICES; REAL ESTATE SITE SELECTION SERVICES, IN CLASS 37 (U.S. CLS. 100, 103 AND 106).

FIRST USE 9-1-2005; IN COMMERCE 9-1-2005.

NO CLAIM IS MADE TO THE EXCLUSIVE RIGHT TO USE "RETAIL PROPERTY", APART FROM THE MARK AS SHOWN.

THE COLOR(S) LIGHT BLUE AND DARK BLUE IS/ARE CLAIMED AS A FEATURE OF THE MARK.

THE MARK CONSISTS OF THE WORDS "RETAIL PROPERTY" IN ALL CAPITAL LETTERS IN DARK BLUE WITH A DESIGN OF A PUZZLE IN LIGHT BLUE UNDERNEATH IT AND THE WORD "SOLUTIONS" IN DARK BLUE NEXT TO IT.

SER. NO. 77-349,063, FILED 12-11-2007.

RICHARD A. STRASER, EXAMINING ATTORNEY

Int. Cls.: 36 and 37

Prior U.S. Cls.: 100, 101, 102, 103 and 106

United States Patent and Trademark Office

Reg. No. 3,519,415

Registered Oct. 21, 2008

**SERVICE MARK
PRINCIPAL REGISTER**

RETAIL PROPERTY SOLUTIONS

RETAIL PROPERTY SOLUTIONS, LLC (GEORGIA LIMITED LIABILITY COMPANY)
2145 SPALDING DRIVE
ATLANTA, GA 30350

FOR: REAL ESTATE CONSULTATION; REAL ESTATE MANAGEMENT CONSULTATION; ASSESSMENT AND MANAGEMENT OF REAL ESTATE, IN CLASS 36 (U.S. CLS. 100, 101 AND 102).

FIRST USE 9-1-2005; IN COMMERCE 9-1-2005.

FOR: REAL ESTATE DEVELOPMENT SERVICES; REAL ESTATE SITE SELECTION SERVICES, IN CLASS 37 (U.S. CLS. 100, 103 AND 106).

FIRST USE 9-1-2005; IN COMMERCE 9-1-2005.

THE MARK CONSISTS OF STANDARD CHARACTERS WITHOUT CLAIM TO ANY PARTICULAR FONT, STYLE, SIZE, OR COLOR.

NO CLAIM IS MADE TO THE EXCLUSIVE RIGHT TO USE "RETAIL PROPERTY", APART FROM THE MARK AS SHOWN.

SER. NO. 77-349,156, FILED 12-11-2007.

RICHARD A. STRASER, EXAMINING ATTORNEY

Int. Cl.: 36

Prior U.S. Cls.: 100, 101 and 102

United States Patent and Trademark Office

Reg. No. 3,519,416

Registered Oct. 21, 2008

**SERVICE MARK
PRINCIPAL REGISTER**

BROCKWAY MORAN & PARTNERS

BROCKWAY MORAN & PARTNERS, INC.
(FLORIDA CORPORATION)
225 NE MIZNER BLVD., SUITE 700
BOCA RATON, FL 33432

OWNER OF U.S. REG. NO. 2,417,699.

FOR: INVESTMENT BANKING SERVICES AND
INVESTMENT MANAGEMENT SERVICES, IN
CLASS 36 (U.S. CLS. 100, 101 AND 102).

NO CLAIM IS MADE TO THE EXCLUSIVE
RIGHT TO USE "PARTNERS", APART FROM THE
MARK AS SHOWN.

FIRST USE 5-0-1998; IN COMMERCE 5-0-1998.

SER. NO. 77-349,204, FILED 12-11-2007.

THE MARK CONSISTS OF STANDARD CHAR-
ACTERS WITHOUT CLAIM TO ANY PARTICULAR
FONT, STYLE, SIZE, OR COLOR.

YAT SYE, LEE, EXAMINING ATTORNEY

Int. Cl.: 37

Prior U.S. Cls.: 100, 103 and 106

United States Patent and Trademark Office

Reg. No. 3,519,417

Registered Oct. 21, 2008

**SERVICE MARK
PRINCIPAL REGISTER**

QUALITY STAIR BUILDERS

QUALITY STAIR BUILDERS, INC. (NEW YORK CORPORATION)
95 SCHMITT BOULEVARD
FARMINGDALE, NY 11735

NO CLAIM IS MADE TO THE EXCLUSIVE RIGHT TO USE "STAIR BUILDERS", APART FROM THE MARK AS SHOWN.

FOR: CONSTRUCTION AND REPAIR OF STAIRS AND RAILINGS, IN CLASS 37 (U.S. CLS. 100, 103 AND 106).

SEC. 2(F).

FIRST USE 0-0-1955; IN COMMERCE 0-0-1955.

SER. NO. 77-351,542, FILED 12-13-2007.

THE MARK CONSISTS OF STANDARD CHARACTERS WITHOUT CLAIM TO ANY PARTICULAR FONT, STYLE, SIZE, OR COLOR.

KAREN SEVERSON, EXAMINING ATTORNEY

Int. Cl.: 9

Prior U.S. Cls.: 21, 23, 26, 36 and 38

United States Patent and Trademark Office

Reg. No. 3,519,418

Registered Oct. 21, 2008

**TRADEMARK
PRINCIPAL REGISTER**

PHOTOSPIN

PHOTOSPIN, INC. (CALIFORNIA CORPORATION)
100 OCEANGATE BLVD., SUITE 1200
LONG BEACH, CA 90802

FOR: DOWNLOADABLE DIGITAL STOCK IMAGES, PHOTOGRAPHS, ILLUSTRATIONS, FONTS, AUDIO AND VIDEO FILES FEATURING A WIDE VARIETY OF SUBJECT MATTERS, IN CLASS 9 (U.S. CLS. 21, 23, 26, 36 AND 38).

FIRST USE 3-18-1998; IN COMMERCE 3-18-1998.

THE MARK CONSISTS OF STANDARD CHARACTERS WITHOUT CLAIM TO ANY PARTICULAR FONT, STYLE, SIZE, OR COLOR.

OWNER OF U.S. REG. NOS. 2,196,128 AND 2,285,790.

SER. NO. 77-351,665, FILED 12-13-2007.

ALICIA COLLINS, EXAMINING ATTORNEY

Int. Cl.: 41

Prior U.S. Cls.: 100, 101 and 107

United States Patent and Trademark Office

Reg. No. 3,519,419

Registered Oct. 21, 2008

**SERVICE MARK
PRINCIPAL REGISTER**

Tipping the Velvet Entertainment

HOLMES, ERSLYNN ANNETTE (UNITED STATES INDIVIDUAL)
UNIT 1013W
2251 SHERMAN AVE NW
WASHINGTON, DC 20059

FOR: ARRANGING AND CONDUCTING NIGHT-CLUB ENTERTAINMENT EVENTS; ARRANGING AND CONDUCTING NIGHTCLUB PARTIES; DANCE EVENTS; ORGANIZATION OF DANCING EVENTS; SPECIAL EVENT PLANNING, IN CLASS 41 (U.S. CLS. 100, 101 AND 107).

FIRST USE 9-30-2007; IN COMMERCE 10-9-2007.

THE MARK CONSISTS OF STANDARD CHARACTERS WITHOUT CLAIM TO ANY PARTICULAR FONT, STYLE, SIZE, OR COLOR.

NO CLAIM IS MADE TO THE EXCLUSIVE RIGHT TO USE "ENTERTAINMENT", APART FROM THE MARK AS SHOWN.

SER. NO. 77-351,873, FILED S.R. 12-13-2007 AM.
P.R. 4-28-2008.

ALYSSA PALADINO, EXAMINING ATTORNEY

Int. Cl.: 41

Prior U.S. Cls.: 100, 101 and 107

United States Patent and Trademark Office

Reg. No. 3,519,420

Registered Oct. 21, 2008

SERVICE MARK
PRINCIPAL REGISTER



CURTIS, LAVEDA V. (UNITED STATES INDIVIDUAL)
PO BOX 16945
PHILADELPHIA, PA 19142

FOR: EDUCATION SERVICES, NAMELY, A PROGRAM TO PROMOTE THE USE OF PROPER PUNCTUATION TO SCHOOL AGE CHILDREN; EDUCATIONAL AND ENTERTAINMENT SERVICES, NAMELY, A CONTINUING PROGRAM ABOUT EDUCATING CHILDREN ACCESSIBLE BY RADIO, TELEVISION, SATELLITE, AUDIO, VIDEO AND COMPUTER NETWORKS; EDUCATIONAL PROGRAMS, NAMELY, PRE-SCHOOLS; EDUCATIONAL SERVICES, NAMELY, CONDUCTING PROGRAMS IN THE FIELD OF CHILDREN'S ENTERTAINMENT; ENTERTAINMENT IN THE NATURE OF ON-GOING TELEVISION PROGRAMS IN THE FIELD OF CHILDREN'S EDUCATION; ENTERTAINMENT SERVICES IN THE NATURE OF ON-GOING TELEVISION PROGRAMS IN THE FIELD OF CHILDREN'S ENTERTAINMENT; ENTERTAINMENT SERVICES, NAMELY, PROVIDING A TELEVISION PROGRAM IN THE FIELD OF CHILDREN'S EDUCATION VIA A GLOBAL COMPUTER NETWORK; PRODUCTION OF DVDS, VIDEOTAPES AND TELEVISION PROGRAMS FEATURING CHILDREN'S EDUCATION AND EN-

TERTAINMENT, IN CLASS 41 (U.S. CLS. 100, 101 AND 107).

FIRST USE 3-21-2007; IN COMMERCE 3-21-2007.

THE COLOR(S) RED, YELLOW, BLUE AND ORANGE IS/ARE CLAIMED AS A FEATURE OF THE MARK.

THE MARK CONSISTS OF THE WORD "GET" WITH A RED "G", YELLOW "E" AND BLUE "T" ALL OUTLINED IN ORANGE, THE WORD "READY" WITH A RED "R", YELLOW "E", BLUE "A", RED "D" AND YELLOW "Y" ALL OUTLINED IN ORANGE, AND THE WORD "TEDDY'S" WITH A RED "T", YELLOW "E", TWO STYLIZED "D'S" THAT RESEMBLE BEAR HEADS TURNED VERTICAL, THE FIRST OUTLINED IN BLUE AND THE SECOND OUTLINED IN RED, BOTH HAVING TWO DOTS AND A CREST SHAPE IN THE CENTER, YELLOW "Y", BLUE APOSTROPHE AND RED "S" ALL OUTLINED IN ORANGE EXCEPT THE TWO STYLIZED "D'S".

SER. NO. 77-351,905, FILED 12-13-2007.

DOMINICK J. SALEMI, EXAMINING ATTORNEY

Int. Cl.: 9

Prior U.S. Cls.: 21, 23, 26, 36 and 38

Reg. No. 3,519,421

United States Patent and Trademark Office

Registered Oct. 21, 2008

**TRADEMARK
PRINCIPAL REGISTER**

JEWELL INSTRUMENTS

JEWELL INSTRUMENTS, LLC (DELAWARE
LIMITED LIABILITY COMPANY)
850 PERIMETER ROAD
MANCHESTER, NH 03103

FOR: ELECTRICAL AND ELECTRONIC MEASURING AND CONTROL INSTRUMENTS, NAMELY, ANALOG AND DIGITAL PANEL METERS; AND AIRCRAFT NAVIGATIONAL INSTRUMENTS AND INERTIAL SENSORS, NAMELY, ACCELEROMETERS AND INCLINOMETERS, IN CLASS 9 (U.S. CLS. 21, 23, 26, 36 AND 38).

FIRST USE 10-1-2000; IN COMMERCE 10-1-2000.

THE MARK CONSISTS OF STANDARD CHARACTERS WITHOUT CLAIM TO ANY PARTICULAR FONT, STYLE, SIZE, OR COLOR.

OWNER OF U.S. REG. NO. 2,506,958.

NO CLAIM IS MADE TO THE EXCLUSIVE RIGHT TO USE "INSTRUMENTS", APART FROM THE MARK AS SHOWN.

SEC. 2(F).

SER. NO. 77-352,049, FILED 12-14-2007.

ESTHER BELENKER, EXAMINING ATTORNEY

Int. Cl.: 9

Prior U.S. Cls.: 21, 23, 26, 36 and 38

Reg. No. 3,519,422

United States Patent and Trademark Office

Registered Oct. 21, 2008

**TRADEMARK
PRINCIPAL REGISTER**



JEWELL INSTRUMENTS, LLC (DELAWARE
LIMITED LIABILITY COMPANY)
850 PERIMETER ROAD
MANCHESTER, NH 03103

FOR: ELECTRICAL AND ELECTRONIC MEASURING AND CONTROL INSTRUMENTS, NAMELY, ANALOG AND DIGITAL PANEL METERS; AND AIRCRAFT NAVIGATIONAL INSTRUMENTS AND INERTIAL SENSORS, NAMELY, ACCELEROMETERS AND INCLINOMETERS, IN CLASS 9 (U.S. CLS. 21, 23, 26, 36 AND 38).

FIRST USE 10-1-2000; IN COMMERCE 10-1-2000.

OWNER OF U.S. REG. NO. 2,506,958.

NO CLAIM IS MADE TO THE EXCLUSIVE RIGHT TO USE "INSTRUMENTS", APART FROM THE MARK AS SHOWN.

THE COLOR(S) GREEN IS/ARE CLAIMED AS A FEATURE OF THE MARK.

THE COLOR GREEN APPEARS IN THE WORD "JEWELL", AND IN THE BACKGROUND BEHIND THE WORD "INSTRUMENTS". THE WORD "INSTRUMENTS" DOES NOT CONTAIN ANY COLOR (I.E. IT IS CLEAR), NOR DOES THE BACKGROUND BEHIND THE WORD "JEWELL". THEREFORE, THE WORD "INSTRUMENTS" AND THE BACKGROUND BEHIND THE WORD "JEWELL" SHOWS THE COLOR OF THE ITEM ON WHICH IT IS PLACED.

SEC. 2(F).

SER. NO. 77-352,118, FILED 12-14-2007.

ESTHER BELENKER, EXAMINING ATTORNEY

Int. Cl.: 35

Prior U.S. Cls.: 100, 101 and 102

United States Patent and Trademark Office

Reg. No. 3,519,423

Registered Oct. 21, 2008

**SERVICE MARK
PRINCIPAL REGISTER**

94.8 ANALYTICS

BATES, ANDREE (UNITED KINGDOM INDIVIDUAL)
18 GAINSFORD SREET, 44 TAMARIND COURT
LONDON, ENGLAND SE12NE

FOR: ADVERTISING AND ADVERTISEMENT SERVICES; ADVERTISING, MARKETING AND PROMOTION SERVICES; ADVERTISING AND PROMOTION SERVICES AND RELATED CONSULTING; ADVERTISING CONSULTATION; CONDUCTING MARKETING STUDIES; MARKET ANALYSIS; MARKET RESEARCH CONSULTATION; MARKET RESEARCH SERVICES; MARKET RESEARCH STUDIES; PROMOTION AND MARKETING SERVICES AND RELATED CONSULTING; PROVIDING ADVERTISING, MARKETING AND PROMOTIONAL SERVICES FOR THE PHARMA-

CEUTICAL AND MEDICAL INDUSTRY, IN CLASS 35 (U.S. CLS. 100, 101 AND 102).

FIRST USE 9-1-2007; IN COMMERCE 9-1-2007.

THE MARK CONSISTS OF STANDARD CHARACTERS WITHOUT CLAIM TO ANY PARTICULAR FONT, STYLE, SIZE, OR COLOR.

NO CLAIM IS MADE TO THE EXCLUSIVE RIGHT TO USE "ANALYTICS", APART FROM THE MARK AS SHOWN.

SER. NO. 77-353,318, FILED 12-17-2007.

CARYN GLASSER, EXAMINING ATTORNEY

Int. Cl.: 41

Prior U.S. Cls.: 100, 101 and 107

United States Patent and Trademark Office

Reg. No. 3,519,424

Registered Oct. 21, 2008

**SERVICE MARK
PRINCIPAL REGISTER**

HOLLYWOOD MOBILE AWARDS

CARLOS ABREU (UNITED STATES INDIVIDUAL)
433 N. CAMDEN DR., STE 600
BEVERLY HILLS, CA 90210

FOR: PROVIDING RECOGNITION AND INCENTIVES BY THE WAY OF AWARDS AND CONTESTS TO DEMONSTRATE EXCELLENCE IN THE FIELD OF FILM AND MUSIC, IN CLASS 41 (U.S. CLS. 100, 101 AND 107).

FIRST USE 12-16-2007; IN COMMERCE 12-16-2007.

THE MARK CONSISTS OF STANDARD CHARACTERS WITHOUT CLAIM TO ANY PARTICULAR FONT, STYLE, SIZE, OR COLOR.

OWNER OF U.S. REG. NOS. 2,493,697, 3,128,570, AND 3,150,407.

NO CLAIM IS MADE TO THE EXCLUSIVE RIGHT TO USE "MOBILE AWARDS", APART FROM THE MARK AS SHOWN.

SEC. 2(F) AS TO "HOLLYWOOD".

SER. NO. 77-353,327, FILED 12-17-2007.

DAYNA BROWNE, EXAMINING ATTORNEY

Int. Cl.: 29

Prior U.S. Cl.: 46

United States Patent and Trademark Office

Reg. No. 3,519,425

Registered Oct. 21, 2008

**TRADEMARK
PRINCIPAL REGISTER**

OH BOY! OBERTO TURKEY JERKY

OBERTO SAUSAGE COMPANY (WASHINGTON
CORPORATION)
P.O. BOX 429
KENT, WA 98035

FOR: MEAT; JERKY, IN CLASS 29 (U.S. CL. 46).

FIRST USE 12-31-1999; IN COMMERCE 12-31-1999.

THE MARK CONSISTS OF STANDARD CHAR-
ACTERS WITHOUT CLAIM TO ANY PARTICULAR
FONT, STYLE, SIZE, OR COLOR.

OWNER OF U.S. REG. NOS. 2,905,251, 3,069,238
AND OTHERS.

NO CLAIM IS MADE TO THE EXCLUSIVE
RIGHT TO USE "TURKEY JERKY", APART FROM
THE MARK AS SHOWN.

SER. NO. 77-354,774, FILED 12-18-2007.

STEVEN R. FOSTER, EXAMINING ATTORNEY

Int. Cl.: 33

Prior U.S. Cls.: 47 and 49

United States Patent and Trademark Office

Reg. No. 3,519,426

Registered Oct. 21, 2008

**TRADEMARK
PRINCIPAL REGISTER**

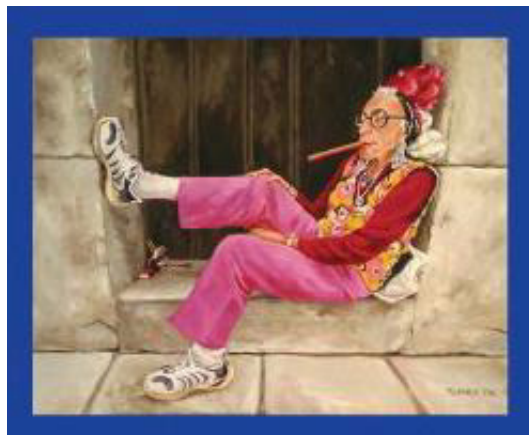

CARIBBEAN CONNECTION, INC. (NEVADA CORPORATION)
34225 RANCHO CALIFORNIA RD.
TEMECULA, CA 92591

FOR: GRAPE WINE, IN CLASS 33 (U.S. CLS. 47 AND 49).

FIRST USE 8-1-2006; IN COMMERCE 8-1-2006.

OWNER OF U.S. REG. NO. 3,396,284.

THE LIKENESS IN THE MARK IDENTIFIES A LIVING INDIVIDUAL WHOSE CONSENT IS OF RECORD.

THE COLOR(S) TAN, BROWN, WHITE, PINK, RED, ORANGE, YELLOW, BLACK AND BLUE IS/ ARE CLAIMED AS A FEATURE OF THE MARK.

THE MARK CONSISTS OF THE COLORS TAN AND BROWN THAT APPEAR IN THE STEPS, GROUND, AND WOODEN DOOR IN THE BACKGROUND; THE COLOR BROWN APPEARS ON THE CIGAR AND THE RIM IN THE WOMAN'S EYEGLASSES; THE COLOR WHITE APPEARS IN THE WOMAN'S SNEAKERS, SOCKS AND HAIR; THE COLOR PINK APPEARS IN THE WOMAN'S PANTS; THE COLOR RED APPEARS IN THE WOMAN'S SHIRT AND HAT; THE COLORS ORANGE AND YELLOW APPEAR IN THE WOMAN'S VEST; THE COLOR BLACK APPEARS AS STRIPES AND LINES IN THE WOMAN'S SNEAKERS; THE COLOR BLUE APPEARS IN THE RECTANGULAR BORDER SURROUNDING THE DRAWING OF THE WOMAN.

SER. NO. 77-354,839, FILED 12-18-2007.

JOHN GARTNER, EXAMINING ATTORNEY

Int. Cl.: 20

Prior U.S. Cls.: 2, 13, 22, 25, 32 and 50

United States Patent and Trademark Office

Reg. No. 3,519,427

Registered Oct. 21, 2008

**TRADEMARK
PRINCIPAL REGISTER**

Sleep Smith

ENDICK, MITCHELL (UNITED STATES INDIVIDUAL)
606 E. STATE ST.
ATHENS, OH 45701

FOR: BOX SPRINGS; MATTRESSES, IN CLASS 20
(U.S. CLS. 2, 13, 22, 25, 32 AND 50).

FIRST USE 3-10-2006; IN COMMERCE 10-10-2007.

THE MARK CONSISTS OF STANDARD CHARACTERS WITHOUT CLAIM TO ANY PARTICULAR FONT, STYLE, SIZE, OR COLOR.

OWNER OF U.S. REG. NO. 3,045,829.

SER. NO. 77-355,030, FILED 12-18-2007.

GRETTA YAO, EXAMINING ATTORNEY

Int. Cl.: 7

Prior U.S. Cls.: 13, 19, 21, 23, 31, 34 and 35

Reg. No. 3,519,428

United States Patent and Trademark Office

Registered Oct. 21, 2008

**TRADEMARK
PRINCIPAL REGISTER**

CORRECT-ALIGN

ZOOPS PRODUCTS INC. (CALIFORNIA CORPORATION)
931 LINCOLN STREET
BANNING, CA 92220

FOR: AUTOMOTIVE INTAKE MANIFOLDS; AUTOMOTIVE PARTS, NAMELY, ENGINE AND TRANSMISSION SEALS; AIR-INTAKE TUBES AND FILTERS FOR AFTER-MARKET INSTALLATION OF AUTOMOTIVE ENGINES; AUTOMOTIVE ENGINE BLOCKS; ENGINE PARTS, NAMELY, CONTACT POINTS; ENHANCEMENT PARTS FOR INTERNAL COMBUSTION ENGINES, NAMELY, FUEL CATALYSTS; INTERNAL COMBUSTION ENGINES FOR MACHINE OPERATION AND REPLA-

CEMENT PARTS THEREFOR; MECHANICAL ENGINE PARTS FOR LAND VEHICLES; VEHICLE PARTS, NAMELY, ENGINE CASES, IN CLASS 7 (U.S. CLS. 13, 19, 21, 23, 31, 34 AND 35).

FIRST USE 7-1-2005; IN COMMERCE 7-1-2005.

THE MARK CONSISTS OF STANDARD CHARACTERS WITHOUT CLAIM TO ANY PARTICULAR FONT, STYLE, SIZE, OR COLOR.

SER. NO. 77-355,644, FILED 12-19-2007.

PAULA MAHONEY, EXAMINING ATTORNEY

Int. Cl.: 35

Prior U.S. Cls.: 100, 101 and 102

United States Patent and Trademark Office

Reg. No. 3,519,429

Registered Oct. 21, 2008

**SERVICE MARK
PRINCIPAL REGISTER**



LEAD HOTLINE, INC. (FLORIDA CORPORATION)
4686 SUNBEAM ROAD
JACKSONVILLE, FL 32202

FOR: ADVERTISING AND MARKETING, IN CLASS 35 (U.S. CLS. 100, 101 AND 102).

FIRST USE 8-13-2007; IN COMMERCE 10-1-2007.

NO CLAIM IS MADE TO THE EXCLUSIVE RIGHT TO USE "LEAD" , APART FROM THE MARK AS SHOWN.

THE MARK CONSISTS OF THE WORDS "LEAD" AND "HOTLINE.COM" WITH CIRCLES WITHIN CERTAIN LETTERS. GRAY IS NOT A FEATURE OF THE MARK.

SER. NO. 77-355,931, FILED 12-19-2007.

TOBY BULLOFF, EXAMINING ATTORNEY

Int. Cl.: 40

Prior U.S. Cls.: 100, 103 and 106

United States Patent and Trademark Office

Reg. No. 3,519,430

Registered Oct. 21, 2008

**SERVICE MARK
PRINCIPAL REGISTER**

MYPRINTPLUS

GRAPHIC SOLUTIONS ADVERTISING, INC.
(NORTH CAROLINA CORPORATION)
4700 N. CROATAN HIGHWAY
KITTY HAWK, NC 27949

THE MARK CONSISTS OF STANDARD CHAR-
ACTERS WITHOUT CLAIM TO ANY PARTICULAR
FONT, STYLE, SIZE, OR COLOR.

FOR: PRINTING SERVICES; DESIGN PRINTING
FOR OTHERS, IN CLASS 40 (U.S. CLS. 100, 103 AND
106).

SER. NO. 77-356,014, FILED 12-19-2007.

FIRST USE 12-20-2001; IN COMMERCE 12-20-2001.

MICHAEL KEATING, EXAMINING ATTORNEY

Int. Cl.: 28

Prior U.S. Cls.: 22, 23, 38 and 50

Reg. No. 3,519,431

United States Patent and Trademark Office

Registered Oct. 21, 2008

TRADEMARK
PRINCIPAL REGISTER

STERLING

SUNNYWOOD, INC. (ILLINOIS CORPORATION)
UNIT H
2503 SPRING RIDGE DR.
SPRING GROVE, IL 60081

FOR: DART GAMES; ELECTRONIC DART GAMES; GAME TABLES; GAMING TABLES; BACK-GAMMON GAME SETS; ACTION SKILL GAMES; ACTION TARGET GAMES; ACTION-TYPE TARGET GAMES; AERO-DYNAMIC DISK FOR USE IN PLAYING CATCHING GAMES; AMUSEMENT GAME MACHINES; APPARATUS FOR ELECTRONIC GAMES OTHER THAN THOSE ADAPTED FOR USE WITH AN EXTERNAL DISPLAY SCREEN OR MONITOR; ARCADE GAMES; ARCADE-TYPE ELECTRONIC EDUCATION VIDEO GAMES; ARCADE-TYPE ELECTRONIC VIDEO GAMES; BACK-GAMMON GAMES; BADMINTON GAME PLAYING EQUIPMENT; BALLS FOR GAMES; BASKETBALL TABLE TOP GAMES; BATS FOR GAMES; BINGO GAME PLAYING EQUIPMENT; BOARD GAMES; BUILDING GAMES; CARD GAME FOR BUSINESS TRAINING; CARD GAMES; CHESS GAMES; COIN-OPERATED VIDEO GAMES; COUNTERS AND MARBLES FOR GAMES; CRAPS GAME PLAYING EQUIPMENT; DICE GAMES; DISPOSABLE TICKET SETS FOR PLAYING GAMES OF CHANCE; ELECTRONIC EDUCATIONAL GAME MACHINES FOR CHILDREN; ELECTRONIC GAME EQUIPMENT WITH A WATCH FUNCTION; ELECTRONIC GAMES OTHER THAN THOSE ADAPTED FOR USE WITH TELEVISION RECEIVERS ONLY; ELECTRONIC HUNTING GAME CALL WITH INTERCHANGEABLE SOUND CARTRIDGES; ELECTRONIC TARGETS FOR GAMES AND SPORTS; EQUIPMENT FOR PLAYING A VERTICAL HOOP TARGET GAME; EQUIPMENT SOLD AS A UNIT FOR PLAYING A MEMORY GAME; EQUIPMENT SOLD AS A UNIT FOR PLAYING ACTION TYPE TARGET GAMES; EQUIPMENT SOLD AS A UNIT FOR PLAYING BOARD GAMES; EQUIPMENT SOLD AS A UNIT FOR PLAYING CARD GAMES;

EQUIPMENT SOLD AS A UNIT FOR PLAYING CRAPS GAMES; EXERCISE MACHINES INCORPORATING ELECTRONIC AND VIDEO GAME CONTROLLERS; FLOOR-STANDING UNITS FOR PLAYING ELECTRONIC GAMES OTHER THAN IN CONJUNCTION WITH A TELEVISION OR COMPUTER; GAME EQUIPMENT, NAMELY, CHIPS; GAME RANDOMIZER FOR RANDOMLY DETERMINING GAME PLAY IN A PARLOR GAME, SOLD AS A COMPONENT PART THEREOF; GAMING EQUIPMENT, NAMELY, CRAPS TABLES; GAMING EQUIPMENT, NAMELY, CHIPS; GAMING EQUIPMENT, NAMELY, GAME WHEELS; GAMING EQUIPMENT, NAMELY, POKER CHIPS; GAMING TABLES, NAMELY, CRAPS TABLES; GO GAMES; HAND HELD UNIT FOR PLAYING ELECTRONIC GAMES; HAND HELD UNIT FOR PLAYING VIDEO GAMES; HAND-HELD GAMES WITH LIQUID CRYSTAL DISPLAYS; HORIZONTAL PINBALL MACHINE, NAMELY, KORINTO-GAME MACHINES; HORSESHOE GAMES; HUNTING GAME CALLS; JAPANESE CHESS, NAMELY, SHOGI GAMES; JAPANESE DICE GAMES, NAMELY, SUGOROKU; KARUTA PLAYING CARDS, NAMELY, JAPANESE CARD GAME; KITS FOR BUILDING OUTDOOR PLAY EQUIPMENT; LCD GAME MACHINES; MAH JONG GAMES; MANIPULATIVE GAMES; MARBLES FOR GAMES; MEMORY GAMES; NETS FOR BALL GAMES; OUTDOOR ACTIVITY GAMES IN THE NATURE OF, NAMELY, CROQUET, BOCCE BALL, LADDER GOLF, LAWN BOWLING, KICK-BALL, DISC GOLF; PADDLE BALL GAMES; PADDLES FOR USE IN PADDLE BALL GAMES; PARLOR GAMES; PARLOUR GAMES; PARTY GAMES; PINBALL GAMES; PINBALL-TYPE GAMES; PLAY YARDS IN THE NATURE OF OUTDOOR PLAY STRUCTURES; PLAYING CARDS AND CARD GAMES; POSITIONABLE PRINTED TOY FIGURES FOR USE IN GAMES; POSITIONABLE THREE DIMENSIONAL TOYS FOR USE IN GAMES; POSITIONABLE TWO DIMENSIONAL TOYS FOR USE IN GAMES; PRINTED POSITION-

ABLE TOYS FOR USE IN CHILDREN'S BOARD GAMES; PROMOTIONAL GAME CARDS; PROMOTIONAL GAME MATERIALS; PROTECTIVE CARRYING CASES SPECIALLY ADAPTED FOR HANDHELD VIDEO GAMES; QUILTS; RING GAMES; ROLE PLAYING GAMES; STAND ALONE VIDEO GAME MACHINES; STAND ALONE VIDEO OUTPUT GAME MACHINES; STONE-PIECES POTS FOR GO GAME, NAMELY, GOKE POTS; TABLETOP UNITS FOR PLAYING ELECTRONIC GAMES OTHER THAN IN CONJUNCTION WITH A TELEVISION OR COMPUTER; TARGET GAMES; TIBETAN DICE GAME; TOY, NAMELY, BATTERY-POWERED COMPUTER GAME WITH LCD SCREEN WHICH FEATURES ANIMATION AND SOUND EFFECTS; TOYS, NAMELY, A DISK TO TOSS IN PLAYING A GAME WHEREIN OTHER DISKS ARE FLIPPED AND COLLECTED; TRADING CARD

GAMES; TWO AND THREE DIMENSIONAL POSITIONABLE GAME FIGURES THAT MAY BE AFFIXED TO CLOTHING; VOLLEYBALL GAME PLAYING EQUIPMENT; WOODEN PIECES FOR SHOGI GAME, NAMELY, KOMA, IN CLASS 28 (U.S. CLS. 22, 23, 38 AND 50).

FIRST USE 12-15-1997; IN COMMERCE 7-25-2000.

THE MARK CONSISTS OF STANDARD CHARACTERS WITHOUT CLAIM TO ANY PARTICULAR FONT, STYLE, SIZE, OR COLOR.

OWNER OF U.S. REG. NO. 2,371,224.

SER. NO. 77-356,262, FILED 12-19-2007.

LOURDES AYALA, EXAMINING ATTORNEY

Int. Cl.: 36

Prior U.S. Cls.: 100, 101 and 102

United States Patent and Trademark Office

Reg. No. 3,519,432

Registered Oct. 21, 2008

**SERVICE MARK
PRINCIPAL REGISTER**

ARGO RE

ARGO GROUP INTERNATIONAL HOLDINGS,
LTD. (BERMUDA CORPORATION)

110 PITTS BAY ROAD

PEMBROKE, BERMUDA HM08

FOR: REINSURANCE UNDERWRITING, IN
CLASS 36 (U.S. CLS. 100, 101 AND 102).

FIRST USE 4-7-2008; IN COMMERCE 4-7-2008.

THE MARK CONSISTS OF STANDARD CHAR-
ACTERS WITHOUT CLAIM TO ANY PARTICULAR
FONT, STYLE, SIZE, OR COLOR.

NO CLAIM IS MADE TO THE EXCLUSIVE
RIGHT TO USE "RE", APART FROM THE MARK
AS SHOWN.

SER. NO. 77-356,432, FILED 12-20-2007.

CHRISIE B. KING, EXAMINING ATTORNEY

Int. Cl.: 35

Prior U.S. Cls.: 100, 101 and 102

United States Patent and Trademark Office

Reg. No. 3,519,433

Registered Oct. 21, 2008

**SERVICE MARK
PRINCIPAL REGISTER**

FIRSTBORN

FIRSTBORN MULTIMEDIA CORPORATION
(DELAWARE CORPORATION)
630 NINTH AVENUE
NEW YORK, NY 10036

FOR: DESIGN OF DIGITAL MARKETING MATERIAL FOR OTHERS; DESIGN OF INTERNET ADVERTISING; MARKETING SERVICES, NAMELY, INFORMATIONAL WEB PAGES DESIGNED TO GENERATE SALES TRAFFIC VIA HYPERLINKS TO OTHER WEBSITES; ADVERTISING SERVICES, NAMELY, PROMOTING AND MARKETING THE GOODS AND SERVICES OF OTHERS THROUGH ALL PUBLIC COMMUNICATIONS MEANS; PROVI-

SION OF SPACE ON WEBSITES FOR ADVERTISING GOODS AND SERVICES, IN CLASS 35 (U.S. CLS. 100, 101 AND 102).

FIRST USE 0-0-1997; IN COMMERCE 0-0-1997.

THE MARK CONSISTS OF STANDARD CHARACTERS WITHOUT CLAIM TO ANY PARTICULAR FONT, STYLE, SIZE, OR COLOR.

SER. NO. 77-357,040, FILED 12-20-2007.

HENRY S. ZAK, EXAMINING ATTORNEY

Int. Cl.: 9

Prior U.S. Cls.: 21, 23, 26, 36 and 38

United States Patent and Trademark Office

Reg. No. 3,519,434

Registered Oct. 21, 2008

**TRADEMARK
PRINCIPAL REGISTER**

THE WEIGHT LOSS MINDSET

GILCHRIST, RANDY (UNITED STATES INDIVIDUAL)
2722 LEDGESTONE LANE
LINCOLN, CA 95648

FOR: PRE-RECORDED CD'S FEATURING A THERAPEUTIC WEIGHT CONTROL AND APETITE SUPPRESSION PROGRAM, IN CLASS 9 (U.S. CLS. 21, 23, 26, 36 AND 38).

FIRST USE 11-13-2005; IN COMMERCE 11-13-2006.

THE MARK CONSISTS OF STANDARD CHARACTERS WITHOUT CLAIM TO ANY PARTICULAR FONT, STYLE, SIZE, OR COLOR.

NO CLAIM IS MADE TO THE EXCLUSIVE RIGHT TO USE "WEIGHT LOSS", APART FROM THE MARK AS SHOWN.

SER. NO. 77-357,803, FILED 12-21-2007.

MARGARET POWER, EXAMINING ATTORNEY

Int. Cls.: 35 and 44

Prior U.S. Cls.: 100, 101 and 102

United States Patent and Trademark Office

Reg. No. 3,519,435

Registered Oct. 21, 2008

**SERVICE MARK
PRINCIPAL REGISTER**

REMEDYLIFE

MEDIZINE, LLC (DELAWARE LIMITED LIABILITY COMPANY)
SUITE 1900
500 FIFTH AVENUE
NEW YORK, NY 10110

FOR: ARRANGING FOR DISCOUNTS ON HEALTH-RELATED PRODUCTS AND SERVICES FOR SUBSCRIBING MEMBERS; MARKETING SERVICES IN THE FIELD OF HEALTH, NAMELY, PROMOTING THE HEALTH-RELATED PRODUCTS OR SERVICES OF OTHERS; CONDUCTING ONLINE SURVEYS IN THE FIELD OF HEALTH; CONDUCTING ONLINE POLLS IN THE FIELD OF HEALTH, IN CLASS 35 (U.S. CLS. 100, 101 AND 102).

FIRST USE 12-15-2007; IN COMMERCE 12-15-2007.

FOR: PROVIDING ONLINE HEALTH INFORMATION, IN CLASS 44 (U.S. CLS. 100 AND 101).

FIRST USE 12-15-2007; IN COMMERCE 12-15-2007.

THE MARK CONSISTS OF STANDARD CHARACTERS WITHOUT CLAIM TO ANY PARTICULAR FONT, STYLE, SIZE, OR COLOR.

OWNER OF U.S. REG. NO. 2,615,377.

SER. NO. 77-358,076, FILED 12-21-2007.

STEPHEN AQUILA, EXAMINING ATTORNEY

Int. Cl.: 28

Prior U.S. Cls.: 22, 23, 38 and 50

United States Patent and Trademark Office

Reg. No. 3,519,436

Registered Oct. 21, 2008

**TRADEMARK
PRINCIPAL REGISTER**

STRIKE TRAINER

INTERQUANTUM, LLC (CALIFORNIA LIMITED
LIABILITY COMPANY)
15760 VENTURA BOULEVARD, FIRST FLOOR
ENCINO, CA 91436

FOR: EQUIPMENT FOR PHYSICAL AND GYM-
NASTIC AND SPORTS EXERCISES, FOR MUSCLE
TRAINING AND FOR AEROBIC AND CARDIO-
VASCULAR EXERCISE, NAMELY, MANUALLY-
OPERATED EXERCISE MACHINES, AND MANU-
ALLY-OPERATED AEROBIC EXERCISE MA-
CHINES, IN CLASS 28 (U.S. CLS. 22, 23, 38 AND 50).

FIRST USE 1-14-2008; IN COMMERCE 1-14-2008.

THE MARK CONSISTS OF STANDARD CHAR-
ACTERS WITHOUT CLAIM TO ANY PARTICULAR
FONT, STYLE, SIZE, OR COLOR.

NO CLAIM IS MADE TO THE EXCLUSIVE
RIGHT TO USE "TRAINER", APART FROM THE
MARK AS SHOWN.

SER. NO. 77-358,515, FILED 12-21-2007.

SUSAN RICHARDS, EXAMINING ATTORNEY

Int. Cl.: 28

Prior U.S. Cls.: 22, 23, 38 and 50

United States Patent and Trademark Office

Reg. No. 3,519,437

Registered Oct. 21, 2008

**TRADEMARK
PRINCIPAL REGISTER**



INTERQUANTUM, LLC (CALIFORNIA LIMITED LIABILITY COMPANY)
15760 VENTURA BOULEVARD, FIRST FLOOR
ENCINO, CA 91436

FOR: EQUIPMENT FOR PHYSICAL AND GYM-NASTIC AND SPORTS EXERCISES, FOR MUSCLE TRAINING AND FOR AEROBIC AND CARDIO-VASCULAR EXERCISE, NAMELY, MANUALLY-OPERATED EXERCISE MACHINES, AND MANU-ALLY-OPERATED AEROBIC EXERCISE MA-CHINES, IN CLASS 28 (U.S. CLS. 22, 23, 38 AND 50).

FIRST USE 1-14-2008; IN COMMERCE 1-14-2008.

NO CLAIM IS MADE TO THE EXCLUSIVE RIGHT TO USE "TRAINER", APART FROM THE MARK AS SHOWN.

THE COLOR(S) YELLOW, RED AND BLACK IS/ ARE CLAIMED AS A FEATURE OF THE MARK.

THE MARK CONSISTS OF THE COLOR YELLOW APPEARS IN THE BACKGROUND OF THE MARK; THE COLOR RED APPEARS IN THE DESIGN OF THE FLAME, AND THE COLOR BLACK APPEARS IN THE OUTLINE OF THE LETTERS IN THE MARK AND THE OUTLINE OF THE DESIGN OF THE FLAME, AND IN THE SHADOWING FOR THE LETTERS.

SER. NO. 77-358,527, FILED 12-21-2007.

SUSAN RICHARDS, EXAMINING ATTORNEY

Int. Cl.: 37

Prior U.S. Cls.: 100, 103 and 106

United States Patent and Trademark Office

Reg. No. 3,519,438

Registered Oct. 21, 2008

**SERVICE MARK
PRINCIPAL REGISTER**

HAMPTON ISLAND PRESERVE

HAMPTON ISLAND, LLC (GEORGIA LIMITED
LIABILITY COMPANY)
3625 CUMBERLAND BOULEVARD, SUITE 1150
ATLANTA, GA 30339

FOR: PLANNING AND LAYING OUT OF RESI-
DENTIAL COMMUNITIES; HOUSING SERVICES,
NAMELY, DEVELOPMENT OF REAL PROPERTY,
NAMELY, REPAIR, IMPROVEMENT, AND NEW
CONSTRUCTION, IN CLASS 37 (U.S. CLS. 100, 103
AND 106).

FIRST USE 1-0-2004; IN COMMERCE 1-0-2004.

THE MARK CONSISTS OF STANDARD CHAR-
ACTERS WITHOUT CLAIM TO ANY PARTICULAR
FONT, STYLE, SIZE, OR COLOR.

SER. NO. 77-358,788, FILED 12-22-2007.

GEORGIA CARTY, EXAMINING ATTORNEY

Int. Cl.: 39

Prior U.S. Cls.: 100 and 105

United States Patent and Trademark Office

Reg. No. 3,519,439

Registered Oct. 21, 2008

**SERVICE MARK
PRINCIPAL REGISTER**

HAMPTON ISLAND PRESERVE

HAMPTON ISLAND, LLC (GEORGIA LIMITED
LIABILITY COMPANY)
3625 CUMBERLAND BOULEVARD, SUITE 1150
ATLANTA, GA 30339

THE MARK CONSISTS OF STANDARD CHAR-
ACTERS WITHOUT CLAIM TO ANY PARTICULAR
FONT, STYLE, SIZE, OR COLOR.

FOR: MARINA SERVICES; BOAT STORAGE;
PROVIDING INFORMATION ON FISHING EXPE-
DITIONS, IN CLASS 39 (U.S. CLS. 100 AND 105).

SER. NO. 77-358,789, FILED 12-22-2007.

FIRST USE 1-0-2004; IN COMMERCE 1-0-2004.

GEORGIA CARTY, EXAMINING ATTORNEY

Int. Cl.: 41

Prior U.S. Cls.: 100, 101 and 107

United States Patent and Trademark Office

Reg. No. 3,519,440

Registered Oct. 21, 2008

**SERVICE MARK
PRINCIPAL REGISTER**

HAMPTON ISLAND PRESERVE

HAMPTON ISLAND, LLC (GEORGIA LIMITED
LIABILITY COMPANY)
3625 CUMBERLAND BOULEVARD, SUITE 1150
ATLANTA, GA 30339

FOR: GOLF COURSES; GOLF CLUB SERVICES;
PROVIDING FACILITIES FOR RECREATION AC-
TIVITIES; RECREATIONAL SERVICES IN THE
NATURE OF POOLS, HORSEBACK RIDING FACIL-
ITIES; RECREATIONAL SERVICES, NAMELY, PRO-
VIDING HUNTING PRESERVES; PROVIDING
INFORMATION ON RECREATIONAL FISHING;
PROVIDING TENNIS COURTS, IN CLASS 41 (U.S.
CLS. 100, 101 AND 107).

FIRST USE 1-0-2004; IN COMMERCE 1-0-2004.

THE MARK CONSISTS OF STANDARD CHAR-
ACTERS WITHOUT CLAIM TO ANY PARTICULAR
FONT, STYLE, SIZE, OR COLOR.

NO CLAIM IS MADE TO THE EXCLUSIVE
RIGHT TO USE "PRESERVE", APART FROM THE
MARK AS SHOWN.

SER. NO. 77-358,791, FILED 12-22-2007.

GEORGIA CARTY, EXAMINING ATTORNEY

Int. Cl.: 9

Prior U.S. Cls.: 21, 23, 26, 36 and 38

Reg. No. 3,519,441

United States Patent and Trademark Office

Registered Oct. 21, 2008

**TRADEMARK
PRINCIPAL REGISTER**

DESCENT

INTERPLAY ENTERTAINMENT CORP (DELA-
WARE CORPORATION)
100 NORTH CRESCENT DRIVE SUITE 324
BEVERLY HILLS, CA 90210

FOR: COMPUTER PROGRAMS FOR VIDEO
GAMES AND COMPUTER GAMES AND INSTRUC-
TION MANUALS SOLD AS A UNIT WITH THE
GAMES, AND COMPUTER PROGRAMS FOR VI-
DEO GAMES AND COMPUTER GAMES WHICH
MAY BE DOWNLOADED FROM A GLOBAL COM-
PUTER NETWORK, IN CLASS 9 (U.S. CLS. 21, 23, 26,
36 AND 38).

FIRST USE 12-22-1994; IN COMMERCE 12-22-1994.

THE MARK CONSISTS OF STANDARD CHAR-
ACTERS WITHOUT CLAIM TO ANY PARTICULAR
FONT, STYLE, SIZE, OR COLOR.

OWNER OF U.S. REG. NO. 2,314,929.

SER. NO. 77-358,976, FILED 12-24-2007.

MATTHEW EINSTEIN, EXAMINING ATTORNEY

Int. Cl.: 28

Prior U.S. Cls.: 22, 23, 38 and 50

United States Patent and Trademark Office

Reg. No. 3,519,442

Registered Oct. 21, 2008

**TRADEMARK
PRINCIPAL REGISTER**



BRIDGESTONE SPORTS CO., LTD. (JAPAN CORPORATION)
OMORI BELLPORT E BLDG, 6-22-7, MINAMI-OI
SHINAGAWA-KU, TOKYO, JAPAN 140-0013

FOR: GOLF EQUIPMENT, NAMELY, GOLF BALLS, IN CLASS 28 (U.S. CLS. 22, 23, 38 AND 50).

FIRST USE 12-26-2007; IN COMMERCE 12-26-2007.

OWNER OF U.S. REG. NO. 3,231,512.

THE MARK CONSISTS OF THE LETTER "E" INSIDE A CIRCLE WITH THE NUMBER "5" AND A PLUS SIGN.

SER. NO. 77-359,454, FILED 12-26-2007.

NELSON SNYDER, EXAMINING ATTORNEY

Int. Cl.: 28

Prior U.S. Cls.: 22, 23, 38 and 50

United States Patent and Trademark Office

Reg. No. 3,519,443

Registered Oct. 21, 2008

**TRADEMARK
PRINCIPAL REGISTER**



BRIDGESTONE SPORTS CO., LTD. (JAPAN CORPORATION)
OMORI BELLPORT E BLDG, 6-22-7, MINAMI-OI
SHINAGAWA-KU, TOKYO, JAPAN 140-0013

FOR: GOLF EQUIPMENT, NAMELY, GOLF BALLS, IN CLASS 28 (U.S. CLS. 22, 23, 38 AND 50).

FIRST USE 12-26-2007; IN COMMERCE 12-26-2007.

OWNER OF U.S. REG. NO. 3,235,252.

THE MARK CONSISTS OF THE LETTER "E" INSIDE A CIRCLE WITH THE NUMBER "6" AND A PLUS SIGN.

SER. NO. 77-359,460, FILED 12-26-2007.

NELSON SNYDER, EXAMINING ATTORNEY

Int. Cl.: 29

Prior U.S. Cl.: 46

United States Patent and Trademark Office

Reg. No. 3,519,444

Registered Oct. 21, 2008

**TRADEMARK
PRINCIPAL REGISTER**

**SAN JOAQUIN VALLEY FARMS
CALIFORNIA PISTACHIOS**

A&P GROWERS COOPERATIVE (CALIFORNIA
CORPORATION)
26487 N. HWY. 99
TULARE, CA 93274

FOR: DRIED FRUITS; PROCESSED NUTS, IN
CLASS 29 (U.S. CL. 46).

FIRST USE 11-19-1984; IN COMMERCE 11-19-1984.

THE MARK CONSISTS OF STANDARD CHAR-
ACTERS WITHOUT CLAIM TO ANY PARTICULAR
FONT, STYLE, SIZE, OR COLOR.

OWNER OF U.S. REG. NO. 2,424,978.

NO CLAIM IS MADE TO THE EXCLUSIVE
RIGHT TO USE "CALIFORNIA PISTACHIOS",
APART FROM THE MARK AS SHOWN.

SEC. 2(F).

SER. NO. 77-359,633, FILED 12-26-2007.

LINDSEY RUBIN, EXAMINING ATTORNEY

Int. Cl.: 9

Prior U.S. Cls.: 21, 23, 26, 36 and 38

Reg. No. 3,519,445

United States Patent and Trademark Office

Registered Oct. 21, 2008

**TRADEMARK
PRINCIPAL REGISTER**

Battle Chess

INTERPLAY ENTERTAINMENT CORP (DELA-
WARE CORPORATION)
100 NORTH CRESCENT DRIVE SUITE 324
BEVERLY HILLS, CA 90210

FOR: COMPUTER PROGRAMS FOR VIDEO
GAMES AND COMPUTER GAMES AND INSTRUC-
TION MANUALS SOLD AS A UNIT WITH THE
GAMES, AND COMPUTER PROGRAMS FOR VI-
DEO GAMES AND COMPUTER GAMES WHICH
MAY BE DOWNLOADED FROM A GLOBAL COM-
PUTER NETWORK, IN CLASS 9 (U.S. CLS. 21, 23, 26,
36 AND 38).

FIRST USE 9-2-1988; IN COMMERCE 9-2-1988.

THE MARK CONSISTS OF STANDARD CHAR-
ACTERS WITHOUT CLAIM TO ANY PARTICULAR
FONT, STYLE, SIZE, OR COLOR.

NO CLAIM IS MADE TO THE EXCLUSIVE
RIGHT TO USE "CHESS", APART FROM THE
MARK AS SHOWN.

SER. NO. 77-359,901, FILED 12-27-2007.

MATTHEW EINSTEIN, EXAMINING ATTORNEY

Int. Cls.: 9 and 42

Prior U.S. Cls.: 21, 23, 26, 36, 38, 100 and 101

United States Patent and Trademark Office

Reg. No. 3,519,446

Registered Oct. 21, 2008

**TRADEMARK
SERVICE MARK
PRINCIPAL REGISTER**

INFOVIEWER

INFODESK, INC. (DELAWARE CORPORATION)
SUITE 300
660 WHITE PLAINS ROAD
TARRYTOWN, NY 10591

FOR: COMPUTER SOFTWARE FOR MANAGEMENT, DISPLAY AND DELIVERY OVER ELECTRONIC COMMUNICATIONS NETWORKS, OF DIGITAL CONTENT, INCLUDING VIDEO, AUDIO, TEXT AND GRAPHICS, IN CLASS 9 (U.S. CLS. 21, 23, 26, 36 AND 38).

FIRST USE 4-1-2001; IN COMMERCE 4-1-2001.

FOR: PROVIDING ON-LINE NON-DOWNLOADABLE SOFTWARE FOR MANAGEMENT, DISPLAY

AND DELIVERY OVER ELECTRONIC COMMUNICATIONS NETWORKS, OF DIGITAL CONTENT, INCLUDING VIDEO, AUDIO, TEXT AND GRAPHICS, IN CLASS 42 (U.S. CLS. 100 AND 101).

FIRST USE 4-1-2001; IN COMMERCE 4-1-2001.

THE MARK CONSISTS OF STANDARD CHARACTERS WITHOUT CLAIM TO ANY PARTICULAR FONT, STYLE, SIZE, OR COLOR.

SEC. 2(F).

SER. NO. 77-360,060, FILED 12-27-2007.

SUNG IN, EXAMINING ATTORNEY

Int. Cl.: 41

Prior U.S. Cls.: 100, 101 and 107

Reg. No. 3,519,447

United States Patent and Trademark Office

Registered Oct. 21, 2008

**SERVICE MARK
PRINCIPAL REGISTER**



SOLOMON, CRYSTAL (VIRGINIA SOLE PROPRIETORSHIP), DBA GITA GIRLS FOUNDATION
P.O. BOX 2022
WOODBIDGE, VA 22195

FOR: PROVIDING MENTORING IN THE FIELD OF PERSONAL MOTIVATION AND GOAL ATTAINMENT; PROVIDING CAREER COUNSELING; PROVIDING LIFE TRAINING SKILLS, NAMELY, LIFE COACHING SERVICES IN THE FIELD OF PERSONAL MOTIVATION AND GOAL ATTAINMENT, IN CLASS 41 (U.S. CLS. 100, 101 AND 107).

FIRST USE 10-1-2006; IN COMMERCE 10-1-2006.

NO CLAIM IS MADE TO THE EXCLUSIVE RIGHT TO USE "GIRLS", APART FROM THE MARK AS SHOWN.

THE MARK CONSISTS OF THE WORD "GITA" IN LOWER CASE SCRIPT FONT; THE SLOGAN "GIRLS INSPIRED TO ACHIEVE" AND THE HIGHLY STYLIZED DESIGN OF A GIRL WITH LONG HAIR.

SER. NO. 77-360,078, FILED 12-27-2007.

LEIGH CAROLINE CASE, EXAMINING ATTORNEY

Int. Cls.: 18 and 20

Prior U.S. Cls.: 1, 2, 3, 13, 22, 25, 32, 41 and 50

United States Patent and Trademark Office

Reg. No. 3,519,448

Registered Oct. 21, 2008

**TRADEMARK
PRINCIPAL REGISTER**

MUD RIVER DOG PRODUCTS

CINTEX INTERNATIONAL (CANADA) LIMITED
(CANADA CORPORATION), DBA MUD RIVER
DOG PRODUCTS
976 MEYERSIDE DRIVE
MISSISSAUGA, CANADA L5T1R9

FOR: ALL-PURPOSE CARRYING BAGS, DOG
LEASHES; DOG APPAREL; DOG COATS; DOG
COLLARS; DOG COLLARS AND LEADS; DOG
PARKAS; DOG SHOES, IN CLASS 18 (U.S. CLS. 1, 2,
3, 22 AND 41).

FIRST USE 8-1-2006; IN COMMERCE 9-1-2006.

FOR: CRATE COVERS FOR PETS; PORTABLE
BEDS FOR PETS, IN CLASS 20 (U.S. CLS. 2, 13, 22, 25,
32 AND 50).

FIRST USE 8-1-2006; IN COMMERCE 9-1-2006.

THE MARK CONSISTS OF STANDARD CHAR-
ACTERS WITHOUT CLAIM TO ANY PARTICULAR
FONT, STYLE, SIZE, OR COLOR.

NO CLAIM IS MADE TO THE EXCLUSIVE
RIGHT TO USE "DOG PRODUCTS", APART FROM
THE MARK AS SHOWN.

SER. NO. 77-360,584, FILED 12-27-2007.

SANDRA MANIOS, EXAMINING ATTORNEY

Int. Cl.: 9

Prior U.S. Cls.: 21, 23, 26, 36 and 38

United States Patent and Trademark Office

Reg. No. 3,519,449

Registered Oct. 21, 2008

**TRADEMARK
PRINCIPAL REGISTER**

DIE BY THE SWORD

INTERPLAY ENTERTAINMENT CORP (DELA-
WARE CORPORATION)
100 NORTH CRESCENT DRIVE SUITE 324
BEVERLY HILLS, CA 90210

FOR: COMPUTER PROGRAMS FOR VIDEO
GAMES AND COMPUTER GAMES AND INSTRUC-
TION MANUALS SOLD AS A UNIT WITH THE
GAMES, AND COMPUTER PROGRAMS FOR VI-
DEO GAMES AND COMPUTER GAMES WHICH
MAY BE DOWNLOADED FROM A GLOBAL COM-
PUTER NETWORK, IN CLASS 9 (U.S. CLS. 21, 23, 26,
36 AND 38).

FIRST USE 3-19-1998; IN COMMERCE 3-19-1998.

THE MARK CONSISTS OF STANDARD CHAR-
ACTERS WITHOUT CLAIM TO ANY PARTICULAR
FONT, STYLE, SIZE, OR COLOR.

SER. NO. 77-360,675, FILED 12-28-2007.

MATTHEW EINSTEIN, EXAMINING ATTORNEY

Int. Cls.: 6, 21 and 31

**Prior U.S. Cls.: 1, 2, 12, 13, 14, 23, 25, 29, 30, 33, 40, 46
and 50**

Reg. No. 3,519,450

United States Patent and Trademark Office

Registered Oct. 21, 2008

**TRADEMARK
PRINCIPAL REGISTER**

PERKY-PET

WOODSTREAM CORPORATION (PENNSYLVANIA CORPORATION)
69 NORTH LOCUST STREET
LITITZ, PA 17543

FOR: METAL BIRD BATHS; METAL HOOKS, POLES AND CHAINS FOR HANGING BIRD FEEDERS, IN CLASS 6 (U.S. CLS. 2, 12, 13, 14, 23, 25 AND 50).

FIRST USE 0-0-1998; IN COMMERCE 0-0-1998.

FOR: BIRD FEEDERS; BIRD HOUSES; PARTS AND ACCESSORIES FOR BIRD FEEDERS, NAMELY, BEE GUARDS, FOAM CLEANING MOPS FOR HUMMINGBIRD FEEDERS; SCOOPS FOR FILLING BIRD FEEDERS WITH BIRDSEED, BAFFLERS AND GUARDS FOR BIRD FEEDERS, IN CLASS 21 (U.S. CLS. 2, 13, 23, 29, 30, 33, 40 AND 50).

FIRST USE 6-30-1958; IN COMMERCE 6-30-1958.

FOR: PET FOOD, NAMELY, BIRD FOOD, IN CLASS 31 (U.S. CLS. 1 AND 46).

FIRST USE 7-31-1960; IN COMMERCE 7-31-1960.

THE MARK CONSISTS OF STANDARD CHARACTERS WITHOUT CLAIM TO ANY PARTICULAR FONT, STYLE, SIZE, OR COLOR.

OWNER OF U.S. REG. NOS. 1,642,105 AND 3,240,372.

SER. NO. 77-361,442, FILED 12-29-2007.

CHERYL CLAYTON, EXAMINING ATTORNEY

Int. Cl.: 35

Prior U.S. Cls.: 100, 101 and 102

United States Patent and Trademark Office

Reg. No. 3,519,451

Registered Oct. 21, 2008

**SERVICE MARK
PRINCIPAL REGISTER**



I-COMMERCE PARTNERS (IOWA LIMITED LIABILITY COMPANY)
1717 FOX TRAIL DR NE
CEDAR RAPIDS, IA 52402

FOR: BUSINESS DEVELOPMENT SERVICES, NAMELY, PROVIDING RECRUITMENT SERVICES, TRAINING, AND ONGOING SUPPORT FOR BUSINESSES OF OTHERS , IN CLASS 35 (U.S. CLS. 100, 101 AND 102).

FIRST USE 4-0-2007; IN COMMERCE 4-0-2007.

NO CLAIM IS MADE TO THE EXCLUSIVE RIGHT TO USE "COMMERCE PARTNERS", APART FROM THE MARK AS SHOWN.

THE MARK CONSISTS OF THE LETTER "I" THE WORDING "COMMERCE PARTNERS" AND "DELIVERING QUALITY OF LIFE".

SER. NO. 77-361,773, FILED 12-31-2007.

REGINA DRUMMOND, EXAMINING ATTORNEY

Int. Cls.: 7 and 28

Prior U.S. Cls.: 13, 19, 21, 22, 23, 31, 34, 35, 38 and 50

Reg. No. 3,519,452

United States Patent and Trademark Office

Registered Oct. 21, 2008

**TRADEMARK
PRINCIPAL REGISTER**

O.S. MAX

OGAWA SEIKI KABUSHIKI KAISHA (JAPAN CORPORATION), DBA O.S. ENGINES MFG. CO., LTD.
6-15, 3-CHOME IMAGAWA
HIGASHISUMIYOSHI-KU
OSAKA, JAPAN

FOR: MACHINE PARTS, NAMELY, ENGINES, MOTORS, STARTERS FOR MOTORS AND ENGINES; ENGINE PARTS AND ACCESSORIES IN THE NATURE OF CYLINDER CASE, CYLINDER HEAD, PISTON, PISTON RING, CYLINDER LINER, CONNECTING ROD, CRANK SHAFT, BALL BEARING, CARBURETOR, GLOW PLUG, SILENCER, AIR CLEANER, CAMSHAFT, MANIFOLD, EXHAUST PIPE, VALVE SPRING, ENGINE MOUNT, EXHAUST MANIFOLD, INTAKE VALVE AND EXHAUST VALVE; ELECTRIC GENERATORS; BEARINGS, NAMELY, ENGINE BEARINGS, IN CLASS 7 (U.S. CLS. 13, 19, 21, 23, 31, 34 AND 35).

FIRST USE 4-1-1957; IN COMMERCE 4-1-1957.

FOR: TOY MODEL VEHICLES, NAMELY, TOY MODEL AIRPLANES AND HELICOPTERS, CARS, LOCOMOTIVES AND BOATS; AND ENGINES AND MOTORS THEREFOR SOLD AS A UNIT, IN CLASS 28 (U.S. CLS. 22, 23, 38 AND 50).

FIRST USE 4-1-1957; IN COMMERCE 4-1-1957.

THE MARK CONSISTS OF STANDARD CHARACTERS WITHOUT CLAIM TO ANY PARTICULAR FONT, STYLE, SIZE, OR COLOR.

THE WORDING "O.S. MAX" HAS NO MEANING IN A FOREIGN LANGUAGE.

SER. NO. 77-362,054, FILED 12-31-2007.

SETH A. RAPPAPORT, EXAMINING ATTORNEY

Int. Cl.: 16

Prior U.S. Cls.: 2, 5, 22, 23, 29, 37, 38 and 50

Reg. No. 3,519,453

United States Patent and Trademark Office

Registered Oct. 21, 2008

**TRADEMARK
PRINCIPAL REGISTER**

WoodPenPro

FINLEY, JIMMY D (UNITED STATES INDIVIDUAL), DBA FINLEY GALLERY LLC
2872 ARIZONA ROAD
HONOLULU, HI 96818

MAKING WRITING PENS, IN CLASS 16 (U.S. CLS. 2, 5, 22, 23, 29, 37, 38 AND 50).

FIRST USE 10-12-2001; IN COMMERCE 7-15-2002.

FOR: BALLPOINT PENS; FOUNTAIN PEN INK CARTRIDGES; FOUNTAIN PENS; GEL ROLLER PENS; INK PENS; MARKING PENS; PEN AND PENCIL CASES AND BOXES; PEN AND PENCIL HOLDERS; PEN AND PENCIL TRAYS; PEN CLIPS; PEN HOLDERS; PEN INK CARTRIDGES; PEN INK REFILLS; PENS; REFILLS FOR BALLPOINT PENS; ROLLER BALL PENS; TIPS FOR BALLPOINT PENS; WRITING PEN KITS COMPRISING PARTS FOR

THE MARK CONSISTS OF STANDARD CHARACTERS WITHOUT CLAIM TO ANY PARTICULAR FONT, STYLE, SIZE, OR COLOR.

SER. NO. 77-362,170, FILED 12-31-2007.

EDWARD NELSON, EXAMINING ATTORNEY

Int. Cl.: 45

Prior U.S. Cls.: 100 and 101

United States Patent and Trademark Office

Reg. No. 3,519,454

Registered Oct. 21, 2008

**SERVICE MARK
PRINCIPAL REGISTER**

JOE BORNSTEIN

THE LAW OFFICES OF JOSEPH L. BORNSTEIN
(MAINE SOLE PROPRIETORSHIP)
FOURTH FLOOR
5 MOULTON STREET
PORTLAND, ME 04101

FOR: LEGAL SERVICES, IN CLASS 45 (U.S. CLS.
100 AND 101).

FIRST USE 12-31-1974; IN COMMERCE 12-31-1999.

THE MARK CONSISTS OF STANDARD CHAR-
ACTERS WITHOUT CLAIM TO ANY PARTICULAR
FONT, STYLE, SIZE, OR COLOR.

THE NAME "JOSEPH L. BORNSTEIN" IDENTI-
FIES A LIVING INDIVIDUAL WHOSE CONSENT IS
OF RECORD.

SER. NO. 77-362,326, FILED 1-2-2008.

BILL DAWE, EXAMINING ATTORNEY

Int. Cl.: 45

Prior U.S. Cls.: 100 and 101

United States Patent and Trademark Office

Reg. No. 3,519,455

Registered Oct. 21, 2008

**SERVICE MARK
PRINCIPAL REGISTER**

**LAW OFFICES OF JOE
BORNSTEIN**

THE LAW OFFICES OF JOSEPH L. BORNSTEIN
(MAINE SOLE PROPRIETORSHIP)
FOURTH FLOOR
5 MOULTON STREET
PORTLAND, ME 04101

FOR: LEGAL SERVICES, IN CLASS 45 (U.S. CLS.
100 AND 101).

FIRST USE 12-31-1974; IN COMMERCE 12-31-1999.

THE MARK CONSISTS OF STANDARD CHAR-
ACTERS WITHOUT CLAIM TO ANY PARTICULAR
FONT, STYLE, SIZE, OR COLOR.

NO CLAIM IS MADE TO THE EXCLUSIVE
RIGHT TO USE "LAW OFFICES OF", APART FROM
THE MARK AS SHOWN.

THE NAME "JOSEPH L BORNSTEIN" IDENTI-
FIES A LIVING INDIVIDUAL WHOSE CONSENT IS
OF RECORD.

SER. NO. 77-362,328, FILED 1-2-2008.

BILL DAWE, EXAMINING ATTORNEY

Int. Cl.: 38

Prior U.S. Cls.: 100, 101 and 104

United States Patent and Trademark Office

Reg. No. 3,519,456

Registered Oct. 21, 2008

**SERVICE MARK
PRINCIPAL REGISTER**



MEDIA & CONSULTING CORP. (NEW YORK CORPORATION)
43-62 163RD STREET
FLUSHING, NY 11358

FOR: PROVIDING ON-LINE FORUMS FOR TRANSMISSION OF MESSAGES AMONG COMPUTER USERS CONCERNING INFORMATION ABOUT MORTGAGES FOR THE MORTGAGE PROFESSIONAL AND OTHER INTERESTED PARTIES, IN CLASS 38 (U.S. CLS. 100, 101 AND 104).

FIRST USE 12-15-2007; IN COMMERCE 12-15-2007.

NO CLAIM IS MADE TO THE EXCLUSIVE RIGHT TO USE "NATIONWIDE MORTGAGE NEWS", APART FROM THE MARK AS SHOWN.

THE COLOR(S) RED AND BLACK AND GREY IS/ ARE CLAIMED AS A FEATURE OF THE MARK.

THE MARK CONSISTS OF THE LETTERS "NMN" REPRESENTING THE GRAPHIC OUTLINE OF A PERSON READING A BOOK. THE LETTER "M" COMPRISES THE OUTLINE OF AN OPEN BOOK. THE PARTIAL FACE OF A PERSON READING CAN BE SEEN PEERING OVER THE TOP OF THE BOOK. THE HANDS OF THE PERSON CAN ALSO BE SEEN HOLDING THE OPEN BOOK. THE WORDS "NATIONWIDE MORTGAGE NEWS" ARE BELOW THE GRAPHIC. THE LETTER "N" TO THE LEFT OF THE BOOK IS BLACK. THE LETTER "M" IS BETWEEN THE TWO LETTER "N" 'S AND IS RED IN COLOR. THE SECOND LETTER "N" IS BLACK. THE WORDS "NATIONWIDE MORTGAGE NEWS" ARE GREY. THE PARTIAL HEAD DESIGN PEERING OVER THE TOP OF THE OPEN BOOK IS BLACK.

SER. NO. 77-362,465, FILED 1-2-2008.

SHAUNIA CARLYLE, EXAMINING ATTORNEY

Int. Cl.: 35

Prior U.S. Cls.: 100, 101 and 102

United States Patent and Trademark Office

Reg. No. 3,519,457

Registered Oct. 21, 2008

**SERVICE MARK
PRINCIPAL REGISTER**



CHRISTOPHER DEAN MAJER (UNITED STATES
INDIVIDUAL)
7121 S. BEN BURR ROAD
SPOKANE, WA 99223

FOR: BUSINESS MANAGEMENT CONSULTAN-
CY AS WELL AS DEVELOPMENT OF PROCESSES
FOR THE ANALYSIS AND THE IMPLEMENTA-
TION OF STRATEGY PLANS AND MANAGEMENT
PROJECTS; BUSINESS MANAGEMENT CONSUL-
TATION IN THE FIELD OF EXECUTIVE AND
LEADERSHIP DEVELOPMENT, IN CLASS 35 (U.S.
CLS. 100, 101 AND 102).

FIRST USE 2-1-2002; IN COMMERCE 2-1-2002.

"THE COLOR(S) WHITE, BLACK, ORANGE AND
GRAY IS/ARE CLAIMED AS A FEATURE OF THE
MARK."

THE MARK CONSISTS OF A BLACK FIGURE
STANDING ASTRIDE A GLOBE WITH THE FIG-
URE'S HANDS RAISED ABOVE ITS HEAD, WITH A
HALO SUN DESIGN BEHIND THE PERSON AND
ABOVE THE GLOBE. THE HALO SUN BEHIND THE
PERSON IS ORANGE, AND THE GLOBE IS GRAY
WITH WHITE MERIDIANS AND PARALLELS.

SER. NO. 77-362,508, FILED 1-2-2008.

RUDY R. SINGLETON, EXAMINING ATTORNEY

Int. Cl.: 44

Prior U.S. Cls.: 100 and 101

United States Patent and Trademark Office

Reg. No. 3,519,458

Registered Oct. 21, 2008

**SERVICE MARK
PRINCIPAL REGISTER**

real life food

MONROE, SUZANNE C. (WISCONSIN LIMITED LIABILITY COMPANY), DBA INTELLIGENT HEALTH GROUP LLC
W66N665 MADISON AVE
CEDARBURG, WI 53012

FOR: FOOD NUTRITION CONSULTATION; NUTRITION COUNSELING; PROVIDING A WEBSITE FEATURING INFORMATION ON HEALTH AND NUTRITION; PROVIDING ASSISTANCE, FITNESS EVALUATION AND CONSULTATION TO CORPORATE CLIENTS TO HELP THEIR EMPLOYEES MAKE HEALTH, WELLNESS AND NUTRITIONAL CHANGES IN THEIR DAILY LIVING TO IMPROVE HEALTH; PROVIDING ASSISTANCE, FITNESS EVALUATION AND CONSULTATION TO INDIVIDUALS TO HELP THEM MAKE HEALTH, WELLNESS AND NUTRITIONAL CHANGES IN THEIR

DAILY LIVING TO IMPROVE HEALTH, IN CLASS 44 (U.S. CLS. 100 AND 101).

FIRST USE 11-1-2007; IN COMMERCE 11-1-2007.

THE MARK CONSISTS OF STANDARD CHARACTERS WITHOUT CLAIM TO ANY PARTICULAR FONT, STYLE, SIZE, OR COLOR.

NO CLAIM IS MADE TO THE EXCLUSIVE RIGHT TO USE "FOOD", APART FROM THE MARK AS SHOWN.

SER. NO. 77-363,802, FILED 1-3-2008.

FRANK LATTUCA, EXAMINING ATTORNEY

Int. Cl.: 35

Prior U.S. Cls.: 100, 101 and 102

United States Patent and Trademark Office

Reg. No. 3,519,459

Registered Oct. 21, 2008

**SERVICE MARK
PRINCIPAL REGISTER**

**KEEN HIRE HIRE WITH CLARITY
& INSIGHT.**

ALLIANCE HR NETWORK, INC. (ILLINOIS
CORPORATION)
SUITE 107
85 W. ALGONQUIN ROAD
ARLINGTON HEIGHTS, IL 60005

FOR: EMPLOYMENT HIRING, RECRUITING,
PLACEMENT, STAFFING AND CAREER NET-
WORKING SERVICES; EMPLOYMENT RECRUIT-
ING CONSULTATION; TESTING TO DETERMINE
EMPLOYMENT SKILLS, IN CLASS 35 (U.S. CLS. 100,
101 AND 102).

FIRST USE 1-1-2007; IN COMMERCE 1-1-2007.

THE MARK CONSISTS OF STANDARD CHAR-
ACTERS WITHOUT CLAIM TO ANY PARTICULAR
FONT, STYLE, SIZE, OR COLOR.

NO CLAIM IS MADE TO THE EXCLUSIVE
RIGHT TO USE "HIRE", APART FROM THE MARK
AS SHOWN.

SER. NO. 77-364,179, FILED 1-4-2008.

LINDA ESTRADA, EXAMINING ATTORNEY

Int. Cl.: 24

Prior U.S. Cls.: 42 and 50

United States Patent and Trademark Office

Reg. No. 3,519,460

Registered Oct. 21, 2008

**TRADEMARK
PRINCIPAL REGISTER**

Alternative Naturals

EPOCH TRADE, LLC (CALIFORNIA LIMITED
LIABILITY COMPANY)
1050 HAYNE ROAD
HILLSBOROUGH, CA 94010

FOR: HOME TEXTILE PRODUCTS, NAMELY,
COMFORTERS, BED BLANKETS, FABRIC WIN-
DOW COVERINGS, NAMELY, CURTAINS AND
DRAPERIES, IN CLASS 24 (U.S. CLS. 42 AND 50).

FIRST USE 8-28-2007; IN COMMERCE 8-28-2007.

THE MARK CONSISTS OF STANDARD CHAR-
ACTERS WITHOUT CLAIM TO ANY PARTICULAR
FONT, STYLE, SIZE, OR COLOR.

NO CLAIM IS MADE TO THE EXCLUSIVE
RIGHT TO USE "NATURALS", APART FROM THE
MARK AS SHOWN.

SER. NO. 77-364,402, FILED 1-4-2008.

TRICIA SONNEBORN, EXAMINING ATTORNEY

Int. Cl.: 35

Prior U.S. Cls.: 100, 101 and 102

United States Patent and Trademark Office

Reg. No. 3,519,461

Registered Oct. 21, 2008

**SERVICE MARK
PRINCIPAL REGISTER**



DEUTSCHE TELEKOM (FED REP GERMANY
AG CORPORATION)
FRIEDRICH-EBERT-ALLEE 140
BONN, FED REP GERMANY 53113

FOR: ADVERTISING SERVICES, NAMELY, PREPARING AND PLACING ADVERTISEMENTS FOR OTHERS, PROMOTING THE GOODS AND SERVICES OF OTHERS THROUGH PRINTED ADVERTISING, PRINTED DIRECTORIES, ENCODED MEDIA, DISSEMINATION OF PROMOTIONAL MATERIALS, DIRECT MAIL ADVERTISING, ELECTRONIC BILLBOARD ADVERTISING AND PREPARING AUDIO-VISUAL PRESENTATIONS FOR USE IN ADVERTISING; BUSINESS INFORMATION SERVICES IN THE FIELD OF TELECOMMUNICATIONS, ADVERTISING, INFORMATION TECHNOLOGY, IN CLASS 35 (U.S. CLS. 100, 101 AND 102).

PRIORITY CLAIMED UNDER SEC. 44(D) ON FED REP GERMANY APPLICATION NO. 30743567.9,

FILED 7-4-2007, REG. NO. 30743567.9, DATED 12-19-2007, EXPIRES 12-19-2017.

OWNER OF U.S. REG. NOS. 3,182,023, 3,190,978, AND 3,191,037.

THE COLOR(S) LIGHT GREY/MAGENTA/DARK GREY IS/ARE CLAIMED AS A FEATURE OF THE MARK.

THE MARK CONSISTS OF A LIGHT GREY BACKGROUND WITH THE COLOR MAGENTA APPEARING IN SEVEN SMALL SQUARES AND THE LETTER "T" AND THE COLOR DARK GREY APPEARING IN THE LANGUAGE "SYSTEMS".

SER. NO. 77-364,453, FILED 1-4-2008.

CAROLINE WOOD, EXAMINING ATTORNEY

Int. Cl.: 35

Prior U.S. Cls.: 100, 101 and 102

United States Patent and Trademark Office

Reg. No. 3,519,462

Registered Oct. 21, 2008

**SERVICE MARK
PRINCIPAL REGISTER**

CREATIVE TRUST

CREATIVE TRUST, INC. (TENNESSEE CORPORATION)
SUITE 320
5141 VIRGINIA WAY
NASHVILLE, TN 37027

FOR: PERSONAL MANAGEMENT SERVICES FOR LITERARY AUTHORS, SONGWRITERS, RECORDING ARTISTS, PRODUCERS, AND FILM PRODUCERS; MARKETING SERVICES, NAMELY, MARKETING, PROMOTION AND ADVERTISING FOR LITERARY AUTHORS, SONGWRITERS, RECORDING ARTISTS, PRODUCERS, AND FILM

PRODUCERS, IN CLASS 35 (U.S. CLS. 100, 101 AND 102).

FIRST USE 1-1-1989; IN COMMERCE 1-1-1989.

THE MARK CONSISTS OF STANDARD CHARACTERS WITHOUT CLAIM TO ANY PARTICULAR FONT, STYLE, SIZE, OR COLOR.

SER. NO. 77-364,469, FILED 1-4-2008.

JASON ROTH, EXAMINING ATTORNEY

Int. Cls.: 35 and 42

Prior U.S. Cls.: 100, 101 and 102

United States Patent and Trademark Office

Reg. No. 3,519,463

Registered Oct. 21, 2008

**SERVICE MARK
PRINCIPAL REGISTER**

EFACTOR MEDIA

THE TASSOS GROUP LLC (CALIFORNIA LIMITED LIABILITY COMPANY)
14282 DANIELSON STREET
POWAY, CA 92064

FOR: ADVERTISING SERVICES, PUBLIC RELATIONS AND MARKETING SERVICES, NAMELY, PROMOTING AND MARKETING THE GOODS AND SERVICES OF OTHERS THROUGH ALL PUBLIC COMMUNICATION MEANS; ADVERTISING SERVICES, NAMELY, CREATING CORPORATE AND BRAND IDENTITY FOR OTHERS; ON-LINE ADVERTISING AND MARKETING SERVICES; SERVICES TO DETERMINE THE AUDIENCE AFFECTED BY ADVERTISEMENTS; CUSTOMER RELATIONSHIP MANAGEMENT, IN CLASS 35 (U.S. CLS. 100, 101 AND 102).

FIRST USE 6-30-1997; IN COMMERCE 6-30-1997.

FOR: WEBSITE DESIGN; DESIGN AND CREATION OF INTERACTIVE MEDIA AND CONTENT, NAMELY, CREATION OF WEB PAGES FOR OTHERS; GRAPHIC DESIGN, IN CLASS 42 (U.S. CLS. 100 AND 101).

FIRST USE 6-30-1997; IN COMMERCE 6-30-1997.

THE MARK CONSISTS OF STANDARD CHARACTERS WITHOUT CLAIM TO ANY PARTICULAR FONT, STYLE, SIZE, OR COLOR.

NO CLAIM IS MADE TO THE EXCLUSIVE RIGHT TO USE "MEDIA", APART FROM THE MARK AS SHOWN.

SER. NO. 77-364,716, FILED 1-4-2008.

INGA ERVIN, EXAMINING ATTORNEY

Int. Cls.: 29 and 43

Prior U.S. Cls.: 46, 100 and 101

United States Patent and Trademark Office

Reg. No. 3,519,464

Registered Oct. 21, 2008

**TRADEMARK
SERVICE MARK
PRINCIPAL REGISTER**

DONNIE'S FAMOUS CHILI

MELTON, DONNIE K. (UNITED STATES INDIVIDUAL)

3425 NEW MIDDLETOWN-ELIZABETH ROAD
NEW MIDDLETOWN, IN 47160 AND

MELTON, REVA L. (UNITED STATES INDIVIDUAL)

3425 NEW MIDDLETOWN-ELIZABETH ROAD
NEW MIDDLETOWN, IN 47160

FOR: CANNED AND PREPACKAGED CHILI, IN CLASS 29 (U.S. CL. 46).

FIRST USE 3-31-2002; IN COMMERCE 3-31-2002.

FOR: RESTAURANT SERVICES, IN CLASS 43 (U.S. CLS. 100 AND 101).

FIRST USE 3-31-2002; IN COMMERCE 3-31-2002.

THE MARK CONSISTS OF STANDARD CHARACTERS WITHOUT CLAIM TO ANY PARTICULAR FONT, STYLE, SIZE, OR COLOR.

NO CLAIM IS MADE TO THE EXCLUSIVE RIGHT TO USE "FAMOUS CHILI", APART FROM THE MARK AS SHOWN.

SER. NO. 77-365,173, FILED 1-7-2008.

JIM RINGLE, EXAMINING ATTORNEY

Int. Cl.: 35

Prior U.S. Cls.: 100, 101 and 102

United States Patent and Trademark Office

Reg. No. 3,519,465

Registered Oct. 21, 2008

**SERVICE MARK
PRINCIPAL REGISTER**

Brand SMART

GLOWAC, HARRIS, MADISON, INC. (WISCONSIN CORPORATION)
SUITE 300
330 S. WHITNEY WAY
MADISON, WI 53705

FOR: ADVERTISING SERVICES, IN CLASS 35
(U.S. CLS. 100, 101 AND 102).

FIRST USE 3-1-2007; IN COMMERCE 3-1-2007.

NO CLAIM IS MADE TO THE EXCLUSIVE
RIGHT TO USE "BRAND", APART FROM THE
MARK AS SHOWN.

THE COLOR(S) BLACK, WHITE AND GREEN IS/
ARE CLAIMED AS A FEATURE OF THE MARK.

THE MARK CONSISTS OF THE WORD "BRAND"
IN THE COLOR WHITE AND THE WORD "SMART"
IN THE COLOR BLACK. A RECTANGULAR DE-
SIGN APPEARS BEHIND THE WORD "BRAND" IN
THE COLOR GREEN.

SER. NO. 77-365,251, FILED 1-7-2008.

MARK T. MULLEN, EXAMINING ATTORNEY

Int. Cl.: 36

Prior U.S. Cls.: 100, 101 and 102

United States Patent and Trademark Office

Reg. No. 3,519,466

Registered Oct. 21, 2008

**SERVICE MARK
PRINCIPAL REGISTER**



SUNFLOWER CHILDREN (CALIFORNIA CORPORATION)
#449
532 LA GUARDIA PLACE
NEW YORK, NY 10012

FOR: CHARITABLE FUND RAISING SERVICES FOR THE MEDICAL, NUTRITIONAL, PSYCHOLOGICAL, EDUCATIONAL, AND HUMANITARIAN SUPPORT FOR THE ORPHANED, DISABLED, ABANDONED, REFUGEE AND IMPOVERISHED CHILDREN OF THE WORLD, IN CLASS 36 (U.S. CLS. 100, 101 AND 102).

FIRST USE 5-21-2008; IN COMMERCE 5-21-2008.

NO CLAIM IS MADE TO THE EXCLUSIVE RIGHT TO USE "CHILDREN", APART FROM THE MARK AS SHOWN.

THE MARK CONSISTS OF THE WORDS "SUNFLOWER CHILDREN" AND A DESIGN OF THE SUN COMPRISED OF STYLIZED HUMAN FIGURES.

SER. NO. 77-365,374, FILED 1-7-2008.

TEJBIR SINGH, EXAMINING ATTORNEY

Int. Cl.: 36

Prior U.S. Cls.: 100, 101 and 102

United States Patent and Trademark Office

Reg. No. 3,519,467

Registered Oct. 21, 2008

**SERVICE MARK
PRINCIPAL REGISTER**

SmartFed

RADLOVIC, MICHAEL M. (UNITED STATES
INDIVIDUAL)
C/O GARY BLUM, ESQ.
3278 WILSHIRE BLVD., STE. 603
LOS ANGELES, CA 90110

FOR: BANKING SERVICES; AUTOMATED TELLER MACHINE SERVICES; SAVINGS, CHECKING AND CERTIFICATE OF DEPOSIT ACCOUNT SERVICES; CHECK CARD SERVICES; CREDIT CARD SERVICES; DEBIT CARD SERVICES; CASH CARD SERVICES; STORED VALUE CARD SERVICES; DEPOSIT CARD SERVICES; ONLINE BANKING SERVICES; ELECTRONIC PAYMENT SERVICES, NAMELY ELECTRONIC PROCESSING AND TRANSMISSION OF BILL PAYMENT DATA, MORTGAGE LENDING SERVICES; HOME EQUITY LENDING SERVICES; CONSUMER LENDING SERVICES; COMMERCIAL LENDING SERVICES;

MORTGAGE BANKING SERVICES; NAMELY, ORIGINATION, ACQUISITION, SERVICING, SPECIALTY FINANCE LENDING SERVICES, NAMELY LENDING TO UNDERSERVED BORROWERS , IN CLASS 36 (U.S. CLS. 100, 101 AND 102).

FIRST USE 1-31-2007; IN COMMERCE 1-31-2007.

THE MARK CONSISTS OF STANDARD CHARACTERS WITHOUT CLAIM TO ANY PARTICULAR FONT, STYLE, SIZE, OR COLOR.

OWNER OF U.S. REG. NO. 3,289,188.

SER. NO. 77-365,763, FILED S.R. 1-7-2008 AM. P.R. 6-5-2008.

ODESSA BIBBINS, EXAMINING ATTORNEY

Int. Cl.: 21

Prior U.S. Cls.: 2, 13, 23, 29, 30, 33, 40 and 50

Reg. No. 3,519,468

United States Patent and Trademark Office

Registered Oct. 21, 2008

**TRADEMARK
PRINCIPAL REGISTER**



HOLSTER, INC. (CALIFORNIA CORPORATION)
358 SO. COCHRAN AVE., SUITE 103
LOS ANGELES, CA 90036

FOR: CADDIES FOR HOLDING HAIR ACCESSORIES FOR HOUSEHOLD AND DOMESTIC USE, NAMELY, A PORTABLE HOLDER FOR HANDS FREE OPERATION OF THE HAIR ACCESSORIES, IN CLASS 21 (U.S. CLS. 2, 13, 23, 29, 30, 33, 40 AND 50).

FIRST USE 1-4-2008; IN COMMERCE 1-4-2008.

THE MARK CONSISTS OF THE WORDS "BLO", AND "GO", CONTAINING WAVES THROUGH THE "O", WITH AN AMPERSAND IN BETWEEN INCORPORATING A DEPICTION OF A HAIR DRYER.

SER. NO. 77-365,941, FILED 1-7-2008.

WILLIAM ROSSMAN, EXAMINING ATTORNEY

Int. Cl.: 35

Prior U.S. Cls.: 100, 101 and 102

United States Patent and Trademark Office

Reg. No. 3,519,469

Registered Oct. 21, 2008

**SERVICE MARK
PRINCIPAL REGISTER**

WORKING FAMILIES TOOLKIT

AMERICAN FEDERATION OF LABOR CON-
GRESS OF INDUSTRIAL ORGANIZATIONS
(D.C. INCORPORATED ASSOCIATION)
815 16TH STREET, NW
WASHINGTON, DC 20006

FOR: PREPARATION OF CUSTOMIZABLE MA-
TERIALS, NAMELY, WORKPLACE FLYERS, SAM-
PLE ARTICLES FOR LOCAL UNION AND
CENTRAL LABOR COUNCIL NEWSLETTERS,
SAMPLE LETTERS FROM LOCAL UNION PRESI-
DENTS TO MEMBERS, DVDS AND POWER POINT
PRESENTATIONS, REGARDING POLITICAL CAM-
PAIGNS AND OTHER ISSUES OF IMPORTANCE TO
WORKERS FOR LABOR UNIONS TO DOWNLOAD
AND DISSEMINATE TO THEIR MEMBERS, IN
CLASS 35 (U.S. CLS. 100, 101 AND 102).

FIRST USE 9-0-2000; IN COMMERCE 9-0-2000.

THE MARK CONSISTS OF STANDARD CHAR-
ACTERS WITHOUT CLAIM TO ANY PARTICULAR
FONT, STYLE, SIZE, OR COLOR.

OWNER OF U.S. REG. NO. 2,576,803.

NO CLAIM IS MADE TO THE EXCLUSIVE
RIGHT TO USE "TOOLKIT", APART FROM THE
MARK AS SHOWN.

SEC. 2(F).

SER. NO. 77-366,244, FILED 1-8-2008.

CHRISTINA SOBRAL, EXAMINING ATTORNEY

Int. Cl.: 11

Prior U.S. Cls.: 13, 21, 23, 31 and 34

United States Patent and Trademark Office

Reg. No. 3,519,470

Registered Oct. 21, 2008

**TRADEMARK
PRINCIPAL REGISTER**

FakeTV

OPTO-ELECTRONIC DESIGN, INC. (MINNESOTA CORPORATION)
6440 FLYING CLOUD DRIVE, SUITE 207
EDEN PRAIRIE, MN 55344

FOR: BURGLAR DETERRENT DEVICES FOR PROVIDING HOME OCCUPANCY SIMULATION, NAMELY, DEVICES FOR PRODUCING A LIGHT OUTPUT THAT SIMULATES THE EFFECT OF AN OPERATING TELEVISION RECEIVER, IN CLASS 11 (U.S. CLS. 13, 21, 23, 31 AND 34).

FIRST USE 2-11-2008; IN COMMERCE 2-11-2008.

THE MARK CONSISTS OF STANDARD CHARACTERS WITHOUT CLAIM TO ANY PARTICULAR FONT, STYLE, SIZE, OR COLOR.

SER. NO. 77-366,650, FILED 1-8-2008.

SARA THOMAS, EXAMINING ATTORNEY

Int. Cl.: 37

Prior U.S. Cls.: 100, 103 and 106

Reg. No. 3,519,471

United States Patent and Trademark Office

Registered Oct. 21, 2008

**SERVICE MARK
PRINCIPAL REGISTER**



US EXTERIOR MAINTENANCE & REPAIR (ILLINOIS LIMITED LIABILITY COMPANY)
SUITE D
10038 CLOW CREEK DR.
PLAINFIELD, IL 60585

FOR: MAINTENANCE AND/OR REPAIR OF SYNTHETIC STUCCO ; INSTALLATION, MAINTENANCE AND REPAIR OF WINDOWS AND DOORS; BUILDING SEALING AND CAULKING SERVICES ; RECOATING, NAMELY, PAINTING OF EXTERIOR SIDING; BUILDING CONSTRUCTION SERVICES, IN CLASS 37 (U.S. CLS. 100, 103 AND 106).

FIRST USE 1-1-2000; IN COMMERCE 1-1-2000.

NO CLAIM IS MADE TO THE EXCLUSIVE RIGHT TO USE "EXTERIOR" AND "MAINTENANCE & REPAIR", APART FROM THE MARK AS SHOWN.

THE MARK CONSISTS OF AN OVAL WITH THE STYLIZED WORDS "U.S. EXTERIOR MAINTENANCE & REPAIR" INSIDE OF THE OVAL.

SEC. 2(F).

SER. NO. 77-367,687, FILED 1-9-2008.

TARA PATE, EXAMINING ATTORNEY

Int. Cl.: 9

Prior U.S. Cls.: 21, 23, 26, 36 and 38

Reg. No. 3,519,472

United States Patent and Trademark Office

Registered Oct. 21, 2008

**TRADEMARK
PRINCIPAL REGISTER**

KUBANEY

KUBANEY ACQUISITION, LLC (DELAWARE
LIMITED LIABILITY COMPANY)
SUITE 230
5757 BLUE LAGOON DRIVE
MIAMI, FL 331262076

THE MARK CONSISTS OF STANDARD CHAR-
ACTERS WITHOUT CLAIM TO ANY PARTICULAR
FONT, STYLE, SIZE, OR COLOR.

FOR: MUSICAL SOUND RECORDINGS, IN
CLASS 9 (U.S. CLS. 21, 23, 26, 36 AND 38).

SER. NO. 77-367,917, FILED 1-9-2008.

FIRST USE 0-0-1966; IN COMMERCE 0-0-1966.

KYLE PEETE, EXAMINING ATTORNEY

Int. Cl.: 44

Prior U.S. Cls.: 100 and 101

United States Patent and Trademark Office

Reg. No. 3,519,473

Registered Oct. 21, 2008

**SERVICE MARK
PRINCIPAL REGISTER**

EDGEWATER CONVENIENT CARE

EDGEWATER URGENT MEDICAL CARE, LLC
(MISSISSIPPI LIMITED LIABILITY COMPA-
NY)
PO BOX 6913
GULFPORT, MS 39506

FOR: HEALTHCARE AND MEDICAL SERVICES,
IN CLASS 44 (U.S. CLS. 100 AND 101).

FIRST USE 12-20-2007; IN COMMERCE 12-20-2007.

THE MARK CONSISTS OF STANDARD CHAR-
ACTERS WITHOUT CLAIM TO ANY PARTICULAR
FONT, STYLE, SIZE, OR COLOR.

NO CLAIM IS MADE TO THE EXCLUSIVE
RIGHT TO USE "CONVENIENT CARE", APART
FROM THE MARK AS SHOWN.

THE WORDING "EDGEWATER" HAS NO MEAN-
ING IN A FOREIGN LANGUAGE.

SER. NO. 77-368,000, FILED 1-9-2008.

REGINA DRUMMOND, EXAMINING ATTORNEY

Int. Cls.: 35 and 41

Prior U.S. Cls.: 100, 101, 102 and 107

United States Patent and Trademark Office

Reg. No. 3,519,474

Registered Oct. 21, 2008

**SERVICE MARK
PRINCIPAL REGISTER**

**Bringing Peaceful Order to
Everyday Life**

LIVING PEACE, LLC (MASSACHUSETTS LIMITED LIABILITY COMPANY)
4 WEDGE POND ROAD
WINCHESTER, MA 01890

FOR: PROVIDING ORGANIZING SERVICES FOR INDIVIDUALS AT HOME, IN HOME OFFICES AND IN BUSINESS OFFICES, THAT PROVIDES HELP WITH TIME AND PAPER MANAGEMENT, IN CLASS 35 (U.S. CLS. 100, 101 AND 102).

FIRST USE 7-1-2003; IN COMMERCE 7-1-2003.

FOR: TRAINING SERVICES IN THE FIELD OF PERSONAL AND BUSINESS ORGANIZATION AND

TIME MANAGEMENT, IN CLASS 41 (U.S. CLS. 100, 101 AND 107).

FIRST USE 7-1-2003; IN COMMERCE 7-1-2003.

THE MARK CONSISTS OF STANDARD CHARACTERS WITHOUT CLAIM TO ANY PARTICULAR FONT, STYLE, SIZE, OR COLOR.

SER. NO. 77-368,513, FILED 1-10-2008.

ALYSSA PALADINO, EXAMINING ATTORNEY

Int. Cl.: 30

Prior U.S. Cl.: 46

United States Patent and Trademark Office

Reg. No. 3,519,475

Registered Oct. 21, 2008

TRADEMARK
PRINCIPAL REGISTER



PARTNERS IN MARKETING (PENNSYLVANIA
CORPORATION)
PO BOX 138
404 MAPLE ST
IRWIN, PA 15642

FOR: FUDGE, IN CLASS 30 (U.S. CL. 46).

FIRST USE 1-1-2002; IN COMMERCE 1-1-2002.

NO CLAIM IS MADE TO THE EXCLUSIVE
RIGHT TO USE "FUDGE", APART FROM THE
MARK AS SHOWN.

THE NAME "CLAUDIA LAYNE" DOES NOT
IDENTIFY A LIVING INDIVIDUAL.

THE COLOR(S) BLUE, WHITE IS/ARE CLAIMED
AS A FEATURE OF THE MARK.

THE MARK CONSISTS OF THE WORDING
"CLAUDIA LAYNE" AND "CL" AND THE OVAL
DESIGN IN THE MARK ARE BLUE; THE WORD-
ING "FUDGE" IS WHITE.

SER. NO. 77-368,624, FILED 1-10-2008.

DANIEL CAPSHAW, EXAMINING ATTORNEY

Int. Cls.: 35 and 37

Prior U.S. Cls.: 100, 101, 102, 103 and 106

United States Patent and Trademark Office

Reg. No. 3,519,476

Registered Oct. 21, 2008

**SERVICE MARK
PRINCIPAL REGISTER**

SECOA

SECOA, INC. (MINNESOTA CORPORATION)
8650 109TH AVE. NORTH
CHAMPLIN, MN 55316

FOR: DISTRIBUTORSHIP SERVICES FOR STAGE, STUDIO, CONVENTION CENTER AND ARENA EQUIPMENT AND SUPPLIES, NAMELY, RIGGING, CURTAINS, ELECTRIC DISTRIBUTION EQUIPMENT, ORCHESTRA SHELLS, ACOUSTICAL CEILINGS, WALL PANELS AND ACOUSTICAL CURTAINS, MOTORIZED ACOUSTICAL CEILINGS, WALL PANELS AND ACOUSTICAL CURTAINS AND CONTROLS, PORTABLE STAGING, MODULAR STAGING AND ORCHESTRA PIT FILLER, MOTORIZED RIGGING AND CONTROLS, LIGHTING EQUIPMENT, SEATING EQUIPMENT, AND ORCHESTRA PIT LIFT EQUIPMENT, IN CLASS 35 (U.S. CLS. 100, 101 AND 102).

FIRST USE 7-1-1957; IN COMMERCE 7-1-1957.

FOR: CONSTRUCTION AND INSTALLATION OF STAGE, STUDIO, CONVENTION CENTER AND ARENA EQUIPMENT AND SUPPLIES, NAMELY,

RIGGING, CURTAINS, ELECTRIC DISTRIBUTION EQUIPMENT, ORCHESTRA SHELLS, ACOUSTICAL CEILINGS, WALL PANELS AND ACOUSTICAL CURTAINS, MOTORIZED ACOUSTICAL CEILINGS, WALL PANELS AND ACOUSTICAL CURTAINS AND CONTROLS, PORTABLE STAGING, MODULAR STAGING AND ORCHESTRA PIT FILLER, MOTORIZED RIGGING AND CONTROLS, LIGHTING EQUIPMENT, SEATING EQUIPMENT, AND ORCHESTRA PIT LIFT EQUIPMENT, IN CLASS 37 (U.S. CLS. 100, 103 AND 106).

FIRST USE 7-1-1957; IN COMMERCE 7-1-1957.

THE MARK CONSISTS OF STANDARD CHARACTERS WITHOUT CLAIM TO ANY PARTICULAR FONT, STYLE, SIZE, OR COLOR.

OWNER OF U.S. REG. NO. 1,285,577.

SER. NO. 77-368,760, FILED 1-10-2008.

DANNEAN HETZEL, EXAMINING ATTORNEY

Int. Cl.: 45

Prior U.S. Cls.: 100 and 101

United States Patent and Trademark Office

Reg. No. 3,519,477

Registered Oct. 21, 2008

**SERVICE MARK
PRINCIPAL REGISTER**

V3locity
a Huron solution

HURON CONSULTING GROUP INC. (DELA-
WARE CORPORATION)
550 WEST VAN BUREN STREET
CHICAGO, IL 60607

FOR: LEGAL CONSULTING SERVICES, NAME-
LY, PROCESSING, HOSTING AND REVIEW OF
DOCUMENTS AND EVIDENCE FOR LEGAL AND

REGULATORY COMPLIANCE DEPARTMENTS, IN
CLASS 45 (U.S. CLS. 100 AND 101).

FIRST USE 11-0-2007; IN COMMERCE 11-0-2007.

SER. NO. 77-368,779, FILED 1-10-2008.

WILLIAM VERHOSEK, EXAMINING ATTORNEY

Int. Cl.: 39

Prior U.S. Cls.: 100 and 105

United States Patent and Trademark Office

Reg. No. 3,519,478

Registered Oct. 21, 2008

**SERVICE MARK
PRINCIPAL REGISTER**

ARCADIUM CUSTOMS

ARCADIUM CUSTOMS, LLC (MINNESOTA LIMITED LIABILITY COMPANY)
707 W 6TH STREET
MONTICELLO, MN 55362

FOR: ON-LINE RETAIL STORE SERVICES FEATURING CUSTOM COMPUTER COMPONENTS, IN CLASS 39 (U.S. CLS. 100 AND 105).

FIRST USE 1-1-2008; IN COMMERCE 1-1-2008.

THE MARK CONSISTS OF STANDARD CHARACTERS WITHOUT CLAIM TO ANY PARTICULAR FONT, STYLE, SIZE, OR COLOR.

NO CLAIM IS MADE TO THE EXCLUSIVE RIGHT TO USE "CUSTOMS", APART FROM THE MARK AS SHOWN.

SER. NO. 77-368,794, FILED 1-10-2008.

ZHALEH DELANEY, EXAMINING ATTORNEY

Int. Cl.: 44

Prior U.S. Cls.: 100 and 101

United States Patent and Trademark Office

Reg. No. 3,519,479

Registered Oct. 21, 2008

**SERVICE MARK
PRINCIPAL REGISTER**

Divas-n-Dudes

KOSCO, KEVIN L. (UNITED STATES INDIVIDUAL)
7813 SECRETARIAT DR.
MIDLOTHIAN, VA 23112 AND
KOSCO, ANGELA, G. (UNITED STATES INDIVIDUAL)
7813 SECRETARIAT DR.
MIDLOTHIAN, VA 23112

FOR: BEAUTY SALONS, IN CLASS 44 (U.S. CLS. 100 AND 101).

FIRST USE 11-6-2006; IN COMMERCE 11-6-2006.

THE MARK CONSISTS OF STANDARD CHARACTERS WITHOUT CLAIM TO ANY PARTICULAR FONT, STYLE, SIZE, OR COLOR.

SER. NO. 77-369,380, FILED 1-11-2008.

JAY FLOWERS, EXAMINING ATTORNEY

Int. Cl.: 21

Prior U.S. Cls.: 2, 13, 23, 29, 30, 33, 40 and 50

Reg. No. 3,519,480

United States Patent and Trademark Office

Registered Oct. 21, 2008

**TRADEMARK
PRINCIPAL REGISTER**



KAYHAN COYNE, SELDA (UNITED STATES
INDIVIDUAL)
138 MAPLEWOOD AVE.
MAPLEWOOD, NJ 07040

FOR: NAPKIN RINGS, IN CLASS 21 (U.S. CLS. 2,
13, 23, 29, 30, 33, 40 AND 50).

FIRST USE 12-18-2007; IN COMMERCE 12-18-2007.

NO CLAIM IS MADE TO THE EXCLUSIVE
RIGHT TO USE "DESIGN STUDIO", APART FROM
THE MARK AS SHOWN.

THE NAME SHOWN IN THE MARK IDENTIFIES
"VERDA KAYHAN" A LIVING INDIVIDUAL,
WHOSE CONSENT IS OF RECORD.

THE MARK CONSISTS OF A STYLIZED "V" AND
"VERDA KAYHAN" IS WRITTEN AT AN ANGLE.
ALL LETTERS IN BLACK HAVE AN ANTIQUE
FINISH AS IF AGED BY TIME.

SER. NO. 77-371,252, FILED 1-14-2008.

KIMBERLY PERRY, EXAMINING ATTORNEY

Int. Cl.: 41

Prior U.S. Cls.: 100, 101 and 107

United States Patent and Trademark Office

Reg. No. 3,519,481

Registered Oct. 21, 2008

**SERVICE MARK
PRINCIPAL REGISTER**



PIMENTEL, LEON (UNITED STATES INDIVIDUAL)
SUITE 6
5362 CAHUENGA BLVD.
NORTH HOLLYWOOD, CA 91601

FOR: ENTERTAINMENT IN THE NATURE OF LIVE PERFORMANCES BY A MUSICAL BAND; ENTERTAINMENT SERVICES, NAMELY, PROVIDING A WEB SITE FEATURING PHOTOGRAPHIC,

AUDIO, VIDEO AND PROSE PRESENTATIONS FEATURING THE WORK OF A MUSICAL BAND, IN CLASS 41 (U.S. CLS. 100, 101 AND 107).

FIRST USE 6-7-2005; IN COMMERCE 7-14-2006.

SER. NO. 77-371,562, FILED 1-14-2008.

KATHERINE CHANG, EXAMINING ATTORNEY

Int. Cl.: 39

Prior U.S. Cls.: 100 and 105

United States Patent and Trademark Office

Reg. No. 3,519,482

Registered Oct. 21, 2008

**SERVICE MARK
PRINCIPAL REGISTER**

HARVEY GULF

HARVEY GULF INTERNATIONAL MARINE,
INC. (LOUISIANA CORPORATION)
BLDG. H, STE. 200
1901 MANHATTAN BLVD.
HARVEY, LA 70058

THE MARK CONSISTS OF STANDARD CHAR-
ACTERS WITHOUT CLAIM TO ANY PARTICULAR
FONT, STYLE, SIZE, OR COLOR.

FOR: TRANSPORT BROKERAGE, NAMELY,
MARINE TRANSPORTATION BROKERING, IN
CLASS 39 (U.S. CLS. 100 AND 105).

SER. NO. 77-372,456, FILED 1-15-2008.

FIRST USE 3-25-1975; IN COMMERCE 3-25-1975.

TINA BROWN, EXAMINING ATTORNEY

Int. Cl.: 39

Prior U.S. Cls.: 100 and 105

United States Patent and Trademark Office

Reg. No. 3,519,483

Registered Oct. 21, 2008

**SERVICE MARK
PRINCIPAL REGISTER**



HARVEY GULF INTERNATIONAL MARINE,
INC. (LOUISIANA CORPORATION)
BLDG. H, STE. 200
1901 MANHATTAN BLVD.
HARVEY, LA 70058

NO CLAIM IS MADE TO THE EXCLUSIVE
RIGHT TO USE "INTERNATIONAL MARINE,
INC.", APART FROM THE MARK AS SHOWN.

FOR: TRANSPORT BROKERAGE, NAMELY,
MARINE TRANSPORTATION BROKERING, IN
CLASS 39 (U.S. CLS. 100 AND 105).

SER. NO. 77-372,490, FILED 1-15-2008.

FIRST USE 4-0-1975; IN COMMERCE 4-0-1975.

TINA BROWN, EXAMINING ATTORNEY

Int. Cls.: 40 and 44

Prior U.S. Cls.: 100, 101, 103 and 106

United States Patent and Trademark Office

Reg. No. 3,519,484

Registered Oct. 21, 2008

**SERVICE MARK
PRINCIPAL REGISTER**



PIKE, CHARLES (UNITED STATES INDIVIDUAL)
D-1
301 SOUTH TUBBS ST.
OAKLAND, FL 34760

FOR: DENTAL TECHNICIAN SERVICES, IN CLASS 40 (U.S. CLS. 100, 103 AND 106).

FIRST USE 9-30-2007; IN COMMERCE 9-30-2007.

FOR: DENTAL HYGIENIST SERVICES; DENTIST SERVICES, IN CLASS 44 (U.S. CLS. 100 AND 101).

FIRST USE 9-30-2007; IN COMMERCE 9-30-2007.

NO CLAIM IS MADE TO THE EXCLUSIVE RIGHT TO USE "DENTAL", APART FROM THE MARK AS SHOWN.

THE COLOR(S) RED, BLACK AND GRAY IS/ARE CLAIMED AS A FEATURE OF THE MARK.

THE MARK CONSISTS OF THE WORDS "ALL ASPECTS" WITH THE WORD "ALL" ABOVE THE WORD "ASPECTS", BOTH WORDS ARE RED WITH BLACK SHADOWING WITH A SINGLE LARGE A FORMING THE FIRST LETTER OF BOTH THE WORDS "ALL" AND "ASPECTS". THE MARK ALSO CONTAINS THE IMAGE OF A GRAY TOOTH TO THE RIGHT OF THE WORD "ALL". THE WORD "DENTAL" IS IN BLACK LETTERS AND A THIN BLACK LINE SEPARATES THE WORDS "ASPECTS" AND "DENTAL".

SER. NO. 77-372,866, FILED 1-16-2008.

LYDIA BELZER, EXAMINING ATTORNEY

Int. Cl.: 9

Prior U.S. Cls.: 21, 23, 26, 36 and 38

Reg. No. 3,519,485

United States Patent and Trademark Office

Registered Oct. 21, 2008

**TRADEMARK
PRINCIPAL REGISTER**

CENTERBRIDGE

BAY BRIDGE DECISION TECHNOLOGIES, INC.
(MARYLAND CORPORATION)
SUITE 210
900 BESTGATE ROAD
ANNAPOLIS, MD 21401

FIRST USE 4-25-2003; IN COMMERCE 4-25-2003.

THE MARK CONSISTS OF STANDARD CHARACTERS WITHOUT CLAIM TO ANY PARTICULAR FONT, STYLE, SIZE, OR COLOR.

FOR: COMPUTER SOFTWARE FOR PLANNING AND ANALYSIS OF THE PERFORMANCE AND OPERATIONS OF CUSTOMER SUPPORT CONTACT CENTERS, IN CLASS 9 (U.S. CLS. 21, 23, 26, 36 AND 38).

SER. NO. 77-373,109, FILED 1-16-2008.

GENE MACIOL, EXAMINING ATTORNEY

Int. Cl.: 16

Prior U.S. Cls.: 2, 5, 22, 23, 29, 37, 38 and 50

United States Patent and Trademark Office

Reg. No. 3,519,486

Registered Oct. 21, 2008

**TRADEMARK
PRINCIPAL REGISTER**

LONGBOARD COWBOYS

KIDD, ROBERT (UNITED STATES INDIVIDUAL)
8652 FENSMUIR ST
SAN DIEGO, CA 92123

THE MARK CONSISTS OF STANDARD CHAR-
ACTERS WITHOUT CLAIM TO ANY PARTICULAR
FONT, STYLE, SIZE, OR COLOR.

FOR: ART ETCHINGS; ART PRINTS; ART
PRINTS ON CANVAS; LITHOGRAPHIC WORKS
OF ART, IN CLASS 16 (U.S. CLS. 2, 5, 22, 23, 29, 37,
38 AND 50).

SER. NO. 77-373,692, FILED 1-16-2008.

FIRST USE 10-5-1967; IN COMMERCE 10-5-1987.

DAVID YONTEF, EXAMINING ATTORNEY

Int. Cl.: 22

Prior U.S. Cls.: 1, 2, 7, 19, 22, 42 and 50

Reg. No. 3,519,487

United States Patent and Trademark Office

Registered Oct. 21, 2008

**TRADEMARK
PRINCIPAL REGISTER**

POWERTYE

CARRILLO, ROBERT G (UNITED STATES INDIVIDUAL)
P.O. BOX 17904
ANAHEIM, CA 92817

FOR: TIE DOWN STRAPS, IN CLASS 22 (U.S. CLS. 1, 2, 7, 19, 22, 42 AND 50).

FIRST USE 10-18-1993; IN COMMERCE 10-18-1993.

THE MARK CONSISTS OF STANDARD CHARACTERS WITHOUT CLAIM TO ANY PARTICULAR FONT, STYLE, SIZE, OR COLOR.

SEC. 2(F).

SER. NO. 77-374,176, FILED 1-17-2008.

ALEX KEAM, EXAMINING ATTORNEY

Int. Cl.: 25

Prior U.S. Cls.: 22 and 39

United States Patent and Trademark Office

Reg. No. 3,519,488

Registered Oct. 21, 2008

**TRADEMARK
PRINCIPAL REGISTER**

LIFE IS WICKED

LIFE IS WICKED COM LLC (CONNECTICUT
LIMITED LIABILITY COMPANY)
28 OAK LEDGE LANE
WILTON, CT 06897

THE MARK CONSISTS OF STANDARD CHAR-
ACTERS WITHOUT CLAIM TO ANY PARTICULAR
FONT, STYLE, SIZE, OR COLOR.

FOR: SHIRTS, T-SHIRTS, IN CLASS 25 (U.S. CLS.
22 AND 39).

SER. NO. 77-374,178, FILED 1-17-2008.

FIRST USE 3-26-2008; IN COMMERCE 3-26-2008.

ALEX KEAM, EXAMINING ATTORNEY

Int. Cl.: 36

Prior U.S. Cls.: 100, 101 and 102

United States Patent and Trademark Office

Reg. No. 3,519,489

Registered Oct. 21, 2008

**SERVICE MARK
PRINCIPAL REGISTER**

LATIGO

LATIGO PARTNERS, L.P. (DELAWARE LIMITED PARTNERSHIP)
590 MADISON AVENUE, 9TH FLOOR
NEW YORK, NY 10022

FOR: FINANCIAL SERVICES, NAMELY, INVESTMENT ADVISORY SERVICES, MANAGEMENT OF INVESTMENT FUNDS, AND FUND MANAGEMENT SERVICES; HEDGE FUND INVESTMENT, MANAGEMENT, AND ADVISORY SERVICES, IN CLASS 36 (U.S. CLS. 100, 101 AND 102).

FIRST USE 6-0-2005; IN COMMERCE 6-0-2005.

THE MARK CONSISTS OF STANDARD CHARACTERS WITHOUT CLAIM TO ANY PARTICULAR FONT, STYLE, SIZE, OR COLOR.

OWNER OF U.S. REG. NO. 3,146,895.

THE ENGLISH TRANSLATION OF THE SPANISH WORD "LATIGO" IS "WHIP".

SER. NO. 77-374,467, FILED 1-17-2008.

DAVID H. STINE, EXAMINING ATTORNEY

Int. Cl.: 35

Prior U.S. Cls.: 100, 101 and 102

United States Patent and Trademark Office

Reg. No. 3,519,490

Registered Oct. 21, 2008

**SERVICE MARK
PRINCIPAL REGISTER**

BLOCK IMAGING

BLOCK IMAGING INTERNATIONAL, INC. (MI-
CHIGAN CORPORATION)
3475 BELLE CHASE WAY
LANSING, MI 48911

FOR: WHOLESALE DISTRIBUTORSHIP SERVI-
CES IN THE FIELD OF MEDICAL DIAGNOSTIC
IMAGING SYSTEMS, IN CLASS 35 (U.S. CLS. 100, 101
AND 102).

FIRST USE 10-0-1997; IN COMMERCE 10-0-1997.

THE MARK CONSISTS OF STANDARD CHAR-
ACTERS WITHOUT CLAIM TO ANY PARTICULAR
FONT, STYLE, SIZE, OR COLOR.

NO CLAIM IS MADE TO THE EXCLUSIVE
RIGHT TO USE "IMAGING", APART FROM THE
MARK AS SHOWN.

SER. NO. 77-374,889, FILED 1-18-2008.

DAWN FELDMAN, EXAMINING ATTORNEY

Int. Cls.: 9 and 36

Prior U.S. Cls.: 21, 23, 26, 36, 38, 100, 101 and 102

Reg. No. 3,519,491

United States Patent and Trademark Office

Registered Oct. 21, 2008

**TRADEMARK
SERVICE MARK
PRINCIPAL REGISTER**

MoniPay

MONITISE GROUP LIMITED (UNITED KINGDOM COMPANY)
PROVIDIAN HOUSE, 16-18 MONUMENT STREET
LONDON, UNITED KINGDOM EC3R8AJ

FOR: COMPUTER SOFTWARE FOR ENABLING MOBILE BANKING AND PAYMENTS AND FOR FACILITATING COMMUNICATION TO A GLOBAL COMPUTER NETWORK, IN CLASS 9 (U.S. CLS. 21, 23, 26, 36 AND 38).

FOR: BANKING AND FINANCIAL INFORMATION AND PAYMENT SERVICES PROVIDED VIA ELECTRONIC MEANS, IN CLASS 36 (U.S. CLS. 100, 101 AND 102).

THE MARK CONSISTS OF STANDARD CHARACTERS WITHOUT CLAIM TO ANY PARTICULAR FONT, STYLE, SIZE, OR COLOR.

PRIORITY CLAIMED UNDER SEC. 44(D) ON UNITED KINGDOM APPLICATION NO. 2472062, FILED 11-12-2007, REG. NO. 2472062, DATED 11-12-2007, EXPIRES 11-12-2017.

SER. NO. 77-375,149, FILED 1-18-2008.

TRACY CROSS, EXAMINING ATTORNEY

Int. Cl.: 35

Prior U.S. Cls.: 100, 101 and 102

United States Patent and Trademark Office

Reg. No. 3,519,492

Registered Oct. 21, 2008

**SERVICE MARK
PRINCIPAL REGISTER**

**QUALITY IN THE BAG.
SAVINGS IN THE BILL.**

HAGGEN, INC. (WASHINGTON CORPORATION)
2211 RIMLAND DRIVE
BELLINGHAM, WA 98226

FOR: RETAIL GROCERY STORE SERVICES; RETAIL PHARMACY AND DRUG STORE SERVICES; RETAIL BAKERY; RETAIL DELICATESSEN; RETAIL SHOP FEATURING FLOWERS; RETAIL STORE SERVICES FEATURING A WIDE VARIETY OF PACKAGED, PREPARED AND FRESH FOOD AND BEVERAGES; ONLINE RETAIL SHOP FEATURING UMBRELLAS, COMPUTER BAGS, COFFEE CUPS, LUNCH BOXES, CALCULATORS, PENS

AND PENCILS, CLOTHING, IN CLASS 35 (U.S. CLS. 100, 101 AND 102).

FIRST USE 7-28-1998; IN COMMERCE 7-28-1998.

THE MARK CONSISTS OF STANDARD CHARACTERS WITHOUT CLAIM TO ANY PARTICULAR FONT, STYLE, SIZE, OR COLOR.

SER. NO. 77-375,679, FILED 1-18-2008.

MARGARET POWER, EXAMINING ATTORNEY

Int. Cl.: 35

Prior U.S. Cls.: 100, 101 and 102

United States Patent and Trademark Office

Reg. No. 3,519,493

Registered Oct. 21, 2008

SERVICE MARK
PRINCIPAL REGISTER



HAGGEN, INC. (WASHINGTON CORPORATION)
2211 RIMLAND DRIVE
BELLINGHAM, WA 98226

FOR: RETAIL GROCERY STORE SERVICES; RETAIL PHARMACY AND DRUG STORE SERVICES; RETAIL BAKERY; RETAIL DELICATESSEN; RETAIL SHOP FEATURING FLOWERS; RETAIL STORE SERVICES FEATURING A WIDE VARIETY OF PACKAGED, PREPARED AND FRESH FOOD AND BEVERAGES; ONLINE RETAIL SHOP FEATURING UMBRELLAS, COMPUTER BAGS, COFFEE CUPS, LUNCH BOXES, CALCULATORS, PENS, PENCILS AND CLOTHING, IN CLASS 35 (U.S. CLS. 100, 101 AND 102).

FIRST USE 10-1-1997; IN COMMERCE 10-1-1997.

OWNER OF U.S. REG. NO. 2,478,119.

NO CLAIM IS MADE TO THE EXCLUSIVE RIGHT TO USE "SINCE 1933", APART FROM THE MARK AS SHOWN.

THE COLOR(S) GREEN, MAROON, WHITE AND GOLD IS/ARE CLAIMED AS A FEATURE OF THE MARK.

THE MARK CONSISTS OF A SUBSTANTIALLY OVAL SHAPE WITH THE WORD "HAGGEN" SUPERIMPOSED OVER CONCENTRIC CIRCLES WITH THE TERMS "SINCE" AND "1933". THE COLOR GREEN APPEARS IN THE SUBSTANTIALLY OVAL SHAPE AND THE INNER AND OUTER CIRCLES. THE COLOR MAROON APPEARS IN THE MIDDLE CIRCLE. THE COLOR GOLD OUTLINES THE CIRCLES AND SHAPE. THE COLOR WHITE APPEARS IN THE WORDING "HAGGEN" AND "SINCE 1933".

SER. NO. 77-375,751, FILED 1-18-2008.

MARGARET POWER, EXAMINING ATTORNEY

Int. Cl.: 37

Prior U.S. Cls.: 100, 103 and 106

United States Patent and Trademark Office

Reg. No. 3,519,494

Registered Oct. 21, 2008

**SERVICE MARK
PRINCIPAL REGISTER**



THE TERMINIX INTERNATIONAL COMPANY
LIMITED PARTNERSHIP (DELAWARE LIM-
ITED PARTNERSHIP)
860 RIDGE LAKE BOULEVARD
MEMPHIS, TN 38120

FOR: TERMITE AND PEST CONTROL, IN CLASS
37 (U.S. CLS. 100, 103 AND 106).

FIRST USE 12-29-2007; IN COMMERCE 12-29-2007.

THE COLOR(S) GREEN AND GRAY IS/ARE
CLAIMED AS A FEATURE OF THE MARK.

THE MARK CONSISTS OF A SHIELD IN THE
COLOR GREEN OUTLINED IN THE COLOR GRAY
AND LETTER "T" IN THE COLOR GRAY, IN
WHICH THE BASE OF THE "T" EXTENDS AT AN
ANGLE TOWARD THE UPPER RIGHT PORTION
OF THE SHIELD, AND THE CROSS MEMBER OF
THE "T" IS HORIZONTALLY LOCATED IN THE
UPPER RIGHT PORTION OF THE SHIELD.

SER. NO. 77-375,981, FILED 1-19-2008.

WILLIAM ROSSMAN, EXAMINING ATTORNEY

Int. Cl.: 37

Prior U.S. Cls.: 100, 103 and 106

Reg. No. 3,519,495

United States Patent and Trademark Office

Registered Oct. 21, 2008

**SERVICE MARK
PRINCIPAL REGISTER**



THE TERMINIX INTERNATIONAL COMPANY
LIMITED PARTNERSHIP (DELAWARE LIMITED PARTNERSHIP)

860 RIDGE LAKE BOULEVARD
MEMPHIS, TN 38120

FOR: TERMITE AND PEST CONTROL, IN CLASS
37 (U.S. CLS. 100, 103 AND 106).

FIRST USE 12-29-2007; IN COMMERCE 12-29-2007.

THE COLOR(S) GREEN AND GRAY IS/ARE
CLAIMED AS A FEATURE OF THE MARK.

THE MARK CONSISTS OF A SHIELD IN THE
COLOR GREEN OUTLINED IN THE COLOR GRAY
AND LETTER "T" IN THE COLOR GRAY, IN
WHICH THE BASE OF THE "T" EXTENDS AT AN
ANGLE TOWARD THE UPPER RIGHT PORTION
OF THE SHIELD, AND THE CROSS MEMBER OF
THE "T" IS HORIZONTALLY LOCATED IN THE
UPPER RIGHT PORTION OF THE SHIELD. THE
SHIELD IS IN THE SHAPE OF A LOCK WITH A KEY
HOLE IN THE CENTER OF THE "T" AND A U-
SHAPED BAR ON TOP OF THE SHIELD.

SER. NO. 77-376,009, FILED 1-19-2008.

WILLIAM ROSSMAN, EXAMINING ATTORNEY

Int. Cl.: 42

Prior U.S. Cls.: 100 and 101

United States Patent and Trademark Office

Reg. No. 3,519,496

Registered Oct. 21, 2008

**SERVICE MARK
PRINCIPAL REGISTER**

**CREATING THERAPIES.
GENERATING HOPE.**

GENSPERA, INC. (DELAWARE CORPORATION)
1223 WILSHIRE BLVD. #1403
SANTA MONICA, CA 90403

FOR: DEVELOPMENT OF PHARMACEUTICAL
PREPARATIONS AND MEDICINES; PHARMACEU-
TICAL DRUG DEVELOPMENT SERVICES; PHAR-
MACEUTICAL RESEARCH AND DEVELOPMENT,
IN CLASS 42 (U.S. CLS. 100 AND 101).

FIRST USE 3-31-2004; IN COMMERCE 3-31-2004.

THE MARK CONSISTS OF STANDARD CHAR-
ACTERS WITHOUT CLAIM TO ANY PARTICULAR
FONT, STYLE, SIZE, OR COLOR.

SER. NO. 77-376,247, FILED 1-20-2008.

DAYNA BROWNE, EXAMINING ATTORNEY

Int. Cl.: 42

Prior U.S. Cls.: 100 and 101

United States Patent and Trademark Office

Reg. No. 3,519,497

Registered Oct. 21, 2008

**SERVICE MARK
PRINCIPAL REGISTER**



GENSPERA, INC. (DELAWARE CORPORATION)
1223 WILSHIRE BLVD. #1403
SANTA MONICA, CA 90403

FOR: DEVELOPMENT OF PHARMACEUTICAL
PREPARATIONS AND MEDICINES; PHARMACEU-
TICAL DRUG DEVELOPMENT SERVICES; PHAR-
MACEUTICAL RESEARCH AND DEVELOPMENT,
IN CLASS 42 (U.S. CLS. 100 AND 101).

FIRST USE 3-31-2004; IN COMMERCE 3-31-2004.

THE MARK CONSISTS OF AN OVAL-SHAPED
SOLID FIGURE DESCENDING ATTACHED TO A
SOLID LINE, WITH THE FIGURE SURROUNDED
BY SEVERAL CURVED-SHAPED LINES.

SER. NO. 77-376,278, FILED 1-20-2008.

DAYNA BROWNE, EXAMINING ATTORNEY

Int. Cls.: 41 and 43

Prior U.S. Cls.: 100, 101 and 107

United States Patent and Trademark Office

Reg. No. 3,519,498

Registered Oct. 21, 2008

**SERVICE MARK
PRINCIPAL REGISTER**

HUNTERS NIGHTCLUBS

MARK HUNTER'S, LTD. (ILLINOIS CORPORATION)
1932 E HIGGINS ROAD
ELK GROVE, IL 60007

FOR: NIGHT CLUBS; ENTERTAINMENT SERVICES, NAMELY, KARAOKE SINGING COMPETITIONS, DANCE PERFORMANCES, LIVE PERFORMANCES BY EXOTIC DANCERS, DANCE COMPETITIONS, LIVE DISC JOCKEY MUSIC AND VIDEO JOCKEY MUSIC, AND DANCE THEATER, IN CLASS 41 (U.S. CLS. 100, 101 AND 107).

FIRST USE 10-20-1982; IN COMMERCE 10-20-1982.

FOR: BAR SERVICES; TAVERN SERVICES, IN CLASS 43 (U.S. CLS. 100 AND 101).

FIRST USE 10-20-1982; IN COMMERCE 10-20-1982.

THE MARK CONSISTS OF STANDARD CHARACTERS WITHOUT CLAIM TO ANY PARTICULAR FONT, STYLE, SIZE, OR COLOR.

NO CLAIM IS MADE TO THE EXCLUSIVE RIGHT TO USE "NIGHTCLUBS", APART FROM THE MARK AS SHOWN.

SER. NO. 77-376,620, FILED 1-21-2008.

TINA KUAN, EXAMINING ATTORNEY

Int. Cl.: 3

Prior U.S. Cls.: 1, 4, 6, 50, 51 and 52

United States Patent and Trademark Office

Reg. No. 3,519,499

Registered Oct. 21, 2008

TRADEMARK
PRINCIPAL REGISTER

Zachariah Dylan

ZACHARIAH DYLAN, LLC (OKLAHOMA LIMITED LIABILITY COMPANY)
2541 NORTHWEST 58TH ST.
OKLAHOMA CITY, OK 73112

FOR: COLOGNE; COLOGNES, PERFUMES AND COSMETICS; PERFUMES, AFTERSHAVES AND COLOGNES, IN CLASS 3 (U.S. CLS. 1, 4, 6, 50, 51 AND 52).

FIRST USE 12-1-2007; IN COMMERCE 12-1-2007.

THE NAME(S), PORTRAIT(S), AND/OR SIGNATURE(S) SHOWN IN THE MARK DOES NOT IDENTIFY A PARTICULAR LIVING INDIVIDUAL.

THE MARK CONSISTS OF THE STYLIZED NAME "ZACHARIAH DYLAN".

SER. NO. 77-376,629, FILED 1-21-2008.

KIMBERLY PERRY, EXAMINING ATTORNEY

Int. Cl.: 6

Prior U.S. Cls.: 2, 12, 13, 14, 23, 25 and 50

Reg. No. 3,519,500

United States Patent and Trademark Office

Registered Oct. 21, 2008

**TRADEMARK
PRINCIPAL REGISTER**

SPEEDPUSH

PEX CONNECTION, INC. (OKLAHOMA CORPORATION)
6601 SOUTH SHIELDS AVENUE
OKLAHOMA CITY, OK 73149

FOR: METAL FITTINGS, NAMELY, PIPE COLLARS, COUPLINGS, CONNECTORS, JOINTS, ADAPTORS, RINGS, SWIVELS, TEES, MANIFOLDS, ELBOWS AND PLUGS , IN CLASS 6 (U.S. CLS. 2, 12, 13, 14, 23, 25 AND 50).

FIRST USE 12-1-2007; IN COMMERCE 12-1-2007.

THE MARK CONSISTS OF STANDARD CHARACTERS WITHOUT CLAIM TO ANY PARTICULAR FONT, STYLE, SIZE, OR COLOR.

SER. NO. 77-377,573, FILED 1-22-2008.

WILLIAM VERHOSEK, EXAMINING ATTORNEY

Int. Cl.: 41

Prior U.S. Cls.: 100, 101 and 107

United States Patent and Trademark Office

Reg. No. 3,519,501

Registered Oct. 21, 2008

**SERVICE MARK
PRINCIPAL REGISTER**



WASHINGTON ATHLETIC CLUB (WASHINGTON NON-PROFIT CORPORATION)
1325 SIXTH AVENUE, P.O. BOX 1709
SEATTLE, WA 98111

FOR: HEALTH, FITNESS AND ATHLETIC CLUB SERVICES, NAMELY, PROVIDING FITNESS, EXERCISE AND RECREATION FACILITIES; EDUCATION SERVICES, NAMELY, PROVIDING GROUP AND INDIVIDUAL CLASSES, CLINICS, SEMINARS, INSTRUCTIONS, WORKSHOPS, TRAINING AND EQUIPMENT IN THE FIELDS OF NUTRITION AND DIETARY MANAGEMENT, WEIGHT LOSS, HEALTH AND WELLNESS, RELAXATION, AQUATIC EXERCISE, EXERCISE AND PHYSICAL FITNESS, USE AND OPERATION OF EXERCISE EQUIPMENT, SWIMMING, SPORTS, PILATES, YOGA, CORE CONDITIONING, INCREASING

STRENGTH, FLEXIBILITY AND CARDIOVASCULAR ENDURANCE, AND DISTRIBUTING MATERIALS IN CONNECTION THEREWITH; PERSONAL TRAINER SERVICES, IN CLASS 41 (U.S. CLS. 100, 101 AND 107).

FIRST USE 12-31-1930; IN COMMERCE 12-31-1930.

OWNER OF U.S. REG. NOS. 2,280,699, 3,355,995, AND 3,355,996.

THE MARK CONSISTS OF STYLIZED WINGS WITH LETTERS "WAC".

SER. NO. 77-378,339, FILED 1-23-2008.

KATHLEEN LORENZO, EXAMINING ATTORNEY

Int. Cl.: 43

Prior U.S. Cls.: 100 and 101

United States Patent and Trademark Office

Reg. No. 3,519,502

Registered Oct. 21, 2008

**SERVICE MARK
PRINCIPAL REGISTER**

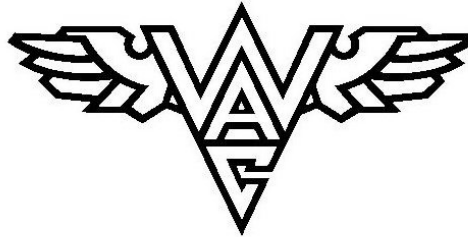

WASHINGTON ATHLETIC CLUB (WASHINGTON NON-PROFIT CORPORATION)
1325 SIXTH AVENUE, P.O. BOX 1709
SEATTLE, WA 98111

FOR: HOTEL, BAR, RESTAURANT, AND CATERING SERVICES; CHILD CARE SERVICES, IN CLASS 43 (U.S. CLS. 100 AND 101).

FIRST USE 12-31-1930; IN COMMERCE 12-31-1930.

OWNER OF U.S. REG. NOS. 2,280,699, 3,355,995, AND 3,355,996.

THE MARK CONSISTS OF STYLIZED WINGS WITH LETTERS "WAC".

SER. NO. 77-378,347, FILED 1-23-2008.

KATHLEEN LORENZO, EXAMINING ATTORNEY

Int. Cl.: 14

Prior U.S. Cls.: 2, 27, 28 and 50

United States Patent and Trademark Office

Reg. No. 3,519,503

Registered Oct. 21, 2008

**TRADEMARK
PRINCIPAL REGISTER**

LineaBolde

DIACOM CORP. (FLORIDA CORPORATION)
BLDG 4 FMB 464
7040 W PALMETTO PARK RD
BOCA RATON, FL 334333407

THE MARK CONSISTS OF STANDARD CHAR-
ACTERS WITHOUT CLAIM TO ANY PARTICULAR
FONT, STYLE, SIZE, OR COLOR.

FOR: DIAMOND JEWELRY; JEWELLERY AND
WATCHES, IN CLASS 14 (U.S. CLS. 2, 27, 28 AND 50).

SER. NO. 77-378,363, FILED 1-23-2008.

FIRST USE 11-6-2007; IN COMMERCE 11-6-2007.

ALEX KEAM, EXAMINING ATTORNEY

Int. Cl.: 42

Prior U.S. Cls.: 100 and 101

United States Patent and Trademark Office

Reg. No. 3,519,504

Registered Oct. 21, 2008

**SERVICE MARK
PRINCIPAL REGISTER**

BIGBLUEQ

BIG BLUE Q LLC (OHIO LIMITED LIABILITY
COMPANY)
SUITE 200
40 N. SANDUSKY STREET
DELAWARE, OH 43015

FOR: APPLICATION SERVICE PROVIDER FEATURING SOFTWARE FOR USE IN SOCIAL AND PROFESSIONAL NETWORKING, FOR USE IN DATA COLLABORATION, SHARING, AND STORAGE, FOR USE IN DATA PROCESSING, FOR USE IN MANAGEMENT OF DATA, INFORMATION, AND BUSINESS INTELLIGENCE, AND FOR USE IN PROVIDING ON-DEMAND CUSTOM, INTER-

ACTIVE REPORTS AND PRE-DEFINED REPORTS, IN CLASS 42 (U.S. CLS. 100 AND 101).

FIRST USE 10-0-2006; IN COMMERCE 10-0-2006.

THE MARK CONSISTS OF STANDARD CHARACTERS WITHOUT CLAIM TO ANY PARTICULAR FONT, STYLE, SIZE, OR COLOR.

SER. NO. 77-378,721, FILED 1-23-2008.

JAY BESCH, EXAMINING ATTORNEY

Int. Cl.: 12

Prior U.S. Cls.: 19, 21, 23, 31, 35 and 44

Reg. No. 3,519,505

United States Patent and Trademark Office

Registered Oct. 21, 2008

**TRADEMARK
PRINCIPAL REGISTER**

..küat..

KUAT INNOVATIONS, LLC (MISSOURI LIMITED LIABILITY COMPANY)
1326 E. TRAFFICWAY #7
SPRINGFIELD, MO 65802

FOR: BICYCLE RACKS FOR VEHICLES, IN CLASS 12 (U.S. CLS. 19, 21, 23, 31, 35 AND 44).

FIRST USE 1-30-2007; IN COMMERCE 1-30-2007.

THE MARK CONSISTS OF TWO DOTS FOLLOWED BY THE LETTERS "KÜAT" FOLLOWED BY TWO DOTS, AND WHEREIN THE LETTER "Ü" INCLUDES AN UMLAUT TO REFLECT PRONUNCIATION.

SER. NO. 77-378,957, FILED 1-23-2008.

JANET LEE, EXAMINING ATTORNEY

Int. Cls.: 25 and 41

Prior U.S. Cls.: 22, 39, 100, 101, 107 and 200

United States Patent and Trademark Office

Reg. No. 3,519,506

Registered Oct. 21, 2008

**TRADEMARK
SERVICE MARK
COLLECTIVE MEMBERSHIP
PRINCIPAL REGISTER**

DELTA PHI SCRAPPA

DELTA PHI SCRAPPA, LLC (MINNESOTA LIMITED LIABILITY COMPANY)
35585 AZTEC ROAD
MOTLEY, MN 56466

FOR: CLOTHING, NAMELY, SHIRTS, T-SHIRTS, SWEATPANTS, SWEATSHIRTS, ZIPPER HOODED SWEATSHIRTS, AND HATS, IN CLASS 25 (U.S. CLS. 22 AND 39).

FIRST USE 9-30-2005; IN COMMERCE 6-30-2006.

FOR: EDUCATIONAL AND ENTERTAINMENT SERVICES IN THE NATURE OF CONDUCTING WORKSHOPS, EXHIBITIONS, MEETINGS AND RETREATS IN THE FIELD OF SCRAPBOOKING, IN CLASS 41 (U.S. CLS. 100, 101 AND 107).

FIRST USE 3-30-2005; IN COMMERCE 4-27-2006.

FOR: INDICATING MEMBERSHIP IN A SISTERHOOD OR SORORITY OF SCRAPBOOKERS, IN CLASS 200 (U.S. CL. 200).

FIRST USE 3-30-2005; IN COMMERCE 4-27-2006.

THE MARK CONSISTS OF STANDARD CHARACTERS WITHOUT CLAIM TO ANY PARTICULAR FONT, STYLE, SIZE, OR COLOR.

SER. NO. 77-379,844, FILED 1-24-2008.

TRICIA SONNEBORN, EXAMINING ATTORNEY

Int. Cl.: 7

Prior U.S. Cls.: 13, 19, 21, 23, 31, 34 and 35

Reg. No. 3,519,507

United States Patent and Trademark Office

Registered Oct. 21, 2008

**TRADEMARK
PRINCIPAL REGISTER**



CANYON STREET CROSSING LIMITED LIABILITY COMPANY (COLORADO LIMITED LIABILITY COMPANY)

SUITE 101
1470 WALNUT STREET
BOULDER, CO 80302

FOR: EARTH ENGAGING, EARTH CUTTING AND EARTH PULVERIZING DISCS AND COULTER BLADES FOR PLOWS, HARROWS, AND LIKE

AGRICULTURAL IMPLEMENTS, IN CLASS 7 (U.S. CLS. 13, 19, 21, 23, 31, 34 AND 35).

FIRST USE 9-0-2007; IN COMMERCE 9-0-2007.

OWNER OF U.S. REG. NOS. 726,468 AND 1,289,834.

SER. NO. 77-379,924, FILED 1-24-2008.

APRIL ROACH, EXAMINING ATTORNEY

Int. Cl.: 7

Prior U.S. Cls.: 13, 19, 21, 23, 31, 34 and 35

Reg. No. 3,519,508

United States Patent and Trademark Office

Registered Oct. 21, 2008

**TRADEMARK
PRINCIPAL REGISTER**



CANYON STREET CROSSING LIMITED LIABILITY COMPANY (COLORADO LIMITED LIABILITY COMPANY)

SUITE 101
1470 WALNUT STREET
BOULDER, CO 80302

FOR: EARTH ENGAGING, EARTH CUTTING AND EARTH PULVERIZING DISCS AND COULTER BLADES FOR PLOWS, HARROWS, AND LIKE

AGRICULTURAL IMPLEMENTS, IN CLASS 7 (U.S. CLS. 13, 19, 21, 23, 31, 34 AND 35).

FIRST USE 7-0-2003; IN COMMERCE 7-0-2003.

OWNER OF U.S. REG. NOS. 726,468 AND 1,289,834.

SER. NO. 77-379,946, FILED 1-24-2008.

APRIL ROACH, EXAMINING ATTORNEY

Int. Cl.: 36

Prior U.S. Cls.: 100, 101 and 102

United States Patent and Trademark Office

Reg. No. 3,519,509

Registered Oct. 21, 2008

**SERVICE MARK
PRINCIPAL REGISTER**

THE RESERVE SHOPPING CENTER

SUTTON BOCA ONE DEVELOPERS LLC (FLOR-
IDA LIMITED LIABILITY COMPANY)
1801 CLINT MOORE ROAD, SUITE 204
BOCA RATON, FL 33487

NO CLAIM IS MADE TO THE EXCLUSIVE
RIGHT TO USE "SHOPPING CENTER", APART
FROM THE MARK AS SHOWN.

FOR: LEASING OF SHOPPING MALL SPACE, IN
CLASS 36 (U.S. CLS. 100, 101 AND 102).

SER. NO. 77-380,437, FILED 1-25-2008.

FIRST USE 1-0-2004; IN COMMERCE 1-0-2004.

THE MARK CONSISTS OF STANDARD CHAR-
ACTERS WITHOUT CLAIM TO ANY PARTICULAR
FONT, STYLE, SIZE, OR COLOR.

DOMINIC J. FERRAIUOLO, EXAMINING ATTOR-
NEY

Int. Cl.: 22

Prior U.S. Cls.: 1, 2, 7, 19, 22, 42 and 50

Reg. No. 3,519,510

United States Patent and Trademark Office

Registered Oct. 21, 2008

**TRADEMARK
PRINCIPAL REGISTER**

MASTER-PULL

MASTER-PULL, LLC (WASHINGTON LIMITED
LIABILITY COMPANY)
BUILDING E, UNIT 9
725 SUNSET POND LANE
BELLINGHAM, WA 98226

FIRST USE 12-6-2000; IN COMMERCE 12-19-2000.

THE MARK CONSISTS OF STANDARD CHAR-
ACTERS WITHOUT CLAIM TO ANY PARTICULAR
FONT, STYLE, SIZE, OR COLOR.

FOR: ANCHORING ROPES; CAR TOWING
ROPES; ROPES; ROPES AND SYNTHETIC ROPES;
TOW ROPES FOR AUTOMOBILES; STRAPS FOR
HANDLING LOADS; TOWING STRAPS, IN CLASS
22 (U.S. CLS. 1, 2, 7, 19, 22, 42 AND 50).

SER. NO. 77-381,139, FILED 1-25-2008.

GENE MACIOL, EXAMINING ATTORNEY

Int. Cl.: 25

Prior U.S. Cls.: 22 and 39

United States Patent and Trademark Office

Reg. No. 3,519,511

Registered Oct. 21, 2008

**TRADEMARK
PRINCIPAL REGISTER**



JIANLIANG LIN (CHINA INDIVIDUAL)
1201 JOHN REED COURT
CITY OF INDUSTRY, CA 91745

FOR: FOOTWEAR; SHOES; BOOTS; SLIPPERS;
SUITS; COATS; JEANS; JACKETS; SHIRTS; SKIRTS;
SHORTS; SOCKS; HATS; BELTS, IN CLASS 25 (U.S.
CLS. 22 AND 39).

FIRST USE 7-1-2007; IN COMMERCE 7-1-2007.

NO CLAIM IS MADE TO THE EXCLUSIVE
RIGHT TO USE "ATHLETIC", APART FROM THE
MARK AS SHOWN.

THE MARK CONSISTS OF A DESIGN OF LET-
TER "A" AND WORD "ATHLETIC" IN A SHAPED
BOX.

SER. NO. 77-381,142, FILED 1-25-2008.

RONALD DELGIZZI, EXAMINING ATTORNEY

Int. Cl.: 25

Prior U.S. Cls.: 22 and 39

United States Patent and Trademark Office

Reg. No. 3,519,512

Registered Oct. 21, 2008

**TRADEMARK
PRINCIPAL REGISTER**



JIANLIANG LIN (CHINA INDIVIDUAL)
1201 JOHN REED COURT
CITY OF INDUSTRY, CA 91745

FOR: FOOTWEAR; SHOES; BOOTS; SLIPPERS;
SUITS; COATS; JEANS; JACKETS; SHIRTS; SKIRTS;
SHORTS; SOCKS; HATS; BELTS, IN CLASS 25 (U.S.
CLS. 22 AND 39).

FIRST USE 7-1-2007; IN COMMERCE 7-1-2007.

NO CLAIM IS MADE TO THE EXCLUSIVE
RIGHT TO USE "ATHLETIC", APART FROM THE
MARK AS SHOWN.

THE MARK CONSISTS OF A DESIGN OF LET-
TER "A" AND WORD "ATHLETIC" WITH "A"
ABOVE "ATHLETIC".

SER. NO. 77-381,182, FILED 1-25-2008.

RONALD DELGIZZI, EXAMINING ATTORNEY

Int. Cl.: 42

Prior U.S. Cls.: 100 and 101

United States Patent and Trademark Office

Reg. No. 3,519,513

Registered Oct. 21, 2008

**SERVICE MARK
PRINCIPAL REGISTER**

Family Builder

IFAMILY INC. (DELAWARE CORPORATION)
41 EAST 60TH STREET, 6TH FLOOR
NEW YORK, NY 10022

FOR: PROVIDING ON-LINE NON-DOWNLOADABLE SOFTWARE AND A WEBSITE FEATURING INFORMATION ON GENEALOGY AND GENEALOGICAL RESEARCH; PROVIDING ON-LINE NON-DOWNLOADABLE SOFTWARE AND A WEBSITE THAT ALLOWS USERS TO RESEARCH GENEALOGY AND FAMILY HISTORY AND TO CREATE A GENEALOGICAL HISTORY AND FAMILY TREE, IN CLASS 42 (U.S. CLS. 100 AND 101).

FIRST USE 1-23-2008; IN COMMERCE 1-23-2008.

THE MARK CONSISTS OF STANDARD CHARACTERS WITHOUT CLAIM TO ANY PARTICULAR FONT, STYLE, SIZE, OR COLOR.

NO CLAIM IS MADE TO THE EXCLUSIVE RIGHT TO USE "FAMILY", APART FROM THE MARK AS SHOWN.

SER. NO. 77-381,511, FILED 1-27-2008.

BARBARA RUTLAND, EXAMINING ATTORNEY

Int. Cl.: 25

Prior U.S. Cls.: 22 and 39

United States Patent and Trademark Office

Reg. No. 3,519,514

Registered Oct. 21, 2008

**TRADEMARK
PRINCIPAL REGISTER**

TWENTY 2 ONE GOLF

RANK, GREGORY (UNITED STATES INDIVIDUAL)
598 MARIANO DRIVE
SONOMA, CA 95476

FOR: T-SHIRTS; SPORT SHIRTS; DRESS SHIRTS; CAMP SHIRTS; KNIT SHIRTS; POLO SHIRTS; SWEAT SHIRTS; SWEATERS; TANK TOPS; BLOUSES; CAMISOLES; BELTS; BLAZERS; GLOVES; MITTENS; SPORT COATS; COATS; VESTS; DRESSES; JACKETS; PANTS; SWEAT PANTS; PULLOVERS; TIES; SCARVES; JEANS; SHORTS; SKIRTS; SKORTS; SLACKS; SOCKS; HOSIERY; SWIMWEAR; UNDERWEAR; CAPS; VISORS; HATS; BEANIES; WARM UP SUITS; WINDSHIRTS; RAINWEAR; SHOES; BOOTS; GOLF CAPS; GOLF SHIRTS; GOLF TROUSERS, IN CLASS 25 (U.S. CLS. 22 AND 39).

FIRST USE 12-7-2007; IN COMMERCE 12-7-2007.

THE MARK CONSISTS OF STANDARD CHARACTERS WITHOUT CLAIM TO ANY PARTICULAR FONT, STYLE, SIZE, OR COLOR.

NO CLAIM IS MADE TO THE EXCLUSIVE RIGHT TO USE "GOLF", APART FROM THE MARK AS SHOWN.

SER. NO. 77-382,392, FILED 1-28-2008.

TEJBIR SINGH, EXAMINING ATTORNEY

Int. Cl.: 16

Prior U.S. Cls.: 2, 5, 22, 23, 29, 37, 38 and 50

United States Patent and Trademark Office

Reg. No. 3,519,515

Registered Oct. 21, 2008

**TRADEMARK
PRINCIPAL REGISTER**

THE GINI METHOD

NCE, NEWCASTLE ENTERTAINMENT, INC (CALIFORNIA CORPORATION)
PMB #268
2658 DEL MAR HEIGHTS RD.
DEL MAR, CA 92014

FOR: PRINTED INSTRUCTIONAL MANUAL FOR LEARNING HOW TO PLAY THE PIANO, IN CLASS 16 (U.S. CLS. 2, 5, 22, 23, 29, 37, 38 AND 50).

FIRST USE 6-10-2007; IN COMMERCE 6-10-2007.

THE MARK CONSISTS OF STANDARD CHARACTERS WITHOUT CLAIM TO ANY PARTICULAR FONT, STYLE, SIZE, OR COLOR.

NO CLAIM IS MADE TO THE EXCLUSIVE RIGHT TO USE "METHOD", APART FROM THE MARK AS SHOWN.

SER. NO. 77-382,566, FILED 1-28-2008.

BRENDAN REGAN, EXAMINING ATTORNEY

Int. Cl.: 9

Prior U.S. Cls.: 21, 23, 26, 36 and 38

United States Patent and Trademark Office

Reg. No. 3,519,516

Registered Oct. 21, 2008

**TRADEMARK
PRINCIPAL REGISTER**

DuraMax

CARL ZEISS AG (FED REP GERMANY CORPORATION)
CARL-ZEISS-STRASSE 22
73447 OBERKOCHEN, FED REP GERMANY

PRIORITY CLAIMED UNDER SEC. 44(D) ON FED REP GERMANY APPLICATION NO. 30768335.4/0, FILED 10-22-2007, REG. NO. 30768335, DATED 1-14-2008, EXPIRES 10-31-2017.

FOR: COORDINATE MEASURING MACHINES AND PARTS THEREOF, IN CLASS 9 (U.S. CLS. 21, 23, 26, 36 AND 38).

SER. NO. 77-383,005, FILED 1-29-2008.

THE MARK CONSISTS OF STANDARD CHARACTERS WITHOUT CLAIM TO ANY PARTICULAR FONT, STYLE, SIZE, OR COLOR.

JORDAN BAKER, EXAMINING ATTORNEY

Int. Cl.: 9

Prior U.S. Cls.: 21, 23, 26, 36 and 38

United States Patent and Trademark Office

Reg. No. 3,519,517

Registered Oct. 21, 2008

**TRADEMARK
PRINCIPAL REGISTER**

ShopMax

CARL ZEISS AG (FED REP GERMANY CORPORATION)
CARL-ZEISS-STRASSE 22
73447 OBERKOCHEN, FED REP GERMANY

PRIORITY CLAIMED UNDER SEC. 44(D) ON FED REP GERMANY APPLICATION NO. 30768334.6/0, FILED 10-22-2007, REG. NO. 30768334, DATED 1-11-2008, EXPIRES 1-11-2018.

FOR: COORDINATE MEASURING MACHINES AND PARTS THEREOF, IN CLASS 9 (U.S. CLS. 21, 23, 26, 36 AND 38).

SER. NO. 77-383,009, FILED 1-29-2008.

THE MARK CONSISTS OF STANDARD CHARACTERS WITHOUT CLAIM TO ANY PARTICULAR FONT, STYLE, SIZE, OR COLOR.

JORDAN BAKER, EXAMINING ATTORNEY

Int. Cl.: 17

Prior U.S. Cls.: 1, 5, 12, 13, 35 and 50

Reg. No. 3,519,518

United States Patent and Trademark Office

Registered Oct. 21, 2008

**TRADEMARK
PRINCIPAL REGISTER**

COMPAC

COMPAC CORPORATION (DELAWARE CORPORATION)
LOT 9, BLOCK 44
103 BILBY ROAD
HACKETTSTOWN, NJ 07840

FOR: PRESSURE SENSITIVE TAPES FOR USE IN THE CONSTRUCTION, INDUSTRIAL, ELECTRONICS, AND MEDICAL INDUSTRIES; VAPOR RETARDERS, NAMELY, INSULATION FACING FOR IMPEDING WATER VAPOR, IN CLASS 17 (U.S. CLS. 1, 5, 12, 13, 35 AND 50).

FIRST USE 1-1-1969; IN COMMERCE 1-1-1969.

THE MARK CONSISTS OF STANDARD CHARACTERS WITHOUT CLAIM TO ANY PARTICULAR FONT, STYLE, SIZE, OR COLOR.

SER. NO. 77-383,121, FILED 1-29-2008.

JAY FLOWERS, EXAMINING ATTORNEY

Int. Cl.: 17

Prior U.S. Cls.: 1, 5, 12, 13, 35 and 50

Reg. No. 3,519,519

United States Patent and Trademark Office

Registered Oct. 21, 2008

**TRADEMARK
PRINCIPAL REGISTER**

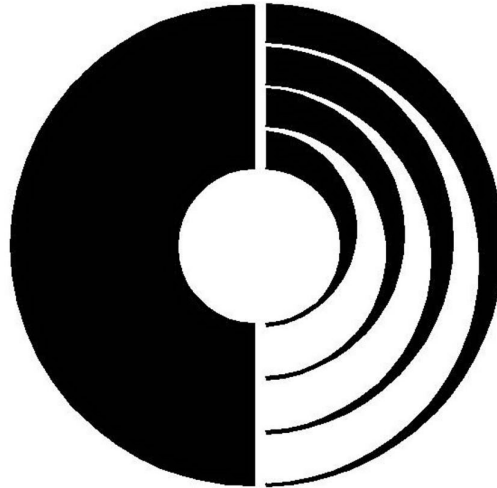

COMPAC CORPORATION (DELAWARE CORPORATION)
LOT 9, BLOCK 44
103 BILBY ROAD
HACKETTSTOWN, NJ 07840

FOR: PRESSURE SENSITIVE TAPES FOR USE IN THE CONSTRUCTION, INDUSTRIAL, ELECTRONICS, AND MEDICAL INDUSTRIES; VAPOR RETARDERS, NAMELY, INSULATION FACING FOR IMPEDING WATER VAPOR, IN CLASS 17 (U.S. CLS. 1, 5, 12, 13, 35 AND 50).

FIRST USE 1-1-2006; IN COMMERCE 1-1-2006.

THE MARK CONSISTS OF THE BLOCK LETTER "C" ON THE LEFT SIDE WITH FOUR SPACED-APART SEMICIRCULAR ARCS ON THE RIGHT SIDE.

SER. NO. 77-383,220, FILED 1-29-2008.

JAY FLOWERS, EXAMINING ATTORNEY

Int. Cl.: 19

Prior U.S. Cls.: 1, 12, 33 and 50

United States Patent and Trademark Office

Reg. No. 3,519,520

Registered Oct. 21, 2008

**TRADEMARK
PRINCIPAL REGISTER**



ADVANTAGE TRIM & LUMBER COMPANY,
INC. (NEW YORK CORPORATION)
601 OHIO STREET
BUFFALO, NY 14203

FOR: LUMBER; BUILDING MATERIALS, NAME-
LY, DECKING BOARDS; WOODEN FLOORING, IN
CLASS 19 (U.S. CLS. 1, 12, 33 AND 50).

FIRST USE 8-31-2007; IN COMMERCE 8-31-2007.

NO CLAIM IS MADE TO THE EXCLUSIVE
RIGHT TO USE "TRIM AND LUMBER", APART
FROM THE MARK AS SHOWN.

THE MARK CONSISTS OF A RING IN WHICH
THE WORD "ADVANTAGE" IS WRITTEN AT THE
TOP AND "TRIM & LUMBER" ARE WRITTEN AT
THE BOTTOM, SURROUNDING A CIRCLE CON-
TAINING A DRAWING OF A TREE WITH ROOTS.

SER. NO. 77-383,228, FILED 1-29-2008.

ANTHONY RINKER, EXAMINING ATTORNEY

Prior U.S. Cl.: 200

United States Patent and Trademark Office

Reg. No. 3,519,521

Registered Oct. 21, 2008

**COLLECTIVE MEMBERSHIP
PRINCIPAL REGISTER**

**COMMUNICATE LOCALLY.
SUCCEED GLOBALLY.**

GLOBALIZATION AND LOCALIZATION ASSO-
CIATION, INC. (MASSACHUSETTS COR-
PORATION)
23 MAIN STREET
ANDOVER, MA 01810

FOR: INDICATING MEMBERSHIP IN A TRADE
ASSOCIATION FOR THE TRANSLATION, INTER-
NATIONALIZATION, LOCALIZATION AND GLO-
BALIZATION INDUSTRY, IN CLASS 200 (U.S. CL.
200).

FIRST USE 6-19-2007; IN COMMERCE 7-19-2007.

THE MARK CONSISTS OF STANDARD CHAR-
ACTERS WITHOUT CLAIM TO ANY PARTICULAR
FONT, STYLE, SIZE, OR COLOR.

SER. NO. 77-383,590, FILED 1-29-2008.

ELLEN B. AWRICH, EXAMINING ATTORNEY

Int. Cl.: 37

Prior U.S. Cls.: 100, 103 and 106

United States Patent and Trademark Office

Reg. No. 3,519,522

Registered Oct. 21, 2008

**SERVICE MARK
PRINCIPAL REGISTER**

5 MINUTE OIL CHANGE

OJALA, LLC (LOUISIANA LIMITED LIABILITY
COMPANY)
321 N. VERMONT STREET
COVINGTON, LA 70433

FOR: AUTOMOTIVE LUBRICATION MAINTENANCE SERVICES, NAMELY, CHANGING MOTOR OIL, REFILLING FLUID RESERVOIRS, FLUSHING AND FILLING COOLANT SYSTEMS AND REPLACING OIL, FUEL AND AIR FILTERS, IN CLASS 37 (U.S. CLS. 100, 103 AND 106).

FIRST USE 11-20-1996; IN COMMERCE 11-20-1996.

THE MARK CONSISTS OF STANDARD CHARACTERS WITHOUT CLAIM TO ANY PARTICULAR FONT, STYLE, SIZE, OR COLOR.

NO CLAIM IS MADE TO THE EXCLUSIVE RIGHT TO USE "OIL CHANGE", APART FROM THE MARK AS SHOWN.

SEC. 2(F).

SER. NO. 77-384,089, FILED 1-30-2008.

CYNTHIA TRIPI, EXAMINING ATTORNEY

Int. Cl.: 35

Prior U.S. Cls.: 100, 101 and 102

United States Patent and Trademark Office

Reg. No. 3,519,523

Registered Oct. 21, 2008

**SERVICE MARK
PRINCIPAL REGISTER**

HCM: 21

FITZENZ, JOHN A. (UNITED STATES INDIVIDUAL), DBA HUMAN CAPITAL SOURCE, INC.
8321 PINOTAGE COURT
SAN JOSE, CA 95135

FOR: MANAGEMENT AND BUSINESS CONSULTING SERVICES IN THE FIELD OF TRAINING AND RECRUITMENT, IN CLASS 35 (U.S. CLS. 100, 101 AND 102).

FIRST USE 9-1-2007; IN COMMERCE 9-1-2007.

THE MARK CONSISTS OF STANDARD CHARACTERS WITHOUT CLAIM TO ANY PARTICULAR FONT, STYLE, SIZE, OR COLOR.

NO CLAIM IS MADE TO THE EXCLUSIVE RIGHT TO USE "HCM", APART FROM THE MARK AS SHOWN.

SER. NO. 77-384,180, FILED 1-30-2008.

JULIE WATSON, EXAMINING ATTORNEY

Int. Cl.: 9

Prior U.S. Cls.: 21, 23, 26, 36 and 38

Reg. No. 3,519,524

United States Patent and Trademark Office

Registered Oct. 21, 2008

**TRADEMARK
PRINCIPAL REGISTER**

ProPlate

GRACE BIO-LABS., INC. (OREGON CORPORATION)
61140 BILLADEAU
BEND, OR 97702

FOR: MICROSCOPE PARTS FOR USE WITH MICROSCOPE SLIDES, NAMELY, MICROSCOPE SLIDE MODULES COMPRISED OF A NON-METAL WELL PLATE HAVING A WELL ARRAY, A NON-METAL GASKET HAVING A WELL ARRAY, AND METAL AND NON-METAL CLAMPS, THAT ARE SOLD AS INDIVIDUAL MICROSCOPE SLIDE MODULES AND ALSO SOLD AS INTEGRAL PARTS OF A MICROSCOPE TRAY SET COMPRISED OF A TRAY HAVING A MICROTITER PLATE FOOTPRINT AND

WELL SPACING AND MICROSCOPE SLIDE MODULES; MICROTITER PLATES, IN CLASS 9 (U.S. CLS. 21, 23, 26, 36 AND 38).

FIRST USE 7-31-2001; IN COMMERCE 7-31-2001.

THE MARK CONSISTS OF STANDARD CHARACTERS WITHOUT CLAIM TO ANY PARTICULAR FONT, STYLE, SIZE, OR COLOR.

SER. NO. 77-384,325, FILED 1-30-2008.

MARY MUNSON, EXAMINING ATTORNEY

Int. Cl.: 41

Prior U.S. Cls.: 100, 101 and 107

United States Patent and Trademark Office

Reg. No. 3,519,525

Registered Oct. 21, 2008

SERVICE MARK
PRINCIPAL REGISTER



The logo consists of the word "Creation" in a cursive script, followed by "to" in a smaller, simpler font, and "REVELATION" in a bold, all-caps serif font. A large cross symbol is superimposed over the "to" and extends upwards through the "C" of "Creation".

RESTER, H.S (UNITED STATES INDIVIDUAL),
DBA CREATION TO REVELATION
2043 SOUTH BEND AVE. #242
SOUTH BEND, IN 46637

FOR: PROVIDING ONLINE RELIGIOUS IN-
STRUCTION PROMOTING CHRISTIAN AND FA-
MILY VALUES; RELIGIOUS INSTRUCTION
SERVICES, IN CLASS 41 (U.S. CLS. 100, 101 AND 107).

FIRST USE 5-15-2007; IN COMMERCE 6-12-2007.

THE MARK CONSISTS OF SCRIPTIVE LETTER-
ING OF THE WORDS "CREATION TO REVELA-

TION" IN WHICH A CROSS SYMBOL REPLACES
THE LETTER "T" A TOTAL OF THREE TIMES. THE
"T" IN THE WORD CREATION EXTENDS DOWN
AND BECOMES THE LEFT PART OF THE LETTER
"R" IN THE WORD REVELATION. THE WORD "TO"
HAS THE CROSS SYMBOL REPLACING THE LET-
TER "T" AND THE WORD REVELATION HAS THE
CROSS SYMBOL REPLACING THE LETTER "T".

SER. NO. 77-384,459, FILED 1-30-2008.

ALICIA COLLINS, EXAMINING ATTORNEY

Int. Cls.: 9 and 41

Prior U.S. Cls.: 21, 23, 26, 36, 38, 100, 101 and 107

Reg. No. 3,519,526

United States Patent and Trademark Office

Registered Oct. 21, 2008

**TRADEMARK
SERVICE MARK
PRINCIPAL REGISTER**

modofac

PERRITT, HENRY H., JR. (UNITED STATES INDIVIDUAL), DBA PERRITT, HANK
1131 CAROL LANE
GLENCOE, IL 60022

FOR: DOWNLOADABLE MUSICAL SOUND RECORDINGS; MUSICAL SOUND RECORDINGS, IN CLASS 9 (U.S. CLS. 21, 23, 26, 36 AND 38).

FIRST USE 5-1-2007; IN COMMERCE 5-1-2007.

FOR: ENTERTAINMENT IN THE NATURE OF VISUAL AND AUDIO PERFORMANCES, NAMELY, MUSICAL BAND, ROCK GROUP, GYMNASTIC, DANCE, AND BALLET PERFORMANCES; ENTERTAINMENT SERVICES, NAMELY, PROVIDING A WEB SITE FEATURING MUSICAL PERFORMANCES, MUSICAL VIDEOS, RELATED FILM CLIPS, PHOTOGRAPHS, AND OTHER MULTIMEDIA MATERIALS; ENTERTAINMENT SERVICES, NAMELY, PROVIDING PRERECORDED MUSIC,

INFORMATION IN THE FIELD OF MUSIC, AND COMMENTARY AND ARTICLES ABOUT MUSIC, ALL ON-LINE VIA A GLOBAL COMPUTER NETWORK; ENTERTAINMENT, NAMELY, LIVE PERFORMANCES BY A MUSICAL BAND; ENTERTAINMENT, NAMELY, LIVE PERFORMANCES BY MUSICAL BANDS; PRESENTATION OF MUSICAL PERFORMANCE, IN CLASS 41 (U.S. CLS. 100, 101 AND 107).

FIRST USE 5-1-2007; IN COMMERCE 5-1-2007.

THE MARK CONSISTS OF STANDARD CHARACTERS WITHOUT CLAIM TO ANY PARTICULAR FONT, STYLE, SIZE, OR COLOR.

SER. NO. 77-384,871, FILED 1-30-2008.

HEATHER SAPP, EXAMINING ATTORNEY

Int. Cl.: 5

Prior U.S. Cls.: 6, 18, 44, 46, 51 and 52

Reg. No. 3,519,527

United States Patent and Trademark Office

Registered Oct. 21, 2008

**TRADEMARK
PRINCIPAL REGISTER**

Mother Natures

MOTHER NATURES MINIATURES, LLC (MISSOURI LIMITED LIABILITY COMPANY)
P O BOX 560
ROGERSVILLE, MO 657420560

THE MARK CONSISTS OF STANDARD CHARACTERS WITHOUT CLAIM TO ANY PARTICULAR FONT, STYLE, SIZE, OR COLOR.

FOR: DIAGNOSTIC TEST KIT TO ASSIST IN DETERMINING THE TIME WHEN A MARE WILL FOAL, IN CLASS 5 (U.S. CLS. 6, 18, 44, 46, 51 AND 52).

SER. NO. 77-385,349, FILED 1-31-2008.

FIRST USE 1-1-2003; IN COMMERCE 1-1-2003.

SUE LAWRENCE, EXAMINING ATTORNEY

Int. Cl.: 36

Prior U.S. Cls.: 100, 101 and 102

United States Patent and Trademark Office

Reg. No. 3,519,528

Registered Oct. 21, 2008

**SERVICE MARK
PRINCIPAL REGISTER**

IWIZARDONLINE

TAUNTON FEDERAL CREDIT UNION (UNITED
STATES FEDERAL CREDIT UNION)
14 CHURCH GREEN
TAUNTON, MA 02780

THE MARK CONSISTS OF STANDARD CHAR-
ACTERS WITHOUT CLAIM TO ANY PARTICULAR
FONT, STYLE, SIZE, OR COLOR.

FOR: BANKING SERVICES, IN CLASS 36 (U.S.
CLS. 100, 101 AND 102).

SER. NO. 77-385,906, FILED 1-31-2008.

FIRST USE 1-1-2003; IN COMMERCE 1-1-2003.

JENNY PARK, EXAMINING ATTORNEY

Int. Cls.: 9 and 41

Prior U.S. Cls.: 21, 23, 26, 36, 38, 100, 101 and 107

United States Patent and Trademark Office

Reg. No. 3,519,529

Registered Oct. 21, 2008

**TRADEMARK
SERVICE MARK
PRINCIPAL REGISTER**

Answers Research Journal

ANSWERS IN GENESIS OF KENTUCKY, INC.
(KENTUCKY CORPORATION), DBA AN-
SWERS IN GENESIS
P.O. BOX 510
HEBRON, KY 41048

FOR: DOWNLOADABLE ELECTRONIC PUBLI-
CATION IN THE NATURE OF TECHNICAL JOUR-
NALS FEATURING INTERDISCIPLINARY
SCIENTIFIC AND OTHER RELEVANT RESEARCH
IN THE FIELDS OF CREATION AND THE GLOBAL
FLODD WITHIN THE BIBLICAL FRAMEWORK, IN
CLASS 9 (U.S. CLS. 21, 23, 26, 36 AND 38).

FIRST USE 1-9-2008; IN COMMERCE 1-9-2008.

FOR: PROVIDING NON-DOWNLOADABLE ON-
LINE PUBLICATIONS IN THE NATURE OF TECH-
NICAL JOURNALS FEATURING INTERDISCI-
PLINARY SCIENTIFIC AND OTHER RELEVANT
RESEARCH IN THE FIELD OF CREATION AND

THE GLOBAL FLOOD WITHIN THE BIBLICAL
FRAMEWORK, IN CLASS 41 (U.S. CLS. 100, 101
AND 107).

FIRST USE 1-9-2008; IN COMMERCE 1-9-2008.

THE MARK CONSISTS OF STANDARD CHAR-
ACTERS WITHOUT CLAIM TO ANY PARTICULAR
FONT, STYLE, SIZE, OR COLOR.

OWNER OF U.S. REG. NOS. 3,214,151, 3,247,230
AND OTHERS.

NO CLAIM IS MADE TO THE EXCLUSIVE
RIGHT TO USE "RESEARCH JOURNAL", APART
FROM THE MARK AS SHOWN.

SER. NO. 77-386,489, FILED 2-1-2008.

KAELIE KUNG, EXAMINING ATTORNEY

Int. Cl.: 40

Prior U.S. Cls.: 100, 103 and 106

United States Patent and Trademark Office

Reg. No. 3,519,530

Registered Oct. 21, 2008

**SERVICE MARK
PRINCIPAL REGISTER**

COINFORCE.COM

HAINES, JORDAN S. (UNITED STATES INDIVIDUAL)
6306 HILLCREST DRIVE SW
LAKEWOOD, WA 98499

THE MARK CONSISTS OF STANDARD CHARACTERS WITHOUT CLAIM TO ANY PARTICULAR FONT, STYLE, SIZE, OR COLOR.

FOR: CUSTOMIZED PRINTING OF COMPANY NAMES AND LOGOS FOR PROMOTIONAL AND ADVERTISING PURPOSES ON THE GOODS OF OTHERS, IN CLASS 40 (U.S. CLS. 100, 103 AND 106).

SER. NO. 77-386,709, FILED 2-1-2008.

FIRST USE 10-28-2005; IN COMMERCE 10-28-2005.

JESSICA A. POWERS, EXAMINING ATTORNEY

Int. Cls.: 7 and 12

Prior U.S. Cls.: 13, 19, 21, 23, 31, 34, 35 and 44

United States Patent and Trademark Office

Reg. No. 3,519,531

Registered Oct. 21, 2008

**TRADEMARK
PRINCIPAL REGISTER**

RECOVERY SOLUTIONS

RECOVERY SOLUTIONS, INC. (VIRGINIA CORPORATION)
4320 BAINBRIDGE BLVD
CHESAPEAKE, VA 23324

FOR: WRECKERS, IN CLASS 7 (U.S. CLS. 13, 19, 21, 23, 31, 34 AND 35).

FIRST USE 1-1-1997; IN COMMERCE 1-1-1997.

FOR: TRUCKS; TRUCKS AND STRUCTURAL PARTS THEREFOR, IN CLASS 12 (U.S. CLS. 19, 21, 23, 31, 35 AND 44).

FIRST USE 1-1-1997; IN COMMERCE 1-1-1997.

THE MARK CONSISTS OF STANDARD CHARACTERS WITHOUT CLAIM TO ANY PARTICULAR FONT, STYLE, SIZE, OR COLOR.

SEC. 2(F).

SER. NO. 77-386,762, FILED 2-1-2008.

KATHERINE CHANG, EXAMINING ATTORNEY

Int. Cl.: 30

Prior U.S. Cl.: 46

United States Patent and Trademark Office

Reg. No. 3,519,532

Registered Oct. 21, 2008

TRADEMARK
PRINCIPAL REGISTER



DOBIAGIO (FLORIDA LIMITED LIABILITY
COMPANY)
21471 SAWMILL COURT
BOCA RATON, FL 33498

FOR: RICE FLOUR; WHEAT FLOUR, IN CLASS
30 (U.S. CL. 46).

FIRST USE 12-1-2007; IN COMMERCE 1-1-2008.

NO CLAIM IS MADE TO THE EXCLUSIVE
RIGHT TO USE "LEVE", APART FROM THE MARK
AS SHOWN.

THE STIPPLING IS FOR SHADING PURPOSES
ONLY.

THE MARK CONSISTS OF A STYLIZED DEPICTION OF THE SUN CONTAINING THE WORDING "BIO +" ABOVE THE WORDING "LEVE". THERE ARE TWO WHEAT SPROUTS COMING OUT OF THE "O" IN THE WORD "BIO" AND THERE IS A CURVED LINE UNDER THE WORD "BIO".

THE ENGLISH TRANSLATION OF THE WORD
"LEVE" IN THE MARK IS "LIGHT".

SER. NO. 77-387,005, FILED 2-1-2008.

TINA BROWN, EXAMINING ATTORNEY

Int. Cl.: 37

Prior U.S. Cls.: 100, 103 and 106

United States Patent and Trademark Office

Reg. No. 3,519,533

Registered Oct. 21, 2008

**SERVICE MARK
PRINCIPAL REGISTER**

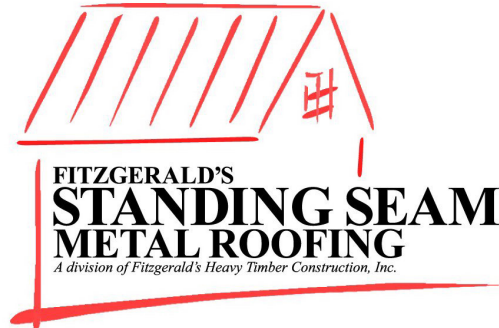

FITZGERALD'S HEAVY TIMBER CONSTRUCTION, INC. (MARYLAND CORPORATION)
10801 POWELL ROAD
THURMONT, MD 21788

FOR: INSTALLATION OF STANDING SEAM METAL ROOFING, IN CLASS 37 (U.S. CLS. 100, 103 AND 106).

FIRST USE 0-0-2007; IN COMMERCE 0-0-2007.

NO CLAIM IS MADE TO THE EXCLUSIVE RIGHT TO USE "STANDING SEAM METAL ROOFING," "A DIVISION OF," AND "HEAVY TIMBER CONSTRUCTION, INC.", APART FROM THE MARK AS SHOWN.

THE COLOR(S) RED AND BLACK IS/ARE CLAIMED AS A FEATURE OF THE MARK.

THE MARK CONSISTS OF THE WORDS "FITZGERALD'S STANDING SEAM METAL ROOFING A DIVISION OF FITZGERALD'S HEAVY TIMBER CONSTRUCTION, INC." IN BLACK SURMOUNTED BY THE OUTLINE OF A STYLIZED BUILDING IN RED.

SER. NO. 77-387,187, FILED 2-2-2008.

GEOFFREY FOSDICK, EXAMINING ATTORNEY

Int. Cl.: 5

Prior U.S. Cls.: 6, 18, 44, 46, 51 and 52

Reg. No. 3,519,534

United States Patent and Trademark Office

Registered Oct. 21, 2008

**TRADEMARK
PRINCIPAL REGISTER**

DAKIBIS

TAKEDA PHARMACEUTICAL COMPANY LIM-
ITED (JAPAN CORPORATION)
1-1, DOSHOMACHI 4-CHOME
CHUO-KU, OSAKA, JAPAN

PRIORITY CLAIMED UNDER SEC. 44(D) ON
JAPAN APPLICATION NO. 2007-116143, FILED 11-
16-2007, REG. NO. 5132417, DATED 4-25-2008, EX-
PIRES 4-25-2018.

FOR: PHARMACEUTICAL PREPARATIONS FOR
THE TREATMENT AND PREVENTION OF DIA-
BETIC DISEASES, IN CLASS 5 (U.S. CLS. 6, 18, 44, 46,
51 AND 52).

SER. NO. 77-387,685, FILED 2-4-2008.

THE MARK CONSISTS OF STANDARD CHAR-
ACTERS WITHOUT CLAIM TO ANY PARTICULAR
FONT, STYLE, SIZE, OR COLOR.

RONALD DELGIZZI, EXAMINING ATTORNEY

Int. Cl.: 36

Prior U.S. Cls.: 100, 101 and 102

United States Patent and Trademark Office

Reg. No. 3,519,535

Registered Oct. 21, 2008

**SERVICE MARK
PRINCIPAL REGISTER**

Financial Advocate

SPC FINANCIAL, INC. (MARYLAND CORPORATION)
SUITE 400
3202 TOWER OAKS BOULEVARD
ROCKVILLE, MD 20852

FOR: FINANCIAL PLANNING AND INVESTMENT ADVISORY SERVICES, IN CLASS 36 (U.S. CLS. 100, 101 AND 102).

FIRST USE 9-12-2007; IN COMMERCE 9-12-2007.

THE MARK CONSISTS OF STANDARD CHARACTERS WITHOUT CLAIM TO ANY PARTICULAR FONT, STYLE, SIZE, OR COLOR.

NO CLAIM IS MADE TO THE EXCLUSIVE RIGHT TO USE "FINANCIAL", APART FROM THE MARK AS SHOWN.

SER. NO. 77-388,472, FILED 2-5-2008.

DAWN FELDMAN, EXAMINING ATTORNEY

Int. Cl.: 41

Prior U.S. Cls.: 100, 101 and 107

United States Patent and Trademark Office

Reg. No. 3,519,536

Registered Oct. 21, 2008

**SERVICE MARK
PRINCIPAL REGISTER**

NATURE'S WONDERS

THE RITZ-CARLTON HOTEL COMPANY, L.L.C.
(DELAWARE LIMITED LIABILITY COMPAN-
NY)
10400 FERNWOOD ROAD
BETHESDA, MD 20817

FOR: ENTERTAINMENT AND RECREATIONAL SERVICES, NAMELY, PROVIDING NATURE-THEMED ACTIVITIES IN THE FORM OF NATURE WALKS, BOAT RIDES, FIELD TRIPS, SCIENCE EXPERIMENTS, MOTION PICTURE EXHIBITIONS, AND PLANT AND ANIMAL EXHIBITIONS; EDUCATIONAL SERVICES, NAMELY, CONDUCTING PROGRAMS IN THE FIELDS OF ENVIRONMEN-

TAL CONSERVATION, NATURE AND WILDLIFE, IN CLASS 41 (U.S. CLS. 100, 101 AND 107).

FIRST USE 10-1-2006; IN COMMERCE 10-1-2006.

THE MARK CONSISTS OF STANDARD CHARACTERS WITHOUT CLAIM TO ANY PARTICULAR FONT, STYLE, SIZE, OR COLOR.

SER. NO. 77-388,930, FILED 2-5-2008.

JORDAN BAKER, EXAMINING ATTORNEY

Int. Cl.: 11

Prior U.S. Cls.: 13, 21, 23, 31 and 34

Reg. No. 3,519,537

United States Patent and Trademark Office

Registered Oct. 21, 2008

**TRADEMARK
PRINCIPAL REGISTER**

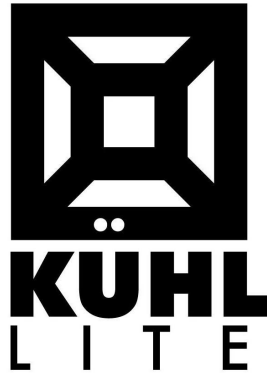

TABLETOP STUDIO LLC (MASSACHUSETTS
LIMITED LIABILITY COMPANY)
#11
4187 CARPINTERIA AVENUE
CARPINTERIA, CA 93013

FOR: ELECTRIC LIGHTING FIXTURES FOR
PHOTOGRAPHIC AND VIDEO USE, IN CLASS 11
(U.S. CLS. 13, 21, 23, 31 AND 34).

FIRST USE 1-29-2008; IN COMMERCE 1-29-2008.

NO CLAIM IS MADE TO THE EXCLUSIVE
RIGHT TO USE "LITE", APART FROM THE MARK
AS SHOWN.

THE MARK CONSISTS OF A SQUARE DESIGN
INCORPORATING FOUR INTERSECTING LINES
ABOVE THE WORD "KÜHL LITE".

SER. NO. 77-389,212, FILED 2-5-2008.

TEJBIR SINGH, EXAMINING ATTORNEY

Int. Cl.: 7

Prior U.S. Cls.: 13, 19, 21, 23, 31, 34 and 35

Reg. No. 3,519,538

United States Patent and Trademark Office

Registered Oct. 21, 2008

**TRADEMARK
PRINCIPAL REGISTER**



QUICK ATTACH ATTACHMENTS INC. (MINNESOTA CORPORATION)
PO BOX 128
ALEXANDRIA, MN 56308

THE COLOR(S) RED, YELLOW, BLACK AND WHITE IS/ARE CLAIMED AS A FEATURE OF THE MARK.

FOR: AGRICULTURAL MACHINERY AND ATTACHMENTS THEREFORE, NAMELY, ROTARY MOWERS, BOX SCRAPERS, AND THREE-POINT ATTACHMENTS; ATTACHMENTS FOR VEHICLES, NAMELY, GRAPPLE BUCKETS AND BLADES FOR MOVING EARTH AND LOOSE OBJECTS; POWER OPERATED BLOWERS; SNOW BLOWERS; SNOW PLOWS; SNOW THROWERS, IN CLASS 7 (U.S. CLS. 13, 19, 21, 23, 31, 34 AND 35).

THE MARK CONSISTS OF THE COLORS RED, YELLOW, BLACK AND WHITE, WITH THE COLOR RED APPEARING IN THE WORDING ATTACH, THE COLOR YELLOW APPEARING IN THE WORDING QUICK AND OVAL BORDER, THE COLOR BLACK APPEARING IN THE BACKGROUND OF THE OVAL, AND THE COLOR WHITE APPEARING IN THE WORDING ATTACHMENTS, INC.

FIRST USE 11-1-2002; IN COMMERCE 11-1-2002.

SEC. 2(F).

NO CLAIM IS MADE TO THE EXCLUSIVE RIGHT TO USE "ATTACH" AND "ATTACHMENTS, INC.", APART FROM THE MARK AS SHOWN.

SER. NO. 77-389,246, FILED 2-5-2008.

SOPHIA S. KIM, EXAMINING ATTORNEY

Int. Cl.: 35

Prior U.S. Cls.: 100, 101 and 102

United States Patent and Trademark Office

Reg. No. 3,519,539

Registered Oct. 21, 2008

SERVICE MARK
PRINCIPAL REGISTER

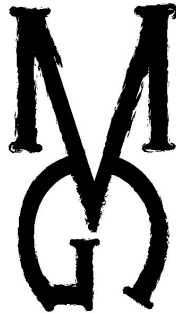

THE MEPHISTO GROUP

COALITION BMX, LLC (CALIFORNIA LIMITED
LIABILITY COMPANY)
64 ORCHARD PARK BLVD.
ROCHESTER, NY 14609

THE MARK CONSISTS OF THE STYLIZED LET-
TERS "MG", AND THE STYLIZED WORDS "THE
MEPHISTO GROUP".

FOR: DISTRIBUTORSHIP SERVICES IN THE
FIELD OF BICYCLE PARTS AND ACCESSORIES,
CLOTHING, SKATEBOARDS, WATCHES, IN CLASS
35 (U.S. CLS. 100, 101 AND 102).

SER. NO. 77-389,347, FILED 2-5-2008.

FIRST USE 9-1-2007; IN COMMERCE 9-1-2007.

TEJBIR SINGH, EXAMINING ATTORNEY

Int. Cl.: 7

Prior U.S. Cls.: 13, 19, 21, 23, 31, 34 and 35

United States Patent and Trademark Office

Reg. No. 3,519,540

Registered Oct. 21, 2008

TRADEMARK
PRINCIPAL REGISTER

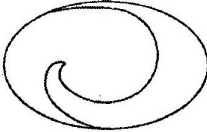
KING  AIR

SAINTYU GROUP CO., LTD. (TAIWAN CORPORATION)
4F, NO.1, JHONGCING RD., BEITUN DIST.
TAICHUNG, TAIWAN

FOR: COMBINATION OIL/WATER SEPARATOR,
OIL SEPARATOR, WATER SEPARATOR, CENTRI-
FUGAL SEPARATOR, IN CLASS 7 (U.S. CLS. 13, 19,
21, 23, 31, 34 AND 35).

FIRST USE 3-14-2006; IN COMMERCE 3-14-2006.

NO CLAIM IS MADE TO THE EXCLUSIVE
RIGHT TO USE "AIR", APART FROM THE MARK
AS SHOWN.

THE MARK CONSISTS OF WORDING "KING
AIR" AND A STYLIZED OVAL.

SER. NO. 77-389,542, FILED 2-5-2008.

CHARLES L. JENKINS, EXAMINING ATTORNEY

Int. Cl.: 35

Prior U.S. Cls.: 100, 101 and 102

United States Patent and Trademark Office

Reg. No. 3,519,541

Registered Oct. 21, 2008

**SERVICE MARK
PRINCIPAL REGISTER**

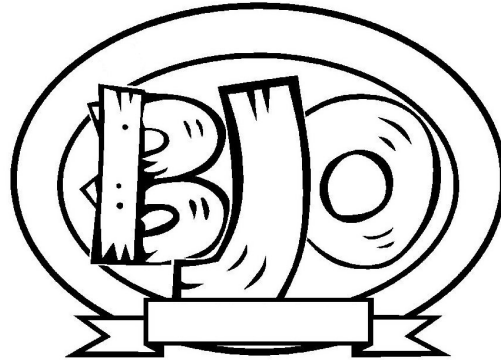

CAD, LLC (TENNESSEE LIMITED LIABILITY
COMPANY)
739 LOUISVILLE ROAD
ALCOA, TN 37701

FOR: DISTRIBUTORSHIP SERVICES FEATUR-
ING MEAT PRODUCTS, IN CLASS 35 (U.S. CLS. 100,
101 AND 102).

FIRST USE 10-13-2007; IN COMMERCE 10-13-2007.

THE MARK CONSISTS OF STYLIZED LETTERS
"BJO" APPEARING WITHIN AN OVAL FRAME
AND A RIBBON APPEARING BENEATH THE STY-
LIZED LETTERS.

SER. NO. 77-389,671, FILED 2-6-2008.

STEPHANIE ALI, EXAMINING ATTORNEY

Int. Cl.: 18

Prior U.S. Cls.: 1, 2, 3, 22 and 41

United States Patent and Trademark Office

Reg. No. 3,519,542

Registered Oct. 21, 2008

**TRADEMARK
PRINCIPAL REGISTER**

imjuky

OKEKE, NKEMDILIM (UNITED STATES INDIVIDUAL)
P.O. BOX 130216
HOUSTON, TX 77219

THE MARK CONSISTS OF STANDARD CHARACTERS WITHOUT CLAIM TO ANY PARTICULAR FONT, STYLE, SIZE, OR COLOR.

FOR: DIAPER BAGS, IN CLASS 18 (U.S. CLS. 1, 2, 3, 22 AND 41).

SER. NO. 77-389,953, FILED 2-6-2008.

FIRST USE 1-3-2008; IN COMMERCE 1-3-2008.

MICHAEL TANNER, EXAMINING ATTORNEY

Int. Cl.: 29

Prior U.S. Cl.: 46

United States Patent and Trademark Office

Reg. No. 3,519,543

Registered Oct. 21, 2008

**TRADEMARK
PRINCIPAL REGISTER**

Malibu Olive Company

JAYE, ROBERT C. (UNITED STATES INDIVIDUAL)

75-550 CALLE DEL SUR

INDIAN WELLS, CA 92210

FOR: PROCESSED OLIVES, NAMELY, OLIVE OIL, IN CLASS 29 (U.S. CL. 46).

FIRST USE 1-1-2008; IN COMMERCE 1-1-2008.

THE MARK CONSISTS OF STANDARD CHARACTERS WITHOUT CLAIM TO ANY PARTICULAR FONT, STYLE, SIZE, OR COLOR.

NO CLAIM IS MADE TO THE EXCLUSIVE RIGHT TO USE "OLIVE COMPANY", APART FROM THE MARK AS SHOWN.

SER. NO. 77-391,089, FILED 2-7-2008.

BRIAN PINO, EXAMINING ATTORNEY

Int. Cl.: 36

Prior U.S. Cls.: 100, 101 and 102

United States Patent and Trademark Office

Reg. No. 3,519,544

Registered Oct. 21, 2008

**SERVICE MARK
PRINCIPAL REGISTER**



B&B REALTY, INC. (ILLINOIS CORPORATION)
12835 GRANDE POPLAR CIRCLE
PLAINFIELD, IL 60585

FOR: REAL ESTATE AGENCIES; REAL ESTATE
BROKERAGE AND MANAGEMENT, IN CLASS 36
(U.S. CLS. 100, 101 AND 102).

FIRST USE 2-0-2007; IN COMMERCE 2-0-2007.

NO CLAIM IS MADE TO THE EXCLUSIVE
RIGHT TO USE "REALTY, INC.", APART FROM
THE MARK AS SHOWN.

THE MARK CONSISTS OF A BUMBLEBEE WITH
THREE POLYGONS.

SER. NO. 77-391,380, FILED 2-7-2008.

MICHELE SWAIN, EXAMINING ATTORNEY

Int. Cl.: 36

Prior U.S. Cls.: 100, 101 and 102

United States Patent and Trademark Office

Reg. No. 3,519,545

Registered Oct. 21, 2008

**SERVICE MARK
PRINCIPAL REGISTER**



B&B REALTY, INC. (ILLINOIS CORPORATION)
12835 GRANDE POPLAR CIRCLE
PLAINFIELD, IL 60585

THE MARK CONSISTS OF A BUMBLEBEE WITH
THREE POLYGONS.

FOR: REAL ESTATE AGENCIES; REAL ESTATE
BROKERAGE AND MANAGEMENT, IN CLASS 36
(U.S. CLS. 100, 101 AND 102).

SER. NO. 77-391,473, FILED 2-7-2008.

FIRST USE 2-0-2007; IN COMMERCE 2-0-2007.

MICHELE SWAIN, EXAMINING ATTORNEY

Int. Cl.: 35

Prior U.S. Cls.: 100, 101 and 102

United States Patent and Trademark Office

Reg. No. 3,519,546

Registered Oct. 21, 2008

**SERVICE MARK
PRINCIPAL REGISTER**



KatyArea
Economic Development Council
Teaming with Talent. Energizing the World.

KATY AREA ECONOMIC DEVELOPMENT
COUNCIL, INC. (TEXAS CORPORATION)
SUITE 111
6301 SOUTH STADIUM LN.
KATY, TX 77494

FOR: PROMOTING THE ECONOMIC DEVELOPMENT IN THE GREATER KATY, TEXAS AREA AND THE STATE OF TEXAS, IN CLASS 35 (U.S. CLS. 100, 101 AND 102).

FIRST USE 1-1-2007; IN COMMERCE 1-1-2007.

NO CLAIM IS MADE TO THE EXCLUSIVE RIGHT TO USE "KATY AREA ECONOMIC DEVELOPMENT COUNCIL", APART FROM THE MARK AS SHOWN.

THE COLOR(S) RED AND BLACK AND WHITE IS/ARE CLAIMED AS A FEATURE OF THE MARK.

THE MARK CONSISTS OF A RED GEOMETRIC REPRESENTATION OF A SPINNING GLOBE. THE WORD "KATY" AND THE WORDING "TEAMING WITH TALENT. ENERGIZING THE WORLD" APPEAR IN RED. THE WORD "AREA" AND THE WORDING "ECONOMIC DEVELOPMENT COUNCIL" APPEAR IN BLACK.

SER. NO. 77-391,618, FILED 2-7-2008.

REBECCA SMITH, EXAMINING ATTORNEY

Int. Cl.: 9

Prior U.S. Cls.: 21, 23, 26, 36 and 38

Reg. No. 3,519,547

United States Patent and Trademark Office

Registered Oct. 21, 2008

**TRADEMARK
PRINCIPAL REGISTER**

LIKE A PRO

POLING, KENT E. (UNITED STATES INDIVIDUAL), DBA SUGAR CREEK MUSIC CO.
83 GRANVILLE ST.
GAHANNA, OH 43230

AND DVDS FEATURING THE INSTRUCTIONS ON THE USE, MAINTENANCE, AND REPAIR OF MUSICAL INSTRUMENTS, IN CLASS 9 (U.S. CLS. 21, 23, 26, 36 AND 38).

FOR: AUDIO RECORDINGS FEATURING THE INSTRUCTIONS ON THE USE, MAINTENANCE, AND REPAIR OF MUSICAL INSTRUMENTS; DIGITAL MEDIA, NAMELY, PRE-RECORDED VIDEO CASSETTES, DIGITAL VIDEO DISCS, DIGITAL VERSATILE DISCS, DOWNLOADABLE AUDIO AND VIDEO RECORDINGS, DVDS, AND HIGH DEFINITION DIGITAL DISKS FEATURING THE INSTRUCTIONS ON THE USE, MAINTENANCE, AND REPAIR OF MUSICAL INSTRUMENTS; PRE-RECORDED CDS, VIDEO TAPES, LASER DISKS

FIRST USE 7-10-1997; IN COMMERCE 7-11-1997.

THE MARK CONSISTS OF STANDARD CHARACTERS WITHOUT CLAIM TO ANY PARTICULAR FONT, STYLE, SIZE, OR COLOR.

SER. NO. 77-391,901, FILED 2-8-2008.

JANET LEE, EXAMINING ATTORNEY

Int. Cls.: 36 and 37

Prior U.S. Cls.: 100, 101, 102, 103 and 106

United States Patent and Trademark Office

Reg. No. 3,519,548

Registered Oct. 21, 2008

**SERVICE MARK
PRINCIPAL REGISTER**

MCWHINNEY

MCWHINNEY HOLDING COMPANY, LLLP
(COLORADO LIMITED LIABILITY LIMITED
PARTNERSHIP)
RANGEVIEW ONE OFFICE BLDG. AT CENTERRA
2725 ROCKY MOUNTAIN AVE., SUITE 200
LOVELAND, CO 80538

FOR: REAL ESTATE MANAGEMENT; REAL
ESTATE LISTING; REAL ESTATE BROKERAGE;
REAL ESTATE AGENCIES; REAL ESTATE INVEST-
MENT; LEASING OF REAL PROPERTY; LEASING
OF RESIDENTIAL AND COMMERCIAL REAL ES-
TATE; SHOPPING CENTER SERVICES, NAMELY,
RENTAL OF SHOPPING CENTER SPACE; LEASING
OF SHOPPING MALL SPACE, IN CLASS 36 (U.S.
CLS. 100, 101 AND 102).

FIRST USE 10-31-2005; IN COMMERCE 10-31-2005.

FOR: REAL ESTATE DEVELOPMENT SERVICES;
LAND DEVELOPMENT SERVICES, NAMELY,
PLANNING AND LAYING OUT OF COMMERCIAL
AND RESIDENTIAL COMMUNITIES; RESIDEN-

TIAL AND COMMERCIAL BUILDING CONSTRU-
TION AND REPAIR; CUSTOM CONSTRUCTION
AND BUILDING RENOVATION; RESIDENTIAL
REAL ESTATE DEVELOPMENT, CONSTRUCTION
AND REPAIR; COMMERCIAL REAL ESTATE DE-
VELOPMENT, CONSTRUCTION AND REPAIR;
SHOPPING CENTER REAL ESTATE DEVELOP-
MENT, CONSTRUCTION AND REPAIR, IN CLASS
37 (U.S. CLS. 100, 103 AND 106).

FIRST USE 10-31-2005; IN COMMERCE 10-31-2005.

THE MARK CONSISTS OF STANDARD CHAR-
ACTERS WITHOUT CLAIM TO ANY PARTICULAR
FONT, STYLE, SIZE, OR COLOR.

SEC. 2(F).

SER. NO. 77-391,991, FILED 2-8-2008.

LOURDES AYALA, EXAMINING ATTORNEY

Int. Cl.: 25

Prior U.S. Cls.: 22 and 39

United States Patent and Trademark Office

Reg. No. 3,519,549

Registered Oct. 21, 2008

**TRADEMARK
PRINCIPAL REGISTER**

GOT FREEDOM?

EAGLE CREST, INC. (FLORIDA CORPORATION)
5353-1 RAMONA BLVD.
JACKSONVILLE, FL 32205

FOR: CLOTHING, NAMELY, HATS, SHIRTS,
UNDERGARMENTS, SWIMSUITS, SWEATSHIRTS,
SWEATERS, JACKETS, COATS, GLOVES, SCARVES,
BELTS, HEADBANDS, WRISTBANDS, PANTS,
SHORTS, SKIRTS, DRESSES, OVERALLS, SOCKS,
STOCKINGS, AND LEGGINGS, IN CLASS 25 (U.S.
CLS. 22 AND 39).

FIRST USE 10-25-2005; IN COMMERCE 10-25-2005.

THE MARK CONSISTS OF STANDARD CHAR-
ACTERS WITHOUT CLAIM TO ANY PARTICULAR
FONT, STYLE, SIZE, OR COLOR.

OWNER OF U.S. REG. NOS. 3,421,508, 3,421,512
AND OTHERS.

SER. NO. 77-392,056, FILED 2-8-2008.

ALICE SUE CARRUTHERS, EXAMINING ATTOR-
NEY

Int. Cl.: 30

Prior U.S. Cl.: 46

United States Patent and Trademark Office

Reg. No. 3,519,550

Registered Oct. 21, 2008

**TRADEMARK
PRINCIPAL REGISTER**



AMERICAN BLUE MILLS, INC (CALIFORNIA CORPORATION)
30502 HUNTWOOD AVE
HAYWARD, CA 94544

FOR: FLAVORINGS OF LEMON; SPICE BLENDS; SPICES; SWEETS; BAKING SPICES, IN CLASS 30 (U.S. CL. 46).

FIRST USE 1-0-2008; IN COMMERCE 1-0-2008.

THE COLOR(S) DARK GREEN, WHITE, AND YELLOW IS/ARE CLAIMED AS A FEATURE OF THE MARK.

THE COLOR DARK GREEN APPEARS IN THE DESIGN OF THE OVAL AND THE RECTANGLE;

THE COLOR WHITE APPEARS IN THE ARABIC CHARACTERS AND THE WORDING "KHUDARI"; AND THE COLOR YELLOW APPEARS IN THE OUTLINE OF THE OVAL AND RECTANGLE.

THE ENGLISH TRANSLATION OF THE WORD KHUDARI IN THE MARK IS LAST NAME.

THE NON-LATIN CHARACTER(S) IN THE MARK TRANSLITERATE INTO KHUDARI.

SER. NO. 77-392,162, FILED S.R. 2-8-2008 AM. P.R. 6-25-2008.

YAT SYE, LEE, EXAMINING ATTORNEY

Int. Cl.: 35

Prior U.S. Cls.: 100, 101 and 102

United States Patent and Trademark Office

Reg. No. 3,519,551

Registered Oct. 21, 2008

**SERVICE MARK
PRINCIPAL REGISTER**



CANADIAN TOURISM COMMISSION (CANADA CROWN CORPORATION)
SUITE 1400, FOUR BENTALL CENTRE
1055 DUNSMUIR STREET, BOX 49230
VANCOUVER, CANADA V7X1L2

FOR: PROMOTION OF TOURISM IN CANADA; PROMOTION AND ADVERTISEMENT OF CANADA AS AN INTERNATIONAL TOURISM DESTINATION; PROVISION OF A WEBSITE FEATURING PROMOTIONAL AND ADVERTISING INFORMATIONAL INFORMATION RELATED TO TOURISM IN CANADA; BUSINESS RESEARCH, ADVERTISING, MARKETING, MARKET STUDY AND ANALYSIS SERVICES IN THE NATURE OF COMPILATION, EVALUATION, ANALYSIS, RESEARCH, STUDIES, PROVISION AND DISSEMINATION OF INFORMATION AND DATA ON THE TOURISM INDUSTRY, TOURISM MARKET AND TOURISM TRENDS; MARKETING RESEARCH AND STUDIES IN THE FIELD OF TOURISM; PUBLIC RELATIONS AND PUBLICITY SERVICES; PUBLICATION OF PUBLICITY TEXTS; ARRANGING, ORGANIZING AND CONDUCTING TRADE SHOWS, TRADE FAIRS, EXHIBITIONS AND PRESENTATIONS FOR ADVERTISING AND PROMOTION OF TOURISM IN CANADA; ADVERTISING AGENCIES, NAMELY, PROMOTING TOURISM AND TRAVEL THROUGH THE DISTRIBUTION AND DISSEMINATION OF PRINTED AND AUDIO PROMOTIONAL MATERIALS, RADIO ADVERTISING AND COMMERCIALS, TELEVISION ADVERTISING AND COMMERCIALS, TRADE SHOWS, TRADE FAIRS, EXHIBITIONS, PRESENTATIONS, BY RENDERING SALES PROMOTION ADVICE, DISTRIBUTION OF SAMPLES OF PRODUCTS AND BANNER ADVERTISING; DIRECT MAIL AND ADVERTISING FOR PROMOTING AND FOSTERING TOURISM; CONTESTS AND INCENTIVE AWARD PROGRAMS TO PROMOTE THE SALE OF PRODUCTS AND SERVICES OF OTHERS IN THE FIELDS OF TOURISM AND PROMOTION OF TOURISM AND TRAVEL; RENTAL OF ADVERTISING SPACE; BUSINESS ADVISORY, MANAGEMENT AND CONSULTATION SERVICES IN THE FIELD OF TOURISM AND PROMOTION OF TOURISM AND TRAVEL, IN CLASS 35 (U.S. CLS. 100, 101 AND 102).

FIRST USE 1-15-2007; IN COMMERCE 1-15-2007.

NO CLAIM IS MADE TO THE EXCLUSIVE RIGHT TO USE "CANADA", APART FROM THE MARK AS SHOWN.

THE MARK CONSISTS OF THE WORDS "CANADA" AND "KEEP EXPLORING" AND A DESIGN OF A MAPLE LEAF.

SER. NO. 77-392,251, FILED 2-8-2008.

REBECCA GILBERT, EXAMINING ATTORNEY

Int. Cl.: 35

Prior U.S. Cls.: 100, 101 and 102

United States Patent and Trademark Office

Reg. No. 3,519,552

Registered Oct. 21, 2008

**SERVICE MARK
PRINCIPAL REGISTER**



CANADIAN TOURISM COMMISSION (CANADA
CROWN CORPORATION)
SUITE 1400, FOUR BENTALL CENTRE
1055 DUNSMUIR STREET, BOX 49230
VANCOUVER, CANADA V7X1L2

FOR: PROMOTION OF TOURISM IN CANADA; PROMOTION AND ADVERTISEMENT OF CANADA AS AN INTERNATIONAL TOURISM DESTINATION; PROVISION OF A WEBSITE FEATURING PROMOTIONAL AND ADVERTISING INFORMATIONAL INFORMATION RELATED TO TOURISM IN CANADA; BUSINESS RESEARCH, ADVERTISING, MARKETING, MARKET STUDY AND ANALYSIS SERVICES IN THE NATURE OF COMPILATION, EVALUATION, ANALYSIS, RESEARCH, STUDIES, PROVISION AND DISSEMINATION OF INFORMATION AND DATA ON THE TOURISM INDUSTRY, TOURISM MARKET AND TOURISM TRENDS; MARKETING RESEARCH AND STUDIES IN THE FIELD OF TOURISM; PUBLIC RELATIONS AND PUBLICITY SERVICES; PUBLICATION OF PUBLICITY TEXTS; ARRANGING, ORGANIZING AND CONDUCTING TRADE SHOWS, TRADE FAIRS, EXHIBITIONS AND PRESENTATIONS FOR ADVERTISING AND PROMOTION OF TOURISM IN CANADA; ADVERTISING AGENCIES, NAMELY, PROMOTING TOURISM AND TRAVEL THROUGH THE DISTRIBUTION AND DISSEMINATION OF PRINTED AND AUDIO PROMOTIONAL MATERIALS, RADIO ADVERTIS-

ING AND COMMERCIALS, TELEVISION ADVERTISING AND COMMERCIALS, TRADE SHOWS, TRADE FAIRS, EXHIBITIONS, PRESENTATIONS, BY RENDERING SALES PROMOTION ADVICE, DISTRIBUTION OF SAMPLES OF PRODUCTS AND BANNER ADVERTISING; DIRECT MAIL AND ADVERTISING FOR PROMOTING AND FOSTERING TOURISM; CONTESTS AND INCENTIVE AWARD PROGRAMS TO PROMOTE THE SALE OF PRODUCTS AND SERVICES OF OTHERS IN THE FIELDS OF TOURISM AND PROMOTION OF TOURISM AND TRAVEL; RENTAL OF ADVERTISING SPACE; BUSINESS ADVISORY, MANAGEMENT AND CONSULTATION SERVICES IN THE FIELD OF TOURISM AND PROMOTION OF TOURISM AND TRAVEL, IN CLASS 35 (U.S. CLS. 100, 101 AND 102).

FIRST USE 1-15-2007; IN COMMERCE 1-15-2007.

NO CLAIM IS MADE TO THE EXCLUSIVE RIGHT TO USE "CANADA", APART FROM THE MARK AS SHOWN.

THE MARK CONSISTS OF THE WORD "CANADA" AND A DESIGN OF A MAPLE LEAF.

SER. NO. 77-392,259, FILED 2-8-2008.

REBECCA GILBERT, EXAMINING ATTORNEY

Int. Cl.: 35

Prior U.S. Cls.: 100, 101 and 102

United States Patent and Trademark Office

Reg. No. 3,519,553

Registered Oct. 21, 2008

**SERVICE MARK
PRINCIPAL REGISTER**

KEEP EXPLORING

CANADIAN TOURISM COMMISSION (CANADA
CROWN CORPORATION)
SUITE 1400, FOUR BENTALL CENTRE
1055 DUNSMUIR STREET, BOX 49230
VANCOUVER, CANADA V7X1L2

FOR: PROMOTION OF TOURISM IN CANADA;
PROMOTION AND ADVERTISEMENT OF CANADA
AS AN INTERNATIONAL TOURISM DESTINATION;
PROVISION OF A WEBSITE FEATURING
PROMOTIONAL AND ADVERTISING INFORMATION
RELATED TO TOURISM IN CANADA; BUSINESS
RESEARCH, ADVERTISING, MARKETING,
MARKET STUDY AND ANALYSIS SERVICES
IN THE NATURE OF COMPILATION,
EVALUATION, ANALYSIS, RESEARCH,
STUDIES, PROVISION AND DISSEMINATION
OF INFORMATION AND DATA ON THE
TOURISM INDUSTRY, TOURISM MARKET
AND TOURISM TRENDS; MARKETING
RESEARCH AND STUDIES IN THE FIELD
OF TOURISM; PUBLIC RELATIONS AND
PUBLICITY SERVICES; PUBLICATION
OF PUBLICITY TEXTS; ARRANGING,
ORGANIZING AND CONDUCTING TRADE
SHOWS, TRADE FAIRS, EXHIBITIONS
AND PRESENTATIONS FOR ADVERTISING
AND PROMOTION OF TOURISM IN
CANADA; ADVERTISING AGENCIES,
NAMELY, PROMOTING TOURISM AND
TRAVEL THROUGH THE DISTRIBUTION
AND DISSEMINATION OF PRINTED AND AUDIO

PROMOTIONAL MATERIALS, RADIO
ADVERTISING AND COMMERCIALS,
TELEVISION ADVERTISING AND
COMMERCIALS, TRADE SHOWS,
TRADE FAIRS, EXHIBITIONS,
PRESENTATIONS, BY RENDERING
SALES PROMOTION ADVICE,
DISTRIBUTION OF SAMPLES OF
PRODUCTS AND BANNER
ADVERTISING; DIRECT MAIL
AND ADVERTISING FOR PROMOTING
AND FOSTERING TOURISM;
CONTESTS AND INCENTIVE
AWARD PROGRAMS TO PROMOTE
THE SALE OF PRODUCTS AND
SERVICES OF OTHERS IN THE
FIELDS OF TOURISM AND
PROMOTION OF TOURISM AND
TRAVEL; RENTAL OF
ADVERTISING SPACE; BUSINESS
ADVISORY, MANAGEMENT
AND CONSULTATION SERVICES
IN THE FIELD OF TOURISM
AND PROMOTION OF TOURISM
AND TRAVEL, IN CLASS 35
(U.S. CLS. 100, 101 AND 102).

FIRST USE 1-15-2007; IN COMMERCE 1-15-2007.

THE MARK CONSISTS OF STANDARD
CHARACTERS WITHOUT CLAIM TO
ANY PARTICULAR FONT, STYLE,
SIZE, OR COLOR.

SER. NO. 77-392,261, FILED 2-8-2008.

REBECCA GILBERT, EXAMINING ATTORNEY

Int. Cl.: 33

Prior U.S. Cls.: 47 and 49

United States Patent and Trademark Office

Reg. No. 3,519,554

Registered Oct. 21, 2008

**TRADEMARK
PRINCIPAL REGISTER**

PEY-LUCIA VINEYARDS

SCENIC ROOT WINEGROWERS, LLC (CALIFORNIA LIMITED LIABILITY COMPANY)
PO BOX 912
SAN ANSELMO, CA 94979

FOR: GRAPE WINE, IN CLASS 33 (U.S. CLS. 47 AND 49).

FIRST USE 1-24-2008; IN COMMERCE 1-24-2008.

THE MARK CONSISTS OF STANDARD CHARACTERS WITHOUT CLAIM TO ANY PARTICULAR FONT, STYLE, SIZE, OR COLOR.

OWNER OF U.S. REG. NO. 2,896,981.

NO CLAIM IS MADE TO THE EXCLUSIVE RIGHT TO USE "VINEYARDS", APART FROM THE MARK AS SHOWN.

SER. NO. 77-392,333, FILED 2-8-2008.

KATHLEEN LORENZO, EXAMINING ATTORNEY

Int. Cl.: 8

Prior U.S. Cls.: 23, 28 and 44

Reg. No. 3,519,555

United States Patent and Trademark Office

Registered Oct. 21, 2008

**TRADEMARK
PRINCIPAL REGISTER**

SUPER-SORT

HEARTLAND AG PRODUCTS (SOUTH DAKOTA
LIMITED LIABILITY COMPANY)
4908 9TH AVE SW
WATERTOWN, SD 57201

FOR: LIVESTOCK HERD MANAGING DEVICES,
NAMELY, AGRICULTURAL HAND TOOLS IN THE
NATURE OF LIVESTOCK HERDING PADDLES
INTENDED FOR RANCHERS TO CONTROL THE
MOVEMENT OF LIVESTOCK, IN CLASS 8 (U.S. CLS.
23, 28 AND 44).

FIRST USE 1-1-2008; IN COMMERCE 1-1-2008.

THE MARK CONSISTS OF STANDARD CHAR-
ACTERS WITHOUT CLAIM TO ANY PARTICULAR
FONT, STYLE, SIZE, OR COLOR.

SER. NO. 77-392,380, FILED 2-8-2008.

MARY MUNSON, EXAMINING ATTORNEY

Int. Cl.: 42

Prior U.S. Cls.: 100 and 101

United States Patent and Trademark Office

Reg. No. 3,519,556

Registered Oct. 21, 2008

**SERVICE MARK
PRINCIPAL REGISTER**

EAGLE GEOPHYSICAL

EAGLE GEOPHYSICAL, INC. (DELAWARE CORPORATION)
SUITE 400
908 TOWN & COUNTRY BLVD.
HOUSTON, TX 77024

FOR: SEISMOGRAPHIC EXPLORATION SERVICES, NAMELY, CONDUCTING PARAMETER DESIGN AND FEASIBILITY STUDIES, MAPPING, RECORDING AND INFIELD PROCESSING OF DATA FOR OTHERS ON OPTICAL, DIGITAL AND MAGNETIC MEDIA FOR LATER ELECTRONIC STORAGE, ALL FOR THE OIL AND GAS INDUSTRY, IN CLASS 42 (U.S. CLS. 100 AND 101).

FIRST USE 5-22-1997; IN COMMERCE 5-22-1997.

THE MARK CONSISTS OF STANDARD CHARACTERS WITHOUT CLAIM TO ANY PARTICULAR FONT, STYLE, SIZE, OR COLOR.

NO CLAIM IS MADE TO THE EXCLUSIVE RIGHT TO USE "GEOPHYSICAL", APART FROM THE MARK AS SHOWN.

SER. NO. 77-392,661, FILED 2-8-2008.

DAVID MURRAY, EXAMINING ATTORNEY

Int. Cl.: 9

Prior U.S. Cls.: 21, 23, 26, 36 and 38

Reg. No. 3,519,557

United States Patent and Trademark Office

Registered Oct. 21, 2008

**TRADEMARK
PRINCIPAL REGISTER**



INTELLIGENTZ CORPORATION (DELAWARE CORPORATION)
SUITE 200
115 E. 5TH STREET
AUSTIN, TX 78701

FOR: DATABASE MANAGEMENT SOFTWARE FOR TRACKING AND DISPOSING OF EVIDENCE, IN CLASS 9 (U.S. CLS. 21, 23, 26, 36 AND 38).

FIRST USE 10-1-2007; IN COMMERCE 10-1-2007.

NO CLAIM IS MADE TO THE EXCLUSIVE RIGHT TO USE "EVIDENCE", APART FROM THE MARK AS SHOWN.

THE COLOR(S) RED, YELLOW AND BLACK IS/ ARE CLAIMED AS A FEATURE OF THE MARK.

THE MARK CONSISTS OF THE WORD "CLUES" APPEARING IN RED AND UNDERNEATH THE WORDS "THE EVIDENCE CONNECTION" APPEARING IN BLACK ON TOP OF A YELLOW RECTANGLE.

SER. NO. 77-392,663, FILED 2-8-2008.

APRIL ROACH, EXAMINING ATTORNEY

Int. Cls.: 35 and 38

Prior U.S. Cls.: 100, 101, 102 and 104

United States Patent and Trademark Office

Reg. No. 3,519,558

Registered Oct. 21, 2008

**SERVICE MARK
PRINCIPAL REGISTER**

The logo for 'The Funded' features the words 'The Funded' in a bold, white, serif font with a thick green outline. The text is set against a light green rectangular background that has a subtle gradient and a slight drop shadow effect.

THEFUNDED, INCORPORATED (DELAWARE CORPORATION)
2ND FLOOR
C/O 101 E. 15TH ST.
NEW YORK, NY 10003

FOR: PROVIDING A WEB SITE FEATURING USER-CREATED RATINGS, REVIEWS AND RECOMMENDATIONS OF VENTURE CAPITAL FIRMS, IN CLASS 35 (U.S. CLS. 100, 101 AND 102).

FIRST USE 6-13-2007; IN COMMERCE 6-13-2007.

FOR: PROVIDING ON-LINE FORUMS FOR TRANSMISSION OF MESSAGES AMONG COMPUTER USERS CONCERNING ISSUES RELATED TO RAISING CAPITAL FOR PRIVATE AND PUBLIC

COMPANIES, IN CLASS 38 (U.S. CLS. 100, 101 AND 104).

FIRST USE 6-13-2007; IN COMMERCE 6-13-2007.

THE COLOR(S) WHITE AND GREEN IS/ARE CLAIMED AS A FEATURE OF THE MARK.

THE MARK CONSISTS OF THE WORDING "THE FUNDED" IN WHITE OUTLINED IN GREEN WITH A GREEN SHADED RECTANGULAR BACKGROUND.

SER. NO. 77-392,885, FILED 2-8-2008.

DANIEL CAPSHAW, EXAMINING ATTORNEY

Int. Cl.: 25

Prior U.S. Cls.: 22 and 39

United States Patent and Trademark Office

Reg. No. 3,519,559

Registered Oct. 21, 2008

TRADEMARK
PRINCIPAL REGISTER

OSCAR THE THIRD

OSCAR THE THIRD PTY LTD. (AUSTRALIA
LIMITED LIABILITY COMPANY)
16 STAFFORD GROVE, HEATHPOOL
SOUTH AUSTRALIA, AUSTRALIA

FOR: BATHING COSTUMES FOR WOMEN; COATS FOR MEN AND WOMEN; FOOTWEAR FOR MEN AND WOMEN; FOOTWEAR FOR WOMEN; LEOTARDS AND TIGHTS FOR WOMEN, MEN AND CHILDREN OF NYLON, COTTON OR OTHER TEXTILE FIBERS; MEN AND WOMEN JACKETS, COATS, TROUSERS, VESTS; MEN'S SUITS, WOMEN'S SUITS; SUSPENDER BELTS FOR WOMEN; WOMEN'S CEREMONIAL DRESSES; WOMEN'S SHOES; WOMEN'S UNDERWEAR; BELTS; BIBS NOT OF CLOTH OR PAPER; CAPS; CHILDREN'S AND INFANTS' CLOTH BIBS; CHILDREN'S CLOTH EATING BIBS; CLOTH BIBS; CLOTH BIBS FOR ADULT DINERS; CLOTH BIBS FOR USE BY SENIOR CITIZENS OR PHYSICALLY-OR MENTALLY-CHALLENGED PERSONS; CLOTH DIAPERS; CLOTHING FOR WEAR IN JUDO PRACTICES; CLOTHING FOR WEAR IN WRESTLING GAMES; CLOTHING, NAMELY, ARM WARMERS; CLOTHING, NAMELY, FOLK COSTUMES; CLOTHING, NAMELY, HAND-WARMERS; CLOTHING, NAMELY, KNEE WARMERS; CLOTHING, NAMELY, NECK TUBES; CLOTHING, NAMELY, THOBES; CLOTHING, NAMELY, WRAP-AROUNDS; CORSETS; DUSTERS; FOULARDS; HOODS; INFANT AND TODDLER ONE PIECE CLOTHING; INFANT CLOTH DIAPERS; JERSEYS; LEATHER BELTS; MANTLES; MUFFLERS; NON-DISPOSABLE CLOTH TRAINING PANTS; PAPER HATS FOR USE AS CLOTHING ITEMS; PARTS OF CLOTHING, NAMELY, GUSSETS FOR TIGHTS, GUSSETS FOR STOCKINGS, GUSSETS FOR BATHING SUITS, GUSSETS FOR UNDERWEAR, GUSSETS FOR LEOTARDS AND GUSSETS FOR FOOTLETS; PER-

SPIRATION ABSORBENT UNDERWEAR CLOTHING; SHIFTS; SHORT SETS; SHOULDER WRAPS; SWADDLING CLOTHES; TIES; TOPS; TRIATHLON CLOTHING, NAMELY, TRIATHLON TIGHTS, TRIATHLON SHORTS, TRIATHLON SINGLET, TRIATHLON SHIRTS, TRIATHLON SUITS; UNDERARM CLOTHING SHIELDS; WRAPS; LADIES' BOOTS; LADIES' SUITS; LADIES' UNDERWEAR; SWIM WEAR FOR GENTLEMEN AND LADIES; LINGERIE ACCESSORIES, NAMELY, REMOVABLE SILICONE BREAST ENHANCER PADS USED IN A BRA; UNDERGARMENT ACCESSORIES, NAMELY, REMOVABLE SILICONE BUTTOCK ENHANCER PADS; HEAD WEAR; INFANT WEAR; SKI WEAR; SURF WEAR; SWIM WEAR; TENNIS WEAR; BATHING SUITS FOR MEN; FOOTWEAR FOR MEN; MEN'S SOCKS; MEN'S SUITS; SUSPENDER BELTS FOR MEN; BRIDESMAID DRESSES; DRESS SHIELDS; DRESS SHIRTS; DRESS SUITS; DRESSES; DRESSES MADE FROM SKINS; DRESSING GOWNS; EVENING DRESSES; NURSE DRESSES; SKIRTS AND DRESSES; WEDDING DRESSES, IN CLASS 25 (U.S. CLS. 22 AND 39).

FIRST USE 1-16-2008; IN COMMERCE 1-16-2008.

THE MARK CONSISTS OF STANDARD CHARACTERS WITHOUT CLAIM TO ANY PARTICULAR FONT, STYLE, SIZE, OR COLOR.

THE NAME(S), PORTRAIT(S), AND/OR SIGNATURE(S) SHOWN IN THE MARK IDENTIFIES OSCAR BOYLE POLK, III, WHOSE CONSENT(S) TO REGISTER IS SUBMITTED.

SER. NO. 77-393,919, FILED 2-11-2008.

ROBIN CHOSID, EXAMINING ATTORNEY

Int. Cl.: 45

Prior U.S. Cls.: 100 and 101

United States Patent and Trademark Office

Reg. No. 3,519,560

Registered Oct. 21, 2008

**SERVICE MARK
PRINCIPAL REGISTER**

BULLETPROOF

ARBOGAST PROPERTY MANAGEMENT, LLC
(WYOMING LIMITED LIABILITY COMPANY)
PO BOX 759
GENOA, NV 89411

THE MARK CONSISTS OF STANDARD CHAR-
ACTERS WITHOUT CLAIM TO ANY PARTICULAR
FONT, STYLE, SIZE, OR COLOR.

FOR: LEGAL SERVICES; INTELLECTUAL PROP-
ERTY CONSULTATION, IN CLASS 45 (U.S. CLS. 100
AND 101).

SER. NO. 77-394,875, FILED 2-12-2008.

FIRST USE 6-0-2006; IN COMMERCE 6-0-2006.

MARY ROSSMAN, EXAMINING ATTORNEY

Int. Cl.: 45

Prior U.S. Cls.: 100 and 101

United States Patent and Trademark Office

Reg. No. 3,519,561

Registered Oct. 21, 2008

**SERVICE MARK
PRINCIPAL REGISTER**

**Florida Rural Legal
Services, Inc.**

FLORIDA RURAL LEGAL SERVICES, INC.
(FLORIDA CORPORATION)
P.O. BOX 219
3210 CLEVELAND AVENUE
FORT MYERS, FL 339020219

NO CLAIM IS MADE TO THE EXCLUSIVE
RIGHT TO USE "LEGAL SERVICES, INC.", APART
FROM THE MARK AS SHOWN.

FOR: ATTORNEY SERVICES, IN CLASS 45 (U.S.
CLS. 100 AND 101).

SEC. 2(F).

FIRST USE 12-31-1966; IN COMMERCE 1-1-1977.

SER. NO. 77-395,741, FILED 2-13-2008.

THE MARK CONSISTS OF STANDARD CHAR-
ACTERS WITHOUT CLAIM TO ANY PARTICULAR
FONT, STYLE, SIZE, OR COLOR.

CARYN GLASSER, EXAMINING ATTORNEY

Int. Cl.: 42

Prior U.S. Cls.: 100 and 101

United States Patent and Trademark Office

Reg. No. 3,519,562

Registered Oct. 21, 2008

**SERVICE MARK
PRINCIPAL REGISTER**

R/T Extender

MERCURY DATA EXCHANGE, INC. (VIRGINIA CORPORATION)
6025 SANDY SPRINGS CIRCLE
SANDY SPRINGS, GA 30328

FOR: APPLICATION SERVICE PROVIDER (ASP) FEATURING SOFTWARE FOR USE IN REAL-TIME PROCESSING OF DENTAL HEALTH INSURANCE TRANSACTIONS; PROVIDING ON-LINE NON-DOWNLOADABLE SOFTWARE FOR USE IN REAL-TIME PROCESSING OF DENTAL HEALTH INSURANCE TRANSACTIONS, IN CLASS 42 (U.S. CLS. 100 AND 101).

FIRST USE 1-0-2007; IN COMMERCE 1-0-2007.

THE MARK CONSISTS OF STANDARD CHARACTERS WITHOUT CLAIM TO ANY PARTICULAR FONT, STYLE, SIZE, OR COLOR.

NO CLAIM IS MADE TO THE EXCLUSIVE RIGHT TO USE "R/T", APART FROM THE MARK AS SHOWN.

SER. NO. 77-395,768, FILED 2-13-2008.

CHRISTINE BLOMQUIST, EXAMINING ATTORNEY

Int. Cls.: 35 and 36

Prior U.S. Cls.: 100, 101 and 102

United States Patent and Trademark Office

Reg. No. 3,519,563

Registered Oct. 21, 2008

**SERVICE MARK
PRINCIPAL REGISTER**



WILDERNESS REWARDS

MXT CARD SERVICES (DELAWARE LIMITED LIABILITY COMPANY)
2 PENNS WAY, SUITE 201
NEW CASTLE, DE 19720

FOR: ARRANGING AND CONDUCTING INCENTIVE REWARD PROGRAMS TO PROMOTE THE SALE OF CREDIT CARDS; CONTESTS AND INCENTIVE AWARD PROGRAMS TO PROMOTE THE SALE OF PRODUCTS AND SERVICES OF OTHERS; PROMOTING THE SALE OF CREDIT CARD ACCOUNTS THROUGH THE ADMINISTRATION OF INCENTIVE AWARD PROGRAMS, IN CLASS 35 (U.S. CLS. 100, 101 AND 102).

FIRST USE 12-1-2007; IN COMMERCE 2-1-2008.

FOR: CREDIT CARD SERVICES; ISSUING CREDIT CARDS, IN CLASS 36 (U.S. CLS. 100, 101 AND 102).

FIRST USE 12-1-2007; IN COMMERCE 2-1-2008.

NO CLAIM IS MADE TO THE EXCLUSIVE RIGHT TO USE "REWARDS", APART FROM THE MARK AS SHOWN.

THE COLOR(S) PANTONE WARM GREY 9, WHITE, AND PANTONE 576 IS/ARE CLAIMED AS A FEATURE OF THE MARK.

THE MARK CONSISTS OF A DIAMOND SHAPE OUTLINED IN GREY WITH A SECOND INNER OUTLINE IN WHITE. THE CENTER OF THE DIAMOND IS GREEN WITH A WHITE CIRCULAR CUT-OUT, A WHITE LETTER "W" SHAPE CUT-OUT, AND A WHITE INSERTED TRIANGLE CUT-OUT WITH THE WORDS "WILDERNESS REWARDS" TO THE SIDE APPEARING IN GREY.

SER. NO. 77-395,931, FILED S.R. 2-13-2008 AM. P.R. 6-6-2008.

NORA BUCHANAN WILL, EXAMINING ATTORNEY

Int. Cls.: 37, 40 and 42

Prior U.S. Cls.: 100, 101, 103 and 106

United States Patent and Trademark Office

Reg. No. 3,519,564

Registered Oct. 21, 2008

**SERVICE MARK
PRINCIPAL REGISTER**

DECRANE AEROSPACE

DECRANE AEROSPACE, INC. (DELAWARE CORPORATION)
8425 PULSAR PLACE, SUITE 340
COLUMBUS, OH 43240

FOR: UPGRADING AND RETROFITTING OF PRODUCTS FOR THE CORPORATE AIRCRAFT INDUSTRY, NAMELY, AIRCRAFT AND CABIN FURNISHINGS, LIGHTING, COMMUNICATION SYSTEMS, IN-FLIGHT ENTERTAINMENT EQUIPMENT, FUEL TANK SYSTEMS AND POWER UNITS, CABIN SHELLS, SIDEWALLS AND PARTITIONS, AUDIO-VISUAL EQUIPMENT, FLIGHT DECK INSTRUMENTATION AND INSTRUMENTATION DISPLAY COMPONENTS, GLOBAL POSITIONING EQUIPMENT AND TRAFFIC COLLISION AVOIDANCE EQUIPMENT, AND AVIONICS SYSTEMS, IN CLASS 37 (U.S. CLS. 100, 103 AND 106).

FIRST USE 4-18-2007; IN COMMERCE 4-18-2007.

FOR: CUSTOM MANUFACTURE OF PRODUCTS FOR THE CORPORATE AIRCRAFT INDUSTRY, NAMELY, AIRCRAFT AND CABIN FURNISHINGS, LIGHTING, COMMUNICATION SYSTEMS, IN-FLIGHT ENTERTAINMENT EQUIPMENT, FUEL TANK SYSTEMS AND POWER UNITS, CABIN SHELLS, SIDEWALLS AND PARTITIONS, AUDIO-VISUAL EQUIPMENT, FLIGHT DECK INSTRUMENTATION AND INSTRUMENTATION DISPLAY COMPONENTS, GLOBAL POSITIONING EQUIPMENT AND TRAFFIC COLLISION AVOIDANCE EQUIPMENT, AND AVIONICS SYSTEMS, IN CLASS 40 (U.S. CLS. 100, 103 AND 106).

FIRST USE 4-18-2007; IN COMMERCE 4-18-2007.

FOR: AIRCRAFT EQUIPMENT DESIGN AND AIRCRAFT INTERIOR DESIGN FOR THE CORPO-

RATE AIRCRAFT INDUSTRY, NAMELY, DEVELOPING AND ENGINEERING AIRCRAFT AND CABIN FURNISHINGS, LIGHTING, COMMUNICATION SYSTEMS, IN-FLIGHT ENTERTAINMENT EQUIPMENT, FUEL TANK SYSTEMS AND POWER UNITS, CABIN SHELLS, SIDEWALLS AND PARTITIONS, AUDIO-VISUAL EQUIPMENT, FLIGHT DECK INSTRUMENTATION AND INSTRUMENTATION DISPLAY COMPONENTS, GLOBAL POSITIONING EQUIPMENT AND TRAFFIC COLLISION AVOIDANCE EQUIPMENT, AVIONICS SYSTEMS, ENGINEERING SERVICES, PRODUCT DEVELOPMENT SERVICES FOR OTHERS IN THE CORPORATE AIRCRAFT INDUSTRY, TESTING, ANALYSIS AND EVALUATION OF THE GOODS AND SERVICES OF OTHERS IN THE CORPORATE AIRCRAFT INDUSTRY FOR THE PURPOSE OF CERTIFICATION, IN CLASS 42 (U.S. CLS. 100 AND 101).

FIRST USE 4-18-2007; IN COMMERCE 4-18-2007.

THE MARK CONSISTS OF STANDARD CHARACTERS WITHOUT CLAIM TO ANY PARTICULAR FONT, STYLE, SIZE, OR COLOR.

OWNER OF U.S. REG. NO. 2,617,181.

NO CLAIM IS MADE TO THE EXCLUSIVE RIGHT TO USE "AEROSPACE", APART FROM THE MARK AS SHOWN.

SEC. 2(F).

SER. NO. 77-395,993, FILED 2-13-2008.

LINDA ESTRADA, EXAMINING ATTORNEY

Int. Cls.: 9 and 28

Prior U.S. Cls.: 21, 22, 23, 26, 36, 38 and 50

Reg. No. 3,519,565

United States Patent and Trademark Office

Registered Oct. 21, 2008

**TRADEMARK
PRINCIPAL REGISTER**

TRIXTER

TRIXTER DEVELOPMENTS LIMITED PLC (UNITED KINGDOM CORPORATION)
TRIXTER HOUSE, LONDON ROAD, STROUD
GLOUCESTERSHIRE, UNITED KINGDOM GL52AY

FOR: COMPUTER GAME SOFTWARE AND COMPUTER PERIPHERALS FOR USE IN SIMULATING BICYCLE RIDING EXPERIENCES; COMPUTER HARDWARE; DOWNLOADABLE COMPUTER GAMES AND COMPUTER SOFTWARE FOR USE IN SIMULATING BICYCLE RIDING EXPERIENCES; COMPUTERS AND COMPUTER PERIPHERALS THEREFORE FOR USE WITH PHYSICAL REHABILITATION, PHYSICAL THERAPY, SPORTS MEDICINE, AND PHYSICAL TRAINING; COMPUTER SOFTWARE FOR USE WITH EXERCISE AND FITNESS MACHINES; COMPUTER SOFTWARE FOR MONITORING CARDIOVASCULAR CONDITIONING, BALANCE, STABILITY AND WEIGHT BEARING CAPACITIES, REACTION TIME, STRIKE AND MOVEMENT, RANGE OF MOTION, STRENGTH, EXTENSION AND FLEXION AND INSTRUCTION MANUALS IN ELECTRONIC FORMAT SOLD AS A UNIT THEREWITH, AVAILABLE BOTH BY DOWNLOAD AND ON RECORDED COMPUTER MEDIA; COMPUTER GAME PROGRAMS; COMPUTER GAME CARTRIDGES, SOFTWARE, DISCS, TAPES, AND INSTRUCTION MANUALS IN ELECTRONIC FORMAT SOLD TOGETHER AS A UNIT THEREWITH; COMPUTER GAME PROGRAMS THAT MAY BE DOWNLOADABLE FROM A GLOBAL COMPUTER NETWORK; EDUCATIONAL SOFTWARE IN THE FORM OF A VIDEO GAME THAT MAY BE DOWNLOADED FROM A GLOBAL COMPUTER NETWORK; EDUCATIONAL SOFTWARE IN THE FIELD OF VIDEO GAMES THAT MAY BE DOWNLOADED FROM A GLOBAL COMPUTER NETWORK; COMPUTER GAMES THAT MAY BE DOWNLOADED FROM A GLOBAL COMPUTER NETWORK; INTERACTIVE MULTI-MEDIA COMPUTER GAMES COMPRISED OF COMPUTER

HARDWARE AND COMPUTER GAMES SOFTWARE; COMPUTER JOYSTICKS, COMPUTER GAME TAPES, DISC AND CASSETTES; VIDEO GAME TAPE CASSETTES AND DISCS; COMPUTER SOFTWARE GAME SIMULATION CONTROLS, NAMELY, HANDLEBAR AND SEAT JOYSTICKS FOR CONTROLLING STEERING, BALANCE AND WEIGHT DISTRIBUTION IN THE USE OF PEDAL DRIVEN CROSS-TRAINING EQUIPMENT; COMPUTER GAME SOFTWARE INTERFACE CONTROLS FOR SIMULATING STEERING, BALANCE AND WEIGHT DISTRIBUTION IN THE USE OF PEDAL DRIVEN CROSS-TRAINING EQUIPMENT; COMPUTER CONTROLLERS, NAMELY, WEIGHT DISTRIBUTION MONITORS, PHYSIOLOGICAL MONITORS, AND BALANCE MONITORS; AND COMPUTER JOYSTICKS FOR USE WITH ASSOCIATED COMPUTER GAME HARDWARE AND SOFTWARE; CDS FEATURING MUSIC; DVDS WITH INSTRUCTIONAL VIDEOS RECORDED THEREON FOR USE WITH PEDAL DRIVEN CROSS-TRAINING FITNESS EQUIPMENT; CD ROMS WITH INSTRUCTIONAL VIDEOS RECORDED THEREON FOR USE WITH PROVIDE INSTRUCTION ON USE OF PEDAL DRIVEN CROSS-TRAINING FITNESS EQUIPMENT, IN CLASS 9 (U.S. CLS. 21, 23, 26, 36 AND 38).

FIRST USE 10-1-2003; IN COMMERCE 10-1-2003.

FOR: FITNESS AND EXERCISE MACHINES, NAMELY, PEDAL DRIVEN CROSS-TRAINING FITNESS MACHINE, IN CLASS 28 (U.S. CLS. 22, 23, 38 AND 50).

FIRST USE 10-1-2003; IN COMMERCE 10-1-2003.

THE MARK CONSISTS OF STANDARD CHARACTERS WITHOUT CLAIM TO ANY PARTICULAR FONT, STYLE, SIZE, OR COLOR.

SER. NO. 77-396,152, FILED 2-13-2008.

SHAUNIA CARLYLE, EXAMINING ATTORNEY

Int. Cl.: 41

Prior U.S. Cls.: 100, 101 and 107

United States Patent and Trademark Office

Reg. No. 3,519,566

Registered Oct. 21, 2008

**SERVICE MARK
PRINCIPAL REGISTER**

MINDWORKS STUDIO LLC

MINDWORKS STUDIO LLC (ARIZONA LIMITED LIABILITY COMPANY)
4522 N CAMINITO DE LA PUERTA
TUCSON, AZ 85718

FOR: EDUCATION SERVICES, NAMELY, PROVIDING CLASSES AND WORKSHOPS IN THE FIELDS OF MENTAL FITNESS, EMOTIONAL WELLNESS AND PEAK PERFORMANCE; TRAINING SERVICES IN THE FIELD OF MENTAL FITNESS, EMOTIONAL WELLNESS AND PEAK PERFORMANCE THROUGH BIOFEEDBACK, NEUROFEEDBACK AND COMPUTER GAMES, IN CLASS 41 (U.S. CLS. 100, 101 AND 107).

FIRST USE 9-1-2007; IN COMMERCE 11-7-2007.

THE MARK CONSISTS OF STANDARD CHARACTERS WITHOUT CLAIM TO ANY PARTICULAR FONT, STYLE, SIZE, OR COLOR.

NO CLAIM IS MADE TO THE EXCLUSIVE RIGHT TO USE "STUDIO LLC", APART FROM THE MARK AS SHOWN.

SER. NO. 77-396,479, FILED 2-13-2008.

MICHAEL WIENER, EXAMINING ATTORNEY

Int. Cl.: 16

Prior U.S. Cls.: 2, 5, 22, 23, 29, 37, 38 and 50

United States Patent and Trademark Office

Reg. No. 3,519,567

Registered Oct. 21, 2008

**TRADEMARK
PRINCIPAL REGISTER**

HOW TO CHEAT

BREDENBERG, JEFFREY E. (UNITED STATES
INDIVIDUAL)
609 BRADFORD ROAD
ORELAND, PA 19075

FOR: SERIES OF GUIDE BOOKS FEATURING
TIPS AND SHORTCUTS ON LIFESTYLE AND CON-
SUMER SUBJECTS, IN CLASS 16 (U.S. CLS. 2, 5, 22,
23, 29, 37, 38 AND 50).

FIRST USE 10-31-2006; IN COMMERCE 10-31-2006.

THE MARK CONSISTS OF STANDARD CHAR-
ACTERS WITHOUT CLAIM TO ANY PARTICULAR
FONT, STYLE, SIZE, OR COLOR.

SER. NO. 77-397,098, FILED 2-14-2008.

ALICE SUE CARRUTHERS, EXAMINING ATTOR-
NEY

Int. Cl.: 35

Prior U.S. Cls.: 100, 101 and 102

United States Patent and Trademark Office

Reg. No. 3,519,568

Registered Oct. 21, 2008

**SERVICE MARK
PRINCIPAL REGISTER**

Equiclaim

ENGBERS CORPORATION (INDIANA CORPORATION)
25 N. 2ND STREET
MARTINSVILLE, IN 46151

FOR: NEWS REPORTING SERVICES, NAMELY, PROVIDING REAL-TIME INFORMATION RELATED TO THE TRACKING OF SALES OF THOROUGHBRED HORSES, IN CLASS 35 (U.S. CLS. 100, 101 AND 102).

FIRST USE 1-15-2008; IN COMMERCE 1-15-2008.

THE MARK CONSISTS OF STANDARD CHARACTERS WITHOUT CLAIM TO ANY PARTICULAR FONT, STYLE, SIZE, OR COLOR.

SER. NO. 77-397,108, FILED 2-14-2008.

MELISSA VALLILLO, EXAMINING ATTORNEY

Int. Cl.: 25

Prior U.S. Cls.: 22 and 39

United States Patent and Trademark Office

Reg. No. 3,519,569

Registered Oct. 21, 2008

**TRADEMARK
PRINCIPAL REGISTER**

CZ

ZAPF, CAROLINA (UNITED STATES INDIVIDUAL)
211 CENTRAL PARK WEST, SUITE 9K
NEW YORK, NY 10024

FOR: CLOTHING FOR INFANTS, CHILDREN AND ADULTS, NAMELY, SWEATERS, SHIRTS, BLOUSES, JACKETS, CARDIGANS, COATS, VESTS, SKIRTS, PANTS, SHORTS, DRESSES, SCARVES, WRAPS AND HEADWEAR; KNITWEAR, NAMELY, DRESSES, SWEATERS, CARDIGANS, PANTS, SCARVES, HATS, MITTENS, SHIRTS, BATHROBES, SKIRTS AND OVERALLS; AND OUTERWEAR, NAMELY, JACKETS, PARKAS, COATS, VESTS, PANTS, SCARVES, WRAPS AND HEADWEAR, MITTENS, IN CLASS 25 (U.S. CLS. 22 AND 39).

FIRST USE 1-31-2005; IN COMMERCE 1-31-2005.

THE MARK CONSISTS OF STANDARD CHARACTERS WITHOUT CLAIM TO ANY PARTICULAR FONT, STYLE, SIZE, OR COLOR.

OWNER OF U.S. REG. NOS. 2,680,837 AND 3,094,798.

SER. NO. 77-397,614, FILED 2-14-2008.

KATHERINE CONNOLLY, EXAMINING ATTORNEY

Int. Cl.: 16

Prior U.S. Cls.: 2, 5, 22, 23, 29, 37, 38 and 50

Reg. No. 3,519,570

United States Patent and Trademark Office

Registered Oct. 21, 2008

**TRADEMARK
PRINCIPAL REGISTER**

— d e s i g n i n g —
WEALTH

BKH MEDIA, LLC (WASHINGTON LIMITED
LIABILITY COMPANY)
P.O. BOX 832
AUBURN, WA 980710832

FOR: MAGAZINES FEATURING LIFESTYLE
AND FINANCE, IN CLASS 16 (U.S. CLS. 2, 5, 22, 23,
29, 37, 38 AND 50).

FIRST USE 1-28-2008; IN COMMERCE 1-28-2008.

NO CLAIM IS MADE TO THE EXCLUSIVE
RIGHT TO USE "WEALTH", APART FROM THE
MARK AS SHOWN.

THE MARK CONSISTS OF THE WORD "DESIGN-
ING" IN LOWERCASE CENTERED ABOVE THE
WORD "WEALTH" IN UPPERCASE WITH A FEW
STYLIZED LINES AND SPACING BETWEEN LET-
TERS.

SER. NO. 77-397,686, FILED 2-14-2008.

MICHELLE DUBOIS, EXAMINING ATTORNEY

Int. Cl.: 35

Prior U.S. Cls.: 100, 101 and 102

United States Patent and Trademark Office

Reg. No. 3,519,571

Registered Oct. 21, 2008

**SERVICE MARK
PRINCIPAL REGISTER**



GASOLINE ALLEY CLASSICS, INC. (OKLAHOMA CORPORATION)
8220 SOUTH 202ND EAST AVENUE
BROKEN ARROW, OK 74014

FOR: RETAIL STORES FEATURING GOODS WITH AN AUTOMOTIVE THEME, NAMELY, NOVELTY ITEMS, AUTOMOTIVE MEMORABILIA, DISPLAY CASES, CLOCKS AND AUTOMOTIVE ACCESSORIES; ONLINE RETAIL STORE SERVICES FEATURING GOODS WITH AN AUTOMOTIVE THEME, NAMELY, NOVELTY ITEMS, AUTOMOTIVE MEMORABILIA, DISPLAY CASES, CLOCKS AND AUTOMOTIVE ACCESSORIES, IN CLASS 35 (U.S. CLS. 100, 101 AND 102).

FIRST USE 1-1-2003; IN COMMERCE 1-1-2003.

OWNER OF U.S. REG. NO. 3,203,733.

THE MARK CONSISTS OF A WOMAN STANDING BETWEEN TWO CHECKERED FLAGS WITH A RIBBON BANNER READING "LADY LUCK" UNDERNEATH. THE WOMAN IS DRESSED IN A TOP COMPRISING THE IMAGES OF TWO POOL BALLS WITH THE NUMBER "8" ON EACH, AND A SARONG SKIRT WITH A HEART DESIGN, AND IS HOLDING A WRENCH IN ONE HAND AND A FOUR-LEAF CLOVER IN THE OTHER. THERE IS A HORSESHOE ADORNING HER HAIR AND SHE IS WEARING DICE AS EARRINGS.

SER. NO. 77-397,940, FILED 2-15-2008.

ELLEN BURNS, EXAMINING ATTORNEY

Int. Cl.: 42

Prior U.S. Cls.: 100 and 101

United States Patent and Trademark Office

Reg. No. 3,519,572

Registered Oct. 21, 2008

**SERVICE MARK
PRINCIPAL REGISTER**

Unrivaled Support

COLO4DALLAS, L.P. (TEXAS LIMITED PART-
NERSHIP)
3000 IRVING BLVD.
DALLAS, TX 75247

FOR: COMPUTER COLLOCATION SERVICES,
NAMELY, PROVIDING FACILITIES FOR THE LO-
CATION OF COMPUTER SERVERS WITH THE
EQUIPMENT OF OTHERS, IN CLASS 42 (U.S. CLS.
100 AND 101).

FIRST USE 3-5-2007; IN COMMERCE 3-5-2007.

THE MARK CONSISTS OF STANDARD CHAR-
ACTERS WITHOUT CLAIM TO ANY PARTICULAR
FONT, STYLE, SIZE, OR COLOR.

SER. NO. 77-398,008, FILED 2-15-2008.

YAT SYE, LEE, EXAMINING ATTORNEY

Int. Cl.: 9

Prior U.S. Cls.: 21, 23, 26, 36 and 38

Reg. No. 3,519,573

United States Patent and Trademark Office

Registered Oct. 21, 2008

**TRADEMARK
PRINCIPAL REGISTER**

TOTAL-TRAX

SKY-TRAX INCORPORATED (DELAWARE CORPORATION)
98 QUIGLEY BLVD
NEW CASTLE, DE 19720

FOR: FACILITY MANAGEMENT- VEHICLE FLEET MANAGEMENT AND INVENTORY CONTROL EQUIPMENT COMPOSED OF VEHICLE MOUNTED OPTICAL COMPONENTS IN THE NATURE OF CAMERAS AND CAMERA ASSEMBLIES, AND RECEIVERS, TRANSMITTERS AND COMPUTER SOFTWARE FOR COLLECTING AND MANAGING INFORMATION ON VEHICLE LOCATIONS,

MOVEMENT POSITIONS AND REMOTE MONITORING, IN CLASS 9 (U.S. CLS. 21, 23, 26, 36 AND 38).

FIRST USE 12-0-2007; IN COMMERCE 12-0-2007.

THE MARK CONSISTS OF STANDARD CHARACTERS WITHOUT CLAIM TO ANY PARTICULAR FONT, STYLE, SIZE, OR COLOR.

SER. NO. 77-398,539, FILED 2-15-2008.

HENRY S. ZAK, EXAMINING ATTORNEY

Int. Cl.: 42

Prior U.S. Cls.: 100 and 101

United States Patent and Trademark Office

Reg. No. 3,519,574

Registered Oct. 21, 2008

**SERVICE MARK
PRINCIPAL REGISTER**

COMSYNC

DESORMEAUX, HORACE GREGORY (UNITED STATES INDIVIDUAL)
5410 LUBBOCK ROAD
FORESTVILLE, MD 20747

FOR: COMPUTER NETWORKING SERVICES, NAMELY, COMPUTER NETWORK CONSULTATION, DESIGN, DEVELOPMENT AND IMPLEMENTATION OF COMPUTER NETWORKS FOR OTHERS, COMPUTER SYSTEM ADMINISTRATION FOR OTHERS, COMPUTER SECURITY SERVICES, NAMELY, RESTRICTING ACCESS TO AND BY COMPUTER NETWORKS TO AND OF UNDESIRED WEBSITES, MEDIA AND INDIVIDUALS AND FACILITIES, REPAIR OF COMPUTER SOFT-

WARE, COMPUTER VIRUS PROTECTION SERVICES, NAMELY, VIRUS DETECTION AND REMOVAL, IN CLASS 42 (U.S. CLS. 100 AND 101).

FIRST USE 5-21-2002; IN COMMERCE 5-28-2002.

THE MARK CONSISTS OF STANDARD CHARACTERS WITHOUT CLAIM TO ANY PARTICULAR FONT, STYLE, SIZE, OR COLOR.

SER. NO. 77-398,719, FILED 2-15-2008.

JULIE WATSON, EXAMINING ATTORNEY

Int. Cl.: 41

Prior U.S. Cls.: 100, 101 and 107

United States Patent and Trademark Office

Reg. No. 3,519,575

Registered Oct. 21, 2008

**SERVICE MARK
PRINCIPAL REGISTER**

DANCING WITH CLASS

MAY I HAVE THIS DANCE INC. (ILLINOIS CORPORATION)
UNIT A
4234 N. KOLMAR AVE.
CHICAGO, IL 606411964

FOR: DANCE CLASSES; ORGANIZING AND CONDUCTING DANCE PARTIES AND FORMAL DANCE EVENTS; DANCE CLUBS; ORGANIZING AND CONDUCTING DANCE CONVENTIONS; ENTERTAINMENT IN THE NATURE OF DANCE PERFORMANCES; PROVIDING PRIVATE AND GROUP DANCE LESSONS; PROVIDING YOUTH DANCE CLASSES AND ORGANIZING AND CONDUCTING YOUTH DANCE PARTIES AND DANCE EVENTS; PROVIDING DANCE CLASSES FOR SCHOOL CHILDREN IN PRE-KINDERGARTEN THROUGH TWELFTH GRADE AND ORGANIZING AND CONDUCTING SCHOOL DANCE PARTIES

AND DANCE EVENTS FOR CHILDREN IN PRE-KINDERGARTEN THROUGH TWELFTH GRADE; HOSTING DANCE EVENTS, IN CLASS 41 (U.S. CLS. 100, 101 AND 107).

FIRST USE 3-22-2006; IN COMMERCE 3-22-2006.

THE MARK CONSISTS OF STANDARD CHARACTERS WITHOUT CLAIM TO ANY PARTICULAR FONT, STYLE, SIZE, OR COLOR.

NO CLAIM IS MADE TO THE EXCLUSIVE RIGHT TO USE "DANCING", APART FROM THE MARK AS SHOWN.

SER. NO. 77-398,878, FILED 2-15-2008.

LINDA LAVACHE, EXAMINING ATTORNEY

Int. Cl.: 5

Prior U.S. Cls.: 6, 18, 44, 46, 51 and 52

Reg. No. 3,519,576

United States Patent and Trademark Office

Registered Oct. 21, 2008

**TRADEMARK
PRINCIPAL REGISTER**

Sexiflex

HOLLAND, LISA ANN (UNITED STATES INDIVIDUAL)
102 CLOVERSHIRE DR
NAZARETH, PA 18064 AND
HOLLAND, VINCENT (UNITED STATES INDIVIDUAL)
102 CLOVERSHIRE DR
NAZARETH, PA 18064

FOR: DIETARY AND NUTRITIONAL SUPPLEMENTS, IN CLASS 5 (U.S. CLS. 6, 18, 44, 46, 51 AND 52).

FIRST USE 2-1-2003; IN COMMERCE 2-1-2003.

THE MARK CONSISTS OF STANDARD CHARACTERS WITHOUT CLAIM TO ANY PARTICULAR FONT, STYLE, SIZE, OR COLOR.

SER. NO. 77-399,013, FILED 2-16-2008.

JULIE WATSON, EXAMINING ATTORNEY

Int. Cl.: 35

Prior U.S. Cls.: 100, 101 and 102

United States Patent and Trademark Office

Reg. No. 3,519,577

Registered Oct. 21, 2008

**SERVICE MARK
PRINCIPAL REGISTER**

FAUCETLINE.COM

EMARKETLINE, INC. (NEW YORK CORPORATION), DBA FAUCETLINE.COM
102-06 63 AVE. 2F
FOREST HILLS, NY 11375

THE MARK CONSISTS OF STANDARD CHARACTERS WITHOUT CLAIM TO ANY PARTICULAR FONT, STYLE, SIZE, OR COLOR.

FOR: OPERATING AN ONLINE SHOPPING SITE IN THE FIELD OF KITCHEN AND BATH PRODUCTS, IN CLASS 35 (U.S. CLS. 100, 101 AND 102).

SER. NO. 77-399,096, FILED 2-17-2008.

FIRST USE 6-21-2004; IN COMMERCE 6-21-2004.

KATHRYN COWARD, EXAMINING ATTORNEY

Int. Cl.: 42

Prior U.S. Cls.: 100 and 101

United States Patent and Trademark Office

Reg. No. 3,519,578

Registered Oct. 21, 2008

**SERVICE MARK
PRINCIPAL REGISTER**

familybuilder

IFAMILY INC. (DELAWARE CORPORATION)
41 EAST 60TH STREET, 6TH FLOOR
NEW YORK, NY 10022

FOR: PROVIDING ON-LINE NON-DOWNLOADABLE SOFTWARE AND A WEBSITE FEATURING INFORMATION ON GENEALOGY AND GENEALOGICAL RESEARCH; PROVIDING ON-LINE NON-DOWNLOADABLE SOFTWARE AND A WEBSITE THAT ALLOWS USERS TO RESEARCH GENEALOGY AND FAMILY HISTORY AND TO

CREATE A GENEALOGICAL HISTORY AND FAMILY TREE, IN CLASS 42 (U.S. CLS. 100 AND 101).

FIRST USE 1-23-2007; IN COMMERCE 1-23-2007.

THE MARK CONSISTS OF STANDARD CHARACTERS WITHOUT CLAIM TO ANY PARTICULAR FONT, STYLE, SIZE, OR COLOR.

SER. NO. 77-399,120, FILED 2-17-2008.

BARBARA RUTLAND, EXAMINING ATTORNEY

Int. Cl.: 35

Prior U.S. Cls.: 100, 101 and 102

United States Patent and Trademark Office

Reg. No. 3,519,579

Registered Oct. 21, 2008

**SERVICE MARK
PRINCIPAL REGISTER**

Neats and Sweets

THOMAS J NESTER (ILLINOIS SOLE PROPRIETORSHIP)
1712 BLUE ISLAND DRIVE
CRYSTAL LAKE, IL 60012

FOR: ON-LINE RETAIL STORE SERVICES FEATURING TOYS, NOVELTIES AND CANDY; RETAIL SHOPS FEATURING TOYS, NOVELTIES AND CANDY, IN CLASS 35 (U.S. CLS. 100, 101 AND 102).

FIRST USE 5-13-2008; IN COMMERCE 6-20-2008.

THE MARK CONSISTS OF STANDARD CHARACTERS WITHOUT CLAIM TO ANY PARTICULAR FONT, STYLE, SIZE, OR COLOR.

NO CLAIM IS MADE TO THE EXCLUSIVE RIGHT TO USE "SWEETS", APART FROM THE MARK AS SHOWN.

SER. NO. 77-399,158, FILED 2-17-2008.

JESSICA FATHY, EXAMINING ATTORNEY

Int. Cls.: 35 and 36

Prior U.S. Cls.: 100, 101 and 102

United States Patent and Trademark Office

Reg. No. 3,519,580

Registered Oct. 21, 2008

**SERVICE MARK
PRINCIPAL REGISTER**

Marketing & Brokerage Objectives
Mortgage & Financing Solutions
Provided By



Marketeers & Purveyors of
Exceptional Real Estate Services

RONI REBELO (FLORIDA SOLE PROPRIETORSHIP), DBA THE OFFICES OF RONI REBELO 13615 SOUTH DIXIE HIGHWAY, 540 PALMETTO BAY, FL 33176

FOR: REAL ESTATE MARKETING SERVICES IN THE FIELD OF REAL ESTATE BROKERAGE, AND MORTGAGE AND FINANCING OF RESIDENTIAL REAL ESTATE, COMMERCIAL REAL ESTATE, VACANT/RAW LAND AND ACREAGE REAL ESTATE, AND BUSINESS REAL ESTATE AND OPPORTUNITIES, IN CLASS 35 (U.S. CLS. 100, 101 AND 102).

FIRST USE 1-0-2008; IN COMMERCE 1-0-2008.

FOR: REAL ESTATE BROKERAGE; FACILITATING AND ARRANGING FOR THE FINANCING OF RESIDENTIAL REAL ESTATE, COMMERCIAL REAL ESTATE, VACANT/RAW LAND AND ACREAGE REAL ESTATE, AND BUSINESS REAL ESTATE AND OPPORTUNITIES; MORTGAGE BROKERAGE; MORTGAGE PROCUREMENT FOR OTHERS, IN CLASS 36 (U.S. CLS. 100, 101 AND 102).

FIRST USE 1-0-2008; IN COMMERCE 1-0-2008.

NO CLAIM IS MADE TO THE EXCLUSIVE RIGHT TO USE "MARKETING & BROKERAGE OBJECTIVES MORTGAGE & FINANCING SOLUTIONS PROVIDED BY MARKETTERS & PURVEYORS OF EXCEPTIONAL REAL ESTATE SERVICES", APART FROM THE MARK AS SHOWN.

THE NAME "RONI REBELO" IDENTIFIES A LIVING INDIVIDUAL WHOSE CONSENT IS OF RECORD.

THE COLOR(S) WHITE, BLUE, AND GOLD IS/ ARE CLAIMED AS A FEATURE OF THE MARK.

THE MARK CONSISTS OF THE TEXT ABOVE THE RECTANGULAR PORTION OF LOGO, "MARKETING & BROKERAGE OBJECTIVES MORTGAGE & FINANCING SOLUTIONS PROVIDED BY", IN BLUE; OUTER RECTANGULAR OUTLINE IN BLUE; INNER RECTANGULAR OUTLINE IN GOLD; WHITE SPACE BETWEEN OUTER BLUE AND INNER GOLD RECTANGULAR OUTLINES; INNER-MOST RECTANGULAR BOX CONTAINING THE LETTERS "RR", IN BLUE; THE LETTERS "RR" IN WHITE WITH THE ENDS OF THE "RR" PART OF THE WHITE SPACE OF THE AREA BETWEEN THE INNER GOLD RECTANGULAR OUTLINE AND INNER-MOST RECTANGULAR BLUE BOX; THE NAME "RONI REBELO" IS IN BLUE AND IS LOCATED BELOW INNER-MOST BLUE RECTANGULAR BOX AND ABOVE THE INNER GOLD RECTANGULAR OUTLINE; THE TEXT BELOW THE RECTANGULAR PORTION OF THE LOGO, "MARKETEERS & PURVEYORS OF EXCEPTIONAL REAL ESTATE SERVICES", IN BLUE.

SER. NO. 77-399,210, FILED 2-17-2008.

JENNIFER MARTIN, EXAMINING ATTORNEY

Int. Cl.: 38

Prior U.S. Cls.: 100, 101 and 104

United States Patent and Trademark Office

Reg. No. 3,519,581

Registered Oct. 21, 2008

**SERVICE MARK
PRINCIPAL REGISTER**

Business Only Broadband 

BOB, LLC (ILLINOIS LIMITED LIABILITY COMPANY), DBA BUSINESS ONLY BROADBAND, LLC

SUITE 2000
777 OAKMONT LANE
WESTMONT, IL 60559

FOR: WIRELESS BROADBAND COMMUNICATION SERVICES, IN CLASS 38 (U.S. CLS. 100, 101 AND 104).

FIRST USE 1-23-2008; IN COMMERCE 1-23-2008.

NO CLAIM IS MADE TO THE EXCLUSIVE RIGHT TO USE "BUSINESS ONLY BROADBAND", APART FROM THE MARK AS SHOWN.

THE COLOR(S) BLUE, ORANGE, AND WHITE IS/ ARE CLAIMED AS A FEATURE OF THE MARK.

THE MARK CONSISTS OF THE WORDS "BUSINESS ONLY BROADBAND" IN BLUE ITALICIZED LETTERS FOLLOWED BY AN ORANGE AND WHITE DRAWING REPRESENTING THE TRANSMISSION OF SOUND WAVES OR ELECTRONIC SIGNALS.

SER. NO. 77-399,323, FILED 2-18-2008.

TEJBIR SINGH, EXAMINING ATTORNEY

Int. Cl.: 35

Prior U.S. Cls.: 100, 101 and 102

United States Patent and Trademark Office

Reg. No. 3,519,582

Registered Oct. 21, 2008

**SERVICE MARK
PRINCIPAL REGISTER**

LIVEPORT

LIVEPORT CORPORATION (CANADA CORPORATION)
3689 YORKTON ROAD
WESTBANK, CANADA V4T2T7

FOR: CUSTOMER SERVICE IN THE FIELD OF LIVE TELEPHONE SUPPORT SERVICES FOR WIRELESS INTERNET USERS AT HOTELS AND PUBLIC VENUES, IN CLASS 35 (U.S. CLS. 100, 101 AND 102).

FIRST USE 1-1-2008; IN COMMERCE 1-1-2008.

THE MARK CONSISTS OF STANDARD CHARACTERS WITHOUT CLAIM TO ANY PARTICULAR FONT, STYLE, SIZE, OR COLOR.

SER. NO. 77-399,433, FILED 2-18-2008.

KRISTIN CARLSON, EXAMINING ATTORNEY

Int. Cl.: 25

Prior U.S. Cls.: 22 and 39

United States Patent and Trademark Office

Reg. No. 3,519,583

Registered Oct. 21, 2008

TRADEMARK
PRINCIPAL REGISTER

since feudalism

CAPKOVIC, MICHAEL (UNITED STATES INDIVIDUAL)

#12

3101 S 28TH PL.

ROGERS, AR 72758

FOR: CAPS; HATS; HEADWEAR, IN CLASS 25
(U.S. CLS. 22 AND 39).

FIRST USE 9-1-2007; IN COMMERCE 9-1-2007.

THE MARK CONSISTS OF THE STYLIZED TEXT "SINCE FEUDALISM" WITH TWO CIRCLES ATTACHED TO THE LETTER "S" IN THE WORD "SINCE" AND TWO CIRCLES ATTACHED TO THE LETTER "S" IN THE WORD "FEUDALISM". IN ADDITION, THE LETTER "S" IN THE TERM "FEUDALISM" APPEARS BACKWARDS.

SER. NO. 77-399,633, FILED 2-18-2008.

MICHAEL TANNER, EXAMINING ATTORNEY

Int. Cl.: 43

Prior U.S. Cls.: 100 and 101

United States Patent and Trademark Office

Reg. No. 3,519,584

Registered Oct. 21, 2008

SERVICE MARK
PRINCIPAL REGISTER



HIGH DIVE INC. (CALIFORNIA CORPORATION), DBA THE HIGH DIVE
1801 MORENA BLVD
SAN DIEGO, CA 92110

FOR: BAR AND RESTAURANT SERVICES, IN CLASS 43 (U.S. CLS. 100 AND 101).

FIRST USE 7-1-2006; IN COMMERCE 9-1-2006.

NO CLAIM IS MADE TO THE EXCLUSIVE RIGHT TO USE "GRILL BY THE BAY", APART FROM THE MARK AS SHOWN.

THE COLOR(S) BLACK, WHITE, ORANGE, YELLOW, BLUE, RED IS/ARE CLAIMED AS A FEATURE OF THE MARK.

THE COLOR(S) DARK BROWN, LIGHT BROWN, WHITE, BLACK, YELLOW, ORANGE, FLESH AND

BLUE IS/ARE CLAIMED AS A FEATURE OF THE MARK. THE MARK CONSISTS OF THE WORDING "THE HIGH DIVE" IN THE COLORS DARK BROWN AND LIGHT BROWN, THE SETTING SUN IS IN DARK BROWN AND LIGHT BROWN WITH WHITE CIRCLES ON THE OUTER EDGE AND THE OUTER MOST EDGE IS IN BLACK, THE WORDING "GRILL BY THE BAY" IS IN BLACK, THE BANNER IS IN YELLOW WITH BLACK ON THE OUTSIDE PART OF THE BANNER AND ORANGE ON THE BACK SIDE OF THE BANNER, THE HUMAN FIGURE HAS SKIN IN FLESH COLOR WITH BLACK HAIR AND THE BODY IS EDGED IN BLACK, THE SILHOUETTE OF THE HUMAN FIGURE IS IN WHITE, THE BATHING SUIT IS IN BLACK AND YELLOW AND THE GOGGLES ARE IN BLUE, BLACK AND WHITE.

SER. NO. 77-399,755, FILED 2-18-2008.

EDWARD NELSON, EXAMINING ATTORNEY

Int. Cl.: 35

Prior U.S. Cls.: 100, 101 and 102

United States Patent and Trademark Office

Reg. No. 3,519,585

Registered Oct. 21, 2008

**SERVICE MARK
PRINCIPAL REGISTER**

Palace Beauty

CHO, BYUNG DUCK (UNITED STATES INDIVIDUAL)
1517 S. WESTERN AVENUE
LOS ANGELES, CA 90006

FOR: RETAIL STORES FEATURING BEAUTY SUPPLIES, BEAUTY CREAMS, BEAUTY CREAMS FOR BODY CARE, BEAUTY GELS, BEAUTY LOTIONS, BEAUTY MASKS, BEAUTY MILKS, BEAUTY SERUMS, BODY AND BEAUTY CARE COSMETICS, FACE AND BODY BEAUTY CREAMS, FACIAL BEAUTY MASKS, IN CLASS 35 (U.S. CLS. 100, 101 AND 102).

FIRST USE 2-1-1996; IN COMMERCE 2-1-1996.

THE MARK CONSISTS OF STANDARD CHARACTERS WITHOUT CLAIM TO ANY PARTICULAR FONT, STYLE, SIZE, OR COLOR.

NO CLAIM IS MADE TO THE EXCLUSIVE RIGHT TO USE "BEAUTY", APART FROM THE MARK AS SHOWN.

SER. NO. 77-399,809, FILED 2-18-2008.

ZACHARY BELLO, EXAMINING ATTORNEY

Int. Cl.: 44

Prior U.S. Cls.: 100 and 101

United States Patent and Trademark Office

Reg. No. 3,519,586

Registered Oct. 21, 2008

**SERVICE MARK
PRINCIPAL REGISTER**

LIPO-EX

DURANTE HOLDINGS L.P. (TEXAS LIMITED
PARTNERSHIP)
307 WEST 7TH STREET; SUITE 220
FORT WORTH, TX 76102

FOR: HEALTH SPA SERVICES, NAMELY, COS-
METIC BODY CARE SERVICES FEATURING
RADIO FREQUENCY ASSISTED LIPOPLASTY, IN
CLASS 44 (U.S. CLS. 100 AND 101).

FIRST USE 1-9-2008; IN COMMERCE 2-1-2008.

THE MARK CONSISTS OF STANDARD CHAR-
ACTERS WITHOUT CLAIM TO ANY PARTICULAR
FONT, STYLE, SIZE, OR COLOR.

SER. NO. 77-399,862, FILED 2-18-2008.

REBECCA SMITH, EXAMINING ATTORNEY

Int. Cl.: 44

Prior U.S. Cls.: 100 and 101

United States Patent and Trademark Office

Reg. No. 3,519,587

Registered Oct. 21, 2008

**SERVICE MARK
PRINCIPAL REGISTER**

WE MELT FAT

DURANTE HOLDINGS L.P. (TEXAS LIMITED
PARTNERSHIP)
307 WEST 7TH STREET; SUITE 220
FORT WORTH, TX 76102

FOR: HEALTH SPA SERVICES, NAMELY, COS-
METIC BODY CARE SERVICES FEATURING
RADIO FREQUENCY ASSISTED LIPOPLASTY, IN
CLASS 44 (U.S. CLS. 100 AND 101).

FIRST USE 11-1-2007; IN COMMERCE 2-1-2008.

THE MARK CONSISTS OF STANDARD CHAR-
ACTERS WITHOUT CLAIM TO ANY PARTICULAR
FONT, STYLE, SIZE, OR COLOR.

SER. NO. 77-399,863, FILED 2-18-2008.

REBECCA SMITH, EXAMINING ATTORNEY

Int. Cl.: 13

Prior U.S. Cls.: 2 and 9

United States Patent and Trademark Office

Reg. No. 3,519,588

Registered Oct. 21, 2008

**TRADEMARK
PRINCIPAL REGISTER**

**STRAPLESS LOCKING ACTION
SHOULDER HOLSTER**

PHALANX CORPORATION (FLORIDA CORPORATION)
4501 NORTH DIXIE HIGHWAY
BOCA RATON, FL 33431

FOR: HOLSTERS, IN CLASS 13 (U.S. CLS. 2 AND 9).

FIRST USE 10-4-2000; IN COMMERCE 10-4-2000.

THE MARK CONSISTS OF STANDARD CHARACTERS WITHOUT CLAIM TO ANY PARTICULAR FONT, STYLE, SIZE, OR COLOR.

OWNER OF U.S. REG. NO. 2,548,564.

NO CLAIM IS MADE TO THE EXCLUSIVE RIGHT TO USE "SHOULDER HOLSTER", APART FROM THE MARK AS SHOWN.

SEC. 2(F).

SER. NO. 77-400,102, FILED 2-19-2008.

JULIE GUTTADAURO, EXAMINING ATTORNEY

Int. Cls.: 25 and 41

Prior U.S. Cls.: 22, 39, 100, 101 and 107

United States Patent and Trademark Office

Reg. No. 3,519,589

Registered Oct. 21, 2008

**TRADEMARK
SERVICE MARK
PRINCIPAL REGISTER**



HAWAII WINTER BASEBALL, INC. (HAWAII CORPORATION)
SUITE 904
1000 BISHOP STREET
HONOLULU, HI 96813

FOR: CLOTHING, NAMELY, HATS, T-SHIRTS AND POLO SHIRTS, IN CLASS 25 (U.S. CLS. 22 AND 39).

FIRST USE 10-0-2006; IN COMMERCE 10-0-2006.

FOR: ENTERTAINMENT, IN THE NATURE OF BASEBALL GAMES, IN CLASS 41 (U.S. CLS. 100, 101 AND 107).

FIRST USE 10-0-2006; IN COMMERCE 10-0-2006.

THE MARK CONSISTS OF A TURTLE PROFILE IN FRONT OF AN ELIPSE HOLDING A BASEBALL BAT AND WEARING A HAT.

SER. NO. 77-400,230, FILED 2-19-2008.

CURTIS FRENCH, EXAMINING ATTORNEY

Int. Cl.: 8

Prior U.S. Cls.: 23, 28 and 44

United States Patent and Trademark Office

Reg. No. 3,519,590

Registered Oct. 21, 2008

**TRADEMARK
PRINCIPAL REGISTER**



DEMOLITION TOOLS, INC. (NEVADA CORPORATION)
2533 N. CARSON ST. SUITE 3266
CARSON CITY, NV 89706

FOR: HAND TOOLS, NAMELY, HAMMERS, IN CLASS 8 (U.S. CLS. 23, 28 AND 44).

FIRST USE 9-1-2007; IN COMMERCE 1-2-2008.

NO CLAIM IS MADE TO THE EXCLUSIVE RIGHT TO USE "DEMOLITION TOOLS", APART FROM THE MARK AS SHOWN.

THE COLOR(S) BLACK, WHITE, GRAY, SILVER, RED, ORANGE, AND YELLOW ARE IS/ARE CLAIMED AS A FEATURE OF THE MARK.

THE MARK CONSISTS OF THE WORDING "DEMOLITION TOOLS" IN BLACK WITH A RED OUTLINE. A WRECKING BALL IN RED WITH A GRAY AND SILVER CHAIN COMPRISES THE FIRST LETTER "O" IN "DEMOLITION" AND COLLIDES WITH THE LETTER "M". THE WRECKING BALL AND THE LETTER "M" HAS A WHITE FLASH BETWEEN THEM, AND WHITE CRACKS ARE IN THE LETTER "M". RED, ORANGE AND YELLOW FLAMES COME FROM THE WRECKING BALL WHICH FLOW THROUGH THE LETTERS "L", "I", "T", "O", "O", "L", "S".

SER. NO. 77-400,811, FILED 2-19-2008.

TOBY BULLOFF, EXAMINING ATTORNEY

Int. Cl.: 35

Prior U.S. Cls.: 100, 101 and 102

United States Patent and Trademark Office

Reg. No. 3,519,591

Registered Oct. 21, 2008

**SERVICE MARK
PRINCIPAL REGISTER**

MAR-VEL International

MAR-VEL INTERNATIONAL, INC. (NEW JERSEY CORPORATION)
7115 AIRPORT HIGHWAY
PENNSAUKEN, NJ 08109

FOR: OPERATING AN ONLINE SHOPPING SITE IN THE FIELD OF EQUIPMENT AND CLOTHING FOR EXTREME ENVIRONMENTS CONSISTING OF DIVING, MILITARY AND RESCUE, IN CLASS 35 (U.S. CLS. 100, 101 AND 102).

FIRST USE 1-1-2003; IN COMMERCE 1-1-2003.

THE MARK CONSISTS OF STANDARD CHARACTERS WITHOUT CLAIM TO ANY PARTICULAR FONT, STYLE, SIZE, OR COLOR.

NO CLAIM IS MADE TO THE EXCLUSIVE RIGHT TO USE "INTERNATIONAL", APART FROM THE MARK AS SHOWN.

SER. NO. 77-400,877, FILED 2-19-2008.

DORITT L. CARROLL, EXAMINING ATTORNEY

Int. Cl.: 36

Prior U.S. Cls.: 100, 101 and 102

United States Patent and Trademark Office

Reg. No. 3,519,592

Registered Oct. 21, 2008

**SERVICE MARK
PRINCIPAL REGISTER**

The Real Deal on Money

VANWEELDEN, JOHN D. (UNITED STATES IN-
DIVIDUAL)
6352 NEW MARKET COURT
WEST CHESTER, OH 45069

THE MARK CONSISTS OF STANDARD CHAR-
ACTERS WITHOUT CLAIM TO ANY PARTICULAR
FONT, STYLE, SIZE, OR COLOR.

FOR: FINANCIAL ADVICE, IN CLASS 36 (U.S.
CLS. 100, 101 AND 102).

SER. NO. 77-400,981, FILED 2-19-2008.

FIRST USE 7-7-2007; IN COMMERCE 7-7-2007.

ANDREA BUTLER, EXAMINING ATTORNEY

Int. Cl.: 11

Prior U.S. Cls.: 13, 21, 23, 31 and 34

Reg. No. 3,519,593

United States Patent and Trademark Office

Registered Oct. 21, 2008

**TRADEMARK
PRINCIPAL REGISTER**

Z-TRAX

LINDSAY CORPORATION (DELAWARE CORPORATION)
SUITE 102
2707 NORTH 108TH STREET
OMAHA, NE 68164

FOR: TRACK MANAGEMENT SYSTEM FOR MECHANICAL MOVE IRRIGATION, IN CLASS 11 (U.S. CLS. 13, 21, 23, 31 AND 34).

FIRST USE 8-15-2007; IN COMMERCE 8-15-2007.

THE MARK CONSISTS OF STANDARD CHARACTERS WITHOUT CLAIM TO ANY PARTICULAR FONT, STYLE, SIZE, OR COLOR.

OWNER OF U.S. REG. NO. 2,955,739.

SER. NO. 77-401,208, FILED 2-20-2008.

HEATHER SAPP, EXAMINING ATTORNEY

Int. Cl.: 16

Prior U.S. Cls.: 2, 5, 22, 23, 29, 37, 38 and 50

United States Patent and Trademark Office

Reg. No. 3,519,594

Registered Oct. 21, 2008

TRADEMARK
PRINCIPAL REGISTER



ACCELLART, LLC (MISSOURI LIMITED LIABILITY COMPANY)
407 S. PENNSYLVANIA AVENUE
JOPLIN, MO 64801

FOR: CALENDARS, IN CLASS 16 (U.S. CLS. 2, 5, 22, 23, 29, 37, 38 AND 50).

FIRST USE 12-31-2006; IN COMMERCE 12-31-2006.

NO CLAIM IS MADE TO THE EXCLUSIVE RIGHT TO USE "COLORING CALENDAR", APART FROM THE MARK AS SHOWN.

THE MARK CONSISTS OF THE WORDS "BEVERLY'S JUST FOR YOU" IN STYLIZED FORM ABOVE THE ARTISTIC DRAWING OF THE WORDS "COLOR CALENDAR" WHEREIN THE "L'S ARE DRAWN TO REPRESENT CRAYONS.

SER. NO. 77-401,326, FILED 2-20-2008.

TRACY CROSS, EXAMINING ATTORNEY

Int. Cl.: 29

Prior U.S. Cl.: 46

United States Patent and Trademark Office

Reg. No. 3,519,595

Registered Oct. 21, 2008

**TRADEMARK
PRINCIPAL REGISTER**

ONEG

ONEG FOODS, INC. (ILLINOIS CORPORATION)
9508 WINONA AVE.
SCHILLER PARK, IL 60176

FOR: CHEESE, IN CLASS 29 (U.S. CL. 46).

FIRST USE 3-28-2006; IN COMMERCE 3-28-2006.

THE MARK CONSISTS OF STANDARD CHARACTERS WITHOUT CLAIM TO ANY PARTICULAR FONT, STYLE, SIZE, OR COLOR.

THE ENGLISH TRANSLATION OF THE WORD "ONEG" IN THE MARK IS "ENJOYMENT".

SER. NO. 77-401,572, FILED 2-20-2008.

APRIL HESIK, EXAMINING ATTORNEY

Int. Cl.: 17

Prior U.S. Cls.: 1, 5, 12, 13, 35 and 50

United States Patent and Trademark Office

Reg. No. 3,519,596

Registered Oct. 21, 2008

TRADEMARK
PRINCIPAL REGISTER



ER
SYSTEMS

ELASTOMERIC ROOFING

ELASTOMERIC ROOFING SYSTEMS, INC. (MINNESOTA CORPORATION)
6900 BLECK DRIVE
ROCKFORD, MN 55373

FOR: RESIN-BASED SEALANTS FOR USE ON ROOFS, WALLS AND PAVEMENTS; SEALANTS FOR BUILDINGS; WATERPROOF SEALANTS, IN CLASS 17 (U.S. CLS. 1, 5, 12, 13, 35 AND 50).

FIRST USE 6-30-2005; IN COMMERCE 6-30-2005.

NO CLAIM IS MADE TO THE EXCLUSIVE RIGHT TO USE "SYSTEMS" AND "ELASTOMERIC ROOFING", APART FROM THE MARK AS SHOWN.

THE MARK CONSISTS OF "ER" OVER THE WORD "SYSTEMS". THE "ER" PORTION OF THE MARK HAS A THIN LINE ABOVE IT AND BELOW IT, WITH ANOTHER THIN LINE BELOW THE WORD "SYSTEMS". THE WORDS "ELASTOMERIC ROOFING" ARE BELOW THE THIRD LINE.

SER. NO. 77-402,502, FILED 2-21-2008.

MICHELE SWAIN, EXAMINING ATTORNEY

Int. Cls.: 9 and 35

Prior U.S. Cls.: 21, 23, 26, 36, 38, 100, 101 and 102

Reg. No. 3,519,597

United States Patent and Trademark Office

Registered Oct. 21, 2008

**TRADEMARK
SERVICE MARK
PRINCIPAL REGISTER**

GREEN GLANCE

LUTRON ELECTRONICS CO., INC. (PENNSYLVANIA CORPORATION)
7200 SUTER ROAD
COOPERSBURG, PA 18036

FOR: COMPUTER SOFTWARE THAT PROVIDES REAL-TIME LIGHTING ENERGY SAVINGS AND LIGHTING POWER SAVINGS, IN CLASS 9 (U.S. CLS. 21, 23, 26, 36 AND 38).

FIRST USE 12-0-2006; IN COMMERCE 5-0-2007.

FOR: PROVIDING INFORMATION IN THE FIELD OF LIGHTING ENERGY EFFICIENCY, IN CLASS 35 (U.S. CLS. 100, 101 AND 102).

FIRST USE 12-0-2006; IN COMMERCE 5-0-2007.

THE MARK CONSISTS OF STANDARD CHARACTERS WITHOUT CLAIM TO ANY PARTICULAR FONT, STYLE, SIZE, OR COLOR.

NO CLAIM IS MADE TO THE EXCLUSIVE RIGHT TO USE "GREEN", APART FROM THE MARK AS SHOWN.

SER. NO. 77-402,699, FILED 2-21-2008.

PAM WILLIS, EXAMINING ATTORNEY

Int. Cl.: 9

Prior U.S. Cls.: 21, 23, 26, 36 and 38

Reg. No. 3,519,598

United States Patent and Trademark Office

Registered Oct. 21, 2008

**TRADEMARK
PRINCIPAL REGISTER**

INSIGHT

RATNER & PRESTIA, P.C. (PENNSYLVANIA CORPORATION), DBA RATNERPRESTIA
SUITE 301
1235 WESTLAKES DRIVE
BERWYN, PA 19312

FOR: DOWNLOADABLE ELECTRONIC NEWSLETTERS IN THE LEGAL FIELD OF INTELLECTUAL PROPERTY, IN CLASS 9 (U.S. CLS. 21, 23, 26, 36 AND 38).

FIRST USE 5-0-2000; IN COMMERCE 5-0-2000.

THE MARK CONSISTS OF STANDARD CHARACTERS WITHOUT CLAIM TO ANY PARTICULAR FONT, STYLE, SIZE, OR COLOR.

OWNER OF U.S. REG. NO. 1,891,051.

SER. NO. 77-403,446, FILED 2-22-2008.

AMY MCMENAMIN, EXAMINING ATTORNEY

Int. Cl.: 41

Prior U.S. Cls.: 100, 101 and 107

United States Patent and Trademark Office

Reg. No. 3,519,599

Registered Oct. 21, 2008

**SERVICE MARK
PRINCIPAL REGISTER**

LIVEHUNTSVEGAS

DINE CONSULT, INC. (ALABAMA CORPORATION)
6917 STEEPLECHASE STREET
HUNTSVILLE, AL 35806

FOR: PROVIDING NEWS AND INFORMATION OVER AN INTERACTIVE GLOBAL COMPUTER NETWORK IN THE FIELD OF CURRENT EVENTS AND ENTERTAINMENT GENERALLY RELATED TO HUNTSVILLE, ALABAMA, MADISON COUNTY ALABAMA, AND NEIGHBORING COMMUNITIES, IN CLASS 41 (U.S. CLS. 100, 101 AND 107).

FIRST USE 5-15-2008; IN COMMERCE 5-15-2008.

THE MARK CONSISTS OF STANDARD CHARACTERS WITHOUT CLAIM TO ANY PARTICULAR FONT, STYLE, SIZE, OR COLOR.

SER. NO. 77-403,554, FILED 2-22-2008.

AMY HELLA, EXAMINING ATTORNEY

Int. Cl.: 41

Prior U.S. Cls.: 100, 101 and 107

United States Patent and Trademark Office

Reg. No. 3,519,600

Registered Oct. 21, 2008

**SERVICE MARK
PRINCIPAL REGISTER**

PLAYS FOR LIVING

PLAYS FOR LIVING, INC. (NEW YORK CORPORATION)
ATTN: KEITH MCHENRY
505 EIGHTH AVENUE, SUITE 1202
NEW YORK, NY 10018

FOR: EDUCATION SERVICES, NAMELY, PROVIDING WORKSHOPS AND SEMINARS IN THE FIELDS OF MULTI-CULTURAL EDUCATION, DIVERSITY TRAINING, ETHICS, CONFLICT RESOLUTION AND DOMESTIC VIOLENCE; ENTERTAINMENT IN THE NATURE OF THEATER PRODUCTIONS; SCRIPT WRITING SERVICES, IN CLASS 41 (U.S. CLS. 100, 101 AND 107).

FIRST USE 1-1-1959; IN COMMERCE 10-30-1959.

THE MARK CONSISTS OF STANDARD CHARACTERS WITHOUT CLAIM TO ANY PARTICULAR FONT, STYLE, SIZE, OR COLOR.

NO CLAIM IS MADE TO THE EXCLUSIVE RIGHT TO USE "PLAYS", APART FROM THE MARK AS SHOWN.

SER. NO. 77-403,604, FILED 2-22-2008.

STEPHEN AQUILA, EXAMINING ATTORNEY

Int. Cls.: 9, 16 and 41

**Prior U.S. Cls.: 2, 5, 21, 22, 23, 26, 29, 36, 37, 38, 50,
100, 101 and 107**

Reg. No. 3,519,601

United States Patent and Trademark Office

Registered Oct. 21, 2008

**TRADEMARK
SERVICE MARK
PRINCIPAL REGISTER**

NBI | NATIONAL
BUSINESS
INSTITUTE

NBI, INC. (WISCONSIN CORPORATION)
1218 MCCANN DRIVE
ALTOONA, WI 54720

FOR: AUDIO TAPES, VIDEO TAPES AND COMPACT DISCS FEATURING PARALEGAL EDUCATION, IN CLASS 9 (U.S. CLS. 21, 23, 26, 36 AND 38).

FIRST USE 2-12-2007; IN COMMERCE 2-12-2007.

FOR: PRINTED EDUCATIONAL AND INSTRUCTIONAL MATERIALS AND AIDS IN THE FIELD OF PARALEGAL EDUCATION, IN CLASS 16 (U.S. CLS. 2, 5, 22, 23, 29, 37, 38 AND 50).

FIRST USE 2-12-2007; IN COMMERCE 2-12-2007.

FOR: EDUCATIONAL SERVICES, NAMELY, CONDUCTING SEMINARS, CONFERENCES,

WORKSHOPS OR CONTINUING EDUCATION CLASSES IN THE FIELD OF PARALEGAL EDUCATION AND DISTRIBUTING COURSE MATERIALS IN CONNECTION THEREWITH, IN CLASS 41 (U.S. CLS. 100, 101 AND 107).

FIRST USE 2-12-2007; IN COMMERCE 2-12-2007.

OWNER OF U.S. REG. NOS. 2,790,771, 2,819,229, AND 2,822,524.

NO CLAIM IS MADE TO THE EXCLUSIVE RIGHT TO USE "NATIONAL BUSINESS INSTITUTE", APART FROM THE MARK AS SHOWN.

SER. NO. 77-403,849, FILED 2-22-2008.

HOWARD FRIEDMAN, EXAMINING ATTORNEY

Int. Cls.: 9, 16 and 41

Prior U.S. Cls.: 2, 5, 21, 22, 23, 26, 29, 36, 37, 38, 50,
100, 101 and 107

Reg. No. 3,519,602

United States Patent and Trademark Office

Registered Oct. 21, 2008

TRADEMARK
SERVICE MARK
PRINCIPAL REGISTER

IPE
INSTITUTE *for*
PARALEGAL EDUCATION

NBI, INC. (WISCONSIN CORPORATION)
1218 MCCANN DRIVE
ALTOONA, WI 54720

FOR: AUDIO TAPES, VIDEO TAPES AND COMPACT DISCS FEATURING PARALEGAL EDUCATION, IN CLASS 9 (U.S. CLS. 21, 23, 26, 36 AND 38).

FIRST USE 6-5-2007; IN COMMERCE 6-5-2007.

FOR: PRINTED EDUCATIONAL AND INSTRUCTIONAL MATERIALS AND AIDS IN THE FIELD OF PARALEGAL EDUCATION, IN CLASS 16 (U.S. CLS. 2, 5, 22, 23, 29, 37, 38 AND 50).

FIRST USE 6-5-2007; IN COMMERCE 6-5-2007.

FOR: EDUCATIONAL SERVICES, NAMELY, CONDUCTING SEMINARS, CONFERENCES,

WORKSHOPS OR CONTINUING EDUCATION CLASSES IN THE FIELD OF PARALEGAL EDUCATION AND DISTRIBUTING COURSE MATERIALS IN CONNECTION THEREWITH, IN CLASS 41 (U.S. CLS. 100, 101 AND 107).

FIRST USE 6-5-2007; IN COMMERCE 6-5-2007.

OWNER OF U.S. REG. NOS. 2,819,228, 2,822,525 AND OTHERS.

NO CLAIM IS MADE TO THE EXCLUSIVE RIGHT TO USE "INSTITUTE FOR PARALEGAL EDUCATION", APART FROM THE MARK AS SHOWN.

SER. NO. 77-403,904, FILED 2-22-2008.

HOWARD FRIEDMAN, EXAMINING ATTORNEY

Int. Cl.: 16

Prior U.S. Cls.: 2, 5, 22, 23, 29, 37, 38 and 50

United States Patent and Trademark Office

Reg. No. 3,519,603

Registered Oct. 21, 2008

**TRADEMARK
PRINCIPAL REGISTER**

THE RECONNECTION

PEARL, ERIC (UNITED STATES INDIVIDUAL)
P.O. BOX 3600
HOLLYWOOD, CA 90078

FOR: PRINTED MATTER AND PAPER GOODS, NAMELY, PENCILS; BINDERS; PAPER PRODUCTS, NAMELY, STATIONERY, NOTE PADS AND POSTCARDS; NOTE CARDS; POSTERS; ADDRESS BOOKS, BLANK JOURNAL BOOKS, PENS, PRINTED EDUCATIONAL CARDS FEATURING INFORMATION REGARDING PHYSICAL, EMOTIONAL, SPIRITUAL AND ENERGETIC HEALING; PRINTED NEWSLETTERS, BROCHURES, SEMINARS, PAMPHLETS, FLYERS, AND PRINTED INSTRUCTIONAL AND TEACHING MATERIALS ON THE SUBJECT OF PHYSICAL, EMOTIONAL, SPIRITUAL

AND ENERGETIC HEALING, IN CLASS 16 (U.S. CLS. 2, 5, 22, 23, 29, 37, 38 AND 50).

FIRST USE 12-1-1997; IN COMMERCE 12-1-1997.

THE MARK CONSISTS OF STANDARD CHARACTERS WITHOUT CLAIM TO ANY PARTICULAR FONT, STYLE, SIZE, OR COLOR.

OWNER OF U.S. REG. NOS. 2,757,926 AND 2,967,837.

SER. NO. 77-404,961, FILED 2-25-2008.

TINA KUAN, EXAMINING ATTORNEY

Int. Cl.: 43

Prior U.S. Cls.: 100 and 101

United States Patent and Trademark Office

Reg. No. 3,519,604

Registered Oct. 21, 2008

**SERVICE MARK
PRINCIPAL REGISTER**

A HAWAIIAN CLASSIC

HYATT CORPORATION (DELAWARE CORPORATION)
14TH FLOOR
71 S. WACKER DRIVE
CHICAGO, IL 60606

FOR: HOTEL AND RESTAURANT SERVICES, IN CLASS 43 (U.S. CLS. 100 AND 101).

FIRST USE 4-30-1989; IN COMMERCE 4-30-1989.

THE MARK CONSISTS OF STANDARD CHARACTERS WITHOUT CLAIM TO ANY PARTICULAR FONT, STYLE, SIZE, OR COLOR.

NO CLAIM IS MADE TO THE EXCLUSIVE RIGHT TO USE "HAWAIIAN", APART FROM THE MARK AS SHOWN.

SER. NO. 77-404,981, FILED 2-25-2008.

MICHAEL KEATING, EXAMINING ATTORNEY

Int. Cl.: 9

Prior U.S. Cls.: 21, 23, 26, 36 and 38

Reg. No. 3,519,605

United States Patent and Trademark Office

Registered Oct. 21, 2008

**TRADEMARK
PRINCIPAL REGISTER**

FILMCOUCH

SPOUT LLC (MICHIGAN LIMITED LIABILITY
COMPANY)
80 OTTAWA AVENUE NW, SUITE 310
GRAND RAPIDS, MI 49503

FOR: DOWNLOADABLE PODCASTS FEATUR-
ING REVIEWS OF MOVIES, PRE-RECORDED VI-
DEOS, MUSICAL RECORDINGS, COMPUTER
GAMES AND BOOKS; DOWNLOADABLE POD-
CASTS FEATURING MOVIES, MUSICAL RECORD-
INGS, COMPUTER GAMES AND BOOKS;
DOWNLOADABLE PODCASTS FEATURING IN-

TERVIEWS OF FAMOUS PERSONS, IN CLASS 9
(U.S. CLS. 21, 23, 26, 36 AND 38).

FIRST USE 12-21-2006; IN COMMERCE 1-9-2007.

THE MARK CONSISTS OF STANDARD CHAR-
ACTERS WITHOUT CLAIM TO ANY PARTICULAR
FONT, STYLE, SIZE, OR COLOR.

SER. NO. 77-405,036, FILED 2-25-2008.

DAWN FELDMAN, EXAMINING ATTORNEY

Int. Cl.: 35

Prior U.S. Cls.: 100, 101 and 102

United States Patent and Trademark Office

Reg. No. 3,519,606

Registered Oct. 21, 2008

**SERVICE MARK
PRINCIPAL REGISTER**



NYPSA, INC. (WASHINGTON CORPORATION)
14941 NE 95TH STREET
REDMOND, WA 98052

FOR: MARKETING SERVICES, NAMELY, PREPARATION OF AUDIO-VISUAL MARKETING PRESENTATIONS FEATURING ADVERTISING LAYOUTS FOR YELLOW PAGES, PRINT AND INTERNET ADVERTISING AND SEARCH ENGINE MARKETING, IN CLASS 35 (U.S. CLS. 100, 101 AND 102).

FIRST USE 6-30-2007; IN COMMERCE 6-30-2007.

OWNER OF U.S. REG. NO. 3,391,143.

NO CLAIM IS MADE TO THE EXCLUSIVE RIGHT TO USE "NATIONAL YELLOW PAGES SERVICE AGENCY" AND THE WALKING FINGERS DESIGN, APART FROM THE MARK AS SHOWN.

THE COLOR(S) GOLD, BLACK, RED, AND WHITE IS/ARE CLAIMED AS A FEATURE OF THE MARK.

THE MARK CONSISTS OF GOLD FINGERS, COMPUTER MOUSE, AND COMPUTER MOUSE CORD IN GOLD HIGHLIGHTED WITH WHITE, A GOLD RECTANGLE FILLED IN WITH GOLD ABOVE AN OPEN GOLD BOOK AND FILLED IN WITH WHITE BELOW THE GOLD BOOK, THE LETTERS "NYPSA" IN BLACK LETTERING, "NATIONAL" IN RED LETTERING, AND "YELLOW PAGES SERVICE AGENCY" IN BLACK LETTERING.

SER. NO. 77-405,630, FILED 2-25-2008.

SARA THOMAS, EXAMINING ATTORNEY

Int. Cl.: 42

Prior U.S. Cls.: 100 and 101

United States Patent and Trademark Office

Reg. No. 3,519,607

Registered Oct. 21, 2008

**SERVICE MARK
PRINCIPAL REGISTER**

Phil Graham Studio

ValleyCrest DesignGroup

VALLEYCREST COMPANIES (CALIFORNIA CORPORATION)
24151 VENTURA BOULEVARD
CALABASAS, CA 91302

FOR: LANDSCAPE ARCHITECTURAL DESIGN,
IN CLASS 42 (U.S. CLS. 100 AND 101).

FIRST USE 12-31-2006; IN COMMERCE 12-31-2006.

OWNER OF U.S. REG. NOS. 2,889,769, 3,358,081
AND OTHERS.

NO CLAIM IS MADE TO THE EXCLUSIVE
RIGHT TO USE "STUDIO" AND "DESIGN GROUP",
APART FROM THE MARK AS SHOWN.

THE NAME(S), PORTRAIT(S), AND/OR SIGNA-
TURE(S) SHOWN IN THE MARK IDENTIFIES

"PHIL GRAHAM", WHOSE CONSENT(S) TO REG-
ISTER IS SUBMITTED.

THE COLOR(S) ORANGE AND BLACK IS/ARE
CLAIMED AS A FEATURE OF THE MARK.

THE MARK CONSISTS OF THE WORDS "PHIL
GRAHAM" IN ORANGE LETTERS FOLLOWED BY
"STUDIO" IN BLACK LETTERS ABOVE A BLACK
DOTTED LINE WITH THE WORDS "VALLEYCR-
EST DESIGNGROUP" IN BLACK LETTERS BELOW
IT.

SER. NO. 77-405,641, FILED 2-25-2008.

LINDA ESTRADA, EXAMINING ATTORNEY

Int. Cl.: 41

Prior U.S. Cls.: 100, 101 and 107

United States Patent and Trademark Office

Reg. No. 3,519,608

Registered Oct. 21, 2008

**SERVICE MARK
PRINCIPAL REGISTER**

Hooping for Hope

BECKS, SUNNY (UNITED STATES INDIVIDUAL)
1515 FORREST AVENUE
NASHVILLE, TN 37206

FOR: DANCE INSTRUCTION USING HOOPS; ENTERTAINMENT IN THE NATURE OF DANCE PERFORMANCES USING HOOPS; TRAINING INSTRUCTORS IN THE FIELD OF USING HOOPS; CONDUCTING CLASSES IN THE FIELD OF DANCE USING HOOPS; EDUCATION SERVICES, NAMELY, CONDUCTING CLASSES IN THE FIELD OF DANCE USING HOOPS; PHYSICAL FITNESS INSTRUCTION UTILIZING HOOPS TO WOMEN WHO HAVE OR HAVE HAD BREAST CANCER; CHARITABLE SERVICES, NAMELY, PROVIDING ATHLETIC

EQUIPMENT AND PHYSICAL FITNESS INSTRUCTION UTILIZING HULA HOOPS TO WOMEN WHO HAVE OR HAVE HAD BREAST CANCER, IN CLASS 41 (U.S. CLS. 100, 101 AND 107).

FIRST USE 2-23-2008; IN COMMERCE 2-23-2008.

THE MARK CONSISTS OF STANDARD CHARACTERS WITHOUT CLAIM TO ANY PARTICULAR FONT, STYLE, SIZE, OR COLOR.

SER. NO. 77-405,783, FILED 2-26-2008.

DARRYL SPRUILL, EXAMINING ATTORNEY

Int. Cl.: 35

Prior U.S. Cls.: 100, 101 and 102

United States Patent and Trademark Office

Reg. No. 3,519,609

Registered Oct. 21, 2008

**SERVICE MARK
PRINCIPAL REGISTER**

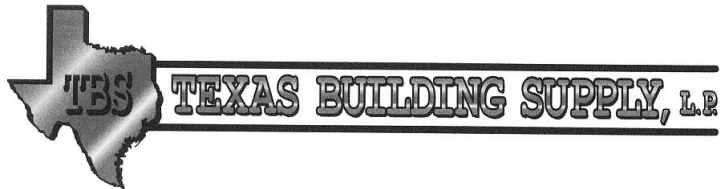

TEXAS BUILDING SUPPLY, L.P. (TEXAS LIMITED PARTNERSHIP)
11704 US HWY 380
CROSS ROADS, TX 76227

FOR: WHOLESALE DISTRIBUTORSHIP SERVICES FEATURING BUILDING MATERIALS AND BUILDING SUPPLIES, IN CLASS 35 (U.S. CLS. 100, 101 AND 102).

FIRST USE 3-1-2001; IN COMMERCE 3-1-2001.

NO CLAIM IS MADE TO THE EXCLUSIVE RIGHT TO USE "BUILDING SUPPLY, L.P.", APART FROM THE MARK AS SHOWN.

THE MARK CONSISTS OF THE LETTERS "TBS" INSIDE A MAP OF THE STATE OF TEXAS FOLLOWED BY THE WORDS "TEXAS BUILDING SUPPLY, L.P." THAT ARE BRACKETED ABOVE AND BELOW BY SINGLE HORIZONTAL LINES EXTENDING TO THE RIGHT FROM THE TEXAS MAP.

SEC. 2(F) AS TO "TEXAS" AND THE OUTLINE OF THE STATE OF TEXAS.

SER. NO. 77-405,904, FILED 2-26-2008.

BARBARA GAYNOR, EXAMINING ATTORNEY

Int. Cl.: 9

Prior U.S. Cls.: 21, 23, 26, 36 and 38

Reg. No. 3,519,610

United States Patent and Trademark Office

Registered Oct. 21, 2008

**TRADEMARK
PRINCIPAL REGISTER**

Iron Pocket

6 HEARTS, INC. (FLORIDA CORPORATION)
208 SE 6TH ST
FT. LAUDERDALE, FL 33301

FOR: HEAT RESISTANT CARRYING CASE FOR
ELECTRIC HAIR STRAIGHTENERS, NAMELY,
FLAT IRONS, ELECTRIC CURLING IRONS, AND
HEATED ELECTRIC HAIR IRONS, IN CLASS 9 (U.S.
CLS. 21, 23, 26, 36 AND 38).

FIRST USE 6-1-2007; IN COMMERCE 7-18-2007.

THE MARK CONSISTS OF STANDARD CHAR-
ACTERS WITHOUT CLAIM TO ANY PARTICULAR
FONT, STYLE, SIZE, OR COLOR.

NO CLAIM IS MADE TO THE EXCLUSIVE
RIGHT TO USE "IRON", APART FROM THE MARK
AS SHOWN.

SER. NO. 77-405,962, FILED 2-26-2008.

BARBARA BROWN, EXAMINING ATTORNEY

Int. Cl.: 14

Prior U.S. Cls.: 2, 27, 28 and 50

United States Patent and Trademark Office

Reg. No. 3,519,611

Registered Oct. 21, 2008

**TRADEMARK
PRINCIPAL REGISTER**

JENNIFER FISHER

JENNIFER FISHER (UNITED STATES INDIVIDUAL)

25 NORTH MOORE STREET

NEW YORK, NY 10013

FOR: JEWELRY, IN CLASS 14 (U.S. CLS. 2, 27, 28 AND 50).

FIRST USE 4-30-2006; IN COMMERCE 4-30-2006.

THE MARK CONSISTS OF STANDARD CHARACTERS WITHOUT CLAIM TO ANY PARTICULAR FONT, STYLE, SIZE, OR COLOR.

THE NAME "JENNIFER FISHER" IDENTIFIES A LIVING INDIVIDUAL WHOSE CONSENT IS OF RECORD.

SER. NO. 77-406,192, FILED 2-26-2008.

MATTHEW EINSTEIN, EXAMINING ATTORNEY

Int. Cl.: 41

Prior U.S. Cls.: 100, 101 and 107

United States Patent and Trademark Office

Reg. No. 3,519,612

Registered Oct. 21, 2008

**SERVICE MARK
PRINCIPAL REGISTER**

Scholarly Exchange

SCHOLARLY EXCHANGE (DELAWARE CORPORATION)
320 DUDLEY STREET
BROOKLINE, MA 024455936

THE MARK CONSISTS OF STANDARD CHARACTERS WITHOUT CLAIM TO ANY PARTICULAR FONT, STYLE, SIZE, OR COLOR.

FOR: PUBLISHING OF ELECTRONIC PUBLICATIONS, IN CLASS 41 (U.S. CLS. 100, 101 AND 107).

SER. NO. 77-406,443, FILED 2-26-2008.

FIRST USE 9-27-2002; IN COMMERCE 9-27-2002.

ANGELA GAW, EXAMINING ATTORNEY

Int. Cl.: 7

Prior U.S. Cls.: 13, 19, 21, 23, 31, 34 and 35

United States Patent and Trademark Office

Reg. No. 3,519,613

Registered Oct. 21, 2008

**TRADEMARK
PRINCIPAL REGISTER**

PROFIVE

RED DEVIL EQUIPMENT COMPANY (MINNE-
SOTA CORPORATION)
14900 21ST AVENUE NORTH
PLYMOUTH, MN 55447

THE MARK CONSISTS OF STANDARD CHAR-
ACTERS WITHOUT CLAIM TO ANY PARTICULAR
FONT, STYLE, SIZE, OR COLOR.

FOR: PORTABLE MIXING MACHINE FOR
COATING MATERIALS, IN CLASS 7 (U.S. CLS. 13,
19, 21, 23, 31, 34 AND 35).

SER. NO. 77-406,555, FILED 2-26-2008.

FIRST USE 1-31-2008; IN COMMERCE 1-31-2008.

SIMON TENG, EXAMINING ATTORNEY

Int. Cl.: 9

Prior U.S. Cls.: 21, 23, 26, 36 and 38

Reg. No. 3,519,614

United States Patent and Trademark Office

Registered Oct. 21, 2008

**TRADEMARK
PRINCIPAL REGISTER**

SEED

THEORY GARDEN LLC (OHIO LIMITED LIABILITY COMPANY)
65 WASHINGTON STREET
CHAGRIN FALLS, OH 44022

THE MARK CONSISTS OF STANDARD CHARACTERS WITHOUT CLAIM TO ANY PARTICULAR FONT, STYLE, SIZE, OR COLOR.

FOR: COMPUTER SOFTWARE FOR USE IN ORGANIZING ONE'S THOUGHTS AND IDEAS AND FOR SHARING THEM WITH OTHERS, IN CLASS 9 (U.S. CLS. 21, 23, 26, 36 AND 38).

SER. NO. 77-407,173, FILED 2-27-2008.

FIRST USE 2-15-2008; IN COMMERCE 2-15-2008.

WENDY GOODMAN, EXAMINING ATTORNEY

Int. Cls.: 16 and 41

Prior U.S. Cls.: 2, 5, 22, 23, 29, 37, 38, 50, 100, 101 and 107

United States Patent and Trademark Office

Reg. No. 3,519,615

Registered Oct. 21, 2008

**TRADEMARK
SERVICE MARK
PRINCIPAL REGISTER**

THE HOLLYWOOD REPORTER

NIELSEN BUSINESS MEDIA, INC. (DELAWARE CORPORATION)
770 BROADWAY
NEW YORK, NY 100039595

FOR: PRINTED NEWSPAPERS, MAGAZINES, AND PERIODICALS IN THE FIELD OF THE ENTERTAINMENT INDUSTRY, IN CLASS 16 (U.S. CLS. 2, 5, 22, 23, 29, 37, 38 AND 50).

FIRST USE 9-3-1930; IN COMMERCE 9-3-1930.

FOR: PROVIDING INFORMATION IN THE FIELD OF FILM, TELEVISION, MUSIC AND ENTERTAINMENT VIA THE INTERNET, IN CLASS 41 (U.S. CLS. 100, 101 AND 107).

FIRST USE 7-24-1995; IN COMMERCE 7-24-1995.

THE MARK CONSISTS OF STANDARD CHARACTERS WITHOUT CLAIM TO ANY PARTICULAR FONT, STYLE, SIZE, OR COLOR.

OWNER OF U.S. REG. NOS. 856,584, 2,245,657 AND OTHERS.

NO CLAIM IS MADE TO THE EXCLUSIVE RIGHT TO USE "REPORTER", APART FROM THE MARK AS SHOWN.

SEC. 2(F).

SER. NO. 77-407,221, FILED 2-27-2008.

ANTHONY RINKER, EXAMINING ATTORNEY

Int. Cl.: 36

Prior U.S. Cls.: 100, 101 and 102

United States Patent and Trademark Office

Reg. No. 3,519,616

Registered Oct. 21, 2008

**SERVICE MARK
PRINCIPAL REGISTER**

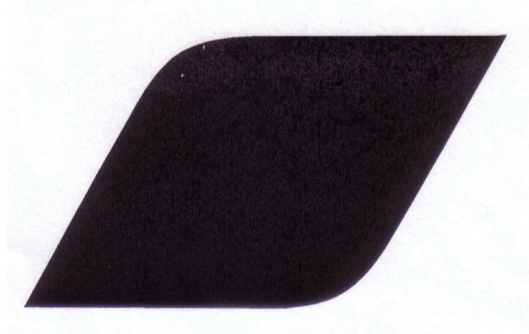

EMPLOYERS MUTUAL CASUALTY COMPANY
(IOWA CORPORATION)
P.O. BOX 712
717 MULBERRY
DES MOINES, IA 503030712

FOR: CREDIT UNION SERVICES, IN CLASS 36
(U.S. CLS. 100, 101 AND 102).

FIRST USE 10-30-2001; IN COMMERCE 10-30-2001.

OWNER OF U.S. REG. NO. 2,654,582.

SER. NO. 77-407,599, FILED 2-27-2008.

SHAUNIA CARLYLE, EXAMINING ATTORNEY

Int. Cl.: 42

Prior U.S. Cls.: 100 and 101

United States Patent and Trademark Office

Reg. No. 3,519,617

Registered Oct. 21, 2008

SERVICE MARK
PRINCIPAL REGISTER

VECTOR
ENGINEERING, INC.

VECTOR ENGINEERING, INC. (CALIFORNIA CORPORATION)
143E SPRING HILL DRIVE
GRASS VALLEY, CA 95945

FOR: CIVIL ENGINEERING; HYDROLOGIC AND ENGINEERING MODELING AND DESIGN OF MEASURES TO PROTECT AREAS LIKELY TO BE INUNDATED BY STORM-WATER AND FLOOD-WATERS; TESTING OR RESEARCH ON CIVIL ENGINEERING; ENVIRONMENTAL SERVICES, NAMELY, TECHNICAL CONSULTATION IN THE FIELD OF ENVIRONMENTAL SCIENCE, ENGINEERING SERVICES, DESIGN FOR OTHERS IN THE FIELD OF ENVIRONMENTAL ENGINEERING, DESIGNING AND TESTING OF NEW ENVIRONMENTALLY FRIENDLY PRODUCTS FOR OTHERS; ENGINEERING SERVICES FOR BUILDING AND PROPERTY CONDITION ASSESSMENT, FACILITY MANAGEMENT, REPAIR AND RESTORATION, BUILDING INSTRUMENTATION AND MONITORING, AND ENVIRONMENTAL CONSULTING; ENVIRONMENTAL SERVICES, NAMELY, DETECTION OF CONTAMINANTS IN WATER; GEOLOGICAL SURVEYS OR RESEARCH; ENGINEERING SERVICES FOR THE CONSTRUCTION OF WATER TREATMENT AND PURIFICATION PLANTS, SOLID WASTE TREATMENT PLANTS AND OTHER MUNICIPAL INFRASTRUCTURE FACILITIES; CIVIL ENGINEERING RELAT-

ING TO WATER IRRIGATION; CIVIL ENGINEERING FOR THE DESIGN OF HYDROLOGICAL, GEOTECHNICAL, MINING AND ENVIRONMENTAL STRUCTURES, FACILITIES AND IMPROVEMENTS, IN CLASS 42 (U.S. CLS. 100 AND 101).

FIRST USE 7-2-1986; IN COMMERCE 7-2-1986.

OWNER OF U.S. REG. NO. 2,073,593.

NO CLAIM IS MADE TO THE EXCLUSIVE RIGHT TO USE "ENGINEERING, INC.", APART FROM THE MARK AS SHOWN.

THE MARK CONSISTS OF THE WORDS "VECTOR ENGINEERING, INC." IN ALL CAPITAL LETTERS AND SLIGHTLY INCLINED TO THE RIGHT WITH "VECTOR" ON ONE LINE AND "ENGINEERING, INC." ON ANOTHER BELOW THE FIRST. "VECTOR" IS LARGER THAN "ENGINEERING, INC." AND THE "V" IN "VECTOR" IS LARGER STILL, WITH THE "V" TAKING UP BOTH LINES OF THE MARK.

SER. NO. 77-407,677, FILED 2-27-2008.

JILL C. ALT, EXAMINING ATTORNEY

Int. Cl.: 35

Prior U.S. Cls.: 100, 101 and 102

United States Patent and Trademark Office

Reg. No. 3,519,618

Registered Oct. 21, 2008

**SERVICE MARK
PRINCIPAL REGISTER**



CHAMBERLAIN, PAUL (UNITED STATES INDIVIDUAL)
4275 BEULAH DR.
LA CANADA FLINTRIDGE, CA 91011

FOR: ON-LINE RETAIL STORE SERVICES FEATURING PORTRAIT, EVENT AND SPORTS PHOTOGRAPHS; RETAIL STORE SERVICES FEATURING PORTRAIT, EVENT AND SPORTS PHOTOGRAPHS, IN CLASS 35 (U.S. CLS. 100, 101 AND 102).

FIRST USE 1-1-2001; IN COMMERCE 6-6-2001.

THE MARK CONSISTS OF THREE ANIMATED CARTOON CHARACTERS. FROM LEFT TO RIGHT, A SKATEBOARDER, WIZARD, AND BALLERINA. ABOVE THE CHARACTERS IS THE STYLIZED WORDS "FREE TO BE ME", AND BELOW THE CHARACTERS IS THE STYLIZED WORDS "PICTURE THEIR IMAGINATION".

SER. NO. 77-407,750, FILED 2-27-2008.

CARYN GLASSER, EXAMINING ATTORNEY

Int. Cl.: 3

Prior U.S. Cls.: 1, 4, 6, 50, 51 and 52

United States Patent and Trademark Office

Reg. No. 3,519,619

Registered Oct. 21, 2008

**TRADEMARK
PRINCIPAL REGISTER**

THE OLIVE MARKET

CONSUMER PRODUCTS DESIGN, LTD (NEW
YORK CORPORATION)
SUITE 2320
60 EAST 42ND STREET
NEW YORK, NY 10165

FOR: NON-MEDICATED SKIN CARE PREPARA-
TIONS; BATH SOAPS IN LIQUID, SOLID OR GEL
FORM; FRAGRANCES FOR PERSONAL USE;
HOUSEHOLD CLEANING PREPARATIONS; HAIR
CARE PREPARATIONS; ROOM FRAGRANCES, IN
CLASS 3 (U.S. CLS. 1, 4, 6, 50, 51 AND 52).

FIRST USE 2-26-2008; IN COMMERCE 2-26-2008.

THE MARK CONSISTS OF STANDARD CHAR-
ACTERS WITHOUT CLAIM TO ANY PARTICULAR
FONT, STYLE, SIZE, OR COLOR.

NO CLAIM IS MADE TO THE EXCLUSIVE
RIGHT TO USE "OLIVE", APART FROM THE
MARK AS SHOWN.

SER. NO. 77-407,890, FILED 2-27-2008.

TRACY CROSS, EXAMINING ATTORNEY

Int. Cl.: 35

Prior U.S. Cls.: 100, 101 and 102

United States Patent and Trademark Office

Reg. No. 3,519,620

Registered Oct. 21, 2008

**SERVICE MARK
PRINCIPAL REGISTER**

SALES AUTOPSY

SEIDMAN, DANIEL P. (UNITED STATES INDIVIDUAL)
190 E. DUNDEE RD.
BARRINGTON, IL 60010

FOR: BUSINESS MARKETING CONSULTING SERVICES, IN CLASS 35 (U.S. CLS. 100, 101 AND 102).

FIRST USE 11-30-1992; IN COMMERCE 11-30-1992.

THE MARK CONSISTS OF STANDARD CHARACTERS WITHOUT CLAIM TO ANY PARTICULAR FONT, STYLE, SIZE, OR COLOR.

SEC. 2(F).

SER. NO. 77-408,274, FILED 2-28-2008.

BARBARA RUTLAND, EXAMINING ATTORNEY

Int. Cl.: 14

Prior U.S. Cls.: 2, 27, 28 and 50

United States Patent and Trademark Office

Reg. No. 3,519,621

Registered Oct. 21, 2008

TRADEMARK
PRINCIPAL REGISTER



PHYLLIS G. PESSOLANO (UNITED STATES INDIVIDUAL)
99 FOX MEADOW ROAD
SCARSDALE, NY 10583

FOR: JEWELRY, NAMELY, NECKLACES, BRACELETS AND EARRINGS, IN CLASS 14 (U.S. CLS. 2, 27, 28 AND 50).

FIRST USE 3-12-2008; IN COMMERCE 3-12-2008.

THE COLOR(S) BROWN, WHITE, BLACK, YELLOW, BLUE AND PINK IS/ARE CLAIMED AS A FEATURE OF THE MARK.

THE MARK CONSISTS OF THE WORDING "PRECIOUS PIGGIE" IN BLUE AND A GUINEA PIG WITH BROWN AND WHITE FUR, BLACK EYES, PINK NOSE, MOUTH AND WHISKERS AND BLACK DETAILING. THE GUINEA PIG IS WEARING YELLOW AND BLUE EARRINGS AND YELLOW AND BLUE NECKLACE, ALL OF WHICH ARE OUTLINED IN BLACK.

SER. NO. 77-408,365, FILED 2-28-2008.

MARTHA FROMM, EXAMINING ATTORNEY

Int. Cl.: 16

Prior U.S. Cls.: 2, 5, 22, 23, 29, 37, 38 and 50

Reg. No. 3,519,622

United States Patent and Trademark Office

Registered Oct. 21, 2008

**TRADEMARK
PRINCIPAL REGISTER**

SF-12

MEDICAL OUTCOMES TRUST, INC. (MASSACHUSETTS CORPORATION)
275 WYMAN STREET, SUITE 120
WALTHAM, MA 02451

FOR: PRINTED HEALTH STATUS QUESTIONNAIRES AND USER MANUAL RELATING TO ADMINISTERING, SCORING AND ANALYZING HEALTH STATUS SURVEY RESULTS; PRINTED INDIVIDUAL AND GROUP HEALTH SURVEY REPORTS AND DOCUMENTATION AND USER MANUALS FOR COMPUTERIZED ANALYSIS OF HEALTH STATUS SURVEYS, IN CLASS 16 (U.S. CLS. 2, 5, 22, 23, 29, 37, 38 AND 50).

FIRST USE 5-31-1994; IN COMMERCE 7-31-1995.

THE MARK CONSISTS OF STANDARD CHARACTERS WITHOUT CLAIM TO ANY PARTICULAR FONT, STYLE, SIZE, OR COLOR.

OWNER OF U.S. REG. NOS. 1,837,851, 3,289,836, AND 3,289,838.

SER. NO. 77-408,590, FILED 2-28-2008.

BARBARA RUTLAND, EXAMINING ATTORNEY

Int. Cl.: 28

Prior U.S. Cls.: 22, 23, 38 and 50

United States Patent and Trademark Office

Reg. No. 3,519,623

Registered Oct. 21, 2008

**TRADEMARK
PRINCIPAL REGISTER**

K-9 KICKER

CHARLES A. VIOLA (UNITED STATES INDIVIDUAL)

511 SOUTH 2ND STREET

FAIRFIELD, IA 52556

FOR: DOG TOYS, IN CLASS 28 (U.S. CLS. 22, 23, 38 AND 50).

FIRST USE 2-18-2002; IN COMMERCE 2-18-2002.

THE MARK CONSISTS OF STANDARD CHARACTERS WITHOUT CLAIM TO ANY PARTICULAR FONT, STYLE, SIZE, OR COLOR.

NO CLAIM IS MADE TO THE EXCLUSIVE RIGHT TO USE "K-9", APART FROM THE MARK AS SHOWN.

SER. NO. 77-408,764, FILED 2-28-2008.

MATTHEW EINSTEIN, EXAMINING ATTORNEY

Int. Cl.: 13

Prior U.S. Cls.: 2 and 9

United States Patent and Trademark Office

Reg. No. 3,519,624

Registered Oct. 21, 2008

**TRADEMARK
PRINCIPAL REGISTER**

CowTown Shooters

CTD, INC. (TEXAS CORPORATION)
2524 NE LOOP 820
FT. WORTH, TX 76106

FOR: FIREARMS AND SHOOTING ACCESSORIES, NAMELY, GOLF BALL LAUNCHERS FOR ATTACHMENT TO FIREARMS, BRASS CATCHER MESH BAGS FOR CATCHING EJECTED CARTRIDGES FROM FIREARMS, RIFLE SLINGS, SNIPER FIREARM SLINGS, SHOOTING SUPPORT BAGS FOR FIREARMS AND HOLSTERS, IN CLASS 13 (U.S. CLS. 2 AND 9).

FIRST USE 2-14-2008; IN COMMERCE 2-14-2008.

THE MARK CONSISTS OF STANDARD CHARACTERS WITHOUT CLAIM TO ANY PARTICULAR FONT, STYLE, SIZE, OR COLOR.

NO CLAIM IS MADE TO THE EXCLUSIVE RIGHT TO USE "SHOOTERS", APART FROM THE MARK AS SHOWN.

SER. NO. 77-409,018, FILED 2-28-2008.

DOMINIC J. FERRAIUOLO, EXAMINING ATTORNEY

Int. Cl.: 9

Prior U.S. Cls.: 21, 23, 26, 36 and 38

United States Patent and Trademark Office

Reg. No. 3,519,625

Registered Oct. 21, 2008

**TRADEMARK
PRINCIPAL REGISTER**

The Panderers

WYNN, SCOTT (UNITED STATES INDIVIDUAL)
17188 HOGAN HILL RD.
MOORES HILL, IN 47032

FOR: DIGITAL MATERIALS, NAMELY, CDS,
DVDS, DOWNLOADABLE AUDIO FILES FEATUR-
ING MUSIC, IN CLASS 9 (U.S. CLS. 21, 23, 26, 36 AND
38).

FIRST USE 10-1-2006; IN COMMERCE 4-25-2007.

THE MARK CONSISTS OF STANDARD CHAR-
ACTERS WITHOUT CLAIM TO ANY PARTICULAR
FONT, STYLE, SIZE, OR COLOR.

SER. NO. 77-409,110, FILED 2-28-2008.

DOMINIC J. FERRAIUOLO, EXAMINING ATTOR-
NEY

Int. Cl.: 13

Prior U.S. Cls.: 2 and 9

United States Patent and Trademark Office

Reg. No. 3,519,626

Registered Oct. 21, 2008

**TRADEMARK
PRINCIPAL REGISTER**



CTD, INC. (TEXAS CORPORATION)
2524 NE LOOP 820
FT. WORTH, TX 76106

FOR: FIREARMS AND SHOOTING ACCESSORIES, NAMELY, GOLF BALL LAUNCHERS FOR ATTACHMENT TO FIREARMS, BRASS CATCHER MESH BAGS FOR CATCHING EJECTED CARTRIDGES FROM FIREARMS, RIFLE SLINGS, SNIPER FIREARM SLINGS, SHOOTING SUPPORT BAGS FOR FIREARMS AND HOLSTERS, IN CLASS 13 (U.S. CLS. 2 AND 9).

FIRST USE 2-14-2008; IN COMMERCE 2-14-2008.

NO CLAIM IS MADE TO THE EXCLUSIVE RIGHT TO USE "SHOOTERS", APART FROM THE MARK AS SHOWN.

THE MARK CONSISTS OF A "LONGHORN SKULL" SUPERIMPOSED OVER TWO CROSSED RIFLES OVER A HALF-CIRCLE ATOP A BANNER WITH THE NAME "COWTOWN SHOOTERS".

SER. NO. 77-409,122, FILED 2-28-2008.

DOMINIC J. FERRAIUOLO, EXAMINING ATTORNEY

Int. Cl.: 20

Prior U.S. Cls.: 2, 13, 22, 25, 32 and 50

United States Patent and Trademark Office

Reg. No. 3,519,627

Registered Oct. 21, 2008

TRADEMARK
PRINCIPAL REGISTER



ELEVATION STUDIOS INC. (ILLINOIS CORPORATION)
962 S. DARLA CT.
WAUKEGAN, IL 60085

FOR: FURNITURE FOR DISPLAYING GOODS;
POINT OF PURCHASE DISPLAYS, IN CLASS 20
(U.S. CLS. 2, 13, 22, 25, 32 AND 50).

FIRST USE 11-1-2006; IN COMMERCE 11-1-2006.

NO CLAIM IS MADE TO THE EXCLUSIVE
RIGHT TO USE "STUDIOS INC.", APART FROM
THE MARK AS SHOWN.

THE COLOR(S) WHITE GREEN BLUE IS/ARE
CLAIMED AS A FEATURE OF THE MARK.

THE MARK CONSISTS OF GREEN SQUARE
WITH 4 WHITE ARROW SHAPED FORMS INSIDE
SQUARE 1 BLUE ARROW SHAPED FORM IN
UPPER RIGHT CORNER OF SQUARE. TEXT LO-
CATED TO THE RIGHT OF SQUARE GRAPHIC.

SER. NO. 77-409,609, FILED 2-29-2008.

RONALD AIKENS, EXAMINING ATTORNEY

Int. Cl.: 36

Prior U.S. Cls.: 100, 101 and 102

United States Patent and Trademark Office

Reg. No. 3,519,628

Registered Oct. 21, 2008

SERVICE MARK
PRINCIPAL REGISTER



MIDDLESEX MUTUAL ASSURANCE COMPANY
(CONNECTICUT CORPORATION)
P.O. BOX 891
213 COURT STREET
MIDDLETOWN, CT 06457

FOR: UNDERWRITING PROPERTY AND CAUS-
ALTY INSURANCE, IN CLASS 36 (U.S. CLS. 100, 101
AND 102).

FIRST USE 9-25-2006; IN COMMERCE 9-25-2006.

OWNER OF U.S. REG. NOS. 3,344,826, 3,346,091,
AND 3,346,310.

NO CLAIM IS MADE TO THE EXCLUSIVE
RIGHT TO USE "SPECIALTY", APART FROM THE
MARK AS SHOWN.

THE MARK CONSISTS OF THE WORD "MID-
DLEOAK" WITH THE WORD "SPECIALTY" UN-
DERNEATH WITH SIX CURVED LINES FORMING
A TREE NEXT TO THE WORDS.

SER. NO. 77-409,949, FILED 2-29-2008.

FRANK LATTUCA, EXAMINING ATTORNEY

Int. Cl.: 20

Prior U.S. Cls.: 2, 13, 22, 25, 32 and 50

Reg. No. 3,519,629

United States Patent and Trademark Office

Registered Oct. 21, 2008

**TRADEMARK
PRINCIPAL REGISTER**



FOAMORDER.COM, INC. (CALIFORNIA CORPORATION)
1325 HOWARD STREET
SAN FRANCISCO, CA 94103

FOR: MATTRESSES AND PILLOWS, IN CLASS 20
(U.S. CLS. 2, 13, 22, 25, 32 AND 50).

FIRST USE 6-4-2007; IN COMMERCE 9-3-2007.

NO CLAIM IS MADE TO THE EXCLUSIVE RIGHT TO USE "ALL NATURAL FOAM MADE FROM TREE SAP", APART FROM THE MARK AS SHOWN.

THE MARK CONSISTS OF THE LITERAL ELEMENT "NATURAL SENSE" WITH A SOLID TRIANGLE ABOVE IT CONFORMING TO THE SHAPE OF THE LETTERS AND A SOLID TRIANGLE BELOW IT CONTAINING THE LITERAL ELEMENT "ALL NATURAL FOAM MADE FROM TREE SAP."

SER. NO. 77-409,989, FILED 2-29-2008.

MELISSA VALLILLO, EXAMINING ATTORNEY

Int. Cl.: 16

Prior U.S. Cls.: 2, 5, 22, 23, 29, 37, 38 and 50

United States Patent and Trademark Office

Reg. No. 3,519,630

Registered Oct. 21, 2008

**TRADEMARK
PRINCIPAL REGISTER**

BULLETPROOF

ARBOGAST PROPERTY MANAGEMENT, LLC
(WYOMING LIMITED LIABILITY COMPANY)
PO BOX 759
GENOA, NV 89411

FOR: NEWSLETTERS IN THE FIELD OF LAW,
PATENTS, TRADEMARKS, PERSONAL FINANCE,
LEGAL SELF-HELP, ASSET PROTECTION, BUSI-
NESS STRUCTURING, INCORPORATION, POLI-
TICS, MARKETING, BUSINESS, IN CLASS 16 (U.S.
CLS. 2, 5, 22, 23, 29, 37, 38 AND 50).

FIRST USE 2-29-2008; IN COMMERCE 2-29-2008.

THE MARK CONSISTS OF STANDARD CHAR-
ACTERS WITHOUT CLAIM TO ANY PARTICULAR
FONT, STYLE, SIZE, OR COLOR.

OWNER OF U.S. REG. NOS. 1,808,859 AND
3,381,466.

SER. NO. 77-410,013, FILED 2-29-2008.

MARY ROSSMAN, EXAMINING ATTORNEY

Int. Cl.: 3

Prior U.S. Cls.: 1, 4, 6, 50, 51 and 52

Reg. No. 3,519,631

United States Patent and Trademark Office

Registered Oct. 21, 2008

**TRADEMARK
PRINCIPAL REGISTER**

THE OLIVE PRESS

CONSUMER PRODUCTS DESIGN, LTD (NEW
YORK CORPORATION)
SUITE 2320
60 EAST 42ND STREET
NEW YORK, NY 10165

FOR: NON-MEDICATED SKIN CARE PREPARA-
TIONS; BATH SOAPS IN LIQUID, SOLID OR GEL
FORM; FRAGRANCES FOR PERSONAL USE;
HOUSEHOLD CLEANING PREPARATIONS; HAIR
CARE PREPARATIONS; ROOM FRAGRANCES, IN
CLASS 3 (U.S. CLS. 1, 4, 6, 50, 51 AND 52).

FIRST USE 2-26-2008; IN COMMERCE 2-26-2008.

THE MARK CONSISTS OF STANDARD CHAR-
ACTERS WITHOUT CLAIM TO ANY PARTICULAR
FONT, STYLE, SIZE, OR COLOR.

NO CLAIM IS MADE TO THE EXCLUSIVE
RIGHT TO USE "OLIVE", APART FROM THE
MARK AS SHOWN.

SER. NO. 77-410,077, FILED 2-29-2008.

TRACY CROSS, EXAMINING ATTORNEY

Int. Cl.: 41

Prior U.S. Cls.: 100, 101 and 107

United States Patent and Trademark Office

Reg. No. 3,519,632

Registered Oct. 21, 2008

**SERVICE MARK
PRINCIPAL REGISTER**

SNAP!

LEADERSHIP GATHERING LLC (SOUTH CAROLINA LIMITED LIABILITY COMPANY),
DBA SNAP!
REMBRANDT YARD 1301 SPRUCE STREET
BOULDER, CA 80302

FOR: EDUCATIONAL SERVICES, NAMELY, CONDUCTING CONFERENCES, SEMINARS AND WORKSHOPS IN THE FIELD OF SCIENCE, NATURE, ART, CULTURE, ENVIRONMENT, HUMAN RIGHTS AND HUMAN SOCIETY; ARRANGING AND CONDUCTING EDUCATIONAL CONFERENCES; EDUCATIONAL SERVICES, NAMELY, A LEARNING AND INNOVATION CENTER FEATURING FULLY CUSTOMIZED LEADERSHIP, MOTIVATIONAL, EDUCATIONAL, AND BRAINSTORMING TRAINING; EDUCATIONAL

SERVICES, NAMELY, CONDUCTING PROGRAMS IN THE FIELD OF SCIENCE, NATURE, ART, CULTURE, ENVIRONMENT, HUMAN RIGHTS AND HUMAN SOCIETY, IN CLASS 41 (U.S. CLS. 100, 101 AND 107).

FIRST USE 11-14-2007; IN COMMERCE 11-14-2007.

THE MARK CONSISTS OF STANDARD CHARACTERS WITHOUT CLAIM TO ANY PARTICULAR FONT, STYLE, SIZE, OR COLOR.

SER. NO. 77-410,319, FILED 2-29-2008.

ROBERT LAVACHE, EXAMINING ATTORNEY

Int. Cl.: 25

Prior U.S. Cls.: 22 and 39

United States Patent and Trademark Office

Reg. No. 3,519,633

Registered Oct. 21, 2008

**TRADEMARK
PRINCIPAL REGISTER**

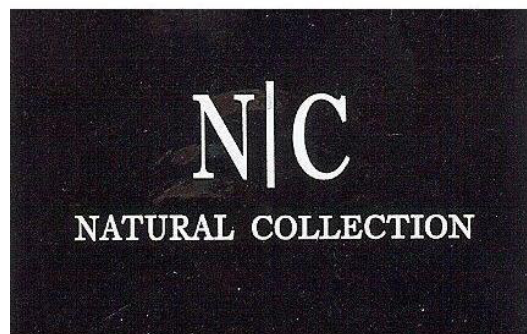

NATURAL COLLECTION, CORP. (CALIFORNIA CORPORATION)
2277 EAST 16TH STREET
LOS ANGELES, CA 90021

FOR: A-SHIRTS; BALLOON PANTS; BED JACKETS; BUTTON-FRONT ALOHA SHIRTS; CAMP SHIRTS; CAPRI PANTS; CARGO PANTS; DENIM JACKETS; DENIMS; DOWN JACKETS; DRESS SHIRTS; FISHERMEN'S JACKETS; FUR COATS AND JACKETS; FUR JACKETS; GOLF SHIRTS; HEAVY JACKETS; HOODED SWEAT SHIRTS; JACKET LINERS; JACKETS; JOGGING PANTS; KNIT SHIRTS; LEATHER JACKETS; LEATHER PANTS; LIGHT-REFLECTING JACKETS; LONG JACKETS; LONG-SLEEVED SHIRTS; LOUNGE PANTS; MEN AND WOMEN JACKETS, COATS, TROUSERS, VESTS; NIGHT SHIRTS; NON-DISPOSABLE CLOTH TRAINING PANTS; NURSE PANTS;

OPEN-NECKED SHIRTS; PANTS; PETTI-PANTS; PIQUE SHIRTS; POLO SHIRTS; RAIN JACKETS; RAINPROOF JACKETS; REVERSIBLE JACKETS; RUGBY SHIRTS; SHELL JACKETS; SHIRT FRONTS; SHIRT YOKES; SHIRTS; SHIRTS FOR SUITS; ALL OF THE FOREGOING ITEMS ARE COMPOSED IN WHOLE OR IN PART OF NATURAL FIBERS OR FABRICS, IN CLASS 25 (U.S. CLS. 22 AND 39).

FIRST USE 4-1-2000; IN COMMERCE 4-1-2000.

NO CLAIM IS MADE TO THE EXCLUSIVE RIGHT TO USE "NATURAL COLLECTION", APART FROM THE MARK AS SHOWN.

SER. NO. 77-410,446, FILED 2-29-2008.

TOBY BULLOFF, EXAMINING ATTORNEY

Int. Cl.: 13

Prior U.S. Cls.: 2 and 9

United States Patent and Trademark Office

Reg. No. 3,519,634

Registered Oct. 21, 2008

**TRADEMARK
PRINCIPAL REGISTER**

THE ALTERNATIVE

AWATER LTD (NEVADA LIMITED LIABILITY
COMPANY)
390 RIVER FLOW DRIVE
RENO, NV 89523

FOR: LESS-LETHAL PROJECTILE, NAMELY, A
ROUNDED METAL BLOCK ENCAPSULATED IN
RUBBER, DISCHARGED FROM A PISTOL TO
TEMPORARILY INCAPACITATE A PERSON, IN
CLASS 13 (U.S. CLS. 2 AND 9).

FIRST USE 9-30-2005; IN COMMERCE 10-30-2007.

THE MARK CONSISTS OF STANDARD CHAR-
ACTERS WITHOUT CLAIM TO ANY PARTICULAR
FONT, STYLE, SIZE, OR COLOR.

SER. NO. 77-410,543, FILED 3-1-2008.

LEIGH CAROLINE CASE, EXAMINING ATTOR-
NEY

Int. Cl.: 45

Prior U.S. Cls.: 100 and 101

United States Patent and Trademark Office

Reg. No. 3,519,635

Registered Oct. 21, 2008

**SERVICE MARK
PRINCIPAL REGISTER**

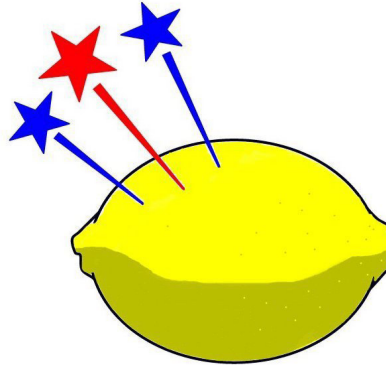

ZABAWA, BARBARA J (UNITED STATES INDIVIDUAL)
3114 ASHFORD LN
MADISON, WI 53713

FOR: PROVIDING INFORMATION IN THE FIELD OF SELF-IMPROVEMENT, IN CLASS 45 (U.S. CLS. 100 AND 101).

FIRST USE 2-19-2008; IN COMMERCE 2-19-2008.

THE COLOR(S) YELLOW, BLUE, RED AND BLACK IS/ARE CLAIMED AS A FEATURE OF THE MARK.

THE MARK CONSISTS OF A LEMON DESIGN WHICH IS IN YELLOW, TWO OUTSIDE STARBURSTS THAT ARE IN BLUE, A MIDDLE STARBURST IN RED AND THE ENTIRE DESIGN IS OUTLINED IN BLACK.

SER. NO. 77-410,620, FILED 3-1-2008.

JOHN GARTNER, EXAMINING ATTORNEY

Int. Cl.: 45

Prior U.S. Cls.: 100 and 101

United States Patent and Trademark Office

Reg. No. 3,519,636

Registered Oct. 21, 2008

**SERVICE MARK
PRINCIPAL REGISTER**

LemonSpark

ZABAWA, BARBARA J. (UNITED STATES INDIVIDUAL)
3114 ASHFORD LN
MADISON, WI 53713

THE MARK CONSISTS OF STANDARD CHARACTERS WITHOUT CLAIM TO ANY PARTICULAR FONT, STYLE, SIZE, OR COLOR.

FOR: PROVIDING INFORMATION IN THE FIELD OF SELF-IMPROVEMENT, IN CLASS 45 (U.S. CLS. 100 AND 101).

SER. NO. 77-410,622, FILED 3-1-2008.

FIRST USE 2-19-2008; IN COMMERCE 2-19-2008.

JOHN GARTNER, EXAMINING ATTORNEY

Int. Cl.: 30

Prior U.S. Cl.: 46

United States Patent and Trademark Office

Reg. No. 3,519,637

Registered Oct. 21, 2008

**TRADEMARK
PRINCIPAL REGISTER**

Lisa Ann's Cookies To Go

DE LOS SANTOS, LISA, ANN (UNITED STATES
INDIVIDUAL), DBA LISA ANN'S
4733 TORRANCE BLVD., #482
TORRANCE, CA 90503

FOR: FOOD PACKAGE COMBINATIONS CON-
SISTING PRIMARILY OF BREAD, CRACKERS
AND/OR COOKIES, IN CLASS 30 (U.S. CL. 46).

FIRST USE 2-4-2008; IN COMMERCE 2-4-2008.

THE MARK CONSISTS OF STANDARD CHAR-
ACTERS WITHOUT CLAIM TO ANY PARTICULAR
FONT, STYLE, SIZE, OR COLOR.

NO CLAIM IS MADE TO THE EXCLUSIVE
RIGHT TO USE "COOKIES TO GO", APART FROM
THE MARK AS SHOWN.

SER. NO. 77-410,632, FILED 3-1-2008.

WENDY GOODMAN, EXAMINING ATTORNEY

Int. Cl.: 21

Prior U.S. Cls.: 2, 13, 23, 29, 30, 33, 40 and 50

United States Patent and Trademark Office

Reg. No. 3,519,638

Registered Oct. 21, 2008

**TRADEMARK
PRINCIPAL REGISTER**

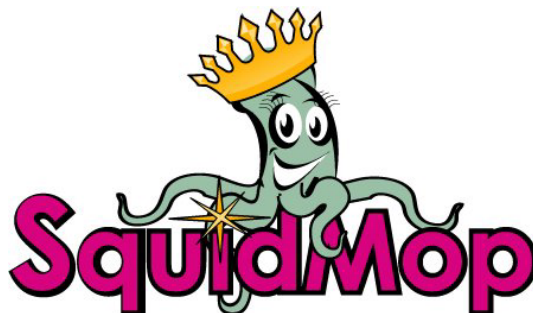

NOWAK, JACQUE' (TEXAS SOLE PROPRIETORSHIP), DBA SQUID PRODUCTS
11628 WOODLAND HILLS TRAIL
AUSTIN, TX 78732

FOR: MOPS, IN CLASS 21 (U.S. CLS. 2, 13, 23, 29, 30, 33, 40 AND 50).

FIRST USE 11-1-2007; IN COMMERCE 1-15-2008.

THE COLOR(S) GOLD, GREEN, PINK, BLACK, WHITE IS/ARE CLAIMED AS A FEATURE OF THE MARK.

THE MARK CONSISTS OF THE COLORS GOLD, GREEN, PINK, BLACK, AND WHITE, WITH THE

COLOR GOLD APPEARING IN THE CROWN DESIGN, THE COLOR GREEN APPEARING IN THE SQUID DESIGN, THE COLOR PINK APPEARING IN THE LETTERING OF THE WORDING "SQUID-MOP", THE COLOR BLACK APPEARING IN THE OUTLINE OF THE MARK AND THE EYELASHES, EYEBROWS, EYEBALLS, LIPS, AND BACKS OF THE EYES OF THE SQUID DESIGN, AND THE COLOR WHITE APPEARING IN THE MOUTH AND EYES OF THE SQUID DESIGN.

SER. NO. 77-410,637, FILED 3-1-2008.

TINA KUAN, EXAMINING ATTORNEY

Int. Cl.: 1

Prior U.S. Cls.: 1, 5, 6, 10, 26 and 46

Reg. No. 3,519,639

United States Patent and Trademark Office

Registered Oct. 21, 2008

**TRADEMARK
PRINCIPAL REGISTER**

HAMPOSYL

ELCAT, INC. (DELAWARE CORPORATION)
SUITE 101
163 WASHINGTON VALLEY ROAD
WARREN, NJ 07059

FOR: CHEMICALLY MODIFIED FATTY ACIDS
FOR USE IN PERSONAL CARE PRODUCTS,
CLEANING PRODUCTS, MACHINERY AND
CHAIN LUBRICANTS, CORROSION INHIBITORS,
LEATHER TREATING CHEMICALS, MINING AND
MINERAL SEPARATION AIDES, AGRICULTURAL
ADJUVANTS AND COMPATIBILIZERS, TEXTILE
LUBRICANTS, POLYMER ANTISTATIC AND AN-
TIFOGGING ADDITIVES, BIOTECHNOLOGY PRO-

DUCT SEPARATION AND PURIFICATION AIDES,
AND DISPERSANTS, IN CLASS 1 (U.S. CLS. 1, 5, 6, 10,
26 AND 46).

FIRST USE 1-21-1964; IN COMMERCE 4-22-1964.

THE MARK CONSISTS OF STANDARD CHAR-
ACTERS WITHOUT CLAIM TO ANY PARTICULAR
FONT, STYLE, SIZE, OR COLOR.

SER. NO. 77-410,905, FILED 3-3-2008.

BRIAN CALLAGHAN, EXAMINING ATTORNEY

Int. Cl.: 25

Prior U.S. Cls.: 22 and 39

United States Patent and Trademark Office

Reg. No. 3,519,640

Registered Oct. 21, 2008

**TRADEMARK
PRINCIPAL REGISTER**



CLINTON BASEBALL CLUB, INC. (IOWA CORPORATION)
537 BALLPARK DRIVE
CLINTON, IA 52732

FOR: CLOTHING, NAMELY, APRONS, ATHLETIC UNIFORMS, BANDANAS, BOXER SHORTS, CAPS, CLOTH BABY BIBS, COATS, GOLF SHIRTS, GYM SHORTS, GYM SUITS, HATS, JACKETS, JERSEYS, JOGGING SUITS, KNIT SHIRTS, PAJAMAS, POLO SHIRTS, PONCHOS, PULLOVERS, RAIN COATS, RAINWEAR, SWEATERS, SWEAT PANTS, SWEAT SHIRTS, SWEAT SUITS, SOCKS, SPORT SHIRTS, T- SHIRTS, TANK TOPS, TIES, VISORS,

WIND RESISTANT JACKETS AND WRISTBANDS, IN CLASS 25 (U.S. CLS. 22 AND 39).

FIRST USE 12-1-2007; IN COMMERCE 12-1-2007.

OWNER OF U.S. REG. NO. 2,087,382.

THE MARK CONSISTS OF A LUMBERJACK WEARING A CROWN SWINGING A BASEBALL BAT.

SER. NO. 77-410,972, FILED 3-3-2008.

CHRISTINA SOBRAL, EXAMINING ATTORNEY

Int. Cl.: 14

Prior U.S. Cls.: 2, 27, 28 and 50

United States Patent and Trademark Office

Reg. No. 3,519,641

Registered Oct. 21, 2008

**TRADEMARK
PRINCIPAL REGISTER**

CHARMS FOR CHANGE

A.B.C. HOME FURNISHINGS, INC. (NEW YORK CORPORATION)

888 BROADWAY

NEW YORK, NY 10008

FOR: JEWELRY, IN CLASS 14 (U.S. CLS. 2, 27, 28 AND 50).

FIRST USE 11-1-2007; IN COMMERCE 11-1-2007.

THE MARK CONSISTS OF STANDARD CHARACTERS WITHOUT CLAIM TO ANY PARTICULAR FONT, STYLE, SIZE, OR COLOR.

NO CLAIM IS MADE TO THE EXCLUSIVE RIGHT TO USE "CHARMS", APART FROM THE MARK AS SHOWN.

SER. NO. 77-410,997, FILED 3-3-2008.

ROBERT LAVACHE, EXAMINING ATTORNEY

Int. Cl.: 42

Prior U.S. Cls.: 100 and 101

United States Patent and Trademark Office

Reg. No. 3,519,642

Registered Oct. 21, 2008

**SERVICE MARK
PRINCIPAL REGISTER**



STEVENS, TERRI LEWIS (TEXAS PROFESSIONAL LIMITED LIABILITY COMPANY), DBA LSARCHITECTURE, PLLC

3525 LAZY LANE
BEAUMONT, TX 77706

FOR: ARCHITECTURAL AND ENGINEERING SERVICES, IN CLASS 42 (U.S. CLS. 100 AND 101).

FIRST USE 4-30-2004; IN COMMERCE 4-30-2004.

NO CLAIM IS MADE TO THE EXCLUSIVE RIGHT TO USE "ARCHITECTURE", APART FROM THE MARK AS SHOWN.

THE COLOR(S) RED, BLACK AND GREY IS/ARE CLAIMED AS A FEATURE OF THE MARK.

THE MARK CONSISTS OF THE COLOR GREY APPEARS IN THE FLEUR DE LIS, WITH LIGHT GREY HIGHLIGHTS, AND AS A SHADOW IN THE WORDING, THE COLOR RED APPEARS IN THE LETTERS "LS", THE COLOR BLACK APPEARS IN THE WORDING "ARCHITECTURE" AND "WWW.LSARCHITECTURE.COM".

SER. NO. 77-411,238, FILED 3-3-2008.

DAYNA BROWNE, EXAMINING ATTORNEY

Int. Cl.: 4

Prior U.S. Cls.: 1, 6 and 15

United States Patent and Trademark Office

Reg. No. 3,519,643

Registered Oct. 21, 2008

TRADEMARK
PRINCIPAL REGISTER



ISLAND L.P. GAS SERVICES, INC. (HAWAII CORPORATION), DBA PROPANE MANE
94-171 LEONUI STREET
WAIPAHU, HI 96797

FOR: PROPANE GAS; AND PROPANE GAS SOLD IN CYLINDERS, IN CLASS 4 (U.S. CLS. 1, 6 AND 15).

FIRST USE 1-1-1984; IN COMMERCE 1-1-1984.

NO CLAIM IS MADE TO THE EXCLUSIVE RIGHT TO USE "PROPANE", APART FROM THE MARK AS SHOWN.

THE COLOR(S) RED, BLUE YELLOW, TAN, GRAY, WHITE, PINK AND BLACK IS/ARE CLAIMED AS A FEATURE OF THE MARK.

THE MARK CONSISTS OF DESIGN OF MALE SUPER HERO WEARING A BLUE TIGHTS WITH A BLACK "P" ON THE CHEST, YELLOW AND BLACK SHOES, YELLOW AND BLACK BELT WITH THE LETTER "M" IN YELLOW, A YELLOW AND BLACK LOIN CLOTH, YELLOW AND BLACK CAPE, YELLOW AND BLACK HAIR, PINK TONGUE, TAN SKIN, WHITE TEETH, BLACK AND WHITE EYES, YELLOW GLOVES, HOLDING A GRAY, BLACK AND RED PROPANE CYLINDER THE WITH TERMS "PROPANE MAN" IN YELLOW ON IT.

SER. NO. 77-411,295, FILED 3-3-2008.

ANTHONY RINKER, EXAMINING ATTORNEY

Int. Cl.: 39

Prior U.S. Cls.: 100 and 105

United States Patent and Trademark Office

Reg. No. 3,519,644

Registered Oct. 21, 2008

**SERVICE MARK
PRINCIPAL REGISTER**



GENESIS LEASE LIMITED (BERMUDA CORPORATION)
4230 ATLANTIC AVENUE
WESTPARK, SHANNON, IRELAND

FOR: LEASING OF AIRPLANES, IN CLASS 39
(U.S. CLS. 100 AND 105).

FIRST USE 12-19-2006; IN COMMERCE 12-19-2006.

NO CLAIM IS MADE TO THE EXCLUSIVE
RIGHT TO USE "LEASE LIMITED", APART FROM
THE MARK AS SHOWN.

THE COLOR(S) GREEN AND GRAY IS/ARE
CLAIMED AS A FEATURE OF THE MARK.

THE MARK CONSISTS OF A DESIGN COM-
POSED OF THREE TRIANGLES WITH TWO TRI-
ANGLES IN GREEN AND THE CENTER
TRIANGLE IN GRAY ABOVE THE WORDS "GEN-
ESIS LEASE" IN GREEN ABOVE THE WORD "LIM-
ITED" IN GRAY.

SER. NO. 77-411,372, FILED 3-3-2008.

CHRISTINE BLOMQUIST, EXAMINING ATTOR-
NEY

Int. Cl.: 35

Prior U.S. Cls.: 100, 101 and 102

United States Patent and Trademark Office

Reg. No. 3,519,645

Registered Oct. 21, 2008

**SERVICE MARK
PRINCIPAL REGISTER**

PPC HERO

HANAPIN MARKETING LLC (INDIANA LIMITED LIABILITY COMPANY)
525 S WALKER ST
BLOOMINGTON, IN 47403

FOR: PROVIDING INFORMATION IN THE FIELD OF ONLINE MARKETING, SPECIFICALLY PAY PER CLICK ADVERTISING, IN CLASS 35 (U.S. CLS. 100, 101 AND 102).

FIRST USE 3-31-2007; IN COMMERCE 3-31-2007.

THE MARK CONSISTS OF STANDARD CHARACTERS WITHOUT CLAIM TO ANY PARTICULAR FONT, STYLE, SIZE, OR COLOR.

NO CLAIM IS MADE TO THE EXCLUSIVE RIGHT TO USE "PPC", APART FROM THE MARK AS SHOWN.

SER. NO. 77-411,635, FILED 3-3-2008.

CHRISIE B. KING, EXAMINING ATTORNEY

Int. Cl.: 10

Prior U.S. Cls.: 26, 39 and 44

United States Patent and Trademark Office

Reg. No. 3,519,646

Registered Oct. 21, 2008

**TRADEMARK
PRINCIPAL REGISTER**

GALIL DIAMOND BURS

DIALOM DIAMOND TOOLS LIMITED (ISRAEL
LIMITED COMPANY (LTD.))

PO BOX 3082

RAMAT GAN, ISRAEL

FOR: DENTAL BURRS, IN CLASS 10 (U.S. CLS. 26,
39 AND 44).

FIRST USE 3-1-1985; IN COMMERCE 3-1-1985.

THE MARK CONSISTS OF STANDARD CHAR-
ACTERS WITHOUT CLAIM TO ANY PARTICULAR
FONT, STYLE, SIZE, OR COLOR.

NO CLAIM IS MADE TO THE EXCLUSIVE
RIGHT TO USE "DIAMOND BURS", APART FROM
THE MARK AS SHOWN.

SER. NO. 77-411,806, FILED 3-3-2008.

BARNEY CHARLON, EXAMINING ATTORNEY

Int. Cls.: 36 and 41

Prior U.S. Cls.: 100, 101, 102 and 107

United States Patent and Trademark Office

Reg. No. 3,519,647

Registered Oct. 21, 2008

**SERVICE MARK
PRINCIPAL REGISTER**

**IMPROVING LIVES THROUGH
FINANCIAL EDUCATION**

MONEY MANAGEMENT INTERNATIONAL,
INC. (TEXAS CORPORATION)
7TH FLOOR
9009 WEST LOOP SOUTH
HOUSTON, TX 77096

FOR: DEBT COUNSELING SERVICES; FINANCIAL MANAGEMENT, NAMELY, MONEY MANAGEMENT SERVICES; CREDIT CONSULTATION; FINANCIAL ANALYSIS AND CONSULTATION; DEBT MANAGEMENT CONSULTATION, IN CLASS 36 (U.S. CLS. 100, 101 AND 102).

FIRST USE 8-31-2007; IN COMMERCE 8-31-2007.

FOR: EDUCATIONAL SERVICES, NAMELY, CONDUCTING CLASSES, COURSES, WORKSHOPS, AND SEMINARS IN THE FIELDS OF MONEY AND

DEBT MANAGEMENT, CREDIT AND DEBT EDUCATION IN THE FIELDS OF BANKRUPTCY AND HOUSING, IN CLASS 41 (U.S. CLS. 100, 101 AND 107).

FIRST USE 8-31-2007; IN COMMERCE 8-31-2007.

THE MARK CONSISTS OF STANDARD CHARACTERS WITHOUT CLAIM TO ANY PARTICULAR FONT, STYLE, SIZE, OR COLOR.

NO CLAIM IS MADE TO THE EXCLUSIVE RIGHT TO USE "FINANCIAL EDUCATION", APART FROM THE MARK AS SHOWN.

SER. NO. 77-412,257, FILED 3-4-2008.

CURTIS FRENCH, EXAMINING ATTORNEY

Int. Cls.: 9 and 42

Prior U.S. Cls.: 21, 23, 26, 36, 38, 100 and 101

United States Patent and Trademark Office

Reg. No. 3,519,648

Registered Oct. 21, 2008

**TRADEMARK
SERVICE MARK
PRINCIPAL REGISTER**

Front Row

FRONT ROW SYSTEMS, INC. (GEORGIA CORPORATION)
3810 MT CARMEL CHURCH RD
MONROE, GA 306555343

FOR: TAX MANAGEMENT DATA COLLECTION SOFTWARE FOR CORPORATE TAX AND ACCOUNTING DEPARTMENTS, IN CLASS 9 (U.S. CLS. 21, 23, 26, 36 AND 38).

FIRST USE 6-1-1993; IN COMMERCE 6-1-1993.

FOR: CONSULTING SERVICES IN THE FIELD OF COMPUTER-BASED INFORMATION SYSTEMS FOR BUSINESSES; COMPUTER SOFTWARE DESIGN, COMPUTER PROGRAMMING, OR MAINTENANCE OF COMPUTER SOFTWARE; ALL OF THE

FORGOING FOR CORPORATE TAX AND ACCOUNTING DEPARTMENTS, IN CLASS 42 (U.S. CLS. 100 AND 101).

FIRST USE 6-1-1993; IN COMMERCE 6-1-1993.

THE COLOR(S) RED IS/ARE CLAIMED AS A FEATURE OF THE MARK.

THE MARK CONSISTS OF A STYLIZED FORM OF THE WORDS "FRONT ROW" IN RED LETTERS.

SER. NO. 77-412,276, FILED 3-4-2008.

G. MAYERSCHOFF, EXAMINING ATTORNEY

Int. Cl.: 43

Prior U.S. Cls.: 100 and 101

United States Patent and Trademark Office

Reg. No. 3,519,649

Registered Oct. 21, 2008

**SERVICE MARK
PRINCIPAL REGISTER**

MACKS

MACK'S PIZZA, INC. (NEW JERSEY CORPORATION)
4200 BOARDWALK
WILDWOOD, NJ 08260

THE MARK CONSISTS OF STANDARD CHARACTERS WITHOUT CLAIM TO ANY PARTICULAR FONT, STYLE, SIZE, OR COLOR.

FOR: RESTAURANT SERVICES, IN CLASS 43
(U.S. CLS. 100 AND 101).

SER. NO. 77-412,496, FILED 3-4-2008.

FIRST USE 1-0-1955; IN COMMERCE 1-0-1955.

MARK SPARACINO, EXAMINING ATTORNEY

Int. Cls.: 35 and 41

Prior U.S. Cls.: 100, 101, 102 and 107

United States Patent and Trademark Office

Reg. No. 3,519,650

Registered Oct. 21, 2008

**SERVICE MARK
PRINCIPAL REGISTER**

Access Best Care

NEBRASKA METHODIST HEALTH SYSTEM,
INC. (NEBRASKA CORPORATION)
8511 WEST DODGE ROAD
OMAHA, NE 68114

FOR: ADMINISTRATION OF A PROGRAM FOR ENABLING PARTICIPANTS TO OBTAIN DISCOUNTS ON GOODS AND SERVICES THROUGH USE OF A DISCOUNT MEMBERSHIP CARD AND MEDICAL BILLING SUPPORT SERVICES, NAMELY, PROVIDING ASSISTANCE WITH MANAGEMENT AND RESOLUTION OF MEDICAL BILLING QUESTIONS, IN CLASS 35 (U.S. CLS. 100, 101 AND 102).

FIRST USE 1-7-2008; IN COMMERCE 1-7-2008.

FOR: PROVIDING AN ONLINE MAGAZINE WITH INFORMATIONAL HEALTH ARTICLES

AND ARRANGING AND CONDUCTING CLASSES AND SEMINARS COVERING HEALTH AND LIFESTYLE IMPROVEMENT RELATED SUBJECTS, IN CLASS 41 (U.S. CLS. 100, 101 AND 107).

FIRST USE 1-7-2008; IN COMMERCE 1-7-2008.

THE MARK CONSISTS OF STANDARD CHARACTERS WITHOUT CLAIM TO ANY PARTICULAR FONT, STYLE, SIZE, OR COLOR.

NO CLAIM IS MADE TO THE EXCLUSIVE RIGHT TO USE "BEST CARE", APART FROM THE MARK AS SHOWN.

SER. NO. 77-412,513, FILED 3-4-2008.

MARK SPARACINO, EXAMINING ATTORNEY

Int. Cl.: 43

Prior U.S. Cls.: 100 and 101

United States Patent and Trademark Office

Reg. No. 3,519,651

Registered Oct. 21, 2008

**SERVICE MARK
PRINCIPAL REGISTER**

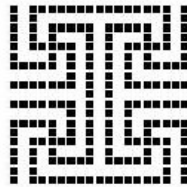

US HOTELS

US HOTELS, INC. (DELAWARE CORPORATION)
C/O LIBRA CAPITAL US, INC.
134 E. 40TH STREET
NEW YORK, NY 10016

FOR: HOTELS, MOTELS, INNS, RESTAURANTS,
BARS, AND CATERING SERVICES; HOTEL, MO-
TEL, INN, RESTAURANT, BAR AND CATERING
SERVICES, IN CLASS 43 (U.S. CLS. 100 AND 101).

FIRST USE 3-3-2008; IN COMMERCE 3-3-2008.

NO CLAIM IS MADE TO THE EXCLUSIVE
RIGHT TO USE "US HOTELS", APART FROM THE
MARK AS SHOWN.

THE MARK CONSISTS OF A TILE DESIGN
ABOVE THE WORDS "US HOTELS".

SER. NO. 77-412,671, FILED 3-4-2008.

TEJBIR SINGH, EXAMINING ATTORNEY

Int. Cl.: 25

Prior U.S. Cls.: 22 and 39

United States Patent and Trademark Office

Reg. No. 3,519,652

Registered Oct. 21, 2008

TRADEMARK
PRINCIPAL REGISTER



EDUCATION PAYS INC (GEORGIA CORPORATION)
9325 BRUMBELOW CROSSING WAY
ALPHARETTA, GA 30022

FOR: T-SHIRTS, IN CLASS 25 (U.S. CLS. 22 AND 39).

FIRST USE 2-1-2008; IN COMMERCE 2-1-2008.

NO CLAIM IS MADE TO THE EXCLUSIVE RIGHT TO USE "INC.", APART FROM THE MARK AS SHOWN.

THE MARK CONSISTS OF A STYLIZED DEPICTION OF THE LETTER "A" WEARING A GRADUATION CAP, HOLDING A REPORT CARD IN ONE HAND AND MONEY IN THE OTHER.

SER. NO. 77-412,802, FILED 3-4-2008.

TOBY BULLOFF, EXAMINING ATTORNEY

Int. Cl.: 16

Prior U.S. Cls.: 2, 5, 22, 23, 29, 37, 38 and 50

Reg. No. 3,519,653

United States Patent and Trademark Office

Registered Oct. 21, 2008

TRADEMARK
PRINCIPAL REGISTER



PARK, GLENNA SANDRA (UNITED STATES INDIVIDUAL), DBA SUPER STAR PARK
13950 GARZA CT.
FT. PIERCE, FL 34951

FOR: POSTERS MADE OF PAPER; BUMPER STICKERS, IN CLASS 16 (U.S. CLS. 2, 5, 22, 23, 29, 37, 38 AND 50).

FIRST USE 12-31-2007; IN COMMERCE 12-31-2007.

THE COLOR(S) PINK AND BLUE IS/ARE CLAIMED AS A FEATURE OF THE MARK.

THE MARK CONSISTS OF A FIVE-POINTED STAR WITH PINK COLOR THROUGHOUT AND,

WITH FOUR DIFFERENT LEVELS AND SIZES OF BLUE STAR-SHAPED OUTLINES TO DEPICT DEPTH, CHARACTER AND OPTICAL ILLUSION. THE WORDING "SUPER STAR PARK" IS THE COLOR PINK WITH A BLUE SHADOW THAT IS OFFSET SLIGHTLY TO THE LEFT AND BOTTOM OF "SUPER STAR PARK" WHILE STILL MAINTAINING CONTACT WITH THAT WORDING, THE WORDING "PROMOTING LOVE, CIVILITY AND PEACE" IS THE COLOR BLUE, AND "WWW.SUPERSTARPARK.COM" IS THE COLOR PINK.

SER. NO. 77-412,836, FILED 3-4-2008.

DANIEL BRODY, EXAMINING ATTORNEY

Int. Cl.: 25

Prior U.S. Cls.: 22 and 39

United States Patent and Trademark Office

Reg. No. 3,519,654

Registered Oct. 21, 2008

**TRADEMARK
PRINCIPAL REGISTER**

**PROFESSIONAL BEER DRINKERS
ASSOCIATION**

CALLUM MACSWEEN (UNITED STATES INDIVIDUAL)
75 RIO VIA
OAKVIEW, CA 93022

FOR: SHORT-SLEEVED OR LONG-SLEEVED T-SHIRTS; TANK TOPS, IN CLASS 25 (U.S. CLS. 22 AND 39).

FIRST USE 6-30-2005; IN COMMERCE 6-30-2005.

THE MARK CONSISTS OF STANDARD CHARACTERS WITHOUT CLAIM TO ANY PARTICULAR FONT, STYLE, SIZE, OR COLOR.

NO CLAIM IS MADE TO THE EXCLUSIVE RIGHT TO USE "ASSOCIATION", APART FROM THE MARK AS SHOWN.

SER. NO. 77-412,917, FILED 3-4-2008.

VERNA BETH RIRIE, EXAMINING ATTORNEY

Int. Cl.: 41

Prior U.S. Cls.: 100, 101 and 107

United States Patent and Trademark Office

Reg. No. 3,519,655

Registered Oct. 21, 2008

**SERVICE MARK
PRINCIPAL REGISTER**

Hollywood Hot Rods

TROY L. LADD (UNITED STATES INDIVIDUAL)
16493 MANCHESTER
APPLE VALLEY, CA 92394

FOR: ENTERTAINMENT SERVICES, NAMELY,
AN ON-GOING SERIES FEATURING AUTOMO-
BILE RELATED SUBJECTS PROVIDED THROUGH
BROADCAST TELEVISION, CABLE TELEVISION,
SATELLITE TELEVISION, AND WEB BASED PRO-
GRAMS, IN CLASS 41 (U.S. CLS. 100, 101 AND 107).

FIRST USE 12-31-1991; IN COMMERCE 1-19-2005.

THE MARK CONSISTS OF STANDARD CHAR-
ACTERS WITHOUT CLAIM TO ANY PARTICULAR
FONT, STYLE, SIZE, OR COLOR.

OWNER OF U.S. REG. NO. 3,312,394.

NO CLAIM IS MADE TO THE EXCLUSIVE
RIGHT TO USE "HOT RODS", APART FROM THE
MARK AS SHOWN.

SER. NO. 77-413,186, FILED 3-5-2008.

JULIE GUTTADAURO, EXAMINING ATTORNEY

Int. Cl.: 36

Prior U.S. Cls.: 100, 101 and 102

United States Patent and Trademark Office

Reg. No. 3,519,656

Registered Oct. 21, 2008

SERVICE MARK
PRINCIPAL REGISTER



T.A.G. INSURANCE AND FINANCIAL SERVICES INC. (CALIFORNIA CORPORATION)
3708 SAN FERNANDO RD.
GLENDALE, CA 91204

FOR: INSURANCE BROKERAGE; LIFE INSURANCE BROKERAGE; MUTUAL FUND BROKERAGE, IN CLASS 36 (U.S. CLS. 100, 101 AND 102).

FIRST USE 4-5-2007; IN COMMERCE 4-5-2007.

NO CLAIM IS MADE TO THE EXCLUSIVE RIGHT TO USE "FIRM" AND "INSURANCE AGENCY" AND "HOME AUTO LIFE WORK", APART FROM THE MARK AS SHOWN.

THE MARK CONSISTS OF A CIRCLE WITH TWO COIL DESIGNS IN IT WITH THE LARGER SPIN-

NING CLOCKWISE, AND A SMALLER ONE INSIDE OF BIG COIL SPINNING COUNTER CLOCK WISE. OUTSIDE OF THE OVERALL CIRCULAR DESIGN ARE THE STYLIZED WORDS "SAFE FIRM" AROUND THE TOP HALF, AND "INSURANCE AGENCY" AROUND THE LOWER PORTION. INSIDE THE CIRCLE BETWEEN THE SPIRAL COILS ARE THE STYLIZED WORDS "HOME", "AUTO", "LIFE", AND "WORK". SEPARATING THE WORDS "SAFE FIRM" AND "INSURANCE AGENCY" ON BOTH SIDES OF THE OVERALL CIRCULAR DESIGN ARE TWO SMALL CIRCLES, EACH CONTAINING THE LETTERS "SF".

SER. NO. 77-413,358, FILED 3-5-2008.

LINDA POWELL, EXAMINING ATTORNEY

Int. Cl.: 8

Prior U.S. Cls.: 23, 28 and 44

United States Patent and Trademark Office

Reg. No. 3,519,657

Registered Oct. 21, 2008

**TRADEMARK
PRINCIPAL REGISTER**

Dominator

MAYHEW STEEL PRODUCTS, INC (MASSACHUSETTS CORPORATION)
199 INDUSTRIAL BLVD
TURNERS FALLS, MA 01376

FOR: EXTENSION BARS FOR HAND TOOLS; HAND TOOLS, NAMELY, RIPPING BARS; EXTENSIONS FOR HAND TOOLS; HAND TOOLS, NAMELY, ADZES; HAND TOOLS, NAMELY, AWLS; HAND TOOLS, NAMELY, NAIL SETS; HAND TOOLS, NAMELY, NUT DRIVERS; HAND TOOLS, NAMELY, PICKS; HAND TOOLS, NAMELY, PUNCHES; HAND TOOLS, NAMELY, SCRAPERS; HAND TOOLS, NAMELY, SCREWDRIVERS; HAND-OPERATED CUTTING TOOLS; HAND-OPERATED

TOOLS, NAMELY, CHISELS; MANUALLY OPERATED TOOLS, NAMELY, SHEET BENDING BRAKES AND COMPONENTS THEREOF, IN CLASS 8 (U.S. CLS. 23, 28 AND 44).

FIRST USE 1-1-2000; IN COMMERCE 1-1-2000.

THE MARK CONSISTS OF STANDARD CHARACTERS WITHOUT CLAIM TO ANY PARTICULAR FONT, STYLE, SIZE, OR COLOR.

SER. NO. 77-413,604, FILED 3-5-2008.

TASHIA BUNCH, EXAMINING ATTORNEY

Int. Cl.: 35

Prior U.S. Cls.: 100, 101 and 102

United States Patent and Trademark Office

Reg. No. 3,519,658

Registered Oct. 21, 2008

**SERVICE MARK
PRINCIPAL REGISTER**

DRIVING SUCCESS.

FIRST NATIONAL OF NEBRASKA, INC. (NE-
BRASKA CORPORATION)
STOP 3290
1620 DODGE STREET
OMAHA, NE 681973290

THE MARK CONSISTS OF STANDARD CHAR-
ACTERS WITHOUT CLAIM TO ANY PARTICULAR
FONT, STYLE, SIZE, OR COLOR.

FOR: ACQUISITION AND MERGER CONSULTA-
TION, IN CLASS 35 (U.S. CLS. 100, 101 AND 102).

SER. NO. 77-413,645, FILED 3-5-2008.

FIRST USE 3-1-2007; IN COMMERCE 3-1-2007.

IRA J. GOODSID, EXAMINING ATTORNEY

Int. Cl.: 41

Prior U.S. Cls.: 100, 101 and 107

United States Patent and Trademark Office

Reg. No. 3,519,659

Registered Oct. 21, 2008

**SERVICE MARK
PRINCIPAL REGISTER**

POSTIE

IZEA, INC. (DELAWARE CORPORATION)
150 N. ORANGE AVENUE, SUITE 304
ORLANDO, FL 32801

FOR: PROVIDING ONLINE BLOG CONTENT
FEATURING COMMENTARY AND CONVERSATIONS
PERTAINING TO WEBSITES, SOCIAL MEDIA
AND CONSUMER PRODUCTS AND SERVICES,
IN CLASS 41 (U.S. CLS. 100, 101 AND 107).

FIRST USE 4-14-2008; IN COMMERCE 4-14-2008.

THE MARK CONSISTS OF STANDARD CHARACTERS
WITHOUT CLAIM TO ANY PARTICULAR
FONT, STYLE, SIZE, OR COLOR.

SER. NO. 77-413,768, FILED 3-5-2008.

AISHA CLARKE, EXAMINING ATTORNEY

Int. Cl.: 36

Prior U.S. Cls.: 100, 101 and 102

United States Patent and Trademark Office

Reg. No. 3,519,660

Registered Oct. 21, 2008

**SERVICE MARK
PRINCIPAL REGISTER**

ACTS 1:8 FOUNDATION

ACTS 1:8 MINISTRY, INCORPORATED (WIS-
CONSIN CORPORATION)

2121 S. ONEIDA STREET

GREEN BAY, WI 54304

FOR: CHARITABLE FOUNDATION SERVICES,
NAMELY, FUND RAISING AND PHILANTHROPIC
SERVICES CONCERNING MONETARY DONA-
TIONS, IN CLASS 36 (U.S. CLS. 100, 101 AND 102).

FIRST USE 12-30-2005; IN COMMERCE 12-30-2005.

THE MARK CONSISTS OF STANDARD CHAR-
ACTERS WITHOUT CLAIM TO ANY PARTICULAR
FONT, STYLE, SIZE, OR COLOR.

OWNER OF U.S. REG. NO. 3,224,164.

NO CLAIM IS MADE TO THE EXCLUSIVE
RIGHT TO USE "FOUNDATION", APART FROM
THE MARK AS SHOWN.

SER. NO. 77-413,776, FILED 3-5-2008.

AISHA CLARKE, EXAMINING ATTORNEY

Int. Cl.: 43

Prior U.S. Cls.: 100 and 101

United States Patent and Trademark Office

Reg. No. 3,519,661

Registered Oct. 21, 2008

**SERVICE MARK
PRINCIPAL REGISTER**

R-WILD HORSE RANCH

R-WILD HORSE RANCH (CALIFORNIA CORPORATION)
6700 HWY 36 W
PLATINA, CA 96076

FOR: PRIVATE RESIDENCE CLUB SERVICES, NAMELY, PROVISION TO CLUB MEMBERS OF TEMPORARY ACCOMMODATIONS IN COMPANY OWNED PRIVATE RESIDENCES LOCATED ON A HORSE RANCH WHERE MEMBERS HAVE FULL USE OF THE PROPERTY, HORSES AND ALL RECREATIONAL ACTIVITIES AVAILABLE, IN CLASS 43 (U.S. CLS. 100 AND 101).

FIRST USE 5-20-1985; IN COMMERCE 5-20-1985.

THE MARK CONSISTS OF STANDARD CHARACTERS WITHOUT CLAIM TO ANY PARTICULAR FONT, STYLE, SIZE, OR COLOR.

NO CLAIM IS MADE TO THE EXCLUSIVE RIGHT TO USE "HORSE RANCH", APART FROM THE MARK AS SHOWN.

SER. NO. 77-413,946, FILED 3-5-2008.

AMY GEARIN, EXAMINING ATTORNEY

Int. Cl.: 43

Prior U.S. Cls.: 100 and 101

United States Patent and Trademark Office

Reg. No. 3,519,662

Registered Oct. 21, 2008

**SERVICE MARK
PRINCIPAL REGISTER**



R-WILD HORSE RANCH (CALIFORNIA CORPORATION)
6700 HWY 36 W
PLATINA, CA 96076

FOR: PRIVATE RESIDENCE CLUB SERVICES, NAMELY, PROVISION TO CLUB MEMBERS OF TEMPORARY ACCOMMODATIONS IN COMPANY OWNED PRIVATE RESIDENCES LOCATED ON A HORSE RANCH WHERE MEMBERS HAVE FULL USE OF THE PROPERTY, HORSES AND ALL

RECREATIONAL ACTIVITIES AVAILABLE, IN CLASS 43 (U.S. CLS. 100 AND 101).

FIRST USE 5-20-1985; IN COMMERCE 5-20-1985.

THE MARK CONSISTS OF A STYLIZED SIDE VIEW OF A HORSES HEAD IN A CIRCLE.

SER. NO. 77-413,970, FILED 3-5-2008.

AMY GEARIN, EXAMINING ATTORNEY

Int. Cl.: 3

Prior U.S. Cls.: 1, 4, 6, 50, 51 and 52

Reg. No. 3,519,663

United States Patent and Trademark Office

Registered Oct. 21, 2008

**TRADEMARK
PRINCIPAL REGISTER**

THE OLIVE HARVEST

CONSUMER PRODUCTS DESIGN, LTD (NEW
YORK CORPORATION)
SUITE 2320
60 EAST 42ND STREET
NEW YORK, NY 10165

FOR: NON-MEDICATED SKIN CARE PREPARA-
TIONS; BATH SOAPS IN LIQUID, SOLID OR GEL
FORM; FRAGRANCES FOR PERSONAL USE;
HOUSEHOLD CLEANING PREPARATIONS; HAIR
CARE PREPARATIONS; ROOM FRAGRANCES, IN
CLASS 3 (U.S. CLS. 1, 4, 6, 50, 51 AND 52).

FIRST USE 3-3-2008; IN COMMERCE 3-3-2008.

THE MARK CONSISTS OF STANDARD CHAR-
ACTERS WITHOUT CLAIM TO ANY PARTICULAR
FONT, STYLE, SIZE, OR COLOR.

NO CLAIM IS MADE TO THE EXCLUSIVE
RIGHT TO USE "OLIVE", APART FROM THE
MARK AS SHOWN.

SER. NO. 77-414,034, FILED 3-5-2008.

TRACY CROSS, EXAMINING ATTORNEY

Int. Cl.: 16

Prior U.S. Cls.: 2, 5, 22, 23, 29, 37, 38 and 50

Reg. No. 3,519,664

United States Patent and Trademark Office

Registered Oct. 21, 2008

**TRADEMARK
PRINCIPAL REGISTER**

BULLETPROOF

ARBOGAST PROPERTY MANAGEMENT, LLC
(WYOMING LIMITED LIABILITY COMPANY)
PO BOX 759
GENOA, NV 89411

FOR: BOOKS IN THE FIELD OF LAW, ASSET PROTECTION, FORMATION OF BUSINESS STRUCTURES INCLUDING INCORPORATING CORPORATIONS, LIMITED LIABILITY COMPANIES, LIMITED PARTNERSHIPS AND OTHER BUSINESS ENTITIES, PATENTS, TRADEMARKS, PERSONAL FINANCE, LEGAL SELF-HELP, BRAND SELECTION, MARKETING, BUSINESS, IN CLASS 16 (U.S. CLS. 2, 5, 22, 23, 29, 37, 38 AND 50).

FIRST USE 9-14-2007; IN COMMERCE 9-14-2007.

THE MARK CONSISTS OF STANDARD CHARACTERS WITHOUT CLAIM TO ANY PARTICULAR FONT, STYLE, SIZE, OR COLOR.

OWNER OF U.S. REG. NOS. 1,808,859 AND 3,381,466.

SER. NO. 77-414,188, FILED 3-5-2008.

MARY ROSSMAN, EXAMINING ATTORNEY

Int. Cls.: 35 and 41

Prior U.S. Cls.: 100, 101, 102 and 107

United States Patent and Trademark Office

Reg. No. 3,519,665

Registered Oct. 21, 2008

**SERVICE MARK
PRINCIPAL REGISTER**



SALES AND MARKETING EXECUTIVES INTERNATIONAL, INC. (NEW YORK CORPORATION)
726 CHERRY STREET
SUMAS, WA 98295

FOR: PROMOTING THE INTERESTS AND CONCERNS OF SALES AND MARKETING PROFESSIONALS, IN CLASS 35 (U.S. CLS. 100, 101 AND 102).

FIRST USE 9-15-2002; IN COMMERCE 9-15-2002.

FOR: EDUCATIONAL SERVICES FOR SALES AND MARKETING PROFESSIONALS IN THE NATURE OF CONFERENCES, SEMINARS, LECTURES,

AND CLASSES IN THE FIELDS OF SALES AND MARKETING, IN CLASS 41 (U.S. CLS. 100, 101 AND 107).

FIRST USE 9-15-2002; IN COMMERCE 9-15-2002.

THE MARK CONSISTS OF THREE INTERSECTING CRESCENTS, A DOT AND THE LETTERS "SMEI".

SER. NO. 77-414,419, FILED 3-6-2008.

STEPHEN AQUILA, EXAMINING ATTORNEY

Int. Cl.: 41

Prior U.S. Cls.: 100, 101 and 107

United States Patent and Trademark Office

Reg. No. 3,519,666

Registered Oct. 21, 2008

**SERVICE MARK
PRINCIPAL REGISTER**



COLUMBIA BOOKS, INC. (D.C. CORPORATION)
SUITE 110
8120 WOODMONT AVENUE
BETHESDA, MD 20814

FOR: BI-WEEKLY EMAIL NEWSLETTER CONTAINING NEWS AND INFORMATION ON FEDERAL GOVERNMENT RELATIONS AND LOBBYING INDUSTRY, IN CLASS 41 (U.S. CLS. 100, 101 AND 107).

FIRST USE 1-7-2008; IN COMMERCE 1-7-2008.

NO CLAIM IS MADE TO THE EXCLUSIVE RIGHT TO USE "GOVERNMENT RELATIONS" AND "LOBBYISTS INFO", APART FROM THE MARK AS SHOWN.

THE COLOR(S) RED, WHITE, BLUE, YELLOW IS/ ARE CLAIMED AS A FEATURE OF THE MARK.

THE MARK CONSISTS OF A BLUE BANNER CONTAINING A DEPICTION OF THE U.S. CAPITOL DOME WITH THE LETTERS "GOVERNMENT RELATIONS" IN WHITE AND THE WORDS THE AND "ALERT" IN YELLOW OVER A RED BANNER BEARING THE WORDS "LOBBYISTS.INFO" IN WHITE.

SER. NO. 77-414,435, FILED 3-6-2008.

GRETТА YAO, EXAMINING ATTORNEY

Int. Cl.: 37

Prior U.S. Cls.: 100, 103 and 106

United States Patent and Trademark Office

Reg. No. 3,519,667

Registered Oct. 21, 2008

**SERVICE MARK
PRINCIPAL REGISTER**

THE EURO BOND SYSTEM

CONCRETE TECHNOLOGY, INC. (FLORIDA
CORPORATION)
8770 133RD AVENUE NORTH
LARGO, FL 33773

FOR: REMODELING OF KITCHEN COUNTER-
TOPS; RENOVATION IN THE FIELD OF KITCHEN
COUNTERTOPS, IN CLASS 37 (U.S. CLS. 100, 103
AND 106).

FIRST USE 2-22-2008; IN COMMERCE 2-22-2008.

THE MARK CONSISTS OF STANDARD CHAR-
ACTERS WITHOUT CLAIM TO ANY PARTICULAR
FONT, STYLE, SIZE, OR COLOR.

NO CLAIM IS MADE TO THE EXCLUSIVE
RIGHT TO USE "BOND SYSTEM", APART FROM
THE MARK AS SHOWN.

SER. NO. 77-414,445, FILED 3-6-2008.

ESTHER BELENKER, EXAMINING ATTORNEY

Int. Cl.: 41

Prior U.S. Cls.: 100, 101 and 107

United States Patent and Trademark Office

Reg. No. 3,519,668

Registered Oct. 21, 2008

**SERVICE MARK
PRINCIPAL REGISTER**

**AMERICA'S SIMPLEST
PARENTING PROGRAM**

PARENTMAGIC, INC. (ILLINOIS CORPORATION)

B-309

800 ROOSEVELT ROAD
GLEN ELLYN, IL 60137

FOR: EDUCATIONAL SERVICES, NAMELY, CONDUCTING CLASSES, SEMINARS AND WORKSHOPS IN THE FIELD OF PARENTING AND CHILD DISCIPLINE AND DISSEMINATION OF COURSE MATERIALS IN CONNECTION THEREWITH; EDUCATIONAL SERVICES, NAMELY, CONDUCTING PROGRAMS AND WORKSHOPS FOR TRAINERS IN THE FIELD OF PARENTING AND CHILD DISCIPLINE AND DISSEMINATION OF COURSE MATERIALS IN CONNECTION THEREWITH, IN CLASS 41 (U.S. CLS. 100, 101 AND 107).

FIRST USE 11-7-2007; IN COMMERCE 11-7-2007.

THE MARK CONSISTS OF STANDARD CHARACTERS WITHOUT CLAIM TO ANY PARTICULAR FONT, STYLE, SIZE, OR COLOR.

NO CLAIM IS MADE TO THE EXCLUSIVE RIGHT TO USE "PARENTING PROGRAM", APART FROM THE MARK AS SHOWN.

SER. NO. 77-414,474, FILED 3-6-2008.

TAMARA FRAZIER, EXAMINING ATTORNEY

Int. Cls.: 35 and 36

Prior U.S. Cls.: 100, 101 and 102

United States Patent and Trademark Office

Reg. No. 3,519,669

Registered Oct. 21, 2008

**SERVICE MARK
PRINCIPAL REGISTER**



VERACITY WORLDWIDE LLC (DELAWARE
LIMITED LIABILITY COMPANY)
28 W 44TH ST. SUITE 1014
NEW YORK, NY 10036

FOR: BUSINESS INVESTIGATIONS; BUSINESS
RISK MANAGEMENT CONSULTATION, IN CLASS
35 (U.S. CLS. 100, 101 AND 102).

FIRST USE 2-1-2007; IN COMMERCE 4-1-2007.

FOR: FINANCIAL DUE DILIGENCE, IN CLASS 36
(U.S. CLS. 100, 101 AND 102).

FIRST USE 2-1-2007; IN COMMERCE 4-1-2007.

NO CLAIM IS MADE TO THE EXCLUSIVE
RIGHT TO USE "WORLDWIDE" AND "GLOBAL
MARKET INTELLIGENCE", APART FROM THE
MARK AS SHOWN.

THE MARK CONSISTS OF STYLIZED IMAGE OF
A SEXTANT BETWEEN THE WORDS "VERACITY"
AND "WORLDWIDE".

SER. NO. 77-414,960, FILED 3-6-2008.

JAY FLOWERS, EXAMINING ATTORNEY

Int. Cl.: 41

Prior U.S. Cls.: 100, 101 and 107

United States Patent and Trademark Office

Reg. No. 3,519,670

Registered Oct. 21, 2008

**SERVICE MARK
PRINCIPAL REGISTER**

Blue Max Dog

CAROL C. AHEARN (UNITED STATES INDIVIDUAL)

120 WALPOLE STREET

NORWOOD, MA 02062

FOR: DOG TRAINING, IN CLASS 41 (U.S. CLS. 100, 101 AND 107).

FIRST USE 4-15-2003; IN COMMERCE 4-15-2003.

THE MARK CONSISTS OF STANDARD CHARACTERS WITHOUT CLAIM TO ANY PARTICULAR FONT, STYLE, SIZE, OR COLOR.

NO CLAIM IS MADE TO THE EXCLUSIVE RIGHT TO USE "DOG", APART FROM THE MARK AS SHOWN.

SER. NO. 77-415,051, FILED 3-6-2008.

BERYL GARDNER, EXAMINING ATTORNEY

Int. Cl.: 44

Prior U.S. Cls.: 100 and 101

United States Patent and Trademark Office

Reg. No. 3,519,671

Registered Oct. 21, 2008

**SERVICE MARK
PRINCIPAL REGISTER**

HopeFoil Project

MEDICINE HORSE PROGRAM (COLORADO
NON-PROFIT CORPORATION)

8778 ARAPAHOE ROAD

BOULDER, CO 80303

FOR: MENTAL HEALTH SERVICES, IN CLASS 44
(U.S. CLS. 100 AND 101).

FIRST USE 10-15-2002; IN COMMERCE 10-15-2002.

THE MARK CONSISTS OF STANDARD CHAR-
ACTERS WITHOUT CLAIM TO ANY PARTICULAR
FONT, STYLE, SIZE, OR COLOR.

NO CLAIM IS MADE TO THE EXCLUSIVE
RIGHT TO USE "PROJECT", APART FROM THE
MARK AS SHOWN.

SER. NO. 77-415,173, FILED 3-6-2008.

KATHLEEN LORENZO, EXAMINING ATTORNEY

Int. Cl.: 30

Prior U.S. Cl.: 46

United States Patent and Trademark Office

Reg. No. 3,519,672

Registered Oct. 21, 2008

**TRADEMARK
PRINCIPAL REGISTER**

PANTRY CANDIES

HAMMOND'S CANDIES SINCE 1920 II, LLC
(COLORADO LIMITED LIABILITY COMPA-
NY)

5735 N. WASHINGTON ST.

DENVER, CO 80216

FOR: CANDY, IN CLASS 30 (U.S. CL. 46).

FIRST USE 1-31-2006; IN COMMERCE 1-31-2006.

THE MARK CONSISTS OF STANDARD CHAR-
ACTERS WITHOUT CLAIM TO ANY PARTICULAR
FONT, STYLE, SIZE, OR COLOR.

NO CLAIM IS MADE TO THE EXCLUSIVE
RIGHT TO USE "CANDIES", APART FROM THE
MARK AS SHOWN.

SER. NO. 77-415,338, FILED 3-6-2008.

KATHLEEN LORENZO, EXAMINING ATTORNEY

Int. Cl.: 14

Prior U.S. Cls.: 2, 27, 28 and 50

United States Patent and Trademark Office

Reg. No. 3,519,673

Registered Oct. 21, 2008

**TRADEMARK
PRINCIPAL REGISTER**

SUSAN HELMICH

HELMICH, SUSAN (UNITED STATES INDIVIDUAL)
P.O. BOX 1194
MONUMENT, CO 80132

FOR: JEWELRY, NAMELY, PENDANTS, BROOCHES, NAMELY, BROOCHES FOR WOMEN AND TIE TACKS FOR MEN, EARRINGS, NECKLACES, RINGS, CHARMS, LAPEL PINS, BRACELETS AND CUFFLINKS, IN CLASS 14 (U.S. CLS. 2, 27, 28 AND 50).

FIRST USE 9-1-1974; IN COMMERCE 9-1-1974.

THE MARK CONSISTS OF STANDARD CHARACTERS WITHOUT CLAIM TO ANY PARTICULAR FONT, STYLE, SIZE, OR COLOR.

THE NAME(S), PORTRAIT(S), AND/OR SIGNATURE(S) SHOWN IN THE MARK IDENTIFIES "SUSAN HELMICH", WHOSE CONSENT(S) TO REGISTER IS SUBMITTED.

SER. NO. 77-415,346, FILED 3-6-2008.

MARY MUNSON, EXAMINING ATTORNEY

Int. Cl.: 35

Prior U.S. Cls.: 100, 101 and 102

United States Patent and Trademark Office

Reg. No. 3,519,674

Registered Oct. 21, 2008

**SERVICE MARK
PRINCIPAL REGISTER**

CHEMSOURCE TECHNOLOGIES

CHEMSOURCE TECHNOLOGIES, LLC (DELA-
WARE LIMITED LIABILITY COMPANY)
SUITE 130
201 8TH STREET
SEAL BEACH, CA 90740

FOR: DISTRIBUTORSHIPS FEATURING BUILD-
ING CONSTRUCTION MATERIALS, CEMENT AND
CONCRETE-BASED PRODUCTS, ADHESIVES AND
COATINGS, IN CLASS 35 (U.S. CLS. 100, 101 AND
102).

FIRST USE 1-26-2007; IN COMMERCE 1-26-2007.

THE MARK CONSISTS OF STANDARD CHAR-
ACTERS WITHOUT CLAIM TO ANY PARTICULAR
FONT, STYLE, SIZE, OR COLOR.

NO CLAIM IS MADE TO THE EXCLUSIVE
RIGHT TO USE "TECHNOLOGIES", APART FROM
THE MARK AS SHOWN.

SER. NO. 77-415,371, FILED 3-6-2008.

EVELYN BRADLEY, EXAMINING ATTORNEY

Int. Cl.: 5

Prior U.S. Cls.: 6, 18, 44, 46, 51 and 52

Reg. No. 3,519,675

United States Patent and Trademark Office

Registered Oct. 21, 2008

**TRADEMARK
PRINCIPAL REGISTER**

MACA MIRACLE

ADREZIN, BJ (UNITED STATES INDIVIDUAL)
5835 SW CORBETT AVENUE
PORTLAND, OR 97239

FOR: DIETARY AND NUTRITIONAL SUPPLEMENTS AND FOOD SUPPLEMENTS IN SOLID, CRACKER, POWDER, LIQUID DRINK AND SNACK BAR FORM, IN CLASS 5 (U.S. CLS. 6, 18, 44, 46, 51 AND 52).

FIRST USE 1-15-2008; IN COMMERCE 1-15-2008.

THE MARK CONSISTS OF STANDARD CHARACTERS WITHOUT CLAIM TO ANY PARTICULAR FONT, STYLE, SIZE, OR COLOR.

NO CLAIM IS MADE TO THE EXCLUSIVE RIGHT TO USE "MACA", APART FROM THE MARK AS SHOWN.

SER. NO. 77-415,392, FILED 3-6-2008.

KAPIL BHANOT, EXAMINING ATTORNEY

Int. Cl.: 37

Prior U.S. Cls.: 100, 103 and 106

United States Patent and Trademark Office

Reg. No. 3,519,676

Registered Oct. 21, 2008

SERVICE MARK
PRINCIPAL REGISTER



DETECTION LOGIC FIRE PROTECTION, INC.
(CALIFORNIA CORPORATION)
7605 N. SAN FERNANDO ROAD
BURBANK, CA 91505

FOR: INSTALLATION AND MAINTENANCE OF BURGLAR AND/OR FIRE ALARMS; INSTALLATION AND MAINTENANCE OF FIRE ALARM, DETECTION AND SUPPRESSION SYSTEMS; REPAIR OR MAINTENANCE OF FIRE ALARMS, IN CLASS 37 (U.S. CLS. 100, 103 AND 106).

FIRST USE 3-1-2006; IN COMMERCE 3-1-2006.

OWNER OF U.S. REG. NO. 3,388,088.

NO CLAIM IS MADE TO THE EXCLUSIVE RIGHT TO USE "DETECTION" AND "FIRE PRO-

TECTION INC.", APART FROM THE MARK AS SHOWN.

THE COLOR(S) BLUE AND RED IS/ARE CLAIMED AS A FEATURE OF THE MARK.

THE COLOR BLUE APPEARS IN THE WORDING "DETECTION LOGIC" AND "FIRE PROTECTION, INC.", WITH A RED SQUIGGLE DESIGN RUNNING UNDERNEATH AND IN BETWEEN THE WORDS "DETECTION" AND "LOGIC" AND THE WORDS "FIRE PROTECTION, INC." ARE BENEATH THAT.

SER. NO. 77-415,460, FILED 3-6-2008.

ASMAT KHAN, EXAMINING ATTORNEY

Int. Cl.: 25

Prior U.S. Cls.: 22 and 39

United States Patent and Trademark Office

Reg. No. 3,519,677

Registered Oct. 21, 2008

TRADEMARK
PRINCIPAL REGISTER



SPYDER ACTIVE SPORTS, INC. (COLORADO CORPORATION)
4725 WALNUT ST.
BOULDER, CO 80301

FOR: FOOTWEAR; HEADWEAR; CLOTHING, NAMELY, JACKETS, WIND-RESISTANT JACKETS, WATERPROOF JACKETS, WATERPROOF PANTS, SHORTS, PANTS, HATS, VESTS, WIND-RESISTANT VESTS, SHIRTS, SHELL JACKETS, PULLOVERS, BUTTON SHIRTS, SWEATERS, FLEECE JACKETS, MITTENS, GLOVES, SWEATSHIRTS, HOODED SWEATSHIRTS, INSULATED PANTS, WATER-PROOF PANTS, UNDERWEAR, TIGHTS, KNICKERS, T-SHIRTS, TANK TOPS, BALACLAVAS, NECK

GAITER, CAPS, FISHING WADERS, BUTTON SHIRTS, GAITERS, VISORS; BOOTS; WADER BOOTS, IN CLASS 25 (U.S. CLS. 22 AND 39).

FIRST USE 7-1-1997; IN COMMERCE 7-1-1997.

OWNER OF U.S. REG. NO. 2,278,756.

THE MARK CONSISTS OF STYLIZED "C" ENCIRCLING AN ABSTRACT "M" AND "W".

SER. NO. 77-415,503, FILED 3-6-2008.

PAULA MAHONEY, EXAMINING ATTORNEY

Int. Cl.: 16

Prior U.S. Cls.: 2, 5, 22, 23, 29, 37, 38 and 50

Reg. No. 3,519,678

United States Patent and Trademark Office

Registered Oct. 21, 2008

TRADEMARK
PRINCIPAL REGISTER



NEW CREATIONS CUSTOM DESIGNS FOR
KINGDOM LIVING, LLP (MARYLAND LIM-
ITED LIABILITY PARTNERSHIPS)
429 GREENLOW ROAD
CATONSVILLE, MD 21228

FOR: EDUCATIONAL PUBLICATIONS, NAME-
LY, EDUCATIONAL LEARNING CARDS, FLASH
CARDS, ACTIVITY CARDS, WORKBOOKS, TEXT-
BOOKS, ACTIVITY BOOKS, STORY BOOKS, PUZ-
ZLE BOOKS, PRINTED PUZZLES, TEACHER
GUIDES, MANUALS, POSTERS, EDUCATIONAL
CARD GAMES AND EDUCATIONAL BOOKLETS
IN THE FIELD OF CHRISTIAN BIBLICAL STUDY,
IN CLASS 16 (U.S. CLS. 2, 5, 22, 23, 29, 37, 38 AND 50).

FIRST USE 0-0-2002; IN COMMERCE 3-1-2008.

NO CLAIM IS MADE TO THE EXCLUSIVE
RIGHT TO USE "SCRIPTURE" "PRAYER" AND
"FOR THE SHOWER, HOME, OFFICE & CAR",
APART FROM THE MARK AS SHOWN.

THE COLOR(S) GOLD, NAVY BLUE, ORANGE-
RED, BURGUNDY, BLACK AND OLIVE GREEN IS/
ARE CLAIMED AS A FEATURE OF THE MARK.

THE MARK CONSISTS OF LETTERS IN "SCRIP-
TURE YOUR SPACE" IN NAVY BLUE IN KOZUKA
GOTHIC PRO "L" FONT, LETTERS IN "INSPIRA-
TIONAL PRAYER TOOLS" IN ORANGE-RED IN
THE NUEVA STD CONDENSED FONT, A CURVED
RIBBON-LIKE LINE IN GOLD CURVING LIKE THE
LETTER "C", COMING TO A PEAK THEN GOING
STRAIGHT DOWN WITH A SLIGHT CURVE UP,
THIS CURVED RIBBON-LIKE GOLD LINE IS NEXT
TO THE LETTER "Y" IN "YOUR", A BUTTERFLY
WITH A BLACK DOT FOR THE HEAD, 2 OLIVE
GREEN ANTENNAE, ONE BURGUNDY WING
AND ONE ORANGE-RED WING ON TOP OF THIS
RIBBON-LIKE GOLD LINE, LETTERS IN "FOR THE
SHOWER, HOME, OFFICE & CAR" IN BLACK IN
THE KOZUKA GOTHIC PRO EL FONT.

SER. NO. 77-415,623, FILED 3-6-2008.

SKYE YOUNG, EXAMINING ATTORNEY

Int. Cl.: 12

Prior U.S. Cls.: 19, 21, 23, 31, 35 and 44

Reg. No. 3,519,679

United States Patent and Trademark Office

Registered Oct. 21, 2008

**TRADEMARK
PRINCIPAL REGISTER**

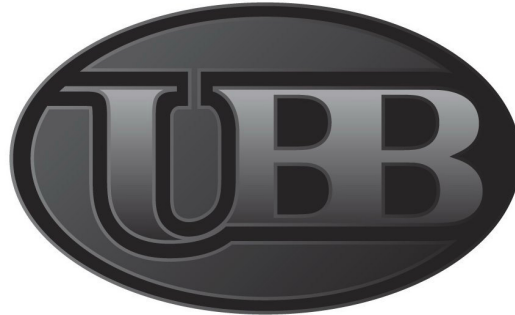

PORTER, TIMOTHY (UNITED KINGDOM INDIVIDUAL)
HIGH TREES, FARTHING HILL
HORSHAM, UNITED KINGDOM RH121TS

THE MARK CONSISTS OF A CIRCULAR SHAPE
CONTAINING THE LETTERS "UBB".

FOR: CARS; RACING CARS; RACING MOTOR
CARS, IN CLASS 12 (U.S. CLS. 19, 21, 23, 31, 35 AND
44).

SER. NO. 77-415,695, FILED 3-7-2008.

FIRST USE 1-10-2008; IN COMMERCE 1-10-2008.

AHSEN KHAN, EXAMINING ATTORNEY

Int. Cl.: 40

Prior U.S. Cls.: 100, 103 and 106

United States Patent and Trademark Office

Reg. No. 3,519,680

Registered Oct. 21, 2008

SERVICE MARK
PRINCIPAL REGISTER



CAFFREY, SHELBY (UNITED STATES INDIVIDUAL)
123 WOODBINE AVENUE
STATEN ISLAND, NY 10314

FOR: CUSTOM CONSTRUCTION OF PICTURE BOOKS FOR CHILDREN; PRINTING OF BOOKS, IN CLASS 40 (U.S. CLS. 100, 103 AND 106).

FIRST USE 3-2-2008; IN COMMERCE 3-2-2008.

NO CLAIM IS MADE TO THE EXCLUSIVE RIGHT TO USE "BABY", APART FROM THE MARK AS SHOWN.

THE MARK CONSISTS OF AN IMAGE OF A DEVIL BABY. TO THE RIGHT OF THE IMAGE IS THE STYLIZED WORDS "THE DEVIL BABY". A DEVIL TAIL COMING OUT OF THE "Y" AND HORNS ON THE "A".

SER. NO. 77-415,808, FILED 3-7-2008.

B. PARADEWELAI, EXAMINING ATTORNEY

Int. Cl.: 35

Prior U.S. Cls.: 100, 101 and 102

United States Patent and Trademark Office

Reg. No. 3,519,681

Registered Oct. 21, 2008

**SERVICE MARK
PRINCIPAL REGISTER**

The Excellent Leader

EXCELLENCE IN BUSINESS, INC. (OREGON
CORPORATION)
21210 BOONES FERRY ROAD NE
AURORA, OR 97002

FOR: BUSINESS MANAGEMENT CONSULTA-
TION IN THE FIELD OF EXECUTIVE AND LEA-
DERSHIP DEVELOPMENT; BUSINESS
MANAGEMENT CONSULTING IN THE FIELD OF
TEAM DEVELOPMENT, IN CLASS 35 (U.S. CLS. 100,
101 AND 102).

FIRST USE 11-11-2006; IN COMMERCE 7-30-2007.

THE MARK CONSISTS OF STANDARD CHAR-
ACTERS WITHOUT CLAIM TO ANY PARTICULAR
FONT, STYLE, SIZE, OR COLOR.

SER. NO. 77-416,076, FILED 3-7-2008.

MARK PILARO, EXAMINING ATTORNEY

Int. Cl.: 20

Prior U.S. Cls.: 2, 13, 22, 25, 32 and 50

Reg. No. 3,519,682

United States Patent and Trademark Office

Registered Oct. 21, 2008

**TRADEMARK
PRINCIPAL REGISTER**

LEVOLOR

NEWELL OPERATING COMPANY (DELAWARE
CORPORATION)
10B GLENLAKE PKWY., SUITE 600
ATLANTA, GA 30328

FOR: VENETIAN AND VERTICAL WINDOW
BLINDS; ROLL UP AND BEAD CHAIN WINDOW
SHADES; SAMPLERS IN THE NATURE OF DIS-
PLAYS CONSISTING OF SMALL SIZE WINDOW
BLINDS OF ALL TYPES AND OPERATING HARD-
WARE FOR SUCH BLINDS SOLD AS A UNIT
THEREWITH, USED FOR ILLUSTRATIVE AND
DEMONSTRATION PURPOSES; DECKS OF WIN-
DOW BLIND SLAT SEGMENTS FOR COLOR IL-

LUSTRATION PURPOSES, IN CLASS 20 (U.S. CLS. 2,
13, 22, 25, 32 AND 50).

FIRST USE 1-21-1941; IN COMMERCE 1-21-1941.

THE MARK CONSISTS OF STANDARD CHAR-
ACTERS WITHOUT CLAIM TO ANY PARTICULAR
FONT, STYLE, SIZE, OR COLOR.

SER. NO. 77-416,082, FILED 3-7-2008.

MELISSA VALLILLO, EXAMINING ATTORNEY

Int. Cl.: 20

Prior U.S. Cls.: 2, 13, 22, 25, 32 and 50

Reg. No. 3,519,683

United States Patent and Trademark Office

Registered Oct. 21, 2008

**TRADEMARK
PRINCIPAL REGISTER**

LEVOLOR

NEWELL OPERATING COMPANY (DELAWARE
CORPORATION)
10B GLENLAKE PKWY., SUITE 600
ATLANTA, GA 30328

THE MARK CONSISTS OF STANDARD CHAR-
ACTERS WITHOUT CLAIM TO ANY PARTICULAR
FONT, STYLE, SIZE, OR COLOR.

FOR: PLEATED, SPRING ROLLER, AND ROLL-
UP WINDOW SHADES ALL MADE OF FABRIC, IN
CLASS 20 (U.S. CLS. 2, 13, 22, 25, 32 AND 50).

SER. NO. 77-416,287, FILED 3-7-2008.

FIRST USE 5-11-1954; IN COMMERCE 5-11-1954.

MELISSA VALLILLO, EXAMINING ATTORNEY

Int. Cl.: 42

Prior U.S. Cls.: 100 and 101

United States Patent and Trademark Office

Reg. No. 3,519,684

Registered Oct. 21, 2008

**SERVICE MARK
PRINCIPAL REGISTER**

**CONTAINING IMPROVING
SUSTAINING**

PREFERRED SOURCING LLC (INDIANA LIMITED LIABILITY COMPANY)
3802 NORTH 600 WEST, SUITE A
GREENFIELD, IN 46140

FOR: TECHNICAL CONSULTATION RELATING TO THE DETECTION, ANALYSIS, CONTAINMENT AND REPORTING OF NON-CONFORMING PARTS AND MATERIALS IN THE MANUFACTURING PROCESSES OF THE AUTOMOTIVE, AEROSPACE, ELECTRONICS AND AGRICULTURAL INDUSTRIES; QUALITY CONTROL SERVICES FOR OTHERS, NAMELY, THE DETECTION, ANALYSIS, CONTAINMENT AND REPORTING OF NON-CONFORMING PARTS AND MATERIALS IN THE MAN-

UFACTURING PROCESSES OF THE AUTOMOTIVE, AEROSPACE, ELECTRONICS AND AGRICULTURAL INDUSTRIES, IN CLASS 42 (U.S. CLS. 100 AND 101).

FIRST USE 12-18-2007; IN COMMERCE 12-18-2007.

THE MARK CONSISTS OF STANDARD CHARACTERS WITHOUT CLAIM TO ANY PARTICULAR FONT, STYLE, SIZE, OR COLOR.

SER. NO. 77-416,348, FILED 3-7-2008.

KATHERINE STOIDES, EXAMINING ATTORNEY

Int. Cl.: 22

Prior U.S. Cls.: 1, 2, 7, 19, 22, 42 and 50

Reg. No. 3,519,685

United States Patent and Trademark Office

Registered Oct. 21, 2008

**TRADEMARK
PRINCIPAL REGISTER**

LEVOLOR

NEWELL OPERATING COMPANY (DELAWARE
CORPORATION)
10B GLENLAKE PKWY., SUITE 600
ATLANTA, GA 30328

THE MARK CONSISTS OF STANDARD CHAR-
ACTERS WITHOUT CLAIM TO ANY PARTICULAR
FONT, STYLE, SIZE, OR COLOR.

FOR: VENETIAN BLIND LADDER TAPES, IN
CLASS 22 (U.S. CLS. 1, 2, 7, 19, 22, 42 AND 50).

SER. NO. 77-416,368, FILED 3-7-2008.

FIRST USE 1-21-1941; IN COMMERCE 1-21-1941.

MELISSA VALLILLO, EXAMINING ATTORNEY

Int. Cl.: 18

Prior U.S. Cls.: 1, 2, 3, 22 and 41

United States Patent and Trademark Office

Reg. No. 3,519,686

Registered Oct. 21, 2008

**TRADEMARK
PRINCIPAL REGISTER**

AVION EXPRES

INTERNATIONAL DESIGN ASSOCIATES LTD
(NEW YORK CORPORATION)
SUITE 2320
60 EAST 42ND STREET
NEW YORK, NY 10165

FOR: ALL PURPOSE SPORT BAGS; ALL-PURPOSE CARRYING BAGS; BABY CARRYING BAGS; BAGS FOR CARRYING BABIES' ACCESSORIES; BACKPACKS, BOOK BAGS, SPORTS BAGS, BUM BAGS, WALLETS AND HANDBAGS; BEACH BAGS; BELT BAGS AND HIP BAGS; CANVAS SHOPPING BAGS; COSMETIC BAGS SOLD EMPTY; TOILETRY BAGS SOLD EMPTY; DIAPER BAGS; DUFFEL BAGS; SHOPPING BAGS WITH WHEELS ATTACHED; BILLFOLDS; BRIEFCASES AND AT-TACHE CASES; LUGGAGE; LUGGAGE TAGS;

STRAPS FOR LUGGAGE; UMBRELLAS, IN CLASS 18 (U.S. CLS. 1, 2, 3, 22 AND 41).

FIRST USE 3-3-2008; IN COMMERCE 3-3-2008.

THE MARK CONSISTS OF STANDARD CHARACTERS WITHOUT CLAIM TO ANY PARTICULAR FONT, STYLE, SIZE, OR COLOR.

THE FOREIGN WORDING IN THE MARK TRANSLATES INTO ENGLISH AS "AIRPLANE EXPRESS".

SER. NO. 77-416,370, FILED 3-7-2008.

NELSON SNYDER, EXAMINING ATTORNEY

Int. Cls.: 35 and 40

Prior U.S. Cls.: 100, 101, 102, 103 and 106

United States Patent and Trademark Office

Reg. No. 3,519,687

Registered Oct. 21, 2008

**SERVICE MARK
PRINCIPAL REGISTER**

NEW WORLD TRADING

NWT NEW WORLD ARTS, INC. (CALIFORNIA CORPORATION), DBA NEW WORLD TRADING
36-450 BANKSIDE DRIVE
CATHEDRAL CITY, CA 92234

FOR: WHOLESALE STORE SERVICES, WHOLESALE DISTRIBUTORSHIP SERVICES, AND ONLINE RETAIL AND WHOLESALE STORE SERVICES FEATURING FURNITURE, MIRRORS, PICTURE FRAMES, WASTEBASKETS, HAND-TOOLED LEATHER FURNITURE, FURNITURE CHESTS, FURNITURE MADE FROM WOOD, DECORATIVE PLATES, HAND-TOOLED LEATHER LIGHTING FIXTURES, PILLOWS, SERVING TRAYS, KEY HOLDERS, COASTERS, STORAGE BOXES, PICTURE FRAMES, TRUNKS, TISSUE HOLDERS, WINE HOLDERS, IN CLASS 35 (U.S. CLS. 100, 101 AND 102).

FIRST USE 2-0-1997; IN COMMERCE 2-0-1997.

FOR: CUSTOM MANUFACTURE OF FURNITURE, MIRRORS, PICTURE FRAMES, WASTEBAS-

KETS, HAND-TOOLED LEATHER FURNITURE, FURNITURE CHESTS, FURNITURE MADE FROM WOOD, DECORATIVE PLATES, HAND-TOOLED LEATHER LIGHTING FIXTURES, PILLOWS, SERVING TRAYS, KEY HOLDERS, COASTERS, STORAGE BOXES, PICTURE FRAMES, TRUNKS, TISSUE HOLDERS, WINE HOLDERS, IN CLASS 40 (U.S. CLS. 100, 103 AND 106).

FIRST USE 8-0-1997; IN COMMERCE 8-0-1997.

THE MARK CONSISTS OF STANDARD CHARACTERS WITHOUT CLAIM TO ANY PARTICULAR FONT, STYLE, SIZE, OR COLOR.

NO CLAIM IS MADE TO THE EXCLUSIVE RIGHT TO USE "TRADING" , APART FROM THE MARK AS SHOWN.

SER. NO. 77-416,372, FILED 3-7-2008.

SHANNON TWOHIG, EXAMINING ATTORNEY

Int. Cl.: 20

Prior U.S. Cls.: 2, 13, 22, 25, 32 and 50

United States Patent and Trademark Office

Reg. No. 3,519,688

Registered Oct. 21, 2008

**TRADEMARK
PRINCIPAL REGISTER**

PAN MINDER

SPIRIT SPECIALTY SOLUTIONS, INC. (PENNSYLVANIA CORPORATION)

326 DERWYN ROAD

LANSDOWNE, PA 19050

FOR: PLASTIC MERCHANDISING LABELS FEATURING PRODUCT INFORMATION FOR FOOD ITEMS, IN CLASS 20 (U.S. CLS. 2, 13, 22, 25, 32 AND 50).

FIRST USE 11-0-2006; IN COMMERCE 11-0-2006.

THE MARK CONSISTS OF STANDARD CHARACTERS WITHOUT CLAIM TO ANY PARTICULAR FONT, STYLE, SIZE, OR COLOR.

OWNER OF U.S. REG. NO. 2,502,708.

NO CLAIM IS MADE TO THE EXCLUSIVE RIGHT TO USE "PAN", APART FROM THE MARK AS SHOWN.

SER. NO. 77-416,412, FILED 3-7-2008.

NATALIE POLZER, EXAMINING ATTORNEY

Int. Cl.: 41

Prior U.S. Cls.: 100, 101 and 107

United States Patent and Trademark Office

Reg. No. 3,519,689

Registered Oct. 21, 2008

**SERVICE MARK
PRINCIPAL REGISTER**



ADVANCED COLLEGE (CALIFORNIA CORPORATION)
13180 PARAMOUNT BLVD
SOUTH GATE, CA 90280

FOR: EDUCATING AT UNIVERSITY OR COLLEGES, IN CLASS 41 (U.S. CLS. 100, 101 AND 107).

FIRST USE 7-1-1999; IN COMMERCE 7-1-1999.

NO CLAIM IS MADE TO THE EXCLUSIVE RIGHT TO USE "ADVANCED COLLEGE", APART FROM THE MARK AS SHOWN.

THE COLOR(S) RED, BLUE, WHITE AND GREEN IS/ARE CLAIMED AS A FEATURE OF THE MARK.

THE COLOR RED APPEARS IN A CIRCLE WHICH ENCLOSES A BLUE AND GREEN GLOBE; THE COLOR WHITE APPEARS AS AN OUTLINE AROUND THE GLOBE AND IN THE WORDING "ADVANCE COLLEGE".

SER. NO. 77-416,447, FILED 3-7-2008.

JORDAN BAKER, EXAMINING ATTORNEY

Int. Cl.: 42

Prior U.S. Cls.: 100 and 101

United States Patent and Trademark Office

Reg. No. 3,519,690

Registered Oct. 21, 2008

**SERVICE MARK
PRINCIPAL REGISTER**

CLOUDWORKS 

HOSTED FINANCIALS, INC. (COLORADO CORPORATION)
100 E. THOUSAND OAKS BLVD., SUITE 231
THOUSAND OAKS, CA 91360

FOR: APPLICATION SERVICE PROVIDER (ASP), NAMELY, HOSTING COMPUTER SOFTWARE APPLICATIONS OF OTHERS; COMPUTER SERVICE, NAMELY, ACTING AS AN APPLICATION SERVICE PROVIDER IN THE FIELD OF KNOWLEDGE MANAGEMENT TO HOST COMPUTER APPLICATION SOFTWARE FOR THE COLLECTION, EDITING, ORGANIZING, MODIFYING, BOOK MARKING, TRANSMISSION, STORAGE AND SHARING OF DATA AND INFORMATION; COMPUTER SERVICES, NAMELY, REMOTE AND ON-SITE MANAGEMENT OF ELECTRONIC MESSAGING SYSTEMS AND APPLICATIONS FOR OTHERS; COMPUTER SERVICES, NAMELY, REMOTE MANAGEMENT OF COMPUTER APPLICATIONS FOR OTHERS; RENTAL OF APPLICATION SOFTWARE; COMPUTER CONSULTATION; COMPUTER CONSULTATION IN THE FIELD OF COMPUTER SECURITY;

COMPUTER SOFTWARE CONSULTANCY; COMPUTER SOFTWARE CONSULTATION; CONSULTATION SERVICES IN THE FIELDS OF SELECTION, IMPLEMENTATION AND USE OF COMPUTER HARDWARE AND SOFTWARE SYSTEMS FOR OTHERS; CONSULTING SERVICES IN THE FIELD OF DESIGN, SELECTION, IMPLEMENTATION AND USE OF COMPUTER HARDWARE AND SOFTWARE SYSTEMS FOR OTHERS; INFORMATION TECHNOLOGY CONSULTATION, IN CLASS 42 (U.S. CLS. 100 AND 101).

FIRST USE 8-7-2007; IN COMMERCE 8-7-2007.

THE MARK CONSISTS OF THE WORD "CLOUDWORKS" IN TWO DIFFERENT TYPEFACES FOLLOWED BY A CIRCLE CONTAINING SHAPES REMINISCENT OF DARK AND LIGHT CLOUDS.

SER. NO. 77-416,477, FILED 3-7-2008.

HOWARD SMIGA, EXAMINING ATTORNEY

Int. Cl.: 41

Prior U.S. Cls.: 100, 101 and 107

United States Patent and Trademark Office

Reg. No. 3,519,691

Registered Oct. 21, 2008

**SERVICE MARK
PRINCIPAL REGISTER**

JAZZERCISE TEAM DANCE

JAZZERCISE, INC. (CALIFORNIA CORPORATION)
2460 IMPALA DRIVE
CARLSBAD, CA 92008

OWNER OF U.S. REG. NOS. 1,079,083, 2,658,984,
AND 3,106,514.

FOR: EDUCATIONAL SERVICES, NAMELY,
CONDUCTING CLASSES IN DANCE AND EXERCISE,
IN CLASS 41 (U.S. CLS. 100, 101 AND 107).

NO CLAIM IS MADE TO THE EXCLUSIVE
RIGHT TO USE "TEAM DANCE", APART FROM
THE MARK AS SHOWN.

FIRST USE 1-1-2006; IN COMMERCE 1-1-2006.

SER. NO. 77-416,537, FILED 3-7-2008.

THE MARK CONSISTS OF STANDARD CHARACTERS
WITHOUT CLAIM TO ANY PARTICULAR
FONT, STYLE, SIZE, OR COLOR.

ASMAT KHAN, EXAMINING ATTORNEY

Int. Cl.: 16

Prior U.S. Cls.: 2, 5, 22, 23, 29, 37, 38 and 50

United States Patent and Trademark Office

Reg. No. 3,519,692

Registered Oct. 21, 2008

**TRADEMARK
PRINCIPAL REGISTER**

Your restaurant has an image...
Your bags should too.

COMMAND PACKAGING (CALIFORNIA COR-
PORATION)
3840 E 26TH STREET
LOS ANGELES, CA 90023

NO CLAIM IS MADE TO THE EXCLUSIVE
RIGHT TO USE "BAGS", APART FROM THE MARK
AS SHOWN.

FOR: MERCHANDISE BAGS, IN CLASS 16 (U.S.
CLS. 2, 5, 22, 23, 29, 37, 38 AND 50).

SER. NO. 77-416,720, FILED 3-7-2008.

FIRST USE 4-1-2007; IN COMMERCE 4-1-2007.

KATHERINE STOIDES, EXAMINING ATTORNEY

Int. Cls.: 38 and 41

Prior U.S. Cls.: 100, 101, 104 and 107

United States Patent and Trademark Office

Reg. No. 3,519,693

Registered Oct. 21, 2008

**SERVICE MARK
PRINCIPAL REGISTER**

Serenity Channel

SERENITY CHANNEL LLC (MICHIGAN LIMITED LIABILITY COMPANY)
106 BRIGHTON PARK
BATTLE CREEK, MI 49015

FOR: BROADCASTING PROGRAMS VIA A GLOBAL COMPUTER NETWORK; CABLE RADIO BROADCASTING; CABLE TELEVISION BROADCASTING; PODCASTING SERVICES; PROVIDING ON-LINE CHAT ROOMS AND ELECTRONIC BULLETIN BOARDS FOR TRANSMISSION OF MESSAGES AMONG USERS IN THE FIELD OF GENERAL INTEREST; SATELLITE TELEVISION BROADCASTING; SATELLITE, CABLE, NETWORK TRANSMISSION OF SOUNDS, IMAGES, SIGNALS AND DATA; STREAMING OF AUDIO MATERIAL ON THE INTERNET; STREAMING OF VIDEO MATERIAL ON THE INTERNET; VIDEO BROADCASTING; VIDEO-ON-DEMAND TRANSMISSION SERVICES; WEBCASTING SERVICES; TELEVISION AND RADIO BROADCASTING SERVICES, IN CLASS 38 (U.S. CLS. 100, 101 AND 104).

FIRST USE 10-12-2007; IN COMMERCE 3-7-2008.

FOR: ENTERTAINMENT SERVICES, NAMELY, PRODUCTION OF TELEVISION SHOWS; ENTER-

TAINMENT SERVICES, NAMELY, PROVIDING TELEVISION PROGRAMS IN THE FIELD OF SCENES FROM NATURE VIA A GLOBAL COMPUTER NETWORK; PRODUCTION OF RADIO OR TELEVISION PROGRAMS; ENTERTAINMENT IN THE NATURE OF ON-GOING TELEVISION PROGRAMS FEATURING NATURE SCENES BROADCAST OVER TELEVISION, SATELLITE, AUDIO, AND VIDEO MEDIA, IN CLASS 41 (U.S. CLS. 100, 101 AND 107).

FIRST USE 10-12-2007; IN COMMERCE 3-7-2008.

THE MARK CONSISTS OF STANDARD CHARACTERS WITHOUT CLAIM TO ANY PARTICULAR FONT, STYLE, SIZE, OR COLOR.

NO CLAIM IS MADE TO THE EXCLUSIVE RIGHT TO USE "CHANNEL", APART FROM THE MARK AS SHOWN.

SER. NO. 77-416,872, FILED 3-8-2008.

DAVID MURRAY, EXAMINING ATTORNEY

Int. Cl.: 45

Prior U.S. Cls.: 100 and 101

United States Patent and Trademark Office

Reg. No. 3,519,694

Registered Oct. 21, 2008

**SERVICE MARK
PRINCIPAL REGISTER**

Life Makeover Mentor

SELF LOVE CONSULTING (NEW YORK LIMITED LIABILITY COMPANY)
61 GROVE STREET #5C
NEW YORK, NY 10014

FOR: ORGANIZATIONAL SERVICES FOR HOME OR PERSONAL PURPOSES, NAMELY, ORGANIZING CLOSET SPACE AND PERSONAL SCHEDULES, IN CLASS 45 (U.S. CLS. 100 AND 101).

FIRST USE 12-1-2007; IN COMMERCE 12-1-2007.

THE MARK CONSISTS OF STANDARD CHARACTERS WITHOUT CLAIM TO ANY PARTICULAR FONT, STYLE, SIZE, OR COLOR.

NO CLAIM IS MADE TO THE EXCLUSIVE RIGHT TO USE "MAKEOVER MENTOR", APART FROM THE MARK AS SHOWN.

SER. NO. 77-416,885, FILED 3-8-2008.

CAROLINE WOOD, EXAMINING ATTORNEY

Int. Cl.: 10

Prior U.S. Cls.: 26, 39 and 44

United States Patent and Trademark Office

Reg. No. 3,519,695

Registered Oct. 21, 2008

**TRADEMARK
PRINCIPAL REGISTER**

Feather Light

ULTRALIGHT OPTIX INC. (CALIFORNIA CORPORATION), AKA ULTRALIGHT
9526 MARIPOSA AVE.
FOUNTAIN VALLEY, CA 92708

FOR: DENTAL INSTRUMENTS, NAMELY, LIGHTWEIGHT LOUPE LIGHTING SYSTEMS, IN CLASS 10 (U.S. CLS. 26, 39 AND 44).

FIRST USE 9-1-2007; IN COMMERCE 9-1-2007.

THE MARK CONSISTS OF STANDARD CHARACTERS WITHOUT CLAIM TO ANY PARTICULAR FONT, STYLE, SIZE, OR COLOR.

NO CLAIM IS MADE TO THE EXCLUSIVE RIGHT TO USE "LIGHT", APART FROM THE MARK AS SHOWN.

SER. NO. 77-417,110, FILED 3-9-2008.

MARK PILARO, EXAMINING ATTORNEY

Int. Cl.: 43

Prior U.S. Cls.: 100 and 101

United States Patent and Trademark Office

Reg. No. 3,519,696

Registered Oct. 21, 2008

**SERVICE MARK
PRINCIPAL REGISTER**



DPR II ENTERPRISES, INC. (VIRGINIA CORPORATION), DBA CAPITOL GROUNDS COFFEE

5414 WILLOW VALLEY ROAD
CLIFTON, VA 20124

FOR: CAFE AND RESTAURANT SERVICES; COFFEE SHOPS; DELICATESSENS, IN CLASS 43 (U.S. CLS. 100 AND 101).

FIRST USE 1-1-1996; IN COMMERCE 1-1-1996.

NO CLAIM IS MADE TO THE EXCLUSIVE RIGHT TO USE "COFFEE" AND "WASHINGTON, D.C.", APART FROM THE MARK AS SHOWN.

THE MARK CONSISTS OF A PLAIN LINE CIRCLE CONTAINING A STYLIZED DRAWING OF THE U.S. CAPITOL BUILDING WITH A COFFEE CUP WITH STEAM RISING FROM THE CUP ON TOP OF THE BUILDING AND THE WORDING "CAPITOL GROUNDS" IN THE TOP OF THE CIRCLE ABOVE THE BUILDING ON EITHER SIDE OF THE COFFEE CUP. THE WORD "COFFEE" APPEARS UNDER THE BUILDING AND IS UNDERLINED BY AN ARCHED LINE. THE WORDING "WASHINGTON, D.C." APPEARS IN THE BOTTOM OF THE CIRCLE.

SER. NO. 77-417,152, FILED 3-10-2008.

RENEE SERVANCE, EXAMINING ATTORNEY

Int. Cl.: 12

Prior U.S. Cls.: 19, 21, 23, 31, 35 and 44

United States Patent and Trademark Office

Reg. No. 3,519,697

Registered Oct. 21, 2008

**TRADEMARK
PRINCIPAL REGISTER**



ADRIAN STEEL COMPANY (MICHIGAN CORPORATION)

906 JAMES STREET

ADRIAN, MI 48221

FOR: STEEL ACCESSORIES SPECIFICALLY FITTED FOR USE IN SERVICE VEHICLES, NAMELY, BINS, CABINETS, DRAWER UNITS, SHELVING, CAB/CARGO PARTITIONS, ROOF RACKS FOR LADDERS, AND FILE CABINETS FOR CATALOGS

AND BOOKS, IN CLASS 12 (U.S. CLS. 19, 21, 23, 31, 35 AND 44).

FIRST USE 0-0-1963; IN COMMERCE 0-0-1963.

THE MARK CONSISTS OF THE LETTERS "AS" IN A STYLIZED MANNER.

SER. NO. 77-417,211, FILED 3-10-2008.

NATALIE POLZER, EXAMINING ATTORNEY

Int. Cl.: 9

Prior U.S. Cls.: 21, 23, 26, 36 and 38

Reg. No. 3,519,698

United States Patent and Trademark Office

Registered Oct. 21, 2008

**TRADEMARK
PRINCIPAL REGISTER**

HEXALON FLEX

LUSTRA LINE, INC. (PENNSYLVANIA CORPORATION)
2901 BRIGHTON ROAD
PITTSBURGH, PA 15212

OWNER OF U.S. REG. NO. 1,742,887.

FOR: RADIOGRAPHIC INTENSIFYING SCREENS FOR USE IN IMAGING EQUIPMENT, IN CLASS 9 (U.S. CLS. 21, 23, 26, 36 AND 38).

NO CLAIM IS MADE TO THE EXCLUSIVE RIGHT TO USE "FLEX", APART FROM THE MARK AS SHOWN.

FIRST USE 10-0-2007; IN COMMERCE 10-0-2007.

SER. NO. 77-417,259, FILED 3-10-2008.

THE MARK CONSISTS OF STANDARD CHARACTERS WITHOUT CLAIM TO ANY PARTICULAR FONT, STYLE, SIZE, OR COLOR.

JORDAN BAKER, EXAMINING ATTORNEY

Int. Cl.: 35

Prior U.S. Cls.: 100, 101 and 102

United States Patent and Trademark Office

Reg. No. 3,519,699

Registered Oct. 21, 2008

**SERVICE MARK
PRINCIPAL REGISTER**

NEXIDIOM NETWORK

NEXIDIOM, INC. (PENNSYLVANIA CORPORATION)
BOX 301
3567 MOUNTAIN VIEW DRIVE
WEST MIFFLIN, PA 151222447

FOR: ADVERTISING VIA ELECTRONIC MEDIA
AND SPECIFICALLY THE INTERNET, IN CLASS 35
(U.S. CLS. 100, 101 AND 102).

FIRST USE 11-15-2007; IN COMMERCE 2-26-2008.

THE MARK CONSISTS OF STANDARD CHARACTERS WITHOUT CLAIM TO ANY PARTICULAR FONT, STYLE, SIZE, OR COLOR.

NO CLAIM IS MADE TO THE EXCLUSIVE RIGHT TO USE "NETWORK", APART FROM THE MARK AS SHOWN.

SER. NO. 77-417,324, FILED 3-10-2008.

GEORGIA CARTY, EXAMINING ATTORNEY

Int. Cl.: 41

Prior U.S. Cls.: 100, 101 and 107

United States Patent and Trademark Office

Reg. No. 3,519,700

Registered Oct. 21, 2008

**SERVICE MARK
PRINCIPAL REGISTER**

MRS. WYOMING

MRS. WYOMING AMERICA PAGEANT (COLOR-
ADO CORPORATION)
11717 CR 78
EATON, CO 80615

THE MARK CONSISTS OF STANDARD CHAR-
ACTERS WITHOUT CLAIM TO ANY PARTICULAR
FONT, STYLE, SIZE, OR COLOR.

FOR: ENTERTAINMENT IN THE NATURE OF
BEAUTY PAGEANTS, IN CLASS 41 (U.S. CLS. 100,
101 AND 107).

SER. NO. 77-417,512, FILED 3-10-2008.

FIRST USE 7-29-1976; IN COMMERCE 1-29-1977.

HANNO RITTNER, EXAMINING ATTORNEY

Int. Cl.: 25

Prior U.S. Cls.: 22 and 39

United States Patent and Trademark Office

Reg. No. 3,519,701

Registered Oct. 21, 2008

**TRADEMARK
PRINCIPAL REGISTER**

UNDERSLIMS FOR MEN

HUDSON, CHERYL E. (UNITED STATES INDIVIDUAL)
PO BOX 82942
SAN DIEGO, CA 92138

FOR: LEOTARDS AND TIGHTS FOR MEN OF NYLON, COTTON OR OTHER TEXTILE FIBERS; CORSETS FOR MEN, IN CLASS 25 (U.S. CLS. 22 AND 39).

FIRST USE 1-1-2004; IN COMMERCE 1-1-2004.

THE MARK CONSISTS OF STANDARD CHARACTERS WITHOUT CLAIM TO ANY PARTICULAR FONT, STYLE, SIZE, OR COLOR.

NO CLAIM IS MADE TO THE EXCLUSIVE RIGHT TO USE "FOR MEN", APART FROM THE MARK AS SHOWN.

SER. NO. 77-417,563, FILED 3-10-2008.

WENDY JUN, EXAMINING ATTORNEY

Int. Cl.: 36

Prior U.S. Cls.: 100, 101 and 102

United States Patent and Trademark Office

Reg. No. 3,519,702

Registered Oct. 21, 2008

**SERVICE MARK
PRINCIPAL REGISTER**



BUYERS NATION, LLC (WISCONSIN LIMITED
LIABILITY COMPANY)
16800 W. GREENFIELD AVE.
BROOKFIELD, WI 53005

FOR: REAL ESTATE BROKERAGE; REAL ES-
TATE CONSULTANCY; REAL ESTATE CONSUL-
TATION; REAL ESTATE LENDING SERVICES;
REAL ESTATE MULTIPLE LISTING SERVICES ,
IN CLASS 36 (U.S. CLS. 100, 101 AND 102).

FIRST USE 7-6-2007; IN COMMERCE 7-6-2007.

NO CLAIM IS MADE TO THE EXCLUSIVE
RIGHT TO USE "REAL ESTATE", APART FROM
THE MARK AS SHOWN.

THE MARK CONSISTS OF A COMPUTER WITH
A ROOF TO THE LEFT OF THE STYLIZED TEXT
"BUYERS NATION REAL ESTATE EVOLVED".

SER. NO. 77-417,568, FILED 3-10-2008.

KATHERINE STOIDES, EXAMINING ATTORNEY

Int. Cls.: 29 and 43

Prior U.S. Cls.: 46, 100 and 101

United States Patent and Trademark Office

Reg. No. 3,519,703

Registered Oct. 21, 2008

**TRADEMARK
SERVICE MARK
PRINCIPAL REGISTER**

CHURCH'S

CAJUN FUNDING CORPORATION (DELAWARE
CORPORATION)
980 HAMMOND DRIVE, SUITE 1100
ATLANTA, GA 30328

FOR: PREPARED MEALS CONSISTING PRIMAR-
ILY OF CHICKEN FOR CONSUMPTION ON OR
OFF THE PREMISES, IN CLASS 29 (U.S. CL. 46).

FIRST USE 0-0-1952; IN COMMERCE 0-0-1952.

FOR: RESTAURANT SERVICES, IN CLASS 43
(U.S. CLS. 100 AND 101).

FIRST USE 0-0-1952; IN COMMERCE 0-0-1952.

THE MARK CONSISTS OF STANDARD CHAR-
ACTERS WITHOUT CLAIM TO ANY PARTICULAR
FONT, STYLE, SIZE, OR COLOR.

OWNER OF U.S. REG. NOS. 815,076, 2,721,849 AND
OTHERS.

SER. NO. 77-417,629, FILED 3-10-2008.

BARBARA GAYNOR, EXAMINING ATTORNEY

Int. Cl.: 42

Prior U.S. Cls.: 100 and 101

United States Patent and Trademark Office

Reg. No. 3,519,704

Registered Oct. 21, 2008

**SERVICE MARK
PRINCIPAL REGISTER**

GLITTERFY

BINARY INERTIA LLC (IOWA LIMITED LIABILITY COMPANY)
439 ELMDALE AVENUE
OTTUMWA, IA 52501

FOR: PROVIDING A WEB SITE THAT GIVES COMPUTER USERS THE ABILITY TO UPLOAD, EXCHANGE AND SHARE PHOTOS, VIDEOS AND VIDEO LOGS; COMPUTER SERVICES, NAMELY, INTERACTIVE HOSTING SERVICES WHICH ALLOW THE USER TO PUBLISH AND SHARE THEIR OWN CONTENT AND IMAGES ON-LINE, IN CLASS 42 (U.S. CLS. 100 AND 101).

FIRST USE 11-30-2006; IN COMMERCE 11-30-2006.

THE MARK CONSISTS OF STANDARD CHARACTERS WITHOUT CLAIM TO ANY PARTICULAR FONT, STYLE, SIZE, OR COLOR.

SER. NO. 77-417,707, FILED 3-10-2008.

KHANH LE, EXAMINING ATTORNEY

Int. Cl.: 29

Prior U.S. Cl.: 46

United States Patent and Trademark Office

Reg. No. 3,519,705

Registered Oct. 21, 2008

**TRADEMARK
PRINCIPAL REGISTER**

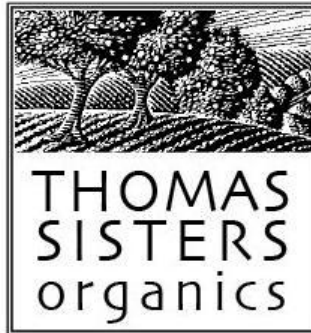

THOMAS SISTERS ORGANICS (OREGON CORPORATION), DBA THOMAS SISTERS ORGANICS
1046 SW PALATINE ST.
PORTLAND, OR 97219

FOR: ORGANIC NUT MEATS; ORGANIC DEHYDRATED FRUIT SNACKS, IN CLASS 29 (U.S. CL. 46).

FIRST USE 3-15-2004; IN COMMERCE 3-15-2004.

NO CLAIM IS MADE TO THE EXCLUSIVE RIGHT TO USE "SISTERS ORGANICS", APART FROM THE MARK AS SHOWN.

THE MARK CONSISTS OF ORCHARD SCENE WITH "THOMAS SISTERS ORGANICS" WORDING.

SER. NO. 77-417,709, FILED 3-10-2008.

NICHOLAS COLEMAN, EXAMINING ATTORNEY

Int. Cl.: 41

Prior U.S. Cls.: 100, 101 and 107

United States Patent and Trademark Office

Reg. No. 3,519,706

Registered Oct. 21, 2008

**SERVICE MARK
PRINCIPAL REGISTER**

GAMESTRATA

GAMESTRATA, INC. (DELAWARE CORPORATION)
3RD FLOOR
28 E. 23RD AVE.
SAN MATEO, CA 94401

FOR: PROVIDING INFORMATION IN THE FIELD OF VIDEO GAMES, NAMELY, COMPILATION OF STATISTICS, RANKINGS AND LEADER BOARDS RELATED TO VIDEO GAMES, IN CLASS 41 (U.S. CLS. 100, 101 AND 107).

FIRST USE 1-29-2008; IN COMMERCE 1-29-2008.

THE MARK CONSISTS OF STANDARD CHARACTERS WITHOUT CLAIM TO ANY PARTICULAR FONT, STYLE, SIZE, OR COLOR.

SER. NO. 77-417,848, FILED 3-10-2008.

KATHERINE E. HALMEN, EXAMINING ATTORNEY

Int. Cl.: 18

Prior U.S. Cls.: 1, 2, 3, 22 and 41

United States Patent and Trademark Office

Reg. No. 3,519,707

Registered Oct. 21, 2008

**TRADEMARK
PRINCIPAL REGISTER**

PEILIN

TU WEN HSIANG CO., LTD. (TAIWAN CORPORATION)
JHONGHE CITY
NO. 27, LANE 50, SEC. 3, SIOULANG RD.
TAIPEI COUNTY 235, TAIWAN

FOR: WALLETS; PURSES; BACKPACKS; HAVESACKS; SCHOOL BAGS; SCHOOL KNAPSACKS; LUGGAGE TRUNKS; LEATHER CASES; TRAVELING CASES OF LEATHER; COSMETIC CASES SOLD EMPTY; COSMETIC BAGS SOLD EMPTY; VANITY CASES SOLD EMPTY; OVERNIGHT CASES; ATTACHE CASES; BRIEFCASES; SUITCASES; RUCKSACKS FOR MOUNTAINEERS; GARMENT BAGS FOR TRAVEL; BELT BAGS; CARRY-ON BAGS;

HANDBAGS; STRAPS FOR HANDBAGS; SHOE BAGS FOR TRAVEL, IN CLASS 18 (U.S. CLS. 1, 2, 3, 22 AND 41).

FIRST USE 2-1-2008; IN COMMERCE 2-1-2008.

THE MARK CONSISTS OF STANDARD CHARACTERS WITHOUT CLAIM TO ANY PARTICULAR FONT, STYLE, SIZE, OR COLOR.

SER. NO. 77-418,008, FILED 3-10-2008.

DAVID HOFFMAN, EXAMINING ATTORNEY

Int. Cl.: 11

Prior U.S. Cls.: 13, 21, 23, 31 and 34

Reg. No. 3,519,708

United States Patent and Trademark Office

Registered Oct. 21, 2008

**TRADEMARK
PRINCIPAL REGISTER**



LEE, DAVID (UNITED STATES INDIVIDUAL)
#103
14011 S. BUDLONG AVE.
GARDENA, CA 90247

FOR: LIGHTS FOR VEHICLES, IN CLASS 11 (U.S.
CLS. 13, 21, 23, 31 AND 34).

FIRST USE 8-16-2005; IN COMMERCE 8-16-2005.

THE MARK CONSISTS OF A STYLIZED SHIELD
BEARING A TRIANGULAR ELEMENT TO THE
LEFT OF THE STYLIZED TEXT "RIKENSPORT"
AND "THE SPIRIT OF PERFORMANCE" THAT
APPEARS ON TWO LINES OF TEXT SEPARATED
BY A LINE.

SER. NO. 77-418,204, FILED 3-10-2008.

LINDA POWELL, EXAMINING ATTORNEY

Int. Cl.: 35

Prior U.S. Cls.: 100, 101 and 102

United States Patent and Trademark Office

Reg. No. 3,519,709

Registered Oct. 21, 2008

**SERVICE MARK
PRINCIPAL REGISTER**

Go Free Credit.com

CONSUMERTRACK, INC. (CALIFORNIA CORPORATION)
2381 ROSECRANS AVENUE, SUITE 336
EL SEGUNDO, CA 90245

FOR: MONITORING CONSUMER CREDIT REPORTS AND PROVIDING AN ALERT AS TO ANY CHANGES THEREIN; ADVERTISING, PROMOTION AND MARKETING SERVICES IN THE NATURE OF CONSUMER CREDIT REPORTS FOR OTHERS, IN CLASS 35 (U.S. CLS. 100, 101 AND 102).

FIRST USE 10-21-2006; IN COMMERCE 10-21-2006.

THE MARK CONSISTS OF LETTERS CONSISTING OF "GO"; THE LETTERS "FREE" INSIDE AN OVAL; AND "CREDIT.COM".

SER. NO. 77-418,211, FILED 3-10-2008.

WILLIAM ROSSMAN, EXAMINING ATTORNEY

Int. Cl.: 3

Prior U.S. Cls.: 1, 4, 6, 50, 51 and 52

Reg. No. 3,519,710

United States Patent and Trademark Office

Registered Oct. 21, 2008

**TRADEMARK
PRINCIPAL REGISTER**

Laundry Door

AINSWORTH, PAUL (UNITED STATES INDIVIDUAL)
1330 EOLUS AVE.
ENCINITAS, CA 92024

FOR: FILTER BAG FILLED WITH DRIED LAVENDER DESIGNED TO BE PLACED IN A CLOTHING DRYER WITH CLOTHS WITH THE PURPOSE OF SCENTING THEM, IN CLASS 3 (U.S. CLS. 1, 4, 6, 50, 51 AND 52).

FIRST USE 6-25-2005; IN COMMERCE 4-21-2006.

THE MARK CONSISTS OF STANDARD CHARACTERS WITHOUT CLAIM TO ANY PARTICULAR FONT, STYLE, SIZE, OR COLOR.

NO CLAIM IS MADE TO THE EXCLUSIVE RIGHT TO USE "LAUNDRY", APART FROM THE MARK AS SHOWN.

SER. NO. 77-418,212, FILED 3-10-2008.

ANN E. SAPPENFIELD, EXAMINING ATTORNEY

Int. Cls.: 29 and 43

Prior U.S. Cls.: 46, 100 and 101

United States Patent and Trademark Office

Reg. No. 3,519,711

Registered Oct. 21, 2008

**TRADEMARK
SERVICE MARK
PRINCIPAL REGISTER**

CHURCH'S CHICKEN

CAJUN FUNDING CORPORATION (DELAWARE CORPORATION)
980 HAMMOND DRIVE, SUITE 1100
ATLANTA, GA 30328

FOR: PREPARED MEALS CONSISTING PRIMARILY OF CHICKEN FOR CONSUMPTION ON OR OFF THE PREMISES, IN CLASS 29 (U.S. CL. 46).

FIRST USE 0-0-1952; IN COMMERCE 0-0-1952.

FOR: RESTAURANT SERVICES, IN CLASS 43 (U.S. CLS. 100 AND 101).

FIRST USE 0-0-1952; IN COMMERCE 0-0-1952.

THE MARK CONSISTS OF STANDARD CHARACTERS WITHOUT CLAIM TO ANY PARTICULAR FONT, STYLE, SIZE, OR COLOR.

OWNER OF U.S. REG. NOS. 815,076, 2,721,849 AND OTHERS.

NO CLAIM IS MADE TO THE EXCLUSIVE RIGHT TO USE "CHICKEN", APART FROM THE MARK AS SHOWN.

SER. NO. 77-418,468, FILED 3-11-2008.

BARBARA GAYNOR, EXAMINING ATTORNEY

Int. Cl.: 41

Prior U.S. Cls.: 100, 101 and 107

United States Patent and Trademark Office

Reg. No. 3,519,712

Registered Oct. 21, 2008

**SERVICE MARK
PRINCIPAL REGISTER**



WOMEN'S WELLNESS AND MATERNITY CENTER (TENNESSEE NON-PROFIT ORGANIZATION)

3459 NEW HIGHWAY 68
MADISONVILLE, TN 37354

FOR: PROVIDING ASSISTANCE, PERSONAL TRAINING AND PHYSICAL FITNESS CONSULTATION TO INDIVIDUALS TO HELP THEM MAKE PHYSICAL FITNESS, STRENGTH, CONDITIONING, AND EXERCISE IMPROVEMENT IN THEIR DAILY LIVING; EDUCATION SERVICES, NAMELY, PROVIDING CLASSES AND WORKSHOPS IN THE FIELD OF HEALTH AND NUTRITION EDUCATION, IN CLASS 41 (U.S. CLS. 100, 101 AND 107).

FIRST USE 12-1-2007; IN COMMERCE 12-1-2007.

THE COLOR(S) GREEN AND BLACK IS/ARE CLAIMED AS A FEATURE OF THE MARK.

THE MARK CONSISTS OF THE STYLIZED WORDS "GET WITH IT" IN BLACK AND THE SILHOUETTE OF A WOMAN RUNNING IN GREEN. THE SOLE OF THE WOMAN'S LEFT SHOE IS ENLARGED AND THE WORD "IT" APPEARS INSIDE AS WELL AS GREEN WAVY LINES REPRESENTING TREAD.

SER. NO. 77-418,641, FILED 3-11-2008.

JERI J. FICKES, EXAMINING ATTORNEY

Int. Cl.: 41

Prior U.S. Cls.: 100, 101 and 107

United States Patent and Trademark Office

Reg. No. 3,519,713

Registered Oct. 21, 2008

SERVICE MARK
PRINCIPAL REGISTER



ESPN STARWAVE PARTNERS (NEW YORK PARTNERSHIP), DBA D/B/A ESPN INTERNET VENTURES

ESPN PLAZA
BRISTOL, CT 06010

FOR: PROVIDING INFORMATION IN THE FIELD OF BASKETBALL VIA THE INTERNET, IN CLASS 41 (U.S. CLS. 100, 101 AND 107).

FIRST USE 12-0-2001; IN COMMERCE 12-0-2001.

NO CLAIM IS MADE TO THE EXCLUSIVE RIGHT TO USE "WWW.HOOPGURLZ.COM", APART FROM THE MARK AS SHOWN.

THE MARK CONSISTS OF THE WORDING "WWW.HOOPGURLZ.COM" WITH A DESIGN ELEMENT COMPRISED OF A BASKETBALL AND THE FEMALE SYMBOL.

SER. NO. 77-418,644, FILED 3-11-2008.

JERI J. FICKES, EXAMINING ATTORNEY

Int. Cl.: 35

Prior U.S. Cls.: 100, 101 and 102

United States Patent and Trademark Office

Reg. No. 3,519,714

Registered Oct. 21, 2008

**SERVICE MARK
PRINCIPAL REGISTER**



STARFISHPEOPLE, LLC. (WISCONSIN LIMITED
LIABILITY COMPANY)
SUITE 219
10936 N. PORT WASHINGTON RD.
MEQUON, WI 53092

FOR: THE BRINGING TOGETHER, FOR THE
BENEFIT OF OTHERS, OF A VARIETY OF GOODS
AND SERVICES, ENABLING CUSTOMERS TO
CONVENIENTLY VIEW AND PURCHASE THOSE
GOODS AND SERVICES FROM AN INTERNET
WEBSITE PARTICULARLY SPECIALIZING IN
THE MARKETING OF THE SALE OF GOODS
AND SERVICES OF OTHERS, IN CLASS 35 (U.S.
CLS. 100, 101 AND 102).

FIRST USE 3-1-2008; IN COMMERCE 3-10-2008.

THE COLOR(S) ORANGE AND GRAY IS/ARE
CLAIMED AS A FEATURE OF THE MARK.

THE MARK CONSISTS OF AN ABSTRACT STAR-
FISH IMAGE IN ORANGE TO THE LEFT OF
"STARFISHPEOPLE.COM", WITH "YOUR CON-
SULTING CONNECTION" IN GRAY UNDER-
NEATH. "STARFISH" AND ".COM" ARE GRAY
AND PEOPLE IS ORANGE.

SER. NO. 77-418,749, FILED 3-11-2008.

KARANENDRA S. CHHINA, EXAMINING ATTOR-
NEY

Int. Cl.: 36

Prior U.S. Cls.: 100, 101 and 102

United States Patent and Trademark Office

Reg. No. 3,519,715

Registered Oct. 21, 2008

**SERVICE MARK
PRINCIPAL REGISTER**

NOVAPRO RISK SOLUTIONS

NOVAPRO RISK SOLUTIONS, LP (GEORGIA
LIMITED PARTNERSHIP)

SUITE #1400

401 WEST A STREET

SAN DIEGO, CA, CA 92101

FOR: INSURANCE CLAIMS ADMINISTRATION,
IN CLASS 36 (U.S. CLS. 100, 101 AND 102).

FIRST USE 2-0-2008; IN COMMERCE 2-0-2008.

THE MARK CONSISTS OF STANDARD CHAR-
ACTERS WITHOUT CLAIM TO ANY PARTICULAR
FONT, STYLE, SIZE, OR COLOR.

NO CLAIM IS MADE TO THE EXCLUSIVE
RIGHT TO USE "RISK SOLUTIONS", APART FROM
THE MARK AS SHOWN.

SER. NO. 77-419,251, FILED 3-11-2008.

CIMMERIAN COLEMAN, EXAMINING ATTOR-
NEY

Int. Cl.: 9

Prior U.S. Cls.: 21, 23, 26, 36 and 38

Reg. No. 3,519,716

United States Patent and Trademark Office

Registered Oct. 21, 2008

**TRADEMARK
PRINCIPAL REGISTER**

NEXTENGINE

NEXTENGINE, INC. (DELAWARE CORPORATION)
401 WILSHIRE BOULEVARD, SUITE 900
SANTA MONICA, CA 90401

FOR: SCANNERS, COMPUTER CONTROLLED
TURNABLES FOR ROTATING OBJECTS, IMAGE
SCANNING SOFTWARE, COMPUTER SOFTWARE
FOR USE IN THE FIELD OF THREE-DIMENSIONAL
MODELING, AND COMPUTER AIDED DESIGN
SOFTWARE, IN CLASS 9 (U.S. CLS. 21, 23, 26, 36 AND
38).

FIRST USE 9-23-2003; IN COMMERCE 9-23-2003.

THE MARK CONSISTS OF STANDARD CHARACTERS
WITHOUT CLAIM TO ANY PARTICULAR
FONT, STYLE, SIZE, OR COLOR.

SER. NO. 77-419,253, FILED 3-11-2008.

CIMMERIAN COLEMAN, EXAMINING ATTORNEY

Int. Cl.: 12

Prior U.S. Cls.: 19, 21, 23, 31, 35 and 44

United States Patent and Trademark Office

Reg. No. 3,519,717

Registered Oct. 21, 2008

**TRADEMARK
PRINCIPAL REGISTER**



BULLZYE PTY. LTD (AUSTRALIA CORPORATION), DBA BULLZYE DESIGN
3/433 WONDALL RD. TINGALPA.
BRISBANE, AUSTRALIA

FOR: FITTED COVERS FOR VEHICLE STEERING WHEELS; FITTED AUTOMOTIVE SEAT COVERS; SEAT COVERS FOR VEHICLES; STEERING WHEEL COVERS; SUN SHIELDS AND VISORS FOR MOTOR CARS; VEHICLE SEAT COVERS, IN CLASS 12 (U.S. CLS. 19, 21, 23, 31, 35 AND 44).

FIRST USE 12-10-2004; IN COMMERCE 12-10-2004.

NO CLAIM IS MADE TO THE EXCLUSIVE RIGHT TO USE "AUSTRALIA", APART FROM THE MARK AS SHOWN.

THE MARK CONSISTS OF A STYLIZED BULL'S HEAD SURROUNDED BY AN INCOMPLETE CIRCLE WITH THE WORDING "BULLZYE AUSTRALIA" BELOW THE DESIGN.

SER. NO. 77-419,258, FILED 3-11-2008.

CIMMERIAN COLEMAN, EXAMINING ATTORNEY

Int. Cl.: 35

Prior U.S. Cls.: 100, 101 and 102

United States Patent and Trademark Office

Reg. No. 3,519,718

Registered Oct. 21, 2008

**SERVICE MARK
PRINCIPAL REGISTER**

SEAWOOD PHOTO

SEAWOOD PHOTO, INC. (CALIFORNIA CORPORATION)
115 TUNSTEAD AVE.
SAN ANSELMO, CA 94960

FOR: RETAIL STORES FEATURING NEW AND USED CAMERAS, PHOTO ACCESSORIES AND SUPPLIES, IN CLASS 35 (U.S. CLS. 100, 101 AND 102).

FIRST USE 8-0-1961; IN COMMERCE 8-0-1961.

THE MARK CONSISTS OF STANDARD CHARACTERS WITHOUT CLAIM TO ANY PARTICULAR FONT, STYLE, SIZE, OR COLOR.

NO CLAIM IS MADE TO THE EXCLUSIVE RIGHT TO USE "PHOTO", APART FROM THE MARK AS SHOWN.

SER. NO. 77-419,297, FILED 3-11-2008.

EMILY CARLSEN, EXAMINING ATTORNEY

Int. Cl.: 44

Prior U.S. Cls.: 100 and 101

United States Patent and Trademark Office

Reg. No. 3,519,719

Registered Oct. 21, 2008

**SERVICE MARK
PRINCIPAL REGISTER**

Don't Cheat Your Body

ABSOLUTE FIT (GEORGIA CORPORATION)
3012 LAFAYETTE ROAD
FORT OGLETHORPE, GA 30742

THE MARK CONSISTS OF STANDARD CHAR-
ACTERS WITHOUT CLAIM TO ANY PARTICULAR
FONT, STYLE, SIZE, OR COLOR.

FOR: WEIGHT REDUCTION DIET PLANNING
AND SUPERVISION, IN CLASS 44 (U.S. CLS. 100
AND 101).

SER. NO. 77-419,347, FILED 3-11-2008.

FIRST USE 1-1-1992; IN COMMERCE 1-1-1992.

CYNTHIA TRIPI, EXAMINING ATTORNEY

Int. Cls.: 9 and 41

Prior U.S. Cls.: 21, 23, 26, 36, 38, 100, 101 and 107

Reg. No. 3,519,720

United States Patent and Trademark Office

Registered Oct. 21, 2008

**TRADEMARK
SERVICE MARK
PRINCIPAL REGISTER**

voice of vision

OLIVER, TYLER (UNITED STATES INDIVIDUAL)
APT. 31
3 DERRY WAY
DERRY, NH 03038

FOR: PRERECORDED CD'S, MP3'S AND DVD'S FEATURING MUSIC AND MUSICAL VIDEOS, IN CLASS 9 (U.S. CLS. 21, 23, 26, 36 AND 38).

FIRST USE 10-25-2004; IN COMMERCE 9-1-2005.

FOR: ENTERTAINMENT, NAMELY, LIVE AUDIO AND VISUAL PERFORMANCE BY A MUSICAL GROUP; A WEB SITE FEATURING MUSI-

CAL PERFORMANCES, MUSICAL VIDEOS, RELATED FILM CLIPS, PHOTOGRAPHS, AND OTHER MULTIMEDIA MATERIALS, IN CLASS 41 (U.S. CLS. 100, 101 AND 107).

FIRST USE 10-25-2004; IN COMMERCE 9-1-2005.

THE MARK CONSISTS OF STANDARD CHARACTERS WITHOUT CLAIM TO ANY PARTICULAR FONT, STYLE, SIZE, OR COLOR.

SER. NO. 77-419,369, FILED 3-11-2008.

LINDA M. KING, EXAMINING ATTORNEY

Int. Cl.: 35

Prior U.S. Cls.: 100, 101 and 102

United States Patent and Trademark Office

Reg. No. 3,519,721

Registered Oct. 21, 2008

**SERVICE MARK
PRINCIPAL REGISTER**



SWEENEY, KATHRYN MARION (ARIZONA
SOLE PROPRIETORSHIP), DBA RESUME
WRITERS RESOURCE

4109 E. CAMDEN AVE
QUEEN CREEK, AZ 85240

FOR: BUSINESS MANAGEMENT CONSULTING
AND ADVISORY SERVICES, IN CLASS 35 (U.S. CLS.
100, 101 AND 102).

FIRST USE 1-1-2008; IN COMMERCE 1-1-2008.

NO CLAIM IS MADE TO THE EXCLUSIVE
RIGHT TO USE "RESUME WRITERS RESOURCE",
APART FROM THE MARK AS SHOWN.

THE COLOR(S) BLACK, BROWN, TAN, AND
RUST IS/ARE CLAIMED AS A FEATURE OF THE
MARK.

THE MARK CONSISTS OF THE WORDS "RE-
SUME" IN BROWN, "WRITERS" IN RUST, AND
"RESOURCE" IN BLACK, WITH A BLACK ARROW
CURVING UPWARD TO THE LEFT OF THE
WORDS, AND FOUR TAN RECTANGULAR
SHAPES GRADUATING UPWARD TO THE LEFT
OF THE ARROW.

SER. NO. 77-419,390, FILED 3-11-2008.

KRISTIN CARLSON, EXAMINING ATTORNEY

Int. Cl.: 43

Prior U.S. Cls.: 100 and 101

United States Patent and Trademark Office

Reg. No. 3,519,722

Registered Oct. 21, 2008

**SERVICE MARK
PRINCIPAL REGISTER**

COMELLAS

288 INC. (MASSACHUSETTS CORPORATION)
288 WASHINGTON STREET
WELLESLEY, MA 02481

THE MARK CONSISTS OF STANDARD CHAR-
ACTERS WITHOUT CLAIM TO ANY PARTICULAR
FONT, STYLE, SIZE, OR COLOR.

FOR: RESTAURANT AND CATERING SERVI-
CES, IN CLASS 43 (U.S. CLS. 100 AND 101).

SER. NO. 77-419,561, FILED 3-12-2008.

FIRST USE 0-0-1990; IN COMMERCE 0-0-1990.

JORDAN BAKER, EXAMINING ATTORNEY

Int. Cl.: 5

Prior U.S. Cls.: 6, 18, 44, 46, 51 and 52

United States Patent and Trademark Office

Reg. No. 3,519,723

Registered Oct. 21, 2008

**TRADEMARK
PRINCIPAL REGISTER**

DR. JOHN'S HERBAL CANDY

DR. JOHN'S CANDIES, LLC (MICHIGAN LIMITED LIABILITY COMPANY)
2242 CARDIFF CT NE
GRAND RAPIDS, MI 49505

FOR: HERBAL SUPPLEMENT IN CANDY FORM FOR THE PREVENTION OF DENTAL DECAY AND CAVITIES, IN CLASS 5 (U.S. CLS. 6, 18, 44, 46, 51 AND 52).

FIRST USE 7-1-2006; IN COMMERCE 7-1-2006.

THE MARK CONSISTS OF STANDARD CHARACTERS WITHOUT CLAIM TO ANY PARTICULAR FONT, STYLE, SIZE, OR COLOR.

OWNER OF U.S. REG. NO. 3,224,997.

NO CLAIM IS MADE TO THE EXCLUSIVE RIGHT TO USE "HERBAL CANDY", APART FROM THE MARK AS SHOWN.

THE NAME(S), PORTRAIT(S), AND/OR SIGNATURE(S) SHOWN IN THE MARK IDENTIFIES "DR. JOHN BRUINSMA", WHOSE CONSENT(S) TO REGISTER IS SUBMITTED.

SER. NO. 77-419,568, FILED 3-12-2008.

KOURTNEE HODGES, EXAMINING ATTORNEY

Int. Cls.: 36 and 37

Prior U.S. Cls.: 100, 101, 102, 103 and 106

United States Patent and Trademark Office

Reg. No. 3,519,724

Registered Oct. 21, 2008

**SERVICE MARK
PRINCIPAL REGISTER**

DEXUS

DEXUS INDUSTRIAL PROPERTIES INC.
(MARYLAND CORPORATION)
C/O 875 NORTH MICHIGAN AVENUE, STE. 410
CHICAGO, IL 606111803

FOR: REAL ESTATE MANAGEMENT SERVICES,
NAMELY, LISTING, BROKERAGE, AND MAN-
AGEMENT OF COMMERCIAL, INDUSTRIAL,
AND RETAIL PROPERTIES; REAL ESTATE LEAS-
ING SERVICES; REAL ESTATE INVESTMENT SER-
VICES, NAMELY, ASSET ACQUISITION,
DEVELOPMENT, AND MANAGEMENT SERVICES,
IN CLASS 36 (U.S. CLS. 100, 101 AND 102).

FIRST USE 2-21-2008; IN COMMERCE 2-21-2008.

FOR: COMMERCIAL, INDUSTRIAL, AND RE-
TAIL REAL ESTATE DEVELOPMENT SERVICES,
IN CLASS 37 (U.S. CLS. 100, 103 AND 106).

FIRST USE 2-21-2008; IN COMMERCE 2-21-2008.

THE MARK CONSISTS OF STANDARD CHAR-
ACTERS WITHOUT CLAIM TO ANY PARTICULAR
FONT, STYLE, SIZE, OR COLOR.

SER. NO. 77-419,676, FILED 3-12-2008.

DARRYL SPRUILL, EXAMINING ATTORNEY

Int. Cl.: 41

Prior U.S. Cls.: 100, 101 and 107

United States Patent and Trademark Office

Reg. No. 3,519,725

Registered Oct. 21, 2008

**SERVICE MARK
PRINCIPAL REGISTER**

Sun City Kids

PERRY, STEVEN (UNITED STATES INDIVIDUAL)
10545 W. CAMDEN AVE.
SUN CITY, AZ 85351

FOR: ENTERTAINMENT IN THE NATURE OF LIVE PERFORMANCES BY A MASTER OF CEREMONIES PROVIDING AN INTERACTIVE QUIZ SHOW, IN CLASS 41 (U.S. CLS. 100, 101 AND 107).

FIRST USE 5-1-2000; IN COMMERCE 5-1-2000.

THE MARK CONSISTS OF STANDARD CHARACTERS WITHOUT CLAIM TO ANY PARTICULAR FONT, STYLE, SIZE, OR COLOR.

NO CLAIM IS MADE TO THE EXCLUSIVE RIGHT TO USE "SUN CITY", APART FROM THE MARK AS SHOWN.

SER. NO. 77-419,722, FILED 3-12-2008.

WANDA KAY PRICE, EXAMINING ATTORNEY

Int. Cl.: 31

Prior U.S. Cls.: 1 and 46

United States Patent and Trademark Office

Reg. No. 3,519,726

Registered Oct. 21, 2008

**TRADEMARK
PRINCIPAL REGISTER**



BOYETT, GARY QUIN (UNITED STATES INDIVIDUAL)
59 YARBRO ROAD
KENTON, TN 38233

FOR: ANIMAL FEED, IN CLASS 31 (U.S. CLS. 1 AND 46).

FIRST USE 1-0-2007; IN COMMERCE 2-1-2007.

NO CLAIM IS MADE TO THE EXCLUSIVE RIGHT TO USE "NUTRITION", APART FROM THE MARK AS SHOWN.

THE STIPPLING IS FOR SHADING PURPOSES ONLY.

THE MARK CONSISTS OF A TORCH WITH A FLAME CENTERED IN FRONT OF A CIRCLE WITH THE NAME "PRIME LINE NUTRITION" CENTERED BELOW AND IN FRONT OF THE FLAME.

SER. NO. 77-419,748, FILED 3-12-2008.

BARBARA BROWN, EXAMINING ATTORNEY

Int. Cl.: 1

Prior U.S. Cls.: 1, 5, 6, 10, 26 and 46

United States Patent and Trademark Office

Reg. No. 3,519,727

Registered Oct. 21, 2008

**TRADEMARK
PRINCIPAL REGISTER**

Calva Lacto-Fresh

CALVA PRODUCTS CO., INC. (CALIFORNIA CORPORATION)
4351 E WINERY RD
ACAMPO, CA 95220

FOR: PRESERVATIVE COMPOSITION FOR USE IN MILK REPLACEMENT FOR CALVES, IN CLASS 1 (U.S. CLS. 1, 5, 6, 10, 26 AND 46).

FIRST USE 1-0-1998; IN COMMERCE 1-0-1998.

NO CLAIM IS MADE TO THE EXCLUSIVE RIGHT TO USE "LACTO-FRESH", APART FROM THE MARK AS SHOWN.

THE COLOR(S) BLACK AND BLUE IS/ARE CLAIMED AS A FEATURE OF THE MARK.

THE MARK CONSISTS OF THE WORDS "CALVA LACTO-FRESH" IN STYLIZED WRITING WITH EACH LETTER BEING THE COLOR BLUE OUTLINED IN THE COLOR BLACK.

THE ENGLISH TRANSLATION OF THE WORD "CALVA" IN THE MARK IS BALD.

SER. NO. 77-419,821, FILED 3-12-2008.

APRIL ROACH, EXAMINING ATTORNEY

Int. Cl.: 21

Prior U.S. Cls.: 2, 13, 23, 29, 30, 33, 40 and 50

United States Patent and Trademark Office

Reg. No. 3,519,728

Registered Oct. 21, 2008

**TRADEMARK
PRINCIPAL REGISTER**

MAGIC ERASER

THE PROCTER & GAMBLE COMPANY (OHIO
CORPORATION)
ONE PROCTER & GAMBLE PLAZA
CINCINNATI, OH 45202

FOR: HOUSEHOLD CLEANING TOOLS, NAME-
LY, MOPS AND REPLACEMENT MOP HEADS, IN
CLASS 21 (U.S. CLS. 2, 13, 23, 29, 30, 33, 40 AND 50).

FIRST USE 12-31-2005; IN COMMERCE 12-31-2005.

THE MARK CONSISTS OF STANDARD CHAR-
ACTERS WITHOUT CLAIM TO ANY PARTICULAR
FONT, STYLE, SIZE, OR COLOR.

OWNER OF U.S. REG. NOS. 2,926,903, 3,160,306
AND OTHERS.

SER. NO. 77-419,839, FILED 3-12-2008.

TOBY BULLOFF, EXAMINING ATTORNEY

Int. Cl.: 36

Prior U.S. Cls.: 100, 101 and 102

United States Patent and Trademark Office

Reg. No. 3,519,729

Registered Oct. 21, 2008

SERVICE MARK
PRINCIPAL REGISTER



THE NATIONAL CHURCH SUPPLY COMPANY,
INC. (WEST VIRGINIA CORPORATION)
PO BOX 269
CHESTER, WV 26034

FOR: PROVIDING ELECTRONIC PROCESSING
OF ACH AND CREDIT CARD TRANSACTIONS
AND ELECTRONIC PAYMENTS VIA A GLOBAL
COMPUTER NETWORK; CHARITABLE FUND
RAISING; CHARITABLE FUND RAISING SERVI-
CES, IN CLASS 36 (U.S. CLS. 100, 101 AND 102).

FIRST USE 1-31-2008; IN COMMERCE 1-31-2008.

NO CLAIM IS MADE TO THE EXCLUSIVE
RIGHT TO USE "E-GIVING", APART FROM THE
MARK AS SHOWN.

THE COLOR(S) LIGHT BLUE, DARK BLUE AND
WHITE IS/ARE CLAIMED AS A FEATURE OF THE
MARK.

THE MARK CONSISTS OF A BLUE STARBURST
THAT FADES TO A WHITE STAR IN THE CENTER.
THE WORDS "E-GIVING" ARE IN DARK BLUE
AND ARE BORDERED IN WHITE AND SHA-
DOWED IN LIGHT BLUE.

SER. NO. 77-419,886, FILED 3-12-2008.

MARY CRAWFORD, EXAMINING ATTORNEY

Int. Cl.: 36

Prior U.S. Cls.: 100, 101 and 102

United States Patent and Trademark Office

Reg. No. 3,519,730

Registered Oct. 21, 2008

**SERVICE MARK
PRINCIPAL REGISTER**

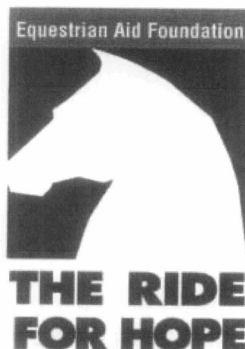

EQUESTRIAN AID FOUNDATION, INC. (FLORIDA CORPORATION)
12028 LONGWOOD GREEN DRIVE
WELLINGTON, FL 33414

FOR: MEMBERSHIP BASED ORGANIZATION FEATURING SERVICES TO ASSIST INDIVIDUALS IN THE EQUESTRIAN WORLD THAT HAVE SUFFERED A LIFE-THREATENING ILLNESS, CATASTROPHIC ACCIDENT OR INJURY BY PROVIDING DIRECT FINANCIAL SUPPORT FOR THEIR MEDICAL OR OTHER BASIC NEEDS, IN CLASS 36 (U.S. CLS. 100, 101 AND 102).

FIRST USE 10-1-2006; IN COMMERCE 10-1-2006.

NO CLAIM IS MADE TO THE EXCLUSIVE RIGHT TO USE "EQUESTRIAN AID FOUNDATION", APART FROM THE MARK AS SHOWN.

THE MARK CONSISTS OF THE PROFILE OF A HORSE, IN WHITE, ON A BLACK BACKGROUND, WITH THE WORDS "EQUESTRIAN AID FOUNDATION" ABOVE THE HORSE, AND THE WORDS "THE RIDE FOR HOPE" BELOW THE HORSE. THE HORSE AND LETTERING ARE WHITE.

SER. NO. 77-420,016, FILED 3-12-2008.

RONALD AIKENS, EXAMINING ATTORNEY

Int. Cl.: 35

Prior U.S. Cls.: 100, 101 and 102

United States Patent and Trademark Office

Reg. No. 3,519,731

Registered Oct. 21, 2008

**SERVICE MARK
PRINCIPAL REGISTER**

MATTER

LUXE & PRODUCT LLC (NEW YORK LIMITED
LIABILITY COMPANY), DBA MATTER
227 5TH AVENUE
BROOKLYN, NY 11215

FOR: RETAIL SHOPS FEATURING FURNITURE
AND LIGHTING AND DECORATIVE ACCESSOR-
IES FOR HOME AND OFFICE, IN CLASS 35 (U.S.
CLS. 100, 101 AND 102).

FIRST USE 7-1-2003; IN COMMERCE 9-1-2003.

THE MARK CONSISTS OF UPPER-CASE BLOCK
LETTERS ALL ATTACHED.

SER. NO. 77-420,018, FILED 3-12-2008.

RONALD AIKENS, EXAMINING ATTORNEY

Int. Cl.: 37

Prior U.S. Cls.: 100, 103 and 106

United States Patent and Trademark Office

Reg. No. 3,519,732

Registered Oct. 21, 2008

**SERVICE MARK
PRINCIPAL REGISTER**

PRO TAPPING

PRO TAPPING, INC. (NEW JERSEY CORPORATION)
8 WEST LAKE AVENUE
MEDFORD, NJ 08055

FOR: PIPELINE MAINTENANCE AND REPAIR SERVICES; NAMELY, PRESSURE TAPPING, VALVE INSERTIONS, PIPE FREEZING AND LINE STOPS, IN CLASS 37 (U.S. CLS. 100, 103 AND 106).

FIRST USE 4-30-1984; IN COMMERCE 4-30-1994.

THE MARK CONSISTS OF STANDARD CHARACTERS WITHOUT CLAIM TO ANY PARTICULAR FONT, STYLE, SIZE, OR COLOR.

OWNER OF U.S. REG. NO. 1,705,436.

NO CLAIM IS MADE TO THE EXCLUSIVE RIGHT TO USE "TAPPING", APART FROM THE MARK AS SHOWN.

SEC. 2(F).

SER. NO. 77-420,098, FILED 3-12-2008.

KATHY DE JONGE, EXAMINING ATTORNEY

Int. Cl.: 45

Prior U.S. Cls.: 100 and 101

United States Patent and Trademark Office

Reg. No. 3,519,733

Registered Oct. 21, 2008

**SERVICE MARK
PRINCIPAL REGISTER**

MCGARRY BAIR

MCGARRY BAIR PC (MICHIGAN CORPORATION)
32 MARKET AVENUE SW, SUITE 500
GRAND RAPIDS, MI 49503

THE MARK CONSISTS OF STANDARD CHARACTERS WITHOUT CLAIM TO ANY PARTICULAR FONT, STYLE, SIZE, OR COLOR.

FOR: LEGAL SERVICES, IN CLASS 45 (U.S. CLS. 100 AND 101).

SER. NO. 77-420,222, FILED 3-12-2008.

FIRST USE 10-1-2001; IN COMMERCE 10-1-2001.

STEVEN PEREZ, EXAMINING ATTORNEY

Int. Cl.: 37

Prior U.S. Cls.: 100, 103 and 106

United States Patent and Trademark Office

Reg. No. 3,519,734

Registered Oct. 21, 2008

**SERVICE MARK
PRINCIPAL REGISTER**

WELCOME
HEALTHY HOUSEKEEPING
WE CARE ABOUT YOUR HEALTH

THE IBS SERVICES GROUP, INC. (NEW YORK
CORPORATION)
68 THOMAS STREET
NEW YORK, NY 10013

FOR: CLEANING OF BUILDINGS, IN CLASS 37
(U.S. CLS. 100, 103 AND 106).

FIRST USE 1-1-2007; IN COMMERCE 1-1-2007.

THE MARK CONSISTS OF STANDARD CHAR-
ACTERS WITHOUT CLAIM TO ANY PARTICULAR
FONT, STYLE, SIZE, OR COLOR.

OWNER OF U.S. REG. NOS. 2,425,597, 3,038,227
AND OTHERS.

NO CLAIM IS MADE TO THE EXCLUSIVE
RIGHT TO USE "HEALTHY HOUSEKEEPING",
APART FROM THE MARK AS SHOWN.

SER. NO. 77-420,351, FILED 3-12-2008.

HELENE LIWINSKI, EXAMINING ATTORNEY

Int. Cl.: 43

Prior U.S. Cls.: 100 and 101

United States Patent and Trademark Office

Reg. No. 3,519,735

Registered Oct. 21, 2008

**SERVICE MARK
PRINCIPAL REGISTER**



DEMETRIOS K. PANTAZIS FAMILY LIMITED
PARTNERSHIP (CALIFORNIA LIMITED
PARTNERSHIP)

4900 GOULD AVENUE
LA CANADA, CA 91011

FOR: RESTAURANT SERVICES, IN CLASS 43
(U.S. CLS. 100 AND 101).

FIRST USE 11-0-2006; IN COMMERCE 11-0-2006.

NO CLAIM IS MADE TO THE EXCLUSIVE
RIGHT TO USE "CHICKEN AND BURGERS" AND
"EST. 1968", APART FROM THE MARK AS SHOWN.

THE MARK CONSISTS OF THE OUTLINE OF A
FANCIFUL CHICKEN INSIDE A DIAMOND WITH
THE WORDS DINO'S CHICKEN AND BURGERS
EST. 1968 .

SER. NO. 77-420,517, FILED 3-12-2008.

MICHAEL LITZAU, EXAMINING ATTORNEY

Int. Cl.: 33

Prior U.S. Cls.: 47 and 49

United States Patent and Trademark Office

Reg. No. 3,519,736

Registered Oct. 21, 2008

TRADEMARK
PRINCIPAL REGISTER



CRISTALL U.S.A., INC. (FLORIDA CORPORATION)
902 CLINT MOORE ROAD, SUITE 146
BOCA RATON, FL 33487

FOR: ALCOHOLIC BEVERAGE, NAMELY, VODKA, IN CLASS 33 (U.S. CLS. 47 AND 49).

FIRST USE 2-1-2007; IN COMMERCE 2-1-2007.

OWNER OF U.S. REG. NOS. 2,301,166, 2,770,506 AND OTHERS.

NO CLAIM IS MADE TO THE EXCLUSIVE RIGHT TO USE "ULTRA PREMIUM RUSSIAN VODKA" AND "SIGNATURE SERIES", APART FROM THE MARK AS SHOWN.

THE COLOR(S) BLACK, GOLD AND RED IS/ARE CLAIMED AS A FEATURE OF THE MARK.

THE MARK CONSISTS OF THE WORD "CRISTALL" IS GOLD IN COLOR AND VERTICALLY DISPLAYED WITHIN A RECTANGULAR DOMED FRAME. THE OVERALL BACKGROUND COLOR OF THE WHOLE FRAME IS BLACK. THE LETTER "I" IN THE VERTICAL WORD "CRISTALL" IS DOTTED WITH A RED CROWN. THE RED CROWN IS OUTLINED IN THE COLOR GOLD. CENTERED INSIDE THE DOMED FRAME TOWARDS THE TOP OF THE FRAME IS A RED COLORED CROWN OUTLINED IN THE COLOR GOLD. THE COLORS BLACK, GOLD AND RED ARE AN INTEGRAL PART OF THE MARK.

SER. NO. 77-420,541, FILED 3-12-2008.

SANJEEV VOHRA, EXAMINING ATTORNEY

Int. Cl.: 41

Prior U.S. Cls.: 100, 101 and 107

United States Patent and Trademark Office

Reg. No. 3,519,737

Registered Oct. 21, 2008

**SERVICE MARK
PRINCIPAL REGISTER**



SALAS, ANTONIO (MEXICO INDIVIDUAL), DBA
LOS GUERREROS DEL ARPA
247 SANTINI COURT
SANTA ROSA, CA 95407

THE FOREIGN WORDING IN THE MARK
TRANSLATES INTO ENGLISH AS "THE HARP
WARRIORS".

FOR: ENTERTAINMENT, NAMELY, LIVE PER-
FORMANCES BY A MUSICAL BAND, IN CLASS 41
(U.S. CLS. 100, 101 AND 107).

SER. NO. 77-420,554, FILED 3-12-2008.

FIRST USE 1-1-2006; IN COMMERCE 1-1-2006.

RAUL CORDOVA, EXAMINING ATTORNEY

Int. Cl.: 41

Prior U.S. Cls.: 100, 101 and 107

United States Patent and Trademark Office

Reg. No. 3,519,738

Registered Oct. 21, 2008

**SERVICE MARK
PRINCIPAL REGISTER**



MAGNOLIAS INTERNATIONAL, LLC (MICHIGAN LIMITED LIABILITY COMPANY), DBA THEBEERCARTGIRL.COM
P.O. BOX 643
WASHINGTON, MI 48094

FOR: PROVIDING A WEB SITE THROUGH WHICH GOLFERS LOCATE INFORMATION ABOUT GOLF COURSES AND GOLF TOURNAMENTS; PROVIDING A WEB SITE THROUGH WHICH GOLFERS RESERVE TEE TIMES AT GOLF COURSES, IN CLASS 41 (U.S. CLS. 100, 101 AND 107).

FIRST USE 3-12-2008; IN COMMERCE 3-13-2008.

THE COLOR(S) ORANGE, BLACK, PEACH, GRAY, BROWN, BLUE, RED, PINK AND WHITE IS/ARE CLAIMED AS A FEATURE OF THE MARK.

THE MARK CONSISTS OF A GIRL WITH PEACH SKIN, ORANGE HAIR, BROWN EYEBROWS, BLACK EYELASHES, BLUE AND WHITE EYES WITH BLACK AND WHITE PUPILS AND DARK PEACH OUTLINE, A DARK PEACH NOSE AND INNER EAR, AND PINK AND RED LIPS. THE GIRL IS WEARING A BLUE HAIR TIE AND GRAY AND BLACK VISOR. THE WORDING THEBEERCARTGIRL.COM IS UNDER THE GIRL, WITH "BEER" AND "GIRL" IN ORANGE AND THE REMAINDER OF THE WORDING IN BLACK.

SER. NO. 77-420,619, FILED 3-13-2008.

ROBIN MITTLER, EXAMINING ATTORNEY

Int. Cl.: 35

Prior U.S. Cls.: 100, 101 and 102

United States Patent and Trademark Office

Reg. No. 3,519,739

Registered Oct. 21, 2008

**SERVICE MARK
PRINCIPAL REGISTER**

IDENX.COM

DIEBOLD, INCORPORATED (OHIO CORPORATION)
5995 MAYFAIR ROAD
NORTH CANTON, OH 44720

THE MARK CONSISTS OF STANDARD CHARACTERS WITHOUT CLAIM TO ANY PARTICULAR FONT, STYLE, SIZE, OR COLOR.

FOR: COMPUTERIZED ON-LINE RETAIL STORE SERVICES IN THE FIELD OF SECURITY IDENTIFICATION CARDS, IN CLASS 35 (U.S. CLS. 100, 101 AND 102).

SER. NO. 77-420,706, FILED 3-13-2008.

FIRST USE 3-12-2008; IN COMMERCE 3-12-2008.

CURTIS FRENCH, EXAMINING ATTORNEY

Int. Cl.: 25

Prior U.S. Cls.: 22 and 39

United States Patent and Trademark Office

Reg. No. 3,519,740

Registered Oct. 21, 2008

**TRADEMARK
PRINCIPAL REGISTER**

MAY PANG INSTAMATIC KARMA

PANG, MAY (UNITED STATES INDIVIDUAL)
P.O. BOX 314
POMONA, NY 10970

FOR: A-SHIRTS; BUTTON-FRONT ALOHA SHIRTS; CAMP SHIRTS; DRESS SHIRTS; GOLF SHIRTS; HOODED SWEAT SHIRTS; KNIT SHIRTS; LONG-SLEEVED SHIRTS; NIGHT SHIRTS; OPEN-NECKED SHIRTS; PIQUE SHIRTS; POLO SHIRTS; RUGBY SHIRTS; SHIRT FRONTS; SHIRT YOKES; SHIRTS; SHIRTS FOR SUITS; SHORT-SLEEVED OR LONG-SLEEVED T-SHIRTS; SHORT-SLEEVED SHIRTS; SLEEP SHIRTS; SPORT SHIRTS; SPORTS SHIRTS; SPORTS SHIRTS WITH SHORT SLEEVES; SWEAT SHIRTS; T-SHIRTS; TEE SHIRTS; TRIATHLON CLOTHING, NAMELY, TRIATHLON TIGHTS, TRIATHLON SHORTS, TRIATHLON SINGLET, TRIATHLON SHIRTS, TRIATHLON SUITS; WIND SHIRTS; YOGA SHIRTS; HEAD SCARVES; SCARVES; SHOULDER SCARVES; SILK SCARVES; BICYCLE GLOVES; BICYCLING GLOVES; CROSS-COUNTRY GLOVES; GLOVES; GLOVES FOR PERSONAL HAND CONDITIONING USE; GLOVES INCLUDING THOSE MADE OF SKIN, HIDE OR FUR; MOTORCYCLE GLOVES; OUTDOOR GLOVES; RIDING GLOVES; SKI GLOVES; SNOWBOARD GLOVES; WET SUIT GLOVES; CHEF'S HATS; FUR HATS; HAT BANDS; HATS; PAPER HATS FOR USE AS CLOTHING ITEMS; SEDGE HATS OR SUGEGASA; SMALL HATS; TOBOGGAN HATS, PANTS AND CAPS; WOOLLY HATS; BALLOON PANTS; CAPRI PANTS; CARGO PANTS; DENIMS; JOGGING PANTS; LEATHER PANTS; LOUNGE PANTS; NON-DISPOSABLE CLOTH TRAINING PANTS; NURSE PANTS; PANTS; PETTI-PANTS; SKI PANTS; SNOW PANTS; SNOWBOARD PANTS; STRETCH PANTS;

SWEAT PANTS; TAP PANTS; TRACK PANTS; WATERPROOF JACKETS AND PANTS; WIND PANTS; YOGA PANTS; BED JACKETS; DENIM JACKETS; DOWN JACKETS; FISHERMEN'S JACKETS; FUR COATS AND JACKETS; FUR JACKETS; HEAVY JACKETS; JACKET LINERS; JACKETS; LEATHER JACKETS; LIGHT-REFLECTING JACKETS; LONG JACKETS; MEN AND WOMEN JACKETS, COATS, TROUSERS, VESTS; PADDED JACKETS; PADDING JACKETS; RAIN JACKETS; RAINPROOF JACKETS; REVERSIBLE JACKETS; SHELL JACKETS; SKI JACKETS; SLEEVED OR SLEEVELESS JACKETS; SMOKING JACKETS; SPORTS JACKETS; STUFF JACKETS; SUEDE JACKETS; SWEAT JACKETS; TRACK JACKETS; WIND RESISTANT JACKETS; WIND-JACKETS; PLEATED SKIRTS FOR FORMAL KIMONOS OR HAKAMA; SKIRT SUITS; SKIRTS; SKIRTS AND DRESSES; FISHING VESTS; FLEECE VESTS; HUNTING VESTS; LONG SLEEVED VESTS; QUILTED VESTS; VEST EXTENDERS; VESTED SUITS; VESTS; WIND VESTS, IN CLASS 25 (U.S. CLS. 22 AND 39).

FIRST USE 3-4-2008; IN COMMERCE 3-4-2008.

THE MARK CONSISTS OF STANDARD CHARACTERS WITHOUT CLAIM TO ANY PARTICULAR FONT, STYLE, SIZE, OR COLOR.

OWNER OF U.S. REG. NOS. 3,022,610 AND 3,289,123.

SER. NO. 77-420,838, FILED 3-13-2008.

ZACHARY BELLO, EXAMINING ATTORNEY

Int. Cl.: 16

Prior U.S. Cls.: 2, 5, 22, 23, 29, 37, 38 and 50

United States Patent and Trademark Office

Reg. No. 3,519,741

Registered Oct. 21, 2008

**TRADEMARK
PRINCIPAL REGISTER**

NEOTHINK

INTEGRATED MANAGEMENT ASSOCIATES,
INC. (NEVADA CORPORATION)
2435 W. HORIZON RIDGE PARKWAY
HENDERSON, NV 89052

THE MARK CONSISTS OF STANDARD CHAR-
ACTERS WITHOUT CLAIM TO ANY PARTICULAR
FONT, STYLE, SIZE, OR COLOR.

FOR: A SERIES OF BOOKS AND WRITTEN
ARTICLES IN THE FIELD OF SELF-HELP, PHILO-
SOPHY AND POLITICS, IN CLASS 16 (U.S. CLS. 2, 5,
22, 23, 29, 37, 38 AND 50).

SER. NO. 77-420,872, FILED 3-13-2008.

FIRST USE 8-0-1989; IN COMMERCE 8-0-1989.

DAYNA BROWNE, EXAMINING ATTORNEY

Int. Cl.: 41

Prior U.S. Cls.: 100, 101 and 107

United States Patent and Trademark Office

Reg. No. 3,519,742

Registered Oct. 21, 2008

**SERVICE MARK
PRINCIPAL REGISTER**

The Mercurial

SORIANO, ANTHONY S. (UNITED STATES INDIVIDUAL)

2627 COLUMBUS AVE

NORTH BELLMORE, NY 11710 AND

COHEN, DANIEL T. (UNITED STATES INDIVIDUAL)

2627 COLUMBUS AVE

NORTH BELLMORE, NY 11710 AND

SANCHEZ, RAYMOND C. (UNITED STATES INDIVIDUAL)

2627 COLUMBUS AVE

NORTH BELLMORE, NY 11710

FOR: ENTERTAINMENT, NAMELY, LIVE PERFORMANCES BY A MUSICAL BAND, IN CLASS 41 (U.S. CLS. 100, 101 AND 107).

FIRST USE 6-1-2004; IN COMMERCE 6-1-2004.

THE MARK CONSISTS OF STANDARD CHARACTERS WITHOUT CLAIM TO ANY PARTICULAR FONT, STYLE, SIZE, OR COLOR.

SER. NO. 77-420,907, FILED 3-13-2008.

KELLY CHOE, EXAMINING ATTORNEY

Int. Cl.: 3

Prior U.S. Cls.: 1, 4, 6, 50, 51 and 52

United States Patent and Trademark Office

Reg. No. 3,519,743

Registered Oct. 21, 2008

TRADEMARK
PRINCIPAL REGISTER



ALOE VERA OF AMERICA, INC. (TEXAS CORPORATION)
13745 JUPITER ROAD
DALLAS, TX 75238

FOR: COSMETIC PRODUCTS, NAMELY, SKIN CLEANSERS, SKIN EXFOLIATORS, SKIN TONERS, SKIN MOISTURIZERS, AND NON-MEDICATED SKIN SERUMS, IN CLASS 3 (U.S. CLS. 1, 4, 6, 50, 51 AND 52).

FIRST USE 11-30-2007; IN COMMERCE 11-30-2007.

OWNER OF U.S. REG. NOS. 2,351,373 AND 2,500,129.

THE MARK CONSISTS OF THE WORD "SONYA" IN STYLIZED SCRIPT FORM WITH A FANCIFUL UPWARD CURVING ARC DESIGN EXTENDING ABOVE AND A FANCIFUL DOWNWARD CURVING ARC DESIGN EXTENDING BELOW THE EXTENSION OF THE LETTER "A".

SER. NO. 77-421,024, FILED 3-13-2008.

EDWARD FENNESSY, EXAMINING ATTORNEY

Int. Cl.: 18

Prior U.S. Cls.: 1, 2, 3, 22 and 41

United States Patent and Trademark Office

Reg. No. 3,519,744

Registered Oct. 21, 2008

**TRADEMARK
PRINCIPAL REGISTER**

ELECTION ON WHEELS

MASCOT METROPOLITAN INC. (CALIFORNIA CORPORATION)
380 SWIFT AVE. #18, S.S. F. CA 94080
SOUTH SAN FRANCISCO, CA 94080

FOR: LUGGAGE PRIMARILY FOR VOTING EQUIPMENT AND SUPPLIES, IN CLASS 18 (U.S. CLS. 1, 2, 3, 22 AND 41).

FIRST USE 11-30-2005; IN COMMERCE 11-30-2005.

THE MARK CONSISTS OF STANDARD CHARACTERS WITHOUT CLAIM TO ANY PARTICULAR FONT, STYLE, SIZE, OR COLOR.

OWNER OF U.S. REG. NOS. 2,802,228, 3,261,162 AND OTHERS.

SER. NO. 77-421,051, FILED 3-13-2008.

AMY ALFIERI, EXAMINING ATTORNEY

Int. Cl.: 2

Prior U.S. Cls.: 6, 11 and 16

United States Patent and Trademark Office

Reg. No. 3,519,745

Registered Oct. 21, 2008

**TRADEMARK
PRINCIPAL REGISTER**

ECHELON

ACE HARDWARE CORPORATION (DELAWARE
CORPORATION)
2200 KENSINGTON COURT
OAK BROOK, IL 60523

THE MARK CONSISTS OF STANDARD CHAR-
ACTERS WITHOUT CLAIM TO ANY PARTICULAR
FONT, STYLE, SIZE, OR COLOR.

FOR: INDOOR AND OUTDOOR HOUSE AND
HOME FURNISHING PAINTS, PRIMERS, COAT-
INGS AND VARNISHES, IN CLASS 2 (U.S. CLS. 6, 11
AND 16).

SER. NO. 77-421,074, FILED 3-13-2008.

FIRST USE 8-19-2007; IN COMMERCE 8-19-2007.

REGINA DRUMMOND, EXAMINING ATTORNEY

Int. Cl.: 2

Prior U.S. Cls.: 6, 11 and 16

United States Patent and Trademark Office

Reg. No. 3,519,746

Registered Oct. 21, 2008

**TRADEMARK
PRINCIPAL REGISTER**

PAINT SMART, PAINT BETTER.

ACE HARDWARE CORPORATION (DELAWARE
CORPORATION)
2200 KENSINGTON COURT
OAK BROOK, IL 60523

FOR: INDOOR AND OUTDOOR HOUSE AND
HOME FURNISHING PAINTS, PRIMERS, COAT-
INGS AND VARNISHES, IN CLASS 2 (U.S. CLS. 6, 11
AND 16).

FIRST USE 8-19-2007; IN COMMERCE 8-19-2007.

THE MARK CONSISTS OF STANDARD CHAR-
ACTERS WITHOUT CLAIM TO ANY PARTICULAR
FONT, STYLE, SIZE, OR COLOR.

SER. NO. 77-421,114, FILED 3-13-2008.

REGINA DRUMMOND, EXAMINING ATTORNEY

Int. Cl.: 43

Prior U.S. Cls.: 100 and 101

United States Patent and Trademark Office

Reg. No. 3,519,747

Registered Oct. 21, 2008

SERVICE MARK
PRINCIPAL REGISTER



EZ TAKE OUT BURGER, LLC (DELAWARE
LIMITED LIABILITY COMPANY)
11 SUNSWEPT MESA
ALISO VIEJO, CA 92656

FOR: FAST-FOOD RESTAURANTS, IN CLASS 43
(U.S. CLS. 100 AND 101).

FIRST USE 0-0-1985; IN COMMERCE 1-0-2008.

OWNER OF U.S. REG. NO. 1,656,497.

NO CLAIM IS MADE TO THE EXCLUSIVE
RIGHT TO USE "TAKE OUT BURGER EST. 1969",
APART FROM THE MARK AS SHOWN.

THE COLOR(S) RED, BLACK, AND WHITE IS/
ARE CLAIMED AS A FEATURE OF THE MARK.

THE MARK CONSISTS OF THE WORDS "EZ
TAKE OUT" IN ALL CAPS AND RED WITH A
BLACK SHADOW EFFECT BEHIND THEM. BELOW
THAT, THE WORD "BURGER" IN ALL CAPS AND
BLACK. BELOW THAT, THE PHRASE "EST. 1969" IN
ALL CAPS AND BLACK. ALL LETTERING ON A
WHITE BACKGROUND WITH A THICK RED LINE
SURROUNDING IT IN THE SHAPE OF A RECTAN-
GLE WITH CURVED CORNERS.

SER. NO. 77-421,162, FILED 3-13-2008.

AMY GEARIN, EXAMINING ATTORNEY

Int. Cls.: 16 and 25

Prior U.S. Cls.: 2, 5, 22, 23, 29, 37, 38, 39 and 50

United States Patent and Trademark Office

Reg. No. 3,519,748

Registered Oct. 21, 2008

**TRADEMARK
PRINCIPAL REGISTER**



CEDAR RAPIDS PROFESSIONAL BASEBALL CLUB, INC. (IOWA CORPORATION)
950 ROCKFORD ROAD SOUTH
WEST CEDAR RAPIDS, IA 52404

FOR: PAPER GOODS AND PRINTED MATTER, NAMELY, BASEBALL PROGRAMS AND MEDIA GUIDES, BASEBALL TRADING CARDS, ENVELOPES, NEWLETTERS RELATING TO BASEBALL, BUMPER STICKERS, PENS, PENCILS, STATIONERY, POSTERS, PRINTED PAPER SIGNS, SCORECARDS, SCORESHEETS, BASEBALL REFERENCE BOOKS, MERCHANDISE BAGS, PRINTED GAME TICKETS, PRINTED GAME SCHEDULES, STICKERS, DECALS, IN CLASS 16 (U.S. CLS. 2, 5, 22, 23, 29, 37, 38 AND 50).

FIRST USE 11-1-2006; IN COMMERCE 11-1-2006.

FOR: CLOTHING, NAMELY, ATHLETIC UNIFORMS, SHIRTS, CAPS, HATS, SHORTS, T-SHIRTS, JACKETS, SWEATSHIRTS, JERSEYS, CLOTH DIAPER SETS WITH UNDERSHIRT AND DIAPER

COVER, BABY BIBS, BABY HATS, GOLF SHIRTS, VISORS, KNIT SHIRTS, TANK TOPS, RAINWEAR, IN CLASS 25 (U.S. CLS. 22 AND 39).

FIRST USE 11-1-2006; IN COMMERCE 11-1-2006.

OWNER OF U.S. REG. NOS. 1,938,747 AND 1,938,748.

NO CLAIM IS MADE TO THE EXCLUSIVE RIGHT TO USE "CEDAR RAPIDS", APART FROM THE MARK AS SHOWN.

THE MARK CONSISTS OF A STYLIZED "KERNELS" WITH CEDAR RAPIDS ABOVE, ALL TEXT IN FRONT OF AN ANIMATED CORN COB BAT.

SER. NO. 77-421,192, FILED 3-13-2008.

JOHN SCHUYLER YARD, EXAMINING ATTORNEY

Int. Cl.: 8

Prior U.S. Cls.: 23, 28 and 44

Reg. No. 3,519,749

United States Patent and Trademark Office

Registered Oct. 21, 2008

TRADEMARK
PRINCIPAL REGISTER



US EDGEWORKS (FLORIDA CORPORATION),
DBA WASHI SCISSOR COMPANY
585 N. CYPRESS DR.
TEQUESTA, FL 33469

FOR: HAIR CUTTING SCISSORS, IN CLASS 8
(U.S. CLS. 23, 28 AND 44).

FIRST USE 4-1-1999; IN COMMERCE 1-1-2000.

NO CLAIM IS MADE TO THE EXCLUSIVE
RIGHT TO USE "SCISSOR COMPANY", APART
FROM THE MARK AS SHOWN.

THE COLOR(S) RED, ORANGE, YELLOW,
GREEN, BLUE, PURPLE AND BLACK IS/ARE
CLAIMED AS A FEATURE OF THE MARK.

THE MARK CONSISTS OF THE WORDS "WASHI
SCISSOR COMPANY" AND TWO JAPANESE KANJI
CHARACTERS. THE COLOR APPEAR IN THE
JAPANESE KANJI CHARACTERS AND THE WORD
"WASHI" AND A REPEAT OF THE CHARACTER,
FADING, IN ORDER, FROM RED INTO ORANGE,
YELLOW, GREEN, BLUE AND PURPLE, AND IS
OUTLINED IN BLACK. THE WORDS "SCISSOR
COMPANY" APPEAR IN BLACK UNDERNEATH
THE WORD "WASHI" AND A KANJI CHARACTER.

THE NON-LATIN CHARACTERS IN THE MARK
TRANSLITERATE TO "WASHI", AND THIS MEANS
"EAGLE" IN ENGLISH.

SER. NO. 77-421,221, FILED 3-13-2008.

EUGENIA MARTIN, EXAMINING ATTORNEY

Int. Cl.: 25

Prior U.S. Cls.: 22 and 39

United States Patent and Trademark Office

Reg. No. 3,519,750

Registered Oct. 21, 2008

**TRADEMARK
PRINCIPAL REGISTER**



Z-TECH, INC. (NEW MEXICO CORPORATION)
6932 4TH STREET, N.W.
ALBUQUERQUE, NM 87107

THE MARK CONSISTS OF A SILHOUETTE OF
FOOTWEAR HAVING A COILED SPRING ADJA-
CENT THE HEEL.

FOR: FOOTWEAR, IN CLASS 25 (U.S. CLS. 22 AND
39).

SER. NO. 77-421,258, FILED 3-13-2008.

FIRST USE 1-1-2005; IN COMMERCE 1-1-2005.

EUGENIA MARTIN, EXAMINING ATTORNEY

Int. Cl.: 29

Prior U.S. Cl.: 46

United States Patent and Trademark Office

Reg. No. 3,519,751

Registered Oct. 21, 2008

**TRADEMARK
PRINCIPAL REGISTER**

Black Sheep Truffle

CARR VALLEY CHEESE COMPANY, INC. (WIS-
CONSIN CORPORATION)
S3797 COUNTY G
LA VALLE, WI 53941

NO CLAIM IS MADE TO THE EXCLUSIVE
RIGHT TO USE "SHEEP TRUFFLE", APART FROM
THE MARK AS SHOWN.

FOR: CHEESE, IN CLASS 29 (U.S. CL. 46).

FIRST USE 0-0-2005; IN COMMERCE 0-0-2005.

SER. NO. 77-421,293, FILED 3-13-2008.

THE MARK CONSISTS OF STANDARD CHAR-
ACTERS WITHOUT CLAIM TO ANY PARTICULAR
FONT, STYLE, SIZE, OR COLOR.

FRANK LATTUCA, EXAMINING ATTORNEY

Int. Cls.: 9, 16, 41 and 42

**Prior U.S. Cls.: 2, 5, 21, 22, 23, 26, 29, 36, 37, 38, 50,
100, 101 and 107**

Reg. No. 3,519,752

United States Patent and Trademark Office

Registered Oct. 21, 2008

**TRADEMARK
SERVICE MARK
PRINCIPAL REGISTER**

POLYSPACE

THE MATHWORKS, INC. (DELAWARE CORPORATION)
3 APPLE HILL DRIVE
NATICK, MA 01760

FOR: PRERECORDED MAGNETIC DATA CARRIERS, PRERECORDED DISKS, PRERECORDED CDROMS, PRERECORDED COMPUTER SOFTWARE, ALL FEATURING PROGRAMS FOR COMPUTER SOFTWARE DEVELOPMENT AND COMPUTER SOFTWARE VERIFICATION AND VALIDATION, IN CLASS 9 (U.S. CLS. 21, 23, 26, 36 AND 38).

FIRST USE 9-30-1999; IN COMMERCE 7-26-2000.

FOR: PRINTED TECHNICAL AND COMPUTER MANUALS, GUIDES AND DOCUMENTATION FOR COMPUTER SOFTWARE DEVELOPMENT AND COMPUTER SOFTWARE VERIFICATION AND VALIDATION; PRINTED INSTRUCTIONAL MATERIAL ON COMPUTER SOFTWARE DEVELOPMENT, AND COMPUTER SOFTWARE VERIFICATION AND VALIDATION; PRINTED INSTRUCTIONAL, EDUCATIONAL, AND TEACHING MATERIALS IN THE FIELD OF COMPUTER SOFTWARE DEVELOPMENT AND COMPUTER SOFTWARE VERIFICATION AND VALIDATION; PRINTED EVALUATION REPORTS IN THE FIELD OF COMPUTER SOFTWARE DEVELOPMENT AND COMPUTER SOFTWARE VERIFICATION AND VALIDATION, AND EDUCATIONAL PUBLICATIONS, NAMELY, TRAINING MANUALS IN THE FIELD OF COMPUTER SOFTWARE DEVELOPMENT AND COMPUTER SOFTWARE VERIFICATION AND VALIDATION, IN CLASS 16 (U.S. CLS. 2, 5, 22, 23, 29, 37, 38 AND 50).

FIRST USE 9-30-1999; IN COMMERCE 7-26-2000.

FOR: TRAINING SERVICES IN THE FIELD OF COMPUTER SOFTWARE DEVELOPMENT, AND COMPUTER SOFTWARE VERIFICATION AND VALIDATION, EDUCATIONAL SERVICES, NAMELY, CONDUCTING SEMINARS, SYMPOSIUMS, AND WORKSHOPS IN THE FIELD OF COMPUTER SOFTWARE DEVELOPMENT, AND COMPUTER SOFTWARE VERIFICATION AND VALIDATION, AND DISTRIBUTION OF MATERIALS IN CONNECTION THEREWITH, IN CLASS 41 (U.S. CLS. 100, 101 AND 107).

FIRST USE 9-30-1999; IN COMMERCE 7-26-2000.

FOR: COMPUTER SOFTWARE CONSULTATION; COMPUTER SOFTWARE DESIGN FOR OTHERS; COMPUTER SOFTWARE DEVELOPMENT; CONSULTING SERVICES IN THE FIELD OF DESIGN, SELECTION, IMPLEMENTATION AND USE OF COMPUTER SOFTWARE SYSTEMS FOR OTHERS; INSTALLATION OF COMPUTER SOFTWARE, MAINTENANCE OF COMPUTER SOFTWARE, AND DEVELOPMENT OF COMPUTER SOFTWARE DEVELOPMENT TOOLS AND COMPUTER SOFTWARE UTILITIES FOR OTHERS; DEVELOPMENT OF COMPUTER SOFTWARE LIBRARIES USED TO MODEL COMPUTER SOFTWARE FUNCTIONS; TECHNICAL SUPPORT SERVICES, NAMELY, TROUBLESHOOTING OF COMPUTER SOFTWARE PROBLEMS, UPDATING OF COMPUTER SOFTWARE FOR OTHERS, AND PROVIDING INFORMATION IN THE FIELD OF COMPUTER SOFTWARE DEVELOPMENT AND COMPUTER SOFTWARE VERIFICATION AND VALIDATION, IN CLASS 42 (U.S. CLS. 100 AND 101).

FIRST USE 9-30-1999; IN COMMERCE 7-26-2000.

THE MARK CONSISTS OF STANDARD CHAR-
ACTERS WITHOUT CLAIM TO ANY PARTICULAR
FONT, STYLE, SIZE, OR COLOR.

SER. NO. 77-421,416, FILED 3-13-2008.

HEATHER THOMPSON, EXAMINING ATTORNEY

Int. Cl.: 14

Prior U.S. Cls.: 2, 27, 28 and 50

United States Patent and Trademark Office

Reg. No. 3,519,753

Registered Oct. 21, 2008

**TRADEMARK
PRINCIPAL REGISTER**



GLENN MILLER ASSOCIATES (CALIFORNIA
SOLE PROPRIETORSHIP)
SUITE 500
4909 LAKEWOOD BLVD.
LAKEWOOD, CA 90712

THE MARK CONSISTS OF THE LETTERS "J"
AND "A" STYLIZED.

FOR: JEWELRY, IN CLASS 14 (U.S. CLS. 2, 27, 28
AND 50).

SER. NO. 77-421,548, FILED 3-13-2008.

FIRST USE 3-0-2007; IN COMMERCE 3-0-2007.

LIEF MARTIN, EXAMINING ATTORNEY

Int. Cl.: 38

Prior U.S. Cls.: 100, 101 and 104

United States Patent and Trademark Office

Reg. No. 3,519,754

Registered Oct. 21, 2008

**SERVICE MARK
PRINCIPAL REGISTER**

GENMAY

CROWDGATHER, INC. (CALIFORNIA CORPORATION)
20300 VENTURA BLVD
SUITE 330
WOODLAND HILLS, CA 91364

FOR: PROVIDING ON-LINE FORUMS FOR TRANSMISSION OF MESSAGES AMONG COMPUTER USERS CONCERNING HOBBIES, PARENTING, MUSIC, ACTING, CONSPIRACY THEORIES, GENERAL DISCUSSION, TECHNOLOGY, LITERATURE, HISTORY, SCIENCE, AND COMPUTING, IN CLASS 38 (U.S. CLS. 100, 101 AND 104).

FIRST USE 6-1-2007; IN COMMERCE 6-1-2007.

THE MARK CONSISTS OF STANDARD CHARACTERS WITHOUT CLAIM TO ANY PARTICULAR FONT, STYLE, SIZE, OR COLOR.

SER. NO. 77-421,600, FILED 3-13-2008.

JOHN GARTNER, EXAMINING ATTORNEY

Int. Cl.: 37

Prior U.S. Cls.: 100, 103 and 106

United States Patent and Trademark Office

Reg. No. 3,519,755

Registered Oct. 21, 2008

**SERVICE MARK
PRINCIPAL REGISTER**



LEGACY PEST CONTROL (ARIZONA LIMITED LIABILITY COMPANY)
5722 E. JAEGER ST.
MESA, AZ 85205

FOR: PEST CONTROL, IN CLASS 37 (U.S. CLS. 100, 103 AND 106).

FIRST USE 9-1-2007; IN COMMERCE 9-14-2007.

NO CLAIM IS MADE TO THE EXCLUSIVE RIGHT TO USE "PEST CONTROL", APART FROM THE MARK AS SHOWN.

THE MARK CONSISTS OF A SHIELD WITH THE STYLIZED LETTER "L". TO THE RIGHT OF THE SHIELD IS THE STYLIZED TEXT "LEGACY PEST CONTROL". BELOW THE TEXT IS AN IMAGE OF A SPIDER, CRICKET, ANT AND SCORPION WALKING ON A LINE.

SER. NO. 77-421,675, FILED 3-13-2008.

GEORGE LORENZO, EXAMINING ATTORNEY

Int. Cl.: 3

Prior U.S. Cls.: 1, 4, 6, 50, 51 and 52

Reg. No. 3,519,756

United States Patent and Trademark Office

Registered Oct. 21, 2008

TRADEMARK
PRINCIPAL REGISTER



BY THE BROOKE BATH & GIFT SHOPPE (TEN-
NESSEE LIMITED LIABILITY COMPANY)
2007 WALL ST.
SPRING HILL, TN 37174

FOR: BODY GLITTER; BODY SPRAYS; BUBBLE
BATH; FACIAL CLEANSERS; HAIR CONDITION-
ER; HAIR GEL; HAIR SHAMPOO; MASSAGE OIL;
SHOWER GEL; SKIN LOTION; SKIN TONERS;
SOAPS FOR BODY CARE, IN CLASS 3 (U.S. CLS. 1,
4, 6, 50, 51 AND 52).

FIRST USE 8-1-2006; IN COMMERCE 10-28-2007.

NO CLAIM IS MADE TO THE EXCLUSIVE
RIGHT TO USE "BATH & GIFT SHOPPE", APART
FROM THE MARK AS SHOWN.

THE MARK CONSISTS OF AN OAK LEAF & THE
UPPER TRI-LEAF OF A HICKORY TREE OVER-
LAPPED TO THE LEFT OF THE STYLIZED TEXT
"BY THE BROOKE BATH & GIFT SHOPPE".

SER. NO. 77-421,688, FILED 3-13-2008.

MARY ROSSMAN, EXAMINING ATTORNEY

Int. Cl.: 10

Prior U.S. Cls.: 26, 39 and 44

United States Patent and Trademark Office

Reg. No. 3,519,757

Registered Oct. 21, 2008

**TRADEMARK
PRINCIPAL REGISTER**

Rhythmedics

HONEYCUTT, JAMES DAVID (UNITED STATES
INDIVIDUAL)

#C8-171

13215 SE MILL PLAIN BLVD
VANCOUVER, WA 98684 AND

HONEYCUTT, VICTORIA LYNN (UNITED STATES
INDIVIDUAL)

45390 DRIFTWOOD DR
PALM DESERT, CA 92260

FOR: CIRCADIAN RHYTHMIC ELECTROMAG-
NETIC THERAPY APPARATUS, IN CLASS 10 (U.S.
CLS. 26, 39 AND 44).

FIRST USE 8-30-2006; IN COMMERCE 1-4-2007.

THE MARK CONSISTS OF STANDARD CHAR-
ACTERS WITHOUT CLAIM TO ANY PARTICULAR
FONT, STYLE, SIZE, OR COLOR.

SER. NO. 77-421,762, FILED 3-14-2008.

AMY MCMENAMIN, EXAMINING ATTORNEY

Int. Cl.: 41

Prior U.S. Cls.: 100, 101 and 107

United States Patent and Trademark Office

Reg. No. 3,519,758

Registered Oct. 21, 2008

**SERVICE MARK
PRINCIPAL REGISTER**

idea implementation

WILDERNESS GRAPHICS, INC. (FLORIDA CORPORATION)
324-G WEST VAN BUREN STREET
TALLAHASSEE, FL 32301

FOR: ORGANIZING EXHIBITIONS FOR INDOOR AND OUTDOOR VENUES AND RELATED OPPORTUNITIES FOR INTERPRETATION AND PUBLIC USE IN THE SUBJECTS OF NATURAL AND CULTURAL HISTORY, IN CLASS 41 (U.S. CLS. 100, 101 AND 107).

FIRST USE 1-1-2004; IN COMMERCE 1-1-2004.

THE MARK CONSISTS OF STANDARD CHARACTERS WITHOUT CLAIM TO ANY PARTICULAR FONT, STYLE, SIZE, OR COLOR.

SER. NO. 77-421,815, FILED 3-14-2008.

HOWARD B. LEVINE, EXAMINING ATTORNEY

Int. Cl.: 9

Prior U.S. Cls.: 21, 23, 26, 36 and 38

Reg. No. 3,519,759

United States Patent and Trademark Office

Registered Oct. 21, 2008

**TRADEMARK
PRINCIPAL REGISTER**

TIMESIGHT SYSTEMS

DIGITAL OCULAR NETWORKS, INC. (CALIFORNIA CORPORATION)
180 TUCKERTON ROAD, SUITE 17
MEDFORD, NJ 08055

FOR: COMPUTER SOFTWARE AND HARDWARE FOR THE COLLECTION, STORAGE AND MANAGEMENT OF DATA FROM VIDEO AND OTHER ELECTRONIC SURVEILLANCE CAMERAS AND DEVICES , IN CLASS 9 (U.S. CLS. 21, 23, 26, 36 AND 38).

FIRST USE 10-1-2007; IN COMMERCE 10-1-2007.

THE MARK CONSISTS OF STANDARD CHARACTERS WITHOUT CLAIM TO ANY PARTICULAR FONT, STYLE, SIZE, OR COLOR.

NO CLAIM IS MADE TO THE EXCLUSIVE RIGHT TO USE "SYSTEMS", APART FROM THE MARK AS SHOWN.

SER. NO. 77-421,824, FILED 3-14-2008.

YONG KIM, EXAMINING ATTORNEY

Int. Cl.: 36

Prior U.S. Cls.: 100, 101 and 102

United States Patent and Trademark Office

Reg. No. 3,519,760

Registered Oct. 21, 2008

**SERVICE MARK
PRINCIPAL REGISTER**

**PROSPERITY CAPITAL
MANAGEMENT**

PROSPERITY CAPITAL MANAGEMENT LIMITED (CAYMAN ISLANDS LIMITED COMPANY (LTD.))
3RD FLOOR, ONE CAPITAL PLACE
SHEDDEN ROAD, P.O. BOX 897
GEORGE TOWN, CAYMAN ISLANDS KY1-1103

FOR: FINANCIAL SERVICES, NAMELY, INVESTMENT ADVISORY SERVICES, INVESTMENT MANAGEMENT SERVICES, ASSET MANAGEMENT SERVICES, AND FINANCIAL CONSULTANCY SERVICES, ALL RELATING TO INVESTMENTS IN EMERGING MARKETS, IN CLASS 36 (U.S. CLS. 100, 101 AND 102).

FIRST USE 9-19-1996; IN COMMERCE 5-6-2003.

THE MARK CONSISTS OF STANDARD CHARACTERS WITHOUT CLAIM TO ANY PARTICULAR FONT, STYLE, SIZE, OR COLOR.

NO CLAIM IS MADE TO THE EXCLUSIVE RIGHT TO USE "CAPITAL MANAGEMENT", APART FROM THE MARK AS SHOWN.

SER. NO. 77-421,834, FILED 3-14-2008.

ELLEN BURNS, EXAMINING ATTORNEY

Int. Cl.: 36

Prior U.S. Cls.: 100, 101 and 102

United States Patent and Trademark Office

Reg. No. 3,519,761

Registered Oct. 21, 2008

**SERVICE MARK
PRINCIPAL REGISTER**



Prosperity Capital Management

PROSPERITY CAPITAL MANAGEMENT LIMITED (CAYMAN ISLANDS LIMITED COMPANY (LTD.))
3RD FLOOR, ONE CAPITAL PLACE
SHEDDEN ROAD, P.O. BOX 897
GEORGE TOWN, CAYMAN ISLANDS KY1-1103

FOR: FINANCIAL SERVICES, NAMELY, INVESTMENT ADVISORY SERVICES, INVESTMENT MANAGEMENT SERVICES, ASSET MANAGEMENT SERVICES, AND FINANCIAL CONSULTANCY SERVICES, ALL RELATING TO INVESTMENTS IN EMERGING MARKETS, IN CLASS 36 (U.S. CLS. 100, 101 AND 102).

FIRST USE 9-19-1996; IN COMMERCE 5-6-2003.

NO CLAIM IS MADE TO THE EXCLUSIVE RIGHT TO USE "CAPITAL MANAGEMENT", APART FROM THE MARK AS SHOWN.

THE MARK CONSISTS OF SLIGHTLY OVERLAPPING UPPER CASE LETTERS "P", "C" AND "M" PLACED IN THE CENTER OF A SHADED OVAL WITH THE WORDS PROSPERITY CAPITAL MANAGEMENT, INITIAL CAPS, PRINTED DIRECTLY BENEATH THE SHADED OVAL.

SER. NO. 77-421,837, FILED 3-14-2008.

ELLEN BURNS, EXAMINING ATTORNEY

Int. Cls.: 35, 36 and 41

Prior U.S. Cls.: 100, 101, 102 and 107

United States Patent and Trademark Office

Reg. No. 3,519,762

Registered Oct. 21, 2008

**SERVICE MARK
PRINCIPAL REGISTER**

TRADE FOR LIFE

VELEZ CAPITAL MANAGEMENT, LLC (NEW YORK LIMITED LIABILITY COMPANY)
SUITE 450
130 WEST 42ND STREET,
NEW YORK, NY 10036

FOR: BUSINESS INFORMATION IN THE FIELD OF STOCK PICKS, TRADING OF STOCKS AND MARKET ANALYSIS, IN CLASS 35 (U.S. CLS. 100, 101 AND 102).

FIRST USE 2-19-2007; IN COMMERCE 2-19-2007.

FOR: AGENCIES OR BROKERAGE FOR TRADING OF SECURITIES, SECURITIES INDEX FUTURES, SECURITIES OPTIONS, AND OVERSEAS MARKET SECURITIES FUTURES; SECURITIES TRADING AND INVESTING SERVICES FOR OTHERS VIA THE INTERNET, IN CLASS 36 (U.S. CLS. 100, 101 AND 102).

FIRST USE 2-19-2007; IN COMMERCE 2-19-2007.

FOR: ARRANGING PROFESSIONAL WORKSHOP AND TRAINING COURSES; BUSINESS TRAINING; TEACHING AND TRAINING IN BUSINESS, INDUSTRY AND INFORMATION TECHNOLOGY; TRAINING SERVICES IN THE FIELD OF STOCK PICKS, TRADING OF STOCKS AND MARKET ANALYSIS, IN CLASS 41 (U.S. CLS. 100, 101 AND 107).

FIRST USE 2-19-2007; IN COMMERCE 2-19-2007.

THE MARK CONSISTS OF STANDARD CHARACTERS WITHOUT CLAIM TO ANY PARTICULAR FONT, STYLE, SIZE, OR COLOR.

NO CLAIM IS MADE TO THE EXCLUSIVE RIGHT TO USE "TRADE", APART FROM THE MARK AS SHOWN.

SER. NO. 77-421,887, FILED 3-14-2008.

TASNEEM HUSSAIN, EXAMINING ATTORNEY

Int. Cl.: 41

Prior U.S. Cls.: 100, 101 and 107

United States Patent and Trademark Office

Reg. No. 3,519,763

Registered Oct. 21, 2008

**SERVICE MARK
PRINCIPAL REGISTER**

Casual Elegance Photography

MARK L. ANDERSON, LLC (GEORGIA LIMITED LIABILITY COMPANY)

150 HEMBREE GROVE COURT

ROSWELL, GA 30076

FOR: PHOTOGRAPHY, IN CLASS 41 (U.S. CLS. 100, 101 AND 107).

FIRST USE 11-1-2001; IN COMMERCE 11-1-2001.

THE MARK CONSISTS OF STANDARD CHARACTERS WITHOUT CLAIM TO ANY PARTICULAR FONT, STYLE, SIZE, OR COLOR.

NO CLAIM IS MADE TO THE EXCLUSIVE RIGHT TO USE "PHOTOGRAPHY", APART FROM THE MARK AS SHOWN.

SER. NO. 77-421,896, FILED 3-14-2008.

CYNTHIA TRIPI, EXAMINING ATTORNEY

Int. Cl.: 44

Prior U.S. Cls.: 100 and 101

United States Patent and Trademark Office

Reg. No. 3,519,764

Registered Oct. 21, 2008

SERVICE MARK
PRINCIPAL REGISTER

Massage  Eden

MESSAGE EDEN, LLC (FLORIDA LIMITED LIABILITY COMPANY), DBA MESSAGE EDEN
9490 BRADSHAW LANE
TAMARAC, FL 33321

FOR: BEAUTY SALONS; FACIAL TREATMENT SERVICES, NAMELY, COSMETIC PEELS; MASSAGE AND THERAPEUTIC SHIATSU MASSAGE, IN CLASS 44 (U.S. CLS. 100 AND 101).

FIRST USE 3-14-2008; IN COMMERCE 3-14-2008.

NO CLAIM IS MADE TO THE EXCLUSIVE RIGHT TO USE "MESSAGE", APART FROM THE MARK AS SHOWN.

THE MARK CONSISTS OF A CUSTOMIZED FLORAL SILHOUETTE DESIGN ENCLOSED A STYLIZED FULL CIRCLE BETWEEN THE WORDS "MESSAGE EDEN".

SER. NO. 77-422,007, FILED 3-14-2008.

ZACHARY BELLO, EXAMINING ATTORNEY

Int. Cl.: 36

Prior U.S. Cls.: 100, 101 and 102

United States Patent and Trademark Office

Reg. No. 3,519,765

Registered Oct. 21, 2008

**SERVICE MARK
PRINCIPAL REGISTER**

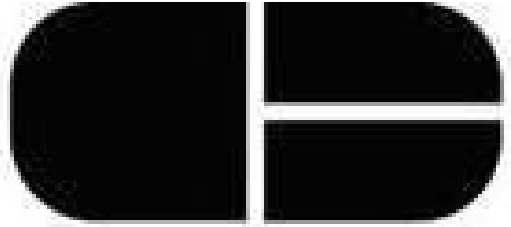

COMMUNITY BANCORP (NEVADA CORPORATION)
400 SOUTH FOURTH STREET, SUITE 215
LAS VEGAS, NV 89101

FOR: BANKING SERVICES; CREDIT CARD AND DEBIT CARD SERVICES; ELECTRONIC PAYMENT, NAMELY, ELECTRONIC PROCESSING AND TRANSMISSION OF BILL PAYMENT DATA; FINANCIAL MANAGEMENT; FINANCIAL CONSULTATION; FINANCIAL INVESTMENT IN THE FIELD OF INVESTMENT SECURITIES AND CERTIFICATES OF DEPOSIT, IN CLASS 36 (U.S. CLS. 100, 101 AND 102).

FIRST USE 7-14-1995; IN COMMERCE 7-14-1995.

THE MARK CONSISTS OF A SOLID OVAL BISECTED BY A VERTICAL LINE AND A HORIZONTAL LINE CENTERED WITHIN THE RIGHT SIDE OF THE BISECTED OVAL.

SER. NO. 77-422,028, FILED 3-14-2008.

KATHRYN COWARD, EXAMINING ATTORNEY

Int. Cl.: 44

Prior U.S. Cls.: 100 and 101

United States Patent and Trademark Office

Reg. No. 3,519,766

Registered Oct. 21, 2008

**SERVICE MARK
PRINCIPAL REGISTER**



**CANINE & CONDITIONING
REHABILITATION GROUP**

CANINE REHABILITATION & CONDITIONING
GROUP, LLC (COLORADO LIMITED LIABILITY COMPANY)
3760 S. LIPAN STREET
ENGLEWOOD, CO 80110

FOR: PHYSICAL REHABILITATION AND PHYSICAL THERAPY FOR CANINES, IN CLASS 44 (U.S. CLS. 100 AND 101).

FIRST USE 12-1-2004; IN COMMERCE 12-1-2004.

NO CLAIM IS MADE TO THE EXCLUSIVE RIGHT TO USE "CANINE REHABILITATION & CONDITIONING GROUP", APART FROM THE MARK AS SHOWN.

THE STIPPLING IS FOR SHADING PURPOSES ONLY.

THE MARK CONSISTS OF THE LETTERS "CRCG" ABOVE A CROSS WITH THE HEAD OF A DOG ON WATER SUPERIMPOSED IN FRONT. THE WORDING "CANINE REHABILITATION & CONDITIONING GROUP" APPEARS BELOW.

SER. NO. 77-422,071, FILED 3-14-2008.

KELLY MCCOY, EXAMINING ATTORNEY

Int. Cl.: 1

Prior U.S. Cls.: 1, 5, 6, 10, 26 and 46

United States Patent and Trademark Office

Reg. No. 3,519,767

Registered Oct. 21, 2008

**TRADEMARK
PRINCIPAL REGISTER**

DURAFORM

3D SYSTEMS, INC. (CALIFORNIA CORPORATION)
333 THREE D SYSTEMS CIRCLE
ROCK HILL, SC 29730

FOR: CHEMICAL SUBSTANCE IN THE FORM OF
A CONJOINABLE POWDER MATERIAL FOR USE
WITH COMPUTER CONTROLLED APPARATUS
FOR PROCESSING DESIGN DATA INTO THREE
DIMENSIONAL OBJECTS , IN CLASS 1 (U.S. CLS. 1,
5, 6, 10, 26 AND 46).

FIRST USE 12-31-1997; IN COMMERCE 12-31-1997.

THE MARK CONSISTS OF STANDARD CHARACTERS WITHOUT CLAIM TO ANY PARTICULAR FONT, STYLE, SIZE, OR COLOR.

OWNER OF U.S. REG. NO. 2,611,081.

SER. NO. 77-422,134, FILED 3-14-2008.

TINA BROWN, EXAMINING ATTORNEY

Int. Cl.: 9

Prior U.S. Cls.: 21, 23, 26, 36 and 38

Reg. No. 3,519,768

United States Patent and Trademark Office

Registered Oct. 21, 2008

**TRADEMARK
PRINCIPAL REGISTER**

ATTORNEYS ON CALL

WHITLEY, RODGMAN & WHITLEY (NORTH
CAROLINA LIMITED LIABILITY PARTNER-
SHIP)
2902-B N. HERRITAGE STREET
KINSTON, NC 28503

FOR: PRE-RECORDED DIGITAL MEDIA FEATURING INFORMATION ON THE LAW, THE JUSTICE SYSTEM, AND LEGAL SERVICES, IN CLASS 9 (U.S. CLS. 21, 23, 26, 36 AND 38).

FIRST USE 1-29-2008; IN COMMERCE 1-29-2008.

THE MARK CONSISTS OF STANDARD CHARACTERS WITHOUT CLAIM TO ANY PARTICULAR FONT, STYLE, SIZE, OR COLOR.

SER. NO. 77-422,141, FILED 3-14-2008.

NANCY CLARKE, EXAMINING ATTORNEY

Int. Cl.: 25

Prior U.S. Cls.: 22 and 39

United States Patent and Trademark Office

Reg. No. 3,519,769

Registered Oct. 21, 2008

TRADEMARK
PRINCIPAL REGISTER



PONCHO & GOLDSTEIN, INC (CALIFORNIA CORPORATION)
5 NOVILLA
LAGUNA NIGUEL, CA 92677

FIRST USE 1-4-2008; IN COMMERCE 3-13-2008.

NO CLAIM IS MADE TO THE EXCLUSIVE RIGHT TO USE "HAWAIIAN", APART FROM THE MARK AS SHOWN.

FOR: MEN'S, WOMEN'S, BOYS', GIRLS CLOTHING, NAMELY, KNIT AND WOVEN SHIRTS; KNIT AND WOVEN PANTS, SHORTS AND JEANS; SWEATERS, JACKETS, VESTS, COATS, RAINWEAR, BELTS, SOCKS AND HATS , IN CLASS 25 (U.S. CLS. 22 AND 39).

SER. NO. 77-422,227, FILED 3-14-2008.

CHERYL CLAYTON, EXAMINING ATTORNEY

Int. Cl.: 4

Prior U.S. Cls.: 1, 6 and 15

United States Patent and Trademark Office

Reg. No. 3,519,770

Registered Oct. 21, 2008

**TRADEMARK
PRINCIPAL REGISTER**

EXCELLIUM

TOTAL S.A. (FRANCE CORPORATION)
LA DEFENSE 6
2, PLACE DE LA COUPOLE
92400 COURBEVOIE, FRANCE

FOR: MOTOR OILS, IN CLASS 4 (U.S. CLS. 1, 6
AND 15).

FIRST USE 3-1-2004; IN COMMERCE 3-1-2004.

THE MARK CONSISTS OF STANDARD CHAR-
ACTERS WITHOUT CLAIM TO ANY PARTICULAR
FONT, STYLE, SIZE, OR COLOR.

THE WORD "EXCELLIUM" HAS NO MEANING
IN A FOREIGN LANGUAGE.

SER. NO. 77-422,294, FILED 3-14-2008.

TINA BROWN, EXAMINING ATTORNEY

Int. Cl.: 35

Prior U.S. Cls.: 100, 101 and 102

United States Patent and Trademark Office

Reg. No. 3,519,771

Registered Oct. 21, 2008

SERVICE MARK
PRINCIPAL REGISTER



PERFORMANCE MEDIA, LLC (MAINE LIMITED
LIABILITY COMPANY)
107 ELM STREET
SALISBURY, MA 01952

FOR: MOTORSPORTS CONSUMER TRADE
SHOW FOR RACERS AND FANS OF RACING, IN
CLASS 35 (U.S. CLS. 100, 101 AND 102).

FIRST USE 12-1-2006; IN COMMERCE 12-1-2006.

NO CLAIM IS MADE TO THE EXCLUSIVE
RIGHT TO USE "EXPO", APART FROM THE MARK
AS SHOWN.

THE COLOR(S) RED, YELLOW, BLACK AND
WHITE IS/ARE CLAIMED AS A FEATURE OF
THE MARK.

THE MARK CONSISTS OF THE WORD SPEED-
WAY IN RED LETTERS OUTLINED IN BLACK
AND WHITE IMMEDIATELY FOLLOWED BY THE
WORD "EXPO" IN YELLOW LETTERS OUTLINED
IN BLACK WITH A BLACK AND WHITE CHECK-
ERED FLAG BETWEEN THE WORD SPEEDWAY
AND "EXPO".

SER. NO. 77-422,403, FILED 3-14-2008.

MARIA-VICTORIA SUAREZ, EXAMINING ATTOR-
NEY

Int. Cls.: 35 and 42

Prior U.S. Cls.: 100, 101 and 102

United States Patent and Trademark Office

Reg. No. 3,519,772

Registered Oct. 21, 2008

**SERVICE MARK
PRINCIPAL REGISTER**

ESG

THE ENTERPRISE STRATEGY GROUP, INC.
(MASSACHUSETTS CORPORATION)
20 ASYLUM ST.
MILFORD, MA 01757

FOR: BUSINESS CONSULTING SERVICES IN
THE FIELD OF INFORMATION TECHNOLOGY,
IN CLASS 35 (U.S. CLS. 100, 101 AND 102).

FIRST USE 11-9-1999; IN COMMERCE 11-9-1999.

FOR: CONSULTING SERVICES IN THE FIELDS
OF INFORMATION TECHNOLOGY, INFORMA-
TION SECURITY AND INFORMATION STORAGE

MANAGEMENT AND PROVIDING NEW PRO-
DUCT TESTING OF THE FOREGOING FOR OTH-
ERS, IN CLASS 42 (U.S. CLS. 100 AND 101).

FIRST USE 11-9-1999; IN COMMERCE 11-9-1999.

THE MARK CONSISTS OF STANDARD CHAR-
ACTERS WITHOUT CLAIM TO ANY PARTICULAR
FONT, STYLE, SIZE, OR COLOR.

SER. NO. 77-422,610, FILED 3-14-2008.

H. M. FISHER, EXAMINING ATTORNEY

Int. Cl.: 17

Prior U.S. Cls.: 1, 5, 12, 13, 35 and 50

United States Patent and Trademark Office

Reg. No. 3,519,773

Registered Oct. 21, 2008

**TRADEMARK
PRINCIPAL REGISTER**

ULTRASEAL

ILLINOIS TOOL WORKS INC. (DELAWARE
CORPORATION)
3600 WEST LAKE AVENUE
GLENVIEW, IL 600261215

THE MARK CONSISTS OF STANDARD CHAR-
ACTERS WITHOUT CLAIM TO ANY PARTICULAR
FONT, STYLE, SIZE, OR COLOR.

FOR: DUCT SEALANTS, NAMELY, SEALANTS
FOR USE IN HEATING, VENTILATION AND AIR
CONDITIONING SYSTEMS IN BUILDINGS, IN
CLASS 17 (U.S. CLS. 1, 5, 12, 13, 35 AND 50).

SER. NO. 77-422,617, FILED 3-14-2008.

FIRST USE 10-0-2005; IN COMMERCE 10-0-2005.

MARLENE BELL, EXAMINING ATTORNEY

Int. Cl.: 29

Prior U.S. Cl.: 46

United States Patent and Trademark Office

Reg. No. 3,519,774

Registered Oct. 21, 2008

**TRADEMARK
PRINCIPAL REGISTER**



YOPLAIT MARQUES INTERNATIONALES
(FRANCE CORPORATION)
170 BIS, BOULEVARD DU MONTPARNASSE
75014 PARIS, FRANCE

FOR: DAIRY PRODUCTS EXCLUDING ICE
CREAM, ICE MILK AND FROZEN YOGURT, IN
CLASS 29 (U.S. CL. 46).

FIRST USE 9-0-1974; IN COMMERCE 9-0-1974.

THE MARK CONSISTS OF A FLOWER.

SER. NO. 77-422,744, FILED 3-14-2008.

NATALIE POLZER, EXAMINING ATTORNEY

Int. Cl.: 37

Prior U.S. Cls.: 100, 103 and 106

United States Patent and Trademark Office

Reg. No. 3,519,775

Registered Oct. 21, 2008

**SERVICE MARK
PRINCIPAL REGISTER**

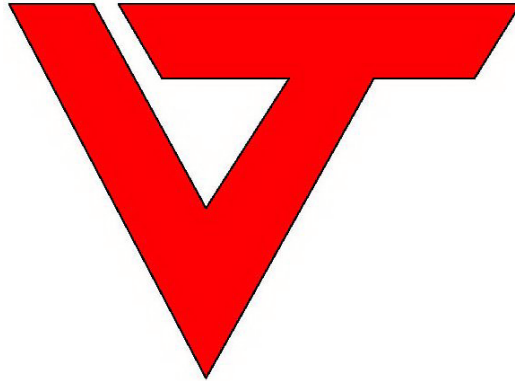

VT CONSTRUCTION, INC. (NEVADA CORPORATION)
4344 WEST CHEYENNE AVE.
NORTH LAS VEGAS, NV 890322484

FOR: CONSTRUCTION GRADING SERVICES, IN
CLASS 37 (U.S. CLS. 100, 103 AND 106).

FIRST USE 2-0-2000; IN COMMERCE 2-0-2000.

THE COLOR(S) RED AND BLACK IS/ARE
CLAIMED AS A FEATURE OF THE MARK.

THE MARK CONSISTS OF A CAPITAL "V" WITH
THE RIGHT LEG OF THE "V" CROSSED TO MAKE
A CAPITAL "T" IN THE COLOR RED OUTLINED IN
BLACK.

SER. NO. 77-422,834, FILED 3-14-2008.

PRISCILLA MILTON, EXAMINING ATTORNEY

Int. Cl.: 38

Prior U.S. Cls.: 100, 101 and 104

United States Patent and Trademark Office

Reg. No. 3,519,776

Registered Oct. 21, 2008

**SERVICE MARK
PRINCIPAL REGISTER**



FACE TO FACE LIVE, INC. (DELAWARE CORPORATION)
STE. 314
14500 N. NORTHSIGHT BLVD.
SCOTTSDALE, AZ 852603663

FOR: AUDIO AND VIDEO BROADCASTING SERVICES OVER THE INTERNET; ELECTRONIC TRANSMISSION OF VOICE, DATA AND IMAGES BY TELEVISION AND VIDEO BROADCASTING; PROVIDING CO-LOCATION SERVICES FOR VOICE, VIDEO AND DATA COMMUNICATIONS APPLICATIONS; PROVIDING FACILITIES AND EQUIPMENT FOR VIDEO CONFERENCING; STREAMING OF VIDEO MATERIAL ON THE INTERNET; TELECOMMUNICATION SERVICES, NAMELY, LOCAL AND LONG DISTANCE TRANSMISSION OF VOICE, DATA, GRAPHICS AND VIDEO BY MEANS OF BROADBAND OPTICAL OR WIRELESS NETWORKS; TELECOMMUNICATION SERVICES, NAMELY, LOCAL AND LONG DISTANCE TRANSMISSION OF VOICE, DATA, GRAPHICS AND VIDEO BY MEANS OF BROADBAND, COPPER AND OPTICAL OR WIRELESS NETWORKS; TELECONFERENCING AND VIDEO CONFERENCING SERVICES; TRANSMISSION OF INFORMATION THROUGH VIDEO COMMUNICA-

TION SYSTEMS; TRANSMISSION OF SOUND, VIDEO AND INFORMATION; VIDEO BROADCASTING; VIDEO BROADCASTING SERVICES VIA THE INTERNET; VIDEO CONFERENCING SERVICES; VIDEO STREAMING SERVICES VIA THE INTERNET, FEATURING INDEPENDENT FILMS AND MOVIES; VIDEO TELECONFERENCING; VIDEO TELEPHONE SERVICES, IN CLASS 38 (U.S. CLS. 100, 101 AND 104).

FIRST USE 2-25-2008; IN COMMERCE 2-26-2008.

THE COLOR(S) BLACK, GREY, AND BLUE IS/ARE CLAIMED AS A FEATURE OF THE MARK.

THE MARK CONSISTS OF THE LETTER "F" FACING ANOTHER "F" WITH TWO SWIRL MARKS SURROUNDING THEM. THE FIRST "F" IS BLACK AND THE SECOND "F" IS BLUE. THE SWIRL MARKS START BLACK, THEN GREY AND THEN BLUE.

SER. NO. 77-422,869, FILED 3-14-2008.

CAROL SPILS, EXAMINING ATTORNEY

Int. Cl.: 30

Prior U.S. Cl.: 46

United States Patent and Trademark Office

Reg. No. 3,519,777

Registered Oct. 21, 2008

**TRADEMARK
PRINCIPAL REGISTER**

DONA~DULCE

HOLM, DONNA J. (UNITED STATES INDIVIDUAL)
1380 WHISTLERS LANE
ROSEBURG, OR 97470

FOR: CANDY, NAMELY, OREGON HAZELNUT TOFFEE, IN CLASS 30 (U.S. CL. 46).

FIRST USE 10-0-2007; IN COMMERCE 10-0-2007.

THE MARK CONSISTS OF STANDARD CHARACTERS WITHOUT CLAIM TO ANY PARTICULAR FONT, STYLE, SIZE, OR COLOR.

THE FOREIGN WORDING IN THE MARK TRANSLATES INTO ENGLISH AS SWEET DONNA.

SER. NO. 77-422,878, FILED 3-14-2008.

YONG KIM, EXAMINING ATTORNEY

Int. Cl.: 34

Prior U.S. Cls.: 2, 8, 9 and 17

United States Patent and Trademark Office

Reg. No. 3,519,778

Registered Oct. 21, 2008

**TRADEMARK
PRINCIPAL REGISTER**

VANILLA ICE

BBK TOBACCO & FOODS, LLP (UNITED STATES
LIMITED LIABILITY PARTNERSHIP), DBA
HBI INTERNATIONAL

3315 W. BUCKEYE RD., SUITE B
PHOENIX, AZ 85009

FOR: CIGARETTE PAPERS; CIGARETTE ROLL-
ING PAPERS, IN CLASS 34 (U.S. CLS. 2, 8, 9 AND 17).

FIRST USE 1-27-2008; IN COMMERCE 3-12-2008.

THE MARK CONSISTS OF STANDARD CHAR-
ACTERS WITHOUT CLAIM TO ANY PARTICULAR
FONT, STYLE, SIZE, OR COLOR.

NO CLAIM IS MADE TO THE EXCLUSIVE
RIGHT TO USE "VANILLA", APART FROM THE
MARK AS SHOWN.

SER. NO. 77-422,880, FILED 3-14-2008.

ELLEN PERKINS, EXAMINING ATTORNEY

Int. Cl.: 38

Prior U.S. Cls.: 100, 101 and 104

United States Patent and Trademark Office

Reg. No. 3,519,779

Registered Oct. 21, 2008

**SERVICE MARK
PRINCIPAL REGISTER**

**Managed Telepresence.
Simplified.**

FACE TO FACE LIVE, INC. (DELAWARE CORPORATION)
STE. 314
14500 N. NORTHSIGHT BLVD.
SCOTTSDALE, AZ 852603663

FOR: AUDIO AND VIDEO BROADCASTING SERVICES OVER THE INTERNET; BROADCASTING SERVICES AND PROVISION OF TELECOMMUNICATION ACCESS TO VIDEO AND AUDIO CONTENT PROVIDED VIA A VIDEO-ON-DEMAND SERVICE VIA THE INTERNET; ELECTRONIC TRANSMISSION OF VOICE, DATA AND IMAGES BY TELEVISION AND VIDEO BROADCASTING; PROVIDING CO-LOCATION SERVICES FOR VOICE, VIDEO AND DATA COMMUNICATIONS APPLICATIONS; PROVIDING FACILITIES AND EQUIPMENT FOR VIDEO CONFERENCING; STREAMING OF VIDEO MATERIAL ON THE INTERNET; TELECOMMUNICATION SERVICES, NAMELY, LOCAL AND LONG DISTANCE TRANSMISSION OF VOICE, DATA, GRAPHICS AND VIDEO BY MEANS OF BROADBAND OPTICAL OR WIRELESS NETWORKS; TELECOMMUNICATION SERVICES, NAMELY, LOCAL AND LONG DISTANCE TRANSMISSION OF VOICE, DATA, GRAPHICS AND VIDEO BY MEANS OF BROADBAND, COPPER AND OPTICAL OR WIRELESS NET-

WORKS; TELECOMMUNICATION SERVICES, NAMELY, TRANSMISSION OF VOICE, DATA, GRAPHICS, SOUND AND VIDEO BY MEANS OF BROADBAND POWER LINE OR WIRELESS NETWORKS; TELECONFERENCING AND VIDEO CONFERENCING SERVICES; TRANSMISSION OF INFORMATION THROUGH VIDEO COMMUNICATION SYSTEMS; TRANSMISSION OF SOUND, VIDEO AND INFORMATION; VIDEO BROADCASTING; VIDEO BROADCASTING SERVICES VIA THE INTERNET; VIDEO CONFERENCING SERVICES; VIDEO STREAMING SERVICES VIA THE INTERNET, FEATURING INDEPENDENT FILMS AND MOVIES; VIDEO TELECONFERENCING; VIDEO TELEPHONE SERVICES, IN CLASS 38 (U.S. CLS. 100, 101 AND 104).

FIRST USE 2-25-2008; IN COMMERCE 2-26-2008.

THE MARK CONSISTS OF STANDARD CHARACTERS WITHOUT CLAIM TO ANY PARTICULAR FONT, STYLE, SIZE, OR COLOR.

SER. NO. 77-422,907, FILED 3-14-2008.

CAROL SPILS, EXAMINING ATTORNEY

Int. Cl.: 42

Prior U.S. Cls.: 100 and 101

United States Patent and Trademark Office

Reg. No. 3,519,780

Registered Oct. 21, 2008

**SERVICE MARK
PRINCIPAL REGISTER**

Percepted

ENOCK, MATTHEW (UNITED STATES INDIVIDUAL)
345 EAST 93RD STREET, APT. 14 B
NEW YORK, NY 10128

FOR: GRAPHIC DESIGN, IN CLASS 42 (U.S. CLS. 100 AND 101).

FIRST USE 3-10-2008; IN COMMERCE 3-10-2008.

THE MARK CONSISTS OF STANDARD CHARACTERS WITHOUT CLAIM TO ANY PARTICULAR FONT, STYLE, SIZE, OR COLOR.

SER. NO. 77-422,935, FILED 3-14-2008.

JOHN SCHUYLER YARD, EXAMINING ATTORNEY

Int. Cl.: 45

Prior U.S. Cls.: 100 and 101

United States Patent and Trademark Office

Reg. No. 3,519,781

Registered Oct. 21, 2008

**SERVICE MARK
PRINCIPAL REGISTER**

**TRUCE IS BETTER THAN
FRICTION**

PEACE TALKS MEDIATION SERVICES, INC.
(CALIFORNIA CORPORATION)
8055 WEST MANCHESTER AVENUE, SUITE 201
PLAYA DEL REY, CA 902937962

THE MARK CONSISTS OF STANDARD CHAR-
ACTERS WITHOUT CLAIM TO ANY PARTICULAR
FONT, STYLE, SIZE, OR COLOR.

FOR: MEDIATION, IN CLASS 45 (U.S. CLS. 100
AND 101).

SER. NO. 77-423,035, FILED 3-15-2008.

FIRST USE 2-15-2008; IN COMMERCE 2-15-2008.

JORDAN BAKER, EXAMINING ATTORNEY

Int. Cl.: 35

Prior U.S. Cls.: 100, 101 and 102

United States Patent and Trademark Office

Reg. No. 3,519,782

Registered Oct. 21, 2008

**SERVICE MARK
PRINCIPAL REGISTER**

**Business Class Software
Solutions**

GLOBALNOW INC. (TEXAS CORPORATION)
319 JESSICA DRIVE
GARLAND, TX 75040

FOR: VALUE-ADDED RESELLER SERVICES,
NAMELY, DISTRIBUTORSHIP SERVICES FEATURING
COMPUTER SOFTWARE, IN CLASS 35
(U.S. CLS. 100, 101 AND 102).

FIRST USE 11-15-2007; IN COMMERCE 3-3-2008.

THE MARK CONSISTS OF STANDARD CHARACTERS
WITHOUT CLAIM TO ANY PARTICULAR FONT,
STYLE, SIZE, OR COLOR.

NO CLAIM IS MADE TO THE EXCLUSIVE
RIGHT TO USE "BUSINESS" AND "SOFTWARE
SOLUTIONS", APART FROM THE MARK AS
SHOWN.

SER. NO. 77-423,062, FILED 3-15-2008.

ROBIN CHOSID, EXAMINING ATTORNEY

Int. Cl.: 41

Prior U.S. Cls.: 100, 101 and 107

United States Patent and Trademark Office

Reg. No. 3,519,783

Registered Oct. 21, 2008

**SERVICE MARK
PRINCIPAL REGISTER**

Pro/MENTOR

UNIVERSAL PARAMETRICS, INC. (MICHIGAN CORPORATION)
1050 HIGHLAND DRIVE, SUITE F
ANN ARBOR, MI 48108 AND
FREY, STEVEN J. (UNITED STATES INDIVIDUAL)
3955 MAYFAIR STREET
DEARBORN HEIGHTS, MI 48125

FOR: EDUCATION SERVICES, NAMELY, PROVIDING MENTORING, TUTORING, CLASSES, SEMINARS AND WORKSHOPS IN THE FIELD OF COMPUTER SOFTWARE, IN CLASS 41 (U.S. CLS. 100, 101 AND 107).

FIRST USE 6-24-1999; IN COMMERCE 6-24-1999.

THE MARK CONSISTS OF STANDARD CHARACTERS WITHOUT CLAIM TO ANY PARTICULAR FONT, STYLE, SIZE, OR COLOR.

NO CLAIM IS MADE TO THE EXCLUSIVE RIGHT TO USE "MENTOR", APART FROM THE MARK AS SHOWN.

SEC. 2(F).

SER. NO. 77-423,088, FILED 3-15-2008.

KATHERINE M. DUBRAY, EXAMINING ATTORNEY

Int. Cl.: 41

Prior U.S. Cls.: 100, 101 and 107

United States Patent and Trademark Office

Reg. No. 3,519,784

Registered Oct. 21, 2008

**SERVICE MARK
PRINCIPAL REGISTER**

SINGLE FOR A REASON

COAKLEY, PATRICIA (UNITED STATES INDIVIDUAL)
116 STONE RIDGE ROAD
FRANKLIN, MA 02038

FOR: INTERACTIVE ONLINE JOURNALS, NAMELY, A BLOG FEATURING ARTICLES ES-SAYS PHOTOS VIDEOS AND COMMENTARY IN THE FIELDS OF HUMOR ENTERTAINMENT HUMAN INTEREST STORIES AND LIFESTYLE OBSERVATIONS, IN CLASS 41 (U.S. CLS. 100, 101 AND 107).

FIRST USE 3-10-2008; IN COMMERCE 3-10-2008.

THE MARK CONSISTS OF STANDARD CHARACTERS WITHOUT CLAIM TO ANY PARTICULAR FONT, STYLE, SIZE, OR COLOR.

SER. NO. 77-423,239, FILED 3-16-2008.

ALICE BENMAMAN, EXAMINING ATTORNEY

Int. Cl.: 35

Prior U.S. Cls.: 100, 101 and 102

United States Patent and Trademark Office

Reg. No. 3,519,785

Registered Oct. 21, 2008

**SERVICE MARK
PRINCIPAL REGISTER**

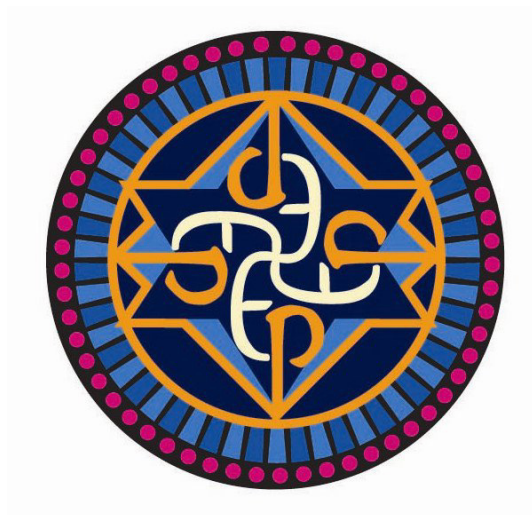

EVENT PRODUCERS, LLC (CONNECTICUT LIMITED LIABILITY COMPANY), DBA ENLIGHTENED PROFESSIONALS

23 SENECA ROAD
WEST HARTFORD, CT 061172246

FOR: PROMOTING PUBLIC AWARENESS OF WAYS TO ENHANCE WELLNESS AND SPIRITUAL GROWTH FOR INDIVIDUALS, ORGANIZATIONS AND BUSINESSES , IN CLASS 35 (U.S. CLS. 100, 101 AND 102).

FIRST USE 5-20-2007; IN COMMERCE 5-20-2007.

THE COLOR(S) BLUE, ORANGE, GREY, RED, CREAM, AND BLACK IS/ARE CLAIMED AS A FEATURE OF THE MARK.

THE MARK CONSISTS OF A CIRCLE CONTAINING GREY, BLACK, BLUE AND RED CIRCLES,

STARS, SQUARES AND OTHER FOUR-SIDED SHAPES, WITH GREY, BLACK AND ORANGE BORDERLINES, AND CREAM AND ORANGE LETTERS "E" AND "P" IN THE CENTER OF THE DESIGN AND REPEATING IN A ROTATIONAL MANNER SO AS TO GIVE THE APPEARANCE OF A CROSS-SHAPED DESIGN USING THE LETTERS "E" AND "P" SUPERIMPOSED ON A SIX-POINTED STAR-SHAPED DESIGN SURROUNDED BY A CIRCULAR ORANGE BORDERLINE WHICH IS IN TURN ENCIRCLED BY A RING OF BLUE FOUR-SIDED SHAPES WHICH IS IN TURN ENCIRCLED BY A RING OF RED CIRCLES ON A BLACK CIRCULAR BACKGROUND.

SER. NO. 77-423,250, FILED 3-16-2008.

KATHERINE M. DUBRAY, EXAMINING ATTORNEY

Int. Cl.: 35

Prior U.S. Cls.: 100, 101 and 102

United States Patent and Trademark Office

Reg. No. 3,519,786

Registered Oct. 21, 2008

**SERVICE MARK
PRINCIPAL REGISTER**

OmPass

HELLMAN, ANDREA (UNITED STATES INDIVIDUAL)
PO BOX 276 DENVER CO 80201
DENVER, CO 80201

FOR: ADMINISTRATION OF A DISCOUNT PROGRAM FOR ENABLING PARTICIPANTS TO OBTAIN DISCOUNTS ON GOODS AND SERVICES THROUGH USE OF A DISCOUNT MEMBERSHIP CARD, IN CLASS 35 (U.S. CLS. 100, 101 AND 102).

FIRST USE 10-1-2005; IN COMMERCE 1-3-2006.

THE MARK CONSISTS OF STANDARD CHARACTERS WITHOUT CLAIM TO ANY PARTICULAR FONT, STYLE, SIZE, OR COLOR.

SER. NO. 77-423,251, FILED 3-16-2008.

NATALIE POLZER, EXAMINING ATTORNEY

Int. Cl.: 32

Prior U.S. Cls.: 45, 46 and 48

United States Patent and Trademark Office

Reg. No. 3,519,787

Registered Oct. 21, 2008

**TRADEMARK
PRINCIPAL REGISTER**

LIFE 2 GO

FUNCTIONAL BRANDS (MICHIGAN LIMITED
LIABILITY COMPANY)
300 RIVER PLACE, SUITE 5350
DETROIT, MI 48207

FOR: ENERGY DRINKS; FRUIT BEVERAGES;
FRUIT DRINKS; FRUIT FLAVORED DRINKS;
FRUIT-FLAVORED BEVERAGES; NON-ALCOHOL-
IC BEVERAGES CONTAINING FRUIT JUICES;
NON-ALCOHOLIC COCKTAIL MIXES; SPORTS
DRINKS; WHEY BEVERAGES, IN CLASS 32 (U.S.
CLS. 45, 46 AND 48).

FIRST USE 3-14-2008; IN COMMERCE 3-14-2008.

THE MARK CONSISTS OF STANDARD CHAR-
ACTERS WITHOUT CLAIM TO ANY PARTICULAR
FONT, STYLE, SIZE, OR COLOR.

SER. NO. 77-423,266, FILED 3-16-2008.

CHRISTINA SOBRAL, EXAMINING ATTORNEY

Int. Cl.: 24

Prior U.S. Cls.: 42 and 50

United States Patent and Trademark Office

Reg. No. 3,519,788

Registered Oct. 21, 2008

**TRADEMARK
PRINCIPAL REGISTER**

Bed Hog

EASTERN EXCEL, INC. (CALIFORNIA CORPORATION), DBA BED HOG
1180 ALAMEDA DE LAS PULGAS
SAN CARLOS, CA 94070

FOR: BED AND TABLE LINEN; BED AND TABLE LINEN, WALL HANGINGS OF TEXTILE; BED BLANKETS; BED CANOPIES; BED LINEN; BED LINEN AND TABLE LINEN; BED PADS; BED SHEETS; BED SHEETS, FITTED BED SHEET COVERS, BED FLAT SHEETS, AND PILLOW CASES USED IN THE BEDDING, HEALTH CARE, HOME-HEALTH CARE AND NURSING HOME INDUSTRIES MADE OF BIODEGRADABLE FILM CREATED FROM RENEWABLE BIO-POLYMER RESOURCES; BED SKIRTS; BED SPREADS; FEATH-

ER BEDS; SILK BED BLANKETS; TABLE AND BED LINEN, IN CLASS 24 (U.S. CLS. 42 AND 50).

FIRST USE 3-1-2008; IN COMMERCE 5-30-2008.

THE MARK CONSISTS OF STANDARD CHARACTERS WITHOUT CLAIM TO ANY PARTICULAR FONT, STYLE, SIZE, OR COLOR.

NO CLAIM IS MADE TO THE EXCLUSIVE RIGHT TO USE "BED", APART FROM THE MARK AS SHOWN.

SER. NO. 77-423,281, FILED 3-17-2008.

YAT SYE, LEE, EXAMINING ATTORNEY

Int. Cl.: 29

Prior U.S. Cl.: 46

United States Patent and Trademark Office

Reg. No. 3,519,789

Registered Oct. 21, 2008

**TRADEMARK
PRINCIPAL REGISTER**

SLAPSHOT

LESSLIE, JAMES (UNITED STATES INDIVIDUAL)
100-20 159TH AVE
HOWARD BEACH, NY 11414

FOR: MEAT-BASED SNACK FOODS, IN CLASS 29
(U.S. CL. 46).

FIRST USE 6-10-1995; IN COMMERCE 6-10-1995.

THE MARK CONSISTS OF STANDARD CHARACTERS WITHOUT CLAIM TO ANY PARTICULAR FONT, STYLE, SIZE, OR COLOR.

OWNER OF U.S. REG. NO. 2,097,182.

SER. NO. 77-423,291, FILED 3-17-2008.

LESLEY LAMOTHE, EXAMINING ATTORNEY

Int. Cl.: 41

Prior U.S. Cls.: 100, 101 and 107

United States Patent and Trademark Office

Reg. No. 3,519,790

Registered Oct. 21, 2008

**SERVICE MARK
PRINCIPAL REGISTER**

KSOURCE ONLINE LEARNING

APPDEV PRODUCTS, LLC (MINNESOTA CORPORATION)
SUITE 120
10250 VALLEY VIEW ROAD
EDEN PRAIRIE, MN 55344

FOR: PROVIDING ON-LINE TRAINING, NAME-
LY, DEMONSTRATIONS, EXAMS, COURSES, SEMI-
NARS AND WORKSHOPS, IN THE FIELD OF END
USER SOFTWARE SYSTEMS , IN CLASS 41 (U.S.
CLS. 100, 101 AND 107).

FIRST USE 2-22-2008; IN COMMERCE 2-22-2008.

THE MARK CONSISTS OF STANDARD CHAR-
ACTERS WITHOUT CLAIM TO ANY PARTICULAR
FONT, STYLE, SIZE, OR COLOR.

NO CLAIM IS MADE TO THE EXCLUSIVE
RIGHT TO USE "ONLINE LEARNING", APART
FROM THE MARK AS SHOWN.

SER. NO. 77-423,346, FILED 3-17-2008.

NORA BUCHANAN WILL, EXAMINING ATTOR-
NEY

Int. Cl.: 9

Prior U.S. Cls.: 21, 23, 26, 36 and 38

Reg. No. 3,519,791

United States Patent and Trademark Office

Registered Oct. 21, 2008

**TRADEMARK
PRINCIPAL REGISTER**

JISCC

NATIONAL GUARD BUREAU (NGB) (VIRGINIA
AGENCY OF THE UNITED STATES GOVERN-
MENT)
NGB-J6 CIO (JP1 7400)
1411 JEFFERSON DAVIS HWY
ARLINGTON, VA 22202

FOR: CONTINGENCY RESPONSE COMMUNI-
CATION SYSTEM DESIGNED TO PROVIDE RADIO
INTEROPERABILITY, STREAMING VIDEO, WIRE-
LESS INTERNET, AND VOIP PHONE, IN CLASS 9
(U.S. CLS. 21, 23, 26, 36 AND 38).

FIRST USE 3-7-2005; IN COMMERCE 8-1-2005.

THE MARK CONSISTS OF STANDARD CHAR-
ACTERS WITHOUT CLAIM TO ANY PARTICULAR
FONT, STYLE, SIZE, OR COLOR.

SER. NO. 77-423,347, FILED 3-17-2008.

WILLIAM P. SHANAHAN, EXAMINING ATTOR-
NEY

Int. Cl.: 20

Prior U.S. Cls.: 2, 13, 22, 25, 32 and 50

United States Patent and Trademark Office

Reg. No. 3,519,792

Registered Oct. 21, 2008

**TRADEMARK
PRINCIPAL REGISTER**



MUMOOOCIE, INC. (FLORIDA CORPORATION)
2040 COURTYARD LOOP #100
SANFORD, FL 32771

FOR: PILLOWS, IN CLASS 20 (U.S. CLS. 2, 13, 22,
25, 32 AND 50).

FIRST USE 2-19-2008; IN COMMERCE 2-19-2008.

THE MARK CONSISTS OF THE WORD "MU-
MOOCIE" WITH THE LETTERING RESEMBLING
STITCHING WITH A CAPITAL M, A BACKWARDS
C, BOTH O'S FILLED IN AND THE DOT OVER THE
I AS A FILLED IN CIRCLE.

SER. NO. 77-423,392, FILED 3-17-2008.

JILL PRATER, EXAMINING ATTORNEY

Int. Cl.: 5

Prior U.S. Cls.: 6, 18, 44, 46, 51 and 52

Reg. No. 3,519,793

United States Patent and Trademark Office

Registered Oct. 21, 2008

**TRADEMARK
PRINCIPAL REGISTER**

GERMAINE

GERMAINE LABORATORIES, INC. (TEXAS
CORPORATION)
4139 GARDENDALE CENTER, #101
SAN ANTONIO, TX 78229

FIRST USE 6-18-1997; IN COMMERCE 6-18-1997.

FOR: DIAGNOSTIC TEST KITS COMPRISED OF
REAGENTS, TEST DEVICES, AND TEST STRIPS
FOR IN VITRO USE IN CLINICAL OR MEDICAL
LABORATORY, AND HOME USE, MEDICAL DI-
AGNOSTIC REAGENTS, IN CLASS 5 (U.S. CLS. 6, 18,
44, 46, 51 AND 52).

THE MARK CONSISTS OF STANDARD CHAR-
ACTERS WITHOUT CLAIM TO ANY PARTICULAR
FONT, STYLE, SIZE, OR COLOR.

SER. NO. 77-423,396, FILED 3-17-2008.

JILL PRATER, EXAMINING ATTORNEY

Int. Cl.: 25

Prior U.S. Cls.: 22 and 39

United States Patent and Trademark Office

Reg. No. 3,519,794

Registered Oct. 21, 2008

**TRADEMARK
PRINCIPAL REGISTER**

BELLA

COLOR IMAGE APPAREL, INC. (CALIFORNIA CORPORATION)
6670 FLOTILLA STREET
COMMERCE, CA 90040

FOR: WOMEN'S CLOTHING, NAMELY, TEE SHIRTS, SHORT SLEEVE SHIRTS, LONG SLEEVE SHIRTS, TANK TOPS, FLEECE TOPS, FLEECE PANTS, SHIRTS, PANTS, YOGA PANTS, CAPRI PANTS, SHORTS, BRAS, UNDERWEAR, CAMISOLES, SWEATSHIRTS, POLO SHIRTS, AND JACKETS, IN CLASS 25 (U.S. CLS. 22 AND 39).

FIRST USE 1-1-2000; IN COMMERCE 1-1-2000.

THE MARK CONSISTS OF STANDARD CHARACTERS WITHOUT CLAIM TO ANY PARTICULAR FONT, STYLE, SIZE, OR COLOR.

OWNER OF U.S. REG. NOS. 3,158,111, 3,293,659 AND OTHERS.

THE ENGLISH TRANSLATION OF THE WORD "BELLA" IN THE MARK IS "BEAUTIFUL".

SER. NO. 77-423,400, FILED 3-17-2008.

LYDIA BELZER, EXAMINING ATTORNEY

Int. Cl.: 35

Prior U.S. Cls.: 100, 101 and 102

United States Patent and Trademark Office

Reg. No. 3,519,795

Registered Oct. 21, 2008

**SERVICE MARK
PRINCIPAL REGISTER**

THE REVOLVING DOOR

FERRIN, ABIGAIL (UNITED STATES INDIVIDUAL)
1409 S. LAMAR STREET, SUITE 103
DALLAS, TX 75215

THE MARK CONSISTS OF STANDARD CHARACTERS WITHOUT CLAIM TO ANY PARTICULAR FONT, STYLE, SIZE, OR COLOR.

FOR: RETAIL CLOTHING BOUTIQUES; RETAIL CLOTHING STORES, IN CLASS 35 (U.S. CLS. 100, 101 AND 102).

SER. NO. 77-423,446, FILED 3-17-2008.

FIRST USE 11-30-2004; IN COMMERCE 11-30-2004.

JAMES LOVELACE, EXAMINING ATTORNEY

Int. Cl.: 39

Prior U.S. Cls.: 100 and 105

United States Patent and Trademark Office

Reg. No. 3,519,796

Registered Oct. 21, 2008

SERVICE MARK
PRINCIPAL REGISTER



LIKE A LOCAL, LLC (FLORIDA LIMITED LIABILITY COMPANY)

185 SE 14 TER #2806
MIAMI, FL 33131

FOR: ARRANGING AND COORDINATING TRAVEL ARRANGEMENTS FOR INDIVIDUALS AND GROUPS, NAMELY, DESTINATIONS STAYS, HONEYMOONS, FAMILY VACATIONS, AND DESTINATION WEDDINGS; COORDINATING TRAVEL ARRANGEMENTS FOR INDIVIDUALS AND FOR GROUPS; PROVISION OF TRAVEL INFORMATION; RESERVATION AND BOOKING OF SEATS FOR TRAVEL; TRAVEL PLANNING FOR INDIVIDUALS, FAMILIES, AND GROUPS FOR SPECIAL OCCASIONS SUCH AS DESTINATION WEDDINGS AND HONEYMOONS; TRAVEL COURIER AND TRAVEL GUIDE SERVICES; TRAVEL GUIDE AND TRAVEL INFORMATION SERVICES; TRAVEL GUIDE SERVICES; TRAVEL INFORMATION SERVICES; TRAVEL INFORMATION SERVICES, NAMELY, PROVIDING A WEB SITE THAT NOTIFIES PEOPLE WHEN SOMEONE IS DUE BACK FROM A TRIP BUT HAS NOT YET ARRIVED; TRAVEL, EXCURSION AND CRUISE ARRANGEMENT; ESCORTING TRAVELLERS; ORGANIZATION OF TRAVEL; ORGANIZATION OF EXCURSIONS, SIGHTSEEING TOURS, HOLIDAYS, TOURS AND TRAVEL; ORGANIZATION OF TRAVEL AND BOAT TRIPS; PROVIDING AN ON-LINE COMPUTER DATABASE IN THE FIELD OF TRAVEL INFORMATION SERVICES; PROVIDING AUTOMATED CHECK-IN AND TICKETING SERVICES FOR AIR TRAVELERS; PROVIDING INFORMATION, NEWS AND COMMENTARY IN THE FIELD OF TRAVEL; PROVIDING LINKS TO WEB SITES OF OTHERS FEATURING TRAVEL; PROVIDING REVIEWS OF TRAVEL SERVICE PROVIDERS; TRANSPORT OF TRAVELLERS; TRANSPORTATION OF GOODS, PASSENGERS AND TRAVELLERS BY AIR; TRAVEL AGENCY SERVICES, NAMELY, MAKING RESERVATIONS AND BOOKINGS FOR TRANSPORTATION;

TRAVEL AGENCY SERVICES, NAMELY, MAKING RESERVATIONS AND BOOKINGS FOR TRANSPORTATION FOR DOGS; TRAVEL AND TOUR INFORMATION SERVICE; TRAVEL AND TOUR TICKET RESERVATION SERVICE; TRAVEL BOOKING AGENCIES; TRAVEL CLUBS; ARRANGING FOR TRAVEL VISAS, PASSPORTS AND TRAVEL DOCUMENTS FOR PERSONS TRAVELING ABROAD; ARRANGING TRAVEL TOURS; ARRANGING TRAVEL TOURS AS A BONUS PROGRAM FOR CREDIT CARDS CUSTOMERS; BOOKING OF SEATS FOR TRAVEL, IN CLASS 39 (U.S. CLS. 100 AND 105).

FIRST USE 3-1-2008; IN COMMERCE 3-1-2008.

THE COLOR(S) BLACK, PINK, YELLOW, BLUE IS/ARE CLAIMED AS A FEATURE OF THE MARK.

THE MARK CONSISTS OF THE BACKDROP OF THE COMPANY LOGO IS THE BLACK SILHOUETTE OF THE DOWNTOWN MIAMI BUILDINGS, ALSO KNOWN AS THE MIAMI SKYLINE. ALONG THE BOTTOM ARE THE WORDS "PARTY LIKE A LOCAL". UNDER THE WORDS "PARTY LIKE A LOCAL" IS THE REFLECTION THOSE SAME WORDS, APPEARING UPSIDE DOWN. THE LETTER FONT FOR THE TEXT, AND THE REFLECTION, CONSISTS OF A SERIES OF DOTS. THE WORD "PARTY" APPEARS IN THE COLOR PINK, THE WORD "LIKE" APPEARS IN THE COLOR YELLOW, THE WORD "A" APPEARS IN THE COLOR BLUE, THE WORD "LOCAL" APPEARS IN THE COLOR PINK. IN THE REFLECTION PART OF THE LOGO, ALL WORDS APPEAR IN THE COLOR BLUE. ADDITIONALLY, THE LETTER "E" IS STYLIZED. THE LEFT PART OF THE LETTER "E" IN THE WORD "LIKE" IS CONTINUED UPWARD, ALONG THE FRONT OF THE LOGO, USING THE SAME DOTTED FONT. THE UPWARD PART OF THE STYLIZED LETTER ENDS AT THE TIP OF THE

ANTENNA OF ONE OF THE BUILDINGS ON THE
SKYLINE SILHOUETTE.

SER. NO. 77-423,488, FILED 3-17-2008.

BARBARA GAYNOR, EXAMINING ATTORNEY

Int. Cl.: 44

Prior U.S. Cls.: 100 and 101

United States Patent and Trademark Office

Reg. No. 3,519,797

Registered Oct. 21, 2008

**SERVICE MARK
PRINCIPAL REGISTER**



THE PRINCETON LONGEVITY CENTER, LLC
(NEW JERSEY LIMITED LIABILITY COMPAN-
NY)
46 VREELAND DRIVE
SKILLMAN, NJ 08558

FOR: PREVENTIVE MEDICAL CARE AND
HEALTH CARE SERVICES, IN CLASS 44 (U.S. CLS.
100 AND 101).

FIRST USE 9-5-2002; IN COMMERCE 9-5-2002.

THE MARK CONSISTS OF THE LETTERS "PLC"
WHICH INTERSECT IN AN OVAL DESIGN.

SER. NO. 77-423,511, FILED 3-17-2008.

ROBERT LAVACHE, EXAMINING ATTORNEY

Int. Cl.: 5

Prior U.S. Cls.: 6, 18, 44, 46, 51 and 52

United States Patent and Trademark Office

Reg. No. 3,519,798

Registered Oct. 21, 2008

**TRADEMARK
PRINCIPAL REGISTER**

HOUSTON ENZYMES

HOUSTON NUTRACEUTICALS, INC. (ARKAN-
SAS CORPORATION)
100 S. BROADWAY, SUITE G
SILOAM SPRINGS, AR 72761

FOR: DIETARY AND NUTRITIONAL SUPPLE-
MENTS, IN CLASS 5 (U.S. CLS. 6, 18, 44, 46, 51 AND
52).

FIRST USE 4-15-2006; IN COMMERCE 4-15-2006.

THE MARK CONSISTS OF STANDARD CHAR-
ACTERS WITHOUT CLAIM TO ANY PARTICULAR
FONT, STYLE, SIZE, OR COLOR.

NO CLAIM IS MADE TO THE EXCLUSIVE
RIGHT TO USE "ENZYMES", APART FROM THE
MARK AS SHOWN.

SER. NO. 77-423,556, FILED 3-17-2008.

MICHAEL KEATING, EXAMINING ATTORNEY

Int. Cl.: 42

Prior U.S. Cls.: 100 and 101

United States Patent and Trademark Office

Reg. No. 3,519,799

Registered Oct. 21, 2008

**SERVICE MARK
PRINCIPAL REGISTER**

OlySoft

OLYSOFT (GEORGIA CORPORATION)
SUITE 34
4994 LOWER ROSWELL ROAD
MARIETTA, GA 30068

FOR: COMPUTER HARDWARE AND SOFTWARE CONSULTING SERVICES, NAMELY, COMPUTER SOFTWARE TECHNOLOGY CONSULTING AND SOFTWARE CONFIGURATION, MAINTENANCE AND UPDATING; COMPUTER AND RELATED IT DISASTER RECOVERY PLANNING AND CONSULTATION RENDERED IN CONNECTION THEREWITH; DESIGNING OF INTRANET AND EXTRANET DOCUMENT MANAGEMENT POR-

TALS AND WORKFLOW FOR BUSINESS PROCESS AUTOMATION, IN CLASS 42 (U.S. CLS. 100 AND 101).

FIRST USE 3-15-1988; IN COMMERCE 9-15-1996.

THE MARK CONSISTS OF STANDARD CHARACTERS WITHOUT CLAIM TO ANY PARTICULAR FONT, STYLE, SIZE, OR COLOR.

SER. NO. 77-423,591, FILED 3-17-2008.

KATHLEEN M. VANSTON, EXAMINING ATTORNEY

Int. Cl.: 14

Prior U.S. Cls.: 2, 27, 28 and 50

United States Patent and Trademark Office

Reg. No. 3,519,800

Registered Oct. 21, 2008

**TRADEMARK
PRINCIPAL REGISTER**

PAY IT FORWARD

SNUGZ/USA INCORPORATED (UTAH COR-
PORATION)
SUITE 301
5200 SOUTH HIGHLAND DRIVE
SALT LAKE CITY, UT 84117

THE MARK CONSISTS OF STANDARD CHAR-
ACTERS WITHOUT CLAIM TO ANY PARTICULAR
FONT, STYLE, SIZE, OR COLOR.

FOR: BRACELETS; RUBBER OR SILICON
WRISTBANDS IN THE NATURE OF A BRACELET,
IN CLASS 14 (U.S. CLS. 2, 27, 28 AND 50).

SER. NO. 77-423,653, FILED 3-17-2008.

FIRST USE 7-31-2007; IN COMMERCE 7-31-2007.

CHRISIE B. KING, EXAMINING ATTORNEY

Int. Cl.: 41

Prior U.S. Cls.: 100, 101 and 107

United States Patent and Trademark Office

Reg. No. 3,519,801

Registered Oct. 21, 2008

**SERVICE MARK
PRINCIPAL REGISTER**



FLORIDA KEYS COMMUNITY COLLEGE
(FLORIDA STATE AGENCY)
5901 COLLEGE ROAD
KEY WEST, FL 33040

FOR: EDUCATING AT UNIVERSITY OR COLLE-
GES, IN CLASS 41 (U.S. CLS. 100, 101 AND 107).

FIRST USE 1-28-2008; IN COMMERCE 2-1-2008.

NO CLAIM IS MADE TO THE EXCLUSIVE
RIGHT TO USE "FLORIDA KEYS COMMUNITY
COLLEGE", APART FROM THE MARK AS SHOWN.

THE COLOR(S) LITTLE SPROUT GREEN, PURE
CYAN AND WHITE IS/ARE CLAIMED AS A FEAT-
TURE OF THE MARK.

THE MARK CONSISTS OF A SQUARE, WITH
ROUNDED EDGES, DIVIDED HORIZONTALLY
AND EQUALLY BY A SINE WAVE; THE TOP
HEMISPHERE COLORED PURE CYAN, THE BOT-
TOM HEMISPHERE COLORED LITTLE SPROUT
GREEN; A WHITE THATCH PALM FROND COV-
ERS BOTH HEMISPHERES, WITH THE HEAD IN
THE TOP AND MOST OF THE STEM IN THE
BOTTOM, AND THE WORDING "FLORIDA KEYS
COMMUNITY COLLEGE ISLAND LIVING, ISLAND
LEARNING" IN CYAN BLUE.

SER. NO. 77-423,679, FILED 3-17-2008.

ANGELA M. MICHELI, EXAMINING ATTORNEY

Int. Cl.: 38

Prior U.S. Cls.: 100, 101 and 104

United States Patent and Trademark Office

Reg. No. 3,519,802

Registered Oct. 21, 2008

**SERVICE MARK
PRINCIPAL REGISTER**

MY GROUP

NE COLORADO CELLULAR, INC. (COLORADO CORPORATION), DBA VIAERO WIRELESS
1224 WEST PLATTE AVENUE
FORT MORGAN, CO 80701

THE MARK CONSISTS OF STANDARD CHARACTERS WITHOUT CLAIM TO ANY PARTICULAR FONT, STYLE, SIZE, OR COLOR.

FOR: WIRELESS MOBILE TELEPHONE CALLING PLAN, IN CLASS 38 (U.S. CLS. 100, 101 AND 104).

SER. NO. 77-423,680, FILED 3-17-2008.

FIRST USE 2-28-2008; IN COMMERCE 2-28-2008.

ANGELA M. MICHELI, EXAMINING ATTORNEY

Int. Cl.: 41

Prior U.S. Cls.: 100, 101 and 107

United States Patent and Trademark Office

Reg. No. 3,519,803

Registered Oct. 21, 2008

**SERVICE MARK
PRINCIPAL REGISTER**

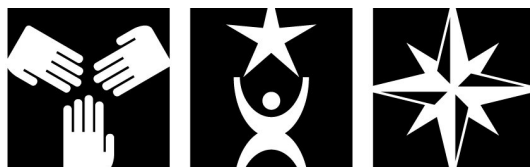

SIGMA ALPHA LAMBDA
SERVICE ♦ ACHIEVEMENT ♦ LEADERSHIP

SIGMA ALPHA LAMDA, INC. (GEORGIA CORPORATION)

SUITE 1

501 VILLAGE GREEN PARKWAY
BRADENTON, FL 34209

FOR: EDUCATIONAL SERVICES, NAMELY, ENCOURAGING ACADEMIC ACHIEVEMENT BY SPONSORING SCHOLAR GROUPS, STUDY GROUPS AND ACADEMIC MENTORING TO SCHOOL CHILDREN, ORGANIZING AND CONDUCTING CAMPUS AWARENESS ACTIVITIES IN THE NATURE OF CAMPUS FAIRS AND SPECIAL EVENTS THAT PROMOTE VOLUNTEERISM, PROVIDING RECOGNITION AND INCENTIVES BY THE WAY OF AWARDS TO NEW MEMBERS THAT DEMONSTRATE EXCELLENCE IN THE FIELD OF COMMUNITY SERVICE, PROVIDING TRAINING PROGRAMS IN THE FIELD OF LEADERSHIP DEVELOPMENT, IN CLASS 41 (U.S. CLS. 100, 101 AND 107).

FIRST USE 10-11-2005; IN COMMERCE 10-11-2005.

OWNER OF U.S. REG. NOS. 2,996,454 AND 3,061,557.

NO CLAIM IS MADE TO THE EXCLUSIVE RIGHT TO USE "LEADERSHIP", APART FROM THE MARK AS SHOWN.

THE MARK CONSISTS OF THREE HORIZONTALLY ALIGNED SHADED SQUARES WITH CONTRASTING SYMBOLOGY DEPICTING IN LEFT-TO-RIGHT ORDER, THREE HANDS INTERSECTING ABOUT A CENTER AXIS OF THE LEFT-MOST SQUARE, A STAR ABOVE AN ANTHROPOMORPHIC SHAPE IN THE CENTER SQUARE AND AN 8-POINT STAR IN THE RIGHT-MOST SQUARE. CENTERED UNDER THE THREE SQUARES THE WORDS, "SIGMA" "ALPHA" "LAMBDA", A LINE-BREAK AND WORDS "SERVICE" (A BULLET) "ACHIEVEMENT" (A BULLET) AND "LEADERSHIP".

SER. NO. 77-423,751, FILED 3-17-2008.

SARA THOMAS, EXAMINING ATTORNEY

Int. Cl.: 41

Prior U.S. Cls.: 100, 101 and 107

United States Patent and Trademark Office

Reg. No. 3,519,804

Registered Oct. 21, 2008

**SERVICE MARK
PRINCIPAL REGISTER**

WALHALLA WAVE

BUSCH ENTERTAINMENT CORPORATION (DE-
LAWARE CORPORATION)

202-6

ONE BUSCH PLACE

ST. LOUIS, MO 63118

FOR: ENTERTAINMENT IN THE NATURE OF
AN AMUSEMENT PARK RIDE, IN CLASS 41 (U.S.
CLS. 100, 101 AND 107).

FIRST USE 3-1-2008; IN COMMERCE 3-1-2008.

THE MARK CONSISTS OF STANDARD CHAR-
ACTERS WITHOUT CLAIM TO ANY PARTICULAR
FONT, STYLE, SIZE, OR COLOR.

NO CLAIM IS MADE TO THE EXCLUSIVE
RIGHT TO USE "WAVE", APART FROM THE
MARK AS SHOWN.

SER. NO. 77-423,781, FILED 3-17-2008.

CHRISIE B. KING, EXAMINING ATTORNEY

Int. Cl.: 33

Prior U.S. Cls.: 47 and 49

United States Patent and Trademark Office

Reg. No. 3,519,805

Registered Oct. 21, 2008

**TRADEMARK
PRINCIPAL REGISTER**

Bunnell Family Cellar

RIVERAERIE CELLARS LLC (WASHINGTON
LIMITED LIABILITY COMPANY)

87203 W. 134 PR NW

PROSSER, WA 99350

FOR: GRAPE WINE, IN CLASS 33 (U.S. CLS. 47
AND 49).

FIRST USE 3-1-2006; IN COMMERCE 5-1-2006.

THE MARK CONSISTS OF STANDARD CHAR-
ACTERS WITHOUT CLAIM TO ANY PARTICULAR
FONT, STYLE, SIZE, OR COLOR.

NO CLAIM IS MADE TO THE EXCLUSIVE
RIGHT TO USE "FAMILY CELLAR", APART FROM
THE MARK AS SHOWN.

SER. NO. 77-423,892, FILED 3-17-2008.

LYDIA BELZER, EXAMINING ATTORNEY

Int. Cls.: 35, 36, 37 and 39

Prior U.S. Cls.: 100, 101, 102, 103, 105 and 106

United States Patent and Trademark Office

Reg. No. 3,519,806

Registered Oct. 21, 2008

**SERVICE MARK
PRINCIPAL REGISTER**



THE CATAMARAN COMPANY

CATAMARAN SALES, INC. (FLORIDA CORPORATION)
10455 NW 12 ST
MIAMI, FL 33172

NO CLAIM IS MADE TO THE EXCLUSIVE RIGHT TO USE "THE CATAMARAN COMPANY", APART FROM THE MARK AS SHOWN.

FOR: BOAT DEALERSHIPS, IN CLASS 35 (U.S. CLS. 100, 101 AND 102).

THE COLOR(S) BLACK, WHITE AND BLUE IS/ ARE CLAIMED AS A FEATURE OF THE MARK.

FIRST USE 6-1-2004; IN COMMERCE 6-1-2004.

FOR: YACHT BROKERAGE , IN CLASS 36 (U.S. CLS. 100, 101 AND 102).

THE MARK CONSISTS OF A CIRCLE, THE LEFT HALF OF WHICH IS BLUE, THE RIGHT HALF OF WHICH IS BLACK WITH A WHITE LINE CUTTING THROUGH THE CENTER OF THE CIRCLE FROM THE TOP OF THE CIRCLE TO THE BOTTOM. THROUGH THAT LINE AND BOTH HALVES OF THE CIRCLE IS A WHITE CUT OUT OF A CATAMARAN BOAT. CENTERED UNDERNEATH THE CIRCLE IS THE BLACK LETTERS "THE" FOLLOWED BY "CATAMARAN" IN BLUE AND "COMPANY" IN BLACK.

FIRST USE 6-1-2004; IN COMMERCE 6-1-2004.

FOR: MAINTENANCE AND/OR REPAIR OF BOATS & YACHTS, IN CLASS 37 (U.S. CLS. 100, 103 AND 106).

FIRST USE 6-1-2004; IN COMMERCE 6-1-2004.

FOR: CHARTERING OF YACHTS AND BOATS, BOAT STORAGE, LEASING OF BOAT SLIPS, IN CLASS 39 (U.S. CLS. 100 AND 105).

SER. NO. 77-424,012, FILED 3-17-2008.

FIRST USE 6-1-2004; IN COMMERCE 6-1-2004.

APRIL HESIK, EXAMINING ATTORNEY

Int. Cls.: 36 and 44

Prior U.S. Cls.: 100, 101 and 102

United States Patent and Trademark Office

Reg. No. 3,519,807

Registered Oct. 21, 2008

**SERVICE MARK
PRINCIPAL REGISTER**

HSA EXPRESS

CONNECTYOURCARE LLC (MARYLAND LIMITED LIABILITY COMPANY)

307 INTERNATIONAL CIRCLE, STE 200

HUNT VALLEY, MD 21030

FOR: DEBIT CARD SERVICES, NAMELY, PROVIDING DEBIT CARDS FOR USE IN RELATION TO HEALTH CARE ACCOUNTS AND PROVIDING HEALTH CARE DEBIT CARD ACCOUNT INFORMATION OVER THE INTERNET; ADMINISTRATION AND PROCESSING OF HEALTH CARE INSURANCE REIMBURSEMENT CLAIMS, IN CLASS 36 (U.S. CLS. 100, 101 AND 102).

FIRST USE 12-0-2006; IN COMMERCE 12-0-2006.

FOR: PROVIDING HEALTH CARE INFORMATION OVER THE INTERNET, IN CLASS 44 (U.S. CLS. 100 AND 101).

FIRST USE 12-0-2006; IN COMMERCE 12-0-2006.

THE MARK CONSISTS OF STANDARD CHARACTERS WITHOUT CLAIM TO ANY PARTICULAR FONT, STYLE, SIZE, OR COLOR.

NO CLAIM IS MADE TO THE EXCLUSIVE RIGHT TO USE "HSA", APART FROM THE MARK AS SHOWN.

SER. NO. 77-424,121, FILED 3-17-2008.

MARK T. MULLEN, EXAMINING ATTORNEY

Int. Cls.: 39 and 41

Prior U.S. Cls.: 100, 101, 105 and 107

United States Patent and Trademark Office

Reg. No. 3,519,808

Registered Oct. 21, 2008

**SERVICE MARK
PRINCIPAL REGISTER**



GLOBAL LEADERSHIP ADVENTURES, INC.
(DELAWARE CORPORATION)

2633 LINCOLN BLVD. #427

SANTA MONICA, CA 90405

FOR: ORGANIZATION OF EXCURSIONS, SIGHTSEEING TOURS, TOURS, TRAVEL, INTERNATIONAL EDUCATION AND LEADERSHIP TRAINING FOR HIGH SCHOOL STUDENTS , IN CLASS 39 (U.S. CLS. 100 AND 105).

FIRST USE 9-26-2006; IN COMMERCE 9-26-2006.

FOR: INTERNATIONAL EDUCATION AND LEADERSHIP TRAINING, ALL FOR HIGH SCHOOL STUDENTS, IN CLASS 41 (U.S. CLS. 100, 101 AND 107).

FIRST USE 9-26-2006; IN COMMERCE 9-26-2006.

NO CLAIM IS MADE TO THE EXCLUSIVE RIGHT TO USE "GLOBAL LEADERSHIP" AND "FOR HIGH SCHOOL STUDENTS", APART FROM THE MARK AS SHOWN.

THE COLOR(S) WHITE, BLACK, RED, ORANGE, LIGHT BLUE, DARK TAN AND TAN IS/ARE CLAIMED AS A FEATURE OF THE MARK.

THE MARK CONSISTS OF THE LETTERS "GLA" IN THE COLOR WHITE INSIDE A SHIELD LINED IN BLACK. THE TOP HALF OF THE SHIELD IS RED WITH A WHITE BORDER. THE BOTTOM OF THE SHIELD CONSISTS OF A PORTION OF A GLOBE IN THE COLOR LIGHT BLUE FADING INTO WHITE FROM THE BOTTOM UP WITH BLACK GRID LINES. A DARK TAN LINE EXTENDS FROM THE BOTTOM HALF OF THE SHIELD AND FADES OUT TO THE END OF THE MARK ON THE RIGHT. THE WORDING "GLOBAL LEADERSHIP ADVENTURES" APPEARS IN THE COLOR TAN ABOVE THE LINE. THE WORDING "LIFE-CHANGING JOURNEYS FOR HIGH SCHOOL STUDENTS" APPEARS BELOW THE LINE. THE ENTIRE MARK IS ON A RED RECTANGLE THAT FADES INTO ORANGE FROM TOP TO BOTTOM.

SER. NO. 77-424,128, FILED 3-17-2008.

SANDRA MANIOS, EXAMINING ATTORNEY

Int. Cl.: 35

Prior U.S. Cls.: 100, 101 and 102

United States Patent and Trademark Office

Reg. No. 3,519,809

Registered Oct. 21, 2008

**SERVICE MARK
PRINCIPAL REGISTER**



ELAYNE M. DUDLEY (NEW HAMPSHIRE SOLE PROPRIETORSHIP), DBA INSIDE SALES GROUP

P.O. BOX 777

EXETER, NH 03833

FOR: ADVERTISING AND MARKETING SERVICES, NAMELY, PROMOTING THE GOODS AND SERVICES OF OTHERS BY DEVELOPING BUSINESS LEADS, GENERATING, CONFIRMING AND QUALIFYING PROSPECTS OR EXISTING CLIENTS VIA TELEMARKETING AND ELECTRONIC MAIL, IN CLASS 35 (U.S. CLS. 100, 101 AND 102).

FIRST USE 8-1-2004; IN COMMERCE 12-15-2004.

NO CLAIM IS MADE TO THE EXCLUSIVE RIGHT TO USE "INSIDE SALES" AND "GROUP", APART FROM THE MARK AS SHOWN.

THE MARK CONSISTS OF A SOLID HORIZONTAL RECTANGLE CARRYING A LOWER CASE "I" AND A STYLIZED LETTER "S" EXTENDING FROM THE TOP TO THE BOTTOM OF THE RECTANGLE. THE WORD "INSIDE" APPEARS ABOVE THE WORD "SALES" ON THE RIGHT SIDE OF THE RECTANGLE. THE WORD "GROUP" APPEARS VERTICALLY ALONG THE RIGHT OF THE RECTANGLE.

SER. NO. 77-424,134, FILED 3-17-2008.

SANDRA MANIOS, EXAMINING ATTORNEY

Int. Cl.: 45

Prior U.S. Cls.: 100 and 101

United States Patent and Trademark Office

Reg. No. 3,519,810

Registered Oct. 21, 2008

SERVICE MARK
PRINCIPAL REGISTER



HULL VENTURES, LLC (CALIFORNIA LIMITED
LIABILITY COMPANY)
SUITE 204
30101 AGOURA COURT
AGOURA HILLS, CA 91301

FOR: PROVIDING HOURLY AND LIVE-IN NON-
MEDICAL PERSONAL ASSISTANCE SERVICES
FOR OTHERS IN THE NATURE OF PLANNING,
ORGANIZING, COORDINATING, ARRANGING
AND ASSISTING INDIVIDUALS TO PERFORM
DAILY TASKS ALSO KNOWN AS ACTIVITIES OF
DAILY LIVING, IN CLASS 45 (U.S. CLS. 100 AND
101).

FIRST USE 8-1-2006; IN COMMERCE 10-1-2006.

NO CLAIM IS MADE TO THE EXCLUSIVE
RIGHT TO USE "HOME CARE" AND "A PROFES-
SIONAL HOME CARE SOLUTION", APART FROM
THE MARK AS SHOWN.

THE STIPPLING IS FOR SHADING PURPOSES
ONLY.

THE MARK CONSISTS OF A LETTER "S" INSIDE
A HOME. ITALIZED WORD "SELECT" AND LOW-
ER CASE WORDS "A PROFESSIONAL HOME CARE
SOLUTION" BELOW DETACHED HOME AND
WORD "SELECT".

SER. NO. 77-424,346, FILED 3-17-2008.

KIM MONINGHOFF, EXAMINING ATTORNEY

Int. Cl.: 42

Prior U.S. Cls.: 100 and 101

United States Patent and Trademark Office

Reg. No. 3,519,811

Registered Oct. 21, 2008

**SERVICE MARK
PRINCIPAL REGISTER**



SMOOTH COMMUNICATIONS (NORTH DAKOTA LIMITED PARTNERSHIP)
5602 CYPRESS POINT DRIVE
GRAND FORKS, ND 58201

FOR: COMPUTER SOFTWARE CONSULTATION; COMPUTER SOFTWARE DESIGN; COMPUTER SOFTWARE DESIGN FOR OTHERS; COMPUTER SOFTWARE DEVELOPMENT; APPLICATION SERVICE PROVIDER (ASP) FEATURING SOFTWARE FOR USE AS AN ONLINE ORGANIZER AND COMMUNICATION TOOL, NAMELY, AN ELECTRONIC CALENDAR, TASK MANAGER, E-MAIL SERVICE AND CONTACT MANAGER THAT ANALYZES PERSONAL DATA TO ADVERTISE AND PROMOTE SERVICES FROM INTERACTIVE CONTENT STORED IN A DATABASE; PROVIDING ONLINE NON-DOWNLOADABLE SOFTWARE FOR AN ONLINE ORGANIZER AND COMMUNICATION TOOL, NAMELY, AN ELECTRONIC CALENDAR, TASK MANAGER, E-MAIL SERVICE AND

CONTACT MANAGER THAT ANALYZES PERSONAL DATA TO ADVERTISE AND PROMOTE SERVICES FROM INTERACTIVE CONTENT STORED IN A DATABASE, IN CLASS 42 (U.S. CLS. 100 AND 101).

FIRST USE 3-7-2008; IN COMMERCE 3-7-2008.

NO CLAIM IS MADE TO THE EXCLUSIVE RIGHT TO USE "COMMUNICATIONS", APART FROM THE MARK AS SHOWN.

THE MARK CONSISTS OF THE TEXT "SMOOTH COMMUNICATIONS" ADJACENT TO CIRCLE DESIGNS.

SER. NO. 77-424,391, FILED 3-17-2008.

MARY MUNSON, EXAMINING ATTORNEY

Int. Cl.: 37

Prior U.S. Cls.: 100, 103 and 106

United States Patent and Trademark Office

Reg. No. 3,519,812

Registered Oct. 21, 2008

**SERVICE MARK
PRINCIPAL REGISTER**



FACILITIES ELECTRIC, INC. (TEXAS CORPORATION)
12933 BRITTMORE PARK DRIVE
HOUSTON, TX 77041

FOR: ELECTRICAL CONTRACTOR SERVICES; ELECTRICAL CONTRACTING; ELECTRICAL REPAIRS AND INSTALLATION OF ELECTRICAL SYSTEMS; INSTALLATION OF ELECTRICAL AND GENERATING MACHINERY; REPAIR OR MAINTENANCE OF ELECTRIC LIGHTING APPARATUS; INSTALLATION OF ELECTRICAL SYSTEMS; INSTALLATION OF ELECTRONIC AND DIGITAL CONNECTION TO A CALL CENTRE, IN CLASS 37 (U.S. CLS. 100, 103 AND 106).

FIRST USE 8-1-1998; IN COMMERCE 8-1-1998.

NO CLAIM IS MADE TO THE EXCLUSIVE RIGHT TO USE "FACILITIES" AND "ELECTRIC", APART FROM THE MARK AS SHOWN.

THE COLOR(S) YELLOW AND BLACK IS/ARE CLAIMED AS A FEATURE OF THE MARK.

THE MARK CONSISTS OF LETTERS "FE" WITH A YELLOW THUNDERBOLT BETWEEN THE LETTERS BETWEEN THE WORDS "FACILITIES" AND "ELECTRIC"; THE LETTERS "FE" AND THE WORDS "FACILITIES" AND "ELECTRIC" ARE BLACK.

SER. NO. 77-424,453, FILED 3-18-2008.

G. MAYERSCHOFF, EXAMINING ATTORNEY

Int. Cl.: 41

Prior U.S. Cls.: 100, 101 and 107

United States Patent and Trademark Office

Reg. No. 3,519,813

Registered Oct. 21, 2008

**SERVICE MARK
PRINCIPAL REGISTER**

LifeCamp

MOOERS, GREG (UNITED STATES INDIVIDUAL)
24 ALOHA DRIVE
PACIFIC PALISADES, CA 90272

THE MARK CONSISTS OF STANDARD CHARACTERS WITHOUT CLAIM TO ANY PARTICULAR FONT, STYLE, SIZE, OR COLOR.

FOR: EDUCATIONAL SERVICES, NAMELY, PROVIDING PUBLIC SPEAKING SERVICES, RADIO HOSTING AND GUESTING SERVICES AND TRAINING SERVICES IN THE FIELDS OF EMPOWERMENT AND SELF-IMPROVEMENT, IN CLASS 41 (U.S. CLS. 100, 101 AND 107).

OWNER OF U.S. REG. NO. 2,924,847.

SER. NO. 77-424,460, FILED 3-18-2008.

FIRST USE 10-10-1996; IN COMMERCE 10-10-1996.

JORDAN BAKER, EXAMINING ATTORNEY

Int. Cl.: 41

Prior U.S. Cls.: 100, 101 and 107

United States Patent and Trademark Office

Reg. No. 3,519,814

Registered Oct. 21, 2008

**SERVICE MARK
PRINCIPAL REGISTER**

NEW YORK YACHT CLUB

NEW YORK YACHT CLUB (NEW YORK NON-
PROFIT CORPORATION)
37 WEST 44TH STREET
NEW YORK, NY 10036

FOR: YACHT CLUB SERVICES, IN CLASS 41 (U.S.
CLS. 100, 101 AND 107).

FIRST USE 7-31-1844; IN COMMERCE 7-31-1844.

THE MARK CONSISTS OF STANDARD CHAR-
ACTERS WITHOUT CLAIM TO ANY PARTICULAR
FONT, STYLE, SIZE, OR COLOR.

NO CLAIM IS MADE TO THE EXCLUSIVE
RIGHT TO USE "YACHT CLUB", APART FROM
THE MARK AS SHOWN.

SEC. 2(F).

SER. NO. 77-424,479, FILED 3-18-2008.

CHARLES L. JENKINS, EXAMINING ATTORNEY

Int. Cl.: 41

Prior U.S. Cls.: 100, 101 and 107

United States Patent and Trademark Office

Reg. No. 3,519,815

Registered Oct. 21, 2008

**SERVICE MARK
PRINCIPAL REGISTER**

NYYC

NEW YORK YACHT CLUB (NEW YORK NON-
PROFIT CORPORATION)
37 WEST 44TH STREET
NEW YORK, NY 10036

FOR: YACHT CLUB SERVICES, IN CLASS 41 (U.S.
CLS. 100, 101 AND 107).

FIRST USE 7-31-1844; IN COMMERCE 7-31-1844.

THE MARK CONSISTS OF STANDARD CHAR-
ACTERS WITHOUT CLAIM TO ANY PARTICULAR
FONT, STYLE, SIZE, OR COLOR.

OWNER OF U.S. REG. NO. 2,689,231.

SER. NO. 77-424,484, FILED 3-18-2008.

CHARLES L. JENKINS, EXAMINING ATTORNEY

Prior U.S. Cl.: 200

United States Patent and Trademark Office

Reg. No. 3,519,816

Registered Oct. 21, 2008

**COLLECTIVE MEMBERSHIP
PRINCIPAL REGISTER**

NYYC

NEW YORK YACHT CLUB (NEW YORK NON-
PROFIT CORPORATION)
37 WEST 34TH STREET
NEW YORK, NY 10036

FOR: INDICATING MEMBERSHIP IN A YACHT
CLUB, IN CLASS 200 (U.S. CL. 200).

FIRST USE 7-31-1844; IN COMMERCE 7-31-1844.

THE MARK CONSISTS OF STANDARD CHAR-
ACTERS WITHOUT CLAIM TO ANY PARTICULAR
FONT, STYLE, SIZE, OR COLOR.

OWNER OF U.S. REG. NO. 2,689,231.

SER. NO. 77-424,502, FILED 3-18-2008.

CHARLES L. JENKINS, EXAMINING ATTORNEY

Int. Cl.: 44

Prior U.S. Cls.: 100 and 101

United States Patent and Trademark Office

Reg. No. 3,519,817

Registered Oct. 21, 2008

**SERVICE MARK
PRINCIPAL REGISTER**

**LIFE-SAVING TECHNOLOGY
WITHIN REACH**

DEFIBTECH, LLC (NEW JERSEY LIMITED LIABILITY COMPANY)
SUITE 2W
630 W. STRATFORD PLACE
CHICAGO, IL 60657

THE MARK CONSISTS OF STANDARD CHARACTERS WITHOUT CLAIM TO ANY PARTICULAR FONT, STYLE, SIZE, OR COLOR.

FOR: PROVIDING HEALTH INFORMATION, IN CLASS 44 (U.S. CLS. 100 AND 101).

SER. NO. 77-424,515, FILED 3-18-2008.

FIRST USE 5-23-2003; IN COMMERCE 5-23-2003.

STEVEN R. FINE, EXAMINING ATTORNEY

Int. Cl.: 1

Prior U.S. Cls.: 1, 5, 6, 10, 26 and 46

Reg. No. 3,519,818

United States Patent and Trademark Office

Registered Oct. 21, 2008

**TRADEMARK
PRINCIPAL REGISTER**

FERTAMINOS

SYNATEK LP (PENNSYLVANIA LIMITED PART-
NERSHIP)
SUITE 4
261 SCHOOLHOUSE ROAD
SOUDERTON, PA 18964

THE MARK CONSISTS OF STANDARD CHAR-
ACTERS WITHOUT CLAIM TO ANY PARTICULAR
FONT, STYLE, SIZE, OR COLOR.

FOR: FERTILIZERS, IN CLASS 1 (U.S. CLS. 1, 5, 6,
10, 26 AND 46).

SER. NO. 77-424,531, FILED 3-18-2008.

FIRST USE 10-6-2006; IN COMMERCE 10-6-2006.

ALYSSA PALADINO, EXAMINING ATTORNEY

Int. Cl.: 28

Prior U.S. Cls.: 22, 23, 38 and 50

United States Patent and Trademark Office

Reg. No. 3,519,819

Registered Oct. 21, 2008

**TRADEMARK
PRINCIPAL REGISTER**

TALKTILES

INTELLIGENT AUTOMATION, INC. (MARY-
LAND CORPORATION)
SUITE 400
15400 CALHOUN DRIVE
ROCKVILLE, MD 20850

FOR: EQUIPMENT SOLD AS A UNIT FOR PLAY-
ING EDUCATIONAL PARLOR GAMES IN THE
NATURE OF PLAYER-MANIPULATED TILES TO
BE PLACED IN RECESSES IN A CRADLE , IN
CLASS 28 (U.S. CLS. 22, 23, 38 AND 50).

FIRST USE 3-1-2004; IN COMMERCE 3-1-2004.

THE MARK CONSISTS OF STANDARD CHAR-
ACTERS WITHOUT CLAIM TO ANY PARTICULAR
FONT, STYLE, SIZE, OR COLOR.

SER. NO. 77-424,537, FILED 3-18-2008.

VERNA BETH RIRIE, EXAMINING ATTORNEY

Int. Cl.: 43

Prior U.S. Cls.: 100 and 101

United States Patent and Trademark Office

Reg. No. 3,519,820

Registered Oct. 21, 2008

**SERVICE MARK
PRINCIPAL REGISTER**

THE FOODS YOU LOVE. ONLY
BETTER.

EARTH FARE, INC. (NORTH CAROLINA COR-
PORATION)
SUITE 150
145 CANE CREEK INDUSTRIAL DRIVE
FLETCHER, NC 28732

THE MARK CONSISTS OF STANDARD CHAR-
ACTERS WITHOUT CLAIM TO ANY PARTICULAR
FONT, STYLE, SIZE, OR COLOR.

FOR: RESTAURANT, CAFE AND DELICATES-
SEN SERVICES, IN CLASS 43 (U.S. CLS. 100 AND
101).

SER. NO. 77-424,556, FILED 3-18-2008.

FIRST USE 1-3-2005; IN COMMERCE 1-3-2005.

MICHAEL TANNER, EXAMINING ATTORNEY

Int. Cl.: 44

Prior U.S. Cls.: 100 and 101

United States Patent and Trademark Office

Reg. No. 3,519,821

Registered Oct. 21, 2008

**SERVICE MARK
PRINCIPAL REGISTER**



STAMPER EXECUTIVE SOLUTIONS INC. (KENTUCKY CORPORATION)
2717 ALEXANDRIA PIKE
HIGHLAND HEIGHTS, KY 41076

FOR: ANIMAL GROOMING; PET CARE SERVICES, NAMELY, DOG WALKING, DOG BATHING, NON-MEDICATED PET GROOMING AND IN-HOME MEDICAL CARE; VETERINARY SERVICES, IN CLASS 44 (U.S. CLS. 100 AND 101).

FIRST USE 1-1-2008; IN COMMERCE 1-1-2008.

NO CLAIM IS MADE TO THE EXCLUSIVE RIGHT TO USE "PET", APART FROM THE MARK AS SHOWN.

THE STIPLING IS FOR SHADING PURPOSES ONLY.

THE MARK CONSISTS OF THE STYLIZED WORDS "PET WÖW WELLNESS ON WHEELS". IMAGE OF TWO DOG BONES CROSSED TO THE LEFT OF THE STYLIZED WORDS. THERE ARE STYLIZED PAW PRINT MARKS ABOVE THE LETTER "O".

SER. NO. 77-424,562, FILED 3-18-2008.

KELLY BOULTON, EXAMINING ATTORNEY

Int. Cl.: 35

Prior U.S. Cls.: 100, 101 and 102

United States Patent and Trademark Office

Reg. No. 3,519,822

Registered Oct. 21, 2008

**SERVICE MARK
PRINCIPAL REGISTER**

Newport Pleasure Draw

LORILLARD LICENSING COMPANY, LLC
(NORTH CAROLINA LIMITED LIABILITY
COMPANY)

1601 WACHOVIA TOWER, 300 N. GREENE ST.
GREENSBORO, NC 27402

FOR: CUSTOMER LOYALTY SERVICES FOR
COMMERCIAL, PROMOTIONAL AND/OR ADVER-
TISING PURPOSES, NAMELY, SWEEPSTAKES FOR
CIGARETTES, IN CLASS 35 (U.S. CLS. 100, 101 AND
102).

FIRST USE 6-18-2007; IN COMMERCE 6-18-2007.

THE MARK CONSISTS OF STANDARD CHAR-
ACTERS WITHOUT CLAIM TO ANY PARTICULAR
FONT, STYLE, SIZE, OR COLOR.

OWNER OF U.S. REG. NOS. 3,164,986, 3,292,908
AND OTHERS.

NO CLAIM IS MADE TO THE EXCLUSIVE
RIGHT TO USE "DRAW", APART FROM THE
MARK AS SHOWN.

SER. NO. 77-424,624, FILED 3-18-2008.

KELLY MCCOY, EXAMINING ATTORNEY

Int. Cl.: 35

Prior U.S. Cls.: 100, 101 and 102

United States Patent and Trademark Office

Reg. No. 3,519,823

Registered Oct. 21, 2008

**SERVICE MARK
PRINCIPAL REGISTER**

**WE RESCUE TREASURES &
LOCATE HOMES FOR THEM**

LK MIX, LLC (FLORIDA LIMITED LIABILITY
COMPANY)
1617 NORTH PALM WAY
LAKE WORTH, FL 33460

FOR: RETAIL STORE SERVICES FEATURING
FURNITURE, DECORATIVE HOME FURNISH-
INGS, DINING AND KITCHEN GOODS, TEXTILES,
LAMPS, BATHROOM ACCESSORIES, NOVELTY
ITEMS AND PICTURE FRAMES, IN CLASS 35 (U.S.
CLS. 100, 101 AND 102).

FIRST USE 10-26-2007; IN COMMERCE 10-26-2007.

THE MARK CONSISTS OF STANDARD CHAR-
ACTERS WITHOUT CLAIM TO ANY PARTICULAR
FONT, STYLE, SIZE, OR COLOR.

SER. NO. 77-424,664, FILED 3-18-2008.

CHERYL CLAYTON, EXAMINING ATTORNEY

Int. Cls.: 36 and 44

Prior U.S. Cls.: 100, 101 and 102

United States Patent and Trademark Office

Reg. No. 3,519,824

Registered Oct. 21, 2008

**SERVICE MARK
PRINCIPAL REGISTER**

Steps2WELLth

STEPS 2 WELLTH (GEORGIA PARTNERSHIP)
4540 OAK BROOK DRIVE
SMYRNA, GA 30082

FOR: ADMINISTRATION OF EMPLOYEE WEL-
FARE BENEFIT PLANS, IN CLASS 36 (U.S. CLS. 100,
101 AND 102).

FIRST USE 1-15-2007; IN COMMERCE 1-15-2007.

FOR: COUNSELING SERVICES IN THE FIELDS
OF HEALTH, NUTRITION AND LIFESTYLE WELL-
NESS; HEALTH CARE SERVICES, NAMELY, DIS-

EASE MANAGEMENT PROGRAMS; MEDICAL
CLINICS, IN CLASS 44 (U.S. CLS. 100 AND 101).

FIRST USE 1-15-2007; IN COMMERCE 1-15-2007.

THE MARK CONSISTS OF STANDARD CHAR-
ACTERS WITHOUT CLAIM TO ANY PARTICULAR
FONT, STYLE, SIZE, OR COLOR.

SER. NO. 77-424,755, FILED 3-18-2008.

JAY FLOWERS, EXAMINING ATTORNEY

Int. Cl.: 35

Prior U.S. Cls.: 100, 101 and 102

United States Patent and Trademark Office

Reg. No. 3,519,825

Registered Oct. 21, 2008

**SERVICE MARK
PRINCIPAL REGISTER**

WhyPark

WHYPARK, LLC (OHIO LIMITED LIABILITY COMPANY)
38613 ANDREWS RIDGE WAY
WILLOUGHBY, OH 44094

FOR: ONLINE MARKETING AND ADVERTISING SERVICES; MARKETING SERVICES, NAMELY, PROVIDING INFORMATIONAL WEB PAGES DESIGNED TO GENERATE SALES TRAFFIC VIA HYPERLINKS TO OTHER WEB SITES; SERVICES RELATING TO THE ANALYSIS, EVALUATION, CREATION AND BRAND ESTABLISHMENT OF TRADEMARKS, TRADE NAMES AND DOMAIN NAMES; ADVERTISING AND BUSINESS MANAGEMENT CONSULTANCY; PROMOTING THE GOODS

AND SERVICES OF OTHERS THROUGH SEARCH ENGINE REFERRAL TRAFFIC ANALYSIS AND REPORTING, IN CLASS 35 (U.S. CLS. 100, 101 AND 102).

FIRST USE 4-17-2006; IN COMMERCE 4-17-2006.

THE MARK CONSISTS OF STANDARD CHARACTERS WITHOUT CLAIM TO ANY PARTICULAR FONT, STYLE, SIZE, OR COLOR.

SER. NO. 77-424,784, FILED 3-18-2008.

INGA ERVIN, EXAMINING ATTORNEY

Int. Cl.: 41

Prior U.S. Cls.: 100, 101 and 107

United States Patent and Trademark Office

Reg. No. 3,519,826

Registered Oct. 21, 2008

SERVICE MARK
PRINCIPAL REGISTER



HAMAN, KEN (UNITED STATES INDIVIDUAL)
C/O E. HANSCOM, 7395 PORTAGE WAY
CARLSBAD, CA 92011

FOR: PHYSICAL FITNESS CONDITIONING CLASSES; PHYSICAL FITNESS CONSULTATION; PHYSICAL FITNESS INSTRUCTION; PHYSICAL FITNESS TRAINING SERVICES; PROVIDING A WEB SITE FEATURING INFORMATION ON EXERCISE AND FITNESS; PROVIDING FITNESS AND EXERCISE FACILITIES; HEALTH CLUB SERVICES, NAMELY, PROVIDING INSTRUCTION AND EQUIPMENT IN THE FIELD OF PHYSICAL EXERCISE; PROVIDING ASSISTANCE, PERSONAL TRAINING AND PHYSICAL FITNESS CONSULTATION TO CORPORATE CLIENTS TO HELP THEIR EMPLOYEES MAKE PHYSICAL FITNESS, STRENGTH, CONDITIONING, AND EXERCISE ALTERATIONS IN THEIR DAILY LIVING; PROVIDING ASSISTANCE, PERSONAL TRAINING AND PHYSICAL FITNESS CONSULTATION TO INDIVIDUALS TO HELP THEM MAKE PHYSICAL FITNESS, STRENGTH, CONDITIONING, AND

EXERCISE IMPROVEMENT IN THEIR DAILY LIVING, IN CLASS 41 (U.S. CLS. 100, 101 AND 107).

FIRST USE 6-15-2002; IN COMMERCE 6-15-2002.

NO CLAIM IS MADE TO THE EXCLUSIVE RIGHT TO USE "FITNESS" AND "FITNESS SERVICES", APART FROM THE MARK AS SHOWN.

THE COLOR(S) RED, BLACK, WHITE, BLUE AND GREEN IS/ARE CLAIMED AS A FEATURE OF THE MARK.

THE MARK CONSISTS OF A WHITE STYLIZED CUBE WITH BLACK OUTLINING, WITH THE WORD "ATHLETICS" IN RED, "EXERCUBE" IN BLUE, AND "FITNESS SERVICES" IN GREEN, WITH THE WORD "FITNESS" IN WHITE WITH A BLACK RECTANGULAR BACKGROUND.

SER. NO. 77-424,874, FILED 3-18-2008.

MARK PILARO, EXAMINING ATTORNEY

Int. Cl.: 45

Prior U.S. Cls.: 100 and 101

United States Patent and Trademark Office

Reg. No. 3,519,827

Registered Oct. 21, 2008

**SERVICE MARK
PRINCIPAL REGISTER**

**Grow in faith - Fall in
love**

CATHOLIC MATCH, LLC (PENNSYLVANIA
LIMITED LIABILITY COMPANY)
211 E. GRANDVIEW AVENUE
ZELIENOPLE, PA 16063

THE MARK CONSISTS OF STANDARD CHAR-
ACTERS WITHOUT CLAIM TO ANY PARTICULAR
FONT, STYLE, SIZE, OR COLOR.

FOR: INTERNET BASED SOCIAL NETWORK-
ING, INTRODUCTION, AND DATING SERVICES,
IN CLASS 45 (U.S. CLS. 100 AND 101).

SER. NO. 77-424,894, FILED 3-18-2008.

FIRST USE 8-0-2006; IN COMMERCE 10-0-2006.

DANIEL BRODY, EXAMINING ATTORNEY

Int. Cl.: 35

Prior U.S. Cls.: 100, 101 and 102

United States Patent and Trademark Office

Reg. No. 3,519,828

Registered Oct. 21, 2008

**SERVICE MARK
PRINCIPAL REGISTER**

SMARTSOURCE FLOORTALK

NEWS AMERICA MARKETING PROPERTIES
LLC (DELAWARE LIMITED LIABILITY COM-
PANY)
303 E. WACKER DRIVE
CHICAGO, IL 60601

FOR: ADVERTISING AND PROMOTION SERVI-
CES, NAMELY, PROVIDING ADVERTISING SPACE
ON STORE FLOORS FOR THE MARKETING OF
THE GOODS AND SERVICE OF OTHERS TO CON-
SUMERS, IN CLASS 35 (U.S. CLS. 100, 101 AND 102).

FIRST USE 8-30-1999; IN COMMERCE 8-30-1999.

THE MARK CONSISTS OF STANDARD CHAR-
ACTERS WITHOUT CLAIM TO ANY PARTICULAR
FONT, STYLE, SIZE, OR COLOR.

OWNER OF U.S. REG. NO. 2,874,691.

SER. NO. 77-424,948, FILED 3-18-2008.

PRISCILLA MILTON, EXAMINING ATTORNEY

Int. Cl.: 11

Prior U.S. Cls.: 13, 21, 23, 31 and 34

Reg. No. 3,519,829

United States Patent and Trademark Office

Registered Oct. 21, 2008

**TRADEMARK
PRINCIPAL REGISTER**

FIBER-FAB

FIBER-FAB LLC (OREGON LIMITED LIABILITY
COMPANY)
12657 PORTLAND ROAD NE
GERVAIS, OR 97026

THE MARK CONSISTS OF STANDARD CHAR-
ACTERS WITHOUT CLAIM TO ANY PARTICULAR
FONT, STYLE, SIZE, OR COLOR.

FOR: SHOWERS, BATHTUBS, SHOWER TUBS,
SPAS AND SHOWER BASES, IN CLASS 11 (U.S. CLS.
13, 21, 23, 31 AND 34).

SER. NO. 77-424,962, FILED 3-18-2008.

FIRST USE 0-0-1957; IN COMMERCE 0-0-1957.

LEIGH CAROLINE CASE, EXAMINING ATTOR-
NEY

Int. Cl.: 25

Prior U.S. Cls.: 22 and 39

United States Patent and Trademark Office

Reg. No. 3,519,830

Registered Oct. 21, 2008

**TRADEMARK
PRINCIPAL REGISTER**



LAPRISE, SHERRY L. (UNITED STATES INDIVIDUAL)
4 FARMSTEAD LANE
FARMINGTON, CT 06032 AND
LAPRISE, DEREK J. (UNITED STATES INDIVIDUAL)
4 FARMSTEAD LANE
FARMINGTON, CT 06032

FOR: HEADGEAR, NAMELY, HATS AND VISORS; SHIRTS; T-SHIRTS; SWEATSHIRTS, IN CLASS 25 (U.S. CLS. 22 AND 39).

FIRST USE 11-1-2007; IN COMMERCE 11-1-2007.

THE MARK CONSISTS OF THE OUTLINE OF A FIGURE THAT IS RUNNING, WITH TWO LINES ON THE LEFT SIDE TO INDICATE MOTION.

SER. NO. 77-424,978, FILED 3-18-2008.

CIMMERIAN COLEMAN, EXAMINING ATTORNEY

Int. Cl.: 42

Prior U.S. Cls.: 100 and 101

United States Patent and Trademark Office

Reg. No. 3,519,831

Registered Oct. 21, 2008

**SERVICE MARK
PRINCIPAL REGISTER**

VEEDBACK

HU, JASON C. (UNITED STATES INDIVIDUAL)
P.O. BOX 24054
SAN JOSE, CA 95154

FIRST USE 2-25-2008; IN COMMERCE 2-25-2008.

FOR: COMPUTER SERVICES, NAMELY, CREATING AN ONLINE COMMUNITY FOR USERS TO SUBMIT, DISPLAY, SHARE, AND DISCUSS CONSUMER FEEDBACKS AND REVIEWS ON PRODUCTS, SERVICES, BUSINESS ORGANIZATIONS, AND OTHER RESOURCES OVER THE INTERNET OR OTHER COMMUNICATIONS NETWORK, IN CLASS 42 (U.S. CLS. 100 AND 101).

THE MARK CONSISTS OF STANDARD CHARACTERS WITHOUT CLAIM TO ANY PARTICULAR FONT, STYLE, SIZE, OR COLOR.

SER. NO. 77-424,983, FILED 3-18-2008.

CIMMERIAN COLEMAN, EXAMINING ATTORNEY

Int. Cl.: 41

Prior U.S. Cls.: 100, 101 and 107

United States Patent and Trademark Office

Reg. No. 3,519,832

Registered Oct. 21, 2008

**SERVICE MARK
PRINCIPAL REGISTER**



PLANET HOLLYWOOD (REGION IV), INC.
(MINNESOTA CORPORATION)
7598 W. SAND LAKE ROAD
ORLANDO, FL 32819

FOR: PROVIDING FACILITIES FOR SPORTS EXHIBITIONS, IN CLASS 41 (U.S. CLS. 100, 101 AND 107).

FIRST USE 3-13-2008; IN COMMERCE 3-13-2008.

OWNER OF U.S. REG. NOS. 3,398,027 AND 3,400,112.

NO CLAIM IS MADE TO THE EXCLUSIVE RIGHT TO USE "RING", APART FROM THE MARK AS SHOWN.

THE MARK CONSISTS OF LOWER CASE LETTERS, "PH", THAT ARE PLACED WITHIN TWO CONCENTRIC SEMI-CIRCLES OF DIFFERENT DIAMETERS FOLLOWED BY THE WORD "RING" IN CAPITALIZED LETTERING.

SER. NO. 77-424,990, FILED 3-18-2008.

JESSICA A. POWERS, EXAMINING ATTORNEY

Int. Cl.: 45

Prior U.S. Cls.: 100 and 101

United States Patent and Trademark Office

Reg. No. 3,519,833

Registered Oct. 21, 2008

**SERVICE MARK
PRINCIPAL REGISTER**



UNITED SECURITY PROTECTIVE SERVICES
LLC (NEW JERSEY LIMITED LIABILITY
COMPANY)

411 EDGEWATER AVENUE
WESTVILLE, NJ 08093

FOR: SECURITY GUARD SERVICES, IN CLASS
45 (U.S. CLS. 100 AND 101).

FIRST USE 6-1-2005; IN COMMERCE 10-1-2005.

THE COLOR(S) GOLD IS/ARE CLAIMED AS A
FEATURE OF THE MARK.

THE MARK CONSISTS OF A GOLD EAGLE'S
HEAD COMPOSED OF BROAD STROKES AND
FILLING A CIRCULAR REGION.

SER. NO. 77-424,996, FILED 3-18-2008.

TOBY BULLOFF, EXAMINING ATTORNEY

Int. Cl.: 41

Prior U.S. Cls.: 100, 101 and 107

United States Patent and Trademark Office

Reg. No. 3,519,834

Registered Oct. 21, 2008

**SERVICE MARK
PRINCIPAL REGISTER**

Deafening Silence

HERNANDEZ, SANTIAGO (UNITED STATES IN-
DIVIDUAL)
9829 KENTON CIRCLE
COMMERCE CITY, CO 80022

THE MARK CONSISTS OF STANDARD CHAR-
ACTERS WITHOUT CLAIM TO ANY PARTICULAR
FONT, STYLE, SIZE, OR COLOR.

FOR: ENTERTAINMENT, NAMELY, LIVE PER-
FORMANCES BY A MUSICAL BAND, IN CLASS 41
(U.S. CLS. 100, 101 AND 107).

SER. NO. 77-425,010, FILED 3-18-2008.

FIRST USE 7-7-2006; IN COMMERCE 7-7-2006.

LAURIE KAUFMAN, EXAMINING ATTORNEY

Int. Cl.: 45

Prior U.S. Cls.: 100 and 101

United States Patent and Trademark Office

Reg. No. 3,519,835

Registered Oct. 21, 2008

**SERVICE MARK
PRINCIPAL REGISTER**

**UNITED SECURITY PROTECTIVE
SERVICES**

UNITED SECURITY PROTECTIVE SERVICES
LLC (NEW JERSEY LIMITED LIABILITY
COMPANY)

411 EDGEWATER AVENUE
WESTVILLE, NJ 08093

FOR: SECURITY GUARD SERVICES, IN CLASS
45 (U.S. CLS. 100 AND 101).

FIRST USE 6-1-2005; IN COMMERCE 10-1-2005.

THE MARK CONSISTS OF STANDARD CHAR-
ACTERS WITHOUT CLAIM TO ANY PARTICULAR
FONT, STYLE, SIZE, OR COLOR.

NO CLAIM IS MADE TO THE EXCLUSIVE
RIGHT TO USE "SECURITY PROTECTIVE SERVI-
CES", APART FROM THE MARK AS SHOWN.

SER. NO. 77-425,013, FILED 3-18-2008.

TOBY BULLOFF, EXAMINING ATTORNEY

Int. Cl.: 41

Prior U.S. Cls.: 100, 101 and 107

United States Patent and Trademark Office

Reg. No. 3,519,836

Registered Oct. 21, 2008

**SERVICE MARK
PRINCIPAL REGISTER**

Octane TV On Demand

RIPE DIGITAL ENTERTAINMENT, INC. (DELA-
WARE CORPORATION)
729 SEWARD AVENUE
LOS ANGELES, CA 90038

FOR: PROVISION OF NON-DOWNLOADABLE
ON-GOING AUDIO VISUAL FILM AND TELEVI-
SION PROGRAMS VIA VIDEO ON DEMAND, TEL-
EVISION PROGRAMS VIA VIDEO ON DEMAND,
TELEVISION BROADCAST, CABLE TELEVISION,
BROADBAND, INTERNET AND MOBILE DEVICE
SERVICES, IN CLASS 41 (U.S. CLS. 100, 101 AND 107).

FIRST USE 6-1-2003; IN COMMERCE 6-1-2003.

THE MARK CONSISTS OF STANDARD CHAR-
ACTERS WITHOUT CLAIM TO ANY PARTICULAR
FONT, STYLE, SIZE, OR COLOR.

NO CLAIM IS MADE TO THE EXCLUSIVE
RIGHT TO USE "TV ON DEMAND", APART FROM
THE MARK AS SHOWN.

SER. NO. 77-425,020, FILED 3-18-2008.

CAROLYN CATALDO, EXAMINING ATTORNEY

Int. Cl.: 41

Prior U.S. Cls.: 100, 101 and 107

United States Patent and Trademark Office

Reg. No. 3,519,837

Registered Oct. 21, 2008

**SERVICE MARK
PRINCIPAL REGISTER**



PLANET HOLLYWOOD (REGION IV), INC.
(MINNESOTA CORPORATION)
7598 W. SAND LAKE ROAD
ORLANDO, FL 32819

FOR: PROVIDING FACILITIES FOR SPORTS EXHIBITIONS, IN CLASS 41 (U.S. CLS. 100, 101 AND 107).

FIRST USE 3-18-2008; IN COMMERCE 3-18-2008.

OWNER OF U.S. REG. NOS. 3,398,027 AND 3,400,112.

NO CLAIM IS MADE TO THE EXCLUSIVE RIGHT TO USE "RING", APART FROM THE MARK AS SHOWN.

THE MARK CONSISTS OF LOWER CASE LETTERS, "PH", THAT ARE PLACED WITHIN TWO CONCENTRIC SEMI-CIRCLES OF DIFFERENT DIAMETERS WITH THE WORDS "IN", "THE", "AND RING" IN CAPITALIZED LETTERING.

SER. NO. 77-425,032, FILED 3-18-2008.

JESSICA A. POWERS, EXAMINING ATTORNEY

Int. Cl.: 36

Prior U.S. Cls.: 100, 101 and 102

United States Patent and Trademark Office

Reg. No. 3,519,838

Registered Oct. 21, 2008

**SERVICE MARK
PRINCIPAL REGISTER**



MAXN SYSTEMS, INC. (CALIFORNIA CORPORATION)
355 W. OLIVE AVENUE, SUITE #205
SUNNYVALE, CA 94086

FOR: INSURANCE AGENCIES IN THE FIELD OF INTERNATIONAL TRAVEL INSURANCE AND TRAVEL HEALTH INSURANCE, IN CLASS 36 (U.S. CLS. 100, 101 AND 102).

FIRST USE 3-12-2006; IN COMMERCE 3-12-2006.

NO CLAIM IS MADE TO THE EXCLUSIVE RIGHT TO USE "VISITORS COVERAGE", APART FROM THE MARK AS SHOWN.

THE MARK CONSISTS OF A STYLIZED REPRESENTATION OF A HUMAN FIGURE COMPOSED OF GEOMETRIC SHAPES, HOLDING A SUITCASE, WITH A CRESCENT SHAPE EXTENDING FROM THE SUITCASE AND CONTINUING ABOVE THE STYLIZED FIGURE, FOLLOWED BY THE WORDS "VISITORS COVERAGE".

SER. NO. 77-425,034, FILED 3-18-2008.

JESSICA A. POWERS, EXAMINING ATTORNEY

Int. Cls.: 35, 40, 41 and 42

Prior U.S. Cls.: 100, 101, 102, 103, 106 and 107

United States Patent and Trademark Office

Reg. No. 3,519,839

Registered Oct. 21, 2008

**SERVICE MARK
PRINCIPAL REGISTER**



ALLEN PRESS, INC. (KANSAS CORPORATION)
810 EAST 10TH STREET
LAWRENCE, KS 660440368

FOR: SUBSCRIPTIONS TO ELECTRONIC JOURNALS, IN CLASS 35 (U.S. CLS. 100, 101 AND 102).

FIRST USE 6-1-2007; IN COMMERCE 6-1-2007.

FOR: BINDERY SERVICES FOR OTHERS, NAME-
LY, COLLATING, FOLDING, STAPLING, PERFOR-
ATING, CUTTING AND BINDING OF PRINTED,
PHOTOCOPIED AND TYPEWRITTEN MATERIALS;
DESIGN PRINTING FOR OTHERS; PRINTING, IN
CLASS 40 (U.S. CLS. 100, 103 AND 106).

FIRST USE 6-1-2007; IN COMMERCE 6-1-2007.

FOR: PUBLICATION OF PRINTED MATTER;
CONDUCTING WORKSHOPS AND SEMINARS IN
FIELD OF SCHOLARLY PUBLISHING; ON-LINE
PUBLICATION OF JOURNALS; ONLINE ELECTRO-
NIC PUBLISHING OF BOOKS AND PERIODICALS;
PUBLICATION OF JOURNALS , IN CLASS 41 (U.S.
CLS. 100, 101 AND 107).

FIRST USE 6-1-2007; IN COMMERCE 6-1-2007.

FOR: COMPUTER SERVICES, NAMELY, INTER-
ACTIVE HOSTING SERVICES WHICH ALLOW THE
USER TO PUBLISH AND SHARE THEIR OWN
CONTENT AND IMAGES ONLINE, IN CLASS 42
(U.S. CLS. 100 AND 101).

FIRST USE 6-1-2007; IN COMMERCE 6-1-2007.

NO CLAIM IS MADE TO THE EXCLUSIVE
RIGHT TO USE "PRESS", APART FROM THE
MARK AS SHOWN.

THE MARK CONSISTS OF THE NAME "ALLEN
PRESS" IN STYLIZED TYPE UNDERLINED BY A
STYLIZED STROKE WITH A STAR BETWEEN THE
TWO WORDS.

SER. NO. 77-425,070, FILED 3-18-2008.

MICHAEL KEATING, EXAMINING ATTORNEY

Int. Cl.: 30

Prior U.S. Cl.: 46

United States Patent and Trademark Office

Reg. No. 3,519,840

Registered Oct. 21, 2008

**TRADEMARK
PRINCIPAL REGISTER**

LOAFFIN

BRIGATI, ROBERT (UNITED STATES INDIVIDUAL)
1 DAREMY COURT
MELVILLE, NY 11747

THE MARK CONSISTS OF STANDARD CHARACTERS WITHOUT CLAIM TO ANY PARTICULAR FONT, STYLE, SIZE, OR COLOR.

FOR: BAKERY PRODUCTS, NAMELY, MUFFIN VARIETIES BAKED IN THE SHAPE OF A LOAF, IN CLASS 30 (U.S. CL. 46).

SER. NO. 77-425,103, FILED 3-18-2008.

FIRST USE 11-15-2006; IN COMMERCE 11-15-2006.

HEATHER SAPP, EXAMINING ATTORNEY

Int. Cl.: 35

Prior U.S. Cls.: 100, 101 and 102

United States Patent and Trademark Office

Reg. No. 3,519,841

Registered Oct. 21, 2008

SERVICE MARK
PRINCIPAL REGISTER



MMKS, LLC (NEW JERSEY LIMITED LIABILITY COMPANY), DBA MID-TOWN DIRECT REALTY

181 MAPLEWOOD AVE
MAPLEWOOD, NJ 07040

FOR: REAL ESTATE SALES MANAGEMENT; LOBBYING SERVICES, NAMELY, PROMOTING THE INTERESTS OF INTERNATIONAL, REAL ESTATE AND NONPROFIT COMPANIES IN THE FIELDS OF POLITICS, LEGISLATION, AND REGULATION; MATCHING CONSUMERS WITH REAL ESTATE PROFESSIONALS IN THE FIELD OF REAL ESTATE SERVICES VIA COMPUTER NETWORK; MATCHING POTENTIAL BUYERS TO FACILITATE CO-OWNERSHIP OF RESIDENTIAL REAL PROPERTY; NEWS REPORTING SERVICES, NAMELY, PROVIDING REAL-TIME INFORMATION RELATED TO THE TRACKING OF SALES OF THOROUGHBRED HORSES; PROMOTING THE GOODS OF OTHERS BY MEANS OF ON-LINE REAL TIME PRESENTATION FOR INSPECTION, VIEWING OR SHOWING OF REAL ESTATE; PROVIDING A DATABASE FEATURING REAL PROPERTY TAX INFORMATION; PROVIDING INTERACTIVE SALES ASSESSMENT SERVICES VIA THE TELEPHONE FOR MEASURING THE SKILLS AND KNOWLEDGE OF FIELD SALES FORCES IN REAL WORLD SELLING SITUATIONS; PROVIDING REAL ESTATE LEADS FOR PROSPECTIVE PURCHASERS; REAL ESTATE ADVERTISING SERVICES; REAL ESTATE AUCTIONS; REAL ESTATE MARKETING SERVICES IN THE FIELD OF SALES; REAL ESTATE MARKETING SERVICES, NAMELY, ON-LINE SERVICES FEATURING TOURS OF RESIDENTIAL

AND COMMERCIAL REAL ESTATE; REAL ESTATE MARKETING SERVICES, NAMELY, ONLINE SERVICES FEATURING THE PROMOTION OF RESIDENTIAL NEW CONSTRUCTION, WHICH ALSO CONTAINS BACK OFFICE SOLUTIONS FOR BUILDERS, IN CLASS 35 (U.S. CLS. 100, 101 AND 102).

FIRST USE 12-1-2007; IN COMMERCE 1-2-2008.

NO CLAIM IS MADE TO THE EXCLUSIVE RIGHT TO USE "REALTY", APART FROM THE MARK AS SHOWN.

THE COLOR(S) BLACK, RED, WHITE IS/ARE CLAIMED AS A FEATURE OF THE MARK.

THE MARK CONSISTS OF THE IMAGE OF A BLACK TRAIN WITH RED TRIM UNDER A RED TRAIN TUNNEL/HOUSE. THE HOUSE IS BISECTED BY THE TERM "REALTY" WHICH APPEARS IN BLACK. THE WHOLE IMAGE IS ENCLOSED WITHIN THE OUTLINE OF A CIRCLE WHICH APPEARS IN RED AND WHICH CONTAINS THE TERMS "MID-TOWN DIRECT" IN RED OUTLINED IN BLACK. THE OUTLINED WHITE CIRCLE IS BISECTED ON THE RIGHT AND LEFT BY LINES IN BLACK REPRESENTING TRAIN TRACKS.

SER. NO. 77-425,107, FILED 3-18-2008.

JILL PRATER, EXAMINING ATTORNEY

Int. Cls.: 35, 40, 41 and 42

Prior U.S. Cls.: 100, 101, 102, 103, 106 and 107

United States Patent and Trademark Office

Reg. No. 3,519,842

Registered Oct. 21, 2008

**SERVICE MARK
PRINCIPAL REGISTER**

Allen Press

ALLEN PRESS, INC. (KANSAS CORPORATION)
810 EAST 10TH STREET
LAWRENCE, KS 660440368

FOR: SUBSCRIPTIONS TO ELECTRONIC JOURNALS, IN CLASS 35 (U.S. CLS. 100, 101 AND 102).

FIRST USE 12-15-1935; IN COMMERCE 12-15-1997.

FOR: BINDERY SERVICES FOR OTHERS, NAME-
LY, COLLATING, FOLDING, STAPLING, PERFOR-
ATING, CUTTING AND BINDING OF PRINTED,
PHOTOCOPIED AND TYPEWRITTEN MATERIALS;
DESIGN PRINTING FOR OTHERS; PRINTING, IN
CLASS 40 (U.S. CLS. 100, 103 AND 106).

FIRST USE 12-15-1935; IN COMMERCE 12-15-1935.

FOR: PUBLICATION AND EDITING OF PRIN-
TED MATTER; CONDUCTING WORKSHOPS AND
SEMINARS IN FIELD OF SCHOLARLY PUBLISH-
ING; ON-LINE PUBLICATION OF JOURNALS; ON-
LINE ELECTRONIC PUBLISHING OF BOOKS AND

PERIODICALS; PUBLICATION OF JOURNALS, IN
CLASS 41 (U.S. CLS. 100, 101 AND 107).

FIRST USE 12-15-1935; IN COMMERCE 12-15-1935.

FOR: COMPUTER SERVICES, NAMELY, INTER-
ACTIVE HOSTING SERVICES WHICH ALLOW THE
USER TO PUBLISH AND SHARE THEIR OWN
CONTENT AND IMAGES ONLINE, IN CLASS 42
(U.S. CLS. 100 AND 101).

FIRST USE 12-15-1935; IN COMMERCE 12-15-1997.

THE MARK CONSISTS OF STANDARD CHAR-
ACTERS WITHOUT CLAIM TO ANY PARTICULAR
FONT, STYLE, SIZE, OR COLOR.

NO CLAIM IS MADE TO THE EXCLUSIVE
RIGHT TO USE "PRESS" , APART FROM THE
MARK AS SHOWN.

SER. NO. 77-425,124, FILED 3-18-2008.

MICHAEL KEATING, EXAMINING ATTORNEY

Int. Cl.: 3

Prior U.S. Cls.: 1, 4, 6, 50, 51 and 52

United States Patent and Trademark Office

Reg. No. 3,519,843

Registered Oct. 21, 2008

**TRADEMARK
PRINCIPAL REGISTER**

Get Your Glow Back

ROSY GLOW BEAUTY COMPANY (OHIO CORPORATION)
P.O. BOX 2488
WHITEHOUSE, OH 43571

THE MARK CONSISTS OF STANDARD CHARACTERS WITHOUT CLAIM TO ANY PARTICULAR FONT, STYLE, SIZE, OR COLOR.

FOR: BODY AND BEAUTY CARE COSMETICS,
IN CLASS 3 (U.S. CLS. 1, 4, 6, 50, 51 AND 52).

SER. NO. 77-425,139, FILED 3-18-2008.

FIRST USE 1-17-2008; IN COMMERCE 2-16-2008.

CARRIE GENOVESE, EXAMINING ATTORNEY

Int. Cl.: 25

Prior U.S. Cls.: 22 and 39

United States Patent and Trademark Office

Reg. No. 3,519,844

Registered Oct. 21, 2008

**TRADEMARK
PRINCIPAL REGISTER**

Fleur De Lis

U.S. TOP IMPORTERS, INC. (CALIFORNIA CORPORATION)
2171 EAST 25TH STREET
LOS ANGELES, CA 90058

THE MARK CONSISTS OF STANDARD CHARACTERS WITHOUT CLAIM TO ANY PARTICULAR FONT, STYLE, SIZE, OR COLOR.

FOR: CLOTHING, NAMELY, WOMENS BLOUSES, TANK TOPS, T-SHIRTS, SWEATERS, DRESSES, SKIRTS, AND PANTS, IN CLASS 25 (U.S. CLS. 22 AND 39).

SER. NO. 77-425,149, FILED 3-18-2008.

FIRST USE 2-22-2008; IN COMMERCE 2-22-2008.

DORITT L. CARROLL, EXAMINING ATTORNEY

Prior U.S. Cl.: B

United States Patent and Trademark Office

Reg. No. 3,519,845

Registered Oct. 21, 2008

**CERTIFICATION MARK
PRINCIPAL REGISTER**

CNRN

AMERICAN BOARD OF NEUROSCIENCE NURSING (ILLINOIS NOT-FOR-PROFIT CORPORATION)
4700 W. LAKE AVENUE
GLENVIEW, IL 60025

FOR: NURSING SERVICES, NAMELY, THE CARE OF PATIENTS WITH NEUROLOGICAL TRAUMA AND ILLNESS, IN CLASS B (U.S. CL. B).

FIRST USE 12-31-1978; IN COMMERCE 12-31-1978.

THE MARK CONSISTS OF STANDARD CHARACTERS WITHOUT CLAIM TO ANY PARTICULAR FONT, STYLE, SIZE, OR COLOR.

THE CERTIFICATION MARK, AS USED BY AUTHORIZED PERSONS, CERTIFIES THAT THROUGH A COMBINATION OF LICENSURE, EDUCATION, WORK EXPERIENCE, AND EXAMINATION IN THE FIELD OF NEUROSCIENCE NURSING, THE PERSON MEETS MINIMUM QUALIFICATIONS FOR CERTIFICATION AS A REGISTERED NURSE IN THE CARE OF PATIENTS WITH NEUROLOGICAL TRAUMA AND ILLNESS.

SER. NO. 77-425,157, FILED 3-18-2008.

MARTHA FROMM, EXAMINING ATTORNEY

Int. Cl.: 24

Prior U.S. Cls.: 42 and 50

United States Patent and Trademark Office

Reg. No. 3,519,846

Registered Oct. 21, 2008

**TRADEMARK
PRINCIPAL REGISTER**

CONSCIOUS COUTURE

A.B.C. HOME FURNISHINGS, INC. (NEW YORK CORPORATION)
888 BROADWAY
NEW YORK, NY 10003

FOR: UPHOLSTERY FABRICS COMPRISED OF SUSTAINABLE MATERIALS, IN CLASS 24 (U.S. CLS. 42 AND 50).

FIRST USE 10-1-2007; IN COMMERCE 10-1-2007.

THE MARK CONSISTS OF STANDARD CHARACTERS WITHOUT CLAIM TO ANY PARTICULAR FONT, STYLE, SIZE, OR COLOR.

NO CLAIM IS MADE TO THE EXCLUSIVE RIGHT TO USE "COUTURE", APART FROM THE MARK AS SHOWN.

SER. NO. 77-425,175, FILED 3-18-2008.

ROBERT LAVACHE, EXAMINING ATTORNEY

Int. Cl.: 29

Prior U.S. Cl.: 46

United States Patent and Trademark Office

Reg. No. 3,519,847

Registered Oct. 21, 2008

**TRADEMARK
PRINCIPAL REGISTER**

**THE ULTIMATE SOUTHWEST
BLEND**

BIRDS EYE FOODS, INC. (DELAWARE CORPORATION), DBA LINDEN OAKS CORPORATION

90 LINDEN OAKS
ROCHESTER, NY 14625

FOR: FROZEN VEGETABLES, IN CLASS 29 (U.S. CL. 46).

FIRST USE 2-0-2001; IN COMMERCE 2-0-2001.

THE MARK CONSISTS OF STANDARD CHARACTERS WITHOUT CLAIM TO ANY PARTICULAR FONT, STYLE, SIZE, OR COLOR.

OWNER OF U.S. REG. NO. 2,554,312.

SEC. 2(F).

SER. NO. 77-425,188, FILED 3-18-2008.

CHRISTINA SOBRAL, EXAMINING ATTORNEY

Int. Cl.: 41

Prior U.S. Cls.: 100, 101 and 107

United States Patent and Trademark Office

Reg. No. 3,519,848

Registered Oct. 21, 2008

**SERVICE MARK
PRINCIPAL REGISTER**

KITTY OF THE CITY

T. JEANNIE JONES (UNITED STATES INDIVIDUAL)
1300 MERCANTILE LANE SUITE 100 D
LARGO, MD 20775

FOR: ENTERTAINMENT SERVICES, NAMELY, LIVE PERSONAL APPEARANCES BY AN ENTERTAINER, PERSONALITY, OR CELEBRITY PRESENTING LIVE PERFORMANCES; PROVIDING COMMENTARY ABOUT MUSIC, TELEVISION, FILM AND CELEBRITIES; PRESENTATION OF LIVE SHOW PERFORMANCES; ENTERTAINMENT SERVICES, NAMELY, PROVIDING INFORMATION, COMMENTARY AND ARTICLES ABOUT MUSIC, TELEVISION, MOVIES, AND GENERAL ENTERTAINMENT, ALL ON-LINE VIA A GLOBAL COMPUTER NETWORK; ENTERTAINMENT SERVICES, NAMELY, PROVIDING A WEB SITE FEATURING MUSICAL PERFORMANCES, MUSIC VIDEOS, RELATED FILM CLIPS, PHOTOGRAPHS, AND OTHER MULTIMEDIA MATERIALS; MUSIC COMPOSITION AND TRANSCRIPTION FOR OTHERS; SONGWRITING SERVICES; RECORDING STUDIOS; RADIO ENTERTAINMENT AND TELEVISION PRODUCTION, FILM EDITING, SPECIAL EFFECTS ANIMATION SERVICES FOR FILM AND VIDEO; ENTERTAINMENT SERVICES IN THE NATURE OF ON-GOING TELEVISION, CABLE TELEVISION AND RADIO PROGRAMS FEATURING MUSIC, NEWS, COMEDY, DRAMA, FASHION

SHOWS, TALK, TALENT COMPETITIONS AND VARIETY; ENTERTAINMENT IN THE NATURE OF BEAUTY PAGEANTS AND FASHION SHOWS, ARRANGING CONTESTS; ENTERTAINMENT SERVICES, NAMELY, CONDUCTING PARTIES, EDUCATIONAL SERVICES, NAMELY, CONDUCTING COURSES, CLASSES, SEMINARS, WORKSHOPS, LECTURES, TUTORIAL SESSIONS AND CONFERENCES IN THE FIELDS OF MUSIC, RADIO, TELEVISION, FILM, FASHION, MODELING, ACTING, THE ARTS, PHYSICAL FITNESS, HEALTH AND NUTRITION, AND DISTRIBUTING COURSE MATERIALS IN CONNECTION THEREWITH; CHARITABLE SERVICES, NAMELY, ACADEMIC MENTORING OF SCHOOL AGE CHILDREN AND YOUNG ADULTS; ENTERTAINMENT IN THE NATURE OF THEATER PRODUCTIONS, IN CLASS 41 (U.S. CLS. 100, 101 AND 107).

FIRST USE 1-1-2000; IN COMMERCE 1-1-2000.

THE MARK CONSISTS OF STANDARD CHARACTERS WITHOUT CLAIM TO ANY PARTICULAR FONT, STYLE, SIZE, OR COLOR.

SER. NO. 77-425,199, FILED 3-18-2008.

Laurie Kaufman, Examining Attorney

Int. Cl.: 41

Prior U.S. Cls.: 100, 101 and 107

United States Patent and Trademark Office

Reg. No. 3,519,849

Registered Oct. 21, 2008

**SERVICE MARK
PRINCIPAL REGISTER**

BREAKOUT

BREAKOUT ENDURANCE SPORTS COACHING,
L.L.C. (NEW JERSEY LIMITED LIABILITY
COMPANY), DBA MAYA HUNNEWELL
100 PINE CONE TRAIL
MEDFORD, NJ 08055

FOR: PERSONAL COACHING SERVICES IN THE
FIELD OF ENDURANCE SPORTS; PROFESSIONAL
COACHING SERVICES IN THE FIELD OF ENDUR-
ANCE SPORTS, IN CLASS 41 (U.S. CLS. 100, 101 AND
107).

FIRST USE 1-30-2008; IN COMMERCE 1-30-2008.

THE MARK CONSISTS OF STANDARD CHAR-
ACTERS WITHOUT CLAIM TO ANY PARTICULAR
FONT, STYLE, SIZE, OR COLOR.

SER. NO. 77-425,214, FILED 3-18-2008.

JOHN DWYER, EXAMINING ATTORNEY

Int. Cl.: 9

Prior U.S. Cls.: 21, 23, 26, 36 and 38

Reg. No. 3,519,850

United States Patent and Trademark Office

Registered Oct. 21, 2008

**TRADEMARK
PRINCIPAL REGISTER**

phpMyDirectory

ACCOMPLISH TECHNOLOGY, LLC (MISSOURI
LIMITED LIABILITY COMPANY)
1499 E. WILDER
SPRINGFIELD, MO 65804

FIRST USE 7-14-2005; IN COMMERCE 7-14-2005.

FOR: COMPUTER SOFTWARE FOR USE IN
DATABASE MANAGEMENT THAT MAY BE
DOWNLOADED FROM A GLOBAL COMPUTER
NETWORK, IN CLASS 9 (U.S. CLS. 21, 23, 26, 36 AND
38).

THE MARK CONSISTS OF STANDARD CHAR-
ACTERS WITHOUT CLAIM TO ANY PARTICULAR
FONT, STYLE, SIZE, OR COLOR.

SER. NO. 77-425,266, FILED 3-18-2008.

LYDIA BELZER, EXAMINING ATTORNEY

Int. Cl.: 16

Prior U.S. Cls.: 2, 5, 22, 23, 29, 37, 38 and 50

United States Patent and Trademark Office

Reg. No. 3,519,851

Registered Oct. 21, 2008

TRADEMARK
PRINCIPAL REGISTER

creating
Keepsakes

CKMEDIA LLC (DELAWARE LIMITED LIABILITY COMPANY)
711 FIFTH AVENUE, 15TH FLOOR
NEW YORK, NY 10022

FOR: PRINTED MATTER, NAMELY, MAGAZINES FEATURING INFORMATION ON SCRAPBOOKS, IN CLASS 16 (U.S. CLS. 2, 5, 22, 23, 29, 37, 38 AND 50).

FIRST USE 11-30-2007; IN COMMERCE 11-30-2007.

OWNER OF U.S. REG. NOS. 2,765,973 AND 2,778,816.

SEC. 2(F).

SER. NO. 77-425,289, FILED 3-18-2008.

PATRICIA EVANKO, EXAMINING ATTORNEY

Int. Cl.: 25

Prior U.S. Cls.: 22 and 39

United States Patent and Trademark Office

Reg. No. 3,519,852

Registered Oct. 21, 2008

**TRADEMARK
PRINCIPAL REGISTER**

SKINSATIONS

O'BRYAN BROS., INC. (ILLINOIS CORPORATION)
4220 WEST BELMONT
CHICAGO, IL 60641

THE MARK CONSISTS OF STANDARD CHARACTERS WITHOUT CLAIM TO ANY PARTICULAR FONT, STYLE, SIZE, OR COLOR.

FOR: UNDERWEAR, IN CLASS 25 (U.S. CLS. 22 AND 39).

SER. NO. 77-425,344, FILED 3-18-2008.

FIRST USE 9-30-2006; IN COMMERCE 9-30-2006.

HANNO RITTNER, EXAMINING ATTORNEY

Int. Cl.: 39

Prior U.S. Cls.: 100 and 105

United States Patent and Trademark Office

Reg. No. 3,519,853

Registered Oct. 21, 2008

**SERVICE MARK
PRINCIPAL REGISTER**

RiderPlanet

RIDERPLANET (NEVADA LIMITED LIABILITY
COMPANY)

#G12-158

3702 S. VIRGINIA ST.

RENO, NV 89502

FOR: PROVIDING A WEB SITE AND WEB SITE
LINKS TO GEOGRAPHIC INFORMATION, MAP
IMAGES, AND TRIP ROUTING; PROVIDING AN
ON-LINE COMPUTER DATABASE IN THE FIELD
OF TRAVEL INFORMATION SERVICES, IN CLASS
39 (U.S. CLS. 100 AND 105).

FIRST USE 7-1-2002; IN COMMERCE 8-5-2002.

THE MARK CONSISTS OF STANDARD CHAR-
ACTERS WITHOUT CLAIM TO ANY PARTICULAR
FONT, STYLE, SIZE, OR COLOR.

SER. NO. 77-425,551, FILED 3-18-2008.

ASMAT KHAN, EXAMINING ATTORNEY

Int. Cl.: 35

Prior U.S. Cls.: 100, 101 and 102

United States Patent and Trademark Office

Reg. No. 3,519,854

Registered Oct. 21, 2008

**SERVICE MARK
PRINCIPAL REGISTER**



ABI SARKIS, TEDDY (UNITED STATES INDIVIDUAL), DBA PREPBOOKS, LLC
6025 SANDY SPRINGS CIR STE 300
ATLANTA, GA 30328

FOR: THE BRINGING TOGETHER, FOR THE BENEFIT OF OTHERS, OF A VARIETY OF GOODS AND SERVICES, ENABLING CUSTOMERS TO CONVENIENTLY VIEW AND PURCHASE THOSE GOODS AND SERVICES FROM AN INTERNET WEBSITE PARTICULARLY SPECIALIZING IN THE MARKETING OF THE SALE OF GOODS AND SERVICES OF OTHERS, IN CLASS 35 (U.S. CLS. 100, 101 AND 102).

FIRST USE 3-18-2008; IN COMMERCE 3-18-2008.

THE COLOR(S) RED, BLACK, WHITE, GREY, DARK GREY, OLIVE GREEN, LIGHT YELLOW IS/ARE CLAIMED AS A FEATURE OF THE MARK.

THE MARK CONSISTS OF A MALE FICTIONAL CHARACTER READING A BOOK, DRAWN WITH BLACK LINES. THE CHARACTER HAIR COLOR IS BLACK AND IS COMBED BACKWARDS. CHARACTER HAS LIGHT YELLOW SKIN COLOR ON ITS FACE, NECK AND HANDS. CHARACTER IS WEARING A LONG SLEEVE GREY SHIRT AND A RED TIE. CHARACTER IS WEARING DARK GREY PANTS AND BLACK SHOES. CHARACTER IS HOLDING AN OLIVE GREEN BOOK WITH ONE HAND AND APPEARS TO BE READING. THE EDGES OF THE PAGES OF THE BOOK ARE WHITE. THE OTHER HAND IS IN THE RIGHT POCKET OF DARK GREY PANTS. CHARACTER APPROXIMATE AGE IS OF A TEENAGER OR YOUNG GUY.

SER. NO. 77-425,653, FILED 3-18-2008.

JAMES MACFARLANE, EXAMINING ATTORNEY

Int. Cl.: 16

Prior U.S. Cls.: 2, 5, 22, 23, 29, 37, 38 and 50

Reg. No. 3,519,855

United States Patent and Trademark Office

Registered Oct. 21, 2008

**TRADEMARK
PRINCIPAL REGISTER**

CORPORATE LOGO

VIRGO PUBLISHING, LLC (DELAWARE LIMITED LIABILITY COMPANY)
SUITE 300
3300 N. CENTRAL AVENUE
PHOENIX, AZ 85012

FOR: TRADE MAGAZINE PROVIDING NEWS, FEATURE STORIES, AND ARTICLES TO THE APPAREL AND ACCESSORY PROMOTIONAL-PRODUCTS INDUSTRY, IN CLASS 16 (U.S. CLS. 2, 5, 22, 23, 29, 37, 38 AND 50).

FIRST USE 12-27-2000; IN COMMERCE 12-27-2000.

THE MARK CONSISTS OF STANDARD CHARACTERS WITHOUT CLAIM TO ANY PARTICULAR FONT, STYLE, SIZE, OR COLOR.

OWNER OF U.S. REG. NO. 2,132,838.

SER. NO. 77-425,758, FILED 3-19-2008.

YONG KIM, EXAMINING ATTORNEY

Int. Cl.: 36

Prior U.S. Cls.: 100, 101 and 102

United States Patent and Trademark Office

Reg. No. 3,519,856

Registered Oct. 21, 2008

SERVICE MARK
PRINCIPAL REGISTER



CAPITOL BANCORP LTD (MICHIGAN CORPORATION), DBA CAPITOL BANCORP LIMITED
200 N. WASHINGTON SQUARE
LANSING, MI 48933

FOR: CHARITABLE FUND RAISING, IN CLASS 36 (U.S. CLS. 100, 101 AND 102).

FIRST USE 5-1-2004; IN COMMERCE 5-1-2005.

OWNER OF U.S. REG. NO. 3,015,245.

NO CLAIM IS MADE TO THE EXCLUSIVE RIGHT TO USE "5K" OR "BANCORP", APART FROM THE MARK AS SHOWN.

THE COLOR(S) WHITE, BROWN, BLACK AND RED IS/ARE CLAIMED AS A FEATURE OF THE MARK.

THE MARK CONSISTS OF A BLACK CHALKBOARD WITH A BROWN WOOD FRAME. A PAIR OF RED SHOES WITH BLACK AND WHITE STRIPES, WHITE SHOELACES AND BLACK CLEATS IS HUNG OVER THE UPPER RIGHT HAND CORNER OF THE CHALKBOARD. A RED APPLE IS SUPERIMPOSED ON THE RIGHT EDGE OF THE CHALKBOARD. THE WORDING "CAPITOL BANCORP 5K FOR JA" APPEARS IN WHITE LETTERING ON THE BLACK CHALKBOARD.

SER. NO. 77-425,793, FILED 3-19-2008.

DAVID H. STINE, EXAMINING ATTORNEY

Int. Cl.: 41

Prior U.S. Cls.: 100, 101 and 107

United States Patent and Trademark Office

Reg. No. 3,519,857

Registered Oct. 21, 2008

**SERVICE MARK
PRINCIPAL REGISTER**

STATE OF THE NET

INTERNET EDUCATION FOUNDATION (D.C.
NON-PROFIT CORPORATION)
1634 EYE STREET, NW
WASHINGTON, DC 20006

FOR: EDUCATIONAL SERVICES, NAMELY,
CONDUCTING CONFERENCES IN THE FIELD OF
INTERNET TECHNOLOGY POLICY AND DISTRI-
BUTION OF COURSE MATERIAL IN CONNEC-
TION THEREWITH, IN CLASS 41 (U.S. CLS. 100, 101
AND 107).

FIRST USE 5-9-2001; IN COMMERCE 5-9-2001.

THE MARK CONSISTS OF STANDARD CHAR-
ACTERS WITHOUT CLAIM TO ANY PARTICULAR
FONT, STYLE, SIZE, OR COLOR.

NO CLAIM IS MADE TO THE EXCLUSIVE
RIGHT TO USE "NET", APART FROM THE MARK
AS SHOWN.

SER. NO. 77-425,830, FILED 3-19-2008.

CHRISTINA SOBRAL, EXAMINING ATTORNEY

Int. Cl.: 41

Prior U.S. Cls.: 100, 101 and 107

United States Patent and Trademark Office

Reg. No. 3,519,858

Registered Oct. 21, 2008

**SERVICE MARK
PRINCIPAL REGISTER**



ORSA INSTITUTE LLC (DELAWARE LIMITED
LIABILITY COMPANY)
P.O. BOX 220965
EL PASO, TX 79913

FOR: EDUCATIONAL SERVICES, NAMELY,
PROVIDING SEMINARS AND CONDUCTING
WORKSHOPS IN THE FIELD OF LEADERSHIP
TRAINING, IN CLASS 41 (U.S. CLS. 100, 101 AND
107).

FIRST USE 9-7-2007; IN COMMERCE 9-7-2007.

THE MARK CONSISTS OF THE IMAGE OF A
HIGHWAY SIGN, THE WORDS ROADMAP TO
ORSA AND A CURVED LINE UNDER THE WORD
"ORSA" .

SER. NO. 77-425,875, FILED 3-19-2008.

BARBARA BROWN, EXAMINING ATTORNEY

Int. Cl.: 44

Prior U.S. Cls.: 100 and 101

United States Patent and Trademark Office

Reg. No. 3,519,859

Registered Oct. 21, 2008

SERVICE MARK
PRINCIPAL REGISTER



BRYAN, DALE (UNITED STATES INDIVIDUAL)
1147 HIGHWAY 41
PELHAM, TN 37366

FOR: PLANT NURSERIES; TREE NURSERIES, IN
CLASS 44 (U.S. CLS. 100 AND 101).

FIRST USE 5-1-2003; IN COMMERCE 5-1-2003.

NO CLAIM IS MADE TO THE EXCLUSIVE
RIGHT TO USE "TREE.FARMS" , APART FROM
THE MARK AS SHOWN.

THE STIPPLING IS FOR SHADING PURPOSES
ONLY.

THE MARK CONSISTS OF THE STYLIZED TEXT
"FREEDOM" WITH AN IMAGE OF A LEAF BOVE
THE TEXT. THE STYLZIED TEXT "TREE . FARMS"
IS CURVED UNDER "FREEDOM" WITH A LINE
ABOVE AND BELOW THE TEXT.

SER. NO. 77-425,885, FILED 3-19-2008.

ZACHARY BELLO, EXAMINING ATTORNEY

Int. Cl.: 35

Prior U.S. Cls.: 100, 101 and 102

United States Patent and Trademark Office

Reg. No. 3,519,860

Registered Oct. 21, 2008

**SERVICE MARK
PRINCIPAL REGISTER**

auxano

AUXANO CONSULTING, LLC (TEXAS LIMITED
LIABILITY COMPANY)
P.O. BOX 590285
HOUSTON, TX 772590285

THE MARK CONSISTS OF THE STYLZIED TEXT
"AUXANO" WITH A STRAIGHT HORIZONTAL
LINE ABOVE THE "O".

FOR: BUSINESS CONSULTATION SERVICES;
BUSINESS LEADERSHIP DEVELOPMENT, IN
CLASS 35 (U.S. CLS. 100, 101 AND 102).

SER. NO. 77-425,889, FILED 3-19-2008.

FIRST USE 3-1-2004; IN COMMERCE 5-1-2004.

JORDAN BAKER, EXAMINING ATTORNEY

Int. Cl.: 37

Prior U.S. Cls.: 100, 103 and 106

United States Patent and Trademark Office

Reg. No. 3,519,861

Registered Oct. 21, 2008

**SERVICE MARK
PRINCIPAL REGISTER**

SIMPLY BETTER

JET, INC. (OHIO CORPORATION)
750 ALPHA DRIVE
CLEVELAND, OH 44143

FOR: INSTALLATION, REPAIR, AND MAINTENANCE OF WASTEWATER TREATMENT AND DISPOSAL PLANTS FOR RESIDENTIAL AND COMMERCIAL USE, IN CLASS 37 (U.S. CLS. 100, 103 AND 106).

FIRST USE 1-17-2007; IN COMMERCE 1-17-2007.

THE MARK CONSISTS OF STANDARD CHARACTERS WITHOUT CLAIM TO ANY PARTICULAR FONT, STYLE, SIZE, OR COLOR.

SER. NO. 77-425,902, FILED 3-19-2008.

CURTIS FRENCH, EXAMINING ATTORNEY

Int. Cl.: 42

Prior U.S. Cls.: 100 and 101

United States Patent and Trademark Office

Reg. No. 3,519,862

Registered Oct. 21, 2008

SERVICE MARK
PRINCIPAL REGISTER

BUZZcurve

MUKTI INCORPORATED (CALIFORNIA CORPORATION)
SUITE B
33722 CHULA VISTA AVENUE
DANA POINT, CA 926291600

FOR: PROVIDING ON-LINE NON-DOWNLOADABLE SOFTWARE FOR AUTOMATION OF CONSUMER TESTING OF ADVERTISING, MIXED-MEDIA, HTML, AND PRINT AND VIDEO CONTENT ON SOCIAL NETWORKING SITES, IN CLASS 42 (U.S. CLS. 100 AND 101).

FIRST USE 5-1-2007; IN COMMERCE 6-1-2007.

THE STIPLING IS FOR SHADING PURPOSES ONLY.

THE MARK CONSISTS OF A COMBINATION OF TWO WORDS: "BUZZ" AND "CURVE" PRESENTED AS ONE IN UPPER AND LOWER CASE TEXT.

SER. NO. 77-425,994, FILED 3-19-2008.

MATTHEW PAPPAS, EXAMINING ATTORNEY

Int. Cl.: 41

Prior U.S. Cls.: 100, 101 and 107

United States Patent and Trademark Office

Reg. No. 3,519,863

Registered Oct. 21, 2008

**SERVICE MARK
PRINCIPAL REGISTER**

Pet-Centered Practice

TRIPP, SUSAN (UNITED STATES INDIVIDUAL)
15340 PASTRANA DRIVE
LA MIRADA, CA 90638

FOR: EDUCATION SERVICES, NAMELY, PROVIDING LIVE AND ON-LINE LECTURES, CLASSES, SEMINARS, WORKSHOPS IN THE FIELD OF PET CARE AND PET BEHAVIOR, IN CLASS 41 (U.S. CLS. 100, 101 AND 107).

FIRST USE 1-1-2006; IN COMMERCE 1-1-2006.

THE MARK CONSISTS OF STANDARD CHARACTERS WITHOUT CLAIM TO ANY PARTICULAR FONT, STYLE, SIZE, OR COLOR.

NO CLAIM IS MADE TO THE EXCLUSIVE RIGHT TO USE "PRACTICE", APART FROM THE MARK AS SHOWN.

SER. NO. 77-426,000, FILED 3-19-2008.

DOMINICK J. SALEMI, EXAMINING ATTORNEY

Int. Cl.: 41

Prior U.S. Cls.: 100, 101 and 107

United States Patent and Trademark Office

Reg. No. 3,519,864

Registered Oct. 21, 2008

**SERVICE MARK
PRINCIPAL REGISTER**

THE CITY IS OUR GYM

BIANCHI, GREGORY ALEXANDER (UNITED STATES INDIVIDUAL), DBA BIANCHI FITNESS
114 TEXAS STREET
SAN FRANCISCO, CA 94107

FOR: PHYSICAL FITNESS CONDITIONING CLASSES; PHYSICAL FITNESS CONSULTATION; PHYSICAL FITNESS INSTRUCTION, IN CLASS 41 (U.S. CLS. 100, 101 AND 107).

FIRST USE 6-0-2006; IN COMMERCE 6-0-2006.

THE MARK CONSISTS OF STANDARD CHARACTERS WITHOUT CLAIM TO ANY PARTICULAR FONT, STYLE, SIZE, OR COLOR.

SER. NO. 77-426,038, FILED 3-19-2008.

BRENDAN REGAN, EXAMINING ATTORNEY

Int. Cl.: 45

Prior U.S. Cls.: 100 and 101

United States Patent and Trademark Office

Reg. No. 3,519,865

Registered Oct. 21, 2008

**SERVICE MARK
PRINCIPAL REGISTER**

Empowering creative works

**COPYRIGHT, INC. (WASHINGTON CORPORATION), DBA DATA DEPTH CORPORATION
NUMBER 475
4580 KLAHANIE DRIVE SE
ISSAQUAH, WA 98029**

THE MARK CONSISTS OF STANDARD CHARACTERS WITHOUT CLAIM TO ANY PARTICULAR FONT, STYLE, SIZE, OR COLOR.

**FOR: COPYRIGHT MANAGEMENT, IN CLASS 45
(U.S. CLS. 100 AND 101).**

SER. NO. 77-426,047, FILED 3-19-2008.

FIRST USE 3-7-2008; IN COMMERCE 3-17-2008.

STEVEN R. FOSTER, EXAMINING ATTORNEY

Int. Cl.: 35

Prior U.S. Cls.: 100, 101 and 102

United States Patent and Trademark Office

Reg. No. 3,519,866

Registered Oct. 21, 2008

**SERVICE MARK
PRINCIPAL REGISTER**

FIRST CONNECTIONS

CITY PUBLIC SERVICE OF SAN ANTONIO,
TEXAS (TEXAS CORPORATION)
P.O. BOX 1771
SAN ANTONIO, TX 782961771

FOR: BUSINESS SERVICES, NAMELY, COORDINATING ADDRESS CHANGES IN RELATION TO UTILITIES, SECURITY SYSTEMS, CABLE TELEVISION SERVICE, NEWSPAPER DELIVERY, UNITED STATES MAIL DELIVERY, AND OTHER SERVICES FOR OTHERS, IN CLASS 35 (U.S. CLS. 100, 101 AND 102).

FIRST USE 11-30-2007; IN COMMERCE 11-30-2007.

THE COLOR(S) RED, BLACK, ORANGE AND YELLOW IS/ARE CLAIMED AS A FEATURE OF THE MARK.

THE MARK CONSISTS OF THE WORD "FIRST" IN RED SPELLED VERTICALLY UPWARDS WITH THE WORD "CONNECTIONS" IN BLACK TO THE RIGHT OF THE WORD "FIRST"; A MULTI-COLOR HORIZONTAL LINE THROUGH THE WORD "CONNECTIONS" TRANSITIONING FROM RED TO ORANGE TO YELLOW TO ORANGE TO RED WHICH FORMS THE MIDDLE LINE OF THE LETTER "E" IN "CONNECTIONS".

SER. NO. 77-426,125, FILED 3-19-2008.

DAWN HAN, EXAMINING ATTORNEY

Int. Cl.: 35

Prior U.S. Cls.: 100, 101 and 102

United States Patent and Trademark Office

Reg. No. 3,519,867

Registered Oct. 21, 2008

**SERVICE MARK
PRINCIPAL REGISTER**

UMANSYS

UMANSYS, INC. (TEXAS CORPORATION)
10701 N. STEMMONS FRWY
DALLAS, TX 75220

THE MARK CONSISTS OF STANDARD CHAR-
ACTERS WITHOUT CLAIM TO ANY PARTICULAR
FONT, STYLE, SIZE, OR COLOR.

FOR: BUSINESS MANAGEMENT CONSULTING
AND ADVISORY SERVICES, IN CLASS 35 (U.S. CLS.
100, 101 AND 102).

SER. NO. 77-426,145, FILED 3-19-2008.

FIRST USE 1-15-2000; IN COMMERCE 9-5-2000.

ANDREA SAUNDERS, EXAMINING ATTORNEY

Int. Cl.: 25

Prior U.S. Cls.: 22 and 39

United States Patent and Trademark Office

Reg. No. 3,519,868

Registered Oct. 21, 2008

**TRADEMARK
PRINCIPAL REGISTER**

DOLCE & B

M & R SUPPLIES IMPORT EXPORT, INC. (NEW
YORK CORPORATION), DBA M & R SUP-
PLIES
APT. 26A
43-23 COLDEN STREET
FLUSHING, NY 11355

FOR: JEANS; SHORT-SLEEVED OR LONG-
SLEEVED T-SHIRTS; T-SHIRTS; DENIM JACKETS;
DENIMS; PANTS, IN CLASS 25 (U.S. CLS. 22 AND 39).

FIRST USE 3-1-2006; IN COMMERCE 3-1-2006.

THE MARK CONSISTS OF STANDARD CHAR-
ACTERS WITHOUT CLAIM TO ANY PARTICULAR
FONT, STYLE, SIZE, OR COLOR.

THE ENGLISH TRANSLATION OF "DOLCE" IS
SWEET.

SER. NO. 77-426,165, FILED 3-19-2008.

MARY ROSSMAN, EXAMINING ATTORNEY

Int. Cl.: 41

Prior U.S. Cls.: 100, 101 and 107

United States Patent and Trademark Office

Reg. No. 3,519,869

Registered Oct. 21, 2008

**SERVICE MARK
PRINCIPAL REGISTER**

Brave Rave

DYAR, DAVID CHARLES (UNITED STATES IN-
DIVIDUAL)
2105 PEBBLE BEACH DR.
CARMEL, IN 46032

THE MARK CONSISTS OF STANDARD CHAR-
ACTERS WITHOUT CLAIM TO ANY PARTICULAR
FONT, STYLE, SIZE, OR COLOR.

FOR: ENTERTAINMENT, NAMELY, LIVE MU-
SIC CONCERTS, IN CLASS 41 (U.S. CLS. 100, 101
AND 107).

SER. NO. 77-426,166, FILED 3-19-2008.

FIRST USE 1-20-2007; IN COMMERCE 1-27-2007.

MARY ROSSMAN, EXAMINING ATTORNEY

Int. Cl.: 5

Prior U.S. Cls.: 6, 18, 44, 46, 51 and 52

Reg. No. 3,519,870

United States Patent and Trademark Office

Registered Oct. 21, 2008

**TRADEMARK
PRINCIPAL REGISTER**

STERIGRAFT

TRANSPLANT TECHNOLOGIES OF TEXAS LTD.
(TEXAS LIMITED PARTNERSHIP), DBA
BONE BANK ALLOGRAFTS
4808 RESEARCH DR.
SAN ANTONIO, TX 78240

FOR: BIOLOGICAL HUMAN DONOR BONE AND
TISSUE INTENDED FOR SUBSEQUENT IMPLANTATION,
IN CLASS 5 (U.S. CLS. 6, 18, 44, 46, 51 AND 52).

FIRST USE 3-17-2008; IN COMMERCE 3-17-2008.

THE MARK CONSISTS OF STANDARD CHARACTERS
WITHOUT CLAIM TO ANY PARTICULAR FONT,
STYLE, SIZE, OR COLOR.

SER. NO. 77-426,249, FILED 3-19-2008.

NANCY CLARKE, EXAMINING ATTORNEY

Int. Cl.: 42

Prior U.S. Cls.: 100 and 101

United States Patent and Trademark Office

Reg. No. 3,519,871

Registered Oct. 21, 2008

**SERVICE MARK
PRINCIPAL REGISTER**



CLEARFUELS TECHNOLOGY, INC. (HAWAII CORPORATION)
SUITE A454
99-193 AIEA HEIGHTS DRIVE
AIEA, HI 96701

FOR: RESEARCH AND DEVELOPMENT AND CONSULTATION RELATED THERETO IN THE FIELD OF ENERGY PRODUCTION, IN CLASS 42 (U.S. CLS. 100 AND 101).

FIRST USE 2-2-2005; IN COMMERCE 2-2-2005.

NO CLAIM IS MADE TO THE EXCLUSIVE RIGHT TO USE TECHNOLOGY, INC., APART FROM THE MARK AS SHOWN.

THE COLOR(S) BLUE, GREEN, YELLOW AND WHITE IS/ARE CLAIMED AS A FEATURE OF THE MARK.

THE MARK CONSISTS OF THE WORDS "CLEAR-FUELS TECHNOLOGY, INC." AND A LEAF AND FLAME DESIGN. THE COLOR GRAY APPEARS IN THE TEXT OF THE WORDING "CLEARFUELS TECHNOLOGY, INC." HOWEVER, GRAY IS NOT CLAIMED AS A FEATURE OF THE MARK, AND IS FOR SHADING PURPOSES ONLY. THE COLOR BLUE APPEARS AS THE SHADING IN THE GAS FLAME DESIGN. THE COLOR GREEN APPEARS AT THE BASE OF THE LEAF DESIGN, AND GRADUALLY FADES UPWARD INTO YELLOW. THE COLOR WHITE APPEARS AS THE SHADING FOR THE STEM DESIGN IN THE LEAF, AND IN THE INTERIOR OF THE FLAME.

SER. NO. 77-426,262, FILED 3-19-2008.

ELI HELLMAN, EXAMINING ATTORNEY

Int. Cl.: 5

Prior U.S. Cls.: 6, 18, 44, 46, 51 and 52

United States Patent and Trademark Office

Reg. No. 3,519,872

Registered Oct. 21, 2008

**TRADEMARK
PRINCIPAL REGISTER**

GRAFTCLEANSE

TRANSPLANT TECHNOLOGIES OF TEXAS LTD.
(TEXAS LIMITED PARTNERSHIP), DBA
BONE BANK ALLOGRAFTS
4808 RESEARCH DR.
SAN ANTONIO, TX 78240

FOR: PROCESSED HUMAN DONOR BONE AND
TISSUE INTENDED FOR SUBSEQUENT IMPLAN-
TATION, IN CLASS 5 (U.S. CLS. 6, 18, 44, 46, 51 AND
52).

FIRST USE 3-17-2008; IN COMMERCE 3-17-2008.

THE MARK CONSISTS OF STANDARD CHAR-
ACTERS WITHOUT CLAIM TO ANY PARTICULAR
FONT, STYLE, SIZE, OR COLOR.

SER. NO. 77-426,268, FILED 3-19-2008.

NANCY CLARKE, EXAMINING ATTORNEY

Int. Cl.: 18

Prior U.S. Cls.: 1, 2, 3, 22 and 41

United States Patent and Trademark Office

Reg. No. 3,519,873

Registered Oct. 21, 2008

**TRADEMARK
PRINCIPAL REGISTER**

The logo for Achilles, featuring a stylized black silhouette of a heel with a white diagonal line, followed by the word "Achilles" in a bold, black, sans-serif font.

ACHILLES CORPORATION (JAPAN CORPORATION)
22-5, DAIKYO-CHO, SHINJUKU-KU
TOKYO, JAPAN

OWNER OF U.S. REG. NO. 1,289,972.

SER. NO. 77-426,269, FILED 3-19-2008.

FOR: SYNTHETIC LEATHER SOLD IN BULK, IN
CLASS 18 (U.S. CLS. 1, 2, 3, 22 AND 41).

FIRST USE 1-0-1997; IN COMMERCE 1-0-1997.

MATTHEW MCDOWELL, EXAMINING ATTORNEY

Int. Cl.: 5

Prior U.S. Cls.: 6, 18, 44, 46, 51 and 52

Reg. No. 3,519,874

United States Patent and Trademark Office

Registered Oct. 21, 2008

**TRADEMARK
PRINCIPAL REGISTER**

GRAFTSHIELD

TRANSPLANT TECHNOLOGIES OF TEXAS LTD.
(TEXAS LIMITED PARTNERSHIP), DBA
BONE BANK ALLOGRAFTS
4808 RESEARCH DR.
SAN ANTONIO, TX 78240

FOR: BIOLOGICAL IMPLANTS, NAMELY, HUMAN BONE AND TISSUE PROTECTED AGAINST CONTAMINATION BY VALIDATED QUALITY CONTROLS AND RECORD KEEPING, IN CLASS 5 (U.S. CLS. 6, 18, 44, 46, 51 AND 52).

FIRST USE 3-17-2008; IN COMMERCE 3-17-2008.

THE MARK CONSISTS OF STANDARD CHARACTERS WITHOUT CLAIM TO ANY PARTICULAR FONT, STYLE, SIZE, OR COLOR.

SER. NO. 77-426,283, FILED 3-19-2008.

NANCY CLARKE, EXAMINING ATTORNEY

Int. Cl.: 30

Prior U.S. Cl.: 46

United States Patent and Trademark Office

Reg. No. 3,519,875

Registered Oct. 21, 2008

TRADEMARK
PRINCIPAL REGISTER



JANIE'S CAKES, LP (TEXAS LIMITED PART-
NERSHIP)
420 E. 5TH STREET
TYLER, TX 75701

FOR: CAKES, IN CLASS 30 (U.S. CL. 46).

FIRST USE 10-1-2003; IN COMMERCE 11-1-2003.

NO CLAIM IS MADE TO THE EXCLUSIVE
RIGHT TO USE "CAKES", APART FROM THE
MARK AS SHOWN.

THE COLOR(S) BLACK, WHITE, BLUE, TEAL,
BROWN, RED, GREY, FLESH TONE, PINK AND
YELLOW IS/ARE CLAIMED AS A FEATURE OF
THE MARK.

THE MARK CONSISTS OF A YELLOW CIRCLE
IN FRONT OF WHICH A WOMAN STANDS WEAR-
ING A TEAL AND BLUE DRESS WITH A WHITE
AND GREY APRON. THE WOMAN IS WEARING
BLACK SHOES AND HER SILHOUETTE IS OUT-

LINED IN BLACK. THE WOMAN'S ARMS AND
LEGS ARE FLESH TONE AND THE WOMAN'S
LEFT HAND HAS A RED RING ON HER FINGER
AND THE LEFT HAND IS DOWN NEAR HER SIDE.
THE WOMAN'S RIGHT ARM IS HOLDING A
LIGHT BROWN POUND CAKE THAT IS SLIGHTLY
TIPPED FORWARD AND ON A WHITE BASE OUT-
LINED IN BLACK. THE WOMAN IS WEARING A
NECKLACE WITH FOUR WHITE AND GREY
PEARLS AND WHITE AND GREY PEARL EARR-
INGS. THE WOMAN'S FACE IS FLESH COLOR
WITH PINK CHEEKS AND LIPS. THE WOMAN HAS
LIGHT BROWN, WHITE AND BLACK HAIR, AND
IS WEARING A WHITE, GREY AND BLACK
CHEF'S HAT WITH THE BLACK WORDS "PLAIN
JANE" WRITTEN ON THE FRONT OF THE HAT.
ABOVE THE WOMAN AND TO THE LEFT AP-
PEARS THE DARK BLUE, AND OUTLINED IN
TEAL WORDS "JANIE'S CAKES".

SER. NO. 77-426,288, FILED 3-19-2008.

STEPHANIE ALI, EXAMINING ATTORNEY

Int. Cls.: 35 and 36

Prior U.S. Cls.: 100, 101 and 102

United States Patent and Trademark Office

Reg. No. 3,519,876

Registered Oct. 21, 2008

**SERVICE MARK
PRINCIPAL REGISTER**

DIA

DIA CENTER FOR THE ARTS, INC. (NEW YORK CORPORATION)
535 WEST 22ND STREET, 4TH FLOOR
NEW YORK, NY 10011

FOR: ART GALLERIES, IN CLASS 35 (U.S. CLS. 100, 101 AND 102).

FIRST USE 12-0-1974; IN COMMERCE 12-0-1974.

FOR: REAL ESTATE SERVICES, NAMELY, LEASING OF REAL ESTATE, RENTAL OF REAL ESTATE AND REAL ESTATE MANAGEMENT, IN CLASS 36 (U.S. CLS. 100, 101 AND 102).

FIRST USE 12-0-1974; IN COMMERCE 12-0-1974.

THE MARK CONSISTS OF STANDARD CHARACTERS WITHOUT CLAIM TO ANY PARTICULAR FONT, STYLE, SIZE, OR COLOR.

THE ENGLISH TRANSLATION OF THE GERMAN WORD "DIA" IN THE MARK IS "SLIDE".

SER. NO. 77-426,312, FILED 3-19-2008.

ELLEN BURNS, EXAMINING ATTORNEY

Int. Cl.: 35

Prior U.S. Cls.: 100, 101 and 102

United States Patent and Trademark Office

Reg. No. 3,519,877

Registered Oct. 21, 2008

**SERVICE MARK
PRINCIPAL REGISTER**

DIA:BEACON

DIA CENTER FOR THE ARTS, INC. (NEW YORK CORPORATION)
535 WEST 22ND STREET, 4TH FLOOR
NEW YORK, NY 10011

FOR: ART GALLERIES, IN CLASS 35 (U.S. CLS. 100, 101 AND 102).

FIRST USE 12-0-1999; IN COMMERCE 12-0-1999.

THE MARK CONSISTS OF STANDARD CHARACTERS WITHOUT CLAIM TO ANY PARTICULAR FONT, STYLE, SIZE, OR COLOR.

NO CLAIM IS MADE TO THE EXCLUSIVE RIGHT TO USE "BEACON", APART FROM THE MARK AS SHOWN.

THE ENGLISH TRANSLATION OF THE GERMAN WORD "DIA" IN THE MARK IS "SLIDE".

SER. NO. 77-426,324, FILED 3-19-2008.

ELLEN BURNS, EXAMINING ATTORNEY

Int. Cl.: 35

Prior U.S. Cls.: 100, 101 and 102

United States Patent and Trademark Office

Reg. No. 3,519,878

Registered Oct. 21, 2008

**SERVICE MARK
PRINCIPAL REGISTER**

BARKLEYREI

BARKLEY EVERGREEN & PARTNERS, INC
(MISSOURI CORPORATION)
1740 MAIN STREET
KANSAS CITY, MO 64108

FOR: ADVERTISING AND MARKETING, IN
CLASS 35 (U.S. CLS. 100, 101 AND 102).

FIRST USE 3-7-2008; IN COMMERCE 3-7-2008.

THE MARK CONSISTS OF STANDARD CHAR-
ACTERS WITHOUT CLAIM TO ANY PARTICULAR
FONT, STYLE, SIZE, OR COLOR.

OWNER OF U.S. REG. NO. 3,420,823.

SER. NO. 77-426,332, FILED 3-19-2008.

REGINA DRUMMOND, EXAMINING ATTORNEY

Int. Cl.: 20

Prior U.S. Cls.: 2, 13, 22, 25, 32 and 50

United States Patent and Trademark Office

Reg. No. 3,519,879

Registered Oct. 21, 2008

**TRADEMARK
PRINCIPAL REGISTER**

HI-PLAS

HIGHLAND PLASTICS, INC. (CALIFORNIA
CORPORATION)
965 N. FAIR OAKS AVE.
PASADENA, CA 91103

THE MARK CONSISTS OF STANDARD CHAR-
ACTERS WITHOUT CLAIM TO ANY PARTICULAR
FONT, STYLE, SIZE, OR COLOR.

FOR: MOLDED PLASTIC CONTAINERS FOR
CONSUMER PACKAGING, IN CLASS 20 (U.S. CLS.
2, 13, 22, 25, 32 AND 50).

SER. NO. 77-426,451, FILED 3-19-2008.

FIRST USE 12-31-1958; IN COMMERCE 12-31-1958.

ROBIN CHOSID, EXAMINING ATTORNEY

Int. Cl.: 35

Prior U.S. Cls.: 100, 101 and 102

United States Patent and Trademark Office

Reg. No. 3,519,880

Registered Oct. 21, 2008

**SERVICE MARK
PRINCIPAL REGISTER**

TRAIN TIME HOBBY

LILLEY, RODNEY (UNITED STATES INDIVIDUAL), DBA TRAIN TIME HOBBY
7566 SOUTH 84TH STREET
LAVISTA, NE 68128

FOR: ON-LINE RETAIL STORE SERVICES FEATURING MODEL TRAINS AND ACCESSORIES THEREFOR; RETAIL STORE SERVICES FEATURING MODEL TRAINS AND ACCESSORIES THEREFOR, IN CLASS 35 (U.S. CLS. 100, 101 AND 102).

FIRST USE 7-30-2004; IN COMMERCE 7-30-2004.

THE MARK CONSISTS OF STANDARD CHARACTERS WITHOUT CLAIM TO ANY PARTICULAR FONT, STYLE, SIZE, OR COLOR.

NO CLAIM IS MADE TO THE EXCLUSIVE RIGHT TO USE "TRAIN" AND "HOBBY", APART FROM THE MARK AS SHOWN.

SER. NO. 77-426,510, FILED 3-19-2008.

SUSAN RICHARDS, EXAMINING ATTORNEY

Int. Cl.: 5

Prior U.S. Cls.: 6, 18, 44, 46, 51 and 52

Reg. No. 3,519,881

United States Patent and Trademark Office

Registered Oct. 21, 2008

**TRADEMARK
PRINCIPAL REGISTER**

BAHAMA BAG

AMERICAN COVERS, INC. (UTAH CORPORATION)
675 WEST 14600 SOUTH
BLUFFDALE, UT 84065

THE MARK CONSISTS OF STANDARD CHARACTERS WITHOUT CLAIM TO ANY PARTICULAR FONT, STYLE, SIZE, OR COLOR.

FOR: AIR FRESHENER AND AIR DEODORIZER,
IN CLASS 5 (U.S. CLS. 6, 18, 44, 46, 51 AND 52).

SER. NO. 77-426,559, FILED 3-19-2008.

FIRST USE 12-0-2006; IN COMMERCE 12-0-2006.

DOMINICK J. SALEMI, EXAMINING ATTORNEY

Int. Cl.: 25

Prior U.S. Cls.: 22 and 39

United States Patent and Trademark Office

Reg. No. 3,519,882

Registered Oct. 21, 2008

TRADEMARK
PRINCIPAL REGISTER



TROPICAL TUX, LLC. (CALIFORNIA LIMITED
LIABILITY COMPANY)
6446 OPAL WAY
CARLSBAD, CA 92011

FOR: DRESS SHIRTS; SHIRTS FOR SUITS, IN
CLASS 25 (U.S. CLS. 22 AND 39).

FIRST USE 3-1-2007; IN COMMERCE 3-1-2007.

NO CLAIM IS MADE TO THE EXCLUSIVE
RIGHT TO USE "TUX", APART FROM THE MARK
AS SHOWN.

THE COLOR(S) GREEN AND BLACK IS/ARE
CLAIMED AS A FEATURE OF THE MARK.

THE MARK CONSISTS OF THE WORDS "TROPICAL TUX" AND A DESIGN ELEMENT COMPRISING TWO PALM TREES. THE COLOR BLACK APPEARS IN THE WORDING "TROPICAL TUX" AND THE COLOR GREEN APPEARS IN THE PALM TREES.

SER. NO. 77-426,634, FILED 3-19-2008.

Laurie Kaufman, Examining Attorney

Int. Cl.: 41

Prior U.S. Cls.: 100, 101 and 107

United States Patent and Trademark Office

Reg. No. 3,519,883

Registered Oct. 21, 2008

SERVICE MARK
PRINCIPAL REGISTER

Artifact Park 

BARSKI, ROGER (UNITED STATES INDIVIDUAL)
319 NORTH ORCHARD DRIVE
PARK FOREST, IL 60466

FOR: PROVIDING UNDERWATER ARCHEOLOGY TRAINING FACILITIES, IN CLASS 41 (U.S. CLS. 100, 101 AND 107).

FIRST USE 6-1-2007; IN COMMERCE 6-1-2007.

NO CLAIM IS MADE TO THE EXCLUSIVE RIGHT TO USE "ARTIFACT PARK", APART FROM THE MARK AS SHOWN.

THE MARK CONSISTS OF AN IMAGE OF AN OCULUS EYE AND THE TEXT "ARTIFACT PARK".

SER. NO. 77-426,671, FILED 3-19-2008.

CHRISTINA SOBRAL, EXAMINING ATTORNEY

Int. Cl.: 37

Prior U.S. Cls.: 100, 103 and 106

United States Patent and Trademark Office

Reg. No. 3,519,884

Registered Oct. 21, 2008

**SERVICE MARK
PRINCIPAL REGISTER**

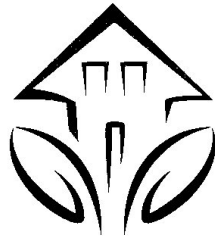

Green Building

WILLS, INC. (IDAHO CORPORATION)
222 SHOSHONE ST. WEST
TWIN FALLS, ID 833030346

FOR: CONSTRUCTION OF BUILDINGS; LAND DEVELOPMENT SERVICES, NAMELY, PLANNING AND LAYING OUT OF RESIDENTIAL AND/OR COMMERCIAL COMMUNITIES, IN CLASS 37 (U.S. CLS. 100, 103 AND 106).

FIRST USE 2-25-2008; IN COMMERCE 2-25-2008.

NO CLAIM IS MADE TO THE EXCLUSIVE RIGHT TO USE "GREEN BUILDING", APART FROM THE MARK AS SHOWN.

THE MARK CONSISTS OF AN OUTLINE OF A PLANT WITH A LEAF ON EACH SIDE WITH AN OUTLINE OF A SMALL HOUSE WITH TWO WINDOWS EMERGING OUT THE TOP OF THE PLANT. BELOW THE TWO LEAFS IS THE STYLIZED TEXT "GREEN BUILDING".

SER. NO. 77-426,674, FILED 3-19-2008.

GISELLE AGOSTO, EXAMINING ATTORNEY

Int. Cl.: 6

Prior U.S. Cls.: 2, 12, 13, 14, 23, 25 and 50

Reg. No. 3,519,885

United States Patent and Trademark Office

Registered Oct. 21, 2008

**TRADEMARK
PRINCIPAL REGISTER**

The Beam

RUSS BASSETT CORPORATION (CALIFORNIA
CORPORATION)
8189 BYRON RD.
WHITTIER, CA 90606

THE MARK CONSISTS OF STANDARD CHAR-
ACTERS WITHOUT CLAIM TO ANY PARTICULAR
FONT, STYLE, SIZE, OR COLOR.

FOR: METAL CONDUIT, IN CLASS 6 (U.S. CLS. 2,
12, 13, 14, 23, 25 AND 50).

SER. NO. 77-426,699, FILED 3-19-2008.

FIRST USE 12-31-2004; IN COMMERCE 12-31-2004.

ATTIYA MALIK, EXAMINING ATTORNEY

Int. Cl.: 1

Prior U.S. Cls.: 1, 5, 6, 10, 26 and 46

Reg. No. 3,519,886

United States Patent and Trademark Office

Registered Oct. 21, 2008

**TRADEMARK
PRINCIPAL REGISTER**

N-GLYCANASE

PROZYME, INC. (CALIFORNIA CORPORATION)
1933 DAVIS STREET, SUITE 207
SAN LEANDRO, CA 94577

THE MARK CONSISTS OF STANDARD CHAR-
ACTERS WITHOUT CLAIM TO ANY PARTICULAR
FONT, STYLE, SIZE, OR COLOR.

FOR: ENZYME FOR CLIPPING THE SUGAR
PORTION FROM THE PROTEIN PORTION OF
GLYCOPROTEINS FOR IN VITRO LABORATORY
USE, IN CLASS 1 (U.S. CLS. 1, 5, 6, 10, 26 AND 46).

SER. NO. 77-426,800, FILED 3-19-2008.

FIRST USE 1-30-2003; IN COMMERCE 1-30-2003.

JOHN DWYER, EXAMINING ATTORNEY

Int. Cl.: 45

Prior U.S. Cls.: 100 and 101

United States Patent and Trademark Office

Reg. No. 3,519,887

Registered Oct. 21, 2008

**SERVICE MARK
PRINCIPAL REGISTER**

The Mess Meister

WALLS, JUDITH A. (UNITED STATES INDIVIDUAL), DBA THE MESS MEISTER
2010 STAPLETON DRIVE
FRIENDSWOOD, TX 77546

FOR: ORGANIZATIONAL SERVICES FOR HOME OR PERSONAL PURPOSES, NAMELY, ORGANIZING THE POSSESSIONS AND THE ROOMS IN HOMES OR OFFICES THROUGH HANDS ON SORTING, PURGING AND ARRANGING ITEMS, AND MANAGEMENT OF FILES AND PAPERWORK, IN CLASS 45 (U.S. CLS. 100 AND 101).

FIRST USE 1-21-2006; IN COMMERCE 1-23-2006.

THE MARK CONSISTS OF STANDARD CHARACTERS WITHOUT CLAIM TO ANY PARTICULAR FONT, STYLE, SIZE, OR COLOR.

SER. NO. 77-426,805, FILED 3-19-2008.

KAPIL BHANOT, EXAMINING ATTORNEY

Int. Cl.: 41

Prior U.S. Cls.: 100, 101 and 107

United States Patent and Trademark Office

Reg. No. 3,519,888

Registered Oct. 21, 2008

**SERVICE MARK
PRINCIPAL REGISTER**



WILSON-COLEMAN, STEPHANIE E. (UNITED STATES INDIVIDUAL)
7858 S. HALSTED
CHICAGO, IL 60621

FOR: PERSONAL APPEARANCES BY AN INSPIRATIONAL AND MOTIVATIONAL SPEAKER; EDUCATIONAL SERVICES, NAMELY, PROVIDING WORKSHOPS, SEMINARS AND TRAINING IN THE FIELD OF SELF IMPROVEMENT, SELF-EMPOWERMENT AND SELF-RELIANCE; MEETING FACILITATOR, NAMELY, ARRANGING WORKSHOPS, SEMINARS AND TRAINING COURSES IN THE FIELD OF SELF IMPROVEMENT, SELF-EMPOWERMENT, AND SELF-RELIANCE FOR BUSINESSES AND INDIVIDUALS, IN CLASS 41 (U.S. CLS. 100, 101 AND 107).

FIRST USE 1-15-1995; IN COMMERCE 1-15-1995.

THE COLOR(S) BLUE, WHITE, GOLD AND GRAY IS/ARE CLAIMED AS A FEATURE OF THE MARK.

THE COLOR GOLD APPEARS IN THE WORDING "CC" WHILE THE WHITE APPEARS IN THE SWIRLS BEHIND THE WORDING. THE BACKGROUND OF THE MARK IS A DIAMOND SHAPE IN THE COLOR BLUE AND THERE IS A GRAY SHADOW AROUND THE OUTSIDE OF THE ENTIRE MARK.

SER. NO. 77-426,821, FILED 3-20-2008.

MARCIE MILONE, EXAMINING ATTORNEY

Int. Cl.: 9

Prior U.S. Cls.: 21, 23, 26, 36 and 38

Reg. No. 3,519,889

United States Patent and Trademark Office

Registered Oct. 21, 2008

**TRADEMARK
PRINCIPAL REGISTER**

STILL QUIET PLACE

AMY SALTZMAN M.D. (UNITED STATES INDIVIDUAL)
SUITE 212
885 OAK GROVE AVENUE
MENLO PARK, CA 94025

FOR: PRERECORDED COMPACT DISCS FEATURING AUDIO PRACTICES IN MINDFULNESS AND MEDITATION FOR CHILDREN AND ADULTS, IN CLASS 9 (U.S. CLS. 21, 23, 26, 36 AND 38).

FIRST USE 10-14-2004; IN COMMERCE 1-5-2005.

THE MARK CONSISTS OF STANDARD CHARACTERS WITHOUT CLAIM TO ANY PARTICULAR FONT, STYLE, SIZE, OR COLOR.

SER. NO. 77-426,831, FILED 3-20-2008.

GIANCARLO CASTRO, EXAMINING ATTORNEY

Int. Cl.: 25

Prior U.S. Cls.: 22 and 39

United States Patent and Trademark Office

Reg. No. 3,519,890

Registered Oct. 21, 2008

**TRADEMARK
PRINCIPAL REGISTER**

PEOPLE WITH AGENDAS

ALVIN JOHN BARRERA (UNITED STATES IN-
DIVIDUAL)
18023 MARTHA PL
CERRITOS, CA 90703

FOR: CLOTHING, NAMELY, PANTS, SOCKS,
BELTS, BLAZERS, BLOUSES, COATS, DRESSES,
FOOTWEAR, HALTER TOPS, HATS, JACKETS,
JEANS, JERSEYS, JUMPERS, JUMPSUITS, OVER-
ALLS, PULLOVERS, SHIRTS, SHORTS, SKIRTS,
SLACKS, SPORT COATS, SWEATSHIRTS, T-SHIRTS
AND TANK TOPS, IN CLASS 25 (U.S. CLS. 22 AND
39).

FIRST USE 2-1-2006; IN COMMERCE 2-1-2006.

THE MARK CONSISTS OF STANDARD CHAR-
ACTERS WITHOUT CLAIM TO ANY PARTICULAR
FONT, STYLE, SIZE, OR COLOR.

SER. NO. 77-426,841, FILED 3-20-2008.

ASMAT KHAN, EXAMINING ATTORNEY

Int. Cl.: 16

Prior U.S. Cls.: 2, 5, 22, 23, 29, 37, 38 and 50

Reg. No. 3,519,891

United States Patent and Trademark Office

Registered Oct. 21, 2008

**TRADEMARK
PRINCIPAL REGISTER**

THE PERFECT LABOR STORM

WOLFE, IRA S. (UNITED STATES INDIVIDUAL)
SUITE 218
2137 EMBASSY DRIVE
LANCASTER, PA 17603

THE MARK CONSISTS OF STANDARD CHAR-
ACTERS WITHOUT CLAIM TO ANY PARTICULAR
FONT, STYLE, SIZE, OR COLOR.

FOR: A SERIES OF BOOKS, WRITTEN ARTICLES,
HANDOUTS AND WORKSHEETS IN THE FIELD
OF HUMAN RESOURCES CONSULTING, IN CLASS
16 (U.S. CLS. 2, 5, 22, 23, 29, 37, 38 AND 50).

SER. NO. 77-426,863, FILED 3-20-2008.

FIRST USE 5-1-2004; IN COMMERCE 5-1-2004.

NORA BUCHANAN WILL, EXAMINING ATTOR-
NEY

Int. Cl.: 35

Prior U.S. Cls.: 100, 101 and 102

United States Patent and Trademark Office

Reg. No. 3,519,892

Registered Oct. 21, 2008

**SERVICE MARK
PRINCIPAL REGISTER**

LIFTING AS WE CLIMB

NATIONAL ASSOCIATION OF BLACK ACCOUNTANTS, INC. (NEW YORK CORPORATION)
7249-A HANOVER PARKWAY
GREENBELT, MD 20770

FOR: ASSOCIATION SERVICES, NAMELY, PROMOTING THE INTERESTS OF MINORITIES IN THE FIELD OF ACCOUNTING, IN CLASS 35 (U.S. CLS. 100, 101 AND 102).

FIRST USE 3-31-1994; IN COMMERCE 3-31-1994.

THE MARK CONSISTS OF STANDARD CHARACTERS WITHOUT CLAIM TO ANY PARTICULAR FONT, STYLE, SIZE, OR COLOR.

SER. NO. 77-426,869, FILED 3-20-2008.

BARBARA BROWN, EXAMINING ATTORNEY

Int. Cl.: 14

Prior U.S. Cls.: 2, 27, 28 and 50

United States Patent and Trademark Office

Reg. No. 3,519,893

Registered Oct. 21, 2008

**TRADEMARK
PRINCIPAL REGISTER**

**IMPERIAL CROWN CULTURED
PEARLS**

THE BAZAR GROUP, INC. (RHODE ISLAND
CORPORATION)
795 WATERMAN AVE.
EAST PROVIDENCE, RI 02914

FOR: PEARLS, NAMELY, CULTURED PEARLS;
NECKLACES FEATURING CULTURED PEARLS;
RINGS FEATURING CULTURED PEARLS; JEWEL-
RY FEATURING CULTURED PEARLS, IN CLASS 14
(U.S. CLS. 2, 27, 28 AND 50).

FIRST USE 2-1-2002; IN COMMERCE 2-1-2002.

THE MARK CONSISTS OF STANDARD CHAR-
ACTERS WITHOUT CLAIM TO ANY PARTICULAR
FONT, STYLE, SIZE, OR COLOR.

OWNER OF U.S. REG. NOS. 500,280 AND 2,656,515.

NO CLAIM IS MADE TO THE EXCLUSIVE
RIGHT TO USE "CULTURED PEARLS", APART
FROM THE MARK AS SHOWN.

SER. NO. 77-426,891, FILED 3-20-2008.

JOHN KELLY, EXAMINING ATTORNEY

Int. Cl.: 11

Prior U.S. Cls.: 13, 21, 23, 31 and 34

United States Patent and Trademark Office

Reg. No. 3,519,894

Registered Oct. 21, 2008

**TRADEMARK
PRINCIPAL REGISTER**

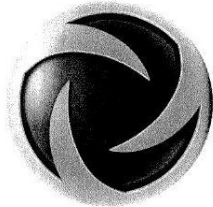

MYSON

RETTIG USA INC. (DELAWARE CORPORATION)
948 HERCULES DRIVE
COLCHESTER, VT 05446

FOR: ENVIRONMENTAL CONTROL APPARATUS FOR RESIDENTIAL USE; NAMELY, RADIATORS, ELECTRIC TOWEL WARMERS, AND FAN CONVECTION HEATERS, IN CLASS 11 (U.S. CLS. 13, 21, 23, 31 AND 34).

FIRST USE 1-1-2008; IN COMMERCE 1-1-2008.

OWNER OF U.S. REG. NOS. 1,801,995, 1,803,173, AND 2,494,192.

THE MARK CONSISTS OF THE WORD "MYSON" TOGETHER WITH A STYLIZED REPRESENTATION OF A FIREBALL.

SER. NO. 77-426,897, FILED 3-20-2008.

JOHN KELLY, EXAMINING ATTORNEY

Int. Cl.: 12

Prior U.S. Cls.: 19, 21, 23, 31, 35 and 44

Reg. No. 3,519,895

United States Patent and Trademark Office

Registered Oct. 21, 2008

**TRADEMARK
PRINCIPAL REGISTER**

AMBASSADOR

AUTOMATIC EQUIPMENT MANUFACTURING
COMPANY (NEBRASKA CORPORATION)
ONE MILL ROAD, INDUSTRIAL PARK
PENDER, NE 68047

THE MARK CONSISTS OF STANDARD CHAR-
ACTERS WITHOUT CLAIM TO ANY PARTICULAR
FONT, STYLE, SIZE, OR COLOR.

FOR: TOW BARS FOR VEHICLES, IN CLASS 12
(U.S. CLS. 19, 21, 23, 31, 35 AND 44).

SER. NO. 77-426,900, FILED 3-20-2008.

FIRST USE 3-0-1998; IN COMMERCE 3-0-1998.

RENEE SERVANCE, EXAMINING ATTORNEY

Int. Cl.: 35

Prior U.S. Cls.: 100, 101 and 102

United States Patent and Trademark Office

Reg. No. 3,519,896

Registered Oct. 21, 2008

**SERVICE MARK
PRINCIPAL REGISTER**



FRY'S ELECTRONICS, INC. (CALIFORNIA CORPORATION)
600 E. BROKAW ROAD
SAN JOSE, CA 95112

FOR: RETAIL STORE SERVICES AND WHOLESALE STORES FEATURING PERSONAL COMPUTERS, COMPUTER HARDWARE, COMPONENTS AND ACCESSORIES, AND RELATED MERCHANDISE, PHOTOCOPY MACHINES AND SCANNERS, HOME OFFICE PRODUCTS AND FURNISHINGS, TELECOMMUNICATION EQUIPMENT, DEVICES AND ACCESSORIES, NETWORKING EQUIPMENT, DEVICES AND ACCESSORIES, PHOTOGRAPHIC EQUIPMENT, DEVICES AND ACCESSORIES, VIDEO EQUIPMENT, DEVICES, ACCESSORIES AND RECORDINGS, VIDEO GAMES, TELEVISIONS, PROJECTORS, MONITORS AND DISPLAYS, IMAGING EQUIPMENT, AUDIO EQUIPMENT, DEVICES, ACCESSORIES AND RECORDINGS, MULTIMEDIA EQUIPMENT, DEVICES, ACCESSORIES AND RECORDINGS, CONSUMER ELECTRONICS, ELECTRONIC EQUIPMENT, DEVICES AND ACCESSORIES, DIGITAL EQUIPMENT, DEVICES AND ACCESSORIES, STORAGE MEDIA, MUSICAL INSTRUMENTS, AUTOMOTIVE AUDIO

EQUIPMENT, DEVICES AND ACCESSORIES, HOUSEHOLD APPLIANCES, BOOKS AND MAGAZINES, TOYS, HEALTH CARE, SKIN CARE, PERSONAL CARE, PERSONAL SAFETY, PERSONAL HOME COMFORT AND THERAPY PRODUCTS, SPA PRODUCTS, CLOTHING AND FOOD AND BEVERAGES, IN CLASS 35 (U.S. CLS. 100, 101 AND 102).

FIRST USE 5-17-1985; IN COMMERCE 5-17-1985.

OWNER OF U.S. REG. NOS. 2,031,351 AND 2,102,637.

NO CLAIM IS MADE TO THE EXCLUSIVE RIGHT TO USE "ELECTRONICS", APART FROM THE MARK AS SHOWN.

SEC. 2(F).

SER. NO. 77-426,924, FILED 3-20-2008.

LEIGH CAROLINE CASE, EXAMINING ATTORNEY

Int. Cl.: 45

Prior U.S. Cls.: 100 and 101

United States Patent and Trademark Office

Reg. No. 3,519,897

Registered Oct. 21, 2008

**SERVICE MARK
PRINCIPAL REGISTER**

Creatif Licensing Corp

CREATIF LICENSING CORP (NEW YORK CORPORATION)
31 OLD TOWN CROSSING
MOUNT KISCO, NY 105494030

FOR: LICENSING OF ARTWORK, ILLUSTRATION, DESIGN AND CONCEPTUAL PROPERTIES, IN CLASS 45 (U.S. CLS. 100 AND 101).

FIRST USE 6-6-1975; IN COMMERCE 9-29-1975.

THE MARK CONSISTS OF STANDARD CHARACTERS WITHOUT CLAIM TO ANY PARTICULAR FONT, STYLE, SIZE, OR COLOR.

NO CLAIM IS MADE TO THE EXCLUSIVE RIGHT TO USE "LICENSING CORP", APART FROM THE MARK AS SHOWN.

THE FOREIGN WORDING IN THE MARK TRANSLATES INTO ENGLISH AS CREATIVE DESIGNER.

SEC. 2(F).

SER. NO. 77-426,926, FILED 3-20-2008.

RON FAIRBANKS, EXAMINING ATTORNEY

Int. Cl.: 9

Prior U.S. Cls.: 21, 23, 26, 36 and 38

Reg. No. 3,519,898

United States Patent and Trademark Office

Registered Oct. 21, 2008

**TRADEMARK
PRINCIPAL REGISTER**

COMPUTERCOP

COMPUTERCOP SOFTWARE CORP. (NEW
YORK CORPORATION)
SUITE 201
3880 VETERANS MEMORIAL HIGHWAY
BOHEMIA, NY 11716

FOR: COMPUTER SOFTWARE PROGRAMS
THAT MONITOR ACTIVITY ON A COMPUTER,
NAMELY, COMPUTER SOFTWARE THAT MONI-
TORS COMMUNICATIONS BETWEEN COMPU-
TERS AND/OR THE GLOBAL INFORMATION
NETWORK; COMPUTER SOFTWARE FOR MONI-
TORING AND BLOCKING ACCESS TO CERTAIN
INFORMATION; COMPUTER SOFTWARE FOR
MONITORING DISK AND MEMORY COMPUTER
CONTENT; COMPUTER SOFTWARE FOR USE IN

ACCESSING AND EVALUATING INFORMATION
REGARDING INFORMATION OBTAINED VIA
THE GLOBAL INFORMATION NETWORK AND
ON-LINE COMMUNICATIONS, IN CLASS 9 (U.S.
CLS. 21, 23, 26, 36 AND 38).

FIRST USE 2-20-2001; IN COMMERCE 2-20-2001.

THE MARK CONSISTS OF STANDARD CHAR-
ACTERS WITHOUT CLAIM TO ANY PARTICULAR
FONT, STYLE, SIZE, OR COLOR.

SER. NO. 77-426,928, FILED 3-20-2008.

RON FAIRBANKS, EXAMINING ATTORNEY

Int. Cls.: 9 and 35

Prior U.S. Cls.: 21, 23, 26, 36, 38, 100, 101 and 102

Reg. No. 3,519,899

United States Patent and Trademark Office

Registered Oct. 21, 2008

**TRADEMARK
SERVICE MARK
PRINCIPAL REGISTER**

FRY'S

FRY'S ELECTRONICS, INC. (CALIFORNIA CORPORATION)
600 E. BROKAW ROAD
SAN JOSE, CA 95112

FOR: COMPUTERS, IN CLASS 9 (U.S. CLS. 21, 23, 26, 36 AND 38).

FIRST USE 5-17-1985; IN COMMERCE 5-17-1985.

FOR: RETAIL STORE SERVICES AND WHOLESALE STORES FEATURING PERSONAL COMPUTERS, COMPUTER HARDWARE, COMPONENTS AND ACCESSORIES, AND RELATED MERCHANDISE, PHOTOCOPY MACHINES AND SCANNERS, HOME OFFICE PRODUCTS AND FURNISHINGS, TELECOMMUNICATION EQUIPMENT, DEVICES AND ACCESSORIES, NETWORKING EQUIPMENT, DEVICES AND ACCESSORIES, PHOTOGRAPHIC EQUIPMENT, DEVICES AND ACCESSORIES, VIDEO EQUIPMENT, DEVICES, ACCESSORIES AND RECORDINGS, VIDEO GAMES, TELEVISIONS, PROJECTORS, MONITORS AND DISPLAYS, IMAGING EQUIPMENT, AUDIO EQUIPMENT, DEVICES, ACCESSORIES AND RECORDINGS, MULTIMEDIA EQUIPMENT, DEVICES, ACCESSORIES AND RECORDINGS, CONSUMER ELECTRONICS, ELECTRONIC EQUIPMENT, DEVICES

AND ACCESSORIES, DIGITAL EQUIPMENT, DEVICES AND ACCESSORIES, STORAGE MEDIA, MUSICAL INSTRUMENTS, AUTOMOTIVE AUDIO EQUIPMENT, DEVICES AND ACCESSORIES, HOUSEHOLD APPLIANCES, BOOKS AND MAGAZINES, TOYS, HEALTH CARE, SKIN CARE, PERSONAL CARE, PERSONAL SAFETY, PERSONAL HOME COMFORT AND THERAPY PRODUCTS, SPA PRODUCTS, CLOTHING AND FOOD AND BEVERAGES, IN CLASS 35 (U.S. CLS. 100, 101 AND 102).

FIRST USE 5-17-1985; IN COMMERCE 5-17-1985.

THE MARK CONSISTS OF STANDARD CHARACTERS WITHOUT CLAIM TO ANY PARTICULAR FONT, STYLE, SIZE, OR COLOR.

OWNER OF U.S. REG. NOS. 2,031,351 AND 2,102,637.

SEC. 2(F).

SER. NO. 77-426,945, FILED 3-20-2008.

LEIGH CAROLINE CASE, EXAMINING ATTORNEY

Int. Cls.: 9 and 35

Prior U.S. Cls.: 21, 23, 26, 36, 38, 100, 101 and 102

Reg. No. 3,519,900

United States Patent and Trademark Office

Registered Oct. 21, 2008

**TRADEMARK
SERVICE MARK
PRINCIPAL REGISTER**



FRY'S ELECTRONICS, INC. (CALIFORNIA CORPORATION)
600 E. BROKAW ROAD
SAN JOSE, CA 95112

FOR: ELECTRONIC COMPONENTS AND SUPPLIES, NAMELY, SEMICONDUCTOR DEVICES, ELECTRICAL CONNECTORS, ELECTRIC CABLING, RESISTORS, CAPACITORS, INDUCTORS, HEAT SINKS, TEST CLIPS, TEST LEADS AND WIRE WRAPS, IN CLASS 9 (U.S. CLS. 21, 23, 26, 36 AND 38).

FIRST USE 5-17-1985; IN COMMERCE 5-17-1985.

FOR: RETAIL STORE SERVICES AND WHOLESALE STORES FEATURING PERSONAL COMPUTERS, COMPUTER HARDWARE, COMPONENTS AND ACCESSORIES, AND RELATED MERCHANDISE, PHOTOCOPY MACHINES AND SCANNERS, HOME OFFICE PRODUCTS AND FURNISHINGS, TELECOMMUNICATION EQUIPMENT, DEVICES AND ACCESSORIES, NETWORKING EQUIPMENT, DEVICES AND ACCESSORIES, PHOTOGRAPHIC EQUIPMENT, DEVICES AND ACCESSORIES, VIDEO EQUIPMENT, DEVICES, ACCESSORIES AND RECORDINGS, VIDEO GAMES, TELEVISIONS, PROJECTORS, MONITORS AND DISPLAYS, IMAGING EQUIPMENT, AUDIO EQUIPMENT, DEVICES, ACCESSORIES AND RECORDINGS, MULTIMEDIA EQUIPMENT, DEVICES, ACCESSORIES AND RECORDINGS, CONSUMER ELECTRONICS, ELECTRONIC EQUIPMENT, DEVICES AND ACCESSORIES, DIGITAL EQUIPMENT, DE-

VICES AND ACCESSORIES, STORAGE MEDIA, MUSICAL INSTRUMENTS, AUTOMOTIVE AUDIO EQUIPMENT, DEVICES AND ACCESSORIES, HOUSEHOLD APPLIANCES, BOOKS AND MAGAZINES, TOYS, HEALTH CARE, SKIN CARE, PERSONAL CARE, PERSONAL SAFETY, PERSONAL HOME COMFORT AND THERAPY PRODUCTS, SPA PRODUCTS, CLOTHING AND FOOD AND BEVERAGES, IN CLASS 35 (U.S. CLS. 100, 101 AND 102).

FIRST USE 5-17-1985; IN COMMERCE 5-17-1985.

OWNER OF U.S. REG. NOS. 2,031,351 AND 2,102,637.

NO CLAIM IS MADE TO THE EXCLUSIVE RIGHT TO USE "ELECTRONICS", APART FROM THE MARK AS SHOWN.

THE COLOR(S) RED IS/ARE CLAIMED AS A FEATURE OF THE MARK.

THE WORDING APPEARS IN RED.

SEC. 2(F).

SER. NO. 77-426,955, FILED 3-20-2008.

LEIGH CAROLINE CASE, EXAMINING ATTORNEY

Int. Cl.: 12

Prior U.S. Cls.: 19, 21, 23, 31, 35 and 44

Reg. No. 3,519,901

United States Patent and Trademark Office

Registered Oct. 21, 2008

**TRADEMARK
PRINCIPAL REGISTER**

ADVENTURER

AUTOMATIC EQUIPMENT MANUFACTURING
COMPANY (NEBRASKA CORPORATION)
ONE MILL ROAD, INDUSTRIAL PARK
PENDER, NE 68047

THE MARK CONSISTS OF STANDARD CHAR-
ACTERS WITHOUT CLAIM TO ANY PARTICULAR
FONT, STYLE, SIZE, OR COLOR.

FOR: TOW BARS FOR VEHICLES, IN CLASS 12
(U.S. CLS. 19, 21, 23, 31, 35 AND 44).

SER. NO. 77-426,960, FILED 3-20-2008.

FIRST USE 2-0-2004; IN COMMERCE 2-0-2004.

RENEE SERVANCE, EXAMINING ATTORNEY

Int. Cls.: 9 and 35

Prior U.S. Cls.: 21, 23, 26, 36, 38, 100, 101 and 102

Reg. No. 3,519,902

United States Patent and Trademark Office

Registered Oct. 21, 2008

**TRADEMARK
SERVICE MARK
PRINCIPAL REGISTER**



FRY'S ELECTRONICS, INC. (CALIFORNIA CORPORATION)
600 E. BROKAW ROAD
SAN JOSE, CA 95112

FOR: ELECTRONIC COMPONENTS AND SUPPLIES, NAMELY, SEMICONDUCTOR DEVICES, ELECTRICAL CONNECTORS, ELECTRIC CABLING, RESISTORS, CAPACITORS, INDUCTORS, HEAT SINKS, TEST CLIPS, TEST LEADS, WIRE WRAPS, AND COMPUTERS, IN CLASS 9 (U.S. CLS. 21, 23, 26, 36 AND 38).

FIRST USE 5-17-1985; IN COMMERCE 5-17-1985.

FOR: RETAIL STORE SERVICES AND WHOLESALE STORES FEATURING PERSONAL COMPUTERS, COMPUTER HARDWARE, COMPONENTS AND ACCESSORIES, AND RELATED MERCHANDISE, PHOTOCOPY MACHINES AND SCANNERS, HOME OFFICE PRODUCTS AND FURNISHINGS, TELECOMMUNICATION EQUIPMENT, DEVICES AND ACCESSORIES, NETWORKING EQUIPMENT, DEVICES AND ACCESSORIES, PHOTOGRAPHIC EQUIPMENT, DEVICES AND ACCESSORIES, VIDEO EQUIPMENT, DEVICES, ACCESSORIES AND RECORDINGS, VIDEO GAMES, TELEVISIONS, PROJECTORS, MONITORS AND DISPLAYS, IMAGING EQUIPMENT, AUDIO EQUIPMENT, DEVICES, ACCESSORIES AND RECORDINGS, MULTIMEDIA EQUIPMENT, DEVICES, ACCESSORIES AND RECORDINGS, CONSUMER ELEC-

TRONICS, ELECTRONIC EQUIPMENT, DEVICES AND ACCESSORIES, DIGITAL EQUIPMENT, DEVICES AND ACCESSORIES, STORAGE MEDIA, MUSICAL INSTRUMENTS, AUTOMOTIVE AUDIO EQUIPMENT, DEVICES AND ACCESSORIES, HOUSEHOLD APPLIANCES, BOOKS AND MAGAZINES, TOYS, HEALTH CARE, SKIN CARE, PERSONAL CARE, PERSONAL SAFETY, PERSONAL HOME COMFORT AND THERAPY PRODUCTS, SPA PRODUCTS, CLOTHING AND FOOD AND BEVERAGES, IN CLASS 35 (U.S. CLS. 100, 101 AND 102).

FIRST USE 5-17-1985; IN COMMERCE 5-17-1985.

OWNER OF U.S. REG. NOS. 2,031,351 AND 2,102,637.

THE COLOR(S) RED IS/ARE CLAIMED AS A FEATURE OF THE MARK.

THE WORDING APPEARS IN RED.

SEC. 2(F).

SER. NO. 77-426,965, FILED 3-20-2008.

LEIGH CAROLINE CASE, EXAMINING ATTORNEY

Int. Cl.: 12

Prior U.S. Cls.: 19, 21, 23, 31, 35 and 44

Reg. No. 3,519,903

United States Patent and Trademark Office

Registered Oct. 21, 2008

**TRADEMARK
PRINCIPAL REGISTER**

ACCLAIM

AUTOMATIC EQUIPMENT MANUFACTURING
COMPANY (NEBRASKA CORPORATION)
ONE MILL ROAD, INDUSTRIAL PARK
PENDER, NE 68047

THE MARK CONSISTS OF STANDARD CHAR-
ACTERS WITHOUT CLAIM TO ANY PARTICULAR
FONT, STYLE, SIZE, OR COLOR.

FOR: TOW BARS FOR VEHICLES, IN CLASS 12
(U.S. CLS. 19, 21, 23, 31, 35 AND 44).

SER. NO. 77-426,968, FILED 3-20-2008.

FIRST USE 9-0-1997; IN COMMERCE 9-0-1997.

RENEE SERVANCE, EXAMINING ATTORNEY

Int. Cl.: 16

Prior U.S. Cls.: 2, 5, 22, 23, 29, 37, 38 and 50

United States Patent and Trademark Office

Reg. No. 3,519,904

Registered Oct. 21, 2008

**TRADEMARK
PRINCIPAL REGISTER**



J. SOIF, INC. (PENNSYLVANIA CORPORATION)
15 RED ROCK LANE
CHESTER SPRINGS, PA 19425

FOR: PRINTED NOVELTY WINE LABELS, IN
CLASS 16 (U.S. CLS. 2, 5, 22, 23, 29, 37, 38 AND 50).

FIRST USE 3-1-2008; IN COMMERCE 3-1-2008.

THE COLOR(S) YELLOW, BLUE AND WHITE IS/
ARE CLAIMED AS A FEATURE OF THE MARK.

THE MARK CONSISTS OF A YELLOW RECTAN-
GLE WITH THE WORD "YELLOW" WRITTEN IN

BLUE CHARACTERS ACROSS THE CENTER OF
THE RECTANGLE. ADJACENT TO THE EAST
(RIGHT SIDE) IS A SECOND RECTANGLE IN BLUE,
CONTAINING A WHITE PLUS SYMBOL FOL-
LOWED (TO THE EAST/RIGHT) BY THE WORD
"BLUE" WRITTEN IN YELLOW CHARACTERS.
BOTH THE PLUS SYMBOL AND THE WORD
"BLUE" APPEAR ACROSS THE CENTER OF THE
SECOND RECTANGLE.

SER. NO. 77-426,989, FILED 3-20-2008.

LEIGH CAROLINE CASE, EXAMINING ATTOR-
NEY

Int. Cl.: 11

Prior U.S. Cls.: 13, 21, 23, 31 and 34

United States Patent and Trademark Office

Reg. No. 3,519,905

Registered Oct. 21, 2008

**TRADEMARK
PRINCIPAL REGISTER**

PhaseCore

FIRST LINE TECHNOLOGY, LLC (VIRGINIA
LIMITED LIABILITY COMPANY)

#4

3656 CENTERVIEW DRIVE
CHANTILLY, VA 20151

FOR: HEATING AND COOLING PACKS FILLED
WITH CHEMICAL SUBSTANCES THAT REACT
WHEN REQUIRED TO WARM OR COOL THE
BODY, IN CLASS 11 (U.S. CLS. 13, 21, 23, 31 AND 34).

FIRST USE 6-1-2006; IN COMMERCE 6-1-2006.

THE MARK CONSISTS OF STANDARD CHAR-
ACTERS WITHOUT CLAIM TO ANY PARTICULAR
FONT, STYLE, SIZE, OR COLOR.

SER. NO. 77-427,029, FILED 3-20-2008.

MARY ROSSMAN, EXAMINING ATTORNEY

Int. Cl.: 35

Prior U.S. Cls.: 100, 101 and 102

United States Patent and Trademark Office

Reg. No. 3,519,906

Registered Oct. 21, 2008

**SERVICE MARK
PRINCIPAL REGISTER**

SCARDANA

SCARDANA CORPORATION CANADA LTD.
(CANADA CORPORATION)
123 CHURCHILL STREET
GREENFIELD PARK, CANADA J4V2MI

THE MARK CONSISTS OF STANDARD CHAR-
ACTERS WITHOUT CLAIM TO ANY PARTICULAR
FONT, STYLE, SIZE, OR COLOR.

FOR: PROCUREMENT SERVICES, NAMELY,
PURCHASING MACHINERY, EQUIPMENT, ELEC-
TRICAL UTILITIES AND SPARE PARTS FOR SHIPS,
IN CLASS 35 (U.S. CLS. 100, 101 AND 102).

SER. NO. 77-427,057, FILED 3-20-2008.

FIRST USE 12-31-1974; IN COMMERCE 6-30-1984.

LINDA ESTRADA, EXAMINING ATTORNEY

Int. Cl.: 25

Prior U.S. Cls.: 22 and 39

United States Patent and Trademark Office

Reg. No. 3,519,907

Registered Oct. 21, 2008

**TRADEMARK
PRINCIPAL REGISTER**

RIOUXLETTE

KANTROWICH, ALISON (UNITED STATES IN-
DIVIDUAL)

#16

5050 ROMAINE STREET
LOS ANGELES, CA 90029

THE MARK CONSISTS OF STANDARD CHAR-
ACTERS WITHOUT CLAIM TO ANY PARTICULAR
FONT, STYLE, SIZE, OR COLOR.

FOR: GLOVES; HATS; HOODED PULLOVERS;
JACKETS; SCARVES; SHIRTS; UNDERWEAR, IN
CLASS 25 (U.S. CLS. 22 AND 39).

SER. NO. 77-427,070, FILED 3-20-2008.

FIRST USE 2-28-2008; IN COMMERCE 3-1-2008.

DAVID YONTEF, EXAMINING ATTORNEY

Int. Cl.: 1

Prior U.S. Cls.: 1, 5, 6, 10, 26 and 46

Reg. No. 3,519,908

United States Patent and Trademark Office

Registered Oct. 21, 2008

**TRADEMARK
PRINCIPAL REGISTER**

SILCARB

PAMAS & COMPANY, INC. (PENNSYLVANIA
CORPORATION)
707 EAGLEVIEW ROAD
EXTON, PA 19341

FOR: NITRIDE-BONDED SILICON CARBIDE
COMPOSITE FOR MANUFACTURE OF SIDEWALL
BLOCKS FOR USE IN LINING POTS IN ALUMI-
NUM SMELTERS, IN CLASS 1 (U.S. CLS. 1, 5, 6, 10, 26
AND 46).

FIRST USE 0-0-1994; IN COMMERCE 0-0-1994.

THE MARK CONSISTS OF STANDARD CHAR-
ACTERS WITHOUT CLAIM TO ANY PARTICULAR
FONT, STYLE, SIZE, OR COLOR.

SER. NO. 77-427,071, FILED 3-20-2008.

IRA J. GOODSaid, EXAMINING ATTORNEY

Int. Cl.: 42

Prior U.S. Cls.: 100 and 101

United States Patent and Trademark Office

Reg. No. 3,519,909

Registered Oct. 21, 2008

**SERVICE MARK
PRINCIPAL REGISTER**



DIANNA L. HUND (UNITED STATES INDIVIDUAL)
25011 MAMMOTH CIRCLE
LAKE FOREST, CA 92630

FOR: DIGITAL TRANSFER SERVICES FOR TRANSFERRING HOME VIDEOS AND FILM ON OLD MEDIA TO DVD AND CD, IN CLASS 42 (U.S. CLS. 100 AND 101).

FIRST USE 3-15-2006; IN COMMERCE 4-1-2006.

NO CLAIM IS MADE TO THE EXCLUSIVE RIGHT TO USE "BEST DVD SOLUTIONS", APART FROM THE MARK AS SHOWN.

THE COLOR(S) PURPLE, LAVENDER, GOLD, WHITE, BLACK, MAGENTA AND GREEN IS/ARE CLAIMED AS A FEATURE OF THE MARK.

THE MARK CONSISTS OF THE WORDS "BEST DVD SOLUTIONS" IN PURPLE AND LAVENDER AROUND A STYLIZED THREE-DIMENSIONAL GOLD DISK WITH A WHITE AND BLACK CENTER AND GRADIENT HIGHLIGHTS OF MAGENTA, PURPLE AND GREEN EMANATING FROM THE CENTER ACROSS THE DISK.

SER. NO. 77-427,073, FILED 3-20-2008.

DAVID YONTEF, EXAMINING ATTORNEY

Int. Cl.: 28

Prior U.S. Cls.: 22, 23, 38 and 50

United States Patent and Trademark Office

Reg. No. 3,519,910

Registered Oct. 21, 2008

**TRADEMARK
PRINCIPAL REGISTER**

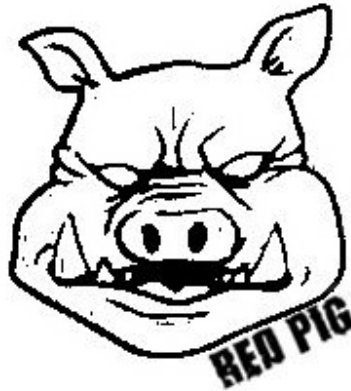

WILLIAMS, BRANT (UNITED STATES INDIVIDUAL)
810 SATURN STREET, SUITE 23
JUPITER, FL 33477

THE MARK CONSISTS OF A PIG'S FACE WITH THE WORDS "RED PIG" UNDER THE LOWER LEFT PORTION OF THE PIG'S FACE.

FOR: FISHING RODS; FISHING REELS, IN CLASS 28 (U.S. CLS. 22, 23, 38 AND 50).

SER. NO. 77-427,080, FILED 3-20-2008.

FIRST USE 11-1-2007; IN COMMERCE 11-1-2007.

MATTHEW PAPPAS, EXAMINING ATTORNEY

Int. Cl.: 16

Prior U.S. Cls.: 2, 5, 22, 23, 29, 37, 38 and 50

Reg. No. 3,519,911

United States Patent and Trademark Office

Registered Oct. 21, 2008

**TRADEMARK
PRINCIPAL REGISTER**

INDEPENDENT SCHOOL

NATIONAL ASSOCIATION OF INDEPENDENT
SCHOOLS (MASSACHUSETTS CORPORATION)
1620 L STREET, N.W., SUITE 1100
WASHINGTON, DC 200365695

FOR: MAGAZINES FEATURING INFORMATION IN THE FIELD OF ELEMENTARY AND SECONDARY EDUCATION , IN CLASS 16 (U.S. CLS. 2, 5, 22, 23, 29, 37, 38 AND 50).

FIRST USE 10-0-1976; IN COMMERCE 10-0-1976.

THE MARK CONSISTS OF STANDARD CHARACTERS WITHOUT CLAIM TO ANY PARTICULAR FONT, STYLE, SIZE, OR COLOR.

SEC. 2(F).

SER. NO. 77-427,092, FILED 3-20-2008.

KAELIE KUNG, EXAMINING ATTORNEY

Int. Cl.: 1

Prior U.S. Cls.: 1, 5, 6, 10, 26 and 46

Reg. No. 3,519,912

United States Patent and Trademark Office

Registered Oct. 21, 2008

**TRADEMARK
PRINCIPAL REGISTER**

SILGRAPH

PAMAS & COMPANY, INC. (PENNSYLVANIA
CORPORATION)
707 EAGLEVIEW ROAD
EXTON, PA 19341

FOR: SILICON CARBIDE AND GRAPHITE COM-
POSITE FOR MANUFACTURE OF SIDEWALL
BLOCKS FOR USE IN LINING POTS IN ALUMI-
NUM SMELTERS, IN CLASS 1 (U.S. CLS. 1, 5, 6, 10, 26
AND 46).

FIRST USE 0-0-1994; IN COMMERCE 0-0-1994.

THE MARK CONSISTS OF STANDARD CHAR-
ACTERS WITHOUT CLAIM TO ANY PARTICULAR
FONT, STYLE, SIZE, OR COLOR.

SER. NO. 77-427,097, FILED 3-20-2008.

IRA J. GOODSaid, EXAMINING ATTORNEY

Int. Cl.: 37

Prior U.S. Cls.: 100, 103 and 106

United States Patent and Trademark Office

Reg. No. 3,519,913

Registered Oct. 21, 2008

**SERVICE MARK
PRINCIPAL REGISTER**

FOCUS 180

COVERALL NORTH AMERICA, INC. (DELA-
WARE CORPORATION)
5201 CONGRESS AVENUE
BOCA RATON, FL 33487

THE MARK CONSISTS OF STANDARD CHAR-
ACTERS WITHOUT CLAIM TO ANY PARTICULAR
FONT, STYLE, SIZE, OR COLOR.

FOR: MAINTENANCE AND CLEANING OF OF-
FICES AND OTHER COMMERCIAL BUILDINGS,
IN CLASS 37 (U.S. CLS. 100, 103 AND 106).

SER. NO. 77-427,100, FILED 3-20-2008.

FIRST USE 0-0-2001; IN COMMERCE 0-0-2001.

BENJAMIN OKEKE, EXAMINING ATTORNEY

Int. Cl.: 32

Prior U.S. Cls.: 45, 46 and 48

United States Patent and Trademark Office

Reg. No. 3,519,914

Registered Oct. 21, 2008

**TRADEMARK
PRINCIPAL REGISTER**



SANPELLEGRINO S.P.A. (ITALY SOCIETÀ PER
AZIONI (SPA))
VIA LODOVICO IL MORO, 35
20143 MILANO, ITALY

FOR: SPARKLING FRUIT BEVERAGES, IN
CLASS 32 (U.S. CLS. 45, 46 AND 48).

FIRST USE 10-30-2007; IN COMMERCE 10-30-2007.

OWNER OF U.S. REG. NOS. 692,142, 2,232,355 AND
OTHERS.

THE COLOR(S) BLUE, WHITE AND RED IS/ARE
CLAIMED AS A FEATURE OF THE MARK.

THE MARK CONSISTS OF A ROUNDED SHAPE
EDGED IN DARK BLUE AND WHITE WITH SAN
PELLEGRINO IN DARK BLUE AND A RED STAR
ABOVE THE WORDS ON A BLUE AND WHITE
PATTERNED BACKGROUND.

SER. NO. 77-427,106, FILED 3-20-2008.

PATRICIA EVANKO, EXAMINING ATTORNEY

Int. Cl.: 37

Prior U.S. Cls.: 100, 103 and 106

United States Patent and Trademark Office

Reg. No. 3,519,915

Registered Oct. 21, 2008

**SERVICE MARK
PRINCIPAL REGISTER**

C.A.R.E.

COVERALL NORTH AMERICA, INC. (DELA-
WARE CORPORATION)
5201 CONGRESS AVENUE
BOCA RATON, FL 33487

THE MARK CONSISTS OF STANDARD CHAR-
ACTERS WITHOUT CLAIM TO ANY PARTICULAR
FONT, STYLE, SIZE, OR COLOR.

FOR: MAINTENANCE AND CLEANING OF OF-
FICES AND COMMERCIAL BUILDINGS, IN CLASS
37 (U.S. CLS. 100, 103 AND 106).

SER. NO. 77-427,113, FILED 3-20-2008.

FIRST USE 0-0-2001; IN COMMERCE 0-0-2001.

BENJAMIN OKEKE, EXAMINING ATTORNEY

Int. Cl.: 18

Prior U.S. Cls.: 1, 2, 3, 22 and 41

United States Patent and Trademark Office

Reg. No. 3,519,916

Registered Oct. 21, 2008

**TRADEMARK
PRINCIPAL REGISTER**

RAIN OR SHINE

PEGGY LEEVE UMBRELLAS, INC. (NEW YORK
CORPORATION)
RAIN OR SHINE 18 WEST 55TH STREET
NEW YORK, NY 10019

FOR: UMBRELLAS; PARASOLS, IN CLASS 18
(U.S. CLS. 1, 2, 3, 22 AND 41).

FIRST USE 1-2-2001; IN COMMERCE 5-3-2004.

THE MARK CONSISTS OF STANDARD CHAR-
ACTERS WITHOUT CLAIM TO ANY PARTICULAR
FONT, STYLE, SIZE, OR COLOR.

OWNER OF U.S. REG. NO. 3,067,488.

SER. NO. 77-427,157, FILED 3-20-2008.

TEJBIR SINGH, EXAMINING ATTORNEY

Int. Cl.: 41

Prior U.S. Cls.: 100, 101 and 107

United States Patent and Trademark Office

Reg. No. 3,519,917

Registered Oct. 21, 2008

**SERVICE MARK
PRINCIPAL REGISTER**

SPEECHLESS

THE INSPIRATIONAL NETWORK, INC. (NORTH
CAROLINA NON-PROFIT CORPORATION)
CITY OF LIGHT
3000 WORLDREACH DRIVE
INDIAN LAND, SC 29707

FOR: ENTERTAINMENT SERVICES, NAMELY, A
TELEVISION PROGRAMMING SERIES REGARD-
ING RELIGIOUS TOPICS, IN CLASS 41 (U.S. CLS.
100, 101 AND 107).

FIRST USE 3-1-2008; IN COMMERCE 3-1-2008.

THE MARK CONSISTS OF STANDARD CHAR-
ACTERS WITHOUT CLAIM TO ANY PARTICULAR
FONT, STYLE, SIZE, OR COLOR.

SER. NO. 77-427,159, FILED 3-20-2008.

G. MAYERSCHOFF, EXAMINING ATTORNEY

Int. Cl.: 43

Prior U.S. Cls.: 100 and 101

United States Patent and Trademark Office

Reg. No. 3,519,918

Registered Oct. 21, 2008

**SERVICE MARK
PRINCIPAL REGISTER**

SOLDIER ON

UNITED VETERANS OF AMERICA, INC. (MAS-
SACHUSETTS CORPORATION)
421 NORTH MAIN STREET, BUILDING 6
LEEDS, MA 01053

FOR: PROVIDING TEMPORARY HOUSING AC-
COMMODATIONS FOR VETERANS WHO ARE
HOMELESS OR AT RISK OF HOMELESSNESS, IN
CLASS 43 (U.S. CLS. 100 AND 101).

FIRST USE 11-28-2007; IN COMMERCE 11-28-2007.

THE MARK CONSISTS OF STANDARD CHAR-
ACTERS WITHOUT CLAIM TO ANY PARTICULAR
FONT, STYLE, SIZE, OR COLOR.

SER. NO. 77-427,189, FILED 3-20-2008.

NICHOLAS COLEMAN, EXAMINING ATTORNEY

Int. Cls.: 38 and 42

Prior U.S. Cls.: 100, 101 and 104

United States Patent and Trademark Office

Reg. No. 3,519,919

Registered Oct. 21, 2008

**SERVICE MARK
PRINCIPAL REGISTER**

DIMDIM

DIMDIM INC. (DELAWARE CORPORATION)
8 TINKHAM AVENUE
BURLINGTON, MA 01803

FOR: WEB CONFERENCING SERVICES, IN
CLASS 38 (U.S. CLS. 100, 101 AND 104).

FIRST USE 8-5-2006; IN COMMERCE 8-5-2006.

FOR: COMPUTER SERVICES, NAMELY, HOST-
ING ON-LINE WEB FACILITIES FOR OTHERS FOR
ORGANIZING AND CONDUCTING ON-LINE
MEETINGS, GATHERINGS, AND INTERACTIVE
DISCUSSIONS; TECHNICAL SUPPORT SERVICES,

NAMELY, MONITORING AND TROUBLESHOOT-
ING OF NETWORK SYSTEMS AND COMPUTER
SOFTWARE PROBLEMS, IN CLASS 42 (U.S. CLS. 100
AND 101).

FIRST USE 8-5-2006; IN COMMERCE 8-5-2006.

THE MARK CONSISTS OF STANDARD CHAR-
ACTERS WITHOUT CLAIM TO ANY PARTICULAR
FONT, STYLE, SIZE, OR COLOR.

SER. NO. 77-427,210, FILED 3-20-2008.

JAY FLOWERS, EXAMINING ATTORNEY

Int. Cl.: 37

Prior U.S. Cls.: 100, 103 and 106

United States Patent and Trademark Office

Reg. No. 3,519,920

Registered Oct. 21, 2008

**SERVICE MARK
PRINCIPAL REGISTER**

EXHS

H.O.M.E., INC (EXECUTIVE HOME SERVICES)
(INDIANA CORPORATION)
132 W. CARMEL DRIVE
CARMEL, IN 46032

THE MARK CONSISTS OF STANDARD CHAR-
ACTERS WITHOUT CLAIM TO ANY PARTICULAR
FONT, STYLE, SIZE, OR COLOR.

FOR: CLEANING OF RESIDENTIAL HOUSES,
CARPET CLEANING AND WINDOW CLEANING,
IN CLASS 37 (U.S. CLS. 100, 103 AND 106).

SER. NO. 77-427,214, FILED 3-20-2008.

FIRST USE 1-1-2002; IN COMMERCE 1-1-2002.

MAYUR VAGHANI, EXAMINING ATTORNEY

Int. Cl.: 41

Prior U.S. Cls.: 100, 101 and 107

United States Patent and Trademark Office

Reg. No. 3,519,921

Registered Oct. 21, 2008

**SERVICE MARK
PRINCIPAL REGISTER**

GRIPTIONARY

MATTHEWS STUDIO EQUIPMENT, INC. (CALIFORNIA CORPORATION)
2405 EMPIRE AVENUE
BURBANK, CA 91504

FOR: PROVIDING AN ONLINE NON-DOWNLOADABLE ELECTRONIC GLOSSARY OF TERMS AND IDENTIFYING IMAGES FOR USE IN STUDIO AND NON-STUDIO LIGHTING, PHOTOGRAPHY AND MOTION PICTURE INDUSTRY, IN CLASS 41 (U.S. CLS. 100, 101 AND 107).

FIRST USE 12-1-1998; IN COMMERCE 12-1-1998.

THE MARK CONSISTS OF STANDARD CHARACTERS WITHOUT CLAIM TO ANY PARTICULAR FONT, STYLE, SIZE, OR COLOR.

SER. NO. 77-427,241, FILED 3-20-2008.

MAYUR VAGHANI, EXAMINING ATTORNEY

Int. Cl.: 42

Prior U.S. Cls.: 100 and 101

United States Patent and Trademark Office

Reg. No. 3,519,922

Registered Oct. 21, 2008

**SERVICE MARK
PRINCIPAL REGISTER**

**HALL ENVIRONMENTAL
ANALYSIS LABORATORY**

HALL ENVIRONMENTAL ANALYSIS LABORA-
TORY INC. (NEW MEXICO CORPORATION)
4901 HAWKINS NE
ALBUQUERQUE, NM 87109

FOR: LABORATORY SERVICES, NAMELY, EN-
VIRONMENTAL ANALYSIS OF WATER, WASTE-
WATER, SOIL, SOLID WASTES, AIR, AND
CONTAMINANTS, IN CLASS 42 (U.S. CLS. 100
AND 101).

FIRST USE 5-0-1991; IN COMMERCE 5-0-1991.

THE MARK CONSISTS OF STANDARD CHAR-
ACTERS WITHOUT CLAIM TO ANY PARTICULAR
FONT, STYLE, SIZE, OR COLOR.

NO CLAIM IS MADE TO THE EXCLUSIVE
RIGHT TO USE "ENVIRONMENTAL ANALYSIS
LABORATORY", APART FROM THE MARK AS
SHOWN.

SER. NO. 77-427,264, FILED 3-20-2008.

JUDITH HELFMAN, EXAMINING ATTORNEY

Int. Cl.: 36

Prior U.S. Cls.: 100, 101 and 102

United States Patent and Trademark Office

Reg. No. 3,519,923

Registered Oct. 21, 2008

**SERVICE MARK
PRINCIPAL REGISTER**

**Sallie Mae Dental School
Loans**

SALLIE MAE, INC. (DELAWARE CORPORATION)
12061 BLUEMONT WAY
RESTON, VA 20190

FOR: STUDENT LOAN SERVICES, IN CLASS 36
(U.S. CLS. 100, 101 AND 102).

FIRST USE 3-20-2008; IN COMMERCE 3-20-2008.

THE MARK CONSISTS OF STANDARD CHARACTERS WITHOUT CLAIM TO ANY PARTICULAR FONT, STYLE, SIZE, OR COLOR.

OWNER OF U.S. REG. NOS. 1,337,128, 3,271,420
AND OTHERS.

NO CLAIM IS MADE TO THE EXCLUSIVE
RIGHT TO USE "DENTAL SCHOOL LOANS",
APART FROM THE MARK AS SHOWN.

SER. NO. 77-427,266, FILED 3-20-2008.

EUGENIA MARTIN, EXAMINING ATTORNEY

Int. Cl.: 33

Prior U.S. Cls.: 47 and 49

United States Patent and Trademark Office

Reg. No. 3,519,924

Registered Oct. 21, 2008

**TRADEMARK
PRINCIPAL REGISTER**

B & G

BARTON & GUESTIER (FRANCE SOCIÉTÉ PAR
ACTIONS SIMPLIFIÉE (SAS))
CHATEAU MAGNOL 87 RUE DU DEHEZ
BLANQUEFORT, FRANCE 33290

FOR: ALCOHOLIC BEVERAGES, NAMELY,
WINES, IN CLASS 33 (U.S. CLS. 47 AND 49).

FIRST USE 0-0-1932; IN COMMERCE 0-0-1932.

THE MARK CONSISTS OF STANDARD CHAR-
ACTERS WITHOUT CLAIM TO ANY PARTICULAR
FONT, STYLE, SIZE, OR COLOR.

OWNER OF U.S. REG. NOS. 1,697,913, 1,977,965
AND OTHERS.

SER. NO. 77-427,285, FILED 3-20-2008.

JAMES LOVELACE, EXAMINING ATTORNEY

Int. Cl.: 41

Prior U.S. Cls.: 100, 101 and 107

United States Patent and Trademark Office

Reg. No. 3,519,925

Registered Oct. 21, 2008

**SERVICE MARK
PRINCIPAL REGISTER**

VIDL

INTEGRATED GEOPHYSICS CORPORATION
(TEXAS CORPORATION)
3131 W. ALABAMA, SUITE 120
HOUSTON, TX 77098

THE MARK CONSISTS OF STANDARD CHAR-
ACTERS WITHOUT CLAIM TO ANY PARTICULAR
FONT, STYLE, SIZE, OR COLOR.

FOR: PROVIDING ON-LINE, VIRTUAL DIGITAL
LIBRARY, IN CLASS 41 (U.S. CLS. 100, 101 AND 107).

SER. NO. 77-427,310, FILED 3-20-2008.

FIRST USE 8-0-2002; IN COMMERCE 8-0-2002.

EMILY CARLSEN, EXAMINING ATTORNEY

Int. Cl.: 36

Prior U.S. Cls.: 100, 101 and 102

United States Patent and Trademark Office

Reg. No. 3,519,926

Registered Oct. 21, 2008

**SERVICE MARK
PRINCIPAL REGISTER**

Sallie Mae Law School Loans

SALLIE MAE, INC. (DELAWARE CORPORATION)
12061 BLUEMONT WAY
RESTON, VA 20190

OWNER OF U.S. REG. NOS. 1,337,128, 3,271,420
AND OTHERS.

FOR: STUDENT LOAN SERVICES, IN CLASS 36
(U.S. CLS. 100, 101 AND 102).

NO CLAIM IS MADE TO THE EXCLUSIVE
RIGHT TO USE "LAW SCHOOL LOANS", APART
FROM THE MARK AS SHOWN.

FIRST USE 3-20-2008; IN COMMERCE 3-20-2008.

SER. NO. 77-427,313, FILED 3-20-2008.

THE MARK CONSISTS OF STANDARD CHARACTERS
WITHOUT CLAIM TO ANY PARTICULAR
FONT, STYLE, SIZE, OR COLOR.

EUGENIA MARTIN, EXAMINING ATTORNEY

Int. Cl.: 41

Prior U.S. Cls.: 100, 101 and 107

United States Patent and Trademark Office

Reg. No. 3,519,927

Registered Oct. 21, 2008

**SERVICE MARK
PRINCIPAL REGISTER**

SILENCING THE CHRISTIANS

INSPIRATIONAL NETWORK, INC., THE
(NORTH CAROLINA NON-PROFIT COR-
PORATION)
CITY OF LIGHT
3000 WORLDREACH DRIVE
INDIAN LAND, SC 29707

FOR: ENTERTAINMENT SERVICES, NAMELY, A
TELEVISION PROGRAMMING SERIES REGARD-
ING RELIGIOUS TOPICS, IN CLASS 41 (U.S. CLS.
100, 101 AND 107).

FIRST USE 3-1-2008; IN COMMERCE 3-1-2008.

THE MARK CONSISTS OF STANDARD CHAR-
ACTERS WITHOUT CLAIM TO ANY PARTICULAR
FONT, STYLE, SIZE, OR COLOR.

SER. NO. 77-427,323, FILED 3-20-2008.

G. MAYERSCHOFF, EXAMINING ATTORNEY

Int. Cl.: 36

Prior U.S. Cls.: 100, 101 and 102

United States Patent and Trademark Office

Reg. No. 3,519,928

Registered Oct. 21, 2008

**SERVICE MARK
PRINCIPAL REGISTER**

**SALLIE MAE MEDICAL SCHOOL
LOANS**

SALLIE MAE, INC. (VIRGINIA CORPORATION)
12061 BLUEMONT WAY
RESTON, VA 20190

OWNER OF U.S. REG. NOS. 1,337,128, 3,271,420
AND OTHERS.

FOR: STUDENT LOAN SERVICES, IN CLASS 36
(U.S. CLS. 100, 101 AND 102).

NO CLAIM IS MADE TO THE EXCLUSIVE
RIGHT TO USE "MEDICAL SCHOOL LOANS",
APART FROM THE MARK AS SHOWN.

FIRST USE 3-20-2008; IN COMMERCE 3-20-2008.

SER. NO. 77-427,331, FILED 3-20-2008.

THE MARK CONSISTS OF STANDARD CHAR-
ACTERS WITHOUT CLAIM TO ANY PARTICULAR
FONT, STYLE, SIZE, OR COLOR.

EUGENIA MARTIN, EXAMINING ATTORNEY

Int. Cl.: 35

Prior U.S. Cls.: 100, 101 and 102

United States Patent and Trademark Office

Reg. No. 3,519,929

Registered Oct. 21, 2008

**SERVICE MARK
PRINCIPAL REGISTER**



MICROVU, LLC (ARIZONA LIMITED LIABILITY COMPANY)
9495 EAST SAN SALVADOR DRIVE STE 105
SCOTTSDALE, AZ 85259

FOR: ADMINISTRATION OF A DISCOUNT PROGRAM FOR ENABLING PARTICIPANTS TO OBTAIN DISCOUNTS ON GOODS AND SERVICES THROUGH USE OF A DISCOUNT MEMBERSHIP CARD, IN CLASS 35 (U.S. CLS. 100, 101 AND 102).

FIRST USE 3-12-2008; IN COMMERCE 3-17-2008.

NO CLAIM IS MADE TO THE EXCLUSIVE RIGHT TO USE "EMPLOYEE DIRECT DISCOUNT MEDICAL CARD", APART FROM THE MARK AS SHOWN.

THE COLOR(S) DARK BLUE, LIGHT BLUE, TEAL, AND GREY IS/ARE CLAIMED AS A FEATURE OF THE MARK.

THE MARK CONSISTS OF THE WORDS EMPLOYEE DIRECT IN LARGE, BOLD LETTERING COLORED DARK BLUE. THE WORDS DISCOUNT MEDICAL CARD IN MEDIUM BLUE BELOW THE WORDS EMPLOYEE DIRECT. TWO HALF CIRCLES WITH ARROWS ON ONE END WRAPPING AROUND THE FIRST THREE LETTERS OF EMPLOYEE, COLORED TEAL WITH A GREY SHADOW.

SER. NO. 77-427,344, FILED 3-20-2008.

GINA FINK, EXAMINING ATTORNEY

Int. Cl.: 11

Prior U.S. Cls.: 13, 21, 23, 31 and 34

United States Patent and Trademark Office

Reg. No. 3,519,930

Registered Oct. 21, 2008

**TRADEMARK
PRINCIPAL REGISTER**

NORDICPURE

NORDIC PLUS, INC. (TEXAS CORPORATION),
DBA NORDICPURE
2500 N. LOUISIANA ST.
CELINA, TX 75009

THE MARK CONSISTS OF STANDARD CHAR-
ACTERS WITHOUT CLAIM TO ANY PARTICULAR
FONT, STYLE, SIZE, OR COLOR.

FOR: AIR FILTERS FOR DOMESTIC USE, IN
CLASS 11 (U.S. CLS. 13, 21, 23, 31 AND 34).

SER. NO. 77-427,382, FILED 3-20-2008.

FIRST USE 1-0-2004; IN COMMERCE 1-0-2004.

WENDY GOODMAN, EXAMINING ATTORNEY

Int. Cl.: 42

Prior U.S. Cls.: 100 and 101

United States Patent and Trademark Office

Reg. No. 3,519,931

Registered Oct. 21, 2008

**SERVICE MARK
PRINCIPAL REGISTER**

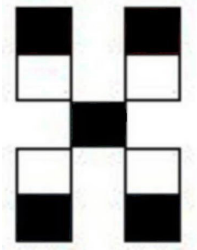

HALL ENVIRONMENTAL ANALYSIS LABORATORY INC. (NEW MEXICO CORPORATION)
4901 HAWKINS NE
ALBUQUERQUE, NM 87109

FOR: LABORATORY SERVICES, NAMELY, ENVIRONMENTAL ANALYSIS OF WATER, WASTEWATER, SOIL, SOLID WASTES, AIR, AND CONTAMINANTS, IN CLASS 42 (U.S. CLS. 100 AND 101).

FIRST USE 5-0-1991; IN COMMERCE 5-0-1991.

THE MARK CONSISTS OF A STYLIZED "H" COMPRISED OF FIVE RECTANGLES, WITH EACH RECTANGULAR LEG DIVIDED INTO AN UPPER AND LOWER SECTION. THE CENTER OF THE "H" AND THE OUTERMOST SECTIONS OF THE LEGS ARE FULLY SHADED.

SER. NO. 77-427,391, FILED 3-20-2008.

JUDITH HELFMAN, EXAMINING ATTORNEY

Int. Cl.: 41

Prior U.S. Cls.: 100, 101 and 107

United States Patent and Trademark Office

Reg. No. 3,519,932

Registered Oct. 21, 2008

**SERVICE MARK
PRINCIPAL REGISTER**

**NDNQI Award for
Outstanding Nursing Quality**

AMERICAN NURSES ASSOCIATION (D.C. CORPORATION)
SUITE 400
8515 GEORGIA AVENUE
SILVER SPRING, MD 20910

FOR: PROVIDING RECOGNITION AND INCENTIVES BY THE WAY OF AWARDS TO DEMONSTRATE EXCELLENCE IN THE FIELD OF NURSING BY HOSPITALS THAT HAVE ACHIEVED SUSTAINED OVERALL EXCELLENCE IN NURSING-SENSITIVE QUALITY INDICATORS, INCLUDING RN SATISFACTION, PATIENT OUTCOMES AND NURSE STAFFING, IN CLASS 41 (U.S. CLS. 100, 101 AND 107).

FIRST USE 1-30-2008; IN COMMERCE 1-30-2008.

THE MARK CONSISTS OF STANDARD CHARACTERS WITHOUT CLAIM TO ANY PARTICULAR FONT, STYLE, SIZE, OR COLOR.

OWNER OF U.S. REG. NO. 2,804,641.

NO CLAIM IS MADE TO THE EXCLUSIVE RIGHT TO USE "AWARD FOR OUTSTANDING NURSING QUALITY", APART FROM THE MARK AS SHOWN.

SER. NO. 77-427,446, FILED 3-20-2008.

MONIQUE MILLER, EXAMINING ATTORNEY

Int. Cl.: 41

Prior U.S. Cls.: 100, 101 and 107

United States Patent and Trademark Office

Reg. No. 3,519,933

Registered Oct. 21, 2008

**SERVICE MARK
PRINCIPAL REGISTER**

BADFISH

BADFISH, INC. (RHODE ISLAND CORPORATION)
C/O JOEL HANKS P.O. BOX 3215
NARRAGANSETT, RI 02882

FOR: ENTERTAINMENT SERVICES IN THE NATURE OF LIVE MUSICAL PERFORMANCES; ENTERTAINMENT, NAMELY, LIVE MUSIC CONCERTS; ENTERTAINMENT, NAMELY, LIVE PERFORMANCES BY A MUSICAL BAND; ENTERTAINMENT, NAMELY, LIVE PERFORMANCES BY ROCK GROUPS, IN CLASS 41 (U.S. CLS. 100, 101 AND 107).

FIRST USE 8-17-1996; IN COMMERCE 8-17-1996.

THE MARK CONSISTS OF STANDARD CHARACTERS WITHOUT CLAIM TO ANY PARTICULAR FONT, STYLE, SIZE, OR COLOR.

SER. NO. 77-427,455, FILED 3-20-2008.

BRIAN NEVILLE, EXAMINING ATTORNEY

Int. Cl.: 33

Prior U.S. Cls.: 47 and 49

United States Patent and Trademark Office

Reg. No. 3,519,934

Registered Oct. 21, 2008

TRADEMARK
PRINCIPAL REGISTER

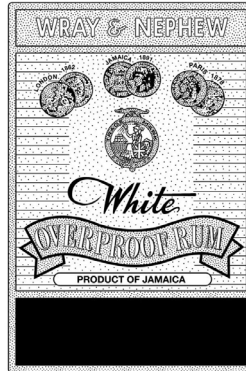

J. WRAY & NEPHEW LIMITED (JAMAICA CORPORATION)
234 SPANISH TOWN ROAD
KINGSTON 11, JAMAICA

FOR: ALCOHOLIC BEVERAGES EXCLUDING BEER, IN CLASS 33 (U.S. CLS. 47 AND 49).

FIRST USE 9-7-1962; IN COMMERCE 10-10-1962.

OWNER OF U.S. REG. NO. 771,648.

NO CLAIM IS MADE TO THE EXCLUSIVE RIGHT TO USE "WHITE OVERPROOF RUM", "PRODUCT OF JAMAICA", "LONDON, 1862", "JAMAICA, 1891", "PARIS, 1878", AND "TRADE MARK", APART FROM THE MARK AS SHOWN.

THE STIPPLING IS FOR SHADING PURPOSES ONLY.

SER. NO. 77-427,471, FILED 3-20-2008.

DANNEAN HETZEL, EXAMINING ATTORNEY

Int. Cl.: 35

Prior U.S. Cls.: 100, 101 and 102

United States Patent and Trademark Office

Reg. No. 3,519,935

Registered Oct. 21, 2008

**SERVICE MARK
PRINCIPAL REGISTER**

medicallyours

MIDWEST MOBILITY SOLUTIONS, INC. (IOWA CORPORATION)
2212 INGERSOLL AVENUE
DES MOINES, IA 50312

FOR: RETAIL STORE SERVICES FEATURING MEDICAL EQUIPMENT, IN CLASS 35 (U.S. CLS. 100, 101 AND 102).

FIRST USE 12-21-2007; IN COMMERCE 12-21-2007.

THE MARK CONSISTS OF STANDARD CHARACTERS WITHOUT CLAIM TO ANY PARTICULAR FONT, STYLE, SIZE, OR COLOR.

OWNER OF U.S. REG. NO. 2,317,830.

SER. NO. 77-427,500, FILED 3-20-2008.

HOWARD FRIEDMAN, EXAMINING ATTORNEY

Int. Cl.: 25

Prior U.S. Cls.: 22 and 39

United States Patent and Trademark Office

Reg. No. 3,519,936

Registered Oct. 21, 2008

**TRADEMARK
PRINCIPAL REGISTER**



GLAMOUR CAMPAIGN, INC. (CALIFORNIA
CORPORATION)

#103

1840 BUTLER AVE
LOS ANGELES, CA 90025

FOR: HOODED SWEAT SHIRTS; BLAZERS;
PANTS; COATS; HATS; DRESSES; LINGERIE;
SHORTS, IN CLASS 25 (U.S. CLS. 22 AND 39).

FIRST USE 6-1-2006; IN COMMERCE 6-1-2006.

THE MARK CONSISTS OF A STYLIZED SKULL.

SER. NO. 77-427,562, FILED 3-20-2008.

ARETHA SOMERVILLE, EXAMINING ATTORNEY

Int. Cl.: 10

Prior U.S. Cls.: 26, 39 and 44

United States Patent and Trademark Office

Reg. No. 3,519,937

Registered Oct. 21, 2008

**TRADEMARK
PRINCIPAL REGISTER**

IN THE GROOVE

IN THE GROOVE, L.L.C. (MICHIGAN LIMITED
LIABILITY COMPANY)
7600 MADELINE STREET
SAGINAW, MI 48609

THE MARK CONSISTS OF STANDARD CHAR-
ACTERS WITHOUT CLAIM TO ANY PARTICULAR
FONT, STYLE, SIZE, OR COLOR.

FOR: ORTHOPEDIC BRACES; BRACES FOR
LIMBS AND JOINTS, FOR MEDICAL USE; MEDI-
CAL BRACES FOR KNEES, IN CLASS 10 (U.S. CLS.
26, 39 AND 44).

SER. NO. 77-427,651, FILED 3-20-2008.

FIRST USE 2-0-2006; IN COMMERCE 2-0-2006.

FRANK LATTUCA, EXAMINING ATTORNEY

Int. Cl.: 25

Prior U.S. Cls.: 22 and 39

United States Patent and Trademark Office

Reg. No. 3,519,938

Registered Oct. 21, 2008

**TRADEMARK
PRINCIPAL REGISTER**



y o u

a r e

g o o d

LYNCH-ROUNTREE, JENNIFER (UNITED STATES INDIVIDUAL)
3201 OXSHEER DRIVE
AUSTIN, TX 78732

THE MARK CONSISTS OF THE STYLIZED SPACED WORDS "YOU ARE GOOD". EACH WORD IS DIVIDED BY A THIN LINE. ABOVE THE WORDS IS AN IMAGE OF ANGEL WINGS.

FOR: BOTTOMS; T-SHIRTS; TANK TOPS; TOPS,
IN CLASS 25 (U.S. CLS. 22 AND 39).

SER. NO. 77-427,655, FILED 3-20-2008.

FIRST USE 12-10-2007; IN COMMERCE 12-10-2007.

JIM RINGLE, EXAMINING ATTORNEY

Int. Cl.: 35

Prior U.S. Cls.: 100, 101 and 102

United States Patent and Trademark Office

Reg. No. 3,519,939

Registered Oct. 21, 2008

**SERVICE MARK
PRINCIPAL REGISTER**

REELDIGS.COM

FRIES FRAME PRODUCTIONS, INC. (ILLINOIS
CORPORATION)
881 NORTH LASALLE STREET
CHICAGO, IL 60610

FOR: REAL ESTATE MARKETING SERVICES,
NAMELY, PRODUCTION OF VIDEO HOME TOURS
FOR ACTIVE REAL ESTATE LISTINGS FOR VIEW-
ING VIA TELEVISION, INTERNET AND MOBILE
PHONES, IN CLASS 35 (U.S. CLS. 100, 101 AND 102).

FIRST USE 5-17-2007; IN COMMERCE 5-17-2007.

THE MARK CONSISTS OF STANDARD CHAR-
ACTERS WITHOUT CLAIM TO ANY PARTICULAR
FONT, STYLE, SIZE, OR COLOR.

SER. NO. 77-427,678, FILED 3-20-2008.

SAIMA MAKHDOOM, EXAMINING ATTORNEY

Int. Cl.: 35

Prior U.S. Cls.: 100, 101 and 102

United States Patent and Trademark Office

Reg. No. 3,519,940

Registered Oct. 21, 2008

**SERVICE MARK
PRINCIPAL REGISTER**



METRO TAX INC. (WISCONSIN CORPORATION), DBA METRO INCOME TAX SERVICES
3431 W. VLIET ST.
MILWAUKEE, WI 53208

FOR: INCOME TAX PREPARATION, IN CLASS 35
(U.S. CLS. 100, 101 AND 102).

FIRST USE 9-1-2007; IN COMMERCE 9-1-2007.

NO CLAIM IS MADE TO THE EXCLUSIVE
RIGHT TO USE "INCOME TAX SERVICES", APART
FROM THE MARK AS SHOWN.

THE COLOR(S) GREEN AND BLACK IS/ARE
CLAIMED AS A FEATURE OF THE MARK.

THE MARK CONSISTS OF GREEN ARCH ON
TOP, BLACK ARCH ON THE BOTTOM, THE WORD
"METRO" IN BLACK IN THE MIDDLE, "INCOME
TAX SERVICES" IN BLACK UNDER THE WORD
"METRO".

SER. NO. 77-427,828, FILED 3-20-2008.

CHRISTINE BLOMQUIST, EXAMINING ATTORNEY

Int. Cl.: 12

Prior U.S. Cls.: 19, 21, 23, 31, 35 and 44

United States Patent and Trademark Office

Reg. No. 3,519,941

Registered Oct. 21, 2008

**TRADEMARK
PRINCIPAL REGISTER**

ZAPTRUCK

ZAP (CALIFORNIA CORPORATION)
501 FOURTH STREET
SANTA ROSA, CA 95401

FOR: ELECTRIC VEHICLES, NAMELY, PASSENGER TRUCKS, IN CLASS 12 (U.S. CLS. 19, 21, 23, 31, 35 AND 44).

FIRST USE 2-3-2007; IN COMMERCE 2-3-2007.

THE MARK CONSISTS OF STANDARD CHARACTERS WITHOUT CLAIM TO ANY PARTICULAR FONT, STYLE, SIZE, OR COLOR.

OWNER OF U.S. REG. NOS. 1,794,866 AND 2,912,329.

SER. NO. 77-427,838, FILED 3-20-2008.

SHAUNIA CARLYLE, EXAMINING ATTORNEY

Int. Cl.: 9

Prior U.S. Cls.: 21, 23, 26, 36 and 38

Reg. No. 3,519,942

United States Patent and Trademark Office

Registered Oct. 21, 2008

**TRADEMARK
PRINCIPAL REGISTER**

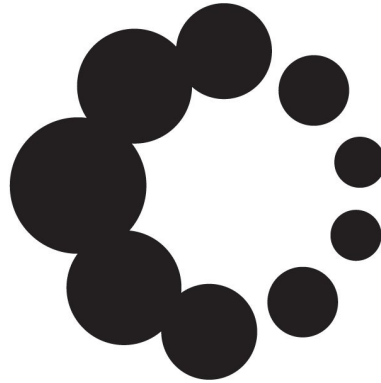

CLEVERSAFE, INC. (DELAWARE CORPORATION)
SUITE 500
224 N DESPLAINES ST
CHICAGO, IL 60661

FOR: COMPUTER HARDWARE FOR DIVIDING, DISTRIBUTING, STORING AND REASSEMBLING DIGITAL DATA; COMPUTER HARDWARE FOR MONITORING COMPUTER STORAGE DEVICES; COMPUTER SOFTWARE FOR DIVIDING, DISTRI-

BUTING, STORING AND REASSEMBLING DIGITAL DATA, IN CLASS 9 (U.S. CLS. 21, 23, 26, 36 AND 38).

FIRST USE 2-19-2008; IN COMMERCE 2-19-2008.

SER. NO. 77-427,847, FILED 3-20-2008.

MICHAEL GAAFAR, EXAMINING ATTORNEY

Int. Cl.: 35

Prior U.S. Cls.: 100, 101 and 102

United States Patent and Trademark Office

Reg. No. 3,519,943

Registered Oct. 21, 2008

**SERVICE MARK
PRINCIPAL REGISTER**

CHICKDOWNTOWN.COM

CHICK LLC (PENNSYLVANIA LIMITED LIABILITY COMPANY)

#2300

717 LIBERTY AVENUE
PITTSBURGH, PA 15222

FOR: ON-LINE RETAIL STORE SERVICES FEATURING CLOTHING; RETAIL STORES FEATURING CLOTHING, IN CLASS 35 (U.S. CLS. 100, 101 AND 102).

FIRST USE 5-15-2007; IN COMMERCE 5-15-2007.

THE MARK CONSISTS OF STANDARD CHARACTERS WITHOUT CLAIM TO ANY PARTICULAR FONT, STYLE, SIZE, OR COLOR.

SER. NO. 77-427,858, FILED 3-20-2008.

CHERYL CLAYTON, EXAMINING ATTORNEY

Int. Cl.: 9

Prior U.S. Cls.: 21, 23, 26, 36 and 38

United States Patent and Trademark Office

Reg. No. 3,519,944

Registered Oct. 21, 2008

**TRADEMARK
PRINCIPAL REGISTER**

iZAP

ZAP (CALIFORNIA CORPORATION)
501 FOURTH STREET
SANTA ROSA, CA 95401

FOR: RECHARGEABLE ELECTRIC BATTERIES,
IN CLASS 9 (U.S. CLS. 21, 23, 26, 36 AND 38).

FIRST USE 1-14-2007; IN COMMERCE 1-14-2007.

THE MARK CONSISTS OF STANDARD CHAR-
ACTERS WITHOUT CLAIM TO ANY PARTICULAR
FONT, STYLE, SIZE, OR COLOR.

OWNER OF U.S. REG. NOS. 1,794,866 AND
3,254,373.

SER. NO. 77-427,860, FILED 3-20-2008.

SHAUNIA CARLYLE, EXAMINING ATTORNEY

Int. Cl.: 42

Prior U.S. Cls.: 100 and 101

United States Patent and Trademark Office

Reg. No. 3,519,945

Registered Oct. 21, 2008

**SERVICE MARK
PRINCIPAL REGISTER**

CREATING A BRIGHTER FUTURE

JOHNSON, MIRMIRAN & THOMPSON, INC.
(MARYLAND CORPORATION)
72 LOVETON CIRCLE
SPARKS, MD 21152

FOR: ENGINEERING; ARCHITECTURAL AND
ENGINEERING SERVICES; CIVIL ENGINEERING;
DESIGN FOR OTHERS IN THE FIELD OF ENGI-
NEERING; ARCHITECTURE; INFORMATION
TECHNOLOGY CONSULTATION; CONSULTING
SERVICES IN THE FIELD OF DESIGN, SELECTION,
IMPLEMENTATION AND USE OF COMPUTER
HARDWARE AND SOFTWARE SYSTEMS FOR
OTHERS, IN CLASS 42 (U.S. CLS. 100 AND 101).

FIRST USE 11-29-2007; IN COMMERCE 1-15-2008.

THE MARK CONSISTS OF STANDARD CHAR-
ACTERS WITHOUT CLAIM TO ANY PARTICULAR
FONT, STYLE, SIZE, OR COLOR.

OWNER OF U.S. REG. NO. 2,912,944.

SER. NO. 77-427,863, FILED 3-20-2008.

MICHAEL TANNER, EXAMINING ATTORNEY

Int. Cl.: 42

Prior U.S. Cls.: 100 and 101

United States Patent and Trademark Office

Reg. No. 3,519,946

Registered Oct. 21, 2008

**SERVICE MARK
PRINCIPAL REGISTER**

REDLINE SOLUTIONS

REDLINE SOLUTIONS, INC. (NEVADA CORPORATION)
1700 WYATT DRIVE, SUITE 15
SANTA CLARA, CA 95054

FOR: SOFTWARE DEVELOPMENT AND SYSTEMS INTEGRATION SERVICES FOR WIRELESS AND MOBILE DEVICES, IN CLASS 42 (U.S. CLS. 100 AND 101).

FIRST USE 4-0-1997; IN COMMERCE 4-0-1997.

THE MARK CONSISTS OF STANDARD CHARACTERS WITHOUT CLAIM TO ANY PARTICULAR FONT, STYLE, SIZE, OR COLOR.

SER. NO. 77-427,866, FILED 3-20-2008.

ALEXANDER L. POWERS, EXAMINING ATTORNEY

Int. Cl.: 9

Prior U.S. Cls.: 21, 23, 26, 36 and 38

Reg. No. 3,519,947

United States Patent and Trademark Office

Registered Oct. 21, 2008

**TRADEMARK
PRINCIPAL REGISTER**

SLICESTOR

CLEVERSAFE, INC. (DELAWARE CORPORATION)
SUITE 500
224 N DESPLAINES ST
CHICAGO, IL 60661

THE MARK CONSISTS OF STANDARD CHARACTERS WITHOUT CLAIM TO ANY PARTICULAR FONT, STYLE, SIZE, OR COLOR.

FOR: COMPUTER HARDWARE FOR STORING DIGITAL DATA, IN CLASS 9 (U.S. CLS. 21, 23, 26, 36 AND 38).

SER. NO. 77-427,869, FILED 3-20-2008.

FIRST USE 11-6-2007; IN COMMERCE 11-6-2007.

MICHAEL GAAFAR, EXAMINING ATTORNEY

Int. Cl.: 32

Prior U.S. Cls.: 45, 46 and 48

United States Patent and Trademark Office

Reg. No. 3,519,948

Registered Oct. 21, 2008

**TRADEMARK
PRINCIPAL REGISTER**

TRES AGAVES

ROCKS NO SALT, INC. (CALIFORNIA CORPORATION)

NO. 10

199 SOUTH PARK

SAN FRANCISCO, CA 94107

FOR: NON-ALCOHOLIC BEVERAGES INTENDED TO BE MIXED WITH ALCOHOL, NAMELY, AGAVE NECTAR; SYRUP PREPARED FROM AGAVE NECTAR USED AS A BEVERAGE INGREDIENT, IN CLASS 32 (U.S. CLS. 45, 46 AND 48).

FIRST USE 1-28-2008; IN COMMERCE 1-28-2008.

THE MARK CONSISTS OF STANDARD CHARACTERS WITHOUT CLAIM TO ANY PARTICULAR FONT, STYLE, SIZE, OR COLOR.

NO CLAIM IS MADE TO THE EXCLUSIVE RIGHT TO USE "AGAVES", APART FROM THE MARK AS SHOWN.

THE ENGLISH TRANSLATION OF THE WORD "TRES" IN THE MARK IS "THREE".

SER. NO. 77-427,874, FILED 3-20-2008.

JAMES MACFARLANE, EXAMINING ATTORNEY

Int. Cl.: 33

Prior U.S. Cls.: 47 and 49

United States Patent and Trademark Office

Reg. No. 3,519,949

Registered Oct. 21, 2008

TRADEMARK
PRINCIPAL REGISTER

The image shows the trademark 'four Maxed'. The word 'four' is written in a large, bold, black, sans-serif font with a stippled texture. The word 'Maxed' is written in a smaller, black, cursive script font, positioned to the right and slightly below the end of 'four'.

PHUSION PROJECTS (DELAWARE LIMITED
LIABILITY COMPANY)

#424

1658 MILWAUKEE AVE.
CHICAGO, IL 60647

FOR: FLAVORED BREWED MALT BEVERAGE,
IN CLASS 33 (U.S. CLS. 47 AND 49).

FIRST USE 10-1-2007; IN COMMERCE 11-1-2007.

THE STIPPLING IS FOR SHADING PURPOSES
ONLY.

THE MARK CONSISTS OF THE STYLIZED TEXT
"FOUR MAXED".

SER. NO. 77-427,876, FILED 3-20-2008.

TAMARA FRAZIER, EXAMINING ATTORNEY

Int. Cl.: 42

Prior U.S. Cls.: 100 and 101

United States Patent and Trademark Office

Reg. No. 3,519,950

Registered Oct. 21, 2008

**SERVICE MARK
PRINCIPAL REGISTER**

DriveNeutral

CLIMATE CHECK CORPORATION (CANADA CORPORATION)
325 DALHOUSIE STREET
OTTAWA, CANADA K1N7G2

FOR: CONSULTING SERVICES IN THE FIELD OF ENVIRONMENTAL ASSESSMENT, COMPLIANCE AND PLANNING; PROVIDING TECHNOLOGICAL AND SCIENTIFIC INFORMATION ABOUT ENVIRONMENTALLY-CONSCIOUS AND GREEN INNOVATIONS; COMPUTER SERVICES, NAMELY, HOSTING AND MAINTAINING AN ONLINE WEB

SITE FOR OTHERS TO CALCULATE CARBON EMISSIONS, IN CLASS 42 (U.S. CLS. 100 AND 101).

FIRST USE 10-31-2005; IN COMMERCE 10-31-2005.

THE MARK CONSISTS OF STANDARD CHARACTERS WITHOUT CLAIM TO ANY PARTICULAR FONT, STYLE, SIZE, OR COLOR.

SER. NO. 77-427,880, FILED 3-20-2008.

KAREN BRACEY, EXAMINING ATTORNEY

Int. Cl.: 36

Prior U.S. Cls.: 100, 101 and 102

United States Patent and Trademark Office

Reg. No. 3,519,951

Registered Oct. 21, 2008

**SERVICE MARK
PRINCIPAL REGISTER**



THE QUERCUS TRUST (CALIFORNIA TRUST)
1835 NEWPORT BLVD., A109 - PMB 467
COSTA MESA, CA 92627

FOR: CAPITAL INVESTMENT IN THE FIELD OF DEBT AND EQUITY; FINANCIAL INVESTMENT IN THE FIELDS OF REAL ESTATE, DEBT AND EQUITY SECURITIES, DERIVATIVE SECURITIES AND OTHER INVESTMENT VEHICLES, SUCH AS PARTNERSHIP AND LIMITED LIABILITY COMPANY INTERESTS AND TRUSTS; MUTUAL FUNDS IN-

VESTMENT, IN CLASS 36 (U.S. CLS. 100, 101 AND 102).

FIRST USE 3-19-2008; IN COMMERCE 3-19-2008.

THE MARK CONSISTS OF A TREE ABOVE THE WORD "QUERCUSTRUST".

SER. NO. 77-427,881, FILED 3-20-2008.

TAMARA FRAZIER, EXAMINING ATTORNEY

Int. Cl.: 42

Prior U.S. Cls.: 100 and 101

United States Patent and Trademark Office

Reg. No. 3,519,952

Registered Oct. 21, 2008

**SERVICE MARK
PRINCIPAL REGISTER**

FlyNeutral

CLIMATE CHECK CORPORATION (CANADA CORPORATION)
325 DALHOUSIE STREET
OTTAWA, CANADA K1N7G2

FOR: CONSULTING SERVICES IN THE FIELD OF ENVIRONMENTAL ASSESSMENT, COMPLIANCE AND PLANNING; PROVIDING TECHNOLOGICAL AND SCIENTIFIC INFORMATION ABOUT ENVIRONMENTALLY-CONSCIOUS AND GREEN INNOVATIONS; COMPUTER SERVICES, NAMELY, HOSTING AND MAINTAINING AN ONLINE WEB

SITE FOR OTHERS TO CALCULATE CARBON EMISSIONS, IN CLASS 42 (U.S. CLS. 100 AND 101).

FIRST USE 5-31-2007; IN COMMERCE 5-31-2007.

THE MARK CONSISTS OF STANDARD CHARACTERS WITHOUT CLAIM TO ANY PARTICULAR FONT, STYLE, SIZE, OR COLOR.

SER. NO. 77-427,887, FILED 3-20-2008.

KAREN BRACEY, EXAMINING ATTORNEY

Int. Cl.: 9

Prior U.S. Cls.: 21, 23, 26, 36 and 38

United States Patent and Trademark Office

Reg. No. 3,519,953

Registered Oct. 21, 2008

**TRADEMARK
PRINCIPAL REGISTER**

REDLINEMOBILE

REDLINE SOLUTIONS, INC. (NEVADA CORPORATION)
1700 WYATT DRIVE, SUITE 15
SANTA CLARA, CA 95054

FOR: MOBILITY SOFTWARE APPLICATIONS
FOR SUPPLY CHAIN MANAGEMENT, IN CLASS 9
(U.S. CLS. 21, 23, 26, 36 AND 38).

FIRST USE 1-1-2005; IN COMMERCE 1-1-2005.

THE MARK CONSISTS OF STANDARD CHARACTERS WITHOUT CLAIM TO ANY PARTICULAR FONT, STYLE, SIZE, OR COLOR.

SER. NO. 77-427,889, FILED 3-20-2008.

ALEXANDER L. POWERS, EXAMINING ATTORNEY

Int. Cl.: 41

Prior U.S. Cls.: 100, 101 and 107

United States Patent and Trademark Office

Reg. No. 3,519,954

Registered Oct. 21, 2008

**SERVICE MARK
PRINCIPAL REGISTER**

great dates

ENGLISH, CYNTHIA S. (UNITED STATES INDIVIDUAL), DBA GREAT DATES
4018 FARMVIEW ROAD
KINBURN, CANADA K0A2H0

FOR: EDUCATION AND ENTERTAINMENT, NAMELY, PROVIDING INFORMATION ON-LINE REGARDING ENTERTAINMENT IDEAS FOR SPECIAL TIMES AND OUTINGS , IN CLASS 41 (U.S. CLS. 100, 101 AND 107).

FIRST USE 9-4-1998; IN COMMERCE 9-4-1998.

THE MARK CONSISTS OF STANDARD CHARACTERS WITHOUT CLAIM TO ANY PARTICULAR FONT, STYLE, SIZE, OR COLOR.

OWNER OF U.S. REG. NO. 2,469,933.

NO CLAIM IS MADE TO THE EXCLUSIVE RIGHT TO USE "DATES", APART FROM THE MARK AS SHOWN.

SER. NO. 77-427,941, FILED 3-20-2008.

H. M. FISHER, EXAMINING ATTORNEY

Int. Cl.: 44

Prior U.S. Cls.: 100 and 101

United States Patent and Trademark Office

Reg. No. 3,519,955

Registered Oct. 21, 2008

**SERVICE MARK
PRINCIPAL REGISTER**

Gravesite Masters

GRAVESITE MASTERS, LLC (KANSAS LIMITED
LIABILITY COMPANY)
7001 S CUNNINGHAM
GYPSUM, KS 67448

FOR: CEMETERY PLOT BEAUTIFICATION AND
MAINTENANCE AND CONTINUAL UPKEEP OF
FAMILY CEMETERY PLOTS, IN CLASS 44 (U.S.
CLS. 100 AND 101).

FIRST USE 3-13-2008; IN COMMERCE 3-13-2008.

THE MARK CONSISTS OF STANDARD CHAR-
ACTERS WITHOUT CLAIM TO ANY PARTICULAR
FONT, STYLE, SIZE, OR COLOR.

NO CLAIM IS MADE TO THE EXCLUSIVE
RIGHT TO USE "GRAVESITE", APART FROM
THE MARK AS SHOWN.

SER. NO. 77-427,953, FILED 3-21-2008.

DAVID COLLIER, EXAMINING ATTORNEY

Int. Cl.: 25

Prior U.S. Cls.: 22 and 39

United States Patent and Trademark Office

Reg. No. 3,519,956

Registered Oct. 21, 2008

**TRADEMARK
PRINCIPAL REGISTER**

Upicka

SCHWARTZBURG, CHELSEA (UNITED STATES
INDIVIDUAL)
850 BEECH ST #701
SAN DIEGO, CA 92101

FOR: BABY BODYSUITS; BABY BOTTOMS; BABY
TOPS; INFANT AND TODDLER ONE PIECE
CLOTHING; CLOTH DIAPERS; ONE PIECE GAR-
MENT FOR INFANTS AND TODDLERS; INFANT
WEAR; INFANTS' TROUSERS , IN CLASS 25 (U.S.
CLS. 22 AND 39).

FIRST USE 3-1-2008; IN COMMERCE 3-1-2008.

THE MARK CONSISTS OF STANDARD CHAR-
ACTERS WITHOUT CLAIM TO ANY PARTICULAR
FONT, STYLE, SIZE, OR COLOR.

SER. NO. 77-427,963, FILED 3-21-2008.

SUSAN STIGLITZ, EXAMINING ATTORNEY

Int. Cl.: 45

Prior U.S. Cls.: 100 and 101

United States Patent and Trademark Office

Reg. No. 3,519,957

Registered Oct. 21, 2008

**SERVICE MARK
PRINCIPAL REGISTER**

Buyadate

SEVERANCE, SCOTT D. (UNITED STATES IN-
DIVIDUAL)
PO BOX 804901
CHICAGO, IL 60680

FOR: ONLINE DATING SERVICES, IN CLASS 45
(U.S. CLS. 100 AND 101).

FIRST USE 10-31-2007; IN COMMERCE 12-8-2007.

THE MARK CONSISTS OF STANDARD CHAR-
ACTERS WITHOUT CLAIM TO ANY PARTICULAR
FONT, STYLE, SIZE, OR COLOR.

SER. NO. 77-427,969, FILED 3-21-2008.

CHRISTOPHER BUONGIORNO, EXAMINING AT-
TORNEY

Int. Cl.: 41

Prior U.S. Cls.: 100, 101 and 107

United States Patent and Trademark Office

Reg. No. 3,519,958

Registered Oct. 21, 2008

**SERVICE MARK
PRINCIPAL REGISTER**

Healthbuzz

JAMES E. KEANY, MD, A PROFESSIONAL MEDICAL CORP (CALIFORNIA CORPORATION)
27700 MEDICAL CENTER ROAD
MISSION VIEJO, CA 92691

FOR: ENTERTAINMENT SERVICES, NAMELY, PROVIDING A RADIO PROGRAM IN THE FIELD OF HEALTH AND/OR MEDICINE VIA A GLOBAL COMPUTER NETWORK; ENTERTAINMENT SERVICES, NAMELY, PROVIDING AN ON-GOING RADIO PROGRAM IN THE FIELD OF HEALTH AND/OR MEDICINE; PRODUCTION AND DISTRIBUTION OF RADIO PROGRAMS; PRODUCTION OF RADIO PROGRAMS; ENTERTAINMENT SERVICES, NAMELY, PROVIDING PODCASTS IN THE

FIELD OF HEALTH AND/OR MEDICINE; ON-LINE JOURNALS, NAMELY, BLOGS FEATURING HEALTH AND/OR MEDICINE, IN CLASS 41 (U.S. CLS. 100, 101 AND 107).

FIRST USE 11-29-2006; IN COMMERCE 11-29-2006.

THE MARK CONSISTS OF STANDARD CHARACTERS WITHOUT CLAIM TO ANY PARTICULAR FONT, STYLE, SIZE, OR COLOR.

SER. NO. 77-427,970, FILED 3-21-2008.

MICHAEL TANNER, EXAMINING ATTORNEY

Int. Cl.: 14

Prior U.S. Cls.: 2, 27, 28 and 50

United States Patent and Trademark Office

Reg. No. 3,519,959

Registered Oct. 21, 2008

**TRADEMARK
PRINCIPAL REGISTER**

ULTRASPEED

DOXA WATCHES LTD (SWITZERLAND CORPORATION)
RUE DE ZURICH 23
BIENNE, SWITZERLAND 2500

FOR: DIVING WATCHES; JEWELRY WATCHES; MECHANICAL AND AUTOMATIC WATCHES; STOP WATCHES; WATCH PARTS; WATCHES AND CLOCKS; WATCHES FOR OUTDOOR USE; WATCHES, CLOCKS; WRIST WATCHES; WATCHES AND JEWELRY; CHRONOGRAPHS FOR USE AS TIMEPIECES; CHRONOGRAPHS FOR USE AS WATCHES, IN CLASS 14 (U.S. CLS. 2, 27, 28 AND 50).

FIRST USE 1-2-1972; IN COMMERCE 1-2-1973.

THE MARK CONSISTS OF STANDARD CHARACTERS WITHOUT CLAIM TO ANY PARTICULAR FONT, STYLE, SIZE, OR COLOR.

SER. NO. 77-427,978, FILED 3-21-2008.

JOHN WILKE, EXAMINING ATTORNEY

Int. Cl.: 9

Prior U.S. Cls.: 21, 23, 26, 36 and 38

Reg. No. 3,519,960

United States Patent and Trademark Office

Registered Oct. 21, 2008

**TRADEMARK
PRINCIPAL REGISTER**

SPACE NAVIGATOR

EXCALIBUR ELECTRONICS, INC. (FLORIDA
CORPORATION)
13755 SW 119TH AVENUE
MIAMI, FL 33186

THE MARK CONSISTS OF STANDARD CHAR-
ACTERS WITHOUT CLAIM TO ANY PARTICULAR
FONT, STYLE, SIZE, OR COLOR.

FOR: HAND-HELD ELECTRONIC STAR, PLA-
NET AND CONSTELLATION LOCATOR AND
IDENTIFIER, IN CLASS 9 (U.S. CLS. 21, 23, 26, 36
AND 38).

SER. NO. 77-427,982, FILED 3-21-2008.

FIRST USE 10-31-2006; IN COMMERCE 10-31-2006.

ODESSA BIBBINS, EXAMINING ATTORNEY

Int. Cls.: 38, 39 and 42

Prior U.S. Cls.: 100, 101, 104 and 105

United States Patent and Trademark Office

Reg. No. 3,519,961

Registered Oct. 21, 2008

**SERVICE MARK
PRINCIPAL REGISTER**

**A LIFETIME OF MOBILE
PHOTOS IN ONE SAFE PLACE**

ITOOKTHISONMYPHONE.COM, INC. (OHIO
CORPORATION)
11103 DEERFIELD ROAD
CINCINNATI, OH 45242

FOR: COMPUTER AIDED TRANSMISSION OF
INFORMATION AND IMAGES, IN CLASS 38 (U.S.
CLS. 100, 101 AND 104).

FIRST USE 10-25-2007; IN COMMERCE 10-25-2007.

FOR: STORAGE SERVICES FOR ARCHIVING
DATABASES, IMAGES AND OTHER ELECTRONIC
DATA, IN CLASS 39 (U.S. CLS. 100 AND 105).

FIRST USE 10-25-2007; IN COMMERCE 10-25-2007.

FOR: COMPUTER SERVICES, NAMELY, INTER-
ACTIVE HOSTING SERVICES WHICH ALLOW THE
USER TO PUBLISH AND SHARE THEIR OWN
CONTENT AND IMAGES ON-LINE, IN CLASS 42
(U.S. CLS. 100 AND 101).

FIRST USE 10-25-2007; IN COMMERCE 10-25-2007.

THE MARK CONSISTS OF STANDARD CHAR-
ACTERS WITHOUT CLAIM TO ANY PARTICULAR
FONT, STYLE, SIZE, OR COLOR.

SER. NO. 77-428,041, FILED 3-21-2008.

LEIGH CAROLINE CASE, EXAMINING ATTOR-
NEY

Int. Cl.: 41

Prior U.S. Cls.: 100, 101 and 107

United States Patent and Trademark Office

Reg. No. 3,519,962

Registered Oct. 21, 2008

**SERVICE MARK
PRINCIPAL REGISTER**

SESSIONS ONLINE

SESSIONS.EDU, INC. (DELAWARE CORPORATION)
SUITE 1203
350 SEVENTH AVENUE
NEW YORK, NY 10001

FOR: EDUCATIONAL SERVICES, NAMELY, PROVIDING PROGRAMS, COURSES AND CERTIFICATES IN GRAPHIC DESIGN, WEB SITE DESIGN, MULTIMEDIA ART DESIGN, FINE ARTS, GAME ART, DIGITAL ART AND PHOTOGRAPHY, BUSINESS MARKETING DESIGN AND BRAND IDENTITY, IN CLASS 41 (U.S. CLS. 100, 101 AND 107).

FIRST USE 2-19-2008; IN COMMERCE 2-19-2008.

THE MARK CONSISTS OF STANDARD CHARACTERS WITHOUT CLAIM TO ANY PARTICULAR FONT, STYLE, SIZE, OR COLOR.

NO CLAIM IS MADE TO THE EXCLUSIVE RIGHT TO USE "ONLINE", APART FROM THE MARK AS SHOWN.

SER. NO. 77-428,043, FILED 3-21-2008.

JORDAN BAKER, EXAMINING ATTORNEY

Int. Cl.: 43

Prior U.S. Cls.: 100 and 101

United States Patent and Trademark Office

Reg. No. 3,519,963

Registered Oct. 21, 2008

**SERVICE MARK
PRINCIPAL REGISTER**

MAJESTIC BURGER

MAJESTIC BURGER, LLC (MISSISSIPPI LIMITED LIABILITY COMPANY)
SUITE 800 - 117
119 COLONY CROSSING WAY
MADISON, MS 39110

FOR: RESTAURANT SERVICES, IN CLASS 43
(U.S. CLS. 100 AND 101).

FIRST USE 9-17-2007; IN COMMERCE 9-17-2007.

THE MARK CONSISTS OF STANDARD CHARACTERS WITHOUT CLAIM TO ANY PARTICULAR FONT, STYLE, SIZE, OR COLOR.

NO CLAIM IS MADE TO THE EXCLUSIVE RIGHT TO USE "BURGER", APART FROM THE MARK AS SHOWN.

SER. NO. 77-428,123, FILED 3-21-2008.

TASNEEM HUSSAIN, EXAMINING ATTORNEY

Int. Cl.: 25

Prior U.S. Cls.: 22 and 39

United States Patent and Trademark Office

Reg. No. 3,519,964

Registered Oct. 21, 2008

TRADEMARK
PRINCIPAL REGISTER

Vincenté

SHARON YOUNG INC (UTAH CORPORATION)
10367 BROCKWOOD RD
DALLAS, TX 75238

FIRST USE 1-1-2008; IN COMMERCE 1-1-2008.

FOR: CLOTHING, NAMELY, SKIRTS, JACKETS,
BLOUSES, SWEATERS, PANTS, VESTS, SKORTS,
DRESSES, SHIRTS, IN CLASS 25 (U.S. CLS. 22 AND
39).

SER. NO. 77-428,138, FILED 3-21-2008.

DEZMONA MIZELLE, EXAMINING ATTORNEY

Int. Cl.: 18

Prior U.S. Cls.: 1, 2, 3, 22 and 41

United States Patent and Trademark Office

Reg. No. 3,519,965

Registered Oct. 21, 2008

**TRADEMARK
PRINCIPAL REGISTER**



GLOBAL DESIGN CONCEPTS, INC. (DELA-
WARE CORPORATION)
10 WEST 33RD STREET
NEW YORK, NY 10001

FOR: LUGGAGE, HANDBAGS, BACKPACKS,
DIAPER BAGS, TOTE BAGS AND COORDINATED
ACCESSORIES, IN CLASS 18 (U.S. CLS. 1, 2, 3, 22
AND 41).

FIRST USE 1-0-2008; IN COMMERCE 1-0-2008.

THE MARK CONSISTS OF DISTINCTIVE "BOT-
TLE SHAPE" OF A HANG TAG.

SER. NO. 77-428,142, FILED 3-21-2008.

RAUL CORDOVA, EXAMINING ATTORNEY

Int. Cl.: 34

Prior U.S. Cls.: 2, 8, 9 and 17

United States Patent and Trademark Office

Reg. No. 3,519,966

Registered Oct. 21, 2008

**TRADEMARK
PRINCIPAL REGISTER**

BATTLE OF THE BRANDS

THOMPSON & CO. OF TAMPA, INC. (FLORIDA CORPORATION)
5401 HANGAR COURT
TAMPA, FL 33634

FOR: CIGARS, NAMELY, A BUNDLED SELECTION OF DIFFERENT VARIETIES OF CIGARS, IN CLASS 34 (U.S. CLS. 2, 8, 9 AND 17).

FIRST USE 2-18-2008; IN COMMERCE 2-18-2008.

THE MARK CONSISTS OF STANDARD CHARACTERS WITHOUT CLAIM TO ANY PARTICULAR FONT, STYLE, SIZE, OR COLOR.

NO CLAIM IS MADE TO THE EXCLUSIVE RIGHT TO USE "BRANDS", APART FROM THE MARK AS SHOWN.

SER. NO. 77-428,145, FILED 3-21-2008.

RAUL CORDOVA, EXAMINING ATTORNEY

Int. Cl.: 41

Prior U.S. Cls.: 100, 101 and 107

United States Patent and Trademark Office

Reg. No. 3,519,967

Registered Oct. 21, 2008

**SERVICE MARK
PRINCIPAL REGISTER**

FREEDOM ACRES

FREEDOM ACRES, LLC (CALIFORNIA LIMITED
LIABILITY COMPANY)
1429 NORTH PALM AVENUE
UPLAND, CA 91786

FOR: ADULT SOCIAL CLUB SERVICES, NAME-
LY, ARRANGING, ORGANIZING, AND HOSTING
SOCIAL EVENTS, GET-TOGETHERS, AND PAR-
TIES FOR CLUB MEMBERS , IN CLASS 41 (U.S.
CLS. 100, 101 AND 107).

FIRST USE 2-19-1981; IN COMMERCE 2-19-1981.

THE MARK CONSISTS OF STANDARD CHAR-
ACTERS WITHOUT CLAIM TO ANY PARTICULAR
FONT, STYLE, SIZE, OR COLOR.

SER. NO. 77-428,164, FILED 3-21-2008.

GRETTA YAO, EXAMINING ATTORNEY

Int. Cl.: 29

Prior U.S. Cl.: 46

United States Patent and Trademark Office

Reg. No. 3,519,968

Registered Oct. 21, 2008

**TRADEMARK
PRINCIPAL REGISTER**

SEABOARD FOODS

SEABOARD CORPORATION (DELAWARE CORPORATION)
9000 WEST 67TH STREET
SHAWNEE MISSION, KS 66202

OWNER OF U.S. REG. NOS. 2,246,196, 3,000,193
AND OTHERS.

FOR: MEAT; PROCESSED MEAT, NAMELY, BACON, HAM AND SAUSAGE, IN CLASS 29 (U.S. CL. 46).

NO CLAIM IS MADE TO THE EXCLUSIVE RIGHT TO USE "FOODS", APART FROM THE MARK AS SHOWN.

FIRST USE 5-11-2005; IN COMMERCE 2-29-2008.

SER. NO. 77-428,173, FILED 3-21-2008.

THE MARK CONSISTS OF STANDARD CHARACTERS WITHOUT CLAIM TO ANY PARTICULAR FONT, STYLE, SIZE, OR COLOR.

BARBARA RUTLAND, EXAMINING ATTORNEY

Int. Cl.: 29

Prior U.S. Cl.: 46

United States Patent and Trademark Office

Reg. No. 3,519,969

Registered Oct. 21, 2008

**TRADEMARK
PRINCIPAL REGISTER**

FLEUR DE LUXE

KHAYAT-TOUBIA, RITA (FRANCE INDIVIDUAL)
5958 PALA MESA DRIVE
SAN JOSE, CA 95123

OWNER OF U.S. REG. NO. 3,405,406.

FOR: BLENDED OIL; EDIBLE OIL; OLIVE OIL;
SALAD OIL, IN CLASS 29 (U.S. CL. 46).

THE ENGLISH TRANSLATION OF "FLEUR DE
LUXE IS FLOWER OF LUXURY"

FIRST USE 2-23-2005; IN COMMERCE 4-1-2005.

SER. NO. 77-428,217, FILED 3-21-2008.

THE MARK CONSISTS OF STANDARD CHARACTERS WITHOUT CLAIM TO ANY PARTICULAR FONT, STYLE, SIZE, OR COLOR.

MONIQUE MILLER, EXAMINING ATTORNEY

Int. Cl.: 41

Prior U.S. Cls.: 100, 101 and 107

United States Patent and Trademark Office

Reg. No. 3,519,970

Registered Oct. 21, 2008

**SERVICE MARK
PRINCIPAL REGISTER**

HIGHPOINTS

HIGHPOINTS (GEORGIA CORPORATION)
SUITE 210
3505 DULUTH PARK LANE
DULUTH, GA 30096

FOR: EDUCATIONAL SERVICES, NAMELY,
PROVIDING TUTORING IN THE FIELDS OF PRI-
MARY AND SECONDARY CLASSES; PROVIDING
ON-LINE TRAINING BY MEANS OF COMPUTERS,
INTERNET, SURVEYS, QUESTIONAIRES, APPLI-
CATIONS AND COURSES IN THE FIELD OF PRI-

MARY AND SECONDARY CLASSES, IN CLASS 41
(U.S. CLS. 100, 101 AND 107).

FIRST USE 2-28-2005; IN COMMERCE 2-28-2005.

THE MARK CONSISTS OF STANDARD CHAR-
ACTERS WITHOUT CLAIM TO ANY PARTICULAR
FONT, STYLE, SIZE, OR COLOR.

SER. NO. 77-428,226, FILED 3-21-2008.

MONIQUE MILLER, EXAMINING ATTORNEY

Int. Cl.: 5

Prior U.S. Cls.: 6, 18, 44, 46, 51 and 52

Reg. No. 3,519,971

United States Patent and Trademark Office

Registered Oct. 21, 2008

**TRADEMARK
PRINCIPAL REGISTER**

GO FROM TEAR TO CLEAR

I'M A LITTLE TEA CUP (FLORIDA CORPORATION), DBA ANGEL'S EYES
2089 N. UNIVERSITY DRIVE
CORAL SPRINGS, FL 33071

THE MARK CONSISTS OF STANDARD CHARACTERS WITHOUT CLAIM TO ANY PARTICULAR FONT, STYLE, SIZE, OR COLOR.

FOR: EDIBLE DOG TREATS, NAMELY, DOG TREATS INCORPORATING NUTRITIONAL ADDITIVES FOR MEDICAL PURPOSES, IN CLASS 5 (U.S. CLS. 6, 18, 44, 46, 51 AND 52).

SER. NO. 77-428,231, FILED 3-21-2008.

FIRST USE 6-30-2005; IN COMMERCE 6-30-2005.

ANTHONY RINKER, EXAMINING ATTORNEY

Int. Cl.: 30

Prior U.S. Cl.: 46

United States Patent and Trademark Office

Reg. No. 3,519,972

Registered Oct. 21, 2008

**TRADEMARK
PRINCIPAL REGISTER**

**RIDICULOUSLY EASY
SERIOUSLY GOOD**

REDBONE, INC. (SOUTH CAROLINA CORPORATION)
1903 WEST PALMETTO STREET
FLORENCE, SC 29501

THE MARK CONSISTS OF STANDARD CHARACTERS WITHOUT CLAIM TO ANY PARTICULAR FONT, STYLE, SIZE, OR COLOR.

FOR: CONDIMENTS, NAMELY, AIOLI AND FLAVORED MAYONNAISE, IN CLASS 30 (U.S. CL. 46).

SER. NO. 77-428,234, FILED 3-21-2008.

FIRST USE 2-14-2007; IN COMMERCE 8-1-2007.

JAY FLOWERS, EXAMINING ATTORNEY

Int. Cl.: 9

Prior U.S. Cls.: 21, 23, 26, 36 and 38

Reg. No. 3,519,973

United States Patent and Trademark Office

Registered Oct. 21, 2008

**TRADEMARK
PRINCIPAL REGISTER**



WIREFREE CORPORATION (DELAWARE CORPORATION)
1010 OLD HENDERSON ROAD, SUITE 205
COLUMBUS, OH 43220

NO CLAIM IS MADE TO THE EXCLUSIVE RIGHT TO USE "WIREFREE", APART FROM THE MARK AS SHOWN.

FOR: COMPUTER HARDWARE AND SOFTWARE SYSTEMS FOR MONITORING BUSINESS, ENVIRONMENTAL, MANUFACTURING AND OTHER PROCESSES AND CONDITIONS BY TRANSMITTING DATA AND INFORMATION VIA ELECTRONIC COMMUNICATIONS NETWORKS, IN CLASS 9 (U.S. CLS. 21, 23, 26, 36 AND 38).

THE MARK CONSISTS OF THE WORD "WIRE-FREE" WITH A SERIES OF HALF ARCS ABOVE THE "E" AND "F".

SER. NO. 77-428,245, FILED 3-21-2008.

FIRST USE 9-0-2006; IN COMMERCE 9-0-2006.

CYNTHIA SLOAN, EXAMINING ATTORNEY

Int. Cl.: 41

Prior U.S. Cls.: 100, 101 and 107

United States Patent and Trademark Office

Reg. No. 3,519,974

Registered Oct. 21, 2008

**SERVICE MARK
PRINCIPAL REGISTER**



CREME DE LA CREME, INC. (DELAWARE CORPORATION)
8400 EAST PRENTICE AVENUE, SUITE 1320
GREENWOOD VILLAGE, CO 80111

FOR: EDUCATIONAL SERVICES, NAMELY, PROVIDING COURSES OF INSTRUCTION AT THE PRE-SCHOOL LEVEL, IN CLASS 41 (U.S. CLS. 100, 101 AND 107).

FIRST USE 4-19-2004; IN COMMERCE 4-19-2004.

OWNER OF U.S. REG. NOS. 2,086,131, 3,135,025 AND OTHERS.

THE MARK CONSISTS OF THE WORD "CRÈME" WITH LETTERS ON A BACKGROUND OF ALTERNATELY LIGHT AND DARK SHADED BLOCKS .

THE FOREIGN WORDING IN THE MARK TRANSLATES INTO ENGLISH AS "CREAM"

SER. NO. 77-428,251, FILED 3-21-2008.

CYNTHIA SLOAN, EXAMINING ATTORNEY

Int. Cl.: 35

Prior U.S. Cls.: 100, 101 and 102

United States Patent and Trademark Office

Reg. No. 3,519,975

Registered Oct. 21, 2008

**SERVICE MARK
PRINCIPAL REGISTER**



**KNOWLEDGE
NETWORK
INTERNATIONAL**

BOWEY, VINCENT (UNITED STATES INDIVIDUAL)
311 GIBSON ROAD
WOODLAND, CA 95695 AND
ALBRIGHT, HUNTER (UNITED STATES INDIVIDUAL)
311 GIBSON ROAD
WOODLAND, CA 95695

FOR: BUSINESS MANAGEMENT CONSULTING,
IN CLASS 35 (U.S. CLS. 100, 101 AND 102).

FIRST USE 1-0-2007; IN COMMERCE 1-0-2007.

NO CLAIM IS MADE TO THE EXCLUSIVE
RIGHT TO USE "NETWORK" AND "INTERNATIONAL",
APART FROM THE MARK AS SHOWN.

THE MARK CONSISTS OF A GLOBE WITH
THREE PEOPLE WITH THEIR ARMS OUTSTRETCHED
AROUND THE GLOBE. THE WORDS
"KNOWLEDGE NETWORK INTERNATIONAL"
ARE TO THE RIGHT OF THE LOGO. THE WORDS
"KNOWLEDGE" AND "NETWORK" ARE ALL
CAPITALS. THE WORD "INTERNATIONAL" IS ALL
CAPITALS AND IT IS SMALLER THAN THE
WORDS "KNOWLEDGE" AND "NETWORK".
"KNOWLEDGE" IS ABOVE "NETWORK", "NET-
WORK" IS ABOVE "INTERNATIONAL".

SER. NO. 77-428,254, FILED 3-21-2008.

WILLIAM P. SHANAHAN, EXAMINING ATTORNEY

Int. Cl.: 2

Prior U.S. Cls.: 6, 11 and 16

United States Patent and Trademark Office

Reg. No. 3,519,976

Registered Oct. 21, 2008

**TRADEMARK
PRINCIPAL REGISTER**

Armorgranite

SPECIALTY COATINGS, INC (NEW JERSEY CORPORATION), DBA ARMORPOXY
939 LEHIGH AVE
UNION, NJ 07083

FOR: CLEAR AND PIGMENTED COATINGS USED IN THE NATURE OF PAINT; COATINGS IN THE NATURE OF INDUSTRIAL SEALANTS FOR WATERPROOFING AND SURFACE HARDENING; COATINGS USED FOR FURNITURE FINISHING; DECORATIVE SPRAY COATING; EPOXY COATING FOR USE ON CONCRETE INDUSTRIAL FLOORS; EXTERIOR PAINT; HOUSE PAINT; INTERIOR PAINT; MIXED PAINTS; PAINT FOR ARTISTS; PAINT FOR CONCRETE FLOORS; PAINTS,

LACQUERS, VARNISHES, IN CLASS 2 (U.S. CLS. 6, 11 AND 16).

FIRST USE 1-1-2006; IN COMMERCE 1-1-2006.

THE MARK CONSISTS OF STANDARD CHARACTERS WITHOUT CLAIM TO ANY PARTICULAR FONT, STYLE, SIZE, OR COLOR.

SER. NO. 77-428,257, FILED 3-21-2008.

WILLIAM P. SHANAHAN, EXAMINING ATTORNEY

Int. Cl.: 35

Prior U.S. Cls.: 100, 101 and 102

United States Patent and Trademark Office

Reg. No. 3,519,977

Registered Oct. 21, 2008

**SERVICE MARK
PRINCIPAL REGISTER**



ANF LLC (MINNESOTA LIMITED LIABILITY
COMPANY)
14300 BUCKHILL ROAD
BURNSVILLE, MN 55306

THE MARK CONSISTS OF THE STYLIZED TEXT
"ZIDA".

FOR: RETAIL STORE SERVICES FEATURING
FASHION AND HOME ACCESSORIES, IN CLASS 35
(U.S. CLS. 100, 101 AND 102).

SER. NO. 77-428,265, FILED 3-21-2008.

FIRST USE 8-17-2007; IN COMMERCE 8-17-2007.

SEAN CROWLEY, EXAMINING ATTORNEY

Int. Cl.: 41

Prior U.S. Cls.: 100, 101 and 107

United States Patent and Trademark Office

Reg. No. 3,519,978

Registered Oct. 21, 2008

**SERVICE MARK
PRINCIPAL REGISTER**

CVE

GLOBAL TRAINING SOLUTIONS, INC. (DELA-
WARE CORPORATION)
9204 MEADOW SWEET COURT
RALEIGH, NC 27603

THE MARK CONSISTS OF STANDARD CHAR-
ACTERS WITHOUT CLAIM TO ANY PARTICULAR
FONT, STYLE, SIZE, OR COLOR.

FOR: TRAINING SERVICES IN THE FIELD OF
INFORMATION TECHNOLOGY, IN CLASS 41 (U.S.
CLS. 100, 101 AND 107).

SER. NO. 77-428,271, FILED 3-21-2008.

FIRST USE 9-3-2007; IN COMMERCE 9-3-2007.

TINA L. SNAPP, EXAMINING ATTORNEY

Int. Cl.: 25

Prior U.S. Cls.: 22 and 39

United States Patent and Trademark Office

Reg. No. 3,519,979

Registered Oct. 21, 2008

**TRADEMARK
PRINCIPAL REGISTER**

Solange

SOLANGE INC. (NEVADA CORPORATION)
22382 AVENIDA EMPRESA
RANCHO SANTA MARGARITA, CA 92688

FOR: WOMEN'S CLOTHING, NAMELY, DRESSES, SUITS, PANTS, SKIRTS AND TOPS, IN CLASS 25 (U.S. CLS. 22 AND 39).

FIRST USE 1-6-2003; IN COMMERCE 1-6-2003.

THE MARK CONSISTS OF STANDARD CHARACTERS WITHOUT CLAIM TO ANY PARTICULAR FONT, STYLE, SIZE, OR COLOR.

SER. NO. 77-428,275, FILED 3-21-2008.

CHRISTOPHER BUONGIORNO, EXAMINING ATTORNEY

Int. Cl.: 35

Prior U.S. Cls.: 100, 101 and 102

United States Patent and Trademark Office

Reg. No. 3,519,980

Registered Oct. 21, 2008

**SERVICE MARK
PRINCIPAL REGISTER**

ARMORY GARAGE

ARMORY GARAGE (NEW YORK CORPORATION)
926 CENTRAL AVENUE
ALBANY, NY 12205

FOR: AUTOMOBILE DEALERSHIPS; ON-LINE
RETAIL STORE SERVICES FEATURING NEW
AND PREOWNED AUTOMOBILES, PARTS AND
ACCESSORIES, IN CLASS 35 (U.S. CLS. 100, 101 AND
102).

FIRST USE 12-0-1918; IN COMMERCE 12-0-1918.

THE MARK CONSISTS OF STANDARD CHAR-
ACTERS WITHOUT CLAIM TO ANY PARTICULAR
FONT, STYLE, SIZE, OR COLOR.

NO CLAIM IS MADE TO THE EXCLUSIVE
RIGHT TO USE "GARAGE", APART FROM THE
MARK AS SHOWN.

SER. NO. 77-428,286, FILED 3-21-2008.

ANNE E. GUSTASON, EXAMINING ATTORNEY

Int. Cl.: 41

Prior U.S. Cls.: 100, 101 and 107

United States Patent and Trademark Office

Reg. No. 3,519,981

Registered Oct. 21, 2008

**SERVICE MARK
PRINCIPAL REGISTER**

ALPHA CAT

MCCULLOUGH, ELIZABETH (UNITED STATES
INDIVIDUAL)
18 BOYCE ROAD
GLENFORD, NY 12433

FOR: ENTERTAINMENT IN THE NATURE OF
LIVE PERFORMANCES BY SOLO ARTIST; ENTER-
TAINMENT SERVICES, NAMELY, PROVIDING A
WEB SITE FEATURING MUSICAL PERFORMAN-
CES, MUSICAL VIDEOS, RELATED FILM CLIPS,
PHOTOGRAPHS, AND OTHER MULTIMEDIA MA-
TERIALS; MULTIMEDIA ENTERTAINMENT SER-
VICES IN THE NATURE OF RECORDING,
PRODUCTION AND POST-PRODUCTION SERVI-

CES IN THE FIELDS OF MUSIC, VIDEO, AND
FILMS, IN CLASS 41 (U.S. CLS. 100, 101 AND 107).

FIRST USE 9-0-1999; IN COMMERCE 9-0-1999.

THE MARK CONSISTS OF STANDARD CHAR-
ACTERS WITHOUT CLAIM TO ANY PARTICULAR
FONT, STYLE, SIZE, OR COLOR.

SER. NO. 77-428,289, FILED 3-21-2008.

AMOS T. MATTHEWS, JR., EXAMINING ATTOR-
NEY

Int. Cl.: 22

Prior U.S. Cls.: 1, 2, 7, 19, 22, 42 and 50

Reg. No. 3,519,982

United States Patent and Trademark Office

Registered Oct. 21, 2008

**TRADEMARK
PRINCIPAL REGISTER**

SAPPHIRE

GARWARE-WALL ROPES LTD. (INDIA CORPORATION)
M.I.D.C CHINCHWAD
PLOT NO 11, BLOCK D1
PUNE, INDIA 411019

FOR: FISHING NETS; TWINE, IN CLASS 22 (U.S. CLS. 1, 2, 7, 19, 22, 42 AND 50).

FIRST USE 2-26-2004; IN COMMERCE 2-26-2004.

THE MARK CONSISTS OF STANDARD CHARACTERS WITHOUT CLAIM TO ANY PARTICULAR FONT, STYLE, SIZE, OR COLOR.

SER. NO. 77-428,296, FILED 3-21-2008.

AMOS T. MATTHEWS, JR., EXAMINING ATTORNEY

Int. Cl.: 16

Prior U.S. Cls.: 2, 5, 22, 23, 29, 37, 38 and 50

Reg. No. 3,519,983

United States Patent and Trademark Office

Registered Oct. 21, 2008

**TRADEMARK
PRINCIPAL REGISTER**

BRAIDED RIVER

MOUNTAINEERS, THE (WASHINGTON NON-
PROFIT CORPORATION)
300 THIRD AVE WEST
SEATTLE, WA 98119

THE MARK CONSISTS OF STANDARD CHAR-
ACTERS WITHOUT CLAIM TO ANY PARTICULAR
FONT, STYLE, SIZE, OR COLOR.

FOR: BOOKS IN THE FIELD OF A WIDE VARI-
ETY OF GENERAL ENVIRONMENTAL, CONSER-
VATION AND NATURAL HISTORY TOPICS, IN
CLASS 16 (U.S. CLS. 2, 5, 22, 23, 29, 37, 38 AND 50).

SER. NO. 77-428,304, FILED 3-21-2008.

FIRST USE 12-4-2007; IN COMMERCE 12-19-2007.

ELLEN B. AWRICH, EXAMINING ATTORNEY

Int. Cls.: 29 and 30

Prior U.S. Cl.: 46

United States Patent and Trademark Office

Reg. No. 3,519,984

Registered Oct. 21, 2008

**TRADEMARK
PRINCIPAL REGISTER**

RED BONE ALLEY

REDBONE, INC. (SOUTH CAROLINA CORPORATION)
1903 WEST PALMETTO STREET
FLORENCE, SC 29501

FOR: COMPOUND BUTTER, NAMELY, FLAVORED BUTTER IN THE NATURE OF DIJON HORSERADISH BUTTER, SCAMPI BUTTER, LEMON HERB BUTTER, AND BLUE CHEESE PEPPER-CORN BUTTER, IN CLASS 29 (U.S. CL. 46).

FIRST USE 2-1-2007; IN COMMERCE 3-14-2008.

FOR: RUBBING SPICES, CONDIMENTS, NAMELY, AIOLI AND FLAVORED MAYONNAISE, IN CLASS 30 (U.S. CL. 46).

FIRST USE 8-20-2007; IN COMMERCE 9-13-2007.

THE MARK CONSISTS OF STANDARD CHARACTERS WITHOUT CLAIM TO ANY PARTICULAR FONT, STYLE, SIZE, OR COLOR.

OWNER OF U.S. REG. NO. 1,829,734.

SER. NO. 77-428,308, FILED 3-21-2008.

JAY FLOWERS, EXAMINING ATTORNEY

Int. Cl.: 36

Prior U.S. Cls.: 100, 101 and 102

United States Patent and Trademark Office

Reg. No. 3,519,985

Registered Oct. 21, 2008

**SERVICE MARK
PRINCIPAL REGISTER**

BRAIDED RIVER

MOUNTAINEERS, THE (WASHINGTON NON-
PROFIT CORPORATION)
300 THIRD AVE WEST
SEATTLE, WA 98119

FOR: CHARITABLE FUNDRAISING SERVICE
THAT SUPPORTS CAUSES RELATING TO A WIDE
VARIETY OF GENERAL ENVIRONMENTAL, CON-
SERVATION AND NATURAL HISTORY TOPICS, IN
CLASS 36 (U.S. CLS. 100, 101 AND 102).

FIRST USE 3-0-2007; IN COMMERCE 12-0-2007.

THE MARK CONSISTS OF STANDARD CHAR-
ACTERS WITHOUT CLAIM TO ANY PARTICULAR
FONT, STYLE, SIZE, OR COLOR.

SER. NO. 77-428,309, FILED 3-21-2008.

ELLEN B. AWRICH, EXAMINING ATTORNEY

Int. Cl.: 18

Prior U.S. Cls.: 1, 2, 3, 22 and 41

United States Patent and Trademark Office

Reg. No. 3,519,986

Registered Oct. 21, 2008

**TRADEMARK
PRINCIPAL REGISTER**

PERIPATETIC

MCKENNA LUXURY GOODS LTD. (NEW YORK CORPORATION)
SUITE 2320
60 EAST 42ND STREET
NEW YORK, NY 10165

FOR: ALL PURPOSE SPORT BAGS; ALL-PURPOSE CARRYING BAGS; BABY CARRYING BAGS; BAGS FOR CARRYING BABIES' ACCESSORIES; BACKPACKS, BOOK BAGS, SPORTS BAGS, BUM BAGS, WALLETS AND HANDBAGS; BEACH BAGS; BELT BAGS AND HIP BAGS; CANVAS SHOPPING BAGS; COSMETIC BAGS SOLD EMPTY; TOILETRY BAGS SOLD EMPTY; DIAPER BAGS; DUFFEL BAGS; SHOPPING BAGS WITH WHEELS ATTACHED; BILLFOLDS; BRIEFCASES AND AT-

TACHE CASES; LUGGAGE; LUGGAGE TAGS; STRAPS FOR LUGGAGE; UMBRELLAS, IN CLASS 18 (U.S. CLS. 1, 2, 3, 22 AND 41).

FIRST USE 3-17-2008; IN COMMERCE 3-17-2008.

THE MARK CONSISTS OF STANDARD CHARACTERS WITHOUT CLAIM TO ANY PARTICULAR FONT, STYLE, SIZE, OR COLOR.

SER. NO. 77-428,322, FILED 3-21-2008.

CHRISTOPHER BUONGIORNO, EXAMINING ATTORNEY

Int. Cl.: 35

Prior U.S. Cls.: 100, 101 and 102

United States Patent and Trademark Office

Reg. No. 3,519,987

Registered Oct. 21, 2008

**SERVICE MARK
PRINCIPAL REGISTER**

5 TO DRIVE

MAZDA MOTOR OF AMERICA, INC. (CALIFORNIA CORPORATION)
7755 IRVINE CENTER DRIVE
IRVINE, CA 92618

THE MARK CONSISTS OF STANDARD CHARACTERS WITHOUT CLAIM TO ANY PARTICULAR FONT, STYLE, SIZE, OR COLOR.

FOR: AUTOMOBILE DEALERSHIPS, IN CLASS 35 (U.S. CLS. 100, 101 AND 102).

SER. NO. 77-428,343, FILED 3-21-2008.

FIRST USE 3-12-2008; IN COMMERCE 3-12-2008.

MELVIN AXILBUND, EXAMINING ATTORNEY

Int. Cl.: 16

Prior U.S. Cls.: 2, 5, 22, 23, 29, 37, 38 and 50

Reg. No. 3,519,988

United States Patent and Trademark Office

Registered Oct. 21, 2008

**TRADEMARK
PRINCIPAL REGISTER**

SKIPSTONE

THE MOUNTAINEERS (WASHINGTON NON-
PROFIT CORPORATION)
300 THIRD AVE WEST
SEATTLE, WA 98119

FOR: BOOKS IN THE FIELDS OF SUSTAINABLE
LIFESTYLES, FOOD AND COOKING, GARDEN-
ING, CRAFTS, HOME, HEALTH, WELLNESS, FIT-
NESS, PETS, OUTDOORS, THE ENVIRONMENT
AND CONSERVATION, IN CLASS 16 (U.S. CLS. 2,
5, 22, 23, 29, 37, 38 AND 50).

FIRST USE 10-10-2007; IN COMMERCE 10-16-2007.

THE MARK CONSISTS OF STANDARD CHAR-
ACTERS WITHOUT CLAIM TO ANY PARTICULAR
FONT, STYLE, SIZE, OR COLOR.

SER. NO. 77-428,345, FILED 3-21-2008.

ELLEN B. AWRICH, EXAMINING ATTORNEY

Int. Cl.: 9

Prior U.S. Cls.: 21, 23, 26, 36 and 38

Reg. No. 3,519,989

United States Patent and Trademark Office

Registered Oct. 21, 2008

**TRADEMARK
PRINCIPAL REGISTER**

The Incredible Heat Machine

THE INCREDIBLE HEAT MACHINE LLP (TENNESSEE LIMITED PARTNERSHIP)
4802 BARFIELD CRESCENT RD.
MURFREESBORO, TN 37128

FOR: AUDIO RECORDINGS FEATURING MUSIC; DOWNLOADABLE MP3 FILES, MP3 RECORDINGS, ONLINE DISCUSSION BOARDS, WEBCASTS AND PODCASTS FEATURING MUSIC, AUDIO BOOKS AND NEWS BROADCASTS; DOWNLOADABLE MUSICAL SOUND RECORDINGS; DOWNLOADABLE RING TONES, GRAPHICS AND MUSIC VIA A GLOBAL COMPUTER NETWORK AND WIRELESS DEVICES; DOWNLOADABLE VIDEO RECORDINGS FEATURING MUSIC; DOWNLOADABLE MUSIC VIA THE INTERNET AND WIRELESS DEVICES; MUSICAL SOUND RECORDINGS; MUSICAL VIDEO RECORDINGS; SOUND RECORD-

INGS FEATURING MUSIC; VIDEO RECORDINGS FEATURING MUSIC; VISUAL RECORDINGS AND AUDIO VISUAL RECORDINGS FEATURING MUSIC AND ANIMATION, IN CLASS 9 (U.S. CLS. 21, 23, 26, 36 AND 38).

FIRST USE 4-8-2005; IN COMMERCE 4-8-2005.

THE MARK CONSISTS OF STANDARD CHARACTERS WITHOUT CLAIM TO ANY PARTICULAR FONT, STYLE, SIZE, OR COLOR.

SER. NO. 77-428,355, FILED 3-21-2008.

LEIGH CAROLINE CASE, EXAMINING ATTORNEY

Int. Cl.: 35

Prior U.S. Cls.: 100, 101 and 102

United States Patent and Trademark Office

Reg. No. 3,519,990

Registered Oct. 21, 2008

**SERVICE MARK
PRINCIPAL REGISTER**



MAZDA MOTOR OF AMERICA, INC. (CALIFORNIA CORPORATION)
7755 IRVINE CENTER DRIVE
IRVINE, CA 92618

FOR: AUTOMOBILE DEALERSHIPS, IN CLASS 35
(U.S. CLS. 100, 101 AND 102).

FIRST USE 3-12-2008; IN COMMERCE 3-12-2008.

NO CLAIM IS MADE TO THE EXCLUSIVE
RIGHT TO USE "SALES EVENT", APART FROM
THE MARK AS SHOWN.

THE MARK CONSISTS OF THE NUMBER 5
SHOWN ON A CIRCULAR BACKGROUND, WITH
THE WORDS TO DRIVE SHOWN TO THE RIGHT,
AND THE WORDS SALES EVENT BENEATH THE
WORD DRIVE.

SER. NO. 77-428,364, FILED 3-21-2008.

MELVIN AXILBUND, EXAMINING ATTORNEY

Int. Cls.: 5 and 42

Prior U.S. Cls.: 6, 18, 44, 46, 51, 52, 100 and 101

United States Patent and Trademark Office

Reg. No. 3,519,991

Registered Oct. 21, 2008

**TRADEMARK
SERVICE MARK
PRINCIPAL REGISTER**

ARTHRODYNAMIC

ARTHRODYNAMIC TECHNOLOGIES, ANIMAL
HEALTH DIVISION, INC. (KENTUCKY COR-
PORATION), DBA ARTHRODYNAMIC TECH-
NOLOGIES, LLC

P.O. BOX 516
LEXINGTON, KY 40588

FOR: PHARMACEUTICAL PREPARATIONS FOR
USE IN THE PREVENTION AND TREATMENT OF
OSTEOARTHRITIS, OSTEOCHONDROSIS DESSI-
CANS, SYNOVITIS, INFLAMMATORY ARTHRITIS,
SEPTIC ARTHRITIS, DEGENERATIVE JOINT DIS-
EASE, INFLAMMATION AND SURGICAL TRAU-
MA, IN CLASS 5 (U.S. CLS. 6, 18, 44, 46, 51 AND 52).

FIRST USE 1-0-2006; IN COMMERCE 1-0-2006.

FOR: RESEARCH AND DEVELOPMENT IN THE
FIELD OF PHARMACEUTICALS, IN CLASS 42 (U.S.
CLS. 100 AND 101).

FIRST USE 1-0-2006; IN COMMERCE 1-0-2006.

THE MARK CONSISTS OF STANDARD CHAR-
ACTERS WITHOUT CLAIM TO ANY PARTICULAR
FONT, STYLE, SIZE, OR COLOR.

SER. NO. 77-428,419, FILED 3-21-2008.

JOHN WILKE, EXAMINING ATTORNEY

Int. Cl.: 5

Prior U.S. Cls.: 6, 18, 44, 46, 51 and 52

Reg. No. 3,519,992

United States Patent and Trademark Office

Registered Oct. 21, 2008

**TRADEMARK
PRINCIPAL REGISTER**

POLYGLYCAN

ARTHRODYNAMIC TECHNOLOGIES, ANIMAL
HEALTH DIVISION, INC. (KENTUCKY COR-
PORATION), DBA ARTHRODYNAMIC TECH-
NOLOGIES, LLC
P.O. BOX 516
LEXINGTON, KY 40588

FOR: PHARMACEUTICAL PREPARATIONS FOR
USE IN THE PREVENTION AND TREATMENT OF
OSTEOARTHRITIS, OSTEOCHONDROSIS DESSI-
CANS, SYNOVITIS, INFLAMMATORY ARTHRITIS,
SEPTIC ARTHRITIS, DEGENERATIVE JOINT DIS-
EASE, INFLAMMATION, AND SURGICAL TRAU-
MA, IN CLASS 5 (U.S. CLS. 6, 18, 44, 46, 51 AND 52).

FIRST USE 11-0-2002; IN COMMERCE 11-0-2002.

THE MARK CONSISTS OF STANDARD CHAR-
ACTERS WITHOUT CLAIM TO ANY PARTICULAR
FONT, STYLE, SIZE, OR COLOR.

OWNER OF U.S. REG. NO. 3,042,937.

SEC. 2(F).

SER. NO. 77-428,428, FILED 3-21-2008.

JOHN WILKE, EXAMINING ATTORNEY

Int. Cl.: 45

Prior U.S. Cls.: 100 and 101

United States Patent and Trademark Office

Reg. No. 3,519,993

Registered Oct. 21, 2008

**SERVICE MARK
PRINCIPAL REGISTER**

crossconnexion.com

VISIONFIRST OMNIMEDIA, LLC (ALABAMA
LIMITED LIABILITY COMPANY)
706 FIFTEENTH STREET WEST
BIRMINGHAM, AL 35208

FOR: ONLINE CHRISTIAN SOCIAL NETWORK-
ING SERVICES, IN CLASS 45 (U.S. CLS. 100 AND
101).

FIRST USE 11-12-2007; IN COMMERCE 11-12-2007.

THE MARK CONSISTS OF THE WORDS CROSS-
CONNEXION.COM WITH THE "X" DEPICTED AS A
STYLIZED CROSS SLANTED TO THE RIGHT,
WITH THE PHRASE "CROSSCONNEXION" DIS-
PLAYED IN LARGER FONT THAN ".COM".

SER. NO. 77-428,436, FILED 3-21-2008.

JOHN WILKE, EXAMINING ATTORNEY

Int. Cl.: 33

Prior U.S. Cls.: 47 and 49

United States Patent and Trademark Office

Reg. No. 3,519,994

Registered Oct. 21, 2008

**TRADEMARK
PRINCIPAL REGISTER**

The Original Zin

SCHINDLER, STEPHAN (AUSTRIA INDIVIDUAL)
196 FORREST AVE.
FAIRFAX, CA 94930 AND
TSCHEPPE, STEFAN (AUSTRIA INDIVIDUAL)
196 FORREST AVE.
FAIRFAX, CA 94930

THE MARK CONSISTS OF STANDARD CHARACTERS WITHOUT CLAIM TO ANY PARTICULAR FONT, STYLE, SIZE, OR COLOR.

SER. NO. 77-428,446, FILED 3-21-2008.

FOR: WINE, IN CLASS 33 (U.S. CLS. 47 AND 49).

FIRST USE 3-19-2008; IN COMMERCE 3-20-2008.

APRIL HESIK, EXAMINING ATTORNEY

Int. Cl.: 30

Prior U.S. Cl.: 46

United States Patent and Trademark Office

Reg. No. 3,519,995

Registered Oct. 21, 2008

**TRADEMARK
PRINCIPAL REGISTER**

Bad Girl Chocolates

DINAPOLI-TIETZ, KAREN (UNITED STATES
INDIVIDUAL)

6363 FIREFLY DRIVE

SAN JOSE, CA 95120

FOR: CHOCOLATES, COOKIES, AND CANDY, IN
CLASS 30 (U.S. CL. 46).

FIRST USE 12-1-2007; IN COMMERCE 12-1-2007.

THE MARK CONSISTS OF STANDARD CHAR-
ACTERS WITHOUT CLAIM TO ANY PARTICULAR
FONT, STYLE, SIZE, OR COLOR.

NO CLAIM IS MADE TO THE EXCLUSIVE
RIGHT TO USE "CHOCOLATES", APART FROM
THE MARK AS SHOWN.

SER. NO. 77-428,476, FILED 3-21-2008.

KAREN BRACEY, EXAMINING ATTORNEY

Int. Cl.: 35

Prior U.S. Cls.: 100, 101 and 102

Reg. No. 3,519,996

United States Patent and Trademark Office

Registered Oct. 21, 2008

**SERVICE MARK
PRINCIPAL REGISTER**

TEMPTATION IN EVERY AISLE

FANCY FOODS SOUTH ORANGE, LLC (NEW
JERSEY LIMITED LIABILITY COMPANY)
420 A NYC TERMINAL MARKET
BRONX, NY 10474

THE MARK CONSISTS OF STANDARD CHAR-
ACTERS WITHOUT CLAIM TO ANY PARTICULAR
FONT, STYLE, SIZE, OR COLOR.

FOR: RETAIL STORE SERVICES FEATURING A
WIDE VARIETY OF CONSUMER GOODS OF OTH-
ERS, IN CLASS 35 (U.S. CLS. 100, 101 AND 102).

SER. NO. 77-428,487, FILED 3-21-2008.

FIRST USE 1-1-2007; IN COMMERCE 1-1-2007.

JUDITH HELFMAN, EXAMINING ATTORNEY

Int. Cl.: 41

Prior U.S. Cls.: 100, 101 and 107

United States Patent and Trademark Office

Reg. No. 3,519,997

Registered Oct. 21, 2008

**SERVICE MARK
PRINCIPAL REGISTER**

YEEHAW PRODUCTIONS

SUNNY JOHNSON (UNITED STATES INDIVIDUAL), DBA SUNNY SAVAGE
P.O. BOX 296
TOPANGA, CA 90290

FOR: ENTERTAINMENT PRODUCTION SERVICES, NAMELY, VIDEO PRODUCTION, TELEVISION PRODUCTION, FILM PRODUCTION AND DOCUMENTARY TELEVISION, FILM AND VIDEO PRODUCTION, IN CLASS 41 (U.S. CLS. 100, 101 AND 107).

FIRST USE 11-15-2006; IN COMMERCE 11-15-2006.

THE MARK CONSISTS OF STANDARD CHARACTERS WITHOUT CLAIM TO ANY PARTICULAR FONT, STYLE, SIZE, OR COLOR.

NO CLAIM IS MADE TO THE EXCLUSIVE RIGHT TO USE "PRODUCTIONS", APART FROM THE MARK AS SHOWN.

SER. NO. 77-428,514, FILED 3-21-2008.

JAY BESCH, EXAMINING ATTORNEY

Int. Cl.: 9

Prior U.S. Cls.: 21, 23, 26, 36 and 38

Reg. No. 3,519,998

United States Patent and Trademark Office

Registered Oct. 21, 2008

**TRADEMARK
PRINCIPAL REGISTER**

CoDrive

COFFIN, CHARLES, RONALD (UNITED STATES
INDIVIDUAL)
1301 N.W MEYERS BUTTE RD.
POWELL BUTTE, OR 97753

THE MARK CONSISTS OF STANDARD CHAR-
ACTERS WITHOUT CLAIM TO ANY PARTICULAR
FONT, STYLE, SIZE, OR COLOR.

FOR: LOUDSPEAKERS, IN CLASS 9 (U.S. CLS. 21,
23, 26, 36 AND 38).

SER. NO. 77-428,528, FILED 3-21-2008.

FIRST USE 0-0-1998; IN COMMERCE 0-0-1999.

GEORGIA CARTY, EXAMINING ATTORNEY

Int. Cl.: 41

Prior U.S. Cls.: 100, 101 and 107

United States Patent and Trademark Office

Reg. No. 3,519,999

Registered Oct. 21, 2008

**SERVICE MARK
PRINCIPAL REGISTER**



SUNNY JOHNSON (UNITED STATES INDIVIDUAL), DBA SUNNY SAVAGE
P.O. BOX 296
TOPANGA, CA 90290

FOR: ENTERTAINMENT PRODUCTION SERVICES, NAMELY, VIDEO PRODUCTION, TELEVISION PRODUCTION, FILM PRODUCTION AND DOCUMENTARY TELEVISION, FILM AND VIDEO PRODUCTION, IN CLASS 41 (U.S. CLS. 100, 101 AND 107).

FIRST USE 3-7-2008; IN COMMERCE 3-7-2008.

NO CLAIM IS MADE TO THE EXCLUSIVE RIGHT TO USE "PRODUCTIONS", APART FROM THE MARK AS SHOWN.

THE MARK CONSISTS OF STYLIZED WORDS "YEEHAW PRODUCTIONS" WITH STYLIZED SUN DESIGN.

SER. NO. 77-428,537, FILED 3-21-2008.

JAY BESCH, EXAMINING ATTORNEY

Int. Cl.: 35

Prior U.S. Cls.: 100, 101 and 102

United States Patent and Trademark Office

Reg. No. 3,520,000

Registered Oct. 21, 2008

**SERVICE MARK
PRINCIPAL REGISTER**

FAST. FRESH. FOOLPROOF.

SHAW'S SUPERMARKETS, INC. (MASSACHU-
SETTS CORPORATION)
250 E. PARKCENTER BOULEVARD
BOISE, ID 83706

THE MARK CONSISTS OF STANDARD CHAR-
ACTERS WITHOUT CLAIM TO ANY PARTICULAR
FONT, STYLE, SIZE, OR COLOR.

FOR: RETAIL GROCERY STORE SERVICES, IN
CLASS 35 (U.S. CLS. 100, 101 AND 102).

SER. NO. 77-428,559, FILED 3-21-2008.

FIRST USE 4-25-2008; IN COMMERCE 4-25-2008.

PATRICIA EVANKO, EXAMINING ATTORNEY

Int. Cls.: 25 and 35

Prior U.S. Cls.: 22, 39, 100, 101 and 102

United States Patent and Trademark Office

Reg. No. 3,520,001

Registered Oct. 21, 2008

**TRADEMARK
SERVICE MARK
PRINCIPAL REGISTER**

MJC

M.J.C. TEXTILE, INC. (CALIFORNIA CORPORATION)

N-8

600 E. WASHINGTON BL
LOS ANGELES, CA 90015

FOR: DRESS SHIRTS; SHIRTS; SHORT-SLEEVED OR LONG-SLEEVED T-SHIRTS; SPORTS SHIRTS; SWEAT SHIRTS; T-SHIRTS; SHORTS; SWEATERS; PANTS; JEANS; JACKETS; COATS; BRIEFS; UNDERWEAR; NECKWEAR; FOOTWEAR; HEADWEAR; HATS; SOCKS, IN CLASS 25 (U.S. CLS. 22 AND 39).

FIRST USE 9-1-2007; IN COMMERCE 9-1-2007.

FOR: ON-LINE RETAIL STORE SERVICES FEATURING CLOTHING; RETAIL CLOTHING STORES; WHOLESALE DISTRIBUTORSHIPS FEATURING CLOTHING; WHOLESALE STORES FEATURING CLOTHING, IN CLASS 35 (U.S. CLS. 100, 101 AND 102).

FIRST USE 12-1-2007; IN COMMERCE 12-1-2007.

THE MARK CONSISTS OF STANDARD CHARACTERS WITHOUT CLAIM TO ANY PARTICULAR FONT, STYLE, SIZE, OR COLOR.

SER. NO. 77-428,562, FILED 3-21-2008.

BRIAN CALLAGHAN, EXAMINING ATTORNEY

Int. Cl.: 36

Prior U.S. Cls.: 100, 101 and 102

United States Patent and Trademark Office

Reg. No. 3,520,002

Registered Oct. 21, 2008

**SERVICE MARK
PRINCIPAL REGISTER**

BEXLEY AT BRIER CREEK

WEINSTEIN MANAGEMENT CO., INC. (VIRGINIA CORPORATION)
3951-A STILLMAN PARKWAY
GLEN ALLEN, VA 23060

FOR: REAL ESTATE SERVICES, NAMELY, LEASING AND MANAGEMENT OF REAL PROPERTY, IN CLASS 36 (U.S. CLS. 100, 101 AND 102).

FIRST USE 1-25-2008; IN COMMERCE 1-25-2008.

THE MARK CONSISTS OF STANDARD CHARACTERS WITHOUT CLAIM TO ANY PARTICULAR FONT, STYLE, SIZE, OR COLOR.

OWNER OF U.S. REG. NOS. 2,889,355, 3,222,386 AND OTHERS.

SER. NO. 77-428,563, FILED 3-21-2008.

LAURA HAMMEL, EXAMINING ATTORNEY

Int. Cl.: 35

Prior U.S. Cls.: 100, 101 and 102

United States Patent and Trademark Office

Reg. No. 3,520,003

Registered Oct. 21, 2008

**SERVICE MARK
PRINCIPAL REGISTER**

**MARKETING SOLUTIONS THAT
PUT ACCOUNTABILITY FIRST**

CAMPBELL AUTOMOTIVE MARKETING, INC.
(SOUTH CAROLINA CORPORATION)
510 SUNSET DRIVE
CLOVER, SC 29710

THE MARK CONSISTS OF STANDARD CHAR-
ACTERS WITHOUT CLAIM TO ANY PARTICULAR
FONT, STYLE, SIZE, OR COLOR.

FOR: MARKETING AND PROMOTION SERVI-
CES FOR TARGETING PROSPECTIVE CUSTO-
MERS FOR AUTOMOBILE DEALERS, IN CLASS 35
(U.S. CLS. 100, 101 AND 102).

SER. NO. 77-428,595, FILED 3-21-2008.

FIRST USE 1-21-2008; IN COMMERCE 1-21-2008.

G. MAYERSCHOFF, EXAMINING ATTORNEY

Int. Cl.: 44

Prior U.S. Cls.: 100 and 101

United States Patent and Trademark Office

Reg. No. 3,520,004

Registered Oct. 21, 2008

**SERVICE MARK
PRINCIPAL REGISTER**

Developmental Rhythms

PIERRE BRENNAN (UNITED STATES INDIVIDUAL)
1101 OAKWOOD DRIVE
MILLBRAE, CA 94030

FOR: MUSIC THERAPY FOR PHYSICAL, PSYCHOLOGICAL AND COGNITIVE PURPOSES; MUSIC THERAPY FOR SOCIAL ASSIMILATION PURPOSES, IN CLASS 44 (U.S. CLS. 100 AND 101).

FIRST USE 11-1-2004; IN COMMERCE 11-1-2004.

THE MARK CONSISTS OF STANDARD CHARACTERS WITHOUT CLAIM TO ANY PARTICULAR FONT, STYLE, SIZE, OR COLOR.

SER. NO. 77-428,644, FILED 3-21-2008.

EMILY CARLSEN, EXAMINING ATTORNEY

Int. Cl.: 35

Prior U.S. Cls.: 100, 101 and 102

United States Patent and Trademark Office

Reg. No. 3,520,005

Registered Oct. 21, 2008

**SERVICE MARK
PRINCIPAL REGISTER**

The Heart Link Network

BILLINGS, DAWN L. (UNITED STATES INDIVIDUAL)
680 VININGS ESTATES DRIVE
MABLETON, GA 30126

FOR: ADVERTISING AND COMMERCIAL INFORMATION SERVICES, VIA THE INTERNET, IN CLASS 35 (U.S. CLS. 100, 101 AND 102).

FIRST USE 3-14-2008; IN COMMERCE 3-14-2008.

THE MARK CONSISTS OF STANDARD CHARACTERS WITHOUT CLAIM TO ANY PARTICULAR FONT, STYLE, SIZE, OR COLOR.

NO CLAIM IS MADE TO THE EXCLUSIVE RIGHT TO USE "LINK NETWORK", APART FROM THE MARK AS SHOWN.

SER. NO. 77-428,685, FILED 3-21-2008.

MICHAEL GAAFAR, EXAMINING ATTORNEY

Int. Cls.: 29 and 31

Prior U.S. Cls.: 1 and 46

United States Patent and Trademark Office

Reg. No. 3,520,006

Registered Oct. 21, 2008

**TRADEMARK
PRINCIPAL REGISTER**

ARCTIC STORM

ARCTIC STORM, INC. (WASHINGTON CORPORATION)

#3201

400 NORTH 34TH STREET
SEATTLE, WA 981038600

FOR: SEAFOOD, NAMELY, WHOLE FISH, DRESSED FISH, FISH FILLETS, MINCED FISH, AND FISH ROE, IN CLASS 29 (U.S. CL. 46).

FIRST USE 2-0-1987; IN COMMERCE 2-0-1987.

FOR: FISH MEAL FOR ANIMAL FEED, IN CLASS 31 (U.S. CLS. 1 AND 46).

FIRST USE 2-0-1987; IN COMMERCE 2-0-1987.

THE MARK CONSISTS OF STANDARD CHARACTERS WITHOUT CLAIM TO ANY PARTICULAR FONT, STYLE, SIZE, OR COLOR.

OWNER OF U.S. REG. NO. 1,474,339.

SER. NO. 77-428,688, FILED 3-21-2008.

ANDREA HACK, EXAMINING ATTORNEY

Int. Cls.: 29 and 31

Prior U.S. Cls.: 1 and 46

United States Patent and Trademark Office

Reg. No. 3,520,007

Registered Oct. 21, 2008

**TRADEMARK
PRINCIPAL REGISTER**



ARCTIC STORM, INC. (WASHINGTON CORPORATION)

#3201

400 NORTH 34TH STREET
SEATTLE, WA 981038600

FOR: SEAFOOD, NAMELY, WHOLE FISH, DRESSED FISH, FISH FILLETS, MINCED FISH, AND FISH ROE, IN CLASS 29 (U.S. CL. 46).

FIRST USE 2-0-1987; IN COMMERCE 2-0-1987.

FOR: FISH MEAL FOR ANIMAL FEED, IN CLASS 31 (U.S. CLS. 1 AND 46).

FIRST USE 2-0-1987; IN COMMERCE 2-0-1987.

OWNER OF U.S. REG. NO. 1,471,541.

SER. NO. 77-428,691, FILED 3-21-2008.

ANDREA HACK, EXAMINING ATTORNEY

Int. Cl.: 35

Prior U.S. Cls.: 100, 101 and 102

United States Patent and Trademark Office

Reg. No. 3,520,008

Registered Oct. 21, 2008

**SERVICE MARK
PRINCIPAL REGISTER**

DON'T FORGET YOUR CHILD

DON'T FORGET YOUR CHILD, LLC (MISSISSIPPI LIMITED LIABILITY COMPANY)
219 CEDAR HILL RD.
FLORA, MS 39071

FOR: PUBLIC ADVOCACY TO PROMOTE AWARENESS OF THE DANGERS OF LEAVING YOUR CHILD IN THE BACK SEAT OF A VEHICLE, RESULTING IN DEATH BY HYPOTHERMIA, HEAT STROKE, OR NEGLECT; PROMOTIONAL SERVICES, NAMELY, PROMOTING THE CHARITIES OF OTHERS; PROMOTING PUBLIC AWARENESS OF THE NEED FOR ATTENTION TO THE DANGERS OF LEAVING YOUR CHILD IN THE BACK SEAT OF A VEHICLE, RESULTING IN DEATH BY HYPOTHERMIA, HEAT STROKE, OR NEGLECT; PROMOTING PUBLIC AWARENESS OF THE DANGERS OF LEAVING YOUR CHILD IN THE BACK SEAT OF A VEHICLE, RESULTING IN DEATH BY HYPOTHERMIA, HEAT STROKE, OR NEGLECT; OR-

GANIZING AND CONDUCTING CHARITY AUCTIONS FOR CHARITABLE FUNDRAISING PURPOSES; CHARITABLE SERVICES, NAMELY, ORGANIZING AND CONDUCTING VOLUNTEER PROGRAMS AND COMMUNITY SERVICE PROJECTS; DEVELOPING AND COORDINATING VOLUNTEER PROJECTS FOR CHARITABLE ORGANIZATIONS, IN CLASS 35 (U.S. CLS. 100, 101 AND 102).

FIRST USE 9-5-2007; IN COMMERCE 9-10-2007.

THE MARK CONSISTS OF STANDARD CHARACTERS WITHOUT CLAIM TO ANY PARTICULAR FONT, STYLE, SIZE, OR COLOR.

SER. NO. 77-428,715, FILED 3-21-2008.

DANIEL BRODY, EXAMINING ATTORNEY

Int. Cl.: 36

Prior U.S. Cls.: 100, 101 and 102

United States Patent and Trademark Office

Reg. No. 3,520,009

Registered Oct. 21, 2008

**SERVICE MARK
PRINCIPAL REGISTER**

**IT'S A PRIVILEGE TO SERVE
YOU**

MERRILL LYNCH BANK & TRUST CO., FSB
(UNITED STATES FEDERAL SAVINGS
BANK), DBA FIRST REPUBLIC BANK
4 WORLD FINANCIAL CENTER
NEW YORK, NY 10038

FOR: CREDIT CARD SERVICES; DEBIT CARD SERVICES; COMMERCIAL AND CONSUMER LENDING, LEASING, AND FINANCING; TRUST, ESTATE, AND FIDUCIARY MANAGEMENT, PLANNING, AND CONSULTING; INVESTMENT SERVICES, NAMELY, PROVIDING INVESTMENT ANALYSIS, CONSULTATION, PLANNING, MANAGEMENT, ADVISORY, BROKERAGE, BANKING, AND RESEARCH SERVICES WITH RESPECT TO STOCKS, MUTUAL FUNDS, SECURITIES, BONDS, COMMODITIES, REAL ESTATE AND OTHER INSTRUMENTS OF INVESTMENT; PROVIDING SECURE FINANCIAL TRANSACTIONS IN THE NATURE OF ELECTRONIC CASH TRANSACTIONS, ELECTRONIC CREDIT CARD TRANSACTIONS, ELECTRONIC DEBIT TRANSACTIONS,

ELECTRONIC CHECK PROCESSING TRANSACTIONS AND ELECTRONIC TRANSMISSION OF BILL PAYMENT DATA VIA A GLOBAL COMPUTER NETWORK; FINANCIAL PLANNING AND INVESTMENT ADVISORY SERVICES; FINANCIAL PLANNING CONSULTATION; AUTOMATED TELLER MACHINE SERVICES, IN CLASS 36 (U.S. CLS. 100, 101 AND 102).

FIRST USE 9-1-1997; IN COMMERCE 9-1-1997.

THE MARK CONSISTS OF STANDARD CHARACTERS WITHOUT CLAIM TO ANY PARTICULAR FONT, STYLE, SIZE, OR COLOR.

OWNER OF U.S. REG. NO. 2,209,636.

SER. NO. 77-428,724, FILED 3-21-2008.

ALEXANDER L. POWERS, EXAMINING ATTORNEY

Int. Cl.: 35

Prior U.S. Cls.: 100, 101 and 102

United States Patent and Trademark Office

Reg. No. 3,520,010

Registered Oct. 21, 2008

**SERVICE MARK
PRINCIPAL REGISTER**

agelessaesthetics

AGELESS AESTHETICS, INC (COLORADO CORPORATION)

#400

5889 GREENWOOD PLAZA BLVD.
GREENWOOD VILLAGE, CO 80111

FOR: DISTRIBUTORSHIP SERVICES IN THE
FIELD OF SKIN CARE PRODUCTS AND EQUIP-
MENT, IN CLASS 35 (U.S. CLS. 100, 101 AND 102).

FIRST USE 6-1-2001; IN COMMERCE 6-1-2001.

THE MARK CONSISTS OF STANDARD CHAR-
ACTERS WITHOUT CLAIM TO ANY PARTICULAR
FONT, STYLE, SIZE, OR COLOR.

SER. NO. 77-428,740, FILED 3-21-2008.

KATHERINE M. DUBRAY, EXAMINING ATTOR-
NEY

Int. Cl.: 14

Prior U.S. Cls.: 2, 27, 28 and 50

Reg. No. 3,520,011

United States Patent and Trademark Office

Registered Oct. 21, 2008

**TRADEMARK
PRINCIPAL REGISTER**

Aubrey Ellen

TAYLOR, STEPHANIE (UNITED STATES INDIVIDUAL)
16350 HAVENPARK CT.
HOUSTON, TX 77059

FOR: JEWELRY, NAMELY, NECKLACES, EARRINGS, PENDANTS, BRACELETS, AND RINGS, IN CLASS 14 (U.S. CLS. 2, 27, 28 AND 50).

FIRST USE 10-13-2007; IN COMMERCE 10-13-2007.

THE MARK CONSISTS OF STANDARD CHARACTERS WITHOUT CLAIM TO ANY PARTICULAR FONT, STYLE, SIZE, OR COLOR.

THE NAME "AUBREY ELLEN" DOES NOT IDENTIFY A LIVING INDIVIDUAL.

SER. NO. 77-428,752, FILED 3-21-2008.

CYNTHIA SLOAN, EXAMINING ATTORNEY

Int. Cl.: 35

Prior U.S. Cls.: 100, 101 and 102

United States Patent and Trademark Office

Reg. No. 3,520,012

Registered Oct. 21, 2008

**SERVICE MARK
PRINCIPAL REGISTER**

LOCAL PROMOTE

LOCAL.COM CORPORATION (DELAWARE CORPORATION)
ONE TECHNOLOGY DRIVE, BUILDING G
IRVINE, CA 92618

FOR: DISSEMINATION OF ADVERTISING FOR OTHERS VIA THE INTERNET; ONLINE ADVERTISING SERVICES FOR OTHERS, NAMELY, PROVIDING ADVERTISING SPACE ON INTERNET WEB SITES; ADVERTISING SERVICES, INCLUDING, PROVIDING ONLINE MARKETING SERVICES IN THE NATURE OF BANNER ADVERTISING, DISPLAY ADVERTISING, LINK EXCHANGES AND SEARCH ENGINE PLACEMENT AND KEYWORD SELECTION SERVICES; BUSINESS MARKETING

AND ADVERTISING CONSULTATION IN THE FIELD OF SEARCH ENGINE OPTIMIZATION AND WEBSITE MARKETING, IN CLASS 35 (U.S. CLS. 100, 101 AND 102).

FIRST USE 10-0-2006; IN COMMERCE 10-0-2006.

THE MARK CONSISTS OF STANDARD CHARACTERS WITHOUT CLAIM TO ANY PARTICULAR FONT, STYLE, SIZE, OR COLOR.

SER. NO. 77-428,756, FILED 3-21-2008.

ANNE MADDEN, EXAMINING ATTORNEY

Int. Cl.: 35

Prior U.S. Cls.: 100, 101 and 102

United States Patent and Trademark Office

Reg. No. 3,520,013

Registered Oct. 21, 2008

**SERVICE MARK
PRINCIPAL REGISTER**



ASLINGER, ED (UNITED STATES INDIVIDUAL)
131 REYNOLDS DRIVE
ROSSVILLE, GA 30741

FOR: ON-LINE ADVERTISING AND MARKET-
ING SERVICES, IN CLASS 35 (U.S. CLS. 100, 101 AND
102).

FIRST USE 3-7-2008; IN COMMERCE 3-7-2008.

NO CLAIM IS MADE TO THE EXCLUSIVE
RIGHT TO USE "CHATTANOOGA", APART FROM
THE MARK AS SHOWN.

THE STIPLING IS FOR SHADING PURPOSES
ONLY.

THE MARK CONSISTS OF THE STYLIZED TEXT
"WWW.SEE CHATTANOOGA NOW.COM". THERE
IS A CIRCLE WITH AN IMAGE OF THE SUN
BEHIND A PEAKED-ROOF BUILDING.

SER. NO. 77-428,757, FILED 3-21-2008.

CYNTHIA SLOAN, EXAMINING ATTORNEY

Int. Cl.: 35

Prior U.S. Cls.: 100, 101 and 102

United States Patent and Trademark Office

Reg. No. 3,520,014

Registered Oct. 21, 2008

SERVICE MARK
PRINCIPAL REGISTER



THE FABULOUS STORE LLC (MARYLAND LIMITED LIABILITY COMPANY)
1037 JEANETT WAY
BEL AIR, MD 21014

FOR: ON-LINE RETAIL STORE SERVICES FEATURING SCRAPBOOK-RELATED PRODUCTS, IN CLASS 35 (U.S. CLS. 100, 101 AND 102).

FIRST USE 11-0-2006; IN COMMERCE 11-0-2006.

NO CLAIM IS MADE TO THE EXCLUSIVE RIGHT TO USE "SCRAPBOOK STORE", APART FROM THE MARK AS SHOWN.

THE MARK CONSISTS OF THE WORDING "THE FABULOUS SCRAPBOOK STORE WWW.FABULOUSSCRAPBOOK.COM", ALONG WITH FOUR DIAMONDS - TWO IN THE TOP LEFT CORNER AND TWO IN THE BOTTOM RIGHT CORNER.

SER. NO. 77-428,789, FILED 3-21-2008.

ALICE SUE CARRUTHERS, EXAMINING ATTORNEY

Int. Cl.: 37

Prior U.S. Cls.: 100, 103 and 106

United States Patent and Trademark Office

Reg. No. 3,520,015

Registered Oct. 21, 2008

**SERVICE MARK
PRINCIPAL REGISTER**

METALOCK

METALOCK CORPORATION (DELAWARE COR-
PORATION)
205 WILLOW SPRINGS ROAD
P.O. BOX 205
WILLOW SPRINGS, IL 604800205

THE MARK CONSISTS OF STANDARD CHAR-
ACTERS WITHOUT CLAIM TO ANY PARTICULAR
FONT, STYLE, SIZE, OR COLOR.

FOR: MACHINERY REPAIR SERVICES, IN
CLASS 37 (U.S. CLS. 100, 103 AND 106).

SER. NO. 77-428,842, FILED 3-21-2008.

FIRST USE 9-1-1937; IN COMMERCE 9-1-1937.

LINDA M. KING, EXAMINING ATTORNEY

Int. Cl.: 32

Prior U.S. Cls.: 45, 46 and 48

United States Patent and Trademark Office

Reg. No. 3,520,016

Registered Oct. 21, 2008

**TRADEMARK
PRINCIPAL REGISTER**

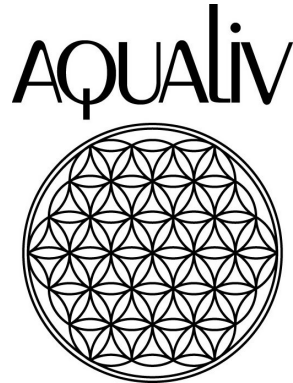

HOFFMAN HOSPITALITY LLC (WASHINGTON
LIMITED LIABILITY COMPANY)
PO BOX 1179
RAINIER, WA 98576

THE MARK CONSISTS OF THE WORD "AQUA-
LIV" IN CONJUNCTION WITH 19 OVERLAPPING
CIRCLES, ALL CONTAINED IN A 20TH CIRCLE,
FURTHER CONTAINED IN A 21ST CIRCLE.

FOR: BOTTLED WATER, IN CLASS 32 (U.S. CLS.
45, 46 AND 48).

SER. NO. 77-428,858, FILED 3-22-2008.

FIRST USE 12-1-2006; IN COMMERCE 1-1-2007.

INGA ERVIN, EXAMINING ATTORNEY

Int. Cl.: 9

Prior U.S. Cls.: 21, 23, 26, 36 and 38

Reg. No. 3,520,017

United States Patent and Trademark Office

Registered Oct. 21, 2008

**TRADEMARK
PRINCIPAL REGISTER**

MOBLTZ

MOBLTZ, LLC (CALIFORNIA LIMITED LIABILITY COMPANY)
APT. E
1540E PERSHING DR.
SAN FRANCISCO, CA 94129

THE MARK CONSISTS OF STANDARD CHARACTERS WITHOUT CLAIM TO ANY PARTICULAR FONT, STYLE, SIZE, OR COLOR.

FOR: COMPUTER PROGRAMS FOR USING THE INTERNET AND THE WORLD WIDE WEB, IN CLASS 9 (U.S. CLS. 21, 23, 26, 36 AND 38).

SER. NO. 77-428,866, FILED 3-22-2008.

FIRST USE 1-25-2008; IN COMMERCE 1-25-2008.

MICHAEL SOUDERS, EXAMINING ATTORNEY

Int. Cl.: 16

Prior U.S. Cls.: 2, 5, 22, 23, 29, 37, 38 and 50

Reg. No. 3,520,018

United States Patent and Trademark Office

Registered Oct. 21, 2008

**TRADEMARK
PRINCIPAL REGISTER**

FINE POINTS

GREGG APPLIANCES, INC. (INDIANA CORPORATION)
4151 E. 96TH STREET
INDIANAPOLIS, IN 46240

FOR: MAGAZINES FEATURING INFORMATION REGARDING CONSUMER APPLIANCES, ELECTRONICS, COOKING, FOODS, DRINKS, AND PERSONAL LIFESTYLE, RECIPES AND PROMOTIONAL MATERIALS, IN CLASS 16 (U.S. CLS. 2, 5, 22, 23, 29, 37, 38 AND 50).

FIRST USE 8-0-2006; IN COMMERCE 8-0-2006.

THE MARK CONSISTS OF STANDARD CHARACTERS WITHOUT CLAIM TO ANY PARTICULAR FONT, STYLE, SIZE, OR COLOR.

SER. NO. 77-428,871, FILED 3-22-2008.

DAVID TAYLOR, EXAMINING ATTORNEY

Int. Cl.: 35

Prior U.S. Cls.: 100, 101 and 102

United States Patent and Trademark Office

Reg. No. 3,520,019

Registered Oct. 21, 2008

**SERVICE MARK
PRINCIPAL REGISTER**

WEBSTOCK

GREGG APPLIANCES, INC. (INDIANA CORPORATION)
4151 E. 96TH STREET
INDIANAPOLIS, IN 46240

FOR: ON-LINE RETAIL STORE SERVICES FEATURING CONSUMER APPLIANCES, ELECTRONICS, PHOTOGRAPHIC EQUIPMENT, TELECOMMUNICATION EQUIPMENT, VIDEO EQUIPMENT, AUDIO EQUIPMENT, SATELLITE RECEIVING EQUIPMENT, HOME OFFICE EQUIPMENT, CAR EQUIPMENT, COMPUTER HARDWARE, COMPUTER SOFTWARE, ENTERTAINMENT SOFTWARE, AND RELATED

EQUIPMENT AND MERCHANDISE, IN CLASS 35 (U.S. CLS. 100, 101 AND 102).

FIRST USE 10-10-2006; IN COMMERCE 10-10-2006.

THE MARK CONSISTS OF STANDARD CHARACTERS WITHOUT CLAIM TO ANY PARTICULAR FONT, STYLE, SIZE, OR COLOR.

SER. NO. 77-428,873, FILED 3-22-2008.

DAVID TAYLOR, EXAMINING ATTORNEY

Int. Cls.: 35, 36, 37 and 39

Prior U.S. Cls.: 100, 101, 102, 103, 105 and 106

United States Patent and Trademark Office

Reg. No. 3,520,020

Registered Oct. 21, 2008

**SERVICE MARK
PRINCIPAL REGISTER**

HHGREGG

GREGG APPLIANCES, INC. (INDIANA CORPORATION)
4151 E. 96TH STREET
INDIANAPOLIS, IN 46240

FOR: ON-LINE RETAIL STORE SERVICES FEATURING CONSUMER APPLIANCES, ELECTRONICS, PHOTOGRAPHIC EQUIPMENT, TELECOMMUNICATION EQUIPMENT, VIDEO EQUIPMENT, AUDIO EQUIPMENT, SATELLITE RECEIVING EQUIPMENT, HOME OFFICE EQUIPMENT, CAR EQUIPMENT, COMPUTER HARDWARE, COMPUTER SOFTWARE, ENTERTAINMENT SOFTWARE, AND RELATED EQUIPMENT AND MERCHANDISE; RETAIL STORE SERVICES FEATURING CONSUMER APPLIANCES, ELECTRONICS, PHOTOGRAPHIC EQUIPMENT, TELECOMMUNICATION EQUIPMENT, VIDEO EQUIPMENT, AUDIO EQUIPMENT, SATELLITE RECEIVING EQUIPMENT, HOME OFFICE EQUIPMENT, CAR EQUIPMENT, COMPUTER HARDWARE, COMPUTER SOFTWARE, ENTERTAINMENT SOFTWARE, AND RELATED EQUIPMENT AND MERCHANDISE, IN CLASS 35 (U.S. CLS. 100, 101 AND 102).

FIRST USE 12-0-1999; IN COMMERCE 12-0-1999.

FOR: CREDIT CARD SERVICES; PROVIDING EXTENDED WARRANTIES ON ON ELECTRONICS, EQUIPMENT, APPLIANCES, COMPUTERS AND

RELATED MERCHANDISE; FACILITATING AND ARRANGING FOR THE FINANCING OF ELECTRONICS, EQUIPMENT, APPLIANCES, COMPUTERS AND RELATED MERCHANDISE, IN CLASS 36 (U.S. CLS. 100, 101 AND 102).

FIRST USE 12-0-1999; IN COMMERCE 12-0-1999.

FOR: INSTALLATION, MAINTENANCE AND REPAIR OF ELECTRONICS, EQUIPMENT, APPLIANCES, COMPUTERS AND RELATED MERCHANDISE, IN CLASS 37 (U.S. CLS. 100, 103 AND 106).

FIRST USE 12-0-1999; IN COMMERCE 12-0-1999.

FOR: DISTRIBUTION SERVICES, NAMELY, DELIVERY OF ELECTRONICS, EQUIPMENT, APPLIANCES, COMPUTERS AND RELATED MERCHANDISE, IN CLASS 39 (U.S. CLS. 100 AND 105).

FIRST USE 12-0-1999; IN COMMERCE 12-0-1999.

THE MARK CONSISTS OF STANDARD CHARACTERS WITHOUT CLAIM TO ANY PARTICULAR FONT, STYLE, SIZE, OR COLOR.

SER. NO. 77-428,877, FILED 3-22-2008.

DAVID TAYLOR, EXAMINING ATTORNEY

Int. Cl.: 42

Prior U.S. Cls.: 100 and 101

United States Patent and Trademark Office

Reg. No. 3,520,021

Registered Oct. 21, 2008

**SERVICE MARK
PRINCIPAL REGISTER**

Litigation Unleashed

LEXBE LC (TEXAS LIMITED LIABILITY COMPANY)
3801 N CAPITAL OF TX HWY, SUITE E420/152
AUSTIN, TX 78746

FOR: COMPUTER SERVICES, NAMELY, HOSTING AND MAINTAINING AN ONLINE WEB SITE FOR OTHERS TO MANAGE LITIGATION AND LEGAL MATTERS, DOCUMENT, FILE AND DATA STORAGE, ANALYSIS AND RETRIEVAL, REPORTING, AND DATABASE FUNCTIONS, IN CLASS 42 (U.S. CLS. 100 AND 101).

FIRST USE 2-25-2008; IN COMMERCE 2-25-2008.

THE MARK CONSISTS OF STANDARD CHARACTERS WITHOUT CLAIM TO ANY PARTICULAR FONT, STYLE, SIZE, OR COLOR.

NO CLAIM IS MADE TO THE EXCLUSIVE RIGHT TO USE "LITIGATION", APART FROM THE MARK AS SHOWN.

SER. NO. 77-428,930, FILED 3-22-2008.

ERIN FALK, EXAMINING ATTORNEY

Int. Cl.: 11

Prior U.S. Cls.: 13, 21, 23, 31 and 34

Reg. No. 3,520,022

United States Patent and Trademark Office

Registered Oct. 21, 2008

**TRADEMARK
PRINCIPAL REGISTER**

QUICKTRIM

WCM INDUSTRIES, INC. (COLORADO CORPORATION)
2121 WAYNOKA ROAD
COLORADO SPRINGS, CO 80915

THE MARK CONSISTS OF STANDARD CHARACTERS WITHOUT CLAIM TO ANY PARTICULAR FONT, STYLE, SIZE, OR COLOR.

FOR: TUB PARTS, NAMELY, TUB WASTE COVERS, IN CLASS 11 (U.S. CLS. 13, 21, 23, 31 AND 34).

SER. NO. 77-428,936, FILED 3-22-2008.

FIRST USE 9-0-2007; IN COMMERCE 9-0-2007.

INGA ERVIN, EXAMINING ATTORNEY

Int. Cl.: 11

Prior U.S. Cls.: 13, 21, 23, 31 and 34

United States Patent and Trademark Office

Reg. No. 3,520,023

Registered Oct. 21, 2008

**TRADEMARK
PRINCIPAL REGISTER**

PRESFLO

WCM INDUSTRIES, INC. (COLORADO CORPORATION)
2121 WAYNOKA ROAD
COLORADO SPRINGS, CO 80915

THE MARK CONSISTS OF STANDARD CHARACTERS WITHOUT CLAIM TO ANY PARTICULAR FONT, STYLE, SIZE, OR COLOR.

FOR: DRAINS, IN CLASS 11 (U.S. CLS. 13, 21, 23, 31 AND 34).

SER. NO. 77-428,939, FILED 3-22-2008.

FIRST USE 1-0-1998; IN COMMERCE 1-0-1998.

INGA ERVIN, EXAMINING ATTORNEY

Int. Cl.: 45

Prior U.S. Cls.: 100 and 101

United States Patent and Trademark Office

Reg. No. 3,520,024

Registered Oct. 21, 2008

**SERVICE MARK
PRINCIPAL REGISTER**

Pal Posse

POST, LUANA C. (UNITED STATES INDIVIDUAL)
580 SWEET STREAM TRACE
DULUTH, GA 30097 AND
BENELLI, ELLEN (UNITED STATES INDIVIDUAL)
605 SWEET STREAM TRACE
DULUTH, GA 30097

FOR: PROVIDING NON-MEDICAL PERSONAL ASSISTANT SERVICES FOR OTHERS IN THE NATURE OF PLANNING, ORGANIZING, COORDINAT-

ING, ARRANGING AND ASSISTING INDIVIDUALS TO PERFORM DAILY TASKS, IN CLASS 45 (U.S. CLS. 100 AND 101).

FIRST USE 3-13-2008; IN COMMERCE 3-13-2008.

SER. NO. 77-428,956, FILED 3-22-2008.

KARANENDRA S. CHHINA, EXAMINING ATTORNEY

Int. Cl.: 40

Prior U.S. Cls.: 100, 103 and 106

United States Patent and Trademark Office

Reg. No. 3,520,025

Registered Oct. 21, 2008

**SERVICE MARK
PRINCIPAL REGISTER**

SHRED-MAX

LUKAS INVESTMENTS LLC (MICHIGAN LIMITED LIABILITY COMPANY), DBA SHRED-MAX
3758 COVERT RD.
WATERFORD, MI 48328

FOR: DOCUMENT DESTRUCTION; DOCUMENT SHREDDING SERVICES, IN CLASS 40 (U.S. CLS. 100, 103 AND 106).

FIRST USE 11-20-2007; IN COMMERCE 1-1-2008.

THE MARK CONSISTS OF STANDARD CHARACTERS WITHOUT CLAIM TO ANY PARTICULAR FONT, STYLE, SIZE, OR COLOR.

SER. NO. 77-428,957, FILED 3-22-2008.

KARANENDRA S. CHHINA, EXAMINING ATTORNEY

Int. Cl.: 45

Prior U.S. Cls.: 100 and 101

United States Patent and Trademark Office

Reg. No. 3,520,026

Registered Oct. 21, 2008

**SERVICE MARK
PRINCIPAL REGISTER**

COUNSELORS TO INSPIRATION

SEAN HOGLE PC (COLORADO CORPORATION)
802 B STREET
SAN RAFAEL, CA 94901

FOR: LEGAL SERVICES, IN CLASS 45 (U.S. CLS.
100 AND 101).

FIRST USE 3-18-2008; IN COMMERCE 3-18-2008.

THE MARK CONSISTS OF STANDARD CHAR-
ACTERS WITHOUT CLAIM TO ANY PARTICULAR
FONT, STYLE, SIZE, OR COLOR.

NO CLAIM IS MADE TO THE EXCLUSIVE
RIGHT TO USE "COUNSELORS", APART FROM
THE MARK AS SHOWN.

SER. NO. 77-428,966, FILED 3-22-2008.

DANNEAN HETZEL, EXAMINING ATTORNEY

Int. Cl.: 21

Prior U.S. Cls.: 2, 13, 23, 29, 30, 33, 40 and 50

Reg. No. 3,520,027

United States Patent and Trademark Office

Registered Oct. 21, 2008

**TRADEMARK
PRINCIPAL REGISTER**

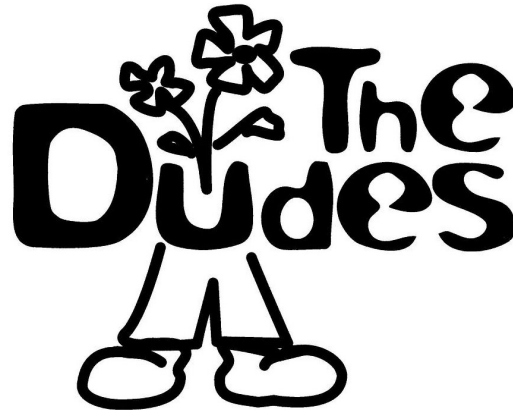

CAPT, GABRIELA DÍAZ (ARGENTINA INDIVIDUAL)
109 BILLMAN AVENUE
SPENCER, OH 44275

FOR: PLANTERS FOR FLOWERS AND PLANTS,
IN CLASS 21 (U.S. CLS. 2, 13, 23, 29, 30, 33, 40 AND 50).

FIRST USE 5-1-2004; IN COMMERCE 12-24-2006.

THE MARK CONSISTS OF THE WORDS "THE Dudes" WITH TWO FLOWERS COMING OUT OF THE TOP OF THE "U" AND LEGS WITH PANTS AND SHOES COMING OUT OF THE BOTTOM OF THE "U".

SER. NO. 77-428,983, FILED 3-22-2008.

FRED MANDIR, EXAMINING ATTORNEY

Int. Cl.: 35

Prior U.S. Cls.: 100, 101 and 102

United States Patent and Trademark Office

Reg. No. 3,520,028

Registered Oct. 21, 2008

SERVICE MARK
PRINCIPAL REGISTER



LANDERS, JAMES B. (UNITED STATES INDIVIDUAL)

2807 IVYDALE STREET
SILVER SPRING, MD 20902

FOR: ADVERTISING AND MARKETING; BUSINESS MARKETING SERVICES, IN CLASS 35 (U.S. CLS. 100, 101 AND 102).

FIRST USE 0-0-2008; IN COMMERCE 0-0-2008.

NO CLAIM IS MADE TO THE EXCLUSIVE RIGHT TO USE "INTERACTIVE", APART FROM THE MARK AS SHOWN.

THE COLOR(S) BLUE/PURPLE/WHITE/BLACK IS/ARE CLAIMED AS A FEATURE OF THE MARK.

THE MARK CONSISTS OF A CIRCLE WITH BLUE/PURPLE UPPER HALF AND BLACK LOWER HALF PARTIALLY SURROUNDED BY A BLUE STYLIZED "C". THE WORDS "BLUE" AND "CORONA" WITH THE FIRST "O" IN THE WORD "CORONA" IN PURPLE AND THE WORD "INTERACTIVE" BELOW IN PURPLE. THE BACKGROUND IS WHITE.

SER. NO. 77-428,985, FILED 3-22-2008.

ANDREA SAUNDERS, EXAMINING ATTORNEY

Int. Cl.: 9

Prior U.S. Cls.: 21, 23, 26, 36 and 38

Reg. No. 3,520,029

United States Patent and Trademark Office

Registered Oct. 21, 2008

**TRADEMARK
PRINCIPAL REGISTER**

See It Bigger

SEE IT BIGGER LLC (DELAWARE LIMITED
LIABILITY COMPANY)
3918 TIEFORT DRIVE
FORT IRWIN, CA 92310

THE MARK CONSISTS OF STANDARD CHAR-
ACTERS WITHOUT CLAIM TO ANY PARTICULAR
FONT, STYLE, SIZE, OR COLOR.

FOR: MAGNIFYING GLASSES, IN CLASS 9 (U.S.
CLS. 21, 23, 26, 36 AND 38).

SER. NO. 77-428,989, FILED 3-22-2008.

FIRST USE 3-6-2008; IN COMMERCE 3-17-2008.

KATINA MISTER, EXAMINING ATTORNEY

Int. Cl.: 41

Prior U.S. Cls.: 100, 101 and 107

United States Patent and Trademark Office

Reg. No. 3,520,030

Registered Oct. 21, 2008

**SERVICE MARK
PRINCIPAL REGISTER**

Bronx Underground

BRONX UNDERGROUND LLC (NEW YORK
LIMITED LIABILITY COMPANY)
3829 GRISWOLD AVE
BRONX, NY 10465

FOR: ARRANGING AND CONDUCTING OF
CONCERTS; CONCERT BOOKING; ENTERTAIN-
MENT, NAMELY, LIVE MUSIC CONCERTS, IN
CLASS 41 (U.S. CLS. 100, 101 AND 107).

FIRST USE 9-15-2000; IN COMMERCE 10-15-2000.

THE MARK CONSISTS OF STANDARD CHAR-
ACTERS WITHOUT CLAIM TO ANY PARTICULAR
FONT, STYLE, SIZE, OR COLOR.

SEC. 2(F).

SER. NO. 77-429,048, FILED 3-23-2008.

WILLIAM ROSSMAN, EXAMINING ATTORNEY

Int. Cl.: 11

Prior U.S. Cls.: 13, 21, 23, 31 and 34

United States Patent and Trademark Office

Reg. No. 3,520,031

Registered Oct. 21, 2008

**TRADEMARK
PRINCIPAL REGISTER**



GALPA INVESTMENT LTD. (BARBADOS CORPORATION)

WORTHING CORPORATE CENTRE

WORTHING

CHRIST CHURCH, BARBADOS BB15008

FOR: AIR CONDITIONERS; AIR CONDITIONING UNITS; APPLIANCES FOR DOMESTIC USE, NAMELY, TEMPERATURE CONTROLLED WINE CELLARS; WINE COOLERS, NAMELY, REFRIGERATED CABINETS CONTAINING RACKS FOR WINE BOTTLES AND STORAGE SHELVES; DEHUMIDIFIERS, IN CLASS 11 (U.S. CLS. 13, 21, 23, 31 AND 34).

FIRST USE 12-31-2003; IN COMMERCE 12-31-2003.

THE COLOR(S) WHITE, BLACK, GREY AND BLUE IS/ARE CLAIMED AS A FEATURE OF THE MARK.

THE MARK CONSISTS OF THE WORD "ECOX" IN STYLIZED BLACK LETTERS. A BLUE ARCH LIKE FIGURE APPEARS OVER THE DRAWING, INTERSECTING PORTIONS OF THE LETTERS "E", "C" AND "O". THE COLOR WHITE APPEARS IN THE AREAS OF THE LETTER "E" THE ARCH LIKE FIGURE CROSSES. THE COLOR GREY APPEARS IN THE AREAS OF THE LETTERS "C" AND "O" THE ARCH LIKE FIGURE CROSSES.

SER. NO. 77-429,076, FILED 3-23-2008.

MARLENE BELL, EXAMINING ATTORNEY

Int. Cl.: 16

Prior U.S. Cls.: 2, 5, 22, 23, 29, 37, 38 and 50

Reg. No. 3,520,032

United States Patent and Trademark Office

Registered Oct. 21, 2008

**TRADEMARK
PRINCIPAL REGISTER**

SILVER VISIONS

KAUFMAN, ROBERT (UNITED STATES INDIVIDUAL)
58 ROUNDWOOD RD
NEWTON, MA 02464

FOR: CALENDAR-FINISHED PAPER; CALENDARS; CALENDARS AND DIARIES; PRINTED CALENDARS; WALL CALENDARS, IN CLASS 16 (U.S. CLS. 2, 5, 22, 23, 29, 37, 38 AND 50).

FIRST USE 6-1-1977; IN COMMERCE 8-1-1977.

THE MARK CONSISTS OF STANDARD CHARACTERS WITHOUT CLAIM TO ANY PARTICULAR FONT, STYLE, SIZE, OR COLOR.

OWNER OF U.S. REG. NO. 1,247,684.

SER. NO. 77-429,117, FILED 3-23-2008.

PAM WILLIS, EXAMINING ATTORNEY

Int. Cl.: 35

Prior U.S. Cls.: 100, 101 and 102

United States Patent and Trademark Office

Reg. No. 3,520,033

Registered Oct. 21, 2008

**SERVICE MARK
PRINCIPAL REGISTER**

SHOEBUY.COM

SHOEBUY.COM, INC. (DELAWARE CORPORATION)
16TH FLOOR
101 ARCH STREET
BOSTON, MA 02110

FOR: ON-LINE RETAIL STORE SERVICES FEATURING BAGS, NAMELY, BACKPACKS, HANDBAGS, COMPUTER BAGS, AND LUGGAGE; ON-LINE RETAIL STORE SERVICES FEATURING APPAREL, NAMELY, PANTS, SHORTS, SKIRTS, TOPS, JACKETS, ACTIVE WEAR, UNDERWEAR AND OUTERWEAR; ON-LINE RETAIL STORE SERVICES FEATURING ACCESSORIES, NAMELY, BELTS, GLOVES, HEADBANDS, SCARVES, SUNGLASSES, INSOLES, SOCKS, WALLETS, WATCHES, AND

SHOE CARE PRODUCTS, IN CLASS 35 (U.S. CLS. 100, 101 AND 102).

FIRST USE 12-31-2002; IN COMMERCE 12-31-2002.

THE MARK CONSISTS OF STANDARD CHARACTERS WITHOUT CLAIM TO ANY PARTICULAR FONT, STYLE, SIZE, OR COLOR.

OWNER OF U.S. REG. NOS. 2,518,099 AND 2,871,916.

SER. NO. 77-429,134, FILED 3-23-2008.

INGA ERVIN, EXAMINING ATTORNEY

Int. Cl.: 9

Prior U.S. Cls.: 21, 23, 26, 36 and 38

United States Patent and Trademark Office

Reg. No. 3,520,034

Registered Oct. 21, 2008

**TRADEMARK
PRINCIPAL REGISTER**

What's Up?

FROGWARE, LLC (TEXAS LIMITED LIABILITY
COMPANY)
P.O. BOX 537
CYPRESS, TX 77410

FOR: COMPUTER SOFTWARE FOR PERSONAL
ORGANIZATION AND CONTACT MANAGEMENT,
NAMELY, FOR MANAGING PERSONAL CON-
TACTS, BUSINESS CONTACTS, BIRTHDAYS, AN-
NIVERSARIES, PARTIES, AND HOLIDAY CARDS,
IN CLASS 9 (U.S. CLS. 21, 23, 26, 36 AND 38).

FIRST USE 7-1-2007; IN COMMERCE 12-1-2007.

THE MARK CONSISTS OF STANDARD CHAR-
ACTERS WITHOUT CLAIM TO ANY PARTICULAR
FONT, STYLE, SIZE, OR COLOR.

SER. NO. 77-429,138, FILED 3-23-2008.

PRISCILLA MILTON, EXAMINING ATTORNEY

Int. Cl.: 41

Prior U.S. Cls.: 100, 101 and 107

United States Patent and Trademark Office

Reg. No. 3,520,035

Registered Oct. 21, 2008

**SERVICE MARK
PRINCIPAL REGISTER**



ROY ELGHANAYAN (UNITED STATES INDIVIDUAL), DBA KRAV MAGA L.A.
10760 ROSE AVE
LOS ANGELES, CA 90034

THE MARK CONSISTS OF CLENCHED FIST INSIDE OF A DIAMOND, CENTERED ON A PAIR OF WINGS.

FOR: MARTIAL ARTS INSTRUCTION; OPERATING OF MARTIAL ARTS' SCHOOLS; OPERATING OF MARTIAL ARTS' STUDIOS, IN CLASS 41 (U.S. CLS. 100, 101 AND 107).

SER. NO. 77-429,167, FILED 3-24-2008.

FIRST USE 4-1-2007; IN COMMERCE 4-1-2007.

TARA PATE, EXAMINING ATTORNEY

Int. Cl.: 35

Prior U.S. Cls.: 100, 101 and 102

United States Patent and Trademark Office

Reg. No. 3,520,036

Registered Oct. 21, 2008

**SERVICE MARK
PRINCIPAL REGISTER**



BEAUCOUP WEDDINGFAVORS, INC. (SOUTH
CAROLINA CORPORATION)
201 SAN ANTONIO CIRCLE, STE. 135
MOUNTAIN VIEW, CA 94040

FOR: ON-LINE RETAIL STORE SERVICES FEATURING SPECIAL OCCASION FAVORS AND GIFTS, IN CLASS 35 (U.S. CLS. 100, 101 AND 102).

FIRST USE 1-1-2002; IN COMMERCE 1-1-2002.

THE MARK CONSISTS OF THE WORD "BEAUCOUP" IN STYLIZED LETTERING, WITH A DRAW-

ING OF A FLOWER BEHIND THE WORD. THE FIRST HALF OF THE MARK, "BEAU" IS IN THIN LETTERING AND THE SECOND HALF, "COUP" IS IN THICK LETTERING.

THE FOREIGN WORDING IN THE MARK TRANSLATES INTO ENGLISH AS "MUCH".

SER. NO. 77-429,175, FILED 3-24-2008.

MYRIAH HABEEB, EXAMINING ATTORNEY

Int. Cl.: 28

Prior U.S. Cls.: 22, 23, 38 and 50

United States Patent and Trademark Office

Reg. No. 3,520,037

Registered Oct. 21, 2008

**TRADEMARK
PRINCIPAL REGISTER**

PHANTOM FORCE

EXCALIBUR ELECTRONICS, INC. (FLORIDA
CORPORATION)
13755 SW 119TH AVENUE
MIAMI, FL 33186

THE MARK CONSISTS OF STANDARD CHAR-
ACTERS WITHOUT CLAIM TO ANY PARTICULAR
FONT, STYLE, SIZE, OR COLOR.

FOR: ELECTRONIC CHESS GAME, IN CLASS 28
(U.S. CLS. 22, 23, 38 AND 50).

SER. NO. 77-429,182, FILED 3-24-2008.

FIRST USE 10-31-2007; IN COMMERCE 10-31-2007.

ODESSA BIBBINS, EXAMINING ATTORNEY

Int. Cl.: 30

Prior U.S. Cl.: 46

United States Patent and Trademark Office

Reg. No. 3,520,038

Registered Oct. 21, 2008

TRADEMARK
PRINCIPAL REGISTER



JANIE'S CAKES, LP (TEXAS LIMITED PART-
NERSHIP)
420 E. 5TH ST.
TYLER, TX 75701

FOR: CAKES, IN CLASS 30 (U.S. CL. 46).

FIRST USE 10-1-2003; IN COMMERCE 11-1-2003.

NO CLAIM IS MADE TO THE EXCLUSIVE
RIGHT TO USE "CAKES TYLER TEXAS", APART
FROM THE MARK AS SHOWN.

THE COLOR(S) YELLOW, WHITE AND BLUE IS/
ARE CLAIMED AS A FEATURE OF THE MARK.

THE MARK CONSISTS OF A THREE-DIMEN-
SIONAL WHITE BOX WITH AN OVERLAPPING
YELLOW AND WHITE VERTICALLY STRIPED
LID. ON THE LID APPEARS AN OVAL OUTLINED
IN BLUE THAT CONTAINS THE BLUE WORDS
"JANIE'S CAKES" ABOVE THE BLUE WORDS "TY-
LER, TEXAS". A BLUE RIBBON WRAPS AROUND
THE BOX AND TIES IN THE MIDDLE.

SER. NO. 77-429,194, FILED 3-24-2008.

STEPHANIE ALI, EXAMINING ATTORNEY

Int. Cl.: 9

Prior U.S. Cls.: 21, 23, 26, 36 and 38

United States Patent and Trademark Office

Reg. No. 3,520,039

Registered Oct. 21, 2008

**TRADEMARK
PRINCIPAL REGISTER**

TIGHTEN UP

DONOVAN MARINE, INC. (LOUISIANA COR-
PORATION)
6316 HUMPHREYS STREET
HARAHAN, LA 70123

THE MARK CONSISTS OF STANDARD CHAR-
ACTERS WITHOUT CLAIM TO ANY PARTICULAR
FONT, STYLE, SIZE, OR COLOR.

FOR: LIFE JACKETS, IN CLASS 9 (U.S. CLS. 21, 23,
26, 36 AND 38).

SER. NO. 77-429,226, FILED 3-24-2008.

FIRST USE 2-14-2004; IN COMMERCE 2-14-2004.

JASON TURNER, EXAMINING ATTORNEY

Int. Cl.: 9

Prior U.S. Cls.: 21, 23, 26, 36 and 38

Reg. No. 3,520,040

United States Patent and Trademark Office

Registered Oct. 21, 2008

**TRADEMARK
PRINCIPAL REGISTER**

3X RBA

BOXICOM, INC. (DELAWARE CORPORATION)
1275 KINNEAR ROAD
COLUMBUS, OH 43212

FIRST USE 9-1-2007; IN COMMERCE 10-14-2007.

FOR: HARDWARE AND SOFTWARE FOR COMPUTER BACKUP AND RECOVERY, NAMELY, FOR POINT-IN-TIME ARCHIVING OF DATABASES, IMAGES, AND OTHER ELECTRONIC DATA, IN CLASS 9 (U.S. CLS. 21, 23, 26, 36 AND 38).

THE MARK CONSISTS OF STANDARD CHARACTERS WITHOUT CLAIM TO ANY PARTICULAR FONT, STYLE, SIZE, OR COLOR.

SER. NO. 77-429,279, FILED 3-24-2008.

JILL PRATER, EXAMINING ATTORNEY

Int. Cl.: 1

Prior U.S. Cls.: 1, 5, 6, 10, 26 and 46

Reg. No. 3,520,041

United States Patent and Trademark Office

Registered Oct. 21, 2008

**TRADEMARK
PRINCIPAL REGISTER**

DOWNDRAFT

UNITED SUPPLIERS, INC. (IOWA CORPORATION)
P.O. BOX 538
ELDORA, IA 50627

THE MARK CONSISTS OF STANDARD CHARACTERS WITHOUT CLAIM TO ANY PARTICULAR FONT, STYLE, SIZE, OR COLOR.

FOR: ADJUVANT FOR DEPOSITION AND DRIFT REDUCTION ADDED TO HERBICIDE TANK MIXTURES, IN CLASS 1 (U.S. CLS. 1, 5, 6, 10, 26 AND 46).

SER. NO. 77-429,288, FILED 3-24-2008.

FIRST USE 3-20-2008; IN COMMERCE 3-20-2008.

JOHN WILKE, EXAMINING ATTORNEY

Int. Cl.: 9

Prior U.S. Cls.: 21, 23, 26, 36 and 38

Reg. No. 3,520,042

United States Patent and Trademark Office

Registered Oct. 21, 2008

**TRADEMARK
PRINCIPAL REGISTER**

3X

BOXICOM, INC. (DELAWARE CORPORATION)
1275 KINNEAR ROAD
COLUMBUS, OH 43212

FIRST USE 9-1-2007; IN COMMERCE 10-14-2007.

FOR: HARDWARE AND SOFTWARE FOR COMPUTER BACKUP AND RECOVERY, NAMELY, FOR POINT-IN-TIME ARCHIVING OF DATABASES, IMAGES, AND OTHER ELECTRONIC DATA, IN CLASS 9 (U.S. CLS. 21, 23, 26, 36 AND 38).

THE MARK CONSISTS OF STANDARD CHARACTERS WITHOUT CLAIM TO ANY PARTICULAR FONT, STYLE, SIZE, OR COLOR.

SER. NO. 77-429,293, FILED 3-24-2008.

JILL PRATER, EXAMINING ATTORNEY

Int. Cl.: 42

Prior U.S. Cls.: 100 and 101

United States Patent and Trademark Office

Reg. No. 3,520,043

Registered Oct. 21, 2008

**SERVICE MARK
PRINCIPAL REGISTER**

ABATOR

ABATOR INFORMATION SERVICES, INC.
(PENNSYLVANIA CORPORATION)
P.O. BOX 82549
PITTSBURGH, PA 15218

FOR: CONSULTING IN THE FIELD OF INFORMATION TECHNOLOGY, IN CLASS 42 (U.S. CLS. 100 AND 101).

FIRST USE 11-3-1993; IN COMMERCE 11-3-1993.

THE MARK CONSISTS OF STANDARD CHARACTERS WITHOUT CLAIM TO ANY PARTICULAR FONT, STYLE, SIZE, OR COLOR.

OWNER OF U.S. REG. NO. 1,460,297.

SER. NO. 77-429,310, FILED 3-24-2008.

LINDSEY RUBIN, EXAMINING ATTORNEY

Int. Cl.: 41

Prior U.S. Cls.: 100, 101 and 107

United States Patent and Trademark Office

Reg. No. 3,520,044

Registered Oct. 21, 2008

**SERVICE MARK
PRINCIPAL REGISTER**

CREATEXPLORE

BRADLEY, ELIZABETH BRANTLEY TURNER
(UNITED STATES INDIVIDUAL)
100 W 76TH STREET APT. 6S
NEW YORK, NY 10023

FOR: EDUCATION AND TRAINING, NAMELY,
PROVIDING HIGH SCHOOL LEVEL EDUCATION
THROUGH TRAVEL TO FOREIGN NATIONS,
STUDYING ART, COMMERCE, ENVIRONMENTAL
ISSUES, SOCIAL ISSUES, FOREIGN CULTURE
AND FOREIGN LANGUAGES; ARRANGING AND
CONDUCTING OF CONFERENCES, SEMINARS,
AND EXHIBITIONS FOR CULTURAL OR EDUCA-
TIONAL PURPOSES; CONDUCTING WORKSHOPS
IN THE FIELDS OF ART APPRECIATION AND

SELF-AWARENESS; PUBLICATION OF BOOKS
AND EDUCATION MATERIALS REGARDING
EDUCATION ABROAD ON A GLOBAL SCALE, IN
CLASS 41 (U.S. CLS. 100, 101 AND 107).

FIRST USE 10-26-2007; IN COMMERCE 10-26-2007.

THE MARK CONSISTS OF STANDARD CHAR-
ACTERS WITHOUT CLAIM TO ANY PARTICULAR
FONT, STYLE, SIZE, OR COLOR.

SER. NO. 77-429,323, FILED 3-24-2008.

JOHN WILKE, EXAMINING ATTORNEY

Int. Cl.: 2

Prior U.S. Cls.: 6, 11 and 16

United States Patent and Trademark Office

Reg. No. 3,520,045

Registered Oct. 21, 2008

**TRADEMARK
PRINCIPAL REGISTER**

PSM

TEINNOVATIONS INC. (ILLINOIS CORPORATION)
30W108 BUTTERFIELD ROAD
WARRENVILLE, IL 60555

THE MARK CONSISTS OF STANDARD CHARACTERS WITHOUT CLAIM TO ANY PARTICULAR FONT, STYLE, SIZE, OR COLOR.

FOR: BIODEGRADABLE AND COMPOSTABLE RESIN MADE PRIMARILY FROM STARCH, IN CLASS 2 (U.S. CLS. 6, 11 AND 16).

SER. NO. 77-429,326, FILED 3-24-2008.

FIRST USE 1-18-2006; IN COMMERCE 1-18-2006.

BENJAMIN ALLEN, EXAMINING ATTORNEY

Int. Cl.: 35

Prior U.S. Cls.: 100, 101 and 102

United States Patent and Trademark Office

Reg. No. 3,520,046

Registered Oct. 21, 2008

**SERVICE MARK
PRINCIPAL REGISTER**

ISLAND ADVANTAGE

ISLAND ADVANTAGE REALTY, LLC (NEW
YORK LIMITED LIABILITY COMPANY)
1160 E. JERICHO TURNPIKE
HUNTINGTON, NY 11743

FOR: REAL ESTATE ADVERTISING SERVICES;
REAL ESTATE AUCTIONS; REAL ESTATE MAR-
KETING SERVICES IN THE FIELD OF REAL
ESTATE OWNED (REO) PROPERTIES; REAL ES-
TATE SALES MANAGEMENT, IN CLASS 35 (U.S.
CLS. 100, 101 AND 102).

FIRST USE 10-6-1998; IN COMMERCE 10-6-1998.

THE MARK CONSISTS OF STANDARD CHAR-
ACTERS WITHOUT CLAIM TO ANY PARTICULAR
FONT, STYLE, SIZE, OR COLOR.

SER. NO. 77-429,346, FILED 3-24-2008.

WENDY GOODMAN, EXAMINING ATTORNEY

Int. Cl.: 37

Prior U.S. Cls.: 100, 103 and 106

United States Patent and Trademark Office

Reg. No. 3,520,047

Registered Oct. 21, 2008

**SERVICE MARK
PRINCIPAL REGISTER**

ISLAND ADVANTAGE

ISLAND ADVANTAGE REALTY, LLC (NEW
YORK LIMITED LIABILITY COMPANY)
1160 E. JERICHO TURNPIKE
HUNTINGTON, NY 11743

FOR: CONSTRUCTION CONSULTATION; CON-
STRUCTION PLANNING; CONSTRUCTION SU-
PERVISION; CONSTRUCTION AND
RENOVATION OF BUILDINGS, IN CLASS 37 (U.S.
CLS. 100, 103 AND 106).

FIRST USE 10-6-1998; IN COMMERCE 10-6-1998.

THE MARK CONSISTS OF STANDARD CHAR-
ACTERS WITHOUT CLAIM TO ANY PARTICULAR
FONT, STYLE, SIZE, OR COLOR.

SER. NO. 77-429,351, FILED 3-24-2008.

WENDY GOODMAN, EXAMINING ATTORNEY

Int. Cl.: 42

Prior U.S. Cls.: 100 and 101

United States Patent and Trademark Office

Reg. No. 3,520,048

Registered Oct. 21, 2008

**SERVICE MARK
PRINCIPAL REGISTER**

ISLAND ADVANTAGE

ISLAND ADVANTAGE REALTY, LLC (NEW
YORK LIMITED LIABILITY COMPANY)
1160 E. JERICHO TURNPIKE
HUNTINGTON, NY 11743

FOR: REAL ESTATE RESEARCH SERVICES;
REAL ESTATE INSPECTION SERVICES TO DETER-
MINE A PROPERTY'S CONDITION, VERIFICA-
TION OF OCCUPANCY OR VACANCY AND
INTERVIEW OF BORROWER, IN CLASS 42 (U.S.
CLS. 100 AND 101).

FIRST USE 10-6-1998; IN COMMERCE 10-6-1998.

THE MARK CONSISTS OF STANDARD CHAR-
ACTERS WITHOUT CLAIM TO ANY PARTICULAR
FONT, STYLE, SIZE, OR COLOR.

SER. NO. 77-429,353, FILED 3-24-2008.

WENDY GOODMAN, EXAMINING ATTORNEY

Int. Cl.: 35

Prior U.S. Cls.: 100, 101 and 102

United States Patent and Trademark Office

Reg. No. 3,520,049

Registered Oct. 21, 2008

SERVICE MARK
PRINCIPAL REGISTER



ISLAND ADVANTAGE REALTY, LLC (NEW
YORK LIMITED LIABILITY COMPANY)

1160 E. JERICHO TURNPIKE

HUNTINGTON, NY 11743

FOR: REAL ESTATE ADVERTISING SERVICES;
REAL ESTATE AUCTIONS; REAL ESTATE MAR-
KETING SERVICES IN THE FIELD OF REAL
ESTATE OWNED (REO) PROPERTIES; REAL ES-
TATE SALES MANAGEMENT, IN CLASS 35 (U.S.
CLS. 100, 101 AND 102).

FIRST USE 10-6-1998; IN COMMERCE 10-6-1998.

NO CLAIM IS MADE TO THE EXCLUSIVE
RIGHT TO USE "REALTY, LLC", APART FROM
THE MARK AS SHOWN.

THE MARK CONSISTS OF TWO SAILS WITHIN A
CIRCLE, WHICH IS ENCLOSED IN A SQUARE,
NEXT TO THE LITERAL ELEMENT "ISLAND",
WHICH IS ON TOP OF THE LITERAL ELEMENT
"ADVANTAGE", WHICH IS ON TOP OF THE LIT-
ERAL ELEMENT "REALTY, LLC", WHICH IS EN-
CLOSED IN A RECTANGLE.

SER. NO. 77-429,355, FILED 3-24-2008.

WENDY GOODMAN, EXAMINING ATTORNEY

Int. Cl.: 37

Prior U.S. Cls.: 100, 103 and 106

United States Patent and Trademark Office

Reg. No. 3,520,050

Registered Oct. 21, 2008

SERVICE MARK
PRINCIPAL REGISTER



ISLAND ADVANTAGE REALTY, LLC (NEW
YORK LIMITED LIABILITY COMPANY)
1160 E. JERICO TURNPIKE
HUNTINGTON, NY 11743

FOR: CONSTRUCTION CONSULTATION; CON-
STRUCTION PLANNING; CONSTRUCTION SU-
PERVISION; CONSTRUCTION AND
RENOVATION OF BUILDINGS, IN CLASS 37 (U.S.
CLS. 100, 103 AND 106).

FIRST USE 10-6-1998; IN COMMERCE 10-6-1998.

NO CLAIM IS MADE TO THE EXCLUSIVE
RIGHT TO USE "REALTY, LLC", APART FROM
THE MARK AS SHOWN.

THE MARK CONSISTS OF TWO SAILS WITHIN A
CIRCLE, WHICH IS ENCLOSED IN A SQUARE,
NEXT TO THE LITERAL ELEMENT "ISLAND",
WHICH IS ON TOP OF THE LITERAL ELEMENT
"ADVANTAGE", WHICH IS ON TOP OF THE LIT-
ERAL ELEMENT "REALTY, LLC", WHICH IS EN-
CLOSED IN A RECTANGLE.

SER. NO. 77-429,359, FILED 3-24-2008.

WENDY GOODMAN, EXAMINING ATTORNEY

Int. Cl.: 42

Prior U.S. Cls.: 100 and 101

United States Patent and Trademark Office

Reg. No. 3,520,051

Registered Oct. 21, 2008

SERVICE MARK
PRINCIPAL REGISTER



ISLAND ADVANTAGE REALTY, LLC (NEW
YORK LIMITED LIABILITY COMPANY)

1160 E. JERICHO TURNPIKE

HUNTINGTON, NY 11743

FOR: REAL ESTATE RESEARCH SERVICES;
REAL ESTATE INSPECTION SERVICES TO DETER-
MINE A PROPERTY'S CONDITION, VERIFICA-
TION OF OCCUPANCY OR VACANCY AND
INTERVIEW OF BORROWER, IN CLASS 42 (U.S.
CLS. 100 AND 101).

FIRST USE 10-6-1998; IN COMMERCE 10-6-1998.

NO CLAIM IS MADE TO THE EXCLUSIVE
RIGHT TO USE "REALTY, LLC", APART FROM
THE MARK AS SHOWN.

THE MARK CONSISTS OF TWO SAILS WITHIN A
CIRCLE, WHICH IS ENCLOSED IN A SQUARE,
NEXT TO THE LITERAL ELEMENT "ISLAND",
WHICH IS ON TOP OF THE LITERAL ELEMENT
"ADVANTAGE", WHICH IS ON TOP OF THE LIT-
ERAL ELEMENT "REALTY, LLC", WHICH IS EN-
CLOSED IN A RECTANGLE.

SER. NO. 77-429,361, FILED 3-24-2008.

WENDY GOODMAN, EXAMINING ATTORNEY

Int. Cl.: 35

Prior U.S. Cls.: 100, 101 and 102

United States Patent and Trademark Office

Reg. No. 3,520,052

Registered Oct. 21, 2008

**SERVICE MARK
PRINCIPAL REGISTER**

Friend+1

MYJAMBI, INC. (DELAWARE CORPORATION),
DBA MYJAMBI, LLC
37 EAST 28TH STREET, SUITE 201
NEW YORK, NY 10016

FOR: PROVIDING A WEB SITE THAT FEATURES AN ONLINE MARKET FOR USERS TO LIST OFFERED OR WANTED PERSONAL AND BUSINESS ASSETS AND SKILLS FOR HIRE, OFFERING ADVERTISING AND INFORMATION DISTRIBUTION SERVICES, NAMELY, PROVIDING CLASSIFIED ADVERTISING SPACE VIA THE GLOBAL COMPU-

TER NETWORK, IN CLASS 35 (U.S. CLS. 100, 101 AND 102).

FIRST USE 2-26-2008; IN COMMERCE 2-26-2008.

THE MARK CONSISTS OF STANDARD CHARACTERS WITHOUT CLAIM TO ANY PARTICULAR FONT, STYLE, SIZE, OR COLOR.

SER. NO. 77-429,370, FILED 3-24-2008.

ANNE E. GUSTASON, EXAMINING ATTORNEY

Int. Cl.: 41

Prior U.S. Cls.: 100, 101 and 107

United States Patent and Trademark Office

Reg. No. 3,520,053

Registered Oct. 21, 2008

**SERVICE MARK
PRINCIPAL REGISTER**

ShotBee

SHOTBEE EVENT PHOTOGRAPHY, INC. (MISSOURI CORPORATION)
514 WEST 26TH STREET
KANSAS CITY, MO 64108

THE MARK CONSISTS OF STANDARD CHARACTERS WITHOUT CLAIM TO ANY PARTICULAR FONT, STYLE, SIZE, OR COLOR.

FOR: PHOTOGRAPHY SERVICES, IN CLASS 41 (U.S. CLS. 100, 101 AND 107).

SER. NO. 77-429,376, FILED 3-24-2008.

FIRST USE 1-1-2003; IN COMMERCE 1-1-2003.

STEVEN R. FINE, EXAMINING ATTORNEY

Int. Cl.: 41

Prior U.S. Cls.: 100, 101 and 107

United States Patent and Trademark Office

Reg. No. 3,520,054

Registered Oct. 21, 2008

**SERVICE MARK
PRINCIPAL REGISTER**

Maiden Spirit

LIFE BLESSING INSTITUTE, THE (OREGON
LIMITED LIABILITY COMPANY)
18250 S. CLARK LANE
OREGON CITY, OR 97045

FOR: EDUCATIONAL SERVICES, NAMELY,
CONDUCTING PROGRAMS IN THE FIELD OF
GIRLS SELF ESTEEM AND EMPOWERMENT
AND DISTRIBUTION OF COURSE MATERIAL IN
CONNECTION THEREWITH, IN CLASS 41 (U.S.
CLS. 100, 101 AND 107).

FIRST USE 3-19-2003; IN COMMERCE 3-19-2004.

THE MARK CONSISTS OF STANDARD CHAR-
ACTERS WITHOUT CLAIM TO ANY PARTICULAR
FONT, STYLE, SIZE, OR COLOR.

SER. NO. 77-429,377, FILED 3-24-2008.

SANI KHOURI, EXAMINING ATTORNEY

Int. Cl.: 18

Prior U.S. Cls.: 1, 2, 3, 22 and 41

United States Patent and Trademark Office

Reg. No. 3,520,055

Registered Oct. 21, 2008

**TRADEMARK
PRINCIPAL REGISTER**



LI JIANGUO (CHINA INDIVIDUAL)
12-4, DEZHENG WEST ROAD, NANJIAO VILLAGE
LU CHENG DISTRICT, CHINA

FOR: PURSES; VALISES; FUR; TEXTILE SHOPPING BAGS; MESH SHOPPING BAGS; CANVAS SHOPPING BAGS; LEATHER SHOPPING BAGS; SHOPPING BAGS WITH WHEELS ATTACHED; ATTACHE CASES; TRAVELING TRUNKS; HANDBAGS; GARMENT BAGS FOR TRAVEL; BAGS FOR

SPORTS; LEATHER FOR FURNITURE, IN CLASS 18 (U.S. CLS. 1, 2, 3, 22 AND 41).

FIRST USE 6-0-2006; IN COMMERCE 1-0-2007.

THE MARK CONSISTS OF THE STYLIZED LETTER "E".

SER. NO. 77-429,394, FILED 3-24-2008.

MICHAEL SOUDERS, EXAMINING ATTORNEY

Int. Cl.: 16

Prior U.S. Cls.: 2, 5, 22, 23, 29, 37, 38 and 50

United States Patent and Trademark Office

Reg. No. 3,520,056

Registered Oct. 21, 2008

**TRADEMARK
PRINCIPAL REGISTER**

**No, Thanks... I've got a
bag**

ANDREWS, ADELAIDE (UNITED STATES INDIVIDUAL)
PMB D-407
2240 ENCINITAS BLVD.
ENCINITAS, CA 92024

THE MARK CONSISTS OF STANDARD CHARACTERS WITHOUT CLAIM TO ANY PARTICULAR FONT, STYLE, SIZE, OR COLOR.

FOR: REUSABLE POLYPROPYLENE GROCERY AND SHOPPING BAGS, IN CLASS 16 (U.S. CLS. 2, 5, 22, 23, 29, 37, 38 AND 50).

SER. NO. 77-429,398, FILED 3-24-2008.

FIRST USE 11-1-2007; IN COMMERCE 11-1-2007.

WENDY GOODMAN, EXAMINING ATTORNEY

Int. Cl.: 25

Prior U.S. Cls.: 22 and 39

United States Patent and Trademark Office

Reg. No. 3,520,057

Registered Oct. 21, 2008

**TRADEMARK
PRINCIPAL REGISTER**

PIMPNERD

VILLAFLOR, DEL (UNITED STATES INDIVIDUAL)
4917 CASPAR STREET
UNION CITY, CA 94587

THE MARK CONSISTS OF STANDARD CHARACTERS WITHOUT CLAIM TO ANY PARTICULAR FONT, STYLE, SIZE, OR COLOR.

FOR: CAPS; HATS; HEADWEAR; JACKETS; PANTS; SHIRTS; SHORTS; T-SHIRTS; TANK TOPS; WIND RESISTANT JACKETS; SWEAT SUITS; SWEAT SHIRTS, IN CLASS 25 (U.S. CLS. 22 AND 39).

SER. NO. 77-429,404, FILED 3-24-2008.

FIRST USE 9-1-2003; IN COMMERCE 7-20-2004.

EUGENIA MARTIN, EXAMINING ATTORNEY

Int. Cl.: 9

Prior U.S. Cls.: 21, 23, 26, 36 and 38

Reg. No. 3,520,058

United States Patent and Trademark Office

Registered Oct. 21, 2008

**TRADEMARK
PRINCIPAL REGISTER**



FAUNOS, LLC (COLORADO LIMITED LIABILITY COMPANY)
SUITE #1000
6001 SOUTH WILLOW DRIVE
GREENWOOD VILLAGE, CO 80111

FIRST USE 6-3-2007; IN COMMERCE 6-3-2007.

THE STIPPLING IS FOR SHADING PURPOSES ONLY.

FOR: COMPUTER SOFTWARE FOR DATABASE MANAGEMENT, FOR USE AS AN OPERATING SYSTEM, FOR WORD PROCESSING, FOR ELECTRONIC DATA PROCESSING, AND FOR NETWORKING, AND USER MANUALS SOLD AS A UNIT; PRERECORDED COMPUTER PROGRAMS FOR USE AS AN OPERATING SYSTEM, FOR WORD PROCESSING, FOR ELECTRONIC DATA PROCESSING, AND FOR NETWORKING, AND USER MANUALS SOLD AS A UNIT, IN CLASS 9 (U.S. CLS. 21, 23, 26, 36 AND 38).

THE MARK CONSISTS OF THE STYLIZED WORD "FAUNOS". IMAGE OF A MYTHICAL FAUN HOLDING A LAMP TO THE LEFT OF THE WORDS.

SER. NO. 77-429,410, FILED 3-24-2008.

KAPIL BHANOT, EXAMINING ATTORNEY

Int. Cl.: 41

Prior U.S. Cls.: 100, 101 and 107

Reg. No. 3,520,059

United States Patent and Trademark Office

Registered Oct. 21, 2008

**SERVICE MARK
PRINCIPAL REGISTER**



SHOTBEE EVENT PHOTOGRAPHY, INC. (MISSOURI CORPORATION)
514 WEST 26TH STREET
KANSAS CITY, MO 64108

THE MARK CONSISTS OF THE WORD "SHOT-BEE" PLUS BEE DESIGN.

FOR: PHOTOGRAPHY SERVICES, IN CLASS 41 (U.S. CLS. 100, 101 AND 107).

SER. NO. 77-429,417, FILED 3-24-2008.

FIRST USE 1-1-2003; IN COMMERCE 1-1-2003.

STEVEN R. FINE, EXAMINING ATTORNEY

Int. Cl.: 35

Prior U.S. Cls.: 100, 101 and 102

United States Patent and Trademark Office

Reg. No. 3,520,060

Registered Oct. 21, 2008

**SERVICE MARK
PRINCIPAL REGISTER**

NIELSEN HEALTHCARE GROUP

INTERIM HEALTHCARE MANAGERS, INC.
(MISSOURI CORPORATION)
SUITE 2
600 S. HOLMES AVE.
ST. LOUIS, MO 63122

NO CLAIM IS MADE TO THE EXCLUSIVE
RIGHT TO USE "HEALTHCARE GROUP", APART
FROM THE MARK AS SHOWN.

FOR: EMPLOYEE STAFFING AND PLACEMENT
SERVICES, IN CLASS 35 (U.S. CLS. 100, 101 AND 102).

SEC. 2(F) AS TO "NIELSEN".

FIRST USE 12-0-1992; IN COMMERCE 12-0-1992.

SER. NO. 77-429,420, FILED 3-24-2008.

THE MARK CONSISTS OF STANDARD CHAR-
ACTERS WITHOUT CLAIM TO ANY PARTICULAR
FONT, STYLE, SIZE, OR COLOR.

STEVEN R. FINE, EXAMINING ATTORNEY

Int. Cl.: 45

Prior U.S. Cls.: 100 and 101

United States Patent and Trademark Office

Reg. No. 3,520,061

Registered Oct. 21, 2008

**SERVICE MARK
PRINCIPAL REGISTER**

BAUE

THE BAUE FUNERAL HOME CO. (MISSOURI
CORPORATION)
620 JEFFERSON ST.
ST. CHARLES, MO 63301

FOR: FUNERAL HOME SERVICES; CREMA-
TIONS, IN CLASS 45 (U.S. CLS. 100 AND 101).

FIRST USE 0-0-1935; IN COMMERCE 0-0-1935.

THE MARK CONSISTS OF STANDARD CHAR-
ACTERS WITHOUT CLAIM TO ANY PARTICULAR
FONT, STYLE, SIZE, OR COLOR.

SEC. 2(F).

SER. NO. 77-429,431, FILED 3-24-2008.

CURTIS FRENCH, EXAMINING ATTORNEY

Int. Cl.: 45

Prior U.S. Cls.: 100 and 101

United States Patent and Trademark Office

Reg. No. 3,520,062

Registered Oct. 21, 2008

**SERVICE MARK
PRINCIPAL REGISTER**



THE BAUE FUNERAL HOME CO. (MISSOURI
CORPORATION)
620 JEFFERSON ST.
ST. CHARLES, MO 63301

SEC. 2(F) AS TO "BAUE".

FOR: FUNERAL HOME SERVICES; CREMA-
TIONS, IN CLASS 45 (U.S. CLS. 100 AND 101).

SER. NO. 77-429,441, FILED 3-24-2008.

FIRST USE 0-0-1998; IN COMMERCE 0-0-1998.

CURTIS FRENCH, EXAMINING ATTORNEY

Int. Cl.: 35

Prior U.S. Cls.: 100, 101 and 102

United States Patent and Trademark Office

Reg. No. 3,520,063

Registered Oct. 21, 2008

**SERVICE MARK
PRINCIPAL REGISTER**

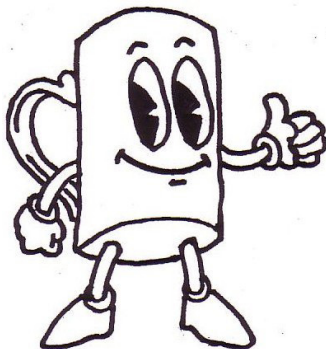

CUPMERCIAL, LLC (GEORGIA LIMITED LIABILITY COMPANY)
28 ST. MARTIN CIRCLE
RICHMOND HILL, GA 31324

FOR: ADVERTISING AND PROMOTIONAL SERVICES; PREPARATION OF CUSTOM ADVERTISEMENTS FOR OTHERS, IN CLASS 35 (U.S. CLS. 100, 101 AND 102).

FIRST USE 5-0-2007; IN COMMERCE 5-0-2007.

THE MARK CONSISTS OF CARICATURE OF A MUG WITH A HANDLE ATTACHED TO THE MUG IN THE USUAL POSITION AND TWO ARMS WITH

GLOVED HANDS ON THE SIDES OF THE MUG, BOTH GLOVED HANDS ARE IN THE SHAPE OF A FIST WITH THE THUMBS UP POSITION OF THE LEFT FIST, AND TWO LEGS WITH BOOTED FEET ATTACHED TO THE BOTTOM OF THE MUG, AND ON THE FRONT OF THE MUG IS A SMILING FACE WHICH CONSISTS OF TWO EYE BROWS OVER TWO OPEN EYES AND A SHORT ACCENT LINE UNDER THE SMILE GIVING THE APPEARANCE OF A CHIN.

SER. NO. 77-429,448, FILED 3-24-2008.

JAY FLOWERS, EXAMINING ATTORNEY

Int. Cl.: 31

Prior U.S. Cls.: 1 and 46

United States Patent and Trademark Office

Reg. No. 3,520,064

Registered Oct. 21, 2008

TRADEMARK
PRINCIPAL REGISTER



JAMES, ELLEN (UNITED STATES INDIVIDUAL)
13688 ELKIN HWY. 268
RONDA, NC 28670

FOR: GOURMET DOG TREATS, IN CLASS 31
(U.S. CLS. 1 AND 46).

FIRST USE 9-22-2007; IN COMMERCE 9-22-2007.

THE MARK CONSISTS OF A DOG WITH A
BOWTIE ON HIS NECK AND A HEART SHAPE
ON HIS CHEST, ALONG WITH THE STYLIZED
WORDS "THE FINICKY HOUND", THIS IS EN-
CLOSED BY A WOODEN SIGN FRAME.

SER. NO. 77-429,457, FILED 3-24-2008.

CAROL SPILS, EXAMINING ATTORNEY

Int. Cl.: 16

Prior U.S. Cls.: 2, 5, 22, 23, 29, 37, 38 and 50

Reg. No. 3,520,065

United States Patent and Trademark Office

Registered Oct. 21, 2008

**TRADEMARK
PRINCIPAL REGISTER**

BIKINI NATION

HAGAN, JENNIFER (UNITED STATES INDIVIDUAL)

2319 FENWICK VILLAGE DRIVE

SAVANNAH, GA 31419

FOR: CALENDARS; POSTERS, IN CLASS 16 (U.S. CLS. 2, 5, 22, 23, 29, 37, 38 AND 50).

FIRST USE 6-1-2006; IN COMMERCE 10-1-2007.

THE MARK CONSISTS OF STANDARD CHARACTERS WITHOUT CLAIM TO ANY PARTICULAR FONT, STYLE, SIZE, OR COLOR.

NO CLAIM IS MADE TO THE EXCLUSIVE RIGHT TO USE "BIKINI", APART FROM THE MARK AS SHOWN.

SER. NO. 77-429,462, FILED 3-24-2008.

CAROL SPILS, EXAMINING ATTORNEY

Int. Cl.: 45

Prior U.S. Cls.: 100 and 101

United States Patent and Trademark Office

Reg. No. 3,520,066

Registered Oct. 21, 2008

**SERVICE MARK
PRINCIPAL REGISTER**



LIVE TO EAT (WISCONSIN LIMITED LIABILITY
COMPANY)
8104 W. HIGHLAND RD.
MEQUON, WI 53097

THE MARK CONSISTS OF THE STYLIZED TEXT
"LIVE TO EAT".

FOR: PERSONAL CHEF SERVICES, IN CLASS 45
(U.S. CLS. 100 AND 101).

SER. NO. 77-429,478, FILED 3-24-2008.

FIRST USE 3-1-2007; IN COMMERCE 1-23-2008.

RENEE MCCRAY, EXAMINING ATTORNEY

Int. Cl.: 37

Prior U.S. Cls.: 100, 103 and 106

United States Patent and Trademark Office

Reg. No. 3,520,067

Registered Oct. 21, 2008

**SERVICE MARK
PRINCIPAL REGISTER**

THE LIFESTYLE YOU WANT
FROM THE BUILDER YOU TRUST

ROLWES CO. (MISSOURI CORPORATION)
SUITE 101
2705 DOUGHERTY FERRY RD.
ST. LOUIS, MO 63122

FOR: RESIDENTIAL HOME CONSTRUCTION
SERVICES, IN CLASS 37 (U.S. CLS. 100, 103 AND 106).

FIRST USE 2-0-2008; IN COMMERCE 2-0-2008.

THE MARK CONSISTS OF STANDARD CHAR-
ACTERS WITHOUT CLAIM TO ANY PARTICULAR
FONT, STYLE, SIZE, OR COLOR.

SER. NO. 77-429,483, FILED 3-24-2008.

AMOS T. MATTHEWS, JR., EXAMINING ATTOR-
NEY

Int. Cl.: 39

Prior U.S. Cls.: 100 and 105

United States Patent and Trademark Office

Reg. No. 3,520,068

Registered Oct. 21, 2008

**SERVICE MARK
PRINCIPAL REGISTER**

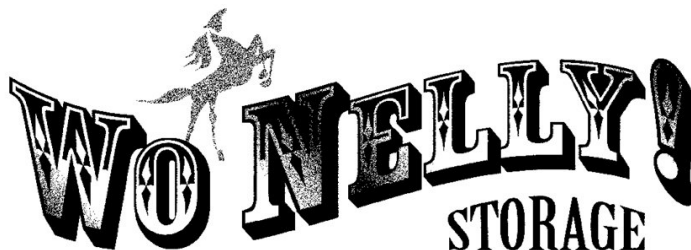

WO NELLY! STORAGE, LLC (FLORIDA LIMITED LIABILITY COMPANY)
4432 DUNCAN ROAD
PUNTA GORDA, FL 33982

FOR: BOAT STORAGE; PROVIDING SELF-STORAGE FACILITIES FOR OTHERS; RENTAL OF MAIL BOXES; RENTAL OF MOVING EQUIPMENT, NAMELY, PADS, STRAPS, HITCHES, DOLLIES, BOXES, CARRIERS, AND HAND TRUCKS; RENTAL OF MOVING VANS; RENTAL OF PARKING SPACES; RENTAL OF STORAGE CONTAINERS; RENTAL OF VEHICLES; RENTAL OF WAREHOUSE SPACE; TRUCK AND TRAILER RENTAL, IN CLASS 39 (U.S. CLS. 100 AND 105).

FIRST USE 10-1-2007; IN COMMERCE 10-1-2007.

NO CLAIM IS MADE TO THE EXCLUSIVE RIGHT TO USE "STORAGE", APART FROM THE MARK AS SHOWN.

THE STIPLING IS FOR SHADING PURPOSES ONLY.

THE MARK CONSISTS OF THE STYLIZED TEXT "WO NELLY! STORAGE". THERE IS AN IMAGE OF A SPIRITED HORSE BETWEEN "WO" AND "NELLY!".

SER. NO. 77-429,484, FILED 3-24-2008.

AMOS T. MATTHEWS, JR., EXAMINING ATTORNEY

Int. Cl.: 28

Prior U.S. Cls.: 22, 23, 38 and 50

United States Patent and Trademark Office

Reg. No. 3,520,069

Registered Oct. 21, 2008

**TRADEMARK
PRINCIPAL REGISTER**

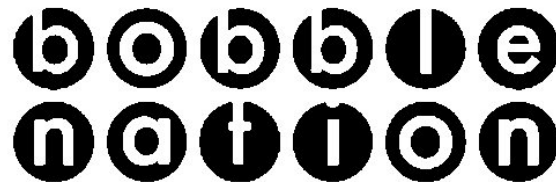

BOBBLE NATION LLC (CALIFORNIA LIMITED
LIABILITY COMPANY)
1605 MONTELLANO COURT
SAN JOSE, CA 95120

THE MARK CONSISTS OF THE WORDING
"BOBBLE NATION"; EACH LETTER IS INSIDE A
SHADED CIRCLE.

FOR: BOBBLEHEAD DOLLS, IN CLASS 28 (U.S.
CLS. 22, 23, 38 AND 50).

SER. NO. 77-429,492, FILED 3-24-2008.

FIRST USE 12-19-2007; IN COMMERCE 3-1-2008.

NO CLAIM IS MADE TO THE EXCLUSIVE
RIGHT TO USE "BOBBLE", APART FROM THE
MARK AS SHOWN.

ALICE SUE CARRUTHERS, EXAMINING ATTOR-
NEY

Int. Cl.: 30

Prior U.S. Cl.: 46

United States Patent and Trademark Office

Reg. No. 3,520,070

Registered Oct. 21, 2008

TRADEMARK
PRINCIPAL REGISTER



THRIVE FOODS, INC. (NEVADA CORPORATION)
9524 MILDEN ST
LA MESA, CA 91942

FOR: VEGAN CAKES; VEGAN CHEESECAKE;
VEGAN COOKIES; VEGAN CUP CAKES; VEGAN
PIES; BARBEQUE SAUCE; HOT SAUCE; READY-
MADE SAUCES; SALAD SAUCES; SAUCES; STEAK
SAUCE; TERIYAKI SAUCE; BAKERY DESSERTS;
SALAD DRESSINGS; CANDIES; CANDY; COOKIES;
PIES; CAKES; CUP CAKES; CHEESECAKE, IN
CLASS 30 (U.S. CL. 46).

FIRST USE 10-4-2004; IN COMMERCE 10-4-2004.

THE MARK CONSISTS OF THE STYLIZED TERM
"THRIVE" WITH AN IMAGE OF A LEAF LOCATED
DIRECTLY ABOVE IT.

SER. NO. 77-429,496, FILED 3-24-2008.

CHRISTINA SOBRAL, EXAMINING ATTORNEY

Int. Cl.: 9

Prior U.S. Cls.: 21, 23, 26, 36 and 38

United States Patent and Trademark Office

Reg. No. 3,520,071

Registered Oct. 21, 2008

**TRADEMARK
PRINCIPAL REGISTER**



ProVise

REMAL IT (SAUDI ARABIA LIMITED LIABILITY COMPANY)
5402
DAMMAM, SAUDI ARABIA 32414

THE MARK CONSISTS OF AN EYE WITH DIGITAL THEME. REPRESENTING AUTOMATIC MONITORING OF EMPLOYEES.

FOR: COMPUTER SOFTWARE FOR PROJECT MANAGEMENT AND AUTOMATIC SUPERVISION, IN CLASS 9 (U.S. CLS. 21, 23, 26, 36 AND 38).

SER. NO. 77-429,513, FILED 3-24-2008.

FIRST USE 6-15-2007; IN COMMERCE 6-15-2007.

DORITT L. CARROLL, EXAMINING ATTORNEY

Int. Cl.: 19

Prior U.S. Cls.: 1, 12, 33 and 50

United States Patent and Trademark Office

Reg. No. 3,520,072

Registered Oct. 21, 2008

**TRADEMARK
PRINCIPAL REGISTER**

RockGrout

CARIELLO, BART (UNITED STATES INDIVIDUAL)
162 WHALEY STREET
FREEPORT, NY 11520

THE MARK CONSISTS OF STANDARD CHARACTERS WITHOUT CLAIM TO ANY PARTICULAR FONT, STYLE, SIZE, OR COLOR.

FOR: UNDERWATER CEMENT GROUT FOR REPAIRING MARINE STRUCTURES, IN CLASS 19 (U.S. CLS. 1, 12, 33 AND 50).

SER. NO. 77-429,521, FILED 3-24-2008.

FIRST USE 10-1-1993; IN COMMERCE 10-1-1993.

HOWARD B. LEVINE, EXAMINING ATTORNEY

Int. Cl.: 41

Prior U.S. Cls.: 100, 101 and 107

United States Patent and Trademark Office

Reg. No. 3,520,073

Registered Oct. 21, 2008

**SERVICE MARK
PRINCIPAL REGISTER**

CELEB 4 A DAY

CELEB 4 A DAY (TEXAS LIMITED LIABILITY
COMPANY)
9016 ANNA ST.
AUSTIN, TX 78748

THE MARK CONSISTS OF THE STYLIZED
WORDS AND NUMBER "CELEB 4 A DAY". THE
WORDS AND NUMBER "CELEB", "4", "A" IS FOL-
LOWED BY A STAR.

FOR: PHOTOGRAPHY SERVICES; VIDEO TAPE
RECORDING FOR OTHERS, IN CLASS 41 (U.S. CLS.
100, 101 AND 107).

SER. NO. 77-429,526, FILED 3-24-2008.

FIRST USE 11-1-2007; IN COMMERCE 12-1-2007.

BENJAMIN OKEKE, EXAMINING ATTORNEY

Int. Cl.: 37

Prior U.S. Cls.: 100, 103 and 106

United States Patent and Trademark Office

Reg. No. 3,520,074

Registered Oct. 21, 2008

**SERVICE MARK
PRINCIPAL REGISTER**



STEWARD'S PLUMBING, INC (NEW MEXICO CORPORATION)
P.O. BOX 40086
ALBUQUERQUE, NM 87196

THE MARK CONSISTS OF A IMAGE OF AN ANIMATED PLUMBER RUNNING WITH A TOOL BOX HOLDING A WRENCH WEARING A CAP.

FOR: PLUMBING SERVICES; INSTALLATION, MAINTENANCE AND REPAIR OF GAS, HEATING, COOLING, AND DRAINING SYSTEMS, IN CLASS 37 (U.S. CLS. 100, 103 AND 106).

SER. NO. 77-429,540, FILED 3-24-2008.

FIRST USE 3-1-1985; IN COMMERCE 3-1-1985.

LAURA HAMMEL, EXAMINING ATTORNEY

Int. Cl.: 20

Prior U.S. Cls.: 2, 13, 22, 25, 32 and 50

United States Patent and Trademark Office

Reg. No. 3,520,075

Registered Oct. 21, 2008

**TRADEMARK
PRINCIPAL REGISTER**



LI JIANGUO (CHINA INDIVIDUAL)
12-4, DEZHENG WEST ROAD, NANJIAO VILLAGE
LU CHENG DISTRICT, CHINA

FOR: FURNITURE; SIDEBOARDS; BEDS; MIR-
RORS AS FURNITURE; PILLOWS; SLEEPING BAGS
FOR CAMPING; COSTUME DISPLAY STANDS;
CHAIRS; SOFAS , IN CLASS 20 (U.S. CLS. 2, 13, 22,
25, 32 AND 50).

FIRST USE 8-0-2006; IN COMMERCE 3-0-2007.

THE MARK CONSISTS OF THE STYLIZED LET-
TER "E".

SER. NO. 77-429,560, FILED 3-24-2008.

MICHAEL SOUDERS, EXAMINING ATTORNEY

Int. Cl.: 25

Prior U.S. Cls.: 22 and 39

United States Patent and Trademark Office

Reg. No. 3,520,076

Registered Oct. 21, 2008

**TRADEMARK
PRINCIPAL REGISTER**



LI JIANGUO (CHINA INDIVIDUAL)
12-4, DEZHENG WEST ROAD, NANJIAO VILLAGE
LU CHENG DISTRICT, CHINA

FOR: CLOTHING, NAMELY, SHIRTS, SKIRTS,
TROUSERS, JACKETS, COATS, T-SHIRTS; SWIM-
SUITS; MASQUERADE COSTUMES; SHOES; CAPS
AS CLOTHING; HOSIERY; SHAWLS; GIRDLES AS
FOUNDATION GARMENTS; LAYETTES, IN CLASS
25 (U.S. CLS. 22 AND 39).

FIRST USE 5-0-2006; IN COMMERCE 2-0-2007.

THE MARK CONSISTS OF THE STYLIZED LET-
TER "E".

SER. NO. 77-429,600, FILED 3-24-2008.

MICHAEL SOUDERS, EXAMINING ATTORNEY

Int. Cl.: 3

Prior U.S. Cls.: 1, 4, 6, 50, 51 and 52

Reg. No. 3,520,077

United States Patent and Trademark Office

Registered Oct. 21, 2008

**TRADEMARK
PRINCIPAL REGISTER**



SUTHERLAND PRODUCTS, INC. (NORTH CAROLINA CORPORATION)
203 NORTH FIRST AVENUE
MAYODAN, NC 27027

FOR: ALL-PURPOSE CLEANING SOAP FOR INDUSTRIAL USE; ALL-PURPOSE CLEANING SOAP IN THE NATURE OF LIQUID SOAP; ALL-PURPOSE CLEANERS, NAMELY, SOAP, IN CLASS 3 (U.S. CLS. 1, 4, 6, 50, 51 AND 52).

FIRST USE 3-10-2008; IN COMMERCE 3-10-2008.

NO CLAIM IS MADE TO THE EXCLUSIVE RIGHT TO USE "GREEN", "SAFE", "POWERFUL" AND "GREEN", APART FROM THE MARK AS SHOWN.

THE MARK CONSISTS OF THE STYLIZED LETTERS "SP" OVER THE STYLIZED WORD "GREEN" OVER THE STYLIZED WORDS "SAFE - POWERFUL - GREEN".

SER. NO. 77-429,603, FILED 3-24-2008.

ANDREA HACK, EXAMINING ATTORNEY

Int. Cl.: 3

Prior U.S. Cls.: 1, 4, 6, 50, 51 and 52

Reg. No. 3,520,078

United States Patent and Trademark Office

Registered Oct. 21, 2008

**TRADEMARK
PRINCIPAL REGISTER**

GENOMA SKIN

EPIGENETIC ARCHETYPES, LLC (CONNECTI-
CUT LIMITED LIABILITY COMPANY)
218 BENEDICT HILL ROAD
NEW CANAAN, CT 06840

FOR: COSMETIC CREAMS FOR SKIN CARE;
COSMETIC PREPARATIONS FOR SKIN RENEWAL;
SKIN CREAM; SKIN LOTION; SKIN MOISTURI-
ZER; SKIN TONERS; BEAUTY SERUMS; SKIN
CONDITIONERS; FACIAL CLEANSERS; SKIN
CLEANSERS; SOAPS FOR PERSONAL USE; HAND
CREAMS; LIP CREAM; FACE CREAMS; BODY
CREAM, IN CLASS 3 (U.S. CLS. 1, 4, 6, 50, 51 AND 52).

FIRST USE 2-1-2008; IN COMMERCE 2-1-2008.

THE MARK CONSISTS OF STANDARD CHAR-
ACTERS WITHOUT CLAIM TO ANY PARTICULAR
FONT, STYLE, SIZE, OR COLOR.

NO CLAIM IS MADE TO THE EXCLUSIVE
RIGHT TO USE "SKIN", APART FROM THE MARK
AS SHOWN.

SER. NO. 77-429,608, FILED 3-24-2008.

GRETТА YAO, EXAMINING ATTORNEY

Int. Cl.: 35

Prior U.S. Cls.: 100, 101 and 102

United States Patent and Trademark Office

Reg. No. 3,520,079

Registered Oct. 21, 2008

**SERVICE MARK
PRINCIPAL REGISTER**

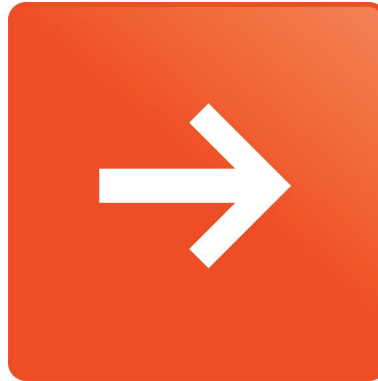

DIGITAL BUSINESS SOLUTIONS, INC. (KENTUCKY CORPORATION)
SUITE 303
333 WEST GUTHRIE AVENUE
LOUISVILLE, KY 40202

FOR: CREATIVE MARKETING DESIGN SERVICES; BUSINESS MARKETING CONSULTING SERVICES; ON-LINE ADVERTISING AND MARKETING SERVICES, IN CLASS 35 (U.S. CLS. 100, 101 AND 102).

FIRST USE 4-1-2007; IN COMMERCE 5-1-2007.

THE COLOR(S) ORANGE AND WHITE IS/ARE CLAIMED AS A FEATURE OF THE MARK.

THE MARK CONSISTS OF AN ORANGE COLOR FILLED SQUARE HAVING ROUNDED CORNERS; IN THE CENTER OF THE SQUARE IS WHITE-COLORED ARROW POINTING TO THE RIGHT.

SER. NO. 77-429,613, FILED 3-24-2008.

CHARLES L. JENKINS, EXAMINING ATTORNEY

Int. Cl.: 5

Prior U.S. Cls.: 6, 18, 44, 46, 51 and 52

United States Patent and Trademark Office

Reg. No. 3,520,080

Registered Oct. 21, 2008

**TRADEMARK
PRINCIPAL REGISTER**



PHARMAVITE LLC (CALIFORNIA LIMITED
LIABILITY COMPANY)

P.O. BOX 9606

MISSION HILLS, CA 913469606

FOR: DIETARY SUPPLEMENTS, IN CLASS 5 (U.S.
CLS. 6, 18, 44, 46, 51 AND 52).

FIRST USE 11-30-2005; IN COMMERCE 11-30-2005.

OWNER OF U.S. REG. NOS. 1,963,505 AND
2,451,597.

THE MARK CONSISTS OF THE WORDS "NAT-
URE MADE" WITH TWO LEAVES ABOVE, EN-
CLOSED WITHIN A LINED BORDER.

SER. NO. 77-429,626, FILED 3-24-2008.

KIMBERLY FRYE, EXAMINING ATTORNEY

Int. Cl.: 3

Prior U.S. Cls.: 1, 4, 6, 50, 51 and 52

United States Patent and Trademark Office

Reg. No. 3,520,081

Registered Oct. 21, 2008

**TRADEMARK
PRINCIPAL REGISTER**

VIOLETAS TIERNAS

MENPER DISTRIBUTORS INC. (FLORIDA CORPORATION)
6500 NW 35TH. AVE.
MIAMI, FL 33247

FOR: BABY LOTION, IN CLASS 3 (U.S. CLS. 1, 4, 6, 50, 51 AND 52).

FIRST USE 1-15-2004; IN COMMERCE 1-15-2004.

THE MARK CONSISTS OF STANDARD CHARACTERS WITHOUT CLAIM TO ANY PARTICULAR FONT, STYLE, SIZE, OR COLOR.

NO CLAIM IS MADE TO THE EXCLUSIVE RIGHT TO USE "VIOLETAS", APART FROM THE MARK AS SHOWN.

THE FOREIGN WORDING IN THE MARK TRANSLATES INTO ENGLISH AS TENDER VIOLETS.

SER. NO. 77-429,636, FILED 3-24-2008.

KAELIE KUNG, EXAMINING ATTORNEY

Int. Cl.: 35

Prior U.S. Cls.: 100, 101 and 102

United States Patent and Trademark Office

Reg. No. 3,520,082

Registered Oct. 21, 2008

**SERVICE MARK
PRINCIPAL REGISTER**

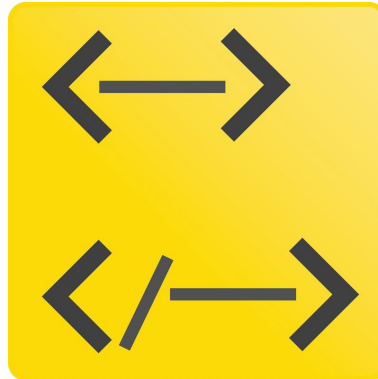

DIGITAL BUSINESS SOLUTIONS, INC. (KENTUCKY CORPORATION)
SUITE 303
333 WEST GUTHRIE AVENUE
LOUISVILLE, KY 40202

FOR: CREATIVE MARKETING DESIGN SERVICES; BUSINESS MARKETING CONSULTING SERVICES; ON-LINE ADVERTISING AND MARKETING SERVICES, IN CLASS 35 (U.S. CLS. 100, 101 AND 102).

FIRST USE 4-1-2007; IN COMMERCE 5-1-2007.

THE COLOR(S) YELLOW AND BLACK IS/ARE CLAIMED AS A FEATURE OF THE MARK.

THE MARK CONSISTS OF A YELLOW COLOR-FILLED SQUARE HAVING ROUNDED CORNERS; AT THE TOP CENTER OF THE SQUARE ARE BLACK-COLORED CHARACTERS "<->", WITH THE CHARACTER "-" BEING ELONGATED; AND AT THE BOTTOM CENTER OF THE SQUARE ARE BLACK-COLORED CHARACTERS "</->", WITH THE CHARACTER "-" BEING ELONGATED.

SER. NO. 77-429,644, FILED 3-24-2008.

CHARLES L. JENKINS, EXAMINING ATTORNEY

Int. Cls.: 39 and 43

Prior U.S. Cls.: 100, 101 and 105

United States Patent and Trademark Office

Reg. No. 3,520,083

Registered Oct. 21, 2008

**SERVICE MARK
PRINCIPAL REGISTER**

CHOICE DESTINATIONS

CHOICE HOTELS INTERNATIONAL, INC. (DELAWARE CORPORATION)
10750 COLUMBIA PIKE
SILVER SPRING, MD 20901

FOR: TRAVEL GUIDE AND TRAVEL INFORMATION SERVICES, IN CLASS 39 (U.S. CLS. 100 AND 105).

FIRST USE 1-1-2001; IN COMMERCE 1-1-2001.

FOR: HOTEL AND MOTEL RESERVATION SERVICES FOR OTHERS; ONLINE HOTEL AND MOTEL RESERVATION SERVICES FOR OTHERS; PROVIDING INFORMATION ON HOTELS AND TEMPORARY ACCOMMODATIONS, IN CLASS 43 (U.S. CLS. 100 AND 101).

FIRST USE 6-4-2006; IN COMMERCE 6-4-2006.

THE MARK CONSISTS OF STANDARD CHARACTERS WITHOUT CLAIM TO ANY PARTICULAR FONT, STYLE, SIZE, OR COLOR.

OWNER OF U.S. REG. NOS. 2,638,841, 3,068,858 AND OTHERS.

NO CLAIM IS MADE TO THE EXCLUSIVE RIGHT TO USE "DESTINATIONS", APART FROM THE MARK AS SHOWN.

SER. NO. 77-429,659, FILED 3-24-2008.

NATALIE POLZER, EXAMINING ATTORNEY

Int. Cl.: 35

Prior U.S. Cls.: 100, 101 and 102

United States Patent and Trademark Office

Reg. No. 3,520,084

Registered Oct. 21, 2008

**SERVICE MARK
PRINCIPAL REGISTER**



DIGITAL BUSINESS SOLUTIONS, INC. (KENTUCKY CORPORATION)
SUITE 303
333 WEST GUTHRIE AVENUE
LOUISVILLE, KY 40202

FOR: CREATIVE MARKETING DESIGN SERVICES; BUSINESS MARKETING CONSULTING SERVICES; ON-LINE ADVERTISING AND MARKETING SERVICES, IN CLASS 35 (U.S. CLS. 100, 101 AND 102).

FIRST USE 4-1-2007; IN COMMERCE 5-1-2007.

THE COLOR(S) ORANGE AND WHITE IS/ARE CLAIMED AS A FEATURE OF THE MARK.

THE MARK CONSISTS OF AN ORANGE COLOR-FILLED SQUARE HAVING ROUNDED CORNERS; AT THE CENTER OF THE SQUARE IS A WHITE-COLORED "X" CHARACTER GEOMETRICALLY SURROUNDED ON BOTH SIDES BY A PAIR OF STYLIZED, WHITE-COLORED CHEVRONS.

SER. NO. 77-429,664, FILED 3-24-2008.

CHARLES L. JENKINS, EXAMINING ATTORNEY

Int. Cl.: 44

Prior U.S. Cls.: 100 and 101

United States Patent and Trademark Office

Reg. No. 3,520,085

Registered Oct. 21, 2008

**SERVICE MARK
PRINCIPAL REGISTER**

Dr. Richard R. Moy, DPM Inc

RICHARD R MOY, DPM INC (CALIFORNIA CORPORATION)

29300 PORTOLA PARKWAY, SUITE B

LAKE FOREST, CA 92630

FOR: SURGERY, IN CLASS 44 (U.S. CLS. 100 AND 101).

FIRST USE 8-5-2002; IN COMMERCE 8-5-2002.

THE MARK CONSISTS OF STANDARD CHARACTERS WITHOUT CLAIM TO ANY PARTICULAR FONT, STYLE, SIZE, OR COLOR.

NO CLAIM IS MADE TO THE EXCLUSIVE RIGHT TO USE "DR." AND "DPM INC.", APART FROM THE MARK AS SHOWN.

SER. NO. 77-429,679, FILED 3-24-2008.

MARCIE MILONE, EXAMINING ATTORNEY

Int. Cl.: 41

Prior U.S. Cls.: 100, 101 and 107

United States Patent and Trademark Office

Reg. No. 3,520,086

Registered Oct. 21, 2008

**SERVICE MARK
PRINCIPAL REGISTER**

CPO

CHURCHILL DOWNS INCORPORATED (KEN-
TUCKY CORPORATION)
700 CENTRAL AVENUE
LOUISVILLE, KY 40208

THE MARK CONSISTS OF STANDARD CHAR-
ACTERS WITHOUT CLAIM TO ANY PARTICULAR
FONT, STYLE, SIZE, OR COLOR.

FOR: ENTERTAINMENT SERVICES, NAMELY,
CONDUCTING CONTESTS, IN CLASS 41 (U.S. CLS.
100, 101 AND 107).

SER. NO. 77-429,689, FILED 3-24-2008.

FIRST USE 3-17-2008; IN COMMERCE 3-17-2008.

KIM MONINGHOFF, EXAMINING ATTORNEY

Int. Cl.: 42

Prior U.S. Cls.: 100 and 101

United States Patent and Trademark Office

Reg. No. 3,520,087

Registered Oct. 21, 2008

**SERVICE MARK
PRINCIPAL REGISTER**



DIGITAL BUSINESS SOLUTIONS, INC. (KENTUCKY CORPORATION)
SUITE 303
333 WEST GUTHRIE AVENUE
LOUISVILLE, KY 40202

FOR: COMPUTER PROGRAMMING AND MAINTENANCE OF COMPUTER PROGRAMS; COMPUTER PROGRAMMING SERVICES; PROGRAMMING OF MULTIMEDIA APPLICATIONS, IN CLASS 42 (U.S. CLS. 100 AND 101).

FIRST USE 4-1-2007; IN COMMERCE 5-1-2007.

THE COLOR(S) GREY, BLACK, ORANGE, GREEN AND WHITE IS/ARE CLAIMED AS A FEATURE OF THE MARK.

THE MARK CONSISTS OF A GREY AND BLACK SQUARE WITH GREEN AND ORANGE DIAGONAL LINES HAVING ROUNDED CORNERS; AT THE BOTTOM LEFT OF THE SQUARE THE WHITE-COLORED CHARACTERS ">—", WITH THE WHITE COLORED CHARACTER "—" BEING ELONGATED.

SER. NO. 77-429,690, FILED 3-24-2008.

CHARLES L. JENKINS, EXAMINING ATTORNEY

Int. Cl.: 41

Prior U.S. Cls.: 100, 101 and 107

United States Patent and Trademark Office

Reg. No. 3,520,088

Registered Oct. 21, 2008

**SERVICE MARK
PRINCIPAL REGISTER**

CHIEF PARTY OFFICER

CHURCHILL DOWNS INCORPORATED (KEN-
TUCKY CORPORATION)
700 CENTRAL AVENUE
LOUISVILLE, KY 40208

FOR: ENTERTAINMENT SERVICES, NAMELY,
CONDUCTING CONTESTS, IN CLASS 41 (U.S. CLS.
100, 101 AND 107).

FIRST USE 3-17-2008; IN COMMERCE 3-17-2008.

THE MARK CONSISTS OF STANDARD CHAR-
ACTERS WITHOUT CLAIM TO ANY PARTICULAR
FONT, STYLE, SIZE, OR COLOR.

SER. NO. 77-429,715, FILED 3-24-2008.

KIM MONINGHOFF, EXAMINING ATTORNEY

Int. Cl.: 11

Prior U.S. Cls.: 13, 21, 23, 31 and 34

United States Patent and Trademark Office

Reg. No. 3,520,089

Registered Oct. 21, 2008

TRADEMARK
PRINCIPAL REGISTER



VITAL SAUNAS INC. (CALIFORNIA CORPORATION)

10596 LANSFORD LANE

SAN DIEGO, CA 92126

FOR: SAUNAS, IN CLASS 11 (U.S. CLS. 13, 21, 23, 31 AND 34).

FIRST USE 3-24-2008; IN COMMERCE 3-24-2008.

NO CLAIM IS MADE TO THE EXCLUSIVE RIGHT TO USE "SAUNAS" , APART FROM THE MARK AS SHOWN.

THE MARK CONSISTS OF THE WORDING "VITAL SAUNAS" IN STYLIZED FONT WITH TWO CURVED LINES SEPARATING THE TWO TERMS.

SER. NO. 77-429,740, FILED 3-24-2008.

MARCIE MILONE, EXAMINING ATTORNEY

Int. Cl.: 25

Prior U.S. Cls.: 22 and 39

United States Patent and Trademark Office

Reg. No. 3,520,090

Registered Oct. 21, 2008

**TRADEMARK
PRINCIPAL REGISTER**

ZWELD

MOUNTAIN HARDWEAR, INC. (UTAH COR-
PORATION)
14375 NW SCIENCE PARK DRIVE
PORTLAND, OR 97229

THE MARK CONSISTS OF STANDARD CHAR-
ACTERS WITHOUT CLAIM TO ANY PARTICULAR
FONT, STYLE, SIZE, OR COLOR.

FOR: JACKETS; PANTS; SHIRTS, IN CLASS 25
(U.S. CLS. 22 AND 39).

SER. NO. 77-429,770, FILED 3-24-2008.

FIRST USE 7-0-2005; IN COMMERCE 7-0-2005.

BRENDAN REGAN, EXAMINING ATTORNEY

Int. Cl.: 9

Prior U.S. Cls.: 21, 23, 26, 36 and 38

Reg. No. 3,520,091

United States Patent and Trademark Office

Registered Oct. 21, 2008

**TRADEMARK
PRINCIPAL REGISTER**

EARHURTS

CIRRUS HEALTHCARE PRODUCTS, LLC (DE-
LAWARE LIMITED LIABILITY COMPANY)
60 MAIN STREET
COLD HARBOR, NY 11724

THE MARK CONSISTS OF STANDARD CHAR-
ACTERS WITHOUT CLAIM TO ANY PARTICULAR
FONT, STYLE, SIZE, OR COLOR.

FOR: EAR PLUGS NOT FOR MEDICAL PURPO-
SES, IN CLASS 9 (U.S. CLS. 21, 23, 26, 36 AND 38).

SER. NO. 77-429,788, FILED 3-24-2008.

FIRST USE 2-28-2008; IN COMMERCE 2-28-2008.

KAREN SEVERSON, EXAMINING ATTORNEY

Int. Cl.: 9

Prior U.S. Cls.: 21, 23, 26, 36 and 38

Reg. No. 3,520,092

United States Patent and Trademark Office

Registered Oct. 21, 2008

**TRADEMARK
PRINCIPAL REGISTER**

SINISTAR

MIDWAY AMUSEMENT GAMES, LLC (DELA-
WARE LIMITED LIABILITY COMPANY)
2704 W. ROSCOE STREET
CHICAGO, IL 60618

THE MARK CONSISTS OF STANDARD CHAR-
ACTERS WITHOUT CLAIM TO ANY PARTICULAR
FONT, STYLE, SIZE, OR COLOR.

FOR: COMPUTER AND VIDEO GAME PRO-
GRAMS RECORDED ON CARTRIDGES, DISCS,
CD-ROMS, CASSETTES, TAPES AND MINI DISCS;
VIDEO AND COMPUTER GAME SOFTWARE , IN
CLASS 9 (U.S. CLS. 21, 23, 26, 36 AND 38).

OWNER OF U.S. REG. NO. 1,282,636.

SER. NO. 77-429,811, FILED 3-24-2008.

FIRST USE 11-18-2003; IN COMMERCE 11-18-2003.

JASON ROTH, EXAMINING ATTORNEY

Int. Cl.: 18

Prior U.S. Cls.: 1, 2, 3, 22 and 41

United States Patent and Trademark Office

Reg. No. 3,520,093

Registered Oct. 21, 2008

**TRADEMARK
PRINCIPAL REGISTER**

NATURAL WONDERS

CONSUMER PRODUCTS DESIGN, LTD (NEW
YORK CORPORATION)
SUITE 2320
60 EAST 42ND STREET
NEW YORK, NY 10165

FOR: ALL PURPOSE SPORT BAGS; ALL-PUR-
POSE CARRYING BAGS; BABY CARRYING BAGS;
BAGS FOR CARRYING BABIES' ACCESSORIES;
BACKPACKS, BOOK BAGS, SPORTS BAGS, BUM
BAGS, WALLETS AND HANDBAGS; BEACH BAGS;
BELT BAGS AND HIP BAGS; CANVAS SHOPPING
BAGS; COSMETIC BAGS SOLD EMPTY; TOILETRY
BAGS SOLD EMPTY; DIAPER BAGS; DUFFEL
BAGS; SHOPPING BAGS WITH WHEELS AT-

TACHED; BILLFOLDS; BRIEFCASES AND AT-
TACHE CASES; LUGGAGE; LUGGAGE TAGS;
STRAPS FOR LUGGAGE; UMBRELLAS, IN CLASS
18 (U.S. CLS. 1, 2, 3, 22 AND 41).

FIRST USE 3-24-2008; IN COMMERCE 3-24-2008.

THE MARK CONSISTS OF STANDARD CHAR-
ACTERS WITHOUT CLAIM TO ANY PARTICULAR
FONT, STYLE, SIZE, OR COLOR.

SER. NO. 77-429,815, FILED 3-24-2008.

REBECCA GILBERT, EXAMINING ATTORNEY

Int. Cl.: 39

Prior U.S. Cls.: 100 and 105

United States Patent and Trademark Office

Reg. No. 3,520,094

Registered Oct. 21, 2008

**SERVICE MARK
PRINCIPAL REGISTER**

**CATTARA ADVENTURES WITH
INSIGHT**

TAYLOR, CATHY ANN (UNITED STATES INDIVIDUAL)

P.O. BOX 1366

SAUSALITO, CA 94966

FOR: ORGANIZING AND ARRANGING TRAVEL TOURS, IN CLASS 39 (U.S. CLS. 100 AND 105).

FIRST USE 1-0-2008; IN COMMERCE 1-0-2008.

THE MARK CONSISTS OF STANDARD CHARACTERS WITHOUT CLAIM TO ANY PARTICULAR FONT, STYLE, SIZE, OR COLOR.

NO CLAIM IS MADE TO THE EXCLUSIVE RIGHT TO USE "ADVENTURES", APART FROM THE MARK AS SHOWN.

SER. NO. 77-429,819, FILED 3-24-2008.

TINA BROWN, EXAMINING ATTORNEY

Int. Cl.: 35

Prior U.S. Cls.: 100, 101 and 102

United States Patent and Trademark Office

Reg. No. 3,520,095

Registered Oct. 21, 2008

**SERVICE MARK
PRINCIPAL REGISTER**



LEAN JOURNEY LLC (MICHIGAN LIMITED
LIABILITY COMPANY)
54 CHATEAUX DU LAC DRIVE
FENTON, MI 48430

FOR: BUSINESS CONSULTING AND BUSINESS
INFORMATION FOR ENTERPRISES, IN CLASS 35
(U.S. CLS. 100, 101 AND 102).

FIRST USE 3-1-2008; IN COMMERCE 3-1-2008.

NO CLAIM IS MADE TO THE EXCLUSIVE
RIGHT TO USE "LLC", APART FROM THE MARK
AS SHOWN.

THE MARK CONSISTS OF ASCENDING STEPS.

SER. NO. 77-429,827, FILED 3-24-2008.

ROBIN CHOSID, EXAMINING ATTORNEY

Int. Cl.: 33

Prior U.S. Cls.: 47 and 49

United States Patent and Trademark Office

Reg. No. 3,520,096

Registered Oct. 21, 2008

TRADEMARK
PRINCIPAL REGISTER



FLAT CREEK ESTATE, LLC (TEXAS LIMITED LIABILITY COMPANY), DBA FLAT CREEK ESTATE

24912 SINGLETON BEND EAST
MARBLE FALLS, TX 78654

FOR: WINE, IN CLASS 33 (U.S. CLS. 47 AND 49).

FIRST USE 1-3-2000; IN COMMERCE 1-5-2000.

THE MARK CONSISTS OF THE WORDS FLAT AND CREEK ON EITHER SIDE OF AN IMAGE OF AN OUTLINED GRAPE CLUSTER OVERLAYED ON AN OUTLINE OF THE STATE OF TEXAS, SURROUNDED BY A DOUBLE-LINE BORDER.

SER. NO. 77-429,845, FILED 3-24-2008.

KARANENDRA S. CHHINA, EXAMINING ATTORNEY

Int. Cl.: 18

Prior U.S. Cls.: 1, 2, 3, 22 and 41

United States Patent and Trademark Office

Reg. No. 3,520,097

Registered Oct. 21, 2008

**TRADEMARK
PRINCIPAL REGISTER**

LAND, AIR & SEA

CONSUMER PRODUCTS DESIGN, LTD (NEW
YORK CORPORATION)
SUITE 2320
60 EAST 42ND STREET
NEW YORK, NY 10165

FOR: ALL PURPOSE SPORT BAGS; ALL-PUR-
POSE CARRYING BAGS; BABY CARRYING BAGS;
BAGS FOR CARRYING BABIES' ACCESSORIES;
BACKPACKS, BOOK BAGS, SPORTS BAGS, BUM
BAGS, WALLETS AND HANDBAGS; BEACH BAGS;
BELT BAGS AND HIP BAGS; CANVAS SHOPPING
BAGS; COSMETIC BAGS SOLD EMPTY; TOILETRY
BAGS SOLD EMPTY; DIAPER BAGS; DUFFEL
BAGS; SHOPPING BAGS WITH WHEELS AT-

TACHED; BILLFOLDS; BRIEFCASES AND AT-
TACHE CASES; LUGGAGE; LUGGAGE TAGS;
STRAPS FOR LUGGAGE; UMBRELLAS, IN CLASS
18 (U.S. CLS. 1, 2, 3, 22 AND 41).

FIRST USE 3-24-2008; IN COMMERCE 3-24-2008.

THE MARK CONSISTS OF STANDARD CHAR-
ACTERS WITHOUT CLAIM TO ANY PARTICULAR
FONT, STYLE, SIZE, OR COLOR.

SER. NO. 77-429,846, FILED 3-24-2008.

REBECCA GILBERT, EXAMINING ATTORNEY

Int. Cl.: 30

Prior U.S. Cl.: 46

United States Patent and Trademark Office

Reg. No. 3,520,098

Registered Oct. 21, 2008

**TRADEMARK
PRINCIPAL REGISTER**

THE NEW WORLD BAKERY

THE NEW WORLD BAKERY, INC. (TEXAS CORPORATION)

310 EDWARDS DRIVE

KYLE, TX 78640

FOR: BREAD AND BREAD ROLLS, IN CLASS 30 (U.S. CL. 46).

FIRST USE 5-0-1995; IN COMMERCE 5-0-1996.

THE MARK CONSISTS OF STANDARD CHARACTERS WITHOUT CLAIM TO ANY PARTICULAR FONT, STYLE, SIZE, OR COLOR.

NO CLAIM IS MADE TO THE EXCLUSIVE RIGHT TO USE "BAKERY", APART FROM THE MARK AS SHOWN.

SER. NO. 77-429,855, FILED 3-24-2008.

BARBARA BROWN, EXAMINING ATTORNEY

Int. Cl.: 9

Prior U.S. Cls.: 21, 23, 26, 36 and 38

Reg. No. 3,520,099

United States Patent and Trademark Office

Registered Oct. 21, 2008

**TRADEMARK
PRINCIPAL REGISTER**

ROBOTRON 2084

MIDWAY AMUSEMENT GAMES, LLC (DELA-
WARE LIMITED LIABILITY COMPANY)
2704 W. ROSCOE STREET
CHICAGO, IL 60618

THE MARK CONSISTS OF STANDARD CHAR-
ACTERS WITHOUT CLAIM TO ANY PARTICULAR
FONT, STYLE, SIZE, OR COLOR.

FOR: COMPUTER AND VIDEO GAME PRO-
GRAMS RECORDED ON CARTRIDGES, DISCS,
CD-ROMS, CASSETTES, TAPES AND MINI DISCS;
VIDEO AND COMPUTER GAME SOFTWARE , IN
CLASS 9 (U.S. CLS. 21, 23, 26, 36 AND 38).

OWNER OF U.S. REG. NO. 1,240,987.

SER. NO. 77-429,860, FILED 3-24-2008.

FIRST USE 11-18-2003; IN COMMERCE 11-18-2003.

JASON ROTH, EXAMINING ATTORNEY

Int. Cl.: 9

Prior U.S. Cls.: 21, 23, 26, 36 and 38

Reg. No. 3,520,100

United States Patent and Trademark Office

Registered Oct. 21, 2008

**TRADEMARK
PRINCIPAL REGISTER**

GYZ

GS YUASA CORPORATION (JAPAN CORPORATION)
MINAMI-KU, KYOTO-SHI
1, INOBABA-CHO, NISHINOSHO, KISSHOIN,
KYOTO, JAPAN

PRIORITY CLAIMED UNDER SEC. 44(D) ON
JAPAN APPLICATION NO. 2007-105183, FILED 10-
11-2007, REG. NO. 5132849, DATED 5-2-2008, EX-
PIRES 5-2-2018.

FOR: BATTERIES AND ELECTRICAL CELLS, IN
CLASS 9 (U.S. CLS. 21, 23, 26, 36 AND 38).

SER. NO. 77-429,864, FILED 3-24-2008.

THE MARK CONSISTS OF STANDARD CHAR-
ACTERS WITHOUT CLAIM TO ANY PARTICULAR
FONT, STYLE, SIZE, OR COLOR.

BARBARA BROWN, EXAMINING ATTORNEY

Int. Cls.: 37 and 40

Prior U.S. Cls.: 100, 103 and 106

United States Patent and Trademark Office

Reg. No. 3,520,101

Registered Oct. 21, 2008

**SERVICE MARK
PRINCIPAL REGISTER**

CORPORATE CARE

STRUMBONO II, L.L.C. (TEXAS CORPORATION)
3530 WEST T.C. JESTER BOULEVARD
HOUSTON, TX 77018

FOR: CLEANING, REPAIR, MAINTENANCE,
AND RESTORATION OF CARPETS, UPHOL-
STERED FURNISHINGS, WALL FABRICS, TEX-
TILES, LEVEL FLOOR SURFACES AND HARD
SURFACES , IN CLASS 37 (U.S. CLS. 100, 103 AND
106).

FIRST USE 8-0-1983; IN COMMERCE 8-0-1983.

FOR: TOPICAL PROTECTIVE TREATMENT AND
FLAME RETARDANT TREATMENT OF CARPETS,

UPHOLSTERED FURNISHINGS, WALL FABRICS,
TEXTILES, LEVEL FLOOR SURFACES, AND HARD
SURFACES, IN CLASS 40 (U.S. CLS. 100, 103 AND
106).

FIRST USE 8-0-1983; IN COMMERCE 8-0-1983.

THE MARK CONSISTS OF STANDARD CHAR-
ACTERS WITHOUT CLAIM TO ANY PARTICULAR
FONT, STYLE, SIZE, OR COLOR.

SER. NO. 77-429,870, FILED 3-24-2008.

WANDA KAY PRICE, EXAMINING ATTORNEY

Int. Cl.: 42

Prior U.S. Cls.: 100 and 101

United States Patent and Trademark Office

Reg. No. 3,520,102

Registered Oct. 21, 2008

**SERVICE MARK
PRINCIPAL REGISTER**

GISCI

GIS CERTIFICATION INSTITUTE (ILLINOIS
NON-PROFIT CORPORATION)
1460 RENAISSANCE DR., SUITE 305
PARK RIDGE, IL 60068

FOR: TESTING, ANALYSIS AND EVALUATION
OF THE SERVICES OF OTHERS FOR THE PUR-
POSE OF CERTIFICATION IN THE FIELD OF
GEOGRAPHIC INFORMATION SYSTEMS , IN
CLASS 42 (U.S. CLS. 100 AND 101).

FIRST USE 1-0-2004; IN COMMERCE 1-0-2004.

THE MARK CONSISTS OF STANDARD CHAR-
ACTERS WITHOUT CLAIM TO ANY PARTICULAR
FONT, STYLE, SIZE, OR COLOR.

SER. NO. 77-429,876, FILED 3-24-2008.

MARTHA SANTOMARTINO, EXAMINING ATTOR-
NEY

Int. Cl.: 35

Prior U.S. Cls.: 100, 101 and 102

United States Patent and Trademark Office

Reg. No. 3,520,103

Registered Oct. 21, 2008

**SERVICE MARK
PRINCIPAL REGISTER**



**EMERGENCE
CONSULTING**

EMERGENCE CONSULTING LLC (WASHINGTON LIMITED LIABILITY COMPANY)
13110 NE 177TH PLACE, #147
WOODINVILLE, WA 98072

FOR: PROVIDING ORGANIZATIONAL DEVELOPMENT CONSULTING SERVICES, IN CLASS 35 (U.S. CLS. 100, 101 AND 102).

FIRST USE 3-29-2006; IN COMMERCE 3-29-2006.

NO CLAIM IS MADE TO THE EXCLUSIVE RIGHT TO USE "CONSULTING", APART FROM THE MARK AS SHOWN.

THE COLOR(S) PURPLE AND BLACK IS/ARE CLAIMED AS A FEATURE OF THE MARK.

THE MARK CONSISTS OF THE WORDS "EMERGENCE CONSULTING" WITH THE INITIAL "E" TWICE THE SIZE OF THE REST OF THE WORD "EMERGENCE" IN A CURSIVE FONT IN THE COLOR PURPLE. THE WORD "CONSULTING" IS POSITIONED BELOW THE WORD "EMERGENCE" WITH THE INITIAL "C" POSITIONED IN BETWEEN THE "E" AND "R" OF "EMERGENCE". THE COLOR BLACK APPEARS IN THE REMAINING LETTERS OF "EMERGENCE" AND IN THE TERM "CONSULTING".

SER. NO. 77-429,885, FILED 3-24-2008.

ANNE FARRELL, EXAMINING ATTORNEY

Int. Cl.: 11

Prior U.S. Cls.: 13, 21, 23, 31 and 34

United States Patent and Trademark Office

Reg. No. 3,520,104

Registered Oct. 21, 2008

**TRADEMARK
PRINCIPAL REGISTER**

SENSI-COIL

EVAPCO, INC. (MARYLAND CORPORATION)
P.O. BOX 1300
WESTMINSTER, MD 21158

THE MARK CONSISTS OF STANDARD CHAR-
ACTERS WITHOUT CLAIM TO ANY PARTICULAR
FONT, STYLE, SIZE, OR COLOR.

FOR: COMPONENTS FOR AIR CONDITIONING
AND COOLING SYSTEMS, NAMELY, EVAPORA-
TIVE AIR COOLERS, IN CLASS 11 (U.S. CLS. 13, 21,
23, 31 AND 34).

SER. NO. 77-429,910, FILED 3-24-2008.

FIRST USE 7-1-2006; IN COMMERCE 7-1-2006.

ATTIYA MALIK, EXAMINING ATTORNEY

Int. Cls.: 21 and 25

Prior U.S. Cls.: 2, 13, 22, 23, 29, 30, 33, 39, 40 and 50

United States Patent and Trademark Office

Reg. No. 3,520,105

Registered Oct. 21, 2008

**TRADEMARK
PRINCIPAL REGISTER**



SISTERS OF THE HOLY SPIRIT (OHIO CHARITABLE, NON-PROFIT CORPORATION)
10102 GRANGER ROAD
GARFIELD HEIGHTS, OH 44125

OWNER OF U.S. REG. NOS. 3,156,334 AND 3,180,723.

FOR: MUGS, IN CLASS 21 (U.S. CLS. 2, 13, 23, 29, 30, 33, 40 AND 50).

THE MARK CONSISTS OF THE WORDS "NUN BETTER" AND A CARICATURE OF A SMILING NUN HOLDING A TRAY OF COOKIES.

FIRST USE 5-0-2005; IN COMMERCE 9-0-2007.

SER. NO. 77-429,913, FILED 3-24-2008.

FOR: APRONS, IN CLASS 25 (U.S. CLS. 22 AND 39).

FIRST USE 3-0-2006; IN COMMERCE 9-0-2007.

MICHAEL TANNER, EXAMINING ATTORNEY

Int. Cl.: 18

Prior U.S. Cls.: 1, 2, 3, 22 and 41

United States Patent and Trademark Office

Reg. No. 3,520,106

Registered Oct. 21, 2008

**TRADEMARK
PRINCIPAL REGISTER**

BOARDING PASS

CONSUMER PRODUCTS DESIGN, LTD (NEW
YORK CORPORATION)
SUITE 2320
60 EAST 42ND STREET
NEW YORK, NY 10165

FOR: ALL PURPOSE SPORT BAGS; ALL-PUR-
POSE CARRYING BAGS; BABY CARRYING BAGS;
BAGS FOR CARRYING BABIES' ACCESSORIES;
BACKPACKS, BOOK BAGS, SPORTS BAGS, BUM
BAGS, WALLETS AND HANDBAGS; BEACH BAGS;
BELT BAGS AND HIP BAGS; CANVAS SHOPPING
BAGS; COSMETIC BAGS SOLD EMPTY; TOILETRY
BAGS SOLD EMPTY; DIAPER BAGS; DUFFEL
BAGS; SHOPPING BAGS WITH WHEELS AT-

TACHED; BILLFOLDS; BRIEFCASES AND AT-
TACHE CASES; LUGGAGE; LUGGAGE TAGS;
STRAPS FOR LUGGAGE; UMBRELLAS, IN CLASS
18 (U.S. CLS. 1, 2, 3, 22 AND 41).

FIRST USE 3-24-2008; IN COMMERCE 3-24-2008.

THE MARK CONSISTS OF STANDARD CHAR-
ACTERS WITHOUT CLAIM TO ANY PARTICULAR
FONT, STYLE, SIZE, OR COLOR.

SER. NO. 77-429,914, FILED 3-24-2008.

REBECCA GILBERT, EXAMINING ATTORNEY

Int. Cl.: 20

Prior U.S. Cls.: 2, 13, 22, 25, 32 and 50

Reg. No. 3,520,107

United States Patent and Trademark Office

Registered Oct. 21, 2008

**TRADEMARK
PRINCIPAL REGISTER**

HOME SELECTS

TECHNIMARK, INC. (NORTH CAROLINA COR-
PORATION)
P. O. BOX 2068
180 COMMERCE PLACE
ASHEBORO, NC 272042068

FOR: CLOTHES HANGERS, IN CLASS 20 (U.S.
CLS. 2, 13, 22, 25, 32 AND 50).

FIRST USE 5-31-2007; IN COMMERCE 5-31-2007.

THE MARK CONSISTS OF STANDARD CHAR-
ACTERS WITHOUT CLAIM TO ANY PARTICULAR
FONT, STYLE, SIZE, OR COLOR.

SER. NO. 77-429,923, FILED 3-24-2008.

NORA BUCHANAN WILL, EXAMINING ATTOR-
NEY

Int. Cl.: 20

Prior U.S. Cls.: 2, 13, 22, 25, 32 and 50

United States Patent and Trademark Office

Reg. No. 3,520,108

Registered Oct. 21, 2008

**TRADEMARK
PRINCIPAL REGISTER**

RENEW

TECHNIMARK, INC. (NORTH CAROLINA COR-
PORATION)
P. O. BOX 2068
180 COMMERCE PLACE
ASHEBORO, NC 272042068

FOR: CLOTHES HANGERS, IN CLASS 20 (U.S.
CLS. 2, 13, 22, 25, 32 AND 50).

FIRST USE 6-30-2007; IN COMMERCE 6-30-2007.

THE MARK CONSISTS OF STANDARD CHAR-
ACTERS WITHOUT CLAIM TO ANY PARTICULAR
FONT, STYLE, SIZE, OR COLOR.

SER. NO. 77-429,932, FILED 3-24-2008.

NORA BUCHANAN WILL, EXAMINING ATTOR-
NEY

Int. Cl.: 35

Prior U.S. Cls.: 100, 101 and 102

United States Patent and Trademark Office

Reg. No. 3,520,109

Registered Oct. 21, 2008

**SERVICE MARK
PRINCIPAL REGISTER**

**PICK YOUR PRICE, PICK YOUR
COMFORT**

SERTA, INC. (DELAWARE CORPORATION)
2600 FORBS AVENUE
HOFFMAN ESTATES, IL 60192

THE MARK CONSISTS OF STANDARD CHAR-
ACTERS WITHOUT CLAIM TO ANY PARTICULAR
FONT, STYLE, SIZE, OR COLOR.

FOR: RETAIL STORE SERVICES FEATURING
MATTRESSES, IN CLASS 35 (U.S. CLS. 100, 101 AND
102).

SER. NO. 77-429,939, FILED 3-24-2008.

FIRST USE 2-21-2008; IN COMMERCE 2-21-2008.

KATINA MISTER, EXAMINING ATTORNEY

Int. Cl.: 16

Prior U.S. Cls.: 2, 5, 22, 23, 29, 37, 38 and 50

Reg. No. 3,520,110

United States Patent and Trademark Office

Registered Oct. 21, 2008

**TRADEMARK
PRINCIPAL REGISTER**

THE UMBRELLA

CARSTENS & CAHOON, LLP (TEXAS LIMITED
LIABILITY PARTNERSHIP)
SUITE 900
13760 NOEL ROAD
DALLAS, TX 75240

THE MARK CONSISTS OF STANDARD CHAR-
ACTERS WITHOUT CLAIM TO ANY PARTICULAR
FONT, STYLE, SIZE, OR COLOR.

FOR: NEWSLETTERS IN THE FIELD OF INTEL-
LECTUAL PROPERTY LAW, IN CLASS 16 (U.S. CLS.
2, 5, 22, 23, 29, 37, 38 AND 50).

SER. NO. 77-429,943, FILED 3-24-2008.

FIRST USE 9-1-2007; IN COMMERCE 9-1-2007.

JOHN KELLY, EXAMINING ATTORNEY

Int. Cl.: 45

Prior U.S. Cls.: 100 and 101

United States Patent and Trademark Office

Reg. No. 3,520,111

Registered Oct. 21, 2008

**SERVICE MARK
PRINCIPAL REGISTER**

ROYAL FUNERAL HOME

ROYAL FUNERAL HOME, INC. (ALABAMA
CORPORATION)

4315 OAKWOOD AVENUE

HUNTSVILLE, AL 35810

FOR: FUNERAL HOME SERVICES, IN CLASS 45
(U.S. CLS. 100 AND 101).

FIRST USE 12-31-1949; IN COMMERCE 12-31-1949.

THE MARK CONSISTS OF STANDARD CHAR-
ACTERS WITHOUT CLAIM TO ANY PARTICULAR
FONT, STYLE, SIZE, OR COLOR.

NO CLAIM IS MADE TO THE EXCLUSIVE
RIGHT TO USE "FUNERAL HOME", APART FROM
THE MARK AS SHOWN.

SER. NO. 77-429,956, FILED 3-24-2008.

MAUREEN DALL, EXAMINING ATTORNEY

Int. Cl.: 45

Prior U.S. Cls.: 100 and 101

United States Patent and Trademark Office

Reg. No. 3,520,112

Registered Oct. 21, 2008

**SERVICE MARK
PRINCIPAL REGISTER**

WHEN ONLY MEMORIES REMAIN,
LET THEM BE BEAUTIFUL.

ROYAL FUNERAL HOME, INC. (ALABAMA
CORPORATION)
4315 OAKWOOD AVENUE
HUNTSVILLE, AL 35810

THE MARK CONSISTS OF STANDARD CHAR-
ACTERS WITHOUT CLAIM TO ANY PARTICULAR
FONT, STYLE, SIZE, OR COLOR.

FOR: FUNERAL HOME SERVICES, IN CLASS 45
(U.S. CLS. 100 AND 101).

SER. NO. 77-429,964, FILED 3-24-2008.

FIRST USE 12-31-1967; IN COMMERCE 12-31-1967.

MAUREEN DALL, EXAMINING ATTORNEY

Int. Cl.: 42

Prior U.S. Cls.: 100 and 101

United States Patent and Trademark Office

Reg. No. 3,520,113

Registered Oct. 21, 2008

**SERVICE MARK
PRINCIPAL REGISTER**

INTEGRATION DELIVERED

MEDDIUS, LLC (VIRGINIA LIMITED LIABILITY
COMPANY)
100 10TH STREET NE, SUITE 303
CHARLOTTESVILLE, VA 22902

FOR: CONSULTING SERVICES AND SOFTWARE
DEVELOPMENT SERVICES FOR DATA EX-
CHANGE AND ENABLING DATA COMMUNICA-
TION BETWEEN APPLICATION PROGRAMS AND
DOCUMENTS, IN CLASS 42 (U.S. CLS. 100 AND 101).

FIRST USE 2-25-2008; IN COMMERCE 2-25-2008.

THE MARK CONSISTS OF STANDARD CHAR-
ACTERS WITHOUT CLAIM TO ANY PARTICULAR
FONT, STYLE, SIZE, OR COLOR.

SER. NO. 77-429,966, FILED 3-24-2008.

ATTIYA MALIK, EXAMINING ATTORNEY

Int. Cls.: 21 and 25

Prior U.S. Cls.: 2, 13, 22, 23, 29, 30, 33, 39, 40 and 50

United States Patent and Trademark Office

Reg. No. 3,520,114

Registered Oct. 21, 2008

**TRADEMARK
PRINCIPAL REGISTER**

NUN BETTER

SISTERS OF THE HOLY SPIRIT (OHIO CHARITABLE, NON-PROFIT CORPORATION)
10102 GRANGER ROAD
GARFIELD HEIGHTS, OH 44125

THE MARK CONSISTS OF STANDARD CHARACTERS WITHOUT CLAIM TO ANY PARTICULAR FONT, STYLE, SIZE, OR COLOR.

FOR: MUGS; COOKIE JARS, IN CLASS 21 (U.S. CLS. 2, 13, 23, 29, 30, 33, 40 AND 50).

OWNER OF U.S. REG. NOS. 3,156,334 AND 3,180,723.

FIRST USE 5-0-2005; IN COMMERCE 4-0-2007.

SER. NO. 77-429,982, FILED 3-24-2008.

FOR: APRONS, IN CLASS 25 (U.S. CLS. 22 AND 39).

FIRST USE 3-0-2006; IN COMMERCE 9-0-2007.

MICHAEL TANNER, EXAMINING ATTORNEY

Int. Cl.: 9

Prior U.S. Cls.: 21, 23, 26, 36 and 38

Reg. No. 3,520,115

United States Patent and Trademark Office

Registered Oct. 21, 2008

**TRADEMARK
PRINCIPAL REGISTER**

ASPEN

ASPEN AVIONICS, INC. (DELAWARE CORPORATION)
5001 INDIAN SCHOOL ROAD, NE
ALBUQUERQUE, NM 87110

FOR: AVIONIC SENSOR SYSTEMS, NAMELY, AIRCRAFT AIRSPEED SENSORS; AVIONIC SENSOR SYSTEMS, NAMELY, AIRCRAFT ALTITUDE INDICATORS; AVIONIC SENSOR SYSTEMS, NAMELY, NAVIGATION SYSTEMS; APPARATUS FOR CHECKING FLIGHT PARAMETERS; ELECTRONIC NAVIGATIONAL AND POSITIONING AP-

PARATUS AND INSTRUMENTS, IN CLASS 9 (U.S. CLS. 21, 23, 26, 36 AND 38).

FIRST USE 1-31-2005; IN COMMERCE 1-31-2005.

THE MARK CONSISTS OF STANDARD CHARACTERS WITHOUT CLAIM TO ANY PARTICULAR FONT, STYLE, SIZE, OR COLOR.

SER. NO. 77-429,987, FILED 3-24-2008.

JENNY PARK, EXAMINING ATTORNEY

Int. Cl.: 29

Prior U.S. Cl.: 46

United States Patent and Trademark Office

Reg. No. 3,520,116

Registered Oct. 21, 2008

**TRADEMARK
PRINCIPAL REGISTER**

Gold 300

SOYLINK, LLC (SOUTH DAKOTA LIMITED
LIABILITY COMPANY)
ATTN: LILA AKRAD
4615 NORTH LEWIS AVENUE
SIOUX FALLS, SD 57104

THE MARK CONSISTS OF STANDARD CHAR-
ACTERS WITHOUT CLAIM TO ANY PARTICULAR
FONT, STYLE, SIZE, OR COLOR.

FOR: SOY POWDER FOR USE AS A FOOD
ADDITIVE, IN CLASS 29 (U.S. CL. 46).

SER. NO. 77-430,005, FILED 3-24-2008.

FIRST USE 9-1-2000; IN COMMERCE 9-1-2000.

AMY MCMENAMIN, EXAMINING ATTORNEY

Int. Cl.: 31

Prior U.S. Cls.: 1 and 46

United States Patent and Trademark Office

Reg. No. 3,520,117

Registered Oct. 21, 2008

**TRADEMARK
PRINCIPAL REGISTER**

HUSKY

TRIPLE B CORPORATION (WASHINGTON COR-
PORATION)
4103 2ND AVENUE SOUTH
SEATTLE, WA 98124

FOR: FRESH FRUITS AND VEGETABLES; UN-
PROCESSED NUTS, AND CUT FLOWERS, IN
CLASS 31 (U.S. CLS. 1 AND 46).

FIRST USE 12-31-1958; IN COMMERCE 12-31-1958.

THE MARK CONSISTS OF STANDARD CHAR-
ACTERS WITHOUT CLAIM TO ANY PARTICULAR
FONT, STYLE, SIZE, OR COLOR.

OWNER OF U.S. REG. NO. 2,098,580.

SER. NO. 77-430,009, FILED 3-24-2008.

JASON ROTH, EXAMINING ATTORNEY

Int. Cl.: 24

Prior U.S. Cls.: 42 and 50

United States Patent and Trademark Office

Reg. No. 3,520,118

Registered Oct. 21, 2008

**TRADEMARK
PRINCIPAL REGISTER**

Tywik

XYMID, L.L.C. (VIRGINIA LIMITED LIABILITY
COMPANY)
3141 CRAIG RATH BOULEVARD
MIDLOTHIAN, VA 23112

FOR: ABSORBENT TEXTILE FABRIC OF SYN-
THETIC FIBERS, IN CLASS 24 (U.S. CLS. 42 AND 50).

FIRST USE 9-30-1998; IN COMMERCE 9-30-1998.

THE MARK CONSISTS OF STANDARD CHAR-
ACTERS WITHOUT CLAIM TO ANY PARTICULAR
FONT, STYLE, SIZE, OR COLOR.

SER. NO. 77-430,010, FILED 3-24-2008.

JOHN SCHUYLER YARD, EXAMINING ATTOR-
NEY

Int. Cl.: 29

Prior U.S. Cl.: 46

United States Patent and Trademark Office

Reg. No. 3,520,119

Registered Oct. 21, 2008

**TRADEMARK
PRINCIPAL REGISTER**

Gold 1000

SOYLINK, LLC (SOUTH DAKOTA LIMITED
LIABILITY COMPANY)
ATTN: LILA A. T. AKRAD
4615 N. LEWIS AVENUE
SIOUX FALLS, SD 57104

THE MARK CONSISTS OF STANDARD CHAR-
ACTERS WITHOUT CLAIM TO ANY PARTICULAR
FONT, STYLE, SIZE, OR COLOR.

FOR: SOY POWDER FOR USE AS A FOOD
ADDITIVE, IN CLASS 29 (U.S. CL. 46).

SER. NO. 77-430,017, FILED 3-24-2008.

FIRST USE 9-1-2000; IN COMMERCE 9-1-2000.

AMY MCMENAMIN, EXAMINING ATTORNEY

Int. Cl.: 29

Prior U.S. Cl.: 46

United States Patent and Trademark Office

Reg. No. 3,520,120

Registered Oct. 21, 2008

**TRADEMARK
PRINCIPAL REGISTER**

Silver 300

SOYLINK, LLC (SOUTH DAKOTA LIMITED
LIABILITY COMPANY)
ATTN: LILA A. T. AKRAD
4615 NORTH LEWIS AVENUE
SIOUX FALLS, SD 57104

THE MARK CONSISTS OF STANDARD CHAR-
ACTERS WITHOUT CLAIM TO ANY PARTICULAR
FONT, STYLE, SIZE, OR COLOR.

FOR: SOY POWDER FOR USE AS A FOOD
ADDITIVE, IN CLASS 29 (U.S. CL. 46).

SER. NO. 77-430,020, FILED 3-24-2008.

FIRST USE 9-1-2000; IN COMMERCE 9-1-2000.

AMY MCMENAMIN, EXAMINING ATTORNEY

Int. Cl.: 29

Prior U.S. Cl.: 46

United States Patent and Trademark Office

Reg. No. 3,520,121

Registered Oct. 21, 2008

**TRADEMARK
PRINCIPAL REGISTER**

Silver 1000

SOYLINK, LLC (SOUTH DAKOTA LIMITED
LIABILITY COMPANY)
ATTN: LILA A. T. AKRAD
4615 NORTH LEWIS AVENUE
SIOUX FALLS, SD 57104

THE MARK CONSISTS OF STANDARD CHAR-
ACTERS WITHOUT CLAIM TO ANY PARTICULAR
FONT, STYLE, SIZE, OR COLOR.

FOR: SOY POWDER FOR USE AS A FOOD
ADDITIVE, IN CLASS 29 (U.S. CL. 46).

SER. NO. 77-430,029, FILED 3-24-2008.

FIRST USE 9-1-2000; IN COMMERCE 9-1-2000.

AMY MCMENAMIN, EXAMINING ATTORNEY

Int. Cl.: 29

Prior U.S. Cl.: 46

United States Patent and Trademark Office

Reg. No. 3,520,122

Registered Oct. 21, 2008

**TRADEMARK
PRINCIPAL REGISTER**

Jade 300

SOYLINK, LLC (SOUTH DAKOTA LIMITED
LIABILITY COMPANY)
ATTN: LILA A. T. AKRAD, ESQ.
4615 N. LEWIS AVENUE
SIOUX FALLS, SD 57104

THE MARK CONSISTS OF STANDARD CHAR-
ACTERS WITHOUT CLAIM TO ANY PARTICULAR
FONT, STYLE, SIZE, OR COLOR.

FOR: SOY POWDER FOR USE AS A FOOD
ADDITIVE, IN CLASS 29 (U.S. CL. 46).

SER. NO. 77-430,034, FILED 3-24-2008.

FIRST USE 1-1-2004; IN COMMERCE 1-1-2004.

AMY MCMENAMIN, EXAMINING ATTORNEY

Int. Cl.: 29

Prior U.S. Cl.: 46

United States Patent and Trademark Office

Reg. No. 3,520,123

Registered Oct. 21, 2008

**TRADEMARK
PRINCIPAL REGISTER**

Jade 1000

SOYLINK, LLC (SOUTH DAKOTA LIMITED
LIABILITY COMPANY)
ATTN: LILA A. T. AKRAD, ESQ.
4615 N. LEWIS AVENUE
SIOUX FALLS, SD 57104

THE MARK CONSISTS OF STANDARD CHAR-
ACTERS WITHOUT CLAIM TO ANY PARTICULAR
FONT, STYLE, SIZE, OR COLOR.

FOR: SOY POWDER FOR USE AS A FOOD
ADDITIVE, IN CLASS 29 (U.S. CL. 46).

SER. NO. 77-430,039, FILED 3-24-2008.

FIRST USE 6-1-2003; IN COMMERCE 6-1-2003.

AMY MCMENAMIN, EXAMINING ATTORNEY

Int. Cl.: 31

Prior U.S. Cls.: 1 and 46

United States Patent and Trademark Office

Reg. No. 3,520,124

Registered Oct. 21, 2008

**TRADEMARK
PRINCIPAL REGISTER**



TRIPLE B CORPORATION (WASHINGTON COR-
PORATION)
4103 2ND AVENUE SOUTH
SEATTLE, WA 98124

FOR: FRESH FRUITS AND VEGETABLES; UN-
PROCESSED NUTS, AND CUT FLOWERS, IN
CLASS 31 (U.S. CLS. 1 AND 46).

FIRST USE 12-31-1958; IN COMMERCE 12-31-1958.

OWNER OF U.S. REG. NO. 2,098,580.

SER. NO. 77-430,045, FILED 3-24-2008.

JASON ROTH, EXAMINING ATTORNEY

Int. Cl.: 9

Prior U.S. Cls.: 21, 23, 26, 36 and 38

Reg. No. 3,520,125

United States Patent and Trademark Office

Registered Oct. 21, 2008

**TRADEMARK
PRINCIPAL REGISTER**

DEFENDER

MIDWAY AMUSEMENT GAMES, LLC (DELA-
WARE LIMITED LIABILITY COMPANY)
2704 W. ROSCOE STREET
CHICAGO, IL 60618

THE MARK CONSISTS OF STANDARD CHAR-
ACTERS WITHOUT CLAIM TO ANY PARTICULAR
FONT, STYLE, SIZE, OR COLOR.

FOR: COMPUTER AND VIDEO GAME PRO-
GRAMS RECORDED ON CARTRIDGES, DISCS,
CD-ROMS, CASSETTES, TAPES AND MINI DISCS;
VIDEO AND COMPUTER GAME SOFTWARE , IN
CLASS 9 (U.S. CLS. 21, 23, 26, 36 AND 38).

OWNER OF U.S. REG. NO. 1,288,008.

SER. NO. 77-430,070, FILED 3-24-2008.

FIRST USE 11-18-2003; IN COMMERCE 11-18-2003.

JASON ROTH, EXAMINING ATTORNEY

Int. Cls.: 30 and 35

Prior U.S. Cls.: 46, 100, 101 and 102

United States Patent and Trademark Office

Reg. No. 3,520,126

Registered Oct. 21, 2008

**TRADEMARK
SERVICE MARK
PRINCIPAL REGISTER**

EAGLE COFFEE

EAGLE COFFEE COMPANY, INC. (MARYLAND CORPORATION)
1027 HILLEN ST.
BALTIMORE, MD 21202

FOR: ROASTED COFFEE BEANS; GROUND COFFEE, IN CLASS 30 (U.S. CL. 46).

FIRST USE 1-1-1921; IN COMMERCE 1-1-1921.

FOR: ONLINE RETAIL STORE SERVICES AND DISTRIBUTORSHIP SERVICES FOR COFFEE, TEA, SYRUPS, COFFEE EQUIPMENT, GOURMET PRODUCTS, IN CLASS 35 (U.S. CLS. 100, 101 AND 102).

FIRST USE 1-1-1999; IN COMMERCE 1-1-1999.

THE MARK CONSISTS OF STANDARD CHARACTERS WITHOUT CLAIM TO ANY PARTICULAR FONT, STYLE, SIZE, OR COLOR.

OWNER OF U.S. REG. NO. 3,133,135.

NO CLAIM IS MADE TO THE EXCLUSIVE RIGHT TO USE "COFFEE", APART FROM THE MARK AS SHOWN.

SER. NO. 77-430,100, FILED 3-24-2008.

KYLE PEETE, EXAMINING ATTORNEY

Int. Cl.: 9

Prior U.S. Cls.: 21, 23, 26, 36 and 38

Reg. No. 3,520,127

United States Patent and Trademark Office

Registered Oct. 21, 2008

**TRADEMARK
PRINCIPAL REGISTER**

GIGAPHOTON

GIGAPHOTON USA INC. (OREGON CORPORATION)
SUITE 219
3003 SW 153RD
BEAVERTON, OR 97006

THE MARK CONSISTS OF STANDARD CHARACTERS WITHOUT CLAIM TO ANY PARTICULAR FONT, STYLE, SIZE, OR COLOR.

FOR: EXCIMER LASERS USED FOR LITHOGRAPHY IN THE PRODUCTION OF SEMICONDUCTORS, IN CLASS 9 (U.S. CLS. 21, 23, 26, 36 AND 38).

SER. NO. 77-430,103, FILED 3-24-2008.

FIRST USE 9-1-2000; IN COMMERCE 9-1-2000.

KYLE PEETE, EXAMINING ATTORNEY

Int. Cl.: 35

Prior U.S. Cls.: 100, 101 and 102

United States Patent and Trademark Office

Reg. No. 3,520,128

Registered Oct. 21, 2008

**SERVICE MARK
PRINCIPAL REGISTER**



INDIAN HANDICRAFTS & TEXTILES SYNDI-
CATE (INDIA PARTNERSHIP)
GULAB BHWAN, G-365 PREET VIHAR
NEW DELHI, INDIA 110092

FOR: DISTRIBUTORSHIP SERVICES IN THE
FIELD OF FINE BLADEWARE, CUTLERY AND
REPRODUCTION WEAPONRY, NAMELY, KNIVES,
SWORDS, DAGGERS, REPLICA ARMOUR, HEL-
METS, SHIELDS, AXES, POLE ARMS AND OTHER
HISTORICAL ARTIFACTS OF WEAPONRY AND
RELATED COLLECTIBLES AND ACCESSORIES;
RETAIL STORE SERVICES FEATURING FINE BLA-
DEWARE, CUTLERY AND REPRODUCTION
WEAPONRY, NAMELY, KNIVES, SWORDS, DAG-
GERS, REPLICA ARMOUR, HELMETS, SHIELDS,
AXES, POLE ARMS AND OTHER HISTORICAL
ARTIFACTS OF WEAPONRY AND RELATED COL-

LECTIBLES AND ACCESSORIES; ON-LINE ORDER-
ING SERVICES FEATURING FINE BLADEWARE,
CUTLERY AND REPRODUCTION WEAPONRY,
NAMELY, KNIVES, SWORDS, DAGGERS, REPLICA
ARMOUR, HELMETS, SHIELDS, AXES, POLE
ARMS AND OTHER HISTORICAL ARTIFACTS OF
WEAPONRY AND RELATED COLLECTIBLES AND
ACCESSORIES, IN CLASS 35 (U.S. CLS. 100, 101 AND
102).

FIRST USE 1-18-2008; IN COMMERCE 1-18-2008.

THE MARK CONSISTS OF A FLYING PHOENIX.

SER. NO. 77-430,109, FILED 3-24-2008.

JASON ROTH, EXAMINING ATTORNEY

Int. Cl.: 27

Prior U.S. Cls.: 19, 20, 37, 42 and 50

Reg. No. 3,520,129

United States Patent and Trademark Office

Registered Oct. 21, 2008

**TRADEMARK
PRINCIPAL REGISTER**



SAXONY DISTRIBUTORS, INC. (FLORIDA CORPORATION)
SUITE 211
660 LINTON BOULEVARD
DELRAY BEACH, FL 33444

THE MARK CONSISTS OF THE WORD "SAXONY" WITH THE CAPITAL LETTER "S" IN RED AND SHADOWED WITH A BLACK/GRAY "S" UNDERNEATH IT AND THE LETTERS "AXONY" IN BLACK.

FOR: FLOOR COVERINGS, IN CLASS 27 (U.S. CLS. 19, 20, 37, 42 AND 50).

SER. NO. 77-430,110, FILED 3-24-2008.

FIRST USE 1-1-2006; IN COMMERCE 1-1-2006.

THE COLOR(S) BLACK AND RED IS/ARE CLAIMED AS A FEATURE OF THE MARK.

HOWARD SMIGA, EXAMINING ATTORNEY

Int. Cl.: 35

Prior U.S. Cls.: 100, 101 and 102

United States Patent and Trademark Office

Reg. No. 3,520,130

Registered Oct. 21, 2008

**SERVICE MARK
PRINCIPAL REGISTER**



INDIAN HANDICRAFTS & TEXTILES SYNDI-
CATE (INDIA PARTNERSHIP)
GULAB BHWAN, G-365 PREET VIHAR
NEW DELHI, INDIA 110092

FOR: DISTRIBUTORSHIP SERVICES IN THE
FIELD OF FINE BLADEWARE, CUTLERY AND
REPRODUCTION WEAPONRY, NAMELY, KNIVES,
SWORDS, DAGGERS, ARMOUR, HELMETS,
SHIELDS, AXES, POLE ARMS AND OTHER HIS-
TORICAL ARTIFACTS OF WEAPONRY AND RE-
LATED COLLECTIBLES AND ACCESSORIES; ON-
LINE ORDERING SERVICES FEATURING FINE
BLADEWARE, CUTLERY AND REPRODUCTION
WEAPONRY, NAMELY, KNIVES, SWORDS, DAG-
GERS, ARMOUR, HELMETS, SHIELDS, AXES,
POLE ARMS AND OTHER HISTORICAL ARTI-
FACTS OF WEAPONRY AND RELATED COLLEC-

TIBLES AND ACCESSORIES; RETAIL STORE
SERVICES FEATURING FINE BLADEWARE, CUT-
LERY AND REPRODUCTION WEAPONRY, NAME-
LY, KNIVES, SWORDS, DAGGERS, ARMOUR,
HELMETS, SHIELDS, AXES, POLE ARMS AND
OTHER HISTORICAL ARTIFACTS OF WEAPONRY
AND RELATED COLLECTIBLES AND ACCESSOR-
IES, IN CLASS 35 (U.S. CLS. 100, 101 AND 102).

FIRST USE 1-18-2008; IN COMMERCE 1-18-2008.

THE MARK CONSISTS OF THE CAPITALIZED
LETTERS "GDFB" ENCLOSED IN AN OVAL.

SER. NO. 77-430,124, FILED 3-24-2008.

JASON ROTH, EXAMINING ATTORNEY

Int. Cl.: 36

Prior U.S. Cls.: 100, 101 and 102

United States Patent and Trademark Office

Reg. No. 3,520,131

Registered Oct. 21, 2008

**SERVICE MARK
PRINCIPAL REGISTER**

CREDILIFE

CREDILIFE, INC. (FLORIDA CORPORATION)
STE. 101
5000 SW 75TH AVE.
MIAMI, FL 33155

THE MARK CONSISTS OF STANDARD CHAR-
ACTERS WITHOUT CLAIM TO ANY PARTICULAR
FONT, STYLE, SIZE, OR COLOR.

FOR: FINANCIAL INFORMATION AND ADVI-
SORY SERVICES, IN CLASS 36 (U.S. CLS. 100, 101
AND 102).

SER. NO. 77-430,141, FILED 3-24-2008.

FIRST USE 1-15-2005; IN COMMERCE 1-15-2005.

AMEETA JORDAN, EXAMINING ATTORNEY

Int. Cl.: 9

Prior U.S. Cls.: 21, 23, 26, 36 and 38

Reg. No. 3,520,132

United States Patent and Trademark Office

Registered Oct. 21, 2008

**TRADEMARK
PRINCIPAL REGISTER**

COOLIRIS

COOLIRIS, INC. (CALIFORNIA CORPORATION)
2750 SANDHILL ROAD
MENLO PARK, CA 94025

THE MARK CONSISTS OF STANDARD CHAR-
ACTERS WITHOUT CLAIM TO ANY PARTICULAR
FONT, STYLE, SIZE, OR COLOR.

FOR: COMPUTER SOFTWARE FOR ENHAN-
CING DISPLAY OF RICH MEDIA AND USER
EXPERIENCE IN A WORLD WIDE WEB INTER-
FACE, IN CLASS 9 (U.S. CLS. 21, 23, 26, 36 AND 38).

SER. NO. 77-430,176, FILED 3-24-2008.

FIRST USE 1-31-2006; IN COMMERCE 1-31-2006.

ANNE FARRELL, EXAMINING ATTORNEY

Int. Cl.: 37

Prior U.S. Cls.: 100, 103 and 106

United States Patent and Trademark Office

Reg. No. 3,520,133

Registered Oct. 21, 2008

**SERVICE MARK
PRINCIPAL REGISTER**

Ecoshine Auto Spa

ECOSHINE, LLC (ARIZONA LIMITED LIABILITY COMPANY), DBA ECOSHINE AUTO SPA
320 W. LONE CACTUS DR.
PHOENIX, AZ 85027

FOR: AUTOMOBILE CLEANING; AUTOMOBILE CLEANING AND CAR WASHING; CAR CLEANING; CAR WASHING; CLEANING OF CARS, RECREATIONAL VEHICLES, AND AUTOMOBILES USING WATERLESS/LOW-WATER SYSTEM; AUTOMOBILE WASHING; WASHING OF CARS, RECREATIONAL VEHICLES, AND AUTOMOBILES USING WATERLESS/LOW-WATER SYSTEM; VEHICLE CLEANING; VEHICLE WASHING, IN CLASS 37 (U.S. CLS. 100, 103 AND 106).

FIRST USE 6-0-2007; IN COMMERCE 6-0-2007.

THE MARK CONSISTS OF STANDARD CHARACTERS WITHOUT CLAIM TO ANY PARTICULAR FONT, STYLE, SIZE, OR COLOR.

NO CLAIM IS MADE TO THE EXCLUSIVE RIGHT TO USE "AUTO SPA", APART FROM THE MARK AS SHOWN.

SER. NO. 77-430,179, FILED 3-24-2008.

GISELLE AGOSTO, EXAMINING ATTORNEY

Int. Cls.: 9 and 38

Prior U.S. Cls.: 21, 23, 26, 36, 38, 100, 101 and 104

United States Patent and Trademark Office

Reg. No. 3,520,134

Registered Oct. 21, 2008

**TRADEMARK
SERVICE MARK
PRINCIPAL REGISTER**

cogoblue

ISPBX LLC (NEW JERSEY LIMITED LIABILITY
COMPANY)
SUITE 202
75 BLOOMFIELD AVE
DENVER, NJ 07834

FOR: COMPUTER HARDWARE AND SOFTWARE FOR SETTING UP AND CONFIGURING LOCAL AREA NETWORKS; COMPUTER HARDWARE AND SOFTWARE FOR SETTING UP AND CONFIGURING WIDE AREA NETWORKS; TELEPHONE CALL ROUTER, FOR HOME AND OFFICE TOUCHTONE PHONES, FOR INTERNATIONAL AND LONG DISTANCE CALLS MADE FROM VARIOUS TELEPHONY PLATFORMS INCLUDING VOIP PLATFORM WITHOUT THE REQUIREMENT FOR INTERNET; TELEPHONE CALL ROUTERS FOR LONG DISTANCE CALLS MADE THROUGH PSTN AND VOIP PLATFORMS FROM ANY TOUCHTONE PHONE WITHOUT A REQUIRE-

MENT FOR INTERNET ACCESS, IN CLASS 9 (U.S. CLS. 21, 23, 26, 36 AND 38).

FIRST USE 1-25-2006; IN COMMERCE 1-25-2006.

FOR: VOICE OVER INTERNET PROTOCOL (VOIP) SERVICES, IN CLASS 38 (U.S. CLS. 100, 101 AND 104).

FIRST USE 1-25-2006; IN COMMERCE 1-25-2006.

THE MARK CONSISTS OF STANDARD CHARACTERS WITHOUT CLAIM TO ANY PARTICULAR FONT, STYLE, SIZE, OR COLOR.

SER. NO. 77-430,180, FILED 3-24-2008.

ANNE E. GUSTASON, EXAMINING ATTORNEY

Int. Cl.: 45

Prior U.S. Cls.: 100 and 101

United States Patent and Trademark Office

Reg. No. 3,520,135

Registered Oct. 21, 2008

**SERVICE MARK
PRINCIPAL REGISTER**

Parents Go First

CHILDREN, FAMILIES AND COMMUNITIES,
INC. (MAINE CORPORATION), DBA CENTER
FOR INTEGRATED AWARENESS- MAINE
102 MAIN ST., STE A
ELLSWORTH, ME 04605

THE MARK CONSISTS OF STANDARD CHAR-
ACTERS WITHOUT CLAIM TO ANY PARTICULAR
FONT, STYLE, SIZE, OR COLOR.

FOR: INFORMATION IN THE FIELD OF PAR-
ENTING CONCERNING INTRAFAMILY RELA-
TIONSHPIS, IN CLASS 45 (U.S. CLS. 100 AND 101).

SER. NO. 77-430,181, FILED 3-24-2008.

FIRST USE 6-1-2002; IN COMMERCE 6-1-2002.

MAUREEN DALL, EXAMINING ATTORNEY

Int. Cl.: 35

Prior U.S. Cls.: 100, 101 and 102

United States Patent and Trademark Office

Reg. No. 3,520,136

Registered Oct. 21, 2008

**SERVICE MARK
PRINCIPAL REGISTER**

SEACOLOGY

SEACOLOGY CORPORATION (UTAH CORPORATION)
1623 SOLANO AVENUE
BERKELEY, CA 94707

FOR: PROMOTING PUBLIC AWARENESS OF THE NEED FOR PRESERVING AND PROTECTING THE ENVIRONMENTS AND CULTURES OF ISLANDS THROUGHOUT THE WORLD, IN CLASS 35 (U.S. CLS. 100, 101 AND 102).

FIRST USE 5-1-1991; IN COMMERCE 5-1-1991.

THE MARK CONSISTS OF STANDARD CHARACTERS WITHOUT CLAIM TO ANY PARTICULAR FONT, STYLE, SIZE, OR COLOR.

SER. NO. 77-430,197, FILED 3-24-2008.

SHAUNIA CARLYLE, EXAMINING ATTORNEY

Int. Cl.: 37

Prior U.S. Cls.: 100, 103 and 106

United States Patent and Trademark Office

Reg. No. 3,520,137

Registered Oct. 21, 2008

**SERVICE MARK
PRINCIPAL REGISTER**

**Where Conservation Meets
Innovation**

ECOSHINE, LLC (ARIZONA LIMITED LIABILITY COMPANY), DBA ECOSHINE AUTO SPA
320 W. LONE CACTUS DR.
PHOENIX, AZ 85027

FOR: AUTOMOBILE CLEANING; AUTOMOBILE CLEANING AND CAR WASHING; CAR CLEANING; CAR WASHING; CLEANING OF CARS, RECREATIONAL VEHICLES, AND AUTOMOBILES USING WATERLESS/LOW-WATER SYSTEM; AUTOMOBILE WASHING; WASHING OF CARS, RECREATIONAL VEHICLES, AND AUTOMOBILES USING WATERLESS/LOW-WATER SYSTEM; VEHI-

CLE CLEANING; VEHICLE WASHING, IN CLASS 37 (U.S. CLS. 100, 103 AND 106).

FIRST USE 6-0-2007; IN COMMERCE 6-0-2007.

THE MARK CONSISTS OF STANDARD CHARACTERS WITHOUT CLAIM TO ANY PARTICULAR FONT, STYLE, SIZE, OR COLOR.

SER. NO. 77-430,198, FILED 3-24-2008.

GISELLE AGOSTO, EXAMINING ATTORNEY

Int. Cl.: 38

Prior U.S. Cls.: 100, 101 and 104

United States Patent and Trademark Office

Reg. No. 3,520,138

Registered Oct. 21, 2008

**SERVICE MARK
PRINCIPAL REGISTER**

Rock of Your Life

DENNY SOMACH PRODUCTIONS (PENNSYLVANIA CORPORATION)
812 DARBY RD.
HAVERTOWN, PA 19083

THE MARK CONSISTS OF STANDARD CHARACTERS WITHOUT CLAIM TO ANY PARTICULAR FONT, STYLE, SIZE, OR COLOR.

FOR: RADIO BROADCASTING, IN CLASS 38 (U.S. CLS. 100, 101 AND 104).

SER. NO. 77-430,204, FILED 3-24-2008.

FIRST USE 4-1-1985; IN COMMERCE 5-1-1985.

SUZANNE BLANE, EXAMINING ATTORNEY

Int. Cl.: 5

Prior U.S. Cls.: 6, 18, 44, 46, 51 and 52

United States Patent and Trademark Office

Reg. No. 3,520,139

Registered Oct. 21, 2008

**TRADEMARK
PRINCIPAL REGISTER**

SKIP THE HANGOVER!

LMS HOLDING INC. (NEBRASKA CORPORATION)
51 MACDOUGAL STREET SUITE 445
NEW YORK, NY 10012

FOR: DIETARY SUPPLEMENTS; DIETARY AND NUTRITIONAL SUPPLEMENTS; DIETARY SUPPLEMENTAL DRINKS; AMINO ACIDS FOR NUTRITIONAL PURPOSES; DIETARY SUPPLEMENTS FOR HUMAN CONSUMPTION; NUTRACEUTICALS FOR USE AS A DIETARY SUPPLEMENT; NUTRITIONAL SUPPLEMENTS; POWDERED NU-

TRITIONAL SUPPLEMENT DRINK MIX, IN CLASS 5 (U.S. CLS. 6, 18, 44, 46, 51 AND 52).

FIRST USE 1-1-2008; IN COMMERCE 3-20-2008.

THE MARK CONSISTS OF STANDARD CHARACTERS WITHOUT CLAIM TO ANY PARTICULAR FONT, STYLE, SIZE, OR COLOR.

SER. NO. 77-430,215, FILED 3-24-2008.

SUZANNE BLANE, EXAMINING ATTORNEY

Int. Cl.: 41

Prior U.S. Cls.: 100, 101 and 107

United States Patent and Trademark Office

Reg. No. 3,520,140

Registered Oct. 21, 2008

**SERVICE MARK
PRINCIPAL REGISTER**

THINK PROGRESS

CENTER FOR AMERICAN PROGRESS ACTION
FUND (D.C. CORPORATION)
10TH STREET, 1333 H. STREET, NW
WASHINGTON, DC 20005

FOR: PROVIDING ON-LINE PERIODICAL AND
NEWSGATHERING INFORMATION IN THE
FIELDS OF POLITICS AND POLICY-MAKING; AR-
RANGING AND ORGANIZING EDUCATIONAL
CONFERENCES, SEMINARS, AND SYMPOSIA IN
THE FIELDS OF POLITICS AND POLICY-MAKING,
IN CLASS 41 (U.S. CLS. 100, 101 AND 107).

FIRST USE 1-0-2005; IN COMMERCE 1-0-2005.

THE MARK CONSISTS OF STANDARD CHAR-
ACTERS WITHOUT CLAIM TO ANY PARTICULAR
FONT, STYLE, SIZE, OR COLOR.

SER. NO. 77-430,217, FILED 3-24-2008.

GINA FINK, EXAMINING ATTORNEY

Int. Cl.: 30

Prior U.S. Cl.: 46

United States Patent and Trademark Office

Reg. No. 3,520,141

Registered Oct. 21, 2008

**TRADEMARK
PRINCIPAL REGISTER**

MOUNTAIN LIGHTNING SALSA

LOPEZ, BRENDA E. (UNITED STATES INDIVIDUAL)

10210 LOY CREEK ROAD

WOODLAND PARK, CO 80863

FOR: NATURAL SALSA, IN CLASS 30 (U.S. CL. 46).

FIRST USE 2-1-2008; IN COMMERCE 2-1-2008.

THE MARK CONSISTS OF STANDARD CHARACTERS WITHOUT CLAIM TO ANY PARTICULAR FONT, STYLE, SIZE, OR COLOR.

NO CLAIM IS MADE TO THE EXCLUSIVE RIGHT TO USE "SALSA", APART FROM THE MARK AS SHOWN.

SER. NO. 77-430,219, FILED 3-24-2008.

GISELLE AGOSTO, EXAMINING ATTORNEY

Int. Cl.: 25

Prior U.S. Cls.: 22 and 39

United States Patent and Trademark Office

Reg. No. 3,520,142

Registered Oct. 21, 2008

**TRADEMARK
PRINCIPAL REGISTER**

RACIN' DIRTY

COLE, TIMOTHY (UNITED STATES INDIVIDUAL)
912 ESSEX AVE
HENDERSON, NV 89015

FOR: T-SHIRTS; BATHING SUITS FOR MEN; CAMP SHIRTS; A-SHIRTS; GOLF SHIRTS; HOODED SWEAT SHIRTS; KNIT SHIRTS; LONG-SLEEVED SHIRTS; NIGHT SHIRTS; OPEN-NECKED SHIRTS; PIQUE SHIRTS; POLO SHIRTS; RUGBY SHIRTS; SHIRTS; SHORT-SLEEVED OR LONG-SLEEVED T-SHIRTS; SHORT-SLEEVED SHIRTS; SPORT SHIRTS; SPORTS SHIRTS WITH SHORT SLEEVES; SWEAT SHIRTS; WIND SHIRTS; SWIMWEAR; BERMUDA SHORTS; BOARD SHORTS; BOXER SHORTS;

FLEECE SHORTS; GYM SHORTS; PANTIES, SHORTS AND BRIEFS; SHORTS; HEADGEAR, NAMELY, CAPS, HATS, BEANIES, IN CLASS 25 (U.S. CLS. 22 AND 39).

FIRST USE 1-1-2008; IN COMMERCE 1-2-2008.

THE MARK CONSISTS OF STANDARD CHARACTERS WITHOUT CLAIM TO ANY PARTICULAR FONT, STYLE, SIZE, OR COLOR.

SER. NO. 77-430,225, FILED 3-24-2008.

MICHELE SWAIN, EXAMINING ATTORNEY

Int. Cl.: 41

Prior U.S. Cls.: 100, 101 and 107

United States Patent and Trademark Office

Reg. No. 3,520,143

Registered Oct. 21, 2008

**SERVICE MARK
PRINCIPAL REGISTER**

CLIMATE PROGRESS

CENTER FOR AMERICAN PROGRESS ACTION
FUND (D.C. CORPORATION)
10TH STREET, 1333 H. STREET, NW
WASHINGTON, DC 20005

FOR: PROVIDING ON-LINE PERIODICAL AND
NEWSGATHERING INFORMATION IN THE
FIELDS OF CLIMATE, SCIENCE, POLITICS AND
POLICY-MAKING; ARRANGING AND ORGANIZ-
ING EDUCATIONAL CONFERENCES, SEMINARS,
AND SYMPOSIA IN THE FIELDS OF CLIMATE,
SCIENCE, POLITICS AND POLICY-MAKING, IN
CLASS 41 (U.S. CLS. 100, 101 AND 107).

FIRST USE 8-0-2006; IN COMMERCE 8-0-2006.

THE MARK CONSISTS OF STANDARD CHAR-
ACTERS WITHOUT CLAIM TO ANY PARTICULAR
FONT, STYLE, SIZE, OR COLOR.

NO CLAIM IS MADE TO THE EXCLUSIVE
RIGHT TO USE "CLIMATE", APART FROM THE
MARK AS SHOWN.

SER. NO. 77-430,228, FILED 3-24-2008.

GINA FINK, EXAMINING ATTORNEY

Int. Cl.: 41

Prior U.S. Cls.: 100, 101 and 107

United States Patent and Trademark Office

Reg. No. 3,520,144

Registered Oct. 21, 2008

**SERVICE MARK
PRINCIPAL REGISTER**

THE WONK ROOM

CENTER FOR AMERICAN PROGRESS ACTION
FUND (D.C. CORPORATION)
10TH STREET, 1333 H. STREET, NW
WASHINGTON, DC 20005

FOR: PROVIDING ON-LINE PERIODICAL AND
NEWSGATHERING INFORMATION IN THE
FIELDS OF POLITICS, POLITICAL CAMPAIGNS
AND POLICY-MAKING; ARRANGING AND OR-
GANIZING EDUCATIONAL CONFERENCES,
SEMINARS, AND SYMPOSIA IN THE FIELDS OF
POLITICS, POLITICAL CAMPAIGNS AND POLICY-
MAKING, IN CLASS 41 (U.S. CLS. 100, 101 AND 107).

FIRST USE 3-17-2008; IN COMMERCE 3-17-2008.

THE MARK CONSISTS OF STANDARD CHAR-
ACTERS WITHOUT CLAIM TO ANY PARTICULAR
FONT, STYLE, SIZE, OR COLOR.

SER. NO. 77-430,237, FILED 3-24-2008.

GINA FINK, EXAMINING ATTORNEY

Int. Cl.: 41

Prior U.S. Cls.: 100, 101 and 107

United States Patent and Trademark Office

Reg. No. 3,520,145

Registered Oct. 21, 2008

**SERVICE MARK
PRINCIPAL REGISTER**



SKYZONE, LLC (NEVADA LIMITED LIABILITY
COMPANY)
172 SOUTH LAS PALMAS
LOS ANGELES, CA 90004

FOR: PHYSICAL FITNESS INSTRUCTION,
NAMELY, AEROBIC CLASSES; ENTERTAINMENT
SERVICES IN THE NATURE OF PROVIDING ON-
GOING ATHLETIC PROGRAMS FOR YOUNG
ADULTS; ORGANIZING AND CONDUCTING
SPORTING CONTESTS AND GAMES; AND PRO-
VIDING RECREATIONAL FACILITIES THERE-
FOR, IN CLASS 41 (U.S. CLS. 100, 101 AND 107).

FIRST USE 2-0-2008; IN COMMERCE 2-0-2008.

THE MARK CONSISTS OF THE LETTERS "SZ"
SUPERIMPOSED ON A GRID OF TWELVE
SQUARES.

SER. NO. 77-430,248, FILED 3-24-2008.

JAMES LOVELACE, EXAMINING ATTORNEY

Int. Cl.: 21

Prior U.S. Cls.: 2, 13, 23, 29, 30, 33, 40 and 50

United States Patent and Trademark Office

Reg. No. 3,520,146

Registered Oct. 21, 2008

**TRADEMARK
PRINCIPAL REGISTER**

The Boo Birds

THE BOO BIRDS (PENNSYLVANIA LIMITED
LIABILITY COMPANY)
P.O. BOX 431
POCONO PINES, PA 18350

FOR: BEER MUGS; COFFEE CUPS, TEA CUPS
AND MUGS; BEVERAGE GLASSWARE, IN CLASS
21 (U.S. CLS. 2, 13, 23, 29, 30, 33, 40 AND 50).

FIRST USE 9-1-2006; IN COMMERCE 9-1-2006.

THE MARK CONSISTS OF STANDARD CHAR-
ACTERS WITHOUT CLAIM TO ANY PARTICULAR
FONT, STYLE, SIZE, OR COLOR.

OWNER OF U.S. REG. NO. 3,281,784.

SEC. 2(F).

SER. NO. 77-430,278, FILED 3-24-2008.

CHERYL CLAYTON, EXAMINING ATTORNEY

Int. Cl.: 45

Prior U.S. Cls.: 100 and 101

United States Patent and Trademark Office

Reg. No. 3,520,147

Registered Oct. 21, 2008

**SERVICE MARK
PRINCIPAL REGISTER**

PUBSCHOLAR

PUBSCHOLAR, INC. (DELAWARE CORPORATION)
11212 SORREL RIDGE LANE
OAKTON, VA 22124

THE MARK CONSISTS OF STANDARD CHARACTERS WITHOUT CLAIM TO ANY PARTICULAR FONT, STYLE, SIZE, OR COLOR.

FOR: ONLINE SOCIAL NETWORKING SERVICES, IN CLASS 45 (U.S. CLS. 100 AND 101).

SER. NO. 77-430,291, FILED 3-24-2008.

FIRST USE 3-3-2008; IN COMMERCE 3-3-2008.

WANDA KAY PRICE, EXAMINING ATTORNEY

Int. Cl.: 41

Prior U.S. Cls.: 100, 101 and 107

United States Patent and Trademark Office

Reg. No. 3,520,148

Registered Oct. 21, 2008

**SERVICE MARK
PRINCIPAL REGISTER**

Create for your kids

DOW, MICHAEL STEPHEN (UNITED STATES
INDIVIDUAL)
2449 S CASS AVE
TUCSON, AZ 85708

THE MARK CONSISTS OF STANDARD CHAR-
ACTERS WITHOUT CLAIM TO ANY PARTICULAR
FONT, STYLE, SIZE, OR COLOR.

FOR: PROVIDING ADVICE AND INFORMATION
IN THE FIELD OF EDUCATIONAL AND ENTER-
TAINMENT ACTIVITIES AND EVENTS FOR CHIL-
DREN, IN CLASS 41 (U.S. CLS. 100, 101 AND 107).

SER. NO. 77-430,315, FILED 3-25-2008.

FIRST USE 3-24-2008; IN COMMERCE 3-24-2008.

ZHALEH DELANEY, EXAMINING ATTORNEY

Int. Cl.: 34

Prior U.S. Cls.: 2, 8, 9 and 17

United States Patent and Trademark Office

Reg. No. 3,520,149

Registered Oct. 21, 2008

**TRADEMARK
PRINCIPAL REGISTER**

DON ELÍAS

TABACALERA EL ARTISTA, S.A. (DOMINICAN
REP CORPORATION)
PRESIDENTE VÁZQUEA 115, TAMBORIL
SANTIAGO, DOMINICAN REP

FOR: CIGARS, IN CLASS 34 (U.S. CLS. 2, 8, 9 AND
17).

FIRST USE 10-0-1997; IN COMMERCE 7-0-1998.

THE MARK CONSISTS OF STANDARD CHAR-
ACTERS WITHOUT CLAIM TO ANY PARTICULAR
FONT, STYLE, SIZE, OR COLOR.

THE ENGLISH TRANSLATION OF THE WORD
"DON" IN THE MARK IS MR.

SER. NO. 77-430,323, FILED 3-25-2008.

ZHALEH DELANEY, EXAMINING ATTORNEY

Int. Cl.: 9

Prior U.S. Cls.: 21, 23, 26, 36 and 38

Reg. No. 3,520,150

United States Patent and Trademark Office

Registered Oct. 21, 2008

**TRADEMARK
PRINCIPAL REGISTER**

G-Fire

BOOSWEET ENTERPRISES, LLC (CALIFORNIA
LIMITED LIABILITY COMPANY)
5857 MAGNOLIA AVENUE
RIALTO, CA 92377

FIRST USE 1-15-2002; IN COMMERCE 1-15-2002.

FOR: DOWNLOADABLE MUSICAL SOUND RE-
CORDINGS; MUSICAL SOUND RECORDINGS;
MUSICAL VIDEO RECORDINGS; SOUND RE-
CORDINGS FEATURING MUSIC; VIDEO RECORD-
INGS FEATURING MUSIC; PRE-RECORDED CDS,
VIDEO TAPES, LASER DISKS AND DVDS FEATUR-
ING MUSIC, IN CLASS 9 (U.S. CLS. 21, 23, 26, 36 AND
38).

THE MARK CONSISTS OF STANDARD CHAR-
ACTERS WITHOUT CLAIM TO ANY PARTICULAR
FONT, STYLE, SIZE, OR COLOR.

SER. NO. 77-430,331, FILED 3-25-2008.

CARYN GLASSER, EXAMINING ATTORNEY

Int. Cl.: 19

Prior U.S. Cls.: 1, 12, 33 and 50

United States Patent and Trademark Office

Reg. No. 3,520,151

Registered Oct. 21, 2008

**TRADEMARK
PRINCIPAL REGISTER**

SNOW WHITE

NEWMAN BROTHERS OF CALIFORNIA, INC.
(CALIFORNIA CORPORATION), DBA A-1
GRIT COMPANY
P.O. BOX 5675
RIVERSIDE, CA 92517

THE MARK CONSISTS OF STANDARD CHAR-
ACTERS WITHOUT CLAIM TO ANY PARTICULAR
FONT, STYLE, SIZE, OR COLOR.

FOR: AGGREGATE MATERIAL COMPOSED OF
MARBLE FOR ROOFING, IN CLASS 19 (U.S. CLS. 1,
12, 33 AND 50).

SER. NO. 77-430,343, FILED 3-25-2008.

FIRST USE 1-1-2008; IN COMMERCE 1-1-2008.

ESTHER BELENKER, EXAMINING ATTORNEY

Int. Cl.: 41

Prior U.S. Cls.: 100, 101 and 107

United States Patent and Trademark Office

Reg. No. 3,520,152

Registered Oct. 21, 2008

**SERVICE MARK
PRINCIPAL REGISTER**

**HIRING AND DEVELOPING
WINNERS**

LIFE ASSOCIATES LLC (DELAWARE LIMITED
LIABILITY COMPANY)
122 NOXON ROAD
POUGHKEEPSIE, NY 12603

FOR: WORKSHOPS AND SEMINARS IN THE
FIELD OF BUSINESS MANAGEMENT, LIFE
COACHING AND CONSULTING SERVICES, IN
CLASS 41 (U.S. CLS. 100, 101 AND 107).

FIRST USE 0-0-1993; IN COMMERCE 0-0-1993.

THE MARK CONSISTS OF STANDARD CHAR-
ACTERS WITHOUT CLAIM TO ANY PARTICULAR
FONT, STYLE, SIZE, OR COLOR.

SEC. 2(F).

SER. NO. 77-430,391, FILED 3-25-2008.

SUNG IN, EXAMINING ATTORNEY

Int. Cl.: 41

Prior U.S. Cls.: 100, 101 and 107

United States Patent and Trademark Office

Reg. No. 3,520,153

Registered Oct. 21, 2008

**SERVICE MARK
PRINCIPAL REGISTER**

MANAGING BY VALUES

LIFE ASSOCIATES LLC (DELAWARE LIMITED
LIABILITY COMPANY)
122 NOXON ROAD
POUGHKEEPSIE, NY 12603

FOR: WORKSHOPS AND SEMINARS IN THE
FIELD OF BUSINESS MANAGEMENT, LIFE
COACHING AND CONSULTING SERVICES, IN
CLASS 41 (U.S. CLS. 100, 101 AND 107).

FIRST USE 0-0-1994; IN COMMERCE 0-0-1994.

THE MARK CONSISTS OF STANDARD CHAR-
ACTERS WITHOUT CLAIM TO ANY PARTICULAR
FONT, STYLE, SIZE, OR COLOR.

SEC. 2(F).

SER. NO. 77-430,392, FILED 3-25-2008.

SUNG IN, EXAMINING ATTORNEY

Int. Cl.: 10

Prior U.S. Cls.: 26, 39 and 44

United States Patent and Trademark Office

Reg. No. 3,520,154

Registered Oct. 21, 2008

**TRADEMARK
PRINCIPAL REGISTER**

EVO

MEDICAL SPECIALTIES, INC. (NORTH CAROLINA CORPORATION)
SUITE K
4600 LEBANON ROAD
CHARLOTTE, NC 28227

FOR: ATHLETIC ANKLE BRACES FOR MEDICAL USE; BRACES FOR LIMBS AND JOINTS, FOR MEDICAL USE; MEDICAL BRACES FOR ANKLES; ORTHOPEDIC BRACES, IN CLASS 10 (U.S. CLS. 26, 39 AND 44).

FIRST USE 2-6-2008; IN COMMERCE 2-6-2008.

THE MARK CONSISTS OF STANDARD CHARACTERS WITHOUT CLAIM TO ANY PARTICULAR FONT, STYLE, SIZE, OR COLOR.

SER. NO. 77-430,394, FILED 3-25-2008.

SUNG IN, EXAMINING ATTORNEY

Int. Cl.: 43

Prior U.S. Cls.: 100 and 101

United States Patent and Trademark Office

Reg. No. 3,520,155

Registered Oct. 21, 2008

**SERVICE MARK
PRINCIPAL REGISTER**

RUMOR HAZIT

RUMOR HAZIT, LLC (GEORGIA LIMITED LIABILITY COMPANY)
175 N. MAIN ST.
CLAYTON, GA 30525

THE MARK CONSISTS OF STANDARD CHARACTERS WITHOUT CLAIM TO ANY PARTICULAR FONT, STYLE, SIZE, OR COLOR.

FOR: BAR AND RESTAURANT SERVICES, IN CLASS 43 (U.S. CLS. 100 AND 101).

SER. NO. 77-430,395, FILED 3-25-2008.

FIRST USE 9-1-2007; IN COMMERCE 9-1-2007.

SUNG IN, EXAMINING ATTORNEY

Int. Cl.: 42

Prior U.S. Cls.: 100 and 101

United States Patent and Trademark Office

Reg. No. 3,520,156

Registered Oct. 21, 2008

**SERVICE MARK
PRINCIPAL REGISTER**

**TRANSFORMING BUSINESS BY
DESIGN**

FKP ARCHITECTS, INC. (TEXAS CORPORATION)
8 GREENWAY PLAZA, SUITE 300
HOUSTON, TX 77046

FOR: ARCHITECTURAL SERVICES, NAMELY, INTERIOR DESIGN, FACILITIES PLANNING, EQUIPMENT PLANNING, STRATEGIC PLANNING AND DESIGNING OF HEALTHCARE, SCIENCE AND EDUCATIONAL FACILITIES, COMPUTERIZED SIMULATION MODELING OF ARCHITECTURAL DESIGN, CONSULTING SERVICES IN THE

FIELD OF ARCHITECTURAL DESIGN, IN CLASS 42 (U.S. CLS. 100 AND 101).

FIRST USE 8-20-2007; IN COMMERCE 9-28-2007.

THE MARK CONSISTS OF STANDARD CHARACTERS WITHOUT CLAIM TO ANY PARTICULAR FONT, STYLE, SIZE, OR COLOR.

SER. NO. 77-430,429, FILED 3-25-2008.

DAVID TAYLOR, EXAMINING ATTORNEY

Int. Cl.: 41

Prior U.S. Cls.: 100, 101 and 107

United States Patent and Trademark Office

Reg. No. 3,520,157

Registered Oct. 21, 2008

**SERVICE MARK
PRINCIPAL REGISTER**

MENTOR 2 COLLEGE

NORTHWEST EDUCATION LOAN ASSOCIATION (WASHINGTON CORPORATION)
190 QUEEN ANNE AVENUE, SUITE 300
SEATTLE, WA 98109

FOR: EDUCATIONAL SERVICES, NAMELY, CONDUCTING EDUCATIONAL PROGRAMS DIRECTED TO YOUTHS RELATING TO THE AVAILABILITY OF AND FINANCING FOR HIGHER EDUCATION OPPORTUNITIES; AND EDUCATIONAL SERVICES, NAMELY, PROVIDING THIRD PARTIES WITH EDUCATION PROGRAMS FOR ENABLING THOSE THIRD PARTIES TO CONDUCT EDUCATIONAL PROGRAMS DIRECTED TO YOUTHS RELATING TO THE AVAILABILITY OF

AND FINANCING FOR HIGHER EDUCATIONAL OPPORTUNITIES, IN CLASS 41 (U.S. CLS. 100, 101 AND 107).

FIRST USE 9-30-2007; IN COMMERCE 9-30-2007.

THE MARK CONSISTS OF STANDARD CHARACTERS WITHOUT CLAIM TO ANY PARTICULAR FONT, STYLE, SIZE, OR COLOR.

SER. NO. 77-430,435, FILED 3-25-2008.

SUZANNE BLANE, EXAMINING ATTORNEY

Int. Cl.: 35

Prior U.S. Cls.: 100, 101 and 102

United States Patent and Trademark Office

Reg. No. 3,520,158

Registered Oct. 21, 2008

**SERVICE MARK
PRINCIPAL REGISTER**

METROINFO

DANCONIA MEDIA (NEW HAMPSHIRE LIM-
ITED LIABILITY COMPANY)
112 CROSS ROAD
WEARE, NH 03281

THE MARK CONSISTS OF STANDARD CHAR-
ACTERS WITHOUT CLAIM TO ANY PARTICULAR
FONT, STYLE, SIZE, OR COLOR.

FOR: ADVERTISING THROUGH ALL PUBLIC
COMMUNICATION MEANS, IN CLASS 35 (U.S. CLS.
100, 101 AND 102).

SER. NO. 77-430,436, FILED 3-25-2008.

FIRST USE 4-18-2008; IN COMMERCE 4-18-2008.

HEATHER THOMPSON, EXAMINING ATTORNEY

Int. Cl.: 9

Prior U.S. Cls.: 21, 23, 26, 36 and 38

Reg. No. 3,520,159

United States Patent and Trademark Office

Registered Oct. 21, 2008

**TRADEMARK
PRINCIPAL REGISTER**

SLINGS

DOUGHERTY, ROBERT D. (UNITED STATES
INDIVIDUAL), DBA BODY SPECS EYEWEAR
20840 INSPIRATION LANE
GRASS VALLEY, CA 95949

THE MARK CONSISTS OF STANDARD CHAR-
ACTERS WITHOUT CLAIM TO ANY PARTICULAR
FONT, STYLE, SIZE, OR COLOR.

FOR: EYEWEAR, IN CLASS 9 (U.S. CLS. 21, 23, 26,
36 AND 38).

SER. NO. 77-430,439, FILED 3-25-2008.

FIRST USE 1-0-2004; IN COMMERCE 1-0-2004.

HEATHER THOMPSON, EXAMINING ATTORNEY

Int. Cl.: 13

Prior U.S. Cls.: 2 and 9

United States Patent and Trademark Office

Reg. No. 3,520,160

Registered Oct. 21, 2008

**TRADEMARK
PRINCIPAL REGISTER**

ARMATAC

ARMATAC INDUSTRIES, INC. (VIRGINIA CORPORATION)
104 NORTH BAKER STREET
CHARLOTTESVILLE, VA 22903

THE MARK CONSISTS OF STANDARD CHARACTERS WITHOUT CLAIM TO ANY PARTICULAR FONT, STYLE, SIZE, OR COLOR.

FOR: MAGAZINES FOR WEAPONS, IN CLASS 13 (U.S. CLS. 2 AND 9).

SER. NO. 77-430,451, FILED 3-25-2008.

FIRST USE 4-1-2005; IN COMMERCE 4-1-2005.

NICHOLAS ALTREE, EXAMINING ATTORNEY

Int. Cl.: 9

Prior U.S. Cls.: 21, 23, 26, 36 and 38

Reg. No. 3,520,161

United States Patent and Trademark Office

Registered Oct. 21, 2008

**TRADEMARK
PRINCIPAL REGISTER**

SEVONE

SEVONE INC (DELAWARE CORPORATION)
SUITE 200 5 INNOVATION WAY
NEWARK, DE 19711

THE MARK CONSISTS OF STANDARD CHAR-
ACTERS WITHOUT CLAIM TO ANY PARTICULAR
FONT, STYLE, SIZE, OR COLOR.

FOR: COMPUTER NETWORKING HARDWARE;
SOFTWARE FOR MANAGING COMPUTER NET-
WORKS, IN CLASS 9 (U.S. CLS. 21, 23, 26, 36 AND 38).

SER. NO. 77-430,457, FILED 3-25-2008.

FIRST USE 1-0-2005; IN COMMERCE 1-0-2005.

NATALIE POLZER, EXAMINING ATTORNEY

Int. Cl.: 38

Prior U.S. Cls.: 100, 101 and 104

United States Patent and Trademark Office

Reg. No. 3,520,162

Registered Oct. 21, 2008

**SERVICE MARK
PRINCIPAL REGISTER**

mobileyodel 

MOBILE YODEL (DELAWARE LIMITED LIABILITY COMPANY)
903 BETHLEHEM PIKE
ERDENHEIM, PA 19038

FOR: CELLULAR TELEPHONE COMMUNICATION, IN CLASS 38 (U.S. CLS. 100, 101 AND 104).

FIRST USE 2-15-2008; IN COMMERCE 3-4-2008.

THE MARK CONSISTS OF THE STYLIZED WORDS "MOBILE YODEL". TO THE RIGHT OF

THE WORD "YODEL" APPEARS THREE HORIZONTAL LINES WITH THE TOP LINE DIRECTED ON AN UPWARDS SLANT AND THE BOTTOM LINE DIRECTED ON A DOWNWARDS SLANT. THE MIDDLE LINE APPEARS STRAIGHT HORIZONTAL.

SER. NO. 77-430,482, FILED 3-25-2008.

KATHERINE M. DUBRAY, EXAMINING ATTORNEY

Int. Cl.: 37

Prior U.S. Cls.: 100, 103 and 106

United States Patent and Trademark Office

Reg. No. 3,520,163

Registered Oct. 21, 2008

**SERVICE MARK
PRINCIPAL REGISTER**



PEARL SERVICES, INC. (SOUTH CAROLINA CORPORATION)
405 WHISPERING PINES LN
SALEM, SC 29676

FOR: JANITORIAL SERVICES; CLEANING OF INDUSTRIAL PREMISES; CLEANING OF RESIDENTIAL HOUSES, IN CLASS 37 (U.S. CLS. 100, 103 AND 106).

FIRST USE 11-1-2005; IN COMMERCE 11-1-2005.

NO CLAIM IS MADE TO THE EXCLUSIVE RIGHT TO USE "SERVICES, INC", APART FROM THE MARK AS SHOWN.

THE COLOR(S) IVORY, VIOLET, AND BLACK IS/ ARE CLAIMED AS A FEATURE OF THE MARK.

THE MARK CONSISTS OF THE LITERAL ELEMENT "PEARL" IN VIOLET, AND "SERVICES, INC" IN BLACK LOCATED BENEATH A DESIGN OF A IVORY COLORED PEARL CASTING A SHADOW.

SER. NO. 77-430,486, FILED 3-25-2008.

SANJEEV VOHRA, EXAMINING ATTORNEY

Int. Cl.: 36

Prior U.S. Cls.: 100, 101 and 102

United States Patent and Trademark Office

Reg. No. 3,520,164

Registered Oct. 21, 2008

**SERVICE MARK
PRINCIPAL REGISTER**

PresPoint Capital

PRESPOINT CAPITAL LLC (CALIFORNIA LIMITED LIABILITY COMPANY)
38 KEYES AVENUE, SUITE 100
SAN FRANCISCO, CA 94129

FOR: HEDGE FUND INVESTMENT SERVICES; INVESTMENT MANAGEMENT, IN CLASS 36 (U.S. CLS. 100, 101 AND 102).

FIRST USE 3-7-2008; IN COMMERCE 3-14-2008.

THE MARK CONSISTS OF STANDARD CHARACTERS WITHOUT CLAIM TO ANY PARTICULAR FONT, STYLE, SIZE, OR COLOR.

NO CLAIM IS MADE TO THE EXCLUSIVE RIGHT TO USE "CAPITAL", APART FROM THE MARK AS SHOWN.

SER. NO. 77-430,518, FILED 3-25-2008.

RENEE MCCRAY, EXAMINING ATTORNEY

Int. Cl.: 18

Prior U.S. Cls.: 1, 2, 3, 22 and 41

United States Patent and Trademark Office

Reg. No. 3,520,165

Registered Oct. 21, 2008

**TRADEMARK
PRINCIPAL REGISTER**



SCOTT USA, INC. (DELAWARE CORPORATION)
101 LEWIS STREET
KETCHUM, ID 83340

OWNER OF U.S. REG. NOS. 1,837,348, 2,643,873
AND OTHERS.

FOR: ALL PURPOSE SPORTS BAGS; BACK-
PACKS, IN CLASS 18 (U.S. CLS. 1, 2, 3, 22 AND 41).

SER. NO. 77-430,524, FILED 3-25-2008.

FIRST USE 0-0-2000; IN COMMERCE 0-0-2000.

JENNY PARK, EXAMINING ATTORNEY

Int. Cl.: 9

Prior U.S. Cls.: 21, 23, 26, 36 and 38

Reg. No. 3,520,166

United States Patent and Trademark Office

Registered Oct. 21, 2008

**TRADEMARK
PRINCIPAL REGISTER**

PICLENS

COOLIRIS, INC. (CALIFORNIA CORPORATION)
2750 SANDHILL ROAD
MENLO PARK, CA 94025

THE MARK CONSISTS OF STANDARD CHARACTERS WITHOUT CLAIM TO ANY PARTICULAR FONT, STYLE, SIZE, OR COLOR.

FOR: COMPUTER SOFTWARE FOR ENHANCING DISPLAY OF RICH MEDIA AND USER EXPERIENCE IN A WORLD WIDE WEB INTERFACE, IN CLASS 9 (U.S. CLS. 21, 23, 26, 36 AND 38).

SER. NO. 77-430,573, FILED 3-25-2008.

FIRST USE 9-30-2006; IN COMMERCE 9-30-2006.

ANNE FARRELL, EXAMINING ATTORNEY

Int. Cl.: 25

Prior U.S. Cls.: 22 and 39

United States Patent and Trademark Office

Reg. No. 3,520,167

Registered Oct. 21, 2008

**TRADEMARK
PRINCIPAL REGISTER**

EVERTAN

CHUN, DAVID H. (UNITED STATES INDIVIDUAL)
SUITE "C", 14525 VALLEY VIEW AVE.
SANTA FE SPRINGS, CA 90670

THE MARK CONSISTS OF STANDARD CHARACTERS WITHOUT CLAIM TO ANY PARTICULAR FONT, STYLE, SIZE, OR COLOR.

FOR: GOLF APPAREL, NAMELY, VISORS, SOCKS AND GLOVES, IN CLASS 25 (U.S. CLS. 22 AND 39).

SER. NO. 77-430,593, FILED 3-25-2008.

FIRST USE 1-24-1996; IN COMMERCE 1-24-1996.

ANNE FARRELL, EXAMINING ATTORNEY

Int. Cl.: 16

Prior U.S. Cls.: 2, 5, 22, 23, 29, 37, 38 and 50

United States Patent and Trademark Office

Reg. No. 3,520,168

Registered Oct. 21, 2008

**TRADEMARK
PRINCIPAL REGISTER**

ASTRAL

KARE DISTRIBUTION, INC. (DELAWARE COR-
PORATION)
30TH FLOOR
1250 BROADWAY
NEW YORK, NY 10001

FOR: PRE-PAID TELEPHONE CALLING CARDS,
NOT MAGNETICALLY ENCODED, IN CLASS 16
(U.S. CLS. 2, 5, 22, 23, 29, 37, 38 AND 50).

FIRST USE 3-25-2008; IN COMMERCE 3-25-2008.

THE MARK CONSISTS OF STANDARD CHAR-
ACTERS WITHOUT CLAIM TO ANY PARTICULAR
FONT, STYLE, SIZE, OR COLOR.

SER. NO. 77-430,613, FILED 3-25-2008.

JOHN SCHUYLER YARD, EXAMINING ATTOR-
NEY

Int. Cl.: 25

Prior U.S. Cls.: 22 and 39

United States Patent and Trademark Office

Reg. No. 3,520,169

Registered Oct. 21, 2008

**TRADEMARK
PRINCIPAL REGISTER**

ESCALADE

GENERAL MOTORS CORPORATION (DELA-
WARE CORPORATION)
300 RENAISSANCE CENTER, P.O. BOX 300
DETROIT, MI 482653000

FOR: CLOTHING, NAMELY, T-SHIRTS, IN
CLASS 25 (U.S. CLS. 22 AND 39).

FIRST USE 1-14-2002; IN COMMERCE 1-14-2002.

THE MARK CONSISTS OF STANDARD CHAR-
ACTERS WITHOUT CLAIM TO ANY PARTICULAR
FONT, STYLE, SIZE, OR COLOR.

OWNER OF U.S. REG. NOS. 2,269,827, 2,931,763,
AND 3,435,186.

SER. NO. 77-430,614, FILED 3-25-2008.

NANCY CLARKE, EXAMINING ATTORNEY

Int. Cls.: 35 and 42

Prior U.S. Cls.: 100, 101 and 102

United States Patent and Trademark Office

Reg. No. 3,520,170

Registered Oct. 21, 2008

**SERVICE MARK
PRINCIPAL REGISTER**

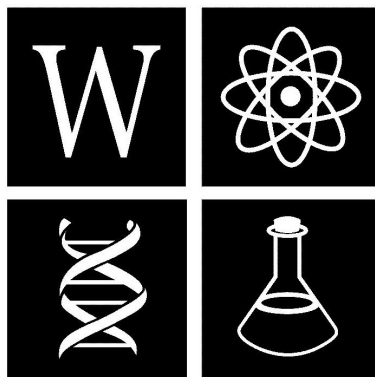

THE WEINBERG GROUP INC. (MARYLAND CORPORATION)
SUITE 300
1220 NINETEENTH STREET, N.W.
WASHINGTON, DC 20036

FOR: LEGISLATIVE SUPPORT CONSULTING SERVICES, NAMELY, CRITICAL ANALYSIS OF THE SCIENTIFIC, ECONOMIC, BUSINESS, MARKET, AND SOCIO-POLITICAL ASPECTS OF ISSUES RAISED IN LEGISLATION, FOR COMPANIES IN THE FIELDS OF PHARMACEUTICALS, MEDICAL EQUIPMENT AND TECHNOLOGY, BIOTECH, TOXICOLOGY, CONSUMER PRODUCTS, COSMETICS AND TOILETRIES, DIETARY SUPPLEMENTS, FOODS, ELECTRONICS, CHEMICALS, EMISSIONS AND WASTE PRODUCTS, PESTICIDES, AGRICULTURE AND UTILITIES; BUSINESS MARKETING CONSULTATION AND ECONOMIC ANALYSIS AND EVALUATION FOR COMPANIES IN THE FIELDS OF PHARMACEUTICALS, MEDICAL EQUIPMENT AND TECHNOLOGY, BIOTECH, TOXICOLOGY, CONSUMER PRODUCTS, COSMETICS AND TOILETRIES, DIETARY SUPPLEMENTS, FOODS, ELECTRONICS, CHEMICALS, EMISSIONS AND WASTE PRODUCTS, PESTICIDES, AGRICULTURE AND UTILITIES, IN CLASS 35 (U.S. CLS. 100, 101 AND 102).

FIRST USE 2-25-2008; IN COMMERCE 2-25-2008.

FOR: SCIENTIFIC ANALYSIS, SCIENTIFIC RESEARCH, PHARMACEUTICAL RESEARCH SERVICES, PRODUCT DEVELOPMENT CONSULTATION,

GOVERNMENT REGULATORY COMPLIANCE, AND LITIGATION SUPPORT CONSULTING SERVICES; RISK ASSESSMENT, NAMELY, RESEARCH, ANALYSIS AND EVALUATION OF POTENTIAL RISKS OF PRODUCTS, SUBSTANCES, AND MANUFACTURING PROCESSES TO HEALTH, SAFETY AND THE ENVIRONMENT, ALL FOR COMPANIES IN THE FIELDS OF PHARMACEUTICALS, MEDICAL EQUIPMENT AND TECHNOLOGY, BIOTECH, TOXICOLOGY, CONSUMER PRODUCTS, COSMETICS AND TOILETRIES, DIETARY SUPPLEMENTS, FOODS, ELECTRONICS, CHEMICALS, EMISSIONS AND WASTE PRODUCTS, PESTICIDES, AGRICULTURE AND UTILITIES, IN CLASS 42 (U.S. CLS. 100 AND 101).

FIRST USE 2-25-2008; IN COMMERCE 2-25-2008.

OWNER OF U.S. REG. NO. 3,075,159.

THE MARK CONSISTS OF A DESIGN OF FOUR ADJACENT SQUARES. THE TOP LEFT SQUARE CONTAINS THE LETTER "W"; THE TOP RIGHT SQUARE CONTAINS A STYLIZED ATOM; THE BOTTOM LEFT SQUARE CONTAINS A STYLIZED DNA DOUBLE HELIX; AND THE BOTTOM RIGHT SQUARE CONTAINS A STYLIZED FLASK WITH LIQUID IN IT.

SER. NO. 77-430,615, FILED 3-25-2008.

JOHN SCHUYLER YARD, EXAMINING ATTORNEY

Int. Cl.: 41

Prior U.S. Cls.: 100, 101 and 107

United States Patent and Trademark Office

Reg. No. 3,520,171

Registered Oct. 21, 2008

**SERVICE MARK
PRINCIPAL REGISTER**

MOMTINI LOUNGE

SMITH, AMY (UNITED STATES INDIVIDUAL),
DBA THE BUSINESS OF MOTHERHOOD
10706 CLOVERBROOKE DRIVE
POTOMAC, MD 20854

THE MARK CONSISTS OF STANDARD CHAR-
ACTERS WITHOUT CLAIM TO ANY PARTICULAR
FONT, STYLE, SIZE, OR COLOR.

FOR: ON-LINE JOURNALS, NAMELY, BLOGS
FEATURING INFORMATION ABOUT PARENT-
ING, IN CLASS 41 (U.S. CLS. 100, 101 AND 107).

SER. NO. 77-430,649, FILED 3-25-2008.

FIRST USE 7-31-2007; IN COMMERCE 7-31-2007.

LESLIE RICHARDS, EXAMINING ATTORNEY

Int. Cl.: 34

Prior U.S. Cls.: 2, 8, 9 and 17

United States Patent and Trademark Office

Reg. No. 3,520,172

Registered Oct. 21, 2008

TRADEMARK
PRINCIPAL REGISTER



THE CIGAR AGENCY (NEW HAMPSHIRE LIMITED LIABILITY COMPANY)

#25-B

76 NORTHEASTERN BLVD.
NASHUA, NH 03062

FOR: CIGARS ; CIGAR ASHTRAYS; CIGAR LIGHTERS; CIGAR CUTTERS; CIGAR HUMIDORS; CIGAR AGING CABINETS; CIGAR CASES; CIGAR HOLDERS, IN CLASS 34 (U.S. CLS. 2, 8, 9 AND 17).

FIRST USE 9-30-2007; IN COMMERCE 9-30-2007.

THE MARK CONSISTS OF THE STYLZIED TEXT "TWENTY" WITH A STYLZIED BACKGROUND.

SER. NO. 77-430,651, FILED 3-25-2008.

JOHN DWYER, EXAMINING ATTORNEY

Int. Cl.: 40

Prior U.S. Cls.: 100, 103 and 106

United States Patent and Trademark Office

Reg. No. 3,520,173

Registered Oct. 21, 2008

**SERVICE MARK
PRINCIPAL REGISTER**

SIGMATRON

SIGMATRON INTERNATIONAL, INC. (DELA-
WARE CORPORATION)
2201 LANDMEIER ROAD
ELK GROVE VILLAGE, IL 60007

FOR: CUSTOM MANUFACTURING OF ELEC-
TRONIC COMPONENTS, PRINTED CIRCUIT
BOARD ASSEMBLIES AND TURNKEY ELECTRO-
NIC PRODUCTS TO THE ORDER AND/OR SPECI-
FICATIONS OF OTHERS, IN CLASS 40 (U.S. CLS.
100, 103 AND 106).

FIRST USE 5-12-1987; IN COMMERCE 5-12-1987.

THE MARK CONSISTS OF STANDARD CHAR-
ACTERS WITHOUT CLAIM TO ANY PARTICULAR
FONT, STYLE, SIZE, OR COLOR.

SER. NO. 77-430,662, FILED 3-25-2008.

ANDREA HACK, EXAMINING ATTORNEY

Int. Cl.: 14

Prior U.S. Cls.: 2, 27, 28 and 50

United States Patent and Trademark Office

Reg. No. 3,520,174

Registered Oct. 21, 2008

**TRADEMARK
PRINCIPAL REGISTER**

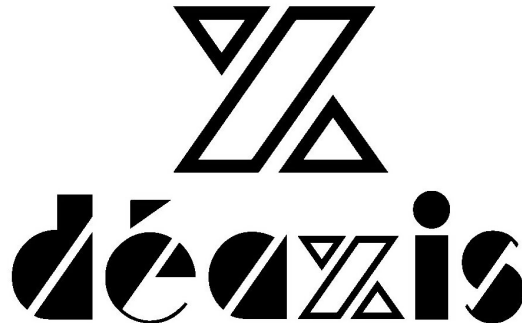

DEAXIS LLC (CALIFORNIA LIMITED LIABILITY COMPANY)
1135 S. SAN TOMAS AQUINO ROAD
CAMPBELL, CA 95008

FOR: ANKLE BRACELETS; BRACELETS; BROOCHES; COSTUME JEWELRY; EARRINGS; JEWELRY; NECK CHAINS; RINGS, IN CLASS 14 (U.S. CLS. 2, 27, 28 AND 50).

FIRST USE 1-10-2006; IN COMMERCE 1-10-2006.

THE MARK CONSISTS OF THE TEXT "DEAXIS" WHICH APPEARS UNDER A BIG LETTER "X"; THERE IS AN ACCENT ON THE "E" IN "DEAXIS" ("DÉAXIS").

THE WORDING "DÉAXIS" HAS NO MEANING IN A FOREIGN LANGUAGE.

SER. NO. 77-430,675, FILED 3-25-2008.

ESTHER BELENKER, EXAMINING ATTORNEY

Int. Cl.: 3

Prior U.S. Cls.: 1, 4, 6, 50, 51 and 52

Reg. No. 3,520,175

United States Patent and Trademark Office

Registered Oct. 21, 2008

**TRADEMARK
PRINCIPAL REGISTER**

WOLFE
BROTHERS
FACE ART & FX

WOLFE BROTHERS FACE ART & FX (FLORIDA
LIMITED LIABILITY COMPANY)
#310
424 E CENTRAL BLVD.
ORLANDO, FL 32801

THE MARK CONSISTS OF A STYLIZED EYE
SIMILAR TO A WOLF EYE AS THE "O" IN
"WOLFE", AND A HORIZONTAL LINE SEPARAT-
ING THE TEXT "BROTHERS" AND "FACE ART &
FX".

FOR: COSMETICS; FACE GLITTER; MAKE-UP,
IN CLASS 3 (U.S. CLS. 1, 4, 6, 50, 51 AND 52).

FIRST USE 4-1-2004; IN COMMERCE 5-1-2004.

SER. NO. 77-430,677, FILED 3-25-2008.

NO CLAIM IS MADE TO THE EXCLUSIVE
RIGHT TO USE "BROTHERS" OR "FACE ART &
EFFECTS", APART FROM THE MARK AS SHOWN.

ESTHER BELENKER, EXAMINING ATTORNEY

Int. Cl.: 35

Prior U.S. Cls.: 100, 101 and 102

United States Patent and Trademark Office

Reg. No. 3,520,176

Registered Oct. 21, 2008

**SERVICE MARK
PRINCIPAL REGISTER**



SOUTHEASTERN GOLF CARS (VIRGINIA LIMITED LIABILITY COMPANY)
3505 FIGSBORO ROAD
MARTINSVILLE, VA 24112

FOR: CATALOG ORDERING SERVICE FEATURING GOLF CART PARTS, AND ACCESSORIES, GOLF CART TIRES AND WHEELS, GOLF CART SEAT COVERS, GOLF CART STAINLESS BUMPERS, GOLF CART LIFT KITS, GOLF CART LIGHTS, GOLF CART DIAMOND PLATE, ANY PARTS AND ACCESSORIES FOR A GOLF CART; ON-LINE RETAIL STORE SERVICES FEATURING GOLF CART PARTS, AND ACCESSORIES, GOLF CART TIRES AND WHEELS, GOLF CART SEAT COVERS, GOLF CART STAINLESS BUMPERS, GOLF CART LIFT KITS, GOLF CART LIGHTS, GOLF CART DIAMOND PLATE, ANY PARTS AND

ACCESSORIES FOR A GOLF CART, IN CLASS 35 (U.S. CLS. 100, 101 AND 102).

FIRST USE 6-30-2007; IN COMMERCE 6-30-2007.

THE STIPPLING IS FOR SHADING PURPOSES ONLY.

THE MARK CONSISTS OF A CIRCLE WITH THE LETTERS "E" AND "C" INSIDE WITH THE "E" FACING FORWARD AND THE "C" BEING BACKWARDS, AND THE STYLIZED TEXT "EVERYTHING CARTS".

SER. NO. 77-430,679, FILED 3-25-2008.

WENDY JUN, EXAMINING ATTORNEY

Int. Cl.: 42

Prior U.S. Cls.: 100 and 101

United States Patent and Trademark Office

Reg. No. 3,520,177

Registered Oct. 21, 2008

**SERVICE MARK
PRINCIPAL REGISTER**

SIGMATRON

SIGMATRON INTERNATIONAL, INC. (DELA-
WARE CORPORATION)
2201 LANDMEIER ROAD
ELK GROVE VILLAGE, IL 60007

THE MARK CONSISTS OF STANDARD CHAR-
ACTERS WITHOUT CLAIM TO ANY PARTICULAR
FONT, STYLE, SIZE, OR COLOR.

FOR: TESTING OF ELECTRONIC COMPO-
NENTS, PRINTED CIRCUIT BOARD ASSEMBLIES
AND TURNKEY ELECTRONIC PRODUCTS, IN
CLASS 42 (U.S. CLS. 100 AND 101).

SER. NO. 77-430,680, FILED 3-25-2008.

FIRST USE 5-12-1987; IN COMMERCE 5-12-1987.

ANDREA HACK, EXAMINING ATTORNEY

Int. Cl.: 26

Prior U.S. Cls.: 37, 39, 40, 42 and 50

Reg. No. 3,520,178

United States Patent and Trademark Office

Registered Oct. 21, 2008

**TRADEMARK
PRINCIPAL REGISTER**

SHAINS

SHAINSWARE (CALIFORNIA CORPORATION)
4284 SEA VIEW LANE
LOS ANGELES, CA 90065

FIRST USE 7-30-2007; IN COMMERCE 7-30-2007.

FOR: SMALL DECORATIVE OBJECTS MADE OF RUBBER, PLASTIC, PASTE, GLASS, NON-PRECIOUS STONES OR NON-PRECIOUS METAL, NAMELY, SHOE ORNAMENTS, BUTTONS FOR CLOTHING, BROOCHES AS CLOTHING ACCESSORIES AND NOT AS IMITATION JEWELRY, SNAP FASTENERS, SLIDE FASTENERS, AND ZIPPER FASTENERS, IN CLASS 26 (U.S. CLS. 37, 39, 40, 42 AND 50).

THE MARK CONSISTS OF STANDARD CHARACTERS WITHOUT CLAIM TO ANY PARTICULAR FONT, STYLE, SIZE, OR COLOR.

SER. NO. 77-430,682, FILED 3-25-2008.

MARIA-VICTORIA SUAREZ, EXAMINING ATTORNEY

Int. Cl.: 9

Prior U.S. Cls.: 21, 23, 26, 36 and 38

Reg. No. 3,520,179

United States Patent and Trademark Office

Registered Oct. 21, 2008

**TRADEMARK
PRINCIPAL REGISTER**

Switch-Smart

NORTHEAST ELECTRONIC DESIGN CENTER
(NEW YORK CORPORATION)
951 SOUTH 2ND STREET
RONKONKOMA, NY 11779

THE MARK CONSISTS OF STANDARD CHARACTERS WITHOUT CLAIM TO ANY PARTICULAR FONT, STYLE, SIZE, OR COLOR.

FOR: VEHICLE PARTS, NAMELY, ELECTRONIC SWITCHES, IN CLASS 9 (U.S. CLS. 21, 23, 26, 36 AND 38).

SER. NO. 77-430,684, FILED 3-25-2008.

FIRST USE 7-1-2007; IN COMMERCE 10-1-2007.

MARIA-VICTORIA SUAREZ, EXAMINING ATTORNEY

Int. Cl.: 33

Prior U.S. Cls.: 47 and 49

United States Patent and Trademark Office

Reg. No. 3,520,180

Registered Oct. 21, 2008

**TRADEMARK
PRINCIPAL REGISTER**

**GIRLFRIENDS
"GET SOME!"**

CARIBBEAN CONNECTION, INC. (NEVADA
CORPORATION), DBA DBA/ LA CEREZA
WINERY
34225 RANCHO CALIFORNIA ROAD
TEMECULA, CA 92591

THE MARK CONSISTS OF STANDARD CHAR-
ACTERS WITHOUT CLAIM TO ANY PARTICULAR
FONT, STYLE, SIZE, OR COLOR.

FOR: GRAPE WINE, IN CLASS 33 (U.S. CLS. 47
AND 49).

SER. NO. 77-430,693, FILED 3-25-2008.

FIRST USE 1-26-2008; IN COMMERCE 1-26-2008.

CHERYL CLAYTON, EXAMINING ATTORNEY

Int. Cl.: 42

Prior U.S. Cls.: 100 and 101

United States Patent and Trademark Office

Reg. No. 3,520,181

Registered Oct. 21, 2008

**SERVICE MARK
PRINCIPAL REGISTER**

NELA DEBT MANAGER

NORTHWEST EDUCATION LOAN ASSOCIATION (WASHINGTON CORPORATION)
190 QUEEN ANNE AVENUE, SUITE 300
SEATTLE, WA 98109

FOR: PROVIDING TEMPORARY USE OF NON-DOWNLOADABLE COMPUTER DATABASE MANAGEMENT EDUCATION CREDIT SOFTWARE TO THOSE WORKING WITH STUDENT LOANS AND STUDENT LOAN BORROWERS TO ENABLE SUCH PERSONS TO MANAGE STUDENT LOAN BORROWER REPAYMENT AND INFORMATION ABOUT STUDENT LOAN BORROWERS, IN CLASS 42 (U.S. CLS. 100 AND 101).

FIRST USE 3-24-2008; IN COMMERCE 3-24-2008.

THE MARK CONSISTS OF STANDARD CHARACTERS WITHOUT CLAIM TO ANY PARTICULAR FONT, STYLE, SIZE, OR COLOR.

OWNER OF U.S. REG. NOS. 2,617,968, 3,346,818 AND OTHERS.

NO CLAIM IS MADE TO THE EXCLUSIVE RIGHT TO USE "DEBT MANAGER", APART FROM THE MARK AS SHOWN.

SER. NO. 77-430,703, FILED 3-25-2008.

SUZANNE BLANE, EXAMINING ATTORNEY

Int. Cl.: 9

Prior U.S. Cls.: 21, 23, 26, 36 and 38

United States Patent and Trademark Office

Reg. No. 3,520,182

Registered Oct. 21, 2008

**TRADEMARK
PRINCIPAL REGISTER**

FILESTOR

PROPERTYINFO CORPORATION (TEXAS COR-
PORATION)
SUITE 900
1990 POST OAK BOULEVARD
HOUSTON, TX 77056

FOR: COMPUTER SOFTWARE FOR USE IN
DOCUMENT MANAGEMENT, IN CLASS 9 (U.S.
CLS. 21, 23, 26, 36 AND 38).

FIRST USE 11-17-1992; IN COMMERCE 11-17-1992.

THE MARK CONSISTS OF STANDARD CHAR-
ACTERS WITHOUT CLAIM TO ANY PARTICULAR
FONT, STYLE, SIZE, OR COLOR.

SER. NO. 77-430,708, FILED 3-25-2008.

MARTHA SANTOMARTINO, EXAMINING ATTOR-
NEY

Int. Cl.: 35

Prior U.S. Cls.: 100, 101 and 102

United States Patent and Trademark Office

Reg. No. 3,520,183

Registered Oct. 21, 2008

**SERVICE MARK
PRINCIPAL REGISTER**

SELECTSTAFF

SELECT STAFFING SOLUTIONS, INC. (MASSACHUSETTS CORPORATION)
60 WORCESTER ROAD
FRAMINGHAM, MA 01701

THE MARK CONSISTS OF STANDARD CHARACTERS WITHOUT CLAIM TO ANY PARTICULAR FONT, STYLE, SIZE, OR COLOR.

FOR: EMPLOYMENT STAFFING SERVICES, IN CLASS 35 (U.S. CLS. 100, 101 AND 102).

SER. NO. 77-430,710, FILED 3-25-2008.

FIRST USE 5-31-2000; IN COMMERCE 5-31-2000.

H. M. FISHER, EXAMINING ATTORNEY

Int. Cl.: 28

Prior U.S. Cls.: 22, 23, 38 and 50

United States Patent and Trademark Office

Reg. No. 3,520,184

Registered Oct. 21, 2008

**TRADEMARK
PRINCIPAL REGISTER**

U-HAUL

U-HAUL INTERNATIONAL, INC. (ARIZONA CORPORATION)

2727 NORTH CENTRAL AVENUE

PHOENIX, AZ 85004

FOR: STUFFED TOYS AND PLUSH TOYS, IN CLASS 28 (U.S. CLS. 22, 23, 38 AND 50).

FIRST USE 10-10-2006; IN COMMERCE 10-10-2006.

THE MARK CONSISTS OF STANDARD CHARACTERS WITHOUT CLAIM TO ANY PARTICULAR FONT, STYLE, SIZE, OR COLOR.

OWNER OF U.S. REG. NOS. 746,034, 893,891 AND OTHERS.

SER. NO. 77-430,711, FILED 3-25-2008.

LEIGH CAROLINE CASE, EXAMINING ATTORNEY

Int. Cl.: 25

Prior U.S. Cls.: 22 and 39

United States Patent and Trademark Office

Reg. No. 3,520,185

Registered Oct. 21, 2008

**TRADEMARK
PRINCIPAL REGISTER**

ESCALADE

GENERAL MOTORS CORPORATION (DELA-
WARE CORPORATION)
300 RENAISSANCE CENTER, P.O. BOX 300
DETROIT, MI 482653000

FOR: CLOTHING, NAMELY, JACKETS, IN CLASS
25 (U.S. CLS. 22 AND 39).

FIRST USE 11-10-2006; IN COMMERCE 11-10-2006.

THE MARK CONSISTS OF STANDARD CHAR-
ACTERS WITHOUT CLAIM TO ANY PARTICULAR
FONT, STYLE, SIZE, OR COLOR.

OWNER OF U.S. REG. NOS. 2,269,827, 2,931,763,
AND 3,435,186.

SER. NO. 77-430,751, FILED 3-25-2008.

NANCY CLARKE, EXAMINING ATTORNEY

Int. Cls.: 6 and 11

Prior U.S. Cls.: 2, 12, 13, 14, 21, 23, 25, 31, 34 and 50

United States Patent and Trademark Office

Reg. No. 3,520,186

Registered Oct. 21, 2008

**TRADEMARK
PRINCIPAL REGISTER**



HEATEC, INC. (TENNESSEE CORPORATION)
5200 WILSON ROAD
CHATTANOOGA, TN 37410

FOR: METAL TANKS FOR STORAGE OF ASPHALT CEMENT; METAL TANKS FOR STORAGE OF FUEL, IN CLASS 6 (U.S. CLS. 2, 12, 13, 14, 23, 25 AND 50).

FIRST USE 7-31-2001; IN COMMERCE 7-31-2001.

FOR: THERMAL FLUID HEATERS FOR USE IN CONNECTION WITH THE PRODUCTION OF ASPHALT; THERMAL FLUID HEATERS FOR INDUSTRIAL USE; WATER HEATERS FOR INDUSTRIAL USE; THERMAL FLUID HEATERS FOR COMMERCIAL

USE FOR PREHEATING FUEL STORAGE TANKS; ELECTRIC HEATERS FOR COMMERCIAL USE FOR PREHEATING FUEL STORAGE TANKS; ELECTRICALLY HEATED METAL STORAGE TANKS; ELECTRICALLY HEATED STEAM GENERATORS, IN CLASS 11 (U.S. CLS. 13, 21, 23, 31 AND 34).

FIRST USE 12-28-2000; IN COMMERCE 12-28-2000.

THE MARK CONSISTS OF A REPRESENTATION OF A FLAME.

SER. NO. 77-430,763, FILED 3-25-2008.

DAVID YONTEF, EXAMINING ATTORNEY

Int. Cl.: 9

Prior U.S. Cls.: 21, 23, 26, 36 and 38

Reg. No. 3,520,187

United States Patent and Trademark Office

Registered Oct. 21, 2008

**TRADEMARK
PRINCIPAL REGISTER**

Right Fielder

MELISSA DATA CORP. (CALIFORNIA CORPORATION)
22382 AVENIDA EMPRESA
RANCHO SANTA MARGARITA, CA 92688

FIRST USE 10-1-1990; IN COMMERCE 10-1-1990.

FOR: MARKETING AND MAILING SOFTWARE THAT EXAMINES DATA AND MAKES SURE THAT THE DATA IS IN THE CORRECT FIELD BY EXAMINING AND DISTINGUISHING BETWEEN NAMES, TITLES, DEPARTMENTS, COMPANIES, ADDRESSES, CITIES, STATES, ZIP CODES, AND PHONE NUMBERS, IN CLASS 9 (U.S. CLS. 21, 23, 26, 36 AND 38).

THE MARK CONSISTS OF STANDARD CHARACTERS WITHOUT CLAIM TO ANY PARTICULAR FONT, STYLE, SIZE, OR COLOR.

SER. NO. 77-430,764, FILED 3-25-2008.

H. M. FISHER, EXAMINING ATTORNEY

Int. Cl.: 25

Prior U.S. Cls.: 22 and 39

United States Patent and Trademark Office

Reg. No. 3,520,188

Registered Oct. 21, 2008

**TRADEMARK
PRINCIPAL REGISTER**

ESCALADE

GENERAL MOTORS CORPORATION (DELA-
WARE CORPORATION)
300 RENAISSANCE CENTER, P.O. BOX 300
DETROIT, MI 482653000

FOR: CLOTHING, NAMELY, HATS, IN CLASS 25
(U.S. CLS. 22 AND 39).

FIRST USE 5-9-2005; IN COMMERCE 5-9-2005.

THE MARK CONSISTS OF STANDARD CHAR-
ACTERS WITHOUT CLAIM TO ANY PARTICULAR
FONT, STYLE, SIZE, OR COLOR.

OWNER OF U.S. REG. NOS. 2,269,827, 2,931,763,
AND 3,435,186.

SER. NO. 77-430,772, FILED 3-25-2008.

NANCY CLARKE, EXAMINING ATTORNEY

Int. Cl.: 31

Prior U.S. Cls.: 1 and 46

United States Patent and Trademark Office

Reg. No. 3,520,189

Registered Oct. 21, 2008

TRADEMARK
PRINCIPAL REGISTER



MCRAE, JOANNE (UNITED STATES INDIVIDUAL)
BLDG. E, APT. 356
3600 S. COLLEGE RD.
WILMINGTON, NC 28412

FOR: PET FOODS, IN CLASS 31 (U.S. CLS. 1 AND 46).

FIRST USE 7-1-2003; IN COMMERCE 7-1-2003.

NO CLAIM IS MADE TO THE EXCLUSIVE RIGHT TO USE "PET BAKERY" , APART FROM THE MARK AS SHOWN.

THE MARK CONSISTS OF A DOG WITH PAW PRINTS ON IT BODY WITH A BACKGROUND CONTAINING BONES.

SER. NO. 77-430,774, FILED 3-25-2008.

GINA FINK, EXAMINING ATTORNEY

Int. Cl.: 16

Prior U.S. Cls.: 2, 5, 22, 23, 29, 37, 38 and 50

Reg. No. 3,520,190

United States Patent and Trademark Office

Registered Oct. 21, 2008

**TRADEMARK
PRINCIPAL REGISTER**



WHIMSY HILL STUDIO (OHIO LIMITED LIABILITY COMPANY), DBA WHIMSY HILL PUBLISHING
15401 EATON PIKE
WEST ALEXANDRIA, OH 453819610

FOR: SERIES OF FICTION AND NON-FICTION BOOKS ON A VARIETY OF TOPICS, IN CLASS 16 (U.S. CLS. 2, 5, 22, 23, 29, 37, 38 AND 50).

FIRST USE 1-7-2008; IN COMMERCE 1-7-2008.

NO CLAIM IS MADE TO THE EXCLUSIVE RIGHT TO USE "PUBLISHING" AND "EST. 2001", APART FROM THE MARK AS SHOWN.

THE MARK CONSISTS OF A WINGED HORSE INSIDE AN OVAL THAT'S THICKER ON THE TOP AND BOTTOM, NARROWER ON THE SIDES. THE WORDS "WHIMSY HILL PUBLISHING" LINE THE INSIDE EDGES OF THE OVAL. "EST. 2001" IS PLACED ON EITHER SIDE OF THE HORSE ("EST." ON THE LEFT, "2001" ON THE RIGHT).

SER. NO. 77-430,782, FILED 3-25-2008.

GINA FINK, EXAMINING ATTORNEY

Int. Cl.: 35

Prior U.S. Cls.: 100, 101 and 102

United States Patent and Trademark Office

Reg. No. 3,520,191

Registered Oct. 21, 2008

**SERVICE MARK
PRINCIPAL REGISTER**

LYRICARIO

HERNANDEZ, JOSEPH (UNITED STATES INDIVIDUAL)
5 SAINT JOHNS ROAD
RIDGEWOOD, NY 11385

THE MARK CONSISTS OF STANDARD CHARACTERS WITHOUT CLAIM TO ANY PARTICULAR FONT, STYLE, SIZE, OR COLOR.

FOR: ENTERTAINMENT MARKETING SERVICES, NAMELY, MARKETING, PROMOTION AND ADVERTISING FOR INDEPENDENT RECORDING ARTISTS, IN CLASS 35 (U.S. CLS. 100, 101 AND 102).

SER. NO. 77-430,811, FILED 3-25-2008.

FIRST USE 7-1-1998; IN COMMERCE 7-8-2006.

CHERYL CLAYTON, EXAMINING ATTORNEY

Int. Cl.: 29

Prior U.S. Cl.: 46

United States Patent and Trademark Office

Reg. No. 3,520,192

Registered Oct. 21, 2008

**TRADEMARK
PRINCIPAL REGISTER**

Black Goat Truffle

CARR VALLEY CHEESE COMPANY, INC. (WIS-
CONSIN CORPORATION)
S3797 COUNTY G
LA VALLE, WI 53941

NO CLAIM IS MADE TO THE EXCLUSIVE
RIGHT TO USE "GOAT TRUFFLE", APART FROM
THE MARK AS SHOWN.

FOR: CHEESE FOOD, IN CLASS 29 (U.S. CL. 46).

FIRST USE 0-0-2007; IN COMMERCE 0-0-2007.

SER. NO. 77-430,856, FILED 3-25-2008.

THE MARK CONSISTS OF STANDARD CHAR-
ACTERS WITHOUT CLAIM TO ANY PARTICULAR
FONT, STYLE, SIZE, OR COLOR.

FRANK LATTUCA, EXAMINING ATTORNEY

Int. Cl.: 42

Prior U.S. Cls.: 100 and 101

United States Patent and Trademark Office

Reg. No. 3,520,193

Registered Oct. 21, 2008

**SERVICE MARK
PRINCIPAL REGISTER**

SCREEN TEST AMERICA

CAHOON, DAVID CRAWFORD (UNITED STATES INDIVIDUAL)

199

3069 ANDERSON SNOW RD.
SPRING HILL, FL 34609

FOR: COMPUTER SERVICES, NAMELY, CREATING AN ONLINE COMMUNITY FOR REGISTERED USERS TO PARTICIPATE IN COMPETITIONS, SHOWCASE THEIR SKILLS, GET FEEDBACK FROM THEIR PEERS, FORM VIRTUAL COMMUNITIES, ENGAGE IN SOCIAL NETWORKING AND IMPROVE THEIR TALENT, IN CLASS 42 (U.S. CLS. 100 AND 101).

FIRST USE 2-5-2008; IN COMMERCE 3-15-2008.

THE MARK CONSISTS OF STANDARD CHARACTERS WITHOUT CLAIM TO ANY PARTICULAR FONT, STYLE, SIZE, OR COLOR.

SER. NO. 77-430,874, FILED 3-25-2008.

WILLIAM P. SHANAHAN, EXAMINING ATTORNEY

Int. Cl.: 30

Prior U.S. Cl.: 46

United States Patent and Trademark Office

Reg. No. 3,520,194

Registered Oct. 21, 2008

**TRADEMARK
PRINCIPAL REGISTER**

PACARI

SKS FLOWERS S.C.C. (ECUADOR CORPORATION), DBA ECUADORIAN ORGANICS
JULIO ZALDUMBIDE 225 Y AV. LA CORUÑA
QUITO, ECUADOR

FOR: CHOCOLATE, CHOCOLATE BARS, CHOCOLATE CANDIES, CHOCOLATE COVERED DRIED FRUITS, CHOCOLATE COVERED COFFEE BEANS, IN CLASS 30 (U.S. CL. 46).

FIRST USE 1-1-2008; IN COMMERCE 1-1-2008.

THE MARK CONSISTS OF STANDARD CHARACTERS WITHOUT CLAIM TO ANY PARTICULAR FONT, STYLE, SIZE, OR COLOR.

THE FOREIGN WORDING IN THE MARK TRANSLATES INTO ENGLISH AS "NATURE".

SER. NO. 77-430,895, FILED 3-25-2008.

KRISTINA MORRIS, EXAMINING ATTORNEY

Int. Cl.: 41

Prior U.S. Cls.: 100, 101 and 107

United States Patent and Trademark Office

Reg. No. 3,520,195

Registered Oct. 21, 2008

**SERVICE MARK
PRINCIPAL REGISTER**

ARTS FOR FITNESS

ARTS FOR FITNESS, LLC (SOUTH CAROLINA
LIMITED LIABILITY COMPANY)
3545 MARY ADER AVE.
CHARLESTON, SC 29414

FOR: INSTRUCTION IN THE FIELD OF PHYSI-
CAL ARTS AND FITNESS, IN CLASS 41 (U.S. CLS.
100, 101 AND 107).

FIRST USE 9-1-2005; IN COMMERCE 9-1-2005.

THE MARK CONSISTS OF STANDARD CHAR-
ACTERS WITHOUT CLAIM TO ANY PARTICULAR
FONT, STYLE, SIZE, OR COLOR.

NO CLAIM IS MADE TO THE EXCLUSIVE
RIGHT TO USE "FITNESS", APART FROM THE
MARK AS SHOWN.

SER. NO. 77-430,917, FILED 3-25-2008.

HEATHER THOMPSON, EXAMINING ATTORNEY

Int. Cl.: 41

Prior U.S. Cls.: 100, 101 and 107

United States Patent and Trademark Office

Reg. No. 3,520,196

Registered Oct. 21, 2008

**SERVICE MARK
PRINCIPAL REGISTER**

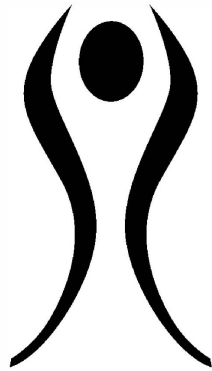

ARTS FOR FITNESS, LLC (SOUTH CAROLINA
LIMITED LIABILITY COMPANY)
3545 MARY ADER AVE.
CHARLESTON, SC 29414

THE MARK CONSISTS OF A SILHOUETTE OF A
MAN.

FOR: INSTRUCTION IN THE FIELD OF PHYSI-
CAL ARTS AND FITNESS, IN CLASS 41 (U.S. CLS.
100, 101 AND 107).

SER. NO. 77-430,918, FILED 3-25-2008.

FIRST USE 1-14-2008; IN COMMERCE 1-14-2008.

HEATHER THOMPSON, EXAMINING ATTORNEY

Int. Cl.: 41

Prior U.S. Cls.: 100, 101 and 107

United States Patent and Trademark Office

Reg. No. 3,520,197

Registered Oct. 21, 2008

**SERVICE MARK
PRINCIPAL REGISTER**



ARTS FOR FITNESS, LLC (SOUTH CAROLINA
LIMITED LIABILITY COMPANY)
3545 MARY ADER AVE
CHARLESTON, SC 29414

FOR: INSTRUCTION IN THE FIELD OF PHYSI-
CAL ARTS AND FITNESS, IN CLASS 41 (U.S. CLS.
100, 101 AND 107).

FIRST USE 9-1-2005; IN COMMERCE 9-1-2005.

NO CLAIM IS MADE TO THE EXCLUSIVE
RIGHT TO USE "FITNESS", APART FROM THE
MARK AS SHOWN.

THE MARK CONSISTS OF THE LITERAL ELE-
MENT AND A GLOBE, BOTH OF WHICH ARE
LOCATED WITHIN A CIRCLE AND THE GLOBE
HAVING LONGITUDE AND LATITUDE LINES
AND A MAN SILHOUETTE LOCATED WITHIN
THE GLOBE.

SER. NO. 77-430,920, FILED 3-25-2008.

HEATHER THOMPSON, EXAMINING ATTORNEY

Int. Cl.: 39

Prior U.S. Cls.: 100 and 105

United States Patent and Trademark Office

Reg. No. 3,520,198

Registered Oct. 21, 2008

**SERVICE MARK
PRINCIPAL REGISTER**

Destination360

STUDIO360, INC. (WASHINGTON CORPORATION), DBA DESTINATION360
2105 N 51ST ST. #204
1400 20TH AVE.
SEATTLE, WA 98122

FOR: PROVIDING AUTOMATED CHECK-IN AND TICKETING SERVICES FOR AIR TRAVELERS; PROVIDING INFORMATION, NEWS AND COMMENTARY IN THE FIELD OF TRAVEL; PROVISION OF TRAVEL INFORMATION; RESERVATION AND BOOKING OF SEATS FOR TRAVEL; TRAVEL AND TOUR INFORMATION SERVICE; TRAVEL AND TOUR TICKET RESERVATION SERVICE; ARRANGING TRAVEL TOURS AS A BONUS PROGRAM FOR CREDIT CARDS CUSTOMERS; BOOKING OF SEATS FOR TRAVEL; TRAVEL

GUIDE AND TRAVEL INFORMATION SERVICES; TRAVEL INFORMATION; TRAVEL INFORMATION SERVICES; TRAVEL, EXCURSION AND CRUISE ARRANGEMENT, IN CLASS 39 (U.S. CLS. 100 AND 105).

FIRST USE 1-1-2001; IN COMMERCE 1-1-2001.

THE MARK CONSISTS OF STANDARD CHARACTERS WITHOUT CLAIM TO ANY PARTICULAR FONT, STYLE, SIZE, OR COLOR.

SER. NO. 77-430,937, FILED 3-25-2008.

ANTHONY RINKER, EXAMINING ATTORNEY

Int. Cl.: 9

Prior U.S. Cls.: 21, 23, 26, 36 and 38

Reg. No. 3,520,199

United States Patent and Trademark Office

Registered Oct. 21, 2008

**TRADEMARK
PRINCIPAL REGISTER**

AMERICA CABLE SYSTEMS

WPFY, INC. (DELAWARE CORPORATION)
1105 NORTH MARKET STREET
WILMINGTON, DE 19801

OWNER OF U.S. REG. NO. 2,122,562.

FOR: ELECTRICAL WIRING ASSEMBLIES,
NAMELY, PREFABRICATED MODULAR WIRING
FOR READY INSTALLATION IN BUILDINGS, IN
CLASS 9 (U.S. CLS. 21, 23, 26, 36 AND 38).

NO CLAIM IS MADE TO THE EXCLUSIVE
RIGHT TO USE "CABLE SYSTEMS", APART FROM
THE MARK AS SHOWN.

FIRST USE 8-9-1993; IN COMMERCE 8-9-1993.

SEC. 2(F).

THE MARK CONSISTS OF STANDARD CHAR-
ACTERS WITHOUT CLAIM TO ANY PARTICULAR
FONT, STYLE, SIZE, OR COLOR.

SER. NO. 77-430,965, FILED 3-25-2008.

BARBARA GAYNOR, EXAMINING ATTORNEY

Int. Cls.: 5 and 42

Prior U.S. Cls.: 6, 18, 44, 46, 51, 52, 100 and 101

United States Patent and Trademark Office

Reg. No. 3,520,200

Registered Oct. 21, 2008

**TRADEMARK
SERVICE MARK
PRINCIPAL REGISTER**

PARAGON BIOSERVICES

PARAGON BIOSERVICES, INC. (MARYLAND CORPORATION)
JOHNS HOPKINS BAYVIEW RESEARCH CAMPUS
5210 EASTERN AVENUE
BALTIMORE, MD 21224

FOR: PHARMACEUTICAL PRODUCTS, NAME-
LY, MEDICAL DIAGNOSTIC REAGENTS FOR USE
IN IMMUNO PURIFICATION, IMAGING AND AS-
SAYS, BACTERIOLOGICAL CULTURE MEDIA
FOR MEDICAL USE, IN CLASS 5 (U.S. CLS. 6, 18,
44, 46, 51 AND 52).

FIRST USE 3-1-1999; IN COMMERCE 3-1-1999.

FOR: PHARMACEUTICAL RESEARCH AND
PRODUCT DEVELOPMENT SERVICES FOR OTH-
ERS, NAMELY, PRECLINICAL CONTRACT RE-

SEARCH, CURRENT GOOD MANUFACTURING
AND PRODUCT DEVELOPMENT FOR PHARMA-
CEUTICAL AND BIOTECHNOLOGY COMPANIES,
IN CLASS 42 (U.S. CLS. 100 AND 101).

FIRST USE 3-1-1999; IN COMMERCE 3-1-1999.

THE MARK CONSISTS OF STANDARD CHAR-
ACTERS WITHOUT CLAIM TO ANY PARTICULAR
FONT, STYLE, SIZE, OR COLOR.

OWNER OF U.S. REG. NO. 2,490,138.

SER. NO. 77-430,976, FILED 3-25-2008.

AISHA CLARKE, EXAMINING ATTORNEY

Int. Cl.: 42

Prior U.S. Cls.: 100 and 101

United States Patent and Trademark Office

Reg. No. 3,520,201

Registered Oct. 21, 2008

**SERVICE MARK
PRINCIPAL REGISTER**

WE ARE ENVIRONMENTAL

ATHLETES FOR A FIT PLANET LLC (MASSACHUSETTS LIMITED LIABILITY COMPANY)
153 LOCUST STREET
HOLLISTON, MA 01746

FOR: CONSULTING SERVICES, NAMELY, ASSISTING RACE AND EVENT COORDINATORS IN IDENTIFYING AND ADOPTING SOLUTIONS TO REDUCING WASTE AND EMISSIONS AND SIMILAR ENVIRONMENTALLY RESPONSIBLE PRACTICES, IN CLASS 42 (U.S. CLS. 100 AND 101).

FIRST USE 3-24-2008; IN COMMERCE 3-24-2008.

THE MARK CONSISTS OF STANDARD CHARACTERS WITHOUT CLAIM TO ANY PARTICULAR FONT, STYLE, SIZE, OR COLOR.

SER. NO. 77-431,019, FILED 3-25-2008.

AISHA CLARKE, EXAMINING ATTORNEY

Int. Cls.: 5 and 42

Prior U.S. Cls.: 6, 18, 44, 46, 51, 52, 100 and 101

United States Patent and Trademark Office

Reg. No. 3,520,202

Registered Oct. 21, 2008

**TRADEMARK
SERVICE MARK
PRINCIPAL REGISTER**



PARAGON BIOSERVICES, INC. (MARYLAND CORPORATION)
JOHNS HOPKINS BAYVIEW RESEARCH CAMPUS
5210 EASTERN AVENUE
WASHINGTON, DC 20036

FOR: PHARMACEUTICAL PRODUCTS, NAME-
LY, MEDICAL DIAGNOSTIC REAGENTS FOR USE
IN IMMUNO PURIFICATION, IMAGING AND AS-
SAYS, BACTERIOLOGICAL CULTURE MEDIA
FOR MEDICAL USE, IN CLASS 5 (U.S. CLS. 6, 18,
44, 46, 51 AND 52).

FIRST USE 3-1-1999; IN COMMERCE 3-1-1999.

FOR: PHARMACEUTICAL RESEARCH AND
PRODUCT DEVELOPMENT SERVICES FOR OTH-
ERS, NAMELY, PRECLINICAL CONTRACT RE-

SEARCH, CURRENT GOOD MANUFACTURING
AND PRODUCT DEVELOPMENT FOR PHARMA-
CEUTICAL AND BIOTECHNOLOGY COMPANIES,
IN CLASS 42 (U.S. CLS. 100 AND 101).

FIRST USE 3-1-1999; IN COMMERCE 3-1-1999.

OWNER OF U.S. REG. NO. 2,490,138.

THE MARK CONSISTS OF A PARTIALLY SHA-
DED CIRCLE THAT LOOKS LIKE A PEARL WITH A
SHADOW BENEATH THE PARTIALLY SHADED
CIRCLE.

SER. NO. 77-431,020, FILED 3-25-2008.

AISHA CLARKE, EXAMINING ATTORNEY

Int. Cl.: 3

Prior U.S. Cls.: 1, 4, 6, 50, 51 and 52

United States Patent and Trademark Office

Reg. No. 3,520,203

Registered Oct. 21, 2008

**TRADEMARK
PRINCIPAL REGISTER**

RARE HARVEST

OJON CORPORATION (DELAWARE CORPORATION)
767 FIFTH AVENUE
NEW YORK, NY 10153

THE MARK CONSISTS OF STANDARD CHARACTERS WITHOUT CLAIM TO ANY PARTICULAR FONT, STYLE, SIZE, OR COLOR.

FOR: HAIR CARE PREPARATIONS; NON-MEDICATED SKIN CARE PREPARATIONS; BODY AND BEAUTY CARE COSMETICS, IN CLASS 3 (U.S. CLS. 1, 4, 6, 50, 51 AND 52).

SER. NO. 77-431,025, FILED 3-25-2008.

FIRST USE 10-31-2006; IN COMMERCE 10-31-2006.

BARNEY CHARLON, EXAMINING ATTORNEY

Int. Cl.: 41

Prior U.S. Cls.: 100, 101 and 107

United States Patent and Trademark Office

Reg. No. 3,520,204

Registered Oct. 21, 2008

**SERVICE MARK
PRINCIPAL REGISTER**

MARTY HYMAN PHOTOGRAPHY

HYMAN, MARTIN R. (UNITED STATES INDIVIDUAL)

15 FIRETHORN LANE

VALLEY STREAM, NY 11581

FOR: PHOTOGRAPHY SERVICES, IN CLASS 41
(U.S. CLS. 100, 101 AND 107).

FIRST USE 7-0-1980; IN COMMERCE 7-0-1980.

THE MARK CONSISTS OF STANDARD CHARACTERS WITHOUT CLAIM TO ANY PARTICULAR FONT, STYLE, SIZE, OR COLOR.

NO CLAIM IS MADE TO THE EXCLUSIVE RIGHT TO USE "PHOTOGRAPHY", APART FROM THE MARK AS SHOWN.

SER. NO. 77-431,026, FILED 3-25-2008.

AISHA CLARKE, EXAMINING ATTORNEY

Int. Cl.: 9

Prior U.S. Cls.: 21, 23, 26, 36 and 38

United States Patent and Trademark Office

Reg. No. 3,520,205

Registered Oct. 21, 2008

**TRADEMARK
PRINCIPAL REGISTER**

Tattle-Trail

TATTLE-TRAIL LLC (FLORIDA LIMITED LIABILITY COMPANY)
SUITE 220
7887 BRYAN DAIRY RD
LARGO, FL 33777

FOR: VEHICLE SAFETY EQUIPMENT, NAMELY, VIBRATION, SHOCK, MOTION, ANGLE, TEMPERATURE AND VOLTAGE MONITOR, IN CLASS 9 (U.S. CLS. 21, 23, 26, 36 AND 38).

FIRST USE 6-7-2007; IN COMMERCE 10-18-2007.

THE MARK CONSISTS OF STANDARD CHARACTERS WITHOUT CLAIM TO ANY PARTICULAR FONT, STYLE, SIZE, OR COLOR.

SER. NO. 77-431,031, FILED 3-25-2008.

AISHA CLARKE, EXAMINING ATTORNEY

Int. Cl.: 35

Prior U.S. Cls.: 100, 101 and 102

United States Patent and Trademark Office

Reg. No. 3,520,206

Registered Oct. 21, 2008

**SERVICE MARK
PRINCIPAL REGISTER**

Greenfish Adventure Sports

GREENFISH ADVENTURE SPORTS (NEW YORK CORPORATION)
294 DEPOT ST.
ANDES, NY 13731

FOR: COMPUTERIZED ON-LINE RETAIL STORE SERVICES IN THE FIELD OF SPORTING GOODS, IN CLASS 35 (U.S. CLS. 100, 101 AND 102).

FIRST USE 7-22-2001; IN COMMERCE 7-22-2001.

THE MARK CONSISTS OF STANDARD CHARACTERS WITHOUT CLAIM TO ANY PARTICULAR FONT, STYLE, SIZE, OR COLOR.

NO CLAIM IS MADE TO THE EXCLUSIVE RIGHT TO USE "ADVENTURE SPORTS", APART FROM THE MARK AS SHOWN.

SER. NO. 77-431,038, FILED 3-25-2008.

ARETHA SOMERVILLE, EXAMINING ATTORNEY

Int. Cl.: 29

Prior U.S. Cl.: 46

United States Patent and Trademark Office

Reg. No. 3,520,207

Registered Oct. 21, 2008

**TRADEMARK
PRINCIPAL REGISTER**



KENOSHA BEEF INTERNATIONAL LTD. (WIS-
CONSIN CORPORATION)
3111 - 152ND AVENUE
KENOSHA, WI 53144

FOR: GROUND BEEF, GROUND PORK AND
OTHER GROUND BEEF AND PORK PRODUCTS,
NAMELY, PROCESSED, COOKED OR SEASONED
BEEF AND PORK, IN CLASS 29 (U.S. CL. 46).

FIRST USE 4-30-2008; IN COMMERCE 4-30-2008.

THE MARK CONSISTS OF A CHEF GRILLING
WITH WORDS "CHEF'S GRILL".

SER. NO. 77-431,042, FILED 3-25-2008.

AISHA CLARKE, EXAMINING ATTORNEY

Int. Cl.: 35

Prior U.S. Cls.: 100, 101 and 102

United States Patent and Trademark Office

Reg. No. 3,520,208

Registered Oct. 21, 2008

**SERVICE MARK
PRINCIPAL REGISTER**

Greenfish Sports

GREENFISH ADVENTURE SPORTS, INC (NEW
YORK CORPORATION)
294 DEPOT ST.
ANDES, NY 13731

FOR: COMPUTERIZED ON-LINE RETAIL STORE
SERVICES IN THE FIELD OF SPORTING GOODS,
IN CLASS 35 (U.S. CLS. 100, 101 AND 102).

FIRST USE 7-22-2001; IN COMMERCE 7-22-2001.

THE MARK CONSISTS OF STANDARD CHAR-
ACTERS WITHOUT CLAIM TO ANY PARTICULAR
FONT, STYLE, SIZE, OR COLOR.

NO CLAIM IS MADE TO THE EXCLUSIVE
RIGHT TO USE "SPORTS", APART FROM THE
MARK AS SHOWN.

SER. NO. 77-431,085, FILED 3-25-2008.

ARETHA SOMERVILLE, EXAMINING ATTORNEY

Int. Cl.: 36

Prior U.S. Cls.: 100, 101 and 102

United States Patent and Trademark Office

Reg. No. 3,520,209

Registered Oct. 21, 2008

**SERVICE MARK
PRINCIPAL REGISTER**

LIVESTRONG

LANCE ARMSTRONG FOUNDATION (TEXAS
NON-PROFIT CORPORATION)
P.O. BOX 161150
AUSTIN, TX 787161150

FOR: PROVIDING A WEBSITE FEATURING
HEALTH CARE INSURANCE AND SHORT TERM
MEDICAL INSURANCE INFORMATION; PROVID-
ING A WEBSITE FEATURING INFORMATION IN
THE FIELD OF HEALTH INSURANCE, SHORT
TERM MEDICAL INSURANCE, HEALTH SAVINGS
ACCOUNTS, AND FINANCE IN THE FIELD OF
HEALTH CARE, IN CLASS 36 (U.S. CLS. 100, 101
AND 102).

FIRST USE 4-0-2004; IN COMMERCE 4-0-2004.

THE MARK CONSISTS OF STANDARD CHAR-
ACTERS WITHOUT CLAIM TO ANY PARTICULAR
FONT, STYLE, SIZE, OR COLOR.

OWNER OF U.S. REG. NOS. 3,052,284, 3,296,017
AND OTHERS.

SER. NO. 77-431,086, FILED 3-25-2008.

LAURA HAMMEL, EXAMINING ATTORNEY

Int. Cl.: 21

Prior U.S. Cls.: 2, 13, 23, 29, 30, 33, 40 and 50

United States Patent and Trademark Office

Reg. No. 3,520,210

Registered Oct. 21, 2008

**TRADEMARK
PRINCIPAL REGISTER**

KITTY KAN

**BRAVOS, ZACHARY M. (UNITED STATES IN-
DIVIDUAL)
SUITE B1
600 WEST ROOSEVELT ROAD
WHEATON, IL 60187**

**FOR: PET LITTER BOXES, IN CLASS 21 (U.S. CLS.
2, 13, 23, 29, 30, 33, 40 AND 50).**

FIRST USE 9-24-1989; IN COMMERCE 9-24-1989.

**THE MARK CONSISTS OF STANDARD CHAR-
ACTERS WITHOUT CLAIM TO ANY PARTICULAR
FONT, STYLE, SIZE, OR COLOR.**

**THE NAME(S), PORTRAIT(S), AND/OR SIGNA-
TURE(S) SHOWN IN THE MARK DOES NOT IDEN-
TIFY A PARTICULAR LIVING INDIVIDUAL.**

SER. NO. 77-431,090, FILED 3-25-2008.

MAUREEN DALL, EXAMINING ATTORNEY

Int. Cls.: 4, 25, 35, 36, 37, 39 and 45

**Prior U.S. Cls.: 1, 6, 15, 22, 39, 100, 101, 102, 103, 105
and 106**

Reg. No. 3,520,211

United States Patent and Trademark Office

Registered Oct. 21, 2008

**TRADEMARK
SERVICE MARK
PRINCIPAL REGISTER**

CENEX

CHS INC. (MINNESOTA CORPORATION)
5500 CENEX DRIVE
INVER GROVE HEIGHTS, MN 55077

FOR: FUELS, NAMELY, GASOLINE, DIESEL, BIODIESEL, PROPANE AND FUEL OIL; LUBRICATING OILS AND GREASES FOR VEHICLES AND MACHINES, IN CLASS 4 (U.S. CLS. 1, 6 AND 15).

FIRST USE 0-0-1973; IN COMMERCE 0-0-1973.

FOR: CLOTHING, NAMELY, GLOVES, HATS, SHIRTS, SWEATERS, JACKETS, CAPS, IN CLASS 25 (U.S. CLS. 22 AND 39).

FIRST USE 0-0-1973; IN COMMERCE 0-0-1973.

FOR: RETAIL STORE SERVICES FEATURING AGRICULTURAL PRODUCTS AND SUPPLIES, OILS, FUELS, ALTERNATIVE FUELS AND LUBRICANTS; DISTRIBUTORSHIP SERVICES FEATURING AGRICULTURAL PRODUCTS AND SUPPLIES, OILS, FUELS, ALTERNATIVE FUELS AND LUBRICANTS; RETAIL MOTOR VEHICLE FUEL SUPPLY SERVICES BY MEANS OF PUMP ISLAND CREDIT CARD READERS; RETAIL STORE SERVICES FEATURING CONVENIENCE STORE ITEMS AND MOTOR FUELS; COOPERATIVE AND DEALER ADVERTISING AND MARKETING FOR FUEL PRODUCT PRODUCERS; DISTRIBUTORSHIPS IN THE FIELD OF REFINED FUELS, LUBRICANTS, PROPANE AND ALTERNATIVE FUELS; ASSOCIATION SERVICES, NAMELY, PROMOTING THE INTERESTS OF COOPERATIVE MEMBERS AND DEALERS, IN CLASS 35 (U.S. CLS. 100, 101 AND 102).

FIRST USE 0-0-1973; IN COMMERCE 0-0-1973.

FOR: FINANCIAL RISK MANAGEMENT SERVICES IN THE PROPANE, FUELS AND LUBRICANTS INDUSTRY, IN CLASS 36 (U.S. CLS. 100, 101 AND 102).

FIRST USE 0-0-1973; IN COMMERCE 0-0-1973.

FOR: AUTOMOBILE SERVICE STATION SERVICES, IN CLASS 37 (U.S. CLS. 100, 103 AND 106).

FIRST USE 0-0-1973; IN COMMERCE 0-0-1973.

FOR: STORAGE AND TRANSPORTATION OF GOODS BY RAILROAD AND TRUCK; STORAGE, DISTRIBUTION, AND TRANSPORTATION OF NATURAL GAS, PROPANE, FUELS, OILS, AMMONIA AND LUBRICANTS; PUBLIC UTILITY SERVICES IN THE NATURE OF NATURAL GAS AND PROPANE DISTRIBUTION, IN CLASS 39 (U.S. CLS. 100 AND 105).

FIRST USE 0-0-1975; IN COMMERCE 0-0-1975.

FOR: CONSULTATION SERVICES IN THE FIELD OF NATURAL GAS, FUELS AND PROPANE SAFETY, IN CLASS 45 (U.S. CLS. 100 AND 101).

FIRST USE 0-0-1973; IN COMMERCE 0-0-1973.

THE MARK CONSISTS OF STANDARD CHARACTERS WITHOUT CLAIM TO ANY PARTICULAR FONT, STYLE, SIZE, OR COLOR.

OWNER OF U.S. REG. NOS. 1,070,076, 1,591,300 AND OTHERS.

SER. NO. 77-431,095, FILED 3-25-2008.

DOMINICK J. SALEMI, EXAMINING ATTORNEY

Int. Cl.: 35

Prior U.S. Cls.: 100, 101 and 102

United States Patent and Trademark Office

Reg. No. 3,520,212

Registered Oct. 21, 2008

**SERVICE MARK
PRINCIPAL REGISTER**

VIRTUAL MAILBOX

RESEARCH HORIZONS LLC (DELAWARE LIMITED LIABILITY COMPANY), DBA PHOENIX MARKETING INTERNATIONAL
6423 MONTGOMERY STREET - SUITE 12
RHINEBECK, NY 12572

FOR: CONSULTING SERVICES RELATING TO BUSINESS AND MARKET RESEARCH; CONDUCTING ON-LINE BUSINESS AND MARKET RESEARCH SURVEYS, IN CLASS 35 (U.S. CLS. 100, 101 AND 102).

FIRST USE 4-23-2007; IN COMMERCE 4-23-2007.

THE MARK CONSISTS OF STANDARD CHARACTERS WITHOUT CLAIM TO ANY PARTICULAR FONT, STYLE, SIZE, OR COLOR.

SER. NO. 77-431,097, FILED 3-25-2008.

DOMINICK J. SALEMI, EXAMINING ATTORNEY

Int. Cl.: 1

Prior U.S. Cls.: 1, 5, 6, 10, 26 and 46

Reg. No. 3,520,213

United States Patent and Trademark Office

Registered Oct. 21, 2008

**TRADEMARK
PRINCIPAL REGISTER**

ZIPLEX

XCEED MOLECULAR CORPORATION (CANADA CORPORATION)
1 MARMAC DRIVE
TORONTO, CANADA M9W1E7

FOR: DIAGNOSTIC REAGENTS FOR SCIENTIFIC USE; DIAGNOSTIC TEST KITS FOR SCIENTIFIC USE COMPRISED OF REAGENTS, PROCESSING CHEMICALS, AND POROUS SUBSTRATE MATERIALS, ALONE OR ATTACHED TO A SOLID BODY FOR HANDLING, IN CLASS 1 (U.S. CLS. 1, 5, 6, 10, 26 AND 46).

FIRST USE 7-1-2007; IN COMMERCE 7-1-2007.

THE MARK CONSISTS OF STANDARD CHARACTERS WITHOUT CLAIM TO ANY PARTICULAR FONT, STYLE, SIZE, OR COLOR.

OWNER OF U.S. REG. NOS. 3,427,680 AND 3,454,591.

SER. NO. 77-431,117, FILED 3-25-2008.

ALLISON SCHRODY, EXAMINING ATTORNEY

Int. Cl.: 33

Prior U.S. Cls.: 47 and 49

United States Patent and Trademark Office

Reg. No. 3,520,214

Registered Oct. 21, 2008

TRADEMARK
PRINCIPAL REGISTER



VAZQUEZ OLIVAS ALFONSO (MEXICO INDIVIDUAL)
CALLEJÓN PUNTA QUEBRADA S/N CD DEL CIELO
LA PAZ, MEXICO 23010

FOR: DISTILLED SPIRITS; TEQUILA, IN CLASS 33 (U.S. CLS. 47 AND 49).

FIRST USE 5-25-2007; IN COMMERCE 5-25-2007.

THE MARK CONSISTS OF THE DESIGN OF AN OVAL IN THE CENTER OF THE LOGO WHERE APPEARS THE MARK "LAS VARITAS" (THE WANDS), IN THE UPPER PART HAS A DESIGN

SIMULATING AN AGAVE PLANT, IN BOTH SIDES LEFT AND RIGHT OF THE UPPER PART IT HAS AN OLIVE LEAVES PAIR, IN THE LOWER PART THERE IS A RIBBON AND CONTAINS THREE DESIGNS THAT DO NOT REPRESENT ANYTHING PARTICULARLY, THEY ARE ONLY GRAPHIC ELEMENTS OF THE DESIGN.

THE FOREIGN WORDING IN THE MARK TRANSLATES INTO ENGLISH AS "THE WANDS".

SER. NO. 77-431,132, FILED 3-25-2008.

BRIAN NEVILLE, EXAMINING ATTORNEY

Int. Cl.: 1

Prior U.S. Cls.: 1, 5, 6, 10, 26 and 46

United States Patent and Trademark Office

Reg. No. 3,520,215

Registered Oct. 21, 2008

**TRADEMARK
PRINCIPAL REGISTER**

XCEED MOLECULAR

XCEED MOLECULAR CORPORATION (CANADA CORPORATION)
1 MARMAC DRIVE
TORONTO, CANADA M9W1E7

FOR: DIAGNOSTIC REAGENTS FOR SCIENTIFIC USE; DIAGNOSTIC TEST KITS FOR SCIENTIFIC USE COMPRISED OF REAGENTS, PROCESSING CHEMICALS, AND POROUS SUBSTRATE MATERIALS, ALONE OR ATTACHED TO A SOLID BODY FOR HANDLING, IN CLASS 1 (U.S. CLS. 1, 5, 6, 10, 26 AND 46).

FIRST USE 7-1-2007; IN COMMERCE 7-1-2007.

THE MARK CONSISTS OF STANDARD CHARACTERS WITHOUT CLAIM TO ANY PARTICULAR FONT, STYLE, SIZE, OR COLOR.

OWNER OF U.S. REG. NOS. 3,438,921, 3,438,933, AND 3,438,934.

SER. NO. 77-431,141, FILED 3-25-2008.

ALLISON SCHRODY, EXAMINING ATTORNEY

Int. Cl.: 42

Prior U.S. Cls.: 100 and 101

United States Patent and Trademark Office

Reg. No. 3,520,216

Registered Oct. 21, 2008

**SERVICE MARK
PRINCIPAL REGISTER**

THERE IS MORE TO THIS RING
THAN ITS SPARKLE

INTERNATIONAL GEMOLOGICAL INSTITUTE,
INC. (NEW YORK CORPORATION)
589 FIFTH AVENUE
NEW YORK, NY 10017

THE MARK CONSISTS OF STANDARD CHAR-
ACTERS WITHOUT CLAIM TO ANY PARTICULAR
FONT, STYLE, SIZE, OR COLOR.

FOR: GEMOLOGICAL SERVICES, NAMELY,
GRADING PRECIOUS STONES, IN CLASS 42 (U.S.
CLS. 100 AND 101).

SER. NO. 77-431,148, FILED 3-25-2008.

FIRST USE 3-1-2008; IN COMMERCE 3-1-2008.

WILLIAM ROSSMAN, EXAMINING ATTORNEY

Int. Cls.: 5, 29 and 32

Prior U.S. Cls.: 6, 18, 44, 45, 46, 48, 51 and 52

United States Patent and Trademark Office

Reg. No. 3,520,217

Registered Oct. 21, 2008

**TRADEMARK
PRINCIPAL REGISTER**

WAIKALAND

WAIKALAND (FLORIDA CORPORATION)
4605 FOWLER STREET
FORT MYERS, FL 33907

FOR: DIETARY AND NUTRITIONAL SUPPLEMENTS; VITAMIN SUPPLEMENTS, IN CLASS 5 (U.S. CLS. 6, 18, 44, 46, 51 AND 52).

FIRST USE 3-25-2008; IN COMMERCE 3-25-2008.

FOR: FRUIT-BASED FOOD BEVERAGE; SOY-BASED FOOD BEVERAGE USED AS A MILK SUBSTITUTE, IN CLASS 29 (U.S. CL. 46).

FIRST USE 3-25-2008; IN COMMERCE 3-25-2008.

FOR: ENERGY DRINKS, IN CLASS 32 (U.S. CLS. 45, 46 AND 48).

FIRST USE 3-25-2008; IN COMMERCE 3-25-2008.

THE MARK CONSISTS OF STANDARD CHARACTERS WITHOUT CLAIM TO ANY PARTICULAR FONT, STYLE, SIZE, OR COLOR.

SER. NO. 77-431,166, FILED 3-25-2008.

DANNEAN HETZEL, EXAMINING ATTORNEY

Int. Cl.: 37

Prior U.S. Cls.: 100, 103 and 106

United States Patent and Trademark Office

Reg. No. 3,520,218

Registered Oct. 21, 2008

**SERVICE MARK
PRINCIPAL REGISTER**

GLOBAL GARAGE FLOORING

GLOBAL GARAGE FLOORING, LLC (COLOR-
ADO LIMITED LIABILITY COMPANY)
1545 W. BAYAUD AVE., UNIT 1
DENVER, CO 80223

FOR: RENOVATION AND RESTORATION OF
BUILDINGS, NAMELY, RENOVATION OF GAR-
AGES, IN CLASS 37 (U.S. CLS. 100, 103 AND 106).

FIRST USE 12-6-2005; IN COMMERCE 12-6-2005.

THE MARK CONSISTS OF STANDARD CHAR-
ACTERS WITHOUT CLAIM TO ANY PARTICULAR
FONT, STYLE, SIZE, OR COLOR.

NO CLAIM IS MADE TO THE EXCLUSIVE
RIGHT TO USE "GARAGE FLOORING", APART
FROM THE MARK AS SHOWN.

SER. NO. 77-431,175, FILED 3-25-2008.

JENNIFER MARTIN, EXAMINING ATTORNEY

Int. Cl.: 25

Prior U.S. Cls.: 22 and 39

United States Patent and Trademark Office

Reg. No. 3,520,219

Registered Oct. 21, 2008

**TRADEMARK
PRINCIPAL REGISTER**

BREASTFEST

O'BRIEN, ANNE (UNITED STATES INDIVIDUAL)
1610 SHAKESPEARE STREET
BALTIMORE, MD 21231

FOR: SHIRTS, IN CLASS 25 (U.S. CLS. 22 AND 39).

FIRST USE 10-11-2007; IN COMMERCE 10-11-2007.

THE MARK CONSISTS OF STANDARD CHARACTERS WITHOUT CLAIM TO ANY PARTICULAR FONT, STYLE, SIZE, OR COLOR.

OWNER OF U.S. REG. NO. 2,612,210.

SER. NO. 77-431,217, FILED 3-25-2008.

CYNTHIA SLOAN, EXAMINING ATTORNEY

Int. Cl.: 33

Prior U.S. Cls.: 47 and 49

United States Patent and Trademark Office

Reg. No. 3,520,220

Registered Oct. 21, 2008

**TRADEMARK
PRINCIPAL REGISTER**

Ψ CLONE

BABCOCK ENTERPRISES, INC. (CALIFORNIA
CORPORATION)
PO BOX 637
LOMPOC, CA 93438

THE MARK CONSISTS OF THE GREEK LETTER
PSI AND THE WORD "CLONE".

FOR: WINES, IN CLASS 33 (U.S. CLS. 47 AND 49).

SER. NO. 77-431,224, FILED 3-25-2008.

FIRST USE 8-31-2007; IN COMMERCE 8-31-2007.

WANDA KAY PRICE, EXAMINING ATTORNEY

Int. Cl.: 41

Prior U.S. Cls.: 100, 101 and 107

United States Patent and Trademark Office

Reg. No. 3,520,221

Registered Oct. 21, 2008

**SERVICE MARK
PRINCIPAL REGISTER**

TWD The Wise Decision

THE WISE DECISION (MICHIGAN LIMITED
LIABILITY COMPANY)
20251 STOTTER STREET
DETROIT, MI 48234

THE MARK CONSISTS OF STANDARD CHAR-
ACTERS WITHOUT CLAIM TO ANY PARTICULAR
FONT, STYLE, SIZE, OR COLOR.

FOR: PERSONAL TRAINER SERVICES, IN CLASS
41 (U.S. CLS. 100, 101 AND 107).

SER. NO. 77-431,225, FILED 3-25-2008.

FIRST USE 4-14-2007; IN COMMERCE 5-14-2007.

WANDA KAY PRICE, EXAMINING ATTORNEY

Int. Cl.: 9

Prior U.S. Cls.: 21, 23, 26, 36 and 38

Reg. No. 3,520,222

United States Patent and Trademark Office

Registered Oct. 21, 2008

**TRADEMARK
PRINCIPAL REGISTER**

Bren-Tronics

BREN-TRONICS, INC. (NEW YORK CORPORATION)
10 BRAYTON COURT
COMMACK, NY 11725

THE MARK CONSISTS OF STANDARD CHARACTERS WITHOUT CLAIM TO ANY PARTICULAR FONT, STYLE, SIZE, OR COLOR.

FOR: BATTERIES AND BATTERY CHARGERS,
IN CLASS 9 (U.S. CLS. 21, 23, 26, 36 AND 38).

SER. NO. 77-431,226, FILED 3-25-2008.

FIRST USE 8-31-1973; IN COMMERCE 8-31-1973.

WANDA KAY PRICE, EXAMINING ATTORNEY

Int. Cl.: 44

Prior U.S. Cls.: 100 and 101

United States Patent and Trademark Office

Reg. No. 3,520,223

Registered Oct. 21, 2008

**SERVICE MARK
PRINCIPAL REGISTER**



HY GORGEOUS, LLC (NEW JERSEY LIMITED
LIABILITY COMPANY)
50 ESTE PLACE
BLOOMFIELD, NJ 07003

FOR: BEAUTY SALON SERVICES, IN CLASS 44
(U.S. CLS. 100 AND 101).

FIRST USE 1-1-2007; IN COMMERCE 1-1-2008.

THE MARK CONSISTS OF AN IMAGE OF TWO
HEARTS SHAPED CHERRIES. THE STEMS OF THE

HEART SHAPE CHERRIES ARE ATTACHED.
WHERE THE STEMS ATTACH IS A LEAF. INSIDE
THE LEFT HEART SHAPED CHERRY IS THE
STYLIZED WORDS "HY GORGEOUS" IN A BAN-
NER. IN THE BACKGROUNDS THE BANNER IS
THE STYLED LETTERS "HG".

SER. NO. 77-431,250, FILED 3-25-2008.

GISELLE AGOSTO, EXAMINING ATTORNEY

Int. Cl.: 42

Prior U.S. Cls.: 100 and 101

United States Patent and Trademark Office

Reg. No. 3,520,224

Registered Oct. 21, 2008

**SERVICE MARK
PRINCIPAL REGISTER**



SEEPATHSOLUTIONS

BREAKTHROUGH SOLUTIONS LLC (NEW JERSEY LIMITED LIABILITY COMPANY), DBA SEEPATH SOLUTIONS

#1011
30 NEWPORT PARKWAY
JERSEY CITY, NJ 07310

FOR: COMPUTER SOFTWARE TECHNOLOGY CONSULTING, IN CLASS 42 (U.S. CLS. 100 AND 101).

FIRST USE 12-1-2005; IN COMMERCE 12-1-2005.

THE STIPPLING IS FOR SHADING PURPOSES ONLY.

THE MARK CONSISTS OF THE STYLIZED WORD "SEEPATHSOLUTIONS". ABOVE THE STYLIZED WORD IS AN ABSTRACT DESIGN.

SER. NO. 77-431,263, FILED 3-25-2008.

LAURIE KAUFMAN, EXAMINING ATTORNEY

Int. Cl.: 38

Prior U.S. Cls.: 100, 101 and 104

United States Patent and Trademark Office

Reg. No. 3,520,225

Registered Oct. 21, 2008

**SERVICE MARK
PRINCIPAL REGISTER**

Your Ultimate C.Y.A.

LASENSKY, PETER (UNITED STATES INDIVIDUAL)
3525A DEL MAR HEIGHTS RD, 109
SAN DIEGO, CA 92130

FOR: COMMUNICATION SERVICES, NAMELY, TRANSMISSION OF VOICE, AUDIO, VISUAL IMAGES AND DATA BY TELECOMMUNICATIONS NETWORKS, WIRELESS COMMUNICATION NETWORKS, THE INTERNET, INFORMATION SERVICES NETWORKS AND DATA NETWORKS; COMMUNICATIONS VIA MULTINATIONAL TELECOMMUNICATION NETWORKS; ELECTRONIC EXCHANGE OF DATA STORED IN DATABASES

ACCESSIBLE VIA TELECOMMUNICATION NETWORKS, IN CLASS 38 (U.S. CLS. 100, 101 AND 104).

FIRST USE 3-10-2008; IN COMMERCE 3-10-2008.

THE MARK CONSISTS OF STANDARD CHARACTERS WITHOUT CLAIM TO ANY PARTICULAR FONT, STYLE, SIZE, OR COLOR.

SER. NO. 77-431,306, FILED 3-25-2008.

RUDY R. SINGLETON, EXAMINING ATTORNEY

Int. Cls.: 9 and 41

Prior U.S. Cls.: 21, 23, 26, 36, 38, 100, 101 and 107

United States Patent and Trademark Office

Reg. No. 3,520,226

Registered Oct. 21, 2008

**TRADEMARK
SERVICE MARK
PRINCIPAL REGISTER**

THE PLANE TRUTH

JIM HARDY, INC. (TEXAS CORPORATION)
12777 JONES ROAD, SUITE 150
HOUSTON, TX 77070

FOR: PRE-RECORDED CD'S, VIDEO TAPES, AUDIO TAPES, LASER DISKS AND DVD'S FEATURING GOLF INSTRUCTION; DOWNLOADABLE VIDEO RECORDINGS FEATURING GOLF INSTRUCTION; EDUCATIONAL SOFTWARE FEATURING INSTRUCTION IN GOLF, IN CLASS 9 (U.S. CLS. 21, 23, 26, 36 AND 38).

FIRST USE 3-1-2005; IN COMMERCE 7-1-2006.

FOR: EDUCATIONAL SERVICES, NAMELY, CONDUCTING CLASSES, DEMONSTRATIONS,

SEMINARS, AND WORKSHOPS IN THE FIELD OF GOLF; PROVIDING GOLF INSTRUCTION; ONLINE INFORMATIONAL SERVICES IN THE FIELD OF GOLF OFFERED VIA A GLOBAL COMPUTER NETWORK, IN CLASS 41 (U.S. CLS. 100, 101 AND 107).

FIRST USE 3-1-2005; IN COMMERCE 3-1-2005.

THE MARK CONSISTS OF STANDARD CHARACTERS WITHOUT CLAIM TO ANY PARTICULAR FONT, STYLE, SIZE, OR COLOR.

SER. NO. 77-431,328, FILED 3-25-2008.

FRED MANDIR, EXAMINING ATTORNEY

Int. Cl.: 25

Prior U.S. Cls.: 22 and 39

United States Patent and Trademark Office

Reg. No. 3,520,227

Registered Oct. 21, 2008

**TRADEMARK
PRINCIPAL REGISTER**

Hip Hop vs America

JACKSONS VIP HOLDINGS INC. (MISSISSIPPI CORPORATION), DBA HIP HOP VS AMERICA
313 PLANTERS GROVE
RIDGELAND, MS 39157

FOR: MEN'S, WOMEN'S AND CHILDREN'S CLOTHING AND FASHION ACCESSORIES, NAMELY, DRESSES, COATS, SHORTS, SHIRTS, DRESS SHIRTS, PANTS, DRESS PANTS, JEANS, SWEATERS, JACKETS, SUITS, TUXEDOS, DINNER JACKETS, T-SHIRTS, BLOUSES, KNIT TOPS, HALTER TOPS, SMOCK TOPS, VESTS, WIND RESISTANT JACKETS, JOGGING SUITS, SWEATSHIRTS, SWEATPANTS, SKI JACKETS, SKI PANTS, MUFFLERS, HEAD BANDS, BELTS, GLOVES, SHAWLS, SCARVES, PONCHOS, SHOULDER WRAPS, NECKERCHIEFS, STOCKINGS, HOSIERY, SOCKS, TIGHTS, LEGGINGS, LEOTARDS, PAJAMAS,

ROBES, NIGHTGOWNS, PANTIES, BRAS, UNDERWEAR, UNDERSHIRTS, RAINWEAR, RAINCOATS, SWIMWEAR, BATHING SUITS, COVER-UPS, AND WOMEN'S LINGERIE; FOOTWEAR, HEADWEAR, TIES, CAPS, AND HATS, IN CLASS 25 (U.S. CLS. 22 AND 39).

FIRST USE 1-20-2006; IN COMMERCE 1-20-2006.

THE MARK CONSISTS OF STANDARD CHARACTERS WITHOUT CLAIM TO ANY PARTICULAR FONT, STYLE, SIZE, OR COLOR.

SER. NO. 77-431,348, FILED 3-25-2008.

MARK RADEMACHER, EXAMINING ATTORNEY

Int. Cl.: 3

Prior U.S. Cls.: 1, 4, 6, 50, 51 and 52

Reg. No. 3,520,228

United States Patent and Trademark Office

Registered Oct. 21, 2008

**TRADEMARK
PRINCIPAL REGISTER**

NOATO

WELL-BEING HOUSE, LLC (CALIFORNIA LIMITED LIABILITY COMPANY), DBA TEA-LOVE
WELL-BEING HOUSE, LLC
9434 GARDEN GROVE BLVD.
GARDEN GROVE, CA 92844

THE MARK CONSISTS OF STANDARD CHARACTERS WITHOUT CLAIM TO ANY PARTICULAR FONT, STYLE, SIZE, OR COLOR.

FOR: MOISTURIZING CREAMS, IN CLASS 3 (U.S. CLS. 1, 4, 6, 50, 51 AND 52).

SER. NO. 77-431,356, FILED 3-25-2008.

FIRST USE 9-20-2007; IN COMMERCE 11-20-2007.

KEVIN CORWIN, EXAMINING ATTORNEY

Int. Cl.: 35

Prior U.S. Cls.: 100, 101 and 102

United States Patent and Trademark Office

Reg. No. 3,520,229

Registered Oct. 21, 2008

**SERVICE MARK
PRINCIPAL REGISTER**

BANANATOYS.COM

BANANATOYS.COM, INC. (CALIFORNIA CORPORATION)
724 REMUDA DRIVE
GLEN DORA, CA 91740

THE MARK CONSISTS OF STANDARD CHARACTERS WITHOUT CLAIM TO ANY PARTICULAR FONT, STYLE, SIZE, OR COLOR.

FOR: ON-LINE RETAIL STORE SERVICES FEATURING TOYS, ACTION FIGURES, AND GAMES, IN CLASS 35 (U.S. CLS. 100, 101 AND 102).

SER. NO. 77-431,367, FILED 3-25-2008.

FIRST USE 8-1-2003; IN COMMERCE 10-1-2003.

MONIQUE MILLER, EXAMINING ATTORNEY

Int. Cl.: 5

Prior U.S. Cls.: 6, 18, 44, 46, 51 and 52

United States Patent and Trademark Office

Reg. No. 3,520,230

Registered Oct. 21, 2008

**TRADEMARK
PRINCIPAL REGISTER**

OverSize

DYNAMIC BRIDGE INC. (CALIFORNIA CORPORATION)
11221 RUSH STREET #E
SOUTH EL MONTE, CA 91733

THE MARK CONSISTS OF STANDARD CHARACTERS WITHOUT CLAIM TO ANY PARTICULAR FONT, STYLE, SIZE, OR COLOR.

FOR: DIETARY SUPPLEMENTS, IN CLASS 5 (U.S. CLS. 6, 18, 44, 46, 51 AND 52).

SER. NO. 77-431,368, FILED 3-25-2008.

FIRST USE 8-15-2006; IN COMMERCE 8-15-2006.

LINDA ORNDORFF, EXAMINING ATTORNEY

Int. Cl.: 5

Prior U.S. Cls.: 6, 18, 44, 46, 51 and 52

Reg. No. 3,520,231

United States Patent and Trademark Office

Registered Oct. 21, 2008

**TRADEMARK
PRINCIPAL REGISTER**

Spermcare

INVITROCARE, INC. (CALIFORNIA CORPORATION)
SUITE F
8415 PROGRESS DRIVE
FREDERICK, MD 21701

THE MARK CONSISTS OF STANDARD CHARACTERS WITHOUT CLAIM TO ANY PARTICULAR FONT, STYLE, SIZE, OR COLOR.

FOR: SPERM ISOLATING LIQUID SOLUTION MEDIA FOR INTRAUTERINE INSEMINATION, IN CLASS 5 (U.S. CLS. 6, 18, 44, 46, 51 AND 52).

SER. NO. 77-431,382, FILED 3-25-2008.

FIRST USE 5-0-1998; IN COMMERCE 5-0-1998.

MAYUR VAGHANI, EXAMINING ATTORNEY

Int. Cl.: 5

Prior U.S. Cls.: 6, 18, 44, 46, 51 and 52

United States Patent and Trademark Office

Reg. No. 3,520,232

Registered Oct. 21, 2008

**TRADEMARK
PRINCIPAL REGISTER**

Fertiplex

DYNAMIC BRIDGE (CALIFORNIA CORPORATION)
11221 RUSH STREET #E
SOUTH EL MONTE, CA 91733

THE MARK CONSISTS OF STANDARD CHARACTERS WITHOUT CLAIM TO ANY PARTICULAR FONT, STYLE, SIZE, OR COLOR.

FOR: HERBAL SUPPLEMENTS, IN CLASS 5 (U.S. CLS. 6, 18, 44, 46, 51 AND 52).

SER. NO. 77-431,387, FILED 3-25-2008.

FIRST USE 8-15-2006; IN COMMERCE 8-15-2006.

ALEX KEAM, EXAMINING ATTORNEY

Int. Cls.: 10, 14, 25, 26 and 28

Prior U.S. Cls.: 2, 22, 23, 26, 27, 28, 37, 38, 39, 40, 42,
44 and 50

Reg. No. 3,520,233

United States Patent and Trademark Office

Registered Oct. 21, 2008

TRADEMARK
PRINCIPAL REGISTER



UNITED TRADEMARK HOLDINGS, INC. (CALI-
FORNIA CORPORATION)
141 S. LAPEER DRIVE
BEVERLY HILLS, CA 90211

FOR: BABY BOTTLES; PACIFIERS FOR BABIES,
IN CLASS 10 (U.S. CLS. 26, 39 AND 44).

FIRST USE 1-1-2008; IN COMMERCE 1-1-2008.

FOR: COSTUME JEWELRY, IN CLASS 14 (U.S.
CLS. 2, 27, 28 AND 50).

FIRST USE 1-1-2008; IN COMMERCE 1-1-2008.

FOR: BELTS; CHILDREN'S AND INFANTS'
CLOTH BIBS; FLIP FLOPS; FOOTWEAR; GLOVES;
HATS; MITTENS; SANDALS; SCARVES, IN CLASS
25 (U.S. CLS. 22 AND 39).

FIRST USE 1-1-2008; IN COMMERCE 1-1-2008.

FOR: BARRETTES; HAIR BANDS; HAIR CLIPS;
HAIR PINS; HAIR SCRUNCHIES; PONYTAIL
HOLDERS, IN CLASS 26 (U.S. CLS. 37, 39, 40, 42
AND 50).

FIRST USE 1-1-2008; IN COMMERCE 1-1-2008.

FOR: CHILDREN'S PLAY COSMETICS, IN CLASS
28 (U.S. CLS. 22, 23, 38 AND 50).

FIRST USE 1-1-2008; IN COMMERCE 1-1-2008.

THE STIPLING IS FOR SHADING PURPOSES
ONLY.

THE MARK CONSISTS OF THE STYLIZED TEXT
"JUNIOR ELF FAIRYTALE PRINCESS" ABOVE AN
IMAGE OF THREE FAIRYTALE PRINCESSES.

SER. NO. 77-431,392, FILED 3-25-2008.

ALEX KEAM, EXAMINING ATTORNEY

Int. Cl.: 42

Prior U.S. Cls.: 100 and 101

United States Patent and Trademark Office

Reg. No. 3,520,234

Registered Oct. 21, 2008

**SERVICE MARK
PRINCIPAL REGISTER**

Chictopia

CHICTOPIA (CALIFORNIA LIMITED LIABILITY
COMPANY)

APT. 1

411 DOLORES STREET

SAN FRANCISCO, CA 94110

FOR: PROVIDING A WEBSITE FEATURING AN
ONLINE COMMUNITY IN REGARDS TO FASH-
ION, STYLE AND SHOPPING, IN CLASS 42 (U.S.
CLS. 100 AND 101).

FIRST USE 12-4-2007; IN COMMERCE 1-9-2008.

THE MARK CONSISTS OF STANDARD CHAR-
ACTERS WITHOUT CLAIM TO ANY PARTICULAR
FONT, STYLE, SIZE, OR COLOR.

SER. NO. 77-431,393, FILED 3-25-2008.

LINDSEY RUBIN, EXAMINING ATTORNEY

Int. Cl.: 25

Prior U.S. Cls.: 22 and 39

United States Patent and Trademark Office

Reg. No. 3,520,235

Registered Oct. 21, 2008

**TRADEMARK
PRINCIPAL REGISTER**

13ANK

SANNER, ADAM (UNITED STATES INDIVIDUAL)
109 DRAKE COURT
FRANKLIN, TN 37064

FOR: HATS; SWEAT SHIRTS; T-SHIRTS, IN CLASS 25 (U.S. CLS. 22 AND 39).

FIRST USE 2-3-2008; IN COMMERCE 2-3-2008.

THE MARK CONSISTS OF STANDARD CHARACTERS WITHOUT CLAIM TO ANY PARTICULAR FONT, STYLE, SIZE, OR COLOR.

SER. NO. 77-431,402, FILED 3-25-2008.

WILLIAM P. SHANAHAN, EXAMINING ATTORNEY

Int. Cl.: 41

Prior U.S. Cls.: 100, 101 and 107

United States Patent and Trademark Office

Reg. No. 3,520,236

Registered Oct. 21, 2008

**SERVICE MARK
PRINCIPAL REGISTER**

Activities Children Enjoy

TUCH (CALIFORNIA PARTNERSHIP)
#331
7162 BEVERLY BLVD.
LOS ANGELES, CA 90036

FOR: PROVIDING AFTER SCHOOL EDUCATIONAL PROGRAMS FOR CHILDREN IN GRADES PRESCHOOL-8TH GRADE, IN CLASS 41 (U.S. CLS. 100, 101 AND 107).

FIRST USE 12-5-2007; IN COMMERCE 12-5-2007.

THE MARK CONSISTS OF STANDARD CHARACTERS WITHOUT CLAIM TO ANY PARTICULAR FONT, STYLE, SIZE, OR COLOR.

SER. NO. 77-431,408, FILED 3-25-2008.

MELVIN AXILBUND, EXAMINING ATTORNEY

Int. Cl.: 41

Prior U.S. Cls.: 100, 101 and 107

United States Patent and Trademark Office

Reg. No. 3,520,237

Registered Oct. 21, 2008

**SERVICE MARK
PRINCIPAL REGISTER**

Athelas

GILCHREST, ANNELIESE, M (UNITED STATES
INDIVIDUAL)
1179 COUNTY HWY 5
OTEGO, NY 13825

THE MARK CONSISTS OF STANDARD CHAR-
ACTERS WITHOUT CLAIM TO ANY PARTICULAR
FONT, STYLE, SIZE, OR COLOR.

FOR: RECREATIONAL SERVICES IN THE NAT-
URE OF HORSEBACK RIDING FACILITIES, IN
CLASS 41 (U.S. CLS. 100, 101 AND 107).

SER. NO. 77-431,413, FILED 3-25-2008.

FIRST USE 1-26-2008; IN COMMERCE 1-26-2008.

ALEX KEAM, EXAMINING ATTORNEY

Int. Cl.: 25

Prior U.S. Cls.: 22 and 39

United States Patent and Trademark Office

Reg. No. 3,520,238

Registered Oct. 21, 2008

**TRADEMARK
PRINCIPAL REGISTER**

PHOTOGRAPHER WORKING!

PARAS, MICHAEL N. (UNITED STATES INDIVIDUAL)
350 SEVENTH AVE, SUITE 2205
NEW YORK, NY 10001

THE MARK CONSISTS OF STANDARD CHARACTERS WITHOUT CLAIM TO ANY PARTICULAR FONT, STYLE, SIZE, OR COLOR.

FOR: SHIRTS; SWEAT SHIRTS; COATS; WIND COATS; OVER COATS; RAIN COATS; HATS, IN CLASS 25 (U.S. CLS. 22 AND 39).

SER. NO. 77-431,476, FILED 3-25-2008.

FIRST USE 3-25-2008; IN COMMERCE 3-25-2008.

HENRY S. ZAK, EXAMINING ATTORNEY

Int. Cl.: 16

Prior U.S. Cls.: 2, 5, 22, 23, 29, 37, 38 and 50

Reg. No. 3,520,239

United States Patent and Trademark Office

Registered Oct. 21, 2008

**TRADEMARK
PRINCIPAL REGISTER**

**PYA Series - Protect Your
Assets**

NURSE ATTORNEY INSTITUTE, LLC (LOUISIANA LIMITED LIABILITY COMPANY)
SUITE 100
81 YOSEMITE
NEW ORLEANS, LA 70130

FOR: EDUCATIONAL BOOKS FEATURING NURSING LAW AND ETHICS; EDUCATIONAL PUBLICATIONS, NAMELY, EDUCATIONAL LEARNING CARDS, FLASH CARDS, ACTIVITY CARDS, WORKBOOKS, TEXTBOOKS, ACTIVITY BOOKS, STORY BOOKS, PUZZLE BOOKS, PRINTED PUZZLES, TEACHER GUIDES, MANUALS, POSTERS, EDUCATIONAL CARD GAMES AND EDUCATIONAL BOOKLETS IN THE FIELD OF NURSING LAW AND ETHICS; EDUCATIONAL PUBLICATIONS, NAMELY, TRAINING MANUALS IN THE FIELD OF NURSING LAW AND ETHICS; EDUCATIONAL PUBLICATIONS, NAMELY, BRO-

CHURES, LAMINATED INSTRUCTIONAL CARDS IN THE FIELDS OF NURSING LAW AND ETHICS; PRINTED EDUCATIONAL MATERIAL, NAMELY, TEACHING TILES; PRINTED INSTRUCTIONAL, EDUCATIONAL, AND TEACHING MATERIALS IN THE FIELD OF NURSING LAW AND ETHICS, IN CLASS 16 (U.S. CLS. 2, 5, 22, 23, 29, 37, 38 AND 50).

FIRST USE 3-21-2008; IN COMMERCE 3-24-2008.

THE MARK CONSISTS OF STANDARD CHARACTERS WITHOUT CLAIM TO ANY PARTICULAR FONT, STYLE, SIZE, OR COLOR.

SER. NO. 77-431,479, FILED 3-25-2008.

HENRY S. ZAK, EXAMINING ATTORNEY

Int. Cl.: 25

Prior U.S. Cls.: 22 and 39

United States Patent and Trademark Office

Reg. No. 3,520,240

Registered Oct. 21, 2008

**TRADEMARK
PRINCIPAL REGISTER**

Kimbros

DOLPHIN GLOBE INTERNATIONAL (CALIFORNIA LIMITED LIABILITY COMPANY)
7685 HERMITAGE AVE.
NEWARK, CA 94560

FOR: BASEBALL CAPS; BERMUDA SHORTS; BLOUSES; BOARD SHORTS; CAP VISORS; CAPRI PANTS; CAPS; CARGO PANTS; DENIMS; FLEECE SHORTS; GOLF CAPS; GYM SHORTS; HATS; JEANS; JOGGING PANTS; KNITTED CAPS; LOUNGE PANTS; PANTIES, SHORTS AND BRIEFS; PANTS; POLO SHIRTS; SHORT TROUSERS; SHORT-SLEEVED OR LONG-SLEEVED T-SHIRTS; SHORT-SLEEVED SHIRTS; SHORTS; SKULL CAPS; SWEAT

PANTS; SWEAT SHORTS; T-SHIRTS; WALKING SHORTS; WIND PANTS, IN CLASS 25 (U.S. CLS. 22 AND 39).

FIRST USE 8-28-2007; IN COMMERCE 8-28-2007.

THE MARK CONSISTS OF STANDARD CHARACTERS WITHOUT CLAIM TO ANY PARTICULAR FONT, STYLE, SIZE, OR COLOR.

SER. NO. 77-431,489, FILED 3-25-2008.

HENRY S. ZAK, EXAMINING ATTORNEY

Int. Cl.: 5

Prior U.S. Cls.: 6, 18, 44, 46, 51 and 52

Reg. No. 3,520,241

United States Patent and Trademark Office

Registered Oct. 21, 2008

**TRADEMARK
PRINCIPAL REGISTER**

GameOn

MENAGE INNOVATIONS, INC. (TENNESSEE
CORPORATION)
3580 AIR PARK ST
MEMPHIS, TN 38118

THE MARK CONSISTS OF STANDARD CHAR-
ACTERS WITHOUT CLAIM TO ANY PARTICULAR
FONT, STYLE, SIZE, OR COLOR.

FOR: POWDER USED IN THE PREPARATION OF
NUTRITIONAL DRINKS ENHANCED WITH VITA-
MINS, MINERALS, AND PROTEIN, IN CLASS 5 (U.S.
CLS. 6, 18, 44, 46, 51 AND 52).

SER. NO. 77-431,492, FILED 3-26-2008.

FIRST USE 3-7-2008; IN COMMERCE 3-7-2008.

HENRY S. ZAK, EXAMINING ATTORNEY

Int. Cl.: 42

Prior U.S. Cls.: 100 and 101

United States Patent and Trademark Office

Reg. No. 3,520,242

Registered Oct. 21, 2008

SERVICE MARK
PRINCIPAL REGISTER

DyNamite!

THOMAS, DAVEIA N. (UNITED STATES INDIVIDUAL)
389 EAST 38TH ST
PATERSON, NJ 07504

FOR: GRAPHIC DESIGN SERVICES, IN CLASS 42
(U.S. CLS. 100 AND 101).

FIRST USE 12-1-2002; IN COMMERCE 12-1-2003.

THE MARK CONSISTS OF THE WORD "DYNAMITE" WITH MY INITIALS "DNT" IN CAPITAL LETTERS AND AN EXCLAMATION POINT AT THE END.

SER. NO. 77-431,496, FILED 3-26-2008.

SUNG IN, EXAMINING ATTORNEY

Int. Cl.: 3

Prior U.S. Cls.: 1, 4, 6, 50, 51 and 52

United States Patent and Trademark Office

Reg. No. 3,520,243

Registered Oct. 21, 2008

**TRADEMARK
PRINCIPAL REGISTER**

MORNINGSIDE

MORNINGSIDE LLC (IDAHO LIMITED LIABILITY COMPANY)
P.O. BOX 140135
GARDEN CITY, ID 83714

FOR: BATH SOAPS IN LIQUID, SOLID OR GEL FORM; LIQUID SOAPS FOR HANDS, FACE AND BODY; PERFUMED SOAPS, SOAPS FOR BODY CARE, BODY LOTION, SKIN LOTIONS, HAND CREAMS, PERFUMED CREAMS, HAND SOAPS, FRAGRANCES FOR PERSONAL USE AND PERFUMERY, IN CLASS 3 (U.S. CLS. 1, 4, 6, 50, 51 AND 52).

FIRST USE 6-1-2007; IN COMMERCE 6-1-2007.

THE MARK CONSISTS OF STANDARD CHARACTERS WITHOUT CLAIM TO ANY PARTICULAR FONT, STYLE, SIZE, OR COLOR.

SER. NO. 77-431,511, FILED 3-26-2008.

CHRISTOPHER BUONGIORNO, EXAMINING ATTORNEY

Int. Cl.: 36

Prior U.S. Cls.: 100, 101 and 102

United States Patent and Trademark Office

Reg. No. 3,520,244

Registered Oct. 21, 2008

**SERVICE MARK
PRINCIPAL REGISTER**

BETTER ALLIANCE

BOWSER, TODD A. (UNITED STATES INDIVIDUAL)
4105 MORNING MIST LANE
CUMMING, GA 30028

FOR: REAL ESTATE AGENCIES; REAL ESTATE BROKERAGE; REAL ESTATE CONSULTANCY, IN CLASS 36 (U.S. CLS. 100, 101 AND 102).

FIRST USE 12-1-2007; IN COMMERCE 12-1-2007.

THE MARK CONSISTS OF STANDARD CHARACTERS WITHOUT CLAIM TO ANY PARTICULAR FONT, STYLE, SIZE, OR COLOR.

NO CLAIM IS MADE TO THE EXCLUSIVE RIGHT TO USE "ALLIANCE", APART FROM THE MARK AS SHOWN.

SER. NO. 77-431,524, FILED 3-26-2008.

ELISSA GARBER KON, EXAMINING ATTORNEY

Int. Cl.: 35

Prior U.S. Cls.: 100, 101 and 102

United States Patent and Trademark Office

Reg. No. 3,520,245

Registered Oct. 21, 2008

**SERVICE MARK
PRINCIPAL REGISTER**

Naymz

VIABLE VENTURES LLC (ILLINOIS LIMITED
LIABILITY COMPANY), DBA NAYMZ
2858 W. DIVERSEY
CHICAGO, IL 60647

THE MARK CONSISTS OF STANDARD CHAR-
ACTERS WITHOUT CLAIM TO ANY PARTICULAR
FONT, STYLE, SIZE, OR COLOR.

FOR: ONLINE BUSINESS NETWORKING SERVI-
CES, IN CLASS 35 (U.S. CLS. 100, 101 AND 102).

SER. NO. 77-431,527, FILED 3-26-2008.

FIRST USE 11-1-2005; IN COMMERCE 5-1-2006.

ELISSA GARBER KON, EXAMINING ATTORNEY

Int. Cl.: 41

Prior U.S. Cls.: 100, 101 and 107

Reg. No. 3,520,246

United States Patent and Trademark Office

Registered Oct. 21, 2008

**SERVICE MARK
PRINCIPAL REGISTER**

BUZZGRINDER

WERKHEISER, SETH (UNITED STATES INDIVIDUAL)

#1
1044 PUTNAM AVENUE
BROOKLYN, NY 11221

FOR: ENTERTAINMENT SERVICES, NAMELY, PROVIDING INFORMATION IN THE FIELD OF MUSIC NAMELY, NEWS, INFORMATION AND OPINIONS; PROVIDING COMMENTARY AND ARTICLES ABOUT MUSIC AND MUSIC PRODUCTION; ENTERTAINMENT SERVICES, NAMELY, PROVIDING A WEB SITE FEATURING MUSICAL PERFORMANCES, MUSICAL VIDEOS, RELATED FILM CLIPS, BAND PHOTOGRAPHS, MULTIMEDIA MATERIALS AND DISSEMINATION OF IN-

FORMATION ABOUT BANDS, MUSICAL PERFORMANCES AND TELEVISION ON A GLOBAL COMPUTER NETWORK, IN CLASS 41 (U.S. CLS. 100, 101 AND 107).

FIRST USE 6-24-2001; IN COMMERCE 7-1-2002.

THE MARK CONSISTS OF STANDARD CHARACTERS WITHOUT CLAIM TO ANY PARTICULAR FONT, STYLE, SIZE, OR COLOR.

SER. NO. 77-431,546, FILED 3-26-2008.

EDWARD NELSON, EXAMINING ATTORNEY

Int. Cl.: 5

Prior U.S. Cls.: 6, 18, 44, 46, 51 and 52

United States Patent and Trademark Office

Reg. No. 3,520,247

Registered Oct. 21, 2008

**TRADEMARK
PRINCIPAL REGISTER**

BANSECT

SERGEANT'S PET CARE PRODUCTS, INC. (NE-
VADA CORPORATION)
2625 S 158TH PLAZA
OMAHA, NE 681301770

FOR: FLEA AND TICK CONTROL PRODUCTS,
NAMELY, ANTIPARASITIC COLLARS, SPRAYS,
MEDICATED SHAMPOOS, MEDICATED POW-
DERS AND TOPICAL OINTMENTS FOR PETS;
FLEA AND TICK CONTROL SPRAYS, POWDERS
AND AEROSOL FOGGERS FOR PREMISE APPLI-
CATIONS; AND CARPET INSECTICIDES AND
FRESHENERS, IN CLASS 5 (U.S. CLS. 6, 18, 44, 46,
51 AND 52).

FIRST USE 12-0-1998; IN COMMERCE 12-0-1998.

THE MARK CONSISTS OF STANDARD CHAR-
ACTERS WITHOUT CLAIM TO ANY PARTICULAR
FONT, STYLE, SIZE, OR COLOR.

OWNER OF U.S. REG. NO. 893,965.

SER. NO. 77-431,547, FILED 3-26-2008.

ARETHA SOMERVILLE, EXAMINING ATTORNEY

Int. Cl.: 35

Prior U.S. Cls.: 100, 101 and 102

United States Patent and Trademark Office

Reg. No. 3,520,248

Registered Oct. 21, 2008

**SERVICE MARK
PRINCIPAL REGISTER**

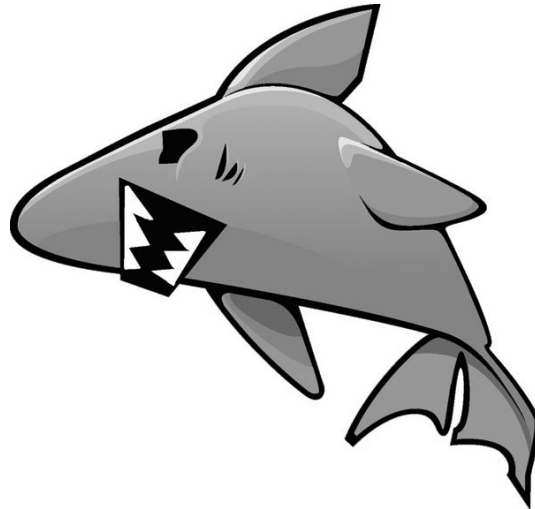

GREENFISH ADVENTURE SPORTS, INC (NEW
YORK CORPORATION)
294 DEPOT ST.
ANDES, NY 13731

THE MARK CONSISTS OF A FISH WITH WHITE
TEETH, BLACK OUTLINE AND SHADES OF GRAY
FILL.

FOR: COMPUTERIZED ON-LINE RETAIL STORE
SERVICES IN THE FIELD OF SPORTING GOODS,
IN CLASS 35 (U.S. CLS. 100, 101 AND 102).

SER. NO. 77-431,570, FILED 3-26-2008.

FIRST USE 7-22-2001; IN COMMERCE 7-22-2001.

ARETHA SOMERVILLE, EXAMINING ATTORNEY

Int. Cl.: 41

Prior U.S. Cls.: 100, 101 and 107

United States Patent and Trademark Office

Reg. No. 3,520,249

Registered Oct. 21, 2008

**SERVICE MARK
PRINCIPAL REGISTER**

CHEMTECH

AMERICAN CHEMICAL SOCIETY (D.C. CORPORATION), DBA ACS
1155 16TH STREET, NW
WASHINGTON, DC 20036

FOR: ON-LINE PUBLICATION OF JOURNAL IN
THE FIELD OF CHEMISTRY TECHNOLOGY, IN
CLASS 41 (U.S. CLS. 100, 101 AND 107).

FIRST USE 1-26-2008; IN COMMERCE 1-26-2008.

THE MARK CONSISTS OF STANDARD CHARACTERS WITHOUT CLAIM TO ANY PARTICULAR FONT, STYLE, SIZE, OR COLOR.

OWNER OF U.S. REG. NO. 1,081,673.

SER. NO. 77-431,577, FILED 3-26-2008.

MONIQUE MILLER, EXAMINING ATTORNEY

Int. Cl.: 35

Prior U.S. Cls.: 100, 101 and 102

United States Patent and Trademark Office

Reg. No. 3,520,250

Registered Oct. 21, 2008

**SERVICE MARK
PRINCIPAL REGISTER**

greenfish

GREENFISH ADVENTURE SPORTS, INC (NEW
YORK CORPORATION)
294 DEPOT ST.
ANDES, NY 13731

THE MARK CONSISTS OF STANDARD CHAR-
ACTERS WITHOUT CLAIM TO ANY PARTICULAR
FONT, STYLE, SIZE, OR COLOR.

FOR: ON-LINE RETAIL STORE SERVICES FEATURING SPORTING GOODS, IN CLASS 35 (U.S. CLS. 100, 101 AND 102).

SER. NO. 77-431,591, FILED 3-26-2008.

FIRST USE 7-22-2001; IN COMMERCE 7-22-2001.

ARETHA SOMERVILLE, EXAMINING ATTORNEY

Int. Cl.: 41

Prior U.S. Cls.: 100, 101 and 107

United States Patent and Trademark Office

Reg. No. 3,520,251

Registered Oct. 21, 2008

**SERVICE MARK
PRINCIPAL REGISTER**

PREACHING FROM THE CENTER

GENERAL BOARD OF DISCIPLESHIP OF THE
UNITED METHODIST CHURCH (TENNESSEE
NON-PROFIT CORPORATION)
1908 GRAND AVENUE
NASHVILLE, TN 37212

FOR: EDUCATIONAL SERVICES, NAMELY,
CONDUCTING CLASSES, SEMINARS, CONFEREN-
CES, COURSES, LECTURES, AND WORKSHOPS IN
THE FIELDS OF CHRISTIAN, RELIGIOUS AND
SPIRITUAL DEVELOPMENT, CHRISTIAN DISCI-
PLESHIP, CHRISTIAN, RELIGIOUS AND SPIRI-
TUAL MINISTRY, CHRISTIAN STEWARDSHIP,
CHURCH DEVELOPMENT, CHURCH LEADER-
SHIP, CHURCH MINISTRY, CHURCH REVITALI-
ZATION, CONGREGATIONAL DEVELOPMENT,
CONGREGATIONAL LEADERSHIP, CONGREGA-
TIONAL MINISTRY, CONGREGATIONAL, IN-
SPIRATIONAL AND RELIGIOUS PROGRAMS,
DEVOTIONAL TOPICS, EVANGELISM, FAITH,
FAITH FORMATION, LAY MINISTRIES, LEADER-

SHIP, LEADERSHIP DEVELOPMENT, LEADER-
SHIP FORMATION, LEADERSHIP SKILLS,
PERSONAL DEVELOPMENT, PERSONAL PIETY,
PERSONAL TRANSFORMATION, PRAYER, RELI-
GION, RELIGIOUS CONGREGATIONS, RELI-
GIOUS EDUCATION, RELIGIOUS LEADERSHIP,
SPIRITUALITY, SPIRITUAL GROWTH, AND SPIRI-
TUAL LEADERSHIP, AND DISTRIBUTING
COURSE MATERIALS IN CONNECTION THERE-
WITH, IN CLASS 41 (U.S. CLS. 100, 101 AND 107).

FIRST USE 7-0-2002; IN COMMERCE 7-0-2002.

THE MARK CONSISTS OF STANDARD CHAR-
ACTERS WITHOUT CLAIM TO ANY PARTICULAR
FONT, STYLE, SIZE, OR COLOR.

SER. NO. 77-431,599, FILED 3-26-2008.

SUNG IN, EXAMINING ATTORNEY

Int. Cl.: 9

Prior U.S. Cls.: 21, 23, 26, 36 and 38

Reg. No. 3,520,252

United States Patent and Trademark Office

Registered Oct. 21, 2008

TRADEMARK
PRINCIPAL REGISTER



NU MONY TECHNOLOGY, INC. (NEW YORK CORPORATION)
2600 SOUTH ROAD, SUITE 44-25
POUGHKEEPSIE, NY 12601

FOR: MAGNETICALLY ENCODED DEBIT CARDS, IN CLASS 9 (U.S. CLS. 21, 23, 26, 36 AND 38).

FIRST USE 2-1-2008; IN COMMERCE 2-1-2008.

NO CLAIM IS MADE TO THE EXCLUSIVE RIGHT TO USE "HUDSON VALLEY" AND "GIFT CARD", APART FROM THE MARK AS SHOWN.

THE MARK CONSISTS OF THE WORD "NU" INSIDE A SQUARE WITH LINE BREAKS IN THE SQUARE ON THE TOP AND BOTTOM, FOLLOWED

BY THE WORD "MONY'S" AND THEN "HUDSON VALLEY" ON THE TOP LINE. ON THE SECOND LINE, THE WORD "GIFT" (IN LARGER FONT THAN THE FIRST LINE) FOLLOWED BY THE IMAGE OF A THREE-PART TALL SHIP SAIL AND MAST WITH A FLAG ATOP THE SAILS, FOLLOWED BY THE WORD "CARD." THE FLAG ATOP THE SAILS EXTENDS UP INTO THE TOP LINE OF THE IMAGE AND IS IN BETWEEN THE WORDS "NUMONY'S" AND THE WORDS "HUDSON VALLEY".

SER. NO. 77-431,606, FILED 3-26-2008.

GINA FINK, EXAMINING ATTORNEY

Int. Cl.: 35

Prior U.S. Cls.: 100, 101 and 102

United States Patent and Trademark Office

Reg. No. 3,520,253

Registered Oct. 21, 2008

**SERVICE MARK
PRINCIPAL REGISTER**

Mom Corps

THE MOM CORPS, INC (GEORGIA CORPORATION)
SUITE 136 #507
1205 JOHNSON FERRY RD.
MARIETTA, GA 30068

FOR: PROVIDING AN ON-LINE SEARCHABLE DATABASE FEATURING CLASSIFIED AD LISTINGS AND EMPLOYMENT OPPORTUNITIES; JOB AND PERSONNEL PLACEMENT , IN CLASS 35 (U.S. CLS. 100, 101 AND 102).

FIRST USE 1-1-2006; IN COMMERCE 1-1-2006.

THE MARK CONSISTS OF STANDARD CHARACTERS WITHOUT CLAIM TO ANY PARTICULAR FONT, STYLE, SIZE, OR COLOR.

SER. NO. 77-431,641, FILED 3-26-2008.

KARANENDRA S. CHHINA, EXAMINING ATTORNEY

Int. Cl.: 37

Prior U.S. Cls.: 100, 103 and 106

United States Patent and Trademark Office

Reg. No. 3,520,254

Registered Oct. 21, 2008

**SERVICE MARK
PRINCIPAL REGISTER**

HYPERSPECS

MASONRY TECHNOLOGY, INC. (IOWA CORPORATION)
24235 ELECTRIC STREET
CRESCO, IA 52136

THE MARK CONSISTS OF STANDARD CHARACTERS WITHOUT CLAIM TO ANY PARTICULAR FONT, STYLE, SIZE, OR COLOR.

FOR: PROVIDING ON-LINE INFORMATION FOR CONSTRUCTION PROFESSIONALS, IN CLASS 37 (U.S. CLS. 100, 103 AND 106).

SER. NO. 77-431,659, FILED 3-26-2008.

FIRST USE 3-26-2008; IN COMMERCE 3-26-2008.

H. M. FISHER, EXAMINING ATTORNEY

Int. Cls.: 35 and 42

Prior U.S. Cls.: 100, 101 and 102

United States Patent and Trademark Office

Reg. No. 3,520,255

Registered Oct. 21, 2008

**SERVICE MARK
PRINCIPAL REGISTER**

VeraBridge

VERABRIDGE, LLC (GEORGIA LIMITED LIABILITY COMPANY)
SUITE 1880
1349 W. PEACHTREE ST., NW
ATLANTA, GA 30309

FOR: CONSULTING SERVICES, NAMELY, ADVISING FINANCIAL SERVICE COMPANIES AND INSTITUTIONS IN THE FIELD OF CUSTOMER BUYING BEHAVIOR AND ESTABLISHMENT OF OPTIMAL PRICING STRATEGIES FOR GOODS AND SERVICES SOLD BY FINANCIAL SERVICE COMPANIES AND INSTITUTIONS, IN CLASS 35 (U.S. CLS. 100, 101 AND 102).

FIRST USE 2-11-2008; IN COMMERCE 3-25-2008.

FOR: COMPUTER SERVICES, NAMELY, HOSTING AND PROVIDING A CUSTOMIZABLE ONLINE WEB SITE FOR FINANCIAL SERVICE COMPANIES

AND INSTITUTIONS THAT ENABLES SUCH COMPANIES TO IDENTIFYING, TRACK, AND ANALYZE CUSTOMER BUYING BEHAVIOR AND TO OPTIMIZE PRICING STRATEGIES FOR GOODS AND SERVICES SOLD BY FINANCIAL SERVICE COMPANIES AND INSTITUTIONS, IN CLASS 42 (U.S. CLS. 100 AND 101).

FIRST USE 2-11-2008; IN COMMERCE 3-25-2008.

THE MARK CONSISTS OF STANDARD CHARACTERS WITHOUT CLAIM TO ANY PARTICULAR FONT, STYLE, SIZE, OR COLOR.

SER. NO. 77-431,687, FILED 3-26-2008.

JOHN SCHUYLER YARD, EXAMINING ATTORNEY

Int. Cl.: 16

Prior U.S. Cls.: 2, 5, 22, 23, 29, 37, 38 and 50

United States Patent and Trademark Office

Reg. No. 3,520,256

Registered Oct. 21, 2008

**TRADEMARK
PRINCIPAL REGISTER**



GENEVA CUBS BASEBALL, INC (NEW YORK CORPORATION)
1700 W. FOURTH ST.
WILLIAMSPORT, PA 17701

FOR: PAPER GOODS AND PRINTED MATTER, NAMELY, AUTOGRAPH BOOKS, BINDERS, BOOKMARKS, BUMPER STICKERS, CALENDARS, CATALOGS OF INTEREST TO BASEBALL FANS, DECALS, MERCHANDISE BAGS, NEWSLETTERS OF INTEREST TO BASEBALL FANS, NOTE PADS, PAPER CONTAINERS, PAPER PENNANTS, PAPER SCHEDULES, PENS, PENCILS, POSTCARDS, POSTERS, PRINTED AWARDS, PRINTED GAME TICKETS, PRINTED GUIDES OF INTEREST TO BASEBALL FANS, REFERENCE BOOKS OF INTEREST TO BASEBALL FANS, SCORE BOOKS, SCORE CARDS, SCORE SHEETS, STATIONERY, STICKERS,

STICKER ALBUMS AND TRADING CARDS, IN CLASS 16 (U.S. CLS. 2, 5, 22, 23, 29, 37, 38 AND 50).

FIRST USE 1-17-2008; IN COMMERCE 1-17-2008.

OWNER OF U.S. REG. NO. 2,345,664.

NO CLAIM IS MADE TO THE EXCLUSIVE RIGHT TO USE "WILLIAMSPORT", APART FROM THE MARK AS SHOWN.

THE MARK CONSISTS OF A LUMBERJACK IN FRONT OF A LOG WITH "CROSSCUTTERS" IN FRONT AND "WILLIAMSPORT" ARCHED ABOVE.

SER. NO. 77-431,695, FILED 3-26-2008.

REGINA DRUMMOND, EXAMINING ATTORNEY

Int. Cl.: 43

Prior U.S. Cls.: 100 and 101

United States Patent and Trademark Office

Reg. No. 3,520,257

Registered Oct. 21, 2008

**SERVICE MARK
PRINCIPAL REGISTER**

ANTOON'S PIZZA

ABRAHAM, RAWADA (UNITED STATES INDIVIDUAL)

3302 WARD STREET

PITTSBURGH, PA 15213

FOR: RESTAURANT SERVICES, IN CLASS 43
(U.S. CLS. 100 AND 101).

FIRST USE 9-1-1997; IN COMMERCE 9-1-1997.

THE MARK CONSISTS OF STANDARD CHARACTERS WITHOUT CLAIM TO ANY PARTICULAR FONT, STYLE, SIZE, OR COLOR.

NO CLAIM IS MADE TO THE EXCLUSIVE RIGHT TO USE "PIZZA", APART FROM THE MARK AS SHOWN.

SER. NO. 77-431,708, FILED 3-26-2008.

YONG KIM, EXAMINING ATTORNEY

Int. Cls.: 9 and 16

Prior U.S. Cls.: 2, 5, 21, 22, 23, 26, 29, 36, 37, 38 and 50

Reg. No. 3,520,258

United States Patent and Trademark Office

Registered Oct. 21, 2008

**TRADEMARK
PRINCIPAL REGISTER**

TYPE TO LEARN

SUNBURST TECHNOLOGY CORPORATION
(DELAWARE CORPORATION)
1550 EXECUTIVE DRIVE
ELGIN, IL 60123

FOR: CD-ROM-BASED COMPUTER SOFTWARE PROGRAMS FOR USE IN TEACHING KEYBOARD TECHNIQUES FOR THE COMPUTER, IN CLASS 9 (U.S. CLS. 21, 23, 26, 36 AND 38).

FIRST USE 6-0-1986; IN COMMERCE 6-0-1986.

FOR: PRINTED INSTRUCTIONAL, EDUCATIONAL, AND TEACHING MATERIALS FOR USE IN TEACHING KEYBOARDING TECHNIQUES FOR THE COMPUTER, IN CLASS 16 (U.S. CLS. 2, 5, 22, 23, 29, 37, 38 AND 50).

FIRST USE 6-0-1986; IN COMMERCE 6-0-1986.

THE MARK CONSISTS OF STANDARD CHARACTERS WITHOUT CLAIM TO ANY PARTICULAR FONT, STYLE, SIZE, OR COLOR.

NO CLAIM IS MADE TO THE EXCLUSIVE RIGHT TO USE "TYPE", APART FROM THE MARK AS SHOWN.

SER. NO. 77-431,731, FILED 3-26-2008.

MARIA-VICTORIA SUAREZ, EXAMINING ATTORNEY

Int. Cl.: 11

Prior U.S. Cls.: 13, 21, 23, 31 and 34

United States Patent and Trademark Office

Reg. No. 3,520,259

Registered Oct. 21, 2008

**TRADEMARK
PRINCIPAL REGISTER**

LBL LIGHTING

TECH LIGHTING, L.L.C. (DELAWARE LIMITED
LIABILITY COMPANY)

7400 LINDER AVENUE

SKOKIE, IL 60077

FOR: ELECTRIC LIGHTING FIXTURES, IN
CLASS 11 (U.S. CLS. 13, 21, 23, 31 AND 34).

FIRST USE 0-0-1991; IN COMMERCE 0-0-1991.

THE MARK CONSISTS OF STANDARD CHAR-
ACTERS WITHOUT CLAIM TO ANY PARTICULAR
FONT, STYLE, SIZE, OR COLOR.

NO CLAIM IS MADE TO THE EXCLUSIVE
RIGHT TO USE "LIGHTING", APART FROM THE
MARK AS SHOWN.

SER. NO. 77-431,733, FILED 3-26-2008.

H. M. FISHER, EXAMINING ATTORNEY

Int. Cl.: 3

Prior U.S. Cls.: 1, 4, 6, 50, 51 and 52

United States Patent and Trademark Office

Reg. No. 3,520,260

Registered Oct. 21, 2008

**TRADEMARK
PRINCIPAL REGISTER**

ELGYDIUM

PIERRE FABRE MEDICAMENT (FRANCE SOCI-
ETE ANONYME (SA))
45, PLACE ABEL GANCE
BOULOGNE, FRANCE 92100

FOR: MOUTHWASHES, IN CLASS 3 (U.S. CLS. 1, 4,
6, 50, 51 AND 52).

FIRST USE 1-0-1972; IN COMMERCE 1-4-2008.

THE MARK CONSISTS OF STANDARD CHAR-
ACTERS WITHOUT CLAIM TO ANY PARTICULAR
FONT, STYLE, SIZE, OR COLOR.

OWNER OF U.S. REG. NOS. 989,726 AND 1,186,812.

SER. NO. 77-431,738, FILED 3-26-2008.

LANA PHAM, EXAMINING ATTORNEY

Int. Cl.: 35

Prior U.S. Cls.: 100, 101 and 102

United States Patent and Trademark Office

Reg. No. 3,520,261

Registered Oct. 21, 2008

**SERVICE MARK
PRINCIPAL REGISTER**

STREETGAME

PPF SYRACUSE, INC. (NEW YORK CORPORATION)
339 SOUTH STREET SALINA STREET
SYRACUSE, NY 13202

FOR: RETAIL STORE SERVICES FEATURING
FOOTWEAR, SPORTSWEAR, SHIRTS, SWEAT-
SHIRTS, PANTS, SWEAT PANTS, JACKETS, HATS,
AND SOCKS, IN CLASS 35 (U.S. CLS. 100, 101 AND
102).

FIRST USE 7-1-2004; IN COMMERCE 7-1-2004.

THE MARK CONSISTS OF STANDARD CHAR-
ACTERS WITHOUT CLAIM TO ANY PARTICULAR
FONT, STYLE, SIZE, OR COLOR.

SER. NO. 77-431,746, FILED 3-26-2008.

CHARLES L. JENKINS, EXAMINING ATTORNEY

Int. Cl.: 40

Prior U.S. Cls.: 100, 103 and 106

United States Patent and Trademark Office

Reg. No. 3,520,262

Registered Oct. 21, 2008

**SERVICE MARK
PRINCIPAL REGISTER**

SmileSecret

BIO-CAM, LC (FLORIDA LIMITED LIABILITY
COMPANY)
SUITE 4
5651 CORPORATE WAY
WEST PALM BEACH, FL 33407

THE MARK CONSISTS OF STANDARD CHAR-
ACTERS WITHOUT CLAIM TO ANY PARTICULAR
FONT, STYLE, SIZE, OR COLOR.

FOR: CUSTOM MANUFACTURE OF DENTAL
PROSTHETICS, IN CLASS 40 (U.S. CLS. 100, 103 AND
106).

SER. NO. 77-431,748, FILED 3-26-2008.

FIRST USE 1-11-2008; IN COMMERCE 1-11-2008.

LANA PHAM, EXAMINING ATTORNEY

Int. Cl.: 37

Prior U.S. Cls.: 100, 103 and 106

United States Patent and Trademark Office

Reg. No. 3,520,263

Registered Oct. 21, 2008

**SERVICE MARK
PRINCIPAL REGISTER**



TENNESSEE NATIONAL, LLC (DELAWARE
LIMITED LIABILITY COMPANY)
12000 CORPORATE PARK DRIVE
LOUDEN, TN 37774

FOR: REAL ESTATE DEVELOPMENT, IN CLASS
37 (U.S. CLS. 100, 103 AND 106).

FIRST USE 3-2-2008; IN COMMERCE 3-2-2008.

THE COLOR(S) BLUE, GREEN AND WHITE IS/
ARE CLAIMED AS A FEATURE OF THE MARK.

THE MARK CONSISTS OF TWO STYLIZED DE-
PICTIONS OF GREEN MOUNTAINS AND A STY-
LIZED DEPICTION OF A BLUE RIVER RUNNING
UNDERNEATH AND WHITE IN THE SPACES
BETWEEN THE DEPICTIONS.

SER. NO. 77-431,784, FILED 3-26-2008.

LAURIE KAUFMAN, EXAMINING ATTORNEY

Int. Cl.: 37

Prior U.S. Cls.: 100, 103 and 106

United States Patent and Trademark Office

Reg. No. 3,520,264

Registered Oct. 21, 2008

**SERVICE MARK
PRINCIPAL REGISTER**



AROUND THE HOUSE HOME REPAIR (KANSAS
LIMITED LIABILITY COMPANY)
15105 S. BLACKFEATHER DRIVE
OLATHE, KS 66062

FOR: CARPENTRY; ELECTRICAL CONTRACT-
ING; PAINTING; REPAIR WORK ON BUILDINGS;
PLUMBING, IN CLASS 37 (U.S. CLS. 100, 103 AND
106).

FIRST USE 9-18-2003; IN COMMERCE 9-18-2003.

NO CLAIM IS MADE TO THE EXCLUSIVE
RIGHT TO USE "HOME REPAIR, LLC", APART
FROM THE MARK AS SHOWN.

THE STIPPLING IS FOR SHADING PURPOSES
ONLY.

THE MARK CONSISTS OF THE WORDS
"AROUND THE HOUSE" IN A CURVED FORMAT
ABOVE AN ART WORK OF A HANDYMAN. THE
WORD "HOME" APPEARS TO THE LEFT OF THE
ART WORK IN A STRAIGHT FORMAT. THE WORD
AND LETTERS "REPAIR, LLC" APPEAR TO THE
RIGHT OF THE ART WORK IN A STRAIGHT
FORMAT.

SER. NO. 77-431,790, FILED 3-26-2008.

BARBARA BROWN, EXAMINING ATTORNEY

Int. Cl.: 3

Prior U.S. Cls.: 1, 4, 6, 50, 51 and 52

United States Patent and Trademark Office

Reg. No. 3,520,265

Registered Oct. 21, 2008

**TRADEMARK
PRINCIPAL REGISTER**

BANSECT

SERGEANT'S PET CARE PRODUCTS, INC. (NE-
VADA CORPORATION)
2625 S 158TH PLAZA
OMAHA, NE 681301770

FOR: PET SHAMPOO, IN CLASS 3 (U.S. CLS. 1, 4, 6,
50, 51 AND 52).

FIRST USE 1-0-2005; IN COMMERCE 1-0-2005.

THE MARK CONSISTS OF STANDARD CHAR-
ACTERS WITHOUT CLAIM TO ANY PARTICULAR
FONT, STYLE, SIZE, OR COLOR.

OWNER OF U.S. REG. NO. 893,965.

SER. NO. 77-431,795, FILED 3-26-2008.

ARETHA SOMERVILLE, EXAMINING ATTORNEY

Int. Cl.: 11

Prior U.S. Cls.: 13, 21, 23, 31 and 34

United States Patent and Trademark Office

Reg. No. 3,520,266

Registered Oct. 21, 2008

**TRADEMARK
PRINCIPAL REGISTER**



TECH LIGHTING, L.L.C. (DELAWARE LIMITED
LIABILITY COMPANY)
7400 LINDER AVENUE
SKOKIE, IL 60077

FIRST USE 0-0-1987; IN COMMERCE 0-0-1987.

SER. NO. 77-431,812, FILED 3-26-2008.

FOR: ELECTRIC LIGHTING FIXTURES, IN
CLASS 11 (U.S. CLS. 13, 21, 23, 31 AND 34).

H. M. FISHER, EXAMINING ATTORNEY

Int. Cl.: 16

Prior U.S. Cls.: 2, 5, 22, 23, 29, 37, 38 and 50

United States Patent and Trademark Office

Reg. No. 3,520,267

Registered Oct. 21, 2008

**TRADEMARK
PRINCIPAL REGISTER**

Toughquip

TOUGHQUIP LLC (TEXAS LIMITED LIABILITY
COMPANY)
P.O. BOX 2405
257 CR 3110
JACKSONVILLE, TX 75766

THE MARK CONSISTS OF STANDARD CHAR-
ACTERS WITHOUT CLAIM TO ANY PARTICULAR
FONT, STYLE, SIZE, OR COLOR.

FOR: PRINTED GUIDES FOR BUYING CON-
STRUCTION EQUIPMENT, IN CLASS 16 (U.S. CLS.
2, 5, 22, 23, 29, 37, 38 AND 50).

SER. NO. 77-431,814, FILED 3-26-2008.

FIRST USE 1-22-2004; IN COMMERCE 6-5-2004.

REGINA DRUMMOND, EXAMINING ATTORNEY

Int. Cl.: 41

Prior U.S. Cls.: 100, 101 and 107

United States Patent and Trademark Office

Reg. No. 3,520,268

Registered Oct. 21, 2008

**SERVICE MARK
PRINCIPAL REGISTER**

CatDography

VAKALOPOULOS, NICK (UNITED STATES IN-
DIVIDUAL)

#44

183 MT. AUBURN STREET
WATERTOWN, MA 02472

FOR: PHOTOGRAPHY SERVICES, IN CLASS 41
(U.S. CLS. 100, 101 AND 107).

FIRST USE 8-4-2006; IN COMMERCE 5-1-2007.

THE MARK CONSISTS OF STANDARD CHAR-
ACTERS WITHOUT CLAIM TO ANY PARTICULAR
FONT, STYLE, SIZE, OR COLOR.

SER. NO. 77-431,818, FILED 3-26-2008.

REGINA DRUMMOND, EXAMINING ATTORNEY

Int. Cl.: 42

Prior U.S. Cls.: 100 and 101

United States Patent and Trademark Office

Reg. No. 3,520,269

Registered Oct. 21, 2008

**SERVICE MARK
PRINCIPAL REGISTER**

Cortell

CORTELL INTERNATIONAL CORP. (TEXAS
CORPORATION)
18015 ROCK BRANCH DRIVE
DALLAS, TX 75287

THE MARK CONSISTS OF STANDARD CHAR-
ACTERS WITHOUT CLAIM TO ANY PARTICULAR
FONT, STYLE, SIZE, OR COLOR.

FOR: COMPUTER SOFTWARE TECHNOLOGY
CONSULTING, IN CLASS 42 (U.S. CLS. 100 AND 101).

SER. NO. 77-431,823, FILED 3-26-2008.

FIRST USE 10-1-1996; IN COMMERCE 11-1-1996.

SUZANNE BLANE, EXAMINING ATTORNEY

Int. Cls.: 18 and 25

Prior U.S. Cls.: 1, 2, 3, 22, 39 and 41

Reg. No. 3,520,270

United States Patent and Trademark Office

Registered Oct. 21, 2008

**TRADEMARK
PRINCIPAL REGISTER**



GOLD, KEN (UNITED STATES INDIVIDUAL)
17 SHADOWLAWN DRIVE
LIVINGSTON, NJ 07039

FOR: BACKPACKS; TOTE BAGS, IN CLASS 18
(U.S. CLS. 1, 2, 3, 22 AND 41).

FIRST USE 4-30-2007; IN COMMERCE 4-30-2007.

FOR: T-SHIRTS; TANK TOPS; SWEAT SHORTS;
BOARD SHORTS; SHORTS; SKIRTS; DRESSES;
SKORTS; CAPRI PANTS; SHIRTS; PAJAMA BOT-

TOMS; PAJAMAS; UNDERWEAR, IN CLASS 25 (U.S.
CLS. 22 AND 39).

FIRST USE 4-30-2007; IN COMMERCE 4-30-2007.

THE MARK CONSISTS OF THE WORD MARK
"LIKEWEAR", WITH A CHARACTERIZED VER-
SION OF THE LETTER "I" AND AN OVAL
AROUND THE ENTIRE WORD.

SER. NO. 77-431,858, FILED 3-26-2008.

JULIE VEPPUMTHARA, EXAMINING ATTORNEY

Int. Cls.: 18 and 25

Prior U.S. Cls.: 1, 2, 3, 22, 39 and 41

United States Patent and Trademark Office

Reg. No. 3,520,271

Registered Oct. 21, 2008

**TRADEMARK
PRINCIPAL REGISTER**

WEAR WHAT YOU LIKE

GOLD, KEN (UNITED STATES INDIVIDUAL)
17 SHADOWLAWN DRIVE
LIVINGSTON, NJ 07039

FOR: BACKPACKS; TOTE BAGS, IN CLASS 18
(U.S. CLS. 1, 2, 3, 22 AND 41).

FIRST USE 4-30-2007; IN COMMERCE 4-30-2007.

FOR: T-SHIRTS; TANK TOPS; SWEAT SHORTS;
BOARD SHORTS; SHORTS; SKIRTS; DRESSES;
SKORTS; CAPRI PANTS; SHIRTS; PAJAMA BOT-

TOMS; PAJAMAS; UNDERWEAR, IN CLASS 25 (U.S.
CLS. 22 AND 39).

FIRST USE 4-30-2007; IN COMMERCE 4-30-2007.

THE MARK CONSISTS OF STANDARD CHAR-
ACTERS WITHOUT CLAIM TO ANY PARTICULAR
FONT, STYLE, SIZE, OR COLOR.

SER. NO. 77-431,879, FILED 3-26-2008.

JULIE VEPPUMTHARA, EXAMINING ATTORNEY

Int. Cl.: 41

Prior U.S. Cls.: 100, 101 and 107

United States Patent and Trademark Office

Reg. No. 3,520,272

Registered Oct. 21, 2008

**SERVICE MARK
PRINCIPAL REGISTER**

iCitizen

RESOURCE VENTURES, LTD. (OHIO LIMITED
LIABILITY COMPANY)
343 NORTH FRONT STREET
COLUMBUS, OH 43215

FOR: EDUCATIONAL SERVICES, NAMELY,
CONDUCTING SEMINARS, WORKSHOPS, AND
SYMPOSIUMS IN THE FIELD OF CONSUMER
RESEARCH AND MARKETING AND DISTRIBUTION
OF COURSE MATERIAL IN CONNECTION
THEREWITH, IN CLASS 41 (U.S. CLS. 100, 101 AND
107).

FIRST USE 5-5-2006; IN COMMERCE 5-5-2006.

THE MARK CONSISTS OF STANDARD CHAR-
ACTERS WITHOUT CLAIM TO ANY PARTICULAR
FONT, STYLE, SIZE, OR COLOR.

SER. NO. 77-431,923, FILED 3-26-2008.

SUZANNE BLANE, EXAMINING ATTORNEY

Int. Cl.: 35

Prior U.S. Cls.: 100, 101 and 102

United States Patent and Trademark Office

Reg. No. 3,520,273

Registered Oct. 21, 2008

**SERVICE MARK
PRINCIPAL REGISTER**



QNICOM INC. (NEW YORK CORPORATION)
225 DUPONT STREET
PLAINVIEW, NY 11803

FOR: RETAIL STORE SERVICES FEATURING WIRELESS SERVICE PLANS AND WIRELESS SERVICE ACTIVATION; RETAIL AND WHOLESALE STORE SERVICES FEATURING CELL PHONES, CELL PHONE ACCESSORIES AND PROMOTIONAL ITEMS, IN CLASS 35 (U.S. CLS. 100, 101 AND 102).

FIRST USE 12-21-2007; IN COMMERCE 1-0-2008.

THE COLOR(S) RED AND WHITE IS/ARE CLAIMED AS A FEATURE OF THE MARK.

THE COLOR RED APPEARS IN THE CIRCULAR DESIGN, WHITE APPEARS FOR THE FILL COLOR OF THE CIRCULAR DESIGN ELEMENTS AND BACKGROUND COLOR.

SER. NO. 77-431,936, FILED 3-26-2008.

ANTHONY RINKER, EXAMINING ATTORNEY

Int. Cl.: 9

Prior U.S. Cls.: 21, 23, 26, 36 and 38

Reg. No. 3,520,274

United States Patent and Trademark Office

Registered Oct. 21, 2008

TRADEMARK
PRINCIPAL REGISTER

EPSON

SEIKO EPSON KABUSHIKI KAISHA ATA SEIKO
EPSON CORPORATION (JAPAN CORPORATION)
4-1, NISHI-SHINJUKU 2-CHOME
SHINJUKU-KU, TOKYO, JAPAN

FOR: LIQUID CRYSTAL DISPLAYS; COMPACT
LIQUID CRYSTAL DISPLAYS; EYEGASSES; LENSES
FOR EYEGASSES; EYEGASS FRAMES; CONTACT
LENSES; RARE-EARTH MAGNETS; INTEGRATED
CIRCUITS; LARGE SCALE INTEGRATED
CIRCUITS; SEMICONDUCTOR MEMORIES;
DIODES; CRYSTAL OSCILLATORS; CRYSTAL
OSCILLATOR DEVICES, NAMELY, CRYSTAL
UNITS COMPRISING CRYSTAL CHIPS AND
CRYSTAL OSCILLATOR CIRCUITS, ALL FOR
USE IN ELECTRONICS PRODUCTS SUCH AS
CELLULAR TELEPHONES, COMPUTERS AND
GLOBAL POSI-

TIONING DEVICES, IN CLASS 9 (U.S. CLS. 21, 23, 26,
36 AND 38).

FIRST USE 6-30-1975; IN COMMERCE 3-31-1988.

THE MARK CONSISTS OF STANDARD CHARACTERS
WITHOUT CLAIM TO ANY PARTICULAR FONT,
STYLE, SIZE, OR COLOR.

OWNER OF U.S. REG. NOS. 3,092,025 AND
3,385,501.

SER. NO. 77-431,947, FILED 3-26-2008.

NORA BUCHANAN WILL, EXAMINING ATTORNEY

Int. Cl.: 35

Prior U.S. Cls.: 100, 101 and 102

United States Patent and Trademark Office

Reg. No. 3,520,275

Registered Oct. 21, 2008

**SERVICE MARK
PRINCIPAL REGISTER**



QNICOM INC. (NEW YORK CORPORATION)
225 DUPONT STREET
PLAINVIEW, NY 11803

FOR: RETAIL STORE SERVICES FEATURING WIRELESS SERVICE PLANS AND WIRELESS SERVICE ACTIVATION; RETAIL AND WHOLESALE STORE SERVICES FEATURING CELL PHONES, CELL PHONE ACCESSORIES AND PROMOTIONAL ITEMS, IN CLASS 35 (U.S. CLS. 100, 101 AND 102).

FIRST USE 12-21-2007; IN COMMERCE 1-0-2008.

THE COLOR(S) RED, WHITE AND BLACK IS/ ARE CLAIMED AS A FEATURE OF THE MARK.

THE COLOR BLACK APPEARS AS THE LETTERING QNICOM, RED APPEARS IN THE CIRCULAR DESIGN AND THE DOT OVER THE LETTER I, WHITE APPEARS FOR THE FILL COLOR OF THE CIRCULAR DESIGN ELEMENTS AND BACKGROUND COLOR.

SER. NO. 77-431,949, FILED 3-26-2008.

ANTHONY RINKER, EXAMINING ATTORNEY

Int. Cl.: 35

Prior U.S. Cls.: 100, 101 and 102

United States Patent and Trademark Office

Reg. No. 3,520,276

Registered Oct. 21, 2008

**SERVICE MARK
PRINCIPAL REGISTER**

QNICOM

QNICOM INC. (NEW YORK CORPORATION)
225 DUPONT STREET
PLAINVIEW, NY 11803

FOR: RETAIL STORE SERVICES FEATURING WIRELESS SERVICE PLANS AND WIRELESS SERVICE ACTIVATION; RETAIL AND WHOLESALE STORE SERVICES FEATURING CELL PHONES, CELL PHONE ACCESSORIES AND PROMOTIONAL ITEMS, IN CLASS 35 (U.S. CLS. 100, 101 AND 102).

FIRST USE 12-21-2007; IN COMMERCE 1-0-2008.

THE MARK CONSISTS OF STANDARD CHARACTERS WITHOUT CLAIM TO ANY PARTICULAR FONT, STYLE, SIZE, OR COLOR.

SER. NO. 77-431,955, FILED 3-26-2008.

ANTHONY RINKER, EXAMINING ATTORNEY

Int. Cl.: 36

Prior U.S. Cls.: 100, 101 and 102

United States Patent and Trademark Office

Reg. No. 3,520,277

Registered Oct. 21, 2008

**SERVICE MARK
PRINCIPAL REGISTER**



**A P A R T M E N T
B R O K E R A G E T E A M**

APARTMENT BROKERAGE TEAM, LLC (OKLAHOMA LIMITED LIABILITY COMPANY)
1502 NORTH WASHINGTON
STILLWATER, OK 74075

FOR: APARTMENT AND COMMERCIAL REAL ESTATE BROKERAGE SERVICES, IN CLASS 36 (U.S. CLS. 100, 101 AND 102).

FIRST USE 11-27-2007; IN COMMERCE 11-27-2007.

NO CLAIM IS MADE TO THE EXCLUSIVE RIGHT TO USE "APARTMENT BROKERAGE TEAM", APART FROM THE MARK AS SHOWN.

THE MARK CONSISTS OF CONCENTRIC CIRCLES WITH A CHEVRON MARK IN THE CENTER OF THE CIRCLES USED WITH THE WORDS APARTMENT BROKERAGE TEAM IN BLOCK LETTERS.

SER. NO. 77-431,973, FILED 3-26-2008.

ESTHER BELENKER, EXAMINING ATTORNEY

Int. Cl.: 35

Prior U.S. Cls.: 100, 101 and 102

United States Patent and Trademark Office

Reg. No. 3,520,278

Registered Oct. 21, 2008

**SERVICE MARK
PRINCIPAL REGISTER**

PDX

PARTS DISTRIBUTION XPRESS INC. (PENNSYLVANIA CORPORATION)
P.O. BOX 329
ESSINGTON, PA 19029

THE MARK CONSISTS OF STANDARD CHARACTERS WITHOUT CLAIM TO ANY PARTICULAR FONT, STYLE, SIZE, OR COLOR.

FOR: TRANSPORTATION LOGISTICS SERVICES, NAMELY, PROVIDING DRIVERS FOR COMPANIES IN THE AUTOMOBILE INDUSTRY, IN CLASS 35 (U.S. CLS. 100, 101 AND 102).

SER. NO. 77-431,981, FILED 3-26-2008.

FIRST USE 0-0-1998; IN COMMERCE 0-0-1998.

ROBIN CHOSID, EXAMINING ATTORNEY

Int. Cl.: 21

Prior U.S. Cls.: 2, 13, 23, 29, 30, 33, 40 and 50

United States Patent and Trademark Office

Reg. No. 3,520,279

Registered Oct. 21, 2008

**TRADEMARK
PRINCIPAL REGISTER**



ZEROEDGE AQUARIUM CORPORATION (ILLINOIS CORPORATION), DBA A SPLASH OF LIFE, INC.
43W484 BURLINGTON RD.
ELGIN, IL 60124

THE MARK CONSISTS OF THE TERM "ZEROEDGE" WHEREIN THE "O" CONTAINS A STYLIZED WAVE.

FOR: AQUARIUMS, IN CLASS 21 (U.S. CLS. 2, 13, 23, 29, 30, 33, 40 AND 50).

SER. NO. 77-431,989, FILED 3-26-2008.

FIRST USE 3-1-2007; IN COMMERCE 3-1-2007.

OWNER OF U.S. REG. NO. 3,257,312.

KARANENDRA S. CHHINA, EXAMINING ATTORNEY

Int. Cl.: 35

Prior U.S. Cls.: 100, 101 and 102

United States Patent and Trademark Office

Reg. No. 3,520,280

Registered Oct. 21, 2008

**SERVICE MARK
PRINCIPAL REGISTER**



GENOCIDE INTERVENTION

— NETWORK —

Have a hand in stopping genocide

GENOCIDE INTERVENTION NETWORK (DELAWARE NON-PROFIT ORGANIZATION)
1333 H STREET NW, FIRST FLOOR
WASHINGTON, DC 20005

FOR: CHARITABLE SERVICES, NAMELY, PROMOTING PUBLIC AWARENESS OF GENOCIDE, DEVELOPING AND COORDINATING VOLUNTEER PROJECTS; ORGANIZING ADVOCATE GROUPS TO UNDERTAKE CHARITABLE PROJECTS IN THE FIELD OF GENOCIDE INTERVENTION; PUBLIC ADVOCACY TO PROMOTE THE AWARENESS AND PREVENTION OF GENOCIDE, IN CLASS 35 (U.S. CLS. 100, 101 AND 102).

FIRST USE 11-0-2004; IN COMMERCE 11-0-2004.

NO CLAIM IS MADE TO THE EXCLUSIVE RIGHT TO USE "GENOCIDE INTERVENTION NETWORK", APART FROM THE MARK AS SHOWN.

THE MARK CONSISTS OF AN OUTFACED HAND IN A CIRCLE NEXT TO THE WORDS GENOCIDE INTERVENTION OVER THE WORD NETWORK WITH LINES ON BOTH SIDES OF THE WORD, OVER THE WORDS HAVE A HAND IN STOPPING GENOCIDE.

SER. NO. 77-432,005, FILED 3-26-2008.

EUGENIA MARTIN, EXAMINING ATTORNEY

Int. Cl.: 35

Prior U.S. Cls.: 100, 101 and 102

United States Patent and Trademark Office

Reg. No. 3,520,281

Registered Oct. 21, 2008

**SERVICE MARK
PRINCIPAL REGISTER**



GENOCIDE INTERVENTION NETWORK (DELA-
WARE NON-PROFIT ORGANIZATION)
1333 H STREET NW, FIRST FLOOR
WASHINGTON, DC 20005

FOR: CHARITABLE SERVICES, NAMELY, PRO-
MOTING PUBLIC AWARENESS OF GENOCIDE,
DEVELOPING AND COORDINATING VOLUN-
TEER PROJECTS; ORGANIZING ADVOCATE
GROUPS TO UNDERTAKE CHARITABLE PRO-
JECTS IN THE FIELD OF GENOCIDE INTERVEN-
TION; PUBLIC ADVOCACY TO PROMOTE THE
AWARENESS AND PREVENTION OF GENOCIDE,
IN CLASS 35 (U.S. CLS. 100, 101 AND 102).

FIRST USE 8-0-2006; IN COMMERCE 8-0-2006.

NO CLAIM IS MADE TO THE EXCLUSIVE
RIGHT TO USE "A STUDENT ANTI-GENOCIDE
COALITION", APART FROM THE MARK AS
SHOWN.

THE MARK CONSISTS OF THE OUTLINES OF
FOUR PEOPLE STANDING IN FRONT OF THE
EARTH WITH THE WORD "STAND" NEXT TO THE
IMAGE AND OVER THE WORDS "A STUDENT
ANTI-GENOCIDE COALITION".

SER. NO. 77-432,015, FILED 3-26-2008.

EUGENIA MARTIN, EXAMINING ATTORNEY

Int. Cl.: 25

Prior U.S. Cls.: 22 and 39

United States Patent and Trademark Office

Reg. No. 3,520,282

Registered Oct. 21, 2008

**TRADEMARK
PRINCIPAL REGISTER**

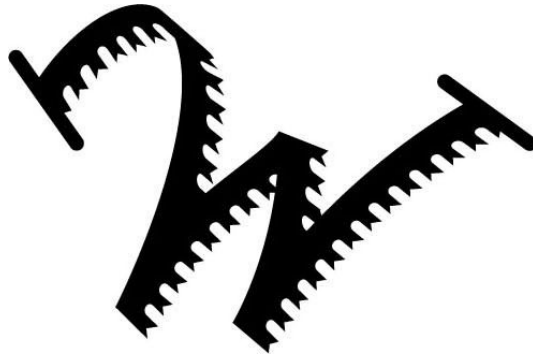

GENEVA CUBS BASEBALL, INC (NEW YORK CORPORATION)
1700 W. FOURTH ST.
WILLIAMSPORT, PA 17701

FOR: CLOTHING, NAMELY, APRONS, ATHLETIC UNIFORMS, BANDANAS, BOXER SHORTS, CAPS, CLOTH BABY BIBS, COATS, GOLF SHIRTS, GYM SHORTS, GYM SUITS, HATS, JACKETS, JERSEYS, KNIT SHIRTS, POLO SHIRTS, PONCHOS, PULLOVERS, RAIN COATS, RAINWEAR, SWEATERS, SWEAT PANTS, SWEAT SHIRTS, SWEAT SUITS, SOCKS, SPORT SHIRTS, T- SHIRTS, TANK TOPS, TIES, VISORS, WIND RESISTANT JACKETS

AND WRISTBANDS, IN CLASS 25 (U.S. CLS. 22 AND 39).

FIRST USE 1-17-2008; IN COMMERCE 1-17-2008.

OWNER OF U.S. REG. NO. 3,264,322.

THE MARK CONSISTS OF A STYLIZED "W" TO LOOK LIKE SAW BLADES.

SER. NO. 77-432,031, FILED 3-26-2008.

REGINA DRUMMOND, EXAMINING ATTORNEY

Int. Cl.: 45

Prior U.S. Cls.: 100 and 101

United States Patent and Trademark Office

Reg. No. 3,520,283

Registered Oct. 21, 2008

**SERVICE MARK
PRINCIPAL REGISTER**

CMLS

CENTRAL MINNESOTA LEGAL SERVICES, INC.
(MINNESOTA CORPORATION)
SUITE 359
430 FIRST AVENUE NORTH
MINNEAPOLIS, MN 55401

THE MARK CONSISTS OF STANDARD CHAR-
ACTERS WITHOUT CLAIM TO ANY PARTICULAR
FONT, STYLE, SIZE, OR COLOR.

FOR: LEGAL SERVICES, IN CLASS 45 (U.S. CLS.
100 AND 101).

SER. NO. 77-432,033, FILED 3-26-2008.

FIRST USE 12-31-1977; IN COMMERCE 12-31-1978.

CHARLES L. JENKINS, EXAMINING ATTORNEY

Int. Cl.: 35

Prior U.S. Cls.: 100, 101 and 102

United States Patent and Trademark Office

Reg. No. 3,520,284

Registered Oct. 21, 2008

**SERVICE MARK
PRINCIPAL REGISTER**



PARTS DISTRIBUTION XPRESS INC. (PENNSYLVANIA CORPORATION)
P.O. BOX 329
ESSINGTON, PA 19029

FOR: TRANSPORTATION LOGISTICS SERVICES, NAMELY, PROVIDING DRIVERS FOR COMPANIES IN THE AUTOMOBILE INDUSTRY, IN CLASS 35 (U.S. CLS. 100, 101 AND 102).

FIRST USE 3-0-2002; IN COMMERCE 3-0-2002.

THE MARK CONSISTS OF LETTERS "PDX" WITH ARCHING ARROW.

SER. NO. 77-432,037, FILED 3-26-2008.

ROBIN CHOSID, EXAMINING ATTORNEY

Int. Cl.: 35

Prior U.S. Cls.: 100, 101 and 102

United States Patent and Trademark Office

Reg. No. 3,520,285

Registered Oct. 21, 2008

**SERVICE MARK
PRINCIPAL REGISTER**

You Got It!

EZ OFFICE PRODUCTS, L.L.C. (WISCONSIN
LIMITED LIABILITY COMPANY)
802 WALSH ROAD
MADISON, WI 53714

THE MARK CONSISTS OF STANDARD CHAR-
ACTERS WITHOUT CLAIM TO ANY PARTICULAR
FONT, STYLE, SIZE, OR COLOR.

FOR: RETAIL STORE SERVICES IN THE FIELD
OF OFFICE SUPPLIES, STATIONERY, OFFICE
EQUIPMENT, AND RELATED OFFICE ACCESSOR-
IES, IN CLASS 35 (U.S. CLS. 100, 101 AND 102).

SER. NO. 77-432,056, FILED 3-26-2008.

FIRST USE 1-1-2006; IN COMMERCE 1-1-2006.

BARBARA GAYNOR, EXAMINING ATTORNEY

Int. Cl.: 32

Prior U.S. Cls.: 45, 46 and 48

United States Patent and Trademark Office

Reg. No. 3,520,286

Registered Oct. 21, 2008

**TRADEMARK
PRINCIPAL REGISTER**

THIRSTY DOG BREWING COMPANY

THIRSTY DOG BREWING COMPANY (OHIO
CORPORATION)
SUITE B
529 GRANT ST.
AKRON, OH 44311

FOR: MALT LIQUOR, IN CLASS 32 (U.S. CLS. 45,
46 AND 48).

FIRST USE 2-4-1997; IN COMMERCE 2-4-1997.

THE MARK CONSISTS OF STANDARD CHAR-
ACTERS WITHOUT CLAIM TO ANY PARTICULAR
FONT, STYLE, SIZE, OR COLOR.

OWNER OF U.S. REG. NOS. 2,182,857 AND
2,186,602.

NO CLAIM IS MADE TO THE EXCLUSIVE
RIGHT TO USE "BREWING COMPANY", APART
FROM THE MARK AS SHOWN.

SER. NO. 77-432,069, FILED 3-26-2008.

BARNEY CHARLON, EXAMINING ATTORNEY

Int. Cl.: 3

Prior U.S. Cls.: 1, 4, 6, 50, 51 and 52

United States Patent and Trademark Office

Reg. No. 3,520,287

Registered Oct. 21, 2008

**TRADEMARK
PRINCIPAL REGISTER**

SKINBIOTICS

STEARN'S PRODUCTS, INC. (CALIFORNIA
CORPORATION)
4485 RUNWAY STREET
SIMI VALLEY, CA 93063

THE MARK CONSISTS OF STANDARD CHAR-
ACTERS WITHOUT CLAIM TO ANY PARTICULAR
FONT, STYLE, SIZE, OR COLOR.

FOR: SKIN CREAM, IN CLASS 3 (U.S. CLS. 1, 4, 6,
50, 51 AND 52).

SER. NO. 77-432,114, FILED 3-26-2008.

FIRST USE 3-11-2008; IN COMMERCE 3-11-2008.

JERI J. FICKES, EXAMINING ATTORNEY

Int. Cls.: 35 and 45

Prior U.S. Cls.: 100, 101 and 102

United States Patent and Trademark Office

Reg. No. 3,520,288

Registered Oct. 21, 2008

**SERVICE MARK
PRINCIPAL REGISTER**

**GOVERNORS HIGHWAY SAFETY
ASSOCIATION**

GOVERNORS HIGHWAY SAFETY ASSOCIATION (D.C. NON-PROFIT CORPORATION)

SUITE 720

750 FIRST STREET, NE

WASHINGTON, DC 20002

FOR: PROMOTING PUBLIC AWARENESS OF HIGHWAY AND TRAFFIC SAFETY ISSUES; PUBLIC ADVOCACY TO PROMOTE AWARENESS OF HIGHWAY AND TRAFFIC SAFETY ISSUES; LOBBYING SERVICES, NAMELY, PROMOTING THE INTERESTS OF STATE AND TERRITORIAL HIGHWAY SAFETY OFFICES IN THE FIELDS OF LEGISLATION AND REGULATION, IN CLASS 35 (U.S. CLS. 100, 101 AND 102).

FIRST USE 9-22-2002; IN COMMERCE 9-22-2002.

FOR: PROVIDING INFORMATION IN THE FIELD OF HIGHWAY AND TRAFFIC SAFETY, IN CLASS 45 (U.S. CLS. 100 AND 101).

FIRST USE 9-22-2002; IN COMMERCE 9-22-2002.

THE MARK CONSISTS OF STANDARD CHARACTERS WITHOUT CLAIM TO ANY PARTICULAR FONT, STYLE, SIZE, OR COLOR.

NO CLAIM IS MADE TO THE EXCLUSIVE RIGHT TO USE "ASSOCIATION", APART FROM THE MARK AS SHOWN.

SEC. 2(F).

SER. NO. 77-432,146, FILED 3-26-2008.

MICHAEL TANNER, EXAMINING ATTORNEY

Int. Cl.: 35

Prior U.S. Cls.: 100, 101 and 102

United States Patent and Trademark Office

Reg. No. 3,520,289

Registered Oct. 21, 2008

SERVICE MARK
PRINCIPAL REGISTER



TEVA PHARMACEUTICALS USA, INC. (DELA-
WARE CORPORATION)
1090 HORSHAM ROAD
NORTH WALES, PA 19454

FOR: ADMINISTERING PHARMACY REIMBUR-
SEMENT PROGRAMS AND SERVICES; ADMINIS-
TRATION OF PATIENT REIMBURSEMENT
PROGRAMS; MEDICAL BILLING SUPPORT SER-
VICES; PROVIDING OFFICE SUPPORT STAFF SER-
VICES, IN CLASS 35 (U.S. CLS. 100, 101 AND 102).

FIRST USE 4-28-2008; IN COMMERCE 4-28-2008.

OWNER OF U.S. REG. NO. 2,962,577.

THE MARK CONSISTS OF THE WORDS
"GROWTH SOLUTIONS" IN FANCIFUL SCRIPT
WITH A FLOWER ATTACHED TO THE "L" IN
THE WORD "SOLUTIONS" THAT STANDS FOR
THE "O" IN THE WORD "GROWTH".

SER. NO. 77-432,151, FILED 3-26-2008.

SUNG IN, EXAMINING ATTORNEY

Int. Cl.: 10

Prior U.S. Cls.: 26, 39 and 44

United States Patent and Trademark Office

Reg. No. 3,520,290

Registered Oct. 21, 2008

**TRADEMARK
PRINCIPAL REGISTER**

AQUATEC

INVACARE AQUATEC GMBH (FED REP GER-
MANY LIMITED LIABILITY COMPANY)
ALEMANNENSTRASSE 10
ISNY, FED REP GERMANY

FOR: INVALID LIFTS, IN CLASS 10 (U.S. CLS. 26,
39 AND 44).

FIRST USE 5-12-1987; IN COMMERCE 5-12-1987.

THE MARK CONSISTS OF STANDARD CHAR-
ACTERS WITHOUT CLAIM TO ANY PARTICULAR
FONT, STYLE, SIZE, OR COLOR.

OWNER OF U.S. REG. NO. 1,477,529.

SER. NO. 77-432,157, FILED 3-26-2008.

MICHAEL TANNER, EXAMINING ATTORNEY

Int. Cl.: 35

Prior U.S. Cls.: 100, 101 and 102

United States Patent and Trademark Office

Reg. No. 3,520,291

Registered Oct. 21, 2008

**SERVICE MARK
PRINCIPAL REGISTER**

RELAX. REFRESH. ENJOY.

MULTIPLEX PROPERTIES, INC. (DELAWARE
CORPORATION)
SUITE 1704
300 DELAWARE AVENUE
WILMINGTON, DE 19803

THE MARK CONSISTS OF STANDARD CHAR-
ACTERS WITHOUT CLAIM TO ANY PARTICULAR
FONT, STYLE, SIZE, OR COLOR.

FOR: CONCESSION STANDS FEATURING FOOD
AND DRINK, IN CLASS 35 (U.S. CLS. 100, 101 AND
102).

SER. NO. 77-432,158, FILED 3-26-2008.

FIRST USE 10-17-2007; IN COMMERCE 10-17-2007.

ARETHA SOMERVILLE, EXAMINING ATTORNEY

Int. Cl.: 35

Prior U.S. Cls.: 100, 101 and 102

United States Patent and Trademark Office

Reg. No. 3,520,292

Registered Oct. 21, 2008

SERVICE MARK
PRINCIPAL REGISTER



TEVA PHARMACEUTICALS USA, INC. (DELAWARE CORPORATION)
1090 HORSHAM ROAD
NORTH WALES, PA 19454

FOR: ADMINISTERING PHARMACY REIMBURSEMENT PROGRAMS AND SERVICES; ADMINISTRATION OF PATIENT REIMBURSEMENT PROGRAMS; MEDICAL BILLING SUPPORT SERVICES; PROVIDING OFFICE SUPPORT STAFF SERVICES, IN CLASS 35 (U.S. CLS. 100, 101 AND 102).

FIRST USE 4-28-2008; IN COMMERCE 4-28-2008.

OWNER OF U.S. REG. NO. 2,962,577.

THE COLOR(S) RED AND BLUE IS/ARE CLAIMED AS A FEATURE OF THE MARK.

THE MARK CONSISTS OF THE WORDS "GROWTH SOLUTIONS" IN FANCIFUL SCRIPT WITH A FLOWER ATTACHED TO THE "L" IN THE WORD "SOLUTIONS" THAT FORMS THE "O" IN THE WORD "GROWTH". THE WORD "GROWTH", ALONG WITH THE OUTSIDE OF THE FLOWER DESIGN, APPEARS IN RED AND THE WORD "SOLUTIONS", ALONG WITH THE INSIDE OF THE FLOWER DESIGN, APPEARS IN BLUE. THE CURVED LINE UNDERNEATH THE TERMS APPEARS IN RED.

SER. NO. 77-432,160, FILED 3-26-2008.

SUNG IN, EXAMINING ATTORNEY

Int. Cl.: 41

Prior U.S. Cls.: 100, 101 and 107

United States Patent and Trademark Office

Reg. No. 3,520,293

Registered Oct. 21, 2008

**SERVICE MARK
PRINCIPAL REGISTER**

FINAL WORD

BLOOMBERG L.P. (DELAWARE LIMITED PART-
NERSHIP)
731 LEXINGTON AVENUE
NEW YORK, NY 10021

FOR: ENTERTAINMENT SERVICES IN THE NATURE OF PROGRAMMING DISTRIBUTED OVER BROADCAST, TELEVISION, RADIO, CABLE AND DIRECT SATELLITE IN THE FIELDS OF NEWS, BUSINESS, FINANCE, CURRENT EVENTS, SECURITIES AND ENERGY MARKETS AND INDUSTRIES; ENTERTAINMENT SERVICES IN THE NATURE OF PRODUCING AND DISTRIBUTING PROGRAMMING DISTRIBUTED OVER BROADCAST, TELEVISION, RADIO, CABLE AND DIRECT SATELLITES IN THE FIELDS OF NEWS, BUSINESS,

FINANCE, CURRENT EVENTS, SECURITIES, SECURITIES MARKETS, IN CLASS 41 (U.S. CLS. 100, 101 AND 107).

FIRST USE 3-19-2007; IN COMMERCE 3-19-2007.

THE MARK CONSISTS OF STANDARD CHARACTERS WITHOUT CLAIM TO ANY PARTICULAR FONT, STYLE, SIZE, OR COLOR.

SER. NO. 77-432,169, FILED 3-26-2008.

DOMINIC J. FERRAIUOLO, EXAMINING ATTORNEY

Int. Cl.: 38

Prior U.S. Cls.: 100, 101 and 104

United States Patent and Trademark Office

Reg. No. 3,520,294

Registered Oct. 21, 2008

**SERVICE MARK
PRINCIPAL REGISTER**

WFAV

THE TRUSTEES OF TRUST B OF THE LORIN E.
MILNER REVOCABLE TRUST (ILLINOIS
TRUST)
SUITE 2301
1560 SANDBURG TERRACE
CHICAGO, IL 60610

FOR: RADIO BROADCASTING, IN CLASS 38 (U.S.
CLS. 100, 101 AND 104).

FIRST USE 10-1-2007; IN COMMERCE 10-1-2007.

THE MARK CONSISTS OF STANDARD CHAR-
ACTERS WITHOUT CLAIM TO ANY PARTICULAR
FONT, STYLE, SIZE, OR COLOR.

SER. NO. 77-432,178, FILED 3-26-2008.

COLLEEN KEARNEY, EXAMINING ATTORNEY

Int. Cl.: 35

Prior U.S. Cls.: 100, 101 and 102

United States Patent and Trademark Office

Reg. No. 3,520,295

Registered Oct. 21, 2008

**SERVICE MARK
PRINCIPAL REGISTER**

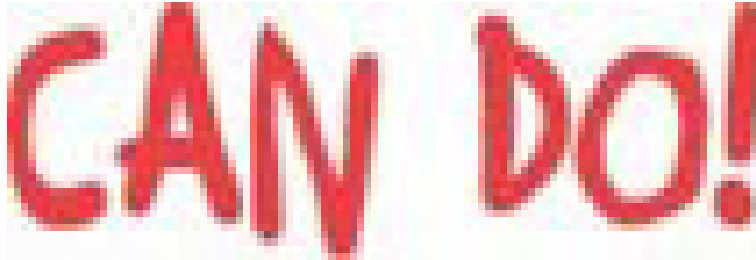

TEVA PHARMACEUTICALS USA, INC. (DELA-
WARE CORPORATION)
1090 HORSHAM ROAD
NORTH WALES, PA 19454

FOR: ADMINISTRATION OF PATIENT REIM-
BURSEMENT PROGRAMS; ADMINISTERING
PHARMACY REIMBURSEMENT PROGRAMS
AND SERVICES; MEDICAL BILLING SUPPORT
SERVICES; PROVIDING OFFICE SUPPORT STAFF
SERVICES, IN CLASS 35 (U.S. CLS. 100, 101 AND 102).

FIRST USE 4-28-2008; IN COMMERCE 4-28-2008.

THE COLOR(S) RED IS/ARE CLAIMED AS A
FEATURE OF THE MARK.

THE MARK CONSISTS OF THE WORDS "CAN
DO" IN A FANCIFUL FONT WITH AN EXCLAMA-
TION POINT IN RED.

SER. NO. 77-432,180, FILED 3-26-2008.

SUNG IN, EXAMINING ATTORNEY

Int. Cl.: 35

Prior U.S. Cls.: 100, 101 and 102

United States Patent and Trademark Office

Reg. No. 3,520,296

Registered Oct. 21, 2008

**SERVICE MARK
PRINCIPAL REGISTER**

CAN DO!

TEVA PHARMACEUTICALS USA, INC. (DELA-
WARE CORPORATION)
1090 HORSHAM ROAD
NORTH WALES, DE 19454

FOR: ADMINISTRATION OF PATIENT REIM-
BURSEMENT PROGRAMS; ADMINISTERING
PHARMACY REIMBURSEMENT PROGRAMS
AND SERVICES; MEDICAL BILLING SUPPORT
SERVICES; PROVIDING OFFICE SUPPORT STAFF
SERVICES, IN CLASS 35 (U.S. CLS. 100, 101 AND 102).

FIRST USE 4-28-2008; IN COMMERCE 4-28-2008.

THE MARK CONSISTS OF STANDARD CHAR-
ACTERS WITHOUT CLAIM TO ANY PARTICULAR
FONT, STYLE, SIZE, OR COLOR.

SER. NO. 77-432,187, FILED 3-26-2008.

SUNG IN, EXAMINING ATTORNEY

Int. Cls.: 35, 41 and 45

Prior U.S. Cls.: 100, 101, 102 and 107

United States Patent and Trademark Office

Reg. No. 3,520,297

Registered Oct. 21, 2008

**SERVICE MARK
PRINCIPAL REGISTER**

My Event Guru

CORPORATE NETWORKING COLLABORATIVE,
INC (NEVADA CORPORATION), DBA MY
EVENT GURU

P.O. BOX 960732
BOSTON, MA 02196

FOR: PROVIDING MARKETING AND PROMOTION OF SPECIAL EVENTS; PROVIDING ON-LINE REGISTRATION SERVICES FOR EVENTS; ADVERTISING AND BUSINESS SERVICES, NAMELY, SECURING AIRTIME ON ALL FORMS OF MEDIA COMMUNICATIONS STATIONS, SYSTEMS, NETWORKS, AND SERVICES FOR THE PURPOSE OF PROMOTING THE GOODS AND SERVICES OF OTHERS; BUSINESS NETWORKING; ONLINE BUSINESS NETWORKING SERVICES; DISSEMINATION OF ADVERTISING, SCHEDULING AND MANAGING OF TRAINING COURSES AND PROGRAMS FOR OTHERS VIA A GLOBAL COMPUTER NETWORK, IN CLASS 35 (U.S. CLS. 100, 101 AND 102).

FIRST USE 2-1-2007; IN COMMERCE 2-1-2007.

FOR: PROVIDING A WEB SITE WHERE USERS CAN POST RATINGS, REVIEWS AND RECOMMENDATIONS ON EVENTS AND ACTIVITIES IN THE FIELD OF ENTERTAINMENT AND EDUCATION, IN CLASS 41 (U.S. CLS. 100, 101 AND 107).

FIRST USE 2-1-2007; IN COMMERCE 2-1-2007.

FOR: PROVIDING AN INTERACTIVE WEB SITE FOR PERSONS TO LOCATE OTHER INDIVIDUALS WITH SIMILAR INTERESTS TO PARTICIPATE WITH THEM IN, OR ACCOMPANY THEM TO, EVENTS AND ACTIVITIES, IN CLASS 45 (U.S. CLS. 100 AND 101).

FIRST USE 2-1-2007; IN COMMERCE 2-1-2007.

THE MARK CONSISTS OF STANDARD CHARACTERS WITHOUT CLAIM TO ANY PARTICULAR FONT, STYLE, SIZE, OR COLOR.

SER. NO. 77-432,189, FILED 3-26-2008.

SUNG IN, EXAMINING ATTORNEY

Int. Cl.: 37

Prior U.S. Cls.: 100, 103 and 106

United States Patent and Trademark Office

Reg. No. 3,520,298

Registered Oct. 21, 2008

**SERVICE MARK
PRINCIPAL REGISTER**

BE SAFE AMERICA

CARSTAR FRANCHISE SYSTEMS, INC. (KAN-
SAS CORPORATION)

8400 WEST 110TH ST

SUITE 200

OVERLAND PARK, KS 66210

FOR: AUTOMOBILE COLLISION REPAIR SER-
VICES, IN CLASS 37 (U.S. CLS. 100, 103 AND 106).

FIRST USE 8-22-2005; IN COMMERCE 8-22-2005.

THE MARK CONSISTS OF STANDARD CHAR-
ACTERS WITHOUT CLAIM TO ANY PARTICULAR
FONT, STYLE, SIZE, OR COLOR.

NO CLAIM IS MADE TO THE EXCLUSIVE
RIGHT TO USE "AMERICA", APART FROM THE
MARK AS SHOWN.

SER. NO. 77-432,208, FILED 3-26-2008.

ALICE SUE CARRUTHERS, EXAMINING ATTOR-
NEY

Int. Cl.: 41

Prior U.S. Cls.: 100, 101 and 107

United States Patent and Trademark Office

Reg. No. 3,520,299

Registered Oct. 21, 2008

**SERVICE MARK
PRINCIPAL REGISTER**

Mummer-able

IANNAcone, RONALD C. (UNITED STATES
INDIVIDUAL)
3402 TUSCANY DRIVE
PHILADELPHIA, PA 19145

THE MARK CONSISTS OF STANDARD CHAR-
ACTERS WITHOUT CLAIM TO ANY PARTICULAR
FONT, STYLE, SIZE, OR COLOR.

FOR: ENTERTAINMENT, NAMELY, LIVE PER-
FORMANCES BY A MUSICAL BAND, IN CLASS 41
(U.S. CLS. 100, 101 AND 107).

SER. NO. 77-432,221, FILED 3-26-2008.

FIRST USE 1-1-1995; IN COMMERCE 11-1-2007.

JOHN DWYER, EXAMINING ATTORNEY

Int. Cls.: 16, 35 and 41

**Prior U.S. Cls.: 2, 5, 22, 23, 29, 37, 38, 50, 100, 101, 102
and 107**

Reg. No. 3,520,300

United States Patent and Trademark Office

Registered Oct. 21, 2008

**TRADEMARK
SERVICE MARK
PRINCIPAL REGISTER**

MACHINERY PETE

PETERSON, GREGORY A. (UNITED STATES
INDIVIDUAL)
P.O. BOX 1021
ROCHESTER, MN 55903

FOR: PRINTED PUBLICATIONS, NAMELY,
BOOKS, ARTICLES, AND COLUMNS FEATURING
INFORMATION REGARDING MARKET TRENDS,
AUCTIONS, AND PRICING INFORMATION FOR
USED EQUIPMENT AND MACHINERY, IN CLASS
16 (U.S. CLS. 2, 5, 22, 23, 29, 37, 38 AND 50).

FIRST USE 1-0-2001; IN COMMERCE 1-0-2001.

FOR: PROVIDING AUCTION AND PRICING IN-
FORMATION FOR USED EQUIPMENT AND MA-
CHINERY TO SUBSCRIBERS; PROVIDING
COMMENTARY ON MARKET TRENDS, AUC-
TIONS, AND PRICING INFORMATION FOR USED
EQUIPMENT AND MACHINERY, IN CLASS 35 (U.S.
CLS. 100, 101 AND 102).

FIRST USE 3-0-2000; IN COMMERCE 3-0-2000.

FOR: PROVIDING ON-LINE PUBLICATIONS,
NAMELY, ARTICLES AND COLUMNS FEATUR-
ING INFORMATION REGARDING MARKET
TRENDS, AUCTIONS, AND PRICING INFORMA-
TION FOR USED EQUIPMENT AND MACHINERY,
IN CLASS 41 (U.S. CLS. 100, 101 AND 107).

FIRST USE 11-0-2007; IN COMMERCE 11-0-2007.

THE MARK CONSISTS OF STANDARD CHAR-
ACTERS WITHOUT CLAIM TO ANY PARTICULAR
FONT, STYLE, SIZE, OR COLOR.

NO CLAIM IS MADE TO THE EXCLUSIVE
RIGHT TO USE "MACHINERY", APART FROM
THE MARK AS SHOWN.

SER. NO. 77-432,246, FILED 3-26-2008.

LEIGH CAROLINE CASE, EXAMINING ATTOR-
NEY

Int. Cl.: 42

Prior U.S. Cls.: 100 and 101

United States Patent and Trademark Office

Reg. No. 3,520,301

Registered Oct. 21, 2008

**SERVICE MARK
PRINCIPAL REGISTER**

WHERE TEAMS CONNECT

INTERCOLLEGIATE SPORTS SCHEDULING,
LLC (VIRGINIA LIMITED LIABILITY COM-
PANY)

207 FAIRWAY DRIVE
HARRISONBURG, VA 22802

FOR: PROVIDING ON-LINE NON-DOWNLOAD-
ABLE SOFTWARE FOR USE BY COLLEGE COA-
CHES, ATHLETIC ADMINISTRATORS AND
CONFERENCE OFFICES IN SCHEDULING GAMES
AND COMMUNICATION WITH OTHER COLLEGE
COACHES, ATHLETIC ADMINISTRATORS AND

CONFERENCE OFFICES, IN CLASS 42 (U.S. CLS.
100 AND 101).

FIRST USE 12-8-2006; IN COMMERCE 12-8-2006.

THE MARK CONSISTS OF STANDARD CHAR-
ACTERS WITHOUT CLAIM TO ANY PARTICULAR
FONT, STYLE, SIZE, OR COLOR.

SER. NO. 77-432,257, FILED 3-26-2008.

EMILY CARLSEN, EXAMINING ATTORNEY

Int. Cl.: 35

Prior U.S. Cls.: 100, 101 and 102

United States Patent and Trademark Office

Reg. No. 3,520,302

Registered Oct. 21, 2008

**SERVICE MARK
PRINCIPAL REGISTER**

TAKE BACK YOUR LIFE

CARSTAR FRANCHISE SYSTEMS, INC. (KAN-
SAS CORPORATION)
SUITE 200
8400 WEST 110TH ST
OVERLAND PARK, KS 66210

FOR: FRANCHISING SERVICES, NAMELY, OF-
FERING TECHNICAL ASSISTANCE IN THE ESTAB-
LISHMENT AND/OR OPERATION OF
AUTOMOBILE BODY REPAIR SHOPS , IN CLASS
35 (U.S. CLS. 100, 101 AND 102).

FIRST USE 2-13-2007; IN COMMERCE 2-13-2007.

THE MARK CONSISTS OF STANDARD CHAR-
ACTERS WITHOUT CLAIM TO ANY PARTICULAR
FONT, STYLE, SIZE, OR COLOR.

SER. NO. 77-432,266, FILED 3-26-2008.

ALICE SUE CARRUTHERS, EXAMINING ATTOR-
NEY

Int. Cl.: 9

Prior U.S. Cls.: 21, 23, 26, 36 and 38

United States Patent and Trademark Office

Reg. No. 3,520,303

Registered Oct. 21, 2008

**TRADEMARK
PRINCIPAL REGISTER**

NEUTON

COUNTRY HOME PRODUCTS, INC. (VERMONT CORPORATION)

MEIGS ROAD, P.O. BOX 25

VERGENNES, VT 05491

FOR: BATTERIES, IN CLASS 9 (U.S. CLS. 21, 23, 26, 36 AND 38).

FIRST USE 2-0-2003; IN COMMERCE 2-0-2003.

THE MARK CONSISTS OF STANDARD CHARACTERS WITHOUT CLAIM TO ANY PARTICULAR FONT, STYLE, SIZE, OR COLOR.

OWNER OF U.S. REG. NOS. 2,906,108 AND 3,450,114.

SER. NO. 77-432,275, FILED 3-26-2008.

LEIGH CAROLINE CASE, EXAMINING ATTORNEY

Int. Cl.: 17

Prior U.S. Cls.: 1, 5, 12, 13, 35 and 50

United States Patent and Trademark Office

Reg. No. 3,520,304

Registered Oct. 21, 2008

**TRADEMARK
PRINCIPAL REGISTER**

Micro-Len

LENDELL MANUFACTURING, INC. (MICHIGAN CORPORATION)
5301 S. GRAHAM ROAD
SAINT CHARLES, MI 48655

THE MARK CONSISTS OF STANDARD CHARACTERS WITHOUT CLAIM TO ANY PARTICULAR FONT, STYLE, SIZE, OR COLOR.

FOR: OPEN CELL FOAM IN ROLL FORM, IN CLASS 17 (U.S. CLS. 1, 5, 12, 13, 35 AND 50).

SER. NO. 77-432,281, FILED 3-26-2008.

FIRST USE 3-26-2008; IN COMMERCE 3-26-2008.

KIMBERLY FRYE, EXAMINING ATTORNEY

Int. Cl.: 25

Prior U.S. Cls.: 22 and 39

United States Patent and Trademark Office

Reg. No. 3,520,305

Registered Oct. 21, 2008

TRADEMARK
PRINCIPAL REGISTER



SPITZER, ELLIOT (UNITED STATES INDIVIDUAL)
838 KENT AVE., # 3
BROOKLYN, NY 11205

FOR: COATS; JACKETS; MEN'S SUITS; NECKWEAR; PANTS; SPORT COATS; SPORTS JACKETS; SUITS; TIES; TROUSERS; VESTED SUITS; VESTS, IN CLASS 25 (U.S. CLS. 22 AND 39).

FIRST USE 1-1-2008; IN COMMERCE 1-1-2008.

THE NAME(S), PORTRAIT(S), AND/OR SIGNATURE(S) SHOWN IN THE MARK DOES NOT IDENTIFY A PARTICULAR LIVING INDIVIDUAL.

THE MARK CONSISTS OF THE WORDS "E.J. SAMUEL" IN A STYLIZED SCRIPT FORMAT, BELOW THE DEPICTION OF A STYLIZED CROWN.

SER. NO. 77-432,299, FILED 3-26-2008.

DEZMONA MIZELLE, EXAMINING ATTORNEY

Int. Cls.: 20 and 25

Prior U.S. Cls.: 2, 13, 22, 25, 32, 39 and 50

United States Patent and Trademark Office

Reg. No. 3,520,306

Registered Oct. 21, 2008

**TRADEMARK
PRINCIPAL REGISTER**

CONDUIT

MOUNTAIN HARDWEAR, INC. (UTAH CORPORATION)
14375 NW SCIENCE PARK DRIVE
PORTLAND, OR 97229

FOR: SLEEPING BAGS, IN CLASS 20 (U.S. CLS. 2, 13, 22, 25, 32 AND 50).

FIRST USE 12-0-1997; IN COMMERCE 12-0-1997.

FOR: JACKETS; PARKAS; COATS; PANTS; SKI BIBS; SNOW SUITS; GLOVES; MITTENS; GAITERS; HEADWEAR, IN CLASS 25 (U.S. CLS. 22 AND 39).

FIRST USE 7-0-1997; IN COMMERCE 7-0-1997.

THE MARK CONSISTS OF STANDARD CHARACTERS WITHOUT CLAIM TO ANY PARTICULAR FONT, STYLE, SIZE, OR COLOR.

SER. NO. 77-432,314, FILED 3-26-2008.

BRENDAN REGAN, EXAMINING ATTORNEY

Int. Cl.: 29

Prior U.S. Cl.: 46

United States Patent and Trademark Office

Reg. No. 3,520,307

Registered Oct. 21, 2008

**TRADEMARK
PRINCIPAL REGISTER**

MRS. SIPPS

MRS. SIPPS LLC (ILLINOIS LIMITED LIABILITY
COMPANY)
1871 ABERDEEN DR
GLENVIEW, IL 60025

FOR: CONFECTIONARY PRODUCTS, NAMELY,
ROASTED, SALTED, SUGARED, SPICED, CAN-
DIED, OR SEASONED NUTS, IN CLASS 29 (U.S.
CL. 46).

FIRST USE 4-20-2007; IN COMMERCE 4-20-2007.

THE MARK CONSISTS OF STANDARD CHAR-
ACTERS WITHOUT CLAIM TO ANY PARTICULAR
FONT, STYLE, SIZE, OR COLOR.

THE NAME(S), PORTRAIT(S), AND/OR SIGNA-
TURE(S) SHOWN IN THE MARK DOES NOT IDEN-
TIFY A PARTICULAR LIVING INDIVIDUAL.

SER. NO. 77-432,335, FILED 3-26-2008.

RENEE MCCRAY, EXAMINING ATTORNEY

Int. Cls.: 35 and 42

Prior U.S. Cls.: 100, 101 and 102

United States Patent and Trademark Office

Reg. No. 3,520,308

Registered Oct. 21, 2008

**SERVICE MARK
PRINCIPAL REGISTER**

EIC

WILK, SANFORD (UNITED STATES INDIVIDUAL), DBA EIC DESIGN
1357 BROADWAY, BOX 409
NEW YORK, NY 10018

FOR: ADVERTISING AND PUBLICITY SERVICES, NAMELY, PROMOTING THE GOODS, SERVICES, BRAND IDENTITY AND COMMERCIAL INFORMATION AND NEWS OF THIRD PARTIES THROUGH PRINT, AUDIO, VIDEO, DIGITAL AND ON-LINE MEDIUM; BUSINESS CONSULTATION AND MANAGEMENT REGARDING MARKETING ACTIVITIES AND LAUNCHING OF NEW PRODUCTS, IN CLASS 35 (U.S. CLS. 100, 101 AND 102).

FIRST USE 2-18-2006; IN COMMERCE 2-18-2006.

FOR: WEB SITE DESIGN, IN CLASS 42 (U.S. CLS. 100 AND 101).

FIRST USE 2-18-2006; IN COMMERCE 2-18-2006.

THE MARK CONSISTS OF STANDARD CHARACTERS WITHOUT CLAIM TO ANY PARTICULAR FONT, STYLE, SIZE, OR COLOR.

SER. NO. 77-432,338, FILED 3-26-2008.

NICHOLAS ALTREE, EXAMINING ATTORNEY

Int. Cl.: 29

Prior U.S. Cl.: 46

United States Patent and Trademark Office

Reg. No. 3,520,309

Registered Oct. 21, 2008

TRADEMARK
PRINCIPAL REGISTER



MRS. SIPPS LLC (ILLINOIS LIMITED LIABILITY COMPANY)
1871 ABERDEEN DR
GLENVIEW, IL 60025

FOR: CONFECTIONARY PRODUCTS, NAMELY, ROASTED, SALTED, SUGARED, SPICED, CANDIED, OR SEASONED NUTS, IN CLASS 29 (U.S. CL. 46).

FIRST USE 4-20-2007; IN COMMERCE 4-20-2007.

NO CLAIM IS MADE TO THE EXCLUSIVE RIGHT TO USE "PURVEYOR OF SPICED NUTS", APART FROM THE MARK AS SHOWN.

THE NAME(S), PORTRAIT(S), AND/OR SIGNATURE(S) SHOWN IN THE MARK DOES NOT IDENTIFY A PARTICULAR LIVING INDIVIDUAL.

THE MARK CONSISTS OF A RIVER BETWEEN TWO MASSES OF LAND, A FLYING BIRD, A FULL MOON AND THE STYLIZED WORDS "MRS. SIPPS" CONTAINED WITHIN A SQUARE-SHAPED CARRIER ABOVE THE STYLIZED WORDS "PURVEYOR OF SPICED NUTS" WHICH ARE CONTAINED WITHIN A RIBBON DESIGN BELOW THE RIVER.

SER. NO. 77-432,354, FILED 3-26-2008.

RENEE MCCRAY, EXAMINING ATTORNEY

Int. Cl.: 35

Prior U.S. Cls.: 100, 101 and 102

United States Patent and Trademark Office

Reg. No. 3,520,310

Registered Oct. 21, 2008

**SERVICE MARK
PRINCIPAL REGISTER**

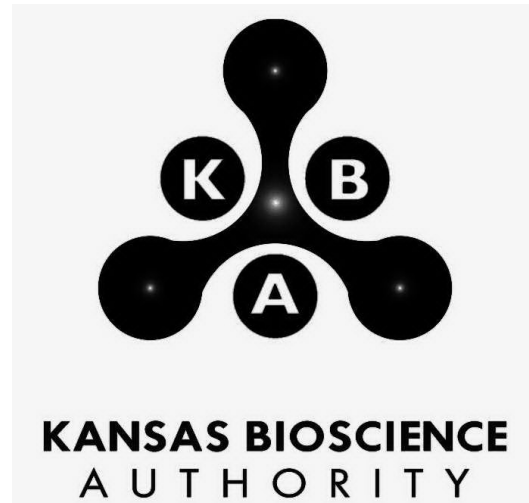

KANSAS BIOSCIENCE AUTHORITY (KANSAS CORPORATION)
SUITE 100
25501 WEST VALLEY PARKWAY
OLATHE, KS 66061

FOR: PROMOTING THE ECONOMIC DEVELOPMENT OF KANSAS IN THE FIELD OF BIOSCIENCE RESEARCH AND INDUSTRY, IN CLASS 35 (U.S. CLS. 100, 101 AND 102).

FIRST USE 4-19-2004; IN COMMERCE 4-19-2004.

NO CLAIM IS MADE TO THE EXCLUSIVE RIGHT TO USE "KANSAS BIOSCIENCE AUTHORITY", APART FROM THE MARK AS SHOWN.

THE MARK CONSISTS OF THE LETTERS "K", "B" AND "A" WITHIN A MOLECULE STRUCTURE WITH "KANSAS BIOSCIENCE AUTHORITY" REFERENCED BELOW.

SER. NO. 77-432,369, FILED 3-26-2008.

ESTHER BELENKER, EXAMINING ATTORNEY

Int. Cl.: 20

Prior U.S. Cls.: 2, 13, 22, 25, 32 and 50

Reg. No. 3,520,311

United States Patent and Trademark Office

Registered Oct. 21, 2008

**TRADEMARK
PRINCIPAL REGISTER**

**FIGURE
PRINTS**

FIGUREPRINTS, LLC (WASHINGTON LIMITED
LIABILITY COMPANY)

7629 NE CHAMPAGNE POINT PLACE

KIRKLAND, WA 98034

FOR: FIGURINES OF PLASTER, IN CLASS 20
(U.S. CLS. 2, 13, 22, 25, 32 AND 50).

FIRST USE 8-17-2007; IN COMMERCE 8-17-2007.

THE MARK CONSISTS OF STANDARD CHAR-
ACTERS WITHOUT CLAIM TO ANY PARTICULAR
FONT, STYLE, SIZE, OR COLOR.

NO CLAIM IS MADE TO THE EXCLUSIVE
RIGHT TO USE "FIGURE", APART FROM THE
MARK AS SHOWN.

SER. NO. 77-432,378, FILED 3-26-2008.

ESTHER BELENKER, EXAMINING ATTORNEY

Int. Cl.: 35

Prior U.S. Cls.: 100, 101 and 102

United States Patent and Trademark Office

Reg. No. 3,520,312

Registered Oct. 21, 2008

**SERVICE MARK
PRINCIPAL REGISTER**

NKF Consulting

NEWMARK KNIGHT FRANK (GEORGIA LIMITED LIABILITY COMPANY)
1680 ROBERTS BLVD., SUITE 408
KENNESAW, GA 30144

FOR: BUSINESS CONSULTING AND BUSINESS INFORMATION FOR ENTERPRISES; BUSINESS CONSULTING AND INFORMATION SERVICES; BUSINESS CONSULTING SERVICES RELATING TO PRODUCT DISTRIBUTION, OPERATIONS MANAGEMENT SERVICES, LOGISTICS, REVERSE LOGISTICS, SUPPLY CHAIN, AND PRODUCTION SYSTEMS AND DISTRIBUTION SOLUTIONS; BUSINESS CONSULTING, MANAGEMENT, PLANNING AND SUPERVISION; BUSINESS MANAGEMENT CONSULTING AND ADVISORY SERVICES; BUSINESS ORGANIZATION CONSULTING; PROFESSIONAL BUSINESS CONSULTING; PROVIDING BUSINESS MANAGEMENT INFORMATION IN

CONNECTION WITH CONSULTING AND ADVISORY SERVICES IN THE FIELD OF STRATEGIC PLANNING, IN CLASS 35 (U.S. CLS. 100, 101 AND 102).

FIRST USE 1-1-2008; IN COMMERCE 1-1-2008.

THE MARK CONSISTS OF STANDARD CHARACTERS WITHOUT CLAIM TO ANY PARTICULAR FONT, STYLE, SIZE, OR COLOR.

NO CLAIM IS MADE TO THE EXCLUSIVE RIGHT TO USE "CONSULTING", APART FROM THE MARK AS SHOWN.

SER. NO. 77-432,386, FILED 3-26-2008.

DOMINICK J. SALEMI, EXAMINING ATTORNEY

Int. Cl.: 6

Prior U.S. Cls.: 2, 12, 13, 14, 23, 25 and 50

United States Patent and Trademark Office

Reg. No. 3,520,313

Registered Oct. 21, 2008

**TRADEMARK
PRINCIPAL REGISTER**

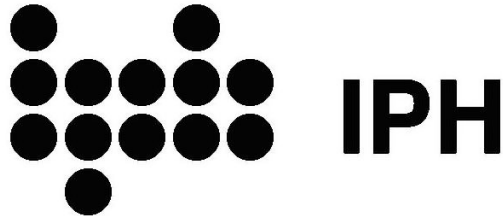

I.P.H. S.A.I.C.F. (ARGENTINA CORPORATION)
ARTURO ILLIA 4001
SAN MIGUEL, ARGENTINA 1663

OWNER OF ARGENTINA REG. NO. 1913339,
DATED 9-10-2003, EXPIRES 9-10-2013.

SER. NO. 77-432,405, FILED 3-26-2008.

FOR: NON-ELECTRIC STEEL CABLES, IN CLASS
6 (U.S. CLS. 2, 12, 13, 14, 23, 25 AND 50).

CHRISTOPHER BUONGIORNO, EXAMINING AT-
TORNEY

Int. Cls.: 29, 30 and 43

Prior U.S. Cls.: 46, 100 and 101

United States Patent and Trademark Office

Reg. No. 3,520,314

Registered Oct. 21, 2008

**TRADEMARK
SERVICE MARK
PRINCIPAL REGISTER**

COWAMONGUS

COWAMONGUS, LLC (TEXAS LIMITED LIABILITY COMPANY)
PO BOX 536025
GRAND PRAIRIE, TX 750536025

FOR: FRUIT TOPPING; DAIRY-BASED BEVERAGES; MEAT, NAMELY, BEEF, CHICKEN AND PORK, IN CLASS 29 (U.S. CL. 46).

FIRST USE 3-1-2005; IN COMMERCE 3-1-2005.

FOR: FROZEN CUSTARD, ICE CREAM, FROZEN YOGURT, FROZEN CONFECTIONS, SAUCES, CHOCOLATE TOPPING, COFFEE, AND COFFEE-BASED BEVERAGES, IN CLASS 30 (U.S. CL. 46).

FIRST USE 3-1-2005; IN COMMERCE 3-1-2005.

FOR: RESTAURANT SERVICES, IN CLASS 43 (U.S. CLS. 100 AND 101).

FIRST USE 3-1-2005; IN COMMERCE 3-1-2005.

THE MARK CONSISTS OF STANDARD CHARACTERS WITHOUT CLAIM TO ANY PARTICULAR FONT, STYLE, SIZE, OR COLOR.

SER. NO. 77-432,422, FILED 3-26-2008.

RUDY R. SINGLETON, EXAMINING ATTORNEY

Int. Cl.: 42

Prior U.S. Cls.: 100 and 101

United States Patent and Trademark Office

Reg. No. 3,520,315

Registered Oct. 21, 2008

**SERVICE MARK
PRINCIPAL REGISTER**

RealAgile

MCDANIEL, TERRY (UNITED STATES INDIVIDUAL)
144 IRONGATE COURT
ALAMO, CA 94507

FOR: PROVIDING ONLINE, NON-DOWNLOADABLE SOFTWARE FOR USE IN PREDICTING THE LIKELIHOOD OF A HOMEOWNER SELLING THEIR HOME SO THAT THE AGENT CAN MORE EFFICIENTLY MARKET SERVICES , IN CLASS 42 (U.S. CLS. 100 AND 101).

FIRST USE 5-23-2007; IN COMMERCE 5-23-2007.

THE MARK CONSISTS OF STANDARD CHARACTERS WITHOUT CLAIM TO ANY PARTICULAR FONT, STYLE, SIZE, OR COLOR.

SER. NO. 77-432,426, FILED 3-26-2008.

MARCIE MILONE, EXAMINING ATTORNEY

Int. Cl.: 9

Prior U.S. Cls.: 21, 23, 26, 36 and 38

Reg. No. 3,520,316

United States Patent and Trademark Office

Registered Oct. 21, 2008

**TRADEMARK
PRINCIPAL REGISTER**

SHOCKENDER

GRACE SAFETY PRODUCTS, L.L.C. (WEST VIRGINIA LIMITED LIABILITY COMPANY)
2612 WARREN WAY
FREDERICK, MD 21701

THE MARK CONSISTS OF STANDARD CHARACTERS WITHOUT CLAIM TO ANY PARTICULAR FONT, STYLE, SIZE, OR COLOR.

FOR: PROTECTIVE INSULATING FOREARM SLEEVE FOR USE IN PROTECTING USERS FROM ELECTRICAL CURRENT AND SHOCK, IN CLASS 9 (U.S. CLS. 21, 23, 26, 36 AND 38).

SER. NO. 77-432,431, FILED 3-26-2008.

FIRST USE 10-17-2006; IN COMMERCE 10-17-2006.

MARCIE MILONE, EXAMINING ATTORNEY

Int. Cl.: 41

Prior U.S. Cls.: 100, 101 and 107

United States Patent and Trademark Office

Reg. No. 3,520,317

Registered Oct. 21, 2008

**SERVICE MARK
PRINCIPAL REGISTER**

ART PROJECTS INTERNATIONAL

ART PROJECTS INTERNATIONAL, INC. (NEW YORK CORPORATION), DBA ART PROJECTS INTERNATIONAL
SUITE 5B
429 GREENWICH STREET
NEW YORK, NY 10013

FOR: CONSULTING SERVICES IN THE FIELD OF CURATING ART EXHIBITIONS, ART GALLERIES AND MUSEUMS; CONSULTING SERVICES IN THE FIELD OF RUNNING MUSEUMS; CONSULTING SERVICES IN THE FIELD OF ORGANIZING ART EXHIBITIONS; ARRANGING AND CONDUCTING EDUCATIONAL CONFERENCES AND SYMPOSIA FOR ART GALLERIES, INSTITUTIONS AND MUSEUMS, IN CLASS 41 (U.S. CLS. 100, 101 AND 107).

FIRST USE 9-1-1993; IN COMMERCE 9-1-1993.

THE MARK CONSISTS OF STANDARD CHARACTERS WITHOUT CLAIM TO ANY PARTICULAR FONT, STYLE, SIZE, OR COLOR.

OWNER OF U.S. REG. NO. 1,992,315.

NO CLAIM IS MADE TO THE EXCLUSIVE RIGHT TO USE "ART" , APART FROM THE MARK AS SHOWN.

SEC. 2(F) AS TO "PROJECTS INTERNATIONAL".

SER. NO. 77-432,450, FILED 3-26-2008.

SANDRA MANIOS, EXAMINING ATTORNEY

Int. Cl.: 25

Prior U.S. Cls.: 22 and 39

United States Patent and Trademark Office

Reg. No. 3,520,318

Registered Oct. 21, 2008

**TRADEMARK
PRINCIPAL REGISTER**

The word "Glorified" is written in a highly decorative, blackletter-style gothic font. The letters are thick and feature elaborate, swirling flourishes and serifs, particularly on the 'G' and 'L'. The overall appearance is that of a classic, ornate typeface.

KJM ENTERPRISES (CALIFORNIA CORPORATION)
9590 DISTRIBUTION AVE.
SAN DIEGO, CA 92121

THE MARK CONSISTS OF THE STYLIZED
WORD "GLORIFIED".

FOR: TOPS, SHIRTS, SWEATSHIRTS, AND HATS,
IN CLASS 25 (U.S. CLS. 22 AND 39).

SER. NO. 77-432,458, FILED 3-26-2008.

FIRST USE 9-26-2007; IN COMMERCE 9-26-2007.

EUGENIA MARTIN, EXAMINING ATTORNEY

Int. Cl.: 42

Prior U.S. Cls.: 100 and 101

United States Patent and Trademark Office

Reg. No. 3,520,319

Registered Oct. 21, 2008

**SERVICE MARK
PRINCIPAL REGISTER**

**BRIDGING STRATEGY AND
SUCCESS**

COGENTES, INC. (GEORGIA CORPORATION)
13275 GEORGIA HWY 231
DAVISBORO, GA 31018

FOR: INFORMATION TECHNOLOGY CON-
SULTING, IN CLASS 42 (U.S. CLS. 100 AND 101).

FIRST USE 9-10-2007; IN COMMERCE 9-10-2007.

THE MARK CONSISTS OF STANDARD CHAR-
ACTERS WITHOUT CLAIM TO ANY PARTICULAR
FONT, STYLE, SIZE, OR COLOR.

SER. NO. 77-432,459, FILED 3-26-2008.

KARANENDRA S. CHHINA, EXAMINING ATTOR-
NEY

Int. Cl.: 42

Prior U.S. Cls.: 100 and 101

United States Patent and Trademark Office

Reg. No. 3,520,320

Registered Oct. 21, 2008

**SERVICE MARK
PRINCIPAL REGISTER**

**BUSINESS STRATEGY
REALIZATION**

COGENTES, INC. (GEORGIA CORPORATION)
13275 GEORGIA HWY 231
DAVISBORO, GA 31018

FOR: INFORMATION TECHNOLOGY CON-
SULTING, IN CLASS 42 (U.S. CLS. 100 AND 101).

FIRST USE 9-14-2007; IN COMMERCE 9-14-2007.

THE MARK CONSISTS OF STANDARD CHAR-
ACTERS WITHOUT CLAIM TO ANY PARTICULAR
FONT, STYLE, SIZE, OR COLOR.

SER. NO. 77-432,466, FILED 3-26-2008.

KARANENDRA S. CHHINA, EXAMINING ATTOR-
NEY

Int. Cl.: 35

Prior U.S. Cls.: 100, 101 and 102

United States Patent and Trademark Office

Reg. No. 3,520,321

Registered Oct. 21, 2008

**SERVICE MARK
PRINCIPAL REGISTER**

VINTAGE RENEWAL

CONNOLLY, JEANNE (UNITED STATES INDIVIDUAL)

#204

2210 BLAKE STREET
DENVER, CO 80205

FOR: ON-LINE RETAIL STORE SERVICES FEATURING FURNITURE, CHAIRS, STOOLS, CLOTHING, BAGS, LINENS, SLIPCOVERS, TABLE CLOTHS, WINDOW TREATMENTS, BABY CLOTHES, DOG CLOTHES, HEADBOARDS, PILLOWS, BEDDING, IN CLASS 35 (U.S. CLS. 100, 101 AND 102).

FIRST USE 8-1-2007; IN COMMERCE 8-1-2007.

THE MARK CONSISTS OF STANDARD CHARACTERS WITHOUT CLAIM TO ANY PARTICULAR FONT, STYLE, SIZE, OR COLOR.

NO CLAIM IS MADE TO THE EXCLUSIVE RIGHT TO USE "VINTAGE", APART FROM THE MARK AS SHOWN.

SER. NO. 77-432,488, FILED 3-26-2008.

EUGENIA MARTIN, EXAMINING ATTORNEY

Int. Cl.: 35

Prior U.S. Cls.: 100, 101 and 102

United States Patent and Trademark Office

Reg. No. 3,520,322

Registered Oct. 21, 2008

SERVICE MARK
PRINCIPAL REGISTER

ReducedEffort

REDUCED EFFORT, INC. (NEVADA CORPORATION)

#250

777 NORTH RAINBOW BLVD.
LAS VEGAS, NV 89107

FOR: BUSINESS CONSULTING SERVICES IN THE FIELD OF ORGANIZATIONAL CHANGE MANAGEMENT, IN CLASS 35 (U.S. CLS. 100, 101 AND 102).

FIRST USE 3-7-2008; IN COMMERCE 3-7-2008.

THE MARK CONSISTS OF THE STYLIZED WORD "REDUCEDEFFORT".

SER. NO. 77-432,494, FILED 3-26-2008.

RUDY R. SINGLETON, EXAMINING ATTORNEY

Int. Cl.: 28

Prior U.S. Cls.: 22, 23, 38 and 50

United States Patent and Trademark Office

Reg. No. 3,520,323

Registered Oct. 21, 2008

**TRADEMARK
PRINCIPAL REGISTER**

ACU-STRENGTH

DYNAFLEX INTERNATIONAL, INC. (CALIFORNIA CORPORATION)
1144 N GROVE ST
ANAHEIM, CA 928062109

THE MARK CONSISTS OF STANDARD CHARACTERS WITHOUT CLAIM TO ANY PARTICULAR FONT, STYLE, SIZE, OR COLOR.

FOR: HAND EXERCISING DEVICE, NAMELY, STRESS RELIEF EXERCISERS FOR HAND EXERCISE, IN CLASS 28 (U.S. CLS. 22, 23, 38 AND 50).

SER. NO. 77-432,505, FILED 3-26-2008.

FIRST USE 3-26-2008; IN COMMERCE 3-26-2008.

SONYA STEPHENS, EXAMINING ATTORNEY

Int. Cl.: 35

Prior U.S. Cls.: 100, 101 and 102

United States Patent and Trademark Office

Reg. No. 3,520,324

Registered Oct. 21, 2008

**SERVICE MARK
PRINCIPAL REGISTER**

CAADAC

CALIFORNIA ASSOCIATION OF ALCOHOLISM
AND DRUG ABUSE COUNSELORS (CALI-
FORNIA CORPORATION)
3400 BRADSHAW ROAD, SUITE A5
SACRAMENTO, CA 95827

FOR: ASSOCIATION SERVICES, NAMELY, PRO-
MOTING THE INTERESTS OF CALIFORNIA AL-
COHOLISM AND DRUG ABUSE COUNSELORS , IN
CLASS 35 (U.S. CLS. 100, 101 AND 102).

FIRST USE 4-0-1985; IN COMMERCE 10-15-1985.

THE MARK CONSISTS OF STANDARD CHAR-
ACTERS WITHOUT CLAIM TO ANY PARTICULAR
FONT, STYLE, SIZE, OR COLOR.

SER. NO. 77-432,536, FILED 3-26-2008.

ESTHER BELENKER, EXAMINING ATTORNEY

Int. Cl.: 41

Prior U.S. Cls.: 100, 101 and 107

United States Patent and Trademark Office

Reg. No. 3,520,325

Registered Oct. 21, 2008

**SERVICE MARK
PRINCIPAL REGISTER**



BODY TRANSIT INC. (PENNSYLVANIA CORPORATION)
7 EAGLEVIEW LANE
SCHWENKSVILLE, PA 19473

FOR: PROVIDING A WEB SITE FEATURING INFORMATION ON EXERCISE AND FITNESS; PROVIDING FITNESS AND EXERCISE FACILITIES, IN CLASS 41 (U.S. CLS. 100, 101 AND 107).

FIRST USE 7-1-2007; IN COMMERCE 9-1-2007.

NO CLAIM IS MADE TO THE EXCLUSIVE RIGHT TO USE "FITNESS", APART FROM THE MARK AS SHOWN.

THE STIPPLING IS FOR SHADING PURPOSES ONLY.

THE MARK CONSISTS OF THE STYLIZED TEXT "RASCALS FITNESS". TO THE LEFT OF THE TEXT IS A STYLIZED CIRCLE WITH A FACE THAT IS SPLIT UP IN FOUR PIECES.

SER. NO. 77-432,544, FILED 3-26-2008.

ALEXANDER L. POWERS, EXAMINING ATTORNEY

Int. Cl.: 41

Prior U.S. Cls.: 100, 101 and 107

United States Patent and Trademark Office

Reg. No. 3,520,326

Registered Oct. 21, 2008

**SERVICE MARK
PRINCIPAL REGISTER**



FUNKY DIVAS (CALIFORNIA PARTNERSHIP)

#201

3742 HUGHES AVE.

LOS ANGELES, CA 90034

FOR: DANCE INSTRUCTION; PARTY PLANNING; SUMMER CAMPS, IN CLASS 41 (U.S. CLS. 100, 101 AND 107).

FIRST USE 1-15-2002; IN COMMERCE 1-15-2002.

THE STIPLING IS FOR SHADING PURPOSES ONLY.

THE MARK CONSISTS OF A STYLIZED STAR TO THE LEFT OF THE STYLIZED TEXT "FUNKY DIVAS". THERE IS A STAR ABOVE THE LETTER "I" TO REPRESENT THE DOT IN THE TEXT "DIVAS".

SER. NO. 77-432,552, FILED 3-26-2008.

KELLY MCCOY, EXAMINING ATTORNEY

Int. Cl.: 45

Prior U.S. Cls.: 100 and 101

United States Patent and Trademark Office

Reg. No. 3,520,327

Registered Oct. 21, 2008

**SERVICE MARK
PRINCIPAL REGISTER**

Wrapper Girlz

GONZALEZ, JOYCE M. (UNITED STATES INDIVIDUAL)

#10

475 PEERLESS WAY

TRACY, CA 95376

FOR: GIFT WRAPPING, IN CLASS 45 (U.S. CLS. 100 AND 101).

FIRST USE 10-15-2007; IN COMMERCE 11-1-2007.

THE MARK CONSISTS OF STANDARD CHARACTERS WITHOUT CLAIM TO ANY PARTICULAR FONT, STYLE, SIZE, OR COLOR.

SER. NO. 77-432,557, FILED 3-26-2008.

WILLIAM P. SHANAHAN, EXAMINING ATTORNEY

Int. Cl.: 42

Prior U.S. Cls.: 100 and 101

United States Patent and Trademark Office

Reg. No. 3,520,328

Registered Oct. 21, 2008

**SERVICE MARK
PRINCIPAL REGISTER**

PROJECT360°

CATALYST SOLUTIONS LLC (DELAWARE LIMITED LIABILITY COMPANY)
16625 REDMOND WAY, SUITE M270
REDMOND, WA 98052

FOR: PROVIDING ON-LINE NON-DOWNLOADABLE SOFTWARE FOR PROJECT MANAGEMENT, TIME TRACKING AND BILLING, IN CLASS 42 (U.S. CLS. 100 AND 101).

FIRST USE 6-0-2007; IN COMMERCE 6-0-2007.

THE MARK CONSISTS OF STANDARD CHARACTERS WITHOUT CLAIM TO ANY PARTICULAR FONT, STYLE, SIZE, OR COLOR.

OWNER OF U.S. REG. NO. 3,450,915.

SER. NO. 77-432,577, FILED 3-26-2008.

GINA FINK, EXAMINING ATTORNEY

Int. Cl.: 37

Prior U.S. Cls.: 100, 103 and 106

United States Patent and Trademark Office

Reg. No. 3,520,329

Registered Oct. 21, 2008

**SERVICE MARK
PRINCIPAL REGISTER**

YOUR NEIGHBORS KNOW !!!

ULTIMATE CONCEPTS (OHIO SOLE PROPRIETORSHIP)
SUITE #206
2101 SOUTH HAMILTON RD.
COLUMBUS, OH 43232

FOR: INSTALLATION OF DECKING, FENCING, SIDING, WINDOWS, PATIO ROOMS, FINISHED BASEMENTS, IN CLASS 37 (U.S. CLS. 100, 103 AND 106).

FIRST USE 6-1-1997; IN COMMERCE 6-1-1997.

THE MARK CONSISTS OF STANDARD CHARACTERS WITHOUT CLAIM TO ANY PARTICULAR FONT, STYLE, SIZE, OR COLOR.

SER. NO. 77-432,578, FILED 3-26-2008.

GINA FINK, EXAMINING ATTORNEY

Int. Cl.: 35

Prior U.S. Cls.: 100, 101 and 102

United States Patent and Trademark Office

Reg. No. 3,520,330

Registered Oct. 21, 2008

**SERVICE MARK
PRINCIPAL REGISTER**

CREATE WHAT'S NEXT

DISNEY ENTERPRISES, INC. (DELAWARE CORPORATION)
500 SOUTH BUENA VISTA STREET
BURBANK, CA 91521

FOR: HUMAN RESOURCES, NAMELY, HUMAN RESOURCES MANAGEMENT SERVICES AND EMPLOYMENT HIRING AND RECRUITING, PLACEMENT, STAFFING AND CAREER NETWORKING SERVICES, IN CLASS 35 (U.S. CLS. 100, 101 AND 102).

FIRST USE 10-0-2007; IN COMMERCE 10-0-2007.

THE MARK CONSISTS OF STANDARD CHARACTERS WITHOUT CLAIM TO ANY PARTICULAR FONT, STYLE, SIZE, OR COLOR.

SER. NO. 77-432,580, FILED 3-26-2008.

DANNEAN HETZEL, EXAMINING ATTORNEY

Int. Cls.: 35 and 37

Prior U.S. Cls.: 100, 101, 102, 103 and 106

United States Patent and Trademark Office

Reg. No. 3,520,331

Registered Oct. 21, 2008

**SERVICE MARK
PRINCIPAL REGISTER**

EASYTURF

EASY-TURF, INC. (CALIFORNIA CORPORATION)
2418 VINEYARD AVENUE
ESCONDIDO, CA 92029

FOR: ON-LINE RETAIL STORE SERVICES FEATURING SYNTHETIC LAWNS, SYNTHETIC PUTTING GREENS, AND ARTIFICIAL GRASS SURFACES, FOR RESIDENTIAL AND COMMERCIAL USES; RETAIL STORE SERVICES FEATURING SYNTHETIC LAWNS, SYNTHETIC PUTTING GREENS, AND ARTIFICIAL GRASS SURFACES, FOR RESIDENTIAL AND COMMERCIAL USES, IN CLASS 35 (U.S. CLS. 100, 101 AND 102).

FIRST USE 6-1-2000; IN COMMERCE 8-21-2006.

FOR: INSTALLATION OF SYNTHETIC LAWNS, SYNTHETIC PUTTING GREENS, AND ARTIFICIAL GRASS SURFACES, FOR RESIDENTIAL AND COMMERCIAL USES, IN CLASS 37 (U.S. CLS. 100, 103 AND 106).

FIRST USE 6-1-2000; IN COMMERCE 8-21-2006.

THE MARK CONSISTS OF STANDARD CHARACTERS WITHOUT CLAIM TO ANY PARTICULAR FONT, STYLE, SIZE, OR COLOR.

SER. NO. 77-432,590, FILED 3-26-2008.

ARETHA SOMERVILLE, EXAMINING ATTORNEY

Int. Cl.: 2

Prior U.S. Cls.: 6, 11 and 16

United States Patent and Trademark Office

Reg. No. 3,520,332

Registered Oct. 21, 2008

**TRADEMARK
PRINCIPAL REGISTER**

ELASTO-POXY

ILLINOIS TOOL WORKS INC. (DELAWARE
CORPORATION)
3600 WEST LAKE AVENUE
GLENVIEW, IL 60026

THE MARK CONSISTS OF STANDARD CHAR-
ACTERS WITHOUT CLAIM TO ANY PARTICULAR
FONT, STYLE, SIZE, OR COLOR.

FOR: PRIMERS, IN CLASS 2 (U.S. CLS. 6, 11 AND
16).

SER. NO. 77-432,591, FILED 3-26-2008.

FIRST USE 0-0-1972; IN COMMERCE 0-0-1972.

MELVIN AXILBUND, EXAMINING ATTORNEY

Int. Cl.: 30

Prior U.S. Cl.: 46

United States Patent and Trademark Office

Reg. No. 3,520,333

Registered Oct. 21, 2008

**TRADEMARK
PRINCIPAL REGISTER**

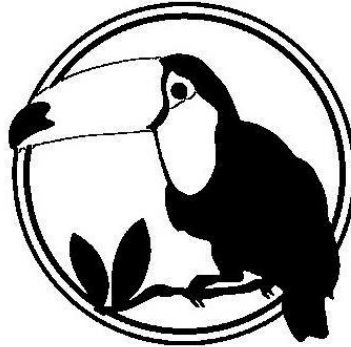

BEST OF TROPICS (NEW JERSEY LIMITED
LIABILITY COMPANY)
UNIT 3
1464 RIVER ROAD
EDGEWATER, NJ 07020

THE MARK CONSISTS OF A TROPICAL TUCAN
BIRD SITTING ON THE TREE BRANCH.

FOR: COCOA; COCOA-BASED BEVERAGES;
COFFEE, IN CLASS 30 (U.S. CL. 46).

SER. NO. 77-432,608, FILED 3-26-2008.

FIRST USE 12-31-2007; IN COMMERCE 12-31-2007.

SUZANNE BLANE, EXAMINING ATTORNEY

Int. Cl.: 13

Prior U.S. Cls.: 2 and 9

United States Patent and Trademark Office

Reg. No. 3,520,334

Registered Oct. 21, 2008

TRADEMARK
PRINCIPAL REGISTER



TIGER CORPORATION (HAWAII CORPORATION)
1448 YOUNG STREET, SUITE 18
HONOLULU, HI 96814

FOR: FIREWORKS, IN CLASS 13 (U.S. CLS. 2 AND 9).

FIRST USE 6-27-2005; IN COMMERCE 6-7-2005.

NO CLAIM IS MADE TO THE EXCLUSIVE RIGHT TO USE "FIREWORKS", APART FROM THE MARK AS SHOWN.

THE COLOR(S) BLACK, RED, ORANGE, YELLOW, BEIGE, AND BLUE IS/ARE CLAIMED AS A FEATURE OF THE MARK.

THE MARK CONSISTS OF THE BUST OF AN EMPEROR WITH BEARD AND HEADWEAR IN

THE COLORS BLACK, BEIGE, ORANGE, YELLOW AND BLUE, OVER THE CHINESE SYMBOL WANG OR WONG FOR KING OR EMPEROR, ALL ON A BLACK BACKGROUND AND ABOVE THE WORDS "EMPEROR" IN BOLD BLACK LETTERS ABOVE THE WORD "FIREWORKS" IN SMALLER STYLED LETTERS, THE WORD PORTION OF THE MARK BEING SUPERIMPOSED OVER A YELLOW, ORANGE AND RED BACKGROUND.

THE NON-LATIN CHARACTER(S) IN THE MARK TRANSLITERATE INTO WANG OR WONG, AND THIS MEANS KING OR EMPEROR IN ENGLISH.

SER. NO. 77-432,613, FILED 3-26-2008.

JASON TURNER, EXAMINING ATTORNEY

Int. Cl.: 5

Prior U.S. Cls.: 6, 18, 44, 46, 51 and 52

United States Patent and Trademark Office

Reg. No. 3,520,335

Registered Oct. 21, 2008

**TRADEMARK
PRINCIPAL REGISTER**

Dingbats

STARR, MICHAEL JAY (UNITED STATES INDIVIDUAL)
17759 W CAPE JASMINE
CANYON COUNTRY, CA 91387

FOR: ADHESIVE BANDAGES, IN CLASS 5 (U.S. CLS. 6, 18, 44, 46, 51 AND 52).

FIRST USE 1-12-2008; IN COMMERCE 2-1-2008.

THE MARK CONSISTS OF STANDARD CHARACTERS WITHOUT CLAIM TO ANY PARTICULAR FONT, STYLE, SIZE, OR COLOR.

SER. NO. 77-432,615, FILED 3-26-2008.

MATTHEW MCDOWELL, EXAMINING ATTORNEY

Int. Cl.: 13

Prior U.S. Cls.: 2 and 9

United States Patent and Trademark Office

Reg. No. 3,520,336

Registered Oct. 21, 2008

**TRADEMARK
PRINCIPAL REGISTER**

KING THUNDER

TIGER CORPORATION (HAWAII CORPORATION)
1448 YOUNG STREET, SUITE 18
HONOLULU, HI 96814

THE MARK CONSISTS OF STANDARD CHARACTERS WITHOUT CLAIM TO ANY PARTICULAR FONT, STYLE, SIZE, OR COLOR.

FOR: FIREWORKS, IN CLASS 13 (U.S. CLS. 2 AND 9).

SER. NO. 77-432,622, FILED 3-26-2008.

FIRST USE 12-26-2007; IN COMMERCE 12-26-2007.

JASON TURNER, EXAMINING ATTORNEY

Int. Cl.: 13

Prior U.S. Cls.: 2 and 9

United States Patent and Trademark Office

Reg. No. 3,520,337

Registered Oct. 21, 2008

TRADEMARK
PRINCIPAL REGISTER



TIGER CORPORATION (HAWAII CORPORATION)
1448 YOUNG STREET, SUITE 18
HONOLULU, HI 96814

FOR: FIREWORKS, IN CLASS 13 (U.S. CLS. 2 AND 9).

FIRST USE 12-26-2007; IN COMMERCE 12-26-2007.

NO CLAIM IS MADE TO THE EXCLUSIVE RIGHT TO USE "FIREWORKS" , APART FROM THE MARK AS SHOWN.

THE COLOR(S) RED, YELLOW, ORANGE, BLUE, WHITE, AND BLACK IS/ARE CLAIMED AS A FEATURE OF THE MARK.

THE MARK CONSISTS OF A STYLIZED DRAWING OF A DRAGON HAVING A FACE COLORED RED, YELLOW, ORANGE AND WHITE AND A BODY OF BLUE, ORANGE AND WHITE, WITH THE WORD "DESTRUCTION" IN BOLD BLACK LETTERS ABOVE, AND THE WORD "FIREWORKS" IN NARROWER BLACK LETTERS BELOW, ALL ENCLOSED WITHIN A NARROW CIRCLE COLORED RED, ORANGE AND YELLOW.

SER. NO. 77-432,629, FILED 3-26-2008.

JASON TURNER, EXAMINING ATTORNEY

Int. Cl.: 41

Prior U.S. Cls.: 100, 101 and 107

United States Patent and Trademark Office

Reg. No. 3,520,338

Registered Oct. 21, 2008

**SERVICE MARK
PRINCIPAL REGISTER**

Black Wolf Books

BLACK WOLF BOOKS, INC. (TEXAS CORPORATION)
6659 DICK PRICE RD
MANSFIELD, TX 760635243

FOR: BOOK PUBLISHING, IN CLASS 41 (U.S. CLS. 100, 101 AND 107).

FIRST USE 12-1-2005; IN COMMERCE 12-1-2005.

THE MARK CONSISTS OF STANDARD CHARACTERS WITHOUT CLAIM TO ANY PARTICULAR FONT, STYLE, SIZE, OR COLOR.

NO CLAIM IS MADE TO THE EXCLUSIVE RIGHT TO USE "BOOKS", APART FROM THE MARK AS SHOWN.

SER. NO. 77-432,665, FILED 3-26-2008.

WILLIAM P. SHANAHAN, EXAMINING ATTORNEY

Int. Cl.: 41

Prior U.S. Cls.: 100, 101 and 107

United States Patent and Trademark Office

Reg. No. 3,520,339

Registered Oct. 21, 2008

**SERVICE MARK
PRINCIPAL REGISTER**

ADJACK

BOLAND, DAVID M. (UNITED STATES INDIVIDUAL)
8 SANCTUARY DRIVE
ITHACA, NY 14850

FOR: ENTERTAINMENT SERVICES, NAMELY, PROGRAMS FEATURING COMMERCIALS BROADCAST OVER THE INTERNET AND WIRELESS AND MOBILE COMMUNICATIONS DEVICES; ENTERTAINMENT SERVICES, NAMELY, PROVIDING A WEBSITE FEATURING A PROGRAM FEATURING COMMERCIALS VIA A GLOBAL COMPUTER NETWORK OR ACCESSED BY ANY

MOBILE COMMUNICATIONS DEVICE, IN CLASS 41 (U.S. CLS. 100, 101 AND 107).

FIRST USE 7-1-2007; IN COMMERCE 1-10-2008.

THE MARK CONSISTS OF STANDARD CHARACTERS WITHOUT CLAIM TO ANY PARTICULAR FONT, STYLE, SIZE, OR COLOR.

SER. NO. 77-432,670, FILED 3-26-2008.

KELLY MCCOY, EXAMINING ATTORNEY

Int. Cl.: 26

Prior U.S. Cls.: 37, 39, 40, 42 and 50

Reg. No. 3,520,340

United States Patent and Trademark Office

Registered Oct. 21, 2008

**TRADEMARK
PRINCIPAL REGISTER**

WING SUN

WING SUN METAL PRODUCTS LIMITED
(HONG KONG LIMITED LIABILITY COMPAN-
NY)

12/F., YEE LIM FTY. BLDG.
32-40 KWAI TING ROAD, KWAI CHUNG
NEW TERRITORIES, HONG KONG

FOR: LACE AND EMBROIDERY; RIBBONS AND
BRAID; BUTTONS, HOOKS AND EYES; SEWING
PINS; NEEDLES; ARTIFICIAL FLOWERS; BEADS
OTHER THAN FOR MAKING JEWELRY; ORNA-
MENTAL NOVELTY BADGES; HAT ORNAMENTS
NOT OF PRECIOUS METAL; SHOE ORNAMENTS
NOT OF PRECIOUS METAL; BUCKLES FOR
CLOTHING; ZIPPERS; HAIR ORNAMENTS; ARTI-

FICIAL FRUIT; COLLAR STAYS; ORNAMENTAL
CLOTH PATCHES; COMPETITORS' NUMBERS
NOT OF TEXTILE; TEA COSIES, IN CLASS 26 (U.S.
CLS. 37, 39, 40, 42 AND 50).

FIRST USE 6-15-1976; IN COMMERCE 1-1-1980.

THE MARK CONSISTS OF STANDARD CHAR-
ACTERS WITHOUT CLAIM TO ANY PARTICULAR
FONT, STYLE, SIZE, OR COLOR.

SER. NO. 77-432,671, FILED 3-26-2008.

SANDRA MANIOS, EXAMINING ATTORNEY

Int. Cl.: 41

Prior U.S. Cls.: 100, 101 and 107

United States Patent and Trademark Office

Reg. No. 3,520,341

Registered Oct. 21, 2008

**SERVICE MARK
PRINCIPAL REGISTER**



BLACK WOLF BOOKS, INC. (TEXAS CORPORATION)
6659 DICK PRICE RD
MANSFIELD, TX 760635243

FOR: BOOK PUBLISHING, IN CLASS 41 (U.S. CLS. 100, 101 AND 107).

FIRST USE 12-1-2005; IN COMMERCE 12-1-2005.

NO CLAIM IS MADE TO THE EXCLUSIVE RIGHT TO USE "BOOKS" , APART FROM THE MARK AS SHOWN.

THE COLOR(S) BLACK, GRAY AND BLUE IS/ARE CLAIMED AS A FEATURE OF THE MARK.

THE MARK CONSISTS OF "BLACK WOLF BOOKS" IN STYLIZED LETTERING IN THE COLOR OF BLUE, BENEATH BLUE WOLF EYES AND DARK GRAY WOLF EYEBROWS, ALL ON A BLACK BACKGROUND.

SER. NO. 77-432,677, FILED 3-26-2008.

WILLIAM P. SHANAHAN, EXAMINING ATTORNEY

Int. Cl.: 25

Prior U.S. Cls.: 22 and 39

United States Patent and Trademark Office

Reg. No. 3,520,342

Registered Oct. 21, 2008

**TRADEMARK
PRINCIPAL REGISTER**

lipsplitter

VENOM ENTERPRISES, LLC (NEVADA LIMITED LIABILITY COMPANY)
3415 RAWHIDE STREET
LAS VEGAS, NV 89120

FOR: CLOTHING, NAMELY, TRUNKS, TANK TOPS, BELTS, CAPS, BASEBALL CAPS, COATS, GLOVES, HATS, HEADBANDS, JACKETS, SKULL CAPS, THONG UNDERWEAR, WRISTBANDS, G-STRINGS, SWEATPANTS, JERSEYS, BRIEFS, PULL-OVERS, SHIRTS, SWEATSHIRTS, T-SHIRTS, SOCKS, SWEATERS, SWIMSUITS, TROUSERS, IN CLASS 25 (U.S. CLS. 22 AND 39).

FIRST USE 9-25-2005; IN COMMERCE 9-1-2007.

THE MARK CONSISTS OF STANDARD CHARACTERS WITHOUT CLAIM TO ANY PARTICULAR FONT, STYLE, SIZE, OR COLOR.

SER. NO. 77-432,722, FILED 3-27-2008.

JULIE WATSON, EXAMINING ATTORNEY

Int. Cls.: 9, 38 and 42

Prior U.S. Cls.: 21, 23, 26, 36, 38, 100, 101 and 104

Reg. No. 3,520,343

United States Patent and Trademark Office

Registered Oct. 21, 2008

**TRADEMARK
SERVICE MARK
PRINCIPAL REGISTER**

EXARI

EXARI SYSTEMS, INC. (DELAWARE CORPORATION), DBA SPEEDLEGAL, INC.
THE PRUDENTIAL TOWER, 800 BOYLSTON STREET
BOSTON, MA 02199

FOR: COMPUTER SOFTWARE FOR CONTRACT LIFECYCLE MANAGEMENT AND DOCUMENT ASSEMBLY; COMPUTER PROGRAMMES FOR DOCUMENT MANAGEMENT; COMPUTER SOFTWARE FOR THE COLLECTION, EDITING, ORGANIZING, MODIFYING, BOOK MARKING, TRANSMISSION, STORAGE AND SHARING OF DATA AND INFORMATION; COMPUTER SOFTWARE THAT PROVIDES REAL-TIME, INTEGRATED BUSINESS MANAGEMENT INTELLIGENCE BY COMBINING INFORMATION FROM VARIOUS DATABASES AND PRESENTING IT IN AN EASY-TO-UNDERSTAND USER INTERFACE; DATA AND WORD PROCESSORS; COMPUTER SOFTWARE FOR CREATING SEARCHABLE DATABASES OF INFORMATION AND DATA, IN CLASS 9 (U.S. CLS. 21, 23, 26, 36 AND 38).

FIRST USE 9-6-2005; IN COMMERCE 9-6-2005.

FOR: COMMUNICATION SERVICES, NAMELY, ELECTRONIC TRANSMISSION OF DATA AND DOCUMENTS AMONG USERS OF COMPUTERS; ELECTRONIC DELIVERY OF LOAN DOCUMENTS; ELECTRONIC TRANSMISSION OF DATA AND DOCUMENTS VIA COMPUTER TERMINALS; ELECTRONIC TRANSMISSION OF MESSAGES AND DATA; ON-LINE DOCUMENT DELIVERY VIA A GLOBAL COMPUTER NETWORK; PROVISION OF ACCESS TO A GLOBAL COMPUTER NETWORK; PROVISION OF ACCESS TO DATA OR DOCUMENTS STORED ELECTRONICALLY IN CENTRAL FILES FOR REMOTE CONSULTATION; PROVISION OF ACCESS TO ELECTRONIC SITES, IN CLASS 38 (U.S. CLS. 100, 101 AND 104).

FIRST USE 9-6-2005; IN COMMERCE 9-6-2005.

FOR: APPLICATION SERVICE PROVIDER (ASP) FEATURING SOFTWARE FOR USE IN DOCUMENT ASSEMBLY AND LIFECYCLE CONTRACT MANAGEMENT; PROVIDING ON-LINE NON-DOWNLOADABLE SOFTWARE FOR USE IN DOCUMENT ASSEMBLY AND CONTRACT LIFECYCLE MANAGEMENT; COMPUTER HARDWARE AND SOFTWARE CONSULTING SERVICES; COMPUTER SOFTWARE CONSULTANCY; COMPUTER PROGRAMMING SERVICES; PROVIDING COMPUTER PROGRAMMING SERVICES TO CUSTOMERS THAT ENABLES THE CUSTOMER'S WEB-SITE TO PROCESS NATURAL LANGUAGE QUERIES; COMPUTER PROGRAMMING AND COMPUTER SYSTEM ANALYSIS; COMPUTER PROGRAMMING AND MAINTENANCE OF COMPUTER PROGRAMS; COMPUTER PROGRAMMING AND SOFTWARE DESIGN; COMPUTER PROJECT MANAGEMENT SERVICES; TECHNICAL SUPPORT SERVICES, NAMELY, TROUBLESHOOTING OF COMPUTER HARDWARE AND SOFTWARE PROBLEMS; TECHNICAL SUPPORT SERVICES, NAMELY, TROUBLESHOOTING OF COMPUTER SOFTWARE PROBLEMS; TECHNICAL SUPPORT SERVICES, NAMELY, TROUBLESHOOTING OF INDUSTRIAL PROCESS CONTROL COMPUTER SOFTWARE PROBLEMS; UP-DATING OF COMPUTER SOFTWARE; UPDATING AND DESIGN OF COMPUTER SOFTWARE; DEVELOPMENT, UPDATING AND MAINTENANCE OF SOFTWARE AND DATA BASES; UPDATING AND MAINTENANCE OF COMPUTER SOFTWARE; DESIGN, MAINTENANCE, DEVELOPMENT AND UPDATING OF COMPUTER SOFTWARE; DEVELOPING AND UPDATING COMPUTER SOFTWARE; DEVELOPING COMPUTER SOFTWARE; COMPUTER SOFTWARE INSTALLATION AND MAINTENANCE; INSTALLATION AND MAINTENANCE OF COMPUTER SOFTWARE; INSTALLATION,

MAINTENANCE AND REPAIR OF COMPUTER SOFTWARE; INSTALLATION, REPAIR AND MAINTENANCE OF COMPUTER SOFTWARE; MAINTENANCE AND UPDATING OF COMPUTER SOFTWARE; MAINTENANCE AND UPGRADING OF COMPUTER SOFTWARE; COMPUTER SOFTWARE DESIGN, COMPUTER PROGRAMMING, OR MAINTENANCE OF COMPUTER SOFTWARE; DESIGN AND MAINTENANCE OF COMPUTER SITES FOR THIRD PARTIES; MAINTENANCE OF COMPUTER SOFTWARE; COMPUTER SOFTWARE DESIGN; COMPUTER SOFTWARE DEVELOPMENT; DESIGN AND DEVELOPMENT OF ON-LINE COMPUTER SOFTWARE SYSTEMS; DESIGN OF HOME PAGES; DESIGN OF HOME PAGES AND WEB SITES; DESIGN OF HOME PAGES, COMPUTER SOFTWARE AND WEB SITES; COMPUTER SERVICE, NAMELY, ACTING AS AN APPLICATION SERVICE PROVIDER IN THE FIELD OF KNOWLEDGE MANAGEMENT TO HOST COMPUTER APPLICATION SOFTWARE FOR CREATING SEARCHABLE DATABASES OF INFORMATION AND DATA; CONVERSION OF DATA OR DOCUMENTS FROM PHYSICAL TO ELECTRONIC MEDIA; DOCUMENT DATA TRANSFER FROM ONE COMPUTER FORMAT TO ANOTHER; APPLICATION SERVICE PROVIDER FEATURING SOFTWARE FOR PROVIDING AN ON-LINE DATABASE IN THE FIELD OF TRANSACTION PROCESSING TO UPLOAD TRANSACTIONAL DATA, PROVIDE

STATISTICAL ANALYSIS, AND PRODUCE NOTIFICATIONS AND REPORTS; COMPUTER SERVICE, NAMELY, ACTING AS AN APPLICATION SERVICE PROVIDER IN THE FIELD OF KNOWLEDGE MANAGEMENT TO HOST COMPUTER APPLICATION SOFTWARE FOR SEARCHING AND RETRIEVING INFORMATION FROM DATABASES AND COMPUTER NETWORKS; COMPUTER SERVICE, NAMELY, ACTING AS AN APPLICATION SERVICE PROVIDER IN THE FIELD OF KNOWLEDGE MANAGEMENT TO HOST COMPUTER APPLICATION SOFTWARE FOR THE COLLECTION, EDITING, ORGANIZING, MODIFYING, BOOK MARKING, TRANSMISSION, STORAGE AND SHARING OF DATA AND INFORMATION; COMPUTER SERVICES, NAMELY, INTERACTIVE HOSTING SERVICES WHICH ALLOW THE USER TO PUBLISH AND SHARE THEIR OWN CONTENT AND IMAGES ONLINE, IN CLASS 42 (U.S. CLS. 100 AND 101).

FIRST USE 9-6-2005; IN COMMERCE 9-6-2005.

THE MARK CONSISTS OF STANDARD CHARACTERS WITHOUT CLAIM TO ANY PARTICULAR FONT, STYLE, SIZE, OR COLOR.

SER. NO. 77-432,724, FILED 3-27-2008.

KAREN BRACEY, EXAMINING ATTORNEY

Int. Cl.: 36

Prior U.S. Cls.: 100, 101 and 102

United States Patent and Trademark Office

Reg. No. 3,520,344

Registered Oct. 21, 2008

**SERVICE MARK
PRINCIPAL REGISTER**

YACHT HOP

STARS US, INC. (SOUTH CAROLINA CORPORATION)

PO BOX 5507

HILTON HEAD ISLAND, SC 29938

FOR: CHARITABLE FUND RAISING, IN CLASS 36 (U.S. CLS. 100, 101 AND 102).

FIRST USE 10-1-2007; IN COMMERCE 10-1-2007.

THE MARK CONSISTS OF STANDARD CHARACTERS WITHOUT CLAIM TO ANY PARTICULAR FONT, STYLE, SIZE, OR COLOR.

NO CLAIM IS MADE TO THE EXCLUSIVE RIGHT TO USE "YACHT", APART FROM THE MARK AS SHOWN.

SER. NO. 77-432,735, FILED 3-27-2008.

RONALD DELGIZZI, EXAMINING ATTORNEY

Int. Cl.: 9

Prior U.S. Cls.: 21, 23, 26, 36 and 38

United States Patent and Trademark Office

Reg. No. 3,520,345

Registered Oct. 21, 2008

**TRADEMARK
PRINCIPAL REGISTER**

HEDGEHOG

SENTRIGO INC. (DELAWARE CORPORATION)
SUITE 130
155M NEW BOSTON STREET
WOBURN, MA 01801

THE MARK CONSISTS OF STANDARD CHAR-
ACTERS WITHOUT CLAIM TO ANY PARTICULAR
FONT, STYLE, SIZE, OR COLOR.

FOR: COMPUTER SOFTWARE FOR PROTECT-
ING AND SECURING DATABASES, IN CLASS 9
(U.S. CLS. 21, 23, 26, 36 AND 38).

SER. NO. 77-432,752, FILED 3-27-2008.

FIRST USE 6-18-2007; IN COMMERCE 6-18-2007.

IRA J. GOODSID, EXAMINING ATTORNEY

Int. Cl.: 9

Prior U.S. Cls.: 21, 23, 26, 36 and 38

United States Patent and Trademark Office

Reg. No. 3,520,346

Registered Oct. 21, 2008

**TRADEMARK
PRINCIPAL REGISTER**

SENTRIGO

SENTRIGO INC. (DELAWARE CORPORATION)
SUITE 130
155M NEW BOSTON STREET
WOBURN, MA 01801

FOR: COMPUTER SOFTWARE FOR PROTECT-
ING AND SECURING DATABASES, IN CLASS 9
(U.S. CLS. 21, 23, 26, 36 AND 38).

FIRST USE 6-18-2007; IN COMMERCE 6-18-2007.

THE MARK CONSISTS OF STANDARD CHAR-
ACTERS WITHOUT CLAIM TO ANY PARTICULAR
FONT, STYLE, SIZE, OR COLOR.

THE WORDING "SENTRIGO" HAS NO MEAN-
ING IN A FOREIGN LANGUAGE.

SER. NO. 77-432,753, FILED 3-27-2008.

IRA J. GOODSaid, EXAMINING ATTORNEY

Int. Cl.: 9

Prior U.S. Cls.: 21, 23, 26, 36 and 38

United States Patent and Trademark Office

Reg. No. 3,520,347

Registered Oct. 21, 2008

**TRADEMARK
PRINCIPAL REGISTER**



SENTRIGO INC. (DELAWARE CORPORATION)
SUITE 130
155M NEW BOSTON STREET
WOBURN, MA 01801

FIRST USE 6-18-2007; IN COMMERCE 6-18-2007.

THE MARK CONSISTS OF PICTURE OF A
HEDGEHOG WITH WORDING.

FOR: COMPUTER SOFTWARE FOR PROTECT-
ING AND SECURING DATABASES, IN CLASS 9
(U.S. CLS. 21, 23, 26, 36 AND 38).

SER. NO. 77-432,755, FILED 3-27-2008.

IRA J. GOODSAY, EXAMINING ATTORNEY

Int. Cl.: 41

Prior U.S. Cls.: 100, 101 and 107

United States Patent and Trademark Office

Reg. No. 3,520,348

Registered Oct. 21, 2008

**SERVICE MARK
PRINCIPAL REGISTER**

SOUL STALKAZ

MCGLYNN, CHRIS W. (UNITED STATES INDIVIDUAL)

6611 STONECROFT DRIVE
OAK RIDGE, NC 27310 AND

ATKINS, KEVIN L. (UNITED STATES INDIVIDUAL)

821 LEE STREET
KERNERSVILLE, NC 27284

FOR: ENTERTAINMENT SERVICES IN THE NATURE OF LIVE MUSICAL PERFORMANCES; ENTERTAINMENT, NAMELY, LIVE PERFORMAN-

CES BY MUSICAL BANDS, IN CLASS 41 (U.S. CLS. 100, 101 AND 107).

FIRST USE 8-13-2005; IN COMMERCE 10-21-2005.

THE MARK CONSISTS OF STANDARD CHARACTERS WITHOUT CLAIM TO ANY PARTICULAR FONT, STYLE, SIZE, OR COLOR.

SER. NO. 77-432,783, FILED 3-27-2008.

CHRISTINA SOBRAL, EXAMINING ATTORNEY

Prior U.S. Cl.: B

United States Patent and Trademark Office

Reg. No. 3,520,349

Registered Oct. 21, 2008

**CERTIFICATION MARK
PRINCIPAL REGISTER**

OCNS-C

ORTHOPAEDIC NURSES CERTIFICATION
BOARD (NEW JERSEY CORPORATION)
PO BOX 87
COLUMBIA, SC 29202

FOR: ORTHOPEDIC NURSING, IN CLASS B (U.S.
CL. B).

FIRST USE 4-30-2006; IN COMMERCE 7-1-2006.

THE MARK CONSISTS OF STANDARD CHAR-
ACTERS WITHOUT CLAIM TO ANY PARTICULAR
FONT, STYLE, SIZE, OR COLOR.

THE CERTIFICATION MARK, AS USED BY
AUTHORIZED PERSONS, CERTIFIES THAT THESE
PERSONS PROVIDE A CERTAIN TYPE OF SER-

VICE, NAMELY CLINICAL NURSE SPECIALIST
LEVEL ORTHOPEDIC NURSING SERVICES, AND
THAT THESE PERSONS PROVIDE SUCH SERVICES
WITH A CERTAIN LEVEL OF EXPERTISE AS
DEMONSTRATED BY THEIR RECEIVING AD-
VANCED EDUCATIONAL TRAINING AND/OR
WORK EXPERIENCE AND SUPERVISION IN THE
FIELD PROVIDED BY THE CERTIFIER AND SUC-
CESSFULLY SATISFYING AND CONTINUING TO
SATISFY THE MINIMAL STANDARDS AND CRI-
TERIA ESTABLISHED BY THE CERTIFIER.

SER. NO. 77-432,807, FILED 3-27-2008.

CHRISTINA SOBRAL, EXAMINING ATTORNEY

Int. Cl.: 41

Prior U.S. Cls.: 100, 101 and 107

United States Patent and Trademark Office

Reg. No. 3,520,350

Registered Oct. 21, 2008

**SERVICE MARK
PRINCIPAL REGISTER**

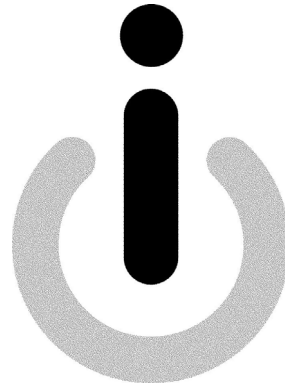

RESOURCE VENTURES, LTD. (OHIO LIMITED
LIABILITY COMPANY)
343 NORTH FRONT STREET
COLUMBUS, OH 43215

FOR: EDUCATIONAL SERVICES, NAMELY,
CONDUCTING SEMINARS, WORKSHOPS, AND
SYMPOSIUMS IN THE FIELD OF CONSUMER
RESEARCH AND MARKETING AND DISTRIBUTION
OF COURSE MATERIAL IN CONNECTION
THEREWITH, IN CLASS 41 (U.S. CLS. 100, 101 AND
107).

FIRST USE 5-5-2006; IN COMMERCE 5-5-2006.

THE MARK CONSISTS OF THE LOWER CASE
LETTERS "I" AND "C", WITH THE LETTER "C"
WRAPPING AROUND THE LOWER PORTION OF
THE LETTER "I".

SER. NO. 77-432,810, FILED 3-27-2008.

SUZANNE BLANE, EXAMINING ATTORNEY

Int. Cl.: 12

Prior U.S. Cls.: 19, 21, 23, 31, 35 and 44

Reg. No. 3,520,351

United States Patent and Trademark Office

Registered Oct. 21, 2008

**TRADEMARK
PRINCIPAL REGISTER**

Volcanic

VOLCANIC MANUFACTURING LLC (WA-
SHINGTON LIMITED LIABILITY COMPANY)
2103 HARRISON AVENUE NW
PMB 2644
OLYMPIA, WA 985022626

THE MARK CONSISTS OF STANDARD CHAR-
ACTERS WITHOUT CLAIM TO ANY PARTICULAR
FONT, STYLE, SIZE, OR COLOR.

FOR: BICYCLES, IN CLASS 12 (U.S. CLS. 19, 21, 23,
31, 35 AND 44).

SER. NO. 77-432,812, FILED 3-27-2008.

FIRST USE 12-31-2003; IN COMMERCE 12-31-2003.

ANNE E. GUSTASON, EXAMINING ATTORNEY

Prior U.S. Cl.: B

United States Patent and Trademark Office

Reg. No. 3,520,352

Registered Oct. 21, 2008

**CERTIFICATION MARK
PRINCIPAL REGISTER**

ONP-C

ORTHOPAEDIC NURSES CERTIFICATION
BOARD (NEW JERSEY CORPORATION)
PO BOX 87
COLUMBIA, SC 29202

FOR: ORTHOPEDIC NURSING, IN CLASS B (U.S.
CL. B).

FIRST USE 4-30-2006; IN COMMERCE 7-1-2006.

THE MARK CONSISTS OF STANDARD CHAR-
ACTERS WITHOUT CLAIM TO ANY PARTICULAR
FONT, STYLE, SIZE, OR COLOR.

THE CERTIFICATION MARK, AS USED BY
AUTHORIZED PERSONS, CERTIFIES THAT THESE
PERSONS PROVIDE A CERTAIN TYPE OF SER-

VICE, NAMELY NURSE PRACTITIONER LEVEL
ORTHOPEDIC NURSING SERVICES, AND THAT
THESE PERSONS PROVIDE SUCH SERVICES WITH
A CERTAIN LEVEL OF EXPERTISE AS DEMON-
STRATED BY THEIR RECEIVING ADVANCED
EDUCATIONAL TRAINING AND/OR WORK EX-
PERIENCE AND SUPERVISION IN THE FIELD
PROVIDED BY THE CERTIFIER AND SUCCESS-
FULLY SATISFYING AND CONTINUING TO SA-
TISFY THE MINIMAL STANDARDS AND
CRITERIA ESTABLISHED BY THE CERTIFIER.

SER. NO. 77-432,823, FILED 3-27-2008.

CHRISTINA SOBRAL, EXAMINING ATTORNEY

Int. Cl.: 35

Prior U.S. Cls.: 100, 101 and 102

United States Patent and Trademark Office

Reg. No. 3,520,353

Registered Oct. 21, 2008

**SERVICE MARK
PRINCIPAL REGISTER**

ONCB

ORTHOPAEDIC NURSES CERTIFICATION
BOARD (NEW JERSEY CORPORATION)
PO BOX 87
COLUMBIA, SC 29202

FOR: PROVIDING OCCUPATIONAL TESTING
SERVICES TO DETERMINE THE PROFESSIONAL
COMPETENCE OF NURSES IN THE FIELD OF
ORTHOPEDICS, IN CLASS 35 (U.S. CLS. 100, 101
AND 102).

FIRST USE 12-11-1986; IN COMMERCE 12-11-1986.

THE MARK CONSISTS OF STANDARD CHAR-
ACTERS WITHOUT CLAIM TO ANY PARTICULAR
FONT, STYLE, SIZE, OR COLOR.

SER. NO. 77-432,838, FILED 3-27-2008.

CHRISTINA SOBRAL, EXAMINING ATTORNEY

Int. Cl.: 25

Prior U.S. Cls.: 22 and 39

United States Patent and Trademark Office

Reg. No. 3,520,354

Registered Oct. 21, 2008

**TRADEMARK
PRINCIPAL REGISTER**

BIBELOT

BARBARA HODES, LTD. (NEW YORK COR-
PORATION)
SUITE 9D
180 WEST 58TH STREET
NEW YORK, NY 10019

THE MARK CONSISTS OF STANDARD CHAR-
ACTERS WITHOUT CLAIM TO ANY PARTICULAR
FONT, STYLE, SIZE, OR COLOR.

FOR: SWEATERS, DRESSES, T-SHIRTS, IN CLASS
25 (U.S. CLS. 22 AND 39).

SER. NO. 77-432,853, FILED 3-27-2008.

FIRST USE 6-5-1999; IN COMMERCE 6-5-1999.

REBECCA EISINGER, EXAMINING ATTORNEY

Int. Cls.: 29, 30, 35 and 43

Prior U.S. Cls.: 46, 100, 101 and 102

United States Patent and Trademark Office

Reg. No. 3,520,355

Registered Oct. 21, 2008

**TRADEMARK
SERVICE MARK
PRINCIPAL REGISTER**

RED OSIER

MOORE, ROBERT P., SR. (UNITED STATES INDIVIDUAL)

3987 GRAYWOOD CENTER
GENESEO, NY 14454 AND

MOORE, NOREEN O. (UNITED STATES INDIVIDUAL)

3987 GRAYWOOD CENTER
GENESEO, NY 14454

FOR: MEAT, MEAT JUICES, PREPARED MEAT, PROCESSED MEAT, LUNCHEON MEATS, PREPARED NON-FROZEN MEAT ENTREES, IN CLASS 29 (U.S. CL. 46).

FIRST USE 12-27-1979; IN COMMERCE 2-1-2003.

FOR: MEAT GRAVIES, CONDIMENTS, NAME- LY, AU JUS MEAT SAUCE AND HORSERADISH- MAYONNAISE SAUCE, IN CLASS 30 (U.S. CL. 46).

FIRST USE 12-27-1979; IN COMMERCE 2-1-2003.

FOR: FOOD KIOSK SERVICES, IN CLASS 35 (U.S. CLS. 100, 101 AND 102).

FIRST USE 12-27-1979; IN COMMERCE 2-1-2003.

FOR: RESTAURANT SERVICES, CATERING SERVICES, SNACK BAR AND CANTEEN SERVICES, IN CLASS 43 (U.S. CLS. 100 AND 101).

FIRST USE 12-27-1979; IN COMMERCE 2-1-2003.

THE MARK CONSISTS OF STANDARD CHARACTERS WITHOUT CLAIM TO ANY PARTICULAR FONT, STYLE, SIZE, OR COLOR.

THE FOREIGN WORDING IN THE MARK TRANSLATES INTO ENGLISH AS "WICKER".

SER. NO. 77-432,859, FILED 3-27-2008.

JORDAN BAKER, EXAMINING ATTORNEY

Int. Cl.: 36

Prior U.S. Cls.: 100, 101 and 102

United States Patent and Trademark Office

Reg. No. 3,520,356

Registered Oct. 21, 2008

**SERVICE MARK
PRINCIPAL REGISTER**

**STRONGER WOMEN, STRONGER
NATIONS**

WOMEN FOR WOMEN INTERNATIONAL (DE-
LAWARE CHARITABLE, NON-PROFIT COR-
PORATION)

SUITE 200

4455 CONNECTICUT AVENUE, N.W.

WASHINGTON, DC 20008

FOR: CHARITABLE FUND RAISING SERVICES
TO ASSIST WOMEN VICTIMS OF WAR AND CIVIL
STRIFE; ESTABLISHING AND ADMINISTERING
MONETARY CHARITABLE PROGRAMS TO PRO-
VIDE INCOME-GENERATING SUPPORT AND MI-
CRO CREDIT LOANS TO BENEFIT WOMEN

VICTIMS OF WAR AND CIVIL STRIFE, IN CLASS
36 (U.S. CLS. 100, 101 AND 102).

FIRST USE 6-1-2007; IN COMMERCE 6-1-2007.

THE MARK CONSISTS OF STANDARD CHAR-
ACTERS WITHOUT CLAIM TO ANY PARTICULAR
FONT, STYLE, SIZE, OR COLOR.

SER. NO. 77-432,868, FILED 3-27-2008.

REBECCA SMITH, EXAMINING ATTORNEY

Int. Cl.: 35

Prior U.S. Cls.: 100, 101 and 102

United States Patent and Trademark Office

Reg. No. 3,520,357

Registered Oct. 21, 2008

**SERVICE MARK
PRINCIPAL REGISTER**

TOWN & COUNTRY RESOURCES

TOWN & COUNTRY RESOURCES, INC. (CALIFORNIA CORPORATION)
425 SHERMAN AVENUE, SUITE 130
PALO ALTO, CA 94306

FOR: EMPLOYMENT AGENCY SERVICES IN THE FIELD OF EXECUTIVE ASSISTANTS, FAMILY ASSISTANTS, DOMESTIC COUPLES, DRIVERS, HOUSEMEN, LAUNDRESSES, PROFESSIONAL CAREGIVERS, AND PARTY HELPERS TO ASSIST IN PARTY SETUP, FOOD AND BEVERAGE SERVICE, AND CLEAN UP, IN CLASS 35 (U.S. CLS. 100, 101 AND 102).

FIRST USE 9-0-2005; IN COMMERCE 9-0-2005.

THE MARK CONSISTS OF STANDARD CHARACTERS WITHOUT CLAIM TO ANY PARTICULAR FONT, STYLE, SIZE, OR COLOR.

OWNER OF U.S. REG. NOS. 2,418,392 AND 2,530,653.

NO CLAIM IS MADE TO THE EXCLUSIVE RIGHT TO USE "RESOURCES", APART FROM THE MARK AS SHOWN.

SER. NO. 77-432,869, FILED 3-27-2008.

CHRISTINA SOBRAL, EXAMINING ATTORNEY

Int. Cl.: 41

Prior U.S. Cls.: 100, 101 and 107

United States Patent and Trademark Office

Reg. No. 3,520,358

Registered Oct. 21, 2008

**SERVICE MARK
PRINCIPAL REGISTER**

PEN WORLD VOICES

PEN AMERICAN CENTER, INC. (NEW YORK CORPORATION)
ROOM 303
588 BROADWAY
NEW YORK, NY 10012

FOR: ARRANGING AND CONDUCTING EDUCATIONAL CONFERENCES; EDUCATIONAL SERVICES, NAMELY, DEVELOPING, ARRANGING, AND CONDUCTING EDUCATIONAL CONFERENCES AND PROGRAMS AND PROVIDING COURSES OF INSTRUCTION IN THE FIELD OF INTERNA-

TIONAL LITERATURE, IN CLASS 41 (U.S. CLS. 100, 101 AND 107).

FIRST USE 4-16-2005; IN COMMERCE 4-16-2005.

THE MARK CONSISTS OF STANDARD CHARACTERS WITHOUT CLAIM TO ANY PARTICULAR FONT, STYLE, SIZE, OR COLOR.

SER. NO. 77-432,891, FILED 3-27-2008.

CURTIS FRENCH, EXAMINING ATTORNEY

Int. Cl.: 12

Prior U.S. Cls.: 19, 21, 23, 31, 35 and 44

Reg. No. 3,520,359

United States Patent and Trademark Office

Registered Oct. 21, 2008

**TRADEMARK
PRINCIPAL REGISTER**

EMP

EXTREME METAL PRODUCTS, LLC (OHIO LIMITED LIABILITY COMPANY)
4730 BRIAR RD
CLEVELAND, OH 44135

FOR: LAND VEHICLE PARTS, NAMELY, WINDSHIELDS; RECREATIONAL VEHICLES, NAMELY, CAMPERS; METAL PARTS FOR VEHICLES, NAMELY, AUTOMOTIVE EXTERIOR AND INTERIOR METAL DECORATIVE AND PROTECTIVE TRIM, IN CLASS 12 (U.S. CLS. 19, 21, 23, 31, 35 AND 44).

FIRST USE 8-21-2005; IN COMMERCE 8-21-2005.

THE MARK CONSISTS OF STANDARD CHARACTERS WITHOUT CLAIM TO ANY PARTICULAR FONT, STYLE, SIZE, OR COLOR.

SER. NO. 77-432,903, FILED 3-27-2008.

GEOFFREY FOSDICK, EXAMINING ATTORNEY

Int. Cl.: 35

Prior U.S. Cls.: 100, 101 and 102

United States Patent and Trademark Office

Reg. No. 3,520,360

Registered Oct. 21, 2008

**SERVICE MARK
PRINCIPAL REGISTER**

**BIJOU BRIDAL & SPECIAL
OCCASION**

J. JOU INC. (NEW JERSEY CORPORATION),
DBA BIJOU BRIDAL & SPECIAL OCCASION
26 MARIE MAJOR DRIVE
ALPINE, NJ 076200459

FOR: RETAIL STORE SERVICES FEATURING
WEDDING GOWNS, BRIDAL GOWNS, BRIDES-
MAID DRESSES, PROM DRESSES, SPECIAL OCCA-
SION DRESSES AND COORDINATING
ACCESSORIES, IN CLASS 35 (U.S. CLS. 100, 101
AND 102).

FIRST USE 12-16-2005; IN COMMERCE 12-14-2006.

THE MARK CONSISTS OF STANDARD CHAR-
ACTERS WITHOUT CLAIM TO ANY PARTICULAR
FONT, STYLE, SIZE, OR COLOR.

NO CLAIM IS MADE TO THE EXCLUSIVE
RIGHT TO USE "BRIDAL & SPECIAL OCCASION",
APART FROM THE MARK AS SHOWN.

SER. NO. 77-432,905, FILED 3-27-2008.

GEOFFREY FOSDICK, EXAMINING ATTORNEY

Int. Cl.: 37

Prior U.S. Cls.: 100, 103 and 106

United States Patent and Trademark Office

Reg. No. 3,520,361

Registered Oct. 21, 2008

**SERVICE MARK
PRINCIPAL REGISTER**

DIESEL DIRECT

DIESEL DIRECT, INC. (MASSACHUSETTS CORPORATION)
74 MAPLE STREET
STOUGHTON, MA 02072

FOR: RE-FUELING SERVICES FOR DIESEL OPERATED VEHICLES AT CUSTOMER ON-SITE LOCATIONS AND ON-SITE SERVICES FOR FUELING VEHICLE FLEETS AND FUELING SKID TANKS AT CONSTRUCTION SITES, IN CLASS 37 (U.S. CLS. 100, 103 AND 106).

FIRST USE 5-1-1998; IN COMMERCE 5-1-1998.

THE MARK CONSISTS OF STANDARD CHARACTERS WITHOUT CLAIM TO ANY PARTICULAR FONT, STYLE, SIZE, OR COLOR.

NO CLAIM IS MADE TO THE EXCLUSIVE RIGHT TO USE "DIESEL", APART FROM THE MARK AS SHOWN.

SER. NO. 77-432,927, FILED 3-27-2008.

REBECCA GILBERT, EXAMINING ATTORNEY

Int. Cl.: 35

Prior U.S. Cls.: 100, 101 and 102

United States Patent and Trademark Office

Reg. No. 3,520,362

Registered Oct. 21, 2008

**SERVICE MARK
PRINCIPAL REGISTER**

DIGICOMM INTERNATIONAL

DIGICOMM INTERNATIONAL, INC. (COLORADO CORPORATION)
1 DIGICOMM DRIVE
ENGLEWOOD, CO 80112

FOR: WORLDWIDE RETAIL AND WHOLESALE DISTRIBUTORSHIP SERVICES FEATURING BROADBAND PRODUCTS FOR THE CABLE TELEVISION INDUSTRY, NAMELY, COAXIAL AND FIBEROPTIC CABLE, AMPLIFIERS, SWITCHES, AND SIGNAL CONVERTERS, IN CLASS 35 (U.S. CLS. 100, 101 AND 102).

FIRST USE 9-1-1993; IN COMMERCE 2-1-1994.

THE MARK CONSISTS OF STANDARD CHARACTERS WITHOUT CLAIM TO ANY PARTICULAR FONT, STYLE, SIZE, OR COLOR.

NO CLAIM IS MADE TO THE EXCLUSIVE RIGHT TO USE "INTERNATIONAL", APART FROM THE MARK AS SHOWN.

SER. NO. 77-432,928, FILED 3-27-2008.

REBECCA GILBERT, EXAMINING ATTORNEY

Int. Cl.: 6

Prior U.S. Cls.: 2, 12, 13, 14, 23, 25 and 50

Reg. No. 3,520,363

United States Patent and Trademark Office

Registered Oct. 21, 2008

**TRADEMARK
PRINCIPAL REGISTER**

Brite-Kote

PHIFER INCORPORATED (ALABAMA COR-
PORATION)
ATTN: CHARLES MORGAN
P. O. BOX 1700
TUSCALOOSA, AL 35403

THE MARK CONSISTS OF STANDARD CHAR-
ACTERS WITHOUT CLAIM TO ANY PARTICULAR
FONT, STYLE, SIZE, OR COLOR.

FOR: INSECT SCREENS OF METAL; METAL
WINDOW SCREENS, IN CLASS 6 (U.S. CLS. 2, 12,
13, 14, 23, 25 AND 50).

SER. NO. 77-432,959, FILED 3-27-2008.

FIRST USE 5-30-1975; IN COMMERCE 5-30-1975.

LINDA ORNDORFF, EXAMINING ATTORNEY

Int. Cl.: 29

Prior U.S. Cl.: 46

United States Patent and Trademark Office

Reg. No. 3,520,364

Registered Oct. 21, 2008

**TRADEMARK
PRINCIPAL REGISTER**

Hickory Nut Gap

HICKORY NUT GAP FARM, LLC (NORTH CAROLINA LIMITED LIABILITY COMPANY)
57 SUGAR HOLLOW ROAD
FAIRVIEW, NC 28730

FOR: MEAT; MEAT, FROZEN; MEAT, POULTRY AND GAME; PREPARED MEAT; PRESERVED MEATS AND SAUSAGES; PROCESSED MEAT, IN CLASS 29 (U.S. CL. 46).

FIRST USE 10-31-2000; IN COMMERCE 3-13-2008.

THE MARK CONSISTS OF STANDARD CHARACTERS WITHOUT CLAIM TO ANY PARTICULAR FONT, STYLE, SIZE, OR COLOR.

NO CLAIM IS MADE TO THE EXCLUSIVE RIGHT TO USE "HICKORY", APART FROM THE MARK AS SHOWN.

SER. NO. 77-432,980, FILED 3-27-2008.

REGINA DRUMMOND, EXAMINING ATTORNEY

Int. Cl.: 42

Prior U.S. Cls.: 100 and 101

United States Patent and Trademark Office

Reg. No. 3,520,365

Registered Oct. 21, 2008

**SERVICE MARK
PRINCIPAL REGISTER**



BRIDGES, TERRANCE (UNITED STATES INDIVIDUAL)
8429 STEAMLINE CIRCLE
AUSTIN, TX 78745

FOR: GRAPHIC ART DESIGN, IN CLASS 42 (U.S. CLS. 100 AND 101).

FIRST USE 6-5-2006; IN COMMERCE 7-11-2006.

THE STIPLING IS FOR SHADING PURPOSES ONLY.

THE MARK CONSISTS OF THE STYLIZED TEXT "DIVINE CONCEPTS" WITH AN ABSTRACT DESIGN IN THE BACKGROUND.

SER. NO. 77-433,006, FILED 3-27-2008.

HEATHER THOMPSON, EXAMINING ATTORNEY

Int. Cl.: 42

Prior U.S. Cls.: 100 and 101

United States Patent and Trademark Office

Reg. No. 3,520,366

Registered Oct. 21, 2008

**SERVICE MARK
PRINCIPAL REGISTER**



FIREVAULT, INC. (TEXAS CORPORATION)
1323 GREENSBORO DRIVE
WYLIE, TX 75098

FOR: BACK-UP SERVICES FOR COMPUTER
HARD DRIVE DATA, IN CLASS 42 (U.S. CLS. 100
AND 101).

FIRST USE 1-1-2008; IN COMMERCE 1-1-2008.

THE MARK CONSISTS OF THE STYLIZED TEXT
"FIREVAULT". TO THE RIGHT OF THE TEXT IS A
CIRCLE WITH A FLAME. IN THE CENTER OF THE
CIRCLE IS A LOCK HOLE.

SER. NO. 77-433,047, FILED 3-27-2008.

REGINA DRUMMOND, EXAMINING ATTORNEY

Int. Cl.: 35

Prior U.S. Cls.: 100, 101 and 102

United States Patent and Trademark Office

Reg. No. 3,520,367

Registered Oct. 21, 2008

**SERVICE MARK
PRINCIPAL REGISTER**



BUSCH, BARRY L. (KANSAS SOLE PROPRIETORSHIP), DBA BUSCH ENTERPRISES
5343 SE 49TH ST.
BERRYTON, KS 66409

FOR: RETAIL DELICATESSEN SERVICES; RETAIL GROCERY STORES, IN CLASS 35 (U.S. CLS. 100, 101 AND 102).

FIRST USE 7-1-2007; IN COMMERCE 11-1-2007.

THE COLOR(S) BLUE, RED, BLACK AND TWO SHADES OF GREEN IS/ARE CLAIMED AS A FEATURE OF THE MARK.

THE MARK CONSISTS OF THE WORD "ICE" IN BLUE CONNECTED BY A RED AMPERSAND TO THE WORD "OLIVES" IN GREEN. THE CENTER OF THE "O" IS FILLED WITH A SECOND SHADE OF GREEN TO CREATE THE IMAGE OF AN OLIVE, INCLUDING A RED MARK TO REPRESENT A PIMENTO AND A TWO BLACK MARKS TO HIGHLIGHT THE PIMENTO AND CREATE THE IMAGE OF A TOOTHPICK.

SER. NO. 77-433,067, FILED 3-27-2008.

REGINA DRUMMOND, EXAMINING ATTORNEY

Int. Cl.: 9

Prior U.S. Cls.: 21, 23, 26, 36 and 38

United States Patent and Trademark Office

Reg. No. 3,520,368

Registered Oct. 21, 2008

**TRADEMARK
PRINCIPAL REGISTER**

SALVADOR AND THE DOLLIES

MELAMED, MICHAEL (UNITED STATES INDIVIDUAL)
5744 VIA DOS CAMINOS
RIVERSIDE, CA 92504

THE MARK CONSISTS OF STANDARD CHARACTERS WITHOUT CLAIM TO ANY PARTICULAR FONT, STYLE, SIZE, OR COLOR.

FOR: DOWNLOADABLE MUSICAL SOUND RECORDINGS ; COMPACT DISCS FEATURING MUSIC, IN CLASS 9 (U.S. CLS. 21, 23, 26, 36 AND 38).

SER. NO. 77-433,068, FILED 3-27-2008.

FIRST USE 2-29-2008; IN COMMERCE 2-29-2008.

RONALD DELGIZZI, EXAMINING ATTORNEY

Int. Cl.: 41

Prior U.S. Cls.: 100, 101 and 107

United States Patent and Trademark Office

Reg. No. 3,520,369

Registered Oct. 21, 2008

**SERVICE MARK
PRINCIPAL REGISTER**

THE FINAL WORD

BLOOMBERG L.P. (DELAWARE LIMITED PART-
NERSHIP)
731 LEXINGTON AVENUE
NEW YORK, NY 10021

FOR: ENTERTAINMENT SERVICES IN THE NATURE OF PROGRAMMING DISTRIBUTED OVER BROADCAST, TELEVISION, RADIO, CABLE AND DIRECT SATELLITE IN THE FIELDS OF NEWS, BUSINESS, FINANCE, CURRENT EVENTS, SECURITIES AND ENERGY MARKETS AND INDUSTRIES; ENTERTAINMENT SERVICES IN THE NATURE OF PRODUCING AND DISTRIBUTING PROGRAMMING DISTRIBUTED OVER BROADCAST, TELEVISION, RADIO, CABLE AND DIRECT SATELLITES IN THE FIELDS OF NEWS, BUSINESS,

FINANCE, CURRENT EVENTS, SECURITIES, SECURITIES MARKETS, IN CLASS 41 (U.S. CLS. 100, 101 AND 107).

FIRST USE 3-19-2007; IN COMMERCE 3-19-2007.

THE MARK CONSISTS OF STANDARD CHARACTERS WITHOUT CLAIM TO ANY PARTICULAR FONT, STYLE, SIZE, OR COLOR.

SER. NO. 77-433,102, FILED 3-27-2008.

DOMINIC J. FERRAIUOLO, EXAMINING ATTORNEY

Int. Cl.: 25

Prior U.S. Cls.: 22 and 39

United States Patent and Trademark Office

Reg. No. 3,520,370

Registered Oct. 21, 2008

**TRADEMARK
PRINCIPAL REGISTER**

FUNKYKUFFS

FUNKYKUFFS INC. (ILLINOIS CORPORATION)
14161 RADO DRIVE EAST
HOMER GLEN, IL 60491

THE MARK CONSISTS OF STANDARD CHAR-
ACTERS WITHOUT CLAIM TO ANY PARTICULAR
FONT, STYLE, SIZE, OR COLOR.

FOR: CUFFS, IN CLASS 25 (U.S. CLS. 22 AND 39).

SER. NO. 77-433,144, FILED 3-27-2008.

FIRST USE 3-31-2007; IN COMMERCE 3-31-2007.

SUNG IN, EXAMINING ATTORNEY

Int. Cl.: 16

Prior U.S. Cls.: 2, 5, 22, 23, 29, 37, 38 and 50

United States Patent and Trademark Office

Reg. No. 3,520,371

Registered Oct. 21, 2008

**TRADEMARK
PRINCIPAL REGISTER**

TO DREAM TO DARE TO WIN

KING MIDAS WORLD ENTERTAINMENT, INC.
(DELAWARE CORPORATION)
1500 EAST TROPICANA AVENUE, STE. 100
LAS VEGAS, NE 89119

THE MARK CONSISTS OF STANDARD CHAR-
ACTERS WITHOUT CLAIM TO ANY PARTICULAR
FONT, STYLE, SIZE, OR COLOR.

FOR: SERIES OF FICTION BOOKS, IN CLASS 16
(U.S. CLS. 2, 5, 22, 23, 29, 37, 38 AND 50).

SER. NO. 77-433,151, FILED 3-27-2008.

FIRST USE 3-27-2008; IN COMMERCE 3-27-2008.

JOHN DWYER, EXAMINING ATTORNEY

Int. Cl.: 22

Prior U.S. Cls.: 1, 2, 7, 19, 22, 42 and 50

United States Patent and Trademark Office

Reg. No. 3,520,372

Registered Oct. 21, 2008

**TRADEMARK
PRINCIPAL REGISTER**

CAMPTOWN

BAEJIN CORPORATION (REPUBLIC OF KOREA
CORPORATION)
SEOCHORION 402
1671-5 SEOCHO-DONG, SEOCHO-GU
SEOUL, REPUBLIC OF KOREA

FOR: TENTS, IN CLASS 22 (U.S. CLS. 1, 2, 7, 19, 22,
42 AND 50).

FIRST USE 12-31-2002; IN COMMERCE 12-31-2002.

THE MARK CONSISTS OF STANDARD CHAR-
ACTERS WITHOUT CLAIM TO ANY PARTICULAR
FONT, STYLE, SIZE, OR COLOR.

OWNER OF U.S. REG. NO. 1,466,368.

SER. NO. 77-433,175, FILED 3-27-2008.

SUNG IN, EXAMINING ATTORNEY

Int. Cl.: 5

Prior U.S. Cls.: 6, 18, 44, 46, 51 and 52

United States Patent and Trademark Office

Reg. No. 3,520,373

Registered Oct. 21, 2008

**TRADEMARK
PRINCIPAL REGISTER**

Q-UROL

FARR LABORATORIES, LLC (DELAWARE LIMITED LIABILITY COMPANY)
11100 SANTA MONICA BOULEVARD, SUITE 560
LOS ANGELES, CA 90025

THE MARK CONSISTS OF STANDARD CHARACTERS WITHOUT CLAIM TO ANY PARTICULAR FONT, STYLE, SIZE, OR COLOR.

FOR: DIETARY SUPPLEMENTS, IN CLASS 5 (U.S. CLS. 6, 18, 44, 46, 51 AND 52).

SER. NO. 77-433,200, FILED 3-27-2008.

FIRST USE 4-17-2003; IN COMMERCE 4-17-2003.

SUNG IN, EXAMINING ATTORNEY

Int. Cl.: 35

Prior U.S. Cls.: 100, 101 and 102

United States Patent and Trademark Office

Reg. No. 3,520,374

Registered Oct. 21, 2008

**SERVICE MARK
PRINCIPAL REGISTER**

FOR COMPANIES ON THE MOVE

IMAGWORKS, LLC (CONNECTICUT LIMITED
LIABILITY COMPANY)
27 HARTFORD TURNPIKE, SUITE 202
VERNON, CT 06066

FOR: ADVERTISING AND PUBLICITY SERVICES, NAMELY, PROMOTING THE GOODS, SERVICES, BRAND IDENTITY AND COMMERCIAL INFORMATION AND NEWS OF THIRD PARTIES THROUGH PRINT, AUDIO, VIDEO, DIGITAL AND ON-LINE MEDIUM, IN CLASS 35 (U.S. CLS. 100, 101 AND 102).

FIRST USE 3-5-2008; IN COMMERCE 3-5-2008.

THE MARK CONSISTS OF STANDARD CHARACTERS WITHOUT CLAIM TO ANY PARTICULAR FONT, STYLE, SIZE, OR COLOR.

SER. NO. 77-433,217, FILED 3-27-2008.

WANDA KAY PRICE, EXAMINING ATTORNEY

Int. Cl.: 12

Prior U.S. Cls.: 19, 21, 23, 31, 35 and 44

Reg. No. 3,520,375

United States Patent and Trademark Office

Registered Oct. 21, 2008

**TRADEMARK
PRINCIPAL REGISTER**

JFLAP

JAEGER, JASON (UNITED STATES INDIVIDUAL)
295 S. HEWITT RD.
YPSILANTI, MI 48197

THE MARK CONSISTS OF STANDARD CHARACTERS WITHOUT CLAIM TO ANY PARTICULAR FONT, STYLE, SIZE, OR COLOR.

FOR: MUD FLAPS FOR VEHICLES, IN CLASS 12 (U.S. CLS. 19, 21, 23, 31, 35 AND 44).

SER. NO. 77-433,220, FILED 3-27-2008.

FIRST USE 11-9-2005; IN COMMERCE 11-9-2005.

WANDA KAY PRICE, EXAMINING ATTORNEY

Int. Cl.: 1

Prior U.S. Cls.: 1, 5, 6, 10, 26 and 46

Reg. No. 3,520,376

United States Patent and Trademark Office

Registered Oct. 21, 2008

**TRADEMARK
PRINCIPAL REGISTER**

VERICHEM

VERICHEM LABORATORIES, INC. (RHODE ISLAND CORPORATION)
90 NARRAGANSETT AVE.
PROVIDENCE, RI 02907

FOR: BILIRUBIN STANDARD KIT COMPRISING OF BILIRUBIN CONJUGATE IN A BASE OF BOVINE SERUM ALBUMIN FOR LABORATORY AND RESEARCH USE IN CALIBRATION OR VERIFICATION OF MEDICAL DIAGNOSTIC TEST EQUIPMENT; FOR CHEMISTRY REFERENCE KIT CONTAINING SODIUM, POTASSIUM, CHLORIDE, CALCIUM, PHOSPHORUS, MAGNESIUM, GLUCOSE, UREA NITROGEN, CREATININE AND TRIGLYCERIDE IN BASE OF BOVINE ALBUMIN FOR CALIBRATION OR VERIFICATION OF MEDICAL DIAGNOSTIC TEST SYSTEMS; FOR TOTAL PROTEIN / ALBUMIN STANDARD KIT CONSISTING OF ALBUMIN AND BOVINE GAMMA GLOBULIN FOR CALIBRATION OR VERIFICATION OF MEDICAL DIAGNOSTIC TEST SYSTEMS; FOR ELECTROLYTE STANDARD KIT CONSISTING OF SODIUM, POTASSIUM, CHLORIDE, LITHIUM AND IONIZED CALCIUM IN A BASE OF BOVINE ALBUMIN FOR CALIBRATION OR VERIFICATION OF MEDICAL DIAGNOSTIC TEST SYSTEMS; FOR CARBON DIOXIDE STANDARD KIT CONSISTING OF CARBON DIOXIDE FOR CALIBRATION OR VERIFICATION OF MEDICAL DIAGNOSTIC TEST SYSTEMS; FOR CHOLESTEROL REFERENCE KIT CONSISTING OF CHOLESTEROL AND URIC ACID FOR CALIBRATION OR VERIFICATION OF MEDICAL DIAGNOSTIC TEST SYSTEMS; FOR MULTI-ENZYME VERIFIER KIT CONSISTING OF ASPARTATE AMINOTRANSFERASE, ALANINE AMINOTRANSFERASE, ALKALINE PHOSPHATASE, LACTATE DEHYDROGENASE, CREATINE PHOSPHOKINASE, GAMMA GLUTAMYLTRANSFERASE, ALPHA-AMYLASE AND LIPASE FOR CALIBRATION OR VERIFICATION OF MEDICAL DIAGNOSTIC TEST SYSTEMS; FOR ENZYME ER VERIFIER KIT CONSISTING OF ASPARTATE AMI-

NOTRANSFERASE, ALANINE AMINOTRANSFERASE, ALKALINE PHOSPHATASE, LACTATE DEHYDROGENASE, CREATINE PHOSPHOKINASE, GAMMA GLUTAMYLTRANSFERASE, ALPHA-AMYLASE, LIPASE AND CHOLINESTERASE FOR CALIBRATION OR VERIFICATION OF MEDICAL DIAGNOSTIC TEST SYSTEMS; FOR TRU-ZERO BILIRUBIN STANDARD CONSISTING OF ZERO LEVELS OF BILIRUBIN IN A BASE OF BOVINE SERUM ALBUMIN FOR CALIBRATION OR VERIFICATION OF MEDICAL DIAGNOSTIC TEST SYSTEMS; FOR ELECTROLYTE CONTROL KIT CONSISTING OF NORMAL AND ABNORMAL LEVELS OF SODIUM, POTASSIUM, CHLORIDE, LITHIUM AND IONIZED CALCIUM IN A BASE OF BOVINE ALBUMIN FOR ROUTINE CONTROL OF MEDICAL DIAGNOSTIC TEST SYSTEMS; FOR AMMONIA / IRON STANDARD KIT CONSISTING OF AMMONIA AND IRON FOR CALIBRATION OR VERIFICATION OF MEDICAL DIAGNOSTIC TEST SYSTEMS; FOR MICROPROTEIN STANDARD KIT CONSISTING OF TRACE LEVELS OF ALBUMIN AND GAMMA GLOBULIN FOR CALIBRATION OR VERIFICATION OF MEDICAL DIAGNOSTIC TEST SYSTEMS; FOR HDL CHOLESTEROL VERIFIER KIT CONSISTING OF HIGH AND LOW DENSITY LIPOPROTEIN CHOLESTEROL IN A BASE OF HUMAN ALBUMIN FOR CALIBRATION OR VERIFICATION OF MEDICAL DIAGNOSTIC TEST SYSTEMS; FOR URINE CHEMISTRY STANDARD KIT CONTAINING SODIUM, POTASSIUM, CHLORIDE, CALCIUM, PHOSPHORUS, MAGNESIUM, UREA NITROGEN, AND CREATININE IN DILUTE SULFURIC ACID FOR CALIBRATION OR VERIFICATION OF MEDICAL DIAGNOSTIC TEST SYSTEMS; FOR ETHANOL STANDARD KIT CONSISTING OF ETHANOL, LACTATE, ACETAMINOPHEN AND SALICYLATE IN A BASE OF BOVINE ALBUMIN FOR CALIBRATION OR VERIFICATION OF MEDICAL DIAGNOSTIC TEST SYSTEMS; FOR IRON STANDARD CONSISTING OF IRON FOR CALIBRATION OR VERIFICATION

OF MEDICAL DIAGNOSTIC TEST SYSTEMS; FOR LIPASE VERIFIER CONSISTING OF LIPASE FOR CALIBRATION OR VERIFICATION OF MEDICAL DIAGNOSTIC TEST SYSTEMS; FOR LOW LEVEL ENZYME VERIFIER KIT CONSISTING OF ASPARTATE AMINOTRANSFERASE, ALANINE AMINOTRANSFERASE, ALKALINE PHOSPHATASE, LACTATE DEHYDROGENASE, CREATINE PHOSPHOKINASE, GAMMA GLUTAMYLTRANSFERASE, ALPHA-AMYLASE AND LIPASE FOR CALIBRATION OR VERIFICATION OF MEDICAL DIAGNOSTIC TEST SYSTEMS; FOR BILIRUBIN MID-RANGE STANDARD KIT COMPRISING OF BILIRUBIN CONJUGATE IN A BASE OF BOVINE SERUM ALBUMIN FOR LABORATORY AND RESEARCH USE IN CALIBRATION AND LINEARITY EVALUATION OF MEDICAL DIAGNOSTIC TEST EQUIPMENT; FOR TRIGLYCERIDE REFERENCE

CONSISTING OF TRIGLYCERIDE FOR CALIBRATION OR VERIFICATION OF MEDICAL DIAGNOSTIC TEST SYSTEMS; LIPOPROTEIN VERIFIER KIT CONSISTING OF HIGH AND LOW DENSITY LIPOPROTEIN CHOLESTEROL IN A BASE OF HUMAN ALBUMIN FOR CALIBRATION OR VERIFICATION OF MEDICAL DIAGNOSTIC TEST SYSTEMS, IN CLASS 1 (U.S. CLS. 1, 5, 6, 10, 26 AND 46).

FIRST USE 3-1-1988; IN COMMERCE 9-1-1988.

THE MARK CONSISTS OF STANDARD CHARACTERS WITHOUT CLAIM TO ANY PARTICULAR FONT, STYLE, SIZE, OR COLOR.

SER. NO. 77-433,227, FILED 3-27-2008.

RONALD AIKENS, EXAMINING ATTORNEY

Int. Cl.: 45

Prior U.S. Cls.: 100 and 101

United States Patent and Trademark Office

Reg. No. 3,520,377

Registered Oct. 21, 2008

**SERVICE MARK
PRINCIPAL REGISTER**

LAW IS WAR

CLAUS, C. CONRAD (NEVADA SOLE PROPRIETORSHIP), DBA CLAUS, C. CONRAD
SUITE 207
528 S. CASINO CENTER BLVD.
LAS VEGAS, NV 89101

FOR: ATTORNEY SERVICES, IN CLASS 45 (U.S. CLS. 100 AND 101).

FIRST USE 2-1-2005; IN COMMERCE 2-1-2005.

THE MARK CONSISTS OF STANDARD CHARACTERS WITHOUT CLAIM TO ANY PARTICULAR FONT, STYLE, SIZE, OR COLOR.

SER. NO. 77-433,243, FILED 3-27-2008.

CHRISTINE BLOMQUIST, EXAMINING ATTORNEY

Int. Cl.: 3

Prior U.S. Cls.: 1, 4, 6, 50, 51 and 52

Reg. No. 3,520,378

United States Patent and Trademark Office

Registered Oct. 21, 2008

**TRADEMARK
PRINCIPAL REGISTER**

ONSEN

OD INTERNATIONAL, INC (CALIFORNIA CORPORATION)
9420 LURLINE AVE STE E
CHATSWORTH, CA 91311

FOR: SKIN CARE PREPARATIONS, FOR THE FACE, AND THE BODY IN THE FORM OF, FACIAL MOISTURIZER, FACIAL CREAM, FACIAL PEELING, FACIAL MASK, FACIAL CLEANSER, NON-MEDICATED FACIAL AND EYE SERUM, EYE GEL, ANTI-AGING EYE CREAM, ANTI-AGING FACE CREAM, NON-MEDICATED INSTANT FACE LIFTING CREAM, NON-MEDICATED INSTANT STRETCHING MASK, HAND CREAM, SALT FACIAL SCRUB, BODY CREAM, NON-MEDICATED COSMETIC PREPARATIONS FOR THE BATH IN THE FORM OF, BATH SALTS, BATH MINERALS, GELS AND OILS, NON-MEDICATED FOOT CREAM AND BODY LOTION, NON-MEDICATED ANTI-AGING PREPARATIONS IN THE FORM OF LO-

TIONS, MILKS, CREAMS AND GELS, COSMETIC PREPARATION FOR NAIL CARE IN THE FORM OF BUFFERS, FILERS, SHAPERS, HAND AND NAIL CONDITIONER, IN CLASS 3 (U.S. CLS. 1, 4, 6, 50, 51 AND 52).

FIRST USE 7-1-2005; IN COMMERCE 7-1-2005.

THE MARK CONSISTS OF STANDARD CHARACTERS WITHOUT CLAIM TO ANY PARTICULAR FONT, STYLE, SIZE, OR COLOR.

THE MEANING OF THE NAME "ONSEN" IS HOT SPRINGS IN JAPANESE.

SER. NO. 77-433,258, FILED 3-27-2008.

NORA BUCHANAN WILL, EXAMINING ATTORNEY

Int. Cl.: 19

Prior U.S. Cls.: 1, 12, 33 and 50

United States Patent and Trademark Office

Reg. No. 3,520,379

Registered Oct. 21, 2008

**TRADEMARK
PRINCIPAL REGISTER**

FT

FLORIDA TILE, INC. (DELAWARE CORPORATION)
320 W. MAIN STREET
LAKELAND, FL 33815

FOR: CERAMIC TILES, IN CLASS 19 (U.S. CLS. 1, 12, 33 AND 50).

FIRST USE 5-15-1954; IN COMMERCE 5-15-1954.

THE MARK CONSISTS OF STANDARD CHARACTERS WITHOUT CLAIM TO ANY PARTICULAR FONT, STYLE, SIZE, OR COLOR.

OWNER OF U.S. REG. NO. 660,002.

SER. NO. 77-433,285, FILED 3-27-2008.

WANDA KAY PRICE, EXAMINING ATTORNEY

Int. Cl.: 18

Prior U.S. Cls.: 1, 2, 3, 22 and 41

Reg. No. 3,520,380

United States Patent and Trademark Office

Registered Oct. 21, 2008

**TRADEMARK
PRINCIPAL REGISTER**

OPEN ROAD

CONSUMER PRODUCTS DESIGN, LTD. (NEW
YORK CORPORATION)
SUITE 2320
60 EAST 42ND STREET
NEW YORK, NY 10165

FOR: ALL PURPOSE SPORT BAGS; ALL-PUR-
POSE CARRYING BAGS; BABY CARRYING BAGS;
BACKPACKS, BOOK BAGS, SPORTS BAGS, BUM
BAGS, WALLETS AND HANDBAGS; BAGS FOR
CARRYING BABIES' ACCESSORIES; BEACH BAGS;
BELT BAGS AND HIP BAGS; BILLFOLDS; BRIEF-
CASES AND ATTACHE CASES; CANVAS SHOP-
PING BAGS; COSMETIC BAGS SOLD EMPTY;
DIAPER BAGS; DUFFEL BAGS; LUGGAGE; LUG-

GAGE TAGS; STRAPS FOR LUGGAGE; SHOPPING
BAGS WITH WHEELS ATTACHED; TOILETRY
BAGS SOLD EMPTY; UMBRELLAS, IN CLASS 18
(U.S. CLS. 1, 2, 3, 22 AND 41).

FIRST USE 3-24-2008; IN COMMERCE 3-24-2008.

THE MARK CONSISTS OF STANDARD CHAR-
ACTERS WITHOUT CLAIM TO ANY PARTICULAR
FONT, STYLE, SIZE, OR COLOR.

SER. NO. 77-433,297, FILED 3-27-2008.

JASON TURNER, EXAMINING ATTORNEY

Int. Cl.: 18

Prior U.S. Cls.: 1, 2, 3, 22 and 41

Reg. No. 3,520,381

United States Patent and Trademark Office

Registered Oct. 21, 2008

**TRADEMARK
PRINCIPAL REGISTER**

RAMBLER

CONSUMER PRODUCTS DESIGN, LTD. (NEW
YORK CORPORATION)
SUITE 2320
60 EAST 42ND STREET
NEW YORK, NY 10165

FOR: ALL PURPOSE SPORT BAGS; ALL-PUR-
POSE CARRYING BAGS; BABY CARRYING BAGS;
BACKPACKS, BOOK BAGS, SPORTS BAGS, BUM
BAGS, WALLETS AND HANDBAGS; BAGS FOR
CARRYING BABIES' ACCESSORIES; BEACH BAGS;
BELT BAGS AND HIP BAGS; BILLFOLDS; BRIEF-
CASES AND ATTACHE CASES; CANVAS SHOP-
PING BAGS; COSMETIC BAGS SOLD EMPTY;
DIAPER BAGS; DUFFEL BAGS; LUGGAGE; LUG-

GAGE TAGS; STRAPS FOR LUGGAGE; SHOPPING
BAGS WITH WHEELS ATTACHED; TOILETRY
BAGS SOLD EMPTY; UMBRELLAS, IN CLASS 18
(U.S. CLS. 1, 2, 3, 22 AND 41).

FIRST USE 3-24-2008; IN COMMERCE 3-24-2008.

THE MARK CONSISTS OF STANDARD CHAR-
ACTERS WITHOUT CLAIM TO ANY PARTICULAR
FONT, STYLE, SIZE, OR COLOR.

SER. NO. 77-433,310, FILED 3-27-2008.

JASON TURNER, EXAMINING ATTORNEY

Int. Cl.: 31

Prior U.S. Cls.: 1 and 46

United States Patent and Trademark Office

Reg. No. 3,520,382

Registered Oct. 21, 2008

**TRADEMARK
PRINCIPAL REGISTER**

MOSSVINE

NATURAL PACK, INC. (CALIFORNIA CORPORATION)
PO BOX 30352
SANTA BARBARA, CA 93130

FOR: NATURAL MOSS AND OTHER MOSSES SOLD DRIED, DYED AND PRESERVED FOR USE WITH FLORAL ARRANGEMENTS, ARTS, CRAFTS, HOBBIES, PETS, AND FOR USE IN THE GARDEN, IN CLASS 31 (U.S. CLS. 1 AND 46).

FIRST USE 10-26-2007; IN COMMERCE 10-26-2007.

THE MARK CONSISTS OF STANDARD CHARACTERS WITHOUT CLAIM TO ANY PARTICULAR FONT, STYLE, SIZE, OR COLOR.

OWNER OF U.S. REG. NOS. 2,839,305 AND 3,036,981.

SER. NO. 77-433,324, FILED 3-27-2008.

GISELLE AGOSTO, EXAMINING ATTORNEY

Int. Cl.: 1

Prior U.S. Cls.: 1, 5, 6, 10, 26 and 46

Reg. No. 3,520,383

United States Patent and Trademark Office

Registered Oct. 21, 2008

**TRADEMARK
PRINCIPAL REGISTER**

AMPLE

PACER TECHNOLOGY, INC. (IDAHO CORPORATION)
P.O. BOX 48
TWIN FALLS, ID 83303

THE MARK CONSISTS OF STANDARD CHARACTERS WITHOUT CLAIM TO ANY PARTICULAR FONT, STYLE, SIZE, OR COLOR.

FOR: FERTILIZERS, IN CLASS 1 (U.S. CLS. 1, 5, 6, 10, 26 AND 46).

SER. NO. 77-433,368, FILED 3-27-2008.

FIRST USE 6-0-1990; IN COMMERCE 6-0-1990.

RONALD AIKENS, EXAMINING ATTORNEY

Int. Cls.: 35 and 39

Prior U.S. Cls.: 100, 101, 102 and 105

United States Patent and Trademark Office

Reg. No. 3,520,384

Registered Oct. 21, 2008

**SERVICE MARK
PRINCIPAL REGISTER**



COYOTE LOGISTICS, LLC (DELAWARE LIMITED LIABILITY COMPANY)
191 EAST DEERPATH ROAD
LAKE FOREST, IL 60045

FOR: TRANSPORTATION LOGISTIC SERVICES, NAMELY, ARRANGING FOR THE TRANSPORTATION OF GOODS FOR OTHERS, IN CLASS 35 (U.S. CLS. 100, 101 AND 102).

FIRST USE 4-20-2007; IN COMMERCE 4-20-2007.

FOR: FREIGHT FORWARDING, BROKERING AND LOGISTIC SERVICES RELATING TO THE TRANSPORTATION OF FREIGHT AND PROPERTY BY LAND, SEA, AIR OR RAIL; DELIVERY OF

GOODS BY TRUCK, IN CLASS 39 (U.S. CLS. 100 AND 105).

FIRST USE 4-20-2007; IN COMMERCE 4-20-2007.

THE MARK CONSISTS OF A SILHOUETTE OF A COYOTE HEAD HOWLING. THE SILHOUETTE OF THE COYOTE HEAD IS WITHIN A HALF MOON SHAPE WHICH ALSO CONTAINS STARS ABOVE THE COYOTE HEAD.

SER. NO. 77-433,369, FILED 3-27-2008.

KAREN BRACEY, EXAMINING ATTORNEY

Int. Cl.: 41

Prior U.S. Cls.: 100, 101 and 107

United States Patent and Trademark Office

Reg. No. 3,520,385

Registered Oct. 21, 2008

**SERVICE MARK
PRINCIPAL REGISTER**

TOP AGENT

MCMONIGLE, JOHN (UNITED STATES INDIVIDUAL)
42 BLUE HERON
IRVINE, CA 92603

FOR: EDUCATION SERVICES, NAMELY, PROVIDING SALES TRAINING PROGRAMS IN THE FIELD OF REAL ESTATE, IN CLASS 41 (U.S. CLS. 100, 101 AND 107).

FIRST USE 9-11-2007; IN COMMERCE 9-11-2007.

THE MARK CONSISTS OF STANDARD CHARACTERS WITHOUT CLAIM TO ANY PARTICULAR FONT, STYLE, SIZE, OR COLOR.

SER. NO. 77-433,387, FILED 3-27-2008.

JILL PRATER, EXAMINING ATTORNEY

Int. Cl.: 41

Prior U.S. Cls.: 100, 101 and 107

United States Patent and Trademark Office

Reg. No. 3,520,386

Registered Oct. 21, 2008

**SERVICE MARK
PRINCIPAL REGISTER**

Rescue Bear Workshop

STANEART, DOUG M (UNITED STATES INDIVIDUAL), DBA THE LEADER'S INSTITUTE, LLC
3233 SPRING CREST CT
HURST, TX 76053

FOR: EDUCATION SERVICES, NAMELY, PROVIDING CLASSES, SEMINARS, AND WORKSHOPS IN THE FIELD OF TEAM BUILDING AND LEADERSHIP, IN CLASS 41 (U.S. CLS. 100, 101 AND 107).

FIRST USE 3-24-2008; IN COMMERCE 3-24-2008.

THE MARK CONSISTS OF STANDARD CHARACTERS WITHOUT CLAIM TO ANY PARTICULAR FONT, STYLE, SIZE, OR COLOR.

NO CLAIM IS MADE TO THE EXCLUSIVE RIGHT TO USE "WORKSHOP", APART FROM THE MARK AS SHOWN.

SER. NO. 77-433,405, FILED 3-27-2008.

DANNEAN HETZEL, EXAMINING ATTORNEY

Int. Cl.: 35

Prior U.S. Cls.: 100, 101 and 102

United States Patent and Trademark Office

Reg. No. 3,520,387

Registered Oct. 21, 2008

**SERVICE MARK
PRINCIPAL REGISTER**

ONE CLEAR CHOICE

BOOKS ARE FUN, LTD. (IOWA CORPORATION)
1680 HIGHWAY 1 NORTH
FAIRFIELD, IA 52556

FIRST USE 1-31-2006; IN COMMERCE 1-31-2006.

FOR: DISTRIBUTORSHIP SERVICES IN THE
FIELD OF GENERAL INTEREST BOOKS, CHILDREN'S
BOOKS, REFERENCE BOOKS, COOKBOOKS,
PRE-RECORDED VIDEOTAPES, PRE-RECORDED
DVDS, PRE-RECORDED MUSIC COMPILATIONS,
COMPUTER SOFTWARE, TOYS AND DECORATIVE
HOME FURNISHINGS, IN CLASS 35 (U.S. CLS.
100, 101 AND 102).

THE MARK CONSISTS OF STANDARD CHARACTERS
WITHOUT CLAIM TO ANY PARTICULAR FONT,
STYLE, SIZE, OR COLOR.

SER. NO. 77-433,438, FILED 3-27-2008.

CHARLOTTE CORWIN, EXAMINING ATTORNEY

Int. Cls.: 35, 36 and 41

Prior U.S. Cls.: 100, 101, 102 and 107

United States Patent and Trademark Office

Reg. No. 3,520,388

Registered Oct. 21, 2008

**SERVICE MARK
PRINCIPAL REGISTER**

China Foundation

CHINA FOUNDATION, THE (MARYLAND
FOUNDATION)
ATTN: JANE H HU
2103 OPAL RIDGE
VISTA, CA 92081

FOR: CHARITABLE SERVICES, NAMELY, ORGANIZING AND CONDUCTING VOLUNTEER PROGRAMS AND COMMUNITY SERVICE PROJECTS, IN CLASS 35 (U.S. CLS. 100, 101 AND 102).

FIRST USE 5-0-2000; IN COMMERCE 5-0-2000.

FOR: CHARITABLE FUND RAISING; ACCEPTING AND ADMINISTERING MONETARY CHARITABLE CONTRIBUTIONS; CHARITABLE SERVICES, NAMELY, GRANTING FUNDS TO SCHOOLS; PROVIDING PROJECT GRANTS FOR ENVIRONMENTAL AND HIV/AIDS PROJECTS, IN CLASS 36 (U.S. CLS. 100, 101 AND 102).

FIRST USE 11-0-1999; IN COMMERCE 11-0-1999.

FOR: ARRANGING AND CONDUCTING EDUCATIONAL CONFERENCES; ORGANIZING CONFERENCES IN THE FIELD OF PUBLIC HEALTH AND MEDICAL SCIENCE, IN CLASS 41 (U.S. CLS. 100, 101 AND 107).

FIRST USE 11-0-1999; IN COMMERCE 11-0-1999.

THE MARK CONSISTS OF STANDARD CHARACTERS WITHOUT CLAIM TO ANY PARTICULAR FONT, STYLE, SIZE, OR COLOR.

NO CLAIM IS MADE TO THE EXCLUSIVE RIGHT TO USE "FOUNDATION", APART FROM THE MARK AS SHOWN.

SEC. 2(F).

SER. NO. 77-433,447, FILED 3-27-2008.

MICHAEL KEATING, EXAMINING ATTORNEY

Int. Cl.: 36

Prior U.S. Cls.: 100, 101 and 102

United States Patent and Trademark Office

Reg. No. 3,520,389

Registered Oct. 21, 2008

**SERVICE MARK
PRINCIPAL REGISTER**

ACTS-travaganza

ACTS HIV/AIDS MINISTRY (TEXAS CORPORATION)
P.O. BOX 100535
SAN ANTONIO, TX 78201

THE MARK CONSISTS OF STANDARD CHARACTERS WITHOUT CLAIM TO ANY PARTICULAR FONT, STYLE, SIZE, OR COLOR.

FOR: CHARITABLE FUNDRAISING SERVICES FOR PERSONS INFECTED WITH AND AFFECTED BY HIV AND AIDS, IN CLASS 36 (U.S. CLS. 100, 101 AND 102).

SER. NO. 77-433,459, FILED 3-27-2008.

FIRST USE 7-1-2005; IN COMMERCE 7-1-2005.

NANCY CLARKE, EXAMINING ATTORNEY

Int. Cl.: 1

Prior U.S. Cls.: 1, 5, 6, 10, 26 and 46

Reg. No. 3,520,390

United States Patent and Trademark Office

Registered Oct. 21, 2008

**TRADEMARK
PRINCIPAL REGISTER**



VERICHEM LABORATORIES, INC. (RHODE ISLAND CORPORATION)
90 NARRAGANSETT AVE.
PROVIDENCE, RI 02907

FOR: BILIRUBIN STANDARD KIT COMPRISING OF BILIRUBIN CONJUGATE IN A BASE OF BOVINE SERUM ALBUMIN FOR LABORATORY AND RESEARCH USE IN CALIBRATION OR VERIFICATION OF MEDICAL DIAGNOSTIC TEST EQUIPMENT; FOR CHEMISTRY REFERENCE KIT CONTAINING SODIUM, POTASSIUM, CHLORIDE, CALCIUM, PHOSPHORUS, MAGNESIUM, GLUCOSE, UREA NITROGEN, CREATININE AND TRIGLYCERIDE IN BASE OF BOVINE ALBUMIN FOR CALIBRATION OR VERIFICATION OF MEDICAL DIAGNOSTIC TEST SYSTEMS; FOR TOTAL PROTEIN / ALBUMIN STANDARD KIT CONSISTING OF ALBUMIN AND BOVINE GAMMA GLOBULIN FOR CALIBRATION OR VERIFICATION OF MEDICAL DIAGNOSTIC TEST SYSTEMS; FOR ELECTROLYTE STANDARD KIT CONSISTING OF SODIUM, POTASSIUM, CHLORIDE, LITHIUM AND IONIZED CALCIUM IN A BASE OF BOVINE ALBUMIN FOR CALIBRATION OR VERIFICATION OF MEDICAL DIAGNOSTIC TEST SYSTEMS; FOR CARBON DIOXIDE STANDARD KIT CONSISTING OF CARBON DIOXIDE FOR CALIBRATION OR VERIFICATION OF MEDICAL DIAGNOSTIC TEST SYSTEMS; FOR CHOLESTEROL REFERENCE KIT CONSISTING OF CHOLESTEROL AND URIC ACID FOR CALIBRATION OR VERIFICATION OF MEDICAL DIAGNOSTIC TEST SYSTEMS; FOR MULTI-

ENZYME VERIFIER KIT CONSISTING OF ASPARTATE AMINOTRANSFERASE, ALANINE AMINOTRANSFERASE, ALKALINE PHOSPHATASE, LACTATE DEHYDROGENASE, CREATINE PHOSPHOKINASE, GAMMA GLUTAMYLTRANSFERASE, ALPHA-AMYLASE AND LIPASE FOR CALIBRATION OR VERIFICATION OF MEDICAL DIAGNOSTIC TEST SYSTEMS; FOR ENZYME VERIFIER KIT CONSISTING OF ASPARTATE AMINOTRANSFERASE, ALANINE AMINOTRANSFERASE, ALKALINE PHOSPHATASE, LACTATE DEHYDROGENASE, CREATINE PHOSPHOKINASE, GAMMA GLUTAMYLTRANSFERASE, ALPHA-AMYLASE, LIPASE AND CHOLINESTERASE FOR CALIBRATION OR VERIFICATION OF MEDICAL DIAGNOSTIC TEST SYSTEMS; FOR TRUZERO BILIRUBIN STANDARD CONSISTING OF ZERO LEVELS OF BILIRUBIN IN A BASE OF BOVINE SERUM ALBUMIN FOR CALIBRATION OR VERIFICATION OF MEDICAL DIAGNOSTIC TEST SYSTEMS; FOR ELECTROLYTE CONTROL KIT CONSISTING OF NORMAL AND ABNORMAL LEVELS OF SODIUM, POTASSIUM, CHLORIDE, LITHIUM AND IONIZED CALCIUM IN A BASE OF BOVINE ALBUMIN FOR ROUTINE CONTROL OF MEDICAL DIAGNOSTIC TEST SYSTEMS; FOR AMMONIA / IRON STANDARD KIT CONSISTING OF AMMONIA AND IRON FOR CALIBRATION OR VERIFICATION OF MEDICAL DIAGNOSTIC TEST SYSTEMS; FOR MICROPROTEIN STANDARD KIT CONSISTING OF TRACE LEVELS OF ALBUMIN AND GAMMA GLOBULIN FOR CALIBRATION OR

VERIFICATION OF MEDICAL DIAGNOSTIC TEST SYSTEMS; FOR HDL CHOLESTEROL VERIFIER KIT CONSISTING OF HIGH AND LOW DENSITY LIPOPROTEIN CHOLESTEROL IN A BASE OF HUMAN ALBUMIN FOR CALIBRATION OR VERIFICATION OF MEDICAL DIAGNOSTIC TEST SYSTEMS; FOR URINE CHEMISTRY STANDARD KIT CONTAINING SODIUM, POTASSIUM, CHLORIDE, CALCIUM, PHOSPHORUS, MAGNESIUM, UREA NITROGEN, AND CREATININE IN DILUTE SULFURIC ACID FOR CALIBRATION OR VERIFICATION OF MEDICAL DIAGNOSTIC TEST SYSTEMS; FOR ETHANOL STANDARD KIT CONSISTING OF ETHANOL, LACTATE, ACETAMINOPHEN AND SALICYLATE IN A BASE OF BOVINE ALBUMIN FOR CALIBRATION OR VERIFICATION OF MEDICAL DIAGNOSTIC TEST SYSTEMS; FOR IRON STANDARD CONSISTING OF IRON FOR CALIBRATION OR VERIFICATION OF MEDICAL DIAGNOSTIC TEST SYSTEMS; FOR LIPASE VERIFIER CONSISTING OF LIPASE FOR CALIBRATION OR VERIFICATION OF MEDICAL DIAGNOSTIC TEST SYSTEMS; FOR LOW LEVEL ENZYME VERIFIER KIT CONSISTING OF ASPARTATE AMINOTRANSFERASE, ALANINE AMINOTRANSFERASE, ALKALINE PHOSPHATASE, LACTATE DEHYDROGENASE, CREATINE PHOSPHOKINASE, GAMMA GLUTAMYLTRANSFER-

ASE, ALPHA-AMYLASE AND LIPASE FOR CALIBRATION OR VERIFICATION OF MEDICAL DIAGNOSTIC TEST SYSTEMS; FOR BILIRUBIN MID-RANGE STANDARD KIT COMPRISING OF BILIRUBIN CONJUGATE IN A BASE OF BOVINE SERUM ALBUMIN FOR LABORATORY AND RESEARCH USE IN CALIBRATION AND LINEARITY EVALUATION OF MEDICAL DIAGNOSTIC TEST EQUIPMENT; FOR TRIGLYCERIDE REFERENCE CONSISTING OF TRIGLYCERIDE FOR CALIBRATION OR VERIFICATION OF MEDICAL DIAGNOSTIC TEST SYSTEMS; LIPOPROTEIN VERIFIER KIT CONSISTING OF HIGH AND LOW DENSITY LIPOPROTEIN CHOLESTEROL IN A BASE OF HUMAN ALBUMIN FOR CALIBRATION OR VERIFICATION OF MEDICAL DIAGNOSTIC TEST SYSTEMS, IN CLASS 1 (U.S. CLS. 1, 5, 6, 10, 26 AND 46).

FIRST USE 3-1-1988; IN COMMERCE 9-1-1988.

OWNER OF U.S. REG. NO. 2,517,091.

THE MARK CONSISTS OF AN INVERTED TRIANGLE WITH A BLOOD DROP THEREIN.

SER. NO. 77-433,488, FILED 3-27-2008.

RONALD AIKENS, EXAMINING ATTORNEY

Int. Cl.: 37

Prior U.S. Cls.: 100, 103 and 106

United States Patent and Trademark Office

Reg. No. 3,520,391

Registered Oct. 21, 2008

**SERVICE MARK
PRINCIPAL REGISTER**

**HEAL YOUR HOME WITH
HELITECH**

SLAB MASTERS, INC. (ILLINOIS CORPORATION)
P.O. BOX 24067
BELLEVILLE, IL 62223

FOR: STRUCTURAL REPAIR, NAMELY, PIERING AND FOUNDATION REPAIR, CONCRETE REPAIR AND WATERPROOFING, IN CLASS 37 (U.S. CLS. 100, 103 AND 106).

FIRST USE 1-0-2005; IN COMMERCE 1-0-2005.

THE MARK CONSISTS OF STANDARD CHARACTERS WITHOUT CLAIM TO ANY PARTICULAR FONT, STYLE, SIZE, OR COLOR.

OWNER OF U.S. REG. NOS. 2,301,603 AND 3,242,451.

SER. NO. 77-433,508, FILED 3-27-2008.

JULIE VEPPUMTHARA, EXAMINING ATTORNEY

Int. Cl.: 12

Prior U.S. Cls.: 19, 21, 23, 31, 35 and 44

Reg. No. 3,520,392

United States Patent and Trademark Office

Registered Oct. 21, 2008

**TRADEMARK
PRINCIPAL REGISTER**



SCOTT USA, INC (DELAWARE CORPORATION)
101 LEWIS STREET
KETCHUM, ID 83340

OWNER OF U.S. REG. NOS. 1,837,348, 2,632,715
AND OTHERS.

FOR: BICYCLES AND BICYCLE HANDLEBARS
AND PARTS THEREOF; GRIPS FOR HANDLEBARS
FOR MOTORCYCLES AND BICYCLES, IN CLASS 12
(U.S. CLS. 19, 21, 23, 31, 35 AND 44).

THE MARK CONSISTS OF A STYLIZED "S" AND
THE WORD "SCOTT".

SER. NO. 77-433,520, FILED 3-27-2008.

FIRST USE 0-0-2000; IN COMMERCE 0-0-2000.

MARK T. MULLEN, EXAMINING ATTORNEY

Int. Cl.: 35

Prior U.S. Cls.: 100, 101 and 102

United States Patent and Trademark Office

Reg. No. 3,520,393

Registered Oct. 21, 2008

**SERVICE MARK
PRINCIPAL REGISTER**

BLACKHEART INTERNATIONAL

BLACKHEART INTERNATIONAL, LLC (WEST VIRGINIA LIMITED LIABILITY COMPANY)
RR3 BOX 115
PHILIPPI, WV 26416

FOR: COMPUTERIZED ON-LINE RETAIL STORE SERVICES IN THE FIELD OF TACTICAL GEAR, INSTRUCTIONAL MATERIALS, EMERGENCY AND LOGISTICS MATERIALS AND EQUIPMENT, FOR MILITARY, PARA-MILITARY, LAW ENFORCEMENT AND PRIVATE SECURITY SERVICES; ON-LINE RETAIL STORE SERVICES FEATURING TACTICAL GEAR, INSTRUCTIONAL MATERIALS, EMERGENCY AND LOGISTICS MATERIALS AND EQUIPMENT, FOR MILITARY, PARA-MILITARY, LAW ENFORCEMENT AND PRIVATE SECURITY SERVICES; RETAIL STORE SERVICES FEATURING TACTICAL GEAR, INSTRUCTIONAL MATERIALS, EMERGENCY AND LOGISTICS MATERIALS AND

EQUIPMENT, FOR MILITARY, PARA-MILITARY, LAW ENFORCEMENT AND PRIVATE SECURITY SERVICES, IN CLASS 35 (U.S. CLS. 100, 101 AND 102).

FIRST USE 12-31-1999; IN COMMERCE 12-31-1999.

THE MARK CONSISTS OF STANDARD CHARACTERS WITHOUT CLAIM TO ANY PARTICULAR FONT, STYLE, SIZE, OR COLOR.

NO CLAIM IS MADE TO THE EXCLUSIVE RIGHT TO USE "INTERNATIONAL", APART FROM THE MARK AS SHOWN.

SER. NO. 77-433,523, FILED 3-27-2008.

CHARLOTTE CORWIN, EXAMINING ATTORNEY

Int. Cl.: 41

Prior U.S. Cls.: 100, 101 and 107

United States Patent and Trademark Office

Reg. No. 3,520,394

Registered Oct. 21, 2008

**SERVICE MARK
PRINCIPAL REGISTER**

Where the game is

HOOPS BASKETBALL ACADEMY, LLC (KEN-
TUCKY LIMITED LIABILITY COMPANY)
12101 SYCAMORE STATION PLACE
LOUISVILLE, KY 40299

FOR: AMATEUR YOUTH SPORTS SERVICES,
NAMELY, ORGANIZING, PROVIDING AND
MANAGING YOUTH SPORTS ACTIVITIES, IN
CLASS 41 (U.S. CLS. 100, 101 AND 107).

FIRST USE 1-2-2007; IN COMMERCE 1-2-2007.

THE MARK CONSISTS OF STANDARD CHAR-
ACTERS WITHOUT CLAIM TO ANY PARTICULAR
FONT, STYLE, SIZE, OR COLOR.

SER. NO. 77-433,528, FILED 3-27-2008.

JOHN KELLY, EXAMINING ATTORNEY

Int. Cl.: 44

Prior U.S. Cls.: 100 and 101

United States Patent and Trademark Office

Reg. No. 3,520,395

Registered Oct. 21, 2008

**SERVICE MARK
PRINCIPAL REGISTER**

SAVA SPA

SAVA SPA, INC. (NEW YORK CORPORATION)
211 PINEHURST AVENUE
NEW YORK, NY 10033

FOR: DAY SPA SERVICES, NAMELY, NAIL CARE, MANICURES, PEDICURES AND NAIL ENHANCEMENTS; HEALTH SPA SERVICES, NAMELY, COSMETIC BODY CARE SERVICES, IN CLASS 44 (U.S. CLS. 100 AND 101).

FIRST USE 10-24-2003; IN COMMERCE 10-24-2003.

THE MARK CONSISTS OF STANDARD CHARACTERS WITHOUT CLAIM TO ANY PARTICULAR FONT, STYLE, SIZE, OR COLOR.

NO CLAIM IS MADE TO THE EXCLUSIVE RIGHT TO USE "SPA", APART FROM THE MARK AS SHOWN.

SER. NO. 77-433,583, FILED 3-27-2008.

CHRISTINE BLOMQUIST, EXAMINING ATTORNEY

Int. Cl.: 35

Prior U.S. Cls.: 100, 101 and 102

United States Patent and Trademark Office

Reg. No. 3,520,396

Registered Oct. 21, 2008

**SERVICE MARK
PRINCIPAL REGISTER**

ARCADE AMERICA

A & E STORES, INC. (NEW YORK CORPORATION)
1000 HUYLER STREET
TETERBORO, NJ 07608

FOR: RETAIL STORE SERVICES IN THE FIELD OF CLOTHING AND LEATHER BAGS, BACKPACKS, JEWELRY, SUNGLASSES, HAIR ACCESSORIES AND CLOTHING ACCESSORIES, IN CLASS 35 (U.S. CLS. 100, 101 AND 102).

FIRST USE 11-23-1999; IN COMMERCE 11-23-1999.

THE MARK CONSISTS OF STANDARD CHARACTERS WITHOUT CLAIM TO ANY PARTICULAR FONT, STYLE, SIZE, OR COLOR.

NO CLAIM IS MADE TO THE EXCLUSIVE RIGHT TO USE "AMERICA", APART FROM THE MARK AS SHOWN.

SER. NO. 77-433,610, FILED 3-27-2008.

LINDA LAVACHE, EXAMINING ATTORNEY

Int. Cl.: 45

Prior U.S. Cls.: 100 and 101

United States Patent and Trademark Office

Reg. No. 3,520,397

Registered Oct. 21, 2008

**SERVICE MARK
PRINCIPAL REGISTER**

Who Owns The Rights

WENZLAU LAW GROUP, PLLC (ARIZONA LIMITED LIABILITY COMPANY)
SUITE 103
10575 NORTH 114TH STREET
SCOTTSDALE, AZ 85259

FOR: LEGAL SERVICES, IN CLASS 45 (U.S. CLS. 100 AND 101).

FIRST USE 1-1-2008; IN COMMERCE 1-1-2008.

THE MARK CONSISTS OF STANDARD CHARACTERS WITHOUT CLAIM TO ANY PARTICULAR FONT, STYLE, SIZE, OR COLOR.

SER. NO. 77-433,626, FILED 3-27-2008.

ANDREA SAUNDERS, EXAMINING ATTORNEY

Int. Cl.: 31

Prior U.S. Cls.: 1 and 46

United States Patent and Trademark Office

Reg. No. 3,520,398

Registered Oct. 21, 2008

**TRADEMARK
PRINCIPAL REGISTER**

ECOLOTURF

A-G SOD FARMS, INC. (NEBRASKA CORPORATION)
2900 ADAMS STREET, SUITE C230
RIVERSIDE, CA 92504

THE MARK CONSISTS OF STANDARD CHARACTERS WITHOUT CLAIM TO ANY PARTICULAR FONT, STYLE, SIZE, OR COLOR.

FOR: GRASS PRODUCTS, NAMELY, NON-ARTIFICIAL TURF AND GRASS SEEDS AND SOD, IN CLASS 31 (U.S. CLS. 1 AND 46).

SER. NO. 77-433,627, FILED 3-27-2008.

FIRST USE 1-1-2005; IN COMMERCE 1-1-2005.

JOHN DWYER, EXAMINING ATTORNEY

Int. Cl.: 9

Prior U.S. Cls.: 21, 23, 26, 36 and 38

Reg. No. 3,520,399

United States Patent and Trademark Office

Registered Oct. 21, 2008

**TRADEMARK
PRINCIPAL REGISTER**

DARP

AKM ENTERPRISE, INC. (TEXAS CORPORATION)
5353 WEST ALABAMA, SUITE 300
HOUSTON, TX 77056

FOR: COMPUTER SOFTWARE FOR RETREIVAL, TRANSLATION AND DISTRIBUTION OF DATA ACROSS MULTIPLE FORMATS, OPTIMIZED FOR MANAGEMENT OF GEOGRAPHICALLY SEPARATE SOURCES AND USERS , IN CLASS 9 (U.S. CLS. 21, 23, 26, 36 AND 38).

FIRST USE 2-1-2008; IN COMMERCE 2-1-2008.

THE MARK CONSISTS OF STANDARD CHARACTERS WITHOUT CLAIM TO ANY PARTICULAR FONT, STYLE, SIZE, OR COLOR.

SER. NO. 77-433,632, FILED 3-27-2008.

CHARLOTTE CORWIN, EXAMINING ATTORNEY

Int. Cl.: 25

Prior U.S. Cls.: 22 and 39

United States Patent and Trademark Office

Reg. No. 3,520,400

Registered Oct. 21, 2008

**TRADEMARK
PRINCIPAL REGISTER**

MONROE & MAIN

THE SWISS COLONY, INC. (WISCONSIN CORPORATION)
1112 SEVENTH AVENUE
MONROE, WI 535668016

FOR: DRESSES; PANTS; PANTSUITS; SKIRT SUITS; SKIRTS; TOPS; JACKETS; SWIMWEAR; SWEATERS; ROBES; SLEEPWEAR; LOUNGEWEAR; SHOES, IN CLASS 25 (U.S. CLS. 22 AND 39).

FIRST USE 0-0-2000; IN COMMERCE 0-0-2000.

THE MARK CONSISTS OF STANDARD CHARACTERS WITHOUT CLAIM TO ANY PARTICULAR FONT, STYLE, SIZE, OR COLOR.

OWNER OF U.S. REG. NO. 2,619,056.

SER. NO. 77-433,643, FILED 3-27-2008.

JILL C. ALT, EXAMINING ATTORNEY

Int. Cl.: 41

Prior U.S. Cls.: 100, 101 and 107

United States Patent and Trademark Office

Reg. No. 3,520,401

Registered Oct. 21, 2008

**SERVICE MARK
PRINCIPAL REGISTER**



ART PROJECTS INTERNATIONAL, INC. (NEW YORK CORPORATION), DBA ART PROJECTS INTERNATIONAL
SUITE 5B
429 GREENWICH STREET
NEW YORK, NY 10013

FOR: CONSULTING SERVICES IN THE FIELD OF CURATING ART EXHIBITIONS, ART GALLERIES AND MUSEUMS; CONSULTING SERVICES IN THE FIELD OF RUNNING MUSEUMS; CONSULTING SERVICES IN THE FIELD OF ORGANIZING ART EXHIBITIONS; ARRANGING AND CONDUCTING EDUCATIONAL CONFERENCES AND SYMPOSIA FOR ART GALLERIES, INSTITUTIONS

AND MUSEUMS, IN CLASS 41 (U.S. CLS. 100, 101 AND 107).

FIRST USE 9-1-1993; IN COMMERCE 9-1-1993.

OWNER OF U.S. REG. NO. 1,992,315.

THE MARK CONSISTS OF THE LETTERS "A", "P" AND "I" IN OFFSET FASHION WITHIN A SQUARE.

SER. NO. 77-433,670, FILED 3-27-2008.

SANDRA MANIOS, EXAMINING ATTORNEY

Int. Cl.: 44

Prior U.S. Cls.: 100 and 101

United States Patent and Trademark Office

Reg. No. 3,520,402

Registered Oct. 21, 2008

**SERVICE MARK
PRINCIPAL REGISTER**



BLUE MEDSPA, LLC (GEORGIA LIMITED LIABILITY COMPANY)
190 10TH STREET
ATLANTA, GA 30309

THE COLOR(S) BLUE IS/ARE CLAIMED AS A FEATURE OF THE MARK.

FOR: HEALTH SPA SERVICES, NAMELY, COSMETIC BODY CARE SERVICES, IN CLASS 44 (U.S. CLS. 100 AND 101).

THE MARK CONSISTS OF TEXT IN TWO SHADES OF THE COLOR BLUE.

FIRST USE 1-1-2006; IN COMMERCE 1-1-2006.

SER. NO. 77-433,692, FILED 3-27-2008.

NO CLAIM IS MADE TO THE EXCLUSIVE RIGHT TO USE "MEDSPA", APART FROM THE MARK AS SHOWN.

KARANENDRA S. CHHINA, EXAMINING ATTORNEY

Int. Cl.: 18

Prior U.S. Cls.: 1, 2, 3, 22 and 41

United States Patent and Trademark Office

Reg. No. 3,520,403

Registered Oct. 21, 2008

**TRADEMARK
PRINCIPAL REGISTER**

URBAN LEGEND

INTERNATIONAL DESIGN ASSOCIATES LTD
(NEW YORK CORPORATION)
SUITE 2320
60 EAST 42ND STREET
NEW YORK, NY 10165

FOR: ALL PURPOSE SPORT BAGS; ALL-PURPOSE CARRYING BAGS; BABY CARRYING BAGS; BAGS FOR CARRYING BABIES' ACCESSORIES; BACKPACKS, BOOK BAGS, SPORTS BAGS, BUM BAGS, WALLETS AND HANDBAGS; BEACH BAGS; BELT BAGS AND HIP BAGS; CANVAS SHOPPING BAGS; COSMETIC BAGS SOLD EMPTY; TOILETRY BAGS SOLD EMPTY; DIAPER BAGS; DUFFEL BAGS; SHOPPING BAGS WITH WHEELS AT-

TACHED; BILLFOLDS; BRIEFCASES AND ATTACHE CASES; LUGGAGE; LUGGAGE TAGS; STRAPS FOR LUGGAGE; UMBRELLAS, IN CLASS 18 (U.S. CLS. 1, 2, 3, 22 AND 41).

FIRST USE 3-24-2008; IN COMMERCE 3-24-2008.

THE MARK CONSISTS OF STANDARD CHARACTERS WITHOUT CLAIM TO ANY PARTICULAR FONT, STYLE, SIZE, OR COLOR.

SER. NO. 77-433,697, FILED 3-27-2008.

ANTHONY RINKER, EXAMINING ATTORNEY

Int. Cl.: 25

Prior U.S. Cls.: 22 and 39

United States Patent and Trademark Office

Reg. No. 3,520,404

Registered Oct. 21, 2008

**TRADEMARK
PRINCIPAL REGISTER**

MIDNIGHT VELVET

THE SWISS COLONY, INC. (WISCONSIN CORPORATION)
1112 SEVENTH AVENUE
MONROE, WI 535668016

FOR: DRESSES; PANTS; PANTSUITS; SKIRT SUITS; SKIRTS; TOPS; JACKETS; ROBES; SLEEPWEAR; LOUNGEWEAR; SWIMWEAR; SWEATERS, IN CLASS 25 (U.S. CLS. 22 AND 39).

FIRST USE 0-0-2000; IN COMMERCE 0-0-2000.

THE MARK CONSISTS OF STANDARD CHARACTERS WITHOUT CLAIM TO ANY PARTICULAR FONT, STYLE, SIZE, OR COLOR.

OWNER OF U.S. REG. NOS. 1,505,336, 3,223,144 AND OTHERS.

SER. NO. 77-433,699, FILED 3-27-2008.

JILL C. ALT, EXAMINING ATTORNEY

Int. Cls.: 35 and 41

Prior U.S. Cls.: 100, 101, 102 and 107

United States Patent and Trademark Office

Reg. No. 3,520,405

Registered Oct. 21, 2008

**SERVICE MARK
PRINCIPAL REGISTER**

TELEVUTION

MENON, KRISHNAN (INDIA INDIVIDUAL)
749 N. CRESCENT HEIGHTS BLVD
LOS ANGELES, CA 90046

FOR: MARKETING CONSULTATION IN THE
FIELD OF ENTERTAINMENT, MEDIA, INTERNET,
BRANDED ENTERTAINMENT AND SOCIAL NET-
WORKS, IN CLASS 35 (U.S. CLS. 100, 101 AND 102).

FIRST USE 4-21-2005; IN COMMERCE 4-26-2007.

FOR: ON-LINE JOURNALS, NAMELY, BLOGS
FEATURING MEDIA, ENTERTAINMENT, ENTER-

TAINMENT TECHNOLOGY AND MARKETING, IN
CLASS 41 (U.S. CLS. 100, 101 AND 107).

FIRST USE 3-21-2004; IN COMMERCE 5-26-2007.

THE MARK CONSISTS OF STANDARD CHAR-
ACTERS WITHOUT CLAIM TO ANY PARTICULAR
FONT, STYLE, SIZE, OR COLOR.

SER. NO. 77-433,709, FILED 3-27-2008.

RUDY R. SINGLETON, EXAMINING ATTORNEY

Int. Cl.: 25

Prior U.S. Cls.: 22 and 39

United States Patent and Trademark Office

Reg. No. 3,520,406

Registered Oct. 21, 2008

**TRADEMARK
PRINCIPAL REGISTER**

MIDNIGHT VELVET STYLE

THE SWISS COLONY, INC. (WISCONSIN CORPORATION)
1112 SEVENTH AVENUE
MONROE, WI 535668016

FOR: DRESSES; PANTS; PANTSUITS; SKIRTS; SKIRT SUITS; TOPS; JACKETS; ROBES; SLEEPWEAR; LOUNGEWEAR; SWIMWEAR; SWEATERS, IN CLASS 25 (U.S. CLS. 22 AND 39).

FIRST USE 0-0-2000; IN COMMERCE 0-0-2000.

THE MARK CONSISTS OF STANDARD CHARACTERS WITHOUT CLAIM TO ANY PARTICULAR FONT, STYLE, SIZE, OR COLOR.

OWNER OF U.S. REG. NOS. 1,505,336, 3,223,145 AND OTHERS.

SER. NO. 77-433,730, FILED 3-27-2008.

JILL C. ALT, EXAMINING ATTORNEY

Int. Cl.: 5

Prior U.S. Cls.: 6, 18, 44, 46, 51 and 52

Reg. No. 3,520,407

United States Patent and Trademark Office

Registered Oct. 21, 2008

**TRADEMARK
PRINCIPAL REGISTER**

SPT ADVANTAGE

LAUB BIOCHEMICALS CORPORATION (CALI-
FORNIA CORPORATION)
1401 QUAIL STREET, SUITE 121
NEWPORT BEACH, CA 92660

FOR: NUTRITIONAL SUPPLEMENTS, DIETARY
SUPPLEMENTS; PHARMACEUTICAL PREPARA-
TION FOR USE IN THE TREATMENT OF HUMAN
VIRAL DISEASE, IN CLASS 5 (U.S. CLS. 6, 18, 44, 46,
51 AND 52).

FIRST USE 2-22-2008; IN COMMERCE 3-14-2008.

THE MARK CONSISTS OF STANDARD CHAR-
ACTERS WITHOUT CLAIM TO ANY PARTICULAR
FONT, STYLE, SIZE, OR COLOR.

SER. NO. 77-433,732, FILED 3-27-2008.

JOHN KELLY, EXAMINING ATTORNEY

Int. Cl.: 3

Prior U.S. Cls.: 1, 4, 6, 50, 51 and 52

United States Patent and Trademark Office

Reg. No. 3,520,408

Registered Oct. 21, 2008

**TRADEMARK
PRINCIPAL REGISTER**

MIDNIGHT VELVET STYLE

THE SWISS COLONY, INC. (WISCONSIN CORPORATION)
1112 SEVENTH AVENUE
MONROE, WI 535668016

FOR: PERFUME; FRAGRANCES; COMPACTS CONTAINING MAKE-UP, IN CLASS 3 (U.S. CLS. 1, 4, 6, 50, 51 AND 52).

FIRST USE 0-0-2007; IN COMMERCE 0-0-2007.

THE MARK CONSISTS OF STANDARD CHARACTERS WITHOUT CLAIM TO ANY PARTICULAR FONT, STYLE, SIZE, OR COLOR.

OWNER OF U.S. REG. NOS. 1,505,336, 3,223,145 AND OTHERS.

SER. NO. 77-433,771, FILED 3-27-2008.

JILL C. ALT, EXAMINING ATTORNEY

Int. Cl.: 21

Prior U.S. Cls.: 2, 13, 23, 29, 30, 33, 40 and 50

United States Patent and Trademark Office

Reg. No. 3,520,409

Registered Oct. 21, 2008

**TRADEMARK
PRINCIPAL REGISTER**

Dust Defender

KELERIN CORP. (ILLINOIS CORPORATION)
627 EDGEWOOD AVENUE
ELMHURST, IL 60126

FOR: CLEANING SUPPLIES, NAMELY, MICRO FIBER DUST MOPS, DUST CLOTHS AND CLEANING MOPS THAT CAN BE MOISTENED, IN CLASS 21 (U.S. CLS. 2, 13, 23, 29, 30, 33, 40 AND 50).

FIRST USE 7-1-2005; IN COMMERCE 7-1-2005.

THE MARK CONSISTS OF STANDARD CHARACTERS WITHOUT CLAIM TO ANY PARTICULAR FONT, STYLE, SIZE, OR COLOR.

NO CLAIM IS MADE TO THE EXCLUSIVE RIGHT TO USE "DUST", APART FROM THE MARK AS SHOWN.

SER. NO. 77-433,809, FILED 3-27-2008.

ANDREA SAUNDERS, EXAMINING ATTORNEY

Int. Cls.: 8, 9, 18 and 28

**Prior U.S. Cls.: 1, 2, 3, 21, 22, 23, 26, 28, 36, 38, 41, 44
and 50**

Reg. No. 3,520,410

United States Patent and Trademark Office

Registered Oct. 21, 2008

**TRADEMARK
PRINCIPAL REGISTER**

Open Water

HYI (CALIFORNIA CORPORATION)
222 NORTH VINCENT AVENUE
COVINA, CA 91722

FOR: HAND TOOLS, NAMELY, BILLY CLUBS,
KNIVES, KNIFE SHEATHS, PLIERS, FORCEPS,
CRIMPERS AND FISHING LINE CUTTERS, IN
CLASS 8 (U.S. CLS. 23, 28 AND 44).

FIRST USE 10-12-2005; IN COMMERCE 10-12-2005.

FOR: ELECTRICAL AND SCIENTIFIC APPARA-
TUS, NAMELY, SUNGLASSES AND STRAPS, IN
CLASS 9 (U.S. CLS. 21, 23, 26, 36 AND 38).

FIRST USE 10-12-2005; IN COMMERCE 10-12-2005.

FOR: NON-LEATHER ALL PURPOSE ATHLETIC
BAGS, NAMELY, NYLON ALL-PURPOSE ATHLET-
IC BAGS; NON-LEATHER BACKPACKS, NAMELY,
NYLON BACKPACKS, IN CLASS 18 (U.S. CLS. 1, 2, 3,
22 AND 41).

FIRST USE 10-12-2005; IN COMMERCE 10-12-2005.

FOR: SPORTING GOODS, NAMELY, FISHING
TACKLE BAGS, FISHING TACKLE BOXES, UTILI-
TY BOXES FOR FISHING WEIGHTS, FISHING
LURES AND FISHING HOOKS, FISHING REEL
COVERS, FISHING ROD HOLDERS, FISHING
ROD GUARDS, FISHING ROD WRAPS AND NON-
LEATHER FISHING JIG TUBE BAGS, IN CLASS 28
(U.S. CLS. 22, 23, 38 AND 50).

FIRST USE 10-12-2005; IN COMMERCE 10-12-2005.

THE MARK CONSISTS OF STANDARD CHAR-
ACTERS WITHOUT CLAIM TO ANY PARTICULAR
FONT, STYLE, SIZE, OR COLOR.

OWNER OF U.S. REG. NO. 3,207,921.

SER. NO. 77-433,811, FILED 3-27-2008.

JILL C. ALT, EXAMINING ATTORNEY

Int. Cl.: 18

Prior U.S. Cls.: 1, 2, 3, 22 and 41

United States Patent and Trademark Office

Reg. No. 3,520,411

Registered Oct. 21, 2008

**TRADEMARK
PRINCIPAL REGISTER**

SO.BOO

JACKSON, JULIA (GREAT BRITAIN INDIVIDUAL)
4336 WINDHAVEN LANE
DALLAS, TX 75287

THE MARK CONSISTS OF STANDARD CHARACTERS WITHOUT CLAIM TO ANY PARTICULAR FONT, STYLE, SIZE, OR COLOR.

FOR: HANDBAGS, IN CLASS 18 (U.S. CLS. 1, 2, 3, 22 AND 41).

SER. NO. 77-433,813, FILED 3-27-2008.

FIRST USE 1-0-2007; IN COMMERCE 11-0-2007.

JILL C. ALT, EXAMINING ATTORNEY

Int. Cl.: 3

Prior U.S. Cls.: 1, 4, 6, 50, 51 and 52

United States Patent and Trademark Office

Reg. No. 3,520,412

Registered Oct. 21, 2008

**TRADEMARK
PRINCIPAL REGISTER**

loose lips

EAST COAST SKIN CARE LLC (NEW YORK
LIMITED LIABILITY COMPANY)
241 EAST 76TH STREET
NEW YORK, NY 10021

THE MARK CONSISTS OF STANDARD CHAR-
ACTERS WITHOUT CLAIM TO ANY PARTICULAR
FONT, STYLE, SIZE, OR COLOR.

FOR: BODY AND BEAUTY CARE COSMETICS;
COSMETICS, NAMELY, LIP PRIMER; LIPSTICK;
LIPSTICKS, IN CLASS 3 (U.S. CLS. 1, 4, 6, 50, 51 AND
52).

SER. NO. 77-433,852, FILED 3-27-2008.

FIRST USE 3-1-2008; IN COMMERCE 3-1-2008.

JILL PRATER, EXAMINING ATTORNEY

Int. Cl.: 16

Prior U.S. Cls.: 2, 5, 22, 23, 29, 37, 38 and 50

United States Patent and Trademark Office

Reg. No. 3,520,413

Registered Oct. 21, 2008

**TRADEMARK
PRINCIPAL REGISTER**

Globe Guard

SALAZAR PACKAGING, INC. (ILLINOIS CORPORATION)
12351 S. INDUSTRIAL DRIVE EAST
PLAINFIELD, IL 60585

THE MARK CONSISTS OF STANDARD CHARACTERS WITHOUT CLAIM TO ANY PARTICULAR FONT, STYLE, SIZE, OR COLOR.

FOR: CARDBOARD PACKAGING, IN CLASS 16 (U.S. CLS. 2, 5, 22, 23, 29, 37, 38 AND 50).

SER. NO. 77-433,865, FILED 3-27-2008.

FIRST USE 3-1-2008; IN COMMERCE 3-1-2008.

JILL PRATER, EXAMINING ATTORNEY

Int. Cls.: 35 and 44

Prior U.S. Cls.: 100, 101 and 102

United States Patent and Trademark Office

Reg. No. 3,520,414

Registered Oct. 21, 2008

**SERVICE MARK
PRINCIPAL REGISTER**



FAMILY EYE CLINIC & CONTACT LENS CENTER, PA (MINNESOTA CORPORATION)

#3

1495 COUNTY ROAD 101 N.
PLYMOUTH, MN 55447

FOR: RETAIL STORE SERVICES FEATURING SPECTACLE FRAMES AND LENSES, CONTACT LENSES, AND OPTICALLY RELATED GOODS, IN CLASS 35 (U.S. CLS. 100, 101 AND 102).

FIRST USE 4-1-2005; IN COMMERCE 4-1-2005.

FOR: OPTOMETRY SERVICES, IN CLASS 44 (U.S. CLS. 100 AND 101).

FIRST USE 4-1-2005; IN COMMERCE 4-1-2005.

THE MARK CONSISTS OF AN ABSTRACT DESIGN OF AN EYE.

SER. NO. 77-433,866, FILED 3-27-2008.

G. MAYERSCHOFF, EXAMINING ATTORNEY

Int. Cl.: 11

Prior U.S. Cls.: 13, 21, 23, 31 and 34

United States Patent and Trademark Office

Reg. No. 3,520,415

Registered Oct. 21, 2008

**TRADEMARK
PRINCIPAL REGISTER**

CSL

TROY-CSL LIGHTING, INC. (NEW YORK CORPORATION)
14625 EAST CLARK AVENUE
CITY OF INDUSTRY, CA 91745

FOR: ELECTRICAL LIGHTING APPARATUS, NAMELY, FIXTURES, SPOT LIGHTS, DOWNLIGHTS AND LIGHTING STRIPS, IN CLASS 11 (U.S. CLS. 13, 21, 23, 31 AND 34).

FIRST USE 0-0-1958; IN COMMERCE 0-0-1958.

THE MARK CONSISTS OF STANDARD CHARACTERS WITHOUT CLAIM TO ANY PARTICULAR FONT, STYLE, SIZE, OR COLOR.

OWNER OF U.S. REG. NO. 2,831,438.

SER. NO. 77-433,887, FILED 3-27-2008.

NORA BUCHANAN WILL, EXAMINING ATTORNEY

Int. Cl.: 7

Prior U.S. Cls.: 13, 19, 21, 23, 31, 34 and 35

Reg. No. 3,520,416

United States Patent and Trademark Office

Registered Oct. 21, 2008

**TRADEMARK
PRINCIPAL REGISTER**

CIM-TEK

CENTRAL ILLINOIS MANUFACTURING COM-
PANY (ILLINOIS CORPORATION)
201 N CHAMPAIGN STREET
BEMENT, IL 61813

THE MARK CONSISTS OF STANDARD CHAR-
ACTERS WITHOUT CLAIM TO ANY PARTICULAR
FONT, STYLE, SIZE, OR COLOR.

FOR: FILTERS FOR REMOVING PARTICULATE
CONTAMINANTS AND WATER FROM PETRO-
LEUM BASED FLUIDS, IN CLASS 7 (U.S. CLS. 13,
19, 21, 23, 31, 34 AND 35).

SER. NO. 77-433,899, FILED 3-27-2008.

FIRST USE 0-0-1995; IN COMMERCE 0-0-1995.

JASON TURNER, EXAMINING ATTORNEY

Int. Cl.: 35

Prior U.S. Cls.: 100, 101 and 102

United States Patent and Trademark Office

Reg. No. 3,520,417

Registered Oct. 21, 2008

**SERVICE MARK
PRINCIPAL REGISTER**

Polka Dot Panda

SILVA, DENISE L. (UNITED STATES INDIVIDUAL)
191 TOMAHAWK TRL.
CRANSTON, RI 02921

THE MARK CONSISTS OF STANDARD CHARACTERS WITHOUT CLAIM TO ANY PARTICULAR FONT, STYLE, SIZE, OR COLOR.

FOR: RETAIL APPAREL STORES, IN CLASS 35 (U.S. CLS. 100, 101 AND 102).

SER. NO. 77-433,916, FILED 3-27-2008.

FIRST USE 9-26-2004; IN COMMERCE 7-25-2006.

DEZMONA MIZELLE, EXAMINING ATTORNEY

Int. Cl.: 9

Prior U.S. Cls.: 21, 23, 26, 36 and 38

Reg. No. 3,520,418

United States Patent and Trademark Office

Registered Oct. 21, 2008

**TRADEMARK
PRINCIPAL REGISTER**



PACIFIC LINK TRADE USA, INC. (GEORGIA CORPORATION)
SUITE 3
1223 CORONET DRIVE
DALTON, GA 30720

FOR: SUNGLASSES, IN CLASS 9 (U.S. CLS. 21, 23, 26, 36 AND 38).

FIRST USE 1-0-2008; IN COMMERCE 1-0-2008.

OWNER OF U.S. REG. NOS. 3,042,689, 3,392,413 AND OTHERS.

THE MARK CONSISTS OF THE STYLIZED NUMBER "8", WHEREIN "E" SHAPED ELEMENTS EXTEND OUTWARDLY AND UPWARDLY FROM THE "8" ON EITHER SIDE.

SER. NO. 77-434,103, FILED 3-28-2008.

GEOFFREY FOSDICK, EXAMINING ATTORNEY

Int. Cl.: 35

Prior U.S. Cls.: 100, 101 and 102

United States Patent and Trademark Office

Reg. No. 3,520,419

Registered Oct. 21, 2008

**SERVICE MARK
PRINCIPAL REGISTER**



COLORADO RESORT REFERRALS, LLC (COL-
ORADO LIMITED LIABILITY COMPANY)

SUITE 400

9800 MOUNT PYRAMID COURT

ENGLEWOOD, CO 80112

FOR: REFERRALS IN THE FIELD OF REAL
ESTATE AGENTS, IN CLASS 35 (U.S. CLS. 100, 101
AND 102).

FIRST USE 5-25-2007; IN COMMERCE 5-25-2007.

NO CLAIM IS MADE TO THE EXCLUSIVE
RIGHT TO USE "COLORADO RESORT REFER-
RALS", APART FROM THE MARK AS SHOWN.

THE COLOR(S) BLUE AND BLACK IS/ARE
CLAIMED AS A FEATURE OF THE MARK.

THE MARK CONSISTS OF A STYLIZED MOUN-
TAIN RANGE IN BLUE OVER THE WORD "COL-
ORADO" WHICH APPEARS IN BLACK. UNDER
THE WORD "COLORADO" A THIN BLACK HOR-
IZONTAL LINE IS PROVIDED AND UNDER THE
LINE IN A SLIGHTLY SMALLER FONT SIZE THAN
THE WORD "COLORADO" IS WRITTEN "RESORT
REFERRALS" IN BLACK.

SER. NO. 77-434,111, FILED 3-28-2008.

ODESSA BIBBINS, EXAMINING ATTORNEY

Int. Cl.: 35

Prior U.S. Cls.: 100, 101 and 102

United States Patent and Trademark Office

Reg. No. 3,520,420

Registered Oct. 21, 2008

**SERVICE MARK
PRINCIPAL REGISTER**

PACLOOT

PACIFIC SUNWEAR OF CALIFORNIA, INC.
(CALIFORNIA CORPORATION)
3450 EAST MIRALOMA AVE.
ANAHEIM, CA 92086

FIRST USE 3-8-2006; IN COMMERCE 3-8-2006.

FOR: RETAIL CLOTHING STORE SERVICES
FEATURING A BUYER REWARD PROGRAM IN
WHICH PURCHASES OVER A SET AMOUNT ARE
REWARDED WITH A COUPON FOR DISCOUNTS
ON FUTURE PURCHASES, IN CLASS 35 (U.S. CLS.
100, 101 AND 102).

THE MARK CONSISTS OF STANDARD CHAR-
ACTERS WITHOUT CLAIM TO ANY PARTICULAR
FONT, STYLE, SIZE, OR COLOR.

SER. NO. 77-434,124, FILED 3-28-2008.

JENNIFER VASQUEZ, EXAMINING ATTORNEY

Int. Cl.: 9

Prior U.S. Cls.: 21, 23, 26, 36 and 38

United States Patent and Trademark Office

Reg. No. 3,520,421

Registered Oct. 21, 2008

**TRADEMARK
PRINCIPAL REGISTER**

CounselDirect

ECONOMIC ANALYSIS GROUP, LTD. (D.C.
CORPORATION)
SUITE 1060
1828 L STREET, N.W.
WASHINGTON, DC 20036

FOR: COMPUTER SOFTWARE FOR TRACKING
LEGAL FEES AND LEGAL SERVICES FEES AND
COSTS, MONITORING BUDGETS, AND ELECTRO-
NIC BILLING OF LEGAL SERVICES AND SERVI-
CES PROVIDED IN CONNECTION WITH LEGAL
MATTERS, IN CLASS 9 (U.S. CLS. 21, 23, 26, 36 AND
38).

FIRST USE 3-28-2007; IN COMMERCE 4-6-2007.

THE MARK CONSISTS OF STANDARD CHAR-
ACTERS WITHOUT CLAIM TO ANY PARTICULAR
FONT, STYLE, SIZE, OR COLOR.

SER. NO. 77-434,131, FILED 3-28-2008.

KATHY DE JONGE, EXAMINING ATTORNEY

Int. Cl.: 25

Prior U.S. Cls.: 22 and 39

United States Patent and Trademark Office

Reg. No. 3,520,422

Registered Oct. 21, 2008

**TRADEMARK
PRINCIPAL REGISTER**

**VILLANOVA UNIVERSITY
ALUMNI ASSOCIATION**

VILLANOVA UNIVERSITY (PENNSYLVANIA
NON-PROFIT CORPORATION)
800 LANCASTER AVENUE
VILLANOVA, PA 190851603

OWNER OF U.S. REG. NOS. 1,353,326, 2,603,598
AND OTHERS.

FOR: CLOTHING, NAMELY, SHIRTS, HATS,
SWEATERS, SWEATSHIRTS, IN CLASS 25 (U.S.
CLS. 22 AND 39).

NO CLAIM IS MADE TO THE EXCLUSIVE
RIGHT TO USE "UNIVERSITY ALUMNI ASSOCIA-
TION", APART FROM THE MARK AS SHOWN.

FIRST USE 6-0-1995; IN COMMERCE 6-0-1995.

SER. NO. 77-434,133, FILED 3-28-2008.

THE MARK CONSISTS OF STANDARD CHAR-
ACTERS WITHOUT CLAIM TO ANY PARTICULAR
FONT, STYLE, SIZE, OR COLOR.

PAUL F. GAST, EXAMINING ATTORNEY

Int. Cl.: 41

Prior U.S. Cls.: 100, 101 and 107

United States Patent and Trademark Office

Reg. No. 3,520,423

Registered Oct. 21, 2008

**SERVICE MARK
PRINCIPAL REGISTER**

CARDRUNNERS

CARDRUNNERS, LLC (ILLINOIS LIMITED LIABILITY COMPANY)
2505 HANFORD LANE
AURORA, IL 60502

THE MARK CONSISTS OF STANDARD CHARACTERS WITHOUT CLAIM TO ANY PARTICULAR FONT, STYLE, SIZE, OR COLOR.

FOR: PROVIDING POKER TRAINING SERVICES ACCESSED VIA AN INTERACTIVE WEBSITE, IN CLASS 41 (U.S. CLS. 100, 101 AND 107).

SER. NO. 77-434,157, FILED 3-28-2008.

FIRST USE 1-1-2007; IN COMMERCE 1-1-2007.

DOUGLAS LEE, EXAMINING ATTORNEY

Int. Cl.: 35

Prior U.S. Cls.: 100, 101 and 102

United States Patent and Trademark Office

Reg. No. 3,520,424

Registered Oct. 21, 2008

**SERVICE MARK
PRINCIPAL REGISTER**

MIDISCOUNTS

BENTON, ADAM (UNITED STATES INDIVIDUAL)
2724 E. NORMANDAY
SPRINGFIELD, MO 65804

FOR: PROMOTING THE GOODS AND SERVICES OF OTHERS THROUGH THE ADMINISTRATION OF DISCOUNT, REBATE, INCENTIVE AWARDS, AND CUSTOMER LOYALTY PROGRAMS; PROVIDING PROGRAMS TO PROMOTE THE SALE OF PRODUCTS AND SERVICES OF OTHERS; PROMOTING FINANCIAL SERVICES, ON BEHALF OF THIRD PARTIES; THE BRINGING TOGETHER, FOR THE BENEFIT OF OTHERS, OF A VARIETY OF GOODS AND SERVICES, ENABLING CUSTOMERS TO CONVENIENTLY VIEW AND PURCHASE

THOSE GOODS AND SERVICES FROM AN INTERNET WEBSITE AND/OR A RETAIL STORE PARTICULARLY SPECIALIZING IN THE MARKETING OF THE SALE OF GOODS AND SERVICES OF OTHERS, IN CLASS 35 (U.S. CLS. 100, 101 AND 102).

FIRST USE 6-12-2007; IN COMMERCE 6-12-2007.

THE MARK CONSISTS OF STANDARD CHARACTERS WITHOUT CLAIM TO ANY PARTICULAR FONT, STYLE, SIZE, OR COLOR.

SER. NO. 77-434,163, FILED 3-28-2008.

JORDAN BAKER, EXAMINING ATTORNEY

Int. Cl.: 11

Prior U.S. Cls.: 13, 21, 23, 31 and 34

Reg. No. 3,520,425

United States Patent and Trademark Office

Registered Oct. 21, 2008

**TRADEMARK
PRINCIPAL REGISTER**

Paralda

ALEN CORPORATION (DELAWARE CORPORATION)
5114 BALCONES WOODS DR SUITE 307-299
AUSTIN, TX 78759

THE MARK CONSISTS OF STANDARD CHARACTERS WITHOUT CLAIM TO ANY PARTICULAR FONT, STYLE, SIZE, OR COLOR.

FOR: AIR PURIFIERS, IN CLASS 11 (U.S. CLS. 13, 21, 23, 31 AND 34).

SER. NO. 77-434,203, FILED 3-28-2008.

FIRST USE 3-24-2008; IN COMMERCE 3-24-2008.

TARA PATE, EXAMINING ATTORNEY

Int. Cl.: 25

Prior U.S. Cls.: 22 and 39

United States Patent and Trademark Office

Reg. No. 3,520,426

Registered Oct. 21, 2008

**TRADEMARK
PRINCIPAL REGISTER**

LEAVE ZERO

LEAVE ZERO (RHODE ISLAND PARTNERSHIP)
100 ELMBROOK DR.
WARWICK, RI 02889

THE MARK CONSISTS OF STANDARD CHAR-
ACTERS WITHOUT CLAIM TO ANY PARTICULAR
FONT, STYLE, SIZE, OR COLOR.

FOR: SHIRTS, TOPS, SWEAT SHIRTS, IN CLASS
25 (U.S. CLS. 22 AND 39).

SER. NO. 77-434,220, FILED 3-28-2008.

FIRST USE 1-0-2008; IN COMMERCE 3-13-2008.

KIMBERLY FRYE, EXAMINING ATTORNEY

Int. Cl.: 16

Prior U.S. Cls.: 2, 5, 22, 23, 29, 37, 38 and 50

Reg. No. 3,520,427

United States Patent and Trademark Office

Registered Oct. 21, 2008

**TRADEMARK
PRINCIPAL REGISTER**

PRIME TIMES

PREVENTION RESEARCH INSTITUTE, INC.
(KENTUCKY CORPORATION)
841 CORPORATE DRIVE, SUITE 300
LEXINGTON, KY 40503

THE MARK CONSISTS OF STANDARD CHARACTERS WITHOUT CLAIM TO ANY PARTICULAR FONT, STYLE, SIZE, OR COLOR.

FOR: NEWSLETTERS IN THE FIELD OF PREVENTION OF DRUG AND ALCOHOL RELATED PROBLEMS, IN CLASS 16 (U.S. CLS. 2, 5, 22, 23, 29, 37, 38 AND 50).

SER. NO. 77-434,231, FILED 3-28-2008.

FIRST USE 10-1-1999; IN COMMERCE 10-1-1999.

ELISSA GARBER KON, EXAMINING ATTORNEY

Int. Cl.: 42

Prior U.S. Cls.: 100 and 101

United States Patent and Trademark Office

Reg. No. 3,520,428

Registered Oct. 21, 2008

**SERVICE MARK
PRINCIPAL REGISTER**

DriveshaftPro

POWER TRAIN INDUSTRIES, INC. (CALIFORNIA CORPORATION)
7532 ANTHONY AVENUE
GARDEN GROVE, CA 92841

FOR: APPLICATION SERVICE PROVIDER (ASP) FEATURING SOFTWARE FOR USE IN CREATING WORK ORDERS, INVOICES AND PURCHASE ORDERS AS WELL KEEPING TRACK OF SALES SPECIFICALLY FOR DRIVE SHAFT REPAIR SHOPS, IN CLASS 42 (U.S. CLS. 100 AND 101).

FIRST USE 1-28-2007; IN COMMERCE 9-1-2007.

THE MARK CONSISTS OF STANDARD CHARACTERS WITHOUT CLAIM TO ANY PARTICULAR FONT, STYLE, SIZE, OR COLOR.

SER. NO. 77-434,242, FILED 3-28-2008.

DAVID MURRAY, EXAMINING ATTORNEY

Int. Cl.: 1

Prior U.S. Cls.: 1, 5, 6, 10, 26 and 46

United States Patent and Trademark Office

Reg. No. 3,520,429

Registered Oct. 21, 2008

**TRADEMARK
PRINCIPAL REGISTER**

BREAKOUT

BIO-LAB, INC. (DELAWARE CORPORATION)
1735 NORTH BROWN ROAD
LAWRENCEVILLE, GA 30043

FOR: OXIDIZING AGENT FOR USE IN REMOV-
ING OR REDUCING ORGANIC CONTAMINANTS
AND INCREASING WATER CLARITY IN SWIM-
MING POOLS AND OTHER BODIES OF WATER, IN
CLASS 1 (U.S. CLS. 1, 5, 6, 10, 26 AND 46).

FIRST USE 7-27-1977; IN COMMERCE 7-27-1977.

THE MARK CONSISTS OF STANDARD CHAR-
ACTERS WITHOUT CLAIM TO ANY PARTICULAR
FONT, STYLE, SIZE, OR COLOR.

OWNER OF U.S. REG. NO. 1,087,933.

SER. NO. 77-434,261, FILED 3-28-2008.

RICHARD WHITE, EXAMINING ATTORNEY

Int. Cls.: 9 and 41

Prior U.S. Cls.: 21, 23, 26, 36, 38, 100, 101 and 107

Reg. No. 3,520,430

United States Patent and Trademark Office

Registered Oct. 21, 2008

**TRADEMARK
SERVICE MARK
PRINCIPAL REGISTER**

UNICUS FITNESS

UNICUS PERFORMANCE TRAINING, LLC (ILLINOIS LIMITED LIABILITY COMPANY)
217 CASCADE DRIVE
INDIAN HEAD PARK, IL 60525

FOR: PRE-RECORDED DVDS FEATURING FITNESS TRAINING PROGRAMS, IN CLASS 9 (U.S. CLS. 21, 23, 26, 36 AND 38).

FIRST USE 1-2-2005; IN COMMERCE 1-2-2005.

FOR: PHYSICAL FITNESS INSTRUCTION, PERSONAL FITNESS TRAINING AND PHYSICAL FITNESS CONSULTATION, IN CLASS 41 (U.S. CLS. 100, 101 AND 107).

FIRST USE 1-2-2005; IN COMMERCE 1-2-2005.

THE MARK CONSISTS OF STANDARD CHARACTERS WITHOUT CLAIM TO ANY PARTICULAR FONT, STYLE, SIZE, OR COLOR.

NO CLAIM IS MADE TO THE EXCLUSIVE RIGHT TO USE "FITNESS", APART FROM THE MARK AS SHOWN.

SER. NO. 77-434,323, FILED 3-28-2008.

HAI-LY LAM, EXAMINING ATTORNEY

Int. Cl.: 9

Prior U.S. Cls.: 21, 23, 26, 36 and 38

Reg. No. 3,520,431

United States Patent and Trademark Office

Registered Oct. 21, 2008

**TRADEMARK
PRINCIPAL REGISTER**

LifeInPocket

ROADCOMM, INC. (CALIFORNIA CORPORATION), DBA LIFEINPOCKET
1601 S. DE ANZA BLVD. SUITE 230
CUPERTINO, CA 95014

FOR: CELL PHONES; CELLULAR PHONES; COMPUTER APPLICATION SOFTWARE FOR MOBILE PHONES; COMPUTER SOFTWARE TO ENABLE THE TRANSMISSION OF PHOTOGRAPHS TO MOBILE TELEPHONES; COMPUTER SOFTWARE, NAMELY, AN APPLICATION ALLOWING SALES AND FIELD SERVICE EMPLOYEES TO UPDATE AND RECEIVE DATA STORED IN AN ENTERPRISE'S COMPUTER DATABASES IN REAL TIME, USING A MOBILE DEVICE, WITH FULL TELEPHONY INTEGRATION WITH THE TELEPHONE AND/OR SOFTWARE FEATURES OF THE MOBILE DEVICE; COMPUTER SOFTWARE, NAMELY, SOFTWARE DEVELOPMENT TOOLS FOR THE CREATION OF MOBILE INTERNET APPLICATIONS AND CLIENT INTERFACES; MOBILE COMPUTERS; MOBILE PHONES; INTERNET PHONES; INTERNET SERVERS; COMPUTER PROGRAMS FOR USING THE INTERNET AND THE WORLD WIDE WEB; WIRELESS TELEPHONES; COMPUTER HARDWARE, NAMELY, WIRELESS ACCESS POINT (WAP) DEVICES; COMPUTER PROGRAMS FOR USING THE INTERNET AND THE WORLD-WIDE WEB; COMPUTER SOFTWARE FOR WIRELESS CONTENT DELIVERY; CONTINGENCY RESPONSE COMMUNICATION SYSTEM DESIGNED TO PROVIDE RADIO INTEROPERABILITY, STREAMING VIDEO, WIRELESS INTERNET,

AND VOIP PHONE; PERSONAL DIGITAL ASSISTANTS (PDA); PROTECTIVE CARRYING CASES SPECIALLY ADAPTED FOR PERSONAL DIGITAL ASSISTANTS (PDA); COMMUNICATIONS SERVERS; INTRANET SERVERS; NETWORK ACCESS SERVER OPERATING SOFTWARE; SOFTWARE UTILIZING BIDIRECTIONAL COMMUNICATION VIA ETHERNET AND INTERNET TO MONITOR AND/OR CONFIGURE PROGRAMMABLE LOGIC CONTROLS FOR WINE CELLARS; AVIONIC SENSOR SYSTEMS, NAMELY, NAVIGATION SYSTEMS; CAR NAVIGATION COMPUTERS; ELECTRIC NAVIGATIONAL INSTRUMENTS; ELECTRONIC NAVIGATIONAL AND POSITIONING APPARATUS AND INSTRUMENTS; NAVIGATION APPARATUS FOR VEHICLES; NAVIGATION APPARATUS FOR VEHICLES IN THE NATURE OF ON-BOARD COMPUTERS; NAVIGATIONAL BUOYS; SATELLITE NAVIGATIONAL SYSTEM, NAMELY, A GLOBAL POSITIONING SYSTEM (GPS); PORTABLE TELECOMMUNICATION INSTANT MESSAGING DEVICES, IN CLASS 9 (U.S. CLS. 21, 23, 26, 36 AND 38).

FIRST USE 10-1-2006; IN COMMERCE 10-7-2007.

THE MARK CONSISTS OF STANDARD CHARACTERS WITHOUT CLAIM TO ANY PARTICULAR FONT, STYLE, SIZE, OR COLOR.

SER. NO. 77-434,326, FILED 3-28-2008.

RENEE MCCRAY, EXAMINING ATTORNEY

Int. Cl.: 35

Prior U.S. Cls.: 100, 101 and 102

United States Patent and Trademark Office

Reg. No. 3,520,432

Registered Oct. 21, 2008

**SERVICE MARK
PRINCIPAL REGISTER**

Dnewmedia

TRESPLAN GROUP INC. (FLORIDA CORPORATION)
3243 GIFFORD LANE
MIAMI, FL 33133

THE MARK CONSISTS OF STANDARD CHARACTERS WITHOUT CLAIM TO ANY PARTICULAR FONT, STYLE, SIZE, OR COLOR.

FOR: ADVERTISING AND MARKETING, IN CLASS 35 (U.S. CLS. 100, 101 AND 102).

SER. NO. 77-434,344, FILED 3-28-2008.

FIRST USE 7-25-2006; IN COMMERCE 7-25-2006.

JOHN GARTNER, EXAMINING ATTORNEY

Int. Cl.: 16

Prior U.S. Cls.: 2, 5, 22, 23, 29, 37, 38 and 50

United States Patent and Trademark Office

Reg. No. 3,520,433

Registered Oct. 21, 2008

**TRADEMARK
PRINCIPAL REGISTER**



THE MOUNTAINEERS (WASHINGTON NON-
PROFIT CORPORATION)
300 THIRD AVE. WEST
SEATTLE, WA 98119

FOR: BOOKS IN THE FIELDS OF SUSTAINABLE
LIFESTYLES, FOOD AND COOKING, GARDEN-
ING, CRAFTS, HOME, HEALTH, WELLNESS, FIT-
NESS, PETS, OUTDOORS, THE ENVIRONMENT

AND CONSERVATION, IN CLASS 16 (U.S. CLS. 2,
5, 22, 23, 29, 37, 38 AND 50).

FIRST USE 10-10-2007; IN COMMERCE 10-16-2007.

SER. NO. 77-434,345, FILED 3-28-2008.

ELLEN B. AWRICH, EXAMINING ATTORNEY

Int. Cl.: 19

Prior U.S. Cls.: 1, 12, 33 and 50

United States Patent and Trademark Office

Reg. No. 3,520,434

Registered Oct. 21, 2008

**TRADEMARK
PRINCIPAL REGISTER**

Zero-F

**KRONOSPAN SCHWEIZ AG (SWITZERLAND
CORPORATION)**

CH-6122

MENZNAU, SWITZERLAND

**FOR: PARTICLE BOARDS AND MEDIUM DEN-
SITY FIBREBOARDS, IN CLASS 19 (U.S. CLS. 1, 12, 33
AND 50).**

**THE MARK CONSISTS OF STANDARD CHAR-
ACTERS WITHOUT CLAIM TO ANY PARTICULAR
FONT, STYLE, SIZE, OR COLOR.**

**OWNER OF SWITZERLAND REG. NO. 563588,
DATED 7-19-2007, EXPIRES 7-19-2017.**

SER. NO. 77-434,368, FILED 3-28-2008.

ANDREA SAUNDERS, EXAMINING ATTORNEY

Int. Cl.: 42

Prior U.S. Cls.: 100 and 101

United States Patent and Trademark Office

Reg. No. 3,520,435

Registered Oct. 21, 2008

**SERVICE MARK
PRINCIPAL REGISTER**

Viable Bytes

VIABLE BYTES INC. (INDIANA CORPORATION)
6505 EAST 82ND STREET
SUITE 110
INDIANAPOLIS, IN 46250

FOR: ENGINEERING SERVICES, NAMELY, ENGINEERING FOR THE SOFTWARE APPLICATIONS IN THE FIELDS OF MEDICAL, INDUSTRIAL, COMMERCIAL AND MILITARY, IN CLASS 42 (U.S. CLS. 100 AND 101).

FIRST USE 1-1-2007; IN COMMERCE 1-1-2007.

THE MARK CONSISTS OF STANDARD CHARACTERS WITHOUT CLAIM TO ANY PARTICULAR FONT, STYLE, SIZE, OR COLOR.

SER. NO. 77-434,391, FILED 3-28-2008.

PAUL F. GAST, EXAMINING ATTORNEY

Int. Cl.: 45

Prior U.S. Cls.: 100 and 101

United States Patent and Trademark Office

Reg. No. 3,520,436

Registered Oct. 21, 2008

**SERVICE MARK
PRINCIPAL REGISTER**

Traverse Legal

TRAVERSE LEGAL PLC (MICHIGAN LIMITED
LIABILITY COMPANY)
UNIT G-20
810 COTTAGEVIEW DRIVE
TRAVERSE CITY, MI 49684

FOR: LEGAL SERVICES, IN CLASS 45 (U.S. CLS.
100 AND 101).

FIRST USE 1-1-2005; IN COMMERCE 1-1-2005.

THE MARK CONSISTS OF STANDARD CHAR-
ACTERS WITHOUT CLAIM TO ANY PARTICULAR
FONT, STYLE, SIZE, OR COLOR.

NO CLAIM IS MADE TO THE EXCLUSIVE
RIGHT TO USE "LEGAL", APART FROM THE
MARK AS SHOWN.

SER. NO. 77-434,409, FILED 3-28-2008.

KIM SAITO, EXAMINING ATTORNEY

Int. Cl.: 19

Prior U.S. Cls.: 1, 12, 33 and 50

United States Patent and Trademark Office

Reg. No. 3,520,437

Registered Oct. 21, 2008

**TRADEMARK
PRINCIPAL REGISTER**

Kaléi

KALEI INC (CALIFORNIA CORPORATION)
1933 S. BROADWAY #LL-02
LOS ANGELES, CA 90007

THE MARK CONSISTS OF STANDARD CHAR-
ACTERS WITHOUT CLAIM TO ANY PARTICULAR
FONT, STYLE, SIZE, OR COLOR.

FOR: GLASS TILES, IN CLASS 19 (U.S. CLS. 1, 12,
33 AND 50).

SER. NO. 77-434,456, FILED 3-28-2008.

FIRST USE 4-20-2007; IN COMMERCE 4-20-2007.

GRETTA YAO, EXAMINING ATTORNEY

Int. Cls.: 9 and 41

Prior U.S. Cls.: 21, 23, 26, 36, 38, 100, 101 and 107

United States Patent and Trademark Office

Reg. No. 3,520,438

Registered Oct. 21, 2008

**TRADEMARK
SERVICE MARK
PRINCIPAL REGISTER**

GRR

WIDELOAD GAMES INC. (ILLINOIS CORPORATION)
SUITE 230
560 W. WASHINGTON BLVD.
CHICAGO, IL 60661

FOR: VIDEO AND COMPUTER GAME PROGRAMS; VIDEO AND COMPUTER GAME SOFTWARE; VIDEO AND COMPUTER GAME CARTRIDGES, CASSETTES, TAPES AND DISKS; ELECTRONIC GAME SOFTWARE; ELECTRONIC GAME PROGRAMS; VIDEO, COMPUTER AND ELECTRONIC GAME CARTRIDGES FOR HANDHELD DEVICES; VIDEO, COMPUTER AND ELECTRONIC GAME SOFTWARE FOR HANDHELD DEVICES; VIDEO, COMPUTER AND ELECTRONIC GAME PROGRAMS FOR HANDHELD DEVICES, IN CLASS 9 (U.S. CLS. 21, 23, 26, 36 AND 38).

FIRST USE 6-1-2006; IN COMMERCE 12-1-2007.

FOR: PROVIDING INFORMATION, NEWS AND COMMENTARY IN THE FIELD OF ENTERTAINMENT, NAMELY, VIDEO, COMPUTER AND ELEC-

TRONIC GAMES; PROVIDING INFORMATION, NEWS AND COMMENTARY IN THE FIELD OF RECREATION AND LEISURE ACTIVITIES, NAMELY, VIDEO, COMPUTER AND ELECTRONIC GAMES; PROVIDING A WEB SITE FEATURING INFORMATION, NEWS AND COMMENTARY IN THE FIELD OF ENTERTAINMENT, RECREATION AND LEISURE ACTIVITIES, NAMELY, VIDEO, COMPUTER AND ELECTRONIC GAMES; PROVIDING ONLINE INFORMATION ON VIDEO, COMPUTER AND ELECTRONIC GAMES, IN CLASS 41 (U.S. CLS. 100, 101 AND 107).

FIRST USE 6-1-2006; IN COMMERCE 12-1-2007.

THE MARK CONSISTS OF STANDARD CHARACTERS WITHOUT CLAIM TO ANY PARTICULAR FONT, STYLE, SIZE, OR COLOR.

SER. NO. 77-434,532, FILED 3-28-2008.

DAVID MILLER, EXAMINING ATTORNEY

Int. Cl.: 33

Prior U.S. Cls.: 47 and 49

United States Patent and Trademark Office

Reg. No. 3,520,439

Registered Oct. 21, 2008

**TRADEMARK
PRINCIPAL REGISTER**

MYTHE

MERCO SPIRITS INC. (FLORIDA CORPORATION)
1292 PRINCETON ROAD
TEANECK, NJ 076662821

THE MARK CONSISTS OF STANDARD CHARACTERS WITHOUT CLAIM TO ANY PARTICULAR FONT, STYLE, SIZE, OR COLOR.

FOR: DISTILLED SPIRITS, IN CLASS 33 (U.S. CLS. 47 AND 49).

SER. NO. 77-434,599, FILED 3-28-2008.

FIRST USE 3-24-2008; IN COMMERCE 3-24-2008.

DAVID MILLER, EXAMINING ATTORNEY

Int. Cl.: 35

Prior U.S. Cls.: 100, 101 and 102

United States Patent and Trademark Office

Reg. No. 3,520,440

Registered Oct. 21, 2008

**SERVICE MARK
PRINCIPAL REGISTER**

Media Mayhem

MEDIA MAYHEM CORPORATION (CALIFORNIA CORPORATION)
11040 SANTA MONICA BLVD., SUITE 201
LOS ANGELES, CA 90025

FOR: ADVERTISING AND MARKETING; ADVERTISING SERVICES, NAMELY, PROMOTING AND MARKETING THE GOODS AND SERVICES OF OTHERS THROUGH ALL PUBLIC COMMUNICATION MEANS; ADVERTISING, MARKETING AND PROMOTION SERVICES; BUSINESS MARKETING SERVICES; DEVELOPMENT OF MARKETING STRATEGIES AND CONCEPTS; DIRECT MARKETING ADVERTISING FOR OTHERS; DIRECT MARKETING SERVICES; PROVIDING INFORMATION IN THE FIELD OF MARKETING AND ON-LINE MARKETING MEDIA VIA THE INTERNET; ON-LINE ADVERTISING AND MARKETING SERVICES; PROMOTING, ADVERTISING AND MARKETING OF THE ON-LINE WEB SITES OF OTHERS; PROMOTION, ADVERTISING AND MARKETING OF ON-LINE WEB SITES; ADVERTIS-

ING SERVICES, PUBLIC RELATIONS AND MARKETING SERVICES, NAMELY, PROMOTING AND MARKETING THE GOODS AND SERVICES OF OTHERS THROUGH ALL PUBLIC COMMUNICATION MEANS, IN CLASS 35 (U.S. CLS. 100, 101 AND 102).

FIRST USE 8-7-2006; IN COMMERCE 8-7-2006.

THE MARK CONSISTS OF STANDARD CHARACTERS WITHOUT CLAIM TO ANY PARTICULAR FONT, STYLE, SIZE, OR COLOR.

NO CLAIM IS MADE TO THE EXCLUSIVE RIGHT TO USE "MEDIA", APART FROM THE MARK AS SHOWN.

SER. NO. 77-434,614, FILED 3-28-2008.

JAMES LOVELACE, EXAMINING ATTORNEY

Int. Cls.: 9 and 42

Prior U.S. Cls.: 21, 23, 26, 36, 38, 100 and 101

United States Patent and Trademark Office

Reg. No. 3,520,441

Registered Oct. 21, 2008

**TRADEMARK
SERVICE MARK
PRINCIPAL REGISTER**

Zenōss

ZENOSS, INC. (DELAWARE CORPORATION)
SUITE 204
275 WEST STREET
ANNAPOLIS, MD 21401

FOR: COMPUTER SOFTWARE FOR MONITORING AND MANAGING ENTERPRISE INFORMATION TECHNOLOGY SYSTEMS, IN CLASS 9 (U.S. CLS. 21, 23, 26, 36 AND 38).

FIRST USE 5-1-2006; IN COMMERCE 5-1-2006.

FOR: COMPUTER SERVICES, NAMELY, INSTALLATION, INTEGRATION, MAINTENANCE, AND TROUBLE-SHOOTING OF COMPUTER SOFTWARE IN THE FIELD OF INFORMATION TECHNOLOGY SYSTEMS; CUSTOM DESIGN OF

COMPUTER SOFTWARE FOR OTHERS, IN CLASS 42 (U.S. CLS. 100 AND 101).

FIRST USE 5-1-2006; IN COMMERCE 5-1-2006.

THE MARK CONSISTS OF THE WORD "ZENOSS" IN AKZIDENZ FONT, INITIAL LETTER CAPITALIZED, WITH THE "O" DRAWN AS A BRUSHSTROKE CIRCLE WITH VARYING OPACITY AND FEATHERING. ABOVE THE "O" IS A SUPERSCRIPIT BRUSHSTROKE ACCENT THAT FADES FROM LEFT TO RIGHT.

SER. NO. 77-434,633, FILED 3-28-2008.

GEOFFREY FOSDICK, EXAMINING ATTORNEY

Int. Cl.: 30

Prior U.S. Cl.: 46

United States Patent and Trademark Office

Reg. No. 3,520,442

Registered Oct. 21, 2008

TRADEMARK
PRINCIPAL REGISTER



PETITT, ROBERT (UNITED STATES INDIVIDUAL)
4728 TEAK DRIVE
COLUMBUS, GA 31909

FOR: BARBEQUE SAUCE, IN CLASS 30 (U.S. CL. 46).

FIRST USE 12-1-2007; IN COMMERCE 12-1-2007.

THE COLOR(S) RED, BLACK AND WHITE IS/ARE CLAIMED AS A FEATURE OF THE MARK.

THE WORD "SWINEHEARTS" IS RED AND FEATURES A THICK WHITE OUTLINE AND THIN BLACK OUTLINE. THE LETTER "A" APPEARS AS AN UPSIDE-DOWN RED HEART, ALSO FEATURING A THICK WHITE OUTLINE AND THIN BLACK OUTLINE. THE GRAY IN THE MARK REPRESENTS SHADING AND IS NOT PART OF THE MARK. THE MARK APPEARS ON A TRANSPARENT BACKGROUND, AND NO OTHER COLOR IS CLAIMED AS A FEATURE OF THE MARK.

SER. NO. 77-434,647, FILED 3-28-2008.

DAVID MILLER, EXAMINING ATTORNEY

Int. Cl.: 3

Prior U.S. Cls.: 1, 4, 6, 50, 51 and 52

United States Patent and Trademark Office

Reg. No. 3,520,443

Registered Oct. 21, 2008

**TRADEMARK
PRINCIPAL REGISTER**

GREENGARD

STAINSAFE, INC. (FLORIDA CORPORATION)
354 HIATT DRIVE
PALM BEACH GARDENS, FL 33418

THE MARK CONSISTS OF STANDARD CHAR-
ACTERS WITHOUT CLAIM TO ANY PARTICULAR
FONT, STYLE, SIZE, OR COLOR.

FOR: CLEANING PREPARATIONS FOR HOUSE-
HOLD PURPOSES, IN CLASS 3 (U.S. CLS. 1, 4, 6, 50, 51
AND 52).

SER. NO. 77-434,653, FILED 3-28-2008.

FIRST USE 12-17-2007; IN COMMERCE 2-5-2008.

DANIEL CAPSHAW, EXAMINING ATTORNEY

Int. Cl.: 3

Prior U.S. Cls.: 1, 4, 6, 50, 51 and 52

United States Patent and Trademark Office

Reg. No. 3,520,444

Registered Oct. 21, 2008

**TRADEMARK
PRINCIPAL REGISTER**

ECO-WISE

STAINSAFE, INC. (FLORIDA CORPORATION)
354 HIATT DRIVE
PALM BEACH GARDENS, FL 33418

THE MARK CONSISTS OF STANDARD CHAR-
ACTERS WITHOUT CLAIM TO ANY PARTICULAR
FONT, STYLE, SIZE, OR COLOR.

FOR: CLEANING PREPARATIONS FOR HOUSE-
HOLD PURPOSES, IN CLASS 3 (U.S. CLS. 1, 4, 6, 50, 51
AND 52).

SER. NO. 77-434,684, FILED 3-28-2008.

FIRST USE 12-17-2007; IN COMMERCE 2-5-2008.

DANIEL CAPSHAW, EXAMINING ATTORNEY

Int. Cl.: 24

Prior U.S. Cls.: 42 and 50

United States Patent and Trademark Office

Reg. No. 3,520,445

Registered Oct. 21, 2008

**TRADEMARK
PRINCIPAL REGISTER**

GIATI ELEMENTS

GIATI DESIGNS, INC. (CALIFORNIA CORPORATION)
220 WEST MONTECITO STREET
SANTA BARBARA, CA 93101

FOR: TEXTILES FOR FURNITURE AND HOME
AND OUTDOOR FURNISHINGS, IN CLASS 24 (U.S.
CLS. 42 AND 50).

FIRST USE 5-23-2007; IN COMMERCE 5-23-2007.

THE MARK CONSISTS OF STANDARD CHARACTERS WITHOUT CLAIM TO ANY PARTICULAR FONT, STYLE, SIZE, OR COLOR.

OWNER OF U.S. REG. NO. 3,358,474.

SER. NO. 77-434,720, FILED 3-28-2008.

CURTIS FRENCH, EXAMINING ATTORNEY

Int. Cl.: 35

Prior U.S. Cls.: 100, 101 and 102

United States Patent and Trademark Office

Reg. No. 3,520,446

Registered Oct. 21, 2008

**SERVICE MARK
PRINCIPAL REGISTER**

MISTUDENT

BENTON, ADAM (UNITED STATES INDIVIDUAL)
2724 E. NORMANDY
SPRINGFIELD, MO 65804

FOR: PROMOTING THE GOODS AND SERVICES OF OTHERS THROUGH THE ADMINISTRATION OF DISCOUNT, REBATE, INCENTIVE AWARDS, AND CUSTOMER LOYALTY PROGRAMS; PROVIDING PROGRAMS TO PROMOTE THE SALE OF PRODUCTS AND SERVICES OF OTHERS; PROMOTING FINANCIAL SERVICES, ON BEHALF OF THIRD PARTIES; THE BRINGING TOGETHER, FOR THE BENEFIT OF OTHERS, OF A VARIETY OF GOODS AND SERVICES, ENABLING CUSTOMERS TO CONVENIENTLY VIEW AND PURCHASE

THOSE GOODS AND SERVICES FROM AN INTERNET WEBSITE OR RETAIL STORE PARTICULARLY SPECIALIZING IN THE MARKETING OF THE SALE OF GOODS AND SERVICES OF OTHERS, IN CLASS 35 (U.S. CLS. 100, 101 AND 102).

FIRST USE 3-28-2008; IN COMMERCE 3-28-2008.

THE MARK CONSISTS OF STANDARD CHARACTERS WITHOUT CLAIM TO ANY PARTICULAR FONT, STYLE, SIZE, OR COLOR.

SER. NO. 77-434,723, FILED 3-28-2008.

JORDAN BAKER, EXAMINING ATTORNEY

Int. Cl.: 39

Prior U.S. Cls.: 100 and 105

United States Patent and Trademark Office

Reg. No. 3,520,447

Registered Oct. 21, 2008

**SERVICE MARK
PRINCIPAL REGISTER**

Balloonytoons

HERGET, JAMES (UNITED STATES INDIVIDUAL)
4387 SAN JUAN AVE.
FREMONT, CA 94536

THE MARK CONSISTS OF STANDARD CHARACTERS WITHOUT CLAIM TO ANY PARTICULAR FONT, STYLE, SIZE, OR COLOR.

FOR: DELIVERY OF GOODS AND MESSAGES ACCOMPANIED BY BALLOONS AND/OR NOVELTY PRESENTATIONS, IN CLASS 39 (U.S. CLS. 100 AND 105).

SER. NO. 77-434,743, FILED 3-28-2008.

FIRST USE 12-1-2007; IN COMMERCE 12-1-2007.

STEVEN JACKSON, EXAMINING ATTORNEY

Int. Cl.: 35

Prior U.S. Cls.: 100, 101 and 102

United States Patent and Trademark Office

Reg. No. 3,520,448

Registered Oct. 21, 2008

**SERVICE MARK
PRINCIPAL REGISTER**

**METLIFE PENSION RESOURCE
CENTER**

METROPOLITAN LIFE INSURANCE COMPANY
(NEW YORK CORPORATION)
1 METLIFE PLAZA, 27-01 QUEENS PLAZA NO.
LONG ISLAND CITY, NY 11010

FOR: PROVIDING A RESOURCE FOR ADMINISTRATION OF RETIREMENT SERVICES, NAMELY, PROVIDING PROVIDER SEARCHES, INVESTMENT AND FIDUCIARY REVIEW, ADMINISTRATION AND PLAN DESIGN ILLUSTRATIONS, REGULATORY UPDATES, PROSPECTING TOOLS, QUALIFIED PLAN TECHNICAL ASSISTANCE, PRODUCT SOLUTIONS, AND SALES MARKETING, IN CLASS 35 (U.S. CLS. 100, 101 AND 102).

FIRST USE 3-3-2008; IN COMMERCE 3-3-2008.

THE MARK CONSISTS OF STANDARD CHARACTERS WITHOUT CLAIM TO ANY PARTICULAR FONT, STYLE, SIZE, OR COLOR.

OWNER OF U.S. REG. NOS. 1,541,862, 2,724,666, AND 3,119,644.

NO CLAIM IS MADE TO THE EXCLUSIVE RIGHT TO USE "PENSION RESOURCE CENTER" , APART FROM THE MARK AS SHOWN.

SER. NO. 77-434,758, FILED 3-28-2008.

JULIE GUTTADAURO, EXAMINING ATTORNEY

Int. Cl.: 41

Prior U.S. Cls.: 100, 101 and 107

Reg. No. 3,520,449

United States Patent and Trademark Office

Registered Oct. 21, 2008

**SERVICE MARK
PRINCIPAL REGISTER**

MusInk

HARDIE, WILLIAM (UNITED STATES INDIVIDUAL)
2514 OAK AVE.
CORONA, CA 92882

THE MARK CONSISTS OF STANDARD CHARACTERS WITHOUT CLAIM TO ANY PARTICULAR FONT, STYLE, SIZE, OR COLOR.

FOR: CONDUCTING ENTERTAINMENT EXHIBITIONS IN THE NATURE OF TATTOO AND MUSIC FESTIVALS, IN CLASS 41 (U.S. CLS. 100, 101 AND 107).

SER. NO. 77-434,816, FILED 3-28-2008.

FIRST USE 1-1-2006; IN COMMERCE 1-1-2006.

JEAN IM, EXAMINING ATTORNEY

Int. Cls.: 35 and 41

Prior U.S. Cls.: 100, 101, 102 and 107

United States Patent and Trademark Office

Reg. No. 3,520,450

Registered Oct. 21, 2008

**SERVICE MARK
PRINCIPAL REGISTER**

ARISE

ARISE VIRTUAL SOLUTIONS INC. (DELAWARE CORPORATION)
SUITE 620
3450 LAKESIDE DRIVE
MIRAMAR, FL 330274148

FOR: OUTSOURCING SERVICES, NAMELY, CONNECTING BUSINESSES WITH REMOTE CUSTOMER SERVICES REPRESENTATIVES CERTIFIED TO WORK IN THE FIELDS OF TELEPHONE AND ELECTRONIC CONTACT CENTER SERVICES, CUSTOMER SERVICE, CUSTOMER SATISFACTION, SALES, TECHNICAL SUPPORT, AND DATA PROCESSING AND MANAGEMENT, IN CLASS 35 (U.S. CLS. 100, 101 AND 102).

FIRST USE 2-0-2007; IN COMMERCE 2-0-2007.

FOR: EDUCATIONAL SERVICES, NAMELY, PROVIDING INSTRUCTION VIA WEB BASED

COURSES FOR CERTIFICATION AND CONTINUING EDUCATION OF CUSTOMER SERVICE REPRESENTATIVES IN THE FIELDS OF TELEPHONE AND ELECTRONIC CONTACT CENTER SERVICES, CUSTOMER SERVICE, CUSTOMER SATISFACTION, SALES, TECHNICAL SUPPORT, AND DATA PROCESSING AND MANAGEMENT, IN CLASS 41 (U.S. CLS. 100, 101 AND 107).

FIRST USE 2-0-2007; IN COMMERCE 2-0-2007.

THE MARK CONSISTS OF STANDARD CHARACTERS WITHOUT CLAIM TO ANY PARTICULAR FONT, STYLE, SIZE, OR COLOR.

SER. NO. 77-434,818, FILED 3-28-2008.

SHAUNIA CARLYLE, EXAMINING ATTORNEY

Int. Cls.: 35 and 41

Prior U.S. Cls.: 100, 101, 102 and 107

United States Patent and Trademark Office

Reg. No. 3,520,451

Registered Oct. 21, 2008

**SERVICE MARK
PRINCIPAL REGISTER**

**WORK. FREEDOM. TRUST.
RESULTS.**

ARISE VIRTUAL SOLUTIONS INC. (DELAWARE CORPORATION)
SUITE 620
3450 LAKESIDE DRIVE
MIRAMAR, FL 330274148

FOR: OUTSOURCING SERVICES, NAMELY, CONNECTING BUSINESSES WITH REMOTE CUSTOMER SERVICES REPRESENTATIVES CERTIFIED TO WORK IN THE FIELDS OF TELEPHONE AND ELECTRONIC CONTACT CENTER SERVICES, CUSTOMER SERVICE, CUSTOMER SATISFACTION, SALES, TECHNICAL SUPPORT, AND DATA PROCESSING AND MANAGEMENT, IN CLASS 35 (U.S. CLS. 100, 101 AND 102).

FIRST USE 2-0-2007; IN COMMERCE 2-0-2007.

FOR: EDUCATIONAL SERVICES, NAMELY, PROVIDING INSTRUCTION VIA WEB BASED

COURSES FOR CERTIFICATION AND CONTINUING EDUCATION OF CUSTOMER SERVICE REPRESENTATIVES IN THE FIELDS OF TELEPHONE AND ELECTRONIC CONTACT CENTER SERVICES, CUSTOMER SERVICE, CUSTOMER SATISFACTION, SALES, TECHNICAL SUPPORT, AND DATA PROCESSING AND MANAGEMENT, IN CLASS 41 (U.S. CLS. 100, 101 AND 107).

FIRST USE 2-0-2007; IN COMMERCE 2-0-2007.

THE MARK CONSISTS OF STANDARD CHARACTERS WITHOUT CLAIM TO ANY PARTICULAR FONT, STYLE, SIZE, OR COLOR.

SER. NO. 77-434,840, FILED 3-28-2008.

SHAUNIA CARLYLE, EXAMINING ATTORNEY

Int. Cl.: 41

Prior U.S. Cls.: 100, 101 and 107

United States Patent and Trademark Office

Reg. No. 3,520,452

Registered Oct. 21, 2008

**SERVICE MARK
PRINCIPAL REGISTER**

MIGHTY MOVES

THE STATE BOARD OF GOVERNORS, ACTING
BY AND THROUGH COLORADO STATE UNI-
VERSITY (COLORADO AN INSTITUTION OF
HIGHER LEARNING OF THE STATE OF
COLORADO)

SUITE 640
110 16TH STREET
DENVER, CO 80202

FOR: DEVELOPMENT AND DISSEMINATION
OF EDUCATION MATERIALS FOR OTHERS IN
THE FIELDS OF ANTI-OBESITY AND EXERCISE;
EDUCATIONAL SERVICES, NAMELY, A PRO-

GRAM TO PROMOTE ANTI-OBESITY AND EXER-
CISE, IN CLASS 41 (U.S. CLS. 100, 101 AND 107).

FIRST USE 1-12-2006; IN COMMERCE 3-3-2006.

THE MARK CONSISTS OF STANDARD CHAR-
ACTERS WITHOUT CLAIM TO ANY PARTICULAR
FONT, STYLE, SIZE, OR COLOR.

SER. NO. 77-434,881, FILED 3-28-2008.

CORY BOONE, EXAMINING ATTORNEY

Int. Cl.: 7

Prior U.S. Cls.: 13, 19, 21, 23, 31, 34 and 35

United States Patent and Trademark Office

Reg. No. 3,520,453

Registered Oct. 21, 2008

**TRADEMARK
PRINCIPAL REGISTER**

MONOSHOX

MONOSEM, INC. (KANSAS CORPORATION)
17135 WEST 116TH STREET
LENEXA, KS 66219

FOR: COMPONENT PART OF A SEED PLANTER,
NAMELY, LINKAGE AND A SHOCK ABSORBER
FOR INTERCONNECTING A PLANTING UNIT TO
THE TOOLBAR OF A PLANTER, IN CLASS 7 (U.S.
CLS. 13, 19, 21, 23, 31, 34 AND 35).

FIRST USE 11-0-2007; IN COMMERCE 11-0-2007.

THE MARK CONSISTS OF STANDARD CHAR-
ACTERS WITHOUT CLAIM TO ANY PARTICULAR
FONT, STYLE, SIZE, OR COLOR.

SER. NO. 77-434,886, FILED 3-28-2008.

CORY BOONE, EXAMINING ATTORNEY

Int. Cl.: 31

Prior U.S. Cls.: 1 and 46

United States Patent and Trademark Office

Reg. No. 3,520,454

Registered Oct. 21, 2008

**TRADEMARK
PRINCIPAL REGISTER**

Better Bites

ADAPTIVE ACTIVITIES NONPROFIT COR-
PORATION (WASHINGTON CORPORATION)
16915 31ST DRIVE SE
BOTHELL, WA 98012

THE MARK CONSISTS OF STANDARD CHAR-
ACTERS WITHOUT CLAIM TO ANY PARTICULAR
FONT, STYLE, SIZE, OR COLOR.

FOR: PET TREATS, IN CLASS 31 (U.S. CLS. 1 AND
46).

SER. NO. 77-434,893, FILED 3-28-2008.

FIRST USE 3-1-2008; IN COMMERCE 3-15-2008.

CORY BOONE, EXAMINING ATTORNEY

Int. Cl.: 41

Prior U.S. Cls.: 100, 101 and 107

United States Patent and Trademark Office

Reg. No. 3,520,455

Registered Oct. 21, 2008

**SERVICE MARK
PRINCIPAL REGISTER**

blue transit

STEP 5 PRODUCTIONS, L.L.C. (INDIANA LIMITED LIABILITY COMPANY)
1841 NORTH 425 EAST
AVON, IN 46123

THE MARK CONSISTS OF STANDARD CHARACTERS WITHOUT CLAIM TO ANY PARTICULAR FONT, STYLE, SIZE, OR COLOR.

FOR: ENTERTAINMENT, NAMELY, LIVE PERFORMANCES BY A MUSICAL BAND, IN CLASS 41 (U.S. CLS. 100, 101 AND 107).

SER. NO. 77-434,907, FILED 3-28-2008.

FIRST USE 1-1-2006; IN COMMERCE 1-1-2006.

JAMES STEIN, EXAMINING ATTORNEY

Int. Cl.: 35

Prior U.S. Cls.: 100, 101 and 102

United States Patent and Trademark Office

Reg. No. 3,520,456

Registered Oct. 21, 2008

**SERVICE MARK
PRINCIPAL REGISTER**

Paint-the-Picture

SALES RESULT INC. (WASHINGTON CORPORATION)
STE 800
500 108TH AVE. NE
BELLEVUE, WA 98004

FOR: BUSINESS CONSULTATION IN THE FIELD OF BUSINESS MARKETING AND STRATEGIC BUSINESS PLANNING WITH RESPECT TO SALES AND MARKETING ANALYSIS, SALES OPERATIONS, SALES PRESENTATIONS, PROJECT MANAGEMENT AND TARGETED BUSINESS

ASSESSMENTS, IN CLASS 35 (U.S. CLS. 100, 101 AND 102).

FIRST USE 4-10-2004; IN COMMERCE 4-10-2004.

THE MARK CONSISTS OF STANDARD CHARACTERS WITHOUT CLAIM TO ANY PARTICULAR FONT, STYLE, SIZE, OR COLOR.

SER. NO. 77-434,908, FILED 3-28-2008.

JAMES STEIN, EXAMINING ATTORNEY

Int. Cl.: 37

Prior U.S. Cls.: 100, 103 and 106

United States Patent and Trademark Office

Reg. No. 3,520,457

Registered Oct. 21, 2008

**SERVICE MARK
PRINCIPAL REGISTER**



STRIZER CONSTRUCTION, INC. (CALIFORNIA CORPORATION)
1800 TARAVAL STREET #685
SAN FRANCISCO, CA 94116

FOR: RESIDENTIAL AND COMMERCIAL BUILDING CONSTRUCTION, IN CLASS 37 (U.S. CLS. 100, 103 AND 106).

FIRST USE 0-0-1999; IN COMMERCE 0-0-1999.

NO CLAIM IS MADE TO THE EXCLUSIVE RIGHT TO USE "CONSTRUCTION", APART FROM THE MARK AS SHOWN.

THE MARK CONSISTS OF THE STYLIZED WORDS "STRIZER CONSTRUCTION" AND A PENTAGON DESIGN.

SER. NO. 77-434,944, FILED 3-28-2008.

TOBY BULLOFF, EXAMINING ATTORNEY

Int. Cl.: 5

Prior U.S. Cls.: 6, 18, 44, 46, 51 and 52

United States Patent and Trademark Office

Reg. No. 3,520,458

Registered Oct. 21, 2008

**TRADEMARK
PRINCIPAL REGISTER**

BR Super ENERGY BAR

TERRY ANN ABBLETT (UNITED STATES INDIVIDUAL)
3445 CLAYTON ROAD
CONCORD, CA 94519 AND
DAVID EUGENE ABBLETT, DC (UNITED STATES INDIVIDUAL)
3445 CLAYTON ROAD
CONCORD, CA 94519

THE MARK CONSISTS OF STANDARD CHARACTERS WITHOUT CLAIM TO ANY PARTICULAR FONT, STYLE, SIZE, OR COLOR.

NO CLAIM IS MADE TO THE EXCLUSIVE RIGHT TO USE "SUPER ENERGY BAR", APART FROM THE MARK AS SHOWN.

FOR: MEAL REPLACEMENT BARS, IN CLASS 5 (U.S. CLS. 6, 18, 44, 46, 51 AND 52).

SER. NO. 77-434,956, FILED 3-28-2008.

FIRST USE 3-15-2008; IN COMMERCE 3-15-2008.

JOHN WILKE, EXAMINING ATTORNEY

Int. Cl.: 41

Prior U.S. Cls.: 100, 101 and 107

United States Patent and Trademark Office

Reg. No. 3,520,459

Registered Oct. 21, 2008

**SERVICE MARK
PRINCIPAL REGISTER**

Complete Desire

EPPS, RODNEY J. (UNITED STATES INDIVIDUAL)
P.O. BOX 741271
RIVERDALE, GA 30274

THE MARK CONSISTS OF STANDARD CHARACTERS WITHOUT CLAIM TO ANY PARTICULAR FONT, STYLE, SIZE, OR COLOR.

FOR: ENTERTAINMENT SERVICES, NAMELY, LIVE PERFORMANCES, BY A VOCAL AND MUSICAL GROUP, IN CLASS 41 (U.S. CLS. 100, 101 AND 107).

SER. NO. 77-434,990, FILED 3-28-2008.

FIRST USE 1-12-1995; IN COMMERCE 1-12-1995.

DAVID H. STINE, EXAMINING ATTORNEY

Int. Cl.: 3

Prior U.S. Cls.: 1, 4, 6, 50, 51 and 52

United States Patent and Trademark Office

Reg. No. 3,520,460

Registered Oct. 21, 2008

**TRADEMARK
PRINCIPAL REGISTER**

Maoli Perfumes

MAOLI PERFUMES, LLC (PUERTO RICO LIMITED LIABILITY COMPANY)
PO BOX 1047
BARRANQUITAS, PUERTO RICO 00704

FOR: COSMETICS IN GENERAL, INCLUDING PERFUMES, IN CLASS 3 (U.S. CLS. 1, 4, 6, 50, 51 AND 52).

FIRST USE 1-16-2000; IN COMMERCE 1-16-2000.

THE MARK CONSISTS OF STANDARD CHARACTERS WITHOUT CLAIM TO ANY PARTICULAR FONT, STYLE, SIZE, OR COLOR.

NO CLAIM IS MADE TO THE EXCLUSIVE RIGHT TO USE "PERFUMES", APART FROM THE MARK AS SHOWN.

THE FOREIGN WORDING IN THE MARK TRANSLATES INTO ENGLISH AS "ABORIGINE, INDIGENOUS".

SER. NO. 77-434,994, FILED 3-28-2008.

DANIEL CAPSHAW, EXAMINING ATTORNEY

Int. Cl.: 16

Prior U.S. Cls.: 2, 5, 22, 23, 29, 37, 38 and 50

Reg. No. 3,520,461

United States Patent and Trademark Office

Registered Oct. 21, 2008

**TRADEMARK
PRINCIPAL REGISTER**

CATHERINE ANDREWS

ANDREWS, CATHERINE (UNITED KINGDOM
INDIVIDUAL)
1334 GOUCHER STREET
PACIFIC PALISADES, CA 90272

FOR: ART PRINTS; GRAPHIC ART REPRODUCTIONS;
GREETING CARDS; GICLEE PRINTS, IN
CLASS 16 (U.S. CLS. 2, 5, 22, 23, 29, 37, 38 AND 50).

FIRST USE 1-1-1973; IN COMMERCE 1-1-1973.

THE MARK CONSISTS OF STANDARD CHARACTERS
WITHOUT CLAIM TO ANY PARTICULAR FONT,
STYLE, SIZE, OR COLOR.

THE NAME "CATHERINE ANDREWS" IDENTIFIES
A LIVING INDIVIDUAL WHOSE CONSENT IS
OF RECORD.

SER. NO. 77-435,637, FILED 3-31-2008.

JENNIFER DIXON, EXAMINING ATTORNEY

Int. Cl.: 43

Prior U.S. Cls.: 100 and 101

United States Patent and Trademark Office

Reg. No. 3,520,462

Registered Oct. 21, 2008

**SERVICE MARK
PRINCIPAL REGISTER**

MICHAEL MINA

THE MINA GROUP, LLC (CALIFORNIA LIMITED LIABILITY COMPANY)

335 POWELL STREET, 13TH FLOOR

SAN FRANCISCO, CA 94102

FOR: RESTAURANT, BAR AND CATERING SERVICES; COCKTAIL LOUNGES, IN CLASS 43 (U.S. CLS. 100 AND 101).

FIRST USE 6-0-2003; IN COMMERCE 6-0-2003.

THE MARK CONSISTS OF STANDARD CHARACTERS WITHOUT CLAIM TO ANY PARTICULAR FONT, STYLE, SIZE, OR COLOR.

THE NAME "MICHAEL MINA" IDENTIFIES A LIVING INDIVIDUAL WHOSE CONSENT IS OF RECORD.

SER. NO. 77-436,091, FILED 3-31-2008.

KATHERINE CONNOLLY, EXAMINING ATTORNEY

Int. Cl.: 43

Prior U.S. Cls.: 100 and 101

United States Patent and Trademark Office

Reg. No. 3,520,463

Registered Oct. 21, 2008

**SERVICE MARK
PRINCIPAL REGISTER**



M I C H A E L M I N A

THE MINA GROUP, LLC (CALIFORNIA LIMITED LIABILITY COMPANY)
335 POWELL STREET, 13TH FLOOR
SAN FRANCISCO, CA 94102

FOR: RESTAURANT, BAR AND CATERING SERVICES; COCKTAIL LOUNGES, IN CLASS 43 (U.S. CLS. 100 AND 101).

FIRST USE 6-0-2003; IN COMMERCE 6-0-2003.

THE NAME "MICHAEL MINA" IDENTIFIES A LIVING INDIVIDUAL WHOSE CONSENT IS OF RECORD.

THE MARK CONSISTS OF THE LETTER "M" CENTERED OVER THE TEXT "MICHAEL MINA".

SER. NO. 77-436,178, FILED 3-31-2008.

KATHERINE CONNOLLY, EXAMINING ATTORNEY

Int. Cl.: 11

Prior U.S. Cls.: 13, 21, 23, 31 and 34

United States Patent and Trademark Office

Reg. No. 3,520,464

Registered Oct. 21, 2008

**TRADEMARK
PRINCIPAL REGISTER**

Vital Rays

VITAL SAUNAS INC. (CALIFORNIA CORPORATION)
10596 LANSFORD LANE
SAN DIEGO, CA 92126

THE MARK CONSISTS OF STANDARD CHARACTERS WITHOUT CLAIM TO ANY PARTICULAR FONT, STYLE, SIZE, OR COLOR.

FOR: HEATING ELEMENTS SOLD AS A COMPONENT PART OF SAUNAS, IN CLASS 11 (U.S. CLS. 13, 21, 23, 31 AND 34).

SER. NO. 77-436,311, FILED 3-31-2008.

FIRST USE 3-25-2008; IN COMMERCE 3-25-2008.

MARCIE MILONE, EXAMINING ATTORNEY

Int. Cl.: 30

Prior U.S. Cl.: 46

United States Patent and Trademark Office

Reg. No. 3,520,465

Registered Oct. 21, 2008

**TRADEMARK
PRINCIPAL REGISTER**

VIVA

LESAFFRE ET COMPAGNIE (FRANCE COR-
PORATION)
41, RUE ETIENNE MARCEL
PARIS, FRANCE 75001

OWNER OF ERPN CMNTY TM OFC REG. NO.
3798485, DATED 9-14-2005, EXPIRES 4-27-2014.

FOR: YEAST, IN CLASS 30 (U.S. CL. 46).

SER. NO. 77-437,799, FILED 4-2-2008.

THE MARK CONSISTS OF STANDARD CHAR-
ACTERS WITHOUT CLAIM TO ANY PARTICULAR
FONT, STYLE, SIZE, OR COLOR.

PAM WILLIS, EXAMINING ATTORNEY

Int. Cls.: 3, 18 and 25

Prior U.S. Cls.: 1, 2, 3, 4, 6, 22, 39, 41, 50, 51 and 52

United States Patent and Trademark Office

Reg. No. 3,520,466

Registered Oct. 21, 2008

TRADEMARK
PRINCIPAL REGISTER

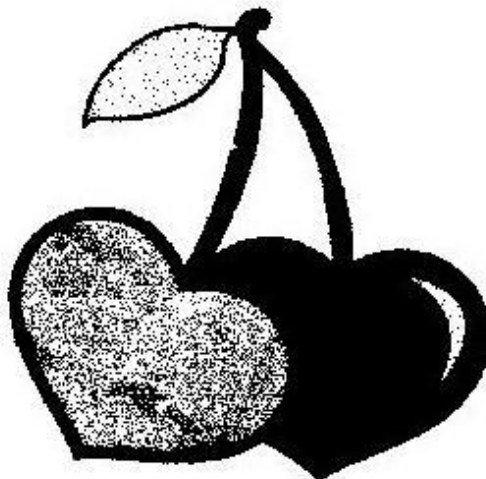

HY GORGEOUS, LLC (NEW JERSEY LIMITED
LIABILITY COMPANY)
50 ESTE PLACE
BLOOMFIELD, NJ 07003

FOR: NAIL POLISH ; MAKE-UP, IN CLASS 3 (U.S.
CLS. 1, 4, 6, 50, 51 AND 52).

FIRST USE 3-17-2007; IN COMMERCE 3-17-2007.

FOR: HANDBAGS, IN CLASS 18 (U.S. CLS. 1, 2, 3,
22 AND 41).

FIRST USE 3-17-2007; IN COMMERCE 3-17-2007.

FOR: T-SHIRTS, DRESSES, PANTS, LINGERIE,
SHOES, SHIRTS, IN CLASS 25 (U.S. CLS. 22 AND 39).

FIRST USE 3-17-2007; IN COMMERCE 3-17-2007.

THE STIPPLING IS FOR SHADING PURPOSES
ONLY.

THE MARK CONSISTS OF TWO HEARTS WITH
TWO STEMS AND A LEAF.

SER. NO. 77-438,452, FILED 4-2-2008.

GISELLE AGOSTO, EXAMINING ATTORNEY

Int. Cl.: 41

Prior U.S. Cls.: 100, 101 and 107

United States Patent and Trademark Office

Reg. No. 3,520,467

Registered Oct. 21, 2008

**SERVICE MARK
PRINCIPAL REGISTER**

FLYPSIDE

DIGITAL MEDIA INTERNATIONAL LLC (DE-
LAWARE LIMITED LIABILITY COMPANY)
SUITE 1900
10 EAST 40TH STREET
NEW YORK, NY 10016

FOR: PUBLICATION OF ELECTRONIC MAGA-
ZINES, IN CLASS 41 (U.S. CLS. 100, 101 AND 107).

FIRST USE 3-12-2008; IN COMMERCE 3-12-2008.

THE MARK CONSISTS OF STANDARD CHAR-
ACTERS WITHOUT CLAIM TO ANY PARTICULAR
FONT, STYLE, SIZE, OR COLOR.

SER. NO. 77-438,550, FILED 4-2-2008.

KATHERINE M. DUBRAY, EXAMINING ATTOR-
NEY

Int. Cl.: 41

Prior U.S. Cls.: 100, 101 and 107

United States Patent and Trademark Office

Reg. No. 3,520,468

Registered Oct. 21, 2008

**SERVICE MARK
PRINCIPAL REGISTER**

FLYP FLICKS

DIGITAL MEDIA INTERNATIONAL LLC (DE-
LAWARE LIMITED LIABILITY COMPANY)
SUITE 1900
10 EAST 40TH STREET
NEW YORK, NY 10016

FOR: PUBLICATION OF ELECTRONIC MAGA-
ZINES, IN CLASS 41 (U.S. CLS. 100, 101 AND 107).

FIRST USE 3-12-2008; IN COMMERCE 3-12-2008.

THE MARK CONSISTS OF STANDARD CHAR-
ACTERS WITHOUT CLAIM TO ANY PARTICULAR
FONT, STYLE, SIZE, OR COLOR.

SER. NO. 77-438,551, FILED 4-2-2008.

KATHERINE M. DUBRAY, EXAMINING ATTOR-
NEY

Int. Cl.: 9

Prior U.S. Cls.: 21, 23, 26, 36 and 38

United States Patent and Trademark Office

Reg. No. 3,520,469

Registered Oct. 21, 2008

**TRADEMARK
PRINCIPAL REGISTER**



IOLO TECHNOLOGIES, LLC (CALIFORNIA LIMITED LIABILITY COMPANY)
7470 NORTH FIGUEROA STREET
LOS ANGELES, CA 90041

FOR: COMPUTER SOFTWARE, NAMELY, COMPUTER SOFTWARE PROVIDING UTILITY PROGRAMS FOR ASSURING THE EFFICIENT MAINTENANCE AND OPERATION OF OPERATING SYSTEMS, IN CLASS 9 (U.S. CLS. 21, 23, 26, 36 AND 38).

FIRST USE 3-7-2008; IN COMMERCE 3-7-2008.

THE COLOR(S) BLACK, WHITE, GRAY, RED, AND GREEN IS/ARE CLAIMED AS A FEATURE OF THE MARK.

THE MARK CONSISTS OF A CIRCULAR GAUGE DESIGN OUTLINED IN GRAY WITH AN INNER RING OF WHITE. WITHIN THE GRAY AND WHITE

CIRCLES, THERE ARE THREE INDIVIDUAL GAUGES, ONE LARGE AND TWO SMALL, ALL OF WHICH ARE IDENTICAL IN STYLE AND COLOR. THE BACKGROUND OF THE GAUGES IS BLACK, THE INDICATOR NEEDLES ARE RED, EXTENDING FROM A GRAY CIRCLE WITH WHITE SHADING. THE ARCHED INDICATOR PORTION OF THE GAUGES IS DIVIDED INTO FOUR SECTIONS WITH THE LEFT-MOST SECTION BEING RED AND FADING TO GREEN IN THE RIGHT-MOST SECTION. THE INTERIM SECTIONS ARE A COMBINATION OF RED COMBINED WITH GREEN, WITH RED BEING THE PREDOMINANT SHADE IN THE LEFT INNER PORTION AND GREEN BEING THE PREDOMINANT SHADE IN THE RIGHT INNER PORTION.

SER. NO. 77-438,975, FILED 4-3-2008.

KAREN SEVERSON, EXAMINING ATTORNEY

Int. Cl.: 9

Prior U.S. Cls.: 21, 23, 26, 36 and 38

United States Patent and Trademark Office

Reg. No. 3,520,470

Registered Oct. 21, 2008

**TRADEMARK
PRINCIPAL REGISTER**

CANDY STRIPERS

ARROW PRODUCTIONS, LTD. (NEVADA CORPORATION)
631 LAS VEGAS BOULEVARD SOUTH
LAS VEGAS, NV 89101

FOR: PRERECORDED VIDEO CASSETTES AND DIGITAL VIDEO DISCS FEATURING ADULT ENTERTAINMENT, IN CLASS 9 (U.S. CLS. 21, 23, 26, 36 AND 38).

FIRST USE 12-26-1978; IN COMMERCE 12-26-1978.

THE MARK CONSISTS OF STANDARD CHARACTERS WITHOUT CLAIM TO ANY PARTICULAR FONT, STYLE, SIZE, OR COLOR.

SER. NO. 77-439,321, FILED 4-3-2008.

WILLIAM P. SHANAHAN, EXAMINING ATTORNEY

Int. Cl.: 42

Prior U.S. Cls.: 100 and 101

United States Patent and Trademark Office

Reg. No. 3,520,471

Registered Oct. 21, 2008

**SERVICE MARK
PRINCIPAL REGISTER**

Go To Your Site

ADCUENT, INC. (FLORIDA CORPORATION)
16328 MIRA VISTA LN
DELRAY BEACH, FL 33446

FOR: PROVIDING TEMPORARY USE OF ON-
LINE NON-DOWNLOADABLE SOFTWARE FOR
THE DEVELOPMENT AND HOSTING OF WEBSITE
APPLICATIONS, IN CLASS 42 (U.S. CLS. 100 AND
101).

FIRST USE 6-14-2007; IN COMMERCE 6-14-2007.

THE MARK CONSISTS OF STANDARD CHAR-
ACTERS WITHOUT CLAIM TO ANY PARTICULAR
FONT, STYLE, SIZE, OR COLOR.

SER. NO. 77-439,482, FILED 4-3-2008.

HEATHER THOMPSON, EXAMINING ATTORNEY

Int. Cl.: 41

Prior U.S. Cls.: 100, 101 and 107

United States Patent and Trademark Office

Reg. No. 3,520,472

Registered Oct. 21, 2008

**SERVICE MARK
PRINCIPAL REGISTER**

Exploring Innovation 

FEDERAL RESERVE BANK OF ST. LOUIS (UNITED STATES FEDERALLY CHARTERED CORPORATION)
ONE FEDERAL RESERVE BANK PLAZA
ST. LOUIS, MO 63166

FOR: EDUCATIONAL SERVICES, NAMELY, DEVELOPING, ARRANGING, AND CONDUCTING EDUCATIONAL CONFERENCES IN THE FIELD OF COMMUNITY DEVELOPMENT FINANCE, IN CLASS 41 (U.S. CLS. 100, 101 AND 107).

FIRST USE 5-2-2007; IN COMMERCE 5-2-2007.

THE MARK CONSISTS OF IN PART, A STYLIZED RING WITH TWO SPHERES.

SER. NO. 77-439,530, FILED 4-3-2008.

MARK SPARACINO, EXAMINING ATTORNEY

Int. Cl.: 20

Prior U.S. Cls.: 2, 13, 22, 25, 32 and 50

Reg. No. 3,520,473

United States Patent and Trademark Office

Registered Oct. 21, 2008

**TRADEMARK
PRINCIPAL REGISTER**

Maccabee Sports

TOFASCO OF AMERICA, INC. (CALIFORNIA
CORPORATION)
1661 FAIPLEX DRIVE
LA VERNE, CA 91750

THE MARK CONSISTS OF STANDARD CHAR-
ACTERS WITHOUT CLAIM TO ANY PARTICULAR
FONT, STYLE, SIZE, OR COLOR.

FOR: FURNITURE, NAMELY, INDOOR AND
OUTDOOR FURNITURE AND CHILDREN'S FUR-
NITURE, IN CLASS 20 (U.S. CLS. 2, 13, 22, 25, 32 AND
50).

SER. NO. 77-439,686, FILED 4-3-2008.

FIRST USE 6-11-1993; IN COMMERCE 6-11-1993.

RAMONA ORTIGA, EXAMINING ATTORNEY

Int. Cl.: 5

Prior U.S. Cls.: 6, 18, 44, 46, 51 and 52

United States Patent and Trademark Office

Reg. No. 3,520,474

Registered Oct. 21, 2008

**TRADEMARK
PRINCIPAL REGISTER**

Calva-Lac

CALVA PRODUCTS CO. INC (CALIFORNIA CORPORATION)
4351 E. WINERY RD.
ACAMPO, CA 95220

THE MARK CONSISTS OF THE WORDS "CALVA-LAC" IN OFFSET BLACK LETTERING.

FOR: MEDICATED DRINK FOR ANIMALS, NAMELY, MEDICATED MILK REPLACEMENT FOR CALVES, IN CLASS 5 (U.S. CLS. 6, 18, 44, 46, 51 AND 52).

THE ENGLISH TRANSLATION OF THE WORD "CALVA" IN THE MARK IS BALD.

FIRST USE 1-1-1952; IN COMMERCE 1-1-1952.

SER. NO. 77-440,006, FILED 4-4-2008.

THE COLOR(S) BLACK IS/ARE CLAIMED AS A FEATURE OF THE MARK.

APRIL ROACH, EXAMINING ATTORNEY

Int. Cl.: 43

Prior U.S. Cls.: 100 and 101

United States Patent and Trademark Office

Reg. No. 3,520,475

Registered Oct. 21, 2008

**SERVICE MARK
PRINCIPAL REGISTER**

Celebrated Hotels

CELEBRATED MANAGEMENT COMPANY, INC.
(ALABAMA CORPORATION)
2323 WAYSIDE DRIVE NE
ATLANTA, GA 30319

FOR: HOTELS, RESORT HOTELS, A COLLECTION OF HOTELS, NAMELY, FULL SERVICES HOTELS, BOUTIQUE HOTELS, MAKING HOTEL RESERVATIONS FOR OTHERS, PROVIDING PERSONALIZED INFORMATION ABOUT HOTELS AND TEMPORARY ACCOMMODATIONS FOR TRAVEL VIA THE INTERNET, IN CLASS 43 (U.S. CLS. 100 AND 101).

FIRST USE 1-31-1989; IN COMMERCE 1-31-1989.

THE MARK CONSISTS OF STANDARD CHARACTERS WITHOUT CLAIM TO ANY PARTICULAR FONT, STYLE, SIZE, OR COLOR.

NO CLAIM IS MADE TO THE EXCLUSIVE RIGHT TO USE "HOTELS", APART FROM THE MARK AS SHOWN.

SER. NO. 77-440,312, FILED 4-4-2008.

PAULA MAHONEY, EXAMINING ATTORNEY

Int. Cl.: 18

Prior U.S. Cls.: 1, 2, 3, 22 and 41

United States Patent and Trademark Office

Reg. No. 3,520,476

Registered Oct. 21, 2008

**TRADEMARK
PRINCIPAL REGISTER**

SUMMER OF LOVE

CONSUMER PRODUCTS DESIGN, LTD (NEW
YORK CORPORATION)
SUITE 2320
60 EAST 42ND STREET
NEW YORK, NY 10165

FOR: ALL PURPOSE SPORT BAGS; ALL-PUR-
POSE CARRYING BAGS; BABY CARRYING BAGS;
BAGS FOR CARRYING BABIES' ACCESSORIES;
BACKPACKS, BOOK BAGS, SPORTS BAGS, BUM
BAGS, WALLETS AND HANDBAGS; BEACH BAGS;
BELT BAGS AND HIP BAGS; CANVAS SHOPPING
BAGS; COSMETIC BAGS SOLD EMPTY; TOILETRY
BAGS SOLD EMPTY; DIAPER BAGS; DUFFEL
BAGS; SHOPPING BAGS WITH WHEELS AT-

TACHED; BILLFOLDS; BRIEFCASES AND AT-
TACHE CASES; LUGGAGE; LUGGAGE TAGS;
STRAPS FOR LUGGAGE; UMBRELLAS, IN CLASS
18 (U.S. CLS. 1, 2, 3, 22 AND 41).

FIRST USE 4-1-2008; IN COMMERCE 4-1-2008.

THE MARK CONSISTS OF STANDARD CHAR-
ACTERS WITHOUT CLAIM TO ANY PARTICULAR
FONT, STYLE, SIZE, OR COLOR.

SER. NO. 77-440,423, FILED 4-4-2008.

REBECCA GILBERT, EXAMINING ATTORNEY

Int. Cl.: 41

Prior U.S. Cls.: 100, 101 and 107

United States Patent and Trademark Office

Reg. No. 3,520,477

Registered Oct. 21, 2008

**SERVICE MARK
PRINCIPAL REGISTER**

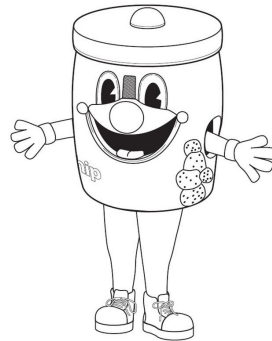

COMMUNITYSOUTH FINANCIAL CORPORATION (SOUTH CAROLINA CORPORATION)
6602 CALHOUN MEMORIAL HIGHWAY
EASLEY, SC 29460

FOR: ENTERTAINMENT SERVICES IN THE NATURE OF PERSONAL PERFORMANCES AND APPEARANCES OF A COSTUMED MASCOT INCIDENT TO PROVIDING BANKING AND FINANCIAL SERVICES, IN CLASS 41 (U.S. CLS. 100, 101 AND 107).

FIRST USE 8-20-2007; IN COMMERCE 8-20-2007.

THE MARK CONSISTS OF A STYLIZED REPRESENTATION OF A PERSON COSTUMED AS A COOKIE JAR.

SER. NO. 77-441,332, FILED 4-7-2008.

TRICIA SONNEBORN, EXAMINING ATTORNEY

Int. Cl.: 44

Prior U.S. Cls.: 100 and 101

United States Patent and Trademark Office

Reg. No. 3,520,478

Registered Oct. 21, 2008

**SERVICE MARK
PRINCIPAL REGISTER**

**SHAPING THE MEDICINES OF
TOMORROW**

JOHNSON & JOHNSON (NEW JERSEY CORPORATION)
ONE JOHNSON & JOHNSON PLAZA
NEW BRUNSWICK, NJ 089337001

FOR: WEBSITE PROVIDING INFORMATION ON SMALL MOLECULE DRUGS, BIOLOGICS, VACCINES, AND THE TECHNOLOGIES AND FORMULATIONS THEREOF, IN CLASS 44 (U.S. CLS. 100 AND 101).

FIRST USE 4-11-2007; IN COMMERCE 4-11-2007.

THE MARK CONSISTS OF STANDARD CHARACTERS WITHOUT CLAIM TO ANY PARTICULAR FONT, STYLE, SIZE, OR COLOR.

SER. NO. 77-441,406, FILED 4-7-2008.

TINA KUAN, EXAMINING ATTORNEY

Int. Cl.: 5

Prior U.S. Cls.: 6, 18, 44, 46, 51 and 52

Reg. No. 3,520,479

United States Patent and Trademark Office

Registered Oct. 21, 2008

**TRADEMARK
PRINCIPAL REGISTER**

GENTLE FIBERS

JARROW FORMULAS, INC. (CALIFORNIA CORPORATION)
1824 SOUTH ROBERTSON BLVD.
LOS ANGELES, CA 900354317

FOR: DIETARY AND NUTRITIONAL SUPPLEMENTS, IN CLASS 5 (U.S. CLS. 6, 18, 44, 46, 51 AND 52).

FIRST USE 1-31-1994; IN COMMERCE 1-31-1994.

THE MARK CONSISTS OF STANDARD CHARACTERS WITHOUT CLAIM TO ANY PARTICULAR FONT, STYLE, SIZE, OR COLOR.

NO CLAIM IS MADE TO THE EXCLUSIVE RIGHT TO USE "FIBERS", APART FROM THE MARK AS SHOWN.

SER. NO. 77-441,448, FILED 4-7-2008.

MATTHEW EINSTEIN, EXAMINING ATTORNEY

Int. Cl.: 42

Prior U.S. Cls.: 100 and 101

United States Patent and Trademark Office

Reg. No. 3,520,480

Registered Oct. 21, 2008

**SERVICE MARK
PRINCIPAL REGISTER**

GoToGreenPlanet

ADCUENT, INC. (FLORIDA CORPORATION)
16328 MIRA VISTA LN
DELRAY BEACH, FL 33446

THE MARK CONSISTS OF STANDARD CHAR-
ACTERS WITHOUT CLAIM TO ANY PARTICULAR
FONT, STYLE, SIZE, OR COLOR.

FOR: PROVIDING TEMPORARY USE OF ON-
LINE NON-DOWNLOADABLE SOFTWARE FOR
THE PURPOSE OF ACCESSING A HOSTING EN-
VIRONMENT, IN CLASS 42 (U.S. CLS. 100 AND 101).

SER. NO. 77-442,126, FILED 4-7-2008.

FIRST USE 4-15-2007; IN COMMERCE 4-15-2007.

HEATHER THOMPSON, EXAMINING ATTORNEY

Int. Cl.: 25

Prior U.S. Cls.: 22 and 39

United States Patent and Trademark Office

Reg. No. 3,520,481

Registered Oct. 21, 2008

**TRADEMARK
PRINCIPAL REGISTER**



JADE APPAREL, INC. (CALIFORNIA CORPORATION)
4551 LOMA VISTA AVE.
VERNON, CA 90058

THE MARK CONSISTS OF A FROG WEARING A HAT, SHIRT, PANTS AND SHOES LEANING ON A GOLF IRON.

FOR: SHIRTS, GOLF SHIRTS, SWEATERS, VEST, PANTS, SOCKS, SHOES, CAPS, HATS, JACKETS, SWEAT SHIRTS, IN CLASS 25 (U.S. CLS. 22 AND 39).

SER. NO. 77-442,233, FILED 4-7-2008.

FIRST USE 2-1-2008; IN COMMERCE 2-1-2008.

BILL DAWE, EXAMINING ATTORNEY

Int. Cl.: 31

Prior U.S. Cls.: 1 and 46

United States Patent and Trademark Office

Reg. No. 3,520,482

Registered Oct. 21, 2008

**TRADEMARK
PRINCIPAL REGISTER**

CFP

PACER TECHNOLOGY, INC. (IDAHO CORPORATION)
P.O. BOX 48
TWIN FALLS, ID 83303

THE MARK CONSISTS OF STANDARD CHARACTERS WITHOUT CLAIM TO ANY PARTICULAR FONT, STYLE, SIZE, OR COLOR.

FOR: ANIMAL FEED, IN CLASS 31 (U.S. CLS. 1 AND 46).

SER. NO. 77-442,794, FILED 4-8-2008.

FIRST USE 1-0-1996; IN COMMERCE 1-0-1996.

RONALD AIKENS, EXAMINING ATTORNEY

Int. Cl.: 45

Prior U.S. Cls.: 100 and 101

United States Patent and Trademark Office

Reg. No. 3,520,483

Registered Oct. 21, 2008

**SERVICE MARK
PRINCIPAL REGISTER**

Confident Technologies

VIDOOOP LLC (OKLAHOMA LIMITED LIABILITY
COMPANY)
15 WEST 6TH STREET, SUITE 2400
TULSA, OK 74119

FOR: AUTHENTICATION, ISSUANCE AND VALIDATION OF DIGITAL CERTIFICATES; IDENTIFICATION VERIFICATION SERVICES, NAMELY, PROVIDING AUTHENTICATION OF PERSONAL IDENTIFICATION INFORMATION; IDENTIFICATION VERIFICATION SERVICES, NAMELY, PROVIDING AUTHENTICATION OF PERSONAL IDENTIFICATION INFORMATION VIA SECURE STORAGE AND TRANSMITTING SUCH INFORMATION VIA THE INTERNET; PROVIDING USER AUTHENTICATION SERVICES IN E-COMMERCE

TRANSACTIONS, IN CLASS 45 (U.S. CLS. 100 AND 101).

FIRST USE 3-25-2008; IN COMMERCE 3-25-2008.

THE MARK CONSISTS OF STANDARD CHARACTERS WITHOUT CLAIM TO ANY PARTICULAR FONT, STYLE, SIZE, OR COLOR.

NO CLAIM IS MADE TO THE EXCLUSIVE RIGHT TO USE "TECHNOLOGIES", APART FROM THE MARK AS SHOWN.

SER. NO. 77-443,044, FILED 4-8-2008.

LINDA M. KING, EXAMINING ATTORNEY

Int. Cl.: 25

Prior U.S. Cls.: 22 and 39

United States Patent and Trademark Office

Reg. No. 3,520,484

Registered Oct. 21, 2008

**TRADEMARK
PRINCIPAL REGISTER**

AIR FORCE I

NIKE, INC. (OREGON CORPORATION)
ONE BOWERMAN DRIVE
BEAVERTON, OR 97005

THE MARK CONSISTS OF STANDARD CHAR-
ACTERS WITHOUT CLAIM TO ANY PARTICULAR
FONT, STYLE, SIZE, OR COLOR.

FOR: FOOTWEAR, IN CLASS 25 (U.S. CLS. 22 AND
39).

SER. NO. 77-443,326, FILED 4-8-2008.

FIRST USE 10-28-1982; IN COMMERCE 10-28-1982.

MATTHEW MCDOWELL, EXAMINING ATTOR-
NEY

Int. Cl.: 35

Prior U.S. Cls.: 100, 101 and 102

United States Patent and Trademark Office

Reg. No. 3,520,485

Registered Oct. 21, 2008

**SERVICE MARK
PRINCIPAL REGISTER**

MD TouchPoint

RESEARCH HORIZONS LLC (DELAWARE LIMITED LIABILITY COMPANY), DBA PHOENIX MARKETING INTERNATIONAL
6423 MONTGOMERY STREET, SUITE 12
RHINEBECK, NY 12572

FOR: MARKET RESEARCH SERVICES; CREATION OF MARKETING TOOLS DESIGNED TO INCREASE A CLIENT COMPANY'S KNOWLEDGE OF CUSTOMER NEEDS, AND ITS COMPETITORS' PRODUCTS AND SERVICES, PRICING, ADVERTISING STRATEGY AND SALES STRATEGY; BUSINESS MANAGEMENT CONSULTING WITH RELATION TO STRATEGY, MARKETING, SALES, OPERATION, PRODUCT DESIGN PARTICULARLY SPECIALIZING IN THE USE OF ANALYTIC AND STATISTIC MODELS FOR THE UNDERSTANDING AND PREDICTING OF CONSUMERS, BUSINESSES,

AND MARKET TRENDS AND ACTIONS, IN CLASS 35 (U.S. CLS. 100, 101 AND 102).

FIRST USE 2-1-2008; IN COMMERCE 2-1-2008.

THE MARK CONSISTS OF STANDARD CHARACTERS WITHOUT CLAIM TO ANY PARTICULAR FONT, STYLE, SIZE, OR COLOR.

NO CLAIM IS MADE TO THE EXCLUSIVE RIGHT TO USE "MD", APART FROM THE MARK AS SHOWN.

SER. NO. 77-443,602, FILED 4-9-2008.

DOMINICK J. SALEMI, EXAMINING ATTORNEY

Int. Cl.: 11

Prior U.S. Cls.: 13, 21, 23, 31 and 34

Reg. No. 3,520,486

United States Patent and Trademark Office

Registered Oct. 21, 2008

**TRADEMARK
PRINCIPAL REGISTER**

HYDROFORCE

MJSI, INC. (ILLINOIS CORPORATION)
SUITE 3
205 EARL ROAD
SHOREWOOD, IL 60404

THE MARK CONSISTS OF STANDARD CHAR-
ACTERS WITHOUT CLAIM TO ANY PARTICULAR
FONT, STYLE, SIZE, OR COLOR.

FOR: PARTS FOR TOILETS, NAMELY, TOILET
TANK FLAPPERS, IN CLASS 11 (U.S. CLS. 13, 21, 23,
31 AND 34).

SER. NO. 77-443,733, FILED 4-9-2008.

FIRST USE 4-20-2007; IN COMMERCE 4-20-2007.

KATHLEEN M. VANSTON, EXAMINING ATTOR-
NEY

Int. Cl.: 36

Prior U.S. Cls.: 100, 101 and 102

United States Patent and Trademark Office

Reg. No. 3,520,487

Registered Oct. 21, 2008

**SERVICE MARK
PRINCIPAL REGISTER**

SallieMae | Business School Loans

SALLIE MAE, INC. (DELAWARE CORPORATION)
12061 BLUEMONT WAY
RESTON, VA 20190

FOR: STUDENT LOAN SERVICES, IN CLASS 36
(U.S. CLS. 100, 101 AND 102).

FIRST USE 4-7-2008; IN COMMERCE 4-7-2008.

OWNER OF U.S. REG. NOS. 1,337,128, 3,271,420
AND OTHERS.

NO CLAIM IS MADE TO THE EXCLUSIVE
RIGHT TO USE "BUSINESS SCHOOL LOANS",
APART FROM THE MARK AS SHOWN.

THE MARK CONSISTS OF THE WORD "SALLIE
MAE BUSINESS SCHOOL LOANS" WITH A HASH
MARK BETWEEN THE WORDS "MAE" AND "BUSI-
NESS".

SER. NO. 77-443,831, FILED 4-9-2008.

EUGENIA MARTIN, EXAMINING ATTORNEY

Int. Cls.: 9 and 37

Prior U.S. Cls.: 21, 23, 26, 36, 38, 100, 103 and 106

Reg. No. 3,520,488

United States Patent and Trademark Office

Registered Oct. 21, 2008

**TRADEMARK
SERVICE MARK
PRINCIPAL REGISTER**



Farris Authorized Service Team

CURTISS-WRIGHT FLOW CONTROL CORPORATION (NEW YORK CORPORATION)
SUITE 850
2941 FAIRVIEW PARK DRIVE
FALLS CHURCH, VA 22042

FOR: PRESSURE RELIEF VALVES FOR INDUSTRIAL APPLICATIONS, IN CLASS 9 (U.S. CLS. 21, 23, 26, 36 AND 38).

FIRST USE 6-0-2005; IN COMMERCE 6-0-2005.

FOR: REPAIR AND MAINTENANCE OF PRESSURE RELIEF VALVES, IN CLASS 37 (U.S. CLS. 100, 103 AND 106).

FIRST USE 6-0-2005; IN COMMERCE 6-0-2005.

NO CLAIM IS MADE TO THE EXCLUSIVE RIGHT TO USE "AUTHORIZED SERVICE TEAM", APART FROM THE MARK AS SHOWN.

THE MARK CONSISTS OF THE WORD "FAST", BEFORE WHICH IS AN INCOMPLETE CIRCLE EXTENDING TO THE LETTER "S" IN THE WORD "FAST"; THE WORD FAST CONTAINS LINES THAT DEPICT SPEED OR WIND; UNDERNEATH THE WORD "FAST" ARE THE WORDS "FARRIS AUTHORIZED SERVICE TEAM".

SER. NO. 77-445,104, FILED 4-10-2008.

JORDAN BAKER, EXAMINING ATTORNEY

Int. Cl.: 5

Prior U.S. Cls.: 6, 18, 44, 46, 51 and 52

Reg. No. 3,520,489

United States Patent and Trademark Office

Registered Oct. 21, 2008

TRADEMARK
PRINCIPAL REGISTER



CALVA PRODUCTS CO., INC (CALIFORNIA CORPORATION)
4351 E. WINERY RD
ACAMPO, CA 95220

FOR: NON-MEDICATED LIQUID SUPPLEMENT FOR ANIMAL FEED FOR USE AS A NUTRITIONAL SUPPLEMENT, NAMELY SALT AND MINERAL PREPARATION FOR NUTRITIONAL SUPPORT AND BODY FLUID REPLENISHMENT FOR USE IN NON-RUMINATING CALVES, IN CLASS 5 (U.S. CLS. 6, 18, 44, 46, 51 AND 52).

FIRST USE 4-1-1986; IN COMMERCE 4-1-1986.

NO CLAIM IS MADE TO THE EXCLUSIVE RIGHT TO USE "PRODUCTS RECOVER ELECTROLYTES", APART FROM THE MARK AS SHOWN.

THE COLOR(S) RED, YELLOW, BLACK AND WHITE IS/ARE CLAIMED AS A FEATURE OF THE MARK.

THE MARK CONSISTS OF A BLACK AND WHITE COW STANDING ON BLACK GRASS IN A YELLOW CIRCLE OUTLINED IN BLACK, WITH A WHITE INNER BORDER OUTLINED IN BLACK AND A WIDE RED OUTER BORDER OUTLINED IN BLACK WITH THE WORDING "RECOVER" AND "ELECTROLYTES" IN WHITE WITH A BLACK OUTLINE AND TWO WHITE STARS THAT ARE ALSO OUTLINED IN BLACK, A HORIZONTAL YELLOW OVAL OUTLINED IN BLACK WITH THE WORDING "CALVA PRODUCTS" IN BLACK AND TWO BLACK DOTS IN THE YELLOW OVAL WHICH HAS A RED INNER BORDER AND WHITE OUTER BORDER, BOTH WITH A BLACK OUTLINE, AND BLACK AND WHITE HORIZONTAL LINES UNDER THE CIRCLE AND OVAL.

THE ENGLISH TRANSLATION OF THE WORD "CALVA" IN THE MARK IS BALD.

SER. NO. 77-445,939, FILED 4-11-2008.

APRIL ROACH, EXAMINING ATTORNEY

Int. Cl.: 41

Prior U.S. Cls.: 100, 101 and 107

United States Patent and Trademark Office

Reg. No. 3,520,490

Registered Oct. 21, 2008

SERVICE MARK
PRINCIPAL REGISTER



GILCHREST, ANNELIESE (UNITED STATES INDIVIDUAL), DBA ATHELAS

1179 COUNTY HWY 5

OTEGO, NY 13825

FOR: RECREATIONAL SERVICES IN THE NATURE OF HORSEBACK RIDING FACILITIES, IN CLASS 41 (U.S. CLS. 100, 101 AND 107).

FIRST USE 2-1-2008; IN COMMERCE 2-1-2008.

NO CLAIM IS MADE TO THE EXCLUSIVE RIGHT TO USE "THERAPEUTIC RIDING", APART FROM THE MARK AS SHOWN.

THE MARK CONSISTS OF FIGURE OF HORSE AND RIDER WITH ARMS OUTSPREAD SURROUNDED BY CIRCLES AND THE WORDING ATHELAS THERAPEUTIC RIDING.

SER. NO. 77-446,702, FILED 4-11-2008.

ALEX KEAM, EXAMINING ATTORNEY

Int. Cl.: 36

Prior U.S. Cls.: 100, 101 and 102

United States Patent and Trademark Office

Reg. No. 3,520,491

Registered Oct. 21, 2008

**SERVICE MARK
PRINCIPAL REGISTER**

O2 FUR LIFE

WAG'N ENTERPRISES, LLC (VIRGINIA LIMITED LIABILITY COMPANY)
SUITE 5B
795 CENTER STREET
HERNDON, VA 20170

FOR: CHARITABLE FUND RAISING; PROVIDING FUND RAISING SERVICES FOR OTHERS VIA A GLOBAL COMPUTER NETWORK, IN CLASS 36 (U.S. CLS. 100, 101 AND 102).

FIRST USE 12-6-2007; IN COMMERCE 12-6-2007.

THE MARK CONSISTS OF STANDARD CHARACTERS WITHOUT CLAIM TO ANY PARTICULAR FONT, STYLE, SIZE, OR COLOR.

SER. NO. 77-446,966, FILED 4-13-2008.

KATHERINE CONNOLLY, EXAMINING ATTORNEY

Int. Cls.: 25, 36 and 41

Prior U.S. Cls.: 22, 39, 100, 101, 102 and 107

Reg. No. 3,520,492

United States Patent and Trademark Office

Registered Oct. 21, 2008

**TRADEMARK
SERVICE MARK
PRINCIPAL REGISTER**



JELD-WEN
TRADITION

JELD-WEN, INC. (OREGON CORPORATION)
3250 LAKEPORT BOULEVARD
KLAMATH FALLS, OR 97601

FOR: CLOTHING, NAMELY, HATS, VISORS,
SHIRTS AND JACKETS, IN CLASS 25 (U.S. CLS. 22
AND 39).

FIRST USE 5-31-2007; IN COMMERCE 5-31-2007.

FOR: CHARITABLE FUND RAISING SERVICES,
IN CLASS 36 (U.S. CLS. 100, 101 AND 102).

FIRST USE 11-30-2006; IN COMMERCE 11-30-2006.

FOR: ENTERTAINMENT SERVICES, NAMELY,
ORGANIZING, PROMOTING AND CONDUCTING
A GOLF TOURNAMENT, IN CLASS 41 (U.S. CLS.
100, 101 AND 107).

FIRST USE 11-30-2006; IN COMMERCE 11-30-2006.

OWNER OF U.S. REG. NOS. 1,388,339, 3,072,535
AND OTHERS.

THE MARK CONSISTS OF THE WORD "JELD-
WEN" IN A STYLIZED LARGER FONT ABOVE THE

WORD "TRADITION" IN SMALLER FONT, BOTH
WORDS UNDERNEATH THE DESIGN OF A WIN-
DOW PANE. THE SHADED BORDER OF THE
WINDOW PANE DESIGN CONTAINS A CURVED
UPPER HALF AND BOTTOM HALF WITH
STRAIGHT SIDES AND BOTTOM EDGE. THE UP-
PER BORDER OF THE WINDOW PANE BISECTS
THE DESIGN OF A GOLF FLAG ATTACHED TO A
GOLF COURSE FLAGSTICK. INSIDE THE WIN-
DOW PANE IS THE DESIGN OF THE SAME GOLF
FLAGSTICK IN A SHADED GOLF HOLE ON THE
SHADED DESIGN OF A PUTTING GREEN. THE
PUTTING SURFACE HAS A CURVED UPPER AND
LEFT EDGE, AND BORDERS THE SHADED DE-
SIGN OF A GOLF COURSE PLAYING SURFACE.
ABOVE THIS PLAYING SURFACE IS A THINNER
CURVED AREA REPRESENTING A GOLF COURSE
BUNKER. ABOVE THE BUNKER DESIGN, THE
UPPER HALF OF THE DESIGN INSIDE THE WIN-
DOW PANE IS SHADED AND REPRESENTS THE
SKY.

SER. NO. 77-447,336, FILED 4-14-2008.

CHRISTINE COOPER, EXAMINING ATTORNEY

Int. Cl.: 25

Prior U.S. Cls.: 22 and 39

United States Patent and Trademark Office

Reg. No. 3,520,493

Registered Oct. 21, 2008

**TRADEMARK
PRINCIPAL REGISTER**

Volcanic

VOLCANIC MANUFACTURING LLC (WA-
SHINGTON LIMITED LIABILITY COMPANY)
2103 HARRISON AVENUE NW PMB 2644
OLYMPIA, WA 985022626

THE MARK CONSISTS OF STANDARD CHAR-
ACTERS WITHOUT CLAIM TO ANY PARTICULAR
FONT, STYLE, SIZE, OR COLOR.

FOR: SHIRTS; CAPS, IN CLASS 25 (U.S. CLS. 22
AND 39).

SER. NO. 77-447,471, FILED 4-14-2008.

FIRST USE 12-31-2003; IN COMMERCE 12-31-2003.

ANNE E. GUSTASON, EXAMINING ATTORNEY

Int. Cl.: 25

Prior U.S. Cls.: 22 and 39

United States Patent and Trademark Office

Reg. No. 3,520,494

Registered Oct. 21, 2008

**TRADEMARK
PRINCIPAL REGISTER**



VOLCANIC MANUFACTURING LLC (WA-
SHINGTON LIMITED LIABILITY COMPANY)
2103 HARRISON AVENUE NW PMB 2644
OLYMPIA, WA 985022626

THE MARK CONSISTS OF AN IMAGE OF A
VOLCANO .

FOR: SHIRTS; CAPS, IN CLASS 25 (U.S. CLS. 22
AND 39).

SER. NO. 77-447,489, FILED 4-14-2008.

FIRST USE 12-31-2003; IN COMMERCE 12-31-2003.

ANNE E. GUSTASON, EXAMINING ATTORNEY

Int. Cls.: 35 and 39

Prior U.S. Cls.: 100, 101, 102 and 105

United States Patent and Trademark Office

Reg. No. 3,520,495

Registered Oct. 21, 2008

**SERVICE MARK
PRINCIPAL REGISTER**

**EXPERIENCE DRIVEN
INNOVATION**

COYOTE LOGISTICS, LLC (DELAWARE LIMITED LIABILITY COMPANY)
191 EAST DEERPATH ROAD
LAKE FOREST, IL 60045

FOR: TRANSPORTATION LOGISTIC SERVICES, NAMELY, ARRANGING FOR THE TRANSPORTATION OF GOODS FOR OTHERS, IN CLASS 35 (U.S. CLS. 100, 101 AND 102).

FIRST USE 11-0-2004; IN COMMERCE 11-0-2004.

FOR: FREIGHT FORWARDING, BROKERING AND LOGISTIC SERVICES RELATING TO THE TRANSPORTATION OF FREIGHT AND PROPER-

TY BY LAND, SEA, AIR OR RAIL; DELIVERY OF GOODS BY TRUCK, IN CLASS 39 (U.S. CLS. 100 AND 105).

FIRST USE 11-0-2004; IN COMMERCE 11-0-2004.

THE MARK CONSISTS OF STANDARD CHARACTERS WITHOUT CLAIM TO ANY PARTICULAR FONT, STYLE, SIZE, OR COLOR.

SER. NO. 77-447,670, FILED 4-14-2008.

KAREN BRACEY, EXAMINING ATTORNEY

Int. Cl.: 35

Prior U.S. Cls.: 100, 101 and 102

United States Patent and Trademark Office

Reg. No. 3,520,496

Registered Oct. 21, 2008

**SERVICE MARK
PRINCIPAL REGISTER**

CUPMERCIAL

CUPMERCIAL, LLC (GEORGIA LIMITED LIABILITY COMPANY)
28 ST. MARTIN CIRCLE
RICHMOND HILL, GA 31324

THE MARK CONSISTS OF STANDARD CHARACTERS WITHOUT CLAIM TO ANY PARTICULAR FONT, STYLE, SIZE, OR COLOR.

FOR: ADVERTISING AND PROMOTIONAL SERVICES; PREPARATION OF CUSTOM ADVERTISEMENTS FOR OTHERS, IN CLASS 35 (U.S. CLS. 100, 101 AND 102).

SER. NO. 77-448,402, FILED 4-15-2008.

FIRST USE 5-0-2007; IN COMMERCE 5-0-2007.

JAY FLOWERS, EXAMINING ATTORNEY

Int. Cl.: 25

Prior U.S. Cls.: 22 and 39

United States Patent and Trademark Office

Reg. No. 3,520,497

Registered Oct. 21, 2008

**TRADEMARK
PRINCIPAL REGISTER**



ACHILLES CORPORATION (JAPAN CORPORATION)
22-5, DAIKYO-CHO, SHINJUKU-KU
TOKYO, JAPAN

FOR: FOOTWEAR, IN CLASS 25 (U.S. CLS. 22 AND 39).

FIRST USE 1-0-1987; IN COMMERCE 6-1-2004.

THE MARK CONSISTS OF THE LETTERS "IC" IN A STYLIZED FONT.

THE WORDING "IC" HAS NO MEANING OTHER THAN TRADEMARK SIGNIFICANCE.

SER. NO. 77-448,642, FILED 4-15-2008.

MATTHEW MCDOWELL, EXAMINING ATTORNEY

Int. Cl.: 30

Prior U.S. Cl.: 46

United States Patent and Trademark Office

Reg. No. 3,520,498

Registered Oct. 21, 2008

TRADEMARK
PRINCIPAL REGISTER



MATE REVOLUTION INC. (OREGON CORPORATION), DBA ECOTEAS
PO BOX 1192
ASHLAND, OR 97520

FOR: HERBAL TEA, IN CLASS 30 (U.S. CL. 46).

FIRST USE 1-1-2007; IN COMMERCE 6-1-2007.

NO CLAIM IS MADE TO THE EXCLUSIVE RIGHT TO USE "TEAS", APART FROM THE MARK AS SHOWN.

THE MARK CONSISTS OF THE WORD "ECOTEAS", SPLIT BETWEEN "ECO" AND "TEAS" BY A STYLIZED IMAGE OF A BUTTERFLY STANDING ON A BOMBILLA (TEA FILTER STRAW) THAT IS INSERTED INTO A SPIRAL-EMBELLISHED GOURD VESSEL FILLED WITH THE HERB YERBA MATE.

SER. NO. 77-448,931, FILED 4-15-2008.

ALICE SUE CARRUTHERS, EXAMINING ATTORNEY

Int. Cl.: 42

Prior U.S. Cls.: 100 and 101

United States Patent and Trademark Office

Reg. No. 3,520,499

Registered Oct. 21, 2008

**SERVICE MARK
PRINCIPAL REGISTER**

GoToCleanInternet

ADCUENT, INC. (FLORIDA CORPORATION)
16328 MIRA VISTA LN
DELRAY BEACH, FL 33446

THE MARK CONSISTS OF STANDARD CHAR-
ACTERS WITHOUT CLAIM TO ANY PARTICULAR
FONT, STYLE, SIZE, OR COLOR.

FOR: PROVIDING TEMPORARY USE OF ON-
LINE NON-DOWNLOADABLE SOFTWARE FOR
THE PURPOSE OF ACCESSING A HOSTING EN-
VIRONMENT, IN CLASS 42 (U.S. CLS. 100 AND 101).

SER. NO. 77-449,167, FILED 4-15-2008.

FIRST USE 4-15-2007; IN COMMERCE 4-15-2007.

HEATHER THOMPSON, EXAMINING ATTORNEY

Int. Cl.: 34

Prior U.S. Cls.: 2, 8, 9 and 17

United States Patent and Trademark Office

Reg. No. 3,520,500

Registered Oct. 21, 2008

**TRADEMARK
PRINCIPAL REGISTER**

NO SMOKING NO PROBLEM.

LORILLARD LICENSING COMPANY, LLC
(NORTH CAROLINA LIMITED LIABILITY
COMPANY)
1601 WACHOVIA TOWER, 300 N. GREENE ST.
GREENSBORO, NC 27401

THE MARK CONSISTS OF STANDARD CHAR-
ACTERS WITHOUT CLAIM TO ANY PARTICULAR
FONT, STYLE, SIZE, OR COLOR.

FOR: SMOKELESS TOBACCO; TOBACCO POW-
DER, NAMELY, SNUS; SNUFF, IN CLASS 34 (U.S.
CLS. 2, 8, 9 AND 17).

SER. NO. 77-449,874, FILED 4-16-2008.

FIRST USE 1-28-2008; IN COMMERCE 1-28-2008.

KELLY MCCOY, EXAMINING ATTORNEY

Int. Cl.: 12

Prior U.S. Cls.: 19, 21, 23, 31, 35 and 44

United States Patent and Trademark Office

Reg. No. 3,520,501

Registered Oct. 21, 2008

**TRADEMARK
PRINCIPAL REGISTER**

ZAPINA

ZAP (CALIFORNIA CORPORATION)
501 FOURTH STREET
SANTA ROSA, CA 95401

FOR: ELECTRIC VEHICLES, NAMELY, MOTOR-
CYCLES, IN CLASS 12 (U.S. CLS. 19, 21, 23, 31, 35 AND
44).

FIRST USE 2-12-2008; IN COMMERCE 2-12-2008.

THE MARK CONSISTS OF STANDARD CHAR-
ACTERS WITHOUT CLAIM TO ANY PARTICULAR
FONT, STYLE, SIZE, OR COLOR.

OWNER OF U.S. REG. NO. 3,297,140.

SER. NO. 77-450,105, FILED 4-16-2008.

SHAUNIA CARLYLE, EXAMINING ATTORNEY

Int. Cls.: 36 and 41

Prior U.S. Cls.: 100, 101, 102 and 107

United States Patent and Trademark Office

Reg. No. 3,520,502

Registered Oct. 21, 2008

**SERVICE MARK
PRINCIPAL REGISTER**

MARCH ON STAGE

HARD ROCK CAFE INTERNATIONAL (USA),
INC. (FLORIDA CORPORATION)
6100 OLD PARK LANE
ORLANDO, FL 32835

FOR: CHARITABLE FUND RAISING SERVICES,
NAMELY, PRESENTATION OF LIVE MUSIC CON-
CERTS WITH PROCEEDS BENEFITING MUSIC-
RELATED CHARITIES , IN CLASS 36 (U.S. CLS.
100, 101 AND 102).

FIRST USE 3-1-2007; IN COMMERCE 3-1-2007.

FOR: ENTERTAINMENT SERVICES, NAMELY,
PRESENTATION OF LIVE MUSIC CONCERTS, IN
CLASS 41 (U.S. CLS. 100, 101 AND 107).

FIRST USE 3-1-2007; IN COMMERCE 3-1-2007.

THE MARK CONSISTS OF STANDARD CHAR-
ACTERS WITHOUT CLAIM TO ANY PARTICULAR
FONT, STYLE, SIZE, OR COLOR.

SER. NO. 77-451,148, FILED 4-17-2008.

JIM RINGLE, EXAMINING ATTORNEY

Int. Cl.: 17

Prior U.S. Cls.: 1, 5, 12, 13, 35 and 50

Reg. No. 3,520,503

United States Patent and Trademark Office

Registered Oct. 21, 2008

**TRADEMARK
PRINCIPAL REGISTER**

Novalux

LENDELL MANUFACTURING, INC. (MICHIGAN CORPORATION)
5301 S. GRAHAM RD.
SAINT CHARLES, MI 48655

THE MARK CONSISTS OF STANDARD CHARACTERS WITHOUT CLAIM TO ANY PARTICULAR FONT, STYLE, SIZE, OR COLOR.

FOR: OPEN CELL FOAM IN ROLL FORM, IN CLASS 17 (U.S. CLS. 1, 5, 12, 13, 35 AND 50).

SER. NO. 77-451,562, FILED 4-18-2008.

FIRST USE 2-22-2000; IN COMMERCE 2-22-2000.

KIMBERLY FRYE, EXAMINING ATTORNEY

Int. Cl.: 17

Prior U.S. Cls.: 1, 5, 12, 13, 35 and 50

United States Patent and Trademark Office

Reg. No. 3,520,504

Registered Oct. 21, 2008

**TRADEMARK
PRINCIPAL REGISTER**

HSS X-7

LENDELL MANUFACTURING, INC. (MICHIGAN CORPORATION)
5301 S. GRAHAM RD.
SAINT CHARLES, MI 48655

THE MARK CONSISTS OF STANDARD CHARACTERS WITHOUT CLAIM TO ANY PARTICULAR FONT, STYLE, SIZE, OR COLOR.

FOR: OPEN CELL FOAM IN ROLL FORM, IN CLASS 17 (U.S. CLS. 1, 5, 12, 13, 35 AND 50).

SER. NO. 77-451,580, FILED 4-18-2008.

FIRST USE 1-24-2005; IN COMMERCE 1-24-2008.

KIMBERLY FRYE, EXAMINING ATTORNEY

Int. Cl.: 41

Prior U.S. Cls.: 100, 101 and 107

United States Patent and Trademark Office

Reg. No. 3,520,505

Registered Oct. 21, 2008

**SERVICE MARK
PRINCIPAL REGISTER**



MEDITATION AS TONIC, LLC (OHIO LIMITED
LIABILITY COMPANY)
1585 WEDGEWOOD WAY
WOOSTER, OH 44691

THE MARK CONSISTS OF A SEATED PERSON
WITH PALMS PRESSED TOGETHER; AN AURA
EMANATES FROM THE CHEST AND ENCOMPAS-
SES THE UPPER BODY.

FOR: MEDITATION TRAINING; YOGA IN-
STRUCTION, IN CLASS 41 (U.S. CLS. 100, 101 AND
107).

SER. NO. 77-451,677, FILED 4-18-2008.

FIRST USE 3-31-2008; IN COMMERCE 3-31-2008.

BRENDAN MCCAULEY, EXAMINING ATTORNEY

Int. Cl.: 14

Prior U.S. Cls.: 2, 27, 28 and 50

United States Patent and Trademark Office

Reg. No. 3,520,506

Registered Oct. 21, 2008

**TRADEMARK
PRINCIPAL REGISTER**

GATE B9

MIMI SO INTERNATIONAL LLC (DELAWARE
LIMITED LIABILITY COMPANY)
550 FIFTH AVENUE, 7TH FLOOR
NEW YORK, NY 10036

THE MARK CONSISTS OF STANDARD CHAR-
ACTERS WITHOUT CLAIM TO ANY PARTICULAR
FONT, STYLE, SIZE, OR COLOR.

FOR: JEWELRY, IN CLASS 14 (U.S. CLS. 2, 27, 28
AND 50).

SER. NO. 77-451,822, FILED 4-18-2008.

FIRST USE 10-1-2005; IN COMMERCE 6-3-2006.

ATTIYA MALIK, EXAMINING ATTORNEY

Int. Cl.: 28

Prior U.S. Cls.: 22, 23, 38 and 50

United States Patent and Trademark Office

Reg. No. 3,520,507

Registered Oct. 21, 2008

**TRADEMARK
PRINCIPAL REGISTER**

ACU-GRIP

DYNAFLEX INTERNATIONAL, INC. (CALIFORNIA CORPORATION)
1144 N GROVE ST
ANAHEIM, CA 928062109

THE MARK CONSISTS OF STANDARD CHARACTERS WITHOUT CLAIM TO ANY PARTICULAR FONT, STYLE, SIZE, OR COLOR.

FOR: MANUALLY-OPERATED EXERCISE EQUIPMENT; STRESS RELIEF BALLS FOR HAND EXERCISE, IN CLASS 28 (U.S. CLS. 22, 23, 38 AND 50).

SER. NO. 77-452,183, FILED 4-18-2008.

FIRST USE 3-26-2008; IN COMMERCE 3-26-2008.

SONYA STEPHENS, EXAMINING ATTORNEY

Int. Cl.: 28

Prior U.S. Cls.: 22, 23, 38 and 50

United States Patent and Trademark Office

Reg. No. 3,520,508

Registered Oct. 21, 2008

**TRADEMARK
PRINCIPAL REGISTER**

BOING BOING BUNNY

DAN-DEE INTERNATIONAL, LTD. (DELAWARE
CORPORATION)
106 HARBOR DRIVE
JERSEY CITY, NJ 07065

FOR: STUFFED TOYS AND ANIMATED
STUFFED TOYS, IN CLASS 28 (U.S. CLS. 22, 23, 38
AND 50).

FIRST USE 6-10-1994; IN COMMERCE 6-10-1994.

THE MARK CONSISTS OF STANDARD CHAR-
ACTERS WITHOUT CLAIM TO ANY PARTICULAR
FONT, STYLE, SIZE, OR COLOR.

NO CLAIM IS MADE TO THE EXCLUSIVE
RIGHT TO USE "BUNNY", APART FROM THE
MARK AS SHOWN.

SER. NO. 77-452,355, FILED 4-18-2008.

DANNEAN HETZEL, EXAMINING ATTORNEY

Int. Cls.: 5 and 30

Prior U.S. Cls.: 6, 18, 44, 46, 51 and 52

United States Patent and Trademark Office

Reg. No. 3,520,509

Registered Oct. 21, 2008

**TRADEMARK
PRINCIPAL REGISTER**

**HAPPY CHOCOLATES THAT
SATISFY**

ISAGENIX WORLDWIDE, LLC (DELAWARE
LIMITED LIABILITY COMPANY)
2225 S. PRICE ROAD
CHANDLER, AZ 85286

FOR: NUTRITIONAL AND DIETARY SUPPLE-
MENTS, IN CLASS 5 (U.S. CLS. 6, 18, 44, 46, 51 AND
52).

FIRST USE 1-18-2008; IN COMMERCE 1-18-2008.

FOR: CHOCOLATES FORTIFIED WITH VITA-
MINS, MINERALS, AND TRACE ELEMENTS, IN
CLASS 30 (U.S. CL. 46).

FIRST USE 1-18-2008; IN COMMERCE 1-18-2008.

THE MARK CONSISTS OF STANDARD CHAR-
ACTERS WITHOUT CLAIM TO ANY PARTICULAR
FONT, STYLE, SIZE, OR COLOR.

SER. NO. 77-452,683, FILED 4-18-2008.

ALICE SUE CARRUTHERS, EXAMINING ATTOR-
NEY

Int. Cls.: 5 and 30

Prior U.S. Cls.: 6, 18, 44, 46, 51 and 52

United States Patent and Trademark Office

Reg. No. 3,520,510

Registered Oct. 21, 2008

**TRADEMARK
PRINCIPAL REGISTER**

ISADELIGHT

ISAGENIX WORLDWIDE, LLC (DELAWARE
LIMITED LIABILITY COMPANY)
2225 S. PRICE ROAD
CHANDLER, AZ 85286

THE MARK CONSISTS OF STANDARD CHAR-
ACTERS WITHOUT CLAIM TO ANY PARTICULAR
FONT, STYLE, SIZE, OR COLOR.

FOR: NUTRITIONAL AND DIETARY SUPPLE-
MENTS, IN CLASS 5 (U.S. CLS. 6, 18, 44, 46, 51 AND
52).

OWNER OF U.S. REG. NOS. 2,198,293, 3,339,556
AND OTHERS.

FIRST USE 1-18-2008; IN COMMERCE 1-18-2008.

SER. NO. 77-453,091, FILED 4-21-2008.

FOR: CHOCOLATES, IN CLASS 30 (U.S. CL. 46).

FIRST USE 1-18-2008; IN COMMERCE 1-18-2008.

ALICE SUE CARRUTHERS, EXAMINING ATTOR-
NEY

Int. Cl.: 9

Prior U.S. Cls.: 21, 23, 26, 36 and 38

Reg. No. 3,520,511

United States Patent and Trademark Office

Registered Oct. 21, 2008

**TRADEMARK
PRINCIPAL REGISTER**

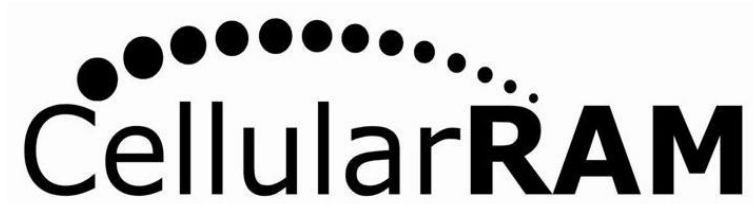

MICRON TECHNOLOGY, INC. (DELAWARE CORPORATION)
8000 SOUTH FEDERAL WAY
BOISE, ID 83707

THE MARK CONSISTS OF THE WORD "CELLULARRAM" IN STYLIZED FONT WITH A SERIES OF DOTS ABOVE THE WORD.

FOR: SEMICONDUCTOR DEVICES, IN CLASS 9 (U.S. CLS. 21, 23, 26, 36 AND 38).

SEC. 2(F) AS TO "CELLULARRAM".

FIRST USE 3-4-2003; IN COMMERCE 3-4-2003.

SER. NO. 77-453,245, FILED 4-21-2008.

OWNER OF U.S. REG. NOS. 3,266,728 AND 3,266,741.

KEVIN DINALLO, EXAMINING ATTORNEY

Int. Cls.: 9, 38 and 42

Prior U.S. Cls.: 21, 23, 26, 36, 38, 100, 101 and 104

United States Patent and Trademark Office

Reg. No. 3,520,512

Registered Oct. 21, 2008

**TRADEMARK
SERVICE MARK
PRINCIPAL REGISTER**

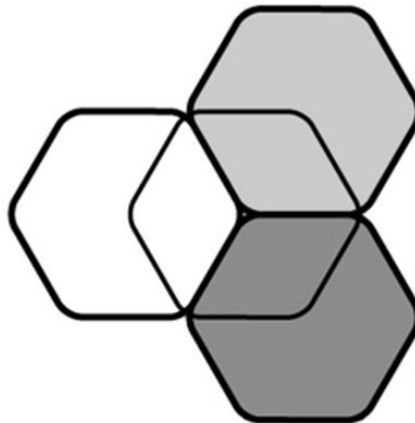

EXARI SYSTEMS, INC. (DELAWARE CORPORATION), DBA SPEEDLEGAL, INC.
THE PRUDENTIAL TOWER, 800 BOYLSTON STREET
BOSTON, MA 02199

FOR: COMPUTER SOFTWARE FOR CONTRACT LIFECYCLE MANAGEMENT AND DOCUMENT ASSEMBLY; COMPUTER PROGRAMMES FOR DOCUMENT MANAGEMENT; COMPUTER SOFTWARE FOR THE COLLECTION, EDITING, ORGANIZING, MODIFYING, BOOK MARKING, TRANSMISSION, STORAGE AND SHARING OF DATA AND INFORMATION; COMPUTER SOFTWARE THAT PROVIDES REAL-TIME, INTEGRATED BUSINESS MANAGEMENT INTELLIGENCE BY COMBINING INFORMATION FROM VARIOUS DATABASES AND PRESENTING IT IN AN EASY-TO-UNDERSTAND USER INTERFACE; DATA AND WORD PROCESSORS; COMPUTER SOFTWARE FOR CREATING SEARCHABLE DATABASES OF INFORMATION AND DATA, IN CLASS 9 (U.S. CLS. 21, 23, 26, 36 AND 38).

FIRST USE 9-6-2005; IN COMMERCE 9-6-2005.

FOR: COMMUNICATION SERVICES, NAMELY, ELECTRONIC TRANSMISSION OF DATA AND DOCUMENTS AMONG USERS OF COMPUTERS; ELECTRONIC DELIVERY OF LOAN DOCUMENTS; ELECTRONIC TRANSMISSION OF DATA AND

DOCUMENTS VIA COMPUTER TERMINALS; ELECTRONIC TRANSMISSION OF MESSAGES AND DATA; ON-LINE DOCUMENT DELIVERY VIA A GLOBAL COMPUTER NETWORK; PROVISION OF ACCESS TO A GLOBAL COMPUTER NETWORK; PROVISION OF ACCESS TO DATA OR DOCUMENTS STORED ELECTRONICALLY IN CENTRAL FILES FOR REMOTE CONSULTATION; PROVISION OF ACCESS TO ELECTRONIC SITES, IN CLASS 38 (U.S. CLS. 100, 101 AND 104).

FIRST USE 9-6-2005; IN COMMERCE 9-6-2005.

FOR: APPLICATION SERVICE PROVIDER (ASP) FEATURING SOFTWARE FOR USE IN DOCUMENT ASSEMBLY AND LIFECYCLE CONTRACT MANAGEMENT; PROVIDING ON-LINE NON-DOWNLOADABLE SOFTWARE FOR USE IN DOCUMENT ASSEMBLY AND CONTRACT LIFECYCLE MANAGEMENT; COMPUTER HARDWARE AND SOFTWARE CONSULTING SERVICES; COMPUTER SOFTWARE CONSULTANCY; COMPUTER PROGRAMMING SERVICES; PROVIDING COMPUTER PROGRAMMING SERVICES TO CUSTOMERS THAT ENABLES THE CUSTOMER'S WEB-SITE TO PROCESS NATURAL LANGUAGE QUERIES; COMPUTER PROGRAMMING AND COMPUTER SYSTEM ANALYSIS; COMPUTER PROGRAMMING AND MAINTENANCE OF COMPUTER PROGRAMS; COMPUTER PROGRAMMING AND SOFTWARE DESIGN; COMPUTER PROJECT MAN-

AGEMENT SERVICES; TECHNICAL SUPPORT SERVICES, NAMELY, TROUBLESHOOTING OF COMPUTER HARDWARE AND SOFTWARE PROBLEMS; TECHNICAL SUPPORT SERVICES, NAMELY, TROUBLESHOOTING OF COMPUTER SOFTWARE PROBLEMS; TECHNICAL SUPPORT SERVICES, NAMELY, TROUBLESHOOTING OF INDUSTRIAL PROCESS CONTROL COMPUTER SOFTWARE PROBLEMS; UP-DATING OF COMPUTER SOFTWARE; UPDATING AND DESIGN OF COMPUTER SOFTWARE; DEVELOPMENT, UPDATING AND MAINTENANCE OF SOFTWARE AND DATA BASES; UPDATING AND MAINTENANCE OF COMPUTER SOFTWARE; DESIGN, MAINTENANCE, DEVELOPMENT AND UPDATING OF COMPUTER SOFTWARE; DEVELOPING AND UPDATING COMPUTER SOFTWARE; DEVELOPING COMPUTER SOFTWARE; COMPUTER SOFTWARE INSTALLATION AND MAINTENANCE; INSTALLATION AND MAINTENANCE OF COMPUTER SOFTWARE; INSTALLATION, MAINTENANCE AND REPAIR OF COMPUTER SOFTWARE; INSTALLATION, REPAIR AND MAINTENANCE OF COMPUTER SOFTWARE; MAINTENANCE AND UPDATING OF COMPUTER SOFTWARE; MAINTENANCE AND UPGRADING OF COMPUTER SOFTWARE; COMPUTER SOFTWARE DESIGN, COMPUTER PROGRAMMING, OR MAINTENANCE OF COMPUTER SOFTWARE; DESIGN AND MAINTENANCE OF COMPUTER SITES FOR THIRD PARTIES; MAINTENANCE OF COMPUTER SOFTWARE; COMPUTER SOFTWARE DESIGN; COMPUTER SOFTWARE DEVELOPMENT; DESIGN AND DEVELOPMENT OF ON-LINE COMPUTER SOFTWARE SYSTEMS; DESIGN OF HOME PAGES; DESIGN OF HOME PAGES AND WEB SITES; DESIGN OF HOME PAGES, COMPUTER SOFTWARE AND WEB SITES; COMPUTER SERVICE, NAMELY, ACTING AS AN APPLICATION SERVICE PROVIDER IN THE FIELD OF KNOWLEDGE MANAGEMENT TO HOST COMPUTER AP-

PLICATION SOFTWARE FOR CREATING SEARCHABLE DATABASES OF INFORMATION AND DATA; CONVERSION OF DATA OR DOCUMENTS FROM PHYSICAL TO ELECTRONIC MEDIA; DOCUMENT DATA TRANSFER FROM ONE COMPUTER FORMAT TO ANOTHER; APPLICATION SERVICE PROVIDER FEATURING SOFTWARE FOR PROVIDING AN ON-LINE DATABASE IN THE FIELD OF TRANSACTION PROCESSING TO UPLOAD TRANSACTIONAL DATA, PROVIDE STATISTICAL ANALYSIS, AND PRODUCE NOTIFICATIONS AND REPORTS; COMPUTER SERVICE, NAMELY, ACTING AS AN APPLICATION SERVICE PROVIDER IN THE FIELD OF KNOWLEDGE MANAGEMENT TO HOST COMPUTER APPLICATION SOFTWARE FOR SEARCHING AND RETRIEVING INFORMATION FROM DATABASES AND COMPUTER NETWORKS; COMPUTER SERVICE, NAMELY, ACTING AS AN APPLICATION SERVICE PROVIDER IN THE FIELD OF KNOWLEDGE MANAGEMENT TO HOST COMPUTER APPLICATION SOFTWARE FOR THE COLLECTION, EDITING, ORGANIZING, MODIFYING, BOOK MARKING, TRANSMISSION, STORAGE AND SHARING OF DATA AND INFORMATION; COMPUTER SERVICES, NAMELY, INTERACTIVE HOSTING SERVICES WHICH ALLOW THE USER TO PUBLISH AND SHARE THEIR OWN CONTENT AND IMAGES ONLINE, IN CLASS 42 (U.S. CLS. 100 AND 101).

FIRST USE 9-6-2005; IN COMMERCE 9-6-2005.

THE MARK CONSISTS OF HONEYCOMB OF 4 OVERLAPPING HEXAGONS WITH SHADING OF DIFFERENT DEPTHS IN TWO OF THE HEXAGONS.

SER. NO. 77-454,088, FILED 4-21-2008.

KAREN BRACEY, EXAMINING ATTORNEY

Int. Cl.: 39

Prior U.S. Cls.: 100 and 105

United States Patent and Trademark Office

Reg. No. 3,520,513

Registered Oct. 21, 2008

**SERVICE MARK
PRINCIPAL REGISTER**



AUTO EUROPE, LLC (DELAWARE LIMITED
LIABILITY COMPANY)
39 COMMERCIAL STREET
PORTLAND, ME 04104

FOR: TRAVEL AGENCY SERVICES, NAMELY,
MAKING RESERVATIONS AND BOOKINGS FOR
TRANSPORTATION; CAR RENTAL, IN CLASS 39
(U.S. CLS. 100 AND 105).

FIRST USE 1-1-1961; IN COMMERCE 1-1-1961.

OWNER OF U.S. REG. NOS. 2,827,877, 3,176,876
AND OTHERS.

THE MARK CONSISTS OF A FANCIFUL DEPICTION
OF THE LETTERS "AE" WITHIN A CIRCLE.

SER. NO. 77-454,470, FILED 4-22-2008.

ANDREA SAUNDERS, EXAMINING ATTORNEY

Int. Cl.: 35

Prior U.S. Cls.: 100, 101 and 102

United States Patent and Trademark Office

Reg. No. 3,520,514

Registered Oct. 21, 2008

**SERVICE MARK
PRINCIPAL REGISTER**

AdPi

RESEARCH HORIZONS LLC (DELAWARE LIMITED LIABILITY COMPANY), DBA PHOENIX MARKETING INTERNATIONAL
SUITE 12
6423 MONTGOMERY STREET
RHINEBECK, NY 12572

FOR: MARKET RESEARCH CONSULTATION; MARKET RESEARCH SERVICES; CREATION OF MARKETING TOOLS DESIGNED TO INCREASE A CLIENT COMPANY'S KNOWLEDGE OF CUSTOMER NEEDS, AND ITS COMPETITORS' PRODUCTS AND SERVICES, PRICING, ADVERTISING STRATEGY AND SALES STRATEGY; BUSINESS MANAGEMENT CONSULTING WITH RELATION TO STRATEGY, MARKETING, SALES, OPERATION, PRODUCT DESIGN PARTICULARLY SPECIALIZ-

ING IN THE USE OF ANALYTIC AND STATISTIC MODELS FOR THE UNDERSTANDING AND PREDICTING OF CONSUMERS, BUSINESSES, AND MARKET TRENDS AND ACTIONS; MARKET OPINION POLLING STUDIES, IN CLASS 35 (U.S. CLS. 100, 101 AND 102).

FIRST USE 1-1-2001; IN COMMERCE 8-13-2003.

THE MARK CONSISTS OF STANDARD CHARACTERS WITHOUT CLAIM TO ANY PARTICULAR FONT, STYLE, SIZE, OR COLOR.

SER. NO. 77-455,374, FILED 4-23-2008.

DOMINICK J. SALEMI, EXAMINING ATTORNEY

Int. Cl.: 35

Prior U.S. Cls.: 100, 101 and 102

United States Patent and Trademark Office

Reg. No. 3,520,515

Registered Oct. 21, 2008

**SERVICE MARK
PRINCIPAL REGISTER**

BrandPi

RESEARCH HORIZONS LLC (DELAWARE LIMITED LIABILITY COMPANY), DBA PHOENIX MARKETING INTERNATIONAL
SUITE 12
6423 MONTGOMERY STREET
RHINEBECK, NY 12572

FOR: BUSINESS MANAGEMENT CONSULTING WITH RELATION TO STRATEGY, MARKETING, SALES, OPERATION, PRODUCT DESIGN PARTICULARLY SPECIALIZING IN THE USE OF ANALYTIC AND STATISTIC MODELS FOR THE UNDERSTANDING AND PREDICTING OF CONSUMERS, BUSINESSES, AND MARKET TRENDS AND ACTIONS; CREATION OF MARKETING TOOLS DESIGNED TO INCREASE A CLIENT COMPANY'S KNOWLEDGE OF CUSTOMER NEEDS, AND ITS COMPETITORS' PRODUCTS AND SERVI-

CES, PRICING, ADVERTISING STRATEGY AND SALES STRATEGY; MARKET OPINION POLLING STUDIES; MARKET RESEARCH; MARKET RESEARCH SERVICES; MARKET RESEARCH STUDIES; MARKETING SERVICES, NAMELY, CONSUMER MARKETING RESEARCH, IN CLASS 35 (U.S. CLS. 100, 101 AND 102).

FIRST USE 1-1-2001; IN COMMERCE 8-13-2003.

THE MARK CONSISTS OF STANDARD CHARACTERS WITHOUT CLAIM TO ANY PARTICULAR FONT, STYLE, SIZE, OR COLOR.

SER. NO. 77-455,377, FILED 4-23-2008.

DOMINICK J. SALEMI, EXAMINING ATTORNEY

Int. Cl.: 16

Prior U.S. Cls.: 2, 5, 22, 23, 29, 37, 38 and 50

United States Patent and Trademark Office

Reg. No. 3,520,516

Registered Oct. 21, 2008

**TRADEMARK
PRINCIPAL REGISTER**

COMMUNICATIONS TECHNOLOGY

ACCESS INTELLIGENCE, LLC (DELAWARE
LIMITED LIABILITY COMPANY)
4 CHOKE CHERRY ROAD
ROCKVILLE, MD 20850

FOR: PUBLICATIONS, NAMELY, MAGAZINES
IN THE FIELDS OF CABLE TELECOMMUNICA-
TIONS AND TECHNOLOGIES, IN CLASS 16 (U.S.
CLS. 2, 5, 22, 23, 29, 37, 38 AND 50).

FIRST USE 7-0-1993; IN COMMERCE 7-0-1993.

THE MARK CONSISTS OF STANDARD CHAR-
ACTERS WITHOUT CLAIM TO ANY PARTICULAR
FONT, STYLE, SIZE, OR COLOR.

SEC. 2(F).

SER. NO. 77-455,388, FILED 4-23-2008.

RON FAIRBANKS, EXAMINING ATTORNEY

Int. Cl.: 27

Prior U.S. Cls.: 19, 20, 37, 42 and 50

United States Patent and Trademark Office

Reg. No. 3,520,517

Registered Oct. 21, 2008

**TRADEMARK
PRINCIPAL REGISTER**

CHOICES THAT WORK

MANNINGTON MILLS, INC. (NEW JERSEY CORPORATION)
75 MANNINGTON MILLS RD.
SALEM, NJ 08079

FOR: CARPET BACKING; CARPET TILES; CARPETING; RESILIENT HARD SURFACE COVERING FOR FLOORS, WALLS AND OTHER SURFACES, IN CLASS 27 (U.S. CLS. 19, 20, 37, 42 AND 50).

FIRST USE 11-1-2007; IN COMMERCE 11-1-2007.

THE MARK CONSISTS OF STANDARD CHARACTERS WITHOUT CLAIM TO ANY PARTICULAR FONT, STYLE, SIZE, OR COLOR.

SER. NO. 77-455,431, FILED 4-23-2008.

KEVIN DINALLO, EXAMINING ATTORNEY

Int. Cl.: 35

Prior U.S. Cls.: 100, 101 and 102

United States Patent and Trademark Office

Reg. No. 3,520,518

Registered Oct. 21, 2008

**SERVICE MARK
PRINCIPAL REGISTER**

IVY VENTURES

IVY VENTURES, LLC (VIRGINIA LIMITED LIABILITY COMPANY)
SUITE 306
7231 FOREST AVE.
RICHMOND, VA 23226

FOR: BUSINESS CONSULTING SERVICES FOR THE HEALTHCARE INDUSTRY; BUSINESS MANAGEMENT AND CONSULTING SERVICES IN THE FIELD OF HEALTHCARE SERVICES AND THE HEALTHCARE INDUSTRY, IN CLASS 35 (U.S. CLS. 100, 101 AND 102).

FIRST USE 6-0-2003; IN COMMERCE 6-0-2003.

THE MARK CONSISTS OF STANDARD CHARACTERS WITHOUT CLAIM TO ANY PARTICULAR FONT, STYLE, SIZE, OR COLOR.

NO CLAIM IS MADE TO THE EXCLUSIVE RIGHT TO USE "VENTURES", APART FROM THE MARK AS SHOWN.

SER. NO. 77-458,100, FILED 4-25-2008.

PAUL E. FAHRENKOPF, EXAMINING ATTORNEY

Int. Cl.: 41

Prior U.S. Cls.: 100, 101 and 107

United States Patent and Trademark Office

Reg. No. 3,520,519

Registered Oct. 21, 2008

**SERVICE MARK
PRINCIPAL REGISTER**



UNITED STATES YOUTH SOCCER ASSOCIATION, INC. (TENNESSEE NON-PROFIT CORPORATION)

9220 WORLD CUP WAY
FRISCO, TX 75034

FOR: ORGANIZING SOCCER LEAGUES, SOCCER EXHIBITIONS AND SOCCER GAMES, IN CLASS 41 (U.S. CLS. 100, 101 AND 107).

FIRST USE 9-0-2005; IN COMMERCE 9-0-2005.

OWNER OF U.S. REG. NOS. 2,739,940, 3,200,986 AND OTHERS.

NO CLAIM IS MADE TO THE EXCLUSIVE RIGHT TO USE "YOUTH SOCCER", APART FROM THE MARK AS SHOWN.

THE COLOR(S) RED, WHITE, BLACK AND BLUE IS/ARE CLAIMED AS A FEATURE OF THE MARK.

THE MARK CONSISTS OF A SHIELD DESIGN WITH A BACKGROUND OF BLACK AND RED; THE WORDS "US" AND "SOCCER" IN RED; THE WORD "YOUTH" IN BLUE; THE COLOR WHITE IS A BORDER AROUND ALL WORDS; WHITE ALSO COMPOSES A LAUREL LEAF DESIGN AND 2 SETS OF STRIPES ON EITHER SIDE OF THE WORDING; A BLACK AND WHITE DESIGN ABOVE THE LETTER "Y" THAT IS OUTLINED IN WHITE.

SEC. 2(F) AS TO "US YOUTH SOCCER".

SER. NO. 77-458,103, FILED 4-25-2008.

LINDA LAVACHE, EXAMINING ATTORNEY

Int. Cl.: 9

Prior U.S. Cls.: 21, 23, 26, 36 and 38

United States Patent and Trademark Office

Reg. No. 3,520,520

Registered Oct. 21, 2008

**TRADEMARK
PRINCIPAL REGISTER**

COSMIC SMASH

KABUSHIKI KAISHA SEGA (JAPAN CORPORATION), DBA D/B/A SEGA CORPORATION
2-12, HANEDA 1-CHOME
OHTA-KU, TOKYO, JAPAN

FOR: HOME VIDEO GAME MACHINES FOR USE WITH TELEVISION; PLAYER-OPERATED ELECTRONIC CONTROLLERS FOR ELECTRONIC VIDEO GAME MACHINES; VIDEO GAME INTERACTIVE CONTROLLERS, NAMELY, HAND HELD PADS, AND FLOOR PADS OR MATS; JOY-STICKS FOR VIDEO GAMES; COMPUTER CURSOR CONTROL DEVICES, NAMELY, COMPUTER MOUSE; FLASH MEMORY CARDS; VIDEO GAME SOFTWARE, COMPUTER GAME PROGRAMS, IN CLASS 9 (U.S. CLS. 21, 23, 26, 36 AND 38).

THE MARK CONSISTS OF STANDARD CHARACTERS WITHOUT CLAIM TO ANY PARTICULAR FONT, STYLE, SIZE, OR COLOR.

OWNER OF JAPAN REG. NO. 4402366, DATED 7-21-2000, EXPIRES 7-21-2010.

OWNER OF U.S. REG. NO. 2,606,363.

SER. NO. 77-458,144, FILED 4-25-2008.

JANICE L. MCMORROW, EXAMINING ATTORNEY

Int. Cl.: 6

Prior U.S. Cls.: 2, 12, 13, 14, 23, 25 and 50

Reg. No. 3,520,521

United States Patent and Trademark Office

Registered Oct. 21, 2008

**TRADEMARK
PRINCIPAL REGISTER**

Architectural Sun Control

ASCA, INC. (NEW HAMPSHIRE CORPORATION)
3 MARKET SQUARE
PORTSMOUTH, NH 03801

FOR: ARCHITECTURAL METALWORK, IN
CLASS 6 (U.S. CLS. 2, 12, 13, 14, 23, 25 AND 50).

FIRST USE 1-1-1993; IN COMMERCE 1-1-1993.

THE MARK CONSISTS OF STANDARD CHAR-
ACTERS WITHOUT CLAIM TO ANY PARTICULAR
FONT, STYLE, SIZE, OR COLOR.

SEC. 2(F).

SER. NO. 77-459,200, FILED 4-28-2008.

JILL PRATER, EXAMINING ATTORNEY

Int. Cl.: 35

Prior U.S. Cls.: 100, 101 and 102

United States Patent and Trademark Office

Reg. No. 3,520,522

Registered Oct. 21, 2008

**SERVICE MARK
PRINCIPAL REGISTER**



AMERICAN CHEMICAL SOCIETY (D.C. CORPORATION), DBA ACS
1155 SIXTEENTH ST., NW
WASHINGTON, DC 20036

FOR: CONSULTING SERVICES RELATED TO THE COMMERCIAL ADMINISTRATION OF DEVELOPING, ADVANCING, ACQUIRING OR LICENSING OF NEW TECHNOLOGY IN THE FIELDS OF CHEMICAL AND APPLIED SCIENCES OF OTHERS, IN CLASS 35 (U.S. CLS. 100, 101 AND 102).

FIRST USE 2-1-2008; IN COMMERCE 2-1-2008.

THE MARK CONSISTS OF THE WORD "TECH-CATALYST" WITH AN ARROW BELOW THE TECH PORTION OF THE WORD.

SER. NO. 77-459,215, FILED 4-28-2008.

MONIQUE MILLER, EXAMINING ATTORNEY

Int. Cl.: 42

Prior U.S. Cls.: 100 and 101

United States Patent and Trademark Office

Reg. No. 3,520,523

Registered Oct. 21, 2008

**SERVICE MARK
PRINCIPAL REGISTER**

FabTrac

ASCA, INC. (NEW HAMPSHIRE CORPORATION)
3 MARKET SQUARE
PORTSMOUTH, NH 03801

THE MARK CONSISTS OF STANDARD CHAR-
ACTERS WITHOUT CLAIM TO ANY PARTICULAR
FONT, STYLE, SIZE, OR COLOR.

FOR: PROVIDING SPECIFIC INFORMATION AS
REQUESTED BY CUSTOMERS VIA THE INTER-
NET, IN CLASS 42 (U.S. CLS. 100 AND 101).

SER. NO. 77-459,365, FILED 4-28-2008.

FIRST USE 1-1-2001; IN COMMERCE 1-1-2001.

JILL PRATER, EXAMINING ATTORNEY

Int. Cl.: 40

Prior U.S. Cls.: 100, 103 and 106

United States Patent and Trademark Office

Reg. No. 3,520,524

Registered Oct. 21, 2008

**SERVICE MARK
PRINCIPAL REGISTER**

Allwoods Conceal

OUTHERE SMARTWEAR, INC. (FLORIDA CORPORATION)

6 LAKESIDE PALMS COURT

LAKE WORTH, FL 33460

FOR: PATTERN PRINTING, IN CLASS 40 (U.S. CLS. 100, 103 AND 106).

FIRST USE 3-31-2008; IN COMMERCE 4-28-2008.

THE MARK CONSISTS OF STANDARD CHARACTERS WITHOUT CLAIM TO ANY PARTICULAR FONT, STYLE, SIZE, OR COLOR.

NO CLAIM IS MADE TO THE EXCLUSIVE RIGHT TO USE "ALLWOODS CONCEAL", APART FROM THE MARK AS SHOWN.

SER. NO. 77-459,575, FILED 4-28-2008.

RONALD AIKENS, EXAMINING ATTORNEY

Int. Cl.: 16

Prior U.S. Cls.: 2, 5, 22, 23, 29, 37, 38 and 50

United States Patent and Trademark Office

Reg. No. 3,520,525

Registered Oct. 21, 2008

TRADEMARK
PRINCIPAL REGISTER



NH TRIPLE PLAY, LLC (NEW HAMPSHIRE
LIMITED LIABILITY COMPANY)
1 LINE DRIVE
MANCHESTER, NH 03101

FOR: PAPER GOODS AND PRINTED MATTER,
NAMELY, AUTOGRAPH BOOKS, BINDERS, BOOK-
MARKS, BUMPER STICKERS, CALENDARS, CAT-
ALOGS OF INTEREST TO BASEBALL FANS,
CHILDREN'S ACTIVITY BOOKS, CHILDREN'S
BOOKS, DECALS, GAME PROGRAMS, MERCHAN-
DISE BAGS, NEWSLETTERS OF INTEREST TO
BASEBALL FANS, NOTE PADS, PAPER CONTAIN-
ERS, PAPER PENNANTS, PAPER SCHEDULES,
PENS, PENCILS, POSTCARDS, POSTERS, PRINTED
AWARDS, PRINTED GAME TICKETS, PRINTED
GUIDES OF INTEREST TO BASEBALL FANS, RE-
FERENCE BOOKS OF INTEREST TO BASEBALL
FANS, SCORE BOOKS, SCORE CARDS, SCORE
SHEETS, STATIONERY, STICKERS, STICKER AL-

BUMS AND TRADING CARDS, IN CLASS 16 (U.S.
CLS. 2, 5, 22, 23, 29, 37, 38 AND 50).

FIRST USE 11-28-2007; IN COMMERCE 11-28-2007.

OWNER OF U.S. REG. NO. 2,936,249.

NO CLAIM IS MADE TO THE EXCLUSIVE
RIGHT TO USE "NEW HAMPSHIRE", APART
FROM THE MARK AS SHOWN.

THE MARK CONSISTS OF A SCRIPT "FISHER
CATS" WITH CAT PEEKING OVER LETTERS
FROM BEHIND. "NEW HAMPSHIRE" IN ARC
ABOVE CAT.

SER. NO. 77-459,635, FILED 4-28-2008.

ELLEN PERKINS, EXAMINING ATTORNEY

Int. Cl.: 37

Prior U.S. Cls.: 100, 103 and 106

United States Patent and Trademark Office

Reg. No. 3,520,526

Registered Oct. 21, 2008

**SERVICE MARK
PRINCIPAL REGISTER**

**PROTECT YOUR GREATEST
ASSET.... YOUR HOME**

SLAB MASTERS, INC. (ILLINOIS CORPORATION)
P.O. BOX 24067
BELLEVILLE, IL 62223

THE MARK CONSISTS OF STANDARD CHARACTERS WITHOUT CLAIM TO ANY PARTICULAR FONT, STYLE, SIZE, OR COLOR.

FOR: STRUCTURAL REPAIR, NAMELY, PIERING AND FOUNDATION REPAIR, CONCRETE REPAIR AND WATERPROOFING, IN CLASS 37 (U.S. CLS. 100, 103 AND 106).

SER. NO. 77-459,730, FILED 4-28-2008.

FIRST USE 1-0-2000; IN COMMERCE 1-0-2000.

JULIE VEPPUMTHARA, EXAMINING ATTORNEY

Int. Cl.: 25

Prior U.S. Cls.: 22 and 39

United States Patent and Trademark Office

Reg. No. 3,520,527

Registered Oct. 21, 2008

TRADEMARK
PRINCIPAL REGISTER



NH TRIPLE PLAY, LLC (NEW HAMPSHIRE
LIMITED LIABILITY COMPANY)
ONE LINE DRIVE
MANCHESTER, NH 03101

OWNER OF U.S. REG. NO. 2,936,249.

FOR: CLOTHING, NAMELY, ATHLETIC UNI-
FORMS, CAPS, CLOTH BABY BIBS, GOLF SHIRTS,
GYM SHORTS, GYM SUITS, HATS, JACKETS, JER-
SEYS, JOGGING SUITS, KNIT SHIRTS, PAJAMAS,
POLO SHIRTS, PONCHOS, PULLOVERS, RAIN
COATS, RAINWEAR, SWEATERS, SWEAT PANTS,
SWEAT SHIRTS, SWEAT SUITS, SOCKS, SPORT
SHIRTS, T- SHIRTS, TANK TOPS, TIES, VISORS,
WIND RESISTANT JACKETS AND WRISTBANDS,
IN CLASS 25 (U.S. CLS. 22 AND 39).

NO CLAIM IS MADE TO THE EXCLUSIVE
RIGHT TO USE "NEW HAMPSHIRE", APART
FROM THE MARK AS SHOWN.

THE MARK CONSISTS OF A SCRIPT "FISHER
CATS" WITH CAT PEEKING OVER LETTERS
FROM BEHIND AND THE WORDS "NEW HAMP-
SHIRE" IN THE ARC ABOVE CAT.

SER. NO. 77-459,752, FILED 4-28-2008.

FIRST USE 11-28-2007; IN COMMERCE 11-28-2007.

ELLEN PERKINS, EXAMINING ATTORNEY

Int. Cl.: 37

Prior U.S. Cls.: 100, 103 and 106

United States Patent and Trademark Office

Reg. No. 3,520,528

Registered Oct. 21, 2008

**SERVICE MARK
PRINCIPAL REGISTER**

**SAVING THE PLANET, ONE
GALLON AT THE TIME!**

GROMAN, ELLIOT (UNITED STATES INDIVIDUAL)
APT. # 20R
35 SEACOAST TERRACE
BROOKLYN, NY 11235

THE MARK CONSISTS OF STANDARD CHARACTERS WITHOUT CLAIM TO ANY PARTICULAR FONT, STYLE, SIZE, OR COLOR.

FOR: WASTE OIL COLLECTION FOR RECYCLING, IN CLASS 37 (U.S. CLS. 100, 103 AND 106).

SER. NO. 77-459,922, FILED 4-28-2008.

FIRST USE 2-15-2008; IN COMMERCE 2-15-2008.

SANI KHOURI, EXAMINING ATTORNEY

Int. Cl.: 9

Prior U.S. Cls.: 21, 23, 26, 36 and 38

United States Patent and Trademark Office

Reg. No. 3,520,529

Registered Oct. 21, 2008

**TRADEMARK
PRINCIPAL REGISTER**

GODOUGH

JACK HENRY SOFTWARE/COMMLINK, L.P.
(TEXAS LIMITED PARTNERSHIP)
663 WEST HWY 60
MONETT, MO 65708

FOR: COMPUTER SOFTWARE LICENSED TO BANKS, CREDIT UNIONS AND THRIFT FINANCIAL INSTITUTIONS TO ENABLE THEIR CUSTOMERS TO USE CELL PHONES, PDAS AND OTHER ELECTRONIC MOBILE COMMUNICATION DEVICES TO INITIATE TRANSACTIONS AND VIEW ACCOUNT RECORDS, IN CLASS 9 (U.S. CLS. 21, 23, 26, 36 AND 38).

FIRST USE 7-17-2007; IN COMMERCE 7-17-2007.

THE MARK CONSISTS OF STANDARD CHARACTERS WITHOUT CLAIM TO ANY PARTICULAR FONT, STYLE, SIZE, OR COLOR.

SER. NO. 77-459,978, FILED 4-28-2008.

KATHERINE M. DUBRAY, EXAMINING ATTORNEY

Int. Cl.: 3

Prior U.S. Cls.: 1, 4, 6, 50, 51 and 52

United States Patent and Trademark Office

Reg. No. 3,520,530

Registered Oct. 21, 2008

**TRADEMARK
PRINCIPAL REGISTER**

BLUSH -N- BRIGHTEN

LAURA GELLER MAKE-UP STUDIOS LTD.
(NEW YORK CORPORATION)
1044 LEXINGTON AVENUE
NEW YORK, NY 10021

FOR: BLUSH, IN CLASS 3 (U.S. CLS. 1, 4, 6, 50, 51
AND 52).

FIRST USE 5-1-2006; IN COMMERCE 5-1-2006.

THE MARK CONSISTS OF STANDARD CHAR-
ACTERS WITHOUT CLAIM TO ANY PARTICULAR
FONT, STYLE, SIZE, OR COLOR.

OWNER OF U.S. REG. NOS. 2,989,610 AND
3,168,706.

SER. NO. 77-460,397, FILED 4-29-2008.

KELLY CHOE, EXAMINING ATTORNEY

Int. Cl.: 36

Prior U.S. Cls.: 100, 101 and 102

United States Patent and Trademark Office

Reg. No. 3,520,531

Registered Oct. 21, 2008

**SERVICE MARK
PRINCIPAL REGISTER**

Mystique

POPULAR, INC. (PUERTO RICO CORPORATION)
POPULAR CENTER BUILDING, 9TH FLOOR
209 MUNOZ RIVERA AVENUE
SAN JUAN, PUERTO RICO 00918

THE MARK CONSISTS OF STANDARD CHARACTERS WITHOUT CLAIM TO ANY PARTICULAR FONT, STYLE, SIZE, OR COLOR.

FOR: CREDIT CARD SERVICES, IN CLASS 36
(U.S. CLS. 100, 101 AND 102).

SER. NO. 77-460,445, FILED 4-29-2008.

FIRST USE 10-26-2007; IN COMMERCE 10-26-2007.

STEVEN PEREZ, EXAMINING ATTORNEY

Int. Cl.: 41

Prior U.S. Cls.: 100, 101 and 107

United States Patent and Trademark Office

Reg. No. 3,520,532

Registered Oct. 21, 2008

**SERVICE MARK
PRINCIPAL REGISTER**

**POSITIVE PET PARENTING
SAVES LIVES**

TRIPP, SUSAN (UNITED STATES INDIVIDUAL)
15340 PASTRANA DRIVE
LA MIRADA, CA 90638

THE MARK CONSISTS OF STANDARD CHAR-
ACTERS WITHOUT CLAIM TO ANY PARTICULAR
FONT, STYLE, SIZE, OR COLOR.

FOR: EDUCATION SERVICES, NAMELY, PRO-
VIDING CLASSES, SEMINARS, AND WORKSHOPS
IN THE FIELD OF PET PARENTS WHO ADOPT
PETS FROM SHELTERS OR RESCUE GROUPS
FROM PARTICIPATING SHELTERS , IN CLASS 41
(U.S. CLS. 100, 101 AND 107).

OWNER OF U.S. REG. NO. 3,433,607.

SER. NO. 77-460,547, FILED 4-29-2008.

FIRST USE 4-1-2006; IN COMMERCE 8-1-2007.

DOMINICK J. SALEMI, EXAMINING ATTORNEY

Int. Cl.: 35

Prior U.S. Cls.: 100, 101 and 102

United States Patent and Trademark Office

Reg. No. 3,520,533

Registered Oct. 21, 2008

**SERVICE MARK
PRINCIPAL REGISTER**

RESORT REPORT CARDS

TIMESHARING TODAY, INC. (NEW JERSEY CORPORATION)
SUITE 114
140 COUNTY ROAD
TENAFLY, NJ 07670

OWNER OF U.S. REG. NO. 2,017,926.

FOR: RATING OF ACCOMMODATIONS, IN CLASS 35 (U.S. CLS. 100, 101 AND 102).

NO CLAIM IS MADE TO THE EXCLUSIVE RIGHT TO USE "RESORT", APART FROM THE MARK AS SHOWN.

FIRST USE 5-1-1993; IN COMMERCE 5-1-1993.

SER. NO. 77-460,842, FILED 4-29-2008.

THE MARK CONSISTS OF STANDARD CHARACTERS WITHOUT CLAIM TO ANY PARTICULAR FONT, STYLE, SIZE, OR COLOR.

JENNIFER MARTIN, EXAMINING ATTORNEY

Int. Cl.: 3

Prior U.S. Cls.: 1, 4, 6, 50, 51 and 52

Reg. No. 3,520,534

United States Patent and Trademark Office

Registered Oct. 21, 2008

**TRADEMARK
PRINCIPAL REGISTER**

XI'A XI'ANG

GARCEAU, ARTHUR H. (UNITED STATES IN-
DIVIDUAL)

1411 N. 16TH COURT

HOLLYWOOD, FL 33020

FOR: COLOGNES, PERFUMES AND COSMET-
ICS, IN CLASS 3 (U.S. CLS. 1, 4, 6, 50, 51 AND 52).

FIRST USE 6-13-2004; IN COMMERCE 6-13-2004.

THE MARK CONSISTS OF STANDARD CHAR-
ACTERS WITHOUT CLAIM TO ANY PARTICULAR
FONT, STYLE, SIZE, OR COLOR.

THE FOREIGN WORDING IN THE MARK
TRANSLATES INTO ENGLISH AS "THE FRA-
GRANCE OF THE IMAGINATION".

SER. NO. 77-461,282, FILED 4-29-2008.

ANGELA M. MICHELI, EXAMINING ATTORNEY

Int. Cl.: 2

Prior U.S. Cls.: 6, 11 and 16

United States Patent and Trademark Office

Reg. No. 3,520,535

Registered Oct. 21, 2008

**TRADEMARK
PRINCIPAL REGISTER**

LINE-PLEX

THE SHERWIN-WILLIAMS COMPANY (OHIO
CORPORATION)
101 PROSPECT AVENUE NW
CLEVELAND, OH 441151075

THE MARK CONSISTS OF STANDARD CHAR-
ACTERS WITHOUT CLAIM TO ANY PARTICULAR
FONT, STYLE, SIZE, OR COLOR.

FOR: PAINTS, IN CLASS 2 (U.S. CLS. 6, 11 AND 16).

SER. NO. 77-461,822, FILED 4-30-2008.

FIRST USE 3-14-2008; IN COMMERCE 3-14-2008.

JUDITH HELFMAN, EXAMINING ATTORNEY

Int. Cl.: 2

Prior U.S. Cls.: 6, 11 and 16

United States Patent and Trademark Office

Reg. No. 3,520,536

Registered Oct. 21, 2008

**TRADEMARK
PRINCIPAL REGISTER**

db

THE SHERWIN-WILLIAMS COMPANY (OHIO
CORPORATION)
101 PROSPECT AVENUE NW
CLEVELAND, OH 441151075

THE MARK CONSISTS OF STANDARD CHAR-
ACTERS WITHOUT CLAIM TO ANY PARTICULAR
FONT, STYLE, SIZE, OR COLOR.

FOR: PAINTS, IN CLASS 2 (U.S. CLS. 6, 11 AND 16).

SER. NO. 77-461,824, FILED 4-30-2008.

FIRST USE 2-21-2008; IN COMMERCE 2-21-2008.

JUDITH HELFMAN, EXAMINING ATTORNEY

Int. Cl.: 2

Prior U.S. Cls.: 6, 11 and 16

United States Patent and Trademark Office

Reg. No. 3,520,537

Registered Oct. 21, 2008

**TRADEMARK
PRINCIPAL REGISTER**



THE SHERWIN-WILLIAMS COMPANY (OHIO
CORPORATION)
101 PROSPECT AVENUE NW
CLEVELAND, OH 441151075

FIRST USE 2-21-2008; IN COMMERCE 2-21-2008.

SER. NO. 77-461,827, FILED 4-30-2008.

FOR: PAINTS, IN CLASS 2 (U.S. CLS. 6, 11 AND 16).

JUDITH HELFMAN, EXAMINING ATTORNEY

Int. Cl.: 11

Prior U.S. Cls.: 13, 21, 23, 31 and 34

Reg. No. 3,520,538

United States Patent and Trademark Office

Registered Oct. 21, 2008

**TRADEMARK
PRINCIPAL REGISTER**

EZ BREATHE

EVERDRY MARKETING & MANAGEMENT,
INC. (OHIO CORPORATION)
365 E. HIGHLAND ROAD
MACEDONIA, OH 44056

THE MARK CONSISTS OF STANDARD CHAR-
ACTERS WITHOUT CLAIM TO ANY PARTICULAR
FONT, STYLE, SIZE, OR COLOR.

FOR: VENTILATION SYSTEMS COMPRISED OF
VENTILATION EXHAUST FANS, ELECTRONIC
FAN CONTROLS, DUCTING FOR ELECTRIC
CABLES, VENTILATION LOUVERS AND RELA-
TIVE HUMIDITY SENSORS, IN CLASS 11 (U.S.
CLS. 13, 21, 23, 31 AND 34).

OWNER OF U.S. REG. NO. 2,787,212.

SER. NO. 77-461,883, FILED 4-30-2008.

FIRST USE 6-30-2006; IN COMMERCE 6-30-2006.

SUE LAWRENCE, EXAMINING ATTORNEY

Int. Cl.: 44

Prior U.S. Cls.: 100 and 101

United States Patent and Trademark Office

Reg. No. 3,520,539

Registered Oct. 21, 2008

**SERVICE MARK
PRINCIPAL REGISTER**

Green People Salon

BLUE MEDSPA, LLC (GEORGIA LIMITED LIABILITY COMPANY)
190 10TH STREET
ATLANTA, GA 30309

FOR: HAIR SALON SERVICES, IN CLASS 44 (U.S. CLS. 100 AND 101).

FIRST USE 10-1-2007; IN COMMERCE 10-1-2007.

THE MARK CONSISTS OF STANDARD CHARACTERS WITHOUT CLAIM TO ANY PARTICULAR FONT, STYLE, SIZE, OR COLOR.

NO CLAIM IS MADE TO THE EXCLUSIVE RIGHT TO USE "SALON", APART FROM THE MARK AS SHOWN.

SER. NO. 77-463,333, FILED 5-1-2008.

KARANENDRA S. CHHINA, EXAMINING ATTORNEY

Int. Cl.: 7

Prior U.S. Cls.: 13, 19, 21, 23, 31, 34 and 35

United States Patent and Trademark Office

Reg. No. 3,520,540

Registered Oct. 21, 2008

**TRADEMARK
PRINCIPAL REGISTER**

MEERKAT

M-I L.L.C. (DELAWARE LIMITED LIABILITY
COMPANY)
LEGAL - TRADEMARKS
5950 NORTH COURSE DR.
HOUSTON, TX 77072

THE MARK CONSISTS OF STANDARD CHAR-
ACTERS WITHOUT CLAIM TO ANY PARTICULAR
FONT, STYLE, SIZE, OR COLOR.

FOR: VIBRATORY SCREEN SEPARATORS, IN
CLASS 7 (U.S. CLS. 13, 19, 21, 23, 31, 34 AND 35).

SER. NO. 77-463,345, FILED 5-1-2008.

FIRST USE 1-1-2008; IN COMMERCE 1-1-2008.

CORY BOONE, EXAMINING ATTORNEY

Int. Cls.: 36 and 37

Prior U.S. Cls.: 100, 101, 102, 103 and 106

United States Patent and Trademark Office

Reg. No. 3,520,541

Registered Oct. 21, 2008

**SERVICE MARK
PRINCIPAL REGISTER**



THE QUADRANT CORPORATION (WASHING-
TON CORPORATION)
14725 SE 36TH STREET, SUITE 200
BELLEVUE, WA 98009

FOR: REAL ESTATE BROKERAGE, IN CLASS 36
(U.S. CLS. 100, 101 AND 102).

FIRST USE 12-1-2006; IN COMMERCE 12-1-2006.

FOR: BUILDING CONSTRUCTION SERVICES;
REAL ESTATE DEVELOPMENT, IN CLASS 37 (U.S.
CLS. 100, 103 AND 106).

FIRST USE 12-1-2006; IN COMMERCE 12-1-2006.

THE MARK CONSISTS OF THE WORDS "AU-
TUMN WOODS" IN WHITE LETTERING TO THE
RIGHT OF A STYLIZED IMAGE OF ACORNS ON A
BLACK RECTANGULAR BACKGROUND.

SER. NO. 77-463,501, FILED 5-1-2008.

RONALD DELGIZZI, EXAMINING ATTORNEY

Int. Cl.: 14

Prior U.S. Cls.: 2, 27, 28 and 50

United States Patent and Trademark Office

Reg. No. 3,520,542

Registered Oct. 21, 2008

TRADEMARK
PRINCIPAL REGISTER



SANOY INC. (NEW JERSEY CORPORATION)
8TH FLOOR
19 WEST 36TH STREET
NEW YORK, NY 10018

THE MARK CONSISTS OF THE WORD "RA-
CHEL" IN STYLIZED LETTERS WITH A STAR
DEVICE UNDERNEATH.

FOR: JEWELRY, IN CLASS 14 (U.S. CLS. 2, 27, 28
AND 50).

SER. NO. 77-463,979, FILED 5-2-2008.

FIRST USE 9-25-1997; IN COMMERCE 9-25-1997.

TEJBIR SINGH, EXAMINING ATTORNEY

Int. Cl.: 45

Prior U.S. Cls.: 100 and 101

United States Patent and Trademark Office

Reg. No. 3,520,543

Registered Oct. 21, 2008

**SERVICE MARK
PRINCIPAL REGISTER**

NAUGHTY OR NICE

TRUEBEGINNINGS, LLC (TEXAS LIMITED LIABILITY COMPANY)
300 DECKER DRIVE
IRVING, TX 75062

FOR: COMPUTER DATING SERVICES; DATING SERVICES; VIDEO DATING SERVICES; MATCH-MAKING SERVICES; ONLINE SOCIAL NETWORKING SERVICES; PROVIDING INFORMATION IN THE FIELD OF SELF-IMPROVEMENT; PERSONAL BACKGROUND INVESTIGATIONS, IN CLASS 45 (U.S. CLS. 100 AND 101).

FIRST USE 12-1-2005; IN COMMERCE 12-1-2005.

THE MARK CONSISTS OF STANDARD CHARACTERS WITHOUT CLAIM TO ANY PARTICULAR FONT, STYLE, SIZE, OR COLOR.

SER. NO. 77-464,172, FILED 5-2-2008.

WENDY GOODMAN, EXAMINING ATTORNEY

Int. Cl.: 11

Prior U.S. Cls.: 13, 21, 23, 31 and 34

United States Patent and Trademark Office

Reg. No. 3,520,544

Registered Oct. 21, 2008

**TRADEMARK
PRINCIPAL REGISTER**

HYDROWORKS

MJSI, INC. (ILLINOIS CORPORATION)
SUITE 3
205 EARL ROAD
SHOREWOOD, IL 60404

FOR: PLUMBING SUPPLIES AND PARTS, NAME-
LY, TOILET FILL VALVES, TOILET FLAPPERS
AND KITS FOR TOILET REPAIR COMPRISED
PRIMARILY OF A TOILET FILL VALVE, TOILET
FLAPPER, AND TANK CLEANING TUBE, IN
CLASS 11 (U.S. CLS. 13, 21, 23, 31 AND 34).

FIRST USE 6-1-2007; IN COMMERCE 6-1-2007.

THE MARK CONSISTS OF STANDARD CHAR-
ACTERS WITHOUT CLAIM TO ANY PARTICULAR
FONT, STYLE, SIZE, OR COLOR.

SER. NO. 77-464,640, FILED 5-2-2008.

KATHLEEN M. VANSTON, EXAMINING ATTOR-
NEY

Int. Cl.: 7

Prior U.S. Cls.: 13, 19, 21, 23, 31, 34 and 35

Reg. No. 3,520,545

United States Patent and Trademark Office

Registered Oct. 21, 2008

**TRADEMARK
PRINCIPAL REGISTER**



EMERSON ELECTRIC CO. (MISSOURI CORPORATION)
8000 W. FLORISSANT AVE.
ST. LOUIS, MO 63136

FOR: VACUUM CLEANERS AND REPLACEMENT PARTS THEREFOR; ACCESSORIES FOR VACUUM CLEANERS, NAMELY, BRUSHES, HOSES AND VACUUM CLEANER BAGS, IN CLASS 7 (U.S. CLS. 13, 19, 21, 23, 31, 34 AND 35).

FIRST USE 7-31-2007; IN COMMERCE 7-31-2007.

THE MARK CONSISTS OF A SILHOUETTE OF A DOG'S HEAD WITH THE WORDS "DIRT HOUND" TO THE RIGHT OF THE HEAD.

SER. NO. 77-464,891, FILED 5-2-2008.

GINA FINK, EXAMINING ATTORNEY

Int. Cl.: 9

Prior U.S. Cls.: 21, 23, 26, 36 and 38

Reg. No. 3,520,546

United States Patent and Trademark Office

Registered Oct. 21, 2008

**TRADEMARK
PRINCIPAL REGISTER**

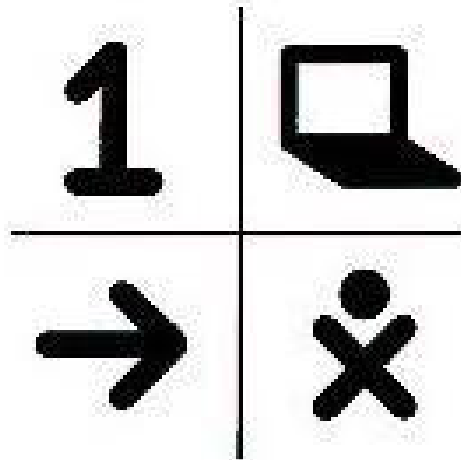

ONE LAPTOP PER CHILD ASSOCIATION, INC.
(DELAWARE NON-STOCK CORPORATION)
10TH FLOOR, ONE CAMBRIDGE CENTER
CAMBRIDGE, MA 02142

FOR: COMPUTERS; COMPUTER HARDWARE;
COMPUTER PERIPHERALS; COMPUTER NET-
WORKING HARDWARE; SOFTWARE DRIVERS
FOR COMPUTER PERIPHERALS , IN CLASS 9
(U.S. CLS. 21, 23, 26, 36 AND 38).

FIRST USE 11-0-2007; IN COMMERCE 11-0-2007.

THE MARK CONSISTS OF FOUR IMAGES, THE
NUMERAL ONE, A STYLIZED LAPTOP COMPU-
TER, AN ARROW POINTING TO THE RIGHT AND
A STYLIZED CHILD FIGURE, WITH THE IMAGES
SEPARATED BY SOLID LINES AND ARRANGED
IN A 2 X 2 GRID.

SER. NO. 77-465,343, FILED 5-5-2008.

LEIGH CAROLINE CASE, EXAMINING ATTOR-
NEY

Int. Cl.: 41

Prior U.S. Cls.: 100, 101 and 107

United States Patent and Trademark Office

Reg. No. 3,520,547

Registered Oct. 21, 2008

SERVICE MARK
PRINCIPAL REGISTER



NEW YORK YACHT CLUB (NEW YORK NON-PROFIT CORPORATION)

37 WEST 44TH STREET
NEW YORK, NY 10036

FOR: YACHT CLUB SERVICES, IN CLASS 41 (U.S. CLS. 100, 101 AND 107).

FIRST USE 7-31-1844; IN COMMERCE 7-31-1844.

NO CLAIM IS MADE TO THE EXCLUSIVE RIGHT TO USE "YACHT CLUB", APART FROM THE MARK AS SHOWN.

THE COLOR(S) RED, WHITE, BLUE AND GOLD IS/ARE CLAIMED AS A FEATURE OF THE MARK.

THE MARK CONSISTS OF A BLUE FLAG WITH RED CROSSED LINES AND A WHITE STAR WITHIN A GOLD CIRCLE CONTAINING THE WORDS "NEW YORK YACHT CLUB 1844".

SEC. 2(F).

SER. NO. 77-465,357, FILED 5-5-2008.

CHARLES L. JENKINS, EXAMINING ATTORNEY

Int. Cl.: 39

Prior U.S. Cls.: 100 and 105

United States Patent and Trademark Office

Reg. No. 3,520,548

Registered Oct. 21, 2008

**SERVICE MARK
PRINCIPAL REGISTER**

MyUS Shopper

ACCESS USA SHIPPING, INC. (FLORIDA CORPORATION), DBA FKA GAIL BAIRD & ASSOCIATES, INC.
ATTN LEGAL
1899 60TH PL E
BRADENTON, FL 34203

FOR: SUPPLY CHAIN, LOGISTICS AND REVERSE LOGISTICS SERVICES, NAMELY, STORAGE, TRANSPORTATION AND DELIVERY OF DOCUMENTS, PACKAGES, RAW MATERIALS, AND OTHER FREIGHT FOR OTHERS BY AIR, RAIL, SHIP OR TRUCK, IN CLASS 39 (U.S. CLS. 100 AND 105).

FIRST USE 5-5-2008; IN COMMERCE 5-5-2008.

THE MARK CONSISTS OF STANDARD CHARACTERS WITHOUT CLAIM TO ANY PARTICULAR FONT, STYLE, SIZE, OR COLOR.

NO CLAIM IS MADE TO THE EXCLUSIVE RIGHT TO USE "SHOPPER", APART FROM THE MARK AS SHOWN.

SER. NO. 77-465,477, FILED 5-5-2008.

SUNG IN, EXAMINING ATTORNEY

Int. Cls.: 3 and 5

Prior U.S. Cls.: 1, 4, 6, 18, 44, 46, 50, 51 and 52

United States Patent and Trademark Office

Reg. No. 3,520,549

Registered Oct. 21, 2008

**TRADEMARK
PRINCIPAL REGISTER**

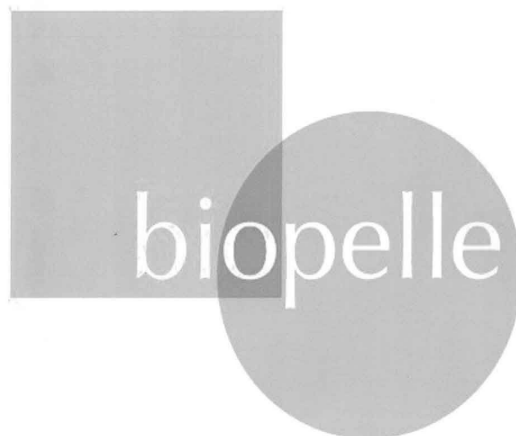

FERNDALE IP, INC. (MICHIGAN CORPORATION)

780 WEST EIGHT MILE ROAD

FERNDALE, MI 48220

FOR: COSMETICS, BEAUTY AIDS, NAMELY, BEAUTY CARE PREPARATIONS, NON-MEDICATED SKIN CARE PREPARATIONS, SKIN CREAMS, SKIN CLARIFIERS, NAMELY, CLARIFYING GELS, FACIAL PEELS, IN CLASS 3 (U.S. CLS. 1, 4, 6, 50, 51 AND 52).

FIRST USE 12-8-2005; IN COMMERCE 12-8-2005.

FOR: MEDICATED SKIN CARE PREPARATIONS, SKIN CREAMS, TOPICAL ANESTHETICS, IN CLASS 5 (U.S. CLS. 6, 18, 44, 46, 51 AND 52).

FIRST USE 12-8-2005; IN COMMERCE 12-8-2005.

OWNER OF U.S. REG. NO. 3,218,885.

THE MARK CONSISTS OF AN OVERLAPPING BOX AND CIRCLE BEHIND THE WORD "BIOPELLE" IN STYLIZED LETTERS.

SER. NO. 77-465,529, FILED 5-5-2008.

NANCY CLARKE, EXAMINING ATTORNEY

Int. Cl.: 20

Prior U.S. Cls.: 2, 13, 22, 25, 32 and 50

Reg. No. 3,520,550

United States Patent and Trademark Office

Registered Oct. 21, 2008

**TRADEMARK
PRINCIPAL REGISTER**

PLUGGY

ZAP (CALIFORNIA CORPORATION)
501 FOURTH STREET
SANTA ROSA, CA 95401

FIRST USE 2-29-2008; IN COMMERCE 2-29-2008.

FOR: PROMOTIONAL FIGURINES, NAMELY,
PLASTIC CARICATURES OF PERSONS WITH
THEIR HEAD IN THE SHAPE OF AN ELECTRIC
PLUG AND FEET IN THE SHAPE OF A VEHICLE
TIRE, IN CLASS 20 (U.S. CLS. 2, 13, 22, 25, 32 AND 50).

THE MARK CONSISTS OF STANDARD CHAR-
ACTERS WITHOUT CLAIM TO ANY PARTICULAR
FONT, STYLE, SIZE, OR COLOR.

SER. NO. 77-466,211, FILED 5-5-2008.

SHAUNIA CARLYLE, EXAMINING ATTORNEY

Int. Cl.: 43

Prior U.S. Cls.: 100 and 101

United States Patent and Trademark Office

Reg. No. 3,520,551

Registered Oct. 21, 2008

**SERVICE MARK
PRINCIPAL REGISTER**

BLUE BAYOU

DISNEY ENTERPRISES, INC. (DELAWARE CORPORATION)
500 SOUTH BUENA VISTA STREET
BURBANK, CA 91521

THE MARK CONSISTS OF STANDARD CHARACTERS WITHOUT CLAIM TO ANY PARTICULAR FONT, STYLE, SIZE, OR COLOR.

FOR: RESTAURANT SERVICES, IN CLASS 43 (U.S. CLS. 100 AND 101).

SER. NO. 77-466,262, FILED 5-5-2008.

FIRST USE 3-18-1967; IN COMMERCE 3-18-1967.

DANNEAN HETZEL, EXAMINING ATTORNEY

Int. Cl.: 41

Prior U.S. Cls.: 100, 101 and 107

United States Patent and Trademark Office

Reg. No. 3,520,552

Registered Oct. 21, 2008

**SERVICE MARK
PRINCIPAL REGISTER**

INTERBOOK

THINK COMPUTER CORPORATION (OHIO
CORPORATION)
884 COLLEGE AVENUE
PALO ALTO, CA 943061303

FOR: BOOK PUBLISHING; PUBLICATION OF
BOOKS IN CONJUNCTION WITH RELATED WEB
SITES RESPECTIVELY PROVIDING BIBLIO-
GRAPHIC AND SUPPLEMENTAL CONTEXTUAL
INFORMATION ON THE BASIS OF EACH PAGE,
LINE, PHRASE OR WORD, IN CLASS 41 (U.S. CLS.
100, 101 AND 107).

FIRST USE 4-26-2008; IN COMMERCE 4-26-2008.

THE MARK CONSISTS OF STANDARD CHAR-
ACTERS WITHOUT CLAIM TO ANY PARTICULAR
FONT, STYLE, SIZE, OR COLOR.

SER. NO. 77-466,307, FILED 5-5-2008.

AMY GEARIN, EXAMINING ATTORNEY

Int. Cl.: 1

Prior U.S. Cls.: 1, 5, 6, 10, 26 and 46

Reg. No. 3,520,553

United States Patent and Trademark Office

Registered Oct. 21, 2008

TRADEMARK
PRINCIPAL REGISTER



XCEED MOLECULAR CORPORATION (CANADA CORPORATION)
1 MARMAC DRIVE
TORONTO, CANADA M9W1E7

FOR: DIAGNOSTIC REAGENTS FOR SCIENTIFIC USE; DIAGNOSTIC TEST KITS FOR SCIENTIFIC USE COMPRISED OF REAGENTS, PROCESSING CHEMICALS, AND POROUS SUBSTRATE MATERIALS, ALONE OR ATTACHED TO A SOLID BODY FOR HANDLING, IN CLASS 1 (U.S. CLS. 1, 5, 6, 10, 26 AND 46).

FIRST USE 7-1-2007; IN COMMERCE 7-1-2007.

OWNER OF U.S. REG. NOS. 3,438,921, 3,438,933, AND 3,438,934.

THE COLOR(S) BLACK, GRAY, LIGHT BLUE-GRAY AND MEDIUM BLUE-GRAY IS/ARE CLAIMED AS A FEATURE OF THE MARK.

THE MARK CONSISTS OF FOUR THREE-DIMENSIONAL, FOUR-SIDED PARTIAL COLUMNS, SIDEWAYS IN A DIAMOND-LIKE ARRANGEMENT, ALL TO THE LEFT OF THE WORDS "XCEED MOLECULAR" WITH THE WORD "XCEED" APPEARING ABOVE THE WORD "MOLECULAR". COLOR LOCATION STATEMENT: THE MARK CONSISTS OF FOUR THREE-DIMENSIONAL, FOUR-SIDED PARTIAL COLUMNS, SIDEWAYS IN A DIAMOND-LIKE ARRANGEMENT, EACH WITH ITS LOWER LEFT SIDE IN LIGHT BLUE-GREY, AND ITS RIGHT END IN MEDIUM BLUE-GREY ALL TO THE LEFT OF THE WORDS "XCEED" IN BLACK AND "MOLECULAR" IN GRAY.

SER. NO. 77-466,773, FILED 5-6-2008.

ALLISON SCHRODY, EXAMINING ATTORNEY

Int. Cl.: 36

Prior U.S. Cls.: 100, 101 and 102

United States Patent and Trademark Office

Reg. No. 3,520,554

Registered Oct. 21, 2008

**SERVICE MARK
PRINCIPAL REGISTER**

BEXLEY AT HERITAGE

WEINSTEIN MANAGEMENT CO., INC. (VIRGINIA CORPORATION)
3951-A STILLMAN PARKWAY
GLEN ALLEN, VA 230604198

FOR: REAL ESTATE SERVICES, NAMELY, LEASING AND MANAGEMENT OF REAL PROPERTY, IN CLASS 36 (U.S. CLS. 100, 101 AND 102).

FIRST USE 4-29-2008; IN COMMERCE 4-29-2008.

THE MARK CONSISTS OF STANDARD CHARACTERS WITHOUT CLAIM TO ANY PARTICULAR FONT, STYLE, SIZE, OR COLOR.

OWNER OF U.S. REG. NOS. 2,889,355, 3,222,386 AND OTHERS.

SER. NO. 77-466,776, FILED 5-6-2008.

LAURA HAMMEL, EXAMINING ATTORNEY

Int. Cl.: 21

Prior U.S. Cls.: 2, 13, 23, 29, 30, 33, 40 and 50

Reg. No. 3,520,555

United States Patent and Trademark Office

Registered Oct. 21, 2008

**TRADEMARK
PRINCIPAL REGISTER**

ADAPT-A-JUG

WEISENBACH SPECIALTY PRINTING, INC.
(OHIO CORPORATION)
437 HOLTZMAN AVENUE
COLUMBUS, OH 432051604

FIRST USE 3-13-1990; IN COMMERCE 3-13-1990.

FOR: GOODS MADE OF RECYCLED PLASTIC,
NAMELY, FUNNELS, AUTOMOBILE OIL FUN-
NELS, COOKING FUNNELS, POURING SPOUTS
FOR HOUSEHOLD USE, AND POURING SPOUTS
FOR HOUSEHOLD AUTOMOBILE USE, IN CLASS
21 (U.S. CLS. 2, 13, 23, 29, 30, 33, 40 AND 50).

THE MARK CONSISTS OF STANDARD CHAR-
ACTERS WITHOUT CLAIM TO ANY PARTICULAR
FONT, STYLE, SIZE, OR COLOR.

SER. NO. 77-469,043, FILED 5-8-2008.

JAMES LOVELACE, EXAMINING ATTORNEY

Int. Cl.: 44

Prior U.S. Cls.: 100 and 101

United States Patent and Trademark Office

Reg. No. 3,520,556

Registered Oct. 21, 2008

**SERVICE MARK
PRINCIPAL REGISTER**

FAMILYCONNECT

AMERICAN FOUNDATION FOR THE BLIND,
INC. (NEW YORK CORPORATION)
SUITE 300
11 PENN PLAZA
NEW YORK, NY 10001

FOR: PROVIDING ON-LINE INFORMATION ON
CONDITIONS OF THE EYE, AVAILABLE SERVICES
AND EDUCATION FOR PARENTS AND FAMILIES
OF CHILDREN WITH VISUAL IMPAIRMENTS , IN
CLASS 44 (U.S. CLS. 100 AND 101).

FIRST USE 2-28-2008; IN COMMERCE 2-28-2008.

THE MARK CONSISTS OF STANDARD CHAR-
ACTERS WITHOUT CLAIM TO ANY PARTICULAR
FONT, STYLE, SIZE, OR COLOR.

SER. NO. 77-469,108, FILED 5-8-2008.

SUZANNE BLANE, EXAMINING ATTORNEY

Int. Cl.: 7

Prior U.S. Cls.: 13, 19, 21, 23, 31, 34 and 35

Reg. No. 3,520,557

United States Patent and Trademark Office

Registered Oct. 21, 2008

**TRADEMARK
PRINCIPAL REGISTER**



HYDROSORB

CENTRAL ILLINOIS MANUFACTURING COM-
PANY (ILLINOIS CORPORATION)
201 N CHAMPAIGN STREET
BEMENT, IL 61813

THE MARK CONSISTS OF THE STYLIZED TERM
"HYDROSORB" WITH THREE WAVY LINES UN-
DERNEATH.

FOR: FUEL PUMP FILTERS THAT REMOVE
AND DETECT WATER IN PETROLEUM FUELS
AND BIO-FUELS, IN CLASS 7 (U.S. CLS. 13, 19, 21, 23,
31, 34 AND 35).

SER. NO. 77-469,880, FILED 5-8-2008.

FIRST USE 0-0-2005; IN COMMERCE 0-0-2005.

JASON TURNER, EXAMINING ATTORNEY

Int. Cl.: 25

Prior U.S. Cls.: 22 and 39

United States Patent and Trademark Office

Reg. No. 3,520,558

Registered Oct. 21, 2008

**TRADEMARK
PRINCIPAL REGISTER**



KBT DIRECT, INC. (TEXAS CORPORATION)
PO BOX 560025
DALLAS, TX 75356

FOR: T-SHIRTS; TOPS; CARGO PANTS; PANTS;
JEANS; HATS; CAPS; BELTS; LEATHER BELTS, IN
CLASS 25 (U.S. CLS. 22 AND 39).

FIRST USE 6-25-2004; IN COMMERCE 6-25-2004.

THE MARK CONSISTS OF COAT OF ARMS WITH
LION ON LEFT SIDE, UNICORN ON RIGHT SIDE,
SHIELD IN CENTER WITH STYLIZED "H" AND
"W", BANNERS BELOW COAT OF ARMS WITH
STYLIZED "HARD" AND "WEAR" WORDS WITHIN
BANNER.

SER. NO. 77-469,908, FILED 5-9-2008.

RUDY R. SINGLETON, EXAMINING ATTORNEY

Int. Cl.: 18

Prior U.S. Cls.: 1, 2, 3, 22 and 41

United States Patent and Trademark Office

Reg. No. 3,520,559

Registered Oct. 21, 2008

**TRADEMARK
PRINCIPAL REGISTER**

PORTOFINO

CONSUMER PRODUCTS DESIGN, LTD. (NEW
YORK CORPORATION)
SUITE 2320
60 EAST 42ND STREET
NEW YORK, NY 10165

FOR: ALL PURPOSE SPORT BAGS; ALL-PUR-
POSE CARRYING BAGS; BABY CARRYING BAGS;
BACKPACKS, BOOK BAGS, SPORTS BAGS, BUM
BAGS, WALLETS AND HANDBAGS; BAGS FOR
CARRYING BABIES' ACCESSORIES; BEACH BAGS;
BELT BAGS AND HIP BAGS; BRIEFCASES AND
ATTACHE CASES; COSMETIC BAGS SOLD EMPTY;
DIAPER BAGS; DUFFEL BAGS; LUGGAGE; LUG-
GAGE TAGS; STRAPS FOR LUGGAGE; SHOPPING
BAGS WITH WHEELS ATTACHED; TOILETRY

BAGS SOLD EMPTY; UMBRELLAS, IN CLASS 18
(U.S. CLS. 1, 2, 3, 22 AND 41).

FIRST USE 4-7-2008; IN COMMERCE 4-7-2008.

THE MARK CONSISTS OF STANDARD CHAR-
ACTERS WITHOUT CLAIM TO ANY PARTICULAR
FONT, STYLE, SIZE, OR COLOR.

THE FOREIGN WORDING IN THE MARK
TRANSLATES INTO ENGLISH AS "FINE PORT".

SER. NO. 77-469,942, FILED 5-9-2008.

JASON TURNER, EXAMINING ATTORNEY

Int. Cl.: 9

Prior U.S. Cls.: 21, 23, 26, 36 and 38

United States Patent and Trademark Office

Reg. No. 3,520,560

Registered Oct. 21, 2008

**TRADEMARK
PRINCIPAL REGISTER**

Diner Dash Flo on the Go

PLAYFIRST, INC. (DELAWARE CORPORATION)
160 SPEAR STREET, SUITE 1300
SAN FRANCISCO, CA 941051546

FOR: COMPUTER GAME SOFTWARE; ELEC-
TRONIC GAME SOFTWARE; GAME SOFTWARE;
VIDEO GAME SOFTWARE, IN CLASS 9 (U.S. CLS.
21, 23, 26, 36 AND 38).

FIRST USE 8-25-2006; IN COMMERCE 8-25-2006.

THE MARK CONSISTS OF STANDARD CHAR-
ACTERS WITHOUT CLAIM TO ANY PARTICULAR
FONT, STYLE, SIZE, OR COLOR.

OWNER OF U.S. REG. NO. 3,127,997.

SER. NO. 77-470,090, FILED 5-9-2008.

MATTHEW PAPPAS, EXAMINING ATTORNEY

Int. Cl.: 32

Prior U.S. Cls.: 45, 46 and 48

Reg. No. 3,520,561

United States Patent and Trademark Office

Registered Oct. 21, 2008

TRADEMARK
PRINCIPAL REGISTER

VASA

MARRIOTT INTERNATIONAL, INC. (DELA-
WARE CORPORATION)
10400 FERNWOOD ROAD
BETHESDA, MD 20817

FOR: DRINKING WATER, IN CLASS 32 (U.S. CLS.
45, 46 AND 48).

FIRST USE 7-1-1998; IN COMMERCE 7-1-1998.

THE MARK CONSISTS OF STANDARD CHAR-
ACTERS WITHOUT CLAIM TO ANY PARTICULAR
FONT, STYLE, SIZE, OR COLOR.

OWNER OF U.S. REG. NO. 2,258,142.

SER. NO. 77-470,137, FILED 5-9-2008.

MARTHA SANTOMARTINO, EXAMINING ATTOR-
NEY

Int. Cl.: 38

Prior U.S. Cls.: 100, 101 and 104

United States Patent and Trademark Office

Reg. No. 3,520,562

Registered Oct. 21, 2008

**SERVICE MARK
PRINCIPAL REGISTER**

The Ultimate C.Y.A.

NOTEVAULT, INC. (CALIFORNIA CORPORATION)
3525A DEL MAR HEIGHTS RD, 109
SAN DIEGO, CA 92130

FOR: COMMUNICATION SERVICES, NAMELY, TRANSMISSION OF VOICE, AUDIO, VISUAL IMAGES AND DATA BY TELECOMMUNICATIONS NETWORKS, WIRELESS COMMUNICATION NETWORKS, THE INTERNET, INFORMATION SERVICES NETWORKS AND DATA NETWORKS; COMMUNICATION VIA RADIO, TELEGRAPH, TELEPHONE AND TELEVISION TRANSMISSIONS; COMMUNICATIONS BY COMPUTER TERMINALS; COMMUNICATIONS BY MEANS OF MOBILE PHONES; COMMUNICATIONS BY TELEPHONE;

COMMUNICATIONS SERVICES, NAMELY, TRANSMITTING STREAMED SOUND AND AUDIOVISUAL RECORDINGS VIA THE INTERNET, IN CLASS 38 (U.S. CLS. 100, 101 AND 104).

FIRST USE 5-8-2008; IN COMMERCE 5-8-2008.

THE MARK CONSISTS OF STANDARD CHARACTERS WITHOUT CLAIM TO ANY PARTICULAR FONT, STYLE, SIZE, OR COLOR.

SER. NO. 77-471,798, FILED 5-12-2008.

RUDY R. SINGLETON, EXAMINING ATTORNEY

Int. Cl.: 31

Prior U.S. Cls.: 1 and 46

United States Patent and Trademark Office

Reg. No. 3,520,563

Registered Oct. 21, 2008

**TRADEMARK
PRINCIPAL REGISTER**

SIRLOINS

SERGEANT'S PET CARE PRODUCTS, INC. (NE-
VADA CORPORATION)

2625 S 158TH PLAZA

OMAHA, NE 681301770

FOR: PET TREATS, IN CLASS 31 (U.S. CLS. 1 AND
46).

FIRST USE 6-1-2001; IN COMMERCE 6-1-2001.

THE MARK CONSISTS OF STANDARD CHAR-
ACTERS WITHOUT CLAIM TO ANY PARTICULAR
FONT, STYLE, SIZE, OR COLOR.

OWNER OF U.S. REG. NO. 2,610,844.

SEC. 2(F).

SER. NO. 77-472,198, FILED 5-12-2008.

ARETHA SOMERVILLE, EXAMINING ATTORNEY

Int. Cl.: 28

Prior U.S. Cls.: 22, 23, 38 and 50

United States Patent and Trademark Office

Reg. No. 3,520,564

Registered Oct. 21, 2008

**TRADEMARK
PRINCIPAL REGISTER**

FEELS SO REAL

DAN-DEE INTERNATIONAL, LTD. (DELAWARE
CORPORATION)
106 HARBOR DRIVE
JERSEY CITY, NJ 07065

THE MARK CONSISTS OF STANDARD CHAR-
ACTERS WITHOUT CLAIM TO ANY PARTICULAR
FONT, STYLE, SIZE, OR COLOR.

FOR: PLUSH TOYS, SOUND-GENERATING
PLUSH TOYS, AND ANIMATED PLUSH TOYS, IN
CLASS 28 (U.S. CLS. 22, 23, 38 AND 50).

SER. NO. 77-472,733, FILED 5-13-2008.

FIRST USE 5-15-2003; IN COMMERCE 5-15-2003.

DANNEAN HETZEL, EXAMINING ATTORNEY

Int. Cl.: 34

Prior U.S. Cls.: 2, 8, 9 and 17

United States Patent and Trademark Office

Reg. No. 3,520,565

Registered Oct. 21, 2008

**TRADEMARK
PRINCIPAL REGISTER**

Menthol Gold

LORILLARD LICENSING COMPANY, LLC
(NORTH CAROLINA LIMITED LIABILITY
COMPANY)

1601 WACHOVIA TOWER, 300 N. GREENE ST.
GREENSBORO, NC 27401

FOR: CIGARETTES, IN CLASS 34 (U.S. CLS. 2, 8, 9
AND 17).

FIRST USE 5-0-2007; IN COMMERCE 5-0-2007.

THE MARK CONSISTS OF STANDARD CHAR-
ACTERS WITHOUT CLAIM TO ANY PARTICULAR
FONT, STYLE, SIZE, OR COLOR.

NO CLAIM IS MADE TO THE EXCLUSIVE
RIGHT TO USE "MENTHOL", APART FROM THE
MARK AS SHOWN.

SER. NO. 77-472,757, FILED 5-13-2008.

KELLY MCCOY, EXAMINING ATTORNEY

Int. Cl.: 34

Prior U.S. Cls.: 2, 8, 9 and 17

United States Patent and Trademark Office

Reg. No. 3,520,566

Registered Oct. 21, 2008

**TRADEMARK
PRINCIPAL REGISTER**

Menthol Blue

LORILLARD LICENSING COMPANY, LLC
(NORTH CAROLINA LIMITED LIABILITY
COMPANY)

1601 WACHOVIA TOWER, 300 N. GREENE ST.
GREENSBORO, NC 27401

FOR: CIGARETTES, IN CLASS 34 (U.S. CLS. 2, 8, 9
AND 17).

FIRST USE 5-0-2006; IN COMMERCE 5-0-2006.

THE MARK CONSISTS OF STANDARD CHAR-
ACTERS WITHOUT CLAIM TO ANY PARTICULAR
FONT, STYLE, SIZE, OR COLOR.

NO CLAIM IS MADE TO THE EXCLUSIVE
RIGHT TO USE "MENTHOL", APART FROM THE
MARK AS SHOWN.

SER. NO. 77-472,770, FILED 5-13-2008.

KELLY MCCOY, EXAMINING ATTORNEY

Int. Cl.: 34

Prior U.S. Cls.: 2, 8, 9 and 17

United States Patent and Trademark Office

Reg. No. 3,520,567

Registered Oct. 21, 2008

**TRADEMARK
PRINCIPAL REGISTER**



LORILLARD LICENSING COMPANY, LLC
(NORTH CAROLINA LIMITED LIABILITY
COMPANY)
1601 WACHOVIA TOWER, 300 N. GREENE ST.
GREENSBORO, NC 27401

FOR: CIGARETTES, IN CLASS 34 (U.S. CLS. 2, 8, 9
AND 17).

FIRST USE 5-0-2007; IN COMMERCE 5-0-2007.

OWNER OF U.S. REG. NO. 1,178,413.

THE COLOR(S) GREEN, GOLD AND WHITE IS/
ARE CLAIMED AS A FEATURE OF THE MARK.

THE MARK CONSISTS OF A GOLD SPINNAKER
OUTLINED IN WHITE ON A GREEN BACK-
GROUND.

SER. NO. 77-473,292, FILED 5-13-2008.

KELLY MCCOY, EXAMINING ATTORNEY

Int. Cl.: 34

Prior U.S. Cls.: 2, 8, 9 and 17

United States Patent and Trademark Office

Reg. No. 3,520,568

Registered Oct. 21, 2008

**TRADEMARK
PRINCIPAL REGISTER**

GRAPES GONE WILD

BBK TOBACCO & FOODS, LLP (ARIZONA LIMITED LIABILITY PARTNERSHIP)
3315 W. BUCKEYE RD., STE. B
PHOENIX, AZ 85009

FOR: CIGARETTE PAPER; CIGARETTE PAPERS; CIGARETTE ROLLING PAPERS; CIGARS, IN CLASS 34 (U.S. CLS. 2, 8, 9 AND 17).

FIRST USE 4-29-2008; IN COMMERCE 5-9-2008.

THE MARK CONSISTS OF STANDARD CHARACTERS WITHOUT CLAIM TO ANY PARTICULAR FONT, STYLE, SIZE, OR COLOR.

NO CLAIM IS MADE TO THE EXCLUSIVE RIGHT TO USE "GRAPES", APART FROM THE MARK AS SHOWN.

SER. NO. 77-473,635, FILED 5-13-2008.

ELLEN PERKINS, EXAMINING ATTORNEY

Int. Cl.: 7

Prior U.S. Cls.: 13, 19, 21, 23, 31, 34 and 35

Reg. No. 3,520,569

United States Patent and Trademark Office

Registered Oct. 21, 2008

**TRADEMARK
PRINCIPAL REGISTER**

DURA-PLUS

GRANITE CITY TOOL COMPANY (MINNESOTA
CORPORATION)
247 18TH AVENUE SOUTH
WAITE PARK, MN 56387

FOR: ABRASIVE DISKS FOR POWER-OPERATED GRINDERS; POWER TOOLS, NAMELY, GRINDING PADS AND POLISHING PADS FOR POWER TOOLS, IN CLASS 7 (U.S. CLS. 13, 19, 21, 23, 31, 34 AND 35).

FIRST USE 4-30-2007; IN COMMERCE 4-30-2007.

THE MARK CONSISTS OF STANDARD CHARACTERS WITHOUT CLAIM TO ANY PARTICULAR FONT, STYLE, SIZE, OR COLOR.

SER. NO. 77-474,195, FILED 5-14-2008.

JENNIFER DIXON, EXAMINING ATTORNEY

Int. Cl.: 34

Prior U.S. Cls.: 2, 8, 9 and 17

United States Patent and Trademark Office

Reg. No. 3,520,570

Registered Oct. 21, 2008

**TRADEMARK
PRINCIPAL REGISTER**

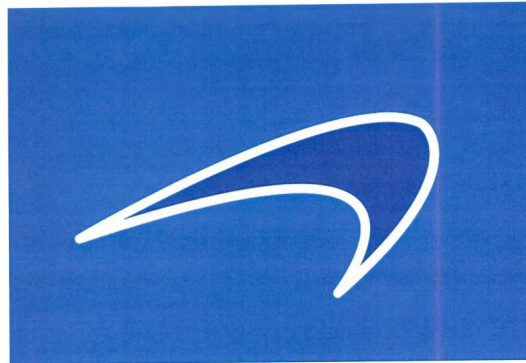

LORILLARD LICENSING COMPANY (NORTH
CAROLINA LIMITED LIABILITY COMPANY)
1601 WACHOVIA TOWER, 300 N. GREENE ST.
GREENSBORO, NC 27401

FOR: CIGARETTES, IN CLASS 34 (U.S. CLS. 2, 8, 9
AND 17).

FIRST USE 5-0-2006; IN COMMERCE 5-0-2006.

OWNER OF U.S. REG. NO. 1,178,413.

THE COLOR(S) BLUE AND WHITE IS/ARE
CLAIMED AS A FEATURE OF THE MARK.

THE MARK CONSISTS OF A BLUE SPINNAKER
OUTLINED IN WHITE ON A BLUE BACK-
GROUND.

SER. NO. 77-474,343, FILED 5-14-2008.

KELLY MCCOY, EXAMINING ATTORNEY

Int. Cl.: 18

Prior U.S. Cls.: 1, 2, 3, 22 and 41

Reg. No. 3,520,571

United States Patent and Trademark Office

Registered Oct. 21, 2008

**TRADEMARK
PRINCIPAL REGISTER**

ARRIVEDERCI

INTERNATIONAL DESIGN ASSOCIATES LTD
(NEW YORK CORPORATION)
SUITE 2320
60 EAST 42ND STREET
NEW YORK, NY 10165

FOR: TOTE BAGS; LUGGAGE; LUGGAGE TAGS;
UMBRELLAS; TOILETRY BAGS SOLD EMPTY, IN
CLASS 18 (U.S. CLS. 1, 2, 3, 22 AND 41).

FIRST USE 4-7-2008; IN COMMERCE 4-7-2008.

THE MARK CONSISTS OF STANDARD CHAR-
ACTERS WITHOUT CLAIM TO ANY PARTICULAR
FONT, STYLE, SIZE, OR COLOR.

THE FOREIGN WORDING IN THE MARK
TRANSLATES INTO ENGLISH AS FAREWELL;
GOODBYE.

SER. NO. 77-474,459, FILED 5-14-2008.

ANTHONY RINKER, EXAMINING ATTORNEY

Int. Cl.: 4

Prior U.S. Cls.: 1, 6 and 15

United States Patent and Trademark Office

Reg. No. 3,520,572

Registered Oct. 21, 2008

**TRADEMARK
PRINCIPAL REGISTER**

ANYFIRE

DURAFLAME, INC. (CALIFORNIA CORPORATION)
2894 MONTE DIABLO AVENUE
STOCKTON, CA 95203

THE MARK CONSISTS OF STANDARD CHARACTERS WITHOUT CLAIM TO ANY PARTICULAR FONT, STYLE, SIZE, OR COLOR.

FOR: ARTIFICIAL FIRELOGS, IN CLASS 4 (U.S. CLS. 1, 6 AND 15).

SER. NO. 77-476,039, FILED 5-15-2008.

FIRST USE 10-0-2007; IN COMMERCE 10-0-2007.

ALLISON SCHRODY, EXAMINING ATTORNEY

Int. Cl.: 30

Prior U.S. Cl.: 46

United States Patent and Trademark Office

Reg. No. 3,520,573

Registered Oct. 21, 2008

**TRADEMARK
PRINCIPAL REGISTER**

SOUR WOWER

WELLS' DAIRY, INC. (IOWA CORPORATION)
ONE BLUE BUNNY DRIVE, P.O. BOX 1310
LE MARS, IA 51031

FOR: FROZEN CONFECTIONS, IN CLASS 30 (U.S.
CL. 46).

FIRST USE 2-11-2008; IN COMMERCE 2-11-2008.

THE MARK CONSISTS OF STANDARD CHAR-
ACTERS WITHOUT CLAIM TO ANY PARTICULAR
FONT, STYLE, SIZE, OR COLOR.

NO CLAIM IS MADE TO THE EXCLUSIVE
RIGHT TO USE "SOUR", APART FROM THE MARK
AS SHOWN.

SER. NO. 77-477,651, FILED 5-19-2008.

BRENDAN MCCAULEY, EXAMINING ATTORNEY

Int. Cl.: 41

Prior U.S. Cls.: 100, 101 and 107

United States Patent and Trademark Office

Reg. No. 3,520,574

Registered Oct. 21, 2008

**SERVICE MARK
PRINCIPAL REGISTER**



AMGEN INC. (DELAWARE CORPORATION)
ONE AMGEN CENTER DRIVE
THOUSAND OAKS, CA 913201799

THE MARK CONSISTS OF A STYLIZED HUMAN
FIGURE ON A BICYCLE.

FOR: CONDUCTING AND SPONSORING BI-
CYCLE RACES, IN CLASS 41 (U.S. CLS. 100, 101
AND 107).

SER. NO. 77-477,699, FILED 5-19-2008.

FIRST USE 11-2-2005; IN COMMERCE 11-2-2005.

ASMAT KHAN, EXAMINING ATTORNEY

Int. Cl.: 36

Prior U.S. Cls.: 100, 101 and 102

United States Patent and Trademark Office

Reg. No. 3,520,575

Registered Oct. 21, 2008

**SERVICE MARK
PRINCIPAL REGISTER**

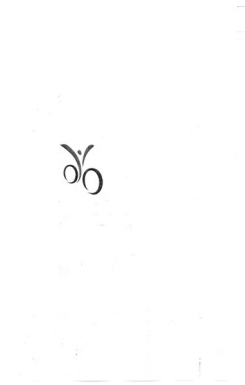

AMGEN INC. (DELAWARE CORPORATION)
ONE AMGEN CENTER DRIVE
THOUSAND OAKS, CA 913201799

FOR: CHARITABLE FUNDRAISING, NAMELY,
RAISING FUNDS FOR CANCER RESEARCH, CAN-
CER TREATMENT AND CANCER AWARENESS, IN
CLASS 36 (U.S. CLS. 100, 101 AND 102).

FIRST USE 1-31-2005; IN COMMERCE 1-31-2005.

THE MARK CONSISTS OF A STYLIZED HUMAN
FIGURE WITH UPRAISED ARMS ON A BICYCLE.

SER. NO. 77-478,449, FILED 5-19-2008.

ASMAT KHAN, EXAMINING ATTORNEY

Int. Cl.: 34

Prior U.S. Cls.: 2, 8, 9 and 17

United States Patent and Trademark Office

Reg. No. 3,520,576

Registered Oct. 21, 2008

**TRADEMARK
PRINCIPAL REGISTER**



PHILIP MORRIS USA INC. (VIRGINIA CORPORATION)
6601 WEST BROAD STREET
RICHMOND, VA 23230

FOR: TOBACCO PRODUCTS, NAMELY, CIGARETTES, IN CLASS 34 (U.S. CLS. 2, 8, 9 AND 17).

FIRST USE 9-10-2007; IN COMMERCE 9-10-2007.

OWNER OF U.S. REG. NOS. 68,502, 938,510 AND OTHERS.

THE MARK CONSISTS OF A STRIATED RECTANGLE WITH ONE HORIZONTAL LINE ALONG THE TOP EDGE AND TWO HORIZONTAL LINES

ALONG THE BOTTOM EDGE. THERE IS A RECTANGLE LOCATED IN THE UPPER RIGHT HAND CORNER OF THE STRIATED RECTANGLE WITH A BORDER ON THREE SIDES AND A CIRCULAR PATTERN AND A LEAF DESIGN LOCATED WITHIN THE BORDER. NEAR THE CENTER OF THE STRIATED RECTANGLE IS A CREST CONSISTING OF A HORSE ON EITHER SIDE OF AN OVAL, ON TOP OF WHICH IS A CROWN, BELOW WHICH IS A BANNER DESIGN.

SER. NO. 77-479,851, FILED 5-21-2008.

ELI HELLMAN, EXAMINING ATTORNEY

Int. Cl.: 18

Prior U.S. Cls.: 1, 2, 3, 22 and 41

United States Patent and Trademark Office

Reg. No. 3,520,577

Registered Oct. 21, 2008

**TRADEMARK
PRINCIPAL REGISTER**

GLITTERATI

INTERNATIONAL DESIGN ASSOCIATES LTD
(NEW YORK CORPORATION)
SUITE 2320
60 EAST 42ND STREET
NEW YORK, NY 10165

THE MARK CONSISTS OF STANDARD CHAR-
ACTERS WITHOUT CLAIM TO ANY PARTICULAR
FONT, STYLE, SIZE, OR COLOR.

FOR: TOTE BAGS; LUGGAGE; LUGGAGE TAGS;
UMBRELLAS; TOILETRY BAGS SOLD EMPTY, IN
CLASS 18 (U.S. CLS. 1, 2, 3, 22 AND 41).

SER. NO. 77-480,149, FILED 5-21-2008.

FIRST USE 5-21-2008; IN COMMERCE 5-21-2008.

ANTHONY RINKER, EXAMINING ATTORNEY

Int. Cl.: 18

Prior U.S. Cls.: 1, 2, 3, 22 and 41

Reg. No. 3,520,578

United States Patent and Trademark Office

Registered Oct. 21, 2008

**TRADEMARK
PRINCIPAL REGISTER**

TEAM PLAYER

INTERNATIONAL DESIGN ASSOCIATES LTD
(NEW YORK CORPORATION)
SUITE 2320
60 EAST 42ND STREET
NEW YORK, NY 10165

THE MARK CONSISTS OF STANDARD CHARACTERS WITHOUT CLAIM TO ANY PARTICULAR FONT, STYLE, SIZE, OR COLOR.

FOR: LUGGAGE; LUGGAGE TAGS; TOILETRY BAGS SOLD EMPTY; TOTE BAGS; DUFFEL BAGS, IN CLASS 18 (U.S. CLS. 1, 2, 3, 22 AND 41).

SER. NO. 77-480,190, FILED 5-21-2008.

FIRST USE 5-21-2008; IN COMMERCE 5-21-2008.

ANTHONY RINKER, EXAMINING ATTORNEY

Int. Cl.: 41

Prior U.S. Cls.: 100, 101 and 107

United States Patent and Trademark Office

Reg. No. 3,520,579

Registered Oct. 21, 2008

**SERVICE MARK
PRINCIPAL REGISTER**

Measure For Measure

THE NEW YORK TIMES COMPANY (NEW
YORK CORPORATION)
620 EIGHTH AVENUE
NEW YORK, NY 10018

FOR: ON-LINE JOURNALS, NAMELY, BLOGS
FEATURING INFORMATION IN THE FIELDS OF
MUSIC AND SONGWRITING; PROVIDING ON-
LINE PUBLICATIONS IN THE NATURE OF NEWS-
PAPER AND MAGAZINE COLUMNS IN THE FIELD
OF MUSIC AND SONGWRITING, IN CLASS 41 (U.S.
CLS. 100, 101 AND 107).

FIRST USE 3-26-2008; IN COMMERCE 3-26-2008.

THE MARK CONSISTS OF STANDARD CHAR-
ACTERS WITHOUT CLAIM TO ANY PARTICULAR
FONT, STYLE, SIZE, OR COLOR.

SER. NO. 77-480,450, FILED 5-21-2008.

SAMUEL E. SHARPER JR., EXAMINING ATTOR-
NEY

Int. Cl.: 11

Prior U.S. Cls.: 13, 21, 23, 31 and 34

Reg. No. 3,520,580

United States Patent and Trademark Office

Registered Oct. 21, 2008

**TRADEMARK
PRINCIPAL REGISTER**

PARASCOPE

PARAMOUNT LEISURE INDUSTRIES, INC. (ARIZONA CORPORATION)

#100

295 EAST CORPORATE PLACE

CHANDLER, AZ 85225

THE MARK CONSISTS OF STANDARD CHARACTERS WITHOUT CLAIM TO ANY PARTICULAR FONT, STYLE, SIZE, OR COLOR.

FOR: SWIMMING POOL FOUNTAINS, IN CLASS 11 (U.S. CLS. 13, 21, 23, 31 AND 34).

SER. NO. 77-481,503, FILED 5-22-2008.

FIRST USE 4-28-2008; IN COMMERCE 4-28-2008.

STEPHEN AQUILA, EXAMINING ATTORNEY

Int. Cl.: 35

Prior U.S. Cls.: 100, 101 and 102

United States Patent and Trademark Office

Reg. No. 3,520,581

Registered Oct. 21, 2008

**SERVICE MARK
PRINCIPAL REGISTER**

JHG

JAYNE HANCOCK GROUP, INC. (CALIFORNIA CORPORATION)
SUITE 210
6215 FERRIS SQUARE
SAN DIEGO, CA 92121

FOR: ADVERTISING SERVICES, PUBLIC RELATIONS AND MARKETING SERVICES, NAMELY, PROMOTING AND MARKETING THE GOODS AND SERVICES OF OTHERS THROUGH ALL PUBLIC COMMUNICATION MEANS, IN CLASS 35 (U.S. CLS. 100, 101 AND 102).

FIRST USE 7-1-2005; IN COMMERCE 7-1-2005.

THE MARK CONSISTS OF STANDARD CHARACTERS WITHOUT CLAIM TO ANY PARTICULAR FONT, STYLE, SIZE, OR COLOR.

SER. NO. 77-481,687, FILED 5-22-2008.

BRIAN CALLAGHAN, EXAMINING ATTORNEY

Int. Cls.: 29 and 30

Prior U.S. Cl.: 46

United States Patent and Trademark Office

Reg. No. 3,520,582

Registered Oct. 21, 2008

**TRADEMARK
PRINCIPAL REGISTER**

VINTAGE FARMS

COWAMONGUS, LLC (TEXAS LIMITED LIABILITY COMPANY)
PO BOX 536025
GRAND PRAIRIE, TX 750536025

FOR: FRUIT TOPPINGS; FRUIT-BASED PIE FILLING; JAMS, JELLIES, AND PRESERVES; AND SOUPS, IN CLASS 29 (U.S. CL. 46).

FIRST USE 12-31-2004; IN COMMERCE 12-31-2004.

FOR: SAUCES; SALSAS; SALAD DRESSINGS; AND CONDIMENTS, NAMELY KETCHUP AND MAYONNAISE, IN CLASS 30 (U.S. CL. 46).

FIRST USE 12-31-2004; IN COMMERCE 12-31-2004.

THE MARK CONSISTS OF STANDARD CHARACTERS WITHOUT CLAIM TO ANY PARTICULAR FONT, STYLE, SIZE, OR COLOR.

OWNER OF U.S. REG. NO. 3,067,394.

SER. NO. 77-484,257, FILED 5-27-2008.

RUDY R. SINGLETON, EXAMINING ATTORNEY

Int. Cl.: 35

Prior U.S. Cls.: 100, 101 and 102

United States Patent and Trademark Office

Reg. No. 3,520,583

Registered Oct. 21, 2008

**SERVICE MARK
PRINCIPAL REGISTER**

BUILDING FOR HEALTH

BUILDING FOR HEALTH CORPORATION (COLORADO CORPORATION)
P.O. BOX 113
102 MAIN STREET
CARBONDALE, CO 81623

FOR: RETAIL AND WHOLESALE STORE SERVICES FEATURING HEALTHY, GREEN, ENVIRONMENTALLY-FRIENDLY AND/OR SUSTAINABLE BUILDING MATERIALS, HOME IMPROVEMENT ITEMS, HOME DECOR, AND PERSONAL CARE PRODUCTS; ROOFING, PAINTS, STAINS, FINISHES, PLASTER, SEALERS, CAULK, INSULATION, CABINETS, FLOORING, CARPET AND RUGS, LUMBER, GLUES, ADHESIVES, FURNITURE, APPLIANCES, HOME DECORATIONS AND INTERIOR DESIGN PRODUCTS, MATTRESSES AND BEDDING, LINENS AND TOWELS, FABRICS, NAPKINS, KITCHENWARE, HOUSE WARES, COOKING TOOLS, KNIVES, CUTTING BOARDS, CLEANING PRODUCTS, LIGHTING, PERSONAL CARE PRO-

DUCTS, CLOTHING, BABY CLOTHES, BABY PRODUCTS, TOYS, ALTERNATIVE ENERGY SYSTEMS, GARDENING AND LANDSCAPING PRODUCTS, TOOLS, GARDENING, WOODWORKING TOOLS, CANDLES, LIGHTING, BAGS, HANDBAGS, BACKPACKS, COTTON BAGS, HEMP BAGS, DUFFEL BAGS, BOOKS AND VIDEOS, HOME SAFETY EQUIPMENT, IN CLASS 35 (U.S. CLS. 100, 101 AND 102).

FIRST USE 6-1-1988; IN COMMERCE 12-1-1988.

THE MARK CONSISTS OF STANDARD CHARACTERS WITHOUT CLAIM TO ANY PARTICULAR FONT, STYLE, SIZE, OR COLOR.

SER. NO. 77-486,092, FILED 5-29-2008.

ALLISON SCHRODY, EXAMINING ATTORNEY

Int. Cl.: 30

Prior U.S. Cl.: 46

United States Patent and Trademark Office

Reg. No. 3,520,584

Registered Oct. 21, 2008

TRADEMARK
PRINCIPAL REGISTER

SANTITAS

FRITO-LAY NORTH AMERICA, INC. (DELA-
WARE CORPORATION)
7701 LEGACY DRIVE
PLANO, TX 75024

FOR: HOT SAUCE; SALSA, IN CLASS 30 (U.S. CL.
46).

FIRST USE 5-19-2007; IN COMMERCE 5-19-2007.

THE MARK CONSISTS OF STANDARD CHAR-
ACTERS WITHOUT CLAIM TO ANY PARTICULAR
FONT, STYLE, SIZE, OR COLOR.

OWNER OF U.S. REG. NOS. 1,408,752 AND
3,077,510.

THE ENGLISH TRANSLATION OF THE WORD
"SANTITAS" IN THE MARK IS "LITTLE FEMALE
SAINTS".

SER. NO. 77-486,923, FILED 5-30-2008.

JILL PRATER, EXAMINING ATTORNEY

Int. Cl.: 25

Prior U.S. Cls.: 22 and 39

United States Patent and Trademark Office

Reg. No. 3,520,585

Registered Oct. 21, 2008

**TRADEMARK
PRINCIPAL REGISTER**



NEW YORK YACHT CLUB (NEW YORK NON-
PROFIT CORPORATION)

37 WEST 44TH STREET
NEW YORK, NY 10036

FOR: CLOTHING, NAMELY, SHIRTS, PANTS,
SHORTS, SWEATERS, JACKETS, VESTS, CAPS,
HATS, TIES AND SCARVES, IN CLASS 25 (U.S.
CLS. 22 AND 39).

FIRST USE 0-0-1960; IN COMMERCE 0-0-1960.

OWNER OF U.S. REG. NOS. 822,593, 2,287,370 AND
OTHERS.

THE MARK CONSISTS OF A FLAG DESIGN
WITH A FIVE-POINTED STAR-POINT-UP IN THE
CENTER OF TWO CROSSED STRIPES.

SEC. 2(F).

SER. NO. 77-487,357, FILED 5-30-2008.

COLLEEN DOMBROW, EXAMINING ATTORNEY

Int. Cl.: 29

Prior U.S. Cl.: 46

United States Patent and Trademark Office

Reg. No. 3,520,586

Registered Oct. 21, 2008

**TRADEMARK
PRINCIPAL REGISTER**

DURKEE

ACH FOOD COMPANIES, INC. (DELAWARE
CORPORATION)
7171 GOODLETT FARMS PARKWAY
CORDOVA, TN 38016

FOR: DRIED AND COOKED VEGETABLES; BUT-
TER SUBSTITUTES; PROCESSED COCONUT;
FRENCH FRIED ONIONS; PROCESSED OLIVES,
IN CLASS 29 (U.S. CL. 46).

FIRST USE 4-24-1967; IN COMMERCE 4-24-1967.

THE MARK CONSISTS OF STANDARD CHAR-
ACTERS WITHOUT CLAIM TO ANY PARTICULAR
FONT, STYLE, SIZE, OR COLOR.

OWNER OF U.S. REG. NOS. 866,908, 2,698,852 AND
OTHERS.

SEC. 2(F).

SER. NO. 77-495,119, FILED 6-10-2008.

SUSAN RICHARDS, EXAMINING ATTORNEY

Int. Cl.: 5

Prior U.S. Cls.: 6, 18, 44, 46, 51 and 52

Reg. No. 3,520,587

United States Patent and Trademark Office

Registered Oct. 21, 2008

**TRADEMARK
PRINCIPAL REGISTER**

NUTRIDAY

MAIN STREET DIRECT, LLC (DELAWARE LIMITED LIABILITY COMPANY)
1 PARK AVENUE
NEW YORK, NY 10016

FOR: HERBAL SUPPLEMENTS; MINERAL NUTRITIONAL SUPPLEMENTS; MINERAL SUPPLEMENTS; NUTRITIONAL SUPPLEMENTS; VITAMINS, IN CLASS 5 (U.S. CLS. 6, 18, 44, 46, 51 AND 52).

FIRST USE 9-1-1998; IN COMMERCE 1-2-1999.

THE MARK CONSISTS OF STANDARD CHARACTERS WITHOUT CLAIM TO ANY PARTICULAR FONT, STYLE, SIZE, OR COLOR.

SER. NO. 77-497,581, FILED 6-12-2008.

MICHAEL W. BAIRD, EXAMINING ATTORNEY

Int. Cls.: 17 and 21

Prior U.S. Cls.: 1, 2, 5, 12, 13, 23, 29, 30, 33, 35, 40 and 50

United States Patent and Trademark Office

Reg. No. 3,520,588

Registered Oct. 21, 2008

**TRADEMARK
PRINCIPAL REGISTER**



NEW PENDULUM CORP. (DELAWARE CORPORATION)
STE 1300
1105 N. MARKET ST
WILMINGTON, DE 19801

FOR: TEXTILES AND ABSORBENTS SOLD IN ROLLS AND PADS FOR ABSORBING INDUSTRIAL LIQUIDS, IN CLASS 17 (U.S. CLS. 1, 5, 12, 13, 35 AND 50).

FIRST USE 5-16-2008; IN COMMERCE 5-16-2008.

FOR: CLEANING PADS AND WIPES MADE OF SYNTHETIC AND NATURAL ABSORBENT TEX-

TILES FOR ABSORBING INDUSTRIAL LIQUIDS, IN CLASS 21 (U.S. CLS. 2, 13, 23, 29, 30, 33, 40 AND 50).

FIRST USE 5-16-2008; IN COMMERCE 5-16-2008.

THE MARK CONSISTS OF THE WORD "SUNSAFE" IN CAPITAL BLOCK LETTERS WITH AN OUTLINE OF SUN RAYS PRECEDING AND PARTIALLY SURROUNDING THE FIRST LETTER "S" OF THE WORD "SUNSAFE".

SER. NO. 77-498,223, FILED 6-13-2008.

STEPHANIE ALI, EXAMINING ATTORNEY

Int. Cl.: 9

Prior U.S. Cls.: 21, 23, 26, 36 and 38

Reg. No. 3,520,589

United States Patent and Trademark Office

Registered Oct. 21, 2008

**TRADEMARK
PRINCIPAL REGISTER**

Tennis Rocks

WRIGHT, BRUCE D (UNITED STATES INDIVIDUAL)
2199A PRINCETON STREET
SARASOTA, FL 34237

THE MARK CONSISTS OF STANDARD CHARACTERS WITHOUT CLAIM TO ANY PARTICULAR FONT, STYLE, SIZE, OR COLOR.

FOR: MUSICAL SOUND RECORDINGS; MUSICAL VIDEO RECORDINGS, IN CLASS 9 (U.S. CLS. 21, 23, 26, 36 AND 38).

SER. NO. 77-500,944, FILED 6-17-2008.

FIRST USE 6-17-2008; IN COMMERCE 6-17-2008.

JOHN WILKE, EXAMINING ATTORNEY

Int. Cl.: 28

Prior U.S. Cls.: 22, 23, 38 and 50

Reg. No. 3,520,590

United States Patent and Trademark Office

Registered Oct. 21, 2008

**TRADEMARK
PRINCIPAL REGISTER**

DXT

MATHEW A. MCPHERSON (UNITED STATES
INDIVIDUAL)
ROUTE 2, P.O. BOX 58
19055 INCLINE ROAD
NORWALK, WI 54648

THE MARK CONSISTS OF STANDARD CHAR-
ACTERS WITHOUT CLAIM TO ANY PARTICULAR
FONT, STYLE, SIZE, OR COLOR.

FOR: ARCHERY BOWS, IN CLASS 28 (U.S. CLS.
22, 23, 38 AND 50).

SER. NO. 77-501,817, FILED 6-18-2008.

FIRST USE 12-31-2007; IN COMMERCE 12-31-2007.

SUSAN RICHARDS, EXAMINING ATTORNEY

Int. Cl.: 35

Prior U.S. Cls.: 100, 101 and 102

United States Patent and Trademark Office

Reg. No. 3,520,591

Registered Oct. 21, 2008

**SERVICE MARK
PRINCIPAL REGISTER**

HARD ROCK HOTEL

HARD ROCK CAFE INTERNATIONAL (USA),
INC. (FLORIDA CORPORATION)
6100 OLD PARK LANE
ORLANDO, FL 32835

OWNER OF U.S. REG. NOS. 1,909,483, 3,422,550
AND OTHERS.

FOR: REAL ESTATE MARKETING SERVICES IN
THE FIELD OF CONDOMINIUM HOTELS, IN
CLASS 35 (U.S. CLS. 100, 101 AND 102).

NO CLAIM IS MADE TO THE EXCLUSIVE
RIGHT TO USE "HOTEL", APART FROM THE
MARK AS SHOWN.

FIRST USE 12-10-2007; IN COMMERCE 12-10-2007.

SER. NO. 77-502,407, FILED 6-18-2008.

THE MARK CONSISTS OF STANDARD CHAR-
ACTERS WITHOUT CLAIM TO ANY PARTICULAR
FONT, STYLE, SIZE, OR COLOR.

JIM RINGLE, EXAMINING ATTORNEY

Int. Cl.: 38

Prior U.S. Cls.: 100, 101 and 104

United States Patent and Trademark Office

Reg. No. 3,520,592

Registered Oct. 21, 2008

**SERVICE MARK
PRINCIPAL REGISTER**



YOUGHIOGHENY COMMUNICATIONS-IP, LLC
(DELAWARE LIMITED LIABILITY COMPAN-
NY)

2819 NW LOOP 410
SAN ANTONIO, TX 78230

FOR: CELLULAR TELEPHONE SERVICES AND
WIRELESS COMMUNICATIONS SERVICES,
NAMELY, THE TRANSMISSION OF VOICE, DATA,
IMAGES, AUDIO, VIDEO, PAGING, ELECTRONIC
MAIL, VOICE MESSAGING, AND INFORMATION,
IN CLASS 38 (U.S. CLS. 100, 101 AND 104).

FIRST USE 7-31-2006; IN COMMERCE 7-31-2006.

OWNER OF U.S. REG. NO. 3,098,763.

NO CLAIM IS MADE TO THE EXCLUSIVE
RIGHT TO USE "COMMUNICATIONS", APART
FROM THE MARK AS SHOWN.

THE MARK CONSISTS OF "POCKET" WITH
SOUNDWAVES AS THE LETTER "O".

SEC. 2(F).

SER. NO. 77-975,477, FILED 11-16-2006.

BENJAMIN OKEKE, EXAMINING ATTORNEY

Int. Cl.: 41

Prior U.S. Cls.: 100, 101 and 107

United States Patent and Trademark Office

Reg. No. 3,520,593

Registered Oct. 21, 2008

**SERVICE MARK
PRINCIPAL REGISTER**

OSPREY

SCHLUMBERGER TECHNOLOGY CORPORA-
TION (TEXAS CORPORATION)
SUITE 1700
5599 SAN FELIPE
HOUSTON, TX 77027

THE MARK CONSISTS OF STANDARD CHAR-
ACTERS WITHOUT CLAIM TO ANY PARTICULAR
FONT, STYLE, SIZE, OR COLOR.

FOR: TRAINING SERVICES RELATING TO THE
INTEGRATION OF SOFTWARE, IN CLASS 41 (U.S.
CLS. 100, 101 AND 107).

SER. NO. 77-975,606, FILED 9-28-2006.

FIRST USE 7-7-2004; IN COMMERCE 7-7-2004.

MARILYN IZZI, EXAMINING ATTORNEY

Int. Cl.: 36

Prior U.S. Cls.: 100, 101 and 102

United States Patent and Trademark Office

Reg. No. 3,520,594

Registered Oct. 21, 2008

**SERVICE MARK
PRINCIPAL REGISTER**

STRONGWOOD

STRONGWOOD INSURANCE HOLDINGS COR-
PORATION (DELAWARE CORPORATION)
SUITE 100 70 GARDEN COURT
MONTEREY, CA 93940

THE MARK CONSISTS OF STANDARD CHAR-
ACTERS WITHOUT CLAIM TO ANY PARTICULAR
FONT, STYLE, SIZE, OR COLOR.

FOR: PROPERTY AND CASUALTY INSURANCE
UNDERWRITING SERVICES, IN CLASS 36 (U.S.
CLS. 100, 101 AND 102).

SER. NO. 77-975,666, FILED 8-20-2007.

FIRST USE 11-30-2006; IN COMMERCE 11-30-2006.

CHRISTINE COOPER, EXAMINING ATTORNEY

Int. Cl.: 35

Prior U.S. Cls.: 100, 101 and 102

United States Patent and Trademark Office

Reg. No. 3,520,595

Registered Oct. 21, 2008

**SERVICE MARK
PRINCIPAL REGISTER**

KING KEG

AMIN, TARIQ (UNITED STATES INDIVIDUAL)
5241 WEST ROSECRANS AVENUE
HAWTHORNE, CA 90250

THE MARK CONSISTS OF STANDARD CHAR-
ACTERS WITHOUT CLAIM TO ANY PARTICULAR
FONT, STYLE, SIZE, OR COLOR.

FOR: RETAIL STORE SERVICES IN THE FIELDS
OF ICE, IN CLASS 35 (U.S. CLS. 100, 101 AND 102).

SER. NO. 77-975,671, FILED 7-9-2007.

FIRST USE 0-0-2004; IN COMMERCE 0-0-2004.

BERYL GARDNER, EXAMINING ATTORNEY

Int. Cls.: 40 and 42

Prior U.S. Cls.: 100, 101, 103 and 106

United States Patent and Trademark Office

Reg. No. 3,520,596

Registered Oct. 21, 2008

**SERVICE MARK
PRINCIPAL REGISTER**



ASAT LIMITED (HONG KONG CORPORATION)
14/F, 138 TEXACO ROAD
TSUEN WAN, HONG KONG

FOR: CUSTOM ASSEMBLY OF SEMICONDUCTORS AND INTEGRATED CIRCUITS, IN CLASS 40 (U.S. CLS. 100, 103 AND 106).

FIRST USE 12-4-2007; IN COMMERCE 12-4-2007.

FOR: DESIGN AND TESTING OF SEMICONDUCTORS AND INTEGRATED CIRCUITS, IN CLASS 42 (U.S. CLS. 100 AND 101).

FIRST USE 12-4-2007; IN COMMERCE 12-4-2007.

OWNER OF U.S. REG. NO. 1,791,940.

THE COLOR(S) YELLOW AND BLUE IS/ARE CLAIMED AS A FEATURE OF THE MARK.

THE MARK CONSISTS OF THE CAPITALIZED WORD "ASAT" IN BLUE ITALICS TO THE RIGHT OF FOUR YELLOW RAYS, ONE LYING FLAT AND THE OTHER THREE DIRECTED UPWARD AT DIFFERENT ANGLES.

SER. NO. 77-975,997, FILED 1-25-2008.

BRENDAN REGAN, EXAMINING ATTORNEY

Int. Cl.: 9

Prior U.S. Cls.: 21, 23, 26, 36 and 38

United States Patent and Trademark Office

Reg. No. 3,520,597

Registered Oct. 21, 2008

**TRADEMARK
PRINCIPAL REGISTER**

BIG O

SUNRISE INCORPORATED (JAPAN CORPORATION)
2-44-10 KAMIIGUSA SUGINAMI-KU
TOKYO, JAPAN 167-0023

FIRST USE 2-25-2000; IN COMMERCE 2-25-2000.

SER. NO. 78-115,902, FILED 3-19-2002.

FOR: PRE-RECORDED VIDEOTAPES AND DVDS
FEATURING ANIMATED STORIES, IN CLASS 9
(U.S. CLS. 21, 23, 26, 36 AND 38).

DOMINIC J. FERRAIUOLO, EXAMINING ATTORNEY

Int. Cl.: 30

Prior U.S. Cl.: 46

United States Patent and Trademark Office

Reg. No. 3,520,598

Registered Oct. 21, 2008

TRADEMARK
PRINCIPAL REGISTER



CANADA BREAD FROZEN BAKERY LTD. (CANADA CORPORATION)
4000 INDUSTRIEL BOULEVARD
LAVAL, QUEBEC, CANADA H7L 4R9

FOR: BREADS AND UNCOOKED FROZEN BREAD; CAKES; VIENNESE PASTRIES; CROISSANTS; DRY PETIT FOURS; PIES; BRIOCHES; DANISH PASTRIES; BISCUITS AND COOKIES; ROUND FLAT BISCUITS; MUFFINS, IN CLASS 30 (U.S. CL. 46).

FIRST USE 6-30-2001; IN COMMERCE 6-30-2001.

PRIORITY CLAIMED UNDER SEC. 44(D) ON CANADA APPLICATION NO. 1137039, FILED 4-16-2002.

OWNER OF U.S. REG. NO. 1,925,662.

NO CLAIM IS MADE TO THE EXCLUSIVE RIGHT TO USE "SINCE 1921", APART FROM THE MARK AS SHOWN.

SER. NO. 78-124,765, FILED 4-29-2002.

MARCIE MILONE, EXAMINING ATTORNEY

Int. Cl.: 18

Prior U.S. Cls.: 1, 2, 3, 22 and 41

United States Patent and Trademark Office

Reg. No. 3,520,599

Registered Oct. 21, 2008

**TRADEMARK
PRINCIPAL REGISTER**

JEANIUS LEVEL PRODUCTS

KEMISTRE 8 LLC (NEW YORK LIMITED LIABILITY COMPANY)
31 WEST 34TH STREET
NEW YORK, NY 10001

FOR: ALL-PURPOSE SPORT BAGS; ALL-PURPOSE ATHLETIC BAGS; TOTE BAGS; SHOULDER BAGS; TRAVEL ACCESSORY BAGS; CREDIT CARD HOLDERS; CREDIT CARD CASES; HANDBAGS; BEACH BAGS; BRIEFCASES; COSMETIC BAGS SOLD EMPTY; RUCKSACKS; TRAVELING BAGS; SUITCASES; PURSES; CHANGE PURSES; WALLETS; ZIPPED WALLETS; BILLFOLD WALLETS; BOOK BAGS; BACKPACKS; DUFFEL BAGS; KEY CASES; UMBRELLAS; BACKPACKS; BILLFOLDS; BRIEFCASE-TYPE PORTFOLIOS; ATTACHE CASES; BUSINESS CARD CASES; FANNY PACKS; GYM BAGS; KNAPSACKS; LUGGAGE; POCKET-BOOKS; SCHOOL BAGS; STRAPS FOR HANDBAGS AND LUGGAGE AND ACCESSORIES USED THEREWITH, NAMELY, SHOULDER STRAP PADS,

HOLDERS, AND POUCHES; GOODS MADE OF LEATHER AND IMITATIONS OF LEATHER, NAMELY, KEY CHAINS, HANDBAGS, WALLETS, CASES, BILLFOLDS, COSMETIC BAGS SOLD EMPTY, BRIEFCASES, BRIEFCASE-TYPE PORTFOLIOS, ATTACHES, TOTES, TRUNKS AND TRAVELING BAGS; GARMENT BAGS FOR TRAVEL; SHOE BAGS FOR TRAVEL, IN CLASS 18 (U.S. CLS. 1, 2, 3, 22 AND 41).

FIRST USE 8-1-1999; IN COMMERCE 1-1-2000.

NO CLAIM IS MADE TO THE EXCLUSIVE RIGHT TO USE "PRODUCTS", APART FROM THE MARK AS SHOWN.

SER. NO. 78-137,152, FILED 6-19-2002.

GIANCARLO CASTRO, EXAMINING ATTORNEY

Int. Cls.: 9, 14, 18, 25 and 35

**Prior U.S. Cls.: 1, 2, 3, 21, 22, 23, 26, 27, 28, 36, 38, 39,
41, 50, 100, 101 and 102**

Reg. No. 3,520,600

United States Patent and Trademark Office

Registered Oct. 21, 2008

**TRADEMARK
SERVICE MARK
PRINCIPAL REGISTER**

MXM STYLE

REITMANS (CANADA) LIMITED (CANADA CORPORATION)
250 SAUVÉ STREET WEST
MONTRÉAL, QUEBEC, CANADA H3L 1Z2

FOR: FASHION ACCESSORIES, NAMELY, SUNGLASSES, IN CLASS 9 (U.S. CLS. 21, 23, 26, 36 AND 38).

FOR: JEWELRY, NAMELY, NECKLACES, EARRINGS, BRACELETS, AND RINGS, IN CLASS 14 (U.S. CLS. 2, 27, 28 AND 50).

FOR: FASHION ACCESSORIES, NAMELY, HANDBAGS AND UMBRELLAS, IN CLASS 18 (U.S. CLS. 1, 2, 3, 22 AND 41).

FOR: WOMEN'S OVERSIZE CLOTHING, SPORTSWEAR AND OUTERWEAR AND PLUS-SIZE FASHIONS, NAMELY, DRESSES, SKIRTS, JEANS, JACKETS, OUTERWEAR JACKETS, VESTS, SHIRTS, BOTTOMS, PANTS, SHORTS, T-SHIRTS, SWEATSHIRTS, COATS, RAINCOATS, JOGGING SUITS, OVERALLS, SUITS, PONCHOS, SWEATERS, DUFFEL COATS, PARKAS, CULOTTES, JUMP SUITS, POLO SHIRTS, BODY SUITS, BLAZERS, SLEEP WEAR, BRAS, PANTIES, AND SCARVES; FASHION ACCESSORIES, NAMELY, HATS, BELTS, AND GLOVES; FOOTWEAR, NAMELY, SHOES,

RUNNERS, BOOTS, SANDALS, AND SLIPPERS, IN CLASS 25 (U.S. CLS. 22 AND 39).

FOR: RETAIL STORE SERVICES AND RETAIL STORE SERVICES WITHIN LARGER RETAIL STORES FEATURING WOMEN'S CLOTHING, SPORTSWEAR, OUTERWEAR AND PLUS-SIZE FASHIONS, FASHION ACCESSORIES, JEWELRY, HANDBAGS, FOOTWEAR, COSMETICS, BATH PRODUCTS, GIFTS, AND WATER; RETAIL STORE SERVICES SELLING WOMEN'S CLOTHING, SPORTSWEAR, OUTERWEAR AND PLUS-SIZE FASHIONS, FASHION ACCESSORIES, JEWELRY, HANDBAGS, FOOTWEAR, COSMETICS, BATH PRODUCTS, GIFTS, AND WATER, IN CLASS 35 (U.S. CLS. 100, 101 AND 102).

PRIORITY CLAIMED UNDER SEC. 44(D) ON CANADA APPLICATION NO. 1152235, FILED 9-16-2002, REG. NO. TMA608502, DATED 4-26-2004, EXPIRES 4-26-2014.

NO CLAIM IS MADE TO THE EXCLUSIVE RIGHT TO USE STYLE, APART FROM THE MARK AS SHOWN.

SER. NO. 78-172,101, FILED 10-8-2002.

MICHAEL ENGEL, EXAMINING ATTORNEY

Int. Cls.: 30 and 32

Prior U.S. Cls.: 45, 46 and 48

United States Patent and Trademark Office

Reg. No. 3,520,601

Registered Oct. 21, 2008

TRADEMARK
PRINCIPAL REGISTER



GREEN SCIENCE INTERNATIONAL LTD.
(HONG KONG CORPORATION)
28TH FLOOR, CAROLINE CENTRE
28 YUN PING ROAD, CAUSEWAY BAY
HONG KONG, HONG KONG

FOR: PREPARATIONS FOR MAKING TRADITIONAL CHINESE HERBAL FOOD BEVERAGES; TRADITIONAL CHINESE HERBAL FOOD BEVERAGES, IN CLASS 30 (U.S. CL. 46).

FOR: MINERAL AND AERATED WATERS; FRUIT DRINKS AND FRUIT JUICES; SYRUPS FOR MAKING BEVERAGES; TONIC WATER, IN CLASS 32 (U.S. CLS. 45, 46 AND 48).

OWNER OF HONG KONG REG. NO. 2003B15045,
DATED 12-8-2003, EXPIRES 1-8-2010.

NO CLAIM IS MADE TO THE EXCLUSIVE RIGHT TO USE NON-ENGLISH CHARACTER FOR NOURISHMENT, APART FROM THE MARK AS SHOWN.

THE ENGLISH TRANSLATION OF THE NON-LATIN CHARACTERS IN THE MARK IS GREEN, NOURISHMENT, MART.

THE NON-LATIN CHARACTERS IN THE MARK TRANSLITERATE TO LU YANG FANG.

SER. NO. 78-201,558, FILED 1-9-2003.

BARNEY CHARLON, EXAMINING ATTORNEY

Int. Cl.: 35

Prior U.S. Cls.: 100, 101 and 102

United States Patent and Trademark Office

Reg. No. 3,520,602

Registered Oct. 21, 2008

**SERVICE MARK
PRINCIPAL REGISTER**



RX WEST, INC. (DELAWARE CORPORATION)
7472 S. TUCSON WAY, SUITE 100
CENTENNIAL, CO 80112

NO CLAIM IS MADE TO THE EXCLUSIVE
RIGHT TO USE "SYSTEMS", APART FROM THE
MARK AS SHOWN.

FOR: MANAGED CARE SERVICES, NAMELY,
ELECTRONIC PROCESSING OF PRESCRIPTION
DRUG BENEFIT PLAN INFORMATION AND BEN-
EFITS, IN CLASS 35 (U.S. CLS. 100, 101 AND 102).

SER. NO. 78-229,326, FILED 3-24-2003.

FIRST USE 10-25-2002; IN COMMERCE 10-25-2002.

GIANCARLO CASTRO, EXAMINING ATTORNEY

Int. Cls.: 5, 40, 41 and 42

**Prior U.S. Cls.: 6, 18, 44, 46, 51, 52, 100, 101, 103, 106
and 107**

Reg. No. 3,520,603

United States Patent and Trademark Office

Registered Oct. 21, 2008

**TRADEMARK
SERVICE MARK
PRINCIPAL REGISTER**

LIFECYCLE PHARMA

LIFECYCLE PHARMA A/S (DENMARK CORPORATION)
KOGLE ALLE 4
DK-2970 HORSHOOLM, DENMARK

FOR: PHARMACEUTICAL PREPARATIONS; MEDICAL PREPARATIONS; AND DRUG DELIVERY SYSTEMS, PHARMACEUTICAL MODIFIED RELEASE SYSTEMS, AND CONTROLLED RELEASE SYSTEMS, COMPRISED OF TABLETS, GRANULES, PILLS, SACHETS, POWDERS, AND CAPSULES; ALL OF THE ABOVE FOR USE IN THE TREATMENT OF MENTAL AND PHYSICAL DISORDERS, TRAUMAS AND EMERGENCIES, ADDICTIONS, AGING, ALLERGY/IMMUNOLOGY, BURNS, DISEASES OF THE HEART AND BLOOD VESSELS, DENTAL AND GUM DISEASES, SKIN DISEASES, NUTRITIONAL AND DIETARY DISEASES, DISEASES OF THE ENDOCRINOLOGICAL SYSTEM AND PANCREATIC DISEASES, DIABETES, EPIDEMICAL DISEASES, DISEASES AND AFFLICTIONS OF THE GASTROENTEROLOGICAL SYSTEM, DISEASES OF THE BLOOD, INFECTIOUS DISEASES, NEUROLOGICAL DISEASES, NEPHROLOGICAL DISEASES, DISEASES IN THE OBSTETRICAL- AND GYNECOLOGICAL FIELD, CANCER, OPHTHALMOLOGICAL DISEASES, DISEASES AND AFFLICTIONS AFFECTING THE BONES, JOINTS, CARTILAGE MATERIAL AND MUSCLES, DISEASES AND AFFLICTIONS OF THE EAR, NOSE AND THROAT, DISEASES AND AFFLICTIONS IN THE PSYCHIATRIC FIELD, PULMONOLOGICAL DISEASES AND AFFLICTIONS, RHEUMATISM, UROLOGICAL DISEASES AND AFFLICTIONS AND GENERALISED PAIN, IN CLASS 5 (U.S. CLS. 6, 18, 44, 46, 51 AND 52).

FOR: TREATMENT OF MATERIALS, NAMELY, MILLING, GRINDING, MIXING, COMPRESSING,

AND MELTING OF PHARMACEUTICAL, MEDICINAL, BIOTECHNICAL AND BACTERIOLOGICAL SUBSTANCES, PREPARATIONS, FORMULATIONS, SOLUTIONS, FOR USE IN THE PHARMACEUTICAL AND MEDICAL INDUSTRIES, IN CLASS 40 (U.S. CLS. 100, 103 AND 106).

FOR: EDUCATIONAL TRAINING SERVICES, NAMELY, ARRANGING AND CONDUCTING OF SEMINARS, WORKSHOPS, CONFERENCES, LECTURES AND CONGRESSES, ALL IN THE MEDICAL, CHEMICAL AND PHARMACEUTICAL FIELDS, IN CLASS 41 (U.S. CLS. 100, 101 AND 107).

FOR: SCIENTIFIC RESEARCH WITHIN THE MEDICAL, PHARMACEUTICAL, BIOTECHNICAL AND BACTERIOLOGICAL AREAS AND PROVIDING CONSULTATION AND INFORMATION RELATING THERETO; CONDUCTING OF TESTS REGARDING MEDICAL APPLICATIONS; PACKAGING DESIGN FOR OTHERS; DESIGNING AND DEVELOPMENT OF MEDICAL EQUIPMENT; DESIGNING PHARMACEUTICAL MEDICAL PREPARATIONS; PREPARATION OF PHARMACEUTICAL FORMULATIONS; DESIGN AND DEVELOPMENT OF GRANULATION TECHNOLOGY AND TABLET TECHNOLOGY AND PROVIDING CONSULTATION AND INFORMATION THERETO; AND MATERIALS TESTING FOR THE PHARMACEUTICAL AND MEDICAL INDUSTRIES., IN CLASS 42 (U.S. CLS. 100 AND 101).

OWNER OF DENMARK REG. NO. VR200302449,
DATED 7-11-2003, EXPIRES 7-11-2013.

SER. NO. 78-250,680, FILED 5-16-2003.

Alicia Collins, Examining Attorney

Int. Cl.: 35

Prior U.S. Cls.: 100, 101 and 102

United States Patent and Trademark Office

Reg. No. 3,520,604

Registered Oct. 21, 2008

**SERVICE MARK
PRINCIPAL REGISTER**

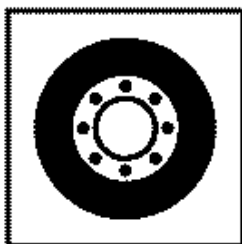

Mobiltech

MESSE FRANKFURT EXHIBITION GMBH (FED
REP GERMANY LIMITED LIABILITY COM-
PANY)

LUDWIG-ERHARD-ANLAGE 1
FRANKFURT AM MAIN, FED REP GERMANY
60327

FOR: PREPARING ADVERTISEMENTS FOR
OTHERS IN CONJUNCTION WITH ORGANIZING
FAIRS AND EXHIBITIONS; PREPARING TRADE
SHOW DISPLAYS AND EXHIBITS FOR OTHERS;
COOPERATIVE ADVERTISING AND MARKET-
ING; BUSINESS MANAGEMENT; PERSONNEL
MANAGEMENT CONSULTATION; ADMINISTRA-
TION OF BUSINESS PAYROLL FOR OTHERS;
OFFICE SERVICES, NAMELY, SECRETARIAL
AND CLERICAL SERVICES; RENTAL OF ADVER-
TISING SPACE; RENTAL OF ADVERTISING DIS-

PLAYS; ORGANIZING AND ARRANGING FAIRS
AND EXHIBITIONS FOR COMMERCIAL AND AD-
VERTISING PURPOSES IN THE FIELD OF TECH-
NICAL TEXTILES FOR USE IN VEHICLE
COMPONENT CONSTRUCTION; ORGANIZING
AND ARRANGING CONFERENCES, CONGRES-
SES, AND SYMPOSIA FOR BUSINESS AND COM-
MERCIAL PURPOSES., IN CLASS 35 (U.S. CLS. 100,
101 AND 102).

OWNER OF ERPN CMNTY TM OFC REG. NO.
002388874, DATED 1-22-2003, EXPIRES 9-26-2011.

SER. NO. 78-276,778, FILED 7-21-2003.

GINA HAYES, EXAMINING ATTORNEY

Int. Cl.: 42

Prior U.S. Cls.: 100 and 101

United States Patent and Trademark Office

Reg. No. 3,520,605

Registered Oct. 21, 2008

**SERVICE MARK
PRINCIPAL REGISTER**

TWINSTRAND THERAPEUTICS

TWINSTRAND THERAPEUTICS, INC. (CANADA CORPORATION)
8081 LOUGHEED HIGHWAY
BURNABY, CANADA V5A 1W9

FOR: RESEARCH IN THE FIELD OF BIOPHARMACOLOGY, AND MEDICAL TESTING IN THE NATURE OF CLINICAL TRIALS IN THE FIELD OF BIOPHARMACOLOGY, IN CLASS 42 (U.S. CLS. 100 AND 101).

OWNER OF CANADA REG. NO. TMA714180, DATED 5-12-2008, EXPIRES 5-12-2023.

NO CLAIM IS MADE TO THE EXCLUSIVE RIGHT TO USE "THERAPEUTICS", APART FROM THE MARK AS SHOWN.

SER. NO. 78-286,933, FILED 8-13-2003.

MELVIN AXILBUND, EXAMINING ATTORNEY

Int. Cl.: 42

Prior U.S. Cls.: 100 and 101

United States Patent and Trademark Office

Reg. No. 3,520,606

Registered Oct. 21, 2008

**SERVICE MARK
PRINCIPAL REGISTER**

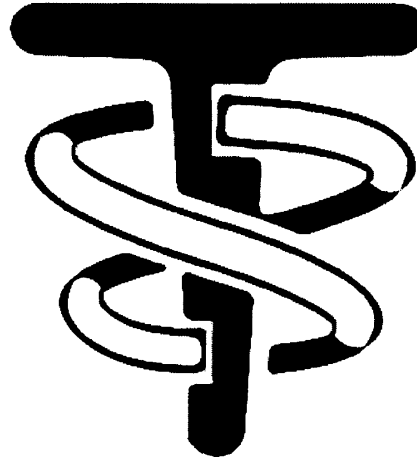

TWINSTRAND THERAPEUTICS, INC. (CANADA CORPORATION)

8081 LOUGHEED HIGHWAY
BURNABY, CANADA V5A 1W9

FOR: RESEARCH IN THE FIELD OF BIOPHARMACOLOGY, AND MEDICAL TESTING IN THE NATURE OF CLINICAL TRIALS IN THE FIELD OF

BIOPHARMACOLOGY, IN CLASS 42 (U.S. CLS. 100 AND 101).

OWNER OF CANADA REG. NO. TMA705877, DATED 1-29-2008, EXPIRES 1-29-2023.

SER. NO. 78-286,937, FILED 8-13-2003.

MELVIN AXILBUND, EXAMINING ATTORNEY

Int. Cl.: 31

Prior U.S. Cls.: 1 and 46

United States Patent and Trademark Office

Reg. No. 3,520,607

Registered Oct. 21, 2008

TRADEMARK
PRINCIPAL REGISTER

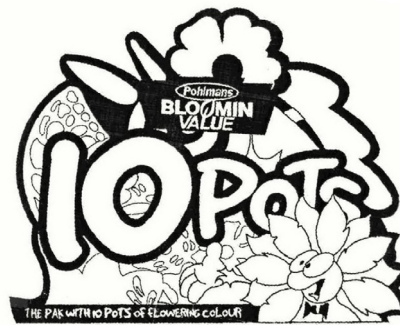

POHLMANS NURSERY PTY LTD. (AUSTRALIA
LIMITED COMPANY)
REDBANK CREEK
GATTON, AUSTRALIA 4343

NO CLAIM IS MADE TO THE EXCLUSIVE
RIGHT TO USE "10 POTS", APART FROM THE
MARK AS SHOWN.

FOR: LIVE PLANTS, PLANT SEEDS, SEEDLINGS
AND LIVE FLOWERS, IN CLASS 31 (U.S. CLS. 1 AND
46).

SER. NO. 78-288,228, FILED 8-15-2003.

OWNER OF AUSTRALIA REG. NO. 1160743,
DATED 2-9-2007, EXPIRES 2-9-2017.

KATHERINE CHANG, EXAMINING ATTORNEY

Int. Cls.: 1 and 4

Prior U.S. Cls.: 1, 5, 6, 10, 15, 26 and 46

United States Patent and Trademark Office

Reg. No. 3,520,608

Registered Oct. 21, 2008

**TRADEMARK
PRINCIPAL REGISTER**



SAFETY-KLEEN SYSTEMS, INC. (WISCONSIN CORPORATION)
5400 LEGACY DRIVE
CLUSTER II, BUILDING 3
PLANO, TX 75024

FOR: CHEMICAL ADDITIVES FOR FUEL TREATMENT; CHEMICAL MOTOR OIL ADDITIVES, CHEMICAL TRANSMISSION FLUID ADDITIVES, IN CLASS 1 (U.S. CLS. 1, 5, 6, 10, 26 AND 46).

FOR: AUTOMOTIVE GREASES, GREASE FOR MACHINES; AUTOMOTIVE LUBRICANTS; NON-CHEMICAL ADDITIVES FOR FUEL TREATMENT; NON-CHEMICAL MOTOR OIL ADDITIVES, NON-CHEMICAL TRANSMISSION FLUID ADDITIVES; ALL PURPOSE LUBRICANTS; INDUSTRIAL LU-

BRICANTS IN THE NATURE OF PENETRATING AND EXTREME PRESSURE LUBRICANTS, IN CLASS 4 (U.S. CLS. 1, 6 AND 15).

PRIORITY CLAIMED UNDER SEC. 44(D) ON CANADA APPLICATION NO. 1169952, FILED 3-7-2003, REG. NO. TMA714103, DATED 5-9-2008, EXPIRES 5-9-2023.

THE MARK CONSISTS OF "ECOPOWER" AND ATOM DESIGN.

SER. NO. 78-297,060, FILED 9-8-2003.

AMY HELLA, EXAMINING ATTORNEY

Int. Cl.: 30

Prior U.S. Cl.: 46

United States Patent and Trademark Office

Reg. No. 3,520,609

Registered Oct. 21, 2008

**TRADEMARK
PRINCIPAL REGISTER**

**Mobile Foodie
Survival Kit**

MCWHORTER, HOLLY SUZANNE (UNITED STATES INDIVIDUAL)
302 BEDFORD AVE. #100
BROOKLYN, NY 11211

FOR: MOBILE KIT CONSISTING PRIMARILY OF SPICES, IN CLASS 30 (U.S. CL. 46).

FIRST USE 10-23-2003; IN COMMERCE 10-23-2003.

THE MARK CONSISTS OF STANDARD CHARACTERS WITHOUT CLAIM TO ANY PARTICULAR FONT, STYLE, SIZE, OR COLOR.

NO CLAIM IS MADE TO THE EXCLUSIVE RIGHT TO USE "MOBILE FOODIE" OR "KIT", APART FROM THE MARK AS SHOWN.

SER. NO. 78-337,672, FILED 12-8-2003.

JOHN KELLY, EXAMINING ATTORNEY

Int. Cl.: 30

Prior U.S. Cl.: 46

United States Patent and Trademark Office

Reg. No. 3,520,610

Registered Oct. 21, 2008

**TRADEMARK
PRINCIPAL REGISTER**

AMBRE JAVA

BARRY CALLEBAUT FRANCE (FRANCE CORPORATION)
5, BOULEVARD MICHELET
78250 HARDRICOURT, FRANCE

FOR: CHOCOLATE COUVERTURES, IN CLASS 30 (U.S. CL. 46).

THE MARK CONSISTS OF STANDARD CHARACTERS WITHOUT CLAIM TO ANY PARTICULAR FONT, STYLE, SIZE, OR COLOR.

OWNER OF FRANCE REG. NO. 1638349, DATED 7-28-2000, EXPIRES 7-28-2010.

THE WORDS AMBRE JAVA MAY BE TRANSLATED AS "JAVA AMBER".

SER. NO. 78-340,506, FILED 12-13-2003.

CAROLYN CATALDO, EXAMINING ATTORNEY

Int. Cls.: 5 and 35

Prior U.S. Cls.: 6, 18, 44, 46, 51, 52, 100, 101 and 102

United States Patent and Trademark Office

Reg. No. 3,520,611

Registered Oct. 21, 2008

**TRADEMARK
SERVICE MARK
PRINCIPAL REGISTER**



MARY C. ORWIG (UNITED STATES INDIVIDUAL)

P.O. BOX 4, 9725 94TH AVE., SE
ELLENDALE, ND 58436 AND

STEVE ORWIG (UNITED STATES INDIVIDUAL)

P.O. BOX 4, 9725 94TH AVE., SE
ELLENDALE, ND 58436

FOR: FEED SUPPLEMENTS FOR LIVESTOCK, IN
CLASS 5 (U.S. CLS. 6, 18, 44, 46, 51 AND 52).

FIRST USE 1-0-1990; IN COMMERCE 1-0-1990.

FOR: DISTRIBUTORSHIP SERVICES IN THE
FIELD OF FEED SUPPLEMENTS FOR LIVESTOCK,
IN CLASS 35 (U.S. CLS. 100, 101 AND 102).

FIRST USE 7-0-1989; IN COMMERCE 1-0-1990.

SER. NO. 78-366,919, FILED 2-12-2004.

LESLEY LAMOTHE, EXAMINING ATTORNEY

Int. Cl.: 28

Prior U.S. Cls.: 22, 23, 38 and 50

United States Patent and Trademark Office

Reg. No. 3,520,612

Registered Oct. 21, 2008

**TRADEMARK
PRINCIPAL REGISTER**

AIR TECH

FRANKLIN SPORTS, INC. (DELAWARE CORPORATION)
17 CAMPANELLI PARKWAY
STOUGHTON, MA 02072

FOR: INFLATABLE TOYS; INFLATABLE SPORTS EQUIPMENT, NAMELY, SPORTS BALLS, PLAYGROUND BALLS, BASKETBALLS, FOOTBALLS, SOCCER BALLS, AND VOLLEYBALLS; TABLETOP SPORTS GAMES, NAMELY, HOCKEY, SOCCER, AND BASEBALL; AND HOCKEY STICKS, IN CLASS 28 (U.S. CLS. 22, 23, 38 AND 50).

FIRST USE 7-1-1998; IN COMMERCE 7-1-1998.

THE MARK CONSISTS OF STANDARD CHARACTERS WITHOUT CLAIM TO ANY PARTICULAR FONT, STYLE, SIZE, OR COLOR.

OWNER OF U.S. REG. NO. 2,735,440.

NO CLAIM IS MADE TO THE EXCLUSIVE RIGHT TO USE "AIR", APART FROM THE MARK AS SHOWN.

SER. NO. 78-370,967, FILED 2-19-2004.

BRIAN PINO, EXAMINING ATTORNEY

Int. Cl.: 9

Prior U.S. Cls.: 21, 23, 26, 36 and 38

United States Patent and Trademark Office

Reg. No. 3,520,613

Registered Oct. 21, 2008

**TRADEMARK
PRINCIPAL REGISTER**

RADDICAL

SHELL TRADEMARK MANAGEMENT BV
(NETHERLANDS CORPORATION)
CAREL VAN BYLANDTLAAN 30
2596 HR GRAVENHAGE
THE HAGUE, NETHERLANDS

FOR: COMPUTER SOFTWARE FOR DATA RE-
TRIEVAL, IN CLASS 9 (U.S. CLS. 21, 23, 26, 36 AND
38).

THE MARK CONSISTS OF STANDARD CHAR-
ACTERS WITHOUT CLAIM TO ANY PARTICULAR
FONT, STYLE, SIZE, OR COLOR.

OWNER OF BENELUX REG. NO. 0736939, DATED
9-12-2003, EXPIRES 9-12-2013.

SER. NO. 78-382,337, FILED 3-11-2004.

PRISCILLA MILTON, EXAMINING ATTORNEY

Int. Cls.: 9 and 41

Prior U.S. Cls.: 21, 23, 26, 36, 38, 100, 101 and 107

United States Patent and Trademark Office

Reg. No. 3,520,614

Registered Oct. 21, 2008

**TRADEMARK
SERVICE MARK
PRINCIPAL REGISTER**

**SECOND CITY TELEVISION
NETWORK**

SECOND CITY, INC. (NEVADA CORPORATION)
1616 N. WELLS STREET
CHICAGO, IL 60614

FOR: (BASED ON USE IN COMMERCE) (BASED ON 44(E)) CINEMATOGRAPHIC FILMS FEATURING TELEVISED DRAMATIC, MUSICAL, ANIMATED, ARTISTIC AND LITERARY WORKS, IN CLASS 9 (U.S. CLS. 21, 23, 26, 36 AND 38).

FIRST USE 0-0-1976; IN COMMERCE 0-0-1976.

FOR: (BASED ON 44(E)) ENTERTAINMENT SERVICES IN THE NATURE OF AN ON-GOING TELEVISION PROGRAM FEATURING DRAMATIC, MUSICAL, ANIMATED, ARTISTIC AND LITERARY WORKS, IN CLASS 41 (U.S. CLS. 100, 101 AND 107).

THE MARK CONSISTS OF STANDARD CHARACTERS WITHOUT CLAIM TO ANY PARTICULAR FONT, STYLE, SIZE, OR COLOR.

PRIORITY CLAIMED UNDER SEC. 44(D) ON CANADA APPLICATION NO. 1203158, FILED 1-12-2004, REG. NO. TMA712853, DATED 4-25-2008, EXPIRES 4-25-2023.

OWNER OF U.S. REG. NOS. 1,413,702 AND 1,472,660.

NO CLAIM IS MADE TO THE EXCLUSIVE RIGHT TO USE "TELEVISION NETWORK", APART FROM THE MARK AS SHOWN.

SEC. 2(F) AS TO "SECOND CITY".

SER. NO. 78-391,685, FILED 3-26-2004.

REBECCA POVARCHUK, EXAMINING ATTORNEY

Int. Cls.: 18, 20 and 25

Prior U.S. Cls.: 1, 2, 3, 13, 22, 25, 32, 39, 41 and 50

United States Patent and Trademark Office

Reg. No. 3,520,615

Registered Oct. 21, 2008

**TRADEMARK
PRINCIPAL REGISTER**



LABRADOR RETRIEVER CO., LTD. (JAPAN CORPORATION)
23-26 SHIBUYA 1-CHOME, SHIBUYA-KU
TOKYO, JAPAN

FOR: TRAVELING BAGS OF LEATHER AND IMITATION LEATHER, ALL PURPOSE SPORTS BAGS, ATHLETIC BAGS, GARMENT BAGS FOR TRAVEL, VALISES, BRIEFCASES, POUCHES OF LEATHER AND IMITATION LEATHER, DRAW-STRING POUCHES, GOLF SHOE BAGS FOR TRAVEL AND CARRYING CASES, BACKPACKS, HANDBAGS, SHOULDER BAGS, SHOPPING BAGS OF LEATHER AND IMITATION LEATHER, TOTE BAGS, BEACH BAGS, SCHOOL SATCHELS, PURSES, WALLETS, BUSINESS CARD CASES, CREDIT CARD CASES; CLOTHING FOR PETS; PET ACCESSORIES, NAMELY, LEADS AND COLLARS, HARNESSSES FOR ANIMALS; UMBRELLAS, PARASOLS, IN CLASS 18 (U.S. CLS. 1, 2, 3, 22 AND 41).

FOR: NON-METAL COMMUTATION-TICKLET HOLDERS, IN CLASS 20 (U.S. CLS. 2, 13, 22, 25, 32 AND 50).

FOR: SHIRTS, TEE-SHIRTS, POLO SHIRTS, BLOUSES, TANK TOPS, CAMISOLES, SWEAT-

SHIRTS, PULLOVERS, VESTS, SWEATERS, CARDIGANS, JACKETS, DRESSES, PARKAS, COATS, PANTS, SWEATPANTS, OVERALLS, ROMPERS, CREEPERS, TROUSERS, SHORTS, SKIRTS, UNDERWEAR, PAJAMAS, SOCKS, BABY BIBS NOT OF PAPER, APRONS, MUFFLERS, BANDANNAS, GLOVES; HATS, CAPS, SUN VISORS; BELTS; SNEAKERS, SANDALS, SLIPPERS, IN CLASS 25 (U.S. CLS. 22 AND 39).

PRIORITY CLAIMED UNDER SEC. 44(D) ON JAPAN APPLICATION NO. 2004-20621, FILED 3-5-2004, REG. NO. 4841269, DATED 2-25-2005, EXPIRES 2-25-2015.

OWNER OF JAPAN REG. NO. 4366969, DATED 3-10-2000, EXPIRES 3-10-2010.

THE MARK CONSISTS OF A SILHOUETTE OF THE BACK VIEW OF A SITTING DOG.

SER. NO. 78-404,723, FILED 4-20-2004.

ALEXANDER L. POWERS, EXAMINING ATTORNEY

Int. Cl.: 1

Prior U.S. Cls.: 1, 5, 6, 10, 26 and 46

Reg. No. 3,520,616

United States Patent and Trademark Office

Registered Oct. 21, 2008

**TRADEMARK
PRINCIPAL REGISTER**

BUILDER'S CHOICE

THE GLIDDEN COMPANY (DELAWARE CORPORATION)

15885 W. SPRAGUE ROAD
STRONGSVILLE, OH 44136

FOR: CONSTRUCTION ADHESIVES, IN CLASS 1
(U.S. CLS. 1, 5, 6, 10, 26 AND 46).

FIRST USE 12-31-1996; IN COMMERCE 12-31-1996.

THE MARK CONSISTS OF STANDARD CHARACTERS WITHOUT CLAIM TO ANY PARTICULAR FONT, STYLE, SIZE, OR COLOR.

NO CLAIM IS MADE TO THE EXCLUSIVE RIGHT TO USE "BUILDER'S", APART FROM THE MARK AS SHOWN.

SER. NO. 78-406,509, FILED 4-22-2004.

ANNE FARRELL, EXAMINING ATTORNEY

Int. Cl.: 1

Prior U.S. Cls.: 1, 5, 6, 10, 26 and 46

Reg. No. 3,520,617

United States Patent and Trademark Office

Registered Oct. 21, 2008

**TRADEMARK
PRINCIPAL REGISTER**

LIMIT

FMC CORPORATION (DELAWARE CORPORATION)
1735 MARKET STREET
PHILADELPHIA, PA 19103

THE MARK CONSISTS OF STANDARD CHARACTERS WITHOUT CLAIM TO ANY PARTICULAR FONT, STYLE, SIZE, OR COLOR.

FOR: DESICCANTS, NAMELY, DRYING AGENTS FOR GENERAL INDUSTRIAL USE, IN CLASS 1 (U.S. CLS. 1, 5, 6, 10, 26 AND 46).

SER. NO. 78-422,941, FILED 5-21-2004.

FIRST USE 8-16-1994; IN COMMERCE 8-16-1994.

CAROLYN CATALDO, EXAMINING ATTORNEY

Int. Cl.: 6

Prior U.S. Cls.: 2, 12, 13, 14, 23, 25 and 50

Reg. No. 3,520,618

United States Patent and Trademark Office

Registered Oct. 21, 2008

**TRADEMARK
PRINCIPAL REGISTER**



COMPANHIA SIDERÚRGICA NACIONAL (BRAZIL JOINT STOCK COMPANY)
RUA LAURO MULLER NO 116, 36TH FLOOR, SUITE 3402, BOTAFOGO;
RIO DE JANEIRO, BRAZIL

FOR: METAL PLATES AND SHEETS, NAMELY, HOT ROLLED STEEL PLATES, COLD ROLLED STEEL PLATES, GALVANIZED LAMINATE STEEL PLATES; STEEL SHEETS; TIN PLATES AND SHEETS, IN CLASS 6 (U.S. CLS. 2, 12, 13, 14, 23, 25 AND 50).

PRIORITY CLAIMED UNDER SEC. 44(D) ON BRAZIL APPLICATION NO. 826753582, FILED 7-22-

2004, REG. NO. 826.753.582, DATED 10-2-2007, EXPIRES 10-2-2017.

THE MARK CONSISTS OF THE WORDING "CSN GALVASUD" TOGETHER WITH A HEXAGONAL DESIGN, A LINE ABOVE AND BELOW "CSN" AND TWO LINES ACROSS THE HEXAGONAL DESIGN.

THE WORDING "GALVASUD" HAS NO MEANING IN A FOREIGN LANGUAGE.

SER. NO. 78-456,085, FILED 7-23-2004.

LINDA ESTRADA, EXAMINING ATTORNEY

Int. Cl.: 45

Prior U.S. Cls.: 100 and 101

United States Patent and Trademark Office

Reg. No. 3,520,619

Registered Oct. 21, 2008

**SERVICE MARK
PRINCIPAL REGISTER**



JEWISHAMERICANSINGLES.COM (MICHIGAN CORPORATION)
P.O. BOX 279
BIRMINGHAM, MI 480120279

NO CLAIM IS MADE TO THE EXCLUSIVE RIGHT TO USE "JEWISHAMERICANSINGLE-S.COM", APART FROM THE MARK AS SHOWN.

FOR: ON LINE DATING AND SOCIAL NETWORKING SERVICES, IN CLASS 45 (U.S. CLS. 100 AND 101).

SER. NO. 78-460,372, FILED 8-2-2004.

FIRST USE 7-1-2004; IN COMMERCE 7-1-2004.

JOHN WILKE, EXAMINING ATTORNEY

Int. Cls.: 29 and 30

Prior U.S. Cl.: 46

United States Patent and Trademark Office

Reg. No. 3,520,620

Registered Oct. 21, 2008

TRADEMARK
PRINCIPAL REGISTER



MYOJO SHOKUHIN KABUSHIKI KAISHA (JAPAN CORPORATION), TA MYOJO FOODS CO., LTD.
50-11, SENDAGAYA 3-CHOME, SHIBUYA-KU
TOKYO, JAPAN

FOR: POTATO CHIPS; SOUP FOR CHINESE NOODLE; SOUP FOR UDON NOODLES; SOUP FOR SOBA NOODLES, IN CLASS 29 (U.S. CL. 46).

FOR: TEA; CHINESE NOODLE SNACKS; POP-CORN; JAPANESE CONFECTIONERY, NAMELY, SWEET RED BEAN SOUP WITH POUNDED RICE CAKE KNOWN AS SHIRUKO, INSTANT SHIRUKO, SWEET SOUP OF RED BEAN FLOUR WITH POUNDED RICE CAKE KNOWN AS ZENZAI, POWDERED ZENZAI; WESTERN-STYLE CONFECTIONERY, NAMELY, ICE CREAM, CAKE, CASTELLA CAKE, SHIP BISCUITS KNOWN AS PILOT BREAD, SHERBETS, SORBETS, SPONGE CAKE, PIES, CHINESE FOOD FLAVOR NOODLE SNACKS, JAPANESE FOOD FLAVOR NOODLE SNACKS, TORTILLA CHIPS; SAUCES FOR FRIED CHINESE NOODLES; SOBA-TSUYU; MAYONNAISE; SALAD DRESSINGS; OTHER SEASONINGS, NAMELY FERMENTED SOYBEAN PASTE CALLED MISO, WORCESTERSHIRE SAUCE, MEAT GRAVIES, KETCHUP, SOY SAUCE, VINEGAR, VINEGAR MIXES, DIPPING SOUP FOR SOBA NOODLE, CALLED SOBA-TSUYU, SALAD DRESSINGS, WHITE SAUCE, MAYONNAISE, SAUCES FOR BARBECUED MEAT, FRUCTOSE FOR FOOD, SUGAR, MALTOSE FOR FOOD, GLUCOSE FOR FOOD, STARCH SYRUP FOR FOOD, TABLE SALT MIXED WITH SESAME SEEDS, COOKING SALT, ROASTED AND GROUND SESAME SEEDS, CELERY SALT, CHEMICAL SEASONINGS NAMELY MONOSO-

DIUM GLUTAMATE; PEPPER FOR CHINESE NOODLES; MUSTARD AND OTHER SPICES, NAMELY MUSTARD POWDER, CURRY POWDER, PEPPER POWDER, JAPANESE PEPPER POWDER SPICE KNOWN AS SANSHO POWDER, CLOVE POWDER, HOT PEPPER POWDER, CINNAMON POWDER, JAPANESE HORSERADISH POWDER SPICE KNOWN AS WASABI POWDER; INSTANT ICE CREAM MIXES; INSTANT SHERBET MIXES; UDON NOODLES, UNCOOKED; FRIED CHINESE NOODLES, UNCOOKED; SOBA NOODLES, UNCOOKED; CHINESE NOODLES, UNCOOKED; INSTANT OR PRECOOKED UDON NOODLES; INSTANT OR PRECOOKED FRIED CHINESE NOODLES; INSTANT OR PRECOOKED SOBA NOODLES; INSTANT OR PRECOOKED CHINESE NOODLES; SPAGHETTI, UNCOOKED; PASTA, UNCOOKED; INSTANT OR PRECOOKED SPAGHETTI; MACARONI, UNCOOKED; PASTA-WRAPPINGS FOR CHINESE STUFFED DUMPLINGS, GYOZA; WON-TON; BEAN-STARCH NOODLES, HARUSAME UNCOOKED; CHINESE RICE NOODLES, BIFUN UNCOOKED; POUNDED RICE CAKES, MOCHI; DRIED COOKED-RICE; CANNED COOKED RICE; PROCESSED CEREALS EXCLUDING BREAKFAST CEREALS AND CEREAL-BASED SNACK FOOD BARS; COOKED CHINESE NOODLES; COOKED UDON NOODLES; COOKED WON-TON; COOKED BEAN-STARCH NOODLES, HARUSAME; COOKED CHINESE RICE NOODLES BIFUN; COOKED SOBA NOODLES; COOKED FRIED CHINESE NOODLES; COOKED SPAGHETTI; COOKED PASTA; CHINESE STUFFED DUMPLINGS, GYOZA; CHINESE STEAMED DUMPLINGS, SHUMAI; SANDWICHES; BOX LUNCHESES, NAMELY, READY-MADE BOX LUNCH SET CONSISTING

PRIMARILY OF BOILED RICE; STEAMED BUNS STUFFED WITH MINCED MEAT, CHINESE MEAT BUNS; PIZZAS; RAVIOLI; SUSHI; RICE; PROCESSED HUSKED OATS AND BARLEY; GLUTEN FOR FOOD; FRIED BALLS OF BATTER MIX WITH SMALL PIECES OF OCTOPUS, TAKOYAKI, NOODLES; WRAPPERS FOR SPRING ROLLS; WRAPPERS FOR WON TON; WRAPPERS FOR CHINESE STEAMED DUMPLINGS; SHUMAI; WRAPPERS FOR JIAOZI (GYOZA), IN CLASS 30 (U.S. CL. 46).

PRIORITY CLAIMED UNDER SEC. 44(D) ON JAPAN APPLICATION NO. 200422983, FILED 3-11-2004, REG. NO. 4826515, DATED 12-17-2004, EXPIRES 12-17-2014.

THE MARK CONSISTS OF THE WORD MYOJO IN ENGLISH AND IN CHINESE CHARACTERS WITH LINE APPEARING BETWEEN; THE REPRESENTATION OF A CHICKEN ALL IN A THREE LINE STYLE.

THE FOREIGN WORDING IN THE MARK TRANSLATES INTO ENGLISH AS A BRIGHT STAR.

THE NON-LATIN CHARACTER(S) IN THE MARK TRANSLITERATES INTO MYOJO, AND THIS MEANS A BRIGHT STAR IN ENGLISH.

SER. NO. 78-477,472, FILED 9-1-2004.

ADA HAN, EXAMINING ATTORNEY

Int. Cl.: 26

Prior U.S. Cls.: 37, 39, 40, 42 and 50

Reg. No. 3,520,621

United States Patent and Trademark Office

Registered Oct. 21, 2008

TRADEMARK
PRINCIPAL REGISTER

The logo for 'Aritzia' is written in a large, elegant, black cursive script. The letter 'A' is particularly large and features a decorative flourish. The 'i's have small dots, and the overall style is classic and sophisticated.

ARITZIA, LP (CANADA LIMITED PARTNER-
SHIP)
NO. 327 - 611 ALEXANDER STREET
VANCOUVER, B.C., CANADA V6A 1E1

PRIORITY CLAIMED UNDER SEC. 44(D) ON
CANADA APPLICATION NO. 1209743, FILED 3-15-
2004, REG. NO. TMA677883, DATED 11-29-2006, EX-
PIRES 11-29-2021.

FOR: HAIR ORNAMENTS, NAMELY, HAIR
BANDS, HAIR BARRETTES, HAIR CLIPS, HAIR
PINS, HAIR RUFFLES, FABRIC BOWS, IN CLASS 26
(U.S. CLS. 37, 39, 40, 42 AND 50).

SER. NO. 78-484,367, FILED 9-15-2004.

SALLY SHIH, EXAMINING ATTORNEY

Int. Cl.: 25

Prior U.S. Cls.: 22 and 39

United States Patent and Trademark Office

Reg. No. 3,520,622

Registered Oct. 21, 2008

TRADEMARK
PRINCIPAL REGISTER

the myth of. Jade

J & N SALES, LLC (CONNECTICUT LIMITED
LIABILITY COMPANY)
76 LASALLE ROAD
WEST HARTFORD, CT 06107

FOR: WOMEN'S AND CHILDREN'S APPAREL
AND ACCESSORIES, NAMELY, JEANS, PANTS,
SKIRTS, SHORTS, T-SHIRTS, SWEATSHIRTS, KNIT

TOPS, SHIRTS, SWEATERS, IN CLASS 25 (U.S. CLS.
22 AND 39).

FIRST USE 8-18-2004; IN COMMERCE 8-18-2004.

SER. NO. 78-484,882, FILED 9-16-2004.

DANIEL BRODY, EXAMINING ATTORNEY

Int. Cl.: 25

Prior U.S. Cls.: 22 and 39

United States Patent and Trademark Office

Reg. No. 3,520,623

Registered Oct. 21, 2008

TRADEMARK
PRINCIPAL REGISTER



WARRIOR SPORTS, INC. (MICHIGAN CORPORATION)
32125 HOLLINGSWORTH AVE.
WARREN, MI 48092

FOR: CLOTHING, NAMELY, TEE SHIRTS, SWEATSHIRTS, SHORTS, COLLARED SHIRTS, JERSEYS, HATS AND FOOTWEAR; MOISTURE MANAGEMENT GARMENTS, NAMELY, TEE SHIRTS, SWEATSHIRTS, SHORTS, COLLARED SHIRTS, JERSEYS, HATS AND FOOTWEAR, IN CLASS 25 (U.S. CLS. 22 AND 39).

FIRST USE 6-1-1996; IN COMMERCE 6-1-1996.

THE MARK CONSISTS OF THE LETTER "W" AND THE WORD "WARRIOR" IN STYLIZED FORM.

SER. NO. 78-486,191, FILED 9-20-2004.

ALLISON HOLTZ, EXAMINING ATTORNEY

Int. Cl.: 43

Prior U.S. Cls.: 100 and 101

United States Patent and Trademark Office

Reg. No. 3,520,624

Registered Oct. 21, 2008

SERVICE MARK
PRINCIPAL REGISTER

out of Africa

KENYA NUT COMPANY LTD (KENYA CORPORATION)
P.O. BOX 28035
NAIROBI, KENYA

FOR: RESTAURANT SERVICES AND PROVISION OF TEMPORARY ACCOMMODATION, ALL OF THE FOREGOING EXCLUDING SERVICES OFFERED AT OR IN CONNECTION WITH THEME PARKS, IN CLASS 43 (U.S. CLS. 100 AND 101).

OWNER OF KENYA REG. NO. 57050, DATED 3-11-2005, EXPIRES 3-11-2012.

OWNER OF U.S. REG. NO. 2,646,397.

SER. NO. 78-489,252, FILED 9-24-2004.

ELLEN B. AWRICH, EXAMINING ATTORNEY

Int. Cls.: 14, 16 and 18

**Prior U.S. Cls.: 1, 2, 3, 5, 22, 23, 27, 28, 29, 37, 38, 41
and 50**

Reg. No. 3,520,625

United States Patent and Trademark Office

Registered Oct. 21, 2008

**TRADEMARK
PRINCIPAL REGISTER**



UNION HARBOUR LTD. (HONG KONG CORPORATION)
31/F THE CENTER, 99 QUEEN'S RD. CENTRAL
HONG KONG, HONG KONG

FOR: PRECIOUS METALS AND THEIR ALLOYS AND GOODS IN PRECIOUS METALS OR COATED THEREWITH, NOT INCLUDED IN OTHER CLASSES, NAMELY, BADGES, KEY RINGS, AND KEY BANDS; JEWELRY, PRECIOUS STONES, HOROLOGICAL AND CHRONOMETRIC INSTRUMENTS, NAMELY WATCHES AND JEWELRY, IN CLASS 14 (U.S. CLS. 2, 27, 28 AND 50).

FOR: PAPER AND PLASTIC SHOPPING BAGS, IN CLASS 16 (U.S. CLS. 2, 5, 22, 23, 29, 37, 38 AND 50).

FOR: LEATHER AND MESH SHOPPING BAGS; BRIEFCASES; BEACH BAGS; POCKET WALLETS; BAGS FOR CAMPERS; PURSES; PURSES NOT OF PRECIOUS METAL; VALISES; HANDBAGS; HUNTERS' GAME BAGS; GARMENT BAGS FOR TRAVEL; VANITY CASES NOT FITTED; TRAVELING

TRUNKS; TRAVELING BAGS; SPORT BAGS, SCHOOL BAGS, SCHOOL SACHELS, BOOK BAGS, KNAPSACKS, BACKPACKS; BAGS FOR CLIMBERS; HAVERSACKS, IN CLASS 18 (U.S. CLS. 1, 2, 3, 22 AND 41).

OWNER OF HONG KONG REG. NO. 300436662AA, DATED 6-10-2005, EXPIRES 6-10-2015.

THE MARK CONSISTS OF THREE VERTICALLY ALIGNED STYLIZED LIONS, SEPARATED BY A VERTICAL LINE FROM THE VERTICALLY ALIGNED WORDS GEORGE / GINA & / LUCY (IN WHICH THE "/" HERE INDICATES SEPARATE LINES ON WHICH THESE WORDS OCCUR IN THE VERTICAL ALIGNMENT BUT DOES NOT APPEAR IN THE ACTUAL MARK).

SER. NO. 78-554,097, FILED 1-26-2005.

JASON ROTH, EXAMINING ATTORNEY

Int. Cl.: 41

Prior U.S. Cls.: 100, 101 and 107

Reg. No. 3,520,626

United States Patent and Trademark Office

Registered Oct. 21, 2008

**SERVICE MARK
PRINCIPAL REGISTER**

THE ART EXPLORERS

THE ART EXPLORERS, INC. (ILLINOIS CORPORATION)
SUITE 923
737 N. MICHIGAN AVENUE
CHICAGO, IL 60610

FOR: EDUCATIONAL AND ENTERTAINMENT SERVICES, NAMELY, CREATING, DEVELOPING, PRODUCING AND DIRECTING EDUCATIONAL, ARTISTIC AND CULTURAL TRAVEL PROGRAMS FOR TELEVISION AND RADIO BROADCASTERS, FILM, VIDEO TAPE AND DIGITAL VIDEO DISK DISTRIBUTORS, AND FOR IN-DOOR AND OUT-DOOR PERFORMANCE PROMOTERS; EDUCATIONAL AND ENTERTAINMENT SERVICES, NAMELY, COORDINATING AND CONDUCTING EDUCATIONAL, ARTISTIC AND CULTURAL LECTURES, WORKSHOPS, AND SEMINARS FOR THE PUBLIC; EDUCATIONAL AND ENTERTAINMENT SERVICES, NAMELY, CREATING, DEVELOPING,

AND WRITING ARTICLES, COMMENTARIES, AND NOTES FOR NEWSPAPER, MAGAZINE, PERIODICAL, AND BOOK PUBLISHERS, IN CLASS 41 (U.S. CLS. 100, 101 AND 107).

FIRST USE 8-1-2001; IN COMMERCE 1-1-2002.

THE MARK CONSISTS OF STANDARD CHARACTERS WITHOUT CLAIM TO ANY PARTICULAR FONT, STYLE, SIZE, OR COLOR.

NO CLAIM IS MADE TO THE EXCLUSIVE RIGHT TO USE "ART", APART FROM THE MARK AS SHOWN.

SER. NO. 78-555,806, FILED 1-28-2005.

PAUL E. FAHRENKOPF, EXAMINING ATTORNEY

Int. Cl.: 29

Prior U.S. Cl.: 46

United States Patent and Trademark Office

Reg. No. 3,520,627

Registered Oct. 21, 2008

**TRADEMARK
PRINCIPAL REGISTER**

CHEVRELAIT BRAND

ATALANTA CORPORATION (NEW YORK CORPORATION)
1 ATALANTA PLAZA
ELIZABETH, NJ 07206

FOR: GOAT CHEESE, IN CLASS 29 (U.S. CL. 46).

FIRST USE 3-1-1997; IN COMMERCE 3-1-1997.

THE MARK CONSISTS OF STANDARD CHARACTERS WITHOUT CLAIM TO ANY PARTICULAR FONT, STYLE, SIZE, OR COLOR.

NO CLAIM IS MADE TO THE EXCLUSIVE RIGHT TO USE "BRAND", APART FROM THE MARK AS SHOWN.

THE ENGLISH TRANSLATION OF "CHEVRE" IS "GOAT," THE ENGLISH TRANSLATION OF "LAIT" IS MILK; BUT THE COMBINED WORD "CHEVRE-LAIT" HAS NO MEANING IN ENGLISH.

SER. NO. 78-580,501, FILED 3-4-2005.

DANIEL BRODY, EXAMINING ATTORNEY

Int. Cls.: 31 and 41

Prior U.S. Cls.: 1, 46, 100, 101 and 107

United States Patent and Trademark Office

Reg. No. 3,520,628

Registered Oct. 21, 2008

**TRADEMARK
SERVICE MARK
PRINCIPAL REGISTER**

**PLANTS WITH
PERSONALITY**

804935 ONTARIO LTD. (CANADA CORPORATION)
3764 JORDAN ROAD, P.O. BOX 2
JORDAN STATION, CANADA L0R 1S0

FOR: LIVE POTTED PLANTS; LIVE PLANT BULBS; FLORAL ARRANGEMENTS CONSISTING OF LIVE OR CUT FLOWERS OR LIVE PLANTS OR PLANT CUTTINGS OR COMBINATIONS THEREOF; PLANT ARRANGEMENTS CONSISTING OF LIVE OR CUT FLOWERS OR LIVE PLANTS OR PLANT CUTTINGS OR COMBINATIONS THEREOF; CUT FLOWERS, IN CLASS 31 (U.S. CLS. 1 AND 46).

FOR: EDUCATIONAL SERVICES, NAMELY, CONDUCTING ON-LINE EXHIBITIONS AND DISPLAYS AND INTERACTIVE EXHIBITS IN THE FIELD OF FLOWERS AND PLANTS, IN CLASS 41 (U.S. CLS. 100, 101 AND 107).

THE MARK CONSISTS OF STANDARD CHARACTERS WITHOUT CLAIM TO ANY PARTICULAR FONT, STYLE, SIZE, OR COLOR.

PRIORITY CLAIMED UNDER SEC. 44(D) ON CANADA APPLICATION NO. 1250146, FILED 3-10-2005, REG. NO. TMA709959, DATED 3-19-2008, EXPIRES 3-19-2023.

NO CLAIM IS MADE TO THE EXCLUSIVE RIGHT TO USE "PLANTS", APART FROM THE MARK AS SHOWN.

SER. NO. 78-586,428, FILED 3-14-2005.

KAPIL BHANOT, EXAMINING ATTORNEY

Int. Cl.: 3

Prior U.S. Cls.: 1, 4, 6, 50, 51 and 52

United States Patent and Trademark Office

Reg. No. 3,520,629

Registered Oct. 21, 2008

**TRADEMARK
PRINCIPAL REGISTER**

BIRTHDAY CAKE

DEMETER F.L. INC. (NEW YORK CORPORATION)
12 NORTH GATE ROAD
GREAT NECK, NY 11023

FOR: FRAGRANCE FOR PERSONAL USE, ROOM
FRAGRANCE, COLOGNE, BATH OIL, BATH GEL
AND BODY LOTION, IN CLASS 3 (U.S. CLS. 1, 4, 6,
50, 51 AND 52).

FIRST USE 0-0-2000; IN COMMERCE 0-0-2000.

THE MARK CONSISTS OF STANDARD CHARACTERS WITHOUT CLAIM TO ANY PARTICULAR FONT, STYLE, SIZE, OR COLOR.

SER. NO. 78-593,649, FILED 3-23-2005.

JENNIFER MARTIN, EXAMINING ATTORNEY

Int. Cl.: 35

Prior U.S. Cls.: 100, 101 and 102

United States Patent and Trademark Office

Reg. No. 3,520,630

Registered Oct. 21, 2008

**SERVICE MARK
PRINCIPAL REGISTER**

Lyndhurst Naturals

LYNDHURST CONSULTANCY LTD. (CANADA CORPORATION)
727 EAST 6TH STREET
NORTH VANCOUVER, BC, CANADA V7L 1R5

FOR: IMPORT OF COSMETIC AND CLEANING PRODUCTS, DISTRIBUTORSHIPS FEATURING COSMETIC AND CLEANING PRODUCTS, AND RETAIL AND WHOLESALE STORES FEATURING COSMETIC AND CLEANING PRODUCTS, IN CLASS 35 (U.S. CLS. 100, 101 AND 102).

THE MARK CONSISTS OF STANDARD CHARACTERS WITHOUT CLAIM TO ANY PARTICULAR FONT, STYLE, SIZE, OR COLOR.

PRIORITY CLAIMED UNDER SEC. 44(D) ON CANADA APPLICATION NO. 1259811, FILED 5-2-2005, REG. NO. TMA710423, DATED 3-28-2008, EXPIRES 3-28-2023.

NO CLAIM IS MADE TO THE EXCLUSIVE RIGHT TO USE "NATURALS", APART FROM THE MARK AS SHOWN.

SER. NO. 78-643,787, FILED 6-4-2005.

MICHELLE DUBOIS, EXAMINING ATTORNEY

Int. Cl.: 28

Prior U.S. Cls.: 22, 23, 38 and 50

United States Patent and Trademark Office

Reg. No. 3,520,631

Registered Oct. 21, 2008

**TRADEMARK
PRINCIPAL REGISTER**

SPARKLE THE SECRET STARFISH

MATTEL, INC. (DELAWARE CORPORATION)
333 CONTINENTAL BLVD.
M1-1518
EL SEGUNDO, CA 902455012

OWNER OF U.S. REG. NOS. 2,666,737, 2,718,115,
AND 2,738,973.

FOR: TOYS, GAMES AND PLAYTHINGS, NAME-
LY, DOLL PLAYSETS AND ACCESSORIES THERE-
FOR, IN CLASS 28 (U.S. CLS. 22, 23, 38 AND 50).

NO CLAIM IS MADE TO THE EXCLUSIVE
RIGHT TO USE "STARFISH", APART FROM THE
MARK AS SHOWN.

FIRST USE 1-23-2006; IN COMMERCE 1-23-2006.

SER. NO. 78-656,356, FILED 6-22-2005.

THE MARK CONSISTS OF STANDARD CHAR-
ACTERS WITHOUT CLAIM TO ANY PARTICULAR
FONT, STYLE, SIZE, OR COLOR.

ALEXANDER L. POWERS, EXAMINING ATTOR-
NEY

Int. Cl.: 9

Prior U.S. Cls.: 21, 23, 26, 36 and 38

Reg. No. 3,520,632

United States Patent and Trademark Office

Registered Oct. 21, 2008

**TRADEMARK
PRINCIPAL REGISTER**

Iris Records

IRIS RECORDS, LLC (COLORADO LIMITED
LIABILITY COMPANY)
5419 EVERGREEN HEIGHTS DRIVE
EVERGREEN, CO 80439

FOR: COMPACT DISCS, AUDIO CASSETTES,
PHOTOGRAPH RECORDS, AND PRERECORDED
VIDEO TAPES FEATURING MUSICAL AND VO-
CAL PERFORMANCES. , IN CLASS 9 (U.S. CLS. 21,
23, 26, 36 AND 38).

FIRST USE 5-1-2002; IN COMMERCE 5-1-2002.

THE MARK CONSISTS OF STANDARD CHAR-
ACTERS WITHOUT CLAIM TO ANY PARTICULAR
FONT, STYLE, SIZE, OR COLOR.

NO CLAIM IS MADE TO THE EXCLUSIVE
RIGHT TO USE "RECORDS", APART FROM THE
MARK AS SHOWN.

SER. NO. 78-664,955, FILED 7-6-2005.

DAWN HAN, EXAMINING ATTORNEY

Int. Cls.: 9 and 41

Prior U.S. Cls.: 21, 23, 26, 36, 38, 100, 101 and 107

Reg. No. 3,520,633

United States Patent and Trademark Office

Registered Oct. 21, 2008

**TRADEMARK
SERVICE MARK
PRINCIPAL REGISTER**

ENTREPRENEUR

ENTREPRENEUR MEDIA, INC. (CALIFORNIA CORPORATION)
2445 MCCABE WAY
IRVINE, CA 92614

FOR: PRE-RECORDED AUDIO AND VISUAL MEDIA NAMELY CDS, VIDEOTAPES, AUDIOTAPES, AND FLOPPY DISCS FEATURING PROGRAMS GEARED TO BUSINESS OWNERS AND INTERESTED MEMBERS OF THE GENERAL PUBLIC CONCERNING STARTING, OWNING AND OPERATING BUSINESSES, IN CLASS 9 (U.S. CLS. 21, 23, 26, 36 AND 38).

FIRST USE 9-0-1989; IN COMMERCE 9-0-1989.

FOR: PRODUCTION OF RADIO AND TELEVISION PROGRAMS GEARED TO BUSINESS OWNERS AND INTERESTED MEMBERS OF THE

GENERAL PUBLIC CONCERNING STARTING, OWNING AND OPERATING BUSINESSES, IN CLASS 41 (U.S. CLS. 100, 101 AND 107).

FIRST USE 11-1-1997; IN COMMERCE 11-1-1997.

THE MARK CONSISTS OF STANDARD CHARACTERS WITHOUT CLAIM TO ANY PARTICULAR FONT, STYLE, SIZE, OR COLOR.

OWNER OF U.S. REG. NOS. 1,453,968, 2,263,883, AND 2,502,032.

SEC. 2(F).

SER. NO. 78-685,136, FILED 8-3-2005.

AISHA CLARKE, EXAMINING ATTORNEY

Int. Cl.: 9

Prior U.S. Cls.: 21, 23, 26, 36 and 38

Reg. No. 3,520,634

United States Patent and Trademark Office

Registered Oct. 21, 2008

**TRADEMARK
PRINCIPAL REGISTER**

PS|Ship

LYNCH MARKS, LLC (CALIFORNIA LIMITED
LIABILITY COMPANY)
1327 SOLANO AVE.
ALBANY, CA 94706

FOR: COMPUTER SOFTWARE FOR MANAGING BUSINESS PROCESSES ASSOCIATED WITH THE SHIPMENT OF PACKAGES; COMPUTER SOFTWARE FOR GENERATING SHIPPING MANIFESTS; COMPUTER SOFTWARE FOR TRACKING SHIPMENTS; COMPUTER SOFTWARE FOR INTEGRATING SHIPPING PROCESSES WITH ELECTRONIC MAIL, GROUPWARE, AND CUSTOMER RELATIONSHIP MANAGEMENT SYSTEMS AND DATABASES; COMPUTER SOFTWARE FOR INTEGRATING SHIPPING PROCESSES WITH COST ALLOCATION AND COST RECOVERY SYSTEMS AND DATABASES; COMPUTER SOFTWARE FOR BUSINESS ACCOUNTING; COMPUTER SOFTWARE FOR PROCESSING VENDOR INVOICES;

USER MANUALS SUPPLIED AS A UNIT WITH COMPUTER SOFTWARE, IN CLASS 9 (U.S. CLS. 21, 23, 26, 36 AND 38).

FIRST USE 9-30-2002; IN COMMERCE 9-30-2002.

NO CLAIM IS MADE TO THE EXCLUSIVE RIGHT TO USE SHIP, APART FROM THE MARK AS SHOWN.

THE MARK CONSISTS OF THE WORDING PS AND SHIP SEPARATED BY A "PIPE" OR "VERTICAL BAR" CHARACTER.

SER. NO. 78-688,156, FILED 8-8-2005.

JENNIFER VASQUEZ, EXAMINING ATTORNEY

Int. Cl.: 9

Prior U.S. Cls.: 21, 23, 26, 36 and 38

Reg. No. 3,520,635

United States Patent and Trademark Office

Registered Oct. 21, 2008

**TRADEMARK
PRINCIPAL REGISTER**

The logo consists of the letters 'PS' in a bold, sans-serif font, followed by a stylized cube icon, and then the letters 'SHIP' in the same bold, sans-serif font. The cube icon is a 3D wireframe representation of a cube, positioned between the 'S' and 'H'.

LYNCH MARKS, LLC (CALIFORNIA LIMITED
LIABILITY COMPANY)
1327 SOLANO AVE.
ALBANY, CA 94706

FOR: COMPUTER SOFTWARE FOR MANAGING BUSINESS PROCESSES ASSOCIATED WITH THE SHIPMENT OF PACKAGES; COMPUTER SOFTWARE FOR GENERATING SHIPPING MANIFESTS; COMPUTER SOFTWARE FOR TRACKING SHIPMENTS; COMPUTER SOFTWARE FOR INTEGRATING SHIPPING PROCESSES WITH ELECTRONIC MAIL, GROUPWARE, AND CUSTOMER RELATIONSHIP MANAGEMENT SYSTEMS AND DATABASES; COMPUTER SOFTWARE FOR INTEGRATING SHIPPING PROCESSES WITH COST ALLOCATION AND COST RECOVERY SYSTEMS AND DATABASES; COMPUTER SOFTWARE FOR BUSINESS ACCOUNTING; COMPUTER SOFT-

WARE FOR PROCESSING VENDOR INVOICES; USER MANUALS SUPPLIED AS A UNIT WITH COMPUTER SOFTWARE, IN CLASS 9 (U.S. CLS. 21, 23, 26, 36 AND 38).

FIRST USE 9-30-2002; IN COMMERCE 9-30-2002.

NO CLAIM IS MADE TO THE EXCLUSIVE RIGHT TO USE SHIP, APART FROM THE MARK AS SHOWN.

THE MARK CONSISTS OF THE WORDING PS AND SHIP SEPARATED BY A DESIGN OF A CUBE.

SER. NO. 78-688,160, FILED 8-8-2005.

JENNIFER VASQUEZ, EXAMINING ATTORNEY

Int. Cl.: 22

Prior U.S. Cls.: 1, 2, 7, 19, 22, 42 and 50

United States Patent and Trademark Office

Reg. No. 3,520,636

Registered Oct. 21, 2008

**TRADEMARK
PRINCIPAL REGISTER**

TRILOGY

FIESTA TENTS LTD. (CANADA CORPORATION)

1575, 50TH AVENUE

LACHINE, QUEBEC, CANADA H8T 3C8

FOR: TENTS, CLEAR SPAN FRAME TENTS,
FRAME TENTS WITH SUPPORTS AND MAR-
QUEES, ALL FOR COMMERCIAL USE AND NOT
FOR CAMPING, IN CLASS 22 (U.S. CLS. 1, 2, 7, 19, 22,
42 AND 50).

THE MARK CONSISTS OF STANDARD CHAR-
ACTERS WITHOUT CLAIM TO ANY PARTICULAR
FONT, STYLE, SIZE, OR COLOR.

PRIORITY CLAIMED UNDER SEC. 44(D) ON
CANADA APPLICATION NO. 1269619, FILED 8-23-
2005, REG. NO. TMA708451, DATED 2-28-2008, EX-
PIRES 2-28-2023.

SER. NO. 78-700,211, FILED 8-25-2005.

DAVID YONTEF, EXAMINING ATTORNEY

Int. Cl.: 32

Prior U.S. Cls.: 45, 46 and 48

United States Patent and Trademark Office

Reg. No. 3,520,637

Registered Oct. 21, 2008

**TRADEMARK
PRINCIPAL REGISTER**

CHAMPION NUTRITION

CHAMPION PERFORMANCE PRODUCTS, INC.
(CALIFORNIA CORPORATION), DBA CHAM-
PION NUTRITION
2615 STANWELL DR.
CONCORD, CA 94520

OWNER OF U.S. REG. NOS. 1,963,221 AND
2,647,807.

FOR: POWDER DRINK MIXES FOR THE PRE-
PARATION OF SPORTS DRINKS, IN CLASS 32 (U.S.
CLS. 45, 46 AND 48).

NO CLAIM IS MADE TO THE EXCLUSIVE
RIGHT TO USE "NUTRITION", APART FROM
THE MARK AS SHOWN.

FIRST USE 12-31-1992; IN COMMERCE 12-31-1992.

SER. NO. 78-704,777, FILED 8-31-2005.

THE MARK CONSISTS OF STANDARD CHAR-
ACTERS WITHOUT CLAIM TO ANY PARTICULAR
FONT, STYLE, SIZE, OR COLOR.

JOHN GARTNER, EXAMINING ATTORNEY

Int. Cls.: 35, 38 and 41

Prior U.S. Cls.: 100, 101, 102, 104 and 107

United States Patent and Trademark Office

Reg. No. 3,520,638

Registered Oct. 21, 2008

**SERVICE MARK
PRINCIPAL REGISTER**

AMERICAN MUSIC CHANNEL

J-KOM MEDIA GROUP, INC. (TENNESSEE CORPORATION)
1616 WEST GATE CIRCLE
BRENTWOOD, TN 37027

FOR: ON-LINE RETAIL STORE SERVICES IN THE GENRE OF COUNTRY, BLUEGRASS, AMERICANA, AND CONTEMPORARY CHRISTIAN MUSIC FEATURING DOWNLOADABLE PRERECORDED MUSIC AND VIDEOS, RECORDS, COMPACT DISCS, TAPES, DVDS AND VIDEO-TAPES, IN CLASS 35 (U.S. CLS. 100, 101 AND 102).

FIRST USE 4-1-2000; IN COMMERCE 4-1-2000.

FOR: COMMUNICATION SERVICES, NAMELY, TRANSMITTING STREAMED SOUND AND AUDIO-VISUAL RECORDINGS VIA THE INTERNET, IN CLASS 38 (U.S. CLS. 100, 101 AND 104).

FIRST USE 4-1-2000; IN COMMERCE 4-1-2000.

FOR: ON-LINE ENTERTAINMENT SERVICES, NAMELY, PROVIDING PRERECORDED MUSIC, INFORMATION IN THE FIELD OF COUNTRY, BLUEGRASS, AMERICANA, AND CONTEMPORARY CHRISTIAN MUSIC, AND COMMENTARY AND ARTICLES ABOUT COUNTRY, BLUEGRASS,

AMERICANA, AND CONTEMPORARY CHRISTIAN MUSIC, VIA A GLOBAL COMPUTER NETWORK; PROVIDING NEWSLETTERS IN THE FIELD OF COUNTRY, BLUEGRASS, AMERICANA, AND CONTEMPORARY CHRISTIAN MUSIC VIA E-MAIL; ON-LINE ENTERTAINMENT SERVICES, NAMELY, PROVIDING TELEVISION PROGRAMMING AND PRODUCTION SERVICES VIA A GLOBAL COMPUTER NETWORK, IN CLASS 41 (U.S. CLS. 100, 101 AND 107).

FIRST USE 4-1-2000; IN COMMERCE 4-1-2000.

THE MARK CONSISTS OF STANDARD CHARACTERS WITHOUT CLAIM TO ANY PARTICULAR FONT, STYLE, SIZE, OR COLOR.

NO CLAIM IS MADE TO THE EXCLUSIVE RIGHT TO USE "MUSIC", APART FROM THE MARK AS SHOWN.

SEC. 2(F).

SER. NO. 78-705,546, FILED 9-1-2005.

BONNIE LUKEN, EXAMINING ATTORNEY

Int. Cl.: 36

Prior U.S. Cls.: 100, 101 and 102

United States Patent and Trademark Office

Reg. No. 3,520,639

Registered Oct. 21, 2008

**SERVICE MARK
PRINCIPAL REGISTER**

LIFETIME INCOME ADVANTAGE

LIFE INSURANCE COMPANY OF THE SOUTH-
WEST (TEXAS CORPORATION)
1300 WEST MOCKINGBIRD LANE
DALLAS, TX 75247

FOR: FINANCIAL SERVICES, NAMELY, FINAN-
CIAL PLANNING FOR RETIREMENT; PROVIDING
FINANCIAL INFORMATION IN THE FIELD OF
RETIREMENT PLANNING; INVESTMENT MAN-
AGEMENT IN THE FIELD OF ANNUITIES, IN
CLASS 36 (U.S. CLS. 100, 101 AND 102).

FIRST USE 6-5-2005; IN COMMERCE 6-5-2005.

THE MARK CONSISTS OF STANDARD CHAR-
ACTERS WITHOUT CLAIM TO ANY PARTICULAR
FONT, STYLE, SIZE, OR COLOR.

NO CLAIM IS MADE TO THE EXCLUSIVE
RIGHT TO USE "LIFETIME INCOME", APART
FROM THE MARK AS SHOWN.

SER. NO. 78-726,120, FILED 10-4-2005.

KATHERINE CONNOLLY, EXAMINING ATTOR-
NEY

Int. Cl.: 16

Prior U.S. Cls.: 2, 5, 22, 23, 29, 37, 38 and 50

United States Patent and Trademark Office

Reg. No. 3,520,640

Registered Oct. 21, 2008

**TRADEMARK
PRINCIPAL REGISTER**

FOLSOM ELDORADOHILLS STYLE

SIERRASTYLE PUBLISHING, INC., (CALIFORNIA CORPORATION)

6611 FOLSOM-AUBURN RD. STE. F

FOLSOM, CA 95630

FOR: GENERAL FEATURE MAGAZINES; MAGAZINES FEATURING LUXURY BUSINESSES, ITEMS AND SERVICES, IN CLASS 16 (U.S. CLS. 2, 5, 22, 23, 29, 37, 38 AND 50).

FIRST USE 4-10-2005; IN COMMERCE 4-15-2005.

THE MARK CONSISTS OF STANDARD CHARACTERS WITHOUT CLAIM TO ANY PARTICULAR FONT, STYLE, SIZE, OR COLOR.

OWNER OF U.S. REG. NO. 2,943,027.

NO CLAIM IS MADE TO THE EXCLUSIVE RIGHT TO USE "FOLSOM EL DORADO HILLS", APART FROM THE MARK AS SHOWN.

SER. NO. 78-727,017, FILED 10-5-2005.

BARBARA GAYNOR, EXAMINING ATTORNEY

Int. Cl.: 35

Prior U.S. Cls.: 100, 101 and 102

United States Patent and Trademark Office

Reg. No. 3,520,641

Registered Oct. 21, 2008

**SERVICE MARK
PRINCIPAL REGISTER**

TEEN READ WEEK

AMERICAN LIBRARY ASSOCIATION (MASSACHUSETTS NON-PROFIT CORPORATION)
50 EAST HURON
CHICAGO, IL 606112795

FOR: ASSOCIATION SERVICES, NAMELY PROMOTING READING AND LITERACY AMONG TEENS, IN CLASS 35 (U.S. CLS. 100, 101 AND 102).

FIRST USE 10-1-1999; IN COMMERCE 10-1-1999.

THE MARK CONSISTS OF STANDARD CHARACTERS WITHOUT CLAIM TO ANY PARTICULAR FONT, STYLE, SIZE, OR COLOR.

OWNER OF U.S. REG. NO. 2,426,661.

NO CLAIM IS MADE TO THE EXCLUSIVE RIGHT TO USE "WEEK", APART FROM THE MARK AS SHOWN.

SEC. 2(F).

SER. NO. 78-727,713, FILED 10-6-2005.

DORITT L. CARROLL, EXAMINING ATTORNEY

Int. Cl.: 30

Prior U.S. Cl.: 46

United States Patent and Trademark Office

Reg. No. 3,520,642

Registered Oct. 21, 2008

**TRADEMARK
PRINCIPAL REGISTER**

Moose Muffins

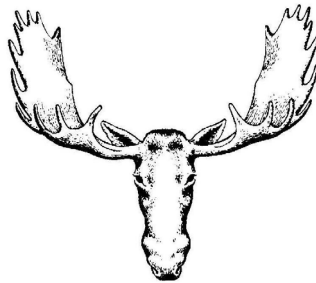

SOUTHINGTON RECORDS, INC. (OHIO CORPORATION)
3280 WARREN-BURTON RD.
SOUTHINGTON, OH 44470

THE STIPLING IS FOR SHADING PURPOSES ONLY.

FOR: BAKERY DESSERTS; BAKERY GOODS; BAKERY PRODUCTS; BAKERY PRODUCTS, NAMELY, SWEET BAKERY GOODS; MIXES FOR BAKERY GOODS, IN CLASS 30 (U.S. CL. 46).

THE MARK CONSISTS OF A LINE DRAWING OF A MOOSE'S HEAD, AND THE STYLIZED WORDS "MOOSE MUFFINS".

FIRST USE 10-1-2005; IN COMMERCE 10-1-2005.

SER. NO. 78-745,234, FILED 11-2-2005.

NO CLAIM IS MADE TO THE EXCLUSIVE RIGHT TO USE "MUFFINS", APART FROM THE MARK AS SHOWN.

STEPHEN AQUILA, EXAMINING ATTORNEY

Int. Cls.: 16, 35 and 41

**Prior U.S. Cls.: 2, 5, 22, 23, 29, 37, 38, 50, 100, 101, 102
and 107**

Reg. No. 3,520,643

United States Patent and Trademark Office

Registered Oct. 21, 2008

**TRADEMARK
SERVICE MARK
PRINCIPAL REGISTER**

THE ART OF PERFECTION

MOLEIRO, MANUEL (SPAIN INDIVIDUAL)
TRAVESERA DE GRACIA, 17, 6-2
08021 BARCELONA, SPAIN

FOR: BOOKS IN THE FIELD OF ART, HISTORY, RELIGION, ALCHEMY AND/OR BIBLIOPHILY; MANUSCRIPT BOOKS, NON-FICTION AND/OR FICTION BOOKS AND/OR PRINTS AND/OR CALENDARS AND/OR CHARTS ON ART, HISTORY, RELIGION, ALCHEMY AND/OR BIBLIOPHILY; POSTCARDS; CARDBOARD; NOVELS; BIBLES; PRAYER BOOKS; PORTRAITS; PARCHMENT PAPER; BOOK BINDINGS; PRINTED ART REPRODUCTIONS; PAPER; PAINTINGS; MAGAZINES IN THE FIELD OF ART, HISTORY, RELIGION, ALCHEMY AND/OR BIBLIOPHILY; ENGRAVINGS AND THEIR REPRODUCTIONS, GRAPHIC ART REPRODUCTIONS; PAINTINGS AND THEIR REPRODUCTIONS AND/OR REPRODUCTION PAPER IN THE FIELD OF ART, HISTORY, RELIGION, ALCHEMY AND/OR BIBLIOPHILY, IN CLASS 16 (U.S. CLS. 2, 5, 22, 23, 29, 37, 38 AND 50).

FIRST USE 10-21-2004; IN COMMERCE 10-21-2004.

FOR: ADVERTISING AND ADVERTISEMENT SERVICES; COMMERCIAL MANAGEMENT; PUBLICATION OF PUBLICITY TEXTS; PUBLICATION OF ADVERTISING TEXTS; PROMOTING THE GOODS AND SERVICES OF OTHERS BY MEANS OF OPERATING AN ON-LINE SHOPPING MALL; BUSINESS INTERMEDIARY AND ADVISORY SERVICES IN THE FIELD OF SELLING PRODUCTS AND RENDERING SERVICES; EXPORT AND IM-

PORT AGENCIES; ADMINISTRATION OF CULTURAL AND EDUCATIONAL EXCHANGE PROGRAMS; PRODUCT MERCHANDISING; ELECTRONIC RETAILING SERVICES VIA COMPUTER FEATURING PRINTED PRODUCTS, NAMELY, BOOKS, CHARTS, MAPS, AND SCULPTURES; DOCUMENT REPRODUCTION, IN CLASS 35 (U.S. CLS. 100, 101 AND 102).

FIRST USE 10-21-2004; IN COMMERCE 10-21-2004.

FOR: MAGAZINE PUBLISHING; PUBLICATION OF BOOKS, OF MAGAZINES, OF JOURNALS, OF NEWSPAPERS, OF PERIODICALS, OF CATALOGS, OF BROCHURES, OF TEXTS, OF ALMANACS AND JOURNALS AND ORGANIZING EXHIBITIONS ON ART, HISTORY, RELIGION, ALCHEMY AND/OR BIBLIOPHILY; EDUCATIONAL AND ENTERTAINMENT SERVICES, NAMELY, PROVIDING MOTIVATIONAL AND EDUCATIONAL SPEAKERS IN THE FIELD OF ART, HISTORY, RELIGION, ALCHEMY AND/OR BIBLIOPHILY, IN CLASS 41 (U.S. CLS. 100, 101 AND 107).

FIRST USE 10-21-2004; IN COMMERCE 10-21-2004.

THE MARK CONSISTS OF STANDARD CHARACTERS WITHOUT CLAIM TO ANY PARTICULAR FONT, STYLE, SIZE, OR COLOR.

SER. NO. 78-755,994, FILED 11-17-2005.

ROBIN CHOSID, EXAMINING ATTORNEY

Int. Cls.: 16, 35 and 41

**Prior U.S. Cls.: 2, 5, 22, 23, 29, 37, 38, 50, 100, 101, 102
and 107**

Reg. No. 3,520,644

United States Patent and Trademark Office

Registered Oct. 21, 2008

**TRADEMARK
SERVICE MARK
PRINCIPAL REGISTER**



MOLEIRO, MANUEL (SPAIN INDIVIDUAL)
TRAVESERA DE GRACIA, 17, 6-2
08021 BARCELONA, SPAIN

FOR: BOOKS IN THE FIELD OF ART, HISTORY, RELIGION, ALCHEMY AND/OR BIBLIOPHILY; MANUSCRIPT BOOKS, NON-FICTION AND/OR FICTION BOOKS AND/OR PRINTS AND/OR CALENDARS AND/OR CHARTS ON ART, HISTORY, RELIGION, ALCHEMY AND/OR BIBLIOPHILY; POSTCARDS; CARDBOARD; NOVELS; BIBLES; PRAYER BOOKS; PORTRAITS; PARCHMENT PAPER; BOOK BINDINGS; PRINTED ART REPRODUCTIONS; PAPER; PAINTINGS; MAGAZINES IN THE FIELD OF ART, HISTORY, RELIGION, ALCHEMY AND/OR BIBLIOPHILY; ENGRAVINGS AND THEIR REPRODUCTIONS, GRAPHIC ART REPRODUCTIONS; PAINTINGS AND THEIR REPRODUCTIONS AND/OR REPRODUCTION PAPER IN THE FIELD OF ART, HISTORY, RELIGION, ALCHEMY AND/OR BIBLIOPHILY, IN CLASS 16 (U.S. CLS. 2, 5, 22, 23, 29, 37, 38 AND 50).

FIRST USE 10-21-2004; IN COMMERCE 10-21-2004.

FOR: ADVERTISING AND ADVERTISEMENT SERVICES; COMMERCIAL MANAGEMENT; PUBLICATION OF PUBLICITY TEXTS; PUBLICATION OF ADVERTISING TEXTS; PROMOTING THE GOODS AND SERVICES OF OTHERS BY MEANS OF OPERATING AN ON-LINE SHOPPING MALL; BUSINESS INTERMEDIARY AND ADVISORY SERVICES IN THE FIELD OF SELLING PRODUCTS AND RENDERING SERVICES; EXPORT AND IM-

PORT AGENCIES; ADMINISTRATION OF CULTURAL AND EDUCATIONAL EXCHANGE PROGRAMS; PRODUCT MERCHANDISING; ELECTRONIC RETAILING SERVICES VIA COMPUTER FEATURING PRINTED PRODUCTS, NAMELY, BOOKS, CHARTS, MAPS, AND SCULPTURES; DOCUMENT REPRODUCTION, IN CLASS 35 (U.S. CLS. 100, 101 AND 102).

FIRST USE 10-21-2004; IN COMMERCE 10-21-2004.

FOR: MAGAZINE PUBLISHING; PUBLICATION OF BOOKS, OF MAGAZINES, OF JOURNALS, OF NEWSPAPERS, OF PERIODICALS, OF CATALOGS, OF BROCHURES, OF TEXTS, OF ALMANACS AND JOURNALS AND ORGANIZING EXHIBITIONS ON ART, HISTORY, RELIGION, ALCHEMY AND/OR BIBLIOPHILY; EDUCATIONAL AND ENTERTAINMENT SERVICES, NAMELY, PROVIDING MOTIVATIONAL AND EDUCATIONAL SPEAKERS IN THE FIELD OF ART, HISTORY, RELIGION, ALCHEMY AND/OR BIBLIOPHILY, IN CLASS 41 (U.S. CLS. 100, 101 AND 107).

FIRST USE 10-21-2004; IN COMMERCE 10-21-2004.

THE MARK CONSIST IN TWO OPPOSITE 90 DEGREES ROTATED TRIANGLES ACCOMPANIED BY TWO BALLS. IT'S AN ABSTRACT SYMBOL AND DOESN'T HAVE A PARTICULAR SENSE.

SER. NO. 78-756,053, FILED 11-17-2005.

ROBIN CHOSID, EXAMINING ATTORNEY

Int. Cl.: 42

Prior U.S. Cls.: 100 and 101

United States Patent and Trademark Office

Reg. No. 3,520,645

Registered Oct. 21, 2008

SERVICE MARK
PRINCIPAL REGISTER

LIFETREE
CLINICAL RESEARCH



Growing a Better Quality of Life

LIFETREE CLINICAL RESEARCH, L.C. (UTAH
LIMITED LIABILITY COMPANY)
3838 SOUTH 700 EAST SUITE 202
SALT LAKE CITY, UT 84106

FOR: PHARMACEUTICAL RESEARCH SERVI-
CES, IN CLASS 42 (U.S. CLS. 100 AND 101).

FIRST USE 4-30-2003; IN COMMERCE 4-30-2003.

NO CLAIM IS MADE TO THE EXCLUSIVE
RIGHT TO USE "CLINICAL RESEARCH", APART
FROM THE MARK AS SHOWN.

THE MARK CONSISTS OF A STYLIZED TREE.

SER. NO. 78-758,532, FILED 11-21-2005.

GIANCARLO CASTRO, EXAMINING ATTORNEY

Int. Cl.: 9

Prior U.S. Cls.: 21, 23, 26, 36 and 38

Reg. No. 3,520,646

United States Patent and Trademark Office

Registered Oct. 21, 2008

**TRADEMARK
PRINCIPAL REGISTER**

GLOBAL GAMING GROUP INC

GLOBAL GAMING GROUP (NEVADA CORPORATION)
3035 E. PATRICK LANE
LAS VEGAS, NV 89120

FOR: GAMBLING MACHINES; GAMING EQUIPMENT, NAMELY, SLOT MACHINES WITH OR WITHOUT VIDEO OUTPUT; GAMING MACHINES; MACHINES FOR PLAYING GAMES OF CHANCE; SLOT MACHINES, IN CLASS 9 (U.S. CLS. 21, 23, 26, 36 AND 38).

FIRST USE 7-1-2005; IN COMMERCE 7-1-2005.

THE MARK CONSISTS OF STANDARD CHARACTERS WITHOUT CLAIM TO ANY PARTICULAR FONT, STYLE, SIZE, OR COLOR.

NO CLAIM IS MADE TO THE EXCLUSIVE RIGHT TO USE "GAMING GROUP, INC.", APART FROM THE MARK AS SHOWN.

SER. NO. 78-759,866, FILED 11-22-2005.

HOWARD SMIGA, EXAMINING ATTORNEY

Int. Cl.: 21

Prior U.S. Cls.: 2, 13, 23, 29, 30, 33, 40 and 50

Reg. No. 3,520,647

United States Patent and Trademark Office

Registered Oct. 21, 2008

**TRADEMARK
PRINCIPAL REGISTER**

ETI-KITS

AMOROSO, SHARYN (UNITED STATES INDIVIDUAL)
149 WILKIE DRIVE
WALNUT CREEK, CA 94598

FIRST USE 3-1-2005; IN COMMERCE 1-9-2006.

FOR: MANUALS, PAMPHLETS, BOOKS, NOTE CARDS, REMINDER CARDS AND BOOKLETS FOR TEACHING MANNERS AND/OR ETIQUETTE, SOLD AS A COMPONENT OF PLASTIC NAPKIN HOLDERS, IN CLASS 21 (U.S. CLS. 2, 13, 23, 29, 30, 33, 40 AND 50).

THE MARK CONSISTS OF STANDARD CHARACTERS WITHOUT CLAIM TO ANY PARTICULAR FONT, STYLE, SIZE, OR COLOR.

SER. NO. 78-764,932, FILED 12-1-2005.

JOHN GARTNER, EXAMINING ATTORNEY

Int. Cl.: 38

Prior U.S. Cls.: 100, 101 and 104

United States Patent and Trademark Office

Reg. No. 3,520,648

Registered Oct. 21, 2008

**SERVICE MARK
PRINCIPAL REGISTER**



INSIGHT COMMUNICATIONS COMPANY, INC.
(DELAWARE CORPORATION)
810 SEVENTH AVENUE
NEW YORK, NY 10019

FOR: TELECOMMUNICATION SERVICES, NAMELY, ELECTRONIC TRANSMISSION OF VOICE, DATA, VIDEO AND DIGITAL SIGNALS BY MEANS OF CABLE TELEVISION TRANSMISSIONS; TWO-WAY WIRELESS TRANSMISSION OF EMAIL AND TEXT BETWEEN WIRELESS TELECOMMUNICATIONS TERMINALS AND COMPUTERS THROUGH CABLE TELEVISION; PROVIDING HIGH-SPEED ACCESS TO THE INTERNET AND PRIVATE AREA NETWORKS; PROVIDING ONLINE CHAT ROOMS AND NEWS GROUPS FOR TRANSMISSION OF MESSAGES AMONG COMPUTER USERS CONCERNING MATTERS OF GENERAL INTEREST; COMMUNICATIONS SERVICES, NAMELY, PROVIDING LOCAL AND LONG DISTANCE TELEPHONE SERVICES AND CALL MANAGEMENT SERVICES; AND TELEPHONE

CALL MANAGEMENT SERVICES VIA THE INTERNET, NAMELY, WRITTEN AND VOICE MESSAGE NOTIFICATION, RECORDING, RETRIEVAL AND FORWARDING, IN CLASS 38 (U.S. CLS. 100, 101 AND 104).

FIRST USE 11-11-2005; IN COMMERCE 11-11-2005.

OWNER OF U.S. REG. NO. 1,520,156.

NO CLAIM IS MADE TO THE EXCLUSIVE RIGHT TO USE "BUSINESS", APART FROM THE MARK AS SHOWN.

THE MARK CONSISTS OF A CLUSTER OF ELECTRIC WIRES AND THE WORDS "INSIGHT BUSINESS".

SER. NO. 78-766,488, FILED 12-5-2005.

JOHN WILKE, EXAMINING ATTORNEY

Int. Cl.: 38

Prior U.S. Cls.: 100, 101 and 104

United States Patent and Trademark Office

Reg. No. 3,520,649

Registered Oct. 21, 2008

**SERVICE MARK
PRINCIPAL REGISTER**

INSIGHT BUSINESS

INSIGHT COMMUNICATIONS COMPANY, INC.
(DELAWARE CORPORATION)
810 SEVENTH AVENUE
NEW YORK, NY 10019

FOR: TELECOMMUNICATION SERVICES, NAMELY, ELECTRONIC TRANSMISSION OF VOICE, DATA, VIDEO AND DIGITAL SIGNALS BY MEANS OF CABLE TELEVISION TRANSMISSIONS; TWO-WAY WIRELESS TRANSMISSION OF EMAIL AND TEXT BETWEEN WIRELESS TELECOMMUNICATIONS TERMINALS AND COMPUTERS THROUGH CABLE TELEVISION; PROVIDING HIGH-SPEED ACCESS TO THE INTERNET AND PRIVATE AREA NETWORKS; PROVIDING ONLINE CHAT ROOMS AND NEWS GROUPS FOR TRANSMISSION OF MESSAGES AMONG COMPUTER USERS CONCERNING MATTERS OF GENERAL INTEREST; COMMUNICATIONS SERVICES, NAMELY, PROVIDING LOCAL AND LONG DISTANCE TELEPHONE SERVICES AND CALL

MANAGEMENT SERVICES; AND TELEPHONE CALL MANAGEMENT SERVICES VIA THE INTERNET, NAMELY, WRITTEN AND VOICE MESSAGE NOTIFICATION, RECORDING, RETRIEVAL AND FORWARDING, IN CLASS 38 (U.S. CLS. 100, 101 AND 104).

FIRST USE 11-11-2005; IN COMMERCE 11-11-2005.

THE MARK CONSISTS OF STANDARD CHARACTERS WITHOUT CLAIM TO ANY PARTICULAR FONT, STYLE, SIZE, OR COLOR.

NO CLAIM IS MADE TO THE EXCLUSIVE RIGHT TO USE "BUSINESS", APART FROM THE MARK AS SHOWN.

SER. NO. 78-766,571, FILED 12-5-2005.

JOHN WILKE, EXAMINING ATTORNEY

Int. Cls.: 3, 5 and 42

Prior U.S. Cls.: 1, 4, 6, 18, 44, 46, 50, 51, 52, 100 and 101

Reg. No. 3,520,650

United States Patent and Trademark Office

Registered Oct. 21, 2008

**TRADEMARK
SERVICE MARK
PRINCIPAL REGISTER**

aRigen

ARIGEN PHARMACEUTICALS, INC. (JAPAN CORPORATION)
PLACE CANADA 3F
3-37, AKASAKA 7-CHOME, MINATO-KU
TOKYO, JAPAN

FOR: COSMETICS, IN CLASS 3 (U.S. CLS. 1, 4, 6, 50, 51 AND 52).

FOR: MEDICINES, NAMELY, ANTIPROTOZOAL PHARMACEUTICALS, ANTIVIRAL PHARMACEUTICALS, SYNTHETIC ANTIBACTERIALS, AND ANTIBIOTICS ALL FOR THE TREATMENT OF INFECTIOUS DISEASES IN HUMANS, IN CLASS 5 (U.S. CLS. 6, 18, 44, 46, 51 AND 52).

FOR: TESTING, INSPECTION OR RESEARCH OF PHARMACEUTICALS, COSMETICS OR FOODSTUFFS; RESEARCH ON BUILDING CONSTRUCTION OR CITY PLANNING; TESTING OR

RESEARCH ON PREVENTION OF POLLUTION; TESTING OR RESEARCH ON ELECTRICITY; TESTING OR RESEARCH ON CIVIL ENGINEERING; TESTING, INSPECTION OR RESEARCH ON AGRICULTURE, LIVESTOCK BREEDING OR FISHERIES; TESTING OR RESEARCH ON MACHINES, APPARATUS AND INSTRUMENTS, IN CLASS 42 (U.S. CLS. 100 AND 101).

THE MARK CONSISTS OF STANDARD CHARACTERS WITHOUT CLAIM TO ANY PARTICULAR FONT, STYLE, SIZE, OR COLOR.

OWNER OF JAPAN REG. NO. 5129189, DATED 4-18-2008, EXPIRES 4-18-2018.

SER. NO. 78-766,812, FILED 12-5-2005.

ALLISON HOLTZ, EXAMINING ATTORNEY

Int. Cl.: 43

Prior U.S. Cls.: 100 and 101

United States Patent and Trademark Office

Reg. No. 3,520,651

Registered Oct. 21, 2008

**SERVICE MARK
PRINCIPAL REGISTER**



MONTEX FINANCIAL SERVICES CORP. (CANADA CORPORATION)
18TH FLOOR, ATRIA III
2225 SHEPPARD AVENUE EAST
TORONTO, ONTARIO, CANADA M2J 5C2

FOR: PLANNING OF VACATIONS FOR INDIVIDUALS AND GROUPS, NAMELY, MAKING RESERVATIONS FOR TEMPORARY LODGING; MAKING HOTEL AND LODGING RESERVATIONS FOR OTHERS, NAMELY, THE PROVISION OF VACATION PREMISES FOR OTHERS, IN CLASS 43 (U.S. CLS. 100 AND 101).

FIRST USE 6-0-1990; IN COMMERCE 6-0-1990.

OWNER OF CANADA REG. NO. TMA706718, DATED 2-6-2008, EXPIRES 2-6-2023.

THE MARK CONSISTS OF WAVY LINES WITH THE REPRESENTATION OF THE SUN APPEARING TO THE LEFT. THE MARK IS NOT IN COLOR.

SER. NO. 78-783,141, FILED 12-30-2005.

SEAN CROWLEY, EXAMINING ATTORNEY

Int. Cl.: 9

Prior U.S. Cls.: 21, 23, 26, 36 and 38

Reg. No. 3,520,652

United States Patent and Trademark Office

Registered Oct. 21, 2008

**TRADEMARK
PRINCIPAL REGISTER**

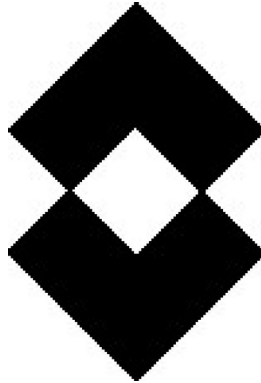

FLIR SYSTEMS, INC. (OREGON CORPORATION)
27700A SW PARKWAY AVENUE
WILSONVILLE, OR 97070

FOR: ELECTRONIC VISIONS SYSTEMS, NAME-
LY, IMAGE PROCESSORS AND CAMERAS SEN-
SING ELECTROMAGNETIC RADIATION
INCLUDING VISIBLE LIGHT, INFRARED RADIA-
TION AND OTHER THERMAL RADIATION PRI-
MARILY SOLD TO MILITARY AND LAW

ENFORCEMENT ENTITIES", IN CLASS 9 (U.S.
CLS. 21, 23, 26, 36 AND 38).

FIRST USE 1-31-1980; IN COMMERCE 1-31-1980.

OWNER OF U.S. REG. NO. 2,975,668.

SER. NO. 78-784,343, FILED 1-3-2006.

PAUL CROWLEY, EXAMINING ATTORNEY

Int. Cls.: 9 and 41

Prior U.S. Cls.: 21, 23, 26, 36, 38, 100, 101 and 107

Reg. No. 3,520,653

United States Patent and Trademark Office

Registered Oct. 21, 2008

**TRADEMARK
SERVICE MARK
PRINCIPAL REGISTER**

CATHOUSE

HOME BOX OFFICE, INC. (DELAWARE CORPORATION)
1100 AVENUE OF THE AMERICAS
NEW YORK, NY 10036

FOR: PRE-RECORDED DVD'S FEATURING CONTENT FROM OR RELATING TO A DRAMATIC TELEVISION SERIES CONCERNING A LEGAL BROTHEL., IN CLASS 9 (U.S. CLS. 21, 23, 26, 36 AND 38).

FIRST USE 6-7-2005; IN COMMERCE 6-7-2005.

FOR: ENTERTAINMENT SERVICES IN THE NATURE OF AN ONGOING DRAMATIC TELEVI-

SION PROGRAM SERIES, IN CLASS 41 (U.S. CLS. 100, 101 AND 107).

FIRST USE 12-8-2002; IN COMMERCE 12-8-2002.

THE MARK CONSISTS OF STANDARD CHARACTERS WITHOUT CLAIM TO ANY PARTICULAR FONT, STYLE, SIZE, OR COLOR.

SEC. 2(F).

SER. NO. 78-784,813, FILED 1-4-2006.

MELVIN AXILBUND, EXAMINING ATTORNEY

Int. Cl.: 35

Prior U.S. Cls.: 100, 101 and 102

United States Patent and Trademark Office

Reg. No. 3,520,654

Registered Oct. 21, 2008

**SERVICE MARK
PRINCIPAL REGISTER**



JACOBSON ACQUISITION CO. (DELAWARE CORPORATION)
3811 DIXON STREET
DES MOINES, IA 50313

FOR: SUPPLY CHAIN MANAGEMENT SERVICES, NAMELY, INVENTORY MANAGEMENT, WAREHOUSE ORDER PROCESSING, TRANSPORTATION ROUTING AND TRACKING, AND SHIPMENT TRACING, IN CLASS 35 (U.S. CLS. 100, 101 AND 102).

FIRST USE 1-11-2005; IN COMMERCE 1-11-2005.

OWNER OF U.S. REG. NO. 1,857,946.

SER. NO. 78-804,686, FILED 2-1-2006.

STEVEN R. FINE, EXAMINING ATTORNEY

Int. Cls.: 9 and 42

Prior U.S. Cls.: 21, 23, 26, 36, 38, 100 and 101

United States Patent and Trademark Office

Reg. No. 3,520,655

Registered Oct. 21, 2008

**TRADEMARK
SERVICE MARK
PRINCIPAL REGISTER**



CENTRO DE TECNOLOGIA DE LAS COMUNICACIONES, S.A. (SPAIN SOCIEDAD ANONIMA)

PARQUE TECNOLOGICO DE ANDALUCIA C/ SEVE

RO OCHOA, S/N;

CAMPANILLAS (MALAGA), SPAIN 29590

FOR: SOFTWARE FOR OPERATING MOBILE TELEPHONES, WIRELESS TELEPHONY, AND SHORT-RANGE RADIO TECHNOLOGY FOR WIRELESS PERSONAL AREA NETWORKS (PANS) IN THE FIELD OF TELECOMMUNICATIONS; SOFTWARE FOR CONTROLLING AND TESTING MOBILE TELEPHONES, WIRELESS TELEPHONY, AND SHORT-RANGE RADIO TECHNOLOGY FOR WIRELESS PAN SYSTEMS IN THE FIELD OF TELECOMMUNICATIONS; TESTING APPARATUS FOR MOBILE TELEPHONY, WIRELESS TELEPHONY, AND SHORT-RANGE RADIO TECHNOLOGY FOR WIRELESS PAN SYSTEMS IN CONNECTION WITH CONFORMANCE AND CERTIFICATION REQUIREMENTS FOR WORLDWIDE INTEROPERABILITY FOR MICROWAVE ACCESS (WIMAX), WIRELESS PERSONAL AREA NETWORKS (WPAN), RADIO FREQUENCY IDENTIFICATION (RFID) AND GLOBAL SYSTEM FOR MOBILE COMMUNICATIONS (GSM), UNIVERSAL MOBILE TELECOMMUNICATIONS SYSTEM (UMTS) RELATED TECHNOLOGIES; MEASURING AND CONTROL DEVICES FOR MOBILE TELEPHONES, WIRELESS TELEPHONY, AND SHORT-RANGE RADIO TECHNOLOGY FOR WIRELESS PAN SYSTEMS IN CONNECTION WITH CONFORMANCE AND CERTIFICATION REQUIREMENTS

FOR WIMAX, WPAN, RFID AND GSM, UMTS RELATED TECHNOLOGIES; COMPUTER COMPONENTS TESTING AND CALIBRATING EQUIPMENTS, IN CLASS 9 (U.S. CLS. 21, 23, 26, 36 AND 38).

FOR: TECHNICAL CONSULTATION IN THE FIELD OF TELECOMMUNICATIONS EQUIPMENT; CONSULTATION IN THE FIELD OF GOVERNMENT REGULATION OF TELECOMMUNICATIONS, AND CONSULTATIONS IN THE FIELD OF REGULATORY APPROVAL PAPERWORK FOR TELECOMMUNICATIONS EQUIPMENT AND PROJECTS; TESTING, ANALYSIS AND EVALUATION OF THE GOODS AND SERVICES OF OTHERS, IN THE FIELD OF TELECOMMUNICATIONS, FOR THE PURPOSE OF CERTIFICATION; COMPUTER-AIDED ENGINEERING SERVICES FOR OTHERS; ENGINEERING SERVICES IN THE FIELD OF TELECOMMUNICATION APPARATUS, MOBILE TELEPHONY, WIRELESS TELEPHONY AND SHORT-RANGE RADIO TECHNOLOGY FOR WIRELESS PAN SYSTEMS; ACCREDITATION SERVICES, NAMELY, DEVELOPING, EVALUATING, AND TESTING STANDARDS FOR TELECOMMUNICATION APPARATUS FOR THE PURPOSE OF ACCREDITATION; TESTING OR RESEARCH ON MACHINES, APPARATUS AND INSTRUMENTS; TESTING, ANALYSIS AND EVALUATION OF THE GOODS AND SERVICES OF THE OTHERS FOR THE PURPOSE OF CERTIFICATION, IN CLASS 42 (U.S. CLS. 100 AND 101).

PRIORITY CLAIMED UNDER SEC. 44(D) ON SPAIN APPLICATION NO. 2.682.412, FILED 11-29-2005.

OWNER OF SPAIN REG. NO. 2682412, DATED 10-26-2006, EXPIRES 11-29-2015.

NO CLAIM IS MADE TO THE EXCLUSIVE RIGHT TO USE "WIRELESS", APART FROM THE MARK AS SHOWN.

THE COLOR(S) DARK BLUE, BLUE, LIGHT BLUE, AND GREEN IS/ARE CLAIMED AS A FEATURE OF THE MARK.

THE MARK CONSISTS OF THE WORDING "AT4 WIRELESS" APPEARING IN DARK BLUE. A DESIGN CONSISTING OF VARIOUS INCOMPLETE CIRCLES WITHIN ONE ANOTHER ALTERNATING IN BLUE, LIGHT BLUE, AND GREEN WITH A GREEN CHECK-MARK ALONG THE EDGE APPEARS TO THE RIGHT OF THE WORDING "AT4" AND ABOVE "WIRELESS".

SER. NO. 78-812,571, FILED 2-10-2006.

SANDRA MANIOS, EXAMINING ATTORNEY

Int. Cl.: 19

Prior U.S. Cls.: 1, 12, 33 and 50

United States Patent and Trademark Office

Reg. No. 3,520,656

Registered Oct. 21, 2008

**TRADEMARK
PRINCIPAL REGISTER**

HUSKY STAIN

COMMONWEALTH PLYWOOD CO. LTD. (CANADA CORPORATION)
15, LABELLE BLVD.
STE. THERESE, QUEBEC, CANADA J7E4H9

FOR: BUILDING MATERIALS, NAMELY, ROUGH OR PRE-FINISHED SOLID WOOD FLOORING BOARDS, IN CLASS 19 (U.S. CLS. 1, 12, 33 AND 50).

THE MARK CONSISTS OF STANDARD CHARACTERS WITHOUT CLAIM TO ANY PARTICULAR FONT, STYLE, SIZE, OR COLOR.

PRIORITY CLAIMED UNDER SEC. 44(D) ON CANADA APPLICATION NO. 1288707, FILED 2-6-2006, REG. NO. TMA696651, DATED 9-18-2007, EXPIRES 9-18-2022.

OWNER OF U.S. REG. NO. 1,177,236.

SER. NO. 78-815,145, FILED 2-15-2006.

WENDY JUN, EXAMINING ATTORNEY

Int. Cl.: 19

Prior U.S. Cls.: 1, 12, 33 and 50

United States Patent and Trademark Office

Reg. No. 3,520,657

Registered Oct. 21, 2008

**TRADEMARK
PRINCIPAL REGISTER**

HUSKY FINISH

COMMONWEALTH PLYWOOD CO. LTD. (CANADA CORPORATION)
15, LABELLE BLVD.
STE. THERESE, QUEBEC, CANADA J7E4H9

FOR: BUILDING MATERIALS, NAMELY, ROUGH OR PRE-FINISHED SOLID WOOD FLOORING BOARDS, IN CLASS 19 (U.S. CLS. 1, 12, 33 AND 50).

THE MARK CONSISTS OF STANDARD CHARACTERS WITHOUT CLAIM TO ANY PARTICULAR FONT, STYLE, SIZE, OR COLOR.

OWNER OF CANADA REG. NO. 1288713, DATED 9-18-2007, EXPIRES 9-18-2022.

OWNER OF U.S. REG. NO. 1,177,236.

SER. NO. 78-816,416, FILED 2-16-2006.

WENDY JUN, EXAMINING ATTORNEY

Int. Cl.: 25

Prior U.S. Cls.: 22 and 39

United States Patent and Trademark Office

Reg. No. 3,520,658

Registered Oct. 21, 2008

**TRADEMARK
PRINCIPAL REGISTER**

BP.

NORDSTROM, INC. (WASHINGTON CORPORATION)
SUITE 500
1617 SIXTH AVENUE
SEATTLE, WA 98101

FOR: GIRL'S AND YOUNG WOMEN'S FASHION CLOTHING, NAMELY, JACKETS, TURTLENECKS, TANK TOPS, DRESSES, SHORTS, OVERALLS, BLAZERS, SWEATERS, CARDIGANS, COATS, SWEATSHIRTS, VESTS, SKIRTS, SWEATPANTS, SHIRTS, LINGERIE, MOCK TURTLENECKS, SOCKS, PANTS AND SKORTS; AND WOMEN'S FOOTWEAR, IN CLASS 25 (U.S. CLS. 22 AND 39).

FIRST USE 0-0-1985; IN COMMERCE 0-0-1985.

THE MARK CONSISTS OF STANDARD CHARACTERS WITHOUT CLAIM TO ANY PARTICULAR FONT, STYLE, SIZE, OR COLOR.

OWNER OF U.S. REG. NO. 3,027,963.

SER. NO. 78-833,726, FILED 3-9-2006.

STEPHEN AQUILA, EXAMINING ATTORNEY

Int. Cl.: 20

Prior U.S. Cls.: 2, 13, 22, 25, 32 and 50

United States Patent and Trademark Office

Reg. No. 3,520,659

Registered Oct. 21, 2008

**TRADEMARK
PRINCIPAL REGISTER**

Take It Pocket

CHUN-CHIEH HUANG (UNITED STATES INDIVIDUAL)
5704 HAZEL AVE SE
AUBURN, WA 98092

THE MARK CONSISTS OF STANDARD CHARACTERS WITHOUT CLAIM TO ANY PARTICULAR FONT, STYLE, SIZE, OR COLOR.

FOR: NON-METAL HOLDER FOR SIGNS, IN CLASS 20 (U.S. CLS. 2, 13, 22, 25, 32 AND 50).

SER. NO. 78-837,308, FILED 3-15-2006.

FIRST USE 2-16-2006; IN COMMERCE 2-16-2006.

PATRICIA EVANKO, EXAMINING ATTORNEY

Int. Cl.: 28

Prior U.S. Cls.: 22, 23, 38 and 50

United States Patent and Trademark Office

Reg. No. 3,520,660

Registered Oct. 21, 2008

**TRADEMARK
PRINCIPAL REGISTER**

I-TATTOO

SPIN MASTER LTD. (CANADA CORPORATION)
450 FRONT STREET WEST
TORONTO, ONTARIO, CANADA M5V 1B6

FOR: TOYS, GAMES AND PLAYTHINGS, NAME-
LY, TOY PENS FOR APPLYING TATTOOS, AND
ACCESSORIES THEREFOR., IN CLASS 28 (U.S. CLS.
22, 23, 38 AND 50).

THE MARK CONSISTS OF STANDARD CHAR-
ACTERS WITHOUT CLAIM TO ANY PARTICULAR
FONT, STYLE, SIZE, OR COLOR.

PRIORITY CLAIMED UNDER SEC. 44(D) ON
CANADA APPLICATION NO. 1290566, FILED 2-20-
2006, REG. NO. TMA695468, DATED 9-4-2007, EX-
PIRES 9-4-2022.

SER. NO. 78-842,491, FILED 3-21-2006.

MARY CRAWFORD, EXAMINING ATTORNEY

Int. Cl.: 43

Prior U.S. Cls.: 100 and 101

United States Patent and Trademark Office

Reg. No. 3,520,661

Registered Oct. 21, 2008

**SERVICE MARK
PRINCIPAL REGISTER**

STAMPS SUPER Burgers

STAMPS, ALGERNON SR. (UNITED STATES
INDIVIDUAL)

1801 DALTON STREET

JACKSON, MS 39204

FOR: RESTAURANTS, IN CLASS 43 (U.S. CLS. 100
AND 101).

FIRST USE 3-30-1993; IN COMMERCE 3-30-1993.

THE MARK CONSISTS OF STANDARD CHAR-
ACTERS WITHOUT CLAIM TO ANY PARTICULAR
FONT, STYLE, SIZE, OR COLOR.

NO CLAIM IS MADE TO THE EXCLUSIVE
RIGHT TO USE "SUPER BURGERS", APART FROM
THE MARK AS SHOWN.

SER. NO. 78-842,571, FILED 3-21-2006.

JOHN GARTNER, EXAMINING ATTORNEY

Int. Cl.: 16

Prior U.S. Cls.: 2, 5, 22, 23, 29, 37, 38 and 50

Reg. No. 3,520,662

United States Patent and Trademark Office

Registered Oct. 21, 2008

**TRADEMARK
PRINCIPAL REGISTER**

TONY BENNETT

BENEDETTO ARTS GMBH (FED REP GERMA-
NY GMBH)
GRUENEWALDER STR. 30
SOLINGEN, FED REP GERMANY 42657

FOR: ALBUMS FOR PHOTOGRAPHS AND KEEP
SAKES; APPOINTMENT BOOKS; WRITING BOOKS;
BOOKS FOR SKETCHING AND DRAWING; ART
ETCHINGS; MOUNTS, NAMELY, ART MOUNTS,
PAPER PICTURE MOUNTS AND PHOTOGRAPH
MOUNTS; PADS, NAMELY, NOTE, MEMO AND
DESK PADS, PAPER, ART PRINTS, POSTERS AND
GRAPHIC ART REPRODUCTIONS; CALENDARS;
CANVAS FOR PAINTING; CHILDREN'S BOOKS;
COOKBOOKS; DESK SETS AND ORGANIZERS;
PAINTING SETS FOR ARTISTS AND CHILDREN;
PAINTINGS; SHEET MUSIC; SONG BOOKS; STA-
TIONERY; WRITING AND DRAWING MATERIALS
AND APPARATUS, NAMELY, PAINTBRUSHES,
PASTELS, PENCILS, PENS, MARKERS, INK, NAME-
LY, WRITING INK AND STAMPING INK, FOUN-

TAIN PENS, FELT TIP MARKERS, FELT TIP PENS,
IN CLASS 16 (U.S. CLS. 2, 5, 22, 23, 29, 37, 38 AND 50).

THE MARK CONSISTS OF STANDARD CHAR-
ACTERS WITHOUT CLAIM TO ANY PARTICULAR
FONT, STYLE, SIZE, OR COLOR.

PRIORITY CLAIMED UNDER SEC. 44(D) ON FED
REP GERMANY APPLICATION NO. 305569139,
FILED 9-27-2005, REG. NO. 30556913, DATED 12-1-
2005, EXPIRES 9-30-2015.

THE NAME(S), PORTRAIT(S), AND/OR SIGNA-
TURE(S) SHOWN IN THE MARK IDENTIFIES
"TONY BENNETT", WHOSE CONSENT(S) TO REG-
ISTER IS SUBMITTED.

SER. NO. 78-845,774, FILED 3-24-2006.

MARY MUNSON, EXAMINING ATTORNEY

Int. Cl.: 11

Prior U.S. Cls.: 13, 21, 23, 31 and 34

United States Patent and Trademark Office

Reg. No. 3,520,663

Registered Oct. 21, 2008

**TRADEMARK
PRINCIPAL REGISTER**

TROJANUV3000PLUS

TROJAN TECHNOLOGIES INC. (CANADA CORPORATION)

3020 GORE ROAD

LONDON, ONTARIO, CANADA N5V 5T7

FOR: WATER AND FLUID TREATMENT EQUIPMENT, NAMELY, MECHANICAL EQUIPMENT WHICH UTILIZES ULTRA-VIOLET TECHNOLOGY FOR THE TREATMENT, DISINFECTION, PURIFICATION, AND STERILIZATION OF WATER AND OTHER FLUIDS FOR INDUSTRIAL, COMMERCIAL, MUNICIPAL, AND RESIDENTIAL USE, IN CLASS 11 (U.S. CLS. 13, 21, 23, 31 AND 34).

THE MARK CONSISTS OF STANDARD CHARACTERS WITHOUT CLAIM TO ANY PARTICULAR FONT, STYLE, SIZE, OR COLOR.

PRIORITY CLAIMED UNDER SEC. 44(D) ON CANADA APPLICATION NO. 1,295,819, FILED 3-29-2006, REG. NO. TMA692,106, DATED 7-16-2007, EXPIRES 7-16-2022.

OWNER OF U.S. REG. NOS. 1,916,336, 3,052,154 AND OTHERS.

SER. NO. 78-854,176, FILED 4-5-2006.

RONALD DELGIZZI, EXAMINING ATTORNEY

Int. Cls.: 9, 41 and 42

Prior U.S. Cls.: 21, 23, 26, 36, 38, 100, 101 and 107

Reg. No. 3,520,664

United States Patent and Trademark Office

Registered Oct. 21, 2008

**TRADEMARK
SERVICE MARK
PRINCIPAL REGISTER**

ALAMY SPEEDLOAD

ALAMY LIMITED (UNITED KINGDOM COMPAN-
NY)
127 MILTON PARK
ABINGDON, UNITED KINGDOM OX14 4SA

FOR: DOWNLOADABLE DIGITAL MEDIA, NAMELY, DOWNLOADABLE PHOTOGRAPHIC, VIDEO, AUDIO AND TEXT FILES FEATURING THE SUBJECT MATTER OF MAN AND HUMANITY, WILDLIFE, NATURE, GEOGRAPHY, ARCHITECTURE, ART, CULTURE, THE ABSTRACT, CONCEPTUALIZATION, SCIENCE, TRANSPORTATION, SPORTS, TRAVEL, INDUSTRY, COMMERCE AND OTHER SUBJECTS OF PHOTOGRAPHY INTENDED FOR PUBLICATION IN PRINTED AND ELECTRONIC FORM, OVER AN ELECTRONIC COMMUNICATIONS NETWORK, IN CLASS 9 (U.S. CLS. 21, 23, 26, 36 AND 38).

FOR: ENTERTAINMENT SERVICES, NAMELY, PROVIDING AN ON-LINE GALLERY WEBSITE FEATURING PHOTOGRAPHIC PRESENTATIONS IN THE FIELD OF PHOTOGRAPHY AND PROVIDING AN ON-LINE COMPUTER DATABASE FEATURING

TURING INFORMATION REGARDING PHOTOGRAPHY AND ART VIA A GLOBAL COMMUNICATION NETWORK AND COMPUTER NETWORK, IN CLASS 41 (U.S. CLS. 100, 101 AND 107).

FOR: COMPUTER SERVICES, NAMELY, PROVIDING SEARCH ENGINES AND IMAGE BASED SEARCH ENGINES FOR OBTAINING DATA FROM AN IMAGE DATABASE AND ACCESSIBLE VIA A GLOBAL COMPUTER NETWORK, IN CLASS 42 (U.S. CLS. 100 AND 101).

THE MARK CONSISTS OF STANDARD CHARACTERS WITHOUT CLAIM TO ANY PARTICULAR FONT, STYLE, SIZE, OR COLOR.

OWNER OF UNITED KINGDOM REG. NO. 2403349, DATED 3-24-2006, EXPIRES 3-24-2016.

SER. NO. 78-855,306, FILED 4-6-2006.

WILLIAM ROSSMAN, EXAMINING ATTORNEY

Int. Cl.: 30

Prior U.S. Cl.: 46

United States Patent and Trademark Office

Reg. No. 3,520,665

Registered Oct. 21, 2008

**TRADEMARK
PRINCIPAL REGISTER**

EL REY

FABRICA DE ESPECIAS Y PRODUCTOS EL REY
S.A. (COLOMBIA CORPORATION)
CALLE 40 SUR NO. 68D - 55
7700500 BOGOTA, COLOMBIA

FOR: SPICES; PROCESSED HERBS; ROASTED
AND GROUND SESAME SEEDS, MINCED, POW-
DERED AND PROCESSED SPICES; SEASONINGS
AND SEASONING PASTES; CONDIMENTS, NAME-
LY, GARLIC SAUCE, HOT CHILI SAUCE, SOY
SAUCE, WORCESTERSHIRE SAUCE, ONION
SAUCE AND BASIL SAUCE, IN CLASS 30 (U.S. CL.
46).

FIRST USE 6-30-1940; IN COMMERCE 5-11-2000.

THE MARK CONSISTS OF STANDARD CHAR-
ACTERS WITHOUT CLAIM TO ANY PARTICULAR
FONT, STYLE, SIZE, OR COLOR.

OWNER OF COLOMBIA REG. NO. 94250, DATED
6-26-1978, EXPIRES 6-26-2013.

THE FOREIGN WORDING IN THE MARK
TRANSLATES INTO ENGLISH AS THE KING.

SER. NO. 78-860,723, FILED 4-13-2006.

YONG KIM, EXAMINING ATTORNEY

Int. Cls.: 9, 36 and 41

Prior U.S. Cls.: 21, 23, 26, 36, 38, 100, 101, 102 and 107

United States Patent and Trademark Office

Reg. No. 3,520,666

Registered Oct. 21, 2008

**TRADEMARK
SERVICE MARK
PRINCIPAL REGISTER**

The Faculty of Trading

HOWLETT, IAN, GRAHAM (UNITED KINGDOM INDIVIDUAL)
WORCESTER COLLEGE
OXFORD, UNITED KINGDOM OX12HB

FOR: COMPUTER GAME PROGRAMS; COMPUTER GAME SOFTWARE; COMPUTER PROGRAMS FOR THE PROVISION OF FINANCIAL TRAINING; COMPUTER SOFTWARE FOR ACCESSING INFORMATION DIRECTORIES THAT MAY BE DOWNLOADED FROM THE GLOBAL COMPUTER NETWORK; COMPUTER SOFTWARE FOR APPLICATION AND DATABASE INTEGRATION; COMPUTER SOFTWARE FOR CREATING SEARCHABLE DATABASES OF INFORMATION AND DATA; COMPUTER SOFTWARE FOR PROVIDING AN ONLINE DATABASE IN THE FIELD OF TRANSACTION PROCESSING TO UPLOAD TRANSACTIONAL DATA, PROVIDE STATISTICAL ANALYSIS, AND PRODUCE NOTIFICATIONS AND REPORTS; COMPUTER SOFTWARE FOR THE PROVISION OF FINANCIAL TRAINING; COMPUTER SOFTWARE FOR THE PROVISION OF FINANCIAL TRAINING THAT MAY BE DOWNLOADED FROM A GLOBAL COMPUTER NETWORK; COMPUTER SOFTWARE PLATFORMS FOR THE PROVISION OF FINANCIAL TRAINING; ELECTRONIC PUBLICATIONS, NAMELY, MANUALS, BOOKS, PAPERS, MAGAZINES, NEWSLETTERS, JOURNALS, PERIODICALS AND BROCHURES FEATURING FINANCIAL TRAINING RECORDED ON COMPUTER MEDIA; ENCODED MICRO PARTICULATES, TAGS AND TAGGANTS OF PLASTIC, METAL OR SILICATE FOR USE IN THE FIELD OF PASSIVE LABELING, TRACING OR TRACKING OF PERSONS, ANIMALS, VEHICLES OR GOODS OF ANY KIND, IN CLASS 9 (U.S. CLS. 21, 23, 26, 36 AND 38).

FOR: ADVICE RELATING TO INVESTMENTS; COMMODITY INVESTMENT ADVICE; FINANCIAL ANALYSIS AND CONSULTATION; FINANCIAL

CONSULTATION; FINANCIAL INFORMATION PROCESSING; FINANCIAL INFORMATION PROVIDED BY ELECTRONIC MEANS; FINANCIAL MANAGEMENT; FINANCIAL PLANNING; FINANCIAL PLANNING CONSULTATION; FINANCIAL PLANNING, NAMELY, THE CREATION OF PERSONALIZED STRATEGIES TO ACHIEVE FINANCIAL INDEPENDENCE; FINANCIAL PORTFOLIO MANAGEMENT; FINANCIAL RESEARCH; FINANCIAL RISK MANAGEMENT; INVESTMENT ADVICE; INVESTMENT ADVISORY SERVICES; INVESTMENT CONSULTATION; INVESTMENT MANAGEMENT; PROVIDING ON-LINE FINANCIAL CALCULATORS; PROVIDING STOCK MARKET INFORMATION; PROVIDING STOCK/SECURITIES MARKET INFORMATION; RISK MANAGEMENT; RISK MANAGEMENT CONSULTATION; STOCK EXCHANGE PRICE QUOTATIONS, IN CLASS 36 (U.S. CLS. 100, 101 AND 102).

FOR: ARRANGING OF SEMINARS AND CONFERENCES; ARRANGING PROFESSIONAL WORKSHOP AND TRAINING COURSES; BOOK AND REVIEW PUBLISHING; BUSINESS TRAINING; COMPUTER EDUCATION TRAINING; COMPUTER EDUCATION TRAINING SERVICES; CONDUCTING EDUCATIONAL EXHIBITIONS IN THE NATURE OF FINANCIAL TRADING; CONDUCTING WORKSHOPS AND SEMINARS IN FINANCIAL TRADING; CORRESPONDENCE SCHOOLS; EDUCATION IN THE FIELD OF FINANCIAL TRADING RENDERED THROUGH CORRESPONDENCE COURSES; EDUCATION SERVICES, NAMELY, MENTORING IN THE FIELD OF FINANCIAL TRADING; EDUCATION SERVICES, NAMELY, ONE-ON-ONE MENTORING IN THE FIELD OF FINANCIAL TRADING; EDUCATION SERVICES, NAMELY, PROVIDING TUTORIAL SESSIONS IN THE FIELD OF FINANCIAL TRADING; EDUCATION SERVICES, NAMELY, PROVIDING TUTORING IN THE FIELD OF FINANCIAL TRADING;

EDUCATION SERVICES, NAMELY, PROVIDING CLASSES, SEMINARS, WORKSHOPS, CONFERENCES AND EVENTS IN THE FIELD OF FINANCIAL TRADING; EDUCATIONAL DEMONSTRATIONS; EDUCATIONAL RESEARCH; EDUCATIONAL SERVICES, NAMELY, CONDUCTING PROGRAMS IN THE FIELD OF FINANCIAL TRADING; EDUCATIONAL SERVICES, NAMELY, CONDUCTING ON-LINE EXHIBITIONS AND DISPLAYS AND INTERACTIVE EXHIBITS IN THE FIELD OF FINANCIAL TRADING; EDUCATIONAL SERVICES, NAMELY, PROVIDING COURSES OF INSTRUCTION AT THE PROFESSIONAL AND NON-PROFESSIONAL LEVEL ; EDUCATIONAL SERVICES, NAMELY, CONDUCTING CLASSES, SEMINARS, WORKSHOPS, CONFERENCES AND EVENTS IN THE FIELD OF FINANCIAL TRADING ; EDUCATIONAL TESTING; ELECTRONIC PUBLISHING SERVICES, NAMELY, PUBLICATION OF TEXT AND GRAPHIC WORKS OF OTHERS ON CD, DVD AND ONLINE FEATURING FINANCIAL TRADING; ENTERTAINMENT SERVICES, NAMELY, PROVIDING AN ON-LINE COMPUTER GAME; ENTERTAINMENT SERVICES, NAMELY, PROVIDING ON-LINE COMPUTER GAMES; INFORMATION ABOUT EDUCATION; INFORMATION ON EDUCATION; ON-LINE EDUCATION CREDIT AND DEGREE EVALUATION AND COMPARISON SERVICES; ON-LINE PUBLICATION OF FINANCIAL TRADING INFORMATION; ON-LINE JOURNALS, NAMELY, BLOGS FEATURING FINANCIAL TRADING; ORGANIZING EXHIBITIONS FOR FINANCIAL TRADING; PROVIDING A COMPUTER GAME THAT MAY BE ACCESSED NETWORK-WIDE BY NETWORK USERS; PROVIDING COURSES OF INSTRUCTION AT THE PROFESSIONAL AND NON-PROFESSIONAL LEVEL; PROVIDING NEWSLETTERS IN THE FIELD OF FINANCIAL TRADING VIA E-MAIL; PROVIDING ON-LINE MANUALS, BOOKS, PAPERS, MAGAZINES, NEWSLETTERS, JOURNALS, PERIODICALS AND BROCHURES IN THE FIELD OF FINANCIAL TRADING ; PUBLICATION OF BOOKS; PUBLICATION OF BOOKS, MAGAZINES, ALMANACS AND JOURNALS; PUBLICATION OF BOOKS, OF MAGAZINES, OF JOURNALS, OF NEWSPAPERS, OF PER-

IODICALS, OF CATALOGS, OF BROCHURES; PUBLICATION OF BROCHURES; PUBLICATION OF DOCUMENTS IN THE FIELD OF TRAINING, SCIENCE, PUBLIC LAW AND SOCIAL AFFAIRS; PUBLICATION OF ELECTRONIC MAGAZINES; PUBLICATION OF ELECTRONIC NEWSPAPERS ACCESSIBLE VIA A GLOBAL COMPUTER NETWORK; PUBLICATION OF JOURNALS; PUBLICATION OF LEAFLETS; PUBLICATION OF MAGAZINES; PUBLICATION OF MANUALS; PUBLICATION OF PRINTED MATTER; PUBLICATION OF TEXT BOOKS; PUBLICATION OF TEXTS, BOOKS, JOURNALS; PUBLICATION OF TEXTS, BOOKS, MAGAZINES AND OTHER PRINTED MATTER; PUBLICATION OF THE EDITORIAL CONTENT OF SITES ACCESSIBLE VIA A GLOBAL COMPUTER NETWORK; TRAINING COURSES IN STRATEGIC PLANNING RELATING TO ADVERTISING, PROMOTION, MARKETING AND BUSINESS; TRAINING IN THE USE AND OPERATION OF FINANCIAL TRADING SYSTEMS; TRAINING SERVICES IN THE FIELD OF FINANCIAL TRADING; WORKSHOPS AND SEMINARS IN THE FIELD OF FINANCIAL TRADING, IN CLASS 41 (U.S. CLS. 100, 101 AND 107).

THE MARK CONSISTS OF STANDARD CHARACTERS WITHOUT CLAIM TO ANY PARTICULAR FONT, STYLE, SIZE, OR COLOR.

PRIORITY CLAIMED UNDER SEC. 44(D) ON UNITED KINGDOM APPLICATION NO. REF200650266, FILED 4-16-2006.

OWNER OF UNITED KINGDOM REG. NO. 2419478, DATED 4-18-2006, EXPIRES 4-16-2016.

NO CLAIM IS MADE TO THE EXCLUSIVE RIGHT TO USE "TRADING", APART FROM THE MARK AS SHOWN.

SER. NO. 78-862,374, FILED 4-16-2006.

CHERYL CLAYTON, EXAMINING ATTORNEY

Int. Cls.: 16, 42 and 44

Prior U.S. Cls.: 2, 5, 22, 23, 29, 37, 38, 50, 100 and 101

Reg. No. 3,520,667

United States Patent and Trademark Office

Registered Oct. 21, 2008

**TRADEMARK
SERVICE MARK
PRINCIPAL REGISTER**

WOMAC

BELLAMY, NICHOLAS (AUSTRALIA INDIVIDUAL)
267 MCGINN ROAD
FERNY GROVE, AUSTRALIA 4055

FOR: EDUCATIONAL PUBLICATIONS, NAME-
LY, MANUALS, BROCHURES, BOOKLETS,
PAMPHLETS AND MAGAZINES, AND QUESTION-
NAIRES IN PAPER FORM IN THE FIELD OF
OSTEOARTHRITIS, IN CLASS 16 (U.S. CLS. 2, 5, 22,
23, 29, 37, 38 AND 50).

FIRST USE 2-0-1999; IN COMMERCE 2-0-1999.

FOR: PROVIDING ONLINE QUESTIONNAIRES
IN THE FIELD OF OSTEOARTHRITIS FOR ASSES-
SING THE SEVERITY OF PAIN, STIFFNESS AND
PHYSICAL DISABILITY DUE TO OSTEOARTHRI-
TIS FOR MEDICAL RESEARCH PURPOSES, IN
CLASS 42 (U.S. CLS. 100 AND 101).

FIRST USE 2-0-1999; IN COMMERCE 2-0-1999.

FOR: CONSULTING SERVICES IN THE FIELD
OF HEALTH CARE; PROVIDING ONLINE QUES-
TIONNAIRES IN THE FIELD OF OSTEOARTHRITIS
FOR ASSESSING THE SEVERITY OF PAIN, STIFF-
NESS AND PHYSICAL DISABILITY DUE TO OS-
TEOARTHRITIS FOR MONITORING PATIENTS'
RESPONSE TO TREATMENT, IN CLASS 44 (U.S.
CLS. 100 AND 101).

FIRST USE 2-0-1999; IN COMMERCE 2-0-1999.

THE MARK CONSISTS OF STANDARD CHAR-
ACTERS WITHOUT CLAIM TO ANY PARTICULAR
FONT, STYLE, SIZE, OR COLOR.

SER. NO. 78-865,283, FILED 4-19-2006.

DANNEAN HETZEL, EXAMINING ATTORNEY

Int. Cl.: 25

Prior U.S. Cls.: 22 and 39

United States Patent and Trademark Office

Reg. No. 3,520,668

Registered Oct. 21, 2008

TRADEMARK
PRINCIPAL REGISTER



D.L.S. OUTFITTERS, INC. (NEW YORK CORPORATION)
2ND FLOOR
44 WEST 55TH STREET
NEW YORK, NY 10019

THE COLOR(S) RED, GREEN AND YELLOW IS/ARE CLAIMED AS A FEATURE OF THE MARK.

FOR: CLOTHING, NAMELY, SLACKS, PANTS, JEANS, JACKETS, BLAZERS, SPORT COATS, SUITS, SHIRTS, TIES, OUTERWEAR, NAMELY OVERCOATS, RAINCOATS, AND WIND RESISTANT JACKETS, FOOTWEAR, SKIRTS, BLOUSES, BELTS, HATS, SCARVES AND SOCKS, IN CLASS 25 (U.S. CLS. 22 AND 39).

THE COLOR RED APPEARS IN THE LETTERING "JUDSON", THE COLOR GREEN APPEARS IN THE LETTERING "WADE" AND "COLLECTION". THE COLOR YELLOW APPEARS IN THE BACKGROUND OF THE RECTANGLE DESIGN ELEMENT IN THE MARK.

FIRST USE 7-3-2006; IN COMMERCE 8-7-2006.

SER. NO. 78-869,640, FILED 4-26-2006.

NO CLAIM IS MADE TO THE EXCLUSIVE RIGHT TO USE "COLLECTION", APART FROM THE MARK AS SHOWN.

GEORGIA CARTY, EXAMINING ATTORNEY

Int. Cl.: 35

Prior U.S. Cls.: 100, 101 and 102

United States Patent and Trademark Office

Reg. No. 3,520,669

Registered Oct. 21, 2008

**SERVICE MARK
PRINCIPAL REGISTER**

Global Advantage Program

POROUS MEDIA CORPORATION (MICHIGAN CORPORATION)
1350 HAMMOND ROAD
ST. PAUL, MN 55110

FOR: CONSULTING SERVICES IN THE FIELD OF PURCHASE OF FILTER MEDIA, NAMELY, RECOMMENDING WHICH FILTER SEPARATION PRODUCTS RELATING TO AIR, WATER, HYDRO-CARBON, AND CHEMICAL PROCESSING AND TREATMENT A CLIENT SHOULD PURCHASE BASED UPON THE CLIENT'S INDIVIDUAL NEEDS, IN CLASS 35 (U.S. CLS. 100, 101 AND 102).

FIRST USE 1-1-1998; IN COMMERCE 1-1-1998.

THE MARK CONSISTS OF STANDARD CHARACTERS WITHOUT CLAIM TO ANY PARTICULAR FONT, STYLE, SIZE, OR COLOR.

NO CLAIM IS MADE TO THE EXCLUSIVE RIGHT TO USE "GLOBAL" AND "PROGRAM", APART FROM THE MARK AS SHOWN.

SER. NO. 78-874,147, FILED 5-2-2006.

LINDA LAVACHE, EXAMINING ATTORNEY

Int. Cl.: 33

Prior U.S. Cls.: 47 and 49

United States Patent and Trademark Office

Reg. No. 3,520,670

Registered Oct. 21, 2008

**TRADEMARK
PRINCIPAL REGISTER**

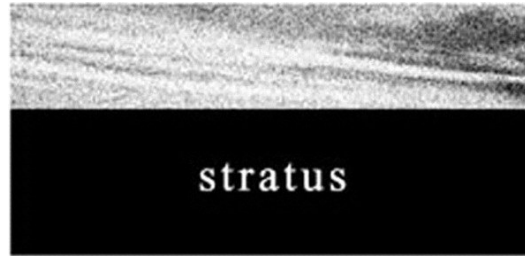

STRATUS VINEYARDS LIMITED (CANADA
CORPORATION)
1150 FLINT ROAD
DOWNSVIEW, CANADA M3J 2J5

2005, REG. NO. TMA677110, DATED 11-16-2006, EX-
PIRES 11-16-2021.

FOR: WINE, IN CLASS 33 (U.S. CLS. 47 AND 49).

OWNER OF U.S. REG. NO. 3,081,133.

FIRST USE 2-28-2005; IN COMMERCE 12-1-2005.

SER. NO. 78-874,677, FILED 5-2-2006.

PRIORITY CLAIMED UNDER SEC. 44(D) ON
CANADA APPLICATION NO. 1278901, FILED 11-8-

BENJAMIN OKEKE, EXAMINING ATTORNEY

Int. Cls.: 30 and 32

Prior U.S. Cls.: 45, 46 and 48

United States Patent and Trademark Office

Reg. No. 3,520,671

Registered Oct. 21, 2008

**TRADEMARK
PRINCIPAL REGISTER**

Bonobo Brew

SALLY J. COXE (UNITED STATES INDIVIDUAL)
2701 CONNECTICUT AVE, NW #702
WASHINGTON, DC 20008

FOR: COFFEE SOLD IN CONNECTION WITH RAISING FUNDS FOR, AND AWARENESS OF, THE BONOBO AND ITS HABITAT, IN CLASS 30 (U.S. CL. 46).

FIRST USE 1-10-2005; IN COMMERCE 2-0-2006.

FOR: BEER SOLD IN CONNECTION WITH RAISING FUNDS FOR, AND AWARENESS OF, THE BONOBO AND ITS HABITAT, IN CLASS 32 (U.S. CLS. 45, 46 AND 48).

FIRST USE 1-10-2005; IN COMMERCE 2-0-2006.

THE MARK CONSISTS OF STANDARD CHARACTERS WITHOUT CLAIM TO ANY PARTICULAR FONT, STYLE, SIZE, OR COLOR.

NO CLAIM IS MADE TO THE EXCLUSIVE RIGHT TO USE "BREW", APART FROM THE MARK AS SHOWN.

SER. NO. 78-877,323, FILED 5-5-2006.

CORY BOONE, EXAMINING ATTORNEY

Int. Cls.: 7 and 21

**Prior U.S. Cls.: 2, 13, 19, 21, 23, 29, 30, 31, 33, 34, 35,
40 and 50**

Reg. No. 3,520,672

United States Patent and Trademark Office

Registered Oct. 21, 2008

**TRADEMARK
PRINCIPAL REGISTER**

CRYSTALAB

CERION GMBH (FED REP GERMANY GMBH)
LUBBECKER STRASSE 240
MINDEN, FED REP GERMANY 32429

GLASS FOR FACADE ELEMENTS, DOORS AND
TABLE TOPS, IN CLASS 21 (U.S. CLS. 2, 13, 23, 29, 30,
33, 40 AND 50).

FOR: MACHINES AND MACHINE TOOLS, PAR-
TICULARLY MACHINES FOR OPERATING LA-
SERS FOR CUTTING OR FOR SURFACE OR
SUBSURFACE ENGRAVING PLASTICS AND
GLASS, LASER MACHINES, PARTICULARLY FOR
MAKING INNER ENGRAVINGS AND SURFACE
ENGRAVINGS, AS WELL AS FOR CUTTING PLAS-
TICS, GLASS AND OTHER MATERIALS, IN CLASS
7 (U.S. CLS. 13, 19, 21, 23, 31, 34 AND 35).

THE MARK CONSISTS OF STANDARD CHAR-
ACTERS WITHOUT CLAIM TO ANY PARTICULAR
FONT, STYLE, SIZE, OR COLOR.

PRIORITY CLAIMED UNDER SEC. 44(D) ON
ERPN CMNTY TM OFC APPLICATION NO.
005014261, FILED 3-28-2006, REG. NO. 005014261,
DATED 6-13-2007, EXPIRES 3-28-2016.

SER. NO. 78-877,585, FILED 5-5-2006.

FOR: RAW OR PARTIALLY PROCESSED GLASS
NOT BEING CONSTRUCTION GLASS, NAMELY,

ESTHER A. BORSUK, EXAMINING ATTORNEY

Int. Cl.: 3

Prior U.S. Cls.: 1, 4, 6, 50, 51 and 52

United States Patent and Trademark Office

Reg. No. 3,520,673

Registered Oct. 21, 2008

**TRADEMARK
PRINCIPAL REGISTER**

re : mov

EASY LIFE SOLUTIONS, INC. (FLORIDA CORPORATION)
SUITE N
6404 MANATEE AVE. WEST
BRADENTON, FL 34209

FOR: CHEMICAL PREPARATIONS, NAMELY, SILICONE AND ADHESIVE REMOVERS, IN CLASS 3 (U.S. CLS. 1, 4, 6, 50, 51 AND 52).

FIRST USE 4-0-2006; IN COMMERCE 4-0-2006.

NO CLAIM IS MADE TO THE EXCLUSIVE RIGHT TO USE "REMOVE", APART FROM THE MARK AS SHOWN.

THE MARK CONSISTS OF COINED WORD MARKS "RE" AND "MOV" IN COMBINATION WITH A DESIGN COMPRISING FIVE CIRCLES.

SER. NO. 78-881,688, FILED 5-11-2006.

AMY ALFIERI, EXAMINING ATTORNEY

Int. Cls.: 35, 37, 41 and 42

Prior U.S. Cls.: 100, 101, 102, 103, 106 and 107

United States Patent and Trademark Office

Reg. No. 3,520,674

Registered Oct. 21, 2008

**SERVICE MARK
PRINCIPAL REGISTER**

Follow the Wire

ALTERNATIVE TECHNOLOGY, INC. (COLORADO CORPORATION)
24 INVERNESS PLACE EAST
ENGLEWOOD, CO 80112

FOR: OUTSOURCING SERVICES FOR OTHERS IN THE FIELD OF COMPUTER NETWORK SYSTEMS; PROVIDING OF INFORMATION RELATING TO BUSINESS MANAGEMENT, EFFICIENCY OF BUSINESS OPERATIONS, AND BUSINESS TRANSACTIONS BETWEEN COMPANIES; PROVIDING COMMUNICATION CARRIERS WITH INFORMATION IN THE FIELD OF CUSTOMER RELATIONS MANAGEMENT; PROVIDING MANUFACTURERS AND DISTRIBUTORS WITH INFORMATION RELATING TO SUPPLY CHAIN MANAGEMENT AND DEMAND CHAIN MANAGEMENT; BUSINESS MANAGEMENT, NAMELY, ASSISTING OTHERS IN MANAGING WIRELESS ELECTRONIC COMPUTING AND WIRELESS ELECTRONIC COMMERCE; DATABASE MANAGEMENT FOR USE IN ASSISTING VALUE ADDED RESELLERS IN SERVICING RETAIL CUSTOMERS, IN CLASS 35 (U.S. CLS. 100, 101 AND 102).

FIRST USE 6-8-2005; IN COMMERCE 6-8-2005.

FOR: MAINTENANCE AND REPAIR OF COMPUTERS, COMPUTER HARDWARE, COMPUTER HARDWARE SYSTEMS, COMPUTER NETWORKS, AND COMMUNICATIONS NETWORKS; COMPUTER INSTALLATION; MAINTENANCE AND REPAIR OF COMPUTER HARDWARE AND NETWORKS USED FOR ORGANIZING, DIRECTING, AND CONTROLLING COMMUNICATION, INFORMATION, TASKS, AND INTERACTION BETWEEN REMOTE SITES AND BETWEEN REMOTE SITES AND A CENTRAL LOCATION; MAINTENANCE OF COMPUTERS, IN CLASS 37 (U.S. CLS. 100, 103 AND 106).

FIRST USE 6-8-2005; IN COMMERCE 6-8-2005.

FOR: EDUCATION SERVICES, NAMELY, CONDUCTING CLASSES, SEMINARS, CONFERENCES, AND WORKSHOPS IN THE FIELD OF COMPUTERS, COMPUTER PERIPHERALS, AND COMPUTER SOFTWARE RELATED TO THIN-CLIENT/ SERVER BASED COMPUTING, COMPUTER INFRASTRUCTURE, NETWORK SECURITY AND MANAGEMENT, AND WIRELESS ELECTRONIC COMPUTING AND COMMERCE, IN CLASS 41 (U.S. CLS. 100, 101 AND 107).

FIRST USE 6-8-2005; IN COMMERCE 6-8-2005.

FOR: TECHNICAL SUPPORT, NAMELY, TROUBLESHOOTING OF COMPUTER HARDWARE, SOFTWARE, AND NETWORK PROBLEMS; MONITORING OF NETWORK SYSTEMS; TECHNICAL SUPPORT OF ELECTRONIC COMMUNICATIONS NETWORKS AND WIRELESS ELECTRONIC COMMUNICATIONS NETWORKS; MAINTENANCE AND REPAIR OF COMPUTER SOFTWARE AND COMPUTER PORTALS; INSTALLATION OF COMPUTER SOFTWARE USED FOR ORGANIZING, DIRECTING, AND CONTROLLING COMMUNICATION, INFORMATION, TASKS, AND INTERACTION BETWEEN REMOTE SITES AND BETWEEN REMOTE SITES AND A CENTRAL LOCATION; TECHNICAL SUPPORT SERVICES, NAMELY, TROUBLE SHOOTING OF PROBLEMS WITH COMPUTER HARDWARE, SOFTWARE, AND NETWORKS USED FOR ORGANIZING, DIRECTING, AND CONTROLLING COMMUNICATION, INFORMATION, TASKS, AND INTERACTION BETWEEN REMOTE SITES AND BETWEEN REMOTE SITES AND A CENTRAL LOCATION; MAINTENANCE AND REPAIR OF COMPUTER SOFTWARE USED FOR ORGANIZING, DIRECTING, AND CONTROLLING COMMUNICATION, INFORMATION, TASKS, AND INTERACTION BETWEEN REMOTE SITES AND BETWEEN REMOTE SITES AND A CENTRAL LOCATION, IN CLASS 42 (U.S. CLS. 100 AND 101).

FIRST USE 6-8-2005; IN COMMERCE 6-8-2005.

SER. NO. 78-881,951, FILED 5-11-2006.

THE MARK CONSISTS OF STANDARD CHARACTERS WITHOUT CLAIM TO ANY PARTICULAR FONT, STYLE, SIZE, OR COLOR.

TRACY WHITTAKER-BROWN, EXAMINING ATTORNEY

Int. Cls.: 35, 37, 41 and 42

Prior U.S. Cls.: 100, 101, 102, 103, 106 and 107

United States Patent and Trademark Office

Reg. No. 3,520,675

Registered Oct. 21, 2008

**SERVICE MARK
PRINCIPAL REGISTER**

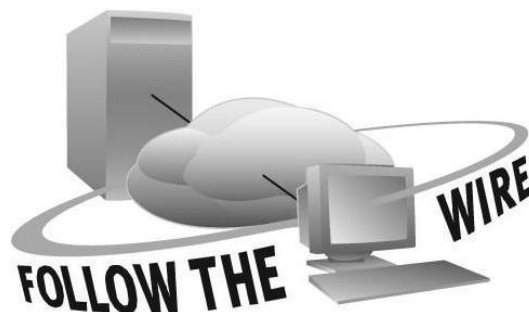

ALTERNATIVE TECHNOLOGY, INC. (COLORADO CORPORATION)

24 INVERNESS PLACE EAST
ENGLEWOOD, CO 80112

FOR: OUTSOURCING SERVICES FOR OTHERS IN THE FIELD OF COMPUTER NETWORK SYSTEMS; PROVIDING OF INFORMATION RELATING TO BUSINESS MANAGEMENT, EFFICIENCY OF BUSINESS OPERATIONS, AND BUSINESS TRANSACTIONS BETWEEN COMPANIES; PROVIDING COMMUNICATION CARRIERS WITH INFORMATION IN THE FIELD OF CUSTOMER RELATIONS MANAGEMENT; PROVIDING MANUFACTURERS AND DISTRIBUTORS WITH INFORMATION RELATING TO SUPPLY CHAIN MANAGEMENT AND DEMAND CHAIN MANAGEMENT; BUSINESS MANAGEMENT, NAMELY, ASSISTING OTHERS IN MANAGING WIRELESS ELECTRONIC COMPUTING AND WIRELESS ELECTRONIC COMMERCE; DATABASE MANAGEMENT FOR USE IN ASSISTING VALUE ADDED RESELLERS IN SERVICING RETAIL CUSTOMERS, IN CLASS 35 (U.S. CLS. 100, 101 AND 102).

FIRST USE 6-8-2005; IN COMMERCE 6-8-2005.

FOR: MAINTENANCE AND REPAIR OF COMPUTERS, COMPUTER HARDWARE, COMPUTER HARDWARE SYSTEMS, COMPUTER NETWORKS, AND COMMUNICATIONS NETWORKS; COMPUTER INSTALLATION; MAINTENANCE AND REPAIR OF COMPUTER HARDWARE AND NETWORKS USED FOR ORGANIZING, DIRECTING, AND CONTROLLING COMMUNICATION, INFORMATION, TASKS, AND INTERACTION BETWEEN REMOTE SITES AND BETWEEN REMOTE SITES AND A CENTRAL LOCATION; MAINTENANCE

OF COMPUTERS, IN CLASS 37 (U.S. CLS. 100, 103 AND 106).

FIRST USE 6-8-2005; IN COMMERCE 6-8-2005.

FOR: EDUCATION SERVICES, NAMELY, CONDUCTING CLASSES, SEMINARS, CONFERENCES, AND WORKSHOPS IN THE FIELD OF COMPUTERS, COMPUTER PERIPHERALS, AND COMPUTER SOFTWARE RELATED TO THIN-CLIENT/SERVER BASED COMPUTING, COMPUTER INFRASTRUCTURE, NETWORK SECURITY AND MANAGEMENT, AND WIRELESS ELECTRONIC COMPUTING AND COMMERCE, IN CLASS 41 (U.S. CLS. 100, 101 AND 107).

FIRST USE 6-8-2005; IN COMMERCE 6-8-2005.

FOR: TECHNICAL SUPPORT, NAMELY, TROUBLESHOOTING OF COMPUTER HARDWARE, SOFTWARE, AND NETWORK PROBLEMS; MONITORING OF NETWORK SYSTEMS; TECHNICAL SUPPORT OF ELECTRONIC COMMUNICATIONS NETWORKS AND WIRELESS ELECTRONIC COMMUNICATIONS NETWORKS; MAINTENANCE AND REPAIR OF COMPUTER SOFTWARE AND COMPUTER PORTALS; INSTALLATION OF COMPUTER SOFTWARE USED FOR ORGANIZING, DIRECTING, AND CONTROLLING COMMUNICATION, INFORMATION, TASKS, AND INTERACTION BETWEEN REMOTE SITES AND BETWEEN REMOTE SITES AND A CENTRAL LOCATION; TECHNICAL SUPPORT SERVICES, NAMELY, TROUBLE SHOOTING OF PROBLEMS WITH COMPUTER HARDWARE, SOFTWARE, AND NETWORKS USED FOR ORGANIZING, DIRECTING, AND CONTROLLING COMMUNICATION, INFORMATION, TASKS, AND INTERACTION BETWEEN REMOTE SITES AND BETWEEN REMOTE SITES

AND A CENTRAL LOCATION; MAINTENANCE AND REPAIR OF COMPUTER SOFTWARE USED FOR ORGANIZING, DIRECTING, AND CONTROLLING COMMUNICATION, INFORMATION, TASKS, AND INTERACTION BETWEEN REMOTE SITES AND BETWEEN REMOTE SITES AND A CENTRAL LOCATION, IN CLASS 42 (U.S. CLS. 100 AND 101).

FIRST USE 6-8-2005; IN COMMERCE 6-8-2005.

THE MARK CONSISTS OF A COMPUTER SERVER CONNECTED WITH A DESKTOP COMPUTER VIA A NETWORK CLOUD IMAGE. THE NETWORK

CLOUD IS SURROUNDED BY AN OVAL RING THAT PIERCES THE MONITOR IN THE DESKTOP COMPUTER. THE WORDS "FOLLOW THE WIRE" APPEAR BENEATH THE OVAL AND FOLLOW THE PATH OF THE OVAL. THE WORDS "FOLLOW THE" APPEAR ON THE LEFT SIDE OF THE DESKTOP COMPUTER AND THE WORD "WIRE" APPEARS ON THE RIGHT SIDE OF THE DESKTOP COMPUTER.

SER. NO. 78-881,963, FILED 5-11-2006.

TRACY WHITTAKER-BROWN, EXAMINING ATTORNEY

Int. Cls.: 25 and 43

Prior U.S. Cls.: 22, 39, 100 and 101

United States Patent and Trademark Office

Reg. No. 3,520,676

Registered Oct. 21, 2008

TRADEMARK
SERVICE MARK
PRINCIPAL REGISTER



CAROLINA SPICE COMPANY, LLC (SOUTH
CAROLINA LIMITED LIABILITY COMPANY)
130 WHITEFORD WAY, SUITE D
LEXINGTON, SC 29072

FOR: BASEBALL CAPS; CAP VISORS; CAPS WITH
VISORS; GOLF CAPS; GOLF SHIRTS; KNIT SHIRTS;
OPEN-NECKED SHIRTS; POLO SHIRTS; SHIRTS;
SPORT SHIRT; SWEAT SHIRTS; T-SHIRTS, IN
CLASS 25 (U.S. CLS. 22 AND 39).

FIRST USE 3-18-1996; IN COMMERCE 3-18-1996.

FOR: CARRY-OUT RESTAURANTS; FAST-FOOD
RESTAURANTS; PREPARATION OF FOOD AND
BEVERAGES; RESTAURANT AND BAR SERVICES;
RESTAURANT SERVICES; RESTAURANTS; SER-

VING OF FOOD AND DRINK/BEVERAGES; TAKE-
OUT RESTAURANT SERVICES, IN CLASS 43 (U.S.
CLS. 100 AND 101).

FIRST USE 3-18-1996; IN COMMERCE 3-18-1996.

NO CLAIM IS MADE TO THE EXCLUSIVE
RIGHT TO USE "WINGS" IN INTERNATIONAL
CLASS 043, APART FROM THE MARK AS SHOWN.

SEC. 2(F).

SER. NO. 78-887,478, FILED 5-19-2006.

HELENE LIWINSKI, EXAMINING ATTORNEY

Int. Cl.: 44

Prior U.S. Cls.: 100 and 101

United States Patent and Trademark Office

Reg. No. 3,520,677

Registered Oct. 21, 2008

**SERVICE MARK
PRINCIPAL REGISTER**

MYCLEARVISION

REFRACTEC, INC. (CALIFORNIA CORPORATION)
5 JENNER, STE. 150
IRVINE, CA 92618

THE MARK CONSISTS OF STANDARD CHARACTERS WITHOUT CLAIM TO ANY PARTICULAR FONT, STYLE, SIZE, OR COLOR.

FOR: PROVIDING A WEBSITE THAT FEATURES A COLLECTION OF INFORMATION ABOUT THE EYE, VISION AND VISION CORRECTION SURGERY, IN CLASS 44 (U.S. CLS. 100 AND 101).

SER. NO. 78-888,041, FILED 5-19-2006.

FIRST USE 1-30-2001; IN COMMERCE 1-30-2001.

DAVID MILLER, EXAMINING ATTORNEY

Int. Cl.: 36

Prior U.S. Cls.: 100, 101 and 102

United States Patent and Trademark Office

Reg. No. 3,520,678

Registered Oct. 21, 2008

**SERVICE MARK
PRINCIPAL REGISTER**

INFORMA

INFORMA USA, INC. (MASSACHUSETTS CORPORATION)
ONE RESEARCH DRIVE
WESTBOROUGH, MA 01581

FOR: PROVIDING INFORMATION, ANALYSIS AND COMMENTARY IN THE FIELDS OF FINANCE AND INSURANCE; PROVIDING INFORMATION, ANALYSIS, AND COMMENTARY IN THE FIELDS OF FINANCE AND INSURANCE BY MEANS OF THE INTERNET; PROVIDING ON-LINE COMPUTER DATABASES IN THE FIELD OF FINANCE; FINANCIAL PLANNING; FINANCIAL PLANNING CONSULTATION AND FINANCIAL

RESEARCH, IN CLASS 36 (U.S. CLS. 100, 101 AND 102).

FIRST USE 1-1-2000; IN COMMERCE 1-1-2000.

THE MARK CONSISTS OF STANDARD CHARACTERS WITHOUT CLAIM TO ANY PARTICULAR FONT, STYLE, SIZE, OR COLOR.

SER. NO. 78-896,972, FILED 5-31-2006.

GEOFFREY FOSDICK, EXAMINING ATTORNEY

Int. Cl.: 12

Prior U.S. Cls.: 19, 21, 23, 31, 35 and 44

Reg. No. 3,520,679

United States Patent and Trademark Office

Registered Oct. 21, 2008

**TRADEMARK
PRINCIPAL REGISTER**

INVADER

DUAL-TECH, INC. (TENNESSEE CORPORATION)
540 INDUSTRIAL DRIVE
BEAN STATION, TN 37708

THE MARK CONSISTS OF STANDARD CHARACTERS WITHOUT CLAIM TO ANY PARTICULAR FONT, STYLE, SIZE, OR COLOR.

FOR: TILT BED TRAILERS MOUNTED ON TOWING AND WRECKER TRUCKS, IN CLASS 12 (U.S. CLS. 19, 21, 23, 31, 35 AND 44).

SER. NO. 78-897,159, FILED 5-31-2006.

FIRST USE 0-0-1996; IN COMMERCE 0-0-1996.

TRACY WHITTAKER-BROWN, EXAMINING ATTORNEY

Int. Cl.: 19

Prior U.S. Cls.: 1, 12, 33 and 50

United States Patent and Trademark Office

Reg. No. 3,520,680

Registered Oct. 21, 2008

**TRADEMARK
PRINCIPAL REGISTER**

CEILITE

EDWARDS, JAMES LEWIS (AUSTRALIA INDIVIDUAL)
18 HAWKER STREET
CURRUMBIN, AUSTRALIA 4223

FOR: LAMINATES, NAMELY, LAMINATES COMPRISING ONE OR MORE NON-METALLIC PANELS LAMINATED WITH A PAPER COATING; NON-METALLIC LAMINATED BUILDING PANELS; NON-STRUCTURAL PANELS, NOT OF METAL, FOR USE IN BUILDING; IN-FILL PANELS, NOT OF METAL, FOR FILLING SPACES IN WALLS AND CEILINGS; DECORATIVE LAMINATES AND PANELS, NAMELY, NON-METALLIC LAMINATES AND PANELS HAVING A DECORATIVE FINISH ON ONE SURFACE FOR PLACING IN WALLS OR

CEILINGS; NON-METAL CEILING PANELS, IN CLASS 19 (U.S. CLS. 1, 12, 33 AND 50).

THE MARK CONSISTS OF STANDARD CHARACTERS WITHOUT CLAIM TO ANY PARTICULAR FONT, STYLE, SIZE, OR COLOR.

PRIORITY CLAIMED UNDER SEC. 44(D) ON AUSTRALIA APPLICATION NO. 1089127, FILED 12-6-2005, REG. NO. 1089127, DATED 12-6-2005, EXPIRES 12-6-2015.

SER. NO. 78-899,388, FILED 6-2-2006.

PAUL E. FAHRENKOPF, EXAMINING ATTORNEY

Int. Cl.: 19

Prior U.S. Cls.: 1, 12, 33 and 50

United States Patent and Trademark Office

Reg. No. 3,520,681

Registered Oct. 21, 2008

**TRADEMARK
PRINCIPAL REGISTER**



EURO PLASTIC PROFILES INC. (CANADA CORPORATION)
21 REGINA ROAD
WOODBIDGE, CANADA L4L 8L9

FOR: EXTRUDED NON-METAL WINDOW AND DOOR PROFILES FOR USE IN MANUFACTURING WINDOWS AND DOORS, IN CLASS 19 (U.S. CLS. 1, 12, 33 AND 50).

PRIORITY CLAIMED UNDER SEC. 44(D) ON CANADA APPLICATION NO. 1282148, FILED 12-6-

2005, REG. NO. TMA693086, DATED 7-31-2007, EXPIRES 7-31-2022.

NO CLAIM IS MADE TO THE EXCLUSIVE RIGHT TO USE "PLASTIC PROFILES INC.", APART FROM THE MARK AS SHOWN.

SER. NO. 78-899,420, FILED 6-2-2006.

CIMMERIAN COLEMAN, EXAMINING ATTORNEY

Int. Cls.: 6, 7, 40 and 42

**Prior U.S. Cls.: 2, 12, 13, 14, 19, 21, 23, 25, 31, 34, 35,
50, 100, 101, 103 and 106**

Reg. No. 3,520,682

United States Patent and Trademark Office

Registered Oct. 21, 2008

**TRADEMARK
SERVICE MARK
PRINCIPAL REGISTER**

THERMOFAT

FEDERAL-MOGUL NURNBERG, GMBH (FED
REP GERMANY GMBH)
NOPITSCHSTRASSE 67
NUREMBERG, FED REP GERMANY 90441

FOR: FINISHED CAST MOLDED PARTS, NAME-
LY, METAL BOLTS FOR AIR AND WATER INTER-
NATIONAL COMBUSTION ENGINES, IN CLASS 6
(U.S. CLS. 2, 12, 13, 14, 23, 25 AND 50).

FOR: UNFINISHED DEAD-MOLD CAST LIGHT
METAL MACHINE PARTS, NAMELY, PISTONS,
PISTON RINGS, PISTON LOCKING RINGS AND
BEARNG HOUSING FOR PARTS OF INTERNAL
COMBUSTION ENGINES FOR AIR, WATER AND
AUTOMOTIVE VEHICLES, IN CLASS 7 (U.S. CLS. 13,
19, 21, 23, 31, 34 AND 35).

FOR: MATERIAL PROCESSING, NAMELY, CUS-
TOM TREATMENT OF MATERIALS BY LASER
BEAM, NAMELY, LIGHT METALS AND THEIR
ALLOYS FOR INTERNAL COMBUSTION ENGINES
OF AIR, WATER, AND LAND VEHICLES, IN CLASS
40 (U.S. CLS. 100, 103 AND 106).

FOR: ENGINEERING SERVICES; NEW PRO-
DUCT MATERIALS DEVELOPMENT FOR THIRD
PARTIES IN THE FIELD OF AUTOMOTIVE TECH-
NOLOGY, IN PARTICULAR PISTONS AND PARTS
THEREOF FOR INTERNAL COMBUSTION EN-
GINES AND COMPRESSORS; INDUSTRIAL RE-
SEARCH AND TECHNICAL RESEARCH,
NAMELY, CALCULATIONS FOR NEW PRODUCT
DEVELOPMENT FOR OTHERS IN THE FIELD OF
AUTOMOBILE TECHNOLOGY, IN PARTICULAR
PISTONS AND PARTS THEREOF FOR INTERNAL
COMBUSTION ENGINES AND COMPRESSORS, IN
CLASS 42 (U.S. CLS. 100 AND 101).

THE MARK CONSISTS OF STANDARD CHAR-
ACTERS WITHOUT CLAIM TO ANY PARTICULAR
FONT, STYLE, SIZE, OR COLOR.

OWNER OF FED REP GERMANY REG. NO.
DE30572471, DATED 12-6-2005, EXPIRES 12-6-2015.

SER. NO. 78-900,435, FILED 6-5-2006.

JASON TURNER, EXAMINING ATTORNEY

Int. Cls.: 6, 7, 40 and 42

**Prior U.S. Cls.: 2, 12, 13, 14, 19, 21, 23, 25, 31, 34, 35,
50, 100, 101, 103 and 106**

Reg. No. 3,520,683

United States Patent and Trademark Office

Registered Oct. 21, 2008

**TRADEMARK
SERVICE MARK
PRINCIPAL REGISTER**

GASOLITE

FEDERAL-MOGUL NURNBERG GMBH (FED
REP GERMANY GMBH)
NOPITSCHSTRASSE 67
NUREMBERG, FED REP GERMANY 90441

FOR: FINISHED CAST MOLDED PARTS, NAME-
LY, METAL BOLTS FOR AIR AND WATER INTER-
NATIONAL COMBUSTION ENGINES, IN CLASS 6
(U.S. CLS. 2, 12, 13, 14, 23, 25 AND 50).

FOR: UNFINISHED DEAD-MOLD CAST LIGHT
METAL MACHINE PARTS, NAMELY, PISTONS,
PISTON RINGS, PISTON LOCKING RINGS AND
BEARING HOUSING FOR PARTS OF INTERNAL
COMBUSTION ENGINES FOR AIR, WATER AND
AUTOMOTIVE VEHICLES, IN CLASS 7 (U.S. CLS. 13,
19, 21, 23, 31, 34 AND 35).

FOR: MATERIAL PROCESSING, NAMELY, CUS-
TOM TREATMENT OF MATERIALS BY LASER
BEAM, NAMELY, LIGHT METALS AND THEIR
ALLOYS FOR INTERNAL COMBUSTION ENGINES
OF AIR, WATER AND LAND VEHICLES FOR
OTHERS, IN CLASS 40 (U.S. CLS. 100, 103 AND 106).

FOR: ENGINEERING SERVICES; NEW PRO-
DUCT MATERIALS DEVELOPMENT FOR THIRD
PARTIES IN THE FIELD OF AUTOMOTIVE TECH-
NOLOGY, IN PARTICULAR PISTONS AND PARTS
THEREOF FOR INTERNAL COMBUSTION EN-
GINES AND COMPRESSORS; INDUSTRIAL RE-
SEARCH AND TECHNICAL RESEARCH,
NAMELY, CALCULATIONS FOR NEW PRODUCT
DEVELOPMENT FOR OTHERS IN THE FIELD OF
AUTOMOBILE TECHNOLOGY, IN PARTICULAR
PISTONS AND PARTS THEREOF FOR INTERNAL
COMBUSTION ENGINES AND COMPRESSORS, IN
CLASS 42 (U.S. CLS. 100 AND 101).

THE MARK CONSISTS OF STANDARD CHAR-
ACTERS WITHOUT CLAIM TO ANY PARTICULAR
FONT, STYLE, SIZE, OR COLOR.

OWNER OF FED REP GERMANY REG. NO.
30572474, DATED 4-13-2006, EXPIRES 12-31-2015.

SER. NO. 78-900,511, FILED 6-5-2006.

JASON TURNER, EXAMINING ATTORNEY

Int. Cls.: 6, 7, 40 and 42

**Prior U.S. Cls.: 2, 12, 13, 14, 19, 21, 23, 25, 31, 34, 35,
50, 100, 101, 103 and 106**

Reg. No. 3,520,684

United States Patent and Trademark Office

Registered Oct. 21, 2008

**TRADEMARK
SERVICE MARK
PRINCIPAL REGISTER**

FORCEGROOVE

FEDERAL-MOGUL NURNBERG GMBH (FED
REP GERMANY GMBH)
NOPITSCHSTRASSE 67
NUREMBERG, FED REP GERMANY 90441

FOR: FINISHED CAST MOLDED PARTS, NAME-
LY, METAL BOLTS FOR AIR AND WATER INTER-
NATIONAL COMBUSTION ENGINES, IN CLASS 6
(U.S. CLS. 2, 12, 13, 14, 23, 25 AND 50).

FOR: UNFINISHED DEAD-MOLD CAST LIGHT
METAL MACHINE PARTS, NAMELY, PISTONS,
PISTON RINGS, PISTON LOCKING RINGS AND
BEARING HOUSING FOR PARTS OF INTERNAL
COMBUSTION ENGINES FOR AIR, WATER VEHI-
CLES AND AUTOMOTIVE VEHICLES, IN CLASS 7
(U.S. CLS. 13, 19, 21, 23, 31, 34 AND 35).

FOR: MATERIAL PROCESSING, NAMELY, CUS-
TOM TREATMENT OF MATERIALS BY LASER
BEAM, NAMELY, LIGHT METALS AND THEIR
ALLOYS FOR INTERNAL COMBUSTION ENGINES
OF AIR, WATER, AND LAND VEHICLES, IN CLASS
40 (U.S. CLS. 100, 103 AND 106).

FOR: ENGINEERING SERVICES; NEW PRO-
DUCT MATERIALS DEVELOPMENT FOR THIRD
PARTIES IN THE FIELD OF AUTOMOTIVE TECH-
NOLOGY, IN PARTICULAR PISTONS AND PARTS
THEREOF FOR INTERNAL COMBUSTION EN-
GINES AND COMPRESSORS; INDUSTRIAL RE-
SEARCH AND TECHNICAL RESEARCH,
NAMELY, CALCULATIONS FOR NEW PRODUCT
DEVELOPMENT FOR OTHERS IN THE FIELD OF
AUTOMOBILE TECHNOLOGY, IN PARTICULAR
PISTONS AND PARTS THEREOF FOR INTERNAL
COMBUSTION ENGINES AND COMPRESSORS, IN
CLASS 42 (U.S. CLS. 100 AND 101).

THE MARK CONSISTS OF STANDARD CHAR-
ACTERS WITHOUT CLAIM TO ANY PARTICULAR
FONT, STYLE, SIZE, OR COLOR.

OWNER OF FED REP GERMANY REG. NO.
30572473, DATED 4-13-2006, EXPIRES 12-31-2015.

SER. NO. 78-900,540, FILED 6-5-2006.

JASON TURNER, EXAMINING ATTORNEY

Int. Cls.: 6, 7, 40 and 42

**Prior U.S. Cls.: 2, 12, 13, 14, 19, 21, 23, 25, 31, 34, 35,
50, 100, 101, 103 and 106**

Reg. No. 3,520,685

United States Patent and Trademark Office

Registered Oct. 21, 2008

**TRADEMARK
SERVICE MARK
PRINCIPAL REGISTER**

DURABOWL

FEDERAL-MOGUL NURNBERG GMBH (FED
REP GERMANY GMBH)
NOPITSCHSTRASSE 67
NUREMBERG, FED REP GERMANY 90441

FOR: FINISHED CAST MOLDED PARTS, NAME-
LY, METAL BOLTS FOR AIR AND WATER IN
INTERNATIONAL COMBUSTION ENGINES, IN
CLASS 6 (U.S. CLS. 2, 12, 13, 14, 23, 25 AND 50).

FOR: UNFINISHED DEAD-MOLD CAST LIGHT
METAL MACHINE PARTS, NAMELY, PISTONS,
PISTON RINGS, PISTON LOCKING RINGS AND
BEARING HOUSING FOR PARTS OF INTERNAL
COMBUSTION ENGINES FOR AIR, WATER AND
AUTOMOTIVE VEHICLES, IN CLASS 7 (U.S. CLS. 13,
19, 21, 23, 31, 34 AND 35).

FOR: MATERIAL PROCESSING, NAMELY, CUS-
TOM TREATMENT OF MATERIALS BY LASER
BEAM, NAMELY, LIGHT METALS AND THEIR
ALLOYS FOR INTERNAL COMBUSTION ENGINES
OF AIR, WATER, AND LAND VEHICLES, IN CLASS
40 (U.S. CLS. 100, 103 AND 106).

FOR: ENGINEERING SERVICES; NEW PRO-
DUCT MATERIALS DEVELOPMENT FOR THIRD
PARTIES IN THE FIELD OF AUTOMOTIVE TECH-
NOLOGY, IN PARTICULAR PISTONS AND PARTS
THEREOF FOR INTERNAL COMBUSTION EN-
GINES AND COMPRESSORS; INDUSTRIAL RE-
SEARCH AND TECHNICAL RESEARCH,
NAMELY, CALCULATIONS FOR NEW PRODUCT
DEVELOPMENT FOR OTHERS IN THE FIELD OF
AUTOMOBILE TECHNOLOGY, IN PARTICULAR
PISTONS AND PARTS THEREOF FOR INTERNAL
COMBUSTION ENGINES AND COMPRESSORS, IN
CLASS 42 (U.S. CLS. 100 AND 101).

THE MARK CONSISTS OF STANDARD CHAR-
ACTERS WITHOUT CLAIM TO ANY PARTICULAR
FONT, STYLE, SIZE, OR COLOR.

OWNER OF FED REP GERMANY REG. NO.
30572468, DATED 4-13-2006, EXPIRES 12-31-2015.

SER. NO. 78-900,584, FILED 6-5-2006.

JASON TURNER, EXAMINING ATTORNEY

Int. Cls.: 6, 7, 40 and 42

**Prior U.S. Cls.: 2, 12, 13, 14, 19, 21, 23, 25, 31, 34, 35,
50, 100, 101, 103 and 106**

Reg. No. 3,520,686

United States Patent and Trademark Office

Registered Oct. 21, 2008

**TRADEMARK
SERVICE MARK
PRINCIPAL REGISTER**

CARBODUR

FEDERAL-MOGUL NURNBERG GMBH (FED
REP GERMANY GMBH)
NOPITSCHSTRASSE 67
NUREMBERG, FED REP GERMANY 90441

FOR: FINISHED CAST MOLDED PARTS, NAME-
LY, METAL BOLTS FOR AIR AND WATER INTER-
NATIONAL COMBUSTION ENGINES, IN CLASS 6
(U.S. CLS. 2, 12, 13, 14, 23, 25 AND 50).

FOR: UNFINISHED DEAD-MOLD CAST LIGHT
METAL MACHINE PARTS, NAMELY, PISTONS,
PISTON RINGS, PISTON LOCKING RINGS AND
BEARING HOUSING FOR PARTS OF INTERNAL
COMBUSTION ENGINES FOR AIR, WATER AND
AUTOMOTIVE VEHICLES, IN CLASS 7 (U.S. CLS. 13,
19, 21, 23, 31, 34 AND 35).

FOR: MATERIAL PROCESSING, NAMELY, CUS-
TOM TREATMENT OF MATERIALS BY LASER
BEAM, NAMELY, LIGHT METALS AND THEIR
ALLOYS FOR INTERNAL COMBUSTION ENGINES
OF AIR, WATER AND LAND VEHICLES, IN CLASS
40 (U.S. CLS. 100, 103 AND 106).

FOR: ENGINEERING SERVICES; NEW PRO-
DUCT MATERIALS DEVELOPMENT FOR THIRD

PARTIES IN THE FIELD OF AUTOMOTIVE TECH-
NOLOGY, IN PARTICULAR PISTONS AND PARTS
THEREOF FOR INTERNAL COMBUSTION EN-
GINES AND COMPRESSORS; INDUSTRIAL RE-
SEARCH AND TECHNICAL RESEARCH,
NAMELY, CALCULATIONS FOR NEW PRODUCT
DEVELOPMENT FOR OTHERS IN THE FIELD OF
AUTOMOBILE TECHNOLOGY, IN PARTICULAR
PISTONS AND PARTS THEREOF FOR INTERNAL
COMBUSTION ENGINES AND COMPRESSORS, IN
CLASS 42 (U.S. CLS. 100 AND 101).

THE MARK CONSISTS OF STANDARD CHAR-
ACTERS WITHOUT CLAIM TO ANY PARTICULAR
FONT, STYLE, SIZE, OR COLOR.

PRIORITY CLAIMED UNDER SEC. 44(D) ON FED
REP GERMANY APPLICATION NO. 305758969,
FILED 12-21-2005, REG. NO. 305758969, DATED 12-
21-2005, EXPIRES 12-31-2015.

SER. NO. 78-900,609, FILED 6-5-2006.

JASON TURNER, EXAMINING ATTORNEY

Int. Cls.: 1, 6, 7, 8, 19, 20, 35, 37 and 42

Prior U.S. Cls.: 1, 2, 5, 6, 10, 12, 13, 14, 19, 21, 22, 23, 25, 26, 28, 31, 32, 33, 34, 35, 44, 46, 50, 100, 101, 102, 103 and 106

Reg. No. 3,520,687

United States Patent and Trademark Office

Registered Oct. 21, 2008

**TRADEMARK
SERVICE MARK
PRINCIPAL REGISTER**

RED HORSE

DISSING TRADING A/S (DENMARK CORPORATION)
HÅRBY
STABELVEJ 5
SKANDERBORG, DENMARK 8660

FOR: CHEMICALS USED IN INDUSTRY, SCIENCE AND PHOTOGRAPHY; CHEMICALS USED FOR POWDER PAINTING AND LACKING; UNPROCESSED ARTIFICIAL RESINS FOR THE BUILDING AND CONSTRUCTION INDUSTRY; UNPROCESSED PLASTICS; MANURERS; FIRE EXTINGUISHING COMPOSITIONS; TEMPERING CHEMICALS FOR USE IN METAL WORKING AND SOLDERING; ADHESIVES USED IN THE CONSTRUCTION INDUSTRY, IN CLASS 1 (U.S. CLS. 1, 5, 6, 10, 26 AND 46).

FOR: METAL FASTENERS, NAMELY, SCREWS, RIVETS ANCHORS, PLUGS, INJECTION BOLTS, METAL CABLE CLIPS, METAL JUNCTIONS FOR PIPES, METAL SHELF BRACKETS, AND NAILS; NON-ELECTRIC CABLES AND WIRES OF COMMON METAL; IRONMONGERY, NAMELY, SCREWS RIVETS PIPES AND TUBES OF METAL, METAL SAFES, IN CLASS 6 (U.S. CLS. 2, 12, 13, 14, 23, 25 AND 50).

FOR: MACHINE AND MACHINE TOOLS, NAMELY, ELECTRIC HAND TOOLS, NAMELY, PERCUSSION DRILLS, HAMMER DRILLS, DRILL CHISEL, DEMOLITION HAMMERS, DRILL/SCREW DRIVERS, BORING MACHINES, PLATE SHEARS, RIGHT-ANGLED BORING, BAYONET SAWS, ANGLE GRINDERS; RIVET HAMMERS, PLANING MACHINES FOR METALWORKING, DIAMOND DRILLING MACHINES, ELECTRIC BELT SANDERS, CIRCULAR SAWS, COMPASS SAWS, POWER

DRILLS AND DIAMOND-POINTED METAL CUTTING TOOLS, NAMELY, DIAMOND CUTTING DISCS, DIAMOND THROUGH-DRILLING MACHINES, DIAMOND GRINDING HEADS, POWER-OPERATED DIAMOND DRILLS, POWER HAMMER DRILLS, ELECTRIC BELT SANDERS, POWER-OPERATED POLISHER, POWER-OPERATED TOOLS, NAMELY, HAMMERS AND SCREWDRIVERS, IN CLASS 7 (U.S. CLS. 13, 19, 21, 23, 31, 34 AND 35).

FOR: HAND TOOLS AND BITS FOR USE IN THE FASTENING INDUSTRY, NAMELY, MANUAL DRILLS, MANUALLY OPERATED HAND TOOLS, NAMELY, HAMMERS AND SCREWDRIVERS, SPANNERS, TORQUE WRENCHES, SHEET PLIERS, AND BELT SANDERS; MANUAL CONCRETE CHISELS, MANUAL WALL DRILLS, MANUAL SHEET DRILLS, MANUAL SINGLE AND MANUAL DOUBLE DRILLS, BLADES FOR HAND COMPASS SAWS, BLADES FOR HAND BAYONET SAWS AND HAND TOOLS, AND MANUALLY-OPERATED GRINDING WHEELS, IN CLASS 8 (U.S. CLS. 23, 28 AND 44).

FOR: NON-METALLIC BUILDING MATERIALS, NAMELY, WINDOWS; NON-METALLIC RIGID PIPES FOR BUILDING; ASPHALT AND PITCH, IN CLASS 19 (U.S. CLS. 1, 12, 33 AND 50).

FOR: FURNITURE, MIRRORS, PICTURE FRAMES OF WOOD, CORK, REED, CANE, WICKER, HORN, BONE, IVORY, WHALEBONE, SHELL, AMBER, MOTHER-OF-PEARL, MEERSCHAUM AND SUBSTITUTES FOR ALL THESE MATERIALS, OR OF PLASTICS, IN CLASS 20 (U.S. CLS. 2, 13, 22, 25, 32 AND 50).

FOR: ADVERTISING AND MARKETING; BUSINESS MANAGEMENT; BUSINESS ADMINISTRATION AND MANAGEMENT; PROVIDING OFFICE FUNCTIONS, IN CLASS 35 (U.S. CLS. 100, 101 AND 102).

FOR: RESIDENTIAL AND COMMERCIAL BUILDING CONSTRUCTION, IN CLASS 37 (U.S. CLS. 100, 103 AND 106).

FOR: DESIGN OF COMPUTER HARDWARE AND SOFTWARE FOR OTHERS, DEVELOPMENT OF COMPUTER HARDWARE AND SOFTWARE, IN CLASS 42 (U.S. CLS. 100 AND 101).

THE MARK CONSISTS OF STANDARD CHARACTERS WITHOUT CLAIM TO ANY PARTICULAR FONT, STYLE, SIZE, OR COLOR.

PRIORITY CLAIMED UNDER SEC. 44(D) ON DENMARK APPLICATION NO. VA20050561, FILED 12-9-2005, REG. NO. VR20060099, DATED 3-16-2006, EXPIRES 3-16-2016.

SER. NO. 78-904,844, FILED 6-9-2006.

KATHERINE STOIDES, EXAMINING ATTORNEY

Int. Cl.: 5

Prior U.S. Cls.: 6, 18, 44, 46, 51 and 52

United States Patent and Trademark Office

Reg. No. 3,520,688

Registered Oct. 21, 2008

**TRADEMARK
PRINCIPAL REGISTER**

ONCOPORE

LYTIX BIOPHARMA AS (NORWAY CORPORATION)
FORSKNINGSPARKEN, POSTBOKS 6447
TROMSO, NORWAY N-9294

FOR: PHARMACEUTICAL PREPARATIONS FOR
THE TREATMENT OF CANCER, IN CLASS 5 (U.S.
CLS. 6, 18, 44, 46, 51 AND 52).

THE MARK CONSISTS OF STANDARD CHAR-
ACTERS WITHOUT CLAIM TO ANY PARTICULAR
FONT, STYLE, SIZE, OR COLOR.

PRIORITY CLAIMED UNDER SEC. 44(D) ON
NORWAY APPLICATION NO. 200606241, FILED 6-
14-2006, REG. NO. 236469, DATED 11-24-2006, EX-
PIRES 11-24-2016.

SER. NO. 78-908,494, FILED 6-14-2006.

PATRICIA EVANKO, EXAMINING ATTORNEY

Int. Cl.: 9

Prior U.S. Cls.: 21, 23, 26, 36 and 38

Reg. No. 3,520,689

United States Patent and Trademark Office

Registered Oct. 21, 2008

**TRADEMARK
PRINCIPAL REGISTER**

TV-TAC-TOE

SEPAND RIAHI (UNITED STATES INDIVIDUAL)
2130 MARIETTA AVENUE
PO BOX 6370
LANCASTER, PA 17603

THE MARK CONSISTS OF STANDARD CHAR-
ACTERS WITHOUT CLAIM TO ANY PARTICULAR
FONT, STYLE, SIZE, OR COLOR.

FOR: DVDS FEATURING AN INTERACTIVE
MULTIMEDIA COMPUTER GAME PROGRAM, IN
CLASS 9 (U.S. CLS. 21, 23, 26, 36 AND 38).

SER. NO. 78-917,689, FILED 6-27-2006.

FIRST USE 6-1-2006; IN COMMERCE 6-26-2006.

ROBIN CHOSID, EXAMINING ATTORNEY

Int. Cl.: 32

Prior U.S. Cls.: 45, 46 and 48

United States Patent and Trademark Office

Reg. No. 3,520,690

Registered Oct. 21, 2008

**TRADEMARK
PRINCIPAL REGISTER**

BONAFONT

BONAFONT, S.A. DE C.V. (MEXICO CORPORATION)
GUILLERMO GONZALEZ CAMARENA 333
CENTRO DE CIUDAD SANTA FÉ, ALVARO OBREGON
MEXICO, D.F., MEXICO C.P. 0121

FOR: STILL AND SPARKLING WATERS; MINERAL WATER AND NON MINERAL, NAMELY, DRINKING WATER; SPRING WATERS, AERATED WATERS; FLAVORED WATERS; FRUIT JUICES AND VEGETABLE JUICES, FRUIT DRINKS AND VEGETABLE DRINKS; LEMONADES, CARBONATED SOFT DRINKS, SORBETS IN THE FORM OF BEVERAGES, PREPARATIONS FOR MAKING SOFT DRINKS, CONCENTRATES, SYRUPS USED IN THE PREPARATION OF SOFT DRINKS, NON-ALCOHOLIC FRUIT EXTRACTS USED IN THE PREPARATION OF BEVERAGES, NON-ALCOHOLIC

VEGETABLE EXTRACTS USED IN THE PREPARATION OF BEVERAGES; NON-ALCOHOLIC BEVERAGES CONTAINING SMALL AMOUNTS OF LACTIC FERMENTS, NON-ALCOHOLIC DRINKS CONSISTING PARTIALLY OF MILK STARTER CULTURES, IN CLASS 32 (U.S. CLS. 45, 46 AND 48).

THE MARK CONSISTS OF STANDARD CHARACTERS WITHOUT CLAIM TO ANY PARTICULAR FONT, STYLE, SIZE, OR COLOR.

OWNER OF MEXICO REG. NO. 420754, DATED 8-28-1992, EXPIRES 6-11-2012.

SER. NO. 78-923,662, FILED 7-6-2006.

STEPHANIE ALI, EXAMINING ATTORNEY

Int. Cl.: 41

Prior U.S. Cls.: 100, 101 and 107

United States Patent and Trademark Office

Reg. No. 3,520,691

Registered Oct. 21, 2008

**SERVICE MARK
PRINCIPAL REGISTER**

VENUS IN FURS

BURSACK, ADAM JEREMY (UNITED STATES
INDIVIDUAL)
1514 5TH ST N
FARGO, ND 58102

FOR: ENTERTAINMENT IN THE NATURE OF
VISUAL AND AUDIO PERFORMANCES BY A
MUSICAL GROUP, ENTERTAINMENT IN THE
NATURE OF LIVE PERFORMANCES BY A MUSI-
CAL GROUP, IN CLASS 41 (U.S. CLS. 100, 101 AND
107).

FIRST USE 0-0-1997; IN COMMERCE 5-7-1999.

THE MARK CONSISTS OF STANDARD CHAR-
ACTERS WITHOUT CLAIM TO ANY PARTICULAR
FONT, STYLE, SIZE, OR COLOR.

SER. NO. 78-924,179, FILED 7-7-2006.

KELLY BOULTON, EXAMINING ATTORNEY

Int. Cl.: 12

Prior U.S. Cls.: 19, 21, 23, 31, 35 and 44

Reg. No. 3,520,692

United States Patent and Trademark Office

Registered Oct. 21, 2008

**TRADEMARK
PRINCIPAL REGISTER**

TREXA

CLEAN-TECH LLC (CALIFORNIA LIMITED LIABILITY COMPANY)
1025 NOWITA PLACE
VENICE, CA 90291

THE MARK CONSISTS OF STANDARD CHARACTERS WITHOUT CLAIM TO ANY PARTICULAR FONT, STYLE, SIZE, OR COLOR.

FOR: AUTOMOBILES AND STRUCTURAL PARTS THEREFOR, IN CLASS 12 (U.S. CLS. 19, 21, 23, 31, 35 AND 44).

SER. NO. 78-926,231, FILED 7-10-2006.

FIRST USE 6-20-2006; IN COMMERCE 6-20-2006.

WARREN L. OLANDRIA, EXAMINING ATTORNEY

Int. Cl.: 36

Prior U.S. Cls.: 100, 101 and 102

United States Patent and Trademark Office

Reg. No. 3,520,693

Registered Oct. 21, 2008

**SERVICE MARK
PRINCIPAL REGISTER**



BYRON UDELL AND ASSOCIATES, INC. (ILLI-
NOIS CORPORATION)
1400 S WOLF ROAD BLDG 500
WHEELING, IL 600906588

FOR: LIFE INSURANCE BROKERAGE, IN CLASS
36 (U.S. CLS. 100, 101 AND 102).

FIRST USE 1-1-1996; IN COMMERCE 1-1-1996.

OWNER OF U.S. REG. NO. 2,405,370.

"THE COLOR(S) BLUE IS/ARE CLAIMED AS A
FEATURE OF THE MARK."

"THE MARK CONSISTS OF THE COLOR BLUE
IN THE TERM "ACQUQUOTE" AND IN THE STY-
LIZED LETTER "Q"."

SER. NO. 78-929,936, FILED 7-14-2006.

TASHIA BUNCH, EXAMINING ATTORNEY

Int. Cl.: 15

Prior U.S. Cls.: 2, 21 and 36

United States Patent and Trademark Office

Reg. No. 3,520,694

Registered Oct. 21, 2008

**TRADEMARK
PRINCIPAL REGISTER**

MIRRORACULOUS

JOBES, DALE A. (UNITED STATES INDIVIDUAL), DBA MIRRORACULOUS OF LAS VEGAS UNLIMITED
3422 VILLA KNOLLS WEST DRIVE
LAS VEGAS, NV 89120

FOR: A VERSATILE CONFIGURATION TYPE OF PICK GUARD FOR MUSICAL INSTRUMENTS THAT FITS TOGETHER FLUSH BETWEEN PIECES OR CAN BE SEPARATED FOR PERSONAL ARTISTIC OR FUNCTIONAL TASTE, IN CLASS 15 (U.S. CLS. 2, 21 AND 36).

FIRST USE 1-8-2006; IN COMMERCE 1-8-2006.

THE MARK CONSISTS OF STANDARD CHARACTERS WITHOUT CLAIM TO ANY PARTICULAR FONT, STYLE, SIZE, OR COLOR.

SER. NO. 78-938,566, FILED 7-27-2006.

INGRID C. EULIN, EXAMINING ATTORNEY

Int. Cl.: 3

Prior U.S. Cls.: 1, 4, 6, 50, 51 and 52

Reg. No. 3,520,695

United States Patent and Trademark Office

Registered Oct. 21, 2008

**TRADEMARK
PRINCIPAL REGISTER**

bouteaque

BOUTEAQUE, LLC (NEW YORK LIMITED LIABILITY COMPANY)
PO BOX 3270
NEW YORK, NY 10163

FIRST USE 5-24-1995; IN COMMERCE 8-23-1995.

FOR: NATURAL BATH AND BODY LINE OF PRODUCTS THAT ARE TEA-INSPIRED, NAMELY, LOTIONS, SHAMPOOS AND CONDITIONERS, BATH TEAS AND SALTS, HAND AND BODY SOAPS, SHOWER GELS, AND AROMATHERAPY CREAMS, LOTIONS AND OILS., IN CLASS 3 (U.S. CLS. 1, 4, 6, 50, 51 AND 52).

THE MARK CONSISTS OF STANDARD CHARACTERS WITHOUT CLAIM TO ANY PARTICULAR FONT, STYLE, SIZE, OR COLOR.

SER. NO. 78-939,595, FILED 7-28-2006.

ANDREA BUTLER, EXAMINING ATTORNEY

Int. Cl.: 33

Prior U.S. Cls.: 47 and 49

United States Patent and Trademark Office

Reg. No. 3,520,696

Registered Oct. 21, 2008

TRADEMARK
PRINCIPAL REGISTER

Carr
VINEYARDS & WINERY

CARR WINERY, INC. (CALIFORNIA CORPORATION)

205 ANACAPA STREET

SANTA BARBARA, CA 93101

FOR: WINE, IN CLASS 33 (U.S. CLS. 47 AND 49).

FIRST USE 8-1-2002; IN COMMERCE 8-1-2002.

NO CLAIM IS MADE TO THE EXCLUSIVE RIGHT TO USE VINEYARDS & WINERY, APART FROM THE MARK AS SHOWN.

SEC. 2(F).

SER. NO. 78-950,136, FILED S.R. 8-11-2006 AM. P.R. 7-7-2007.

CAROLINE WOOD, EXAMINING ATTORNEY

Int. Cls.: 1, 3, 4, 9 and 13

**Prior U.S. Cls.: 1, 2, 4, 5, 6, 9, 10, 15, 21, 23, 26, 36, 38,
46, 50, 51 and 52**

Reg. No. 3,520,697

United States Patent and Trademark Office

Registered Oct. 21, 2008

**TRADEMARK
PRINCIPAL REGISTER**

FRANKFORD ARSENAL

BATTENFELD TECHNOLOGIES, INC. (MISSOURI CORPORATION)
5885 W. VAN HORN TAVERN ROAD
COLUMBIA, MO 65203

FOR: BULLET CASTING FLUX, NAMELY, COMPOUNDS FOR USE IN SEPARATING DROSS FROM LEAD IN THE CASTING OF BULLETS, IN CLASS 1 (U.S. CLS. 1, 5, 6, 10, 26 AND 46).

FIRST USE 3-12-1998; IN COMMERCE 3-12-1998.

FOR: AMMUNITION LOADING AND RELOADING EQUIPMENT, NAMELY, CLEANING PREPARATIONS FOR BULLET MOLDS, IN CLASS 3 (U.S. CLS. 1, 4, 6, 50, 51 AND 52).

FIRST USE 3-12-1998; IN COMMERCE 3-12-1998.

FOR: AMMUNITION LOADING AND RELOADING EQUIPMENT, NAMELY, CASE LUBRICANT AND BULLET MOLD LUBRICANT, IN CLASS 4 (U.S. CLS. 1, 6 AND 15).

FIRST USE 3-12-1998; IN COMMERCE 3-12-1998.

FOR: AMMUNITION LOADING AND RELOADING EQUIPMENT, NAMELY, RELOADING MICROMETERS AND RELOADING CALIPERS, IN CLASS 9 (U.S. CLS. 21, 23, 26, 36 AND 38).

FIRST USE 3-12-1998; IN COMMERCE 3-12-1998.

FOR: AMMUNITION LOADING AND RELOADING EQUIPMENT, NAMELY, CARTRIDGE GAGES, TUMBLERS, NAMELY, VIBRATORY DEVICES THAT CLEAN CARTRIDGES AFTER FIRING; COMPONENT PARTS FOR TUMBLERS, NAMELY, TUMBLER NUTS AND TUMBLER BOWLS; CASE CLEANING MEDIA, MEDIA SEPARATORS, SIFTERS, PORTABLE RELOADING STANDS, POWDER FUNNELS, BULLET PULLERS, PRIMER TUBE FILLERS, AMMUNITION BOXES, RELOADING PRESSES, AND RELOADING TRAYS, IN CLASS 13 (U.S. CLS. 2 AND 9).

FIRST USE 3-12-1998; IN COMMERCE 3-12-1998.

THE MARK CONSISTS OF STANDARD CHARACTERS WITHOUT CLAIM TO ANY PARTICULAR FONT, STYLE, SIZE, OR COLOR.

NO CLAIM IS MADE TO THE EXCLUSIVE RIGHT TO USE "ARSENAL", APART FROM THE MARK AS SHOWN.

SER. NO. 78-951,749, FILED 8-14-2006.

MARK PILARO, EXAMINING ATTORNEY

Int. Cls.: 9 and 42

Prior U.S. Cls.: 21, 23, 26, 36, 38, 100 and 101

United States Patent and Trademark Office

Reg. No. 3,520,698

Registered Oct. 21, 2008

**TRADEMARK
SERVICE MARK
PRINCIPAL REGISTER**



SN SYSTEMS LTD. (UNITED KINGDOM LIMITED LIABILITY COMPANY)

4TH FLOOR

REDCLIFF QUAY, 120 REDCLIFF STREET

BRISTOL, UNITED KINGDOM BS1 6HU

FOR: COMPUTERS; COMPUTER SOFTWARE AND FIRMWARE, NAMELY, MIDDLE WARE AND GAME SOFTWARE DEVELOPMENT TOOLS FOR GAMES OF CHANCE AND GAMES FOR EDUCATION AND/OR ENTERTAINMENT PURPOSES ON ANY COMPUTERIZED PLATFORM, INCLUDING DEDICATED GAMING CONSOLES; VIDEO GAMES FOR USE WITH TELEVISIONS; INTERACTIVE VIDEO GAME PROGRAMS; COMPUTER HARDWARE; PERIPHERAL ITEMS FOR COMPUTERS, NAMELY, MICE, KEYBOARDS, SPEAKERS, PRINTERS; VIDEO GAME MACHINES FOR USE WITH TELEVISIONS; VIDEO GAME SOFTWARE; BLANK MAGNETIC DATA CARRIERS; RECORDED MAGNETIC DATA CARRIERS FEATURING GAME SOFTWARE DEVELOPMENT TOOLS; BLANK VIDEO DISCS AND RECORDED VIDEO DISCS FEATURING GAME SOFTWARE DEVELOPMENT TOOLS; BLANK OPTICAL DISCS AND RECORDED OPTICAL DISCS FEATURING GAME SOFTWARE DEVELOPMENT TOOLS; BLANK DVD-ROMS AND RECORDED DVD-ROMS FEATURING GAME SOFTWARE DEVELOPMENT TOOLS; BLANK COMPACT DISCS AND RECORDED COMPACT DISCS FEATURING SOFTWARE DEVELOPMENT TOOLS; COMPUTER SOFTWARE DEVELOPMENT TOOLS, IN CLASS 9 (U.S. CLS. 21, 23, 26, 36 AND 38).

FOR: LICENSING OF INTELLECTUAL PROPERTY; ADVICE AND/OR CONSULTANCY SERVICES RELATING TO THE LICENSING OF INTELLECTUAL PROPERTY; COMPUTER SOFTWARE DESIGN, DEVELOPMENT, IMPLEMENTATION, UPDATING, CONFIGURATION, MAINTENANCE AND CONSULTANCY SERVICES RELATED TO THE FOREGOING; COMPUTER HARDWARE DESIGN, DEVELOPMENT, IMPLEMENTATION, UPDATING, CONFIGURATION, MAINTENANCE AND CONSULTANCY SERVICES RELATED TO THE FOREGOING; ADVISORY AND/OR CONSULTANCY SERVICES RELATING TO COMPUTER HARDWARE AND/OR SOFTWARE, NAMELY, MIDDLE WARE AND GAME SOFTWARE DEVELOPMENT TOOLS FOR GAMES OF CHANCE AND GAMES FOR EDUCATION AND/OR ENTERTAINMENT PURPOSES ON ANY COMPUTERIZED PLATFORM INCLUDING DEDICATED GAMING CONSOLES; LEGAL SERVICES RELATED TO DESIGN AND DEVELOPMENT SERVICES FOR MULTIMEDIA PRODUCTS; PRODUCT DEVELOPMENT SERVICES FOR THIRD PARTIES, IN CLASS 42 (U.S. CLS. 100 AND 101).

PRIORITY CLAIMED UNDER SEC. 44(D) ON UNITED KINGDOM APPLICATION NO. 2424175, FILED 6-12-2006, REG. NO. 2424175, DATED 7-27-2007, EXPIRES 6-12-2016.

OWNER OF U.S. REG. NO. 2,651,142.

SER. NO. 78-952,775, FILED 8-15-2006.

MICHAEL KEATING, EXAMINING ATTORNEY

Int. Cl.: 9

Prior U.S. Cls.: 21, 23, 26, 36 and 38

Reg. No. 3,520,699

United States Patent and Trademark Office

Registered Oct. 21, 2008

**TRADEMARK
PRINCIPAL REGISTER**

SAF Q

SDL ATLAS, LLC (ILLINOIS LIMITED LIABILITY COMPANY)
4114 N RAVENSWOOD
CHICAGO, IL 60613

FOR: ELECTRONIC AND MECHANICAL TESTING EQUIPMENT FOR USE IN DETERMINING TENSILE STRENGTH, COMPRESSIVE STRENGTH, TORQUE SHARPNESS AND FIRE RESISTANCE OF CONSUMER PRODUCTS; ELECTRONIC AND MECHANICAL TESTING EQUIPMENT USED TO DETERMINE WHETHER CONSUMER PRODUCTS OPERATE IN COMPLIANCE WITH SPECIFICATION STANDARDS WITH REGARD TO ENVIRONMENTAL CONDITIONS SUCH AS TEMPERATURE, HUMIDITY, VIBRATION, SUNLIGHT, ULTRA VIOLET LIGHT AND GASES, NAMELY, OZONE, NITROGEN OXIDE, AND FUME GAS; ELECTRONIC AND MECHANICAL TESTING EQUIPMENT USED

TO DETERMINE WHETHER CONSUMER PRODUCTS ARE IN COMPLIANCE WITH SPECIFICATION STANDARDS WITH REGARD TO DIMENSIONAL ACCURACY, SUCH AS GAUGE TEMPLATES AND MARKERS, IN CLASS 9 (U.S. CLS. 21, 23, 26, 36 AND 38).

FIRST USE 3-27-1998; IN COMMERCE 4-16-1998.

THE MARK CONSISTS OF STANDARD CHARACTERS WITHOUT CLAIM TO ANY PARTICULAR FONT, STYLE, SIZE, OR COLOR.

OWNER OF U.S. REG. NO. 2,872,430.

SER. NO. 78-953,460, FILED 8-16-2006.

KEVON CHISOLM, EXAMINING ATTORNEY

Int. Cl.: 35

Prior U.S. Cls.: 100, 101 and 102

United States Patent and Trademark Office

Reg. No. 3,520,700

Registered Oct. 21, 2008

**SERVICE MARK
PRINCIPAL REGISTER**

imacron

IMACRON, INC. (PHILIPPINES CORPORATION)
115 KAMUNING ROAD
QUEZON CITY, PHILIPPINES 1103

THE MARK CONSISTS OF "IMACRON" WORD
IN LOWERCASE, WITH FONT TYPE: IMPACT.

FOR: POST-PRODUCTION EDITING SERVICES
FOR VIDEO AND AUDIO COMMERCIALS, IN
CLASS 35 (U.S. CLS. 100, 101 AND 102).

SER. NO. 78-958,166, FILED 8-23-2006.

FIRST USE 7-3-1993; IN COMMERCE 11-12-2005.

SUNG IN, EXAMINING ATTORNEY

Int. Cl.: 25

Prior U.S. Cls.: 22 and 39

United States Patent and Trademark Office

Reg. No. 3,520,701

Registered Oct. 21, 2008

**TRADEMARK
PRINCIPAL REGISTER**

FALCON THREADS

RAMIREZ, JOSUE (UNITED STATES INDIVIDUAL)
902 N. MADISON AVE.
LOS ANGELES, CA 90029

FOR: ATHLETIC SHOES; BANDANAS; BASEBALL CAPS; BASKETBALL SNEAKERS; BEACH SHOES; BOARD SHORTS; BOXER SHORTS; CANVAS SHOES; CAP VISORS; CAPS ; CAPS WITH VISORS; DECK-SHOES; DRESS SHIRTS; FLEECE SHORTS; GOLF CAPS; GOLF SHIRTS; GYM SHORTS; HAT BANDS; HATS; HEADGEAR, NAME-
LY, HATS AND CAPS; INFANTS' SHOES AND BOOTS; KNIT SHIRTS; KNITTED CAPS; LEATHER SHOES; OPEN-NECKED SHIRTS; PANTIES, SHORTS AND BRIEFS; POLO SHIRTS; RUBBER SHOES; RUGBY SHORTS; SHIRTS; SHOES; SHORT-SLEEVED OR LONG-SLEEVED T-SHIRTS; SHORT-SLEEVED SHIRTS; SKULL CAPS; SLIDING SHORTS; SNEAKERS; SPORT SHIRTS; SPORTS

SHIRTS; SPORTS SHIRTS WITH SHORT SLEEVES; SWEAT SHIRTS; SWEAT SHORTS; T-SHIRTS; TENNIS SHOES; WALKING SHORTS; WIND SHIRTS, IN CLASS 25 (U.S. CLS. 22 AND 39).

FIRST USE 7-1-2005; IN COMMERCE 7-1-2005.

THE MARK CONSISTS OF STANDARD CHARACTERS WITHOUT CLAIM TO ANY PARTICULAR FONT, STYLE, SIZE, OR COLOR.

NO CLAIM IS MADE TO THE EXCLUSIVE RIGHT TO USE "THREADS", APART FROM THE MARK AS SHOWN.

SER. NO. 78-959,621, FILED 8-24-2006.

MICHAEL SOUDERS, EXAMINING ATTORNEY

Int. Cls.: 9 and 42

Prior U.S. Cls.: 21, 23, 26, 36, 38, 100 and 101

United States Patent and Trademark Office

Reg. No. 3,520,702

Registered Oct. 21, 2008

**TRADEMARK
SERVICE MARK
PRINCIPAL REGISTER**



COOLIT SYSTEMS INC. (CANADA CORPORATION)
#513A, 3208 - 8 AVENUE N.E.
CALGARY, CANADA

FOR: COOLING DEVICE, NAMELY, A COOLER FOR COOLING ELECTRONIC COMPONENTS, NAMELY, PROCESSORS AND INTEGRATED CIRCUITS, IN CLASS 9 (U.S. CLS. 21, 23, 26, 36 AND 38).

FIRST USE 6-0-2003; IN COMMERCE 6-0-2003.

FOR: TECHNOLOGY CONSULTATION AND RESEARCH IN THE FIELD OF COOLING DEVICES AND SYSTEMS, NAMELY, COOLING ELECTRONIC COMPONENTS, NAMELY, PROCESSORS AND

INTEGRATED CIRCUITS, IN CLASS 42 (U.S. CLS. 100 AND 101).

FIRST USE 6-0-2003; IN COMMERCE 6-0-2003.

OWNER OF CANADA REG. NO. 703307, DATED 12-17-2007, EXPIRES 12-17-2017.

THE MARK CONSISTS OF THE STYLIZED LETTERS "LI".

SER. NO. 78-961,582, FILED 8-28-2006.

LOURDES AYALA, EXAMINING ATTORNEY

Int. Cls.: 14, 18 and 25

Prior U.S. Cls.: 1, 2, 3, 22, 27, 28, 39, 41 and 50

United States Patent and Trademark Office

Reg. No. 3,520,703

Registered Oct. 21, 2008

**TRADEMARK
PRINCIPAL REGISTER**



W H APS (DENMARK CORPORATION)
RYESGADE 19C
COPENHAGEN N, DENMARK DK-2200

FOR: PRECIOUS METALS AND THEIR ALLOYS;
JEWELLERY, PRECIOUS STONES; HOROLOGICAL
AND CHRONOMETRIC INSTRUMENTS, IN CLASS
14 (U.S. CLS. 2, 27, 28 AND 50).

FOR: LEATHER AND IMITATIONS OF LEA-
THER, AND GOODS MADE OF THESE MATERI-
ALS, NAMELY, HANDBAGS, POCKET WALLETS,
SHOPPING BAGS, SCHOOL BAGS, BEACH BAGS,
ATTACHE CASES, BOXES AND CASES; ANIMAL
SKINS, HIDES; TRUNKS AND TRAVELLING BAGS;
UMBRELLAS, PARASOLS AND WALKING STICKS;

WHIPS, HARNESS AND SADDLERY, IN CLASS 18
(U.S. CLS. 1, 2, 3, 22 AND 41).

FOR: CLOTHING, NAMELY, BELTS, BLOUSES,
COATS, GLOVES, JACKETS, JEANS, JUMPERS,
LEGGINGS, PANTS, PULLOVERS, SCARVES,
SHIRTS, SKIRTS, SUITS, SWEATERS, SWEAT-
SHIRTS, T-SHIRTS, TROUSERS, FOOTWEAR,
HEADGEAR, NAMELY, HATS AND CAPS, IN
CLASS 25 (U.S. CLS. 22 AND 39).

OWNER OF ERPN CMNTY TM OFC REG. NO.
003961761, DATED 3-7-2006, EXPIRES 8-2-2014.

SER. NO. 78-968,990, FILED 9-7-2006.

ANDREA HACK, EXAMINING ATTORNEY

Int. Cls.: 9 and 16

Prior U.S. Cls.: 2, 5, 21, 22, 23, 26, 29, 36, 37, 38 and 50

United States Patent and Trademark Office

Reg. No. 3,520,704

Registered Oct. 21, 2008

**TRADEMARK
PRINCIPAL REGISTER**

REDMERE

REDMERE TECHNOLOGY LTD. (IRELAND CORPORATION)
MILLMOUNT DEVELOPMENT CENTRE, #3
DROGHEDA, IRELAND

FOR: CONSUMER ELECTRONICS PRODUCTS, NAMELY, MIXED MEDIA ENCLOSED ELECTRONIC CHIPS, CABLES, RECEIVERS, TRANSMITTERS, REPEATERS FOR HIGH SPEED COMMUNICATIONS AND NETWORKING BETWEEN CONSUMER ELECTRONICS MULTIMEDIA PRODUCTS; SOFTWARE FOR USE IN CONSUMER ELECTRONICS PRODUCTS FOR HIGH SPEED COMMUNICATIONS AND NETWORKING BETWEEN CONSUMER ELECTRONICS MULTIMEDIA PRODUCTS, NAMELY, BETWEEN MIXED MEDIA ENCLOSED ELECTRONIC CHIPS, CABLES, RECEIVERS, TRANSMITTERS, AND REPEATERS, IN CLASS 9 (U.S. CLS. 21, 23, 26, 36 AND 38).

FOR: PRINTED MATTERS, NAMELY, NEWSLETTERS, BROCHURES AND USER MANUALS FEATURING INSTRUCTIONS AND INFORMATION IN REFERENCE TO CONSUMER ELECTRONICS MULTIMEDIA PRODUCTS, IN CLASS 16 (U.S. CLS. 2, 5, 22, 23, 29, 37, 38 AND 50).

THE MARK CONSISTS OF STANDARD CHARACTERS WITHOUT CLAIM TO ANY PARTICULAR FONT, STYLE, SIZE, OR COLOR.

OWNER OF IRELAND REG. NO. 005295035, DATED 10-31-2007, EXPIRES 9-5-2016.

SER. NO. 78-969,994, FILED 9-8-2006.

ESTHER A. BORSUK, EXAMINING ATTORNEY

Int. Cl.: 9

Prior U.S. Cls.: 21, 23, 26, 36 and 38

United States Patent and Trademark Office

Reg. No. 3,520,705

Registered Oct. 21, 2008

TRADEMARK
PRINCIPAL REGISTER

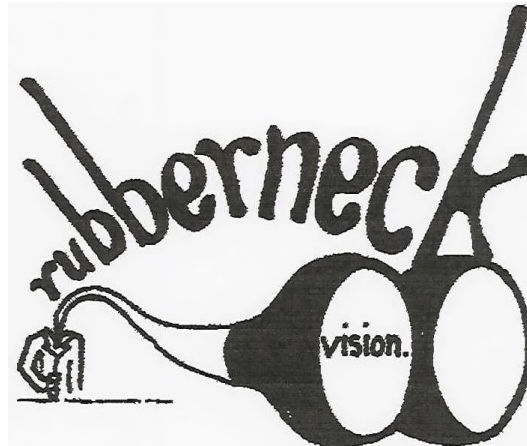

HENRY AMOR, STEVEN JAMES (AUSTRALIA
INDIVIDUAL)
16 JUDITH STREET
AHS GROVE, QLD, AUSTRALIA 4060

FOR: OPTICAL GOODS, NAMELY, BINOCULARS AND TELESCOPES, IN CLASS 9 (U.S. CLS. 21, 23, 26, 36 AND 38).

OWNER OF AUSTRALIA REG. NO. 742529, DATED 8-28-1997, EXPIRES 8-28-2017.

NO CLAIM IS MADE TO THE EXCLUSIVE RIGHT TO USE "VISION", APART FROM THE MARK AS SHOWN.

SER. NO. 78-971,990, FILED 9-12-2006.

TRACY WHITTAKER-BROWN, EXAMINING ATTORNEY

Int. Cl.: 36

Prior U.S. Cls.: 100, 101 and 102

United States Patent and Trademark Office

Reg. No. 3,520,706

Registered Oct. 21, 2008

**SERVICE MARK
PRINCIPAL REGISTER**



FIGHT FOREVER FOUNDATION (ILLINOIS
NON-PROFIT CORPORATION)
SUITE 5125
311 SOUTH WACKER DRIVE
CHICAGO, IL 60606

FOR: CHARITABLE FUND RAISING, IN CLASS
36 (U.S. CLS. 100, 101 AND 102).

FIRST USE 12-15-2006; IN COMMERCE 12-15-2006.

THE MARK CONSISTS OF HEART DESIGN.

SER. NO. 78-974,451, FILED 9-14-2006.

CHRISTINA SOBRAL, EXAMINING ATTORNEY

Int. Cl.: 36

Prior U.S. Cls.: 100, 101 and 102

United States Patent and Trademark Office

Reg. No. 3,520,707

Registered Oct. 21, 2008

**SERVICE MARK
PRINCIPAL REGISTER**

MEMBERHEALTH

MEMBERHEALTH, INC. (OHIO CORPORATION)
29100 AURORA ROAD
OLON, OH 44139

THE MARK CONSISTS OF STANDARD CHAR-
ACTERS WITHOUT CLAIM TO ANY PARTICULAR
FONT, STYLE, SIZE, OR COLOR.

FOR: PHARMACEUTICAL BENEFIT MANAGE-
MENT SERVICES, NAMELY ADMINISTRATION
OF PRESCRIPTION DRUG BENEFITS, IN CLASS
36 (U.S. CLS. 100, 101 AND 102).

SER. NO. 78-974,743, FILED 9-14-2006.

FIRST USE 1-22-1998; IN COMMERCE 1-22-1998.

NATALIE POLZER, EXAMINING ATTORNEY

Int. Cl.: 36

Prior U.S. Cls.: 100, 101 and 102

United States Patent and Trademark Office

Reg. No. 3,520,708

Registered Oct. 21, 2008

**SERVICE MARK
PRINCIPAL REGISTER**



MEMBERHEALTH, INC. (OHIO CORPORATION)
29100 AURORA ROAD
OLON, OH 44139

FIRST USE 6-0-2006; IN COMMERCE 6-0-2006.

FOR: PHARMACEUTICAL BENEFIT MANAGE-
MENT SERVICES, NAMELY ADMINISTRATION
OF PRESCRIPTION DRUG BENEFITS, IN CLASS
36 (U.S. CLS. 100, 101 AND 102).

SER. NO. 78-974,779, FILED 9-14-2006.

NATALIE POLZER, EXAMINING ATTORNEY

Int. Cl.: 36

Prior U.S. Cls.: 100, 101 and 102

United States Patent and Trademark Office

Reg. No. 3,520,709

Registered Oct. 21, 2008

SERVICE MARK
PRINCIPAL REGISTER



MEMBERHEALTH, INC. (OHIO CORPORATION)
29100 AURORA ROAD
SOLON, OH 44139

FIRST USE 6-0-2006; IN COMMERCE 6-0-2006.

FOR: PHARMACEUTICAL BENEFIT MANAGE-
MENT SERVICES, NAMELY ADMINISTRATION
OF PRESCRIPTION DRUG BENEFITS, IN CLASS
36 (U.S. CLS. 100, 101 AND 102).

SER. NO. 78-974,794, FILED 9-14-2006.

NATALIE POLZER, EXAMINING ATTORNEY

Int. Cl.: 25

Prior U.S. Cls.: 22 and 39

United States Patent and Trademark Office

Reg. No. 3,520,710

Registered Oct. 21, 2008

**TRADEMARK
PRINCIPAL REGISTER**

DREAM ON

THE DALMATIAN DREAMS FOUNDATION
(CALIFORNIA CORPORATION), DBA THE
DREAM FOUNDATION

1528 CHAPALA STREET, SUITE 304
SANTA BARBARA, CA 93101

FOR: HATS; T-SHIRTS, IN CLASS 25 (U.S. CLS. 22
AND 39).

FIRST USE 10-1-2001; IN COMMERCE 10-1-2001.

THE MARK CONSISTS OF STANDARD CHAR-
ACTERS WITHOUT CLAIM TO ANY PARTICULAR
FONT, STYLE, SIZE, OR COLOR.

OWNER OF U.S. REG. NO. 3,259,225.

SEC. 2(F).

SER. NO. 78-974,804, FILED 9-14-2006.

KAREN K. BUSH, EXAMINING ATTORNEY

Int. Cl.: 41

Prior U.S. Cls.: 100, 101 and 107

United States Patent and Trademark Office

Reg. No. 3,520,711

Registered Oct. 21, 2008

**SERVICE MARK
PRINCIPAL REGISTER**



BOARD OF REGENTS OF THE UNIVERSITY
SYSTEM OF GEORGIA (GEORGIA STATE
AGENCY)

270 WASHINGTON STREET, SW
ATLANTA, GA 30334

FOR: EDUCATIONAL SERVICES, NAMELY PRO-
VIDING COURSES OF STUDY AT THE UNIVERSI-
TY LEVEL AND ENTERTAINMENT SERVICES,
NAMELY PROVIDING INTERCOLLEGIATE

SPORTING EVENTS, IN CLASS 41 (U.S. CLS. 100,
101 AND 107).

FIRST USE 9-19-2005; IN COMMERCE 9-19-2005.

SER. NO. 78-978,793, FILED 8-14-2006.

JEFF DEFORD, EXAMINING ATTORNEY

Int. Cls.: 38 and 40

Prior U.S. Cls.: 100, 101, 103, 104 and 106

United States Patent and Trademark Office

Reg. No. 3,520,712

Registered Oct. 21, 2008

**SERVICE MARK
PRINCIPAL REGISTER**

ONECLICK CAPTURE

GRM INFORMATION MANAGEMENT SERVICES, INC. (NEW JERSEY CORPORATION)
215 COLES STREET
JERSEY CITY, NJ 07310

FOR: COMMUNICATION SERVICES, NAMELY, ELECTRONIC TRANSMISSION OF DATA AND DOCUMENTS AMONG USERS OF COMPUTERS; ELECTRONIC DELIVERY OF IMAGES AND PHOTOGRAPHS VIA A GLOBAL COMPUTER NETWORK; ELECTRONIC TRANSMISSION OF DATA AND DOCUMENTS VIA COMPUTER TERMINALS; ELECTRONIC, ELECTRIC, AND DIGITAL TRANSMISSION OF VOICE, DATA, IMAGES, SIGNALS, AND MESSAGES; INFORMATION TRANSMISSION SERVICES VIA DIGITAL NETWORKS; ON-LINE DOCUMENT DELIVERY VIA A GLOBAL COMPU-

TER NETWORK, IN CLASS 38 (U.S. CLS. 100, 101 AND 104).

FIRST USE 8-31-2006; IN COMMERCE 8-31-2006.

FOR: DOCUMENT SHREDDING SERVICES, IN CLASS 40 (U.S. CLS. 100, 103 AND 106).

FIRST USE 8-31-2006; IN COMMERCE 8-31-2006.

THE MARK CONSISTS OF STANDARD CHARACTERS WITHOUT CLAIM TO ANY PARTICULAR FONT, STYLE, SIZE, OR COLOR.

SER. NO. 78-980,376, FILED 7-28-2006.

DAWN FELDMAN, EXAMINING ATTORNEY

Int. Cls.: 16, 25, 35 and 41

Prior U.S. Cls.: 2, 5, 22, 23, 29, 37, 38, 39, 50, 100, 101, 102 and 107

Reg. No. 3,520,713

United States Patent and Trademark Office

Registered Oct. 21, 2008

**TRADEMARK
SERVICE MARK
PRINCIPAL REGISTER**



AMERICA MOVIL, S.A. DE C.V. (MEXICO CORPORATION)

LAGO ALBERTO NO. 366 COL. ANAHUAC DELE

GACION MIGUEL HIDALGO

MEXICO, MEXICO 11320

FOR: ADVERTISING SIGNS OF PAPER OR CARDBOARD; BINDERS; BOOK BINDINGS; BOOKLETS FEATURING TELECOMMUNICATIONS SERVICES BOOKMARKS; BOOKS FEATURING TELECOMMUNICATIONS SERVICES; BOXES OF CARDBOARD OR PAPER; CALENDARS; CARDBOARD ARTICLES, NAMELY, BOXES, CARTONS AND CONTAINERS; CATALOGUES FEATURING TELECOMMUNICATIONS PRODUCTS AND SERVICES; COASTERS OF PAPER; DECALCOMANIAS, ENVELOPES; FOUNTAIN PENS; GREETING CARDS; PRINTED HANDBOOKS FEATURING TELECOMMUNICATIONS PRODUCTS AND SERVICES; PRINTED PAPER LABELS; MANUALS IN THE FIELD OF TELECOMMUNICATIONS PRODUCTS; NEWSPAPERS FOR GENERAL CIRCULATION; OFFICE SUPPLIES, NAMELY, ENVELOPES AND FOLDERS; PACKING PAPER; BOND PAPER; PAPER SHEETS FOR NOTE TAKING; PEN CASES; PENS; PENCILS; POSTCARDS; POSTERS; PRINTING BLOCKS; PRINTED PUBLICATIONS, NAMELY BOOKS, MAGAZINES, PAMPHLETS AND INSTRUCTIONAL MANUALS IN THE FIELD OF TELECOMMUNICATIONS; INFORMATIONAL FLYERS FEATURING TELECOMMUNICATIONS PRODUCTS AND SERVICES; POSTERS, PAPER AND CARDBOARD BOARDS FEATURING TELECOMMUNICATIONS PRODUCTS AND SERVICES; STATIONERY, STICKERS, WRITING PADS AND WRITING PAPER, IN CLASS 16 (U.S. CLS. 2, 5, 22, 23, 29, 37, 38 AND 50).

FOR: CLOTHING, NAMELY, SHIRTS, T-SHIRTS, JACKETS, SWEATERS, OVERALLS, CAPS AND HATS, IN CLASS 25 (U.S. CLS. 22 AND 39).

FOR: ADVERTISING, DIRECT MAIL ADVERTISING, DISSEMINATION OF ADVERTISEMENT MATTERS, BUSINESS INFORMATION AND INQUIRIES IN THE FIELD OF TELECOMMUNICATIONS PRODUCTS AND SERVICES, ASSISTANCE IN THE MANAGEMENT OF BUSINESS ACTIVITIES, DEMONSTRATION OF GOODS AND SERVICES BY ELECTRONIC MEANS, ORGANIZATION OF EXHIBITIONS FOR ADVERTISING PURPOSES IN THE FIELD OF TELECOMMUNICATIONS PRODUCTS AND SERVICES; RETAIL STORE SERVICES FEATURING GOODS RELATED TO CELLULAR TELEPHONY; TRACKING, LOCATING AND MONITORING OF VEHICLES FOR COMMERCIAL PURPOSES; ARRANGING AND CONDUCTING RAFFLES AND COMPETITIONS TO PROMOTE THE SALE OF TELECOMMUNICATIONS PRODUCTS AND SERVICES OF OTHERS, IN CLASS 35 (U.S. CLS. 100, 101 AND 102).

FOR: EDUCATIONAL SERVICES, NAMELY, CONDUCTING SEMINARS, CONFERENCES, WORKSHOPS, IN THE FIELD OF TELECOMMUNICATIONS SERVICES; ENTERTAINMENT, NAMELY, ARRANGING AND CONDUCTING CONTESTS; PROVIDING INFORMATION IN THE FIELD OF ENTERTAINMENT AND RECREATION; PROVIDING INFORMATION ON EDUCATION, IN CLASS 41 (U.S. CLS. 100, 101 AND 107).

PRIORITY CLAIMED UNDER SEC. 44(D) ON MEXICO APPLICATION NO. 703158, FILED 2-21-2005, REG. NO. 883148, DATED 5-26-2005, EXPIRES 5-26-2015.

OWNER OF MEXICO REG. NO. 878427, DATED 4-26-2005, EXPIRES 4-26-2015.

OWNER OF MEXICO REG. NO. 886047, DATED 6-16-2005, EXPIRES 6-16-2015.

OWNER OF MEXICO REG. NO. 883148, DATED 5-26-2005, EXPIRES 5-26-2015.

OWNER OF U.S. REG. NO. 2,924,487.

NO CLAIM IS MADE TO THE EXCLUSIVE RIGHT TO USE "AMERICA MOVIL", APART FROM THE MARK AS SHOWN.

THE COLOR(S) BLACK, PINK, BLUE, PURPLE AND GREEN IS/ARE CLAIMED AS A FEATURE OF THE MARK.

THE MARK CONSISTS OF A SPHERE WITH TEN ORBITS. FOR THE UPPERMOST FIRST AND SECOND ORBITS, THE LEFT-HAND SIDE IS BLACK AND THE RIGHT-HAND SIDE IS PINK. FOR THE THIRD AND FOURTH ORBITS, THE LEFT-HAND SIDE IS DARK BLUE AND THE RIGHT-HAND SIDE IS PURPLE. FOR THE FIFTH, SIXTH AND SEVENTH ORBITS, THE LEFT-HAND SIDE IS DARK BLUE AND THE RIGHT-HAND SIDE IS MEDIUM BLUE. FOR THE EIGHTH, NINTH AND TENTH ORBITS, THE LEFT-HAND SIDE IS BLACK AND THE RIGHT-HAND SIDE IS GREEN. THE LITERAL ELEMENTS APPEAR IN BLACK.

THE ENGLISH TRANSLATION OF AMERICA MOVIL IS AMERICA MOBILE.

SER. NO. 78-980,593, FILED 5-2-2005.

CHRISIE B. KING, EXAMINING ATTORNEY

Int. Cls.: 16, 25, 35 and 41

Prior U.S. Cls.: 2, 5, 22, 23, 29, 37, 38, 39, 50, 100, 101, 102 and 107

Reg. No. 3,520,714

United States Patent and Trademark Office

Registered Oct. 21, 2008

**TRADEMARK
SERVICE MARK
PRINCIPAL REGISTER**



AMERICA MOVIL, S.A. DE C.V. (MEXICO CORPORATION)

LAGO ALBERTO NO. 366 COL. ANAHUAC DELE

GACION MIGUEL HILDAGO

MEXICO, MEXICO 11320

FOR: ADVERTISING SIGNS OF PAPER OR CARDBOARD; BINDERS; BOOK BINDINGS; BOOKLETS FEATURING TELECOMMUNICATIONS SERVICES BOOKMARKS; BOOKS FEATURING TELECOMMUNICATIONS SERVICES; BOXES OF CARDBOARD OR PAPER; CALENDARS; CARDBOARD ARTICLES, NAMELY, BOXES, CARTONS AND CONTAINERS; CATALOGUES FEATURING TELECOMMUNICATIONS PRODUCTS AND SERVICES; COASTERS OF PAPER; DECALCOMANIAS, ENVELOPES; FOUNTAIN PENS; GREETING CARDS; PRINTED HANDBOOKS FEATURING TELECOMMUNICATIONS PRODUCTS AND SERVICES; PRINTED PAPER LABELS; MANUALS IN THE FIELD OF TELECOMMUNICATIONS PRODUCTS; NEWSPAPERS FOR GENERAL CIRCULATION; OFFICE SUPPLIES, NAMELY, ENVELOPES AND FOLDERS; PACKING PAPER; BOND PAPER; PAPER SHEETS FOR NOTE TAKING; PEN CASES; PENS; PENCILS; POSTCARDS; POSTERS; PRINTING BLOCKS; PRINTED PUBLICATIONS, NAMELY, BOOKS, MAGAZINES, PAMPHLETS AND INSTRUCTIONAL MANUALS IN THE FIELD OF TELECOMMUNICATIONS; INFORMATIONAL FLYERS FEATURING TELECOMMUNICATIONS PRODUCTS AND SERVICES; POSTERS, PAPER AND CARDBOARD BOARDS FEATURING TELECOMMUNICATIONS PRODUCTS AND SERVICES; STATIONERY, STICKERS, WRITING PADS AND WRITING PAPER, IN CLASS 16 (U.S. CLS. 2, 5, 22, 23, 29, 37, 38 AND 50).

FOR: CLOTHING, NAMELY, SHIRTS, T-SHIRTS, JACKETS, SWEATERS, OVERALLS, CAPS AND HATS, IN CLASS 25 (U.S. CLS. 22 AND 39).

FOR: ADVERTISING, DIRECT MAIL ADVERTISING, DISSEMINATION OF ADVERTISEMENT MATTERS, BUSINESS INFORMATION AND INQUIRIES IN THE FIELD OF TELECOMMUNICATIONS PRODUCTS AND SERVICES, ASSISTANCE IN THE MANAGEMENT OF BUSINESS ACTIVITIES, DEMONSTRATION OF GOODS AND SERVICES BY ELECTRONIC MEANS, ORGANIZATION OF EXHIBITIONS FOR ADVERTISING PURPOSES IN THE FIELD OF TELECOMMUNICATIONS PRODUCTS AND SERVICES; RETAIL STORE SERVICES FEATURING GOODS RELATED TO CELLULAR TELEPHONY; TRACKING, LOCATING AND MONITORING OF VEHICLES FOR COMMERCIAL PURPOSES; ARRANGING AND CONDUCTING RAFFLES AND COMPETITIONS TO PROMOTE THE SALE OF TELECOMMUNICATIONS PRODUCTS AND SERVICES OF OTHERS, IN CLASS 35 (U.S. CLS. 100, 101 AND 102).

FOR: EDUCATIONAL SERVICES, NAMELY, CONDUCTING SEMINARS, CONFERENCES, WORKSHOPS, IN THE FIELD OF TELECOMMUNICATIONS SERVICES; ENTERTAINMENT, NAMELY, ARRANGING AND CONDUCTING CONTESTS; PROVIDING INFORMATION IN THE FIELD OF ENTERTAINMENT AND RECREATION; PROVIDING INFORMATION ON EDUCATION, IN CLASS 41 (U.S. CLS. 100, 101 AND 107).

PRIORITY CLAIMED UNDER SEC. 44(D) ON MEXICO APPLICATION NO. 703152, FILED 2-21-2005, REG. NO. 880201, DATED 4-29-2005, EXPIRES 4-29-2015.

PRIORITY CLAIMED UNDER SEC. 44(D) ON MEXICO APPLICATION NO. 703150, FILED 2-21-2005, REG. NO. 878426, DATED 4-26-2005, EXPIRES 4-26-2015.

PRIORITY CLAIMED UNDER SEC. 44(D) ON MEXICO APPLICATION NO. 703183, FILED 2-21-2005, REG. NO. 886048, DATED 6-16-2005, EXPIRES 6-16-2015.

PRIORITY CLAIMED UNDER SEC. 44(D) ON MEXICO APPLICATION NO. 703185, FILED 2-21-2005, REG. NO. 883153, DATED 5-26-2005, EXPIRES 5-26-2015.

OWNER OF U.S. REG. NO. 2,924,487.

NO CLAIM IS MADE TO THE EXCLUSIVE RIGHT TO USE "AMERICA MOVIL", APART FROM THE MARK AS SHOWN.

THE TRANSLATION OF AMERICA MOVIL IS AMERICA MOBILE.

SER. NO. 78-980,610, FILED 5-2-2005.

CHRISIE B. KING, EXAMINING ATTORNEY

Int. Cls.: 9 and 16

Prior U.S. Cls.: 2, 5, 21, 22, 23, 26, 29, 36, 37, 38 and 50

Reg. No. 3,520,715

United States Patent and Trademark Office

Registered Oct. 21, 2008

**TRADEMARK
PRINCIPAL REGISTER**

RUDE BRITANNIA

GALAXY PUBLICATIONS LIMITED (UNITED KINGDOM LIMITED LIABILITY COMPANY)
FREEBOURNES HOUSE
FREEBOURNES ROAD; WITHAM, ESSEX CM8 3UH
UNITED KINGDOM

FOR: ADULT VIDEO RECORDINGS; DOWNLOADABLE ADULT VIDEO RECORDINGS; ELECTRONIC PUBLICATIONS, NAMELY, MAGAZINES, NEWSLETTERS, PICTURES FEATURING ADULT SUBJECT MATTER; DOWNLOADABLE ELECTRONIC PUBLICATIONS, NAMELY, MAGAZINES, NEWSLETTERS, PICTURES FEATURING ADULT SUBJECT MATTER; DVDS FEATURING ADULT SUBJECT MATTER; MULTI-MEDIA SOFTWARE RECORDED ON CD-ROM FEATURING ADULT SUBJECT MATER, IN CLASS 9 (U.S. CLS. 21, 23, 26, 36 AND 38).

FOR: PRINTED MATTER AND PUBLICATIONS, NAMELY, ADULT MAGAZINES; CALENDARS;

PHOTOGRAPHS; PICTURES; CARTOON STRIPS, IN CLASS 16 (U.S. CLS. 2, 5, 22, 23, 29, 37, 38 AND 50).

THE MARK CONSISTS OF STANDARD CHARACTERS WITHOUT CLAIM TO ANY PARTICULAR FONT, STYLE, SIZE, OR COLOR.

PRIORITY DATE OF 1-20-2004 IS CLAIMED.

OWNER OF INTERNATIONAL REGISTRATION 0830713 DATED 6-21-2004, EXPIRES 6-21-2014.

NO CLAIM IS MADE TO THE EXCLUSIVE RIGHT TO USE "BRITANNIA", APART FROM THE MARK AS SHOWN.

SER. NO. 79-004,437, FILED 6-21-2004.

CHRISIE B. KING, EXAMINING ATTORNEY

Int. Cl.: 7

Prior U.S. Cls.: 13, 19, 21, 23, 31, 34 and 35

United States Patent and Trademark Office

Reg. No. 3,520,716

Registered Oct. 21, 2008

**TRADEMARK
PRINCIPAL REGISTER**

TriLynx

AIXTRON AG (FED REP GERMANY COMPANY
LIMITED BY SHARES)
KACKERTSTRASSE 15-17
D-52072 AACHEN
FED REP GERMANY

FOR: MACHINES FOR MANUFACTURING
SEMICONDUCTORS AND STRUCTURAL PARTS
THEREFOR, IN CLASS 7 (U.S. CLS. 13, 19, 21, 23, 31,
34 AND 35).

THE MARK CONSISTS OF STANDARD CHAR-
ACTERS WITHOUT CLAIM TO ANY PARTICULAR
FONT, STYLE, SIZE, OR COLOR.

PRIORITY DATE OF 6-28-2004 IS CLAIMED.

OWNER OF INTERNATIONAL REGISTRATION
0837033 DATED 8-9-2004, EXPIRES 8-9-2014.

SER. NO. 79-006,678, FILED 8-9-2004.

LEIGH LOWRY, EXAMINING ATTORNEY

Int. Cls.: 37, 39, 41, 43 and 45

Prior U.S. Cls.: 100, 101, 103, 105, 106 and 107

United States Patent and Trademark Office

Reg. No. 3,520,717

Registered Oct. 21, 2008

**SERVICE MARK
PRINCIPAL REGISTER**



gsi • groundservice international

GSi GROUND SERVICE INTERNATIONAL
GMBH (FED REP GERMANY COMPANY)
MITTELSTRABE 5/5A
12529 SCHÖNEFELD
FED REP GERMANY

FOR: AIRCRAFT AND AIRPORT CLEANING SERVICES; INSTALLATION AND MAINTENANCE OF DRINK AND SNACK DISPENSERS , IN CLASS 37 (U.S. CLS. 100, 103 AND 106).

FOR: PROVIDING PASSENGER CHECK-IN, GATE HANDLING AND AIRCRAFT BOARDING SERVICES; PROVIDING INFORMATION FOR PASSENGERS BEFORE AND AFTER FLIGHTS IN THE NATURE OF INFORMATION RELATED TO ARRIVING AND DEPARTING FLIGHTS, CONNECTING FLIGHT INFORMATION AND GROUND TRANSPORTATION SERVICES; PROVIDING TRANSPORTATION SERVICES FOR HANDICAPPED PASSENGERS BETWEEN DEPARTURE LOUNGES AND AIRPLANES VIA WHEEL CHAIRS; PROVIDING RESERVATION SERVICES FOR TRAVEL BY AIR; PROVIDING BAGGAGE CART RENTALS FOR AIR PASSENGERS, IN CLASS 39 (U.S. CLS. 100 AND 105).

FOR: EDUCATIONAL SERVICES, NAMELY, PROVIDING SEMINARS IN THE FIELDS OF AIR-

PLANE SERVICING, GROUND HANDLING SERVICES AND COMMUNICATIONS, IN CLASS 41 (U.S. CLS. 100, 101 AND 107).

FOR: MAKING HOTEL RESERVATIONS FOR OTHERS, IN CLASS 43 (U.S. CLS. 100 AND 101).

FOR: ADMISSION CONTROL AND IDENTITY CHECK OF PERSONS AT AIRPORTS AND IN AIRPLANES, AND X-RAY INSPECTION OF PERSONS AND OF LUGGAGE , IN CLASS 45 (U.S. CLS. 100 AND 101).

PRIORITY DATE OF 8-21-2003 IS CLAIMED.

OWNER OF INTERNATIONAL REGISTRATION 0837283 DATED 2-5-2004, EXPIRES 2-5-2014.

NO CLAIM IS MADE TO THE EXCLUSIVE RIGHT TO USE "GROUND SERVICE INTERNATIONAL", APART FROM THE MARK AS SHOWN.

SER. NO. 79-006,760, FILED 2-5-2004.

NANCY CLARKE, EXAMINING ATTORNEY

Int. Cls.: 35 and 43

Prior U.S. Cls.: 100, 101 and 102

United States Patent and Trademark Office

Reg. No. 3,520,718

Registered Oct. 21, 2008

**SERVICE MARK
PRINCIPAL REGISTER**

EMPORIO  ARMANI
CAFFÈ

GIORGIO ARMANI S.P.A. (ITALY CORPORATION)
VIA BORGONUOVO, 11
I-20121 MILANO, ITALY

FOR: ADVERTISING SERVICES, BUSINESS MANAGEMENT, BUSINESS ADMINISTRATION, PROVIDING OFFICE FUNCTIONS, IN CLASS 35 (U.S. CLS. 100, 101 AND 102).

FOR: SERVING FOOD AND DRINKS; PROVIDING TEMPORARY ACCOMMODATIONS, IN CLASS 43 (U.S. CLS. 100 AND 101).

OWNER OF INTERNATIONAL REGISTRATION 0849600 DATED 9-10-2004, EXPIRES 9-10-2014.

NO CLAIM IS MADE TO THE EXCLUSIVE RIGHT TO USE "EMPORIO" AND "CAFFÈ", APART FROM THE MARK AS SHOWN.

THE LINING SHOWN IN THE DRAWING IS A FEATURE OF THE MARK.

THE MARK CONSISTS IN PART OF A STYLIZED EAGLE DESIGN WITH THE LETTERS "GA".

THE ENGLISH TRANSLATION OF "EMPORIO" AND "CAFFÈ" IS EMPORIUM AND CAFE.

SER. NO. 79-010,914, FILED 9-10-2004.

ALEX KEAM, EXAMINING ATTORNEY

Int. Cls.: 8, 16, 21, 24, 29, 30, 31, 32, 33, 41 and 43

Prior U.S. Cls.: 1, 2, 5, 13, 22, 23, 28, 29, 30, 33, 37, 38, 40, 42, 44, 45, 46, 47, 48, 49, 50, 100, 101 and 107

Reg. No. 3,520,719

United States Patent and Trademark Office

Registered Oct. 21, 2008

**TRADEMARK
SERVICE MARK
PRINCIPAL REGISTER**



DI NALLO EGERIA (ITALY INDIVIDUAL)
VIA DELLE ROSE, 15
I-40136 BOLOGNA (BO), ITALY

FOR: MANUALLY OPERATED HAND TOOLS TO BE USED IN A KITCHEN, ESPECIALLY FOR PREPARING AND COOKING ANY KIND OF FOOD, NAMELY, KNIVES, CAN OPENERS, KITCHEN PINNERS; CUTLERY, NAMELY, SPOONS, FORKS, KNIVES, IN CLASS 8 (U.S. CLS. 23, 28 AND 44).

FOR: PAPER; CARDBOARD; PAPER GOODS, NAMELY, BAGS, KITCHEN ROLLS, BLOTTING PAPER, TABLE CLOTHS, NAPKINS, TABLE MATS, BABY BIBS, BANNERS, FESTOONS, GIFT WRAPPING PAPER, DRAWING PAPER, CARDS, CALENDARS, POSTERS, EXERCISE BOOKS; CARDBOARD GOODS, NAMELY, CARTONS, BOXES; PRINTED MATTER, NAMELY, RECIPE BOOKS, GUIDES, LESSONS, MAIL RESPONSE CARDS RELATING TO FOOD AND DRINK AND TO THE ITALIAN TRADITIONAL GASTRONOMIC LEGACY AND KNOW-HOW AS TO FOOD CULTURE AND CUSTOMS, PRESS RELEASES, PRODUCT GUIDES AND REPORTS FEATURING THE ITALIAN TRADITIONAL GASTRONOMIC LEGACY AND KNOW-HOW AS TO FOOD CULTURE AND CUSTOMS; PHOTOGRAPHS; STATIONERY; PENS AND PENCILS; ADHESIVES FOR STATIONERY OR HOUSEHOLD PURPOSES; PRINTED INSTRUCTIONAL AND TEACHING MATERIALS IN THE FIELD OF ITALIAN TRADITIONAL GASTRONOMIC LEGACY AND KNOW-HOW AS TO FOOD CULTURE AND CUSTOMS; PLASTIC MATERIALS FOR

PACKAGING, NAMELY, PLASTIC BAGS; ARTISTS' MATERIALS, NAMELY, PENCILS, PENS, ERASERS, IN CLASS 16 (U.S. CLS. 2, 5, 22, 23, 29, 37, 38 AND 50).

FOR: HOUSEHOLD OR KITCHEN UTENSILS, NAMELY, POTS AND PANS, SCRAPERS, ROLLING PINS, SPATULAS, TURNERS, WHISKS; CONTAINERS NOT OF PRECIOUS METAL OR COATED THEREWITH FOR HOUSEHOLD AND KITCHEN USE, NAMELY, SETS OF PAPER PLATES AND CUPS; KITCHEN BRUSHES; CLEANING SPONGES; ARTICLES FOR CLEANING PURPOSES, NAMELY, CLEANING CLOTH, SPONGES, METAL WOOL, MITTS OF FABRIC; STEELWOOL; UNWORKED OR SEMI-WORKED GLASS NOT FOR BUILDING; GLASSWARE, CONTAINERS FOR HOUSEHOLD OR KITCHEN USE, POTS, PANS AND DISHES MADE OF PORCELAIN, PAPER AND EARTHENWARE; BOTTLE OPENERS; COOKING GRATERS, IN CLASS 21 (U.S. CLS. 2, 13, 23, 29, 30, 33, 40 AND 50).

FOR: TEXTILES AND TEXTILE GOODS, NAMELY, FACE TOWELS MADE OF TEXTILE MATERIALS, QUILTS OF TEXTILES, TEXTILE NAPKINS, TEXTILE PLACE MATS; TEXTILE BED COVERS; TABLE CLOTHS NOT OF PAPER, IN CLASS 24 (U.S. CLS. 42 AND 50).

FOR: MEAT, FISH, POULTRY AND BIRD GAME, LAND GAME AND SEA GAME AS INGREDIENTS OF TRADITIONAL ITALIAN RECIPES; MEAT EXTRACTS; PRESERVED, DRIED AND COOKED FRUITS AND VEGETABLES; JELLIES, JAMS, COM-

POTES; EGGS, MILK AND MILK PRODUCTS EXCLUDING ICE CREAM, ICE MILK AND FROZEN YOGURT; EDIBLE OILS AND FATS; ASPICS, IN CLASS 29 (U.S. CL. 46).

FOR: COFFEE, TEA, COCOA, SUGAR, RICE, TAPIOCA, SAGO, ARTIFICIAL COFFEE; FLOUR AND PREPARATIONS MADE FROM PROCESSED CEREALS, BREAD, PASTRY AND CONFECTIONERY, NAMELY, FROZEN YOGURT, FRUIT JELLY, ASPICS, EDIBLE FRUIT FLAVORED, FRUIT OR CREAM ICES, NAMELY, HOME-MADE ICE CREAMS, SORBETS, COLD DESSERTS, NAMELY, DESSERT MOUSSE, DESSERT PUDDINGS, DESSERT SOUFFLÉS, CARAMEL CREAM PUDDING, DESSERT CAKES; HONEY, TREACLE; YEAST, BAKING-POWDER; SALT, MUSTARD; VINEGAR, SAUCES; SPICES; ICE, IN CLASS 30 (U.S. CL. 46).

FOR: SEEDS AND GRAINS OF WHEAT, BARLEY, CORN AND RICE; LIVE ANIMALS; FRESH FRUITS AND VEGETABLES; APPLE TREE SEEDS, LIVING PLANTS AND FLOWERS; MALTS FOR BREWING AND DISTILLING; FRESH, RAW OR UNPROCESSED FRUITS, FRESH, RAW OR UNPROCESSED VEGETABLES, LIVING PLANTS AND FLOWERS ALL USED FOR TABLE DECORATIONS, IN CLASS 31 (U.S. CLS. 1 AND 46).

FOR: BEERS; MINERAL AND AERATED WATERS AND OTHER NON-ALCOHOLIC DRINKS, NAMELY, NON-ALCOHOLIC BEER, CARBONATED BEVERAGES, BEVERAGES WITH TEA FLAVOR, MALT BEVERAGES, MALT COOLERS; FRUIT DRINKS AND FRUIT JUICES; SYRUPS AND OTHER PREPARATIONS FOR MAKING FRUIT DRINKS, IN CLASS 32 (U.S. CLS. 45, 46 AND 48).

FOR: ALCOHOLIC BEVERAGES, NAMELY, MULLED WINE, SWEET WINE, LIQUEURS, APERITIFS BITTERS, BITTERS, ESSENCES, GRAPPAS, FRUIT EXTRACTS, PUNCH, MALT COOLERS, IN CLASS 33 (U.S. CLS. 47 AND 49).

FOR: EDUCATION SERVICES, NAMELY, PROVIDING CLASS, SEMINARS, WORKSHOPS, CONVENTIONS IN THE FIELD OF ITALIAN TRADITIONAL GASTRONOMIC LEGACY AND KNOW-HOW AS TO FOOD CULTURE AND CUSTOMS; TRAINING THROUGH BOTH PRACTICAL COURSES AND COMPUTER COURSES IN THE FIELD OF ITALIAN TRADITIONAL GASTRONOMIC LEGACY AND KNOW-HOW AS TO FOOD CULTURE AND CUSTOMS; ENTERTAINMENT, NAMELY, ART EXHIBITIONS, FOOD AND WINE

TASTINGS, COOKING COURSES, ETHNIC FESTIVALS; ORGANIZING CULTURAL EVENTS SUCH AS EXHIBITIONS, CHARITABLE EXHIBITIONS, LECTURES, CONGRESSES, CONCERTS, MEETINGS, BOOK PRESENTATIONS, PARTIES TO PROMOTE AND PRESERVE ITALIAN TRADITIONAL GASTRONOMIC LEGACY AND KNOW-HOW AS TO FOOD CULTURE AND CUSTOMS, IN CLASS 41 (U.S. CLS. 100, 101 AND 107).

FOR: PROVIDING TEMPORARY ACCOMMODATIONS, BAR SERVICES, CAFETERIAS, CAFÉS, CANTEENS, CATERING, RESTAURANTS, SELF-SERVICE RESTAURANTS, SNACK-BARS ALL OF WHICH FEATURING HOME-MADE ITALIAN FOOD AND DRINK SERVED TO MEMBERS OF CLUBS AND ASSOCIATIONS AND TO THE MEMBERS' HOSTS, IN CLASS 43 (U.S. CLS. 100 AND 101).

PRIORITY DATE OF 12-15-2004 IS CLAIMED.

OWNER OF INTERNATIONAL REGISTRATION 0857438 DATED 4-28-2005, EXPIRES 4-28-2015.

NO CLAIM IS MADE TO THE EXCLUSIVE RIGHT TO USE "HOME FOOD" AS TO CLASSES 29, 30, 31, 32 AND 43, APART FROM THE MARK AS SHOWN.

THE MARK CONSISTS OF A CARTOON OF A WOMAN WHOSE BODY IS IN PROFILE WHILE HER FACE IS SEEN FROM THE FRONT. THE WOMAN IS WEARING A SHORT DRESS, WITH A TRIM AND AN APRON, AND A CHEF'S HAT. THE WOMAN IS SMILING AND SHE IS PRESENTING A DISH OF STEAMING HOT PASTA IN HER HANDS; THE STEAM RISING FROM THE HOT PASTA FORMS THE SHAPE OF A HEART. DIRECTLY BENEATH THIS PICTURE THERE ARE THE WORDS "LE CESARINE" WRITTEN IN A SCRIPT FONT WHERE THE DOT OF THE "I" IS REPLACED WITH THE IMAGE OF A SMALL TOMATO. "HOME FOOD" IS DIRECTLY UNDERNEATH THE TERMS "LE CESARINE".

THE FOREIGN WORDING IN THE MARK TRANSLATES INTO ENGLISH AS "WOMEN OF THE HOME WHO PRESERVE ITALIAN COOKING AND FOOD TRADITIONS AND CULTURE".

SER. NO. 79-013,654, FILED 4-28-2005.

RENEE SERVANCE, EXAMINING ATTORNEY

Int. Cls.: 9, 28, 32 and 41

Prior U.S. Cls.: 21, 22, 23, 26, 36, 38, 45, 46, 48, 50, 100, 101 and 107

Reg. No. 3,520,720

United States Patent and Trademark Office

Registered Oct. 21, 2008

**TRADEMARK
SERVICE MARK
PRINCIPAL REGISTER**



GIAN CHRISTIAN (AUSTRALIA INDIVIDUAL)
63A MURPHY STREET
SOUTH YARRA VIC 3141, AUSTRALIA AND
DINA MCPHERSON (AUSTRALIA INDIVIDUAL)
63A MURPHY STREET
SOUTH YARRA VIC 3141, AUSTRALIA

FOR: CDS, DVDS, RECORDS, CASSETTE TAPES, VIDEO TAPES AND/OR CD ROMS FEATURING SOUND AND/OR VIDEO RECORDINGS IN THE NATURE OF SONGS, MUSICAL PERFORMANCES AND PROGRAMS FOR CHILDREN; BLANK RECORD DISCS; BLANK RECORDABLE OPTICAL DISCS; AUTOMATIC VENDING MACHINES; COMPUTERS; COMPUTER GAME DISCS AND PROGRAMS; ALL OF THE FOREGOING SPECIFICALLY FOR CHILDREN AND NONE OF THE FOREGOING GOODS USED IN CONNECTION WITH OR FOR THE PROMOTION OF THE SPORT OF BASKETBALL, IN CLASS 9 (U.S. CLS. 21, 23, 26, 36 AND 38).

FOR: GAMES AND PLAYTHINGS, NAMELY, BOARD GAMES, ACTION FIGURES, COLLECTABLE TOY FIGURES, ACTION SKILL GAMES, CARD GAMES, PLAYING CARDS, CHESS SETS, MANIPULATIVE GAMES, PUZZLES JIGSAW PUZZLES, PARTY GAMES, DOLLS, PAPER DOLLS, SOFT SCULPTURE DOLLS, DOLLS' HOUSES, DOLL CLOTHING, DOLL ACCESSORIES, DOLL PLAYSETS, BEAN BAG DOLLS, PUPPETS, PLUSH TOYS, PLUSH TOY ANIMALS, SOFT TOYS, FINGER PUPPETS, STUFFED TOYS, STUFFED TOY ANIMALS, CRIB TOYS, SQUEEZE TOYS, TEDDY BEARS, PLAY

SWIMMING POOLS, SURF BOARDS, SKATEBOARDS, BOWLING BALLS, SPORT BALLS, BEACH BALLS, INFLATABLE TOYS, INFLATABLE POOL TOYS, INFLATABLE MASCOTS, INFLATABLE BALLS, INFLATABLE CARS, SPINNING TOPS, KITES, BALLOONS, BATH TOYS, BATH TUB TOYS, INFLATABLE BATH TOYS, MUSICAL TOYS, MUSIC BOX TOYS, TOY MICROPHONES, TOY DRUM KITS, TOY CYMBALS, TOY GUITARS, TOY ELECTRONIC KEYBOARDS, TOY MONEY BANKS, TOY VEHICLES, TOY CARS AND TRUCKS, TOY CAR PARTS, TOY SCOOTERS, TOY TRICK NOISEMAKERS, TOY MOBILES, TOY MODEL HOBBY CRAFT KITS, TOY STAMPS, TOY WATCHES, WIND-UP TOYS, YO-YOS, KALEIDOSCOPES; BUBBLE MAKING WANDS AND SOLUTION SETS, CHILDREN'S PLAY COSMETICS, GOLF BALLS, GOLF GLOVES, GOLF BALL MARKERS, BAND HELD UNIT FOR PLAYING ELECTRONIC GAMES, MAGIC TRICKS, MARBLES, MECHANICAL TOYS, PARLOR GAMES, ROLLER SKATES, RUBBER BALLS, TABLE TENNIS TABLES, TARGET GAMES, TENNIS BALLS, TOY BUCKET AND SHOVEL SETS. ALL OF THE FOREGOING SPECIFICALLY FOR CHILDREN AND NONE OF THE FOREGOING GOODS USED IN CONNECTION WITH OR FOR THE PROMOTION OF THE SPORT OF BASKETBALL, IN CLASS 28 (U.S. CLS. 22, 23, 38 AND 50).

FOR: SOFT DRINKS, MINERAL AND AERATED WATERS; FRUIT DRINKS AND FRUIT JUICES; CONCENTRATES, SYRUPS OR POWDERS USED IN THE PREPARATION OF SOFT DRINKS; ALL OF

THE FOREGOING SPECIFICALLY FOR CHILDREN AND NONE OF THE FOREGOING USED IN CONNECTION WITH OR FOR THE PROMOTION OR THE SPORT OF BASKETBALL, IN CLASS 32 (U.S. CLS. 45, 46 AND 48).

FOR: EDUCATIONAL SERVICES, NAMELY, PROVIDING COURSES OF INSTRUCTION AND SEMINARS IN THE FIELD OF CHILD EDUCATION; ENTERTAINMENT SERVICES, NAMELY, AMUSEMENT ARCADES AND PARKS, BOOKING OF SEATS FOR SHOWS, MOTION PICTURE FILM PRODUCTION, LIVE PERFORMANCES BY A MUSICAL GROUP, MUSIC COMPOSITION, MUSIC PUBLISHING, PRODUCTION OF MUSIC, PRODUCTION OF RADIO AND TELEVISION PROGRAMS, PUBLICATION OF BOOKS, SCRIPT WRITING AND SCRIPT WRITING SERVICES, SOUND RECORDING, ENTERTAINMENT SERVICES IN THE NATURE OF ON-GOING TELEVISION PROGRAMS IN THE FIELD OF CHILDREN'S ENTERTAINMENT, THEATRE PRODUCTIONS, VIDEO TAPE AND VIDEO DISC PRODUCTION, VIDEO TAPE EDITING AND FILMING, RADIO AND TELEVISION ENTERTAINMENT PRODUCTION; LIVE PERFORMANCES FEATURING COSTUMED CHARACTERS;

PROVIDING ON-LINE ENTERTAINMENT FOR CHILDREN IN THE NATURE OF SONGS, STORIES, DRAMA AND GAMES; PRODUCTION, PRESENTATION, DISTRIBUTION OF CHILDREN'S ENTERTAINMENT SHOWS AND INTERACTIVE PROGRAMS FOR DISTRIBUTION VIA TELEVISION, CABLE, SATELLITE, AND ELECTRONIC MEANS OVER A GLOBAL COMPUTER NETWORK; PRODUCTION OF CHILDREN'S ENTERTAINMENT SHOWS AND INTERACTIVE PROGRAMS FOR AUDIO AND VIDEO MEDIA, NAMELY, CASSETTES, CARTRIDGES, CDS, DVDS, DIGITAL VERSATILE DISCS, LASERDISCS AND COMPUTER DISCS; ALL OF THE FOREGOING SPECIFICALLY FOR CHILDREN AND NONE OF THE FOREGOING GOODS USED IN CONNECTION WITH OR FOR THE PROMOTION OF THE SPORT OF BASKETBALL, IN CLASS 41 (U.S. CLS. 100, 101 AND 107).

OWNER OF INTERNATIONAL REGISTRATION 0858053 DATED 5-2-2005, EXPIRES 5-2-2015.

SER. NO. 79-013,906, FILED 5-2-2005.

DANIEL CAPSHAW, EXAMINING ATTORNEY

Int. Cl.: 25

Prior U.S. Cls.: 22 and 39

United States Patent and Trademark Office

Reg. No. 3,520,721

Registered Oct. 21, 2008

TRADEMARK
PRINCIPAL REGISTER



ZELAL GIYIM SANAYI VE TICARET LIMITED
SIRKETI (TURKEY LIMITED COMPANY)
SIRACEVIZLER CAD.
HUZUR SOK. NO: 21
BOMONTI-SISLI/ISTANBUL, TURKEY

FOR: CARDIGANS, JEANS, CLOTHING OF LEATHER, NAMELY, LEATHER COATS, LEATHER JACKETS; TRACK SUITS; BATHING SUITS, BEACHWEAR, UNDERWEAR, GLOVES, NAMELY, BICYCLE GLOVES, RIDING GLOVES; SOCKS; SHOES, BOOTS, SLIPPERS, SPORTS SHOES, NAMELY, FOOTBALL SHOES, GYMNAS TIC SHOES, STOCKINGS, OVERSHOES; HEADGEAR, NAMELY, HATS, CAPS; BIBS NOT OF PAPER FOR CHILDREN; NECKTIES, BOW-TIES, FOULARDS, SHAWLS, SCARVES, CLOTHING, NAMELY, COL-

LARS, MUFFS, BANDANAS IN THE NATURE OF NECKERCHIEFS, WRISTBANDS, AND BELTS; SUSPENDERS, AND ANKLE GARTERS, IN CLASS 25 (U.S. CLS. 22 AND 39).

OWNER OF INTERNATIONAL REGISTRATION
0859895 DATED 12-31-2004, EXPIRES 12-31-2014.

THE FOREIGN WORDING IN THE MARK
TRANSLATES INTO ENGLISH AS APPLE JUICE.

SER. NO. 79-014,430, FILED 12-31-2004.

JULIE WATSON, EXAMINING ATTORNEY

Int. Cls.: 7, 12, 37 and 42

**Prior U.S. Cls.: 13, 19, 21, 23, 31, 34, 35, 44, 100, 101,
103 and 106**

Reg. No. 3,520,722

United States Patent and Trademark Office

Registered Oct. 21, 2008

**TRADEMARK
SERVICE MARK
PRINCIPAL REGISTER**

ZAUGG

ZAUGG AG EGGIWIL (SWITZERLAND CORPORATION)

HOLZMATT

CH-3537 EGGIWIL, SWITZERLAND

FOR: AGRICULTURAL MACHINES AND INSTRUMENTS, NAMELY, TRACTORS, CULTIVATORS, PLOWS, DISK HARROWS, ROTOTILLERS, SPADING MACHINES, SUBSOILERS, SEEDERS, PLANTERS, SEED DRILLS, FERTILIZER SPREADERS, HARVESTERS, BALERS, MOWER, LOADERS, WHICH ARE NOT HAND-OPERATED, MOTOR-OPERATED INSTRUMENTS, NAMELY, SNOW PLOWS, SNOW BLOWERS, SNOW THROWERS, FOR REMOVING SNOW FROM ROADS, RAILWAYS AND RUNWAYS, MACHINES FOR CLEARING ROADS, NAMELY, ROAD SWEEPING MACHINES, EDGE TRIMMERS, ROTARY WEEDERS, MOWERS, GRADERS, SNOWPLOWS, SNOW AND ICE CUTTERS AS MACHINE PARTS; MACHINES, NAMELY, SNOW BLOWERS, FULLY TRACKED VEHICLE DESIGNED TO MOVE ON SNOW FOR GROOMING SKI TRAILS AND SNOW MOBILE TRAILS, GROOMERS, FOR PREPARING SKI RUNS, MACHINES, NAMELY, ROLLERS, CUTTERS, MILLING MACHINES, PAVEMENT BREAKERS, PAYERS, FOR PREPARING ROADS, ELECTRICALLY OPERATED BRUSHES, BEING PARTS OF MACHINES, ROAD MAINTENANCE MACHINES, NAMELY, ROAD SWEEPING MACHINES, EDGE TRIMMERS, ROTARY WEEDERS, MOWERS, GRADERS, FLATTENING MACHINES FOR COMPACTING SURFACES, NAMELY, SOIL AND ROAD PAVEMENT; SELF-PROPELLED SNOW AND ICE MACHINE CUTTERS; SPECIAL VEHICLES, NAMELY, SNOW PLOWS, SNOW BLOWERS, SNOW THROWERS, ROAD SWEEPING MACHINES, EDGE TRIMMERS, ROTARY WEEDERS, MOWERS, GRADERS, FOR SNOW AND ROAD CLEARANCE, IN CLASS 7 (U.S. CLS. 13, 19, 21, 23, 31, 34 AND 35).

FOR: VEHICLES, NAMELY, CARS, VANS, TRUCKS, PICK-UP TRUCKS, BOATS, SNOW CRAFTS, NAMELY, SNOW MOBILES, ALL-TERRAIN VEHICLES, AMPHIBIOUS VEHICLES, CRAWLER TYPE VEHICLES, NAMELY, ALL-TERRAIN TRACKED VEHICLES, TRACTORS, VEHICLES FOR LOCOMOTION ON RAILS, NAMELY, TRAINS AND STRUCTURAL PARTS THEREFOR, AND TRAILERS, IN CLASS 12 (U.S. CLS. 19, 21, 23, 31, 35 AND 44).

FOR: VEHICLE REPAIR AND MAINTENANCE, REPAIR OR MAINTENANCE OF MACHINES, NAMELY, SNOW PLOWS, SNOW BLOWERS, SNOW THROWERS, ROAD SWEEPING MACHINES, EDGE TRIMMERS, ROTARY WEEDERS, MOWERS, GRADERS, FLATTENING MACHINES, SELF-PROPELLED SNOW AND ICE MACHINE CUTTERS, IN CLASS 37 (U.S. CLS. 100, 103 AND 106).

FOR: DEVELOPMENT OF NEW MACHINES, NAMELY, DEVELOPMENT OF MACHINES FOR REMOVING SNOW AND CLEARING ROADS, FOR SNOW TREATMENT AND FOR PREPARING SKI RUNS FOR OTHERS, IN CLASS 42 (U.S. CLS. 100 AND 101).

THE MARK CONSISTS OF STANDARD CHARACTERS WITHOUT CLAIM TO ANY PARTICULAR FONT, STYLE, SIZE, OR COLOR.

PRIORITY DATE OF 8-19-2005 IS CLAIMED.

OWNER OF INTERNATIONAL REGISTRATION 0874059 DATED 11-7-2005, EXPIRES 11-7-2015.

SEC. 2(F).

SER. NO. 79-019,906, FILED 11-7-2005.

ALICE BENMAMAN, EXAMINING ATTORNEY

Int. Cls.: 2, 4, 16, 20, 23, 24 and 26

Prior U.S. Cls.: 1, 2, 5, 6, 11, 13, 15, 16, 22, 23, 25, 29, 32, 37, 38, 39, 40, 42, 43 and 50

Reg. No. 3,520,723

United States Patent and Trademark Office

Registered Oct. 21, 2008

**TRADEMARK
PRINCIPAL REGISTER**

RICO
DESIGN

RICO DESIGN GMBH & CO. KG (FED REP GERMANY LIMITED PARTNERSHIP)
INDUSTRIESTRAÙE 19-23
33034 BRAKEL
FED REP GERMANY

FOR: PAINTS, LACQUERS, COLORANTS EXCLUSIVELY FOR CREATIVE PAINTING BY HAND USING A PAINTBRUSH OR PENCILS, IN CLASS 2 (U.S. CLS. 6, 11 AND 16).

FOR: FUELS, CANDLES, AND WICKS FOR LIGHTING; ILLUMINANTS, NAMELY, OIL, WAX, WAX POWDER, WAX GRANULATE AND GEL ALL FOR USE AS FUEL FOR ILLUMINATING FIRE TORCHES, IN CLASS 4 (U.S. CLS. 1, 6 AND 15).

FOR: HANDICRAFT MATERIAL, NAMELY, PAPER AND CARDBOARD AND GOODS MADE FROM THESE MATERIALS IN THE FORM OF ART PAPER, BOOK COVER PAPER, CALLIGRAPHY PAPER, ORIGAMI PAPER, DECORATIVE PAPER CENTERPIECES, DRAWING PAPER, GIFT WRAP PAPER, GUMMED PAPER, HEAT TRANSFER PAPER, KRAFT PAPER, PAPER BUNTING, PAPER CAKE DECORATIONS, PAPER DOILIES, PAPER FLAGS, PAPER FLOWER POT COVERS, PAPER GIFT BAGS, PAPER LACE, PAPER MACHE, PAPER PARTY DECORATIONS, PAPER RIBBONS, PAPER FOR USE IN THE GRAPHIC ARTS INDUSTRY FOR USE IN THE PREPARATION OF HANDICRAFTS, ARTISTS TOOLS IN THE NATURE OF HANDHELD PERFORATORS AND PUNCHES FOR USE IN PERFORATION OF HANDICRAFTS; PRINTED INSTRUCTIONAL AND TEACHING MATERI-

AL RELATED TO HANDICRAFTS; PLASTIC BAGS FOR PACKAGING, PRINTER'S TYPE, PRINTER'S BLOCKS; ENVELOPES, BOXES AND BAGS OF PAPER AND CARDBOARD, STICKERS, MEMO PADS, MEMO BLOCKS, STENCILS, PAPER AND CARDBOARD FOR SCRAP BOOKS AND FOR DECOUPAGE; PAPER NAPKINS, ADHESIVES FOR STATIONERY OR HOUSEHOLD PURPOSES; ARTISTS MATERIAL, NAMELY, BRUSHES, PASTELS, PENCILS, CANVAS PANELS, PAINTING SETS CUTTING PENCILS, PAINTBRUSHES; OFFICE REQUISITES, NAMELY, TAPE DISPENSERS, AUTOMATIC PAPER CLIP DISPENSING MACHINES, DOCUMENT BINDING MACHINES, DOCUMENT LAMINATORS FOR OFFICE AND HANDICRAFT USE; LABELING MACHINES FOR OFFICE AND HANDICRAFT USE; BOOK BINDING; PHOTOGRAPHS; STATIONERY, IN CLASS 16 (U.S. CLS. 2, 5, 22, 23, 29, 37, 38 AND 50).

FOR: MIRRORS, PICTURE FRAMES; HANDICRAFT PRODUCTS MADE FROM WOOD, CORK, REED, CANE, WICKER, HORN, BONE, IVORY AND WHALE BONE, SHELL, AMBER, MOTHER OF PEARL, MEERSCHAUM, AND SUBSTITUTES THEREFORE, NAMELY, VINYL APPLIQUES FOR ATTACHMENT TO WINDOWS, MIRRORS AND OTHER SOLID SURFACES, ORNAMENTS AND THREE DIMENSIONAL ORNAMENTS NOT FOR CHRISTMAS TREES, IN CLASS 20 (U.S. CLS. 2, 13, 22, 25, 32 AND 50).

FOR: YARNS, IN CLASS 23 (U.S. CL. 43).

FOR: TEXTILES AND TEXTILE GOODS, NAME-
LY, TABLE LINENS AND KITCHEN LINENS AS
FAR AS INCLUDED IN THIS CLASS EXCEPT BED
COVERS; TABLE COVERS NOT OF PAPER, IN
CLASS 24 (U.S. CLS. 42 AND 50).

FOR: LACE AND EMBROIDERY, RIBBONS AND
BRAID; BUTTONS FOR CLOTHING, HOOKS AND
EYES, ARTIFICIAL FLOWERS, IN CLASS 26 (U.S.
CLS. 37, 39, 40, 42 AND 50).

OWNER OF INTERNATIONAL REGISTRATION
0882979 DATED 12-22-2005, EXPIRES 12-22-2015.

NO CLAIM IS MADE TO THE EXCLUSIVE
RIGHT TO USE "DESIGN", APART FROM THE
MARK AS SHOWN.

SER. NO. 79-023,130, FILED 12-22-2005.

HEATHER THOMPSON, EXAMINING ATTORNEY

Int. Cls.: 2, 4, 16 and 20

**Prior U.S. Cls.: 1, 2, 5, 6, 11, 13, 15, 16, 22, 23, 25, 29,
32, 37, 38 and 50**

Reg. No. 3,520,724

United States Patent and Trademark Office

Registered Oct. 21, 2008

**TRADEMARK
PRINCIPAL REGISTER**

RICO

RICO DESIGN GMBH & CO. KG (FED REP
GERMANY LIMITED PARTNERSHIP)
INDUSTRIESTRAÙE 19-23
BRAKEL, FED REP GERMANY 33034

FOR: PAINTS, LACQUERS, COLORANTS EX-
CLUSIVELY FOR CREATIVE PAINTING BY HAND
USING A PAINTBRUSH OR PENCILS, IN CLASS 2
(U.S. CLS. 6, 11 AND 16).

FOR: FUELS CANDLES, AND WICKS FOR
LIGHTING; ILLUMINANTS, NAMELY, OIL, WAX,
WAX POWDER, WAX GRANULATE AND GEL ALL
FOR USE AS FUEL FOR ILLUMINATING FIRE
TORCHES, IN CLASS 4 (U.S. CLS. 1, 6 AND 15).

FOR: HANDICRAFT MATERIAL, NAMELY, PA-
PER AND CARDBOARD AND GOODS MADE
FROM THESE MATERIALS IN THE FORM OF
ART PAPER, BOOK COVER PAPER, CALLIGRA-
PHY PAPER, ORIGAMI PAPER, DECORATIVE PA-
PER CENTERPIECES, DRAWING PAPER, GIFT
WRAP PAPER, GUMMED PAPER, HEAT TRANS-
FER PAPER, KRAFT PAPER, PAPER BUNTING,
PAPER CAKE DECORATIONS, PAPER DOILIES,
PAPER FLAGS, PAPER FLOWERPOT COVERS,
PAPER GIFT BAGS, PAPER LACE, PAPER MACHE,
PAPER PARTY DECORATIONS, PAPER RIBBONS,
PAPER FOR USE IN THE GRAPHIC ARTS INDUS-
TRY FOR USE IN THE PREPARATION OF HANDI-
CRAFTS, ARTISTS TOOLS IN THE NATURE OF
HANDHELD PERFORATORS AND PUNCHES FOR
USE IN PERFORATION OF HANDICRAFTS; PRIN-
TED INSTRUCTIONAL AND TEACHING MATERI-
AL RELATED TO HANDICRAFTS; PLASTIC BAGS
FOR PACKAGING, PRINTER'S TYPE, PRINTER'S
BLOCKS; ENVELOPES, BAGS AND BOXES OF

PAPER AND CARDBOARD, STICKERS, MEMO
PADS, MEMO BLOCKS, STENCILS, PAPER AND
CARDBOARD FOR SCRAP BOOKS AND FOR DE-
COUPAGE; PAPER NAPKINS, ADHESIVES FOR
STATIONERY OR HOUSEHOLD PURPOSES; AR-
TISTS MATERIAL, NAMELY, BRUSHES, PASTELS,
PENCILS, CANVAS PANELS, PAINTING SETS, CUT-
TING PENCILS, PAINT BRUSHES; OFFICE REQUI-
SITES, NAMELY, TAPE DISPENSERS, AUTOMATIC
PAPER CLIP DISPENSING MACHINES, DOCU-
MENT BINDING MACHINES, DOCUMENT LAMI-
NATORS FOR OFFICE AND HANDICRAFT USE;
LABELING MACHINES FOR OFFICE AND HANDI-
CRAFT USE; BOOK BINDING; PHOTOGRAPHS;
STATIONERY, IN CLASS 16 (U.S. CLS. 2, 5, 22, 23,
29, 37, 38 AND 50).

FOR: MIRRORS, PICTURE FRAMES; HANDI-
CRAFT PRODUCTS MADE FROM WOOD, CORK,
REED, CANE, WICKER, HORN, BONE, IVORY AND
WHALE BONE, SHELL, EMBER, MOTHER OF
PEARL, MEERSCHAUM, AND SUBSTITUTES
THEREFORE, NAMELY, VINYL APPLIQUES FOR
ATTACHMENT TO WINDOWS, MIRRORS AND
OTHER SOLID SURFACES, ORNAMENTS AND
THREE DIMENSIONAL ORNAMENTS NOT FOR
CHRISTMAS TREES, IN CLASS 20 (U.S. CLS. 2, 13, 22,
25, 32 AND 50).

OWNER OF INTERNATIONAL REGISTRATION
0882993 DATED 12-22-2005, EXPIRES 12-22-2015.

SER. NO. 79-023,131, FILED 12-22-2005.

HEATHER THOMPSON, EXAMINING ATTORNEY

Int. Cl.: 33

Prior U.S. Cls.: 47 and 49

United States Patent and Trademark Office

Reg. No. 3,520,725

Registered Oct. 21, 2008

TRADEMARK
PRINCIPAL REGISTER

jules

DOMAINE DU GRAND CROS (EARL) (FRANCE
EXPLOITATION AGRICOLE A RESPONS-
ABILITE LIMITE)

RD 13

F-83660 CARNOULES
FRANCE

FOR: WINES, IN CLASS 33 (U.S. CLS. 47 AND 49).

THE MARK CONSISTS OF STANDARD CHAR-
ACTERS WITHOUT CLAIM TO ANY PARTICULAR
FONT, STYLE, SIZE, OR COLOR.

OWNER OF INTERNATIONAL REGISTRATION
0887302 DATED 4-18-2006, EXPIRES 4-18-2016.

THE ENGLISH TRANSLATION OF "JULES" IS
BOYFRIEND OR LOVER.

SER. NO. 79-024,755, FILED 4-18-2006.

TRACY WHITTAKER-BROWN, EXAMINING AT-
TORNEY

Int. Cls.: 9, 16, 28, 37, 38, 41 and 42

**Prior U.S. Cls.: 2, 5, 21, 22, 23, 26, 29, 36, 37, 38, 50,
100, 101, 103, 104, 106 and 107**

Reg. No. 3,520,726

United States Patent and Trademark Office

Registered Oct. 21, 2008

**TRADEMARK
SERVICE MARK
PRINCIPAL REGISTER**



DIGITOTE SOFTWARE GMBH DEUTSCHLAND
(FED REP GERMANY LIMITED LIABILITY
COMPANY)

WULLENER FELD 60

58454 WITTEN

FED REP GERMANY

FOR: COMPUTER HARDWARE AND SOFTWARE USED FOR BOOKMAKING, LOTTERIES, GAMES OF CHANCE, SPORTS BETTING AND OTHER BETTING SYSTEMS; COMPUTER-BASED BETTING TERMINALS; COMPUTER-BASED BETTING TERMINALS WITH SELF-SERVICE FUNCTIONS; TOTALISATORS; AUTOMATIC GAMING MACHINES; AUTOMATIC GAMING MACHINES FOR INTERACTIVE GAMES FOR USE WITH TELEVISION RECEIVERS; AUTOMATIC GAMES OF CHANCE MACHINES FOR USE WITH TELEVISION RECEIVERS; AUTOMATIC GAMES OF CHANCE MACHINES WITH SELF-SERVICE FUNCTIONS FOR USE WITH TELEVISION RECEIVERS; GAMES OF CHANCE AND BETTING GAMES RECORDED ON VISUAL DATA CARRIERS; ELECTRIC AND ELECTRONIC CONTROL AND MONITORING APPARATUS, NAMELY, CONTROL SYSTEMS FOR MACHINES, GATEWAY ROUTERS IN THE NATURE OF COMPUTER CONTROL HARDWARE, VIDEO GAME INTERACTIVE HAND HELD REMOTE CONTROLS FOR PLAYING ELECTRONIC GAMES, COMPUTER TERMINALS, VIDEO LOTTERY TERMINALS, IN CLASS 9 (U.S. CLS. 21, 23, 26, 36 AND 38).

FOR: PRINTED MATERIALS, NAMELY, LISTS FEATURING BETTING FORECASTS FOR HORSE RACING, DOG RACING, AND SPORTING COMPETITIONS, NEWSPAPERS IN THE FIELD OF RACE TRACKS, IN CLASS 16 (U.S. CLS. 2, 5, 22, 23, 29, 37, 38 AND 50).

FOR: ARCADE-TYPE AUTOMATIC AND ELECTRONIC VIDEO GAMING MACHINES; AUTOMATIC AND ELECTRONIC GAMING MACHINES FOR INTERACTIVE GAMES; AUTOMATIC GAMES OF CHANCE MACHINES; AUTOMATIC GAMES OF CHANCE MACHINES WITH SELF-SERVICE FUNCTIONS; THE AFOREMENTIONED GOODS NOT BEING ADAPTED FOR USE WITH TELEVISION RECEIVERS, IN CLASS 28 (U.S. CLS. 22, 23, 38 AND 50).

FOR: SETTING UP, INSTALLATION, MAINTENANCE, AND REPAIR OF OFFICE EQUIPMENT AND COMPUTER HARDWARE, NAMELY, THE SETTING UP AND MAINTENANCE OF ELECTRONIC LOTTERY, BOOKMAKING, SPORTS BETTING AND OTHER BETTING SYSTEMS AND BETTING TERMINALS AND GAMING MACHINES, IN CLASS 37 (U.S. CLS. 100, 103 AND 106).

FOR: TRANSMISSION OF SPORTS NEWS AND SPORTS AND BETTING RESULTS VIA RADIO AND TELEVISION, BY COMPUTER OR BY MEANS OF OTHER ELECTRONIC TRANSMISSION APPARATUS, IN CLASS 38 (U.S. CLS. 100, 101 AND 104).

FOR: BETTING SERVICES, NAMELY, BOOK-MAKING, OFF-TRACK BETTING FACILITIES; BETTING OFFICES, CASINOS AND SPORTS FACILITIES, ORGANIZATION OF SPORTS EVENTS IN THE FIELDS OF HORSE RACING, DOG RACING, TEAM SPORTS, OLYMPIC SPORTS, WATER SPORTS, SOLO SPORTS, ADVENTURE SPORTS, PROFESSIONAL SPORTS, SNOW SPORTS; PUBLICATION OF SPORTS NEWS AND SPORT BETTING RESULTS VIA PRINT MEDIA; RENTAL OF BETTING TERMINALS, NAMELY, THOSE WITH SELF-SERVICE FUNCTIONS, TOTALISATORS, GAMING MACHINES, AUTOMATIC GAMES OF CHANCE MACHINES WITH SELF-SERVICE FUNCTIONS AND GAMES OF CHANCE AND BETTING GAMES RECORDED ON VISUAL DATA CARRIERS, IN CLASS 41 (U.S. CLS. 100, 101 AND 107).

FOR: DEVELOPMENT OF SECTOR-SPECIFIC COMPUTER SOFTWARE, NAMELY, FOR BOOK-

MAKING, RACE TRACKS, SPORTS EVENT ORGANISERS, LOTTERIES, GAMES OF CHANCE, SPORTS BETTING AND OTHER BETTING SYSTEMS, IN CLASS 42 (U.S. CLS. 100 AND 101).

PRIORITY DATE OF 12-28-2004 IS CLAIMED.

OWNER OF INTERNATIONAL REGISTRATION 0892109 DATED 6-22-2005, EXPIRES 6-22-2015.

"DIGIBET" HAS NO MEANING IN A FOREIGN LANGUAGE.

SER. NO. 79-026,475, FILED 6-22-2005.

SUZANNE BLANE, EXAMINING ATTORNEY

Int. Cls.: 42 and 44

Prior U.S. Cls.: 100 and 101

United States Patent and Trademark Office

Reg. No. 3,520,727

Registered Oct. 21, 2008

**SERVICE MARK
PRINCIPAL REGISTER**



INSTITUT CURIE (FRANCE PRIVATE NOT
PROFIT FOUNDATION)
26, RUE D'ULM
F-75248 PARIS CEDEX 05
FRANCE

FOR: INDUSTRIAL, SCIENTIFIC, AND MEDICAL RESEARCH SERVICES AND PHARMACEUTICAL AND BIOLOGICAL DEVELOPMENT SERVICES, ALL IN THE FIELD OF MOLECULAR BIOLOGY, BIOINFORMATICS, CANCER TREATMENT AND DIAGNOSIS, AND PRODUCTS FOR GENE THERAPY AND BIOTECHNOLOGY; RESEARCH IN THE LEGAL AND REGULATORY FIELD AS REGARDS MEDICINE; RESEARCH IN THE FIELDS OF BIOLOGY, BIOTECHNOLOGY, CHEMISTRY, BACTERIOLOGY, CHEMOTHERAPY; QUALITY CONTROL FOR OTHERS; MEDICAL LABORATORIES; DESIGN OF COMPUTER SOFTWARE IN THE FIELD OF BIOLOGY, BIOTECHNOLOGY, CHEMISTRY, BACTERIOLOGY, CHEMOTHERAPY; SOFTWARE UPDATING FOR OTHERS; INSTALLATION OF COMPUTER SOFTWARE; COMPUTER SOFTWARE MAINTENANCE; COMPUTER SOFTWARE RENTAL; COMPUTER PROGRAMMING; RECONSTRUCTION OF DATABASES; CONDUCTING CLINICAL TRIALS; DEVELOPMENT OF DIAGNOSTIC METHODS IN THE FIELD OF CANCER RESEARCH; DEVELOPMENT OF KITS AND TESTS FOR MEDICAL PURPOSES; DESIGN AND DEVELOPMENT OF DIAGNOSTIC KITS AND DIAGNOSTIC TESTS, IN CLASS 42 (U.S. CLS. 100 AND 101).

FOR: MEDICAL SERVICES; PHARMACEUTICAL CONSULTING; VETERINARY SERVICES; HEALTH

SUPPORT IN THE NATURE OF PROVIDING HEALTH INFORMATION AND HOME HEALTH CARE SERVICES; MEDICAL, PHARMACEUTICAL, AND PUBLIC HEALTH CONSULTING SERVICES; REST AND CONVALESCENT HOMES; HOSPITALS, IN CLASS 44 (U.S. CLS. 100 AND 101).

PRIORITY DATE OF 7-28-2005 IS CLAIMED.

OWNER OF INTERNATIONAL REGISTRATION
0894176 DATED 1-19-2006, EXPIRES 1-19-2016.

THE COLOR(S) ORANGE, GREY AND WHITE IS/
ARE CLAIMED AS A FEATURE OF THE MARK.

THE COLOR ORANGE APPEARS IN THE FIGURATIVE ELEMENT ON THE RIGHT; THE COLOR GREY APPEARS IN THE FIGURATIVE ELEMENT ON THE LEFT, AND THE COLOR WHITE APPEARS IN THE BACKGROUND.

THE MARK COMPRISES TWO INTERLACED CIRCULAR FIGURATIVE ELEMENTS; THE FIGURATIVE ELEMENT ON THE LEFT IS IN GREY; THE FIGURATIVE ELEMENT ON THE RIGHT IS IN ORANGE.

SER. NO. 79-027,213, FILED 1-19-2006.

SUZANNE BLANE, EXAMINING ATTORNEY

Int. Cls.: 5 and 10

Prior U.S. Cls.: 6, 18, 26, 39, 44, 46, 51 and 52

United States Patent and Trademark Office

Reg. No. 3,520,728

Registered Oct. 21, 2008

**TRADEMARK
PRINCIPAL REGISTER**

HEALON D

ADVANCED MEDICAL OPTICS UPPSALA AB
(SWEDEN AKTIEBOLAG (AB))
SE-751 82 UPPSALA
SWEDEN

FOR: PHARMACEUTICAL PREPARATIONS
AND SUBSTANCES FOR USE DURING PHACOE-
MULSIFICATION SURGERY; PHARMACEUTICAL
PREPARATIONS IN THE NATURE OF HYALURO-
NIC ACID FOR USE IN OPHTHALMIC SURGERY,
IN CLASS 5 (U.S. CLS. 6, 18, 44, 46, 51 AND 52).

FOR: MEDICAL AND SURGICAL EQUIPMENT
AND APPARATUS, NAMELY, FOR USE DURING
PHACOEMULSIFICATION SURGERY, IN CLASS 10
(U.S. CLS. 26, 39 AND 44).

PRIORITY DATE OF 7-10-2006 IS CLAIMED.

OWNER OF INTERNATIONAL REGISTRATION
0895500 DATED 7-12-2006, EXPIRES 7-12-2016.

OWNER OF U.S. REG. NOS. 940,849, 1,812,655,
AND 2,716,012.

SER. NO. 79-027,718, FILED 7-12-2006.

HEATHER THOMPSON, EXAMINING ATTORNEY

Int. Cls.: 9, 35, 38, 41 and 42

**Prior U.S. Cls.: 21, 23, 26, 36, 38, 100, 101, 102, 104
and 107**

Reg. No. 3,520,729

United States Patent and Trademark Office

Registered Oct. 21, 2008

**TRADEMARK
SERVICE MARK
PRINCIPAL REGISTER**

COSMETICSDESIGN

DECISION NEWS MEDIA SAS (FRANCE SOCI-
ÉTÉ PAR ACTIONS SIMPLIFIÉE (SAS))
LE BELEM -
355 RUE VENDÉMAIRE
F-34000 MONTPELLIER, FRANCE

FOR: COMPUTER PROGRAMS AND SOFTWARE
FOR CREATING, PUBLISHING AND MANAGING
ONLINE CONTENT IN THE FORM OF MESSAGES,
DATA, TEXTS, IMAGES AND VIDEOS AND RE-
LATING TO THE PUBLICATION OF INFORMATI-
ON FOR PROFESSIONALS IN THE COSMETICS
AND BEAUTY PRODUCTS INDUSTRY, DOWN-
LOADABLE FROM AN EXTERNAL COMPUTER
NETWORK OR FROM THE INTERNET; DOWN-
LOADABLE PUBLICATIONS, NAMELY, NEWSLET-
TERS, NEWS ARTICLES, AND MARKET REPORTS
IN THE FIELD OF COSMETICS IN ELECTRONIC
FORM SUPPLIED FROM A DATABASE OR FROM
THE INTERNET, IN CLASS 9 (U.S. CLS. 21, 23, 26, 36
AND 38).

FOR: ADVERTISING; BUSINESS PROMOTION
AND INFORMATION SERVICES THROUGH THE
INTERNET, NAMELY, PROMOTING THE BUSI-
NESS OF OTHERS IN THE COSMETICS BUSINESS
AND PROVIDING BUSINESS INFORMATION SER-
VICES RELATING TO THE COSMETICS BUSINESS;
COMPILING BUSINESS ADVERTISEMENTS FOR
THIRD PARTIES, NAMELY, DISPLAYING ADVER-
TISEMENTS FOR OTHERS; RENTAL OF ADVER-
TISING SPACE ONLINE FOR PROMOTING GOODS
AND SERVICES BETWEEN PROFESSIONALS, IN
CLASS 35 (U.S. CLS. 100, 101 AND 102).

FOR: TELECOMMUNICATION SERVICES,
NAMELY, ELECTRONIC MESSAGING SERVICES
VIA THE INTERNET FOR TECHNICAL, SCIENTI-
FIC AND PROFESSIONAL NEWS AND INFORMATI-
ON ABOUT THE COSMETICS AND BEAUTY
PRODUCTS INDUSTRY; TRANSMISSION OF MES-
SAGES, DATA, TEXTS AND IMAGES BY ELECTRO-

NIC MEANS; COMMUNICATIONS BY COMPUTER
TERMINALS; TRANSMISSION OF INFORMATION
HELD IN A DATABASE OR ON THE INTERNET
VIA EMAIL, IN CLASS 38 (U.S. CLS. 100, 101 AND
104).

FOR: PUBLISHING SERVICES FOR NEWS ARTI-
CLES, NEWSLETTERS, AND MARKET REPORTS
FEATURING SCIENTIFIC, INDUSTRIAL AND
TECHNICAL INFORMATION AND NEWS FOR
PROFESSIONALS IN THE COSMETICS INDUSTRY
INVOLVED IN MANUFACTURING TECHNOLO-
GIES FOR COSMETICS PRODUCTS, IN CLASS 41
(U.S. CLS. 100, 101 AND 107).

FOR: DESIGN AND DEVELOPMENT OF WEB-
SITES FOR OTHERS; COMPILATION FOR OTHERS
OF WEB PAGES ON THE INTERNET, NAMELY,
PROVIDING LINKS TO WEB SITES OF OTHERS
FEATURING THE DESIGN AND DEVELOPMENT
OF COSMETICS; RENTAL OF A DATABASE SER-
VER TO THIRD PARTIES, IN CLASS 42 (U.S. CLS.
100 AND 101).

THE MARK CONSISTS OF STANDARD CHAR-
ACTERS WITHOUT CLAIM TO ANY PARTICULAR
FONT, STYLE, SIZE, OR COLOR.

PRIORITY DATE OF 9-26-2005 IS CLAIMED.

OWNER OF INTERNATIONAL REGISTRATION
0897396 DATED 3-24-2006, EXPIRES 3-24-2016.

SEC. 2(F).

SER. NO. 79-028,463, FILED 3-24-2006.

REBECCA POVARCHUK, EXAMINING ATTOR-
NEY

Int. Cls.: 7, 9, 16, 20, 35, 36, 37, 38 and 42

Prior U.S. Cls.: 2, 5, 13, 19, 21, 22, 23, 25, 26, 29, 31, 32, 34, 35, 36, 37, 38, 50, 100, 101, 102, 103, 104 and 106

Reg. No. 3,520,730

United States Patent and Trademark Office

Registered Oct. 21, 2008

**TRADEMARK
SERVICE MARK
PRINCIPAL REGISTER**

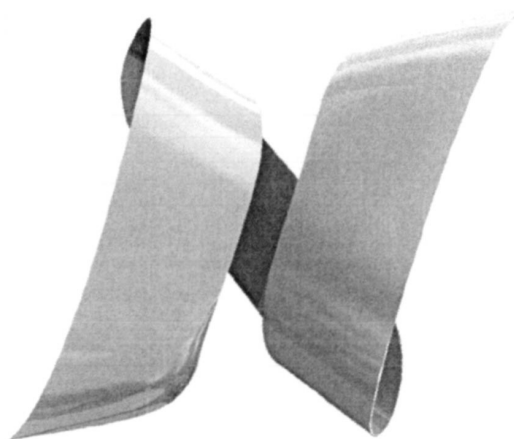

NEOPOST S.A. (FRANCE SOCIETE ANONYME)
113, RUE JEAN MARIN NAUDIN
BAGNEUX, FRANCE F92220

FOR: MACHINES FOR PROCESSING MAIL, NAMELY, FEEDERS, CONVEYORS, FOLDERS, INSERTERS, STACKERS, PARTS AND COMPONENTS OF THE ABOVE MACHINES, LETTER SORTING MACHINES, BURSTERS, NAMELY, PAPER PROCESSING MACHINES DESIGNED TO AUTOMATICALLY SEPARATE DOCUMENTS PRODUCED BY COMPUTERS IN A CONTINUOUS TAPE, EXTRACTORS, NAMELY, MACHINES FOR OPENING LETTERS AND EXTRACTING THEIR CONTENT AUTOMATICALLY; MAIL PROCESSING EQUIPMENT, APPARATUS AND DEVICES, NAMELY, MACHINES FOR PRINTING, IN PARTICULAR ADDRESS PRINTING, WITH OR WITHOUT POSTAGE METERING IMPRESSION; COUNTER EQUIPMENT FOR FRANKING APPLICATIONS, NAMELY, LETTER SORTING MACHINES, BAR CODING EQUIPMENT FOR APPLICATIONS FOR MAIL PURPOSES, NAMELY, CODING MACHINE, IN CLASS 7 (U.S. CLS. 13, 19, 21, 23, 31, 34 AND 35).

FOR: ELECTRONIC APPARATUS FOR MAIL PROCESSING, NAMELY, COMPUTER SOFTWARE AND HARDWARE, ELECTRONIC DATA PROCESSING APPARATUS DESIGNED FOR PREPARING

MAIL, NAMELY, LETTERS AND PACKAGES FOR DISPATCH, NAMELY, APPARATUS FOR FOLDING AND INSERTING LETTERS IN ENVELOPES, ELECTRONIC APPARATUS FOR PROGRAMMING AND CONTROLLING APPARATUS FOR FOLDING AND INSERTING, POSTAL CALCULATING SCALES, RECORDED COMPUTER PROGRAMS FOR PROCESSING MAIL, PACKAGES AND FOR TRACKING THEIR ROUTING AND DELIVERY; RECORDED COMPUTER PROGRAMS FOR PROCESSING POSTAL ADDRESSES; RECORDED COMPUTER PROGRAMS FOR OPTIMIZING TARIFFS FOR DISPATCH OF PACKAGES, MAIL AND EXPENDITURE MANAGEMENT; RECORDED COMPUTER PROGRAMS FOR UPDATING MAILING TARIFFS AND DATA; RECORDED COMPUTER PROGRAMS FOR ENABLING OF ACCESS TO REMOTE POSTAL SERVICES; RECORDED COMPUTER PROGRAMS FOR CONVERTING DATA FROM A PHYSICAL MEDIUM TO AN ELECTRONIC MEDIUM; MAIL PROCESSING EQUIPMENT, APPARATUS AND DEVICES, NAMELY, DATERS, POSTAL MACHINES FOR POST OFFICES, NAMELY, DISPENSERS OF POSTAL ITEMS, AUTOMATED FRANKING MACHINES, COUNTER EQUIPMENT FOR FRANKING APPLICATIONS, NAMELY, ELECTRONIC APPLIANCES FOR VERIFYING FRANKING PARTICULARLY DESIGNED FOR COUNTER-TOP USE; MAIL PROCESSING APPARATUS FOR USE IN

CONJUNCTION WITH COMPUTERS, NAMELY, ELECTRONIC APPARATUS TO CHECK FRANKING, APPARATUS FOR CANCELING FRANKING, FOLDING/INSERTING MAIL; COMPUTER EQUIPMENT FOR DATA PROCESSING, NAMELY, CENTRAL DATA PROCESSING UNITS, APPARATUS FOR RECORDING, TRANSMITTING AND REPRODUCING IMAGES, COMPUTER PRINTERS, MACHINES AND APPARATUS FOR FRANKING CONTROL, READING BAR-CODES, MAIL PROCESSING, FRANKING AND RELATED DOCUMENT MANAGEMENT SOFTWARE, PROGRAMS ENABLING ACCESS TO COMPUTER SERVICES VIA THE INTERNET OR OTHER COMPUTER TELECOMMUNICATIONS NETWORKS; ELECTRONIC APPARATUS, NAMELY, SOFTWARE AND PRINTERS FOR FRANKING, NAMELY, PAYMENT AND REGISTRATION OF POSTAL OR CARRIAGE FOR PRIVATE DISPATCH SERVICES COSTS FOR LETTERS AND PACKAGES, INCLUDING VIA REMOTE CONTROL AND DOWNLOADING, VIA INTERNET OR INTRANET NETWORKS; COMPUTERS AND THEIR PERIPHERAL DEVICES, NAMELY, PRINTERS AND DIGITIZERS, IN CLASS 9 (U.S. CLS. 21, 23, 26, 36 AND 38).

FOR: LABELS FOR LETTERS AND PARCELS, NAMELY, ADDRESS LABELS, SHIPPING LABELS, BAR CODE LABELS, LABEL PRINTING MACHINES AND APPARATUS FOR PRINTING ADDRESSES, USER MANUALS AND RELATED DOCUMENTS IN THE FIELD OF MAIL PROCESSING; MACHINES FOR PROCESSING MAIL, NAMELY, FRANKING MACHINES, ELECTRONIC PREPAID DISPENSERS FOR FRANKING LETTERS AND PARCELS DISPATCHED BY POSTAL SERVICES OR BY PRIVATE CARRIERS, DOCUMENT SHREDDERS; EQUIPMENT, APPARATUS AND DEVICES FOR PROCESSING MAIL, NAMELY, FRANKING MACHINES, FRANKING BASES AND HEADS, AND SPARE COMPONENTS AND PARTS OF FRANKING MACHINES; COUNTER EQUIPMENT FOR FRANKING APPLICATIONS, NAMELY, FRANKING MACHINES; ADDRESSING EQUIPMENT, NAMELY, ADDRESSING MACHINES; LETTER OPENERS, IN CLASS 16 (U.S. CLS. 2, 5, 22, 23, 29, 37, 38 AND 50).

FOR: OFFICE FURNITURE ESPECIALLY ADAPTED FOR MAIL PROCESSING EQUIPMENT, APPARATUS AND DEVICES, IN CLASS 20 (U.S. CLS. 2, 13, 22, 25, 32 AND 50).

FOR: COMPUTER-ASSISTED MAIL FRANKING SERVICES, MAIL FRANKING SERVICES USING THE INTERNET; BUSINESS MARKETING AND DIRECT MAIL CONSULTING SERVICES, NAMELY, SERVICES OF SELECTION AND PROCESSING OF PRIVATE AND COMPANY ADDRESSES BY MEANS OF COMPUTER NETWORKS, ASSISTANCE AND CONSULTING SERVICES IN THE FIELD OF MAIL MANAGEMENT, BUSINESS MANAGEMENT AND CONSULTATION IN THE FIELDS OF LOGISTICS, TRANSPORT, ROUTING OF GOODS, PACKAGES AND MAIL; DOCUMENT REPRODUCTION SERVICES; BUSINESS CONSULTATION, NAMELY, ASSISTANCE TO COMPANIES IN OPTIMIZATION

OF DISPATCH TARIFFS FOR PACKAGES AND MAIL AND IN THEIR EXPENDITURE MANAGEMENT, THE SAID SERVICES ALSO AVAILABLE ONLINE; MANAGEMENT OF COMPUTERIZED FILES; MANAGEMENT AND COMPILATION OF INFORMATION INTO COMPUTER DATABASES, THESE SERVICES ALSO AVAILABLE ONLINE; BUSINESS CONSULTATION, NAMELY, ASSISTANCE TO COMPANIES IN MANAGEMENT OF THEIR LETTER OR PARCEL DISPATCH SERVICES, THESE SERVICES ALSO AVAILABLE ONLINE; PROVISION FOR OTHERS OF PERSONNEL PERFORMING MAIL PROCESSING OPERATIONS, NAMELY, PROVIDING INFORMATION FOR OTHERS AS TO PERSONNEL PERFORMING MAIL PROCESSING OPERATIONS, IN CLASS 35 (U.S. CLS. 100, 101 AND 102).

FOR: FINANCIAL ACCOUNT MANAGEMENT SERVICES FOR REMOTE FRANKING OF LETTERS AND PACKAGES; FINANCIAL SERVICES, NAMELY, RECHARGING OF POSTAL CREDIT; FINANCIAL SERVICES, NAMELY, PROCESSING OF TRANSFERS AND DIRECT DEBIT OF FRANKING COSTS FOR LETTERS AND PACKAGES; LEASING AND RENTAL WITH OR WITHOUT PROMISE OF SALE OF ALL EQUIPMENT, MACHINES, APPARATUS AND DEVICES CONNECTED WITH THE PROCESSING, TRANSPORT AND DELIVERY OF MAIL FOR FACTORIES, WORKSHOPS AND OFFICES; FINANCIAL PORTFOLIO MANAGEMENT, NAMELY, MANAGEMENT OF A PORTFOLIO OF HOLDINGS AND SECURITIES AND OPERATIONS RELATED THERETO, REAL ESTATE MANAGEMENT, IN CLASS 36 (U.S. CLS. 100, 101 AND 102).

FOR: INSTALLATION, MAINTENANCE AND REPAIR OF MAIL PROCESSING, TRANSPORT AND DELIVERY MACHINES, EQUIPMENT, APPARATUS AND DEVICES, THESE SERVICES ALSO AVAILABLE ONLINE, IN CLASS 37 (U.S. CLS. 100, 103 AND 106).

FOR: PROVIDING ACCESS TO COMPUTER TELECOMMUNICATION NETWORKS, PROVIDING MULTIPLE-USER ACCESS TO A GLOBAL COMPUTER INFORMATION NETWORK BY MEANS OF COMPUTERS GROUPED ON A GLOBAL COMMUNICATION NETWORK OTHERWISE KNOWN AS AN INTRANET, OR A PRIVATE OR RESERVED ACCESS NETWORK, IN CLASS 38 (U.S. CLS. 100, 101 AND 104).

FOR: COMPUTER SOFTWARE DESIGN AND DEVELOPMENT FOR OTHERS; MAINTENANCE OF COMPUTER SOFTWARE; TECHNICAL RESEARCH AND TECHNICAL EXPERTISE SERVICES IN THE FIELD OF MAIL AND PACKAGES PROCESSING TECHNIQUES, NAMELY, TROUBLESHOOTING OF COMPUTER HARDWARE AND SOFTWARE PROBLEMS, TROUBLESHOOTING OF INDUSTRIAL PROCESS CONTROL COMPUTER SOFTWARE PROBLEMS; INSTALLATION OF COMPUTER SOFTWARE, NAMELY, ADVICE AND ASSISTANCE FOR THE INSTALLATION, MAINTENANCE AND UPDATING OF SOFTWARE FOR THE ELECTRONIC PROCESSING OF DATA

USED FOR TRACKING, MONITORING AND LOCATING OF PACKAGES, MAIL AND PALLETS DURING THEIR PROCESSING, TRANSPORT AND DELIVERY, TECHNICAL CONSULTING SERVICES FOR THE INSTALLATION OF SOFTWARE FOR ELECTRONIC PROCESSING OF DATA USED FOR TRACKING AND LOCATING PACKAGES, MAIL AND PALLETS DURING THEIR TRANSPORT AND DELIVERY; DATA CONVERSION OF COMPUTER PROGRAM DATA OR INFORMATION; CONVERSION OF DATA AND DOCUMENTS FROM PHYSICAL TO ELECTRONIC MEDIA, IN CLASS 42 (U.S. CLS. 100 AND 101).

PRIORITY DATE OF 8-8-2005 IS CLAIMED.

OWNER OF INTERNATIONAL REGISTRATION
0901477 DATED 2-2-2006, EXPIRES 2-2-2016.

SER. NO. 79-030,075, FILED 2-2-2006.

DOMINIC FATHY, EXAMINING ATTORNEY

Int. Cls.: 11 and 19

Prior U.S. Cls.: 1, 12, 13, 21, 23, 31, 33, 34 and 50

Reg. No. 3,520,731

United States Patent and Trademark Office

Registered Oct. 21, 2008

**TRADEMARK
PRINCIPAL REGISTER**

The logo for LINAX features a large, stylized letter 'L' on the left. The 'L' is composed of two thick, black rectangular blocks. The top block is taller than the bottom block, and they are connected at the bottom. To the right of the 'L' is the word 'INAX' in a bold, black, sans-serif font. The letters are closely spaced and have a slightly irregular, hand-drawn appearance.

INAX CORPORATION (JAPAN CORPORATION)
NO. 1, KOIEHONMACHI 5-CHOME
TOKONAME-SHI
AICHI-KEN 479-0838, JAPAN

FOR: SHOWER TOILETS AND STRUCTURAL PARTS THEREFOR; TOILET SEATS, TOILET SEATS WITH WASHING WATER SQUIRTER; TOILET BOWLS, TOILET BOWLS EQUIPPED WITH WASHING WATER SQUIRTER; TOILET SEATS FOR HEATING, WASHING AND DRYING BODY PARTS; BIDETS AND REMOTE CONTROLS FOR USE WITH BIDETS, SOLD TOGETHER AS A UNIT; WATER CLOSETS AND REMOTE CONTROLS FOR USE WITH WATER CLOSETS, SOLD TOGETHER AS A UNIT; TOILET TANKS AND STRUCTURAL PARTS THEREFOR; TOILET TANK ASSEMBLIES COMPRISED OF TOILET TANK BOWLS FOR FLUSHING TOILET TANKS; TOILETS AND REMOTE CONTROLS FOR USE WITH TOILETS, SOLD TOGETHER AS A UNIT; TANKS, NAMELY, CISTERN TANKS FOR TOILETS; TOILET TANK BALLS; TAP WATER FAUCETS; FIXED SPOUTS USED DIRECTLY IN BIDETS AND TOILETS; PLUMBING FIXTURES, NAMELY, SHOWER HEAD SPRAYERS FOR USE WITH TOILETS AND BIDETS; BIDET NOZZLES; ELECTRIC HAND DRYING APPARATUS FOR WASHROOMS, NAMELY, ELECTRIC HOT AIR HAND DRYERS; ELECTRIC WATER WARMER, NAMELY, WATER HEATERS; HOT WATER HEATER USING GAS AND STRUCTURAL PARTS THEREFOR; HOT WATER HEATER USING OIL AND STRUCTURAL PANS THEREFOR; WASHBOWLS BEING PARTS OF SANITARY INSTALLATIONS; HANDLES FOR FLUSHING TOILET WATER OPERATED BY REMOTE CONTROL; CONTROL VALVES FOR TOILET FLUSHING WATER; SINKS; BATH FITTINGS, NAMELY, BATH TUBS WITH WASHING PLACE; BATH TUBS WITH BUBBLE GENERATION APPARATUS; SHOWERS;

BATH TUBS; HOT WATER HEATERS FOR BATH TUBS; WATER PURIFIERS FOR HOUSEHOLD USE; BATH UNITS, NAMELY, PRE-FABRICATED BATH ROOMS CONTAINING A FAUCET, BATH TUB, FLOOR, WALLS, CEILING BOARD AND SHOWER; WASTE WATER PURIFICATION TANKS; SEPTIC TANKS FOR HUMAN WASTE; HOUSEHOLD WASTE WATER PURIFICATION TANKS; HOUSEHOLD SEPTIC TANKS FOR HUMAN WASTE; FLOOR HEATING APPARATUS, NAMELY, ELECTRIC FLOOR RADIANT HEATERS; HEATING AND COOLING APPARATUS, NAMELY, AIR-CONDITIONERS, ELECTRIC FOOT RADIANT HEATERS AND ELECTRIC RADIANT HEATERS FOR TOILETS; LAVATORIES, IN CLASS 11 (U.S. CLS. 13, 21, 23, 31 AND 34).

FOR: CERAMIC MATERIALS, NAMELY, WALL BOARDS MADE OF CERAMIC, USED EXCLUSIVELY FOR BUILDING, BRICKS; REFRACTORY CONSTRUCTION MATERIALS, NOT OF METAL; BUILDING MATERIAL NOT OF METAL, NAMELY, DOORS FOR BATHROOMS AND WALL-MOUNTED PANEL UNITS FOR PARTITIONING BATHROOMS; CEMENTS AND THE PRODUCTS MADE OF CEMENTS, NAMELY, WALL PANELS MADE OF CEMENTS, STONES, NAMELY, BUILDING STONES; ARTIFICIAL STONES; NON-METAL RAILS, NAMELY, HANDRAILS, NOT OF METAL; BUILDING TIMBER; BUILDING GLASSES, NAMELY, GLASS PANELS FOR BUILDING CONSTRUCTION PURPOSES; NON-METALLIC MINERALS FOR BUILDINGS/OR CONSTRUCTION; REAL CERAMIC TILED PANELS FOR BUILDINGS; CERAMIC TILES; WALL PANELS NOT OF METAL, NAMELY, WALL PANELS MADE OF RESIN FOR BATHROOM; FLOOR PANELS MADE OF RESIN FOR BATHROOM; WALL PANELS MADE OF CEMENT FOR BATHROOM; MOLDS FOR FORMING CEMENT PRODUCTS, NOT OF METAL, NAMELY,

NON-METAL CASTINGS, IN CLASS 19 (U.S. CLS. 1, 12, 33 AND 50).

OWNER OF U.S. REG. NOS. 1,519,833 AND 2,643,566.

PRIORITY DATE OF 5-26-2004 IS CLAIMED.

SER. NO. 79-030,179, FILED 9-17-2004.

OWNER OF INTERNATIONAL REGISTRATION 0901766 DATED 9-17-2004, EXPIRES 9-17-2014.

JESSICA FATHY, EXAMINING ATTORNEY

Int. Cl.: 43

Prior U.S. Cls.: 100 and 101

United States Patent and Trademark Office

Reg. No. 3,520,732

Registered Oct. 21, 2008

SERVICE MARK
PRINCIPAL REGISTER



CHOCOLATERIE & GROSSKONDI TOREI;
"AIDA" PROUSEK & CO. (AUSTRIA LIMITED
PARTNERSHIP)
SCHÖNTHALERGASSE 1
A-1210 WIEN
AUSTRIA

PRIORITY DATE OF 5-8-2006 IS CLAIMED.

OWNER OF INTERNATIONAL REGISTRATION
0905777 DATED 7-4-2006, EXPIRES 7-4-2016.

FOR: SERVING FOOD AND DRINKS, SERVING
FOOD AND DRINKS IN CAFÉS OR PASTRY SHOPS,
SERVING FOOD AND DRINKS IN RESTAURANTS,
TAVERNS, LUNCHEONETTES; CATERING SERVI-
CES; RENTAL OF TEMPORARY ACCOMMODA-
TIONS FOR CATERED EVENTS; RENTAL OF
TABLES AND CHAIRS, TABLE LINES, AND TABLE-
WARE, IN CLASS 43 (U.S. CLS. 100 AND 101).

THE WORDING "AIDA" HAS NO MEANING IN A
FOREIGN LANGUAGE.

SER. NO. 79-031,828, FILED 7-4-2006.

STEVEN PEREZ, EXAMINING ATTORNEY

Int. Cl.: 33

Prior U.S. Cls.: 47 and 49

United States Patent and Trademark Office

Reg. No. 3,520,733

Registered Oct. 21, 2008

**TRADEMARK
PRINCIPAL REGISTER**

ALEXANDRA

LAURENT-PERRIER (FRANCE SOCIETE ANON-
YME)
32, AVENUE DE CHAMPAGNE
F-51150 TOURS-SUR-MARNE, FRANCE

FOR: AOC OR APPELLATION D'ORIGINE CON-
TRÔLÉE WINE WITH THE GUARANTEED LABEL
OF ORIGIN FROM CHAMPAGNE, FRANCE, IN
CLASS 33 (U.S. CLS. 47 AND 49).

THE MARK CONSISTS OF STANDARD CHAR-
ACTERS WITHOUT CLAIM TO ANY PARTICULAR
FONT, STYLE, SIZE, OR COLOR.

PRIORITY DATE OF 4-14-2006 IS CLAIMED.

OWNER OF INTERNATIONAL REGISTRATION
0907798 DATED 10-9-2006, EXPIRES 10-9-2016.

OWNER OF U.S. REG. NOS. 3,181,111 AND
3,211,512.

THE NAME(S), PORTRAIT(S), AND/OR SIGNA-
TURE(S) SHOWN IN THE MARK DOES NOT IDEN-
TIFY A PARTICULAR LIVING INDIVIDUAL.

SER. NO. 79-032,603, FILED 10-9-2006.

REBECCA POVARCHUK, EXAMINING ATTOR-
NEY

Int. Cls.: 3, 9, 14, 18 and 25

Prior U.S. Cls.: 1, 2, 3, 4, 6, 21, 22, 23, 26, 27, 28, 36,
38, 39, 41, 50, 51 and 52

Reg. No. 3,520,734

United States Patent and Trademark Office

Registered Oct. 21, 2008

TRADEMARK
PRINCIPAL REGISTER

GIANFRANCO
FERRE

GIANFRANCO FERRE' S.P.A. (ITALY COR-
PORATION)
VIA PONTACCIO 21
MILANO, ITALY I20121

FOR: PERFUMES, TOILET WATER, PERSONAL DEODORANTS, ESSENTIAL OILS FOR PERSONAL USE, BODY LOTIONS, AFTER SHAVE LOTIONS, SHAVING BALMS, SHAVING CREAM, SHOWER GEL, BUBBLE BATH, BATH PEARLS, SKIN SOAPS, EYE SHADOWS, COSMETIC PENCILS, FOUNDATION MAKE-UP, FACE POWDERS, TALCUM POWDER, ROUGES, LIPSTICKS, MASCARAS, SKIN CLEANSING CREAMS, SKIN CLEANSING LOTIONS, SUN SCREEN PREPARATION, NAIL POLISH, BEAUTY MASKS, FACIAL SCRUBS, FACE CREAMS, BODY CREAMS; COSMETIC CREAMS, CREAMS AND GELS ALL FOR WEIGHT REDUCTION OR SLIMMING PURPOSES; COSMETIC CREAMS, CREAMS AND GELS ALL FOR THE PREVENTION, REDUCTION AND ELIMINATION OF CELLULITE; HAIR SHAMPOOS, HAIR SPRAYS, HAIR LOTIONS, HAIR DYE, HAIR RINSES, HAIR LIGHTENERS, HAIR CONDITIONERS, HAIR MOISTURIZERS, HAIR STYLING FOAM AND GELS, DENTIFRICES, IN CLASS 3 (U.S. CLS. 1, 4, 6, 50, 51 AND 52).

FOR: EYEGLASSES, SUNGLASSES, CASES FOR GLASSES, SPORT GLASSES, FRAMES FOR GLASSES, LENSES FOR GLASSES, PINCE-NEZ, IN CLASS 9 (U.S. CLS. 21, 23, 26, 36 AND 38).

FOR: EARRINGS, BRACELETS, NECKLACES, RINGS, PENDANTS, BROOCHES, JEWELRY CHAINS, PINS BEING JEWELRY, DIADEMS, MEDALLIONS, CUFFLINKS, TIE CLIPS, JEWELRY, IMITATION JEWELRY; WATCHES, CLOCKS,

CHRONOMETERS, WATCH STRAPS; JEWELRY AND WATCH CASES MADE OF PRECIOUS METALS, TRAYS AND ASHTRAYS OF PRECIOUS METALS, CIGARETTE BOXES OF PRECIOUS METALS, NAPKIN RINGS OF PRECIOUS METALS, IN CLASS 14 (U.S. CLS. 2, 27, 28 AND 50).

FOR: HANDBAGS, LUGGAGE, SHOULDER BAGS, BEACH BAGS, CLUTCH BAGS, ALL PURPOSE SPORTS BAGS, ATTACHE CASES, SCHOOL BAGS, TOTE BAGS, TRAVELLING BAGS, DOCUMENT CASES, COSMETIC CASES SOLD EMPTY, KEY CASES, KNAPSACKS, RUCKSACKS, BRIEFCASES, PURSES, WALLETS, TRAVELLING TRUNKS, SUITCASES, UMBRELLAS, PARASOLS, WALKING STICKS, IN CLASS 18 (U.S. CLS. 1, 2, 3, 22 AND 41).

FOR: BRASSIERES, CORSETS, SINGLETS, PETTICOATS, NIGHTGOWNS, PYJAMAS, DRESSING GOWNS, PULLOVERS, BATH ROBES, BATHING SUITS, GLOVES, CARDIGANS, JERSEYS, NECKTIES, NECKERCHIEFS; SCARVES, SWEATERS, SOCKS, STOCKINGS, TIGHTS, TROUSERS, LEGGINGS, SKIRTS, JACKETS, JERKINS, SHIRTS, VESTS, WAISTCOATS, JUMPERS, TRACK SUITS, BLOUSES, JEANS, PANTIES, UNDERPANTS, BERMUDA SHORTS, T-SHIRTS, SWEAT-SHIRTS, SUITS AND DRESSES, OVERCOATS, ANORAKS, COATS, RAINCOATS, BELTS, SUSPENDERS, PAREUS, SHOES, BOOTS, SLIPPERS, HATS, CAPS, IN CLASS 25 (U.S. CLS. 22 AND 39).

OWNER OF INTERNATIONAL REGISTRATION
0631102 DATED 1-24-1995, EXPIRES 1-24-2015.

OWNER OF U.S. REG. NOS. 1,278,049, 1,616,353
AND OTHERS.

SER. NO. 79-033,465, FILED 8-18-2005.

THE NAME "GIANFRANCO FERRE" IDENTI-
FIES A LIVING INDIVIDUAL WHOSE CONSENT IS
OF RECORD.

SETH A. RAPPAPORT, EXAMINING ATTORNEY

Int. Cls.: 29 and 32

Prior U.S. Cls.: 45, 46 and 48

United States Patent and Trademark Office

Reg. No. 3,520,735

Registered Oct. 21, 2008

TRADEMARK
PRINCIPAL REGISTER



HORTEX HOLDING S.A. (POLAND JOINT STOCK COMPANY)

UL. WARECKA 11A

PL-00-034 WARSZAWA, POLAND

FOR: MEAT, MEAT PRODUCTS, NAMELY, BUTCHER'S MEAT, SAUSAGES, FISH, POULTRY, GAME, MEAT EXTRACTS; STOCK IN THE NATURE OF BEEF, CHICKEN, MUSHROOM AND FISH STOCK; PRESERVED, DRIED AND COOKED FRUITS AND VEGETABLES, FRUITS AND VEGETABLES PRESERVED IN ALCOHOL; BREAD SPREADS IN THE FORM OF JELLIES AND FRUIT JELLIES, JAMS; COMPOTES; EGGS, POWDERED EGGS; MILK, DAIRY PRODUCTS, NAMELY, MILK BEVERAGES WITH MILK PREDOMINATING, YOGURT, MILK BEVERAGE IN THE NATURE OF KEPHIR, MILK BASED BEVERAGES CONTAINING FRUIT JUICE, MILK BASED BEVERAGES CONTAINING FRUITS, CHEESES; EDIBLE OILS AND FATS, BUTTER, COCOA BUTTER FOR FOOD PURPOSES, COCONUT BUTTER, MARGARINE, LARD; FRUIT AND VEGETABLE PRODUCTS, NAMELY, FROZEN FRUITS AND VEGETABLES, MIXTURES OF FROZEN FRUITS OR VEGETABLES, VEGETARIAN PREPARED AND DEEP-FROZEN DISHES MADE WITH VEGETABLES, PREPARED AND DEEP-FROZEN DISHES MADE WITH MEAT; FRUIT MOUSSES, FRUIT AND VEGETABLE PUREES, FRUIT AND VEGETABLE SALADS, FRUIT PEELS, FRUIT PULP, UNFLAVORED, UNSWEETENED GELATIN FOR FOOD, FRUIT CHIPS, CANDIED FRUITS, FRUIT AND VEGETABLE PRESERVES, CRYSTALLIZED FRUIT; SEAFOOD, NAMELY, SHELLFISH, CRABMEAT, CRAWFISH, OCTOPUS, SHRIMP, PRAWNS; SOUPS, NAMELY, THICK SOUPS, INSTANT OR PRE-COOKED SOUPS, INGREDIENTS FOR PREPARING SOUPS, NAMELY, BROTHS AND MEAT AND VEGETABLE EXTRACTS FOR SOUPS; PRESERVED MUSHROOMS;

DIETETIC FOODSTUFFS, NAMELY, FRUIT-BASED ORGANIC FOOD BARS, FRUIT-BASED FOOD BARS ALSO CONTAINING DRIED FRUIT, PROCESSED FRUIT, FRUITS JUICE, GRAINS, VEGETABLES, NUTS, SEEDS, CHOCOLATE, SOY-BASED SNACK FOODS, VEGETABLE-BASED SNACK FOODS, SOY-BASED LOW CALORIE FOOD BARS AND FOODSTUFFS REDUCED IN FAT, SUGAR AND CHOLESTEROL, NAMELY, PRE-PACKAGED COMBINATION DINNERS PRIMARILY CONSISTING OF MEAT AND PROCESSED FRUIT OR VEGETABLES; TOMATO CONCENTRATE USED AS A FOOD INGREDIENT; EDIBLE PROCESSED POLLEN FOR FOOD PURPOSES, PROCESSED, PRESERVED AND DRIED GRAPES; ALMONDS, NAMELY, PROCESSED AND GROUND ALMONDS, IN CLASS 29 (U.S. CL. 46).

FOR: BEERS; NON-CARBONATED AND CARBONATED WATER, MINERAL WATER, TABLE WATERS, SOFT DRINKS, NON-ALCOHOLIC BEVERAGES, NAMELY, FRUIT JUICES, BEVERAGES AND NECTARS, VEGETABLE JUICES, BEVERAGES AND NECTARS, MIXED FRUIT-VEGETABLE JUICES, BEVERAGES AND NECTARS, CONDENSED FRUIT AND VEGETABLE JUICES, FRUIT AND VEGETABLE PUREE JUICES, MIXED FRUIT-VEGETABLE PUREE JUICES, LOW-ENERGY JUICES AND BEVERAGES, FRUIT AND VEGETABLE AS WELL AS MIXED FRUIT-VEGETABLE BEVERAGES AND JUICES, ENRICHED WITH VITAMINS AND CALCIUM, SORBETS IN THE FORM OF BEVERAGES, ISOTONIC BEVERAGES, ENERGY DRINKS, WHEY BEVERAGES, SYRUPS AND PREPARATIONS FOR PREPARATION OF BEVERAGES, ESSENCES FOR BEVERAGES, EXTRACTS FOR BEVERAGES, NAMELY, NON-ALCOHOLIC FRUIT EXTRACTS, IN CLASS 32 (U.S. CLS. 45, 46 AND 48).

OWNER OF INTERNATIONAL REGISTRATION
0859148 DATED 6-6-2005, EXPIRES 6-6-2015.

OWNER OF U.S. REG. NOS. 771,973, 2,378,344,
AND 2,811,978.

THE COLOR(S) GREEN, RED AND WHITE IS/
ARE CLAIMED AS A FEATURE OF THE MARK.

THE MARK CONSISTS OF A SEMI-CIRCULAR
FRAMING MADE IN GREEN COLOR CONTAIN-

ING INSIDE A CENTRALLY LOCATED WORD
"HORTEX" IN CAPITAL LETTERS AND BOLD
TYPE FONT IN RED COLOR AND OF A FANCY
FLOWER DESIGN ABOVE THE WORD "HORTEX"
HAVING GREEN PETALS AND A ROUND RED
CENTER TOWARD THE FRAMING, WORD AND
FLOWER DESIGN ARE PLACED AGAINST A
WHITE BACKGROUND.

SER. NO. 79-033,481, FILED 4-6-2006.

LINDA ESTRADA, EXAMINING ATTORNEY

Int. Cl.: 16

Prior U.S. Cls.: 2, 5, 22, 23, 29, 37, 38 and 50

United States Patent and Trademark Office

Reg. No. 3,520,736

Registered Oct. 21, 2008

TRADEMARK
PRINCIPAL REGISTER

base xx

DICOTA GMBH
PLEIDELSHEIMER STRASSE 15
74321 BIETIGHEIM-BISSINGEN
FED REP GERMANY

FOR: ELASTIC BANDS FOR OFFICES; COVERS, NAMELY, BOOK COVERS, DOCUMENT COVERS; FILES, NAMELY, CARD FILES, DOCUMENT FILES, FILE FOLDERS, LETTER FILES; OFFICE REQUISITES, NAMELY, OFFICE BINDERS, GLUE FOR THE OFFICE, ELECTRIC STAPLERS FOR OFFICES, COLLATORS FOR OFFICE USE; WRITING INSTRUMENTS, NOTEPADS, BUSINESS

CARDS, IN CLASS 16 (U.S. CLS. 2, 5, 22, 23, 29, 37, 38 AND 50).

THE MARK CONSISTS OF STANDARD CHARACTERS WITHOUT CLAIM TO ANY PARTICULAR FONT, STYLE, SIZE, OR COLOR.

OWNER OF INTERNATIONAL REGISTRATION
0890057 DATED 4-25-2005, EXPIRES 4-25-2015.

SER. NO. 79-033,594, FILED 12-13-2006.

EMILY CARLSEN, EXAMINING ATTORNEY

Int. Cl.: 36

Prior U.S. Cls.: 100, 101 and 102

United States Patent and Trademark Office

Reg. No. 3,520,737

Registered Oct. 21, 2008

**SERVICE MARK
PRINCIPAL REGISTER**

STAYING ROOTED IN REALITY

METROPOLE GESTION (FRANCE SOCIÉTÉ ANONYME (S.A.))
9 RUE DES FILLES-SAINT-THOMAS
F-75002 PARIS
FRANCE

FOR: FINANCIAL SERVICES, NAMELY, BANKING SERVICES, MUTUAL FUND AND ELECTRONIC FUNDS TRANSFER, FINANCIAL PORTFOLIO MANAGEMENT IN STOCKS, BONDS, SECURITIES, MONETARY INVESTMENT AND EQUITIES, INVESTMENT OF FUNDS FOR OTHERS, FUND MANAGEMENT SERVICES, MUTUAL FUND BROKERAGE AND MUTUAL FUND INVESTMENT SERVICES, CREATION, MANAGEMENT AND BROKERAGE OF MUTUAL FUNDS FOR THIRD PARTIES, SERVICES FOR THE ESTABLISHMENT OF PORTFOLIOS OF SECURITIES FOR OTHERS AND MANAGEMENT OF SECURITIES PORTFOLIOS; BANKING; INSURANCE BROKERAGE SERVICES; LIFE INSURANCE BROKERAGE AND CONSULTING; INSURANCE CONSULTING; FINANCIAL CONSULTING; FUNDS INVESTMENT; MONETARY INVESTMENT AND CONSULTATION SERVICES, NAMELY, CAPITAL INVESTMENT SERVICES AND CONSULTATION IN THE FIELD OF SECURITIES; FINANCIAL ANALYSIS; FINANCIAL

PORTFOLIO MANAGEMENT SERVICES; FINANCIAL TRANSACTIONS SERVICES, NAMELY ASSISTING OTHERS WITH THE COMPLETION OF FINANCIAL TRANSACTIONS FOR STOCKS, BONDS, SECURITIES, EQUITIES; STOCK BROKERAGE; FINANCIAL EVALUATIONS FOR INSURANCE AND BANKING PURPOSES; CAPITAL INVESTMENT CONSULTATION; INVESTMENT SERVICES, NAMELY, ASSET MANAGEMENT SERVICES; SAFE DEPOSIT BOX SERVICES; FINANCIAL MANAGEMENT; SAVINGS AND LOAN SERVICES; ACTUARIAL SERVICES, IN CLASS 36 (U.S. CLS. 100, 101 AND 102).

THE MARK CONSISTS OF STANDARD CHARACTERS WITHOUT CLAIM TO ANY PARTICULAR FONT, STYLE, SIZE, OR COLOR.

OWNER OF INTERNATIONAL REGISTRATION
0910977 DATED 12-1-2006, EXPIRES 12-1-2016.

SER. NO. 79-033,645, FILED 12-1-2006.

EDWARD FENNESSY, EXAMINING ATTORNEY

Int. Cls.: 9 and 11

Prior U.S. Cls.: 13, 21, 23, 26, 31, 34, 36 and 38

Reg. No. 3,520,738

United States Patent and Trademark Office

Registered Oct. 21, 2008

**TRADEMARK
PRINCIPAL REGISTER**

ARRIMAX

ARNOLD & RICHTER CINE TECHNIK GMBH &
CO. BETRIEBS KG (FED REP GERMANY
LIMITED PARTNERSHIP)

TÜRKENSTRASSE 89
80799 MÜNCHEN
FED REP GERMANY

FOR: FILM AND VIDEO RECORDING AND PLAY-BACK APPARATUS; NAMELY, FILM CAMERAS, VIDEO CAMERAS, VIDEO RECORDERS, MONITORS, VIDEO SCREENS, VIDEO DISPLAY TERMINALS, VIDEO ASSISTS, NAMELY, ELECTRONIC DEVICES FOR ENABLING PLAYBACK OF VIEW FINDER IMAGE TO PLAYBACK DEVICES INCLUDING VIEW MONITORS; FILM AND VIDEO PROCESSING AND VIEWING APPARATUS, NAMELY, COPYING MACHINES, PICTURE EDITORS, DATA CONVERTER, POST PRODUCTION MACHINES FOR RECORDING AND CONVERTING ANALOGUE OR DIGITAL INFORMATION STORED ON FILMSTRIPS TO DIGITAL DATA CARRIERS AND VISA VERSA, COLOR DETERMINATION MACHINES; TEST EQUIPMENT FOR THE ANALYSIS OF PICTURE QUALITY, NAMELY, COMPUTER SOFTWARE FOR IMPROVING PICTURE QUALITY; ACCESSORIES FOR FILM AND VIDEO RECORDING, PLAY-BACK, PROCESSING AND VIEWING APPARATUS, NAMELY, TRIPODS, TRIPOD HEADS, REMOTE CONTROL EQUIPMENT, NAMELY, RADIO TRANSCEIVERS FOR THE EXCHANGE OF CONTROL SIGNALS, HAND-HELD REMOTE CONTROL UNITS FOR CAMERAS, WIRELESS REMOTE CONTROL ADAPTERS, CAMERA LENSES, BLANK FILM CASSETTES AND VIDEO TAPES, PRE-RECORDED FILM CASSETTES AND VIDEO TAPES IN THE FIELD OF CAMERA EQUIPMENT AND MOVIE AND VIDEO PRODUCTION MACHINES; LENS HOODS; OPTICAL FILTERS AND FILTER HOLDERS IN THE NATURE OF METAL FRAMES FOR ADJUSTING OPTICAL FILTERS; PHOTOGRAPHIC EXPOSURE METERS; ADAPTERS, FOR USE WITH VIDEO AND CAMERA PRODUCTS, TRIPODS AND TRIPODS, MONITORS BEING VISUAL DISPLAY UNITS, MARKER DISCS FOR PROVIDING MEANS FOR THE SETTING OF

CAMERA WITH RESPECT TO THE FIXATION OF SET VALUES, COUNTERS, MOUNTED ACCUMULATORS, SOUNDPROOF CAMERA CASES, ANAMORPHIC CAMERA LENSES, ELECTRONIC TIME CODING UNITS; MEMORY CHIPS; APPARATUS FOR DIGITAL PICTURE PROCESSING, NAMELY, POST PRODUCTION MACHINES FOR ADAPTION, EDITING AND TRANSFORMATION OF PICTURE DATA; SCANNERS; BATTERIES, RECHARGEABLE BATTERIES, POWER SUPPLIES, VOLTAGE CONVERTERS AND ELECTRICAL DEVICES FOR THE CONTROLLING AND REMOTE CONTROLLING OF THE BRIGHTNESS, COLOR, BEAM CHARACTERISTICS AND OPERATING CONDITIONS OF LAMPS, SPOTLIGHTS, SEARCHLIGHTS AND OTHER LIGHTING; BALLASTS FOR LAMPS, SPOTLIGHTS, SEARCH LIGHTS AND OTHER LIGHTING, NOT AS PARTS OF THE AFOREMENTIONED GOODS; CAMERA FLASHES AND FLASH-LIGHTS FOR PHOTOGRAPHY; OPTICAL FIBRES, NAMELY, LIGHT CONDUCTORS AND DISTRIBUTORS, IN CLASS 9 (U.S. CLS. 21, 23, 26, 36 AND 38).

FOR: FILM, VIDEO AND STAGE LIGHTING APPARATUS AND INSTALLATIONS, NAMELY, ELECTRICAL LAMP FIXTURES, REFLECTORS, REFRACTORS, PANELS, SCREENS, GLOBES AND FIXTURES; ACCESSORIES FOR THE AFOREMENTIONED GOODS, NAMELY, DEVICES FOR INFLUENCING COLOUR, BRIGHTNESS AND REFLECTIVE FEATURES, NAMELY, BARNDOORS, COLOR CHANGERS, PROJECTORS, FOLLOW SPOTS, DIMMERS, SHUTTERS AND DOUSERS, ADAPTED HANGING MOUNTING FASTENERS AND FIXATIONS AND BEARINGS FOR LAMPS, IN CLASS 11 (U.S. CLS. 13, 21, 23, 31 AND 34).

THE MARK CONSISTS OF STANDARD CHARACTERS WITHOUT CLAIM TO ANY PARTICULAR FONT, STYLE, SIZE, OR COLOR.

PRIORITY DATE OF 6-27-2005 IS CLAIMED.

OWNER OF INTERNATIONAL REGISTRATION
0910901 DATED 12-8-2005, EXPIRES 12-8-2015.

SER. NO. 79-033,647, FILED 12-8-2005.

OWNER OF U.S. REG. NOS. 581,339, 3,076,843,
AND 3,174,262.

DOMINIC FATHY, EXAMINING ATTORNEY

Int. Cls.: 6, 7, 8, 9, 11 and 12

Prior U.S. Cls.: 2, 12, 13, 14, 19, 21, 23, 25, 26, 28, 31, 34, 35, 36, 38, 44 and 50

Reg. No. 3,520,739

United States Patent and Trademark Office

Registered Oct. 21, 2008

**TRADEMARK
PRINCIPAL REGISTER**



A.M.A. S.P.A. (ITALY JOINT STOCK CORPORATION)
VIA PUCCINI, 28
I-42018 SAN MARTINO IN RIO (REGGIO EMILIA)
ITALY

FOR: METAL CONSTRUCTION MATERIALS, NAMELY, BRACES, SUPPORTS, SHORES; METAL WINDOW AND DOOR FRAMES AND PARTS, NAMELY, DOOR JAMBS, METAL WINDOW PULL-EYS; METAL HARDWARE, NAMELY, WASHERS, SPRINGS, THIMBLES, HIGH SECURITY LOCKS; METAL NAILS, METAL SCREWS, METAL NUTS, METAL RIVETS; METAL CONSTRUCTION ELEMENTS, NAMELY, SHORES, SUPPORTS, BRACES; METAL BOXES, METAL CONTAINERS FOR THE STORAGE AND TRANSPORTATION OF GOODS, METAL CONTAINERS FOR COMPRESSED GAS OR LIQUID AIR, METAL HOOKS, METAL PIPES, METAL PIPE FITTINGS, METAL BINDING STRIPS USED ON PACKAGING, NON-ELECTRICAL METAL CABLES AND WIRES, IN CLASS 6 (U.S. CLS. 2, 12, 13, 14, 23, 25 AND 50).

FOR: MACHINES AND MACHINE TOOLS, NAMELY, PULPING MACHINES, ROVING MACHINES, AGRICULTURAL MACHINES, NAMELY, CULTIVATORS, HARVESTERS, DISK HARROWS, SEEDERS, AGRICULTURAL SEED PLANTING MACHINES, COMBINES, THRESHERS, TILLERS, WIND ROWERS, REAPERS, EARTH COMPACTING MACHINES, EARTH MOVING MACHINES, NAMELY, SCARIFIERS, SCRAPERS, EXCAVATORS, BACKHOES, GRADERS, LOADERS, HARVEST DRYING MACHINES, EXCAVATING MACHINES, ENGRAVING MACHINES; TOOL BITS FOR MACHINES; ENGINES NOT FOR LAND VEHICLES; ENGINE PARTS AND SPARE PARTS, NAMELY, CONTACT POINTS, ELECTRONIC FUEL INJECTION MODULES, FUEL INJECTOR PARTS FOR

LAND VEHICLE ENGINES, PISTONS, PISTON RINGS, CONDENSERS, CONTACT POINTS, CONNECTING RODS, ENGINE SEALS, CAM COVERS, COILS, DISTRIBUTOR ROTORS, DISTRIBUTOR CAPS, AIR CLEANERS, OIL TANKS, OIL TANK PLUGS AND CAPS, CRANKCASE BREATHERS, OIL COOLERS, PUSH RODS, ROCKER ARMS; JOINTS AND TRANSMISSION ELEMENTS, NAMELY, POWER TRANSMISSION BELTS FOR MACHINES, TRANSMISSION GEARS FOR MACHINES, POWER TRANSMISSION BELTS FOR MACHINES, MOTORS AND ENGINES USED IN INDUSTRIAL APPLICATIONS; UNIVERSAL JOINTS FOR LAND VEHICLES; POWER TRANSMISSIONS FOR MACHINES; MACHINE PARTS, NAMELY, CHAINS FOR ELEVATORS; DRIVE CHAINS OTHER THAN THOSE FOR LAND-BASED VEHICLES; AGRICULTURAL TOOLS OTHER THAN THOSE CONTROLLED MANUALLY, THEIR PARTS AND SPARE PARTS, NAMELY, TILLERS, BALERS; GARDENING MACHINES, THEIR PARTS AND SPARE PARTS, NAMELY, CHIPPER, SHREDDERS, LAWN AND GARDEN TILLING MACHINES; MACHINES FOR WORKING LAWNS AND GARDENS, THEIR PARTS AND SPARE PARTS, NAMELY, LAWN AND GARDEN EDGERS, LAWN AND GARDEN STRING TRIMMERS; MACHINES, NAMELY, LAWNMOWERS; MACHINES, NAMELY, BUSH-CUTTERS; MACHINES, NAMELY, ELECTRIC RECHARGEABLE HEDGE-CUTTERS, THEIR PARTS AND SPARE PARTS; MANUAL CLIPPERS, NAMELY, HAND-HELD POWER-OPERATED CLIPPERS; PLOUGHS AND SPARE PARTS FOR PLOUGHS; MACHINES, NAMELY, CIRCULAR SAWS, JIG SAWS AND CHAIN SAWS; POWER CHIPPER FOR LAWN AND GARDEN; POWER SHREDDERS FOR LAWN AND GARDEN; CLEANING MACHINES AND EQUIPMENT, NAMELY, MACHINES FOR CLEANING SURFACES USING HIGH PRESSURE WATER,

STEAM CLEANING MACHINES, SAND CLEANING MACHINES, CARPET CLEANING MACHINES; SNOW PLOWS, MECHANICAL BRUSHES FOR SNOW, POWER OPERATED BRUSHES BEING PARTS OF MACHINES, ROTARY BRUSHES FOR MACHINES, ELECTRICALLY OPERATED BRUSHES, BEING PARTS OF MACHINES, WIRE BRUSHES FOR USE IN MACHINES; ENSILAGE BLOWERS OF FORAGE; RIDING LAWN AND TRACTOR-TOWED AGRICULTURAL IMPLEMENTS, NAMELY, PLOWS, HARROWS, REAPERS, HARVESTERS, HAY RAKES, HAY BALERS, BROADCAST SEEDERS, MANURE SPREADERS, FERTILIZER DISTRIBUTORS, CORN HUSKERS, ROLLERS, MOWERS, TRACTOR-TOWED FERTILIZER APPLICATORS, TRACTOR-TOWED HARROWS; MACHINES, NAMELY, ELECTRIC, CENTRIFUGAL PUMPS, FUEL PUMPS FOR LAND VEHICLES, OIL PUMPS FOR LAND VEHICLES, PNEUMATIC PUMPS, MACHINE PARTS AND MOTORS, NAMELY, ENGINE COOLING, COMPRESSED AIR PUMPS, OIL PUMPS FOR USE IN MOTORS AND ENGINES, PUMPS FOR COOLING ENGINES; HYDRAULIC PUMPS; HYDRAULIC GEAR PUMPS; HYDRAULIC CYLINDERS; INSTRUMENTS FOR DEVIATING THE FLOW IN PIPING ON HYDRAULIC SYSTEMS, NAMELY, JETAVATORS; PARTS AND COMPONENTS FOR THE ENGINES OF LAND-BASED VEHICLES, NAMELY, DISTRIBUTOR CAPS, COILS, FUEL INJECTOR PARTS FOR LAND VEHICLE ENGINES, CONNECTING RODS, DISTRIBUTOR ROTORS, OIL TANKS, OIL TANK PLUGS AND CAPS, OIL COOLERS, PUSH RODS, CRANKCASE BREATHERS, ROCKER ARMS, ENGINE CASES, IN CLASS 7 (U.S. CLS. 13, 19, 21, 23, 31, 34 AND 35).

FOR: TOOLS AND INSTRUMENTS OPERATED MANUALLY, NAMELY, HAMMERS, CLAMPS, SHOVELS, WRENCHES, SCREWDRIVERS, DRILLS, MANUALLY-OPERATED GRINDING WHEELS; MANUAL CUTTING TOOLS FOR GARDENING AND PARKLAND MAINTENANCE; AGRICULTURAL TOOLS OPERATED MANUALLY, NAMELY, HATCHETS, CULTIVATORS, TROWELS, WEEDING FORKS, CHIPPERS, SHREDDERS; MANUAL BUSH-CUTTERS; MANUAL LAWNMOWERS AND HEDGE CUTTERS; TOOLS, NAMELY, HAND, CROSSCUT SAW BLADES; TOOLS, NAMELY, HAND OPERATED SAWS, SCISSORS; GARDENING EQUIPMENT, NAMELY, SPADES, RAKES, HOES; METAL AND NON-METAL TOOLBOXES SOLD WITH TOOLS, IN CLASS 8 (U.S. CLS. 23, 28 AND 44).

FOR: ELECTRICAL CABLES AND WIRES; ELECTRICAL INSTRUMENTS, NAMELY, ELECTRIC COILS, ELECTRIC CORDS, ELECTRIC AND ELECTRICAL CONNECTORS, ELECTRIC CONTROL PANELS; PROTECTIVE GOGGLES AND VISORS, PROTECTIVE HELMETS, PROTECTIVE CLOTHING FOR PROTECTION AGAINST ACCIDENTS, RADIATION AND FIRE, PROTECTIVE GLOVES FOR PROTECTION AGAINST ACCIDENTS; ELECTRONIC SPEED CONTROLLERS FOR VEHICLES; ODOMETERS FOR VEHICLES; VOLTMETERS FOR VEHICLES; EQUIPMENT FOR RECORDING, TRANSMISSION AND PLAYBACK OF SOUND

AND IMAGES FOR INSTALLATION IN SLOW-MOVING MACHINES AND LAND-BASED VEHICLES IN GENERAL; ELECTRICAL AND SIGNALING EQUIPMENT FOR USE WITH SLOW-MOVING MACHINES AND LAND-BASED VEHICLES IN GENERAL, NAMELY, SIGNAL WHISTLES, SIGNAL PROCESSORS, ELECTRICAL WIRES; COMPUTER PROGRAMS FOR INSTALLATION IN SLOW-MOVING MACHINES AND LAND-BASED VEHICLES IN GENERAL USED FOR CONTROLLING INSTRUMENTS OF MACHINES, NAMELY, ODOMETERS, HOUR COUNTERS, ANTI-OVERTURNING SYSTEM, AND FOR MOVEMENT CHECK AND MONITORING OF SEVERAL MOTOR PARAMETERS; ACOUSTIC INDICATORS FOR VEHICLES, NAMELY, ACOUSTIC CONDUITS, IN CLASS 9 (U.S. CLS. 21, 23, 26, 36 AND 38).

FOR: LIGHTING EQUIPMENT FOR VEHICLES, NAMELY, RUNNING LIGHTS FOR LAND VEHICLES, BACKUP LIGHTS FOR LAND VEHICLES, LIGHTS FOR VEHICLES, TAIL LIGHTS FOR LAND VEHICLES, TAIL LIGHTS FOR VEHICLES; HEADLIGHTS AND REAR LIGHTS FOR VEHICLES; HEATING AND AIR CONDITIONING SYSTEMS FOR VEHICLES, COMPOSED OF AIR CONDITIONERS, FANS, ELECTRIC HEATERS, AND VALVES; REFLECTORS FOR VEHICLES; REVERSING LIGHTS FOR VEHICLES, IN CLASS 11 (U.S. CLS. 13, 21, 23, 31 AND 34).

FOR: COMPONENTS FOR LAND VEHICLES, NAMELY, TIRE CHAINS, WINDSHIELDS, FENDERS, WHEELS, TRANSMISSIONS, DIFFERENTIALS, FENDER FLARES, DRIVE BELTS, DRIVE GEARS, MUDGUARDS, RUNNING BOARDS; SHOCK ABSORBERS FOR VEHICLES; ANTITHEFT DEVICES FOR MOTORCARS; TRUNKS FOR VEHICLES; GEARS FOR LAND-BASED VEHICLES; VEHICLE BODYWORK, NAMELY, AUTOMOBILE BODIES AND TRUCK BODIES, LAND VEHICLE BODIES; VEHICLE CANOPIES, WHEEL RIMS FOR VEHICLES; WHEEL SPOKES FOR VEHICLES; SEAT BELTS AND SAFETY BELTS FOR VEHICLE SEATS; SLEEPING BERTHS FOR VEHICLES; ENGINES FOR LAND VEHICLES; BRAKES FOR VEHICLES AND THEIR PARTS, NAMELY, BRAKE DRUMS, BRAKE CYLINDERS, BRAKE BLOCKS FOR LAND VEHICLES, BRAKE DISCS, BRAKE FACINGS FOR VEHICLES, BRAKE HARDWARE FOR VEHICLES, BRAKE LINES FOR VEHICLES, BRAKE LINING FOR LAND VEHICLES, BRAKE SYSTEMS FOR VEHICLES; INDICATORS FOR VEHICLES, NAMELY, TURN SIGNALS; WINDSCREENS, WINDOWS, CAR DOORS, PANELS FOR DOORS, PARTITIONS FOR DIVIDING CARGO AREAS IN VEHICLES AND FOR SEPARATING PASSENGER AREAS FROM CARGO AREAS IN VEHICLES, ALL FOR VEHICLES; VEHICLE TIRES, TIRES AND INNER TUBES FOR TIRES AND VEHICLE TIRES; TRAILERS; TRAILER ATTACHMENTS FOR VEHICLES, NAMELY, TRAILER HITCHES; VEHICLE SEATS, THEIR PARTS AND ACCESSORIES, NAMELY, VEHICLE SEAT COVERS, BOOSTER SEATS FOR USE IN VEHICLES, SEAT BELTS FOR USE IN VEHICLES, AIR SPRINGS FOR VEHICLE SUSPENSION COMPONENTS FOR CUSHIONING DRIVERS' SEATS

AND CABS, MECHANICAL AND AIR SUSPENSION COMPONENTS FOR SEATS, ARM AND HEAD RESTS FOR SEATS; COVERINGS FOR VEHICLE SEATS; VEHICLE CHASSIS; BUMPERS FOR VEHICLES; STEERING WHEELS FOR VEHICLES; DRIVE CHAINS FOR LAND-BASED VEHICLES, IN CLASS 12 (U.S. CLS. 19, 21, 23, 31, 35 AND 44).

PRIORITY DATE OF 3-3-2006 IS CLAIMED.

OWNER OF INTERNATIONAL REGISTRATION 0911674 DATED 5-30-2006, EXPIRES 5-30-2016.

THE COLOR(S) WHITE, BLUE IS/ARE CLAIMED AS A FEATURE OF THE MARK.

THE MARK CONSISTS OF THE WORD "AMA" IN FANCY CHARACTERS, IN FULL BORDER, IN WHITE COLOUR PUT INSIDE AN OVAL GEOMETRICAL FIGURE IN FULL BORDER, IN BLUE COLOUR.

SER. NO. 79-033,988, FILED 5-30-2006.

MARK PILARO, EXAMINING ATTORNEY

Int. Cls.: 12 and 41

Prior U.S. Cls.: 19, 21, 23, 31, 35, 44, 100, 101 and 107

United States Patent and Trademark Office

Reg. No. 3,520,740

Registered Oct. 21, 2008

**TRADEMARK
SERVICE MARK
PRINCIPAL REGISTER**

GRAFFER

GRAFFER SEGGIOVIE S.R.L. (ITALY LIMITED
LIABILITY COMPANY)
VIA 4 NOVEMBRE, 93
GARDOLO TN, ITALY I38014

FOR: SKI LIFTS, CHAIR LIFTS, CABLE CARS,
SLEDGE LIFTS AND SKI-TOWS, NAMELY, SKI
LIFTS COMPRISED OF MOVING CABLES FOR
TOWING SKIERS AND SLEDGES UP A MOUN-
TAIN, IN CLASS 12 (U.S. CLS. 19, 21, 23, 31, 35 AND
44).

FOR: ORGANIZATION AND DIRECTION OF
EDUCATIONAL COURSES AND SEMINARS IN
THE FIELD OF SKIING; ARRANGING ATHLETIC
COMPETITIONS; ORGANIZING AND DIRECTING
ENTERTAINMENT IN THE NATURE OF SKI RA-
CES, IN CLASS 41 (U.S. CLS. 100, 101 AND 107).

THE MARK CONSISTS OF STANDARD CHAR-
ACTERS WITHOUT CLAIM TO ANY PARTICULAR
FONT, STYLE, SIZE, OR COLOR.

OWNER OF INTERNATIONAL REGISTRATION
0912691 DATED 11-30-2006, EXPIRES 11-30-2016.

THE WORDING "GRAFFER" HAS NO MEANING
IN A FOREIGN LANGUAGE.

SER. NO. 79-034,314, FILED 11-30-2006.

NELSON SNYDER, EXAMINING ATTORNEY

Int. Cls.: 5, 10 and 42

Prior U.S. Cls.: 6, 18, 26, 39, 44, 46, 51, 52, 100 and 101

Reg. No. 3,520,741

United States Patent and Trademark Office

Registered Oct. 21, 2008

**TRADEMARK
SERVICE MARK
PRINCIPAL REGISTER**



BIOTISSUE TECHNOLOGIES GMBH (FED REP GERMANY G.M.B.H.)
4B, ENGESSERSTRASSE
79108 FREIBURG, FED REP GERMANY

FOR: POLYMER-BASED PHARMACEUTICAL PREPARATIONS FOR USE IN TISSUE AND ORGAN TRANSPLANTATION, NAMELY, REGENERATIVE, REPARATIVE AND HEMOSTATIC PREPARATIONS, CONSISTING OF HYALURONIC ACID AND BIORESORBABLE POLYGLYCOLIC ACID POLYMERS; BIOMEDICAL POLYMER-BASED PHARMACEUTICAL PREPARATIONS, NAMELY, PREPARATIONS FOR USE IN TISSUE AND ORGAN TRANSPLANTATION, NAMELY REGENERATIVE, REPARATIVE AND HEMOSTATIC PREPARATIONS, CONSISTING OF HYALURONIC ACID AND BIORESORBABLE POLYGLYCOLIC ACID POLYMERS, IN CLASS 5 (U.S. CLS. 6, 18, 44, 46, 51 AND 52).

FOR: MEDICAL DEVICES IN THE NATURE OF SURGICAL IMPLANTS PRIMARILY COMPRISING ARTIFICIAL TISSUE, ALSO CONSISTING OF BIOLOGICAL CARTILAGE, INTERVERTEBRAL DISC, MENISCUS, TENDON, LIGAMENT, BONE AND CONNECTIVE TISSUE SUBSTITUTES INTENDED FOR SUBSEQUENT IMPLANTATION, ALL SOLD AS A UNIT; SURGICAL IMPLANTS PRIMARILY COMPRISING ARTIFICIAL TISSUE, ALSO CONSISTING OF HYALURONIC ACID, BIOLOGICAL POLYMERS, BIORESORBABLE POLYMERS AND COMBINATIONS THEREOF, ALL SOLD AS A UNIT; BIOLOGICAL SURGICAL IMPLANTS PRIMARILY COMPRISING ARTIFICIAL TISSUE ALSO CONSISTING OF HYALURONIC ACID, BIOLOGICAL POLYMERS, BIORESORBABLE POLYMERS AND COMBINATIONS THEREOF, ALL SOLD AS A UNIT; HEALTH CARE PRODUCTS IN THE NATURE OF SURGICAL IMPLANTS PRIMARILY COMPRISING ARTIFICIAL TISSUE, ALSO CONSISTING OF BIOLOGICAL CARTILAGE, INTERVERTEBRAL DISC, MENISCUS, TENDON, LIGAMENT, BONE AND

CONNECTIVE TISSUE SUBSTITUTES INTENDED FOR SUBSEQUENT IMPLANTATION, ALL SOLD AS A UNIT; PRODUCTS OF TISSUE ENGINEERING, NAMELY, SURGICAL IMPLANTS AND MODIFIED SURGICAL IMPLANTS PRIMARILY COMPRISING ARTIFICIAL MATERIAL, ALSO CONSISTING OF BIOLOGICAL MATERIALS, ALL SOLD AS A UNIT; TISSUE PRECURSORS, NAMELY, SURGICAL IMPLANTS PRIMARILY COMPRISING ARTIFICIAL MATERIAL ALSO CONSISTING OF MOLECULES, NAMELY, HYALURONIC ACID, BIOLOGICAL POLYMERS, BIORESORBABLE POLYMERS AND COMBINATIONS THEREOF PRODUCED IN VITRO FOR REPLACING AND SUPPORTING THE FUNCTION OF ABSENT OR INJURED BODY PARTS, ALL SOLD AS A UNIT; ARTIFICIAL CARTILAGE REPLACEMENTS AND TISSUE REPLACEMENTS, NAMELY, PRIMARILY ARTIFICIAL SUBSTITUTES FOR BONES, CARTILAGE, LIGAMENTS, AND TENDONS, ALSO CONSISTING OF IMPLANTS OF HYALURONIC ACID, BIOLOGICAL POLYMERS, BIORESORBABLE POLYMERS AND COMBINATIONS THEREOF, ALL SOLD AS A UNIT; BIOLOGICAL REPLACEMENT AND BIOLOGICAL PROTECTION OF MESENCHYMAL TISSUE, NAMELY, PRIMARILY ARTIFICIAL SUBSTITUTES FOR BONES, CARTILAGE, LIGAMENTS AND TENDONS ALSO CONSISTING OF IMPLANTS OF HYALURONIC ACID, BIOLOGICAL POLYMERS, BIORESORBABLE POLYMERS AND COMBINATIONS THEREOF, ALL SOLD AS A UNIT, IN CLASS 10 (U.S. CLS. 26, 39 AND 44).

FOR: RESEARCH AND DEVELOPMENT OF PHARMACEUTICAL PREPARATIONS AND MEDICINES; CONSULTANCY IN THE FIELD OF BIOMEDICINE, IN CLASS 42 (U.S. CLS. 100 AND 101).

PRIORITY DATE OF 6-26-2006 IS CLAIMED.

OWNER OF INTERNATIONAL REGISTRATION
0912957 DATED 12-22-2006, EXPIRES 12-22-2016.

NO CLAIM IS MADE TO THE EXCLUSIVE
RIGHT TO USE "CHONDROTISSUE", APART
FROM THE MARK AS SHOWN.

THE MARK CONSISTS OF A CIRCLE SEPARA-
TED INTO TWO PARTS BY A CURVILINEAR LINE
NEXT TO THE TERM "CHONDROTISSUE".

SER. NO. 79-034,419, FILED 12-22-2006.

JAMES STEIN, EXAMINING ATTORNEY

Int. Cls.: 3, 14, 18, 24 and 25

Prior U.S. Cls.: 1, 2, 3, 4, 6, 22, 27, 28, 39, 41, 42, 50, 51 and 52

Reg. No. 3,520,742

United States Patent and Trademark Office

Registered Oct. 21, 2008

TRADEMARK
PRINCIPAL REGISTER



MAMARELLA GMBH (FED REP GERMANY
LIMITED LIABILITY COMPANY)
MARIAHILFSTRABE 8
81541 MÜNCHEN
FED REP GERMANY

FOR: LAUNDRY BLEACH, BLUING, DETERGENT, PRE-SOAK, SIZING AND STARCH; GENERAL PURPOSE CLEANING, POLISHING AND ABRASIVE LIQUIDS AND POWDERS; PERFUMERY; ESSENTIAL OILS; COSMETICS; HAIR LOTIONS; DENTIFRICES; BABY, BODY, BATH AND MASSAGE OILS FOR USE BY PREGNANT OR LACTATING WOMEN; BABY LOTION, OIL, POWDER, SHAMPOO AND WIPES, IN CLASS 3 (U.S. CLS. 1, 4, 6, 50, 51 AND 52).

FOR: JEWELRY; PRECIOUS STONES, IN CLASS 14 (U.S. CLS. 2, 27, 28 AND 50).

FOR: IMITATION LEATHER; LEATHER SOLD IN BULK; LEATHER AND IMITATION LEATHER BAGS, CASES, HANDBAGS, KEY CHAINS, LUGGAGE, PURSES AND STRAPS; BABY CARRYING BAGS, DIAPER BAGS; HANDBAGS; SHOULDER BAGS, IN CLASS 18 (U.S. CLS. 1, 2, 3, 22 AND 41).

FOR: TEXTILE FABRICS FOR THE MANUFACTURE OF CLOTHING, FOR LINGERIE AND FOR HOME AND COMMERCIAL INTERIORS; TEXTILE LABELS, SIGNAGE PANELS AND WALL HANG-

INGS; BED LINEN, IN CLASS 24 (U.S. CLS. 42 AND 50).

FOR: FOOTWEAR; HEADWEAR; MATERNITY LINGERIE AND SLEEPWEAR; BABY BIBS NOT OF PAPER; BABY BUNTING; ONE PIECE GARMENT FOR INFANTS AND TODDLERS; INFANT CLOTH DIAPERS, SLEEPERS AND TROUSERS; NURSING BRAS; CLOTHING, NAMELY, BOTTOMS, TOPS, PANTS, SHORTS, SHIRTS, DRESSES, COATS, JACKETS, JUMPERS, SWEATERS, UNDERWEAR AND VESTS, IN CLASS 25 (U.S. CLS. 22 AND 39).

OWNER OF INTERNATIONAL REGISTRATION 0913056 DATED 12-7-2006, EXPIRES 12-7-2016.

THE COLOR(S) PINK AND PURPLE IS/ARE CLAIMED AS A FEATURE OF THE MARK.

THE COLOR PURPLE APPEARS IN THE WORDING. THE DESIGN OF A BUTTERFLY AND TWO DOTS ARE PINK.

SER. NO. 79-034,450, FILED 12-7-2006.

IRA J. GOODSID, EXAMINING ATTORNEY

Int. Cls.: 25 and 26

Prior U.S. Cls.: 22, 37, 39, 40, 42 and 50

United States Patent and Trademark Office

Reg. No. 3,520,743

Registered Oct. 21, 2008

**TRADEMARK
PRINCIPAL REGISTER**

SP LA SPOSA

SAN PATRICK, S.L. (SPAIN LIMITED LIABILITY COMPANY)
POL. IND. MANSO MATEU, S/N
E-08820 EL PRAT DE LLOBREGAT (BARCELONA)
SPAIN

FOR: CLOTHING, NAMELY, WEDDING DRESSES AND GOWNS, AND EVENING DRESSES; FOOTWEAR; HEADWEAR, NAMELY, VEILS , IN CLASS 25 (U.S. CLS. 22 AND 39).

FOR: LACE AND EMBROIDERY, RIBBONS AND BRAID; BUTTONS FOR CLOTHING, HOOKS AND EYES, HAIR PINS AND NEEDLES; ARTIFICIAL FLOWERS, IN CLASS 26 (U.S. CLS. 37, 39, 40, 42 AND 50).

OWNER OF INTERNATIONAL REGISTRATION 0854750 DATED 7-15-2005, EXPIRES 7-15-2015.

NO CLAIM IS MADE TO THE EXCLUSIVE RIGHT TO USE "LA SPOSA", APART FROM THE MARK AS SHOWN.

THE ENGLISH TRANSLATION OF "LA SPOSA" IS "THE BRIDE".

SER. NO. 79-034,784, FILED 2-1-2007.

NELSON SNYDER, EXAMINING ATTORNEY

Int. Cls.: 9, 16, 35, 38, 41 and 42

**Prior U.S. Cls.: 2, 5, 21, 22, 23, 26, 29, 36, 37, 38, 50,
100, 101, 102, 104 and 107**

Reg. No. 3,520,744

United States Patent and Trademark Office

Registered Oct. 21, 2008

**TRADEMARK
SERVICE MARK
PRINCIPAL REGISTER**

TALENT2

TALENT2 PTY LIMITED (AUSTRALIA CORPORATION)

LEVEL 4

77 PACIFIC HIGHWAY

NORTH SYDNEY NSW 2060, AUSTRALIA

FOR: COMPUTER SOFTWARE FOR USE IN DATA MANAGEMENT IN THE FIELDS OF HUMAN RESOURCE MANAGEMENT, HUMAN RESOURCE RECRUITMENT AND HUMAN RESOURCE TRAINING; COMPUTER SOFTWARE THAT PROVIDES INTEGRATED HUMAN RESOURCE MANAGEMENT INTELLIGENCE, HUMAN RESOURCE RECRUITMENT INTELLIGENCE AND HUMAN RESOURCE TRAINING INTELLIGENCE BY COMBINING INFORMATION FROM VARIOUS DATABASES; COMPUTER SOFTWARE FOR USE IN THE CALCULATION, MANAGEMENT AND PAYMENT OF HUMAN RESOURCE REMUNERATION AND OTHER HUMAN RESOURCE ENTITLEMENTS; EDUCATIONAL SOFTWARE FEATURING INSTRUCTION TEMPLATES TO ENABLE SELF TRAINING OVER THE INTERNET; COMPUTER SOFTWARE FOR USE IN MANAGING HUMAN RESOURCE TRAINING PROVIDERS, THE FOREGOING NOT USED FOR VALIDATED PSYCHOMETRIC TESTING SERVICES, NAMELY, THE DEVELOPMENT OF STANDARDIZED STATISTICALY BASED PRODUCTS FOR THE QUANTITATIVE MEASUREMENT, PROFILING AND ANALYSIS OF COGNITIVE AND PROBLEM SOLVING ABILITY, PSYCHOLOGICAL AND PERSONALITY TRAITS, OCCUPATIONAL COMPETENCIES, APTITUDE AND WORK PREFERENCES, IN CLASS 9 (U.S. CLS. 21, 23, 26, 36 AND 38).

FOR: BOOKS, MAGAZINES AND NEWSLETTERS; PRINTED INSTRUCTIONAL AND TEACHING MATERIALS; MANUALS; WRITING PADS; STATIONERY; ALL THE FOREGOING RELATING TO RECRUITMENT AND PLACEMENT SERVICES, THE FOREGOING NOT USED FOR VALIDATED PSYCHOMETRIC TESTING SERVICES, NAMELY, THE DEVELOPMENT OF STANDARDIZED STATISTICALY BASED PRODUCTS FOR THE QUANTITATIVE MEASUREMENT, PROFILING AND ANALYSIS OF COGNITIVE AND PROBLEM SOLVING ABILITY, PSYCHOLOGICAL AND PERSONALITY TRAITS, OCCUPATIONAL COMPETENCIES, APTITUDE AND WORK PREFERENCES, IN CLASS 16 (U.S. CLS. 2, 5, 22, 23, 29, 37, 38 AND 50).

FOR: ADVERTISING SERVICES RELATING TO THE RECRUITMENT OF PERSONNEL; BUSINESS ADMINISTRATION AND CONSULTING SERVICES; BUSINESS MANAGEMENT SERVICES, NAMELY, CONSULTANCY RELATING TO THE SELECTION AND MANAGEMENT OF PERSONNEL, EXECUTIVE SELECTION AND SEARCH, MANAGEMENT CONSULTING, MANAGEMENT CONTRACTING, LABOR HIRE AND TRADE PERSONS CONTRACTING, OUTPLACEMENT SERVICES, SECRETARIAL AND CLERICAL RECRUITMENT AND CONTRACTING, PERSONNEL LOCATION, SELECTION, RECRUITMENT, PLACEMENT, HIRING AND ADMINISTRATION; EXECUTIVE, MANAGEMENT AND PERSONNEL RECRUITMENT AGENCY SERVICES; INTERVIEWING SERVICES FOR PERSONNEL RECRUITMENT; PROFESSIONAL CONSULTANCY SERVICES RELATING TO HUMAN RESOURCES; COUNSELING AND RECRUITING, NAMELY, COUNSELING SERVICES IN RELATION TO EMPLOYMENT AND FOR RECRUITING EXECUTIVES, MANAGEMENT AND

PERSONNEL USING PSYCHOLOGICAL TESTING, ALL OF THE FOREGOING EXCLUDING VALIDATED PSYCHOMETRIC TESTING SERVICES, NAMELY, THE DEVELOPMENT OF STANDARDIZED STATISTICALLY BASED PRODUCTS FOR THE QUANTITATIVE MEASUREMENT, PROFILING AND ANALYSIS OF COGNITIVE AND PROBLEM SOLVING ABILITY, PSYCHOLOGICAL AND PERSONALITY TRAITS, OCCUPATIONAL COMPETENCIES, APTITUDE AND WORK PREFERENCES, IN CLASS 35 (U.S. CLS. 100, 101 AND 102).

FOR: ELECTRONIC TRANSMISSION OF DATA RELATING TO PERSONNEL SEARCH AND RECRUITMENT VIA COMPUTER AND COMMUNICATION NETWORKS AND THE INTERNET; ELECTRONIC MAIL SERVICES; INSTANT ELECTRONIC MESSAGING SERVICES; PROVIDING FACILITIES AND EQUIPMENT FOR TELEPHONE AND VIDEO CONFERENCES FOR THE PURPOSES OF PERSONNEL SEARCH AND RECRUITMENT, ALL OF THE FOREGOING EXCLUDING VALIDATED PSYCHOMETRIC TESTING SERVICES, NAMELY, THE DEVELOPMENT OF STANDARDIZED STATISTICALLY BASED PRODUCTS FOR THE QUANTITATIVE MEASUREMENT, PROFILING AND ANALYSIS OF COGNITIVE AND PROBLEM SOLVING ABILITY, PSYCHOLOGICAL AND PERSONALITY TRAITS, OCCUPATIONAL COMPETENCIES, APTITUDE AND WORK PREFERENCES, IN CLASS 38 (U.S. CLS. 100, 101 AND 104).

FOR: EDUCATION SERVICES, NAMELY, EDUCATIONAL CONSULTANCY SERVICES IN THE FIELD OF RECRUITMENT, HUMAN RESOURCES AND PAYROLL SERVICES; TRAINING SERVICES, NAMELY, TRAINING FOR EXECUTIVE AND PERSONNEL PERSONAL DEVELOPMENT AND SKILLS; CONSULTANCY SERVICES RELATING TO THE ANALYSIS OF TRAINING REQUIREMENTS FOR THE DEVELOPMENT OF EXECUTIVE AND PERSONNEL SKILLS; CONSULTANCY SERVICES RELATING TO THE PRODUCTION OF TRAINING COURSE MATERIALS; VOCATIONAL GUIDANCE SERVICES IN RELATION TO EMPLOYMENT, ALL OF THE FOREGOING EXCLUDING

VALIDATED PSYCHOMETRIC TESTING SERVICES, NAMELY, THE DEVELOPMENT OF STANDARDIZED STATISTICALLY BASED PRODUCTS FOR THE QUANTITATIVE MEASUREMENT, PROFILING AND ANALYSIS OF COGNITIVE AND PROBLEM SOLVING ABILITY, PSYCHOLOGICAL AND PERSONALITY TRAITS, OCCUPATIONAL COMPETENCIES, APTITUDE AND WORK PREFERENCES, IN CLASS 41 (U.S. CLS. 100, 101 AND 107).

FOR: DESIGN AND DEVELOPMENT OF COMPUTER SOFTWARE AND SYSTEMS; THE WRITING OF COMPUTER PROGRAMS; COMPUTER CONSULTING SERVICES; LICENSING OF COMPUTER SOFTWARE; MAINTENANCE AND SUPPORT SERVICES FOR COMPUTER SOFTWARE, NAMELY, THE DIAGNOSIS AND CORRECTION OF SOFTWARE ERRORS, SUPPLY OF SOFTWARE PATCHES, SUPPLY OF SOFTWARE UPGRADES AND SUPPLY OF TELEPHONE HELP DESK SERVICES; QUALITY CONTROL SERVICES FOR OTHERS IN RELATION TO HUMAN RESOURCES, ALL OF THE FOREGOING EXCLUDING VALIDATED PSYCHOMETRIC TESTING SERVICES, NAMELY, THE DEVELOPMENT OF STANDARDIZED STATISTICALLY BASED PRODUCTS FOR THE QUANTITATIVE MEASUREMENT, PROFILING AND ANALYSIS OF COGNITIVE AND PROBLEM SOLVING ABILITY, PSYCHOLOGICAL AND PERSONALITY TRAITS, OCCUPATIONAL COMPETENCIES, APTITUDE AND WORK PREFERENCES, IN CLASS 42 (U.S. CLS. 100 AND 101).

THE MARK CONSISTS OF STANDARD CHARACTERS WITHOUT CLAIM TO ANY PARTICULAR FONT, STYLE, SIZE, OR COLOR.

OWNER OF INTERNATIONAL REGISTRATION 0897382 DATED 3-9-2006, EXPIRES 3-9-2016.

SER. NO. 79-034,787, FILED 1-19-2007.

MARK SPARACINO, EXAMINING ATTORNEY

Int. Cls.: 1, 6, 7, 8, 9, 11, 12, 16, 17, 19, 20, 21 and 40

Prior U.S. Cls.: 1, 2, 5, 6, 10, 12, 13, 14, 19, 21, 22, 23, 25, 26, 28, 29, 30, 31, 32, 33, 34, 35, 36, 37, 38, 40, 44, 46, 50, 100, 103 and 106

Reg. No. 3,520,745

United States Patent and Trademark Office

Registered Oct. 21, 2008

**TRADEMARK
SERVICE MARK
PRINCIPAL REGISTER**

PLASTIC OMNIUM

COMPAGNIE PLASTIC OMNIUM (FRANCE SOCIÉTÉ ANONYME À CONSEIL D'ADMINISTRATION)

19, AVENUE JULES CARTERET
F-69007 LYON
FRANCE

FOR: UNPROCESSED PLASTICS, UNPROCESSED ARTIFICIAL RESINS AND SYNTHETIC RESINS FOR USE IN MANUFACTURE, ADHESIVES FOR INDUSTRIAL PURPOSES, IN CLASS 1 (U.S. CLS. 1, 5, 6, 10, 26 AND 46).

FOR: METALLIC TUBES AND PIPES COVERED WITH OR SHEATHED WITH PLASTIC, IN PARTICULAR PTFE, FEP, PVDF OR PEEK PLASTICS; ELBOW PIPES; METAL PIPE CONNECTORS AND PLASTIC-COATED METALLIC CONNECTORS FOR PIPE LINES; GENERAL PURPOSE METAL STORAGE CONTAINERS IN THE NATURE OF FIXED AND WHEELED BINS AND CONTAINERS; NON-LUMINOUS AND NON-MECHANICAL METAL SIGNS AND SIGNALING PANELS, IN CLASS 6 (U.S. CLS. 2, 12, 13, 14, 23, 25 AND 50).

FOR: METAL MOULDS FOR MOULDING OF PLASTIC MATERIAL; MACHINE PARTS AND COMPONENTS MADE OF PLASTIC INCLUDING MOULDED PLASTIC, FOR USE WITH DOMESTIC MACHINES, INDUSTRIAL MACHINES AND MACHINE TOOLS, NAMELY, BUSHINGS, BEARINGS, BEARING INSERTS, GUIDE HANDLES, SWITCHES, TOOL HOLDERS, PULLEY SAFETY GUARDS, TABLES, BASES, COLUMNS; VALVES AND SLIDE VALVES BEING MACHINE PARTS FOR INJECTION PLASTIC MOULDING MACHINES AND FOR POLISHING MACHINES FOR USE IN GRINDING AND POLISHING METAL, WOOD, CERAMICS AND PLASTICS, IN CLASS 7 (U.S. CLS. 13, 19, 21, 23, 31, 34 AND 35).

FOR: HAND-OPERATED TOOLS AND INSTRUMENTS, NAMELY, MANUALLY OPERATED HAND-HELD TOOL FOR THE PURPOSE OF DIS-

PENSING PLASTIC WRAP AROUND PALLETS OR PRODUCT FOR THE PURPOSE OF SHIPPING, TRANSPORTING OR STORAGE; HAND-OPERATED TOOLS AND INSTRUMENTS, NAMELY, ADZES, AUGERS, AWLS, CLAMPS, CRIMPING IRONS, DIES, DRILLS, FILES, HAMMERS, HAND JACKS, MANUALLY-OPERATED GRINDING WHEELS, MITRE BOXES, MANUALLY-OPERATED SHARPENING WHEELS, PICKS, PLANERS, PLANES, PUNCHES, RASPS, RATCHET WRENCHES, REAMERS, SAWS, SCRAPERS, SCREWDRIVERS, SOCKET SETS, SHEET METAL SHRINKING AND STRETCHING DEVICES, TAPS, TONGS, WRENCHES, HAND-OPERATED REACHING DEVICES FOR PICKING UP AND REMOVING TRASH AND OBJECTS, RIPPING BARS, SANDERS, BOLT CUTTERS, WIRE STRIPPERS, PAINT SCRAPERS, WIRE CRIMPERS, SHOVELS, IN CLASS 8 (U.S. CLS. 23, 28 AND 44).

FOR: STRUCTURAL PARTS AND COMPONENTS MADE OF PLASTIC, IN PARTICULAR MOULDED PLASTIC, INCLUDING PTFE, FEP, PFA, PVDE OR PEEK PLASTICS, BEING PARTS AND COMPONENTS OF, AND SOLD AS A UNIT WITH, RADIOS, TELEVISIONS AND TELEVISION SETS; STRUCTURAL PARTS AND COMPONENTS MADE OF PLASTIC, IN PARTICULAR MOULDED PLASTIC, INCLUDING PTFE, FEP, PFA, PVDE OR PEEK PLASTICS, BEING PARTS AND COMPONENTS OF, AND SOLD AS A UNIT WITH, SPEAKING MACHINES IN THE NATURE OF APPARATUS FOR RECORDING, TRANSMISSION OR REPRODUCTION OF SOUND AND IMAGES, ELECTRONIC TESTING EQUIPMENT, NAMELY, SOUND LEVEL METERS, PERSONAL HEADPHONES FOR USE WITH SOUND TRANSMITTING SYSTEMS, SOUND AMPLIFIERS, SOUND BOARD, SOUND CARDS, SOUND MIXERS, SOUND RECORDING APPARATUS AND INSTRUMENTS, DVD PLAYERS, CD PLAYERS; STRUCTURAL PARTS AND COMPONENTS MADE OF PLASTIC, IN PARTICULAR MOULDED PLASTIC, INCLUDING PTFE, FEP, PFA, PVDE OR PEEK PLASTICS, BEING PARTS

AND COMPONENTS OF, AND SOLD AS A UNIT WITH, PHOTOGRAPHIC APPARATUS IN THE NATURE OF CAMERAS AND VIDEO CAMERAS; STRUCTURAL PARTS AND COMPONENTS MADE OF PLASTIC, IN PARTICULAR MOULDED PLASTIC, INCLUDING PTFE, FEP, PFA, PVDE OR PEEK PLASTICS, BEING PARTS AND COMPONENTS OF, AND SOLD AS A UNIT WITH, CINEMATOGRAPHIC APPARATUS IN THE NATURE OF SOUND AND VIDEO RECORDING AND PLAYBACK MACHINES; STRUCTURAL PARTS AND COMPONENTS MADE OF PLASTIC, IN PARTICULAR MOULDED PLASTIC, INCLUDING PTFE, FEP, PFA, PVDE OR PEEK PLASTICS, BEING PARTS AND COMPONENTS OF, AND SOLD AS A UNIT WITH, OPTICAL APPARATUS IN THE NATURE OF ELECTRONIC AND OPTICAL COMMUNICATIONS INSTRUMENTS AND COMPONENTS, NAMELY, OPTICAL TRANSMITTERS, RECEIVERS, OPTICAL DISC DRIVES, OPTICAL DATA LINKS, OPTICAL CABLES, OPTICAL FIBER CABLES, OPTICAL FILTERS, OPTICAL REFLECTORS, SCANNERS, OPTICAL SHUTTERS, OPTICAL MIRRORS, NON-STOP ELECTRICAL OPTICAL DETECTORS OF THE FILLING UP RATE OF TRASH CONTAINERS; STRUCTURAL PARTS AND COMPONENTS MADE OF PLASTIC, IN PARTICULAR MOULDED PLASTIC, INCLUDING PTFE, FEP, PFA, PVDE OR PEEK PLASTICS, BEING PARTS AND COMPONENTS OF, AND SOLD AS A UNIT WITH, WEIGHING APPARATUS IN THE NATURE OF SCALES AND BALANCES; STRUCTURAL PARTS AND COMPONENTS MADE OF PLASTIC, IN PARTICULAR MOULDED PLASTIC, INCLUDING PTFE, FEP, PFA, PVDE OR PEEK PLASTICS, BEING PARTS AND COMPONENTS OF, AND SOLD AS A UNIT WITH, MEASURING APPARATUS IN THE NATURE OF APPARATUS FOR MEASURING CHEMICAL COMPONENTS IN PAINTINGS, APPARATUS FOR MEASURING THE SPREADING OF PAINTINGS ON A SURFACE, APPARATUS TO MEASURE THE WEARING SURFACE AND RESISTANCE OF PLASTIC PARTS AND COMPONENTS, FOR INSTANCE TO LIGHT, HEAT, COLD, HUMIDITY AND SHOCKS IN THE NATURE OF COLLISIONS, APPARATUS TO TEST THE RESISTANCE OF THE FOREGOING GOODS; STRUCTURAL PARTS AND COMPONENTS MADE OF PLASTIC, IN PARTICULAR MOULDED PLASTIC, INCLUDING PTFE, FEP, PFA, PVDE OR PEEK PLASTICS, BEING PARTS AND COMPONENTS OF, AND SOLD AS A UNIT WITH, SIGNALING APPARATUS IN THE NATURE OF ROTATING LIGHTS, SIGNALING BUOYS, TRAFFIC LIGHT APPARATUS, ELECTRONIC EQUIPMENT FOR INSPECTION AND DETECTION OF FOREIGN MATERIAL WITHIN CONTAINERS; STRUCTURAL PARTS AND COMPONENTS MADE OF PLASTIC, IN PARTICULAR MOULDED PLASTIC, INCLUDING PTFE, FEP, PFA, PVDE OR PEEK PLASTICS, BEING PARTS AND COMPONENTS OF, AND SOLD AS A UNIT WITH, CONTROL APPARATUS IN THE NATURE OF ELECTRIC CONTROL PANELS AND INDUSTRIAL AUTOMATION CONTROLS FOR USE IN THE FIELDS OF GARBAGE COLLECTION AND RUBBISH/GARBAGE PROCESSING, VEHICLE SAFETY, DESIGN OF VEHICLES' PARTS AND COMPONENTS, ENVIRONMENTAL-

LY FRIENDLY PRODUCT DESIGN AND ENVIRONMENTAL POLICY; STRUCTURAL PARTS AND COMPONENTS MADE OF PLASTIC, IN PARTICULAR MOULDED PLASTIC, INCLUDING PTFE, FEP, PFA, PVDE OR PEEK PLASTICS, BEING PARTS AND COMPONENTS OF, AND SOLD AS A UNIT WITH, CALCULATORS, FOR ELECTRICAL AND ELECTRONIC INDUSTRY, IN THE NATURE OF CASES, CASINGS, SCREENS, CONTACTORS, AND SWITCHES; STRUCTURAL PARTS AND COMPONENTS MADE OF PLASTIC, IN PARTICULAR MOULDED PLASTIC, INCLUDING PTFE, FEP, PFA, PVDE OR PEEK PLASTICS, BEING PARTS AND COMPONENTS OF, AND SOLD AS A UNIT WITH, LABORATORY CONTAINERS IN THE NATURE OF BEAKERS, STORAGE TUBES, FLASKS, TEST TUBES, BURETTES, AND LABORATORY UTENSILS OF PLASTIC IN THE NATURE OF STERILE FORKS, MEASURING CUPS AND BOWLS, BUCKETS WITH COVER SOLD AS A UNIT THEREWITH; LUMINOUS SIGNS; MECHANICAL SIGNS; STRUCTURAL PARTS AND COMPONENTS MADE OF PLASTIC, IN PARTICULAR MOULDED PLASTIC, INCLUDING PTFE, FEP, PFA, PVDE OR PEEK PLASTICS, BEING PARTS AND COMPONENTS OF, AND SOLD AS A UNIT WITH, TEACHING APPARATUS IN THE NATURE OF COMPUTER DISKS, CD ROMS AND DVD'S FOR SOFTWARE, ELECTRONIC GAME PROGRAMS, VEHICLE DRIVING SIMULATORS, AND EDUCATIONAL GARBAGE AND RUBBISH SORTING SIMULATORS, ALL FOR USE IN THE FIELDS OF GARBAGE COLLECTION AND RUBBISH/GARBAGE PROCESSING, VEHICLE SAFETY, DESIGN OF VEHICLES' PARTS AND COMPONENTS, ENVIRONMENTALLY FRIENDLY PRODUCT DESIGN AND ENVIRONMENTAL POLICY, IN CLASS 9 (U.S. CLS. 21, 23, 26, 36 AND 38).

FOR: STRUCTURAL PARTS AND COMPONENTS MADE OF PLASTIC IN PARTICULAR MOULDED PLASTIC, BEING PARTS AND COMPONENTS OF, AND SOLD AS A UNIT WITH, HOUSEHOLD APPLIANCES IN THE NATURE OF DEHUMIDIFIERS; STRUCTURAL PARTS AND COMPONENTS MADE OF PLASTIC IN PARTICULAR MOULDED PLASTIC, BEING PARTS AND COMPONENTS OF, AND SOLD AS A UNIT WITH, LIGHTING APPLIANCES IN THE NATURE OF ELECTRIC LIGHTING FIXTURES; STRUCTURAL PARTS AND COMPONENTS MADE OF PLASTIC IN PARTICULAR MOULDED PLASTIC, BEING PARTS AND COMPONENTS OF, AND SOLD AS A UNIT WITH, HEATING APPLIANCES IN THE NATURE OF ELECTRIC HEATING FANS, FURNACES; STRUCTURAL PARTS AND COMPONENTS MADE OF PLASTIC IN PARTICULAR MOULDED PLASTIC, BEING PARTS AND COMPONENTS OF, AND SOLD AS A UNIT WITH, STEAM GENERATING APPLIANCES IN THE NATURE OF STEAM GENERATORS; STRUCTURAL PARTS AND COMPONENTS MADE OF PLASTIC IN PARTICULAR MOULDED PLASTIC, BEING PARTS AND COMPONENTS OF, AND SOLD AS A UNIT WITH, COOKING APPLIANCES IN THE NATURE OF ELECTRIC, GAS OR MICROWAVE OVENS AND COOKTOPS; STRUCTURAL PARTS AND COMPONENTS MADE OF PLASTIC IN

PARTICULAR MOULDED PLASTIC, BEING PARTS AND COMPONENTS OF, AND SOLD AS A UNIT WITH, REFRIGERATING APPLIANCES IN THE NATURE OF ELECTRIC REFRIGERATORS AND REFRIGERATION UNITS FOR FOOD AND BEVERAGE CHILLING; STRUCTURAL PARTS AND COMPONENTS MADE OF PLASTIC IN PARTICULAR MOULDED PLASTIC, BEING PARTS AND COMPONENTS OF, AND SOLD AS A UNIT WITH, DRYING APPLIANCES IN THE NATURE OF CLOTHES DRYERS, HAIR DRYERS; STRUCTURAL PARTS AND COMPONENTS MADE OF PLASTIC IN PARTICULAR MOULDED PLASTIC, BEING PARTS AND COMPONENTS OF, AND SOLD AS A UNIT WITH, VENTILATING APPLIANCES IN THE NATURE OF AIR CONDITIONERS AND FANS; STRUCTURAL PARTS AND COMPONENTS MADE OF PLASTIC IN PARTICULAR MOULDED PLASTIC, BEING PARTS AND COMPONENTS OF, AND SOLD AS A UNIT WITH, WATER SUPPLY INSTALLATIONS, IN THE NATURE OF WATER FILTERING UNITS; AND STRUCTURAL PARTS AND COMPONENTS MADE OF PLASTIC IN PARTICULAR MOULDED PLASTIC, BEING PARTS AND COMPONENTS OF, AND SOLD AS A UNIT WITH, SANITARY INSTALLATIONS IN THE NATURE OF TOILETS; VALVES AND VALVING OF PLASTIC, OR COVERED WITH PLASTIC FOR INDUSTRY, NAMELY, VALVES AS PARTS OF RADIATORS, VALVES FOR AIR CONDITIONERS AND STEAM VALVES, IN CLASS 11 (U.S. CLS. 13, 21, 23, 31 AND 34).

FOR: STRUCTURAL PARTS MADE OF PLASTIC, IN PARTICULAR MOULDED PLASTIC, BEING PARTS FOR VEHICLES, NAMELY, AIRPLANES, HELICOPTERS, AND AUTOMOBILES; COMPONENTS MADE OF PLASTIC, IN PARTICULAR MOULDED PLASTIC, BEING PARTS AND COMPONENTS OF, AND SOLD AS A UNIT WITH, VEHICLES, NAMELY, AIRPLANES, HELICOPTERS, AND AUTOMOBILES; FUEL TANKS FOR VEHICLES, NAMELY, AUTOMOBILES AND TRUCKS; WASTE BIN CARRIER TROLLEYS, WHEELED CONTAINERS IN THE NATURE OF CARTS, IN CLASS 12 (U.S. CLS. 19, 21, 23, 31, 35 AND 44).

FOR: STRUCTURAL PARTS AND COMPONENTS MADE OF PLASTIC, IN PARTICULAR MOULDED PLASTIC, BEING PARTS AND COMPONENTS OF, AND SOLD AS A UNIT WITH, TYPEWRITERS AND OFFICE MACHINES IN THE NATURE OF LABELING MACHINES AND DOCUMENT BINDING MACHINES FOR OFFICE USE, ADHESIVE APPLYING MACHINES, AUTOMATIC PAPER CLIP DISPENSING MACHINES, CD AND PAPER SHREDDING MACHINES, ELECTRIC STAPLERS; OFFICE ARTICLES MADE OF PLASTIC, NAMELY, DESK STANDS, HOLDERS FOR PENS, PENCILS AND INK, DRAWING RULERS, HOLE PUNCHERS, STAPLERS, AND BINDERS; WASTE BAGS MADE OF PLASTIC, IN CLASS 16 (U.S. CLS. 2, 5, 22, 23, 29, 37, 38 AND 50).

FOR: SEMI-FINISHED PRODUCTS, NAMELY, SHEETS, PLATES, RODS, STICKS, TAPES, STRIPS, CANES, TUBES, FLEXIBLE HOSES, UNLINED PIPES, COUPLINGS, BRIDLES, WEDGES, GASKET SEALS, AND CASINGS FOR CABLES, ALL MADE OF PLASTIC AND PTFE, FEP, PFA, PVDF, OR PEEK, FOR USE IN PUMPS, VALVES, COMPRESSORS, SEMICONDUCTORS, FLUID CONDUCTORS, NON-METALLIC FLEXIBLE TUBES; BRAIDS AND LININGS OF PTFE, FEP, PFA, PVDF, OR PEEK FOR USE IN VEHICLES AND AERONAUTICS, IN CLASS 17 (U.S. CLS. 1, 5, 12, 13, 35 AND 50).

FOR: URBAN FURNITURE IN THE NATURE OF NON-METAL SHELTER STRUCTURES; NON-LUMINOUS, NON-MECHANICAL SIGNS NOT OF METAL; NON-METAL TELEPHONE BOOTHS; PIPES OF RIGID PLASTIC, EARTHENWARE, CEMENT, AND SANDSTONE FOR BUILDING; NON-METALLIC, RIGID TUBES AND PIPES, IN CLASS 19 (U.S. CLS. 1, 12, 33 AND 50).

FOR: PLASTIC FLUID STORAGE TANKS AND WASTE AND STORAGE CONTAINERS FOR INDUSTRY, TRANSPORT AND INDUSTRIAL HANDLING, IN CLASS 20 (U.S. CLS. 2, 13, 22, 25, 32 AND 50).

FOR: SMALL PLASTIC HOUSEHOLD UTENSILS, NAMELY, PAN SCRAPERS, ROLLING PINS, SPATULAS, TURNERS, WHISKS, SERVING SPOONS, BOTTLE OPENERS; AND RECEPTACLES OF PLASTIC, NAMELY, STORAGE CONTAINERS FOR DOMESTIC USE OR TRASH CANS, BUCKETS, COMPOST BINS FOR HOUSEHOLD USE; BINS AND CONTAINERS FOR WASTE, REFUSE, OR GLASS, MADE OF METAL OR PLASTIC; WASTE PAPER BASKET, IN CLASS 21 (U.S. CLS. 2, 13, 23, 29, 30, 33, 40 AND 50).

FOR: MATERIALS PROCESSING OF PLASTICS BY MOULDING, INJECTION, EXTRUSION, BLOWING, FOAMING, CALENDARING ROTATIONAL MOULDING TO THE ORDER AND/OR SPECIFICATION OF OTHERS; METAL PLATING OF PLASTIC PARTS AND APPLYING PROTECTIVE COATING TO PLASTIC PARTS, IN CLASS 40 (U.S. CLS. 100, 103 AND 106).

OWNER OF INTERNATIONAL REGISTRATION
0915488 DATED 10-11-2006, EXPIRES 10-11-2016.

OWNER OF U.S. REG. NO. 1,119,507.

NO CLAIM IS MADE TO THE EXCLUSIVE RIGHT TO USE "PLASTIC", APART FROM THE MARK AS SHOWN.

SER. NO. 79-035,221, FILED 10-11-2006.

KAELIE KUNG, EXAMINING ATTORNEY

Int. Cls.: 5, 29, 30, 31, 32, 35 and 43

**Prior U.S. Cls.: 1, 6, 18, 44, 45, 46, 48, 51, 52, 100, 101
and 102**

Reg. No. 3,520,746

United States Patent and Trademark Office

Registered Oct. 21, 2008

**TRADEMARK
SERVICE MARK
PRINCIPAL REGISTER**

VIVARTIA

VIVARTIA INDUSTRIAL & COMMERCIAL
COMPANY OF FOOD PRODUCTS & CATER-
ING SERVICES S.A. (GREECE CORPORA-
TION)

10, ZIRIDI STR., MAROUSSI
GR-151 23 ATHENS
GREECE

FOR: FOOD FOR INFANTS, BABY FOOD, IN
CLASS 5 (U.S. CLS. 6, 18, 44, 46, 51 AND 52).

FOR: MEAT, FISH, POULTRY AND GAME,
MEAT EXTRACTS, PRESERVED, DRIED AND
COOKED FRUITS AND VEGETABLES, ALL THE
AFORESAID GOODS AS FROZEN PRODUCTS AS
WELL; JELLIES, JAMS, COMPOTES; EGGS, MILK,
YOGURTS, MILK DESSERTS EXCLUDING ICE
CREAM, ICE MILK, AND FROZEN YOGURTS,
DAIRY CREAMS; MILK DRINKS, NAMELY, MILK
BEVERAGES WITH HIGH MILK CONTENT; MILK
PREPARATIONS FOR COFFEE, NAMELY, CREAM,
HALF AND HALF, MILK BASED BEVERAGE CON-
TAINING COFFEE; CHEESE AND CHEESE PRO-
DUCTS, NAMELY, CHEESE SPREADS, CHEESE
POWDERS, BUTTER AND OTHER DAIRY PRO-
DUCTS, EXCLUDING ICE CREAM, ICE MILK AND
FROZEN YOGURT, FRUIT PULPS AND VEGETA-
BLE PULPS, SOUPS, EDIBLE OILS AND FATS, IN
CLASS 29 (U.S. CL. 46).

FOR: COFFEE, TEA, COCOA, SUGAR, RICE,
TAPIOCA, SAGO, ARTIFICIAL COFFEE, FLOUR;
PREPARATIONS MADE FROM CEREALS, NAME-
LY, CEREAL BASED SNACK FOODS, PROCESSED
CEREALS, PITA BREAD; BREAD, PREPARED
SANDWICHES; PASTRY; CONFECTIONERY,
NAMELY, SWEET BAKERY PRODUCTS, CROIS-
SANTS, SWISS ROLLS, LAYER CAKES, WAFERS,
CANDY, ICE-CREAM, HONEY, TREACLE; YEAST,
BAKING-POWDER; SALT, MUSTARD; VINEGAR,

SAUCES, SPICES; ICE FOR REFRESHMENT; ED-
IBLE MALT EXTRACTS FOR FOOD, IN CLASS 30
(U.S. CL. 46).

FOR: FRESH FRUITS AND VEGETABLES, IN
CLASS 31 (U.S. CLS. 1 AND 46).

FOR: BEERS; MINERAL AND AERATED WA-
TERS AND OTHER NON-ALCOHOLIC DRINKS,
NAMELY, FRUIT DRINKS AND FRUIT JUICES;
NON-ALCOHOLIC FRUIT EXTRACTS USED FOR
THE PREPARATION OF BEVERAGES, IN CLASS 32
(U.S. CLS. 45, 46 AND 48).

FOR: ADVERTISING, BUSINESS MANAGE-
MENT; BUSINESS ADMINISTRATION; OFFICE
FUNCTIONS, IN CLASS 35 (U.S. CLS. 100, 101 AND
102).

FOR: PROVIDING FOOD AND DRINK, NAME-
LY, CATERING SERVICES, CAFÉS AND RESTAU-
RANTS, FAST-FOOD RESTAURANTS, IN CLASS 43
(U.S. CLS. 100 AND 101).

THE MARK CONSISTS OF STANDARD CHAR-
ACTERS WITHOUT CLAIM TO ANY PARTICULAR
FONT, STYLE, SIZE, OR COLOR.

PRIORITY DATE OF 7-13-2006 IS CLAIMED.

OWNER OF INTERNATIONAL REGISTRATION
0916036 DATED 12-6-2006, EXPIRES 12-6-2016.

SER. NO. 79-035,418, FILED 12-6-2006.

TRACY WHITTAKER-BROWN, EXAMINING AT-
TORNEY

Int. Cls.: 9, 41 and 44

Prior U.S. Cls.: 21, 23, 26, 36, 38, 100, 101 and 107

Reg. No. 3,520,747

United States Patent and Trademark Office

Registered Oct. 21, 2008

TRADEMARK
SERVICE MARK
PRINCIPAL REGISTER



JENNY LEGGE (AUSTRALIA INDIVIDUAL)
PO BOX 8740
MOUNT PLEASANT QLD 4740
AUSTRALIA

FOR: COMPUTER SOFTWARE FOR RECORDING AND COMPARING PHYSICAL ASPECTS OF WORKERS AND JOBS FOR USE IN WORKPLACE INJURY REHABILITATION, PRE-EMPLOYMENT FUNCTIONAL CAPABILITY AND PHYSICAL AGILITY TESTING, IDENTIFICATION OF WORKPLACE INJURY AND ILLNESS RISK FACTORS, EMPLOYMENT ALLOCATION FOR HEALTH IMPAIRED WORKERS, HEALTH SURVEILLANCE MANAGEMENT, IN CLASS 9 (U.S. CLS. 21, 23, 26, 36 AND 38).

FOR: TRAINING SERVICES, NAMELY, COMPUTER SOFTWARE EDUCATION TRAINING, IN CLASS 41 (U.S. CLS. 100, 101 AND 107).

FOR: MEDICAL SERVICES IN THE FIELD OF OCCUPATIONAL REHABILITATION AND INJURY PREVENTION AND PHYSIOTHERAPY AND EMPLOYEE PHYSICAL REHABILITATION, MEDICAL REHABILITATION CONSULTANCY, REHABILITATION MANAGEMENT, NAMELY, ASSESSING FUNCTIONAL CAPACITY OF WORKERS TO BE ENTERED INTO A REHABILITATION PROGRAM, MONITORING REHABILITATION OF WORKERS DURING EMPLOYMENT AND MONITORING OCCUPATIONAL HEALTH OF WORKERS DURING EMPLOYMENT, PHYSICAL REHABILITATION FOR INJURED WORKERS, PROVIDING EMPLOYMENT WELLNESS SERVICES FOR HEALTH IM-

PAIRED WORKERS, NAMELY, PROVIDING STANDARDIZED WORKER ASSESSMENTS AND TASK ANALYSIS PROGRAMS TO ASSIST WITH EMPLOYMENT ALLOCATION FOR HEALTH IMPAIRED WORKERS, HEALTH SURVEILLANCE MANAGEMENT SERVICES, NAMELY, EMPLOYEE HEALTH AND WELLNESS MONITORING AND ASSESSMENT SERVICES, PROVIDING WELLNESS SERVICES, NAMELY, RISK MANAGEMENT ASSESSMENT FOR INDIVIDUALS INCLUDING EMPLOYEES, NAMELY, PROVIDING STANDARDIZED WORKER ASSESSMENTS AND TASK ANALYSIS PROGRAMS TO MONITOR EMPLOYEE HEALTH AND WELLNESS DURING EMPLOYMENT, IN CLASS 44 (U.S. CLS. 100 AND 101).

OWNER OF INTERNATIONAL REGISTRATION
0917616 DATED 4-21-2006, EXPIRES 4-21-2016.

NO CLAIM IS MADE TO THE EXCLUSIVE RIGHT TO USE "JOB FIT SYSTEM", APART FROM THE MARK AS SHOWN.

THE MARK CONSISTS OF THE WORD JOB ENCLOSED WITHIN A PUZZLE PIECE DESIGN TO THE LEFT OF THE WORD FIT ENCLOSED WITHIN A PUZZLE PIECE DESIGN. THE WORD "SYSTEM" IS LOCATED BELOW THE WORDING "JOB" AND "FIT".

SER. NO. 79-036,067, FILED 4-21-2006.

DOMINIC FATHY, EXAMINING ATTORNEY

Int. Cls.: 6, 16, 20 and 35

**Prior U.S. Cls.: 2, 5, 12, 13, 14, 22, 23, 25, 29, 32, 37,
38, 50, 100, 101 and 102**

United States Patent and Trademark Office

Reg. No. 3,520,748

Registered Oct. 21, 2008

**TRADEMARK
SERVICE MARK
PRINCIPAL REGISTER**

CCS digital_fabric

CCS DIGITAL—FABRIC GMBH (FED REP GER-
MANY LIMITED LIABILITY COMPANY)
UNGELSHEIMER WEG 1-3
40472 DÜSSELDORF
FED REP GERMANY

FOR: PARTITION WALLS OF METAL, AFORE-
SAID PARTITION WALLS IN PARTICULAR DIS-
MOUNTABLE; STATIONERY OR MOBILE
PARTITION WALLS PRIMARILY COMPOSED OF
METAL; REMOVABLE PARTITION WALLS OF
METAL; REMOVABLE PARTITION WALLS PRI-
MARILY COMPOSED OF METAL FOR FAIRS, IN
CLASS 6 (U.S. CLS. 2, 12, 13, 14, 23, 25 AND 50).

FOR: ADVERTISING SIGNS OF PAPER OR
CARDBOARD; PHOTOGRAPH STANDS OF PLAS-
TICS OR METALS; POSTERS; PRINTED MATTER,
PRODUCED BY DIGITAL PRINTING MACHINES,
NAMELY, WALL CALENDARS, ILLUSTRATION
BOARDS, PHOTO PRINTS; BANNERS AND POS-
TERS, IN CLASS 16 (U.S. CLS. 2, 5, 22, 23, 29, 37, 38
AND 50).

FOR: PICTURE FRAMES; PICTURE FRAME
BRACKETS; POINT OF PURCHASE DISPLAYS
AND DISPLAY BOARDS; DISPLAY STANDS, IN
CLASS 20 (U.S. CLS. 2, 13, 22, 25, 32 AND 50).

FOR: PHOTOCOPYING; PREPARATION OF COL-
OUR DOCUMENT REPRODUCTIONS, IN CLASS 35
(U.S. CLS. 100, 101 AND 102).

THE MARK CONSISTS OF STANDARD CHAR-
ACTERS WITHOUT CLAIM TO ANY PARTICULAR
FONT, STYLE, SIZE, OR COLOR.

OWNER OF INTERNATIONAL REGISTRATION
0918068 DATED 3-27-2006, EXPIRES 3-27-2016.

SER. NO. 79-036,220, FILED 3-27-2006.

DOMINIC FATHY, EXAMINING ATTORNEY

Int. Cl.: 6

Prior U.S. Cls.: 2, 12, 13, 14, 23, 25 and 50

Reg. No. 3,520,749

United States Patent and Trademark Office

Registered Oct. 21, 2008

**TRADEMARK
PRINCIPAL REGISTER**

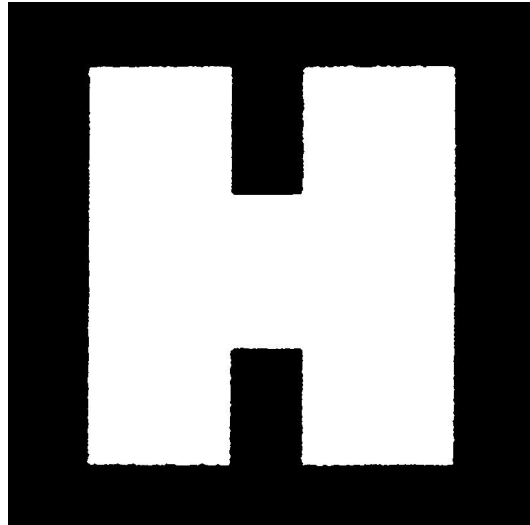

HIRSCHVOGEL UMFORMTECHNIK GMBH.;
GESENKSCHMIEDE UND PRESSWERK (FED
REP GERMANY GMBH)
MÜHLSTRASSE 6
86920 DENKLINGEN
FED REP GERMANY

OWNER OF INTERNATIONAL REGISTRATION
0918514 DATED 12-13-2006, EXPIRES 12-13-2016.

FOR: COMMON METALS AND THEIR ALLOYS,
NAMELY, INGOTS OF COMMON METAL; ALL OF
THE AFOREMENTIONED GOODS EXCLUDING
CHAINS AND MARINE ANCHORS, IN CLASS 6
(U.S. CLS. 2, 12, 13, 14, 23, 25 AND 50).

OWNER OF U.S. REG. NO. 2,798,049.

SER. NO. 79-036,406, FILED 12-13-2006.

PRIORITY DATE OF 6-21-2006 IS CLAIMED.

ROBERT STRUCK, EXAMINING ATTORNEY

Int. Cls.: 1, 5, 6, 7, 9, 11 and 19

Prior U.S. Cls.: 1, 2, 5, 6, 10, 12, 13, 14, 18, 19, 21, 23, 25, 26, 31, 33, 34, 35, 36, 38, 44, 46, 50, 51 and 52

Reg. No. 3,520,750

United States Patent and Trademark Office

Registered Oct. 21, 2008

**TRADEMARK
PRINCIPAL REGISTER**



BWT AKTIENGESELLSCHAFT (AUSTRIA SOCIÉTÉ ANONYME)
4, WALTER-SIMMER-STRASSE
A-5310 MONDSEE
AUSTRIA

FOR: INDUSTRIAL CHEMICALS FOR TREATING, CLARIFYING, SOFTENING, DESALINATING, CLEANING, DE-ACIDIFYING AND DISINFECTING WATER, IN CLASS 1 (U.S. CLS. 1, 5, 6, 10, 26 AND 46).

FOR: PRODUCTS FOR DESTROYING ALGAE AND BACTERIA, NAMELY, ANTIMICROBIAL COATINGS TO TREAT THE GROWTH OF ALGAE AND BACTERIA; BIOCIDES, IN CLASS 5 (U.S. CLS. 6, 18, 44, 46, 51 AND 52).

FOR: METAL POOLS FOR SWIMMING AND BATHING; WATER PIPES OF METAL; MANUALLY OPERATED METAL VALVES FOR WATER PIPES, IN CLASS 6 (U.S. CLS. 2, 12, 13, 14, 23, 25 AND 50).

FOR: DEVICES FOR SWIMMING POOLS, NAMELY, CIRCULATING PUMP FACILITIES IN THE NATURE OF WATER PUMPS FOR SWIMMING POOLS, VALVES FOR PUMPS; STRUCTURAL COMPONENT PARTS OF ALL THE AFORESAID GOODS; SUCTION APPARATUS FOR CLEANING THE BOTTOM OF POOLS FOR SWIMMING AND BATHING,

NAMELY, SWIMMING POOL SWEEPERS, IN CLASS 7 (U.S. CLS. 13, 19, 21, 23, 31, 34 AND 35).

FOR: PHYSICAL AND CHEMICAL APPARATUS FOR FILTERING AND METERING SOLID, PASTY, LIQUID AND GASEOUS MATERIALS, NAMELY, MASS METERS, FLOW METERS; WATER METERS; WATER FILTER CONTROLLERS; WATER PURIFIERS; LEVELING APPARATUS, NAMELY, LEVELING RODS; STRUCTURAL COMPONENT PARTS OF ALL THE AFORESAID GOODS, NOT INCLUDED IN OTHER CLASSES, IN CLASS 9 (U.S. CLS. 21, 23, 26, 36 AND 38).

FOR: BATH INSTALLATIONS, NAMELY, TAPS; BATHTUBS; INSTALLATIONS AND APPARATUS FOR TREATING, CLARIFYING, WASTEWATER, FOR SOFTENING, DESALINATING SEA WATER, FOR CLEANING, DE-ACIDIFYING, DE-CHLORINATING AND DISINFECTING WATER, NAMELY, FILTERING UNITS FOR WATER FILTRATION, INDUSTRIAL WATER PURIFYING APPARATUS, INDUSTRIAL WATER PURIFYING APPARATUS AND WASTE WATER PURIFICATION UNITS; METERED VALVES FOR WATER SUPPLY; OZONE SANITIZERS FOR WATER; WATER FILTERS; WATER TREATMENT EQUIPMENT, NAMELY, ULTRAVIOLET STERILIZATION UNITS; INDUSTRIAL WATER PURIFYING APPARATUS; FILTERING UNITS FOR PRODUCING POTABLE WATER FOR DOMESTIC UNITS; REGULATING

ACCESSORIES FOR WATER SUPPLY, NAMELY, METERED VALVES; WATER SOFTENING UNITS; SUCTION APPARATUS FOR CLEANING THE BOTTOM OF POOLS FOR SWIMMING AND BATHING, NAMELY, POOL SKIMMER DIVERTER; STRUCTURAL COMPONENT PARTS OF ALL THE AFORESAID GOODS NOT INCLUDED IN OTHER CLASSES, IN CLASS 11 (U.S. CLS. 13, 21, 23, 31 AND 34).

FOR: PLASTIC AND NON-METAL POOLS FOR SWIMMING AND BATHING; WATER PIPES OF PLASTIC MATERIALS; STRUCTURAL COMPONENT PARTS OF ALL THE AFORESAID GOODS NOT INCLUDED IN OTHER CLASSES, IN CLASS 19 (U.S. CLS. 1, 12, 33 AND 50).

PRIORITY DATE OF 6-26-2006 IS CLAIMED.

OWNER OF INTERNATIONAL REGISTRATION 0918857 DATED 12-21-2006, EXPIRES 12-21-2016.

OWNER OF U.S. REG. NOS. 2,443,895 AND 2,525,470.

"THE COLOR(S) WHITE AND ORANGE IS/ARE CLAIMED AS A FEATURE OF THE MARK."

THE MARK CONSISTS OF THE LETTERS "W BY BWT" AND THE DROPLET DESIGN IN WHITE INSIDE AN ORANGE RECTANGLE.

SER. NO. 79-036,506, FILED 12-21-2006.

ROBERT STRUCK, EXAMINING ATTORNEY

Int. Cls.: 1, 5, 6, 7, 9, 11 and 19

Prior U.S. Cls.: 1, 2, 5, 6, 10, 12, 13, 14, 18, 19, 21, 23, 25, 26, 31, 33, 34, 35, 36, 38, 44, 46, 50, 51 and 52

Reg. No. 3,520,751

United States Patent and Trademark Office

Registered Oct. 21, 2008

**TRADEMARK
PRINCIPAL REGISTER**



water + more

BWT AKTIENGESELLSCHAFT (AUSTRIA SOCIÉTÉ ANONYME)

4, WALTER-SIMMER-STRASSE

A-5310 MONDSEE

AUSTRIA

FOR: INDUSTRIAL CHEMICALS FOR TREATING, CLARIFYING, SOFTENING, DESALINATING, CLEANING, DE-ACIDIFYING AND DISINFECTING WATER, IN CLASS 1 (U.S. CLS. 1, 5, 6, 10, 26 AND 46).

FOR: PRODUCTS FOR DESTROYING ALGAE AND BACTERIA, NAMELY, ANTIMICROBIAL COATINGS TO TREAT THE GROWTH OF ALGAE AND BACTERIA; BIOCIDES, IN CLASS 5 (U.S. CLS. 6, 18, 44, 46, 51 AND 52).

FOR: METAL POOLS FOR SWIMMING AND BATHING; WATER PIPES OF METAL; MANUALLY OPERATED METAL VALVES FOR WATER PIPES, IN CLASS 6 (U.S. CLS. 2, 12, 13, 14, 23, 25 AND 50).

FOR: DEVICES FOR SWIMMING POOLS, NAMELY, CIRCULATING PUMP FACILITIES IN THE NATURE OF WATER PUMPS FOR SWIMMING POOLS, VALVES FOR PUMPS; STRUCTURAL COMPONENT PARTS OF ALL THE AFORESAID GOODS; SUCTION APPARATUS FOR CLEANING THE BOTTOM OF POOLS FOR SWIMMING AND BATHING, NAMELY, SWIMMING POOL SWEEPERS, IN CLASS 7 (U.S. CLS. 13, 19, 21, 23, 31, 34 AND 35).

FOR: PHYSICAL AND CHEMICAL APPARATUS FOR FILTERING AND METERING SOLID, PASTY, LIQUID AND GASEOUS MATERIALS, NAMELY, MASS METERS, FLOW METERS; WATER METERS; WATER FILTER CONTROLLERS; WATER PURIFIERS; LEVELING APPARATUS, NAMELY, LEVELING RODS; STRUCTURAL COMPONENT PARTS OF ALL THE AFORESAID GOODS, NOT INCLUDED IN OTHER CLASSES, IN CLASS 9 (U.S. CLS. 21, 23, 26, 36 AND 38).

FOR: BATH INSTALLATIONS, NAMELY, TAPS; BATHTUBS; INSTALLATIONS AND APPARATUS FOR TREATING, CLARIFYING, WASTEWATER, FOR SOFTENING, DESALINATING SEA WATER, FOR CLEANING, DE-ACIDIFYING, DE-CHLORINATING AND DISINFECTING WATER, NAMELY, FILTERING UNITS FOR WATER FILTRATION, INDUSTRIAL WATER PURIFYING APPARATUS, INDUSTRIAL WATER PURIFYING APPARATUS AND WASTE WATER PURIFICATION UNITS; METERED VALVES FOR WATER SUPPLY; OZONE SANITIZERS FOR WATER; WATER FILTERS; WATER TREATMENT EQUIPMENT, NAMELY, ULTRAVIOLET STERILIZATION UNITS; INDUSTRIAL WATER PURIFYING APPARATUS; FILTERING UNITS FOR PRODUCING POTABLE WATER FOR DOMESTIC UNITS; REGULATING ACCESSORIES FOR WATER SUPPLY, NAMELY, METERED VALVES; WATER SOFTENING UNITS; SUCTION APPARATUS FOR CLEANING THE BOTTOM OF POOLS FOR SWIMMING AND BATHING, NAMELY, POOL SKIMMER DIVERTER; STRUCTURAL COMPONENT PARTS OF ALL THE AFORESAID GOODS NOT INCLUDED IN OTHER CLASSES, IN CLASS 11 (U.S. CLS. 13, 21, 23, 31 AND 34).

FOR: PLASTIC AND NON-METAL POOLS FOR SWIMMING AND BATHING; WATER PIPES OF PLASTIC MATERIALS; STRUCTURAL COMPONENT PARTS OF ALL THE AFORESAID GOODS NOT INCLUDED IN OTHER CLASSES, IN CLASS 19 (U.S. CLS. 1, 12, 33 AND 50).

PRIORITY DATE OF 6-26-2006 IS CLAIMED.

OWNER OF INTERNATIONAL REGISTRATION 0918858 DATED 12-21-2006, EXPIRES 12-21-2016.

OWNER OF U.S. REG. NOS. 2,443,895 AND 2,525,470.

"THE COLOR(S) WHITE, ORANGE AND BLUE IS/
ARE CLAIMED AS A FEATURE OF THE MARK."

AGAINST AN ORANGE RECTANGLE. THE WORD-
ING "WATER + MORE" IS IN BLUE.

THE MARK CONSISTS OF THE LETTERS "W BY
BWT" AND THE DROPLET DESIGN IN WHITE

SER. NO. 79-036,507, FILED 12-21-2006.

ROBERT STRUCK, EXAMINING ATTORNEY

Int. Cl.: 9

Prior U.S. Cls.: 21, 23, 26, 36 and 38

United States Patent and Trademark Office

Reg. No. 3,520,752

Registered Oct. 21, 2008

**TRADEMARK
PRINCIPAL REGISTER**

TELPADS

TOKYO ELECTRON LIMITED (JAPAN JOINT
STOCK COMPANY)
3-1, AKASAKA 5-CHOME
MINATO-KU
TOKYO, JAPAN 1078481

FOR: OPTICAL INSPECTION APPARATUS FOR
INDUSTRIAL USE, NAMELY, FOR SEMICONDUCTOR
WAFER INSPECTION MACHINES FOR THE
PURPOSES OF DETECTING MARKS CAUSED BY
WAFER PROBING; AND COMPUTERS, IN CLASS 9
(U.S. CLS. 21, 23, 26, 36 AND 38).

THE MARK CONSISTS OF STANDARD CHAR-
ACTERS WITHOUT CLAIM TO ANY PARTICULAR
FONT, STYLE, SIZE, OR COLOR.

PRIORITY DATE OF 8-23-2006 IS CLAIMED.

OWNER OF INTERNATIONAL REGISTRATION
0919235 DATED 9-12-2006, EXPIRES 9-12-2016.

THE WORDING "TELPADS" HAS NO MEANING
IN A FOREIGN LANGUAGE.

SER. NO. 79-036,644, FILED 9-12-2006.

WILLIAM ROSSMAN, EXAMINING ATTORNEY

Int. Cls.: 9, 16, 35 and 42

**Prior U.S. Cls.: 2, 5, 21, 22, 23, 26, 29, 36, 37, 38, 50,
100, 101 and 102**

Reg. No. 3,520,753

United States Patent and Trademark Office

Registered Oct. 21, 2008

**TRADEMARK
SERVICE MARK
PRINCIPAL REGISTER**

BIGMOUTHMEDIA

BIGMOUTHMEDIA LTD. (UNITED KINGDOM
LIMITED LIABILITY COMPANY)

51 TIMBERBUSH

EDINBURGH EH6 6QH, UNITED KINGDOM

FOR: COMPUTER PROGRAMS FOR USE IN SEARCH ENGINE OPTIMIZATION, WEB ADVERTISING AND WEB TRAFFIC ANALYSIS; SOFTWARE PRODUCTS IN THE FIELD OF WEBSITE OPTIMIZATION AND WEB CONTENT MANAGEMENT, NAMELY, COMPUTER SOFTWARE FOR USE IN DATABASE MANAGEMENT AND WEBSITE OPTIMIZATION; SEARCH ENGINE OPTIMIZATION PRODUCTS AND WEB TRAFFIC TRACKING PRODUCTS, NAMELY, COMPUTER SEARCH ENGINE SOFTWARE AND COMPUTER SOFTWARE FOR TRACKING WEB TRAFFIC; COMPUTER SOFTWARE FOR USE IN WEB SITE OPTIMIZATION AND DATA BASE MANAGEMENT FOR USE IN CONNECTION WITH THE INTERNET AND THE WORLD WIDE WEB THAT MAY BE DOWNLOADED FROM A GLOBAL COMPUTER NETWORK; APPARATUS FOR RECORDING, TRANSMISSION OR REPRODUCTION OF SOUND, DATA AND IMAGES; ELECTRONIC APPARATUS AND INSTRUMENTS, NAMELY, ELECTRONIC CIRCUIT BOARDS AND ELECTRONIC CARD READERS, BLANK MAGNETIC COMPUTER TAPES; BLANK MAGNETIC DISCS FOR COMPUTERS; BLANK MAGNETIC DATA CARRIERS; INFORMATION STORAGE DEVICES, NAMELY, COMPUTER STORAGE DEVICES, NAMELY, JUMP DRIVES, FLASH DRIVES AND PORTABLE COMPUTER MEMORIES FOR DATA STORAGE; BLANK CD ROM'S FOR SOUND OR VIDEO RECORDING; DOWNLOADABLE ELECTRONIC PUBLICATIONS IN THE NATURE OF NEWSLETTERS, MANUALS AND BROCHURES IN THE FIELD OF SEARCH ENGINE MARKETING, MULTILINGUAL SEARCH ENGINE OPTIMIZATION, PAY PER CLICK MANAGEMENT, SEO CONSULTANCY, PARTNERSHIPS, BRAND NOISE, MARKETING FOR REBRANDS, SEARCH ENGINE POSITIONS, TRACKING AND WEB TRAFFIC ANALYSIS IN THE FIELD OF WEB SITE AND SEARCH ENGINE OPTIMIZATION

THAT ARE AVAILABLE ON-LINE FROM DATABASES OR VIA THE INTERNET; ELECTRONIC PUBLICATIONS, NAMELY, BOOKS, MAGAZINES AND MANUALS FEATURING SEARCH ENGINE MARKETING, MULTILINGUAL SEARCH ENGINE OPTIMIZATION, PAY PER CLICK MANAGEMENT, SEO CONSULTANCY, PARTNERSHIPS, BRAND NOISE, MARKETING FOR REBRANDS, SEARCH ENGINE POSITIONS, TRACKING AND WEB TRAFFIC ANALYSIS RECORDED ON COMPUTER MEDIA AND PROVIDED BY ELECTRONIC MAIL; COMMUNICATIONS HARDWARE AND SOFTWARE, NAMELY, COMMUNICATION SERVERS, COMMUNICATIONS SOFTWARE FOR CONNECTING COMPUTER NETWORK USERS AND GLOBAL COMPUTER NETWORKS; INTERACTIVE COMPUTER SYSTEMS COMPRISED OF COMPUTERS, COMPUTER HARDWARE AND COMPUTER PERIPHERALS; INTERACTIVE ELECTRONIC APPARATUS, NAMELY, ELECTRONIC CIRCUIT BOARDS AND ELECTRONIC CARD READERS, AND BLANK MAGNETIC COMPUTER TAPES, IN CLASS 9 (U.S. CLS. 21, 23, 26, 36 AND 38).

FOR: PRINTED MATTER, NAMELY, PRINTED VISUALS IN THE NATURE OF PROMOTIONAL MATERIAL; PUBLICATIONS, NAMELY, BROCHURES, BOOKLETS AND TEACHING MATERIALS IN THE FIELD OF SEARCH ENGINE OPTIMIZATION AND WEB ADVERTISING; ALMANACS; BOOKS IN THE FIELD OF SEARCH ENGINE OPTIMIZATION AND WEB ADVERTISING; DIARIES; DIRECTORIES; PRINTED GUIDES FOR USE IN RELATION TO SEARCH ENGINE OPTIMIZATION AND WEB ADVERTISING; HANDBOOKS IN THE FIELD OF SEARCH ENGINE OPTIMIZATION AND WEB ADVERTISING; JOURNALS CONCERNING SEARCH ENGINE OPTIMIZATION AND WEB ADVERTISING; LEAFLETS ABOUT SEARCH ENGINE OPTIMIZATION AND WEB ADVERTISING; NOTEBOOKS; PAMPHLETS IN THE FIELD OF SEARCH ENGINE OPTIMIZATION AND WEB ADVERTISING; MANUALS IN THE FIELD OF SEARCH ENGINE OPTIMIZATION AND WEB ADVERTISING; PRINTED PERIODICALS IN THE

FIELD OF SEARCH ENGINE OPTIMIZATION AND WEB ADVERTISING; PRINTED REPORTS FEATURING SEARCH ENGINE MARKETING, MULTILINGUAL SEARCH ENGINE OPTIMIZATION, PAY PER CLICK MANAGEMENT, SEO CONSULTANCY, PARTNERSHIPS, BRAND NOISE, MARKETING FOR REBRANDS, SEARCH ENGINE POSITIONS, TRACKING AND WEB TRAFFIC ANALYSIS IN THE FIELD OF WEB SITE AND SEARCH ENGINE OPTIMIZATION; PRINTED PRODUCTS, NAMELY, LISTS FEATURING SEARCH ENGINE MARKETING, MULTILINGUAL SEARCH ENGINE OPTIMIZATION, PAY PER CLICK MANAGEMENT, SEO CONSULTANCY, PARTNERSHIPS, BRAND NOISE, MARKETING FOR REBRANDS, SEARCH ENGINE POSITIONS, TRACKING AND WEB TRAFFIC ANALYSIS IN THE FIELD OF WEB SITE AND SEARCH ENGINE OPTIMIZATION; BOOKS IN THE FIELD OF SEARCH ENGINE MARKETING, MULTILINGUAL SEARCH ENGINE OPTIMIZATION, PAY PER CLICK MANAGEMENT, SEO CONSULTANCY, PARTNERSHIPS, BRAND NOISE, MARKETING FOR REBRANDS, SEARCH ENGINE POSITIONS, TRACKING AND WEB TRAFFIC ANALYSIS IN THE FIELD OF WEB SITE AND SEARCH ENGINE OPTIMIZATION; BOOKLETS IN THE FIELD OF SEARCH ENGINE MARKETING, MULTILINGUAL SEARCH ENGINE OPTIMIZATION, PAY PER CLICK MANAGEMENT, SEO CONSULTANCY, PARTNERSHIPS, BRAND NOISE, MARKETING FOR REBRANDS, SEARCH ENGINE POSITIONS, TRACKING AND WEB TRAFFIC ANALYSIS IN THE FIELD OF WEB SITE AND SEARCH ENGINE OPTIMIZATION; PAMPHLETS IN THE FIELD OF SEARCH ENGINE MARKETING, MULTILINGUAL SEARCH ENGINE OPTIMIZATION, PAY PER CLICK MANAGEMENT, SEO CONSULTANCY, PARTNERSHIPS, BRAND NOISE, MARKETING FOR REBRANDS, SEARCH ENGINE POSITIONS, TRACKING AND WEB TRAFFIC ANALYSIS IN THE FIELD OF WEB SITE AND SEARCH ENGINE OPTIMIZATION; PUBLICATIONS, NAMELY, BROCHURES, BOOKLETS AND TEACHING MATERIALS IN THE FIELD OF SEARCH ENGINE MARKETING, MULTILINGUAL SEARCH ENGINE OPTIMIZATION, PAY PER CLICK MANAGEMENT, SEO CONSULTANCY, PARTNERSHIPS, BRAND NOISE, MARKETING FOR REBRANDS, SEARCH ENGINE POSITIONS, TRACKING AND WEB TRAFFIC ANALYSIS IN THE FIELD OF WEB SITE AND SEARCH ENGINE OPTIMIZATION; MAGAZINES FEATURING SEARCH ENGINE MARKETING, MULTILINGUAL SEARCH ENGINE OPTIMIZATION, PAY PER CLICK MANAGEMENT, SEO CONSULTANCY, PARTNERSHIPS, BRAND NOISE, MARKETING FOR REBRANDS, SEARCH ENGINE POSITIONS, TRACKING AND WEB TRAFFIC ANALYSIS IN THE FIELD OF WEB SITE AND SEARCH ENGINE OPTIMIZATION; PRINTED PERIODICALS IN THE FIELD OF SEARCH ENGINE MARKETING, MULTILINGUAL SEARCH ENGINE OPTIMIZATION, PAY PER CLICK MANAGEMENT, SEO CONSULTANCY, PARTNERSHIPS, BRAND NOISE, MARKETING FOR REBRANDS, SEARCH ENGINE POSITIONS, TRACKING AND WEB TRAFFIC ANALYSIS IN THE FIELD OF WEB SITE AND SEARCH ENGINE OPTIMIZATION; COMPUTER PRINT

OUTS, NAMELY, PRINTED REPORTS FEATURING SEARCH ENGINE MARKETING, MULTILINGUAL SEARCH ENGINE OPTIMIZATION, PAY PER CLICK MANAGEMENT, SEO CONSULTANCY, PARTNERSHIPS, BRAND NOISE, MARKETING FOR REBRANDS, SEARCH ENGINE POSITIONS, TRACKING AND WEB TRAFFIC ANALYSIS IN THE FIELD OF WEB SITE AND SEARCH ENGINE OPTIMIZATION; PRINTED VISUALS IN THE NATURE OF PROMOTIONAL MATERIAL; PRINTED VISUALS IN THE NATURE OF BROCHURES ABOUT SEARCH ENGINE OPTIMIZATION AND WEB ADVERTISING; STATIONERY AND PRINTED FORMS; PRINTED INSTRUCTIONAL AND TEACHING MATERIALS IN THE FIELD OF SEARCH ENGINE MARKETING, MULTILINGUAL SEARCH ENGINE OPTIMIZATION, PAY PER CLICK MANAGEMENT, SEO CONSULTANCY, PARTNERSHIPS, BRAND NOISE, MARKETING FOR REBRANDS, SEARCH ENGINE POSITIONS, TRACKING AND WEB TRAFFIC ANALYSIS IN THE FIELD OF WEB SITE AND SEARCH ENGINE OPTIMIZATION; GOODS MADE OF PAPER AND CARDBOARD, NAMELY, CARDBOARD CONTAINERS, CARDBOARD PACKAGING, ADVERTISING BOARDS MADE OF CARDBOARD OR PAPER; HANDBOOKS IN THE FIELD OF WEB SITE OPTIMIZATION AND SEARCH ENGINE OPTIMIZATION; PUBLICATIONS, NAMELY, BROCHURES, BOOKLETS, AND TEACHING MATERIALS IN THE FIELD OF WEB SITE OPTIMIZATION AND SEARCH ENGINE OPTIMIZATION; COMPUTER REFERENCE MANUALS FOR WEB SITE OPTIMIZATION AND SEARCH ENGINE OPTIMIZATION; COMPUTER USERS GUIDES FOR WEB SITE OPTIMIZATION AND SEARCH ENGINE OPTIMIZATION; COMPUTER INSTRUCTION MANUALS FOR WEB SITE OPTIMIZATION AND SEARCH ENGINE OPTIMIZATION; COMPUTER MANUALS FOR WEB SITE OPTIMIZATION AND SEARCH ENGINE OPTIMIZATION; PRINTED PUBLICATIONS IN THE NATURE OF BOOKS, PERIODICALS, MAGAZINES, BROCHURES AND MANUALS IN THE FIELD OF SEARCH ENGINE OPTIMIZATION, WEB ADVERTISING, WEB TRAFFIC ANALYSIS, TECHNOLOGY, DIGITAL TERMINOLOGY AND GADGETS, IN CLASS 16 (U.S. CLS. 2, 5, 22, 23, 29, 37, 38 AND 50).

FOR: BUSINESS INFORMATION MANAGEMENT, NAMELY, COMPILATION, MONITORING, STORAGE, MANAGEMENT, ANALYSIS, EVALUATION AND RETRIEVAL OF COMMERCIAL AND BUSINESS INFORMATION, DATA AND STATISTICS RELATING TO SEARCH ENGINE OPTIMIZATION; THE BRINGING TOGETHER FOR THE BENEFIT OF OTHERS OF A VARIETY OF GOODS AND SERVICES RELATING TO SEARCH ENGINE OPTIMIZATION, ENABLING CUSTOMERS TO CONVENIENTLY VIEW AND PURCHASE THOSE GOODS AND SERVICES FROM AN INTERNET WEBSITE, IN CLASS 35 (U.S. CLS. 100, 101 AND 102).

FOR: INTERNET SERVICES, NAMELY, THE HOSTING OF DIGITAL CONTENT ON THE INTERNET; INTERNET ADVICE SERVICES, NAMELY, TECHNOLOGY ADVICE PROVIDED TO INTERNET USERS BY MEANS OF A SUPPORT HOTLINE;

DATA LINKS SERVICES, NAMELY, COMPUTER DATA RECOVERY SERVICES, COMPUTER HARD DRIVE DATA BACKUP SERVICES, NETWORKING TECHNICAL SUPPORT SERVICES, NAMELY, MONITORING OF NETWORK SYSTEMS; INTERNET SECURITY AND SURVEILLANCE SERVICES, NAMELY, RESTRICTING ACCESS TO AND BY COMPUTER NETWORKS TO AND OF UNDESIRE WEB SITES, MEDIA AND INDIVIDUALS AND FACILITIES; COMPUTER RESEARCH, DEVELOPMENT, ADVISORY AND CONSULTANCY SERVICES; COMPILATION OF SCIENTIFIC INFORMATION IN THE FIELD OF SEARCH ENGINE OPTIMIZATION, WEB ADVERTISING AND WEB TRAFFIC ANALYSIS; TECHNICAL RESEARCH IN THE FIELD OF COMPUTING, NAMELY, DOCUMENTARY RESEARCH RELATING TO INFORMATION STORAGE AND DOCUMENTARY RESEARCH RELATING TO INFORMATION RETRIEVAL; COMPUTER SYSTEMS ANALYSIS; PROVIDING TECHNOLOGY INFORMATION IN THE FIELD OF SEARCH ENGINE OPTIMIZATION, WEB ADVERTISING AND WEB TRAFFIC ANALYSIS; COMPUTER HELPLINE SERVICES, NAMELY, TECHNOLOGY ADVICE PROVIDED TO INTERNET USERS BY MEANS OF A SUPPORT HOTLINE; COMPUTER HARDWARE AND SOFTWARE SUPPORT SERVICES, NAMELY, TECHNICAL SUPPORT SERVICES IN THE NATURE OF TROUBLE SHOOTING OF COMPUTER HARDWARE AND SOFTWARE PROBLEMS; PROVIDING INFORMATION IN THE FIELD OF COMPUTERS; DATABASE SERVICES, NAMELY, DATABASE DEVELOPMENT AND DESIGN SERVICES; EVALUATIONS, ASSESSMENTS AND RESEARCH IN THE FIELDS OF SCIENCE AND TECHNOLOGY PROVIDED BY ENGINEERS; DESIGN, DEVELOPMENT, INSTALLATION, UPDATING AND MAINTENANCE OF SOFTWARE; SCIENTIFIC AND TECHNOLOGY SERVICES AND RESEARCH AND DESIGN RELATING THERETO, NAMELY, SCIENTIFIC RESEARCH AND TECHNOLOGICAL RESEARCH IN THE FIELD OF COMPUTERS AND COMPUTER SOFTWARE; INDUSTRIAL ANALYSIS AND RESEARCH IN THE FIELD OF SEARCH ENGINE OPTIMIZATION, WEB ADVERTISING AND WEB TRAFFIC ANALYSIS; DESIGN AND DEVELOPMENT OF COMPUTER HARDWARE AND SOFTWARE; COMPUTER HARDWARE AND SOFTWARE CONSULTING SERVICES; RENTAL OF COMPUTER HARDWARE AND SOFTWARE; MULTIMEDIA AND AUDIO-VISUAL SOFTWARE CONSULTING SERVICES; COMPUTER PROGRAMMING; COMPUTER CONSULTATION, NAMELY, SUPPORT CONSULTATION SERVICES FOR DEVELOPING COMPUTER SYSTEMS, DATABASES AND APPLICATIONS; GRAPHIC DESIGN SERVICES FOR THE COMPILATION OF WEB PAGES ON THE INTERNET; PROVIDING INFORMATION IN THE FIELD

OF COMPUTER HARDWARE OR SOFTWARE VIA ONLINE GLOBAL COMPUTER NETWORKS OR THE INTERNET; CREATING AND MAINTAINING WEB SITES FOR OTHERS; PROVIDING A WEBSITE THAT FEATURES INFORMATION ON COMPUTER TECHNOLOGY AND PROGRAMMING USING MULTIMEDIA MATERIALS; WEB SITE HOSTING SERVICES FOR OTHERS; LICENSING OF INTELLECTUAL PROPERTY; COMPUTER SERVICES, NAMELY, PROVIDING SEARCH ENGINES FOR OBTAINING DATA VIA COMMUNICATIONS NETWORKS; PROVIDING DATABASES IN THE FIELD OF SEARCH ENGINE OPTIMIZATION, WEB ADVERTISING AND WEB TRAFFIC ANALYSIS VIA COMMUNICATIONS NETWORKS FOR OBTAINING DATA; APPLICATION SERVICE PROVIDER (ASP) SERVICES FEATURING SOFTWARE FOR USE IN CONNECTION WITH ONLINE DATABASE SERVICES, NAMELY, FOR USE IN DATABASE MANAGEMENT; INTERNET SERVICES, CREATING INDEXES OF INFORMATION RECEIVED FROM USERS OF GLOBAL COMPUTER NETWORKS FOR OTHERS; PROVIDING USERS OF ELECTRONIC COMMUNICATIONS NETWORKS WITH MEANS OF IDENTIFYING, LOCATING, GROUPING, DISTRIBUTING AND MANAGING DATA, NAMELY, BY PROVIDING COMPUTER SEARCH ENGINES FOR OBTAINING DATA ON A GLOBAL COMPUTER NETWORK; ORGANIZING CONTENT OF INFORMATION PROVIDED OVER A GLOBAL COMPUTER NETWORK AND STORING AND DISSEMINATING SUCH INFORMATION, NAMELY ACTING AS AN APPLICATION SERVICE PROVIDER IN THE FIELD OF KNOWLEDGE MANAGEMENT TO HOST COMPUTER APPLICATION SOFTWARE FOR THE ORGANIZING, STORING AND DISSEMINATING OF INFORMATION; PROVIDING COMPUTER DATABASES IN THE FIELD OF COMPUTERS; INFORMATION, ADVISORY AND CONSULTANCY SERVICES RELATING TO ALL THE AFORESAID, IN CLASS 42 (U.S. CLS. 100 AND 101).

THE MARK CONSISTS OF STANDARD CHARACTERS WITHOUT CLAIM TO ANY PARTICULAR FONT, STYLE, SIZE, OR COLOR.

PRIORITY DATE OF 5-8-2006 IS CLAIMED.

OWNER OF INTERNATIONAL REGISTRATION 0919689 DATED 10-14-2006, EXPIRES 10-14-2016.

SER. NO. 79-036,759, FILED 10-14-2006.

KATHERINE E. HALMEN, EXAMINING ATTORNEY

Int. Cls.: 6, 9 and 19

**Prior U.S. Cls.: 1, 2, 12, 13, 14, 21, 23, 25, 26, 33, 36, 38
and 50**

Reg. No. 3,520,754

United States Patent and Trademark Office

Registered Oct. 21, 2008

**TRADEMARK
PRINCIPAL REGISTER**

MEGAFIX

IBC SOLAR AG (FED REP GERMANY AG)
AM HOCHGERICHT 10
96231 BAD STAFFELSTEIN, FED REP GERMANY

FOR: METAL BUILDING MATERIALS, NAME-
LY, METAL SHEETS, METAL MOUNTINGS, ME-
TAL MOUNTING SHEETS, CROSSBEAMS,
RETAINING TUBES, FRONT PLATES, PROFILES,
CARRIER RAILS; IRONMONGERY IN THE NA-
TURE OF SMALL ITEMS OF METAL HARDWARE,
NAMELY, RIVETS, METAL BOLTS, RETAINING
ANGLES, MOUNTING CORNERS, ROOF HOOKS;
PIPES AND TUBES OF METAL; GOODS OF COM-
MON METAL NOT INCLUDED IN OTHER CLAS-
SES, NAMELY, ANCHORS, GUTTERS,
INTERCONNECTION PIECES FOR ROOFS; BUILD-
INGS OF METAL, NAMELY, STRUCTURES FOR
PHOTOVOLTAIC SOLAR OR SOLAR HEATING
MODULES; COTTER PINS; CLIPS OF METAL,
NAMELY, METAL CLAMPS; FRAMEWORK OF
METAL FOR BUILDING; CLADDING OF METAL
FOR BUILDING, IN CLASS 6 (U.S. CLS. 2, 12, 13, 14,
23, 25 AND 50).

FOR: APPARATUS AND INSTRUMENTS FOR
CONDUCTING, SWITCHING, TRANSFORMING,
ACCUMULATING, REGULATING OR CONTROL-
LING ELECTRICITY, NAMELY, INVERTERS,
MONITORING AND MEASURING EQUIPMENT
FOR SOLAR POWER AND HEATING SYSTEMS IN
THE NATURE OF POWER INVERTERS AND ELEC-
TRIC LUMINESCENT DISPLAY PANELS FEATUR-
ING YIELD, POWER, AND AVOIDED EMISSIONS
INFORMATION, CHARGE REGULATORS, ELEC-
TRONIC CONTROLS FOR ELECTRICITY SYS-
TEMS, SOLAR CHARGE REGULATORS,
CONVERTERS, TRANSFORMERS, ELECTRIC AC-
TUATORS; ELECTRIC WIRES; ELECTRIC CABLES;
SOLAR MODULES, NAMELY, PHOTOVOLTAIC

SOLAR MODULES FOR CONVERTING ELECTRO-
NIC RADIATION TO ELECTRICAL ENERGY, IN
CLASS 9 (U.S. CLS. 21, 23, 26, 36 AND 38).

FOR: NON-METAL BUILDING MATERIALS,
NAMELY, NON-METAL SHEETS, NON-METAL
MOUNTINGS, NONMETAL MOUNTING SHEETS,
NON-METAL FRONT PLATES, NON-METAL PRO-
FILES AND CARRIER RAILS, NON-METAL GUT-
TERS; NON-METAL RIGID PIPES FOR BUILDINGS,
BUILDINGS NOT OF METAL, NAMELY, STRUC-
TURES FOR PHOTOVOLTAIC SOLAR OR SOLAR
HEATING MODULES; FRAMEWORK NOT OF ME-
TAL, FOR BUILDING; BRACKETS,SUPPORTS AND
PROPS NOT OF METAL FOR BUILDING, NAMELY,
NON-METAL RIVETS, NON-METAL CLAMPS,
NON-METAL BOLTS, NON-METAL INTERCON-
NECTION PIECES FOR ROOFS, NON-METAL AN-
CHORS, ASPHALT IMPREGNATED FOAM
SEALANT STRIPS USED FOR EXPANSION JOINTS;
SURFACING NOT OF METAL FOR BUILDING,
NAMELY, NON-METAL ROOFING, SOLAR MOD-
ULES FOR USE AS BUILDING MATERIALS OF
POLY AND MONOCRYSTALLINE AND SILICON
USED AS NON-METAL ROOF COVERINGS INCOR-
PORATING SOLAR CELLS, IN CLASS 19 (U.S. CLS.
1, 12, 33 AND 50).

PRIORITY DATE OF 8-1-2006 IS CLAIMED.

OWNER OF INTERNATIONAL REGISTRATION
0920418 DATED 1-31-2007, EXPIRES 1-31-2017.

SER. NO. 79-037,065, FILED 1-31-2007.

DAYNA BROWNE, EXAMINING ATTORNEY

Int. Cls.: 41 and 43

Prior U.S. Cls.: 100, 101 and 107

United States Patent and Trademark Office

Reg. No. 3,520,755

Registered Oct. 21, 2008

**SERVICE MARK
PRINCIPAL REGISTER**

**POMP DUCK
AND CIRCUMSTANCE**

Hell's Kitchen

WALTER FEUCHT (FED REP GERMANY INDIVIDUAL)
MAIENWEG 96
89081 ULM, FED REP GERMANY

FOR: EDUCATION SERVICES, NAMELY, PROVIDING CLASSES, SEMINARS, WORKSHOPS IN THE FIELD OF PROVIDING FOOD AND DRINK AND TEMPORARY ACCOMMODATION; PROVIDING OF TRAINING IN THE FIELD OF PROVIDING FOOD AND DRINK AND TEMPORARY ACCOMMODATION; ENTERTAINMENT IN THE NATURE OF LIVE MUSIC SHOWS; ENTERTAINMENT IN THE NATURE OF LIVE MUSICAL GROUP PERFORMANCES, ETHNIC FESTIVALS; ENTERTAINMENT IN THE NATURE OF LIVE MUSICAL PERFORMANCES; ENTERTAINMENT IN THE NATURE OF THEATRE PRODUCTIONS; ORGANIZING COMMUNITY SPORTING AND CULTUR-

AL EVENTS, IN CLASS 41 (U.S. CLS. 100, 101 AND 107).

FOR: SERVICES FOR PROVIDING FOOD AND DRINK; PROVIDING TEMPORARY ACCOMMODATION, IN CLASS 43 (U.S. CLS. 100 AND 101).

OWNER OF INTERNATIONAL REGISTRATION 0921771 DATED 10-20-2006, EXPIRES 10-20-2016.

NO CLAIM IS MADE TO THE EXCLUSIVE RIGHT TO USE "HELL'S KITCHEN", APART FROM THE MARK AS SHOWN.

SER. NO. 79-037,608, FILED 10-20-2006.

RONALD DELGIZZI, EXAMINING ATTORNEY

Int. Cls.: 7, 9, 35, 37 and 42

Prior U.S. Cls.: 13, 19, 21, 23, 26, 31, 34, 35, 36, 38,
100, 101, 102, 103 and 106

Reg. No. 3,520,756

United States Patent and Trademark Office

Registered Oct. 21, 2008

**TRADEMARK
SERVICE MARK
PRINCIPAL REGISTER**



YOUR SUCCESS - BASED ON MENCK

MENCK GMBH (FED REP GERMANY LIMITED
LIABILITY COMPANY)
INDUSTRIEGEBIET MOORKATEN
AM SPRINGMOOR; 24568 KALTENKIRCHEN
FED REP GERMANY

FOR: WINCHES AND REPLACEMENT PARTS THEREFOR; DRIVES FOR MACHINES AND MOTORS, NAMELY, DIESEL ENGINES, ELECTRIC MOTORS, AND VARIABLE FREQUENCY DRIVES FOR LARGE POWER MACHINES AND MACHINE MOTOR APPLICATIONS IN THE OIL AND GAS, METAL, MARINE, WIND TURBINE AND OTHER INDUSTRIES, AND REPLACEMENT PARTS THEREFOR; MECHANICAL PILE-DRIVING EQUIPMENT, NAMELY, OFFSHORE AND ON-SHORE HYDRAULIC HAMMERS, HYDRAULIC UNDERWATER HAMMERS, STEAM POWERED HAMMERS, AIR POWERED HAMMERS, DOUBLE-ACTING PNEUMATIC HAMMERS, PILE DRIVERS, PNEUMATIC PILE HAMMERS, AND WINCHES; CRANES, MECHANICAL ROCK-BREAKING MACHINES, NAMELY, ROCK-CRUSHERS, AND REPLACEMENT PARTS THEREFOR; HYDRAULIC EXCAVATORS AND REPLACEMENT PARTS THEREFOR; EARTH MOVING MACHINES, NAMELY, EXCAVATORS AND REPLACEMENT PARTS THEREFOR; MACHINERY FOR SOIL AND HYDRAULIC ENGINEERING, NAMELY, SCRAPERS, CABLE CRANE SCRAPERS, TRACKED SCRAPERS, CRAWLER-TRACKED LOADERS; STEAM ENGINES AND REPLACEMENT PARTS THEREFOR; HYDRAULIC PUMPS, COMPRESSED AIR PUMPS, BILGE PUMPS, CENTRIFUGAL PUMPS, ELECTRIC PUMPS, MACERATOR PUMPS,

PNEUMATIC PUMPS, POSITIVE DISPLACEMENT PUMPS, SILT PUMPS, SLUDGE PUMPS, SUBMERSIBLE PUMPS, SUCTION PUMPS, SUMP PUMPS, VERTICAL TURBINE PUMPS, AND REPLACEMENT PARTS FOR THE AFORESAID GOODS; COMPRESSORS FOR MACHINES AND REPLACEMENT PARTS THEREFOR; NON-METAL STEAM DUCTS AND STEAM PIPES SOLD AS INTEGRAL COMPONENTS OF FINISHED STEAM POWERED PILE DRIVERS; STEAM POWERED PILE DRIVERS AND REPLACEMENT PARTS THEREFOR; MACHINE-DRIVEN POWER SUPPLIES FOR HYDRAULIC OR PNEUMATIC MACHINES, NAMELY, DIESEL ENGINES, ELECTRIC MOTORS, AND VARIABLE FREQUENCY DRIVES FOR LARGE POWER MACHINES AND MACHINE MOTOR APPLICATIONS IN THE OIL AND GAS, METAL, MARINE, WIND TURBINE AND OTHER INDUSTRIES, IN CLASS 7 (U.S. CLS. 13, 19, 21, 23, 31, 34 AND 35).

FOR: ELECTRO-MECHANICAL CONTROLS FOR MOTORS; ELECTRICAL CONTROL DEVICES FOR HEATING AND ENERGY MANAGEMENT; MECHANICAL, ELECTRICAL, HYDRAULIC AND PNEUMATIC CONTROL APPARATUS, NAMELY, MONITORS AND DOCUMENTATION SYSTEMS COMPRISED OF ELECTRIC OR ELECTRONIC SENSORS FOR DIFFERENTIAL PRESSURE, OIL PRESSURE, TEMPERATURE, VOLTAGE, AMPERAGE, OIL LEVEL AND OUTPUT DEVICES IN THE NATURE OF ELECTRIC LUMINESCENT DISPLAY PANELS AND PRINTERS; ELECTROMECHANICAL CONTROLS FOR USE IN CONTROLLING AND MONITORING HYDRAULIC EXCAVATORS,

PNEUMATIC CONVEYORS, HYDRAULIC HAMMERS, DEEP WATER HYDRAULIC AND PNEUMATIC PILE DRIVING EQUIPMENT, AND REPLACEMENT PARTS THEREFOR, IN CLASS 9 (U.S. CLS. 21, 23, 26, 36 AND 38).

FOR: PRODUCT MERCHANDISING; BUSINESS MANAGEMENT CONSULTATION TO INDUSTRIAL COMPANIES IN THE FIELDS OF STRUCTURAL FOUNDATION WORK AND SOIL AND HYDRAULIC ENGINEERING, IN CLASS 35 (U.S. CLS. 100, 101 AND 102).

FOR: INSTALLATION, MAINTENANCE AND REPAIR OF MECHANICAL PILE-DRIVING EQUIPMENT, IMPACT TRANSFER DEVICES FOR MECHANICAL PILE-DRIVING EQUIPMENT, NON-FLOATING CRANES, MECHANICAL ROCK-BREAKING DEVICES, EXCAVATORS, MACHINERY FOR SOIL AND HYDRAULIC ENGINEERING, STEAM ENGINES, HYDRAULIC PUMPS, COMPRESSED AIR PUMPS, BILGE PUMPS, CENTRIFUGAL PUMPS, ELECTRIC PUMPS, MACERATOR PUMPS, PNEUMATIC PUMPS, POSITIVE DISPLACEMENT PUMPS, SILT PUMPS, SLUDGE PUMPS,

SUBMERSIBLE PUMPS, SUCTION PUMPS, SUMP PUMPS, VERTICAL TURBINE PUMPS, COMPRESSORS AS MACHINES, VALVES AS MECHANICAL, ELECTRICAL, HYDRAULIC OR PNEUMATIC CONTROL APPARATUS, AND ELECTRO MECHANICAL APPARATUS; RENTAL OF CONSTRUCTION EQUIPMENT FOR STRUCTURAL FOUNDATION WORK AND SOIL AND HYDRAULIC-ENGINEERING, IN CLASS 37 (U.S. CLS. 100, 103 AND 106).

FOR: TECHNICAL CONSULTATION IN THE FIELDS OF STRUCTURAL FOUNDATION ENGINEERING AND SOIL AND HYDRAULIC ENGINEERING, IN CLASS 42 (U.S. CLS. 100 AND 101).

OWNER OF INTERNATIONAL REGISTRATION 0817804 DATED 9-12-2003, EXPIRES 9-12-2013.

OWNER OF U.S. REG. NO. 2,677,205.

SER. NO. 79-037,968, FILED 8-21-2006.

NELSON SNYDER, EXAMINING ATTORNEY

Int. Cl.: 25

Prior U.S. Cls.: 22 and 39

United States Patent and Trademark Office

Reg. No. 3,520,757

Registered Oct. 21, 2008

**TRADEMARK
PRINCIPAL REGISTER**

Saona®

LES GANTS ELEGANTS (FRANCE SOCIETE
ANONYME)
47 RUE MARCEL DASSAULT
F-92100 BOULOGNE BILLANCOURT, FRANCE

THE WORDING "SAONA" HAS NO MEANING IN
A FOREIGN LANGUAGE.

FOR: CLOTHING, NAMELY, SKIRTS, DRESSES,
COATS, SHIRTS, PANTS, BUSTIERS, AND JACK-
ETS, IN CLASS 25 (U.S. CLS. 22 AND 39).

SER. NO. 79-038,632, FILED 3-8-2007.

OWNER OF INTERNATIONAL REGISTRATION
0924613 DATED 3-8-2007, EXPIRES 3-8-2017.

DEZMONA MIZELLE, EXAMINING ATTORNEY

Int. Cl.: 7

Prior U.S. Cls.: 13, 19, 21, 23, 31, 34 and 35

United States Patent and Trademark Office

Reg. No. 3,520,758

Registered Oct. 21, 2008

**TRADEMARK
PRINCIPAL REGISTER**

k1 Tune

CANON KABUSHIKI KAISHA (JAPAN CORPORATION LIMITED)
30-2, SHIMOMARUKO 3-CHOME
OHTA-KU, TOKYO 146-8501
JAPAN

FOR: SEMICONDUCTOR MANUFACTURING MACHINES, IN CLASS 7 (U.S. CLS. 13, 19, 21, 23, 31, 34 AND 35).

PRIORITY DATE OF 2-8-2007 IS CLAIMED.

OWNER OF INTERNATIONAL REGISTRATION
0924747 DATED 5-10-2007, EXPIRES 5-10-2017.

NO CLAIM IS MADE TO THE EXCLUSIVE RIGHT TO USE "K1", APART FROM THE MARK AS SHOWN.

SER. NO. 79-038,689, FILED 5-10-2007.

GILBERT SWIFT, EXAMINING ATTORNEY

Int. Cls.: 6, 8, 11, 17, 37 and 42

Prior U.S. Cls.: 1, 2, 5, 12, 13, 14, 21, 23, 25, 28, 31, 34, 35, 44, 50, 100, 101, 103 and 106

Reg. No. 3,520,759

United States Patent and Trademark Office

Registered Oct. 21, 2008

**TRADEMARK
SERVICE MARK
PRINCIPAL REGISTER**

TELE-HYDRANT

HAWLE ARMATUREN GMBH (FED REP GER-
MANY LIMITED LIABILITY COMPANY)
LIEGNITZER STRABE 6
83395 FREILASSING, FED REP GERMANY

FOR: GAS AND LIQUID PIPING AND PIPELINE COMPONENTS MADE PREDOMINANTLY OF METAL, NAMELY, SLEEVES, SHUTTERS, SLEEVE SHUTTERS, STRAPS, SHACKLES, CAPS, FLANGES, PIPES, PIPE FITTINGS, PIPE CLIPS, PIPE COLLARS, PIPE CONNECTORS, PIPE COUPLINGS AND JOINTS, JUNCTIONS FOR PIPES, PIPE MUFFS, MANUALLY OPERATED VALVES, SEALING RINGS, GASKET RINGS, BALL LOCK PINS, CAPS FOR PIPES AND PIPE ENDS, CLOSURES FOR PIPES AND PIPE ENDS, LIDS, PLUGS, SEALS, MANHOLE COVERS, PIPE SAFETY FITTINGS THAT MINIMIZE TRACTION, DIRT, AND ROTATION, HAND WHEELS, NON-ELECTRIC POSITION INDICATORS BEING PARTS OF PIPE VALVES, DUMMY COVERS, INSERTION PIPES, NIPPLES, GASKET RINGS; METAL SHAFT COVERS, METAL HEIGHT-ADJUSTABLE AND METAL LEVELLABLE SHAFT COVERS AND THEIR METAL BASE COMPONENTS AND FRAMES, METAL BRACKETS, AND METAL SADDLES FOR USE IN THE CONSTRUCTION, ASSEMBLY AND INSTALLATION OF PIPING, IN CLASS 6 (U.S. CLS. 2, 12, 13, 14, 23, 25 AND 50).

FOR: HAND-OPERATED TOOLS FOR ASSEMBLING AND DISASSEMBLING, MAINTAINING AND REPAIRING PIPES AND PIPE BRACKETS, NAMELY, HAND HELD CUTTING TOOLS, PINCHERS, WRENCHES, PLIERS, PIPE BEVELING DEVICES IN THE NATURE OF PIPE CUTTERS, TAPS, HEX KEY WRENCHES, EXTENSIONS FOR HAND TOOLS, IN CLASS 8 (U.S. CLS. 23, 28 AND 44).

FOR: HYDRANTS, PLUMBING FITTINGS, NAMELY, VENTILATING AND EVACUATING VALVES AND CONTROL VALVES, IN CLASS 11 (U.S. CLS. 13, 21, 23, 31 AND 34).

FOR: PARTS, PREDOMINANTLY MADE OF METAL, FOR GAS AND LIQUID BRACES, NAMELY, GASKETS, IN CLASS 17 (U.S. CLS. 1, 5, 12, 13, 35 AND 50).

FOR: ASSEMBLING AND DISASSEMBLING PLUMBING FITTINGS AND METAL PIPE FITTINGS FOR GAS AND WATER PIPING AND PIPELINES, AND GAS AND LIQUID CONDUCTION SYSTEMS, IN CLASS 37 (U.S. CLS. 100, 103 AND 106).

FOR: TECHNICAL PLANNING OF GAS AND LIQUID PIPING AND PIPELINES; TECHNICAL PLANNING SERVICES IN THE NATURE OF INDUSTRIAL DESIGN OF PLUMBING FITTINGS AND METAL PIPE FITTINGS; TECHNICAL PLANNING OF GAS AND LIQUID CONDUCTION SYSTEMS, IN CLASS 42 (U.S. CLS. 100 AND 101).

THE MARK CONSISTS OF STANDARD CHARACTERS WITHOUT CLAIM TO ANY PARTICULAR FONT, STYLE, SIZE, OR COLOR.

PRIORITY DATE OF 8-16-2006 IS CLAIMED.

OWNER OF INTERNATIONAL REGISTRATION
0924773 DATED 12-11-2006, EXPIRES 12-11-2016.

SER. NO. 79-038,700, FILED 12-11-2006.

DEBRA LEE, EXAMINING ATTORNEY

Int. Cl.: 9

Prior U.S. Cls.: 21, 23, 26, 36 and 38

United States Patent and Trademark Office

Reg. No. 3,520,760

Registered Oct. 21, 2008

**TRADEMARK
PRINCIPAL REGISTER**

k1 Tune

CANON KABUSHIKI KAISHA (JAPAN CORPORATION LIMITED)
30-2, SHIMOMARUKO 3-CHOME
OHTA-KU, TOKYO 146-8501
JAPAN

OWNER OF INTERNATIONAL REGISTRATION
0924916 DATED 5-10-2007, EXPIRES 5-10-2017.

FOR: COMPUTER APPLICATION SOFTWARE FOR OPTIMIZING EXPOSURE CONDITIONS AND MASK CONDITIONS IN THE OPERATION OF SEMICONDUCTOR MANUFACTURING MACHINES (STEPPERS) BY USING PRACTICAL DATA OF SUCH MACHINES, IN CLASS 9 (U.S. CLS. 21, 23, 26, 36 AND 38).

NO CLAIM IS MADE TO THE EXCLUSIVE RIGHT TO USE "K1", APART FROM THE MARK AS SHOWN.

SER. NO. 79-038,760, FILED 5-10-2007.

PRIORITY DATE OF 2-8-2007 IS CLAIMED.

GILBERT SWIFT, EXAMINING ATTORNEY

Int. Cl.: 4

Prior U.S. Cls.: 1, 6 and 15

United States Patent and Trademark Office

Reg. No. 3,520,761

Registered Oct. 21, 2008

TRADEMARK
PRINCIPAL REGISTER

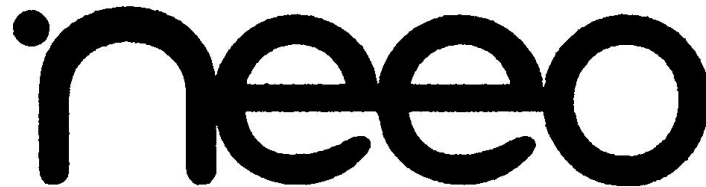

ZHEJIANG NEEO; HOME DECORATION
CO.,LTD (CHINA CORPORATION)
SONGXINGTANG CHENGJIANG
HUANGYAN TAIZHOU
ZHEJIANG, CHINA

OWNER OF INTERNATIONAL REGISTRATION
0925064 DATED 5-21-2007, EXPIRES 5-21-2017.

FOR: CERESINE, NAMELY, OZOCERITE FOR
USE IN THE MAKING OF CANDLES; FRAGRANT
CANDLE; PARAFFIN; ILLUMINATING WAX FOR
USE AS CANDLES; CANDLES; CHRISTMAS TREE
CANDLES; TAPERS; CARNAUBA WAX; WICKS
FOR CANDLES; BEESWAX FOR USE IN THE
MANUFACTURE OF CANDLES, IN CLASS 4 (U.S.
CLS. 1, 6 AND 15).

THE WORDING "NEEO" HAS NO MEANING IN
A FOREIGN LANGUAGE.

SER. NO. 79-038,827, FILED 5-21-2007.

MARCIE MILONE, EXAMINING ATTORNEY

Int. Cls.: 16, 18, 21, 25 and 28

Prior U.S. Cls.: 1, 2, 3, 5, 13, 22, 23, 29, 30, 33, 37, 38, 39, 40, 41 and 50

Reg. No. 3,520,762

United States Patent and Trademark Office

Registered Oct. 21, 2008

TRADEMARK
PRINCIPAL REGISTER



WACHIFIELD LICENSING, INC. (JAPAN CORPORATION)
4-26-5, INOGASHIRA
MITAKA-SHI; TOKYO 181-0001
JAPAN

FOR: FOOD WRAPPING PLASTIC FILM FOR HOUSEHOLD USE; GARBAGE BAGS OF PAPER FOR HOUSE BOLD USE; GARBAGE BAGS OF PLASTICS FOR HOUSE BOLD USE; EMBROIDERY DESIGN PATTERNS PRINTED ON PAPER; TAILORS' CHALK; BANNERS OF PAPER; FLAGS OF PAPER; HYGIENIC PAPER; TOWELS OF PAPER; TABLE NAPKINS OF PAPER; HAND TOWELS OF PAPER; HANDKERCHIEFS OF PAPER; BAGGAGE TAGS; TABLE CLOTHS OF PAPER; PAPER AND CARDBOARD, NAMELY, PRINTING PAPER, INDIA PAPER, CARBON PAPER, GLASSINE PAPER, NEWSPRINT PAPER, BLOTTER, TYPEWRITING PAPER, TOILET PAPER, WRITING PAPER, WRAPPING PAPER, RICE PAPER, PARCHMENT PAPER, FILTER PAPER, IVORY MANILA BOARD, COLORBOARD COLORED PAPERBOARD, STRAWBOARD, WHITE PAPERBOARD, FLUTING PAPER, CORRUGATING MEDIUM, LINERBOARD FOR CORRUGATED CARDBOARD, CHIPBOARD, MILLBOARD, POSTCARD PAPER, JAPANESE PAPER, MULCH PAPER, OILED PAPER FOR PAPER UMBRELLAS (KASA-GAMI), GUNPOWDER WRAPPING PAPER, TISSUE PAPER FOR USE AS MATERIAL OF STENCIL PAPER (GANPISHI), JAPANESE HANDICRAFT PAPER, PAPER MADE FROM PAPER MULBERRY (KOHZO-GAMI), PAPER FOR USE AS MATERIAL OF STOCK CERTIFICATES (SHOKENSHI), PAPER FOR JAPANESE SLIDING SCREENS (SHOJI-GAMI), CALLIGRAPHY PAPER, CARDBOARD MADE FROM PAPER MUL-

BERRY (SENKASI), COARSE TISSUE (FOR TOILETRY USE), PAPER MADE FROM PAPER MULBERRY (TENGUJOSI), STENCIL PAPER MIMEOGRAPH PAPER, JAPANESE PAPER (TORINOKO-GAMI), NAPKIN PAPER, DUPLICATING PAPER, THICK JAPANESE PAPER (HOSHO-GAMI), CONVERTED PAPER PROCESSED PAPER, PAPER LACE, IMITATION LEATHER PAPER, PERFORATED CARDS FOR JACQUARD LOOMS, ACID-RESISTANT PAPER, CORRUGATED CARDBOARD, PARAFFIN COATED PAPER WAXED PAPER, PAPER FOR JAPANESE INDOOR SLIDING PARTITIONS (FUSUMA-GAMI), FIRE PROOF PAPER, MILDEW PROOF PAPER, WATER PROOF PAPER, OIL PROOF PAPER, LUMINOUS PAPER, CELLOPHANE PAPER, ORDINARY CELLOPHANE PAPER, MOISTUREPROOF CELLOPHANE PAPER AND SYNTHETIC PAPER; MISCELLANEOUS PRINTED MATTER, NAMELY, PICTURE POSTCARDS, SHEET MUSIC, SONG BOOKS, CATALOGUES IN THE FIELD OF TOYS, CATALOGUES IN THE FIELD OF BAGS, CALENDARS, POSTERS, PRINTED TIMETABLES, PICTURE BOOKS, STORY BOOKS, NEWSPAPERS, GEOGRAPHICAL MAPS, DIARIES, NEWSLETTERS IN THE FIELD OF TOYS, NEWSLETTERS IN THE FIELD OF BAGS; MAGAZINES IN THE FIELD OF TOYS, MAGAZINES IN THE FIELD OF BAGS AND PAMPHLETS IN THE FIELD OF TOYS, PAMPHLETS IN THE FIELD OF BAGS; STATIONERY AND STUDY MATERIALS, NAMELY, PAPER STATIONERY, EVENT ALBUMS, NOTE CARDS, CARDS FOR PLAYING CARDS; CARDS FOR JAPANESE PLAYING CARDS (HANAFUDA AND UTAGARUTA); SCRAPBOOKS, SKETCH BOOKS, SCORE CARDS, SCORE BOOKS, ACCOUNT BOOKS, POCKET MEMORANDUM

BOOKS, ACCOUNT SLIP PADS, NOTE BOOKS, WRITING PADS, ENVELOPES, PLOTTING PAPER, GRAPH PAPER AS FINISHED PRODUCT, SEMI-FINISHED BUSINESS CARD PAPER, FINISHED LETTER PAPER PRODUCTS, NAMELY, LETTER PAPER, LOOSE-LEAF PADS, WRITING IMPLEMENTS WRITING INSTRUMENTS, PENCILS, PENCIL POINT PROTECTORS, FELT WRITING PENS, MECHANICAL PENCILS, SLATE PENCILS, STEEL PENS, STYLUSES, STENCIL PENS, CHALK, FELT MARKING PENS, PEN NIBS, PENHOLDERS, BALL-POINT PENS, FOUNTAIN PENS, WRITING BRUSHES, PAINTERS' EASELS, DRAWING BOARDS, PAINTERS' ARTICLES, NAMELY, PAINT BOXES, CANVAS FOR PAINTING, CRAYONS, PAINTBRUSHES, PASTELS, PALETTES FOR PAINTERS, CHARCOAL PENCILS, WRITING INK, INK ERASERS, INKWELLS, RUBBER STAMPS, SEALING STAMPS, STAMP CASES, STAMP STANDS, SEAL INK PADS, PENCIL SHARPENERS, THUMB TACKS, PAPER CLIPS, RUBBER ERASERS, BLACKBOARDS, BLACKBOARD ERASERS, CHALK ERASERS, PAPER TAGS, SEALS FOR STATIONERY, BOOKMARKERS, UNDERLAYS FOR WRITING PAPER, CORRECTING FLUID FOR TYPE, UNGRADUATED RULERS, LETTER RACKS, PAPER FOLDERS, INK STONES, INK RESERVOIRS, INKING PADS, STICKERS FOR STATIONERY, INK STICKS (SUMI), WRITING SLATES, ADHESIVE TAPES FOR STATIONERY OR HOUSEHOLD PURPOSES, ADHESIVE TAPE DISPENSERS, STRIPS OF FANCY PAPER (TANZAKU), TERRESTRIAL GLOBES, PRICE TAGS, NUMBERING STAMPS, DATE STAMPS, STANDS FOR PEN AND PENCIL, PEN AND PENCIL CASES AND BOXES, PAPERWEIGHTS, PAPER KNIVES, LETTER OPENERS, INDIAN INK, STAPLING PRESSES NON-ELECTRIC STAPLERS, JAPANESE CEREMONIAL PAPER STRINGS (MIZUHIKI), FINGER-STALLS AND NON-TEXTILE PAPER LABELS; PHOTOGRAPHS; PHOTOGRAPH STANDS; BABIES' DIAPERS OF PAPER; INDUSTRIAL PACKAGING CONTAINERS OF PAPER, NAMELY, PAPERBOARD BOXES FOR INDUSTRIAL PACKAGING, PAPER BAGS AND SACKS, CORRUGATED CARDBOARD BOXES AND FIBERBOARD BOXES; COLORING BOOKS, IN CLASS 16 (U.S. CLS. 2, 5, 22, 23, 29, 37, 38 AND 50).

FOR: CLOTHING FOR DOMESTIC PETS, NAMELY, DOG SHOES, DOG COLLARS, CLOTHING FOR DOGS, DOG BELLY BANDS, CAT SHOES, CAT COLLARS, CLOTHING FOR CATS AND CAT BELLY BANDS; BAGS AND THE LIKE, NAMELY, FOLDING BRIEFCASES, SHOULDER BAGS, GLADSTONE BAGS, JAPANESE WICKER TRUNKS (KORI), BRIEFCASES, SUITCASES, CARRY-ON BAGS, TRUNKS, HANDBAGS, BOSTON BAGS, SCHOOLCHILDREN'S BACKPACKS AND BACKPACKS, RUCKSACKS; POUCHES AND THE LIKE, NAMELY, CHARM BAGS (OMAMORI-IRE), NOTE CARD CASES, SHOPPING BAGS WITH WHEELS ATTACHED, PURSES, KEY CASES, WALLETS, JAPANESE UTILITY POUCHES (SHINGEN-BUKURO), WALLETS FOR COMMUTATION TICKETS AND BUSINESS CARDS; VANITY CASES SOLD EMPTY; UMBRELLAS AND THEIR PARTS, NAMELY, TELESCOPIC UMBRELLAS, JAPANESE PAPER

UMBRELLAS (KARAKASA), JAPANESE OILED PAPER UMBRELLAS (JANOME-GASA), RAINPROOF PARASOLS, BEACH UMBRELLAS BEACH PARASOLS, PARASOLS, SUN UMBRELLAS, UMBRELLAS, UMBRELLA COVERS, UMBRELLA HANDLES, METAL PARTS OF UMBRELLAS, FRAMES FOR UMBRELLAS AND BAGS FOR UMBRELLAS; WALKING STICKS; CANES; METAL PARTS OF CANES AND WALKING-STICKS; HANDLES OF CANES AND WALKING-STICKS, IN CLASS 18 (U.S. CLS. 1, 2, 3, 22 AND 41).

FOR: COOKING POTS AND PANS, NAMELY, NON-ELECTRIC RICE COOKING POTS, GRIDDLERS, COOKING PANS, MESS-TINS, RICE COOKING CANTEENS, FRYING PANS AND COOKING STEAMERS; NON-ELECTRIC COFFEE-POTS; JAPANESE CAST IRON KETTLES (TETSUBIN); NON-ELECTRIC KETTLES; TABLEWARE, NAMELY, SOUP BOWLS, CUPS AND MUGS, JAPANESE STYLE TEA-SERVING POTS (KYUSU), DRINKING CUPS, SAKE CUPS, DISHES AND PLATES, SALAD BOWLS, JAPANESE NESTS OF FOOD BOXES (JUBAKO), JAPANESE RICE BOWLS NOT OF PRECIOUS METAL (CHAWAN), DISH COVERS, DECANTERS, SAKE SERVING BOTTLES (TOKKURI), SERVING BOWLS (HACHI), BEER MUGS, LUNCH-BOXES, JUGS (NOT OF PRECIOUS METAL), TEACUPS (YUNOMI), JAPANESE STYLE SOUP SERVING BOWLS (WAN), CONTAINERS FOR HOUSEHOLD USE, NAMELY, CANS FOR CONFECTIONERY, KITCHEN KEGS AND BARRELS, TEA CANISTERS, KITCHEN URNS AND BREAD CASES FOR KITCHEN USE; PORTABLE, NON-ELECTRIC COLDBOXES; RICE CHESTS; FOOD PRESERVING JARS OF GLASS; TRAVEL DRINKING FLASKS; VACUUM BOTTLES, INSULATED FLASKS; CONTAINERS OF GLASS, PLASTIC, CERAMIC FOR FOOD PRESERVING; PORTABLE COOKING KITS FOR OUTDOOR USE; ICE PAILS; NON-ELECTRIC WHISKS; COOKING STRAINERS; PEPPER POTS; SUGAR BOWLS; SALT SHAKERS; EGG CUPS; NAPKIN HOLDERS; NAPKIN RINGS; SERVING TRAYS; TOOTHPICK HOLDERS; COLANDERS; SALT SHAKERS; JAPANESE STYLE COOKED RICE SCOOPS (SHAMOJI); HAND-OPERATED COFFEE GRINDERS AND PEPPER MILLS; COOKING FUNNELS; JAPANESE STYLE WOODEN PESTLES (SURIKOGI); JAPANESE STYLE EARTHENWARE MORTARS (SURIBACHI); JAPANESE STYLE PERSONAL DINING TRAYS OR STANDS (ZEN); BOTTLE OPENERS; COOKING GRATERS; PAN-MATS; CHOPSTICKS; CHOPSTICK CASES; LADLES; COOKING SIEVES AND SIFTERS; CHOPPING BOARDS FOR KITCHEN USE; ROLLING PINS OR COOKING PURPOSES; GRILLS; COOKING UTENSILS; TOOTHPICKS; LEMON SQUEEZERS; CITRUS JUICERS; NON-ELECTRIC WAFFLE IRONS; SPICE RACKS; CLEANING TOOLS AND WASHING UTENSILS, NAMELY, WASHING BOARDS, CLOTHES PEGS, CLOTHES PINS, WASHING BRUSHES, WASH BASINS, DUSTING OR CLEANING CLOTHS, WASH-TUBS, SCRUBBING BRUSHES, WASTE BASKETS, DUSTPANS, BUCKETS, DUSTERS, DRYING BOARDS FOR WASHED, STARCHED AND THEN STRETCHED PIECES OF KIMONO (HARI-ITA), BROOMS,

MOPS, CLOTHES HANGING RODS USED AS WASHING LINES AND CLOTHES DRYING HANGERS, GLOVES FOR HOUSEHOLD PURPOSES, STIRRERS FOR HOT BATHTUB WATER (YUKAKIBO); BATHROOM PAILS; BATH TUBS FOR BABIES; CANDLE EXTINGUISHERS; CANDLESTICKS; CINDER SIFTERS FOR HOUSEHOLD PURPOSES; COAL SCUTTLES; MOUSE TRAPS; FLOWER POTS; WATERING CANS; FEEDING VESSELS FOR PETS; BRUSHES FOR PETS; BIRD CAGES; BIRD BATHS; GLASS BOWLS FOR LIVE GOLDFISH; CLOTHES BRUSHES; TOILET PAPER HOLDERS; NON-METAL PIGGY BANKS; BOXES OF METAL FOR DISPENSING PAPER TOWELS; BOOT JACKS; SOAP DISPENSERS; FLOWER VASES; FLOWER BOWLS; WIND CHIMES; SHOE BRUSHES; SHOE HORNS; SHOE SHINE CLOTHS; HANDY SHOE SHINERS; SHOE-TREES; SHOE STRETCHERS; COSMETIC AND TOILET UTENSILS, NAMELY, PERSONAL WASHING CLOTHS, FACE-POWDER CASES SOLD EMPTY, COMBS, COMB CASES, COSMETIC CREAM CASES SOLD EMPTY, TOILET SPONGES, TOILET BRUSHES, FITTED VANITY CASES, PERFUME SPRAYERS SOLD EMPTY, POWDER COMPACTS, SOAP HOLDERS AND BOXES, NAIL BRUSHES, POWDER PUFFS, NON-ELECTRIC TOOTHBRUSHES NON-ELECTRIC, TOOTHBRUSH CASES, SHAVING BRUSHES, SHAVING BRUSH STANDS, HAIR BRUSHES, LIP BRUSHES AND EYEBROW BRUSHES; IRONING BOARDS; AND IRONING BOARDS (KOTEDAI), IN CLASS 21 (U.S. CLS. 2, 13, 23, 29, 30, 33, 40 AND 50).

FOR: NON-JAPANESE STYLE OUTERWEAR, OUTERCLOTHING, NAMELY, EVENING DRESSES, SCHOOL UNIFORMS, JACKETS, JOGGING PANTS, SWEATPANTS, SUITS, SKIRTS, SKI JACKETS, SKI PANTS, TROUSERS, SMOCKS; COATS, NAMELY, OVERCOATS, TOPCOATS, MANTLES AND RAINCOATS; SWEATERS AND THE LIKE, NAMELY, CARDIGANS, SWEATERS, VESTS AND WAISTCOATS; SHIRTS AND THE LIKE, NAMELY, OPEN-NECKED SHIRTS, CUFFS, COLLARS FOR CLOTHING, SPORT SHIRTS, BLOUSES, POLO SHIRTS AND SHIRTS FOR SUITS; NIGHTWEAR, NAMELY, NIGHT GOWNS, NEGLIGEEES, JAPANESE SLEEPING ROBES (NEMAKI), PAJAMAS AND BATH ROBES; UNDERWEAR; UNDERCLOTHING, NAMELY, CAMISOLES, CORSETS, CLOTHING COMBINATIONS, UNDERSHIRTS, CHEMISES, DRAWERS AND UNDERPANTS, SLIPS, PANTIES, SHORTS AND BRIEFS, BRASSIERES AND PETTICOATS; SWIMWEAR; BATHING SUITS; SWIMMING CAPS; BATHING CAPS; JAPANESE TRADITIONAL CLOTHING, NAMELY, INFORMAL KIMONOS IN SUMMER (YUKATA), INFORMAL KIMONOS FOR SUMMER (JINBEI), JAPANESE TRADITIONAL KIMONO FOR FESTIVAL (HAPPI), SASH BANDS FOR KIMONO (OBI), BUSTLE HOLDER BANDS FOR OBI (OBIAGE), BUSTLES FOR OBI-KNOTS (OBIAGE-SHIN), WAIST STRINGS FOR KIMONOS (KOSBIHIMO), UNDERSHIRTS FOR KIMONOS (KOSHIMAKI), UNDERSHIRTS FOR KIMONOS (JUBAN), TIGHTENING-UP STRINGS FOR KIMONOS (DATEJIME), WRAP BELTS FOR KIMONOS (DATEMAKI), FULL-LENGTH KIMONOS (NAGAGI), SHORT OVERCOAT FOR KIMONO

(HAORI), STRING FASTENERS FOR HAORI (HAORI-HIMO), PLEATED SKIRTS FOR FORMAL KIMONOS (HAKAMA) AND DETACHABLE NECKPIECES FOR KIMONOS (HANERI); APRONS COLLAR PROTECTORS FOR WEAR; SOCKS AND STOCKINGS; PUTTEES AND GAITERS; FUR STOLES; SHAWLS; SCARVES; SCARFS; JAPANESE STYLE SOCKS (TABI); JAPANESE STYLE SOCKS (TABI COVERS); GLOVES AND MITTENS; BABIES' DIAPERS OF TEXTILE; NECKTIES; NECKERCHIEVES; BANDANAS; NECKERCHIEFS; MUFFLERS; EAR MUFFS; HOODS; NIGHTCAPS; HATS; CAPS, SUN-VISORS CLOTHING, NAMELY, SUN VISORS; GARTERS; SOCK SUSPENDERS; SUSPENDERS; BRACES; WAISTBANDS; BELTS FOR CLOTHING; RAIN BOOTS; LACE BOOTS; TRAINING SHOES; OVERSHOES; WOODEN SHOES; WORK SHOES AND BOOTS; SANDAL; SHOES; SHOES; JAPANESE SPLIT-TOED WORK FOOTWEAR (JIKATABI); ANGLERS' SHOES; BOOTS; HALF-BOOTS; WOMEN'S SHOES; WINTER BOOTS; HOSIERY SHOES; CANVAS SHOES; INFANTS' SHOES AND BOOTS; INNER SOLES FOR SHOES AND BOOTS; HEELPIECES FOR SHOES AND BOOTS; INSOLES FOR SHOES AND BOOTS; WELTS FOR SHOES AND BOOTS; RUBBER SOLES FOR JIKATABI; FOOTWEAR UPPERS; TIPS FOR FOOTWEAR; SHOE SOLES FOR REPAIR; SHOE DOWELS; SHOE PEGS; TONGUE OR PULLS TRAP FOR SHOES AND BOOTS; HOBNAILS; PROTECTIVE METAL MEMBERS FOR SHOES AND BOOTS; JAPANESE STYLE WOODEN CLOGS (GETA), NAMELY, HIGH RAIN CLOGS (ASHIDA), LOW WOODEN CLOGS (KOMA-GETA), SANDAL-CLOGS, LOW WOODEN CLOGS (HIYORI-GETA); METAL FITTINGS FOR JAPANESE STYLE WOODEN CLOGS; WOODEN MAIN BODIES OF JAPANESE STYLE WOODEN CLOGS; WOODEN SUPPORTS OF JAPANESE STYLE WOODEN CLOGS; TOE STRAPS FOR JAPANESE STYLE WOODEN CLOGS; JAPANESE STYLE SANDALS (ZORI), NAMELY, JAPANESE TOE-STRAP SANDALS (ASAURA-ZORI), JAPANESE STYLE SANDALS OF LEATHER, SLIPPERS, JAPANESE STYLE SANDALS OF FELT AND JAPANESE FOOTWEAR OF RICE STRAW (WARAJI); SLIPPER SOLES; UPPERS FOR JAPANESE STYLE SANDALS; SOLES FOR JAPANESE STYLE SANDALS; TOE STRAPS FOR JAPANESE STYLE SANDALS; UPPERS OF WOVEN RATTAN FOR JAPANESE STYLE SANDALS; MASQUERADE COSTUMES; CLOTHES FOR SPORTS, NAMELY, ANORAKS, KARATE SUITS, SPORTS OVER-UNIFORMS, KENDO OUTFITS, JUDO SUITS, SKI SUITS FOR COMPETITION, HEADBANDS CLOTHING, WIND-JACKETS, SPECIAL SPORTSWEAR UNIFORMS AND STOCKINGS AND WRISTBANDS; BOOTS FOR SPORTS, NAMELY, GOLF SHOES, SOCCER SHOES, SKI BOOTS, GYMNASTIC SHOES, TENNIS SHOES, CLIMBING BOOTS, MOUNTAINEERING BOOTS, BASKETBALL SNEAKERS, VOLLEYBALL SHOES, HANDBALL SHOES, BOWLING SHOES, BOXING SHOES, HOCKEY SHOES, BASEBALL SHOES, RUGBY SHOES, FOOTWEAR FOR TRACK AND FIELD ATHLETICS; HORSE-RIDING BOOTS, IN CLASS 25 (U.S. CLS. 22 AND 39).

FOR: TOY FIGURES; METAL TOYS, NAMELY, ROLLER TOYS, METAL CLOCKWORK TOYS, TOY WHISTLES AND LEVER ACTION TOYS; WOODEN OR BAMBOO TOYS, PAPER TOYS, NAMELY, PAPER BALLOONS, JAPANESE KARUTA PLAYING CARDS, SETS OF SHEET-PAPER DOLLS AND CHANGING CLOTHES THEREFOR, PLUSH TOYS, NAMELY, STUFFED TOYS; PLASTIC TOYS, NAMELY, PLASTIC CLOCKWORK TOYS, RUBBER BALLS, MUSICAL TOYS, HOLLOW RUBBER TOYS FORMED BY BONDING AND SOLID RUBBER TOYS FORMED BY MOULDING PROCESS; MUSICAL TOYS, NAMELY, MUSICAL BOXES, TOY GLOCKENSPIELS, TOY HARMONICAS, TOY PIANOS AND TOY XYLOPHONES; TOY SETS, NAMELY, TOY CONSTRUCTION SETS, TOY SETS OF CARPENTERS' TOOLS AND HOUSEKEEPING PLAY SETS; TOY BEANBAGS (OTEDAMA); MARBLES; TOY PISTOLS; TOY MASKS; TOY FIREWORKS; CORN STEM TOYS (KIBIGARA); TOY CHRISTMAS TREES; HAND-HELD GAMES WITH LIQUID CRYSTAL DISPLAYS; TOY KOI-NOBORI STREAMERS; TOY SCOOTERS; JIGSAW PUZZLES; FOUR-WHEELED GO-CARTS; KITES; SHUTTLECOCKS FOR HAGOITA GAME; BODHIDHARMA DOLLS WITH CLOSED EYES (MENASHI-DARUMA); ROCKING HORSES; TRICYCLES FOR INFANTS; INFLATABLE SWIMMING POOLS; RING GAMES; DOLLS, NAMELY, JAPANESE TRADITIONAL DOLLS, DOLLS IN SITTING POSTURE (OSUWARI DOUS), BOYS' FESTIVAL DOLLS AND THEIR FITTINGS, KOKESHI DOLLS, SAKURA DOLLS, CLOTHES FOR JAPANESE TRADITIONAL

DOLLS, GIRLS' FESTIVAL DOLLS AND THEIR FITTINGS, EUROPEAN STYLE DOLLS AND CUTE FIGURES FOR DECORATING PERSONAL SPACE; GO GAMES, NAMELY, GO STONES, STONE PIECES POTS FOR GO GAME (GOKE POTS), AND GO BOARDS; JAPANESE CHESS (SHOGI GAMES), NAMELY, WOODEN PIECES FOR SHOGI GAME (KOMA), STANDS FOR SHOGI PIECES (KOMADAI) AND SHOGI BOARDS; DICE; JAPANESE DICE GAMES (SUGOROKU); DICE CUPS; DIAMOND GAMES; CHESS GAMES; CHECKERS (CHECKER SETS); DOMINOES; MAH-JONG; BOARD GAMES; GAME MACHINES AND APPARATUS, NAMELY, HORIZONTAL PINBALL MACHINE; KORINTO-GAME MACHINES, JAPANESE HORIZONTAL PINBALL MACHINES; SMARTBALL MACHINES, SLOT MACHINES; AMUSEMENT MACHINES, LOTTERY WHEELS AND JAPANESE VERTICAL PINBALL MACHINE; PACHINKO MACHINES; BILLIARD EQUIPMENT, NAMELY, BILLIARD CUES, CHALK FOR BILLIARD CUES, BILLIARD BALLS, BILLIARD MARKERS AND BILLIARD TABLES; TOYS FOR DOMESTIC PETS, IN CLASS 28 (U.S. CLS. 22, 23, 38 AND 50).

OWNER OF INTERNATIONAL REGISTRATION
0925356 DATED 2-9-2007, EXPIRES 2-9-2017.

SER. NO. 79-038,954, FILED 2-9-2007.

MARK SPARACINO, EXAMINING ATTORNEY

Int. Cls.: 9, 42 and 45

Prior U.S. Cls.: 21, 23, 26, 36, 38, 100 and 101

United States Patent and Trademark Office

Reg. No. 3,520,763

Registered Oct. 21, 2008

**TRADEMARK
SERVICE MARK
PRINCIPAL REGISTER**

ASANTECH

ASAN SECURITY TECHNOLOGIES OY (FINLAND LIMITED LIABILITY COMPANY)
KUTOJANTIE 11
FI-02630 ESPOO
FINLAND

FOR: VIDEO SURVEILLANCE AND MONITORING SYSTEMS USED TO MANAGE, CONTROL AND OPERATE NETWORK VIDEO RECORDERS AND SYSTEMS USED FOR SURVEILLANCE AND MONITORING OF ENVIRONMENTS, LARGE VESSELS AND TRANSPORTATION EQUIPMENT, PARKING FACILITIES, INDUSTRIAL AND OTHER PROPERTY FACILITIES AND INDUSTRIAL EQUIPMENT, COMPRISED OF COMPUTER SERVERS, VIDEO CAMERAS, INTERFACE CIRCUITS FOR VIDEO CAMERAS, LIGHTS FOR USE ON VIDEO CAMERAS, PORTABLE VIDEO CAMERAS WITH BUILT-IN VIDEOCASSETTE RECORDERS, PRERECORDED MAGNETIC DATA CARRIERS AND RECORDING DISCS FEATURING COMPUTER SOFTWARE, NETWORK VIDEO RECORDER SOFTWARE, VIDEO SYSTEM MANAGEMENT AND MONITORING SOFTWARE AND INTELLIGENT VIDEO ANALYSIS SOFTWARE, IN CLASS 9 (U.S. CLS. 21, 23, 26, 36 AND 38).

FOR: RESEARCH, DEVELOPMENT, AND CONSULTATION RELATED THERETO IN THE FIELD OF NETWORK VIDEO RECORDERS USED FOR SURVEILLANCE AND MONITORING OF ENVIRONMENTS AND OF LARGE VESSELS AND TRANSPORTATION EQUIPMENT, THE FIELD OF

NETWORK VIDEO SURVEILLANCE SYSTEMS FOR PARKING FACILITY MANAGEMENT, THE FIELD OF PROPERTY AND INDUSTRIAL ACCESS MANAGEMENT, AND THE FIELD OF MONITORING SOLUTIONS AND PLATFORMS FOR LARGE SCALE VIDEO SURVEILLANCE ENVIRONMENTS; DESIGN AND DEVELOPMENT OF HARDWARE AND SOFTWARE USED IN SAID FIELDS, IN CLASS 42 (U.S. CLS. 100 AND 101).

FOR: SECURITY GUARDING SERVICES FOR THE PROTECTION OF LARGE SCALE VIDEO SURVEILLANCE ENVIRONMENTS, LARGE VESSELS AND TRANSPORTATION EQUIPMENT, PARKING FACILITIES, INDUSTRIAL AND OTHER PROPERTY FACILITIES, IN CLASS 45 (U.S. CLS. 100 AND 101).

THE MARK CONSISTS OF STANDARD CHARACTERS WITHOUT CLAIM TO ANY PARTICULAR FONT, STYLE, SIZE, OR COLOR.

PRIORITY DATE OF 3-27-2007 IS CLAIMED.

OWNER OF INTERNATIONAL REGISTRATION 0925569 DATED 4-18-2007, EXPIRES 4-18-2017.

SER. NO. 79-039,042, FILED 4-18-2007.

GILBERT SWIFT, EXAMINING ATTORNEY

Int. Cls.: 1, 17 and 18

**Prior U.S. Cls.: 1, 2, 3, 5, 6, 10, 12, 13, 22, 26, 35, 41, 46
and 50**

Reg. No. 3,520,764

United States Patent and Trademark Office

Registered Oct. 21, 2008

**TRADEMARK
PRINCIPAL REGISTER**



YANTAI WANHUA; POLYURETHANES CO.,
LTD (CHINA CORPORATION)
NO.7, XINGFU SOUTH ROAD
YANTAI; 264002 SHANDONG
CHINA

FOR: INDUSTRIAL CHEMICALS, NAMELY, ISO-
CYANATE, ESTER, SULPHURIC ACID, POLYUR-
ETHANE, HYDROCHLORIC ACID, ANILINE,
ADHESIVES FOR INDUSTRIAL PURPOSES; FOUN-
DRY MOLDING PREPARATIONS, NAMELY,
FOUNDRY SAND; UNPROCESSED ARTIFICIAL
RESINS, IN CLASS 1 (U.S. CLS. 1, 5, 6, 10, 26 AND 46).

FOR: NATURAL RAW OR PARTLY PROCESSED
RUBBER GUM; CHEMICAL COMPOSITIONS FOR
REPAIRING LEAKS, NAMELY, GENERAL PUR-
POSE SILICONE RUBBER SEALANT, GROUT SEA-
LANT, ADHESIVE SEALANTS FOR GENERAL USE;
PIPE JACKETS NOT OF METAL FOR PLASTIC,
RUBBER PIPES; JUNCTIONS NOT OF METAL FOR
PLASTIC, RUBBER PIPES; SEMI-FINISHED ARTI-
FICIAL RESINS, NAMELY, ARTIFICIAL THERMO-
PLASTIC ELASTOMER RESINS IN BARS, BLOCKS,
PELLETS, RODS, SHEETS AND TUBES FOR USE IN
FURTHER MANUFACTURE; WATERING HOSE;
NON-CONDUCTING MATERIALS FOR RETAIN-

ING HEAT, NAMELY, POLYURETHANE FILM
FOR USE IN SEALING AND INSULATING; SOUND-
PROOFING MATERIALS FOR BUILDINGS; INSU-
LATING MATERIALS, NAMELY,
POLYURETHANE FOAM AND POLYETHYLENE
FOAM; WATERPROOF PACKINGS FOR PREVENT-
ING PLUMBING LEAKS, ISOLATION OF ELECTRI-
CAL WIRES AND CAULKING GLAZINGS, IN
CLASS 17 (U.S. CLS. 1, 5, 12, 13, 35 AND 50).

FOR: IMITATION LEATHER; UNWORKED OR
SEMI-WORKED LEATHER; IMITATION LEATHER,
NAMELY, MOLESKIN; CASES OF IMITATION LEA-
THER; BANDOLIERS; UMBRELLAS; WALKING
STICKS; HARNESS TRACES; GUT FOR MAKING
SAUSAGES, IN CLASS 18 (U.S. CLS. 1, 2, 3, 22 AND
41).

OWNER OF INTERNATIONAL REGISTRATION
0925888 DATED 2-14-2007, EXPIRES 2-14-2017.

SER. NO. 79-039,177, FILED 2-14-2007.

KEVIN CORWIN, EXAMINING ATTORNEY

Int. Cl.: 10

Prior U.S. Cls.: 26, 39 and 44

United States Patent and Trademark Office

Reg. No. 3,520,765

Registered Oct. 21, 2008

**TRADEMARK
PRINCIPAL REGISTER**



Design by Dentists

DIRECTA AB (SWEDEN LIMITED LIABILITY
COMPANY)
P.O. BOX 723
SE-194 27 UPPLANDS VÄSBY
SWEDEN

FOR: DENTAL APPARATUS, INSTRUMENTS
AND CONSUMABLES FOR HUMAN AND VETER-
INARY PURPOSES, ALL IN THE FORM OF AN
INCLUSIVE RANGE OF DEVICES FOR DENTAL
APPLICATIONS AND FOR DENTAL PURPOSES,
NAMELY, DENTAL WEDGES, DENTAL MATRIX
SYSTEMS COMPRISED OF MATRIX BANDS AND
MATRIX BAND RETAINERS, TEMPORARY DEN-
TAL CROWNS, ELEVATORS, NAMELY, PERIOS-
TEAL ELEVATORS, DENTAL APPLICATION
BRUSHES AND STICKS FOR USE BY DENTISTS
DURING OFFICE PROCEDURES, DENTAL PICS,
TRAYS AND CONTAINERS SPECIALLY DE-
SIGNATED TO HOLD, SECURE, MAKE ACCESSIBLE
FOR USE, AND STORE DENTAL INSTRUMENTS

DURING CLINICAL PROCEDURES FOR MEDICAL
AND VETERINARY PURPOSES, IN CLASS 10 (U.S.
CLS. 26, 39 AND 44).

PRIORITY DATE OF 1-22-2007 IS CLAIMED.

OWNER OF INTERNATIONAL REGISTRATION
0926178 DATED 6-4-2007, EXPIRES 6-4-2017.

OWNER OF U.S. REG. NO. 849,514.

NO CLAIM IS MADE TO THE EXCLUSIVE
RIGHT TO USE "DESIGN BY DENTISTS", APART
FROM THE MARK AS SHOWN.

SER. NO. 79-039,309, FILED 6-4-2007.

SUZANNE BLANE, EXAMINING ATTORNEY

Int. Cl.: 32

Prior U.S. Cls.: 45, 46 and 48

United States Patent and Trademark Office

Reg. No. 3,520,766

Registered Oct. 21, 2008

**TRADEMARK
PRINCIPAL REGISTER**

Lion Club



COSKU GIDA TEKSTIL ELEKTRONIK VE; TUR-
IZM HIZMETLERI LIMITED SIRKETI (TUR-
KEY LIMITED COMPANY)
ATASEHIR BULVARI, ATA 2-3 PLAZA,
B-2 BLOK K. 3 NO. 36; ATASEHIR-ISTANBUL
TURKEY

FOR: ENERGY DRINKS, IN CLASS 32 (U.S. CLS.
45, 46 AND 48).

PRIORITY DATE OF 10-30-2006 IS CLAIMED.

OWNER OF INTERNATIONAL REGISTRATION
0926242 DATED 3-23-2007, EXPIRES 3-23-2017.

NO CLAIM IS MADE TO THE EXCLUSIVE
RIGHT TO USE "CLUB", APART FROM THE MARK
AS SHOWN.

THE COLOR(S) RED, BLUE AND WHITE IS/ARE
CLAIMED AS A FEATURE OF THE MARK.

THE COLOR BLUE APPEARS IN THE LION'S
HEAD AND THE WORDS "LION CLUB"; THE
COLOR RED APPEARS IN THE MANE OF THE
LION AND THE LION'S TONGUE, AND THE
COLOR WHITE APPEARS AS BACKGROUND TO
THE ENTIRE MARK AND IN THE LION'S EYE.

SER. NO. 79-039,331, FILED 3-23-2007.

SUZANNE BLANE, EXAMINING ATTORNEY

Int. Cl.: 38

Prior U.S. Cls.: 100, 101 and 104

Reg. No. 3,520,767

United States Patent and Trademark Office

Registered Oct. 21, 2008

**SERVICE MARK
PRINCIPAL REGISTER**

PROSTOR TELECOM

ZAKRYTOE AKTSIONERNOE OBSHESTVO;
"KVANTUM" (RUSSIAN FED. ZAKRYTOE
AKTSIONERNOE OBSHESTVO (CLOSED
(JOINT-STOCK) COMPANY))

ULITSA MILLIONNAJ 12
RU-191186 SAINT-PETERSBURG
RUSSIAN FED.

FOR: NEWS AGENCIES, NAMELY, THE TRANSMISSION OF NEWS ITEMS TO NEWS REPORTING ORGANIZATIONS; TELEVISION BROADCASTING; CABLE TELEVISION BROADCASTING; PROVIDING ON-LINE ELECTRONIC BULLETIN BOARDS FOR THE POSTING AND TRANSMISSION OF MESSAGES AMONG COMPUTER USERS CONCERNING TOPICS OF GENERAL INTEREST; TELECOMMUNICATIONS SERVICES, INTERNET SERVICE PROVIDER SERVICES, PROVIDING TELECOMMUNICATIONS CONNECTIONS TO A GLOBAL COMPUTER NETWORK, TELECOMMUNICATION ROUTING AND JUNCTION SERVICES, ELECTRONIC MAIL, WIRELESS TELEPHONE SERVICES, PROVIDING ACCESS TO PICTURES, VIDEO, ALARM STATUS, BUILDING PLANS AND OTHER BUILDING AND SECURITY INFORMATION AT A REMOTE STATION, PROVIDING ACCESS TO TELECOMMUNICATION NETWORKS, PROVIDING INTERNET ACCESS VIA BROADBAND OPTICAL OR WIRELESS NETWORKS, AND LOCAL AND LONG DISTANCE TRANSMISSION OF VOICE, DATA, GRAPHICS AND VIDEO BY MEANS OF BROADBAND, COPPER AND OPTICAL OR WIRELESS NETWORKS; INFORMATION ABOUT TELECOMMUNICATION; TELECOMMUNICATIONS ROUTING AND JUNCTION SERVICES; PROVIDING MULTIPLE-USER ACCESS TO A GLOBAL COMPUTER NETWORK; INTERNET SERVICE PROVIDER SERVICES; PROVIDING TELECOMMUNICATIONS CONNECTIONS TO A GLOBAL COMPUTER NETWORK; ELECTRONIC MESSAGE SENDING; COMPUTER AIDED TRANSMISSION OF ELECTRONIC MESSAGES AND IMAGES; SENDING OF TELEGRAMS; TRANSMISSION OF TELEGRAMS; ELECTRONIC MAIL; RENTAL OF MESSAGE SENDING APPARATUS AND TELECOMMUNICATIONS EQUIPMENT, NAMELY, TELEPHONES; TELEPHONE ACCESSORIES, AND EQUIPMENT, NAMELY, WIRELESS

TELEPHONES; BATTERIES; CHARGERS; TELEPHONE CARRYING CASES, HANDS-FREE DEVICES, AND CARRYING CLIPS FOR WIRELESS TELEPHONES SOLD AS A UNIT IN COMBINATION WITH WIRELESS TELEPHONES; MICROPHONES; AUDIO RECEIVERS; SPEAKERS; TRANSCEIVERS; COMMUNICATIONS DEVICES IN THE NATURE OF WIRELESS APPLICATION PROTOCOL RECEIVERS AND TRANSMITTERS; COMMUNICATIONS DEVICES IN THE NATURE OF GENERAL PACKET RADIO SERVICE PROTOCOL RECEIVERS AND TRANSMITTERS; DATA TRANSCEIVERS; TELECOMMUNICATIONS TRANSMISSION EQUIPMENT, COMPONENTS, SWITCHING, AND NETWORK SYSTEMS COMPRISED OF - RADIO TRANSMITTERS AND RECEIVERS; ANTENNAS; SWITCHES; SIGNAL TRANSFER POINT SERVERS; SIGNAL CONTROL POINT SERVERS; SERVICE RESOURCE PLATFORM SERVERS; CALL ROUTING SERVERS AND SOFTWARE FOR THE FOREGOING; COMPUTERS AND COMPUTER SOFTWARE FOR THE ACTIVATION AND OPERATION OF WIRELESS TELECOMMUNICATIONS SERVICES; MACHINE READABLE MAGNETICALLY ENCODED CALLING CARDS, CALLER IDENTIFICATION CARDS, DEBIT AND CREDIT CARDS; PAGERS; CALLER IDENTIFICATION EQUIPMENT; WIRELESS HANDHELD COMMUNICATION DEVICES TO TRANSMIT, RECEIVE, OR OTHERWISE ACCESS COMMUNICATIONS NETWORKS; RENTAL OF MODEMS; RENTAL OF TELEPHONES; RENTAL OF FACSIMILE APPARATUS; RADIO BROADCASTING; COMMUNICATIONS BY FIBER OPTIC NETWORKS; CELLULAR TELEPHONE COMMUNICATION; COMMUNICATIONS BY ELECTRONIC COMPUTER TERMINAL; SATELLITE TRANSMISSION; COMMUNICATIONS BY TELEGRAMS; COMMUNICATIONS BY TELEPHONE; FACSIMILE TRANSMISSION; PAGING SERVICES, NAMELY, RADIO, TELEPHONE, OR OTHER MEANS OF ELECTRONIC COMMUNICATION; TELECONFERENCING SERVICES; TELEX SERVICES; TELEGRAPH SERVICES; TELEPHONE SERVICES, IN CLASS 38 (U.S. CLS. 100, 101 AND 104).

OWNER OF INTERNATIONAL REGISTRATION
0926354 DATED 4-23-2007, EXPIRES 4-23-2017.

NO CLAIM IS MADE TO THE EXCLUSIVE
RIGHT TO USE "TELECOM", APART FROM THE
MARK AS SHOWN.

SER. NO. 79-039,369, FILED 4-23-2007.

SALLY SHIH, EXAMINING ATTORNEY

Int. Cls.: 7, 9 and 11

Prior U.S. Cls.: 13, 19, 21, 23, 26, 31, 34, 35, 36 and 38

Reg. No. 3,520,768

United States Patent and Trademark Office

Registered Oct. 21, 2008

**TRADEMARK
PRINCIPAL REGISTER**



WILO AG (FED REP GERMANY AG)
NORTKIRCHENSTRASSE 100
44263 DORTMUND
FED REP GERMANY

FOR: PUMPS EXCEPT FOR PUMPS FOR MEDICAL PURPOSES, NAMELY, PUMPS FOR HEATING UNITS, AGRICULTURAL PUMPS, SUBMERSIBLE PUMPS, BOREHOLE PUMPS, HIGH PRESSURE CENTRIFUGAL PUMPS, PUMPS FOR PRESSURE BOOSTING, HEATING INSTALLATION PUMPS, COOLING INSTALLATION PUMPS, PUMPS FOR MACHINES EXCEPT PUMPS FOR MEDICAL PURPOSES, HIGH PRESSURE PUMPS FOR WASHING APPLIANCES AND INSTALLATIONS; BUILDING INSTALLATION PUMPS, NAMELY, PUMPS FOR HEATING INSTALLATIONS, COOLING INSTALLATIONS, FRESH WATER SUPPLY INSTALLATIONS, WASTEWATER INSTALLATIONS, SEWAGE AND FECES TREATMENT INSTALLATIONS; ELECTRICAL WATER PUMPS EXCEPT FOR PUMPS FOR MEDICAL PURPOSES, NAMELY, WATER SUPPLY PUMPS, SEWAGE TREATMENT PUMPS, PUMPS FOR SWIMMING POOLS, WHIRLPOOLS, BATHS, PONDS, WATER FILTERING UNITS; INDUSTRIAL ELECTRIC MOTORS OTHER THAN FOR LAND VEHICLES, NAMELY, ELECTRIC MOTORS FOR MACHINES AND PUMPS; SPARE PARTS FOR ELECTRIC PUMPS, NAMELY, FILTERS, IN CLASS 7 (U.S. CLS. 13, 19, 21, 23, 31, 34 AND 35).

FOR: REGULATING AND CONTROLLING APPARATUS, NAMELY, SWITCHING DEVICES FOR THE OPERATION OF ONE OR MORE PUMPS WITH A DRIVE MOTOR, CONTROL UNITS IN THE NATURE OF SWITCH BOXES AND OPERATING UNITS FOR THE ELECTRICAL CONNECTION OF

AC AND THREE PHASE PUMPS, FLOW REGULATORS FOR COMMERCIAL AND DOMESTIC USE, ELECTRONIC FLOW AND PRESSURE CONTROLLERS; ELECTRO-TECHNICAL APPARATUS AND INSTRUMENTS, NAMELY, DRY-RUNNING PROTECTION SWITCHES, PRESSURE SWITCHES, FLOAT SWITCHES, IMMERSION PROBES, ELECTRIC COILS, TIME SWITCHES, PRESSURE SENSORS, ELECTRIC CONTROL PANELS, SWITCH GEARS FOR APPLICATION AS CONTRACTOR FOR AC AND THREE-PHASE CURRENT PUMPS; OPERATIONAL MONITORING MEANS FOR SYSTEMS COMPRISING AT LEAST A PUMP OR A MOTOR, FOR MEASURING, TEMPERATURE, CURRENT, PRESSURE OR WATER LEVEL, FOR MONITORING AND INDICATING OPERATING STATUS OF THE PUMP OR MOTOR, AND FOR PROVIDING A WARNING SIGNAL IN CASE OF REACHING A CERTAIN MEASURED VALUE; ELECTRONIC OPERATIONAL MONITORING UNITS FOR CONTROL AND CHECK OF OPERATING STATUS OF ELECTRIC PUMPS; ELECTRICAL CONNECTION PARTS, NAMELY, INSULATED ELECTRICAL CONNECTORS; FIRE-FIGHTING EQUIPMENT, NAMELY, SPRINKLERS; LABORATORY EQUIPMENT FOR MEASURING AND EVALUATING WATER QUALITY, NAMELY, ELECTRONIC WATER QUALITY ANALYZER; FUEL CELLS; COMPUTER SOFTWARE FOR USE IN CONTROL AND MONITORING OF PUMPS AND MOTORS, SOFTWARE FOR USE IN DATABASE MANAGEMENT, IN CLASS 9 (U.S. CLS. 21, 23, 26, 36 AND 38).

FOR: HEATING INSTALLATIONS, NAMELY, HOT WATER HEATING INSTALLATIONS COMPRISING RADIATORS, ELECTRIC HEATING

CABLES, HEATING BOILERS, HEAT PUMPS, HEAT AND STEAM ACCUMULATORS, HEAT-EXCHANGERS AND SOLAR COLLECTORS AS COMPONENTS OF HEATING INSTALLATIONS; HOT-WATER SPACE HEATING APPARATUS COMPRISING PUMPS FOR DOMESTIC HOT WATER CIRCULATORS, SECONDARY CIRCULATORS FOR MECHANICAL BUILDING AND INDUSTRIAL SERVICES, SOLAR THERMIC PUMPS AND PARTS THEREFOR AS COMPONENTS OF THE HOT WATER SPACE HEATING APPARATUS; HOT-WATER HEATERS COMPRISING CENTRAL HOT WATER HEATERS, HOT WATER CIRCULATING PUMPS FOR HOT WATER CIRCULATORS, SECONDARY AND SERVICE WATER HEATERS AND OPEN CONDENSATION WATER HEATERS, GLANDLESS PUMPS FOR HOT WATER HEATERS OF ALL KINDS, CLOSED CHILLED WATER CIRCULATORS, INDUSTRIAL CIRCULATORS AND PARTS THEREFOR; HOT WATER APPARATUS, NAMELY, HOT WATER TANKS, HEATING BOILERS, NAMELY, ELECTRICAL BOILERS, FURNACE BOILERS, INDUSTRIAL BOILERS; HEATING ELEMENTS, NAMELY, ELECTRICAL HEATING CABLES; AIR CONDITIONING INSTALLATIONS; AIR CONDITIONING INSTALLATIONS COMPRISING GLANDLESS PUMPS AS COMPONENTS OF THE INSTALLATIONS; HEAT PUMPS, HEAT ACCUMULATORS AND PRESSURE ACCUMULATORS AS COMPONENTS OF HEATING AND WATER CON-

DUIT INSTALLATION, NAMELY, HEAT ACCUMULATORS, STEAM ACCUMULATORS; INSULATION TUBES AND PUMPS SOLD AS A COMPONENT OF HEATING AND/OR WATER CONDUIT INSTALLATIONS, NAMELY, CERAMIC ENAMEL FIBER INSULATION FOR PUMPS AS COMPONENTS OF HEATING AND/OR WATER CONDUITS INSTALLATIONS, GLASS FIBER INSULATION FOR PUMPS AS COMPONENTS OF HEATING AND/OR WATER CONDUITS INSTALLATIONS, GLASS AND MINERAL WOOL INSULATION FOR PUMPS AS COMPONENTS OF HEATING AND/OR WATER CONDUITS INSTALLATIONS, THERMAL INSULATION FOR PUMPS AS COMPONENTS OF HEATING AND/OR WATER CONDUITS INSTALLATIONS, IN CLASS 11 (U.S. CLS. 13, 21, 23, 31 AND 34).

OWNER OF INTERNATIONAL REGISTRATION 0926671 DATED 5-11-2007, EXPIRES 5-11-2017.

OWNER OF U.S. REG. NO. 3,179,232.

THE WORDING "WILO" HAS NO MEANING IN A FOREIGN LANGUAGE.

SER. NO. 79-039,484, FILED 5-11-2007.

SUZANNE BLANE, EXAMINING ATTORNEY

Int. Cls.: 7, 9 and 17

**Prior U.S. Cls.: 1, 5, 12, 13, 19, 21, 23, 26, 31, 34, 35,
36, 38 and 50**

Reg. No. 3,520,769

United States Patent and Trademark Office

Registered Oct. 21, 2008

**TRADEMARK
PRINCIPAL REGISTER**

APSODRIVE

ANGST & PFISTER AG (SWITZERLAND SOCI-
ÉTÉ ANONYME (A JOINT STOCK COMPANY
UNDER THE LAWS OF SWITZERLAND))
THURGAUERSTRASSE 66
CH-8050 ZÜRICH
SWITZERLAND

FOR: MACHINES, AND MACHINE TOOLS FOR THE CUTTING AND FORMING OF MATERIALS; MACHINE ELEMENTS IN THE NATURE OF SPRINGS AND PARTS OF SPRINGS, AIR FILTERS FOR MACHINES FOR MECHANICAL PURPOSES; PNEUMATIC CONTROLS FOR MACHINES, MOTORS AND ENGINES; MOTORS AND DRIVING MOTORS OTHER THAN FOR LAND VEHICLES; POWER TRANSMISSION SHAFT COUPLINGS FOR INDUSTRIAL MACHINES AND PARTS THEREFORE; AC VARIABLE FREQUENCY DRIVES THAT ARE USED TO CONTROL SMALL AND MEDIUM-SIZED MOTORS IN APPLICATION SUCH AS MANUFACTURING PROCESSES, HVAC AND PUMPS; MACHINE PARTS, NAMELY, V-BELT DRIVES, SYNCHRONOUS BELT DRIVES AND METAL BELT DRIVES; FIXTURES FOR POWER TRANSMISSION OTHER THAN FOR LAND VEHICLES IN THE NATURE OF COUPLINGS AND JIGS; MACHINE PARTS, NAMELY, IMPULSE COUPLING DEVICES AND HYDRAULIC CLUTCHES OTHER THAN FOR LAND VEHICLES, IN CLASS 7 (U.S. CLS. 13, 19, 21, 23, 31, 34 AND 35).

FOR: MEASURING APPARATUS, NAMELY, PRESSURE GAUGES AND PRESSURE MEASURING SENSORS; APPARATUS FOR DISTRIBUTING, ACCUMULATING, REGULATING AND CONTROLLING ELECTRICITY, NAMELY, CONTROL UNITS FOR REGULATING START-UP ELECTRICAL MOTORS, IN CLASS 9 (U.S. CLS. 21, 23, 26, 36 AND 38).

FOR: RUBBER, GUTTA-PERCHA, GUM AND GOODS MADE FROM THESE MATERIALS, NAMELY, STOPS OF RUBBER, RINGS OF RUBBER, V-BELTS, VIBRATING BUFFERS FOR INDUSTRIAL MACHINERY, ADHESIVE BANDS OTHER THAN

STATIONERY AND NOT FOR MEDICAL OR HOUSEHOLD PURPOSES; DRAUGHT EXCLUDER STRIPS, NAMELY, NON-METAL WEATHER STRIPS FOR BUILDINGS; PLASTICS IN EXTRUDED FORM FOR USE IN MANUFACTURE; FILTER MATERIALS, NAMELY, SEMI-FINISHED PLASTICS, SYNTHETIC PLASTIC AS SEMI-FINISHED PRODUCTS IN THE FORM OF FOILS, PLATES, RODS, PROFILES, HOSES, TUBES, BLOCKS, INDUSTRIAL COATINGS, NAMELY, NATURAL AND LIQUID RUBBER; THERMOPLASTIC ELASTOMER RESINS IN PELLET FORM FOR USE IN FURTHER MANUFACTURE; PACKING, STOPPING AND INSULATING MATERIALS, NAMELY, SHEETS OF GRAPHITE-BASED MATERIAL FOR USE AS GASKETS, SEALS, PACKINGS, AND HEAT INSULATORS; GASKET MATERIAL IN SHEETS FOR USE IN BUILDING; GASKET SEALER FOR USE IN PLUMBING; WEATHERSTRIPPING SEALANTS IN THE NATURE OF CAULK; SOUNDPROOFING MATERIALS FOR BUILDINGS AND MACHINERY; FLEXIBLE TUBES OF PLASTIC FOR INDUSTRIAL USE; FLEXIBLE COMPRESSED AIR PIPE FITTINGS, NOT OF METAL; NON-METAL REINFORCING MATERIALS FOR PIPES, NAMELY, SEMI-WORKED SYNTHETIC PLASTICS AS SEMI-FINISHED PRODUCTS IN THE FORM OF FOILS, PLATES, RODS, PROFILES, HOSES, TUBES, BLOCKS; PIPE MUFFS, NOT OF METAL; JUNCTIONS, NOT OF METAL, FOR PLASTIC PIPES, IN CLASS 17 (U.S. CLS. 1, 5, 12, 13, 35 AND 50).

THE MARK CONSISTS OF STANDARD CHARACTERS WITHOUT CLAIM TO ANY PARTICULAR FONT, STYLE, SIZE, OR COLOR.

PRIORITY DATE OF 1-17-2007 IS CLAIMED.

OWNER OF INTERNATIONAL REGISTRATION
0926740 DATED 3-8-2007, EXPIRES 3-8-2017.

THE WORDING "APSODRIVE" HAS NO MEANING IN A FOREIGN LANGUAGE.

SER. NO. 79-039,522, FILED 3-8-2007.

LINDA ESTRADA, EXAMINING ATTORNEY

Int. Cls.: 3, 8, 9, 10, 12, 14, 18, 20, 21, 24, 25, 26 and 28

Prior U.S. Cls.: 1, 2, 3, 4, 6, 13, 19, 21, 22, 23, 25, 26, 27, 28, 29, 30, 31, 32, 33, 35, 36, 37, 38, 39, 40, 41, 42, 44, 50, 51 and 52

Reg. No. 3,520,770

United States Patent and Trademark Office

Registered Oct. 21, 2008

**TRADEMARK
PRINCIPAL REGISTER**



clear to wear

INDUSTRIA DE DISEÑO TEXTIL, S.A.; (INDITEX, S.A.) (SPAIN SOCIEDAD ANONIMA)

AVENIDA DE LA DIPUTACIÓN,

EDIFICIO INDITEX; E-15142 ARTEIXO (A CORUÑA)

SPAIN

FOR: BLEACHING PREPARATIONS AND OTHER SUBSTANCES FOR LAUNDRY USE, NAMELY, GENERAL PURPOSE DETERGENT, BLEACH, FABRIC SOFTENER, STAIN REMOVER, AND STARCH; ALL PURPOSE CLEANING PREPARATIONS, SCOURING POWDER, AND ABRASIVE PASTE FOR KITCHEN, BATHROOM, LAUNDRY, AND HOUSEHOLD USE; PERFUMERY, ESSENTIAL OILS, AND HAIR LOTIONS; DENTIFRICES; EAU DE TOILETTE; COTTON STICKS FOR COSMETIC PURPOSES; HAIR COLORANTS AND DYES; POLISH AND CREAM FOR FOOTWEAR; SHAMPOOS; COSMETIC KITS COMPRISED OF BLUSH, ROUGE, MASCARA, EYE SHADOW, EYELINER, EYEBROW PENCILS, LIP GLOSS, AND LIPSTICKS; DEODORANTS FOR PERSONAL USE IN THE NATURE OF PERFUMERY; HAIR SPRAYS; NAIL POLISH REMOVER; MAKEUP PRODUCTS, NAMELY, BLUSH, ROUGE, MASCARA, EYE SHADOW, EYELINER, EYEBROW PENCILS, LIP GLOSS, AND LIPSTICKS; POMADES FOR COSMETIC PURPOSES; SACHETS FOR PERFUMING LINEN; NAIL POLISH; COBBLER'S WAX; SHOE CREAMS; INCENSE; DECORATIVE TRANSFERS FOR COSMETIC PURPOSES; FALSE NAILS AND EYELASHES; PUMICE STONES FOR PERSONAL USE; POTPOURRI; HAIR WAVING LOTIONS; NON-MEDICATED MOUTH CARE PRODUCTS, NAMELY, MOUTH WASH; OILS FOR TOILETRY PURPOSES; EAU DE COLOGNE, IN CLASS 3 (U.S. CLS. 1, 4, 6, 50, 51 AND 52).

FOR: TABLEWARE, NAMELY, KNIVES, SPOONS, AND FORKS; ELECTRIC AND NON-ELECTRIC RAZORS; NON-ELECTRIC CAN OPENERS; OYSTER OPENERS; NON-ELECTRIC HAND IMPLEMENTS FOR HAIR CURLING; ELECTRICALLY OPERATED AND NON-ELECTRICALLY OPERATED APPLIANCES FOR DEPILATORY PURPOSES; NON-PRECIOUS METAL NUTCRACKERS; ELECTRIC AND NON-ELECTRIC NAIL CLIPPERS; NON-ELECTRIC PIZZA CUTTERS; VEGETABLE SLICERS; CUTLERY; SCALING KNIVES; MANICURE SETS; ELECTRIC MANICURE SETS; PEDICURE SETS; CASES AND COVERS FOR RAZOR KNIVES; RAZOR BLADES; NAIL FILES; ELECTRIC AND NON-ELECTRIC HAIR CLIPPERS FOR PERSONAL USE; NON-ELECTRIC EGG-SLICERS; NON-ELECTRIC CHEESE-SLICERS; HAIR CLIPPERS FOR BEARDS; HAIR-REMOVING TWEEZERS; NAIL CLIPPERS; CUTICLE NIPPERS; SUGAR TONGS; EYELASH CURLERS; SCISSORS, IN CLASS 8 (U.S. CLS. 23, 28 AND 44).

FOR: PRE-RECORDED COMPACT DISCS FEATURING MUSIC; CALCULATORS; ANTI-GLARE SPECTACLES; EYEGLASSES; OPTICAL LENSES; PINCE-NEZ CHAINS; CONTACT LENSES; PINCE-NEZ CORDS; SPECTACLES; CASES FOR SPECTACLES; SPECTACLE FRAMES AND LENSES; SUNGLASSES; CASES FOR EYEGLASSES AND FOR CONTACT LENSES; LIFESAVING JACKETS; SURVIVAL SUITS, NAMELY, INSULATED OVERALL WET SUITS; TELEPHONE SETS; PERSONAL SCALES FOR USE AS A WEIGHING APPARATUS; PROTECTIVE HELMETS; CHRONOGRAPHS FOR USE AS SPECIAL TIME RECORDING APPARATUS; MEASURING SPOONS; PEDOMETERS; TEMPERATURE INDICATORS; ELECTRONIC GAMES PROGRAMS; COMPUTER SOFTWARE FOR GAMES, SCREEN SAVERS, WORD PROCESSING; NON-MEDICAL THERMOMETERS; WALKIE-TALKIES;

BABY INTERCOM MONITORS, IN CLASS 9 (U.S. CLS. 21, 23, 26, 36 AND 38).

FOR: TEETHING RINGS; BABIES' BOTTLES; FEEDING BOTTLE VALVES IN THE NATURE OF NIPPLES; FEEDING BOTTLE TEATS; BABIES' PACIFIERS; BREAST PUMPS; ORTHOPEDIC FOOTWEAR; ARCH SUPPORTS FOR BOOTS AND SHOES, IN CLASS 10 (U.S. CLS. 26, 39 AND 44).

FOR: SAFETY SEATS FOR CHILDREN FOR VEHICLES; BICYCLES; BABY STROLLERS; PRAMS; SLEIGHS, IN CLASS 12 (U.S. CLS. 19, 21, 23, 31, 35 AND 44).

FOR: JEWELRY; PRECIOUS STONES; HOROLOGICAL AND OTHER CHRONOMETRIC INSTRUMENTS; ORNAMENTAL PINS; TIE PINS; NEEDLE CASES OF PRECIOUS METAL; NAPKIN RINGS OF PRECIOUS METAL; WORKS OF ART OF PRECIOUS METAL; FANCY KEY RINGS OF PRECIOUS METAL; SILVER AND GOLD-PLATED ITEMS, NAMELY, SERVING PLATTERS, CANDLESTICKS; ORNAMENTS OF PRECIOUS METAL FOR FOOTWEAR AND HATS; ASHTRAYS OF PRECIOUS METAL FOR SMOKERS; CUFF LINKS, IN CLASS 14 (U.S. CLS. 2, 27, 28 AND 50).

FOR: LEATHER AND ARTIFICIAL LEATHER; TRUNKS AND SUITCASES; UMBRELLAS, PARASOLS AND WALKING STICKS; ALL PURPOSE BAGS AND DUFFEL BAGS FOR USE WHILE CAMPING AND HIKING; BEACH BAGS; HANDBAG FRAMES; FRAMES FOR UMBRELLAS OR PARASOLS; PURSES; HANDBAGS; TRAVELING BAGS; TRAVELING CASES AND KEY CASES OF LEATHER; COLLEGE SATCHELS; GARMENT BAGS FOR TRAVEL; HAT BOXES OF LEATHER FOR TRAVEL; SLING BAGS FOR CARRYING INFANTS; WHEELED SHOPPING BAGS; CONTAINERS AND BOXES OF LEATHER FOR STORING GREETING CARDS; SCHOOL BAGS; POCKETBOOKS; BRIEFCASES; UNFITTED VANITY CASES; ANIMAL COLLARS; LEATHER LEASHES FOR ANIMALS; UMBRELLA COVERS; HAVERSACKS; RUCKSACKS; LEATHER BAGS FOR MERCHANDISE PACKAGING, IN CLASS 18 (U.S. CLS. 1, 2, 3, 22 AND 41).

FOR: FURNITURE; MIRRORS; PICTURE FRAMES; HAND-HELD FANS; PILLOWS; CURTAIN RINGS; WOOD AND PLASTIC CRATES; CUPBOARDS; LECTERNS; BENCHES; TABLE TOPS OTHER THAN FOR CRAPS TABLES; SCREENS; TRUNKS IN THE NATURE OF FURNITURE; BOXES OF WOOD OR PLASTIC; CHESTS FOR TOYS; BEDS; BED HEADBOARDS; TEA CARTS; FURNITURE IN THE NATURE OF WINE BOTTLE RACKS; NON-METALLIC BAKER'S BREAD BASKETS; CUSHIONS; MATTRESSES; BAMBOO BLINDS; COTS; WIND CHIMES FOR USE AS DECORATION; DECORATIVE MOBILES; DIVANS; BOOKSHELVES; CLOTHING COVERS BEING FOR STORAGE AND WARDROBE USE; HAMMOCKS; FLOWER STANDS; JEWELRY BOXES NOT OF METAL; WORKS OF ART OF WOOD, WAX, PLASTER OR PLASTIC; STRAWS FOR DRINKING; UM-

BRELLA STANDS; PLAYPENS FOR BABIES; HANGERS FOR COATS AND HATS; COAT STANDS; DESKS; MAGAZINE RACKS; SLEEPING BAGS FOR CAMPING; CHAIRS; ARMCHAIRS; SOFAS; STOOLS; NON-METALLIC STOPPERS FOR BOTTLES; EMBROIDERY FRAMES; HIGH CHAIRS FOR BABIES; INFANT WALKERS; DECK CHAIRS, IN CLASS 20 (U.S. CLS. 2, 13, 22, 25, 32 AND 50).

FOR: HAIR COMBS; BATH SPONGES; HAIR BRUSHES; COSMETIC BRUSHES; BRUSH-MAKING MATERIALS; UNWORKED OR SEMI-WORKED GLASS EXCEPT CONSTRUCTION GLASS; STEEL WOOL FOR CLEANING; BEVERAGE GLASSWARE; DECORATIVE PORCELAIN AND EARTHENWARE IN THE NATURE OF STATUARY, FIGURINES, ORNAMENTS, PLATES, VASES AND BOWLS; BOTTLE OPENERS; OIL BOTTLES SOLD EMPTY; COCKTAIL SHAKERS; CANDLE SNUFFERS; SUGAR BOWLS; TRAYS; PORTABLE BABY BATH TUBS; CLOTHS FOR WASHING FLOORS; GLASS BOWLS; TEA BALLS; CANDY DISHES; BOTTLES SOLD EMPTY; SHAVING BRUSHES; POTTERY DISHES; COFFEE MACHINES IN THE NATURE OF HAND-OPERATED COFFEE GRINDERS; NON-ELECTRIC BOTTLE WARMERS FOR BABIES; SHOE HORNS; NON-ELECTRIC CANDELABRAS; WINE TASTERS; FLYCATCHERS; TABLE CENTERPIECES IN THE NATURE OF VASES; SHOE BRUSHES; PLANT BASKETS; TEA STRAINERS; TROUSER STRETCHERS; ICE BUCKETS; TIE PRESSES; DOOR HANDLES OF PORCELAIN; COMB CASES; SHAPED IRONING BOARD COVERS; GARDENING GLOVES; GLOVES FOR DOMESTIC USE; POLISHING GLOVES; SHOE TREES; PIGGY BANKS NOT OF METAL; SOAP DISHES; CARAFES; BIRD CAGES FOR DOMESTIC BIRDS; BUTTER DISHES; WORKS OF ART OF PORCELAIN, TERRA COTTA AND GLASS; TOOTHPICK CONTAINERS; BREAD BOXES; PEPPER POTS; PLATES; FEATHER DUSTERS; FACE POWDER CASES IN THE NATURE OF VANITY CASES; SHAVING BRUSH HOLDERS; SPONGE HOLDERS; TOILET ROLL HOLDERS; PERFUME SPRAYERS AND VAPORIZERS SOLD EMPTY; NON-ELECTRIC GRATERS FOR HOUSEHOLD PURPOSES; CRUMB TRAYS; COASTERS FOR BOTTLES NOT OF PAPER AND NOT BEING TABLE LINEN; TRIVETS; BOOT JACKS; SALT CELLARS; CLOTHES DRYING RACKS; COFFEE AND TEA SERVICES; NAPKIN HOLDERS; WASHING AND IRONING BOARDS; BREAD BOARDS; CARVING BOARDS; CUPS; SHIRT STRETCHERS; TEA POTS; FLOWER POTS; THERMALLY INSULATED CONTAINERS FOR FOOD AND BEVERAGES; CLOTHS IMPREGNATED WITH A DETERGENT FOR CLEANING; TOOTHBRUSHES; ELECTRIC TOOTHBRUSHES; DENTAL FLOSS; NON-ELECTRIC JUICERS, IN CLASS 21 (U.S. CLS. 2, 13, 23, 29, 30, 33, 40 AND 50).

FOR: TEXTILES AND TEXTILE GOODS, NAMELY, BED SHEETS, BED BLANKETS, PILLOW COVERS, PILLOW SHAMS, DUST RUFFLES, DUVET COVERS, QUILTS, COMFORTERS, AFGHANS, CRIB BUMPERS, BED SPREADS, PLACEMATS, NAPKINS, OVEN MITTS, POT HOLDERS, TEA TOWELS, TABLE CLOTHS NOT MADE OF PAPER;

BATH LINEN NOT INCLUDING CLOTHING; TISSUES OF TEXTILE FOR REMOVING MAKE-UP; LABELS OF TEXTILE; TEXTILE USED AS LINING FOR CLOTHING; TOILET GLOVES, NAMELY, BATH GLOVES; WALL HANGINGS OF TEXTILE; HANDKERCHIEFS OF TEXTILE; CURTAINS OF TEXTILE OR PLASTIC; HOUSEHOLD LINEN; TOWELS OF TEXTILE; NET CURTAINS; CURTAIN HOLDERS OF TEXTILE MATERIALS, NAMELY, CURTAIN TIE BACKS; FABRIC FLAGS; EIDER-DOWNS; UNFITTED PROTECTIVE FURNITURE COVERS NOT OF PAPER; COVERS FOR CUSHIONS; MOSQUITO NETS; TEXTILE CLOTHS FOR CLEANING GLASS; BILLIARD CLOTH; TRACED CLOTH FOR EMBROIDERY; UPHOLSTERY FABRICS; FACE TOWELS OF TEXTILE; SLEEPING BAGS, IN CLASS 24 (U.S. CLS. 42 AND 50).

FOR: MEN'S, WOMEN'S AND CHILDREN'S READY-TO-WEAR CLOTHING, NAMELY, OVERALLS, TOPS, VESTS, UNDERSHIRTS, UNDERPANTS, TROUSERS, SKIRTS, DRESSES, SLACKS, PANTS, BLOUSES, SHIRTS, T-SHIRTS, SWEATERS, WAISTCOATS, PULLOVERS, CARDIGANS, JERSEYS, JACKETS, SUITS, TUXEDOS, OVERCOATS, COATS, HUNTING JACKETS, TRACK SUITS, ASCOTS, PONCHOS; FOOTWEAR, NOT INCLUDING ORTHOPEDIC FOOTWEAR; HEADGEAR, NAMELY, HATS, SCARVES, KERCHIEFS, EAR MUFFS, CAPS, HEADBANDS, CAP VISORS; CLOTHING FOR MOTORISTS AND CYCLISTS, NAMELY, JACKETS, MOTORCYCLE GLOVES; BIBS, NOT OF PAPER; BATHROBES; SWIMWEAR; BATHING CAPS AND SANDALS; BOAS; UNDERWEAR; DISPOSABLE NAPPIES; SCARVES; FOOTWEAR FOR SPORTS; BEACH FOOTWEAR; HOODS; SHAWLS; BELTS FOR CLOTHING; MONEY BELTS; WET SUITS; TIES; CORSETS; FUR STOLES; GIRDLES; FOULARDS; GLOVES; WATERPROOF CLOTHING, NAMELY, RAINCOATS; MANTILLAS; STOCKINGS; SOCKS; NECKERCHIEFS; TEXTILE NAPPIES; DRESS HANDKERCHIEFS; FUR COATS; PAJAMAS; SOLES FOR FOOTWEAR; HEELS; VEILS; BRACES IN THE NATURE OF SUSPENDERS; PAPER CLOTHING, NAMELY, PAPER HATS; LEOTARDS; LAYETTES; COLLARS; SINGLETS; INSOLES; BOW TIES; PAREUS; WRISTBANDS FOR WEAR; DRESS SHIELDS; CARNIVAL COSTUMES, NOT INCLUDING COSTUME MASKS, IN CLASS 25 (U.S. CLS. 22 AND 39).

FOR: LACE AND EMBROIDERY, RIBBONS AND BRAIDS; BUTTONS FOR CLOTHING; HOOKS AND EYES; NEEDLES; ARTIFICIAL FLOWERS; PIN CUSHIONS; HAT AND SHOE ORNAMENTS NOT OF PRECIOUS METAL; HAT PINS; HAIR ORNAMENTS; HAIR BANDS; REINS FOR GUIDING CHILDREN; BROOCHES BEING CLOTHING ACCESSORIES; SEWING BOXES; BELT CLASPS; SHOE LACES; WREATHS OF ARTIFICIAL FLOWERS; TEA COSIES; ORNAMENTAL NOVELTY BADGES; SEWING THIMBLES; BOWS FOR THE HAIR; NEEDLE CASES, NOT OF PRECIOUS METAL; BUCKLES FOR USE AS CLOTHING ACCESSORIES; SHOE BUCKLES; SHOULDER PADS FOR CLOTHING, HAIR PINS, BODKINS, HAIR CLIPS; LACE TRIMMINGS; FEATHERS FOR USE AS CLOTHING ACCESSORIES; ARTS AND CRAFTS FINDINGS, NAMELY, POMPOMS; ZIPPER FASTENERS, IN CLASS 26 (U.S. CLS. 37, 39, 40, 42 AND 50).

FOR: GAMES, NAMELY, CARD GAMES, SKILL GAMES, BOARD GAMES; TOYS, NAMELY, ROCKING HORSES; TOY VEHICLES, TOY BUILDING BLOCKS, TOY MOBILES, CONSTRUCTION TOYS, MECHANICAL ACTION TOYS, BATTERY-OPERATED TOYS, CHILDREN'S MULTIPLE ACTIVITY TOYS, BATH TOYS, SPORT BALLS, PLUSH AND STUFFED TOYS; SPORTS ARTICLES, NAMELY, SKATEBOARDS, ROLLER AND ICE SKATES; AUTOMATIC GAMES APPARATUS FOR ELECTRONIC GAMES NOT ADAPTED FOR USE WITH TELEVISION RECEIVERS OR EXTERNAL DISPLAY SCREENS OR MONITORS OF ANY NATURE; CHRISTMAS TREE DECORATIONS; CARNIVAL AND THEATRE MASKS; DOLLS' HOUSES; PARTY FAVORS IN THE NATURE OF SMALL TOYS; MARIONETTE PUPPETS; CHRISTMAS TREES OF SYNTHETIC MATERIAL; KITES; BABY RATTLES; KALEIDOSCOPES; TEDDY BEARS; DOLLS; DOLL'S CLOTHES, IN CLASS 28 (U.S. CLS. 22, 23, 38 AND 50).

PRIORITY DATE OF 9-13-2006 IS CLAIMED.

OWNER OF INTERNATIONAL REGISTRATION 0928166 DATED 9-13-2006, EXPIRES 9-13-2016.

SER. NO. 79-040,002, FILED 9-13-2006.

REGINA DRUMMOND, EXAMINING ATTORNEY

Int. Cls.: 10, 12 and 20

**Prior U.S. Cls.: 2, 13, 19, 21, 22, 23, 25, 26, 31, 32, 35,
39, 44 and 50**

Reg. No. 3,520,771

United States Patent and Trademark Office

Registered Oct. 21, 2008

**TRADEMARK
PRINCIPAL REGISTER**



ZYWIECKA FABRYKA SPRZETU; SZPITALNE-
GO FAMED SPÓLKA AKCYJNA (POLAND
JOINT STOCK COMPANY)
UL. FABRYCZNA 1
ZYWIEC, POLAND PL34300

FOR: DENTAL CHAIRS AND UNITS IN THE NATURE OF DENTAL MIRRORS, DENTAL SWIVEL STOOLS, NEONATAL INCUBATORS, REHABILITATION BEDS, PATIENT EXAMINATION TABLES, GYNECOLOGICAL AND BIRTHING DELIVERY CHAIRS, BIRTHING DELIVERY BEDS, STRETCHERS FOR PATIENT TRANSPORT, PATIENT EXAMINATION COUCHES, REHABILITATION COUCHES, CHAIRS FOR BLOOD DONATION, OPHTHALMIC AND LARYNGOLOGICAL CHAIRS, EQUIPMENT FOR OPERATING THEATRES, NAMELY, OPERATING AND TREATMENT TABLES, EQUIPMENT FOR HOSPITAL WARDS, NAMELY, GEL MATTRESSES, CHAIRS FOR DIALYSIS, STANDS FOR INFUSION HOLDERS, PROSTHETIC TABLES, MEDICAL DIAGNOSTIC DEVICES, NAMELY, APPARATUS FOR CLINICAL DIAGNOSIS, CRUTCHES FOR DISABLED PERSONS, STRETCHERS, ROLL-AWAY STRETCHERS, CONTROL TABLES FOR TREATMENT OF PATIENTS, STRETCHERS FOR NEONATES, STRETCHERS FOR BABIES, TREATMENT TABLES FOR BABIES, IN CLASS 10 (U.S. CLS. 26, 39 AND 44).

FOR: HOSPITAL CARTS FOR OPERATING AND TREATMENT APPARATUS AND INSTRUMENTS;

TRANSPORT CARTS FOR DIRTY CLOTHES AND LINEN, ASSISTS CUPBOARDS, NAMELY, MOBILE STORAGE CARTS FEATURING CUPBOARDS FOR DOMESTIC AND COMMERCIAL USE, IN CLASS 12 (U.S. CLS. 19, 21, 23, 31, 35 AND 44).

FOR: HOSPITAL BEDS, CHILDREN'S BEDS, SCREENS, DESKS, ROOM FURNITURE, CHAIRS, STOOLS, BEDSIDE LOCKERS, BEDSIDE TABLES, IN CLASS 20 (U.S. CLS. 2, 13, 22, 25, 32 AND 50).

OWNER OF INTERNATIONAL REGISTRATION 0928182 DATED 3-19-2007, EXPIRES 3-19-2017.

NO CLAIM IS MADE TO THE EXCLUSIVE RIGHT TO USE "ZYWIEC", APART FROM THE MARK AS SHOWN.

THE COLOR(S) BLUE AND WHITE IS/ARE CLAIMED AS A FEATURE OF THE MARK.

THE MARK CONSISTS OF A BLUE OVAL OUTLINED IN WHITE AND THEN OUTLINED AGAIN IN BLUE. THE COLOR WHITE ALSO APPEARS IN THE WORDING "FAMED ZYWIEC" WITHIN THE BLUE OVAL.

SER. NO. 79-040,010, FILED 3-19-2007.

TASHIA BUNCH, EXAMINING ATTORNEY

Int. Cls.: 1 and 9

Prior U.S. Cls.: 1, 5, 6, 10, 21, 23, 26, 36, 38 and 46

United States Patent and Trademark Office

Reg. No. 3,520,772

Registered Oct. 21, 2008

**TRADEMARK
PRINCIPAL REGISTER**

TINTOMETER

THE TINTOMETER LIMITED (UNITED KINGDOM LIMITED LIABILITY COMPANY)
LOVIBOND HOUSE, SOLAR WAY
SOLSTICE PARK; AMESBURY, WILTSHIRE SP4 7SZ
UNITED KINGDOM

FOR: CHEMICAL REAGENTS FOR NON-MEDICAL TRADE, INDUSTRIAL, COMMERCIAL, SCIENTIFIC, LABORATORY AND FIELD USE; CHEMICAL REAGENTS FOR USE WITH SAMPLE TESTING, LIQUID TESTING, WATER TESTING, EFFLUENT TESTING, ION SPECIFIC TESTING, PH TESTING, TURBIDITY TESTING, WATER CONDITIONING, WATER PURIFICATION, OPTICAL TESTING; COLOR TESTING, ALL FOR NON-MEDICAL PURPOSES; CHEMICAL REAGENTS FOR USE WITH OPTICAL TEST APPARATUS AND TEST CELLS FOR NON-MEDICAL PURPOSES; CHEMICAL REAGENTS FOR NON-MEDICAL PURPOSES IN TABLET, POWDER IN CAPSULE AND LIQUID IN CAPSULE FORM, IN CLASS 1 (U.S. CLS. 1, 5, 6, 10, 26 AND 46).

FOR: SCIENTIFIC, LABORATORY, TRADE, COMMERCIAL, INDUSTRIAL AND FIELD MEASUREMENT AND TESTING APPARATUS AND INSTRUMENTATION, NAMELY, TITRATION APPARATUS, BIOLOGICAL OXYGEN DEMAND METERS, HEATERS FOR SAMPLE SOFTENING IN OPTICAL AND COLOR MEASUREMENT APPARATUS, TURBIDITY METERS, FLOCCULATION AND SEDIMENTATION METERS, CHEMICAL OXYGEN DEMAND METERS, REDOX METERS, PH-VALUE METERS, THERMOMETERS, OXYGEN SATURATION AND CONCENTRATION METERS, SALINITY METERS, CHLORINE METERS, AND WATER HARDNESS METERS; COLOR COMPARATORS, NAMELY, NESSLERIZERS; SPECTROPHOTOMETERS; COLOR ANALYTICAL INSTRUMENTATION, NAMELY, COLORIMETERS AND SPECTROPHOTOMETERS; COLOR MEASUREMENT APPARATUS IN THE NATURE OF COLORIMETERS, CAMERAS AND IMAGE PROCESSING SOFTWARE SOLD AS A UNIT; COLOR TEST APPA-

RATUS IN THE NATURE OF SPECTROPHOTOMETERS AND COLORIMETERS; COLOR REFERENCE AND COLOR STANDARD TEST APPARATUS IN THE NATURE OF VISUAL AND AUTOMATIC COLORIMETERS; SCIENTIFIC, LABORATORY AND FIELD APPARATUS FOR COMPARING COLORS OF LIQUIDS AND SOLIDS WITH PERMANENT COLOR REFERENCE STANDARDS; COLOR REFERENCE STANDARDS IN THE NATURE OF COLORED GLASSES, TRANSPARENCIES, FILMS, SLIDES AND DISCS, FOR USE IN COLOR MEASUREMENT, COMPARISON AND TESTING; FILTERS FOR OPTICAL DEVICES; COLORIMETERS; COLORIMETRIC ANALYTICAL INSTRUMENTS, NAMELY, OPTICAL TEST APPARATUS FOR COMPARING COLORS TO PERMANENT COLOR STANDARDS; COLOR GRADING INSTRUMENTS IN THE NATURE OF COMPARATORS FOR IDENTIFYING A SAMPLE BY A SPECIFIED COLOR GRADE; COLOR COMPARATORS; COMPARATORS; COLOR TEST CELLS IN THE FORM OF TRANSPARENCIES, FILMS, SLIDES, AND DISCS FOR TESTING USING SPECTROPHOTOMETRY, PHOTOMETRY AND FLUORESCENCE; WATER TEST APPARATUS FOR MONITORING AND DETECTING CONTAMINATION, INORGANIC AND ORGANIC COMPONENTS AND PHYSICAL AND ELECTROCHEMICAL PARAMETERS; WATER QUALITY PARAMETER TEST APPARATUS FOR MONITORING AND DETECTING CONTAMINATION, INORGANIC AND ORGANIC COMPONENTS AND PHYSICAL AND ELECTROCHEMICAL PARAMETERS; PHOTOMETERS; PORTABLE PHOTOMETRIC TEST KITS COMPRISES OF TEST CELLS IN THE FORM OF TRANSPARENCIES, FILMS, SLIDES, AND DISCS AND PHOTOMETRY AND SPECTROPHOTOMETER APPARATUS; ION SPECIFIC PHOTOMETRIC ANALYTICAL INSTRUMENTS; PARAMETRIC CONCENTRATION MEASUREMENT APPARATUS IN THE NATURE OF PHOTOMETERS AND SPECTROPHOTOMETERS; LABORATORY EQUIPMENT IN THE NATURE OF LIGHTING CABINETS AND LAMPS FOR OPTICAL AND COLOR MEASURE-

MENT, COMPARISON AND TESTING; LABORATORY EQUIPMENT IN THE NATURE OF HEATERS FOR SAMPLE SOFTENING IN OPTICAL AND COLOR MEASUREMENT, COMPARISON AND TESTING; COMPUTER PROGRAMS AND SOFTWARE IN CONNECTION WITH OPTICAL TESTING, COLOR TESTING, COLORIMETRY, COLOR COMPARATORS, SPECTROPHOTOMETRY, PHOTOMETRY, WATER TESTING AND CONDITIONING, IN CLASS 9 (U.S. CLS. 21, 23, 26, 36 AND 38).

OWNER OF INTERNATIONAL REGISTRATION
0928562 DATED 3-8-2007, EXPIRES 3-8-2017.

SER. NO. 79-040,148, FILED 3-8-2007.

ANDREA K. NADELMAN, EXAMINING ATTORNEY

Int. Cl.: 33

Prior U.S. Cls.: 47 and 49

United States Patent and Trademark Office

Reg. No. 3,520,773

Registered Oct. 21, 2008

**TRADEMARK
PRINCIPAL REGISTER**

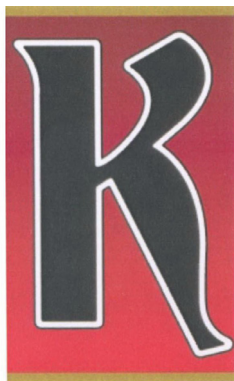

DOUBLE EAGLE BRANDS N.V. (NETHER-
LANDS CORPORATION)
KAYA W.F.G. MENSING 32
WILLEMSTAD, CURAÇAO
NETHERLD ANTILLES

FOR: ALCOHOLIC BEVERAGES, NAMELY, VOD-
KA, GIN, DUTCH GIN, DISTILLED SPIRITS, LI-
QUORS, RUM, WHISKEY AND BRANDY, IN CLASS
33 (U.S. CLS. 47 AND 49).

PRIORITY DATE OF 5-4-2007 IS CLAIMED.

OWNER OF INTERNATIONAL REGISTRATION
0928631 DATED 5-23-2007, EXPIRES 5-23-2017.

THE COLOR(S) BLACK, WHITE, RED AND
GOLD IS/ARE CLAIMED AS A FEATURE OF THE
MARK.

THE COLOR BLACK APPEARS IN THE LETTER
"K", OUTLINED IN WHITE. THE COLOR RED
APPEARS IN THE RECTANGULAR BACK-
GROUND, WITH DARKER RED GRADUATING
TO LIGHTER RED FROM TOP TO BOTTOM OF
THE RECTANGLE. THE COLOR GOLD APPEARS
IN THE BARS ATTACHED TO THE TOP AND
BOTTOM OF THE RED RECTANGLE.

SER. NO. 79-040,187, FILED 5-23-2007.

DAWN HAN, EXAMINING ATTORNEY

Int. Cls.: 7, 9, 10, 11, 17, 35, 36 and 37

Prior U.S. Cls.: 1, 5, 12, 13, 19, 21, 23, 26, 31, 34, 35, 36, 38, 39, 44, 50, 100, 101, 102, 103 and 106

Reg. No. 3,520,774

United States Patent and Trademark Office

Registered Oct. 21, 2008

**TRADEMARK
SERVICE MARK
PRINCIPAL REGISTER**

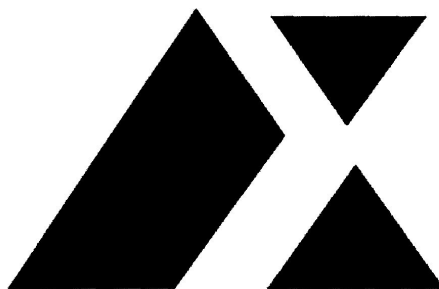

AXEL JOHNSON AB (SWEDEN JOINT STOCK COMPANY)
BOX 26008
SE-100 41 STOCKHOLM
SWEDEN

FOR: BALL-BEARINGS FOR MACHINES, COMPRESSORS, LAWN MOWERS AND HAND TOOLS; HOISTS; WINCHES, ELECTRIC PUMPS MACHINES; MACHINE COMPONENTS, NAMELY, TRANSMISSION COMPONENTS FOR MACHINES, COMPRESSORS, LAWN MOWERS AND HAND TOOLS; EQUIPMENT FOR HANDLING LIQUIDS, NAMELY, MECHANICAL AND HYDRAULIC PUMPS AND VALVE ACTUATORS, AND PARTS AND FITTINGS THERETO, IN CLASS 7 (U.S. CLS. 13, 19, 21, 23, 31, 34 AND 35).

FOR: ELECTRIC GASOLINE PUMPS; MEASURING INSTRUMENTS TO MEASURE FLOW, PRESSURE, TEMPERATURE AND LEVEL OF LIQUIDS AND GASES; TELEPHONE APPARATUS, NAMELY, CELLULAR TELEPHONES, CORDLESS TELEPHONES AND STATIONARY TELEPHONES; FACSIMILE MACHINES, MODEMS, TELEPHONE SWITCHBOARDS, MAGNETICALLY ENCODED CASH CARDS FOR TELEPHONES, IN CLASS 9 (U.S. CLS. 21, 23, 26, 36 AND 38).

FOR: MEDICAL AND VETERINARY APPARATUS AND INSTRUMENTS, NAMELY, DIGITAL X-RAYS AND APPARATUS AND INSTRUMENTS FOR MAMMOGRAPHY AND DIAGNOSTIC RADIOLOGY, IN CLASS 10 (U.S. CLS. 26, 39 AND 44).

FOR: APPARATUS FOR WATER SUPPLY AND SANITARY PURPOSES AND FOR SUPERVISION

AND TREATMENT OF DRAINS AND DRAIN PIPES, NAMELY, WASTEWATER TREATMENT SYSTEMS COMPRISED OF BASINS, AERATION DIFFUSERS AND CLARIFIER AND SETTLING TANK; SEWAGE INFLUENT CLEANING MACHINE; BELT FILTER PRESSES FOR DE-WATERING SLUDGE; MACHINE FOR USE IN WASTEWATER TREATMENT SYSTEM FOR THE REDUCTION OF BIOLOGICAL SOLID WASTE TO A LIQUID; COMBINATION SCREEN AND COMPACTOR USED IN WASTEWATER TREATMENT SYSTEMS; MOVING AERATION CHAINS WHICH SUPPORT CERTAIN APPARATUSES, NAMELY, FINE BUBBLE DIFFUSERS, AIR PIPING MANIFOLD, BLOWERS, PARTITION WALLS, SLUDGE REMOVERS, RAKES AND OVERFLOW WEIRS TO PROVIDE MIXING AND AERATION IN BIOLOGICAL TREATMENT WASTEWATER SYSTEMS; AND HEAT EXCHANGERS, NOT BEING PART OF MACHINES, IN CLASS 11 (U.S. CLS. 13, 21, 23, 31 AND 34).

FOR: PACKING MATERIALS FOR FORMING SEALS, STOPPING MATERIALS, NAMELY, RUBBER STOPPERS; INSULATING MATERIALS, NAMELY, SOUND ABSORBING SHEETS; FLEXIBLE PIPES, NOT OF METAL, IN CLASS 17 (U.S. CLS. 1, 5, 12, 13, 35 AND 50).

FOR: IMPORT-EXPORT AGENCIES; RETAIL STORE SERVICES IN THE FIELD OF TELECOMMUNICATIONS, FLUID HANDLING EQUIPMENT, PUMPS, BALL-BEARINGS, TRANSMISSIONS, MECHANICAL GEARS, SEALS, PHOTOGRAPHIC EQUIPMENT AND PHOTOGRAPHIC EQUIPMENT CONSUMABLES, GRAPHIC ARTS EQUIPMENT AND GRAPHIC ARTS EQUIPMENT CONSUM-

ABLES, MEDICAL IMAGING EQUIPMENT AND MEDICAL IMAGING EQUIPMENT COMPONENTS, COMPONENTS TO HEAVY DUTY VEHICLES, EQUIPMENT AND COMPONENTS FOR LASHING, STEEL WIRES, ROPES, LIFTING, HARNESES AND STRAPPING; BUSINESS MANAGEMENT AND ORGANIZATION CONSULTANCY; COMMERCIAL OR INDUSTRIAL MANAGEMENT ASSISTANCE; BUSINESS APPRAISALS; BUSINESS INVESTIGATIONS; COMPUTERIZED BUSINESS MANAGEMENT FOR OTHERS; COMPUTERIZED COMPILATION OF ORDER LISTS; OFFICE ADMINISTRATION; BUSINESS RESEARCH; RELOCATION SERVICES FOR BUSINESSES; COMPILATION OF INFORMATION INTO COMPUTER DATABASES; BUSINESS ADMINISTRATION; ELECTRONIC TRACKING OF FREIGHT AND GOODS BY COMPUTER, IN CLASS 35 (U.S. CLS. 100, 101 AND 102).

FOR: REAL ESTATE MANAGEMENT; RENTAL OF OFFICES; LEASING OF REAL ESTATE AND BUILDINGS; BROKERAGE OF REAL ESTATE; REAL ESTATE AGENCIES; REAL ESTATE APPRAISAL; VENTURE CAPITAL SERVICES, NAMELY, PROVIDING FINANCING TO EMERGING AND START-UP COMPANIES; FINANCIAL MANAGEMENT; CUSTOMS BROKERAGE; ELECTRONIC FUNDS TRANSFER, IN CLASS 36 (U.S. CLS. 100, 101 AND 102).

FOR: CONSULTANCY SERVICES RELATING TO CONSTRUCTION OF REAL ESTATE PROPERTY AND BUILDINGS FOR INVESTMENT AND SALE; INSTALLATION, REPAIR AND MAINTENANCE OF EACH OF THE FOLLOWING: BALL-BEARINGS FOR MACHINES, COMPRESSORS, LAWN MOWERS AND HAND TOOLS, HOISTS, WINCHES, ELECTRIC PUMP MACHINES, MACHINE COMPONENTS, NAMELY, TRANSMISSION COMPONENTS FOR MACHINES, COMPRESSORS, LAWN MOWERS AND HAND TOOLS; EQUIPMENT FOR HANDLING LIQUIDS, NAMELY, MECHANICAL AND HYDRAULIC PUMPS AND VALVE ACTUATORS, AND PARTS AND FITTINGS THERE-TO, AND ELECTRIC GASOLINE PUMPS; FLOW,

PRESSURE, TEMPERATURE AND LEVEL-MEASURING INSTRUMENTS; TELEPHONE APPARATUS, NAMELY, CELLULAR TELEPHONES, CORDLESS TELEPHONES AND STATIONARY TELEPHONES; FACSIMILE MACHINES, MODEMS, TELEPHONE SWITCHBOARDS, MEDICAL AND VETERINARY APPARATUS AND INSTRUMENTS, NAMELY, DIGITAL X-RAYS AND APPARATUS AND INSTRUMENTS FOR MAMMOGRAPHY AND RADIOLOGY; APPARATUS FOR WATER SUPPLY AND SANITARY PURPOSES AND FOR SUPERVISION AND TREATMENT OF DRAINS AND DRAIN PIPES, NAMELY, WASTEWATER TREATMENT SYSTEMS COMPRISED OF BASINS, AERATION DIFFUSERS AND CLARIFIER AND SETTLING TANK; SEWAGE INFLUENT CLEANING MACHINE; BELT FILTER PRESSES FOR DEWATERING SLUDGE; MACHINE FOR USE IN WASTEWATER TREATMENT SYSTEM FOR THE REDUCTION OF BIOLOGICAL SOLID WASTE TO A LIQUID; COMBINATION SCREEN AND COMPACTOR USED IN WASTEWATER TREATMENT SYSTEMS; MOVING AERATION CHAINS WHICH SUPPORT CERTAIN APPARATUSES, NAMELY, FINE BUBBLE DIFFUSERS, AIR PIPING MANIFOLD, BLOWERS, PARTITION WALLS, SLUDGE REMOVERS, RAKES AND OVERFLOW WEIRS WHICH PROVIDE MIXING AND AERATION IN BIOLOGICAL TREATMENT WASTEWATER SYSTEMS; AND HEAT EXCHANGERS, NOT BEING PART OF MACHINES, IN CLASS 37 (U.S. CLS. 100, 103 AND 106).

PRIORITY DATE OF 12-20-2006 IS CLAIMED.

OWNER OF INTERNATIONAL REGISTRATION 0928847 DATED 1-25-2007, EXPIRES 1-25-2017.

OWNER OF U.S. REG. NO. 2,470,857.

SER. NO. 79-040,255, FILED 1-25-2007.

ANDREA SAUNDERS, EXAMINING ATTORNEY

Int. Cls.: 9, 16, 20, 21, 25, 28 and 41

Prior U.S. Cls.: 2, 5, 13, 21, 22, 23, 25, 26, 29, 30, 32, 33, 36, 37, 38, 39, 40, 50, 100, 101 and 107

Reg. No. 3,520,775

United States Patent and Trademark Office

Registered Oct. 21, 2008

**TRADEMARK
SERVICE MARK
PRINCIPAL REGISTER**

WISPLURKER

ZIP CREATIVE LICENSING LIMITED (UNITED KINGDOM LIMITED COMPANY)
303 VANILLA FACTORY
39 FLEET STREET; LIVERPOOL L1 4AR
UNITED KINGDOM

FOR: COMPUTER GAMES, NAMELY, COMPUTER GAME CARTRIDGES, COMPUTER GAME DISKS, COMPUTER GAME SOFTWARE; ENTERTAINMENT SOFTWARE, NAMELY, INTERACTIVE MULTIMEDIA COMPUTER GAME PROGRAMS, COMPUTER GAME PROGRAMS; COMPUTER GAME SOFTWARE FOR PLAYING A COMPUTER CRAPS GAME; COMPUTER GAME PROGRAMS; COMPUTER GAMES SOFTWARE; PRERECORDED VIDEOS, DVDS, AND VIDEO CASSETTES FEATURING MUSIC, CARTOONS AND CHILDREN'S PROGRAMS; PRERECORDED DVDS AND VIDEOCASSETTES FEATURING ANIMATIONS; GAMES, VIDEOS AND ANIMATIONS FOR MOBILE TELEPHONES, NAMELY, ELECTRONIC GAME SOFTWARE FOR MOBILE PHONES, COMPUTER GAME SOFTWARE DOWNLOADABLE BY MOBILE TELEPHONES, DOWNLOADABLE VIDEOS FOR MOBILE PHONES FEATURING MUSIC AND ANIMATION; DOWNLOADABLE MOBILE PHONE RING TONES; BATTERIES; CASES SPECIFICALLY ADAPTED TO CARRY MOBILE TELEPHONES; BLANK CDS, DVDS, CASSETTES, AND VIDEOCASSETTES; PRERECORDED CDS, DVDS, CASSETTES, VIDEOCASSETTES FEATURING MUSIC, CHILDREN'S STORIES, ANIMATION; MUSIC VIDEO RECORDINGS AND MUSICAL SOUND RECORDINGS FOR MOBILE TELEPHONES, IN CLASS 9 (U.S. CLS. 21, 23, 26, 36 AND 38).

FOR: PAPER, NAMELY, CRAFT PAPER, GIFT WRAPPING PAPER AND COPY PAPER, CARDBOARD; PRINTED MATTER, NAMELY, MAPS, PRINTED GUIDE BOOKS FEATURING TRAVEL, NEWSPAPERS, CHILDREN'S MAGAZINES, COMIC BOOKS AND STRIPS; PRINTED PERIODICALS IN THE FIELD OF MUSIC, DANCE, MOVIES, CARTOONS; PHOTOGRAPHS; STATIONERY; ADHE-

SIVES FOR STATIONERY OR HOUSEHOLD PURPOSES; INSTRUCTIONAL AND TEACHING MATERIAL, NAMELY, INSTRUCTION SHEETS, INSTRUCTIONAL AND TEACHING BOOKS FOR MATHS, ENGLISH, SCIENCE, GEOGRAPHY, HISTORY, FOREIGN LANGUAGES, ARTS AND CRAFTS; PLASTIC MATERIALS FOR PACKAGING, NAMELY, PLASTIC BAGS FOR PACKAGING, PLASTIC BUBBLE PACKS FOR WRAPPING OR PACKAGING; POSTERS; PENS; BOOKMARKS; CALENDARS; WRAPPING PAPER; NOTEPADS; GREETING CARDS; ADHESIVE PRINTED STICKERS; ADHESIVE PRINTED MATTER, NAMELY, ADHESIVE PATCHES TO BE PRINTED WITH AN INDIVIDUAL WEARER'S MEDICAL AND PERSONAL INFORMATION; ALBUMS FOR COINS, PHOTOGRAPHS, AND STICKERS; ANNUALS, NAMELY, CHILDREN'S BOOKS IN THE FIELD OF MUSIC, DANCE, MOVIES, STORIES; ART PRINTS; ARTICLES FOR WRITING AND DRAWING, NAMELY, PENS, PENCILS, STENCILS, COMPASSES, ERASERS; CHILDREN'S MAGAZINES IN THE FIELD OF MUSIC, DANCE, MOVIES, STORIES; COMIC BOOKS, COMIC STRIPS; COMPUTER USER MANUALS; DRAWINGS; EDUCATIONAL MATERIAL, NAMELY, CHILDREN'S INTERACTIVE EDUCATIONAL BOOKS FOR MATHS, ENGLISH, SCIENCE, GEOGRAPHY, HISTORY, FOREIGN LANGUAGES, ARTS AND CRAFTS; GRAPHIC PRINTS, ILLUSTRATIONS; ADDRESS LABELS, PAPER LABELS; WALL PLANNERS, NAMELY, WALL CALENDARS, IN CLASS 16 (U.S. CLS. 2, 5, 22, 23, 29, 37, 38 AND 50).

FOR: FIGURINES, WORKS OF ART, AND MODELS OF WOOD, WAX, PLASTER AND PLASTIC, IN CLASS 20 (U.S. CLS. 2, 13, 22, 25, 32 AND 50).

FOR: BATH COMBS, BLACKING COMBS, PET COMBS, CAKE COMBS, CLOTHES COMBS, COSMETIC COMBS AND BRUSHES; GLASSWARE, NAMELY, SCULPTURES, BEVERAGE GLASSWARE; PORCELAIN AND EARTHENWARE, NAMELY, PORCELAIN MUGS, PORCELAIN

SCULPTURES, PORCELAIN DOORKNOBS, EARTHENWARE MUGS, EARTHENWARE FIGURINES, EARTHENWARE JARS FOR JAMS AND JELLIES; DRINKING GLASSES, MUGS, IN CLASS 21 (U.S. CLS. 2, 13, 23, 29, 30, 33, 40 AND 50).

FOR: CLOTHING, NAMELY, SHIRTS, PANTS, SKIRTS, DRESSES, SHORTS, TIES, UNDERWEAR, JUMPERS, SHIRTS, T-SHIRTS, VESTS, SWIMWEAR; FOOTWEAR; HEADGEAR, NAMELY, HATS, CAPS, IN CLASS 25 (U.S. CLS. 22 AND 39).

FOR: TOYS, GAMES AND PLAYTHINGS, NAMELY, CRIB TOYS, INFANT TOYS, MECHANICAL TOYS, MUSICAL TOYS, TOY VEHICLES, ACTION SKILL GAMES, CARD GAMES, BOARD GAMES, ARCADE GAMES; PLAYING CARDS, IN CLASS 28 (U.S. CLS. 22, 23, 38 AND 50).

FOR: ENTERTAINMENT BY FILM, NAMELY, MOTION PICTURE FILM PRODUCTION, FILM STUDIOS, PLANNING AND CONDUCTING A SERIES OF FILM FESTIVALS; ENTERTAINMENT BY RADIO, NAMELY, RADIO PROGRAMS FEATURING PERFORMANCES BY FICTIONAL CHARACTERS, CHILDREN'S STORIES; ENTERTAINMENT BY TELEVISION, NAMELY, ENTERTAINMENT IN THE NATURE OF CONTINUING TELEVISION FEATURING NEWS, COMEDY VARIETY, AND CHILDREN'S PROGRAMMES; ENTERTAINMENT IN THE NATURE OF THEATRE PRODUCTION; ENTERTAINMENT BY LIVE PERFORMANCES, NAMELY, LIVE MUSIC CONCERTS, LIVE PERFORMANCES BY A PROFESSIONAL ENTERTAINER; ENTERTAINMENT PROVIDED BY TELEVISION PROGRAMMES, CABLES TELEVISION AND INTERNET TELEVISION, NAMELY, ENTERTAIN-

MENT IN THE NATURE OF CONTINUING TELEVISION FEATURING CHILDREN'S PROGRAMMES, NEWS, COMEDY, AND VARIETY; ENTERTAINMENT SERVICES FOR CHILDREN IN THE NATURE OF FASHION SHOWS, ONGOING CHILDREN'S TELEVISION PROGRAMMES AND ONGOING CHILDREN'S ANIMATED TELEVISION PROGRAMMES; ELECTRONIC GAME SERVICES PROVIDED BY MEANS OF THE INTERNET, NAMELY, ONLINE COMPUTER GAMES; PROVISION OF ONLINE NON-DOWNLOADABLE PUBLICATIONS IN THE NATURE OF BOOKS FEATURING ANIMATION; PROVISION OF ONLINE NON-DOWNLOADABLE INSTRUCTIONAL AND EDUCATIONAL PUBLICATIONS IN THE FIELD OF MATHS, ENGLISH, SCIENCE, GEOGRAPHY, HISTORY, FOREIGN LANGUAGES, ARTS AND CRAFTS, AND DIGITAL MUSIC, FROM THE INTERNET, IN CLASS 41 (U.S. CLS. 100, 101 AND 107).

THE MARK CONSISTS OF STANDARD CHARACTERS WITHOUT CLAIM TO ANY PARTICULAR FONT, STYLE, SIZE, OR COLOR.

PRIORITY DATE OF 12-23-2006 IS CLAIMED.

OWNER OF INTERNATIONAL REGISTRATION 0929411 DATED 4-19-2007, EXPIRES 4-19-2017.

SER. NO. 79-040,501, FILED 4-19-2007.

REBECCA POVARCHUK, EXAMINING ATTORNEY

Int. Cls.: 7, 9, 22, 39, 40 and 44

**Prior U.S. Cls.: 1, 2, 7, 13, 19, 21, 22, 23, 26, 31, 34, 35,
36, 38, 42, 50, 100, 101, 103, 105 and 106**

Reg. No. 3,520,776

United States Patent and Trademark Office

Registered Oct. 21, 2008

**TRADEMARK
SERVICE MARK
PRINCIPAL REGISTER**

FONET

FOBOX AS (NORWAY LIMITED COMPANY)
C/O FRED. OLSEN
P.O. BOX 1159, SENTRUM; N-0107
OSLO, NORWAY

FOR: DRILLING TOWERS, DRILLING RIGS AND WAVE DAMPENERS AS INTEGRATED PARTS OF FLOATING AND NON-FLOATING OFFSHORE OIL AND GAS DRILLING AND PRODUCTION PLATFORMS; ELECTRIC AND HYDRAULIC GENERATORS AND BORING MACHINES; ELECTRIC AND HYDRAULIC MOTORS FOR MACHINES AND ENGINES OTHER THAN FOR LAND VEHICLES; GENERATORS FOR ELECTRICITY, IN CLASS 7 (U.S. CLS. 13, 19, 21, 23, 31, 34 AND 35).

FOR: APPARATUS AND INSTRUMENTS FOR CONDUCTING, SWITCHING, TRANSFORMING, ACCUMULATING, PRODUCING, REGULATING OR CONTROLLING ELECTRICITY, NAMELY, ELECTRICAL WIRES, TRANSFORMERS, BATTERIES; HYDRAULIC, ELECTRIC AND/OR MECHANICAL APPARATUS AND INSTRUMENTS FOR CONVERTING WAVE POWER TO ELECTRIC ENERGY, NAMELY, APPARATUS FOR ABSORBING ENERGY FROM WAVES AND TRANSFERRING THE ENERGY TO A HYDRAULIC OR ELECTRIC GENERATOR; MATERIALS FOR TRANSMISSION OF ELECTRICITY, NAMELY, ELECTRIC WIRES AND CABLES, IN CLASS 9 (U.S. CLS. 21, 23, 26, 36 AND 38).

FOR: TOW ROPE; NETS FOR UNDERWATER USE IN ANCHORING, HAULING UP AND TOWING LOADS, AND FOR SEPARATING SEA TRAFFIC, IN CLASS 22 (U.S. CLS. 1, 2, 7, 19, 22, 42 AND 50).

FOR: DISTRIBUTION OF ELECTRIC POWER; OFFSHORE SUPPLY AND DISTRIBUTION OF FRESH WATER; TRANSPORT OF OIL, GAS, CHEMICALS, CONTAINERIZED GOODS, AND PERSONNEL BY SHIP AND PIPELINES, PACKAGING OF CONTAINERIZED GOODS FOR TRANSPORTATION; STORAGE OF CONTAINERIZED GOODS, IN CLASS 39 (U.S. CLS. 100 AND 105).

FOR: PRODUCTION OF ELECTRIC POWER; WATER TREATMENT, IN CLASS 40 (U.S. CLS. 100, 103 AND 106).

FOR: ANIMAL BREEDING, NAMELY, BREEDING OF FISH AND SHELLFISH, IN CLASS 44 (U.S. CLS. 100 AND 101).

THE MARK CONSISTS OF STANDARD CHARACTERS WITHOUT CLAIM TO ANY PARTICULAR FONT, STYLE, SIZE, OR COLOR.

OWNER OF INTERNATIONAL REGISTRATION 0929456 DATED 1-15-2007, EXPIRES 1-15-2017.

SER. NO. 79-040,520, FILED 1-15-2007.

AHSEN KHAN, EXAMINING ATTORNEY

Int. Cls.: 17, 19 and 22

Prior U.S. Cls.: 1, 2, 5, 7, 12, 13, 19, 22, 33, 35, 42 and 50

Reg. No. 3,520,777

United States Patent and Trademark Office

Registered Oct. 21, 2008

**TRADEMARK
PRINCIPAL REGISTER**

DELTA-MAXX-TITAN

EWALD DÖRKEN AG (FED REP GERMANY
JOINT STOCK COMPANY)
WETTERSTRASSE 58
58313 HERDECKE
FED REP GERMANY

FOR: SEMI-FINISHED GOODS MADE FROM PLASTICS, NAMELY, PLASTIC SHEETING FOR USE AS DROP CLOTHS; SEALING MATERIAL, NAMELY, POLYURETHANE FILM FOR USE IN SEALING AND INSULATING; SEALING AND INSULATING SHEETS, NAMELY, SHEETS OF PLASTIC FABRIC USED AS AN INSULATING INFILTRATION BARRIER FOR BUILDING CONSTRUCTION; ROOF UNDERLAY, NAMELY, PLASTIC SHEETING USED IN THE CONSTRUCTION INDUSTRY AS A VAPOR BARRIER; PLASTIC SHEETING USED IN THE CONSTRUCTION INDUSTRY, NAMELY, CARRIER SHEETS, DIMPLED SHEETS, SHEETS FOR HIGH-PITCHED ROOFS, SCAFFOLDING SHEETS MADE FROM PLASTIC; PLASTIC SHEETING USED IN THE CONSTRUCTION INDUSTRY, NAMELY, SEALING AND INSULATING PLASTIC SHEETS IN THE NATURE OF WRAPPINGS FOR FOUNDATIONS AND BASEMENT; PLASTIC SHEETING FOR USE AS DROP CLOTHS, NAMELY, SHEETS FOR HIGH PITCHED ROOFS, SCAFFOLDING SHEETS MADE FROM PLASTIC FOR CONSTRUCTION PURPOSES; INSULATING PLASTIC FILMS, NAMELY, SHEETS OF PLASTIC FABRIC USED AS AN INSULATING INFILTRATION BARRIER IN BUILDING OR BUILDING INSULATION, INSULATING WATERPROOFING MEMBRANES; PLASTIC FILMS, NAMELY, COVERINGS FOR STORE ROOMS; PLASTIC SHEETING FOR AGRICULTURAL PURPOSES; PROTECTION AND DRAINING SHEETS MADE FROM PLASTIC, NAMELY, PLASTIC SHEETING FOR UNDERGROUND CONSTRUCTION PURPOSES, NAMELY, COVERING AND PROTECTING THE EXTERIOR SURFACES OF BASEMENT AND FOUNDATION WALLS; BUILDING INSULATION, NAMELY, INSULATING FILMS, INSULATING FABRICS; INSULATING MATERIALS FOR BUILDINGS; INSULATING BOARDS; SCAFFOLDING SHEETS FOR CONSTRUCTION PURPOSES, IN CLASS 17 (U.S. CLS. 1, 5, 12, 13, 35 AND 50).

FOR: REINFORCED AND NON-REINFORCED SEPARATING, PROTECTING AND DRAINING SHEETS FOR CONSTRUCTION PURPOSES, NAMELY, PLASTIC WEBBING MATERIAL USED TO REINFORCE BITUMINOUS WATERPROOFING SHEETS; REINFORCED AND NON-REINFORCED DIMPLED SHEETS FOR CONSTRUCTION PURPOSES, NAMELY, PLASTIC WEBBING MATERIAL USED TO REINFORCE BITUMINOUS WATERPROOFING SHEETS; REINFORCED AND NON-REINFORCED CARRIER SHEETS FOR CONSTRUCTION PURPOSES, NAMELY, PLASTIC COMPOSITE SHEETS FOR BUILDING PURPOSES; INDUSTRIAL TEXTILES AND WOVEN FABRICS FOR CONSTRUCTION PURPOSES, NAMELY, GEOTEXTILES FOR USE IN CONNECTION WITH ROAD CONSTRUCTION, RAILROAD CONSTRUCTION, TUNNEL CONSTRUCTION, WATERWAY CONSTRUCTION AND PUBLIC WORKS CONSTRUCTION; GEOTEXTILES FOR THE PURPOSES OF DRAINAGE, STABILIZING INCLINES, RECULTIVATION, PLANT SUPPORT, ABSORPTION, FILTRATION, SEPARATION, STABILIZATION AND REINFORCEMENT OF THE SOIL; SMALL PREFABRICATED GREEN HOUSES, IN CLASS 19 (U.S. CLS. 1, 12, 33 AND 50).

FOR: TARPAULINS FOR CONSTRUCTION PURPOSES, INCLUDED IN THIS CLASS; STEEP ROOF TARPAULINS, COVERING AND SCAFFOLDING TARPAULINS MADE FROM PLASTICS; COVERING AND SCAFFOLDING TARPAULINS FOR CONSTRUCTION PURPOSES, IN CLASS 22 (U.S. CLS. 1, 2, 7, 19, 22, 42 AND 50).

THE MARK CONSISTS OF STANDARD CHARACTERS WITHOUT CLAIM TO ANY PARTICULAR FONT, STYLE, SIZE, OR COLOR.

PRIORITY DATE OF 12-22-2006 IS CLAIMED.

OWNER OF INTERNATIONAL REGISTRATION
0930190 DATED 5-23-2007, EXPIRES 5-23-2017.

OWNER OF U.S. REG. NOS. 3,154,276 AND
3,185,428.

SER. NO. 79-040,812, FILED 5-23-2007.

SUSAN LESLIE DUBOIS, EXAMINING ATTORNEY

Int. Cls.: 9 and 10

Prior U.S. Cls.: 21, 23, 26, 36, 38, 39 and 44

United States Patent and Trademark Office

Reg. No. 3,520,778

Registered Oct. 21, 2008

**TRADEMARK
PRINCIPAL REGISTER**

LithoSpace

AST GMBH (FED REP GERMANY GMBH)
MORITZ-VON-ROHR-STR. 1A
07745 JENA
FED REP GERMANY

FOR: APPARATUS AND INSTRUMENTS FOR CONVERTING ELECTRICITY, IN PARTICULAR FOR GENERATING SHOCK WAVES, NAMELY, SHOCK WAVE GENERATORS; SOFTWARE FOR OPERATING NAVIGATION DEVICES IN THE NATURE OF DIAGNOSTIC ULTRASOUND MACHINES AND VEHICLE NAVIGATION SYSTEMS, IN CLASS 9 (U.S. CLS. 21, 23, 26, 36 AND 38).

FOR: MEDICAL EQUIPMENT FOR FRAGMENTING HUMAN KIDNEY STONES OR FOR IMPROVING BLOOD SUPPLY TO BONES, NAMELY, LITHOTRIPTERS; MEDICAL APPARATUS AND INSTRUMENTS FOR FRAGMENTING HUMAN

KIDNEY STONES AND FOR IMPROVING BLOOD SUPPLY TO THE BONES; MEDICAL SHOCK WAVE GENERATORS; NAVIGATION DEVICES FOR LOCATING ORGANS, BONES, OR KIDNEY STONES IN HUMAN OR ANIMAL BODIES, NAMELY, MEDICAL ULTRASOUND DEVICES, IN CLASS 10 (U.S. CLS. 26, 39 AND 44).

PRIORITY DATE OF 12-8-2006 IS CLAIMED.

OWNER OF INTERNATIONAL REGISTRATION
0930200 DATED 4-17-2007, EXPIRES 4-17-2017.

SER. NO. 79-040,815, FILED 4-17-2007.

LEIGH LOWRY, EXAMINING ATTORNEY

Int. Cls.: 7, 17 and 20

Prior U.S. Cls.: 1, 2, 5, 12, 13, 19, 21, 22, 23, 25, 31, 32, 34, 35 and 50

Reg. No. 3,520,779

United States Patent and Trademark Office

Registered Oct. 21, 2008

**TRADEMARK
PRINCIPAL REGISTER**



BUCCHI S.R.L. (ITALY SOCIETE A RESPONSABILITE LIMITEE)
VIA BONSI S.N.C.
I-48022 LUGO (RA), ITALY

FOR: TAPS AND VALVES MADE OF METAL AND MADE OF PLASTIC BEING PARTS OF MACHINES USED FOR CIRCULATION OF WATER AND OTHER LIQUIDS, IN CLASS 7 (U.S. CLS. 13, 19, 21, 23, 31, 34 AND 35).

FOR: FLEXIBLE PLASTIC PLUMBING PIPES, PLASTIC CONNECTORS FOR PIPES; PLASTIC SEALS FOR NON-METAL PIPE CONNECTIONS; PLASTIC COUPLINGS FOR PIPES, IN CLASS 17 (U.S. CLS. 1, 5, 12, 13, 35 AND 50).

FOR: WATER-PIPE VALVES OF PLASTIC, IN CLASS 20 (U.S. CLS. 2, 13, 22, 25, 32 AND 50).

OWNER OF INTERNATIONAL REGISTRATION 0930512 DATED 4-5-2007, EXPIRES 4-5-2017.

THE COLOR(S) RED AND GRAY IS/ARE CLAIMED AS A FEATURE OF THE MARK.

THE MARK CONSISTS OF THE GRAPHIC COMPOSITION FORMED BY THE MARK "BD FAST" WRITTEN IN ELECTROBAZAR POLICE TYPE FONT, WHERE THE LETTERS "BD" ARE IN RED AND THE WORD "FAST" IS IN GRAY; THE TWO NAMES ARE INTERCONNECTED BY THE IMAGE OF TWO STYLIZED ARROWS, ONE POINTING UPWARDS AND THE OTHER DOWNWARDS, WHICH ARE RED AND GRAY IN COLOR. THE WHITE AREAS OF THE DRAWING INDICATE TRANSPARENCY.

THE WORDING "BD FAST" HAS NO MEANING IN A FOREIGN LANGUAGE.

SER. NO. 79-041,013, FILED 4-5-2007.

DEBRA LEE, EXAMINING ATTORNEY

Int. Cls.: 39, 43 and 44

Prior U.S. Cls.: 100, 101 and 105

United States Patent and Trademark Office

Reg. No. 3,520,780

Registered Oct. 21, 2008

SERVICE MARK
PRINCIPAL REGISTER

**ROYAL
MANSOUR**

SIGER (MOROCCO JOINT STOCK COMPANY)
5 AV DE LA PRINCESSE LALLA MERYEM
(SOUISSI)
RABAT, MOROCCO

FOR: TRANSPORT OF GOODS; PACKAGING AND STORAGE OF GOODS, NAMELY, FURNITURE, CLOTHES, LUGGAGE, PIECES OF ART AND JEWELS FOR TRANSPORTATION; PACKAGING OF ARTICLES FOR TRANSPORTATION; STORAGE OF FURNITURE, CLOTHES, LUGGAGE, PIECES OF ART, AND JEWELS; ARRANGING OF TRAVEL TOURS, IN CLASS 39 (U.S. CLS. 100 AND 105).

FOR: SERVICES FOR PROVIDING FOOD AND DRINK; PROVIDING TEMPORARY ACCOMMODATION, IN CLASS 43 (U.S. CLS. 100 AND 101).

FOR: MEDICAL SERVICES; VETERINARY SERVICES; SALON SERVICES, NAMELY, HYGIENIC

AND BEAUTY CARE FOR HUMAN BEINGS AND ANIMALS; AGRICULTURE, HORTICULTURE AND FORESTRY SERVICES, NAMELY, PROVIDING GARDENING AND FLORIST SERVICES IN THE NATURE OF FLOWER ARRANGING AND GARDEN AND FLOWERBED CARE, IN CLASS 44 (U.S. CLS. 100 AND 101).

PRIORITY DATE OF 10-4-2006 IS CLAIMED.

OWNER OF INTERNATIONAL REGISTRATION
0930728 DATED 4-4-2007, EXPIRES 4-4-2017.

SER. NO. 79-041,090, FILED 4-4-2007.

DAVID HOFFMAN, EXAMINING ATTORNEY

Int. Cls.: 9, 14, 16 and 18

Prior U.S. Cls.: 1, 2, 3, 5, 21, 22, 23, 26, 27, 28, 29, 36, 37, 38, 41 and 50

Reg. No. 3,520,781

United States Patent and Trademark Office

Registered Oct. 21, 2008

**TRADEMARK
PRINCIPAL REGISTER**

Tutima

TUTIMA UHRENFABRIK GMBH (FED REP GERMANY COMPANY WITH LIMITED LIABILITY)

TRENDELBUSCHER WEG 16-18

27777 GANDERKESEE

FED REP GERMANY

FOR: SPECTACLES, SUNGLASSES, SPECTACLE FRAMES, SPECTACLE GLASSES, SPECTACLE CASES; ELECTRIC NAVIGATIONAL INSTRUMENTS; TIME RECORDING APPARATUS; APPARATUS FOR RECORDING, TRANSMISSION OR REPRODUCTION OF DATA, SOUND OR IMAGES; MOBILE PHONES; BLANK OPTICAL OR MAGNETIC DATA CARRIERS; CALCULATING MACHINES, NAMELY, CALCULATORS, DATA PROCESSING EQUIPMENT, NAMELY, COMPUTERS AND COMPUTER PERIPHERAL EQUIPMENT; CASES AND BAGS FOR THE AFORESAID GOODS, NAMELY, FOR MOBILE PHONES, HANDHELDS OR NOTEBOOK COMPUTERS; STRUCTURAL PARTS AND FITTINGS OF THE AFORESAID GOODS, IN CLASS 9 (U.S. CLS. 21, 23, 26, 36 AND 38).

FOR: DIAMONDS, PRECIOUS STONES, SEMI-PRECIOUS STONES, PEARLS; JEWELLERY; CUFF LINKS; HOROLOGICAL AND CHRONOMETRIC INSTRUMENTS, DIALS, MOVEMENTS, WRIST WATCHES, POCKET WATCHES, WATCH BANDS, WATCH BRACELETS, WATCH STRAPS, WATCH CHAINS, WATCH CASES, WATCH GLASSES, WATCH WINDERS; BOXES AND CASES FOR JEWELLERY OR HOROLOGICAL AND CHRONOMETRIC INSTRUMENTS; STRUCTURAL PARTS AND FITTINGS FOR THE AFORESAID GOODS, IN CLASS 14 (U.S. CLS. 2, 27, 28 AND 50).

FOR: PAPER, CARDBOARD AND GOODS MADE FROM THESE MATERIALS, NAMELY, BOXES AND CARRYING CASES OF CARDBOARD OR PAPER; PRINTED MATTER, NAMELY, CATALO-

GUES, BROCHURES AND BOOKLETS IN THE FIELD OF OPTICS, ELECTRONICS, JEWELRY, WATCHES AND TIMEPIECES, STATIONERY, WRITING INSTRUMENTS, AS WELL AS LEATHER GOODS; POSTERS; PHOTOGRAPHS; STATIONERY; WRITING INSTRUMENTS, NAMELY, FOUNTAIN PENS, ROLLERBALL PENS, BALLPOINT PENS, FELT-TIP PENS, FIBRETIP PENS, MECHANICAL PENCILS; BOXES AND CASES FOR WRITING INSTRUMENTS; HOLDERS AND TRAYS FOR WRITING INSTRUMENTS; STATIONERY-TYPE PORTFOLIOS; WRITING PADS, PAPERWEIGHTS, LETTER TRAYS, PEN INK, INKWELLS, PEN INK CARTRIDGES; DRAWING INSTRUMENTS, DRAWING CASES FOR DRAWING INSTRUMENTS; PAINT BRUSHES; TYPEWRITERS, NAMELY, ELECTRIC AND NON-ELECTRIC TYPEWRITERS; STRUCTURAL PARTS AND FITTINGS FOR THE AFORESAID GOODS, IN CLASS 16 (U.S. CLS. 2, 5, 22, 23, 29, 37, 38 AND 50).

FOR: LEATHER AND IMITATIONS OF LEATHER, AND GOODS MADE OF THESE MATERIALS, NAMELY, BAGS AND CASES, BACKPACKS, BOXES, BRIEFCASES, BRIEFCASE-TYPE PORTFOLIOS FOR DOCUMENTS, CARRYING CASES FOR DOCUMENTS, HANDBAGS, KEY CASES, KNAPSACKS, MONEY BAGS, POUCHES, PURSES, SATCHELS, SCHOOL BAGS, SHOPPING BAGS, SPORTS BAGS, SUITCASES, TRUNKS, TRAVELLING BAGS, VANITY CASES SOLD EMPTY, WALLETS; BAGS AND CASES, NAMELY, BACKPACKS, BRIEFCASES, BRIEFCASE-TYPE PORTFOLIOS FOR DOCUMENTS, CARRYING CASES FOR DOCUMENTS, HANDBAGS, KEY CASES, KNAPSACKS, MONEY BAGS, POUCHES, PURSES, SATCHELS, SCHOOL BAGS, TEXTILE SHOPPING BAGS, SPORTS BAGS; SUITCASES, TRUNKS, TRAVELLING BAGS, VANITY CASES SOLD EMPTY, WALLETS; SHOULDER STRAPS; UMBRELLAS, PARASOLS AND WALKING STICKS; ANIMAL

SKINS, HIDES; WHIPS, HARNESS AND SADDLERY; STRUCTURAL PARTS AND FITTINGS FOR THE AFORESAID GOODS, IN CLASS 18 (U.S. CLS. 1, 2, 3, 22 AND 41).

THE MARK CONSISTS OF STANDARD CHARACTERS WITHOUT CLAIM TO ANY PARTICULAR FONT, STYLE, SIZE, OR COLOR.

PRIORITY DATE OF 1-31-2007 IS CLAIMED.

OWNER OF INTERNATIONAL REGISTRATION 0930758 DATED 4-28-2007, EXPIRES 4-28-2017.

OWNER OF U.S. REG. NO. 1,174,121.

SER. NO. 79-041,104, FILED 4-28-2007.

DOMINIC FATHY, EXAMINING ATTORNEY

Int. Cls.: 9, 14, 16 and 18

Prior U.S. Cls.: 1, 2, 3, 5, 21, 22, 23, 26, 27, 28, 29, 36, 37, 38, 41 and 50

Reg. No. 3,520,782

United States Patent and Trademark Office

Registered Oct. 21, 2008

**TRADEMARK
PRINCIPAL REGISTER**

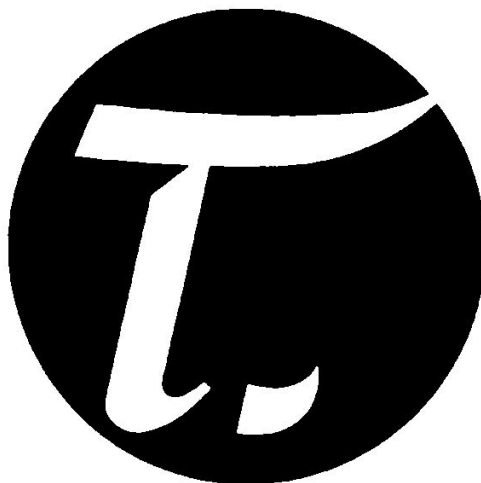

TUTIMA UHRENFABRIK GMBH (FED REP GERMANY COMPANY WITH LIMITED LIABILITY)

TRENDELBUSCHER WEG 16-18

27777 GANDERKESEE

FED REP GERMANY

FOR WRITING INSTRUMENTS; PEN INK, INKWELLS, PEN INK CARTRIDGES; STRUCTURAL PARTS AND FITTINGS FOR THE AFORESAID GOODS, IN CLASS 16 (U.S. CLS. 2, 5, 22, 23, 29, 37, 38 AND 50).

FOR: SPECTACLES, SUNGLASSES, SPECTACLE FRAMES, SPECTACLE GLASSES, SPECTACLE CASES; STRUCTURAL PARTS AND FITTINGS OF THE AFORESAID GOODS, IN CLASS 9 (U.S. CLS. 21, 23, 26, 36 AND 38).

FOR: DIAMONDS, PRECIOUS STONES, SEMI-PRECIOUS STONES, PEARLS; JEWELLERY; CUFF LINKS; HOROLOGICAL AND CHRONOMETRIC INSTRUMENTS, DIALS, MOVEMENTS, WRIST WATCHES, POCKET WATCHES, WATCH BANDS, WATCH BRACELETS, WATCH STRAPS, WATCH CHAINS, WATCH CASES, WATCH GLASSES, WATCH WINDERS; STRUCTURAL PARTS AND FITTINGS FOR THE AFORESAID GOODS; BOXES AND CASES FOR JEWELLERY OR HOROLOGICAL AND CHRONOMETRIC INSTRUMENTS, IN CLASS 14 (U.S. CLS. 2, 27, 28 AND 50).

FOR: WRITING INSTRUMENTS, NAMELY, FOUNTAIN PENS, ROLLERBALL PENS, BALL-POINT PENS, FELT-TIP PENS, FIBRETIP PENS, MECHANICAL PENCILS; BOXES AND CASES FOR WRITING INSTRUMENTS; HOLDERS AND TRAYS

FOR: LEATHER AND IMITATIONS OF LEATHER, AND GOODS MADE OF THESE MATERIALS, NAMELY, BAGS AND CASES, BACKPACKS, BOXES, BRIEFCASES, BRIEFCASE-TYPE PORTFOLIOS FOR DOCUMENTS, CARRYING CASES FOR DOCUMENTS, HANDBAGS, KEY CASES, KNAPSACKS, MONEY BAGS, POUCHES, PURSES, SATCHELS, SCHOOL BAGS, SHOPPING BAGS, SPORTS BAGS, SUITCASES, TRUNKS, TRAVELLING BAGS, VANITY CASES SOLD EMPTY, WALLETS; BAGS AND CASES, NAMELY, BACKPACKS, BRIEFCASES, BRIEFCASE-TYPE PORTFOLIOS FOR DOCUMENTS, CARRYING CASES FOR DOCUMENTS, HANDBAGS, KEY CASES, KNAPSACKS, MONEY BAGS, POUCHES, PURSES, SATCHELS, SCHOOL BAGS, TEXTILE SHOPPING BAGS, SPORTS BAGS; SUITCASES, TRUNKS, TRAVELLING BAGS, VANITY CASES SOLD EMPTY, WALLETS, SHOULDER STRAPS; UMBRELLAS, PARASOLS AND WALKING STICKS; ANIMAL SKINS, HIDES; WHIPS, HARNESS AND SADDLERY; STRUCTURAL PARTS AND FITTINGS FOR THE AFORESAID GOODS, IN CLASS 18 (U.S. CLS. 1, 2, 3, 22 AND 41).

PRIORITY DATE OF 1-31-2007 IS CLAIMED.

SER. NO. 79-041,105, FILED 4-28-2007.

OWNER OF INTERNATIONAL REGISTRATION
0930759 DATED 4-28-2007, EXPIRES 4-28-2017.

DOMINIC FATHY, EXAMINING ATTORNEY

Int. Cls.: 3 and 5

Prior U.S. Cls.: 1, 4, 6, 18, 44, 46, 50, 51 and 52

Reg. No. 3,520,783

United States Patent and Trademark Office

Registered Oct. 21, 2008

**TRADEMARK
PRINCIPAL REGISTER**

pharmaceris

LABORATORIUM KOSMETYCZNE DR IRENA
ERIS SPOLKA AKCYJNA (POLAND JOINT
STOCK COMPANY)
UL. ARMII KRAJOWEJ 12
PL-05-500 PIASECZNO
POLAND

FOR: COSMETICS FOR CARE OF THE SKIN, BODY AND HAIR, NAMELY, COSMETIC PREPARATIONS FOR BODY CARE; SKIN CREAMS, FACIAL CREAMS, BODY EMULSIONS, FACIAL EMULSIONS, SKIN LOTIONS, FACIAL LOTIONS, SKIN GELS, FACIAL GELS, SKIN OILS AND BALSAMS; SOAPS; NON-MEDICATED BATH PREPARATIONS, HAIR CARE PREPARATIONS, HAIR CLEANING PREPARATIONS NAMELY, SHAMPOOS, HAIR CLEANING PREPARATIONS IN FORM OF LIQUIDS, GELS, EMULSIONS; PERFUMERY PRODUCTS, NAMELY, PERFUMES; TOILET WATERS, EAU DE COLOGNES, EAU DE TOILETTE; ESSENTIAL OILS; PERSONAL DEODORANTS AND ANTIPERSPIRANTS; MAKE-UP POWDER AND MAKE-UP REMOVING PREPARATIONS; NON-MEDICATED LIP CARE PREPARATIONS, LIP MAKE-UP PREPARATIONS, NAMELY, LIPSTICKS, LIP GLOSSES, LIP PENCILS; NAIL CARE PREPARATIONS, NAIL COLORING PREPARATIONS, NAMELY, NAIL POLISH AND NAIL ENAMELS; SUNTAN PREPARATIONS, NAMELY, SUNTAN CREAMS, SUNTAN LOTIONS, SUNTAN GELS, SUNTAN EMULSIONS, SUNTAN OILS, SUNTAN BALSAMS, SUNTAN PREPARATIONS PROTECTING

AGAINST UV, NAMELY, SUNBLOCK PREPARATIONS; SELF-TAN PREPARATIONS; DEPILATORY PREPARATIONS, NAMELY, DEPILATORY CREAMS AND DEPILATORY WAXES; AFTER-BATH POWDERS; HYGIENIC POWDERS, NAMELY, TALCUM POWDER; DENTIFRICES, PREPARATIONS FOR ORAL CARE, NAMELY, TOOTHPASTE, NON-MEDICATED TOILETRIES, IN CLASS 3 (U.S. CLS. 1, 4, 6, 50, 51 AND 52).

FOR: COSMETICS FOR MEDICAL USE, NAMELY, MEDICINAL CREAMS, BODY EMULSIONS, FACIAL EMULSIONS, SKIN CREAMS IN LIQUID FORM, SKIN GELS, FACIAL GELS, SKIN OILS, SKIN BALSAMS, BATH SALTS FOR MEDICAL USE AND MEDICAL BATHS, PHARMACEUTICAL SKIN LOTIONS, ALL OF THE FOREGOING FOR THE TREATMENT OF SKIN DISEASES, IN CLASS 5 (U.S. CLS. 6, 18, 44, 46, 51 AND 52).

THE MARK CONSISTS OF STANDARD CHARACTERS WITHOUT CLAIM TO ANY PARTICULAR FONT, STYLE, SIZE, OR COLOR.

OWNER OF INTERNATIONAL REGISTRATION
0930772 DATED 5-18-2007, EXPIRES 5-18-2017.

SER. NO. 79-041,110, FILED 5-18-2007.

TINA KUAN, EXAMINING ATTORNEY

Int. Cls.: 9, 37, 38, 41 and 42

Prior U.S. Cls.: 21, 23, 26, 36, 38, 100, 101, 103, 104,
106 and 107

Reg. No. 3,520,784

United States Patent and Trademark Office

Registered Oct. 21, 2008

TRADEMARK
SERVICE MARK
PRINCIPAL REGISTER

HiPath Open

SIEMENS ENTERPRISE COMMUNICATIONS;
GMBH & CO. KG (FED REP GERMANY
LIMITED PARTNERSHIP WITH A LIMITED
LIABILITY COMPANY AS GENERAL PART-
NER)

HOFMANNSTR. 51
81379 MÜNCHEN
FED REP GERMANY

FOR: OPTICAL, ELECTROTECHNICAL AND ELECTRONIC APPARATUS AND DEVICES, AND ELECTRICAL DEVICES FOR RECORDING, EMISSION, TRANSMISSION, SWITCHING, RECEPTION AND REPRODUCTION AND PROCESSING OF SOUNDS, SIGNALS, CHARACTERS AND IMAGES, NAMELY, COMMUNICATION SERVERS, ROUTERS, SWITCHES, AND GATEWAYS; DEVICES, NAMELY, ROUTERS, SWITCHES, AND GATEWAYS FOR THE INTEGRATION OF VOICE, IMAGE, TEXT, DATA, MULTIMEDIA, FULL-MOTION VIDEO COMMUNICATIONS IN COMPUTER AND TELECOMMUNICATION NETWORKS; COMMUNICATIONS COMPUTERS; SOFTWARE, NAMELY, COMPUTER SOFTWARE FOR MANAGEMENT AND INTEGRATION OF TELECOMMUNICATIONS NETWORKS, COMPUTER SOFTWARE FOR USE IN THE OPERATION AND MAINTENANCE OF TELECOMMUNICATIONS EQUIPMENT, COMPUTER TELEPHONY SOFTWARE, COMPUTER SOFTWARE FOR THE INTEGRATION OF VOICE AND DATA, COMPUTER SOFTWARE FOR USE IN THE OPERATION AND MAINTENANCE OF COMPUTER NETWORKS; OPTICAL, ELECTROTECHNICAL AND ELECTRONIC EQUIPMENT FOR VOICE, IMAGE, TEXT, DATA, MULTIMEDIA AND FULL-MOTION VIDEO NAMELY COMMUNICATION SERVERS, ROUTERS, SWITCHES AND GATEWAYS; AUTOMATIC TELEPHONE DIALING DEVICES; TELEPHONES, VIDEO-PHONES, AND VOICE BOXES; DOMESTIC TELEPHONE SYSTEMS COMPRISING PRIVATE AUTOMATIC BRANCH EXCHANGES; PHOTOCOPIERS; TELECOMMUNICATION NETWORKS CONSISTING OF EXCHANGE AND TRANSMISSION EQUIPMENT,

INDIVIDUAL MODULES AND COMPONENTS OF SUCH EQUIPMENT, NAMELY, POWER SUPPLY UNITS, TRANSMISSION MEDIA IN THE NATURE OF TELECOMMUNICATION CABLES AND OPTICAL FIBERS AND CONNECTION ELEMENTS IN THE NATURE OF CABLE AND ELECTRICAL CONNECTORS; WIRELESS TRANSMISSION MEDIA, NAMELY, INFRARED RECEIVERS AND TRANSMITTERS AND RADIO TELEPHONES FOR WIRELESS COMMUNICATION; AND STRUCTURAL PARTS FOR ALL OF THE AFORESAID GOODS, IN CLASS 9 (U.S. CLS. 21, 23, 26, 36 AND 38).

FOR: INSTALLATION, MOUNTING, MAINTENANCE AND REPAIR OF TELECOMMUNICATION DEVICES, SYSTEMS AND NETWORKS, NAMELY, COMPUTERS AND COMPUTER HARDWARE SYSTEMS AND NETWORKS, IN CLASS 37 (U.S. CLS. 100, 103 AND 106).

FOR: OPERATION OF TELECOMMUNICATION SYSTEMS AND TELECOMMUNICATION NETWORKS, NAMELY, TELECOMMUNICATION GATEWAY SERVICES, TECHNICAL OPERATION AND MONITORING OF TELECOMMUNICATION SYSTEMS AND NETWORKS OF OTHERS AND PROVIDING BACK-UP COMPUTER PROGRAMS AND FACILITIES; CONSULTATION IN THE SETTING-UP OF TELECOMMUNICATION SYSTEMS, DATA PROCESSING SYSTEMS AND TELECOMMUNICATION NETWORKS; RENTAL OF TELECOMMUNICATION EQUIPMENT AND NETWORKS, IN CLASS 38 (U.S. CLS. 100, 101 AND 104).

FOR: TRAINING IN THE SETTING-UP AND OPERATION OF TELECOMMUNICATION SYSTEMS AND TELECOMMUNICATION NETWORKS, IN CLASS 41 (U.S. CLS. 100, 101 AND 107).

FOR: TECHNICAL DEVELOPMENT AND PROJECT DESIGN OF TELECOMMUNICATION AND INFORMATION PROCESSING NETWORKS; PRO-

JECT DESIGN OF TELECOMMUNICATIONS AND DATA PROCESSING SYSTEMS; DESIGN AND DEVELOPMENT OF DATA PROCESSING COMPUTER PROGRAMS FOR TELECOMMUNICATION SYSTEMS FOR OTHERS; RENTAL OF DATA PROCESSING COMPUTER PROGRAMS FOR TELECOMMUNICATION SYSTEMS, IN CLASS 42 (U.S. CLS. 100 AND 101).

THE MARK CONSISTS OF STANDARD CHARACTERS WITHOUT CLAIM TO ANY PARTICULAR FONT, STYLE, SIZE, OR COLOR.

PRIORITY DATE OF 1-16-2007 IS CLAIMED.

OWNER OF INTERNATIONAL REGISTRATION 0931271 DATED 5-18-2007, EXPIRES 5-18-2017.

OWNER OF U.S. REG. NOS. 2,875,915 AND 3,006,048.

SER. NO. 79-041,233, FILED 5-18-2007.

TINA KUAN, EXAMINING ATTORNEY

Int. Cls.: 7 and 9

Prior U.S. Cls.: 13, 19, 21, 23, 26, 31, 34, 35, 36 and 38

Reg. No. 3,520,785

United States Patent and Trademark Office

Registered Oct. 21, 2008

**TRADEMARK
PRINCIPAL REGISTER**

ROLAND DIRECTDRIVE

MANROLAND AG
MÜHLHEIMER STR. 341
63012 OFFENBACH
FED REP GERMANY

FOR: MACHINES FOR THE PRINTING INDUSTRY AND PARTS FOR THE PRINTING MACHINES, NAMELY, MACHINE BEARING HOUSINGS, MACHINE SHAFTS, GEARBOXES FOR PRINTING MACHINES, GEARS FOR PRINTING MACHINE GEARBOXES; WEB-FED OFFSET PRINTING PRESSES, IN PARTICULAR FOR NEWSPAPER AND ILLUSTRATION PRINT; SHEET-FED OFFSET PRINTING PRESSES; STRUCTURAL AND REPLACEMENT PARTS FOR WEB-FED OFFSET PRINTING PRESSES; SUPPLY AND EXECUTION MACHINES FOR THE PRINT FABRIC OF WEB-FED OFFSET PRINTING PRESSES AND SHEET-FED OFFSET PRINTING PRESSES; PLATE BENDING MACHINES; PAPER FOLDING MACHINES FOR PRINTING PRESSES; ACCESSORIES FOR WEB-FED OFFSET PRINTING PRESSES AND SHEET-FED OFFSET PRINTING PRESSES, NAMELY, PRINTING PLATES, PRINTING BLANKETS AND PRINTING CYLINDERS; MACHINE PARTS, NAMELY, SUPPLY DEVICES FOR PLATES OR PRINTING PLATES OF WEB-FED OFFSET PRINTING PRESSES AND SHEET-FED OFFSET PRINTING PRESSES, PARTICULARLY AUTOMATIC CHANGING DEVICES FOR PLATES AND PRINTING PLATES OF WEB-FED OFFSET PRINTING MACHINES AND SHEET-FED OFFSET PRINTING MACHINES; MACHINES FOR PLASTIC PROCESSING, IN PARTICULAR FOR PAINTING AND FOR PRINT REFINEMENT, NAMELY, PRINTING MACHINES FOR PRINTING OF FLAT PLASTIC PRODUCTS; ELECTRIC MOTORS FOR USE IN PRINTING MACHINES AND PARTS THEREFOR, IN CLASS 7 (U.S. CLS. 13, 19, 21, 23, 31, 34 AND 35).

FOR: SOFTWARE FOR THE CONTROL, REGULATION AND MAINTENANCE OF WEB-FED OFFSET PRINTING PRESSES AND SHEET-FED OFFSET PRINTING PRESSES; ELECTRIC AND ELECTRONIC CONTROL UNITS AND REGULATING DEVICES FOR WEB-FED OFFSET PRINTING PRESSES AND SHEET-FED OFFSET PRINTING PRESSES, NAMELY, PRINTING MACHINE SENSOR CIRCUITS, COMPUTER-BASED AND ELECTRONIC PRINTING MACHINE OPERATING CIRCUITS, DISPLAY AND INFORMATION IMPUTING AND OUTPUTTING UNITS, NAMELY, MONITORS, DISPLAYS, MAN-MACHINE INTERFACES, INK AND PAPER REGULATING INSTRUMENTS, NAMELY, ELECTRONIC AND COMPUTER BASED OPERATING CIRCUITS FOR PRINTING, IN CLASS 9 (U.S. CLS. 21, 23, 26, 36 AND 38).

THE MARK CONSISTS OF STANDARD CHARACTERS WITHOUT CLAIM TO ANY PARTICULAR FONT, STYLE, SIZE, OR COLOR.

PRIORITY DATE OF 11-29-2006 IS CLAIMED.

OWNER OF INTERNATIONAL REGISTRATION 0931288 DATED 5-25-2007, EXPIRES 5-25-2017.

NO CLAIM IS MADE TO THE EXCLUSIVE RIGHT TO USE "DIRECT DRIVE", APART FROM THE MARK AS SHOWN.

SER. NO. 79-041,239, FILED 5-25-2007.

DAWN FELDMAN, EXAMINING ATTORNEY

Int. Cl.: 30

Prior U.S. Cl.: 46

United States Patent and Trademark Office

Reg. No. 3,520,786

Registered Oct. 21, 2008

**TRADEMARK
PRINCIPAL REGISTER**

RECIT

RELANGHE S.R.L. (ITALY LIMITED LIABILITY
COMPANY)
CORSO BRA, 105
I-12051 ALBA (CUNEO)
ITALY

FOR: COFFEE, TEA, COCOA, SUGAR, RICE,
TAPIOCA, SAGO, ARTIFICIAL COFFEE; FLOUR,
BREAD, PASTRY, CONFECTIONERY, NAMELY,
CHOCOLATES, CHOCOLATE COVERED NUTS,
CHOCOLATE BARS, CHOCOLATE TRUFFLES,
MILK CHOCOLATE, DARK CHOCOLATE, CANDY,
PASTILLES, CRYSTAL SUGAR PIECES, FON-
DANTS, FROZEN CONFECTIONERY, FROZEN YO-
GURT, FRUIT JELLIES, PEPPERMINT FOR
CONFECTIONERY, FLAVORED ICES; HONEY,
TREACLE; YEAST, BAKING-POWDER; SALT, MUS-
TARD; VINEGAR, SAUCES, SPICES, ICE, IN CLASS
30 (U.S. CL. 46).

THE MARK CONSISTS OF STANDARD CHAR-
ACTERS WITHOUT CLAIM TO ANY PARTICULAR
FONT, STYLE, SIZE, OR COLOR.

OWNER OF INTERNATIONAL REGISTRATION
0931362 DATED 6-26-2007, EXPIRES 6-26-2017.

THE FOREIGN WORDING IN THE MARK
TRANSLATES INTO ENGLISH AS "TALE",
"STORY" OR "NARRATIVE".

SER. NO. 79-041,285, FILED 6-26-2007.

MELISSA VALLILLO, EXAMINING ATTORNEY

Int. Cls.: 29, 30, 31, 32, 33, 35 and 43

Prior U.S. Cls.: 1, 45, 46, 47, 48, 49, 100, 101 and 102

Reg. No. 3,520,787

United States Patent and Trademark Office

Registered Oct. 21, 2008

TRADEMARK
SERVICE MARK
PRINCIPAL REGISTER



OBSHESTVO S OGRANICHENNOI; OTVETSTVENNOSTJU "KOMPANIA ZOLOTOI TEREM" (RUSSIAN FED. LIMITED LIABILITY COMPANY)

BLDG. 4, STROENIE 15
DANILOVSKAYA NAB.; RU-113114 MOSCOW
RUSSIAN FED.

FOR: PROCESSED ANCHOVIES; PEANUTS, PROCESSED; MUSHROOMS, PRESERVED; GAME, DEAD; MEAT JELLIES; JELLIES FOR BREAD; FRUIT JELLIES BEING BREAD SPREADS; SAUSAGES; CAVIAR; CANNED MEAT; CANNED VEGETABLES; CANNED FISH; CANNED FRUITS; GHERKINS; PRAWNS, NOT LIVE; FISH CROQUETTES; LOBSTERS, NOT LIVE; SALMON; MARMALADE; SUNFLOWER OIL FOR FOOD; BUTTER; MUSSELS, NOT LIVE; ALMONDS, GROUND; SHELLFISH, NOT LIVE; MILK; MEAT; VEGETABLES, COOKED; POTATO FRITTERS; NUTS, PREPARED; TOMATO PUREE; LIVER PASTES; PICKLES; HAM; MILK PRODUCTS EXCLUDING ICE CREAM, ICE MILK AND FROZEN YOGURT; FOODS PREPARED FROM FISH, NAMELY, SALTED FISH AND DRIED FISH; CRAYFISH, NOT LIVE; FISH, NOT LIVE; VEGETABLE SALADS; FRUIT SALADS; SARDINES; HERRINGS; VEGETABLE JUICES FOR COOKING; SOUPS; CHEESE; GARDEN HERBS, PRESERVED; TUNA FISH; OYSTERS, NOT LIVE; FRUIT, PRESERVED; FROZEN FRUITS; POTATO FLAKES; POTATO CHIPS; FRUIT CHIPS, IN CLASS 29 (U.S. CL. 46).

FOR: COOKIES; PANCAKES; BREAD ROLLS; WAFFLES; VERMICELLI; MUSTARD; CONFECTIONERY FOR DECORATING CHRISTMAS TREES, NAMELY, CANDY; CAKES; PASTRIES; PEANUT CONFECTIONERY, NAMELY, CANDY CONTAINING PEANUTS; ALMOND CONFEC-

TIONERY, NAMELY, CANDY CONTAINING ALMONDS; FARINACEOUS FOOD PASTES FOR HUMAN CONSUMPTION; PASTY; COCOA PRODUCTS, NAMELY, COCOA MIXES, COCOA SPREADS; CARAMELS; SWEETMEATS; CRACKERS; PROCESSED GROATS FOR HUMAN FOOD; CORN, ROASTED; MUESLI; CRUSHED OATS; HUSKED OATS; CANDY FOR FOOD; HONEY; FRUIT JELLIES BEING CONFECTIONERY; CORN FLOUR; NUTMEGS; BISCUITS; POPCORN; CEREAL PREPARATIONS, NAMELY, BREAKFAST CEREALS, CEREAL BASED SNACK FOODS; FLOUR-MILLING PRODUCTS, NAMELY, RICE FLOUR, SOYA FLOUR; CHEWING GUM, NOT FOR MEDICAL PURPOSES; OAT-BASED FOOD, NAMELY, OATMEAL; CONFECTIONERY, NAMELY, PEANUT BUTTER CONFECTIONERY CHIPS, CANDY; SPAGHETTI; RUSKS; BREADCRUMBS; BREAD; TEA; CHOCOLATE; CORN FLAKES, IN CLASS 30 (U.S. CL. 46).

FOR: UNPROCESSED ORANGES; UNPROCESSED PEANUTS, UNPROCESSED FRUITS; BEANS, FRESH; GRAPES, FRESH; DOG BISCUITS; PEAS, FRESH; MUSHROOMS, FRESH; SOD; LIVE TREES; ADDITIVES TO ANIMAL FODDER, NOT FOR MEDICAL PURPOSES; LIVE CHRISTMAS TREES; LIVE ANIMALS; LIVESTOCK FEED, NAMELY, OIL CAKE; UNPROCESSED GRAINS AND CEREALS; FISH SPAWN; POTATOES, FRESH; ANIMAL FOODSTUFFS; PET FOOD; BIRD FOOD; ROOTS FOR PET FOOD; LIVE PLANTS IN THE NATURE OF NETTLES; GROATS FOR POULTRY FOOD; LIVE BUSHES; FRESH ONIONS, FRESH VEGETABLES; FLOWER BULBS; ANIMAL LITTER; MUSSELS, LIVE; SHELLFISH, LIVE; MEAL FOR ANIMALS; UNPROCESSED OATS; VEGETABLE, FRESH; UNPROCESSED NUTS, FRESH FRUITS; UNPROCES-

SED BRAN; BRAN MASH FOR ANIMAL CONSUMPTION; ANIMAL FATTENING PREPARATIONS, NAMELY, ANIMAL FEED; POULTRY, LIVE; UNPROCESSED WHEAT; CRAYFISH, LIVE; LIVE PLANTS; PLANTS, DRIED, FOR DECORATION; UNPROCESSED RYE; UNPROCESSED BEET; UNPROCESSED GRAINS; HAY; STRAW LITTER, NAMELY, CHOPPED STRAW FOR ANIMAL BEDDING; UNPROCESSED HAZELNUTS; FLOWERS, NATURAL; PINE CONES; BERRIES, BEING FRESH FRUITS; FLOWERS, DRIED, FOR DECORATION, IN CLASS 31 (U.S. CLS. 1 AND 46).

FOR: APERITIFS, NON-ALCOHOLIC; TABLE WATER; COCKTAILS, NON-ALCOHOLIC; LEMONADES; BEVERAGES, NON-ALCOHOLIC, NAMELY, SOFT DRINKS; WHEY BEVERAGES; FRUIT JUICE BEVERAGES, NON-ALCOHOLIC; FRUIT NECTARS, NON-ALCOHOLIC; BEER; POWDERS USED IN PREPARATION OF EFFERVESCING BEVERAGES IN THE NATURE OF SOFT DRINKS; TOMATO JUICE; CIDER, NON-ALCOHOLIC; FRUIT JUICES; PREPARATIONS FOR MAKING AERATED WATER; PREPARATIONS FOR MAKING BEVERAGES IN THE NATURE OF FRUIT DRINKS; PASTILLES FOR EFFERVESCING BEVERAGES, NAMELY, PREPARATIONS FOR MAKING SOFT DRINKS; NON-ALCOHOLIC FRUIT EXTRACTS USED IN THE PREPARATION OF BEVERAGES, IN CLASS 32 (U.S. CLS. 45, 46 AND 48).

FOR: APERITIFS; BRANDY; WINE; WHISKY; VODKA; GIN; DIGESTERS, NAMELY, LIQUORS; PREPARED ALCOHOLIC COCKTAILS; LIQUEURS; ALCOHOLIC BEVERAGES, NAMELY, LIQUORS; ALCOHOLIC BEVERAGES, CONTAINING FRUIT, NAMELY, ALCOHOLIC BEVERAGES OF FRUIT; HYDROMEL BEING MEAD; ALCOHOLIC BITTERS; HARD CIDER; ALCOHOLIC EXTRACTS, IN CLASS 33 (U.S. CLS. 47 AND 49).

FOR: IMPORT-EXPORT AGENCIES; COMMERCIAL INFORMATION AGENCIES; RENTAL OF ADVERTISING SPACE; EMPLOYMENT AGENCIES; COMPUTERIZED FILE MANAGEMENT; EFFICIENCY EXPERTS; DEMONSTRATION OF GOODS; PUBLIC OPINION POLLING; CONDUCTING MARKETING STUDIES; BUSINESS INFORMATION; BUSINESS INVESTIGATIONS; PERSONNEL RECRUITMENT; BUSINESS MANAGEMENT AND ORGANIZATION CONSULTANCY; UPDATING OF ADVERTISING MATERIAL; ORGANIZATION OF EXHIBITIONS FOR COMMERCIAL OR ADVERTISING PURPOSES; ORGANIZATION OF TRADE FAIRS FOR COMMERCIAL OR ADVERTISING PURPOSES; SHOP WINDOW DRESSING SERVICES; BUSINESS MANAGEMENT ASSISTANCE; SALES PROMOTION FOR OTHERS; RENTAL OF ADVERTISING TIME ON COMMUNICATION MEDIA; PUBLICATION OF PUBLICITY TEXTS; RADIO ADVERTISING; DISTRIBUTION OF SAMPLES; DIRECT MAIL ADVERTISING; ADVERTISING; ADVERTISING AGENCIES; PROCUREMENT SERVICES FOR OTHERS, NAMELY, PURCHASING

GOODS AND SERVICES IN THE NATURE OF FOOD STUFF FOR OTHER BUSINESSES; PUBLICITY COLUMNS PREPARATION, NAMELY, WRITING OF PUBLICITY TEXTS; BUSINESS MANAGEMENT OF HOTELS; PSYCHOLOGICAL TESTING FOR THE SELECTION OF PERSONNEL; PUBLIC RELATIONS; MODELLING FOR ADVERTISING OR SALES PROMOTION, IN CLASS 35 (U.S. CLS. 100, 101 AND 102).

FOR: RENTAL FOR TEMPORARY ACCOMMODATION, NAMELY, RENTAL OF BUILDING FOR TEMPORARY OCCUPANCY; RENTAL OF MEETING ROOMS; TOURIST HOMES; MAKING HOTEL RESERVATIONS FOR OTHERS; MAKING BOARDING HOUSE BOOKINGS; MAKING TEMPORARY ACCOMMODATION RESERVATIONS; HOTELS; SNACK-BARS; CAFES; CAFETERIAS; MOTELS; BOARDING HOUSES; BOARDING FOR ANIMALS; RESTAURANTS; SELF-SERVICE RESTAURANTS; CANTEN SERVICES; HOLIDAY CAMP SERVICES, NAMELY, RESORT LODGING SERVICES; BAR SERVICES; PROVIDING CAMPGROUND FACILITIES; FOOD AND DRINK CATERING, IN CLASS 43 (U.S. CLS. 100 AND 101).

PRIORITY DATE OF 7-27-2006 IS CLAIMED.

OWNER OF INTERNATIONAL REGISTRATION 0932498 DATED 12-25-2006, EXPIRES 12-25-2016.

OWNER OF U.S. REG. NO. 3,280,202.

THE COLOR(S) WHITE, LIGHT YELLOW, YELLOW, DARK YELLOW, RED, BROWN IS/ARE CLAIMED AS A FEATURE OF THE MARK.

THE COLOR WHITE APPEARS IN THE CENTER OF THE SUN; THE COLOR LIGHT YELLOW APPEARS IN THE WORDING AND IN THE BORDER OF CIRCLE AND RECTANGLE; THE COLOR YELLOW APPEARS IN THE WORDING, THE SUN, THE CIRCLE, AND THE OUTLINE OF THE RECTANGLE; THE COLOR DARK YELLOW APPEARS IN THE SHADOW OF THE SUN AND THE EDGE OF THE CIRCLE; THE COLOR RED APPEARS IN THE TOP OF THE RECTANGLE AND THE TIPS OF THE SUN'S RAYS; AND THE COLOR BROWN APPEARS IN THE BOTTOM OF THE RECTANGLE.

"BARENTSEV" HAS NO MEANING IN A FOREIGN LANGUAGE.

THE TRANSLITERATION OF THE NON-LATIN CHARACTERS IN THE MARK IS: "BARENTSEV".

SER. NO. 79-041,805, FILED 12-25-2006.

KRISTINA MORRIS, EXAMINING ATTORNEY

Int. Cl.: 28

Prior U.S. Cls.: 22, 23, 38 and 50

United States Patent and Trademark Office

Reg. No. 3,520,788

Registered Oct. 21, 2008

TRADEMARK
PRINCIPAL REGISTER

BARON

MARKER VÖLKL (INTERNATIONAL) GMBH
(SWITZERLAND GESELLSCHAFT MIT BES-
CHRÄNKTER HAFTUNG (GMBH))

RUESSENSTRASSE 6
CH-6341 BAAR
SWITZERLAND

FOR: SPORTING ARTICLES AND SPORTING
APPARATUS, NAMELY, SKIS, SNOWBOARDS, SKI
BINDINGS, SNOWBOARD BINDINGS, SKI STICKS
AND BAGS ESPECIALLY DESIGNED FOR SKIS
AND SNOWBOARDS, EXCLUDING ICE-HOCKEY
PRODUCTS, IN CLASS 28 (U.S. CLS. 22, 23, 38 AND
50).

THE MARK CONSISTS OF STANDARD CHAR-
ACTERS WITHOUT CLAIM TO ANY PARTICULAR
FONT, STYLE, SIZE, OR COLOR.

PRIORITY DATE OF 11-9-2006 IS CLAIMED.

OWNER OF INTERNATIONAL REGISTRATION
0932558 DATED 5-7-2007, EXPIRES 5-7-2017.

SER. NO. 79-041,834, FILED 5-7-2007.

REBECCA POVARCHUK, EXAMINING ATTOR-
NEY

Int. Cls.: 7 and 9

Prior U.S. Cls.: 13, 19, 21, 23, 26, 31, 34, 35, 36 and 38

Reg. No. 3,520,789

United States Patent and Trademark Office

Registered Oct. 21, 2008

**TRADEMARK
PRINCIPAL REGISTER**

SCHNEEBERGER

SCHNEEBERGER HOLDING AG (SWITZER-
LAND SOCIÉTÉ ANONYME)
ST. URBANSTRASSE 12,
CH-4914 ROGGWIL
SWITZERLAND

FOR: MACHINE PARTS, NAMELY, GUIDEWAYS FOR MACHINES AND THEIR PARTS, IN PARTICULAR, LINEAR GUIDEWAYS, PROFILED RAIL GUIDEWAYS, BEARING TABLES AND CROSS MOVEMENT BEARING TABLES EACH WITH BEARING PARTS; SUPPORT PADS, AS PARTS OF MACHINES, FOR INFINITE MOVEMENTS; MACHINES FOR MANUFACTURING COMPONENTS AND PARTS OF CONSUMER DURABLES, NAMELY COMPLETE MULTI-AXIS POSITIONING DEVICES COMPOSED OF AN UPPER AND LOWER PART, PROFILED RAIL GUIDEWAYS, A BALL SCREW, AN ENGINE COUPLING AND A MEASURING INSTRUMENT, IN CLASS 7 (U.S. CLS. 13, 19, 21, 23, 31, 34 AND 35).

FOR: MEASURING APPARATUS AND INSTRUMENTS FOR PROFILED RAIL GUIDEWAYS, NAMELY, ABSOLUTE AND INCREMENTAL LINEAR DISPLACEMENT MEASURING DEVICES CONSISTING OF A SCALE INTEGRATED INTO THE RAIL GUIDEWAY AND A READING DEVICE INTEGRATED INTO THE MOVEABLE SLIDER

AND THEIR ACCESSORIES, NAMELY, ELECTRONICS FOR SIGNAL-CONDITIONING, SENSORS TO IDENTIFY THE DIRECTION OF MOTION, ELECTRONICS TO REMEMBER CERTAIN POSITION EVEN DURING POWER OUTAGE, ALL COMPRISING AN INTEGRATED MEASURING SYSTEM COMPRISED OF A SCALE INTEGRATED INTO THE RAIL GUIDEWAY AND A READING DEVICE INTEGRATED INTO THE MOVEABLE BEARING SLIDER, FOR LINEAR ROLLER OR BALL GUIDEWAYS WITH ANALOG OR DIGITAL INTERFACE FOR USE WITH MACHINE TOOLS AND AUTOMATION OF MANUFACTURING SEQUENCES, IN CLASS 9 (U.S. CLS. 21, 23, 26, 36 AND 38).

PRIORITY DATE OF 1-9-2007 IS CLAIMED.

OWNER OF INTERNATIONAL REGISTRATION
0933003 DATED 6-13-2007, EXPIRES 6-13-2017.

OWNER OF U.S. REG. NO. 2,816,478.

SER. NO. 79-041,989, FILED 6-13-2007.

ESTHER BELENKER, EXAMINING ATTORNEY

Int. Cl.: 7

Prior U.S. Cls.: 13, 19, 21, 23, 31, 34 and 35

United States Patent and Trademark Office

Reg. No. 3,520,790

Registered Oct. 21, 2008

**TRADEMARK
PRINCIPAL REGISTER**

ESM

ESM ENNEPETALER SCHNEID- UND MÄH-
TECHNIK GMBH & CO. KG (FED REP GER-
MANY LIMITED PARTNERSHIP)
KÖLNER STRABE 29
58256 ENNEPETAL
FED REP GERMANY

FOR: AGRICULTURAL MACHINES, NAMELY,
MOWING MACHINES, MOWERS AND CUTTER
BARS FOR CUTTING VEGETATION, PLANTS AND
FODDER; PARTS OF SAID AGRICULTURAL MA-
CHINES, NAMELY, KNIVES, BLADES, MOWING
FINGER BARS, AND BLADE HOLDERS, IN CLASS
7 (U.S. CLS. 13, 19, 21, 23, 31, 34 AND 35).

THE MARK CONSISTS OF STANDARD CHAR-
ACTERS WITHOUT CLAIM TO ANY PARTICULAR
FONT, STYLE, SIZE, OR COLOR.

OWNER OF INTERNATIONAL REGISTRATION
0933640 DATED 8-14-2007, EXPIRES 8-14-2017.

SER. NO. 79-042,267, FILED 8-14-2007.

DEBRA LEE, EXAMINING ATTORNEY

Int. Cl.: 12

Prior U.S. Cls.: 19, 21, 23, 31, 35 and 44

United States Patent and Trademark Office

Reg. No. 3,520,791

Registered Oct. 21, 2008

**TRADEMARK
PRINCIPAL REGISTER**

TTiD

SAAB AUTOMOBILE AB (SWEDEN LIMITED
COMPANY)
SE-461 80 TROLLHÄTTAN, SWEDEN

OWNER OF INTERNATIONAL REGISTRATION
0934398 DATED 7-10-2007, EXPIRES 7-10-2017.

FOR: MOTOR LAND VEHICLES, NAMELY, AU-
TOMOBILES, SPORT UTILITY VEHICLES,
TRUCKS, VANS, ENGINES THEREFOR AND
STRUCTURAL PARTS THEREOF, IN CLASS 12
(U.S. CLS. 19, 21, 23, 31, 35 AND 44).

THE WORDING "TTID" HAS NO MEANING IN A
FOREIGN LANGUAGE.

THE MARK CONSISTS OF STANDARD CHAR-
ACTERS WITHOUT CLAIM TO ANY PARTICULAR
FONT, STYLE, SIZE, OR COLOR.

SER. NO. 79-042,587, FILED 7-10-2007.

PRIORITY DATE OF 1-29-2007 IS CLAIMED.

MATTHEW MCDOWELL, EXAMINING ATTOR-
NEY

Int. Cl.: 39

Prior U.S. Cls.: 100 and 105

United States Patent and Trademark Office

Reg. No. 3,520,792

Registered Oct. 21, 2008

**SERVICE MARK
PRINCIPAL REGISTER**

THIRSTY SWAGMAN

THIRSTY SWAGMAN PTY LTD (AUSTRALIA
CORPORATION)
SUITE 4, 4 CANNING ROAD
KALAMUNDA WA 6076
AUSTRALIA

FOR: TOURISM SERVICES, NAMELY, ARRANGING TRAVEL TOURS; ARRANGING AND CONDUCTING OF TRAVEL TOURS; TRANSPORTATION OF TRAVELLERS BY BUS, AIR, RAIL AND BOAT; ESCORTING OF TRAVELLERS, NAMELY, TOUR ESCORTING; TRAVEL RESERVATIONS, NAMELY, TRAVEL AND TOUR TICKETS RESERVATION SERVICE; AND TRAVEL AGENCY SERVICES, NAMELY, MAKING RESERVATIONS AND BOOKINGS FOR TRANSPORTATION, IN CLASS 39 (U.S. CLS. 100 AND 105).

THE MARK CONSISTS OF STANDARD CHARACTERS WITHOUT CLAIM TO ANY PARTICULAR FONT, STYLE, SIZE, OR COLOR.

PRIORITY DATE OF 1-25-2007 IS CLAIMED.

OWNER OF INTERNATIONAL REGISTRATION
0934455 DATED 7-19-2007, EXPIRES 7-19-2017.

SER. NO. 79-042,604, FILED 7-19-2007.

BENJAMIN OKEKE, EXAMINING ATTORNEY

Int. Cls.: 29 and 30

Prior U.S. Cl.: 46

United States Patent and Trademark Office

Reg. No. 3,520,793

Registered Oct. 21, 2008

**TRADEMARK
PRINCIPAL REGISTER**



ANDELSMEJERIER SÆDAGER (DENMARK
LIMITED LIABILITY COOPERATIVE)
MEJERIVEJ 2
SDR. ONSILD
HOBRO, DENMARK DK9500

FOR: MEAT, FISH, POULTRY AND GAME;
MEAT EXTRACTS; PRESERVED, DRIED AND
COOKED FRUITS AND VEGETABLES; JELLIES,
JAMS, COMPOTES; EGGS; DAIRY PRODUCTS EX-
CLUDING ICE CREAM, ICE MILK AND FROZEN
YOGHURT, IN CLASS 29 (U.S. CL. 46).

FOR: COFFEE, TEA, COCOA, SUGAR, RICE,
TAPIOCA, SAGO, ARTIFICIAL COFFEE; FLOUR

AND PREPARATIONS MADE FROM CEREALS,
NAMELY, CEREAL BASED SNACK FOODS;
BREAD, PASTRY AND CONFECTIONERY CHIPS
FOR BAKING, ICES; HONEY; TREACLE; YEAST,
BAKING-POWDER; SALT, MUSTARD; VINEGAR,
KETCHUP; SPICES; ICE, IN CLASS 30 (U.S. CL. 46).

OWNER OF INTERNATIONAL REGISTRATION
0935269 DATED 8-11-2007, EXPIRES 8-11-2017.

SER. NO. 79-042,929, FILED 8-11-2007.

TEJBIR SINGH, EXAMINING ATTORNEY

Int. Cl.: 9

Prior U.S. Cls.: 21, 23, 26, 36 and 38

Reg. No. 3,520,794

United States Patent and Trademark Office

Registered Oct. 21, 2008

**TRADEMARK
PRINCIPAL REGISTER**

M1 plus

H. STOLL GMBH & CO. KG (FED REP GERMA-
NY LIMITED COMPANY)
STOLLWEG 1
72760 REUTLINGEN
FED REP GERMANY

FOR: COMPUTERS AND COMPUTER PRO-
GRAMS FOR USE IN CONNECTION WITH KNIT-
TING MACHINES, NAMELY, FOR CREATING
DIFFERENT STITCH PATTERNS AND DESIGNS ,
IN CLASS 9 (U.S. CLS. 21, 23, 26, 36 AND 38).

THE MARK CONSISTS OF STANDARD CHAR-
ACTERS WITHOUT CLAIM TO ANY PARTICULAR
FONT, STYLE, SIZE, OR COLOR.

PRIORITY DATE OF 4-13-2007 IS CLAIMED.

OWNER OF INTERNATIONAL REGISTRATION
0935698 DATED 7-23-2007, EXPIRES 7-23-2017.

SER. NO. 79-043,098, FILED 7-23-2007.

CARYN GLASSER, EXAMINING ATTORNEY

Int. Cls.: 16, 20 and 35

**Prior U.S. Cls.: 2, 5, 13, 22, 23, 25, 29, 32, 37, 38, 50,
100, 101 and 102**

Reg. No. 3,520,795

United States Patent and Trademark Office

Registered Oct. 21, 2008

**TRADEMARK
SERVICE MARK
PRINCIPAL REGISTER**

moll

MOLL FUNKTIONSMÖBEL GMBH (FED REP
GERMANY LIMITED LIABILITY COMPANY
UNDER THE GERMAN LAW)
RECHBERGSTRASSE 7
73344 GRUIBINGEN
FED REP GERMANY

FOR: STATIONERY; OFFICE REQUISITES,
NAMELY, ADHESIVE TAPE DISPENSERS; WRIT-
ING IMPLEMENTS; DRAWING RULERS; DESK
PADS; OFFICE ORGANIZATION MATERIALS,
NAMELY, FILE FOLDERS, RING BINDERS, DESK
FILE TRAYS; LETTER FILES; TRANSPARENT
SLEEVES FOR PROTECTING FILES; TRANSPAR-
ENT SLEEVES FOR PROTECTING LETTERS AND
TRANSPARENT SLEEVES FOR PROTECTING
DOCUMENTS; FILE REGISTERS; HANGING LET-
TER FILES AND HANGING DOCUMENT FILES;
SUSPENSION LETTER FILES; SUSPENDED LET-
TER FILES; STORAGE CONTAINERS MADE OF
PAPER OR CARDBOARD AND FILING BOXES
FOR OFFICE RECORDS; AND DOCUMENT FILE
RACKS, IN CLASS 16 (U.S. CLS. 2, 5, 22, 23, 29, 37, 38
AND 50).

FOR: FURNITURE; SEATING FURNITURE; OF-
FICE FURNITURE; FURNITURE FOR CHILDREN
AND YOUNG PEOPLE; TABLES; DESKS; CABI-
NETS; NONMETAL OFFICE CONTAINERS FOR
THE TRANSPORT AND STORAGE OF STATION-
ERY AND OFFICE REQUISITES; SHELVES; AND
CHAIRS, IN CLASS 20 (U.S. CLS. 2, 13, 22, 25, 32 AND
50).

FOR: WHOLESALE AND RETAIL STORE SERVI-
CES FEATURING LIGHTS, OFFICE REQUISITES
AND OFFICE ORGANIZATION MATERIALS, BAGS
AND SCHOOL BAGS, FURNITURE, INCLUDING
OFFICE FURNITURE AND FURNITURE FOR
CHILDREN AND YOUNG PEOPLE, OFFICE EQUIP-
MENT, TEXTILES AND TEXTILE GOODS, CLOTH-
ING, FOOTWEAR AND HEADGEAR; ARRANGING
OF TRADING AND ECONOMICAL CONTACTS,
ALSO OVER THE INTERNET, NAMELY, THE
BRINGING TOGETHER, FOR THE BENEFIT OF
OTHERS, OF A VARIETY OF GOODS AND SERVI-
CES, ENABLING CUSTOMERS TO CONVENIENT-
LY VIEW AND PURCHASE THOSE GOODS AND
SERVICES FROM AN INTERNET WEBSITE PARTI-
CULARLY SPECIALIZING IN THE MARKETING
OF THE SALE OF GOODS AND SERVICES OF
OTHERS, IN CLASS 35 (U.S. CLS. 100, 101 AND 102).

THE MARK CONSISTS OF STANDARD CHAR-
ACTERS WITHOUT CLAIM TO ANY PARTICULAR
FONT, STYLE, SIZE, OR COLOR.

OWNER OF INTERNATIONAL REGISTRATION
0935816 DATED 8-8-2007, EXPIRES 8-8-2017.

OWNER OF U.S. REG. NO. 3,032,524.

SER. NO. 79-043,132, FILED 8-8-2007.

BENJAMIN OKEKE, EXAMINING ATTORNEY

Int. Cls.: 12, 28, 35 and 37

**Prior U.S. Cls.: 19, 21, 22, 23, 31, 35, 38, 44, 50, 100,
101, 102, 103 and 106**

Reg. No. 3,520,796

United States Patent and Trademark Office

Registered Oct. 21, 2008

**TRADEMARK
SERVICE MARK
PRINCIPAL REGISTER**

Catamount

VOLKSWAGEN AG (FED REP GERMANY JOINT
STOCK COMPANY)
38436 WOLFSBURG
FED REP GERMANY

FOR: MOTOR VEHICLES AND THEIR PARTS, NAMELY, AUTOMOBILES, TRUCKS, VANS, SPORT UTILITY VEHICLES, MOTOR CARAVANS, LORRIES, BUSES, MOTORCYCLES, SNOW BIKES, NAMELY, SNOW MOBILES AND STRUCTURAL PARTS THEREFOR INCLUDED IN THIS CLASS; ENGINES FOR LAND VEHICLES; TIRES FOR VEHICLE WHEELS, RIMS FOR VEHICLE WHEELS, COMPLETE VEHICLE WHEELS AND THEIR PARTS FOR LAND VEHICLES; VEHICLES FOR CHILDREN, NAMELY, MOTORIZED SCOOTERS; AND MOTORIZED AUTOMOBILES FOR CHILDREN, IN CLASS 12 (U.S. CLS. 19, 21, 23, 31, 35 AND 44).

FOR: SCALE MODEL VEHICLES, NAMELY, SCALE MODEL AUTOMOBILES; PLAYING CARDS; STUFFED TOY ANIMALS AND OTHER STUFFED TOYS; GAMES, NAMELY, VIDEO GAMES, OTHER THAN THOSE ADAPTED FOR USE WITH EXTERNAL SCREENS OR MONITORS, IN CLASS 28 (U.S. CLS. 22, 23, 38 AND 50).

FOR: RETAIL AND WHOLESALE STORE SERVICES FEATURING AUTOMOBILES, TRUCKS, VANS, SPORT UTILITY VEHICLES, MOTOR CARAVANS, LORRIES, BUSES, MOTORCYCLES, SNOW BIKES AND THEIR STRUCTURAL PARTS AND FITTINGS, NAMELY, VIA RETAIL AND WHOLESALE OUTLETS AND VIA MAIL-ORDER BUSINESS; RETAIL STORE SERVICES, WHOLESALE STORE SERVICES, MAIL-ORDER SERVICES AND ONLINE RETAIL AND WHOLESALE STORE SERVICES FEATURING AUTOMOBILES, TRUCKS, VANS, SPORT UTILITY VEHICLES, MOTOR CARAVANS, LORRIES, BUSES, MOTORCYCLES, SNOW BIKES AND

THEIR STRUCTURAL PARTS AND FITTINGS; BRINGING TOGETHER, BUT NOT TRANSPORTING, OF A VARIETY OF MOTOR VEHICLES AND THEIR PARTS AND FITTINGS FOR THE BENEFIT OF OTHERS, THEREBY ENABLING CUSTOMERS TO VIEW AND PURCHASE THE GOODS; NEGOTIATION OF COMMERCIAL TRANSACTIONS, NAMELY, CONTRACTS FOR THE BENEFIT OF THIRD PARTIES ABOUT SALE AND PURCHASE OF MOTOR VEHICLES AND THEIR PARTS AND FITTINGS, IN CLASS 35 (U.S. CLS. 100, 101 AND 102).

FOR: RECONSTRUCTION REBUILDING, REPAIR, SERVICING, DISMANTLING, CLEANING, MAINTENANCE AND VARNISHING OF VEHICLES AND THEIR PARTS AND MOTORS AND THEIR PARTS; VEHICLE REPAIR IN THE COURSE OF VEHICLE BREAKDOWN SERVICE; TUNING OF AUTOMOBILES, AS FAR AS INCLUDED IN THIS CLASS, IN CLASS 37 (U.S. CLS. 100, 103 AND 106).

THE MARK CONSISTS OF STANDARD CHARACTERS WITHOUT CLAIM TO ANY PARTICULAR FONT, STYLE, SIZE, OR COLOR.

PRIORITY DATE OF 11-13-2006 IS CLAIMED.

OWNER OF INTERNATIONAL REGISTRATION
0935908 DATED 5-10-2007, EXPIRES 5-10-2017.

THE WORDING "CATAMOUNT" HAS NO MEANING IN A FOREIGN LANGUAGE.

SER. NO. 79-043,159, FILED 5-10-2007.

WILLIAM ROSSMAN, EXAMINING ATTORNEY

Int. Cl.: 9

Prior U.S. Cls.: 21, 23, 26, 36 and 38

United States Patent and Trademark Office

Reg. No. 3,520,797

Registered Oct. 21, 2008

**TRADEMARK
PRINCIPAL REGISTER**

AKAPP

AKAPP-STEMMANN B.V. (NETHERLANDS B.V.)
NIJVERHEIDSWEG 14
NL-3771 ME BARNEVELD
NETHERLANDS

CONNECTION BOXES; COMPUTER TERMINALS;
PROTECTIVE SHEATHS FOR FIBER OPTICAL
CABLES; ELECTRIC SOCKETS, IN CLASS 9 (U.S.
CLS. 21, 23, 26, 36 AND 38).

FOR: ELECTRIC CABLES; ELECTRIC WIRES;
ELECTRIC CONNECTORS FOR WIRES AND ELEC-
TRIC CABLES; COAXIAL CABLES; APPARATUS,
INSTRUMENTS AND APPLIANCES FOR MEASUR-
ING CABLES, YARN, STEEL WIRE, ROPES AND
PIPES, NAMELY, TAPE MEASURES; ELECTRICAL
CONTROLLERS FOR ALL OF THE FOLLOWING
GOODS, NAMELY, CONVEYOR BELTS, CONDUCT-
TOR BAR SYSTEMS, ELECTRIC CABLE REELS,
ELECTRIC HOSE REELS, ELECTRIC DRAG
CHAINS, ELECTRIC FESTOON SYSTEMS AND
MOBILE POWER FEEDS SYSTEMS; ELECTRIC

THE MARK CONSISTS OF STANDARD CHAR-
ACTERS WITHOUT CLAIM TO ANY PARTICULAR
FONT, STYLE, SIZE, OR COLOR.

OWNER OF INTERNATIONAL REGISTRATION
0860378 DATED 5-4-2005, EXPIRES 5-4-2015.

SER. NO. 79-043,243, FILED 10-23-2006.

REBECCA SMITH, EXAMINING ATTORNEY

Int. Cls.: 5 and 30

Prior U.S. Cls.: 6, 18, 44, 46, 51 and 52

United States Patent and Trademark Office

Reg. No. 3,520,798

Registered Oct. 21, 2008

**TRADEMARK
PRINCIPAL REGISTER**



SOREMARTEC S.A. (BELGIUM SOCIÉTÉ ANON-
YME)
DRÈVE DE L'ARC-EN-CIEL 102
B-6700 SCHOPPACH-ARLON
BELGIUM

FOR: SUGAR-FREE CONFECTIONERY; SUGAR-
FREE CANDY AND CHEWING GUM; ALL THE
AFORESAID GOODS INTENDED FOR MEDICAL
USE, IN CLASS 5 (U.S. CLS. 6, 18, 44, 46, 51 AND 52).

FOR: CONFECTIONERY; CANDY AND CHEW-
ING GUM; SUGAR-FREE CANDY AND CHEWING
GUM; ALL THE AFORESAID GOODS NOT INTEN-
DED FOR MEDICAL USE, IN CLASS 30 (U.S. CL. 46).

PRIORITY DATE OF 2-15-2007 IS CLAIMED.

OWNER OF INTERNATIONAL REGISTRATION
0936308 DATED 8-3-2007, EXPIRES 8-3-2017.

THE COLOR(S) GREEN IS/ARE CLAIMED AS A
FEATURE OF THE MARK.

THE MARK CONSISTS OF THE WORD "NATUR-
ELLA" APPEARING IN GREEN, WITH A FLOWER
FORMING PART OF THE SECOND LETTER "A".

SER. NO. 79-043,356, FILED 8-3-2007.

LINDSEY RUBIN, EXAMINING ATTORNEY

Int. Cls.: 35 and 41

Prior U.S. Cls.: 100, 101, 102 and 107

United States Patent and Trademark Office

Reg. No. 3,520,799

Registered Oct. 21, 2008

**SERVICE MARK
PRINCIPAL REGISTER**

PensionDCisions

PENSIONDCISIONS LIMITED (ENGLAND LIMITED COMPANY)

DIXON HOUSE

77-97 HARPUR STREET

BEDFORD, BEDGORDSHIRE, MK40 2SY, UNITED KINGDOM

FOR: ADVERTISING; BUSINESS MANAGEMENT; BUSINESS ADMINISTRATION; OFFICE FUNCTIONS; THE ORGANIZATION, OPERATION AND SUPERVISION OF LOYALTY AND INCENTIVE PROGRAMS; ADVERTISING SERVICES PROVIDED VIA THE INTERNET; PRODUCTION OF TELEVISION AND RADIO ADVERTISEMENTS; ACCOUNTANCY; AUCTIONEERING; TRADE FAIRS, NAMELY, PLANNING AND CONDUCTING OF TRADE FAIRS FOR ADVERTISING PURPOSES, CONSULTATION RELATING TO TRADE FAIRS; PUBLIC OPINION POLLING; DATA PROCESSING AND PROVISION OF BUSINESS INFORMATION, IN CLASS 35 (U.S. CLS. 100, 101 AND 102).

FOR: EDUCATION IN THE FIELD OF FINANCE AND INVESTMENT, NAMELY, CLASSES, SEMINARS, WORKSHOPS, AND DISTRIBUTION OF COURSE MATERIALS IN CONNECTION THEREWITH IN THE FORM OF PRINTED REPORTS AND ONLINE ELECTRONIC MATERIALS; PROVIDING OF TRAINING IN THE FIELD OF FINANCE AND INVESTMENT; ELECTRONIC GAMES SERVICES PROVIDED BY MEANS OF THE INTERNET, NAMELY, PROVIDING ONLINE COMPUTER GAMES; PUBLISHING OF ON-LINE ELECTRONIC PUBLICATIONS; NON-DOWNLOADABLE DIGITAL MUSIC FROM THE INTERNET, IN CLASS 41 (U.S. CLS. 100, 101 AND 107).

OWNER OF INTERNATIONAL REGISTRATION 0936662 DATED 5-30-2007, EXPIRES 5-30-2017.

SER. NO. 79-043,521, FILED 5-30-2007.

SANDRA MANIOS, EXAMINING ATTORNEY

Int. Cls.: 35, 38, 39, 41, 42 and 43

Prior U.S. Cls.: 100, 101, 102, 104, 105 and 107

Reg. No. 3,520,800

United States Patent and Trademark Office

Registered Oct. 21, 2008

**SERVICE MARK
PRINCIPAL REGISTER**

The logo for Liligo is rendered in a bold, rounded, lime-green font. The letters are thick and have a slightly irregular, hand-drawn appearance. The 'i' and 'l' are particularly prominent, with the 'i' having a dot and the 'l' being very tall. The 'o' is a simple circle, and the 'g' has a curved tail. The 'o' and 'g' are connected to the 'l' and 'i' respectively.

FINDWORKS TECHNOLOGIES (FRANCE SA,
SOCIETE ANONYME)
PARIS CYBER VILLAGE,
204 RUE DE CRIMÉE; F-75019 PARIS
FRANCE

FOR: ADVERTISING SERVICES, ADVERTISING SERVICES OF A RADIO AND TELEVISION ADVERTISING AGENCY, PUBLISHING OF ADVERTISING TEXTS, NAMELY, PUBLICATION OF ADVERTISING ANNOUNCEMENTS AND MESSAGES, RENTAL OF ADVERTISING SPACE ON WEBSITES; ADVERTISING FLYER DISTRIBUTION, NAMELY, MAILING OF ADVERTISING FLYERS; BUSINESS ADVICE AND INFORMATION, COMMERCIAL INFORMATION AGENCIES; ARRANGING SUBSCRIPTIONS TO TELECOMMUNICATION SERVICES; ARRANGING SUBSCRIPTIONS TO AN INTERNET COMPUTER SERVICE; ARRANGING SUBSCRIPTIONS TO A COMPUTER SERVICE, NAMELY, A COMPUTER DATABASE; SUBSCRIPTIONS TO ELECTRONIC JOURNALS, SUBSCRIPTIONS TO A TELECOMMUNICATION SERVICE IN CONNECTION WITH INFORMATION IN THE FIELD OF TOURISM, ENTERTAINMENT, EDUCATION AND LEISURE; COMPUTER FILE MANAGEMENT, IN CLASS 35 (U.S. CLS. 100, 101 AND 102).

FOR: TELECOMMUNICATION SERVICES, NAMELY, PROVIDING ACCESS TO TELECOMMUNICATION NETWORKS, COMMUNICATIONS BETWEEN COMPUTERS VIA BROADBAND, OPTICAL OR WIRELESS COMPUTER NETWORKS, TRANSMISSION OF DATA, SOUNDS AND IMAGES BY MEANS OF TELECOMMUNICATIONS NETWORKS, TRANSMISSION OF DATA, SOUNDS AND IMAGES VIA COMPUTER TERMINALS; TRANSMISSION OF DATABASE INFORMATION VIA TELECOMMUNICATIONS NETWORKS THAT ARE ACCESSIBLE BY ACCESS CODE; PROVIDING ACCESS TO DATABASES; PROVIDING ON-LINE DISCUSSION FORUMS FOR TRANSMISSION OF

MESSAGES AMONG COMPUTER USERS CONCERNING TOURISM, ENTERTAINMENT, EDUCATION AND LEISURE; TRANSMISSION OF INFORMATION BY ELECTRONIC COMMUNICATIONS NETWORKS IN CONNECTION WITH THE COMPARISON OF DIFFERENT SERVICES IN THE FIELD OF TOURISM, ENTERTAINMENT, EDUCATION AND LEISURE; ELECTRONIC MAIL SERVICES; ELECTRONIC MAIL TRANSMISSION, IN CLASS 38 (U.S. CLS. 100, 101 AND 104).

FOR: INFORMATION IN THE FIELD OF TRAVEL AND TOURISM; TRANSPORTATION RESERVATION SERVICES, IN CLASS 39 (U.S. CLS. 100 AND 105).

FOR: PUBLISHING OF BOOKS AND MAGAZINES; PUBLISHING OF ELECTRONIC EDITORIAL AND AUDIOVISUAL PUBLICATIONS, IN CLASS 41 (U.S. CLS. 100, 101 AND 107).

FOR: DESIGN, DEVELOPMENT, UPDATING, INSTALLATION, AND MAINTENANCE OF COMPUTER SOFTWARE FOR OTHERS, RESEARCH IN THE FIELDS OF SOFTWARE ENGINEERING AND SOFTWARE DEVELOPMENT; DESIGN, DEVELOPMENT, UPDATING, INSTALLATION, AND MAINTENANCE OF SOFTWARE FOR OTHERS FOR DATA PROCESSING AND FOR CREATION, MANAGEMENT, UPDATING AND USE OF DATABASES; DESIGN, DEVELOPMENT, UPDATING, INSTALLATION, AND MAINTENANCE OF SOFTWARE FOR INTERNET PORTAL CREATION FOR OTHERS; COMPUTER PROGRAMMING; CREATING, MAINTAINING, DESIGNING, IMPLEMENTING AND MANAGING WEB SITES FOR OTHERS, IN CLASS 42 (U.S. CLS. 100 AND 101).

FOR: RESERVATION OF HOTELS FOR OTHERS, MAKING RESERVATIONS AND BOOKINGS FOR INDIVIDUAL OR COLLECTIVE TEMPORARY ACCOMODATION; RESERVATION OF ROOMS IN

BOARDING HOUSES FOR TRAVELERS; PROVISION OF FOOD AND DRINKS, IN CLASS 43 (U.S. CLS. 100 AND 101).

OWNER OF INTERNATIONAL REGISTRATION 0936824 DATED 6-11-2007, EXPIRES 6-11-2017.

THE COLOR(S) GREEN (PANTONE 389) IS/ARE CLAIMED AS A FEATURE OF THE MARK.

THE COLOR GREEN APPEARS IN THE WORDING LILIGO.

SER. NO. 79-043,594, FILED 6-11-2007.

ROBIN MITTLER, EXAMINING ATTORNEY

Int. Cls.: 7 and 12

Prior U.S. Cls.: 13, 19, 21, 23, 31, 34, 35 and 44

Reg. No. 3,520,801

United States Patent and Trademark Office

Registered Oct. 21, 2008

**TRADEMARK
PRINCIPAL REGISTER**

MODULINER

KUHN S.A. (FRANCE SOCIÉTÉ ANONYME)
4 IMPASSE DES FABRIQUES
F-67700 SAVERNE
FRANCE

FOR: AGRICULTURAL MACHINERY AND MACHINE TOOLS, IMPLEMENTS NOT BEING HAND OPERATED, AND MACHINES ALL FOR USE IN AGRICULTURE, ANIMAL HUSBANDRY, HORTICULTURE, FORESTRY, EARTHMOVING, GARDENING AND PLEASURE GARDENING OR FARMING, NAMELY, TILLING MACHINES, NAMELY, SPRING TOOTH LEVER HARROWS, ROTARY CROSS-HARROWS, POWER OPERATED ROTARY TILLERS, PLOUGHS, CULTIVATORS, PULVERIZERS BEING EARTHMOVING MACHINES, GRINDERS, SOIL MIXERS, SEEDERS, SOIL DECOMPACTORS, AND LAND PACKING ROLLERS; COMBINED TILLING MACHINES; COMBINED TILLING AND SOWING MACHINES; AGRICULTURAL SEED PLANTING MACHINES, NAMELY, SOWERS, PNEUMATIC SOWERS, MECHANICAL SOWERS, PRECISION SOWERS, PRECISION SOWERS AND SOWERS WITH TINES; HAYMAKING MACHINES, NAMELY, MOWING AND REAPING MACHINES, MOWER CONDITIONERS, GRASS-AERATING MOWERS, TEDDING MACHINES, WINDROWERS, COMBINED TEDDER AND WINDROWER MACHINES, GROUPERS AND WINDROW TURNERS; HARVESTING MACHINES, NAMELY, REAPING MACHINES, COMBINE HARVESTERS AND FODDER BALERS; TREATMENT MACHINES, NAMELY, POWER OPERATED SPRAYERS; LAWN MOWERS; POWER OPERATED HEDGE GRASS SHREDDERS; CONVEYORS; ELEVATORS; POWER OPERATED STRAW BLOWERS AND FEEDERS; MACHINES USED TO PREPARE FOOD FOR LIVESTOCK, NAMELY, SILO UNLOA-

DERS, UNLOADER-DISTRIBUTORS AND FODDER MIXER-DISTRIBUTORS; TRACTOR TOWED AGRICULTURAL ELEMENTS, NAMELY, FERTILIZER SPREADERS; MACHINES FOR EARTH MOVING WORK, NAMELY, BULLDOZERS, BACKHOES AND EXCAVATORS; REPLACEMENT PARTS OF THE AFOREMENTIONED GOODS; SELF-PROPELLED LAND APPARATUS, NAMELY, MOWERS, TEDDERS, WINDROWERS AND PRODUCT GROUPERS FOR PLANT MATERIALS; SELF-PROPELLED LAND APPARATUS, NAMELY TILLERS; SELF-PROPELLED LAND DEVICES, NAMELY, SOWERS; SELF-PROPELLED LAND DEVICES, NAMELY COMBINED TILLERS AND SOWERS, IN CLASS 7 (U.S. CLS. 13, 19, 21, 23, 31, 34 AND 35).

FOR: VEHICLES, NAMELY, LAND VEHICLES, NAMELY, DUMP TRUCKS, FREIGHT TRUCKS, CARTS, TRAILERS, AND DISPENSING WAGONS; SELF-PROPELLED LAND VEHICLES; TRACTORS; MOTOR CARS; WAGONS; AND RAILWAY CARS, IN CLASS 12 (U.S. CLS. 19, 21, 23, 31, 35 AND 44).

THE MARK CONSISTS OF STANDARD CHARACTERS WITHOUT CLAIM TO ANY PARTICULAR FONT, STYLE, SIZE, OR COLOR.

PRIORITY DATE OF 12-7-2006 IS CLAIMED.

OWNER OF INTERNATIONAL REGISTRATION
0937085 DATED 6-5-2007, EXPIRES 6-5-2017.

SER. NO. 79-043,706, FILED 6-5-2007.

KRISTINA MORRIS, EXAMINING ATTORNEY

Int. Cl.: 2

Prior U.S. Cls.: 6, 11 and 16

United States Patent and Trademark Office

Reg. No. 3,520,802

Registered Oct. 21, 2008

**TRADEMARK
PRINCIPAL REGISTER**

JOTUN

JOTUN A/S (NORWAY JOINT STOCK COMPANY)
HYSTADVEIEN 167
N-3209
SANDEFJORD, NORWAY

FOR: PAINTS, VARNISHES, LACQUERS, ANTI-FOULING PAINTS FOR BOATS, SHIPS AND OIL RIGS; COATINGS IN THE NATURE OF PAINTS FOR BOATS, SHIPS AND OIL RIGS; POWDER VARNISHES FOR PROTECTION OF METAL PIPELINES, AND FOR PROTECTION OF IRON REINFORCEMENT AND METAL FRONTAGES, IN CLASS 2 (U.S. CLS. 6, 11 AND 16).

THE MARK CONSISTS OF STANDARD CHARACTERS WITHOUT CLAIM TO ANY PARTICULAR FONT, STYLE, SIZE, OR COLOR.

OWNER OF INTERNATIONAL REGISTRATION
0937270 DATED 7-23-2007, EXPIRES 7-23-2017.

OWNER OF U.S. REG. NO. 2,673,640.

SER. NO. 79-043,754, FILED 7-23-2007.

SCOTT BIBB, EXAMINING ATTORNEY

Int. Cl.: 21

Prior U.S. Cls.: 2, 13, 23, 29, 30, 33, 40 and 50

Reg. No. 3,520,803

United States Patent and Trademark Office

Registered Oct. 21, 2008

TRADEMARK
PRINCIPAL REGISTER

Monna Glass

by  ÖZLEM
KRİSTAL

ÖZLEM KRİSTAL; SANAYİ VE TİCARET ANONİM SİRKETİ (TURKEY ANONİM SİRKETİ)
ÇAGLAYAN MAH. MURAT SOK. NO: 5/1-4
KAGITHANE-İSTANBUL
TURKEY

FOR: GLASSWARE, PORCELAIN AND EARTH-ENWARE FOR HOUSEHOLD AND KITCHEN, NAMELY, VESSELS AND POTS, BUCKETS, WASTE BINS, PANS, PLATES, BASINS; CUPS; MUGS; SAUCERS; DISHES; CANDY DISHES; DECANTERS; BAKING DISHES; ROASTING DISHES; CASSEROLE DISHES; GLASS DISHES; DISH COVERS; BEVERAGE WARE; BAKEWARE; OVENWARE; DINNERWARE; PLASTIC PLATES, GLASSES, CUPS AND TRAYS; DISPOSABLE SERVING SPOONS, DISPOSABLE PAPERBOARD BAKEWARE; PLASTIC STORAGE CONTAINERS FOR HOUSEHOLD OR DOMESTIC USE; BUTTER DISHES; CHEESE COVERS; PIE SERVERS; CAKE DOMES; CAKE SERVERS; CAKE STANDS; CANDLE HOLDERS; CANDLE RINGS; CANDLESTICKS; CARAFES; CHAMPAGNE BUCKETS; COFFEE SERVERS; CREAMER PITCHERS; CRUET STANDS; CRUETS; CRUMB TRAYS; NAPKIN HOLDERS; NAPKIN RINGS; PILLAR CANDLE PLATES; PITCHERS; SALT AND PEPPER SHAKERS; SERVING DISHES; SERVING FORKS; SERVING PLATTERS; SERVING TRAYS; SERVING WARE FOR SERVING FOOD; SPOON RESTS; SAUCEBOATS; GRAVY BOATS; TEA SERVICES; TEA SETS; WINE JUGS; CARVING BOARDS; CHOPPING BOARDS FOR KITCHEN USE; KNIFE BLOCKS; KNIFE BOARDS; KNIFE RESTS; RECIPE BOXES; WOOD COOKING PLANKS FOR USE IN GRILLING; CHOCOLATE MOLDS; PUDDING MOLDS; NON-ELECTRIC GRIDDLES; NON-ELECTRIC DEEP FRYERS; NON-ELECTRIC RICE COOKING POTS; NON-ELECTRIC WOKS; DOUBLE BOILERS; EGG POACHERS; GLASS PANS; MUFFIN TINS; PIE PANS; POT LIDS; SAUCEPANS;

SKILLETS; SWEDISH PANCAKE PANS; PASTRY MOLDS; BOTTLE STANDS; CAKE PANS; CAKE RINGS; CAKE TINS; CARVER RESTS; COFFEE SERVICE; COOKERY MOLDS; COOKIE SHEETS; NON-ELECTRIC COOKING PANS; COOKING POTS; NON-ELECTRIC COOKING STEAMERS; COOLING RACKS FOR BAKED GOODS; DISH DRYING RACKS; DISH STANDS; DUTCH OVENS; FRYING PANS; NOT ELECTRICALLY HEATED HOT POTS; NON-ELECTRIC KETTLES; MENU CARD HOLDERS; POT STANDS; SPICE RACKS; STANDS FOR DISHES; TABLE PLACE CARD HOLDERS; TEA CADDIES; TEA INFUSERS; TEA KETTLES; NON-ELECTRIC TEA POTS; TRAYS FOR DOMESTIC PURPOSES; TRIVETS; NON-ELECTRIC WAFFLE IRONS; WATERING CANS; CUP HOLDERS FOR BATH AND HOUSEHOLD USE; GLASS HOLDERS FOR BATH AND HOUSEHOLD USE; BUCKETS; CANDY BOXES; CANISTER SETS; CERAMIC TISSUE BOX COVERS; CONTAINERS FOR HOUSEHOLD OR KITCHEN USE; FLOWER POT HOLDERS; JUGS; TEA CANISTERS; VASES; WALL SOAP DISHES; PAPER PLATES, GLASSES, CUPS AND TRAYS; NON-ELECTRIC COFFEE POTS; COOKING STRAINERS; TEA STRAINERS; WINE STRAINERS; STRAINERS FOR HOUSEHOLD PURPOSES; SCOOPS, SPATULAS, BOWLS, EGG CUPS, CAKE MOULDS, WATER BOWLS, FOOD PRESERVING BOWLS; COASTERS, NOT OF PAPER AND OTHER THAN TABLE LINEN FOR GLASS AND PANS; FLOWER POTS, SOAP BOXES, SOAP DISPENSERS, METAL BOXES FOR DISPENSING PAPER TOWELS, PORTABLE BABY BATHS, ICE CUBE MOULDS AND ICE BUCKETS; HEAT-INSULATED VESSELS; VACUUM BOTTLES, FLASKS, FITTED PICNIC BASKETS; DRINKING CUPS GIVEN AT SPORTS MATCHES, BREAD BOXES, BREAD BASKETS, BREAD CUTTING BOARDS; KNICK-KNACKS OF PORCELAIN, TERRA-COTTA AND GLASS, NAMELY, FIGURES, BUSTS, COM-

MEMORATIVE PLATES, DECORATIVE CRYSTAL PRISMS, DECORATIVE PLATES, DESKTOP STATUARY, FIGURINES, GLASS ETCHED BY ACID, ORNAMENTS NOT FOR TREES, ORNAMENTAL GLASS SPHERES, PLAQUES, PORCELAIN EGGS, SCULPTURES, SOUVENIR PLATES, STAINED GLASS, AND STATUETTES; STATUES AND WORKS OF ART OF PORCELAIN, TERRA-COTTA AND GLASS; BOTTLES, SOLD EMPTY; JARS, NAMELY, GLASS JARS, COOKIE JARS, INSULATING JARS; DEMIJOHNS, DOOR-HANDLES OF PORCELAIN AND CERAMIC; PERFUME BURNERS, PERFUME SPRAYERS, PERFUME VAPORIZERS SOLD EMPTY; NON-ELECTRIC APPLIANCES FOR REMOVING MAKE-UP, NAMELY, SPONGES, SCRUBBING PUFFS, NON-WOVEN FABRIC COSMETIC WIPES, AND CLEANSING PUFFS, NOT BEING IMPREGNATED WITH PREPARATIONS; POWDER PUFFS; TOILET CASES, NAMELY, PLASTIC STORAGE CONTAINERS FOR HOUSEHOLD PURPOSES SOLD EMPTY; CONTAINERS OF PLASTIC FOR STORAGE OF FEMININE PRODUCTS FOR HOUSEHOLD OR DOMESTIC USE; UN-

WORKED OR SEMI-WORKED GLASS; POWDERED GLASS AND MOSAICS OF GLASS FOR DECORATION, NOT FOR BUILDING, GLASS WOOL OTHER THAN FOR INSULATION, IN CLASS 21 (U.S. CLS. 2, 13, 23, 29, 30, 33, 40 AND 50).

OWNER OF INTERNATIONAL REGISTRATION 0808956 DATED 6-10-2003, EXPIRES 6-10-2013.

NO CLAIM IS MADE TO THE EXCLUSIVE RIGHT TO USE "KRISTAL", APART FROM THE MARK AS SHOWN.

THE ENGLISH TRANSLATION OF "ÖZLEM" IS LONGING OR YEARNING; "KRISTAL" IS CRYSTAL.

SER. NO. 79-043,802, FILED 4-5-2007.

REBECCA POVARCHUK, EXAMINING ATTORNEY

Int. Cls.: 2, 9, 16 and 41

**Prior U.S. Cls.: 2, 5, 6, 11, 16, 21, 22, 23, 26, 29, 36, 37,
38, 50, 100, 101 and 107**

Reg. No. 3,520,804

United States Patent and Trademark Office

Registered Oct. 21, 2008

**TRADEMARK
SERVICE MARK
PRINCIPAL REGISTER**

PhotonPainting

DAGMAR WOYDE-KÖHLER (FED REP GERMA-
NY INDIVIDUAL)
ROONSTRASSE 23
KARLSRUHE, FED REP GERMANY D76137

FOR: PAINTS, VARNISHES, LACQUERS; COLOR-
ANTS; MORDANTS FOR USE IN THE FIELD OF
ARTWORK; RAW NATURAL RESINS; METALS IN
FOIL AND POWDER FORM FOR PAINTERS, DEC-
ORATORS, PRINTERS AND ARTISTS, IN CLASS 2
(U.S. CLS. 6, 11 AND 16).

FOR: COMPUTER SOFTWARE FOR CREATING,
VIEWING, MANIPULATING, EDITING, MANA-
GING, INDEXING, CATALOGUING, SORTING,
ORGANIZING, STORING, TRANSFERRING, SYN-
CHRONIZING, PRINTING, AND EXCHANGING
DIGITAL PHOTOGRAPHS, DIGITAL AND GRA-
PHIC IMAGES, DATA, TEXT, AUDIO, VIDEO,
MULTIMEDIA AND INTERACTIVE DOCUMENTS
AND WORKS, TEXT DOCUMENTS, AND RECOR-
DED INFORMATION, IN CLASS 9 (U.S. CLS. 21, 23,
26, 36 AND 38).

FOR: PAPER AND CARDBOARD; PAPER AND
CARDBOARD GOODS, NAMELY, CANVAS PA-

NELS FOR ARTISTIC PURPOSES; PRINTED MAT-
TER, NAMELY, EXHIBITION CATALOGS IN THE
NATURE OF EVENT PROGRAMS; PHOTO-
GRAPHS; STATIONERY; ARTISTS' MATERIALS,
NAMELY, ARTISTS' PENS; PAINT BRUSHES, IN
CLASS 16 (U.S. CLS. 2, 5, 22, 23, 29, 37, 38 AND 50).

FOR: ORGANIZING EXHIBITIONS FOR CUL-
TURAL AND EDUCATIONAL PURPOSES, NAME-
LY, PUBLIC PRESENTATIONS OF ARTWORK AND
LITERATURE FOR CULTURAL AND EDUCA-
TIONAL PURPOSES, IN CLASS 41 (U.S. CLS. 100,
101 AND 107).

THE MARK CONSISTS OF STANDARD CHAR-
ACTERS WITHOUT CLAIM TO ANY PARTICULAR
FONT, STYLE, SIZE, OR COLOR.

OWNER OF INTERNATIONAL REGISTRATION
0937600 DATED 8-15-2007, EXPIRES 8-15-2017.

SER. NO. 79-043,883, FILED 8-15-2007.

SANJEEV VOHRA, EXAMINING ATTORNEY

Int. Cl.: 9

Prior U.S. Cls.: 21, 23, 26, 36 and 38

United States Patent and Trademark Office

Reg. No. 3,520,805

Registered Oct. 21, 2008

**TRADEMARK
PRINCIPAL REGISTER**

LUXID

TEMIS SA (FRANCE SOCIÉTÉ ANONYME)
TOUR GAMMA -
193-197 RUE DE BERCY; F-75012 PARIS
FRANCE

FOR: COMPUTER SOFTWARE FOR TEXT MINING AND TEXT PROCESSING, NAMELY, FOR INDEXING AND ORGANIZING COLLECTIONS OF DOCUMENTS AND EXTRACTING INFORMATION FROM THEM; COMPUTER SOFTWARE FOR AUTOMATED INFORMATION EXTRACTION AND RETRIEVAL METHODS; COMPUTER SOFTWARE FOR ANALYSIS AND FILTERING OF TECHNOLOGICAL AND ECONOMIC DATA IN THE FIELD OF LIFE SCIENCES, PUBLISHING, AUTOMOTIVE INDUSTRY AND HOMELAND SECURITY; COMPUTER SOFTWARE FOR GATHERING AND STRUCTURING INFORMATION AND DATA IN THE FIELD OF HUMAN RESOURCES, IN THE FIELD OF DATABASES CONTAINING INFORMATION ABOUT CLIENTS AND

ABOUT CLIENTS' FEEDBACK ON PRODUCTS AS CONSUMERS, AND IN THE FIELD OF ECONOMIC INTELLIGENCE; DATA PROCESSING APPARATUS, NAMELY, COMPUTERS, SERVERS, COMPUTER MEMORIES, DATA PROCESSORS, CHIPS, NAMELY, INTEGRATED CIRCUITS; PRINTED CIRCUITS, IN CLASS 9 (U.S. CLS. 21, 23, 26, 36 AND 38).

THE MARK CONSISTS OF STANDARD CHARACTERS WITHOUT CLAIM TO ANY PARTICULAR FONT, STYLE, SIZE, OR COLOR.

OWNER OF INTERNATIONAL REGISTRATION
0937753 DATED 4-24-2007, EXPIRES 4-24-2017.

SER. NO. 79-043,921, FILED 4-24-2007.

Laurie Kaufman, Examining Attorney

Int. Cls.: 16 and 41

Prior U.S. Cls.: 2, 5, 22, 23, 29, 37, 38, 50, 100, 101 and 107

Reg. No. 3,520,806

United States Patent and Trademark Office

Registered Oct. 21, 2008

**TRADEMARK
SERVICE MARK
PRINCIPAL REGISTER**

HANDE ZAPSU

GAYE HANDE ZAPSU (TURKEY INDIVIDUAL)
BÜYÜKDERE CAD. AYSIT
VILLALARI NO:36B
SARIYER / ISTANBUL, TURKEY

OWNER OF INTERNATIONAL REGISTRATION
0937761 DATED 6-29-2007, EXPIRES 6-29-2017.

FOR: PUBLICATIONS, NAMELY, BOOKS, BROCHURES, BOOKLETS, AND TEACHING MATERIALS, STORY BOOKS WHICH ARE PREPARED FOR CHILDREN, IN CLASS 16 (U.S. CLS. 2, 5, 22, 23, 29, 37, 38 AND 50).

THE NAME(S), PORTRAIT(S), AND/OR SIGNATURE(S) SHOWN IN THE MARK IDENTIFIES "HANDE ZAPSU", WHOSE CONSENT(S) TO REGISTER IS SUBMITTED.

FOR: MAGAZINE, BOOKS AND NEWSPAPER PUBLISHING SERVICES, IN CLASS 41 (U.S. CLS. 100, 101 AND 107).

SER. NO. 79-043,923, FILED 6-29-2007.

DAWN HAN, EXAMINING ATTORNEY

Int. Cl.: 36

Prior U.S. Cls.: 100, 101 and 102

United States Patent and Trademark Office

Reg. No. 3,520,807

Registered Oct. 21, 2008

**SERVICE MARK
PRINCIPAL REGISTER**

SwissWay Asset Management

GILDO LUNGARELLA (SWITZERLAND INDIVIDUAL)

WIESENSTRASSE 4

CH-8307 EFFRETIKON

SWITZERLAND

FOR: FINANCIAL AFFAIRS, NAMELY, FINANCIAL MANAGEMENT, FINANCIAL CONSULTING, FINANCIAL PORTFOLIO MANAGEMENT AND ASSET MANAGEMENT; MONETARY AFFAIRS, NAMELY, CAPITAL INVESTMENTS, VENTURE CAPITAL INVESTMENTS AND PRIVATE EQUITY INVESTMENTS; REAL ESTATE AFFAIRS, NAMELY, ASSESSMENT AND MANAGEMENT OF REAL ESTATE, REAL ESTATE INVESTMENT, IN CLASS 36 (U.S. CLS. 100, 101 AND 102).

THE MARK CONSISTS OF STANDARD CHARACTERS WITHOUT CLAIM TO ANY PARTICULAR FONT, STYLE, SIZE, OR COLOR.

PRIORITY DATE OF 2-28-2007 IS CLAIMED.

OWNER OF INTERNATIONAL REGISTRATION 0937852 DATED 8-17-2007, EXPIRES 8-17-2017.

NO CLAIM IS MADE TO THE EXCLUSIVE RIGHT TO USE "ASSET MANAGEMENT", APART FROM THE MARK AS SHOWN.

SER. NO. 79-043,944, FILED 8-17-2007.

PRISCILLA MILTON, EXAMINING ATTORNEY

Int. Cl.: 3

Prior U.S. Cls.: 1, 4, 6, 50, 51 and 52

United States Patent and Trademark Office

Reg. No. 3,520,808

Registered Oct. 21, 2008

**TRADEMARK
PRINCIPAL REGISTER**



YVES SAINT LAURENT PARFUMS, (FRANCE
SOCIÉTÉ PAR ACTIONS SIMPLIFIÉE)
28/34 BOULEVARD DU PARC
F-92200 NEUILLY-SUR-SEINE
FRANCE

FOR: PERFUMES, EAUX DE TOILETTE; DEODORANTS FOR PERSONAL USE; ESSENTIAL OILS FOR PERSONAL USE; OILS FOR COSMETIC PURPOSES; COSMETIC MILK; CREAMS AND LOTIONS FOR FACE AND BODY CARE PURPOSES; BATH AND SHOWER GELS; HAIR LOTIONS; SHAMPOOS, IN CLASS 3 (U.S. CLS. 1, 4, 6, 50, 51 AND 52).

PRIORITY DATE OF 3-15-2007 IS CLAIMED.

OWNER OF INTERNATIONAL REGISTRATION
0937888 DATED 8-31-2007, EXPIRES 8-31-2017.

THE COLOR(S) PURPLE AND GOLD IS/ARE CLAIMED AS A FEATURE OF THE MARK.

THE MARK CONSISTS OF A SPRAY BOTTLE IN THE SHAPE OF A RECTANGULAR PRISM, AND IS THREE-DIMENSIONAL; THE COLOR PURPLE APPEARS IN THE BOTTOM HALF OF THE BOTTLE AND IN THE CAP OF THE BOTTLE; THE COLOR GOLD APPEARS IN THE MIDDLE OF THE BOTTLE.

SER. NO. 79-043,960, FILED 8-31-2007.

KRISTIN DAHLING, EXAMINING ATTORNEY

Int. Cl.: 36

Prior U.S. Cls.: 100, 101 and 102

United States Patent and Trademark Office

Reg. No. 3,520,809

Registered Oct. 21, 2008

**SERVICE MARK
PRINCIPAL REGISTER**

SwissWay Group

GILDO LUNGARELLA (SWITZERLAND INDIVIDUAL)

WIESENSTRASSE 4

CH-8307 EFFRETIKON

SWITZERLAND

FOR: FINANCIAL AFFAIRS, NAMELY, FINANCIAL MANAGEMENT, FINANCIAL CONSULTING, FINANCIAL PORTFOLIO MANAGEMENT AND ASSET MANAGEMENT; MONETARY AFFAIRS, NAMELY, CAPITAL INVESTMENTS, VENTURE CAPITAL INVESTMENTS AND PRIVATE EQUITY INVESTMENTS; REAL ESTATE AFFAIRS, NAMELY, ASSESSMENT AND MANAGEMENT OF REAL ESTATE, REAL ESTATE INVESTMENT, IN CLASS 36 (U.S. CLS. 100, 101 AND 102).

THE MARK CONSISTS OF STANDARD CHARACTERS WITHOUT CLAIM TO ANY PARTICULAR FONT, STYLE, SIZE, OR COLOR.

PRIORITY DATE OF 2-28-2007 IS CLAIMED.

OWNER OF INTERNATIONAL REGISTRATION 0937907 DATED 8-23-2007, EXPIRES 8-23-2017.

NO CLAIM IS MADE TO THE EXCLUSIVE RIGHT TO USE "GROUP" , APART FROM THE MARK AS SHOWN.

SER. NO. 79-043,964, FILED 8-23-2007.

PRISCILLA MILTON, EXAMINING ATTORNEY

Int. Cls.: 3, 25 and 28

Prior U.S. Cls.: 1, 4, 6, 22, 23, 38, 39, 50, 51 and 52

Reg. No. 3,520,810

United States Patent and Trademark Office

Registered Oct. 21, 2008

TRADEMARK
PRINCIPAL REGISTER

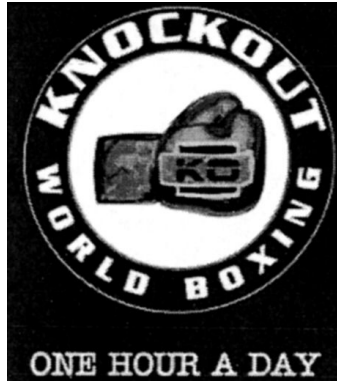

CIRO SANTUCCI (ITALY INDIVIDUAL)
VIA CALATA, 7
I-84040 PELLEZZANO (SA)
ITALY AND
DOMENICO VANGI (ITALY INDIVIDUAL)
VIA GIACOMO GRIZIOTTI, 4
I-20145 MILANO
ITALY

FOR: COSMETICS, PERFUMERY, SOAPS, ESSENTIAL OILS, HAIR LOTIONS, IN CLASS 3 (U.S. CLS. 1, 4, 6, 50, 51 AND 52).

FOR: CLOTHING, NAMELY, PANTS, SHIRTS, T-SHIRTS, TRACKSUITS, SOCKS, STOCKINGS, SHORTS, SWEATSHIRTS, JACKETS, UNDER-SHIRTS, JEANS, UNDERWEAR, BATH ROBES, BOXING JERSEYS, GLOVES, COATS, JOGGING SUITS, BATHING SUITS, BELTS; FOOTWEAR; HEADGEAR, NAMELY, HATS, CAPS, BANDANAS AND VISORS, IN CLASS 25 (U.S. CLS. 22 AND 39).

FOR: GYMNAS TIC AND SPORTING ARTICLES NOT INCLUDED IN OTHER CLASSES, NAMELY, EAR AND EYEBROW PROTECTORS FOR BOXERS, BOXING MASKS, TEETH GUARDS, BOXING GLOVES, STRIKING BAGS, FIGHTING GLOVES, TRAINING DUMMIES, STRIKING-BAG PLATFORMS, DUMBBELLS, ROWING MACHINES, CHEST WEIGHTS, SPRING BARS FOR EXERCIS-

ING, HAND GRIP DEVELOPERS, PUNCHING BAGS, TRAINING BAGS FOR BOXING, JUMP ROPES, ATHLETIC SUPPORTERS, FOOT GUARDS FOR ATHLETIC USE AND MOUTH GUARDS FOR BOXERS, BOXING AND WRESTLING, IN CLASS 28 (U.S. CLS. 22, 23, 38 AND 50).

PRIORITY DATE OF 6-5-2007 IS CLAIMED.

OWNER OF INTERNATIONAL REGISTRATION 0938014 DATED 6-22-2007, EXPIRES 6-22-2017.

NO CLAIM IS MADE TO THE EXCLUSIVE RIGHT TO USE "WORLD BOXING", APART FROM THE MARK AS SHOWN.

THE MARK CONSISTS OF A CIRCLE WITH DOUBLE CIRCUMFERENCE IN WHICH THE WORDING "KNOCKOUT WORLD BOXING" IN SPECIAL CHARACTERS IS INCLUDED; IN THE CENTER OF THE CIRCLE, IS REPRESENTED A BOXING GLOVE HAVING THE WORD "KO" ON ITS UPPER SIDE; BELOW THE CIRCLE IS PLACED THE WORDING "ONE HOUR A DAY".

SER. NO. 79-044,003, FILED 6-22-2007.

RENEE SERVANCE, EXAMINING ATTORNEY

Int. Cls.: 16 and 41

Prior U.S. Cls.: 2, 5, 22, 23, 29, 37, 38, 50, 100, 101 and 107

Reg. No. 3,520,811

United States Patent and Trademark Office

Registered Oct. 21, 2008

TRADEMARK
SERVICE MARK
PRINCIPAL REGISTER

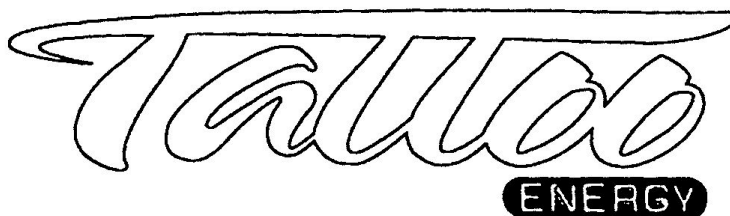

MEDIAFRIENDS SRL (ITALY LIMITED LIABILITY COMPANY)
CORSO LODI, 34/A
I-20135 MILANO
ITALY

FOR: PUBLICATIONS, NAMELY, TRAINING MANUALS IN THE FIELD OF TATTOOING OR BROCHURES, BOOKLETS, AND TEACHING MATERIALS IN THE FIELD OF TATTOOING; PRINTED PRODUCTS, NAMELY, CALENDARS, PRINTED ART REPRODUCTIONS; PAPER, NAMELY, ADHESIVE NOTE PAPER, ART PAPER; CARDBOARD AND PRODUCTS MADE OF THESE MATERIALS, NAMELY, MAGAZINE PAPER, PAPER BAGS, PAPER BOARDS, IN CLASS 16 (U.S. CLS. 2, 5, 22, 23, 29, 37, 38 AND 50).

FOR: TRAINING, NAMELY, TATTOOING TRAINING; LEISURE AND CULTURAL ACTIV-

ITIES, NAMELY, ORGANIZING TATTOOING EVENTS AND EXHIBITIONS FOR ENTERTAINMENT AND CULTURAL PURPOSES, IN CLASS 41 (U.S. CLS. 100, 101 AND 107).

PRIORITY DATE OF 2-8-2007 IS CLAIMED.

OWNER OF INTERNATIONAL REGISTRATION 0938197 DATED 8-7-2007, EXPIRES 8-7-2017.

NO CLAIM IS MADE TO THE EXCLUSIVE RIGHT TO USE "TATTOO", APART FROM THE MARK AS SHOWN.

SER. NO. 79-044,061, FILED 8-7-2007.

CARYN GLASSER, EXAMINING ATTORNEY

Int. Cls.: 16 and 41

Prior U.S. Cls.: 2, 5, 22, 23, 29, 37, 38, 50, 100, 101 and 107

Reg. No. 3,520,812

United States Patent and Trademark Office

Registered Oct. 21, 2008

TRADEMARK
SERVICE MARK
PRINCIPAL REGISTER

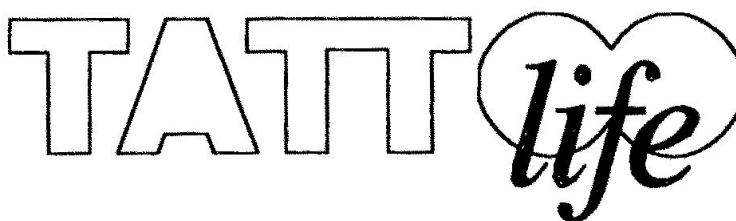

MEDIAFRIENDS SRL (ITALY LIMITED LIABILITY COMPANY)

CORSO LODI, 34/A

I-20135 MILANO, ITALY

FOR: PUBLICATIONS, NAMELY, TRAINING MANUALS IN THE FIELD OF TATTOOING OR BROCHURES, BOOKLETS, AND PRINTED TEACHING MATERIALS IN THE FIELD OF TATTOOING; PRINTED PRODUCTS, NAMELY, CALENDARS, PRINTED ART REPRODUCTIONS; PAPER, NAMELY, ADHESIVE NOTE PAPER, ART PAPER; CARDBOARD AND PRODUCTS MADE OF THESE MATERIALS, NAMELY, MAGAZINE PAPER, PAPER BAGS, PAPER BOARDS, IN CLASS 16 (U.S. CLS. 2, 5, 22, 23, 29, 37, 38 AND 50).

FOR: TRAINING, NAMELY, TATTOOING TRAINING; LEISURE AND CULTURAL ACTIVITIES, NAMELY, ORGANIZING TATTOOING EVENTS AND EXHIBITIONS FOR ENTERTAINMENT AND CULTURAL PURPOSES, IN CLASS 41 (U.S. CLS. 100, 101 AND 107).

PRIORITY DATE OF 2-8-2007 IS CLAIMED.

OWNER OF INTERNATIONAL REGISTRATION 0938198 DATED 8-7-2007, EXPIRES 8-7-2017.

SER. NO. 79-044,062, FILED 8-7-2007.

CARYN GLASSER, EXAMINING ATTORNEY

Int. Cl.: 21

Prior U.S. Cls.: 2, 13, 23, 29, 30, 33, 40 and 50

United States Patent and Trademark Office

Reg. No. 3,520,813

Registered Oct. 21, 2008

**TRADEMARK
PRINCIPAL REGISTER**



CRISAL - CRISTALARIA AUTOMÁTICA, S.A.
(PORTUGAL CORPORATION)
RUA DE PORTUGAL, LOTE 1
ZONA INDUSTRIAL DA MARINHA GRANDE; P-
2431-903 MARINHA GRANDE
PORTUGAL

FOR: GLASSWARE AND CRYSTAL, NAMELY,
BEVERAGE GLASSES AND GOBLETs, DINNER-
WARE, PLATES, SCULPTURES, FIGURINES, VA-
SES, NAPKIN HOLDERS; EARTHENWARE AND
FAIENCE, NAMELY, MUGS, DINNERWARE,
PLATES, SCULPTURES, FIGURINES, VASES, NAP-
KIN HOLDERS; PORCELAIN, NAMELY, DINNER-
WARE, PLATES, SCULPTURES, FIGURINES,
VASES, NAPKIN HOLDERS, IN CLASS 21 (U.S.
CLS. 2, 13, 23, 29, 30, 33, 40 AND 50).

OWNER OF INTERNATIONAL REGISTRATION
0657308 DATED 7-12-1996, EXPIRES 7-12-2016.

OWNER OF U.S. REG. NO. 2,585,550.

NO CLAIM IS MADE TO THE EXCLUSIVE
RIGHT TO USE "GLASS" , APART FROM THE
MARK AS SHOWN.

SER. NO. 79-044,091, FILED 8-20-2007.

INGA ERVIN, EXAMINING ATTORNEY

Int. Cls.: 14, 16, 18, 20, 21, 24, 25, 28 and 34

Prior U.S. Cls.: 1, 2, 3, 5, 8, 9, 13, 17, 22, 23, 25, 27, 28, 29, 30, 32, 33, 37, 38, 39, 40, 41, 42 and 50

Reg. No. 3,520,814

United States Patent and Trademark Office

Registered Oct. 21, 2008

**TRADEMARK
PRINCIPAL REGISTER**

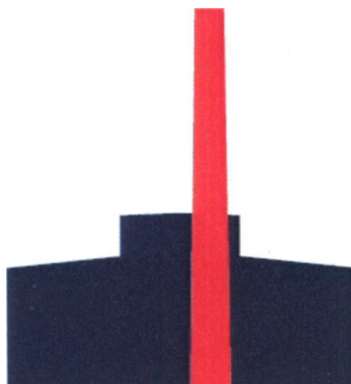

DEGRYSE LAURENT (BELGIUM INDIVIDUAL)
CHEMIN DU BON AIR 20
B-1380 OHAIN
BELGIUM

FOR: PRECIOUS METALS AND THEIR ALLOYS AND GOODS MADE OF OR COATED WITH THESE MATERIALS NOT INCLUDED IN OTHER CLASSES, NAMELY, WATCHES, NECKLACES, EARRINGS, RINGS, AND PINS; JEWELLERY, PRECIOUS STONES; TIMEPIECES AND CHRONOMETRIC INSTRUMENTS, IN CLASS 14 (U.S. CLS. 2, 27, 28 AND 50).

FOR: PAPER, CARDBOARD AND GOODS MADE FROM THESE MATERIALS, NOT INCLUDED IN OTHER CLASSES, NAMELY, NOTEBOOKS, NOTE-PADS, AND PHOTO ALBUMS; PRINTED MATTER, NAMELY, POSTERS, POSTCARDS, BOOKS, LITHOGRAPHS; BOOKBINDING MATERIAL; PHOTOGRAPHS; STATIONERY; ADHESIVES FOR STATIONERY OR HOUSEHOLD PURPOSES; ARTISTS' MATERIALS, NAMELY, WRITING INSTRUMENTS, PENCILS, PENS, AND BOOKMARKS; PAINTBRUSHES; TYPEWRITERS; INSTRUCTIONAL AND TEACHING MATERIAL IN THE FIELDS OF ART, DRAWING, ARCHITECTURE, AND DESIGN; PLASTIC MATERIALS FOR PACKAGING, NAMELY, BUBBLE PACKS, PLASTIC BAGS; PRINTING TYPE; PRINTING BLOCKS, IN CLASS 16 (U.S. CLS. 2, 5, 22, 23, 29, 37, 38 AND 50).

FOR: LEATHER AND IMITATION LEATHER, GOODS MADE OF THESE MATERIALS NOT INCLUDED IN OTHER CLASSES, NAMELY, WAL-

LETS AND CREDIT CARD CASES; ANIMAL SKINS AND HIDES; TRUNKS AND SUITCASES, UMBRELLAS, PARASOLS AND WALKING STICKS; WHIPS, HARNESS AND SADDLERY, IN CLASS 18 (U.S. CLS. 1, 2, 3, 22 AND 41).

FOR: FURNITURE, MIRRORS, PICTURE FRAMES, IN CLASS 20 (U.S. CLS. 2, 13, 22, 25, 32 AND 50).

FOR: HOUSEHOLD OR KITCHEN UTENSILS AND CONTAINERS, NAMELY, ICE CREAM SCOOPS, CHEESE PLANES, BALL WHISKS, AND SALAD SPINNERS; COMBS AND SPONGES FOR HOUSEHOLD PURPOSES; BRUSHES, NAMELY, BASTING BRUSHES; BRUSH-MAKING MATERIALS, ARTICLES FOR CLEANING PURPOSES, NAMELY, SPONGES; STEEL WOOL; UNWORKED OR SEMI-WORKED GLASS, NOT FOR BUILDING; GLASSWARE, PORCELAIN AND EARTHENWARE, NAMELY, EGG CUPS, WOBBLE COGNAC GLASSES, MARTINI GLASSES, TEA CUPS, COFFEE MUGS, SALT AND PEPPER SHAKERS, OVEN TO TABLE SERVING DISHES, IN CLASS 21 (U.S. CLS. 2, 13, 23, 29, 30, 33, 40 AND 50).

FOR: TEXTILES AND TEXTILE GOODS, NAMELY, PLACEMATS; PAPER BED COVERS AND TABLE COVERS NOT OF PAPER, IN CLASS 24 (U.S. CLS. 42 AND 50).

FOR: CLOTHING, NAMELY, TOPS, BOTTOMS, PANTS, SHIRTS, SOCKS, CARDIGANS, PONCHOS, COATS, JACKETS, SCARVES, TIES, BOWTIES, SWEATSHIRTS, AND SWIMSUITS; FOOTWEAR;

HEADGEAR, NAMELY, HATS, CAPS, AND WATER-REPELLENT RAIN HATS, IN CLASS 25 (U.S. CLS. 22 AND 39).

FOR: GAMES AND TOYS, NAMELY, PUZZLES, ANIMAL ALPHABET WOODEN PUZZLES, YOYO TOYS, BUILDING CUBES, AND BUILDING BLOCKS; GYMNAS TIC AND SPORTING ARTICLES, NAMELY, SPORT BALLS; DECORATIONS FOR CHRISTMAS TREES, IN CLASS 28 (U.S. CLS. 22, 23, 38 AND 50).

FOR: TOBACCO; SMOKERS' ARTICLES, NAMELY, ASHTRAYS AND LIGHTERS; MATCHES, IN CLASS 34 (U.S. CLS. 2, 8, 9 AND 17).

PRIORITY DATE OF 5-16-2007 IS CLAIMED.

OWNER OF INTERNATIONAL REGISTRATION 0938350 DATED 8-28-2007, EXPIRES 8-28-2017.

THE COLOR(S) BLACK AND RED IS/ARE CLAIMED AS A FEATURE OF THE MARK.

FACTORY: BLACK AND CHIMNEY: RED.

SER. NO. 79-044,159, FILED 8-28-2007.

DAVID HOFFMAN, EXAMINING ATTORNEY

Int. Cls.: 14, 16, 18, 20, 21, 24, 25, 28 and 34

Prior U.S. Cls.: 1, 2, 3, 5, 8, 9, 13, 17, 22, 23, 25, 27, 28, 29, 30, 32, 33, 37, 38, 39, 40, 41, 42 and 50

Reg. No. 3,520,815

United States Patent and Trademark Office

Registered Oct. 21, 2008

**TRADEMARK
PRINCIPAL REGISTER**



DEGRYSE LAURENT (BELGIUM INDIVIDUAL)
CHEMIN DU BON AIR 20
B-1380 OHAIN
BELGIUM

FOR: PRECIOUS METALS AND THEIR ALLOYS AND GOODS MADE OF OR COATED WITH THESE MATERIALS NOT INCLUDED IN OTHER CLASSES, NAMELY, WATCHES, NECKLACES, EARRINGS, RINGS, AND PINS; JEWELLERY, PRECIOUS STONES; TIMEPIECES AND CHRONOMETRIC INSTRUMENTS, IN CLASS 14 (U.S. CLS. 2, 27, 28 AND 50).

FOR: PAPER, CARDBOARD AND GOODS MADE FROM THESE MATERIALS, NOT INCLUDED IN OTHER CLASSES, NAMELY, NOTEBOOKS, NOTEPADS, AND PHOTO ALBUMS; PRINTED MATTER, NAMELY, POSTERS, POSTCARDS, BOOKS, LITHOGRAPHS; BOOKBINDING MATERIAL; PHOTOGRAPHS; STATIONERY; ADHESIVES FOR STATIONERY OR HOUSEHOLD PURPOSES; ARTISTS' MATERIALS, NAMELY, WRITING INSTRUMENTS, PENCILS, PENS, AND BOOKMARKS; PAINTBRUSHES; TYPEWRITERS; INSTRUCTIONAL AND TEACHING MATERIAL IN THE FIELDS OF ART, DRAWING, ARCHITECTURE, AND DESIGN; PLASTIC MATERIALS FOR PACKAGING, NAMELY, BUBBLE PACKS, PLASTIC BAGS; PRINTING TYPE; PRINTING BLOCKS, IN CLASS 16 (U.S. CLS. 2, 5, 22, 23, 29, 37, 38 AND 50).

FOR: LEATHER AND IMITATION LEATHER, GOODS MADE OF THESE MATERIALS NOT INCLUDED IN OTHER CLASSES, NAMELY, WALLET AND CREDIT CARD CASES; ANIMAL SKINS AND HIDES; TRUNKS AND SUITCASES, UMBRELLAS, PARASOLS AND WALKING STICKS; WHIPS,

HARNESS AND SADDLERY, IN CLASS 18 (U.S. CLS. 1, 2, 3, 22 AND 41).

FOR: FURNITURE, MIRRORS, PICTURE FRAMES, IN CLASS 20 (U.S. CLS. 2, 13, 22, 25, 32 AND 50).

FOR: HOUSEHOLD OR KITCHEN UTENSILS AND CONTAINERS, NAMELY, ICE CREAM SCOOPS, CHEESE PLANES, BALL WHISKS, AND SALAD SPINNERS; COMBS AND SPONGES FOR HOUSEHOLD PURPOSES; BRUSHES, NAMELY, BASTING BRUSHES; BRUSH-MAKING MATERIALS, ARTICLES FOR CLEANING PURPOSES, NAMELY, SPONGES; STEEL WOOL; UNWORKED OR SEMI-WORKED GLASS, NOT FOR BUILDING; GLASSWARE, PORCELAIN AND EARTHENWARE, NAMELY, EGG CUPS, WOBBLE COGNAC GLASSES, MARTINI GLASSES, TEA CUPS, COFFEE MUGS, SALT AND PEPPER SHAKERS, OVEN TO TABLE SERVING DISHES, IN CLASS 21 (U.S. CLS. 2, 13, 23, 29, 30, 33, 40 AND 50).

FOR: TEXTILES AND TEXTILE GOODS, NAMELY, PLACEMATS; PAPER BED COVERS AND TABLE COVERS NOT OF PAPER, IN CLASS 24 (U.S. CLS. 42 AND 50).

FOR: CLOTHING, NAMELY, TOPS, BOTTOMS, PANTS, SHIRTS, SOCKS, CARDIGANS, PONCHOS, COATS, JACKETS, SCARVES, TIES, BOWTIES, SWEATSHIRTS, AND SWIMSUITS; FOOTWEAR; HEADGEAR, NAMELY, HATS, CAPS, AND WATER-REPELLENT RAIN HATS, IN CLASS 25 (U.S. CLS. 22 AND 39).

FOR: GAMES AND TOYS, NAMELY, PUZZLES, ANIMAL ALPHABET WOODEN PUZZLES, YOYO

TOYS, BUILDING CUBES, AND BUILDING BLOCKS; GYMNAS TIC AND SPORTING ARTICLES, NAME LY, SPORT BALLS; DECORATIONS FOR CHRISTMAS TREES, IN CLASS 28 (U.S. CLS. 22, 23, 38 AND 50).

FOR: TOBACCO; SMOKERS' ARTICLES, NAME LY, ASHTRAYS AND LIGHTERS; MATCHES, IN CLASS 34 (U.S. CLS. 2, 8, 9 AND 17).

PRIORITY DATE OF 5-16-2007 IS CLAIMED.

OWNER OF INTERNATIONAL REGISTRATION 0938351 DATED 8-28-2007, EXPIRES 8-28-2017.

THE COLOR(S) BLACK AND RED IS/ARE CLAIMED AS A FEATURE OF THE MARK.

"U": BLACK; "C": RED AND BLACK; "A": RED AND BLACK.

SER. NO. 79-044,160, FILED 8-28-2007.

DAVID HOFFMAN, EXAMINING ATTORNEY

Int. Cls.: 16, 35 and 41

**Prior U.S. Cls.: 2, 5, 22, 23, 29, 37, 38, 50, 100, 101, 102
and 107**

Reg. No. 3,520,816

United States Patent and Trademark Office

Registered Oct. 21, 2008

**TRADEMARK
SERVICE MARK
PRINCIPAL REGISTER**



Erich Lejeune

The World of Motivation!

LEJEUNE ACADEMY GMBH (FED REP GER-
MANY GMBH)
DENNINGER STR. 15
81679 MÜNCHEN
FED REP GERMANY

FOR: PAPER, CARDBOARD AND GOODS MADE FROM THESE MATERIALS, NAMELY, CARDBOARD BOXES; WRITING PAPER, PAPER LABELS AND ADDRESS LABELS OF PAPER; WRITING BOOKS, NAMELY, SCHOOL WRITING BOOKS; WRITING CASES, NAMELY, STATIONERY CASES; DRAWING PADS; PRINTED MATTER, NAMELY, BOOKS, MAGAZINES, CATALOGUES AND BROCHURES IN THE FIELD OF MOTIVATION TRAINING, BIBLIOGRAPHIES OF INDIVIDUALS AND LIFE SCIENCES; PROSPECTUSES, NAMELY, PLANS FOR BUSINESS DEVELOPMENT; COMIC BOOKS, CALENDARS, BOOKMARKERS, BOOK BINDINGS; BOOKENDS; PHOTOGRAPHS; PRINTED INSTRUCTIONAL AND TEACHING MATERIAL IN THE FIELD OF MOTIVATION TRAINING AND SELF-AWARENESS; STATIONERY; DRAWING MATERIALS, NAMELY, PENS AND MARKERS, IN CLASS 16 (U.S. CLS. 2, 5, 22, 23, 29, 37, 38 AND 50).

FOR: BUSINESS MANAGEMENT CONSULTANCY IN PERSONNEL MATTERS AND PERSONNEL MANAGEMENT CONSULTANCY; BUSINESS ORGANIZATION AND MANAGEMENT CONSULTANCY; PUBLIC RELATIONS; PROMOTING THE GOODS AND SERVICES OF OTHERS BY ARRANGING FOR SPONSORS TO AFFILIATE THEIR GOODS AND SERVICES WITH PARTICULAR SPORTS COMPETITIONS AND LIVE PERFORMAN-

CES BY MUSICAL ORCHESTRAS; SALES PROMOTION FOR OTHERS; ADVERTISING SERVICES; ECONOMIC FORECASTING, IN CLASS 35 (U.S. CLS. 100, 101 AND 102).

FOR: EDUCATION SERVICES, NAMELY, PROVIDING CLASSES, SEMINARS, WORKSHOPS IN THE FIELD OF MOTIVATION; CONSULTANCY REGARDING TRAINING AND EDUCATION, NAMELY, CONSULTATION IN THE FIELD OF EDUCATIONAL SYSTEMS, COMPUTER EDUCATION TRAINING CONSULTING; COACHING, NAMELY, PERSONAL COACHING SERVICES IN THE FIELD OF MOTIVATION AND SELF-AWARENESS; ARRANGING AND CONDUCTING SEMINARS AND WORKSHOPS IN THE FIELD OF SELF AWARENESS, MOTIVATION AND ART APPRECIATION; ORGANIZING AND CONDUCTING OF CONGRESSES AND CONFERENCES, NAMELY, ARRANGING AND CONDUCTING EDUCATIONAL CONFERENCES; STAFF DEVELOPMENT THROUGH TRAINING AND CONTINUOUS TRAINING IN THE FIELD OF COMPUTER EDUCATION TRAINING; VOCATIONAL GUIDANCE; PUBLICATION OF BOOKS; TELEVISION ENTERTAINMENT, NAMELY, ENTERTAINMENT IN THE NATURE OF TELEVISION TALK SHOWS AND NEWS SHOWS; PRESENTATION OF LIVE PERFORMANCES, NAMELY, LIVE PERFORMANCES BY MUSICAL BANDS AND MUSICAL ORCHESTRAS; PUBLISHING OF ELECTRONIC PUBLICATIONS; PRODUCTION OF TELEVISION SHOWS, IN CLASS 41 (U.S. CLS. 100, 101 AND 107).

PRIORITY DATE OF 7-12-2007 IS CLAIMED.

OWNER OF INTERNATIONAL REGISTRATION
0938484 DATED 8-9-2007, EXPIRES 8-9-2017.

SER. NO. 79-044,218, FILED 8-9-2007.

THE NAME "ERICH LEJEUNE" IDENTIFIES A
LIVING INDIVIDUAL WHOSE CONSENT IS OF
RECORD.

JENNIFER MARTIN, EXAMINING ATTORNEY

Int. Cl.: 7

Prior U.S. Cls.: 13, 19, 21, 23, 31, 34 and 35

Reg. No. 3,520,817

United States Patent and Trademark Office

Registered Oct. 21, 2008

TRADEMARK
PRINCIPAL REGISTER

Woodfast

QINGDAO CAPITAL RESOURCE; ELECTRIC
CO., LTD. (CHINA CORPORATION)
155 ZHUZHOU ROAD,
HIGH-TECH INDUSTRIAL ZONE.; QINGDAO;
266101 SHANDONG
CHINA

FOR: WOODWORKING MACHINES, NAMELY,
WOOD DRILLING MACHINES, WOOD GRINDING
MACHINES, WOOD MILLING MACHINES, WOOD
PLANING MACHINES, WOOD SAWING MA-
CHINES, WOOD CHIPPING MACHINES, WOOD

BEATING MACHINES, WOOD LATHE, IN CLASS 7
(U.S. CLS. 13, 19, 21, 23, 31, 34 AND 35).

OWNER OF INTERNATIONAL REGISTRATION
0938592 DATED 9-21-2007, EXPIRES 9-21-2017.

SER. NO. 79-044,261, FILED 9-21-2007.

MONIQUE MILLER, EXAMINING ATTORNEY

Int. Cl.: 29

Prior U.S. Cl.: 46

United States Patent and Trademark Office

Reg. No. 3,520,818

Registered Oct. 21, 2008

**TRADEMARK
PRINCIPAL REGISTER**

meytin

MEYTIN İÇ VE DİŞ TİCARET LİMİTED SİRKETİ
(TURKEY LİMİTED COMPANY)
İNÖNÜ MAHALLEİSİ,
115 SOKAK NO: 8 D: 2, AYRANCILAR BELDESİ,
TORBALI - İZMİR
TURKEY

SUNFLOWER OIL; MARGARINES, BUTTERS, IN
CLASS 29 (U.S. CL. 46).

OWNER OF INTERNATIONAL REGISTRATION
0938725 DATED 7-23-2007, EXPIRES 7-23-2017.

FOR: CANNED PROCESSED OLIVES, PRE-
SERVED DRIED AND COOKED OLIVES, PICKLES,
EDIBLE OILS, REFINED OLIVE OIL, COTTON OIL,

SER. NO. 79-044,301, FILED 7-23-2007.

GEORGIA CARTY, EXAMINING ATTORNEY

Int. Cl.: 41

Prior U.S. Cls.: 100, 101 and 107

United States Patent and Trademark Office

Reg. No. 3,520,819

Registered Oct. 21, 2008

**SERVICE MARK
PRINCIPAL REGISTER**



E-WISE B.V. (NETHERLANDS BESLOTEN VEN-
NOOTSCHAP)
JANSSONIUSLAAN 38
AJ UTRECHT, NETHERLANDS NL3528

FOR: EDUCATION SERVICES, NAMELY, PRO-
VIDING CLASSES, SEMINARS, AND WORKSHOPS
IN THE FIELD OF MEDICINE; PROVIDING OF
TRAINING AND COURSES IN THE MEDICAL
FIELD; ONLINE ELECTRONIC PUBLISHING OF
BOOKS AND PERIODICALS IN THE FIELD OF

MEDICINE, IN CLASS 41 (U.S. CLS. 100, 101 AND
107).

OWNER OF INTERNATIONAL REGISTRATION
0938992 DATED 8-28-2007, EXPIRES 8-28-2017.

SER. NO. 79-044,440, FILED 8-28-2007.

DAVID HOFFMAN, EXAMINING ATTORNEY

Int. Cl.: 29

Prior U.S. Cl.: 46

United States Patent and Trademark Office

Reg. No. 3,520,820

Registered Oct. 21, 2008

TRADEMARK
PRINCIPAL REGISTER



OLEIFICIO FABBRI S.P.A. (ITALY LIMITED LIABILITY COMPANY)
VIALE EUROPA, 33/35, LAMMARI
I-55013 CAPANNORI (LUCCA)
ITALY

FOR: EDIBLE OILS AND FATS; OLIVE OIL; PRESERVED, FROZEN, DRY OR COOKED FRUIT AND VEGETABLES, IN CLASS 29 (U.S. CL. 46).

PRIORITY DATE OF 5-21-2007 IS CLAIMED.

OWNER OF INTERNATIONAL REGISTRATION 0939458 DATED 9-4-2007, EXPIRES 9-4-2017.

THE COLOR(S) GOLD, BLUE, BLACK, WHITE AND BROWN IS/ARE CLAIMED AS A FEATURE OF THE MARK.

THE MARK CONSISTS OF A CLOVER LEAF DESIGN WITH FOUR POINTS AT EACH CORNER

WITH A BORDER DESIGN AND A STAR WITHIN A FANCIFUL SHAPE INSIDE THE MIDDLE OF THE CLOVER DESIGN. CENTERED UNDERNEATH IS THE WORD "SIGNUM" WITHIN A RECTANGLE WITH A BORDER DESIGN. THE COLORS BLACK, BROWN AND WHITE APPEARS IN THE BORDER AROUND THE CLOVER DESIGN, THE COLOR BLUE APPEARS IN THE FANCIFUL DESIGN WITHIN THE CLOVER DESIGN AND AS THE BACKGROUND WITHIN THE RECTANGLE, THE COLOR GOLD APPEARS AS THE BACKGROUND COLOR OF THE CLOVER DESIGN AND AS THE BORDER DESIGN OF THE RECTANGLE, AND THE COLOR WHITE APPEARS IN PART OF THE BORDER OF THE CLOVER DESIGN, AS THE STAR WITHIN THE CLOVER, AND IN THE WORD "SIGNUM" WITHIN THE RECTANGLE.

SER. NO. 79-044,576, FILED 9-4-2007.

CARYN GLASSER, EXAMINING ATTORNEY

Int. Cls.: 9, 35 and 41

Prior U.S. Cls.: 21, 23, 26, 36, 38, 100, 101, 102 and 107

United States Patent and Trademark Office

Reg. No. 3,520,821

Registered Oct. 21, 2008

**TRADEMARK
SERVICE MARK
PRINCIPAL REGISTER**

Cinemapaq

LAUTSPRECHER TEUFEL GMBH (FED REP
GERMANY GMBH)
BÜLOWSTR. 66
10783 BERLIN
FED REP GERMANY

FOR: APPARATUS FOR RECORDING, TRANSMISSION OR REPRODUCTION OF SOUND OR IMAGES; LOUDSPEAKERS , IN CLASS 9 (U.S. CLS. 21, 23, 26, 36 AND 38).

FOR: ADVERTISING SERVICES, IN CLASS 35 (U.S. CLS. 100, 101 AND 102).

FOR: ENTERTAINMENT, NAMELY, LIVE PERFORMANCES BY A MUSICAL BAND; ENTERTAINMENT IN THE NATURE OF VISUAL AND AUDIO

PERFORMANCES; LIGHT SHOWS; ORGANIZING COMMUNITY EVENTS IN THE NATURE OF VISUAL AND AUDIO PERFORMANCES, IN CLASS 41 (U.S. CLS. 100, 101 AND 107).

PRIORITY DATE OF 4-11-2007 IS CLAIMED.

OWNER OF INTERNATIONAL REGISTRATION 0939606 DATED 9-19-2007, EXPIRES 9-19-2017.

SER. NO. 79-044,618, FILED 9-19-2007.

TRACY CROSS, EXAMINING ATTORNEY

Int. Cl.: 26

Prior U.S. Cls.: 37, 39, 40, 42 and 50

Reg. No. 3,520,822

United States Patent and Trademark Office

Registered Oct. 21, 2008

**TRADEMARK
PRINCIPAL REGISTER**

QUICKLOOP

YKK CORPORATION (JAPAN CORPORATION)
1, KANDA IZUMI-CHO
CHIYODA-KU; TOKYO 101-8642
JAPAN

HOOKS BEING CLOTHING HOOKS, IN CLASS 26
(U.S. CLS. 37, 39, 40, 42 AND 50).

PRIORITY DATE OF 8-7-2007 IS CLAIMED.

FOR: SLIDE FASTENERS; SNAP BUTTONS
BEING SNAP FASTENERS; BUTTONS; HOOK
AND LOOP FASTENERS FOR USE IN FASTENING
AUTOMOBILE SEAT COVERS; HOOK FASTENING
TAPES BEING FASTENERS FOR CLOTHING AND
FOOTWEAR; PILE FASTENING TAPES BEING
FASTENERS FOR CLOTHING AND FOOTWEAR;
HOOK AND EYES; ELASTIC RIBBONS; BUCKLES
FOR CLOTHING; BUCKLES FOR SHOES; EYELETS
FOR CLOTHES; EYELETS FOR SHOES; SWIVEL

OWNER OF INTERNATIONAL REGISTRATION
0939807 DATED 9-4-2007, EXPIRES 9-4-2017.

OWNER OF U.S. REG. NOS. 2,691,908 AND
3,202,371.

SER. NO. 79-044,718, FILED 9-4-2007.

RUDY R. SINGLETON, EXAMINING ATTORNEY

Int. Cls.: 9, 35 and 41

Prior U.S. Cls.: 21, 23, 26, 36, 38, 100, 101, 102 and 107

United States Patent and Trademark Office

Reg. No. 3,520,823

Registered Oct. 21, 2008

**TRADEMARK
SERVICE MARK
PRINCIPAL REGISTER**

Cinepaq

LAUTSPRECHER TEUFEL GMBH (FED REP
GERMANY GMBH)
BÜLOWSTR. 66
10783 BERLIN
FED REP GERMANY

FOR: APPARATUS FOR RECORDING, TRANSMISSION OR REPRODUCTION OF SOUND OR IMAGES; LOUDSPEAKERS , IN CLASS 9 (U.S. CLS. 21, 23, 26, 36 AND 38).

FOR: ADVERTISING SERVICES, IN CLASS 35 (U.S. CLS. 100, 101 AND 102).

FOR: ENTERTAINMENT, NAMELY, LIVE PERFORMANCES BY A MUSICAL BAND; ENTERTAINMENT IN THE NATURE OF VISUAL AND AUDIO

PERFORMANCES; LIGHT SHOWS; ORGANIZING COMMUNITY EVENTS IN THE NATURE OF VISUAL AND AUDIO PERFORMANCES, IN CLASS 41 (U.S. CLS. 100, 101 AND 107).

PRIORITY DATE OF 4-11-2007 IS CLAIMED.

OWNER OF INTERNATIONAL REGISTRATION 0939816 DATED 9-19-2007, EXPIRES 9-19-2017.

SER. NO. 79-044,720, FILED 9-19-2007.

TRACY CROSS, EXAMINING ATTORNEY

Int. Cl.: 14

Prior U.S. Cls.: 2, 27, 28 and 50

United States Patent and Trademark Office

Reg. No. 3,520,824

Registered Oct. 21, 2008

**TRADEMARK
PRINCIPAL REGISTER**

HAPPY TWELVE

CHOPARD INTERNATIONAL SA (SWITZER-
LAND SOCIÉTÉ ANONYME)
ROUTE DE PROMENTHOUX
CH-1197 PRANGINS
SWITZERLAND

FOR: PRECIOUS METALS AND THEIR ALLOYS;
FANCY KEY RINGS OF PRECIOUS METAL, AL-
LOYED OR PLATED WITH PRECIOUS METALS;
CUFF LINKS, TIE PINS; JEWELLERY; CUT DIA-
MONDS; HOROLOGICAL AND CHRONOMETRIC
INSTRUMENTS AND PARTS THEREOF, IN CLASS
14 (U.S. CLS. 2, 27, 28 AND 50).

THE MARK CONSISTS OF STANDARD CHAR-
ACTERS WITHOUT CLAIM TO ANY PARTICULAR
FONT, STYLE, SIZE, OR COLOR.

PRIORITY DATE OF 5-8-2007 IS CLAIMED.

OWNER OF INTERNATIONAL REGISTRATION
0939981 DATED 9-24-2007, EXPIRES 9-24-2017.

OWNER OF U.S. REG. NOS. 1,180,074, 3,014,862
AND OTHERS.

SER. NO. 79-044,776, FILED 9-24-2007.

MARK PILARO, EXAMINING ATTORNEY

Int. Cls.: 18 and 25

Prior U.S. Cls.: 1, 2, 3, 22, 39 and 41

United States Patent and Trademark Office

Reg. No. 3,520,825

Registered Oct. 21, 2008

**TRADEMARK
PRINCIPAL REGISTER**

KELLY MANCHON

HERMES INTERNATIONAL (FRANCE SOCIÉTÉ
EN COMMANDITE PAR ACTIONS)
24 RUE DU FAUBOURG SAINT HONORÉ
F-75008 PARIS
FRANCE

FOR: LEATHER GOODS OF GENUINE AND
IMITATION LEATHER, NAMELY, GLOVES AND
BELTS, HANDBAGS, TRAVEL BAGS, RUCKSACKS,
SCHOOL BAGS, BEACH BAGS MADE OF LEATHER
OR CANVAS, LEATHER AND FABRIC SHOPPING
BAGS, GARMENT BAGS FOR TRAVEL, POCKET
WALLETS, LEATHER PURSES, CARD HOLDER
WALLETS, ATTACHÉ CASES, LEATHER KEY
CASES, TRUNKS AND SUITCASES, TRAVELING
CASES SOLD EMPTY, VANITY CASES SOLD EMP-
TY, IN CLASS 18 (U.S. CLS. 1, 2, 3, 22 AND 41).

FOR: MUFFS, IN CLASS 25 (U.S. CLS. 22 AND 39).

THE MARK CONSISTS OF STANDARD CHAR-
ACTERS WITHOUT CLAIM TO ANY PARTICULAR
FONT, STYLE, SIZE, OR COLOR.

PRIORITY DATE OF 3-14-2007 IS CLAIMED.

OWNER OF INTERNATIONAL REGISTRATION
0940146 DATED 9-13-2007, EXPIRES 9-13-2017.

THE NAME "KELLY MANCHON" DOES NOT
IDENTIFY A LIVING INDIVIDUAL.

SER. NO. 79-044,818, FILED 9-13-2007.

DEIRDRE ROBERTSON, EXAMINING ATTORNEY

Int. Cls.: 3, 35 and 38

Prior U.S. Cls.: 1, 4, 6, 50, 51, 52, 100, 101, 102 and 104

United States Patent and Trademark Office

Reg. No. 3,520,826

Registered Oct. 21, 2008

**TRADEMARK
SERVICE MARK
PRINCIPAL REGISTER**

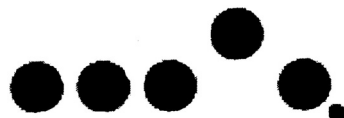

Selective Beauty

SELECTIVE BEAUTY (FRANCE SOCIÉTÉ ANONYME (SA))
LA PLAINE MONTJOIE -
1, RUE DES BLÉS; F-93210 SAINT DENIS LAPLAINE
FRANCE

FOR: PERFUMES, PERFUME WATERS, TOILET WATERS, SOAPS, DEODORANTS FOR PERSONAL USE, COSMETICS, MAINLY CREAMS, MILKS, LOTIONS, GELS AND POWDERS FOR THE FACE, BODY AND HANDS; TANNING AND AFTER-TAN MILKS, GELS AND OILS FOR COSMETIC USE; MAKEUP PREPARATIONS, MAKEUP REMOVERS, SHAMPOOS, HAIR GELS, HAIR FOAMS, BALMS FOR HAIR DRESSING AND HAIR CARE; ESSENTIAL OILS, IN CLASS 3 (U.S. CLS. 1, 4, 6, 50, 51 AND 52).

FOR: BUSINESS MANAGEMENT; COMMERCIAL ADMINISTRATION, NAMELY, BUSINESS ADMINISTRATION SERVICES; BUSINESS CONSULTING, INFORMATION OR INQUIRIES; COMPUTER FILE MANAGEMENT; COMMERCIAL AND ADMINISTRATIVE ORGANIZATION AND MANAGEMENT OF OPERATIONS FOR OTHERS FOR THE MANUFACTURE OF PERFUMERY, COSMETIC AND BEAUTY CARE PRODUCTS; DIRECT AND BUSINESS MARKETING SERVICES; MARKET RESEARCH, STUDY AND ANALYSIS RELATING TO PERFUMERY, COSMETIC AND BEAUTY CARE PRODUCTS; PROCUREMENT SERVICES, NAMELY, PURCHASING AND SELECTION OF PERFUMERY, COSMETIC AND BEAUTY CARE PRODUCTS FOR COMMERCIAL PURPOSES AND

FOR OTHERS; BUSINESS CONSULTING SERVICES, NAMELY, BRINGING BUSINESS PARTNERS TOGETHER IN THE FIELD OF PERFUMES, COSMETICS AND BEAUTY PRODUCTS; ADVERTISING AND PROMOTION OF MANUFACTURERS AND DISTRIBUTORS OF PERFUMES, COSMETICS AND BEAUTY CARE PRODUCTS; COMMUNICATION AND PUBLIC RELATIONS AGENCIES, NAMELY, AGENCIES THAT PROVIDE PUBLIC RELATIONS SERVICES, IN CLASS 35 (U.S. CLS. 100, 101 AND 102).

FOR: TELECOMMUNICATION AND COMMUNICATION SERVICES, NAMELY, ELECTRONIC TRANSMISSION OF INFORMATION IN THE FIELD OF PERFUMES, COSMETICS AND BEAUTY PRODUCTS VIA COMPUTER TERMINALS; INFORMATION AGENCY SERVICES, NAMELY, TRANSMISSION OF NEWS IN THE FIELD OF PERFUMES, COSMETICS AND BEAUTY PRODUCTS, IN CLASS 38 (U.S. CLS. 100, 101 AND 104).

OWNER OF INTERNATIONAL REGISTRATION
0772215 DATED 8-9-2001, EXPIRES 8-9-2011.

NO CLAIM IS MADE TO THE EXCLUSIVE RIGHT TO USE "BEAUTY", APART FROM THE MARK AS SHOWN.

SER. NO. 79-044,891, FILED 8-29-2007.

JENNIFER VASQUEZ, EXAMINING ATTORNEY

Int. Cl.: 5

Prior U.S. Cls.: 6, 18, 44, 46, 51 and 52

United States Patent and Trademark Office

Reg. No. 3,520,827

Registered Oct. 21, 2008

**TRADEMARK
PRINCIPAL REGISTER**

Lactobacillus reuteri Prodentis

BIOGAIA AB (SWEDEN AKTIEBOLAG)
P.O. BOX 3242
SE-103 64 STOCKHOLM
SWEDEN

OWNER OF INTERNATIONAL REGISTRATION
0940280 DATED 9-15-2007, EXPIRES 9-15-2017.

FOR: MEDICINAL DENTAL CARE PREPARA-
TIONS, NAMELY, CHEWING GUM, LOZENGES,
PASTILLES AND MOUTHWASH FOR MEDICAL
PURPOSES, IN CLASS 5 (U.S. CLS. 6, 18, 44, 46, 51
AND 52).

NO CLAIM IS MADE TO THE EXCLUSIVE
RIGHT TO USE "LACTOBACILLUS REUTERI",
APART FROM THE MARK AS SHOWN.

SER. NO. 79-044,971, FILED 9-15-2007.

PRIORITY DATE OF 3-15-2007 IS CLAIMED.

KATHLEEN LORENZO, EXAMINING ATTORNEY

Int. Cl.: 17

Prior U.S. Cls.: 1, 5, 12, 13, 35 and 50

United States Patent and Trademark Office

Reg. No. 3,520,828

Registered Oct. 21, 2008

**TRADEMARK
PRINCIPAL REGISTER**

CASCO

CORCOS INDUSTRIALE DI; FREUDENBERG &
COSSO S.R.L., S.A.S. (ITALY LIMITED COM-
PANY)

CORSO TORINO, 332
I-10064 PINEROLO (TORINO)
ITALY

PRIORITY DATE OF 6-5-2007 IS CLAIMED.

OWNER OF INTERNATIONAL REGISTRATION
0940590 DATED 8-27-2007, EXPIRES 8-27-2017.

FOR: SEALING ELEMENTS FOR ROTATING
SHAFTS, NAMELY, NON-METAL GASKETS FOR
SEALING ROTATING SHAFTS IN MACHINES , IN
CLASS 17 (U.S. CLS. 1, 5, 12, 13, 35 AND 50).

THE FOREIGN WORDING IN THE MARK
TRANSLATES INTO ENGLISH AS HELMET.

SER. NO. 79-045,082, FILED 8-27-2007.

THE MARK CONSISTS OF STANDARD CHAR-
ACTERS WITHOUT CLAIM TO ANY PARTICULAR
FONT, STYLE, SIZE, OR COLOR.

KATHERINE E. HALMEN, EXAMINING ATTOR-
NEY

Int. Cls.: 10 and 20

Prior U.S. Cls.: 2, 13, 22, 25, 26, 32, 39, 44 and 50

Reg. No. 3,520,829

United States Patent and Trademark Office

Registered Oct. 21, 2008

**TRADEMARK
PRINCIPAL REGISTER**

Mobi-Lift

LINET SPOL. S R.O. (CZECH REPUBLIC CORPORATION)
ZELEVCICE 5
CZ-274 01 SLANY
CZECH REPUBLIC

FOR: SPECIAL FURNITURE FOR MEDICAL PURPOSES, NAMELY, HOSPITAL AND NURSING CARE BEDS IN THE NATURE OF MECHANICAL BEDS FOR PATIENT TREATMENT AND FOR TRANSPORT FOR EXAMINATION IN HOSPITAL PREMISES; ELECTRICAL BEDS, WHICH ARE ELECTRICALLY ADJUSTABLE FOR PATIENT USE IN HOSPITAL DEPARTMENTS SPECIALIZING IN PATIENT DIAGNOSIS, FOR PATIENTS WITH RESPIRATORY PROBLEMS AND CARDIAC PROBLEMS AND TO PREVENT AND HELP TREATMENT OF PRESSURE SORES; INTENSIVE CARE BEDS FOR PATIENT RESUSCITATION FOR PATIENTS IN CRITICAL CONDITION AND FOR PATIENT TREATMENT; CHILDREN'S AND INFANTS' BEDS FOR PATIENT TREATMENT AND TRANSPORT FOR EXAMINATION IN HOSPITAL PREMISES; MATERNITY BEDS FOR TREATMENT OF MATERNITY PATIENTS AND FACILITATING INFANT DELIVERY; ACCESSORIES FOR USE WITH SUCH BEDS, NAMELY, INFUSION STANDS, LIFTING POLES AND ORTHOPEDIC EXTENSION SYSTEMS FOR PATIENT TREATMENT; OTHER FURNITURE FOR USE IN MEDICAL AND NURSING FACILITIES, NAMELY, ANTI-DECUBITUS SYSTEMS COMPRISED OF AN ACTIVE ANTI-DE-

CUBITUS MATTRESS SYSTEM FOR THE PREVENTION AND TREATMENT OF BED SORES FOR PATIENT'S TREATMENT; PASSIVE ANTI-DECUBITUS MATTRESSES FOR PREVENTION AND TREATMENT OF PRESSURE SORES; COUCHES FOR PATIENT TREATMENT AND FOR TRANSPORT FOR EXAMINATIONS IN HOSPITAL PREMISES; STRETCHERS AND MATTRESSES FOR PATIENT TREATMENT AND TRANSPORT FOR EXAMINATION IN HOSPITAL PREMISES; SEATS FOR PATIENT TREATMENT AND TRANSPORT IN HOSPITAL FORENSIC, IN CLASS 10 (U.S. CLS. 26, 39 AND 44).

FOR: FURNITURE, MATTRASSES, IN CLASS 20 (U.S. CLS. 2, 13, 22, 25, 32 AND 50).

THE MARK CONSISTS OF STANDARD CHARACTERS WITHOUT CLAIM TO ANY PARTICULAR FONT, STYLE, SIZE, OR COLOR.

PRIORITY DATE OF 12-28-2006 IS CLAIMED.

OWNER OF INTERNATIONAL REGISTRATION 0940647 DATED 4-30-2007, EXPIRES 4-30-2017.

SER. NO. 79-045,107, FILED 4-30-2007.

DAVID I, EXAMINING ATTORNEY

Int. Cl.: 29

Prior U.S. Cl.: 46

United States Patent and Trademark Office

Reg. No. 3,520,830

Registered Oct. 21, 2008

TRADEMARK
PRINCIPAL REGISTER



VILLANI S.P.A. (ITALY CORPORATION)
VIA ZANASI, 24
I-41051 CASTELNUOVO RANGONE (MODENA)
ITALY

FOR: MEAT AND MEAT PRODUCTS, NAMELY, COOKED, CURED AND SMOKED SAUSAGE AND HAM; SALAMI AND MORTADELLA, WHOLE LEG HAMS, BONED OR PACKAGED HAMS, WHOLE AND PACKAGED SPECK (SMOKED HAM); HAMS AND PRESERVED MEATS, SALTED MEATS, SAUSAGES, SPECIALTY HAM, NAMELY, CULATELLO; SPECIALTY SALAMI, NAMELY, COPPA, BACON, IN CLASS 29 (U.S. CL. 46).

PRIORITY DATE OF 2-22-2007 IS CLAIMED.

OWNER OF INTERNATIONAL REGISTRATION
0940806 DATED 5-14-2007, EXPIRES 5-14-2017.

OWNER OF U.S. REG. NO. 2,623,164.

NO CLAIM IS MADE TO THE EXCLUSIVE RIGHT TO USE "SALUMI" AND "DAL 1886", APART FROM THE MARK AS SHOWN.

THE ENGLISH TRANSLATION OF "SALUMI" IS COLD CUTS AND "ARTE DI FAMIGLIA DAL 1886" IS "FAMILY ART SINCE 1886".

SER. NO. 79-045,176, FILED 5-14-2007.

REBECCA POVARCHUK, EXAMINING ATTORNEY

Int. Cl.: 25

Prior U.S. Cls.: 22 and 39

United States Patent and Trademark Office

Reg. No. 3,520,831

Registered Oct. 21, 2008

**TRADEMARK
PRINCIPAL REGISTER**



BALDOVI GIL, ROBERTO (SPAIN INDIVIDUAL)
C/ POLÒNIA, 5
E-08024 BARCELONA
SPAIN

PRIORITY DATE OF 11-2-2006 IS CLAIMED.

FOR: CLOTHING, NAMELY, SHIRTS, TROUSERS, SKIRTS, JACKETS, CAPS, BONNETS, SHOES, SPORTS FOOTWEAR, BELTS, HANDKERCHIEVES, SCARVES, AND GLOVES, IN CLASS 25 (U.S. CLS. 22 AND 39).

OWNER OF INTERNATIONAL REGISTRATION
0940825 DATED 4-23-2007, EXPIRES 4-23-2017.

SER. NO. 79-045,187, FILED 4-23-2007.

REGINA DRUMMOND, EXAMINING ATTORNEY

Int. Cls.: 3, 9, 14, 16, 18, 20, 21, 22, 23, 24, 25, 26, 27, 28, 34 and 41

Prior U.S. Cls.: 1, 2, 3, 4, 5, 6, 7, 8, 9, 13, 17, 19, 20, 21, 22, 23, 25, 26, 27, 28, 29, 30, 32, 33, 36, 37, 38, 39, 40, 41, 42, 43, 50, 51, 52, 100, 101 and 107

Reg. No. 3,520,832

United States Patent and Trademark Office

Registered Oct. 21, 2008

**TRADEMARK
SERVICE MARK
PRINCIPAL REGISTER**

SCHIAP

INTERBASIC HOLDING S.A. (LUXEMBOURG
SOCIÉTÉ ANONYME)
2, RUE J. HACKIN
L-1746 LUXEMBOURG
LUXEMBOURG

FOR: PERFUMERY AND COSMETICS, NAMELY, PERFUME, COLOGNE, AFTER SHAVE, MAKE-UP, DEODORANTS FOR PERSONAL USE; ANTIPERSPIRANTS; ESSENTIAL OILS FOR PERSONAL USE; SOAPS; SHAVING SOAPS; HAIR CARE PREPARATIONS; DENTIFRICES; LAUNDRY PREPARATIONS, NAMELY, BLEACHING DETERGENTS AND LAUNDRY DETERGENTS, IN CLASS 3 (U.S. CLS. 1, 4, 6, 50, 51 AND 52).

FOR: SPECTACLES, SUNGLASSES, GLASSES AND FRAMES; CONTACT LENSES, OPTICAL LENSES, MAGNIFYING GLASSES, CELLULAR TELEPHONES, PORTABLE TELEPHONES AND COMPUTERS; LEATHER COVERS ESPECIALLY MADE FOR ELECTRONIC AGENDAS, IN CLASS 9 (U.S. CLS. 21, 23, 26, 36 AND 38).

FOR: WATCHES AND CLOCKS, PENDULUM CLOCKS, CHRONOGRAPHS FOR USE AS WATCHES AND CHRONOMETERS; ROUGH GEMSTONES, NAMELY, PRECIOUS STONES; EARRINGS, RINGS, NECKLACES, BRACELETS, ORNAMENTAL PINS MADE OF PRECIOUS METAL, SHOE ORNAMENTS OF PRECIOUS METAL, PRECIOUS STONES, CHARMS AS JEWELLERY; LEATHER KEY RINGS, IN CLASS 14 (U.S. CLS. 2, 27, 28 AND 50).

FOR: LEATHER COVERS ESPECIALLY MADE FOR AGENDAS; LEATHER COVERS ESPECIALLY MADE FOR ADDRESS BOOKS; CURTAINS OF PAPER, IN CLASS 16 (U.S. CLS. 2, 5, 22, 23, 29, 37, 38 AND 50).

FOR: BAGS, NAMELY, HANDBAGS, TRAVELING BAGS; LEATHER CREDIT CARD CASES, WALLETS, LEATHER KEY CHAINS, LEATHER CASES FOR KEYS, PURSES NOT OF PRECIOUS METAL, TRUNKS, BRIEFCASES, SUITCASES, IMITATION LEATHER BAGS, LEATHER SHOPPING BAGS, LEATHER POUCHES; SPORT AND ATHLETIC BAGS, VANITY CASES SOLD EMPTY, GARMENT BAGS FOR TRAVEL, PURSES OF PRECIOUS METAL, IN CLASS 18 (U.S. CLS. 1, 2, 3, 22 AND 41).

FOR: FURNITURE, MIRRORS, PICTURE FRAMES, IN CLASS 20 (U.S. CLS. 2, 13, 22, 25, 32 AND 50).

FOR: HOUSEHOLD AND KITCHEN UTENSILS, NAMELY, GRILLS, POT AND PAN SCRAPERS, SPATULAS, WOOD CHOPPING BLOCKS AND HOUSEHOLD CONTAINER FOR FOOD; COMBS AND CLEANING SPONGES; POT CLEANING BRUSHES, HAIR BRUSHES; ARTICLES FOR CLEANING PURPOSES, NAMELY, POLISHING CLOTHS; STEEL WOOL FOR CLEANING, UNWORKED OR SEMI-WORKED GLASS; BEVERAGE GLASSWARE; DINNERWARE, NAMELY, PLATES AND SAUCERS, PORCELAIN AND EARTHENWARE GOODS, NAMELY, COFFEE CUPS, TEA CUPS AND MUGS OF PORCELAIN, VASES OF PORCELAIN, KNOBS OF PORCELAIN, JARS FOR JAMS AND JELLIES OF EARTHENWARE AND PORCELAIN, IN CLASS 21 (U.S. CLS. 2, 13, 23, 29, 30, 33, 40 AND 50).

FOR: RAW FIBROUS TEXTILE, IN CLASS 22 (U.S. CLS. 1, 2, 7, 19, 22, 42 AND 50).

FOR: YARNS AND THREADS FOR TEXTILE USE; WOOLLEN THREAD AND YARN, IN CLASS 23 (U.S. CL. 43).

FOR: TEXTILE AND TEXTILE GOODS, NAME-
LY, FABRICS FOR TEXTILE USE, TEXTILE FAB-
RICS FOR THE MANUFACTURE OF CLOTHING,
TEXTILE FABRIC OF ANIMAL SKINS IMITA-
TIONS, TEXTILE FABRICS FOR LINGERIE, TEX-
TILE SUBSTITUTE MATERIALS MADE FROM
SYNTHETIC MATERIALS, TEXTILE USED AS LIN-
ING FOR CLOTHING, TOWELS OF TEXTILE; BED
BLANKETS, BED-SPREADS, TABLECLOTHS NOT
MADE OF PAPER; CURTAINS OF TEXTILE; BED
AND TEXTILE TABLE COVERS, IN CLASS 24 (U.S.
CLS. 42 AND 50).

FOR: CLOTHING MADE FROM LEATHER,
NAME-
LY, LEATHER JACKETS AND LEATHER
PANTS, BELTS, LEATHER COATS, SHOES; ATH-
LETIC SHOES, BOOTS, SLIPPERS, OVERSHOES,
SUITS, JACKETS, TROUSERS, JEANS, SKIRTS,
DRESSES, COATS, OVERCOATS, RAINCOATS,
PARKAS, PADDING JACKETS, PULLOVERS,
SHIRTS, T-SHIRTS, BLOUSES, SWEATERS, UNDER-
WEAR, NEGLIGEE DRESSING GOWNS, BATH-
ROBES, SWIMMING SUITS, SHAWLS, GLOVES,
HATS AND CAPS, VISORS, SCARVES, TIES, IN
CLASS 25 (U.S. CLS. 22 AND 39).

FOR: RIBBONS, BUTTONS FOR CLOTHING AND
CLOTHING HOOKS, IN CLASS 26 (U.S. CLS. 37, 39,
40, 42 AND 50).

FOR: CARPETS, RUGS, MATS AND MATTING
AS FLOOR COVERINGS, IN CLASS 27 (U.S. CLS. 19,
20, 37, 42 AND 50).

FOR: GAMES AND PLAYTHINGS, NAME-
LY, DOLLS, BILLIARD TABLES, BOARD GAMES, TOY
PISTOLS, DOMINO GAMES; GYMNASTIC AND
SPORTING ARTICLES, NAME-
LY, BASEBALLS,
FOOTBALLS, BASKETBALLS, SOCCER BALLS, BIL-
LIARD BALLS, TENNIS RACQUETS, SNOW SKIS,
WATER SKIS, BAGS SPECIALLY ADAPTED FOR
SPORT EQUIPMENT, IN CLASS 28 (U.S. CLS. 22, 23,
38 AND 50).

FOR: TOBACCO; SMOKERS' ARTICLES, NAME-
LY, LIGHTERS FOR CIGARETTES, MATCHES,

SMOKING PIPES OF PRECIOUS METAL; CASES
FOR CIGARS AND CIGARETTES OF PRECIOUS
METAL, CIGARETTE HOLDERS AND CIGAR
HOLDERS OF PRECIOUS METAL, ASHTRAYS OF
PRECIOUS METAL, IN CLASS 34 (U.S. CLS. 2, 8, 9
AND 17).

FOR: EDUCATIONAL SERVICES, NAME-
LY, CONDUCTING CLASSES, SEMINARS, CONFEREN-
CES, WORKSHOPS IN THE FIELD OF FASHION
AND INTERIOR DESIGN; EDUCATIONAL SERVI-
CES, NAME-
LY, PROVIDING INTERNSHIPS AND
APPRENTICESHIPS IN THE FIELD OF BUSINESS
MANAGEMENT AND DEVELOPMENT; TRAINING
COURSES IN STRATEGIC PLANNING RELATING
TO ADVERTISING, PROMOTION, MARKETING,
BUSINESS; ENTERTAINMENT EXHIBITIONS IN
THE NATURE OF SPORT GAMES; ORGANIZING
AND CONDUCTING ENTERTAINMENT EXHIBI-
TIONS FOR FASHION SHOWS; RADIO AND TELE-
VISION ENTERTAINMENT PRODUCTION,
HEALTH CLUBS, NAME-
LY, PROVIDING IN-
STRUCTION AND EQUIPMENT IN THE FIELD OF
PHYSICAL EXERCISE; DISCOTHEQUE SERVICES;
EDUCATIONAL SERVICES IN THE NATURE OF
BEAUTY SCHOOLS; ARRANGING OF BEAUTY
CONTESTS; GYMNASIUMS, IN CLASS 41 (U.S.
CLS. 100, 101 AND 107).

THE MARK CONSISTS OF STANDARD CHAR-
ACTERS WITHOUT CLAIM TO ANY PARTICULAR
FONT, STYLE, SIZE, OR COLOR.

PRIORITY DATE OF 11-21-2006 IS CLAIMED.

OWNER OF INTERNATIONAL REGISTRATION
0940834 DATED 5-15-2007, EXPIRES 5-15-2017.

SER. NO. 79-045,194, FILED 5-15-2007.

REBECCA POVARCHUK, EXAMINING ATTOR-
NEY

Int. Cls.: 7 and 12

Prior U.S. Cls.: 13, 19, 21, 23, 31, 34, 35 and 44

Reg. No. 3,520,833

United States Patent and Trademark Office

Registered Oct. 21, 2008

**TRADEMARK
PRINCIPAL REGISTER**

Material Handling and Beyond

DAIFUKU CO., LTD. (JAPAN CORPORATION)
2-11, MITEJIMA 3-CHOME
NISHIYODOGAWA-KU.; OSAKA-SHI; OSAKA-FU
555-0012
JAPAN

FOR: CONSTRUCTION MACHINES AND APPARATUS, NAMELY, CONCRETE CONSTRUCTION MACHINES, CONCRETE MIXERS, POWER DRILLS, HYDRAULIC EXCAVATORS; AUTOMATIC WAREHOUSING SYSTEMS COMPRISED PRIMARILY OF CRANES AND ALSO RACKS; CONVEYORS; CRANES; SORTING MACHINES; LOADING AND UNLOADING MACHINES; POWER-DRIVEN ROTARY STORAGE AND RETRIEVAL INSTALLATIONS AND APPARATUS, NAMELY, MATERIAL HANDLING MACHINES IN THE NATURE OF PALLETIZERS, CASE ELEVATORS, AUTOMATIC PALLET DISPENSING MACHINES AND AUTOMATIC SLIP SHEET DISPENSING MACHINES; POWER-DRIVEN SLIDING STORAGE AND RETRIEVAL INSTALLATIONS AND APPARATUS, NAMELY, MATERIAL HANDLING MACHINES IN THE NATURE OF PALLETIZERS, CASE ELEVATORS, AUTOMATIC PALLET DISPENSING MACHINES AND AUTOMATIC SLIP SHEET DISPENSING MACHINES; POWER-DRIVEN MOBILE STORAGE AND RETRIEVAL INSTALLATIONS AND APPARATUS, NAMELY, MATERIAL HANDLING MACHINES IN THE NATURE OF PALLETIZERS, CASE ELEVATORS, AUTOMATIC PALLET DISPENSING MACHINES AND AUTOMATIC SLIP SHEET DISPENSING MACHINES; INDUSTRIAL PALLETIZING ROBOTS AND OTHER LOADING-UNLOADING MACHINES AND APPARATUS, NAMELY, MATERIAL HANDLING MACHINES IN THE NATURE OF PALLETIZERS, CASE ELEVATORS, AUTOMATIC PALLET DISPENSING MACHINES AND AUTOMATIC SLIP SHEET DISPENSING MACHINES; SEWING MACHINES; SHOE MAKING MACHINES; LEATHER TANNING MACHINES; TOBACCO PROCESSING MACHINES; PAINTING MACHINES; PAINTING APPARATUS, NAMELY, PAINT SPRAYERS, AIR BRUSHES FOR APPLYING PAINT, TIPS FOR PAINT SPRAY GUNS; PACKAGING AND WRAPPING MACHINES; PACKAGING AND WRAPPING APPARATUS, NAMELY, VACUUM PACKAGING MACHINES;

POWER-OPERATED POTTERS' WHEELS; SEMI-CONDUCTOR MANUFACTURING MACHINES; SEMI-CONDUCTOR MANUFACTURING SYSTEMS COMPRISED OF SEMI-CONDUCTOR SUBSTRATES MANUFACTURING MACHINES AND SEMI-CONDUCTOR MANUFACTURING MACHINES; ADHESIVE TAPE DISPENSING MACHINES; AUTOMATIC STAMPING MACHINES; DISH WASHING MACHINES; VACUUM CLEANERS; ELECTRIC FOOD BLENDERS; MECHANICAL PARKING SYSTEMS FOR AUTOMOBILES COMPRISED OF POWER-OPERATED LIFTS FOR PARKING VEHICLES; VEHICLE WASHING INSTALLATIONS; POWER SPRAYERS FOR DISINFECTING, INSECTICIDES AND DEODORANTS, NOT FOR AGRICULTURAL PURPOSES; MACHINE ELEMENTS, NOT FOR LAND VEHICLES, NAMELY, VALVES BEING PARTS OF MACHINES, BLOCK BRAKES; LAWNMOWER; ELECTRICALLY OPERATED CURTAIN DRAWING DEVICES; WASTE COMPACTING MACHINES; WASTE CRUSHING MACHINES; STARTERS FOR MOTORS AND ENGINES; AC MOTORS AND DC MOTORS, NOT FOR LAND VEHICLES; PARTS FOR AC MOTORS AND DC MOTORS, NOT FOR LAND VEHICLES, NAMELY, IGNITION DEVICES, BRUSHES BEING PARTS OF MOTORS; AC GENERATORS; DC GENERATORS; DYNAMO BRUSHES; CAM SHAFTS, CRANK SHAFTS, COUPLING SHAFTS, AXLES AND SPINDLES, FOR MACHINES; BEARINGS AS MACHINE ELEMENTS, NOT FOR LAND VEHICLES, NAMELY, ROLLER BEARINGS, ENGINE BEARINGS; SHAFT COUPLINGS AND CONNECTORS AS MACHINE ELEMENTS, NOT FOR LAND VEHICLES; POWER TRANSMISSIONS AND GEARING FOR MACHINES, NOT FOR LAND VEHICLES; BRAKES AS MACHINE ELEMENTS, NOT FOR LAND VEHICLES; VALVES AS MACHINE ELEMENTS, NOT FOR LAND VEHICLES; PALLET WASHING MACHINES; CAR WASHING MACHINES; CAR MAT WASHING MACHINES; INTEGRATED CIRCUIT MANUFACTURING MACHINES, IN CLASS 7 (U.S. CLS. 13, 19, 21, 23, 31, 34 AND 35).

FOR: ROPEWAYS FOR CARGO OR FREIGHT HANDLING, NAMELY, CABLE CARS; UNLOADING TIPLERS FOR TILTING RAILWAY FREIGHT CARS, NAMELY, RAILWAY BOGIES, TRUCKS,

FORK LIFT TRUCKS; PUSHER CARTS FOR MINING; PULLER CARTS FOR MINING; LAND VEHICLES, NAMELY, TRACTION ENGINES; NON-ELECTRIC PRIME MOVERS FOR LAND VEHICLES, NOT INCLUDING THEIR PARTS, NAMELY, ENGINES; MACHINE ELEMENTS FOR LAND VEHICLES, NAMELY, DRIVE BELTS, TRANSMISSIONS; PARACHUTES; ANTI-THEFT ALARMS FOR VEHICLES; WHEELCHAIRS; RAILWAY ROLLING STOCK AND THEIR STRUCTURAL PARTS AND FITTINGS; AUTOMOBILES AND THEIR STRUCTURAL PARTS AND FITTINGS; TWO-WHEELED MOTOR VEHICLES, BICYCLES AND THEIR STRUCTURAL PARTS AND FITTINGS; BABY CARRIAGES BEING PRAMS; RICKSHAW; SLEIGHS AND SLEDS BEING VEHICLES; WHEELBARROWS; CARTS; HORSE DRAWN CARRIAGES; BICYCLE TRAILERS (RIYAKAH); DELIVERY BICYCLES; AUTOMATIC GUIDED VEHICLES;

SORTING CARTS; PICKING CARTS; CARGO-HANDLING CARTS, IN CLASS 12 (U.S. CLS. 19, 21, 23, 31, 35 AND 44).

PRIORITY DATE OF 4-16-2007 IS CLAIMED.

OWNER OF INTERNATIONAL REGISTRATION 0940835 DATED 5-18-2007, EXPIRES 5-18-2017.

NO CLAIM IS MADE TO THE EXCLUSIVE RIGHT TO USE "MATERIAL HANDLING", APART FROM THE MARK AS SHOWN.

SER. NO. 79-045,195, FILED 5-18-2007.

REBECCA POVARCHUK, EXAMINING ATTORNEY

Int. Cls.: 9, 35 and 41

Prior U.S. Cls.: 21, 23, 26, 36, 38, 100, 101, 102 and 107

Reg. No. 3,520,834

United States Patent and Trademark Office

Registered Oct. 21, 2008

**TRADEMARK
SERVICE MARK
PRINCIPAL REGISTER**

NEXXXT GENERATION

GLOBAL DISTRIBUTORS NETHERLANDS B.V.
(NETHERLANDS BESLOTEN VENNOOTSCHAP (B.V.))
SIMON STEVINSTRAAT 7
NL-4004 JV TIEL
NETHERLANDS

FOR: PRERECORDED EROTIC CDS, CD-ROMS AND DVDS; EROTIC VIDEO FILMS, PRERECORDED ON DVDS, VIDEOTAPES; BATTERIES, IN CLASS 9 (U.S. CLS. 21, 23, 26, 36 AND 38).

FOR: WHOLESALE STORE AND RETAIL STORE SERVICES IN THE FIELD OF SEX APPLIANCES AND EROTIC VIDEO FILMS, CDS, CD-ROMS AND DVDS, SALES PROMOTION FOR GOODS IN THE FIELD OF EROTICISM; AND BUSINESS INTERMEDIARY SERVICES FOR GOODS IN THE FIELD OF EROTICISM, NAMELY, DISTRIBUTORSHIPS FOR MAGAZINES AND PRINTED MATTER IN THE FIELD OF EROTICISM, IN CLASS 35 (U.S. CLS. 100, 101 AND 102).

FOR: PUBLICATION AND EDITING OF MAGAZINES AND PRINTED MATTER IN THE FIELD OF EROTICISM; DEVELOPMENT, COMPILATION, PRODUCTION AND EDITING OF FILM AND AUDIOVISUAL PRODUCTIONS; PRODUCTION AND DISTRIBUTION OF FILMS, VIDEO FILMS AND AUDIOVISUAL PRODUCTIONS RECORDED

ON DATA CARRIERS; RENTAL OF SOUND AND IMAGE RECORDINGS; RENTAL OF VIDEO SCREENS, AUDIO EQUIPMENT, TELEVISION SETS; ORGANIZATION OF EVENTS FOR ENTERTAINMENT PURPOSES, NAMELY, DANCE PERFORMANCES, LIVE PRESENTATIONS OF PRERECORDED VIDEOS, PERSONAL APPEARANCES BY A MOVIE STAR; PROVIDING A WEBSITE FEATURING EROTIC INFORMATION AND IMAGES FOR ADULT ENTERTAINMENT; AFOREMENTIONED SERVICES ALSO TO BE PROVIDED VIA THE INTERNET, IN CLASS 41 (U.S. CLS. 100, 101 AND 107).

THE MARK CONSISTS OF STANDARD CHARACTERS WITHOUT CLAIM TO ANY PARTICULAR FONT, STYLE, SIZE, OR COLOR.

PRIORITY DATE OF 1-10-2007 IS CLAIMED.

OWNER OF INTERNATIONAL REGISTRATION 0940837 DATED 5-15-2007, EXPIRES 5-15-2017.

SER. NO. 79-045,197, FILED 5-15-2007.

REBECCA POVARCHUK, EXAMINING ATTORNEY

Int. Cls.: 9, 16 and 42

**Prior U.S. Cls.: 2, 5, 21, 22, 23, 26, 29, 36, 37, 38, 50,
100 and 101**

Reg. No. 3,520,835

United States Patent and Trademark Office

Registered Oct. 21, 2008

**TRADEMARK
SERVICE MARK
PRINCIPAL REGISTER**

BREAKPOINT

CRYOLOG (FRANCE S.A.)
1 PLACE PAUL VERLAINE
F-92100 BOULOGNE BILLANCOURT
FRANCE

FOR: SCIENTIFIC CONTROL APPARATUS AND INSTRUMENTS, NAMELY, COLD CHAIN FAILURE INDICATORS IN THE FORM OF INDICATOR LAMPS; TEMPERATURE CONTROL DEVICES, NAMELY, TEMPERATURE SENSORS; THERMO-SENSITIVE TEMPERATURE INDICATORS IN THE FORM OF STRIPS, INSERT STRIPS AND LABELS, AND HEAT-SENSITIVE DETECTORS; TEMPERATURE INDICATORS FOR DETECTING COLD CHAIN FAILURES AND QUANTIFYING SAME, IN CLASS 9 (U.S. CLS. 21, 23, 26, 36 AND 38).

FOR: BAGS, NAMELY, PAPER BAGS AND PLASTIC BAGS FOR PACKAGING, PAPER POUCHES, PLASTIC POUCHES FOR PACKAGING, PAPER AND PLASTIC BOXES, ALL THESE GOODS BEING DESIGNED FOR MONITORING COLD CHAIN FAILURES AND VIEWING THE STATE OF FRESHNESS OF A PRODUCT; LABELS, NAMELY, ADHESIVE LABELS FOR MONITORING COLD CHAIN

FAILURES AND VIEWING THE STATE OF FRESHNESS OF A PRODUCT, IN CLASS 16 (U.S. CLS. 2, 5, 22, 23, 29, 37, 38 AND 50).

FOR: TECHNOLOGICAL SERVICES, NAMELY, QUALITY CONTROL OF GOODS IN THE AGRIFOOD, RESTAURANT AND HEALTH SECTOR FOR THIRD PARTIES, IN CLASS 42 (U.S. CLS. 100 AND 101).

THE MARK CONSISTS OF STANDARD CHARACTERS WITHOUT CLAIM TO ANY PARTICULAR FONT, STYLE, SIZE, OR COLOR.

PRIORITY DATE OF 11-28-2006 IS CLAIMED.

OWNER OF INTERNATIONAL REGISTRATION 0940842 DATED 5-22-2007, EXPIRES 5-22-2017.

SER. NO. 79-045,200, FILED 5-22-2007.

REBECCA POVARCHUK, EXAMINING ATTORNEY

Int. Cls.: 30 and 32

Prior U.S. Cls.: 45, 46 and 48

United States Patent and Trademark Office

Reg. No. 3,520,836

Registered Oct. 21, 2008

TRADEMARK
PRINCIPAL REGISTER



NATFOOD S.R.L. (ITALY LIMITED LIABILITY COMPANY)
VIA BOSCO, 99/A
LOCATILÀ BOSCO; I-42019 SCANDIANO (REGGIO EMILIA)
ITALY

FOR: COFFEE, TEA, COCOA, SUGAR, RICE, TAPIOCA, SAGO, ARTIFICIAL COFFEE; FLOUR; PREPARATIONS MADE FROM CEREALS, NAMELY, CEREAL BASED SNACK FOOD; BREAD, PASTRY AND FROZEN CONFECTIONERY, FROZEN ICES; HONEY, TREACLE; YEAST, BAKING-POWDER; SALT, MUSTARD; VINEGAR, SAUCES; SPICES; ICE, IN CLASS 30 (U.S. CL. 46).

FOR: BEERS; MINERAL AND AERATED WATERS AND OTHER NON-ALCOHOLIC DRINKS, NAMELY, SOFT DRINKS; FRUIT DRINKS AND FRUIT JUICES; SYRUPS, CONCENTRATES AND POWDERS USED IN PREPARATION OF SOFT DRINKS, IN CLASS 32 (U.S. CLS. 45, 46 AND 48).

PRIORITY DATE OF 6-29-2007 IS CLAIMED.

OWNER OF INTERNATIONAL REGISTRATION
0941167 DATED 8-27-2007, EXPIRES 8-27-2017.

THE MARK CONSISTS OF AN OVAL SHAPE AND THE WORDING "MASCARPONE LATINO" IN TWO HORIZONTAL LINES INSIDE THE OVAL SHAPE; THE WORD "MASCARPONE" APPEARING IN A STYLIZED FORM AND THE LETTER "O" APPEARING IN THE SHAPE OF A CURL WITH AN EMBOSSED LOOK, AND THE WORD "LATINO" IN CAPITAL LETTERS.

THE ENGLISH TRANSLATION OF "MASCARPONE LATINO" IS LATIN MASCARPONE.

SER. NO. 79-045,291, FILED 8-27-2007.

ROBERT STRUCK, EXAMINING ATTORNEY

Int. Cl.: 25

Prior U.S. Cls.: 22 and 39

United States Patent and Trademark Office

Reg. No. 3,520,837

Registered Oct. 21, 2008

TRADEMARK
PRINCIPAL REGISTER



VIDORRETA, S.L. (SPAIN S.L.)
P.I. LARRATE, PARC. 1A
E-26520 CERVERA DEL RIO ALHAMA (LA RIOJA)
SPAIN

FOR: SUITS, SOLES FOR FOOTWEAR, IN CLASS
25 (U.S. CLS. 22 AND 39).

OWNER OF INTERNATIONAL REGISTRATION
0941173 DATED 9-28-2007, EXPIRES 9-28-2017.

THE COLOR(S) BROWN AND YELLOW IS/ARE
CLAIMED AS A FEATURE OF THE MARK.

THE MARK CONSISTS OF THE WORD "VIDOR-
RETA" SUPERIMPOSED ON TOPE OF A CIRCLE OF
SWIRLY LINES. THE COLOR BROWN APPEARS IN
THE WORDING "VIDORRETA", WHILE THE COL-
OR YELLOW APPEARS IN THE SWIRLS THAT
SURROUND THE WORD "VIDORRETA".

SER. NO. 79-045,294, FILED 9-28-2007.

INGA ERVIN, EXAMINING ATTORNEY

Int. Cls.: 14, 16, 18, 20, 21, 24, 25, 28 and 34

Prior U.S. Cls.: 1, 2, 3, 5, 8, 9, 13, 17, 22, 23, 25, 27, 28, 29, 30, 32, 33, 37, 38, 39, 40, 41, 42 and 50

Reg. No. 3,520,838

United States Patent and Trademark Office

Registered Oct. 21, 2008

**TRADEMARK
PRINCIPAL REGISTER**



DEGRYSE LAURENT (BELGIUM INDIVIDUAL)
CHEMIN DU BON AIR 20
B-1380 OHAIN
BELGIUM

FOR: PRECIOUS METALS AND THEIR ALLOYS AND GOODS MADE OF OR COATED WITH THESE MATERIALS NOT INCLUDED IN OTHER CLASSES, NAMELY, WATCHES, NECKLACES, EARRINGS, RINGS, AND PINS; JEWELLERY, PRECIOUS STONES; TIMEPIECES AND CHRONOMETRIC INSTRUMENTS, IN CLASS 14 (U.S. CLS. 2, 27, 28 AND 50).

FOR: PAPER, CARDBOARD AND GOODS MADE FROM THESE MATERIALS, NOT INCLUDED IN OTHER CLASSES, NAMELY, NOTEBOOKS, NOTEPADS, AND PHOTO ALBUMS; PRINTED MATTER, NAMELY, POSTERS, POSTCARDS, BOOKS, LITHOGRAPHS; BOOKBINDING MATERIAL; PHOTOGRAPHS; STATIONERY; ADHESIVES FOR STATIONERY OR HOUSEHOLD PURPOSES; ARTISTS' MATERIALS, NAMELY, WRITING INSTRUMENTS, PENCILS, PENS, AND BOOKMARKS; PAINTBRUSHES; TYPEWRITERS; INSTRUCTIONAL AND TEACHING MATERIAL IN THE FIELDS OF ART, DRAWING, ARCHITECTURE, AND DESIGN; PLASTIC MATERIALS FOR PACKAGING, NAMELY, BUBBLE PACKS, PLASTIC BAGS; PRINTING TYPE; PRINTING BLOCKS, IN CLASS 16 (U.S. CLS. 2, 5, 22, 23, 29, 37, 38 AND 50).

FOR: LEATHER AND IMITATION LEATHER, GOODS MADE OF THESE MATERIALS NOT INCLUDED IN OTHER CLASSES, NAMELY, WALLETS AND CREDIT CARD CASES; ANIMAL SKINS AND HIDES; TRUNKS AND SUITCASES, UMBRELLAS, PARASOLS AND WALKING STICKS; WHIPS, HARNESS AND SADDLERY, IN CLASS 18 (U.S. CLS. 1, 2, 3, 22 AND 41).

FOR: FURNITURE, MIRRORS, PICTURE FRAMES, IN CLASS 20 (U.S. CLS. 2, 13, 22, 25, 32 AND 50).

FOR: HOUSEHOLD OR KITCHEN UTENSILS AND CONTAINERS, NAMELY, ICE CREAM SCOOPS, CHEESE PLANES, BALL WHISKS, AND SALAD SPINNERS; COMBS AND SPONGES FOR HOUSEHOLD PURPOSES; BRUSHES, NAMELY, BASTING BRUSHES; BRUSH-MAKING MATERIALS, ARTICLES FOR CLEANING PURPOSES, NAMELY, SPONGES; STEEL WOOL; UNWORKED OR SEMI-WORKED GLASS, NOT FOR BUILDING; GLASSWARE, PORCELAIN AND EARTHENWARE, NAMELY, EGG CUPS, WOBBLE COGNAC GLASSES, MARTINI GLASSES, TEA CUPS, COFFEE MUGS, SALT AND PEPPER SHAKERS, OVEN TO TABLE SERVING DISHES, IN CLASS 21 (U.S. CLS. 2, 13, 23, 29, 30, 33, 40 AND 50).

FOR: TEXTILES AND TEXTILE GOODS, NAMELY, PLACEMATS; PAPER BED COVERS AND TABLE COVERS NOT OF PAPER, IN CLASS 24 (U.S. CLS. 42 AND 50).

FOR: CLOTHING, NAMELY, TOPS, BOTTOMS, PANTS, SHIRTS, SOCKS, CARDIGANS, PONCHOS, COATS, JACKETS, SCARVES, TIES, BOWTIES, SWEATSHIRTS, AND SWIMSUITS; FOOTWEAR; HEADGEAR, NAMELY, HATS, CAPS, AND WATER-REPELLENT RAIN HATS, IN CLASS 25 (U.S. CLS. 22 AND 39).

FOR: GAMES AND TOYS, NAMELY, PUZZLES, ANIMAL ALPHABET WOODEN PUZZLES, YOYO TOYS, BUILDING CUBES, AND BUILDING BLOCKS; GYMNASTIC AND SPORTING ARTICLES, NAMELY, SPORT BALLS; DECORATIONS FOR CHRISTMAS TREES, IN CLASS 28 (U.S. CLS. 22, 23, 38 AND 50).

FOR: TOBACCO; SMOKERS' ARTICLES, NAME-
LY, ASHTRAYS AND LIGHTERS; MATCHES, IN
CLASS 34 (U.S. CLS. 2, 8, 9 AND 17).

PRIORITY DATE OF 5-16-2007 IS CLAIMED.

OWNER OF INTERNATIONAL REGISTRATION
0941183 DATED 8-28-2007, EXPIRES 8-28-2017.

NO CLAIM IS MADE TO THE EXCLUSIVE
RIGHT TO USE "BEIJING, CENTER FOR CONTEM-
PORARY ART" AND "THE NON-LATIN CHARAC-
TERS THAT MEAN BEIJING" AND "CENTER FOR
CONTEMPORARY ART", APART FROM THE
MARK AS SHOWN.

THE COLOR(S) BLACK AND RED IS/ARE
CLAIMED AS A FEATURE OF THE MARK.

THE MARK CONSISTS OF THE WORDING
"CENTER FOR CONTEMPORARY ART" IN BLACK,
WITH CHINESE CHARACTERS IN RED AT THE
TOP AND THE WORDING "BEIJING 798" IN RED
AT THE BOTTOM."

THE NON-LATIN CHARACTER(S) IN THE
MARK TRANSLITERATES INTO "ULLENS CEN-
TER FOR CONTEMPORARY ART BEIJING 798",
AND THIS MEANS "ULLENS CENTER FOR CON-
TEMPORARY ART BEIJING 798" IN ENGLISH.

SER. NO. 79-045,295, FILED 8-28-2007.

DAVID HOFFMAN, EXAMINING ATTORNEY

Int. Cl.: 9

Prior U.S. Cls.: 21, 23, 26, 36 and 38

Reg. No. 3,520,839

United States Patent and Trademark Office

Registered Oct. 21, 2008

**TRADEMARK
PRINCIPAL REGISTER**

DYNAFLEET

AB VOLVO (SWEDEN LIMITED LIABILITY
COMPANY)
SE-405 08 GÖTEBORG
SWEDEN

THE MARK CONSISTS OF STANDARD CHAR-
ACTERS WITHOUT CLAIM TO ANY PARTICULAR
FONT, STYLE, SIZE, OR COLOR.

FOR: COMPUTERS; RECORDED DOWNLOAD-
ABLE COMPUTER SOFTWARE FOR MODULAR
SYSTEMS FOR COMMUNICATION BETWEEN
HIGHWAY TRUCKS AND TRACTORS AND CENTRAL STATIONS; COMPUTER PERIPHERAL DE-
VICES , IN CLASS 9 (U.S. CLS. 21, 23, 26, 36 AND 38).

OWNER OF INTERNATIONAL REGISTRATION
0941332 DATED 10-3-2007, EXPIRES 10-3-2017.

SER. NO. 79-045,318, FILED 10-3-2007.

DAVID YONTEF, EXAMINING ATTORNEY

Int. Cl.: 24

Prior U.S. Cls.: 42 and 50

United States Patent and Trademark Office

Reg. No. 3,520,840

Registered Oct. 21, 2008

TRADEMARK
PRINCIPAL REGISTER



SVENSKT TENN AKTIEBOLAG (SWEDEN LIMITED LIABILITY COMPANY)
BOX 5478
SE-114 84 STOCKHOLM
SWEDEN

FOR: TEXTILES AND TEXTILE GOODS, NAME-
LY, TABLE CLOTHS NOT OF PAPER, OIL CLOTHS,
TABLE LINEN, TABLE MATS NOT OF PAPER,
PLACE MATS OF TEXTILE MATERIAL, TOWELS
OF TEXTILE, HOUSEHOLD LINEN, HANDKERCH-
IEFS OF TEXTILE, PILLOW SHAMS, BED SHEETS,
BED LINEN, BED BLANKETS, BED COVERS,
NAMELY, DUVET COVERS AND PAPER BED
COVERS; MATTRESS COVERS, UPHOLSTERY
FABRICS, UNFITTED FURNITURE COVERING
OF TEXTILE OR PLASTIC, WALL HANGING OF
TEXTILE, DOOR CURTAINS, CURTAINS OF TEX-
TILE OF PLASTIC, IN CLASS 24 (U.S. CLS. 42 AND
50).

PRIORITY DATE OF 11-30-2006 IS CLAIMED.

OWNER OF INTERNATIONAL REGISTRATION
0929651 DATED 12-1-2006, EXPIRES 12-1-2016.

NO CLAIM IS MADE TO THE EXCLUSIVE
RIGHT TO USE "SVENSKT" AND "STOCKHOLM",
APART FROM THE MARK AS SHOWN.

THE NAME(S), PORTRAIT(S), AND/OR SIGNA-
TURE(S) SHOWN IN THE MARK DOES NOT IDENT-
IFY A PARTICULAR LIVING INDIVIDUAL.

THE MARK CONSISTS OF TWO CONCENTRIC
CIRCLES CREATING THE WORDING "SVENSKT
TENN STOCKHOLM" AROUND IT WITH TOW
ANGLES PRAYING INSIDE THE CIRCLES WITH
A CREST FEATURING THE STYLIZED LETTERS
"ST".

"THE FOREIGN WORDING IN THE MARK
TRANSLATES INTO ENGLISH AS SWEDISH TIN."

SER. NO. 79-045,355, FILED 5-30-2007.

WARREN L. OLANDRIA, EXAMINING ATTOR-
NEY

Int. Cls.: 9 and 20

Prior U.S. Cls.: 2, 13, 21, 22, 23, 25, 26, 32, 36, 38 and 50

Reg. No. 3,520,841

United States Patent and Trademark Office

Registered Oct. 21, 2008

**TRADEMARK
PRINCIPAL REGISTER**



ROCCAT GMBH (FED REP GERMANY COMPAN-
NY WITH LIMITED LIABILITY)
LEVERKUSENSTRASSE 54
22761 HAMBURG
FED REP GERMANY

FOR: DEVICES FOR THE RECORDING, TRANSMISSION AND PLAYBACK OF SOUND AND IMAGES; LOUDSPEAKER, LOUDSPEAKER ENCLOSURE, HEADPHONES, MICROPHONES; DATA PROCESSING EQUIPMENT, NAMELY, COMPUTERS, NOTEBOOK COMPUTERS AND PERSONAL DIGITAL ASSISTANTS (PDA); AUXILIARY EQUIPMENT FOR COMPUTERS, TELEVISION SETS, AND MULTIMEDIA APPARATUS, NAMELY, COMPUTER GAME PROGRAMS, JOYSTICKS, VIDEO GAME INTERACTIVE CONTROL FLOOR PADS OR MATS, VIDEO GAME MACHINES FOR USE WITH TELEVISIONS, AND DIGITAL INPUT AND OUTPUT SCANNERS; VIDEO GAME INTERACTIVE REMOTE CONTROL UNITS, COMPUTER MOUSE AND MOUSE PADS, COMPUTER GRAPHIC BOARDS, KEYBOARDS, COMPUTER KEYPADS, COMPUTER CURSOR CONTROL DEVICES, NAMELY, LIGHT PENS, COMPUTER STYLUS, AND CONTROL PADS, MULTIFUNCTION KEYBOARDS, PLAYER-OPERATED ELECTRONIC CONTROLLERS FOR ELECTRONIC VIDEO GAME MACHINES; PLAYER-OPERATED ELECTRONIC CONTROLLERS IN THE FORM OF ACCELERATOR PEDALS, BRAKE PEDALS, STEERING WHEELS AND STEERING WHEEL COLUMNS, AND GUNS FOR ELECTRONIC GAMES AND FOR OPERATING ELECTRONIC APPARATUS; VIDEO OUTPUT GAME MACHINES FOR USE WITH TELEVISIONS;

PROGRAMMABLE DIGITAL TELEVISION RECORDERS; MAGNIFYING GLASSES AND HOLDERS FOR HOLDING AND OPERATING ELECTRONIC APPARATUS WITH DISPLAYS; LIGHTING FIXTURES IN THE NATURE OF LCD-PANELS, LIGHT EMITTING DIODES FOR USE IN DISPLAY LIGHTING FOR ELECTRONIC GAMES; COMPUTER INTERFACE BOARDS, UPI (UNIVERSAL PERIPHERAL INTERFACE) HARDWARE, PLUG-IN CONNECTORS, FLASH MEMORY CARDS, COMPUTER MEMORIES, MEMORY CARD READERS, MEMORY CARDS, COMPUTER PARALLEL PORTS AND COMPUTER SERIAL PORTS; EXTERNAL COMPUTER DISC DRIVES, BACK UP DRIVES FOR COMPUTERS, COMPUTER STORAGE DEVICES NAMELY, JUMP DRIVES, FLASH DRIVES AND THUMB DRIVES; REMOTE CONTROL FOR CD PLAYERS, DVD PLAYERS, STEREO RECEIVERS, STEREO TUNERS, AMPLIFIERS, VIDEO RECORDERS, SOUND RECORDERS, TELEVISIONS, VIDEO GAME MACHINES AND AUDIO EQUIPMENT; COMPUTER TERMINALS FOR INTERNET CONNECTIONS, COMPUTER TELEPHONY SOFTWARE, TELEPHONES FOR INTERNET USE; ACTIVE LOUDSPEAKERS; ELECTRICAL CONNECTOR CABLES AND ADAPTERS; MODEMS, BATTERIES, ACCUMULATORS, ELECTRICAL POWER SUPPLY DISTRIBUTION BOXES, ELECTRICAL POWER SUPPLY CONNECTORS AND ADAPTORS FOR USE WITH PORTABLE ELECTRONIC DEVICES, BATTERY CHARGERS, AC/DC ADAPTERS, COMPUTER NETWORK SWITCHES AND ROUTERS, TELEVISION DECODERS, ELECTRONIC ADAPTER DEVICES FOR THE DISPLAY OF SCREEN CONTENTS, NAMELY

ELECTRIC LUMINESCENT DISPLAY PANELS; FLASH CARD ADAPTERS; AND CONNECTORS AND ADAPTERS FOR CONNECTING COMPUTER PERIPHERALS, NAMELY, CABLES, CRADLE CONNECTION UNITS, AND CRADLE RECHARGING UNITS FOR PERSONAL DIGITAL ASSISTANTS (PDA'S) AND CELLULAR TELEPHONES; GOODS OF LEATHER AND PLASTIC, NAMELY, PROTECTIVE BAGS, CARRYING BAGS AND BELT BAGS, PROTECTIVE SLEEVES AND CASES SPECIALLY ADAPTED FOR HOLDING AND STORING DATA PROCESSING EQUIPMENT, NAMELY, COMPUTERS, NOTEBOOK COMPUTERS, PERSONAL DIGITAL ASSISTANTS (PDA), VIDEO GAME MACHINES FOR USE WITH TELEVISIONS, AND MULTIMEDIA PROJECTORS; MOUNTINGS DEVICES, NAMELY, STRAPS AND TRAY MOUNTINGS FOR ELECTRONIC GAME; IMPACT PROTECTION SPECIALTY BOXES AND PROTECTIVE HOLDERS SPECIALLY ADAPTED FOR HOLDING AND STORING ELECTRONIC GAME PROGRAMS, NOTEBOOK COMPUTERS AND PERSONAL DIGITAL ASSISTANTS (PDA'S); ARCHIVING AND STORAGE CONTAINERS SPECIALLY ADAPTED FOR HOLDING ELECTRONIC APPARATUS, NAMELY, COMPUTERS, NOTEBOOK COMPUTERS, PERSONAL DIGITAL ASSISTANTS (PDA), VIDEO GAME MACHINES FOR USE WITH TELEVISIONS, EXTERNAL COMPUTER HARD DRIVES; MULTIMEDIA PROJECTORS, AND BLANK FLOPPY COMPUTER DISCS; BAGS AND BOXES SOLD EMPTY SPECIALLY ADAPTED FOR ELECTRONIC MEMORIES

AND MEMORY CARDS; BAGS SPECIALLY ADAPTED FOR ELECTRONIC MEMORIES AND MEMORY CARDS WITH HAND HELD ELECTRONIC DEVICES, NAMELY, PERSONAL DIGITAL ASSISTANTS (PDA), IN CLASS 9 (U.S. CLS. 21, 23, 26, 36 AND 38).

FOR: FURNITURE, NAMELY, FILING AND STORAGE STANDS, NON-METAL BRACKETS, TRAYS AND FRAMES FOR HOLDING ELECTRONIC APPARATUS, ELECTRONIC DATA CARRIERS AND MEMORIES, ELECTRONIC APPARATUS AND APPARATUS MODULES AND FLOPPY DISKS, IN CLASS 20 (U.S. CLS. 2, 13, 22, 25, 32 AND 50).

PRIORITY DATE OF 1-29-2007 IS CLAIMED.

OWNER OF INTERNATIONAL REGISTRATION 0941400 DATED 6-15-2007, EXPIRES 6-15-2017.

THE MARK CONSISTS OF A SILHOUETTE OF A CAT HEAD FACING LEFT WITHIN A CRESCENT-SHAPED BORDER EXTENDING FROM THE NECK OF THE CAT. THREE CLAW MARKS APPEAR ON THE NECK OF THE CAT.

SER. NO. 79-045,373, FILED 6-15-2007.

EUGENIA MARTIN, EXAMINING ATTORNEY

Int. Cl.: 29

Prior U.S. Cl.: 46

United States Patent and Trademark Office

Reg. No. 3,520,842

Registered Oct. 21, 2008

**TRADEMARK
PRINCIPAL REGISTER**

GLENFELL

LIDL STIFTUNG & CO. KG (FED REP GERMA-
NY KOMMANDITGESELLSCHAFT)
STIFTSBERGSTR. 1
74167 NECKARSULM
FED REP GERMANY

FOR: FROZEN AND PRESERVED MEAT AND
MEAT PRODUCTS, NAMELY, MEAT AND SAU-
SAGE, MEAT PRESERVES, SAUSAGE PRESERVES,
SMALL SAUSAGE PRESERVES, MEAT JELLIES;
MEAT PASTE, MEAT JUICES, SAUSAGES, SMALL
SAUSAGES, BLOOD SAUSAGES, RING BOLOGNA,
BRAUNSCHWEIGER, SMOKED SAUSAGE, BRAT-
WURST, POLISH SAUSAGE, ITALIAN SAUSAGE,
SUMMER SAUSAGE, BOLOGNA AND SMOKED
BEEF, FRANKFURTERS, HAMBURGER MEAT,
HOT DOGS, MEAT-BASED MOUSSE, MEAT-BASED
SPREADS, HAM, BACON, SALAMI, MORTADEL-
LA, BACON RINDS, ROAST BEEF, BEEF PATTIES;
VEAL; BEEF MEAT EXTRACTS, CANNED
COOKED MEAT; FROZEN AND PRESERVED
POULTRY AND POULTRY PRODUCTS, NAMELY,

CHICKEN, TURKEY, DUCK, TURKEY SAUSAGE,
CHICKEN SAUSAGE, AND DUCK SAUSAGE; CAN-
NED COOKED CHICKEN, DUCK, OR TURKEY;
CHICKEN MOUSSE, CHICKEN STOCK; TURKEY
BURGER PATTIES, IN CLASS 29 (U.S. CL. 46).

PRIORITY DATE OF 5-3-2007 IS CLAIMED.

OWNER OF INTERNATIONAL REGISTRATION
0941429 DATED 10-1-2007, EXPIRES 10-1-2017.

OWNER OF U.S. REG. NO. 2,690,326.

THE MARK CONSISTS OF THE WORD "GLEN-
FELL".

SER. NO. 79-045,380, FILED 10-1-2007.

SHARON MEIER, EXAMINING ATTORNEY

Int. Cls.: 6, 7, 8 and 16

**Prior U.S. Cls.: 2, 5, 12, 13, 14, 19, 21, 22, 23, 25, 28,
29, 31, 34, 35, 37, 38, 44 and 50**

Reg. No. 3,520,843

United States Patent and Trademark Office

Registered Oct. 21, 2008

**TRADEMARK
PRINCIPAL REGISTER**

HOLDING YOUR WORLD TOGETHER

AVDEL UK LIMITED (UNITED KINGDOM
COMPANY)
PACIFIC HOUSE, 2 SWIFTFIELDS
WATCHMEAD INDUSTRIAL ESTATE,; WELWYN
GARDEN CITY; HERFORDSHIRE AL7 1LY
UNITED KINGDOM

FOR: METAL FASTENERS AND METAL BOLT-
ING DEVICES, NAMELY, METAL RIVETS; METAL
SCREWS; METAL BOLTS; METAL NUTS; METAL
BLIND RIVETS; METAL SWAGED-COLLAR BOLTS;
METAL BLIND THREADED INSERTS; METAL
BLIND STUDS, METAL SEALING PLUGS; METAL
FERRULES; METAL HOLLOW PINS; METAL HOL-
LOW TERMINAL PINS; METAL BREAK STEM
FASTENERS; METAL THREADED RIVETS, IN
CLASS 6 (U.S. CLS. 2, 12, 13, 14, 23, 25 AND 50).

FOR: MACHINE TOOLS, NAMELY, TOOLS FOR
INSTALLING RIVETS, SCREWS, BOLTS, NUTS,
BLIND RIVETS, SWAGED-COLLAR BOLTS, BLIND
THREADED INSERTS, BLIND STUDS, SEALING
PLUGS, FERRULES, HOLLOW PINS, HOLLOW
TERMINAL PINS, THREADED RIVETS, BREAK
STEM FASTENERS; MANDRELS FOR EXPANDING
RIVETS; MACHINE TOOLS FOR REMOVING RIV-
ETS, SCREWS, BOLTS, NUTS, BLIND RIVETS,
SWAGED-COLLAR BOLTS, BLIND THREADED IN-
SERTS, BLIND STUDS, SEALING PLUGS, FER-
RULES, HOLLOW PINS, HOLLOW TERMINAL
PINS, THREADED RIVETS, BREAK STEM FASTEN-
ERS; PARTS OF MACHINE TOOLS, NAMELY, BITS,
SOCKETS AND DRIVING HEADS FOR INSTAL-
LING RIVETS, SCREWS, BOLTS, NUTS, BLIND
RIVETS, SWAGED-COLLAR BOLTS, BLIND
THREADED INSERTS, BLIND STUDS, SEALING
PLUGS, FERRULES, HOLLOW PINS, HOLLOW

TERMINAL PINS, THREADED RIVETS, BREAK
STEM FASTENERS; MACHINE TOOLS FOR FAB-
RICATING DRIVE SURFACES AND DRIVE RECES-
SES ON FASTENERS FOR USE IN THE
CONSTRUCTION INDUSTRY; POWER DRILLS
AND POWER SCREWDRIVERS FOR DRIVING
FASTENERS; MACHINE COUPLINGS; MACHINE
BELTING, NOT FOR LAND VEHICLES, IN CLASS 7
(U.S. CLS. 13, 19, 21, 23, 31, 34 AND 35).

FOR: HAND TOOLS FOR DRIVING FASTENERS,
NAMELY, HAND DRILLS; BITS FOR SCREWDRI-
VERS AND HAND DRILLS; SCREWDRIVERS,
WRENCHES, IN CLASS 8 (U.S. CLS. 23, 28 AND 44).

FOR: PRINTED MATTER AND PRINTED PUB-
LICATIONS, NAMELY, MARKETING LITERA-
TURE, DATA SHEETS, CATALOGUES AND
BROCHURES IN THE FIELD OF FASTENERS;
STATIONARY; PENS; PENCILS; NOTEPADS, IN
CLASS 16 (U.S. CLS. 2, 5, 22, 23, 29, 37, 38 AND 50).

THE MARK CONSISTS OF STANDARD CHAR-
ACTERS WITHOUT CLAIM TO ANY PARTICULAR
FONT, STYLE, SIZE, OR COLOR.

PRIORITY DATE OF 5-25-2007 IS CLAIMED.

OWNER OF INTERNATIONAL REGISTRATION
0941473 DATED 6-28-2007, EXPIRES 6-28-2017.

SER. NO. 79-045,389, FILED 6-28-2007.

REGINA DRUMMOND, EXAMINING ATTORNEY

Int. Cl.: 11

Prior U.S. Cls.: 13, 21, 23, 31 and 34

United States Patent and Trademark Office

Reg. No. 3,520,844

Registered Oct. 21, 2008

**TRADEMARK
PRINCIPAL REGISTER**

DAYRAY

FLUOROSOLAR SYSTEMS LIMITED (AUSTRALIA COMPANY)
PO BOX 201
PARRAMATTA, AUSTRALIA NSW 2150

FOR: APPARATUS FOR BUILDING LIGHTING, NAMELY, SOLAR LIGHT COLLECTORS FOR CHANNELING SUNLIGHT IN BUILDINGS, IN CLASS 11 (U.S. CLS. 13, 21, 23, 31 AND 34).

THE MARK CONSISTS OF STANDARD CHARACTERS WITHOUT CLAIM TO ANY PARTICULAR FONT, STYLE, SIZE, OR COLOR.

PRIORITY DATE OF 5-1-2007 IS CLAIMED.

OWNER OF INTERNATIONAL REGISTRATION 0941635 DATED 7-31-2007, EXPIRES 7-31-2017.

SER. NO. 79-045,441, FILED 7-31-2007.

DAVID YONTEF, EXAMINING ATTORNEY

Int. Cls.: 3, 5, 9, 10, 16, 18, 21, 24, 25, 28, 29, 30, 31, 41, 42 and 44

Prior U.S. Cls.: 1, 2, 3, 4, 5, 6, 13, 18, 21, 22, 23, 26, 29, 30, 33, 36, 37, 38, 39, 40, 41, 42, 44, 46, 50, 51, 52, 100, 101 and 107

Reg. No. 3,520,845

United States Patent and Trademark Office

Registered Oct. 21, 2008

**TRADEMARK
SERVICE MARK
PRINCIPAL REGISTER**

PHILANTROPIK BY MARTINE SAINT-ZEBY

SAINT-ZEBY MARTINE (FRANCE INDIVIDUAL)
81 ROUTE DE L'ENCLOS
F-97233 SCHOELCHER
FRANCE

FOR: SOAPS FOR BODY CARE, BATH SOAPS, MEDICATED SOAPS, DISINFECTANT SOAPS; PERFUMERY, ESSENTIAL OILS, COSMETICS, COSMETIC KITS COMPRISING COSMETIC PENCILS, COSMETIC ROUGES, MASSAGE OILS AND BODY CREAMS; NAIL-CARE PRODUCTS, NAMELY, NAIL VARNISH, NAIL ENAMELS, NAIL CREAMS, MASSAGE OILS FOR NAILS, NAIL CARE PREPARATIONS, LOTIONS FOR STRENGTHENING THE NAILS; TOILETRY PRODUCTS, NOT INCLUDING SANITARY PRODUCTS FOR PERSONAL USE, NAMELY, BODY AND HAND CREAMS, MASSAGE OILS, NON-MEDICATED PREPARATIONS ALL FOR THE CARE OF SKIN, HAIR AND SCALP, MASSAGE OILS FOR BODY, HANDS, AND NAILS FOR USE IN SPECIFIC MASSAGE METHODS, NON-MEDICATED LIP BALM; HAIR-CARE PRODUCTS, NAMELY, HAIR DYES, HAIR GEL, HAIR SPRAYS, NON-MEDICATED HAIR RESTORATION LOTIONS AND CREAMS FOR REPAIR OF THE SCALP, OIL BATHS FOR HAIR CARE, HAIR CARE PREPARATIONS, SHAMPOOS, HAIR CREAMS AND LOTIONS, HAIR MASKS, HAIR SERUMS; BEAUTY MASKS, MAKEUP, IN CLASS 3 (U.S. CLS. 1, 4, 6, 50, 51 AND 52).

FOR: DIETETIC FOODS AND SUPPLEMENTS FOR MEDICAL USE; MEDICINAL HERBS; MEDICINAL BATHS, NAMELY, BATH SALTS, BATH PREPARATIONS, MASSAGE OILS, MEDICATED LOTIONS FOR SKIN, HAIR, AND SCALP; MEDICINAL HAIR-GROWTH PREPARATIONS; HERBAL TEAS, IN CLASS 5 (U.S. CLS. 6, 18, 44, 46, 51 AND 52).

FOR: MAGNETIC DATA CARRIERS, RECORDING DISCS, NAMELY, PRE-RECORDED CD-ROMS AND DVDS IN THE FIELD OF COSMETOLOGY, BEAUTY, HAIR CARE AND MASSAGE METHODS, IN CLASS 9 (U.S. CLS. 21, 23, 26, 36 AND 38).

FOR: MASSAGE APPARATUS, MASSAGE GLOVES, IN CLASS 10 (U.S. CLS. 26, 39 AND 44).

FOR: TISSUES FOR REMOVING MAKEUP, MADE OF PAPER; PAPER HAND TOWELS; PAPER FACE TOWELS, IN CLASS 16 (U.S. CLS. 2, 5, 22, 23, 29, 37, 38 AND 50).

FOR: LEATHER AND IMITATION LEATHER; HANDBAGS, BACKPACKS, WHEELED BAGS; TRAVEL BAGS, AND BEACH BAGS; CASES FOR HOLDING TOILETRIES, IN CLASS 18 (U.S. CLS. 1, 2, 3, 22 AND 41).

FOR: COMBS, IN CLASS 21 (U.S. CLS. 2, 13, 23, 29, 30, 33, 40 AND 50).

FOR: BED LINEN; HOUSEHOLD LINEN NOT OF PAPER; BATH LINEN MADE OF TEXTILE; TISSUES FOR REMOVING MAKEUP, MADE OF TEXTILE, IN CLASS 24 (U.S. CLS. 42 AND 50).

FOR: FOOTWEAR, EXCLUDING ORTHOPAEDIC SHOES AND SHOES FOR PROTECTION AGAINST ACCIDENTS, IRRADIATION AND FIRE, IN CLASS 25 (U.S. CLS. 22 AND 39).

FOR: PHYSICAL EXERCISE MACHINES, STATIONARY EXERCISE BICYCLES, IN CLASS 28 (U.S. CLS. 22, 23, 38 AND 50).

FOR: FOOD SUPPLEMENTS MADE WITH PRESERVED, DRIED AND COOKED FRUITS AND VEGETABLES; BEE POLLEN PROCESSED FOR FOOD PURPOSES, IN CLASS 29 (U.S. CL. 46).

FOR: ROYAL JELLY FOR HUMAN CONSUMPTION AND NOT FOR MEDICAL USE; NON-MEDICINAL HERBAL INFUSIONS; YEAST IN PILL FORM NOT FOR MEDICAL USE; HONEY; PROPOLIS AS IN BEE GLUE FOR HUMAN CONSUMPTION, IN CLASS 30 (U.S. CL. 46).

FOR: PLANT SEEDS; LIVE TREES; SHRUBS; NATURAL FLOWERS; FRESH GARDEN HERBS;

LIVE PLANTS; FRESH FRUITS AND VEGETABLES, IN CLASS 31 (U.S. CLS. 1 AND 46).

FOR: PUBLICATION OF BOOKS AND TEXTS NOT FOR ADVERTISING; ELECTRONIC PUBLICATION OF BOOKS AND TEXTS OTHER THAN FOR ADVERTISING; VIDEO TAPE FILM PRODUCTION; PHYSICAL EDUCATION, IN CLASS 41 (U.S. CLS. 100, 101 AND 107).

FOR: RESEARCH IN THE FIELD OF COSMETOLOGY, IN CLASS 42 (U.S. CLS. 100 AND 101).

FOR: HYGIENIC, BEAUTY AND HAIR CARE FOR HUMAN BEINGS, AROMATHERAPY SERVICES, BEAUTY SALONS, HAIR SALONS, MANICURE SERVICES, MASSAGE SERVICES,

PHYSICAL THERAPY, IN CLASS 44 (U.S. CLS. 100 AND 101).

THE MARK CONSISTS OF STANDARD CHARACTERS WITHOUT CLAIM TO ANY PARTICULAR FONT, STYLE, SIZE, OR COLOR.

PRIORITY DATE OF 2-23-2007 IS CLAIMED.

OWNER OF INTERNATIONAL REGISTRATION 0941806 DATED 6-29-2007, EXPIRES 6-29-2017.

SER. NO. 79-045,503, FILED 6-29-2007.

REGINA DRUMMOND, EXAMINING ATTORNEY

Int. Cls.: 6 and 20

Prior U.S. Cls.: 2, 12, 13, 14, 22, 23, 25, 32 and 50

Reg. No. 3,520,846

United States Patent and Trademark Office

Registered Oct. 21, 2008

**TRADEMARK
PRINCIPAL REGISTER**

ZERODISEGNO



QUATTROCCHIO S.R.L. (ITALY LIMITED LIABILITY COMPANY)

VIA PIACENZA, 122

I-15050 SAN GIULIANO VECCHIO (AL)

ITALY

FOR: MODULAR METAL FRAMES CONSISTING OF LATTICE ELEMENTS, CONNECTING AND JOINT MEMBERS, COVERING ELEMENTS, SHELVES AND SIMILAR ELEMENTS FOR THE CREATION OF INTERNAL OR EXTERNAL OPEN AND/OR CLOSED AREAS AND PIECES OF FURNITURE, IN CLASS 6 (U.S. CLS. 2, 12, 13, 14, 23, 25 AND 50).

FOR: FURNITURE AND PIECES OF FURNITURE, NAMELY, FURNITURE FRAMES, DOORS, SLIDES NOT OF METAL FOR CLOSETS, DRAWERS, SHELVES, TABLES, CHAIRS AND DESKS; DISPLAY STANDS; FURNITURE FRAMES FOR SHOP WINDOWS, IN CLASS 20 (U.S. CLS. 2, 13, 22, 25, 32 AND 50).

OWNER OF INTERNATIONAL REGISTRATION 0585504 DATED 4-10-1992, EXPIRES 4-10-2012.

SER. NO. 79-045,583, FILED 6-20-2007.

REGINA DRUMMOND, EXAMINING ATTORNEY

Int. Cl.: 10

Prior U.S. Cls.: 26, 39 and 44

United States Patent and Trademark Office

Reg. No. 3,520,847

Registered Oct. 21, 2008

**TRADEMARK
PRINCIPAL REGISTER**

INNOTHERA

LABORATOIRES INNOTHERA (FRANCE SOCI-
ÉTÉ PAR ACTIONS SIMPLIFIÉE)
7-9, AVENUE FRANÇOIS-VINCENT RASPAIL
F-94110 ARCUEIL
FRANCE

FOR: MEDICAL APPARATUS AND INSTRU-
MENTS FOR DIAGNOSING OR TREATING VE-
NOUS PATHOLOGY; ORTHOPAEDIC ARTICLES,
NAMELY, ORTHOPAEDIC BANDAGES, ORTHO-
PAEDIC SOLES; COMPRESSIONS ORTHOSES,
NAMELY, ORTHOTIC INSERTS FOR FOOTWEAR;
MEDICAL COMPRESSION STRIPS AND BANDA-
GES, MEDICAL COMPRESSION SOCKS; MEDICAL
COMPRESSION STOCKINGS AND TIGHTS; MEDI-
CAL COMPRESSION STOCKINGS AND TIGHTS

FOR VARICOSE VEINS; STOCKING AND TIGHTS
FOR MEDICAL USE, IN CLASS 10 (U.S. CLS. 26, 39
AND 44).

OWNER OF INTERNATIONAL REGISTRATION
0900353 DATED 9-28-2006, EXPIRES 9-28-2016.

OWNER OF U.S. REG. NOS. 2,438,007 AND
2,611,084.

SER. NO. 79-045,619, FILED 1-25-2007.

NAPOLEON SHARMA, EXAMINING ATTORNEY

Int. Cl.: 10

Prior U.S. Cls.: 26, 39 and 44

United States Patent and Trademark Office

Reg. No. 3,520,848

Registered Oct. 21, 2008

**TRADEMARK
PRINCIPAL REGISTER**



LABORATOIRES INNOTHERA (FRANCE SOCI-
ÉTÉ PAR ACTIONS SIMPLIFIÉE)
7-9, AVENUE FRANÇOIS-VINCENT RASPAIL
F-94110 ARCUEIL
FRANCE

FOR: MEDICAL APPARATUS AND INSTRU-
MENTS FOR DIAGNOSING OR TREATING VE-
NOUS PATHOLOGY; ORTHOPAEDIC ARTICLES,
NAMESLY, ORTHOPAEDIC BANDAGES, ORTHO-
PAEDIC SOLES; COMPRESSIONS ORTHOSES,
NAMESLY, ORTHOTIC INSERTS FOR FOOTWEAR;
MEDICAL COMPRESSION STRIPS AND BANDA-
GES, MEDICAL COMPRESSION SOCKS; MEDICAL
COMPRESSION STOCKINGS AND TIGHTS; MEDI-
CAL COMPRESSION STOCKINGS AND TIGHTS

FOR VARICOSE VEINS; STOCKING AND TIGHTS
FOR MEDICAL USE, IN CLASS 10 (U.S. CLS. 26, 39
AND 44).

OWNER OF INTERNATIONAL REGISTRATION
0900354 DATED 9-28-2006, EXPIRES 9-28-2016.

OWNER OF U.S. REG. NOS. 2,438,007 AND
2,611,084.

SER. NO. 79-045,620, FILED 1-25-2007.

NAPOLEON SHARMA, EXAMINING ATTORNEY

Int. Cls.: 1, 5, 9 and 42

**Prior U.S. Cls.: 1, 5, 6, 10, 18, 21, 23, 26, 36, 38, 44, 46,
51, 52, 100 and 101**

Reg. No. 3,520,849

United States Patent and Trademark Office

Registered Oct. 21, 2008

**TRADEMARK
SERVICE MARK
PRINCIPAL REGISTER**



QIAGEN GMBH (FED REP GERMANY GMBH)
QIAGEN STR. 1
40724 HILDEN
FED REP GERMANY

FOR: CHEMICAL, BIOCHEMICAL AND BIOTECHNOLOGICAL PRODUCTS FOR INDUSTRIAL AND SCIENTIFIC PURPOSES, IN PARTICULAR NUCLEIC ACIDS, ENZYMES, POLYMERASES, REAGENTS FOR STAINING AND MARKING, MOLECULAR PROBES, BUFFER, AQUEOUS AND NON-AQUEOUS SOLUTIONS OF ALCOHOLS AND SALTS, DISTILLED AND PURIFIED WATER, SILICA IN POWDERED, GRANULATE AND GEL FORM AND MAGNETIC PARTICLES IN FLUID FORM, NONE OF THE FOREGOING FOR MEDICAL OR VETERINARY PURPOSES; MATERIALS FOR COLUMNS AND REAGENTS AND SOLVENTS FOR SAMPLE PREPARATION, ALL OF THE FOREGOING FOR THE PURPOSE OF PURIFICATION, LYSIS, MODIFICATION AND MANIPULATION OF CELLS, AS WELL AS FOR THE PERFORMANCE OF MARKING, SEPARATION, ISOLATION, PURIFICATION, AMPLIFICATION AND ANALYTICAL METHODS FOR BIOPOLYMERS, IN PARTICULAR NUCLEIC ACIDS, ENZYMES, PROTEINS, MACRO MOLECULES AND BIOLOGICALLY ACTIVE SUBSTANCES FOR SEPARATION, ANALYSIS AND PURIFICATION OF BIOLOGICAL AND BIOCHEMICAL COMPOUNDS, NONE OF THE FOREGOING FOR MEDICAL OR VETERINARY PURPOSES; KITS COMPRISING CHEMICAL, BIOCHEMICAL AND

BIOTECHNOLOGICAL PRODUCTS FOR SAMPLE PREPARATION, PURIFICATION, LYSIS, MODIFICATION AND MANIPULATION OF CELLS AS WELL AS FOR THE PERFORMANCE OF MARKING, SEPARATION, ISOLATION, PURIFICATION, AMPLIFICATION AND ANALYTICAL METHODS FOR BIOPOLYMERS, IN PARTICULAR NUCLEIC ACIDS, ENZYMES, PROTEINS, MACRO MOLECULES AND BIOLOGICALLY ACTIVE SUBSTANCES FOR SEPARATION, ANALYSIS AND PURIFICATION OF BIOLOGICAL AND BIOCHEMICAL COMPOUNDS, IN PARTICULAR NUCLEIC ACIDS MADE FROM BIOLOGICAL AND BIOCHEMICAL SAMPLE MATERIAL, NONE OF THE FOREGOING FOR MEDICAL OR VETERINARY PURPOSES, IN CLASS 1 (U.S. CLS. 1, 5, 6, 10, 26 AND 46).

FOR: PRODUCTS FOR MEDICAL AND VETERINARY MEDICAL PURPOSES, IN PARTICULAR DIAGNOSTIC PREPARATIONS, IN PARTICULAR NUCLEIC ACIDS, ENZYMES, POLYMERASES, REAGENTS FOR STAINING AND MARKING, MOLECULAR PROBES, BUFFER CHEMICALS AND AQUEOUS AND NON-AQUEOUS SOLUTIONS OF PRIMARY, SECONDARY AND TERTIARY ALCOHOLS AND SALTS, DISTILLED AND PURIFIED WATER, MAGNETIC PARTICLES IN FLUID FORM, AND MATERIALS FOR COLUMNS FOR THE PURPOSE OF PURIFICATION, LYSIS, MODIFICATION AND MANIPULATION OF CELLS, AS WELL AS FOR THE PERFORMANCE OF MARKING, SE-

PARATION, ISOLATION, PURIFICATION, AMPLIFICATION AND ANALYTICAL METHODS FOR BIOPOLYMERS, IN PARTICULAR NUCLEIC ACIDS, ENZYMES, PROTEINS, MACRO MOLECULES AND BIOLOGICALLY ACTIVE SUBSTANCES FOR SEPARATION, ANALYSIS AND PURIFICATION OF BIOLOGICAL AND BIOCHEMICAL COMPOUNDS, ALL OF THE FOREGOING FOR MEDICAL AND VETERINARY PURPOSES; PRODUCTS FOR MEDICAL AND VETERINARY MEDICAL PURPOSES, NAMELY, CHEMICAL, BIOCHEMICAL AND BIOTECHNOLOGICAL PRODUCTS AS WELL AS KITS COMPRISING PRODUCTS FOR MEDICAL AND VETERINARY MEDICAL PURPOSES, IN PARTICULAR CHEMICAL, BIOCHEMICAL AND BIOTECHNOLOGICAL PRODUCTS FOR SAMPLE PREPARATION, PURIFICATION, LYSIS, MODIFICATION AND MANIPULATION OF CELLS, AS WELL AS FOR THE PERFORMANCE OF MARKING, SEPARATION, ISOLATION, PURIFICATION, AMPLIFICATION AND ANALYTICAL METHODS FOR BIOPOLYMERS, IN PARTICULAR NUCLEIC ACIDS FOR MEDICAL AND VETERINARY MEDICAL PURPOSES, ENZYMES, NATURAL AND ARTIFICIAL PROTEINS, MACRO MOLECULES, AND BIOLOGICALLY ACTIVE SUBSTANCES FOR DETECTING PATHOGENS, GENETIC INFORMATION AND CONDITIONS OF THE HUMAN BODY, IN CLASS 5 (U.S. CLS. 6, 18, 44, 46, 51 AND 52).

FOR: SCIENTIFIC APPARATUS, INSTRUMENTS AND EQUIPMENT FOR RESEARCH AND EXAMINATION PURPOSES, NAMELY, LABORATORY EQUIPMENT, NAMELY, CHROMATOGRAPHY COLUMNS; AUTOMATED LABORATORY EQUIPMENT, NAMELY, ROBOTS AND SPARE PARTS AND ADD-ONS THEREFOR, NAMELY, PREPROGRAMMED SMART CARDS FOR DNA PURIFICATION PROTOCOLS; LABORATORY EQUIPMENT, NAMELY, MICROPLATES; LABORATORY EQUIPMENT, NAMELY, PIPETTES, PIPETTE TIPS AND PIPETTE TIP HOLDERS; LABORATORY EQUIPMENT, NAMELY, SAMPLE CONTAINERS, REAGENT HOLDERS, FLASKS, REAGENT TUBE

HOLDERS, HOLDERS FOR MICRO CONTAINERS, MAGNETIC SYRINGES, BIOCHIPS FOR THE PURPOSE OF SCREEN LARGE NUMBERS OF BIOLOGICAL ANALYTES, THERMOCYCLERS FOR THE PURPOSE OF PERFORMING POLYMERASE CHAIN REACTIONS, HOMOGENIZERS FOR THE PURPOSE OF BREAKING UP CELL MEMBRANES AND MIXING THE RESULTING LIQUIDS, AND VACUUM VALVES FOR THE PURPOSE OF PERMITTING THE OPERATION OF LABORATORY PROCESSES UNDER SUBATMOSPHERIC PRESSURE, ALL OF THE AFOREMENTIONED BEING INCLUDED IN THIS CLASS AND BEING FOR SCIENTIFIC RESEARCH AND EXAMINATION PURPOSES, IN CLASS 9 (U.S. CLS. 21, 23, 26, 36 AND 38).

FOR: SCIENTIFIC RESEARCH FOR OTHERS IN THE FIELDS OF CHEMISTRY, GENETICS, BIOLOGY AND BIOCHEMISTRY; SCIENTIFIC DIAGNOSTIC SERVICES FOR OTHERS IN THE FIELDS OF DNA, RNA AND PROTEIN DETECTION AND ANALYSIS; RESEARCH SERVICES IN THE FIELD OF FORENSIC SCIENCE, NAMELY, ANALYSIS, DETECTION AND ISOLATION OF BIOLOGICAL SUBSTANCES IN FORENSIC SAMPLES, IN CLASS 42 (U.S. CLS. 100 AND 101).

PRIORITY DATE OF 10-4-2006 IS CLAIMED.

OWNER OF INTERNATIONAL REGISTRATION 0942109 DATED 2-2-2007, EXPIRES 2-2-2017.

OWNER OF U.S. REG. NOS. 1,630,524 AND 3,181,090.

NO CLAIM IS MADE TO THE EXCLUSIVE RIGHT TO USE "QUALITY", APART FROM THE MARK AS SHOWN.

SER. NO. 79-045,657, FILED 2-2-2007.

EUGENIA MARTIN, EXAMINING ATTORNEY

Int. Cls.: 9 and 11

Prior U.S. Cls.: 13, 21, 23, 26, 31, 34, 36 and 38

United States Patent and Trademark Office

Reg. No. 3,520,850

Registered Oct. 21, 2008

**TRADEMARK
PRINCIPAL REGISTER**

CERAMOS

OSRAM GESELLSCHAFT MIT BESCHRÄNKTER
HAFTUNG. (FED REP GERMANY LIMITED
LIABILITY COMPANY)
HELLABRUNNER STR. 1
81543 MÜNCHEN
FED REP GERMANY

FOR: LIGHT EMITTING DIODES; ELECTRIC
CONTROL CIRCUITS FOR DRIVING LIGHT EMIT-
TING DIODES , IN CLASS 9 (U.S. CLS. 21, 23, 26, 36
AND 38).

FOR: ELECTRIC LAMPS; ELECTRIC LUMI-
NAIRES; ELECTRIC LIGHTING FIXTURES, ADAP-
TED FOR USE IN FLASHLIGHTS, CAMERA FLASH
UNITS, VIDEO CAMERA LIGHT SOURCES, IN-
DOOR COMMERCIAL AND RESIDENTIAL ARCHI-

TECTURAL LIGHTING AND HIGH-LUMINANCE
DISPLAY BACK LIGHTS FOR SIGNS, LIQUID
CRYSTAL DISPLAYS, AND THE LIKE; LIGHT
EMITTING DIODE LAMPS, IN CLASS 11 (U.S. CLS.
13, 21, 23, 31 AND 34).

OWNER OF INTERNATIONAL REGISTRATION
0942371 DATED 5-22-2007, EXPIRES 5-22-2017.

THE WORDING "CERAMOS" HAS NO MEAN-
ING IN A FOREIGN LANGUAGE.

SER. NO. 79-045,743, FILED 5-22-2007.

JAMES MACFARLANE, EXAMINING ATTORNEY

Int. Cls.: 24 and 25

Prior U.S. Cls.: 22, 39, 42 and 50

United States Patent and Trademark Office

Reg. No. 3,520,851

Registered Oct. 21, 2008

**TRADEMARK
PRINCIPAL REGISTER**



PROJECT 9 PTY LTD (AUSTRALIA COMPANY)
1506 MAIN NORTH ROAD
SALISBURY SOUTH SA 5106
AUSTRALIA

FOR: FABRICS FOR TEXTILE USE; TEXTILE
FABRICS FOR THE MANUFACTURE OF CLOTH-
ING, IN CLASS 24 (U.S. CLS. 42 AND 50).

FOR: CLOTHING, NAMELY, JERSEYS, SHIRTS,
SHORT-SLEEVED AND LONG-SLEEVED T-SHIRTS,
HOODS, TOPS, JACKETS, PANTS, SHORTS, SURF
WEAR; SPORTS CLOTHING, NAMELY, JERSEYS,
SHIRTS, SHORT-SLEEVED AND LONG-SLEEVED

T-SHIRTS, HOODS, TOPS, JACKETS, PANTS,
SHORTS, IN CLASS 25 (U.S. CLS. 22 AND 39).

PRIORITY DATE OF 4-20-2007 IS CLAIMED.

OWNER OF INTERNATIONAL REGISTRATION
0942406 DATED 9-20-2007, EXPIRES 9-20-2017.

SER. NO. 79-045,755, FILED 9-20-2007.

JULIE GUTTADAURO, EXAMINING ATTORNEY

Int. Cl.: 33

Prior U.S. Cls.: 47 and 49

United States Patent and Trademark Office

Reg. No. 3,520,852

Registered Oct. 21, 2008

**TRADEMARK
PRINCIPAL REGISTER**

ZENATO RIPASSA

ZENATO AZIENDA VITIVINICOLA S.R.L. (ITALY JOINT STOCK COMPANY LIABILITY)
VIA SAN BENEDETTO, 8 -
PESCHIERA DEL GARDA; I-37010 FRAZ. SAN BENEDETTO DI LUGANA (VR)
ITALY

FOR: WINES, IN CLASS 33 (U.S. CLS. 47 AND 49).

THE MARK CONSISTS OF STANDARD CHARACTERS WITHOUT CLAIM TO ANY PARTICULAR FONT, STYLE, SIZE, OR COLOR.

PRIORITY DATE OF 4-20-2007 IS CLAIMED.

OWNER OF INTERNATIONAL REGISTRATION
0942513 DATED 9-7-2007, EXPIRES 9-7-2017.

THE WORDING "ZENATO" AND "RIPASSA"
HAVE NO MEANING IN A FOREIGN LANGUAGE.

SER. NO. 79-045,797, FILED 9-7-2007.

LINDA E. BLOHM, EXAMINING ATTORNEY

Int. Cls.: 35, 36, 37, 39, 40 and 42

Prior U.S. Cls.: 100, 101, 102, 103, 105 and 106

Reg. No. 3,520,853

United States Patent and Trademark Office

Registered Oct. 21, 2008

**SERVICE MARK
PRINCIPAL REGISTER**



HEEREMA GROUP SERVICES S.A. (LUXEMBOURG SOCIÉTÉ ANONYME)
GRAND RUE 31-33
L-1661 LUXEMBOURG
LUXEMBOURG

FOR: BUSINESS MANAGEMENT, COMMERCIAL MANAGEMENT, BUSINESS ORGANIZATION CONSULTANCY AND BUSINESS ECONOMICS CONSULTANCY, ALL IN THE FIELD OF DESIGNING, CONSTRUCTING, TRANSPORTING, INSTALLING AND DISMANTLING OF OFFSHORE INSTALLATIONS AND ALSO IN THE FIELD OF EXPLOITATION OF OFFSHORE INSTALLATIONS, THE EXPLOITATION OF OIL AND GAS FIELDS AND OTHER ENERGY PRODUCTS; PROVIDING OFFICE FUNCTIONS RELATED TO INVESTMENTS IN THE FIELD OF OIL, GAS AND OTHER ENERGY PRODUCTS; BUSINESS MANAGEMENT SUPERVISION, NAMELY, PROVIDING ASSISTANCE REGARDING THE OPERATIONAL MANAGEMENT INCLUDING THE SUPERVISION OF COMPANIES, IN CLASS 35 (U.S. CLS. 100, 101 AND 102).

FOR: FINANCE SERVICES, NAMELY, FINANCIAL ADVICE; INSURANCE SERVICES, NAMELY, INSURANCE BROKERAGE; FINANCING SERVICES FOR COMPANIES, ACQUISITIONS AND PARTICIPATIONS IN COMPANIES AND PROJECTS; FINANCIAL CONSULTANCY; INVESTMENT SERVICES, NAMELY, ASSET ACQUISITION, CONSULTATION, DEVELOPMENT AND MANAGEMENT SERVICES; REAL ESTATE PROPERTY MANAGEMENT AND CONSULTANCY IN THIS RESPECT; SERVICES OF A TRUST COMPANY; SERVICES OF HOLDING IN TRUST COMPANIES AND INVEST-

MENTS TRUSTS; SERVICES OF FINANCE COMPANIES, NAMELY, BUSINESS FINANCE PROCUREMENT SERVICES; FINANCING OF INDUSTRIAL ACTIVITIES; INVESTMENTS; CONSULTATION AND INFORMATION IN THE FIELD OF ALL SERVICES MENTIONED IN THIS CLASS, IN CLASS 36 (U.S. CLS. 100, 101 AND 102).

FOR: BUILDING, REPAIR, INSTALLATION, AND MAINTENANCE SERVICES OF OFFSHORE HYDROCARBON EXPLORATION AND EXPLOITATION PLATFORMS AND FACILITIES, ON AND UNDER WATER, SHIPS AND OTHER VESSELS, DRY DOCKS AND DRY DOCK FACILITIES, DOCKYARDS, WHARFS, PANELING, DAMS, PIERS, BRIDGES, DRAINAGE SYSTEMS, OIL AND GAS PRODUCING FACILITIES, FLOATING OFFSHORE EQUIPMENT, PIPELINES, STEEL CONSTRUCTIONS AND FLOATING PRODUCTION STORAGE AND OFFLOADING VESSELS, CIVIL ENGINEERING CONSTRUCTIONS AND INDUSTRIAL INSTALLATIONS AND MACHINES; DRILLING PILINGS ON LAND AND AT SEA; MINING EXTRACTION; EXTRACTION OF OIL, GAS AND OTHER ENERGY PRODUCTS, NAMELY, WINDMILLS; DRILLING OF CRUDE OIL AIMED AT EXTRACTING ENERGY PRODUCTS; RENTAL OF APPARATUS FOR THE EXTRACTION OF OIL, GAS AND OTHER ENERGY PRODUCTS, NAMELY, ELECTRICITY; CONSULTATION AND INFORMATION IN THE FIELD OF ALL SERVICES MENTIONED IN THIS CLASS, IN CLASS 37 (U.S. CLS. 100, 103 AND 106).

FOR: TRANSPORT AND STORAGE OF MATERIALS INCLUDING GAS, OIL AND ELECTRICITY

THROUGH PIPELINES AND POWER LINES; TRANSPORT BY BARGE OR HEAVY CARGO VESSELS OF OFFSHORE INSTALLATIONS AND OTHER CIVIL ENGINEERING CONSTRUCTIONS AND INDUSTRIAL INSTALLATIONS AND MACHINERY; CONSULTATION AND INFORMATION IN THE FIELD OF TRANSPORT AND STORAGE OF MATERIALS INCLUDING GASES, LIQUIDS SUCH AS OIL AND OTHER FIXED SUBSTANCES, ALSO THROUGH PIPELINES AND FROM OFFSHORE INSTALLATIONS AND OTHER CIVIL ENGINEERING CONSTRUCTIONS AND INDUSTRIAL INSTALLATIONS; RENTAL OF EQUIPMENT IN THE FIELD OF TRANSPORT AND STORAGE, NAMELY, MOBILE STORAGE TANKS; TRANSPORT OF GOODS OVER WATER AND LAND BY BOATS, TRAINS, AND TRUCKS; SERVICES OF TUG BOATS, NAMELY, BOAT TOWING SERVICES; CONSULTATION AND INFORMATION IN THE FIELD OF ALL SERVICES MENTIONED IN THIS CLASS, IN CLASS 39 (U.S. CLS. 100 AND 105).

FOR: GENERATING, PRODUCING AND CONVERTING ENERGY; SERVICES OF REFINERIES, NAMELY, OIL REFINING; PRESERVING, REFINING AND IMPROVING PETROLEUM, NATURAL GAS, OIL AND OTHER BITUMEN, MINERALS, ELECTRICITY AND HYDROGEN, BOTH IN LIQUID, SOLID AND GAS FORMS; TECHNICAL CONSULTANCY CONCERNING THE TREATMENT OF OIL, PETROLEUM, NATURAL GAS, OTHER BITUMEN AND MINERALS, AND HYDROGEN, BOTH IN LIQUID, SOLID AND GAS FORMS; TREATMENT OF MATERIALS BY GALVANIZATION DURING PRODUCTION OF STEEL AND ALUMINUM COMPONENTS OF PIPELINES, OIL, GAS AND OTHER FACILITIES FOR ENERGY PRODUCTION, DRAINAGE SYSTEMS, INSTRUMENTAL SYSTEMS AND OTHER CIVIL ENGINEERING CONSTRUCTIONS AND INDUSTRIAL INSTALLATIONS AND MACHINERY FOR THE UPSTREAM OIL AND GAS INDUSTRY AND ENERGY INDUSTRY; CONSULTATION AND INFORMATION IN THE FIELD OF ALL SERVICES MENTIONED IN THIS CLASS, IN CLASS 40 (U.S. CLS. 100, 103 AND 106).

FOR: ENGINEERING; INDUSTRIAL PLANNING AND DESIGN AND RELATED CONSULTATION FOR CONSTRUCTION PURPOSES; DESIGN OF

APPARATUS AND INSTALLATIONS FOR OFFSHORE LOCATIONS, ON AND UNDER WATER, SHIPS AND OTHER VESSELS, DRY DOCKS AND DRY DOCK FACILITIES, DOCKYARDS, WHARFS, PANELING, DAMS, PIERS, BRIDGES, DRAINAGE SYSTEMS, OIL AND GAS PRODUCTION FACILITIES, FLOATING OFFSHORE EQUIPMENT FOR PIPELINES, STEEL CONSTRUCTIONS AND OTHER CIVIL ENGINEERING CONSTRUCTIONS AND INDUSTRIAL INSTALLATIONS AND MACHINERY FOR UPSTREAM OIL AND GAS EXPLORATION AND EXPLOITATION PLATFORMS AND FACILITIES; SCIENTIFIC RESEARCH AND INDUSTRIAL RESEARCH IN THE FIELD OF OFFSHORE OIL AND GAS AND TECHNICAL STUDIES, NAMELY, TECHNICAL ANALYSIS OF A PRODUCT OR PROCESS TO DETERMINE HOW TO MAKE IT MORE ENVIRONMENTALLY SOUND; TECHNICAL DESIGN OF SUBSEA AND FLOATING OFFSHORE OIL AND GAS FACILITIES FOR THE OFFSHORE INDUSTRY; SERVICES IN THE FIELD OF GEOLOGICAL AND OCEANOGRAPHIC INSPECTION AND RESEARCH, NAMELY, SEARCH FOR AND RESEARCH OF NATURAL GAS AND OIL WELLS, BITUMEN, MINERALS AND OTHER ENERGY PRODUCTS; CONSULTANCY IN THE FIELD OF TECHNOLOGIES AND TECHNIQUES FOR THE EXPLOITATION AND EXTRACTION OF RAW MATERIALS; QUALITY CONTROL FOR OTHERS CONCERNING SERVICES IN THE FIELD OF CONSTRUCTION, REPAIR, MAINTENANCE, TRANSPORT, STORAGE, RESEARCH AND EXTRACTION OF OIL, GAS, ELECTRICITY AND HYDROGEN; CONSULTATION AND INFORMATION IN THE FIELD OF ALL SERVICES MENTIONED IN THIS CLASS, IN CLASS 42 (U.S. CLS. 100 AND 101).

PRIORITY DATE OF 7-5-2007 IS CLAIMED.

OWNER OF INTERNATIONAL REGISTRATION 0942539 DATED 7-23-2007, EXPIRES 7-23-2017.

OWNER OF U.S. REG. NOS. 2,545,577 AND 2,546,015.

SER. NO. 79-045,812, FILED 7-23-2007.

TASHIA BUNCH, EXAMINING ATTORNEY

Int. Cls.: 16 and 29

Prior U.S. Cls.: 2, 5, 22, 23, 29, 37, 38, 46 and 50

United States Patent and Trademark Office

Reg. No. 3,520,854

Registered Oct. 21, 2008

**TRADEMARK
PRINCIPAL REGISTER**

SYLVAIN



SYLVAIN HÚSIPARI KFT. (HUNGARY CORPORATION)
1623/5 HRSZ.
H-6070 IZSAK
HUNGARY

FOR: PLASTIC PACKAGING, NAMELY, PLASTIC BAGS FOR PACKAGING FISH AND MEAT PRODUCTS, NAMELY, PORK, BEEF, HORSE, AND FOWL, IN CLASS 16 (U.S. CLS. 2, 5, 22, 23, 29, 37, 38 AND 50).

FOR: MEAT PRODUCTS, NAMELY, UNCOOKED MEAT, AND PROCESSED MEAT, NAMELY, ROASTED MEAT, BOILED MEAT, AND SMOKED MEAT, IN CLASS 29 (U.S. CL. 46).

OWNER OF INTERNATIONAL REGISTRATION
0942604 DATED 10-11-2007, EXPIRES 10-11-2017.

THE COLOR(S) RED, BLUE AND BLACK IS/ARE CLAIMED AS A FEATURE OF THE MARK.

THE COLOR RED APPEARS IN THE LETTERS "SYLVA" AND "N" OF THE WORD "SYLVAIN", THE COLOR BLUE APPEARS IN THE LETTER "I", OF THE WORD "SYLVAIN", AND IN THE FIVE STARS CENTERED BELOW, AND THE COLOR BLACK APPEARS IN THE OUTLINE OF THE LETTERS IN THE WORD "SYLVAIN".

SER. NO. 79-045,838, FILED 10-11-2007.

CARYN GLASSER, EXAMINING ATTORNEY

Int. Cls.: 3 and 44

Prior U.S. Cls.: 1, 4, 6, 50, 51, 52, 100 and 101

United States Patent and Trademark Office

Reg. No. 3,520,855

Registered Oct. 21, 2008

**TRADEMARK
SERVICE MARK
PRINCIPAL REGISTER**



CHRISTINE BUSIN (FRANCE INDIVIDUAL)
6 RUE DE LA SOURDIÈRE
F-75001 PARIS
FRANCE

FOR: SOAPS; PERFUMES, ESSENTIAL OILS,
COSMETICS, HAIR LOTIONS; DENTIFRICES; DE-
PILATORY PREPARATIONS; MAKE-UP REMOV-
ING PREPARATIONS; LIPSTICKS; BEAUTY
MASKS; SHAVING PRODUCTS, IN CLASS 3 (U.S.
CLS. 1, 4, 6, 50, 51 AND 52).

FOR: HYGIENIC AND BEAUTY CARE FOR HU-
MAN BEINGS; BEAUTY SALONS; HAIRDRESSING
SALONS, IN CLASS 44 (U.S. CLS. 100 AND 101).

PRIORITY DATE OF 4-10-2007 IS CLAIMED.

OWNER OF INTERNATIONAL REGISTRATION
0942680 DATED 9-17-2007, EXPIRES 9-17-2017.

NO CLAIM IS MADE TO THE EXCLUSIVE
RIGHT TO USE "WAX", APART FROM THE MARK
AS SHOWN.

SER. NO. 79-045,852, FILED 9-17-2007.

RONALD AIKENS, EXAMINING ATTORNEY

Int. Cls.: 29, 30 and 31

Prior U.S. Cls.: 1 and 46

United States Patent and Trademark Office

Reg. No. 3,520,856

Registered Oct. 21, 2008

TRADEMARK
PRINCIPAL REGISTER



LIDL STIFTUNG & CO. KG (FED REP GERMA-
NY KOMMANDITGESELLSCHAFT)
STIFTSBERGSTR. 1
74167 NECKARSULM
FED REP GERMANY

FOR: SNACKS, NAMELY, DRIED, ROASTED,
SALTED AND/OR SPICED PEANUT KERNELS;
NUTS, NAMELY, BLANCHED NUTS, PROCESSED
NUTS, PREPARED NUTS, SEASONED NUTS, AND
SHELLED NUTS, ALMONDS AND CASHEW NUT
KERNELS, POTATO CRISPS AND POTATO STICKS;
SNACKS MADE FROM EXTRUDED POTATO PRO-
DUCTS, NAMELY, POTATO CRISPS AND POTATO
STICKS; DEEP-FRIED POTATO SNACKS; DRIED
FRUITS; FRUIT CHIPS, IN CLASS 29 (U.S. CL. 46).

FOR: CONFECTIONERY, NAMELY, CHOCO-
LATE CHIPS, CHOCOLATE TOPPINGS, CARAMEL
TOPPINGS, CHOCOLATE CANDY, CHOCOLATE
BARS, CHOCOLATE TRUFFLES, MARZIPAN, AL-
MOND CAKE, ALMOND CANDY, ROASTED AL-
MONDS COATED IN CHOCOLATE,
CRYSTALLIZED SUGAR PIECES, SWEETMEATS,
CARAMELS, PASTILLES, CANDY AND SWEETS,
PRALINES, TOFFEE, PEANUT BRITTLE, FRUIT
JELLIES, GUM SWEETS, SHAVED ICE CONFEC-
TIONS, ICE CREAM, BLANCMANGES, ITALIAN
ICE, AND FRUIT ICES; PASTRIES, NAMELY,
SHORTCAKE BISCUITS, SPRITZ COOKIES, WAF-
FLES, SAVOURY PASTRIES, PRETZELS, ONION
PASTRIES AND CHEESE PASTRIES, WAFERS, BIS-
CUITS, RUSKS, GINGERBREAD AND HONEY
CAKES, CRACKERS, READY-TO-EAT PASTRIES
FOR TOASTING, NAMELY, SAVOURY SANDWICH

PASTRIES; POP CORN, CORNFLAKES; SNACKS
MADE FROM EXTRUDED WHEAT, RICE AND
CORN PRODUCTS, IN CLASS 30 (U.S. CL. 46).

FOR: FRESH, RAW, AND UNPROCESSED PEA-
NUTS AND ALMONDS; FRESH FRUITS, IN CLASS
31 (U.S. CLS. 1 AND 46).

PRIORITY DATE OF 4-19-2007 IS CLAIMED.

OWNER OF INTERNATIONAL REGISTRATION
0942747 DATED 10-1-2007, EXPIRES 10-1-2017.

OWNER OF U.S. REG. NO. 3,136,025.

THE COLOR(S) BLACK (PANTONE BLACK C),
YELLOW (PANTONE YELLOW C), BLUE (PAN-
TONE REFLEX BLUE C), RED (PANTONE 485 C),
WHITE IS/ARE CLAIMED AS A FEATURE OF THE
MARK.

THE MARK CONSISTS OF THE TERM "ALESTO"
WRITTEN IN WHITE CONTAINED ON A RED
BANNER WITH YELLOW TRIM. ABOVE THE BAN-
NER ARE SIX WHITE STARS ON A BLUE BANNER
ALSO OUTLINED IN YELLOW TRIM.

SER. NO. 79-045,885, FILED 10-1-2007.

SHARON MEIER, EXAMINING ATTORNEY

Int. Cls.: 18 and 25

Prior U.S. Cls.: 1, 2, 3, 22, 39 and 41

United States Patent and Trademark Office

Reg. No. 3,520,857

Registered Oct. 21, 2008

**TRADEMARK
PRINCIPAL REGISTER**

CAMPANILE

F.LLI CAMPANILE S.P.A. (ITALY SOCIÉTÉ PAR
ACTIONS)
VIA S. BRIGIDA 39,
I-80132 NAPOLI
ITALY

FOR: LEATHER AND IMITATIONS OF LEATHER, AND GOODS MADE OF THESE MATERIALS, NAMELY, WALLETS, COSMETIC CASES SOLD EMPTY, KEY CHAINS, KEY CASES, BAGS NAMELY, HANDBAGS, SHOULDER BAGS, SHOPPING BAGS, TRAVELLING BAGS, CABIN BAGS, SACKS IN THE NATURE OF HANDBAGS, SHOULDER BAGS AND BACKSIDE BAGS, COIN POUCHES, SUITCASES, BRIEFCASES, BACKPACKS, CLUTCH BAGS, ANTI-THEFT BAGS IN THE NATURE OF TRAVELLING BAGS WITH SECURITY LOCKS, TROLLEY BAGS, CHANGE PURSES, WHIPS, TRUNKS, UMBRELLAS, PARASOLS AND WALKING STICKS, HARNESS AND SADDLERY, IN CLASS 18 (U.S. CLS. 1, 2, 3, 22 AND 41).

FOR: CLOTHING, FOOTWEAR, AND HEADGEAR, NAMELY, UNDERWEAR, LOUNGEWEAR,

SWIMWEAR, SANDALS, BOOTS, SHOES, SLIPPERS, NIGHTGOWNS, PAJAMAS, DRESSING GOWNS, PULLOVERS, TUXEDOS, GLOVES, CARDIGANS, HATS, JERSEYS, NECKWEAR, HEAD WEAR, SWEATERS, SOCKS, STOCKINGS, TIGHTS, TROUSERS, LEGGINGS, SKIRTS, JACKETS, JERKINS, SHIRTS, VESTS, WAISTCOATS, JUMPERS, TRACK SUITS, BLOUSES, JEANS, PANTS, BERMUDA SHORTS, T-SHIRTS, SWEATSHIRTS, SUITS AND DRESSES, OVERCOATS, COATS, ANORAKS, RAINCOATS, BELTS, BRACES, IN CLASS 25 (U.S. CLS. 22 AND 39).

OWNER OF INTERNATIONAL REGISTRATION
0639725 DATED 6-12-1995, EXPIRES 6-12-2015.

OWNER OF U.S. REG. NO. 1,966,851.

SER. NO. 79-045,915, FILED 12-29-2006.

HEATHER THOMPSON, EXAMINING ATTORNEY

Int. Cl.: 3

Prior U.S. Cls.: 1, 4, 6, 50, 51 and 52

Reg. No. 3,520,858

United States Patent and Trademark Office

Registered Oct. 21, 2008

**TRADEMARK
PRINCIPAL REGISTER**

CHOPARD HAPPY SPIRIT

CHOPARD INTERNATIONAL SA (SWITZER-
LAND SOCIÉTÉ ANONYME)
ROUTE DE PROMENTHOUX
CH-1197 PRANGINS
SWITZERLAND

OWNER OF INTERNATIONAL REGISTRATION
0942822 DATED 10-11-2007, EXPIRES 10-11-2017.

FOR: SOAPS FOR PERSONAL USE; PERFUM-
ERY, ESSENTIAL OILS, COSMETICS, LOTIONS
FOR THE HAIR; DENTIFRICES, IN CLASS 3 (U.S.
CLS. 1, 4, 6, 50, 51 AND 52).

OWNER OF U.S. REG. NOS. 1,684,243, 2,687,204,
AND 2,995,851.

THE MARK CONSISTS OF STANDARD CHAR-
ACTERS WITHOUT CLAIM TO ANY PARTICULAR
FONT, STYLE, SIZE, OR COLOR.

THE WORDING "CHOPARD" IN THE MARK
HAS NO TRANSLATION INTO ENGLISH.

PRIORITY DATE OF 4-24-2007 IS CLAIMED.

SER. NO. 79-045,969, FILED 10-11-2007.

MARK PILARO, EXAMINING ATTORNEY

Int. Cls.: 1, 4, 11, 37, 40 and 42

**Prior U.S. Cls.: 1, 5, 6, 10, 13, 15, 21, 23, 26, 31, 34, 46,
100, 101, 103 and 106**

Reg. No. 3,520,859

United States Patent and Trademark Office

Registered Oct. 21, 2008

**TRADEMARK
SERVICE MARK
PRINCIPAL REGISTER**

Lurgi MegaDME

LURGI AG (FED REP GERMANY JOINT-STOCK CORPORATION)
LURGIALLEE 5
60295 FRANKFURT AM MAIN
FED REP GERMANY

FOR: CHEMICAL PRODUCTS FOR COMMERCIAL AND SCIENTIFIC PURPOSES, NAMELY, DIMETHYL ETHER AS FUEL FOR DIESEL ENGINES, AEROSOL PROPELLANT; DIMETHYL ETHER, IN CLASS 1 (U.S. CLS. 1, 5, 6, 10, 26 AND 46).

FOR: COMBUSTIBLES, NAMELY, ENGINE FUEL; GASEOUS FUEL, IN CLASS 4 (U.S. CLS. 1, 6 AND 15).

FOR: APPARATUS, DEVICES AND PLANTS AND THEIR PARTS, FOR GENERATION OF DIMETHYL ETHER OF METHANOL AND TECHNICAL GASSES IN A REACTOR SYSTEM ON INDUSTRIAL SCALE FOR THERMAL PROCESSES, IN CLASS 11 (U.S. CLS. 13, 21, 23, 31 AND 34).

FOR: BUILDING, INSTALLATION, ASSEMBLY AND MAINTENANCE OF INDUSTRIAL PLANTS, IN CLASS 37 (U.S. CLS. 100, 103 AND 106).

FOR: CHEMICAL PROCESSING OF METHANOL INTO DIMETHYL ETHER AND PRODUCTS OF DIMETHYL ETHER IN INDUSTRIAL PLANTS, IN CLASS 40 (U.S. CLS. 100, 103 AND 106).

FOR: RESEARCH AND DEVELOPMENT IN THE FIELD OF PROCESS TECHNOLOGY AND CHEMISTRY, IN PARTICULAR THE FIELD OF DIMETHYL ETHER SYNTHESIS AND ITS DERIVATIVES; ENGINEER SERVICES; TECHNICAL DEVELOP-

MENT, PLANNING, CONSTRUCTION DESIGN, TECHNICAL PROJECTING AND TAKING INTO OPERATION OF PLANTS, DEVICES AND METHODS FOR ANALYSIS AND SYNTHESIS, AND TECHNICAL CONSULTING, IN PARTICULAR IN THE FIELD OF DIMETHYL ETHER SYNTHESIS AND THEIR PRODUCTS; EXECUTION AND EVALUATION OF CHEMICAL ANALYSES; EXECUTION AND EVALUATION OF CHEMICAL SYNTHESSES; ISSUANCE OF TECHNICAL EXPERT OPINIONS IN CONNECTION WITH THE PRODUCTION OF DIMETHYL ETHER, IN CLASS 42 (U.S. CLS. 100 AND 101).

THE MARK CONSISTS OF STANDARD CHARACTERS WITHOUT CLAIM TO ANY PARTICULAR FONT, STYLE, SIZE, OR COLOR.

PRIORITY DATE OF 12-22-2006 IS CLAIMED.

OWNER OF INTERNATIONAL REGISTRATION 0942877 DATED 6-21-2007, EXPIRES 6-21-2017.

OWNER OF U.S. REG. NOS. 670,186, 2,495,786 AND OTHERS.

NO CLAIM IS MADE TO THE EXCLUSIVE RIGHT TO USE "MEGA DME", APART FROM THE MARK AS SHOWN.

SER. NO. 79-045,979, FILED 6-21-2007.

DAVID HOFFMAN, EXAMINING ATTORNEY

Int. Cls.: 30 and 32

Prior U.S. Cls.: 45, 46 and 48

United States Patent and Trademark Office

Reg. No. 3,520,860

Registered Oct. 21, 2008

TRADEMARK
PRINCIPAL REGISTER

*"Make Mine
a Builders"*

ELMWOOD DESIGN LIMITED (UNITED KING-
DOM UK LIMITED COMPANY)

ELMWOOD HOUSE,
GHYLL ROAD; GUISELEY LS20 9LT
UNITED KINGDOM

FOR: COFFEE; TEA; BEVERAGES MADE FROM
TEA; ICED TEA; ICED COFFEE; TEA-BASED BEV-
ERAGES; COFFEE-BASED BEVERAGES; HERBAL
TEA OTHER THAN FOR MEDICAL USE; FRUIT
FLAVOURED TEA; TEA CONTAINING FRUIT EX-
TRACTS; AROMATIC TEA; ARTIFICIAL TEA; AR-
TIFICIAL COFFEE; FLOUR AND PREPARATIONS
MADE FROM CEREALS, NAMELY, BISCUITS,
COOKIES, CONFECTIONERY, BREAD AND PAS-
TRY; ICES, IN CLASS 30 (U.S. CL. 46).

FOR: BEERS; MINERAL AND AERATED WA-
TERS AND OTHER NON-ALCOHOLIC BEVERA-
GES, NAMELY, CARBONATED SOFT DRINKS;
FRUIT DRINKS AND FRUIT JUICES; SYRUPS
AND OTHER PREPARATIONS FOR MAKING BEV-
ERAGES, NAMELY, FRUIT DRINKS, FRUIT COR-
DIAL DRINKS, FRUIT EXTRACT DRINKS,
SYRUPS FOR MAKING CARBONATED SOFT
DRINKS, IN CLASS 32 (U.S. CLS. 45, 46 AND 48).

OWNER OF INTERNATIONAL REGISTRATION
0942989 DATED 9-17-2007, EXPIRES 9-17-2017.

SER. NO. 79-046,017, FILED 9-17-2007.

RONALD AIKENS, EXAMINING ATTORNEY

Int. Cls.: 3 and 18

Prior U.S. Cls.: 1, 2, 3, 4, 6, 22, 41, 50, 51 and 52

United States Patent and Trademark Office

Reg. No. 3,520,861

Registered Oct. 21, 2008

**TRADEMARK
PRINCIPAL REGISTER**



WALDHAUSEN GMBH & CO. KG (FED REP
GERMANY GMBH & CO. KG)
VON HÜNEFELD-STRABE 53
50829 KÖLN
FED REP GERMANY

FOR: COSMETIC PREPARATIONS FOR THE
CARE AND WASHING OF HORSES, NAMELY,
LOTIONS FOR THE MANE AND THE TAIL, SHAM-
POO; LEATHER PRESERVATIVES AS FAR AS IN-
CLUDED IN THIS CLASS, NAMELY, SADDLE SOAP
AND PRESERVING OIL, IN CLASS 3 (U.S. CLS. 1, 4,
6, 50, 51 AND 52).

FOR: HORSE BLANKETS; EXERCISE SHEETS
FOR HORSES, NAMELY, SHEETS FOR SADDLES;
GAITERS, NAMELY, JUMPING BOOTS AS LEG-
GINGS, LEG WRAPPINGS AND BINDINGS FOR
HORSES; JUMPING COVERS FOR HORSES, NAME-
LY, SADDLE COVERS; SADDLES FOR HORSES,
STIRRUPS, STIRRUP STRAPS; HARNESSSES, BRI-
DLES AND BITS FOR BRIDLES; HORSE TACK,

NAMELY, GIRTHS AND BRIDOONS AND CURBS
AS PARTS OF HARNESSSES AND BRIDLES; HAL-
TERS FOR HORSES; RIDING WHIPS AND HORSE
WHIPS, IN CLASS 18 (U.S. CLS. 1, 2, 3, 22 AND 41).

PRIORITY DATE OF 4-4-2007 IS CLAIMED.

OWNER OF INTERNATIONAL REGISTRATION
0943079 DATED 9-24-2007, EXPIRES 9-24-2017.

THE NAME "WALDHAUSEN" DOES NOT IDEN-
TIFY A LIVING INDIVIDUAL.

THE WORDING "WALDHAUSEN" HAS NO
MEANING IN A FOREIGN LANGUAGE.

SER. NO. 79-046,053, FILED 9-24-2007.

WILLIAM ROSSMAN, EXAMINING ATTORNEY

Int. Cls.: 6, 9, 18, 21 and 25

Prior U.S. Cls.: 1, 2, 3, 12, 13, 14, 21, 22, 23, 25, 26, 29, 30, 33, 36, 38, 39, 40, 41 and 50

Reg. No. 3,520,862

United States Patent and Trademark Office

Registered Oct. 21, 2008

**TRADEMARK
PRINCIPAL REGISTER**

AWAtec

WALDHAUSEN GMBH & CO. KG (FED REP
GERMANY GMBH & CO. KG)
VON-HÜNEFELD-STRABE 53
50829 KÖLN
FED REP GERMANY

FOR: SPURS, IN CLASS 6 (U.S. CLS. 2, 12, 13, 14, 23, 25 AND 50).

FOR: EQUESTRIAN RIDING HELMETS, IN CLASS 9 (U.S. CLS. 21, 23, 26, 36 AND 38).

FOR: LEATHER AND IMITATIONS OF LEATHER, AND GOODS MADE OF THESE MATERIALS, AS FAR AS INCLUDED IN THIS CLASS, NAMELY, TRUNKS AND TRAVELING BAGS; UMBRELLAS, PARASOLS AND WALKING STICKS; SADDLES FOR HORSES, STIRRUPS, STIRRUP STRAPS, HARNESSSES AND BRIDLES; HORSE TACK, NAMELY, GIRTHS AND BRIDLEBOONS AND CURBS AS PARTS OF HARNESSSES AND BRIDLES; BITS FOR BRIDLES; HALTERS FOR HORSES; HORSE BLANKETS; EXERCISE SHEETS FOR HORSES, NAMELY, SHEETS FOR SADDLES; GAITERS, NAMELY, JUMPING BOOTS AS LEGGINGS, LEG WRAPPINGS AND BINDINGS FOR HORSES; JUMPING COVERS FOR HORSES, NAMELY, SADDLE COVERS; RIDING WHIPS AND HORSE WHIPS, IN CLASS 18 (U.S. CLS. 1, 2, 3, 22 AND 41).

FOR: BRUSHES, CURRYCOMBS AND COMBS FOR THE MANE OF A HORSE; FABRIC STORING BOXES FOR CLEANING AND GROOMING UTENSILS FOR HORSES, IN CLASS 21 (U.S. CLS. 2, 13, 23, 29, 30, 33, 40 AND 50).

FOR: CLOTHING, ESPECIALLY CLOTHING FOR HORSE RIDING, NAMELY, RIDING BREECHES, RIDING JACKETS, RIDING VESTS, RIDING BLOUSES; RAINCOATS, BAD WEATHER JACKETS AND TROUSERS FOR HORSE RIDING; SHOES AND BOOTS; HEADGEAR, NAMELY, CAPS AND TOP HATS FOR HORSE RIDERS; GLOVES, IN CLASS 25 (U.S. CLS. 22 AND 39).

PRIORITY DATE OF 4-4-2007 IS CLAIMED.

OWNER OF INTERNATIONAL REGISTRATION 0943080 DATED 9-21-2007, EXPIRES 9-21-2017.

SER. NO. 79-046,054, FILED 9-21-2007.

WILLIAM ROSSMAN, EXAMINING ATTORNEY

Int. Cls.: 16 and 40

Prior U.S. Cls.: 2, 5, 22, 23, 29, 37, 38, 50, 100, 103 and 106

United States Patent and Trademark Office

Reg. No. 3,520,863

Registered Oct. 21, 2008

**TRADEMARK
SERVICE MARK
PRINCIPAL REGISTER**

The logo for 'myDekor.' features the word 'my' in a lowercase, cursive script font, followed by 'Dekor.' in a clean, uppercase sans-serif font. A red period is positioned at the end of the word.

TECHNOCELL DEKOR GMBH & CO. KG (FED
REP GERMANY KOMMANDITGESELL-
SCHAFT)

BURG GRETESCH

OSNABRUCK, 49086, FED REP GERMANY

FOR: PAPER FOR THE MANUFACTURE OF
DECORATIVE AND INDUSTRIAL LAMINATES,
RESIN IMPREGNATED RAW PAPER AND PRE-
IMPREGNATED RAW PAPER FOR THE MANU-
FACTURE OF DECORATIVE AND INDUSTRIAL
LAMINATES; PAPER FOR THE FURNITURE IN-
DUSTRY AND DECORATIVE INTERIOR FITTING
OF BUILDINGS, IN CLASS 16 (U.S. CLS. 2, 5, 22, 23,
29, 37, 38 AND 50).

FOR: CONSULTANCY FOR THE FURNITURE
INDUSTRY IN THE FIELD FURTHER PROCES-
SING OF PAPER IN THE MANUFACTURE OF
DECORATIVE AND INDUSTRIAL LAMINATES,
IN CLASS 40 (U.S. CLS. 100, 103 AND 106).

PRIORITY DATE OF 4-12-2007 IS CLAIMED.

OWNER OF INTERNATIONAL REGISTRATION
0943119 DATED 10-10-2007, EXPIRES 10-10-2017.

NO CLAIM IS MADE TO THE EXCLUSIVE
RIGHT TO USE "DECOR", APART FROM THE
MARK AS SHOWN.

THE COLOR(S) RED, BLACK IS/ARE CLAIMED
AS A FEATURE OF THE MARK.

THE MARK CONSISTS OF A STYLIZED LITERAL
ELEMENT, "MY DEKOR", FOLLOWED BY A PER-
IOD. THE COLOR BLACK APPEARS IN THE LIT-
ERAL PORTION OF THE MARK. THE COLOR RED
APPEARS IN THE PERIOD PUNCTUATION.

SER. NO. 79-046,073, FILED 10-10-2007.

LAURIE KAUFMAN, EXAMINING ATTORNEY

Int. Cl.: 7

Prior U.S. Cls.: 13, 19, 21, 23, 31, 34 and 35

United States Patent and Trademark Office

Reg. No. 3,520,864

Registered Oct. 21, 2008

TRADEMARK
PRINCIPAL REGISTER

CORE JET

SAMSUNG ELECTRONICS CO., LTD. (REPUBLIC OF KOREA LIMITED COMPANY)
416, MAETAN-DONG,
YEONGTONG-GU.; SUWON-SI; GYEONGGI-DO
REPUBLIC OF KOREA

FOR: ELECTRIC MIXERS FOR HOUSEHOLD PURPOSES; ELECTRIC FOOD GRINDERS FOR HOUSEHOLD PURPOSES; ELECTRIC FOOD BLENDERS FOR HOUSEHOLD PURPOSES; DISHWASHING MACHINES FOR HOUSEHOLD PURPOSES; WASHING MACHINES FOR HOUSEHOLD PURPOSES; VACUUM CLEANERS; VACUUM CLEANER BAGS, IN CLASS 7 (U.S. CLS. 13, 19, 21, 23, 31, 34 AND 35).

THE MARK CONSISTS OF STANDARD CHARACTERS WITHOUT CLAIM TO ANY PARTICULAR FONT, STYLE, SIZE, OR COLOR.

PRIORITY DATE OF 10-2-2007 IS CLAIMED.

OWNER OF INTERNATIONAL REGISTRATION
0943173 DATED 10-4-2007, EXPIRES 10-4-2017.

NO CLAIM IS MADE TO THE EXCLUSIVE RIGHT TO USE "JET" , APART FROM THE MARK AS SHOWN.

SER. NO. 79-046,092, FILED 10-4-2007.

NAPOLEON SHARMA, EXAMINING ATTORNEY

Int. Cl.: 35

Prior U.S. Cls.: 100, 101 and 102

United States Patent and Trademark Office

Reg. No. 3,520,865

Registered Oct. 21, 2008

**SERVICE MARK
PRINCIPAL REGISTER**



LIDL STIFTUNG & CO. KG (FED REP GERMA-
NY KOMMANDITGESELLSCHAFT)
STIFTSBERGSTR. 1
74167 NECKARSULM
FED REP GERMANY

FOR: RETAIL STORE SERVICES, ONLINE RE-
TAIL STORE SERVICES, AND MAIL ORDER RE-
TAIL SERVICES FEATURING FOODSTUFFS,
ALCOHOLIC BEVERAGES AND TOBACCO
GOODS, SANITARY ARTICLES, WASHING AND
CLEANING PREPARATIONS, COSMETICS, MEDI-
CINES, HOUSEHOLD OR KITCHEN ARTICLES
AND UTENSILS, CROCKERY AND CUTLERY,
OFFICE REQUISITES, CRAFT SUPPLIES, DECORA-
TIVE ARTICLES, STATIONERY REQUISITES AND
SCHOOL SUPPLIES, CLOTHING, FOOTWEAR,
TEXTILE GOODS, IN PARTICULAR HOUSEHOLD
TEXTILES, HABERDASHERY, LEATHERWARE,
TRAVEL ARTICLES, ELECTRONIC CONSUMER
EQUIPMENT AND APPARATUS, COMPUTERS,
TELECOMMUNICATIONS APPARATUS, SPORT-
ING ARTICLES AND TOYS, CONSTRUCTION, DO
IT YOURSELF AND GARDENING REQUISITES,
MACHINES, IN PARTICULAR HOUSEHOLD MA-
CHINES AND UTENSILS, FOODSTUFFS FOR ANI-
MALS AND PET ACCESSORIES, IN CLASS 35 (U.S.
CLS. 100, 101 AND 102).

PRIORITY DATE OF 4-24-2007 IS CLAIMED.

OWNER OF INTERNATIONAL REGISTRATION
0943240 DATED 10-22-2007, EXPIRES 10-22-2017.

OWNER OF U.S. REG. NOS. 3,006,706 AND
3,302,791.

THE COLOR(S) BLUE (PANTONE 286 C), RED
(PANTONE 199 C), YELLOW (PANTONE 3955) IS/
ARE CLAIMED AS A FEATURE OF THE MARK.

THE TRADEMARK CONSISTS OF THE COL-
OURS BLUE (PANTONE 286C), RED (PANTONE
199C), YELLOW (PANTONE 3955); THE COLOURS
ARE ARRANGED NEXT TO ONE ANOTHER IN
THE SEQUENCE BLUE, RED, YELLOW; THE RA-
TIO BETWEEN THE COLOURS IS 32.7%:7.7%:59.6%
(BLUE: RED: YELLOW).

SER. NO. 79-046,117, FILED 10-22-2007.

SHARON MEIER, EXAMINING ATTORNEY

Int. Cl.: 14

Prior U.S. Cls.: 2, 27, 28 and 50

United States Patent and Trademark Office

Reg. No. 3,520,866

Registered Oct. 21, 2008

**TRADEMARK
PRINCIPAL REGISTER**

CARRERA Y CARRERA

CARRERA Y CARRERA, S.A. (SPAIN S.A.)
CARRETERA NACIONAL I,
KM. 31,600; E-28750 SAN AGUSTIN DE GUADALIX
(MADRID)
SPAIN

FOR: JEWELRY WRISTWATCHES AND OTHER
WATCHES MADE WITH PRECIOUS METALS
(GOLD, PLATINUM AND STERLING SILVER)
AND MOUNTED WITH OR WITHOUT PRECIOUS
OR NATURAL STONES, IN CLASS 14 (U.S. CLS. 2, 27,
28 AND 50).

PRIORITY DATE OF 4-27-2007 IS CLAIMED.

OWNER OF INTERNATIONAL REGISTRATION
0943315 DATED 9-3-2007, EXPIRES 9-3-2017.

OWNER OF U.S. REG. NO. 1,247,018.

THE ENGLISH TRANSLATION OF THE WORD
"CARRERA Y CARRERA" IN THE MARK IS RACE
AND RACE.

SER. NO. 79-046,143, FILED 9-3-2007.

STEPHEN AQUILA, EXAMINING ATTORNEY

Int. Cls.: 3, 9, 14 and 18

Prior U.S. Cls.: 1, 2, 3, 4, 6, 21, 22, 23, 26, 27, 28, 36, 38, 41, 50, 51 and 52

Reg. No. 3,520,867

United States Patent and Trademark Office

Registered Oct. 21, 2008

**TRADEMARK
PRINCIPAL REGISTER**



SPORTSWEAR COMPANY S.P.A.; (IN SIGLA SPW S.P.A.) (ITALY JOINT STOCK COMPANY)
GALLERIA CAVOUR, 4
I-40124 BOLOGNA
ITALY

FOR: PERFUMES; TOILET WATER; PERSONAL DEODORANTS; ESSENTIAL OILS FOR PERSONAL USE; BODY LOTIONS; SHOWER GEL; BUBBLE BATH; BATH OILS; BATH PEARLS; SKIN SOAPS; SHAVING BALMS; SHAVING CREAM; AFTER-SHAVE LOTIONS; COSMETIC PENCILS; FOUNDATION MAKE-UP; FACE POWDERS; TALCUM POWDER; ROUGES; LIPSTICKS; MASCARAS; SKIN CLEANSING CREAMS; SKIN CLEANSING LOTIONS; SUN SCREEN PREPARATION; NAIL POLISH; BEAUTY MASKS; FACIAL SCRUBS; FACE CREAMS; BODY CREAMS; HAIR SHAMPOOS; HAIR SPRAYS; HAIR LOTIONS; DENTIFRICES, IN CLASS 3 (U.S. CLS. 1, 4, 6, 50, 51 AND 52).

FOR: EYEGASSES; SUNGLASSES; RIM FOR EYEGASS LENSES, BEING PARTS OF EYEGASS FRAMES; EYEGASS LENSES; EYEGASS FRAMES, IN CLASS 9 (U.S. CLS. 21, 23, 26, 36 AND 38).

FOR: BOXES OF PRECIOUS METAL; PURSES OF PRECIOUS METAL; JEWEL CASES OF PRECIOUS METAL; ORNAMENTAL PINS; JEWELRY ARTICLES, NAMELY, BROOCHES, NECKLACES, BRA-

CELETS, CHAINS, TIE CLIPS, RINGS, MEDALLIONS, EARRINGS, PENDANTS, DIADEMS, CUFF LINKS; WATCHES; CLOCKS; CHRONOMETERS; CLOCK CASES; WRISTWATCHES; ALARM CLOCKS; WATCH STRAPS; WATCH BANDS; WATCH CHAINS; WATCH GLASSES; WATCH SPRINGS, IN CLASS 14 (U.S. CLS. 2, 27, 28 AND 50).

FOR: HANDBAGS; LUGGAGE; SHOULDER BAGS; BEACH BAGS; CLUTCH BAGS; ALL PURPOSE SPORTS BAGS; ATTACHE CASES; SCHOOL BAGS; TOTE BAGS; TRAVELING BAGS; CASES OF LEATHER OR IMITATION LEATHER; CREDIT CARD CASES OF LEATHER OR IMITATION LEATHER; DOCUMENTS BRIEFCASES OF LEATHER OR IMITATION LEATHER; COSMETIC CASES SOLD EMPTY; KEYCASES; KNAPSACKS; RUCKSACKS; BRIEFCASES; PURSES; WALLETS; TRAVELING TRUNKS; SUITCASES; UMBRELLAS; PARASOLS; WALKING STICKS, IN CLASS 18 (U.S. CLS. 1, 2, 3, 22 AND 41).

OWNER OF INTERNATIONAL REGISTRATION
0510222 DATED 2-13-1987, EXPIRES 2-13-2017.

SER. NO. 79-046,183, FILED 5-21-2007.

STEPHANIE ALI, EXAMINING ATTORNEY

Int. Cls.: 6 and 11

Prior U.S. Cls.: 2, 12, 13, 14, 21, 23, 25, 31, 34 and 50

United States Patent and Trademark Office

Reg. No. 3,520,868

Registered Oct. 21, 2008

**TRADEMARK
PRINCIPAL REGISTER**



FAR RUBINETTERIE S.P.A. (ITALY JOINT STOCK COMPANY)
VIA MORENA, 20
I-28024 GOZZANO (NO)
ITALY

FOR: MANIFOLDS OF METAL FOR PIPELINES; METAL PLUGS FOR PIPING, IN CLASS 6 (U.S. CLS. 2, 12, 13, 14, 23, 25 AND 50).

FOR: HEATING AND PLUMBING COMPONENTS, NAMELY, VALVES FOR RADIATORS, PIPE CONNECTORS, STRAINERS FOR HYDRO-SANITARY PLANTS; CONTROL UNIT FOR HYDRO-SANITARY PLANTS WITH MOTORIZED BALL VALVES; PRESSURE REDUCING VALVES FOR PLUMBING AND HYDRO-SANITARY FOR PLUMBING AND HYDRO-SANITARY PLANTS; SAFETY VALVES FOR HEATING PLANTS; AIR VENTING VALVES FOR RADIATORS AND HEAT-

ING PLANTS; THERMOSTATIC MIXING VALVES; WATER-FILLING VALVE UNITS FOR HEATING PLANTS, IN CLASS 11 (U.S. CLS. 13, 21, 23, 31 AND 34).

OWNER OF INTERNATIONAL REGISTRATION 0943453 DATED 6-23-2006, EXPIRES 6-23-2016.

THE MARK CONSISTS OF THE WORD "FAR" IN STYLIZED CAPITAL LETTERS SLIGHTLY INCLINED; EACH LETTER IS ENCLOSED IN A PARALLELOGRAM INCLINED IN THE SAME ANGLE; ALL OF WHICH ARE FRAMED INSIDE A PARALLELOGRAM INCLINED IN THE SAME ANGLE.

SER. NO. 79-046,234, FILED 6-23-2006.

FRANK LATTUCA, EXAMINING ATTORNEY

Int. Cl.: 36

Prior U.S. Cls.: 100, 101 and 102

United States Patent and Trademark Office

Reg. No. 3,520,869

Registered Oct. 21, 2008

**SERVICE MARK
PRINCIPAL REGISTER**



MEZHREGIONALNY KOMMERCHESKY BANK;
RAZVITIA SVYAZI I INFORMATIKI; (OTKRI-
TOE AKTSIONERNOE OBSHCHESTVO); (OAO
AKB "SVYAZ-BANK" (RUSSIAN FED. COR-
PORATION)
TVERSKAYA UL., 7
RU-125375 MOSCOW
RUSSIAN FED.

FOR: CREDIT BUREAUS; FINANCIAL ANALY-
SIS; HIRE-PURCHASE FINANCING; SAVINGS
BANKS; ISSUANCE OF CREDIT CARDS; ISSUE OF
TOKENS OF VALUE; CAPITAL INVESTMENTS;
PROVIDING BANK ACCOUNT INSURANCE IN-
FORMATION; PROVIDING FINANCIAL INFOR-
MATION; FINANCIAL CLEARING HOUSES;
FINANCIAL CONSULTANCY; STOCK EXCHANGE
QUOTATIONS; FINANCIAL BUSINESS LIQUIDA-
TION SERVICES; FINANCIAL MANAGEMENT; EX-
CHANGING MONEY; DEBIT CARD SERVICES;
CREDIT CARD SERVICES; HOME BANKING; FAC-
TORING AGENCIES; ORGANIZATION OF COL-
LECTIONS OF DEBT; FINANCIAL EVALUATION
FOR BANKING PURPOSES; ELECTRONIC FUNDS
TRANSFER; FINANCIAL GUARANTEE AND SUR-
ETY; FINANCING LOANS; MONEY, CONSUMER,

REAL ESTATE, COMMERCIAL LENDING
AGAINST SECURITY; CHECK VERIFICATION; FI-
NANCIAL SPONSORSHIP OF SHOW-BUSINESS
EVENTS, SPORTING EVENTS, CONFERENCES
AND CONGRESSES IN THE BANKING INDUSTRY;
MORTGAGE BANKING; INSTALLMENT LOANS;
BANKING; RETIREMENT PAYMENT SERVICES;
BROKERAGE, DISTRIBUTION AND INVESTMENT
IN MUTUAL FUNDS; FINANCING SERVICES;
SAFE DEPOSIT BOX SERVICES; FISCAL ASSES-
MENTS, IN CLASS 36 (U.S. CLS. 100, 101 AND 102).

PRIORITY DATE OF 7-13-2006 IS CLAIMED.

OWNER OF INTERNATIONAL REGISTRATION
0943517 DATED 1-12-2007, EXPIRES 1-12-2017.

THE ENGLISH TRANSLATION OF THE FOR-
EIGN WORD(S) IN THE MARK IS: "NEAR BY".

SER. NO. 79-046,254, FILED 1-12-2007.

FRANK LATTUCA, EXAMINING ATTORNEY

Int. Cls.: 16, 25, 29, 30, 35 and 41

Prior U.S. Cls.: 2, 5, 22, 23, 29, 37, 38, 39, 46, 50, 100, 101, 102 and 107

Reg. No. 3,520,870

United States Patent and Trademark Office

Registered Oct. 21, 2008

**TRADEMARK
SERVICE MARK
PRINCIPAL REGISTER**

DAIRY GOOD FOR LIFE!

DAIRY AUSTRALIA LIMITED (AUSTRALIA COMPANY)

LEVEL 5, IBM TOWER

60 CITY ROAD; SOUTHBANK VIC 3006

AUSTRALIA

FOR: PAPER, CARDBOARD AND GOODS MADE FROM THESE MATERIALS, NAMELY, PAPER BAGS AND PAPER BANNERS; PRINTED PUBLICATIONS AND PROMOTIONAL MATERIALS, NAMELY, BROCHURES, LEAFLETS, BOOKLETS, PAMPHLETS, FLIERS, AND GUIDES, ALL IN THE FIELD OF HEALTH ISSUES, NUTRITIONAL ISSUES, THE DAIRY INDUSTRY, FOOD INDUSTRIES, DAIRY, AND DAIRY PRODUCTS; POSTERS; PRINTED CHARTS; PRINTED INSTRUCTIONAL TEACHING AND EDUCATIONAL MATERIALS IN THE FIELD OF HEALTH ISSUES, NUTRITIONAL ISSUES, THE DAIRY INDUSTRY, FOOD INDUSTRIES, DAIRY, AND DAIRY PRODUCTS, IN CLASS 16 (U.S. CLS. 2, 5, 22, 23, 29, 37, 38 AND 50).

FOR: CLOTHING, NAMELY, T-SHIRTS; HEADGEAR, NAMELY, HATS, CAPS, BASEBALL CAPS, BEANIES, VISORS, EARMUFFS, WOOLY HATS, SKULLCAPS, NIGHTCAPS, HEAD SCARVES, SWIM CAPS, HEADBANDS, AND HEAD SWEATBANDS, IN CLASS 25 (U.S. CLS. 22 AND 39).

FOR: MILK AND MILK PRODUCTS, NAMELY, YOGURT, CHEESE, BUTTER, AND DAIRY DESSERTS, NAMELY, CREAM DESSERTS, NAMELY, CREAM FRAICHE, DAIRY PRODUCTS EXCLUDING ICE CREAM, ICE MILK AND FROZEN YOGURT; DESSERTS MADE FROM MILK, NAMELY, WHIPPED CREAM, DAIRY BASED WHIPPED TOPPING, DAIRY-BASED BEVERAGES, DESSERTS MADE FROM MILK PRODUCTS, NAMELY, WHIPPED CREAM; DAIRY-BASED CHOCOLATE FOOD BEVERAGES; YOGURT-BASED BEVERAGES, MILK-BASED INSTANT DESSERTS, NAMELY, CHOCOLATE MILK AND MILK-BASED PREPARED DESSERTS, NAMELY, WHIPPED CREAM;

MILK FORTIFIED WITH IRON; MILK FORTIFIED WITH CALCIUM, IN CLASS 29 (U.S. CL. 46).

FOR: ICE CREAM, YOGURT ICE CREAM; DESSERTS BEING FROZEN DESSERTS, NAMELY, FROZEN CONFECTIONS, FROZEN CUSTARDS, FROZEN YOGURT, ICE CREAM SANDWICHES, ICE CREAM DRINKS, ICE MILK, GELATO; ICE CREAM DESSERTS, NAMELY, FROZEN CONFECTIONS, MILK SHAKES, ICE CREAM DRINKS, ICE CREAM SANDWICHES; DESSERT MOUSSE; AND CHOCOLATE-BASED PREPARED DESSERTS, NAMELY, TRUFFLES, FONDUE, SOUFFLÉS, PUDDINGS, GELATO, BROWNIES, BONBONS, IN CLASS 30 (U.S. CL. 46).

FOR: ADVERTISING, MARKETING AND PROMOTION SERVICES; PUBLICATION OF PUBLICITY, ADVERTISING, MARKETING AND PROMOTIONAL TEXT; DISSEMINATION OF ADVERTISING MATTER; RENTAL OF ADVERTISING SPACE AND OF PUBLICITY MATERIAL; BILL-POSTING SERVICES; DEMONSTRATION OF PRODUCTS; DISTRIBUTION OF SAMPLES; MARKETING RESEARCH AND STUDIES; ORGANIZATION OF EXHIBITIONS FOR COMMERCIAL OR ADVERTISING PURPOSES; OUTDOOR ADVERTISING, NAMELY, PREPARING AND PLACING OUTDOOR ADVERTISEMENTS FOR OTHERS; ELECTRONIC MEDIA ADVERTISING, NAMELY, PRODUCTION AND DISTRIBUTION OF RADIO AND TELEVISION ADVERTISING AND COMMERCIALS; ONLINE MARKETING AND ADVERTISING SERVICES; ONLINE PUBLICATION OF ADVERTISING MATERIAL, IN CLASS 35 (U.S. CLS. 100, 101 AND 102).

FOR: EDUCATIONAL SERVICES, NAMELY, PROVIDING TRAINING IN THE FIELD OF HEALTH AND NUTRITIONAL ISSUES AND PROVISION OF EDUCATIONAL MATERIALS THEREWITH; EDUCATIONAL SERVICES, NAMELY, PROVIDING TRAINING IN THE FIELD OF DAIRY AND FOOD INDUSTRIES AND PROVISION OF EDUCATIONAL MATERIALS THEREWITH; EDUCATIONAL SERVICES, NAMELY, PROVIDING

LECTURES AND PRESENTATIONS TO SCHOOLS, MEDIA, HEALTH AND SPORTING PERSONNEL AND TO SCHOOL, MEDIA, HEALTH, SPORTING AND COMMUNITY ORGANIZATIONS IN THE FIELD OF DAIRY AND DAIRY PRODUCTS AND PROVISION OF EDUCATIONAL MATERIALS THEREWITH; ENTERTAINMENT SERVICES, NAMELY, CONDUCTING PARTIES, CONDUCTING CONTESTS; SPORTING AND CULTURAL ACTIVITIES, NAMELY, ORGANIZING COMMUNITY SPORTING AND CULTURAL EVENTS; ARRANGING AND CONDUCTING SEMINARS AND EXHIBITIONS IN THE FIELD OF HEALTH ISSUES, NUTRITIONAL ISSUES, THE DAIRY INDUSTRY, FOOD INDUSTRIES, DAIRY, AND DAIRY PRODUCTS; ENTERTAINMENT SERVICES, NAMELY, CONDUCTING FAIRS; AND PROVIDING RECOGNITION AND INCENTIVES BY THE WAY OF

AWARD CEREMONIES DESIGNED TO DEMONSTRATE EXCELLENCE IN THE FIELD OF HEALTH ISSUES, NUTRITIONAL ISSUES, THE DAIRY INDUSTRY, FOOD INDUSTRIES, DAIRY, AND DAIRY PRODUCTS; PUBLICATION OF BOOKS, IN CLASS 41 (U.S. CLS. 100, 101 AND 107).

THE MARK CONSISTS OF STANDARD CHARACTERS WITHOUT CLAIM TO ANY PARTICULAR FONT, STYLE, SIZE, OR COLOR.

OWNER OF INTERNATIONAL REGISTRATION 0943523 DATED 6-5-2007, EXPIRES 6-5-2017.

SER. NO. 79-046,259, FILED 6-5-2007.

RICHARD WHITE, EXAMINING ATTORNEY

Int. Cl.: 9

Prior U.S. Cls.: 21, 23, 26, 36 and 38

Reg. No. 3,520,871

United States Patent and Trademark Office

Registered Oct. 21, 2008

TRADEMARK
PRINCIPAL REGISTER



OPTION, NAAMLOZE VENNOOTSCHAP (BELGIUM JOINT STOCK COMPANY)
GASTON GEENSLAAN 14
B-3001 LEUVEN (HEVERLEE)
BELGIUM

FOR: TELECOMMUNICATION INSTRUMENTS AND APPARATUS, PERIPHERAL APPARATUS AND PARTS THEREFOR, NAMELY, ELECTRONIC CARDS FOR RECORDAL, PROCESSING AND TRANSMITTING DATA AND IMAGES; COMPUTERS, DATA PROCESSING EQUIPMENT, NAMELY, PERSONAL COMPUTER MEMORY CARDS SUCH AS PCMCIA AND PCI EXPRESS CARDS WHICH CAN BE USED FOR WIRELESS CONNECTIVITY, MODEM AND OTHER FUNCTIONS IN LAPTOPS AND NOTEBOOK PERSONAL COMPUTERS, PERSONAL DIGITAL ASSISTANTS (PDA'S), MOBILE INTERNET DEVICES (MID), ULTRA-MOBILE PERSONAL COMPUTERS (UMPC'S), SMART PHONES, SEMICONDUCTOR COMPONENTS, COMPUTER PERIPHERAL APPARATUS AND PARTS THEREFOR; COMPUTER PROGRAMS IN PARTICULAR AN INTERFACE WHICH ENABLES THE INTEGRATION OF MOBILE TELEPHONE SERVICES WITH OTHER SYSTEMS SUCH AS LAP-

TOPS, MOBILE TELEPHONES AND THE LIKE AND TELEPHONES AND FAX MACHINES; APPARATUS FOR REPRODUCTION, TRANSMISSION OR RECORDING OF SOUND, IMAGES AND DATA; TELEPHONE AND FAX APPARATUS AND MACHINES AND PARTS THEREFOR; INSTRUMENTS AND APPARATUS FOR DATA COMMUNICATION, PERIPHERAL APPARATUS, AND PARTS THEREFOR, NAMELY, HEADPHONES, ANTENNAS, MEASURING AND TESTING EQUIPMENT, EXTENSION CRADLES, IN CLASS 9 (U.S. CLS. 21, 23, 26, 36 AND 38).

PRIORITY DATE OF 3-20-2007 IS CLAIMED.

OWNER OF INTERNATIONAL REGISTRATION
0943622 DATED 9-12-2007, EXPIRES 9-12-2017.

OWNER OF U.S. REG. NO. 2,452,286.

SER. NO. 79-046,292, FILED 9-12-2007.

PAM WILLIS, EXAMINING ATTORNEY

Int. Cls.: 29, 30 and 32

Prior U.S. Cls.: 45, 46 and 48

United States Patent and Trademark Office

Reg. No. 3,520,872

Registered Oct. 21, 2008

**TRADEMARK
PRINCIPAL REGISTER**

PATAYA

LIDL STIFTUNG & CO. KG (FED REP GERMA-
NY KOMMANDITGESELLSCHAFT)
STIFTSBERGSTR. 1
74167 NECKARSULM
FED REP GERMANY

FOR: MILK DRINKS CONTAINING FRUITS, IN
CLASS 29 (U.S. CL. 46).

FOR: ICED TEA, ICED TEA WITH ADDED
FRUITS, ICED TEA DRINKS , IN CLASS 30 (U.S.
CL. 46).

FOR: NON-ALCOHOLIC BEVERAGES, NAMELY,
FRUIT BASED SOFT DRINKS FLAVORED WITH
TEA, FRUIT JUICES, FRUIT CORDIALS, MIXED
FRUIT JUICE DRINKS, VEGETABLE JUICES, VE-
GETABLE JUICE BEVERAGES, MIXED VEGETA-

BLE JUICE DRINKS, LEMONADES, WHEY
DRINKS, MINERAL AND AERATED WATERS,
SYRUPS FOR MAKING BEVERAGES, PREPARA-
TIONS FOR MAKING BEVERAGES, NAMELY,
FRUIT DRINKS, IN CLASS 32 (U.S. CLS. 45, 46
AND 48).

PRIORITY DATE OF 4-24-2007 IS CLAIMED.

OWNER OF INTERNATIONAL REGISTRATION
0943677 DATED 10-23-2007, EXPIRES 10-23-2017.

SER. NO. 79-046,314, FILED 10-23-2007.

SHARON MEIER, EXAMINING ATTORNEY

Int. Cl.: 41

Prior U.S. Cls.: 100, 101 and 107

United States Patent and Trademark Office

Reg. No. 3,520,873

Registered Oct. 21, 2008

**SERVICE MARK
PRINCIPAL REGISTER**

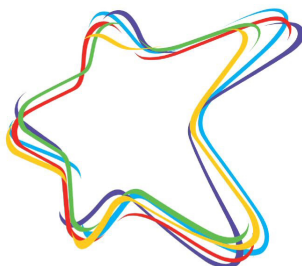

**World City Expo 2009
Incheon, Korea**

INCHEON EXPO FOUNDATION (REPUBLIC OF
KOREA CORPORATION)
1138, GUWALL-DONG, NAMDONG-GU
INCHEON
REPUBLIC OF KOREA

FOR: ORGANIZATION OF EXHIBITIONS FOR CULTURAL OR EDUCATIONAL PURPOSES; ARRANGING AND CONDUCTING OF COLLOQUIUMS IN THE FIELD OF URBAN PLANNING AND DEVELOPMENT, CITY PLANNING, REAL ESTATE PLANNING AND DEVELOPMENT; ARRANGING AND CONDUCTING OF EDUCATIONAL CONFERENCES; ARRANGING AND CONDUCTING OF EDUCATIONAL CONGRESSES; ARRANGING AND CONDUCTING OF SYMPOSIA IN THE FIELD OF URBAN PLANNING AND DEVELOPMENT, CITY PLANNING, REAL ESTATE PLANNING AND DEVELOPMENT; ARRANGING AND CONDUCTING OF WORKSHOPS IN THE FIELD OF URBAN PLANNING AND DEVELOPMENT, CITY PLANNING, REAL ESTATE PLANNING AND DEVELOPMENT; ORGANIZATION OF EXHIBITIONS FOR CULTURAL PURPOSES; ORGANIZATION OF EXHIBITIONS FOR EDUCATIONAL PURPOSES; PRODUCTION OF TELEVISION AND RADIO SHOWS, IN CLASS 41 (U.S. CLS. 100, 101 AND 107).

PRIORITY DATE OF 8-20-2007 IS CLAIMED.

OWNER OF INTERNATIONAL REGISTRATION
0943736 DATED 8-22-2007, EXPIRES 8-22-2017.

NO CLAIM IS MADE TO THE EXCLUSIVE RIGHT TO USE "WORLD CITY EXPO 2009 INCHEON, KOREA", APART FROM THE MARK AS SHOWN.

"THE COLOR(S) BLACK, WHITE, RED, YELLOW, GREEN, BLUE AND PURPLE IS/ARE CLAIMED AS A FEATURE OF THE MARK."

THE COLOR BLACK APPEARS IN THE WORDING "WORLD CITY EXPO 2009 INCHEON, KOREA"; THE COLOR WHITE APPEARS ON THE MARK BACKGROUND; THE COLORS RED, YELLOW, GREEN, BLUE AND PURPLE APPEAR ON THE STAR DESIGN ELEMENT.

SER. NO. 79-046,334, FILED 8-22-2007.

KAELIE KUNG, EXAMINING ATTORNEY

Int. Cls.: 7 and 28

Prior U.S. Cls.: 13, 19, 21, 22, 23, 31, 34, 35, 38 and 50

United States Patent and Trademark Office

Reg. No. 3,520,874

Registered Oct. 21, 2008

**TRADEMARK
PRINCIPAL REGISTER**

ConveyXonic

HUTCHINSON SA (FRANCE SOCIETE ANON-
YME)
2 RUE BALZAC
F-75008 PARIS
FRANCE

FOR: DRIVE BELTS FOR ENGINES OTHER
THAN ENGINES FOR LAND VEHICLES, IN CLASS
7 (U.S. CLS. 13, 19, 21, 23, 31, 34 AND 35).

FOR: BELTS USED FOR PHYSICAL TRAINING
APPARATUS AND ARTICLES, BODY-BUILDING
APPARATUS AND MACHINES FOR PHYSICAL
EXERCISES, NAMELY, BELTS FOR FITNESS CY-

CLES, TREADMILLS, AND ROWING MACHINES,
IN CLASS 28 (U.S. CLS. 22, 23, 38 AND 50).

PRIORITY DATE OF 5-3-2007 IS CLAIMED.

OWNER OF INTERNATIONAL REGISTRATION
0943803 DATED 10-12-2007, EXPIRES 10-12-2017.

SER. NO. 79-046,372, FILED 10-12-2007.

MATTHEW MCDOWELL, EXAMINING ATTOR-
NEY

Int. Cls.: 10, 20 and 44

Prior U.S. Cls.: 2, 13, 22, 25, 26, 32, 39, 44, 50, 100 and 101

United States Patent and Trademark Office

Reg. No. 3,520,875

Registered Oct. 21, 2008

**TRADEMARK
SERVICE MARK
PRINCIPAL REGISTER**

ISURO

OPED GMBH (FED REP GERMANY LIMITED
LIABILITY COMPANY)
MÜHLBACHWEG 2
83626 VALLEY
FED REP GERMANY

FOR: ARTIFICIAL LIMBS, EYES AND TEETH;
SUTURE MATERIAL; MATTRESSES FOR MEDICAL
PURPOSES AND PARTS THEREOF; BEDS FOR
MEDICAL PURPOSES, IN CLASS 10 (U.S. CLS. 26, 39
AND 44).

FOR: FURNITURE, MIRRORS, PICTURE
FRAMES; MATTRESSES, NOT FOR MEDICAL PUR-
POSES, AND PARTS THEREOF; BEDS, IN CLASS 20
(U.S. CLS. 2, 13, 22, 25, 32 AND 50).

FOR: MEDICAL SERVICES; VETERINARY SER-
VICES; HYGIENIC AND BEAUTY CARE FOR HU-
MAN BEINGS OR ANIMALS; SERVICES FOR

MEDICAL CARE, NAMELY, NURSING SERVICES;
MEDICAL CARE COUNSELING, IN CLASS 44 (U.S.
CLS. 100 AND 101).

THE MARK CONSISTS OF STANDARD CHAR-
ACTERS WITHOUT CLAIM TO ANY PARTICULAR
FONT, STYLE, SIZE, OR COLOR.

PRIORITY DATE OF 4-3-2007 IS CLAIMED.

OWNER OF INTERNATIONAL REGISTRATION
0943815 DATED 10-2-2007, EXPIRES 10-2-2017.

SER. NO. 79-046,379, FILED 10-2-2007.

ALLISON HOLTZ, EXAMINING ATTORNEY

Int. Cl.: 36

Prior U.S. Cls.: 100, 101 and 102

United States Patent and Trademark Office

Reg. No. 3,520,876

Registered Oct. 21, 2008

**SERVICE MARK
PRINCIPAL REGISTER**



THE DAI-ICHI MUTUAL LIFE INSURANCE
COMPANY (JAPAN CORPORATION)
13-1, YURAKUCHO 1-CHOME CHIYODA-KU
TOKYO, JAPAN 1000006

FOR: LOANS; DISCOUNT OF BILLS; ACQUISITION AND TRANSFER OF MONETARY CLAIMS; FOREIGN EXCHANGE TRANSACTIONS; PROVIDING STOCK MARKET INFORMATION; EVALUATION OF THE CREDIT WORTHINESS OF COMPANIES; PROVIDING INFORMATION ON PERSONAL PENSION INSURANCE; PROVIDING INFORMATION ON LIFE INSURANCE; PROVIDING INFORMATION IN INSURANCE MATTERS, OTHER THAN LIFE INSURANCE; REINSURANCE UNDERWRITING; FINANCIAL RESEARCH AND PROVIDING INFORMATION ON FINANCE AND SECURITIES MARKET, IN CLASS 36 (U.S. CLS. 100, 101 AND 102).

PRIORITY DATE OF 2-7-2007 IS CLAIMED.

OWNER OF INTERNATIONAL REGISTRATION
0943857 DATED 4-19-2007, EXPIRES 4-19-2017.

OWNER OF U.S. REG. NO. 1,740,165.

NO CLAIM IS MADE TO THE EXCLUSIVE RIGHT TO USE "LIFE", APART FROM THE MARK AS SHOWN.

THE COLOR(S) RED AND WHITE IS/ARE CLAIMED AS A FEATURE OF THE MARK.

THE COLOR WHITE APPEARS IN THE WORDING "DAI-ICHI LIFE" AND THE COLOR RED APPEARS IN THE CURVED POLYGON DESIGN.

THE ENGLISH TRANSLATION OF THE WORD "DAI-ICHI" IN THE MARK IS FIRST.

SER. NO. 79-046,390, FILED 4-19-2007.

LAURA HAMMEL, EXAMINING ATTORNEY

Int. Cls.: 29, 30 and 32

Prior U.S. Cls.: 45, 46 and 48

Reg. No. 3,520,877

United States Patent and Trademark Office

Registered Oct. 21, 2008

TRADEMARK
PRINCIPAL REGISTER

NESFRAPPE

SOCIÉTÉ DES PRODUITS NESTLÉ S.A. (SWITZERLAND CORPORATION)
CH-1800 VEVEY
SWITZERLAND

FOR: PRESERVED, FROZEN, DRIED AND COOKED VEGETABLES, POTATOES AND FRUITS, PRESERVED, DRIED AND COOKED MUSHROOMS; MEAT, POULTRY, GAME, FISH, AND SEAFOOD; MEAT EXTRACTS; JAMS; EGGS; MILK; CREAM; BUTTER; CHEESE; MILK PRODUCTS, NAMELY, HALF AND HALF, MILK PROTEINS AND MILK BEVERAGES WITH HIGH MILK CONTENT; YOGURT; SOY MILK, PRESERVED SOYBEANS FOR HUMAN CONSUMPTION; EDIBLE OILS AND FATS; NON-DAIRY CREAMER; SAUSAGES; CHARCUTERIE; PEANUT BUTTER; SOUPS, CONCENTRATED SOUPS, THICK SOUPS, BOUILLON CUBES; BOUILLONS; AND CLEAR SOUPS, IN CLASS 29 (U.S. CL. 46).

FOR: COFFEE, COFFEE EXTRACTS, COFFEE-BASED BEVERAGES; ICED COFFEE; ARTIFICIAL COFFEE, ARTIFICIAL COFFEE EXTRACTS, BEVERAGES MADE FROM ARTIFICIAL COFFEE; CHICORY; TEA, TEA EXTRACTS, TEA-BASED BEVERAGES; ICED TEA; MALT FOR FOOD PURPOSES; COCOA; COCOA-BASED BEVERAGES; CHOCOLATE; CHOCOLATE-BASED BEVERAGES; CANDY, NAMELY, CONFECTIONERY, SUGAR CONFECTIONERY, AND SWEETS; SUGAR; CHEWING GUM NOT FOR MEDICAL PURPOSES; NATURAL SWEETENERS; BAKERY PRODUCTS; BREAD; YEAST; PASTRIES; BISCUITS; CAKES; COOKIES; WAFERS; CARAMELS; PUDDINGS; ICES; WATER ICES; SORBETS; ICE CONFECTIONERIES; ICED

CAKES; ICE CREAMS; ICE DESSERTS; FROZEN YOGURT; HONEY AND HONEY SUBSTITUTES; BREAKFAST CEREALS; MUESLI; CORN-FLAKES; RICE; PASTA; NOODLES; PIZZAS; SANDWICHES; SAUCES; SOY SAUCE; KETCHUP; PRODUCTS FOR FLAVOURING OR SEASONING FOODSTUFFS; EDIBLE SPICES; SALAD DRESSINGS; MAYONNAISE, MUSTARD AND VINEGAR, IN CLASS 30 (U.S. CL. 46).

FOR: BEER; STILL WATER; SPARKLING AND AERATED WATER; MINERAL WATER; FLAVOURED WATER; FRUIT-FLAVOURED BEVERAGES AND BEVERAGES MADE WITH FRUIT; FRUIT JUICES AND VEGETABLE JUICES; LEMONADES; SOFT DRINKS; CONCENTRATES AND POWDERS FOR MAKING SOFT DRINKS; ISOTONIC BEVERAGES, IN CLASS 32 (U.S. CLS. 45, 46 AND 48).

THE MARK CONSISTS OF STANDARD CHARACTERS WITHOUT CLAIM TO ANY PARTICULAR FONT, STYLE, SIZE, OR COLOR.

PRIORITY DATE OF 6-4-2007 IS CLAIMED.

OWNER OF INTERNATIONAL REGISTRATION 0943932 DATED 10-23-2007, EXPIRES 10-23-2017.

SER. NO. 79-046,413, FILED 10-23-2007.

PATRICIA EVANKO, EXAMINING ATTORNEY

Int. Cl.: 3

Prior U.S. Cls.: 1, 4, 6, 50, 51 and 52

United States Patent and Trademark Office

Reg. No. 3,520,878

Registered Oct. 21, 2008

**TRADEMARK
PRINCIPAL REGISTER**

RADICALLY NO SURGETICS

PARFUMS GIVENCHY S.A. (FRANCE SOCIÉTÉ
ANONYME)
77 RUE ANATOLE FRANCE
LEVALLOIS-PERRET, FRANCE F92300

OWNER OF U.S. REG. NO. 2,853,424.

FOR: ANTI-WRINKLE COSMETICS, IN CLASS 3
(U.S. CLS. 1, 4, 6, 50, 51 AND 52).

THE WORDING IN THE MARK HAS NO MEAN-
ING IN A FOREIGN LANGUAGE.

PRIORITY DATE OF 5-14-2007 IS CLAIMED.

SER. NO. 79-046,451, FILED 10-19-2007.

OWNER OF INTERNATIONAL REGISTRATION
0944010 DATED 10-19-2007, EXPIRES 10-19-2017.

JAMES STEIN, EXAMINING ATTORNEY

Int. Cls.: 6, 9 and 35

**Prior U.S. Cls.: 2, 12, 13, 14, 21, 23, 25, 26, 36, 38, 50,
100, 101 and 102**

Reg. No. 3,520,879

United States Patent and Trademark Office

Registered Oct. 21, 2008

**TRADEMARK
SERVICE MARK
PRINCIPAL REGISTER**



GESELLSCHAFT FÜR WOLFRAM INDUSTRIE
MBH (FED REP GERMANY GESELLSCHAFT
MIT BESCHRÄNKTER HAFTUNG (GMBH))
PERMANEDERSTRASSE 34
83278 TRAUNSTEIN
FED REP GERMANY

WELDING NOZZLES BEING PARTS OF ELECTRIC
WELDING APPARATUS; ELECTRIC WIRES;
TUNGSTEN ELECTRIC EVAPORATION COILS
AND CRUCIBLES USED FOR ELECTRIC ARC
WELDING APPARATUS, IN CLASS 9 (U.S. CLS. 21,
23, 26, 36 AND 38).

FOR: COMMON METALS AND THEIR ALLOYS,
NAMELY, IRON, STEEL, ALUMINUM, COPPER
AND NICKEL AND ALLOYS THEREOF; TUNG-
STEN, MOLYBDENUM, ALLOYS OF TUNGSTEN
OR MOLYBDENUM; GOODS OF COMMON MET-
AL, NAMELY, WIRE; GOODS OF TUNGSTEN OR
MOLYBDENUM, NAMELY, WIRE AND CRUCI-
BLES; MOLYBDENUM BONDED WITH OTHER
METALS IN THE FORM OF SHEETS, PLATES
AND FOILS FOR FURTHER MANUFACTURE;
METAL POWDER FOR MAKING ELECTRODES
AND HEAT SINKS; RODS OF METAL FOR BRAZ-
ING AND WELDING, IN CLASS 6 (U.S. CLS. 2, 12, 13,
14, 23, 25 AND 50).

FOR: WELDING ELECTRODES, ARC ELECTRO-
DES, ELECTRODES FOR DISCHARGE LAMPS,
LAMP ELECTRODES, ELECTRODES FOR APPLY-
ING COATINGS, ELECTRODES FOR INJECTION
PLASMA PROCESSES; HEAT SINKS FOR ELEC-
TRODES; ELECTRODE MATERIAL, NAMELY,
ELECTRODES MADE OF TUNGSTEN AND MO-
LYBDENUM AND ALLOYS THEREOF; PIPE

FOR: ADVERTISING SERVICES; UPDATING OF
ADVERTISING MATERIAL; ADVERTISING CON-
SULTANCY, ADVERTISING SERVICES, NAMELY,
PROVIDING ADVERTISING SPACE IN PERIODI-
CALS, BROCHURES AND NEWSPAPERS; PRO-
MOTING THE SALE OF GOODS AND SERVICES
OF OTHERS THROUGH DISTRIBUTION OF
GOODS, NAMELY, PRINTED MATERIAL AND
PROMOTIONAL CONTESTS FOR ADVERTISING
PURPOSES; ONLINE ADVERTISING IN A COM-
PUTER NETWORK; MARKETING SERVICES; AR-
RANGING, NAMELY, PROCURING OF
CONTRACTS FOR OTHERS FOR THE BUYING
AND SELLING OF GOODS; BUSINESS MERCH-
ANDISING DISPLAY AND DEMONSTRATION OF
GOODS FOR ADVERTISING PURPOSES; SALES
PROMOTION FOR OTHERS PROVIDED
THROUGH A DISTRIBUTION AND ADMINISTRATION
OF PRIVILEGED USER CARDS; CONSULTA-
TION AND ASSISTANCE IN BUSINESS
MANAGEMENT, ORGANIZATION AND PROMO-
TION IN CONNECTION WITH SUPPORT IN THE
OPERATION AND MANAGEMENT OF A COM-

MERCIAL ENTERPRISE; RETAIL STORE SERVICES FEATURING TUNGSTEN AND MOLYBDENUM GOODS; MEDIATION, NEGOTIATION AND CONCLUSION OF COMMERCIAL TRANSACTIONS FOR OTHERS; BUSINESS ORGANIZATION AND MANAGEMENT CONSULTANCY; MARKET RESEARCH; OPINION POLLING; PUBLIC RELATIONS; PRESENTATION OF THE GOODS OF OTHERS VIA A GLOBAL COMPUTER NETWORK AND VIA RADIO, TELEVISION, NEWSPAPERS AND MAGAZINES; ORGANIZATION OF EXHIBITIONS AND TRADE FAIRS FOR COMMERCIAL

OR ADVERTISING PURPOSES, IN CLASS 35 (U.S. CLS. 100, 101 AND 102).

PRIORITY DATE OF 8-16-2007 IS CLAIMED.

OWNER OF INTERNATIONAL REGISTRATION 0944093 DATED 9-21-2007, EXPIRES 9-21-2017.

SER. NO. 79-046,471, FILED 9-21-2007.

WILLIAM ROSSMAN, EXAMINING ATTORNEY

Int. Cl.: 33

Prior U.S. Cls.: 47 and 49

United States Patent and Trademark Office

Reg. No. 3,520,880

Registered Oct. 21, 2008

**TRADEMARK
PRINCIPAL REGISTER**

NO REGRETS

JEREMY MULLER; AS TRUSTEE FOR THE
MULLER FAMILY TRUST (AUSTRALIA
TRUST)

05-02 FONTANA HEIGHTS
39 MOUNT SINAI RISE
SINGAPORE 276957, SINGAPORE

FOR: WINES; RED WINES; WHITE WINES; ES-
TATE PRODUCED WINES; LIQUEURS AND FOR-
TIFIED WINES, IN CLASS 33 (U.S. CLS. 47 AND 49).

THE MARK CONSISTS OF STANDARD CHAR-
ACTERS WITHOUT CLAIM TO ANY PARTICULAR
FONT, STYLE, SIZE, OR COLOR.

PRIORITY DATE OF 4-24-2007 IS CLAIMED.

OWNER OF INTERNATIONAL REGISTRATION
0944136 DATED 10-23-2007, EXPIRES 10-23-2017.

SER. NO. 79-046,482, FILED 10-23-2007.

MICHAEL TANNER, EXAMINING ATTORNEY

Int. Cl.: 9

Prior U.S. Cls.: 21, 23, 26, 36 and 38

Reg. No. 3,520,881

United States Patent and Trademark Office

Registered Oct. 21, 2008

**TRADEMARK
PRINCIPAL REGISTER**

EASYBLANK

AUTOFORM ENGINEERING GMBH (SWITZER-
LAND SOCIÉTÉ À RESPONSABILITÉ LIMIT-
ÉE)

DORFWIESENSTRASSE 7

CH-8173 NEERACH

SWITZERLAND

FOR: COMPUTER SOFTWARE FOR USE IN THE
FIELD OF FORMING TECHNOLOGIES AND IN
THE FIELD OF GEOMETRY MODELING, NAME-
LY, SOFTWARE USED FOR COMPUTER AIDED
ENGINEERING (CAE), DATABASE MANAGE-
MENT, COMPUTER AIDED DESIGN (CAD), COST
ESTIMATION AND PLANNING, IN CLASS 9 (U.S.
CLS. 21, 23, 26, 36 AND 38).

THE MARK CONSISTS OF STANDARD CHAR-
ACTERS WITHOUT CLAIM TO ANY PARTICULAR
FONT, STYLE, SIZE, OR COLOR.

PRIORITY DATE OF 5-8-2007 IS CLAIMED.

OWNER OF INTERNATIONAL REGISTRATION
0944154 DATED 10-26-2007, EXPIRES 10-26-2017.

OWNER OF U.S. REG. NOS. 3,057,945 AND
3,378,876.

SER. NO. 79-046,488, FILED 10-26-2007.

MELISSA VALLILLO, EXAMINING ATTORNEY

Int. Cls.: 16, 38 and 41

**Prior U.S. Cls.: 2, 5, 22, 23, 29, 37, 38, 50, 100, 101, 104
and 107**

Reg. No. 3,520,882

United States Patent and Trademark Office

Registered Oct. 21, 2008

**TRADEMARK
SERVICE MARK
PRINCIPAL REGISTER**

MAKARIA

VILLA SAN CARLO BORROMEIO S.R.L. (ITALY
LIMITED LIABILITY COMPANY)

VIA GABBA FRATELLI, 3

I-20121 MILANO

ITALY

FOR: BOOKS, NEWSPAPERS, JOURNALS, REVIEWS, MAGAZINES, PERIODICALS, PAMPHLETS, INSTRUCTION HANDBOOKS, REFERENCE GUIDES AND CATALOGUES FEATURING TOPICS OF GENERAL INTEREST AND OF CULTURE, ART, HISTORY, MATHEMATICS, SCIENCE, LITERATURE, LANGUAGES AND GEOGRAPHY; AGENDAS, CALENDARS, POSTERS, BOOKMARKS, PAPER LABELS, BLOTTING PAPER, BOND PAPER, ILLUSTRATION PAPER, GIFT WRAPPING PAPER, WRITING PAPER, ENVELOPES, GIFT CARDS, OCCASION CARDS, POSTCARDS, BLANK CARDS, SCRATCH PADS, PAPER BOXES, PAPER BOARDS, GREETING CARDS, CARDBOARD BOXES, PICTURES, ANNIVERSARY BOOKS, RECIPE BOOKS, PICTURE BOOKS, GUEST BOOKS, DRAWING BOOKS, DICTIONARIES, PHOTOGRAPH ALBUMS, EXERCISE BOOKS, PHOTOGRAPHS, RUBBER ERASERS, MAGNETIC BOARDS, PENCIL SHARPENERS, PENS, PENCILS, PENCIL CASES, PEN CASES, OFFICE REQUISITES, NAMELY PUNCHES, GLUE FOR STATIONERY OR HOUSEHOLD USE, ARTISTS' PASTELS, PAINT BRUSHES, PRINTED AND ENGRAVED PICTURES, BOOKBINDINGS, PAPER CUTTERS, PAPERWEIGHTS, PAPER FASTENERS, HOLE PUNCHERS FOR OFFICE USE, PAPER CLIPS, DRAWING SQUARES, RULERS FOR DRAWING, FILE FOLDERS, DOCUMENT HOLDERS, DESK SETS, DESK TOP ORGANIZERS, PAPER BAGS, PLASTIC BAGS FOR PACKAGING PURPOSES, PAPER RIBBONS AND PAPER BOWS, PAPER CAKE DECORATIONS, DECORATIVE PAPER CENTERPIECES, PAPER DOILIES, PAPER TABLE CLOTH, PAPER NAPKINS, PAPER FILTERS FOR COFFEE MAKERS, IN CLASS 16 (U.S. CLS. 2, 5, 22, 23, 29, 37, 38 AND 50).

FOR: ELECTRONIC BULLETIN BOARD SERVICES FEATURING TOPICS OF GENERAL INTEREST TO THE PUBLIC IN THE FIELD OF EDUCATION AND ENTERTAINMENT, TRANSMISSION OF MESSAGES, TEXTS AND IMAGES WITH THE AID OF A COMPUTER, ELECTRONIC MAIL SERVICES, ELECTRONIC TRANSMISSION OF DATA AND DOCUMENTS VIA COMPUTER TERMINALS; TRANSMISSION OF SOUND AND IMAGES VIA SATELLITE OR USING INTERACTIVE MULTIMEDIA EQUIPMENT; ELECTRONIC, ELECTRIC, AND DIGITAL TRANSMISSION OF VOICE, DATA, IMAGES, SIGNALS, AND MESSAGES, INFORMATION TRANSMISSION SERVICES VIA DIGITAL NETWORKS, NETWORK COMMUNICATIONS SERVICES, IN THE FORM OF TRANSMISSION OF STREAMED SOUND AND AUDIO-VISUAL RECORDINGS VIA THE INTERNET, ELECTRONIC TRANSMISSION OF FACSIMILE COMMUNICATIONS AND DATA FEATURING ENCRYPTION AND DECRYPTION, PROVIDING COLLOCATION SERVICES FOR VOICE, VIDEO AND DATA COMMUNICATIONS APPLICATIONS, COMMUNICATIONS VIA COMPUTER TERMINALS, COMMUNICATIONS THROUGH RADIO AND TELEVISION, CABLE AND TERTIARY RADIO/TELEVISION EMITTERS OR BY ONLINE SERVICES VIA TELEMATIC AND DATA PROCESSING NETWORKS, MOBILE RADIOTELEPHONY SERVICES, PROVIDING TELECOMMUNICATIONS CONNECTIONS TO A GLOBAL COMPUTER NETWORK, TELECOMMUNICATIONS CONSULTATION, TELECOMMUNICATIONS GATEWAY SERVICES, PROVIDING LONG DISTANCE TELECOMMUNICATION SERVICES, TELECOMMUNICATIONS SERVICES, NAMELY ISDN SERVICES; PERSONAL TELECOMMUNICATION SERVICES, PROVIDING FIBER OPTIC NETWORK SERVICES FOR TELECOMMUNICATIONS; TELEPHONE TELECOMMUNICATIONS SERVICES INVOLVING PAYMENT BY PREPAID TELEPHONE CALLING CARDS; ALL BEING SERVICES FOR

THIRD PARTIES, IN CLASS 38 (U.S. CLS. 100, 101 AND 104).

FOR: PUBLICATION OF BOOKS AND MAGAZINES, PUBLICATION OF TEXTS EXCEPT OF ADVERTISING TEXTS, PRESENTATIONS IN MUSEUMS, ARRANGING AND CONDUCTING OF CONVENTIONS, CONGRESSES, CONFERENCES, SEMINARS AND SYMPOSIA ALL FOR EDUCATIONAL AND CULTURAL PURPOSES; ORGANIZATION OF EXHIBITIONS FOR EDUCATIONAL, CULTURAL OR ENTERTAINMENT PURPOSES, ORGANIZATION OF SPORTING AND CULTURAL EVENTS, ORGANIZING AND CONDUCTING TRAINING CLASSES, SEMINARS AND WORKSHOPS IN THE FIELD OF MUSIC, ART AND WRITING, IN COOKERY, IN PERSONAL AWARENESS; EDUCATIONAL SERVICES IN THE NATURE OF FINE ARTS SCHOOLS, OF COURSES AT UNIVERSITY LEVEL, COMPUTER EDUCATION TRAINING, SWIMMING INSTRUCTION, HORSE TRAINING, HORSE RACES, AMUSEMENT PARKS, ORGANIZATION OF FESTIVALS FOR CULTURAL PURPOSES, ORGANIZING COMMUNITY FESTIVALS FEATURING A VARIETY OF ACTIVITIES NAMELY FLEA MARKETS; PHYSICAL EDUCATION, NAMELY STRENGTH AND CONDITIONING TRAINING; ARRANGING FOR TICKET RESERVATIONS FOR SHOWS OR OTHER ENTERTAINMENT EVENTS; CASINOS; ENTERTAINMENT EVENTS IN THE NATURE OF DRAMA, BALLET AND DANCE PERFORMANCES, OF ORCHESTRA PERFORMAN-

CES, OF ATHLETICS, OF LIVE MUSICAL GROUPS, OF MUSICAL BANDS, OF COMEDY SHOWS, OF MUSICAL VARIETY, OF AMUSEMENT PARK RIDES, OF FASHION SHOWS, OF GOLF TOURNAMENTS, OF TENNIS TOURNAMENTS, OF SOCCER AND FOOTBALL GAMES, OF TRACK AND FIELD COMPETITIONS; ENTERTAINMENT SERVICES BEING THE PRODUCTION OF MULTIMEDIA AUDIOVISUAL COMPONENTS FOR SOFTWARE USED FOR ENTERTAINMENT PURPOSES; COMPUTER GAME SERVICES FOR ENTERTAINMENT PURPOSES, PRODUCTION AND RENTAL OF FILMS, OF BOOKS, OF MOVIES, RENTAL OF COMPUTER GAMES; ALL BEING SERVICES FOR THIRD PARTIES, IN CLASS 41 (U.S. CLS. 100, 101 AND 107).

THE MARK CONSISTS OF STANDARD CHARACTERS WITHOUT CLAIM TO ANY PARTICULAR FONT, STYLE, SIZE, OR COLOR.

OWNER OF INTERNATIONAL REGISTRATION 0944175 DATED 4-16-2007, EXPIRES 4-16-2017.

MAKARIA, FROM THE GREEK, MEANS "HAPPINESS" IN ENGLISH.

SER. NO. 79-046,495, FILED 4-16-2007.

RICHARD A. STRASER, EXAMINING ATTORNEY

Int. Cls.: 9 and 10

Prior U.S. Cls.: 21, 23, 26, 36, 38, 39 and 44

United States Patent and Trademark Office

Reg. No. 3,520,883

Registered Oct. 21, 2008

**TRADEMARK
PRINCIPAL REGISTER**

myotest

MYOTEST SA (SWITZERLAND SOCIÉTÉ ANON-
YME)
PLACE DE LA GARE 3
CH-1950 SION
SWITZERLAND

FOR: MEASURING APPARATUS NOT FOR MEDICAL PURPOSES, NAMELY, APPARATUS FOR MEASURING MUSCLE STRENGTH AND MUSCLE STIFFNESS, APPARATUS FOR MEASURING POWER, STRENGTH, REACTIVITY, AND VELOCITY FOR ATHLETIC MOVEMENTS; TESTING APPARATUS NOT FOR MEDICAL PURPOSES, NAMELY, APPARATUS FOR TESTING MUSCULAR PERFORMANCE; COMPUTER SOFTWARE FOR REPORTING AND ANALYSIS OF ATHLETIC MOVEMENTS AND MEASUREMENTS, FOR THE EVALUATION OF TRAINING INFORMATION FOR ANALYSIS, COMPARISON, STORING AND SHARING OF TEST RESULTS; INSTRUCTIONAL DVDS AND CDS FOR

USE WITH THE AFOREMENTIONED APPARATUS AND SOFTWARE, IN CLASS 9 (U.S. CLS. 21, 23, 26, 36 AND 38).

FOR: DIAGNOSTIC APPARATUS FOR MEDICAL PURPOSES FOR TESTING OF MUSCLES AND MUSCULAR PERFORMANCE, IN CLASS 10 (U.S. CLS. 26, 39 AND 44).

PRIORITY DATE OF 5-7-2007 IS CLAIMED.

OWNER OF INTERNATIONAL REGISTRATION
0944472 DATED 9-28-2007, EXPIRES 9-28-2017.

SER. NO. 79-046,608, FILED 9-28-2007.

EMILY CHUO, EXAMINING ATTORNEY

Int. Cls.: 7, 9 and 12

Prior U.S. Cls.: 13, 19, 21, 23, 26, 31, 34, 35, 36, 38 and 44

Reg. No. 3,520,884

United States Patent and Trademark Office

Registered Oct. 21, 2008

**TRADEMARK
PRINCIPAL REGISTER**



ZF FRIEDRICHSHAFEN AG (FED REP GERMA-
NY JOINT STOCK COMPANY)
GRAF-VON-SODEN-PLATZ 1
88046 FRIEDRICHSHAFEN
FED REP GERMANY

FOR: WHEELS BEING PARTS OF MACHINES,
NAMELY, TOOTHED WHEELS, OTHER WHEELS
AND PARTS OF WHEELS USED IN THE MACHINE
BUILDING INDUSTRY AND IN FINE MECHAN-
ICS, GEAR SYSTEMS AND DEVICES FOR USE IN
TRANSMISSION OF FORCE AND MOTION FROM
ONE GEAR SYSTEM TO ANOTHER, AND WITHIN
THE SAME GEAR SYSTEM, IN CLASS 7 (U.S. CLS.
13, 19, 21, 23, 31, 34 AND 35).

FOR: TESTING AND MEASURING APPARATUS
DESIGNED FOR VERIFYING THE MANNER AND
EXTENT OF THESE TRANSMISSIONS OF FORCE
AND MOVEMENT, NAMELY, ANALOG AND DI-
GITAL FORCE GAUGES, ANALOG AND DIGITAL
TORQUE GAUGES, AND MANUAL AND MOTOR-

IZED TEST STANDS USED THEREWITH SOLD AS
A UNIT WITH THE GAUGES, IN CLASS 9 (U.S. CLS.
21, 23, 26, 36 AND 38).

FOR: GEARS FOR VEHICLES, NAMELY,
TOOTHED WHEELS, GEARS, AND DEVICES FOR
USE IN TRANSMISSION OF FORCE AND MOTION
FROM ONE GEAR SYSTEM TO ANOTHER, AND
WITHIN THE SAME GEAR SYSTEM, IN CLASS 12
(U.S. CLS. 19, 21, 23, 31, 35 AND 44).

OWNER OF INTERNATIONAL REGISTRATION
0176386 DATED 4-14-1954, EXPIRES 4-14-2014.

OWNER OF U.S. REG. NOS. 1,161,631, 2,780,982
AND OTHERS.

SER. NO. 79-046,670, FILED 5-11-2007.

KRISTINA MORRIS, EXAMINING ATTORNEY

Int. Cls.: 6 and 37

Prior U.S. Cls.: 2, 12, 13, 14, 23, 25, 50, 100, 103 and 106

Reg. No. 3,520,885

United States Patent and Trademark Office

Registered Oct. 21, 2008

**TRADEMARK
SERVICE MARK
PRINCIPAL REGISTER**

CUDECO

CUDECO LIMITED (AUSTRALIA COMPANY)
UNIT 34 BRICKWORKS ANNEX
19 BROLGA AVENUE; SOUTHPORT QLD 4215
AUSTRALIA

FOR: COMMON METALS, NAMELY, INGOTS OF COMMON METAL; COMMON METAL ALLOYS, NAMELY, COPPER ALLOYS, NICKEL ALLOYS, LEAD ALLOYS; ORES OF METAL, NAMELY, COPPER ORES, IRON ORES, LEAD ORES; PROCESSED METAL ORES, NAMELY, SEMI-WORKED COMMON METALS FOR FURTHER MANUFACTURE; COPPER, NAMELY, COPPER ORES, COPPER ALLOYS; COPPER BASED ALLOYS IN WROUGHT FORM, NAMELY, CASTINGS, FOILS, POWDER, AND ROLLED, DRAWN OR EXTRUDED SEMI-FINISHED ARTICLES MADE OF COPPER; COPPER, UNWROUGHT OR SEMI-WROUGHT, NAMELY, CASTINGS, FOILS, POWDER, AND ROLLED, DRAWN OR EXTRUDED SEMI-FINISHED ARTICLES MADE OF COPPER; COPPER SULPHATE PENTAHYDRATE; DISPERSION STRENGTHENED COPPER, NAMELY, SEMI-WORKED COPPER FOR FURTHER MANUFACTURE; SURFACE TREATED COPPER, NAMELY, SEMI-WORKED COPPER FOR

FURTHER MANUFACTURE; UNWROUGHT COPPER BASED ALLOYS FOR FURTHER MANUFACTURE, IN CLASS 6 (U.S. CLS. 2, 12, 13, 14, 23, 25 AND 50).

FOR: MINING, QUARRYING AND EXCAVATION SERVICES; MINING EXTRACTION; BUILDING CONSTRUCTION; REPAIR OF MINES; MAINTENANCE AND INSTALLATION SERVICES OF MINES, IN CLASS 37 (U.S. CLS. 100, 103 AND 106).

THE MARK CONSISTS OF STANDARD CHARACTERS WITHOUT CLAIM TO ANY PARTICULAR FONT, STYLE, SIZE, OR COLOR.

PRIORITY DATE OF 1-30-2007 IS CLAIMED.

OWNER OF INTERNATIONAL REGISTRATION 0945097 DATED 7-30-2007, EXPIRES 7-30-2017.

SER. NO. 79-046,852, FILED 7-30-2007.

DOMINIC FATHY, EXAMINING ATTORNEY

Int. Cl.: 17

Prior U.S. Cls.: 1, 5, 12, 13, 35 and 50

Reg. No. 3,520,886

United States Patent and Trademark Office

Registered Oct. 21, 2008

**TRADEMARK
PRINCIPAL REGISTER**

V I C T R A

NIPPON VALQUA INDUSTRIES, LTD. (JAPAN CORPORATION)
1-1, NISHI-SHINJUKU, 2-CHOME
SHINJUKU-KU.; TOKYO 163-0406
JAPAN

FOR: JOINT PACKINGS FOR USE WITH PIPES FOR LIQUIDS; PACKING MATERIAL FOR FORMING SEALS FOR INDUSTRIAL, RESIDENTIAL AND ORIGINAL MANUFACTURER USES; NON-METAL GASKETS FOR INDUSTRIAL, RESIDENTIAL AND ORIGINAL MANUFACTURER USES EXCEPT FOR USE IN MOTORS AND ENGINE, IN CLASS 17 (U.S. CLS. 1, 5, 12, 13, 35 AND 50).

THE MARK CONSISTS OF STANDARD CHARACTERS WITHOUT CLAIM TO ANY PARTICULAR FONT, STYLE, SIZE, OR COLOR.

OWNER OF INTERNATIONAL REGISTRATION
0945359 DATED 7-18-2007, EXPIRES 7-18-2017.

SER. NO. 79-046,939, FILED 7-18-2007.

LAURIE KAUFMAN, EXAMINING ATTORNEY

Int. Cl.: 11

Prior U.S. Cls.: 13, 21, 23, 31 and 34

United States Patent and Trademark Office

Reg. No. 3,520,887

Registered Oct. 21, 2008

**TRADEMARK
PRINCIPAL REGISTER**

SEDAP

**ATELIER SEDAP, SOCIÉTÉ ANONYME
(FRANCE SOCIÉTÉ ANONYME (SA))
3, RUE SANLECQUE,
F-44000 NANTES
FRANCE**

**OWNER OF INTERNATIONAL REGISTRATION
0555650 DATED 6-12-1990, EXPIRES 6-12-2010.**

**FOR: LIGHTING APPARATUS, NAMELY, LAMP
SHADES; WALL LIGHTS; STANDARD LAMPS;
LAMPS; LAMP BASES; CEILING LIGHTS; PILLAR
LAMPS, IN CLASS 11 (U.S. CLS. 13, 21, 23, 31 AND 34).**

SER. NO. 79-046,962, FILED 7-16-2007.

LAURIE KAUFMAN, EXAMINING ATTORNEY

Int. Cls.: 6, 9, 16, 40 and 42

**Prior U.S. Cls.: 2, 5, 12, 13, 14, 21, 22, 23, 25, 26, 29,
36, 37, 38, 50, 100, 101, 103 and 106**

Reg. No. 3,520,888

United States Patent and Trademark Office

Registered Oct. 21, 2008

**TRADEMARK
SERVICE MARK
PRINCIPAL REGISTER**

TPE

V&M DEUTSCHLAND GMBH (FED REP GER-
MANY CORPORATION)
RATHER KREUZWEG, 106
40472 DÜSSELDORF, FED REP GERMANY

FOR: ROUND AND MOLDED TUBES OF METAL;
STRUCTURAL HOLLOWWARE OF METAL FOR
USE IN LARGE SPAN CONSTRUCTION, IN CLASS 6
(U.S. CLS. 2, 12, 13, 14, 23, 25 AND 50).

FOR: COMPUTER PROGRAMS AND COMPU-
TER SOFTWARE RECORDED ON COMPUTERS
FOR USE IN THE MANUFACTURING OF ROUND
AND MOLDED TUBES AND STRUCTURAL HOL-
LOWWARE FOR USE IN CONSTRUCTION, IN
CLASS 9 (U.S. CLS. 21, 23, 26, 36 AND 38).

FOR: PRINTED MATTER, NAMELY, MANUFAC-
TURING MANUALS IN THE FIELD OF MOLDED
TUBING AND STRUCTURAL HOLLOWWARE;
PRINTED ADVERTISING MATERIAL, NAMELY,
POINT OF SALE CARDS IN THE FIELD OF MOL-
DED TUBING AND STRUCTURAL HOLLOW-
WARE; BUSINESS INFORMATIONAL
BROCHURES RELATING TO MOLDED TUBING
AND STRUCTURAL HOLLOWWARE, IN CLASS 16
(U.S. CLS. 2, 5, 22, 23, 29, 37, 38 AND 50).

FOR: CUSTOM STEEL ROLLING AND FABRICA-
TION TO THE ORDER AND SPECIFICATION OF

OTHERS, NAMELY, ROLLING MASSIVE METAL
BLOCKS AND HOLLOW BLOCKS TO FORM SEAM-
LESS TUBES, IN CLASS 40 (U.S. CLS. 100, 103 AND
106).

FOR: DESIGN AND DEVELOPMENT OF COM-
PUTER SOFTWARE; SCIENTIFIC AND TECHNO-
LOGICAL SERVICES AND RESEARCH WORK
RELATING TO STEEL ROLLING TECHNOLOGY,
IN CLASS 42 (U.S. CLS. 100 AND 101).

THE MARK CONSISTS OF STANDARD CHAR-
ACTERS WITHOUT CLAIM TO ANY PARTICULAR
FONT, STYLE, SIZE, OR COLOR.

PRIORITY DATE OF 2-14-2007 IS CLAIMED.

OWNER OF INTERNATIONAL REGISTRATION
0945484 DATED 8-14-2007, EXPIRES 8-14-2017.

THE WORDING "TPE" HAS NO MEANING IN A
FOREIGN LANGUAGE.

SER. NO. 79-047,002, FILED 8-14-2007.

HEATHER SAPP, EXAMINING ATTORNEY

Int. Cls.: 7, 9 and 42

**Prior U.S. Cls.: 13, 19, 21, 23, 26, 31, 34, 35, 36, 38, 100
and 101**

Reg. No. 3,520,889

United States Patent and Trademark Office

Registered Oct. 21, 2008

**TRADEMARK
SERVICE MARK
PRINCIPAL REGISTER**

MAXOLUTION

SEW-EURODRIVE GMBH & CO. KG (FED REP GERMANY KG)
ERNST-BLICKLE-STRASSE 42
76646 BRUCHSAL, FED REP GERMANY

FOR: ELECTRIC MOTORS, OTHER THAN FOR LAND VEHICLES; GEARED MOTORS; TORQUE CONVERTERS; SERVO GEARS; MECHANICAL VARIABLE SPEED GEARBOXES; HEAVY INDUSTRIAL GEARBOXES; COMPACT DRIVES, NAMELY, DRIVES CONSISTING OF ELECTRIC MOTOR, REDUCTION GEAR AND FREQUENCY CONVERTER IN ONE HOUSING; ELECTRIC DRIVES FOR ELECTRIFIED MONORAILS; ELECTRIFIED MONORAILS; SPEED CONTROLLERS FOR MACHINES AND MOTORS; CONTROLLERS FOR MACHINES AND MOTORS; COUPLINGS, OTHER THAN FOR LAND VEHICLES; BRAKES; MAGNETIC BRAKES, IN CLASS 7 (U.S. CLS. 13, 19, 21, 23, 31, 34 AND 35).

FOR: APPARATUS AND INSTRUMENTS FOR CONDUCTING, SWITCHING, CONVERTING, STORING AND CONTROLLING ELECTRICITY, CONVERTERS, NAMELY, FREQUENCY CONVERTERS FOR THE ELECTRONIC SPEED CONTROL OF ELECTRIC MOTORS; CURRENT CONVERTERS; FREQUENCY CONVERTERS; ELECTRONIC CONTROLS FOR MOTORS AND MACHINES; PROGRAMMABLE LOGIC CONTROLLERS (PLCS); ELECTRIC CABLES; AUTOMATIC ELECTRICAL DISTRIBUTION APPARATUS, NAMELY, DISTRIBUTORS FOR ELECTRIC ENERGY; OPERATING TERMINALS FOR CONTROLLING MACHINES; ELECTRONIC AND ELECTRO-TECHNICAL MEASURING INSTRUMENTS, NAMELY, VOLTMEETERS, CURRENT METERS, TORQUE METERS; ROTARY SPEED SENSORS; ENCODERS AND INCREMENTAL ENCODERS FOR MEASURING ROTARY SPEED AND POSITION OF DRIVES USED IN MACHINERY; ELECTRIC AND ELECTRONIC CONTROL APPARATUS, NAMELY, ELECTRONIC CONTROLS FOR MOTORS; OIL LEVEL SENSORS; OIL STATUS SENSORS; OIL DETERIORATION SENSORS; TEMPERATURE SENSORS; STRUC-

TURE-BORNE SOUND SENSORS; DOWNLOADABLE ELECTRONIC PUBLICATIONS IN THE NATURE OF MANUALS AND CATALOGUES IN THE FIELD OF INDUSTRIAL MACHINERY; ELECTROMECHANICAL CONTROLS FOR USE IN POSITIONING ELECTRIC MOTORS; COMPUTER SOFTWARE FOR CONTROLLING MACHINES; COMPUTER SOFTWARE FOR CONTROLLING INDUSTRIAL PROCESSES; COMPUTER SOFTWARE FOR MONITORING INDUSTRIAL PROCESSES; COMPUTER SOFTWARE FOR PLANNING INDUSTRIAL FACILITIES; FIELD BUS CABLES; FIELD BUS SWITCHES; NETWORK DEVICES, NAMELY, MODEMS AND POWER LAN CHIPS; NETWORK DEVICES FOR WIRELESS NETWORKS, NAMELY, RADIO TRANSMITTERS AND ANTENNAS; WIRELESS LAN MODERNS; DEVICES FOR INDUCTIVE SUPPLYING ELECTRIC DRIVES WITH ELECTRIC ENERGY, NAMELY, LINE CONDUCTORS, PICK-UP COILS, CURRENT TRANSFORMERS, DEVICES FOR THE CONTACTLESS SUPPLY OF ELECTRIC DRIVES WITH ELECTRIC ENERGY, NAMELY, LINE CONDUCTORS, PICK-UP COILS, CURRENT TRANSFORMERS; PARTS OF ALL AFORESAID GOODS, IN CLASS 9 (U.S. CLS. 21, 23, 26, 36 AND 38).

FOR: ENGINEERING SERVICES; CONSTRUCTION PLANNING SERVICES; DEVELOPMENT SERVICES OF NEW PRODUCTS; CONSULTING IN THE FIELD OF MECHANICAL ENGINEERING; CONSULTING SERVICES IN THE FIELD OF INDUSTRIAL DRIVE TECHNOLOGY; PLANNING AND LAYOUT DESIGN SERVICES OF INDUSTRIAL FACILITIES; ENGINEERING CONSULTING IN THE NATURE OF SELECTING AND DESIGNING THE LAYOUT OF DRIVE COMPONENTS TO BE USED IN MACHINERY; APPLICATION DEVELOPMENT; START UP TECHNICAL SUPPORT IN THE NATURE OF PLANNING, DEVELOPMENT AND TECHNICAL SUPPORT OF INDUSTRIAL MACHINERY; TECHNICAL SUPERVISION IN THE FIELD OF ASSEMBLY OF INDUSTRIAL MACHINERY, IN CLASS 42 (U.S. CLS. 100 AND 101).

THE MARK CONSISTS OF STANDARD CHARACTERS WITHOUT CLAIM TO ANY PARTICULAR FONT, STYLE, SIZE, OR COLOR.

OWNER OF INTERNATIONAL REGISTRATION 0945558 DATED 8-4-2007, EXPIRES 8-4-2017.

SER. NO. 79-047,025, FILED 8-4-2007.

PRIORITY DATE OF 2-28-2007 IS CLAIMED.

RENEE SERVANCE, EXAMINING ATTORNEY

Int. Cl.: 7

Prior U.S. Cls.: 13, 19, 21, 23, 31, 34 and 35

United States Patent and Trademark Office

Reg. No. 3,520,890

Registered Oct. 21, 2008

**TRADEMARK
PRINCIPAL REGISTER**



AKYAPAK MAKINA SANAYI VE TICARET;
LIMITED SIRKETI (TURKEY LIMITED COM-
PANY)
AKÇALAR SANAYI
BÖLGESİ SANAYİ CADDESİ NO:8; AKÇALAR/
BURSA
TURKEY

FOR: METALWORKING MACHINE TOOLS FOR CUTTING, PUNCHING, CROPPING, BENDING, ROLLING AND SHAPING METALS, NAMELY, MECHANICAL PRESSES, BENDING MACHINES, PNEUMATIC CONTROLS FOR MACHINES, ENGINES AND MOTORS, PLASMA ETCHING MACHINES, MACHINES FOR MANUFACTURING METAL STRIPS, NAMELY, CONTINUOUS METAL CASTING MACHINES, METAL SAWING MACHINES, METAL CUTTING MACHINES, METAL WELDING MACHINES, NAMELY, ELECTRIC ARC WELDING MACHINES, GAS WELDING MACHINES, LASER WELDING MACHINES, LATHES BEING MACHINE TOOLS, MACHINE PARTS FOR METALWORKING MACHINES, IN CLASS 7 (U.S. CLS. 13, 19, 21, 23, 31, 34 AND 35).

OWNER OF INTERNATIONAL REGISTRATION
0945575 DATED 9-14-2007, EXPIRES 9-14-2017.

THE COLOR(S) BLACK, RED, WHITE, AND PURPLE IS/ARE CLAIMED AS A FEATURE OF THE MARK.

THE MARK CONSISTS OF THE WORDING "AK-BEND", WITH "AK" APPEARING IN BLACK, AND "BEND" APPEARING RED. TO THE LEFT OF THE WORDING IS A DESIGN ELEMENT OF THREE PARALLEL BARS EXTENDING ON A DIAGONAL ANGLE, GETTING LONGER FROM LEFT TO RIGHT. THE FIRST AND THIRD BAR ARE RED, AND THE MIDDLE ONE IS BLACK. A PURPLE RECTANGULAR SHAPE WITH CURVED TOP AND BOTTOM LINES APPEARS AROUND THE WORDING AND THE BARS, AND A SECOND THINNER PURPLE LINE OF THE SAME SHAPE SURROUNDS THE ENTIRE MARK. THE MARK IS ON A WHITE BACKGROUND.

SER. NO. 79-047,034, FILED 9-14-2007.

LYDIA BELZER, EXAMINING ATTORNEY

Int. Cl.: 19

Prior U.S. Cls.: 1, 12, 33 and 50

United States Patent and Trademark Office

Reg. No. 3,520,891

Registered Oct. 21, 2008

**TRADEMARK
PRINCIPAL REGISTER**

MOMODESIGN

MOMO DESIGN S.R.L. (ITALY LIMITED LIABILITY COMPANY)
VIA MEDA, 45
I-20141 MILANO
ITALY

FOR: NON METALLIC BUILDING MATERIALS, NAMELY, NON-METAL TILES, CERAMIC FLOOR AND WALL TILES, FLOOR AND WALL NATURAL STONES, GLASS AND WOOD MATERIALS COMBINED WITH FLOOR AND WALL TILES FOR USE IN BUILDING, IN CLASS 19 (U.S. CLS. 1, 12, 33 AND 50).

OWNER OF INTERNATIONAL REGISTRATION 0945886 DATED 10-19-2007, EXPIRES 10-19-2017.

OWNER OF U.S. REG. NOS. 2,652,011, 3,041,899 AND OTHERS.

NO CLAIM IS MADE TO THE EXCLUSIVE RIGHT TO USE "DESIGN", APART FROM THE MARK AS SHOWN.

WRITING "MOMODESIGN" IN SPECIAL CHARACTERS.

SER. NO. 79-047,138, FILED 10-19-2007.

ANN E. SAPPENFIELD, EXAMINING ATTORNEY

Int. Cl.: 36

Prior U.S. Cls.: 100, 101 and 102

United States Patent and Trademark Office

Reg. No. 3,520,892

Registered Oct. 21, 2008

**SERVICE MARK
PRINCIPAL REGISTER**



ACTION CONTRE LA FAIM (FRANCE ASSOCIATION RÉGIE PAR LA LOI DE 1901)
4 RUE DE NIEPCE
F-75014 PARIS
FRANCE

FOR: CHARITABLE FUND RAISING ; FINANCIAL SPONSORSHIP OF INTERNATIONAL AID AND DEVELOPMENT PROJECTS, IN CLASS 36 (U.S. CLS. 100, 101 AND 102).

PRIORITY DATE OF 12-15-2006 IS CLAIMED.

OWNER OF INTERNATIONAL REGISTRATION
0946078 DATED 6-13-2007, EXPIRES 6-13-2017.

NO CLAIM IS MADE TO THE EXCLUSIVE RIGHT TO USE "INTERNATIONAL NETWORK", APART FROM THE MARK AS SHOWN.

FROM LEFT TO RIGHT AND FROM TOP TO BOTTOM: STYLIZED YOUNG SHOOT OF A PLANT, REPRESENTED HEAD UP AND HEAD DOWN, FOLLOWED ON ITS RIGHT BY THE LETTERS "ACF", THE WHOLE UNDERLINED BY A BANNER INSCRIBED WITH THE LETTERS "ACF INTERNATIONAL NETWORK".

SER. NO. 79-047,215, FILED 6-13-2007.

G. MAYERSCHOFF, EXAMINING ATTORNEY

Int. Cl.: 5

Prior U.S. Cls.: 6, 18, 44, 46, 51 and 52

United States Patent and Trademark Office

Reg. No. 3,520,893

Registered Oct. 21, 2008

**TRADEMARK
PRINCIPAL REGISTER**

NEUROVIVE

NEUROPHARMA I SVERIGE AB (SWEDEN LIMITED LIABILITY COMPANY)
MAGLE STORA KYRKO GATA 6
SE-223 50 LUND
SWEDEN

FOR: PHARMACEUTICAL AND VETERINARY PREPARATIONS, NAMELY, MEDICINES AND PHARMACEUTICAL PREPARATIONS FOR THE TREATMENT AND PREVENTION OF ACUTE AND CHRONIC NEUROLOGICAL ILLNESSES AND CONDITIONS; MEDICINES AND PHARMACEUTICAL PREPARATIONS FOR THE TREATMENT OF NEUROSURGICAL CONDITIONS, NAMELY, FOR BRAIN DAMAGE AND FOR USE IN BRAIN OPERATIONS AND OTHER PHYSICAL AND NEUROLOGICAL AILMENTS OF THE BRAIN; MEDICINES AND PHARMACEUTICAL PREPARATIONS FOR USE IN THE AREA OF NEUROLOGICAL INTENSIVE CARE; MEDICINES AND PHARMACEUTICAL PREPARATIONS FOR

USE AS IMMUNOSUPPRESSIVE AGENTS IN ORGAN TRANSPLANTS OR OTHER MEDICAL AND CLINICAL USES OF IMMUNOSUPPRESSIVE AGENTS AND PREPARATIONS, IN CLASS 5 (U.S. CLS. 6, 18, 44, 46, 51 AND 52).

THE MARK CONSISTS OF STANDARD CHARACTERS WITHOUT CLAIM TO ANY PARTICULAR FONT, STYLE, SIZE, OR COLOR.

PRIORITY DATE OF 8-1-2007 IS CLAIMED.

OWNER OF INTERNATIONAL REGISTRATION 0946112 DATED 9-7-2007, EXPIRES 9-7-2017.

SER. NO. 79-047,227, FILED 9-7-2007.

SAIMA MAKHDOOM, EXAMINING ATTORNEY

Int. Cls.: 7 and 8

Prior U.S. Cls.: 13, 19, 21, 23, 28, 31, 34, 35 and 44

Reg. No. 3,520,894

United States Patent and Trademark Office

Registered Oct. 21, 2008

TRADEMARK
PRINCIPAL REGISTER

WONDERWEED

EXEL INDUSTRIES (FRANCE SOCIÉTÉ ANON-
YME)

54 RUE MARCEL PAUL
F-51200 EPERNAY
FRANCE

FOR: LARGE MACHINERY FOR AGRICULTURAL, VITICULTURAL AND HORTICULTURAL USE, NAMELY, AUTOMOTIVE SPRAYING MACHINES, HARVESTING AND SOIL-ELIMINATING EQUIPMENT FOR BEETS DIGGERS IN THE NATURE OF SOIL ELIMINATORS, LEAF STRIPPERS, SHREDDERS, CUTTING DIVIDERS, AND HOEING MACHINES; MACHINERY FOR PROTECTING VEGETABLES FROM PARASITES IN THE NATURE ATOMIZERS, PUMPS BEING PARTS OF MACHINERY, SPRAY NOZZLES BEING PARTS OF MACHINERY, BOOMS FOR SPRAYING MACHINES, MOTORS, OTHER THAN FOR LAND VEHICLES, TRANSMISSION COUPLINGS AND BELTS, NOT BEING FOR LAND VEHICLES; MACHINES FOR DESTROYING RUBBISH AND WASTE, NAMELY, CRUSHERS, SHREDDERS AND APPARATUS USED TO SHEAR ALL PRODUCTS, REFUSE AND MATERIALS; PAINTING MACHINES AND PARTS THEREFORE IN THE NATURE OF SPRAY GUNS AND PUMPS FOR APPLYING PAINT, MASTICS AND OTHER VISCOUS PRODUCTS; INDUSTRIAL MACHINERY FOR PAINTING AND VARNISHING WORKSHOPS; PNEUMATIC TOOLS FOR PAINTING IN THE NATURE OF PNEUMATIC SPRAY GUNS, SANDING MACHINES, FLOOR POLISHING MACHINES AND COMPONENTS OF SUCH TOOLS; AIR COMPRESSORS AND PARTS OF COMPRESSED-AIR INSTALLATIONS, PISTON COMPRESSORS, AND MOBILE AND PORTABLE STATIONARY COMPRESSORS FOR WORKSHOPS; TOOLS FOR PAINTING WORKSHOPS FOR PNEUMATIC, HYDRAULIC PROJECTION OR FOR ELECTROSTATIC APPLICATION OF LIQUID PAINT OR OF POWDER OR SIMILAR PRODUCTS; SURFACE LINING MACHINERY; ACCESSORIES FOR SURFACE LINING MACHINERY; PAINTING MACHINES; LIQUID, POWDERY OR FIBROUS PRODUCT DISPENSING MACHINES; MACHINERY USED FOR PAINTING, POWDER COATING, ENAMELING, AND FLOCKING; AUTOMATIC

ELECTROSTATIC PAINT SPRAYERS; AUTOMATIC SPRAYERS FOR PAINT FOR USE IN ELECTROSTATIC ENAMELING AND AUTOMATIC SPRAY HEADS FOR USE THEREWITH; AUTOMATIC SPRAY HEADS FOR ELECTROSTATIC DUSTING; MACHINERY, NAMELY, EXTRACTORS FOR POWDERY AND FIBROUS PRODUCTS; MACHINERY, NAMELY, POWDER DISPENSING TANKS; ELECTROSTATIC GENERATORS; HIGH-VOLTAGE GENERATORS; ACCESSORIES FOR ELECTROSTATIC GENERATORS BEING PARTS OF MACHINERY; ACCESSORIES FOR HIGH-VOLTAGE GENERATORS BEING PARTS OF MACHINERY; AUTOMATION MACHINES USED TO INDUSTRIAL APPLICATION OF SURFACE COATINGS; LIQUID DISPENSING PAINT TANKS; PRODUCT CHANGING MACHINES FOR INDUSTRIAL INSTALLATIONS FOR FLOCKING LIQUID OR POWDERY PAINT, IN CLASS 7 (U.S. CLS. 13, 19, 21, 23, 31, 34 AND 35).

FOR: HAND-OPERATED AGRICULTURAL TOOLS AND INSTRUMENTS IN THE NATURE OF INSECTICIDE SPRAYERS, SPRAY GUNS, NOZZLES FOR HAND-HELD SPRAY GUNS, HAND-HELD SPRAY GUNS FOR PAINTING, HAND-OPERATED HAND TOOLS AND INSTRUMENTS FOR TREATING SURFACES BEFORE PAINTING, AND VARIOUS ABRASIVE WHEELS AND SANDERS; HAND-OPERATED AGRICULTURAL TOOLS AND INSTRUMENTS IN THE NATURE OF INSECTICIDE, HERBICIDE AND PESTICIDE SPRAYERS; HAND-HELD SPRAY GUNS FOR ELECTROSTATIC PAINTING; HAND-HELD SPRAY GUNS FOR ELECTROSTATIC ENAMELING; HAND-HELD SPRAY GUNS FOR ELECTROSTATIC DUSTING, IN CLASS 8 (U.S. CLS. 23, 28 AND 44).

THE MARK CONSISTS OF STANDARD CHARACTERS WITHOUT CLAIM TO ANY PARTICULAR FONT, STYLE, SIZE, OR COLOR.

PRIORITY DATE OF 10-25-2006 IS CLAIMED.

OWNER OF INTERNATIONAL REGISTRATION
0946264 DATED 4-24-2007, EXPIRES 4-24-2017.

SER. NO. 79-047,285, FILED 4-24-2007.

ANN E. SAPPENFIELD, EXAMINING ATTORNEY

Int. Cls.: 9, 38 and 42

Prior U.S. Cls.: 21, 23, 26, 36, 38, 100, 101 and 104

Reg. No. 3,520,895

United States Patent and Trademark Office

Registered Oct. 21, 2008

**TRADEMARK
SERVICE MARK
PRINCIPAL REGISTER**

net biscuits

NETBISCUITS GMBH
LUXEMBURGER STRAÙE 2
67657 KAISERSLAUTERN
FED REP GERMANY

FOR: COMPUTER SOFTWARE, NAMELY, WEB-BASED SOFTWARE FOR MOBILE APPLICATION DEVELOPMENT AS WELL AS FOR DIGITAL MEDIA ADAPTATION, FOR RENDERING TEXT, SOUND OR IMAGES-AGES AND FOR DELIVERY OF TEXT, SOUND OR IMAGES FOR MOBILE DEVICES; COMPUTER SOFTWARE FOR TRANSCODING AND DELIVERING OF DIGITAL MEDIA AND PORTALS TO MOBILE DEVICES; COMPUTER SOFTWARE FOR WIRELESS TRANSMISSION OF MULTIMEDIA-DATA, VIDEO, AUDIO, IMAGE AND TEXT-DATA AND FOR DELIVERING OF SOFTWARE APPLICATIONS TO MOBILE DEVICES; COMPUTER SOFTWARE FOR MANAGING AND ENCRYPTING DATA; COMPUTER SOFTWARE FOR WIRELESS MESSAGING, ADVERTISING AND BILLING SYSTEMS FOR USE ON MOBILE DEVICES, IN CLASS 9 (U.S. CLS. 21, 23, 26, 36 AND 38).

FOR: BROADCASTING, DISTRIBUTION AND TRANSMISSION OF TELEVISION, RADIO, TELECOMMUNICATIONS AND DATA SIGNALS VIA DIGITAL AND ANALOG WIRELESS AND/OR CABLE NETWORKS AND PORTALS, INCLUDING VIA ONLINE AND OFFLINE OPERATIONS AND VIA COMPUTER, PARTICULARLY TO MOBILE DEVICES; PROVIDING ACCESS TO TELECOMMUNICATION NETWORKS VIA MOBILE DEVICES, IN CLASS 38 (U.S. CLS. 100, 101 AND 104).

FOR: COMPUTER SOFTWARE DEVELOPMENT, PROGRAMMING AND DE-SIGN FOR OTHERS,

NAMELY, OF WEB-BASED SOFTWARE FOR MOBILE APPLICATION DEVELOPMENT AS WELL AS FOR DIGITAL MEDIA ADAPTATION, FOR RENDERING TEXT, SOUND OR IMAGES AND FOR DELIVERY OF TEXT, SOUND OR IMAGES FOR MOBILE DEVICES AND OF COMPUTER SOFTWARE FOR TRANSCODING AND DELIVERING OF DIGITAL MEDIA AND PORTALS TO MOBILE DEVICES AND OF COMPUTER SOFTWARE FOR WIRELESS TRANSMISSION OF MULTIMEDIA-DATA, VIDEO, AUDIO, IMAGE AND TEXT-DATA AND FOR DELIVERING OF SOFTWARE APPLICATIONS TO MOBILE DEVICES AND OF COMPUTER SOFTWARE FOR MANAGING AND ENCRYPTING DATA AND OF COMPUTER SOFTWARE FOR WIRELESS MESSAGING, ADVERTISING AND BILLING SYSTEMS FOR USE ON MOBILE DEVICES; COMPUTER SOFTWARE MAINTENANCE AND TECHNICAL SUPPORT SERVICES, NAMELY, SOFTWARE TROUBLESHOOTING; CONDUCTING SOFTWARE TESTS AND SIMULATIONS FOR OTHERS, IN CLASS 42 (U.S. CLS. 100 AND 101).

PRIORITY DATE OF 7-5-2007 IS CLAIMED.

OWNER OF INTERNATIONAL REGISTRATION
0946317 DATED 10-1-2007, EXPIRES 10-1-2017.

NO CLAIM IS MADE TO THE EXCLUSIVE RIGHT TO USE "NET", APART FROM THE MARK AS SHOWN.

SER. NO. 79-047,304, FILED 10-1-2007.

ANTHONY RINKER, EXAMINING ATTORNEY

Int. Cls.: 9, 38 and 42

Prior U.S. Cls.: 21, 23, 26, 36, 38, 100, 101 and 104

Reg. No. 3,520,896

United States Patent and Trademark Office

Registered Oct. 21, 2008

**TRADEMARK
SERVICE MARK
PRINCIPAL REGISTER**

NETBISCUITS

NETBISCUITS GMBH
LUXEMBURGER STRAÙE 2
67657 KAISERSLAUTERN
FED REP GERMANY

FOR: COMPUTER SOFTWARE, NAMELY, WEB-BASED SOFTWARE FOR MOBILE APPLICATION DEVELOPMENT AS WELL AS FOR DIGITAL MEDIA ADAPTATION, FOR RENDERING TEXT, SOUND OR IMAGES AND FOR DELIVERY OF TEXT, SOUND OR IMAGES FOR MOBILE DEVICES; COMPUTER SOFTWARE FOR TRANSCODING AND DELIVERING OF DIGITAL MEDIA AND PORTALS TO MOBILE DEVICES; COMPUTER SOFTWARE FOR WIRELESS TRANSMISSION OF MULTIMEDIA-DATA, VIDEO, AUDIO, IMAGE AND TEXT-DATA AND FOR DELIVERING OF SOFTWARE APPLICATIONS TO MOBILE DEVICES; COMPUTER SOFTWARE FOR MANAGING AND ENCRYPTING DATA; COMPUTER SOFTWARE FOR WIRELESS MESSAGING, ADVERTISING AND BILLING SYSTEMS FOR USE ON MOBILE DEVICES, IN CLASS 9 (U.S. CLS. 21, 23, 26, 36 AND 38).

FOR: BROADCASTING, DISTRIBUTION AND TRANSMISSION OF TELEVISION, RADIO, TELECOMMUNICATIONS AND DATA SIGNALS VIA DIGITAL AND ANALOG WIRELESS AND/OR CABLE NETWORKS AND PORTALS, INCLUDING VIA ONLINE AND OFFLINE OPERATIONS AND VIA COMPUTER, PARTICULARLY TO MOBILE DEVICES; PROVIDING ACCESS TO TELECOMMUNICATION NETWORKS VIA MOBILE DEVICES, IN CLASS 38 (U.S. CLS. 100, 101 AND 104).

FOR: COMPUTER SOFTWARE DEVELOPMENT, PROGRAMMING AND DESIGN FOR OTHERS,

NAMELY, OF WEB-BASED SOFTWARE FOR MOBILE APPLICATION DEVELOPMENT AS WELL AS FOR DIGITAL MEDIA ADAPTATION, FOR RENDERING TEXT, SOUND OR IMAGES AND FOR DELIVERY OF TEXT, SOUND OR IMAGES FOR MOBILE DEVICES AND OF COMPUTER SOFTWARE FOR TRANSCODING AND DELIVERING OF DIGITAL MEDIA AND PORTALS TO MOBILE DEVICES AND OF COMPUTER SOFTWARE FOR WIRELESS TRANSMISSION OF MULTIMEDIA-DATA, VIDEO, AUDIO, IMAGE AND TEXT-DATA AND FOR DELIVERING OF SOFTWARE APPLICATIONS TO MOBILE DEVICES AND OF COMPUTER SOFTWARE FOR MANAGING AND ENCRYPTING DATA AND OF COMPUTER SOFTWARE FOR WIRELESS MESSAGING, ADVERTISING AND BILLING SYSTEMS FOR USE ON MOBILE DEVICES; COMPUTER SOFTWARE MAINTENANCE AND TECHNICAL SUPPORT SERVICES, NAMELY, SOFTWARE TROUBLESHOOTING; CONDUCTING SOFTWARE TESTS AND SIMULATIONS FOR OTHERS, IN CLASS 42 (U.S. CLS. 100 AND 101).

THE MARK CONSISTS OF STANDARD CHARACTERS WITHOUT CLAIM TO ANY PARTICULAR FONT, STYLE, SIZE, OR COLOR.

PRIORITY DATE OF 7-5-2007 IS CLAIMED.

OWNER OF INTERNATIONAL REGISTRATION 0946318 DATED 10-1-2007, EXPIRES 10-1-2017.

SER. NO. 79-047,305, FILED 10-1-2007.

ANTHONY RINKER, EXAMINING ATTORNEY

Int. Cl.: 29

Prior U.S. Cl.: 46

United States Patent and Trademark Office

Reg. No. 3,520,897

Registered Oct. 21, 2008

**TRADEMARK
PRINCIPAL REGISTER**

CASCINA SERENA

LIDL STIFTUNG & CO. KG (FED REP GERMA-
NY KOMMANDITGESELLSCHAFT)
STIFTSBERGSTR. 1
74167 NECKARSULM
FED REP GERMANY

FOR: MEAT AND SAUSAGE, MEAT PRODUCTS
AND CHARCUTERIE, NAMELY, MEAT PASTE,
MEAT JUICES, SAUSAGES, SMALL SAUSAGES,
BLOOD SAUSAGES, FRANKFURTERS, HAMBUR-
GERS, HOT DOGS, MEAT-BASED MOUSSE, MEAT-
BASED SPREADS, HAM, BACON, SALAMI, MOR-
TADILLA, BACON RINDS, ROAST BEEF, CORNED
BEEF, BEEF PATTIES, MEAT AND SAUSAGE PRE-
SERVES, MEAT JELLIES, MEAT EXTRACTS; PRE-
PARED MEALS, MAINLY COMPRISING MEAT
AND/OR CHARCUTERIE AND/OR VEGETABLES,
IN CLASS 29 (U.S. CL. 46).

PRIORITY DATE OF 7-2-2007 IS CLAIMED.

OWNER OF INTERNATIONAL REGISTRATION
0946452 DATED 11-29-2007, EXPIRES 11-29-2017.

OWNER OF U.S. REG. NO. 2,708,558.

THE FOREIGN WORDING IN THE MARK
TRANSLATES INTO ENGLISH AS "SERENE
FARM".

SER. NO. 79-047,347, FILED 11-29-2007.

SHARON MEIER, EXAMINING ATTORNEY

Int. Cls.: 9 and 42

Prior U.S. Cls.: 21, 23, 26, 36, 38, 100 and 101

Reg. No. 3,520,898

United States Patent and Trademark Office

Registered Oct. 21, 2008

**TRADEMARK
SERVICE MARK
PRINCIPAL REGISTER**

Lunandscape

LUNASCAPE CO., LTD. (JAPAN CORPORATION)
AZABU PARK SIDE BUILDING 202
AZABUNAGASAKA-CHO 1 BANCHI, MINATU-KU
TOKYO 106-0043, JAPAN

FOR: EAR PLUGS NOT FOR MEDICAL PURPOSE; OPTICAL GLASSES; ELECTRIC ARC WELDING MACHINES; OZONISERS; ELECTROLYSERS; EGG-CANDLERS; CASH REGISTERS; COIN COUNTING OR SORTING MACHINES; ELECTRIC SIGN BOARDS FOR DISPLAYING TARGET FIGURES, CURRENT OUTPUTS OR THE LIKE; PHOTO-COPYING MACHINES; TIME AND DATE STAMPING MACHINES; TIME CLOCKS; PUNCH CLOCKS; VOTING MACHINES; POSTAGE STAMP METERS; VENDING MACHINES; METERED GASOLINE PUMPS FOR SERVICE STATIONS; COIN-OPERATED GATES FOR CAR PARKING FACILITIES; LIFE JACKETS; LIFE NETS; FIRE EXTINGUISHERS; FIRE HYDRANTS; FIRE HOSE NOZZLES; SPRINKLER SYSTEMS FOR FIRE PROTECTION; FIRE ALARMS; ALARMS FOR THE DETECTION OF INFLAMMABLE GASES; THEFT ALARMS; PROTECTIVE HELMETS; RAILWAY SIGNALS; VEHICLE BREAKDOWN WARNING TRIANGLES; LUMINOUS OR MECHANICAL ROAD SIGNS; DIVING HELMETS; DIVING SUITS; APPARATUS FOR ARCADE GAMES ADAPTED FOR USE WITH AN EXTERNAL DISPLAY SCREEN OR MONITOR; ELECTRIC DOOR OPENERS; VEHICLE DRIVE TRAINING SIMULATORS; LABORATORY APPARATUS AND INSTRUMENTS, NAMELY, CENTRIFUGES, INCUBATORS, AND THERMOMETERS; PHOTOGRAPHIC FILTERS; PHOTOGRAPHIC VIEWFINDERS; CINEMATOGRAPHIC MACHINES AND APPARATUS; ELECTRICAL POWER DISTRIBUTION UNITS; ROTARY CONVERTERS; BATTERIES AND ELECTRICAL CELLS; ELECTRIC METERS; CIRCUIT TESTERS; ELECTRIC WIRES AND CABLES; ELECTRIC FLAT IRONS; ELECTRIC HAIR-CURLERS; ELECTRIC BUZZERS; COMPUTER PROGRAMS FOR USING THE INTERNET AND THE WORLD WIDE WEB;

MAGNETIC CORES; RESISTANCE WIRES; ELECTRODES; FIRE BOATS; FIRE ENGINES; CIGAR LIGHTERS FOR AUTOMOBILES; GLOVES FOR PROTECTION AGAINST ACCIDENTS; DUST MASKS; GAS MASKS AND WELDING MASKS; FIREPROOF GARMENTS; SPECTACLES; VIDEO GAME MACHINES ADAPTED FOR USE WITH AN EXTERNAL DISPLAY SCREEN OR MONITOR; ELECTRONIC CIRCUITS RECORDING PROGRAMS AND CD-ROMS RECORDED WITH PROGRAMS FOR HAND-HELD GAMES WITH LIQUID CRYSTAL SCREENS; WEIGHT BELTS; PROTECTIVE HELMETS FOR SPORTS; AIR TANKS; SWIMMING FLUTTER BOARDS; REGULATORS; METRONOMES; ELECTRONIC CIRCUITS AND CD-ROMS RECORDED WITH AUTOMATIC PERFORMANCE PROGRAMS FOR ELECTRONIC MUSICAL INSTRUMENTS; EXPOSED CINEMATOGRAPHIC FILMS; EXPOSED SLIDE FILMS; SLIDE FILM MOUNTS, IN CLASS 9 (U.S. CLS. 21, 23, 26, 36 AND 38).

FOR: PROVIDING METEOROLOGICAL INFORMATION; ARCHITECTURAL DESIGN; SURVEYING; GEOLOGICAL SURVEYS OR RESEARCH; DESIGNING OF MACHINES, APPARATUS, INSTRUMENTS AND THEIR PARTS OR SYSTEMS COMPOSED OF SUCH MACHINES, APPARATUS AND INSTRUMENTS; GRAPHIC ARTS DESIGN; COMPUTER SOFTWARE DESIGN, COMPUTER PROGRAMMING, OR MAINTENANCE OF COMPUTER SOFTWARE; TECHNICAL ADVICE RELATING TO PERFORMANCE AND OPERATION OF COMPUTERS; TESTING, INSPECTION OR RESEARCH OF PHARMACEUTICALS, COSMETICS OR FOODSTUFF; RESEARCH ON BUILDING CONSTRUCTION OR CITY PLANNING; TESTING OR RESEARCH ON PREVENTION OF POLLUTION; TESTING OR RESEARCH ON ELECTRICITY; TESTING OR RESEARCH ON CIVIL ENGINEERING; TESTING, INSPECTION OR RESEARCH ON AGRICULTURE, LIVESTOCK BREEDING OR FISHERIES; TESTING OR RESEARCH ON MACHINES,

APPARATUS AND INSTRUMENTS; RENTAL OF MEASURING APPARATUS; RENTAL OF COMPUTERS; RENTAL OF COMPUTER PROGRAMS; RENTAL OF LABORATORY APPARATUS AND INSTRUMENTS; RENTAL OF DRAFTING INSTRUMENTS, IN CLASS 42 (U.S. CLS. 100 AND 101).

OWNER OF INTERNATIONAL REGISTRATION 0946483 DATED 6-1-2007, EXPIRES 6-1-2017.

SER. NO. 79-047,352, FILED 6-1-2007.

G. MAYERSCHOFF, EXAMINING ATTORNEY

Int. Cl.: 30

Prior U.S. Cl.: 46

United States Patent and Trademark Office

Reg. No. 3,520,899

Registered Oct. 21, 2008

**TRADEMARK
PRINCIPAL REGISTER**

Knights Bridge

LIDL STIFTUNG & CO. KG (FED REP GERMA-
NY KOMMANDITGESELLSCHAFT (LIMITED
PARTNERSHIP))
STIFTSBERGSTRASSE 1
74167 NECKARSULM
FED REP GERMANY

FOR: TEA IMPORTED FROM ENGLAND OR
INTENDED FOR ENGLISH-SPEAKING REGIONS,
IN CLASS 30 (U.S. CL. 46).

THE MARK CONSISTS OF STANDARD CHAR-
ACTERS WITHOUT CLAIM TO ANY PARTICULAR
FONT, STYLE, SIZE, OR COLOR.

OWNER OF INTERNATIONAL REGISTRATION
0710193 DATED 3-10-1999, EXPIRES 3-10-2009.

OWNER OF U.S. REG. NOS. 2,529,868 AND
2,850,968.

SER. NO. 79-047,375, FILED 11-6-2007.

SHARON MEIER, EXAMINING ATTORNEY

Int. Cls.: 6 and 11

Prior U.S. Cls.: 2, 12, 13, 14, 21, 23, 25, 31, 34 and 50

United States Patent and Trademark Office

Reg. No. 3,520,900

Registered Oct. 21, 2008

**TRADEMARK
PRINCIPAL REGISTER**

TWINLINE

ARTWEGER GMBH & CO. KG (FED REP GER-
MANY GMBH & CO. KG)
AUGUSTINERSTR. 3 83395
FREILASSING, FED REP GERMANY

FOR: TRANSPORTABLE BUILDINGS MADE OF
METAL, IN CLASS 6 (U.S. CLS. 2, 12, 13, 14, 23, 25
AND 50).

FOR: SANITARY FACILITIES, NAMELY, BATHS,
BATHTUBS, WHIRLPOOL BATHS AND BATH IN-
STALLATIONS, SHOWER AND BATH CUBICLES,
BATH TUBS AND SHOWER TRAYS, SHOWER
DOORS, SHOWER ENCLOSURES, SHOWER SUR-
ROUNDS, SHOWER TRAYS, SHOWER TUBS,

SHOWERS, IN CLASS 11 (U.S. CLS. 13, 21, 23, 31
AND 34).

THE MARK CONSISTS OF STANDARD CHAR-
ACTERS WITHOUT CLAIM TO ANY PARTICULAR
FONT, STYLE, SIZE, OR COLOR.

OWNER OF INTERNATIONAL REGISTRATION
0946701 DATED 8-10-2007, EXPIRES 8-10-2017.

SER. NO. 79-047,450, FILED 8-10-2007.

DAYNA BROWNE, EXAMINING ATTORNEY

Int. Cl.: 3

Prior U.S. Cls.: 1, 4, 6, 50, 51 and 52

United States Patent and Trademark Office

Reg. No. 3,520,901

Registered Oct. 21, 2008

**TRADEMARK
PRINCIPAL REGISTER**

RYZOLIN

DUTRAC BEHEER BV (NETHERLANDS BESLO-
TEN VENNOOTSCHAP)
KIPLAAN 18
NL-2566 SM DEN HAAG
NETHERLANDS

OWNER OF INTERNATIONAL REGISTRATION
0947333 DATED 10-15-2007, EXPIRES 10-15-2017.

FOR: CLEANING PREPARATIONS, IN CLASS 3
(U.S. CLS. 1, 4, 6, 50, 51 AND 52).

SER. NO. 79-047,655, FILED 10-15-2007.

THE MARK CONSISTS OF STANDARD CHAR-
ACTERS WITHOUT CLAIM TO ANY PARTICULAR
FONT, STYLE, SIZE, OR COLOR.

G. MAYERSCHOFF, EXAMINING ATTORNEY

Int. Cls.: 1, 17 and 19

Prior U.S. Cls.: 1, 5, 6, 10, 12, 13, 26, 33, 35, 46 and 50

Reg. No. 3,520,902

United States Patent and Trademark Office

Registered Oct. 21, 2008

**TRADEMARK
PRINCIPAL REGISTER**

BORECO

BOREALIS AG (AUSTRIA AKTIENGESELL-
SCHAFT)
IZD TOWER, WAGRAMERSTR. 17-19
A-1220 VIENNA
AUSTRIA

FOR: UNPROCESSED ARTIFICIAL OR SYN-
THETIC RESINS; UNPROCESSED PLASTICS; UN-
PROCESSED PLASTICS IN PELLET FORM;
POLYETHYLENE RESINS; POLYPROPYLENE RE-
SINS; POLYOLEFIN RESINS, IN CLASS 1 (U.S. CLS.
1, 5, 6, 10, 26 AND 46).

FOR: SEMI-PROCESSED PLASTIC IN THE FORM
OF FILMS, SHEETS, TUBES, BARS, RODS OR
FIBERS; PLASTICS IN EXTRUDED FORM USED
IN PRODUCTION OF PLASTIC PRODUCTS; SYN-
THETIC RESINS IN EXTRUDED FORM, OR IN
BARS, BLOCKS, PELLETS, RODS, SHEETS AND
TUBES, AS SEMI-FINISHED PRODUCTS ALL FOR
GENERAL INDUSTRIAL USE; SEMI-FINISHED

PRODUCTS, NAMELY, SEMI-FINISHED ACRYLIC
MOLDED PLASTIC SUBSTANCE, FOR USE IN
MAKING PLASTIC PRODUCTS, IN CLASS 17 (U.S.
CLS. 1, 5, 12, 13, 35 AND 50).

FOR: PLASTIC PIPES AND FITTINGS THERE-
FOR FOR CONSTRUCTION AND BUILDING PUR-
POSES, NAMELY, FOR CONVEYING NATURAL
GAS, FOR PLUMBING, WATER PIPES, OR GUTTER
PIPES; PLASTIC SEWER PIPES, IN CLASS 19 (U.S.
CLS. 1, 12, 33 AND 50).

OWNER OF INTERNATIONAL REGISTRATION
0947456 DATED 11-22-2007, EXPIRES 11-22-2017.

SER. NO. 79-047,720, FILED 11-22-2007.

ALYSSA PALADINO, EXAMINING ATTORNEY

Int. Cl.: 25

Prior U.S. Cls.: 22 and 39

United States Patent and Trademark Office

Reg. No. 3,520,903

Registered Oct. 21, 2008

**TRADEMARK
PRINCIPAL REGISTER**

PAOLO ALBIZZATI

ALBY SRL (ITALY LIMITED LIABILITY COM-
PANY)
VIA G. DI VITTORIO, 31
I-21046 MALNATE (VA)
ITALY

THE NAME "PAOLO ALBIZZATI" IDENTIFIES A
LIVING INDIVIDUAL WHOSE CONSENT IS OF
RECORD.

FOR: CLOTHING, NAMELY, NECKWEAR,
SHIRTS, IN CLASS 25 (U.S. CLS. 22 AND 39).

SER. NO. 79-047,760, FILED 11-21-2007.

OWNER OF INTERNATIONAL REGISTRATION
0947573 DATED 11-21-2007, EXPIRES 11-21-2017.

PAULA MAHONEY, EXAMINING ATTORNEY

Int. Cls.: 38 and 42

Prior U.S. Cls.: 100, 101 and 104

United States Patent and Trademark Office

Reg. No. 3,520,904

Registered Oct. 21, 2008

**SERVICE MARK
PRINCIPAL REGISTER**

METEOBLUE

METEOBLUE AG (SWITZERLAND SOCIÉTÉ ANONYME)
C/O MATHIAS D. MÜLLER,
KEMBSERWEG 6; CH-4055 BASEL
SWITZERLAND

FOR: PROVISION OF ACCESS TO DATA STORED ELECTRONICALLY IN CENTRAL FILES FOR REMOTE CONSULTATION; TELETXT SERVICES; DATA TRANSMISSION AND RECEPTION SERVICES VIA TELECOMMUNICATION MEANS; ELECTRONIC TRANSMISSION OF DATA AND DOCUMENTS VIA COMPUTER TERMINALS; ELECTRONIC, ELECTRIC AND DIGITAL TRANSMISSION OF DATA, IMAGES, SIGNALS AND MESSAGES; TRANSMISSION OF DATA, SOUND AND IMAGES BY SATELLITE; PROVIDING USER ACCESS TO A GLOBAL COMPUTER NETWORK; TRANSFER OF DATA BY TELECOMMUNICATIONS, IN CLASS 38 (U.S. CLS. 100, 101 AND 104).

FOR: RESEARCH AND DEVELOPMENT OF NEW PRODUCTS AND PROVIDING TECHNOLOGY INFORMATION IN THE WEATHER FORECASTING FIELD; SCIENTIFIC RESEARCH; INDUSTRIAL RESEARCH IN THE FIELDS OF COMPUTER PROGRAMS AND WEATHER FORECASTING EQUIPMENT; DESIGN AND DEVELOPMENT OF

COMPUTER PROGRAMS; CONVERSION OF DATA OR DOCUMENTS FROM PHYSICAL TO ELECTRONIC MEDIA; RENTAL OF ACCESS TIME TO GLOBAL COMPUTER NETWORKS; COMPUTER VIRUS PROTECTION SERVICES; DEVELOPMENT OF COMPUTER SOFTWARE FOR DATA PROCESSING SERVICES; TECHNOLOGY CONSULTATION IN THE FIELD OF WEATHER FORECASTING AND COMPUTER SOFTWARE DEVELOPMENT; DATA WAREHOUSING FOR COMPUTER DATABANKS, IN CLASS 42 (U.S. CLS. 100 AND 101).

THE MARK CONSISTS OF STANDARD CHARACTERS WITHOUT CLAIM TO ANY PARTICULAR FONT, STYLE, SIZE, OR COLOR.

OWNER OF INTERNATIONAL REGISTRATION 0892635 DATED 5-4-2006, EXPIRES 5-4-2016.

THE FOREIGN WORD "METEO" TRANSLATES INTO ENGLISH AS "WEATHER".

SER. NO. 79-047,831, FILED 8-8-2007.

IRA J. GOODSaid, EXAMINING ATTORNEY

Int. Cl.: 21

Prior U.S. Cls.: 2, 13, 23, 29, 30, 33, 40 and 50

Reg. No. 3,520,905

United States Patent and Trademark Office

Registered Oct. 21, 2008

**TRADEMARK
PRINCIPAL REGISTER**

cip

YONG FENG YUAN INDUSTRY CO., LTD (CHINA CORPORATION OF CHINA)
RM. 04, 17/F., BLOCK A
CARRIANNA FRIENDSHIP SQUARE.; 2002, RENMIN ROAD; SOUTH SHEN ZHEN, P.R. CHINA

FOR: CERAMICS FOR HOUSEHOLD PURPOSES, NAMELY, CERAMIC FIGURINES, CERAMIC SCULPTURES, CERAMIC VASES, CERAMIC PLATES, CERAMIC POTS; POTTERY FOR EVERYDAY USE, NAMELY, BASINS, BOWLS, PLATES, INSULATING JARS, PET TREAT JARS, JUGS, POTS, MARMITES, KETTLES; PORCELAIN FOR EVERYDAY USE, NAMELY, BASINS, BOWLS, PLATES, KETTLES, INSULATING JARS, PET TREAT JARS, JUGS AND POTS; GLASSWARE FOR EVERYDAY USE, NAMELY, CUPS, PLATES, KETTLES AND JARS; WORKS OF ART, OF PORCELAIN, TERRACOTTA OR GLASS; DRINKING VESSELS; COFFEE

SERVICES, NOT OF PRECIOUS METAL; TEA SERVICES, NOT OF PRECIOUS METAL; PORCELAIN COPY, NAMELY, PLATES, BOWLS, FIGURINES MADE OF IMITATION PORCELAIN; POTTERY COPY, NAMELY, POTS, PLATES, BOWLS MADE OF IMITATION POTTERY, IN CLASS 21 (U.S. CLS. 2, 13, 23, 29, 30, 33, 40 AND 50).

OWNER OF INTERNATIONAL REGISTRATION
0910166 DATED 9-26-2006, EXPIRES 9-26-2016.

THE WORDING "CIP" HAS NO MEANING IN A FOREIGN LANGUAGE.

SER. NO. 79-047,832, FILED 12-11-2007.

TINA BROWN, EXAMINING ATTORNEY

Int. Cl.: 16

Prior U.S. Cls.: 2, 5, 22, 23, 29, 37, 38 and 50

Reg. No. 3,520,906

United States Patent and Trademark Office

Registered Oct. 21, 2008

TRADEMARK
PRINCIPAL REGISTER

KING JIM

KING JIM CO., LTD. (JAPAN CORPORATION)
10-18, HIGASHI-KANDA 2-CHOME
CHIYODA-KU; TOKYO 101-0031
JAPAN

FOR: LETTER FILES, CARD FILES, DOCUMENT FILES; CLEAR LETTER FILES, CLEAR CARD FILES, CLEAR DOCUMENT FILES; BOOK COVERS, DOCUMENT COVERS, PAPER REPORT COVERS; FOLDERS FOR PAPERS; CARD HOLDERS; PHOTOGRAPH ALBUMS, STAMP ALBUMS; LOOSE-LEAF BINDERS; LOOSE-LEAF PAPERS; DOCUMENT FILING BOXES OF CARDBOARD OR PAPER; DOCUMENT FILING BOXES OF PLASTIC; DESKTOP STATIONERY CABINETS; CLIPS FOR OFFICES, NAMELY, LETTER CLIPS, PAPER CLIPS, PEN CLIPS; DOCUMENT FILES; INDEX CARDS; INDEXES, NAMELY, INDEX BOOKS, INDEX DIVIDERS, PAPER LABELS, ADHESIVE LABELS, ADDRESS LABELS, SHIPPING LABELS; LETTER TRAYS; NOTE BOOKS; PAPER CLASPS; PAPER-CLIPS; PUNCHES; TAGS FOR INDEX CARDS; HOLDERS FOR PAPERS, NAMELY, WRITING PAPER HOLDERS; CASES FOR DRAWINGS; FOLDERS FOR HOLDING PAPER PADS; ADDRESS STAMPS; ANNOUNCEMENT CARDS; BOOK BINDINGS; CASES FOR STAMPS; HOLDERS FOR STAMPS; INKING PADS; PAPER JACKETS FOR PAPERS, CARDBOARD JACKETS FOR PAPERS; SCRAPBOOKS; STAMP PADS; STAMP STANDS; RUBBER STAMPS, IMPRESSION STAMPS, DATE STAMPS, ADDRESS STAMPS; STAPLING PRESSES

AS OFFICE REQUISITES; STAPLES FOR OFFICES; STATIONERY; FILE POCKETS, PENCIL ORNAMENTS, SEALS; CATALOGS IN THE FIELD OF OFFICE SUPPLIES; PERIODICALS AND JOURNALS ON THE SUBJECT MATTER OF OFFICE SUPPLIES; INDUSTRIAL PACKAGING CONTAINERS OF PAPER; INKING RIBBONS; TYPEWRITERS; TAPE PRINTING MACHINES AS OFFICE REQUISITES; TAPE CARTRIDGE AND INK RIBBON CASSETTES FOR TAPE PRINTING MACHINES; PHOTOGRAPH STANDS, IN CLASS 16 (U.S. CLS. 2, 5, 22, 23, 29, 37, 38 AND 50).

PRIORITY DATE OF 7-12-2007 IS CLAIMED.

OWNER OF INTERNATIONAL REGISTRATION
0948019 DATED 9-14-2007, EXPIRES 9-14-2017.

OWNER OF U.S. REG. NOS. 2,183,479 AND
3,326,929.

THE NAME(S), PORTRAIT(S), AND/OR SIGNATURE(S) SHOWN IN THE MARK DOES NOT IDENTIFY A PARTICULAR LIVING INDIVIDUAL.

SER. NO. 79-047,950, FILED 9-14-2007.

REBECCA POVARCHUK, EXAMINING ATTORNEY

Int. Cls.: 7, 9 and 37

**Prior U.S. Cls.: 13, 19, 21, 23, 26, 31, 34, 35, 36, 38,
100, 103 and 106**

Reg. No. 3,520,907

United States Patent and Trademark Office

Registered Oct. 21, 2008

**TRADEMARK
SERVICE MARK
PRINCIPAL REGISTER**

FFEI

FFEI LIMITED (UNITED KINGDOM CORPORATE BODY)
BLOCK 2, EATON COURT,
EATON ROAD; HEMEL HEMPSTEAD, HERTS HP2
7DR
UNITED KINGDOM

COMMERCIAL OR INDUSTRIAL USE; THERMAL LABEL PRINTING MACHINES FOR COMMERCIAL OR INDUSTRIAL USE; PARTS AND FITTINGS FOR ALL OF THE AFORESAID GOODS, IN CLASS 7 (U.S. CLS. 13, 19, 21, 23, 31, 34 AND 35).

FOR: PRINTING MACHINES FOR COMMERCIAL OR INDUSTRIAL USE; AUTOMATIC PRINTING MACHINES FOR COMMERCIAL OR INDUSTRIAL USE; PRINTING PRESSES; PRINTING PLATES; PLATE SETTING MACHINES FOR PRODUCING IMAGED PRINT PLATES FOR USE IN PRINTING MACHINES; PHOTO SETTING MACHINES, NAMELY, PHOTOTYPESETTING MACHINES; TYPESETTING MACHINES; MACHINE-OPERATED PLATFORMS FOR HANDLING SHEET OUTPUT IN PRINTING PRESSES DURING THE PRINTING PROCESS; MACHINE-OPERATED PLATFORMS FOR HANDLING WEB OUTPUT IN PRINTING PRESSES DURING THE PRINTING PROCESS; MACHINES FOR MAKING PRINTING PLATES; MACHINES FOR PROOFING OF PRINTING PLATES; CONTACT PRINTING MACHINES FOR COMMERCIAL OR INDUSTRIAL USE; MACHINE SUB COMPONENTS OF PRINTING PRESSES FOR PERFORMING OPERATIONAL STEPS IN A PRINTING PRESS; INK JET PRINTING MACHINES FOR COMMERCIAL OR INDUSTRIAL USE; INKING APPARATUS FOR PRINTING MACHINES; OFFSET PRINTING MACHINES FOR COMMERCIAL OR INDUSTRIAL USE; PAPER FEEDERS FOR USE WITH COMMERCIAL OR INDUSTRIAL PRINTING MACHINES; PRINTING MACHINES FOR COMMERCIAL OR INDUSTRIAL ELECTRIC DUPLICATING PROCESSES; PRINTING MACHINES FOR COMMERCIAL OR INDUSTRIAL ELECTRONIC DUPLICATING PROCESSES; REPRODUCTION MACHINES FOR PRINTING IN THE NATURE OF PRINTING MACHINES FOR

FOR: PRINTERS AND SCANNERS; ELECTRONIC AND DIGITAL IMAGING AND PHOTOGRAPHIC APPARATUS, NAMELY, CAMERAS; PHOTOCOPYING MACHINES; COMPUTER HARDWARE AND COMPUTER SOFTWARE FOR PRINTING, SCANNING AND ELECTRONIC IMAGING OF DOCUMENTS, TEXT AND IMAGES, IMAGE PROCESSING, PHOTO SETTING AND TYPESETTING; COMPUTER HARDWARE AND COMPUTER SOFTWARE FOR MANAGING COMPUTER TO PRINTING PLATE WORKFLOW; PRINT COLOR MANAGEMENT SOFTWARE FOR USE IN COMMERCIAL, INDUSTRIAL OR PERSONAL PRINTERS AND PRINTING MACHINES; ELECTROMECHANICAL CONTROLLERS FOR PERFORMING OPERATIONAL STEPS IN A PRINTING PRESS; ELECTRONIC PRINTING APPARATUS FOR USE WITH COMPUTERS, NAMELY, DIGITAL COLOR PRINTERS; PLOTTERS FOR USE IN THE PRINTING OF GRAPHICS; APPARATUS FOR THE TRANSMISSION OF COMMUNICATIONS BETWEEN COMPUTERS, PRINTERS AND PRINTING MACHINES; PRINTING DISSEMINATION APPARATUS, NAMELY, PRINTERS AND FAX MACHINES; PRINTING PLATE SCANNERS; COMPUTER SOFTWARE FOR SIMULATING PRINTING PROCESSES FOR THE PURPOSE OF PRINTING MACHINE CALIBRATION AND THE EXAMINATION OF PRINT QUALITY AND EFFICIENCY; SCANNING APPARATUS FOR USE IN THE PRINTING INDUSTRY, IN CLASS 9 (U.S. CLS. 21, 23, 26, 36 AND 38).

FOR: INSTALLATION, REPAIR AND MAINTENANCE OF COMPUTERS, COMPUTER HARDWARE, PRINTERS, PRINTING MACHINES, SCANNERS AND COMMERCIAL PRINTING EQUIPMENT FOR THE REPROGRAPHICS AND PRINTING INDUSTRIES, IN CLASS 37 (U.S. CLS. 100, 103 AND 106).

PRIORITY DATE OF 10-24-2006 IS CLAIMED.

OWNER OF INTERNATIONAL REGISTRATION 0948260 DATED 4-12-2007, EXPIRES 4-12-2017.

SER. NO. 79-048,032, FILED 4-12-2007.

STEVEN PEREZ, EXAMINING ATTORNEY

Int. Cls.: 7 and 9

Prior U.S. Cls.: 13, 19, 21, 23, 26, 31, 34, 35, 36 and 38

Reg. No. 3,520,908

United States Patent and Trademark Office

Registered Oct. 21, 2008

**TRADEMARK
PRINCIPAL REGISTER**

MARQUIS

ZHEJIANG TEAMS INTERNATIONAL; ECONOMIC & TECHNICAL; COOPERATION CO., LTD. (CHINA CORPORATION)
18 ZHAOTONG XIANG
CHANGJIANG LU.; XINGAN, NINGBO; ZHEJIANG315040
CHINA

FOR: PUMPS, NAMELY, ELECTRIC PUMPS, PUMPS AS PARTS OF MACHINES, MOTORS AND ENGINES, AQUARIUM PUMPS, BILGE PUMPS, CENTRIFUGAL PUMPS, COMPRESSED AIR PUMPS, FUEL PUMPS FOR LAND VEHICLES, HIGH-PRESSURE PUMPS FOR WASHING APPLIANCES AND INSTALLATIONS, HYDRAULIC PUMPS, LUBRICATING PUMPS, SCREW PUMPS, SUMP PUMPS, VACUUM PUMPS, VERTICAL TURBINE PUMPS, VALVES FOR PUMPS; VALVES, NAMELY, VALVES FOR PUMPS, VALVES BEING PARTS OF MACHINES, PUMP CONTROL VALVES, BALL VALVES BEING PARTS OF MACHINES AND SERVO-VALVES; SPRAYING MACHINES; WATER PUMPS FOR SPRINKLING SYSTEMS; ELECTRIC MOTORS, NAMELY, DIRECT CURRENT MOTORS,

ELECTRIC MOTORS FOR MACHINES; ENGINES AND MOTORS FOR THE GENERATION OF ELECTRICITY, LINEAR MOTORS, IN CLASS 7 (U.S. CLS. 13, 19, 21, 23, 31, 34 AND 35).

FOR: CAPACITORS, VOLTAGE-STABILIZING POWER SUPPLIES, PRESSURE GAUGES; AUTOMOTIVE MEASURING INSTRUMENTS, NAMELY, WATER TEMPERATURE GAUGES, AIR-FUEL-RATIO GAUGES, BOOST GAUGES, VACUUM GAUGES AND EXHAUST GAS TEMPERATURE GAUGES, PRESSURE GAUGES; KILOWATT-HOUR METERS; ELECTRIC CURRENT STABILIZERS, VOLTAGE REGULATORS, IN CLASS 9 (U.S. CLS. 21, 23, 26, 36 AND 38).

OWNER OF INTERNATIONAL REGISTRATION
0800530 DATED 12-30-2002, EXPIRES 12-30-2012.

SER. NO. 79-048,058, FILED 10-27-2007.

TINA BROWN, EXAMINING ATTORNEY

Int. Cls.: 14, 18, 25 and 28

Prior U.S. Cls.: 1, 2, 3, 22, 23, 27, 28, 38, 39, 41 and 50

Reg. No. 3,520,909

United States Patent and Trademark Office

Registered Oct. 21, 2008

**TRADEMARK
PRINCIPAL REGISTER**



KILLTEC SPORT; UND FREIZEIT GMBH (FED
REP GERMANY LIMITED LIABILITY COM-
PANY)
ZIMMERERSTR. 5
21244 BUCHHOLZ
FED REP GERMANY

FOR: CLOCKS AND CHRONOMETRICAL IN-
STRUMENTS; JEWELRY ORNAMENTS OF PRE-
CIOUS METAL; WATCH CASES, CLOCK WORKS,
NAMELY, CLOCK HOUSINGS, CLOCK CASES,
CONTAINERS OF PRECIOUS METAL, NAMELY,
BOXES AND JEWELRY CASES, IN CLASS 14 (U.S.
CLS. 2, 27, 28 AND 50).

FOR: TRAVELLING BAGS, SPORT BAGS AND
SUITCASES, BAGS AND SACS OF LEATHER AND
LEATHER IMITATIONS; UMBRELLAS, IN CLASS
18 (U.S. CLS. 1, 2, 3, 22 AND 41).

FOR: CLOTHING, NAMELY, LEISURE CLOTH-
ING, NAMELY, SPORT SHIRTS, SPORT PANTS,
SPORT SHORTS, SPORT JACKETS, SPORT SKIRTS,
SPORTING ANORAKS, LEATHER JACKETS AND
IMITATION LEATHER JACKETS, GLOVES, TIES,
BOW-TIES; SPORT SOCKS, SPORT PULLOVER;
FOOTWEAR, HEADGEAR, NAMELY, SPORT HATS
AND CAPS; POCKET SQUARES FOR CLOTHING;
GLOVES; FLEECE-SHIRTS, IN CLASS 25 (U.S. CLS.
22 AND 39).

FOR: GYMNASTIC AND SPORTING ARTICLES,
NAMELY, TENNIS RACKETS, RACKET BALLS,
RACKETS, BASEBALLS, BATS, BASEBALL BATS,
FISHING RODS AND REELS, BASKETBALLS, VOL-
LEYBALLS, SOCCER BALLS, BASKETBALL NETS,
VOLLEYBALL NETS AND HANDHOLD FISHING
NETS, SKIS AND SKI POLES, GOLF CLUBS; BAGS
ADAPTED FOR SPORTING EQUIPMENT , IN
CLASS 28 (U.S. CLS. 22, 23, 38 AND 50).

OWNER OF INTERNATIONAL REGISTRATION
0929439 DATED 9-19-2006, EXPIRES 9-19-2016.

OWNER OF U.S. REG. NO. 1,448,506.

THE COLOR(S) RED AND BLACK IS/ARE
CLAIMED AS A FEATURE OF THE MARK.

THE MARK CONSISTS OF THE WORDING
"KILLTEC" IN THE COLOR BLACK TO THE RIGHT
OF INCOMPLETE QUADRILATERAL DESIGN IN
THE COLOR BLACK WITH A RED CIRCLE IN THE
UPPER RIGHT OF THE DESIGN.

SER. NO. 79-048,071, FILED 10-23-2007.

DOMINIC FATHY, EXAMINING ATTORNEY

Int. Cls.: 6, 9, 11, 19 and 35

**Prior U.S. Cls.: 1, 2, 12, 13, 14, 21, 23, 25, 26, 31, 33,
34, 36, 38, 50, 100, 101 and 102**

Reg. No. 3,520,910

United States Patent and Trademark Office

Registered Oct. 21, 2008

**TRADEMARK
SERVICE MARK
PRINCIPAL REGISTER**



RITTAL GMBH & CO. KG (FED REP GERMANY
LIMITED LIABILITY COMPANY)
AUF DEM STÜTZELBERG
35726 HERBORN
FED REP GERMANY

FOR: COMPONENTS MADE OF METAL FOR SWITCH CABINETS, NAMELY, RACK PANELS, PROFILES, SUPPORT BASES, GUIDE RAILS, SUPPORT RAILS, DEPOSIT BASES, DRAWERS, ACCOMMODATING CONTAINERS; SHEETING MADE OF SHEET METAL, NAMELY, DOORS, WALLS; CLOSURE APPARATUSES MADE OF METAL, NAMELY, DOOR LOCKS; CONTROL AND MOVEMENT APPARATUSES MADE OF METAL, NAMELY, STATIONARY BASES AND ROLLERS; MOUNTING DEVICES AND MOUNTING AIDS, FIXED OR MOVEABLE, MADE OF METAL, NAMELY, MOUNTING PLATES, PIVOTAL FRAMES, COMPARTMENT BASES; SECURING APPARATUSES MADE OF METAL, NAMELY, HOLDING ANGLES, IN CLASS 6 (U.S. CLS. 2, 12, 13, 14, 23, 25 AND 50).

FOR: SWITCH CABINETS, AND RACKS THEREFORE MADE OF METAL AND/OR PLASTICS MATERIAL; ADAPTED HOUSINGS FOR THE ACCOMMODATION OF ELECTRICAL INSTALLATIONS, IN THE FIELDS OF INDUSTRY, ELECTRONICS, COMPUTERS, INTERACTIVE TERMINAL SYSTEMS AND INFORMATION TRANSFER AND ADAPTED CONSOLES FOR TO PUT UP ELECTRICAL INSTALLATIONS AND WHICH ARE USED PREFERABLY FOR INDUSTRY, INSTALLATION, ELECTRONICS, COMPUTERS, INTERACTIVE TERMINAL SYSTEMS AND DATA TRANSMISSION, ALSO IN CONJUNCTION WITH SUPPORTING ARM SYSTEMS AND/OR EARTHQUAKE-PROOF AND/OR VANDAL-PROOF AND/OR EX-

PLOSION-PROOF, MODULE CARRIERS FOR PLUGGABLE MODULES WITH ELECTRONIC CIRCUITS; SIGNALING DEVICES THAT EMIT SOUNDS AND LIGHT FOR MONITORING AND SECURITY OF SWITCHGEAR CABINETS; ELECTRIC CURRENT DISTRIBUTION COMPONENTS, NAMELY, ELECTRONIC CONNECTORS AND ELECTRONIC APPARATUS ADAPTERS AND LOAD-BREAKERS; MODULES AND SYSTEM COMPONENTS FOR SECONDARY POWER DISTRIBUTION AND POWER SUPPLIES, NAMELY, POWER PACKS, ELECTRIC ACCUMULATORS, POWER GENERATING DEVICES, NAMELY, ELECTRICAL POWER SUPPLIES, AND NO-BREAK POWER SUPPLYING DEVICES, NAMELY, ELECTRICAL POWER SUPPLIES ALSO CONSTRUCTED IN MODULE FORM; CURRENT CONVERTERS, CURRENT INVERTERS; CABLE BUSHINGS FOR ELECTRIC PURPOSES; OVERLOAD PROTECTION FOR SENSITIVE ELECTRONIC DEVICES AND COMPUTERS, NAMELY, FUSES AND MONITORING UNITS; ELECTRIC AND ELECTRONIC CONTROL DEVICES AND SYSTEMS, NAMELY, ACCESS CONTROL AND ALARM MONITORING SYSTEMS FOR THE SECURITY OF ELECTRICAL SWITCHGEAR CABINETS FOR ELECTRONICS AND COMPUTERS, ELECTRIC AND ELECTRONIC APPARATUSES AND INSTRUMENTS, NAMELY, ELECTRICAL CONTROLLERS FOR CONTROL STATIONS, CONTROL OBSERVATION STATIONS, AND CONSOLE WORKPLACES; SOFTWARE FOR USE IN CONFIGURING AND MONITORING SAFE ROOMS IN THE FIELD OF INFORMATION TECHNOLOGY; CABLING AIDS FOR ELECTRIC PURPOSES MADE OF METAL OR PLASTICS MATERIAL, NAMELY, MODULES FOR CABLE MANAGEMENT COMPRISING CABLE ROUTING DUCTS, CABLE BYPASS DUCTS, CABLE SECURING ELEMENTS, NAMELY, CABLE CLAMPING RAILS, CABLE EN-

TRIES ALL SOLD AS A UNIT; CABLING AIDS FOR ELECTRICAL CABLES, NAMELY, RUBBER CLAMPING PROFILES AND ADAPTED LABELING STRIPS, INSERTS FOR MODULE CARRIERS, NAMELY, PLUG-IN CARDS, BUS BARS, CASSETTES, PLUG CONNECTORS; REPLACEMENT PARTS OF ALL THE ABOVE MENTIONED GOODS, IN CLASS 9 (U.S. CLS. 21, 23, 26, 36 AND 38).

FOR: DEVICES FOR AIR CONDITIONING, NAMELY, COOLING DEVICES NAMELY, EVAPORATIVE AIR COOLING UNITS, WATER COOLING UNITS, VENTILATORS, HEAT EXCHANGERS, FILTER VENTILATORS, HEATING INSTALLATIONS, LIQUID COOLERS, ALL FOR USE WITH SWITCH CABINETS; AIR CONDITIONING SYSTEMS AND AIR CONDITIONING DEVICES MADE UP FROM EVAPORATIVE AIR COOLING UNITS, WATER COOLING UNITS, VENTILATORS, HEAT EXCHANGERS, FILTER VENTILATORS, HEATING INSTALLATIONS, LIQUID COOLERS, FOR USE IN ROOM AIR CONDITIONING; INSTALLATION ACCESSORIES, NAMELY, SWITCH CABINET LIGHTS, IN CLASS 11 (U.S. CLS. 13, 21, 23, 31 AND 34).

FOR: CABLE BUSHINGS MADE OF PLASTICS MATERIALS, NAMELY, DOOR AND WALL CLADDINGS; CONTROL AND MOVING APPARATUSES

MADE OF PLASTICS MATERIALS, NAMELY, STATIONARY BASES AND ROLLERS; LININGS MADE OF GLASS OR PLASTICS MATERIAL, NAMELY, DOORS, WALLS, IN CLASS 19 (U.S. CLS. 1, 12, 33 AND 50).

FOR: WHOLESALE ORDERING SERVICES IN THE FIELD OF SERVER RACKS AND ENCLOSURES, SWITCH CABINETS, HOUSINGS, CONSOLES AND ACCESSORIES RELATING TO DATA CENTER POWER MANAGEMENT, COOLING, SECURITY, AND REMOTE MONITORING, IN CLASS 35 (U.S. CLS. 100, 101 AND 102).

PRIORITY DATE OF 2-21-2007 IS CLAIMED.

OWNER OF INTERNATIONAL REGISTRATION 0948500 DATED 8-20-2007, EXPIRES 8-20-2017.

OWNER OF U.S. REG. NOS. 3,148,959, 3,233,642 AND OTHERS.

SER. NO. 79-048,130, FILED 8-20-2007.

EUGENIA MARTIN, EXAMINING ATTORNEY

Int. Cls.: 18, 25 and 28

Prior U.S. Cls.: 1, 2, 3, 22, 23, 38, 39, 41 and 50

United States Patent and Trademark Office

Reg. No. 3,520,911

Registered Oct. 21, 2008

TRADEMARK
PRINCIPAL REGISTER



GEIS BENOIT ROCH (FRANCE INDIVIDUAL)
8 RUE DU BINSBOURG
F-68500 JUNGHOLTZ
FRANCE

FOR: LEATHER AND IMITATION LEATHER; ANIMAL SKINS AND HIDES; TRUNKS AND SUIT-CASES; UMBRELLAS, PARASOLS AND COMBINED CANES AND WHIPS AND SADDLERY; WALLETS; CHANGE PURSES; HANDBAGS; BACK-PACKS; WHEELED BAGS; BAGS FOR CLIMBERS, BAGS FOR CARRYING CAMPING EQUIPMENT, TRAVELING BAGS, BEACH BAGS, SCHOOL BAGS, UNFITTED VANITY CASES, COLLARS AND CLOTHING FOR ANIMALS; SHOPPING BAG; MESH SHOPPING BAGS; LEATHER BAGS FOR MERCHANDISE PACKAGING, IN CLASS 18 (U.S. CLS. 1, 2, 3, 22 AND 41).

FOR: CLOTHING, NAMELY, SHIRTS, T-SHIRTS, PANTS, SHORTS, JACKET; FOOTWEAR; HEAD-GEAR, NAMELY, HATS, CAPS, LEATHER AND IMITATION LEATHER CLOTHING, NAMELY, LEATHER COATS, LEATHER TROUSERS; FUR COATS; BELTS; GLOVES; SCARVES; NECKTIES; HOSIERY; SOCKS; BOOT LINERS; BEACH, SKI AND SPORT FOOTWEAR; BABIES DIAPERS OF TEXTILES; UNDERWEAR, IN CLASS 25 (U.S. CLS. 22 AND 39).

FOR: ACTION SKILL GAMES; TOY ACTION FIGURES, TOY ANIMALS, TOY BALLOONS, TOY BOXES, TOY BUILDING BLOCKS, TOY BUTTERFLY NETS, TOY CARS, TOY CLOCKS AND WATCHES, TOY FIGURES, TOY FILM CARTRIDGES AND VIEWERS, TOY FURNITURE, TOY HOUSES, TOY MOBILES, TOY MODEL CARS, TOY PRISM GLASSES, TOY PUTTY, TOY RECORD PLAYERS, TOY ROBOTS, TOY VEHICLES, TOY WATCHES; DECORATIONS FOR CHRISTMAS TREES EXCLUDING LIGHTING ARTICLES;

CHRISTMAS TREES OF SYNTHETIC MATERIAL, BODY TRAINING AND GYMNASTIC APPARATUS; FISHING TACKLE; BALLS FOR GAMES AND PLAY BALLOONS; BILLIARD TABLES, CUES AND BALLS; CARD AND BOARD GAMES; ICE AND ROLLER SKATES; SAIL AND SURF BOARDS; TOY SCOOTERS; RACKETS AND BATS, SNOWSHOES; SKIS; PROTECTIVE PADDING FOR PLAYING ROLLER SKATES, IN CLASS 28 (U.S. CLS. 22, 23, 38 AND 50).

PRIORITY DATE OF 6-19-2007 IS CLAIMED.

OWNER OF INTERNATIONAL REGISTRATION
0949612 DATED 12-5-2007, EXPIRES 12-5-2017.

THE COLOR(S) WHITE, BLACK, PURPLE, BLUE, ORANGE, GREEN, YELLOW AND RED IS/ARE CLAIMED AS A FEATURE OF THE MARK.

THE MARK CONSISTS OF A PURPLE STYLIZED LETTER "Q" WITH TWO BLACK AND WHITE EYES AND EYEBROWS, A BLACK, WHITE AND BLUE NOSE, A WHITE MOUTH, ORANGE AND WHITE LEGS AND FEET, AND WHITE HANDS. THE LETTERS "OUIKI" ARE DISPLAYED TO THE RIGHT OF THE LETTER "Q." THE "O" IS BLUE AND WHITE AND PARTIALLY OBSCURED BY THE WHITE HAND ON THE LETTER "Q." THE LETTER "U" IS DISPLAYED IN GREEN. THE LETTER "I" IS DISPLAYED IN YELLOW. THE LETTER "L" IS DISPLAYED IN ORANGE. THE LETTER "I" IS DISPLAYED IN RED.

SER. NO. 79-048,530, FILED 12-5-2007.

RENEE SERVANCE, EXAMINING ATTORNEY

Int. Cl.: 1

Prior U.S. Cls.: 1, 5, 6, 10, 26 and 46

United States Patent and Trademark Office

Reg. No. 3,520,912

Registered Oct. 21, 2008

**TRADEMARK
PRINCIPAL REGISTER**

VESTASOL

EVONIK DEGUSSA GMBH (FED REP GERMA-
NY LIMITED LIABILITY COMPANY)
RELLINGHAUSER STRAÙE 1-11
45128 ESSEN, FED REP GERMANY

FOR: CHEMICALS USED IN INDUSTRY, SCI-
ENCE AND PHOTOGRAPHY AND SOLVENTS
USED IN AGRICULTURE, NAMELY, ISOPHOR-
ONE AS SOLVENT FOR HERBICIDES USED IN
THE MANUFACTURE OF HERBICIDES; SOL-
VENTS, NAMELY, ISOPHORONE AS SOLVENT IN
COATINGS AND PRINTING INKS USED IN THE
MANUFACTURE OF COATINGS AND PRINTING
INKS, IN CLASS 1 (U.S. CLS. 1, 5, 6, 10, 26 AND 46).

THE MARK CONSISTS OF STANDARD CHAR-
ACTERS WITHOUT CLAIM TO ANY PARTICULAR
FONT, STYLE, SIZE, OR COLOR.

PRIORITY DATE OF 5-12-2007 IS CLAIMED.

OWNER OF INTERNATIONAL REGISTRATION
0949761 DATED 11-10-2007, EXPIRES 11-10-2017.

SER. NO. 79-048,586, FILED 11-10-2007.

YAT SYE, LEE, EXAMINING ATTORNEY

Int. Cl.: 1

Prior U.S. Cls.: 1, 5, 6, 10, 26 and 46

United States Patent and Trademark Office

Reg. No. 3,520,913

Registered Oct. 21, 2008

**TRADEMARK
PRINCIPAL REGISTER**



**POKON & CHRYSA INTERNATIONAL B.V.
(NETHERLANDS BESLOTEN VENNOOTSCHAP)**

**GOOIMEER 7
NL-1411 DD NAARDEN
NETHERLANDS**

INCLUDING CUT FLOWERS, IN CLASS 1 (U.S. CLS. 1, 5, 6, 10, 26 AND 46).

**OWNER OF INTERNATIONAL REGISTRATION
0877785 DATED 11-9-2005, EXPIRES 11-9-2015.**

**FOR: CHEMICALS USED IN AGRICULTURE,
HORTICULTURE, FORESTRY AND FLORICULTURE,
NAMESLY, CHEMICAL PREPARATIONS
FOR THE TREATMENT OF SEEDS, PLANTS AND
FLOWERS, INCLUDING CUT FLOWERS; NATURAL
AND ARTIFICIAL FERTILIZERS; POTTING
SOIL; COMPOST; PRESERVATIVES FOR FLOWERS;
NUTRIENTS FOR NATURAL PLANTS, FLOWERS,**

**OWNER OF U.S. REG. NOS. 1,811,742 AND
2,680,107.**

SER. NO. 79-048,686, FILED 6-12-2007.

TARAH HARDY, EXAMINING ATTORNEY

Int. Cl.: 34

Prior U.S. Cls.: 2, 8, 9 and 17

United States Patent and Trademark Office

Reg. No. 3,520,914

Registered Oct. 21, 2008

TRADEMARK
PRINCIPAL REGISTER



ROYAL DISTRIBUTION TABAC DISTRI NORD
(FRANCE S.A.R.L (SOCIÉTÉ À RESPONSABILITÉ LIMITÉE))
62/4 RUE DE CANNES
F-59000 LILLE
FRANCE

FOR: SMOKERS' ARTICLES, NAMELY, MATCHES, CIGARETTE PAPER, PIPES, SMOKERS' LIGHTERS, CIGAR BOXES AND CASES, CIGARETTE BOXES AND CASES, SMOKERS' ASHTRAYS, CIGARETTE FILTERS, POCKET MACHINES FOR ROLLING CIGARETTES, SMOKING PIPES, IN CLASS 34 (U.S. CLS. 2, 8, 9 AND 17).

PRIORITY DATE OF 6-12-2007 IS CLAIMED.

OWNER OF INTERNATIONAL REGISTRATION
0950344 DATED 11-26-2007, EXPIRES 11-26-2017.

NO CLAIM IS MADE TO THE EXCLUSIVE RIGHT TO USE "BLUNT" AND "ORIGINAL FLAVOR", APART FROM THE MARK AS SHOWN.

"THE COLOR(S) RED, YELLOW, ORANGE, BLACK AND WHITE IS/ARE CLAIMED AS A FEATURE OF THE MARK."

THE MARK CONSISTS OF THE COLORS RED, BLACK AND YELLOW APPEAR IN THE STAR DESIGN, THE COLOR ORANGE APPEARS IN THE BANNER DESIGN, THE COLORS BLACK AND WHITE APPEAR IN THE WORDING "REDGIES BLUNT" AND "ORIGINAL FLAVORS".

SER. NO. 79-048,822, FILED 11-26-2007.

AMOS T. MATTHEWS, JR., EXAMINING ATTORNEY

Int. Cls.: 9 and 11

Prior U.S. Cls.: 13, 21, 23, 26, 31, 34, 36 and 38

Reg. No. 3,520,915

United States Patent and Trademark Office

Registered Oct. 21, 2008

**TRADEMARK
PRINCIPAL REGISTER**

NIPAX

NITTO KOGYO CORPORATION (JAPAN CORPORATION)
2201, KANIHARA
NAGAKUTE-CHO.; AICHI COUNTY; AICHI 480-1189
JAPAN

FOR: HOUSING CABINETS AND BOXES FOR ELECTRICAL MACHINES, APPARATUS AND ELECTRONIC EQUIPMENT, NAMELY, ELECTRICAL DISTRIBUTION BOARDS, ELECTRICAL DISTRIBUTION CONSOLES, SWITCHBOARDS, ELECTRICAL CONTROL PANELS, MONITORING BOARDS, AND TABLES USED IN MONITORING, ALL FOR MONITORING ELECTRICAL CURRENT, ELECTRICAL ENERGY AND REMOTE CONTROL DEVICES; SWITCH BOXES; JUNCTION BOXES FOR ELECTRICITY; ELECTRICAL BRANCH BOXES; HOUSING CABINETS AND BOXES FOR TELECOMMUNICATION MACHINES AND APPARATUS, NAMELY, FOR TRANSMITTERS, TELEVISIONS, TELEPHONES, JUNCTION BOXES FOR TELECOMMUNICATION; HOUSING CABINETS AND BOXES FOR ELECTRONIC MACHINES AND APPARATUS, NAMELY, FOR COMPUTERS; HOUSING CABINETS AND BOXES FOR MEASURING AND TESTING APPARATUS AND INSTRUMENTS, NAMELY, JUNCTION BOXES FOR OPTICAL FIBERS, ELECTRIC DISTRIBUTION BOARDS, ELECTRIC PANEL BOARDS, ELECTRIC INCOMING BOARDS, ELECTRIC DISTRIBUTION CONSOLES, ELECTRIC SWITCHBOARDS, ELECTRIC LOCAL SWITCHBOARDS, ELECTRIC CONTROL PANELS, ELECTRIC ALARM PANELS, ELECTRICITY MONITORING PANELS, ELECTRIC TERMINAL PANELS, ELECTRIC WIRING BOARDS, ELECTRIC

CIRCUIT BREAKERS, ELECTRIC SWITCHES, ELECTRIC DISCONNECTORS, ELECTRIC CIRCUIT CLOSERS, ELECTRIC TERMINAL BLOCKS, ELECTRIC CABLE TROUGHS; PEDESTALS, NAMELY, CABINETS, HOUSING AND STRUCTURAL MOUNTING PARTS FOR ELECTRICAL APPARATUS AND INSTRUMENTS, NAMELY, ELECTRIC POWER METERS THROUGH WHICH ELECTRIC WIRES AND ELECTRIC CABLES LAID UNDERGROUND ARE DRAWN INTO THE BUILDING FROM THE OUTSIDE, IN CLASS 9 (U.S. CLS. 21, 23, 26, 36 AND 38).

FOR: HEAT EXCHANGERS NOT BEING PARTS OF MACHINES; REFRIGERATORS; AIR CONDITIONERS; DEHUMIDIFIERS; VENTILATORS FOR INDUSTRIAL USE; VENTILATING EXHAUST FANS; AIR FILTERS FOR VENTILATORS; VENTILATING LOUVERS, IN CLASS 11 (U.S. CLS. 13, 21, 23, 31 AND 34).

THE MARK CONSISTS OF STANDARD CHARACTERS WITHOUT CLAIM TO ANY PARTICULAR FONT, STYLE, SIZE, OR COLOR.

OWNER OF INTERNATIONAL REGISTRATION 0950474 DATED 7-24-2007, EXPIRES 7-24-2017.

THE WORDING IN THE MARK HAS NO MEANING IN A FOREIGN LANGUAGE.

SER. NO. 79-048,859, FILED 7-24-2007.

NAPOLEON SHARMA, EXAMINING ATTORNEY

Int. Cls.: 9, 41 and 42

Prior U.S. Cls.: 21, 23, 26, 36, 38, 100, 101 and 107

United States Patent and Trademark Office

Reg. No. 3,520,916

Registered Oct. 21, 2008

**TRADEMARK
SERVICE MARK
PRINCIPAL REGISTER**

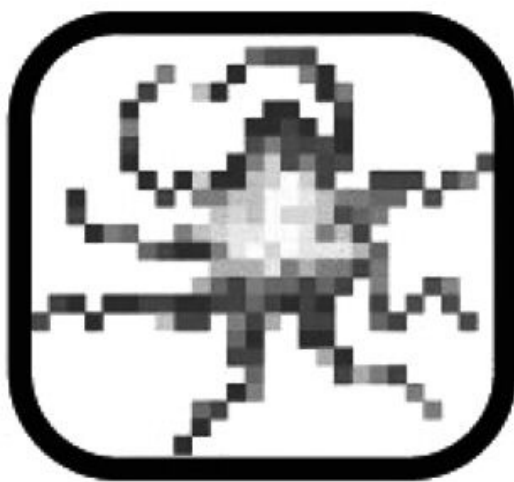

DIPRITEC AB (SWEDEN LIMITED COMPANY)
HÖGBERGSGATAN 36
SE-116 20 STOCKHOLM
SWEDEN

FOR: RECORDED COMPUTER PROGRAMS AND RECORDED SOFTWARE FOR USE IN PRINTING; COMPUTERS AND COMPUTER PERIPHERALS, IN CLASS 9 (U.S. CLS. 21, 23, 26, 36 AND 38).

FOR: EDUCATION SERVICES, NAMELY, PROVIDING CLASSES, SEMINARS, CONFERENCES AND WORKSHOPS IN THE FIELD OF COMPUTER PROGRAMS AND SOFTWARE, COMPUTERS, COMPUTER PERIPHERALS, AND INSTALLATION OF COMPUTER PROGRAMS AND SOFTWARE, IN CLASS 41 (U.S. CLS. 100, 101 AND 107).

FOR: COMPUTER CONSULTANCY SERVICES; DESIGN, DEVELOPMENT, INSTALLATION, MAIN-

TENANCE AND UPDATING COMPUTER PROGRAMS AND SOFTWARE; RENTAL OF COMPUTER PROGRAMS AND SOFTWARE, IN CLASS 42 (U.S. CLS. 100 AND 101).

PRIORITY DATE OF 5-29-2007 IS CLAIMED.

OWNER OF INTERNATIONAL REGISTRATION 0950673 DATED 11-26-2007, EXPIRES 11-26-2017.

THE MARK CONSISTS OF A FRAME WITH AN OCTOPUS INSIDE OF THE FRAME.

SER. NO. 79-048,934, FILED 11-26-2007.

AMOS T. MATTHEWS, JR., EXAMINING ATTORNEY

Int. Cl.: 7

Prior U.S. Cls.: 13, 19, 21, 23, 31, 34 and 35

United States Patent and Trademark Office

Reg. No. 3,520,917

Registered Oct. 21, 2008

**TRADEMARK
PRINCIPAL REGISTER**

OXYFLAM

L'AIR LIQUIDE, SOCIÉTÉ ANONYME; POUR
L'ÉTUDE ET L'EXPLOITATION DES; PRO-
CÉDÉS GEORGES CLAUDE (FRANCE SOCI-
ÉTÉ ANONYME)

75 QUAI D'ORSAY,
F-75321 PARIS CEDEX 07
FRANCE

FOR: NON-ELECTRIC WELDING SETS, NAME-
LY, GAS OPERATED WELDING MACHINES, IN
CLASS 7 (U.S. CLS. 13, 19, 21, 23, 31, 34 AND 35).

THE MARK CONSISTS OF STANDARD CHAR-
ACTERS WITHOUT CLAIM TO ANY PARTICULAR
FONT, STYLE, SIZE, OR COLOR.

OWNER OF INTERNATIONAL REGISTRATION
0950869 DATED 7-30-2007, EXPIRES 7-30-2017.

SER. NO. 79-049,000, FILED 7-30-2007.

DOMINIC FATHY, EXAMINING ATTORNEY

Int. Cls.: 24 and 25

Prior U.S. Cls.: 22, 39, 42 and 50

United States Patent and Trademark Office

Reg. No. 3,520,918

Registered Oct. 21, 2008

**TRADEMARK
PRINCIPAL REGISTER**



SIGLA FASHION S.R.L. (ITALY S.R.L.)
VIA SAN DEFENDENTE, 81
I-20010 BOFFALORA S/T (MI), ITALY

OWNER OF INTERNATIONAL REGISTRATION
0951573 DATED 12-12-2007, EXPIRES 12-12-2017.

FOR: WOVEN FABRICS, IN CLASS 24 (U.S. CLS. 42
AND 50).

NO CLAIM IS MADE TO THE EXCLUSIVE
RIGHT TO USE "FASHION", APART FROM THE
MARK AS SHOWN.

FOR: CLOTHING, NAMELY, T-SHIRTS, TROU-
SERS, SHIRTS, SPORT SHIRTS, DRESS SHIRTS,
POLO SHIRTS, SWEATERS, PULLOVERS, BLOU-
SES, JACKETS, RAINCOATS, OVERCOATS, JEAN
PANTS, PANTS, SWEATPANTS, JOGGING SUITS,
SHORTS, PAJAMAS, BELTS, AND KNITTED
GOODS, NAMELY, PULLOVERS, SWEATERS,
SHIRTS, IN CLASS 25 (U.S. CLS. 22 AND 39).

THE ENGLISH TRANSLATION OF THE WORD
"SIGLA" IN THE MARK IS ABBREVIATION.

SER. NO. 79-049,224, FILED 12-12-2007.

PRIORITY DATE OF 11-14-2007 IS CLAIMED.

MARILYN IZZI, EXAMINING ATTORNEY

Int. Cl.: 24

Prior U.S. Cls.: 42 and 50

United States Patent and Trademark Office

Reg. No. 3,520,919

Registered Oct. 21, 2008

TRADEMARK
PRINCIPAL REGISTER



HANGZHOU HONGFENG; TEXTILE GROUP
CO., LTD. (CHINA CORPORATION)
FENGHUANG VILLAGE
YAQIAN TOWN; XIAOSHAN DISTRICT; HANG-
ZHOU; 311209 ZHEJIANG
CHINA

FOR: KNITTED FABRIC; CLOTH, NAMELY,
LINEN,SILK, DISH CLOTHS; ELASTIC WOVEN
MATERIAL, NAMELY, ELASTIC FABRICS FOR
CLOTHING; COTTON FABRICS; JERSEY AS FAB-
RIC; RAYON FABRIC; LINEN CLOTH; FABRIC,
NAMELY, JEANS, JUTE; UPHOLSTERY FABRICS;
FABRICS FOR TEXTILE USE, IN CLASS 24 (U.S.
CLS. 42 AND 50).

OWNER OF INTERNATIONAL REGISTRATION
0951584 DATED 1-10-2008, EXPIRES 1-10-2018.

THE ENGLISH TRANSLATION OF THE FOR-
EIGN WORD(S) IN THE MARK IS: "GREAT PEAK".

THE TRANSLITERATION OF THE NON-LATIN
CHARACTERS IN THE MARK IS: "HONG FENG".

SER. NO. 79-049,230, FILED 1-10-2008.

SAIMA MAKHDOOM, EXAMINING ATTORNEY

Int. Cl.: 45

Prior U.S. Cls.: 100 and 101

United States Patent and Trademark Office

Reg. No. 3,520,920

Registered Oct. 21, 2008

**SERVICE MARK
PRINCIPAL REGISTER**

STICKNWIZZ

OPTINOV (FRANCE SOCIÉTÉ À RESPONSABILITÉ LIMITÉE)
LA BOSSE
F-42600 CHALAIN D'UZORE
FRANCE

PRIORITY DATE OF 6-29-2007 IS CLAIMED.

FOR: ASSISTANCE IN TRACING LOST PROPERTY USING A PERSONALIZED CODING SYSTEM LINKED TO A WEBSITE VIA A VOICE AND TEXT MESSAGE SERVICE, NAMELY, TRACKING SERVICES FOR RETRIEVAL OF ENCODED PRODUCTS, IN CLASS 45 (U.S. CLS. 100 AND 101).

OWNER OF INTERNATIONAL REGISTRATION 0951701 DATED 12-14-2007, EXPIRES 12-14-2017.

SER. NO. 79-049,272, FILED 12-14-2007.

THE MARK CONSISTS OF STANDARD CHARACTERS WITHOUT CLAIM TO ANY PARTICULAR FONT, STYLE, SIZE, OR COLOR.

MATTHEW MCDOWELL, EXAMINING ATTORNEY

Int. Cl.: 21

Prior U.S. Cls.: 2, 13, 23, 29, 30, 33, 40 and 50

United States Patent and Trademark Office

Reg. No. 3,520,921

Registered Oct. 21, 2008

**TRADEMARK
PRINCIPAL REGISTER**

FUNDIX

BARBERI, S.L. (SPAIN SOCIEDAD LIMITADA)
POLÍGON INDUSTRIAL DE GIRONA, S/N
E-17457 RIUDELLOTS DE LA SELVA
SPAIN

FOR: NON-ELECTRIC STEW-PANS, POTS, FRY-
ING PANS, WOKS, OVEN TO TABLE TRAYS;
KITCHEN UTENSILS, NAMELY, SPATULAS,
GRATERS, SIEVES; HOUSEHOLD CONTAINERS
FOR FOOD NOT OF PRECIOUS METALS OR

COATED THEREWITH, IN CLASS 21 (U.S. CLS. 2,
13, 23, 29, 30, 33, 40 AND 50).

OWNER OF INTERNATIONAL REGISTRATION
0951827 DATED 11-29-2007, EXPIRES 11-29-2017.

SER. NO. 79-049,324, FILED 11-29-2007.

DAYNA BROWNE, EXAMINING ATTORNEY

Int. Cls.: 30 and 35

Prior U.S. Cls.: 46, 100, 101 and 102

United States Patent and Trademark Office

Reg. No. 3,520,922

Registered Oct. 21, 2008

TRADEMARK
SERVICE MARK
PRINCIPAL REGISTER



The expert chocolatier

CHOCOLAT FACTORY, S.L. (SPAIN LIMITED LIABILITY COMPANY)
FRANCESC VILA, S/N, NAVE 8
E-08190 SANT CUGAT DEL VALLES (BARCELONA, SPAIN

FOR: COCOA; CHOCOLATE; CHOCOLATE FOOD BEVERAGES NOT BEING DAIRY-BASED OR VEGETABLE-BASED; CHOCOLATE BEVERAGES WITH MILK; COCOA BEVERAGES WITH MILK; CHOCOLATE BONBONS, IN CLASS 30 (U.S. CL. 46).

FOR: IMPORT-EXPORT AGENCIES; RETAIL STORES AND WHOLESALE STORES FEATURING CHOCOLATE BONBONS AND CHOCOLATES; BUSINESS ORGANIZATION, BUSINESS MANAGEMENT, AND BUSINESS PLANNING SERVICES PROVIDED VIA GLOBAL COMPUTER NETWORK, ALL RELATED TO CHOCOLATE BEVERAGES; ON-LINE RETAIL STORES FEATURING CHOCOLATE BEVERAGES WITH MILK BY MEANS OF A GLOBAL COMPUTER NETWORK; PROMOTION AND ADVERTISING OF BONBON AND CHOCOLATE PRODUCTS; COMMERCIAL ADVISORY SERVICES FOR FRANCHISED SHOPS FOR SALE OF BON-

BONS AND CHOCOLATES, IN CLASS 35 (U.S. CLS. 100, 101 AND 102).

PRIORITY DATE OF 9-20-2007 IS CLAIMED.

OWNER OF INTERNATIONAL REGISTRATION 0951848 DATED 10-2-2007, EXPIRES 10-2-2017.

NO CLAIM IS MADE TO THE EXCLUSIVE RIGHT TO USE "CHOCOLAT" AND "CHOCOLATIER", APART FROM THE MARK AS SHOWN.

THE NAME "MICHEL LALINE" IDENTIFIES A LIVING INDIVIDUAL WHOSE CONSENT IS OF RECORD.

THE ENGLISH TRANSLATION OF THE WORD "CHOCOLAT" IN THE MARK IS CHOCOLATE.

SER. NO. 79-049,334, FILED 10-2-2007.

Laurie Kaufman, Examining Attorney

Int. Cl.: 33

Prior U.S. Cls.: 47 and 49

United States Patent and Trademark Office

Reg. No. 3,520,923

Registered Oct. 21, 2008

**TRADEMARK
PRINCIPAL REGISTER**

SOLDERA

GIANFRANCO SOLDERA (ITALY INDIVIDUAL)
VIA DEI FRASSINI, 39
I-20156 MILANO
ITALY

FOR: WINES, SPIRITS AND LIQUEURS, IN
CLASS 33 (U.S. CLS. 47 AND 49).

THE MARK CONSISTS OF STANDARD CHAR-
ACTERS WITHOUT CLAIM TO ANY PARTICULAR
FONT, STYLE, SIZE, OR COLOR.

OWNER OF INTERNATIONAL REGISTRATION
0952343 DATED 12-20-2007, EXPIRES 12-20-2017.

THE NAME "SOLDERA" IDENTIFIES A LIVING
INDIVIDUAL WHOSE CONSENT IS OF RECORD.

SEC. 2(F).

SER. NO. 79-049,493, FILED 12-20-2007.

JENNIFER VASQUEZ, EXAMINING ATTORNEY

Int. Cls.: 18 and 21

Prior U.S. Cls.: 1, 2, 3, 13, 22, 23, 29, 30, 33, 40, 41 and 50

Reg. No. 3,520,924

United States Patent and Trademark Office

Registered Oct. 21, 2008

**TRADEMARK
PRINCIPAL REGISTER**

Shinzi Katoh

SHINZI KATOH DESIGN LIMITED (JAPAN CORPORATION)
1215-669, SAKASHITACHO 5-CHOME
KASUGAI-SHI; AICHI-KEN 480-0305
JAPAN

FOR: ALL PURPOSE SPORTS BAGS; ALL-PURPOSE ATHLETIC BAGS; ALL PURPOSE CARRYING BAGS; BEACH BAGS; BOOK BAGS; BOSTON BAGS; CANVAS, MESH AND TEXTILE SHOPPING BAGS; COSMETIC BAGS SOLD EMPTY; DIAPER BAGS; DUFFEL BAGS; HIKING BAGS; KEY BAGS; LEATHER AND IMITATION LEATHER BAGS, SUITCASES AND WALLETS; POUCHES AND BAGS SOLD EMPTY FOR ATTACHMENT TO BACKPACKS; SCHOOL BAGS; SHOE BAGS FOR TRAVEL; SHOPPING BAGS WITH WHEELS ATTACHED; SHOULDER BAGS; TOTE BAGS; TRAVEL BAGS; WAIST BAGS; CLOTHING FOR DOMESTIC PETS; VANITY CASES SOLD EMPTY; UMBRELLAS AND THEIR PARTS; WALKING STICKS, IN CLASS 18 (U.S. CLS. 1, 2, 3, 22 AND 41).

FOR: STAINLESS STEEL BOTTLES SOLD EMPTY; DRINKING FLASKS FOR TRAVELERS; VACUUM BOTTLES, NAMELY, INSULATED FLASKS; CHOPSTICK CASES; CHOPSTICKS; GLASS BOXES FOR INDUSTRIAL PACKAGING; CONTAINERS OF GLASS FOR HOUSEHOLD USE; JAPANESE NESTS OF FOOD BOXES (JUBAKO); LUNCH BOXES; DRINKING GLASSES; FRUIT BOWLS OF GLASS; GLASS BEVERAGE WARE; GLASS BOWLS; GLASS CARAFES; GLASS DISHES; GLASS MUGS; PILSNER DRINKING GLASSES; SHOT GLASSES; BEER MUGS; COFFEE CUPS; CUPS; DRINKING CUPS; EARTHENWARE MUGS; EGG CUPS; MUGS; PAPER CUPS; PLASTIC CUPS; PORCELAIN MUGS; SAKE CUPS; NON-ELECTRIC PORTABLE COLD

BOXES; RICE CHESTS; CHOPSTICK RESTS; ICE PAILS; NON-ELECTRIC WHISKS; COOKING STRAINERS; PEPPER POTS; SUGAR BOWLS; SALT SHAKERS; NAPKIN HOLDERS; NAPKIN RINGS; SERVING TRAYS; TOOTHPICKS HOLDERS; COLANDERS; COCKTAIL SHAKERS; JAPANESE STYLE COOKED RICE SCOOPS (SHAMOJI); HAND-OPERATED COFFEE GRINDERS AND PEPPER MILLS; COOKING FUNNELS; JAPANESE STYLE WOODEN PESTLES (SURIKOGI); JAPANESE STYLE EARTHENWARE MORTARS (SURIBACHI); JAPANESE STYLE PERSONAL DINING TRAYS OR STANDS (ZEN); BOTTLE OPENERS; COOKING GRATERS; TART SCOOPS; LADLES FOR KITCHEN USE; COOKING SIEVES AND SIFTERS; CHOPPING BOARDS FOR KITCHEN USE; ROLLING PINS FOR COOKING PURPOSES; COOKING UTENSILS, NAMELY, GRILLS; TOOTHPICKS; LEMON SQUEEZERS; NON-ELECTRIC WAFFLE IRONS, IN CLASS 21 (U.S. CLS. 2, 13, 23, 29, 30, 33, 40 AND 50).

PRIORITY DATE OF 9-27-2007 IS CLAIMED.

OWNER OF INTERNATIONAL REGISTRATION 0952554 DATED 10-26-2007, EXPIRES 10-26-2017.

THE NAME(S), PORTRAIT(S), AND/OR SIGNATURE(S) SHOWN IN THE MARK IDENTIFIES "SHINZI KATOH", WHOSE CONSENT(S) TO REGISTER IS OF RECORD.

SER. NO. 79-049,569, FILED 10-26-2007.

REBECCA POVARCHUK, EXAMINING ATTORNEY

Int. Cls.: 5 and 10

Prior U.S. Cls.: 6, 18, 26, 39, 44, 46, 51 and 52

United States Patent and Trademark Office

Reg. No. 3,520,925

Registered Oct. 21, 2008

**TRADEMARK
PRINCIPAL REGISTER**

NUPRESS

LABORATORIOS ALMIRALL, S.A. (SPAIN SOCI-
EDAD ANÓNIMA)
RONDA DEL GENERAL MITRE, 151
E-08022 BARCELONA
SPAIN

FOR: PHARMACEUTICAL PRODUCTS FOR THE
TREATMENT OF RESPIRATORY ILLNESSES, IN
CLASS 5 (U.S. CLS. 6, 18, 44, 46, 51 AND 52).

FOR: INHALERS FOR MEDICAL PURPOSES, IN
CLASS 10 (U.S. CLS. 26, 39 AND 44).

PRIORITY DATE OF 6-8-2007 IS CLAIMED.

OWNER OF INTERNATIONAL REGISTRATION
0952729 DATED 12-5-2007, EXPIRES 12-5-2017.

SER. NO. 79-049,651, FILED 12-5-2007.

SARA THOMAS, EXAMINING ATTORNEY

Int. Cls.: 6 and 19

Prior U.S. Cls.: 1, 2, 12, 13, 14, 23, 25, 33 and 50

United States Patent and Trademark Office

Reg. No. 3,520,926

Registered Oct. 21, 2008

**TRADEMARK
PRINCIPAL REGISTER**

PSD HALF-HEIGHT BIJOU

KABA GILGEN AG (SWITZERLAND AKTIEN-
GESELLSCHAFT)
FREIBURGSTRASSE 34
CH-3150 SCHWARZENBURG
SWITZERLAND

FOR: DOORS OF METAL, NAMELY, PLATFORM
DOORS OF METAL, AND COMPONENT PARTS
THEREOF, IN CLASS 6 (U.S. CLS. 2, 12, 13, 14, 23, 25
AND 50).

FOR: NON-METAL DOORS, NAMELY, NON-ME-
TAL PLATFORM DOORS AND COMPONENT
PARTS THEREOF, IN CLASS 19 (U.S. CLS. 1, 12, 33
AND 50).

THE MARK CONSISTS OF STANDARD CHAR-
ACTERS WITHOUT CLAIM TO ANY PARTICULAR
FONT, STYLE, SIZE, OR COLOR.

PRIORITY DATE OF 6-5-2007 IS CLAIMED.

OWNER OF INTERNATIONAL REGISTRATION
0952872 DATED 12-3-2007, EXPIRES 12-3-2017.

NO CLAIM IS MADE TO THE EXCLUSIVE
RIGHT TO USE "HALF-HEIGHT", APART FROM
THE MARK AS SHOWN.

THE ENGLISH TRANSLATION OF THE FOR-
EIGN WORD(S) IN THE MARK IS: "JEWELRY".

SER. NO. 79-049,698, FILED 12-3-2007.

JIM RINGLE, EXAMINING ATTORNEY

Int. Cl.: 18

Prior U.S. Cls.: 1, 2, 3, 22 and 41

Reg. No. 3,520,927

United States Patent and Trademark Office

Registered Oct. 21, 2008

**TRADEMARK
PRINCIPAL REGISTER**



Hailuo

WENZHOU CONCH GROUP CO., LTD (CHINA
CORPORATION)
42-19 GEAN ROAD
WENZHOU
ZHEJIANG 325028, CHINA

OWNER OF INTERNATIONAL REGISTRATION
0952938 DATED 2-14-2008, EXPIRES 2-14-2018.

FOR: UMBRELLAS; TRAVELING BAGS; TRAVELING SETS MADE OF LEATHER COMPRISED OF CARRY-ON BAGS, GARMENT BAGS FOR TRAVEL, SUITCASES; ATTACHÉ CASES; HANDBAGS; SCHOOL BAGS; IMITATION LEATHER; WALKING STICKS; HARNESES, IN CLASS 18 (U.S. CLS. 1, 2, 3, 22 AND 41).

"HAILUO" HAS NO MEANING IN FOREIGN LANGUAGE.

SER. NO. 79-049,725, FILED 2-14-2008.

JORDAN BAKER, EXAMINING ATTORNEY

Int. Cls.: 7, 9, 11, 20 and 21

Prior U.S. Cls.: 2, 13, 19, 21, 22, 23, 25, 26, 29, 30, 31, 32, 33, 34, 35, 36, 38, 40 and 50

Reg. No. 3,520,928

United States Patent and Trademark Office

Registered Oct. 21, 2008

**TRADEMARK
PRINCIPAL REGISTER**



FIMAR S.P.A. (ITALY JOINT STOCK COMPANY)
VIA SANDRO PERTINI, 29
I-47827 VERUCCHIO (RN), ITALY

FOR: DOMESTIC ELECTRICAL APPLIANCES FOR THE KITCHEN, NAMELY, CUTTING AND MINCING MACHINES, FOOD MIXERS, ELECTRIC FISH PASTE MAKING MACHINES, CENTRIFUGES AND STRUCTURAL PARTS AND FITTINGS FOR THE AFORESAID GOODS, IN CLASS 7 (U.S. CLS. 13, 19, 21, 23, 31, 34 AND 35).

FOR: ELECTRICAL APPARATUS, NAMELY, ELECTRIC SCALES AND STRUCTURAL PARTS AND FITTINGS FOR THE AFORESAID GOODS, IN CLASS 9 (U.S. CLS. 21, 23, 26, 36 AND 38).

FOR: APPARATUS FOR HEATING, STEAM GENERATING, COOKING, REFRIGERATING, DRYING, VENTILATING AND WATER SUPPLY, NAMELY, ELECTRIC SPACE HEATERS, STEAM GENERATORS, ELECTRIC SLOW COOKERS, REFRIGERATING MACHINES, CLOTHES DRYERS, VENTILATION HOODS AND FILTERS FOR DRINKING WATER, FREEZERS AND STRUCTURAL PARTS AND FITTINGS FOR THE AFORESAID GOODS, IN CLASS 11 (U.S. CLS. 13, 21, 23, 31 AND 34).

FOR: FURNITURE, TEA TROLLEYS, SERVING TROLLEYS, SHOWCASES IN THE NATURE OF CABINETS FOR SHOWCASING BELONGINGS, PACKING CONTAINERS OF PLASTIC MATERIAL, AND STRUCTURAL PARTS AND FITTINGS FOR THE AFORESAID GOODS, IN CLASS 20 (U.S. CLS. 2, 13, 22, 25, 32 AND 50).

FOR: KITCHEN UTENSILS, NAMELY, GRATERS, SIEVES, SPATULAS, STRAINERS AND TURNERS, CONTAINERS, NAMELY, CONTAINERS FOR HOUSEHOLD USE; GARBAGE AND DUST BINS, BASINS, CHAFING DISHES, IN CLASS 21 (U.S. CLS. 2, 13, 23, 29, 30, 33, 40 AND 50).

PRIORITY DATE OF 3-22-2007 IS CLAIMED.

OWNER OF INTERNATIONAL REGISTRATION
0953149 DATED 7-20-2007, EXPIRES 7-20-2017.

THE WORDING "FIMAR" HAS NO MEANING IN A FOREIGN LANGUAGE.

SER. NO. 79-049,841, FILED 7-20-2007.

COLLEEN KEARNEY, EXAMINING ATTORNEY

Int. Cl.: 36

Prior U.S. Cls.: 100, 101 and 102

United States Patent and Trademark Office

Reg. No. 3,520,929

Registered Oct. 21, 2008

**SERVICE MARK
PRINCIPAL REGISTER**

EONIA

EURIBOR; FÉDÉRATION BANCAIRE EUROPÉENNE.; ORGANISATION SCIENTIFIQUE INTERNATIONALE; DE DROIT BELGE (BELGIUM ORGANISATION SCIENTIFIQUE INTERNATIONALE)

RUE MONTOYER 10
B-1000 BRUXELLES
BELGIUM

FOR: FINANCIAL AFFAIRS, NAMELY, FINANCIAL TRUST OPERATIONS; GRANTING OF CREDIT, NAMELY, OFFERING CREDIT CONTRACTS WITH DELAYED REIMBURSEMENT; GRANTING ADVANCES AGAINST SALES PAID BY INSTALLMENTS, SETTLING AND DISTRIBUTION OF CURRENT BASIC INTEREST RATES FOR CREDIT CONTRACTS; GRANTING OF CREDIT; FINAN-

CIAL ANALYSIS; FINANCING SERVICES; AND FINANCIAL INFORMATION AND EVALUATIONS, IN CLASS 36 (U.S. CLS. 100, 101 AND 102).

THE MARK CONSISTS OF STANDARD CHARACTERS WITHOUT CLAIM TO ANY PARTICULAR FONT, STYLE, SIZE, OR COLOR.

OWNER OF INTERNATIONAL REGISTRATION 0932443 DATED 5-30-2007, EXPIRES 5-30-2017.

SER. NO. 79-050,146, FILED 1-23-2008.

FRANK LATTUCA, EXAMINING ATTORNEY

Int. Cls.: 9, 35 and 42

Prior U.S. Cls.: 21, 23, 26, 36, 38, 100, 101 and 102

Reg. No. 3,520,930

United States Patent and Trademark Office

Registered Oct. 21, 2008

**TRADEMARK
SERVICE MARK
PRINCIPAL REGISTER**

JARLTECH

JARLTECH EUROPE GMBH (FED REP GERMA-
NY GMBH)
RAIFFEISENSTRASSE 7
61250 USINGEN, FED REP GERMANY

FOR: ELECTRONIC OPTICAL INSTRUMENTS,
NAMELY, BAR CODE READERS, MAGNETIC RE-
CORDING SUPPORTS IN THE NATURE OF PRE-
RECORDED DATA CARRIERS FEATURING
MATHEMATIC FORMULAS, MAGNETIC RE-
CORDING SUPPORTS IN THE NATURE OF MAG-
NETIC CODED CARD READERS, CASH
REGISTERS, CALCULATING MACHINES, DATA
PROCESSING HARDWARE AND COMPUTERS AS
WELL AS COMPUTER ACCESSORIES, NAMELY,
BAR CODE SCANNERS, BAR CODE READERS;
POINT-OF-SALE COMPUTER HARDWARE, NAME-
LY, POINT OF SALE PERIPHERALS FOR COMPU-
TERS, COMPUTER KEYBOARDS, POLE DISPLAYS
PRIMARILY COMPRISED OF FLAT PANEL DIS-
PLAY SCREENS WITH POLES ATTACHED, AND

COMPUTER TOUCH SCREENS , IN CLASS 9 (U.S.
CLS. 21, 23, 26, 36 AND 38).

FOR: ADVERTISING, BUSINESS MANAGE-
MENT, OFFICE FUNCTIONS, BUSINESS ADMINIS-
TRATION, IN CLASS 35 (U.S. CLS. 100, 101 AND 102).

FOR: COMPUTER PROGRAMMING, IN CLASS
42 (U.S. CLS. 100 AND 101).

THE MARK CONSISTS OF STANDARD CHAR-
ACTERS WITHOUT CLAIM TO ANY PARTICULAR
FONT, STYLE, SIZE, OR COLOR.

OWNER OF INTERNATIONAL REGISTRATION
0954000 DATED 12-20-2007, EXPIRES 12-20-2017.

SER. NO. 79-050,186, FILED 12-20-2007.

MAUREEN DALL, EXAMINING ATTORNEY

Int. Cl.: 7

Prior U.S. Cls.: 13, 19, 21, 23, 31, 34 and 35

United States Patent and Trademark Office

Reg. No. 3,520,931

Registered Oct. 21, 2008

**TRADEMARK
PRINCIPAL REGISTER**

GEHO

WEIR MINERALS NETHERLANDS B.V. (NETH-
ERLANDS BESLOTEN VENNOOTSCHAP)
EGTENRAYSEWEG 9
NL-5928 PH VENLO
NETHERLANDS

FOR: SELF-PRIMING CONTRACTORS' CENTRI-
FUGAL PUMPS, PISTON PUMPS AND PISTON
DIAPHRAGM PUMPS FOR MINERALS, ORES
AND SEWAGE/WASTE WATER PUMPING, IN
CLASS 7 (U.S. CLS. 13, 19, 21, 23, 31, 34 AND 35).

THE MARK CONSISTS OF STANDARD CHAR-
ACTERS WITHOUT CLAIM TO ANY PARTICULAR
FONT, STYLE, SIZE, OR COLOR.

OWNER OF INTERNATIONAL REGISTRATION
0905347 DATED 7-12-2006, EXPIRES 7-12-2016.

OWNER OF U.S. REG. NOS. 2,906,227 AND
2,916,027.

SEC. 2(F).

SER. NO. 79-050,434, FILED 1-15-2008.

KAREN BRACEY, EXAMINING ATTORNEY

Int. Cl.: 43

Prior U.S. Cls.: 100 and 101

United States Patent and Trademark Office

Reg. No. 3,520,932

Registered Oct. 21, 2008

SERVICE MARK
PRINCIPAL REGISTER



EKIN REKLAMCILIK; VE TURISM LIMITED
SIRKETI (TURKEY LIMITED LIABILITY
COMPANY)

NISBETIYE CADDESİ AKMERKEZ NO: 139
BESIKTAS ISTANBUL, TURKEY

FOR: SERVICES FOR PROVIDING FOOD AND
DRINK, TEMPORARY ACCOMMODATION, IN
CLASS 43 (U.S. CLS. 100 AND 101).

OWNER OF INTERNATIONAL REGISTRATION
0955665 DATED 12-10-2007, EXPIRES 12-10-2017.

NO CLAIM IS MADE TO THE EXCLUSIVE
RIGHT TO USE "HOTELS", APART FROM THE
MARK AS SHOWN.

THE COLOR(S) DARK YELLOW IS/ARE
CLAIMED AS A FEATURE OF THE MARK.

THE MARK CONSISTS OF COLOR DARK YEL-
LOW.

SER. NO. 79-050,738, FILED 12-10-2007.

CHARISMA HAMPTON, EXAMINING ATTORNEY

Int. Cl.: 9

Prior U.S. Cls.: 21, 23, 26, 36 and 38

United States Patent and Trademark Office

Reg. No. 3,520,933

Registered Oct. 21, 2008

**TRADEMARK
PRINCIPAL REGISTER**



WIBRAIN INC. (REPUBLIC OF KOREA CORPORATION)
SUITE 306, JEI PLATZ, 459-11
GASAN-DONG, GEUMCHEON-GU,; SEOUL, 153-023
REPUBLIC OF KOREA

"THE COLOR(S) BLUE, LIGHT BLUE, GREEN, YELLOW, ORANGE AND RED IS/ARE CLAIMED AS A FEATURE OF THE MARK."

FOR: ULTRA MOBILE PERSONAL COMPUTERS (UMPC); DISPLAYING DEVICES FOR ULTRA MOBILE PERSONAL COMPUTERS, NAMELY, LIQUID CRYSTAL DISPLAYS; PORTABLE MULTIMEDIA PLAYERS (PMP); PORTABLE MULTIMEDIA PLAYER COMPUTERS (PMPC); ULTRA PORTABLE PERSONAL COMPUTERS (UPPC); NAVIGATION APPARATUS, NAMELY, GLOBAL POSITIONING SYSTEM (GPS); PERSONAL DIGITAL ASSISTANTS (PDA); MPEG AUDIO LAYER-3 (MP3) PLAYERS; COMPACT DISC PLAYERS (CDP); PORTABLE MOBILE COMMUNICATORS, NAMELY, MOBILE TELEPHONES, IN CLASS 9 (U.S. CLS. 21, 23, 26, 36 AND 38).

THE MARK CONSISTS OF THE COLOR BLUE APPEARS IN THE LETTERS "W" AND "BRAIN" AND IN THE TOP BAND RADIATING FROM THE LETTER "I", THE COLOR LIGHT BLUE APPEARS IN THE LOWER TWO BANDS RADIATING FROM THE LETTER "I" AND THE TOP OF THE DOT OVER THE LETTER "I", THE COLOR GREEN APPEARS IN THE DOT OVER THE LETTER "I", THE COLOR YELLOW APPEARS AT THE TOP OF THE LETTER "I", THE COLOR ORANGE APPEARS IN THE MIDDLE OF THE LETTER "I", AND THE COLOR RED APPEARS AT THE BOTTOM OF THE LETTER "I".

PRIORITY DATE OF 5-25-2007 IS CLAIMED.

SER. NO. 79-050,745, FILED 11-23-2007.

OWNER OF INTERNATIONAL REGISTRATION
0955694 DATED 11-23-2007, EXPIRES 11-23-2017.

KRISTINA MORRIS, EXAMINING ATTORNEY

Int. Cl.: 7

Prior U.S. Cls.: 13, 19, 21, 23, 31, 34 and 35

Reg. No. 3,520,934

United States Patent and Trademark Office

Registered Oct. 21, 2008

**TRADEMARK
PRINCIPAL REGISTER**

JUSTMARK

CHAO WANG (CHINA INDIVIDUAL)
630 ZHONGCHU BUILDING,
NO. 23 SHIJINGSHAN ROAD; BEIJING
CHINA

FOR: LUBRICATING PUMPS; HYDRAULIC
PUMPS; VALVES BEING PARTS OF MACHINES;
HYDRAULIC CONTROLS FOR MACHINES, MO-
TORS AND ENGINES; PNEUMATIC CONTROLS
FOR MACHINES, MOTORS AND ENGINES; HY-
DRAULIC VALVES; PRESSURE REGULATING
VALVES BEING PARTS OF MACHINES; HYDRAU-
LIC COMPONENTS OTHER THAN FOR VEHICLE
HYDRAULIC SYSTEMS, NAMELY, HYDRAULIC
PUMPS AND HYDRAULIC VALVE ACTUATORS;

HYDRAULIC FILTERS FOR USE IN MOTORS AND
ENGINES, FOR USE IN LAND VEHICLES, AND
FOR USE IN INDUSTRIAL MACHINES; PNEUMAT-
IC COMPONENTS, NAMELY, PNEUMATIC PUMPS,
PNEUMATIC VALVES FOR FLUID CONTROL, IN
CLASS 7 (U.S. CLS. 13, 19, 21, 23, 31, 34 AND 35).

OWNER OF INTERNATIONAL REGISTRATION
0956276 DATED 1-23-2008, EXPIRES 1-23-2018.

SER. NO. 79-050,934, FILED 1-23-2008.

ESTHER BELENKER, EXAMINING ATTORNEY

Int. Cl.: 18

Prior U.S. Cls.: 1, 2, 3, 22 and 41

United States Patent and Trademark Office

Reg. No. 3,520,935

Registered Oct. 21, 2008

**TRADEMARK
PRINCIPAL REGISTER**

ATIKA

WEILL PRODUCTIONS (FRANCE SOCIÉTÉ
ANONYME)
10, RUE LIVINGSTONE
F-75018 PARIS
FRANCE

FOR: LEATHER AND IMITATION LEATHER,
NAMELY, CALLING CARDS CASES, DOCUMENT
CASES, ATTACHÉ CASES, HANDBAGS, BACK-
PACKS, BEACH BAGS, TRAVELING BAGS, SPORTS
BAGS, TRAVEL BAGS, UNFITTED VANITY CASES,
POUCHES, KEY CASES; WALLETS, PURSES,
SATCHELS, TRUNKS, SUITCASES, UMBRELLAS,
WALKING STICKS, IN CLASS 18 (U.S. CLS. 1, 2, 3, 22
AND 41).

OWNER OF INTERNATIONAL REGISTRATION
0594561 DATED 12-7-1992, EXPIRES 12-7-2012.

OWNER OF U.S. REG. NO. 2,941,747.

THE WORDING "ATIKA" HAS NO MEANING
OTHER THAN TRADEMARK SIGNIFICANCE.

SER. NO. 79-050,964, FILED 9-7-2007.

CYNTHIA SLOAN, EXAMINING ATTORNEY

Int. Cl.: 1

Prior U.S. Cls.: 1, 5, 6, 10, 26 and 46

Reg. No. 3,520,936

United States Patent and Trademark Office

Registered Oct. 21, 2008

**TRADEMARK
PRINCIPAL REGISTER**

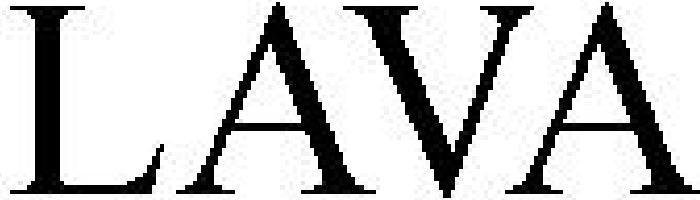

DYSTAR TEXTILFARBEN GMBH & CO.
DEUTSCHLAND KG (FED REP GERMANY
LIMITED PARTNERSHIP)

INDUSTRIEPARK HOECHST
65926 FRANKFURT AM MAIN
FED REP GERMANY

FOR: CHEMICALS USED IN INDUSTRY, NAME-
LY, FOR FINISHING OF TEXTILES, IN CLASS 1
(U.S. CLS. 1, 5, 6, 10, 26 AND 46).

THE MARK CONSISTS OF STANDARD CHAR-
ACTERS WITHOUT CLAIM TO ANY PARTICULAR
FONT, STYLE, SIZE, OR COLOR.

OWNER OF INTERNATIONAL REGISTRATION
0888359 DATED 5-23-2006, EXPIRES 5-23-2016.

SER. NO. 79-050,983, FILED 2-15-2008.

KATHERINE E. HALMEN, EXAMINING ATTOR-
NEY

Int. Cls.: 16 and 25

Prior U.S. Cls.: 2, 5, 22, 23, 29, 37, 38, 39 and 50

Reg. No. 3,520,937

United States Patent and Trademark Office

Registered Oct. 21, 2008

**TRADEMARK
PRINCIPAL REGISTER**

**FIRE
GIRLS**

HOUSE OF DESIGN STANGL KEG (AUSTRIA
LIMITED PARTNERSHIP)
SCHULGASSE 15
A-8010 GRAZ
AUSTRIA

OWNER OF INTERNATIONAL REGISTRATION
0889958 DATED 3-10-2006, EXPIRES 3-10-2016.

FOR: PRINTED MATTER, NAMELY, CALENDARS, PRINTED TIMETABLES, POSTERS, IN CLASS 16 (U.S. CLS. 2, 5, 22, 23, 29, 37, 38 AND 50).

NO CLAIM IS MADE TO THE EXCLUSIVE RIGHT TO USE "GIRLS", APART FROM THE MARK AS SHOWN.

FOR: CLOTHING, NAMELY, SHIRTS, TROUSERS, SHORTS, SWIMWEAR, UNDERWEAR, DRESSES; FOOTWEAR, HEADGEAR, NAMELY, HATS, CAPS, IN CLASS 25 (U.S. CLS. 22 AND 39).

SER. NO. 79-050,984, FILED 9-7-2007.

DANIEL BRODY, EXAMINING ATTORNEY

Int. Cls.: 35, 36, 37, 38, 41 and 42

Prior U.S. Cls.: 100, 101, 102, 103, 104, 106 and 107

United States Patent and Trademark Office

Reg. No. 3,520,938

Registered Oct. 21, 2008

**SERVICE MARK
PRINCIPAL REGISTER**

+ ENGADA +

ENGADA SWISS AG; C/O DR. HANS DURRER
(SWITZERLAND CORPORATION)
GOTTHARDSTRASSE 20
CH-6304 ZUG
SWITZERLAND

FOR: BUSINESS MANAGEMENT; BUSINESS ADMINISTRATION AND OFFICE FUNCTIONS, IN CLASS 35 (U.S. CLS. 100, 101 AND 102).

FOR: FINANCIAL SERVICES, NAMELY, FINANCIAL ADVICE AND CONSULTANCY SERVICES; MONETARY SERVICES, NAMELY, MONETARY EXCHANGE; REAL ESTATE SERVICES, NAMELY, FINANCIAL INVESTMENT IN REAL ESTATE, LEASING OF REAL ESTATE, AND REAL ESTATE PROPERTY MANAGEMENT, IN CLASS 36 (U.S. CLS. 100, 101 AND 102).

FOR: BUILDING, NAMELY, CONSTRUCTION OF BUILDINGS, IN CLASS 37 (U.S. CLS. 100, 103 AND 106).

FOR: TELECOMMUNICATIONS ROUTING AND JUNCTION SERVICES (GATEWAY SERVICES), VOICE MAIL SERVICES, ELECTRONIC MESSAGE SENDING, PROVIDING ACCESS TO DATABASES, COMPUTER AIDED TRANSMISSION OF MESSAGES AND IMAGES PROVIDING TELECOMMUNICATIONS CONNECTIONS TO A GLOBAL COMPUTER NETWORK, SATELLITE TRANSMIS-

SION, COMMUNICATIONS BY FIBRE-OPTIC NETWORKS, IN CLASS 38 (U.S. CLS. 100, 101 AND 104).

FOR: TRAINING IN THE FIELD OF REAL ESTATE LEASING, BUILDING CONSTRUCTION, FINANCIAL SERVICES AND DEVELOPMENT, IN CLASS 41 (U.S. CLS. 100, 101 AND 107).

FOR: SCIENTIFIC AND TECHNOLOGICAL SERVICES AND RELATED RESEARCH AND DESIGN SERVICES IN THE FIELD OF THE BUILDING CONSTRUCTION INDUSTRY AND ASSOCIATED INDUSTRIAL ANALYSIS AND RESEARCH SERVICES; DESIGN AND DEVELOPMENT OF COMPUTER HARDWARE AND SOFTWARE, IN CLASS 42 (U.S. CLS. 100 AND 101).

THE MARK CONSISTS OF STANDARD CHARACTERS WITHOUT CLAIM TO ANY PARTICULAR FONT, STYLE, SIZE, OR COLOR.

PRIORITY DATE OF 11-28-2007 IS CLAIMED.

OWNER OF INTERNATIONAL REGISTRATION 0957095 DATED 2-4-2008, EXPIRES 2-4-2018.

SER. NO. 79-051,285, FILED 2-4-2008.

KIMBERLY PERRY, EXAMINING ATTORNEY

Int. Cl.: 10

Prior U.S. Cls.: 26, 39 and 44

Reg. No. 3,520,939

United States Patent and Trademark Office

Registered Oct. 21, 2008

**TRADEMARK
PRINCIPAL REGISTER**

RESOUND ESSENCE

GN RESOUND A/S (DENMARK LIMITED LIABILITY COMPANY)
LAUTRUPBJERG 9
DK-2750 BALLERUP
DENMARK

OWNER OF INTERNATIONAL REGISTRATION
0957511 DATED 2-15-2008, EXPIRES 2-15-2018.

FOR: HEARING AIDS, IN CLASS 10 (U.S. CLS. 26, 39 AND 44).

OWNER OF U.S. REG. NOS. 1,488,398, 3,427,171
AND OTHERS.

THE MARK CONSISTS OF STANDARD CHARACTERS WITHOUT CLAIM TO ANY PARTICULAR FONT, STYLE, SIZE, OR COLOR.

SER. NO. 79-051,415, FILED 2-15-2008.

PRIORITY DATE OF 11-12-2007 IS CLAIMED.

PATRICIA EVANKO, EXAMINING ATTORNEY

Int. Cl.: 5

Prior U.S. Cls.: 6, 18, 44, 46, 51 and 52

United States Patent and Trademark Office

Reg. No. 3,520,940

Registered Oct. 21, 2008

**TRADEMARK
PRINCIPAL REGISTER**

BUPREDALE

DECHRA LIMITED (UNITED KINGDOM LIMITED LIABILITY COMPANY)
DECHRA HOUSE
JAMAGE INDUSTRIAL ESTATE; TALKE PITS,
STOKE ON TRENT ST7 1XW
UNITED KINGDOM

FOR: VETERINARY PREPARATIONS FOR AN-ALGESIA, IN CLASS 5 (U.S. CLS. 6, 18, 44, 46, 51 AND 52).

THE MARK CONSISTS OF STANDARD CHARACTERS WITHOUT CLAIM TO ANY PARTICULAR FONT, STYLE, SIZE, OR COLOR.

PRIORITY DATE OF 9-10-2007 IS CLAIMED.

OWNER OF INTERNATIONAL REGISTRATION
0957583 DATED 3-10-2008, EXPIRES 3-10-2018.

SER. NO. 79-051,446, FILED 3-10-2008.

DAVID TOOLEY, EXAMINING ATTORNEY

Int. Cl.: 3

Prior U.S. Cls.: 1, 4, 6, 50, 51 and 52

United States Patent and Trademark Office

Reg. No. 3,520,941

Registered Oct. 21, 2008

**TRADEMARK
PRINCIPAL REGISTER**

GIN FIZZ

STRATEGEM, SOCIÉTÉ PAR ACTIONS SIMPLIFIÉE (FRANCE SOCIÉTÉ PAR ACTIONS SIMPLIFIÉE)

3 RUE DU ROULE
F-75001 PARIS, FRANCE

FOR: PERFUME; TOILET WATER; AFTER-SHAVE; PERFUME OILS; COLOGNE; EAU DE PERFUME, EAU DE COLOGNE; MAKE-UP; DENTIFRICES; TOILET SOAPS; BEAUTY PRODUCTS, NAMELY, BEAUTY LOTIONS, FACIAL BEAUTY MASKS, MASCARA, BEAUTY CREAMS, BEAUTY GELS, BEAUTY MILKS, BEAUTY SERUMS, IN CLASS 3 (U.S. CLS. 1, 4, 6, 50, 51 AND 52).

OWNER OF INTERNATIONAL REGISTRATION
0320981 DATED 9-19-1966, EXPIRES 9-19-2016.

THE MARK CONSISTS OF THE WORDS "GIN FIZZ" IN STYLIZED FONT.

THE WORD "FIZZ" HAS NO MEANING IN A FOREIGN LANGUAGE.

SER. NO. 79-051,489, FILED 12-3-2007.

ALYSSA PALADINO, EXAMINING ATTORNEY

Int. Cl.: 12

Prior U.S. Cls.: 19, 21, 23, 31, 35 and 44

Reg. No. 3,520,942

United States Patent and Trademark Office

Registered Oct. 21, 2008

**TRADEMARK
PRINCIPAL REGISTER**



TIANJIN UNITED TIRE & RUBBER INTERNATIONAL CO. LTD. (CHINA CORPORATION)
NO. 50 DONGJIANGDAO HEXIQU
300220 TIANJIN
CHINA

FOR: TIRES, IN CLASS 12 (U.S. CLS. 19, 21, 23, 31, 35 AND 44).

OWNER OF INTERNATIONAL REGISTRATION
0669237 DATED 1-30-1997, EXPIRES 1-30-2017.

THE FOREIGN WORDING IN THE MARK TRANSLATES INTO ENGLISH AS "POWER FROM HEAVEN".

THE NON-LATIN CHARACTER(S) IN THE MARK TRANSLITERATES INTO "TIAN LI", AND THIS MEANS "POWER FROM HEAVEN" IN ENGLISH.

SER. NO. 79-051,498, FILED 1-28-2008.

RONALD DELGIZZI, EXAMINING ATTORNEY

Int. Cl.: 33

Prior U.S. Cls.: 47 and 49

United States Patent and Trademark Office

Reg. No. 3,520,943

Registered Oct. 21, 2008

TRADEMARK
PRINCIPAL REGISTER

AIONE

DORIS WÄLTI (SWITZERLAND INDIVIDUAL)
RTE DE LA CRAUSA 24 A
CH-1789 LUGNORRE FR
SWITZERLAND AND
ROBERT WÄLTI (SWITZERLAND INDIVIDUAL)
RTE DE LA CRAUSA 24 A
CH-1789 LUGNORRE FR
SWITZERLAND

OWNER OF INTERNATIONAL REGISTRATION
0923091 DATED 4-17-2007, EXPIRES 4-17-2017.

THE WORDING "AIONE" REFERS TO A FARM
IN TUSCANY, ITALY AND HAS NO MEANING IN
A FOREIGN LANGUAGE.

FOR: ALCOHOLIC BEVERAGES, NAMELY,
WINE, IN CLASS 33 (U.S. CLS. 47 AND 49).

SER. NO. 79-051,511, FILED 2-6-2008.

THE MARK CONSISTS OF STANDARD CHAR-
ACTERS WITHOUT CLAIM TO ANY PARTICULAR
FONT, STYLE, SIZE, OR COLOR.

MATTHEW MCDOWELL, EXAMINING ATTOR-
NEY

Int. Cl.: 14

Prior U.S. Cls.: 2, 27, 28 and 50

United States Patent and Trademark Office

Reg. No. 3,520,944

Registered Oct. 21, 2008

**TRADEMARK
PRINCIPAL REGISTER**

Satin Ice

BJB LTD (UNITED KINGDOM A COMPANY
INCORPORATED UNDER THE LAWS OF
ENGLAND AND WALES)

14 KIRBY STREET
LONDON EC1N 8TS
UNITED KINGDOM

FOR: JEWELRY AND FASHION JEWELRY OF
PRECIOUS AND NON-PRECIOUS MATERIALS,
WATCHES AND CLOCKS, IN CLASS 14 (U.S. CLS.
2, 27, 28 AND 50).

THE MARK CONSISTS OF STANDARD CHAR-
ACTERS WITHOUT CLAIM TO ANY PARTICULAR
FONT, STYLE, SIZE, OR COLOR.

OWNER OF INTERNATIONAL REGISTRATION
0957776 DATED 1-14-2008, EXPIRES 1-14-2018.

SER. NO. 79-051,541, FILED 1-14-2008.

REGINA DRUMMOND, EXAMINING ATTORNEY

Int. Cl.: 33

Prior U.S. Cls.: 47 and 49

United States Patent and Trademark Office

Reg. No. 3,520,945

Registered Oct. 21, 2008

**TRADEMARK
PRINCIPAL REGISTER**

ETICO

DORIS WÄLTI (SWITZERLAND INDIVIDUAL)
RTE DE LA CRAUSA 24 A
CH-1789 LUGNORRE FR, SWITZERLAND AND
ROBERT WÄLTI (SWITZERLAND INDIVIDUAL)
RTE DE LA CRAUSA 24 A
CH-1789 LUGNORRE FR, SWITZERLAND

FOR: ALCOHOLIC BEVERAGES, NAMELY,
WINE, IN CLASS 33 (U.S. CLS. 47 AND 49).

THE MARK CONSISTS OF STANDARD CHAR-
ACTERS WITHOUT CLAIM TO ANY PARTICULAR
FONT, STYLE, SIZE, OR COLOR.

OWNER OF INTERNATIONAL REGISTRATION
0932911 DATED 7-26-2007, EXPIRES 7-26-2017.

THE ENGLISH TRANSLATION OF THE WORD
"ETICO" IN THE MARK IS ETHICS.

SER. NO. 79-051,716, FILED 2-6-2008.

MATTHEW MCDOWELL, EXAMINING ATTOR-
NEY

Int. Cl.: 32

Prior U.S. Cls.: 45, 46 and 48

United States Patent and Trademark Office

Reg. No. 3,520,946

Registered Oct. 21, 2008

**TRADEMARK
PRINCIPAL REGISTER**

ISKLAR

ISKLAR AS (NORWAY STOCK COMPANY)
STORTINGSGATEN 8
N-0161 OSLO
NORWAY

OWNER OF INTERNATIONAL REGISTRATION
0958365 DATED 2-15-2008, EXPIRES 2-15-2018.

FOR: MINERAL AND AERATED WATERS AND
OTHER NONALCOHOLIC BEVERAGES, NAMELY,
SOFT DRINKS, FRUIT JUICES, AND FRUIT
DRINKS, SYRUPS FOR MAKING BEVERAGES
AND OTHER PREPARATIONS FOR MAKING BEV-
ERAGES, NAMELY, FRUIT DRINKS, IN CLASS 32
(U.S. CLS. 45, 46 AND 48).

THE ENGLISH TRANSLATION OF THE WORD
"ISKLAR" IN THE MARK IS ICE CLEAR.

SER. NO. 79-051,760, FILED 2-15-2008.

PATRICIA EVANKO, EXAMINING ATTORNEY

Int. Cl.: 32

Prior U.S. Cls.: 45, 46 and 48

United States Patent and Trademark Office

Reg. No. 3,520,947

Registered Oct. 21, 2008

**TRADEMARK
PRINCIPAL REGISTER**



ISKLAR AS (NORWAY STOCK COMPANY)
STORTINGSGATEN 8
N-0161 OSLO
NORWAY

FOR: MINERAL AND AERATED WATERS AND OTHER NONALCOHOLIC BEVERAGES, NAMELY, SOFT DRINKS, FRUIT JUICES, AND FRUIT DRINKS, SYRUPS FOR MAKING BEVERAGES AND OTHER PREPARATIONS FOR MAKING BEVERAGES, NAMELY, FRUIT DRINKS, IN CLASS 32 (U.S. CLS. 45, 46 AND 48).

PRIORITY DATE OF 10-25-2007 IS CLAIMED.

OWNER OF INTERNATIONAL REGISTRATION
0958490 DATED 2-15-2008, EXPIRES 2-15-2018.

"THE COLOR(S) BLUE IS/ARE CLAIMED AS A
FEATURE OF THE MARK."

"THE MARK CONSISTS OF TWO SHADES OF
THE COLOR BLUE, WITH THE LIGHT AND DARK
SHADES APPEARING IN AN ALTERNATING PAT-
TERN COMPRISING DIAMONDS THAT FORM A
SNOWFLAKE DESIGN."

SER. NO. 79-051,812, FILED 2-15-2008.

PATRICIA EVANKO, EXAMINING ATTORNEY

Int. Cl.: 7

Prior U.S. Cls.: 13, 19, 21, 23, 31, 34 and 35

Reg. No. 3,520,948

United States Patent and Trademark Office

Registered Oct. 21, 2008

**TRADEMARK
PRINCIPAL REGISTER**

SCREENEX

SCREENEX PTY LTD (AUSTRALIA CORPORATION)
UNIT 1
76-80 VELLA DRIVE; SUNSHINE VIC 3020
AUSTRALIA

FOR: REPLACEABLE MODULAR SCREENING SYSTEM CONSISTING OF MODULAR SCREENING PANELS AND FRAMES AND PARTS THEREFOR, USED IN PARTICLE SEPARATION MACHINERY FOR THE MINING AND QUARRYING INDUSTRY, IN CLASS 7 (U.S. CLS. 13, 19, 21, 23, 31, 34 AND 35).

THE MARK CONSISTS OF STANDARD CHARACTERS WITHOUT CLAIM TO ANY PARTICULAR FONT, STYLE, SIZE, OR COLOR.

OWNER OF INTERNATIONAL REGISTRATION
0959397 DATED 2-15-2008, EXPIRES 2-15-2018.

SER. NO. 79-052,132, FILED 2-15-2008.

SARA THOMAS, EXAMINING ATTORNEY

Int. Cl.: 14

Prior U.S. Cls.: 2, 27, 28 and 50

United States Patent and Trademark Office

Reg. No. 3,520,949

Registered Oct. 21, 2008

**TRADEMARK
PRINCIPAL REGISTER**

DIAGONO

BULGARI S.P.A. (ITALY JOINT STOCK COMPANY)

LUNGOTEVERE MARZIO, 11

I-00186 ROMA

ITALY

FOR: PRECIOUS METALS AND THEIR ALLOYS;
GOODS IN PRECIOUS METALS OR COATED
THEREWITH, NOT INCLUDED IN OTHER CLASSES,
NAMESLY, JEWELRY; PRECIOUS STONES;
HOROLOGICAL AND CHRONOMETRIC INSTRUMENTS,
IN CLASS 14 (U.S. CLS. 2, 27, 28 AND 50).

THE MARK CONSISTS OF STANDARD CHARACTERS
WITHOUT CLAIM TO ANY PARTICULAR FONT,
STYLE, SIZE, OR COLOR.

PRIORITY DATE OF 1-17-2008 IS CLAIMED.

OWNER OF INTERNATIONAL REGISTRATION
0959603 DATED 2-12-2008, EXPIRES 2-12-2018.

SER. NO. 79-052,212, FILED 2-12-2008.

JASON TURNER, EXAMINING ATTORNEY

Int. Cl.: 12

Prior U.S. Cls.: 19, 21, 23, 31, 35 and 44

Reg. No. 3,520,950

United States Patent and Trademark Office

Registered Oct. 21, 2008

**TRADEMARK
PRINCIPAL REGISTER**



CHANGZHOU; YAMASAKI MOTORCYCLE CO.,
LTD (CHINA CORPORATION)
NO. 389 HEHAI WEST ROAD
XINQU, CHANGZHOU
213022 JIANGSU, CHINA

FOR: MOTORCYCLES; BICYCLES; CYCLE CARS;
AUTOMOBILES, IN CLASS 12 (U.S. CLS. 19, 21, 23, 31,
35 AND 44).

OWNER OF INTERNATIONAL REGISTRATION
0960148 DATED 3-20-2008, EXPIRES 3-20-2018.

THE ENGLISH TRANSLATION OF THE FOR-
EIGN WORD(S) IN THE MARK IS: THE FIRST
CHINESE CHARACTER WHOSE TRANSLITERA-
TION IS "SHAN" MEANS "HILL"; THE SECOND

CHINESE CHARACTER WHOSE TRANSLITERA-
TION IS "QI" MEANS "CRAGGED"; THE COMBI-
NATION OF THE TWO CHINESE CHARACTERS
AND THE ENGLISH WORD "YAMASAKI" HAVE
NO SIGNIFICANCE IN THE RELEVANT TRADE
OR INDUSTRY, AND HAVE NO GEOGRAPHICAL
SIGNIFICANCE, AND HAVE NO MEANING IN A
FOREIGN LANGUAGE, AND HAVE NO SIGNIFI-
CANCE AS APPLIED TO THE GOODS.

THE TRANSLITERATION OF THE NON-LATIN
CHARACTERS IN THE MARK IS: SHAN QI.

SER. NO. 79-052,384, FILED 3-20-2008.

CURTIS FRENCH, EXAMINING ATTORNEY

Int. Cl.: 3

Prior U.S. Cls.: 1, 4, 6, 50, 51 and 52

United States Patent and Trademark Office

Reg. No. 3,520,951

Registered Oct. 21, 2008

**TRADEMARK
PRINCIPAL REGISTER**

INCREDIBLE ME

ESCADA AG (FED REP GERMANY PUBLIC
LIMITED COMPANY ORGANISED UNDER
THE LAWS OF GERMANY)
MARGARETHA-LEY-RING 1
85609 ASCHHEIM
FED REP GERMANY

FOR: SOAPS, PERFUMERIES, ESSENTIAL OILS,
COSMETICS, HAIR TONIC, DENTIFRICES, IN
CLASS 3 (U.S. CLS. 1, 4, 6, 50, 51 AND 52).

THE MARK CONSISTS OF STANDARD CHAR-
ACTERS WITHOUT CLAIM TO ANY PARTICULAR
FONT, STYLE, SIZE, OR COLOR.

PRIORITY DATE OF 10-5-2007 IS CLAIMED.

OWNER OF INTERNATIONAL REGISTRATION
0960517 DATED 3-18-2008, EXPIRES 3-18-2018.

SER. NO. 79-052,504, FILED 3-18-2008.

EDWARD NELSON, EXAMINING ATTORNEY

Int. Cls.: 1 and 2

Prior U.S. Cls.: 1, 5, 6, 10, 11, 16, 26 and 46

United States Patent and Trademark Office

Reg. No. 3,520,952

Registered Oct. 21, 2008

**TRADEMARK
PRINCIPAL REGISTER**

KEMWHITE

KEMIRA OYJ (FINLAND PUBLIC LIMITED
COMPANY)
PORKKALANKATU 3
FI-00180 HELSINKI
FINLAND

FOR: CHEMICALS FOR USE IN THE MANUFACTURE OF PAPER, IN CLASS 1 (U.S. CLS. 1, 5, 6, 10, 26 AND 46).

FOR: COATING PIGMENTS FOR USE IN THE MANUFACTURE OF PAPER, IN CLASS 2 (U.S. CLS. 6, 11 AND 16).

THE MARK CONSISTS OF STANDARD CHARACTERS WITHOUT CLAIM TO ANY PARTICULAR FONT, STYLE, SIZE, OR COLOR.

PRIORITY DATE OF 3-10-2008 IS CLAIMED.

OWNER OF INTERNATIONAL REGISTRATION
0960659 DATED 3-19-2008, EXPIRES 3-19-2018.

SER. NO. 79-052,552, FILED 3-19-2008.

MARILYN IZZI, EXAMINING ATTORNEY

Int. Cl.: 5

Prior U.S. Cls.: 6, 18, 44, 46, 51 and 52

United States Patent and Trademark Office

Reg. No. 3,520,953

Registered Oct. 21, 2008

**TRADEMARK
PRINCIPAL REGISTER**

ONYSTER

PIERRE FABRE DERMATOLOGIE (FRANCE SO-
CIEÉTÉ PAR ACTIONS SIMPLIFIÉE)
45 PLACE ABEL GANCE
BOULOGNE, FRANCE F92100

FOR: DERMATOLOGICAL PRODUCTS FOR THE
TREATMENT OF ONYCHOMYCOSES, IN CLASS 5
(U.S. CLS. 6, 18, 44, 46, 51 AND 52).

THE MARK CONSISTS OF STANDARD CHAR-
ACTERS WITHOUT CLAIM TO ANY PARTICULAR
FONT, STYLE, SIZE, OR COLOR.

PRIORITY DATE OF 10-1-2007 IS CLAIMED.

OWNER OF INTERNATIONAL REGISTRATION
0960835 DATED 3-14-2008, EXPIRES 3-14-2018.

SER. NO. 79-052,602, FILED 3-14-2008.

SEAN CROWLEY, EXAMINING ATTORNEY

Int. Cl.: 7

Prior U.S. Cls.: 13, 19, 21, 23, 31, 34 and 35

United States Patent and Trademark Office

Reg. No. 3,520,954

Registered Oct. 21, 2008

**TRADEMARK
PRINCIPAL REGISTER**

ULTIMAZ

PLUMETTAZ S.A. (SWITZERLAND SOCIÉTÉ
ANONYME)
Z.I. EN VANNEL C
ROUTE DE LA GRIBANNAZ 12
CH-1880 BEX, SWITZERLAND

FOR: MACHINES FOR INSTALLING, LAYING
AND REPLACING CABLES OR OTHER SMALL
DIAMETER LONGILINEAL ITEMS, IN CLASS 7
(U.S. CLS. 13, 19, 21, 23, 31, 34 AND 35).

THE MARK CONSISTS OF STANDARD CHAR-
ACTERS WITHOUT CLAIM TO ANY PARTICULAR
FONT, STYLE, SIZE, OR COLOR.

PRIORITY DATE OF 11-8-2007 IS CLAIMED.

OWNER OF INTERNATIONAL REGISTRATION
0960861 DATED 3-20-2008, EXPIRES 3-20-2018.

SER. NO. 79-052,607, FILED 3-20-2008.

CURTIS FRENCH, EXAMINING ATTORNEY

Int. Cl.: 9

Prior U.S. Cls.: 21, 23, 26, 36 and 38

United States Patent and Trademark Office

Reg. No. 3,520,955

Registered Oct. 21, 2008

**TRADEMARK
PRINCIPAL REGISTER**

PORTAFLOW

MICRONICS LIMITED (UNITED KINGDOM PRIVATE LIMITED COMPANY)
KNAVES BEECH BUSINESS CENTRE,
DAVIES WAY, LOUDWATER; HIGH WYCOMBE,
BUCKINGHAMSHIRE HP10 9QR
UNITED KINGDOM

FOR: APPARATUS AND INSTRUMENTS FOR USE IN FLOW MEASUREMENT, AND PARTS AND FITTINGS THEREFOR INCLUDED IN THIS CLASS, IN CLASS 9 (U.S. CLS. 21, 23, 26, 36 AND 38).

THE MARK CONSISTS OF STANDARD CHARACTERS WITHOUT CLAIM TO ANY PARTICULAR FONT, STYLE, SIZE, OR COLOR.

OWNER OF INTERNATIONAL REGISTRATION 0960946 DATED 3-12-2008, EXPIRES 3-12-2018.

SER. NO. 79-052,625, FILED 3-12-2008.

WARREN L. OLANDRIA, EXAMINING ATTORNEY

Int. Cl.: 33

Prior U.S. Cls.: 47 and 49

United States Patent and Trademark Office

Reg. No. 3,520,956

Registered Oct. 21, 2008

**TRADEMARK
PRINCIPAL REGISTER**

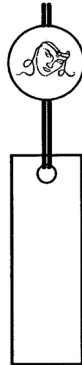

GIANNI GAGLIARDO SRL (ITALY LIMITED
LIABILITY COMPANY)
SERRA DEI TURCHI, 88
I-12064 LA MORRA CN
ITALY

OWNER OF INTERNATIONAL REGISTRATION
0961070 DATED 2-26-2008, EXPIRES 2-26-2018.

FOR: WINES, IN CLASS 33 (U.S. CLS. 47 AND 49).

SER. NO. 79-052,677, FILED 2-26-2008.

PRIORITY DATE OF 2-5-2008 IS CLAIMED.

JULIE GUTTADAURO, EXAMINING ATTORNEY

Int. Cl.: 33

Prior U.S. Cls.: 47 and 49

United States Patent and Trademark Office

Reg. No. 3,520,957

Registered Oct. 21, 2008

**TRADEMARK
PRINCIPAL REGISTER**

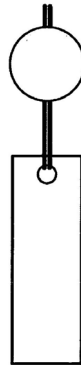

GIANNI GAGLIARDO SRL (ITALY LIMITED
LIABILITY COMPANY)
SERRA DEI TURCHI, 88
I-12064 LA MORRA CN
ITALY

OWNER OF INTERNATIONAL REGISTRATION
0961071 DATED 2-26-2008, EXPIRES 2-26-2018.

FOR: WINES, IN CLASS 33 (U.S. CLS. 47 AND 49).

SER. NO. 79-052,678, FILED 2-26-2008.

PRIORITY DATE OF 2-5-2008 IS CLAIMED.

JULIE GUTTADAURO, EXAMINING ATTORNEY

Int. Cls.: 38, 41 and 42

Prior U.S. Cls.: 100, 101, 104 and 107

United States Patent and Trademark Office

Reg. No. 3,520,958

Registered Oct. 21, 2008

**SERVICE MARK
PRINCIPAL REGISTER**

COMING

BOEHRINGER INGELHEIM INTERNATIONAL
GMBH (FED REP GERMANY CORPORATION)

55218 INGELHEIM
FED REP GERMANY

FOR: PROVISION OF ACCESS VIA THE INTERNET TO MEDICAL AND PHARMACEUTICAL INFORMATION OF PHARMACEUTICAL PREPARATIONS, IN CLASS 38 (U.S. CLS. 100, 101 AND 104).

FOR: PUBLICATION OF PRINTED MATTER OF THE RESULTS OF CLINICAL TRIALS FOR PHARMACEUTICAL PREPARATIONS, ALSO IN ELECTRONIC FORM, IN CLASS 41 (U.S. CLS. 100, 101 AND 107).

FOR: CONDUCTING CLINICAL TRIALS FOR PHARMACEUTICAL PRODUCTS, IN CLASS 42 (U.S. CLS. 100 AND 101).

THE MARK CONSISTS OF STANDARD CHARACTERS WITHOUT CLAIM TO ANY PARTICULAR FONT, STYLE, SIZE, OR COLOR.

PRIORITY DATE OF 11-22-2007 IS CLAIMED.

OWNER OF INTERNATIONAL REGISTRATION 0962235 DATED 3-20-2008, EXPIRES 3-20-2018.

SER. NO. 79-053,093, FILED 3-20-2008.

JASON BLAIR, EXAMINING ATTORNEY

Int. Cls.: 38, 41 and 42

Prior U.S. Cls.: 100, 101, 104 and 107

United States Patent and Trademark Office

Reg. No. 3,520,959

Registered Oct. 21, 2008

**SERVICE MARK
PRINCIPAL REGISTER**

VERXVE

BOEHRINGER INGELHEIM INTERNATIONAL
GMBH (FED REP GERMANY CORPORATION)

55218 INGELHEIM
FED REP GERMANY

FOR: PROVISION OF ACCESS VIA THE INTERNET TO MEDICAL AND PHARMACEUTICAL INFORMATION OF PHARMACEUTICAL PREPARATIONS, IN CLASS 38 (U.S. CLS. 100, 101 AND 104).

FOR: PUBLICATION OF PRINTED MATTER OF THE RESULTS OF CLINICAL TRIALS FOR PHARMACEUTICAL PREPARATIONS, ALSO IN ELECTRONIC FORM AND EXCEPT ADVERTISING TEXTS, IN CLASS 41 (U.S. CLS. 100, 101 AND 107).

FOR: CONDUCTING CLINICAL TRIALS FOR PHARMACEUTICAL PRODUCTS, IN CLASS 42 (U.S. CLS. 100 AND 101).

THE MARK CONSISTS OF STANDARD CHARACTERS WITHOUT CLAIM TO ANY PARTICULAR FONT, STYLE, SIZE, OR COLOR.

PRIORITY DATE OF 11-22-2007 IS CLAIMED.

OWNER OF INTERNATIONAL REGISTRATION 0962239 DATED 4-2-2008, EXPIRES 4-2-2018.

SER. NO. 79-053,094, FILED 4-2-2008.

JASON BLAIR, EXAMINING ATTORNEY

Int. Cl.: 33

Prior U.S. Cls.: 47 and 49

United States Patent and Trademark Office

Reg. No. 3,520,960

Registered Oct. 21, 2008

TRADEMARK
PRINCIPAL REGISTER

麗
子

YAEGAKI SHUZO KABUSHIKI KAISHA; (DO-
ING INTERNATIONAL BUSINESS AS; YAE-
GAKI SAKE & SPIRITS, INC.) (JAPAN
CORPORATION)

681, MUKUDANI,
HAYASHIDA-CHO.; HIMEJI-SHI; HYOGO 679-4298
JAPAN

FOR: JAPANESE LIQUORS, CHINESE LIQUORS,
FLAVORED TONIC LIQUORS, IN CLASS 33 (U.S.
CLS. 47 AND 49).

OWNER OF INTERNATIONAL REGISTRATION
0962325 DATED 3-21-2008, EXPIRES 3-21-2018.

THE ENGLISH TRANSLATION OF THE WORD
REIKO IN THE MARK IS A WOMAN'S FIRST
NAME OR A LOVELY GIRL.

THE NON-LATIN CHARACTERS IN THE MARK
TRANSLITERATE TO "REIKO" AND THIS MEANS
A WOMAN'S FIRST NAME OR A LOVELY GIRL IN
ENGLISH.

SER. NO. 79-053,126, FILED 3-21-2008.

MATTHEW EINSTEIN, EXAMINING ATTORNEY

Int. Cl.: 10

Prior U.S. Cls.: 26, 39 and 44

United States Patent and Trademark Office

Reg. No. 3,520,961

Registered Oct. 21, 2008

**TRADEMARK
PRINCIPAL REGISTER**

LEUKOKIT

GIPHARMA SRL (ITALY LIMITED LIABILITY
COMPANY)
CORSO RE UMBERTO, 54
I-10128 TORINO
ITALY

FOR: MEDICAL DEVICES FOR DIAGNOSTIC
ACTIVITY BY MEANS OF SCINTIGRAPHY, IN
CLASS 10 (U.S. CLS. 26, 39 AND 44).

THE MARK CONSISTS OF STANDARD CHAR-
ACTERS WITHOUT CLAIM TO ANY PARTICULAR
FONT, STYLE, SIZE, OR COLOR.

PRIORITY DATE OF 3-17-2008 IS CLAIMED.

OWNER OF INTERNATIONAL REGISTRATION
0962381 DATED 3-21-2008, EXPIRES 3-21-2018.

SER. NO. 79-053,146, FILED 3-21-2008.

MATTHEW EINSTEIN, EXAMINING ATTORNEY

Int. Cls.: 14, 16 and 18

**Prior U.S. Cls.: 1, 2, 3, 5, 22, 23, 27, 28, 29, 37, 38, 41
and 50**

Reg. No. 3,520,962

United States Patent and Trademark Office

Registered Oct. 21, 2008

**TRADEMARK
PRINCIPAL REGISTER**

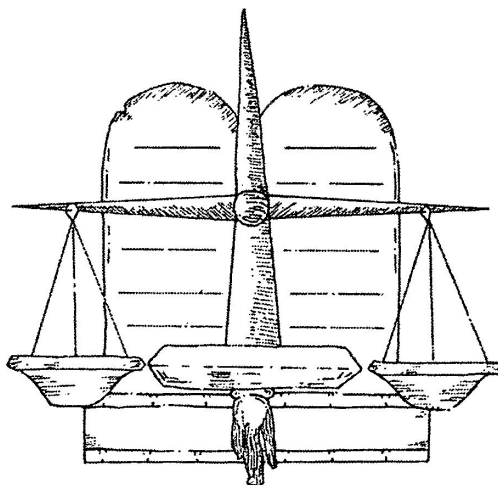

MADINIT S.R.L. (ITALY LIMITED LIABILITY
COMPANY)
VIA XX SETTEMBRE, 51 - SCALA C
I-36015 SCHIO (VICENZA)
ITALY

FOR: JEWELLERY AND IMITATION JEWEL-
LERY; KEY HOLDERS OF PRECIOUS METALS;
TIE PINS, CUFFLINKS, LAPEL PINS; WATCHES
AND CLOCKS, IN CLASS 14 (U.S. CLS. 2, 27, 28 AND
50).

FOR: BOOKS AND JOURNALS IN THE FIELD OF
HISTORY, ARTS, ECONOMICS, ARCHITECTURE;
BOOK MARKS; BOXES OF PAPER OR CARD-
BOARD; CALENDARS AND DIARIES; WRITING
INSTRUMENTS, PENS, BALLPOINT PENS, FELT
WRITING PENS, FOUNTAIN PENS, PEN NIBS;
STANDS FOR PENS AND PENCILS; LETTER PA-
PER, MEMO PADS, OFFICE STATIONERY, PAPER-

WEIGHTS; PAPER KNIVES; PEN AND PENCIL
CASES; PENHOLDERS; PHOTOGRAPHIC ALBUMS,
POSTERS MADE OF PAPER; BUSINESS CARD
CASES , IN CLASS 16 (U.S. CLS. 2, 5, 22, 23, 29, 37, 38
AND 50).

FOR: HANDBAGS, SHOULDER BAGS, BRIEF-
CASES, VANITY CASES SOLD EMPTY, KEY CASES,
WALLETS AND PURSES; SUITCASES AND TRA-
VELLING BAGS; UMBRELLAS, IN CLASS 18 (U.S.
CLS. 1, 2, 3, 22 AND 41).

OWNER OF INTERNATIONAL REGISTRATION
0964166 DATED 1-24-2008, EXPIRES 1-24-2018.

SER. NO. 79-053,774, FILED 1-24-2008.

JESSICA FATHY, EXAMINING ATTORNEY

Int. Cls.: 14, 16 and 18

**Prior U.S. Cls.: 1, 2, 3, 5, 22, 23, 27, 28, 29, 37, 38, 41
and 50**

Reg. No. 3,520,963

United States Patent and Trademark Office

Registered Oct. 21, 2008

**TRADEMARK
PRINCIPAL REGISTER**



MADINIT S.R.L. (ITALY LIMITED LIABILITY
COMPANY)
VIA XX SETTEMBRE 51 -
SCALA C - 1; I-36015 SCHIO (VI)
ITALY

FOR: JEWELLERY AND IMITATION JEWEL-
LERY; KEY HOLDERS OF PRECIOUS METALS;
TIE PINS, CUFFLINKS, LAPEL PINS; WATCHES
AND CLOCKS, IN CLASS 14 (U.S. CLS. 2, 27, 28 AND
50).

FOR: BOOKS AND JOURNALS IN THE FIELD OF
HISTORY, ARTS, ECONOMICS, ARCHITECTURE;
BOOK MARKS; BOXES OF PAPER OR CARD-
BOARD; CALENDARS AND DIARIES; WRITING
INSTRUMENTS, PENS, BALLPOINT PENS, FELT
WRITING PENS, FOUNTAIN PENS, PEN NIBS;
STANDS FOR PENS AND PENCILS; LETTER PA-
PER, MEMO PADS, OFFICE STATIONERY, PAPER-

WEIGHTS; PAPER KNIVES; PEN AND PENCIL
CASES; PENHOLDERS; PHOTOGRAPHIC ALBUMS,
POSTERS MADE OF PAPER; BUSINESS CARD
CASES, IN CLASS 16 (U.S. CLS. 2, 5, 22, 23, 29, 37, 38
AND 50).

FOR: HANDBAGS, SHOULDER BAGS, BRIEF-
CASES, VANITY CASES SOLD EMPTY, KEY CASES,
WALLETS AND PURSES; SUITCASES AND TRA-
VELLING BAGS; UMBRELLAS, IN CLASS 18 (U.S.
CLS. 1, 2, 3, 22 AND 41).

OWNER OF INTERNATIONAL REGISTRATION
0964167 DATED 1-24-2008, EXPIRES 1-24-2018.

SER. NO. 79-053,775, FILED 1-24-2008.

JESSICA FATHY, EXAMINING ATTORNEY

Int. Cls.: 14, 16 and 18

**Prior U.S. Cls.: 1, 2, 3, 5, 22, 23, 27, 28, 29, 37, 38, 41
and 50**

Reg. No. 3,520,964

United States Patent and Trademark Office

Registered Oct. 21, 2008

**TRADEMARK
PRINCIPAL REGISTER**



MADINIT S.R.L. (ITALY LIMITED LIABILITY
COMPANY)
VIA SETTEMBRE 51,
SCALA C - 1; I-36015 SCHIO (VI)
ITALY

FOR: JEWELLERY AND IMITATION JEWEL-
LERY; KEY HOLDERS OF PRECIOUS METALS;
TIE PINS, CUFFLINKS, LAPEL PINS; WATCHES
AND CLOCKS, IN CLASS 14 (U.S. CLS. 2, 27, 28 AND
50).

FOR: BOOKS AND JOURNALS IN THE FIELD OF
HISTORY, ARTS, ECONOMICS, ARCHITECTURE;
BOOK MARKS; BOXES OF PAPER OR CARD-
BOARD; CALENDARS AND DIARIES; WRITING
INSTRUMENTS, PENS, BALLPOINT PENS, FELT
WRITING PENS, FOUNTAIN PENS, PEN NIBS;
STANDS FOR PEN AND PENCIL; LETTER PAPER,
MEMO PADS, OFFICE STATIONERY, PAPER-

WEIGHTS; PAPER KNIVES; PEN AND PENCIL
CASES; PENHOLDERS; PHOTOGRAPHIC ALBUMS,
POSTERS MADE OF PAPER; BUSINESS CARD
CASES, IN CLASS 16 (U.S. CLS. 2, 5, 22, 23, 29, 37, 38
AND 50).

FOR: HANDBAGS, SHOULDER BAGS, BRIEF-
CASES, VANITY CASES SOLD EMPTY, KEY CASES,
WALLETS AND PURSES; SUITCASES AND TRA-
VELLING BAGS; UMBRELLAS, IN CLASS 18 (U.S.
CLS. 1, 2, 3, 22 AND 41).

OWNER OF INTERNATIONAL REGISTRATION
0964168 DATED 1-24-2008, EXPIRES 1-24-2018.

SER. NO. 79-053,776, FILED 1-24-2008.

JESSICA FATHY, EXAMINING ATTORNEY

Int. Cls.: 14, 16 and 18

**Prior U.S. Cls.: 1, 2, 3, 5, 22, 23, 27, 28, 29, 37, 38, 41
and 50**

Reg. No. 3,520,965

United States Patent and Trademark Office

Registered Oct. 21, 2008

**TRADEMARK
PRINCIPAL REGISTER**



MADINIT S.R.L. (ITALY LIMITED LIABILITY
COMPANY)
VIA XX SETTEMBRE, 51 - SCALA C
I-36015 SCHIO (VICENZA)
ITALY

FOR: JEWELLERY AND IMITATION JEWEL-
LERY; KEY HOLDERS OF PRECIOUS METALS;
TIE PINS, CUFFLINKS, LAPEL PINS; WATCHES
AND CLOCKS, IN CLASS 14 (U.S. CLS. 2, 27, 28 AND
50).

FOR: BOOKS AND JOURNALS IN THE FIELD OF
HISTORY, ARTS, ECONOMICS, ARCHITECTURE;
BOOK MARKS; BOXES OF PAPER OR CARD-
BOARD; CALENDARS AND DIARIES; WRITING
INSTRUMENTS, PENS, BALLPOINT PENS, FELT
WRITING PENS, FOUNTAIN PENS, PEN NIBS;
STANDS FOR PEN AND PENCIL; LETTER PAPER,
MEMO PADS, OFFICE STATIONERY, PAPER-

WEIGHTS; PAPER KNIVES; PEN AND PENCIL
CASES; PENHOLDERS; PHOTOGRAPHIC ALBUMS,
POSTERS MADE OF PAPER; BUSINESS CARD
CASES, IN CLASS 16 (U.S. CLS. 2, 5, 22, 23, 29, 37, 38
AND 50).

FOR: HANDBAGS, SHOULDER BAGS, BRIEF-
CASES, VANITY CASES SOLD EMPTY, KEY CASES,
WALLETS AND PURSES; SUITCASES AND TRA-
VELLING BAGS; UMBRELLAS, IN CLASS 18 (U.S.
CLS. 1, 2, 3, 22 AND 41).

OWNER OF INTERNATIONAL REGISTRATION
0964169 DATED 1-24-2008, EXPIRES 1-24-2018.

SER. NO. 79-053,777, FILED 1-24-2008.

JESSICA FATHY, EXAMINING ATTORNEY

Int. Cls.: 14 and 18

Prior U.S. Cls.: 1, 2, 3, 22, 27, 28, 41 and 50

United States Patent and Trademark Office

Reg. No. 3,520,966

Registered Oct. 21, 2008

**TRADEMARK
PRINCIPAL REGISTER**

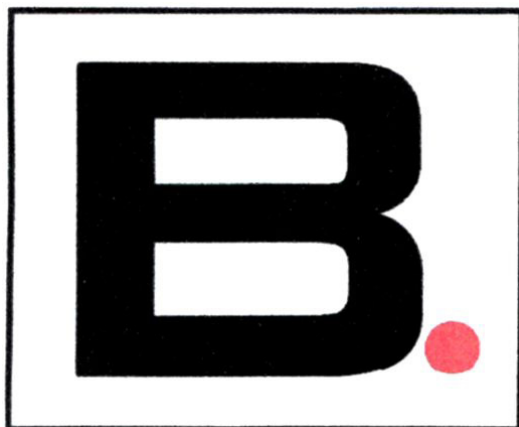

BACIO S.R.L. (ITALY LIMITED LIABILITY COMPANY)
VIA MARTIRI DI CIVITELLA, 3
I-52100 AREZZO
ITALY

FOR: SILVER AND GOLD UNWROUGHT; IMITATION JEWELRY; JEWELRY, NAMELY, THREADS AND WIRES OF PRECIOUS METALS; BOXES OF PRECIOUS METAL; JEWEL CASES; WATCH CASES; PRECIOUS METAL TROPHIES; EARRINGS, ORNAMENTAL CHAINS AND PINS, BRACELETS, NECKLACES, RINGS, PENDANTS, BROOCHES, CHAINS, CHARMS, MEDALLIONS, DIADEMS, CUFFLINKS, TIE CLIPS; JEWELRY; KEY RINGS OF PRECIOUS METALS; WORKS OF ART OF PRECIOUS METAL; WATCH BANDS; WRIST WATCHES, CLOCKS, CHRONOMETERS, IN CLASS 14 (U.S. CLS. 2, 27, 28 AND 50).

FOR: UNWORKED OR SEMI-WORKED LEATHER SOLD IN BULK, FUR-SKINS, LUGGAGE, HANDBAGS, SHOULDER BAGS, GARMENT BAGS FOR TRAVEL, TRAVELLING BAGS, BEACH BAGS, CLUTCH BAGS, ALL PURPOSE SPORTS BAGS, ATTACHE CASES, SCHOOL BAGS, TOTE BAGS, SHOPPING BAGS; CARD CASES, NAMELY, NOTE CASES; VANITY CASES NOT FITTED; KEY CASES, KNAPSACKS, RUCKSACKS, BRIEFCASES, PURSES, WALLETS, POUCHES OF LEATHER FOR PACKAGING; TRAVELLING TRUNKS, SUITCA-

SES, UMBRELLAS, PARASOLS, WALKING STICKS; DOG COLLARS, WHIPS, IN CLASS 18 (U.S. CLS. 1, 2, 3, 22 AND 41).

PRIORITY DATE OF 11-14-2007 IS CLAIMED.

OWNER OF INTERNATIONAL REGISTRATION 0964175 DATED 2-6-2008, EXPIRES 2-6-2018.

THE COLOR(S) BLACK, RED AND WHITE IS/ ARE CLAIMED AS A FEATURE OF THE MARK.

BLACK APPEARS IN THE LETTER "B" AND IN THE FRAME; RED APPEARS IN THE DOT; WHITE APPEARS IN THE BACKGROUND WITHIN THE FRAME.

THE MARK CONSISTS OF A LARGE BLACK LETTER "B", FOLLOWED BY A RED DOT, ALL ON A WHITE BACKGROUND AND WITHIN A THIN BLACK RECTANGULAR FRAME.

SER. NO. 79-053,779, FILED 2-6-2008.

DOMINIC FATHY, EXAMINING ATTORNEY

Int. Cl.: 31

Prior U.S. Cls.: 1 and 46

United States Patent and Trademark Office

Reg. No. 3,520,967

Registered Oct. 21, 2008

**TRADEMARK
PRINCIPAL REGISTER**

Checkies

JUNGPFLANZEN GRÜNEWALD GMBH (FED
REP GERMANY LIMITED LIABILITY COM-
PANY (GERMAN GMBH))
KOCHSTRASSE 6
59379 SELM
FED REP GERMANY

FOR: AGRICULTURAL, HORTICULTURAL
AND FORESTRY PRODUCTS, NAMELY, SEEDS
AND BULBS FOR AGRICULTURAL PURPOSES,
AGRICULTURAL SEEDS, SPORES AND SPAWN
FOR AGRICULTURAL PURPOSES, AGRICULTUR-
AL GRAINS FOR PLANTING, SEEDS AND BULBS
FOR HORTICULTURAL PURPOSES, LIVING
TREES, NON-DEBARKED TIMBER, UNSAWN TIM-
BER, RAW TIMBER, UNPROCESSED TIMBER;
GRAINS, NAMELY, UNPROCESSED GRAINS,
AGRICULTURAL AND HORTICULTURAL
GRAINS FOR PLANTING; FRESH FRUITS AND
VEGETABLES; AGRICULTURAL AND HORTICUL-
TURAL SEEDS, NAMELY, CROP SEEDS, GRASS
SEEDS, PLANT SEEDS; NATURAL PLANTS AND
FLOWERS, NAMELY, LIVE ORNAMENTAL
PLANTS, LIVE YOUNG ORNAMENTAL PLANTS,

LIVE ROOTED AND UNROOTED CUTTINGS OF
ORNAMENTAL PLANTS AND HERBS FOR PRO-
PAGATION, FRESH HERBS, LIVE FLOWERING
PLANTS, LIVING PLANTS, LIVING FRUIT
PLANTS, LIVE FLOWERS; FOODSTUFFS FOR AN-
IMALS, MALT FOR BREWING AND DISTILLING,
INCLUDED IN THIS CLASS, IN CLASS 31 (U.S. CLS.
1 AND 46).

THE MARK CONSISTS OF STANDARD CHAR-
ACTERS WITHOUT CLAIM TO ANY PARTICULAR
FONT, STYLE, SIZE, OR COLOR.

PRIORITY DATE OF 9-19-2007 IS CLAIMED.

OWNER OF INTERNATIONAL REGISTRATION
0964487 DATED 3-17-2008, EXPIRES 3-17-2018.

SER. NO. 79-053,904, FILED 3-17-2008.

SUE LAWRENCE, EXAMINING ATTORNEY

Int. Cl.: 14

Prior U.S. Cls.: 2, 27, 28 and 50

United States Patent and Trademark Office

Reg. No. 3,520,968

Registered Oct. 21, 2008

**TRADEMARK
PRINCIPAL REGISTER**

F-80

SALVATORE FERRAGAMO ITALIA S.P.A. (ITALY JOINT STOCK COMPANY)
VIA DEI TORNABUONI, 2
I-50123 FIRENZE (FI), ITALY

PRIORITY DATE OF 3-5-2008 IS CLAIMED.

FOR: CLOCKS, WATCHES, WRISTWATCHES, DIVING WATCHES, POCKET WATCHES, WATCH BANDS AND STRAPS, WATCH CHAINS, WATCH CASES, CHRONOGRAPHS FOR USE AS TIMEPIECES AND FOR USE AS WATCHES, CHRONOMETERS, IN CLASS 14 (U.S. CLS. 2, 27, 28 AND 50).

OWNER OF INTERNATIONAL REGISTRATION 0964490 DATED 3-27-2008, EXPIRES 3-27-2018.

SER. NO. 79-053,905, FILED 3-27-2008.

THE MARK CONSISTS OF STANDARD CHARACTERS WITHOUT CLAIM TO ANY PARTICULAR FONT, STYLE, SIZE, OR COLOR.

AISHA SALEM, EXAMINING ATTORNEY

Int. Cls.: 7, 9 and 11

Prior U.S. Cls.: 13, 19, 21, 23, 26, 31, 34, 35, 36 and 38

Reg. No. 3,520,969

United States Patent and Trademark Office

Registered Oct. 21, 2008

**TRADEMARK
PRINCIPAL REGISTER**

Casarte

QINGDAO HAIER; MARKETING & PLANNING
CO., LTD (CHINA CORPORATION)
HAIER INDUSTRIAL PARK,
HI-TECH INDUSTRIAL ZONE.; QINGDAO, SHAN-
DONG PROVINCE
CHINA

FOR: DISHWASHERS; ELECTRIC FOOD BLENDERS FOR HOUSEHOLD PURPOSES; KITCHEN MACHINES, NAMELY, ELECTRIC STANDING MIXERS; ELECTRIC FOOD PROCESSORS; SOY-BEAN MILK PREPARATION MACHINES FOR HOUSEHOLD PURPOSES; CLOTHES WASHING MACHINES; LAUNDRY CENTERS, NAMELY, A CLOTHES WASHER COMBINED WITH A CLOTHES DRYER; VACUUM CLEANERS FOR HOUSEHOLD PURPOSES; CARPET CLEANING MACHINES, IN CLASS 7 (U.S. CLS. 13, 19, 21, 23, 31, 34 AND 35).

FOR: DESKTOP COMPUTERS; COMPUTER ROUTERS; COMPUTER NETWORK ADAPTERS; FACSIMILE MACHINES; NEON SIGNS; MOBILE PHONES; TELEVISION SETS; CAMERAS; PORTABLE LISTENING DEVICES, NAMELY, MP3 PLAYERS; DVD PLAYERS; COMPUTER SOFTWARE FOR APPLICATION AND DATABASE INTEGRATION, IN CLASS 9 (U.S. CLS. 21, 23, 26, 36 AND 38).

FOR: LIGHTING FIXTURES; ELECTRIC COOKING OVENS FOR HOUSEHOLD PURPOSES; RE-

FRIGERATORS; AIR CONDITIONING UNITS; ELECTRIC HEATING FANS; HEATING INSTALLATIONS; PIPES BEING PARTS OF SANITARY FACILITIES; DISH DISINFECTANT APPARATUS FOR HOUSEHOLD PURPOSES; ELECTRIC RADIATORS; OVEN GAS IGNITERS; GAS WATER HEATERS FOR HOUSEHOLD USE; MICROWAVE OVENS FOR COOKING; EXTRACTOR HOODS FOR HOUSEHOLD PURPOSES; GAS BURNERS; REFRIGERATING APPLIANCES AND INSTALLATIONS; SOLAR WATER HEATERS; REFRIGERATING DISPLAY CABINETS; ELECTRIC COFFEE MAKERS; CLOTHES DRYERS; VENTILATING EXHAUST FANS; ELECTRIC HOT AIR HAND DRYERS; CENTRAL HEATING RADIATORS, IN CLASS 11 (U.S. CLS. 13, 21, 23, 31 AND 34).

OWNER OF INTERNATIONAL REGISTRATION
0964645 DATED 3-26-2008, EXPIRES 3-26-2018.

WORDS IN STYLIZED FORM.

THE WORDING "CASARTE" HAS NO MEANING
IN A FOREIGN LANGUAGE.

SER. NO. 79-053,981, FILED 3-26-2008.

CHARLES L. JENKINS, EXAMINING ATTORNEY

Int. Cl.: 31

Prior U.S. Cls.: 1 and 46

United States Patent and Trademark Office

Reg. No. 3,520,970

Registered Oct. 21, 2008

**TRADEMARK
PRINCIPAL REGISTER**



FINSIPO S.R.L. (ITALY LIMITED COMPANY)
VIA BOLOGNA, 714
I-44100 FERRARA (FE)
ITALY

FOR: FRESH FRUIT AND VEGETABLES SEEDS,
NATURAL PLANTS, IN CLASS 31 (U.S. CLS. 1 AND
46).

PRIORITY DATE OF 1-22-2008 IS CLAIMED.

OWNER OF INTERNATIONAL REGISTRATION
0964646 DATED 2-13-2008, EXPIRES 2-13-2018.

THE COLOR(S) GREEN, RED, WHITE IS/ARE
CLAIMED AS A FEATURE OF THE MARK.

THE MARK CONSISTS OF THE FOLLOWING,
THE MAN: GREEN, APPLE: RED, LETTER "S":
WHITE, WORD "SALVI": WHITE ON A GREEN
BACKGROUND.

THE MARK CONSISTS OF A STYLIZED SILHOU-
ETTE OF A MAN BRINGING BEFORE THE MOUTH
AN APPLE; ON THE CHEST OF THAT MAN IS
PRINTED THE LETTER "S"; ALL IS SIGNED BY
THE WORD "SALVI".

SER. NO. 79-053,982, FILED 2-13-2008.

HELENE LIWINSKI, EXAMINING ATTORNEY

Int. Cl.: 14

Prior U.S. Cls.: 2, 27, 28 and 50

United States Patent and Trademark Office

Reg. No. 3,520,971

Registered Oct. 21, 2008

TRADEMARK
PRINCIPAL REGISTER



FLASH & PARTNERS S.P.A. (ITALY JOINT
STOCK COMPANY)
VIA TIEPOLO, 6
I-35019 TOMBOLO (PD)
ITALY

FOR: PRECIOUS METAL, NAMELY, GOLD, SIL-
VER, PLATINUM AND PRECIOUS METAL AL-
LOYS; JEWELRY; PRECIOUS STONES; DIVING
WATCHES, POCKET WATCHES, WRISTWATCHES,
SMALL CLOCKS, HOROLOGICAL AND CHRONO-
METRIC INSTRUMENTS AND CASES THEREFOR;
GOODS MADE OF PRECIOUS METALS, NAMELY,

BRACELETS, NECKLACES, EARRINGS, PEN-
DANTS, RINGS BEING JEWELRY, TIE CLIPS, KEY
RINGS, CASES FOR CLOCKS AND WATCHES, IN
CLASS 14 (U.S. CLS. 2, 27, 28 AND 50).

OWNER OF INTERNATIONAL REGISTRATION
0964657 DATED 3-26-2008, EXPIRES 3-26-2018.

SER. NO. 79-053,988, FILED 3-26-2008.

CHARLES L. JENKINS, EXAMINING ATTORNEY

Int. Cl.: 1

Prior U.S. Cls.: 1, 5, 6, 10, 26 and 46

United States Patent and Trademark Office

Reg. No. 3,520,972

Registered Oct. 21, 2008

**TRADEMARK
PRINCIPAL REGISTER**

AQACell

BASF SE (FED REP GERMANY SOCIETAS
EUROPAEA)
CARL-BOSCH-STRASSE 38
67063 LUDWIGSHAFEN AM RHEIN
FED REP GERMANY

FOR: UNPROCESSED PLASTICS, NAMELY,
POLYMERS, IN CLASS 1 (U.S. CLS. 1, 5, 6, 10, 26
AND 46).

THE MARK CONSISTS OF STANDARD CHAR-
ACTERS WITHOUT CLAIM TO ANY PARTICULAR
FONT, STYLE, SIZE, OR COLOR.

PRIORITY DATE OF 10-29-2007 IS CLAIMED.

OWNER OF INTERNATIONAL REGISTRATION
0965145 DATED 4-24-2008, EXPIRES 4-24-2018.

SER. NO. 79-054,168, FILED 4-24-2008.

TINA BROWN, EXAMINING ATTORNEY

Int. Cls.: 20 and 31

Prior U.S. Cls.: 1, 2, 13, 22, 25, 32, 46, and 50

United States Patent and Trademark Office

Reg. No. 3,520,973

Registered Oct. 21, 2008

**TRADEMARK
PRINCIPAL REGISTER**

LYPTUS

ARACRUZ PRODUTOS DE MADEIRA S. A.
(BRAZIL CORPORATION)
ROD BR-418, KM 37
POSTO DA MATA
CITY OF NOVA VICOSA 45920-0000, BRAZIL

FOR: UNPROCESSED RAW WOOD, NAMELY,
TREE TRUNKS, IN CLASS 31 (U.S. CLS. 1 AND 46).

FIRST USE 5-0-1999; IN COMMERCE 8-0-1999.

FOR: FURNITURE, IN CLASS 20 (U.S. CLS. 2, 13,
22, 25, 32 AND 50).

SN 75-834,270, FILED 10-28-1999.

FIRST USE 5-0-1999; IN COMMERCE 8-0-1999.

DAVID H. STINE, EXAMINING ATTORNEY

Int. Cl.: 3

Prior U.S. Cls.: 1, 4, 6, 50, 51, and 52

Reg. No. 3,520,974

United States Patent and Trademark Office

Registered Oct. 21, 2008

**TRADEMARK
PRINCIPAL REGISTER**

VICTORIA'S SECRET PINK

VICTORIA'S SECRET STORES BRAND MAN-
AGEMENT, INC. (DELAWARE CORPORA-
TION)
FOUR LIMITED PARKWAY
REYNOLDSBURG, OH 43068

FOR: PERSONAL CARE PRODUCTS, NAMELY,
BATH OIL, BATH BEADS, BLUSH, COLOGNE,
CREAM FOR THE BODY, CREAM FOR THE FACE,
CREAM FOR THE HANDS, FACE MIST, FRA-
GRANT BODY SPLASH, LOTION FOR THE BODY,
LOTION FOR THE HANDS, LOTION FOR THE
FACE, LIP BALM, LIP GLOSS, LIP MAKEUP PEN-
CILS, LIPSTICK, MAKEUP FOR THE BODY, MA-
KEUP FOR THE FACE, MAKEUP REMOVER,
MASCARA, PERFUME, POWDER FOR THE BODY,
POWDER FOR THE FACE, SHOWER GEL, SOAP

FOR BODY, SOAP FOR FACE, SOAP FOR HANDS,
EYE SHADOW, FOUNDATION, IN CLASS 3 (U.S.
CLS. 1, 4, 6, 50, 51 AND 52).

FIRST USE 3-6-2001; IN COMMERCE 3-6-2001.

OWNER OF U.S. REG. NOS. 1,224,782, 1,908,042,
AND 2,165,974.

NO CLAIM IS MADE TO THE EXCLUSIVE
RIGHT TO USE "PINK", APART FROM THE MARK
AS SHOWN.

SN 76-046,788, FILED 5-11-2000.

GIANCARLO CASTRO, EXAMINING ATTORNEY

Int. Cls.: 9, 14, 16, 25, 28, 38, and 41

Prior U.S. Cls.: 2, 5, 21, 22, 23, 26, 27, 28, 29, 36, 37, 38, 39, 50, 100, 101, 104, and 107

Reg. No. 3,520,975

United States Patent and Trademark Office

Registered Oct. 21, 2008

**TRADEMARK
SERVICE MARK
PRINCIPAL REGISTER**



WEBER, BERNHARD (CANADA INDIVIDUAL)
125 ELMIRE STREET
MONTREAL, QUEBEC, CANADA H2T 1J9

FOR: PRE-RECORDED DIGITAL VIDEO DISCS (DVD), COMPUTER PROGRAMS AND INTERACTIVE AND EDUCATIONAL SOFTWARE IN THE FIELDS OF ART, HISTORY, LITERATURE, ARCHITECTURE, SCIENCE, SPORTS, CURRENT EVENTS AND WORLD EVENTS, IN CLASS 9 (U.S. CLS. 21, 23, 26, 36 AND 38).

FIRST USE 7-0-2007; IN COMMERCE 7-0-2007.

FOR: COINS OF PRECIOUS METAL (NON-MONETARY); MEDALLIONS, IN CLASS 14 (U.S. CLS. 2, 27, 28 AND 50).

FIRST USE 7-0-2007; IN COMMERCE 7-0-2007.

FOR: STICKERS, IN CLASS 16 (U.S. CLS. 2, 5, 22, 23, 29, 37, 38 AND 50).

FIRST USE 6-0-2006; IN COMMERCE 6-0-2006.

FOR: MEN'S, WOMEN'S AND CHILDREN'S CLOTHING, NAMELY, SPORT SHIRTS, DRESS SHIRTS, SHORT SLEEVE GOLF SHIRTS, SWEAT-SHIRTS, T-SHIRTS, JACKETS, NAMELY, NYLON AND LEATHER JACKETS, SWEATERS, SCARVES, TIES, PAJAMAS, NIGHT-DRESSES, HATS, CAPS, RAIN WEAR, SPORTS AND TRAVEL WEAR, NAMELY, SHORTS, PANTS, SHIRTS, TOPS, DRESSES, AND SKIRTS, IN CLASS 25 (U.S. CLS. 22 AND 39).

FIRST USE 6-0-2006; IN COMMERCE 6-0-2006.

FOR: SOFT PLUSH TOYS, IN CLASS 28 (U.S. CLS. 22, 23, 38 AND 50).

FIRST USE 8-27-2008; IN COMMERCE 8-27-2008.

FOR: BROADCASTING MOTION PICTURES VIA A GLOBAL COMPUTER NETWORK; PROVIDING AN ON-LINE BULLETIN BOARD IN THE FIELDS OF ART, HISTORY, LITERATURE, ARCHITECTURE, SCIENCE, SPORTS, CURRENT EVENTS AND WORLD EVENTS; WEB CASTING AUDIO/VISUAL PROGRAMMING VIA A GLOBAL COMPUTER NETWORK, IN CLASS 38 (U.S. CLS. 100, 101 AND 104).

FIRST USE 4-0-2006; IN COMMERCE 4-0-2006.

FOR: PRODUCTION AND DISTRIBUTION OF RADIO, BROADCAST AND CABLE TELEVISION PROGRAMS; PROVIDING ACCESS TO MOTION PICTURE FILMS VIA THE INTERNET AND OTHER ELECTRONIC COMPUTER NETWORKS; PROVIDING ONLINE ELECTRONIC DATABASES, INDEXES AND WEB SITES FEATURING AUDIO, VISUAL AND AUDIO VISUAL INFORMATION AND ENTERTAINMENT IN THE FIELDS OF EDUCATION AND ENTERTAINMENT, IN CLASS 41 (U.S. CLS. 100, 101 AND 107).

FIRST USE 3-0-2007; IN COMMERCE 3-0-2007.

PRIORITY CLAIMED UNDER SEC. 44(D) ON CANADA APPLICATION NO. 1061.530, FILED 6-1-2000.

SN 76-167,338, FILED 11-16-2000.

JAMES A. RAUEN, EXAMINING ATTORNEY

Int. Cl.: 42

Prior U.S. Cls.: 100 and 101

United States Patent and Trademark Office

Reg. No. 3,520,976

Registered Oct. 21, 2008

**SERVICE MARK
PRINCIPAL REGISTER**

REMOTEREAD

STRYKER CORPORATION (MICHIGAN CORPORATION)
POST OFFICE BOX 4085
2725 FAIRFIELD ROAD
KALAMAZOO, MI 490034085

FOR: COMPUTER SERVICES, NAMELY, PROVIDING MEDICAL IMAGES IN THE NATURE OF X-RAY, CAT-SCAN AND MRI IMAGES VIA GLOBAL COMPUTER INFORMATION NETWORKS; AND PROVIDING A WEBSITE ON GLOBAL COM-

PUTER INFORMATION NETWORKS FEATURING MEDICAL INFORMATION AND MEDICAL IMAGES IN THE NATURE OF X-RAY, CAT-SCAN AND MRI IMAGES, IN CLASS 42 (U.S. CLS. 100 AND 101).

FIRST USE 11-15-2007; IN COMMERCE 11-15-2007.

SN 76-171,165, FILED 11-27-2000.

DAVID C. REIHNER, EXAMINING ATTORNEY

Int. Cl.: 9

Prior U.S. Cls.: 21, 23, 26, 36, and 38

Reg. No. 3,520,977

United States Patent and Trademark Office

Registered Oct. 21, 2008

**TRADEMARK
PRINCIPAL REGISTER**

CELERO

SYMYX TECHNOLOGIES, INC. (DELAWARE
CORPORATION)
3100 CENTRAL EXPRESSWAY
SANTA CLARA, CA 95051

TESTING AND OPTIMIZATION OF CATALYSTS,
IN CLASS 9 (U.S. CLS. 21, 23, 26, 36 AND 38).

FIRST USE 10-17-2003; IN COMMERCE 10-17-2003.

FOR: SCIENTIFIC RESEARCH EQUIPMENT,
NAMELY, PARALLEL HETEROGENEOUS CATA-
LYSIS REACTORS USED FOR THE DISCOVERY,

SN 76-190,753, FILED 1-4-2001.

KIMBERLY FRYE, EXAMINING ATTORNEY

Int. Cls.: 16 and 41

Prior U.S. Cls.: 2, 5, 22, 23, 29, 37, 38, 50, 100, 101, and 107

Reg. No. 3,520,978

United States Patent and Trademark Office

Registered Oct. 21, 2008

**TRADEMARK
SERVICE MARK
PRINCIPAL REGISTER**

BILL PHILLIPS

PHILLIPS, WILLIAM N. (UNITED STATES INDIVIDUAL)
10100 SANTA MONICA BOULEVARD, SUITE 1300
LOS ANGELES, CA 90067

FOR: PRINTED INSTRUCTIONAL AND TRAINING MATERIALS IN THE FIELDS OF NUTRITION, HEALTH, EXERCISE, BODYBUILDING AND WELLNESS, IN CLASS 16 (U.S. CLS. 2, 5, 22, 23, 29, 37, 38 AND 50).

FIRST USE 5-20-1999; IN COMMERCE 5-20-1999.

FOR: PROVIDING ONLINE NON-DOWNLOADABLE PUBLICATIONS IN THE NATURE OF INSTRUCTIONAL AND TRAINING MANUALS AND COURSE BOOKS IN THE FIELDS OF NUTRITION, HEALTH, EXERCISE, BODYBUILDING AND WELLNESS; EDUCATIONAL SERVICES, NAMELY,

INSTRUCTIONAL AND TRAINING CLASSES AND CORRESPONDENCE COURSES IN THE FIELDS OF NUTRITION, HEALTH, EXERCISE, BODYBUILDING AND WELLNESS AND THE DISTRIBUTION OF WRITTEN, AUDIO AND VIDEO TAPED MATERIALS IN CONNECTION THEREWITH, IN CLASS 41 (U.S. CLS. 100, 101 AND 107).

FIRST USE 5-6-2008; IN COMMERCE 5-6-2008.

THE NAME "BILL PHILLIPS" IDENTIFIES A LIVING INDIVIDUAL WHOSE CONSENT IS OF RECORD.

SN 76-377,415, FILED 3-1-2002.

CAROLYN CATALDO, EXAMINING ATTORNEY

Int. Cl.: 42

Prior U.S. Cls.: 100 and 101

United States Patent and Trademark Office

Reg. No. 3,520,979

Registered Oct. 21, 2008

**SERVICE MARK
PRINCIPAL REGISTER**

TALENT RESOURCE PLANNING

SOFTSCAPE MASSACHUSETTS, INC (MASSACHUSETTS CORPORATION)
526 BOSTON POST ROAD
WAYLAND, MA 01778

FOR: PROVIDING TEMPORARY USE OF NON-DOWNLOADABLE SOFTWARE FOR EMPLOYEE RECRUITMENT, HIRING, STAFF PLANNING, PERFORMANCE MANAGEMENT AND EVALUATIONS AND REVIEWS, DEVELOPMENT AND TRAINING, AND SUCCESSION PLANNING IN THE FIELDS OF EMPLOYEE DEVELOPMENT AND HUMAN RESOURCES; EXCLUDING SOFTWARE FOR VALIDATED PSYCHOMETRIC TESTING; PROVIDING APPLICATION-HOSTING SERVICES FEATURING SOFTWARE IN THE FIELD OF EMPLOYEE DEVELOPMENT AND HUMAN RESOURCES FOR USE IN EMPLOYEE RECRUITMENT, HIRING, STAFF PLANNING, PERFOR-

MANCE MANAGEMENT AND EVALUATIONS AND REVIEWS, DEVELOPMENT AND TRAINING, AND SUCCESSION PLANNING; EXCLUDING SOFTWARE FOR VALIDATED PSYCHOMETRIC TESTING; ALL FOR COMMERCIAL AND GOVERNMENTAL ENTERPRISES, IN CLASS 42 (U.S. CLS. 100 AND 101).

FIRST USE 4-24-2002; IN COMMERCE 2-13-2006.

NO CLAIM IS MADE TO THE EXCLUSIVE RIGHT TO USE "RESOURCE PLANNING", APART FROM THE MARK AS SHOWN.

SN 76-400,743, FILED 4-24-2002.

LINDA POWELL, EXAMINING ATTORNEY

Int. Cls.: 9, 16, 25, 38, and 41

**Prior U.S. Cls.: 2, 5, 21, 22, 23, 26, 29, 36, 37, 38, 39,
50, 100, 101, 104, and 107**

Reg. No. 3,520,980

United States Patent and Trademark Office

Registered Oct. 21, 2008

**TRADEMARK
SERVICE MARK
PRINCIPAL REGISTER**

P.O.D.

P.O.D. PARTNERSHIP, THE (CALIFORNIA GENERAL PARTNERSHIP)
C/O GANG, TYRE, RAMER & BROWN, INC.
132 SOUTH RODEO DRIVE
BEVERLY HILLS, CA 90212

FOR: SERIES OF MUSICAL SOUND RECORDINGS; DOWNLOADABLE MUSICAL SOUND RECORDINGS; DOWNLOADABLE VISUAL RECORDINGS FEATURING MUSIC AND MUSICAL BASED ENTERTAINMENT; SERIES OF VIDEO RECORDINGS FEATURING MUSIC AND MUSICAL BASED ENTERTAINMENT, IN CLASS 9 (U.S. CLS. 21, 23, 26, 36 AND 38).

FIRST USE 0-0-1991; IN COMMERCE 0-0-1991.

FOR: POSTERS, STICKERS, PRINTED MUSIC BOOKS, IN CLASS 16 (U.S. CLS. 2, 5, 22, 23, 29, 37, 38 AND 50).

FIRST USE 0-0-1992; IN COMMERCE 0-0-1992.

FOR: CLOTHING, NAMELY, T-SHIRTS, TANK-TOPS, JERSEYS, JACKETS, SWEATSHIRTS, HEADWEAR, CAPS, AND BEANIES, IN CLASS 25 (U.S. CLS. 22 AND 39).

FIRST USE 0-0-1992; IN COMMERCE 0-0-1992.

FOR: STREAMING OF AUDIO AND AUDIO VISUAL INFORMATION FEATURING MUSIC AND MUSICAL BASED ENTERTAINMENT; PROVIDING ONLINE CHATROOMS FOR TRANSMISSION OF MESSAGES AMONG COMPUTER USERS CONCERNING A MUSICAL GROUP AND SUCH GROUP'S MUSIC, SOUND AND VIDEO RECORDINGS, PICTURES, NEWS, SPECIAL PROJECTS, TOURS, APPEARANCES AND BIOGRAPHIES, IN CLASS 38 (U.S. CLS. 100, 101 AND 104).

FIRST USE 0-0-1997; IN COMMERCE 0-0-1997.

FOR: ENTERTAINMENT SERVICES, NAMELY, LIVE MUSICAL PERFORMANCES; PROVIDING A WEBSITE ON A GLOBAL COMPUTER NETWORK FEATURING INFORMATION ON A MUSICAL GROUP AND ITS MUSICAL PERFORMANCES, TOURS, BIOGRAPHIES, SOUND AND VIDEO RECORDINGS, AND APPEARANCES; FAN CLUBS, IN CLASS 41 (U.S. CLS. 100, 101 AND 107).

FIRST USE 0-0-1992; IN COMMERCE 0-0-1992.

OWNER OF U.S. REG. NO. 2,230,446.

SN 76-421,448, FILED 6-14-2002.

KATHLEEN M. VANSTON, EXAMINING ATTORNEY

Int. Cls.: 9, 35, and 42

Prior U.S. Cls.: 21, 23, 26, 36, 38, 100, 101, and 102

United States Patent and Trademark Office

Reg. No. 3,520,981

Registered Oct. 21, 2008

**TRADEMARK
SERVICE MARK
PRINCIPAL REGISTER**

LEGION

LEGION INTERNATIONAL LIMITED (GUERNSEY CORPORATION)
20 COMMERCIAL ARCADE, GUERNSEY
CHANNEL ISLANDS, GUERNSEY GY1 1JX

FOR: COMPUTER SOFTWARE, NAMELY, COMPUTER SOFTWARE FOR THE MODELING OF MOVEMENT OF PEOPLE AND VEHICLES THROUGH PUBLIC SPACES AND BUILDING, IN CLASS 9 (U.S. CLS. 21, 23, 26, 36 AND 38).

FIRST USE 5-0-2003; IN COMMERCE 7-15-2003.

FOR: BUSINESS MANAGEMENT ASSISTANCE SERVICES; BUSINESS CONSULTANCY AND ADVI-

SORY SERVICES, IN CLASS 35 (U.S. CLS. 100, 101 AND 102).

FIRST USE 5-8-1997; IN COMMERCE 7-15-2003.

FOR: SCIENTIFIC AND INDUSTRIAL RESEARCH SERVICES; ARCHITECTURAL AND CIVIL ENGINEERING CONSULTANCY SERVICES, IN CLASS 42 (U.S. CLS. 100 AND 101).

FIRST USE 5-8-1997; IN COMMERCE 7-15-2003.

SN 76-426,158, FILED 6-28-2002.

CAROLYN CATALDO, EXAMINING ATTORNEY

Int. Cls.: 28 and 35

Prior U.S. Cls.: 22, 23, 38, 50, 100, 101, and 102

United States Patent and Trademark Office

Reg. No. 3,520,982

Registered Oct. 21, 2008

**TRADEMARK
SERVICE MARK
PRINCIPAL REGISTER**

VOLKS

KABUSHIKI KAISHA VOLKS (JAPAN CORPORATION)
18-27, KAIDEN 1-CHOME, NAGAOKAKYO-SHI
KYOTO 617-0826, JAPAN

FOR: "DOLLS, DOLL ACCESSORIES", IN CLASS
28 (U.S. CLS. 22, 23, 38 AND 50).

FIRST USE 11-19-1972; IN COMMERCE 7-5-1993.

FOR: RETAIL AND WHOLESALE STORE SERVICES
FEATURING DOLLS AND DOLL ACCESSOR-

IES, ONLINE RETAIL AND WHOLESALE STORE
SERVICES IN CONNECTION WITH DOLLS AND
DOLL ACCESSORIES, IN CLASS 35 (U.S. CLS. 100,
101 AND 102).

FIRST USE 11-19-1972; IN COMMERCE 7-5-1993.

SN 76-456,228, FILED 10-7-2002.

CHRIS WELLS, EXAMINING ATTORNEY

Int. Cl.: 38

Prior U.S. Cls.: 100, 101, and 104

United States Patent and Trademark Office

Reg. No. 3,520,983

Registered Oct. 21, 2008

**SERVICE MARK
PRINCIPAL REGISTER**



TELIGENCE (CANADA), INC. (CANADA CORPORATION)
1045 HOWE STREET STE. 700
VANCOUVER, CANADA V6Z 2A9

FOR: ELECTRONIC VOICE MESSAGING, NAME-
LY, THE RECORDING AND SUBSEQUENT TRANS-
MISSION OF VOICE MESSAGES FOR SOCIAL
PURPOSES BY TELEPHONE; TELEPHONE COM-
MUNICATION SERVICES, IN CLASS 38 (U.S. CLS.
100, 101 AND 104).

FIRST USE 6-24-2007; IN COMMERCE 6-24-2007.

THE ENGLISH TRANSLATION OF THE WORD
"LINEA VIVA" IN THE MARK IS LIVE LINE.

THE ENGLISH TRANSLATION OF THE WORD-
ING "LINEA VIVA" IN THE MARK IS LIVE LINE.

SN 76-524,872, FILED 6-12-2003.

MARLENE BELL, EXAMINING ATTORNEY

Int. Cl.: 3

Prior U.S. Cls.: 1, 4, 6, 50, 51, and 52

United States Patent and Trademark Office

Reg. No. 3,520,984

Registered Oct. 21, 2008

TRADEMARK
PRINCIPAL REGISTER



OXI BRITE INTERNATIONAL INC. (CANADA CORPORATION)
405 INDUSTRIAL DRIVE #18
MILTON, ONTARIO, CANADA L9T5B1

FOR: HOUSEHOLD CLEANING PREPARATIONS, NAMELY, STAIN REMOVERS AND ODOUR REMOVERS FOR CLOTHING AND TEXTILE FOR RESIDENTIAL USE AFTER CLEANING PREPARATIONS, IN CLASS 3 (U.S. CLS. 1, 4, 6, 50, 51 AND 52).

FIRST USE 6-30-2003; IN COMMERCE 6-30-2003.

NO CLAIM IS MADE TO THE EXCLUSIVE RIGHT TO USE "OXYGEN ACTIVATED STAIN REMOVER", APART FROM THE MARK AS SHOWN.

SN 76-525,643, FILED 6-27-2003.

INGRID C. EULIN, EXAMINING ATTORNEY

Int. Cl.: 42

Prior U.S. Cls.: 100 and 101

United States Patent and Trademark Office

Reg. No. 3,520,985

Registered Oct. 21, 2008

**SERVICE MARK
PRINCIPAL REGISTER**

SINGULEX

SINGULEX, INC. (MISSOURI CORPORATION)
4041 FOREST PARK BOULEVARD
ST. LOUIS, MO 63108

FOR: RESEARCH AND DEVELOPMENT SERVICES FOR OTHERS IN THE FIELD OF DIAGNOSTIC CHEMICALS, COMPOUNDS AND DEVICES; CHEMICAL SCREENING ANALYSIS AND DIAGNOS-

TIC SERVICES FOR OTHERS , IN CLASS 42 (U.S. CLS. 100 AND 101).

FIRST USE 1-0-2006; IN COMMERCE 8-0-2007.

SN 76-530,310, FILED 7-7-2003.

GENE MACIOL, EXAMINING ATTORNEY

Int. Cl.: 21

Prior U.S. Cls.: 2, 13, 23, 29, 30, 33, 40, and 50

Reg. No. 3,520,986

United States Patent and Trademark Office

Registered Oct. 21, 2008

**TRADEMARK
PRINCIPAL REGISTER**

HOSENCLOSE

OLDCASTLE PRECAST, INC. (WASHINGTON
CORPORATION)
1002 15TH STREET SW, SUITE 110
AUBURN, WA 98001

FOR: NON-METAL STORAGE VAULT FOR WA-
TER HOSES FOR GARDEN AND LANDSCAPE USE,
NAMELY, A VAULT WITH A LID THAT IS PLACED
WITH ITS OPENING BELOW, OR SLIGHTLY
ABOVE, GROUND LEVEL THAT PROVIDES STO-

RAGE FOR A WATER HOSE AND A CONNECTOR
FOR CONNECTION TO A SOURCE OF WATER, IN
CLASS 21 (U.S. CLS. 2, 13, 23, 29, 30, 33, 40 AND 50).

FIRST USE 8-29-2003; IN COMMERCE 8-29-2003.

SN 76-533,923, FILED 8-1-2003.

MARGARET POWER, EXAMINING ATTORNEY

Int. Cls.: 35 and 37

Prior U.S. Cls.: 100, 101, 102, 103, and 106

United States Patent and Trademark Office

Reg. No. 3,520,987

Registered Oct. 21, 2008

**SERVICE MARK
PRINCIPAL REGISTER**

ENVERROS

ARAMARK CORPORATION (DELAWARE CORPORATION)
ARAMARK TOWER, 29TH FLOOR
1101 MARKET STREET
PHILADELPHIA, PA 19107

FOR: BUSINESS SERVICES, NAMELY, FACILITIES MANAGEMENT OF TECHNICAL OPERATIONS, IN CLASS 35 (U.S. CLS. 100, 101 AND 102).

FIRST USE 1-1-2005; IN COMMERCE 1-1-2005.

FOR: JANITORIAL SERVICES; AND BUILDING MAINTENANCE SERVICES, IN CLASS 37 (U.S. CLS. 100, 103 AND 106).

FIRST USE 1-1-2005; IN COMMERCE 1-1-2005.

SN 76-535,005, FILED 8-6-2003.

JULIE GUTTADAURO, EXAMINING ATTORNEY

Int. Cl.: 29

Prior U.S. Cl.: 46

United States Patent and Trademark Office

Reg. No. 3,520,988

Registered Oct. 21, 2008

**TRADEMARK
PRINCIPAL REGISTER**

FEUDO MÀCCARI

LOCHIM MERCHANT LIMITED PARTNERSHIP
(UNITED KINGDOM PARTNERSHIP)
15 ATHOL CRESCENT
EH 38HA EDINBURGH, SCOTLAND

FOR: EDIBLE OILS AND FATS, IN CLASS 29 (U.S.
CL. 46).

FIRST USE 6-30-2008; IN COMMERCE 8-27-2008.

THE MARK CONSISTS OF STANDARD CHAR-
ACTERS WITHOUT CLAIM TO ANY PARTICULAR
FONT, STYLE, SIZE, OR COLOR.

THE MARK WORD FEUDO MACCARL DOES
NOT IDENTIFY A PARTICULAR LIVING INDIVI-
DUAL.

THE MARK MAY BE TRANSLATED INTO ENG-
LISH AS "MACCAN FEUD".

SN 76-543,933, FILED 8-29-2003.

GEOFFREY FOSDICK, EXAMINING ATTORNEY

Int. Cls.: 29 and 43

Prior U.S. Cls.: 46, 100, and 101

United States Patent and Trademark Office

Reg. No. 3,520,989

Registered Oct. 21, 2008

**TRADEMARK
SERVICE MARK
PRINCIPAL REGISTER**

OFFICEMEALS

PAX INTELLECTUAL PROPERTY HOLDINGS
INC. (NEW YORK CORPORATION)
1776 BROADWAY, SUITE 606
NEW YORK, NY 10019

FOR: INDIVIDUALLY PREPARED AND PACK-
AGED FOODS, NAMELY, MEAT, EGGS, FISH,
POTATOES, COOKED VEGETABLES, SOUPS,
FRUITS, CATERED AND DELIVERED FOR CON-
SUMPTION OFF-PREMISES, IN CLASS 29 (U.S. CL.
46).

FIRST USE 7-11-2008; IN COMMERCE 7-11-2008.

FOR: CATERING OF INDIVIDUALLY PRE-
PARED AND PACKAGED FOODS FOR CONSUMP-
TION OFF-PREMISES, IN CLASS 43 (U.S. CLS. 100
AND 101).

FIRST USE 7-11-2008; IN COMMERCE 7-11-2008.

SN 76-547,314, FILED 9-26-2003.

BRIDGETT SMITH, EXAMINING ATTORNEY

Int. Cl.: 5

Prior U.S. Cls.: 6, 18, 44, 46, 51, and 52

Reg. No. 3,520,990

United States Patent and Trademark Office

Registered Oct. 21, 2008

**TRADEMARK
PRINCIPAL REGISTER**

AEROSURF

DISCOVERY LABORATORIES, INC. (DELA-
WARE CORPORATION)
2600 KELLY ROAD
WARRINGTON, PA 18976

FIRST USE 8-6-2008; IN COMMERCE 8-6-2008.

SN 76-555,385, FILED 10-28-2003.

FOR: PHARMACEUTICAL PREPARATIONS
AND SUBSTANCES FOR TREATMENT OF RE-
SPIRATORY CONDITIONS, IN CLASS 5 (U.S. CLS.
6, 18, 44, 46, 51 AND 52).

CHRIS WELLS, EXAMINING ATTORNEY

Int. Cl.: 35

Prior U.S. Cls.: 100, 101, and 102

United States Patent and Trademark Office

Reg. No. 3,520,991

Registered Oct. 21, 2008

**SERVICE MARK
PRINCIPAL REGISTER**

THE LIVING LOBBY

SAGE RETAIL, INC. (ILLINOIS CORPORATION)
733 WOODRIDGE
GLENCOE, IL 60022

FOR: PROVISION OF MARKETING SERVICES,
NAMELY, PREPARING AND PLACING ADVERTISEMENTS
FOCUSED ON THE LEASING OF SPACE IN
COMMERCIAL, RESIDENTIAL AND GOVERNMENTAL
BUILDINGS; PROVISION OF MARKETING SERVICES,
NAMELY, DIRECT MARKETING ADVERTISING FOR
OTHERS FOCUSED ON THE LEASING OF SPACE IN
COMMERCIAL,

RESIDENTIAL AND GOVERNMENTAL BUILDINGS,
IN CLASS 35 (U.S. CLS. 100, 101 AND 102).

FIRST USE 10-15-2007; IN COMMERCE 10-15-2007.

THE MARK CONSISTS OF STANDARD CHARACTERS
WITHOUT CLAIM TO ANY PARTICULAR FONT,
STYLE, SIZE, OR COLOR.

SN 76-566,669, FILED 12-22-2003.

SUE LAWRENCE, EXAMINING ATTORNEY

Int. Cl.: 35

Prior U.S. Cls.: 100, 101, and 102

United States Patent and Trademark Office

Reg. No. 3,520,992

Registered Oct. 21, 2008

**SERVICE MARK
PRINCIPAL REGISTER**

DAVITA NEPHROLOGY PARTNERS

DAVITA INC. (DELAWARE CORPORATION)

601 HAWAII STREET

EL SEGUNDO, CA 90245

FOR: RECRUITING AND PLACEMENT OF MEDICAL PERSONNEL FOR THIRD PARTIES; MANAGEMENT OF MEDICAL PRACTICES AND OFFICES FOR OTHERS, IN CLASS 35 (U.S. CLS. 100, 101 AND 102).

FIRST USE 1-31-2004; IN COMMERCE 1-31-2004.

THE MARK CONSISTS OF STANDARD CHARACTERS WITHOUT CLAIM TO ANY PARTICULAR FONT, STYLE, SIZE, OR COLOR.

OWNER OF U.S. REG. NOS. 2,576,733, 2,804,525, AND OTHERS.

NO CLAIM IS MADE TO THE EXCLUSIVE RIGHT TO USE "NEPHROLOGY PARTNERS", APART FROM THE MARK AS SHOWN.

SN 76-567,278, FILED 12-29-2003.

DAVID MILLER, EXAMINING ATTORNEY

Int. Cl.: 29

Prior U.S. Cl.: 46

United States Patent and Trademark Office

Reg. No. 3,520,993

Registered Oct. 21, 2008

TRADEMARK
PRINCIPAL REGISTER



THE LAST TWIST, INC. (PENNSYLVANIA CORPORATION)
320 FAYETTE STREET, 2ND FLOOR
CONSHOHOCKEN, PA 19428

FOR: HOT DOGS, STEAKS, LAMB CHOPS, PORK CHOPS, VEAL CHOPS, HAMBURGER, IN CLASS 29 (U.S. CL. 46).

FIRST USE 5-31-2002; IN COMMERCE 5-31-2002.

OWNER OF U.S. REG. NO. 2,823,034.

NO CLAIM IS MADE TO THE EXCLUSIVE RIGHT TO USE "NEW YORK", APART FROM THE MARK AS SHOWN.

THE NAME "CHUBBY CHECKER" IDENTIFIES A LIVING INDIVIDUAL WHOSE CONSENT IS OF RECORD.

SN 76-567,762, FILED 12-30-2003.

BRENDAN REGAN, EXAMINING ATTORNEY

Int. Cls.: 29, 30, and 32

Prior U.S. Cls.: 45, 46, and 48

United States Patent and Trademark Office

Reg. No. 3,520,994

Registered Oct. 21, 2008

TRADEMARK
PRINCIPAL REGISTER



THE LAST TWIST, INC. (PENNSYLVANIA CORPORATION)
320 FAYETTE STREET, 2ND FLOOR
CONSHOHOCKEN, PA 19428

FOR: JERKY; HOT DOGS, STEAKS, LAMB CHOPS, PORK CHOPS, VEAL CHOPS, HAMBURGER, CHICKEN, IN CLASS 29 (U.S. CL. 46).

FIRST USE 10-31-2003; IN COMMERCE 10-31-2003.

FOR: POPPED OR PROCESSED POPCORN, CANDY, CHOCOLATE, IN CLASS 30 (U.S. CL. 46).

FIRST USE 10-31-2003; IN COMMERCE 10-31-2003.

FOR: SPRING WATER, IN CLASS 32 (U.S. CLS. 45, 46 AND 48).

FIRST USE 10-31-2003; IN COMMERCE 10-31-2003.

OWNER OF U.S. REG. NO. 2,823,034.

NO CLAIM IS MADE TO THE EXCLUSIVE RIGHT TO USE "SNACKS" AND "FOOD PRODUCTS", APART FROM THE MARK AS SHOWN.

SN 76-567,785, FILED 12-30-2003.

BRENDAN REGAN, EXAMINING ATTORNEY

Int. Cl.: 3

Prior U.S. Cls.: 1, 4, 6, 50, 51, and 52

United States Patent and Trademark Office

Reg. No. 3,520,995

Registered Oct. 21, 2008

**TRADEMARK
PRINCIPAL REGISTER**

CHI CHAI MONCHAN

SANRIO COMPANY, LTD. (JAPAN CORPORATION)
1-6-1 OSAKI, SHINAGAWA-KU
TOKYO 141, JAPAN

FOR: LIP GLOSS, LIPSTICK, AND NAIL POLISH,
IN CLASS 3 (U.S. CLS. 1, 4, 6, 50, 51 AND 52).

FIRST USE 8-1-2005; IN COMMERCE 8-1-2005.

THE MARK CONSISTS OF STANDARD CHARACTERS WITHOUT CLAIM TO ANY PARTICULAR FONT, STYLE, SIZE, OR COLOR.

THE NAME "CHI CHAI MONCHAN DOES NOT IDENTIFY A PARTICULAR LIVING INDIVIDUAL.

"CHI CHAI MONCHAN IS TRANSLATED FROM THE JAPANESE LANGUAGE AS "DEAR SMALL MONKEY."

SN 76-570,764, FILED 1-20-2004.

MATTHEW MCDOWELL, EXAMINING ATTORNEY

Int. Cls.: 29 and 30

Prior U.S. Cl.: 46

United States Patent and Trademark Office

Reg. No. 3,520,996

Registered Oct. 21, 2008

**TRADEMARK
PRINCIPAL REGISTER**



KASIH CANNED FOOD PRODUCTION CO.
(JORDAN CORPORATION)
P. O. BOX 6374
AMMAN 11118, JORDAN

FOR: COOKED VEGETABLES, IN CLASS 29 (U.S.
CL. 46).

FIRST USE 12-31-1996; IN COMMERCE 7-7-2001.

FOR: SAUCES, IN CLASS 30 (U.S. CL. 46).

FIRST USE 12-31-1996; IN COMMERCE 7-7-2001.

THE MARK CONSISTS OF THE WORD "KASIH"
WITHIN AN OVAL, A CHEFS HAT AND A DE-
PENDING RECTANGULAR BANNER.

SN 76-570,793, FILED 1-20-2004.

INGRID C. EULIN, EXAMINING ATTORNEY

Int. Cl.: 28

Prior U.S. Cls.: 22, 23, 38, and 50

United States Patent and Trademark Office

Reg. No. 3,520,997

Registered Oct. 21, 2008

**TRADEMARK
PRINCIPAL REGISTER**

THE GREAT ESCAPE

MASTERGRIP, INC. (TEXAS CORPORATION)
3410 CENTURY CIRCLE
IRVING, TX 75062

FOR: GOLF CLUBS, IN CLASS 28 (U.S. CLS. 22, 23,
38 AND 50).

FIRST USE 6-7-2004; IN COMMERCE 6-7-2004.

THE MARK CONSISTS OF STANDARD CHAR-
ACTERS WITHOUT CLAIM TO ANY PARTICULAR
FONT, STYLE, SIZE, OR COLOR.

SN 76-579,302, FILED 3-5-2004.

AMY GEARIN, EXAMINING ATTORNEY

Int. Cl.: 21

Prior U.S. Cls.: 2, 13, 23, 29, 30, 33, 40, and 50

Reg. No. 3,520,998

United States Patent and Trademark Office

Registered Oct. 21, 2008

**TRADEMARK
PRINCIPAL REGISTER**

BOWL²

SABERT CORPORATION. (NEW YORK CORPORATION)
879-899 MAIN STREET
SAYREVILLE, NJ 08872

FOR: PLASTIC FOOD CONTAINERS, NAMELY, BOWLS AND LIDS THEREFOR SOLD AS A UNIT, PLASTIC PLATES, SERVING PLATTERS, AND SERVING TRAYS NOT OF PRECIOUS METAL, IN CLASS 21 (U.S. CLS. 2, 13, 23, 29, 30, 33, 40 AND 50).

FIRST USE 6-30-2004; IN COMMERCE 6-30-2004.

THE MARK CONSISTS OF STANDARD CHARACTERS WITHOUT CLAIM TO ANY PARTICULAR FONT, STYLE, SIZE, OR COLOR.

NO CLAIM IS MADE TO THE EXCLUSIVE RIGHT TO USE "BOWL", APART FROM THE MARK AS SHOWN.

SN 76-579,925, FILED 3-8-2004.

HELEN BRYAN, EXAMINING ATTORNEY

Int. Cl.: 24

Prior U.S. Cls.: 42 and 50

United States Patent and Trademark Office

Reg. No. 3,520,999

Registered Oct. 21, 2008

**TRADEMARK
PRINCIPAL REGISTER**

RAG TIME QUILT

DAVID TEXTILES, INC. (CALIFORNIA CORPORATION)

1920 S. TUBEWAY AVENUE
CITY OF COMMERCE, CA 90040

FOR: PIECES OF QUILTING FABRIC SOLD AS A KIT TO FABRICATE A FINISHED QUILT, IN CLASS 24 (U.S. CLS. 42 AND 50).

FIRST USE 7-31-2004; IN COMMERCE 7-31-2004.

THE MARK CONSISTS OF STANDARD CHARACTERS WITHOUT CLAIM TO ANY PARTICULAR FONT, STYLE, SIZE, OR COLOR.

NO CLAIM IS MADE TO THE EXCLUSIVE RIGHT TO USE "QUILT", APART FROM THE MARK AS SHOWN.

SN 76-581,707, FILED 3-18-2004.

DAVID H. STINE, EXAMINING ATTORNEY

Int. Cl.: 24

Prior U.S. Cls.: 42 and 50

United States Patent and Trademark Office

Reg. No. 3,521,000

Registered Oct. 21, 2008

**TRADEMARK
PRINCIPAL REGISTER**

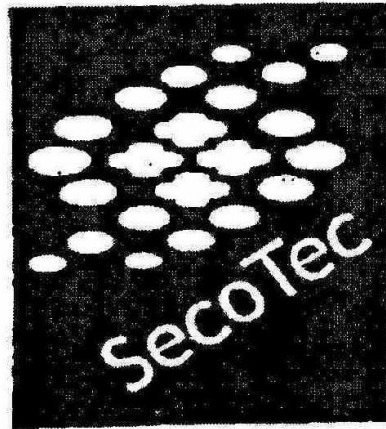

LI PENG ENTERPRISE CO. LTD. (TAIWAN CORPORATION)
6F., NO. 162. SUNG CHIANG RD. TAIPEI 104
TAIPEI, TAIWAN

FOR: TEXTILES AND TEXTILE GOODS, NAME-
LY, SAIL CLOTH, FLAX CLOTH, WOOLEN CLOTH,
SILK CLOTH, BED SHEETS, BEDSPREADS, BED
BLANKETS, TABLE CLOTHS NOT OF PAPER, AND

TEXTILE WALL HANGINGS, IN CLASS 24 (U.S.
CLS. 42 AND 50).

FIRST USE 11-28-2000; IN COMMERCE 11-28-2000.

SN 76-591,969, FILED 5-13-2004.

BARBARA GAYNOR, EXAMINING ATTORNEY

Int. Cl.: 14

Prior U.S. Cls.: 2, 27, 28, and 50

United States Patent and Trademark Office

Reg. No. 3,521,001

Registered Oct. 21, 2008

**TRADEMARK
PRINCIPAL REGISTER**

LISHT

DE AZEVEDO, LISHT MARINHO (BRAZIL IN-
DIVIDUAL)
RUA ALDA GARRIDO 41, APT. 201
RIO DE JANEIRO, BRAZIL

THE MARK CONSISTS OF STANDARD CHAR-
ACTERS WITHOUT CLAIM TO ANY PARTICULAR
FONT, STYLE, SIZE, OR COLOR.

FOR: JEWELRY, IN CLASS 14 (U.S. CLS. 2, 27, 28
AND 50).

SN 76-595,811, FILED 6-7-2004.

FIRST USE 6-22-2006; IN COMMERCE 6-22-2006.

YONG KIM, EXAMINING ATTORNEY

Int. Cl.: 20

Prior U.S. Cls.: 2, 13, 22, 25, 32, and 50

Reg. No. 3,521,002

United States Patent and Trademark Office

Registered Oct. 21, 2008

**TRADEMARK
PRINCIPAL REGISTER**

GO-GO KART

P.S. PIBBS, INC. (NEW YORK CORPORATION)
133-15 32ND AVENUE
FLUSHING, NY 11354

THE MARK CONSISTS OF STANDARD CHARACTERS WITHOUT CLAIM TO ANY PARTICULAR FONT, STYLE, SIZE, OR COLOR.

FOR: BEAUTY SALON FURNITURE, NAMELY, WHEELED STORAGE UNITS CONTAINING DRAWERS FOR STORAGE OF BEAUTY UTENSILS, IN CLASS 20 (U.S. CLS. 2, 13, 22, 25, 32 AND 50).

SN 76-604,725, FILED 7-30-2004.

FIRST USE 5-0-2007; IN COMMERCE 5-0-2007.

JOHN SCHUYLER YARD, EXAMINING ATTORNEY

Int. Cl.: 36

Prior U.S. Cls.: 100, 101, and 102

United States Patent and Trademark Office

Reg. No. 3,521,003

Registered Oct. 21, 2008

**SERVICE MARK
PRINCIPAL REGISTER**

AMERISTAR CARES

AMERISTAR CASINOS, INC. (NEVADA CORPORATION)
3773 HOWARD HUGHES PARKWAY, SUITE 490S
LAS VEGAS, NV 89109

FOR: CHARITABLE FUND RAISING SERVICES, NAMELY, SOLICITING AND RAISING MONETARY AND IN-KIND DONATIONS FOR CHARITIES AND NON-PROFIT HUMAN SERVICE, HUNGER RELIEF, CLOTHING RELIEF, HOUSING, RESIDENTIAL IMPROVEMENT, CULTURAL, HEALTH, MEDICAL, EDUCATION, SUPPORT AND COMMUNITY SERVICE AND OUTREACH PROGRAMS; AND CHARITABLE SERVICES, NAMELY, MAKING MONETARY AND IN-KIND DONATIONS FOR HUMAN SERVICE, HUNGER RELIEF, CLOTHING RELIEF, HOUSING, RESIDENTIAL IMPROVEMENT, CULTURAL, HEALTH,

MEDICAL, EDUCATION, SUPPORT AND COMMUNITY SERVICE AND OUTREACH PROGRAMS, IN CLASS 36 (U.S. CLS. 100, 101 AND 102).

FIRST USE 9-30-2004; IN COMMERCE 9-30-2004.

THE MARK CONSISTS OF STANDARD CHARACTERS WITHOUT CLAIM TO ANY PARTICULAR FONT, STYLE, SIZE, OR COLOR.

OWNER OF U.S. REG. NOS. 1,971,539, 2,697,230, AND OTHERS.

SN 76-605,626, FILED 8-4-2004.

KAPIL BHANOT, EXAMINING ATTORNEY

Int. Cls.: 16, 41, and 44

Prior U.S. Cls.: 2, 5, 22, 23, 29, 37, 38, 50, 100, 101, and 107

Reg. No. 3,521,004

United States Patent and Trademark Office

Registered Oct. 21, 2008

**TRADEMARK
SERVICE MARK
PRINCIPAL REGISTER**

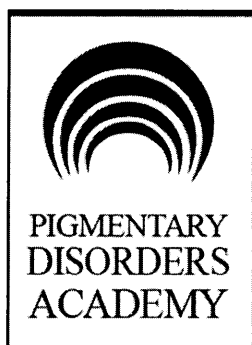

GALDERMA S.A. (SWITZERLAND CORPORATION)
ZUGERSTRASSE 8
CH-6330 CHAM, SWITZERLAND

FOR: INSTRUCTIONAL AND TEACHING MATERIAL, PERIODICALS, AND PRINTED MATERIAL, NAMELY, NEWSLETTERS, MAGAZINES AND BROCHURES, ALL IN THE FIELD OF DERMATOLOGICAL DISEASES AND SKIN CONDITIONS, IN CLASS 16 (U.S. CLS. 2, 5, 22, 23, 29, 37, 38 AND 50).

FIRST USE 12-31-2006; IN COMMERCE 12-31-2006.

FOR: ARRANGING AND CONDUCTING SEMINARS, COLLOQUIUMS AND SYMPOSIUMS IN THE FIELD OF DERMATOLOGICAL DISEASES AND SKIN CONDITIONS; TRAINING SERVICES IN THE FIELD OF HEALTH AND PHARMACEUTICALS; EDUCATIONAL SERVICES, NAMELY, CONDUCTING SEMINARS, COLLOQUIUMS AND SYMPOSIUMS IN THE FIELD OF HEALTH AND PHARMACEUTICALS; PUBLICATION OF TEXTS RELATED TO DERMATOLOGICAL DISEASES

AND SKIN CONDITIONS, IN CLASS 41 (U.S. CLS. 100, 101 AND 107).

FIRST USE 12-31-2006; IN COMMERCE 12-31-2006.

FOR: PROVIDING HEALTH INFORMATION IN THE FIELD OF DERMATOLOGY, IN CLASS 44 (U.S. CLS. 100 AND 101).

FIRST USE 12-31-2006; IN COMMERCE 12-31-2006.

NO CLAIM IS MADE TO THE EXCLUSIVE RIGHT TO USE "PIGMENTARY DISORDERS ACADEMY", APART FROM THE MARK AS SHOWN.

THE MARK CONSISTS OF THE WORDS "PIGMENTARY DISORDERS ACADEMY" DISPLAYED BELOW FOUR CONCENTRIC ARC DESIGNS.

SN 76-606,919, FILED S.R. 8-13-2004; AM. P.R. 8-30-2004.

CHERYL CLAYTON, EXAMINING ATTORNEY

Int. Cl.: 16

Prior U.S. Cls.: 2, 5, 22, 23, 29, 37, 38, and 50

Reg. No. 3,521,005

United States Patent and Trademark Office

Registered Oct. 21, 2008

**TRADEMARK
PRINCIPAL REGISTER**

PLIANT CRYSTAL CLING

PLIANT CORPORATION (UTAH CORPORATION)
1475 WOODFIELD ROAD
SUITE 700
SCHAUMBURG, IL 60173

FOR: COMMERCIAL AND INDUSTRIAL PLASTIC WRAP, IN CLASS 16 (U.S. CLS. 2, 5, 22, 23, 29, 37, 38 AND 50).

FIRST USE 1-31-2007; IN COMMERCE 1-31-2007.

THE MARK CONSISTS OF STANDARD CHARACTERS WITHOUT CLAIM TO ANY PARTICULAR FONT, STYLE, SIZE, OR COLOR.

NO CLAIM IS MADE TO THE EXCLUSIVE RIGHT TO USE "CLING", APART FROM THE MARK AS SHOWN.

SN 76-615,740, FILED 10-14-2004.

KIMBERLY PERRY, EXAMINING ATTORNEY

Int. Cl.: 35

Prior U.S. Cls.: 100, 101, and 102

United States Patent and Trademark Office

Reg. No. 3,521,006

Registered Oct. 21, 2008

**SERVICE MARK
PRINCIPAL REGISTER**

'NITION

CHANDLER CHICCO AGENCY, L.L.C. (NEW
YORK LIMITED LIABILITY COMPANY)
450 WEST 15TH STREET
NEW YORK, NY 10011

FOR: ADVERTISING SERVICES; DESIGN STUDIO SERVICES, NAMELY, CREATING CORPORATE LOGOS AND PROMOTIONAL MATERIALS FOR OTHERS; CREATING CORPORATE AND BRAND IDENTITY FOR OTHERS, IN CLASS 35 (U.S. CLS. 100, 101 AND 102).

FIRST USE 1-1-2005; IN COMMERCE 6-30-2005.

THE MARK CONSISTS OF STANDARD CHARACTERS WITHOUT CLAIM TO ANY PARTICULAR FONT, STYLE, SIZE, OR COLOR.

SN 76-621,063, FILED 11-17-2004.

JASON TURNER, EXAMINING ATTORNEY

Int. Cl.: 29

Prior U.S. Cl.: 46

United States Patent and Trademark Office

Reg. No. 3,521,007

Registered Oct. 21, 2008

**TRADEMARK
PRINCIPAL REGISTER**

CENTRAL AVENUE DELI

SAVAL FOODS CORPORATION (MARYLAND CORPORATION)
6740 DORSEY ROAD
ELKRIDGE, MD 21075

FOR: PREPARED AND PROCESSED MEATS AND MEAT PRODUCTS, NAMELY, DELI-STYLE MEATS AND MEAT PRODUCTS, NAMELY, CORNED BEEF, HAM, PASTRAMI, ROAST BEEF, IN CLASS 29 (U.S. CL. 46).

FIRST USE 8-1-2008; IN COMMERCE 8-1-2008.

THE MARK CONSISTS OF STANDARD CHARACTERS WITHOUT CLAIM TO ANY PARTICULAR FONT, STYLE, SIZE, OR COLOR.

NO CLAIM IS MADE TO THE EXCLUSIVE RIGHT TO USE "DELI", APART FROM THE MARK AS SHOWN.

SN 76-621,240, FILED 11-17-2004.

JASON LOTT, EXAMINING ATTORNEY

Int. Cl.: 3

Prior U.S. Cls.: 1, 4, 6, 50, 51, and 52

Reg. No. 3,521,008

United States Patent and Trademark Office

Registered Oct. 21, 2008

**TRADEMARK
PRINCIPAL REGISTER**

TRIPLE C-WEED

NEW KINGDOM, INC. (DELAWARE CORPORATION), DBA SUE DEVITT STUDIO,
152 MADISON AVENUE SUITE 1600
NEW YORK, NY 10016

FOR: COSMETICS AND NON-MEDICATED SKIN CARE PREPARATIONS CONTAINING SEAWEED, -NAMESLY, LOOSE POWDER, FOUNDATION, PRESSED POWDER, IN CLASS 3 (U.S. CLS. 1, 4, 6, 50, 51 AND 52).

FIRST USE 10-0-2001; IN COMMERCE 10-0-2001.

THE MARK CONSISTS OF STANDARD CHARACTERS WITHOUT CLAIM TO ANY PARTICULAR FONT, STYLE, SIZE, OR COLOR.

NO CLAIM IS MADE TO THE EXCLUSIVE RIGHT TO USE "SEAWEED", APART FROM THE MARK AS SHOWN.

SN 76-626,340, FILED 12-30-2004.

JILL PRATER, EXAMINING ATTORNEY

Int. Cl.: 11

Prior U.S. Cls.: 13, 21, 23, 31, and 34

Reg. No. 3,521,009

United States Patent and Trademark Office

Registered Oct. 21, 2008

**TRADEMARK
PRINCIPAL REGISTER**

LISO

COLUMBIA LIGHTING PROPERTIES, INC. (MI-
CHIGAN CORPORATION)
300 DELAWARE AVENUE, SUITE 328
WILMINGTON, DE 19801

THE MARK CONSISTS OF STANDARD CHAR-
ACTERS WITHOUT CLAIM TO ANY PARTICULAR
FONT, STYLE, SIZE, OR COLOR.

FOR: ELECTRICAL LIGHTING FIXTURES AND
PARTS AND FITTINGS THEREFOR, IN CLASS 11
(U.S. CLS. 13, 21, 23, 31 AND 34).

SN 76-629,219, FILED 1-28-2005.

FIRST USE 6-9-2008; IN COMMERCE 6-9-2008.

LESLEY LAMOTHE, EXAMINING ATTORNEY

Int. Cl.: 35

Prior U.S. Cls.: 100, 101, and 102

United States Patent and Trademark Office

Reg. No. 3,521,010

Registered Oct. 21, 2008

**SERVICE MARK
PRINCIPAL REGISTER**

WERKS

WERKS COMPANY, LLC, THE (FLORIDA CORPORATION)
1226 NE 4TH AVENUE
FT. LAUDERDALE, FL 33304

FOR: RETAIL STORE SERVICES FEATURING MEN AND WOMEN CLOTHING, LINGERIE, SHOES, CLOTHING, AND NOVELTIES FOR ALTERNATIVE LIFESTYLES, IN CLASS 35 (U.S. CLS. 100, 101 AND 102).

FIRST USE 8-1-2008; IN COMMERCE 8-1-2008.

THE MARK CONSISTS OF STANDARD CHARACTERS WITHOUT CLAIM TO ANY PARTICULAR FONT, STYLE, SIZE, OR COLOR.

SN 76-629,578, FILED 1-27-2005.

BRIDGETT SMITH, EXAMINING ATTORNEY

Int. Cl.: 5

Prior U.S. Cls.: 6, 18, 44, 46, 51, and 52

United States Patent and Trademark Office

Reg. No. 3,521,011

Registered Oct. 21, 2008

**TRADEMARK
PRINCIPAL REGISTER**

IMMUNO ZAPPERS

PRIMARY INVESTMENTS GROUP LIMITED
(BR.VIRGIN ISLANDS CORPORATION)
TRUSTNET LIMITED
P.O. BOX 3444
ROAD TOWN, TORTOLA, BR.VIRGIN ISLANDS

FOR: VITAMINS AND NUTRITIONAL SUPPLE-
MENTS, IN CLASS 5 (U.S. CLS. 6, 18, 44, 46, 51 AND
52).

FIRST USE 9-9-2008; IN COMMERCE 9-9-2008.

THE MARK CONSISTS OF STANDARD CHAR-
ACTERS WITHOUT CLAIM TO ANY PARTICULAR
FONT, STYLE, SIZE, OR COLOR.

NO CLAIM IS MADE TO THE EXCLUSIVE
RIGHT TO USE "IMMUNO", APART FROM THE
MARK AS SHOWN.

SN 76-630,557, FILED 2-7-2005.

ESTHER A. BORSUK, EXAMINING ATTORNEY

Int. Cl.: 10

Prior U.S. Cls.: 26, 39, and 44

Reg. No. 3,521,012

United States Patent and Trademark Office

Registered Oct. 21, 2008

**TRADEMARK
PRINCIPAL REGISTER**

INQUIRY OPTIMA

IRVINE BIOMEDICAL, INC. (CALIFORNIA CORPORATION)
2375 MORSE AVENUE
IRVINE, CA 92614

THE MARK CONSISTS OF STANDARD CHARACTERS WITHOUT CLAIM TO ANY PARTICULAR FONT, STYLE, SIZE, OR COLOR.

FOR: MEDICAL DEVICES, NAMELY, CATHETERS INCLUDING ELECTROPHYSIOLOGY CATHETERS BUT EXCLUDING UROLOGY CATHETERS, IN CLASS 10 (U.S. CLS. 26, 39 AND 44).

SN 76-633,957, FILED 3-18-2005.

FIRST USE 1-1-2005; IN COMMERCE 1-1-2005.

MARIA-VICTORIA SUAREZ, EXAMINING ATTORNEY

Int. Cl.: 43

Prior U.S. Cls.: 100 and 101

United States Patent and Trademark Office

Reg. No. 3,521,013

Registered Oct. 21, 2008

**SERVICE MARK
PRINCIPAL REGISTER**

PARROT KEY RESORT

SINGH COMPANY,THE (FLORIDA CORPORATION)
6805 OVERSEAS HIGHWAY
MARATHON, FL 33050

FOR: PROVIDING CONFERENCE, CONVENTION AND GROUP MEETING FACILITIES; REAL ESTATE, CONDOMINIUM AND HOTEL MANAGEMENT SERVICES; HOTEL AND RESORT SERVICES; RESTAURANT SERVICES; BAR SERVICES , IN CLASS 43 (U.S. CLS. 100 AND 101).

FIRST USE 9-15-2007; IN COMMERCE 9-15-2007.

THE MARK CONSISTS OF STANDARD CHARACTERS WITHOUT CLAIM TO ANY PARTICULAR FONT, STYLE, SIZE, OR COLOR.

NO CLAIM IS MADE TO THE EXCLUSIVE RIGHT TO USE "RESORT", APART FROM THE MARK AS SHOWN.

SN 76-642,971, FILED 7-15-2005.

CAROLYN GRAY, EXAMINING ATTORNEY

Int. Cl.: 41

Prior U.S. Cls.: 100, 101, and 107

United States Patent and Trademark Office

Reg. No. 3,521,014

Registered Oct. 21, 2008

**SERVICE MARK
PRINCIPAL REGISTER**

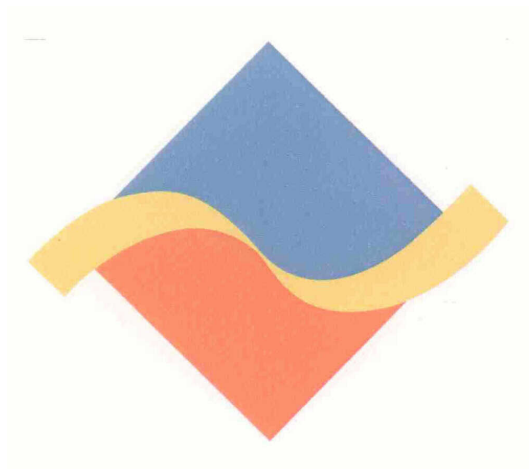

GILEAD SCIENCES, INC. (DELAWARE CORPORATION)
333 LAKESIDE DRIVE
FOSTER CITY, CA 94404

FOR: EDUCATIONAL SERVICES, NAMELY, CONDUCTING OFFLINE AND ONLINE CLASSES, COURSES, WORKSHOPS, HEALTH FAIRS, TUTORIALS AND SEMINARS RELATED TO HIV INFECTION AND DEVELOPMENT AND DISSEMINATION OF BROCHURES, PAMPHLETS, BOOKLETS, DVD'S AND VIDEOS IN CONNECTION THEREWITH, IN CLASS 41 (U.S. CLS. 100, 101 AND 107).

FIRST USE 11-15-2006; IN COMMERCE 11-15-2006.

THE COLOR(S) BLUE, ORANGE AND GOLD IS/ ARE CLAIMED AS A FEATURE OF THE MARK.

THE MARK CONSISTS OF A DIAMOND SHAPE HAVING A BLUE TOP AND AN ORANGE BOTTOM, DIVIDED BY A WAVY GOLD BAND.

SN 76-650,192, FILED 11-14-2005.

PRISCILLA MILTON, EXAMINING ATTORNEY

Int. Cl.: 16

Prior U.S. Cls.: 2, 5, 22, 23, 29, 37, 38, and 50

Reg. No. 3,521,015

United States Patent and Trademark Office

Registered Oct. 21, 2008

**TRADEMARK
PRINCIPAL REGISTER**

ZENCILS

SIEGEL, WILLIAM B. (UNITED STATES INDIVIDUAL)
186-D11 WEST MONTAUK HIGHWAY
HAMPTON BAYS, NY 11946

THE MARK CONSISTS OF STANDARD CHARACTERS WITHOUT CLAIM TO ANY PARTICULAR FONT, STYLE, SIZE, OR COLOR.

FOR: STENCILS FOR PUTTING SYMBOLS, EMBLEMS, ETC; ON TENNIS RACQUET STRINGS, IN CLASS 16 (U.S. CLS. 2, 5, 22, 23, 29, 37, 38 AND 50).

SN 76-651,055, FILED 11-28-2005.

FIRST USE 3-29-2007; IN COMMERCE 3-29-2007.

ANDREW LAWRENCE, EXAMINING ATTORNEY

Int. Cl.: 25

Prior U.S. Cls.: 22 and 39

United States Patent and Trademark Office

Reg. No. 3,521,016

Registered Oct. 21, 2008

**TRADEMARK
PRINCIPAL REGISTER**



PAI, PO JEN (TAIWAN INDIVIDUAL)
3F, NO. 4, ALLEY 12 LANE 151
BAO PING RD.
YONG HO CITY, TAIPEI HSIEN, TAIWAN

FOR: CLOTHING, NAMELY, BELTS, BREECHES,
COATS, FROCKS, GLOVES, JACKETS, SCARVES,
NECKTIES, OVERCOATS, PULLOVERS, SHIRTS,
SINGLETs, SKIRTS, SPORT COATS, SPORT SHIRTS,
SPORTS JACKETS, SPORTS JERSEYS AND BREE-
CHES FOR SPORTS, SUITS, TROUSERS; FOOT-
WEAR, NAMELY, BOOTS, SHOES, ATHLETIC
SHOES, GYMNAS TIC SHOES, LEATHER SHOES,

LEISURE SHOES, SPORTS SHOES, SLIPPERS, SAN-
DALS, SOCKS, STOCKINGS; HEADGEAR, NAME-
LY, CAPS, HATS, HOODS, IN CLASS 25 (U.S. CLS. 22
AND 39).

FIRST USE 12-1-2005; IN COMMERCE 12-1-2005.

THE ENGLISH TRANSLATION FOR THE WORD
"ADVENTURA" IN THE MARK IS ADVENTURE.

SN 76-651,075, FILED 11-29-2005.

SHANNON TWOHIG, EXAMINING ATTORNEY

Int. Cls.: 16 and 41

Prior U.S. Cls.: 2, 5, 22, 23, 29, 37, 38, 50, 100, 101, and 107

Reg. No. 3,521,017

United States Patent and Trademark Office

Registered Oct. 21, 2008

**TRADEMARK
SERVICE MARK
PRINCIPAL REGISTER**

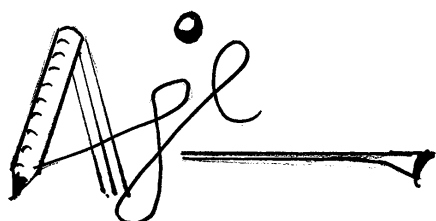

OTASPEED *Writing*

MORROW, TRUDY (UNITED STATES INDIVIDUAL)
2479 FOXON ROAD
NORTH BRANFORD, CT 06471

FOR: TEXTBOOKS, MANUALS AND BROCHURES IN THE FIELD OF SPEEDWRITING, IN CLASS 16 (U.S. CLS. 2, 5, 22, 23, 29, 37, 38 AND 50).

FIRST USE 0-0-1999; IN COMMERCE 0-0-2005.

FOR: PUBLICATION OF TEXTBOOKS, BROCHURES AND MANUALS; TRAINING SERVICES IN THE FIELD OF SPEEDWRITING, IN CLASS 41 (U.S. CLS. 100, 101 AND 107).

FIRST USE 0-0-1999; IN COMMERCE 0-0-2005.

NO CLAIM IS MADE TO THE EXCLUSIVE RIGHT TO USE "WRITING", APART FROM THE MARK AS SHOWN.

THE MARK IS COMPOSED OF A PENCIL POINTING DOWNWARDS AND IS BRACED BY THE SPINE OF A NOTEBOOK SHOWN AS THREE PARALLEL LINES. THIS IS FOLLOWED BY A DESIGN REPRESENTING SYMBOLS IN SHORTHAND WITH A SMALL SHADED CIRCLE APPEARING AT THE TOP OF THE MARK. A SHADED TWO-DIMENSIONAL LINE APPEARS TO THE RIGHT OF THE PENCIL. THE WORDING "OTASPEED WRITING" APPEARS UNDER THE DESIGN. THE WORD AGE DOES NOT APPEAR IN THE MARK.

SN 76-652,631, FILED 12-28-2005.

WILLIAM ROSSMAN, EXAMINING ATTORNEY

Int. Cls.: 35 and 42

Prior U.S. Cls.: 100, 101, and 102

United States Patent and Trademark Office

Reg. No. 3,521,018

Registered Oct. 21, 2008

**SERVICE MARK
PRINCIPAL REGISTER**



**BREATHE
CALIFORNIA**

BREATHE CALIFORNIA INTELLECTUAL PROP-
ERTY TRUST (CALIFORNIA TRUST)
909 12TH STREET
SACRAMENTO, CA 95814

FOR: ASSOCIATION SERVICES, NAMELY, PRO-
MOTING THE INTERESTS OF THE PUBLIC
THROUGH PROMOTING PUBLIC AWARENESS
OF THE DETECTION AND PREVENTION OF
LUNG AND RESPIRATORY DISEASES; PROMOT-
ING PUBLIC AWARENESS OF LUNG HEALTH
ISSUES, IN CLASS 35 (U.S. CLS. 100, 101 AND 102).

FIRST USE 2-2-2006; IN COMMERCE 2-2-2006.

FOR: CONDUCTING RESEARCH IN LUNG
HEALTH, IN CLASS 42 (U.S. CLS. 100 AND 101).

FIRST USE 2-2-2006; IN COMMERCE 2-2-2006.

NO CLAIM IS MADE TO THE EXCLUSIVE
RIGHT TO USE "CALIFORNIA", APART FROM
THE MARK AS SHOWN.

SN 76-653,612, FILED 1-13-2006.

ELIZABETH KAJUBI, EXAMINING ATTORNEY

Int. Cl.: 28

Prior U.S. Cls.: 22, 23, 38, and 50

Reg. No. 3,521,019

United States Patent and Trademark Office

Registered Oct. 21, 2008

TRADEMARK
PRINCIPAL REGISTER

Solano

LONG CHIN SEMICONDUCTOR TECHNOLOGY
CO., LTD. (TAIWAN CORPORATION)
NO. 52, DATONG RD., SHENGANG TOWNSHIP
CHANGHUA COUNTY 509, TAIWAN

FOR: PROTECTIVE PADS FOR ATHLETIC,
NAMELY, FOOTBALL LEG PADS; ATHLETIC
SPORTING GOODS, NAMELY, ATHLETIC WRIST
AND JOINT SUPPORTS; ATHLETIC SUPPORTERS;
ATHLETIC TAPE; ATHLETIC TRAINING DEVICES,
NAMELY, GYMNASIUM TRAINING STOOLS; AN-
KLE AND WRIST WEIGHTS FOR EXERCISE;
CHEST PROTECTORS FOR ATHLETIC USE; LEG
GUARDS FOR ATHLETIC USE; SHIN GUARDS
FOR ATHLETIC USE; SHIN PADS FOR ATHLETIC
USE; SHOULDER PADS FOR ATHLETIC USE;

WAISTBAND FOR SPORTS IN THE NATURE OF
WEIGHT LIFTING BELTS; WRIST SUPPORTS IN
THE NATURE OF WRISTLET FOR ATHLETIC USE;
EXERCISE MACHINE, IN CLASS 28 (U.S. CLS. 22, 23,
38 AND 50).

FIRST USE 10-30-2007; IN COMMERCE 10-30-2007.

THE ENGLISH TRANSLATION OF "SOLANO" IS
HOT WIND.

SN 76-655,371, FILED 2-17-2006.

MARK RADEMACHER, EXAMINING ATTORNEY

Int. Cl.: 35

Prior U.S. Cls.: 100, 101, and 102

United States Patent and Trademark Office

Reg. No. 3,521,020

Registered Oct. 21, 2008

**SERVICE MARK
PRINCIPAL REGISTER**

ZOUNDS

ZZOUNDS MUSIC, LLC (NEW JERSEY LIMITED
LIABILITY CORPORATION)
65 GREENWOOD AVENUE
MIDLAND PARK, NJ 07432

FOR: COMPUTERIZED ON-LINE RETAIL STORE
SERVICES IN THE FIELD OF MUSICAL INSTRU-
MENTS AND AUDIO RECORDING GEAR; MAIL
ORDER CATALOG SERVICES FEATURING MUSI-
CAL INSTRUMENTS AND AUDIO RECORDING
GEAR, IN CLASS 35 (U.S. CLS. 100, 101 AND 102).

FIRST USE 7-16-2007; IN COMMERCE 7-16-2007.

THE MARK CONSISTS OF STANDARD CHAR-
ACTERS WITHOUT CLAIM TO ANY PARTICULAR
FONT, STYLE, SIZE, OR COLOR.

OWNER OF U.S. REG. NO. 2,209,520.

SN 76-655,469, FILED 2-21-2006.

TEJBIR SINGH, EXAMINING ATTORNEY

Int. Cl.: 6

Prior U.S. Cls.: 2, 12, 13, 14, 23, 25, and 50

Reg. No. 3,521,021

United States Patent and Trademark Office

Registered Oct. 21, 2008

**TRADEMARK
PRINCIPAL REGISTER**

GLOBAL WHEEL NUT

NEUMAYER TEKFOR GMBH (FED REP GER-
MANY CORPORATION)
WILHELM-ZANGEN-STR. 9
77756 HAUSACH, FED REP GERMANY

FOR: FASTENING ELEMENTS OF METAL,
NAMELY, METAL NUTS AND BOLTS; METAL
NUTS AND BOLTS FOR MOTOR VEHICLES, IN
CLASS 6 (U.S. CLS. 2, 12, 13, 14, 23, 25 AND 50).

FIRST USE 8-4-2008; IN COMMERCE 8-4-2008.

THE MARK CONSISTS OF STANDARD CHAR-
ACTERS WITHOUT CLAIM TO ANY PARTICULAR
FONT, STYLE, SIZE, OR COLOR.

NO CLAIM IS MADE TO THE EXCLUSIVE
RIGHT TO USE "WHEEL NUT", APART FROM
THE MARK AS SHOWN.

SN 76-656,228, FILED 3-3-2006.

SUE LAWRENCE, EXAMINING ATTORNEY

Int. Cls.: 35, 36, 37, 40, and 42

Prior U.S. Cls.: 100, 101, 102, 103, and 106

United States Patent and Trademark Office

Reg. No. 3,521,022

Registered Oct. 21, 2008

SERVICE MARK
PRINCIPAL REGISTER

ONE SOURCE ONE FIRM

CARTER & BURGESS, INC. (TEXAS CORPORATION)

777 MAIN STREET

FORT WORTH, TX 761012058

FOR: ENERGY AUDITING CONSISTING OF THE ASSESSMENT AND ANALYSIS OF ENERGY USAGE, CONSERVATION, AND SUPPLY FOR COMMERCIAL, RETAIL, INDUSTRIAL AND PUBLIC BUILDINGS AND STRUCTURES; LOGISTICS MANAGEMENT IN THE FIELDS OF RETAIL STORE SERVICES, WHOLESALE DISTRIBUTORSHIPS AND MANUFACTURING, ALL FEATURING DRY GOODS, REFRIGERATED FOODS AND BEVERAGES; ENERGY USAGE AND SUPPLY MANAGEMENT FOR COMMERCIAL, RETAIL, INDUSTRIAL AND PUBLIC BUILDINGS AND STRUCTURES; ECONOMIC FORECASTING AND ANALYSIS IN THE FIELDS OF RAILROAD AND TRANSIT DEVELOPMENT; BUSINESS MANAGEMENT CONSULTATION FOR INFRASTRUCTURE PROVIDERS; BUSINESS MANAGEMENT PLANNING; BUSINESS ORGANIZATIONAL CONSULTATION; AND BUSINESS EVALUATION OF FEE STRUCTURE FOR MUNICIPAL GOVERNMENTS; BUSINESS CONSULTING SERVICES IN THE FIELD OF ENVIRONMENTAL MANAGEMENT, MARKET AND ECONOMIC ANALYSIS FOR LAND DEVELOPMENT PROJECTS; COST ASSESSMENT SERVICES IN THE NATURE OF ECONOMIC MODELS FOR DETERMINING THE COST/BENEFIT RATIO, FINANCIAL MANAGEMENT, AND EVALUATION OF UTILITY RATES FOR UTILITY PROVIDERS BY PROVIDING RATE STUDIES WITH ANALYSIS OF COST OF SERVICE AND COST ALLOCATION, IN CLASS 35 (U.S. CLS. 100, 101 AND 102).

FIRST USE 3-0-2007; IN COMMERCE 3-0-2007.

FOR: COMMERCIAL REAL ESTATE SERVICES, NAMELY, FACILITY MANAGEMENT; ENVIRONMENTAL RISK MANAGEMENT; AND STRATEGIC FINANCIAL PLANNING FOR LAND, RAILROAD

AND UTILITY DEVELOPMENT PROJECTS, IN CLASS 36 (U.S. CLS. 100, 101 AND 102).

FIRST USE 3-0-2007; IN COMMERCE 3-0-2007.

FOR: CONSTRUCTION SERVICES, NAMELY, CONSTRUCTION MANAGEMENT AND PLANNING; LAND DEVELOPMENT, NAMELY, PLANNING, LAYING OUT AND CONSTRUCTION OF RESIDENTIAL, COMMERCIAL AND MIXED-USE BUILDINGS AND COMMUNITIES; CONSTRUCTION, RENOVATION, AND REPAIR OF COMMERCIAL, RETAIL, INDUSTRIAL, AND PUBLIC BUILDINGS AND STRUCTURES; CONSTRUCTION, RENOVATION AND REPAIR OF THEATER, ATHLETIC AND ENTERTAINMENT FACILITIES; CONSTRUCTION, RENOVATION AND REPAIR OF TRANSPORTATION BUILDINGS AND STRUCTURES; CONSTRUCTION, RENOVATION AND REPAIR OF STREETS, ROADS, AND BRIDGES; CONSTRUCTION, RENOVATION AND REPAIR OF PORTS AND HARBORS; CONSTRUCTION, RENOVATION AND REPAIR OF WATER TREATMENT, STORAGE AND DISTRIBUTION BUILDINGS AND STRUCTURES; CONSTRUCTION SERVICES, NAMELY, PLANNING, LAYING OUT AND CONSULTING SERVICES IN THE FIELD OF WATER TREATMENT FACILITIES; ENVIRONMENTAL REMEDIATION CONSULTING SERVICES CONCERNING WASTE DISPOSAL; CONSTRUCTION MANAGEMENT; CONSTRUCTION PROJECT MANAGEMENT; AND CONSTRUCTIONS PROGRAM MANAGEMENT, IN CLASS 37 (U.S. CLS. 100, 103 AND 106).

FIRST USE 3-0-2007; IN COMMERCE 3-0-2007.

FOR: ELECTRONIC IMAGING AND SCANNING OF ARCHITECTURAL AND ENGINEERING DESIGNS; WATER RESOURCES MANAGEMENT IN THE NATURE OF WATER TREATMENT, IN CLASS 40 (U.S. CLS. 100, 103 AND 106).

FIRST USE 3-0-2007; IN COMMERCE 3-0-2007.

FOR: WATER RESOURCES ENGINEERING, NAMELY, THE DEVELOPMENT OF WATER RESOURCES AND WATER QUALITY; ARCHITECTURAL DESIGN SERVICES, ENGINEERING SERVICES, AND SURVEYING SERVICES; DESIGN VISUALIZATION SERVICES FOR USE IN CONNECTION WITH ARCHITECTURAL AND ENGINEERING SERVICES; PROVIDING GEOGRAPHIC INFORMATION SYSTEM SERVICES, NAMELY, CREATING, MANAGING AND EDITING THREE-DIMENSIONAL MAPPING PACKAGES FOR USE IN CONNECTION WITH ENGINEERING AND ARCHITECTURAL SERVICES; COMPUTER SOFTWARE AND CUSTOM APPLICATIONS DEVELOPMENT AND DESIGN SERVICES; ENVIRONMENTAL SERVICES, NAMELY, REVIEW OF STANDARDS AND PRACTICES TO ASSURE COMPLIANCE WITH ENVIRONMENTAL LAWS AND REGULATIONS, AND THE ASSESSMENT AND ANALYSIS OF ENERGY USAGE, CONSERVATION, AND SUPPLY FOR COMMERCIAL, RETAIL, INDUSTRIAL AND PUBLIC BUILDINGS AND STRUCTURES, AND ENVIRONMENTAL AND ECOLOGICAL SURVEY SERVICES; COMPUTER SOFTWARE AND CUSTOM APPLICATIONS DEVELOPMENT AND DESIGN SERVICES; COMPUTER NETWORK DESIGN

FOR OTHERS, NAMELY, PLANNING AND DESIGN OF MASTER INFRASTRUCTURE FOR INFORMATION TECHNOLOGY SYSTEMS; CONSULTING SERVICES IN THE FIELD OF DESIGN, SELECTION, IMPLEMENTATION AND USE OF COMPUTER HARDWARE AND SOFTWARE SYSTEMS FOR OTHERS; COMPUTER SERVICES, NAMELY, SOFTWARE DEVELOPMENT; COMPUTER SERVICES, NAMELY, DESIGNING AND IMPLEMENTING WEB SITES FOR OTHERS; DEVELOPMENT FOR OTHERS OF COMPUTER SOFTWARE FOR USE IN WEB APPLICATIONS; APPLICATION SERVICE PROVIDER (ASP), NAMELY, HOSTING COMPUTER SOFTWARE APPLICATIONS OF OTHERS; AND URBAN PLANNING SERVICES, IN CLASS 42 (U.S. CLS. 100 AND 101).

FIRST USE 3-0-2007; IN COMMERCE 3-0-2007.

THE MARK CONSISTS OF STANDARD CHARACTERS WITHOUT CLAIM TO ANY PARTICULAR FONT, STYLE, SIZE, OR COLOR.

SN 76-656,430, FILED 3-13-2006.

SUSAN LESLIE DUBOIS, EXAMINING ATTORNEY

Int. Cls.: 29 and 35

Prior U.S. Cls.: 46, 100, 101, and 102

United States Patent and Trademark Office

Reg. No. 3,521,023

Registered Oct. 21, 2008

TRADEMARK
SERVICE MARK
PRINCIPAL REGISTER

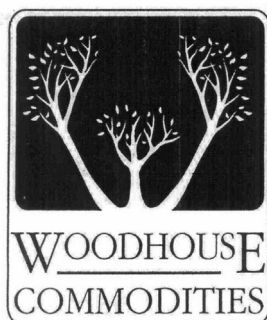

WOODHOUSE COMMODITIES INC. (CALIFORNIA CORPORATION)
21550 OXNARD ST., SUITE 680
WOODLAND HILLS, CA 91367

FOR: PROCESSED EDIBLE SEEDS, PROCESSED NUTS, PROCESSED FRUITS, PROCESSED PUMPKIN SEEDS; PROCESSED ALMONDS, PROCESSED WALNUTS, PROCESSED PISTACHIOS, RAISINS, PRUNES, DRIED PEACHES, DRIED PEARS, PROCESSED POPPY SEEDS, AND PROCESSED CARAWAY SEEDS, IN CLASS 29 (U.S. CL. 46).

FIRST USE 12-1-2006; IN COMMERCE 12-1-2006.

FOR: WHOLESALE DISTRIBUTORSHIPS IN THE FIELD OF SEEDS, NUTS, FRUITS, SPICES, SESAME SEEDS, NATURAL SESAME SEEDS, TOASTED SE-

SAME SEEDS, ALMONDS, WALNUTS, PISTACHIOS, RAISINS, PRUNES, DRIED PEACHES, DRIED PEARS, POPPY SEEDS, CARAWAY SEEDS AND ALLSPICE, IN CLASS 35 (U.S. CLS. 100, 101 AND 102).

FIRST USE 12-1-2006; IN COMMERCE 12-1-2006.

OWNER OF U.S. REG. NO. 3,093,699.

NO CLAIM IS MADE TO THE EXCLUSIVE RIGHT TO USE "COMMODITIES", APART FROM THE MARK AS SHOWN.

SN 76-658,855, FILED 4-24-2006.

KELLY BOULTON, EXAMINING ATTORNEY

Int. Cl.: 44

Prior U.S. Cls.: 100 and 101

United States Patent and Trademark Office

Reg. No. 3,521,024

Registered Oct. 21, 2008

**SERVICE MARK
PRINCIPAL REGISTER**

GAME TIME CUTS

GAME TIME CUTS, LLC (MASSACHUSETTS
LIMITED LIABILITY COMPANY)

59 WALNUT ST.

DEDHAM, MA 02026

FOR: HAIR SALON SERVICES, IN CLASS 44 (U.S.
CLS. 100 AND 101).

FIRST USE 7-22-2008; IN COMMERCE 7-22-2008.

THE MARK CONSISTS OF STANDARD CHAR-
ACTERS WITHOUT CLAIM TO ANY PARTICULAR
FONT, STYLE, SIZE, OR COLOR.

NO CLAIM IS MADE TO THE EXCLUSIVE
RIGHT TO USE "CUTS", APART FROM THE MARK
AS SHOWN.

SN 76-661,510, FILED 6-13-2006.

CHRISTINE COOPER, EXAMINING ATTORNEY

Int. Cl.: 33

Prior U.S. Cls.: 47 and 49

United States Patent and Trademark Office

Reg. No. 3,521,025

Registered Oct. 21, 2008

**TRADEMARK
PRINCIPAL REGISTER**

LIFE IS GOOD

WORDS ON WINE LLC (NEW JERSEY LIMITED
LIABILITY COMPANY)
519 ROUTE 46 EAST
CLIFTON, NJ 07011

THE MARK CONSISTS OF STANDARD CHAR-
ACTERS WITHOUT CLAIM TO ANY PARTICULAR
FONT, STYLE, SIZE, OR COLOR.

FOR: WINE, IN CLASS 33 (U.S. CLS. 47 AND 49).

SN 76-662,154, FILED 6-26-2006.

FIRST USE 7-15-2008; IN COMMERCE 7-15-2008.

LINDA ORNDORFF, EXAMINING ATTORNEY

Int. Cl.: 10

Prior U.S. Cls.: 26, 39, and 44

Reg. No. 3,521,026

United States Patent and Trademark Office

Registered Oct. 21, 2008

TRADEMARK
PRINCIPAL REGISTER

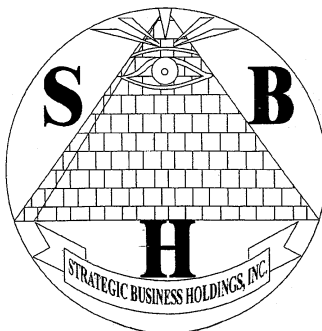

HASHEMI, FARSHAD (UNITED STATES INDIVIDUAL)
25712 LE PARC, SUITE 74
LAKE FOREST, CA 92630

FOR: HAND-HELD SURGICAL DEVICES FOR OPHTHALMIC SURGERY AND LASER EYE AND LASIK SURGERY, NAMELY, MECHANICAL INSTRUMENTS FOR USE IN THOSE TYPES OF SURGERY, NEEDLE HOLDERS, CANNULAS, ABERROMETERS, TOPOGRAPHERS, KERATOMES AND BLADES, PHACOEMULSIFICATION DEVICES, SCALPELS, FORCEPS, SCISSORS, SPECULAS, RETRACTORS, SPATULAS, MANIPULATORS, LACRIMAL INSTRUMENTS, MEASURING AND MARKING INSTRUMENTS, STERILIZING CASES, HOOKS, SPECULUMS, SUTURE CUTTERS, BINOCULAR LOUPES, KNIVES, BLADES, BLADE HOLDERS, HANDLES, SAWS, SPOONS, SPANNERS, STAPLERS, DEPRESSORS, CURETTES, CHISELS

FOR MEDICAL OPERATIONS, DISSECTORS, ELEVATORS, MECHANICAL INSTRUMENTS FOR ELEVATING TISSUE AND ORGANS DURING SURGICAL OPERATIONS, SURGICAL INSTRUMENTS, EXCAVATORS, PROBES, KNIVES, SURGICAL INSTRUMENTS FOR PUNCHING, CUTTING AND MILLING, AND SUTURES, IN CLASS 10 (U.S. CLS. 26, 39 AND 44).

FIRST USE 2-0-2005; IN COMMERCE 6-0-2006.

NO CLAIM IS MADE TO THE EXCLUSIVE RIGHT TO USE "BUSINESS HOLDINGS, INC.", APART FROM THE MARK AS SHOWN.

SN 76-662,736, FILED 7-10-2006.

AMY HELLA, EXAMINING ATTORNEY

Int. Cl.: 25

Prior U.S. Cls.: 22 and 39

United States Patent and Trademark Office

Reg. No. 3,521,027

Registered Oct. 21, 2008

**TRADEMARK
PRINCIPAL REGISTER**

SINVICTOS

ROTSTEIN, DAVID (UNITED STATES INDIVIDUAL)

7122 MATILJA AVE.

VAN NUYS, CA 91405

FOR: SHIRTS, IN CLASS 25 (U.S. CLS. 22 AND 39).

FIRST USE 9-1-2007; IN COMMERCE 9-9-2007.

THE MARK CONSISTS OF STANDARD CHARACTERS WITHOUT CLAIM TO ANY PARTICULAR FONT, STYLE, SIZE, OR COLOR.

THE WORD "SINVICTOS" HAS NO MEANING IN ANY FOREIGN LANGUAGE.

SN 76-662,924, FILED 7-12-2006.

CHARLOTTE CORWIN, EXAMINING ATTORNEY

Int. Cl.: 35

Prior U.S. Cls.: 100, 101, and 102

United States Patent and Trademark Office

Reg. No. 3,521,028

Registered Oct. 21, 2008

**SERVICE MARK
PRINCIPAL REGISTER**

MINESITE

BACKE COMMUNICATIONS, INC. (DELAWARE CORPORATION)
35 CRICKET TERRACE CENTER
ARDMORE, PA 19003

FOR: ADVERTISING AGENCY SERVICES, NAMELY, PROVIDING INFORMATION RELATING TO BRAND DEVELOPMENT SERVICES; DEVELOPMENT OF ADVERTISING CAMPAIGNS FOR ALL PUBLIC COMMUNICATION MEANS; AND PROVISION OF MARKET RESEARCH SERVICES FOR OTHERS, IN CLASS 35 (U.S. CLS. 100, 101 AND 102).

FIRST USE 7-6-2006; IN COMMERCE 7-6-2006.

THE MARK CONSISTS OF STANDARD CHARACTERS WITHOUT CLAIM TO ANY PARTICULAR FONT, STYLE, SIZE, OR COLOR.

SN 76-664,371, FILED 8-9-2006.

AMY MCMENAMIN, EXAMINING ATTORNEY

Int. Cl.: 10

Prior U.S. Cls.: 26, 39, and 44

Reg. No. 3,521,029

United States Patent and Trademark Office

Registered Oct. 21, 2008

**TRADEMARK
PRINCIPAL REGISTER**

PRO-LINE

MEDICAL COMPONENTS, INC. (PENNSYLVANIA CORPORATION)
1499 DELP DRIVE
HARLEYSVILLE, PA 19438

FIRST USE 8-4-2008; IN COMMERCE 8-4-2008.

FOR: CATHETERS, AND CATHETER KITS CONSISTING OF CATHETERS, REMOVABLE HUBS, INJECTION CAPS, GUIDEWIRES, INTRODUCER NEEDLES, SCALPELS, TUNNELING TOOLS, TEAR-AWAY SHEATH INTRODUCERS, STYLETS, VESSEL DILATORS, ARTERIAL EXTENSION SETS, AND CLAMPS, IN CLASS 10 (U.S. CLS. 26, 39 AND 44).

THE MARK CONSISTS OF STANDARD CHARACTERS WITHOUT CLAIM TO ANY PARTICULAR FONT, STYLE, SIZE, OR COLOR.

SN 76-667,309, FILED 10-12-2006.

NAKIA HENRY, EXAMINING ATTORNEY

Int. Cls.: 25 and 35

Prior U.S. Cls.: 22, 39, 100, 101, and 102

Reg. No. 3,521,030

United States Patent and Trademark Office

Registered Oct. 21, 2008

**TRADEMARK
SERVICE MARK
PRINCIPAL REGISTER**

I KILL DEER

WESTLEY WRIGHT (UNITED STATES INDIVIDUAL), DBA WRIGHT REALTY,
4417 FM 624
ROBSTOWN, TX 78380

FOR: APPAREL, NAMELY, T-SHIRTS, CAPS AND VISORS, IN CLASS 25 (U.S. CLS. 22 AND 39).

FIRST USE 8-14-2008; IN COMMERCE 8-14-2008.

FOR: REAL ESTATE MARKETING SERVICES IN THE FIELDS OF HOMES, VACANT LAND AND RANCHES, IN CLASS 35 (U.S. CLS. 100, 101 AND 102).

FIRST USE 8-13-2008; IN COMMERCE 8-14-2008.

THE MARK CONSISTS OF STANDARD CHARACTERS WITHOUT CLAIM TO ANY PARTICULAR FONT, STYLE, SIZE, OR COLOR.

SN 76-667,507, FILED 10-13-2006.

SHARON MEIER, EXAMINING ATTORNEY

Int. Cls.: 25 and 43

Prior U.S. Cls.: 22, 39, 100, and 101

United States Patent and Trademark Office

Reg. No. 3,521,031

Registered Oct. 21, 2008

**TRADEMARK
SERVICE MARK
PRINCIPAL REGISTER**

The Fine Art of Fun Dining

ROCK N BREW, INC. (PENNSYLVANIA CORPORATION)

518 KATRINA COURT

MECHANICSBURG, PA 17050

FOR: CLOTHING, NAMELY, HATS, T-SHIRTS, SWEATSHIRTS, SPORTS JERSEYS, TANK TOPS, SWEATPANTS, TOPS, BOTTOMS, AND SHORTS; HEADGEAR, NAMELY, HATS AND CAPS; FOOTWEAR, IN CLASS 25 (U.S. CLS. 22 AND 39).

FIRST USE 4-1-2007; IN COMMERCE 4-1-2007.

FOR: RESTAURANT AND BAR SERVICES FOR PROVIDING FOOD AND DRINK, IN CLASS 43 (U.S. CLS. 100 AND 101).

FIRST USE 4-1-2007; IN COMMERCE 4-1-2007.

THE MARK CONSISTS OF STANDARD CHARACTERS WITHOUT CLAIM TO ANY PARTICULAR FONT, STYLE, SIZE, OR COLOR.

SN 76-667,911, FILED 10-23-2006.

DOMINIC FATHY, EXAMINING ATTORNEY

Int. Cl.: 5

Prior U.S. Cls.: 6, 18, 44, 46, 51, and 52

United States Patent and Trademark Office

Reg. No. 3,521,032

Registered Oct. 21, 2008

**TRADEMARK
PRINCIPAL REGISTER**

SILVER NOW

APOTHECA, INC. (ARIZONA CORPORATION)
1622 N. 16TH STREET
PHOENIX, AZ 85006

FOR: DIETARY SUPPLEMENTS CONTAINING
COLLOIDAL NANO SILVER, IN CLASS 5 (U.S. CLS.
6, 18, 44, 46, 51 AND 52).

FIRST USE 2-8-2007; IN COMMERCE 2-8-2007.

THE MARK CONSISTS OF STANDARD CHAR-
ACTERS WITHOUT CLAIM TO ANY PARTICULAR
FONT, STYLE, SIZE, OR COLOR.

NO CLAIM IS MADE TO THE EXCLUSIVE
RIGHT TO USE "SILVER", APART FROM THE
MARK AS SHOWN.

SN 76-668,021, FILED 10-25-2006.

CHRIS WELLS, EXAMINING ATTORNEY

Int. Cl.: 11

Prior U.S. Cls.: 13, 21, 23, 31, and 34

United States Patent and Trademark Office

Reg. No. 3,521,033

Registered Oct. 21, 2008

**TRADEMARK
PRINCIPAL REGISTER**

COMFORT MIST

THE ORIENTAL GROUP 3P NORTH AMERICAN
CORPORATION (DELAWARE CORPORA-
TION)

114 FRANKLIN STREET

DUXBURY, MA 02332

FOR: HUMIDIFIERS, IN CLASS 11 (U.S. CLS. 13,
21, 23, 31 AND 34).

FIRST USE 0-0-2006; IN COMMERCE 0-0-2006.

THE MARK CONSISTS OF STANDARD CHAR-
ACTERS WITHOUT CLAIM TO ANY PARTICULAR
FONT, STYLE, SIZE, OR COLOR.

NO CLAIM IS MADE TO THE EXCLUSIVE
RIGHT TO USE "MIST", APART FROM THE MARK
AS SHOWN.

SN 76-669,370, FILED 11-22-2006.

AMOS T. MATTHEWS, JR., EXAMINING ATTOR-
NEY

Int. Cl.: 16

Prior U.S. Cls.: 2, 5, 22, 23, 29, 37, 38, and 50

Reg. No. 3,521,034

United States Patent and Trademark Office

Registered Oct. 21, 2008

**TRADEMARK
PRINCIPAL REGISTER**

Sudoku

“17”

**THE MINIMUM AMOUNT OF STARTING
NUMBERS EVER CREATED!!!!**

AKHAVI, SEAN A.C. (UNITED STATES INDIVIDUAL)
10966 ROEBLING AVE. #6A
LOS ANGELES, CA 90024

THE MARK CONSISTS OF STANDARD CHARACTERS WITHOUT CLAIM TO ANY PARTICULAR FONT, STYLE, SIZE, OR COLOR.

FOR: BOOK SERIES IN THE FIELD OF PUZZLES AND GAMES, IN CLASS 16 (U.S. CLS. 2, 5, 22, 23, 29, 37, 38 AND 50).

SN 76-669,539, FILED 11-27-2006.

FIRST USE 1-16-2007; IN COMMERCE 5-15-2007.

ELLEN PERKINS, EXAMINING ATTORNEY

Int. Cls.: 35 and 41

Prior U.S. Cls.: 100, 101, 102, and 107

United States Patent and Trademark Office

Reg. No. 3,521,035

Registered Oct. 21, 2008

SERVICE MARK
PRINCIPAL REGISTER



VENTURE PERFORMANCE, INC. (COLORADO CORPORATION), DBA GREEN PEAK PARTNERS,
8226 VILLAGE HARBOR DRIVE, SUITE 5
CORNELIUS, NC 28031

FOR: BUSINESS CONSULTING SERVICES, NAMELY, ORGANIZATIONAL CONSULTING, IN CLASS 35 (U.S. CLS. 100, 101 AND 102).

FIRST USE 8-27-2008; IN COMMERCE 8-27-2008.

FOR: PERSONAL COACHING SERVICES IN THE FIELD OF ORGANIZATIONAL DESIGN AND DE-

VELOPMENT, LEADERSHIP DEVELOPMENT, TEAM BUILDING, CONFLICT RESOLUTION, SUCCESSION PLANNING, ASSESSING MANAGEMENT SKILLS, AND EXECUTIVE PLANNING, IN CLASS 41 (U.S. CLS. 100, 101 AND 107).

FIRST USE 8-27-2008; IN COMMERCE 8-27-2008.

SN 76-669,888, FILED 12-4-2006.

MARTHA FROMM, EXAMINING ATTORNEY

Int. Cl.: 43

Prior U.S. Cls.: 100 and 101

United States Patent and Trademark Office

Reg. No. 3,521,036

Registered Oct. 21, 2008

**SERVICE MARK
PRINCIPAL REGISTER**

MERCAT

SAGE HOSPITALITY RESOURCES LLC (DELA-
WARE LIMITED LIABILITY COMPANY)
1512 LARIMER STREET
SUITE NO. 800
DENVER, CO 80202

THE MARK CONSISTS OF STANDARD CHAR-
ACTERS WITHOUT CLAIM TO ANY PARTICULAR
FONT, STYLE, SIZE, OR COLOR.

FOR: RESTAURANT SERVICES, IN CLASS 43
(U.S. CLS. 100 AND 101).

SN 76-670,283, FILED 12-13-2006.

FIRST USE 3-10-2008; IN COMMERCE 3-10-2008.

WENDY JUN, EXAMINING ATTORNEY

Int. Cl.: 41

Prior U.S. Cls.: 100, 101, and 107

United States Patent and Trademark Office

Reg. No. 3,521,037

Registered Oct. 21, 2008

**SERVICE MARK
PRINCIPAL REGISTER**



GRAHAM BROTHERS PARTNERSHIP (TEXAS
GENERAL PARTNERSHIP)
6999 EAST HIGHWAY 90
ODESSA, TX 79762

FIRST USE 5-1-1990; IN COMMERCE 5-1-1990.

SN 76-670,918, FILED 12-29-2006.

FOR: NIGHTCLUB SERVICES, IN CLASS 41 (U.S.
CLS. 100, 101 AND 107).

AMY HELLA, EXAMINING ATTORNEY

Int. Cl.: 44

Prior U.S. Cls.: 100 and 101

United States Patent and Trademark Office

Reg. No. 3,521,038

Registered Oct. 21, 2008

**SERVICE MARK
PRINCIPAL REGISTER**

RSN

RENAL SUPPORT NETWORK (CALIFORNIA
CORPORATION)
1311 N. MARYLAND AVENUE
GLENDALE, CA 91207

FOR: PROVIDING HEALTH INFORMATION,
NAMELY, PROVIDING HEALTH INFORMATION
RELATING TO PERSONS LIVING WITH CHRONIC
KIDNEY DISEASE, IN CLASS 44 (U.S. CLS. 100 AND
101).

FIRST USE 0-0-1993; IN COMMERCE 0-0-1993.

THE MARK CONSISTS OF STANDARD CHAR-
ACTERS WITHOUT CLAIM TO ANY PARTICULAR
FONT, STYLE, SIZE, OR COLOR.

SN 76-672,611, FILED 2-12-2007.

KAPIL BHANOT, EXAMINING ATTORNEY

Int. Cl.: 10

Prior U.S. Cls.: 26, 39, and 44

United States Patent and Trademark Office

Reg. No. 3,521,039

Registered Oct. 21, 2008

**TRADEMARK
PRINCIPAL REGISTER**

IECP

THE SCOTTCARE CORPORATION (DELAWARE CORPORATION)
4791 WEST 150TH STREET
CLEVELAND, OH 44135

THE MARK CONSISTS OF STANDARD CHARACTERS WITHOUT CLAIM TO ANY PARTICULAR FONT, STYLE, SIZE, OR COLOR.

FOR: EXTERNAL MEDICAL DEVICES THAT MOVE BLOOD TOWARDS THE HEART DURING DIASTOLE, IN CLASS 10 (U.S. CLS. 26, 39 AND 44).

SN 76-672,806, FILED 2-16-2007.

FIRST USE 6-30-2007; IN COMMERCE 6-30-2007.

ALLISON SCHRODY, EXAMINING ATTORNEY

Int. Cl.: 9

Prior U.S. Cls.: 21, 23, 26, 36, and 38

Reg. No. 3,521,040

United States Patent and Trademark Office

Registered Oct. 21, 2008

**TRADEMARK
PRINCIPAL REGISTER**

AIMS

ZEUS SCIENTIFIC, INC. (DELAWARE CORPORATION)
200 EVANS WAY
BRANCHBURG, NJ 08876

FOR: FULLY AUTOMATED ROBOTIC WORKSTATION FOR PERFORMING CLINICAL, MEDICAL DIAGNOSTIC SAMPLE TESTING AND ASSAY PROCEDURES, IN CLASS 9 (U.S. CLS. 21, 23, 26, 36 AND 38).

FIRST USE 12-0-2006; IN COMMERCE 12-0-2006.

THE MARK CONSISTS OF STANDARD CHARACTERS WITHOUT CLAIM TO ANY PARTICULAR FONT, STYLE, SIZE, OR COLOR.

THE WORDING "AIMS" HAS NO MEANING IN A FOREIGN LANGUAGE.

SN 76-672,904, FILED 2-21-2007.

HEATHER BIDDULPH, EXAMINING ATTORNEY

Int. Cl.: 10

Prior U.S. Cls.: 26, 39, and 44

United States Patent and Trademark Office

Reg. No. 3,521,041

Registered Oct. 21, 2008

**TRADEMARK
PRINCIPAL REGISTER**

OMNI 2

CHAD THERAPEUTICS, INC. (CALIFORNIA
CORPORATION)
21622 PLUMMER STREET
CHATSWORTH, CA 91311

FOR: OXYGEN CONCENTRATORS FOR MEDI-
CAL APPLICATIONS WITH CYLINDER FILLING
CAPABILITY, IN CLASS 10 (U.S. CLS. 26, 39 AND 44).

FIRST USE 11-14-2007; IN COMMERCE 11-14-2007.

THE MARK CONSISTS OF STANDARD CHAR-
ACTERS WITHOUT CLAIM TO ANY PARTICULAR
FONT, STYLE, SIZE, OR COLOR.

SN 76-673,219, FILED 2-26-2007.

JACQUELINE A. LAVINE, EXAMINING ATTOR-
NEY

Int. Cl.: 7

Prior U.S. Cls.: 13, 19, 21, 23, 31, 34, and 35

United States Patent and Trademark Office

Reg. No. 3,521,042

Registered Oct. 21, 2008

**TRADEMARK
PRINCIPAL REGISTER**

ROBOBLOC

NATIONAL INSTRUMENT, LLC (MARYLAND
LIMITED LIABILITY COMPANY)
4119-27 FORDLEIGH ROAD
BALTIMORE, MD 21215

FOR: FILL-AND-CLOSE MACHINES FOR GLASS
OR PLASTIC VIALS OR CONTAINERS OF LIQUID
COMPRISING SERVO MOTOR-CONTROLLED
FILLING AND CLOSING PROCESSES , IN CLASS 7
(U.S. CLS. 13, 19, 21, 23, 31, 34 AND 35).

FIRST USE 8-15-2008; IN COMMERCE 8-15-2008.

THE MARK CONSISTS OF STANDARD CHAR-
ACTERS WITHOUT CLAIM TO ANY PARTICULAR
FONT, STYLE, SIZE, OR COLOR.

SN 76-673,257, FILED 2-27-2007.

JILL C. ALT, EXAMINING ATTORNEY

Int. Cl.: 9

Prior U.S. Cls.: 21, 23, 26, 36, and 38

United States Patent and Trademark Office

Reg. No. 3,521,043

Registered Oct. 21, 2008

**TRADEMARK
PRINCIPAL REGISTER**

FOXFIRE

VITEX LLC (NEW JERSEY LIMITED LIABILITY
COMPANY)
40 GALESI DR STE 20
WAYNE, NJ 07470

FOR: HDMI CABLES, NAMELY, ELECTRICAL
SIGNAL TRANSMITTING CABLES, IN CLASS 9
(U.S. CLS. 21, 23, 26, 36 AND 38).

FIRST USE 10-1-2007; IN COMMERCE 1-1-2008.

THE MARK CONSISTS OF STANDARD CHAR-
ACTERS WITHOUT CLAIM TO ANY PARTICULAR
FONT, STYLE, SIZE, OR COLOR.

SN 76-674,221, FILED 3-19-2007.

WILLIAM BRECKENFELD, EXAMINING ATTOR-
NEY

Int. Cl.: 11

Prior U.S. Cls.: 13, 21, 23, 31, and 34

United States Patent and Trademark Office

Reg. No. 3,521,044

Registered Oct. 21, 2008

TRADEMARK
PRINCIPAL REGISTER



WILLIAMS FURNACE COMPANY (DELAWARE CORPORATION)
250 W. LAUREL STREET
COLTON, CA 92324

FOR: RESIDENTIAL AND COMMERCIAL DEHUMIDIFIERS, IN CLASS 11 (U.S. CLS. 13, 21, 23, 31 AND 34).

FIRST USE 2-22-2007; IN COMMERCE 5-9-2007.

NO CLAIM IS MADE TO THE EXCLUSIVE RIGHT TO USE "SPACE DEHUMIDIFIER", APART FROM THE MARK AS SHOWN.

THE COLOR(S) BLACK, BLUE, YELLOW-GOLD, AND WHITE IS/ARE CLAIMED AS A FEATURE OF THE MARK.

THE COLOR BLACK FORMS A ROOF AND SIDE WALLS OF A STRUCTURE OVER A YELLOW-GOLD SPONGE CONTAINING WHITE, UNEVEN HOLES; THE YELLOW-GOLD SPONGE CONTAINS LETTERS SPELLING "AIR" IN BLUE WITH A WHITE BORDER AND THE LETTERS "SPONGE" IN BLACK WITH A WHITE BORDER; THREE BLUE WATER DROPLETS [THE MIDDLE ONE LARGER THAN THE OTHER TWO] ARE UNDER THE BLACK ROOF; EACH WATER DROPLET CONTAINS A WHITE FIGURE; THE BLACK RECTANGULAR FOUNDATION CONTAINS THE YELLOW-GOLD WORDS "TOTAL SPACE DEHUMIDIFIER".

SN 76-674,618, FILED 3-26-2007.

GILBERT SWIFT, EXAMINING ATTORNEY

Int. Cl.: 29

Prior U.S. Cl.: 46

United States Patent and Trademark Office

Reg. No. 3,521,045

Registered Oct. 21, 2008

**TRADEMARK
PRINCIPAL REGISTER**

MEAT WITHOUT FEET

GURRERA, JOSEPH R. (UNITED STATES INDIVIDUAL)
2135 BROADWAY
NEW YORK, NY 10023

THE MARK CONSISTS OF STANDARD CHARACTERS WITHOUT CLAIM TO ANY PARTICULAR FONT, STYLE, SIZE, OR COLOR.

FOR: SEAFOOD, IN CLASS 29 (U.S. CL. 46).

SN 76-675,281, FILED 4-10-2007.

FIRST USE 5-14-2007; IN COMMERCE 5-14-2007.

DAVID I, EXAMINING ATTORNEY

Int. Cl.: 41

Prior U.S. Cls.: 100, 101, and 107

United States Patent and Trademark Office

Reg. No. 3,521,046

Registered Oct. 21, 2008

**SERVICE MARK
PRINCIPAL REGISTER**

LED ZEPPELIN - THE RIDE

C+P EIGHTY SIX, LTD. (UNITED KINGDOM
LIMITED COMPANY)
91 TABERNACLE STREET
LONDON EC2A 4JN, ENGLAND

FOR: ENTERTAINMENT SERVICES, NAMELY,
AN AMUSEMENT PARK RIDE, IN CLASS 41 (U.S.
CLS. 100, 101 AND 107).

FIRST USE 12-16-2007; IN COMMERCE 12-16-2007.

THE MARK CONSISTS OF STANDARD CHAR-
ACTERS WITHOUT CLAIM TO ANY PARTICULAR
FONT, STYLE, SIZE, OR COLOR.

NO CLAIM IS MADE TO THE EXCLUSIVE
RIGHT TO USE "RIDE", APART FROM THE MARK
AS SHOWN.

SN 76-675,498, FILED 4-13-2007.

GINA FINK, EXAMINING ATTORNEY

Int. Cl.: 25

Prior U.S. Cls.: 22 and 39

United States Patent and Trademark Office

Reg. No. 3,521,047

Registered Oct. 21, 2008

**TRADEMARK
PRINCIPAL REGISTER**

LED ZEPPELIN - THE RIDE

C+P EIGHTY SIX, LTD. (UNITED KINGDOM
LIMITED COMPANY)
91 TABERNACLE STREET
LONDON EC2A 4JN, ENGLAND

THE MARK CONSISTS OF STANDARD CHAR-
ACTERS WITHOUT CLAIM TO ANY PARTICULAR
FONT, STYLE, SIZE, OR COLOR.

FOR: CLOTHING, NAMELY, T-SHIRTS, POLO
SHIRTS, SWEATSHIRTS, CAPS, HATS, FOOTWEAR
AND JACKETS, IN CLASS 25 (U.S. CLS. 22 AND 39).

SN 76-675,499, FILED 4-13-2007.

FIRST USE 3-14-2008; IN COMMERCE 3-14-2008.

GINA FINK, EXAMINING ATTORNEY

Int. Cl.: 9

Prior U.S. Cls.: 21, 23, 26, 36, and 38

Reg. No. 3,521,048

United States Patent and Trademark Office

Registered Oct. 21, 2008

**TRADEMARK
PRINCIPAL REGISTER**

PARIPROBE

PARICON TECHNOLOGIES CORPORATION
(MASSACHUSETTS CORPORATION)
421 CURRANT ROAD
FALL RIVER, MA 02720

THE MARK CONSISTS OF STANDARD CHARACTERS WITHOUT CLAIM TO ANY PARTICULAR FONT, STYLE, SIZE, OR COLOR.

FOR: CONFORMABLE INTERCONNECTION DEVICES FOR USE BETWEEN ONE OR MORE ELECTRICAL COMPONENTS, NAMELY, CIRCUIT BOARDS, COMPUTER CHIPS, LAND GRID ARRAYS, BALL GRID ARRAYS, FLEX CIRCUITS AND HEAT SINKS, IN CLASS 9 (U.S. CLS. 21, 23, 26, 36 AND 38).

OWNER OF U.S. REG. NOS. 2,443,992, 2,528,224, AND 2,530,457.

SN 76-675,653, FILED 4-18-2007.

FIRST USE 3-10-2008; IN COMMERCE 3-10-2008.

ERNEST SHOSHO, EXAMINING ATTORNEY

Int. Cl.: 41

Prior U.S. Cls.: 100, 101, and 107

United States Patent and Trademark Office

Reg. No. 3,521,049

Registered Oct. 21, 2008

**SERVICE MARK
PRINCIPAL REGISTER**

NIGHTS IN WHITE SATIN THE TRIP

ESSEX MUSIC, INC. (NEW YORK CORPORATION)
266 WEST 37TH STREET, 17TH FLOOR
NEW YORK, NY 10018

THE MARK CONSISTS OF STANDARD CHARACTERS WITHOUT CLAIM TO ANY PARTICULAR FONT, STYLE, SIZE, OR COLOR.

FOR: ENTERTAINMENT SERVICES, NAMELY, AN AMUSEMENT PARK RIDE, IN CLASS 41 (U.S. CLS. 100, 101 AND 107).

SN 76-675,669, FILED 4-18-2007.

FIRST USE 10-31-2007; IN COMMERCE 10-31-2007.

GIANCARLO CASTRO, EXAMINING ATTORNEY

Int. Cl.: 16

Prior U.S. Cls.: 2, 5, 22, 23, 29, 37, 38, and 50

United States Patent and Trademark Office

Reg. No. 3,521,050

Registered Oct. 21, 2008

**TRADEMARK
PRINCIPAL REGISTER**



E-MED INTERNATIONAL (MISSOURI NON-
PROFIT CORPORATION)
210 FABRICATOR DRIVE
FENTON, MO 63026

NO CLAIM IS MADE TO THE EXCLUSIVE
RIGHT TO USE "INC", APART FROM THE MARK
AS SHOWN.

FOR: PRINTED CARDS CONTAINING MEDICAL
INFORMATION, NOT ELECTRONICALLY ENCO-
DED, IN CLASS 16 (U.S. CLS. 2, 5, 22, 23, 29, 37, 38
AND 50).

SN 76-676,006, FILED 4-26-2007.

FIRST USE 7-0-2004; IN COMMERCE 7-0-2004.

HENRY S. ZAK, EXAMINING ATTORNEY

Int. Cl.: 9

Prior U.S. Cls.: 21, 23, 26, 36, and 38

United States Patent and Trademark Office

Reg. No. 3,521,051

Registered Oct. 21, 2008

**TRADEMARK
PRINCIPAL REGISTER**



HUSKY CORPORATION (MISSOURI CORPORATION)
2325 HUSKY WAY
PACIFIC, MO 63069

THE MARK CONSISTS OF STANDARD CHARACTERS WITHOUT CLAIM TO ANY PARTICULAR FONT, STYLE, SIZE, OR COLOR.

FOR: AUTOMATIC LIQUID DISPENSING NOZZLES, IN CLASS 9 (U.S. CLS. 21, 23, 26, 36 AND 38).

SN 76-676,484, FILED 5-7-2007.

FIRST USE 0-0-1986; IN COMMERCE 0-0-1987.

KAREN K. BUSH, EXAMINING ATTORNEY

Int. Cl.: 12

Prior U.S. Cls.: 19, 21, 23, 31, 35, and 44

Reg. No. 3,521,052

United States Patent and Trademark Office

Registered Oct. 21, 2008

**TRADEMARK
PRINCIPAL REGISTER**

PATRIOT

TURNING POINT PROPELLERS, INC. (ILLINOIS
CORPORATION)
896 CAMBRIDGE DRIVE
ELK GROVE VILLAGE, IL 60007

FIRST USE 12-31-2007; IN COMMERCE 12-31-2007.

SN 76-676,954, FILED 5-16-2007.

FOR: MARINE PROPELLERS, IN CLASS 12 (U.S.
CLS. 19, 21, 23, 31, 35 AND 44).

CAROLYN GRAY, EXAMINING ATTORNEY

Int. Cl.: 1

Prior U.S. Cls.: 1, 5, 6, 10, 26, and 46

Reg. No. 3,521,053

United States Patent and Trademark Office

Registered Oct. 21, 2008

**TRADEMARK
PRINCIPAL REGISTER**

THERMO-FOAM

THERMO-TECHNOLOGIES, LLC (NORTH DAKOTA LIMITED LIABILITY COMPANY)
400 EAST BROADWAY, SUITE 50
BISMARCK, ND 58501

THE MARK CONSISTS OF STANDARD CHARACTERS WITHOUT CLAIM TO ANY PARTICULAR FONT, STYLE, SIZE, OR COLOR.

FOR: WATER BASED SURFACTANT-CONTAINING FIRE-FIGHTING FOAM CONCENTRATE SOLUTION FOR FIRE FIGHTING AND FIRE PROTECTION, IN CLASS 1 (U.S. CLS. 1, 5, 6, 10, 26 AND 46).

OWNER OF U.S. REG. NO. 2,366,275.

SN 76-677,697, FILED 6-1-2007.

FIRST USE 8-20-2007; IN COMMERCE 5-5-2008.

MORGAN WYNNE, EXAMINING ATTORNEY

Int. Cl.: 8

Prior U.S. Cls.: 23, 28, and 44

Reg. No. 3,521,054

United States Patent and Trademark Office

Registered Oct. 21, 2008

**TRADEMARK
PRINCIPAL REGISTER**

DEADLOC

AWI ACQUISITION COMPANY (CALIFORNIA CORPORATION), DBA ALLIED INTERNATIONAL, INC.,
13207 BRADLEY AVE.
SYLMAR, CA 91342

THE MARK CONSISTS OF STANDARD CHARACTERS WITHOUT CLAIM TO ANY PARTICULAR FONT, STYLE, SIZE, OR COLOR.

FOR: HAND TOOLS, NAMELY, LOCKABLE RATCHETS, IN CLASS 8 (U.S. CLS. 23, 28 AND 44).

SN 76-677,909, FILED 6-7-2007.

FIRST USE 3-17-2008; IN COMMERCE 3-17-2008.

LOURDES AYALA, EXAMINING ATTORNEY

Int. Cl.: 30

Prior U.S. Cl.: 46

United States Patent and Trademark Office

Reg. No. 3,521,055

Registered Oct. 21, 2008

**TRADEMARK
PRINCIPAL REGISTER**

NIGHT SHIFT

MARKETRIGHT, INC. (ILLINOIS CORPORATION)
11478 RIVER ROAD
PLANO, IL 60545

THE MARK CONSISTS OF STANDARD CHARACTERS WITHOUT CLAIM TO ANY PARTICULAR FONT, STYLE, SIZE, OR COLOR.

FOR: CAFFEINE CHEWING GUM, IN CLASS 30
(U.S. CL. 46).

SN 76-678,200, FILED 6-14-2007.

FIRST USE 4-17-2008; IN COMMERCE 4-17-2008.

SUSAN LESLIE DUBOIS, EXAMINING ATTORNEY

Int. Cl.: 30

Prior U.S. Cl.: 46

United States Patent and Trademark Office

Reg. No. 3,521,056

Registered Oct. 21, 2008

**TRADEMARK
PRINCIPAL REGISTER**

DRIVE SAFE

MARKETRIGHT, INC. (ILLINOIS CORPORATION)
11478 RIVER ROAD
PLANO, IL 60545

THE MARK CONSISTS OF STANDARD CHARACTERS WITHOUT CLAIM TO ANY PARTICULAR FONT, STYLE, SIZE, OR COLOR.

FOR: CAFFEINE CHEWING GUM, IN CLASS 30
(U.S. CL. 46).

SN 76-678,201, FILED 6-14-2007.

FIRST USE 4-17-2008; IN COMMERCE 4-17-2008.

SUSAN LESLIE DUBOIS, EXAMINING ATTORNEY

Int. Cl.: 20

Prior U.S. Cls.: 2, 13, 22, 25, 32, and 50

Reg. No. 3,521,057

United States Patent and Trademark Office

Registered Oct. 21, 2008

**TRADEMARK
PRINCIPAL REGISTER**

ELEMENTS

AWI LICENSING COMPANY (DELAWARE COR-
PORATION)
802 WEST STREET
WILMINGTON, DE 19801

THE MARK CONSISTS OF STANDARD CHAR-
ACTERS WITHOUT CLAIM TO ANY PARTICULAR
FONT, STYLE, SIZE, OR COLOR.

FOR: KITCHEN CABINETS, IN CLASS 20 (U.S.
CLS. 2, 13, 22, 25, 32 AND 50).

SN 76-678,618, FILED 6-22-2007.

FIRST USE 5-8-2007; IN COMMERCE 5-8-2007.

IRA J. GOODSaid, EXAMINING ATTORNEY

Int. Cl.: 10

Prior U.S. Cls.: 26, 39, and 44

United States Patent and Trademark Office

Reg. No. 3,521,058

Registered Oct. 21, 2008

**TRADEMARK
PRINCIPAL REGISTER**

PORTRAIT PLASMA

RHYTEC, INC. (DELAWARE CORPORATION)
130 TURNER STREET, BLDG. 2
WALTHAM, MA 02453

OWNER OF U.S. REG. NO. 3,096,845.

FOR: PULSED PLASMA ENERGY DELIVERY
DEVICE FOR SKIN TREATMENT, IN CLASS 10
(U.S. CLS. 26, 39 AND 44).

NO CLAIM IS MADE TO THE EXCLUSIVE
RIGHT TO USE "PLASMA", APART FROM THE
MARK AS SHOWN.

FIRST USE 9-1-2008; IN COMMERCE 9-1-2008.

SN 76-678,642, FILED 6-25-2007.

THE MARK CONSISTS OF STANDARD CHAR-
ACTERS WITHOUT CLAIM TO ANY PARTICULAR
FONT, STYLE, SIZE, OR COLOR.

JIM RINGLE, EXAMINING ATTORNEY

Int. Cl.: 30

Prior U.S. Cl.: 46

United States Patent and Trademark Office

Reg. No. 3,521,059

Registered Oct. 21, 2008

**TRADEMARK
PRINCIPAL REGISTER**

MuscleUp

CALLOWAY, DONNA C. (UNITED STATES IN-
DIVIDUAL)
2 QUEENSBRIDGE COURT
APT. K
COCKEYSVILLE, MD 21030

THE MARK CONSISTS OF STANDARD CHAR-
ACTERS WITHOUT CLAIM TO ANY PARTICULAR
FONT, STYLE, SIZE, OR COLOR.

FOR: ICE CREAM, IN CLASS 30 (U.S. CL. 46).

SN 76-678,671, FILED 6-25-2007.

FIRST USE 9-1-2006; IN COMMERCE 8-21-2008.

LESLEY LAMOTHE, EXAMINING ATTORNEY

Int. Cl.: 29

Prior U.S. Cl.: 46

United States Patent and Trademark Office

Reg. No. 3,521,060

Registered Oct. 21, 2008

**TRADEMARK
PRINCIPAL REGISTER**

MR. CALAMARI

ARGENTO FOOD CORPORATION (NEW YORK
CORPORATION)
1501 64TH STREET
BROOKLYN, NY 11219

THE MARK CONSISTS OF STANDARD CHAR-
ACTERS WITHOUT CLAIM TO ANY PARTICULAR
FONT, STYLE, SIZE, OR COLOR.

FOR: FROZEN SQUID, IN CLASS 29 (U.S. CL. 46).

SN 76-678,696, FILED 6-25-2007.

FIRST USE 8-1-2007; IN COMMERCE 8-1-2007.

DAVID MILLER, EXAMINING ATTORNEY

Int. Cl.: 45

Prior U.S. Cls.: 100 and 101

United States Patent and Trademark Office

Reg. No. 3,521,061

Registered Oct. 21, 2008

**SERVICE MARK
PRINCIPAL REGISTER**

EDIBLE BIBLE

EMMANUEL-KING, ROSALBA (UNITED STATES INDIVIDUAL)
114 HILLCREST TERRACE
STATEN ISLAND, NY 10305

FOR: MINISTERIAL EVANGELICAL SERVICES AND PREACHING, IN CLASS 45 (U.S. CLS. 100 AND 101).

FIRST USE 2-7-2006; IN COMMERCE 2-7-2006.

THE MARK CONSISTS OF STANDARD CHARACTERS WITHOUT CLAIM TO ANY PARTICULAR FONT, STYLE, SIZE, OR COLOR.

NO CLAIM IS MADE TO THE EXCLUSIVE RIGHT TO USE "BIBLE", APART FROM THE MARK AS SHOWN.

SN 76-678,766, FILED 6-27-2007.

KATHY DE JONGE, EXAMINING ATTORNEY

Int. Cl.: 9

Prior U.S. Cls.: 21, 23, 26, 36, and 38

Reg. No. 3,521,062

United States Patent and Trademark Office

Registered Oct. 21, 2008

**TRADEMARK
PRINCIPAL REGISTER**

SPECTROVIS

VERNIER SOFTWARE & TECHNOLOGY LLC
(OREGON LIMITED LIABILITY COMPANY)
13979 SW MILLIKAN WAY
BEAVERTON, OR 97005

THE MARK CONSISTS OF STANDARD CHARACTERS WITHOUT CLAIM TO ANY PARTICULAR FONT, STYLE, SIZE, OR COLOR.

FOR: LIGHT MEASURING DEVICES FOR USE IN ELEMENTARY, JUNIOR HIGH, HIGH SCHOOL, AND COLLEGE LABORATORIES, IN CLASS 9 (U.S. CLS. 21, 23, 26, 36 AND 38).

SN 76-678,891, FILED 6-29-2007.

FIRST USE 1-5-2008; IN COMMERCE 3-18-2008.

NORA BUCHANAN WILL, EXAMINING ATTORNEY

Int. Cl.: 3

Prior U.S. Cls.: 1, 4, 6, 50, 51, and 52

Reg. No. 3,521,063

United States Patent and Trademark Office

Registered Oct. 21, 2008

**TRADEMARK
PRINCIPAL REGISTER**

THE SHOWER OF POWER

INTIMATE GROOMING ESCENSUALS, LTD.
(DELAWARE CORPORATION)
516 BEIRUT AVENUE
PACIFIC PALISADES, CA 90272

FIRST USE 5-12-2008; IN COMMERCE 5-12-2008.

FOR: NON-MEDICATED FEMININE HYGIENE PRODUCTS, NAMELY, CLEANSING AND SOOTHING CONCENTRATES, AND FEMININE HYGIENE KITS COMPRISED OF INDIVIDUAL PACKETS OF CLEANSING AND SOOTHING CONCENTRATES AND A DISPENSER FOR CONTAINING AND DISPENSING CLEANING AND SOOTHING SOLUTIONS, IN CLASS 3 (U.S. CLS. 1, 4, 6, 50, 51 AND 52).

THE MARK CONSISTS OF STANDARD CHARACTERS WITHOUT CLAIM TO ANY PARTICULAR FONT, STYLE, SIZE, OR COLOR.

SN 76-679,123, FILED 7-5-2007.

ELISSA GARBER KON, EXAMINING ATTORNEY

Int. Cls.: 9, 41, and 42

Prior U.S. Cls.: 21, 23, 26, 36, 38, 100, 101, and 107

United States Patent and Trademark Office

Reg. No. 3,521,064

Registered Oct. 21, 2008

**TRADEMARK
SERVICE MARK
PRINCIPAL REGISTER**

WINDCHILL MPMLINK

PARAMETRIC TECHNOLOGY CORPORATION
(MASSACHUSETTS CORPORATION)
140 KENDRICK STREET
NEEDHAM, MA 024942714

FOR: COMPUTER SOFTWARE FOR COMPUTER AIDED DESIGN, COMPUTER AIDED MANUFACTURING, COMPUTER AIDED ENGINEERING AND ELECTRONIC DESIGN AUTOMATION; COMPUTER SOFTWARE FOR ENTERPRISE-WIDE DEFINITION, VISUALIZATION AND MANAGEMENT OF MANUFACTURING PROCESSES, BILLS OF MATERIALS, WORK INSTRUCTIONS, MANUFACTURING RESOURCES, AND PROCESS PLANS; COMPUTER SOFTWARE FOR ASSOCIATIVE DEFINITION, MANAGEMENT, COMPARISON AND AUTOMATION OF ENGINEERING BILLS OF MATERIALS AND MANUFACTURING BILLS OF MATERIALS, AS WELL AS OTHER MANUFACTURING INFORMATION, RESOURCES AND STANDARDS; COMPUTER SOFTWARE FOR WORKFLOWS, SHARED WORKSPACES AND PRODUCTION PROCESSES FOR THE PURPOSES OF PRODUCT AND MANUFACTURING PLAN CREATION, CONTROL, COLLABORATION, CHANGE AND CONFIGURATION MANAGEMENT; COMPUTER SOFTWARE FOR DYNAMIC GENERATION OF VISUAL WORK INSTRUCTIONS USED BY PLANT/FACILITY OPERATORS; AND COMPUTER SOFTWARE FOR USE IN SOFTWARE DEVELOPMENT; ALONG WITH USER GUIDES SOLD WITH SUCH SOFTWARE AS A UNIT, IN CLASS 9 (U.S. CLS. 21, 23, 26, 36 AND 38).

FIRST USE 9-0-2007; IN COMMERCE 9-0-2007.

FOR: COMPUTER EDUCATION TRAINING SERVICES, IN CLASS 41 (U.S. CLS. 100, 101 AND 107).

FIRST USE 2-0-2008; IN COMMERCE 2-0-2008.

FOR: TECHNICAL SUPPORT SERVICES, NAMELY, TROUBLESHOOTING OF COMPUTER SOFTWARE PROBLEMS VIA TELEPHONE; UPDATING OF COMPUTER SOFTWARE FOR OTHERS; MAINTENANCE OF COMPUTER SOFTWARE, NAMELY, ERROR CORRECTION SERVICES FOR COMPUTER SOFTWARE; CONSULTATION AND SOFTWARE IMPLEMENTATION SERVICES; AND PRODUCT DEVELOPMENT FOR OTHERS, IN CLASS 42 (U.S. CLS. 100 AND 101).

FIRST USE 9-0-2007; IN COMMERCE 9-0-2007.

THE MARK CONSISTS OF STANDARD CHARACTERS WITHOUT CLAIM TO ANY PARTICULAR FONT, STYLE, SIZE, OR COLOR.

OWNER OF U.S. REG. NOS. 2,267,669 AND 3,074,792.

SN 76-679,350, FILED 7-10-2007.

DORITT L. CARROLL, EXAMINING ATTORNEY

Int. Cl.: 41

Prior U.S. Cls.: 100, 101, and 107

United States Patent and Trademark Office

Reg. No. 3,521,065

Registered Oct. 21, 2008

**SERVICE MARK
PRINCIPAL REGISTER**

BASE 9

RIES, SHANE (UNITED STATES INDIVIDUAL)
22324 GOLDEN SPRINGS DRIVE
DIAMOND BAR, CA 91765

FOR: MOTION PICTURE PRODUCTION SERVICES, IN CLASS 41 (U.S. CLS. 100, 101 AND 107).

FIRST USE 5-7-2008; IN COMMERCE 5-7-2008.

THE MARK CONSISTS OF STANDARD CHARACTERS WITHOUT CLAIM TO ANY PARTICULAR FONT, STYLE, SIZE, OR COLOR.

OWNER OF U.S. REG. NO. 2,480,039.

SN 76-680,464, FILED 8-8-2007.

KRISTINA MORRIS, EXAMINING ATTORNEY

Int. Cl.: 35

Prior U.S. Cls.: 100, 101, and 102

United States Patent and Trademark Office

Reg. No. 3,521,066

Registered Oct. 21, 2008

**SERVICE MARK
PRINCIPAL REGISTER**

QGENDA

PRECISION SOFTWARE, INC. (GEORGIA CORPORATION)
1841 PEELER ROAD, SUITE C
ATLANTA, GA 30338

FOR: ONLINE INFORMATION SERVICE IN THE
FIELD OF LABOR AND STAFF SCHEDULING, IN
CLASS 35 (U.S. CLS. 100, 101 AND 102).

FIRST USE 8-8-2008; IN COMMERCE 8-8-2008.

THE MARK CONSISTS OF STANDARD CHARACTERS WITHOUT CLAIM TO ANY PARTICULAR FONT, STYLE, SIZE, OR COLOR.

SN 76-680,488, FILED 8-9-2007.

TRACY WHITTAKER-BROWN, EXAMINING ATTORNEY

Int. Cl.: 24

Prior U.S. Cls.: 42 and 50

United States Patent and Trademark Office

Reg. No. 3,521,067

Registered Oct. 21, 2008

**TRADEMARK
PRINCIPAL REGISTER**

AEROPEDIC

GLOBAL TV CONCEPTS, LTD. (FLORIDA CORPORATION)
676 S. MILITARY TRAIL
DEERFIELD BEACH, FL 33442

THE MARK CONSISTS OF STANDARD CHARACTERS WITHOUT CLAIM TO ANY PARTICULAR FONT, STYLE, SIZE, OR COLOR.

FOR: INFLATABLE MATTRESS TOPPER, IN CLASS 24 (U.S. CLS. 42 AND 50).

SN 76-681,109, FILED 8-24-2007.

FIRST USE 4-1-2008; IN COMMERCE 4-1-2008.

JILL C. ALT, EXAMINING ATTORNEY

Int. Cl.: 36

Prior U.S. Cls.: 100, 101, and 102

United States Patent and Trademark Office

Reg. No. 3,521,068

Registered Oct. 21, 2008

**SERVICE MARK
PRINCIPAL REGISTER**

THE POWER OF PERFORMANCE

TANGLEWOOD CAPITAL MANAGEMENT, INC.
(TEXAS CORPORATION)
1400 POST OAK BLVD., SUITE 550
HOUSTON, TX 77056

THE MARK CONSISTS OF STANDARD CHARACTERS WITHOUT CLAIM TO ANY PARTICULAR FONT, STYLE, SIZE, OR COLOR.

FOR: FINANCIAL INVESTMENT SERVICES IN THE FIELD OF SECURITIES, TRUSTS, INVESTMENT MANAGEMENT, AND FINANCIAL PLANNING, IN CLASS 36 (U.S. CLS. 100, 101 AND 102).

SN 76-681,196, FILED 8-27-2007.

FIRST USE 5-1-2008; IN COMMERCE 5-1-2008.

ELI HELLMAN, EXAMINING ATTORNEY

Int. Cl.: 41

Prior U.S. Cls.: 100, 101, and 107

United States Patent and Trademark Office

Reg. No. 3,521,069

Registered Oct. 21, 2008

**SERVICE MARK
PRINCIPAL REGISTER**

Phooson

MM&A PRODUCTIONS, L.L.C. (ARIZONA LIMITED LIABILITY COMPANY)
2919 E. BROADWAY, SUITE 320
TUCSON, AZ 85716

FOR: ENTERTAINMENT SERVICES, NAMELY, ORGANIZING AND OPERATING COMMUNITY FESTIVALS FEATURING A VARIETY OF ACTIVITIES, NAMELY, LIVE PERFORMANCES BY VARIOUS MUSICIANS, PRESENTATION OF RECORDED MUSIC BY VARIOUS DISC JOCKEYS, PRESENTATIONS BY VISUAL ARTISTS, DANCE TROUPES, THEATER GROUPS, AND OTHER AR-

TISTS; ART EXHIBITS, IN CLASS 41 (U.S. CLS. 100, 101 AND 107).

FIRST USE 1-1-2006; IN COMMERCE 10-16-2006.

THE MARK CONSISTS OF STANDARD CHARACTERS WITHOUT CLAIM TO ANY PARTICULAR FONT, STYLE, SIZE, OR COLOR.

SN 76-682,424, FILED 10-1-2007.

ANDREA K. NADELMAN, EXAMINING ATTORNEY

Int. Cl.: 15

Prior U.S. Cls.: 2, 21, and 36

United States Patent and Trademark Office

Reg. No. 3,521,070

Registered Oct. 21, 2008

**TRADEMARK
PRINCIPAL REGISTER**

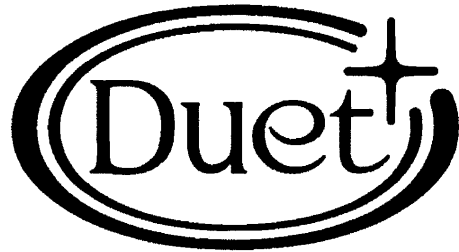

YAMAHA CORPORATION (JAPAN CORPORATION)
10-1, NAKAZAWA-CHO, NAKA-KU
HAMAMATSU-SHI, SHIZUOKA, JAPAN

FIRST USE 2-20-2008; IN COMMERCE 2-20-2008.

SN 76-682,618, FILED 10-4-2007.

FOR: MUSICAL INSTRUMENTS, NAMELY,
WIND MUSICAL INSTRUMENTS; OBOES, IN
CLASS 15 (U.S. CLS. 2, 21 AND 36).

ESTHER BELENKER, EXAMINING ATTORNEY

Int. Cls.: 3, 5, 10, and 16

Prior U.S. Cls.: 1, 2, 4, 5, 6, 18, 22, 23, 26, 29, 37, 38,
39, 44, 46, 50, 51, and 52

Reg. No. 3,521,071

United States Patent and Trademark Office

Registered Oct. 21, 2008

TRADEMARK
PRINCIPAL REGISTER



SAFEWAY INC. (DELAWARE CORPORATION)
5918 STONERIDGE MALL ROAD
PLEASANTON, CA 945882322

FOR: BABY WIPES, NON-MEDICATED TOILET
TRIES FOR BABIES AND CHILDREN, IN CLASS 3
(U.S. CLS. 1, 4, 6, 50, 51 AND 52).

FIRST USE 4-18-2008; IN COMMERCE 4-18-2008.

FOR: BABY FOOD, NURSING PADS, INFANT
FORMULA, IN CLASS 5 (U.S. CLS. 6, 18, 44, 46, 51
AND 52).

FIRST USE 4-18-2008; IN COMMERCE 4-18-2008.

FOR: BABY BOTTLES; BABY BOTTLE NIPPLES;
DISPOSABLE BABY BOTTLE LINERS; NIPPLES

FOR BABY BOTTLES, BABY PACIFIERS, CUPS,
PLATES, BOWLS AND UTENSILS, NAMELY,
FORKS AND SPOONS ADAPTED FOR FEEDING
BABIES AND CHILDREN, IN CLASS 10 (U.S. CLS. 26,
39 AND 44).

FIRST USE 4-18-2008; IN COMMERCE 4-18-2008.

FOR: DIAPERS, NAMELY, PAPER DIAPERS AND
DISPOSABLE DIAPERS, IN CLASS 16 (U.S. CLS. 2, 5,
22, 23, 29, 37, 38 AND 50).

FIRST USE 4-18-2008; IN COMMERCE 4-18-2008.

SN 76-682,753, FILED 10-9-2007.

HEATHER SAPP, EXAMINING ATTORNEY

Int. Cl.: 5

Prior U.S. Cls.: 6, 18, 44, 46, 51, and 52

United States Patent and Trademark Office

Reg. No. 3,521,072

Registered Oct. 21, 2008

**TRADEMARK
PRINCIPAL REGISTER**

CERTAINTY

WALGREEN CO. (ILLINOIS CORPORATION)
200 WILMOT ROAD
DEERFIELD, IL 60015

THE MARK CONSISTS OF STANDARD CHAR-
ACTERS WITHOUT CLAIM TO ANY PARTICULAR
FONT, STYLE, SIZE, OR COLOR.

FOR: ADULT INCONTINENCE DIAPERS, IN
CLASS 5 (U.S. CLS. 6, 18, 44, 46, 51 AND 52).

SN 76-682,830, FILED 10-11-2007.

FIRST USE 6-13-2008; IN COMMERCE 6-13-2008.

RONALD DELGIZZI, EXAMINING ATTORNEY

Int. Cl.: 3

Prior U.S. Cls.: 1, 4, 6, 50, 51, and 52

Reg. No. 3,521,073

United States Patent and Trademark Office

Registered Oct. 21, 2008

**TRADEMARK
PRINCIPAL REGISTER**

EASTSPORT

JEN USA, INC. (DELAWARE CORPORATION)
1280 JERSEY AVENUE
NORTH BRUNSWICK, NJ 08902

FOR: COLOR COSMETICS, NAMELY, LIPSTICKS, LIPSTICK LINERS, LIP GLOSS, EYELINERS, EYE SHADOWS, BLUSHERS, FACE POWDERS, FOUNDATION, MASCARAS, NAIL POLISHES, EYEBROW PENCILS; NON-MEDICATED SKIN TREATMENT PRODUCTS, NAMELY, CLEANERS, TONERS, MOISTURIZERS, EYE CREAMS, HAND AND BODY LOTIONS, BODY AND SHOWER GELS, AND FACIAL SOAP, NAIL CARE PREPARATIONS AND NAIL POLISH REMOVERS; MEN AND WOMEN'S FRAGRANCE PRODUCTS, NAMELY, COLOGNE, PERFUME, TOILET WATER, SCENTED SOAPS, BODY POWDERS, BATH OILS; SUN SCREEN PREPARATIONS; HAIR

CARE PRODUCTS, NAMELY, HAIR COLORING, HAIR BLEACHES, HAIR LIGHTENERS, HIGHLIGHTING PREPARATIONS; SHAMPOOS; CONDITIONERS, HAIR COLOR STAIN REMOVERS; HAIR GELS, MOUSSES, HAIR SPRAYS AND STYLING LOTIONS, AND HAIR CARE PREPARATIONS, NAMELY, HAIR BODY AND ROOT LIFT GELS, IN CLASS 3 (U.S. CLS. 1, 4, 6, 50, 51 AND 52).

FIRST USE 5-17-2006; IN COMMERCE 5-17-2006.

THE MARK CONSISTS OF STANDARD CHARACTERS WITHOUT CLAIM TO ANY PARTICULAR FONT, STYLE, SIZE, OR COLOR.

SN 76-682,968, FILED 10-15-2007.

ANTHONY RINKER, EXAMINING ATTORNEY

Int. Cl.: 44

Prior U.S. Cls.: 100 and 101

United States Patent and Trademark Office

Reg. No. 3,521,074

Registered Oct. 21, 2008

**SERVICE MARK
PRINCIPAL REGISTER**

HEALTHSOURCE WEIGHT LOSS SYSTEMS

HEALTHSOURCE CHIROPRACTIC, INC. (OHIO CORPORATION)
4365 LIBERTY AVENUE
VERMILION, OH 44089

FOR: CHIROPRACTIC SERVICES AND PHYSICAL THERAPY; MEDICAL AND RADIOLOGY SERVICES PERTAINING TO CHIROPRACTIC AND PHYSICAL THERAPY, IN CLASS 44 (U.S. CLS. 100 AND 101).

FIRST USE 1-15-2008; IN COMMERCE 1-15-2008.

THE MARK CONSISTS OF STANDARD CHARACTERS WITHOUT CLAIM TO ANY PARTICULAR FONT, STYLE, SIZE, OR COLOR.

NO CLAIM IS MADE TO THE EXCLUSIVE RIGHT TO USE "WEIGHT LOSS SYSTEMS", APART FROM THE MARK AS SHOWN.

SN 76-683,430, FILED 10-29-2007.

NAAKWAMA ANKRAH, EXAMINING ATTORNEY

Int. Cl.: 42

Prior U.S. Cls.: 100 and 101

United States Patent and Trademark Office

Reg. No. 3,521,075

Registered Oct. 21, 2008

**SERVICE MARK
PRINCIPAL REGISTER**

live. create. play.

LIVE. CREATE. PLAY. (MARYLAND LIMITED
LIABILITY COMPANY)
10010 ROGART ROAD
SILVER SPRING, MD 20901

THE MARK CONSISTS OF STANDARD CHAR-
ACTERS WITHOUT CLAIM TO ANY PARTICULAR
FONT, STYLE, SIZE, OR COLOR.

FOR: GRAPHIC DESIGN SERVICES IN THE
FIELDS OF BROCHURES, INVITATIONS, AND
PUBLICATIONS, IN CLASS 42 (U.S. CLS. 100 AND
101).

SN 76-683,555, FILED 11-1-2007.

FIRST USE 11-2-2007; IN COMMERCE 11-2-2007.

STEPHEN AQUILA, EXAMINING ATTORNEY

Int. Cl.: 41

Prior U.S. Cls.: 100, 101, and 107

United States Patent and Trademark Office

Reg. No. 3,521,076

Registered Oct. 21, 2008

**SERVICE MARK
PRINCIPAL REGISTER**

GLOBAL GRAD

JOSEPH, JOHN, IV (UNITED STATES INDIVIDUAL)
6171 NORTH CLUBVIEW CIRCLE
BESSEMER, AL 35022

FOR: EDUCATION SERVICES, NAMELY, PROVIDING CLASSES, SEMINARS, WORKSHOPS, TUTORING AND MENTORING IN THE FIELD OF COLLEGE PREPARATION, IN CLASS 41 (U.S. CLS. 100, 101 AND 107).

FIRST USE 3-5-2008; IN COMMERCE 3-5-2008.

THE MARK CONSISTS OF STANDARD CHARACTERS WITHOUT CLAIM TO ANY PARTICULAR FONT, STYLE, SIZE, OR COLOR.

SN 76-684,202, FILED 11-20-2007.

BRENDAN MCCAULEY, EXAMINING ATTORNEY

Int. Cl.: 24

Prior U.S. Cls.: 42 and 50

United States Patent and Trademark Office

Reg. No. 3,521,077

Registered Oct. 21, 2008

**TRADEMARK
PRINCIPAL REGISTER**

TEMP TROLL

DONOVAN INDUSTRIES, INC. (FLORIDA CORPORATION)
13401 MCCORMICK DRIVE
TAMPA, FL 336263061

FOR: WASH CLOTHS, TOWELS, IN CLASS 24
(U.S. CLS. 42 AND 50).

FIRST USE 4-2-2008; IN COMMERCE 4-2-2008.

THE MARK CONSISTS OF STANDARD CHARACTERS WITHOUT CLAIM TO ANY PARTICULAR FONT, STYLE, SIZE, OR COLOR.

SN 76-978,820, FILED 8-2-2006.

LEIGH CAROLINE CASE, EXAMINING ATTORNEY

Int. Cl.: 7

Prior U.S. Cls.: 13, 19, 21, 23, 31, 34, and 35

Reg. No. 3,521,078

United States Patent and Trademark Office

Registered Oct. 21, 2008

**TRADEMARK
PRINCIPAL REGISTER**

LEHR

LEHR INCORPORATED (NEVADA CORPORATION)
10866 WASHINGTON BLVD., SUITE 501
CULVER CITY, CA 90232

THE MARK CONSISTS OF STANDARD CHARACTERS WITHOUT CLAIM TO ANY PARTICULAR FONT, STYLE, SIZE, OR COLOR.

FOR: GAS ENGINE DRIVEN POWER TOOLS, NAMELY, STRING TRIMMERS, IN CLASS 7 (U.S. CLS. 13, 19, 21, 23, 31, 34 AND 35).

SN 76-978,863, FILED 4-16-2007.

FIRST USE 5-23-2008; IN COMMERCE 5-23-2008.

JENNIFER MARTIN, EXAMINING ATTORNEY

Int. Cl.: 4

Prior U.S. Cls.: 1, 6, and 15

United States Patent and Trademark Office

Reg. No. 3,521,079

Registered Oct. 21, 2008

**TRADEMARK
PRINCIPAL REGISTER**

A LITTLE SOMETHING WICKED

CARY, GAYLE L. (UNITED STATES INDIVIDUAL)
SUITE 109
3000 E. BIRCH ST.
BREA, CA 92821

THE MARK CONSISTS OF STANDARD CHARACTERS WITHOUT CLAIM TO ANY PARTICULAR FONT, STYLE, SIZE, OR COLOR.

FOR: SCENTED CANDLES, IN CLASS 4 (U.S. CLS. 1, 6 AND 15).

SN 77-001,095, FILED 9-16-2006.

FIRST USE 11-1-2007; IN COMMERCE 11-1-2007.

GENE MACIOL, EXAMINING ATTORNEY

Int. Cl.: 35

Prior U.S. Cls.: 100, 101, and 102

United States Patent and Trademark Office

Reg. No. 3,521,080

Registered Oct. 21, 2008

**SERVICE MARK
PRINCIPAL REGISTER**

**ADVANTUS MEDICAL
INTERNATIONAL**

BARRY JOHNSON ENTERPRISES, INC. (CALI-
FORNIA CORPORATION)
SUITE A
104 W. ANAPAMU STREET
SANTA BARBARA, CA 93101

FOR: INDEPENDENT SALES REPRESENTA-
TIVES IN THE FIELD OF REHABILITATIVE AND
SURGICAL EQUIPMENT; ON-LINE RETAIL STORE
SERVICES FEATURING REHABILITATIVE AND
SURGICAL EQUIPMENT; RETAIL SERVICES BY
DIRECT SOLICITATION BY SALES AGENTS IN
THE FIELD OF REHABILITATIVE AND SURGICAL
EQUIPMENT; RETAIL SHOPS FEATURING REHA-
BILITATIVE AND SURGICAL EQUIPMENT, IN
CLASS 35 (U.S. CLS. 100, 101 AND 102).

FIRST USE 7-14-2006; IN COMMERCE 7-14-2006.

THE MARK CONSISTS OF STANDARD CHAR-
ACTERS WITHOUT CLAIM TO ANY PARTICULAR
FONT, STYLE, SIZE, OR COLOR.

NO CLAIM IS MADE TO THE EXCLUSIVE
RIGHT TO USE "MEDICAL INTERNATIONAL",
APART FROM THE MARK AS SHOWN.

SN 77-002,101, FILED 9-19-2006.

MICHELE SWAIN, EXAMINING ATTORNEY

Int. Cl.: 28

Prior U.S. Cls.: 22, 23, 38, and 50

United States Patent and Trademark Office

Reg. No. 3,521,081

Registered Oct. 21, 2008

**TRADEMARK
PRINCIPAL REGISTER**

FAST FORTRESS

MATTEL, INC. (DELAWARE CORPORATION)
MAIL STOP M1-1518
333 CONTINENTAL BOULEVARD
EL SEGUNDO, CA 90245

THE MARK CONSISTS OF STANDARD CHAR-
ACTERS WITHOUT CLAIM TO ANY PARTICULAR
FONT, STYLE, SIZE, OR COLOR.

FOR: TOYS, GAMES AND PLAYTHINGS, NAME-
LY, TOY VEHICLES AND ACCESSORIES THERE-
FOR, IN CLASS 28 (U.S. CLS. 22, 23, 38 AND 50).

SN 77-002,148, FILED 9-19-2006.

FIRST USE 6-18-2008; IN COMMERCE 6-18-2008.

WILLIAM VERHOSEK, EXAMINING ATTORNEY

Int. Cl.: 25

Prior U.S. Cls.: 22 and 39

United States Patent and Trademark Office

Reg. No. 3,521,082

Registered Oct. 21, 2008

**TRADEMARK
PRINCIPAL REGISTER**

EV'Y FEMMA

THE COMMANDOS GROUP, INC. (CALIFORNIA
CORPORATION)
P.O. BOX 242
LA JOLLA, CA 92038

FOR: DISPOSABLE ADHESIVE-BACKED FABRIC
CLOTHING SHIELDS FOR ADHESION TO THE
INNER SURFACES OF PANTS, JEANS, SHORTS
AND OTHER CLOTHING, TO PROVIDE PROTEC-
TION TO SENSITIVE AREAS OF A WEARER'S
SKIN, IN CLASS 25 (U.S. CLS. 22 AND 39).

FIRST USE 6-30-2008; IN COMMERCE 6-30-2008.

THE MARK CONSISTS OF STANDARD CHAR-
ACTERS WITHOUT CLAIM TO ANY PARTICULAR
FONT, STYLE, SIZE, OR COLOR.

SN 77-002,262, FILED 9-19-2006.

PAUL E. FAHRENKOPF, EXAMINING ATTORNEY

Int. Cl.: 35

Prior U.S. Cls.: 100, 101, and 102

United States Patent and Trademark Office

Reg. No. 3,521,083

Registered Oct. 21, 2008

**SERVICE MARK
PRINCIPAL REGISTER**



SERVICES GROUP OF AMERICA, INC. (ORE-
GON CORPORATION)
SUITE 200
8501 E. PRINCESS DRIVE
SCOTTSDALE, AZ 85255

FOR: DISTRIBUTORSHIP SERVICES FOR FOODS
PACKAGED, MANUFACTURED, AND PREPARED

BY OTHERS, IN CLASS 35 (U.S. CLS. 100, 101 AND
102).

FIRST USE 11-17-2006; IN COMMERCE 11-17-2006.

SN 77-003,227, FILED 9-20-2006.

LINDA MICKLEBURGH, EXAMINING ATTORNEY

Int. Cl.: 11

Prior U.S. Cls.: 13, 21, 23, 31, and 34

United States Patent and Trademark Office

Reg. No. 3,521,084

Registered Oct. 21, 2008

TRADEMARK
PRINCIPAL REGISTER



PRIZER-PAINTER STOVE WORKS, INC. (PENNSYLVANIA CORPORATION)
600 ARLINGTON STREET
READING, PA 196112013

FOR: COOKING APPLIANCES, NAMELY, RANGES, OVENS, GAS STOVES, COOKTOPS AND WARMING DRAWERS FOR COMMERCIAL OR RESIDENTIAL USE AND OUTDOOR GAS GRILLS, IN CLASS 11 (U.S. CLS. 13, 21, 23, 31 AND 34).

FIRST USE 10-0-2002; IN COMMERCE 10-0-2002.

THE MARK CONSISTS OF THE UNDERLINED WORD "PRIZER".

SN 77-003,642, FILED 9-20-2006.

MORGAN WYNNE, EXAMINING ATTORNEY

Int. Cls.: 5 and 35

Prior U.S. Cls.: 6, 18, 44, 46, 51, 52, 100, 101, and 102

Reg. No. 3,521,085

United States Patent and Trademark Office

Registered Oct. 21, 2008

**TRADEMARK
SERVICE MARK
PRINCIPAL REGISTER**

ITV

ITV GLOBAL, INC. (NEVADA CORPORATION)
P.O. BOX 7014
BEVERLY, MA 01915

FOR: DIETARY SUPPLEMENTS, NUTRITIONAL SUPPLEMENTS, IN CLASS 5 (U.S. CLS. 6, 18, 44, 46, 51 AND 52).

FIRST USE 7-8-2005; IN COMMERCE 7-8-2005.

FOR: ADVERTISING AND MARKETING SERVICES FOR OTHERS, NAMELY, PRODUCTION AND DISTRIBUTION OF INFOMERCIALS, TELEVISION COMMERCIALS AND TELEVISED MARKETING PROGRAMS; ORDER PROCESSING AND FULFILLMENT SERVICES; PROVIDING CALL CENTER SERVICES FOR RECEIVING PRODUCT ORDERS

FOR OTHERS; MEDIA PLANNING AND MEDIA BUYING SERVICES; CONSULTATION SERVICES IN THE FIELDS OF MARKETING, BRAND STRATEGY, LOGO DESIGN, TRADEMARK SELECTION, AND MERCHANDISE PACKAGING; CREATING CORPORATE LOGOS FOR OTHERS, IN CLASS 35 (U.S. CLS. 100, 101 AND 102).

FIRST USE 10-1-2004; IN COMMERCE 10-1-2004.

THE MARK CONSISTS OF STANDARD CHARACTERS WITHOUT CLAIM TO ANY PARTICULAR FONT, STYLE, SIZE, OR COLOR.

SN 77-004,655, FILED 9-21-2006.

BENJAMIN ALLEN, EXAMINING ATTORNEY

Int. Cls.: 5 and 35

Prior U.S. Cls.: 6, 18, 44, 46, 51, 52, 100, 101, and 102

United States Patent and Trademark Office

Reg. No. 3,521,086

Registered Oct. 21, 2008

**TRADEMARK
SERVICE MARK
PRINCIPAL REGISTER**

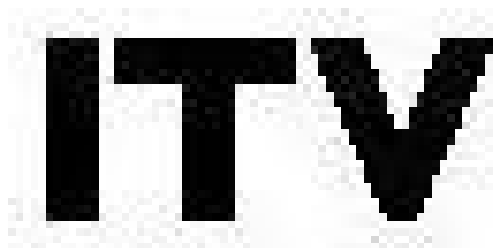

ITV GLOBAL, INC. (NEVADA CORPORATION)
P.O. BOX 7014
BEVERLY, MA 01915

FOR: DIETARY SUPPLEMENTS, NUTRITIONAL SUPPLEMENTS, IN CLASS 5 (U.S. CLS. 6, 18, 44, 46, 51 AND 52).

FIRST USE 7-8-2005; IN COMMERCE 7-8-2005.

FOR: ADVERTISING AND MARKETING SERVICES FOR OTHERS, NAMELY, PRODUCTION AND DISTRIBUTION OF INFOMERCIALS, TELEVISION COMMERCIALS AND TELEVISED MARKETING PROGRAMS; ORDER PROCESSING AND FULFILL-

MENT SERVICES; PROVIDING CALL CENTER SERVICES FOR RECEIVING PRODUCT ORDERS FOR OTHERS; MEDIA PLANNING AND MEDIA BUYING SERVICES; CONSULTATION SERVICES IN THE FIELDS OF MARKETING, BRAND STRATEGY, LOGO DESIGN, TRADEMARK SELECTION, AND MERCHANDISE PACKAGING; CREATING CORPORATE LOGOS FOR OTHERS, IN CLASS 35 (U.S. CLS. 100, 101 AND 102).

FIRST USE 10-1-2004; IN COMMERCE 10-1-2004.

SN 77-004,657, FILED 9-21-2006.

BENJAMIN ALLEN, EXAMINING ATTORNEY

Int. Cl.: 40

Prior U.S. Cls.: 100, 103, and 106

United States Patent and Trademark Office

Reg. No. 3,521,087

Registered Oct. 21, 2008

**SERVICE MARK
PRINCIPAL REGISTER**

CORTO OLIVE

CORTOPASSI PARTNERS (CALIFORNIA LIMITED PARTNERSHIP)
P.O. BOX 3951
MODESTO, CA 953523951

NO CLAIM IS MADE TO THE EXCLUSIVE RIGHT TO USE "OLIVE", APART FROM THE MARK AS SHOWN.

FOR: MANUFACTURING SERVICES FOR OTHERS IN THE FIELD OF EDIBLE OIL AND OLIVE OIL, IN CLASS 40 (U.S. CLS. 100, 103 AND 106).

THE FOREIGN WORDING IN THE MARK TRANSLATES INTO ENGLISH AS SHORT.

FIRST USE 10-25-2007; IN COMMERCE 10-25-2007.

SN 77-005,261, FILED 9-22-2006.

THE MARK CONSISTS OF STANDARD CHARACTERS WITHOUT CLAIM TO ANY PARTICULAR FONT, STYLE, SIZE, OR COLOR.

CAROLYN CATALDO, EXAMINING ATTORNEY

Int. Cl.: 9

Prior U.S. Cls.: 21, 23, 26, 36, and 38

United States Patent and Trademark Office

Reg. No. 3,521,088

Registered Oct. 21, 2008

TRADEMARK
PRINCIPAL REGISTER



A.C.E. INTERNATIONAL COMPANY, INC.
(MASSACHUSETTS CORPORATION)
85 INDEPENDENCE DRIVE
TAUNTON, MA 02780

NO CLAIM IS MADE TO THE EXCLUSIVE
RIGHT TO USE "CLEAN AIR FLOW", APART
FROM THE MARK AS SHOWN.

FOR: PERSONAL EQUIPMENT, NAMELY, HEL-
METS, HOSES AND PARTS THERETO SOLD AS A
UNIT FOR USE IN THE WELDING AND INDUS-
TRIAL INDUSTRY FOR PROTECTION OF THE
EYES, FACE, COOLING AND RESPIRATION, IN
CLASS 9 (U.S. CLS. 21, 23, 26, 36 AND 38).

THE MARK CONSISTS OF DESIGN OF A BOLD
LINE WITH AN ARROW AT THE END.

SN 77-005,411, FILED 9-22-2006.

FIRST USE 8-2-2007; IN COMMERCE 8-2-2007.

MIDGE BUTLER, EXAMINING ATTORNEY

Int. Cl.: 16

Prior U.S. Cls.: 2, 5, 22, 23, 29, 37, 38, and 50

United States Patent and Trademark Office

Reg. No. 3,521,089

Registered Oct. 21, 2008

**TRADEMARK
PRINCIPAL REGISTER**

TEA-KRAFT RIGID

LONGVIEW FIBRE PAPER AND PACKAGING,
INC. (WASHINGTON CORPORATION)
300 FIBRE WAY
LONGVIEW, WA 98632

OWNER OF U.S. REG. NOS. 2,122,441 AND
2,122,443.

FOR: EXTENSIBLE PAPER USED FOR PACKA-
GING PURPOSES, IN CLASS 16 (U.S. CLS. 2, 5, 22, 23,
29, 37, 38 AND 50).

NO CLAIM IS MADE TO THE EXCLUSIVE
RIGHT TO USE "RIGID", APART FROM THE
MARK AS SHOWN.

FIRST USE 5-8-2008; IN COMMERCE 5-8-2008.

SN 77-005,744, FILED 9-22-2006.

THE MARK CONSISTS OF STANDARD CHAR-
ACTERS WITHOUT CLAIM TO ANY PARTICULAR
FONT, STYLE, SIZE, OR COLOR.

MARIAM MAHMOUDI, EXAMINING ATTORNEY

Int. Cl.: 16

Prior U.S. Cls.: 2, 5, 22, 23, 29, 37, 38, and 50

Reg. No. 3,521,090

United States Patent and Trademark Office

Registered Oct. 21, 2008

**TRADEMARK
PRINCIPAL REGISTER**

TEA-KRAFT POROUS

LONGVIEW FIBRE PAPER AND PACKAGING,
INC. (WASHINGTON CORPORATION)
300 FIBRE WAY
LONGVIEW, WA 98632

OWNER OF U.S. REG. NOS. 2,122,441 AND
2,122,443.

FOR: EXTENSIBLE PAPER USED FOR PACKA-
GING PURPOSES, IN CLASS 16 (U.S. CLS. 2, 5, 22, 23,
29, 37, 38 AND 50).

NO CLAIM IS MADE TO THE EXCLUSIVE
RIGHT TO USE "POROUS", APART FROM THE
MARK AS SHOWN.

FIRST USE 6-6-2008; IN COMMERCE 6-6-2008.

SN 77-005,776, FILED 9-22-2006.

THE MARK CONSISTS OF STANDARD CHAR-
ACTERS WITHOUT CLAIM TO ANY PARTICULAR
FONT, STYLE, SIZE, OR COLOR.

MARIAM MAHMOUDI, EXAMINING ATTORNEY

Int. Cl.: 7

Prior U.S. Cls.: 13, 19, 21, 23, 31, 34, and 35

Reg. No. 3,521,091

United States Patent and Trademark Office

Registered Oct. 21, 2008

**TRADEMARK
PRINCIPAL REGISTER**

CarParX

HARDING STEEL, INC. (COLORADO CORPORATION)
730 17TH STREET #650
DENVER, CO 802023514

THE MARK CONSISTS OF STANDARD CHARACTERS WITHOUT CLAIM TO ANY PARTICULAR FONT, STYLE, SIZE, OR COLOR.

FOR: CAR LIFTS; ELEVATORS; ELEVATORS; POWER-OPERATED LIFTS FOR MOVING, PARKING AND STORING LAND VEHICLES, IN CLASS 7 (U.S. CLS. 13, 19, 21, 23, 31, 34 AND 35).

SN 77-006,979, FILED 9-25-2006.

FIRST USE 5-31-2008; IN COMMERCE 5-31-2008.

SHANNON TWOHIG, EXAMINING ATTORNEY

Int. Cls.: 9 and 42

Prior U.S. Cls.: 21, 23, 26, 36, 38, 100, and 101

United States Patent and Trademark Office

Reg. No. 3,521,092

Registered Oct. 21, 2008

**TRADEMARK
SERVICE MARK
PRINCIPAL REGISTER**

MAGILLEM

IFAA AND PARTNERS (DELAWARE LIMITED
LIABILITY COMPANY)
161 WEST 54TH STREET, SUITE 202A
NEW YORK, NY 10019

FOR: COMPUTER SOFTWARE DEVELOPMENT
TOOLS, IN CLASS 9 (U.S. CLS. 21, 23, 26, 36 AND 38).

FIRST USE 10-0-2004; IN COMMERCE 9-18-2007.

FOR: DESIGN OF COMPUTER HARDWARE,
INTEGRATED CIRCUITS, COMMUNICATIONS
HARDWARE AND SOFTWARE AND COMPUTER
NETWORKS FOR OTHERS; DESIGN, DEVELOP-
MENT AND IMPLEMENTATION OF SOFTWARE;

DEVELOPMENT, UPDATING AND MAINTEN-
ANCE OF SOFTWARE AND DATA BASES, IN
CLASS 42 (U.S. CLS. 100 AND 101).

FIRST USE 10-0-2004; IN COMMERCE 9-18-2007.

THE MARK CONSISTS OF STANDARD CHAR-
ACTERS WITHOUT CLAIM TO ANY PARTICULAR
FONT, STYLE, SIZE, OR COLOR.

SN 77-007,026, FILED 9-25-2006.

ROBIN CHOSID, EXAMINING ATTORNEY

Int. Cl.: 36

Prior U.S. Cls.: 100, 101, and 102

United States Patent and Trademark Office

Reg. No. 3,521,093

Registered Oct. 21, 2008

**SERVICE MARK
PRINCIPAL REGISTER**

Mercerelearning.com

MERCER HEALTH & BENEFITS LLC (DELA-
WARE LIMITED LIABILITY COMPANY)
1166 AVENUE OF THE AMERICAS
NEW YORK, NY 10036

FOR: PROVIDING AN INTERACTIVE WEBSITE
ON EMPLOYEE BENEFITS, HEALTH INSURANCE
HEALTH PLANS AND HEALTH SAVINGS AC-
COUNTS; CONSULTING AND ADMINISTRATION
SERVICES IN THE FIELD OF EMPLOYEE BENE-
FITS, HEALTH INSURANCE, HEALTH PLANS AND
HEALTH SAVINGS ACCOUNTS, IN CLASS 36 (U.S.
CLS. 100, 101 AND 102).

FIRST USE 3-25-2008; IN COMMERCE 3-25-2008.

THE MARK CONSISTS OF STANDARD CHAR-
ACTERS WITHOUT CLAIM TO ANY PARTICULAR
FONT, STYLE, SIZE, OR COLOR.

SN 77-007,324, FILED 9-26-2006.

LESLEY LAMOTHE, EXAMINING ATTORNEY

Int. Cl.: 9

Prior U.S. Cls.: 21, 23, 26, 36, and 38

United States Patent and Trademark Office

Reg. No. 3,521,094

Registered Oct. 21, 2008

**TRADEMARK
PRINCIPAL REGISTER**

HOTTRAX CHAMPIONS

GTECH RHODE ISLAND CORPORATION
(RHODE ISLAND CORPORATION)
10 MEMORIAL BOULEVARD
PROVIDENCE, RI 02903

FOR: COMPUTER GAME SOFTWARE; COMPUTER SOFTWARE FOR USE IN CONDUCTING LOTTERY GAMES WHICH RECEIVE AND DISPLAY GAME RESULTS, IN CLASS 9 (U.S. CLS. 21, 23, 26, 36 AND 38).

FIRST USE 11-19-2006; IN COMMERCE 11-19-2006.

THE MARK CONSISTS OF STANDARD CHARACTERS WITHOUT CLAIM TO ANY PARTICULAR FONT, STYLE, SIZE, OR COLOR.

OWNER OF U.S. REG. NOS. 2,582,516, 3,005,915, AND 3,005,916.

SN 77-007,328, FILED 9-26-2006.

JANICE KIM, EXAMINING ATTORNEY

Int. Cl.: 29

Prior U.S. Cl.: 46

United States Patent and Trademark Office

Reg. No. 3,521,095

Registered Oct. 21, 2008

TRADEMARK
PRINCIPAL REGISTER



LY BROTHERS CORPORATION (CALIFORNIA CORPORATION)
1963 SABRE STREET
HAYWARD, CA 94545

FOR: PROCESSED PUMPKIN SEEDS, IN CLASS 29 (U.S. CL. 46).

FIRST USE 9-1-2006; IN COMMERCE 9-1-2006.

NO CLAIM IS MADE TO THE EXCLUSIVE RIGHT TO USE "ALL NATURAL GREEN TEA

PUMPKIN SEED CRUNCHY MUNCHIES", APART FROM THE MARK AS SHOWN.

THE MARK CONSISTS OF A STYLIZED DEPICTION OF PUMPKIN SEEDS ABOVE A BANNER CONTAINING THE STYLIZED WORDS "ALL NATURAL GREEN TEA PUMPKIN SEED CRUNCHY MUNCHIES".

SN 77-007,339, FILED 9-26-2006.

LAURIE MAYES, EXAMINING ATTORNEY

Int. Cl.: 1

Prior U.S. Cls.: 1, 5, 6, 10, 26, and 46

United States Patent and Trademark Office

Reg. No. 3,521,096

Registered Oct. 21, 2008

**TRADEMARK
PRINCIPAL REGISTER**



3B GROUP LLC (DELAWARE LIMITED LIABILITY COMPANY)
4720 YENDER AVENUE
LISLE, IL 60532

FOR: FERTILIZERS, IN CLASS 1 (U.S. CLS. 1, 5, 6, 10, 26 AND 46).

FIRST USE 5-1-2008; IN COMMERCE 5-1-2008.

OWNER OF U.S. REG. NOS. 2,264,044 AND 2,876,961.

THE MARK CONSISTS OF A PICTURE OF THE STATUE OF LIBERTY WITH THE WORDS "FIELD OF DREAMS".

SN 77-007,842, FILED 9-26-2006.

CARYN GLASSER, EXAMINING ATTORNEY

Int. Cls.: 35, 36, 38, and 41

Prior U.S. Cls.: 100, 101, 102, 104, and 107

Reg. No. 3,521,097

United States Patent and Trademark Office

Registered Oct. 21, 2008

**SERVICE MARK
PRINCIPAL REGISTER**

BURILLO AZCARRAGA

BURRILLO AZCARRAGA, INC. (CALIFORNIA CORPORATION)
10900 WILSHIRE BLVD., SUITE 750
LOS ANGELES, CA 90024

FOR: PROVIDING ADVERTISING AND MARKETING SERVICES, IN CLASS 35 (U.S. CLS. 100, 101 AND 102).

FIRST USE 1-0-2007; IN COMMERCE 1-0-2007.

FOR: PROVIDING FINANCIAL SERVICES, NAMELY, INVESTMENT ADVICE AND CONSULTATION, IN CLASS 36 (U.S. CLS. 100, 101 AND 102).

FIRST USE 1-0-2007; IN COMMERCE 1-0-2007.

FOR: PROVIDING TELECOMMUNICATION SERVICES, NAMELY, LOCAL AND LONG DISTANCE TRANSMISSION OF VOICE, DATA, GRAPHICS BY MEANS OF TELEPHONE, TELEGRAPHIC, CABLE, AND SATELLITE TRANSMISSIONS; TELECOMMUNICATION ACCESS SER-

VICES; TRANSFER OF DATA BY TELECOMMUNICATIONS, IN CLASS 38 (U.S. CLS. 100, 101 AND 104).

FIRST USE 1-0-2007; IN COMMERCE 1-0-2007.

FOR: PROVIDING EDUCATIONAL AND TRAINING SERVICES, NAMELY, CONDUCTING SEMINARS IN THE FIELD OF BUSINESS OPERATION, IN CLASS 41 (U.S. CLS. 100, 101 AND 107).

FIRST USE 1-0-2007; IN COMMERCE 1-0-2007.

THE MARK CONSISTS OF STANDARD CHARACTERS WITHOUT CLAIM TO ANY PARTICULAR FONT, STYLE, SIZE, OR COLOR.

SN 77-008,725, FILED 9-27-2006.

JOHN SCHUYLER YARD, EXAMINING ATTORNEY

Int. Cl.: 9

Prior U.S. Cls.: 21, 23, 26, 36, and 38

Reg. No. 3,521,098

United States Patent and Trademark Office

Registered Oct. 21, 2008

**TRADEMARK
PRINCIPAL REGISTER**



97875 CANADA INC. (CANADA CORPORATION)
8270 MAYRAND
MONREAL, CANADA H4P2C5

FOR: COMPUTER SOFTWARE OPERATING AS A STAND ALONE COMPUTER APPLICATION OR AS A COMPUTERIZED PROCESS OPERATING WITHIN A NETWORK FOR MONITORING, ANALYZING, REPORTING DATA IN THE OPERATING SYSTEMS OF COMPUTERIZED VIDEO SYSTEMS AND ALARM SYSTEMS FOR NETWORK SECURITY, AND FOR MONITORING AND ANALYZING IMAGE QUALITY, VIDEO QUALITY, VOICE QUALITY, FACIAL RECOGNITION, VOICE RECOGNITION, STATISTICAL DATA, DATA MINING, ARCHIVAL IMAGE, INTELLIGENT APPLICATIONS AND PROCESSES, INFORMATION STORAGE, ERRORS AND FAILURES, ENVIRONMENTAL CONDITIONS, COMPUTER TAMPERING, CAMERA TAMPERING, VANDALISM, DEFACEMENT AND OBSTRUCTIONS AFFECTING THE OPERATION OF A STANDALONE

COMPUTER, COMPUTER NETWORK, COMPUTERIZED VIDEO SYSTEMS, OR ALARM SYSTEMS, AND FOR PROVIDING REMOTE DIAGNOSTICS FOR THE AFOREMENTIONED SYSTEMS, IN CLASS 9 (U.S. CLS. 21, 23, 26, 36 AND 38).

FIRST USE 2-0-2008; IN COMMERCE 2-0-2008.

NO CLAIM IS MADE TO THE EXCLUSIVE RIGHT TO USE "DIGITAL SECURITY DIAGNOSTICS", APART FROM THE MARK AS SHOWN.

THE MARK CONSISTS OF THE LETTERS "DSD" IN STYLIZED FORM WITH THE WORDS "DIGITAL SECURITY" ABOVE THE WORD "DIAGNOSTICS" ENCOMPASSED IN A RECTANGULAR BOX NEXT TO THE LETTERS "DSD".

SN 77-009,022, FILED 9-27-2006.

ANDREA BUTLER, EXAMINING ATTORNEY

Int. Cls.: 11 and 24

Prior U.S. Cls.: 13, 21, 23, 31, 34, 42, and 50

United States Patent and Trademark Office

Reg. No. 3,521,099

Registered Oct. 21, 2008

**TRADEMARK
PRINCIPAL REGISTER**

AllerGuard

ALKALINE CORPORATION (DELAWARE CORPORATION)

20 MERIDIAN RD #9

EATONTOWN, NJ 07724

FOR: AIR FILTERS FOR USE IN AIR CONDITIONING SYSTEMS, HEATING SYSTEMS, VENTILATION SYSTEMS, AND AIR CLEANING MACHINES, IN CLASS 11 (U.S. CLS. 13, 21, 23, 31 AND 34).

FIRST USE 5-0-2008; IN COMMERCE 5-0-2008.

FOR: COVERS FOR USE ON PILLOWS, MATTRESSES AND BOX SPRINGS, IN CLASS 24 (U.S. CLS. 42 AND 50).

FIRST USE 5-13-1983; IN COMMERCE 5-13-1983.

THE MARK CONSISTS OF STANDARD CHARACTERS WITHOUT CLAIM TO ANY PARTICULAR FONT, STYLE, SIZE, OR COLOR.

SN 77-011,013, FILED 9-29-2006.

JAMES MACFARLANE, EXAMINING ATTORNEY

Int. Cls.: 35 and 36

Prior U.S. Cls.: 100, 101, and 102

United States Patent and Trademark Office

Reg. No. 3,521,100

Registered Oct. 21, 2008

**SERVICE MARK
PRINCIPAL REGISTER**

FNTC AMERICA

IFG GROUP PLC (IRELAND CORPORATION)
IFG HOUSE, BOOTERSTOWN HALL
BOOTERSTOWN, DUBLIN, IRELAND

FOR: BUSINESS ADMINISTRATION SERVICES,
COMPANY RECORD KEEPING, DATABASE MAN-
AGEMENT, COMPUTERIZED REGISTER MAN-
AGEMENT, IN CLASS 35 (U.S. CLS. 100, 101 AND
102).

FIRST USE 7-30-2007; IN COMMERCE 7-30-2007.

FOR: TRUSTEE SERVICES, NAMELY, TRUSTEE-
SHIP OF REAL ESTATE PROPERTY; ADMINISTRA-
TION OF TRUSTS, IN CLASS 36 (U.S. CLS. 100, 101
AND 102).

FIRST USE 7-30-2007; IN COMMERCE 7-30-2007.

THE MARK CONSISTS OF STANDARD CHAR-
ACTERS WITHOUT CLAIM TO ANY PARTICULAR
FONT, STYLE, SIZE, OR COLOR.

NO CLAIM IS MADE TO THE EXCLUSIVE
RIGHT TO USE "AMERICA", APART FROM THE
MARK AS SHOWN.

SN 77-011,500, FILED 10-2-2006.

NATALIE POLZER, EXAMINING ATTORNEY

Int. Cl.: 36

Prior U.S. Cls.: 100, 101, and 102

United States Patent and Trademark Office

Reg. No. 3,521,101

Registered Oct. 21, 2008

**SERVICE MARK
PRINCIPAL REGISTER**

HOPE MOUNTAIN FOUNDATION

HOPE MOUNTAIN FOUNDATION, INC. (MARY-
LAND CORPORATION)
5235 WESTVIEW DRIVE
SUITE 100
FREDERICK, MD 21703

FOR: CHARITABLE FUND RAISING, IN CLASS
36 (U.S. CLS. 100, 101 AND 102).

FIRST USE 4-21-2007; IN COMMERCE 4-21-2007.

THE MARK CONSISTS OF STANDARD CHAR-
ACTERS WITHOUT CLAIM TO ANY PARTICULAR
FONT, STYLE, SIZE, OR COLOR.

NO CLAIM IS MADE TO THE EXCLUSIVE
RIGHT TO USE "FOUNDATION", APART FROM
THE MARK AS SHOWN.

SN 77-011,556, FILED 10-2-2006.

TINA BROWN, EXAMINING ATTORNEY

Int. Cl.: 44

Prior U.S. Cls.: 100 and 101

United States Patent and Trademark Office

Reg. No. 3,521,102

Registered Oct. 21, 2008

**SERVICE MARK
PRINCIPAL REGISTER**

WICKED WIFE

PIETILA, JERI M (UNITED STATES INDIVIDUAL)
4620 M-35
NEGAUNEE, MI 49866

THE MARK CONSISTS OF STANDARD CHARACTERS WITHOUT CLAIM TO ANY PARTICULAR FONT, STYLE, SIZE, OR COLOR.

FOR: TATTOOING, IN CLASS 44 (U.S. CLS. 100 AND 101).

SN 77-012,588, FILED 10-3-2006.

FIRST USE 4-30-2008; IN COMMERCE 9-2-2008.

GISELLE AGOSTO, EXAMINING ATTORNEY

Int. Cl.: 25

Prior U.S. Cls.: 22 and 39

United States Patent and Trademark Office

Reg. No. 3,521,103

Registered Oct. 21, 2008

**TRADEMARK
PRINCIPAL REGISTER**

KENSIE GIRL

WESTCOAST CONTEMPO FASHIONS LTD. (CANADA CORPORATION)

6700 SOUTHRIDGE DRIVE

BRITISH COLUMBIA, CANADA

FOR: CLOTHING, NAMELY, SHIRTS, PANTS, SWEATERS, SKIRTS, DRESSES, COATS, BELTS, SLEEPWEAR, SOCKS, HOSIERY, GLOVES, MITTENS AND SCARVES; FOOTWEAR; HEADWEAR, IN CLASS 25 (U.S. CLS. 22 AND 39).

FIRST USE 6-1-2007; IN COMMERCE 6-1-2007.

THE MARK CONSISTS OF STANDARD CHARACTERS WITHOUT CLAIM TO ANY PARTICULAR FONT, STYLE, SIZE, OR COLOR.

OWNER OF U.S. REG. NOS. 2,685,301 AND 3,062,833.

NO CLAIM IS MADE TO THE EXCLUSIVE RIGHT TO USE "GIRL", APART FROM THE MARK AS SHOWN.

SN 77-013,213, FILED 10-4-2006.

PRISCILLA MILTON, EXAMINING ATTORNEY

Int. Cl.: 16

Prior U.S. Cls.: 2, 5, 22, 23, 29, 37, 38, and 50

Reg. No. 3,521,104

United States Patent and Trademark Office

Registered Oct. 21, 2008

**TRADEMARK
PRINCIPAL REGISTER**

The logo features the word "Le Nouvelliste" in a highly stylized, gothic, blackletter font. The letters are thick and have a textured, slightly distressed appearance. The word "Le" is smaller and positioned above the "N" of "Nouvel". The overall style is reminiscent of traditional newspaper mastheads.

MIKAMAX LIMITED (BR.VIRGIN ISLANDS
CORPORATION)
1020
1000 BRICKELL AVENUE
MIAMI, FL 33131

THE ENGLISH TRANSLATION OF THE WORD
"LE NOUVELLISTE" IN THE MARK IS SHORT
STORY WRITER.

FOR: MAGAZINE IN THE FIELD OF GENERAL
INTEREST NEWS, IN CLASS 16 (U.S. CLS. 2, 5, 22, 23,
29, 37, 38 AND 50).

SN 77-013,224, FILED 10-4-2006.

FIRST USE 5-1-2006; IN COMMERCE 5-1-2006.

KAPIL BHANOT, EXAMINING ATTORNEY

Int. Cl.: 5

Prior U.S. Cls.: 6, 18, 44, 46, 51, and 52

United States Patent and Trademark Office

Reg. No. 3,521,105

Registered Oct. 21, 2008

**TRADEMARK
PRINCIPAL REGISTER**

TRIBALEAN

DALE H ENTERPRISES, INC. (PENNSYLVANIA
CORPORATION)
1224 MARKET STREET
LEWISBURG, PA 17837

THE MARK CONSISTS OF STANDARD CHAR-
ACTERS WITHOUT CLAIM TO ANY PARTICULAR
FONT, STYLE, SIZE, OR COLOR.

FOR: DIETARY AND NUTRITIONAL SUPPLE-
MENTS, IN CLASS 5 (U.S. CLS. 6, 18, 44, 46, 51 AND
52).

SN 77-014,962, FILED 10-5-2006.

FIRST USE 8-0-2007; IN COMMERCE 8-0-2007.

ALICE BENMAMAN, EXAMINING ATTORNEY

Int. Cl.: 29

Prior U.S. Cl.: 46

United States Patent and Trademark Office

Reg. No. 3,521,106

Registered Oct. 21, 2008

TRADEMARK
PRINCIPAL REGISTER

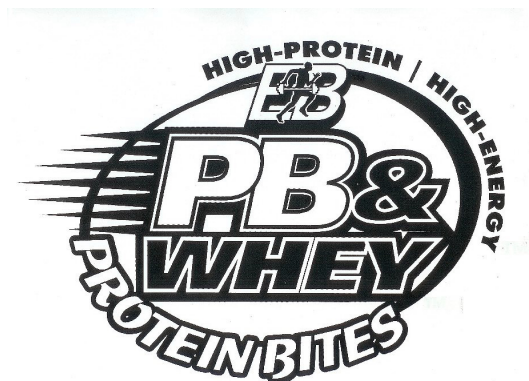

EB PERFORMANCE, LLC (FLORIDA LIMITED LIABILITY COMPANY)
SUITE 115
565 JEFFERSON DRIVE
DEERFIELD BEACH, FL 33442

FOR: PROTEIN BASED, NUTRIENT-DENSE SNACK BARS, IN CLASS 29 (U.S. CL. 46).

FIRST USE 10-0-2006; IN COMMERCE 10-0-2006.

NO CLAIM IS MADE TO THE EXCLUSIVE RIGHT TO USE "HIGH-PROTEIN HIGH-ENERGY" AND "PB & WHEY PROTEIN BITES", APART FROM THE MARK AS SHOWN.

THE MARK CONSISTS OF THE WORDING "PB & WHEY" WITH THE LETTERS "EB" (SMALLER) ON

TOP; SUPERIMPOSED OVER THE "EB" IS A PICTURE OF A RUNNER AND A BARBELL; A SEMI-CIRCLE SURROUNDS ALL THIS WORDING ON THE UPPER, RIGHT SIDE; THE WORDS "PROTEIN BITES" ARE WHERE THE LOWER, LEFT SIDE OF THE CIRCLE WOULD BE; LONG, TRIANGULAR FLAGS SHOOT OUT OF THE LETTER "P" ON THE LEFT-HAND SIDE; THE WORDS "HIGH-PROTEIN / HIGH-ENERGY" SURROUND THE OUTSIDE OF THE SEMI-CIRCLE ON THE UPPER, RIGHT SIDE; THIS IS A BLACK AND WHITE DRAWING, COLOR IS NOT BEING CLAIMED AS A FEATURE OF THE MARK.

SN 77-015,532, FILED 10-6-2006.

HEATHER SAPP, EXAMINING ATTORNEY

Int. Cl.: 1

Prior U.S. Cls.: 1, 5, 6, 10, 26, and 46

Reg. No. 3,521,107

United States Patent and Trademark Office

Registered Oct. 21, 2008

**TRADEMARK
PRINCIPAL REGISTER**

FLORATIME

THERABIOTICS, INC. (MINNESOTA CORPORATION)
8142 ORCHID ST.
VICTORIA, MN 55386

THE MARK CONSISTS OF STANDARD CHARACTERS WITHOUT CLAIM TO ANY PARTICULAR FONT, STYLE, SIZE, OR COLOR.

FOR: FOOD SUPPLEMENTS FOR PLANTS, NAMELY, PROBIOTICS FOR USE AS A NUTRITIONAL SUPPLEMENT FOR PLANTS, IN CLASS 1 (U.S. CLS. 1, 5, 6, 10, 26 AND 46).

SN 77-015,980, FILED 10-6-2006.

FIRST USE 7-31-2008; IN COMMERCE 7-31-2008.

RICHARD A. STRASER, EXAMINING ATTORNEY

Int. Cl.: 41

Prior U.S. Cls.: 100, 101, and 107

United States Patent and Trademark Office

Reg. No. 3,521,108

Registered Oct. 21, 2008

**SERVICE MARK
PRINCIPAL REGISTER**

SMARTFLIX

TECHNICAL VIDEO RENTAL, INC. (MASSACHUSETTS CORPORATION), DBA SMARTFLIX,
1315-A MASSACHUSETTS AVE.
ARLINGTON, MA 02476

THE MARK CONSISTS OF STANDARD CHARACTERS WITHOUT CLAIM TO ANY PARTICULAR FONT, STYLE, SIZE, OR COLOR.

FOR: RENTAL OF VIDEOTAPES, VIDEOCASSETTES AND VIDEOGRAMS, IN CLASS 41 (U.S. CLS. 100, 101 AND 107).

SN 77-016,102, FILED 10-6-2006.

FIRST USE 10-20-2006; IN COMMERCE 10-20-2006.

JENNIFER VASQUEZ, EXAMINING ATTORNEY

Int. Cls.: 9 and 11

Prior U.S. Cls.: 13, 21, 23, 26, 31, 34, 36, and 38

United States Patent and Trademark Office

Reg. No. 3,521,109

Registered Oct. 21, 2008

**TRADEMARK
PRINCIPAL REGISTER**



RADIANS, INC. (TENNESSEE CORPORATION)
7580 BARTLETT CORPORATE DRIVE
BARTLETT, TN 38133

FOR: PROTECTIVE EYEGLASSES, SAFETY EYE-WEAR, SAFETY GOGGLES, SAFETY HELMETS, SUNGLASSES, EAR PLUGS FOR SOUNDPROOFING, EAR PLUGS NOT FOR MEDICAL PURPOSES; PROTECTIVE WORK GLOVES, PROTECTIVE INDUSTRIAL BOOTS, REFLECTIVE SAFETY VESTS, IN CLASS 9 (U.S. CLS. 21, 23, 26, 36 AND 38).

FIRST USE 8-15-2003; IN COMMERCE 3-15-2004.

FOR: FLASHLIGHTS, IN CLASS 11 (U.S. CLS. 13, 21, 23, 31 AND 34).

FIRST USE 2-8-2008; IN COMMERCE 2-8-2008.

OWNER OF U.S. REG. NO. 3,278,543.

THE COLOR(S) RED AND BLACK IS/ARE CLAIMED AS A FEATURE OF THE MARK.

THE MARK CONSISTS OF A STYLIZED RED "R" OVER THE NAME "RADIANS" IN BLACK.

SN 77-016,143, FILED 10-6-2006.

RONALD MCMORROW, EXAMINING ATTORNEY

Int. Cl.: 36

Prior U.S. Cls.: 100, 101, and 102

United States Patent and Trademark Office

Reg. No. 3,521,110

Registered Oct. 21, 2008

**SERVICE MARK
PRINCIPAL REGISTER**

**NATIONAL COMMUNITY
RENAISSANCE**

NATIONAL COMMUNITY RENAISSANCE DEVELOPMENT CORPORATION (CALIFORNIA NON-PROFIT PUBLIC BENEFIT CORPORATION)

9065 HAVEN AVENUE, SUITE 100
RANCHO CUCAMONGA, CA 91730

FOR: MANAGEMENT OF AFFORDABLE RESIDENTIAL PROPERTIES AND COMMERCIAL PROPERTIES, IN CLASS 36 (U.S. CLS. 100, 101 AND 102).

FIRST USE 5-31-2007; IN COMMERCE 5-31-2007.

THE MARK CONSISTS OF STANDARD CHARACTERS WITHOUT CLAIM TO ANY PARTICULAR FONT, STYLE, SIZE, OR COLOR.

NO CLAIM IS MADE TO THE EXCLUSIVE RIGHT TO USE "NATIONAL", APART FROM THE MARK AS SHOWN.

SN 77-016,704, FILED 10-9-2006.

ALICE BENMAMAN, EXAMINING ATTORNEY

Int. Cl.: 41

Prior U.S. Cls.: 100, 101, and 107

United States Patent and Trademark Office

Reg. No. 3,521,111

Registered Oct. 21, 2008

**SERVICE MARK
PRINCIPAL REGISTER**

**NATIONAL COMMUNITY
RENAISSANCE**

NATIONAL COMMUNITY RENAISSANCE DEVELOPMENT CORPORATION (CALIFORNIA NON-PROFIT PUBLIC BENEFIT CORPORATION)

9065 HAVEN AVENUE, SUITE 100
RANCHO CUCAMONGA, CA 91730

FOR: EDUCATIONAL SERVICES, NAMELY, PRESCHOOL, AFTER EDUCATIONAL PROGRAMS FOR CHILDREN IN GRADES PRESCHOOL THROUGH TWELFTH GRADE, AND PROVIDING CLASSES AND WORKSHOPS FOR ADULTS IN THE FIELD OF MANAGEMENT OF PERSONAL FINANCES, IN CLASS 41 (U.S. CLS. 100, 101 AND 107).

FIRST USE 5-31-2007; IN COMMERCE 5-31-2007.

THE MARK CONSISTS OF STANDARD CHARACTERS WITHOUT CLAIM TO ANY PARTICULAR FONT, STYLE, SIZE, OR COLOR.

NO CLAIM IS MADE TO THE EXCLUSIVE RIGHT TO USE "NATIONAL", APART FROM THE MARK AS SHOWN.

SN 77-016,720, FILED 10-9-2006.

ALICE BENMAMAN, EXAMINING ATTORNEY

Int. Cl.: 41

Prior U.S. Cls.: 100, 101, and 107

United States Patent and Trademark Office

Reg. No. 3,521,112

Registered Oct. 21, 2008

**SERVICE MARK
PRINCIPAL REGISTER**

PLATINUM EXPERIENCE

AMERICAN EXPRESS MARKETING & DEVELOPMENT CORP. (DELAWARE CORPORATION)
200 VESEY STREET
NEW YORK, NY 10285

FOR: PROVIDING NEWSLETTERS IN THE FIELD OF CREDIT AND CHARGE CARD SERVICES VIA E-MAIL, IN CLASS 41 (U.S. CLS. 100, 101 AND 107).

FIRST USE 11-0-2006; IN COMMERCE 11-0-2006.

THE MARK CONSISTS OF STANDARD CHARACTERS WITHOUT CLAIM TO ANY PARTICULAR FONT, STYLE, SIZE, OR COLOR.

SN 77-017,410, FILED 10-10-2006.

KAPIL BHANOT, EXAMINING ATTORNEY

Int. Cls.: 9 and 42

Prior U.S. Cls.: 21, 23, 26, 36, 38, 100, and 101

United States Patent and Trademark Office

Reg. No. 3,521,113

Registered Oct. 21, 2008

**TRADEMARK
SERVICE MARK
PRINCIPAL REGISTER**

HYPERFACTOR

DILIGENT TECHNOLOGIES CORPORATION
(DELAWARE CORPORATION)
175 CROSSING BOULEVARD
FRAMINGHAM, MA 01702

FOR: COMPUTER SOFTWARE FOR DISK-BASED DATA PROTECTION AND STORAGE, NAMELY, COMPUTER SOFTWARE FOR IDENTIFYING AND FILTERING OUT DATA THAT HAS BEEN PREVIOUSLY STORED, IN CLASS 9 (U.S. CLS. 21, 23, 26, 36 AND 38).

FIRST USE 6-13-2005; IN COMMERCE 6-13-2005.

FOR: COMPUTER SERVICES, NAMELY, COMPUTER SOFTWARE DESIGN AND DEVELOPMENT FOR DATA SEARCHING, DATA STORAGE AND DATA REDUCTION BY IDENTIFYING AND FIL-

TERING OUT DATA THAT HAS BEEN PREVIOUSLY STORED; INCLUDING PROJECT DESIGN AND ARCHITECTURE, SYSTEM IMPLEMENTATION AND INTEGRATION OF SUCH COMPUTER SOFTWARE FOR SYSTEMS AND NETWORKS FOR OTHERS, IN CLASS 42 (U.S. CLS. 100 AND 101).

FIRST USE 6-13-2005; IN COMMERCE 6-13-2005.

THE MARK CONSISTS OF STANDARD CHARACTERS WITHOUT CLAIM TO ANY PARTICULAR FONT, STYLE, SIZE, OR COLOR.

SN 77-018,484, FILED 10-11-2006.

KATHERINE M. DUBRAY, EXAMINING ATTORNEY

Int. Cl.: 16

Prior U.S. Cls.: 2, 5, 22, 23, 29, 37, 38, and 50

Reg. No. 3,521,114

United States Patent and Trademark Office

Registered Oct. 21, 2008

**TRADEMARK
PRINCIPAL REGISTER**

Halftime Magazine

MUSE MEDIA, LLC (CALIFORNIA LIMITED
LIABILITY COMPANY)
11286 WESTMINSTER AVE. #301
LOS ANGELES, CA 90066

FOR: MAGAZINES FEATURING MARCHING
BANDS, IN CLASS 16 (U.S. CLS. 2, 5, 22, 23, 29, 37,
38 AND 50).

FIRST USE 3-12-2007; IN COMMERCE 7-0-2007.

THE MARK CONSISTS OF STANDARD CHAR-
ACTERS WITHOUT CLAIM TO ANY PARTICULAR
FONT, STYLE, SIZE, OR COLOR.

NO CLAIM IS MADE TO THE EXCLUSIVE
RIGHT TO USE "MAGAZINE", APART FROM THE
MARK AS SHOWN.

SN 77-019,308, FILED 10-12-2006.

LINDA ESTRADA, EXAMINING ATTORNEY

Int. Cls.: 9 and 16

Prior U.S. Cls.: 2, 5, 21, 22, 23, 26, 29, 36, 37, 38, and 50

United States Patent and Trademark Office

Reg. No. 3,521,115

Registered Oct. 21, 2008

**TRADEMARK
PRINCIPAL REGISTER**

MD NetGuide

INTELLISPHERE, LLC (DELAWARE LIMITED LIABILITY COMPANY)
666 PLAINSBORO ROAD - BUILDING 300
PLAINSBORO, NJ 08536

FOR: ELECTRONIC DOWNLOADABLE PUBLICATIONS, NAMELY, MAGAZINES FOR USE BY HEALTHCARE PROFESSIONALS IN THE FIELD OF MEDICINE, IN CLASS 9 (U.S. CLS. 21, 23, 26, 36 AND 38).

FIRST USE 1-1-2006; IN COMMERCE 1-1-2006.

FOR: MAGAZINES FOR HEALTHCARE PROFESSIONALS, IN CLASS 16 (U.S. CLS. 2, 5, 22, 23, 29, 37, 38 AND 50).

FIRST USE 1-1-2006; IN COMMERCE 1-1-2006.

OWNER OF U.S. REG. NOS. 2,454,261, 2,626,990, AND 2,698,957.

NO CLAIM IS MADE TO THE EXCLUSIVE RIGHT TO USE "GUIDE", APART FROM THE MARK AS SHOWN.

THE COLOR(S) MAROON, WHITE AND BLACK IS/ARE CLAIMED AS A FEATURE OF THE MARK.

THE MARK CONSISTS OF THE LETTERS "MD" IN WHITE AGAINST A MAROON BACKGROUND WITHIN THE SAME RECTANGLE AS THE WORD "NET GUIDE" PRINTED IN BLACK AGAINST A WHITE BACKGROUND.

SEC. 2(F).

SN 77-019,922, FILED 10-12-2006.

NATALIE POLZER, EXAMINING ATTORNEY

Int. Cls.: 9, 20, 24, and 27

Prior U.S. Cls.: 2, 13, 19, 20, 21, 22, 23, 25, 26, 32, 36, 37, 38, 42, and 50

Reg. No. 3,521,116

United States Patent and Trademark Office

Registered Oct. 21, 2008

**TRADEMARK
PRINCIPAL REGISTER**

EARTH FX

EARTH FX, INC. (NEVADA CORPORATION)
SUITE 20
707 E TAHQUITZ CANYON WAY
PALM SPRINGS, CA 92262

FOR: ELECTRODE PATCHES, NOT FOR MEDICAL USE, FEATURING CABLES ATTACHABLE TO A BUILDING GROUND SYSTEM OR A GROUNDED CONDUCTOR; ELECTRICAL CIRCUIT PROTECTORS FOR BUILDING GROUND SYSTEMS, IN CLASS 9 (U.S. CLS. 21, 23, 26, 36 AND 38).

FIRST USE 7-1-2008; IN COMMERCE 7-1-2008.

FOR: MATTRESSES AND CHAIRS, NOT FOR MEDICAL USE, FEATURING CABLES ATTACHABLE TO A BUILDING GROUND SYSTEM OR A GROUNDED CONDUCTOR, IN CLASS 20 (U.S. CLS. 2, 13, 22, 25, 32 AND 50).

FIRST USE 7-1-2008; IN COMMERCE 7-1-2008.

FOR: BED SHEETS AND BED PADS, NOT FOR MEDICAL USE, FEATURING CABLES ATTACHABLE TO A BUILDING GROUND SYSTEM OR A GROUNDED CONDUCTOR, IN CLASS 24 (U.S. CLS. 42 AND 50).

FIRST USE 7-1-2008; IN COMMERCE 7-1-2008.

FOR: FLOOR MATS AND CARPETS FEATURING CABLES ATTACHABLE TO A BUILDING GROUND SYSTEM OR A GROUNDED CONDUCTOR, IN CLASS 27 (U.S. CLS. 19, 20, 37, 42 AND 50).

FIRST USE 7-1-2008; IN COMMERCE 7-1-2008.

THE MARK CONSISTS OF STANDARD CHARACTERS WITHOUT CLAIM TO ANY PARTICULAR FONT, STYLE, SIZE, OR COLOR.

SN 77-019,937, FILED 10-12-2006.

ROBERT LAVACHE, EXAMINING ATTORNEY

Int. Cls.: 35 and 42

Prior U.S. Cls.: 100, 101, and 102

United States Patent and Trademark Office

Reg. No. 3,521,117

Registered Oct. 21, 2008

**SERVICE MARK
PRINCIPAL REGISTER**

SLIMBUS

MIPI ALLIANCE, INC. (DELAWARE CORPORATION)
445 HOES LANE
PISCATAWAY, NJ 08854

FOR: BUSINESS SERVICES, NAMELY, BUSINESS CONSULTING SERVICES; ASSOCIATION SERVICES, NAMELY, PROMOTING THE INTERESTS OF MOBILE COMMUNICATIONS DEVICES COMPANIES; ADVERTISING SERVICES FOR OTHERS, NAMELY, PROMOTING A STANDARD FOR AN INTERFACE BETWEEN COMPUTER CHIPS AND PERIPHERAL DEVICES, IN CLASS 35 (U.S. CLS. 100, 101 AND 102).

FIRST USE 1-0-2006; IN COMMERCE 1-0-2006.

FOR: DEVELOPING TECHNICAL SPECIFICATIONS FOR MOBILE COMMUNICATIONS DEVICES, NAMELY, A STANDARD FOR AN INTERFACE BETWEEN COMPUTER CHIPS AND PERIPHERAL DEVICES; IMPLEMENTING TECHNICAL SPECIFICATIONS FOR MOBILE COMMU-

NICATIONS DEVICES, NAMELY, A STANDARD FOR AN INTERFACE BETWEEN COMPUTER CHIPS AND PERIPHERAL DEVICES; DESIGNING TECHNICAL SPECIFICATIONS FOR MOBILE COMMUNICATIONS DEVICES, NAMELY, A STANDARD FOR AN INTERFACE BETWEEN COMPUTER CHIPS AND PERIPHERAL DEVICES; CONSULTING ON TECHNICAL SPECIFICATIONS FOR MOBILE COMMUNICATIONS DEVICES, NAMELY, A STANDARD FOR AN INTERFACE BETWEEN COMPUTER CHIPS AND PERIPHERAL DEVICES, IN CLASS 42 (U.S. CLS. 100 AND 101).

FIRST USE 1-0-2006; IN COMMERCE 1-0-2006.

THE MARK CONSISTS OF STANDARD CHARACTERS WITHOUT CLAIM TO ANY PARTICULAR FONT, STYLE, SIZE, OR COLOR.

SN 77-019,992, FILED 10-12-2006.

KAREN K. BUSH, EXAMINING ATTORNEY

Int. Cls.: 39 and 40

Prior U.S. Cls.: 100, 103, 105, and 106

United States Patent and Trademark Office

Reg. No. 3,521,118

Registered Oct. 21, 2008

**SERVICE MARK
PRINCIPAL REGISTER**



THE AES CORPORATION (DELAWARE CORPORATION)
4300 WILSON BOULEVARD
ARLINGTON, VA 22203

FOR: ELECTRICITY SUPPLY SERVICES, NAME-
LY, THE TRANSMISSION AND DISTRIBUTION OF
ELECTRICITY AND TRANSMISSION OF STEAM
FOR OTHERS, IN CLASS 39 (U.S. CLS. 100 AND 105).

FIRST USE 1-16-2007; IN COMMERCE 1-16-2007.

FOR: ELECTRICITY SUPPLY SERVICES, NAME-
LY, THE GENERATION OF ELECTRICITY AND
STEAM FOR OTHERS, IN CLASS 40 (U.S. CLS. 100,
103 AND 106).

FIRST USE 1-16-2007; IN COMMERCE 1-16-2007.

SN 77-020,373, FILED 10-13-2006.

ELIZABETH KAJUBI, EXAMINING ATTORNEY

Int. Cls.: 39 and 40

Prior U.S. Cls.: 100, 103, 105, and 106

United States Patent and Trademark Office

Reg. No. 3,521,119

Registered Oct. 21, 2008

**SERVICE MARK
PRINCIPAL REGISTER**



THE AES CORPORATION (DELAWARE CORPORATION)
4300 WILSON BOULEVARD
ARLINGTON, VA 22203

FOR: ELECTRICITY SUPPLY SERVICES, NAME-
LY, THE TRANSMISSION AND DISTRIBUTION OF
ELECTRICITY AND TRANSMISSION OF STEAM
FOR OTHERS, IN CLASS 39 (U.S. CLS. 100 AND 105).

FIRST USE 1-16-2007; IN COMMERCE 1-16-2007.

FOR: ELECTRICITY SUPPLY SERVICES, NAME-
LY, THE GENERATION OF ELECTRICITY AND

STEAM FOR OTHERS, IN CLASS 40 (U.S. CLS. 100,
103 AND 106).

FIRST USE 1-16-2007; IN COMMERCE 1-16-2007.

OWNER OF U.S. REG. NOS. 1,290,415 AND
2,682,841.

SN 77-020,377, FILED 10-13-2006.

ELIZABETH KAJUBI, EXAMINING ATTORNEY

Int. Cls.: 35 and 39

Prior U.S. Cls.: 100, 101, 102, and 105

United States Patent and Trademark Office

Reg. No. 3,521,120

Registered Oct. 21, 2008

**SERVICE MARK
PRINCIPAL REGISTER**

INCONTROL

IRON MOUNTAIN INCORPORATED (DELA-
WARE CORPORATION)
745 ATLANTIC AVENUE
BOSTON, MA 021112735

FOR: INVENTORY MANAGEMENT, COMPU-
TERIZED TRACKING AND TRACING SERVICES
FOR BUSINESS RECORDS, DOCUMENT BOXES,
FILES, COMPUTER TAPES AND OTHER PHYSICAL
ASSETS , IN CLASS 35 (U.S. CLS. 100, 101 AND 102).

FIRST USE 8-28-2006; IN COMMERCE 8-28-2006.

FOR: SECURED TRANSPORTATION OF BUSI-
NESS RECORDS, DOCUMENT BOXES, FILES,

COMPUTER TAPES AND OTHER PHYSICAL AS-
SETS BY VANS, CARS, TRUCKS AND TRACTOR
TRAILERS, IN CLASS 39 (U.S. CLS. 100 AND 105).

FIRST USE 8-28-2006; IN COMMERCE 8-28-2006.

THE MARK CONSISTS OF STANDARD CHAR-
ACTERS WITHOUT CLAIM TO ANY PARTICULAR
FONT, STYLE, SIZE, OR COLOR.

SN 77-020,688, FILED 10-13-2006.

BRENDAN MCCAULEY, EXAMINING ATTORNEY

Int. Cl.: 25

Prior U.S. Cls.: 22 and 39

United States Patent and Trademark Office

Reg. No. 3,521,121

Registered Oct. 21, 2008

**TRADEMARK
PRINCIPAL REGISTER**

Blessed to be

SOKAY & CO. LLC (TEXAS LIMITED LIABILITY
COMPANY), DBA BLESSED TO BE,
13507 QUEENSLAND
SAN ANTONIO, TX 78232

THE MARK CONSISTS OF STANDARD CHAR-
ACTERS WITHOUT CLAIM TO ANY PARTICULAR
FONT, STYLE, SIZE, OR COLOR.

FOR: SHIRTS; SHORT-SLEEVED OR LONG-
SLEEVED T-SHIRTS, IN CLASS 25 (U.S. CLS. 22
AND 39).

SN 77-020,738, FILED 10-13-2006.

FIRST USE 11-30-2006; IN COMMERCE 11-30-2006.

WANDA KAY PRICE, EXAMINING ATTORNEY

Int. Cl.: 37

Prior U.S. Cls.: 100, 103, and 106

Reg. No. 3,521,122

United States Patent and Trademark Office

Registered Oct. 21, 2008

**SERVICE MARK
PRINCIPAL REGISTER**



ARGENTUM DEVELOPMENT COMPANY, LLC
(DELAWARE LIMITED LIABILITY COMPAN-
NY)
8478 TYCO ROAD
VIENNA, VA 22182

NO CLAIM IS MADE TO THE EXCLUSIVE
RIGHT TO USE "DEVELOPMENT COMPANY
LLC", APART FROM THE MARK AS SHOWN.

FOR: REAL ESTATE DEVELOPMENT, IN CLASS
37 (U.S. CLS. 100, 103 AND 106).

SN 77-021,010, FILED 10-13-2006.

FIRST USE 2-15-2007; IN COMMERCE 2-15-2007.

JULIE WATSON, EXAMINING ATTORNEY

Int. Cl.: 18

Prior U.S. Cls.: 1, 2, 3, 22, and 41

United States Patent and Trademark Office

Reg. No. 3,521,123

Registered Oct. 21, 2008

**TRADEMARK
PRINCIPAL REGISTER**

ONEPack

MOTHER, LLC (WASHINGTON LIMITED LIABILITY COMPANY)
PO BOX 2341
GIG HARBOR, WA 98335

THE MARK CONSISTS OF STANDARD CHARACTERS WITHOUT CLAIM TO ANY PARTICULAR FONT, STYLE, SIZE, OR COLOR.

FOR: BACKPACKS; HUNTING BAGS; SPORTSMAN'S HUNTING BAGS, IN CLASS 18 (U.S. CLS. 1, 2, 3, 22 AND 41).

SN 77-021,917, FILED 10-16-2006.

FIRST USE 1-1-2008; IN COMMERCE 1-1-2008.

ROBERT LAVACHE, EXAMINING ATTORNEY

Int. Cl.: 41

Prior U.S. Cls.: 100, 101, and 107

United States Patent and Trademark Office

Reg. No. 3,521,124

Registered Oct. 21, 2008

**SERVICE MARK
PRINCIPAL REGISTER**

BOARD REVIEW EXPRESS

AMERICAN ACADEMY OF FAMILY PHYSICIANS (ILLINOIS NON-PROFIT CORPORATION)

11400 TOMAHAWK CREEK PARKWAY
LEAWOOD, KS 662112672

FOR: PREPARING, ADMINISTERING, SCORING, AND ANALYZING FOR OTHERS, TESTS IN THE NATURE OF SELF-ASSESSMENT TESTS PROVIDED IN THE MEDICAL FIELD IN PREPARATION FOR BOARD EXAMS; PROVIDING TRAINING IN SKILLS AND TECHNIQUES FOR TEST TAKING IN THE FIELD OF SELF-ASSESSMENT TESTS PROVIDED IN THE MEDICAL FIELD IN PREPARATION FOR BOARD EXAMS; AND DISTRIBUTION OF WRITTEN COURSE MATERI-

ALS IN CONNECTION THEREWITH, IN CLASS 41 (U.S. CLS. 100, 101 AND 107).

FIRST USE 11-0-2005; IN COMMERCE 11-0-2005.

THE MARK CONSISTS OF STANDARD CHARACTERS WITHOUT CLAIM TO ANY PARTICULAR FONT, STYLE, SIZE, OR COLOR.

NO CLAIM IS MADE TO THE EXCLUSIVE RIGHT TO USE "BOARD REVIEW", APART FROM THE MARK AS SHOWN.

SN 77-022,941, FILED 10-17-2006.

BARBARA A. GOLD, EXAMINING ATTORNEY

Int. Cl.: 9

Prior U.S. Cls.: 21, 23, 26, 36, and 38

United States Patent and Trademark Office

Reg. No. 3,521,125

Registered Oct. 21, 2008

**TRADEMARK
PRINCIPAL REGISTER**

Codetalker

DIGITAL PLOW PARTNERS, LLC (FLORIDA
LIMITED LIABILITY COMPANY)
5243 NW 187 STREET
MIAMI, FL 33055

FOR: COMMUNICATIONS SOFTWARE FOR
CONNECTING LANGUAGE INTERPRETERS, CLI-
ENT USERS; COMPUTER SOFTWARE FOR COM-
MUNICATING WITH USERS OF HAND-HELD
COMPUTERS; GLOBAL POSITIONING SYSTEM
(GPS) CONSISTING OF COMPUTERS, COMPUTER
SOFTWARE, TRANSMITTERS, RECEIVERS, AND

NETWORK INTERFACE DEVICES, IN CLASS 9 (U.S.
CLS. 21, 23, 26, 36 AND 38).

FIRST USE 3-11-2007; IN COMMERCE 6-7-2008.

THE MARK CONSISTS OF STANDARD CHAR-
ACTERS WITHOUT CLAIM TO ANY PARTICULAR
FONT, STYLE, SIZE, OR COLOR.

SN 77-023,067, FILED 10-17-2006.

BRENDAN REGAN, EXAMINING ATTORNEY

Int. Cl.: 12

Prior U.S. Cls.: 19, 21, 23, 31, 35, and 44

Reg. No. 3,521,126

United States Patent and Trademark Office

Registered Oct. 21, 2008

**TRADEMARK
PRINCIPAL REGISTER**

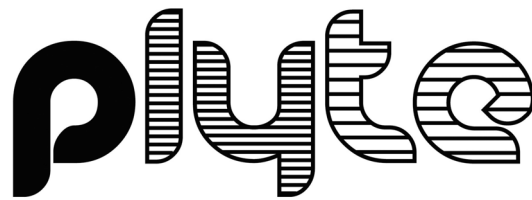

BEAR CORPORATION (CALIFORNIA COR-
PORATION)
16325 ARTHUR STREET
CERRITOS, CA 90703

FIRST USE 10-31-2006; IN COMMERCE 11-30-2006.

SN 77-023,220, FILED 10-17-2006.

FOR: BICYCLE PARTS, NAMELY, TIRES, IN
CLASS 12 (U.S. CLS. 19, 21, 23, 31, 35 AND 44).

ELIZABETH KAJUBI, EXAMINING ATTORNEY

Int. Cl.: 2

Prior U.S. Cls.: 6, 11, and 16

United States Patent and Trademark Office

Reg. No. 3,521,127

Registered Oct. 21, 2008

**TRADEMARK
PRINCIPAL REGISTER**

Monster Paint

JAMES STUART DAVIS (CALIFORNIA SOLE
PROPRIETORSHIP)
33754 ROBLES DRIVE
DANA POINT, CA 92629

FOR: CLEAR AND PIGMENTED COATINGS
USED IN THE NATURE OF PAINT; COATING
COMPOSITION IN THE NATURE OF PAINT FOR
INDUSTRIAL APPLICATIONS; EXTERIOR PAINT;
PAINT FOR CONCRETE FLOORS; PAINT FOR
INDUSTRIAL EQUIPMENT AND MACHINERY,
IN CLASS 2 (U.S. CLS. 6, 11 AND 16).

FIRST USE 8-15-2008; IN COMMERCE 8-15-2008.

THE MARK CONSISTS OF STANDARD CHAR-
ACTERS WITHOUT CLAIM TO ANY PARTICULAR
FONT, STYLE, SIZE, OR COLOR.

NO CLAIM IS MADE TO THE EXCLUSIVE
RIGHT TO USE "PAINT", APART FROM THE
MARK AS SHOWN.

SN 77-023,400, FILED 10-17-2006.

CHARLOTTE CORWIN, EXAMINING ATTORNEY

Int. Cl.: 9

Prior U.S. Cls.: 21, 23, 26, 36, and 38

Reg. No. 3,521,128

United States Patent and Trademark Office

Registered Oct. 21, 2008

**TRADEMARK
PRINCIPAL REGISTER**

**IQ-SUITE FRONTLINE SALES
EFFECTIVENESS**

ECONIQ, INC. (DELAWARE CORPORATION)
4TH FLOOR
35 CORPORATE DRIVE
BURLINGTON, MA 01803

THE MARK CONSISTS OF STANDARD CHARACTERS WITHOUT CLAIM TO ANY PARTICULAR FONT, STYLE, SIZE, OR COLOR.

FOR: COMPUTER SOFTWARE FOR USE IN ANALYZING DATA ACQUIRED FROM CUSTOMERS AND PROVIDING INFORMATION REGARDING PRODUCTS AND SERVICES THAT FIT THE CUSTOMERS' NEEDS, ALL IN THE FIELD OF BANKING, IN CLASS 9 (U.S. CLS. 21, 23, 26, 36 AND 38).

NO CLAIM IS MADE TO THE EXCLUSIVE RIGHT TO USE "FRONTLINE SALES EFFECTIVENESS", APART FROM THE MARK AS SHOWN.

SN 77-023,523, FILED 10-18-2006.

FIRST USE 7-28-2008; IN COMMERCE 7-28-2008.

MAUREEN DALL, EXAMINING ATTORNEY

Int. Cl.: 17

Prior U.S. Cls.: 1, 5, 12, 13, 35, and 50

Reg. No. 3,521,129

United States Patent and Trademark Office

Registered Oct. 21, 2008

**TRADEMARK
PRINCIPAL REGISTER**

SUPERLON

SUPERLON WORLDWIDE SDN BHD (252355-U)
(MALAYSIA CORPORATION)
LOT 2567, JALAN SUNGAI JATI, 41200 KLANG
SELANGOR DARUL EHSAN, MALAYSIA

FOR: RUBBER, GUTTA-PERCHA, RUBBER
GUM, ASBESTOS FILM AND MICA FOR USE IN
THE MANUFACTURE OF PACKAGING AND IN-
SULATING MATERIALS; PLASTICS IN EXTRU-
DED FORM FOR USE IN MANUFACTURE;
PACKING, STOPPING AND INSULATING MATE-
RIALS, NAMELY, INSULATING PLASTER, PACK-
ING FOAM IN SHEET FORM AND RUBBER

STOPPERS; FLEXIBLE PIPES, NOT OF METAL, IN
CLASS 17 (U.S. CLS. 1, 5, 12, 13, 35 AND 50).

FIRST USE 12-31-1985; IN COMMERCE 12-31-1994.

THE ENGLISH TRANSLATION OF THE WORD
"SUPERLON" IN THE MARK IS THE WORLD
POWERFUL DRAGON.

SN 77-023,573, FILED 10-18-2006.

SEAN CROWLEY, EXAMINING ATTORNEY

Int. Cl.: 40

Prior U.S. Cls.: 100, 103, and 106

United States Patent and Trademark Office

Reg. No. 3,521,130

Registered Oct. 21, 2008

**SERVICE MARK
PRINCIPAL REGISTER**

AXI-DENTAL

LEVINE, TODD R. (UNITED STATES INDIVIDUAL)
5875 SOUTH TRANSIT ROAD
LOCKPORT, NY 14094

THE MARK CONSISTS OF STANDARD CHARACTERS WITHOUT CLAIM TO ANY PARTICULAR FONT, STYLE, SIZE, OR COLOR.

FOR: DENTAL LABORATORIES, IN CLASS 40 (U.S. CLS. 100, 103 AND 106).

SN 77-024,243, FILED 10-18-2006.

FIRST USE 3-11-2008; IN COMMERCE 3-11-2008.

HEATHER SAPP, EXAMINING ATTORNEY

Int. Cl.: 35

Prior U.S. Cls.: 100, 101, and 102

United States Patent and Trademark Office

Reg. No. 3,521,131

Registered Oct. 21, 2008

**SERVICE MARK
PRINCIPAL REGISTER**

GOOD ADVICE TRAVELS FAR

BCD TRAVEL USA LLC (GEORGIA LIMITED
LIABILITY COMPANY)
1055 LENOX PARK BOULEVARD, SUITE 420
ATLANTA, GA 30319

FOR: OUTSOURCING SERVICES IN THE FIELDS
OF TRAVEL POLICIES AND GOVERNANCE, TRAVEL
MANAGEMENT, TRAVEL CONTRACT MAN-
AGEMENT, TRAVEL SOURCING MANAGEMENT
AND TRAVEL PROCUREMENT; CONSULTING
SERVICES IN THE FIELDS OF TRAVEL MANAGE-
MENT, TRAVEL CONTRACT MANAGEMENT,
TRAVEL SOURCING MANAGEMENT, TRAVEL
PROCUREMENT, AND MANAGEMENT OF COR-

PORATE TRAVEL POLICIES AND GOVERNANCE,
IN CLASS 35 (U.S. CLS. 100, 101 AND 102).

FIRST USE 10-19-2006; IN COMMERCE 10-19-2006.

THE MARK CONSISTS OF STANDARD CHAR-
ACTERS WITHOUT CLAIM TO ANY PARTICULAR
FONT, STYLE, SIZE, OR COLOR.

SN 77-024,850, FILED 10-19-2006.

MARY CRAWFORD, EXAMINING ATTORNEY

Int. Cl.: 11

Prior U.S. Cls.: 13, 21, 23, 31, and 34

United States Patent and Trademark Office

Reg. No. 3,521,132

Registered Oct. 21, 2008

**TRADEMARK
PRINCIPAL REGISTER**

COUNTRY HEARTH

UNITED STATES STOVE COMPANY (TENNESSEE CORPORATION)

227 INDUSTRIAL PARK DRIVE

SOUTH PITTSBURG, TN 37380

FOR: SOLID FUEL BURNING STOVES, IN CLASS 11 (U.S. CLS. 13, 21, 23, 31 AND 34).

FIRST USE 3-31-2008; IN COMMERCE 3-31-2008.

THE MARK CONSISTS OF STANDARD CHARACTERS WITHOUT CLAIM TO ANY PARTICULAR FONT, STYLE, SIZE, OR COLOR.

NO CLAIM IS MADE TO THE EXCLUSIVE RIGHT TO USE "HEARTH", APART FROM THE MARK AS SHOWN.

SN 77-025,528, FILED 10-20-2006.

STEPHEN AQUILA, EXAMINING ATTORNEY

Int. Cl.: 9

Prior U.S. Cls.: 21, 23, 26, 36, and 38

Reg. No. 3,521,133

United States Patent and Trademark Office

Registered Oct. 21, 2008

**TRADEMARK
PRINCIPAL REGISTER**

DIAGNOSTIC SLICE CHOOSER

HIGH IMPACT LITIGATION, INC. (COLORADO CORPORATION)
SUITE 103
2 INVERNESS DRIVE EAST
ENGLEWOOD, CO 80112

FOR: COMPUTER INTERACTIVE DIGITAL MEDICAL SOFTWARE FOR USE IN DISPLAYING SLICES FROM CT SCANS AND MAGNETIC RESONANCE IMAGING AS PART OF LEGAL AND JUDICIAL PROCEEDINGS, IN CLASS 9 (U.S. CLS. 21, 23, 26, 36 AND 38).

FIRST USE 2-28-2007; IN COMMERCE 2-28-2007.

THE MARK CONSISTS OF STANDARD CHARACTERS WITHOUT CLAIM TO ANY PARTICULAR FONT, STYLE, SIZE, OR COLOR.

NO CLAIM IS MADE TO THE EXCLUSIVE RIGHT TO USE "DIAGNOSTIC SLICE", APART FROM THE MARK AS SHOWN.

SN 77-025,535, FILED 10-20-2006.

HOWARD SMIGA, EXAMINING ATTORNEY

Int. Cl.: 9

Prior U.S. Cls.: 21, 23, 26, 36, and 38

Reg. No. 3,521,134

United States Patent and Trademark Office

Registered Oct. 21, 2008

**TRADEMARK
PRINCIPAL REGISTER**

VOLUMATION

HIGH IMPACT LITIGATION, INC. (COLORADO
CORPORATION)
SUITE 103
2 INVERNESS DRIVE EAST
ENGLEWOOD, CO 80112

FOR: MEDICAL COMPUTER SOFTWARE FOR
PROCESSING AND DISPLAYING MEDICAL
AUDIO IMAGES FOR USE IN LEGAL AND JUDI-
CIAL PROCEEDINGS, IN CLASS 9 (U.S. CLS. 21, 23,
26, 36 AND 38).

FIRST USE 6-30-2006; IN COMMERCE 6-30-2006.

THE MARK CONSISTS OF STANDARD CHAR-
ACTERS WITHOUT CLAIM TO ANY PARTICULAR
FONT, STYLE, SIZE, OR COLOR.

SN 77-025,536, FILED 10-20-2006.

HOWARD SMIGA, EXAMINING ATTORNEY

Int. Cl.: 9

Prior U.S. Cls.: 21, 23, 26, 36, and 38

Reg. No. 3,521,135

United States Patent and Trademark Office

Registered Oct. 21, 2008

**TRADEMARK
PRINCIPAL REGISTER**

3D VOLUMATION

HIGH IMPACT LITIGATION, INC. (COLORADO CORPORATION)
SUITE 103
2 INVERNESS DRIVE EAST
ENGLEWOOD, CO 80112

FOR: COMPUTER SOFTWARE FOR PROCESSING AND DISPLAYING THREE DIMENSIONAL MEDICAL IMAGES FOR USE IN LEGAL AND JUDICIAL PROCEEDINGS , IN CLASS 9 (U.S. CLS. 21, 23, 26, 36 AND 38).

FIRST USE 6-30-2006; IN COMMERCE 6-30-2006.

THE MARK CONSISTS OF STANDARD CHARACTERS WITHOUT CLAIM TO ANY PARTICULAR FONT, STYLE, SIZE, OR COLOR.

NO CLAIM IS MADE TO THE EXCLUSIVE RIGHT TO USE "3D", APART FROM THE MARK AS SHOWN.

SN 77-025,537, FILED 10-20-2006.

HOWARD SMIGA, EXAMINING ATTORNEY

Int. Cl.: 9

Prior U.S. Cls.: 21, 23, 26, 36, and 38

United States Patent and Trademark Office

Reg. No. 3,521,136

Registered Oct. 21, 2008

**TRADEMARK
PRINCIPAL REGISTER**

DIGITAL I.S.

HIGH IMPACT LITIGATION, INC. (COLORADO CORPORATION)
SUITE 103
2 INVERNESS DRIVE EAST
ENGLEWOOD, CO 80112

FOR: INTERACTIVE DIGITAL MEDICAL SOFTWARE FOR USE IN DISPLAYING IMAGES AND SUMMARIZING VARIOUS INJURIES IN LEGAL AND JUDICIAL PROCEEDINGS , IN CLASS 9 (U.S. CLS. 21, 23, 26, 36 AND 38).

FIRST USE 6-30-2005; IN COMMERCE 6-30-2005.

THE MARK CONSISTS OF STANDARD CHARACTERS WITHOUT CLAIM TO ANY PARTICULAR FONT, STYLE, SIZE, OR COLOR.

NO CLAIM IS MADE TO THE EXCLUSIVE RIGHT TO USE "DIGITAL", APART FROM THE MARK AS SHOWN.

SN 77-025,538, FILED 10-20-2006.

HOWARD SMIGA, EXAMINING ATTORNEY

Int. Cl.: 28

Prior U.S. Cls.: 22, 23, 38, and 50

United States Patent and Trademark Office

Reg. No. 3,521,137

Registered Oct. 21, 2008

**TRADEMARK
PRINCIPAL REGISTER**

LA GUADALUPANA

GARATE TURANZAS, ARTURO (MEXICO INDIVIDUAL)
COLONIA EXTREMADURA INSURGENTES
AVENIDA INSURGENTES SUR NO. 1261-PH
CODIGO, MEXICO 03920 AND
MATUTE CORDOVA, CARLOS (MEXICO INDIVIDUAL)
COLONIA SAN ANDRES TOLTEPEC
FRACCIONAMIENTO TLALPUENTE
CODIGO, MEXICO 14460

THE MARK CONSISTS OF STANDARD CHARACTERS WITHOUT CLAIM TO ANY PARTICULAR FONT, STYLE, SIZE, OR COLOR.

THE FOREIGN WORDING IN THE MARK TRANSLATES INTO ENGLISH AS THE WOMAN WHO BELIEVES SHE IS OR IS RELATED TO THE GUADALUPE VIRGIN.

FOR: PLAYING CARDS, IN CLASS 28 (U.S. CLS. 22, 23, 38 AND 50).

SN 77-025,700, FILED 10-20-2006.

FIRST USE 11-1-2006; IN COMMERCE 11-1-2006.

MATTHEW EINSTEIN, EXAMINING ATTORNEY

Int. Cl.: 28

Prior U.S. Cls.: 22, 23, 38, and 50

United States Patent and Trademark Office

Reg. No. 3,521,138

Registered Oct. 21, 2008

**TRADEMARK
PRINCIPAL REGISTER**

MYTHIC RIDER

SKIS DYNASTAR, INC. (DELAWARE CORPORATION)

1441 UTE BLVD. - SUITE 200

PARK CITY, UT 84098

FOR: SKIS, IN CLASS 28 (U.S. CLS. 22, 23, 38 AND 50).

FIRST USE 4-1-2006; IN COMMERCE 1-22-2007.

THE MARK CONSISTS OF STANDARD CHARACTERS WITHOUT CLAIM TO ANY PARTICULAR FONT, STYLE, SIZE, OR COLOR.

NO CLAIM IS MADE TO THE EXCLUSIVE RIGHT TO USE "RIDER", APART FROM THE MARK AS SHOWN.

SN 77-026,006, FILED 10-20-2006.

BENJAMIN OKEKE, EXAMINING ATTORNEY

Int. Cl.: 44

Prior U.S. Cls.: 100 and 101

United States Patent and Trademark Office

Reg. No. 3,521,139

Registered Oct. 21, 2008

**SERVICE MARK
PRINCIPAL REGISTER**

NEXALIN

KALACO SCIENTIFIC, INC. (NEVADA CORPORATION)
1033 APACHE CIRCLE
PRESCOTT, AZ 86303

THE MARK CONSISTS OF STANDARD CHARACTERS WITHOUT CLAIM TO ANY PARTICULAR FONT, STYLE, SIZE, OR COLOR.

FOR: MEDICAL CLINICS, IN CLASS 44 (U.S. CLS. 100 AND 101).

SN 77-026,355, FILED 10-20-2006.

FIRST USE 4-26-2008; IN COMMERCE 4-26-2008.

THEODORE MCBRIDE, EXAMINING ATTORNEY

Int. Cl.: 40

Prior U.S. Cls.: 100, 103, and 106

United States Patent and Trademark Office

Reg. No. 3,521,140

Registered Oct. 21, 2008

**SERVICE MARK
PRINCIPAL REGISTER**

BE @ peace

INNER CHILDREN, LLC (SOUTH CAROLINA
LIMITED LIABILITY COMPANY)
1115A W POINSETT ST
GREER, SC 29650

FIRST USE 11-1-2006; IN COMMERCE 11-1-2006.

SN 77-026,368, FILED 10-20-2006.

FOR: IMPRINTING MESSAGES ON T-SHIRTS; T-
SHIRT EMBROIDERING SERVICES, IN CLASS 40
(U.S. CLS. 100, 103 AND 106).

DANIEL CAPSHAW, EXAMINING ATTORNEY

Int. Cl.: 36

Prior U.S. Cls.: 100, 101, and 102

United States Patent and Trademark Office

Reg. No. 3,521,141

Registered Oct. 21, 2008

**SERVICE MARK
PRINCIPAL REGISTER**

THINKCASH

PAYDAY ONE SERVICE, LLC (DELAWARE LIMITED LIABILITY COMPANY)
SUITE 500
3880 HULEN STREET
FORT WORTH, TX 76107

THE MARK CONSISTS OF STANDARD CHARACTERS WITHOUT CLAIM TO ANY PARTICULAR FONT, STYLE, SIZE, OR COLOR.

FOR: PROVIDING SHORT TERM LOANS VIA THE INTERNET, PHONE, AND RETAIL LOCATIONS, IN CLASS 36 (U.S. CLS. 100, 101 AND 102).

SN 77-026,929, FILED 10-23-2006.

FIRST USE 2-0-2007; IN COMMERCE 2-0-2007.

CARYN GLASSER, EXAMINING ATTORNEY

Int. Cl.: 21

Prior U.S. Cls.: 2, 13, 23, 29, 30, 33, 40, and 50

United States Patent and Trademark Office

Reg. No. 3,521,142

Registered Oct. 21, 2008

**TRADEMARK
PRINCIPAL REGISTER**

Healthy Snack Rack

K.T. DESIGN & PROTOTYPE, INC. (VIRGINIA CORPORATION)

SUITE 1

170 KENNY LANE

WINCHESTER, VA 22602

FOR: HOUSEHOLD CONTAINERS FOR FOODS,
IN CLASS 21 (U.S. CLS. 2, 13, 23, 29, 30, 33, 40 AND 50).

FIRST USE 10-27-2007; IN COMMERCE 5-29-2008.

THE MARK CONSISTS OF STANDARD CHARACTERS WITHOUT CLAIM TO ANY PARTICULAR FONT, STYLE, SIZE, OR COLOR.

NO CLAIM IS MADE TO THE EXCLUSIVE RIGHT TO USE "SNACK RACK", APART FROM THE MARK AS SHOWN.

SN 77-026,955, FILED 10-23-2006.

ANDREA K. NADELMAN, EXAMINING ATTORNEY

Int. Cl.: 36

Prior U.S. Cls.: 100, 101, and 102

United States Patent and Trademark Office

Reg. No. 3,521,143

Registered Oct. 21, 2008

**SERVICE MARK
PRINCIPAL REGISTER**

EZXCHANGE

GVGROUP, INC. (CALIFORNIA CORPORATION)
147 17TH AVE, SUITE A
SAN MATEO, CA 94402

FOR: FINANCIAL SERVICES, NAMELY, CREDIT AND CASH CARD SERVICES, BANKING, PROVIDING ON-LINE STORED VALUE ACCOUNTS IN AN ELECTRONIC ENVIRONMENT, ISSUING STORED VALUE CARDS, AND PROVIDING ELECTRONIC CASH, CREDIT CARD, STORED VALUE CARD AND DEBIT CARD STATEMENTS AND HISTOR-

ICAL RECORDS OF FINANCIAL TRANSACTIONS, IN CLASS 36 (U.S. CLS. 100, 101 AND 102).

FIRST USE 3-8-2005; IN COMMERCE 3-8-2005.

THE MARK CONSISTS OF STANDARD CHARACTERS WITHOUT CLAIM TO ANY PARTICULAR FONT, STYLE, SIZE, OR COLOR.

SN 77-027,595, FILED 10-23-2006.

WILLIAM ROSSMAN, EXAMINING ATTORNEY

Int. Cl.: 16

Prior U.S. Cls.: 2, 5, 22, 23, 29, 37, 38, and 50

Reg. No. 3,521,144

United States Patent and Trademark Office

Registered Oct. 21, 2008

TRADEMARK
PRINCIPAL REGISTER

The logo consists of the word 'élan' in a stylized, outlined font. The 'é' is lowercase and features a small accent mark above it. The 'l' is tall and thin, and the 'a' is lowercase. The 'n' is lowercase and has a slightly curved top. The entire word is rendered in a clean, white outline style against a light gray background.

W O M A N

ELAN WOMAN, LLC (UTAH LIMITED LIABILITY COMPANY)

P. O. BOX 910346

ST. GEORGE, UT 84791

FOR: MAGAZINES FEATURING WOMENS LIFESTYLES, IN CLASS 16 (U.S. CLS. 2, 5, 22, 23, 29, 37, 38 AND 50).

FIRST USE 3-1-2007; IN COMMERCE 3-1-2007.

NO CLAIM IS MADE TO THE EXCLUSIVE RIGHT TO USE "WOMAN", APART FROM THE MARK AS SHOWN.

THE FOREIGN WORDING IN THE MARK TRANSLATES INTO ENGLISH AS ENTHUSIASTIC VIGOR AND LIVELINESS; DISTINCTIVE STYLE OR FLAIR.

SN 77-027,749, FILED 10-24-2006.

KEVIN CORWIN, EXAMINING ATTORNEY

Int. Cls.: 7 and 9

Prior U.S. Cls.: 13, 19, 21, 23, 26, 31, 34, 35, 36, and 38

Reg. No. 3,521,145

United States Patent and Trademark Office

Registered Oct. 21, 2008

**TRADEMARK
PRINCIPAL REGISTER**

IQV

INGERSOLL-RAND COMPANY (NEW JERSEY
CORPORATION)
155 CHESTNUT RIDGE ROAD
MONTVALE, NJ 07645

FIRST USE 9-30-2006; IN COMMERCE 9-30-2006.

FOR: CORDLESS POWER TOOLS, NAMELY, IM-
PACT WRENCHES, DRILLS, RATCHETS, GRIN-
DERS, AND CUTOFF TOOLS, IN CLASS 7 (U.S.
CLS. 13, 19, 21, 23, 31, 34 AND 35).

THE MARK CONSISTS OF STANDARD CHAR-
ACTERS WITHOUT CLAIM TO ANY PARTICULAR
FONT, STYLE, SIZE, OR COLOR.

FIRST USE 9-30-2006; IN COMMERCE 9-30-2006.

SN 77-028,262, FILED 10-24-2006.

FOR: BATTERIES AND BATTERY CHARGERS
FOR USE WITH CORDLESS POWER TOOLS, IN
CLASS 9 (U.S. CLS. 21, 23, 26, 36 AND 38).

JANICE L. MCMORROW, EXAMINING ATTOR-
NEY

Int. Cl.: 35

Prior U.S. Cls.: 100, 101, and 102

United States Patent and Trademark Office

Reg. No. 3,521,146

Registered Oct. 21, 2008

**SERVICE MARK
PRINCIPAL REGISTER**

COINBUG

COINBUG, INC. (FLORIDA CORPORATION)
9804 BENNINGTON DRIVE
TAMPA, FL 33626

FIRST USE 2-26-2007; IN COMMERCE 2-26-2007.

FOR: ON-LINE AND ADVERTISING AND TRADING SERVICES, IN WHICH SELLER POSTS PRODUCTS TO BE AUCTIONED AND BIDDING IS DONE VIA THE INTERNET IN THE FIELD OF COLLECTIBLE COINS AND RELATED ITEMS OF OTHERS, IN CLASS 35 (U.S. CLS. 100, 101 AND 102).

THE MARK CONSISTS OF STANDARD CHARACTERS WITHOUT CLAIM TO ANY PARTICULAR FONT, STYLE, SIZE, OR COLOR.

SN 77-028,608, FILED 10-24-2006.

ESTHER A. BORSUK, EXAMINING ATTORNEY

Int. Cl.: 16

Prior U.S. Cls.: 2, 5, 22, 23, 29, 37, 38, and 50

Reg. No. 3,521,147

United States Patent and Trademark Office

Registered Oct. 21, 2008

**TRADEMARK
PRINCIPAL REGISTER**

KONVICT

THIAM, ALIAUNE (UNITED STATES INDIVIDUAL)
SUITE 850
2839 PACES FERRY ROAD
ATLANTA, GA 30339

FOR: PRINTED PUBLICATIONS AND PAPER GOODS, NAMELY, CALENDARS, DAY PLANNERS, PUBLICATION PAPER, POSTERS, GIFT CARDS, PAPER GIFT BAGS, MAGAZINES FEATURING ENTERTAINMENT, IN CLASS 16 (U.S. CLS. 2, 5, 22, 23, 29, 37, 38 AND 50).

FIRST USE 1-0-2004; IN COMMERCE 1-0-2004.

THE MARK CONSISTS OF STANDARD CHARACTERS WITHOUT CLAIM TO ANY PARTICULAR FONT, STYLE, SIZE, OR COLOR.

SN 77-029,011, FILED 10-25-2006.

KIM MONINGHOFF, EXAMINING ATTORNEY

Int. Cls.: 9 and 41

Prior U.S. Cls.: 21, 23, 26, 36, 38, 100, 101, and 107

United States Patent and Trademark Office

Reg. No. 3,521,148

Registered Oct. 21, 2008

**TRADEMARK
SERVICE MARK
PRINCIPAL REGISTER**



ARTIST & IDEA MANAGEMENT, LTD. (NEW YORK CORPORATION)
5TH FLOOR
201 EAST 16TH STREET
NEW YORK, NY 10003

FOR: MUSICAL SOUND RECORDINGS; MUSICAL VIDEO RECORDINGS; PRE-RECORDED CD'S, VIDEO TAPES, LASER DISKS AND DVD'S FEATURING ENTERTAINMENT-RELATED PROGRAMMING IN THE NATURE OF PUNK MUSIC AND LIFESTYLE, IN CLASS 9 (U.S. CLS. 21, 23, 26, 36 AND 38).

FIRST USE 6-18-2006; IN COMMERCE 9-12-2007.

FOR: ENTERTAINMENT IN THE NATURE OF VISUAL AND AUDIO PERFORMANCES, AND MU-

SICAL, VARIETY, NEWS AND COMEDY SHOWS, IN CLASS 41 (U.S. CLS. 100, 101 AND 107).

FIRST USE 6-18-2006; IN COMMERCE 9-12-2007.

THE MARK CONSISTS OF A FORWARD FACING HUMAN SKULL LACKING ITS MANDIBLE WITH A FIREY MOHAWK RISING FROM THE FRONT AND CENTER OF THE SKULL'S FOREHEAD, FLANKED BY MIRROR IMAGES OF LIGHTNING BOLTS FRAMING THE SKULL LIKE A LETTER "V".

SN 77-029,883, FILED 10-26-2006.

BRIDGETT SMITH, EXAMINING ATTORNEY

Int. Cl.: 33

Prior U.S. Cls.: 47 and 49

United States Patent and Trademark Office

Reg. No. 3,521,149

Registered Oct. 21, 2008

**TRADEMARK
PRINCIPAL REGISTER**

Sandstone

WENTE BROS. (CALIFORNIA CORPORATION)
5565 TESLA ROAD
LIVERMORE, CA 94550

THE MARK CONSISTS OF STANDARD CHAR-
ACTERS WITHOUT CLAIM TO ANY PARTICULAR
FONT, STYLE, SIZE, OR COLOR.

FOR: WINE, IN CLASS 33 (U.S. CLS. 47 AND 49).

SN 77-030,325, FILED 10-26-2006.

FIRST USE 4-12-2007; IN COMMERCE 4-24-2007.

INGRID C. EULIN, EXAMINING ATTORNEY

Int. Cl.: 9

Prior U.S. Cls.: 21, 23, 26, 36, and 38

Reg. No. 3,521,150

United States Patent and Trademark Office

Registered Oct. 21, 2008

**TRADEMARK
PRINCIPAL REGISTER**

HYPEREYE

GREEN VISION SYSTEMS LTD. (ISRAEL CORPORATION)
RAMAT HAHAYAL
27 HABARZEL STREET
TEL AVIV, ISRAEL 69710

GING AND HYPER-SPECTRAL IMAGING, IN CLASS 9 (U.S. CLS. 21, 23, 26, 36 AND 38).

FIRST USE 11-0-2005; IN COMMERCE 12-0-2005.

FOR: ELECTRONIC APPARATUS FOR IMAGING AND IMAGE PROCESSING OF PARTICULATE AND NON-PARTICULATE SUBSTANCES FOR NON-MEDICAL USE, COMPRISED OF MICROSCOPE OR TELESCOPE IMAGING DEVICES, COMPUTER SOFTWARE AND ASSOCIATED COMPUTER HARDWARE ALL SOLD TOGETHER AS A UNIT, IN THE FIELDS OF SPECTRAL IMA-

THE MARK CONSISTS OF STANDARD CHARACTERS WITHOUT CLAIM TO ANY PARTICULAR FONT, STYLE, SIZE, OR COLOR.

SN 77-031,875, FILED 10-30-2006.

RUDY R. SINGLETON, EXAMINING ATTORNEY

Int. Cl.: 30

Prior U.S. Cl.: 46

United States Patent and Trademark Office

Reg. No. 3,521,151

Registered Oct. 21, 2008

**TRADEMARK
PRINCIPAL REGISTER**

AMARITA

HARBAR LLC (MASSACHUSETTS CORPORATION)
320 TURNPIKE STREET
CANTON, MA 02021

THE MARK CONSISTS OF STANDARD CHARACTERS WITHOUT CLAIM TO ANY PARTICULAR FONT, STYLE, SIZE, OR COLOR.

FOR: MEXICAN FOOD, NAMELY, TORTILLA CHIPS, CORN AND WHEAT TORTILLAS, WHEAT FLOUR-BASED CHIPS, IN CLASS 30 (U.S. CL. 46).

SN 77-031,896, FILED 10-30-2006.

FIRST USE 8-8-2007; IN COMMERCE 8-8-2007.

ESTHER BELENKER, EXAMINING ATTORNEY

Int. Cl.: 10

Prior U.S. Cls.: 26, 39, and 44

United States Patent and Trademark Office

Reg. No. 3,521,152

Registered Oct. 21, 2008

**TRADEMARK
PRINCIPAL REGISTER**

EPLY OMNIAX

EPLY RESEARCH, LLC (OREGON LIMITED
LIABILITY COMPANY)
545 NE 47TH AVE
PORTLAND, OR 97213

FOR: MEDICAL APPARATUS, NAMELY, SPA-
TIAL MANIPULATOR FOR SUPPORTING AND
SPATIALLY ORIENTING A PATIENT DURING
CLINICAL DIAGNOSTIC TESTING AND/OR
TREATMENT OF PATIENT VESTIBULAR CONDI-
TION, IN CLASS 10 (U.S. CLS. 26, 39 AND 44).

FIRST USE 9-18-2006; IN COMMERCE 9-18-2006.

THE MARK CONSISTS OF STANDARD CHAR-
ACTERS WITHOUT CLAIM TO ANY PARTICULAR
FONT, STYLE, SIZE, OR COLOR.

SN 77-032,210, FILED 10-30-2006.

PAM WILLIS, EXAMINING ATTORNEY

Int. Cl.: 42

Prior U.S. Cls.: 100 and 101

United States Patent and Trademark Office

Reg. No. 3,521,153

Registered Oct. 21, 2008

**SERVICE MARK
PRINCIPAL REGISTER**

DIRECTOR PROTECTOR

GOIDEL, ERIC M. (UNITED STATES INDIVIDUAL)
377 BROADWAY
NEW YORK, NY 10013

FOR: LEGAL CONSULTING SERVICES TO BE PROVIDED TO COOPERATIVE HOUSING COOPERATIONS AND CONDOMINIUMS, IN CLASS 42 (U.S. CLS. 100 AND 101).

FIRST USE 5-1-2007; IN COMMERCE 5-7-2007.

THE MARK CONSISTS OF STANDARD CHARACTERS WITHOUT CLAIM TO ANY PARTICULAR FONT, STYLE, SIZE, OR COLOR.

SN 77-032,946, FILED 10-31-2006.

AMY HELLA, EXAMINING ATTORNEY

Int. Cl.: 35

Prior U.S. Cls.: 100, 101, and 102

United States Patent and Trademark Office

Reg. No. 3,521,154

Registered Oct. 21, 2008

**SERVICE MARK
PRINCIPAL REGISTER**

KNOWLEDGE POWERING RESULTS

TECHNOLOGY PARTNERS INTERNATIONAL,
INC. (TEXAS CORPORATION), DBA TPI,
10055 GROGAN'S MILL ROAD, SUITE 200
THE WOODLANDS, TX 77380

FOR: BUSINESS CONSULTING SERVICES,
NAMELY, SOURCING ADVISORY SERVICES IN
THE FIELDS OF INFORMATION TECHNOLOGY
OUTSOURCING AND BUSINESS PROCESS OUT-
SOURCING, IN CLASS 35 (U.S. CLS. 100, 101 AND
102).

FIRST USE 11-0-2006; IN COMMERCE 11-0-2006.

THE MARK CONSISTS OF STANDARD CHAR-
ACTERS WITHOUT CLAIM TO ANY PARTICULAR
FONT, STYLE, SIZE, OR COLOR.

SN 77-033,050, FILED 10-31-2006.

NATALIE POLZER, EXAMINING ATTORNEY

Int. Cls.: 3, 18, 20, 21, and 22

Prior U.S. Cls.: 1, 2, 3, 4, 6, 7, 13, 19, 22, 23, 25, 29, 30, 32, 33, 40, 41, 42, 50, 51, and 52

Reg. No. 3,521,155

United States Patent and Trademark Office

Registered Oct. 21, 2008

**TRADEMARK
PRINCIPAL REGISTER**

TIDE

THE PROCTER & GAMBLE COMPANY (OHIO CORPORATION)
1 P&G PLAZA
CINCINNATI, OH 45202

FOR: SCENTED BEADS FOR USE ON CLOTHING HANGERS, IN CLASS 3 (U.S. CLS. 1, 4, 6, 50, 51 AND 52).

FIRST USE 7-31-2007; IN COMMERCE 7-31-2007.

FOR: DUFFEL BAGS, IN CLASS 18 (U.S. CLS. 1, 2, 3, 22 AND 41).

FIRST USE 7-31-2007; IN COMMERCE 7-31-2007.

FOR: HAMPERS, HAMPER SORTERS, LAUNDRY CENTERS, CLOTHING HANGERS, IN CLASS 20 (U.S. CLS. 2, 13, 22, 25, 32 AND 50).

FIRST USE 7-31-2007; IN COMMERCE 7-31-2007.

FOR: IRONING BOARDS, IRONING BOARD COVERS, LINT ROLLERS, CLOTHES PINS/CLIPS, IN CLASS 21 (U.S. CLS. 2, 13, 23, 29, 30, 33, 40 AND 50).

FIRST USE 7-31-2007; IN COMMERCE 7-31-2007.

FOR: SOFT-SIDED STORAGE BAGS FOR GARMENTS/SHOES; LAUNDRY BAGS, IN CLASS 22 (U.S. CLS. 1, 2, 7, 19, 22, 42 AND 50).

FIRST USE 9-30-2007; IN COMMERCE 9-30-2007.

THE MARK CONSISTS OF STANDARD CHARACTERS WITHOUT CLAIM TO ANY PARTICULAR FONT, STYLE, SIZE, OR COLOR.

OWNER OF U.S. REG. NOS. 424,339, 2,973,361, AND OTHERS.

SN 77-033,143, FILED 10-31-2006.

LINDA MICKLEBURGH, EXAMINING ATTORNEY

Int. Cls.: 1, 7, 9, 10, 11, 37, and 42

Prior U.S. Cls.: 1, 5, 6, 10, 13, 19, 21, 23, 26, 31, 34, 35, 36, 38, 39, 44, 46, 100, 101, 103, and 106

Reg. No. 3,521,156

United States Patent and Trademark Office

Registered Oct. 21, 2008

**TRADEMARK
SERVICE MARK
PRINCIPAL REGISTER**

Thermo
S C I E N T I F I C

THERMO FISHER SCIENTIFIC INC. (DELAWARE CORPORATION)
81 WYMAN STREET
WALTHAM, MA 02454

FOR: CHROMATOGRAPHY CHEMICALS, NAMELY, SOLVENTS AND PACKING MATERIALS USED IN CHROMATOGRAPHY; REAGENTS FOR SCIENTIFIC OR MEDICAL RESEARCH USE, NAMELY, SOLVENTS, SOLUTIONS AND BIO-CHEMICALS OF HIGH PURITY FOR SCIENTIFIC OR RESEARCH USE, ANALYSIS AND TESTING, MEDIA FOR GROWING CELLS FOR LABORATORY PURPOSE, MEDIA FOR GROWING CELLS FOR THE COMMERCIAL PRODUCTION OF DIAGNOSTIC AND THERAPEUTIC MATERIALS, IN CLASS 1 (U.S. CLS. 1, 5, 6, 10, 26 AND 46).

FIRST USE 6-15-2008; IN COMMERCE 6-15-2008.

FOR: CENTRIFUGES FOR INDUSTRIAL USE, IN CLASS 7 (U.S. CLS. 13, 19, 21, 23, 31, 34 AND 35).

FIRST USE 1-15-2008; IN COMMERCE 1-15-2008.

FOR: SCIENTIFIC, ELECTRICAL, OPTICAL, MEASURING, LABORATORY AND TEST APPARATUS AND INSTRUMENTS AND PARTS THEREFORE, NAMELY, MASS SPECTROMETERS, OPTICAL EMISSION SPECTROMETERS, SPECTROSCOPY APPARATUS, SPECTROPHOTOMETERS, GAS AND LIQUID CHROMATOGRAPHY APPARATUS, CHROMATOGRAPHY COLUMNS, CENTRIFUGES, INCUBATORS, BIOLOGICAL SAFETY CABINETS, MICROSCOPES, FLUOROMETERS, ASSAY DIAGNOSTIC SLIDES, ELECTROPHORESIS ANALYZERS, COOLERS AND CHILLERS, LABORATORY FREEZERS, LABORATORY SAMPLE CONCENTRATORS, ELECTROMECHANICAL

SHAKERS, DISPENSERS, READERS AND DETECTORS FOR FLUIDS IN LABORATORY ENVIRONMENTS, MICROPLATE INSTRUMENTS, LABORATORY OVENS, THERMAL CYCLERS, LABORATORY MAGNETIC PARTICLE PROCESSORS, GAS DETECTORS, RADIATION DETECTORS, PROCESS GAS ANALYZERS, PARTICLE DETECTORS, AEROSOL MONITORS, X-RAY APPARATUS FOR INSPECTING LIQUIDS IN CONTAINERS, MOISTURE ANALYZERS, NEUTRON GENERATORS, X-RAY APPARATUS SOURCES FOR SCIENTIFIC LABORATORY USES AND FOR THE MEASUREMENT OF WEIGHTS AND THICKNESSES OF INDUSTRIAL ARTICLES, FLOW METERS, SULFUR ANALYZERS, ON-LINE CEMENT, COAL AND MINERALS ANALYZERS, ELECTROMAGNETIC INTERFERENCE SIMULATORS FOR TESTING ELECTRONIC DEVICE, LIQUID LEVEL SENSORS, ROBOTIC LIQUID HANDLING SYSTEMS, VISCOMETERS AND RHEOMETERS, COATING GAUGES, DENSITY METERS, PIPETTES, BELT SCALES, CHECK-WEIGHERS, METAL DETECTORS, PH ELECTRODES, CONDUCTIVITY METERS, DISSOLVED OXYGEN METERS, LABORATORY MIXERS AND EXTRUDERS, DATA ACQUISITION AND RECORDING SYSTEMS COMPRISED OF DATA SCANNER AND GRAPHIC DISPLAY AND MEMORY AND PROGRAMMABLE TOUCH SCREEN AND POWER SUPPLY, COMPUTER SOFTWARE FOR USE IN DATA ACQUISITION, ANALYSIS, AND ARCHIVING IN THE FIELD OF LABORATORY RESEARCH, COMPUTER SOFTWARE FOR USE IN LABORATORY INSTRUMENT OPERATION, CHARGE-INJECTION-DEVICE CAMERAS, MICROSCOPE SLIDES AND COVER GLASSES FOR MICROSCOPE SLIDES, LABORATORY EQUIPMENT FOR USE IN SPECIMEN PREPARATION, NAMELY, TISSUE PROCESSORS; LABORATORY AUTOCLAVES, MEDICAL TEST KITS COMPRISED

OF ANALYSIS OR CALIBRATION EQUIPMENT TO ANALYZE AND DETECT DRUGS AND TOXINS AND OTHER CHEMICALS IN BODILY FLUIDS AND TISSUES FOR CLINICAL LABORATORY USE; LABORATORY APPARATUS, NAMELY, CENTRIFUGES, IN CLASS 9 (U.S. CLS. 21, 23, 26, 36 AND 38).

FIRST USE 1-15-2008; IN COMMERCE 1-15-2008.

FOR: AUTOPSY TABLES, ANATOMICAL PATHOLOGY STATIONS, CRYOTOMES, MICROTOMES AND MICROTOME KNIVES, IN CLASS 10 (U.S. CLS. 26, 39 AND 44).

FIRST USE 1-15-2008; IN COMMERCE 1-15-2008.

FOR: IMMERSION COOLERS; RECIRCULATING CHILLERS; APPARATUS FOR PURIFYING WATER FOR LABORATORY USE; AUTOCLAVES, IN CLASS 11 (U.S. CLS. 13, 21, 23, 31 AND 34).

FIRST USE 1-15-2008; IN COMMERCE 1-15-2008.

FOR: INSTALLATION, MAINTENANCE AND REPAIR SERVICES RELATED TO SCIENTIFIC, ELECTRICAL, OPTICAL, MEASURING, LABORATORY, AND TEST APPARATUS AND INSTRUMENTS AND TO LABORATORY ELECTRICAL APPARATUS AND INSTRUMENTS AND COMPUTER HARDWARE USED IN CONNECTION THEREWITH, IN CLASS 37 (U.S. CLS. 100, 103 AND 106).

FIRST USE 5-0-2008; IN COMMERCE 5-0-2008.

FOR: INSTALLATION OF COMPUTER SOFTWARE RELATED TO SCIENTIFIC, ELECTRICAL, OPTICAL, MEASURING, LABORATORY, AND TEST APPARATUS AND INSTRUMENTS AND TO LABORATORY ELECTRICAL APPARATUS AND INSTRUMENTS; CONSULTING SERVICES RELATED TO THE USE AND OPERATION OF SCIENTIFIC, ELECTRICAL, OPTICAL, MEASURING, LABORATORY, AND TEST APPARATUS AND INSTRUMENTS AND TO LABORATORY ELECTRICAL APPARATUS AND INSTRUMENTS AND COMPUTER HARDWARE USED IN CONNECTION THEREWITH; TECHNICAL SUPPORT, NAMELY, EVALUATING AND TROUBLESHOOTING THE PERFORMANCE OF SCIENTIFIC, ELECTRICAL, OPTICAL, MEASURING, LABORATORY, AND TEST APPARATUS AND INSTRUMENTS, IN CLASS 42 (U.S. CLS. 100 AND 101).

FIRST USE 11-0-2007; IN COMMERCE 11-0-2007.

OWNER OF U.S. REG. NO. 3,146,188.

NO CLAIM IS MADE TO THE EXCLUSIVE RIGHT TO USE "SCIENTIFIC", APART FROM THE MARK AS SHOWN.

SN 77-033,329, FILED 10-31-2006.

AMY GEARIN, EXAMINING ATTORNEY

Int. Cl.: 35

Prior U.S. Cls.: 100, 101, and 102

United States Patent and Trademark Office

Reg. No. 3,521,157

Registered Oct. 21, 2008

**SERVICE MARK
PRINCIPAL REGISTER**

YOUR PAYROLL. OUR PASSION.

SUREPAYROLL, INC. (DELAWARE CORPORATION)
2350 RAVINE DRIVE
GLENVIEW, IL 60025

FOR: ON-LINE WAGE PAYROLL PREPARATION SERVICES PROVIDED VIA A GLOBAL COMPUTER NETWORK; CALCULATION OF WITHHOLDING, INSURANCE, 401K CONTRIBUTIONS, AND OTHER DEDUCTIONS FROM WAGES AND SALARIES; BOOKKEEPING FOR ELECTRONIC FUNDS TRANSFERS; CREATING AND PROVIDING ELECTRONIC PAYROLL REPORTS THAT CAN BE USED BY BUSINESSES TO PREPARE TAX RETURNS

AND GENERATE REQUIRED TAX FORMS, IN CLASS 35 (U.S. CLS. 100, 101 AND 102).

FIRST USE 10-0-2006; IN COMMERCE 10-0-2006.

THE MARK CONSISTS OF STANDARD CHARACTERS WITHOUT CLAIM TO ANY PARTICULAR FONT, STYLE, SIZE, OR COLOR.

SN 77-033,596, FILED 10-31-2006.

CHRISTINE COOPER, EXAMINING ATTORNEY

Int. Cl.: 41

Prior U.S. Cls.: 100, 101, and 107

United States Patent and Trademark Office

Reg. No. 3,521,158

Registered Oct. 21, 2008

**SERVICE MARK
PRINCIPAL REGISTER**

CIRQUE DREAMS COOBRILA

CIRQUE HOLDINGS, LLC (FLORIDA LIMITED
LIABILITY COMPANY)
1985 N.W. 18TH STREET
POMPANO BEACH, FL 33068

FOR: ENTERTAINMENT SERVICES, NAMELY,
PRODUCTION AND PRESENTATION OF THEA-
TRICAL PERFORMANCES FEATURING ARTIS-
TRY, COMEDY, ACROBATICS AND DANCE
ACCOMPANIED BY MUSIC, IN CLASS 41 (U.S.
CLS. 100, 101 AND 107).

FIRST USE 6-16-2007; IN COMMERCE 6-16-2007.

THE MARK CONSISTS OF STANDARD CHAR-
ACTERS WITHOUT CLAIM TO ANY PARTICULAR
FONT, STYLE, SIZE, OR COLOR.

OWNER OF U.S. REG. NO. 2,945,963.

NO CLAIM IS MADE TO THE EXCLUSIVE
RIGHT TO USE "CIRQUE", APART FROM THE
MARK AS SHOWN.

THE FOREIGN WORDING IN THE MARK
TRANSLATES INTO ENGLISH AS CIRCUS.

SN 77-033,668, FILED 10-31-2006.

G. MAYERSCHOFF, EXAMINING ATTORNEY

Int. Cl.: 41

Prior U.S. Cls.: 100, 101, and 107

United States Patent and Trademark Office

Reg. No. 3,521,159

Registered Oct. 21, 2008

**SERVICE MARK
PRINCIPAL REGISTER**

CIRQUE DREAMS ILLUMINATION

CIRQUE HOLDINGS, LLC (FLORIDA LIMITED
LIABILITY COMPANY)
1985 N.W. 18TH STREET
POMPANO BEACH, FL 33068

OWNER OF U.S. REG. NO. 2,945,963.

FOR: ENTERTAINMENT SERVICES, NAMELY,
PRODUCTION AND PRESENTATION OF THEA-
TRICAL PERFORMANCES FEATURING ARTIS-
TRY, COMEDY, ACROBATICS AND DANCE
ACCOMPANIED BY MUSIC, IN CLASS 41 (U.S.
CLS. 100, 101 AND 107).

NO CLAIM IS MADE TO THE EXCLUSIVE
RIGHT TO USE "CIRQUE", APART FROM THE
MARK AS SHOWN.

THE FOREIGN WORDING IN THE MARK
TRANSLATES INTO ENGLISH AS CIRCUS.

FIRST USE 6-12-2007; IN COMMERCE 6-12-2007.

SN 77-033,670, FILED 10-31-2006.

THE MARK CONSISTS OF STANDARD CHAR-
ACTERS WITHOUT CLAIM TO ANY PARTICULAR
FONT, STYLE, SIZE, OR COLOR.

G. MAYERSCHOFF, EXAMINING ATTORNEY

Int. Cl.: 38

Prior U.S. Cls.: 100, 101, and 104

United States Patent and Trademark Office

Reg. No. 3,521,160

Registered Oct. 21, 2008

**SERVICE MARK
PRINCIPAL REGISTER**

AMERICA SECURE

CONFERENCE AMERICA, INC. (ALABAMA
CORPORATION)
7079 UNIVERSITY COURT
MONTGOMERY, AL 36117

FOR: TELECOMMUNICATIONS SERVICES,
NAMELY, AUDIO, VIDEO AND DATA TELECON-
FERENCING, STREAMING OF AUDIO AND VIDEO
MATERIAL ON THE INTERNET, IN CLASS 38 (U.S.
CLS. 100, 101 AND 104).

FIRST USE 6-0-2008; IN COMMERCE 6-0-2008.

THE MARK CONSISTS OF STANDARD CHAR-
ACTERS WITHOUT CLAIM TO ANY PARTICULAR
FONT, STYLE, SIZE, OR COLOR.

SN 77-035,204, FILED 11-2-2006.

DAWN HAN, EXAMINING ATTORNEY

Int. Cl.: 9

Prior U.S. Cls.: 21, 23, 26, 36, and 38

United States Patent and Trademark Office

Reg. No. 3,521,161

Registered Oct. 21, 2008

**TRADEMARK
PRINCIPAL REGISTER**

TERAPIX

BROADLOGIC NETWORK TECHNOLOGIES
INC. (DELAWARE CORPORATION)
1740 TECHNOLOGY DRIVE, SUITE 500
SAN JOSE, CA 95110

FOR: COMPUTER HARDWARE; SEMICONDUCTORS; INTEGRATED CIRCUITS; COMPUTER CHIPS; COMPUTER CHIPS THAT ENABLE MPEG DECODING AND NTSC ENCODING; COMPUTER CHIPSETS FOR NETWORK INFRASTRUCTURE APPLICATIONS; MICROPROCESSORS; VIDEO-PROCESSING MIXED SIGNAL SEMICONDUCTORS, IN CLASS 9 (U.S. CLS. 21, 23, 26, 36 AND 38).

FIRST USE 3-17-2008; IN COMMERCE 3-17-2008.

THE MARK CONSISTS OF STANDARD CHARACTERS WITHOUT CLAIM TO ANY PARTICULAR FONT, STYLE, SIZE, OR COLOR.

SN 77-035,337, FILED 11-2-2006.

BONNIE LUKEN, EXAMINING ATTORNEY

Int. Cl.: 41

Prior U.S. Cls.: 100, 101, and 107

United States Patent and Trademark Office

Reg. No. 3,521,162

Registered Oct. 21, 2008

SERVICE MARK
PRINCIPAL REGISTER



WHITE, GISELE L. (UNITED STATES INDIVIDUAL), DBA PROFESSOR MELONHEAD, 2174 NW DAVIS. STREET # 505 M PORTLAND, OR 97210

FOR: ENTERTAINMENT SERVICES, NAMELY, PROVIDING ON-LINE COMPUTER GAMES, IN CLASS 41 (U.S. CLS. 100, 101 AND 107).

FIRST USE 10-15-2006; IN COMMERCE 10-15-2006.

THE COLOR(S) PURPLE, GREEN, GREY, PINK, BLACK, WHITE IS/ARE CLAIMED AS A FEATURE OF THE MARK.

THE MARK CONSISTS OF A GREEN MELON-HEADED PERSON, OUTLINED IN BLACK, WITH WHITE AND BLACK EYES, WEARING A PURPLE SMOCK AND A BLACK AND GRAY GRADUATION CAP. "PROFESSOR MELONHEAD" WRITTEN IN STYLIZED TEXT IN PURPLE WITH GREEN BANDS AND WITH "O" S WRITTEN AS HALVED MELONS IN PURPLE, GREEN AND PINK WITH BLACK SEEDS.

SN 77-035,481, FILED 11-2-2006.

SCOTT BIBB, EXAMINING ATTORNEY

Int. Cl.: 31

Prior U.S. Cls.: 1 and 46

United States Patent and Trademark Office

Reg. No. 3,521,163

Registered Oct. 21, 2008

**TRADEMARK
PRINCIPAL REGISTER**

**CALIFORNIA GIANT BERRY
FARMS**

CALIFORNIA GIANT, INC. (CALIFORNIA CORPORATION)
P.O. BOX 1359 75 SAKATA LANE
WATSONVILLE, CA 95077

OWNER OF U.S. REG. NOS. 1,612,258, 3,042,288,
AND OTHERS.

FOR: FRESH STRAWBERRIES, FRESH BLUEBERRIES, FRESH BLACKBERRIES, FRESH RASPBERRIES, IN CLASS 31 (U.S. CLS. 1 AND 46).

NO CLAIM IS MADE TO THE EXCLUSIVE RIGHT TO USE "CALIFORNIA" AND "BERRY FARMS", APART FROM THE MARK AS SHOWN.

FIRST USE 8-8-2008; IN COMMERCE 8-8-2008.

SN 77-035,723, FILED 11-2-2006.

THE MARK CONSISTS OF STANDARD CHARACTERS WITHOUT CLAIM TO ANY PARTICULAR FONT, STYLE, SIZE, OR COLOR.

JIM RINGLE, EXAMINING ATTORNEY

Int. Cls.: 16 and 35

Prior U.S. Cls.: 2, 5, 22, 23, 29, 37, 38, 50, 100, 101, and 102

Reg. No. 3,521,164

United States Patent and Trademark Office

Registered Oct. 21, 2008

**TRADEMARK
SERVICE MARK
PRINCIPAL REGISTER**



IDEARC MEDIA CORP. (DELAWARE CORPORATION)
2200 W. AIRFIELD DRIVE
DALLAS/FORT WORTH AIRPORT, TX 752619810

FOR: POSTCARDS THAT PROMOTE THE GOODS AND SERVICES OF OTHERS, IN CLASS 16 (U.S. CLS. 2, 5, 22, 23, 29, 37, 38 AND 50).

FIRST USE 6-0-2006; IN COMMERCE 6-0-2006.

FOR: ADVERTISING AND PROMOTION SERVICES AND CONSULTING SERVICES RELATED

THERETO; PROMOTING THE GOODS AND SERVICES OF OTHERS THROUGH THE DISTRIBUTION OF ADVERTISING MATERIALS THROUGH A VARIETY OF METHODS, IN CLASS 35 (U.S. CLS. 100, 101 AND 102).

FIRST USE 7-25-2007; IN COMMERCE 7-25-2007.

SN 77-036,287, FILED 11-3-2006.

RUDY R. SINGLETON, EXAMINING ATTORNEY

Int. Cl.: 30

Prior U.S. Cl.: 46

United States Patent and Trademark Office

Reg. No. 3,521,165

Registered Oct. 21, 2008

TRADEMARK
PRINCIPAL REGISTER



BIOREV, L.L.C. (WASHINGTON LIMITED LIABILITY COMPANY)
P.O. BOX 12809
OLYMPIA, WA 98508

FOR: COFFEE; COFFEE BEANS; PREPARED COFFEE AND COFFEE-BASED BEVERAGES; READY-TO-DRINK COFFEE-BASED BEVERAGES; TEA; BEVERAGES MADE OF TEA; TEA-BASED BEVERAGES; READY-TO-DRINK TEA-BASED BEVERAGES, IN CLASS 30 (U.S. CL. 46).

FIRST USE 5-17-2008; IN COMMERCE 5-17-2008.

THE COLOR(S) BLUE, GREEN, GRAY, YELLOW AND ORANGE IS/ARE CLAIMED AS A FEATURE OF THE MARK.

THE WORDING "SAMBA" APPEARS IN ORANGE AND YELLOW; THE WORDING "ISLAND" APPEARS IN GREEN AND BLUE; THE LEAVE OF THE PALM TREE IS GREEN WITH GRAY SHADOW; THE BASE OF THE PALM TREE IS ORANGE; AND THE BACKGROUND OF THE MARK CONSISTING OF THE DESIGN OF MULTIPLE RAYS APPEARS IN VARIOUS SHADES OF BLUE.

SN 77-036,560, FILED 11-3-2006.

JENNY PARK, EXAMINING ATTORNEY

Int. Cl.: 38

Prior U.S. Cls.: 100, 101, and 104

United States Patent and Trademark Office

Reg. No. 3,521,166

Registered Oct. 21, 2008

**SERVICE MARK
PRINCIPAL REGISTER**



FOX SPORTS NET, INC. (DELAWARE COR-
PORATION)
10201 WEST PICO BOULEVARD
LOS ANGELES, CA 90035

NO CLAIM IS MADE TO THE EXCLUSIVE
RIGHT TO USE "SPORT SOUTH", APART FROM
THE MARK AS SHOWN.

FOR: TELEVISION TRANSMISSION SERVICES,
IN CLASS 38 (U.S. CLS. 100, 101 AND 104).

SN 77-036,841, FILED 11-3-2006.

FIRST USE 10-13-2006; IN COMMERCE 10-13-2006.

DAVID MURRAY, EXAMINING ATTORNEY

Int. Cl.: 41

Prior U.S. Cls.: 100, 101, and 107

United States Patent and Trademark Office

Reg. No. 3,521,167

Registered Oct. 21, 2008

SERVICE MARK
PRINCIPAL REGISTER

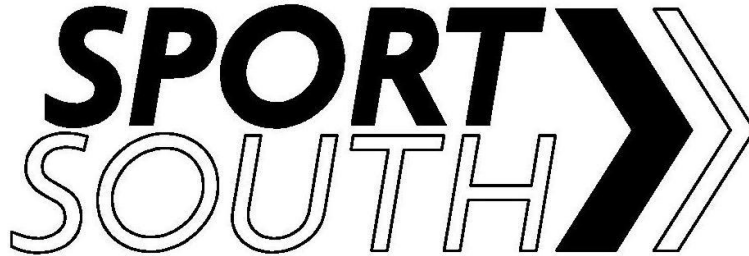

FOX SPORTS NET, INC. (DELAWARE CORPORATION)
10201 WEST PICO BOULEVARD
LOS ANGELES, CA 90035

FIRST USE 10-13-2006; IN COMMERCE 10-13-2006.

FOR: ENTERTAINMENT SERVICES IN THE NATURE OF TELEVISION PROGRAMMING; ENTERTAINMENT SERVICES IN THE NATURE OF PRODUCTION AND DISTRIBUTION OF TELEVISION PROGRAMS FEATURING SPORTS; PROVIDING ON-LINE INFORMATION IN THE FIELD OF SPORTS VIA A GLOBAL COMMUNICATIONS NETWORK, IN CLASS 41 (U.S. CLS. 100, 101 AND 107).

NO CLAIM IS MADE TO THE EXCLUSIVE RIGHT TO USE "SPORT SOUTH", APART FROM THE MARK AS SHOWN.

SN 77-036,862, FILED 11-3-2006.

KIMBERLY FRYE, EXAMINING ATTORNEY

Int. Cl.: 39

Prior U.S. Cls.: 100 and 105

United States Patent and Trademark Office

Reg. No. 3,521,168

Registered Oct. 21, 2008

**SERVICE MARK
PRINCIPAL REGISTER**

BLUE DIAMOND COLLECTION

GRAY LINE CORPORATION (MARYLAND CORPORATION)
P.O. BOX 18267
DENVER, CO 802180267

FOR: CHARTERED TRANSPORTATION OF PASSENGERS BY LAND VIA BUS, MOTOR COACH, MINI-BUS, VAN, AND AUTOMOBILE, AND BY WATER VIA BOAT; SIGHTSEEING SERVICES, TRAVEL TOURS SERVICES AND RENTAL CAR SERVICES, IN CLASS 39 (U.S. CLS. 100 AND 105).

FIRST USE 4-0-2006; IN COMMERCE 4-0-2006.

THE MARK CONSISTS OF STANDARD CHARACTERS WITHOUT CLAIM TO ANY PARTICULAR FONT, STYLE, SIZE, OR COLOR.

SN 77-036,927, FILED 11-4-2006.

KELLEY WELLS, EXAMINING ATTORNEY

Int. Cls.: 35, 41, and 44

Prior U.S. Cls.: 100, 101, 102, and 107

United States Patent and Trademark Office

Reg. No. 3,521,169

Registered Oct. 21, 2008

**SERVICE MARK
PRINCIPAL REGISTER**

PET PUBLIC

DOG PUBLIC LLC (OHIO LIMITED LIABILITY COMPANY)
10754 MOSS HILL LANE
CINCINNATI, OH 45249

FOR: PROMOTING THE GOODS AND SERVICES OF OTHERS BY PROVIDING HYPERTEXT LINKS TO THE WEB SITES OF OTHERS; RENTAL OF ADVERTISING SPACE ON WEB SITES; PROMOTING THE GOODS AND SERVICES OF OTHERS VIA A GLOBAL COMPUTER NETWORK; PROVIDING CONSUMER PRODUCT REVIEWS IN THE FIELD OF NEW PET PRODUCTS VIA A WEBSITE; PROVIDING CONSUMER INFORMATION IN THE FIELD OF ANIMAL AND PET PRODUCTS VIA A GLOBAL COMPUTER NETWORK, IN CLASS 35 (U.S. CLS. 100, 101 AND 102).

FIRST USE 5-28-2008; IN COMMERCE 5-28-2008.

FOR: PROVIDING INFORMATION IN THE FIELD OF PET TRAINING TIPS VIA A GLOBAL COMPUTER NETWORK, IN CLASS 41 (U.S. CLS. 100, 101 AND 107).

FIRST USE 5-28-2008; IN COMMERCE 5-28-2008.

FOR: PROVIDING INFORMATION IN THE FIELD OF ANIMALS AND PETS, NAMELY, BREED INFORMATION, IN CLASS 44 (U.S. CLS. 100 AND 101).

FIRST USE 5-28-2008; IN COMMERCE 5-28-2008.

THE MARK CONSISTS OF STANDARD CHARACTERS WITHOUT CLAIM TO ANY PARTICULAR FONT, STYLE, SIZE, OR COLOR.

NO CLAIM IS MADE TO THE EXCLUSIVE RIGHT TO USE "PET", APART FROM THE MARK AS SHOWN.

SN 77-037,076, FILED 11-5-2006.

DAVID I, EXAMINING ATTORNEY

Int. Cl.: 9

Prior U.S. Cls.: 21, 23, 26, 36, and 38

United States Patent and Trademark Office

Reg. No. 3,521,170

Registered Oct. 21, 2008

**TRADEMARK
PRINCIPAL REGISTER**

Navi2Go

3DVU ISRAEL(2000) LTD. (ISRAEL CORPORATION)
28 LEVY ESHCOL ST.
RAANANA, ISRAEL 43703

FOR: COMPUTER HARDWARE AND COMPUTER SOFTWARE PROGRAMS FOR THE INTEGRATION OF TEXT, AUDIO, GRAPHICS, STILL IMAGE AND MOVING PICTURES INTO AN INTERACTIVE DELIVERY FOR MULTIMEDIA APPLICATIONS, IN CLASS 9 (U.S. CLS. 21, 23, 26, 36 AND 38).

FIRST USE 10-1-2007; IN COMMERCE 4-1-2008.

THE MARK CONSISTS OF STANDARD CHARACTERS WITHOUT CLAIM TO ANY PARTICULAR FONT, STYLE, SIZE, OR COLOR.

SN 77-037,196, FILED 11-6-2006.

BERNICE MIDDLETON, EXAMINING ATTORNEY

Int. Cls.: 29 and 30

Prior U.S. Cl.: 46

United States Patent and Trademark Office

Reg. No. 3,521,171

Registered Oct. 21, 2008

**TRADEMARK
PRINCIPAL REGISTER**

CASCADIAN FARM

SMALL PLANET FOODS (WASHINGTON CORPORATION)
719 METCALF STREET
SEDRO-WOOLLEY, WA 98284

FOR: FROZEN FRUITS, IN CLASS 29 (U.S. CL. 46).

FIRST USE 0-0-1984; IN COMMERCE 0-0-1984.

FOR: FROZEN NOVELTIES, NAMELY, FROZEN DESSERT CONSISTING PRIMARILY OF FRUIT WITH OR WITHOUT DAIRY OR DAIRY SUBSTITUTES; SHERBET, IN CLASS 30 (U.S. CL. 46).

FIRST USE 6-4-2007; IN COMMERCE 6-4-2007.

THE MARK CONSISTS OF STANDARD CHARACTERS WITHOUT CLAIM TO ANY PARTICULAR FONT, STYLE, SIZE, OR COLOR.

OWNER OF U.S. REG. NOS. 1,471,543, 2,365,506, AND 2,995,166.

SN 77-037,409, FILED 11-6-2006.

CHERYL CLAYTON, EXAMINING ATTORNEY

Int. Cl.: 16

Prior U.S. Cls.: 2, 5, 22, 23, 29, 37, 38, and 50

Reg. No. 3,521,172

United States Patent and Trademark Office

Registered Oct. 21, 2008

**TRADEMARK
PRINCIPAL REGISTER**

CROME

CROME MEDIA GROUP, INC. (MICHIGAN CORPORATION)
9411 E. M-36
WHITMORE LAKE, MI 48189

FIRST USE 8-31-2006; IN COMMERCE 8-31-2006.

FOR: PRINTED MATTER AND PUBLICATIONS, NAMELY, MAGAZINES AND PERIODICAL PUBLICATIONS, IN THE FIELD OF MEN'S LIFESTYLES, ENTERTAINMENT, FITNESS, HEALTH, AND RECREATIONAL ACTIVITIES, IN CLASS 16 (U.S. CLS. 2, 5, 22, 23, 29, 37, 38 AND 50).

THE MARK CONSISTS OF STANDARD CHARACTERS WITHOUT CLAIM TO ANY PARTICULAR FONT, STYLE, SIZE, OR COLOR.

SN 77-037,474, FILED 11-6-2006.

PRISCILLA MILTON, EXAMINING ATTORNEY

Int. Cls.: 20 and 25

Prior U.S. Cls.: 2, 13, 22, 25, 32, 39, and 50

United States Patent and Trademark Office

Reg. No. 3,521,173

Registered Oct. 21, 2008

**TRADEMARK
PRINCIPAL REGISTER**

ERGOBUDDY

JOHNSON TECHNOLOGIES CORPORATION
(TENNESSEE CORPORATION)
2034 PITTSWAY DRIVE
NASHVILLE, TN 37207

FOR: COMMERCIAL WORK STATIONS, ACCESSORIES AND COMPONENTS THEREFOR SOLD AS A UNIT, NAMELY FOOT PEDALS TO OPERATE MACHINERY, WORK TABLES, WORK BENCHES FOR INDUSTRIAL USE, WORK STANDS, WORK TOPS AND INTEGRATED ERGONOMIC WORK PADS TO PROVIDE A MORE COMFORTABLE WORK ENVIRONMENT AND TO REDUCE RISK OF INJURY, IN CLASS 20 (U.S. CLS. 2, 13, 22, 25, 32 AND 50).

FIRST USE 4-24-2001; IN COMMERCE 4-24-2001.

FOR: SHOE INSERTS FOR PRIMARILY NON-ORTHOPEDIC PURPOSES; INSOLES FOR SHOES AND BOOTS, IN CLASS 25 (U.S. CLS. 22 AND 39).

FIRST USE 3-0-2007; IN COMMERCE 3-0-2007.

THE MARK CONSISTS OF STANDARD CHARACTERS WITHOUT CLAIM TO ANY PARTICULAR FONT, STYLE, SIZE, OR COLOR.

OWNER OF U.S. REG. NOS. 1,941,970 AND 1,945,229.

SN 77-037,932, FILED 11-6-2006.

ERNEST SHOSHO, EXAMINING ATTORNEY

Int. Cl.: 41

Prior U.S. Cls.: 100, 101, and 107

United States Patent and Trademark Office

Reg. No. 3,521,174

Registered Oct. 21, 2008

**SERVICE MARK
PRINCIPAL REGISTER**

LOS HUEVOS

COHEN, ROGER (UNITED STATES JOINT APPLICANTS)

SUITE 2000

3200 N. CENTRAL AVE.

PHOENIX, AZ 85032 AND

SCHURGIN, ARTHUR (UNITED STATES JOINT APPLICANTS)

SUITE 2000

3200 N. CENTRAL AVE.

PHOENIX, AZ 85012 AND

MULMED, KEVIN (UNITED STATES JOINT APPLICANTS)

SUITE 2000

3200 N. CENTRAL AVE.

PHOENIX, AZ 85012

FOR: ENTERTAINMENT IN THE NATURE OF LIVE PERFORMANCES BY A MUSICAL GROUP, IN CLASS 41 (U.S. CLS. 100, 101 AND 107).

FIRST USE 3-11-2006; IN COMMERCE 3-19-2007.

THE MARK CONSISTS OF STANDARD CHARACTERS WITHOUT CLAIM TO ANY PARTICULAR FONT, STYLE, SIZE, OR COLOR.

THE FOREIGN WORDING IN THE MARK TRANSLATES INTO ENGLISH AS THE "EGGS".

SN 77-038,442, FILED 11-7-2006.

ANDREA SAUNDERS, EXAMINING ATTORNEY

Int. Cl.: 25

Prior U.S. Cls.: 22 and 39

United States Patent and Trademark Office

Reg. No. 3,521,175

Registered Oct. 21, 2008

**TRADEMARK
PRINCIPAL REGISTER**

HEAVENLY SINS

PHANNY SILK GROUP INC. (NEW YORK COR-
PORATION)
ROOM #1005
530 7TH AVENUE
NEW YORK, NY 10016

FOR: WOMEN'S CLOTHING, NAMELY, SKIRTS,
SHIRTS, T-SHIRTS, BLOUSES, PANTS, PANTSUITS,
SLACKS, SHORTS, DRESSES, TOPS, SWEATERS,
SWEAT SUITS, JACKETS, COATS, IN CLASS 25 (U.S.
CLS. 22 AND 39).

FIRST USE 1-30-2007; IN COMMERCE 8-30-2007.

THE MARK CONSISTS OF STANDARD CHAR-
ACTERS WITHOUT CLAIM TO ANY PARTICULAR
FONT, STYLE, SIZE, OR COLOR.

SN 77-038,566, FILED 11-7-2006.

CAROLYN CATALDO, EXAMINING ATTORNEY

Int. Cl.: 11

Prior U.S. Cls.: 13, 21, 23, 31, and 34

United States Patent and Trademark Office

Reg. No. 3,521,176

Registered Oct. 21, 2008

**TRADEMARK
PRINCIPAL REGISTER**



HI-TEC SPORTS PLC (UNITED KINGDOM COMPANY)
AVIATION WAY
SOUTHEND-ON-SEA, ESSEX, UNITED KINGDOM
SS26GH

FOR: GAS OR SOLID FUEL COOKING STOVES
FOR CAMPING; FLASHLIGHTS, IN CLASS 11 (U.S.
CLS. 13, 21, 23, 31 AND 34).

FIRST USE 6-1-2005; IN COMMERCE 6-1-2005.

THE MARK CONSISTS IN PART OF AN ARROW
WITHIN A SHADED CIRCLE.

SN 77-038,620, FILED 11-7-2006.

IRA J. GOODSaid, EXAMINING ATTORNEY

Int. Cls.: 1 and 3

Prior U.S. Cls.: 1, 4, 5, 6, 10, 26, 46, 50, 51, and 52

Reg. No. 3,521,177

United States Patent and Trademark Office

Registered Oct. 21, 2008

**TRADEMARK
PRINCIPAL REGISTER**



ALLIED PRESSROOM CHEMISTRY, INC. (FLORIDA CORPORATION)
2040 LEE STREET
HOLLYWOOD, FL 33020

FOR: CHEMICALS FOR USE IN THE PRINTING INDUSTRY, NAMELY, FOUNTAIN ADDITIVES AND DAMPENING SOLUTIONS, IN CLASS 1 (U.S. CLS. 1, 5, 6, 10, 26 AND 46).

FIRST USE 11-1-2005; IN COMMERCE 11-1-2005.

FOR: CLEANERS FOR USE ON PRINTING PLATES, PRESS FRAMES, PRINTING ROLLERS, AND PRINTING MACHINES; AND PRINTING PRESS WASHES, IN CLASS 3 (U.S. CLS. 1, 4, 6, 50, 51 AND 52).

FIRST USE 11-1-2005; IN COMMERCE 11-1-2005.

NO CLAIM IS MADE TO THE EXCLUSIVE RIGHT TO USE "WORLD CLASS PRESSROOM PRODUCTS", APART FROM THE MARK AS SHOWN.

THE MARK CONSISTS OF A CIRCULAR DESIGN THAT HAS THE WORDS "WORLD CLASS PRESS ROOM PRODUCTS" AROUND THE OUTER EDGE. IN THE CENTER OF THE CIRCLE IS A SPHERICAL DESIGN. IN THE CENTER OF THE SPHERE IS A RECTANGULAR BOX. THE LETTER "A" IS IN THE CENTER OF THE BOX AND HAS THE WORD "ALLIED" WRITTEN ACROSS THE MIDDLE OF THE LETTER.

SN 77-038,819, FILED 11-7-2006.

CHRISTINA SOBRAL, EXAMINING ATTORNEY

Int. Cl.: 16

Prior U.S. Cls.: 2, 5, 22, 23, 29, 37, 38, and 50

Reg. No. 3,521,178

United States Patent and Trademark Office

Registered Oct. 21, 2008

**TRADEMARK
PRINCIPAL REGISTER**

TICKET-A-KID

BARONE, THOMAS (UNITED STATES INDIVIDUAL)
219 WEST PLAIN STREET
WAYLAND, MA 01778

THE MARK CONSISTS OF STANDARD CHARACTERS WITHOUT CLAIM TO ANY PARTICULAR FONT, STYLE, SIZE, OR COLOR.

FOR: CITATION BOOKLETS, IN CLASS 16 (U.S. CLS. 2, 5, 22, 23, 29, 37, 38 AND 50).

SN 77-038,851, FILED 11-7-2006.

FIRST USE 5-31-2008; IN COMMERCE 5-31-2008.

STEPHEN AQUILA, EXAMINING ATTORNEY

Int. Cl.: 10

Prior U.S. Cls.: 26, 39, and 44

Reg. No. 3,521,179

United States Patent and Trademark Office

Registered Oct. 21, 2008

**TRADEMARK
PRINCIPAL REGISTER**

AMES

AMES TECHNOLOGY, INC. (OREGON CORPORATION)
657 SW REGENCY PLACE
PORTLAND, OR 972256060

FOR: ELECTROMECHANICAL THERAPY MEDICAL DEVICE USING ASSISTED MOTION AND VIBRATION STIMULATION TO TREAT NEUROMUSCULAR DISORDERS RESULTING FROM BRAIN INJURY, COMPRISED OF MECHANICAL TENDON VIBRATORS FOR THE FLEXOR AND EXTENSOR TENDONS OF THE TREATED JOINT OR JOINTS, A GRAPHICAL INTERFACE COMPRISED OF A COMPUTER AND SCREEN TO PRESENT VISUAL FEEDBACK AND TO PROVIDE DEVICE CONTROL, A FLEXION-EXTENSION MO-

TION SYSTEM COMPRISED OF A MOTOR AND GEAR BOX, AND A LOAD CELL MOUNTED BETWEEN THE GEARBOX AND THE TREATED LIMB TO DETECT TORQUE, IN CLASS 10 (U.S. CLS. 26, 39 AND 44).

FIRST USE 7-0-2007; IN COMMERCE 7-0-2007.

THE MARK CONSISTS OF STANDARD CHARACTERS WITHOUT CLAIM TO ANY PARTICULAR FONT, STYLE, SIZE, OR COLOR.

SN 77-039,085, FILED 11-7-2006.

KRISTIN DAHLING, EXAMINING ATTORNEY

Int. Cl.: 16

Prior U.S. Cls.: 2, 5, 22, 23, 29, 37, 38, and 50

Reg. No. 3,521,180

United States Patent and Trademark Office

Registered Oct. 21, 2008

**TRADEMARK
PRINCIPAL REGISTER**

QUAD-CORR

STEVEN W. BAUGHMAN (UNITED STATES IN-
DIVIDUAL)
315 N. MANEY AVENUE
MURFREESBORO, TN 37130

THE MARK CONSISTS OF STANDARD CHAR-
ACTERS WITHOUT CLAIM TO ANY PARTICULAR
FONT, STYLE, SIZE, OR COLOR.

FOR: CORRUGATED CARDBOARD; CORRUGA-
TED CARDBOARD BOXES, IN CLASS 16 (U.S. CLS.
2, 5, 22, 23, 29, 37, 38 AND 50).

SN 77-039,522, FILED 11-8-2006.

FIRST USE 7-17-2008; IN COMMERCE 7-17-2008.

JENNY PARK, EXAMINING ATTORNEY

Int. Cl.: 43

Prior U.S. Cls.: 100 and 101

United States Patent and Trademark Office

Reg. No. 3,521,181

Registered Oct. 21, 2008

**SERVICE MARK
PRINCIPAL REGISTER**



SHULA'S STEAK HOUSES LLLP (DELAWARE
LIMITED PARTNERSHIP)
6843 MAIN STREET
MIAMI LAKES, FL 33014

FOR: RESTAURANT SERVICES, FOOD PRE-
PARATION SERVICES AND BEVERAGE PREPARA-
TION SERVICES, IN CLASS 43 (U.S. CLS. 100 AND
101).

FIRST USE 11-8-2006; IN COMMERCE 11-8-2006.

OWNER OF U.S. REG. NOS. 2,147,364, 3,019,370,
AND OTHERS.

NO CLAIM IS MADE TO THE EXCLUSIVE
RIGHT TO USE "GRILL", APART FROM THE
MARK AS SHOWN.

THE NAME(S), PORTRAIT(S), AND/OR SIGNA-
TURE(S) SHOWN IN THE MARK IDENTIFIES A
LIVING INDIVIDUAL WHOSE CONSENT(S) TO
REGISTER IS OF RECORD.

SN 77-039,785, FILED 11-8-2006.

KIMBERLY FRYE, EXAMINING ATTORNEY

Int. Cl.: 43

Prior U.S. Cls.: 100 and 101

United States Patent and Trademark Office

Reg. No. 3,521,182

Registered Oct. 21, 2008

**SERVICE MARK
PRINCIPAL REGISTER**



SHULA'S STEAK HOUSES LLLP (DELAWARE
LIMITED PARTNERSHIP)
6843 MAIN STREET
MIAMI LAKES, FL 33014

FOR: RESTAURANT SERVICES, FOOD PRE-
PARATION SERVICES AND BEVERAGE PREPARA-
TION SERVICES, IN CLASS 43 (U.S. CLS. 100 AND
101).

FIRST USE 11-8-2006; IN COMMERCE 11-8-2006.

OWNER OF U.S. REG. NOS. 2,147,364, 3,019,370,
AND OTHERS.

NO CLAIM IS MADE TO THE EXCLUSIVE
RIGHT TO USE "STEAK & SPORTS", APART FROM
THE MARK AS SHOWN.

THE NAME(S), PORTRAIT(S), AND/OR SIGNA-
TURE(S) SHOWN IN THE MARK IDENTIFIES A
LIVING INDIVIDUAL WHOSE CONSENT(S) TO
REGISTER IS OF RECORD.

SN 77-039,811, FILED 11-8-2006.

KIMBERLY FRYE, EXAMINING ATTORNEY

Int. Cl.: 3

Prior U.S. Cls.: 1, 4, 6, 50, 51, and 52

Reg. No. 3,521,183

United States Patent and Trademark Office

Registered Oct. 21, 2008

TRADEMARK
PRINCIPAL REGISTER

과일나라

WELCOS CO., LTD. (REPUBLIC OF KOREA CORPORATION)
CHUNCHEON-SI
855 TOEGYE-DONG
KWANWON-DO, REPUBLIC OF KOREA

FOR: SKIN EXFOLIATING CREAM, EXFOLIATING SKIN LOTIONS, SKIN NOURISHING CREAMS, LIP GLOSSES, LIP BALMS, BEAUTY MASK PACKS, MASSAGE GEL, MASSAGE OIL, MASSAGE CREAM, HAIR CARE PREPARATIONS, HAIR COLORANTS, HAIR WAVING PREPARATIONS, COLOR-REMOVING PREPARATIONS FOR HAIR, BODY LOTIONS, BODY CREAMS, BODY CLEANSER, SHOWER COLOGNE, SUN MILK, SUNSCREEN LOTIONS, SUNSCREEN CREAMS, SUN OILS, SUN-TANNING PREPARATIONS, SKIN MILK LOTIONS, SKIN FRESHENERS IN THE NATURE OF TOPICAL SKIN SPRAYS FOR COSMETIC PURPOSES, EYE MAKE-UP REMOVERS, AFTER SHAVE LOTIONS, ESSENCES IN THE NATURE OF NON-MEDICATED SERUMS FOR THE FACE AND BODY, EAU DE COLOGNE, EAU DE TOILETTE, SKIN LOTIONS, COLD CREAMS, SOLID MAKE-UP POWDER FOR COMPACTS, SKIN CLEANSING CREAM, SKIN CLEANSING LOTIONS, SKIN CLEANSING FOAM, PERMANENT WAVE PREPARATIONS, NEUTRALIZERS FOR PERMANENT WAVING, FOUNDA-

TION CREAMS, FACE POWDER, SKIN WHITENING CREAMS, HAND CREAMS, PERFUMES, HAIR GEL, HAIR GLAZE, HAIR DRESSINGS, HAIR LOTIONS, HAIR MOISTURIZERS, HAIR MOUSSE, HAIR SPRAY, HAIR CONDITIONERS, HAIR CREAMS, HAIR TONIC, BATH SOAPS, BEAUTY SOAPS, SHAMPOOS, MEDICATED SOAP, HAIR RINSES, COSMETIC SOAPS, IN CLASS 3 (U.S. CLS. 1, 4, 6, 50, 51 AND 52).

FIRST USE 9-7-1994; IN COMMERCE 11-4-2004.

THE MARK CONSISTS OF KOREAN CHARACTERS.

THE MARK TRANSLATES TO "FRUIT WORLD" IN ENGLISH.

THE NON-LATIN CHARACTER(S) IN THE MARK TRANSLITERATES INTO KWA-IL-NA-RA, AND THIS MEANS FRUIT WORLD IN ENGLISH.

SN 77-039,890, FILED 11-8-2006.

STEVEN PEREZ, EXAMINING ATTORNEY

Int. Cls.: 3, 4, and 12

**Prior U.S. Cls.: 1, 4, 6, 15, 19, 21, 23, 31, 35, 44, 50, 51,
and 52**

Reg. No. 3,521,184

United States Patent and Trademark Office

Registered Oct. 21, 2008

**TRADEMARK
PRINCIPAL REGISTER**

ServiceRite

SOUTHEAST TOYOTA DISTRIBUTORS, LLC.
(DELAWARE LIMITED LIABILITY COMPAN-
NY)
100 JIM MORAN BOULEVARD
DEERFIELD BEACH, FL 33442

FOR: AUTOMOBILE CLEANERS, DETERGENTS
FOR AUTOMOBILES, IN CLASS 3 (U.S. CLS. 1, 4, 6,
50, 51 AND 52).

FIRST USE 2-0-2008; IN COMMERCE 2-0-2008.

FOR: AUTOMOBILE LUBRICANTS, IN CLASS 4
(U.S. CLS. 1, 6 AND 15).

FIRST USE 2-0-2008; IN COMMERCE 2-0-2008.

FOR: STRUCTURAL PARTS FOR AUTOMO-
BILES, IN CLASS 12 (U.S. CLS. 19, 21, 23, 31, 35 AND
44).

FIRST USE 2-0-2008; IN COMMERCE 2-0-2008.

THE MARK CONSISTS OF STANDARD CHAR-
ACTERS WITHOUT CLAIM TO ANY PARTICULAR
FONT, STYLE, SIZE, OR COLOR.

SN 77-040,265, FILED 11-9-2006.

ROBIN MITTLER, EXAMINING ATTORNEY

Int. Cl.: 41

Prior U.S. Cls.: 100, 101, and 107

United States Patent and Trademark Office

Reg. No. 3,521,185

Registered Oct. 21, 2008

**SERVICE MARK
PRINCIPAL REGISTER**

HERPES BOY

GAST, BYRON R (UNITED STATES INDIVIDUAL)
PO BOX 461304
LOS ANGELES, CA 90046

FOR: ENTERTAINMENT SERVICES, NAMELY, PROVIDING A WEBSITE FEATURING, PHOTOGRAPHIC, AUDIO, VIDEO AND PROSE PRESENTATIONS FEATURING COMEDY, IN CLASS 41 (U.S. CLS. 100, 101 AND 107).

FIRST USE 12-1-2006; IN COMMERCE 12-1-2006.

THE MARK CONSISTS OF STANDARD CHARACTERS WITHOUT CLAIM TO ANY PARTICULAR FONT, STYLE, SIZE, OR COLOR.

SN 77-040,670, FILED 11-9-2006.

JAMES MACFARLANE, EXAMINING ATTORNEY

Int. Cl.: 42

Prior U.S. Cls.: 100 and 101

United States Patent and Trademark Office

Reg. No. 3,521,186

Registered Oct. 21, 2008

**SERVICE MARK
PRINCIPAL REGISTER**

CUT N' SHUFFLE

GIOIA SYSTEMS, LLC (COLORADO LIMITED
LIABILITY COMPANY)
SUITE 500
650 SOUTH CHERRY STREET
DENVER, CO 80246

FOR: COMPUTER SERVICES, NAMELY, ELECTRONICALLY GATHERING, ANALYZING AND FORMATTING DATA TO PROVIDE ELECTRONIC LISTINGS OF CARDS CORRESPONDING TO A READING OF PHYSICALLY SHUFFLED CARDS FOR USE IN ELECTRONIC OR COMPUTER CARD GAMES AND TO VERIFY THAT ELECTRONIC OR COMPUTER CARD GAMES ARE PLAYED AC-

CORDING TO THE ELECTRONIC LISTINGS OF CARDS, IN CLASS 42 (U.S. CLS. 100 AND 101).

FIRST USE 6-3-2008; IN COMMERCE 6-3-2008.

THE MARK CONSISTS OF STANDARD CHARACTERS WITHOUT CLAIM TO ANY PARTICULAR FONT, STYLE, SIZE, OR COLOR.

SN 77-040,823, FILED 11-9-2006.

DOMINIC FATHY, EXAMINING ATTORNEY

Int. Cl.: 5

Prior U.S. Cls.: 6, 18, 44, 46, 51, and 52

Reg. No. 3,521,187

United States Patent and Trademark Office

Registered Oct. 21, 2008

**TRADEMARK
PRINCIPAL REGISTER**

NAIL SHIELD

SPECIALTY NUTRITION GROUP, INC. (FLORIDA CORPORATION)
ONE SOUTH OCEAN BLVD., SUITE 300
BOCA RATON, FL 33432

FOR: DIETARY SUPPLEMENTS; FOOD SUPPLEMENTS; HERBAL SUPPLEMENTS; MINERAL SUPPLEMENTS; NUTRITIONAL SUPPLEMENTS; VITAMIN SUPPLEMENTS, IN CLASS 5 (U.S. CLS. 6, 18, 44, 46, 51 AND 52).

FIRST USE 4-30-2008; IN COMMERCE 5-16-2008.

THE MARK CONSISTS OF STANDARD CHARACTERS WITHOUT CLAIM TO ANY PARTICULAR FONT, STYLE, SIZE, OR COLOR.

NO CLAIM IS MADE TO THE EXCLUSIVE RIGHT TO USE "NAIL", APART FROM THE MARK AS SHOWN.

SN 77-041,332, FILED 11-10-2006.

ROBIN CHOSID, EXAMINING ATTORNEY

Int. Cls.: 42 and 45

Prior U.S. Cls.: 100 and 101

United States Patent and Trademark Office

Reg. No. 3,521,188

Registered Oct. 21, 2008

**SERVICE MARK
PRINCIPAL REGISTER**



MERRITT, GIOVANNI A (UNITED STATES INDIVIDUAL)
15260 SW 153RD STREET
MIAMI, FL 33187

FOR: COMPUTER SERVICES, NAMELY, CREATING AN ONLINE COMMUNITY FOR REGISTERED USERS TO GET FEEDBACK FROM THEIR PEERS, ENGAGE IN SOCIAL NETWORKING AND HOSTING OF DIGITAL CONTENT ON THE INTERNET, IN CLASS 42 (U.S. CLS. 100 AND 101).

FIRST USE 3-1-2008; IN COMMERCE 3-1-2008.

FOR: INTERNET BASED SOCIAL NETWORKING SERVICES; ONLINE SOCIAL NETWORKING SERVICES; PROVIDING HOROSCOPE INFORMATION VIA COMPUTER NETWORKS, IN CLASS 45 (U.S. CLS. 100 AND 101).

FIRST USE 3-1-2008; IN COMMERCE 3-1-2008.

SN 77-041,579, FILED 11-10-2006.

PAULA MAHONEY, EXAMINING ATTORNEY

Int. Cls.: 25 and 36

Prior U.S. Cls.: 22, 39, 100, 101, and 102

United States Patent and Trademark Office

Reg. No. 3,521,189

Registered Oct. 21, 2008

TRADEMARK
SERVICE MARK
PRINCIPAL REGISTER



UNITED CEREBRAL PALSY ASSOCIATIONS,
INC. (NEW YORK CORPORATION)
SUITE 700
1660 L STREET, N.W.
WASHINGTON, DC 20036

FOR: CLOTHING, NAMELY, T-SHIRTS, SHIRTS,
JACKETS, GLOVES AND BICYCLE RIDING SUITS,
IN CLASS 25 (U.S. CLS. 22 AND 39).

FIRST USE 9-7-2007; IN COMMERCE 9-7-2007.

FOR: CHARITABLE FUNDRAISING; CHARITA-
BLE FUNDRAISING SERVICES, NAMELY, RAIS-
ING MONEY FOR CEREBRAL PALSY AND OTHER
DISABILITIES RESEARCH AND PROGRAMS, AND
RAISING MONEY FOR LOCAL COMMUNITY CER-

EBRAL PALSY AND OTHER DISABILITIES,
HEALTH CARE AND AWARENESS, IN CLASS 36
(U.S. CLS. 100, 101 AND 102).

FIRST USE 9-7-2007; IN COMMERCE 9-7-2007.

OWNER OF U.S. REG. NOS. 2,549,037, 3,105,302,
AND OTHERS.

THE MARK CONSISTS OF A STYLIZED DESIGN
OF A RIDER AND BICYCLE OVER TWO RAYS.

SN 77-041,608, FILED 11-10-2006.

NORA BUCHANAN WILL, EXAMINING ATTOR-
NEY

Int. Cl.: 35

Prior U.S. Cls.: 100, 101, and 102

United States Patent and Trademark Office

Reg. No. 3,521,190

Registered Oct. 21, 2008

**SERVICE MARK
PRINCIPAL REGISTER**

RALPH LAUREN

PRL USA HOLDINGS, INC. (DELAWARE CORPORATION)
103 FOULK ROAD
WILMINGTON, DE 19803

FOR: ON-LINE RETAIL STORE SERVICES FEATURING MEN'S, WOMEN'S AND CHILDREN'S CLOTHING, FOOTWEAR, HEADGEAR, EYEWEAR, HANDBAGS, BACKPACKS, TRAVEL BAGS, WALLET, ATHLETIC BAGS, JEWELRY, WATCHES, SPORTING GOODS AND ACCESSORIES, FRAGRANCE, BODY LOTIONS, HOME FURNISHING IN THE NATURE OF BEDSHEETS, DUVET COVERS, COMFORTERS, BLANKETS, PILLOWS, TOWELS, TABLE CLOTHS, DINNERWARE, PICTURE FRAMES, IN CLASS 35 (U.S. CLS. 100, 101 AND 102).

FIRST USE 6-1-2007; IN COMMERCE 6-1-2007.

THE MARK CONSISTS OF STANDARD CHARACTERS WITHOUT CLAIM TO ANY PARTICULAR FONT, STYLE, SIZE, OR COLOR.

OWNER OF U.S. REG. NOS. 984,005, 1,449,785, AND OTHERS.

THE NAME(S), PORTRAIT(S), AND/OR SIGNATURE(S) SHOWN IN THE MARK IDENTIFIES A LIVING INDIVIDUAL, WHOSE CONSENT(S) TO REGISTER IS SUBMITTED.

SN 77-041,662, FILED 11-10-2006.

JESSICA A. POWERS, EXAMINING ATTORNEY

Int. Cl.: 7

Prior U.S. Cls.: 13, 19, 21, 23, 31, 34, and 35

Reg. No. 3,521,191

United States Patent and Trademark Office

Registered Oct. 21, 2008

**TRADEMARK
PRINCIPAL REGISTER**

SQUEEZ-EZ

WIL-GIL LLC (WISCONSIN LIMITED LIABILITY
COMPANY)
1509 RANDOLPH STREET
WATERTOWN, WI 53094

FIRST USE 2-7-2007; IN COMMERCE 2-7-2007.

FOR: WASHING APPARATUS FOR SPONGES,
TOWELS OR OTHER ABSORBENT MATERIAL,
NAMELY, ELECTRIC WASHING MACHINES THAT
OPERATE BY SQUEEZING DIRTY WATER AND
GROUT OUT OF THE ABSORBENT MATERIAL, IN
CLASS 7 (U.S. CLS. 13, 19, 21, 23, 31, 34 AND 35).

THE MARK CONSISTS OF STANDARD CHAR-
ACTERS WITHOUT CLAIM TO ANY PARTICULAR
FONT, STYLE, SIZE, OR COLOR.

SN 77-041,749, FILED 11-10-2006.

ROBIN MITTLER, EXAMINING ATTORNEY

Int. Cl.: 28

Prior U.S. Cls.: 22, 23, 38, and 50

United States Patent and Trademark Office

Reg. No. 3,521,192

Registered Oct. 21, 2008

**TRADEMARK
PRINCIPAL REGISTER**

P R ● T E C T I N G T H E B ● O Y S

BASEBALL INVENTIONS, LLC (ARIZONA LIMITED LIABILITY COMPANY)
6040 E. MONTECITO
SCOTTSDALE, AZ 85251

FOR: ATHLETIC EQUIPMENT, NAMELY, DEVICES FOR ATHLETIC SUPPORT, NAMELY, CUPS, JOCKSTRAPS, GUARDS, AND GENITAL PROTECTION DEVICES, IN CLASS 28 (U.S. CLS. 22, 23, 38 AND 50).

THE MARK CONSISTS OF THE LETTERS "PROTECTING THE BOYS" APPEARING IN SMOOTHLY CURVED FONT FACE WHERE THE "O" OF "PROTECTING" AND THE "O" OF "BOYS" COMPRISE SOLID CIRCLES.

SN 77-041,884, FILED 11-10-2006.

FIRST USE 2-28-2007; IN COMMERCE 2-28-2007.

MATTHEW EINSTEIN, EXAMINING ATTORNEY

Int. Cls.: 7, 40, and 42

**Prior U.S. Cls.: 13, 19, 21, 23, 31, 34, 35, 100, 101, 103,
and 106**

Reg. No. 3,521,193

United States Patent and Trademark Office

Registered Oct. 21, 2008

**TRADEMARK
SERVICE MARK
PRINCIPAL REGISTER**

**KEEPING TECHNOLOGY ON THE
MOVE**

NEW HAMPSHIRE BALL BEARINGS, INC. (NEW
HAMPSHIRE CORPORATION)
9730 INDEPENDENCE AVENUE
CHATWORTH, CA 91311

FOR: BEARINGS, NAMELY, ENGINE BEARINGS, SMALL MOTOR BEARINGS, BALL BEARINGS AND ROLLER BEARINGS AND COMPONENT PARTS THEREOF FOR MACHINES, MACHINE PARTS, MACHINE TOOLS, INDUSTRIAL EQUIPMENT, ENGINES, MOTOR VEHICLES AND AIRCRAFT; BEARINGS, NAMELY, ENGINE BEARINGS, SMALL MOTOR BEARINGS, BALL BEARINGS AND ROLLER BEARINGS AND COMPONENT PARTS THEREOF FOR USE IN THE FIELDS OF AEROSPACE, DENTAL AND MEDICAL EQUIPMENT, ROBOTICS, FLOW-METERS, MISSILE GUIDANCE, SEMICONDUCTOR PROCESSING, INDUSTRIAL EQUIPMENT, HIGH-TECHNOLOGY EQUIPMENT, AND COMPUTERS, IN CLASS 7 (U.S. CLS. 13, 19, 21, 23, 31, 34 AND 35).

FIRST USE 7-1-2007; IN COMMERCE 7-1-2007.

FOR: CUSTOM MANUFACTURING SERVICES FOR OTHERS IN THE FIELD OF BEARINGS, BALL BEARINGS AND ROLLER BEARINGS, IN CLASS 40 (U.S. CLS. 100, 103 AND 106).

FIRST USE 7-1-2007; IN COMMERCE 7-1-2007.

FOR: CONSULTATION, DESIGN, RESEARCH AND DEVELOPMENT, AND ENGINEERING FOR OTHERS IN THE FIELD OF BEARINGS, BALL BEARINGS AND ROLLER BEARINGS, IN CLASS 42 (U.S. CLS. 100 AND 101).

FIRST USE 7-1-2007; IN COMMERCE 7-1-2007.

THE MARK CONSISTS OF STANDARD CHARACTERS WITHOUT CLAIM TO ANY PARTICULAR FONT, STYLE, SIZE, OR COLOR.

SN 77-042,849, FILED 11-13-2006.

PAULA MAHONEY, EXAMINING ATTORNEY

Int. Cls.: 35 and 38

Prior U.S. Cls.: 100, 101, 102, and 104

United States Patent and Trademark Office

Reg. No. 3,521,194

Registered Oct. 21, 2008

**SERVICE MARK
PRINCIPAL REGISTER**

DIGICLICK

DIGICLICK CORP. (NEW YORK CORPORATION)
FLOOR 5A
150 WEST 36TH STREET
NEW YORK, NY 10018

FOR: ADVERTISING AND MARKETING, NAME-
LY, PROVIDING WEB BASED ADVERTISING,
PRINT ADVERTISEMENTS AND VIRAL MARKET-
ING SERVICES, IN CLASS 35 (U.S. CLS. 100, 101 AND
102).

FIRST USE 8-1-2008; IN COMMERCE 8-1-2008.

FOR: AUDIO AND VIDEO TELECONFEREN-
CING SERVICES, IN CLASS 38 (U.S. CLS. 100, 101
AND 104).

FIRST USE 8-1-2008; IN COMMERCE 1-8-2001.

THE MARK CONSISTS OF STANDARD CHAR-
ACTERS WITHOUT CLAIM TO ANY PARTICULAR
FONT, STYLE, SIZE, OR COLOR.

SN 77-043,216, FILED 11-14-2006.

TOBY BULLOFF, EXAMINING ATTORNEY

Int. Cl.: 28

Prior U.S. Cls.: 22, 23, 38, and 50

United States Patent and Trademark Office

Reg. No. 3,521,195

Registered Oct. 21, 2008

**TRADEMARK
PRINCIPAL REGISTER**

MONEYMAKERS

HENRI KLOK (UNITED STATES INDIVIDUAL)
P.O. BOX 11732
SPRING, TX 77391

THE MARK CONSISTS OF STANDARD CHAR-
ACTERS WITHOUT CLAIM TO ANY PARTICULAR
FONT, STYLE, SIZE, OR COLOR.

FOR: BOARD GAMES, IN CLASS 28 (U.S. CLS. 22,
23, 38 AND 50).

SN 77-043,651, FILED 11-14-2006.

FIRST USE 7-7-2008; IN COMMERCE 7-7-2008.

MAYUR VAGHANI, EXAMINING ATTORNEY

Int. Cl.: 20

Prior U.S. Cls.: 2, 13, 22, 25, 32, and 50

Reg. No. 3,521,196

United States Patent and Trademark Office

Registered Oct. 21, 2008

**TRADEMARK
PRINCIPAL REGISTER**

EAST END ENGRAVABLES

EAST END ENGRAVABLES, LLC (NEW YORK
LIMITED LIABILITY COMPANY)
391 NORFOLK AVENUE
BUFFALO, NY 14215

FOR: PLAQUES OF PLASTIC OR WOOD THAT
ARE ENGRAVED FOR CUSTOMER AND EMPLOY-
EE RECOGNITION PROGRAMS, IN CLASS 20 (U.S.
CLS. 2, 13, 22, 25, 32 AND 50).

FIRST USE 1-25-2008; IN COMMERCE 1-25-2008.

THE MARK CONSISTS OF STANDARD CHAR-
ACTERS WITHOUT CLAIM TO ANY PARTICULAR
FONT, STYLE, SIZE, OR COLOR.

NO CLAIM IS MADE TO THE EXCLUSIVE
RIGHT TO USE "ENGRAVABLES", APART FROM
THE MARK AS SHOWN.

SN 77-043,784, FILED 11-14-2006.

SHARON MEIER, EXAMINING ATTORNEY

Int. Cl.: 28

Prior U.S. Cls.: 22, 23, 38, and 50

United States Patent and Trademark Office

Reg. No. 3,521,197

Registered Oct. 21, 2008

**TRADEMARK
PRINCIPAL REGISTER**

MY DISNEY NURSERY

DISNEY ENTERPRISES, INC. (DELAWARE CORPORATION)
500 SOUTH BUENA VISTA STREET
BURBANK, CA 91521

FOR: ACTION SKILL GAMES; ACTION FIGURES AND ACCESSORIES THEREFORE; BOARD GAMES; CARD GAMES; CHILDREN'S MULTIPLE ACTIVITY TOYS; BADMINTON SETS; BALLOONS; BASKETBALLS; BATH TOYS; BASEBALLS; BEACH BALLS; BEAN BAGS; BEAN BAG DOLLS; TOY BUILDING BLOCKS; BOWLING BALLS; BUBBLE MAKING WANDS AND SOLUTION SETS; CHESS SETS; CHILDREN'S PLAY COSMETICS; CHRISTMAS STOCKINGS; CHRISTMAS TREE DECORATIONS; COLLECTABLE TOY FIGURES; CRIB MOBILES; CRIB TOYS; DISC TOSS TOYS; DOLLS; DOLL CLOTHING; DOLL ACCESSORIES; DOLL PLAYSETS; ELECTRIC ACTION TOYS; EQUIPMENT SOLD AS A UNIT FOR PLAYING CARD GAMES; FISHING TACKLE; GOLF BALLS; GOLF GLOVES; GOLF BALL MARKERS; HAND HELD UNIT FOR PLAYING ELECTRONIC GAMES; HOCKEY PUCKS; INFLATABLE TOYS; JIGSAW PUZZLES; JUMP ROPES; KITES; MAGIC TRICKS; MARBLES; MANIPULATIVE GAMES; MECHANICAL TOYS; MUSIC BOX TOYS; MUSICAL TOYS; PARLOR GAMES; PARTY FAVORS IN THE NATURE OF SMALL TOYS; PARTY GAMES; PLAYING CARDS; PLUSH TOYS; PUPPETS; ROLLER SKATES; RUBBER BALLS; SKATEBOARDS; SNOW GLOBES; SOCCER BALLS; SPINNING TOPS; SQUEEZE TOYS; STUFFED TOYS; TABLE TENNIS TABLES; TALKING TOYS; TARGET GAMES; TEDDY BEARS; TENNIS BALLS; TOY ACTION FIGURES; TOY BUCKET AND SHOVEL SETS; TOY MOBILES; TOY VEHICLES; TOY SCOOTERS; TOY CARS; TOY MODEL HOBBYCRAFT KITS; TOY FIGURES; TOY BANKS; TOY TRUCKS; TOY WATCHES; WIND-UP TOYS; YO-YOS, IN CLASS 28 (U.S. CLS. 22, 23, 38 AND 50).

CAL TOYS; MUSIC BOX TOYS; MUSICAL TOYS; PARLOR GAMES; PARTY FAVORS IN THE NATURE OF SMALL TOYS; PARTY GAMES; PLAYING CARDS; PLUSH TOYS; PUPPETS; ROLLER SKATES; RUBBER BALLS; SKATEBOARDS; SNOW GLOBES; SOCCER BALLS; SPINNING TOPS; SQUEEZE TOYS; STUFFED TOYS; TABLE TENNIS TABLES; TALKING TOYS; TARGET GAMES; TEDDY BEARS; TENNIS BALLS; TOY ACTION FIGURES; TOY BUCKET AND SHOVEL SETS; TOY MOBILES; TOY VEHICLES; TOY SCOOTERS; TOY CARS; TOY MODEL HOBBYCRAFT KITS; TOY FIGURES; TOY BANKS; TOY TRUCKS; TOY WATCHES; WIND-UP TOYS; YO-YOS, IN CLASS 28 (U.S. CLS. 22, 23, 38 AND 50).

FIRST USE 8-31-2007; IN COMMERCE 8-31-2007.

THE MARK CONSISTS OF STANDARD CHARACTERS WITHOUT CLAIM TO ANY PARTICULAR FONT, STYLE, SIZE, OR COLOR.

SN 77-044,721, FILED 11-15-2006.

THEODORE MCBRIDE, EXAMINING ATTORNEY

Int. Cls.: 42 and 45

Prior U.S. Cls.: 100 and 101

United States Patent and Trademark Office

Reg. No. 3,521,198

Registered Oct. 21, 2008

**SERVICE MARK
PRINCIPAL REGISTER**

**TETRA TECH ... COMPLEX
WORLD, CLEAR SOLUTIONS**

TETRA TECH, INC. (DELAWARE CORPORATION)
3475 EAST FOOTHILL BLVD.
PASADENA, CA 91107

FOR: DESIGN AND ENGINEERING OF WATER RESOURCE AND HAZARDOUS WASTE MANAGEMENT FACILITIES AND SYSTEMS; ENGINEERING; DESIGN FOR OTHERS IN THE FIELD OF ENGINEERING; ENGINEERING AND DESIGN SERVICES PROVIDED FOR OTHERS IN THE FIELDS OF EMERGENCY RESPONSE SOLUTIONS, FACILITY PROTECTION SOLUTIONS, AND PHYSICAL AND ELECTRONIC SECURITY SOLUTIONS; TECHNOLOGY CONSULTATION IN THE FIELD OF PHYSICAL AND ELECTRONIC SECURITY, IN CLASS 42 (U.S. CLS. 100 AND 101).

FIRST USE 6-1-2008; IN COMMERCE 6-1-2008.

FOR: PROVIDING CONSULTATION TO COMMERCIAL AND INDUSTRIAL COMPANIES AND TO GOVERNMENTAL ENTITIES, IN THE FIELD OF EMERGENCY RESPONSE; PROVIDING CON-

SULTATION IN THE FIELD OF PHYSICAL AND ELECTRONIC SECURITY, NAMELY, FOR PHYSICAL AND ELECTRONIC SAFETY AND SECURITY NEEDS OF COMMERCIAL AND INDUSTRIAL COMPANIES AND FACILITIES; CONSULTING SERVICES IN THE FIELD OF PHYSICAL AND ELECTRONIC PROTECTION FOR COMMERCIAL AND INDUSTRIAL COMPANIES AND FACILITIES AND FOR GOVERNMENTAL ENTITIES AND FACILITIES, IN CLASS 45 (U.S. CLS. 100 AND 101).

FIRST USE 6-1-2008; IN COMMERCE 6-1-2008.

THE MARK CONSISTS OF STANDARD CHARACTERS WITHOUT CLAIM TO ANY PARTICULAR FONT, STYLE, SIZE, OR COLOR.

OWNER OF U.S. REG. NOS. 1,517,627 AND 1,959,066.

SN 77-044,927, FILED 11-15-2006.

KAREN M. STRYZ, EXAMINING ATTORNEY

Int. Cl.: 36

Prior U.S. Cls.: 100, 101, and 102

United States Patent and Trademark Office

Reg. No. 3,521,199

Registered Oct. 21, 2008

**SERVICE MARK
PRINCIPAL REGISTER**

**Envision Payment Solutions
(Advancing Payments
Optimizing Profits)**

ENVISION PAYMENT SOLUTIONS (GEORGIA
CORPORATION)
P O BOX 157
SUWANEE, GA 300249998

FOR: FINANCIAL SERVICES, NAMELY, PROVIDING MERCHANTS CHECK VERIFICATION AND CHECK GUARANTEE SERVICES IN THE NATURE OF FINANCIAL GUARANTEE AND RECOVERY OF RETURNED CHECKS; FINANCIAL SERVICES THAT PROVIDE MERCHANTS WITH THE CAPABILITY TO ACCEPT ONLINE AND POINT OF PURCHASE PAYMENTS IN THE FORMS OF CREDIT CARDS, DEBIT CARDS, NAMELY, PROVIDING CREDIT CARD AND DEBIT CARD SERVICES; ELECTRONIC FUNDS TRANSFER SERVICES, IN CLASS 36 (U.S. CLS. 100, 101 AND 102).

FIRST USE 6-6-2008; IN COMMERCE 6-6-2008.

THE MARK CONSISTS OF STANDARD CHARACTERS WITHOUT CLAIM TO ANY PARTICULAR FONT, STYLE, SIZE, OR COLOR.

NO CLAIM IS MADE TO THE EXCLUSIVE RIGHT TO USE "PAYMENT SOLUTIONS", APART FROM THE MARK AS SHOWN.

SN 77-044,954, FILED 11-15-2006.

SEAN CROWLEY, EXAMINING ATTORNEY

Int. Cl.: 33

Prior U.S. Cls.: 47 and 49

United States Patent and Trademark Office

Reg. No. 3,521,200

Registered Oct. 21, 2008

**TRADEMARK
PRINCIPAL REGISTER**

RETOUR

OREGON SYNERGY PARTNERS, LLC (CALIFORNIA LIMITED LIABILITY COMPANY)
2086 TRESTLE GLEN ROAD
WALNUT CREEK, CA 94598

THE FOREIGN WORDING IN THE MARK TRANSLATES INTO ENGLISH AS "RETURN" OR "HOMECOMING".

FOR: WINE, IN CLASS 33 (U.S. CLS. 47 AND 49).

FIRST USE 3-16-2008; IN COMMERCE 3-16-2008.

SN 77-045,054, FILED 11-15-2006.

THE MARK CONSISTS OF STANDARD CHARACTERS WITHOUT CLAIM TO ANY PARTICULAR FONT, STYLE, SIZE, OR COLOR.

DANNEAN HETZEL, EXAMINING ATTORNEY

Int. Cl.: 36

Prior U.S. Cls.: 100, 101, and 102

United States Patent and Trademark Office

Reg. No. 3,521,201

Registered Oct. 21, 2008

**SERVICE MARK
PRINCIPAL REGISTER**

BOULEVARDR

INLET, INC. (CALIFORNIA CORPORATION)
SUITE 360
660 KING STREET
SAN FRANCISCO, CA 94107

FOR: FINANCIAL PLANNING, NAMELY, FINANCIAL INVESTMENT ADVICE IN THE AREAS OF RETIREMENT PLANNING AND ADVICE IN OBTAINING INSURANCE, IN CLASS 36 (U.S. CLS. 100, 101 AND 102).

FIRST USE 10-8-2007; IN COMMERCE 10-8-2007.

THE MARK CONSISTS OF STANDARD CHARACTERS WITHOUT CLAIM TO ANY PARTICULAR FONT, STYLE, SIZE, OR COLOR.

SN 77-045,070, FILED 11-15-2006.

MARK SPARACINO, EXAMINING ATTORNEY

Int. Cl.: 9

Prior U.S. Cls.: 21, 23, 26, 36, and 38

United States Patent and Trademark Office

Reg. No. 3,521,202

Registered Oct. 21, 2008

**TRADEMARK
PRINCIPAL REGISTER**

BROADLOGIC

BROADLOGIC NETWORK TECHNOLOGIES
INC. (DELAWARE CORPORATION)
1740 TECHNOLOGY DRIVE, SUITE 500
SAN JOSE, CA 95110

FOR: COMPUTER HARDWARE; SEMICONDUCTORS; INTEGRATED CIRCUITS; COMPUTER CHIPS; COMPUTER CHIPS THAT ENABLE MPEG DECODING AND NTSC ENCODING; COMPUTER CHIPSETS FOR NETWORK INFRASTRUCTURE APPLICATIONS; MICROPROCESSORS; VIDEO-PROCESSING MIXED SIGNAL SEMICONDUCTORS, IN CLASS 9 (U.S. CLS. 21, 23, 26, 36 AND 38).

FIRST USE 3-17-2008; IN COMMERCE 3-17-2008.

THE MARK CONSISTS OF STANDARD CHARACTERS WITHOUT CLAIM TO ANY PARTICULAR FONT, STYLE, SIZE, OR COLOR.

OWNER OF U.S. REG. NO. 2,438,534.

SN 77-046,067, FILED 11-16-2006.

BONNIE LUKEN, EXAMINING ATTORNEY

Int. Cl.: 9

Prior U.S. Cls.: 21, 23, 26, 36, and 38

United States Patent and Trademark Office

Reg. No. 3,521,203

Registered Oct. 21, 2008

**TRADEMARK
PRINCIPAL REGISTER**

**THE MOST FUN YOU'LL EVER
HAVE WORKING OUT**

UKARMA CORPORATION (NEVADA CORPORATION)
520 BROADWAY, SUITE 350
SANTA MONICA, CA 90401

FOR: PRE-RECORDED CDS AND DVDS FEATURING INFORMATION AND INSTRUCTION IN THE FIELDS OF HEALTHY LIVING AND HEALTHY LIVING THROUGH YOGA, FITNESS, DIET AND NUTRITION, PERSONAL RELATIONSHIPS, AND WELLNESS OF THE MIND, BODY, AND SPIRIT; PROVIDING ONLINE, DOWNLOADABLE MULTIMEDIA FILES FOR PLAYBACK ON MOBILE COMMUNICATION DEVICES AND COMPUTERS IN THE FIELDS OF HEALTHY LIVING AND HEALTHY LIVING THROUGH YOGA, FITNESS,

DIET AND NUTRITION, PERSONAL RELATIONSHIPS, AND WELLNESS OF THE MIND, BODY, AND SPIRIT, IN CLASS 9 (U.S. CLS. 21, 23, 26, 36 AND 38).

FIRST USE 4-19-2007; IN COMMERCE 4-19-2007.

THE MARK CONSISTS OF STANDARD CHARACTERS WITHOUT CLAIM TO ANY PARTICULAR FONT, STYLE, SIZE, OR COLOR.

SN 77-046,143, FILED 11-16-2006.

RUSS HERMAN, EXAMINING ATTORNEY

Int. Cl.: 9

Prior U.S. Cls.: 21, 23, 26, 36, and 38

Reg. No. 3,521,204

United States Patent and Trademark Office

Registered Oct. 21, 2008

**TRADEMARK
PRINCIPAL REGISTER**



**BROADLOGIC NETWORK TECHNOLOGIES
INC. (DELAWARE CORPORATION)
1740 TECHNOLOGY DRIVE, SUITE 500
SAN JOSE, CA 95110**

**FOR: COMPUTER HARDWARE; SEMICONDUCTORS;
INTEGRATED CIRCUITS; COMPUTER CHIPS;
COMPUTER CHIPS THAT ENABLE MPEG DECODING
AND NTSC ENCODING; COMPUTER CHIPSETS FOR
NETWORK INFRASTRUCTURE APPLICATIONS;
MICROPROCESSORS; VIDEO-**

**PROCESSING MIXED SIGNAL SEMICONDUCTORS,
IN CLASS 9 (U.S. CLS. 21, 23, 26, 36 AND 38).**

FIRST USE 3-17-2008; IN COMMERCE 3-17-2008.

OWNER OF U.S. REG. NO. 2,522,207.

SN 77-046,157, FILED 11-16-2006.

BONNIE LUKEN, EXAMINING ATTORNEY

Int. Cl.: 9

Prior U.S. Cls.: 21, 23, 26, 36, and 38

United States Patent and Trademark Office

Reg. No. 3,521,205

Registered Oct. 21, 2008

**TRADEMARK
PRINCIPAL REGISTER**

XFLOWSION

UKARMA CORPORATION (NEVADA CORPORATION)
520 BROADWAY, SUITE 350
SANTA MONICA, CA 90401

DIET AND NUTRITION, PERSONAL RELATIONSHIPS, AND WELLNESS OF THE MIND, BODY, AND SPIRIT, IN CLASS 9 (U.S. CLS. 21, 23, 26, 36 AND 38).

FOR: PRE-RECORDED CDS AND DVDS FEATURING INFORMATION AND INSTRUCTION IN THE FIELDS OF HEALTHY LIVING AND HEALTHY LIVING THROUGH YOGA, FITNESS, DIET AND NUTRITION, PERSONAL RELATIONSHIPS, AND WELLNESS OF THE MIND, BODY, AND SPIRIT; PROVIDING ONLINE, DOWNLOADABLE MULTIMEDIA FILES FOR PLAY BACK ON MOBILE COMMUNICATION DEVICES AND COMPUTERS IN THE FIELDS OF HEALTHY LIVING AND HEALTHY LIVING THROUGH YOGA, FITNESS,

FIRST USE 4-19-2007; IN COMMERCE 4-19-2007.

THE MARK CONSISTS OF STANDARD CHARACTERS WITHOUT CLAIM TO ANY PARTICULAR FONT, STYLE, SIZE, OR COLOR.

SN 77-046,165, FILED 11-16-2006.

RUSS HERMAN, EXAMINING ATTORNEY

Int. Cl.: 16

Prior U.S. Cls.: 2, 5, 22, 23, 29, 37, 38, and 50

United States Patent and Trademark Office

Reg. No. 3,521,206

Registered Oct. 21, 2008

**TRADEMARK
PRINCIPAL REGISTER**

NEATOOL

SONG, CHIN HO (UNITED STATES INDIVIDUAL)
P.O. BOX 291291
PHELAN, CA 92329

THE MARK CONSISTS OF STANDARD CHARACTERS WITHOUT CLAIM TO ANY PARTICULAR FONT, STYLE, SIZE, OR COLOR.

FOR: PAINT BRUSH HOLDER THAT ATTACHES TO A PAINT CAN, IN CLASS 16 (U.S. CLS. 2, 5, 22, 23, 29, 37, 38 AND 50).

SN 77-047,196, FILED 11-17-2006.

FIRST USE 9-8-2008; IN COMMERCE 9-8-2008.

SALLY SHIH, EXAMINING ATTORNEY

Int. Cl.: 11

Prior U.S. Cls.: 13, 21, 23, 31, and 34

United States Patent and Trademark Office

Reg. No. 3,521,207

Registered Oct. 21, 2008

**TRADEMARK
PRINCIPAL REGISTER**

PATH WALKER

LI, LI (CANADA INDIVIDUAL)
21 WOODRIVER STREET
RICHMOND HILL, ONTARIO, CANADA L4S1B8
AND
DING, BEI (CANADA INDIVIDUAL)
21 WOODRIVER STREET
RICHMOND HILL, ONTARIO, CANADA L4S1B8

FOR: LIGHTING FIXTURES AND STRUCTURAL
PARTS THEREFOR , IN CLASS 11 (U.S. CLS. 13, 21,
23, 31 AND 34).

FIRST USE 5-31-2007; IN COMMERCE 5-31-2007.

THE MARK CONSISTS OF STANDARD CHAR-
ACTERS WITHOUT CLAIM TO ANY PARTICULAR
FONT, STYLE, SIZE, OR COLOR.

SN 77-047,645, FILED 11-20-2006.

TOBY BULLOFF, EXAMINING ATTORNEY

Int. Cl.: 2

Prior U.S. Cls.: 6, 11, and 16

United States Patent and Trademark Office

Reg. No. 3,521,208

Registered Oct. 21, 2008

**TRADEMARK
PRINCIPAL REGISTER**



EXXONMOBIL OIL CORPORATION (NEW
YORK CORPORATION)
5959 LAS COLINAS BOULEVARD
LAW/TRADEMARKS
IRVING, TX 750392298

OWNER OF U.S. REG. NO. 692,293.

FOR: ANTI-RUST GREASES; ANTI-RUST OILS;
RUST PREVENTATIVES IN THE NATURE OF A
COATING, IN CLASS 2 (U.S. CLS. 6, 11 AND 16).

THE MARK CONSISTS OF FLYING WINGED
HORSE FACING RIGHT.

SN 77-048,069, FILED 11-20-2006.

FIRST USE 1-31-1968; IN COMMERCE 1-31-1968.

LAURA KOVALSKY, EXAMINING ATTORNEY

Int. Cl.: 35

Prior U.S. Cls.: 100, 101, and 102

United States Patent and Trademark Office

Reg. No. 3,521,209

Registered Oct. 21, 2008

**SERVICE MARK
PRINCIPAL REGISTER**



DYNASTY PAINTBALL CLUB, LLC (CALIFORNIA LIMITED LIABILITY COMPANY)
SUITE 2
1452 DIAMOND STREET
PACIFIC BEACH, CA 92109

FOR: ASSOCIATION SERVICES, NAMELY, PROMOTING THE INTERESTS OF PAINTBALL PLAYERS, EQUIPMENT MANUFACTURERS AND FACILITY OWNERS, IN CLASS 35 (U.S. CLS. 100, 101 AND 102).

FIRST USE 1-1-2001; IN COMMERCE 1-1-2001.

THE MARK CONSISTS OF THE WORD "DYNASTY" TOGETHER WITH CHINESE CHARACTERS AND A CURVED LINE RUNNING THROUGH THE MARK.

THE NON-LATIN CHARACTER(S) IN THE MARK TRANSLITERATE INTO CHAO-DAI, AND THIS MEANS DYNASTY IN ENGLISH.

SN 77-048,233, FILED 11-20-2006.

CHARISMA HAMPTON, EXAMINING ATTORNEY

Int. Cl.: 5

Prior U.S. Cls.: 6, 18, 44, 46, 51, and 52

Reg. No. 3,521,210

United States Patent and Trademark Office

Registered Oct. 21, 2008

**TRADEMARK
PRINCIPAL REGISTER**

TRAUMASTAT

ENTEK MANUFACTURING, INC. (OREGON
CORPORATION)
PO BOX 39
LEBANON, OR 97355

THE MARK CONSISTS OF STANDARD CHAR-
ACTERS WITHOUT CLAIM TO ANY PARTICULAR
FONT, STYLE, SIZE, OR COLOR.

FOR: WOUND DRESSINGS, IN CLASS 5 (U.S. CLS.
6, 18, 44, 46, 51 AND 52).

SN 77-048,283, FILED 11-20-2006.

FIRST USE 7-1-2008; IN COMMERCE 7-1-2008.

MONIQUE MILLER, EXAMINING ATTORNEY

Int. Cl.: 35

Prior U.S. Cls.: 100, 101, and 102

United States Patent and Trademark Office

Reg. No. 3,521,211

Registered Oct. 21, 2008

**SERVICE MARK
PRINCIPAL REGISTER**

IT'S HOSPITALITY

SANTOY HOSPITALITY, LLC (D.C. LIMITED LIABILITY COMPANY)
777 9TH STREET, N.W.
WASHINGTON, DC 20001

FOR: BUSINESS ADVICE AND INFORMATION; COMMERCIAL INFORMATION AND ADVICE FOR CONSUMERS; ON-LINE ADVERTISING AND MARKETING SERVICES; PROVIDING AN ON-LINE DATABASE FEATURING TRADE INFORMATION IN THE FIELD OF HOSPITALITY; PROVIDING CAREER INFORMATION VIA THE INTERNET; PROVIDING CONSUMER PRODUCT INFORMATION VIA THE INTERNET; PROVIDING HOTEL RATE COMPARISON INFORMATION; PROVIDING INFORMATION ON THE GOODS AND SERVICES OF OTHERS VIA THE INTERNET; PROVIDING INFORMATION ABOUT AND MAKING REFERRALS IN THE FIELD OF CONSUMER PRODUCTS AND SERVICES FOR RETAIL SERVICES CONCERNING PRODUCTS, SERVICES, ACTIVITIES, ATTRACTIONS AND FACILITIES IN PARTICULAR GEOGRAPHIC LOCATIONS; PROVIDING CONSUMER INFORMATION IN THE FIELD OF HOSPITALITY; PROVIDING CONSUMER INFORMATION IN THE FIELD OF HOSPITALITY VIA THE INTER-

NET; EMPLOYMENT HIRING, RECRUITING, PLACEMENT, STAFFING AND CAREER NETWORK SERVICES; EMPLOYMENT OUTPLACEMENT SERVICES; EMPLOYMENT VERIFICATION; PROVIDING AN ON-LINE SEARCHABLE DATABASE FEATURING CLASSIFIED AD LISTINGS AND EMPLOYMENT OPPORTUNITIES; PROVIDING ON-LINE INFORMATION AND NEWS IN THE FIELD OF EMPLOYMENT, IN CLASS 35 (U.S. CLS. 100, 101 AND 102).

FIRST USE 3-30-2008; IN COMMERCE 3-30-2008.

THE MARK CONSISTS OF STANDARD CHARACTERS WITHOUT CLAIM TO ANY PARTICULAR FONT, STYLE, SIZE, OR COLOR.

NO CLAIM IS MADE TO THE EXCLUSIVE RIGHT TO USE "HOSPITALITY", APART FROM THE MARK AS SHOWN.

SN 77-048,671, FILED 11-21-2006.

SHAILA SETTLES, EXAMINING ATTORNEY

Int. Cls.: 43 and 44

Prior U.S. Cls.: 100 and 101

United States Patent and Trademark Office

Reg. No. 3,521,212

Registered Oct. 21, 2008

**SERVICE MARK
PRINCIPAL REGISTER**

**IT'S ABOUT YOU IT'S ABOUT
TIME**

YELO (NEW YORK LIMITED LIABILITY COMPANY)
500 WEST 56 STREET
NEW YORK, NY 10019

FOR: PROVIDING TEMPORARY ACCOMMODATION, IN CLASS 43 (U.S. CLS. 100 AND 101).

FIRST USE 5-5-2008; IN COMMERCE 5-5-2008.

FOR: MASSAGE TREATMENT; MASSAGE TREATMENTS BASED ON REFLEXOLOGY TECHNIQUES FOR USE IN RELIEVING STRESS, DIGESTIVE SYSTEM DISORDERS, SLEEPING DISORDERS, LOW ENERGY DISORDERS, IM-

MUNE SYSTEM DISORDERS, AND DEPRESSION; COSMETICIAN SERVICES, IN CLASS 44 (U.S. CLS. 100 AND 101).

FIRST USE 5-8-2008; IN COMMERCE 5-8-2008.

THE MARK CONSISTS OF STANDARD CHARACTERS WITHOUT CLAIM TO ANY PARTICULAR FONT, STYLE, SIZE, OR COLOR.

SN 77-048,865, FILED 11-21-2006.

TOBY BULLOFF, EXAMINING ATTORNEY

Int. Cl.: 25

Prior U.S. Cls.: 22 and 39

United States Patent and Trademark Office

Reg. No. 3,521,213

Registered Oct. 21, 2008

**TRADEMARK
PRINCIPAL REGISTER**



RETAIL BRAND ALLIANCE, INC. (DELAWARE CORPORATION)
100 PHOENIX AVENUE
ENFIELD, CT 06082

FOR: BELTS; BLOUSES; BOOTS; BOTTOMS; COATS; DRESSES; EVENING DRESSES; GLOVES; HATS; HOSIERY; JACKETS; MUFFLERS; NECK-TIES; PANTS; RAINWEAR; SCARVES; SHIRTS; SHOES; SHORTS; SKIRTS; SLIPPERS; SOCKS; SUITS; SWEATERS; TIES; TOPS; TROUSERS; VESTS, IN CLASS 25 (U.S. CLS. 22 AND 39).

FIRST USE 0-0-1915; IN COMMERCE 0-0-1915.

OWNER OF U.S. REG. NOS. 1,796,512, 1,949,836, AND 1,949,837.

THE MARK CONSISTS OF A HANGING LAMB DESIGN, KNOWN AS THE GOLDEN FLEECE.

SN 77-049,084, FILED 11-21-2006.

DAVID TAYLOR, EXAMINING ATTORNEY

Int. Cl.: 1

Prior U.S. Cls.: 1, 5, 6, 10, 26, and 46

United States Patent and Trademark Office

Reg. No. 3,521,214

Registered Oct. 21, 2008

**TRADEMARK
PRINCIPAL REGISTER**

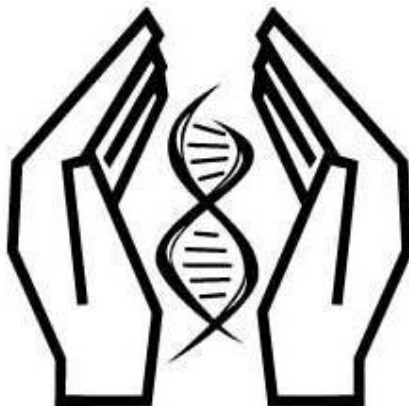

SIERRA MOLECULAR CORPORATION (DELA-
WARE CORPORATION)
21109-C LONGEWAY ROAD
SONORA, CA 95370

FOR: CHEMICAL REAGENTS FOR USE IN PRE-
SERVING DNA, RNA, PROTEINS, HORMONES,
STEROIDS, AND SMALL MOLECULES FOR MO-
LECULAR ANALYSIS, IN CLASS 1 (U.S. CLS. 1, 5, 6,
10, 26 AND 46).

FIRST USE 1-5-2008; IN COMMERCE 1-5-2008.

THE MARK CONSISTS OF TWO CUPPED HANDS
AROUND A DNA ICON.

SN 77-049,123, FILED 11-21-2006.

GEORGIA CARTY, EXAMINING ATTORNEY

Int. Cl.: 41

Prior U.S. Cls.: 100, 101, and 107

United States Patent and Trademark Office

Reg. No. 3,521,215

Registered Oct. 21, 2008

**SERVICE MARK
PRINCIPAL REGISTER**

KIT

MUSICIANS INSTITUTE INCORPORATED (CALIFORNIA CORPORATION)
1655 MCCADDEN PLACE
HOLLYWOOD, CA 90028

FOR: EDUCATIONAL SERVICES, NAMELY, PROVIDING MUSICAL TRAINING IN KEYBOARD INSTRUMENTS, IN CLASS 41 (U.S. CLS. 100, 101 AND 107).

FIRST USE 0-0-1991; IN COMMERCE 0-0-1991.

THE MARK CONSISTS OF STANDARD CHARACTERS WITHOUT CLAIM TO ANY PARTICULAR FONT, STYLE, SIZE, OR COLOR.

SN 77-049,278, FILED 11-21-2006.

ELIZABETH KAJUBI, EXAMINING ATTORNEY

Int. Cl.: 45

Prior U.S. Cls.: 100 and 101

United States Patent and Trademark Office

Reg. No. 3,521,216

Registered Oct. 21, 2008

**SERVICE MARK
PRINCIPAL REGISTER**

LEVERAGE LIFE

LEVERAGE LIFE, LLC (MICHIGAN LIMITED
LIABILITY COMPANY)
2125 BUTTERFIELD ROAD, SUITE 300N
TROY, MI 48084

FOR: CONCIERGE SERVICES FOR OTHERS,
NAMELY, MAKING REQUESTED PERSONAL AR-
RANGEMENTS AND RESERVATIONS AND PRO-
VIDING CUSTOMER-SPECIFIC INFORMATION TO
MEET INDIVIDUALS NEEDS, PER INDIVIDUAL
CLIENT REQUEST, RENDERED BOTH IN BUSI-
NESS OFFICE LOCATIONS AND VIA THE TELE-
PHONE, IN CLASS 45 (U.S. CLS. 100 AND 101).

FIRST USE 2-5-2007; IN COMMERCE 2-5-2007.

THE MARK CONSISTS OF STANDARD CHAR-
ACTERS WITHOUT CLAIM TO ANY PARTICULAR
FONT, STYLE, SIZE, OR COLOR.

SN 77-049,626, FILED 11-22-2006.

LAURA HAMMEL, EXAMINING ATTORNEY

Int. Cl.: 25

Prior U.S. Cls.: 22 and 39

United States Patent and Trademark Office

Reg. No. 3,521,217

Registered Oct. 21, 2008

**TRADEMARK
PRINCIPAL REGISTER**

MINISTART

BENNETT, CHRISTOPHER ROBERT CARLYLE
(NEW ZEALAND INDIVIDUAL)
26 RARANGI ROAD
ST HELIERS, AUCKLAND, NEW ZEALAND AND
BENNETT, COLLEEN FRANCES (NEW ZEALAND
INDIVIDUAL)
26 RARANGI ROAD
ST HELIERS, AUCKLAND, NEW ZEALAND

FOR: BABIES AND INFANTS SHOES , IN CLASS
25 (U.S. CLS. 22 AND 39).

FIRST USE 7-1-2008; IN COMMERCE 7-1-2008.

THE MARK CONSISTS OF STANDARD CHAR-
ACTERS WITHOUT CLAIM TO ANY PARTICULAR
FONT, STYLE, SIZE, OR COLOR.

SN 77-049,922, FILED 11-22-2006.

RAUL CORDOVA, EXAMINING ATTORNEY

Int. Cls.: 14, 18, and 25

Prior U.S. Cls.: 1, 2, 3, 22, 27, 28, 39, 41, and 50

United States Patent and Trademark Office

Reg. No. 3,521,218

Registered Oct. 21, 2008

**TRADEMARK
PRINCIPAL REGISTER**

**GRATIFICATION FOR HARDWORK
AND DEDICATION**

FUCHS, SVETLANA (UNITED STATES INDIVIDUAL)
9025 GROVE CREST LANE
LAS VEGAS, NV 89134

FOR: JEWELRY, IN CLASS 14 (U.S. CLS. 2, 27, 28 AND 50).

FIRST USE 11-30-2006; IN COMMERCE 11-30-2006.

FOR: ATHLETIC BAGS; HANDBAGS; MESSENGER BAGS; PURSES, IN CLASS 18 (U.S. CLS. 1, 2, 3, 22 AND 41).

FIRST USE 11-30-2006; IN COMMERCE 11-30-2006.

FOR: BELTS; COATS; FOOTWEAR; HEADWEAR; JACKETS; JOGGING SUITS; PANTS; SHIRTS; SKIRTS AND DRESSES; SUITS, IN CLASS 25 (U.S. CLS. 22 AND 39).

FIRST USE 11-30-2006; IN COMMERCE 11-30-2006.

THE MARK CONSISTS OF STANDARD CHARACTERS WITHOUT CLAIM TO ANY PARTICULAR FONT, STYLE, SIZE, OR COLOR.

SN 77-050,056, FILED 11-22-2006.

JACQUELINE A. LAVINE, EXAMINING ATTORNEY

Int. Cl.: 30

Prior U.S. Cl.: 46

United States Patent and Trademark Office

Reg. No. 3,521,219

Registered Oct. 21, 2008

**TRADEMARK
PRINCIPAL REGISTER**

River Wave Foods

RIVER WAVE FOODS (WASHINGTON LIMITED
LIABILITY COMPANY)
23512 NE 206TH ST
BATTLE GROUND, WA 98604

NO CLAIM IS MADE TO THE EXCLUSIVE
RIGHT TO USE "FOODS", APART FROM THE
MARK AS SHOWN.

FOR: SAUCES, IN CLASS 30 (U.S. CL. 46).

FIRST USE 5-6-2007; IN COMMERCE 5-6-2007.

SN 77-050,435, FILED 11-24-2006.

THE MARK CONSISTS OF STANDARD CHAR-
ACTERS WITHOUT CLAIM TO ANY PARTICULAR
FONT, STYLE, SIZE, OR COLOR.

PAUL CROWLEY, EXAMINING ATTORNEY

Int. Cl.: 42

Prior U.S. Cls.: 100 and 101

United States Patent and Trademark Office

Reg. No. 3,521,220

Registered Oct. 21, 2008

**SERVICE MARK
PRINCIPAL REGISTER**

iKAM

INTELLIGENT DISTANCE LEARNING SYSTEMS, INC. (DELAWARE CORPORATION)
60 MASSACHUSETTS AVENUE
BOSTON, MA 02115

FOR: PROVIDING TEMPORARY USE OF ON-LINE, NON-DOWNLOADABLE SOFTWARE FOR USE IN FACILITATING STUDENT INTERACTION WITH ON-LINE LEARNING COURSES , IN CLASS 42 (U.S. CLS. 100 AND 101).

FIRST USE 1-1-2003; IN COMMERCE 1-1-2003.

THE MARK CONSISTS OF STANDARD CHARACTERS WITHOUT CLAIM TO ANY PARTICULAR FONT, STYLE, SIZE, OR COLOR.

SN 77-050,773, FILED 11-27-2006.

KELLY BOULTON, EXAMINING ATTORNEY

Int. Cl.: 42

Prior U.S. Cls.: 100 and 101

United States Patent and Trademark Office

Reg. No. 3,521,221

Registered Oct. 21, 2008

**SERVICE MARK
PRINCIPAL REGISTER**

iALS

INTELLIGENT DISTANCE LEARNING SYSTEMS, INC. (DELAWARE CORPORATION)
60 MASSACHUSETTS AVENUE
BOSTON, MA 02115

FOR: PROVIDING TEMPORARY USE OF ON-LINE, NON-DOWNLOADABLE SOFTWARE FOR USE IN FACILITATING STUDENT INTERACTION WITH ON-LINE LEARNING COURSES , IN CLASS 42 (U.S. CLS. 100 AND 101).

FIRST USE 1-1-2003; IN COMMERCE 1-1-2003.

THE MARK CONSISTS OF STANDARD CHARACTERS WITHOUT CLAIM TO ANY PARTICULAR FONT, STYLE, SIZE, OR COLOR.

SN 77-050,774, FILED 11-27-2006.

KELLY BOULTON, EXAMINING ATTORNEY

Int. Cl.: 9

Prior U.S. Cls.: 21, 23, 26, 36, and 38

Reg. No. 3,521,222

United States Patent and Trademark Office

Registered Oct. 21, 2008

**TRADEMARK
PRINCIPAL REGISTER**

MULTITRAK

CHEMTREAT, INC. (VIRGINIA CORPORATION)
4461 COX ROAD, SUITE 106
GLEN ALLEN, VA 230603331

FIRST USE 6-20-2006; IN COMMERCE 6-20-2006.

FOR: ELECTRICAL INSTRUMENTS FOR MONITORING, CONTROLLING AND TREATING WATER CHEMISTRY AND SYSTEM PERFORMANCE IN INDUSTRIAL WATER SYSTEMS, NAMELY, MULTI-FUNCTIONAL ANALYZERS AND SENSORS FOR MEASURING THE CHEMICAL CONTENT AND COLOR OF WATER, IN CLASS 9 (U.S. CLS. 21, 23, 26, 36 AND 38).

THE MARK CONSISTS OF STANDARD CHARACTERS WITHOUT CLAIM TO ANY PARTICULAR FONT, STYLE, SIZE, OR COLOR.

SN 77-051,230, FILED 11-27-2006.

MATTHEW MCDOWELL, EXAMINING ATTORNEY

Int. Cls.: 7 and 8

Prior U.S. Cls.: 13, 19, 21, 23, 28, 31, 34, 35, and 44

United States Patent and Trademark Office

Reg. No. 3,521,223

Registered Oct. 21, 2008

**TRADEMARK
PRINCIPAL REGISTER**

MORE GAIN LESS PAIN

JODA ENTERPRISES, INC. (ILLINOIS CORPORATION)
2440 NORTH LAKEVIEW AVENUE
CHICAGO, IL 60614

FOR: POWER TOOLS, NAMELY, POWER DRIVEN WRENCHES, AIR RATCHETS AND IMPACT WRENCHES, TORQUE WRENCHES, FLAT WRENCHES, CLUTCH WRENCHES, SOCKET WRENCHES, PALM WRENCHES, SPEEDER WRENCHES, SPINNER WRENCHES, BRACE WRENCHES, FLEX HANDLE WRENCHES, T-BAR WRENCHES, NUT DRIVERS, UNIVERSAL NUT DRIVERS, SCREW DRIVERS, UNIVERSAL SCREW DRIVERS; ATTACHMENTS FOR ANY OF THE FOREGOING, NAMELY, EXTENSION BARS, UNIVERSAL JOINTS USED FOR DRIVING AT ANGLES, SOCKETS FOR USE IN CONNECTION WITH NUTS AND BOLTS, UNIVERSAL SOCKETS FOR USE IN CONNECTION WITH NUTS AND BOLTS, SOCKET SETS; POWER TOOLS, NAMELY, DRIVABLE WRENCHES, CROW-FOOT WRENCHES; ATTACHMENTS FOR ANY OF THE FOREGOING, NAMELY, BITS FOR USE IN CONNECTION WITH FASTENERS OR FOR DRILLING, SOCKET BITS FOR USE IN CONNECTION WITH FASTENERS OR FOR DRILLING, AND SOCKET-MOUNTED BITS FOR USE IN CONNECTION WITH FASTENERS OR FOR DRILLING, LOCKS AND QUICK-RELEASE LOCKS; AND SETS CONTAINING ANY OF THE FOREGOING, IN CLASS 7 (U.S. CLS. 13, 19, 21, 23, 31, 34 AND 35).

FIRST USE 12-3-2007; IN COMMERCE 12-3-2007.

FOR: HAND TOOLS, NAMELY, WRENCHES OF ALL SORTS, RATCHET WRENCHES, TORQUE

WRENCHES, FLAT WRENCHES, CLUTCH WRENCHES, SOCKET WRENCHES, PALM WRENCHES, SPEEDER WRENCHES, SPINNER WRENCHES, BRACE WRENCHES, FLEX HANDLE WRENCHES, T-BARS WRENCHES, NUT DRIVERS, UNIVERSAL NUT DRIVERS, SCREW DRIVERS, UNIVERSAL SCREW DRIVERS, AND ATTACHMENTS FOR ANY OF THE FOREGOING, NAMELY, EXTENSION BARS, UNIVERSAL JOINTS USED FOR DRIVING AT ANGLES, SOCKETS FOR USE IN CONNECTION WITH NUTS AND BOLTS, UNIVERSAL SOCKETS FOR USE IN CONNECTION WITH NUTS AND BOLTS, SOCKET SETS; HAND TOOLS, NAMELY, DRIVABLE WRENCHES, CROWFOOT WRENCHES; ATTACHMENTS FOR USE WITH ANY OF THE FOREGOING, NAMELY, BITS FOR USE IN CONNECTION WITH FASTENERS OR FOR DRILLING, SOCKET BITS FOR USE IN CONNECTION WITH FASTENERS OR FOR DRILLING, AND SOCKET-MOUNTED BITS FOR USE IN CONNECTION WITH FASTENERS OR FOR DRILLING, LOCKS AND QUICK-RELEASE LOCKS; AND SETS CONTAINING ANY OF THE FOREGOING, IN CLASS 8 (U.S. CLS. 23, 28 AND 44).

FIRST USE 12-3-2007; IN COMMERCE 12-3-2007.

THE MARK CONSISTS OF STANDARD CHARACTERS WITHOUT CLAIM TO ANY PARTICULAR FONT, STYLE, SIZE, OR COLOR.

SN 77-051,422, FILED 11-27-2006.

CYNTHIA SLOAN, EXAMINING ATTORNEY

Int. Cl.: 35

Prior U.S. Cls.: 100, 101, and 102

United States Patent and Trademark Office

Reg. No. 3,521,224

Registered Oct. 21, 2008

**SERVICE MARK
PRINCIPAL REGISTER**



MXGA, INC. (TEXAS CORPORATION)
3244 SKYWAY CIRCLE NORTH, SUITE 102
IRVING, TX 75038

FOR: MEMBERSHIP CLUB SERVICES IN THE NATURE OF PROVIDING DISCOUNTS FOR THE GOODS AND SERVICES OF OTHERS, NAMELY, PROVIDING DISCOUNTS ON HOTELS, AUTOMOBILE PRODUCTS, CAMPING PARKS, INSURANCE, REPAIR SERVICES AND TOWING, IN CLASS 35 (U.S. CLS. 100, 101 AND 102).

FIRST USE 4-0-2008; IN COMMERCE 4-0-2008.

NO CLAIM IS MADE TO THE EXCLUSIVE RIGHT TO USE "CLUB NORTEAMÉRICA" AND THE DEPICTION OF THE CONTINENT OF NORTH AMERICA, APART FROM THE MARK AS SHOWN.

THE ENGLISH TRANSLATION OF THE WORD "NORTEAMÉRICA" IS NORTH AMERICA.

SN 77-051,719, FILED 11-28-2006.

ROBERT LAVACHE, EXAMINING ATTORNEY

Int. Cl.: 35

Prior U.S. Cls.: 100, 101, and 102

United States Patent and Trademark Office

Reg. No. 3,521,225

Registered Oct. 21, 2008

**SERVICE MARK
PRINCIPAL REGISTER**

ITO

THE ITO PARTNERSHIP, LLC (NEW YORK
LIMITED LIABILITY COMPANY)
400 LAFAYETTE STREET, 5TH FLOOR
NEW YORK, NY 10003

FOR: ADVERTISING AND MARKETING SERVICES; COMMUNICATIONS AND MARKETING CONSULTING, NAMELY, THE DEVELOPMENT OF MEDIA, MARKETING, AND CREATIVE PLANS FOR OTHERS; AND ADVERTISING SERVICES, NAMELY, CREATING CORPORATE AND BRAND IDENTITY FOR OTHERS, IN CLASS 35 (U.S. CLS. 100, 101 AND 102).

FIRST USE 1-0-2007; IN COMMERCE 1-0-2007.

THE MARK CONSISTS OF STANDARD CHARACTERS WITHOUT CLAIM TO ANY PARTICULAR FONT, STYLE, SIZE, OR COLOR.

SN 77-052,244, FILED 11-28-2006.

JASON BLAIR, EXAMINING ATTORNEY

Int. Cl.: 28

Prior U.S. Cls.: 22, 23, 38, and 50

United States Patent and Trademark Office

Reg. No. 3,521,226

Registered Oct. 21, 2008

**TRADEMARK
PRINCIPAL REGISTER**

MAGICAL INNOVATIONS

MAGICAL INNOVATIONS, INC. (FLORIDA
CORPORATION)
#315
301 WEST PLATT STREET
TAMPA, FL 33606

THE MARK CONSISTS OF STANDARD CHAR-
ACTERS WITHOUT CLAIM TO ANY PARTICULAR
FONT, STYLE, SIZE, OR COLOR.

FOR: PLAYTHINGS AND TOYS FOR CHILDREN,
NAMELY, INFANT DEVELOPMENT TOYS, IN
CLASS 28 (U.S. CLS. 22, 23, 38 AND 50).

SN 77-052,656, FILED 11-29-2006.

FIRST USE 10-0-2007; IN COMMERCE 10-0-2007.

DARRYL SPRUILL, EXAMINING ATTORNEY

Int. Cl.: 28

Prior U.S. Cls.: 22, 23, 38, and 50

United States Patent and Trademark Office

Reg. No. 3,521,227

Registered Oct. 21, 2008

**TRADEMARK
PRINCIPAL REGISTER**



MAGICAL INNOVATIONS, INC. (FLORIDA CORPORATION)

#315
301 WEST PLATT STREET
TAMPA, FL 33606

FOR: PLAYTHINGS AND TOYS FOR CHILDREN, NAMELY, INFANT DEVELOPMENT TOYS, IN CLASS 28 (U.S. CLS. 22, 23, 38 AND 50).

FIRST USE 10-0-2007; IN COMMERCE 10-0-2007.

THE MARK CONSISTS OF CHILD LOOKING IN BOX WITH STARS.

SN 77-052,666, FILED 11-29-2006.

DARRYL SPRUILL, EXAMINING ATTORNEY

Int. Cl.: 19

Prior U.S. Cls.: 1, 12, 33, and 50

United States Patent and Trademark Office

Reg. No. 3,521,228

Registered Oct. 21, 2008

**TRADEMARK
PRINCIPAL REGISTER**

PROVENCE

OLDCASTLE ARCHITECTURAL, INC. (DELA-
WARE CORPORATION)
375 NORTHRIDGE ROAD, SUITE 250
ATLANTA, GA 30350

THE MARK CONSISTS OF STANDARD CHAR-
ACTERS WITHOUT CLAIM TO ANY PARTICULAR
FONT, STYLE, SIZE, OR COLOR.

FOR: CONCRETE PAVERS, IN CLASS 19 (U.S.
CLS. 1, 12, 33 AND 50).

SN 77-052,778, FILED 11-29-2006.

FIRST USE 3-0-2007; IN COMMERCE 3-0-2007.

KAPIL BHANOT, EXAMINING ATTORNEY

Int. Cls.: 37, 41, and 42

Prior U.S. Cls.: 100, 101, 103, 106, and 107

United States Patent and Trademark Office

Reg. No. 3,521,229

Registered Oct. 21, 2008

**SERVICE MARK
PRINCIPAL REGISTER**

CLEAR CROSSING

CLEAR CROSSING, LLC (INDIANA LIMITED LIABILITY COMPANY)
17728 SUN PARK DRIVE
WESTFIELD, IN 46074

FOR: HYDRAULIC EXCAVATION OF UNDERGROUND UTILITY LINES AND PIPING, CLEANING OF UNDERGROUND UTILITY LINES AND PIPING; PROVIDING INFORMATION VIA THE INTERNET RELATING TO THE AFOREMENTIONED SERVICES, IN CLASS 37 (U.S. CLS. 100, 103 AND 106).

FIRST USE 5-5-2006; IN COMMERCE 8-31-2006.

FOR: PHOTOGRAPHING AND VIDEO RECORDING OF UNDERGROUND UTILITY LINES AND PIPING, PROVIDING INFORMATION VIA THE INTERNET RELATING TO THE AFOREMENTIONED SERVICES, IN CLASS 41 (U.S. CLS. 100, 101 AND 107).

FIRST USE 5-5-2006; IN COMMERCE 8-31-2006.

FOR: LOCATING AND EXPOSING OF UNDERGROUND UTILITY LINES AND PIPING, INTERNAL AND EXTERNAL INSPECTION OF UNDERGROUND UTILITY LINES AND PIPING, PROVIDING INFORMATION VIA THE INTERNET RELATING TO THE AFOREMENTIONED SERVICES, IN CLASS 42 (U.S. CLS. 100 AND 101).

FIRST USE 5-5-2006; IN COMMERCE 8-31-2006.

THE MARK CONSISTS OF STANDARD CHARACTERS WITHOUT CLAIM TO ANY PARTICULAR FONT, STYLE, SIZE, OR COLOR.

SN 77-053,112, FILED 11-29-2006.

KATHERINE CHANG, EXAMINING ATTORNEY

Int. Cls.: 35 and 43

Prior U.S. Cls.: 100, 101, and 102

United States Patent and Trademark Office

Reg. No. 3,521,230

Registered Oct. 21, 2008

**SERVICE MARK
PRINCIPAL REGISTER**

COMIN' RIGHT UP

CBOCS PROPERTIES, INC. (MICHIGAN CORPORATION)
45525 N. I-94 SERVICE ROAD
BELLEVILLE, MI 48111

FOR: RETAIL GIFT SHOPS, IN CLASS 35 (U.S. CLS. 100, 101 AND 102).

FIRST USE 11-28-2006; IN COMMERCE 11-28-2006.

FOR: RESTAURANT SERVICES , IN CLASS 43 (U.S. CLS. 100 AND 101).

FIRST USE 11-28-2006; IN COMMERCE 11-28-2006.

THE MARK CONSISTS OF STANDARD CHARACTERS WITHOUT CLAIM TO ANY PARTICULAR FONT, STYLE, SIZE, OR COLOR.

OWNER OF U.S. REG. NOS. 1,142,958, 2,255,408, AND OTHERS.

SN 77-053,725, FILED 11-30-2006.

LINDA MICKLEBURGH, EXAMINING ATTORNEY

Int. Cl.: 12

Prior U.S. Cls.: 19, 21, 23, 31, 35, and 44

United States Patent and Trademark Office

Reg. No. 3,521,231

Registered Oct. 21, 2008

**TRADEMARK
PRINCIPAL REGISTER**

GRIM REAPER

GREENBALL CORPORATION (CALIFORNIA
CORPORATION)
2525 EL PRESIDIO STREET
LONG BEACH, CA 90810

THE MARK CONSISTS OF STANDARD CHAR-
ACTERS WITHOUT CLAIM TO ANY PARTICULAR
FONT, STYLE, SIZE, OR COLOR.

FOR: TIRES, IN CLASS 12 (U.S. CLS. 19, 21, 23, 31,
35 AND 44).

SN 77-053,960, FILED 11-30-2006.

FIRST USE 7-22-2008; IN COMMERCE 7-22-2008.

RONALD MCMORROW, EXAMINING ATTORNEY

Int. Cl.: 12

Prior U.S. Cls.: 19, 21, 23, 31, 35, and 44

United States Patent and Trademark Office

Reg. No. 3,521,232

Registered Oct. 21, 2008

**TRADEMARK
PRINCIPAL REGISTER**

AFTERBURN

GREENBALL CORPORATION (CALIFORNIA
CORPORATION)
2525 EL PRESIDIO STREET
LONG BEACH, CA 90810

THE MARK CONSISTS OF STANDARD CHAR-
ACTERS WITHOUT CLAIM TO ANY PARTICULAR
FONT, STYLE, SIZE, OR COLOR.

FOR: TIRES, IN CLASS 12 (U.S. CLS. 19, 21, 23, 31,
35 AND 44).

SN 77-053,970, FILED 11-30-2006.

FIRST USE 4-17-2008; IN COMMERCE 4-24-2008.

RONALD MCMORROW, EXAMINING ATTORNEY

Int. Cl.: 12

Prior U.S. Cls.: 19, 21, 23, 31, 35, and 44

United States Patent and Trademark Office

Reg. No. 3,521,233

Registered Oct. 21, 2008

**TRADEMARK
PRINCIPAL REGISTER**

DIRT COMMANDER

GREENBALL CORPORATION (CALIFORNIA
CORPORATION)
2525 EL PRESIDIO STREET
LONG BEACH, CA 90810

FOR: TIRES, IN CLASS 12 (U.S. CLS. 19, 21, 23, 31,
35 AND 44).

FIRST USE 3-31-2008; IN COMMERCE 3-31-2008.

THE MARK CONSISTS OF STANDARD CHAR-
ACTERS WITHOUT CLAIM TO ANY PARTICULAR
FONT, STYLE, SIZE, OR COLOR.

OWNER OF U.S. REG. NOS. 2,981,431 AND
3,018,275.

SN 77-053,978, FILED 11-30-2006.

RONALD MCMORROW, EXAMINING ATTORNEY

Int. Cl.: 9

Prior U.S. Cls.: 21, 23, 26, 36, and 38

Reg. No. 3,521,234

United States Patent and Trademark Office

Registered Oct. 21, 2008

**TRADEMARK
PRINCIPAL REGISTER**



MERCANTIL COMMERCEBANK, N.A. (UNITED STATES NATIONAL BANKING ASSOCIATION)
220 ALHAMBRA CIRCLE
CORAL GABLES, FL 33134

NO CLAIM IS MADE TO THE EXCLUSIVE RIGHT TO USE "PLATINUM", APART FROM THE MARK AS SHOWN.

FOR: MAGNETICALLY ENCODED CREDIT CARDS, IN CLASS 9 (U.S. CLS. 21, 23, 26, 36 AND 38).

SN 77-054,194, FILED 11-30-2006.

FIRST USE 9-18-2006; IN COMMERCE 9-18-2006.

DAVID HOFFMAN, EXAMINING ATTORNEY

Int. Cls.: 9 and 41

Prior U.S. Cls.: 21, 23, 26, 36, 38, 100, 101, and 107

United States Patent and Trademark Office

Reg. No. 3,521,235

Registered Oct. 21, 2008

**TRADEMARK
SERVICE MARK
PRINCIPAL REGISTER**

HEADS UP PUSH UP CALL UP

PATHWAYS FOUNDATION (ILLINOIS NON-PROFIT CORPORATION), DBA PATHWAYS AWARENESS,
150 N. MICHIGAN AVENUE, SUITE 2100
CHICAGO, IL 60601

FOR: PHOTOGRAPHIC SLIDE TRANSPARENCIES AND PRE-RECORDED CD'S, VIDEO TAPES, LASER DISKS AND DVD'S FEATURING INFORMATION REGARDING INFANT PHYSICAL DEVELOPMENT AND DETECTION OF EARLY MOTOR DELAYS IN CHILDREN, AND CAREER OPPORTUNITIES IN THE FIELD OF PEDIATRIC THERAPY, IN CLASS 9 (U.S. CLS. 21, 23, 26, 36 AND 38).

FIRST USE 11-0-2005; IN COMMERCE 11-0-2005.

FOR: EDUCATIONAL SERVICES, NAMELY, DEVELOPMENT AND DISSEMINATION OF EDUCATIONAL MATERIALS OF OTHERS IN THE FIELDS

OF INFANT PHYSICAL DEVELOPMENT, DETECTION OF EARLY MOTOR DELAYS IN CHILDREN, EARLY INTERVENTION, INCLUSION, AND SERVICES FOR CHILDREN WITH SPECIAL NEEDS, AND CAREER OPPORTUNITIES IN THE FIELD OF PEDIATRIC THERAPY; CONDUCTING SEMINARS, CONFERENCES, AND WORKSHOPS ON INCLUSION FOR CHILDREN WITH SPECIAL NEEDS, IN CLASS 41 (U.S. CLS. 100, 101 AND 107).

FIRST USE 11-0-2005; IN COMMERCE 11-0-2005.

THE MARK CONSISTS OF STANDARD CHARACTERS WITHOUT CLAIM TO ANY PARTICULAR FONT, STYLE, SIZE, OR COLOR.

SN 77-054,230, FILED 11-30-2006.

JENNIFER MARTIN, EXAMINING ATTORNEY

Int. Cl.: 30

Prior U.S. Cl.: 46

United States Patent and Trademark Office

Reg. No. 3,521,236

Registered Oct. 21, 2008

**TRADEMARK
PRINCIPAL REGISTER**

SAPORE SENSUALE

TASTE IT PRESENTS INC. (NEW JERSEY CORPORATION)
200 SUMNER AVENUE
KENILWORTH, NJ 07033

FOR: DESSERTS, NAMELY, CREAM CAKES, MOUSSE, PIES, PASTRIES, PUDDING, SOUFFLE, CANNOLI, CANNOLI CAKE, GELATO AND TARTUFFO, IN CLASS 30 (U.S. CL. 46).

FIRST USE 6-0-2007; IN COMMERCE 6-0-2007.

THE MARK CONSISTS OF STANDARD CHARACTERS WITHOUT CLAIM TO ANY PARTICULAR FONT, STYLE, SIZE, OR COLOR.

THE FOREIGN WORDING IN THE MARK TRANSLATES INTO ENGLISH AS FLAVOR.

SN 77-054,364, FILED 11-30-2006.

BARBARA BROWN, EXAMINING ATTORNEY

Int. Cls.: 11, 20, and 28

Prior U.S. Cls.: 2, 13, 21, 22, 23, 25, 31, 32, 34, 38, and 50

Reg. No. 3,521,237

United States Patent and Trademark Office

Registered Oct. 21, 2008

**TRADEMARK
PRINCIPAL REGISTER**



HI-TEC SPORTS PLC (UNITED KINGDOM COMPANY)
AVIATION WAY
SOUTHEND-ON-SEA, ESSEX, UNITED KINGDOM
SS26GH

FOR: ELECTRIC BEVERAGE HEATERS, GAS WATER HEATERS, KEROSENE HEATERS, THERMOELECTRIC COOLER/HEATER FOR FOODS AND BEVERAGES; PORTABLE ELECTRIC HALOGEN HEATERS FOR USE IN TENTS AND FOR CAMP SITES; PORTABLE ELECTRIC HEATERS, PORTABLE ELECTRIC PARAFFIN HEATERS AND PORTABLE OIL STOVES FOR RECREATIONAL USE; HEATING ELEMENTS FOR PORTABLE ELECTRIC, GAS AND OIL HEATERS; POCKET SEARCH LIGHTS; ELECTRIC COOKING OVENS; REFRIGERATORS; OIL COOKING STOVES; BARBECUES; BARBECUE GRILLS; OUTDOOR COOKERS FOR CURING FOOD; TEMPERATURE-CONTROLLED FOOD AND BEVERAGE DISPENSERS; ELECTRIC AND GAS STOVES; PORTABLE WOOD BURNING, OIL, PARAFFIN AND GAS STOVES; MULTI-FUEL STOVES THAT CAN RUN ON GAS, OIL, SOLID FUEL OR WOOD; CANDLE, ELECTRIC AND OIL LANTERNS; LIGHTERS PRIMARILY FOR LIGHTING GRILLS, BARBECUES, FIREPLACES, PORTABLE OUTDOOR STOVES AND CANDLES; LAVA ROCK FOR USE IN BARBECUE GRILLS; CERAMIC

BRIQUETTES FOR USE IN BARBECUE GRILLS; ROTISSERIES; ROASTERS POWERED BY PROPANE GAS; ELECTRIC FRYING PANS, IN CLASS 11 (U.S. CLS. 13, 21, 23, 31 AND 34).

FIRST USE 6-1-2005; IN COMMERCE 6-1-2005.

FOR: INFLATABLE MATTRESSES AND CUSHIONS FOR USE WHEN CAMPING; CAMP BEDS; CAMPING FURNITURE; SLEEPING BAGS; SLEEPING MATS; NON-METAL, PORTABLE PLASTIC FUEL CONTAINERS, IN CLASS 20 (U.S. CLS. 2, 13, 22, 25, 32 AND 50).

FIRST USE 8-0-2004; IN COMMERCE 8-0-2004.

FOR: TREKKING POLES, IN CLASS 28 (U.S. CLS. 22, 23, 38 AND 50).

FIRST USE 6-1-2005; IN COMMERCE 6-1-2005.

THE MARK CONSISTS IN PART OF AN ARROW WITHIN A SHADED CIRCLE.

SN 77-055,538, FILED 12-1-2006.

IRA J. GOODSaid, EXAMINING ATTORNEY

Int. Cl.: 25

Prior U.S. Cls.: 22 and 39

United States Patent and Trademark Office

Reg. No. 3,521,238

Registered Oct. 21, 2008

**TRADEMARK
PRINCIPAL REGISTER**

BLUTIQUE

GK TRADING, INC. (NEW JERSEY CORPORATION)
UNIT 6
601 PENHORN AVENUE
SECAUCUS, NJ 07094

THE MARK CONSISTS OF STANDARD CHARACTERS WITHOUT CLAIM TO ANY PARTICULAR FONT, STYLE, SIZE, OR COLOR.

FOR: JACKETS, TOPS, BLOUSES, COATS, IN CLASS 25 (U.S. CLS. 22 AND 39).

SN 77-056,196, FILED 12-4-2006.

FIRST USE 6-0-2008; IN COMMERCE 6-0-2008.

KIM SAITO, EXAMINING ATTORNEY

Int. Cl.: 42

Prior U.S. Cls.: 100 and 101

United States Patent and Trademark Office

Reg. No. 3,521,239

Registered Oct. 21, 2008

**SERVICE MARK
PRINCIPAL REGISTER**

AZTAZ

AZTAZ SOFTWARE, LLC (CALIFORNIA LIMITED LIABILITY COMPANY)
90 PURRINGTON ROAD
PETALUMA, CA 94952

THE MARK CONSISTS OF STANDARD CHARACTERS WITHOUT CLAIM TO ANY PARTICULAR FONT, STYLE, SIZE, OR COLOR.

FOR: DESIGN, DEVELOPMENT AND IMPLEMENTATION OF SOFTWARE, IN CLASS 42 (U.S. CLS. 100 AND 101).

SN 77-056,513, FILED 12-4-2006.

FIRST USE 3-0-2006; IN COMMERCE 8-0-2008.

KATHERINE CHANG, EXAMINING ATTORNEY

Int. Cl.: 29

Prior U.S. Cl.: 46

United States Patent and Trademark Office

Reg. No. 3,521,240

Registered Oct. 21, 2008

**TRADEMARK
PRINCIPAL REGISTER**

FAST CLASSICS

ADVANCE BRANDS, L.L.C. (DELAWARE LIMITED LIABILITY COMPANY)
3540 S. BOULEVARD, SUITE 225
EDMOND, OK 73013

THE MARK CONSISTS OF STANDARD CHARACTERS WITHOUT CLAIM TO ANY PARTICULAR FONT, STYLE, SIZE, OR COLOR.

FOR: PREPARED MEALS AND ENTREES CONSISTING PRIMARILY OF CHICKEN OR BEEF OR TURKEY OR VEAL, IN CLASS 29 (U.S. CL. 46).

SN 77-056,669, FILED 12-4-2006.

FIRST USE 1-1-2007; IN COMMERCE 2-1-2007.

LINDA ESTRADA, EXAMINING ATTORNEY

Int. Cl.: 44

Prior U.S. Cls.: 100 and 101

United States Patent and Trademark Office

Reg. No. 3,521,241

Registered Oct. 21, 2008

**SERVICE MARK
PRINCIPAL REGISTER**

A BETTER WAY TO BE WELL

TAKE CARE HEALTH SYSTEMS, LLC (DELA-
WARE LIMITED LIABILITY COMPANY)
SUITE 1400
EIGHT TOWER BRIDGE, 161 WASHINGTON ST.
CONSHOHOCKEN, PA 19428

FOR: MANAGED HEALTH CARE SERVICES,
NAMELY, PROVIDING MEDICAL AND PHARMA-
CEUTICAL CONSULTATION, PERFORMING DI-
AGNOSIS AND TREATMENT OF DISEASES,
MEDICAL TESTING, AND PROVIDING HEALTH
CARE INFORMATION BY PHONE AND THE IN-
TERNET; MEDICAL CLINICS; HOME HEALTH

CARE SERVICES; AND MOBILE HEALTH CARE
CENTERS, IN CLASS 44 (U.S. CLS. 100 AND 101).

FIRST USE 8-21-2006; IN COMMERCE 8-21-2006.

THE MARK CONSISTS OF STANDARD CHAR-
ACTERS WITHOUT CLAIM TO ANY PARTICULAR
FONT, STYLE, SIZE, OR COLOR.

SN 77-056,678, FILED 12-4-2006.

JAMES LOVELACE, EXAMINING ATTORNEY

Int. Cl.: 33

Prior U.S. Cls.: 47 and 49

United States Patent and Trademark Office

Reg. No. 3,521,242

Registered Oct. 21, 2008

**TRADEMARK
PRINCIPAL REGISTER**

ROSEHAVEN

E. & J. GALLO WINERY (CALIFORNIA CORPORATION)
600 YOSEMITE BOULEVARD
MODESTO, CA 95354

THE MARK CONSISTS OF STANDARD CHARACTERS WITHOUT CLAIM TO ANY PARTICULAR FONT, STYLE, SIZE, OR COLOR.

FOR: WINES, IN CLASS 33 (U.S. CLS. 47 AND 49).

SN 77-057,085, FILED 12-5-2006.

FIRST USE 4-15-2008; IN COMMERCE 4-15-2008.

PAM WILLIS, EXAMINING ATTORNEY

Int. Cl.: 35

Prior U.S. Cls.: 100, 101, and 102

United States Patent and Trademark Office

Reg. No. 3,521,243

Registered Oct. 21, 2008

**SERVICE MARK
PRINCIPAL REGISTER**

BIZPLUS

PRIMIS MARKETING GROUP, INC. (DELA-
WARE CORPORATION)
SUITE 240
8755 W. HIGGINS ROAD
CHICAGO, IL 60631

FOR: DATA PROCESSING SERVICES, NAMELY,
PROVIDING A SERVICE WHICH ACCESSES MUL-
TIPLE SOURCES OF BUSINESS MARKETING
DATA SIMULTANEOUSLY TO MAXIMIZE AND
ANALYZE THE QUALITY AND QUANTITY OF
INDIVIDUAL AND UNIQUE RECORDS FOR USE

BY CLIENTS, IN CLASS 35 (U.S. CLS. 100, 101 AND
102).

FIRST USE 1-0-2007; IN COMMERCE 1-0-2007.

THE MARK CONSISTS OF STANDARD CHAR-
ACTERS WITHOUT CLAIM TO ANY PARTICULAR
FONT, STYLE, SIZE, OR COLOR.

SN 77-057,567, FILED 12-5-2006.

JIM RINGLE, EXAMINING ATTORNEY

Int. Cl.: 35

Prior U.S. Cls.: 100, 101, and 102

United States Patent and Trademark Office

Reg. No. 3,521,244

Registered Oct. 21, 2008

**SERVICE MARK
PRINCIPAL REGISTER**

CONSUMERPLUS

PRIMIS MARKETING GROUP, INC. (DELA-
WARE CORPORATION)
SUITE 240
8755 W. HIGGINS ROAD
CHICAGO, IL 60631

FOR: DATA PROCESSING SERVICES, NAMELY,
PROVIDING A SERVICE WHICH ACCESSES MUL-
TIPLE SOURCES OF CONSUMER MARKETING
DATA SIMULTANEOUSLY TO MAXIMIZE AND
ANALYZE THE QUALITY AND QUANTITY OF
INDIVIDUAL AND UNIQUE RECORDS FOR USE

BY CLIENTS, IN CLASS 35 (U.S. CLS. 100, 101 AND
102).

FIRST USE 1-0-2007; IN COMMERCE 1-0-2007.

THE MARK CONSISTS OF STANDARD CHAR-
ACTERS WITHOUT CLAIM TO ANY PARTICULAR
FONT, STYLE, SIZE, OR COLOR.

SN 77-057,603, FILED 12-5-2006.

JIM RINGLE, EXAMINING ATTORNEY

Int. Cl.: 32

Prior U.S. Cls.: 45, 46, and 48

United States Patent and Trademark Office

Reg. No. 3,521,245

Registered Oct. 21, 2008

**TRADEMARK
PRINCIPAL REGISTER**

**SMIRNOFF ICE POMEGRANATE
FUSION**

DIAGEO NORTH AMERICA, INC. (CONNECTI-
CUT CORPORATION)
851 MAIN AVENUE
NORWALK, CT 06851

OWNER OF U.S. REG. NOS. 513,428, 3,020,984,
AND OTHERS.

FOR: BREWED MALT-BASED ALCOHOLIC BEV-
ERAGE IN THE NATURE OF A FLAVORED BEER,
IN CLASS 32 (U.S. CLS. 45, 46 AND 48).

NO CLAIM IS MADE TO THE EXCLUSIVE
RIGHT TO USE "POMEGRANATE FUSION",
APART FROM THE MARK AS SHOWN.

FIRST USE 3-31-2007; IN COMMERCE 3-31-2007.

SN 77-058,094, FILED 12-6-2006.

THE MARK CONSISTS OF STANDARD CHAR-
ACTERS WITHOUT CLAIM TO ANY PARTICULAR
FONT, STYLE, SIZE, OR COLOR.

DAVID ELTON, EXAMINING ATTORNEY

Int. Cl.: 30

Prior U.S. Cl.: 46

United States Patent and Trademark Office

Reg. No. 3,521,246

Registered Oct. 21, 2008

**TRADEMARK
PRINCIPAL REGISTER**

DIP 'EMS

FL FOOD LION, INC. (FLORIDA CORPORATION)
2110 EXECUTIVE DRIVE
SALISBURY, NC 28145

THE MARK CONSISTS OF STANDARD CHARACTERS WITHOUT CLAIM TO ANY PARTICULAR FONT, STYLE, SIZE, OR COLOR.

FOR: SNACK FOODS, NAMELY, CORN CHIPS,
IN CLASS 30 (U.S. CL. 46).

SN 77-058,703, FILED 12-7-2006.

FIRST USE 3-1-2007; IN COMMERCE 3-1-2007.

KRISTIN DAHLING, EXAMINING ATTORNEY

Int. Cl.: 43

Prior U.S. Cls.: 100 and 101

United States Patent and Trademark Office

Reg. No. 3,521,247

Registered Oct. 21, 2008

**SERVICE MARK
PRINCIPAL REGISTER**

LET GO. GO OUTBACK.

OS ASSET, INC. (FLORIDA CORPORATION)
5TH FLOOR 2202 N. WESTSHORE BOULEVARD
TAMPA, FL 33607

FOR: RESTAURANT, CARRY-OUT, AND BAR
SERVICES, IN CLASS 43 (U.S. CLS. 100 AND 101).

FIRST USE 9-30-2007; IN COMMERCE 9-30-2007.

THE MARK CONSISTS OF STANDARD CHAR-
ACTERS WITHOUT CLAIM TO ANY PARTICULAR
FONT, STYLE, SIZE, OR COLOR.

SN 77-059,378, FILED 12-7-2006.

WANDA KAY PRICE, EXAMINING ATTORNEY

Int. Cl.: 28

Prior U.S. Cls.: 22, 23, 38, and 50

United States Patent and Trademark Office

Reg. No. 3,521,248

Registered Oct. 21, 2008

TRADEMARK
PRINCIPAL REGISTER



MAI, WENDY (UNITED STATES INDIVIDUAL)
542 HANBURY LANE
FOSTER CITY, CA 94404

FOR: CHINESE CHESS GAMES; DICE GAMES;
BOARD GAMES, IN CLASS 28 (U.S. CLS. 22, 23, 38
AND 50).

FIRST USE 12-1-2006; IN COMMERCE 12-1-2006.

THE MARK CONSISTS OF A WREATH OR GAR-
LAND SURROUNDING CHINESE CHARACTERS.

THE NON-LATIN CHARACTER(S) IN THE
MARK TRANSLITERATE INTO ZHONG GO FU,
AND THIS MEANS CHINA FORTUNE IN ENGLISH.

SN 77-059,598, FILED 12-7-2006.

CHARISMA HAMPTON, EXAMINING ATTORNEY

Int. Cl.: 36

Prior U.S. Cls.: 100, 101, and 102

United States Patent and Trademark Office

Reg. No. 3,521,249

Registered Oct. 21, 2008

**SERVICE MARK
PRINCIPAL REGISTER**

PHILANTHROPY DNA

HUMAN DYNAMICS INTERNATIONAL LIMITED (BR.VIRGIN ISLANDS CORPORATION)
OMAR HODGE BUILDING, WICKHAM'S CAY
ROAD TOWN, TORTOLA, BR.VIRGIN ISLANDS

OWNER OF U.S. REG. NOS. 2,889,667 AND 2,909,001.

FOR: FINANCIAL PLANNING AND FINANCIAL ANALYSIS AND CONSULTING SERVICES, IN CLASS 36 (U.S. CLS. 100, 101 AND 102).

NO CLAIM IS MADE TO THE EXCLUSIVE RIGHT TO USE "PHILANTHROPY", APART FROM THE MARK AS SHOWN.

FIRST USE 7-1-2003; IN COMMERCE 7-1-2003.

SN 77-060,240, FILED 12-8-2006.

THE MARK CONSISTS OF STANDARD CHARACTERS WITHOUT CLAIM TO ANY PARTICULAR FONT, STYLE, SIZE, OR COLOR.

PAUL CROWLEY, EXAMINING ATTORNEY

Int. Cls.: 11, 20, and 28

Prior U.S. Cls.: 2, 13, 21, 22, 23, 25, 31, 32, 34, 38, and 50

Reg. No. 3,521,250

United States Patent and Trademark Office

Registered Oct. 21, 2008

**TRADEMARK
PRINCIPAL REGISTER**

HI-TEC

HI-TEC SPORTS PLC (UNITED KINGDOM COMPANY)
AVIATION WAY
SOUTHEND-ON-SEA, ESSEX, UNITED KINGDOM
SS26GH

FOR: ELECTRIC BEVERAGE HEATERS, GAS WATER HEATERS, KEROSENE HEATERS, THERMOELECTRIC COOLER/HEATER FOR FOODS AND BEVERAGES; PORTABLE ELECTRIC HALOGEN HEATERS FOR USE IN TENTS AND FOR CAMP SITES; PORTABLE ELECTRIC HEATERS, PORTABLE ELECTRIC PARAFFIN HEATERS AND OIL STOVES FOR RECREATIONAL USE; HEATING ELEMENTS FOR PORTABLE ELECTRIC, GAS AND OIL HEATERS; POCKET SEARCH LIGHTS; ELECTRIC COOKING OVENS; REFRIGERATORS; OIL COOKING STOVES; BARBECUES; BARBECUE GRILLS; OUTDOOR COOKERS FOR CURING FOOD; TEMPERATURE-CONTROLLED FOOD AND BEVERAGE DISPENSERS; ELECTRIC AND GAS STOVES; PORTABLE WOOD BURNING, OIL, PARAFFIN AND GAS STOVES; MULTI-FUEL STOVES THAT CAN RUN ON GAS, OIL, SOLID FUEL OR WOOD; CANDLE, ELECTRIC AND OIL LANTERNS; LIGHTERS PRIMARILY FOR LIGHTING GRILLS, BARBECUES, FIREPLACES, PORTABLE OUTDOOR STOVES AND CANDLES; LAVA ROCK FOR USE IN BARBECUE GRILLS; CERAMIC

BRIQUETTES FOR USE IN BARBECUE GRILLS; ROTISSERIES; ROASTERS POWERED BY PROPANE GAS; ELECTRIC FRYING PANS, IN CLASS 11 (U.S. CLS. 13, 21, 23, 31 AND 34).

FIRST USE 6-1-2005; IN COMMERCE 6-1-2005.

FOR: INFLATABLE MATTRESSES AND CUSHIONS FOR USE WHEN CAMPING; CAMP BEDS; CAMPING FURNITURE; SLEEPING BAGS; SLEEPING MATS; NON-METAL, PORTABLE PLASTIC FUEL CONTAINERS, IN CLASS 20 (U.S. CLS. 2, 13, 22, 25, 32 AND 50).

FIRST USE 8-0-2004; IN COMMERCE 8-0-2004.

FOR: TREKKING POLES, IN CLASS 28 (U.S. CLS. 22, 23, 38 AND 50).

FIRST USE 6-1-2005; IN COMMERCE 6-1-2005.

THE MARK CONSISTS OF STANDARD CHARACTERS WITHOUT CLAIM TO ANY PARTICULAR FONT, STYLE, SIZE, OR COLOR.

SN 77-060,399, FILED 12-8-2006.

IRA J. GOODSaid, EXAMINING ATTORNEY

Int. Cls.: 9 and 42

Prior U.S. Cls.: 21, 23, 26, 36, 38, 100, and 101

Reg. No. 3,521,251

United States Patent and Trademark Office

Registered Oct. 21, 2008

**TRADEMARK
SERVICE MARK
PRINCIPAL REGISTER**

Dynamic TRAITS

BASEPOINT ANALYTICS LLC (DELAWARE
LIMITED LIABILITY COMPANY)
703 PALOMAR AIRPORT ROAD, SUITE 350
CARLSBAD, CA 92011

FOR: COMPUTER SOFTWARE FOR FRAUD
DETECTION IN FINANCIAL TRANSACTIONS
AND APPLICATIONS, IN CLASS 9 (U.S. CLS. 21, 23,
26, 36 AND 38).

FIRST USE 10-28-2005; IN COMMERCE 10-28-2005.

FOR: CONSULTING SERVICES AND SOFTWARE
SUPPORT SERVICES IN THE FIELD OF FRAUD

DETECTION IN FINANCIAL TRANSACTIONS
AND APPLICATIONS, IN CLASS 42 (U.S. CLS. 100
AND 101).

FIRST USE 10-28-2005; IN COMMERCE 10-28-2005.

THE MARK CONSISTS OF STANDARD CHAR-
ACTERS WITHOUT CLAIM TO ANY PARTICULAR
FONT, STYLE, SIZE, OR COLOR.

SN 77-060,596, FILED 12-8-2006.

NAAKWAMA ANKRAH, EXAMINING ATTORNEY

Int. Cl.: 41

Prior U.S. Cls.: 100, 101, and 107

United States Patent and Trademark Office

Reg. No. 3,521,252

Registered Oct. 21, 2008

**SERVICE MARK
PRINCIPAL REGISTER**

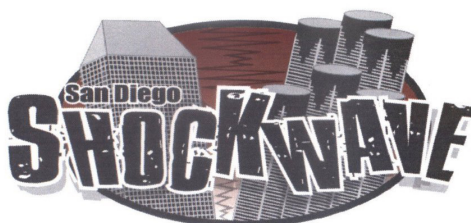

SAN DIEGO SHOCKWAVE, LLC (CALIFORNIA
LIMITED LIABILITY COMPANY)
1954 KELLOGG AVENUE
CARLSBAD, CA 92008

FOR: ENTERTAINMENT IN THE NATURE OF
FOOTBALL GAMES; ORGANIZATION OF SPORTS
EVENTS IN THE FIELD OF FOOTBALL, IN CLASS
41 (U.S. CLS. 100, 101 AND 107).

FIRST USE 3-17-2007; IN COMMERCE 3-17-2007.

NO CLAIM IS MADE TO THE EXCLUSIVE
RIGHT TO USE "SAN DIEGO", APART FROM THE
MARK AS SHOWN.

THE COLOR(S) RED, WHITE, GRAY AND
BLACK IS/ARE CLAIMED AS A FEATURE OF
THE MARK.

THE COLOR RED APPEARS IN THE SKYLINE
AND SUNSET BEHIND THE SKYSCRAPERS. THE
COLOR WHITE APPEARS IN THE OUTLINING OF
THE WORDING "SAN DIEGO SHOCKWAVE". THE
COLOR GRAY APPEARS ON THE SKYSCRAPERS
AND ON THE FAULT LINE BEHIND THE SKY-
SCRAPERS IN THE MARK. THE COLOR BLACK
APPEARS ON THE WORDING "SAN DIEGO
SHOCKWAVE", THE OUTLINING OF THE OVAL
ENCOMPASSING THE WORDING OF THE MARK,
THE FAULT LINE BEHIND THE SKYSCRAPERS
AND ON THE SKYSCRAPERS APPEARING IN THE
MARK.

SN 77-060,762, FILED 12-9-2006.

BRIAN CALLAGHAN, EXAMINING ATTORNEY

Int. Cl.: 41

Prior U.S. Cls.: 100, 101, and 107

United States Patent and Trademark Office

Reg. No. 3,521,253

Registered Oct. 21, 2008

**SERVICE MARK
PRINCIPAL REGISTER**

AMBREA

BR CONSULTING, INC. (NEW JERSEY CORPORATION)
340 JORDAN ROAD
SEDONA, AZ 86336

FOR: EDUCATIONAL SERVICES, NAMELY, PROVIDING CLASSES, SEMINARS, WORKSHOPS IN THE FIELD OF ENHANCING BRAIN FUNCTION AND CAPABILITIES; EDUCATIONAL RESEARCH SERVICES IN THE FIELD OF ENHANCING BRAIN FUNCTION AND CAPABILITIES; CONDUCTING SEMINARS AND CLASSES IN THE FIELD OF ENHANCING BRAIN FUNCTION AND CAPABILITIES; PROVIDING A WEBSITE FEATURING INFORMATION ON

ENHANCING BRAIN FUNCTION AND CAPABILITIES, IN CLASS 41 (U.S. CLS. 100, 101 AND 107).

FIRST USE 8-1-2006; IN COMMERCE 8-1-2006.

THE MARK CONSISTS OF STANDARD CHARACTERS WITHOUT CLAIM TO ANY PARTICULAR FONT, STYLE, SIZE, OR COLOR.

"AMBREA" DOES NOT IDENTIFY A LIVING INDIVIDUAL.

SN 77-061,105, FILED 12-11-2006.

JENNIFER MARTIN, EXAMINING ATTORNEY

Int. Cl.: 9

Prior U.S. Cls.: 21, 23, 26, 36, and 38

United States Patent and Trademark Office

Reg. No. 3,521,254

Registered Oct. 21, 2008

**TRADEMARK
PRINCIPAL REGISTER**

STEREO H2O

MTI WHIRLPOOLS, INC. (GEORGIA CORPORATION)
670 N. PRICE ROAD
SUGAR HILL, GA 30518

FOR: AUDIO SPEAKERS; STEREO AMPLIFIERS;
STEREO RECEIVERS; STEREO TUNERS, IN CLASS
9 (U.S. CLS. 21, 23, 26, 36 AND 38).

FIRST USE 7-15-2008; IN COMMERCE 7-15-2008.

THE MARK CONSISTS OF STANDARD CHARACTERS WITHOUT CLAIM TO ANY PARTICULAR FONT, STYLE, SIZE, OR COLOR.

NO CLAIM IS MADE TO THE EXCLUSIVE RIGHT TO USE "STEREO", APART FROM THE MARK AS SHOWN.

SN 77-061,263, FILED 12-11-2006.

JULIE GUTTADAURO, EXAMINING ATTORNEY

Int. Cl.: 6

Prior U.S. Cls.: 2, 12, 13, 14, 23, 25, and 50

Reg. No. 3,521,255

United States Patent and Trademark Office

Registered Oct. 21, 2008

**TRADEMARK
PRINCIPAL REGISTER**

HOUSTON

BLACK & DECKER CORPORATION, THE
(MARYLAND CORPORATION)
701 E. JOPPA ROAD
TOWSON, MD 21286

FOR: METAL HARDWARE, NAMELY, DOOR
KNOBS, DOOR LEVERS AND LEVER SETS, DOOR
HANDLES AND HANDLE SETS, LATCHES, LOCKS,
DEADBOLTS, KEYS AND KEY BLANKS, IN CLASS
6 (U.S. CLS. 2, 12, 13, 14, 23, 25 AND 50).

FIRST USE 2-28-2007; IN COMMERCE 2-28-2007.

THE MARK CONSISTS OF STANDARD CHAR-
ACTERS WITHOUT CLAIM TO ANY PARTICULAR
FONT, STYLE, SIZE, OR COLOR.

SN 77-061,276, FILED 12-11-2006.

MARGERY A. TIERNEY, EXAMINING ATTORNEY

Int. Cl.: 6

Prior U.S. Cls.: 2, 12, 13, 14, 23, 25, and 50

Reg. No. 3,521,256

United States Patent and Trademark Office

Registered Oct. 21, 2008

**TRADEMARK
PRINCIPAL REGISTER**

MINNEAPOLIS

BLACK & DECKER CORPORATION, THE
(MARYLAND CORPORATION)
701 E. JOPPA ROAD
TOWSON, MD 21286

FOR: METAL HARDWARE, NAMELY, DOOR
KNOBS, DOOR LEVERS AND LEVER SETS, DOOR
HANDLES AND HANDLE SETS, LATCHES, LOCKS,
DEADBOLTS, KEYS AND KEY BLANKS, IN CLASS
6 (U.S. CLS. 2, 12, 13, 14, 23, 25 AND 50).

FIRST USE 2-28-2007; IN COMMERCE 2-28-2007.

THE MARK CONSISTS OF STANDARD CHAR-
ACTERS WITHOUT CLAIM TO ANY PARTICULAR
FONT, STYLE, SIZE, OR COLOR.

SN 77-061,285, FILED 12-11-2006.

MARGERY A. TIERNEY, EXAMINING ATTORNEY

Int. Cl.: 10

Prior U.S. Cls.: 26, 39, and 44

United States Patent and Trademark Office

Reg. No. 3,521,257

Registered Oct. 21, 2008

**TRADEMARK
PRINCIPAL REGISTER**

RETROFLEX

EDWARDS LIFESCIENCES CORPORATION (DE-
LAWARE CORPORATION)
ONE EDWARDS WAY
IRVINE, CA 92614

FOR: HEART VALVE AND HEART VALVE DE-
LIVERY SYSTEM, COMPRISED OF A BALLOON
CATHETER AND GUIDEWIRE FOR PERCUTA-
NEOUS OR MINIMALLY INVASIVE IMPLANTA-
TION OF HEART VALVE, IN CLASS 10 (U.S. CLS. 26,
39 AND 44).

FIRST USE 1-17-2008; IN COMMERCE 1-17-2008.

THE MARK CONSISTS OF STANDARD CHAR-
ACTERS WITHOUT CLAIM TO ANY PARTICULAR
FONT, STYLE, SIZE, OR COLOR.

SN 77-062,820, FILED 12-12-2006.

HEATHER BIDDULPH, EXAMINING ATTORNEY

Int. Cl.: 2

Prior U.S. Cls.: 6, 11, and 16

United States Patent and Trademark Office

Reg. No. 3,521,258

Registered Oct. 21, 2008

**TRADEMARK
PRINCIPAL REGISTER**

TRI-CLPS

BULK CHEMICALS, INC. (PENNSYLVANIA
CORPORATION)
1074 STINSON DRIVE
READING, PA 19605

FOR: COATINGS IN THE NATURE OF SOLUTIONS CONTAINING TRIVALENT CHROMIUM TO IMPROVE PAINT ADHESION AND CORROSION RESISTANCE ON METAL SURFACES, IN CLASS 2 (U.S. CLS. 6, 11 AND 16).

FIRST USE 11-1-2007; IN COMMERCE 11-1-2007.

THE MARK CONSISTS OF STANDARD CHARACTERS WITHOUT CLAIM TO ANY PARTICULAR FONT, STYLE, SIZE, OR COLOR.

OWNER OF U.S. REG. NO. 2,067,564.

SN 77-064,958, FILED 12-15-2006.

LINDA POWELL, EXAMINING ATTORNEY

Int. Cls.: 41 and 44

Prior U.S. Cls.: 100, 101, and 107

United States Patent and Trademark Office

Reg. No. 3,521,259

Registered Oct. 21, 2008

**SERVICE MARK
PRINCIPAL REGISTER**

TRAQ 3D

TRAQ LTD. (OHIO LIMITED LIABILITY COMPANY)
30612 SALEM DRIVE
BAY VILLAGE, OH 44140

FOR: PERSONAL TRAINING SERVICES, NAME-
LY, STRENGTH AND CONDITIONING TRAINING;
PHYSICAL FITNESS CONSULTATION; PROVID-
ING FITNESS AND EXERCISE FACILITIES, IN
CLASS 41 (U.S. CLS. 100, 101 AND 107).

FIRST USE 9-30-2006; IN COMMERCE 9-30-2006.

FOR: HEALTH CARE SERVICES, NAMELY,
WELLNESS PROGRAMS; BODYWORK THERAPY;

PHYSICAL REHABILITATION, IN CLASS 44 (U.S.
CLS. 100 AND 101).

FIRST USE 9-30-2006; IN COMMERCE 9-30-2006.

THE MARK CONSISTS OF STANDARD CHAR-
ACTERS WITHOUT CLAIM TO ANY PARTICULAR
FONT, STYLE, SIZE, OR COLOR.

SN 77-065,998, FILED 12-17-2006.

JOHN HWANG, EXAMINING ATTORNEY

Int. Cls.: 9 and 41

Prior U.S. Cls.: 21, 23, 26, 36, 38, 100, 101, and 107

United States Patent and Trademark Office

Reg. No. 3,521,260

Registered Oct. 21, 2008

**TRADEMARK
SERVICE MARK
PRINCIPAL REGISTER**

EXTREME DINOSAURS

BKN INTERNATIONAL AG (FED REP GERMA-
NY CORPORATION)
GUSTAV-HEINEMANN-UFER 56
COLOGNE, FED REP GERMANY D50968

FOR: VIDEO GAME SOFTWARE AND PRE-RE-
CORDED VIDEO TAPES AND DVDS FEATURING
ANIMATION, VOICES AND MUSIC , IN CLASS 9
(U.S. CLS. 21, 23, 26, 36 AND 38).

FIRST USE 8-20-2007; IN COMMERCE 8-20-2007.

FOR: ENTERTAINMENT IN THE NATURE OF
ON-GOING TELEVISION AND RADIO PROGRAMS
IN THE FIELD OF ANIMATION; ANIMATION
PRODUCTION SERVICES, IN CLASS 41 (U.S. CLS.
100, 101 AND 107).

FIRST USE 8-20-2007; IN COMMERCE 8-20-2007.

THE MARK CONSISTS OF STANDARD CHAR-
ACTERS WITHOUT CLAIM TO ANY PARTICULAR
FONT, STYLE, SIZE, OR COLOR.

NO CLAIM IS MADE TO THE EXCLUSIVE
RIGHT TO USE "DINOSAURS" , APART FROM
THE MARK AS SHOWN.

SN 77-066,549, FILED 12-18-2006.

MICHAEL SOUDERS, EXAMINING ATTORNEY

Int. Cl.: 44

Prior U.S. Cls.: 100 and 101

United States Patent and Trademark Office

Reg. No. 3,521,261

Registered Oct. 21, 2008

SERVICE MARK
PRINCIPAL REGISTER



extrapounds

ANAKENA INTERNET SERVICES S.L. (SPAIN CORPORATION)
C/MALLORCA 235, 3, 2A
BARCELONA, SPAIN 08008

FOR: MEDICAL SERVICES; HYGIENIC AND BEAUTY CARE FOR HUMANS, NAMELY, WEIGHT REDUCTION DIET PLANNING AND SUPERVISION, IN CLASS 44 (U.S. CLS. 100 AND 101).

FIRST USE 11-30-2006; IN COMMERCE 2-5-2007.

"THE COLOR(S) DARK BLUE, GREEN, WHITE, AND BROWN IS/ARE CLAIMED AS A FEATURE OF THE MARK."

"THE MARK CONSISTS OF EXTRA IN DARK BLUE LETTERS AND POUNDS IN GREEN LETTERS WITH THE LETTER O IN THE SHAPE OF A GREEN APPLE WITH A WHITE LIGHTING EFFECT, A BROWN STEM AND A GREEN LEAF."

SN 77-066,915, FILED 12-18-2006.

JAY BESCH, EXAMINING ATTORNEY

Int. Cl.: 28

Prior U.S. Cls.: 22, 23, 38, and 50

United States Patent and Trademark Office

Reg. No. 3,521,262

Registered Oct. 21, 2008

**TRADEMARK
PRINCIPAL REGISTER**



SHIMANO INC. (JAPAN CORPORATION)
3-77 OIMATSU-CHO, SAKAI-KU
SAKAI CITY, OSAKA, JAPAN 590-8577

OWNER OF U.S. REG. NO. 2,917,249.

FOR: FISHING RODS; FISHING TACKLE, IN
CLASS 28 (U.S. CLS. 22, 23, 38 AND 50).

SN 77-067,549, FILED 12-19-2006.

FIRST USE 1-0-2007; IN COMMERCE 1-0-2007.

SUNG IN, EXAMINING ATTORNEY

Int. Cl.: 3

Prior U.S. Cls.: 1, 4, 6, 50, 51, and 52

United States Patent and Trademark Office

Reg. No. 3,521,263

Registered Oct. 21, 2008

**TRADEMARK
PRINCIPAL REGISTER**

REFINE EYE

LOLA COSMETICS, LLC (CALIFORNIA LIMITED LIABILITY COMPANY)
SUITE 700
9663 SANTA MONICA BOULEVARD
BEVERLY HILLS, CA 90210

FOR: COSMETICS, NAMELY, PERFECTING EYE PRIMER, IN CLASS 3 (U.S. CLS. 1, 4, 6, 50, 51 AND 52).

FIRST USE 12-31-2006; IN COMMERCE 2-28-2007.

THE MARK CONSISTS OF STANDARD CHARACTERS WITHOUT CLAIM TO ANY PARTICULAR FONT, STYLE, SIZE, OR COLOR.

NO CLAIM IS MADE TO THE EXCLUSIVE RIGHT TO USE "EYE", APART FROM THE MARK AS SHOWN.

SN 77-068,379, FILED 12-20-2006.

ROBIN CHOSID, EXAMINING ATTORNEY

Int. Cls.: 35, 37, 41, and 42

Prior U.S. Cls.: 100, 101, 102, 103, 106, and 107

United States Patent and Trademark Office

Reg. No. 3,521,264

Registered Oct. 21, 2008

**SERVICE MARK
PRINCIPAL REGISTER**

WORLDWIDE CLINICAL TRIALS



WCT HOLDINGS, LLC (DELAWARE LIMITED LIABILITY COMPANY)
767 FIFTH AVENUE, 48TH FLOOR
NEW YORK, NY 10153

FOR: BUSINESS MANAGEMENT ASSISTANCE AND CONSULTATION FOR CLINICAL TRIALS OF INVESTIGATIONAL DRUGS, NAMELY, ARRANGING FOR SITES TO PERFORM CLINICAL TRIALS, ARRANGING FOR THE IMPORT, PACKAGING, SHIPPING, LABELING, AND DISTRIBUTION OF DRUGS AND OTHER INVESTIGATIONAL SUPPLIES TO AND FROM THE CLINICAL TRIAL SITES, ARRANGING FOR THE CENTRAL COLLECTION OF LABORATORY SPECIMENS FROM CLINICAL TRIAL SITES, MAKING ANY AND ALL FILINGS REQUIRED BY THE FOOD AND DRUG ADMINISTRATION FOR INVESTIGATIONAL NEW DRUGS, PREPARING STATISTICAL REPORTS RESULTING FROM CLINICAL TRIALS, IN CLASS 35 (U.S. CLS. 100, 101 AND 102).

FIRST USE 6-30-2008; IN COMMERCE 6-30-2008.

FOR: REAL ESTATE SITE SELECTION, NAMELY, INSPECTING POTENTIAL SITES FOR HOSTING CLINICAL TRIALS, IN CLASS 37 (U.S. CLS. 100, 103 AND 106).

FIRST USE 6-30-2008; IN COMMERCE 6-30-2008.

FOR: TRAINING CLINICAL TRIAL SITE PERSONNEL CONCERNING DRUG PROTOCOL REQUIREMENTS AND THE USE OF TESTS AND RATING SYSTEMS FOR SUCH PROTOCOL; TRAINING CLINICAL TRIAL SITE PERSONNEL IN THE USE OF MEDICAL AND RESEARCH EQUIPMENT REQUIRED BY DRUG PROTOCOLS, IN CLASS 41 (U.S. CLS. 100, 101 AND 107).

FIRST USE 6-30-2008; IN COMMERCE 6-30-2008.

FOR: TECHNICAL WRITING OF CLINICAL REPORT FORMS FOR OTHERS WHICH ARE REQUIRED BY CLINICAL TRIAL DRUG PROTOCOLS; TECHNICAL WRITING OF CLINICAL TRIAL REPORTS FOR OTHERS; DATABASE DEVELOPMENT SERVICES TO PROCESS DATA COLLECTED FROM CLINICAL TRIALS, IN CLASS 42 (U.S. CLS. 100 AND 101).

FIRST USE 6-30-2008; IN COMMERCE 6-30-2008.

NO CLAIM IS MADE TO THE EXCLUSIVE RIGHT TO USE "WORLDWIDE CLINICAL TRIALS", APART FROM THE MARK AS SHOWN.

SN 77-070,676, FILED 12-22-2006.

MICHELE SWAIN, EXAMINING ATTORNEY

Int. Cl.: 5

Prior U.S. Cls.: 6, 18, 44, 46, 51, and 52

United States Patent and Trademark Office

Reg. No. 3,521,265

Registered Oct. 21, 2008

**TRADEMARK
PRINCIPAL REGISTER**

GLKK gel

NICKELL, ROBERT P (UNITED STATES INDIVIDUAL)
381 VAN NESS AVE., SUITE 1507
TORRANCE, CA 90501

FOR: TOPICAL GEL FOR MEDICAL AND THERAPEUTIC TREATMENT OF PAIN AND INFLAMMATION, IN CLASS 5 (U.S. CLS. 6, 18, 44, 46, 51 AND 52).

FIRST USE 1-1-2008; IN COMMERCE 1-1-2008.

THE MARK CONSISTS OF STANDARD CHARACTERS WITHOUT CLAIM TO ANY PARTICULAR FONT, STYLE, SIZE, OR COLOR.

NO CLAIM IS MADE TO THE EXCLUSIVE RIGHT TO USE "GEL", APART FROM THE MARK AS SHOWN.

SN 77-071,026, FILED 12-24-2006.

THEODORE MCBRIDE, EXAMINING ATTORNEY

Int. Cl.: 5

Prior U.S. Cls.: 6, 18, 44, 46, 51, and 52

Reg. No. 3,521,266

United States Patent and Trademark Office

Registered Oct. 21, 2008

**TRADEMARK
PRINCIPAL REGISTER**

diclogel

NICKELL, ROBERT P (UNITED STATES INDIVIDUAL)
381 VAN NESS AVE., SUITE 1507
TORRANCE, CA 90501

THE MARK CONSISTS OF STANDARD CHARACTERS WITHOUT CLAIM TO ANY PARTICULAR FONT, STYLE, SIZE, OR COLOR.

FOR: PRESCRIPTION, NON-OPHTHALMIC TOPICAL GELS FOR MEDICAL AND THERAPEUTIC TREATMENT OF PAIN AND INFLAMMATION, IN CLASS 5 (U.S. CLS. 6, 18, 44, 46, 51 AND 52).

SN 77-071,035, FILED 12-24-2006.

FIRST USE 1-1-2008; IN COMMERCE 1-1-2008.

THEODORE MCBRIDE, EXAMINING ATTORNEY

Int. Cl.: 10

Prior U.S. Cls.: 26, 39, and 44

United States Patent and Trademark Office

Reg. No. 3,521,267

Registered Oct. 21, 2008

**TRADEMARK
PRINCIPAL REGISTER**

Quickscrew

ROBINSON, RANDOLPH (AMERICAN SAMOA
INDIVIDUAL)
7430 E. PARK MEADOWS DR., SUITE 300
LONE TREE, CO 80124

FIRST USE 7-30-2007; IN COMMERCE 8-31-2007.

FOR: BONE SCREWS; BONE SETTING MA-
CHINES AND INSTRUMENTS; MEDICAL AND
SURGICAL APPARATUS AND INSTRUMENTS,
NAMELY, ORTHOPEDIC FIXATION DEVICE USED
IN ORTHOPEDIC TRANSPLANT AND/OR IM-
PLANT SURGERY; MEDICAL INSTRUMENTS
FOR USE IN BONE SURGERY, IN CLASS 10 (U.S.
CLS. 26, 39 AND 44).

THE MARK CONSISTS OF STANDARD CHAR-
ACTERS WITHOUT CLAIM TO ANY PARTICULAR
FONT, STYLE, SIZE, OR COLOR.

SN 77-071,492, FILED 12-26-2006.

MELVIN AXILBUND, EXAMINING ATTORNEY

Int. Cl.: 41

Prior U.S. Cls.: 100, 101, and 107

United States Patent and Trademark Office

Reg. No. 3,521,268

Registered Oct. 21, 2008

**SERVICE MARK
PRINCIPAL REGISTER**

MIXED UP MASHED UP

DISNEY ENTERPRISES, INC. (DELAWARE CORPORATION)
500 SOUTH BUENA VISTA STREET
BURBANK, CA 91521

FOR: ENTERTAINMENT SERVICES IN THE NATURE OF PRODUCTION AND DISTRIBUTION OF TELEVISION SHOW PROGRAMS FEATURING LIVE-ACTION SERIES, MUSICALS, BY MEANS OF AND FOR CABLE TELEVISION, SATELLITE-DELIVERED AND TELEVISION BROADCASTING; ENTERTAINMENT SERVICES, NAMELY, PROVIDING INFORMATION IN THE FIELD OF ENTERTAINMENT RELATING TO TELEVISION SHOW PROGRAMS, CONTESTS AND FAMILY ENTERTAINMENT VIA A GLOBAL COMMUNICATIONS NETWORK; ENTERTAINMENT SERVICES, NAMELY, PROVIDING A WEBSITE FEATURING

INFORMATION IN THE FIELD OF ENTERTAINMENT RELATING TO TELEVISION SHOW PROGRAMS, CONTESTS AND FAMILY ENTERTAINMENT VIA A GLOBAL COMMUNICATIONS NETWORK, IN CLASS 41 (U.S. CLS. 100, 101 AND 107).

FIRST USE 11-30-2006; IN COMMERCE 11-30-2006.

THE MARK CONSISTS OF STANDARD CHARACTERS WITHOUT CLAIM TO ANY PARTICULAR FONT, STYLE, SIZE, OR COLOR.

SN 77-072,143, FILED 12-27-2006.

SUE LAWRENCE, EXAMINING ATTORNEY

Int. Cl.: 25

Prior U.S. Cls.: 22 and 39

United States Patent and Trademark Office

Reg. No. 3,521,269

Registered Oct. 21, 2008

TRADEMARK
PRINCIPAL REGISTER



Green Tee Apparel
a departure from tradition

GREEN TEE APPAREL (CALIFORNIA PART-
NERSHIP)
72 ANACAPA COURT
FOOTHILL RANCH, CA 92610

FOR: GOLF CLOTHING, NAMELY, ARM WAR-
MERS; GOLF CLOTHING, NAMELY, KNEE WAR-
MERS; GOLF CLOTHING, NAMELY, NECK TUBES;
GOLF CLOTHING, NAMELY, WRAP-AROUNDS;
GOLF CAPS; GOLF SHIRTS; GOLF TROUSERS;
GOLF HOODS; GOLF JERSEYS; GOLF SHORT
SETS; GOLF SHOULDER WRAPS; GOLF TIES;

GOLF TOPS; GOLF WRAPS, IN CLASS 25 (U.S.
CLS. 22 AND 39).

FIRST USE 1-18-2008; IN COMMERCE 1-18-2008.

NO CLAIM IS MADE TO THE EXCLUSIVE
RIGHT TO USE "APPAREL", APART FROM THE
MARK AS SHOWN.

SN 77-072,314, FILED 12-28-2006.

BARNEY CHARLON, EXAMINING ATTORNEY

Int. Cl.: 21

Prior U.S. Cls.: 2, 13, 23, 29, 30, 33, 40, and 50

Reg. No. 3,521,270

United States Patent and Trademark Office

Registered Oct. 21, 2008

**TRADEMARK
PRINCIPAL REGISTER**



MCPHERSON'S LIMITED (AUSTRALIA LIMITED COMPANY)
5 DUNLOP ROAD
MULGRAVE, VICTORIA, AUSTRALIA 3170

FOR: GLASSWARE, NAMELY, DRINKING GLASSES, BEER GLASSES, WINE GLASSES, TUMBLERS, SHOT GLASSES; JUGS, PITCHERS, CARAFES; DRINKING MUGS, IN CLASS 21 (U.S. CLS. 2, 13, 23, 29, 30, 33, 40 AND 50).

FIRST USE 12-31-1996; IN COMMERCE 12-31-2007.

NO CLAIM IS MADE TO THE EXCLUSIVE RIGHT TO USE "GLASSWARE", APART FROM THE MARK AS SHOWN.

THE MARK CONSISTS OF A CROWN AND THE WORDS "CROWN" GLASSWARE.

SN 77-072,878, FILED 12-28-2006.

BILL DAWE, EXAMINING ATTORNEY

Int. Cl.: 9

Prior U.S. Cls.: 21, 23, 26, 36, and 38

United States Patent and Trademark Office

Reg. No. 3,521,271

Registered Oct. 21, 2008

**TRADEMARK
PRINCIPAL REGISTER**

Theatre Sync

The logo for "Theatre Sync" features the word "Theatre" in a standard sans-serif font, followed by "Sync" in a bold, sans-serif font. The "Sync" is partially enclosed by a slanted oval shape that starts above the 'S' and ends below the 'c'.

SONY KABUSHIKI KAISHA ALSO TRADING AS
SONY CORPORATION (JAPAN CORPORATION)

1-7-1 KONAN, MINATO-KU
TOKYO, JAPAN

FOR: TELEVISION SETS; DVD PLAYERS, DVD PLAYERS AND RECORDERS; AUDIO PLAYERS AND RECORDERS FEATURING HARD DISC DRIVE STORAGE MEDIA, VIDEO PLAYERS AND RECORDERS FEATURING HARD DISC DRIVE STORAGE MEDIA, DIGITAL AUDIO PLAYERS, DIGITAL AUDIO PLAYERS AND RECORDERS; AV AMPLIFIER; HOME COMPUTER SERVERS, IN CLASS 9 (U.S. CLS. 21, 23, 26, 36 AND 38).

FIRST USE 4-30-2007; IN COMMERCE 4-30-2007.

NO CLAIM IS MADE TO THE EXCLUSIVE RIGHT TO USE "THEATRE", APART FROM THE MARK AS SHOWN.

THE MARK CONSISTS OF THE WORDING "THEATRE SYNC" IN STYLIZED TYPE WITH THE "SYNC" ELEMENT SURROUNDED BY A SLANTED OVAL.

SN 77-073,264, FILED 12-29-2006.

SARA THOMAS, EXAMINING ATTORNEY

Int. Cl.: 38

Prior U.S. Cls.: 100, 101, and 104

United States Patent and Trademark Office

Reg. No. 3,521,272

Registered Oct. 21, 2008

**SERVICE MARK
PRINCIPAL REGISTER**

Fresh Music & Videos

DUNKIN, GREG (UNITED STATES INDIVIDUAL)
2307 BRIGHT FUTURE WAY
RALEIGH, NC 27614

FOR: CABLE TELEVISION BROADCASTING; CABLE TELEVISION TRANSMISSION; RADIO BROADCASTING; SATELLITE TELEVISION BROADCASTING; STREAMING OF AUDIO MATERIAL ON THE INTERNET; STREAMING OF VIDEO MATERIAL ON THE INTERNET; TELEVISION BROADCASTING; TRANSMISSION OF DATA, SOUND AND IMAGES BY SATELLITE; NONE OF THE FOREGOING RELATING TO ADULT ENTERTAINMENT, IN CLASS 38 (U.S. CLS. 100, 101 AND 104).

FIRST USE 3-5-2008; IN COMMERCE 6-25-2008.

THE MARK CONSISTS OF STANDARD CHARACTERS WITHOUT CLAIM TO ANY PARTICULAR FONT, STYLE, SIZE, OR COLOR.

NO CLAIM IS MADE TO THE EXCLUSIVE RIGHT TO USE "MUSIC & VIDEOS", APART FROM THE MARK AS SHOWN.

SN 77-073,309, FILED 12-29-2006.

IRA J. GOODSaid, EXAMINING ATTORNEY

Int. Cl.: 37

Prior U.S. Cls.: 100, 103, and 106

United States Patent and Trademark Office

Reg. No. 3,521,273

Registered Oct. 21, 2008

**SERVICE MARK
PRINCIPAL REGISTER**

RAPID REPAIR

PUNCHLISTCOMPLETE.COM LLC (FLORIDA
LIMITED LIABILITY COMPANY)
SUITE 211
4100 W. KENNEDY BOULEVARD
TAMPA, FL 33609

FOR: CONSTRUCTION, REMODEL AND RE-
PAIR OF COMMERCIAL, RESIDENTIAL, HOSPI-
TALITY, INSTITUTIONAL, GOVERNMENT,
INDUSTRIAL AND MEDICAL BUILDINGS AND
FACILITIES, IN CLASS 37 (U.S. CLS. 100, 103 AND
106).

FIRST USE 7-17-2006; IN COMMERCE 7-17-2006.

THE MARK CONSISTS OF STANDARD CHAR-
ACTERS WITHOUT CLAIM TO ANY PARTICULAR
FONT, STYLE, SIZE, OR COLOR.

NO CLAIM IS MADE TO THE EXCLUSIVE
RIGHT TO USE "REPAIR", APART FROM THE
MARK AS SHOWN.

SN 77-074,173, FILED 1-2-2007.

KELLEY WELLS, EXAMINING ATTORNEY

Int. Cls.: 1 and 5

Prior U.S. Cls.: 1, 5, 6, 10, 18, 26, 44, 46, 51, and 52

United States Patent and Trademark Office

Reg. No. 3,521,274

Registered Oct. 21, 2008

**TRADEMARK
PRINCIPAL REGISTER**

VIRXSYS

VIRXSYS CORPORATION (DELAWARE CORPORATION)
200 PERRY PARKWAY, SUITE 1A
GAITHERSBURG, MD 20877

FOR: CHEMICAL REAGENTS FOR SCIENTIFIC, MEDICAL RESEARCH OR LABORATORY USE; REAGENTS FOR USE IN GENETIC RESEARCH; BIOLOGICAL VECTOR TRANSPORT SYSTEMS THAT INCORPORATE GENETIC PAYLOADS COMPRISING NUCLEIC ACIDS FOR USE IN RESEARCH, IN CLASS 1 (U.S. CLS. 1, 5, 6, 10, 26 AND 46).

FIRST USE 1-0-2000; IN COMMERCE 7-0-2008.

FOR: GENETIC MEDICINES, NAMELY, RETROVIRAL-BASED AND LENTIVIRAL-BASED GENETIC MEDICINES FOR THE TREATMENT OF HIV; GENE THERAPY PRODUCTS, NAMELY, BIOLOGI-

CAL VECTOR TRANSPORT SYSTEMS WHICH INCORPORATE GENETIC PAYLOADS COMPRISING NUCLEIC ACIDS; PHARMACEUTICAL PREPARATIONS FOR THE TREATMENT OF HIV, IN CLASS 5 (U.S. CLS. 6, 18, 44, 46, 51 AND 52).

FIRST USE 1-0-2000; IN COMMERCE 7-0-2008.

OWNER OF U.S. REG. NO. 3,109,661.

THE MARK CONSISTS OF A THIN DIAGONAL SWIRL DESIGN THROUGH THE CENTER OF THE LITERAL ELEMENT.

SN 77-077,112, FILED 1-5-2007.

BARBARA BROWN, EXAMINING ATTORNEY

Int. Cls.: 1 and 5

Prior U.S. Cls.: 1, 5, 6, 10, 18, 26, 44, 46, 51, and 52

United States Patent and Trademark Office

Reg. No. 3,521,275

Registered Oct. 21, 2008

**TRADEMARK
PRINCIPAL REGISTER**

**DELIVERING THE PROMISE OF
GENETIC MEDICINE**

VIRXSYS CORPORATION (DELAWARE CORPORATION)
200 PERRY PARKWAY, SUITE 1A
GAITHERSBURG, MD 20877

FOR: CHEMICAL REAGENTS FOR SCIENTIFIC, MEDICAL RESEARCH OR LABORATORY USE; REAGENTS FOR USE IN GENETIC RESEARCH; BIOLOGICAL VECTOR TRANSPORT SYSTEMS THAT INCORPORATE GENETIC PAYLOADS COMPRISING NUCLEIC ACIDS FOR USE IN RESEARCH, IN CLASS 1 (U.S. CLS. 1, 5, 6, 10, 26 AND 46).

FIRST USE 1-0-2000; IN COMMERCE 7-0-2008.

FOR: GENETIC MEDICINES, NAMELY, RETROVIRAL-BASED AND LENTIVIRAL-BASED GENETIC MEDICINES FOR THE TREATMENT OF HIV;

GENE THERAPY PRODUCTS, NAMELY, BIOLOGICAL VECTOR TRANSPORT SYSTEMS WHICH INCORPORATE GENETIC PAYLOADS COMPRISING NUCLEIC ACIDS; PHARMACEUTICAL PREPARATIONS FOR THE TREATMENT OF HIV, IN CLASS 5 (U.S. CLS. 6, 18, 44, 46, 51 AND 52).

FIRST USE 1-0-2000; IN COMMERCE 7-0-2008.

THE MARK CONSISTS OF STANDARD CHARACTERS WITHOUT CLAIM TO ANY PARTICULAR FONT, STYLE, SIZE, OR COLOR.

SN 77-077,125, FILED 1-5-2007.

BARBARA BROWN, EXAMINING ATTORNEY

Int. Cl.: 36

Prior U.S. Cls.: 100, 101, and 102

United States Patent and Trademark Office

Reg. No. 3,521,276

Registered Oct. 21, 2008

**SERVICE MARK
PRINCIPAL REGISTER**

PERTUITY

PERTUITY, INC. (DELAWARE CORPORATION)
SUITE 200
8603 WESTWOOD CENTER DRIVE
VIENNA, VA 22182

THE MARK CONSISTS OF STANDARD CHAR-
ACTERS WITHOUT CLAIM TO ANY PARTICULAR
FONT, STYLE, SIZE, OR COLOR.

FOR: ON-LINE BANKING SERVICES, IN CLASS
36 (U.S. CLS. 100, 101 AND 102).

SN 77-077,266, FILED 1-5-2007.

FIRST USE 8-1-2007; IN COMMERCE 8-1-2007.

THEODORE MCBRIDE, EXAMINING ATTORNEY

Int. Cl.: 8

Prior U.S. Cls.: 23, 28, and 44

Reg. No. 3,521,277

United States Patent and Trademark Office

Registered Oct. 21, 2008

**TRADEMARK
PRINCIPAL REGISTER**



AMERICAN SAFETY RAZOR COMPANY (DELA-
WARE CORPORATION)
240 CEDAR KNOLLS ROAD
CEDAR KNOLLS, NJ 07927

THE MARK CONSISTS OF THE TERM "PERSON-
NA" INSIDE AND EMBLEM DESIGN ELEMENT
WITH TWO ELLIPSE DESIGNS SURROUNDING
THE LITERAL ELEMENT WITHIN SUCH EMBLEM.

FOR: RAZORS AND RAZOR BLADES, IN CLASS
8 (U.S. CLS. 23, 28 AND 44).

SN 77-077,853, FILED 1-8-2007.

FIRST USE 1-31-2007; IN COMMERCE 1-31-2007.

OWNER OF U.S. REG. NOS. 436,340, 1,537,220,
AND OTHERS.

JUDITH HELFMAN, EXAMINING ATTORNEY

Int. Cl.: 9

Prior U.S. Cls.: 21, 23, 26, 36, and 38

Reg. No. 3,521,278

United States Patent and Trademark Office

Registered Oct. 21, 2008

**TRADEMARK
PRINCIPAL REGISTER**

FORTUNE 8'S

BALLY GAMING INTERNATIONAL, INC. (DE-
LAWARE CORPORATION)
ATTN: PAM BOWSHER, LAW DEPT.
6601 SOUTH BERMUDA ROAD
LAS VEGAS, NV 89119

FOR: GAMING DEVICES, NAMELY, SLOT MA-
CHINES, WITH OR WITHOUT VIDEO OUTPUT, IN
CLASS 9 (U.S. CLS. 21, 23, 26, 36 AND 38).

FIRST USE 12-10-2007; IN COMMERCE 12-10-2007.

THE MARK CONSISTS OF STANDARD CHAR-
ACTERS WITHOUT CLAIM TO ANY PARTICULAR
FONT, STYLE, SIZE, OR COLOR.

NO CLAIM IS MADE TO THE EXCLUSIVE
RIGHT TO USE "8'S", APART FROM THE MARK
AS SHOWN.

SN 77-079,182, FILED 1-9-2007.

MARK T. MULLEN, EXAMINING ATTORNEY

Int. Cl.: 9

Prior U.S. Cls.: 21, 23, 26, 36, and 38

United States Patent and Trademark Office

Reg. No. 3,521,279

Registered Oct. 21, 2008

**TRADEMARK
PRINCIPAL REGISTER**

CALM DOWN DOG

UKARMA CORPORATION (NEVADA CORPORATION)
520 BROADWAY, SUITE 350
SANTA MONICA, CA 90401

FOR: PRE-RECORDED CDS AND DVDS FEATURING INFORMATION AND INSTRUCTION IN THE FIELDS OF HEALTHY LIVING AND HEALTHY LIVING THROUGH YOGA, FITNESS, DIET AND NUTRITION, PERSONAL RELATIONSHIPS, AND WELLNESS OF THE MIND, BODY, AND SPIRIT; PROVIDING ONLINE, DOWNLOADABLE MULTIMEDIA FILES FOR PLAYBACK ON MOBILE COMMUNICATION DEVICES AND COMPUTERS IN THE FIELDS OF HEALTHY LIVING AND HEALTHY LIVING THROUGH YOGA, FITNESS,

DIET AND NUTRITION, PERSONAL RELATIONSHIPS, AND WELLNESS OF THE MIND, BODY, AND SPIRIT, IN CLASS 9 (U.S. CLS. 21, 23, 26, 36 AND 38).

FIRST USE 4-19-2007; IN COMMERCE 4-19-2007.

THE MARK CONSISTS OF STANDARD CHARACTERS WITHOUT CLAIM TO ANY PARTICULAR FONT, STYLE, SIZE, OR COLOR.

SN 77-080,192, FILED 1-10-2007.

RUSS HERMAN, EXAMINING ATTORNEY

Int. Cl.: 9

Prior U.S. Cls.: 21, 23, 26, 36, and 38

United States Patent and Trademark Office

Reg. No. 3,521,280

Registered Oct. 21, 2008

**TRADEMARK
PRINCIPAL REGISTER**

BODY BLAST

UKARMA CORPORATION (NEVADA CORPORATION)
520 BROADWAY, SUITE 350
SANTA MONICA, CA 90401

FOR: PRE-RECORDED CDS AND DVDS FEATURING INFORMATION AND INSTRUCTION IN THE FIELDS OF HEALTHY LIVING AND HEALTHY LIVING THROUGH YOGA, FITNESS, DIET AND NUTRITION, PERSONAL RELATIONSHIPS, AND WELLNESS OF THE MIND, BODY, AND SPIRIT; PROVIDING ONLINE, DOWNLOADABLE MULTIMEDIA FILES FOR PLAYBACK ON MOBILE COMMUNICATION DEVICES AND COMPUTERS IN THE FIELDS OF HEALTHY LIVING AND HEALTHY LIVING THROUGH YOGA, FITNESS,

DIET AND NUTRITION, PERSONAL RELATIONSHIPS, AND WELLNESS OF THE MIND, BODY, AND SPIRIT, IN CLASS 9 (U.S. CLS. 21, 23, 26, 36 AND 38).

FIRST USE 4-19-2007; IN COMMERCE 4-19-2007.

THE MARK CONSISTS OF STANDARD CHARACTERS WITHOUT CLAIM TO ANY PARTICULAR FONT, STYLE, SIZE, OR COLOR.

SN 77-080,197, FILED 1-10-2007.

RUSS HERMAN, EXAMINING ATTORNEY

Int. Cl.: 36

Prior U.S. Cls.: 100, 101, and 102

United States Patent and Trademark Office

Reg. No. 3,521,281

Registered Oct. 21, 2008

**SERVICE MARK
PRINCIPAL REGISTER**



AMERICAN CAPITAL, LTD. (DELAWARE CORPORATION)
2 BETHESDA METRO CENTER
14TH FLOOR
BETHESDA, MD 20814

FOR: FINANCIAL AND INVESTMENT SERVICES, NAMELY, PRIVATE EQUITY, SENIOR DEBT, MEZZANINE FINANCING AND INVESTMENT AND PORTFOLIO MANAGEMENT; PROVIDING VENTURE CAPITAL AND INVESTMENT CAPITAL FOR MANAGEMENT AND EMPLOYEE BUY-OUTS; CREATION AND MANAGEMENT OF CAPITAL INVESTMENT FUNDS; SECURITIES BROKERAGE; FINANCIAL ANALYSIS AND CONSULTATION, IN CLASS 36 (U.S. CLS. 100, 101 AND 102).

FIRST USE 12-31-2006; IN COMMERCE 12-31-2007.

NO CLAIM IS MADE TO THE EXCLUSIVE RIGHT TO USE "CAPITAL ENERGY", APART FROM THE MARK AS SHOWN.

THE MARK CONSISTS OF THE WORDS AMERICAN CAPITAL ENERGY ADJACENT TO A STYLIZED TRIANGLE SHAPE.

SEC. 2(F) "AMERICAN CAPITAL HAS BECOME DISTINCTIVE OF THE GOODS/SERVICES AS EVIDENCED BY THE OWNERSHIP ON THE PRINCIPAL REGISTER FOR THE SAME MARK FOR RELATED GOODS OR SERVICES OF U.S. REGISTRATION NO(S)2221152 AND 3258097."

SN 77-080,275, FILED 1-10-2007.

RUDY R. SINGLETON, EXAMINING ATTORNEY

Int. Cl.: 42

Prior U.S. Cls.: 100 and 101

United States Patent and Trademark Office

Reg. No. 3,521,282

Registered Oct. 21, 2008

**SERVICE MARK
PRINCIPAL REGISTER**



SKWIBBLE, L.L.C. (CALIFORNIA LIMITED LIABILITY COMPANY)
3355 NORTH KNOLL DR.
LOS ANGELES, CA 90068

FOR: WEB APPLICATION SERVICE PROVIDER FEATURING SOFTWARE INTERFACES FOR USE IN IMAGE SHARING AND DISTRIBUTION OF ADVERTISEMENTS AND PROMOTION OF PRODUCTS AND SERVICES OF THIRD PARTIES THROUGH EMBEDDED ADVERTISEMENTS WITHIN AN IMAGE SHARING ENVIRONMENT, IN CLASS 42 (U.S. CLS. 100 AND 101).

FIRST USE 1-1-2008; IN COMMERCE 1-1-2008.

THE COLOR(S) PURPLE AND YELLOW IS/ARE CLAIMED AS A FEATURE OF THE MARK.

THE MARK CONSISTS OF AN IMAGE OF A PURPLE OCTOPUS AGAINST A YELLOW BACKGROUND.

SN 77-080,442, FILED 1-10-2007.

BARBARA RUTLAND, EXAMINING ATTORNEY

Int. Cl.: 35

Prior U.S. Cls.: 100, 101, and 102

United States Patent and Trademark Office

Reg. No. 3,521,283

Registered Oct. 21, 2008

**SERVICE MARK
PRINCIPAL REGISTER**

SPG MOMENTS

PREFERRED GUEST, INC. (DELAWARE CORPORATION)
1111 WESTCHESTER AVENUE
WHITE PLAINS, NY 10604

FOR: CUSTOMER LOYALTY SERVICES AND CUSTOMER CLUB SERVICES, FOR COMMERCIAL, PROMOTIONAL AND/OR ADVERTISING PURPOSES, IN CLASS 35 (U.S. CLS. 100, 101 AND 102).

FIRST USE 10-0-2007; IN COMMERCE 10-0-2007.

THE MARK CONSISTS OF STANDARD CHARACTERS WITHOUT CLAIM TO ANY PARTICULAR FONT, STYLE, SIZE, OR COLOR.

SN 77-080,445, FILED 1-10-2007.

MARGERY A. TIERNEY, EXAMINING ATTORNEY

Int. Cl.: 35

Prior U.S. Cls.: 100, 101, and 102

United States Patent and Trademark Office

Reg. No. 3,521,284

Registered Oct. 21, 2008

**SERVICE MARK
PRINCIPAL REGISTER**

Crowne Hunter

CRWNE HUNTER INCORPORATED (NEVADA CORPORATION)
101 CONVENTION CENTER DR, STE 700
P.O. BOX 27740
LAS VEGAS, NV 89126

FOR: ARRANGING, CONDUCTING, AND MANAGING ONLINE INTERNET BASED CONSIGNMENT AND SELLER-POSTED AUCTIONS FEATURING A DIVERSIFIED RANGE OF PRODUCTS; AUCTIONEERING FOR ONLINE INTERNET BASED CONSIGNMENT AUCTIONS AND SELLER-POSTED PRODUCT AUCTIONS FEATUR-

ING A DIVERSIFIED RANGE OF PRODUCTS, IN CLASS 35 (U.S. CLS. 100, 101 AND 102).

FIRST USE 9-3-2007; IN COMMERCE 9-3-2007.

THE MARK CONSISTS OF STANDARD CHARACTERS WITHOUT CLAIM TO ANY PARTICULAR FONT, STYLE, SIZE, OR COLOR.

SN 77-080,862, FILED 1-11-2007.

SARA THOMAS, EXAMINING ATTORNEY

Int. Cls.: 9, 20, 24, and 27

Prior U.S. Cls.: 2, 13, 19, 20, 21, 22, 23, 25, 26, 32, 36, 37, 38, 42, and 50

Reg. No. 3,521,285

United States Patent and Trademark Office

Registered Oct. 21, 2008

**TRADEMARK
PRINCIPAL REGISTER**



EARTH FX, INC. (NEVADA CORPORATION)
SUITE 200-23
777 E. TAHQUITZ CANYON WAY
PALM SPRINGS, CA 92262

FOR: ELECTRODE PATCHES, NOT FOR MEDICAL USE, FEATURING CABLES ATTACHABLE TO A BUILDING GROUND SYSTEM OR A GROUNDED CONDUCTOR; ELECTRICAL CIRCUIT PROTECTORS FOR BUILDING GROUND SYSTEMS, IN CLASS 9 (U.S. CLS. 21, 23, 26, 36 AND 38).

FIRST USE 7-1-2008; IN COMMERCE 7-1-2008.

FOR: MATTRESSES AND CHAIRS, NOT FOR MEDICAL USE, FEATURING CABLES ATTACHABLE TO A BUILDING GROUND SYSTEM OR A GROUNDED CONDUCTOR; BEDS; MATTRESS TOPPERS; MATTRESSES, IN CLASS 20 (U.S. CLS. 2, 13, 22, 25, 32 AND 50).

FIRST USE 7-1-2008; IN COMMERCE 7-1-2008.

FOR: BED SHEETS AND BED PADS, NOT FOR MEDICAL USE, FEATURING CABLES ATTACHABLE TO A BUILDING GROUND SYSTEM OR A GROUNDED CONDUCTOR; BED BLANKETS; BED LINEN; BED PADS; BED SHEETS; BED SKIRTS; BED

SPREADS; MATTRESS COVERS; MATTRESS PADS, IN CLASS 24 (U.S. CLS. 42 AND 50).

FIRST USE 7-1-2008; IN COMMERCE 7-1-2008.

FOR: FLOOR MATS AND CARPETS FEATURING CABLES ATTACHABLE TO A BUILDING GROUND SYSTEM OR A GROUNDED CONDUCTOR, IN CLASS 27 (U.S. CLS. 19, 20, 37, 42 AND 50).

FIRST USE 7-1-2008; IN COMMERCE 7-1-2008.

THE COLOR(S) GRAY, DARK GRAY, LIGHT BLUE, BLUE, BLACK, AND WHITE IS/ARE CLAIMED AS A FEATURE OF THE MARK.

THE COLOR GRAY APPEARS IN THE WORDING "EARTH" IN "EARTHFX" AND THE COLOR DARK GRAY APPEARS IN THE WORDING "FX" IN "EARTHFX". THE COLORS BLACK, BLUE, LIGHT BLUE, AND WHITE APPEAR IN THE STYLIZED SPHERE.

SN 77-080,953, FILED 1-11-2007.

ROBERT LAVACHE, EXAMINING ATTORNEY

Int. Cl.: 9

Prior U.S. Cls.: 21, 23, 26, 36, and 38

United States Patent and Trademark Office

Reg. No. 3,521,286

Registered Oct. 21, 2008

**TRADEMARK
PRINCIPAL REGISTER**



ABBOTT LABORATORIES (ILLINOIS CORPORATION)
100 ABBOTT PARK ROAD
ABBOTT PARK, IL 60064

FOR: PERSONAL DIGITAL ASSISTANTS, COMPUTER SOFTWARE AND HARDWARE USED TO MONITOR INVENTORY, COMPUTER SOFTWARE FOR COMMUNICATION WITH USERS OF HAND-HELD COMPUTERS, IN CLASS 9 (U.S. CLS. 21, 23, 26, 36 AND 38).

FIRST USE 2-23-2007; IN COMMERCE 2-23-2007.

THE COLOR(S) DARK BLUE, BLUE, LIGHT BLUE, AND WHITE IS/ARE CLAIMED AS A FEATURE OF THE MARK.

THE MARK CONSISTS OF A CUBE DESIGN MADE UP OF INTERLOCKING PIECES IN THE COLORS OF DARK BLUE, BLUE, AND LIGHT BLUE WITH A WHITE BORDER AROUND THE PIECES, AS WELL AS A DARK BLUE ANTENNA STANDING ON TOP OF THE CUBE AND EXPANDING DARK BLUE, BLUE, AND LIGHT BLUE SOUND WAVES RIPPLING FROM THE TOP OF THE ANTENNA.

SN 77-081,274, FILED 1-11-2007.

TINA KUAN, EXAMINING ATTORNEY

Int. Cl.: 9

Prior U.S. Cls.: 21, 23, 26, 36, and 38

United States Patent and Trademark Office

Reg. No. 3,521,287

Registered Oct. 21, 2008

**TRADEMARK
PRINCIPAL REGISTER**

WEBSNACKS

MARK/SPACE, INC. (CALIFORNIA CORPORATION)
654 N. SANTA CRUZ AVE. #300
LOS GATOS, CA 95030

FOR: COMPUTER AND TELECOMMUNICATIONS SOFTWARE THAT ENABLES OTHERS TO CAPTURE AND TRANSFER ONLINE CONTENT TO ELECTRONIC DEVICES, IN CLASS 9 (U.S. CLS. 21, 23, 26, 36 AND 38).

FIRST USE 6-0-2006; IN COMMERCE 6-0-2006.

THE MARK CONSISTS OF STANDARD CHARACTERS WITHOUT CLAIM TO ANY PARTICULAR FONT, STYLE, SIZE, OR COLOR.

SN 77-081,294, FILED 1-11-2007.

ANN E. SAPPENFIELD, EXAMINING ATTORNEY

Int. Cl.: 35

Prior U.S. Cls.: 100, 101, and 102

United States Patent and Trademark Office

Reg. No. 3,521,288

Registered Oct. 21, 2008

SERVICE MARK
PRINCIPAL REGISTER



PHILLIPS, JOHN C. (UNITED STATES INDIVIDUAL)
1340 WINTER SPRINGS LANE
CORDOVA, TN 38018

FOR: ON-LINE RETAIL STORE SERVICES FEATURING DOWNLOADABLE PRE-RECORDED MUSIC, IN CLASS 35 (U.S. CLS. 100, 101 AND 102).

FIRST USE 6-26-2008; IN COMMERCE 6-26-2008.

NO CLAIM IS MADE TO THE EXCLUSIVE RIGHT TO USE ".COM", APART FROM THE MARK AS SHOWN.

THE WORDING "ZOOBIE" HAS NO MEANING IN A FOREIGN LANGUAGE.

SN 77-082,000, FILED 1-12-2007.

TAMARA FRAZIER, EXAMINING ATTORNEY

Int. Cl.: 33

Prior U.S. Cls.: 47 and 49

United States Patent and Trademark Office

Reg. No. 3,521,289

Registered Oct. 21, 2008

TRADEMARK
PRINCIPAL REGISTER

DOÑA ENGRACIA

TEQUILA DOÑA ENGRACIA S.A. DE C.V. (MEX-
ICO CORPORATION)
COL. LA DESEMBOCADA
CARRETERA A LAS PALMAS S/N
PUERTO VALLARTA, MEXICO 48272

FOR: ALCOHOLIC BEVERAGES, NAMELY, TE-
QUILA; TEQUILA, IN CLASS 33 (U.S. CLS. 47 AND
49).

FIRST USE 2-25-2007; IN COMMERCE 2-25-2007.

THE MARK CONSISTS OF STANDARD CHAR-
ACTERS WITHOUT CLAIM TO ANY PARTICULAR
FONT, STYLE, SIZE, OR COLOR.

"DOÑA ENGRACIA" DOES NOT IDENTIFY A
LIVING INDIVIDUAL.

THE FOREIGN WORDING IN THE MARK
TRANSLATES INTO ENGLISH AS: THE WORD
"DOÑA" IS AN HONORIFIC TITLE FOR A FEMALE
MEANING MS. OR LADY, AND THE WORD "EN-
GRACIA" IS A FEMALE'S NAME THAT MEANS
GRACEFUL.

SN 77-082,945, FILED 1-15-2007.

KATHERINE CHANG, EXAMINING ATTORNEY

Int. Cls.: 5 and 31

Prior U.S. Cls.: 1, 6, 18, 44, 46, 51, and 52

Reg. No. 3,521,290

United States Patent and Trademark Office

Registered Oct. 21, 2008

**TRADEMARK
PRINCIPAL REGISTER**

NUTRITION HORIZONS

NORTH AMERICAN NUTRITION COMPANIES,
INC. (DELAWARE CORPORATION)
6531 ST. RT. 503
LEWISBURG, OH 45338

FOR: ANIMAL FEED SUPPLEMENTS, IN CLASS
5 (U.S. CLS. 6, 18, 44, 46, 51 AND 52).

FIRST USE 1-24-2008; IN COMMERCE 1-24-2008.

FOR: NON-MEDICATED ADDITIVES FOR ANI-
MAL FEED AND ANIMAL FEED, NAMELY, LIVE-
STOCK FEED, HORSE FEED AND PET FOOD, IN
CLASS 31 (U.S. CLS. 1 AND 46).

FIRST USE 1-24-2008; IN COMMERCE 1-24-2008.

THE MARK CONSISTS OF STANDARD CHAR-
ACTERS WITHOUT CLAIM TO ANY PARTICULAR
FONT, STYLE, SIZE, OR COLOR.

NO CLAIM IS MADE TO THE EXCLUSIVE
RIGHT TO USE "NUTRITION", APART FROM
THE MARK AS SHOWN.

SN 77-083,438, FILED 1-16-2007.

H. M. FISHER, EXAMINING ATTORNEY

Int. Cls.: 5 and 31

Prior U.S. Cls.: 1, 6, 18, 44, 46, 51, and 52

United States Patent and Trademark Office

Reg. No. 3,521,291

Registered Oct. 21, 2008

**TRADEMARK
PRINCIPAL REGISTER**



NORTH AMERICAN NUTRITION COMPANIES,
INC. (DELAWARE CORPORATION)
6531 ST. RT. 503
LEWISBURG, OH 45338

FOR: ANIMAL FEED SUPPLEMENTS, IN CLASS
5 (U.S. CLS. 6, 18, 44, 46, 51 AND 52).

FIRST USE 1-24-2008; IN COMMERCE 1-24-2008.

FOR: NON-MEDICATED ADDITIVES FOR ANI-
MAL FEED AND ANIMAL FEED, NAMELY, LIVE-
STOCK FEED, HORSE FEED AND PET FOOD, IN
CLASS 31 (U.S. CLS. 1 AND 46).

FIRST USE 1-24-2008; IN COMMERCE 1-24-2008.

NO CLAIM IS MADE TO THE EXCLUSIVE
RIGHT TO USE "NUTRITION", APART FROM
THE MARK AS SHOWN.

THE MARK CONSISTS OF THE WORDS "NUTRI-
TION HORIZONS" WITH DESIGN.

SN 77-083,494, FILED 1-16-2007.

H. M. FISHER, EXAMINING ATTORNEY

Int. Cl.: 6

Prior U.S. Cls.: 2, 12, 13, 14, 23, 25, and 50

Reg. No. 3,521,292

United States Patent and Trademark Office

Registered Oct. 21, 2008

**TRADEMARK
PRINCIPAL REGISTER**

SUPER BRITE

ALERIS OHIO MANAGEMENT, INC. (DELA-
WARE CORPORATION)
25825 SCIENCE PARK DRIVE, SUITE 400
BEACHWOOD, OH 44122

FOR: ALUMINUM ALLOYS IN THE FORM OF
SHEETS AND PLATES, IN CLASS 6 (U.S. CLS. 2, 12,
13, 14, 23, 25 AND 50).

FIRST USE 4-1-2008; IN COMMERCE 4-1-2008.

THE MARK CONSISTS OF STANDARD CHAR-
ACTERS WITHOUT CLAIM TO ANY PARTICULAR
FONT, STYLE, SIZE, OR COLOR.

NO CLAIM IS MADE TO THE EXCLUSIVE
RIGHT TO USE "BRIGHT", APART FROM THE
MARK AS SHOWN.

SN 77-083,611, FILED 1-16-2007.

LINDA ORNDORFF, EXAMINING ATTORNEY

Int. Cl.: 21

Prior U.S. Cls.: 2, 13, 23, 29, 30, 33, 40, and 50

Reg. No. 3,521,293

United States Patent and Trademark Office

Registered Oct. 21, 2008

**TRADEMARK
PRINCIPAL REGISTER**

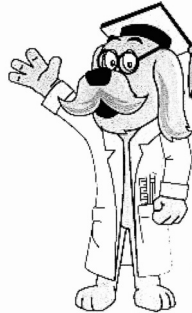

Professor Read-A-Lot

PUIG, MICHAEL J. (UNITED STATES INDIVIDUAL)
1405 W. PETERS COLONY ROAD
CARROLLTON, TX 75007

THE MARK CONSISTS OF A STANDING DOG WEARING A COAT, HAT, AND GLASSES, WITH A RULER AND PENCIL IN THE POCKET OF THE COAT.

FOR: PLATES, IN CLASS 21 (U.S. CLS. 2, 13, 23, 29, 30, 33, 40 AND 50).

SN 77-083,904, FILED 1-16-2007.

FIRST USE 8-15-2008; IN COMMERCE 8-15-2008.

NAKWAMA ANKRAH, EXAMINING ATTORNEY

Int. Cl.: 35

Prior U.S. Cls.: 100, 101, and 102

United States Patent and Trademark Office

Reg. No. 3,521,294

Registered Oct. 21, 2008

**SERVICE MARK
PRINCIPAL REGISTER**

HONEYS & HEROES

PUMPKIN BABES, INC. (CALIFORNIA CORPORATION)
3366 SACRAMENTO ST
SAN FRANCISCO, CA 94108

FOR: RETAIL STORES FEATURING BABY AND CHILDREN'S CLOTHES, NAMELY, T- SHIRTS, PANTS, SWEATERS, DRESSES, SOCKS, HATS, BODYSUITS, JACKETS, SWEATSHIRTS, ROMPERS, SHOES, LAYETTE; BABY AND CHILDREN'S ACCESSORIES, NAMELY, HATS, HEADBANDS, SUN GLASSES, TIGHTS, SCARVES, HAIR CLIPS, SHOES, BELTS, TOYS, DIAPER BAGS, GIFT CARDS, PLUSH TOYS, IN CLASS 35 (U.S. CLS. 100, 101 AND 102).

FIRST USE 6-1-2007; IN COMMERCE 6-1-2007.

THE MARK CONSISTS OF STANDARD CHARACTERS WITHOUT CLAIM TO ANY PARTICULAR FONT, STYLE, SIZE, OR COLOR.

SN 77-084,046, FILED 1-16-2007.

LEIGH CAROLINE CASE, EXAMINING ATTORNEY

Int. Cl.: 5

Prior U.S. Cls.: 6, 18, 44, 46, 51, and 52

Reg. No. 3,521,295

United States Patent and Trademark Office

Registered Oct. 21, 2008

**TRADEMARK
PRINCIPAL REGISTER**

NEW START

SPECIALTY NUTRITION GROUP, INC. (FLORIDA CORPORATION)
ONE SOUTH OCEAN BLVD., SUITE 300
BOCA RATON, FL 33432

THE MARK CONSISTS OF STANDARD CHARACTERS WITHOUT CLAIM TO ANY PARTICULAR FONT, STYLE, SIZE, OR COLOR.

FOR: DIETARY SUPPLEMENTS; FOOD SUPPLEMENTS; NUTRITIONAL SUPPLEMENTS; VITAMIN SUPPLEMENTS, IN CLASS 5 (U.S. CLS. 6, 18, 44, 46, 51 AND 52).

SN 77-084,358, FILED 1-17-2007.

FIRST USE 4-30-2008; IN COMMERCE 5-16-2008.

ANDREA BUTLER, EXAMINING ATTORNEY

Int. Cl.: 9

Prior U.S. Cls.: 21, 23, 26, 36, and 38

Reg. No. 3,521,296

United States Patent and Trademark Office

Registered Oct. 21, 2008

**TRADEMARK
PRINCIPAL REGISTER**

DocuClick

FARM CREDIT SERVICES OF AMERICA, ACA
(UNITED STATES FEDERALLY CHARTERED
CORPORATION)
5015 SOUTH 118TH STREET
OMAHA, NE 68137

FOR: COMPUTER SOFTWARE FOR DOCUMENT
SCANNING, STORAGE, INDEXING, RETRIEVAL
AND SEARCHING, IN CLASS 9 (U.S. CLS. 21, 23, 26,
36 AND 38).

FIRST USE 2-27-2007; IN COMMERCE 5-12-2007.

THE MARK CONSISTS OF STANDARD CHAR-
ACTERS WITHOUT CLAIM TO ANY PARTICULAR
FONT, STYLE, SIZE, OR COLOR.

SN 77-084,373, FILED 1-17-2007.

ANN E. SAPPENFIELD, EXAMINING ATTORNEY

Int. Cls.: 9 and 42

Prior U.S. Cls.: 21, 23, 26, 36, 38, 100, and 101

Reg. No. 3,521,297

United States Patent and Trademark Office

Registered Oct. 21, 2008

**TRADEMARK
SERVICE MARK
PRINCIPAL REGISTER**

MUSICDJ

SONY ERICSSON MOBILE COMMUNICATIONS
AB (SWEDEN CORPORATION)
NYA VATTENTORNET
SE-22188 LUND, SWEDEN

FOR: EMBEDDED SOFTWARE USED AS AN
ELECTRONIC FEATURE FOUND ON MOBILE OR
CELLULAR PHONES FOR THE PURPOSE OF COM-
POSING RING TONES, IN CLASS 9 (U.S. CLS. 21, 23,
26, 36 AND 38).

FIRST USE 4-0-2003; IN COMMERCE 4-0-2003.

FOR: PROVIDING TEMPORARY USE OF NON-
DOWNLOADABLE SOFTWARE FOR THE PUR-

POSE OF COMPOSING AND DOWNLOADING
RING TONES TO MOBILE OR CELLULAR PHONES,
IN CLASS 42 (U.S. CLS. 100 AND 101).

FIRST USE 4-0-2003; IN COMMERCE 4-0-2003.

THE MARK CONSISTS OF STANDARD CHAR-
ACTERS WITHOUT CLAIM TO ANY PARTICULAR
FONT, STYLE, SIZE, OR COLOR.

SN 77-084,823, FILED 1-17-2007.

DARRYL SPRUILL, EXAMINING ATTORNEY

Int. Cl.: 6

Prior U.S. Cls.: 2, 12, 13, 14, 23, 25, and 50

United States Patent and Trademark Office

Reg. No. 3,521,298

Registered Oct. 21, 2008

**TRADEMARK
PRINCIPAL REGISTER**

EASY GLIDE

EX-CELL HOME FASHIONS, INC. (DELAWARE
CORPORATION)
295 FIFTH AVENUE
NEW YORK, NY 10016

THE MARK CONSISTS OF STANDARD CHAR-
ACTERS WITHOUT CLAIM TO ANY PARTICULAR
FONT, STYLE, SIZE, OR COLOR.

FOR: METAL SHOWER RINGS, IN CLASS 6 (U.S.
CLS. 2, 12, 13, 14, 23, 25 AND 50).

SN 77-084,844, FILED 1-17-2007.

FIRST USE 5-0-2005; IN COMMERCE 5-0-2005.

ZACHARY BELLO, EXAMINING ATTORNEY

Int. Cl.: 7

Prior U.S. Cls.: 13, 19, 21, 23, 31, 34, and 35

Reg. No. 3,521,299

United States Patent and Trademark Office

Registered Oct. 21, 2008

**TRADEMARK
PRINCIPAL REGISTER**

AF-600 FP

GENERAL ELECTRIC COMPANY (NEW YORK
CORPORATION)
1 RIVER ROAD
SCHENECTADY, NY 12345

FIRST USE 10-26-2007; IN COMMERCE 10-26-2007.

FOR: AC VARIABLE FREQUENCY DRIVES
THAT ARE USED TO CONTROL SMALL AND
MEDIUM-SIZED MOTORS IN APPLICATIONS
SUCH AS MANUFACTURING PROCESSES, HVAC
AND PUMPS, IN CLASS 7 (U.S. CLS. 13, 19, 21, 23, 31,
34 AND 35).

THE MARK CONSISTS OF STANDARD CHAR-
ACTERS WITHOUT CLAIM TO ANY PARTICULAR
FONT, STYLE, SIZE, OR COLOR.

SN 77-085,816, FILED 1-18-2007.

CARYN GLASSER, EXAMINING ATTORNEY

Int. Cl.: 36

Prior U.S. Cls.: 100, 101, and 102

United States Patent and Trademark Office

Reg. No. 3,521,300

Registered Oct. 21, 2008

**SERVICE MARK
PRINCIPAL REGISTER**



**"I Got a
Reverse
Mortgage"**

WORLD ALLIANCE FINANCIAL CORP. (NEW
YORK CORPORATION)
3 HUNTINGTON QUADRANGLE
MELVILLE, NY 11747

FOR: REVERSE MORTGAGE ORIGINATION
SERVICES, IN CLASS 36 (U.S. CLS. 100, 101 AND 102).

FIRST USE 3-0-2008; IN COMMERCE 3-0-2008.

NO CLAIM IS MADE TO THE EXCLUSIVE
RIGHT TO USE "REVERSE MORTGAGE", APART
FROM THE MARK AS SHOWN.

"THE COLOR(S) DARK BLUE, LIGHT BLUE AND
YELLOW IS/ARE CLAIMED AS A FEATURE OF
THE MARK."

THE MARK CONSISTS OF THE WORDS "I GOT A
REVERSE MORTGAGE" INSIDE QUOTATION
MARKS, ALL OF WHICH ARE DARK BLUE, WITH
LIGHT BLUE SHADING BEHIND EACH LETTER
AND QUOTATION MARK, AND A YELLOW HALF-
SUN DESIGN ABOVE THE FIRST AND LAST
PARTS OF THE QUOTATION MARKS.

SN 77-086,770, FILED 1-19-2007.

MARY CRAWFORD, EXAMINING ATTORNEY

Int. Cl.: 8

Prior U.S. Cls.: 23, 28, and 44

United States Patent and Trademark Office

Reg. No. 3,521,301

Registered Oct. 21, 2008

**TRADEMARK
PRINCIPAL REGISTER**

MARINIZER

KEYSTONE MANUFACTURING INC. (NEW
YORK CORPORATION)
20 NORRIS STREET
BUFFALO, NY 14207

THE MARK CONSISTS OF STANDARD CHAR-
ACTERS WITHOUT CLAIM TO ANY PARTICULAR
FONT, STYLE, SIZE, OR COLOR.

FOR: MEAT TENDERIZER, NAMELY, A BLA-
DED INSTRUMENT FOR PUNCTURING MEAT
AND ADDING MARINADE, IN CLASS 8 (U.S. CLS.
23, 28 AND 44).

SN 77-086,919, FILED 1-19-2007.

FIRST USE 12-6-2007; IN COMMERCE 12-6-2007.

LAURA KOVALSKY, EXAMINING ATTORNEY

Int. Cl.: 25

Prior U.S. Cls.: 22 and 39

United States Patent and Trademark Office

Reg. No. 3,521,302

Registered Oct. 21, 2008

**TRADEMARK
PRINCIPAL REGISTER**

Hollywood Hess

AUSTIN STEPHAN HESS (CALIFORNIA CORPORATION)
P.O. BOX 381052
LOS ANGELES, CA 90038

FOR: DRESS SHIRTS; MEN AND WOMEN JACKETS, COATS, TROUSERS, VESTS; OPEN-NECKED SHIRTS; POLO SHIRTS; SHIRTS FOR SUITS; SHORT-SLEEVED OR LONG-SLEEVED T-SHIRTS; SHORT-SLEEVED SHIRTS, IN CLASS 25 (U.S. CLS. 22 AND 39).

FIRST USE 1-1-2007; IN COMMERCE 1-4-2008.

THE MARK CONSISTS OF STANDARD CHARACTERS WITHOUT CLAIM TO ANY PARTICULAR FONT, STYLE, SIZE, OR COLOR.

NO CLAIM IS MADE TO THE EXCLUSIVE RIGHT TO USE "HOLLYWOOD", APART FROM THE MARK AS SHOWN.

SN 77-087,208, FILED 1-19-2007.

MICHAEL SOUDERS, EXAMINING ATTORNEY

Int. Cl.: 35

Prior U.S. Cls.: 100, 101, and 102

United States Patent and Trademark Office

Reg. No. 3,521,303

Registered Oct. 21, 2008

**SERVICE MARK
PRINCIPAL REGISTER**

CAREER SHIFT

CAREER SHIFT, LLC (OHIO LIMITED LIABILITY COMPANY)
13827 TORTUGA POINTE DRIVE
JACKSONVILLE, FL 32225

THE MARK CONSISTS OF STANDARD CHARACTERS WITHOUT CLAIM TO ANY PARTICULAR FONT, STYLE, SIZE, OR COLOR.

FOR: PROVIDING ON-LINE BUSINESS NETWORKING SERVICES, NAMELY, DEVELOPMENT OF BUSINESS CONTACTS AND MANAGEMENT OF BUSINESS CONTACTS; PROVIDING ON-LINE SEARCHABLE JOB LISTING SERVICES; PROVIDING ON-LINE RESUME, COVER LETTER, AND BUSINESS CARD PREPARATION SERVICES, IN CLASS 35 (U.S. CLS. 100, 101 AND 102).

NO CLAIM IS MADE TO THE EXCLUSIVE RIGHT TO USE "CAREER", APART FROM THE MARK AS SHOWN.

SN 77-087,608, FILED 1-22-2007.

FIRST USE 1-1-2008; IN COMMERCE 1-1-2008.

JEAN IM, EXAMINING ATTORNEY

Int. Cl.: 31

Prior U.S. Cls.: 1 and 46

United States Patent and Trademark Office

Reg. No. 3,521,304

Registered Oct. 21, 2008

**TRADEMARK
PRINCIPAL REGISTER**

MBH Prima

MBH PRIMA SUPPLIES INC. (NEW YORK COR-
PORATION)
22ND FLOOR
1001 SIXTH AVENUE
NEW YORK, NY 10018

THE MARK CONSISTS OF STANDARD CHAR-
ACTERS WITHOUT CLAIM TO ANY PARTICULAR
FONT, STYLE, SIZE, OR COLOR.

FOR: NUTRITIONAL ADDITIVES FOR ANIMAL
FOODSTUFFS, NOT FOR MEDICAL PURPOSES, IN
CLASS 31 (U.S. CLS. 1 AND 46).

SN 77-089,317, FILED 1-23-2007.

FIRST USE 10-1-2007; IN COMMERCE 10-1-2007.

THOMAS MANOR, EXAMINING ATTORNEY

Int. Cl.: 31

Prior U.S. Cls.: 1 and 46

United States Patent and Trademark Office

Reg. No. 3,521,305

Registered Oct. 21, 2008

**TRADEMARK
PRINCIPAL REGISTER**

MBH Prima 2000

MBH PRIMA SUPPLIES INC. (NEW YORK COR-
PORATION)
22ND FLOOR
1001 SIXTH AVENUE
NEW YORK, NY 10018

THE MARK CONSISTS OF STANDARD CHAR-
ACTERS WITHOUT CLAIM TO ANY PARTICULAR
FONT, STYLE, SIZE, OR COLOR.

FOR: NUTRITIONAL ADDITIVES FOR ANIMAL
FOODSTUFFS, NOT FOR MEDICAL PURPOSES, IN
CLASS 31 (U.S. CLS. 1 AND 46).

SN 77-089,329, FILED 1-23-2007.

FIRST USE 10-1-2007; IN COMMERCE 10-1-2007.

THOMAS MANOR, EXAMINING ATTORNEY

Int. Cl.: 41

Prior U.S. Cls.: 100, 101, and 107

United States Patent and Trademark Office

Reg. No. 3,521,306

Registered Oct. 21, 2008

SERVICE MARK
PRINCIPAL REGISTER



ROBERTS, BRITTNY J (UNITED STATES INDIVIDUAL)
7614 HAMPTON AVE #3
WEST HOLLYWOOD, CA 90046

FOR: YOGA INSTRUCTION, IN CLASS 41 (U.S. CLS. 100, 101 AND 107).

FIRST USE 2-22-2007; IN COMMERCE 10-1-2007.

NO CLAIM IS MADE TO THE EXCLUSIVE RIGHT TO USE "YOGA", APART FROM THE MARK AS SHOWN.

THE MARK CONSISTS OF THE WORD "THE" WITH A BOLD LETTER "T", THE WORD "YOGA" WITH THE LETTER "Y" DOUBLING AS BOTH THE ALPHABETICAL CHARACTER "Y" AND AN ABSTRACT HUMAN FIGURE IN THE SHAPE OF THE LETTER "Y", AND THE WORD "STYLE" WITH A BOLD LETTER "S".

SN 77-089,428, FILED 1-23-2007.

ELLEN B. AWRICH, EXAMINING ATTORNEY

Int. Cl.: 25

Prior U.S. Cls.: 22 and 39

United States Patent and Trademark Office

Reg. No. 3,521,307

Registered Oct. 21, 2008

**TRADEMARK
PRINCIPAL REGISTER**

DRYBRID

AMERICAN NEEDLE (ILLINOIS CORPORATION)
1275 BUSCH PARKWAY
BUFFALO GROVE, IL 60089

FOR: MEN'S, WOMEN'S AND CHILDREN'S CLOTHING, NAMELY HEADWEAR, NAMELY, HATS AND CAPS, PANTS, SHIRTS, SKIRTS, COATS, JACKETS, SHOES, AND ACCESSORIES, NAMELY BELTS, IN CLASS 25 (U.S. CLS. 22 AND 39).

FIRST USE 7-3-2008; IN COMMERCE 7-3-2008.

THE MARK CONSISTS OF STANDARD CHARACTERS WITHOUT CLAIM TO ANY PARTICULAR FONT, STYLE, SIZE, OR COLOR.

SN 77-089,769, FILED 1-24-2007.

ERIN FALK, EXAMINING ATTORNEY

Int. Cl.: 25

Prior U.S. Cls.: 22 and 39

United States Patent and Trademark Office

Reg. No. 3,521,308

Registered Oct. 21, 2008

**TRADEMARK
PRINCIPAL REGISTER**

ADDRESSED

MAMIYE BROTHERS, INC. (NEW YORK COR-
PORATION)
ROOM 1000
112 WEST 34TH STREET
NEW YORK, NY 10120

THE MARK CONSISTS OF STANDARD CHAR-
ACTERS WITHOUT CLAIM TO ANY PARTICULAR
FONT, STYLE, SIZE, OR COLOR.

FOR: DRESSES, SKIRT SETS, SKIRTS, JUMPERS,
IN CLASS 25 (U.S. CLS. 22 AND 39).

SN 77-089,796, FILED 1-24-2007.

FIRST USE 5-0-2008; IN COMMERCE 5-0-2008.

SEAN CROWLEY, EXAMINING ATTORNEY

Int. Cl.: 12

Prior U.S. Cls.: 19, 21, 23, 31, 35, and 44

Reg. No. 3,521,309

United States Patent and Trademark Office

Registered Oct. 21, 2008

**TRADEMARK
PRINCIPAL REGISTER**

JUST IN CASE DIESEL

AAA DIESEL REPAIR & SERVICE, INC. (UTAH CORPORATION)
P.O. BOX 71523
SALT LAKE CITY, UT 841710523

FOR: CUSTOM MADE SEMI-TRACTOR TRAILER TRUCK REPAIR KITS COMPRISED PRIMARILY OF COOLANT HOSES AND TUBING, AIR HOSES, HEATER HOSES, HOSE CLAMPS, HOSE SPLICE COUPLERS, AIR LINES AND AIR LINE COUPLERS, TUBING, NAMELY, AIR BRAKE LINES AND AIR BRAKE HOSES, ADHESIVE TAPE, NAMELY, DUCT TAPE AND ELECTRICAL TAPE, ELECTRICAL FUSES AND TERMINALS, AIR GOVERNORS AND RADIATOR CAPS, DRIVE BELTS AND TRANSMISSION BELTS, FUEL FILTERS, OIL FILTERS, FILTER WRENCHES, EMERGENCY WARNING LIGHTS AND EMERGENCY FLARES, CLEANING RAGS, LATEX GLOVES, ELECTRICAL RELAYS, PLASTIC TIES, SOCKET SETS, SOCKET

WRENCHES, RAZOR KNIFE, WRENCHES, RATCHET WRENCHES AND PLIERS, ALL SOLD AS PART OF A TRUCK REPAIR KIT, IN CLASS 12 (U.S. CLS. 19, 21, 23, 31, 35 AND 44).

FIRST USE 5-12-2008; IN COMMERCE 5-12-2008.

THE MARK CONSISTS OF STANDARD CHARACTERS WITHOUT CLAIM TO ANY PARTICULAR FONT, STYLE, SIZE, OR COLOR.

NO CLAIM IS MADE TO THE EXCLUSIVE RIGHT TO USE "DIESEL", APART FROM THE MARK AS SHOWN.

SN 77-089,800, FILED 1-24-2007.

SEAN CROWLEY, EXAMINING ATTORNEY

Int. Cl.: 30

Prior U.S. Cl.: 46

United States Patent and Trademark Office

Reg. No. 3,521,310

Registered Oct. 21, 2008

**TRADEMARK
PRINCIPAL REGISTER**

HEARTH ROOM BLEND

MARRIOTT INTERNATIONAL, INC. (DELA-
WARE CORPORATION)
10400 FERNWOOD ROAD
BETHESDA, MD 20817

NO CLAIM IS MADE TO THE EXCLUSIVE
RIGHT TO USE "BLEND", APART FROM THE
MARK AS SHOWN.

FOR: COFFEE, IN CLASS 30 (U.S. CL. 46).

FIRST USE 5-17-2007; IN COMMERCE 5-17-2007.

SN 77-090,849, FILED 1-25-2007.

THE MARK CONSISTS OF STANDARD CHAR-
ACTERS WITHOUT CLAIM TO ANY PARTICULAR
FONT, STYLE, SIZE, OR COLOR.

MIDGE BUTLER, EXAMINING ATTORNEY

Int. Cl.: 31

Prior U.S. Cls.: 1 and 46

United States Patent and Trademark Office

Reg. No. 3,521,311

Registered Oct. 21, 2008

**TRADEMARK
PRINCIPAL REGISTER**

TRILOGY COLLECTION

THE CHEF'S GARDEN, INC. (OHIO CORPORATION)
9009 HURON-AVERY ROAD
HURON, OH 44839

THE MARK CONSISTS OF STANDARD CHARACTERS WITHOUT CLAIM TO ANY PARTICULAR FONT, STYLE, SIZE, OR COLOR.

FOR: FRESH HERBS; FRESH VEGETABLES, IN CLASS 31 (U.S. CLS. 1 AND 46).

SN 77-091,344, FILED 1-25-2007.

FIRST USE 8-28-2008; IN COMMERCE 8-28-2008.

GISELLE AGOSTO, EXAMINING ATTORNEY

Int. Cl.: 31

Prior U.S. Cls.: 1 and 46

United States Patent and Trademark Office

Reg. No. 3,521,312

Registered Oct. 21, 2008

**TRADEMARK
PRINCIPAL REGISTER**

AMUSE BOUCHE COLLECTION

THE CHEF'S GARDEN, INC. (OHIO CORPORATION)

9009 HURON-AVERY ROAD

HURON, OH 44839

FOR: FRESH HERBS; FRESH VEGETABLES, IN CLASS 31 (U.S. CLS. 1 AND 46).

FIRST USE 8-28-2008; IN COMMERCE 8-28-2008.

THE MARK CONSISTS OF STANDARD CHARACTERS WITHOUT CLAIM TO ANY PARTICULAR FONT, STYLE, SIZE, OR COLOR.

THE ENGLISH TRANSLATION OF THE WORD "AMUSE BOUCHE" IN THE MARK IS AMUSE MOUTH.

SN 77-091,353, FILED 1-25-2007.

GISELLE AGOSTO, EXAMINING ATTORNEY

Int. Cl.: 28

Prior U.S. Cls.: 22, 23, 38, and 50

United States Patent and Trademark Office

Reg. No. 3,521,313

Registered Oct. 21, 2008

**TRADEMARK
PRINCIPAL REGISTER**

MISS MARY BOBO'S

JACK DANIEL'S PROPERTIES, INC. (DELA-
WARE CORPORATION)
4040 CIVIC CENTER DRIVE
SUITE 528
SAN RAFAEL, CA 94903

FOR: GAMES, NAMELY, PLAYING CARDS, IN
CLASS 28 (U.S. CLS. 22, 23, 38 AND 50).

FIRST USE 1-24-2004; IN COMMERCE 1-24-2007.

THE MARK CONSISTS OF STANDARD CHAR-
ACTERS WITHOUT CLAIM TO ANY PARTICULAR
FONT, STYLE, SIZE, OR COLOR.

THE NAME SHOWN IN THE MARK DOES NOT
IDENTIFY A PARTICULAR LIVING INDIVIDUAL.

SN 77-091,544, FILED 1-25-2007.

KATHERINE M. DUBRAY, EXAMINING ATTOR-
NEY

Int. Cl.: 21

Prior U.S. Cls.: 2, 13, 23, 29, 30, 33, 40, and 50

United States Patent and Trademark Office

Reg. No. 3,521,314

Registered Oct. 21, 2008

**TRADEMARK
PRINCIPAL REGISTER**

MISS MARY BOBO'S

JACK DANIEL'S PROPERTIES, INC. (DELA-
WARE CORPORATION)
4040 CIVIC CENTER DRIVE
SUITE 528
SAN RAFAEL, CA 94903

FOR: GLASS AND PLASTIC DRINK CONTAIN-
ERS, NAMELY, CERAMIC MUGS, GLASS MUGS,
BEVERAGE GLASSWARE, PLASTIC MUGS; CERA-
MIC PITCHERS; CRYSTAL PITCHERS; CERAMIC
JUGS; WOOD COASTERS; CORK COASTERS; SWIZ-
ZLE STICKS; DINNERWARE, NAMELY, PLATES,
CUPS, SAUCERS, SOUP BOWLS, PIE PLATES, CAS-
SEROLE DISHES, SERVING BOWLS AND SERVING
TRAYS; GLASS CANDLE HOLDERS; GLASS CAN-
DLESTICKS; SERVING TRAYS OF NON-PRECIOUS

METAL; SKILLETS AND PORTABLE COOLERS, IN
CLASS 21 (U.S. CLS. 2, 13, 23, 29, 30, 33, 40 AND 50).

FIRST USE 1-24-2007; IN COMMERCE 1-24-2007.

THE MARK CONSISTS OF STANDARD CHAR-
ACTERS WITHOUT CLAIM TO ANY PARTICULAR
FONT, STYLE, SIZE, OR COLOR.

THE NAME SHOWN IN THE MARK DOES NOT
IDENTIFY A PARTICULAR LIVING INDIVIDUAL.

SN 77-091,577, FILED 1-25-2007.

KATHERINE M. DUBRAY, EXAMINING ATTOR-
NEY

Int. Cl.: 41

Prior U.S. Cls.: 100, 101, and 107

United States Patent and Trademark Office

Reg. No. 3,521,315

Registered Oct. 21, 2008

**SERVICE MARK
PRINCIPAL REGISTER**

Hurricane Hunter

CHRISTIAN D'ANDREA (UNITED STATES IN-
DIVIDUAL)
11160-C1 SOUTH LAKES DR #626
RESTON, VA 20191

FOR: ENTERTAINMENT SERVICES, NAMELY, A
SERIES OF MOTION PICTURES AND/OR TELEVI-
SION PROGRAMS FEATURING COMEDY, DRA-
MA, ACTION, ADVENTURE, AND/OR
ANIMATION; AND FOR PROVIDING A WEBSITE
FEATURING INFORMATION IN THE FIELD OF
ENTERTAINMENT, IN CLASS 41 (U.S. CLS. 100, 101
AND 107).

FIRST USE 7-20-2008; IN COMMERCE 7-20-2008.

THE MARK CONSISTS OF STANDARD CHAR-
ACTERS WITHOUT CLAIM TO ANY PARTICULAR
FONT, STYLE, SIZE, OR COLOR.

SN 77-091,616, FILED 1-25-2007.

ESTHER A. BORSUK, EXAMINING ATTORNEY

Int. Cls.: 9, 35, and 42

Prior U.S. Cls.: 21, 23, 26, 36, 38, 100, 101, and 102

United States Patent and Trademark Office

Reg. No. 3,521,316

Registered Oct. 21, 2008

**TRADEMARK
SERVICE MARK
PRINCIPAL REGISTER**

VOVICI

VOVICI CORPORATION (DELAWARE CORPORATION)
45365 VINTAGE PARK PLAZA
SUITE 250
DULLES, VA 20166

FOR: COMPUTER SOFTWARE FOR USE IN ADMINISTERING SURVEYS OVER A COMPUTER NETWORK; COMPUTER SOFTWARE FOR USE IN COLLECTING CUSTOMER SURVEY DATA; COMPUTER SOFTWARE FOR USE IN ENTERPRISE FEEDBACK MANAGEMENT AND COMMUNITY RESPONSE MANAGEMENT, IN CLASS 9 (U.S. CLS. 21, 23, 26, 36 AND 38).

FIRST USE 4-2-2007; IN COMMERCE 4-2-2007.

FOR: PROVIDING BUSINESS AND MARKET DATA COLLECTION, NAMELY, COLLECTION, PREPARATION, COMPOSITION, STORAGE, PROCESSING, ACQUISITION AND PROVISION OF BUSINESS INFORMATION, DATA, STATISTICS, AND INDICES; ANALYSIS OF MARKET, BUSINESS, AND PUBLIC OPINION SURVEYS OF OTH-

ERS; CONSULTING SERVICES IN THE FIELDS OF MARKET, BUSINESS AND PUBLIC OPINION SURVEY ANALYSIS; CONSULTATION SERVICES IN THE FIELD OF MARKET RESEARCH AND BUSINESS CONSULTATION, IN CLASS 35 (U.S. CLS. 100, 101 AND 102).

FIRST USE 4-2-2007; IN COMMERCE 4-2-2007.

FOR: COMPUTER SERVICES, NAMELY, DESIGNING AND IMPLEMENTING WEB SITES FOR OTHERS FEATURING SURVEYS, IN CLASS 42 (U.S. CLS. 100 AND 101).

FIRST USE 4-2-2007; IN COMMERCE 4-2-2007.

THE MARK CONSISTS OF STANDARD CHARACTERS WITHOUT CLAIM TO ANY PARTICULAR FONT, STYLE, SIZE, OR COLOR.

SN 77-091,840, FILED 1-26-2007.

JAY BESCH, EXAMINING ATTORNEY

Int. Cl.: 5

Prior U.S. Cls.: 6, 18, 44, 46, 51, and 52

Reg. No. 3,521,317

United States Patent and Trademark Office

Registered Oct. 21, 2008

**TRADEMARK
PRINCIPAL REGISTER**

ESSENTIALIS

ESSENTIALIS, INC. (DELAWARE CORPORATION)
7915 CORTE CARDO
CARLSBAD, CA 92009

FOR: PHARMACEUTICAL PREPARATIONS FOR USE IN TREATING OBESITY, DIABETES, AND NEURODEGENERATIVE CONDITIONS OF THE CENTRAL NERVOUS SYSTEM, IN CLASS 5 (U.S. CLS. 6, 18, 44, 46, 51 AND 52).

FIRST USE 3-0-2007; IN COMMERCE 3-0-2007.

THE MARK CONSISTS OF STANDARD CHARACTERS WITHOUT CLAIM TO ANY PARTICULAR FONT, STYLE, SIZE, OR COLOR.

SN 77-092,715, FILED 1-26-2007.

SUSAN LESLIE DUBOIS, EXAMINING ATTORNEY

Int. Cl.: 11

Prior U.S. Cls.: 13, 21, 23, 31, and 34

United States Patent and Trademark Office

Reg. No. 3,521,318

Registered Oct. 21, 2008

**TRADEMARK
PRINCIPAL REGISTER**



GLOBAL INVENTIVE INDUSTRIES, INC. (CALIFORNIA CORPORATION)
PO BOX 3752
COSTA MESA, CA 92628

FOR: INCINERATORS; TOILETS, IN CLASS 11 (U.S. CLS. 13, 21, 23, 31 AND 34).

FIRST USE 1-15-2008; IN COMMERCE 1-15-2008.

THE COLOR(S) BLACK AND BLUE IS/ARE CLAIMED AS A FEATURE OF THE MARK.

THE MARK CONSISTS OF A BLACK FLYING FIGURE WITH TEXT "ECOJOHN" AFTER. "ECOJOHN" TEXT IS BLACK AND HAS A BLUE OUTLINE.

SN 77-093,092, FILED 1-29-2007.

NAAKWAMA ANKRAH, EXAMINING ATTORNEY

Int. Cl.: 28

Prior U.S. Cls.: 22, 23, 38, and 50

United States Patent and Trademark Office

Reg. No. 3,521,319

Registered Oct. 21, 2008

**TRADEMARK
PRINCIPAL REGISTER**



INTERNATIONAL HOLDINGS LLC (ILLINOIS
LIMITED LIABILITY COMPANY)
790 FRONTAGE ROAD, SUITE 303
NORTHFIELD, IL 60093

FOR: CHILDREN'S TOYS IN THE NATURE OF
FOLDABLE PLASTIC TOY BOXES FEATURING A
FABRIC EXTERIOR; CHILDREN'S TOYS IN THE
NATURE OF FOLDABLE TOY BOXES MADE PRI-
MARILY OF PLASTIC AND FEATURING A CARD-
BOARD CORE; AND CHILDREN'S TOYS IN THE
NATURE OF FOLDABLE PLASTIC TOY BOXES
MADE PRIMARILY OF CARDBOARD AND FEA-

TURING A PAPER EXTERIOR, IN CLASS 28 (U.S.
CLS. 22, 23, 38 AND 50).

FIRST USE 6-15-2007; IN COMMERCE 6-15-2007.

THE MARK CONSISTS OF THE WORDS "QUICK
BIN" IN A STYLIZED FORMAT WITH A DOT IN
THE MIDDLE.

SN 77-093,234, FILED 1-29-2007.

BERNICE MIDDLETON, EXAMINING ATTORNEY

Int. Cl.: 29

Prior U.S. Cl.: 46

United States Patent and Trademark Office

Reg. No. 3,521,320

Registered Oct. 21, 2008

**TRADEMARK
PRINCIPAL REGISTER**

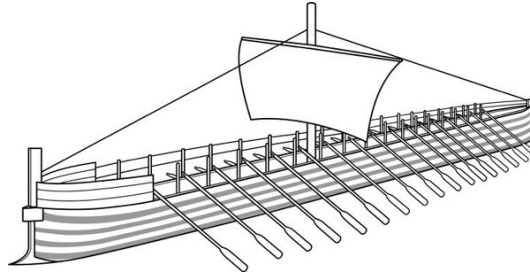

KLONDIKE CHEESE CO. (WISCONSIN COR-
PORATION)
W7839 HIGHWAY 81
MONROE, WI 53566

FIRST USE 8-14-2008; IN COMMERCE 8-14-2008.

SN 77-093,243, FILED 1-29-2007.

FOR: CHEESE, IN CLASS 29 (U.S. CL. 46).

PAUL CROWLEY, EXAMINING ATTORNEY

Int. Cl.: 30

Prior U.S. Cl.: 46

United States Patent and Trademark Office

Reg. No. 3,521,321

Registered Oct. 21, 2008

**TRADEMARK
PRINCIPAL REGISTER**

VANILLA DREAM

CHOCOLADEFABRIKEN LINDT & SPRÜNGLI
AG (SWITZERLAND CORPORATION)

SEESTRAßE 204

CH-8802 KILCHBERG, SWITZERLAND

FOR: CHOCOLATE BARS, IN CLASS 30 (U.S. CL.
46).

FIRST USE 5-0-2007; IN COMMERCE 5-0-2007.

THE MARK CONSISTS OF STANDARD CHAR-
ACTERS WITHOUT CLAIM TO ANY PARTICULAR
FONT, STYLE, SIZE, OR COLOR.

NO CLAIM IS MADE TO THE EXCLUSIVE
RIGHT TO USE "VANILLA", APART FROM THE
MARK AS SHOWN.

SN 77-093,286, FILED 1-29-2007.

TINA BROWN, EXAMINING ATTORNEY

Int. Cl.: 41

Prior U.S. Cls.: 100, 101, and 107

United States Patent and Trademark Office

Reg. No. 3,521,322

Registered Oct. 21, 2008

**SERVICE MARK
PRINCIPAL REGISTER**

YOU24

24 HOUR FITNESS USA, INC. (CALIFORNIA CORPORATION)
12647 ALCOSTA BOULEVARD, SUITE 500
SAN RAMON, CA 94583

FOR: PROVIDING ONLINE PUBLICATIONS IN THE NATURE OF A MAGAZINE IN THE FIELD OF HEALTH, FITNESS AND EXERCISE INSTRUCTION, IN CLASS 41 (U.S. CLS. 100, 101 AND 107).

FIRST USE 5-26-2008; IN COMMERCE 5-26-2008.

THE MARK CONSISTS OF STANDARD CHARACTERS WITHOUT CLAIM TO ANY PARTICULAR FONT, STYLE, SIZE, OR COLOR.

OWNER OF U.S. REG. NO. 2,997,726.

SN 77-093,604, FILED 1-29-2007.

JORDAN BAKER, EXAMINING ATTORNEY

Int. Cl.: 25

Prior U.S. Cls.: 22 and 39

United States Patent and Trademark Office

Reg. No. 3,521,323

Registered Oct. 21, 2008

TRADEMARK
PRINCIPAL REGISTER

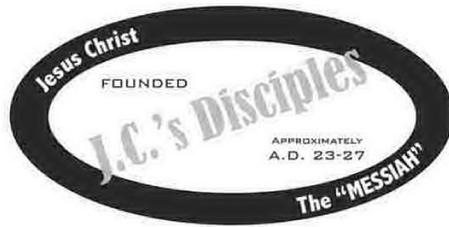

LEACH, TERRY A (UNITED STATES INDIVIDUAL)
TLMANINC@AOL.COM
1895 DARTMOUTH DRIVE
MIDDLEBURG, FL 32068

FOR: TOPS; CAPS, IN CLASS 25 (U.S. CLS. 22 AND 39).

FIRST USE 3-1-2008; IN COMMERCE 3-1-2008.

THE MARK CONSISTS OF AN OVAL WITH A BORDER. THE WORDS "JESUS CHRIST" ARE

LOCATED IN THE UPPER LEFT CORNER INSIDE THE BORDER, AND THE WORDS "THE "MESSIAH" ARE LOCATED IN THE LOWER RIGHT CORNER INSIDE THE BORDER. WITHIN THE OVAL ARE THE WORDS "FOUNDED," "J.C.'S DISCIPLES" AND "APPROXIMATELY A.D. 23-27" WITH THE WORDS "J.C.'S DISCIPLES" POSITIONED DIAGONALLY ACROSS THE CENTER OF THE OVAL.

SN 77-093,909, FILED 1-29-2007.

CARYN GLASSER, EXAMINING ATTORNEY

Int. Cls.: 9 and 18

Prior U.S. Cls.: 1, 2, 3, 21, 22, 23, 26, 36, 38, and 41

United States Patent and Trademark Office

Reg. No. 3,521,324

Registered Oct. 21, 2008

**TRADEMARK
PRINCIPAL REGISTER**



APACER TECHNOLOGY INC. (TAIWAN CORPORATION)

9F, 100 SEC. 1 HSIN TAI WU ROAD, HSICHIH
TAIPEI HSIEN, TAIWAN 221

FOR: HEADPHONES, COMPUTER HARDWARE, COMPUTER FIRMWARE FOR USE IN DATA COMPRESSION, SOUND, PHOTOS, PICTURES, IMAGE PROCESSING AND MEDIA BROADCAST; COMPUTER PERIPHERALS; FLASH MEMORY CARDS, NAMELY, MEMORY CARDS, COMPACT FLASH CARDS, SECURED DIGITAL CARDS, SECURED DIGITAL MEMORY CARDS, MULTI-MEDIA MEMORY CARDS, SMART MEDIA CARDS, MEMORY STICK CARDS AND MEMORY STICK PRO CARDS; USB FLASH DEVICES FEATURING AUDIO TRANSMISSION AND REPRODUCTION OF SOUND OR IMAGES, NAMELY, TELEVISIONS, RADIOS, VIDEOS, CELL PHONES, PERSONAL DIGITAL ASSISTANTS, CD PLAYERS, DVD PLAYERS, MP3 PLAYERS, MP4 PLAYERS, MEDIA PLAYERS, PORTABLE MEDIA PLAYERS, PORTABLE DVD PLAYERS, PORTABLE CD PLAYERS, PORTABLE MP3 PLAYERS AND PORTABLE MP4 PLAYERS; PERSONAL COMPUTERS; WEB CAMERAS; DIGITAL IMAGE STORAGE/CONVERTERS, NAMELY, CD-REWRITABLE (CD-RW) WITH CARD READER, PORTABLE HARD DISK WITH USB CONNECTOR, PORTABLE DVD-REWRITABLE (DVD-RW) WITH USB CONNECTOR, CD-RW WITH USB CONNECTOR; MULTI-FORMAT FLASH DEVICE CONTROL-

TERS; DATA STORAGE DEVICES, NAMELY, DRAM MODULES, INDUSTRIAL COMPACT FLASH (CF) CARD, EMBEDDED SD CARD, FLASH DISK; SOLID-STATE DRIVE, USB DISK MODULE, ADVANCED TECHNOLOGY ATTACHMENT (ATA) DISK DRIVE, ATA DISK CHIP (ADC), ATA DISK MODULE (ADM), SERIAL ADVANCED TECHNOLOGY ATTACHMENT REDUNDANT ARRAY OF INDEPENDENT DISKS FLASH DRIVE (SRFD), AND SERIAL ATA FLASH DRIVE (SAFD) AND DIGITAL STORAGE DEVICES, NAMELY, ELECTRONIC CARD READERS, FLASH CARD READERS AND FLASH DRIVES, IN CLASS 9 (U.S. CLS. 21, 23, 26, 36 AND 38).

FIRST USE 2-28-2007; IN COMMERCE 3-31-2008.

FOR: LEATHER AND IMITATION LEATHER CARD CASES, NAMELY, BUSINESS CARD CASES, CREDIT CARD CASES, CALLING CARD CASES AND NAME CARD CASES, IN CLASS 18 (U.S. CLS. 1, 2, 3, 22 AND 41).

FIRST USE 2-28-2007; IN COMMERCE 3-31-2008.

THE MARK CONSISTS OF A BLACK CIRCLE WITH A WHITE DESIGN IN ITS CENTER.

SN 77-094,192, FILED 1-30-2007.

ZACHARY BELLO, EXAMINING ATTORNEY

Int. Cls.: 14, 16, 18, 25, 32, 35, and 41

Prior U.S. Cls.: 1, 2, 3, 5, 22, 23, 27, 28, 29, 37, 38, 39, 41, 45, 46, 48, 50, 100, 101, 102, and 107

Reg. No. 3,521,325

United States Patent and Trademark Office

Registered Oct. 21, 2008

**TRADEMARK
SERVICE MARK
PRINCIPAL REGISTER**



UNITED STATES OLYMPIC COMMITTEE (UNITED STATES CONGRESSIONALLY CHARTERED NONPROFIT ORGANIZATION)
OFFICE OF THE GENERAL COUNSEL
1 OLYMPIC PLAZA
COLORADO SPRINGS, CO 80909

FOR: JEWELRY AND LAPEL PINS; NON-MONETARY COINS OF PRECIOUS METAL, IN CLASS 14 (U.S. CLS. 2, 27, 28 AND 50).

FIRST USE 6-30-2008; IN COMMERCE 6-30-2008.

FOR: POSTERS, WINDOW CLINGS, NOTEBOOKS AND BINDERS; DIARIES, IN CLASS 16 (U.S. CLS. 2, 5, 22, 23, 29, 37, 38 AND 50).

FIRST USE 6-30-2008; IN COMMERCE 6-30-2008.

FOR: BACKPACKS; ALL-PURPOSE SPORTS BAGS; TOTE BAGS; GYM BAGS; UMBRELLAS; DUFFEL BAGS, IN CLASS 18 (U.S. CLS. 1, 2, 3, 22 AND 41).

FIRST USE 6-30-2008; IN COMMERCE 6-30-2008.

FOR: T-SHIRTS; SWEATSHIRTS; SHIRTS; JACKETS; JERSEYS; HATS, CAPS, BERETS AND VISORS; WIND-RESISTANT JACKETS; GOLF SHIRTS, IN CLASS 25 (U.S. CLS. 22 AND 39).

FIRST USE 11-30-2007; IN COMMERCE 11-30-2007.

FOR: BEERS, IN CLASS 32 (U.S. CLS. 45, 46 AND 48).

FIRST USE 2-20-2008; IN COMMERCE 2-20-2008.

FOR: PROMOTING SELECTION FOR AND PARTICIPATION WITH THE US TEAM FOR AN ELITE ATHLETIC EVENT, IN CLASS 35 (U.S. CLS. 100, 101 AND 102).

FIRST USE 6-30-2008; IN COMMERCE 6-30-2008.

FOR: ORGANIZING AND CONDUCTING ELITE LEVEL SPORTS AND ATHLETIC COMPETITIONS AND DEMONSTRATIONS; PROVIDING INFORMATION IN THE FIELD OF SPORTS BY MEANS OF A WEB SITE ON A GLOBAL COMPUTER NETWORK; ENTERTAINMENT SERVICES, NAMELY, PROVIDING ON-GOING TELEVISION PROGRAMS FEATURING ELITE LEVEL SPORTS COMPETITIONS AND DEMONSTRATIONS, IN CLASS 41 (U.S. CLS. 100, 101 AND 107).

FIRST USE 8-8-2007; IN COMMERCE 8-8-2007.

THE MARK CONSISTS OF A STYLIZED FIGURE "8" COMPRISED IN PART OF A WREATH DESIGN WITH WING-LIKE ELEMENTS.

SN 77-095,010, FILED 1-30-2007.

JEFFERY COWARD, EXAMINING ATTORNEY

Int. Cls.: 41 and 44

Prior U.S. Cls.: 100, 101, and 107

United States Patent and Trademark Office

Reg. No. 3,521,326

Registered Oct. 21, 2008

**SERVICE MARK
PRINCIPAL REGISTER**

HEALTHY CHILD HEALTHY WORLD

HEALTHY CHILD HEALTHY WORLD, INC.
(NEW JERSEY CORPORATION)
12300 WILSHIRE BOULEVARD, STE 320
LOS ANGELES, CA 90025

FOR: EDUCATIONAL SERVICES, NAMELY, CONDUCTING INFORMAL PROGRAMS ABOUT ENVIRONMENTAL TOXINS THAT AFFECT CHILDREN'S HEALTH, AND ACTIONS THAT CAN BE TAKEN TO PROTECT CHILDREN AGAINST SUCH THREATS, USING ON-LINE ACTIVITIES AND INTERACTIVE EXHIBITS, AND PRINTABLE MATERIALS DISTRIBUTED THEREWITH; CONDUCTING EDUCATIONAL WORKSHOPS, SEMINARS, CONFERENCES, TRADE SHOWS, EXHIBITIONS, DISPLAYS, AND CLASSES IN THE FIELDS OF CHILDREN'S HEALTH AND WELLNESS, ENVIRONMENTAL TOXINS AND HAZARDS, SAFER PRODUCTS AND PRACTICES TO MAINTAIN A SAFER HOME; PROVIDING EDUCATIONAL NEWSLETTERS VIA EMAIL IN THE FIELDS OF CHILDREN'S HEALTH AND WELLNESS, ENVIRONMENTAL TOXINS AND HAZARDS, AND SAFER PRODUCTS AND PRACTICES TO MAINTAIN A SAFER HOME, IN CLASS 41 (U.S. CLS. 100, 101 AND 107).

FIRST USE 4-26-2007; IN COMMERCE 4-26-2007.

FOR: PROVIDING INFORMATION IN THE FIELD OF CHILDREN'S HEALTH AND WELLNESS, AND SAFER PRODUCTS AND PRACTICES TO MAINTAIN A HEALTHIER HOME; CONSULTING SERVICES IN THE FIELD OF CHILDREN'S HEALTH AND WELLNESS, AND REGARDING SAFER PRODUCTS AND PRACTICES TO MAINTAIN A HEALTHIER HOME; PROVIDING A WEBSITE FEATURING EDUCATIONAL INFORMATION IN THE FIELD OF CHILDREN'S HEALTH AND WELLNESS, AND SAFER PRODUCTS AND PRACTICES TO MAINTAIN A HEALTHIER HOME, IN CLASS 44 (U.S. CLS. 100 AND 101).

FIRST USE 4-26-2007; IN COMMERCE 4-26-2007.

THE MARK CONSISTS OF STANDARD CHARACTERS WITHOUT CLAIM TO ANY PARTICULAR FONT, STYLE, SIZE, OR COLOR.

SN 77-095,032, FILED 1-30-2007.

INGA ERVIN, EXAMINING ATTORNEY

Int. Cl.: 41

Prior U.S. Cls.: 100, 101, and 107

United States Patent and Trademark Office

Reg. No. 3,521,327

Registered Oct. 21, 2008

SERVICE MARK
PRINCIPAL REGISTER



Knowledge is Power,
Power to drive your business and your success.

SILVER STATE TRAINERS (NEVADA CORPORATION)
1151 BROKEN HILLS DRIVE
HENDERSON, NV 890153077

FOR: EDUCATION SERVICES, NAMELY, PROVIDING CLASSES, SEMINARS, WORKSHOPS IN THE FIELD OF MORTGAGE LENDING, IN CLASS 41 (U.S. CLS. 100, 101 AND 107).

FIRST USE 8-1-2006; IN COMMERCE 8-1-2006.

NO CLAIM IS MADE TO THE EXCLUSIVE RIGHT TO USE "MORTGAGE TRAINERS OF NORTH AMERICA", APART FROM THE MARK AS SHOWN.

THE COLOR(S) BLUE, WHITE AND GRAY IS/ARE CLAIMED AS A FEATURE OF THE MARK.

THE MARK CONSISTS OF THE WORDS "MORTGAGE TRAINERS" IN ALL CAPITALIZED LET-

TERS IN BLUE CENTERED ON TOP OF A CIRCLE, THE CIRCLE IS OUTLINED IN BLUE WITH THE OUTLINE OF MOUNTAINS SHADED IN BLUE ON THE BOTTOM OF THE CIRCLE WITH THE LETTERS "M" AND "T" CAPITALIZED IN GRAY INSIDE THE SHADED MOUNTAINS AND THE REST OF THE CIRCLE IN WHITE, WITH THE WORDS "OF NORTH AMERICA" IN INITIAL CAPITALIZED LETTERS IN BLUE CENTERED UNDERNEATH THE CIRCLE, WITH THE SLOGAN "KNOWLEDGE IS POWER, POWER TO DRIVE YOUR BUSINESS AND YOUR SUCCESS" IN BLUE WITH ONLY THE "K" IN "KNOWLEDGE" AND "P" IN "POWER" CAPITALIZED POSITIONED TO THE LOWER RIGHT HAND CORNER OF THE CIRCLE AND THE WORDS "OF NORTH AMERICA".

SN 77-095,203, FILED 1-30-2007.

MORGAN WYNNE, EXAMINING ATTORNEY

Int. Cl.: 42

Prior U.S. Cls.: 100 and 101

United States Patent and Trademark Office

Reg. No. 3,521,328

Registered Oct. 21, 2008

**SERVICE MARK
PRINCIPAL REGISTER**

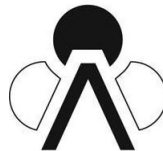

ARISAPH

creating smart medicines

ARISAPH PHARMACEUTICALS, INC. (DELA-
WARE CORPORATION)
SUITE 401
75 KNEELAND STREET
BOSTON, MA 02111

FIRST USE 5-11-2007; IN COMMERCE 5-11-2007.

SN 77-096,989, FILED 2-1-2007.

FOR: BIOTECHNOLOGY AND PHARMACEUTI-
CAL RESEARCH AND DEVELOPMENT SERVICES,
IN CLASS 42 (U.S. CLS. 100 AND 101).

MICHAEL ENGEL, EXAMINING ATTORNEY

Int. Cl.: 9

Prior U.S. Cls.: 21, 23, 26, 36, and 38

Reg. No. 3,521,329

United States Patent and Trademark Office

Registered Oct. 21, 2008

**TRADEMARK
PRINCIPAL REGISTER**

PUSHWIRE

WAGO VERWALTUNGSGESELLSCHAFT MBH
(FED REP GERMANY LIMITED LIABILITY
COMPANY)
HANSASTRASSE 27
32423 MINDEN, FED REP GERMANY

FOR: ELECTRICAL TERMINALS, NAMELY,
EQUIPMENT TERMINALS AND TERMINAL
BLOCKS, ELECTRICAL CONNECTORS, ELECTRICAL
PLUG AND SOCKET CONNECTORS; ELECTRICAL
MODULES WITH BUILT-IN FUNCTION
AND ELECTRICAL SYSTEM COMPONENTS BOTH
FOR CONNECTION AND INTERCONNECTION OF
ELECTRICAL CONDUCTORS AND FOR DISTRIBUTING,
SWITCHING, CONVERTING, PROCES-

SING, INTERFACE ADAPTING AND
TRANSMISSION, SIGNALLING AND CHECKING
OF ELECTRICITY AND DATA, IN CLASS 9 (U.S.
CLS. 21, 23, 26, 36 AND 38).

FIRST USE 1-1-2003; IN COMMERCE 1-1-2003.

THE MARK CONSISTS OF STANDARD CHARACTERS
WITHOUT CLAIM TO ANY PARTICULAR FONT,
STYLE, SIZE, OR COLOR.

SN 77-097,555, FILED 2-2-2007.

TAMARA FRAZIER, EXAMINING ATTORNEY

Int. Cl.: 9

Prior U.S. Cls.: 21, 23, 26, 36, and 38

United States Patent and Trademark Office

Reg. No. 3,521,330

Registered Oct. 21, 2008

**TRADEMARK
PRINCIPAL REGISTER**

THE FIN!

HEIL SOUND LTD. (ILLINOIS CORPORATION)
5800 NORTH ILLINOIS
FAIRVIEW HEIGHTS, IL 62208

THE MARK CONSISTS OF STANDARD CHAR-
ACTERS WITHOUT CLAIM TO ANY PARTICULAR
FONT, STYLE, SIZE, OR COLOR.

FOR: MICROPHONES, IN CLASS 9 (U.S. CLS. 21,
23, 26, 36 AND 38).

SN 77-099,020, FILED 2-5-2007.

FIRST USE 8-31-2007; IN COMMERCE 12-31-2007.

JOHN DALIER, EXAMINING ATTORNEY

Int. Cl.: 9

Prior U.S. Cls.: 21, 23, 26, 36, and 38

United States Patent and Trademark Office

Reg. No. 3,521,331

Registered Oct. 21, 2008

**TRADEMARK
PRINCIPAL REGISTER**

Associated Power Technologies

ASSOCIATED POWER TECHNOLOGIES, INC.
(DELAWARE CORPORATION)
13860 WEST LAUREL DRIVE
LAKE FOREST, IL 60045

FOR: ELECTRICAL AND ELECTRONIC MEASURING AND TESTING PRODUCTS, NAMELY, AC POWER SOURCES, FREQUENCY CONVERTERS, AC POWER SUPPLIES, DC POWER SUPPLIES, DC POWER SOURCES, DC ELECTRONIC LOAD MEASURERS AND TESTERS, AC ELECTRONIC LOAD MEASURERS AND TESTERS, AC SOURCE MEASURERS AND TESTERS, AND DC SOURCE MEASURERS AND TESTERS, IN CLASS 9 (U.S. CLS. 21, 23, 26, 36 AND 38).

FIRST USE 10-0-2007; IN COMMERCE 10-0-2007.

THE MARK CONSISTS OF STANDARD CHARACTERS WITHOUT CLAIM TO ANY PARTICULAR FONT, STYLE, SIZE, OR COLOR.

NO CLAIM IS MADE TO THE EXCLUSIVE RIGHT TO USE "POWER TECHNOLOGIES", APART FROM THE MARK AS SHOWN.

SN 77-099,330, FILED 2-5-2007.

REGINA DRUMMOND, EXAMINING ATTORNEY

Int. Cl.: 28

Prior U.S. Cls.: 22, 23, 38, and 50

United States Patent and Trademark Office

Reg. No. 3,521,332

Registered Oct. 21, 2008

**TRADEMARK
PRINCIPAL REGISTER**

SPIN FITNESS

MAD DOGG ATHLETICS, INC. (CALIFORNIA CORPORATION)
2111 NARCISUS CT.
VENICE, CA 90291

FOR: EXERCISE EQUIPMENT, NAMELY, RESISTANCE TRAINING MACHINES, ELASTIC TUBING, EXERCISE MATS, EXERCISE BLOCKS, EXERCISE STRAPS, EXERCISE BALLS, STABILITY BALLS, WEIGHTED RESISTANCE PRODUCTS IN THE NATURE OF RESISTANCE CABLES, EXERCISE WEIGHTS, IN CLASS 28 (U.S. CLS. 22, 23, 38 AND 50).

FIRST USE 3-31-2008; IN COMMERCE 3-31-2008.

THE MARK CONSISTS OF STANDARD CHARACTERS WITHOUT CLAIM TO ANY PARTICULAR FONT, STYLE, SIZE, OR COLOR.

OWNER OF U.S. REG. NOS. 2,173,202, 2,475,595, AND OTHERS.

NO CLAIM IS MADE TO THE EXCLUSIVE RIGHT TO USE "FITNESS", APART FROM THE MARK AS SHOWN.

SN 77-099,698, FILED 2-5-2007.

KATHERINE CONNOLLY, EXAMINING ATTORNEY

Int. Cl.: 28

Prior U.S. Cls.: 22, 23, 38, and 50

United States Patent and Trademark Office

Reg. No. 3,521,333

Registered Oct. 21, 2008

**TRADEMARK
PRINCIPAL REGISTER**

SPIN PILATES

MAD DOGG ATHLETICS, INC. (CALIFORNIA CORPORATION)
2111 NARCISUS CT.
VENICE, CA 90291

OWNER OF U.S. REG. NOS. 2,173,202, 2,475,595, AND OTHERS.

FOR: EXERCISE EQUIPMENT, NAMELY, RESISTANCE TRAINING MACHINES, IN CLASS 28 (U.S. CLS. 22, 23, 38 AND 50).

NO CLAIM IS MADE TO THE EXCLUSIVE RIGHT TO USE "PILATES", APART FROM THE MARK AS SHOWN.

FIRST USE 10-31-2007; IN COMMERCE 10-31-2007.

SN 77-099,722, FILED 2-5-2007.

THE MARK CONSISTS OF STANDARD CHARACTERS WITHOUT CLAIM TO ANY PARTICULAR FONT, STYLE, SIZE, OR COLOR.

KATHERINE CONNOLLY, EXAMINING ATTORNEY

Int. Cl.: 9

Prior U.S. Cls.: 21, 23, 26, 36, and 38

United States Patent and Trademark Office

Reg. No. 3,521,334

Registered Oct. 21, 2008

**TRADEMARK
PRINCIPAL REGISTER**

EVERRAY

MILLER FELPAX CORPORATION (MINNESOTA
CORPORATION)
1155 EAST EIGHTH STREET
WINONA, MN 55987

THE MARK CONSISTS OF STANDARD CHAR-
ACTERS WITHOUT CLAIM TO ANY PARTICULAR
FONT, STYLE, SIZE, OR COLOR.

FOR: A LIGHT EMITTING DIODE BASED
FLASHING SAFETY LIGHT THAT IS USED AT
HIGHWAY/RAILWAY GRADE CROSSINGS, IN
CLASS 9 (U.S. CLS. 21, 23, 26, 36 AND 38).

SN 77-100,569, FILED 2-6-2007.

FIRST USE 2-7-2007; IN COMMERCE 2-7-2007.

THEODORE MCBRIDE, EXAMINING ATTORNEY

Int. Cl.: 44

Prior U.S. Cls.: 100 and 101

United States Patent and Trademark Office

Reg. No. 3,521,335

Registered Oct. 21, 2008

**SERVICE MARK
PRINCIPAL REGISTER**

PPD

MK3SD, LTD. (TEXAS LIMITED PARTNERSHIP)
3815 COLERIDGE STREET
HOUSTON, TX 77005

FOR: SLEEP APNEA SCREENING FOR EQUIPMENT OPERATORS; MEDICAL EVALUATION SERVICES FOR EQUIPMENT OPERATORS, NAMELY, FUNCTIONAL ASSESSMENT PROGRAM FOR EQUIPMENT OPERATORS WHO ARE SLEEP APNEA PATIENTS RECEIVING MEDICAL REHABILITATION SERVICES FOR PURPOSES OF GUIDING TREATMENT AND ASSESSING PROGRAM EFFECTIVENESS; AND PROVIDING MEDICAL INFOR-

MATION TO EQUIPMENT OPERATORS ON SLEEPING DISORDERS, NAMELY, SLEEP APNEA, IN CLASS 44 (U.S. CLS. 100 AND 101).

FIRST USE 4-1-2006; IN COMMERCE 4-1-2006.

THE MARK CONSISTS OF STANDARD CHARACTERS WITHOUT CLAIM TO ANY PARTICULAR FONT, STYLE, SIZE, OR COLOR.

SN 77-100,918, FILED 2-6-2007.

CHARISMA HAMPTON, EXAMINING ATTORNEY

Int. Cl.: 25

Prior U.S. Cls.: 22 and 39

United States Patent and Trademark Office

Reg. No. 3,521,336

Registered Oct. 21, 2008

TRADEMARK
PRINCIPAL REGISTER

The logo features the word "Steva" in a large, pink, cursive script font. Below it, the word "COLLECTION" is written in a smaller, gray, all-caps, sans-serif font.

RENTA, EDWIN (PUERTO RICO INDIVIDUAL)
PMB 429
1357 ASHFORD AVE
SAN JUAN, PUERTO RICO 00907

FOR: SWIMSUITS; WOMEN'S UNDERWEAR, IN
CLASS 25 (U.S. CLS. 22 AND 39).

FIRST USE 4-19-2007; IN COMMERCE 4-19-2007.

THE COLOR(S) PINK AND GRAY IS/ARE
CLAIMED AS A FEATURE OF THE MARK.

THE MARK CONSISTS OF TWO WORDS. THE
FIRST WORD IS "STEVA" WHICH IS COLOR PINK
AND LOCATED ABOVE THE SECOND WORD
"COLLECTION" WHICH APPEARS IN THE COLOR
GRAY.

SEC. 2(F).

SN 77-100,936, FILED 2-6-2007.

CHARISMA HAMPTON, EXAMINING ATTORNEY

Int. Cl.: 6

Prior U.S. Cls.: 2, 12, 13, 14, 23, 25, and 50

United States Patent and Trademark Office

Reg. No. 3,521,337

Registered Oct. 21, 2008

TRADEMARK
PRINCIPAL REGISTER



BEIJING PANJIAYUAN INTERNATIONAL FOLK
CULTURE DEVELOPMENT CENTER (CHINA
CORPORATION)

NO.18 HUAWAI LANE, CHAOYANG DISTRICT
BEIJING CITY 100021, CHINA

FOR: COMMON METALS AND THEIR ALLOYS
IN THE FORM OF SHEETS, RODS, BARS AND
BILLETS, FOR USE IN FURTHER MANUFACTUR-
ING; DRAIN PIPES MADE OF METAL; METAL
BUILDING MATERIALS, NAMELY, FASCIA; ME-
TAL RAILS; WIRE; METAL PIPE CLIPS; METAL
CABLE CLIPS; NAILS; FITTINGS OF METAL FOR
FURNITURE, NAMELY, NUTS, BOLTS, NAILS,
METAL RIVETS, METAL SCREWS; METAL SAFES;
METAL FLANGES; METAL BELLS; METAL WELD-
ING RODS; ANCHORS; HANDCUFFS; METAL

WEATHER VANES; HUNTING EQUIPMENT,
NAMELY, WILD ANIMAL TRAPS; IRON ORES, IN
CLASS 6 (U.S. CLS. 2, 12, 13, 14, 23, 25 AND 50).

FIRST USE 9-19-1992; IN COMMERCE 9-19-2005.

THE ENGLISH TRANSLATION OF THE MARK IS
"A SURNAME; HOUSE; PARK".

THE NON-LATIN CHARACTERS IN THE MARK
TRANSLITERATE TO "PAN; JIA; YUAN".

SN 77-101,051, FILED 2-7-2007.

ALICE BENMAMAN, EXAMINING ATTORNEY

Int. Cl.: 30

Prior U.S. Cl.: 46

United States Patent and Trademark Office

Reg. No. 3,521,338

Registered Oct. 21, 2008

TRADEMARK
PRINCIPAL REGISTER

IT'S THE ZIP

KRAFT FOODS GLOBAL BRANDS LLC (DELA-
WARE LIMITED LIABILITY COMPANY)
THREE LAKES DRIVE NF-577
NORTHFIELD, IL 60093

FOR: SALAD DRESSING, IN CLASS 30 (U.S. CL.
46).

FIRST USE 5-31-2007; IN COMMERCE 5-31-2007.

THE MARK CONSISTS OF STANDARD CHAR-
ACTERS WITHOUT CLAIM TO ANY PARTICULAR
FONT, STYLE, SIZE, OR COLOR.

SN 77-101,143, FILED 2-7-2007.

AMOS T. MATTHEWS, JR., EXAMINING ATTOR-
NEY

Int. Cl.: 43

Prior U.S. Cls.: 100 and 101

United States Patent and Trademark Office

Reg. No. 3,521,339

Registered Oct. 21, 2008

**SERVICE MARK
PRINCIPAL REGISTER**

MISS MARY BOBO'S

JACK DANIEL'S PROPERTIES, INC. (DELA-
WARE CORPORATION)

4040 CIVIC CENTER DRIVE, SUITE 528

SAN RAFAEL, CA 94903

FOR: RESTAURANT SERVICES, IN CLASS 43
(U.S. CLS. 100 AND 101).

FIRST USE 12-31-1984; IN COMMERCE 12-31-1984.

THE MARK CONSISTS OF STANDARD CHAR-
ACTERS WITHOUT CLAIM TO ANY PARTICULAR
FONT, STYLE, SIZE, OR COLOR.

THE NAME(S), PORTRAIT(S), AND/OR SIGNA-
TURE(S) SHOWN IN THE MARK DOES NOT IDEN-
TIFY A PARTICULAR LIVING INDIVIDUAL.

SN 77-102,088, FILED 2-7-2007.

NATALIE POLZER, EXAMINING ATTORNEY

Int. Cls.: 29 and 30

Prior U.S. Cl.: 46

United States Patent and Trademark Office

Reg. No. 3,521,340

Registered Oct. 21, 2008

**TRADEMARK
PRINCIPAL REGISTER**

MISS MARY BOBO'S

JACK DANIEL'S PROPERTIES, INC. (DELA-
WARE CORPORATION)
4040 CIVIC CENTER DRIVE, SUITE 528
SAN RAFAEL, CA 94903

FOR: PROCESSED FOOD PRODUCTS, NAMELY,
PROCESSED FRUITS, PROCESSED VEGETABLES,
PROCESSED OLIVES, PROCESSED MEATS, PRO-
CESSED NUTS; DEHYDRATED FOOD PRODUCTS,
NAMELY, DEHYDRATED FRUITS, DEHYDRA-
TED VEGETABLES, DEHYDRATED MEATS; PICK-
LED FOOD PRODUCTS, NAMELY, PICKLED
FRUITS, PICKLED VEGETABLES, PICKLED
MEATS, IN CLASS 29 (U.S. CL. 46).

FIRST USE 1-24-2007; IN COMMERCE 1-24-2007.

FOR: PROCESSED FOOD PRODUCTS, NAMELY,
PROCESSED COFFEE, PROCESSED TEA, PROCES-

SED HONEY; VINEGAR; SAUCES; SPICES, IN
CLASS 30 (U.S. CL. 46).

FIRST USE 1-24-2007; IN COMMERCE 1-24-2007.

THE MARK CONSISTS OF STANDARD CHAR-
ACTERS WITHOUT CLAIM TO ANY PARTICULAR
FONT, STYLE, SIZE, OR COLOR.

THE NAME(S), PORTRAIT(S), AND/OR SIGNA-
TURE(S) SHOWN IN THE MARK DOES NOT IDEN-
TIFY A PARTICULAR LIVING INDIVIDUAL.

SN 77-102,109, FILED 2-7-2007.

NATALIE POLZER, EXAMINING ATTORNEY

Int. Cl.: 25

Prior U.S. Cls.: 22 and 39

United States Patent and Trademark Office

Reg. No. 3,521,341

Registered Oct. 21, 2008

TRADEMARK
PRINCIPAL REGISTER



RONDINELLI COMPANY (OHIO CORPORATION)
207 BOARDMAN-CANFIELD ROAD
BOARDMAN, OH 44512

FOR: FORMAL WEAR, NAMELY, VESTS AND TIES, IN CLASS 25 (U.S. CLS. 22 AND 39).

FIRST USE 5-1-2007; IN COMMERCE 5-1-2007.

THE NAME(S), PORTRAIT(S), AND/OR SIGNATURE(S) SHOWN IN THE MARK DOES NOT IDENTIFY A PARTICULAR LIVING INDIVIDUAL.

THE MARK CONSISTS OF A STYLIZED VERSION OF THE WORD/NAME, "GEORGE".

SN 77-102,786, FILED 2-8-2007.

CHRISTINA SOBRAL, EXAMINING ATTORNEY

Int. Cl.: 43

Prior U.S. Cls.: 100 and 101

United States Patent and Trademark Office

Reg. No. 3,521,342

Registered Oct. 21, 2008

**SERVICE MARK
PRINCIPAL REGISTER**



PETRA RESTAURANT VENTURES, LLC (TEXAS
LIMITED LIABILITY COMPANY)
SUITE 300
1751 W. ELDORADO BLVD.
MCKINNEY, TX 75069

FOR: RESTAURANT SERVICES FEATURING
MEXICAN FOOD; AND BAR SERVICES, EXCLUD-
ING THE SALE OF WINE BY THE BOTTLE, IN
CLASS 43 (U.S. CLS. 100 AND 101).

FIRST USE 1-0-2007; IN COMMERCE 3-0-2007.

NO CLAIM IS MADE TO THE EXCLUSIVE
RIGHT TO USE "MEXICO", APART FROM THE
MARK AS SHOWN.

SN 77-102,797, FILED 2-8-2007.

JEAN IM, EXAMINING ATTORNEY

Int. Cl.: 11

Prior U.S. Cls.: 13, 21, 23, 31, and 34

Reg. No. 3,521,343

United States Patent and Trademark Office

Registered Oct. 21, 2008

**TRADEMARK
PRINCIPAL REGISTER**



NEONLITE ELECTRONIC & LIGHTING (HK)
LTD. (HONG KONG LIMITED LIABILITY
COMPANY)
ROOM 2902-6, TOWER 6, THE GATEWAY
9 CANTON ROAD, TSIMSHATSUI
KOWLOON, HONG KONG

FOR: ELECTRIC LIGHT BULBS; ELECTRIC
LAMPS; LAMPS; TRACK LIGHTING UNITS;
LIGHTING TUBES, NAMELY, LUMINOUS TUBES
FOR LIGHTING; SOCKETS FOR ELECTRIC
LIGHTS; STREET LIGHTS, NAMELY, STREET
LIGHTING FIXTURES, LIGHT BULBS, IN CLASS
11 (U.S. CLS. 13, 21, 23, 31 AND 34).

FIRST USE 10-28-2004; IN COMMERCE 5-8-2007.

THE MARK CONSISTS OF THE DESIGN OF AN
OUTLINE OF A RECTANGLE WITH CURVED
ENDS, HAVING A LARGE OVAL CONTAINING
FIVE PAIRS OF CONNECTING CIRCLES IN AN
ARC-SHAPED ORIENTATION AT THE BOTTOM
OF THE OVAL, AND HAVING THE STYLIZED
WORDING "DIMMERABLE" BELOW THE OUT-
LINE OF THE RECTANGLE, OVAL AND FIVE
PAIRS OF CONNECTING CIRCLES.

SN 77-103,888, FILED 2-9-2007.

JAY BESCH, EXAMINING ATTORNEY

Int. Cl.: 9

Prior U.S. Cls.: 21, 23, 26, 36, and 38

Reg. No. 3,521,344

United States Patent and Trademark Office

Registered Oct. 21, 2008

**TRADEMARK
PRINCIPAL REGISTER**

UPLAY

UPLAY, LLC (CALIFORNIA LIMITED LIABILITY COMPANY)
2185 FARADAY AVE. #130
CARLSBAD, CA 92008

THE MARK CONSISTS OF STANDARD CHARACTERS WITHOUT CLAIM TO ANY PARTICULAR FONT, STYLE, SIZE, OR COLOR.

FOR: HANDHELD COMPUTERS; RANGEFINDERS FOR GOLF, IN CLASS 9 (U.S. CLS. 21, 23, 26, 36 AND 38).

SN 77-104,435, FILED 2-10-2007.

FIRST USE 6-4-2008; IN COMMERCE 6-4-2008.

SIMON TENG, EXAMINING ATTORNEY

Int. Cl.: 9

Prior U.S. Cls.: 21, 23, 26, 36, and 38

United States Patent and Trademark Office

Reg. No. 3,521,345

Registered Oct. 21, 2008

**TRADEMARK
PRINCIPAL REGISTER**

Never Ending Radical Dudes

CULBERTSON, MARK SAXON (UNITED STATES INDIVIDUAL)
8205 SANTA MONICA BLVD, #1-165
WEST HOLLYWOOD, CA 90046

THE MARK CONSISTS OF STANDARD CHARACTERS WITHOUT CLAIM TO ANY PARTICULAR FONT, STYLE, SIZE, OR COLOR.

FOR: PRERECORDED CD'S, DVDS FEATURING CHILDREN'S EDUCATION AND ENTERTAINMENT, IN CLASS 9 (U.S. CLS. 21, 23, 26, 36 AND 38).

SN 77-104,650, FILED 2-11-2007.

FIRST USE 0-0-2003; IN COMMERCE 0-0-2004.

GRETTA YAO, EXAMINING ATTORNEY

Int. Cls.: 9 and 42

Prior U.S. Cls.: 21, 23, 26, 36, 38, 100, and 101

United States Patent and Trademark Office

Reg. No. 3,521,346

Registered Oct. 21, 2008

**TRADEMARK
SERVICE MARK
PRINCIPAL REGISTER**

RubyWorks

THOUGHTWORKS, INC. (DELAWARE CORPORATION)
200 E. RANDOLPH ST., 25TH FLOOR
CHICAGO, IL 60601

FOR: COMPUTER PROGRAMS FOR USE IN DEVELOPING COMPUTER SOFTWARE IN THE RUBY COMPUTER PROGRAMMING LANGUAGE, NAMELY, COMPUTER SOFTWARE DEVELOPMENT TOOLS, COMPUTER SOFTWARE DEVELOPMENT LIBRARIES, ENVIRONMENT MANAGEMENT TOOLS, AND ELECTRONIC DOCUMENTATION DISTRIBUTED THEREWITH, IN CLASS 9 (U.S. CLS. 21, 23, 26, 36 AND 38).

FIRST USE 5-18-2007; IN COMMERCE 5-18-2007.

FOR: COMPUTER SOFTWARE DESIGN, COMPUTER PROGRAMMING, OR MAINTENANCE OF COMPUTER SOFTWARE; COMPUTER SOFTWARE DEVELOPMENT, IN CLASS 42 (U.S. CLS. 100 AND 101).

FIRST USE 8-28-2007; IN COMMERCE 8-28-2007.

THE MARK CONSISTS OF STANDARD CHARACTERS WITHOUT CLAIM TO ANY PARTICULAR FONT, STYLE, SIZE, OR COLOR.

SN 77-106,108, FILED 2-13-2007.

JENNIFER VASQUEZ, EXAMINING ATTORNEY

Int. Cls.: 8, 9, and 14

Prior U.S. Cls.: 2, 21, 23, 26, 27, 28, 36, 38, 44, and 50

Reg. No. 3,521,347

United States Patent and Trademark Office

Registered Oct. 21, 2008

**TRADEMARK
PRINCIPAL REGISTER**



AMERICA'S COLLECTIBLES NETWORK, INC.
(TENNESSEE CORPORATION)
10001 KINGSTON PIKE, SUITE 57
KNOXVILLE, TN 37922

FOR: JEWELER'S HAND TOOLS FOR MAKING
JEWELRY, NAMELY, PLIERS, AND CUTTERS, IN
CLASS 8 (U.S. CLS. 23, 28 AND 44).

FIRST USE 2-0-2008; IN COMMERCE 2-0-2008.

FOR: PRE-RECORDED VIDEODISKS FEATUR-
ING INFORMATION ABOUT JEWELRY, JEWELRY
MAKING AND GEMSTONE COLLECTING, IN
CLASS 9 (U.S. CLS. 21, 23, 26, 36 AND 38).

FIRST USE 10-0-2007; IN COMMERCE 10-0-2007.

FOR: JEWELRY MAKING KITS COMPRISED OF
JEWELRY-MAKING SUPPLIES, NAMELY, SEMI-

PRECIOUS GEMS, INSTRUCTIONAL DVD AND
JEWELRY-MAKING TOOLS, NAMELY, CUTTERS,
PLIERS, AND RULERS, ALL SOLD AS A UNIT, IN
CLASS 14 (U.S. CLS. 2, 27, 28 AND 50).

FIRST USE 2-0-2008; IN COMMERCE 2-0-2008.

NO CLAIM IS MADE TO THE EXCLUSIVE
RIGHT TO USE "JEWEL", APART FROM THE
MARK AS SHOWN.

THE MARK CONSISTS OF A STYLIZED LETTER
"J", PUNCTUATED WITH A JEWEL WITH STEM.

SN 77-106,289, FILED 2-13-2007.

GENE MACIOL, EXAMINING ATTORNEY

Int. Cl.: 3

Prior U.S. Cls.: 1, 4, 6, 50, 51, and 52

Reg. No. 3,521,348

United States Patent and Trademark Office

Registered Oct. 21, 2008

**TRADEMARK
PRINCIPAL REGISTER**

FOUR  POINTS

THE SHERATON LLC (DELAWARE LIMITED
LIABILITY COMPANY)
1111 WESTCHESTER AVENUE
WHITE PLAINS, NY 10604

FOR: COSMETICS, NAMELY, BODY LOTION,
SHOWER GEL, SHAMPOO, CONDITIONER, AND
SOAP, IN CLASS 3 (U.S. CLS. 1, 4, 6, 50, 51 AND 52).

FIRST USE 6-0-2006; IN COMMERCE 6-0-2006.

OWNER OF U.S. REG. NOS. 2,003,614 AND
3,018,022.

THE MARK CONSISTS OF THE TERMS "FOUR
POINTS" WITH A PINWHEEL DEVICE BETWEEN
THE WORDS "FOUR" AND "POINTS".

SN 77-106,829, FILED 2-13-2007.

MATTHEW EINSTEIN, EXAMINING ATTORNEY

Int. Cl.: 41

Prior U.S. Cls.: 100, 101, and 107

United States Patent and Trademark Office

Reg. No. 3,521,349

Registered Oct. 21, 2008

**SERVICE MARK
PRINCIPAL REGISTER**

EFCA ENGAGE

THE EVANGELICAL FREE CHURCH OF AMERICA (MINNESOTA NON-PROFIT CORPORATION)

901 EAST 78TH STREET
MINNEAPOLIS, MN 554201300

FOR: EDUCATIONAL AND TRAINING SERVICES, NAMELY, CONDUCTING LIVE CONFERENCES, SEMINARS, RETREATS, CLASSES, COURSES AND WORKSHOPS IN THE FIELD OF EVANGELICAL CHRISTIAN MINISTRY, MISSIONARY TRAINING, RELIGION, RELIGIOUS WORSHIP, THEOLOGY, AND THE EVANGELICAL CHRISTIAN FAITH AND DISTRIBUTING INSTRUCTIONAL MATERIALS IN CONNECTION THEREWITH; RELIGIOUS INSTRUCTION SERVICES; PROVIDING INFORMATION IN THE FIELD OF RELIGIOUS EDUCATION AND RELIGIOUS INSTRUCTION MATERIALS; PROVIDING ONGO-

ING EVANGELICAL CHRISTIAN PROGRAMS BROADCAST OVER TELEVISION, RADIO, SATELLITE AUDIO AND VIDEO MEDIA, CABLE, AND THE INTERNET, IN CLASS 41 (U.S. CLS. 100, 101 AND 107).

FIRST USE 4-2-2007; IN COMMERCE 4-2-2007.

THE MARK CONSISTS OF STANDARD CHARACTERS WITHOUT CLAIM TO ANY PARTICULAR FONT, STYLE, SIZE, OR COLOR.

OWNER OF U.S. REG. NOS. 2,777,789, 2,818,951, AND OTHERS.

SN 77-107,697, FILED 2-14-2007.

SALLY SHIH, EXAMINING ATTORNEY

Int. Cl.: 5

Prior U.S. Cls.: 6, 18, 44, 46, 51, and 52

United States Patent and Trademark Office

Reg. No. 3,521,350

Registered Oct. 21, 2008

**TRADEMARK
PRINCIPAL REGISTER**



MARONNE ORGANIC INNOVATIONS, INC. (DE-
LAWARE CORPORATION)
2121 SECOND STREET
SUITE B-107
DAVIS, CA 95618

FOR: HERBICIDES; HERBICIDES FOR AGRICULTURAL USE; HERBICIDES FOR DOMESTIC USE; HERBICIDES, PESTICIDES FOR HOME, GARDEN AND LAWN USE AND FOR PROFESSIONAL USE, IN CLASS 5 (U.S. CLS. 6, 18, 44, 46, 51 AND 52).

FIRST USE 2-19-2008; IN COMMERCE 2-19-2008.

THE COLOR(S) GREEN AND ORANGE IS/ARE CLAIMED AS A FEATURE OF THE MARK.

THE WORDING "GREEN" AND THE STICK OF THE STYLIZED REPRESENTATION OF A MATCH APPEAR IN THE COLOR GREEN AND THE WORDING "MATCH" AND THE STYLIZED REPRESENTATION OF A FLAME APPEAR IN THE COLOR ORANGE.

SN 77-107,761, FILED 2-14-2007.

KATHERINE CONNOLLY, EXAMINING ATTORNEY

Int. Cls.: 37 and 44

Prior U.S. Cls.: 100, 101, 103, and 106

United States Patent and Trademark Office

Reg. No. 3,521,351

Registered Oct. 21, 2008

**SERVICE MARK
PRINCIPAL REGISTER**

SWIFT SIX

BRADLEY KEEFER (UNITED STATES INDIVIDUAL)
100 CALLE DE ESTABLO
FORT WORTH, TX 76108

FOR: LAND DEVELOPMENT SERVICES, NAME-
LY, PLANNING AND LAYING OUT OF RESIDEN-
TIAL AND/OR COMMERCIAL COMMUNITIES;
REAL ESTATE DEVELOPMENT , IN CLASS 37
(U.S. CLS. 100, 103 AND 106).

FIRST USE 6-24-2008; IN COMMERCE 6-24-2008.

FOR: ANIMAL BREEDING; ANIMAL HUSBAN-
DRY; BREEDING AND STUD SERVICES FOR CAT-

TLE AND HORSES, IN CLASS 44 (U.S. CLS. 100 AND 101).

FIRST USE 6-24-2008; IN COMMERCE 6-24-2008.

THE MARK CONSISTS OF STANDARD CHAR-
ACTERS WITHOUT CLAIM TO ANY PARTICULAR
FONT, STYLE, SIZE, OR COLOR.

SN 77-108,369, FILED 2-15-2007.

MARLENE BELL, EXAMINING ATTORNEY

Int. Cl.: 8

Prior U.S. Cls.: 23, 28, and 44

United States Patent and Trademark Office

Reg. No. 3,521,352

Registered Oct. 21, 2008

**TRADEMARK
PRINCIPAL REGISTER**

SKANDIA

HAMPTON FORGE, LTD. (NEW JERSEY CORPORATION)
422 HIGHWAY 35 SOUTH
EATONTOWN, NJ 07724

THE MARK CONSISTS OF STANDARD CHARACTERS WITHOUT CLAIM TO ANY PARTICULAR FONT, STYLE, SIZE, OR COLOR.

FOR: CUTLERY, NAMELY, FORKS, SPOONS, AND KNIVES, IN CLASS 8 (U.S. CLS. 23, 28 AND 44).

SN 77-109,311, FILED 2-16-2007.

FIRST USE 8-24-2007; IN COMMERCE 8-24-2007.

HOWARD FRIEDMAN, EXAMINING ATTORNEY

Int. Cl.: 11

Prior U.S. Cls.: 13, 21, 23, 31, and 34

United States Patent and Trademark Office

Reg. No. 3,521,353

Registered Oct. 21, 2008

**TRADEMARK
PRINCIPAL REGISTER**

LUMAGEAR

DAS DISTRIBUTORS (PENNSYLVANIA CORPORATION)
724 LAWN ROAD
PALMYRA, PA 17078

THE MARK CONSISTS OF STANDARD CHARACTERS WITHOUT CLAIM TO ANY PARTICULAR FONT, STYLE, SIZE, OR COLOR.

FOR: FLASHLIGHTS, IN CLASS 11 (U.S. CLS. 13, 21, 23, 31 AND 34).

SN 77-109,575, FILED 2-16-2007.

FIRST USE 2-1-2007; IN COMMERCE 7-26-2007.

HENRY S. ZAK, EXAMINING ATTORNEY

Int. Cl.: 28

Prior U.S. Cls.: 22, 23, 38, and 50

United States Patent and Trademark Office

Reg. No. 3,521,354

Registered Oct. 21, 2008

**TRADEMARK
PRINCIPAL REGISTER**

CAKE

DIC ENTERTAINMENT CORPORATION (DELA-
WARE CORPORATION)
4100 WEST ALAMEDA AVENUE
BURBANK, CA 91505

FOR: HOBBY CRAFT KIT SETS FOR MAKING
JEWELRY, CERAMICS, MEMORY BOXES, SCRAP-
BOOKS, PURSES, CARDS, JEWELRY BOXES, HOB-
BY CRAFT KITS COMPRISED PRIMARILY OF
RUBBER AND WOODEN STAMPS, TEMPORARY
TATTOOS, BODY ART, YARN, AND BEADS, IN
CLASS 28 (U.S. CLS. 22, 23, 38 AND 50).

FIRST USE 8-0-2007; IN COMMERCE 8-0-2007.

THE MARK CONSISTS OF STANDARD CHAR-
ACTERS WITHOUT CLAIM TO ANY PARTICULAR
FONT, STYLE, SIZE, OR COLOR.

SN 77-109,916, FILED 2-16-2007.

AMEETA JORDAN, EXAMINING ATTORNEY

Int. Cl.: 28

Prior U.S. Cls.: 22, 23, 38, and 50

Reg. No. 3,521,355

United States Patent and Trademark Office

Registered Oct. 21, 2008

**TRADEMARK
PRINCIPAL REGISTER**



DIC ENTERTAINMENT CORPORATION (DELA-
WARE CORPORATION)
4100 WEST ALAMEDA AVENUE
BURBANK, CA 91505

FOR: HOBBY CRAFT KIT SETS FOR MAKING
JEWELRY, CERAMICS, MEMORY BOXES, SCRAP-
BOOKS, PURSES, CARDS, JEWELRY BOXES, MO-
SAICS, AND PAPER MACHE ITEMS; HOBBY
CRAFT KITS COMPRISED PRIMARILY OF RUB-
BER AND WOODEN STAMPS, TEMPORARY TAT-
TOOS, BODY ART, YARN, AND BEADS, IN CLASS
28 (U.S. CLS. 22, 23, 38 AND 50).

FIRST USE 8-0-2007; IN COMMERCE 8-0-2007.

THE MARK CONSISTS OF THE DESIGN OF A
BOW ON THE TOP, THE LETTERS C,A,K,AND E
WITHIN SQUARES IN THE MIDDLE, AND A
FLOURISH DESIGN ON THE BOTTOM.

SN 77-109,924, FILED 2-16-2007.

AMEETA JORDAN, EXAMINING ATTORNEY

Int. Cl.: 31

Prior U.S. Cls.: 1 and 46

United States Patent and Trademark Office

Reg. No. 3,521,356

Registered Oct. 21, 2008

**TRADEMARK
PRINCIPAL REGISTER**

WHAT'S IN YOUR LITTER BOX

NATURE'S EARTH PRODUCTS, INC. (FLORIDA
CORPORATION)
2200 N. FLORIDA MANGO ROAD
WEST PALM BEACH, FL 33409

FOR: PET LITTER/BEDDING COMPRISED PRI-
MARILY OF WOOD PELLETS, IN CLASS 31 (U.S.
CLS. 1 AND 46).

FIRST USE 6-1-2007; IN COMMERCE 6-1-2007.

THE MARK CONSISTS OF STANDARD CHAR-
ACTERS WITHOUT CLAIM TO ANY PARTICULAR
FONT, STYLE, SIZE, OR COLOR.

SN 77-111,101, FILED 2-20-2007.

DAVID MILLER, EXAMINING ATTORNEY

Int. Cl.: 9

Prior U.S. Cls.: 21, 23, 26, 36, and 38

United States Patent and Trademark Office

Reg. No. 3,521,357

Registered Oct. 21, 2008

**TRADEMARK
PRINCIPAL REGISTER**

AUTOPOD

ANDO MEDIA, LLC (DELAWARE LIMITED LIABILITY COMPANY)
170 WESTMINSTER STREET, SUITE 701
PROVIDENCE, RI 02903

FOR: A FEATURE OF COMPUTER SOFTWARE FOR CREATING DOWNLOADABLE PODCASTS AND TRACKING METRICS ASSOCIATED THEREWITH, INCLUDING NUMBER OF DOWNLOADS, DEMOGRAPHICS AND GEOGRAPHIC DATA, IN CLASS 9 (U.S. CLS. 21, 23, 26, 36 AND 38).

FIRST USE 4-30-2007; IN COMMERCE 4-30-2007.

THE MARK CONSISTS OF STANDARD CHARACTERS WITHOUT CLAIM TO ANY PARTICULAR FONT, STYLE, SIZE, OR COLOR.

SN 77-112,431, FILED 2-21-2007.

SCOTT BIBB, EXAMINING ATTORNEY

Int. Cls.: 3 and 5

Prior U.S. Cls.: 1, 4, 6, 18, 44, 46, 50, 51, and 52

United States Patent and Trademark Office

Reg. No. 3,521,358

Registered Oct. 21, 2008

**TRADEMARK
PRINCIPAL REGISTER**



WHARTON INNOVATIVE PRODUCTS LLC
(NEW JERSEY LIMITED LIABILITY COMPANY)
86 NORTH MAIN STREET
WHARTON, NJ 07885

FOR: MEN'S NON-MEDICATED SKIN CARE PRODUCTS, NAMELY, HAND LOTION, HAND CLEANER, LIP BALM, SUN SCREEN STICK FOR THE FACE, IN CLASS 3 (U.S. CLS. 1, 4, 6, 50, 51 AND 52).

FIRST USE 8-2-2007; IN COMMERCE 8-2-2007.

FOR: MEDICATED MEN'S SKIN CARE PRODUCTS, NAMELY, ANTISEPTIC SKIN PROTECTIVE HAND LOTION, IN CLASS 5 (U.S. CLS. 6, 18, 44, 46, 51 AND 52).

FIRST USE 8-2-2007; IN COMMERCE 8-2-2007.

THE MARK CONSISTS OF A HARD HAT WORKER HOLDING A WRENCH.

SN 77-112,698, FILED 2-21-2007.

PAM WILLIS, EXAMINING ATTORNEY

Int. Cl.: 10

Prior U.S. Cls.: 26, 39, and 44

United States Patent and Trademark Office

Reg. No. 3,521,359

Registered Oct. 21, 2008

**TRADEMARK
PRINCIPAL REGISTER**

ARAS

ZIMMER SPINE, INC. (DELAWARE CORPORATION)
7375 BUSH LAKE ROAD
MINNEAPOLIS, MN 55439

FOR: MEDICAL DEVICES, NAMELY, SURGICAL RETRACTOR INSTRUMENTATION SYSTEM FOR MINIMALLY INVASIVE SPINAL ACCESS CONSISTING OF RETRACTOR, SIDE PLATES, SIDE PLATE HANDLE, TABLE ADAPTER, OBTURATOR, RETRACTOR GUIDE, RAIL CLAMP, FLEX BAR, EXPANDER INSTRUMENT AND INCISION GUIDE, IN CLASS 10 (U.S. CLS. 26, 39 AND 44).

FIRST USE 5-0-2007; IN COMMERCE 5-0-2007.

THE MARK CONSISTS OF STANDARD CHARACTERS WITHOUT CLAIM TO ANY PARTICULAR FONT, STYLE, SIZE, OR COLOR.

SN 77-113,003, FILED 2-21-2007.

SHARON MEIER, EXAMINING ATTORNEY

Int. Cl.: 43

Prior U.S. Cls.: 100 and 101

United States Patent and Trademark Office

Reg. No. 3,521,360

Registered Oct. 21, 2008

**SERVICE MARK
PRINCIPAL REGISTER**

DIRTY COOKING

RUSSO, IAN (UNITED STATES INDIVIDUAL)
6620 VETERANS AVENUE
BROOKLYN, NY 11234 AND
CHANG, MIN YONG (UNITED STATES INDIVIDUAL)
6620 VETERANS AVENUE
BROOKLYN, NY 11234

FOR: RESTAURANT SERVICES, IN CLASS 43
(U.S. CLS. 100 AND 101).

FIRST USE 5-16-2008; IN COMMERCE 5-16-2008.

THE MARK CONSISTS OF STANDARD CHARACTERS WITHOUT CLAIM TO ANY PARTICULAR FONT, STYLE, SIZE, OR COLOR.

NO CLAIM IS MADE TO THE EXCLUSIVE RIGHT TO USE "COOKING", APART FROM THE MARK AS SHOWN.

SN 77-113,268, FILED 2-22-2007.

CHERYL CLAYTON, EXAMINING ATTORNEY

Int. Cl.: 36

Prior U.S. Cls.: 100, 101, and 102

United States Patent and Trademark Office

Reg. No. 3,521,361

Registered Oct. 21, 2008

**SERVICE MARK
PRINCIPAL REGISTER**

**NARFE PREMIER FEDERAL
CREDIT UNION**

NARFE PREMIER (VIRGINIA FEDERALLY
CHARTERED CREDIT UNION)

6462 LITTLE RIVER TURNPIKE

ALEXANDRIA, VA 22312

FOR: CREDIT UNIONS, IN CLASS 36 (U.S. CLS.
100, 101 AND 102).

FIRST USE 3-21-2007; IN COMMERCE 3-21-2007.

THE MARK CONSISTS OF STANDARD CHAR-
ACTERS WITHOUT CLAIM TO ANY PARTICULAR
FONT, STYLE, SIZE, OR COLOR.

NO CLAIM IS MADE TO THE EXCLUSIVE
RIGHT TO USE "PREMIER FEDERAL CREDIT
UNION", APART FROM THE MARK AS SHOWN.

SN 77-113,585, FILED 2-22-2007.

SKYE YOUNG, EXAMINING ATTORNEY

Int. Cl.: 36

Prior U.S. Cls.: 100, 101, and 102

United States Patent and Trademark Office

Reg. No. 3,521,362

Registered Oct. 21, 2008

**SERVICE MARK
PRINCIPAL REGISTER**



NARFE PREMIER (VIRGINIA FEDERALLY
CHARTERED CREDIT UNION)
6462 LITTLE RIVER TURNPIKE
ALEXANDRIA, VA 22312

THE MARK CONSISTS OF THE WORD "NARFE"
IN BOLD WITH STARS ALONG ONE LEG OF THE
"N" AND WITH THE WORDS "PREMIER FEDERAL
CREDIT UNION" PLACED BELOW "NARFE".

FOR: CREDIT UNIONS, IN CLASS 36 (U.S. CLS.
100, 101 AND 102).

FIRST USE 3-21-2007; IN COMMERCE 3-21-2007.

SN 77-113,602, FILED 2-22-2007.

NO CLAIM IS MADE TO THE EXCLUSIVE
RIGHT TO USE "PREMIER FEDERAL CREDIT
UNION", APART FROM THE MARK AS SHOWN.

SKYE YOUNG, EXAMINING ATTORNEY

Int. Cls.: 42 and 44

Prior U.S. Cls.: 100 and 101

United States Patent and Trademark Office

Reg. No. 3,521,363

Registered Oct. 21, 2008

**SERVICE MARK
PRINCIPAL REGISTER**

CCRXPRESS

CONTINUING CARE RX, INC. (PENNSYLVANIA
CORPORATION)
SUITE 101
5775 ALLENTOWN BOULEVARD
HARRISBURG, PA 171124041

FOR: PROVIDING TEMPORARY USE OF ON-
LINE NON-DOWNLOADABLE SOFTWARE FOR
USE IN DATABASE MANAGEMENT IN THE FIELD
OF HEALTHCARE AND PHARMACEUTICAL IN-
FORMATION VIA A GLOBAL COMPUTER NET-
WORK, IN CLASS 42 (U.S. CLS. 100 AND 101).

FIRST USE 9-24-2007; IN COMMERCE 9-24-2007.

FOR: PROVIDING TEMPORARY USE OF AN
ONLINE DATABASE FOR MAINTAINING PERSONAL
PATIENT MEDICAL HISTORY RECORDS, IN
CLASS 44 (U.S. CLS. 100 AND 101).

FIRST USE 9-24-2007; IN COMMERCE 9-24-2007.

THE MARK CONSISTS OF STANDARD CHAR-
ACTERS WITHOUT CLAIM TO ANY PARTICULAR
FONT, STYLE, SIZE, OR COLOR.

SN 77-114,454, FILED 2-23-2007.

LAURIE MAYES, EXAMINING ATTORNEY

Int. Cl.: 9

Prior U.S. Cls.: 21, 23, 26, 36, and 38

United States Patent and Trademark Office

Reg. No. 3,521,364

Registered Oct. 21, 2008

**TRADEMARK
PRINCIPAL REGISTER**



SIMON & SCHUSTER, INC. (NEW YORK CORPORATION)
1230 AVENUE OF THE AMERICAS
NEW YORK, NY 10020

FIRST USE 10-23-2007; IN COMMERCE 10-23-2007.

FOR: INTERACTIVE VIDEO GAME PROGRAMS
FOR USE TOGETHER WITH A SERIES OF CHILDREN'S BOOKS, IN CLASS 9 (U.S. CLS. 21, 23, 26, 36 AND 38).

SN 77-115,004, FILED 2-23-2007.

RENEE MCCRAY, EXAMINING ATTORNEY

Int. Cl.: 33

Prior U.S. Cls.: 47 and 49

United States Patent and Trademark Office

Reg. No. 3,521,365

Registered Oct. 21, 2008

**TRADEMARK
PRINCIPAL REGISTER**

CARNEROS HIGHWAY

OFFENBACHER, DOUG (UNITED STATES IN-
DIVIDUAL)
P.O. BOX 11249
SANTA ROSA, CA 95406

FOR: WINE, IN CLASS 33 (U.S. CLS. 47 AND 49).

FIRST USE 8-21-2008; IN COMMERCE 8-21-2008.

THE MARK CONSISTS OF STANDARD CHAR-
ACTERS WITHOUT CLAIM TO ANY PARTICULAR
FONT, STYLE, SIZE, OR COLOR.

NO CLAIM IS MADE TO THE EXCLUSIVE
RIGHT TO USE "CARNEROS", APART FROM THE
MARK AS SHOWN.

THE FOREIGN WORDING IN THE MARK
TRANSLATES INTO ENGLISH AS RAM.

SN 77-115,073, FILED 2-23-2007.

THEODORE MCBRIDE, EXAMINING ATTORNEY

Int. Cl.: 35

Prior U.S. Cls.: 100, 101, and 102

United States Patent and Trademark Office

Reg. No. 3,521,366

Registered Oct. 21, 2008

**SERVICE MARK
PRINCIPAL REGISTER**

LIVING LOFT

VANN'S, INC. (MONTANA CORPORATION)
3623 BROOKS AVE.
MISSOULA, MT 59801

FIRST USE 3-31-2008; IN COMMERCE 3-31-2008.

FOR: RETAIL STORE SERVICES FEATURING
APPLIANCES, NAMELY, REFRIGERATORS,
OVENS, DISHWASHERS, FREEZERS, RANGES,
CLOTHES WASHING MACHINES AND CLOTHES
DRYERS, IN CLASS 35 (U.S. CLS. 100, 101 AND 102).

THE MARK CONSISTS OF STANDARD CHAR-
ACTERS WITHOUT CLAIM TO ANY PARTICULAR
FONT, STYLE, SIZE, OR COLOR.

SN 77-116,957, FILED 2-27-2007.

ERIN FALK, EXAMINING ATTORNEY

Int. Cl.: 10

Prior U.S. Cls.: 26, 39, and 44

United States Patent and Trademark Office

Reg. No. 3,521,367

Registered Oct. 21, 2008

**TRADEMARK
PRINCIPAL REGISTER**

BHR

T. J. SMITH & NEPHEW, LIMITED (UNITED
KINGDOM CORPORATION)
POST OFFICE BOX 81
101 HESSLE ROAD
HULL, UNITED KINGDOM HU32BN

FOR: TOTAL HIP RESURFACING SYSTEM COM-
PONENTS, NAMELY, ACETABULAR CUPS, FE-
MORAL RESURFACING IMPLANTS AND
SURGICAL INSTRUMENTATION ASSOCIATED
THEREWITH, IN CLASS 10 (U.S. CLS. 26, 39 AND 44).

FIRST USE 6-30-2006; IN COMMERCE 6-30-2006.

THE MARK CONSISTS OF STANDARD CHAR-
ACTERS WITHOUT CLAIM TO ANY PARTICULAR
FONT, STYLE, SIZE, OR COLOR.

SN 77-117,238, FILED 2-27-2007.

LINDA MICKLEBURGH, EXAMINING ATTORNEY

Int. Cl.: 35

Prior U.S. Cls.: 100, 101, and 102

United States Patent and Trademark Office

Reg. No. 3,521,368

Registered Oct. 21, 2008

**SERVICE MARK
PRINCIPAL REGISTER**

LIVING STYLE

VANN'S, INC. (MONTANA CORPORATION)
3623 BROOKS AVE.
MISSOULA, MT 59801

FIRST USE 3-31-2008; IN COMMERCE 3-31-2008.

FOR: RETAIL STORE SERVICES FEATURING
APPLIANCES, NAMELY, REFRIGERATORS,
OVENS, DISHWASHERS, FREEZERS, RANGES,
CLOTHES WASHING MACHINES AND CLOTHES
DRYERS, IN CLASS 35 (U.S. CLS. 100, 101 AND 102).

THE MARK CONSISTS OF STANDARD CHAR-
ACTERS WITHOUT CLAIM TO ANY PARTICULAR
FONT, STYLE, SIZE, OR COLOR.

SN 77-117,660, FILED 2-27-2007.

ERIN FALK, EXAMINING ATTORNEY

Prior U.S. Cl.: B

United States Patent and Trademark Office

Reg. No. 3,521,369

Registered Oct. 21, 2008

**CERTIFICATION MARK
SERVICES
PRINCIPAL REGISTER**

PRM

FARPM, INC. (FLORIDA CORPORATION)
659 MAITLAND AVENUE
ALTAMONTE SPRINGS, FL 32701

FOR: REAL ESTATE SERVICES, IN CLASS B (U.S.
CL. B).

FIRST USE 6-1-2007; IN COMMERCE 6-1-2007.

THE MARK CONSISTS OF STANDARD CHAR-
ACTERS WITHOUT CLAIM TO ANY PARTICULAR
FONT, STYLE, SIZE, OR COLOR.

THE CERTIFICATION MARK IS INTENDED TO
BE USED BY AUTHORIZED PERSONS, IS INTEN-
DED TO CERTIFY THAT CERTAIN INDIVIDUALS
HAVE COMPLETED A SPECIFIC COURSE OF IN-
STRUCTION, HAVE MET CERTAIN STANDARDS,
AND/OR HAVE PASSED TESTS OF COMPETENCY
SET BY THE CERTIFIER

SN 77-117,942, FILED 2-28-2007.

FRANK LATTUCA, EXAMINING ATTORNEY

Int. Cls.: 9 and 18

Prior U.S. Cls.: 1, 2, 3, 21, 22, 23, 26, 36, 38, and 41

United States Patent and Trademark Office

Reg. No. 3,521,370

Registered Oct. 21, 2008

**TRADEMARK
PRINCIPAL REGISTER**



COLLECTIVE CASE, INC. (NEW YORK CORPORATION)
10 W. 33RD. STREET, PENTHOUSE
NEW YORK, NY 10001

FOR: ELECTRONIC DEVICE CARRYING CASES AND HOLDERS FOR COMPUTERS, CAMERAS, PERSONAL DIGITAL ASSISTANTS, MUSIC PLAYERS, EARPHONES, AND TELEPHONES, IN CLASS 9 (U.S. CLS. 21, 23, 26, 36 AND 38).

FIRST USE 5-0-2007; IN COMMERCE 5-0-2007.

FOR: LUGGAGE, BACKPACKS, BRIEFCASES, PURSES, SHOULDER BAGS, IN CLASS 18 (U.S. CLS. 1, 2, 3, 22 AND 41).

FIRST USE 5-0-2007; IN COMMERCE 5-0-2007.

NO CLAIM IS MADE TO THE EXCLUSIVE RIGHT TO USE "SWISS" OR THE GREEK CROSS DESIGN, APART FROM THE MARK AS SHOWN.

THE MARK CONSISTS OF A SHIELD.

SN 77-118,335, FILED 2-28-2007.

KAPIL BHANOT, EXAMINING ATTORNEY

Int. Cl.: 36

Prior U.S. Cls.: 100, 101, and 102

United States Patent and Trademark Office

Reg. No. 3,521,371

Registered Oct. 21, 2008

**SERVICE MARK
PRINCIPAL REGISTER**

**Modern Woodmen of America
Maximizer**

MODERN WOODMEN OF AMERICA (ILLINOIS
CORPORATION)
1701 - 1ST AVENUE
ROCK ISLAND, IL 61201

FOR: PROVIDING FRATERNAL SOCIETY BENEFITS, NAMELY, ANNUITY UNDERWRITING, AND THE ISSUANCE AND ADMINISTRATION OF ANNUITIES, IN CLASS 36 (U.S. CLS. 100, 101 AND 102).

FIRST USE 7-24-2008; IN COMMERCE 7-24-2008.

THE MARK CONSISTS OF STANDARD CHARACTERS WITHOUT CLAIM TO ANY PARTICULAR FONT, STYLE, SIZE, OR COLOR.

NO CLAIM IS MADE TO THE EXCLUSIVE RIGHT TO USE "OF AMERICA", APART FROM THE MARK AS SHOWN.

SN 77-118,680, FILED 2-28-2007.

PAUL E. FAHRENKOPF, EXAMINING ATTORNEY

Int. Cls.: 30 and 35

Prior U.S. Cls.: 46, 100, 101, and 102

United States Patent and Trademark Office

Reg. No. 3,521,372

Registered Oct. 21, 2008

**TRADEMARK
SERVICE MARK
PRINCIPAL REGISTER**



RITA'S WATER ICE FRANCHISE COMPANY,
LLC (DELAWARE LIMITED LIABILITY COM-
PANY)

SUITE 310
1210 NORTHBROOK DRIVE
TREVOSE, PA 19053

FOR: FROZEN CONFECTIONS; FLAVORED WA-
TER ICES; FROZEN CUSTARDS, IN CLASS 30 (U.S.
CL. 46).

FIRST USE 1-0-2007; IN COMMERCE 1-0-2007.

FOR: RETAIL STORE SERVICES FEATURING
ITALIAN ICE, FROZEN CUSTARD AND OTHER
FROZEN CONFECTIONS, FOR CONSUMPTION ON
AND OFF THE PREMISES; RESTAURANT FRAN-
CHISING, IN CLASS 35 (U.S. CLS. 100, 101 AND 102).

FIRST USE 1-0-2007; IN COMMERCE 1-0-2007.

OWNER OF U.S. REG. NOS. 2,614,810, 3,109,750,
AND OTHERS.

NO CLAIM IS MADE TO THE EXCLUSIVE
RIGHT TO USE "CUSTARD" AND "ICE", APART
FROM THE MARK AS SHOWN.

THE COLOR(S) RED, GREEN, WHITE AND BLUE
IS/ARE CLAIMED AS A FEATURE OF THE MARK.

THE MARK CONSISTS OF THE WORD "RITA'S"
APPEARING IN WHITE ON A GREEN BANNER,
WITH THE WORDING "ICE CUSTARD HAPPI-
NESS," IN WHITE, APPEARING BENEATH; ALL
OVER A CIRCLE OUTLINE IN BLUE WITH WHITE
AND RED VERTICAL STRIPES.

SN 77-118,992, FILED 2-28-2007.

GRETTA YAO, EXAMINING ATTORNEY

Int. Cl.: 35

Prior U.S. Cls.: 100, 101, and 102

United States Patent and Trademark Office

Reg. No. 3,521,373

Registered Oct. 21, 2008

**SERVICE MARK
PRINCIPAL REGISTER**

WORKING INNOVATIONS

WORKING INNOVATIONS, INC. (WISCONSIN CORPORATION)
5779 NORTH WITTE LANE
MILWAUKEE, WI 53209

FOR: HUMAN RESOURCE DEVELOPMENT CONSULTING SERVICES IN THE FIELDS OF DEVELOPMENT OF FLEXIBLE ARRANGEMENTS FOR EMPLOYEE WORKING TIMES AND LOCATIONS, DEVELOPMENT OF EMPLOYEE HIRING, FIRING AND DEPARTURE PROCEDURES, MEASUREMENT AND ANALYSIS OF POLICIES, PROCEDURES AND CONTRACTED SERVICES, EMPLOYEE SATISFACTION AND EMPOWERMENT, EMPLOYEE MOTIVATION, EMPLOYEE PERFORMANCE IMPROVEMENT, WORKPLACE

PRODUCTIVITY, IMPLEMENTING PROCEDURES TO MONITOR AND IMPROVE EMPLOYEE SATISFACTION, AND WORKPLACE STRATEGIC PLANNING AND TEAM-BUILDING, IN CLASS 35 (U.S. CLS. 100, 101 AND 102).

FIRST USE 9-16-2005; IN COMMERCE 12-5-2005.

THE MARK CONSISTS OF STANDARD CHARACTERS WITHOUT CLAIM TO ANY PARTICULAR FONT, STYLE, SIZE, OR COLOR.

SN 77-119,002, FILED 2-28-2007.

PRISCILLA MILTON, EXAMINING ATTORNEY

Int. Cls.: 9 and 44

Prior U.S. Cls.: 21, 23, 26, 36, 38, 100, and 101

United States Patent and Trademark Office

Reg. No. 3,521,374

Registered Oct. 21, 2008

**TRADEMARK
SERVICE MARK
PRINCIPAL REGISTER**

CCRXPRESS EPASS

CONTINUING CARE RX, INC. (PENNSYLVANIA CORPORATION)
SUITE 101
5775 ALLENTOWN BOULEVARD
HARRISBURG, PA 171124041

FOR: COMPUTER SOFTWARE FOR USE IN CREATING, REVIEWING AND MANAGING ELECTRONIC MEDICAL RECORDS , IN CLASS 9 (U.S. CLS. 21, 23, 26, 36 AND 38).

FIRST USE 6-19-2008; IN COMMERCE 6-19-2008.

FOR: PROVIDING TEMPORARY USE OF AN ONLINE DATABASE FOR MAINTAINING PERSONAL

PATIENT MEDICAL HISTORY RECORDS; ELECTRONIC DISPENSING OF PHARMACEUTICAL ORDERS FOR OTHERS, IN CLASS 44 (U.S. CLS. 100 AND 101).

FIRST USE 6-19-2008; IN COMMERCE 6-19-2008.

THE MARK CONSISTS OF STANDARD CHARACTERS WITHOUT CLAIM TO ANY PARTICULAR FONT, STYLE, SIZE, OR COLOR.

SN 77-119,923, FILED 3-1-2007.

LAURIE MAYES, EXAMINING ATTORNEY

Int. Cl.: 20

Prior U.S. Cls.: 2, 13, 22, 25, 32, and 50

United States Patent and Trademark Office

Reg. No. 3,521,375

Registered Oct. 21, 2008

**TRADEMARK
PRINCIPAL REGISTER**

HEAVY DUTY

EX-CELL HOME FASHIONS, INC. (DELAWARE
CORPORATION)
295 FIFTH AVENUE
NEW YORK, NY 10016

OWNER OF U.S. REG. NO. 3,191,574.

SEC. 2(F).

FOR: SHOWER CURTAIN RODS, IN CLASS 20
(U.S. CLS. 2, 13, 22, 25, 32 AND 50).

FIRST USE 5-0-2007; IN COMMERCE 5-0-2007.

SN 77-119,973, FILED 3-1-2007.

THE MARK CONSISTS OF STANDARD CHAR-
ACTERS WITHOUT CLAIM TO ANY PARTICULAR
FONT, STYLE, SIZE, OR COLOR.

ZACHARY BELLO, EXAMINING ATTORNEY

Int. Cl.: 5

Prior U.S. Cls.: 6, 18, 44, 46, 51, and 52

Reg. No. 3,521,376

United States Patent and Trademark Office

Registered Oct. 21, 2008

**TRADEMARK
PRINCIPAL REGISTER**

Amberen

LIFECORE, INC. (CALIFORNIA CORPORATION)
6733 SOUTH SEPULVEDA BLVD. SUITE 108
LOS ANGELES, CA 90045

THE MARK CONSISTS OF STANDARD CHAR-
ACTERS WITHOUT CLAIM TO ANY PARTICULAR
FONT, STYLE, SIZE, OR COLOR.

FOR: DIETARY AND NUTRITIONAL SUPPLE-
MENTS, IN CLASS 5 (U.S. CLS. 6, 18, 44, 46, 51 AND
52).

SN 77-120,363, FILED 3-1-2007.

FIRST USE 9-1-2007; IN COMMERCE 9-1-2007.

THEODORE MCBRIDE, EXAMINING ATTORNEY

Int. Cl.: 28

Prior U.S. Cls.: 22, 23, 38, and 50

United States Patent and Trademark Office

Reg. No. 3,521,377

Registered Oct. 21, 2008

**TRADEMARK
PRINCIPAL REGISTER**

THOROTREAD

FITNESS TOOLS, LLC (FLORIDA LIMITED LIABILITY COMPANY)
12330 N.W. 35TH STREET
OCALA, FL 34482

THE MARK CONSISTS OF STANDARD CHARACTERS WITHOUT CLAIM TO ANY PARTICULAR FONT, STYLE, SIZE, OR COLOR.

FOR: EXERCISE TREADMILLS, IN CLASS 28 (U.S. CLS. 22, 23, 38 AND 50).

SN 77-121,035, FILED 3-2-2007.

FIRST USE 7-17-2008; IN COMMERCE 7-17-2008.

JULIE GUTTADAURO, EXAMINING ATTORNEY

Int. Cl.: 9

Prior U.S. Cls.: 21, 23, 26, 36, and 38

Reg. No. 3,521,378

United States Patent and Trademark Office

Registered Oct. 21, 2008

**TRADEMARK
PRINCIPAL REGISTER**

VISÃO

BASS PRO INTELLECTUAL PROPERTY, L.L.C
(MISSOURI LIMITED LIABILITY COMPANY)
2500 EAST KEARNEY
SPRINGFIELD, MO 65898

FOR: BINOCULARS, IN CLASS 9 (U.S. CLS. 21, 23,
26, 36 AND 38).

FIRST USE 8-0-2007; IN COMMERCE 8-0-2007.

THE MARK CONSISTS OF STANDARD CHAR-
ACTERS WITHOUT CLAIM TO ANY PARTICULAR
FONT, STYLE, SIZE, OR COLOR.

THE FOREIGN WORDING IN THE MARK
TRANSLATES INTO ENGLISH AS VISION.

SN 77-122,232, FILED 3-5-2007.

GIANCARLO CASTRO, EXAMINING ATTORNEY

Int. Cl.: 25

Prior U.S. Cls.: 22 and 39

United States Patent and Trademark Office

Reg. No. 3,521,379

Registered Oct. 21, 2008

**TRADEMARK
PRINCIPAL REGISTER**

Agua Bendita

AGUA BENDITA LIMITADA (COLOMBIA LIMITED LIABILITY COMPANY)
CALLE 16 NO 55-129
MEDELLIN, COLOMBIA

FOR: CLOTHING, NAMELY, DRESSES, FORMAL AND INFORMAL SHIRTS, T-SHIRTS, CAMISOLES, TOPS, T-SHIRTS WITHOUT SLEEVES, SMOCKS, JACKETS, VESTS, GABARDINES, OVERCOATS, RAINCOATS, SKIRTS, SHORTS, PANTS, SWEAT-SHIRTS, JEANS, OVERALLS, SWIMWEAR, TIES, BELTS, SOCKS, GLOVES, WRISTBANDS, APRONS, PAJAMAS, UNDERWEAR; FOOTWEAR; HATS, IN CLASS 25 (U.S. CLS. 22 AND 39).

FIRST USE 9-1-2008; IN COMMERCE 9-1-2008.

THE MARK CONSISTS OF STANDARD CHARACTERS WITHOUT CLAIM TO ANY PARTICULAR FONT, STYLE, SIZE, OR COLOR.

THE FOREIGN WORDING IN THE MARK TRANSLATES INTO ENGLISH AS "BLESSED WATER."

SN 77-122,900, FILED 3-6-2007.

ROBERT LAVACHE, EXAMINING ATTORNEY

Int. Cls.: 35 and 40

Prior U.S. Cls.: 100, 101, 102, 103, and 106

United States Patent and Trademark Office

Reg. No. 3,521,380

Registered Oct. 21, 2008

**SERVICE MARK
PRINCIPAL REGISTER**

WE KNOW PORK

LES VIANDES DU BRETON INC. (CANADA CORPORATION)
150, CHEMIN DES RAYMOND
RIVIERE-DU-LOUP, CANADA G5R5X8

FOR: MARKETING AND PROMOTION OF FRESH AND FROZEN PORK PIECES AND CUTS; RETAIL STORE SERVICES FEATURING FRESH AND FROZEN PORK PIECES AND CUTS; AND BUTCHER SHOPS FEATURING FRESH AND FROZEN PORK PIECES AND CUTS, IN CLASS 35 (U.S. CLS. 100, 101 AND 102).

FIRST USE 5-0-2007; IN COMMERCE 5-0-2007.

FOR: PRODUCTION OF FRESH AND FROZEN PORK PIECES AND CUTS, NAMELY, BUTCHER-

ING, FOOD PROCESSING AND FREEZING OF FOODS, IN CLASS 40 (U.S. CLS. 100, 103 AND 106).

FIRST USE 5-0-2007; IN COMMERCE 5-0-2007.

THE MARK CONSISTS OF STANDARD CHARACTERS WITHOUT CLAIM TO ANY PARTICULAR FONT, STYLE, SIZE, OR COLOR.

PRIORITY CLAIMED UNDER SEC. 44(D) ON CANADA APPLICATION NO. 1335075, FILED 2-13-2007.

SN 77-123,417, FILED 3-6-2007.

ROBERT STRUCK, EXAMINING ATTORNEY

Int. Cl.: 25

Prior U.S. Cls.: 22 and 39

United States Patent and Trademark Office

Reg. No. 3,521,381

Registered Oct. 21, 2008

TRADEMARK
PRINCIPAL REGISTER



M.A.D. WEAR INC. (NORTH CAROLINA CORPORATION)

72 YORKTOWN CIRCLE

FLETCHER, NC 28732

FOR: CLOTHING, NAMELY, SHIRTS, LONG-SLEEVE SHIRTS, HATS, AND VISORS, IN CLASS 25 (U.S. CLS. 22 AND 39).

FIRST USE 6-0-2007; IN COMMERCE 6-0-2007.

NO CLAIM IS MADE TO THE EXCLUSIVE RIGHT TO USE "WEAR", APART FROM THE MARK AS SHOWN.

THE DESIGN PORTION OF THE MARK CONSISTS OF A LEAF FORMED BY THE WORDS "MAD WEAR".

SN 77-123,736, FILED 3-6-2007.

ALICE SUE CARRUTHERS, EXAMINING ATTORNEY

Int. Cl.: 30

Prior U.S. Cl.: 46

United States Patent and Trademark Office

Reg. No. 3,521,382

Registered Oct. 21, 2008

**TRADEMARK
PRINCIPAL REGISTER**

BAKED RICE WITH A TWIST

WEHAH FARM, INC. (CALIFORNIA CORPORATION), DBA LUNDBERG FAMILY FARMS,
5370 CHURCH STREET, P.O. BOX 369
RICHVALE, CA 95974

FOR: RICE BASED SNACK FOOD, IN CLASS 30
(U.S. CL. 46).

FIRST USE 4-15-2008; IN COMMERCE 4-15-2008.

THE MARK CONSISTS OF STANDARD CHARACTERS WITHOUT CLAIM TO ANY PARTICULAR FONT, STYLE, SIZE, OR COLOR.

NO CLAIM IS MADE TO THE EXCLUSIVE RIGHT TO USE "BAKED RICE", APART FROM THE MARK AS SHOWN.

SN 77-123,800, FILED 3-6-2007.

GINA HAYES, EXAMINING ATTORNEY

Int. Cl.: 28

Prior U.S. Cls.: 22, 23, 38, and 50

United States Patent and Trademark Office

Reg. No. 3,521,383

Registered Oct. 21, 2008

**TRADEMARK
PRINCIPAL REGISTER**

FLAG ON THE PLAY

BRETT ALAN GOODRUM (UNITED STATES
INDIVIDUAL)
14648 LAS FLORES
DALLAS, TX 75254

THE MARK CONSISTS OF STANDARD CHAR-
ACTERS WITHOUT CLAIM TO ANY PARTICULAR
FONT, STYLE, SIZE, OR COLOR.

FOR: PROMOTIONAL GAME MATERIALS; NO-
VELTY SPORTS ITEMS, NAMELY, CHEERING
FLAGS, IN CLASS 28 (U.S. CLS. 22, 23, 38 AND 50).

SN 77-124,167, FILED 3-7-2007.

FIRST USE 8-15-2008; IN COMMERCE 8-15-2008.

KELLY MCCOY, EXAMINING ATTORNEY

Int. Cl.: 43

Prior U.S. Cls.: 100 and 101

United States Patent and Trademark Office

Reg. No. 3,521,384

Registered Oct. 21, 2008

SERVICE MARK
PRINCIPAL REGISTER



JACK DANIEL'S PROPERTIES, INC. (DELA-
WARE CORPORATION)
SUITE 528
4040 CIVIC CENTER DRIVE
SAN RAFAEL, CA 94903

FOR: RESTAURANT SERVICES, IN CLASS 43
(U.S. CLS. 100 AND 101).

FIRST USE 1-3-2007; IN COMMERCE 1-3-2007.

THE STIPPLING IS FOR SHADING PURPOSES
ONLY.

THE NAME(S), PORTRAIT(S), AND/OR SIGNA-
TURE(S) SHOWN IN THE MARK DOES NOT IDEN-
TIFY A PARTICULAR LIVING INDIVIDUAL.

THE MARK CONSISTS OF THE TEXT "MISS
MARY BOBO'S" WITH A FRYING PAN IN PLACE
OF THE FIRST "O" IN "BOBO'S".

SN 77-125,076, FILED 3-7-2007.

NATALIE POLZER, EXAMINING ATTORNEY

Int. Cl.: 14

Prior U.S. Cls.: 2, 27, 28, and 50

United States Patent and Trademark Office

Reg. No. 3,521,385

Registered Oct. 21, 2008

TRADEMARK
PRINCIPAL REGISTER

Daliano

SORIANO, JESSE (UNITED STATES INDIVIDUAL)
9 HODGENVILLE
IRVINE, CA 92620 AND
DALMACIO, MYLENE (UNITED STATES INDIVIDUAL)
9 HODGENVILLE
IRVINE, CA 92620

FOR: BEADS FOR USE IN THE MANUFACTURE OF JEWELRY; BRACELETS; BRONZE JEWELRY; BROOCHES; CHARMS; COSTUME JEWELRY; IDENTIFICATION BRACELETS; JEWELRY; JEWELRY BOXES; JEWELRY BOXES NOT OF METAL; JEWELRY BOXES OF METAL; JEWELRY BOXES OF PRECIOUS METAL; JEWELRY CASES; JEWELRY CASES NOT OF PRECIOUS METAL; JEWELRY CASES OF PRECIOUS METAL; JEWELRY CASKETS; JEWELRY CASKETS OF PRECIOUS METAL; JEWELRY CHAINS; JEWELRY FINDINGS; JEWEL-

RY FOR THE HEAD; JEWELRY PINS FOR USE ON HATS; JEWELRY WATCHES; JEWELRY, NAMELY, AMULETS; JEWELRY, NAMELY, CROSSES; JEWELRY, NAMELY, PRECIOUS METAL PLATED REAL LEAVES AND FLOWERS; LAPEL PINS; LEATHER JEWELRY AND ACCESSORY BOXES; PET JEWELRY; PINS BEING JEWELRY; RINGS BEING JEWELRY, IN CLASS 14 (U.S. CLS. 2, 27, 28 AND 50).

FIRST USE 11-1-2007; IN COMMERCE 11-1-2007.

THE MARK CONSISTS OF STANDARD CHARACTERS WITHOUT CLAIM TO ANY PARTICULAR FONT, STYLE, SIZE, OR COLOR.

SN 77-125,077, FILED 3-7-2007.

NORA BUCHANAN WILL, EXAMINING ATTORNEY

Int. Cls.: 16 and 20

Prior U.S. Cls.: 2, 5, 13, 22, 23, 25, 29, 32, 37, 38, and 50

Reg. No. 3,521,386

United States Patent and Trademark Office

Registered Oct. 21, 2008

TRADEMARK
PRINCIPAL REGISTER



JACK DANIEL'S PROPERTIES, INC. (DELAWARE CORPORATION)

SUITE 528

4040 CIVIC CENTER DRIVE

SAN RAFAEL, CA 94903

FOR: PAPER AND PAPER ARTICLES, NAMELY, POSTCARDS, MOUNTED AND UNMOUNTED PHOTOGRAPHS; CALENDARS; PENS AND PENCILS AND CASES THEREFOR; PICTURES; PRINTED PERIODICALS IN THE FIELD OF HISTORY, TOURISM AND COOKING, IN CLASS 16 (U.S. CLS. 2, 5, 22, 23, 29, 37, 38 AND 50).

FIRST USE 1-24-2007; IN COMMERCE 1-24-2007.

FOR: HAND HELD FLAT PAPER FANS; HAND-HELD FOLDING PAPER FANS, IN CLASS 20 (U.S. CLS. 2, 13, 22, 25, 32 AND 50).

FIRST USE 1-24-2007; IN COMMERCE 1-24-2007.

THE NAME(S), PORTRAIT(S), AND/OR SIGNATURE(S) SHOWN IN THE MARK DOES NOT IDENTIFY A PARTICULAR LIVING INDIVIDUAL.

THE MARK CONSISTS OF THE TEXT "MISS MARY BOBO'S" WITH A FRYING PAN IN PLACE OF THE FIRST "O" IN "BOBO'S".

SN 77-125,095, FILED 3-7-2007.

NATALIE POLZER, EXAMINING ATTORNEY

Int. Cl.: 12

Prior U.S. Cls.: 19, 21, 23, 31, 35, and 44

United States Patent and Trademark Office

Reg. No. 3,521,387

Registered Oct. 21, 2008

**TRADEMARK
PRINCIPAL REGISTER**

CONVECT-RITE PRIME

ALADDIN TEMP-RITE, LLC (TENNESSEE CORPORATION)
250 EAST MAIN STREET
HENDERSONVILLE, TN 37075

FOR: RETHERMALIZATION AND MEAL DELIVERY CARTS FOR THE DELIVERY OF MEALS IN INSTITUTIONS, IN CLASS 12 (U.S. CLS. 19, 21, 23, 31, 35 AND 44).

FIRST USE 4-24-2008; IN COMMERCE 4-24-2008.

THE MARK CONSISTS OF STANDARD CHARACTERS WITHOUT CLAIM TO ANY PARTICULAR FONT, STYLE, SIZE, OR COLOR.

OWNER OF U.S. REG. NO. 2,518,313.

SN 77-125,299, FILED 3-8-2007.

PAULA MAHONEY, EXAMINING ATTORNEY

Int. Cl.: 18

Prior U.S. Cls.: 1, 2, 3, 22, and 41

United States Patent and Trademark Office

Reg. No. 3,521,388

Registered Oct. 21, 2008

TRADEMARK
PRINCIPAL REGISTER



JACK DANIEL'S PROPERTIES, INC. (DELA-
WARE CORPORATION)
SUITE 528
4040 CIVIC CENTER DRIVE
SAN RAFAEL, CA 94903

FOR: UMBRELLAS, SHOULDER BAGS, LUG-
GAGE TAGS, LEATHER KEY CHAINS AND TOTE
BAGS, IN CLASS 18 (U.S. CLS. 1, 2, 3, 22 AND 41).

FIRST USE 1-24-2007; IN COMMERCE 1-24-2007.

THE NAME(S), PORTRAIT(S), AND/OR SIGNA-
TURE(S) SHOWN IN THE MARK DOES NOT IDEN-
TIFY A PARTICULAR LIVING INDIVIDUAL.

THE MARK CONSISTS OF THE TEXT "MISS
MARY BOBO'S" WITH A FRYING PAN IN PLACE
OF THE FIRST "O" IN "BOBO'S".

SN 77-125,520, FILED 3-8-2007.

NATALIE POLZER, EXAMINING ATTORNEY

Int. Cl.: 21

Prior U.S. Cls.: 2, 13, 23, 29, 30, 33, 40, and 50

Reg. No. 3,521,389

United States Patent and Trademark Office

Registered Oct. 21, 2008

TRADEMARK
PRINCIPAL REGISTER



JACK DANIEL'S PROPERTIES, INC. (DELA-
WARE CORPORATION)
SUITE 528
4040 CIVIC CENTER DRIVE
SAN RAFAEL, CA 94903

FOR: GLASS AND PLASTIC DRINK CONTAIN-
ERS, NAMELY, FLASKS, CERAMIC MUGS, GLASS
MUGS, BEVERAGE GLASSWARE, PLASTIC MUGS;
PEWTER MUGS; CERAMIC PITCHERS; CRYSTAL
PITCHERS; CERAMIC JUGS; SPONGES FOR
HOUSEHOLD PURPOSES; WOOD COASTERS;
CORK COASTERS; SWIZZLE STICKS; DINNER-
WARE, NAMELY, PLATES, CUPS, SAUCERS, SOUP
BOWLS, PIE PLATES, CASSEROLE DISHES, SER-
VING BOWLS AND SERVING TRAYS; GLASS CAN-
DLE HOLDERS; GLASS CANDLESTICKS; SERVING
TRAYS OF NON-PRECIOUS METAL; SKILLETTS

AND PORTABLE COOLERS, IN CLASS 21 (U.S.
CLS. 2, 13, 23, 29, 30, 33, 40 AND 50).

FIRST USE 1-24-2007; IN COMMERCE 1-24-2007.

THE NAME(S), PORTRAIT(S), AND/OR SIGNA-
TURE(S) SHOWN IN THE MARK DOES NOT IDENTI-
FY A PARTICULAR LIVING INDIVIDUAL.

THE MARK CONSISTS OF THE TEXT "MISS
MARY BOBO'S" WITH A FRYING PAN IN PLACE
OF THE FIRST "O" IN "BOBO'S".

SN 77-125,550, FILED 3-8-2007.

NATALIE POLZER, EXAMINING ATTORNEY

Int. Cl.: 25

Prior U.S. Cls.: 22 and 39

United States Patent and Trademark Office

Reg. No. 3,521,390

Registered Oct. 21, 2008

TRADEMARK
PRINCIPAL REGISTER



JACK DANIEL'S PROPERTIES, INC. (DELA-
WARE CORPORATION)
SUITE 528
4040 CIVIC CENTER DRIVE
SAN RAFAEL, CA 94903

FOR: HEADGEAR, NAMELY, CAPS, HATS,
HEADBANDS, VISORS; CLOTHING, NAMELY,
APRONS, T-SHIRTS, POLO SHIRTS, SHIRTS, TOPS,
TANK TOPS, SWEATSHIRTS , IN CLASS 25 (U.S.
CLS. 22 AND 39).

FIRST USE 1-24-2007; IN COMMERCE 1-24-2007.

THE NAME(S), PORTRAIT(S), AND/OR SIGNA-
TURE(S) SHOWN IN THE MARK DOES NOT IDEN-
TIFY A PARTICULAR LIVING INDIVIDUAL.

THE MARK CONSISTS OF THE TEXT "MISS
MARY BOBO'S" WITH A FRYING PAN IN PLACE
OF THE FIRST "O" IN "BOBO'S".

SN 77-125,570, FILED 3-8-2007.

NATALIE POLZER, EXAMINING ATTORNEY

Int. Cl.: 28

Prior U.S. Cls.: 22, 23, 38, and 50

Reg. No. 3,521,391

United States Patent and Trademark Office

Registered Oct. 21, 2008

TRADEMARK
PRINCIPAL REGISTER



JACK DANIEL'S PROPERTIES, INC. (DELA-
WARE CORPORATION)
SUITE 528
4040 CIVIC CENTER DRIVE
SAN RAFAEL, CA 94903

FOR: GAMES, NAMELY, PLAYING CARDS, IN
CLASS 28 (U.S. CLS. 22, 23, 38 AND 50).

FIRST USE 1-24-2007; IN COMMERCE 1-24-2007.

THE NAME(S), PORTRAIT(S), AND/OR SIGNA-
TURE(S) SHOWN IN THE MARK DOES NOT IDEN-
TIFY A PARTICULAR LIVING INDIVIDUAL.

THE MARK CONSISTS OF THE TEXT "MISS
MARY BOBO'S" WITH A FRYING PAN IN PLACE
OF THE FIRST "O" IN "BOBO'S".

SN 77-125,621, FILED 3-8-2007.

NATALIE POLZER, EXAMINING ATTORNEY

Int. Cls.: 29 and 30

Prior U.S. Cl.: 46

United States Patent and Trademark Office

Reg. No. 3,521,392

Registered Oct. 21, 2008

TRADEMARK
PRINCIPAL REGISTER



JACK DANIEL'S PROPERTIES, INC. (DELAWARE CORPORATION)
4040 CIVIC CENTER DRIVE, SUITE 528
SAN RAFAEL, CA 94903

FOR: PROCESSED FOOD PRODUCTS, NAMELY, PROCESSED FRUITS, PROCESSED VEGETABLES, PROCESSED OLIVES, PROCESSED MEATS, PROCESSED NUTS; DEHYDRATED FOOD PRODUCTS, NAMELY, DEHYDRATED FRUITS, DEHYDRATED VEGETABLES, DEHYDRATED MEATS; PICKLED FOOD PRODUCTS, NAMELY, PICKLED FRUITS, PICKLED VEGETABLES, PICKLED MEATS, IN CLASS 29 (U.S. CL. 46).

FIRST USE 1-24-2007; IN COMMERCE 1-24-2007.

FOR: PROCESSED FOOD PRODUCTS, NAMELY, PROCESSED COFFEE, PROCESSED TEA, PROCES-

SED HONEY; VINEGAR; SAUCES; SPICES, IN CLASS 30 (U.S. CL. 46).

FIRST USE 1-24-2008; IN COMMERCE 1-24-2008.

THE NAME(S), PORTRAIT(S), AND/OR SIGNATURE(S) SHOWN IN THE MARK DOES NOT IDENTIFY A PARTICULAR LIVING INDIVIDUAL.

THE MARK CONSISTS OF THE TEXT "MISS MARY BOBO'S" WITH A FRYING PAN IN PLACE OF THE FIRST "O" IN "BOBO'S".

SN 77-125,651, FILED 3-8-2007.

NATALIE POLZER, EXAMINING ATTORNEY

Int. Cl.: 14

Prior U.S. Cls.: 2, 27, 28, and 50

Reg. No. 3,521,393

United States Patent and Trademark Office

Registered Oct. 21, 2008

**TRADEMARK
PRINCIPAL REGISTER**

Angelic Allure

ANGELIC ALLURE LLC (DELAWARE LIMITED
LIABILITY COMPANY)
1310 S. BARRINGTON AVENUE APT. 5
LOS ANGELES, CA 90025

THE MARK CONSISTS OF STANDARD CHAR-
ACTERS WITHOUT CLAIM TO ANY PARTICULAR
FONT, STYLE, SIZE, OR COLOR.

FOR: BRACELETS; CHARMS; JEWELRY; LEA-
THER JEWELRY AND ACCESSORY BOXES; RINGS
BEING JEWELRY; EARRINGS; AND NECKLACES,
IN CLASS 14 (U.S. CLS. 2, 27, 28 AND 50).

SN 77-126,351, FILED 3-9-2007.

FIRST USE 8-31-2007; IN COMMERCE 8-31-2007.

SKYE YOUNG, EXAMINING ATTORNEY

Int. Cls.: 37 and 39

Prior U.S. Cls.: 100, 103, 105, and 106

United States Patent and Trademark Office

Reg. No. 3,521,394

Registered Oct. 21, 2008

**SERVICE MARK
PRINCIPAL REGISTER**

ECO-EDGE

ECO-EDGE, LLC (ARIZONA LIMITED LIABILITY COMPANY)
7400 WEST DETROIT, #150
CHANDLER, AZ 85226

FOR: INSTALLATION AND MAINTENANCE OF ENVIRONMENTAL AND EFFICIENCY PRODUCTS, NAMELY, COMBUSTION CATALYST SYSTEMS, DIESEL POWER KITS, AND FUEL AND OIL FILTRATION SYSTEMS, IN CLASS 37 (U.S. CLS. 100, 103 AND 106).

FIRST USE 7-25-2008; IN COMMERCE 7-25-2008.

FOR: DISTRIBUTION SERVICES, NAMELY, DELIVERY OF ENVIRONMENTAL AND EFFICIENCY

PRODUCTS, NAMELY, COMBUSTION CATALYST SYSTEMS, DIESEL POWER KITS, AND FUEL AND OIL FILTRATION SYSTEMS, IN CLASS 39 (U.S. CLS. 100 AND 105).

FIRST USE 7-25-2008; IN COMMERCE 7-25-2008.

THE MARK CONSISTS OF STANDARD CHARACTERS WITHOUT CLAIM TO ANY PARTICULAR FONT, STYLE, SIZE, OR COLOR.

SN 77-128,575, FILED 3-12-2007.

RICHARD A. STRASER, EXAMINING ATTORNEY

Int. Cl.: 10

Prior U.S. Cls.: 26, 39, and 44

United States Patent and Trademark Office

Reg. No. 3,521,395

Registered Oct. 21, 2008

**TRADEMARK
PRINCIPAL REGISTER**

Back to Life

BACK IN FIVE, LLC (CALIFORNIA LIMITED
LIABILITY COMPANY)
15250 VENTURA BLVD, SUITE 300
SHERMAN OAKS, CA 91403

FOR: DEVICE FOR PREVENTING OR RELIEV-
ING PAIN IN THE LOWER BACK, NAMELY,
EQUIPMENT FOR MOVEMENT AND STRETCH-
ING OF THE LOWER BACK FOR MEDICAL AND/
OR THERAPEUTIC PURPOSES, IN CLASS 10 (U.S.
CLS. 26, 39 AND 44).

FIRST USE 12-1-2007; IN COMMERCE 12-1-2007.

THE MARK CONSISTS OF STANDARD CHAR-
ACTERS WITHOUT CLAIM TO ANY PARTICULAR
FONT, STYLE, SIZE, OR COLOR.

SN 77-128,957, FILED 3-12-2007.

LAURIE KAUFMAN, EXAMINING ATTORNEY

Int. Cl.: 20

Prior U.S. Cls.: 2, 13, 22, 25, 32, and 50

Reg. No. 3,521,396

United States Patent and Trademark Office

Registered Oct. 21, 2008

**TRADEMARK
PRINCIPAL REGISTER**

ALBERRY

KOHLER CO. (WISCONSIN CORPORATION)
444 HIGHLAND DRIVE
KOHLER, WI 53044

THE MARK CONSISTS OF STANDARD CHAR-
ACTERS WITHOUT CLAIM TO ANY PARTICULAR
FONT, STYLE, SIZE, OR COLOR.

FOR: FURNITURE, IN CLASS 20 (U.S. CLS. 2, 13,
22, 25, 32 AND 50).

SN 77-129,031, FILED 3-12-2007.

FIRST USE 5-8-2007; IN COMMERCE 5-8-2007.

NAPOLEON SHARMA, EXAMINING ATTORNEY

Int. Cls.: 3, 5, and 16

**Prior U.S. Cls.: 1, 2, 4, 5, 6, 18, 22, 23, 29, 37, 38, 44,
46, 50, 51, and 52**

United States Patent and Trademark Office

Reg. No. 3,521,397

Registered Oct. 21, 2008

**TRADEMARK
PRINCIPAL REGISTER**

CLEARQUEST

PETEDGE, INC. (MASSACHUSETTS CORPORATION)
PO BOX 1000
BEVERLY, MA 019150700

FOR: PET STAIN REMOVERS; AND PET ODOR
REMOVERS, IN CLASS 3 (U.S. CLS. 1, 4, 6, 50, 51 AND
52).

FIRST USE 8-31-2007; IN COMMERCE 8-31-2007.

FOR: DISINFECTANTS FOR SANITARY PURPOSES,
IN CLASS 5 (U.S. CLS. 6, 18, 44, 46, 51 AND 52).

FIRST USE 8-31-2007; IN COMMERCE 8-31-2007.

FOR: DISPOSABLE HOUSEBREAKING PADS
FOR PETS, IN CLASS 16 (U.S. CLS. 2, 5, 22, 23, 29,
37, 38 AND 50).

FIRST USE 10-31-2007; IN COMMERCE 10-31-2007.

THE MARK CONSISTS OF STANDARD CHAR-
ACTERS WITHOUT CLAIM TO ANY PARTICULAR
FONT, STYLE, SIZE, OR COLOR.

SN 77-129,136, FILED 3-13-2007.

SETH A. RAPPAPORT, EXAMINING ATTORNEY

Int. Cl.: 34

Prior U.S. Cls.: 2, 8, 9, and 17

United States Patent and Trademark Office

Reg. No. 3,521,398

Registered Oct. 21, 2008

**TRADEMARK
PRINCIPAL REGISTER**

Puckifier

CIGARMONY LLC (VIRGINIA LIMITED LIABILITY COMPANY)
43449 LUCKETTS BRIDGE CIRCLE
ASHBURN, VA 20148

THE MARK CONSISTS OF STANDARD CHARACTERS WITHOUT CLAIM TO ANY PARTICULAR FONT, STYLE, SIZE, OR COLOR.

FOR: CIGAR HUMIDIFIERS, IN CLASS 34 (U.S. CLS. 2, 8, 9 AND 17).

SN 77-129,139, FILED 3-13-2007.

FIRST USE 7-17-2007; IN COMMERCE 7-17-2007.

JOHN KELLY, EXAMINING ATTORNEY

Int. Cl.: 7

Prior U.S. Cls.: 13, 19, 21, 23, 31, 34, and 35

Reg. No. 3,521,399

United States Patent and Trademark Office

Registered Oct. 21, 2008

**TRADEMARK
PRINCIPAL REGISTER**

OMNI TRAX

AIR TECHNICAL INDUSTRIES, INC. (OHIO
CORPORATION)
7501 CLOVER AVE
MENTOR, OH 44060

THE MARK CONSISTS OF STANDARD CHAR-
ACTERS WITHOUT CLAIM TO ANY PARTICULAR
FONT, STYLE, SIZE, OR COLOR.

FOR: POWER-OPERATED LIFTING AND MOV-
ING EQUIPMENT, NAMELY, PIPE LAYERS, FORK
LIFTS, TELEHANDLERS, AND LIFTS, IN CLASS 7
(U.S. CLS. 13, 19, 21, 23, 31, 34 AND 35).

SN 77-129,160, FILED 3-13-2007.

FIRST USE 12-1-2007; IN COMMERCE 8-21-2008.

ROBIN CHOSID, EXAMINING ATTORNEY

Int. Cls.: 1 and 5

Prior U.S. Cls.: 1, 5, 6, 10, 18, 26, 44, 46, 51, and 52

United States Patent and Trademark Office

Reg. No. 3,521,400

Registered Oct. 21, 2008

**TRADEMARK
PRINCIPAL REGISTER**

**RAMP**
Response Biomedical

RESPONSE BIOMEDICAL CORPORATION (CANADA CORPORATION)
100-8900 GLENLYON PARKWAY
BURNABY, CANADA V5J5J8

FOR: DISPOSABLE CARTRIDGES CONTAINING REAGENTS AND ASSAYS FOR SCIENTIFIC RESEARCH IN THE NATURE OF ENVIRONMENTAL AND FOOD TESTING , IN CLASS 1 (U.S. CLS. 1, 5, 6, 10, 26 AND 46).

FIRST USE 7-24-2007; IN COMMERCE 7-24-2007.

FOR: DISPOSABLE CARTRIDGES CONTAINING MEDICAL DIAGNOSTIC REAGENTS AND ASSAYS FOR USE IN ANALYZING BODY FLUIDS, IN CLASS 5 (U.S. CLS. 6, 18, 44, 46, 51 AND 52).

FIRST USE 10-22-2007; IN COMMERCE 10-22-2007.

OWNER OF U.S. REG. NOS. 2,605,067 AND 2,632,327.

NO CLAIM IS MADE TO THE EXCLUSIVE RIGHT TO USE "BIOMEDICAL", APART FROM THE MARK AS SHOWN.

THE MARK CONSISTS OF A GRAPHIC RAMP AND THE WORDS RESPONSE BIOMEDICAL.

SN 77-129,628, FILED 3-13-2007.

NICHOLAS ALTREE, EXAMINING ATTORNEY

Int. Cl.: 38

Prior U.S. Cls.: 100, 101, and 104

United States Patent and Trademark Office

Reg. No. 3,521,401

Registered Oct. 21, 2008

**SERVICE MARK
PRINCIPAL REGISTER**

LIVETOPIC

RELYNET, INC. (CALIFORNIA CORPORATION)
4962 ROBERT J MATTHEWS PARKWAY
EL DORADO HILLS, CA 95762

FOR: PROVIDING ON-LINE ELECTRONIC BULLETIN BOARDS FOR TRANSMISSION OF MESSAGES AMONG COMPUTER USERS CONCERNING FIELDS OF GENERAL INTEREST , IN CLASS 38 (U.S. CLS. 100, 101 AND 104).

FIRST USE 8-25-2008; IN COMMERCE 8-25-2008.

THE MARK CONSISTS OF STANDARD CHARACTERS WITHOUT CLAIM TO ANY PARTICULAR FONT, STYLE, SIZE, OR COLOR.

SN 77-129,745, FILED 3-13-2007.

SEAN CROWLEY, EXAMINING ATTORNEY

Int. Cl.: 11

Prior U.S. Cls.: 13, 21, 23, 31, and 34

United States Patent and Trademark Office

Reg. No. 3,521,402

Registered Oct. 21, 2008

**TRADEMARK
PRINCIPAL REGISTER**

PROLOGUE

KOHLER CO. (WISCONSIN CORPORATION)
444 HIGHLAND DRIVE
KOHLER, WI 53044

FOR: SINKS, IN CLASS 11 (U.S. CLS. 13, 21, 23, 31
AND 34).

FIRST USE 5-8-2007; IN COMMERCE 5-8-2007.

THE MARK CONSISTS OF STANDARD CHAR-
ACTERS WITHOUT CLAIM TO ANY PARTICULAR
FONT, STYLE, SIZE, OR COLOR.

SN 77-129,829, FILED 3-13-2007.

NAPOLEON SHARMA, EXAMINING ATTORNEY

Int. Cl.: 5

Prior U.S. Cls.: 6, 18, 44, 46, 51, and 52

United States Patent and Trademark Office

Reg. No. 3,521,403

Registered Oct. 21, 2008

**TRADEMARK
PRINCIPAL REGISTER**

LESS TIME AWAKE. MORE TIME
ASLEEP.

WYETH (DELAWARE CORPORATION)
FIVE GIRALDA FARMS
MADISON, NJ 07940

THE MARK CONSISTS OF STANDARD CHAR-
ACTERS WITHOUT CLAIM TO ANY PARTICULAR
FONT, STYLE, SIZE, OR COLOR.

FOR: ANALGESICS; SLEEP AID PREPARA-
TIONS, NAMELY, PHARMACEUTICAL PREPARA-
TIONS FOR SLEEP AID, IN CLASS 5 (U.S. CLS. 6, 18,
44, 46, 51 AND 52).

SN 77-131,519, FILED 3-15-2007.

FIRST USE 4-30-2007; IN COMMERCE 4-30-2007.

EMILY CHUO, EXAMINING ATTORNEY

Int. Cl.: 11

Prior U.S. Cls.: 13, 21, 23, 31, and 34

United States Patent and Trademark Office

Reg. No. 3,521,404

Registered Oct. 21, 2008

**TRADEMARK
PRINCIPAL REGISTER**

TORQ

KOHLER CO. (WISCONSIN CORPORATION)
444 HIGHLAND DRIVE
KOHLER, WI 53044

FOR: PLUMBING PRODUCTS, NAMELY, FAUCETS, IN CLASS 11 (U.S. CLS. 13, 21, 23, 31 AND 34).

FIRST USE 5-8-2007; IN COMMERCE 5-8-2007.

THE MARK CONSISTS OF STANDARD CHARACTERS WITHOUT CLAIM TO ANY PARTICULAR FONT, STYLE, SIZE, OR COLOR.

SN 77-131,737, FILED 3-15-2007.

NAPOLEON SHARMA, EXAMINING ATTORNEY

Int. Cl.: 12

Prior U.S. Cls.: 19, 21, 23, 31, 35, and 44

Reg. No. 3,521,405

United States Patent and Trademark Office

Registered Oct. 21, 2008

**TRADEMARK
PRINCIPAL REGISTER**

HOSS

FAIRPLAY ELECTRIC CARS, LLC (COLORADO
LIMITED LIABILITY COMPANY)
SUITE 333
743 HORIZON COURT
GRAND JUNCTION, CO 81506

THE MARK CONSISTS OF STANDARD CHAR-
ACTERS WITHOUT CLAIM TO ANY PARTICULAR
FONT, STYLE, SIZE, OR COLOR.

FOR: LAND VEHICLES, NAMELY, GAS AND
ELECTRIC POWERED UTILITY CARS, IN CLASS 12
(U.S. CLS. 19, 21, 23, 31, 35 AND 44).

SN 77-132,586, FILED 3-15-2007.

FIRST USE 10-31-2007; IN COMMERCE 10-31-2007.

NICHOLAS ALTREE, EXAMINING ATTORNEY

Int. Cl.: 43

Prior U.S. Cls.: 100 and 101

United States Patent and Trademark Office

Reg. No. 3,521,406

Registered Oct. 21, 2008

**SERVICE MARK
PRINCIPAL REGISTER**



RITA'S WATER ICE FRANCHISE COMPANY,
LLC (DELAWARE LIMITED LIABILITY COM-
PANY)
SUITE 310
1210 NORTHBROOK DRIVE
TREVOSSE, PA 19053

FOR: RESTAURANT SERVICES, IN CLASS 43
(U.S. CLS. 100 AND 101).

FIRST USE 1-0-2007; IN COMMERCE 1-0-2007.

OWNER OF U.S. REG. NOS. 2,614,810, 3,109,750,
AND OTHERS.

NO CLAIM IS MADE TO THE EXCLUSIVE
RIGHT TO USE "CUSTARD" AND "ICE", APART
FROM THE MARK AS SHOWN.

THE COLOR(S) RED, GREEN, WHITE, AND
LIGHT BLUE IS/ARE CLAIMED AS A FEATURE
OF THE MARK.

THE MARK CONSISTS OF THE WORD "RITA'S"
APPEARING IN WHITE OVER A GREEN BANNER,
WHICH LAYS OVER A CIRCLE OUTLINED IN
LIGHT BLUE WITH ALTERNATING VERTICAL
RED AND WHITE STRIPES, INSIDE A SEMI CIR-
CLE DOME OUTLINED IN GREEN WITH THE
WORDING ICE CUSTARD HAPPINESS APPEAR-
ING THEREON IN WHITE LETTERING OVER
GREEN.

SN 77-133,246, FILED 3-16-2007.

GRETТА YAO, EXAMINING ATTORNEY

Int. Cl.: 9

Prior U.S. Cls.: 21, 23, 26, 36, and 38

United States Patent and Trademark Office

Reg. No. 3,521,407

Registered Oct. 21, 2008

**TRADEMARK
PRINCIPAL REGISTER**

**Internal Positioning
Systems**

CONTESSA, CHRISTOPHER (UNITED STATES
INDIVIDUAL)
930 VIA MIL CUMBRES
#20
SOLANA BEACH, CA 92075

FOR: ELECTRONIC LCD ADVERTISEMENT DISPLAY UNIT WITH MULTI-NETWORKING (TCP/IP) CAPABILITIES; ELECTRONIC ADVERTISEMENT AND MESSAGING DISPLAY UNIT WITH MULTI-NETWORKING (TCP/IP) CAPABILITIES AND REMOTE CONNECTIVITY, IN CLASS 9 (U.S. CLS. 21, 23, 26, 36 AND 38).

FIRST USE 12-1-2007; IN COMMERCE 12-1-2007.

THE MARK CONSISTS OF STANDARD CHARACTERS WITHOUT CLAIM TO ANY PARTICULAR FONT, STYLE, SIZE, OR COLOR.

NO CLAIM IS MADE TO THE EXCLUSIVE RIGHT TO USE "SYSTEMS", APART FROM THE MARK AS SHOWN.

SN 77-133,908, FILED 3-18-2007.

PATRICIA EVANKO, EXAMINING ATTORNEY

Int. Cl.: 6

Prior U.S. Cls.: 2, 12, 13, 14, 23, 25, and 50

Reg. No. 3,521,408

United States Patent and Trademark Office

Registered Oct. 21, 2008

**TRADEMARK
PRINCIPAL REGISTER**

SAMSON POOLS

P.I. INC. (TENNESSEE CORPORATION)

1712 CONGRESS PARKWAY

ATHENS, TN 373710669

FOR: METAL SWIMMING POOLS, IN CLASS 6
(U.S. CLS. 2, 12, 13, 14, 23, 25 AND 50).

FIRST USE 8-1-2007; IN COMMERCE 8-1-2007.

THE MARK CONSISTS OF STANDARD CHARACTERS WITHOUT CLAIM TO ANY PARTICULAR FONT, STYLE, SIZE, OR COLOR.

NO CLAIM IS MADE TO THE EXCLUSIVE RIGHT TO USE "POOLS", APART FROM THE MARK AS SHOWN.

SN 77-134,339, FILED 3-19-2007.

JOHN WILKE, EXAMINING ATTORNEY

Int. Cl.: 41

Prior U.S. Cls.: 100, 101, and 107

United States Patent and Trademark Office

Reg. No. 3,521,409

Registered Oct. 21, 2008

**SERVICE MARK
PRINCIPAL REGISTER**

INSTINCT CIRCUIT PROGRAM

UNISEN, INC. (CALIFORNIA CORPORATION)
14410 MYFORD ROAD
IRVINE, CA 92606

FOR: PROVIDING INSTRUCTION AND EQUIP-
MENT IN THE FIELD OF EXERCISE AND FITNESS,
IN CLASS 41 (U.S. CLS. 100, 101 AND 107).

FIRST USE 6-0-2006; IN COMMERCE 6-0-2006.

THE MARK CONSISTS OF STANDARD CHAR-
ACTERS WITHOUT CLAIM TO ANY PARTICULAR
FONT, STYLE, SIZE, OR COLOR.

NO CLAIM IS MADE TO THE EXCLUSIVE
RIGHT TO USE "CIRCUIT PROGRAM", APART
FROM THE MARK AS SHOWN.

SN 77-134,516, FILED 3-19-2007.

RICHARD A. STRASER, EXAMINING ATTORNEY

Int. Cl.: 39

Prior U.S. Cls.: 100 and 105

United States Patent and Trademark Office

Reg. No. 3,521,410

Registered Oct. 21, 2008

**SERVICE MARK
PRINCIPAL REGISTER**



LATIN ASSIST, INC. (TEXAS CORPORATION)
STE. 1650
222 LAS COLINAS BLVD.
IRVING, TX 75039

FOR: ARRANGING FOR THE TRANSPORTATION AND REPATRIATION OF MORTAL REMAINS IN THE EVENT OF THE DEATH OF A TRAVELER, IN CLASS 39 (U.S. CLS. 100 AND 105).

FIRST USE 11-30-2007; IN COMMERCE 11-30-2007.

THE MARK CONSISTS OF THE WORDING "TUS BRAZOS HERMANOS" AND A STYLIZED REPRESENTATION OF HUMAN HANDS.

THE FOREIGN WORDING IN THE MARK TRANSLATES INTO ENGLISH AS YOUR BROTHERS ARMS OR YOUR FRATERNAL ARMS.

SN 77-135,550, FILED 3-20-2007.

GIANCARLO CASTRO, EXAMINING ATTORNEY

Int. Cl.: 44

Prior U.S. Cls.: 100 and 101

United States Patent and Trademark Office

Reg. No. 3,521,411

Registered Oct. 21, 2008

**SERVICE MARK
PRINCIPAL REGISTER**

**THE CENTER FOR
HABILITATIVE MEDICINE**

ACTIVA HEALTH SERVICES, INC. (CALIFORNIA CORPORATION)
201 COVINA AVE., STE. 4
LONG BEACH, CA 90803

FOR: CONSULTATION SERVICES IN THE FIELD OF PALLIATIVE CARE; CONSULTING SERVICES IN THE FIELD OF MENTAL FITNESS; CONSULTING SERVICES IN THE FIELD OF MENTAL HEALTH AND WELLNESS; HEALTH CARE; HEALTH CARE SERVICES, NAMELY, DISEASE MANAGEMENT PROGRAMS; HEALTH CARE SERVICES, NAMELY, WELLNESS PROGRAMS; HOME HEALTH CARE SERVICES; HOME NURSING AID SERVICES; MEDICAL ASSISTANCE SERVICES; MEDICAL EVALUATION SERVICES, NAMELY, FUNCTIONAL ASSESSMENT PROGRAM FOR PATIENTS RECEIVING MEDICAL REHABILITATION SERVICES FOR PURPOSES OF GUIDING TREATMENT AND ASSESSING PROGRAM EFFECTIVENESS; MEDICAL SERVICES; MENTAL HEALTH SERVICES; OCCUPATIONAL THERAPY SERVICES; PHYSICIAN SERVICES; PROVIDING A WEBSITE FEATURING INFORMATION IN THE FIELD OF MENTAL HEALTH AND WELLNESS; PROVIDING HEALTH CARE INFORMATION BY TELEPHONE AND THE INTERNET; PROVIDING HEALTH IN-

FORMATION; PROVIDING MEDICAL INFORMATION, CONSULTANCY AND ADVISORY SERVICES; PROVIDING SMOKING CESSATION TREATMENT SERVICES; PSYCHIATRIC SERVICES; PSYCHOTHERAPY SERVICES; SERVICES RENDERED BY A DIETICIAN; PHYSICAL REHABILITATION; PROVIDING PHYSICAL REHABILITATION FACILITIES; PHYSICAL THERAPY; SPEECH AND HEARING THERAPY; VITAMIN THERAPY; NURSING CARE, IN CLASS 44 (U.S. CLS. 100 AND 101).

FIRST USE 3-15-2007; IN COMMERCE 3-15-2007.

THE MARK CONSISTS OF STANDARD CHARACTERS WITHOUT CLAIM TO ANY PARTICULAR FONT, STYLE, SIZE, OR COLOR.

NO CLAIM IS MADE TO THE EXCLUSIVE RIGHT TO USE "CENTER" AND "MEDICINE", APART FROM THE MARK AS SHOWN.

SN 77-135,997, FILED 3-20-2007.

ARETHA SOMERVILLE, EXAMINING ATTORNEY

Int. Cl.: 9

Prior U.S. Cls.: 21, 23, 26, 36, and 38

Reg. No. 3,521,412

United States Patent and Trademark Office

Registered Oct. 21, 2008

**TRADEMARK
PRINCIPAL REGISTER**

CIRRUS

DAYMEN PHOTO MARKETING LP (CANADA
LIMITED PARTNERSHIP)
55 VALLEYWOOD DRIVE
MARKHAM, ONTARIO, CANADA L3R 5L9

FOR: BAGS, HARD AND SOFT COVERED CASES,
BACKPACKS, BELT PACKS, HOLSTER STYLE
BAGS, SHOULDER BAGS, MESSENGER BAGS,
POCKETS AND POUCHES, ALL DESIGNED FOR
CARRYING PHOTOGRAPHIC, VIDEOGRAPHIC,
OPTICAL, AUDIO, AND ELECTRONIC EQUIP-
MENT; FILM ORGANIZERS, NAMELY, CASES
FOR CARRYING EXPOSED AND UNEXPOSED
CAMERA FILM; CELL PHONE POUCHES; WAIST

HARNESSES AND SHOULDER HARNESSES DE-
SIGNATED FOR USE WITH THE FOREGOING
GOODS, IN CLASS 9 (U.S. CLS. 21, 23, 26, 36 AND 38).

FIRST USE 6-15-2007; IN COMMERCE 10-19-2007.

THE MARK CONSISTS OF STANDARD CHAR-
ACTERS WITHOUT CLAIM TO ANY PARTICULAR
FONT, STYLE, SIZE, OR COLOR.

SN 77-136,130, FILED 3-21-2007.

APRIL ROACH, EXAMINING ATTORNEY

Int. Cl.: 20

Prior U.S. Cls.: 2, 13, 22, 25, 32, and 50

Reg. No. 3,521,413

United States Patent and Trademark Office

Registered Oct. 21, 2008

**TRADEMARK
PRINCIPAL REGISTER**

ROD BOX

RICHARD PURCELL (UNITED STATES INDIVIDUAL)
879 SILVER OAK DRIVE
SPRING CREEK, NV 89815 AND
TERRY L. SCHNEIDER (UNITED STATES INDIVIDUAL)
HC 36-130, 130 MARTIN AVENUE
SPRING CREEK, NV 89815

FOR: NON-METAL TOOL BOXES, IN CLASS 20
(U.S. CLS. 2, 13, 22, 25, 32 AND 50).

FIRST USE 6-15-2008; IN COMMERCE 6-15-2008.

THE MARK CONSISTS OF STANDARD CHARACTERS WITHOUT CLAIM TO ANY PARTICULAR FONT, STYLE, SIZE, OR COLOR.

NO CLAIM IS MADE TO THE EXCLUSIVE RIGHT TO USE "BOX", APART FROM THE MARK AS SHOWN.

SN 77-136,566, FILED 3-21-2007.

REGINA DRUMMOND, EXAMINING ATTORNEY

Int. Cl.: 36

Prior U.S. Cls.: 100, 101, and 102

United States Patent and Trademark Office

Reg. No. 3,521,414

Registered Oct. 21, 2008

**SERVICE MARK
PRINCIPAL REGISTER**

SUN PRIME VUL

SUN LIFE ASSURANCE COMPANY OF CANADA (CANADA CORPORATION)
150 KING STREET WEST, SUITE 1400
TORONTO, CANADA M5H1J9

OWNER OF U.S. REG. NOS. 830,779, 2,667,674,
AND 2,760,810.

FOR: FINANCIAL SERVICES, NAMELY, UNDERWRITING, ISSUING AND ADMINISTRATION OF LIFE INSURANCE, IN CLASS 36 (U.S. CLS. 100, 101 AND 102).

NO CLAIM IS MADE TO THE EXCLUSIVE RIGHT TO USE "VUL", APART FROM THE MARK AS SHOWN.

FIRST USE 3-3-2008; IN COMMERCE 3-3-2008.

SN 77-136,677, FILED 3-21-2007.

THE MARK CONSISTS OF STANDARD CHARACTERS WITHOUT CLAIM TO ANY PARTICULAR FONT, STYLE, SIZE, OR COLOR.

PAULA MAHONEY, EXAMINING ATTORNEY

Int. Cl.: 16

Prior U.S. Cls.: 2, 5, 22, 23, 29, 37, 38, and 50

Reg. No. 3,521,415

United States Patent and Trademark Office

Registered Oct. 21, 2008

**TRADEMARK
PRINCIPAL REGISTER**

CONCIERGE

DANSON, RICHARD D. (UNITED STATES INDIVIDUAL)
216 W. PUEBLO STREET
SANTA BARBARA, CA 93105

FOR: PRINTED MEDICAL PUBLICATIONS, NAMELY, BOOKS, MAGAZINE, ARTICLES AND HEALTH BULLETINS ABOUT MEDICAL SUBJECTS; PRINTED HEALTHCARE PUBLICATIONS, NAMELY, BOOKS, MAGAZINES, ARTICLES AND HEALTH BULLETINS ABOUT HEALTHCARE; MEDICAL BOOKS, MAGAZINES, ARTICLES AND HEALTHCARE BULLETINS ABOUT MEDICAL

SUBJECTS AND HEALTHCARE, IN CLASS 16 (U.S. CLS. 2, 5, 22, 23, 29, 37, 38 AND 50).

FIRST USE 1-31-2004; IN COMMERCE 3-31-2007.

THE MARK CONSISTS OF STANDARD CHARACTERS WITHOUT CLAIM TO ANY PARTICULAR FONT, STYLE, SIZE, OR COLOR.

SN 77-136,796, FILED 3-21-2007.

GINA FINK, EXAMINING ATTORNEY

Int. Cls.: 9 and 41

Prior U.S. Cls.: 21, 23, 26, 36, 38, 100, 101, and 107

United States Patent and Trademark Office

Reg. No. 3,521,416

Registered Oct. 21, 2008

**TRADEMARK
SERVICE MARK
PRINCIPAL REGISTER**

BEHIND THE TEAM

UNITED STATES GYMNASTICS FEDERATION,
INC. (TEXAS NON-PROFIT CORPORATION)
SUITE 300
201 SOUTH CAPITAL AVENUE
INDIANAPOLIS, IN 46225

FOR: PRERECORDED AUDIO AND VIDEO
TAPES, AUDIO AND VIDEO DISKS, AND DIGITAL
MEDIA FEATURING ATHLETES AND ATHLETIC
EVENTS, IN CLASS 9 (U.S. CLS. 21, 23, 26, 36 AND 38).

FIRST USE 4-0-2007; IN COMMERCE 5-0-2007.

FOR: ENTERTAINMENT SERVICES, NAMELY,
PROVIDING ON-GOING INTERNET BASED
SHOWS AND PROGRAMMING FEATURING ATH-
LETES AND ATHLETIC EVENTS; ENTERTAIN-
MENT SERVICES, NAMELY, PROVIDING

DOCUMENTARY INFORMATION FEATURING
ATHLETES AND ATHLETIC EVENTS; ENTER-
TAINMENT SERVICES, NAMELY, PROVIDING
ON-GOING TELEVISION PROGRAMS FEATUR-
ING ATHLETES AND ATHLETIC EVENTS, IN
CLASS 41 (U.S. CLS. 100, 101 AND 107).

FIRST USE 4-0-2007; IN COMMERCE 5-0-2007.

THE MARK CONSISTS OF STANDARD CHAR-
ACTERS WITHOUT CLAIM TO ANY PARTICULAR
FONT, STYLE, SIZE, OR COLOR.

SN 77-136,861, FILED 3-21-2007.

RICHARD A. STRASER, EXAMINING ATTORNEY

Int. Cl.: 44

Prior U.S. Cls.: 100 and 101

United States Patent and Trademark Office

Reg. No. 3,521,417

Registered Oct. 21, 2008

**SERVICE MARK
PRINCIPAL REGISTER**

VLP

COLEN, HELEN (UNITED STATES INDIVIDUAL)
812 PARK AVENUE, APT. 13-D
NEW YORK, NY 10021

THE MARK CONSISTS OF STANDARD CHARACTERS WITHOUT CLAIM TO ANY PARTICULAR FONT, STYLE, SIZE, OR COLOR.

FOR: RECONSTRUCTIVE VAGINAL SURGERY,
IN CLASS 44 (U.S. CLS. 100 AND 101).

SN 77-136,886, FILED 3-21-2007.

FIRST USE 6-30-2006; IN COMMERCE 6-30-2006.

ROBIN MITTLER, EXAMINING ATTORNEY

Int. Cl.: 30

Prior U.S. Cl.: 46

United States Patent and Trademark Office

Reg. No. 3,521,418

Registered Oct. 21, 2008

**TRADEMARK
PRINCIPAL REGISTER**

CARIBBEAN TEA COMPANY

POLAR CORP. (MASSACHUSETTS CORPORATION)
1001 SOUTHBRIDGE STREET
WORCESTER, MA 01610

FOR: ICED TEA BEVERAGES, IN CLASS 30 (U.S. CL. 46).

FIRST USE 5-27-2007; IN COMMERCE 5-27-2007.

THE MARK CONSISTS OF STANDARD CHARACTERS WITHOUT CLAIM TO ANY PARTICULAR FONT, STYLE, SIZE, OR COLOR.

NO CLAIM IS MADE TO THE EXCLUSIVE RIGHT TO USE "TEA COMPANY", APART FROM THE MARK AS SHOWN.

SN 77-137,284, FILED 3-22-2007.

MATTHEW MCDOWELL, EXAMINING ATTORNEY

Int. Cl.: 35

Prior U.S. Cls.: 100, 101, and 102

United States Patent and Trademark Office

Reg. No. 3,521,419

Registered Oct. 21, 2008

**SERVICE MARK
PRINCIPAL REGISTER**

ONREQUEST IMAGESCAN

ONREQUEST IMAGES, INC. (DELAWARE CORPORATION)
SUITE 300
1415 WESTERN AVENUE
SEATTLE, WA 98101

FOR: BRAND CONSULTING SERVICES, NAME-
LY, REVIEWING AND SEARCHING THE INTER-
NET AND OTHER IMAGE DATABASES FOR USE
OF IMAGES BY COMPETITORS THAT ARE DUPLI-
CATIVE OF IMAGES FOUND IN CLIENT'S BRAND
IMAGE LIBRARY; BRAND CONSULTING SERVI-
CES, NAMELY, PREPARING AND PROVIDING
RECOMMENDATIONS FOR THE RESTRUCTUR-
ING OF THE CLIENT'S ADVERTISING BRAND

IMAGE LIBRARY, IN CLASS 35 (U.S. CLS. 100, 101
AND 102).

FIRST USE 2-1-2007; IN COMMERCE 3-7-2007.

THE MARK CONSISTS OF STANDARD CHAR-
ACTERS WITHOUT CLAIM TO ANY PARTICULAR
FONT, STYLE, SIZE, OR COLOR.

OWNER OF U.S. REG. NO. 3,130,892.

SN 77-137,479, FILED 3-22-2007.

KEVIN CORWIN, EXAMINING ATTORNEY

Int. Cl.: 25

Prior U.S. Cls.: 22 and 39

United States Patent and Trademark Office

Reg. No. 3,521,420

Registered Oct. 21, 2008

**TRADEMARK
PRINCIPAL REGISTER**

COME TRUE

GISKE, JEFFREY (UNITED STATES INDIVIDUAL)
333 EAST 56TH STREET
NEW YORK, NY 10022

THE MARK CONSISTS OF STANDARD CHARACTERS WITHOUT CLAIM TO ANY PARTICULAR FONT, STYLE, SIZE, OR COLOR.

FOR: SWEATERS; TOPS, IN CLASS 25 (U.S. CLS. 22 AND 39).

SN 77-137,610, FILED 3-22-2007.

FIRST USE 7-29-2008; IN COMMERCE 7-29-2008.

JAMES MACFARLANE, EXAMINING ATTORNEY

Int. Cl.: 12

Prior U.S. Cls.: 19, 21, 23, 31, 35, and 44

Reg. No. 3,521,421

United States Patent and Trademark Office

Registered Oct. 21, 2008

**TRADEMARK
PRINCIPAL REGISTER**

EMBARK

JAYCO, INC. (INDIANA CORPORATION)
903 SOUTH MAIN STREET, PO BOX 460
MIDDLEBURY, IN 46540

THE MARK CONSISTS OF STANDARD CHAR-
ACTERS WITHOUT CLAIM TO ANY PARTICULAR
FONT, STYLE, SIZE, OR COLOR.

FOR: RECREATIONAL VEHICLES, NAMELY,
MOTOR HOMES, IN CLASS 12 (U.S. CLS. 19, 21, 23,
31, 35 AND 44).

SN 77-138,442, FILED 3-23-2007.

FIRST USE 7-1-2008; IN COMMERCE 7-1-2008.

AISHA SALEM, EXAMINING ATTORNEY

Int. Cl.: 9

Prior U.S. Cls.: 21, 23, 26, 36, and 38

Reg. No. 3,521,422

United States Patent and Trademark Office

Registered Oct. 21, 2008

**TRADEMARK
PRINCIPAL REGISTER**

XTELECOM

SHENZHEN BANDSHINE COMMUNICATION
DEVELOPMENT CO., LTD. (CHINA COR-
PORATION)

S 4/F, BL. C, NO 1 BLDG, NO 2 IND. AREA
HEDONG, XIXIANG, 49 DIST., BAOAN
SHENZHEN, GUANGDONG, CHINA

FOR: PERSONAL STEREOS; SPECTACLES; BAT-
TERIES; SUPERVISION APPARATUS, NAMELY,
ELECTRIC THEFT PREVENTION ALARMS, NOT

FOR VEHICLES, IN CLASS 9 (U.S. CLS. 21, 23, 26, 36
AND 38).

FIRST USE 11-6-2006; IN COMMERCE 12-10-2007.

SN 77-139,800, FILED 3-26-2007.

JESSICA FATHY, EXAMINING ATTORNEY

Int. Cl.: 5

Prior U.S. Cls.: 6, 18, 44, 46, 51, and 52

United States Patent and Trademark Office

Reg. No. 3,521,423

Registered Oct. 21, 2008

**TRADEMARK
PRINCIPAL REGISTER**

HALLS NATURALS

CADBURY IRELAND LTD. (IRELAND CORPORATION)
MALAHIDE ROAD
COOLOCK, DUBLIN 5, IRELAND

OWNER OF U.S. REG. NOS. 762,199, 1,023,600,
AND OTHERS.

FOR: MEDICATED LOZENGES AND COUGH
DROPS, IN CLASS 5 (U.S. CLS. 6, 18, 44, 46, 51 AND
52).

NO CLAIM IS MADE TO THE EXCLUSIVE
RIGHT TO USE "NATURALS", APART FROM THE
MARK AS SHOWN.

FIRST USE 7-15-2007; IN COMMERCE 7-15-2007.

SN 77-139,903, FILED 3-26-2007.

THE MARK CONSISTS OF STANDARD CHAR-
ACTERS WITHOUT CLAIM TO ANY PARTICULAR
FONT, STYLE, SIZE, OR COLOR.

KEVON CHISOLM, EXAMINING ATTORNEY

Int. Cl.: 39

Prior U.S. Cls.: 100 and 105

United States Patent and Trademark Office

Reg. No. 3,521,424

Registered Oct. 21, 2008

SERVICE MARK
PRINCIPAL REGISTER



VANGUARD TRADEMARK HOLDINGS USA
LLC (DELAWARE LIMITED LIABILITY COM-
PANY)

6929 NORTH LAKEWOOD AVENUE, SUITE 100
TULSA, OK 741171808

FOR: VEHICLE RENTAL AND RESERVATION
SERVICES; VEHICLE LEASING SERVICES, IN
CLASS 39 (U.S. CLS. 100 AND 105).

FIRST USE 8-1-2007; IN COMMERCE 8-1-2007.

OWNER OF U.S. REG. NOS. 1,097,722, 2,427,041,
AND OTHERS.

THE COLOR(S) BLUE, CREME, YELLOW AND
BLACK IS/ARE CLAIMED AS A FEATURE OF THE
MARK.

THE MARK CONSISTS OF THE WORDS HAPPY
TRAILS IN BLUE OUTLINED IN CREME AND
BLACK WITH BLUE SHADOWS, THE WORD WITH
IN BLUE ON A CREME OVAL OUTLINED IN BLUE
AND THE TERM ALAMO IN YELLOW SURROUND-
ED BY A BLUE RECTANGLE WITH YELLOW
AND BLUE OUTLINES.

SN 77-140,040, FILED 3-26-2007.

AMY ALFIERI, EXAMINING ATTORNEY

Int. Cl.: 3

Prior U.S. Cls.: 1, 4, 6, 50, 51, and 52

Reg. No. 3,521,425

United States Patent and Trademark Office

Registered Oct. 21, 2008

**TRADEMARK
PRINCIPAL REGISTER**

DX

FANCL CORPORATION (JAPAN CORPORATION)
89-1, YAMASHITA-CHO
NAKA-KU, YOKOHAMA
KANAGAWA-KEN, JAPAN 231-8528

FOR: SKIN LOTIONS FOR COSMETIC PURPOSES; SKIN MILKY LOTIONS; COSMETIC CREAMS; COSMETIC PREPARATIONS FOR SKIN CARE, NAMELY, TONING LOTIONS FOR FACE, BODY,

AND HANDS; BEAUTY SERUMS, IN CLASS 3 (U.S. CLS. 1, 4, 6, 50, 51 AND 52).

FIRST USE 9-18-2007; IN COMMERCE 11-22-2007.

SN 77-140,529, FILED 3-26-2007.

FRANK LATTUCA, EXAMINING ATTORNEY

Int. Cl.: 6

Prior U.S. Cls.: 2, 12, 13, 14, 23, 25, and 50

Reg. No. 3,521,426

United States Patent and Trademark Office

Registered Oct. 21, 2008

**TRADEMARK
PRINCIPAL REGISTER**

DWR

DEACERO, S.A. DE C.V. (MEXICO CORPORATION)
AVE. LAZARO CARDENAS 2333
OTE. COL. VALLE OTE.
SAN PEDRO GARZA GARCIA, MEXICO N.L.66260

FIRST USE 3-27-2007; IN COMMERCE 3-27-2007.

THE MARK CONSISTS OF STANDARD CHARACTERS WITHOUT CLAIM TO ANY PARTICULAR FONT, STYLE, SIZE, OR COLOR.

FOR: DIAMOND-PATTERN WOVEN MESH COMPRISED OF METAL WIRE; METAL WIRE RODS AND METAL REINFORCING BARS , IN CLASS 6 (U.S. CLS. 2, 12, 13, 14, 23, 25 AND 50).

SN 77-143,171, FILED 3-28-2007.

RUSS HERMAN, EXAMINING ATTORNEY

Int. Cl.: 37

Prior U.S. Cls.: 100, 103, and 106

United States Patent and Trademark Office

Reg. No. 3,521,427

Registered Oct. 21, 2008

SERVICE MARK
PRINCIPAL REGISTER

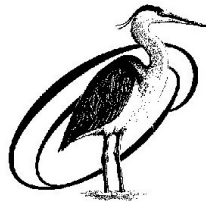

OCEANIA
Victoria

PLANK ROAD REALTY, LLC (MASSACHU-
SETTS LIMITED LIABILITY COMPANY)
98 ELM STREET
SALISBURY, MA 01952

FOR: LAND DEVELOPMENT SERVICES, NAME-
LY, PLANNING AND LAYING OUT OF RESIDEN-
TIAL AND/OR COMMERCIAL COMMUNITIES, IN
CLASS 37 (U.S. CLS. 100, 103 AND 106).

FIRST USE 11-27-2006; IN COMMERCE 11-27-2006.

THE MARK CONSISTS OF OCEANIA VICTORIA
WITH HERON ILLUSTRATION.

SN 77-143,556, FILED 3-29-2007.

NATALIE POLZER, EXAMINING ATTORNEY

Int. Cl.: 9

Prior U.S. Cls.: 21, 23, 26, 36, and 38

Reg. No. 3,521,428

United States Patent and Trademark Office

Registered Oct. 21, 2008

**TRADEMARK
PRINCIPAL REGISTER**

UNHCEMS

UNIVERSITY OF NEW HAMPSHIRE (NEW
HAMPSHIRE NON-PROFIT CORPORATION)
GREGG HALL
DURHAM, NH 03824

THE MARK CONSISTS OF STANDARD CHAR-
ACTERS WITHOUT CLAIM TO ANY PARTICULAR
FONT, STYLE, SIZE, OR COLOR.

FOR: SOFTWARE IN THE FIELD OF CHEMICAL
AND ENVIRONMENTAL MANAGEMENT, IN
CLASS 9 (U.S. CLS. 21, 23, 26, 36 AND 38).

SN 77-143,733, FILED 3-29-2007.

FIRST USE 8-6-2007; IN COMMERCE 8-6-2007.

GIANCARLO CASTRO, EXAMINING ATTORNEY

Int. Cls.: 6, 12, 24, and 25

Prior U.S. Cls.: 2, 12, 13, 14, 19, 21, 22, 23, 25, 31, 35,
39, 42, 44, and 50

Reg. No. 3,521,429

United States Patent and Trademark Office

Registered Oct. 21, 2008

TRADEMARK
PRINCIPAL REGISTER

BAD GAS

DUSTY'S GARAGE, LLC (WISCONSIN LIMITED
LIABILITY COMPANY)
W3889 890TH STREET
BALDWIN, WI 54002

FOR: METAL GAS CANS SOLD EMPTY, IN
CLASS 6 (U.S. CLS. 2, 12, 13, 14, 23, 25 AND 50).

FIRST USE 7-7-2008; IN COMMERCE 7-7-2008.

FOR: AUTOMOTIVE ACCESSORIES, NAMELY,
VALVE COVERS, LICENSE PLATE FRAMES, CAR
SEAT COVERS, VISOR ORGANIZERS, AND SEAT
ORGANIZERS, IN CLASS 12 (U.S. CLS. 19, 21, 23, 31,
35 AND 44).

FIRST USE 7-7-2008; IN COMMERCE 7-7-2008.

FOR: LAP BLANKETS, IN CLASS 24 (U.S. CLS. 42
AND 50).

FIRST USE 7-7-2008; IN COMMERCE 7-7-2008.

FOR: CLOTHING, NAMELY, SHIRTS, T-SHIRTS,
SWEATSHIRTS, UNDERWEAR, SLEEPWEAR,
NECKWEAR, BELTS, HEADWEAR, JACKETS, IN
CLASS 25 (U.S. CLS. 22 AND 39).

FIRST USE 7-1-2007; IN COMMERCE 7-1-2007.

THE MARK CONSISTS OF STANDARD CHAR-
ACTERS WITHOUT CLAIM TO ANY PARTICULAR
FONT, STYLE, SIZE, OR COLOR.

SN 77-143,865, FILED 3-29-2007.

ROBIN CHOSID, EXAMINING ATTORNEY

Int. Cl.: 12

Prior U.S. Cls.: 19, 21, 23, 31, 35, and 44

Reg. No. 3,521,430

United States Patent and Trademark Office

Registered Oct. 21, 2008

**TRADEMARK
PRINCIPAL REGISTER**

California Chrome

JAE ENTERPRISES, INC. (KENTUCKY CORPORATION)
209 RADIO ROAD
ALMO, KY 42020

FOR: CAPS FOR WHEEL RIMS; WHEEL COVERS; WHEEL DISKS FOR VEHICLES; HUB CAP COVERS; METAL PARTS FOR VEHICLES, NAMELY, AUTOMOTIVE EXTERIOR AND INTERIOR METAL DECORATIVE AND PROTECTIVE TRIM; PLASTIC PARTS FOR VEHICLES, NAMELY, AUTOMOTIVE EXTERIOR AND INTERIOR PLASTIC EXTRUDED DECORATIVE AND PROTECTIVE TRIM, IN CLASS 12 (U.S. CLS. 19, 21, 23, 31, 35 AND 44).

FIRST USE 9-12-2008; IN COMMERCE 9-12-2008.

THE MARK CONSISTS OF STANDARD CHARACTERS WITHOUT CLAIM TO ANY PARTICULAR FONT, STYLE, SIZE, OR COLOR.

NO CLAIM IS MADE TO THE EXCLUSIVE RIGHT TO USE "CHROME", APART FROM THE MARK AS SHOWN.

SN 77-143,898, FILED 3-29-2007.

ELIZABETH KAJUBI, EXAMINING ATTORNEY

Int. Cl.: 33

Prior U.S. Cls.: 47 and 49

United States Patent and Trademark Office

Reg. No. 3,521,431

Registered Oct. 21, 2008

TRADEMARK
PRINCIPAL REGISTER

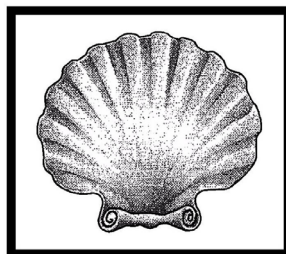

L A M E L L E
I L B O R R O

IL BORRO S.R.L. (ITALY LIMITED LIABILITY COMPANY)
TENUTA IL BORRO, SAN GIUSTINO VALDARNO
(AREZZO), ITALY

FOR: WINES, IN CLASS 33 (U.S. CLS. 47 AND 49).

FIRST USE 3-0-2007; IN COMMERCE 9-0-2007.

OWNER OF U.S. REG. NOS. 2,914,844 AND
3,052,016.

THE MARK CONSISTS OF A DEPICTION OF A
SEA-SHELL SURROUNDED BY A RECTANGULAR

BORDER. BENEATH THIS, THE WORD "LA-
MELLE" APPEARS OVER THE WORD "IL BORRO".
THESE WORDS ARE ALSO SURROUNDED BY A
RECTANGULAR BORDER.

THE FOREIGN WORDING IN THE MARK
TRANSLATES INTO ENGLISH AS "LAMELLAE"
AND THE ENGLISH TRANSLATION OF "IL BOR-
RO" IS THE GUILTY.

SN 77-144,817, FILED 3-30-2007.

DANIEL BRODY, EXAMINING ATTORNEY

Int. Cl.: 28

Prior U.S. Cls.: 22, 23, 38, and 50

United States Patent and Trademark Office

Reg. No. 3,521,432

Registered Oct. 21, 2008

**TRADEMARK
PRINCIPAL REGISTER**

PLAYERSGOAL

SPORTSFIELD SPECIALTIES, INC. (NEW YORK CORPORATION)
PO BOX 231, 41155 STATE HIGHWAY 10
DELHI, NY 13753

FOR: SPORTING GOODS, SPORTS EQUIPMENT AND SPORTS FIELD EQUIPMENT, NAMELY, SOCCER GOALS AND NETS, FIELD HOCKEY GOALS AND NETS, LACROSSE GOALS AND NETS, SOCCER CORNER FLAGS AND MARKERS, FIELD HOCKEY MARKERS, LACROSSE MARKERS, SOCCER GOAL SAFETY PADS AND TRAINING CONES, IN CLASS 28 (U.S. CLS. 22, 23, 38 AND 50).

FIRST USE 8-23-2007; IN COMMERCE 7-24-2008.

THE MARK CONSISTS OF STANDARD CHARACTERS WITHOUT CLAIM TO ANY PARTICULAR FONT, STYLE, SIZE, OR COLOR.

SN 77-144,899, FILED 3-30-2007.

DORITT L. CARROLL, EXAMINING ATTORNEY

Int. Cl.: 41

Prior U.S. Cls.: 100, 101, and 107

United States Patent and Trademark Office

Reg. No. 3,521,433

Registered Oct. 21, 2008

SERVICE MARK
PRINCIPAL REGISTER



CIS CONFERENCE, INC. (TEXAS CORPORATION)
4817 HWY 1417 NORTH
SHERMAN, TX 75092

FOR: EDUCATIONAL SERVICES, NAMELY, CONDUCTING CONFERENCES FOR UTILITY PERSONNEL IN THE FIELDS OF ELECTRICAL, TELEPHONE, TELEPHONY, GAS, WATER AND SEWER UTILITIES THAT WORK IN COOPERATIVES AND MUNICIPALITIES THROUGHOUT THE UNITED STATES AND FOREIGN COUNTRIES, IN CLASS 41 (U.S. CLS. 100, 101 AND 107).

FIRST USE 5-1-2007; IN COMMERCE 5-1-2007.

OWNER OF U.S. REG. NO. 3,196,021.

NO CLAIM IS MADE TO THE EXCLUSIVE RIGHT TO USE "CS" AND "WEEK" AND "COLLEGE", APART FROM THE MARK AS SHOWN.

THE COLOR(S) BLUE AND BLACK IS/ARE CLAIMED AS A FEATURE OF THE MARK.

THE MARK CONSISTS OF THE COLOR BLUE, WHICH APPEARS IN THE TERMS "CS" AND "WEEK" AND "COLLEGE"; AND THE COLOR BLACK WHICH APPEARS IN THE COLUMN AND THE LINE UNDER "CS" AND "WEEK".

SN 77-145,710, FILED 4-1-2007.

JEFF DEFORD, EXAMINING ATTORNEY

Int. Cls.: 5 and 29

Prior U.S. Cls.: 6, 18, 44, 46, 51, and 52

United States Patent and Trademark Office

Reg. No. 3,521,434

Registered Oct. 21, 2008

**TRADEMARK
PRINCIPAL REGISTER**



ABBOTT LABORATORIES (ILLINOIS CORPORATION)
100 ABBOTT PARK ROAD
ABBOTT PARK, IL 60064

FOR: DIETARY SUPPLEMENTAL DRINKS, NUTRITIONAL MEAL REPLACEMENT ENERGY BARS, IN CLASS 5 (U.S. CLS. 6, 18, 44, 46, 51 AND 52).

FIRST USE 8-6-2007; IN COMMERCE 8-6-2007.

FOR: NUTRITIONAL ENERGY BARS, NAMELY, FRUIT BASED FOOD BARS, PROTEIN BASED NUTRIENT DENSE SNACK BARS AND SOY-BASED FOOD BARS, IN CLASS 29 (U.S. CL. 46).

FIRST USE 8-6-2007; IN COMMERCE 8-6-2007.

THE COLOR(S) GREEN, DARK GREEN, LIME GREEN, BLACK, WHITE, PINK, ORANGE, YELLOW, LIGHT YELLOW, AND LIGHT PINK IS/ARE CLAIMED AS A FEATURE OF THE MARK.

THE MARK CONSISTS OF AN ALLIGATOR WITH A GREEN BODY WITH LIGHT YELLOW SHADING, DARK GREEN SPOTS THROUGHOUT THE BODY, A DARK GREEN RIDGE ON THE BACK, LIME GREEN UNDERSIDE OF BODY WITH LIGHT YELLOW SHADING, LIME GREEN LEFT HAND AND LEFT FOOT, BLACK SWIRLS ON KNEES AND RIGHT ELBOW, PINK TONGUE WITH LIGHT PINK SHADING, YELLOW EYES WITH WHITE AND LIGHT YELLOW SHADING, BLACK PUPILS WITH ORANGE RIMS AROUND THEM, WHITE SPECKS IN ORANGE RIMS AROUND PUPILS, GRAY SHADING UNDER NOSTRILS, WHITE TEETH, KICKING A BLACK AND WHITE SOCCER BALL WITH GRAY SHADING, ALL OF WHICH HAS A BLACK BORDER.

SN 77-145,882, FILED 4-2-2007.

TINA KUAN, EXAMINING ATTORNEY

Int. Cl.: 36

Prior U.S. Cls.: 100, 101, and 102

United States Patent and Trademark Office

Reg. No. 3,521,435

Registered Oct. 21, 2008

**SERVICE MARK
PRINCIPAL REGISTER**

PRECOR HOME FITNESS

AMER SPORTS INTERNATIONAL OY (FIN-
LAND CORPORATION)
MAKELANKATU 91
HELSINKI, FINLAND 00610

FOR: CREDIT CARD AND CHARGE CARD
SERVICES, IN CLASS 36 (U.S. CLS. 100, 101 AND 102).

FIRST USE 4-2-2007; IN COMMERCE 4-2-2007.

THE MARK CONSISTS OF STANDARD CHAR-
ACTERS WITHOUT CLAIM TO ANY PARTICULAR
FONT, STYLE, SIZE, OR COLOR.

OWNER OF U.S. REG. NOS. 1,282,674, 3,118,441,
AND 3,118,453.

NO CLAIM IS MADE TO THE EXCLUSIVE
RIGHT TO USE "HOME FITNESS", APART FROM
THE MARK AS SHOWN.

SN 77-145,932, FILED 4-2-2007.

AMOS T. MATTHEWS, JR., EXAMINING ATTOR-
NEY

Int. Cl.: 35

Prior U.S. Cls.: 100, 101, and 102

United States Patent and Trademark Office

Reg. No. 3,521,436

Registered Oct. 21, 2008

**SERVICE MARK
PRINCIPAL REGISTER**

SELECT2PERFORM

PREVISOR INC. (DELAWARE CORPORATION)
SUITE 150
1805 OLD ALABAMA ROAD
ROSWELL, GA 30076

FOR: PRE-EMPLOYMENT TESTING, ASSESSMENT AND SCREENING OF CANDIDATES AND APPLICANTS FOR JOBS FOCUSING ON COGNITIVE ABILITY, PSYCHOLOGICAL, SITUATIONAL JUDGMENT, SKILLS, INTELLIGENCE, AND BEHAVIORAL TESTS TO DETERMINE SUITABILITY, LIKELIHOOD OF SUCCESS AND STRENGTHS AND WEAKNESSES; EMPLOYEE TESTING AND ASSESSMENT SERVICES FOCUSING ON COGNITIVE ABILITY, PSYCHOLOGICAL, SITUATIONAL JUDGMENT, SKILLS, INTELLIGENCE, AND BE-

HAVIORAL TESTS TO DETERMINE SUITABILITY, LIKELIHOOD OF SUCCESS AND STRENGTHS AND WEAKNESSES; EMPLOYMENT COUNSELING AND RECRUITING SERVICES, NAMELY, INTERVIEWING AND PERSONNEL PLACEMENT, IN CLASS 35 (U.S. CLS. 100, 101 AND 102).

FIRST USE 9-30-2006; IN COMMERCE 9-30-2006.

THE MARK CONSISTS OF STANDARD CHARACTERS WITHOUT CLAIM TO ANY PARTICULAR FONT, STYLE, SIZE, OR COLOR.

SN 77-146,352, FILED 4-2-2007.

BENJAMIN ALLEN, EXAMINING ATTORNEY

Int. Cl.: 25

Prior U.S. Cls.: 22 and 39

United States Patent and Trademark Office

Reg. No. 3,521,437

Registered Oct. 21, 2008

**TRADEMARK
PRINCIPAL REGISTER**

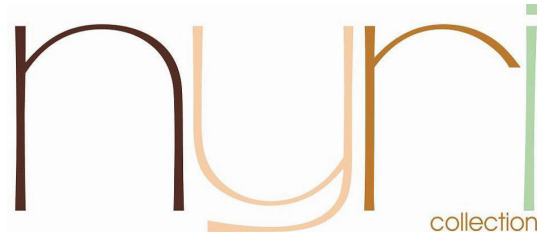

JENKINS, NYRISHA D (UNITED STATES INDIVIDUAL)
PO BOX 278
EAST ORANGE, NJ 07017

FOR: KNIT SHIRTS; SHORT-SLEEVED OR LONG-SLEEVED T-SHIRTS, IN CLASS 25 (U.S. CLS. 22 AND 39).

FIRST USE 7-15-2008; IN COMMERCE 8-1-2008.

NO CLAIM IS MADE TO THE EXCLUSIVE RIGHT TO USE "COLLECTION", APART FROM THE MARK AS SHOWN.

THE COLOR(S) DARK BROWN, PEACH, LIGHT BROWN, AND LIGHT GREEN IS/ARE CLAIMED AS A FEATURE OF THE MARK.

THE MARK CONSISTS OF DARK BROWN "N", PEACH "Y", LIGHT BROWN "R", LIGHT GREEN "I". THE WORD "COLLECTION" LIGHT BROWN BELOW THE "R" AND "I".

SN 77-147,240, FILED 4-3-2007.

STEPHEN AQUILA, EXAMINING ATTORNEY

Int. Cl.: 9

Prior U.S. Cls.: 21, 23, 26, 36, and 38

United States Patent and Trademark Office

Reg. No. 3,521,438

Registered Oct. 21, 2008

**TRADEMARK
PRINCIPAL REGISTER**

P&S SIGNATURE

PASS & SEYMOUR, INC. (NEW YORK CORPORATION)
50 BOYD AVENUE
SOLVAY, NY 13209

FOR: COVERS FOR ELECTRIC OUTLETS; ELECTRIC CONNECTORS; ELECTRIC LIGHT DIMMERS; ELECTRIC LIGHT SWITCHES; ELECTRIC OUTLET COVERS; ELECTRIC SWITCH PLATES; ELECTRIC SWITCHES; ELECTRICAL OUTLETS; ELECTRICAL PLUGS; ELECTRICAL RECEPTACLES, IN CLASS 9 (U.S. CLS. 21, 23, 26, 36 AND 38).

FIRST USE 7-1-2007; IN COMMERCE 7-1-2007.

THE MARK CONSISTS OF STANDARD CHARACTERS WITHOUT CLAIM TO ANY PARTICULAR FONT, STYLE, SIZE, OR COLOR.

OWNER OF U.S. REG. NO. 1,361,579.

SN 77-147,646, FILED 4-3-2007.

PRISCILLA MILTON, EXAMINING ATTORNEY

Int. Cl.: 9

Prior U.S. Cls.: 21, 23, 26, 36, and 38

United States Patent and Trademark Office

Reg. No. 3,521,439

Registered Oct. 21, 2008

**TRADEMARK
PRINCIPAL REGISTER**

P&S BETTER LIVING

PASS & SEYMOUR, INC. (NEW YORK CORPORATION)
50 BOYD AVENUE
SOLVAY, NY 13209

FOR: COVERS FOR ELECTRIC OUTLETS; ELECTRIC CONNECTORS; ELECTRIC LIGHT DIMMERS; ELECTRIC LIGHT SWITCHES; ELECTRIC OUTLET COVERS; ELECTRIC SWITCH PLATES; ELECTRIC SWITCHES; ELECTRICAL OUTLETS; ELECTRICAL PLUGS; ELECTRICAL RECEPTACLES, IN CLASS 9 (U.S. CLS. 21, 23, 26, 36 AND 38).

FIRST USE 7-1-2007; IN COMMERCE 7-1-2007.

THE MARK CONSISTS OF STANDARD CHARACTERS WITHOUT CLAIM TO ANY PARTICULAR FONT, STYLE, SIZE, OR COLOR.

OWNER OF U.S. REG. NO. 1,361,579.

SN 77-147,651, FILED 4-3-2007.

PRISCILLA MILTON, EXAMINING ATTORNEY

Int. Cl.: 9

Prior U.S. Cls.: 21, 23, 26, 36, and 38

United States Patent and Trademark Office

Reg. No. 3,521,440

Registered Oct. 21, 2008

**TRADEMARK
PRINCIPAL REGISTER**

P&S PREMIUM

PASS & SEYMOUR, INC. (NEW YORK CORPORATION)
50 BOYD AVENUE
SOLVAY, NY 13209

FOR: COVERS FOR ELECTRIC OUTLETS; ELECTRIC CONNECTORS; ELECTRIC LIGHT DIMMERS; ELECTRIC LIGHT SWITCHES; ELECTRIC OUTLET COVERS; ELECTRIC SWITCH PLATES; ELECTRIC SWITCHES; ELECTRICAL OUTLETS; ELECTRICAL PLUGS; ELECTRICAL RECEPTACLES, IN CLASS 9 (U.S. CLS. 21, 23, 26, 36 AND 38).

FIRST USE 7-1-2007; IN COMMERCE 7-1-2007.

THE MARK CONSISTS OF STANDARD CHARACTERS WITHOUT CLAIM TO ANY PARTICULAR FONT, STYLE, SIZE, OR COLOR.

OWNER OF U.S. REG. NO. 1,361,579.

NO CLAIM IS MADE TO THE EXCLUSIVE RIGHT TO USE "PREMIUM", APART FROM THE MARK AS SHOWN.

SN 77-147,656, FILED 4-3-2007.

PRISCILLA MILTON, EXAMINING ATTORNEY

Int. Cl.: 9

Prior U.S. Cls.: 21, 23, 26, 36, and 38

United States Patent and Trademark Office

Reg. No. 3,521,441

Registered Oct. 21, 2008

**TRADEMARK
PRINCIPAL REGISTER**

P&S HEAVY DUTY

PASS & SEYMOUR, INC. (NEW YORK CORPORATION)
50 BOYD AVENUE
SOLVAY, NY 13209

FOR: COVERS FOR ELECTRIC OUTLETS; ELECTRIC CONNECTORS; ELECTRIC LIGHT DIMMERS; ELECTRIC LIGHT SWITCHES; ELECTRIC OUTLET COVERS; ELECTRIC SWITCH PLATES; ELECTRIC SWITCHES; ELECTRICAL OUTLETS; ELECTRICAL PLUGS; ELECTRICAL RECEPTACLES, IN CLASS 9 (U.S. CLS. 21, 23, 26, 36 AND 38).

FIRST USE 7-1-2007; IN COMMERCE 7-1-2007.

THE MARK CONSISTS OF STANDARD CHARACTERS WITHOUT CLAIM TO ANY PARTICULAR FONT, STYLE, SIZE, OR COLOR.

OWNER OF U.S. REG. NO. 1,361,579.

NO CLAIM IS MADE TO THE EXCLUSIVE RIGHT TO USE "HEAVY DUTY", APART FROM THE MARK AS SHOWN.

SN 77-147,659, FILED 4-3-2007.

PRISCILLA MILTON, EXAMINING ATTORNEY

Int. Cl.: 9

Prior U.S. Cls.: 21, 23, 26, 36, and 38

United States Patent and Trademark Office

Reg. No. 3,521,442

Registered Oct. 21, 2008

**TRADEMARK
PRINCIPAL REGISTER**

P&S STANDARD

PASS & SEYMOUR, INC. (NEW YORK CORPORATION)
50 BOYD AVENUE
SOLVAY, NY 13209

FOR: COVERS FOR ELECTRIC OUTLETS; ELECTRIC CONNECTORS; ELECTRIC LIGHT DIMMERS; ELECTRIC LIGHT SWITCHES; ELECTRIC OUTLET COVERS; ELECTRIC SWITCH PLATES; ELECTRIC SWITCHES; ELECTRICAL OUTLETS; ELECTRICAL PLUGS; ELECTRICAL RECEPTACLES, IN CLASS 9 (U.S. CLS. 21, 23, 26, 36 AND 38).

FIRST USE 7-1-2007; IN COMMERCE 7-1-2007.

THE MARK CONSISTS OF STANDARD CHARACTERS WITHOUT CLAIM TO ANY PARTICULAR FONT, STYLE, SIZE, OR COLOR.

OWNER OF U.S. REG. NO. 1,361,579.

NO CLAIM IS MADE TO THE EXCLUSIVE RIGHT TO USE "STANDARD", APART FROM THE MARK AS SHOWN.

SN 77-147,662, FILED 4-3-2007.

PRISCILLA MILTON, EXAMINING ATTORNEY

Int. Cl.: 10

Prior U.S. Cls.: 26, 39, and 44

United States Patent and Trademark Office

Reg. No. 3,521,443

Registered Oct. 21, 2008

**TRADEMARK
PRINCIPAL REGISTER**

TUAKI

ACTIVE CONTROL INC. (DELAWARE COR-
PORATION)
66 NEPTUNE DRIVE
C/O JOEL S. DOUGLAS
GROTON, CT 06340

FOR: APPARATUS FOR CLINICAL DIAGNOSIS,
IN CLASS 10 (U.S. CLS. 26, 39 AND 44).

FIRST USE 6-4-2007; IN COMMERCE 6-4-2007.

THE MARK CONSISTS OF STANDARD CHAR-
ACTERS WITHOUT CLAIM TO ANY PARTICULAR
FONT, STYLE, SIZE, OR COLOR.

THE ENGLISH TRANSLATION OF THE MAORI
WORD "TUAKI" IN THE MARK IS DISSECT.

SN 77-148,180, FILED 4-4-2007.

HEATHER BIDDULPH, EXAMINING ATTORNEY

Int. Cl.: 19

Prior U.S. Cls.: 1, 12, 33, and 50

United States Patent and Trademark Office

Reg. No. 3,521,444

Registered Oct. 21, 2008

**TRADEMARK
PRINCIPAL REGISTER**

CYPRESS RIDGE

ELDORADO STONE OPERATIONS, LLC (UTAH
LIMITED LIABILITY COMPANY)
10653 S. RIVER FRONT PARKWAY, SUITE 300
SOUTH JORDAN, UT 84095

THE MARK CONSISTS OF STANDARD CHAR-
ACTERS WITHOUT CLAIM TO ANY PARTICULAR
FONT, STYLE, SIZE, OR COLOR.

FOR: BUILDING PRODUCTS, NAMELY, SYN-
THETIC, ARTIFICIAL, MANUFACTURED, AND
REFORMED STONES, IN CLASS 19 (U.S. CLS. 1, 12,
33 AND 50).

SN 77-148,223, FILED 4-4-2007.

FIRST USE 3-27-2007; IN COMMERCE 4-4-2007.

ALEX KEAM, EXAMINING ATTORNEY

Int. Cl.: 25

Prior U.S. Cls.: 22 and 39

United States Patent and Trademark Office

Reg. No. 3,521,445

Registered Oct. 21, 2008

**TRADEMARK
PRINCIPAL REGISTER**

THE G LINE

ROCKY BRANDS WHOLESALE LLC (DELA-
WARE LIMITED LIABILITY COMPANY)

39 EAST CANAL STREET

NELSONVILLE, OH 45764

FOR: FOOTWEAR, IN CLASS 25 (U.S. CLS. 22 AND
39).

FIRST USE 4-0-2007; IN COMMERCE 4-0-2007.

THE MARK CONSISTS OF STANDARD CHAR-
ACTERS WITHOUT CLAIM TO ANY PARTICULAR
FONT, STYLE, SIZE, OR COLOR.

NO CLAIM IS MADE TO THE EXCLUSIVE
RIGHT TO USE "LINE", APART FROM THE MARK
AS SHOWN.

SN 77-148,522, FILED 4-4-2007.

ELLEN B. AWRICH, EXAMINING ATTORNEY

Int. Cl.: 10

Prior U.S. Cls.: 26, 39, and 44

United States Patent and Trademark Office

Reg. No. 3,521,446

Registered Oct. 21, 2008

**TRADEMARK
PRINCIPAL REGISTER**

SURE BOND

NATVAR HOLDINGS, INC. (DELAWARE CORPORATION)
201 INDUSTRIAL PARKWAY
SOMERVILLE, NJ 08876

FOR: MEDICAL TUBING FOR COMPUTER TOMOGRAPHY, CARDIO-VASCULAR APPLICATION, ANGIOPLASTY, CATHETER DRAINAGE, DRUG DELIVERY INCLUDING INSULIN AND OTHER INTRAVENOUS DELIVERY, IN CLASS 10 (U.S. CLS. 26, 39 AND 44).

FIRST USE 7-14-2008; IN COMMERCE 7-31-2008.

THE MARK CONSISTS OF STANDARD CHARACTERS WITHOUT CLAIM TO ANY PARTICULAR FONT, STYLE, SIZE, OR COLOR.

NO CLAIM IS MADE TO THE EXCLUSIVE RIGHT TO USE "BOND", APART FROM THE MARK AS SHOWN.

SN 77-148,563, FILED 4-4-2007.

CARYN GLASSER, EXAMINING ATTORNEY

Int. Cl.: 9

Prior U.S. Cls.: 21, 23, 26, 36, and 38

United States Patent and Trademark Office

Reg. No. 3,521,447

Registered Oct. 21, 2008

**TRADEMARK
PRINCIPAL REGISTER**

CELLRX

AMETEK SOLIDSTATE CONTROLS (DELA-
WARE CORPORATION)
875 DEARBORN DRIVE
COLUMBUS, OH 43085

FOR: BATTERY MONITORING SYSTEM CON-
SISTING PRIMARILY OF AN ELECTRICAL CON-
TROLLER, AN ELECTRIC CURRENT SENSOR,
AND A DEVICE FOR COLLECTING DC AND AC
VOLTAGE READINGS TO OBTAIN REAL-TIME
AND TRENDING DATA FOR DETERMINING BAT-
TERY HEALTH, IN CLASS 9 (U.S. CLS. 21, 23, 26, 36
AND 38).

FIRST USE 1-0-2007; IN COMMERCE 1-0-2007.

THE MARK CONSISTS OF STANDARD CHAR-
ACTERS WITHOUT CLAIM TO ANY PARTICULAR
FONT, STYLE, SIZE, OR COLOR.

SN 77-148,730, FILED 4-4-2007.

AISHA CLARKE, EXAMINING ATTORNEY

Int. Cl.: 3

Prior U.S. Cls.: 1, 4, 6, 50, 51, and 52

United States Patent and Trademark Office

Reg. No. 3,521,448

Registered Oct. 21, 2008

**TRADEMARK
PRINCIPAL REGISTER**

SPORTIN' STYLE

L'OREAL USA CREATIVE, INC. (DELAWARE
CORPORATION)
575 FIFTH AVENUE
NEW YORK, NY 10017

FOR: HAIR CARE PREPARATIONS AND HAIR
STYLING PREPARATIONS, IN CLASS 3 (U.S. CLS. 1,
4, 6, 50, 51 AND 52).

FIRST USE 1-1-2008; IN COMMERCE 1-1-2008.

THE MARK CONSISTS OF STANDARD CHAR-
ACTERS WITHOUT CLAIM TO ANY PARTICULAR
FONT, STYLE, SIZE, OR COLOR.

OWNER OF U.S. REG. NOS. 1,352,327 AND
1,698,694.

SN 77-148,777, FILED 4-4-2007.

RONALD DELGIZZI, EXAMINING ATTORNEY

Int. Cl.: 25

Prior U.S. Cls.: 22 and 39

United States Patent and Trademark Office

Reg. No. 3,521,449

Registered Oct. 21, 2008

**TRADEMARK
PRINCIPAL REGISTER**

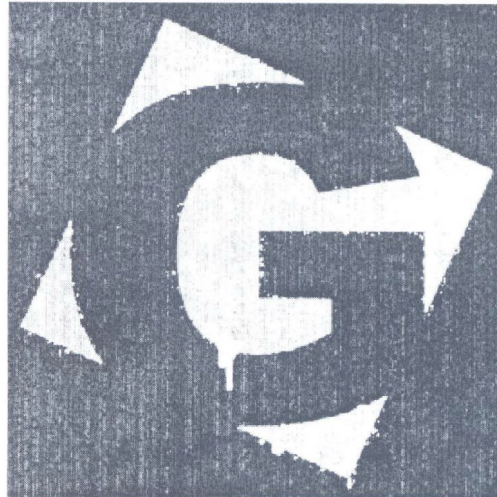

ROCKY BRANDS WHOLESALE LLC (DELA-
WARE LIMITED LIABILITY COMPANY)
39 EAST CANAL STREET
NELSONVILLE, OH 45764

FOR: CLOTHING, NAMELY, T-SHIRTS, JACK-
ETS, PARKAS, COATS, PULLOVERS, VESTS,
PANTS, JEANS, SHIRTS, BIB OVERALLS, COVER-
ALLS, SWEATERS, SWEATSHIRTS, TANK TOPS,
THERMAL UNDERWEAR, HEAD WEAR, NAME-
LY, HATS, CAPS AND HEAD COVER MASKS,
WADERS, RAINWEAR, NAMELY, RAINCOATS
AND RAIN PANTS, SOCKS; CLOTHING ACCES-

SORIES, NAMELY, GLOVES, BELTS, SUSPENDERS,
MITTENS, SWEATBANDS, BANDANNAS, AND
MUFFLERS; AND FOOTWEAR, IN CLASS 25 (U.S.
CLS. 22 AND 39).

FIRST USE 4-0-2007; IN COMMERCE 4-0-2007.

THE MARK CONSISTS OF THE LETTER "G"
ENCLOSED WITHIN A SLANTED SQUARE BOX.

SN 77-149,076, FILED 4-5-2007.

ELLEN B. AWRICH, EXAMINING ATTORNEY

Int. Cls.: 3 and 5

Prior U.S. Cls.: 1, 4, 6, 18, 44, 46, 50, 51, and 52

United States Patent and Trademark Office

Reg. No. 3,521,450

Registered Oct. 21, 2008

**TRADEMARK
PRINCIPAL REGISTER**

Essona

ESSONA ORGANICS, INC. (NEW YORK CORPORATION)
416 MAYNARD DR.
AMHERST, NY 14226

FOR: COSMETIC PREPARATIONS FOR SKIN RENEWAL; EXFOLIANTS FOR SKIN; COSMETIC CREAMS FOR SKIN CARE, IN CLASS 3 (U.S. CLS. 1, 4, 6, 50, 51 AND 52).

FIRST USE 4-30-2008; IN COMMERCE 4-30-2008.

FOR: DIETARY AND NUTRITIONAL SUPPLEMENTS; MINERAL NUTRITIONAL SUPPLEMENTS; NUTRITIONAL DRINK MIX FOR USE AS

A MEAL REPLACEMENT; NUTRITIONAL SUPPLEMENTS; POWDERED NUTRITIONAL SUPPLEMENT DRINK MIX, IN CLASS 5 (U.S. CLS. 6, 18, 44, 46, 51 AND 52).

FIRST USE 4-30-2008; IN COMMERCE 4-30-2008.

THE MARK CONSISTS OF STANDARD CHARACTERS WITHOUT CLAIM TO ANY PARTICULAR FONT, STYLE, SIZE, OR COLOR.

SN 77-149,513, FILED 4-5-2007.

GEOFFREY FOSDICK, EXAMINING ATTORNEY

Int. Cl.: 36

Prior U.S. Cls.: 100, 101, and 102

United States Patent and Trademark Office

Reg. No. 3,521,451

Registered Oct. 21, 2008

SERVICE MARK
PRINCIPAL REGISTER



**Material Handling
FINANCIAL SERVICES**

CLARK MATERIAL HANDLING COMPANY
(DELAWARE CORPORATION)
700 ENTERPRISE DRIVE
LEXINGTON, KY 40510

FOR: FINANCIAL SERVICES, NAMELY, LOAN SERVICES; FINANCIAL SERVICES, NAMELY, WHOLESALE, RETAIL AND OTHER LOAN SERVICES; FINANCIAL SERVICES, NAMELY, PROVIDING FINANCING FOR THE PURCHASE, LEASE OR RENTAL OF MATERIAL HANDLING EQUIPMENT, FORKLIFTS, OFF-ROAD VEHICLES, OVER-THE-ROAD TRUCKS AND MOTOR VEHICLES, AND PARTS, SERVICE AND INSURANCE THEREFOR; FINANCIAL SERVICES, NAMELY, PROVIDING WHOLESALE, RETAIL AND OTHER FINANCING FOR THE PURCHASE, LEASE OR RENTAL OF MATERIAL HANDLING EQUIPMENT, FORKLIFTS, OFF-ROAD VEHICLES, OVER-THE-ROAD TRUCKS AND MOTOR VEHICLES, AND PARTS, SERVICE AND INSURANCE

THEREFOR, IN CLASS 36 (U.S. CLS. 100, 101 AND 102).

FIRST USE 4-21-2007; IN COMMERCE 4-21-2007.

NO CLAIM IS MADE TO THE EXCLUSIVE RIGHT TO USE "MATERIAL HANDLING FINANCIAL SERVICES", APART FROM THE MARK AS SHOWN.

THE MARK CONSISTS OF THE WORD "CLARK" IN UPPER CASE STYLIZED LETTERS SURROUNDED BY A BORDER AND ABOVE THE WORDS "MATERIAL HANDLING" IN INITIAL CAPITAL LETTERS WITH THE WORDS "FINANCIAL SERVICES" BELOW IN CAPITAL LETTERS.

SN 77-150,721, FILED 4-6-2007.

GINA HAYES, EXAMINING ATTORNEY

Int. Cl.: 33

Prior U.S. Cls.: 47 and 49

United States Patent and Trademark Office

Reg. No. 3,521,452

Registered Oct. 21, 2008

**TRADEMARK
PRINCIPAL REGISTER**

LA MASIA

MARIMAR TORRES ESTATE CORPORATION
(CALIFORNIA CORPORATION)
11400 GRATON ROAD
SEBASTOPOL, CA 95472

THE FOREIGN WORDING IN THE MARK
TRANSLATES INTO ENGLISH AS COUNTRY
HOUSE.

FOR: WINE, IN CLASS 33 (U.S. CLS. 47 AND 49).

FIRST USE 12-6-2007; IN COMMERCE 12-6-2007.

SN 77-150,850, FILED 4-6-2007.

THE MARK CONSISTS OF STANDARD CHAR-
ACTERS WITHOUT CLAIM TO ANY PARTICULAR
FONT, STYLE, SIZE, OR COLOR.

KEVIN CORWIN, EXAMINING ATTORNEY

Int. Cls.: 5 and 16

**Prior U.S. Cls.: 2, 5, 6, 18, 22, 23, 29, 37, 38, 44, 46, 50,
51, and 52**

Reg. No. 3,521,453

United States Patent and Trademark Office

Registered Oct. 21, 2008

**TRADEMARK
PRINCIPAL REGISTER**

NUTRIBEAUTY

WALTER SMITH (UNITED STATES INDIVIDUAL)
46 WAKEMAN ROAD
NEW CANAAN, CT 06840

FOR: NUTRITIONAL SUPPLEMENTS, IN CLASS 5 (U.S. CLS. 6, 18, 44, 46, 51 AND 52).

FIRST USE 6-15-2008; IN COMMERCE 6-15-2008.

FOR: PRINTED PUBLICATIONS, NAMELY, NEWSLETTERS IN THE FIELDS OF HEALTH,

NUTRITION AND BEAUTY, IN CLASS 16 (U.S. CLS. 2, 5, 22, 23, 29, 37, 38 AND 50).

FIRST USE 6-22-2008; IN COMMERCE 6-22-2008.

THE MARK CONSISTS OF STANDARD CHARACTERS WITHOUT CLAIM TO ANY PARTICULAR FONT, STYLE, SIZE, OR COLOR.

SN 77-150,989, FILED 4-6-2007.

GIANCARLO CASTRO, EXAMINING ATTORNEY

Int. Cls.: 3, 5, 16, and 42

**Prior U.S. Cls.: 1, 2, 4, 5, 6, 18, 22, 23, 29, 37, 38, 44,
46, 50, 51, 52, 100, and 101**

Reg. No. 3,521,454

United States Patent and Trademark Office

Registered Oct. 21, 2008

**TRADEMARK
SERVICE MARK
PRINCIPAL REGISTER**

FUTURE BEAUTY

WALTER SMITH (UNITED STATES INDIVIDUAL)
46 WAKEMAN ROAD
NEW CANAAN, CT 06840

FOR: NON-MEDICATED SKINCARE PREPARATIONS, IN CLASS 3 (U.S. CLS. 1, 4, 6, 50, 51 AND 52).

FIRST USE 6-15-2008; IN COMMERCE 6-15-2008.

FOR: NUTRITIONAL SUPPLEMENTS, IN CLASS 5 (U.S. CLS. 6, 18, 44, 46, 51 AND 52).

FIRST USE 6-15-2008; IN COMMERCE 6-15-2008.

FOR: PRINTED PUBLICATIONS, NAMELY, NEWSLETTERS IN THE FIELDS OF HEALTH, NUTRITION AND BEAUTY, IN CLASS 16 (U.S. CLS. 2, 5, 22, 23, 29, 37, 38 AND 50).

FIRST USE 6-22-2008; IN COMMERCE 6-22-2008.

FOR: TESTING FOR NEW PRODUCT DEVELOPMENT; PRODUCT SAFETY AND EFFICACY TESTING AND CONSULTATION, IN CLASS 42 (U.S. CLS. 100 AND 101).

FIRST USE 12-1-2007; IN COMMERCE 12-1-2007.

THE MARK CONSISTS OF STANDARD CHARACTERS WITHOUT CLAIM TO ANY PARTICULAR FONT, STYLE, SIZE, OR COLOR.

NO CLAIM IS MADE TO THE EXCLUSIVE RIGHT TO USE "BEAUTY", APART FROM THE MARK AS SHOWN.

SN 77-150,992, FILED 4-6-2007.

GIANCARLO CASTRO, EXAMINING ATTORNEY

Int. Cl.: 9

Prior U.S. Cls.: 21, 23, 26, 36, and 38

United States Patent and Trademark Office

Reg. No. 3,521,455

Registered Oct. 21, 2008

**TRADEMARK
PRINCIPAL REGISTER**

KITCORE

SUBMERSIBLE MUSIC INC. (WASHINGTON CORPORATION)
505 UNION STATION
505 FIFTH AVENUE SOUTH
SEATTLE, WA 98104

FOR: COMPUTER SOFTWARE FEATURING A DATABASE OF MUSICAL INSTRUMENTAL SAMPLES AND LOOPS; AND COMPUTER SOFTWARE, FEATURING A DATABASE OF MUSICAL INSTRUMENTAL SAMPLES AND LOOPS THAT MAY BE DOWNLOADED FROM A GLOBAL COMPUTER

NETWORK, IN CLASS 9 (U.S. CLS. 21, 23, 26, 36 AND 38).

FIRST USE 7-1-2007; IN COMMERCE 7-1-2007.

THE MARK CONSISTS OF STANDARD CHARACTERS WITHOUT CLAIM TO ANY PARTICULAR FONT, STYLE, SIZE, OR COLOR.

SN 77-151,008, FILED 4-6-2007.

GIANCARLO CASTRO, EXAMINING ATTORNEY

Int. Cls.: 19 and 27

Prior U.S. Cls.: 1, 12, 19, 20, 33, 37, 42, and 50

United States Patent and Trademark Office

Reg. No. 3,521,456

Registered Oct. 21, 2008

**TRADEMARK
PRINCIPAL REGISTER**

LG FLOORS

LG CORP. (REPUBLIC OF KOREA CORPORATION)
20, YOIDO-DONG, YOUNGDUNGPO-GU
SEOUL, REPUBLIC OF KOREA

FOR: SYNTHETIC FLOORING MATERIALS, NAMELY, PVC FLOORING; FLOOR BOARDS MADE OF NON-METALLIC MATERIAL; PLASTIC TILES; VINYL TILES; FLOORING MADE OF NON-METALLIC MATERIALS, NAMELY, RUBBER FLOORING, LAMINATE FLOORING AND WOODEN FLOORING, IN CLASS 19 (U.S. CLS. 1, 12, 33 AND 50).

FIRST USE 1-0-2005; IN COMMERCE 1-0-2005.

FOR: PLASTIC FLOOR COVERINGS, FLOOR COVERINGS MADE OF NON-METALLIC MATERI-

AL, NAMELY, HARD SURFACE COVERINGS FOR FLOORS, IN CLASS 27 (U.S. CLS. 19, 20, 37, 42 AND 50).

FIRST USE 1-0-2005; IN COMMERCE 1-0-2005.

OWNER OF U.S. REG. NOS. 2,660,965, 3,250,591, AND OTHERS.

NO CLAIM IS MADE TO THE EXCLUSIVE RIGHT TO USE "FLOORS", APART FROM THE MARK AS SHOWN.

SN 77-152,572, FILED 4-10-2007.

HEATHER THOMPSON, EXAMINING ATTORNEY

Int. Cl.: 38

Prior U.S. Cls.: 100, 101, and 104

United States Patent and Trademark Office

Reg. No. 3,521,457

Registered Oct. 21, 2008

**SERVICE MARK
PRINCIPAL REGISTER**

FIBR2U

CHIBARDUN TELEPHONE COOPERATIVE, INC.
(WISCONSIN CORPORATION)
401 SOUTH 1ST STREET
CAMERON, WI 54822

FOR: TELECOMMUNICATIONS SERVICES, NAMELY, THE ELECTRONIC TRANSMISSION OF DATA, SOUND, TEXT, IMAGES AND VIDEO BY MEANS OF FIBER OPTIC CABLES; PROVIDING TELECOMMUNICATIONS CONNECTIONS TO A GLOBAL COMPUTER NETWORK; PROVIDING MULTIPLE-USER ACCESS TO A GLOBAL COMPUTER INFORMATION NETWORK; PROVIDING INTERNET ACCESS VIA A WIRELESS TELEPHONE; ELECTRONIC TELEPHONE VOICE MESSAGING SERVICES, NAMELY THE RECORDING AND SUBSEQUENT TRANSMISSION OF VOICE MESSAGES

OVER FIBER OPTIC CABLES; TEXT, NUMERIC AND PICTURE WIRELESS DIGITAL MESSAGING SERVICES AND ELECTRONIC MAIL SERVICES; VOICE OVER INTERNET PROTOCOL (VOIP) SERVICES; CABLE TELEVISION TRANSMISSION, IN CLASS 38 (U.S. CLS. 100, 101 AND 104).

FIRST USE 8-27-2007; IN COMMERCE 8-27-2007.

THE MARK CONSISTS OF STANDARD CHARACTERS WITHOUT CLAIM TO ANY PARTICULAR FONT, STYLE, SIZE, OR COLOR.

SN 77-153,077, FILED 4-10-2007.

LAURA HAMMEL, EXAMINING ATTORNEY

Int. Cl.: 1

Prior U.S. Cls.: 1, 5, 6, 10, 26, and 46

Reg. No. 3,521,458

United States Patent and Trademark Office

Registered Oct. 21, 2008

**TRADEMARK
PRINCIPAL REGISTER**

HELIOFAB

ENTHONE INC. (DELAWARE CORPORATION)
350 FRONTAGE ROAD
WEST HAVEN, CT 06516

THE MARK CONSISTS OF STANDARD CHAR-
ACTERS WITHOUT CLAIM TO ANY PARTICULAR
FONT, STYLE, SIZE, OR COLOR.

FOR: CHEMICALS USED FOR ELECTROPLAT-
ING DURING THE MANUFACTURE OF SOLAR
CELLS AND PHOTOVOLTAIC ARRAYS, IN CLASS 1
(U.S. CLS. 1, 5, 6, 10, 26 AND 46).

SN 77-154,033, FILED 4-11-2007.

FIRST USE 1-31-2008; IN COMMERCE 1-31-2008.

KAREN BRACEY, EXAMINING ATTORNEY

Int. Cl.: 15

Prior U.S. Cls.: 2, 21, and 36

United States Patent and Trademark Office

Reg. No. 3,521,459

Registered Oct. 21, 2008

TRADEMARK
PRINCIPAL REGISTER

Highland
ACOUSTIC INSTRUMENTS

AUDIOONE CORPORATION (CANADA CORPORATION)
7105A EDWARDS BL.
MISSISSAUGA, ONTARIO, CANADA L5S1Z2

FOR: STRINGED MUSICAL INSTRUMENTS,
NAMELY, ACOUSTIC, ACOUSTIC/ELECTRIC
AND ELECTRIC GUITARS AND ACOUSTIC,
ACOUSTIC/ELECTRIC AND ELECTRIC BASSES,
IN CLASS 15 (U.S. CLS. 2, 21 AND 36).

FIRST USE 4-0-2008; IN COMMERCE 4-0-2008.

NO CLAIM IS MADE TO THE EXCLUSIVE
RIGHT TO USE "ACOUSTIC INSTRUMENTS",
APART FROM THE MARK AS SHOWN.

SN 77-154,269, FILED 4-11-2007.

MELVIN AXILBUND, EXAMINING ATTORNEY

Int. Cl.: 40

Prior U.S. Cls.: 100, 103, and 106

United States Patent and Trademark Office

Reg. No. 3,521,460

Registered Oct. 21, 2008

**SERVICE MARK
PRINCIPAL REGISTER**

SUNGUARD SELECT

GUARDIAN INDUSTRIES CORP. (DELAWARE
CORPORATION)
2300 HARMON
AUBURN HILLS, MI 48326

FOR: PROVIDING TECHNICAL CONSULTAN-
CY, ADVICE, TROUBLESHOOTING AND INFOR-
MATION IN THE FIELD OF GLASS PROCESSING
AND FABRICATION, IN CLASS 40 (U.S. CLS. 100, 103
AND 106).

FIRST USE 2-0-2008; IN COMMERCE 2-0-2008.

THE MARK CONSISTS OF STANDARD CHAR-
ACTERS WITHOUT CLAIM TO ANY PARTICULAR
FONT, STYLE, SIZE, OR COLOR.

OWNER OF U.S. REG. NO. 2,269,325.

SN 77-154,879, FILED 4-12-2007.

MICHELLE DUBOIS, EXAMINING ATTORNEY

Int. Cl.: 42

Prior U.S. Cls.: 100 and 101

United States Patent and Trademark Office

Reg. No. 3,521,461

Registered Oct. 21, 2008

**SERVICE MARK
PRINCIPAL REGISTER**

ENVIRO.BLR.COM

BUSINESS & LEGAL REPORTS, INC. (CONNECTICUT CORPORATION)
141 MILL ROCK ROAD EAST
OLD SAYBROOK, CT 064754212

FOR: PROVIDING AN ON-LINE INFORMATIONAL, REFERENCE, EDUCATIONAL AND INTERACTIVE WEB SITE FOR ENVIRONMENTAL PROFESSIONALS, IN CLASS 42 (U.S. CLS. 100 AND 101).

FIRST USE 6-18-2008; IN COMMERCE 7-1-2008.

THE MARK CONSISTS OF STANDARD CHARACTERS WITHOUT CLAIM TO ANY PARTICULAR FONT, STYLE, SIZE, OR COLOR.

SN 77-155,463, FILED 4-12-2007.

MICHAEL WEBSTER, EXAMINING ATTORNEY

Int. Cl.: 10

Prior U.S. Cls.: 26, 39, and 44

United States Patent and Trademark Office

Reg. No. 3,521,462

Registered Oct. 21, 2008

**TRADEMARK
PRINCIPAL REGISTER**

MAXVENTURI

MAXTEC, INC. (UTAH CORPORATION)
6526 SOUTH COTTONWOOD STREET (300 WEST)
SALT LAKE CITY, UT 84106

FOR: MEDICAL INSTRUMENTS, NAMELY,
OXYGEN SENSORS, OXYGEN MONITORS, OXY-
GEN ANALYZERS AND OXYGEN BLENDERS, IN
CLASS 10 (U.S. CLS. 26, 39 AND 44).

FIRST USE 5-11-2007; IN COMMERCE 5-11-2007.

THE MARK CONSISTS OF STANDARD CHAR-
ACTERS WITHOUT CLAIM TO ANY PARTICULAR
FONT, STYLE, SIZE, OR COLOR.

SN 77-156,369, FILED 4-13-2007.

MATTHEW MCDOWELL, EXAMINING ATTOR-
NEY

Int. Cl.: 16

Prior U.S. Cls.: 2, 5, 22, 23, 29, 37, 38, and 50

Reg. No. 3,521,463

United States Patent and Trademark Office

Registered Oct. 21, 2008

**TRADEMARK
PRINCIPAL REGISTER**

AMY HODGEPODGE

GIMME DAP PRODUCTIONS, LLC (CALIFORNIA LIMITED LIABILITY COMPANY)
5951 VARIEL AVE.
WOODLAND HILLS, CA 91367

FOR: CHILDREN'S ACTIVITY BOOKS; CHILDREN'S BOOKS; COLORING BOOKS; COMIC BOOKS; NOTE BOOKS; SCHOOL SUPPLY KITS CONTAINING VARIOUS COMBINATIONS OF SELECTED SCHOOL SUPPLIES, NAMELY, WRITING INSTRUMENTS, PENS, PENCILS, MECHANICAL PENCILS, ERASERS, MARKERS, CRAYONS, HIGHLIGHTERS, FOLDERS, NOTEBOOKS, PAPER, GRADUATED RULERS, PROTRACTORS, PAPER CLIPS, PENCIL SHARPENERS, WRITING GRIPS, GLUE AND BOOK MARKS; TALKING CHILDREN'S BOOKS; BUMPER STICKERS; STICKERS; DECALS; TRADING CARDS; POSTERS; TEMPOR-

ARY TATTOOS; ILLUSTRATED NOTEPADS; PENS; PENCILS, IN CLASS 16 (U.S. CLS. 2, 5, 22, 23, 29, 37, 38 AND 50).

FIRST USE 8-22-2008; IN COMMERCE 8-22-2008.

THE MARK CONSISTS OF STANDARD CHARACTERS WITHOUT CLAIM TO ANY PARTICULAR FONT, STYLE, SIZE, OR COLOR.

THE NAME IDENTIFIED IN THE MARK, NAMELY, "AMY HODGEPODGE", DOES NOT IDENTIFY A LIVING INDIVIDUAL.

SN 77-156,570, FILED 4-13-2007.

SUE LAWRENCE, EXAMINING ATTORNEY

Int. Cl.: 25

Prior U.S. Cls.: 22 and 39

United States Patent and Trademark Office

Reg. No. 3,521,464

Registered Oct. 21, 2008

**TRADEMARK
PRINCIPAL REGISTER**

AMY HODGEPODGE

GIMME DAP PRODUCTIONS, LLC (CALIFORNIA LIMITED LIABILITY COMPANY)
5951 VARIEL AVE.
WOODLAND HILLS, CA 91367

FOR: HATS; SHIRTS; T-SHIRTS; PANTS; JEANS; JACKETS; SHOES; SOCKS; PAJAMAS; SLEEPWEAR; BATHING SUITS; RAINWEAR, IN CLASS 25 (U.S. CLS. 22 AND 39).

FIRST USE 8-22-2008; IN COMMERCE 8-22-2008.

THE MARK CONSISTS OF STANDARD CHARACTERS WITHOUT CLAIM TO ANY PARTICULAR FONT, STYLE, SIZE, OR COLOR.

THE NAME IDENTIFIED IN THE MARK, NAMELY, "AMY HODGEPODGE", DOES NOT IDENTIFY A LIVING INDIVIDUAL.

SN 77-156,601, FILED 4-13-2007.

SUE LAWRENCE, EXAMINING ATTORNEY

Int. Cl.: 44

Prior U.S. Cls.: 100 and 101

United States Patent and Trademark Office

Reg. No. 3,521,465

Registered Oct. 21, 2008

**SERVICE MARK
PRINCIPAL REGISTER**

**FRANCISCAN PHYSICIANS
HOSPITAL**

SISTERS OF ST. FRANCIS HEALTH SERVICES,
INC. (INDIANA CORPORATION)
1515 DRAGOON TRAIL
MISHAWAKA, IN 46544

OWNER OF U.S. REG. NO. 3,135,774.

FOR: HOSPITALS, IN CLASS 44 (U.S. CLS. 100
AND 101).

NO CLAIM IS MADE TO THE EXCLUSIVE
RIGHT TO USE "PHYSICIANS HOSPITAL", APART
FROM THE MARK AS SHOWN.

FIRST USE 11-1-2007; IN COMMERCE 11-1-2007.

SN 77-156,832, FILED 4-14-2007.

THE MARK CONSISTS OF STANDARD CHAR-
ACTERS WITHOUT CLAIM TO ANY PARTICULAR
FONT, STYLE, SIZE, OR COLOR.

SOPHIA S. KIM, EXAMINING ATTORNEY

Int. Cl.: 37

Prior U.S. Cls.: 100, 103, and 106

United States Patent and Trademark Office

Reg. No. 3,521,466

Registered Oct. 21, 2008

SERVICE MARK
PRINCIPAL REGISTER

OneServNet

GUY MARESH L (UNITED STATES INDIVIDUAL)
23900 SCOTT RIDGE TERRACE
SHERWOOD, OR 97140

FOR: VEHICLE MAINTENANCE CONSULTATION; VEHICLE REPAIR AND MAINTENANCE; VEHICLE SERVICE STATIONS; REPAIR OR MAINTENANCE OF COMPUTERS; AIRCRAFT MAINTENANCE OR REPAIR; AIRCRAFT REPAIR AND MAINTENANCE; AUTOMOBILE REPAIR AND MAINTENANCE; AUTOMOTIVE MAINTENANCE AND REPAIR; CAR REPAIR AND MAINTENANCE; INFORMATION WITH RELATION TO AIRCRAFT CONSTRUCTION, REPAIR AND MAINTENANCE; MAINTENANCE AND REPAIR OF COMPUTER HARDWARE; MAINTENANCE AND REPAIR OF COMPUTER NETWORKS; MAINTENANCE AND REPAIR OF TELECOMMUNICATIONS NETWORKS, APPARATUS, AND INSTRUMENTS; MAINTENANCE AND SERVICING OF MEDICAL IMAGING

APPARATUS USED IN MEDICAL IMAGING CENTERS; MAINTENANCE OF COMPUTER HARDWARE; MAINTENANCE OF MEDICAL APPARATUS AND INSTRUMENTS; REPAIR AND MAINTENANCE OF AIRCRAFT; REPAIR OR MAINTENANCE OF AUTOMOBILES; REPAIR OR MAINTENANCE OF MEDICAL MACHINES AND APPARATUS, IN CLASS 37 (U.S. CLS. 100, 103 AND 106).

FIRST USE 9-15-2007; IN COMMERCE 6-30-2008.

THE MARK CONSISTS OF STANDARD CHARACTERS WITHOUT CLAIM TO ANY PARTICULAR FONT, STYLE, SIZE, OR COLOR.

SN 77-157,441, FILED 4-16-2007.

HEATHER SAPP, EXAMINING ATTORNEY

Int. Cl.: 16

Prior U.S. Cls.: 2, 5, 22, 23, 29, 37, 38, and 50

United States Patent and Trademark Office

Reg. No. 3,521,467

Registered Oct. 21, 2008

**TRADEMARK
PRINCIPAL REGISTER**

TRUE TO YOU

AGC, LLC (DELAWARE LIMITED LIABILITY
COMPANY)
ONE AMERICAN ROAD
CLEVELAND, OH 44144

THE MARK CONSISTS OF STANDARD CHAR-
ACTERS WITHOUT CLAIM TO ANY PARTICULAR
FONT, STYLE, SIZE, OR COLOR.

FOR: GREETING CARDS, IN CLASS 16 (U.S. CLS.
2, 5, 22, 23, 29, 37, 38 AND 50).

SN 77-157,671, FILED 4-16-2007.

FIRST USE 7-31-2007; IN COMMERCE 7-31-2007.

MICHELE SWAIN, EXAMINING ATTORNEY

Int. Cl.: 35

Prior U.S. Cls.: 100, 101, and 102

United States Patent and Trademark Office

Reg. No. 3,521,468

Registered Oct. 21, 2008

**SERVICE MARK
PRINCIPAL REGISTER**

PRIME RESTAURANTS

PRIME RESTAURANTS OF AMERICA, INC.
(DELAWARE CORPORATION)
SUITE 600
10 KINGSBRIDGE GARDEN CIRCLE
MISSISSAUGA, ONTARIO, CANADA L5R3K6

FOR: FRANCHISING RESTAURANTS AND
BARS, IN CLASS 35 (U.S. CLS. 100, 101 AND 102).

FIRST USE 4-17-2008; IN COMMERCE 4-17-2008.

THE MARK CONSISTS OF STANDARD CHAR-
ACTERS WITHOUT CLAIM TO ANY PARTICULAR
FONT, STYLE, SIZE, OR COLOR.

NO CLAIM IS MADE TO THE EXCLUSIVE
RIGHT TO USE "RESTAURANTS", APART FROM
THE MARK AS SHOWN.

SN 77-157,843, FILED 4-16-2007.

WILLIAM ROSSMAN, EXAMINING ATTORNEY

Int. Cl.: 41

Prior U.S. Cls.: 100, 101, and 107

United States Patent and Trademark Office

Reg. No. 3,521,469

Registered Oct. 21, 2008

**SERVICE MARK
PRINCIPAL REGISTER**

I.A.M.I

MINTZ-BELLO, SUSAN (UNITED STATES INDIVIDUAL)
30 WEST 60 STREET, APT. 12G
NEW YORK, NY 10023

FOR: CONDUCTING WORKSHOPS AND SEMINARS USING ART TECHNIQUES TO PROMOTE SELF AWARENESS, EXPRESSIVE THERAPY AND SPIRITUAL DEVELOPMENT, IN CLASS 41 (U.S. CLS. 100, 101 AND 107).

FIRST USE 7-4-2008; IN COMMERCE 7-4-2008.

THE MARK CONSISTS OF STANDARD CHARACTERS WITHOUT CLAIM TO ANY PARTICULAR FONT, STYLE, SIZE, OR COLOR.

SN 77-158,189, FILED 4-17-2007.

FRANK LATTUCA, EXAMINING ATTORNEY

Int. Cls.: 35 and 42

Prior U.S. Cls.: 100, 101, and 102

United States Patent and Trademark Office

Reg. No. 3,521,470

Registered Oct. 21, 2008

**SERVICE MARK
PRINCIPAL REGISTER**

ATTEND-ESOURCE

METROCONNECTIONS, INC. (MINNESOTA CORPORATION)
1219 MARQUETTE AVENUE, #110
MINNEAPOLIS, MN 55403

FOR: CONSULTING SERVICES FOR PLANNING, ORGANIZING, AND IMPLEMENTING MEETINGS, BUSINESS CONFERENCES, CONVENTIONS, AND TRADE SHOWS , IN CLASS 35 (U.S. CLS. 100, 101 AND 102).

FIRST USE 5-7-2008; IN COMMERCE 5-7-2008.

FOR: DEVELOPING AND OPERATING WEBSITES FOR OTHERS, THAT ARE USED TO PROMOTE MEETINGS, BUSINESS CONFERENCES, CONVENTIONS, AND TRADE SHOWS, AND TO

ENABLE PARTICIPANTS TO RECEIVE INFORMATION ABOUT, REGISTER FOR, AND PARTICIPATE IN, MEETINGS, BUSINESS CONFERENCES, CONVENTIONS, AND TRADE SHOWS, IN CLASS 42 (U.S. CLS. 100 AND 101).

FIRST USE 5-7-2008; IN COMMERCE 5-7-2008.

THE MARK CONSISTS OF STANDARD CHARACTERS WITHOUT CLAIM TO ANY PARTICULAR FONT, STYLE, SIZE, OR COLOR.

SN 77-158,563, FILED 4-17-2007.

JESSICA A. POWERS, EXAMINING ATTORNEY

Int. Cl.: 41

Prior U.S. Cls.: 100, 101, and 107

United States Patent and Trademark Office

Reg. No. 3,521,471

Registered Oct. 21, 2008

SERVICE MARK
PRINCIPAL REGISTER



JITTERSWING, LLC (MISSOURI LIMITED LIABILITY COMPANY)

242 VISTAOAK CT.

BALLWIN, MO 63021

FOR: ORGANIZATION OF DANCING EVENTS; DANCE INSTRUCTION; SOCIAL CLUB FOR PEOPLE WITH AN INTEREST IN DANCING FOR CONDUCTING DANCING EVENTS, IN CLASS 41 (U.S. CLS. 100, 101 AND 107).

FIRST USE 6-0-2008; IN COMMERCE 6-0-2008.

NO CLAIM IS MADE TO THE EXCLUSIVE RIGHT TO USE "DANCE CLUB", APART FROM THE MARK AS SHOWN.

THE STIPPLING IS FOR SHADING PURPOSES ONLY.

THE MARK CONSISTS OF, IN PART, A SILHOUETTE OF A MAN AND WOMAN DANCING.

SN 77-158,826, FILED 4-17-2007.

ANDREA K. NADELMAN, EXAMINING ATTORNEY

Int. Cl.: 30

Prior U.S. Cl.: 46

United States Patent and Trademark Office

Reg. No. 3,521,472

Registered Oct. 21, 2008

**TRADEMARK
PRINCIPAL REGISTER**

HOOSIER MAMA COOKIES

WILCOXSON, BRENT (UNITED STATES INDIVIDUAL)
502 WEST CHESTNUT AVENUE
WINONA LAKE, IN 46590

NO CLAIM IS MADE TO THE EXCLUSIVE RIGHT TO USE "HOOSIER" AND "COOKIES", APART FROM THE MARK AS SHOWN.

FOR: BAKERY GOODS, IN CLASS 30 (U.S. CL. 46).

FIRST USE 7-1-2007; IN COMMERCE 7-1-2007.

SN 77-159,154, FILED 4-18-2007.

THE MARK CONSISTS OF STANDARD CHARACTERS WITHOUT CLAIM TO ANY PARTICULAR FONT, STYLE, SIZE, OR COLOR.

ANTHONY RINKER, EXAMINING ATTORNEY

Int. Cl.: 41

Prior U.S. Cls.: 100, 101, and 107

United States Patent and Trademark Office

Reg. No. 3,521,473

Registered Oct. 21, 2008

**SERVICE MARK
PRINCIPAL REGISTER**



CONNECTICUT ATTORNEYS TITLE INSURANCE COMPANY (CONNECTICUT CORPORATION)
101 CORPORATE PLACE
ROCKY HILL, CT 060671895

FOR: EDUCATIONAL SERVICES, NAMELY, WORKSHOPS AND SEMINARS IN THE FIELD OF TITLE SEARCHING AND REAL PROPERTY LAW, IN CLASS 41 (U.S. CLS. 100, 101 AND 107).

FIRST USE 11-1-2007; IN COMMERCE 11-1-2007.

OWNER OF U.S. REG. NOS. 2,100,831, 3,131,152, AND OTHERS.

THE MARK CONSISTS OF A BLOCK "C" DESIGN WITH THE WORDS "CATIC ACCESS TO SUCCESS."

SN 77-159,191, FILED 4-18-2007.

CHRIS WELLS, EXAMINING ATTORNEY

Int. Cl.: 35

Prior U.S. Cls.: 100, 101, and 102

United States Patent and Trademark Office

Reg. No. 3,521,474

Registered Oct. 21, 2008

**SERVICE MARK
PRINCIPAL REGISTER**



CONNECTICUT ATTORNEYS TITLE INSURANCE COMPANY (CONNECTICUT CORPORATION)
101 CORPORATE PLACE
ROCKY HILL, CT 060671895

FOR: PROMOTING THE GOODS AND SERVICES OF OTHERS BY MEANS OF AN AFFINITY PROGRAM FEATURING DISCOUNTS AND OTHER INCENTIVES FROM SELECTED VENDORS, VIA DIRECT MAIL AND OTHER MEANS; AND PROMOTING THE GOODS AND SERVICES OF OTHERS BY PROVIDING INFORMATION VIA A SPECIAL LOCATION ON WEB SITES FEATURING SELECTED VENDORS AND THEIR PRODUCTS, SERVI-

CES, DISCOUNTS AND OTHER INCENTIVES, IN CLASS 35 (U.S. CLS. 100, 101 AND 102).

FIRST USE 11-1-2007; IN COMMERCE 11-1-2007.

OWNER OF U.S. REG. NOS. 2,100,831, 3,099,414, AND OTHERS.

THE MARK CONSISTS OF A BLOCK "C" DESIGN WITH THE WORDS "CATIC ACCESS TO SUCCESS."

SN 77-159,195, FILED 4-18-2007.

CHRIS WELLS, EXAMINING ATTORNEY

Int. Cl.: 36

Prior U.S. Cls.: 100, 101, and 102

United States Patent and Trademark Office

Reg. No. 3,521,475

Registered Oct. 21, 2008

**SERVICE MARK
PRINCIPAL REGISTER**



CONNECTICUT ATTORNEYS TITLE INSURANCE COMPANY (CONNECTICUT CORPORATION)

101 CORPORATE PLACE
ROCKY HILL, CT 060671895

FOR: TITLE INSURANCE, NAMELY, THE ISSUANCE OF POLICIES; PROVIDING MORTGAGE INFORMATION, ALSO VIA ELECTRONIC MEANS, TELEPHONE OR OTHER FORMS OF DATA TRANSFER; MORTGAGE RELEASE AND DISCHARGE TRACKING SERVICES; OBTAINING AND RECORDING MORTGAGE RELEASES; GENERATING AND RECORDING AFFIDAVIT OF RELEASE DOCUMENTS IN THE FIELD OF MORTGAGES; PROVIDING AN ONLINE DATA-

BASE OF MORTGAGE STATUS INFORMATION, IN CLASS 36 (U.S. CLS. 100, 101 AND 102).

FIRST USE 11-1-2007; IN COMMERCE 11-1-2007.

OWNER OF U.S. REG. NOS. 2,100,831, 3,099,414, AND OTHERS.

THE MARK CONSISTS OF A BLOCK "C" DESIGN WITH THE WORDS "CATIC ACCESS TO SUCCESS."

SN 77-159,214, FILED 4-18-2007.

CHRIS WELLS, EXAMINING ATTORNEY

Int. Cl.: 16

Prior U.S. Cls.: 2, 5, 22, 23, 29, 37, 38, and 50

United States Patent and Trademark Office

Reg. No. 3,521,476

Registered Oct. 21, 2008

**TRADEMARK
PRINCIPAL REGISTER**



CONNECTICUT ATTORNEYS TITLE INSUR-
ANCE COMPANY (CONNECTICUT COR-
PORATION)
101 CORPORATE PLACE
ROCKY HILL, CT 060671895

FOR: PRINTED PUBLICATIONS, NAMELY,
NEWSLETTERS, BULLETINS, AND PROFESSION-
AL JOURNALS IN THE FIELD OF TITLE INSUR-
ANCE AND REAL PROPERTY LAW, IN CLASS 16
(U.S. CLS. 2, 5, 22, 23, 29, 37, 38 AND 50).

FIRST USE 11-1-2007; IN COMMERCE 11-1-2007.

OWNER OF U.S. REG. NOS. 2,100,831, 3,099,414,
AND OTHERS.

THE MARK CONSISTS OF A BLOCK "C" DESIGN
WITH THE WORDS "CATIC ACCESS TO SUCCESS."

SN 77-159,219, FILED 4-18-2007.

CHRIS WELLS, EXAMINING ATTORNEY

Int. Cl.: 42

Prior U.S. Cls.: 100 and 101

United States Patent and Trademark Office

Reg. No. 3,521,477

Registered Oct. 21, 2008

**SERVICE MARK
PRINCIPAL REGISTER**

V-TRADER

VERSIFY, LLC (PENNSYLVANIA LIMITED LIABILITY COMPANY)
SUITE 303
5 CHRISTY DRIVE
CHADDS FORD, PA 19317

FOR: APPLICANT SERVICE PROVIDER (ASP) FEATURING SOFTWARE FOR ANALYZING POWER TRADE PRICE DATA FOR USE BY POWER TRADERS, IN CLASS 42 (U.S. CLS. 100 AND 101).

FIRST USE 3-0-2006; IN COMMERCE 6-0-2006.

THE MARK CONSISTS OF STANDARD CHARACTERS WITHOUT CLAIM TO ANY PARTICULAR FONT, STYLE, SIZE, OR COLOR.

SN 77-159,245, FILED 4-18-2007.

JENNY PARK, EXAMINING ATTORNEY

Int. Cl.: 24

Prior U.S. Cls.: 42 and 50

United States Patent and Trademark Office

Reg. No. 3,521,478

Registered Oct. 21, 2008

**TRADEMARK
PRINCIPAL REGISTER**

REEF

SOUTH CONE, INC. (CALIFORNIA CORPORATION)
5935 DARWIN COURT
CARLSBAD, CA 92008

FOR: BEACH TOWELS, IN CLASS 24 (U.S. CLS. 42 AND 50).

FIRST USE 8-1-2004; IN COMMERCE 8-1-2004.

THE MARK CONSISTS OF STANDARD CHARACTERS WITHOUT CLAIM TO ANY PARTICULAR FONT, STYLE, SIZE, OR COLOR.

OWNER OF U.S. REG. NOS. 2,244,373, 2,418,438, AND OTHERS.

SN 77-159,625, FILED 4-18-2007.

MAUREEN DALL, EXAMINING ATTORNEY

Int. Cls.: 3 and 44

Prior U.S. Cls.: 1, 4, 6, 50, 51, 52, 100, and 101

United States Patent and Trademark Office

Reg. No. 3,521,479

Registered Oct. 21, 2008

**TRADEMARK
SERVICE MARK
PRINCIPAL REGISTER**

JONATHAN JOSEPH

JONATHAN JOSEPH, INC. (CALIFORNIA CORPORATION)

#319

7162 BEVERLY BLVD

LOS ANGELES, CA 90036

FOR: AFTER-SHAVE; ANTI-AGING CREAM; ANTI-PERSPIRANTS; ANTI-WRINKLE CREAMS; BABY OILS; BABY POWDERS; BATH BEADS; BATH CRYSTALS; BATH MILKS; BATH OILS; BATH POWDER; BODY POWDER; BODY SPRAYS; COLOGNE; COSMETICS; COTTON FOR COSMETIC PURPOSES; CUTICLE CREAM; DEPILATORIES; ESSENTIAL OILS; FACE AND BODY GLITTER; FACE CREAMS; FACIAL CLEANSERS; FACIAL WASHES; FOOT POWDER; GEL EYE MASKS; HAIR CARE PREPARATIONS; HAIR CONDITIONERS; HAIR CREAMS; HAIR DYES; HAIR GELS; HAIR MOUSSES; HAIR NOURISHERS; HAIR OILS; HAIR RELAXERS; HAIR RINSES; HAIR SHAMPOO; HAIR SPRAY; HAND LOTIONS; HAND SOAPS; INCENSE; MAKE-UP; MAKE-UP REMOVER; MASSAGE OILS; NAIL POLISH; NAIL POLISH REMOVERS; NON-MEDICATED FOOT CREAM; PERFUMES; POTPOURRI; SHAVING CREAMS; SHAVING PREPARATIONS; SKIN AND BODY TOPICAL LOTIONS, CREAMS AND OILS FOR COSMETIC

USE; SOAPS FOR BODY CARE; SUN BLOCK; SUNTANNING PREPARATIONS, IN CLASS 3 (U.S. CLS. 1, 4, 6, 50, 51 AND 52).

FIRST USE 1-16-1992; IN COMMERCE 1-31-1992.

FOR: BEAUTY SALONS; HAIR CUTTING; HAIR STYLING; HAIRDRESSING SALONS; HAIRDRESSING SERVICES; HEALTH SPA SERVICES, NAMELY, COSMETIC BODY CARE SERVICES, IN CLASS 44 (U.S. CLS. 100 AND 101).

FIRST USE 1-16-1992; IN COMMERCE 1-31-1992.

THE MARK CONSISTS OF STANDARD CHARACTERS WITHOUT CLAIM TO ANY PARTICULAR FONT, STYLE, SIZE, OR COLOR.

THE NAME(S), PORTRAIT(S), AND/OR SIGNATURE(S) SHOWN IN THE MARK IDENTIFIES A LIVING INDIVIDUAL, WHOSE CONSENT(S) TO REGISTER IS MADE OF RECORD.

SN 77-159,808, FILED 4-18-2007.

BARBARA BROWN, EXAMINING ATTORNEY

Int. Cls.: 9 and 41

Prior U.S. Cls.: 21, 23, 26, 36, 38, 100, 101, and 107

United States Patent and Trademark Office

Reg. No. 3,521,480

Registered Oct. 21, 2008

**TRADEMARK
SERVICE MARK
PRINCIPAL REGISTER**

PEYTON JAMES

JAMES, PEYTON (UNITED STATES INDIVIDUAL)
4814 E. WASHINGTON STREET
INDIANAPOLIS, IN 46201

FOR: PRE-RECORDED CDS, DVDS AND DIGITAL AND ELECTRONIC MEDIA FEATURING MUSICAL PERFORMANCES, IN CLASS 9 (U.S. CLS. 21, 23, 26, 36 AND 38).

FIRST USE 0-0-1980; IN COMMERCE 0-0-1980.

FOR: ENTERTAINMENT SERVICES, NAMELY, LIVE MUSICAL PERFORMANCES AND MUSICAL CONCERTS; ENTERTAINMENT SERVICES, NAMELY, ACTING SERVICES; AND, ENTERTAINMENT SERVICES, NAMELY, PROVIDING A WEBSITE

WITH MUSICAL PERFORMANCES, IN CLASS 41 (U.S. CLS. 100, 101 AND 107).

FIRST USE 0-0-1980; IN COMMERCE 0-0-1980.

THE MARK CONSISTS OF STANDARD CHARACTERS WITHOUT CLAIM TO ANY PARTICULAR FONT, STYLE, SIZE, OR COLOR.

THE NAME PEYTON JAMES IDENTIFIES A LIVING INDIVIDUAL WHOSE CONSENT IS OF RECORD.

SN 77-160,015, FILED 4-18-2007.

SEAN CROWLEY, EXAMINING ATTORNEY

Int. Cl.: 25

Prior U.S. Cls.: 22 and 39

United States Patent and Trademark Office

Reg. No. 3,521,481

Registered Oct. 21, 2008

**TRADEMARK
PRINCIPAL REGISTER**

A Legend is a Legacy

PREMIER LEGENDS, INC. (PENNSYLVANIA
CORPORATION)
22 DOBBS LANE
MALVERN, PA 19355

FIRST USE 8-1-2007; IN COMMERCE 8-1-2007.

FOR: SHORT-SLEEVED OR LONG-SLEEVED T-SHIRTS; T-SHIRTS; JERSEYS; SHIRTS; SHORT-SLEEVED SHIRTS; SPORTS SHIRTS; SPORTS SHIRTS WITH SHORT SLEEVES; SWEAT SHIRTS; HATS; PANTS; SWEAT PANTS; SHORTS; SWEAT SHORTS; GYM SHORTS; ATHLETIC SHOES; SHOES; JACKETS, IN CLASS 25 (U.S. CLS. 22 AND 39).

THE MARK CONSISTS OF STANDARD CHARACTERS WITHOUT CLAIM TO ANY PARTICULAR FONT, STYLE, SIZE, OR COLOR.

SN 77-160,815, FILED 4-19-2007.

DAVID C. REIHNER, EXAMINING ATTORNEY

Int. Cls.: 16, 41, and 45

Prior U.S. Cls.: 2, 5, 22, 23, 29, 37, 38, 50, 100, 101, and 107

Reg. No. 3,521,482

United States Patent and Trademark Office

Registered Oct. 21, 2008

**TRADEMARK
SERVICE MARK
PRINCIPAL REGISTER**

**STRATEGIC PARTNERS IN
ADVOCACY**

TSONGAS LITIGATION CONSULTING, INC.
(OREGON CORPORATION)
ONE SW COLUMBIA STREET, SUITE 600
PORTLAND, OR 97258

FOR: NEWSLETTERS IN THE FIELD OF LITIGATION AND TRIAL PREPARATION, IN CLASS 16 (U.S. CLS. 2, 5, 22, 23, 29, 37, 38 AND 50).

FIRST USE 4-0-2008; IN COMMERCE 4-0-2008.

FOR: EDUCATION SERVICES, NAMELY, CONDUCTING SEMINARS IN THE FIELD OF LITIGATION INCLUDING CASE STRATEGY, JURY DECISION MAKING, JURY SELECTION, PRE-TRIAL RESEARCH, WITNESS PREPARATION, IN CLASS 41 (U.S. CLS. 100, 101 AND 107).

FIRST USE 4-1-2008; IN COMMERCE 4-1-2008.

FOR: CONSULTATION SERVICES IN THE FIELD OF LITIGATION, INCLUDING CONSULTATION REGARDING CASE STRATEGY, COMMUNITY ATTITUDE SURVEYS, PRE-TRIAL JURY RESEARCH, WITNESS PREPARATION, JURY SELECTION, PREPARATION OF COURTROOM VISUALS, TRIAL MONITORING AND SHADOW JURY SERVICES, AND POST TRIAL JUROR INTERVIEWS, IN CLASS 45 (U.S. CLS. 100 AND 101).

FIRST USE 4-1-2008; IN COMMERCE 4-1-2008.

THE MARK CONSISTS OF STANDARD CHARACTERS WITHOUT CLAIM TO ANY PARTICULAR FONT, STYLE, SIZE, OR COLOR.

SN 77-160,877, FILED 4-19-2007.

JULIE WATSON, EXAMINING ATTORNEY

Int. Cl.: 36

Prior U.S. Cls.: 100, 101, and 102

United States Patent and Trademark Office

Reg. No. 3,521,483

Registered Oct. 21, 2008

**SERVICE MARK
PRINCIPAL REGISTER**

Digital Allowance

MOBILEKASH (TEXAS CORPORATION)
11420 FERRELL DRIVE
SUITE 307
FARMERS BRANCH, TX 75234

FOR: ELECTRONIC COMMERCE PAYMENT SERVICES, NAMELY, ESTABLISHING FUNDED ACCOUNTS USED TO PURCHASE GOODS AND SERVICES ON THE INTERNET; ELECTRONIC FUNDS TRANSFER BY TELECOMMUNICATIONS; ELECTRONIC FUNDS TRANSFER; ACCEPTING AND ADMINISTERING MONETARY CHARITABLE CONTRIBUTIONS; BILL PAYMENT SERVICES; FINANCIAL SERVICES, NAMELY, PROVIDING ON-LINE STORED VALUE ACCOUNTS IN AN ELECTRONIC ENVIRONMENT; FINANCIAL TRANSACTION SERVICES, NAMELY, PROVIDING SECURE COMMERCIAL TRANSACTIONS AND PAYMENT OPTIONS USING A MOBILE DEVICE AT A POINT OF SALE; ELECTRONIC PAYMENT, NAMELY, ELECTRONIC PROCESSING AND TRANSMISSION OF BILL PAYMENT DATA; PRE-PAID PURCHASE CARD SERVICES, NAMELY,

PROCESSING ELECTRONIC PAYMENTS MADE THROUGH PREPAID CARDS; PRE-PAID PURCHASE CARD SERVICES, NAMELY, PROCESSING ELECTRONIC PAYMENTS THROUGH PRE-PAID CARDS; PROVIDING MULTIPLE PAYMENT OPTIONS BY MEANS OF CUSTOMER-OPERATED ELECTRONIC TERMINALS AVAILABLE ON-SITE IN RETAIL STORES, IN CLASS 36 (U.S. CLS. 100, 101 AND 102).

FIRST USE 5-1-2007; IN COMMERCE 6-1-2007.

THE MARK CONSISTS OF STANDARD CHARACTERS WITHOUT CLAIM TO ANY PARTICULAR FONT, STYLE, SIZE, OR COLOR.

NO CLAIM IS MADE TO THE EXCLUSIVE RIGHT TO USE "DIGITAL", APART FROM THE MARK AS SHOWN.

SN 77-161,590, FILED 4-20-2007.

SUSAN LESLIE DUBOIS, EXAMINING ATTORNEY

Int. Cls.: 38 and 41

Prior U.S. Cls.: 100, 101, 104, and 107

Reg. No. 3,521,484

United States Patent and Trademark Office

Registered Oct. 21, 2008

**SERVICE MARK
PRINCIPAL REGISTER**

:VOCALO.ORG

WBEZ ALLIANCE, INC. (ILLINOIS CORPORATION)
NAVY PIER
484 GRAND AVENUE
CHICAGO, IL 60611

FOR: RADIO BROADCASTING SERVICES, IN CLASS 38 (U.S. CLS. 100, 101 AND 104).

FIRST USE 5-14-2007; IN COMMERCE 5-14-2007.

FOR: ENTERTAINMENT AND EDUCATIONAL SERVICES, NAMELY, THE PRODUCTION AND

DISTRIBUTION OF ONGOING PROGRAMS IN THE FIELD OF NEWS, MUSIC, ART, REVIEWS, INTERVIEWS, CALL-INS, DRAMA, AND SPORTS VIA RADIO BROADCASTS AND THE GLOBAL COMPUTER NETWORK, IN CLASS 41 (U.S. CLS. 100, 101 AND 107).

FIRST USE 5-14-2007; IN COMMERCE 5-14-2007.

SN 77-161,674, FILED 4-20-2007.

ELI HELLMAN, EXAMINING ATTORNEY

Int. Cls.: 35 and 45

Prior U.S. Cls.: 100, 101, and 102

United States Patent and Trademark Office

Reg. No. 3,521,485

Registered Oct. 21, 2008

**SERVICE MARK
PRINCIPAL REGISTER**

Transformatology

SWAY, ANDREW L. (UNITED STATES INDIVIDUAL)
320 E. 23RD STREET #11D
NEW YORK, NY 10010

FOR: BUSINESS CONSULTATION; POLITICAL CONSULTANCY; PROFESSIONAL BUSINESS CONSULTATION; PROVIDING ORGANIZATIONAL DEVELOPMENT CONSULTING SERVICES; PUBLICITY CONSULTATION; HUMAN RESOURCES CONSULTATION; MARKETING CONSULTING; PERSONNEL CONSULTANCY; PERSONNEL MANAGEMENT CONSULTATION; CONSULTANCY OF PERSONNEL RECRUITMENT; CONSULTANCY SERVICES REGARDING BUSINESS STRATEGIES; CONSULTING SERVICES RELATING TO PUBLICITY; BUSINESS MANAGEMENT AND CONSULTATION; BUSINESS MANAGEMENT CONSULTANCY AND ADVISORY SERVICES; BUSINESS MANAGEMENT CONSULTANCY SERVICES; BUSINESS MANAGEMENT CONSULTATION; BUSINESS MANAGEMENT CONSULTATION IN THE FIELD OF EXECUTIVE AND LEADERSHIP DEVELOPMENT; BUSINESS MANAGEMENT CONSULTING AND ADVISORY SERVICES; BUSINESS MARKETING CONSULTING SERVICES; BUSINESS ORGANISATION AND MANAGEMENT CONSULTING SERVICES; BUSINESS ORGANIZATION AND OPERATION CONSULTANCY; BUSINESS ORGANIZATIONAL CONSULTA-

TION; ADVERTISING AND BUSINESS MANAGEMENT CONSULTANCY; ADVERTISING AND PROMOTION SERVICES AND RELATED CONSULTING; ADVERTISING CONSULTATION; BUSINESS ADMINISTRATION CONSULTANCY; BUSINESS ADVISORY SERVICES, CONSULTANCY AND INFORMATION; BUSINESS CONSULTATION SERVICES, IN CLASS 35 (U.S. CLS. 100, 101 AND 102).

FIRST USE 1-1-2008; IN COMMERCE 7-9-2008.

FOR: ASTROLOGY CONSULTATION; PERSONAL GROWTH AND MOTIVATION CONSULTING SERVICES; ZODIAC CONSULTATION; BEREAVEMENT CONSULTING; FASHION TREND CONSULTING FOR THE FASHION INDUSTRY; PERSONAL IMAGE DEVELOPMENT CONSULTATION; PERSONAL LIFESTYLE CONSULTING SERVICES, IN CLASS 45 (U.S. CLS. 100 AND 101).

FIRST USE 1-1-2008; IN COMMERCE 7-9-2008.

THE MARK CONSISTS OF STANDARD CHARACTERS WITHOUT CLAIM TO ANY PARTICULAR FONT, STYLE, SIZE, OR COLOR.

SN 77-161,829, FILED 4-20-2007.

JENNIFER VASQUEZ, EXAMINING ATTORNEY

Int. Cl.: 11

Prior U.S. Cls.: 13, 21, 23, 31, and 34

United States Patent and Trademark Office

Reg. No. 3,521,486

Registered Oct. 21, 2008

**TRADEMARK
PRINCIPAL REGISTER**

BUILT LIKE A TANK

PIZZA EQUIPMENT SUPPLY, INC. (NORTH
CAROLINA CORPORATION)
SUITE 232
1437 E. FRANKLIN BOULEVARD
GASTONIA, NC 28054

THE MARK CONSISTS OF STANDARD CHAR-
ACTERS WITHOUT CLAIM TO ANY PARTICULAR
FONT, STYLE, SIZE, OR COLOR.

FOR: COMMERCIAL COOKING OVENS, IN
CLASS 11 (U.S. CLS. 13, 21, 23, 31 AND 34).

SN 77-161,844, FILED 4-20-2007.

FIRST USE 7-3-2007; IN COMMERCE 7-3-2007.

BENJAMIN ALLEN, EXAMINING ATTORNEY

Int. Cl.: 33

Prior U.S. Cls.: 47 and 49

United States Patent and Trademark Office

Reg. No. 3,521,487

Registered Oct. 21, 2008

**TRADEMARK
PRINCIPAL REGISTER**

THE EVENING LAND

ELV HOLDINGS, INC. (DELAWARE CORPORATION)
P.O. BOX 10217
NAPA, CA 94581

THE MARK CONSISTS OF STANDARD CHARACTERS WITHOUT CLAIM TO ANY PARTICULAR FONT, STYLE, SIZE, OR COLOR.

FOR: WINE, IN CLASS 33 (U.S. CLS. 47 AND 49).

SN 77-162,013, FILED 4-20-2007.

FIRST USE 4-24-2008; IN COMMERCE 4-24-2008.

KHANH LE, EXAMINING ATTORNEY

Int. Cl.: 33

Prior U.S. Cls.: 47 and 49

United States Patent and Trademark Office

Reg. No. 3,521,488

Registered Oct. 21, 2008

**TRADEMARK
PRINCIPAL REGISTER**

EVENING LAND VINEYARDS

ELV HOLDINGS, INC. (DELAWARE CORPORATION)
P.O. BOX 10217
NAPA, CA 94581

NO CLAIM IS MADE TO THE EXCLUSIVE
RIGHT TO USE "VINEYARDS", APART FROM
THE MARK AS SHOWN.

FOR: WINE, IN CLASS 33 (U.S. CLS. 47 AND 49).

FIRST USE 4-24-2008; IN COMMERCE 4-24-2008.

SN 77-162,035, FILED 4-20-2007.

THE MARK CONSISTS OF STANDARD CHARACTERS WITHOUT CLAIM TO ANY PARTICULAR FONT, STYLE, SIZE, OR COLOR.

KHANH LE, EXAMINING ATTORNEY

Int. Cl.: 36

Prior U.S. Cls.: 100, 101, and 102

United States Patent and Trademark Office

Reg. No. 3,521,489

Registered Oct. 21, 2008

**SERVICE MARK
PRINCIPAL REGISTER**

MARINER FINANCE

MARINER FINANCE, LLC (MARYLAND LIMITED LIABILITY COMPANY)
3301 BOSTON STREET
BALTIMORE, MD 21224

FOR: FINANCING AND INSURANCE SERVICES, NAMELY, CONSUMER LENDING SERVICES, NAMELY, LOAN FINANCING, INSTALLMENT LOANS AND REVOLVING LOANS; HOME EQUITY LOANS; MORTGAGE LENDING; MORTGAGE BANKING SERVICES, NAMELY, ORIGINATION, ACQUISITION, SERVICING, SECURITIZATION AND BROKERAGE OF MORTGAGE LOANS; INSURANCE BROKERAGE IN THE FIELD OF MORTGAGE INSURANCE, CREDIT INSURANCE, CREDIT LIFE AND DISABILITY INSURANCE, INVOLUNTARY UNEMPLOYMENT INSURANCE, ACCIDENTAL DEATH AND DISMEMBERMENT INSURANCE, PROPERTY INSURANCE AND NON-FILING INSURANCE ALL RELATING TO

CONSUMER AND MORTGAGE LOANS; AND FINANCING SERVICES FOR MERCHANTS, INCLUDING FINANCING OF PURCHASES, IN CLASS 36 (U.S. CLS. 100, 101 AND 102).

FIRST USE 8-0-2007; IN COMMERCE 8-0-2007.

THE MARK CONSISTS OF STANDARD CHARACTERS WITHOUT CLAIM TO ANY PARTICULAR FONT, STYLE, SIZE, OR COLOR.

NO CLAIM IS MADE TO THE EXCLUSIVE RIGHT TO USE "FINANCE", APART FROM THE MARK AS SHOWN.

SN 77-162,065, FILED 4-20-2007.

STEPHEN AQUILA, EXAMINING ATTORNEY

Int. Cl.: 36

Prior U.S. Cls.: 100, 101, and 102

United States Patent and Trademark Office

Reg. No. 3,521,490

Registered Oct. 21, 2008

**SERVICE MARK
PRINCIPAL REGISTER**



MARINER FINANCE, LLC (MARYLAND LIMITED LIABILITY COMPANY)
3301 BOSTON STREET
BALTIMORE, MD 21224

FOR: FINANCING AND INSURANCE SERVICES, NAMELY, CONSUMER LENDING SERVICES, NAMELY, LOAN FINANCING, INSTALLMENT LOANS AND REVOLVING LOANS; HOME EQUITY LOANS; MORTGAGE LENDING; MORTGAGE BANKING SERVICES, NAMELY, ORIGINATION, ACQUISITION, SERVICING, SECURITIZATION AND BROKERAGE OF MORTGAGE LOANS; INSURANCE BROKERAGE IN THE FIELD OF MORTGAGE INSURANCE, CREDIT INSURANCE, CREDIT LIFE AND DISABILITY INSURANCE, INVOLUNTARY UNEMPLOYMENT INSURANCE, ACCIDENTAL DEATH AND DISMEMBERMENT INSURANCE, PROPERTY INSURANCE AND NON-FILING INSURANCE ALL RELATING TO CONSUMER AND MORTGAGE LOANS; AND FINANCING SERVICES FOR MERCHANTS, INCLUD-

ING FINANCING OF PURCHASES , IN CLASS 36 (U.S. CLS. 100, 101 AND 102).

FIRST USE 8-0-2007; IN COMMERCE 8-0-2007.

NO CLAIM IS MADE TO THE EXCLUSIVE RIGHT TO USE "FINANCE", APART FROM THE MARK AS SHOWN.

THE MARK CONSISTS OF THE DESIGN OF A STAR WITHIN A CIRCLE SIMILAR TO THE DESIGN OF A DIRECTIONAL OR MARINER'S COMPASS, WITH THE WORD "MARINER" BELOW AND TO THE RIGHT OF MOST OF THE STAR DESIGN, AND THE WORD "FINANCE" BELOW THE RIGHT HAND SIDE OF THE WORD "MARINER".

SN 77-162,122, FILED 4-20-2007.

STEPHEN AQUILA, EXAMINING ATTORNEY

Int. Cl.: 9

Prior U.S. Cls.: 21, 23, 26, 36, and 38

United States Patent and Trademark Office

Reg. No. 3,521,491

Registered Oct. 21, 2008

**TRADEMARK
PRINCIPAL REGISTER**

DIGITAL READY

LUIDIA, INC. (DELAWARE CORPORATION)
125 SHOREWAY ROAD, BLD. G
SAN CARLOS, CA 94070

FOR: COMPUTER HARDWARE AND COMPUTER SOFTWARE FOR USE WITH INTERACTIVE DIGITAL WHITEBOARDS, INTERACTIVE DIGITAL DISPLAYS, DATA STORAGE AND DATA CONFERENCING, IN CLASS 9 (U.S. CLS. 21, 23, 26, 36 AND 38).

FIRST USE 3-31-2008; IN COMMERCE 3-31-2008.

THE MARK CONSISTS OF STANDARD CHARACTERS WITHOUT CLAIM TO ANY PARTICULAR FONT, STYLE, SIZE, OR COLOR.

NO CLAIM IS MADE TO THE EXCLUSIVE RIGHT TO USE "DIGITAL", APART FROM THE MARK AS SHOWN.

SN 77-162,136, FILED 4-20-2007.

ANNE E. GUSTASON, EXAMINING ATTORNEY

Int. Cl.: 3

Prior U.S. Cls.: 1, 4, 6, 50, 51, and 52

United States Patent and Trademark Office

Reg. No. 3,521,492

Registered Oct. 21, 2008

**TRADEMARK
PRINCIPAL REGISTER**

WRINKLE SHOT

POLA CHEMICAL INDUSTRIES INC. (JAPAN
CORPORATION)
6-48, YAYOI-CHO
SURUGA-KU, SHIZUOKA-SHI
SHIZUOKA-KEN, JAPAN

FOR: COSMETICS; MAKE-UP POWDER; SKIN
LOTIONS; COSMETIC CREAMS; ROUGES; HAIR
CARE PREPARATIONS; PERFUMES; SOAPS, IN
CLASS 3 (U.S. CLS. 1, 4, 6, 50, 51 AND 52).

FIRST USE 11-1-2001; IN COMMERCE 9-1-2004.

THE MARK CONSISTS OF STANDARD CHAR-
ACTERS WITHOUT CLAIM TO ANY PARTICULAR
FONT, STYLE, SIZE, OR COLOR.

NO CLAIM IS MADE TO THE EXCLUSIVE
RIGHT TO USE "WRINKLE", APART FROM THE
MARK AS SHOWN.

SN 77-163,925, FILED 4-24-2007.

HANNO RITTNER, EXAMINING ATTORNEY

Int. Cls.: 39 and 43

Prior U.S. Cls.: 100, 101, and 105

United States Patent and Trademark Office

Reg. No. 3,521,493

Registered Oct. 21, 2008

**SERVICE MARK
PRINCIPAL REGISTER**

BURT WOLF TRAVELS

BURT WOLF TRAVELS, INC. (DELAWARE CORPORATION)

#1030

ONE WEST 67TH STREET
NEW YORK, NY 10023

FOR: TRAVEL SERVICES, NAMELY, COORDINATING TRAVEL ARRANGEMENTS FOR OTHERS, ARRANGEMENT OF TRAVEL TOURS, RESERVATION AND BOOKING SERVICES FOR TRAVEL AND TOURS TICKETS AND TRANSPORTATION, TRAVEL BOOKING AGENCIES, IN CLASS 39 (U.S. CLS. 100 AND 105).

FIRST USE 8-21-2008; IN COMMERCE 8-21-2008.

FOR: TRAVEL SERVICES, NAMELY, MAKING RESERVATIONS AND BOOKING FOR TEMPORARY LODGING, RESTAURANTS AND MEALS, IN CLASS 43 (U.S. CLS. 100 AND 101).

FIRST USE 8-21-2008; IN COMMERCE 8-21-2008.

THE MARK CONSISTS OF STANDARD CHARACTERS WITHOUT CLAIM TO ANY PARTICULAR FONT, STYLE, SIZE, OR COLOR.

NO CLAIM IS MADE TO THE EXCLUSIVE RIGHT TO USE "TRAVELS", APART FROM THE MARK AS SHOWN.

THE NAME "BURT WOLF" IDENTIFIES A LIVING INDIVIDUAL WHOSE CONSENT IS OF RECORD.

SN 77-164,190, FILED 4-24-2007.

WILLIAM VERHOSEK, EXAMINING ATTORNEY

Int. Cl.: 10

Prior U.S. Cls.: 26, 39, and 44

Reg. No. 3,521,494

United States Patent and Trademark Office

Registered Oct. 21, 2008

TRADEMARK
PRINCIPAL REGISTER

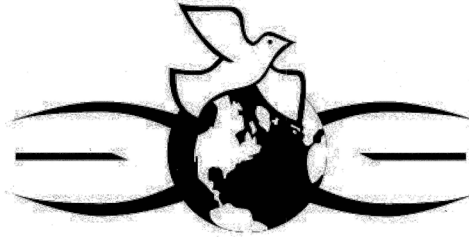

MEDICAL SAFETY TECHNOLOGIES, INC.
(TEXAS CORPORATION)
5412 N. 10TH ST.
MCALLEN, TX 78504

FOR: DISPOSABLE SYRINGES; HYPODERMIC NEEDLES AND SYRINGES; INJECTION INSTRUMENTS WITH NEEDLES; INJECTION NEEDLES; AND NEEDLE-BASED AND NEEDLE-FREE INJECTION SYSTEMS, IN CLASS 10 (U.S. CLS. 26, 39 AND 44).

FIRST USE 3-6-2007; IN COMMERCE 3-6-2007.

THE MARK CONSISTS OF A REPRESENTATION OF THE EARTH, WITH TWO CURVED BANDS

HAVING POINTED ENDS EXTENDING FROM EACH OF THE LEFT AND RIGHT SIDES OF THE EARTH, WHICH FURTHER INCLUDES AN INTERRUPTED HORIZONTAL BAND DISPOSED PROXIMATE TO THE EARTH'S EQUATOR, WITH THE PORTIONS OF THE INTERRUPTED BAND NEAREST THE EARTH TERMINATING IN SLANTED ENDS, AND A DOVE WITH OUTSTRETCHED WINGS PARTIALLY COVERING THE TOP-MOST PORTION OF THE EARTH.

SN 77-164,351, FILED 4-24-2007.

ODESSA BIBBINS, EXAMINING ATTORNEY

Int. Cl.: 40

Prior U.S. Cls.: 100, 103, and 106

United States Patent and Trademark Office

Reg. No. 3,521,495

Registered Oct. 21, 2008

SERVICE MARK
PRINCIPAL REGISTER



LINCOLN INDUSTRIES, INC. (NEBRASKA CORPORATION)
600 WEST E STREET
LINCOLN, NE 68522

FOR: METAL FABRICATION AND FINISHING SERVICES, IN CLASS 40 (U.S. CLS. 100, 103 AND 106).

FIRST USE 5-9-2007; IN COMMERCE 5-9-2007.

NO CLAIM IS MADE TO THE EXCLUSIVE RIGHT TO USE "INDUSTRIES", APART FROM THE MARK AS SHOWN.

THE COLOR(S) GREY, WHITE, PURPLE AND BLUE IS/ARE CLAIMED AS A FEATURE OF THE MARK.

THE MARK CONSISTS OF TWO SQUARES ON THE LEFT. THE UPPER SQUARE IS GREY WITH

THE LEFT EDGE HAVING THREE ELONGATED WHITE OVALS RUNNING HALFWAY INTO THE SQUARE. BELOW THE GREY SQUARE AND TO THE RIGHT A SHORT DISTANCE IS A BLUE SQUARE. THE TWO SQUARES OVERLAP AT THE LOWER RIGHT CORNER OF THE UPPER GREY SQUARE AND THE UPPER LEFT CORNER OF THE LOWER BLUE SQUARE. THE OVERLAPPING SQUARE AREA IS PURPLE. TO THE RIGHT OF THESE SQUARES IS THE WORDING "LINCOLN INDUSTRIES" WITH THE NAME "LINCOLN" IN BLUE BLOCK LETTERING OVER THE WORD "INDUSTRIES" IN PURPLE BLOCK LETTERING. BELOW THE NAME "LINCOLN INDUSTRIES" IS THE LINE "FINISHING IS JUST THE BEGINNING." IN LOWER CASE GREY LETTERING.

SN 77-164,482, FILED 4-24-2007.

HENRY S. ZAK, EXAMINING ATTORNEY

Int. Cl.: 37

Prior U.S. Cls.: 100, 103, and 106

United States Patent and Trademark Office

Reg. No. 3,521,496

Registered Oct. 21, 2008

**SERVICE MARK
PRINCIPAL REGISTER**

ADVANTAGE ROAD SERVICES

FIRST ADVANTAGE CORPORATION (DELA-
WARE CORPORATION)

100 CARILLON PARKWAY

ST. PETERSBURG, FL 33716

FOR: ROADSIDE ASSISTANCE SERVICES, IN
CLASS 37 (U.S. CLS. 100, 103 AND 106).

FIRST USE 6-4-2007; IN COMMERCE 6-4-2007.

THE MARK CONSISTS OF STANDARD CHAR-
ACTERS WITHOUT CLAIM TO ANY PARTICULAR
FONT, STYLE, SIZE, OR COLOR.

NO CLAIM IS MADE TO THE EXCLUSIVE
RIGHT TO USE "ROAD SERVICES", APART FROM
THE MARK AS SHOWN.

SN 77-164,998, FILED 4-25-2007.

AMY MCMENAMIN, EXAMINING ATTORNEY

Int. Cl.: 9

Prior U.S. Cls.: 21, 23, 26, 36, and 38

Reg. No. 3,521,497

United States Patent and Trademark Office

Registered Oct. 21, 2008

**TRADEMARK
PRINCIPAL REGISTER**

**The Last Agency Software
Solution You Will Ever Buy**

GEN4 SYSTEMS, LLC (MARYLAND LIMITED
LIABILITY COMPANY)
8639 B 16TH ST., SUITE 221
SILVER SPRING, MD 20910

THE MARK CONSISTS OF STANDARD CHAR-
ACTERS WITHOUT CLAIM TO ANY PARTICULAR
FONT, STYLE, SIZE, OR COLOR.

FOR: COMPUTER SOFTWARE FOR INSURANCE
AGENCY MANAGEMENT AND ADMINISTRATION,
IN CLASS 9 (U.S. CLS. 21, 23, 26, 36 AND 38).

SN 77-165,199, FILED 4-25-2007.

FIRST USE 4-1-2008; IN COMMERCE 4-1-2008.

MIDGE BUTLER, EXAMINING ATTORNEY

Int. Cl.: 33

Prior U.S. Cls.: 47 and 49

United States Patent and Trademark Office

Reg. No. 3,521,498

Registered Oct. 21, 2008

**TRADEMARK
PRINCIPAL REGISTER**

**OFFICIAL WINE OF AWARDS
SEASON**

FETZER VINEYARDS (CALIFORNIA CORPORATION)
12901 OLD RIVER ROAD
HOPLAND, CA 95449

THE MARK CONSISTS OF STANDARD CHARACTERS WITHOUT CLAIM TO ANY PARTICULAR FONT, STYLE, SIZE, OR COLOR.

FOR: ALCOHOLIC BEVERAGES, NAMELY, WINE, IN CLASS 33 (U.S. CLS. 47 AND 49).

SN 77-165,425, FILED 4-25-2007.

FIRST USE 5-1-2007; IN COMMERCE 5-1-2007.

MONIQUE MILLER, EXAMINING ATTORNEY

Int. Cl.: 38

Prior U.S. Cls.: 100, 101, and 104

United States Patent and Trademark Office

Reg. No. 3,521,499

Registered Oct. 21, 2008

**SERVICE MARK
PRINCIPAL REGISTER**

The Man

FM IDAHO CO., LLC (IDAHO LIMITED LIABILITY COMPANY)
274 KAY DRIVE
TWIN FALLS, ID 83303

THE MARK CONSISTS OF STANDARD CHARACTERS WITHOUT CLAIM TO ANY PARTICULAR FONT, STYLE, SIZE, OR COLOR.

FOR: RADIO BROADCASTING SERVICES, IN CLASS 38 (U.S. CLS. 100, 101 AND 104).

SN 77-165,430, FILED 4-25-2007.

FIRST USE 6-17-2008; IN COMMERCE 6-17-2008.

FRANK LATTUCA, EXAMINING ATTORNEY

Int. Cl.: 40

Prior U.S. Cls.: 100, 103, and 106

United States Patent and Trademark Office

Reg. No. 3,521,500

Registered Oct. 21, 2008

**SERVICE MARK
PRINCIPAL REGISTER**



MONROE LITHO, INC (NEW YORK CORPORATION)
39 DELEVAN STREET
ROCHESTER, NY 14605

FOR: PRINTING, IN CLASS 40 (U.S. CLS. 100, 103 AND 106).

FIRST USE 11-26-2007; IN COMMERCE 11-26-2007.

NO CLAIM IS MADE TO THE EXCLUSIVE RIGHT TO USE "100% WINDPOWER" , APART FROM THE MARK AS SHOWN.

THE COLOR(S) WHITE, BLUE, BROWN, AND GREEN IS/ARE CLAIMED AS A FEATURE OF THE MARK.

THE MARK CONSISTS OF A STYLIZED WINDMILL IN WHITE ON A BLUE, BROWN, AND GREEN BACKGROUND; THE WORDS "100% WINDPOWER" IN BROWN, AND THE WORDS "MAKING A DIFFERENCE, ONE PROJECT AT A TIME" IN BLUE.

SN 77-165,472, FILED 4-25-2007.

RICHARD A. STRASER, EXAMINING ATTORNEY

Int. Cl.: 40

Prior U.S. Cls.: 100, 103, and 106

United States Patent and Trademark Office

Reg. No. 3,521,501

Registered Oct. 21, 2008

**SERVICE MARK
PRINCIPAL REGISTER**



THE TRAYLOR GROUP, INC. (ALABAMA CORPORATION)
160 DILBECK ROAD
RAINSVILLE, AL 35986

FOR: RECYCLING SERVICES, IN CLASS 40 (U.S. CLS. 100, 103 AND 106).

FIRST USE 2-28-1994; IN COMMERCE 2-28-1994.

NO CLAIM IS MADE TO THE EXCLUSIVE RIGHT TO USE "GROUP" OR "RECYCLING", APART FROM THE MARK AS SHOWN.

THE MARK CONSISTS OF THE STYLIZED WORDS, "THE TRAYLOR GROUP", WITH TRIANGULAR DESIGN OF THREE CURVING ARROWS AS THE LETTER "O" IN "TRAYLOR", AND WITH THREE CONCENTRIC SEMI CIRCLES SURROUNDING THE WORD "THE" AND THE LETTERS "TR", AND THE WORDS "REVOLUTIONIZING RECYCLING" BELOW ALL THOSE ELEMENTS AND IN A DIFFERENT FONT.

SN 77-165,492, FILED 4-25-2007.

BRIAN CALLAGHAN, EXAMINING ATTORNEY

Int. Cl.: 9

Prior U.S. Cls.: 21, 23, 26, 36, and 38

Reg. No. 3,521,502

United States Patent and Trademark Office

Registered Oct. 21, 2008

**TRADEMARK
PRINCIPAL REGISTER**

LUXIE

POLYBRITE INTERNATIONAL, INC. (ILLINOIS
CORPORATION)
1751 DIEHL ROAD, SUITE 400
NAPERVILLE, IL 60563

THE MARK CONSISTS OF STANDARD CHAR-
ACTERS WITHOUT CLAIM TO ANY PARTICULAR
FONT, STYLE, SIZE, OR COLOR.

FOR: BATTERY ACTIVATED LIGHT STICKS, IN
CLASS 9 (U.S. CLS. 21, 23, 26, 36 AND 38).

SN 77-165,525, FILED 4-25-2007.

FIRST USE 1-0-2008; IN COMMERCE 1-0-2008.

GENE MACIOL, EXAMINING ATTORNEY

Int. Cl.: 9

Prior U.S. Cls.: 21, 23, 26, 36, and 38

Reg. No. 3,521,503

United States Patent and Trademark Office

Registered Oct. 21, 2008

**TRADEMARK
PRINCIPAL REGISTER**

LUXIELIGHT

POLYBRITE INTERNATIONAL, INC. (ILLINOIS
CORPORATION)
1751 DIEHL ROAD, SUITE 400
NAPERVILLE, IL 60563

THE MARK CONSISTS OF STANDARD CHAR-
ACTERS WITHOUT CLAIM TO ANY PARTICULAR
FONT, STYLE, SIZE, OR COLOR.

FOR: BATTERY ACTIVATED LIGHT STICKS, IN
CLASS 9 (U.S. CLS. 21, 23, 26, 36 AND 38).

SN 77-165,547, FILED 4-25-2007.

FIRST USE 1-0-2008; IN COMMERCE 1-0-2008.

GENE MACIOL, EXAMINING ATTORNEY

Int. Cl.: 12

Prior U.S. Cls.: 19, 21, 23, 31, 35, and 44

Reg. No. 3,521,504

United States Patent and Trademark Office

Registered Oct. 21, 2008

**TRADEMARK
PRINCIPAL REGISTER**

JOURNEY

CHRYSLER LLC (DELAWARE LIMITED LIABILITY COMPANY)
CIMS 483-02-19
1000 CHRYSLER DRIVE
AUBURN HILLS, MI 48326

FIRST USE 1-31-2008; IN COMMERCE 1-31-2008.

THE MARK CONSISTS OF STANDARD CHARACTERS WITHOUT CLAIM TO ANY PARTICULAR FONT, STYLE, SIZE, OR COLOR.

FOR: MOTOR LAND VEHICLES, NAMELY, SPORT UTILITY VEHICLES, AND STRUCTURAL PARTS THEREOF, IN CLASS 12 (U.S. CLS. 19, 21, 23, 31, 35 AND 44).

SN 77-166,156, FILED 4-26-2007.

GIANCARLO CASTRO, EXAMINING ATTORNEY

Int. Cl.: 41

Prior U.S. Cls.: 100, 101, and 107

United States Patent and Trademark Office

Reg. No. 3,521,505

Registered Oct. 21, 2008

**SERVICE MARK
PRINCIPAL REGISTER**

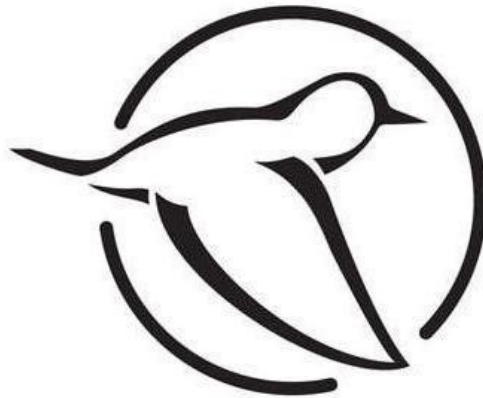

KCI LICENSING, INC. (DELAWARE CORPORATION)
8023 VANTAGE DRIVE
SAN ANTONIO, TX 78230

FOR: MEDICAL SERVICES IN THE NATURE OF
A NURSING PROGRAM, NAMELY, PROVIDING
CONTINUING NURSING EDUCATION COURSES,
IN CLASS 41 (U.S. CLS. 100, 101 AND 107).

FIRST USE 7-0-2007; IN COMMERCE 7-0-2007.

THE MARK CONSISTS OF A BIRD FLYING
WITHIN A CIRCLE.

SN 77-166,309, FILED 4-26-2007.

BARBARA RUTLAND, EXAMINING ATTORNEY

Int. Cl.: 43

Prior U.S. Cls.: 100 and 101

United States Patent and Trademark Office

Reg. No. 3,521,506

Registered Oct. 21, 2008

**SERVICE MARK
PRINCIPAL REGISTER**

Senior Choice Meals

WESLEY COMMUNITY SERVICES (OHIO NON-
PROFIT ORGANIZATION)
3333 GLENMORE AVE.
CINCINNATI, OH 45211

FOR: SUPPLYING MEALS TO THE HOMELESS
OR UNDERPRIVILEGED, IN CLASS 43 (U.S. CLS.
100 AND 101).

FIRST USE 4-10-2008; IN COMMERCE 4-10-2008.

THE MARK CONSISTS OF STANDARD CHAR-
ACTERS WITHOUT CLAIM TO ANY PARTICULAR
FONT, STYLE, SIZE, OR COLOR.

NO CLAIM IS MADE TO THE EXCLUSIVE
RIGHT TO USE "SENIOR" AND "MEALS", APART
FROM THE MARK AS SHOWN.

SN 77-166,400, FILED 4-26-2007.

JOHN E. MICHOS, EXAMINING ATTORNEY

Int. Cl.: 38

Prior U.S. Cls.: 100, 101, and 104

United States Patent and Trademark Office

Reg. No. 3,521,507

Registered Oct. 21, 2008

**SERVICE MARK
PRINCIPAL REGISTER**

Pingo Business

IBASIS, INC. (DELAWARE CORPORATION)
20 SECOND AVENUE
BURLINGTON, MA 01803

FOR: TELEPHONE TELECOMMUNICATIONS SERVICES PROVIDED VIA PREPAID TELEPHONE CALLING CARDS; WIRELESS TELEPHONE TELECOMMUNICATIONS SERVICES, NAMELY, WIRELESS MOBILE TELEPHONE CALLING PLANS; INTERNATIONAL TELEPHONE SERVICES; INTERSTATE TELEPHONE SERVICES; LOCAL AND LONG DISTANCE TELEPHONE SERVICES; PREPAID LONG DISTANCE TELEPHONE SERVICES; TELEPHONE COMMUNICATION SERVICES; VOICE OVER INTERNET PROTOCOL (VOIP) SERVICES, IN CLASS 38 (U.S. CLS. 100, 101 AND 104).

FIRST USE 9-4-2008; IN COMMERCE 9-4-2008.

THE MARK CONSISTS OF STANDARD CHARACTERS WITHOUT CLAIM TO ANY PARTICULAR FONT, STYLE, SIZE, OR COLOR.

OWNER OF U.S. REG. NOS. 3,001,371 AND 3,020,131.

NO CLAIM IS MADE TO THE EXCLUSIVE RIGHT TO USE "BUSINESS", APART FROM THE MARK AS SHOWN.

SN 77-166,487, FILED 4-26-2007.

JORDAN BAKER, EXAMINING ATTORNEY

Int. Cl.: 36

Prior U.S. Cls.: 100, 101, and 102

United States Patent and Trademark Office

Reg. No. 3,521,508

Registered Oct. 21, 2008

**SERVICE MARK
PRINCIPAL REGISTER**

THE ATTILANUS FUND

ANYSIA FINANCIAL MANAGEMENT, LLC (DE-
LAWARE LIMITED LIABILITY COMPANY)
2131 WOODRUFF ROAD, SUITE 2100-117
GREENVILLE, SC 29607

FOR: FINANCIAL INVESTMENT SERVICES IN
THE FIELD OF SENIOR LIFE SETTLEMENTS,
VIATICLES AND ALTERNATIVE INVESTMENTS,
IN CLASS 36 (U.S. CLS. 100, 101 AND 102).

FIRST USE 4-30-2007; IN COMMERCE 4-30-2007.

THE MARK CONSISTS OF STANDARD CHAR-
ACTERS WITHOUT CLAIM TO ANY PARTICULAR
FONT, STYLE, SIZE, OR COLOR.

NO CLAIM IS MADE TO THE EXCLUSIVE
RIGHT TO USE "FUND", APART FROM THE
MARK AS SHOWN.

SN 77-166,497, FILED 4-26-2007.

INGA ERVIN, EXAMINING ATTORNEY

Int. Cl.: 40

Prior U.S. Cls.: 100, 103, and 106

United States Patent and Trademark Office

Reg. No. 3,521,509

Registered Oct. 21, 2008

**SERVICE MARK
PRINCIPAL REGISTER**



LINCOLN INDUSTRIES, INC. (NEBRASKA CORPORATION)

600 WEST E STREET
LINCOLN, NE 68522

FOR: METAL FABRICATION AND FINISHING SERVICES, IN CLASS 40 (U.S. CLS. 100, 103 AND 106).

FIRST USE 5-9-2007; IN COMMERCE 5-9-2007.

NO CLAIM IS MADE TO THE EXCLUSIVE RIGHT TO USE "INDUSTRIES", APART FROM THE MARK AS SHOWN.

THE COLOR(S) GREY, WHITE, PURPLE AND BLUE IS/ARE CLAIMED AS A FEATURE OF THE MARK.

THE MARK CONSISTS OF TWO SQUARES ON THE LEFT. THE UPPER SQUARE IS GREY WITH THE LEFT EDGE HAVING THREE ELONGATED WHITE OVALS RUNNING HALFWAY INTO THE SQUARE. BELOW THE GREY SQUARE AND TO THE RIGHT A SHORT DISTANCE IS A BLUE SQUARE. THE TWO SQUARES OVERLAP AT THE LOWER RIGHT CORNER OF THE UPPER GREY SQUARE AND THE UPPER LEFT CORNER OF THE LOWER BLUE SQUARE. THE OVERLAPPING SQUARE AREA IS PURPLE. TO THE RIGHT OF THESE SQUARES IS THE WORDING "LINCOLN INDUSTRIES" WITH THE NAME LINCOLN IN BLUE BLOCK LETTERING OVER THE WORD INDUSTRIES IN PURPLE BLOCK LETTERING.

SN 77-166,620, FILED 4-26-2007.

HENRY S. ZAK, EXAMINING ATTORNEY

Int. Cl.: 41

Prior U.S. Cls.: 100, 101, and 107

United States Patent and Trademark Office

Reg. No. 3,521,510

Registered Oct. 21, 2008

**SERVICE MARK
PRINCIPAL REGISTER**

SOCO NIGHT INSTITUTE

SOUTHERN COMFORT PROPERTIES, INC. (CALIFORNIA CORPORATION)
4040 CIVIC CENTER DRIVE, SUITE 528
SAN RAFAEL, CA 94903

FOR: ENTERTAINMENT, NAMELY, PROVIDING AN INTERACTIVE WEBSITE FOR ADULTS DEDICATED TO SPOOFING NIGHTLIFE AND THE BAR SCENE, IN CLASS 41 (U.S. CLS. 100, 101 AND 107).

FIRST USE 8-15-2007; IN COMMERCE 8-15-2007.

THE MARK CONSISTS OF STANDARD CHARACTERS WITHOUT CLAIM TO ANY PARTICULAR FONT, STYLE, SIZE, OR COLOR.

OWNER OF U.S. REG. NO. 2,254,264.

SN 77-166,661, FILED 4-26-2007.

COURTNEY MCCORMICK, EXAMINING ATTORNEY

Int. Cls.: 36 and 38

Prior U.S. Cls.: 100, 101, 102, and 104

United States Patent and Trademark Office

Reg. No. 3,521,511

Registered Oct. 21, 2008

**SERVICE MARK
PRINCIPAL REGISTER**



IBASIS, INC. (DELAWARE CORPORATION)
20 SECOND AVENUE
BURLINGTON, MA 01803

FOR: PREPAID TELECOMMUNICATIONS CALLING CARD SERVICES; TELEPHONE CALLING CARD SERVICES, IN CLASS 36 (U.S. CLS. 100, 101 AND 102).

FIRST USE 9-3-2008; IN COMMERCE 9-3-2008.

FOR: TELEPHONE TELECOMMUNICATIONS SERVICES PROVIDED VIA PREPAID TELEPHONE CALLING CARDS; WIRELESS TELEPHONE TELECOMMUNICATIONS SERVICES, NAMELY, WIRELESS MOBILE TELEPHONE CALLING PLANS; INTERNATIONAL TELEPHONE SERVICES; INTERSTATE TELEPHONE SERVICES; INTRASTATE TELEPHONE SERVICES; LOCAL AND LONG DISTANCE TELEPHONE SERVICES; LONG DISTANCE TELEPHONE COMMUNICATION SERVICES; PREPAID LONG DISTANCE TELEPHONE SERVICES; TELECOMMUNICATION SERVICES, NAMELY, LOCAL AND LONG DISTANCE TRANSMISSION OF VOICE, DATA, GRAPHICS BY MEANS OF TELEPHONE, TELEGRAPHIC, CABLE AND

SATELLITE TRANSMISSIONS; VOICE OVER INTERNET PROTOCOL (VOIP) SERVICES, IN CLASS 38 (U.S. CLS. 100, 101 AND 104).

FIRST USE 9-3-2008; IN COMMERCE 9-3-2008.

OWNER OF U.S. REG. NOS. 3,001,371 AND 3,020,131.

THE COLOR(S) BLUE, RED, YELLOW AND GREEN IS/ARE CLAIMED AS A FEATURE OF THE MARK.

THE MARK CONSISTS OF THE TERM "PINGO" IN STYLIZED LETTERING WITH A BLUE "P", RED "I", YELLOW "N", GREEN "G", AND RED "O" COLORED LETTERS, AND A SET OF FOUR RED BALLS WITH INCREASING SIZE FROM LEFT TO RIGHT FORMING AN ARC OVER THE TOP OF THE LETTERING FROM THE LETTER "I" TO THE LETTER "O".

SN 77-166,705, FILED 4-26-2007.

JORDAN BAKER, EXAMINING ATTORNEY

Int. Cl.: 41

Prior U.S. Cls.: 100, 101, and 107

United States Patent and Trademark Office

Reg. No. 3,521,512

Registered Oct. 21, 2008

**SERVICE MARK
PRINCIPAL REGISTER**

BB Tanks

GAMEFACTORY, INC. (CALIFORNIA CORPORATION)
SUITE 500
300 CONTINENTAL BLVD
EL SEGUNDO, CA 90245

FOR: ENTERTAINMENT SERVICES, NAMELY,
PROVIDING ON-LINE COMPUTER GAMES, IN
CLASS 41 (U.S. CLS. 100, 101 AND 107).

FIRST USE 3-1-2008; IN COMMERCE 3-1-2008.

THE MARK CONSISTS OF STANDARD CHARACTERS WITHOUT CLAIM TO ANY PARTICULAR FONT, STYLE, SIZE, OR COLOR.

NO CLAIM IS MADE TO THE EXCLUSIVE RIGHT TO USE "TANKS", APART FROM THE MARK AS SHOWN.

SN 77-167,112, FILED 4-27-2007.

STEVEN PEREZ, EXAMINING ATTORNEY

Int. Cl.: 41

Prior U.S. Cls.: 100, 101, and 107

United States Patent and Trademark Office

Reg. No. 3,521,513

Registered Oct. 21, 2008

**SERVICE MARK
PRINCIPAL REGISTER**

Rumble Fighter

GAMEFACTORY, INC. (CALIFORNIA CORPORATION)
SUITE 500
300 CONTINENTAL BLVD
EL SEGUNDO, CA 90245

THE MARK CONSISTS OF STANDARD CHARACTERS WITHOUT CLAIM TO ANY PARTICULAR FONT, STYLE, SIZE, OR COLOR.

FOR: ENTERTAINMENT SERVICES, NAMELY, PROVIDING ON-LINE COMPUTER GAMES, IN CLASS 41 (U.S. CLS. 100, 101 AND 107).

SN 77-167,113, FILED 4-27-2007.

FIRST USE 2-1-2008; IN COMMERCE 2-1-2008.

STEVEN PEREZ, EXAMINING ATTORNEY

Int. Cl.: 9

Prior U.S. Cls.: 21, 23, 26, 36, and 38

United States Patent and Trademark Office

Reg. No. 3,521,514

Registered Oct. 21, 2008

**TRADEMARK
PRINCIPAL REGISTER**

ZUNATICS

DIAMOND GAME ENTERPRISES, INC. (CALI-
FORNIA CORPORATION)
9340 PENFIELD AVENUE
CHATSWORTH, CA 91311

THE MARK CONSISTS OF STANDARD CHAR-
ACTERS WITHOUT CLAIM TO ANY PARTICULAR
FONT, STYLE, SIZE, OR COLOR.

FOR: GAMING EQUIPMENT, NAMELY, GAM-
ING MACHINES, IN CLASS 9 (U.S. CLS. 21, 23, 26, 36
AND 38).

SN 77-167,952, FILED 4-27-2007.

FIRST USE 8-0-2007; IN COMMERCE 1-0-2008.

MICHAEL WIENER, EXAMINING ATTORNEY

Int. Cl.: 6

Prior U.S. Cls.: 2, 12, 13, 14, 23, 25, and 50

United States Patent and Trademark Office

Reg. No. 3,521,515

Registered Oct. 21, 2008

**TRADEMARK
PRINCIPAL REGISTER**

StayLock

DEACERO, S.A. DE C.V. (MEXICO SOCIEDAD ANONIMA (SA DE CV))
AVE. LAZARO CARDENAS 2333
OTE. COL. VALLE OTE.
SAN PEDRO GARZA GARCIA, MEXICO N.L.66260

FOR: METAL WIRE FENCES, METAL GATES AND FENCES, WIRE FENCES, METAL FIELD FENCES, IN CLASS 6 (U.S. CLS. 2, 12, 13, 14, 23, 25 AND 50).

FIRST USE 6-1-2007; IN COMMERCE 6-1-2007.

THE COLOR(S) GREEN AND BLACK IS/ARE CLAIMED AS A FEATURE OF THE MARK.

THE MARK CONSISTS OF THE WORD "STAY-LOCK" IN STYLIZED LETTERS IN GREEN AND BLACK.

SN 77-168,385, FILED 4-28-2007.

RUSS HERMAN, EXAMINING ATTORNEY

Int. Cl.: 41

Prior U.S. Cls.: 100, 101, and 107

United States Patent and Trademark Office

Reg. No. 3,521,516

Registered Oct. 21, 2008

**SERVICE MARK
PRINCIPAL REGISTER**

BEAM Yoga

MORSE, LINDA M. (UNITED STATES INDIVIDUAL)

823 POTOMAC DRIVE

WEST MELBOURNE, FL 32904

FOR: YOGA INSTRUCTION, IN CLASS 41 (U.S. CLS. 100, 101 AND 107).

FIRST USE 5-25-2008; IN COMMERCE 5-25-2008.

THE MARK CONSISTS OF STANDARD CHARACTERS WITHOUT CLAIM TO ANY PARTICULAR FONT, STYLE, SIZE, OR COLOR.

NO CLAIM IS MADE TO THE EXCLUSIVE RIGHT TO USE "YOGA", APART FROM THE MARK AS SHOWN.

SN 77-168,394, FILED 4-28-2007.

MICHAEL LITZAU, EXAMINING ATTORNEY

Int. Cl.: 36

Prior U.S. Cls.: 100, 101, and 102

United States Patent and Trademark Office

Reg. No. 3,521,517

Registered Oct. 21, 2008

**SERVICE MARK
PRINCIPAL REGISTER**

WELLSADVISOR

WELLS FARGO & COMPANY (DELAWARE
CORPORATION)
1700 WELLS FARGO CENTER, MAC N9305-176
SIXTH AND MARQUETTE
MINNEAPOLIS, MN 55479

THE MARK CONSISTS OF STANDARD CHAR-
ACTERS WITHOUT CLAIM TO ANY PARTICULAR
FONT, STYLE, SIZE, OR COLOR.

FOR: BANKING; INVESTMENT ADVISORY SER-
VICES; INVESTMENT BROKERAGE, IN CLASS 36
(U.S. CLS. 100, 101 AND 102).

SN 77-169,090, FILED 4-30-2007.

FIRST USE 6-18-2007; IN COMMERCE 6-18-2007.

JAY BESCH, EXAMINING ATTORNEY

Int. Cl.: 3

Prior U.S. Cls.: 1, 4, 6, 50, 51, and 52

United States Patent and Trademark Office

Reg. No. 3,521,518

Registered Oct. 21, 2008

**TRADEMARK
PRINCIPAL REGISTER**

**STACY'S CLASSICS
DERMATINE**

MILIOTIS, STACY (UNITED STATES INDIVIDUAL)
117 GARDNER ROAD
NAHANT, MA 01908

FOR: COSMETIC CREAMS FOR SKIN CARE; COSMETIC SOAPS; BODY LOTIONS; FACIAL LOTION; COSMETIC CREAMS; FACIAL CLEANSERS; SKIN CLEANSERS; SHAMPOOS; HAIR CONDITIONER; HAIR CARE LOTIONS; ESSENTIAL OILS, IN CLASS 3 (U.S. CLS. 1, 4, 6, 50, 51 AND 52).

FIRST USE 5-12-2008; IN COMMERCE 5-12-2008.

THE MARK CONSISTS OF STANDARD CHARACTERS WITHOUT CLAIM TO ANY PARTICULAR FONT, STYLE, SIZE, OR COLOR.

NO CLAIM IS MADE TO THE EXCLUSIVE RIGHT TO USE "CLASSICS DERMATINE", APART FROM THE MARK AS SHOWN.

SN 77-169,231, FILED 4-30-2007.

SCOTT BIBB, EXAMINING ATTORNEY

Int. Cl.: 29

Prior U.S. Cl.: 46

United States Patent and Trademark Office

Reg. No. 3,521,519

Registered Oct. 21, 2008

**TRADEMARK
PRINCIPAL REGISTER**

**ANY TIME IS RIGHT FOR
TYSON ANYTIZERS**

TYSON FOODS, INC. (DELAWARE CORPORATION)
2210 W. OAKLAWN DRIVE
SPRINGDALE, AR 72762

FOR: SNACKS AND APPETIZERS CONSISTING
PRIMARILY OF MEAT, ALONG WITH POULTRY,
CHEESE, VEGETABLES OR RICE WHICH ARE
BREADED, COATED OR DOUGH ENROBED, IN
CLASS 29 (U.S. CL. 46).

FIRST USE 9-0-2007; IN COMMERCE 9-0-2007.

THE MARK CONSISTS OF STANDARD CHARACTERS WITHOUT CLAIM TO ANY PARTICULAR FONT, STYLE, SIZE, OR COLOR.

OWNER OF U.S. REG. NOS. 1,748,683 AND 2,810,231.

SN 77-169,295, FILED 4-30-2007.

MARILYN IZZI, EXAMINING ATTORNEY

Int. Cl.: 10

Prior U.S. Cls.: 26, 39, and 44

United States Patent and Trademark Office

Reg. No. 3,521,520

Registered Oct. 21, 2008

**TRADEMARK
PRINCIPAL REGISTER**

PHONERIS

LAZARUS MEDICAL, L.L.C. (OKLAHOMA LIMITED LIABILITY COMPANY)
10805 S. MARION AVENUE
TULSA, OK 74137

THE MARK CONSISTS OF STANDARD CHARACTERS WITHOUT CLAIM TO ANY PARTICULAR FONT, STYLE, SIZE, OR COLOR.

FOR: TRACHEOTOMY TUBES AND CANNULAE, IN CLASS 10 (U.S. CLS. 26, 39 AND 44).

SN 77-170,115, FILED 5-1-2007.

FIRST USE 6-26-2008; IN COMMERCE 6-26-2008.

MICHELLE DUBOIS, EXAMINING ATTORNEY

Int. Cls.: 16, 35, and 41

Prior U.S. Cls.: 2, 5, 22, 23, 29, 37, 38, 50, 100, 101, 102, and 107

Reg. No. 3,521,521

United States Patent and Trademark Office

Registered Oct. 21, 2008

**TRADEMARK
SERVICE MARK
PRINCIPAL REGISTER**

DIABETES LIFE CENTER

MCKESSON CORPORATION (DELAWARE CORPORATION)
LAW DEPARTMENT, 33RD FLOOR
ONE POST STREET
SAN FRANCISCO, CA 94104

FOR: BROCHURES, PAMPHLETS, AND NEWSLETTERS IN THE FIELD OF DIABETIC PATIENT CARE PRODUCTS; PRINTED PAPER AND CARDBOARD SIGNS AND ADVERTISING PAMPHLETS FOR DIABETIC PATIENT CARE PRODUCTS, IN CLASS 16 (U.S. CLS. 2, 5, 22, 23, 29, 37, 38 AND 50).

FIRST USE 7-31-2007; IN COMMERCE 7-31-2007.

FOR: BUSINESS CONSULTING SERVICES RELATING TO DRUG STORE OPERATIONS, ADVERTISING AND PRODUCT MERCHANDISING FOR DIABETIC PATIENT CARE PRODUCTS AND SERVICES; RETAIL DRUG STORE SERVICES FOR DIABETIC PATIENT CARE; BUSINESS CONSULTING SERVICES RELATING TO SUPPLY CHAIN MANAGEMENT OF RETAIL PHARMACIES FOR DIABETES-RELATED DRUG STORE PRODUCTS; DIRECT MAIL ADVERTISING FOR DIABETIC PATIENT CARE, IN CLASS 35 (U.S. CLS. 100, 101 AND 102).

FIRST USE 7-31-2007; IN COMMERCE 7-31-2007.

FOR: EDUCATIONAL SERVICES, NAMELY, CONDUCTING CONTINUING EDUCATION SEMINARS FOR PHARMACISTS AND PROVIDING EDUCATIONAL PROGRAMS FOR RETAIL PHARMACIES TO PRESENT TO CONSUMERS IN THE AREA OF DIABETIC PATIENT CARE, IN CLASS 41 (U.S. CLS. 100, 101 AND 107).

FIRST USE 7-31-2007; IN COMMERCE 7-31-2007.

THE MARK CONSISTS OF STANDARD CHARACTERS WITHOUT CLAIM TO ANY PARTICULAR FONT, STYLE, SIZE, OR COLOR.

NO CLAIM IS MADE TO THE EXCLUSIVE RIGHT TO USE "DIABETES" OR "CENTER", APART FROM THE MARK AS SHOWN.

SN 77-170,446, FILED 5-1-2007.

GEOFFREY FOSDICK, EXAMINING ATTORNEY

Int. Cl.: 29

Prior U.S. Cl.: 46

United States Patent and Trademark Office

Reg. No. 3,521,522

Registered Oct. 21, 2008

**TRADEMARK
PRINCIPAL REGISTER**



THE SOUP KING, INC. (PENNSYLVANIA CORPORATION)
3381 BRISTOL RD
BENSALEM, PA 19020

THE MARK CONSISTS OF AN OVAL DESIGN CONTAINING A SKETCH OF A MAN'S FACE, WITH THE WORDS "SOUP KING" APPEARING DIRECTLY UNDERNEATH.

FOR: SOUPS, IN CLASS 29 (U.S. CL. 46).

FIRST USE 5-0-2008; IN COMMERCE 5-0-2008.

SN 77-170,523, FILED 5-1-2007.

NO CLAIM IS MADE TO THE EXCLUSIVE RIGHT TO USE "SOUP", APART FROM THE MARK AS SHOWN.

GINA HAYES, EXAMINING ATTORNEY

Int. Cl.: 18

Prior U.S. Cls.: 1, 2, 3, 22, and 41

United States Patent and Trademark Office

Reg. No. 3,521,523

Registered Oct. 21, 2008

**TRADEMARK
PRINCIPAL REGISTER**

NATULOEL

TEIJIN CORDLEY LIMITED (JAPAN CORPORATION)
6-7, MINAMIHOMMACHI 1 CHOME, CHUO-KU
OSAKA, JAPAN

THE MARK CONSISTS OF STANDARD CHARACTERS WITHOUT CLAIM TO ANY PARTICULAR FONT, STYLE, SIZE, OR COLOR.

FOR: IMITATION LEATHER, IN CLASS 18 (U.S. CLS. 1, 2, 3, 22 AND 41).

SN 77-170,624, FILED 5-2-2007.

FIRST USE 7-15-2008; IN COMMERCE 7-15-2008.

CYNTHIA SLOAN, EXAMINING ATTORNEY

Int. Cl.: 36

Prior U.S. Cls.: 100, 101, and 102

United States Patent and Trademark Office

Reg. No. 3,521,524

Registered Oct. 21, 2008

**SERVICE MARK
PRINCIPAL REGISTER**

ARSI

AUTO REFINANCE SOURCE, INC. (TEXAS CORPORATION)
SUITE 4400
12200 NORTHWEST FREEWAY
HOUSTON, TX 77092

THE MARK CONSISTS OF STANDARD CHARACTERS WITHOUT CLAIM TO ANY PARTICULAR FONT, STYLE, SIZE, OR COLOR.

FOR: VEHICLE FINANCING AND REFINANCING SERVICES, IN CLASS 36 (U.S. CLS. 100, 101 AND 102).

SN 77-171,154, FILED 5-2-2007.

FIRST USE 2-0-1996; IN COMMERCE 2-0-1997.

MICHAEL KAZAZIAN, EXAMINING ATTORNEY

Int. Cls.: 8 and 21

Prior U.S. Cls.: 2, 13, 23, 28, 29, 30, 33, 40, 44, and 50

Reg. No. 3,521,525

United States Patent and Trademark Office

Registered Oct. 21, 2008

**TRADEMARK
PRINCIPAL REGISTER**

My Favorite

NORPRO, INC. (WASHINGTON CORPORATION)
2215 MERRILL CREEK PKWY
EVERETT, WA 98203

FOR: CUTLERY, NAMELY, KNIVES, FORKS,
NON-ELECTRIC FRUIT AND VEGETABLE PEE-
LERS, AND HAND OPERATED CHOPPERS, IN
CLASS 8 (U.S. CLS. 23, 28 AND 44).

FIRST USE 10-5-2006; IN COMMERCE 10-5-2006.

FOR: HOUSEHOLD UTENSILS, NAMELY, SPA-
TULAS, POT AND PAN SCRAPERS, ROLLING PINS,

TURNERS, WHISKS, AND GRATERS, IN CLASS 21
(U.S. CLS. 2, 13, 23, 29, 30, 33, 40 AND 50).

FIRST USE 6-10-2004; IN COMMERCE 6-10-2004.

THE MARK CONSISTS OF STANDARD CHAR-
ACTERS WITHOUT CLAIM TO ANY PARTICULAR
FONT, STYLE, SIZE, OR COLOR.

SN 77-171,438, FILED 5-2-2007.

BRENDAN MCCAULEY, EXAMINING ATTORNEY

Int. Cl.: 41

Prior U.S. Cls.: 100, 101, and 107

United States Patent and Trademark Office

Reg. No. 3,521,526

Registered Oct. 21, 2008

**SERVICE MARK
PRINCIPAL REGISTER**

KATEMODERN

EQAL, INC. (CALIFORNIA CORPORATION)
201 WILSHIRE BOULEVARD
SECOND FLOOR
SANTA MONIC, CA 90401

FIRST USE 7-19-2007; IN COMMERCE 7-19-2007.

FOR: ENTERTAINMENT, NAMELY, A CONTINUING VIDEO SERIES IN THE FIELD OF DRAMA TRANSMITTED VIA A GLOBAL COMPUTER NETWORK; ONLINE JOURNALS, NAMELY, VIDEO BLOGS FEATURING FICTIONAL CHARACTERS AND PERFORMANCES, IN CLASS 41 (U.S. CLS. 100, 101 AND 107).

THE MARK CONSISTS OF STANDARD CHARACTERS WITHOUT CLAIM TO ANY PARTICULAR FONT, STYLE, SIZE, OR COLOR.

SN 77-171,495, FILED 5-2-2007.

WON TEAK OH, EXAMINING ATTORNEY

Int. Cl.: 16

Prior U.S. Cls.: 2, 5, 22, 23, 29, 37, 38, and 50

Reg. No. 3,521,527

United States Patent and Trademark Office

Registered Oct. 21, 2008

**TRADEMARK
PRINCIPAL REGISTER**

Dogby Walks Alone

TOKYOPOP INC. (CALIFORNIA CORPORATION)
5900 WILSHIRE BLVD SUITE 2000
BUSINESS & LEGAL AFFAIRS
LOS ANGELES, CA 90036

FOR: PRINTED MATTER AND PUBLICATIONS, NAMELY, GRAPHIC NOVELS, COMIC BOOKS, COLORING BOOKS, ADHESIVE STICKERS, NOTEBOOKS AND STATIONERY-TYPE PORTFOLIOS, TRADING CARDS, POSTERS, GREETING CARDS, CALENDARS, INSTRUCTIONAL LEAFLETS, MANUALS AND GUIDEBOOKS ON COMIC BOOKS, ANIMATION, DIGITAL PROGRAMS, ADVERTISEMENT BOARDS OF PAPER OR CARDBOARD,

PICTURES, CATALOGS FEATURING GRAPHIC NOVEL AND ANIMATION MERCHANDISE, PHOTOGRAPHS AND PRINTS, IN CLASS 16 (U.S. CLS. 2, 5, 22, 23, 29, 37, 38 AND 50).

FIRST USE 6-1-2005; IN COMMERCE 6-13-2006.

THE MARK CONSISTS OF STANDARD CHARACTERS WITHOUT CLAIM TO ANY PARTICULAR FONT, STYLE, SIZE, OR COLOR.

SN 77-171,515, FILED 5-2-2007.

CHARLES L. JENKINS, EXAMINING ATTORNEY

Int. Cl.: 33

Prior U.S. Cls.: 47 and 49

United States Patent and Trademark Office

Reg. No. 3,521,528

Registered Oct. 21, 2008

**TRADEMARK
PRINCIPAL REGISTER**

HUNTERS BLEND

HAWKS VIEW VINEYARDS, LLC (MINNESOTA
LIMITED LIABILITY COMPANY)
525 OHIO STREET
ST. PAUL, MN 55107

NO CLAIM IS MADE TO THE EXCLUSIVE
RIGHT TO USE "BLEND", APART FROM THE
MARK AS SHOWN.

FOR: WINE, IN CLASS 33 (U.S. CLS. 47 AND 49).

FIRST USE 3-0-2008; IN COMMERCE 3-0-2008.

SN 77-171,629, FILED 5-3-2007.

THE MARK CONSISTS OF STANDARD CHAR-
ACTERS WITHOUT CLAIM TO ANY PARTICULAR
FONT, STYLE, SIZE, OR COLOR.

CYNTHIA SLOAN, EXAMINING ATTORNEY

Int. Cl.: 33

Prior U.S. Cls.: 47 and 49

United States Patent and Trademark Office

Reg. No. 3,521,529

Registered Oct. 21, 2008

**TRADEMARK
PRINCIPAL REGISTER**

SMILING MOON

HAWKS VIEW VINEYARDS, LLC (MINNESOTA
LIMITED LIABILITY COMPANY)
525 OHIO STREET
ST. PAUL, MN 55107

THE MARK CONSISTS OF STANDARD CHAR-
ACTERS WITHOUT CLAIM TO ANY PARTICULAR
FONT, STYLE, SIZE, OR COLOR.

FOR: WINE, IN CLASS 33 (U.S. CLS. 47 AND 49).

SN 77-171,631, FILED 5-3-2007.

FIRST USE 3-0-2008; IN COMMERCE 3-0-2008.

CYNTHIA SLOAN, EXAMINING ATTORNEY

Int. Cl.: 3

Prior U.S. Cls.: 1, 4, 6, 50, 51, and 52

Reg. No. 3,521,530

United States Patent and Trademark Office

Registered Oct. 21, 2008

**TRADEMARK
PRINCIPAL REGISTER**

VANILLA WAFER

PHILOSOPHY, INC. (ARIZONA CORPORATION)
3809 EAST WATKINS STREET
PHOENIX, AZ 85034

THE MARK CONSISTS OF STANDARD CHAR-
ACTERS WITHOUT CLAIM TO ANY PARTICULAR
FONT, STYLE, SIZE, OR COLOR.

FOR: HAIR CARE PREPARATIONS; NON-MEDI-
CATED BATH PREPARATIONS; SHOWER AND
BATH GEL, IN CLASS 3 (U.S. CLS. 1, 4, 6, 50, 51
AND 52).

SN 77-171,747, FILED 5-3-2007.

FIRST USE 10-18-2007; IN COMMERCE 10-18-2007.

LESLIE RICHARDS, EXAMINING ATTORNEY

Int. Cl.: 31

Prior U.S. Cls.: 1 and 46

United States Patent and Trademark Office

Reg. No. 3,521,531

Registered Oct. 21, 2008

**TRADEMARK
PRINCIPAL REGISTER**

Daisy Mills

HEIFNER, JANINE (UNITED STATES INDIVIDUAL)

1802 S. JEFFERSON AVE.

SIOUX FALLS, SD 57105

FOR: ANIMAL FEED, IN CLASS 31 (U.S. CLS. 1 AND 46).

FIRST USE 8-18-2008; IN COMMERCE 8-18-2008.

THE MARK CONSISTS OF STANDARD CHARACTERS WITHOUT CLAIM TO ANY PARTICULAR FONT, STYLE, SIZE, OR COLOR.

NO CLAIM IS MADE TO THE EXCLUSIVE RIGHT TO USE "MILLS", APART FROM THE MARK AS SHOWN.

SN 77-172,252, FILED 5-3-2007.

ROBIN CHOSID, EXAMINING ATTORNEY

Int. Cls.: 16 and 21

**Prior U.S. Cls.: 2, 5, 13, 22, 23, 29, 30, 33, 37, 38, 40,
and 50**

Reg. No. 3,521,532

United States Patent and Trademark Office

Registered Oct. 21, 2008

**TRADEMARK
PRINCIPAL REGISTER**

ASIO

GEORGIA-PACIFIC CONSUMER PRODUCTS LP
(DELAWARE LIMITED PARTNERSHIP)
GA030-41N
133 PEACHTREE STREET NE
ATLANTA, GA 30303

FOR: PAPER TOWELS, IN CLASS 16 (U.S. CLS. 2, 5,
22, 23, 29, 37, 38 AND 50).

FIRST USE 7-1-2008; IN COMMERCE 7-1-2008.

FOR: DISPENSERS FOR PAPER TOWELS, IN
CLASS 21 (U.S. CLS. 2, 13, 23, 29, 30, 33, 40 AND 50).

FIRST USE 7-1-2008; IN COMMERCE 7-1-2008.

THE MARK CONSISTS OF STANDARD CHAR-
ACTERS WITHOUT CLAIM TO ANY PARTICULAR
FONT, STYLE, SIZE, OR COLOR.

SN 77-172,338, FILED 5-3-2007.

ROBERT C. CLARK JR., EXAMINING ATTORNEY

Int. Cl.: 36

Prior U.S. Cls.: 100, 101, and 102

United States Patent and Trademark Office

Reg. No. 3,521,533

Registered Oct. 21, 2008

**SERVICE MARK
PRINCIPAL REGISTER**



AUTO REFINANCE SOURCE, INC. (TEXAS CORPORATION)
SUITE 4400
12200 NORTHWEST FREEWAY
HOUSTON, TX 77092

FIRST USE 3-0-2002; IN COMMERCE 3-0-2002.

SN 77-172,448, FILED 5-3-2007.

FOR: VEHICLE FINANCING AND REFINANCING SERVICES, IN CLASS 36 (U.S. CLS. 100, 101 AND 102).

MICHAEL KAZAZIAN, EXAMINING ATTORNEY

Int. Cl.: 36

Prior U.S. Cls.: 100, 101, and 102

United States Patent and Trademark Office

Reg. No. 3,521,534

Registered Oct. 21, 2008

**SERVICE MARK
PRINCIPAL REGISTER**



AUTO REFINANCE SOURCE, INC. (TEXAS CORPORATION)
SUITE 4400
12200 NORTHWEST FREEWAY
HOUSTON, TX 77092

FOR: VEHICLE FINANCING AND REFINANCING SERVICES, IN CLASS 36 (U.S. CLS. 100, 101 AND 102).

FIRST USE 10-0-1995; IN COMMERCE 1-0-1997.

OWNER OF U.S. REG. NOS. 2,074,687 AND 2,937,901.

NO CLAIM IS MADE TO THE EXCLUSIVE RIGHT TO USE "AUTO REFINANCE SOURCE, INC.", APART FROM THE MARK AS SHOWN.

THE MARK CONSISTS OF A VEHICLE-SHAPED DESIGN COMPRISING THE LETTERS "ARSI", AND WITH THE WORDS "AUTO REFINANCE SOURCE, INC." ALL WITHIN AN OVAL DESIGN.

SN 77-172,453, FILED 5-3-2007.

MICHAEL KAZAZIAN, EXAMINING ATTORNEY

Int. Cl.: 35

Prior U.S. Cls.: 100, 101, and 102

United States Patent and Trademark Office

Reg. No. 3,521,535

Registered Oct. 21, 2008

**SERVICE MARK
PRINCIPAL REGISTER**

AXIOMLINK

BILINGUALS, INC. (NEW YORK CORPORATION)
8TH FLOOR
60 MADISON AVENUE
NEW YORK, NY 10010

THE MARK CONSISTS OF STANDARD CHARACTERS WITHOUT CLAIM TO ANY PARTICULAR FONT, STYLE, SIZE, OR COLOR.

FOR: PLACEMENT SERVICES FOR SPEECH, OCCUPATIONAL, AND PHYSICAL THERAPISTS, IN CLASS 35 (U.S. CLS. 100, 101 AND 102).

SN 77-173,405, FILED 5-4-2007.

FIRST USE 6-1-2007; IN COMMERCE 6-1-2007.

ERNEST SHOSHO, EXAMINING ATTORNEY

Int. Cl.: 32

Prior U.S. Cls.: 45, 46, and 48

United States Patent and Trademark Office

Reg. No. 3,521,536

Registered Oct. 21, 2008

**TRADEMARK
PRINCIPAL REGISTER**

PALE MOON

MILLERCOORS LLC (DELAWARE LIMITED
LIABILITY COMPANY)
1209 ORANGE STREET
WILMINGTON, DE 19801

THE MARK CONSISTS OF STANDARD CHAR-
ACTERS WITHOUT CLAIM TO ANY PARTICULAR
FONT, STYLE, SIZE, OR COLOR.

FOR: BEER, IN CLASS 32 (U.S. CLS. 45, 46 AND 48).

SN 77-173,561, FILED 5-4-2007.

FIRST USE 5-12-2008; IN COMMERCE 5-12-2008.

MIDGE BUTLER, EXAMINING ATTORNEY

Int. Cl.: 41

Prior U.S. Cls.: 100, 101, and 107

United States Patent and Trademark Office

Reg. No. 3,521,537

Registered Oct. 21, 2008

**SERVICE MARK
PRINCIPAL REGISTER**

SECOND HAND NOISE

HENRY, D. STEVEN (UNITED STATES INDIVIDUAL)
5120 KELSEY
DALLAS, TX 75229

THE MARK CONSISTS OF STANDARD CHARACTERS WITHOUT CLAIM TO ANY PARTICULAR FONT, STYLE, SIZE, OR COLOR.

FOR: ENTERTAINMENT SERVICES, NAMELY, LIVE PERFORMANCE BY A MUSICAL BAND, IN CLASS 41 (U.S. CLS. 100, 101 AND 107).

SN 77-173,657, FILED 5-4-2007.

FIRST USE 11-0-2006; IN COMMERCE 11-0-2006.

JENNY PARK, EXAMINING ATTORNEY

Int. Cl.: 35

Prior U.S. Cls.: 100, 101, and 102

United States Patent and Trademark Office

Reg. No. 3,521,538

Registered Oct. 21, 2008

SERVICE MARK
PRINCIPAL REGISTER



STARR, GAIA (UNITED STATES INDIVIDUAL)
727 GOMEZ ROAD
SANTA FE, NM 87505

THE MARK CONSISTS OF A RUBBER STAMP
DOG STANDING ABOVE THE WORDS "NAMA
STAY".

FOR: CREATIVE MARKETING DESIGN SERVI-
CES, IN CLASS 35 (U.S. CLS. 100, 101 AND 102).

SN 77-173,767, FILED 5-5-2007.

FIRST USE 4-4-2008; IN COMMERCE 4-4-2008.

GISELLE AGOSTO, EXAMINING ATTORNEY

Int. Cl.: 45

Prior U.S. Cls.: 100 and 101

United States Patent and Trademark Office

Reg. No. 3,521,539

Registered Oct. 21, 2008

**SERVICE MARK
PRINCIPAL REGISTER**

The image shows a handwritten-style logo in magenta ink. The text reads "Style with Glee" in a cursive, flowing script. The word "Style" is written in a larger, more decorative font, while "with Glee" is in a smaller, simpler cursive. The entire logo is centered on the page.

SUK, YIN G LEE (UNITED STATES INDIVIDUAL)
182 SOUTH STREET, APT 5E
NEW YORK, NY 10038

THE COLOR(S) MAGENTA IS/ARE CLAIMED AS A FEATURE OF THE MARK.

FOR: COLOR ANALYSIS FOR WARDROBE AND FASHION SELECTION; PROVIDING INFORMATION ABOUT FASHION, IN CLASS 45 (U.S. CLS. 100 AND 101).

THE ENTIRE MARK IS MAGENTA.

SN 77-173,782, FILED 5-5-2007.

FIRST USE 3-1-2008; IN COMMERCE 3-1-2008.

THEODORE MCBRIDE, EXAMINING ATTORNEY

Int. Cl.: 36

Prior U.S. Cls.: 100, 101, and 102

United States Patent and Trademark Office

Reg. No. 3,521,540

Registered Oct. 21, 2008

**SERVICE MARK
PRINCIPAL REGISTER**

ARMORED CARD

ARMORED CARD INT'L CORP. (CALIFORNIA CORPORATION)
3 WHATNEY, SUITE 200
IRVINE, CA 92618

FOR: FINANCIAL SERVICES, NAMELY, PROVIDING ON-LINE STORED VALUE ACCOUNTS IN AN ELECTRONIC ENVIRONMENT, IN CLASS 36 (U.S. CLS. 100, 101 AND 102).

FIRST USE 8-1-2007; IN COMMERCE 8-1-2007.

THE MARK CONSISTS OF STANDARD CHARACTERS WITHOUT CLAIM TO ANY PARTICULAR FONT, STYLE, SIZE, OR COLOR.

NO CLAIM IS MADE TO THE EXCLUSIVE RIGHT TO USE "CARD", APART FROM THE MARK AS SHOWN.

SN 77-173,852, FILED 5-6-2007.

SARA THOMAS, EXAMINING ATTORNEY

Int. Cls.: 9 and 38

Prior U.S. Cls.: 21, 23, 26, 36, 38, 100, 101, and 104

United States Patent and Trademark Office

Reg. No. 3,521,541

Registered Oct. 21, 2008

**TRADEMARK
SERVICE MARK
PRINCIPAL REGISTER**

Communicate Your Way

CALIFORNIA PUBLIC UTILITIES COMMISSION
(CALIFORNIA STATE AGENCY)
3RD FLOOR
505 VAN NESS AVENUE
SAN FRANCISCO, CA 94102

FOR: CELLULAR TELEPHONE APPARATUSES; CELLULAR TELEPHONES; COMPUTER TELEPHONY SOFTWARE; CORDLESS TELEPHONE APPARATUSES; CORDLESS TELEPHONES; HEADSETS FOR TELEPHONES; MOBILE TELEPHONES; PORTABLE TELEPHONES; RECEIVERS FOR TELEPHONE; TELEPHONE ANSWERING APPARATUS; TELEPHONE ANSWERING MACHINES; TELEPHONE APPARATUS; TELEPHONE EQUIPMENT, NAMELY, CALLER IDENTIFICATION BOXES; TELEPHONE HEADSETS; TELEPHONE SETS; TELEPHONE SETS WITH SCREEN AND KEYBOARD; TELEPHONE TERMINAL; TELEPHONE TERMINALS; TELEPHONES; VIDEO-TELEPHONES; WIRELESS TELEPHONES; WIRELESS TELEVISION SET FOR PROVIDING VIDEO CONFERENCING AND TELEPHONE SERVICE OVER THE INTERNET, IN CLASS 9 (U.S. CLS. 21, 23, 26, 36 AND 38).

FIRST USE 7-1-2007; IN COMMERCE 7-23-2007.

FOR: CAPTIONED TELEPHONE SERVICES FOR INDIVIDUALS WHO ARE DEAF, HARD OF HEARING OR SPEECH IMPAIRED; INTRASTATE TELEPHONE SERVICES; TELEPHONE CALL COMPLETION SERVICES FOR DIRECTORY ASSISTANCE CUSTOMERS; TELEPHONE COMMUNICATION SERVICES; TELEPHONE RELAY SERVICES USING ON-SCREEN VIDEO; WIRELESS COMMUNICATIONS SERVICES, NAMELY, TRANSMISSION OF GRAPHICS TO MOBILE TELEPHONES, IN CLASS 38 (U.S. CLS. 100, 101 AND 104).

FIRST USE 7-1-2007; IN COMMERCE 7-23-2007.

THE MARK CONSISTS OF STANDARD CHARACTERS WITHOUT CLAIM TO ANY PARTICULAR FONT, STYLE, SIZE, OR COLOR.

SN 77-173,961, FILED 5-7-2007.

MICHAEL GAAFAR, EXAMINING ATTORNEY

Int. Cl.: 41

Prior U.S. Cls.: 100, 101, and 107

United States Patent and Trademark Office

Reg. No. 3,521,542

Registered Oct. 21, 2008

**SERVICE MARK
PRINCIPAL REGISTER**

XAVIER: RENEGADE ANGEL

THE CARTOON NETWORK, INC. (DELAWARE
CORPORATION)
ONE CNN CENTER, 13 NORTH
C/O TURNER BROADCASTING SYSTEM, INC.
ATLANTA, GA 30303

FOR: ENTERTAINMENT SERVICES, NAMELY,
AN ANIMATED PROGRAM SERIES PROVIDED
THROUGH CABLE TELEVISION, BROADCAST
TELEVISION, INTERNET, VIDEO-ON-DEMAND,
AND THROUGH OTHER DISTRIBUTION PLAT-
FORMS, IN CLASS 41 (U.S. CLS. 100, 101 AND 107).

FIRST USE 11-4-2007; IN COMMERCE 11-4-2007.

THE MARK CONSISTS OF STANDARD CHAR-
ACTERS WITHOUT CLAIM TO ANY PARTICULAR
FONT, STYLE, SIZE, OR COLOR.

SN 77-174,120, FILED 5-7-2007.

RAMONA ORTIGA, EXAMINING ATTORNEY

Int. Cls.: 16 and 25

Prior U.S. Cls.: 2, 5, 22, 23, 29, 37, 38, 39, and 50

United States Patent and Trademark Office

Reg. No. 3,521,543

Registered Oct. 21, 2008

**TRADEMARK
PRINCIPAL REGISTER**

DELIVER US FROM LIBERALS

PEEL ENTERPRISES INC (TEXAS CORPORATION)
1500 COLUMBUS AVE
WACO, TX 76701

FOR: BUMPER STICKERS; DECALS; POSTERS;
VINYL LETTERS AND NUMBER FOR USE IN
MAKING SIGNS, IN CLASS 16 (U.S. CLS. 2, 5, 22,
23, 29, 37, 38 AND 50).

FIRST USE 3-21-2007; IN COMMERCE 12-2-2007.

FOR: COATS; HATS; JACKETS; SHIRTS, IN
CLASS 25 (U.S. CLS. 22 AND 39).

FIRST USE 3-21-2007; IN COMMERCE 12-2-2007.

THE MARK CONSISTS OF STANDARD CHAR-
ACTERS WITHOUT CLAIM TO ANY PARTICULAR
FONT, STYLE, SIZE, OR COLOR.

SN 77-174,380, FILED 5-7-2007.

SOPHIA S. KIM, EXAMINING ATTORNEY

Int. Cl.: 9

Prior U.S. Cls.: 21, 23, 26, 36, and 38

United States Patent and Trademark Office

Reg. No. 3,521,544

Registered Oct. 21, 2008

**TRADEMARK
PRINCIPAL REGISTER**

CAPTURE THE EXPERIENCE!

WINNOV, LP (CALIFORNIA LIMITED PART-
NERSHIP)
3285 SCOTT BLVD.
SANTA CLARA, CA 95054

FOR: COMPUTER HARDWARE; COMPUTER
KEYBOARDS; COMPUTER PERIPHERALS; COM-
PUTER PROGRAMS USED TO CREATE MULTI-
MEDIA PRESENTATIONS; COMPUTER SOFT-
WARE USED TO CREATE PROFESSIONAL MUL-
TI-MEDIA PRESENTATIONS; COMPUTER
SOFTWARE USED TO ENHANCE THE AUDIO-
VISUAL CAPABILITIES OF MULTIMEDIA APPLI-
CATIONS, NAMELY, FOR THE INTEGRATION OF
TEXT, AUDIO, GRAPHICS, STILL IMAGES AND
MOVING PICTURES AND FOR SYNCHRONIZING
AUDIO, VIDEO, AND IMAGE FEEDS FROM MI-

CROPHONES, VIDEO CAMERAS, VCR/DVD PLAY-
ERS, VIDEO CONFERENCING DEVICES, AND
OUTPUT FROM VGA DEVICES; COMPUTER
WHITEBOARDS; ENCODERS; GRAPHICAL USER
INTERFACE SOFTWARE, IN CLASS 9 (U.S. CLS. 21,
23, 26, 36 AND 38).

FIRST USE 7-22-2008; IN COMMERCE 7-22-2008.

THE MARK CONSISTS OF STANDARD CHAR-
ACTERS WITHOUT CLAIM TO ANY PARTICULAR
FONT, STYLE, SIZE, OR COLOR.

SN 77-174,578, FILED 5-7-2007.

JEAN IM, EXAMINING ATTORNEY

Int. Cl.: 41

Prior U.S. Cls.: 100, 101, and 107

United States Patent and Trademark Office

Reg. No. 3,521,545

Registered Oct. 21, 2008

**SERVICE MARK
PRINCIPAL REGISTER**

RECESS ROCKS

COMMUNITY HEALTH CENTER, INC. (CON-
NECTICUT CORPORATION)
635 MAIN STREET
MIDDLETOWN, CT 06457

FOR: EDUCATIONAL SERVICES, NAMELY, DE-
VELOPING, ARRANGING, AND CONDUCTING
EDUCATIONAL CONFERENCES AND PROGRAMS
AND PROVIDING COURSES OF INSTRUCTION IN
THE FIELD OF DANCE INSTRUCTION TO CHIL-
DREN, INCLUDING THE PROVISION OF DANCE
INSTRUCTION TO STUDENTS AT SCHOOL DUR-
ING RECESS AS A MEANS TO COMBAT PEDIA-
TRIC OBESITY, IN CLASS 41 (U.S. CLS. 100, 101 AND
107).

FIRST USE 1-0-2007; IN COMMERCE 1-0-2007.

THE MARK CONSISTS OF STANDARD CHAR-
ACTERS WITHOUT CLAIM TO ANY PARTICULAR
FONT, STYLE, SIZE, OR COLOR.

NO CLAIM IS MADE TO THE EXCLUSIVE
RIGHT TO USE "RECESS", APART FROM THE
MARK AS SHOWN.

SN 77-174,638, FILED 5-7-2007.

BRIAN CALLAGHAN, EXAMINING ATTORNEY

Int. Cl.: 28

Prior U.S. Cls.: 22, 23, 38, and 50

United States Patent and Trademark Office

Reg. No. 3,521,546

Registered Oct. 21, 2008

**TRADEMARK
PRINCIPAL REGISTER**

SHOCKER

WARRIOR SPORTS, INC. (MICHIGAN CORPORATION)
32125 HOLLINGSWORTH AVE.
WARREN, MI 48092

THE MARK CONSISTS OF STANDARD CHARACTERS WITHOUT CLAIM TO ANY PARTICULAR FONT, STYLE, SIZE, OR COLOR.

FOR: PROTECTIVE SPORTS EQUIPMENT, NAMELY, PROTECTIVE GLOVES FOR LACROSSE AND HOCKEY, IN CLASS 28 (U.S. CLS. 22, 23, 38 AND 50).

SN 77-174,701, FILED 5-7-2007.

FIRST USE 9-30-2007; IN COMMERCE 9-30-2007.

DAVID MILLER, EXAMINING ATTORNEY

Int. Cl.: 28

Prior U.S. Cls.: 22, 23, 38, and 50

United States Patent and Trademark Office

Reg. No. 3,521,547

Registered Oct. 21, 2008

**TRADEMARK
PRINCIPAL REGISTER**

VILLAIN

WARRIOR SPORTS, INC. (MICHIGAN CORPORATION)
32125 HOLLINGSWORTH AVE.
WARREN, MI 48092

THE MARK CONSISTS OF STANDARD CHARACTERS WITHOUT CLAIM TO ANY PARTICULAR FONT, STYLE, SIZE, OR COLOR.

FOR: LACROSSE STICKS, HEADS, AND HANDLES, IN CLASS 28 (U.S. CLS. 22, 23, 38 AND 50).

SN 77-174,714, FILED 5-7-2007.

FIRST USE 10-31-2007; IN COMMERCE 10-31-2007.

STEPHEN AQUILA, EXAMINING ATTORNEY

Int. Cl.: 28

Prior U.S. Cls.: 22, 23, 38, and 50

United States Patent and Trademark Office

Reg. No. 3,521,548

Registered Oct. 21, 2008

**TRADEMARK
PRINCIPAL REGISTER**

ODB

WARRIOR SPORTS, INC. (MICHIGAN CORPORATION)
32125 HOLLINGSWORTH AVE.
WARREN, MI 48092

THE MARK CONSISTS OF STANDARD CHARACTERS WITHOUT CLAIM TO ANY PARTICULAR FONT, STYLE, SIZE, OR COLOR.

FOR: LACROSSE STICKS, HEADS, AND HANDLES, IN CLASS 28 (U.S. CLS. 22, 23, 38 AND 50).

SN 77-174,732, FILED 5-7-2007.

FIRST USE 8-31-2007; IN COMMERCE 8-31-2007.

DAVID MILLER, EXAMINING ATTORNEY

Int. Cl.: 25

Prior U.S. Cls.: 22 and 39

United States Patent and Trademark Office

Reg. No. 3,521,549

Registered Oct. 21, 2008

**TRADEMARK
PRINCIPAL REGISTER**



3 DAWG ENTERPRISES, LLC (FLORIDA LIMITED LIABILITY COMPANY)
SUITE 217
20283 STATE ROAD 7
BOCA RATON, FL 33498

FOR: CLOTHING, NAMELY, SHIRTS, T-SHIRTS, PANTS, SKIRTS, SHORTS, SWEATERS, JACKETS, CAPS, HATS, VESTS, OVERALLS AND BELTS, IN CLASS 25 (U.S. CLS. 22 AND 39).

FIRST USE 5-1-2007; IN COMMERCE 5-1-2007.

THE COLOR(S) BLACK AND RED IS/ARE CLAIMED AS A FEATURE OF THE MARK.

THE MARK CONSISTS OF THE NUMBER "3" AND THE WORD "DAWG" IN BLACK, WITH THREE HEART SHAPED DOG PAWS IN RED ABOVE THE NUMBER "3", AND THE LETTERS "A" AND "G".

SN 77-175,178, FILED 5-8-2007.

MARK SPARACINO, EXAMINING ATTORNEY

Int. Cl.: 5

Prior U.S. Cls.: 6, 18, 44, 46, 51, and 52

Reg. No. 3,521,550

United States Patent and Trademark Office

Registered Oct. 21, 2008

**TRADEMARK
PRINCIPAL REGISTER**

CARDI-OMEGA

STELLA PHARMACEUTICAL CANADA INC.
(CANADA CORPORATION)
SUITE 407
220 DUNCAN MILL ROAD
DON MILLS, CANADA M3B3JB

THE MARK CONSISTS OF STANDARD CHAR-
ACTERS WITHOUT CLAIM TO ANY PARTICULAR
FONT, STYLE, SIZE, OR COLOR.

FOR: FISH OIL CONCENTRATE FOOD SUPPLE-
MENT, IN CLASS 5 (U.S. CLS. 6, 18, 44, 46, 51 AND 52).

SN 77-175,189, FILED 5-8-2007.

FIRST USE 4-1-2008; IN COMMERCE 4-1-2008.

MARK SPARACINO, EXAMINING ATTORNEY

Int. Cl.: 18

Prior U.S. Cls.: 1, 2, 3, 22, and 41

United States Patent and Trademark Office

Reg. No. 3,521,551

Registered Oct. 21, 2008

**TRADEMARK
PRINCIPAL REGISTER**

GET HIP GET GREEN

LISA LEIJA WARDLE (UNITED STATES INDIVIDUAL)
5737 KANAN ROAD, SUITE 203
AGOURA HILLS, CA 91301

FOR: REUSEABLE TOTE BAGS, IN CLASS 18 (U.S. CLS. 1, 2, 3, 22 AND 41).

FIRST USE 5-31-2007; IN COMMERCE 5-31-2007.

THE MARK CONSISTS OF STANDARD CHARACTERS WITHOUT CLAIM TO ANY PARTICULAR FONT, STYLE, SIZE, OR COLOR.

SN 77-175,362, FILED 5-8-2007.

KATHLEEN M. VANSTON, EXAMINING ATTORNEY

Int. Cl.: 10

Prior U.S. Cls.: 26, 39, and 44

United States Patent and Trademark Office

Reg. No. 3,521,552

Registered Oct. 21, 2008

**TRADEMARK
PRINCIPAL REGISTER**

SYNERGY R

RMO, INC. (COLORADO CORPORATION)
650 WEST COLFAX AVENUE
DENVER, CO 80204

FOR: ORTHODONTIC APPLIANCES; ORTHODONTIC APPLIANCES, NAMELY, BANDS, WIRES, BRACKETS AND TUBES, IN CLASS 10 (U.S. CLS. 26, 39 AND 44).

FIRST USE 7-11-2007; IN COMMERCE 7-11-2007.

THE MARK CONSISTS OF STANDARD CHARACTERS WITHOUT CLAIM TO ANY PARTICULAR FONT, STYLE, SIZE, OR COLOR.

OWNER OF U.S. REG. NOS. 1,815,385 AND 2,612,947.

SN 77-175,601, FILED 5-8-2007.

LINDSEY RUBIN, EXAMINING ATTORNEY

Int. Cl.: 3

Prior U.S. Cls.: 1, 4, 6, 50, 51, and 52

United States Patent and Trademark Office

Reg. No. 3,521,553

Registered Oct. 21, 2008

**TRADEMARK
PRINCIPAL REGISTER**

GLOW PERFECTING

**KAO KABUSHIKI KAISHA A/T/A KAO COR-
PORATION (JAPAN CORPORATION)**

14-10, NIHONBASHI KAYABACHO 1-CHOME

CHUO-KU, TOKYO, JAPAN 103-8210

**FOR: NON-MEDICATED SKIN CARE PREPARA-
TIONS, IN CLASS 3 (U.S. CLS. 1, 4, 6, 50, 51 AND 52).**

FIRST USE 1-7-2008; IN COMMERCE 1-7-2008.

**THE MARK CONSISTS OF STANDARD CHAR-
ACTERS WITHOUT CLAIM TO ANY PARTICULAR
FONT, STYLE, SIZE, OR COLOR.**

**NO CLAIM IS MADE TO THE EXCLUSIVE
RIGHT TO USE "PERFECTING", APART FROM
THE MARK AS SHOWN.**

SN 77-177,360, FILED 5-10-2007.

MICHAEL KAZAZIAN, EXAMINING ATTORNEY

Int. Cl.: 33

Prior U.S. Cls.: 47 and 49

United States Patent and Trademark Office

Reg. No. 3,521,554

Registered Oct. 21, 2008

**TRADEMARK
PRINCIPAL REGISTER**

AR GUENTOTA

BAQUEDANO, JUAN IGNACIO VELASCO
(SPAIN INDIVIDUAL)
POLIGONO INDUSTRIAL LA ALBERGUERIA, S/N
31230 VIANA, NAVARRA, SPAIN

FOR: ALCOHOLIC BEVERAGES, NAMELY,
WINES, IN CLASS 33 (U.S. CLS. 47 AND 49).

FIRST USE 3-31-2008; IN COMMERCE 3-31-2008.

THE MARK CONSISTS OF STANDARD CHAR-
ACTERS WITHOUT CLAIM TO ANY PARTICULAR
FONT, STYLE, SIZE, OR COLOR.

THE WORDING "AR GUENTOTA" HAS NO
MEANING IN A FOREIGN LANGUAGE.

SN 77-177,419, FILED 5-10-2007.

THEODORE MCBRIDE, EXAMINING ATTORNEY

Int. Cl.: 33

Prior U.S. Cls.: 47 and 49

United States Patent and Trademark Office

Reg. No. 3,521,555

Registered Oct. 21, 2008

**TRADEMARK
PRINCIPAL REGISTER**

SWINTO

BAQUEDANO, JUAN IGNACIO VELASCO
(SPAIN INDIVIDUAL)
POLIGONO INDUSTRIAL LA ALBERGUERIA, S/N
31230 VIANA, NAVARRA, SPAIN

THE MARK CONSISTS OF STANDARD CHAR-
ACTERS WITHOUT CLAIM TO ANY PARTICULAR
FONT, STYLE, SIZE, OR COLOR.

FOR: ALCOHOLIC BEVERAGES, NAMELY,
WINES, IN CLASS 33 (U.S. CLS. 47 AND 49).

SN 77-177,455, FILED 5-10-2007.

FIRST USE 3-31-2008; IN COMMERCE 3-31-2008.

THEODORE MCBRIDE, EXAMINING ATTORNEY

Int. Cl.: 12

Prior U.S. Cls.: 19, 21, 23, 31, 35, and 44

United States Patent and Trademark Office

Reg. No. 3,521,556

Registered Oct. 21, 2008

**TRADEMARK
PRINCIPAL REGISTER**

ZeroSkid

DUALLINER, LLC (WISCONSIN LIMITED LIABILITY COMPANY)
PO BOX 423
114 MAIN STREET
KEWASKUM, WI 53040

THE MARK CONSISTS OF STANDARD CHARACTERS WITHOUT CLAIM TO ANY PARTICULAR FONT, STYLE, SIZE, OR COLOR.

FOR: FITTED LINERS FOR THE CARGO AREA OF VEHICLES; FITTED TRUCK BED LINERS, IN CLASS 12 (U.S. CLS. 19, 21, 23, 31, 35 AND 44).

SN 77-177,927, FILED 5-10-2007.

FIRST USE 7-1-2008; IN COMMERCE 7-1-2008.

KATHERINE CHANG, EXAMINING ATTORNEY

Int. Cl.: 35

Prior U.S. Cls.: 100, 101, and 102

United States Patent and Trademark Office

Reg. No. 3,521,557

Registered Oct. 21, 2008

**SERVICE MARK
PRINCIPAL REGISTER**

CHAAGO

BIG DEAL CORPORATION (WASHINGTON
CORPORATION)
12819 SE 38TH STREET, #37
BELLEVUE, WA 98006

THE MARK CONSISTS OF STANDARD CHAR-
ACTERS WITHOUT CLAIM TO ANY PARTICULAR
FONT, STYLE, SIZE, OR COLOR.

FOR: ADVERTISING SERVICES, IN CLASS 35
(U.S. CLS. 100, 101 AND 102).

SN 77-177,962, FILED 5-10-2007.

FIRST USE 8-18-2007; IN COMMERCE 8-18-2007.

JOHN WILKE, EXAMINING ATTORNEY

Int. Cl.: 35

Prior U.S. Cls.: 100, 101, and 102

United States Patent and Trademark Office

Reg. No. 3,521,558

Registered Oct. 21, 2008

SERVICE MARK
PRINCIPAL REGISTER



BIG DEAL CORPORATION (WASHINGTON CORPORATION)
12819 SE 38TH STREET, #37
BELLEVUE, WA 98006

DIRECTORY INFORMATION SERVICES, IN CLASS 35 (U.S. CLS. 100, 101 AND 102).

FIRST USE 8-18-2007; IN COMMERCE 8-18-2007.

FOR: ADVERTISING SERVICES; PROVIDING INFORMATION IN THE FIELD OF PAYROLL PROCESSING SERVICES; PROVIDING ON-LINE

SN 77-177,963, FILED 5-10-2007.

JOHN WILKE, EXAMINING ATTORNEY

Int. Cl.: 35

Prior U.S. Cls.: 100, 101, and 102

United States Patent and Trademark Office

Reg. No. 3,521,559

Registered Oct. 21, 2008

**SERVICE MARK
PRINCIPAL REGISTER**

...IT'S KIND OF A BIG DEAL

BIG DEAL CORPORATION (WASHINGTON CORPORATION)
12819 SE 38TH STREET, #37
BELLEVUE, WA 98006

FOR: ADVERTISING SERVICES; PROVIDING INFORMATION IN THE FIELD OF PAYROLL PROCESSING SERVICES; PROVIDING ON-LINE DIRECTORY INFORMATION SERVICES, IN CLASS 35 (U.S. CLS. 100, 101 AND 102).

FIRST USE 8-18-2007; IN COMMERCE 8-18-2007.

THE MARK CONSISTS OF STANDARD CHARACTERS WITHOUT CLAIM TO ANY PARTICULAR FONT, STYLE, SIZE, OR COLOR.

SN 77-177,964, FILED 5-10-2007.

JOHN WILKE, EXAMINING ATTORNEY

Int. Cl.: 16

Prior U.S. Cls.: 2, 5, 22, 23, 29, 37, 38, and 50

Reg. No. 3,521,560

United States Patent and Trademark Office

Registered Oct. 21, 2008

**TRADEMARK
PRINCIPAL REGISTER**

FRIGEMATES

DAVIS J.R., C. PAUL (UNITED STATES INDIVIDUAL)
2904 HALIFAX RD
SOUTH BOSTON, VA 24592

THE MARK CONSISTS OF STANDARD CHARACTERS WITHOUT CLAIM TO ANY PARTICULAR FONT, STYLE, SIZE, OR COLOR.

FOR: MAGNETIC BOARDS FOR SCHEDULING ACTIVITIES AND APPOINTMENTS, IN CLASS 16 (U.S. CLS. 2, 5, 22, 23, 29, 37, 38 AND 50).

SN 77-178,177, FILED 5-10-2007.

FIRST USE 8-1-2008; IN COMMERCE 9-1-2008.

TRACY WHITTAKER-BROWN, EXAMINING ATTORNEY

Int. Cl.: 36

Prior U.S. Cls.: 100, 101, and 102

United States Patent and Trademark Office

Reg. No. 3,521,561

Registered Oct. 21, 2008

**SERVICE MARK
PRINCIPAL REGISTER**

INCHARGE REALTY

SMITH, MICHAEL J. (UNITED STATES INDIVIDUAL)
4808 CORINTHIAN BAY DR
FRISCO, TX 75034

FOR: REAL ESTATE BROKERAGE; REAL ESTATE LISTING, IN CLASS 36 (U.S. CLS. 100, 101 AND 102).

FIRST USE 7-21-2008; IN COMMERCE 7-21-2008.

THE MARK CONSISTS OF STANDARD CHARACTERS WITHOUT CLAIM TO ANY PARTICULAR FONT, STYLE, SIZE, OR COLOR.

NO CLAIM IS MADE TO THE EXCLUSIVE RIGHT TO USE "REALTY", APART FROM THE MARK AS SHOWN.

SN 77-178,360, FILED 5-11-2007.

KRISTINA MORRIS, EXAMINING ATTORNEY

Int. Cl.: 35

Prior U.S. Cls.: 100, 101, and 102

United States Patent and Trademark Office

Reg. No. 3,521,562

Registered Oct. 21, 2008

**SERVICE MARK
PRINCIPAL REGISTER**

INCHARGE REALTY

SMITH, MICHAEL J. (UNITED STATES INDIVIDUAL)

4808 CORINTHIAN BAY DR

FRISCO, TX 75034

FOR: REAL ESTATE ADVERTISING SERVICES,
IN CLASS 35 (U.S. CLS. 100, 101 AND 102).

FIRST USE 7-21-2008; IN COMMERCE 7-21-2008.

THE MARK CONSISTS OF STANDARD CHARACTERS WITHOUT CLAIM TO ANY PARTICULAR FONT, STYLE, SIZE, OR COLOR.

NO CLAIM IS MADE TO THE EXCLUSIVE RIGHT TO USE "REALTY", APART FROM THE MARK AS SHOWN.

SN 77-178,363, FILED 5-11-2007.

KRISTINA MORRIS, EXAMINING ATTORNEY

Int. Cl.: 3

Prior U.S. Cls.: 1, 4, 6, 50, 51, and 52

United States Patent and Trademark Office

Reg. No. 3,521,563

Registered Oct. 21, 2008

**TRADEMARK
PRINCIPAL REGISTER**

WISH OF PEACE

AVON PRODUCTS, INC. (NEW YORK CORPORATION)
LEGAL DEPARTMENT - 3RD FL.
1251 AVENUE OF THE AMERICAS
NEW YORK, NY 10020

THE MARK CONSISTS OF STANDARD CHARACTERS WITHOUT CLAIM TO ANY PARTICULAR FONT, STYLE, SIZE, OR COLOR.

FOR: EAU DE TOILETTE; SHOWER GEL; BODY LOTION, IN CLASS 3 (U.S. CLS. 1, 4, 6, 50, 51 AND 52).

SN 77-178,544, FILED 5-11-2007.

FIRST USE 12-13-2007; IN COMMERCE 12-13-2007.

LOURDES AYALA, EXAMINING ATTORNEY

Int. Cl.: 19

Prior U.S. Cls.: 1, 12, 33, and 50

United States Patent and Trademark Office

Reg. No. 3,521,564

Registered Oct. 21, 2008

**TRADEMARK
PRINCIPAL REGISTER**

SOLACE

OWENS CORNING INTELLECTUAL CAPITAL,
LLC (DELAWARE LIMITED LIABILITY COM-
PANY)
ONE OWENS CORNING PARKWAY
TOLEDO, OH 43659

FOR: HEAT INSULATING GLASS PANELS AND
WINDOW PANES SOLD AS A COMPONENT PART
OF NON-METAL WINDOWS, IN CLASS 19 (U.S. CLS.
1, 12, 33 AND 50).

FIRST USE 7-31-2008; IN COMMERCE 7-31-2008.

THE MARK CONSISTS OF STANDARD CHAR-
ACTERS WITHOUT CLAIM TO ANY PARTICULAR
FONT, STYLE, SIZE, OR COLOR.

SN 77-178,684, FILED 5-11-2007.

CARYN GLASSER, EXAMINING ATTORNEY

Int. Cl.: 9

Prior U.S. Cls.: 21, 23, 26, 36, and 38

Reg. No. 3,521,565

United States Patent and Trademark Office

Registered Oct. 21, 2008

**TRADEMARK
PRINCIPAL REGISTER**

ANCHOR BAY

ANCHOR BAY TECHNOLOGIES, INC. (DELAWARE CORPORATION)
983 UNIVERSITY AVENUE, BUILDING A
LOS GATOS, CA 95032

FOR: SEMICONDUCTORS; VIDEO PROCESSING SYSTEMS COMPRISED OF SEMICONDUCTORS, COMPUTER HARDWARE, SOFTWARE AND FIRMWARE, FOR DIGITAL VIDEO AND AUDIO FORMAT CONVERSION, DE-INTERLACING, SCALING, CALIBRATION, DETAIL ENHANCEMENT, PICTURE ENHANCEMENT, EDGE ENHANCEMENT, NOISE REDUCTION, MPEG NOISE REDUCTION, AND SWITCHING, DISTRIBUTION AND CONTROL FOR HOME THEATER AND BUSINESS APPLICATIONS; VIDEO PROCESSING SYSTEMS, NAMELY, INTEGRATED SYSTEM LEVEL PRODUCTS COMPRISED OF SEMICONDUCTORS, COMPUTER HARDWARE, SOFTWARE AND FIRMWARE, FOR DIGITAL VIDEO AND AUDIO

FORMAT CONVERSION, DE-INTERLACING, SCALING, CALIBRATION, DETAIL ENHANCEMENT, PICTURE ENHANCEMENT, EDGE ENHANCEMENT, NOISE REDUCTION, MPEG NOISE REDUCTION, AND SWITCHING, DISTRIBUTION AND CONTROL FOR HOME THEATER AND BUSINESS APPLICATIONS, IN CLASS 9 (U.S. CLS. 21, 23, 26, 36 AND 38).

FIRST USE 1-31-2008; IN COMMERCE 1-31-2008.

THE MARK CONSISTS OF STANDARD CHARACTERS WITHOUT CLAIM TO ANY PARTICULAR FONT, STYLE, SIZE, OR COLOR.

SN 77-178,713, FILED 5-11-2007.

ANTHONY RINKER, EXAMINING ATTORNEY

Int. Cl.: 42

Prior U.S. Cls.: 100 and 101

United States Patent and Trademark Office

Reg. No. 3,521,566

Registered Oct. 21, 2008

**SERVICE MARK
PRINCIPAL REGISTER**

PRECISIONWEB GUARDIAN

ABBOTT LABORATORIES (ILLINOIS CORPORATION)
100 ABBOTT PARK ROAD
ABBOTT PARK, IL 60064

FOR: PROVIDING TEMPORARY USE OF NON-DOWNLOADABLE COMPUTER SOFTWARE FOR THE MAINTENANCE AND MONITORING OF HEALTH DATA MANAGEMENT SYSTEMS, IN CLASS 42 (U.S. CLS. 100 AND 101).

FIRST USE 2-11-2008; IN COMMERCE 2-11-2008.

THE MARK CONSISTS OF STANDARD CHARACTERS WITHOUT CLAIM TO ANY PARTICULAR FONT, STYLE, SIZE, OR COLOR.

OWNER OF U.S. REG. NOS. 2,081,954, 3,097,939, AND OTHERS.

SN 77-179,077, FILED 5-11-2007.

GEOFFREY FOSDICK, EXAMINING ATTORNEY

Int. Cl.: 35

Prior U.S. Cls.: 100, 101, and 102

United States Patent and Trademark Office

Reg. No. 3,521,567

Registered Oct. 21, 2008

**SERVICE MARK
PRINCIPAL REGISTER**

WATERLASE DENTISTRY

BIOLASE TECHNOLOGY, INC. (DELAWARE
CORPORATION)
4 CROMWELL
IRVINE, CA 92618

FOR: ADVERTISING; BUSINESS MANAGE-
MENT; BUSINESS ADMINISTRATION; PROVID-
ING OFFICE FUNCTIONS; BUSINESS
MANAGEMENT, NAMELY, SERVICES RENDERED
PRINCIPALLY WITH THE OBJECT OF HELPING IN
THE WORKING OR MANAGEMENT OF COMMER-
CIAL UNDERTAKINGS, OR HELPING IN THE
MANAGEMENT OF BUSINESS AFFAIRS OR COM-
MERCIAL FUNCTIONS OF AN ENTERPRISE, IN
CLASS 35 (U.S. CLS. 100, 101 AND 102).

FIRST USE 10-31-2004; IN COMMERCE 10-31-2004.

THE MARK CONSISTS OF STANDARD CHAR-
ACTERS WITHOUT CLAIM TO ANY PARTICULAR
FONT, STYLE, SIZE, OR COLOR.

NO CLAIM IS MADE TO THE EXCLUSIVE
RIGHT TO USE "DENTISTRY", APART FROM
THE MARK AS SHOWN.

SN 77-179,623, FILED 5-13-2007.

MARK PILARO, EXAMINING ATTORNEY

Int. Cl.: 3

Prior U.S. Cls.: 1, 4, 6, 50, 51, and 52

United States Patent and Trademark Office

Reg. No. 3,521,568

Registered Oct. 21, 2008

**TRADEMARK
PRINCIPAL REGISTER**

WISH OF LOVE

AVON PRODUCTS, INC. (NEW YORK CORPORATION)
LEGAL DEPARTMENT - 3RD FL.
1251 AVENUE OF THE AMERICAS
NEW YORK, NY 10020

THE MARK CONSISTS OF STANDARD CHARACTERS WITHOUT CLAIM TO ANY PARTICULAR FONT, STYLE, SIZE, OR COLOR.

FOR: EAU DE TOILETTE; SHOWER GEL; BODY LOTION, IN CLASS 3 (U.S. CLS. 1, 4, 6, 50, 51 AND 52).

SN 77-179,850, FILED 5-14-2007.

FIRST USE 12-13-2007; IN COMMERCE 12-13-2007.

LOURDES AYALA, EXAMINING ATTORNEY

Int. Cls.: 37 and 39

Prior U.S. Cls.: 100, 103, 105, and 106

United States Patent and Trademark Office

Reg. No. 3,521,569

Registered Oct. 21, 2008

**SERVICE MARK
PRINCIPAL REGISTER**

GOOD TO KNOW GOOD TO GO

WASTE MANAGEMENT, INC. (DELAWARE
CORPORATION)
1001 FANNIN, SUITE 4000
HOUSTON, TX 77002

FOR: WASTE DISPOSAL FOR OTHERS AND
COLLECTION OF TRASH, IN CLASS 37 (U.S. CLS.
100, 103 AND 106).

FIRST USE 7-7-2008; IN COMMERCE 7-7-2008.

FOR: GARBAGE COLLECTION AND TRANS-
PORT BY TRUCK, IN CLASS 39 (U.S. CLS. 100 AND
105).

FIRST USE 7-7-2008; IN COMMERCE 7-7-2008.

THE MARK CONSISTS OF STANDARD CHAR-
ACTERS WITHOUT CLAIM TO ANY PARTICULAR
FONT, STYLE, SIZE, OR COLOR.

SN 77-179,944, FILED 5-14-2007.

KIMBERLY FRYE, EXAMINING ATTORNEY

Int. Cl.: 40

Prior U.S. Cls.: 100, 103, and 106

United States Patent and Trademark Office

Reg. No. 3,521,570

Registered Oct. 21, 2008

**SERVICE MARK
PRINCIPAL REGISTER**

Great Water, Made Better

WIRELESS CAPITAL PARTNERS, LLC (DELA-
WARE LIMITED LIABILITY COMPANY)

#400

11900 W. OLYMPIC BLVD.

LOS ANGELES, CA 90064

FOR: WATER TREATMENT SERVICES, NAME-
LY, WATER FILTRATION, IN CLASS 40 (U.S. CLS.
100, 103 AND 106).

FIRST USE 6-1-2008; IN COMMERCE 6-1-2008.

THE MARK CONSISTS OF STANDARD CHAR-
ACTERS WITHOUT CLAIM TO ANY PARTICULAR
FONT, STYLE, SIZE, OR COLOR.

NO CLAIM IS MADE TO THE EXCLUSIVE
RIGHT TO USE "WATER", APART FROM THE
MARK AS SHOWN.

SN 77-180,050, FILED 5-14-2007.

RONALD DELGIZZI, EXAMINING ATTORNEY

Int. Cls.: 37 and 39

Prior U.S. Cls.: 100, 103, 105, and 106

United States Patent and Trademark Office

Reg. No. 3,521,571

Registered Oct. 21, 2008

**SERVICE MARK
PRINCIPAL REGISTER**



ECO-EDGE, LLC (ARIZONA LIMITED LIABILITY COMPANY)
7400 WEST DETROIT, #150
CHANDLER, AZ 85226

FOR: INSTALLATION AND MAINTENANCE OF ENVIRONMENTAL AND EFFICIENCY PRODUCTS, NAMELY, COMBUSTION CATALYST SYSTEMS, DIESEL POWER KITS, AND FUEL AND OIL FILTRATION SYSTEMS, IN CLASS 37 (U.S. CLS. 100, 103 AND 106).

FIRST USE 7-25-2008; IN COMMERCE 7-25-2008.

FOR: DISTRIBUTION SERVICES, NAMELY DELIVERY OF ENVIRONMENTAL AND EFFICIENCY PRODUCTS, NAMELY, COMBUSTION CATALYST SYSTEMS, DIESEL POWER KITS, AND FUEL AND OIL FILTRATION SYSTEMS, IN CLASS 39 (U.S. CLS. 100 AND 105).

FIRST USE 7-25-2008; IN COMMERCE 7-25-2008.

THE COLOR(S) GREEN IS/ARE CLAIMED AS A FEATURE OF THE MARK.

THE MARK CONSISTS OF A HORIZONTAL LINE WITH AN ARROW EMINATING UPWARD FROM THE RIGHT END OF THE HORIZONTAL LINE IN A COUNTERCLOCKWISE MANNER AND AN ARROW EMINATING DOWNWARD FROM THE LEFT END OF THE HORIZONTAL LINE IN A COUNTERCLOCKWISE MANNER.

SN 77-180,574, FILED 5-14-2007.

RICHARD A. STRASER, EXAMINING ATTORNEY

Int. Cls.: 35 and 42

Prior U.S. Cls.: 100, 101, and 102

United States Patent and Trademark Office

Reg. No. 3,521,572

Registered Oct. 21, 2008

**SERVICE MARK
PRINCIPAL REGISTER**



ECO-EDGE, LLC (ARIZONA LIMITED LIABILITY COMPANY)
7400 WEST DETROIT, #150
CHANDLER, AZ 85226

FOR: CONSULTING SERVICES, NAMELY, BUSINESS CONSULTING SERVICES IN THE FIELD OF EFFICIENCY AND PERFORMANCE OF DIESEL FREIGHT TRUCK FLEET OPERATIONS, IN CLASS 35 (U.S. CLS. 100, 101 AND 102).

FIRST USE 7-25-2008; IN COMMERCE 7-25-2008.

FOR: CONSULTING SERVICES, NAMELY, TECHNOLOGY CONSULTATION SERVICES IN THE FIELD OF FUEL EFFICIENCY, EMISSION CONTROL, AND AUTOMOTIVE TECHNOLOGY FOR DIESEL FREIGHT TRUCK FLEET OPERATIONS, IN CLASS 42 (U.S. CLS. 100 AND 101).

FIRST USE 7-25-2008; IN COMMERCE 7-25-2008.

THE COLOR(S) GREEN IS/ARE CLAIMED AS A FEATURE OF THE MARK.

THE MARK CONSISTS OF A HORIZONTAL LINE WITH AN ARROW EMINATING UPWARD FROM THE RIGHT END OF THE HORIZONTAL LINE IN A COUNTERCLOCKWISE MANNER AND AN ARROW EMINATING DOWNWARD FROM THE LEFT END OF THE HORIZONTAL LINE IN A COUNTERCLOCKWISE MANNER.

SN 77-180,581, FILED 5-14-2007.

RICHARD A. STRASER, EXAMINING ATTORNEY

Int. Cl.: 3

Prior U.S. Cls.: 1, 4, 6, 50, 51, and 52

United States Patent and Trademark Office

Reg. No. 3,521,573

Registered Oct. 21, 2008

**TRADEMARK
PRINCIPAL REGISTER**



JUICE BEAUTY, INC. (CALIFORNIA CORPORATION)
711 GRAND AVENUE, SUITE 290
SAN RAFAEL, CA 94901

FOR: ORGANIC SKIN AND BODY CARE PRODUCTS, NAMELY, CLEANSERS, LOTIONS, CREAMS, EXFOLIATES, PEELS, IN CLASS 3 (U.S. CLS. 1, 4, 6, 50, 51 AND 52).

FIRST USE 4-0-2006; IN COMMERCE 4-0-2006.

OWNER OF U.S. REG. NOS. 2,650,368, 2,843,823, AND 3,160,774.

NO CLAIM IS MADE TO THE EXCLUSIVE RIGHT TO USE "ORGANICS", APART FROM THE MARK AS SHOWN.

THE COLOR(S) ORANGE, WHITE AND BLACK IS/ARE CLAIMED AS A FEATURE OF THE MARK.

THE MARK CONSISTS OF THE TOP HALF OF AN ORANGE SLICE WITH THE SECTION AND RIND PORTIONS SHOWING IN WHITE, AND THE WORDING JUICE ORGANICS IN BLACK, APPEARING SLIGHTLY ABOVE AND TO THE RIGHT OF THE ORANGE SLICE. THE DOTTED LINES SHOW PLACEMENT OF THE MARK ON A LABEL OR OTHER FLAT SURFACE SUCH AS A BOX.

SN 77-180,689, FILED 5-14-2007.

ELLEN BURNS, EXAMINING ATTORNEY

Int. Cl.: 5

Prior U.S. Cls.: 6, 18, 44, 46, 51, and 52

Reg. No. 3,521,574

United States Patent and Trademark Office

Registered Oct. 21, 2008

**TRADEMARK
PRINCIPAL REGISTER**

LATIGO

HELENA HOLDING COMPANY (DELAWARE
CORPORATION)
300 DELAWARE AVENUE, 9TH FLOOR - DE 5403
WILMINGTON, DE 19801

FOR: PESTICIDES FOR AGRICULTURAL USE,
IN CLASS 5 (U.S. CLS. 6, 18, 44, 46, 51 AND 52).

FIRST USE 4-1-2008; IN COMMERCE 4-1-2008.

THE MARK CONSISTS OF STANDARD CHAR-
ACTERS WITHOUT CLAIM TO ANY PARTICULAR
FONT, STYLE, SIZE, OR COLOR.

THE FOREIGN WORDING IN THE MARK
TRANSLATES INTO ENGLISH AS "A LONG STRAP
ON A SADDLETREE OF A WESTERN SADDLE TO
ADJUST THE CINCH".

SN 77-181,094, FILED 5-15-2007.

INGA ERVIN, EXAMINING ATTORNEY

Int. Cl.: 35

Prior U.S. Cls.: 100, 101, and 102

United States Patent and Trademark Office

Reg. No. 3,521,575

Registered Oct. 21, 2008

**SERVICE MARK
PRINCIPAL REGISTER**

ANOTHER PROFIT CENTER

STEVEN BANKLER, CPA (UNITED STATES INDIVIDUAL)
9901 W. IH-10, SUITE 670
SAN ANTONIO, TX 78230

FOR: BUSINESS MANAGEMENT CONSULTATION SERVICES; ACCOUNTING CONSULTATION SERVICES; INFORMATION, ASSISTANCE, AND ADVICE CONCERNING ORGANIZATION AND MANAGEMENT OF BUSINESSES; FINANCIAL STATEMENTS PREPARATION AND ANALYSIS SERVICES; TAX ADVISORY, TAX RETURN PREPARATION; TAX COMPLIANCE, NAMELY, TAX FILING SERVICES; TAX CONSULTATION AND

TAX PLANNING SERVICES, IN CLASS 35 (U.S. CLS. 100, 101 AND 102).

FIRST USE 6-1-2008; IN COMMERCE 6-1-2008.

THE MARK CONSISTS OF STANDARD CHARACTERS WITHOUT CLAIM TO ANY PARTICULAR FONT, STYLE, SIZE, OR COLOR.

SN 77-181,480, FILED 5-15-2007.

SAMUEL E. SHARPER JR., EXAMINING ATTORNEY

Int. Cl.: 9

Prior U.S. Cls.: 21, 23, 26, 36, and 38

United States Patent and Trademark Office

Reg. No. 3,521,576

Registered Oct. 21, 2008

**TRADEMARK
PRINCIPAL REGISTER**

OWN YOUR HAPPINESS

KATHLEEN A. HALL (UNITED STATES INDIVIDUAL)
495 OWLS NEST LANE
CLARKESVILLE, GA 30523

FOR: AUDIO AND VIDEO TAPES, DVDS AND CD-ROMS FEATURING LECTURES IN THE FIELDS OF PERSONAL SPIRITUAL GROWTH, HEALING AND WELLNESS, AND IDENTIFYING, OVERCOMING AND AVOIDING STRESS AND DESTRUCTIVE BEHAVIOR, IN CLASS 9 (U.S. CLS. 21, 23, 26, 36 AND 38).

FIRST USE 4-14-2007; IN COMMERCE 4-14-2007.

THE MARK CONSISTS OF STANDARD CHARACTERS WITHOUT CLAIM TO ANY PARTICULAR FONT, STYLE, SIZE, OR COLOR.

SN 77-181,550, FILED 5-15-2007.

GIANCARLO CASTRO, EXAMINING ATTORNEY

Int. Cl.: 28

Prior U.S. Cls.: 22, 23, 38, and 50

United States Patent and Trademark Office

Reg. No. 3,521,577

Registered Oct. 21, 2008

**TRADEMARK
PRINCIPAL REGISTER**

DR. SEUSS

DR. SEUSS ENTERPRISES, L.P. (CALIFORNIA
LIMITED PARTNERSHIP)
C/O KARL ZOBELL, ESQ., DLA PIPER US LLP
1200 PROSPECT STREET, SUITE 575
LA JOLLA, CA 920373610

FOR: CHRISTMAS TREE ORNAMENTS, IN
CLASS 28 (U.S. CLS. 22, 23, 38 AND 50).

FIRST USE 11-0-2007; IN COMMERCE 11-0-2007.

THE MARK CONSISTS OF STANDARD CHAR-
ACTERS WITHOUT CLAIM TO ANY PARTICULAR
FONT, STYLE, SIZE, OR COLOR.

OWNER OF U.S. REG. NOS. 2,260,043, 3,100,690,
AND OTHERS.

SN 77-181,946, FILED 5-15-2007.

GIANCARLO CASTRO, EXAMINING ATTORNEY

Int. Cl.: 37

Prior U.S. Cls.: 100, 103, and 106

United States Patent and Trademark Office

Reg. No. 3,521,578

Registered Oct. 21, 2008

**SERVICE MARK
PRINCIPAL REGISTER**

DIAMOND AUTO WASH

DIAMOND AUTO GLASS, INCORPORATED (ARIZONA CORPORATION)
P.O. BOX 43830
PHOENIX, AZ 85027

FOR: VEHICLE REPAIR AND MAINTENANCE, VEHICLE WASHING, VEHICLE CLEANING AND VEHICLE SERVICE STATION SERVICES, IN CLASS 37 (U.S. CLS. 100, 103 AND 106).

FIRST USE 5-15-2007; IN COMMERCE 5-15-2007.

THE MARK CONSISTS OF STANDARD CHARACTERS WITHOUT CLAIM TO ANY PARTICULAR FONT, STYLE, SIZE, OR COLOR.

NO CLAIM IS MADE TO THE EXCLUSIVE RIGHT TO USE "AUTO WASH", APART FROM THE MARK AS SHOWN.

SN 77-181,977, FILED 5-15-2007.

ELI HELLMAN, EXAMINING ATTORNEY

Int. Cl.: 9

Prior U.S. Cls.: 21, 23, 26, 36, and 38

United States Patent and Trademark Office

Reg. No. 3,521,579

Registered Oct. 21, 2008

**TRADEMARK
PRINCIPAL REGISTER**



AZOTEQ (PTY) LTD (SOUTH AFRICA CORPORATION)
109 MAIN STREET
PAARL, SOUTH AFRICA 7620

FOR: ELECTRONIC SWITCHES; ELECTRONIC ACTIVATION AND CONTROL DEVICES; ELECTRIC APPLIANCES AND APPARATUS, NAMELY, ELECTRIC SWITCHES AND ELECTRIC ACTIVA-

TION AND CONTROL DEVICES , IN CLASS 9 (U.S. CLS. 21, 23, 26, 36 AND 38).

FIRST USE 0-0-2005; IN COMMERCE 7-0-2006.

SN 77-182,078, FILED 5-16-2007.

KELLEY WELLS, EXAMINING ATTORNEY

Int. Cl.: 28

Prior U.S. Cls.: 22, 23, 38, and 50

United States Patent and Trademark Office

Reg. No. 3,521,580

Registered Oct. 21, 2008

**TRADEMARK
PRINCIPAL REGISTER**

KILLER COPTER

MATTEL, INC. (DELAWARE CORPORATION)
M1-1518
333 CONTINENTAL BLVD.
EL SEGUNDO, CA 90245

FOR: TOYS, GAMES AND PLAYTHINGS, NAME-
LY, TOY VEHICLES AND ACCESSORIES THERE-
FOR, IN CLASS 28 (U.S. CLS. 22, 23, 38 AND 50).

FIRST USE 8-13-2008; IN COMMERCE 8-13-2008.

THE MARK CONSISTS OF STANDARD CHAR-
ACTERS WITHOUT CLAIM TO ANY PARTICULAR
FONT, STYLE, SIZE, OR COLOR.

NO CLAIM IS MADE TO THE EXCLUSIVE
RIGHT TO USE "COPTER", APART FROM THE
MARK AS SHOWN.

SN 77-182,164, FILED 5-16-2007.

RONALD DELGIZZI, EXAMINING ATTORNEY

Int. Cl.: 9

Prior U.S. Cls.: 21, 23, 26, 36, and 38

Reg. No. 3,521,581

United States Patent and Trademark Office

Registered Oct. 21, 2008

**TRADEMARK
PRINCIPAL REGISTER**

litigation ready

TW STORAGE, INC. (NEW JERSEY CORPORATION), DBA INDEX ENGINES,
17 BLACKPOINT HORSESHOE
RUMSON, NJ 07760

FOR: COMPUTER SOFTWARE FOR THE COLLECTION, EDITING, ORGANIZING, MODIFYING, BOOK MARKING, TRANSMISSION, STORAGE AND SHARING OF DATA AND INFORMATION; COMPUTER PROGRAMS FOR SEARCHING THE CONTENTS OF COMPUTERS AND COMPUTER NETWORKS BY REMOTE CONTROL; COMPUTER SEARCH ENGINE SOFTWARE, IN CLASS 9 (U.S. CLS. 21, 23, 26, 36 AND 38).

FIRST USE 5-2-2007; IN COMMERCE 5-2-2007.

THE MARK CONSISTS OF STANDARD CHARACTERS WITHOUT CLAIM TO ANY PARTICULAR FONT, STYLE, SIZE, OR COLOR.

NO CLAIM IS MADE TO THE EXCLUSIVE RIGHT TO USE "LITIGATION", APART FROM THE MARK AS SHOWN.

SN 77-182,171, FILED 5-16-2007.

ADA HAN, EXAMINING ATTORNEY

Int. Cl.: 21

Prior U.S. Cls.: 2, 13, 23, 29, 30, 33, 40, and 50

United States Patent and Trademark Office

Reg. No. 3,521,582

Registered Oct. 21, 2008

**TRADEMARK
PRINCIPAL REGISTER**

SIMPLYLITE

WKI HOLDING COMPANY, INC. (DELAWARE
CORPORATION)
SUITE 400
5500 N. PEARL ST.
ROSEMONT, IL 60018

FOR: COOKING, BAKING AND SERVING
DISHES AND COVERS MADE OF GLASS, CERA-
MIC, GLASS-CERAMIC OR PLASTIC; STORING
DISHES AND COVERS MADE OF GLASS, CERA-
MIC, GLASS-CERAMIC OR PLASTIC FOR HOUSE-
HOLD AND KITCHEN USE, IN CLASS 21 (U.S. CLS.
2, 13, 23, 29, 30, 33, 40 AND 50).

FIRST USE 6-17-2008; IN COMMERCE 6-17-2008.

THE MARK CONSISTS OF STANDARD CHAR-
ACTERS WITHOUT CLAIM TO ANY PARTICULAR
FONT, STYLE, SIZE, OR COLOR.

SN 77-182,393, FILED 5-16-2007.

RONALD DELGIZZI, EXAMINING ATTORNEY

Int. Cl.: 21

Prior U.S. Cls.: 2, 13, 23, 29, 30, 33, 40, and 50

United States Patent and Trademark Office

Reg. No. 3,521,583

Registered Oct. 21, 2008

**TRADEMARK
PRINCIPAL REGISTER**

PAW MONSTER

SUNBEAM PRODUCTS, INC. (DELAWARE CORPORATION)

2381 EXECUTIVE CENTER DRIVE

BOCA RATON, FL 33431

FOR: PET BRUSHES, IN CLASS 21 (U.S. CLS. 2, 13, 23, 29, 30, 33, 40 AND 50).

FIRST USE 10-31-2007; IN COMMERCE 10-31-2007.

THE MARK CONSISTS OF STANDARD CHARACTERS WITHOUT CLAIM TO ANY PARTICULAR FONT, STYLE, SIZE, OR COLOR.

NO CLAIM IS MADE TO THE EXCLUSIVE RIGHT TO USE "PAW", APART FROM THE MARK AS SHOWN.

SN 77-183,285, FILED 5-17-2007.

LAURA HAMMEL, EXAMINING ATTORNEY

Int. Cl.: 9

Prior U.S. Cls.: 21, 23, 26, 36, and 38

Reg. No. 3,521,584

United States Patent and Trademark Office

Registered Oct. 21, 2008

**TRADEMARK
PRINCIPAL REGISTER**

FIT FOR DUTY

MINE SAFETY APPLIANCES COMPANY (PENNSYLVANIA CORPORATION)
121 GAMMA DRIVE
PITTSBURGH, PA 15238

THE MARK CONSISTS OF STANDARD CHARACTERS WITHOUT CLAIM TO ANY PARTICULAR FONT, STYLE, SIZE, OR COLOR.

FOR: SIZING VESTS FOR MEASURING INDIVIDUALS FOR BODY ARMOR, IN CLASS 9 (U.S. CLS. 21, 23, 26, 36 AND 38).

SN 77-183,478, FILED 5-17-2007.

FIRST USE 5-7-2008; IN COMMERCE 5-7-2008.

LAURA KOVALSKY, EXAMINING ATTORNEY

Int. Cl.: 25

Prior U.S. Cls.: 22 and 39

United States Patent and Trademark Office

Reg. No. 3,521,585

Registered Oct. 21, 2008

**TRADEMARK
PRINCIPAL REGISTER**

PUREPLAY

PUREPLAY LLC (NEW YORK LIMITED LIABILITY COMPANY)
42 WEST 39TH STREET, 13TH FLOOR
NEW YORK, NY 10018

THE MARK CONSISTS OF STANDARD CHARACTERS WITHOUT CLAIM TO ANY PARTICULAR FONT, STYLE, SIZE, OR COLOR.

FOR: CLOTHING, NAMELY, KNIT SHIRTS, SWEATERS, PANTS, TROUSERS, SHORTS, SHIRTS, SWEATSHIRTS, UNDERGARMENTS, JACKETS AND COATS, IN CLASS 25 (U.S. CLS. 22 AND 39).

SN 77-183,700, FILED 5-17-2007.

FIRST USE 2-0-2008; IN COMMERCE 2-0-2008.

JUDITH HELFMAN, EXAMINING ATTORNEY

Int. Cl.: 25

Prior U.S. Cls.: 22 and 39

United States Patent and Trademark Office

Reg. No. 3,521,586

Registered Oct. 21, 2008

**TRADEMARK
PRINCIPAL REGISTER**

WILLIAM GOOD

100MC, LLC (CALIFORNIA LIMITED LIABILITY
COMPANY)
12 E. SIR FRANCIS DRAKE BLVD.
LARKSPUR, CA 94939

FOR: CLOTHING, NAMELY, MEN'S, WOMEN'S
AND CHILDREN'S CASUAL AND DRESS CLOTH-
ING, NAMELY, DRESS AND CASUAL SHIRTS,
PANTS, SHORTS, JACKETS, UNDERWEAR, TOPS,
FOOTWEAR AND HEADWEAR, IN CLASS 25 (U.S.
CLS. 22 AND 39).

FIRST USE 1-15-2008; IN COMMERCE 1-15-2008.

THE MARK CONSISTS OF STANDARD CHAR-
ACTERS WITHOUT CLAIM TO ANY PARTICULAR
FONT, STYLE, SIZE, OR COLOR.

"THE NAME(S), PORTRAIT(S), AND/OR SIGNA-
TURE(S) SHOWN IN THE MARK DOES NOT IDEN-
TIFY A PARTICULAR LIVING INDIVIDUAL."

SN 77-184,140, FILED 5-17-2007.

ANNE E. GUSTASON, EXAMINING ATTORNEY

Int. Cl.: 36

Prior U.S. Cls.: 100, 101, and 102

United States Patent and Trademark Office

Reg. No. 3,521,587

Registered Oct. 21, 2008

**SERVICE MARK
PRINCIPAL REGISTER**

SOMA ASSET MANAGEMENT LLC

SOMA ASSET MANAGEMENT LLC (DELAWARE
LIMITED LIABILITY COMPANY)

1750 MONTGOMERY STREET

SAN FRANCISCO, CA 94111

FOR: FINANCIAL ASSET AND INVESTMENT
MANAGEMENT SERVICES, IN CLASS 36 (U.S.
CLS. 100, 101 AND 102).

FIRST USE 1-1-2008; IN COMMERCE 1-1-2008.

THE MARK CONSISTS OF STANDARD CHAR-
ACTERS WITHOUT CLAIM TO ANY PARTICULAR
FONT, STYLE, SIZE, OR COLOR.

NO CLAIM IS MADE TO THE EXCLUSIVE
RIGHT TO USE "ASSET MANAGEMENT LLC",
APART FROM THE MARK AS SHOWN.

SN 77-184,177, FILED 5-17-2007.

ANDREA K. NADELMAN, EXAMINING ATTOR-
NEY

Int. Cl.: 20

Prior U.S. Cls.: 2, 13, 22, 25, 32, and 50

Reg. No. 3,521,588

United States Patent and Trademark Office

Registered Oct. 21, 2008

**TRADEMARK
PRINCIPAL REGISTER**

STRIVE

KRUEGER INTERNATIONAL, INC. (WISCONSIN CORPORATION)
1330 BELLEVUE STREET
GREEN BAY, WI 54302

THE MARK CONSISTS OF STANDARD CHARACTERS WITHOUT CLAIM TO ANY PARTICULAR FONT, STYLE, SIZE, OR COLOR.

FOR: FURNITURE, IN CLASS 20 (U.S. CLS. 2, 13, 22, 25, 32 AND 50).

SN 77-184,400, FILED 5-18-2007.

FIRST USE 5-2-2008; IN COMMERCE 5-2-2008.

JEAN IM, EXAMINING ATTORNEY

Int. Cls.: 28 and 35

Prior U.S. Cls.: 22, 23, 38, 50, 100, 101, and 102

United States Patent and Trademark Office

Reg. No. 3,521,589

Registered Oct. 21, 2008

**TRADEMARK
SERVICE MARK
PRINCIPAL REGISTER**

THE ONLY NET YOU NEED

THE NET RETURN, LLC (NEW JERSEY LIMITED LIABILITY COMPANY)
121 LINCOLN AVE.
FAIR LAWN, NJ 07410

FOR: SPORTS NETS, NAMELY, BALL RETURN NETS, USED IN A VARIETY OF SPORTS SUCH AS BASKETBALL, FOOTBALL, VOLLEYBALL, BADMINTON, BASEBALL, TENNIS, FIELD HOCKEY, ICE HOCKEY, ROLLER HOCKEY, RACKET BALL, HANDBALL, TABLE TENNIS, BOCCE BALL, SOCCER, RUGBY, GOLF, SQUASH, CRICKET, CROQUET, JAI ALAI, PADDLE BALL, LACROSSE, AND DISCUS THROWING / SHOT PUT, IN CLASS 28 (U.S. CLS. 22, 23, 38 AND 50).

FIRST USE 6-0-2007; IN COMMERCE 6-0-2007.

FOR: RETAIL STORE SERVICES FEATURING SPORTS NETS, NAMELY, BALL RETURN NETS, IN CLASS 35 (U.S. CLS. 100, 101 AND 102).

FIRST USE 6-0-2007; IN COMMERCE 6-0-2007.

THE MARK CONSISTS OF STANDARD CHARACTERS WITHOUT CLAIM TO ANY PARTICULAR FONT, STYLE, SIZE, OR COLOR.

SN 77-184,462, FILED 5-18-2007.

GIANCARLO CASTRO, EXAMINING ATTORNEY

Int. Cl.: 25

Prior U.S. Cls.: 22 and 39

United States Patent and Trademark Office

Reg. No. 3,521,590

Registered Oct. 21, 2008

TRADEMARK
PRINCIPAL REGISTER



SKIDMORE COLLEGE (NEW YORK NON-PROFIT CORPORATION)
815 NORTH BROADWAY
SARATOGA SPRINGS, NY 12866

FOR: CLOTHING NAMELY T-SHIRTS AND HATS, IN CLASS 25 (U.S. CLS. 22 AND 39).

FIRST USE 6-15-2007; IN COMMERCE 6-15-2007.

THE COLOR(S) RED, ORANGE, YELLOW, GREEN, BLUE AND PURPLE IS/ARE CLAIMED AS A FEATURE OF THE MARK.

THE MARK CONSISTS OF A GEOMETRIC TRIANGLE FIGURE CONSISTING OF RED, ORANGE, YELLOW, GREEN AND BLUE SEPARATED IN THREE SEGMENTS BY NEUTRAL SPACE; ONE POINT OF THE TRIANGLE IS OBSCURED BY A CIRCLE WHICH CONTAINS A KALEIDOSCOPE OF GEOMETRIC SHAPES IN RED, ORANGE, YELLOW, GREEN, BLUE AND PURPLE; THE WORDING SARATOGAARTSFEST IS DISPLAYED ALONG THE TOP SIDE OF THE TRIANGLE IN BLUE.

SN 77-184,485, FILED 5-18-2007.

DAVID HOFFMAN, EXAMINING ATTORNEY

Int. Cls.: 9 and 28

Prior U.S. Cls.: 21, 22, 23, 26, 36, 38, and 50

United States Patent and Trademark Office

Reg. No. 3,521,591

Registered Oct. 21, 2008

**TRADEMARK
PRINCIPAL REGISTER**

INTEC

INTEC, INC. (FLORIDA CORPORATION)
5255 N.W. 159TH ST.
MIAMI GARDENS, FL 33014

FOR: VIDEO GAME CASES; COMPUTER SCREEN FILTERS, NAMELY, FILM TO PROTECT A VIDEO SCREEN SURFACE FROM DAMAGE; COMPUTER CABLES, NAMELY, AUDIO, VIDEO, DATA AND POWER CABLES; COMPUTER CURSOR CONTROL DEVICES, NAMELY, STYLUS PENS; RFU ADAPTORS; AC AND DC ADAPTORS FOR VIDEO CONSOLES AND VIDEO ACCESSORIES; DC TO AC POWER INVERTERS; SUPPORT STANDS SPECIALLY DESIGNED FOR HOLDING VIDEO GAME CONSOLES; CPU COOLING FANS FOR VIDEO GAME CONSOLES; RECHARGEABLE ELECTRIC BATTERIES FOR VIDEO GAME CONSOLES AND ACCESSORIES; DOCKING STATIONS FOR CHARGING VIDEO GAMING CONSOLES; AUDIO TRANSMITTERS, NAMELY, DIGITAL TRANSMITTERS FOR TRANSMITTING AN AUDIO

SIGNAL TO A VEHICLE SOUND SYSTEM; VIDEO AND AUDIO COMPACT DISC CLEANER, IN CLASS 9 (U.S. CLS. 21, 23, 26, 36 AND 38).

FIRST USE 12-31-2006; IN COMMERCE 12-31-2006.

FOR: PROTECTIVE CARRYING CASES SPECIALLY ADAPTED FOR HANDHELD VIDEO GAMES, NAMELY, HARD AND SOFT CARRYING CASES AND SHOULDER BAGS, IN CLASS 28 (U.S. CLS. 22, 23, 38 AND 50).

FIRST USE 12-31-2006; IN COMMERCE 12-31-2006.

THE MARK CONSISTS OF STANDARD CHARACTERS WITHOUT CLAIM TO ANY PARTICULAR FONT, STYLE, SIZE, OR COLOR.

SN 77-184,647, FILED 5-18-2007.

JESSICA A. POWERS, EXAMINING ATTORNEY

Int. Cls.: 18 and 25

Prior U.S. Cls.: 1, 2, 3, 22, 39, and 41

United States Patent and Trademark Office

Reg. No. 3,521,592

Registered Oct. 21, 2008

**TRADEMARK
PRINCIPAL REGISTER**

MSTBSTS

PLANET PROPAGANDA, INC. (WISCONSIN CORPORATION)
605 WILLIAMSON STREET
MADISON, WI 53703

FOR: BAGS, CASES AND BANK NOTE HOLDERS, NAMELY, ALL PURPOSE SPORT, ATHLETIC, CARRYING AND BRIEF BAGS, IN CLASS 18 (U.S. CLS. 1, 2, 3, 22 AND 41).

FIRST USE 10-18-2006; IN COMMERCE 4-27-2007.

FOR: CLOTHING, NAMELY, CAPS, HOODS, JERSEYS, BELTS, SCARVES, MUFFLERS, TOPS, JACK-

ETS, PANTS, SHORTS, FOOTWEAR AND UNDERGARMENTS, IN CLASS 25 (U.S. CLS. 22 AND 39).

FIRST USE 10-18-2006; IN COMMERCE 4-27-2007.

THE MARK CONSISTS OF THE LETTERS "MSTBSTS" WITH STYLIZED LETTERING.

SN 77-184,985, FILED 5-18-2007.

HOWARD SMIGA, EXAMINING ATTORNEY

Int. Cls.: 18 and 25

Prior U.S. Cls.: 1, 2, 3, 22, 39, and 41

United States Patent and Trademark Office

Reg. No. 3,521,593

Registered Oct. 21, 2008

**TRADEMARK
PRINCIPAL REGISTER**

mostbestos
UNIFORM

PLANET PROPAGANDA, INC. (WISCONSIN CORPORATION)
605 WILLIAMSON STREET
MADISON, WI 53703

FOR: BAGS, CASES AND BANK NOTE HOLDERS, NAMELY, ALL PURPOSE SPORT, ATHLETIC, CARRYING AND BRIEF BAGS, IN CLASS 18 (U.S. CLS. 1, 2, 3, 22 AND 41).

FIRST USE 10-18-2006; IN COMMERCE 4-27-2007.

FOR: CLOTHING, NAMELY, CAPS, HOODS, JERSEYS, BELTS, SCARVES, MUFFLERS, TOPS, JACKETS, PANTS, SHORTS, FOOTWEAR AND

UNDERGARMENTS, IN CLASS 25 (U.S. CLS. 22 AND 39).

FIRST USE 10-18-2006; IN COMMERCE 4-27-2007.

NO CLAIM IS MADE TO THE EXCLUSIVE RIGHT TO USE "UNIFORM", APART FROM THE MARK AS SHOWN.

THE MARK CONSISTS OF THE WORDS "MOST-BESTOS UNIFORM" WITH STYLIZED LETTERING.

SN 77-185,062, FILED 5-18-2007.

HOWARD SMIGA, EXAMINING ATTORNEY

Int. Cls.: 18 and 25

Prior U.S. Cls.: 1, 2, 3, 22, 39, and 41

United States Patent and Trademark Office

Reg. No. 3,521,594

Registered Oct. 21, 2008

**TRADEMARK
PRINCIPAL REGISTER**

mostbestos

PLANET PROPAGANDA, INC. (WISCONSIN CORPORATION)
605 WILLIAMSON STREET
MADISON, WI 53703

FOR: BAGS, CASES AND BANK NOTE HOLDERS, NAMELY, ALL PURPOSE SPORT, ATHLETIC, CARRYING AND BRIEF BAGS, IN CLASS 18 (U.S. CLS. 1, 2, 3, 22 AND 41).

FIRST USE 10-18-2006; IN COMMERCE 4-27-2007.

FOR: CLOTHING, NAMELY, CAPS, HOODS, JERSEYS, BELTS, SCARVES, MUFFLERS, TOPS, JACK-

ETS, PANTS, SHORTS, FOOTWEAR AND UNDERGARMENTS, IN CLASS 25 (U.S. CLS. 22 AND 39).

FIRST USE 10-18-2006; IN COMMERCE 4-27-2007.

THE MARK CONSISTS OF THE WORD "MOST-BESTOS" WITH STYLIZED LETTERING.

SN 77-185,094, FILED 5-18-2007.

HOWARD SMIGA, EXAMINING ATTORNEY

Int. Cl.: 14

Prior U.S. Cls.: 2, 27, 28, and 50

United States Patent and Trademark Office

Reg. No. 3,521,595

Registered Oct. 21, 2008

**TRADEMARK
PRINCIPAL REGISTER**

AUDRA & DALILAH

AUDI GO BODY CORP. (NEW YORK CORPORATION)
175 WEST 87TH STREET, 8E
NEW YORK, NY 10024

THE MARK CONSISTS OF STANDARD CHARACTERS WITHOUT CLAIM TO ANY PARTICULAR FONT, STYLE, SIZE, OR COLOR.

FOR: JEWELRY, IN CLASS 14 (U.S. CLS. 2, 27, 28 AND 50).

SN 77-185,830, FILED 5-21-2007.

FIRST USE 7-1-2007; IN COMMERCE 7-1-2007.

RUDY R. SINGLETON, EXAMINING ATTORNEY

Int. Cl.: 9

Prior U.S. Cls.: 21, 23, 26, 36, and 38

United States Patent and Trademark Office

Reg. No. 3,521,596

Registered Oct. 21, 2008

**TRADEMARK
PRINCIPAL REGISTER**

VITTORIUM

FRANCO MOISES (SPAIN INDIVIDUAL)
20877 N.E. 32 AVENUE
AVENTURA, FL 33180

THE MARK CONSISTS OF STANDARD CHAR-
ACTERS WITHOUT CLAIM TO ANY PARTICULAR
FONT, STYLE, SIZE, OR COLOR.

FOR: SUNGLASSES; EYEGLOSS FRAMES;
FRAMES FOR SPECTACLES AND SUNGLASSES,
IN CLASS 9 (U.S. CLS. 21, 23, 26, 36 AND 38).

SN 77-185,881, FILED 5-21-2007.

FIRST USE 6-19-2008; IN COMMERCE 6-19-2008.

TRACY CROSS, EXAMINING ATTORNEY

Int. Cl.: 41

Prior U.S. Cls.: 100, 101, and 107

United States Patent and Trademark Office

Reg. No. 3,521,597

Registered Oct. 21, 2008

**SERVICE MARK
PRINCIPAL REGISTER**

QUANTUM NEUROLOGY

GRT SOLUTIONS INC. (CALIFORNIA CORPORATION)
425 NORTH GARDNER STREET
LOS ANGELES, CA 90036

FOR: WORKSHOPS AND SEMINARS IN THE
FIELD OF NEUROLOGY, IN CLASS 41 (U.S. CLS.
100, 101 AND 107).

FIRST USE 12-7-2007; IN COMMERCE 5-11-2008.

THE MARK CONSISTS OF STANDARD CHARACTERS WITHOUT CLAIM TO ANY PARTICULAR FONT, STYLE, SIZE, OR COLOR.

NO CLAIM IS MADE TO THE EXCLUSIVE RIGHT TO USE "NEUROLOGY", APART FROM THE MARK AS SHOWN.

SN 77-186,140, FILED 5-21-2007.

GIANCARLO CASTRO, EXAMINING ATTORNEY

Int. Cl.: 28

Prior U.S. Cls.: 22, 23, 38, and 50

United States Patent and Trademark Office

Reg. No. 3,521,598

Registered Oct. 21, 2008

**TRADEMARK
PRINCIPAL REGISTER**

FREAKY GEEKS

HOPPIN HYDROS, INC. (CALIFORNIA COR-
PORATION)
P.O. BOX 3333
CERRITOS, CA 90703

THE MARK CONSISTS OF STANDARD CHAR-
ACTERS WITHOUT CLAIM TO ANY PARTICULAR
FONT, STYLE, SIZE, OR COLOR.

FOR: TOY FIGURES, IN CLASS 28 (U.S. CLS. 22,
23, 38 AND 50).

SN 77-186,522, FILED 5-21-2007.

FIRST USE 6-24-2007; IN COMMERCE 6-24-2007.

MARY ROSSMAN, EXAMINING ATTORNEY

Int. Cls.: 35 and 41

Prior U.S. Cls.: 100, 101, 102, and 107

United States Patent and Trademark Office

Reg. No. 3,521,599

Registered Oct. 21, 2008

**SERVICE MARK
PRINCIPAL REGISTER**

K. LOVE THE INFINITE

PAYNE, KIMBERLI (UNITED STATES INDIVIDUAL)
4202 ST. GEORGES AVE #5
BALTIMORE, MD 21212

FOR: ON-LINE RETAIL STORE SERVICES FEATURING CDS AND VENDOR SERVICES FEATURING CDS, IN CLASS 35 (U.S. CLS. 100, 101 AND 102).

FIRST USE 5-15-2005; IN COMMERCE 6-1-2007.

FOR: ENTERTAINMENT IN THE NATURE OF LIVE PERFORMANCES BY A RAPPER, IN CLASS 41 (U.S. CLS. 100, 101 AND 107).

FIRST USE 5-15-2005; IN COMMERCE 6-1-2007.

THE MARK CONSISTS OF STANDARD CHARACTERS WITHOUT CLAIM TO ANY PARTICULAR FONT, STYLE, SIZE, OR COLOR.

SN 77-186,575, FILED 5-21-2007.

BARBARA BROWN, EXAMINING ATTORNEY

Int. Cl.: 28

Prior U.S. Cls.: 22, 23, 38, and 50

United States Patent and Trademark Office

Reg. No. 3,521,600

Registered Oct. 21, 2008

**TRADEMARK
PRINCIPAL REGISTER**



ANDERSSON, ROGER L (SWEDEN INDIVIDUAL)
NEDRE FOGELBERGSGATAN 9 A
GOTHENBURG, SWEDEN 41128

THE MARK CONSISTS OF A GREEN "R", A YELLOW "E", A PURPLE "L", AN ORANGE "A", A BLUE "X", A GREEN "!".

FOR: BOARD GAMES, IN CLASS 28 (U.S. CLS. 22, 23, 38 AND 50).

SN 77-186,654, FILED 5-22-2007.

FIRST USE 7-1-2008; IN COMMERCE 7-1-2008.

THE COLOR(S) GREEN, YELLOW, PURPLE, ORANGE, BLUE IS/ARE CLAIMED AS A FEATURE OF THE MARK.

ERNEST SHOSHO, EXAMINING ATTORNEY

Int. Cl.: 41

Prior U.S. Cls.: 100, 101, and 107

United States Patent and Trademark Office

Reg. No. 3,521,601

Registered Oct. 21, 2008

**SERVICE MARK
PRINCIPAL REGISTER**

MATCH GONE WRONG

MICHAELS, NANCY (UNITED STATES INDIVIDUAL)
9 STACEY CIRCLE
CONCORD, MA 01742

FOR: ARRANGING AND CONDUCTING EDUCATIONAL CONFERENCES; ARRANGING OF EXHIBITIONS, SEMINARS AND CONFERENCES; ARRANGING OF SEMINARS; ARRANGING OF SEMINARS AND CONFERENCES; ARRANGING PROFESSIONAL WORKSHOP AND TRAINING COURSES; CONDUCTING WORKSHOPS AND SEMINARS IN PERSONAL AWARENESS; CONDUCTING WORKSHOPS AND SEMINARS IN SELF AWARENESS; EDUCATIONAL AND ENTERTAINMENT SERVICES, NAMELY, PROVIDING MOTIVATIONAL AND EDUCATIONAL SPEAKERS; EDUCATIONAL SERVICES, NAMELY, CONDUCTING PROGRAMS IN THE FIELD OF PERSONAL AWARENESS AND IMPROVEMENT; EDUCATIONAL SERVICES, NAMELY, CONDUCTING INFORMAL ON-LINE PROGRAMS IN THE FIELDS OF PERSONAL AWARENESS AND IMPROVEMENT, AND PRINTABLE MATERIALS DISTRIBUTED THEREWITH; EDUCATIONAL SERVICES, NAMELY, CONDUCTING SEMINARS, COURSES, CLASSES, CONFERENCES IN THE FIELD OF PERSONAL AWARENESS AND IMPROVEMENT AND DISTRIBUTION OF COURSE MATERIAL IN CONNECTION THEREWITH; EDUCATIONAL SERVICES, NAMELY, DEVELOPING, ARRANGING, AND CONDUCTING EDUCATIONAL CONFERENCES AND PROGRAMS AND PROVIDING COURSES OF INSTRUCTION IN THE FIELD OF PERSONAL AWARENESS AND IMPROVEMENT; ENTERTAINMENT SERVICES, NAMELY, PROVIDING A WEBSITE FEATURING, PHOTOGRAPHIC, AUDIO, VIDEO AND PROSE PRESENTATIONS FEATURING PERSONAL AWARENESS AND IMPROVEMENT; ENTERTAINMENT IN THE NATURE OF ON-GOING TELEVISION PROGRAMS IN THE FIELD OF VARIETY; ENTERTAINMENT IN THE

NATURE OF TELEVISION NEWS SHOWS; ENTERTAINMENT IN THE NATURE OF VISUAL AND AUDIO PERFORMANCES, AND MUSICAL, VARIETY, NEWS AND COMEDY SHOWS; ENTERTAINMENT SERVICES IN THE NATURE OF AN ONGOING REALITY BASED TELEVISION PROGRAM; ENTERTAINMENT SERVICES, NAMELY, CONDUCTING PARTIES FOR THE PURPOSE OF DATING AND SOCIAL INTRODUCTION FOR ADULTS; MEETING AND SEMINAR ARRANGING; MOTION PICTURE FILM PRODUCTION; MULTIMEDIA ENTERTAINMENT SERVICES IN THE NATURE OF RECORDING, PRODUCTION AND POST-PRODUCTION SERVICES IN THE FIELDS OF MUSIC, VIDEO, AND FILMS; MULTIMEDIA ENTERTAINMENT SOFTWARE PRODUCTION SERVICES; MULTIMEDIA PUBLISHING OF BOOKS, MAGAZINES, JOURNALS, SOFTWARE, GAMES, MUSIC, AND ELECTRONIC PUBLICATIONS; ON-LINE JOURNALS, NAMELY, BLOGS FEATURING PERSONAL AWARENESS AND IMPROVEMENT; ON-LINE PUBLICATION OF JOURNALS AND ARTICLES IN THE FIELD OF PERSONAL AWARENESS AND IMPROVEMENT; PERSONAL COACHING SERVICES IN THE FIELD OF PERSONAL AWARENESS AND IMPROVEMENT; PRODUCTION AND DISTRIBUTION OF MOTION PICTURES; PRODUCTION AND DISTRIBUTION OF RADIO PROGRAMS; PRODUCTION AND DISTRIBUTION OF TELEVISION SHOWS AND MOVIES; PRODUCTION OF DVDS, VIDEOTAPES AND TELEVISION PROGRAMS FEATURING PERSONAL AWARENESS AND IMPROVEMENT; PRODUCTION OF CABLE TELEVISION PROGRAMS; PRODUCTION OF CLOSED CAPTION TELEVISION PROGRAMS; PRODUCTION OF RADIO AND TELEVISION PROGRAMS; PRODUCTION OF RADIO OR TELEVISION PROGRAMS; PRODUCTION OF VIDEO CASSETTES; PRODUCTION OF VIDEO DISCS AND TAPES; PRODUCTION OF VISUAL EFFECTS FOR VIDEOS, DVDS, TELEVISION AND FOR INTERNET WEB-

SITES; PROVIDING A WEBSITE THAT FEATURES INFORMAL INSTRUCTION ON PERSONAL AWARENESS AND IMPROVEMENT; PROVIDING NEWSLETTERS IN THE FIELD OF PERSONAL AWARENESS AND IMPROVEMENT VIA E-MAIL; PROVIDING ON-LINE PUBLICATIONS IN THE NATURE OF JOURNALS AND ARTICLES IN THE FIELD OF PERSONAL AWARENESS AND IMPROVEMENT; PROVIDING ON-LINE TRAINING COURSES, SEMINARS, WORKSHOPS AND CONFERENCES IN THE FIELD OF IN THE FIELD OF PERSONAL AWARENESS AND IMPROVEMENT; PUBLICATION OF BOOKS; PUBLICATION OF BOOKS, MAGAZINES, ALMANACS AND JOURNALS; PUBLICATION OF BOOKS, OF MAGAZINES, OF JOURNALS, OF NEWSPAPERS, OF PERIODICALS, OF CATALOGS, OF BROCHURES; PUBLICATION OF BROCHURES; PUBLICATION OF ELECTRONIC MAGAZINES; PUBLICATION OF ELECTRONIC NEWSPAPERS ACCESSIBLE VIA A GLOBAL COMPUTER NETWORK; PUBLICATION OF JOURNALS; PUBLICATION OF LEAFLETS; PUBLICATION OF MAGAZINES; PUBLICATION OF MANUALS; PUBLICATION OF PERIODICALS; PUBLICATION OF PRINTED MATTER; PUBLICATION OF TEXT BOOKS; PUBLICATION OF TEXTS, BOOKS, JOURNALS; PUBLICATION OF TEXTS, BOOKS, MAGAZINES AND OTHER PRINTED

MATTER; PUBLISHING OF BOOKS AND REVIEWS; PUBLISHING OF BOOKS, MAGAZINES; PUBLISHING OF ELECTRONIC PUBLICATIONS; PUBLISHING OF JOURNALS, BOOKS AND HANDBOOKS IN THE FIELD OF MEDICINE; PUBLISHING OF WEB MAGAZINES; TELEVISION PRODUCTION; TELEVISION SHOW PRODUCTION; VIDEOTAPING; WORKSHOPS AND SEMINARS IN THE FIELD OF IN THE FIELD OF PERSONAL AWARENESS AND IMPROVEMENT; WRITING OF ARTICLES FOR JOURNALS OTHER THAN FOR ADVERTISING OR PUBLICITY; WRITING OF ARTICLES FOR PERIODICALS OTHER THAN FOR ADVERTISING OR PUBLICITY; WRITING OF ARTICLES FOR PROFESSIONAL JOURNALS OTHER THAN FOR ADVERTISING OR PUBLICITY, IN CLASS 41 (U.S. CLS. 100, 101 AND 107).

FIRST USE 12-8-2007; IN COMMERCE 12-8-2007.

THE MARK CONSISTS OF STANDARD CHARACTERS WITHOUT CLAIM TO ANY PARTICULAR FONT, STYLE, SIZE, OR COLOR.

SN 77-186,659, FILED 5-22-2007.

KRISTINA MORRIS, EXAMINING ATTORNEY

Int. Cls.: 4, 8, 9, 11, 16, 21, and 31

Prior U.S. Cls.: 1, 2, 5, 6, 13, 15, 21, 22, 23, 26, 28, 29, 30, 31, 33, 34, 36, 37, 38, 40, 44, 46, and 50

Reg. No. 3,521,602

United States Patent and Trademark Office

Registered Oct. 21, 2008

**TRADEMARK
PRINCIPAL REGISTER**

HOME 360

FL FOOD LION, INC. (FLORIDA CORPORATION)
2110 EXECUTIVE DRIVE
SALISBURY, NC 28145

FOR: SYNTHETIC FIREPLACE LOGS; CHARCOAL LIGHTER FLUID; AND CHARCOAL STARTER STICKS, IN CLASS 4 (U.S. CLS. 1, 6 AND 15).

FIRST USE 1-24-2008; IN COMMERCE 1-24-2008.

FOR: PAPER SCISSORS AND SHEARS, IN CLASS 8 (U.S. CLS. 23, 28 AND 44).

FIRST USE 5-12-2008; IN COMMERCE 5-12-2008.

FOR: BATTERIES; DISPOSABLE CAMERAS; AND CAMERA FILM, IN CLASS 9 (U.S. CLS. 21, 23, 26, 36 AND 38).

FIRST USE 2-23-2008; IN COMMERCE 2-23-2008.

FOR: LIGHT BULBS, IN CLASS 11 (U.S. CLS. 13, 21, 23, 31 AND 34).

FIRST USE 6-30-2008; IN COMMERCE 6-30-2008.

FOR: ENVELOPES FOR LETTERS AND DOCUMENTS; PENCIL SHARPENERS; DRAWING COMPASSES; PROTRACTORS FOR STATIONERY, SCHOOL, AND OFFICE USE; PAPER CLIPS, PUSH

PINS, RUBBER BANDS; ERASERS AND ERASER CAPS, PAPER PUNCHERS; TAPE FOR STATIONERY, SCHOOL, AND OFFICE USE; AND STICK-ON NOTES, IN CLASS 16 (U.S. CLS. 2, 5, 22, 23, 29, 37, 38 AND 50).

FIRST USE 2-15-2008; IN COMMERCE 2-15-2008.

FOR: SPONGES FOR HOUSEHOLD USE, IN CLASS 21 (U.S. CLS. 2, 13, 23, 29, 30, 33, 40 AND 50).

FIRST USE 4-16-2008; IN COMMERCE 4-16-2008.

FOR: BIRDSEED, IN CLASS 31 (U.S. CLS. 1 AND 46).

FIRST USE 6-30-2008; IN COMMERCE 6-30-2008.

THE MARK CONSISTS OF STANDARD CHARACTERS WITHOUT CLAIM TO ANY PARTICULAR FONT, STYLE, SIZE, OR COLOR.

NO CLAIM IS MADE TO THE EXCLUSIVE RIGHT TO USE "HOME", APART FROM THE MARK AS SHOWN.

SN 77-187,066, FILED 5-22-2007.

CHRIS WELLS, EXAMINING ATTORNEY

Int. Cl.: 9

Prior U.S. Cls.: 21, 23, 26, 36, and 38

United States Patent and Trademark Office

Reg. No. 3,521,603

Registered Oct. 21, 2008

**TRADEMARK
PRINCIPAL REGISTER**

Trakker XL

MJCM, LLC. (TEXAS LIMITED LIABILITY COMPANY)
SUITE 800
1235 NORTH LOOP WEST
HOUSTON, TX 77008

FOR: COMPUTER SOFTWARE FOR USE IN IMPLEMENTING AND MANAGING AN OVERDRAFT PRIVILEGE PROGRAM FOR CHECKING AND SHARE DRAFT ACCOUNTS OFFERED BY FINANCIAL INSTITUTIONS, IN CLASS 9 (U.S. CLS. 21, 23, 26, 36 AND 38).

FIRST USE 9-30-2007; IN COMMERCE 10-31-2007.

THE MARK CONSISTS OF STANDARD CHARACTERS WITHOUT CLAIM TO ANY PARTICULAR FONT, STYLE, SIZE, OR COLOR.

OWNER OF U.S. REG. NO. 2,736,803.

SN 77-187,107, FILED 5-22-2007.

LAURIE MAYES, EXAMINING ATTORNEY

Int. Cl.: 3

Prior U.S. Cls.: 1, 4, 6, 50, 51, and 52

United States Patent and Trademark Office

Reg. No. 3,521,604

Registered Oct. 21, 2008

**TRADEMARK
PRINCIPAL REGISTER**

APPEAR'S

TUPPERWARE PRODUCTS S.A. (SWITZERLAND
CORPORATION)
ROUTE DU JURA 37
FRIBOURG, SWITZERLAND CH-1700

THE MARK CONSISTS OF STANDARD CHAR-
ACTERS WITHOUT CLAIM TO ANY PARTICULAR
FONT, STYLE, SIZE, OR COLOR.

FOR: NON-MEDICATED CREAMS, LOTIONS,
MILKS, OILS AND OINTMENTS FOR THE CARE
AND CLEANSING OF THE SKIN, IN CLASS 3 (U.S.
CLS. 1, 4, 6, 50, 51 AND 52).

SN 77-187,191, FILED 5-22-2007.

FIRST USE 6-14-2008; IN COMMERCE 6-14-2008.

SETH A. RAPPAPORT, EXAMINING ATTORNEY

Int. Cl.: 35

Prior U.S. Cls.: 100, 101, and 102

United States Patent and Trademark Office

Reg. No. 3,521,605

Registered Oct. 21, 2008

**SERVICE MARK
PRINCIPAL REGISTER**

Cleveland+

GREATER CLEVELAND PARTNERSHIP (OHIO CORPORATION)
THE HIGBEE BUILDING, 100 PUBLIC SQUARE
SUITE 210
CLEVELAND, OH 44113

FOR: ADVERTISING AND ADVERTISEMENT SERVICES; ADVERTISING AND MARKETING; ADVERTISING AND PUBLICITY SERVICES, NAMELY, PROMOTING THE GOODS, SERVICES, BRAND IDENTITY AND COMMERCIAL INFORMATION AND NEWS OF THIRD PARTIES THROUGH PRINT, AUDIO, VIDEO, DIGITAL AND ON-LINE MEDIUM; ADVERTISING SERVICES; ADVERTISING SERVICES, NAMELY, PROMOTING AND MARKETING THE GOODS AND SERVICES OF OTHERS THROUGH ALL PUBLIC COMMUNICATION MEANS; ADVERTISING THROUGH ALL PUBLIC COMMUNICATION MEANS; ADVERTISING VIA ELECTRONIC MEDIA AND SPECIFICALLY THE INTERNET; COOPERATIVE ADVERTISING AND MARKETING; CREATING AND UPDATING ADVERTISING MATERIAL; DISSEMINATION OF ADVERTISEMENTS AND OF ADVERTISING MATERIAL; DISSEMINATION OF ADVERTISING MATERIAL; DISSEMINATION OF ADVERTISING MATTER; DISTRIBUTION AND DISSEMINATION OF ADVERTISING MATERIALS; DISTRIBUTION OF ADVERTISEMENTS AND COMMERCIAL ANNOUNCEMENTS; MARKETING

SERVICES, NAMELY, PROVIDING INFORMATIONAL WEB PAGES DESIGNED TO GENERATE SALES TRAFFIC VIA HYPERLINKS TO OTHER WEB SITES; ON-LINE ADVERTISING AND MARKETING SERVICES; PREPARATION AND REALIZATION OF MEDIA AND ADVERTISING PLANS AND CONCEPTS; PROMOTING THE GOODS AND SERVICES OF OTHERS BY DISTRIBUTING ADVERTISING MATERIALS THROUGH A VARIETY OF METHODS; PROMOTING, ADVERTISING AND MARKETING OF THE ON-LINE WEBSITES OF OTHERS; PROVIDING ADVERTISING, MARKETING AND PROMOTIONAL SERVICES, NAMELY, DEVELOPMENT OF ADVERTISING CAMPAIGNS FOR TELEVISION, PRINT, CD ROM, WEB DESIGN; PROVIDING SPACE AT A WEB SITE FOR THE ADVERTISEMENT OF THE GOODS AND SERVICES OF OTHERS; DIRECT MARKETING SERVICES, IN CLASS 35 (U.S. CLS. 100, 101 AND 102).

FIRST USE 4-26-2007; IN COMMERCE 4-26-2007.

THE MARK CONSISTS OF STANDARD CHARACTERS WITHOUT CLAIM TO ANY PARTICULAR FONT, STYLE, SIZE, OR COLOR.

SN 77-187,291, FILED 5-22-2007.

ANGELA M. MICHELI, EXAMINING ATTORNEY

Int. Cl.: 35

Prior U.S. Cls.: 100, 101, and 102

United States Patent and Trademark Office

Reg. No. 3,521,606

Registered Oct. 21, 2008

**SERVICE MARK
PRINCIPAL REGISTER**

**Cleveland+
Akron+Canton+Youngstown**

GREATER CLEVELAND PARTNERSHIP (OHIO CORPORATION)
THE HIGBEE BUILDING, 100 PUBLIC SQUARE
SUITE 210
CLEVELAND, OH 44113

FOR: ADVERTISING AND ADVERTISEMENT SERVICES; ADVERTISING AND MARKETING; ADVERTISING AND PUBLICITY SERVICES; ADVERTISING AND PUBLICITY SERVICES, NAMELY, PROMOTING THE GOODS, SERVICES, BRAND IDENTITY AND COMMERCIAL INFORMATION AND NEWS OF THIRD PARTIES THROUGH PRINT, AUDIO, VIDEO, DIGITAL AND ON-LINE MEDIUM; ADVERTISING SERVICES; ADVERTISING SERVICES, NAMELY, PROMOTING AND MARKETING THE GOODS AND SERVICES OF OTHERS THROUGH ALL PUBLIC COMMUNICATION MEANS; ADVERTISING THROUGH ALL PUBLIC COMMUNICATION MEANS; ADVERTISING VIA ELECTRONIC MEDIA AND SPECIFICALLY THE INTERNET; COOPERATIVE ADVERTISING AND MARKETING; CREATING AND UPDATING ADVERTISING MATERIAL; DISSEMINATION OF ADVERTISEMENTS AND OF ADVERTISING MATERIAL; DISSEMINATION OF ADVERTISING MATERIAL; DISSEMINATION OF ADVERTISING MATTER; DISTRIBUTION AND DISSEMINATION OF ADVERTISING MATERIALS; DISTRIBUTION OF ADVERTISEMENTS AND COMMERCIAL ANNOUNCEMENTS; MARKETING

SERVICES, NAMELY, PROVIDING INFORMATIONAL WEB PAGES DESIGNED TO GENERATE SALES TRAFFIC VIA HYPERLINKS TO OTHER WEB SITES; ON-LINE ADVERTISING AND MARKETING SERVICES; PREPARATION AND REALIZATION OF MEDIA AND ADVERTISING PLANS AND CONCEPTS; PROMOTING THE GOODS AND SERVICES OF OTHERS BY DISTRIBUTING ADVERTISING MATERIALS THROUGH A VARIETY OF METHODS; PROMOTING, ADVERTISING AND MARKETING OF THE ON-LINE WEBSITES OF OTHERS; PROVIDING ADVERTISING, MARKETING AND PROMOTIONAL SERVICES, NAMELY, DEVELOPMENT OF ADVERTISING CAMPAIGNS FOR TELEVISION, PRINT, CD ROM, WEB DESIGN; PROVIDING SPACE AT A WEB SITE FOR THE ADVERTISEMENT OF THE GOODS AND SERVICES OF OTHERS; DIRECT MARKETING SERVICES, IN CLASS 35 (U.S. CLS. 100, 101 AND 102).

FIRST USE 4-26-2007; IN COMMERCE 4-26-2007.

THE MARK CONSISTS OF STANDARD CHARACTERS WITHOUT CLAIM TO ANY PARTICULAR FONT, STYLE, SIZE, OR COLOR.

SN 77-187,335, FILED 5-22-2007.

ANGELA M. MICHELI, EXAMINING ATTORNEY

Int. Cl.: 7

Prior U.S. Cls.: 13, 19, 21, 23, 31, 34, and 35

Reg. No. 3,521,607

United States Patent and Trademark Office

Registered Oct. 21, 2008

**TRADEMARK
PRINCIPAL REGISTER**

ANTRAQUIP

MITTERNDORFER, KARL H. (UNITED STATES
INDIVIDUAL)
435 LINKS VIEW DRIVE
HAGERSTOWN, MD 21740

THE MARK CONSISTS OF STANDARD CHAR-
ACTERS WITHOUT CLAIM TO ANY PARTICULAR
FONT, STYLE, SIZE, OR COLOR.

FOR: ROADHEADERS, TUNNELING MA-
CHINES, ROCK AND CONCRETE CUTTERS, AND
COMPONENTS AND PARTS THEREFOR, IN CLASS
7 (U.S. CLS. 13, 19, 21, 23, 31, 34 AND 35).

SN 77-187,460, FILED 5-22-2007.

FIRST USE 7-19-2008; IN COMMERCE 7-19-2008.

MARGARET POWER, EXAMINING ATTORNEY

Int. Cls.: 9 and 45

Prior U.S. Cls.: 21, 23, 26, 36, 38, 100, and 101

United States Patent and Trademark Office

Reg. No. 3,521,608

Registered Oct. 21, 2008

**TRADEMARK
SERVICE MARK
PRINCIPAL REGISTER**



POSITIONERE, INC. (CALIFORNIA CORPORATION)
26741 PORTOLA PARKWAY
SUITE 1E, BOX #664
FOOTHILL RANCH, CA 926101763

FOR: MOBILE DIGITAL APPLIANCE AND GPS-BASED SYSTEM CONSISTING OF COMPUTERS, COMPUTER SOFTWARE, TRANSMITTERS, RECEIVERS, AND NETWORK INTERFACE DEVICES FOR LOCATING, MONITORING, AND REPORTING THE CURRENT AND HISTORICAL GEOGRAPHIC LOCATION OF A TRACKED OBJECT, PERSON OR PET, IN CLASS 9 (U.S. CLS. 21, 23, 26, 36 AND 38).

FIRST USE 2-28-2008; IN COMMERCE 2-28-2008.

FOR: SURVEILLANCE TRACKING SERVICES RELATING TO THE PROTECTION AND SAFETY OF PERSONS, PETS, AND PROPERTY, IN CLASS 45 (U.S. CLS. 100 AND 101).

FIRST USE 2-28-2008; IN COMMERCE 2-28-2008.

THE MARK CONSISTS OF COMPASS INDICATING NORTH, SOUTH, EAST AND WEST WITH A DOG PAW PRINT IN THE CENTER.

SN 77-187,501, FILED 5-22-2007.

DARRYL SPRUILL, EXAMINING ATTORNEY

Int. Cl.: 35

Prior U.S. Cls.: 100, 101, and 102

United States Patent and Trademark Office

Reg. No. 3,521,609

Registered Oct. 21, 2008

**SERVICE MARK
PRINCIPAL REGISTER**

UNIFIED GROCERS

UNIFIED GROCERS, INC. (CALIFORNIA CORPORATION)

5200 SHEILA STREET

COMMERCE, CA 90040

FOR: DISTRIBUTORSHIP AND ONLINE DISTRIBUTORSHIP SERVICES IN THE FIELD OF GROCERY AND HOUSEHOLD PRODUCTS, IN CLASS 35 (U.S. CLS. 100, 101 AND 102).

FIRST USE 10-1-2007; IN COMMERCE 10-1-2007.

THE MARK CONSISTS OF STANDARD CHARACTERS WITHOUT CLAIM TO ANY PARTICULAR FONT, STYLE, SIZE, OR COLOR.

OWNER OF U.S. REG. NO. 2,659,980.

NO CLAIM IS MADE TO THE EXCLUSIVE RIGHT TO USE "GROCERS", APART FROM THE MARK AS SHOWN.

SN 77-187,560, FILED 5-22-2007.

MICHAEL ENGEL, EXAMINING ATTORNEY

Int. Cl.: 11

Prior U.S. Cls.: 13, 21, 23, 31, and 34

Reg. No. 3,521,610

United States Patent and Trademark Office

Registered Oct. 21, 2008

**TRADEMARK
PRINCIPAL REGISTER**



UNIBEV, LLC (NEW MEXICO LIMITED LIABILITY COMPANY)
2402 CORNELL DR.
ROSWELL, NM 88203

THE COLOR(S) BLUE AND GRAY IS/ARE CLAIMED AS A FEATURE OF THE MARK.

FOR: REFRIGERATED BEVERAGE DISPENSING UNITS; TEMPERATURE-CONTROLLED FOOD AND BEVERAGE DISPENSERS, AND COMPONENTS THEREOF; REFRIGERATION EQUIPMENT, NAMELY, FOOD AND BEVERAGE CHILLING UNITS, IN CLASS 11 (U.S. CLS. 13, 21, 23, 31 AND 34).

THE MARK CONSISTS OF BLUE IN THE WORDING AND THE COLOR GREY APPEARS IN THE WATER DROP DESIGN AND IN THE BACKGROUND.

SN 77-187,575, FILED 5-22-2007.

FIRST USE 5-2-2007; IN COMMERCE 5-15-2007.

DORITT L. CARROLL, EXAMINING ATTORNEY

Int. Cl.: 41

Prior U.S. Cls.: 100, 101, and 107

United States Patent and Trademark Office

Reg. No. 3,521,611

Registered Oct. 21, 2008

**SERVICE MARK
PRINCIPAL REGISTER**

PSYCHE HIKE

BOXWELL, AUDREY A. (UNITED STATES IN-
DIVIDUAL)
7100 EAST HAMPDEN AVENUE
DENVER, CO 80224

FOR: LEADING GROUP HIKES AND FACILI-
TATING INDIVIDUAL AND GROUP DISCUSSIONS
AFTER A BRIEF GUIDED MEDITATION, IN CLASS
41 (U.S. CLS. 100, 101 AND 107).

FIRST USE 6-30-2007; IN COMMERCE 9-30-2007.

THE MARK CONSISTS OF STANDARD CHAR-
ACTERS WITHOUT CLAIM TO ANY PARTICULAR
FONT, STYLE, SIZE, OR COLOR.

NO CLAIM IS MADE TO THE EXCLUSIVE
RIGHT TO USE "HIKE", APART FROM THE MARK
AS SHOWN.

SN 77-188,012, FILED 5-23-2007.

CHRISTOPHER BUONGIORNO, EXAMINING AT-
TORNEY

Int. Cl.: 25

Prior U.S. Cls.: 22 and 39

United States Patent and Trademark Office

Reg. No. 3,521,612

Registered Oct. 21, 2008

**TRADEMARK
PRINCIPAL REGISTER**

NATURALLY BY LEADING LADY

LEADING LADY, INC. (OHIO CORPORATION)
24050 COMMERCE PARK
BEACHWOOD, OH 44122

FOR: WOMEN'S INTIMATE APPAREL, NAME-
LY, NEGLIGEEES, PEIGNOIRS, CAMISOLES, BRAS-
SIERES AND PANTIES, IN CLASS 25 (U.S. CLS. 22
AND 39).

FIRST USE 4-25-2008; IN COMMERCE 4-25-2008.

THE MARK CONSISTS OF STANDARD CHAR-
ACTERS WITHOUT CLAIM TO ANY PARTICULAR
FONT, STYLE, SIZE, OR COLOR.

OWNER OF U.S. REG. NO. 1,807,614.

SN 77-188,132, FILED 5-23-2007.

NAAKWAMA ANKRAH, EXAMINING ATTORNEY

Int. Cl.: 30

Prior U.S. Cl.: 46

United States Patent and Trademark Office

Reg. No. 3,521,613

Registered Oct. 21, 2008

**TRADEMARK
PRINCIPAL REGISTER**

PARK MANOR

HEB GROCERY COMPANY, LP (TEXAS LIMITED PARTNERSHIP)
CORPORATE LAW DEPARTMENT
646 SOUTH MAIN
SAN ANTONIO, TX 78204

FOR: BREAD AND BUNS, IN CLASS 30 (U.S. CL. 46).

FIRST USE 7-0-2007; IN COMMERCE 7-0-2007.

THE MARK CONSISTS OF STANDARD CHARACTERS WITHOUT CLAIM TO ANY PARTICULAR FONT, STYLE, SIZE, OR COLOR.

OWNER OF U.S. REG. NOS. 863,633 AND 867,660.

SN 77-189,161, FILED 5-24-2007.

LINDA POWELL, EXAMINING ATTORNEY

Int. Cl.: 6

Prior U.S. Cls.: 2, 12, 13, 14, 23, 25, and 50

Reg. No. 3,521,614

United States Patent and Trademark Office

Registered Oct. 21, 2008

**TRADEMARK
PRINCIPAL REGISTER**

STEELBUILT WINDOW & DOOR

J.R. FOUR LTD. (WASHINGTON CORPORATION), DBA TECHNICAL GLASS PRODUCTS, 600 SIXTH STREET SOUTH KIRKLAND, WA 98033

FOR: BUILDING CURTAIN WALLS MADE PRIMARILY OF METAL; BUILDING WALL FRAMING MADE PRIMARILY OF METAL; ROOF FRAMING AND TRUSSES MADE PRIMARILY OF METAL; METAL WINDOWS AND DOORS; HINGES MADE OF METAL; METAL WINDOW FRAMES; METAL WINDOW CASEMENTS; METAL WINDOWS; METAL DOOR FRAMES; DOOR CASINGS OF METAL; DOOR JAMBS OF METAL; DOORS OF METAL, IN CLASS 6 (U.S. CLS. 2, 12, 13, 14, 23, 25 AND 50).

FIRST USE 6-0-2007; IN COMMERCE 6-0-2007.

THE MARK CONSISTS OF STANDARD CHARACTERS WITHOUT CLAIM TO ANY PARTICULAR FONT, STYLE, SIZE, OR COLOR.

NO CLAIM IS MADE TO THE EXCLUSIVE RIGHT TO USE "WINDOW & DOOR", APART FROM THE MARK AS SHOWN.

SN 77-189,716, FILED 5-24-2007.

CAROLYN CATALDO, EXAMINING ATTORNEY

Int. Cl.: 3

Prior U.S. Cls.: 1, 4, 6, 50, 51, and 52

Reg. No. 3,521,615

United States Patent and Trademark Office

Registered Oct. 21, 2008

**TRADEMARK
PRINCIPAL REGISTER**

CLAVE

CLAVE BODY CARE INTERNATIONAL, INC.
(ARIZONA CORPORATION)
SUITE 103-173
28150 NORTH ALMA SCHOOL PARKWAY
SCOTTSDALE, AZ 85262

FOR: SOAPS; SHAMPOOS; SHAMPOO-CONDITIONERS; CONDITIONERS; BODY LOTIONS, HAND LOTIONS; GEL FOR THE BODY; BUTTER FOR COSMETIC PURPOSES; FACIAL CLEANSERS; AND SKIN CLEANSERS, IN CLASS 3 (U.S. CLS. 1, 4, 6, 50, 51 AND 52).

FIRST USE 3-17-2008; IN COMMERCE 3-17-2008.

THE MARK CONSISTS OF STANDARD CHARACTERS WITHOUT CLAIM TO ANY PARTICULAR FONT, STYLE, SIZE, OR COLOR.

SN 77-189,835, FILED 5-24-2007.

ATTIYA MALIK, EXAMINING ATTORNEY

Int. Cls.: 29 and 30

Prior U.S. Cl.: 46

United States Patent and Trademark Office

Reg. No. 3,521,616

Registered Oct. 21, 2008

**TRADEMARK
PRINCIPAL REGISTER**

MING TSAI

MING EAST-WEST, LLC (MASSACHUSETTS
LIMITED LIABILITY COMPANY)
583 WASHINGTON STREET
WELLESLEY, MA 02482

FOR: PREPARED MEALS CONSISTING PRIMARILY OF MEAT, FISH, POULTRY OR VEGETABLES; SOY-BASED SNACK FOODS; SMOKED SALMON, IN CLASS 29 (U.S. CL. 46).

FIRST USE 0-0-2000; IN COMMERCE 0-0-2000.

FOR: PREPARED MEALS CONSISTING PRIMARILY OF RICE OR NOODLES; SEASONINGS; SALSA; MARINADES AND SAUCES; TEA SPICES; DRY RUBS; CRACKERS; RICE-BASED SNACK FOODS; DOUGH-BASED POCKETS WITH FILLING CONSISTING PRIMARILY OF MEATS, POULTRY, FISH,

FRUITS, VEGETABLES AND CHEESE; TEA, IN CLASS 30 (U.S. CL. 46).

FIRST USE 0-0-2000; IN COMMERCE 0-0-2000.

THE MARK CONSISTS OF STANDARD CHARACTERS WITHOUT CLAIM TO ANY PARTICULAR FONT, STYLE, SIZE, OR COLOR.

OWNER OF U.S. REG. NO. 2,786,939.

THE NAME "MING TSAI" IDENTIFIES A LIVING INDIVIDUAL WHOSE CONSENT IS OF RECORD.

SN 77-189,842, FILED 5-24-2007.

GISELLE AGOSTO, EXAMINING ATTORNEY

Int. Cl.: 42

Prior U.S. Cls.: 100 and 101

United States Patent and Trademark Office

Reg. No. 3,521,617

Registered Oct. 21, 2008

**SERVICE MARK
PRINCIPAL REGISTER**

AMERISEARCH

ONE LEGAL, LLC (DELAWARE LIMITED LIABILITY COMPANY)
504 REDWOOD BOULEVARD, SUITE 223
NOVATO, CA 94947

FOR: LEGAL SERVICES, NAMELY, RETRIEVING LEGAL DOCUMENTS FROM COURTS AND ADMINISTRATIVE AGENCIES, IN CLASS 42 (U.S. CLS. 100 AND 101).

FIRST USE 7-17-2008; IN COMMERCE 7-17-2008.

THE MARK CONSISTS OF STANDARD CHARACTERS WITHOUT CLAIM TO ANY PARTICULAR FONT, STYLE, SIZE, OR COLOR.

SN 77-189,851, FILED 5-24-2007.

LOURDES AYALA, EXAMINING ATTORNEY

Int. Cls.: 11 and 21

Prior U.S. Cls.: 2, 13, 21, 23, 29, 30, 31, 33, 34, 40, and 50

United States Patent and Trademark Office

Reg. No. 3,521,618

Registered Oct. 21, 2008

**TRADEMARK
PRINCIPAL REGISTER**

OYAMA

VENQUEST TRADING INCORPORATED (CALIFORNIA CORPORATION)
8399 EDGEWATER DRIVE
OAKLAND, CA 94621

FOR: ELECTRIC RICE COOKER; ELECTRIC SLOW COOKERS; HOT WATER HEATERS; ELECTRIC GRILLS, IN CLASS 11 (U.S. CLS. 13, 21, 23, 31 AND 34).

FIRST USE 1-25-2008; IN COMMERCE 2-15-2008.

FOR: THERMAL INSULATED CONTAINERS FOR FOOD OR BEVERAGE; VACUUM BOTTLES, IN CLASS 21 (U.S. CLS. 2, 13, 23, 29, 30, 33, 40 AND 50).

FIRST USE 1-25-2008; IN COMMERCE 2-15-2008.

THE MARK CONSISTS OF STANDARD CHARACTERS WITHOUT CLAIM TO ANY PARTICULAR FONT, STYLE, SIZE, OR COLOR.

THE ENGLISH TRANSLATION OF THE WORD "OYAMA" IN THE MARK IS "BIG MOUNTAIN".

SN 77-190,088, FILED 5-24-2007.

KELLEY WELLS, EXAMINING ATTORNEY

Int. Cls.: 9 and 42

Prior U.S. Cls.: 21, 23, 26, 36, 38, 100, and 101

United States Patent and Trademark Office

Reg. No. 3,521,619

Registered Oct. 21, 2008

**TRADEMARK
SERVICE MARK
PRINCIPAL REGISTER**

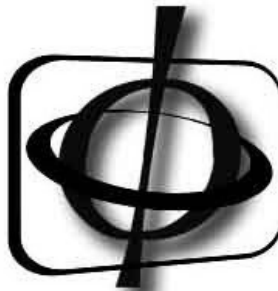

MEDIAPHY CORPORATION (DELAWARE CORPORATION)
180 ROSE ORCHARD WAY
SAN JOSE, CA 95134

FOR: SEMICONDUCTOR DEVICES, IN CLASS 9
(U.S. CLS. 21, 23, 26, 36 AND 38).

FIRST USE 7-1-2005; IN COMMERCE 7-1-2005.

FOR: TECHNICAL SUPPORT, NAMELY, CONSULTING SERVICES RELATING TO THE USE AND OPERATION OF SEMICONDUCTOR DEVICES, IN CLASS 42 (U.S. CLS. 100 AND 101).

FIRST USE 7-1-2005; IN COMMERCE 7-1-2005.

THE MARK IS COMPRISED OF A STYLIZED VERSION OF THE GREEK LETTER PHI WITH AN ORBIT AROUND THE LETTER AND SET AGAINST A RECTANGULAR BOX.

SN 77-190,419, FILED 5-25-2007.

MATTHEW PAPPAS, EXAMINING ATTORNEY

Int. Cls.: 9, 16, and 42

**Prior U.S. Cls.: 2, 5, 21, 22, 23, 26, 29, 36, 37, 38, 50,
100, and 101**

Reg. No. 3,521,620

United States Patent and Trademark Office

Registered Oct. 21, 2008

**TRADEMARK
SERVICE MARK
PRINCIPAL REGISTER**

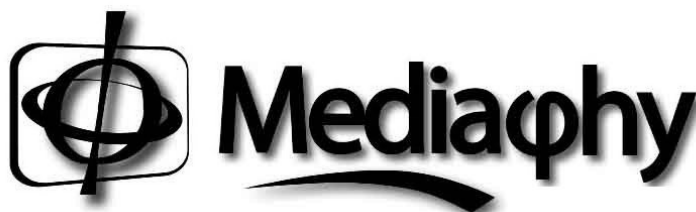

MEDIAPHY CORPORATION (DELAWARE COR-
PORATION)
180 ROSE ORCHARD WAY
SAN JOSE, CA 95134

FOR: SEMICONDUCTOR DEVICES, IN CLASS 9
(U.S. CLS. 21, 23, 26, 36 AND 38).

FIRST USE 7-1-2005; IN COMMERCE 7-1-2005.

FOR: PRINTED MATERIALS, NAMELY, BRO-
CHURES, DATASHEETS, DESIGN GUIDES, MAN-
UALS, AND APPLICATION NOTES RELATED TO
SEMICONDUCTOR DEVICES, IN CLASS 16 (U.S.
CLS. 2, 5, 22, 23, 29, 37, 38 AND 50).

FIRST USE 7-1-2005; IN COMMERCE 7-1-2005.

FOR: TECHNICAL SUPPORT, NAMELY, CON-
SULTING SERVICES RELATING TO THE USE AND
OPERATION OF SEMICONDUCTOR DEVICES, IN
CLASS 42 (U.S. CLS. 100 AND 101).

FIRST USE 7-1-2005; IN COMMERCE 7-1-2005.

THE MARK CONSISTS OF THE WORD "MEDIA-
PHY" WITH THE LETTER "P" RESEMBLING THE
GREEK CHARACTER "PHI" AND THE "MEDIA"
PORTION OF THE WORD UNDERLINED AND A
STYLIZED VERSION OF THE GREEK LETTER PHI
WITH AN ORBIT AROUND THE LETTER, SET
AGAINST A RECTANGULAR BOX.

SN 77-190,435, FILED 5-25-2007.

MATTHEW PAPPAS, EXAMINING ATTORNEY

Int. Cls.: 9 and 42

Prior U.S. Cls.: 21, 23, 26, 36, 38, 100, and 101

United States Patent and Trademark Office

Reg. No. 3,521,621

Registered Oct. 21, 2008

**TRADEMARK
SERVICE MARK
PRINCIPAL REGISTER**

The logo for Mediaphy features the word "Mediaphy" in a bold, sans-serif font. The letter "P" is stylized to resemble the Greek character "phi" (ϕ). A thick, black, curved underline is positioned beneath the letters "i", "a", and "p".

MEDIAPHY CORPORATION (DELAWARE CORPORATION)
180 ROSE ORCHARD WAY
SAN JOSE, CA 95134

FOR: SEMICONDUCTOR DEVICES, IN CLASS 9
(U.S. CLS. 21, 23, 26, 36 AND 38).

FIRST USE 7-1-2005; IN COMMERCE 7-1-2005.

FOR: TECHNICAL SUPPORT, NAMELY, CONSULTING SERVICES RELATING TO THE USE AND OPERATION OF SEMICONDUCTOR DEVICES, IN CLASS 42 (U.S. CLS. 100 AND 101).

FIRST USE 7-1-2005; IN COMMERCE 7-1-2005.

THE MARK CONSISTS OF THE WORD "MEDIAPHY" WITH THE LETTER "P" RESEMBLING THE GREEK CHARACTER "PHI" AND THE "MEDIA" PORTION OF THE WORD UNDERLINED.

SN 77-190,450, FILED 5-25-2007.

MATTHEW PAPPAS, EXAMINING ATTORNEY

Int. Cls.: 9 and 42

Prior U.S. Cls.: 21, 23, 26, 36, 38, 100, and 101

Reg. No. 3,521,622

United States Patent and Trademark Office

Registered Oct. 21, 2008

**TRADEMARK
SERVICE MARK
PRINCIPAL REGISTER**

MEDIAPHY

MEDIAPHY CORPORATION (DELAWARE CORPORATION)
180 ROSE ORCHARD WAY, #100
SAN JOSE, CA 95134

FOR: SEMICONDUCTOR DEVICES, IN CLASS 9
(U.S. CLS. 21, 23, 26, 36 AND 38).

FIRST USE 7-1-2005; IN COMMERCE 7-1-2005.

FOR: TECHNICAL SUPPORT, NAMELY, CONSULTING SERVICES RELATING TO THE USE AND

OPERATION OF SEMICONDUCTOR DEVICES, IN CLASS 42 (U.S. CLS. 100 AND 101).

FIRST USE 7-1-2005; IN COMMERCE 7-1-2005.

THE MARK CONSISTS OF STANDARD CHARACTERS WITHOUT CLAIM TO ANY PARTICULAR FONT, STYLE, SIZE, OR COLOR.

SN 77-190,530, FILED 5-25-2007.

MATTHEW PAPPAS, EXAMINING ATTORNEY

Int. Cls.: 1, 2, 3, 5, and 30

Prior U.S. Cls.: 1, 4, 5, 6, 10, 11, 16, 18, 26, 44, 46, 50,
51, and 52

Reg. No. 3,521,623

United States Patent and Trademark Office

Registered Oct. 21, 2008

TRADEMARK
PRINCIPAL REGISTER

Mooreorganics

A. M. TODD COMPANY (MICHIGAN CORPORATION)
1717 DOUGLAS AVENUE
KALAMAZOO, MI 49007

FOR: BOTANICAL EXTRACTS FOR USE IN MAKING COSMETICS; CHEMICAL ADDITIVES FOR USE AS CLEANSING, DEODORIZING AND REFRESHING INGREDIENTS IN THE MANUFACTURE OF MOUTH SPRAYS, DENTAL CEMENTS AND MEDICINES FOR DENTAL PURPOSES, IN CLASS 1 (U.S. CLS. 1, 5, 6, 10, 26 AND 46).

FIRST USE 6-0-2007; IN COMMERCE 6-0-2007.

FOR: COLORANTS FOR USE IN THE MANUFACTURE OF BEVERAGES; COLORANTS FOR USE IN THE MANUFACTURE OF COSMETICS; COLORANTS FOR USE IN THE MANUFACTURE OF FOOD; COLORANTS FOR USE IN THE MANUFACTURE OF PHARMACEUTICALS; COLORANTS FOR USE IN THE MANUFACTURE OF SOAP; FOOD COLORS FOR DOMESTIC USE; FOOD DYES, IN CLASS 2 (U.S. CLS. 6, 11 AND 16).

FIRST USE 6-0-2007; IN COMMERCE 6-0-2007.

FOR: FOOD FLAVORINGS PREPARED FROM ESSENTIAL OILS; FRAGRANCES FOR PERSONAL USE; ROOM FRAGRANCES; SCENTED OILS USED TO PRODUCE AROMAS WHEN HEATED; PERFUME OILS FOR THE MANUFACTURE OF COSMETIC PREPARATIONS; ESSENTIAL OILS AS

PERFUME FOR LAUNDRY PURPOSES; PERFUMED EXTRACTS FOR TISSUES AND PERFUMES; PERFUMES, IN CLASS 3 (U.S. CLS. 1, 4, 6, 50, 51 AND 52).

FIRST USE 6-0-2007; IN COMMERCE 6-0-2007.

FOR: MEDICINAL HERBAL EXTRACTS FOR MEDICAL PURPOSES; PLANT EXTRACTS FOR MEDICAL, VETERINARY AND PHARMACEUTICAL PURPOSES, IN CLASS 5 (U.S. CLS. 6, 18, 44, 46, 51 AND 52).

FIRST USE 6-0-2007; IN COMMERCE 6-0-2007.

FOR: EXTRACTS USED AS FLAVORING; FOOD FLAVORINGS, IN CLASS 30 (U.S. CL. 46).

FIRST USE 6-0-2007; IN COMMERCE 6-0-2007.

THE COLOR(S) YELLOW AND GREEN IS/ARE CLAIMED AS A FEATURE OF THE MARK.

THE MARK CONSISTS OF THE WORD "MOOREGANICS" WITH "MOORE" IN YELLOW AND "GANICS" IN GREEN.

SN 77-190,654, FILED 5-25-2007.

BRIAN PINO, EXAMINING ATTORNEY

Int. Cl.: 18

Prior U.S. Cls.: 1, 2, 3, 22, and 41

United States Patent and Trademark Office

Reg. No. 3,521,624

Registered Oct. 21, 2008

**TRADEMARK
PRINCIPAL REGISTER**

**CROSS TOWN COMPUTER BAG
COLLECTION**

A.T.X. INTERNATIONAL, INC. (RHODE ISLAND
CORPORATION)
ONE ALBION ROAD
LINCOLN, RI 02865

OWNER OF U.S. REG. NOS. 526,855, 3,083,365,
AND OTHERS.

FOR: BUSINESS TOTE BAGS, IN CLASS 18 (U.S.
CLS. 1, 2, 3, 22 AND 41).

NO CLAIM IS MADE TO THE EXCLUSIVE
RIGHT TO USE "COMPUTER BAG COLLECTION",
APART FROM THE MARK AS SHOWN.

FIRST USE 9-30-2007; IN COMMERCE 9-30-2007.

SN 77-190,655, FILED 5-25-2007.

THE MARK CONSISTS OF STANDARD CHAR-
ACTERS WITHOUT CLAIM TO ANY PARTICULAR
FONT, STYLE, SIZE, OR COLOR.

WILLIAM ROSSMAN, EXAMINING ATTORNEY

Int. Cl.: 21

Prior U.S. Cls.: 2, 13, 23, 29, 30, 33, 40, and 50

United States Patent and Trademark Office

Reg. No. 3,521,625

Registered Oct. 21, 2008

**TRADEMARK
PRINCIPAL REGISTER**

INSIGHTS

QSL CORPORATION (MASSACHUSETTS CORPORATION)
20 COMMERCIAL DRIVE
DRACUT, MA 01826

FOR: NON-METAL PIGGY BANKS; CAFÉ MUGS; NAPKIN HOLDERS; SERVEWARE, NAMELY, APPETIZER PLATES, CHIP AND DIP SERVERS, COASTERS NOT OF PAPER AND NOT BEING TABLE LINEN, CANISTER SETS, CRACKER TRAYS, CREAM AND SUGAR BOWLS; DESSERT PLATES; DIVIDED SERVING TRAYS, OLIVE TRAYS, PITCHERS, PLATES, SALT AND PEPPER SHAKERS, SERVING BOWLS, SAUCERS FOR TEA CUPS, SERVING PLATES, SERVING PLATTERS, SPOON RESTS, TEA SETS; TEA CUPS, TRIVETS; TRAVEL MUGS; VASES; AND WALL PLAQUES OF

EARTHENWARE, IN CLASS 21 (U.S. CLS. 2, 13, 23, 29, 30, 33, 40 AND 50).

FIRST USE 12-31-2003; IN COMMERCE 12-31-2003.

THE MARK CONSISTS OF STANDARD CHARACTERS WITHOUT CLAIM TO ANY PARTICULAR FONT, STYLE, SIZE, OR COLOR.

OWNER OF U.S. REG. NOS. 2,951,815 AND 3,188,630.

SN 77-190,695, FILED 5-25-2007.

ZACHARY BELLO, EXAMINING ATTORNEY

Int. Cl.: 9

Prior U.S. Cls.: 21, 23, 26, 36, and 38

Reg. No. 3,521,626

United States Patent and Trademark Office

Registered Oct. 21, 2008

**TRADEMARK
PRINCIPAL REGISTER**

WEIGHRITE

VALLEY AGRICULTURAL SOFTWARE, INC.
(CALIFORNIA CORPORATION)
3950 SOUTH "K" STREET
TULARE, CA 93274

THE MARK CONSISTS OF STANDARD CHARACTERS WITHOUT CLAIM TO ANY PARTICULAR FONT, STYLE, SIZE, OR COLOR.

FOR: COMPUTER PROGRAMS FOR AUTOMATING THE RECEIPT OF INCOMING COMMODITIES FOR DAIRY HERD MANAGEMENT, IN CLASS 9 (U.S. CLS. 21, 23, 26, 36 AND 38).

SN 77-191,009, FILED 5-25-2007.

FIRST USE 1-1-2007; IN COMMERCE 1-1-2007.

NAAKWAMA ANKRAH, EXAMINING ATTORNEY

Int. Cl.: 25

Prior U.S. Cls.: 22 and 39

United States Patent and Trademark Office

Reg. No. 3,521,627

Registered Oct. 21, 2008

TRADEMARK
PRINCIPAL REGISTER



KAREEM J. HAYES (UNITED STATES INDIVIDUAL)
92-21 76TH STREET
QUEENS, NY 11421

FOR: BELTS; BIBS NOT OF CLOTH OR PAPER; CAPS; CHILDREN'S AND INFANTS' CLOTH BIBS; CHILDREN'S CLOTH EATING BIBS; CLOTH BIBS; CLOTH BIBS FOR ADULT DINERS; CLOTH BIBS FOR USE BY SENIOR CITIZENS OR PHYSICALLY-OR MENTALLY-CHALLENGED PERSONS; CLOTH DIAPERS; CLOTHING FOR WEAR IN JUDO PRACTICES; CLOTHING FOR WEAR IN WRESTLING GAMES; CLOTHING, NAMELY, ARM WARMERS; CLOTHING, NAMELY, FOLK COSTUMES; CLOTHING, NAMELY, HAND-WARMERS; CLOTHING, NAMELY, KNEE WARMERS; CLOTHING, NAMELY, NECK TUBES; CLOTHING, NAMELY, WRAP-AROUND; CORSETS; DUSTERS; FOULARDS; HOODS; INFANT AND TODDLER ONE PIECE

CLOTHING; INFANT CLOTH DIAPERS; JERSEYS; LEATHER BELTS; MANTLES; MUFFLERS; NON-DISPOSABLE CLOTH TRAINING PANTS; PAPER HATS FOR USE AS CLOTHING ITEMS; PARTS OF CLOTHING, NAMELY, GUSSETS FOR TIGHTS, GUSSETS FOR STOCKINGS, GUSSETS FOR BATHING SUITS, GUSSETS FOR UNDERWEAR, GUSSETS FOR LEOTARDS AND GUSSETS FOR FOOTLETS; PERSPIRATION ABSORBENT UNDERWEAR CLOTHING; SHIFTS; SHORT SETS; SHOULDER WRAPS; SWADDLING CLOTHES; TIES; TOPS; UNDERARM CLOTHING SHIELDS; WRAPS, IN CLASS 25 (U.S. CLS. 22 AND 39).

FIRST USE 2-15-2005; IN COMMERCE 1-1-2008.

SN 77-191,150, FILED 5-25-2007.

JOHN KELLY, EXAMINING ATTORNEY

Int. Cl.: 25

Prior U.S. Cls.: 22 and 39

United States Patent and Trademark Office

Reg. No. 3,521,628

Registered Oct. 21, 2008

**TRADEMARK
PRINCIPAL REGISTER**



MCDONALD, GARY O. (UNITED STATES INDIVIDUAL)
9383 SANTA FE TRL
FRISCO, TX 75034

FOR: SHORT SETS; SHOULDER WRAPS; SWADDLING CLOTHES; TIES; TOPS; UNDERARM CLOTHING SHIELDS; WRAPS; CLOTHING, NAMELY, HAND-WARMERS; CLOTHING, NAMELY, KNEE WARMERS; CLOTHING, NAMELY, NECK TUBES; CLOTHING, NAMELY, WRAP-AROUNDS; CORSETS; DUSTERS; FOULARDS; HOODS; INFANT AND TODDLER ONE PIECE CLOTHING; INFANT CLOTH DIAPERS; JERSEYS; LEATHER BELTS; MANTLES; MUFFLERS; NON-DISPOSABLE CLOTH TRAINING PANTS; PAPER HATS FOR USE AS CLOTHING ITEMS; PARTS OF CLOTHING, NAMELY, GUSSETS FOR TIGHTS, GUSSETS FOR STOCKINGS, GUSSETS FOR BATHING SUITS, GUSSETS FOR UNDERWEAR, GUSSETS FOR LEOTARDS AND GUSSETS FOR FOOTLETS; PERSPIRATION ABSORBENT UNDERWEAR CLOTHING; SHIFTS; BELTS; BIBS NOT OF CLOTH

OR PAPER; CAPS; CHILDREN'S AND INFANTS' CLOTH BIBS; CHILDREN'S CLOTH EATING BIBS; CLOTH BIBS; CLOTH BIBS FOR ADULT DINERS; CLOTH BIBS FOR USE BY SENIOR CITIZENS OR PHYSICALLY- OR MENTALLY-CHALLENGED PERSONS; CLOTH DIAPERS; CLOTHING FOR WEAR IN JUDO PRACTICES; CLOTHING FOR WEAR IN WRESTLING GAMES; CLOTHING, NAMELY, ARM WARMERS; CLOTHING, NAMELY, FOLK COSTUMES, IN CLASS 25 (U.S. CLS. 22 AND 39).

FIRST USE 9-1-2007; IN COMMERCE 5-15-2008.

THE MARK CONSISTS OF THE IMAGE OF THE BODIES OF TWO LIONS THAT FORM INTO ONE HEAD.

SN 77-191,384, FILED 5-28-2007.

CARYN GLASSER, EXAMINING ATTORNEY

Int. Cl.: 39

Prior U.S. Cls.: 100 and 105

United States Patent and Trademark Office

Reg. No. 3,521,629

Registered Oct. 21, 2008

**SERVICE MARK
PRINCIPAL REGISTER**

baräaza

JOHNSON, MATTHEW (NEW YORK SOLE PROPRIETORSHIP)
49 LUDLOW STREET, 7A
NEW YORK, NY 10002

THE MARK CONSISTS OF STANDARD CHARACTERS WITHOUT CLAIM TO ANY PARTICULAR FONT, STYLE, SIZE, OR COLOR.

FOR: PROVIDING AN ON-LINE COMPUTER DATABASE IN THE FIELD OF TRAVEL INFORMATION SERVICES, IN CLASS 39 (U.S. CLS. 100 AND 105).

SN 77-191,511, FILED 5-28-2007.

FIRST USE 1-2-2008; IN COMMERCE 3-2-2008.

BRIAN PINO, EXAMINING ATTORNEY

Int. Cl.: 42

Prior U.S. Cls.: 100 and 101

United States Patent and Trademark Office

Reg. No. 3,521,630

Registered Oct. 21, 2008

**SERVICE MARK
PRINCIPAL REGISTER**

coTudo

WU DONG (CHINA INDIVIDUAL)
ROOM 805, NO. 9 JINTIAN NORTH STREET
GUANGZHOU CITY, CHINA

FOR: DESIGN, CREATION, HOSTING, MAINTENANCE OF WEBSITES FOR OTHERS; COMPUTER SOFTWARE DESIGN FOR OTHERS; CONVERSION OF DATA OR DOCUMENTS FROM PHYSICAL TO ELECTRONIC MEDIA; PERIODIC UPGRADING OF COMPUTER SOFTWARE FOR OTHERS; DESIGN OF COMPUTER HARDWARE, INTEGRATED CIRCUITS, COMMUNICATIONS HARDWARE AND SOFTWARE AND COMPUTER NETWORKS FOR

OTHERS; MAINTENANCE OF COMPUTER SOFTWARE; SCIENTIFIC RESEARCH; RECOVERY OF COMPUTER DATA; DUPLICATION OF COMPUTER PROGRAMS, IN CLASS 42 (U.S. CLS. 100 AND 101).

FIRST USE 6-12-2006; IN COMMERCE 6-12-2006.

SN 77-191,569, FILED 5-28-2007.

MATTHEW MCDOWELL, EXAMINING ATTORNEY

Int. Cl.: 37

Prior U.S. Cls.: 100, 103, and 106

United States Patent and Trademark Office

Reg. No. 3,521,631

Registered Oct. 21, 2008

**SERVICE MARK
PRINCIPAL REGISTER**

NATIONAL SPEED

NATIONAL SPEED, INC. (NORTH CAROLINA CORPORATION)
813 SWIFT WIND PLACE
WILMINGTON, NC 28405

FOR: CUSTOMIZATION AND DETAILING OF MOTOR VEHICLES TO ENHANCE THEIR APPEARANCE AND PERFORMANCE, IN CLASS 37 (U.S. CLS. 100, 103 AND 106).

FIRST USE 1-4-2008; IN COMMERCE 1-4-2008.

THE MARK CONSISTS OF STANDARD CHARACTERS WITHOUT CLAIM TO ANY PARTICULAR FONT, STYLE, SIZE, OR COLOR.

NO CLAIM IS MADE TO THE EXCLUSIVE RIGHT TO USE "NATIONAL", APART FROM THE MARK AS SHOWN.

SN 77-191,652, FILED 5-29-2007.

KIM MONINGHOFF, EXAMINING ATTORNEY

Int. Cl.: 28

Prior U.S. Cls.: 22, 23, 38, and 50

United States Patent and Trademark Office

Reg. No. 3,521,632

Registered Oct. 21, 2008

**TRADEMARK
PRINCIPAL REGISTER**

STARBURST POWER FACE

SRI SPORTS KABUSHIKI KAISHA (JAPAN CORPORATION), TA SRI SPORTS LIMITED,
6-9, WAKINOHAMA-CHO 3-CHOME, CHUO-KU
KOBE-SHI, HYOGO, JAPAN

FOR: GOLF CLUB, IN CLASS 28 (U.S. CLS. 22, 23,
38 AND 50).

FIRST USE 7-31-2007; IN COMMERCE 7-31-2007.

THE MARK CONSISTS OF STANDARD CHARACTERS WITHOUT CLAIM TO ANY PARTICULAR FONT, STYLE, SIZE, OR COLOR.

NO CLAIM IS MADE TO THE EXCLUSIVE RIGHT TO USE "FACE", APART FROM THE MARK AS SHOWN.

SN 77-191,773, FILED 5-29-2007.

CHARLOTTE CORWIN, EXAMINING ATTORNEY

Int. Cls.: 16, 35, and 41

Prior U.S. Cls.: 2, 5, 22, 23, 29, 37, 38, 50, 100, 101, 102, and 107

Reg. No. 3,521,633

United States Patent and Trademark Office

Registered Oct. 21, 2008

**TRADEMARK
SERVICE MARK
PRINCIPAL REGISTER**

Personality In Context

THE BRECKENRIDGE INSTITUTE, INC. (COLORADO CORPORATION)
P O BOX 7950
BOULDER, CO 803067950

FOR: PRINTED INSTRUCTIONAL, EDUCATIONAL, AND TEACHING MATERIALS IN THE FIELD OF BUSINESS DEVELOPMENT AT AN INDIVIDUAL AND ORGANIZATIONAL LEVEL, IN CLASS 16 (U.S. CLS. 2, 5, 22, 23, 29, 37, 38 AND 50).

FIRST USE 5-29-2007; IN COMMERCE 7-16-2008.

FOR: BUSINESS MANAGEMENT CONSULTANCY SERVICES, IN CLASS 35 (U.S. CLS. 100, 101 AND 102).

FIRST USE 5-29-2007; IN COMMERCE 7-16-2008.

FOR: EDUCATIONAL SERVICES, NAMELY, CONDUCTING WORKSHOPS AND CLASSES IN THE FIELD OF PERSONAL, BUSINESS, AND ORGANIZATIONAL DEVELOPMENT AT THE INDIVIDUAL AND ORGANIZATIONAL LEVELS AND DISTRIBUTION OF COURSE MATERIAL IN CONNECTION THEREWITH, IN CLASS 41 (U.S. CLS. 100, 101 AND 107).

FIRST USE 5-29-2007; IN COMMERCE 7-16-2008.

THE MARK CONSISTS OF STANDARD CHARACTERS WITHOUT CLAIM TO ANY PARTICULAR FONT, STYLE, SIZE, OR COLOR.

SN 77-191,817, FILED 5-29-2007.

MARK SPARACINO, EXAMINING ATTORNEY

Int. Cl.: 25

Prior U.S. Cls.: 22 and 39

United States Patent and Trademark Office

Reg. No. 3,521,634

Registered Oct. 21, 2008

**TRADEMARK
PRINCIPAL REGISTER**

CONSCIOUSLY HIP

MICHELLE TABER (UNITED STATES INDIVIDUAL)
4893 MENOMINEE LANE
CLARKSTON, MI 48348

THE MARK CONSISTS OF STANDARD CHARACTERS WITHOUT CLAIM TO ANY PARTICULAR FONT, STYLE, SIZE, OR COLOR.

FOR: CLOTHING FOR MEN AND WOMEN, NAMELY, TANK TOPS, T-SHIRTS, SHIRTS, TOPS, IN CLASS 25 (U.S. CLS. 22 AND 39).

SN 77-191,959, FILED 5-29-2007.

FIRST USE 2-12-2008; IN COMMERCE 2-12-2008.

RENEE SERVANCE, EXAMINING ATTORNEY

Int. Cls.: 9 and 42

Prior U.S. Cls.: 21, 23, 26, 36, 38, 100, and 101

United States Patent and Trademark Office

Reg. No. 3,521,635

Registered Oct. 21, 2008

**TRADEMARK
SERVICE MARK
PRINCIPAL REGISTER**

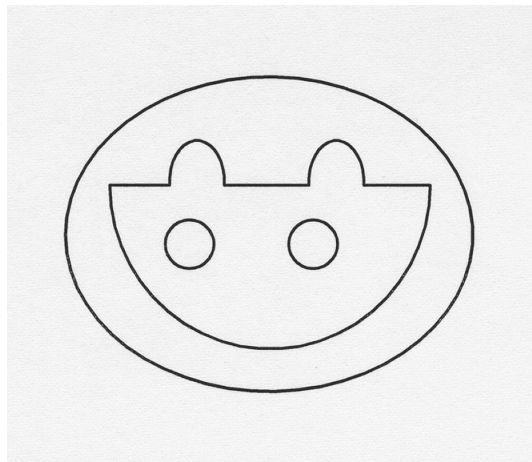

EYESPOT CORPORATION (DELAWARE CORPORATION)
SECOND FLOOR
187 CALLE MAGDALENA #5
ENCINITAS, CA 92024

FOR: DOWNLOADABLE SUITE OF COMPUTER SOFTWARE FOR UPLOADING, EDITING AND SENDING VIDEO CLIPS, AUDIO FILES AND PHOTOS, IN CLASS 9 (U.S. CLS. 21, 23, 26, 36 AND 38).

FIRST USE 2-6-2006; IN COMMERCE 12-22-2006.

FOR: PROVIDING A WEBSITE FEATURING TEMPORARY USE OF NONDOWNLOADABLE

SOFTWARE ALLOWING WEBSITE USERS TO UPLOAD ONLINE VIDEO CLIPS, FILES AND PHOTOS FOR SHARING WITH OTHERS FOR ENTERTAINMENT PURPOSES, IN CLASS 42 (U.S. CLS. 100 AND 101).

FIRST USE 2-6-2006; IN COMMERCE 12-22-2006.

THE MARK CONSISTS OF HALF CIRCLE WITH TWO CIRCLES SIDE BY SIDE WITHIN AN OVAL.

SN 77-192,139, FILED 5-29-2007.

MARK T. MULLEN, EXAMINING ATTORNEY

Int. Cl.: 25

Prior U.S. Cls.: 22 and 39

United States Patent and Trademark Office

Reg. No. 3,521,636

Registered Oct. 21, 2008

**TRADEMARK
PRINCIPAL REGISTER**

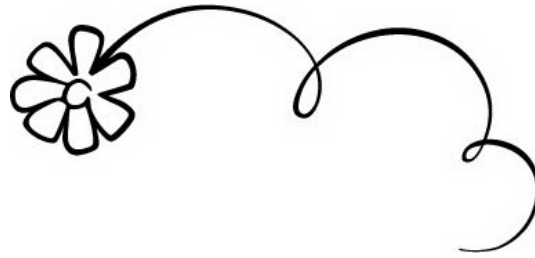

ROCK, JULIE S. (UNITED STATES INDIVIDUAL)
16430 OAK HILL ROAD
SILVER SPRING, MD 20905

FIRST USE 5-1-2007; IN COMMERCE 5-1-2007.

FOR: CLOTHING FOR FEMALES, NAMELY, SHORTS, T-SHIRTS, HATS, SWEATSHIRTS, SWEATPANTS; SPORTS CLOTHING FOR GIRLS AND WOMEN, NAMELY, ATHLETIC SHORTS, COMPRESSION SHORTS, ATHLETIC SHIRTS, ATHLETIC LEGGINGS, ATHLETIC SKORTS, SWEATSHIRT, SWEATPANTS, AND ATHLETIC JACKETS, IN CLASS 25 (U.S. CLS. 22 AND 39).

THE MARK CONSISTS OF FLOWER WITH A LONG LOOPING STEM.

SN 77-192,253, FILED 5-29-2007.

KATHERINE M. DUBRAY, EXAMINING ATTORNEY

Int. Cls.: 9, 16, 20, and 42

**Prior U.S. Cls.: 2, 5, 13, 21, 22, 23, 25, 26, 29, 32, 36,
37, 38, 50, 100, and 101**

Reg. No. 3,521,637

United States Patent and Trademark Office

Registered Oct. 21, 2008

**TRADEMARK
SERVICE MARK
PRINCIPAL REGISTER**

CLASSROOM PLANET

CBT SUPPLY, INC. (MARYLAND CORPORATION)
P.O. BOX 391
HIBERNIA, NJ 07842

FOR: ELECTRICAL CONNECTORS; ELECTRICAL CONNECTION BOXES; CABLE CONNECTORS; TELEPHONE CONNECTORS, IN CLASS 9 (U.S. CLS. 21, 23, 26, 36 AND 38).

FIRST USE 7-1-2007; IN COMMERCE 7-1-2007.

FOR: ARCHITECTURAL PLANS AND SPECIFICATIONS, IN CLASS 16 (U.S. CLS. 2, 5, 22, 23, 29, 37, 38 AND 50).

FIRST USE 7-1-2007; IN COMMERCE 7-1-2007.

FOR: OFFICE FURNITURE, IN CLASS 20 (U.S. CLS. 2, 13, 22, 25, 32 AND 50).

FIRST USE 7-1-2007; IN COMMERCE 7-1-2007.

FOR: ARCHITECTURAL DESIGN; DRAFTING; DESIGN FOR OTHERS IN THE FIELD OF OFFICE FURNITURE, CLASSROOM FURNITURE, RETAIL FURNITURE, HOME FURNITURE AND HOME OFFICES, IN CLASS 42 (U.S. CLS. 100 AND 101).

FIRST USE 7-1-2007; IN COMMERCE 7-1-2007.

THE MARK CONSISTS OF STANDARD CHARACTERS WITHOUT CLAIM TO ANY PARTICULAR FONT, STYLE, SIZE, OR COLOR.

NO CLAIM IS MADE TO THE EXCLUSIVE RIGHT TO USE "CLASSROOM", APART FROM THE MARK AS SHOWN.

SN 77-192,339, FILED 5-29-2007.

BRIAN NEVILLE, EXAMINING ATTORNEY

Int. Cl.: 34

Prior U.S. Cls.: 2, 8, 9, and 17

United States Patent and Trademark Office

Reg. No. 3,521,638

Registered Oct. 21, 2008

**TRADEMARK
PRINCIPAL REGISTER**

CIROLINI

HUMIDIRECT, INC. (MICHIGAN CORPORATION)
952 AYER STREET
IRONWOOD, MI 49938

THE MARK CONSISTS OF STANDARD CHARACTERS WITHOUT CLAIM TO ANY PARTICULAR FONT, STYLE, SIZE, OR COLOR.

FOR: CIGARS, IN CLASS 34 (U.S. CLS. 2, 8, 9 AND 17).

SN 77-192,772, FILED 5-30-2007.

FIRST USE 4-10-2008; IN COMMERCE 4-10-2008.

ELI HELLMAN, EXAMINING ATTORNEY

Int. Cl.: 12

Prior U.S. Cls.: 19, 21, 23, 31, 35, and 44

United States Patent and Trademark Office

Reg. No. 3,521,639

Registered Oct. 21, 2008

**TRADEMARK
PRINCIPAL REGISTER**

TFSI

AUDI AG (FED REP GERMANY JOINT STOCK
COMPANY)
85045
INGOLSTADT, FED REP GERMANY 85045

FOR: AUTOMOBILE ENGINES, IN CLASS 12 (U.S.
CLS. 19, 21, 23, 31, 35 AND 44).

FIRST USE 3-31-2005; IN COMMERCE 3-31-2005.

THE MARK CONSISTS OF STANDARD CHAR-
ACTERS WITHOUT CLAIM TO ANY PARTICULAR
FONT, STYLE, SIZE, OR COLOR.

OWNER OF U.S. REG. NO. 2,519,278.

SN 77-192,811, FILED 5-30-2007.

PAULA MAHONEY, EXAMINING ATTORNEY

Int. Cl.: 36

Prior U.S. Cls.: 100, 101, and 102

United States Patent and Trademark Office

Reg. No. 3,521,640

Registered Oct. 21, 2008

**SERVICE MARK
PRINCIPAL REGISTER**

REAL HELP

HERITAGE HEALTH SYSTEMS, INC. (DELA-
WARE CORPORATION)
SUITE 700
4888 LOOP CENTRAL DRIVE
HOUSTON, TX 77081

FOR: INSURANCE UNDERWRITING IN THE
FIELD OF HEALTH, IN CLASS 36 (U.S. CLS. 100,
101 AND 102).

FIRST USE 8-0-2006; IN COMMERCE 8-0-2006.

THE MARK CONSISTS OF STANDARD CHAR-
ACTERS WITHOUT CLAIM TO ANY PARTICULAR
FONT, STYLE, SIZE, OR COLOR.

SN 77-193,124, FILED 5-30-2007.

RONALD AIKENS, EXAMINING ATTORNEY

Int. Cl.: 9

Prior U.S. Cls.: 21, 23, 26, 36, and 38

Reg. No. 3,521,641

United States Patent and Trademark Office

Registered Oct. 21, 2008

**TRADEMARK
PRINCIPAL REGISTER**

Tank Watch

VALLEY AGRICULTURAL SOFTWARE, INC.
(CALIFORNIA CORPORATION)
3950 SOUTH "K" STREET
TULARE, CA 93274

THE MARK CONSISTS OF STANDARD CHARACTERS WITHOUT CLAIM TO ANY PARTICULAR FONT, STYLE, SIZE, OR COLOR.

FOR: COMPUTER PROGRAMS FOR MONITORING DAIRY PRODUCTION AND ITS COMPONENTS, IN CLASS 9 (U.S. CLS. 21, 23, 26, 36 AND 38).

SN 77-193,390, FILED 5-30-2007.

FIRST USE 1-1-2003; IN COMMERCE 1-1-2003.

NAAKWAMA ANKRAH, EXAMINING ATTORNEY

Int. Cl.: 7

Prior U.S. Cls.: 13, 19, 21, 23, 31, 34, and 35

Reg. No. 3,521,642

United States Patent and Trademark Office

Registered Oct. 21, 2008

**TRADEMARK
PRINCIPAL REGISTER**

PORTAL

THRUBIT LLC (DELAWARE LIMITED LIABILITY COMPANY)
4905 CRANSWICK RD.
HOUSTON, TX 77041

FIRST USE 7-15-2008; IN COMMERCE 7-15-2008.

FOR: DRILL BITS FOR POWER-OPERATED SUB-SURFACE WELLBORE DRILLING HAVING THROUGH PASSAGES FOR WELL EVALUATION AND WELL INTERVENTION EQUIPMENT , IN CLASS 7 (U.S. CLS. 13, 19, 21, 23, 31, 34 AND 35).

THE MARK CONSISTS OF STANDARD CHARACTERS WITHOUT CLAIM TO ANY PARTICULAR FONT, STYLE, SIZE, OR COLOR.

SN 77-193,422, FILED 5-30-2007.

KIM MONINGHOFF, EXAMINING ATTORNEY

Int. Cl.: 9

Prior U.S. Cls.: 21, 23, 26, 36, and 38

United States Patent and Trademark Office

Reg. No. 3,521,643

Registered Oct. 21, 2008

**TRADEMARK
PRINCIPAL REGISTER**

SHOREPHONE

SHORETEL, INC. (CALIFORNIA CORPORATION)
960 STEWART DRIVE
SUNNYVALE, CA 94085

FOR: TELEPHONES, IP TELEPHONES, COMPUTER TELEPHONY SOFTWARE, AND TELEPHONE APPARATUSES, IN CLASS 9 (U.S. CLS. 21, 23, 26, 36 AND 38).

FIRST USE 8-0-2002; IN COMMERCE 8-0-2002.

THE MARK CONSISTS OF STANDARD CHARACTERS WITHOUT CLAIM TO ANY PARTICULAR FONT, STYLE, SIZE, OR COLOR.

OWNER OF U.S. REG. NOS. 2,444,415, 3,272,772, AND OTHERS.

SN 77-193,661, FILED 5-30-2007.

MICHAEL TANNER, EXAMINING ATTORNEY

Int. Cls.: 30 and 43

Prior U.S. Cls.: 46, 100, and 101

United States Patent and Trademark Office

Reg. No. 3,521,644

Registered Oct. 21, 2008

**TRADEMARK
SERVICE MARK
PRINCIPAL REGISTER**

That Cool Yogurt Place

STEVEN W. HELLER (UNITED STATES INDIVIDUAL)
17522 NW 7TH COURT
PEMBROKE PINES, FL 33029

FOR: FROZEN YOGURT, NAMELY, FROZEN YOGURT, SNACKS AND DESSERTS, ALONE OR COMBINED WITH FRUITS, NUTS, CEREALS AND OTHER TOPPINGS, FROZEN YOGURT BASED SHAKES, DRINKS, AND FROZEN YOGURT BASED CAKES, IN CLASS 30 (U.S. CL. 46).

FIRST USE 1-12-2008; IN COMMERCE 1-12-2008.

FOR: RESTAURANT SERVICES, NAMELY, RESTAURANT SERVICES FEATURING FROZEN YOGURT PRODUCTS, IN CLASS 43 (U.S. CLS. 100 AND 101).

FIRST USE 1-12-2008; IN COMMERCE 1-12-2008.

THE MARK CONSISTS OF STANDARD CHARACTERS WITHOUT CLAIM TO ANY PARTICULAR FONT, STYLE, SIZE, OR COLOR.

SN 77-194,225, FILED 5-31-2007.

GILBERT SWIFT, EXAMINING ATTORNEY

Int. Cl.: 41

Prior U.S. Cls.: 100, 101, and 107

United States Patent and Trademark Office

Reg. No. 3,521,645

Registered Oct. 21, 2008

**SERVICE MARK
PRINCIPAL REGISTER**

THOMAS TOWN

GULLANE (THOMAS) LLC (DELAWARE LIMITED LIABILITY COMPANY)
300 DELAWARE AVENUE, SUITE 518
WILMINGTON, DE 19801

FOR: ENTERTAINMENT IN THE NATURE OF AMUSEMENT PARK SERVICES, IN CLASS 41 (U.S. CLS. 100, 101 AND 107).

FIRST USE 6-15-2007; IN COMMERCE 6-15-2007.

THE MARK CONSISTS OF STANDARD CHARACTERS WITHOUT CLAIM TO ANY PARTICULAR FONT, STYLE, SIZE, OR COLOR.

OWNER OF U.S. REG. NO. 3,085,762.

SN 77-194,332, FILED 5-31-2007.

JORDAN BAKER, EXAMINING ATTORNEY

Int. Cl.: 28

Prior U.S. Cls.: 22, 23, 38, and 50

United States Patent and Trademark Office

Reg. No. 3,521,646

Registered Oct. 21, 2008

**TRADEMARK
PRINCIPAL REGISTER**

HYDRO-BLAST

BUZZ BEE TOYS, INC. (DELAWARE CORPORATION)
309 FELLOWSHIP ROAD SUITE 105
MT. LAUREL, NJ 08054

THE MARK CONSISTS OF STANDARD CHARACTERS WITHOUT CLAIM TO ANY PARTICULAR FONT, STYLE, SIZE, OR COLOR.

FOR: WATER PISTOLS; WATER SQUIRTING TOYS, IN CLASS 28 (U.S. CLS. 22, 23, 38 AND 50).

SN 77-194,343, FILED 5-31-2007.

FIRST USE 7-1-2007; IN COMMERCE 1-9-2008.

INGA ERVIN, EXAMINING ATTORNEY

Int. Cl.: 28

Prior U.S. Cls.: 22, 23, 38, and 50

United States Patent and Trademark Office

Reg. No. 3,521,647

Registered Oct. 21, 2008

**TRADEMARK
PRINCIPAL REGISTER**

HYDRO-PULSE

BUZZ BEE TOYS, INC. (DELAWARE CORPORATION)
309 FELLOWSHIP ROAD SUITE 105
MT. LAUREL, NJ 08054

THE MARK CONSISTS OF STANDARD CHARACTERS WITHOUT CLAIM TO ANY PARTICULAR FONT, STYLE, SIZE, OR COLOR.

FOR: WATER PISTOLS; WATER SQUIRTING TOYS, IN CLASS 28 (U.S. CLS. 22, 23, 38 AND 50).

SN 77-194,346, FILED 5-31-2007.

FIRST USE 7-1-2007; IN COMMERCE 1-18-2008.

INGA ERVIN, EXAMINING ATTORNEY

Int. Cl.: 36

Prior U.S. Cls.: 100, 101, and 102

United States Patent and Trademark Office

Reg. No. 3,521,648

Registered Oct. 21, 2008

**SERVICE MARK
PRINCIPAL REGISTER**



The Westchester Bank

WESTCHESTER BANK HOLDING CORPORATION (DELAWARE CORPORATION)
2001 CENTRAL PARK AVENUE
YONKERS, NY 10710

FOR: BANKING AND FINANCIAL SERVICES, NAMELY, BANKING SERVICES, PERSONAL AND COMMERCIAL BANKING SERVICES, CHECKING ACCOUNT SERVICES, SAVINGS ACCOUNT SERVICES, DEPOSIT SERVICES, SAFETY DEPOSIT BOX SERVICES, ONLINE BANKING, ONLINE BILL PAYMENT SERVICES, WIRE TRANSFER SERVICES, AUTOMATED TELLER MACHINE SERVICES, ELECTRONIC FUNDS TRANSFER SERVICES, CREDIT CARD AND DEBIT CARD SERVICES, INVESTMENT BANKING SERVICES, MORTGAGE AND LENDING SERVICES, REAL ESTATE FINANCING SERVICES, FINANCIAL PLANNING AND ANALYSIS, FINANCIAL ADVISORY SERVICES, FINANCIAL MANAGEMENT SERVICES, FINANCIAL MANAGEMENT, NAMELY, ASSET MANAGEMENT, INVESTMENT MANAGEMENT, INVESTMENT CONSULTATION, FUND INVESTMENT SERVICES, INVESTMENT BROKERAGE SERVICES, MONEY MARKET ACCOUNT SERVICES, MUTUAL FUND ADMINISTRATION AND BROKERAGE SERVICES; TRUST SERVICES, NAMELY, INVESTMENT AND TRUST COMPANY SERVICES; FIDUCIARY SERVICES, NAMELY, TRUST AND ESTATE PLAN CONSULTATION, ESTATE SETTLEMENT; TRUST, ESTATE AND INVESTMENT CUSTODY, ADMINISTRATION, RECORD KEEPING AND REPORTING SERVICES, NAMELY, SAFEKEEPING, INVESTING AND MANAGING ASSETS, EXECUTING AND SET-

TLING SECURITIES TRADES, CORPORATE FINANCIAL ACTION REPORTING AND MANAGEMENT, FINANCIAL TRANSACTION PROCESSING, BILL PAYMENT, TRACKING AND REPORTING FINANCIAL ACCOUNT, ASSET AND FINANCIAL TRANSACTION INFORMATION, ONLINE FINANCIAL ACCOUNT SERVICES; PROVIDING INFORMATION IN THE FIELDS OF BANKING, FINANCE, INVESTMENTS, ASSET MANAGEMENT, AND FINANCIAL PLANNING, IN CLASS 36 (U.S. CLS. 100, 101 AND 102).

FIRST USE 5-24-2007; IN COMMERCE 6-18-2008.

NO CLAIM IS MADE TO THE EXCLUSIVE RIGHT TO USE "THE WESTCHESTER BANK", APART FROM THE MARK AS SHOWN.

THE COLOR(S) BLACK, SILVER, BURGUNDY IS/ ARE CLAIMED AS A FEATURE OF THE MARK.

THE MARK CONSISTS OF THE WORDING "THE WESTCHESTER BANK" IN BLACK, IN STYLIZED TYPE. TO THE LEFT OF THE WORDING IS A DESIGN OF A SQUARE CONSISTING OF FOUR "W'S" WITH THE FIRST AND THIRD LINES OF THE "W'S" IN BURGUNDY AND THE SECOND AND FOURTH LINES OF THE "W'S" IN SILVER.

SN 77-194,732, FILED 5-31-2007.

MORGAN WYNNE, EXAMINING ATTORNEY

Int. Cl.: 38

Prior U.S. Cls.: 100, 101, and 104

United States Patent and Trademark Office

Reg. No. 3,521,649

Registered Oct. 21, 2008

**SERVICE MARK
PRINCIPAL REGISTER**

FLEXPAY

T-MOBILE USA, INC. (DELAWARE CORPORATION)
12920 S.E. 38TH STREET
BELLEVUE, WA 98006

THE MARK CONSISTS OF STANDARD CHARACTERS WITHOUT CLAIM TO ANY PARTICULAR FONT, STYLE, SIZE, OR COLOR.

FOR: TELECOMMUNICATIONS SERVICES, NAMELY, WIRELESS VOICE AND DATA TRANSMISSION, IN CLASS 38 (U.S. CLS. 100, 101 AND 104).

SN 77-194,889, FILED 5-31-2007.

FIRST USE 7-0-2007; IN COMMERCE 7-0-2007.

CAROLYN GRAY, EXAMINING ATTORNEY

Int. Cl.: 34

Prior U.S. Cls.: 2, 8, 9, and 17

United States Patent and Trademark Office

Reg. No. 3,521,650

Registered Oct. 21, 2008

**TRADEMARK
PRINCIPAL REGISTER**

UNO BY ARGANESE

ARGANESE INTERNATIONAL LLC (CONNEC-
TICUT LIMITED LIABILITY COMPANY)
149 ALTANTIC AVENUE
WESTERLY, RI 02891

THE MARK CONSISTS OF STANDARD CHAR-
ACTERS WITHOUT CLAIM TO ANY PARTICULAR
FONT, STYLE, SIZE, OR COLOR.

FOR: CIGAR BANDS; CIGAR BOXES; CIGAR
BOXES NOT OF PRECIOUS METAL; CIGAR CASES;
CIGARS, IN CLASS 34 (U.S. CLS. 2, 8, 9 AND 17).

SN 77-195,230, FILED 6-1-2007.

FIRST USE 6-1-2007; IN COMMERCE 6-1-2007.

ANNE MADDEN, EXAMINING ATTORNEY

Int. Cl.: 36

Prior U.S. Cls.: 100, 101, and 102

United States Patent and Trademark Office

Reg. No. 3,521,651

Registered Oct. 21, 2008

**SERVICE MARK
PRINCIPAL REGISTER**

SCRAPPRO

AMWINS GROUP, INC. (NORTH CAROLINA
CORPORATION)
4725 PIEDMONT ROW DRIVE
SUITE 600
CHARLOTTE, NC 28210

FOR: INSURANCE SERVICES, NAMELY, THE
BROKERAGE, UNDERWRITING, ISSUANCE AND
ADMINISTRATION OF PROPERTY, CASUALTY,
PROFESSIONAL LIABILITY AND GENERAL LIA-
BILITY INSURANCE FOR THE SCRAP RECY-
CLING INDUSTRY, IN CLASS 36 (U.S. CLS. 100, 101
AND 102).

FIRST USE 12-31-2006; IN COMMERCE 12-31-2006.

THE MARK CONSISTS OF STANDARD CHAR-
ACTERS WITHOUT CLAIM TO ANY PARTICULAR
FONT, STYLE, SIZE, OR COLOR.

SN 77-195,243, FILED 6-1-2007.

DAVID TOOLEY, EXAMINING ATTORNEY

Int. Cl.: 36

Prior U.S. Cls.: 100, 101, and 102

United States Patent and Trademark Office

Reg. No. 3,521,652

Registered Oct. 21, 2008

**SERVICE MARK
PRINCIPAL REGISTER**

PIZZAPRO

AMWINS GROUP, INC. (DELAWARE CORPORATION)
4064 COLONY ROAD
SUITE 450
CHARLOTTE, NC 28211

FOR: INSURANCE SERVICES, NAMELY, THE BROKERAGE, UNDERWRITING, ISSUANCE AND ADMINISTRATION OF PROPERTY, CASUALTY, PROFESSIONAL LIABILITY AND GENERAL LIABILITY INSURANCE FOR PIZZA OPERATIONS OFFERING DELIVERY SERVICE, IN CLASS 36 (U.S. CLS. 100, 101 AND 102).

FIRST USE 4-30-2000; IN COMMERCE 4-30-2000.

THE MARK CONSISTS OF STANDARD CHARACTERS WITHOUT CLAIM TO ANY PARTICULAR FONT, STYLE, SIZE, OR COLOR.

SN 77-195,343, FILED 6-1-2007.

DAVID TOOLEY, EXAMINING ATTORNEY

Int. Cl.: 16

Prior U.S. Cls.: 2, 5, 22, 23, 29, 37, 38, and 50

United States Patent and Trademark Office

Reg. No. 3,521,653

Registered Oct. 21, 2008

**TRADEMARK
PRINCIPAL REGISTER**

PATRICIA DASH

DASH, PATRICIA (UNITED STATES INDIVIDUAL)
111 VIZCAYA ESTATES DR.
PALM BEACH GARDENS, FL 33418

THE MARK CONSISTS OF STANDARD CHARACTERS WITHOUT CLAIM TO ANY PARTICULAR FONT, STYLE, SIZE, OR COLOR.

FOR: CARDS WITH AND WITHOUT MUSICAL CHIPS SOLD WITH COSTUME JEWELRY, IN CLASS 16 (U.S. CLS. 2, 5, 22, 23, 29, 37, 38 AND 50).

SN 77-195,671, FILED 6-1-2007.

FIRST USE 9-0-2007; IN COMMERCE 9-0-2007.

BARBARA BROWN, EXAMINING ATTORNEY

Int. Cl.: 9

Prior U.S. Cls.: 21, 23, 26, 36, and 38

Reg. No. 3,521,654

United States Patent and Trademark Office

Registered Oct. 21, 2008

**TRADEMARK
PRINCIPAL REGISTER**

BSG II

ELECTRIC VISUAL EVOLUTION, LLC (CALI-
FORNIA LIMITED LIABILITY COMPANY)
SUITE H
1062 CALLE NEGOCIO
SAN CLAMENTE, CA 92673

FOR: SUNGLASSES AND CASES FOR SUNGLAS-
SES, IN CLASS 9 (U.S. CLS. 21, 23, 26, 36 AND 38).

FIRST USE 9-25-2007; IN COMMERCE 9-25-2007.

THE MARK CONSISTS OF STANDARD CHAR-
ACTERS WITHOUT CLAIM TO ANY PARTICULAR
FONT, STYLE, SIZE, OR COLOR.

OWNER OF U.S. REG. NO. 3,241,335.

SN 77-195,920, FILED 6-1-2007.

SEAN CROWLEY, EXAMINING ATTORNEY

Int. Cl.: 25

Prior U.S. Cls.: 22 and 39

United States Patent and Trademark Office

Reg. No. 3,521,655

Registered Oct. 21, 2008

TRADEMARK
PRINCIPAL REGISTER



KINGSTON, HEATHER (UNITED STATES INDIVIDUAL)
18957 OVERLAND DR.
ANDERSON, CA 96007

FOR: GIFT ARRANGEMENT COMPRISED OF A GLASS VASE CONTAINING BABY CLOTHING, NAMELY, ONE PIECE GARMENTS AND SOCKS FASHIONED INTO FLOWER SHAPES, IN CLASS 25 (U.S. CLS. 22 AND 39).

FIRST USE 6-15-2007; IN COMMERCE 6-15-2007.

NO CLAIM IS MADE TO THE EXCLUSIVE RIGHT TO USE "BOUQUET" AND "BOOTIE BLOSSOMS FOR BABIES", APART FROM THE MARK AS SHOWN.

THE MARK CONSISTS OF AN ABSTRACT DESIGN IN THE FORM OF A FLOWER, WITH STYLIZED TEXT.

SN 77-196,096, FILED 6-1-2007.

KAREN K. BUSH, EXAMINING ATTORNEY

Int. Cl.: 25

Prior U.S. Cls.: 22 and 39

United States Patent and Trademark Office

Reg. No. 3,521,656

Registered Oct. 21, 2008

TRADEMARK
PRINCIPAL REGISTER

Urge
Clothing Co.

AARONIAN, MATT (UNITED STATES INDIVIDUAL)
1336 BOLTON DR.
MORROW BAY, CA 93442

FOR: CLOTHING, NAMELY, SHIRTS, T-SHIRTS,
IN CLASS 25 (U.S. CLS. 22 AND 39).

FIRST USE 7-16-2007; IN COMMERCE 7-16-2007.

NO CLAIM IS MADE TO THE EXCLUSIVE
RIGHT TO USE "CLOTHING CO." , APART FROM
THE MARK AS SHOWN.

THE MARK CONSISTS OF THE STYLIZED
WORDS "URGE" AND "CLOTHING CO." WITH
THE WORD "URGE" SUBSTANTIALLY LARGER
AND CENTERED ABOVE THE WORDS "CLOTH-
ING CO."

SN 77-196,153, FILED 6-1-2007.

MARK SPARACINO, EXAMINING ATTORNEY

Int. Cl.: 9

Prior U.S. Cls.: 21, 23, 26, 36, and 38

United States Patent and Trademark Office

Reg. No. 3,521,657

Registered Oct. 21, 2008

**TRADEMARK
PRINCIPAL REGISTER**

**THE ENTERPRISE SOLUTION
FOR PRODUCT INNOVATION**

ALTAIR ENGINEERING, INC. (MICHIGAN CORPORATION)
1820 E. BIG BEAVER ROAD
TROY, MI 480832031

FOR: COMPUTER SOFTWARE FOR COMPUTER AIDED DESIGN, ENGINEERING AND MANUFACTURING SIMULATION; HIGH GRID COMPUTING SOFTWARE, IN CLASS 9 (U.S. CLS. 21, 23, 26, 36 AND 38).

FIRST USE 2-16-2007; IN COMMERCE 2-16-2007.

THE MARK CONSISTS OF STANDARD CHARACTERS WITHOUT CLAIM TO ANY PARTICULAR FONT, STYLE, SIZE, OR COLOR.

SN 77-196,526, FILED 6-4-2007.

SUSAN LESLIE DUBOIS, EXAMINING ATTORNEY

Int. Cl.: 30

Prior U.S. Cl.: 46

United States Patent and Trademark Office

Reg. No. 3,521,658

Registered Oct. 21, 2008

**TRADEMARK
PRINCIPAL REGISTER**

Somethin' Sweet

SWEETSUE, LLC (FLORIDA LIMITED LIABILITY COMPANY)
11017 VIA SAN REMO
BOYNTON BEACH, FL 33437

THE MARK CONSISTS OF STANDARD CHARACTERS WITHOUT CLAIM TO ANY PARTICULAR FONT, STYLE, SIZE, OR COLOR.

FOR: SUGAR SUBSTITUTES, IN CLASS 30 (U.S. CL. 46).

SN 77-196,542, FILED 6-4-2007.

FIRST USE 8-0-2007; IN COMMERCE 12-0-2007.

MARK T. MULLEN, EXAMINING ATTORNEY

Int. Cl.: 37

Prior U.S. Cls.: 100, 103, and 106

United States Patent and Trademark Office

Reg. No. 3,521,659

Registered Oct. 21, 2008

SERVICE MARK
PRINCIPAL REGISTER



NADEAU, LAURIE J (UTAH LIMITED LIABILITY COMPANY)
1877 TOLLGATE CANYON ROAD
WANSHIP, UT 84017

FOR: REAL ESTATE DEVELOPMENT, IN CLASS 37 (U.S. CLS. 100, 103 AND 106).

FIRST USE 1-1-2005; IN COMMERCE 8-8-2008.

NO CLAIM IS MADE TO THE EXCLUSIVE RIGHT TO USE "GREEN BUILT COMMUNITIES", APART FROM THE MARK AS SHOWN.

THE COLOR(S) GREEN AND PURPLE IS/ARE CLAIMED AS A FEATURE OF THE MARK.

THE MARK CONSISTS OF PURPLE HOUSE WITH A GREEN CIRCLE AND GREEN LEAF AROUND IT WITH THE WORD "GREEN" IN GREEN TO THE LEFT OF THE HOUSE AND THE WORD "BUILT" IN GREEN TO THE RIGHT OF THE HOUSE WITH A GREEN LINE UNDER THE "GREEN", HOUSE AND "BUILT". THE GREEN LEAF IS LOCATED AT THE LOWER LEFT CORNER OF THE PURPLE HOUSE. THE WORD "COMMUNITIES" IN PURPLE IS BELOW THE GREEN LINE.

SN 77-196,604, FILED 6-4-2007.

DORITT L. CARROLL, EXAMINING ATTORNEY

Int. Cl.: 9

Prior U.S. Cls.: 21, 23, 26, 36, and 38

Reg. No. 3,521,660

United States Patent and Trademark Office

Registered Oct. 21, 2008

**TRADEMARK
PRINCIPAL REGISTER**

Uni.G

UNIFICATION CO., LTD. (TAIWAN CORPORATION)
3F, NO. 6
WU KUNG 5TH RD., HSIN CHUANG CITY
TAIPEI HSIEN, TAIWAN

FOR: TELEPHONE ANSWERING MACHINES;
AUTOMATIC TELEPHONE DIALERS; BATTERY
CHARGERS; BUFFERS FOR COMPUTERS; CIR-
CUIT BOARDS; ELECTRICAL CIRCUIT BOARDS;
CIRCUIT BREAKERS; ELECTRICAL CIRCUITS;
INTEGRATED CIRCUITS; BLANK DIGITAL
AUDIO TAPES; DIGITAL AUDIO TAPE PLAYERS;

RADIO PAGERS; DIGITAL AUDIO TAPE RECORDER,
IN CLASS 9 (U.S. CLS. 21, 23, 26, 36 AND 38).

FIRST USE 8-1-2008; IN COMMERCE 8-1-2008.

THE MARK CONSISTS OF STANDARD CHARACTERS
WITHOUT CLAIM TO ANY PARTICULAR
FONT, STYLE, SIZE, OR COLOR.

SN 77-196,732, FILED 6-4-2007.

KEVON CHISOLM, EXAMINING ATTORNEY

Int. Cl.: 11

Prior U.S. Cls.: 13, 21, 23, 31, and 34

Reg. No. 3,521,661

United States Patent and Trademark Office

Registered Oct. 21, 2008

**TRADEMARK
PRINCIPAL REGISTER**

BREWMETER

BUNN-O-MATIC CORPORATION (DELAWARE
CORPORATION)
1400 STEVENSON DRIVE
SPRINGFIELD, IL 62703

FOR: TEMPERATURE CONTROLLED BEVER-
AGE DISPENSERS, NAMELY, HEATED BEVERAGE
DISPENSING UNITS FOR COMMERCIAL USE AND
COMPONENTS THEREOF; ELECTRIC COFFEE
AND TEA MAKERS, IN CLASS 11 (U.S. CLS. 13, 21,
23, 31 AND 34).

FIRST USE 6-22-2006; IN COMMERCE 7-0-2007.

THE MARK CONSISTS OF STANDARD CHAR-
ACTERS WITHOUT CLAIM TO ANY PARTICULAR
FONT, STYLE, SIZE, OR COLOR.

SN 77-196,794, FILED 6-4-2007.

SEAN CROWLEY, EXAMINING ATTORNEY

Int. Cl.: 25

Prior U.S. Cls.: 22 and 39

United States Patent and Trademark Office

Reg. No. 3,521,662

Registered Oct. 21, 2008

TRADEMARK
PRINCIPAL REGISTER



AQUATA, LLC (FLORIDA LIMITED LIABILITY
COMPANY)
528 NW 7TH AVENUE
MIAMI, FL 33136

FOR: CLOTHING, NAMELY, JACKETS, PANTS,
SHIRTS, SWIMWEAR, SHORTS AND FOOTWEAR,
IN CLASS 25 (U.S. CLS. 22 AND 39).

FIRST USE 5-7-2008; IN COMMERCE 5-7-2008.

THE MARK CONSISTS OF THE WORDS "DRY
FREAK", BELOW WHICH IS A HORIZONTAL BAR,
AND BELOW WHICH IS A DRAWING OF A WATER
DROPLET IN THE CENTER OF THE UNIVERSAL
SYMBOL FOR "NO."

SN 77-196,840, FILED 6-4-2007.

KAPIL BHANOT, EXAMINING ATTORNEY

Int. Cls.: 12 and 20

**Prior U.S. Cls.: 2, 13, 19, 21, 22, 23, 25, 31, 32, 35, 44,
and 50**

Reg. No. 3,521,663

United States Patent and Trademark Office

Registered Oct. 21, 2008

**TRADEMARK
PRINCIPAL REGISTER**

CLICK & SAFE

BRITAX CHILDCARE GROUP LIMITED (UNI-
TED KINGDOM CORPORATION)
SILVERLESS STREET
1 THE GREEN, MARLBOROUGH
WILTSHIRE, UNITED KINGDOM SN81AL

FOR: SEATS FOR USE IN OR USE WITH APPA-
RATUS FOR LOCOMOTION BY LAND, AIR OR
WATER, NAMELY, CHILDREN'S CAR SEATS;
SAFETY SEATS FOR USE IN OR WITH APPARA-
TUS FOR LOCOMOTION BY LAND, AIR OR WA-
TER, NAMELY, SAFETY SEATS FOR INFANTS
AND CHILDREN IN VEHICLES; BABY AND CHILD
CARRYING SEATS FOR USE IN OR WITH APPA-
RATUS FOR LOCOMOTION BY LAND, AIR OR
WATER, NAMELY, CHILDREN'S AND BABY CAR
SEATS; SAFETY BELTS AND CHILD SAFETY HAR-
NESSES FOR USE IN VEHICLES; SEAT BELTS FOR
USE IN VEHICLES; BABY CARRIAGES, PUSH
CHAIRS AND PRAMS; DETACHABLE SEATS FOR
USE WITH BABY CARRIAGES, PUSH CHAIRS AND
PRAMS; CHILD TRANSPORTATION SYSTEMS,
NAMELY, SMALL WAGONS FOR CHILDREN;
CHILD CARRIER SYSTEMS, NAMELY, CHILD

CARRYING TRAILER FOR USE IN TRANSPORT-
ING CHILDREN WHILE HIKING, JOGGING,
WALKING, SKIING, SNOW SHOEING OR SKAT-
ING; PARTS AND COMPONENTS FOR ALL THE
AFORESAID GOODS; ACCESSORIES FOR BABY
CARRIAGES, NAMELY, COVERS FOR BABY CAR-
RIAGES, IN CLASS 12 (U.S. CLS. 19, 21, 23, 31, 35 AND
44).

FIRST USE 7-1-2008; IN COMMERCE 7-1-2008.

FOR: BABY AND CHILD BOOSTER SEATS, IN
CLASS 20 (U.S. CLS. 2, 13, 22, 25, 32 AND 50).

FIRST USE 7-1-2008; IN COMMERCE 7-1-2008.

THE MARK CONSISTS OF STANDARD CHAR-
ACTERS WITHOUT CLAIM TO ANY PARTICULAR
FONT, STYLE, SIZE, OR COLOR.

SN 77-196,971, FILED 6-4-2007.

APRIL ROACH, EXAMINING ATTORNEY

Int. Cl.: 11

Prior U.S. Cls.: 13, 21, 23, 31, and 34

United States Patent and Trademark Office

Reg. No. 3,521,664

Registered Oct. 21, 2008

**TRADEMARK
PRINCIPAL REGISTER**

MAGNETO

W.C. BRADLEY COMPANY (GEORGIA CORPORATION)
1017 FRONT AVENUE
COLUMBUS, GA 31904

THE MARK CONSISTS OF STANDARD CHARACTERS WITHOUT CLAIM TO ANY PARTICULAR FONT, STYLE, SIZE, OR COLOR.

FOR: BARBECUE GRILL ACCESSORIES, NAME-
LY, CRADLES, HOLDERS, CLIPS AND HOOKS FOR
SECURING UTENSILS TO A BARBECUE GRILL, IN
CLASS 11 (U.S. CLS. 13, 21, 23, 31 AND 34).

SN 77-197,071, FILED 6-4-2007.

FIRST USE 12-31-2007; IN COMMERCE 12-31-2007.

BRIAN PINO, EXAMINING ATTORNEY

Int. Cls.: 35, 37, and 39

Prior U.S. Cls.: 100, 101, 102, 103, 105, and 106

United States Patent and Trademark Office

Reg. No. 3,521,665

Registered Oct. 21, 2008

**SERVICE MARK
PRINCIPAL REGISTER**

**GREAT DEALS. GREAT
SERVICE. NO BADGERS.**

HOL-DAV MANAGEMENT, INC. (NORTH CAROLINA CORPORATION)
5839 CAPITAL BOULEVARD
RALEIGH, NC 27616

FOR: AUTOMOTIVE DEALERSHIP FEATURING NEW AND USED VEHICLES AND AUTOMOTIVE PARTS AND ACCESSORIES, IN CLASS 35 (U.S. CLS. 100, 101 AND 102).

FIRST USE 1-16-2008; IN COMMERCE 1-16-2008.

FOR: REPAIR AND MAINTENANCE OF VEHICLES, IN CLASS 37 (U.S. CLS. 100, 103 AND 106).

FIRST USE 1-10-2007; IN COMMERCE 1-10-2007.

FOR: LEASING OF MOTOR VEHICLES, IN CLASS 39 (U.S. CLS. 100 AND 105).

FIRST USE 7-12-2008; IN COMMERCE 7-12-2008.

THE MARK CONSISTS OF STANDARD CHARACTERS WITHOUT CLAIM TO ANY PARTICULAR FONT, STYLE, SIZE, OR COLOR.

SN 77-197,588, FILED 6-5-2007.

HEATHER BIDDULPH, EXAMINING ATTORNEY

Int. Cl.: 9

Prior U.S. Cls.: 21, 23, 26, 36, and 38

United States Patent and Trademark Office

Reg. No. 3,521,666

Registered Oct. 21, 2008

**TRADEMARK
PRINCIPAL REGISTER**

Guardian Analytics

GUARDIAN ANALYTICS, INC. (DELAWARE CORPORATION)
SUITE 207
289 S. SAN ANTONIO ROAD
LOS ALTOS, CA 94022

FOR: COMPUTER SOFTWARE FOR DETECTING AND MANAGING THE RISK OF FRAUDULENT ACCESS TO ONLINE COMPUTER APPLICATIONS FOR USE BY FINANCIAL INSTITUTIONS; COMPUTER SOFTWARE FOR FRAUD RISK ASSESSMENT, DETECTION, INVESTIGATION, FORENSICS, AND COUNTERMEASURE PERFORMANCE MEASUREMENT FOR ONLINE COMPUTER APPLICATIONS FOR USE BY FINANCIAL INSTITUTIONS, IN CLASS 9 (U.S. CLS. 21, 23, 26, 36 AND 38).

FIRST USE 12-3-2007; IN COMMERCE 12-3-2007.

THE MARK CONSISTS OF STANDARD CHARACTERS WITHOUT CLAIM TO ANY PARTICULAR FONT, STYLE, SIZE, OR COLOR.

NO CLAIM IS MADE TO THE EXCLUSIVE RIGHT TO USE "ANALYTICS", APART FROM THE MARK AS SHOWN.

SN 77-197,662, FILED 6-5-2007.

AMY HELLA, EXAMINING ATTORNEY

Int. Cl.: 41

Prior U.S. Cls.: 100, 101, and 107

United States Patent and Trademark Office

Reg. No. 3,521,667

Registered Oct. 21, 2008

**SERVICE MARK
PRINCIPAL REGISTER**

KAMIKAZE COMEDY

LAUGH OUT LOUD COMEDY, LLC (CALIFORNIA LIMITED LIABILITY COMPANY)
APARTMENT 304
1420 NORTH DETROIT STREET
LOS ANGELES, CA 90046

FOR: ENTERTAINMENT IN THE NATURE OF COMEDY SHOWS, IN CLASS 41 (U.S. CLS. 100, 101 AND 107).

FIRST USE 8-1-2008; IN COMMERCE 8-1-2008.

THE MARK CONSISTS OF STANDARD CHARACTERS WITHOUT CLAIM TO ANY PARTICULAR FONT, STYLE, SIZE, OR COLOR.

NO CLAIM IS MADE TO THE EXCLUSIVE RIGHT TO USE "COMEDY", APART FROM THE MARK AS SHOWN.

SN 77-197,740, FILED 6-5-2007.

DAVID TOOLEY, EXAMINING ATTORNEY

Int. Cl.: 35

Prior U.S. Cls.: 100, 101, and 102

United States Patent and Trademark Office

Reg. No. 3,521,668

Registered Oct. 21, 2008

**SERVICE MARK
PRINCIPAL REGISTER**

**DECORATE MORE! ENTERTAIN
MORE! GIVE MORE!**

FINGERHUT DIRECT MARKETING, INC. (DE-
LAWARE CORPORATION)
6509 FLYING CLOUD DRIVE
EDEN PRAIRIE, MN 55344

FOR: ONLINE RETAIL STORE SERVICES AND
ONLINE ORDERING SERVICES IN THE FIELD OF
GENERAL MERCHANDISE; MAIL ORDER AND
CATALOG SERVICES IN THE FIELD OF GENERAL
MERCHANDISE, IN CLASS 35 (U.S. CLS. 100, 101
AND 102).

FIRST USE 11-0-2007; IN COMMERCE 11-0-2007.

THE MARK CONSISTS OF STANDARD CHAR-
ACTERS WITHOUT CLAIM TO ANY PARTICULAR
FONT, STYLE, SIZE, OR COLOR.

SN 77-197,770, FILED 6-5-2007.

LINDA LAVACHE, EXAMINING ATTORNEY

Int. Cl.: 3

Prior U.S. Cls.: 1, 4, 6, 50, 51, and 52

Reg. No. 3,521,669

United States Patent and Trademark Office

Registered Oct. 21, 2008

**TRADEMARK
PRINCIPAL REGISTER**



SAMY MARK, INC. (FLORIDA CORPORATION)
700 BROOKER CREEK BLVD.
SUITE 1000
OLDSMAR, FL 34677

FIRST USE 12-15-2007; IN COMMERCE 12-15-2007.

SN 77-197,918, FILED 6-5-2007.

FOR: HAIR CARE PREPARATIONS, IN CLASS 3
(U.S. CLS. 1, 4, 6, 50, 51 AND 52).

SUSAN LESLIE DUBOIS, EXAMINING ATTORNEY

Int. Cl.: 34

Prior U.S. Cls.: 2, 8, 9, and 17

United States Patent and Trademark Office

Reg. No. 3,521,670

Registered Oct. 21, 2008

**TRADEMARK
PRINCIPAL REGISTER**

MONUMENT

CAO INTERNATIONAL, INC. (TENNESSEE COR-
PORATION)
6172 COCKRILL BEND CIRCLE
NASHVILLE, TN 37209

THE MARK CONSISTS OF STANDARD CHAR-
ACTERS WITHOUT CLAIM TO ANY PARTICULAR
FONT, STYLE, SIZE, OR COLOR.

FOR: CIGARS, IN CLASS 34 (U.S. CLS. 2, 8, 9 AND
17).

SN 77-198,334, FILED 6-5-2007.

FIRST USE 8-31-2007; IN COMMERCE 9-30-2007.

CURTIS FRENCH, EXAMINING ATTORNEY

Int. Cl.: 36

Prior U.S. Cls.: 100, 101, and 102

United States Patent and Trademark Office

Reg. No. 3,521,671

Registered Oct. 21, 2008

**SERVICE MARK
PRINCIPAL REGISTER**

SAFESTEP MORTGAGES

FEDERAL HOME LOAN MORTGAGE CORPORATION (UNITED STATES FEDERALLY CHARTERED CORPORATION)

MS# 204

8200 JONES BRANCH DRIVE

MCLEAN, VA 22102

FOR: FINANCIAL AND REAL ESTATE SERVICES IN THE FIELD OF MORTGAGE LOANS AND MORTGAGE RELATED SECURITIES , IN CLASS 36 (U.S. CLS. 100, 101 AND 102).

FIRST USE 10-0-2007; IN COMMERCE 10-0-2007.

THE MARK CONSISTS OF STANDARD CHARACTERS WITHOUT CLAIM TO ANY PARTICULAR FONT, STYLE, SIZE, OR COLOR.

NO CLAIM IS MADE TO THE EXCLUSIVE RIGHT TO USE "MORTGAGES", APART FROM THE MARK AS SHOWN.

SN 77-198,658, FILED 6-6-2007.

STEVEN JACKSON, EXAMINING ATTORNEY

Int. Cl.: 1

Prior U.S. Cls.: 1, 5, 6, 10, 26, and 46

United States Patent and Trademark Office

Reg. No. 3,521,672

Registered Oct. 21, 2008

**TRADEMARK
PRINCIPAL REGISTER**

DNADVANCE

BECKMAN COULTER, INC. (DELAWARE CORPORATION)
4300 N. HARBOR BLVD.
FULLERTON, CA 92835

FOR: NUCLEIC ACID ISOLATION AND PURIFICATION KIT CONSISTING OF REAGENTS AND MAGNETIC BEADS FOR SCIENTIFIC RESEARCH PURPOSES, IN CLASS 1 (U.S. CLS. 1, 5, 6, 10, 26 AND 46).

FIRST USE 6-24-2008; IN COMMERCE 6-24-2008.

THE MARK CONSISTS OF STANDARD CHARACTERS WITHOUT CLAIM TO ANY PARTICULAR FONT, STYLE, SIZE, OR COLOR.

SN 77-198,689, FILED 6-6-2007.

LOURDES AYALA, EXAMINING ATTORNEY

Int. Cl.: 20

Prior U.S. Cls.: 2, 13, 22, 25, 32, and 50

Reg. No. 3,521,673

United States Patent and Trademark Office

Registered Oct. 21, 2008

**TRADEMARK
PRINCIPAL REGISTER**

ECOTOTS

THE SIMPLE FURNITURE CO., LLC (INDIANA
LIMITED LIABILITY COMPANY)
5762 W. 74TH ST.
INDIANAPOLIS, IN 46278

THE MARK CONSISTS OF STANDARD CHAR-
ACTERS WITHOUT CLAIM TO ANY PARTICULAR
FONT, STYLE, SIZE, OR COLOR.

FOR: ECO-FRIENDLY FURNITURE FOR CHIL-
DREN, IN CLASS 20 (U.S. CLS. 2, 13, 22, 25, 32 AND
50).

SN 77-198,937, FILED 6-6-2007.

FIRST USE 6-1-2007; IN COMMERCE 6-1-2007.

EDWARD NELSON, EXAMINING ATTORNEY

Int. Cl.: 35

Prior U.S. Cls.: 100, 101, and 102

United States Patent and Trademark Office

Reg. No. 3,521,674

Registered Oct. 21, 2008

**SERVICE MARK
PRINCIPAL REGISTER**

MAHOGANY HOUSE

MAHOGANY & ASSOCIATES, INC. (NORTH
CAROLINA CORPORATION)

240 DEPOT STREET

WAYNESVILLE, NC 28786

FOR: RETAIL FURNITURE STORES, IN CLASS 35
(U.S. CLS. 100, 101 AND 102).

FIRST USE 7-15-2007; IN COMMERCE 7-15-2007.

THE MARK CONSISTS OF STANDARD CHAR-
ACTERS WITHOUT CLAIM TO ANY PARTICULAR
FONT, STYLE, SIZE, OR COLOR.

NO CLAIM IS MADE TO THE EXCLUSIVE
RIGHT TO USE "MAHOGANY", APART FROM
THE MARK AS SHOWN.

SN 77-199,087, FILED 6-6-2007.

MARCIE MILONE, EXAMINING ATTORNEY

Int. Cl.: 45

Prior U.S. Cls.: 100 and 101

United States Patent and Trademark Office

Reg. No. 3,521,675

Registered Oct. 21, 2008

**SERVICE MARK
PRINCIPAL REGISTER**

CHRISTIAN SPACE

POINT B WEB (WASHINGTON PARTNERSHIP)
3620 227TH ST SW
BRIER, WA 98036

FOR: ONLINE SOCIAL NETWORKING SERVICES, IN CLASS 45 (U.S. CLS. 100 AND 101).

FIRST USE 3-2-1999; IN COMMERCE 3-2-1999.

THE MARK CONSISTS OF STANDARD CHARACTERS WITHOUT CLAIM TO ANY PARTICULAR FONT, STYLE, SIZE, OR COLOR.

NO CLAIM IS MADE TO THE EXCLUSIVE RIGHT TO USE "CHRISTIAN", APART FROM THE MARK AS SHOWN.

SN 77-199,747, FILED 6-6-2007.

JEFF DEFORD, EXAMINING ATTORNEY

Int. Cl.: 25

Prior U.S. Cls.: 22 and 39

United States Patent and Trademark Office

Reg. No. 3,521,676

Registered Oct. 21, 2008

TRADEMARK
PRINCIPAL REGISTER

natural Soul
by naturalizer

BROWN SHOE COMPANY, INC. (NEW YORK CORPORATION)
8300 MARYLAND AVENUE
ST. LOUIS, MO 63105

FOR: FOOTWEAR, IN CLASS 25 (U.S. CLS. 22 AND 39).

FIRST USE 12-31-2006; IN COMMERCE 9-15-2007.

OWNER OF U.S. REG. NOS. 780,404, 809,302, AND 2,953,462.

THE MARK CONSISTS OF THE WORD "NATURAL SOUL" WITH THE WORDS "BY NATURALIZER" UNDERNEATH.

SN 77-199,812, FILED 6-6-2007.

JAMES A. RAUEN, EXAMINING ATTORNEY

Int. Cls.: 7 and 42

Prior U.S. Cls.: 13, 19, 21, 23, 31, 34, 35, 100, and 101

United States Patent and Trademark Office

Reg. No. 3,521,677

Registered Oct. 21, 2008

**TRADEMARK
SERVICE MARK
PRINCIPAL REGISTER**



IMPERIAL ELECTRIC COMPANY D/B/A EU-
CLID UNIVERSAL (DELAWARE CORPORA-
TION)

1503 EXETER ROAD
AKRON, OH 44306

FOR: MACHINERY PARTS, NAMELY, GEARS
FOR MACHINERY IN THE FIELDS OF INDUSTRY,
FOOD PROCESSING, PACKAGING AND HEALTH
CARE, GEAR BOX ASSEMBLIES FOR MACHINES,
GEAR MOTORS FOR MACHINES, SINGLE WHEEL
TRACTION DRIVES FOR MACHINES, TRANS-
AXLE TRACTION DRIVES FOR MACHINES, SPEED
REDUCERS FOR MACHINES; AND STRUCTURAL
PARTS FOR THE FORGOING, IN CLASS 7 (U.S. CLS.
13, 19, 21, 23, 31, 34 AND 35).

FIRST USE 8-25-2008; IN COMMERCE 8-25-0208.

FOR: DESIGN FOR OTHERS IN THE FIELDS OF
GEAR DRIVES, GEAR MOTORS AND POWER
TRANSMISSION, IN CLASS 42 (U.S. CLS. 100 AND
101).

FIRST USE 8-25-2008; IN COMMERCE 8-25-2008.

THE MARK CONSISTS OF THE LETTERS "EU"
WITHIN A GEAR SHAPED DESIGN.

SN 77-199,921, FILED 6-7-2007.

SHARON MEIER, EXAMINING ATTORNEY

Int. Cls.: 7 and 42

Prior U.S. Cls.: 13, 19, 21, 23, 31, 34, 35, 100, and 101

United States Patent and Trademark Office

Reg. No. 3,521,678

Registered Oct. 21, 2008

**TRADEMARK
SERVICE MARK
PRINCIPAL REGISTER**

EUCLID UNIVERSAL

IMPERIAL ELECTRIC COMPANY (DELAWARE CORPORATION), DBA EUCLID UNIVERSAL, 1503 EXETER ROAD AKRON, OH 44306

FOR: MACHINERY PARTS, NAMELY, GEARS FOR MACHINERY IN THE FIELDS OF INDUSTRY, FOOD PROCESSING, PACKAGING AND HEALTH CARE, GEAR BOX ASSEMBLIES FOR MACHINES, GEAR MOTORS FOR MACHINES, SINGLE WHEEL TRACTION DRIVES FOR MACHINES, TRANS-AXLE TRACTION DRIVES FOR MACHINES, SPEED REDUCERS FOR MACHINES; AND STRUCTURAL PARTS FOR THE FORGOING, IN CLASS 7 (U.S. CLS. 13, 19, 21, 23, 31, 34 AND 35).

FIRST USE 8-25-2008; IN COMMERCE 8-25-2008.

FOR: DESIGN FOR OTHERS IN THE FIELDS OF GEAR DRIVES, GEAR MOTORS AND POWER TRANSMISSION, IN CLASS 42 (U.S. CLS. 100 AND 101).

FIRST USE 12-31-1965; IN COMMERCE 12-31-1965.

THE MARK CONSISTS OF STANDARD CHARACTERS WITHOUT CLAIM TO ANY PARTICULAR FONT, STYLE, SIZE, OR COLOR.

SN 77-199,935, FILED 6-7-2007.

SHARON MEIER, EXAMINING ATTORNEY

Int. Cl.: 38

Prior U.S. Cls.: 100, 101, and 104

United States Patent and Trademark Office

Reg. No. 3,521,679

Registered Oct. 21, 2008

**SERVICE MARK
PRINCIPAL REGISTER**

We The Students

MORENSKI, KEVIN M (UNITED STATES INDIVIDUAL)
911 JACOB ST.
TROY, NY 12180

FOR: PROVIDING ON-LINE FORUMS FOR TRANSMISSION OF MESSAGES AMONG COMPUTER USERS CONCERNING POLITICS, CURRENT EVENTS, AND THE SOCIAL ISSUES FACING STUDENTS ENROLLED IN A POST-SECONDARY EDUCATION PROGRAM; PROVIDING ON-LINE CHAT ROOMS AND ELECTRONIC BULLETIN BOARDS FOR TRANSMISSION OF MESSAGES AMONG REGISTERED USERS IN THE FIELD OF GENERAL INTEREST, IN CLASS 38 (U.S. CLS. 100, 101 AND 104).

FIRST USE 5-1-2008; IN COMMERCE 8-1-2008.

THE MARK CONSISTS OF STANDARD CHARACTERS WITHOUT CLAIM TO ANY PARTICULAR FONT, STYLE, SIZE, OR COLOR.

NO CLAIM IS MADE TO THE EXCLUSIVE RIGHT TO USE "STUDENTS", APART FROM THE MARK AS SHOWN.

SN 77-199,942, FILED 6-7-2007.

SKYE YOUNG, EXAMINING ATTORNEY

Int. Cl.: 36

Prior U.S. Cls.: 100, 101, and 102

United States Patent and Trademark Office

Reg. No. 3,521,680

Registered Oct. 21, 2008

**SERVICE MARK
PRINCIPAL REGISTER**

SUPERNATURAL

LIQUIDNET HOLDINGS, INC. (DELAWARE CORPORATION)
498 SEVENTH AVENUE
15TH FLOOR
NEW YORK, NY 10018

FOR: STOCK BROKERAGE; BROKERAGE HOUSES IN THE FIELD OF STOCKS, COMMODITIES, AND FUTURES; BROKERAGE IN THE FIELD OF STOCKS.; BROKERAGE OF SHARES AND OTHER SECURITIES; BROKERAGE OF SHARES OR STOCKS AND OTHER SECURITIES; FINANCIAL SERVICES, NAMELY, ASSISTING OTHERS WITH THE COMPLETION OF FINANCIAL TRANSACTIONS FOR STOCKS, BONDS, SECURITIES AND EQUITIES; FINANCIAL SERVICES,

NAMELY, INVESTMENT FUND TRANSFER AND TRANSACTION SERVICES; INVESTMENT BROKERAGE; INVESTMENT BY ELECTRONIC MEANS, IN CLASS 36 (U.S. CLS. 100, 101 AND 102).

FIRST USE 10-1-2007; IN COMMERCE 10-1-2007.

THE MARK CONSISTS OF STANDARD CHARACTERS WITHOUT CLAIM TO ANY PARTICULAR FONT, STYLE, SIZE, OR COLOR.

SN 77-199,958, FILED 6-7-2007.

NORA BUCHANAN WILL, EXAMINING ATTORNEY

Int. Cl.: 21

Prior U.S. Cls.: 2, 13, 23, 29, 30, 33, 40, and 50

United States Patent and Trademark Office

Reg. No. 3,521,681

Registered Oct. 21, 2008

**TRADEMARK
PRINCIPAL REGISTER**

ENVIROMETAL

AVEDA CORPORATION (DELAWARE COR-
PORATION)
4000 PHEASANT RIDGE DRIVE
MINNEAPOLIS, MN 55449

THE MARK CONSISTS OF STANDARD CHAR-
ACTERS WITHOUT CLAIM TO ANY PARTICULAR
FONT, STYLE, SIZE, OR COLOR.

FOR: COMPACTS SOLD EMPTY; COSMETIC
BRUSHES, IN CLASS 21 (U.S. CLS. 2, 13, 23, 29, 30,
33, 40 AND 50).

SN 77-199,967, FILED 6-7-2007.

FIRST USE 9-30-1997; IN COMMERCE 9-30-1997.

KEVIN DINALLO, EXAMINING ATTORNEY

Int. Cl.: 36

Prior U.S. Cls.: 100, 101, and 102

United States Patent and Trademark Office

Reg. No. 3,521,682

Registered Oct. 21, 2008

**SERVICE MARK
PRINCIPAL REGISTER**

AIR Card

DEPARTMENT OF DEFENSE (UNITED STATES
AGENCY OF THE UNITED STATES GOVERN-
MENT)
DEFENSE ENERGY SUPPORT CENTER
8725 JOHN J. KINGMAN RD.
FT. BELVOIR, VA 22060

FOR: CREDIT CARD SERVICES; ELECTRONIC
CREDIT CARD TRANSACTIONS; ISSUING CREDIT
CARDS, IN CLASS 36 (U.S. CLS. 100, 101 AND 102).

FIRST USE 3-20-2008; IN COMMERCE 3-20-2008.

THE MARK CONSISTS OF STANDARD CHAR-
ACTERS WITHOUT CLAIM TO ANY PARTICULAR
FONT, STYLE, SIZE, OR COLOR.

NO CLAIM IS MADE TO THE EXCLUSIVE
RIGHT TO USE "CARD", APART FROM THE
MARK AS SHOWN.

SN 77-199,980, FILED 6-7-2007.

JANET LEE, EXAMINING ATTORNEY

Int. Cl.: 5

Prior U.S. Cls.: 6, 18, 44, 46, 51, and 52

Reg. No. 3,521,683

United States Patent and Trademark Office

Registered Oct. 21, 2008

**TRADEMARK
PRINCIPAL REGISTER**



WYETH (DELAWARE CORPORATION)
FIVE GIRALDA FARMS
MADISON, NJ 07940

FOR: PHARMACEUTICAL PREPARATION TO
TREAT DEPRESSION, IN CLASS 5 (U.S. CLS. 6, 18,
44, 46, 51 AND 52).

FIRST USE 4-16-2008; IN COMMERCE 4-16-2008.

THE COLOR(S) WHITE, PURPLE, GOLD, SKY
BLUE, LIGHT BLUE AND SEA GREEN IS/ARE
CLAIMED AS A FEATURE OF THE MARK.

THE MARK CONSISTS OF A HALF LIGHT BLUE
AND HALF WHITE WALKING HUMAN FORM IN
A PURPLE, GOLD, SEA GREEN AND SKY BLUE
FOUR BOX DESIGN, NEXT TO THE WORD "PRIS-
TIQ" IN PURPLE.

SN 77-200,228, FILED 6-7-2007.

BENJAMIN ALLEN, EXAMINING ATTORNEY

Int. Cl.: 30

Prior U.S. Cl.: 46

United States Patent and Trademark Office

Reg. No. 3,521,684

Registered Oct. 21, 2008

TRADEMARK
PRINCIPAL REGISTER

mellona

ASIA MARE LIMITED (CYPRUS LIMITED LIABILITY COMPANY)
P.O. BOX 54097
LIMASSOL, CYPRUS 3720

THE MARK CONSISTS OF THE TERM "MELLONA" STYLIZED.

FOR: HONEY SPREAD, IN CLASS 30 (U.S. CL. 46).

SN 77-200,490, FILED 6-7-2007.

FIRST USE 12-12-2007; IN COMMERCE 12-12-2007.

KIM MONINGHOFF, EXAMINING ATTORNEY

Int. Cls.: 35, 37, and 39

Prior U.S. Cls.: 100, 101, 102, 103, 105, and 106

United States Patent and Trademark Office

Reg. No. 3,521,685

Registered Oct. 21, 2008

**SERVICE MARK
PRINCIPAL REGISTER**



HOL-DAV MANAGEMENT, INC. (NORTH CAROLINA CORPORATION)
5839 CAPITAL BOULEVARD
RALEIGH, NC 27616

FOR: AUTOMOTIVE DEALERSHIP FEATURING NEW AND USED VEHICLES AND AUTOMOTIVE PARTS AND ACCESSORIES, IN CLASS 35 (U.S. CLS. 100, 101 AND 102).

FIRST USE 11-26-2007; IN COMMERCE 11-26-2007.

FOR: REPAIR AND MAINTENANCE OF VEHICLES, IN CLASS 37 (U.S. CLS. 100, 103 AND 106).

FIRST USE 1-10-2007; IN COMMERCE 1-10-2007.

FOR: LEASING OF MOTOR VEHICLES, IN CLASS 39 (U.S. CLS. 100 AND 105).

FIRST USE 7-12-2008; IN COMMERCE 7-12-2008.

THE MARK CONSISTS OF A BADGER WEARING A SPORT COAT, SHIRT, AND TIE IN THE MIDDLE OF A CIRCLE WITH A LINE RUNNING DIAGONAL FROM UPPER LEFT TO LOWER RIGHT IN THE MIDDLE OF THE CIRCLE.

SN 77-201,182, FILED 6-8-2007.

HEATHER BIDDULPH, EXAMINING ATTORNEY

Int. Cl.: 9

Prior U.S. Cls.: 21, 23, 26, 36, and 38

Reg. No. 3,521,686

United States Patent and Trademark Office

Registered Oct. 21, 2008

**TRADEMARK
PRINCIPAL REGISTER**

TRAV'LER

WINEGARD COMPANY (IOWA CORPORATION)
3000 KIRKWOOD STREET
BURLINGTON, IA 52601

THE MARK CONSISTS OF STANDARD CHAR-
ACTERS WITHOUT CLAIM TO ANY PARTICULAR
FONT, STYLE, SIZE, OR COLOR.

FOR: SATELLITE DISHES, IN CLASS 9 (U.S. CLS.
21, 23, 26, 36 AND 38).

SN 77-201,226, FILED 6-8-2007.

FIRST USE 12-17-2007; IN COMMERCE 12-17-2007.

CAROL SPILS, EXAMINING ATTORNEY

Int. Cl.: 41

Prior U.S. Cls.: 100, 101, and 107

United States Patent and Trademark Office

Reg. No. 3,521,687

Registered Oct. 21, 2008

**SERVICE MARK
PRINCIPAL REGISTER**

Ooh La La

COOLS ENTERTAINMENT (U.S.) INC. (NEVADA
CORPORATION)
1600 SONGLIGHT CT.
LAS VEGAS, NV 89117

THE MARK CONSISTS OF STANDARD CHAR-
ACTERS WITHOUT CLAIM TO ANY PARTICULAR
FONT, STYLE, SIZE, OR COLOR.

FOR: ENTERTAINMENT IN THE NATURE OF
LIVE PERFORMANCES BY TOPLESS REVIEWS, IN
CLASS 41 (U.S. CLS. 100, 101 AND 107).

SN 77-201,669, FILED 6-8-2007.

FIRST USE 6-13-2007; IN COMMERCE 6-13-2007.

KEVON CHISOLM, EXAMINING ATTORNEY

Int. Cl.: 5

Prior U.S. Cls.: 6, 18, 44, 46, 51, and 52

Reg. No. 3,521,688

United States Patent and Trademark Office

Registered Oct. 21, 2008

**TRADEMARK
PRINCIPAL REGISTER**

VITAL8

COSRICH GROUP, INC. (DELAWARE CORPORATION)
12243 BRANFORD STREET
SUN VALLEY, CA 91352

THE MARK CONSISTS OF STANDARD CHARACTERS WITHOUT CLAIM TO ANY PARTICULAR FONT, STYLE, SIZE, OR COLOR.

FOR: VITAMIN SUPPLEMENTS, IN CLASS 5 (U.S. CLS. 6, 18, 44, 46, 51 AND 52).

SN 77-201,835, FILED 6-8-2007.

FIRST USE 7-15-2007; IN COMMERCE 3-14-2008.

JAMES LOVELACE, EXAMINING ATTORNEY

Int. Cl.: 9

Prior U.S. Cls.: 21, 23, 26, 36, and 38

United States Patent and Trademark Office

Reg. No. 3,521,689

Registered Oct. 21, 2008

**TRADEMARK
PRINCIPAL REGISTER**

Xpress CheckIT

SPEEDIT SOFTWARE LLC (IOWA LIMITED LIABILITY COMPANY)
PMB 168, 2884 DEVILS GLEN RD
BETTENDORF, IA 52722

THE MARK CONSISTS OF STANDARD CHARACTERS WITHOUT CLAIM TO ANY PARTICULAR FONT, STYLE, SIZE, OR COLOR.

FOR: COMPUTER SOFTWARE FOR PROCESSING AND VALIDATING ELECTION CODING DATA, IN CLASS 9 (U.S. CLS. 21, 23, 26, 36 AND 38).

SN 77-201,993, FILED 6-8-2007.

FIRST USE 10-1-2007; IN COMMERCE 10-1-2007.

ALICE BENMAMAN, EXAMINING ATTORNEY

Int. Cl.: 5

Prior U.S. Cls.: 6, 18, 44, 46, 51, and 52

United States Patent and Trademark Office

Reg. No. 3,521,690

Registered Oct. 21, 2008

**TRADEMARK
PRINCIPAL REGISTER**

TRADITIONAL HERBALS

TRADITIONAL MEDICINALS, INC. (CALIFORNIA CORPORATION)
4515 ROSS ROAD
SEBASTOPOL, CA 95472

FOR: DIETARY SUPPLEMENTS; HERBAL SUPPLEMENTS; LAXATIVES; COUGH TREATMENT PREPARATIONS; PREPARATIONS FOR TREATING COLDS; PHARMACEUTICAL PREPARATIONS FOR THE TREATMENT OF SYMPTOMS OF PREMENSTRUAL SYNDROM, DIGESTION PROBLEMS, INSOMNIA, URINARY TRACT AND BLADDER PROBLEMS, NAUSEA, MOTION SICKNESS, UPSET STOMACH AND NERVOUSNESS; DIURETIC PREPARATIONS; ANTIDEPRESSANTS; APPETITE SUPPRESSANTS; HERBAL TEAS FOR MEDICINAL PURPOSES; MEDICINAL RADIX GLYCYRRHIZAE; GINSENG FOR MEDICINAL USE; THROAT LOZENGES; MENSTRUAL SYMP-

TOM TREATMENT PREPARATIONS, IN CLASS 5 (U.S. CLS. 6, 18, 44, 46, 51 AND 52).

FIRST USE 2-20-2008; IN COMMERCE 2-20-2008.

THE MARK CONSISTS OF STANDARD CHARACTERS WITHOUT CLAIM TO ANY PARTICULAR FONT, STYLE, SIZE, OR COLOR.

OWNER OF U.S. REG. NOS. 1,553,943, 2,468,980, AND OTHERS.

NO CLAIM IS MADE TO THE EXCLUSIVE RIGHT TO USE "HERBALS", APART FROM THE MARK AS SHOWN.

SN 77-202,105, FILED 6-9-2007.

GIANCARLO CASTRO, EXAMINING ATTORNEY

Int. Cl.: 6

Prior U.S. Cls.: 2, 12, 13, 14, 23, 25, and 50

Reg. No. 3,521,691

United States Patent and Trademark Office

Registered Oct. 21, 2008

**TRADEMARK
PRINCIPAL REGISTER**

MAKE A STATEMENT

BLACK & DECKER CORPORATION, THE
(MARYLAND CORPORATION)
TW-199
701 E. JOPPA ROAD
TOWSON, MD 21286

FOR: METAL HARDWARE, NAMELY, DOOR
KNOBS, DOOR LEVERS AND LEVER SETS, DOOR
HANDLES AND HANDLE SETS, DOOR HINGES
AND LATCHES, LOCKS, DEADBOLTS, KEYS AND
KEY BLANKS, DOOR KICKPLATES, NON-ELEC-
TRIC DOOR BELLS, DOOR KNOCKERS, NON-
MAGNIFIED DOOR VIEWERS, HOUSE ADDRESS
NUMBERS, DRAWER PULLS, DRAWER HAN-

DLES, AND CABINET HINGES, IN CLASS 6 (U.S.
CLS. 2, 12, 13, 14, 23, 25 AND 50).

FIRST USE 5-8-2007; IN COMMERCE 5-8-2007.

THE MARK CONSISTS OF STANDARD CHAR-
ACTERS WITHOUT CLAIM TO ANY PARTICULAR
FONT, STYLE, SIZE, OR COLOR.

SN 77-202,412, FILED 6-11-2007.

ELIZABETH KAJUBI, EXAMINING ATTORNEY

Int. Cl.: 32

Prior U.S. Cls.: 45, 46, and 48

United States Patent and Trademark Office

Reg. No. 3,521,692

Registered Oct. 21, 2008

TRADEMARK
PRINCIPAL REGISTER



ANHEUSER-BUSCH, INCORPORATED (MISSOURI CORPORATION)
202-6
ONE BUSCH PLACE
ST. LOUIS, MO 63118

FOR: BEER, IN CLASS 32 (U.S. CLS. 45, 46 AND 48).

FIRST USE 7-0-2007; IN COMMERCE 7-0-2007.

OWNER OF U.S. REG. NOS. 1,479,871 AND 1,496,854.

NO CLAIM IS MADE TO THE EXCLUSIVE RIGHT TO USE "NATURAL" AND "LIGHT", APART FROM THE MARK AS SHOWN.

THE MARK CONSISTS OF THE WORDS "NATURAL LIGHT" WITH A DOUBLE BOOMERANG DESIGN.

SN 77-202,499, FILED 6-11-2007.

ANN E. SAPPENFIELD, EXAMINING ATTORNEY

Int. Cl.: 35

Prior U.S. Cls.: 100, 101, and 102

United States Patent and Trademark Office

Reg. No. 3,521,693

Registered Oct. 21, 2008

**SERVICE MARK
PRINCIPAL REGISTER**

Deal\$ \$5 and Less

DOLLAR TREE STORES, INC. (VIRGINIA CORPORATION)
500 VOLVO PARKWAY
CHESAPEAKE, VA 23320

FOR: RETAIL VARIETY STORES, IN CLASS 35
(U.S. CLS. 100, 101 AND 102).

FIRST USE 7-0-2007; IN COMMERCE 8-5-2007.

THE MARK CONSISTS OF STANDARD CHARACTERS WITHOUT CLAIM TO ANY PARTICULAR FONT, STYLE, SIZE, OR COLOR.

OWNER OF U.S. REG. NOS. 2,435,011, 2,576,519,
AND OTHERS.

NO CLAIM IS MADE TO THE EXCLUSIVE
RIGHT TO USE "\$5 AND LESS", APART FROM
THE MARK AS SHOWN.

SN 77-202,575, FILED 6-11-2007.

DOMINIC FATHY, EXAMINING ATTORNEY

Int. Cls.: 9 and 40

Prior U.S. Cls.: 21, 23, 26, 36, 38, 100, 103, and 106

Reg. No. 3,521,694

United States Patent and Trademark Office

Registered Oct. 21, 2008

**TRADEMARK
SERVICE MARK
PRINCIPAL REGISTER**

NUFIRE

NUFERN (DELAWARE CORPORATION)
7 AIRPORT PARK ROAD
EAST GRANBY, CT 06026

FOR: FIBER OPTICS AND COMPUTER SOFTWARE FOR USE IN DESIGNING, MONITORING, OPERATING, CONFIGURING AND TESTING OF FIBER OPTICS, IN CLASS 9 (U.S. CLS. 21, 23, 26, 36 AND 38).

FIRST USE 6-18-2007; IN COMMERCE 11-21-2007.

FOR: CUSTOM MANUFACTURE OF FIBER OPTICS, IN CLASS 40 (U.S. CLS. 100, 103 AND 106).

FIRST USE 6-18-2007; IN COMMERCE 9-25-2007.

THE MARK CONSISTS OF STANDARD CHARACTERS WITHOUT CLAIM TO ANY PARTICULAR FONT, STYLE, SIZE, OR COLOR.

SN 77-202,708, FILED 6-11-2007.

BRIAN CALLAGHAN, EXAMINING ATTORNEY

Int. Cl.: 33

Prior U.S. Cls.: 47 and 49

United States Patent and Trademark Office

Reg. No. 3,521,695

Registered Oct. 21, 2008

**TRADEMARK
PRINCIPAL REGISTER**

MONTELARGO

TEQUILERA LA PRIMAVERA S.A. DE C.V.
(MEXICO CORPORATION)
TABASCO NO. 36, COL. CENTRO
TEQUILA, JALISCO, MEXICO C.P.46400

FOR: LIQUEURS; ANISETTE; ALCOHOLIC BEVERAGES OF FRUIT; BRANDY; CURACAO; GIN; VODKA; WHISKEY; WINES; TEQUILA, IN CLASS 33 (U.S. CLS. 47 AND 49).

FIRST USE 3-10-2005; IN COMMERCE 3-23-2008.

THE MARK CONSISTS OF STANDARD CHARACTERS WITHOUT CLAIM TO ANY PARTICULAR FONT, STYLE, SIZE, OR COLOR.

THE FOREIGN WORDING IN THE MARK TRANSLATES INTO ENGLISH AS LONG MOUNT.

SN 77-202,779, FILED 6-11-2007.

KAREN BRACEY, EXAMINING ATTORNEY

Int. Cl.: 35

Prior U.S. Cls.: 100, 101, and 102

United States Patent and Trademark Office

Reg. No. 3,521,696

Registered Oct. 21, 2008

**SERVICE MARK
PRINCIPAL REGISTER**



BIG SUR WATERBEDS, INC. (COLORADO CORPORATION)

5641 N. BROADWAY
DENVER, CO 80216

FOR: RETAIL FURNITURE STORE SERVICES, IN CLASS 35 (U.S. CLS. 100, 101 AND 102).

FIRST USE 12-0-2006; IN COMMERCE 12-0-2006.

OWNER OF U.S. REG. NOS. 1,882,973, 1,909,492, AND 2,469,420.

NO CLAIM IS MADE TO THE EXCLUSIVE RIGHT TO USE "OAK", APART FROM THE MARK AS SHOWN.

SN 77-202,801, FILED 6-11-2007.

LINDA E. BLOHM, EXAMINING ATTORNEY

Int. Cl.: 41

Prior U.S. Cls.: 100, 101, and 107

United States Patent and Trademark Office

Reg. No. 3,521,697

Registered Oct. 21, 2008

**SERVICE MARK
PRINCIPAL REGISTER**

ENERGY ESSENTIALS

EXELON CORPORATION (PENNSYLVANIA
CORPORATION)
2301 MARKET STREET
PHILADELPHIA, PA 191018699

FOR: PROVIDING NEWSLETTERS IN THE
FIELD OF ENERGY IN THE NATURE OF ELEC-
TRICAL POWER, NAMELY, NEWSLETTERS PRO-
VIDING INFORMATION ABOUT ENERGY AND
ENERGY EFFICIENCY VIA AN ELECTRONIC
NEWSLETTER VIA E-MAIL, IN CLASS 41 (U.S.
CLS. 100, 101 AND 107).

FIRST USE 8-0-2007; IN COMMERCE 8-0-2007.

THE MARK CONSISTS OF STANDARD CHAR-
ACTERS WITHOUT CLAIM TO ANY PARTICULAR
FONT, STYLE, SIZE, OR COLOR.

NO CLAIM IS MADE TO THE EXCLUSIVE
RIGHT TO USE "ENERGY", APART FROM THE
MARK AS SHOWN.

SN 77-202,814, FILED 6-11-2007.

KRISTIN DAHLING, EXAMINING ATTORNEY

Int. Cl.: 30

Prior U.S. Cl.: 46

United States Patent and Trademark Office

Reg. No. 3,521,698

Registered Oct. 21, 2008

**TRADEMARK
PRINCIPAL REGISTER**

ON-DEMAND

S & D COFFEE, INC. (NORTH CAROLINA COR-
PORATION)
300 CONCORD PARKWAY SOUTH
CONCORD, NC 28027

THE MARK CONSISTS OF STANDARD CHAR-
ACTERS WITHOUT CLAIM TO ANY PARTICULAR
FONT, STYLE, SIZE, OR COLOR.

FOR: PREPARED COFFEE, IN CLASS 30 (U.S. CL.
46).

SN 77-203,068, FILED 6-11-2007.

FIRST USE 4-0-2007; IN COMMERCE 4-0-2007.

DAVID I, EXAMINING ATTORNEY

Int. Cl.: 32

Prior U.S. Cls.: 45, 46, and 48

Reg. No. 3,521,699

United States Patent and Trademark Office

Registered Oct. 21, 2008

**TRADEMARK
PRINCIPAL REGISTER**

HUMANITY
WHAT CAN YOU DO FOR OUR
WORLD?

SCHMIDT, JOSEPH (UNITED STATES INDIVIDUAL)
715 W. EDNA PLACE
COVINA, CA 91722

THE MARK CONSISTS OF STANDARD CHARACTERS WITHOUT CLAIM TO ANY PARTICULAR FONT, STYLE, SIZE, OR COLOR.

FOR: BOTTLED WATER, DRINKING WATER, PURIFIED WATER, SPRING WATER, MINERAL WATER, DISTILLED DRINKING WATER, IN CLASS 32 (U.S. CLS. 45, 46 AND 48).

SN 77-203,374, FILED 6-11-2007.

FIRST USE 6-21-2007; IN COMMERCE 11-9-2007.

MORGAN WYNNE, EXAMINING ATTORNEY

Int. Cl.: 25

Prior U.S. Cls.: 22 and 39

United States Patent and Trademark Office

Reg. No. 3,521,700

Registered Oct. 21, 2008

TRADEMARK
PRINCIPAL REGISTER

Sailfly

SMITH, ALEXANDER R. (UNITED STATES INDIVIDUAL)
9TH FLOOR
315 W 36TH STREET
NEW YORK, NY 10018

FOR: BERMUDA SHORTS; BOARD SHORTS; BUTTON-FRONT ALOHA SHIRTS; CAMP SHIRTS; FLEECE SHORTS; GOLF SHIRTS; GYM SHORTS; HATS; HEADGEAR, NAMELY, HATS; HEAVY JACKETS; JACKETS; LIGHT-REFLECTING JACKETS; LONG JACKETS; LONG SLEEVED VESTS; MEN AND WOMEN JACKETS, COATS, TROUSERS, VESTS; OPEN-NECKED SHIRTS; PANTIES, SHORTS AND BRIEFS; POLO SHIRTS; RAIN JACKETS; RAINPROOF JACKETS; SHIRTS; SHORT-SLEEVED OR LONG-SLEEVED T-SHIRTS; SHORT-SLEEVED SHIRTS; SHORTS; SLEEVED OR SLEEVELESS JACKETS; SMALL HATS; SPORT SHIRTS; SPORTS

JACKETS; SPORTS SHIRTS; SPORTS SHIRTS WITH SHORT SLEEVES; T-SHIRTS; VESTS; WATER-PROOF JACKETS AND PANTS; WIND RESISTANT JACKETS; WIND SHIRTS; WIND VESTS; WIND-JACKETS; FISHERMEN'S JACKETS; KNIT SHIRTS; SHORT TROUSERS; WALKING SHORTS, IN CLASS 25 (U.S. CLS. 22 AND 39).

FIRST USE 2-14-2008; IN COMMERCE 2-14-2008.

THE MARK CONSISTS OF STANDARD CHARACTERS WITHOUT CLAIM TO ANY PARTICULAR FONT, STYLE, SIZE, OR COLOR.

SN 77-203,447, FILED 6-11-2007.

ANDREW RHIM, EXAMINING ATTORNEY

Int. Cl.: 41

Prior U.S. Cls.: 100, 101, and 107

United States Patent and Trademark Office

Reg. No. 3,521,701

Registered Oct. 21, 2008

**SERVICE MARK
PRINCIPAL REGISTER**

Legacy Pictures

SHUBIN, MARK (UNITED STATES INDIVIDUAL)
6077 BAHIA DEL MAR BLVD. #217
ST. PETERSBURG, FL 33715

FOR: PHOTO EDITING; PHOTOGRAPHY SERVICES; AERIAL PHOTOGRAPHY, IN CLASS 41 (U.S. CLS. 100, 101 AND 107).

FIRST USE 1-1-2007; IN COMMERCE 6-1-2007.

THE MARK CONSISTS OF STANDARD CHARACTERS WITHOUT CLAIM TO ANY PARTICULAR FONT, STYLE, SIZE, OR COLOR.

NO CLAIM IS MADE TO THE EXCLUSIVE RIGHT TO USE "PICTURES", APART FROM THE MARK AS SHOWN.

SN 77-203,738, FILED 6-12-2007.

DAVID HOFFMAN, EXAMINING ATTORNEY

Int. Cls.: 24 and 25

Prior U.S. Cls.: 22, 39, 42, and 50

United States Patent and Trademark Office

Reg. No. 3,521,702

Registered Oct. 21, 2008

**TRADEMARK
PRINCIPAL REGISTER**

3D ALIVE

BLAKEMORE SALES CORP. (MISSOURI CORPORATION)
P.O. BOX 1149
BRANSON, MO 65616

FOR: CAMOUFLAGE TEXTILE AND SYNTHETIC FABRIC FOR USE IN MANUFACTURE OF HUNTING APPAREL, IN CLASS 24 (U.S. CLS. 42 AND 50).

FIRST USE 7-22-2008; IN COMMERCE 7-22-2008.

FOR: CAMOUFLAGE HUNTING APPAREL, NAMELY, PANTS, COATS, JACKETS, COVERALLS, BIB OVERALLS, PULLOVERS, HOODED SWEATSHIRTS, PONCHOS, HEAD WEAR, BALACLAVAS, AND GLOVES, IN CLASS 25 (U.S. CLS. 22 AND 39).

FIRST USE 7-22-2008; IN COMMERCE 7-22-2008.

THE MARK CONSISTS OF STANDARD CHARACTERS WITHOUT CLAIM TO ANY PARTICULAR FONT, STYLE, SIZE, OR COLOR.

NO CLAIM IS MADE TO THE EXCLUSIVE RIGHT TO USE "3D", APART FROM THE MARK AS SHOWN.

SN 77-203,895, FILED 6-12-2007.

MICHAEL KAZAZIAN, EXAMINING ATTORNEY

Int. Cl.: 21

Prior U.S. Cls.: 2, 13, 23, 29, 30, 33, 40, and 50

United States Patent and Trademark Office

Reg. No. 3,521,703

Registered Oct. 21, 2008

**TRADEMARK
PRINCIPAL REGISTER**

AQUA CADDY

KELBEL, INC. (PENNSYLVANIA CORPORATION)
204 CLUBVIEW DRIVE
MCMURRAY, PA 15317

FOR: PORTABLE CLEANING APPARATUS WITH WATER RESERVOIR AND ATTACHED BRUSHES USED TO CLEAN GOLF CLUBS, IN CLASS 21 (U.S. CLS. 2, 13, 23, 29, 30, 33, 40 AND 50).

FIRST USE 6-2-2008; IN COMMERCE 6-2-2008.

THE MARK CONSISTS OF STANDARD CHARACTERS WITHOUT CLAIM TO ANY PARTICULAR FONT, STYLE, SIZE, OR COLOR.

NO CLAIM IS MADE TO THE EXCLUSIVE RIGHT TO USE "CADDY", APART FROM THE MARK AS SHOWN.

SN 77-204,020, FILED 6-12-2007.

JORDAN BAKER, EXAMINING ATTORNEY

Int. Cl.: 10

Prior U.S. Cls.: 26, 39, and 44

United States Patent and Trademark Office

Reg. No. 3,521,704

Registered Oct. 21, 2008

**TRADEMARK
PRINCIPAL REGISTER**

TRU O2

SECOND WIND O2 LLC (ILLINOIS LIMITED
LIABILITY COMPANY)
1480 OLD DEERFIELD ROAD, UNIT 24
HIGHLAND PARK, IL 60035

FOR: APPARATUS FOR DISPENSING NON-
MEDICAL OXYGEN FOR THERAPEUTIC PURPO-
SES, NOT BEING AN APPARATUS FOR BREATH-
ING UNDERWATER, IN CLASS 10 (U.S. CLS. 26, 39
AND 44).

FIRST USE 4-7-2008; IN COMMERCE 4-7-2008.

THE MARK CONSISTS OF STANDARD CHAR-
ACTERS WITHOUT CLAIM TO ANY PARTICULAR
FONT, STYLE, SIZE, OR COLOR.

NO CLAIM IS MADE TO THE EXCLUSIVE
RIGHT TO USE "O2", APART FROM THE MARK
AS SHOWN.

SN 77-204,031, FILED 6-12-2007.

ANDREA SAUNDERS, EXAMINING ATTORNEY

Int. Cls.: 16 and 25

Prior U.S. Cls.: 2, 5, 22, 23, 29, 37, 38, 39, and 50

United States Patent and Trademark Office

Reg. No. 3,521,705

Registered Oct. 21, 2008

**TRADEMARK
PRINCIPAL REGISTER**

Eat My Ice

BALLAS, STANLEY P. (UNITED STATES INDIVIDUAL)
13610 OLD DAIRY ROAD
OAK HILL, VA 20171

FOR: DECALS, STICKERS, IN CLASS 16 (U.S. CLS. 2, 5, 22, 23, 29, 37, 38 AND 50).

FIRST USE 7-17-2008; IN COMMERCE 7-17-2008.

FOR: CLOTHING FOR USE IN ICE HOCKEY, NAMELY, SHIRTS, PANTS, COATS, JACKETS,

HATS, CAPS; TOBOGGAN HATS, PANTS, AND CAPS, IN CLASS 25 (U.S. CLS. 22 AND 39).

FIRST USE 10-5-2007; IN COMMERCE 10-5-2007.

THE MARK CONSISTS OF STANDARD CHARACTERS WITHOUT CLAIM TO ANY PARTICULAR FONT, STYLE, SIZE, OR COLOR.

SN 77-204,309, FILED 6-12-2007.

ODESSA BIBBINS, EXAMINING ATTORNEY

Int. Cl.: 24

Prior U.S. Cls.: 42 and 50

United States Patent and Trademark Office

Reg. No. 3,521,706

Registered Oct. 21, 2008

**TRADEMARK
PRINCIPAL REGISTER**

BUSTEX

BUSTEX, CORPORATION (COLORADO CORPORATION)
3010 WEST 111TH DRIVE
WESTMINSTER, CO 80031

THE MARK CONSISTS OF STANDARD CHARACTERS WITHOUT CLAIM TO ANY PARTICULAR FONT, STYLE, SIZE, OR COLOR.

FOR: UPHOLSTERY FABRICS, IN CLASS 24 (U.S. CLS. 42 AND 50).

SN 77-204,540, FILED 6-12-2007.

FIRST USE 5-22-2008; IN COMMERCE 5-22-2008.

TINA L. SNAPP, EXAMINING ATTORNEY

Int. Cl.: 41

Prior U.S. Cls.: 100, 101, and 107

United States Patent and Trademark Office

Reg. No. 3,521,707

Registered Oct. 21, 2008

**SERVICE MARK
PRINCIPAL REGISTER**

**EVERY STUDENT DESERVES A
CHANCE TO BE GREAT**

ROBERTS EDUCATION CORP (VIRGINIA LIMITED LIABILITY COMPANY), DBA GREAT STUDENT NETWORK,
8240 TOWNSEND STREET
FAIRFAX, VA 22031

FOR: EDUCATING AT SENIOR HIGH SCHOOLS; EDUCATING AT UNIVERSITY OR COLLEGES; EDUCATION SERVICES, NAMELY, PROVIDING LIVE AND ON-LINE COURSES OF INSTRUCTION AT THE PRIMARY, SECONDARY AND COLLEGE LEVEL IN THE FIELD OF STUDENT STUDY SKILLS AND ACADEMIC COURSE PREPARATION; EDUCATIONAL AND ENTERTAINMENT SERVICES, NAMELY, A CONTINUING PROGRAM ABOUT STUDENT STUDY SKILLS AND ACADEMIC COURSE PREPARATION ACCESSIBLE BY RADIO, TELEVISION, SATELLITE, AUDIO, VIDEO AND COMPUTER NETWORKS; EDUCATIONAL AND ENTERTAINMENT SERVICES, NAMELY, PROVIDING MOTIVATIONAL AND EDUCATION-

AL SPEAKERS; PROVIDING A WEB SITE WHERE USERS CAN POST RATINGS, REVIEWS AND RECOMMENDATIONS ON EVENTS AND ACTIVITIES IN THE FIELD OF ENTERTAINMENT AND EDUCATION; ENTERTAINMENT SERVICES, NAMELY, PROVIDING A WEBSITE FEATURING, PHOTOGRAPHIC, AUDIO, VIDEO AND PROSE PRESENTATIONS FEATURING STUDENT, TEACHER AND PARENT PROFILES, IN CLASS 41 (U.S. CLS. 100, 101 AND 107).

FIRST USE 10-1-2007; IN COMMERCE 10-1-2007.

THE MARK CONSISTS OF STANDARD CHARACTERS WITHOUT CLAIM TO ANY PARTICULAR FONT, STYLE, SIZE, OR COLOR.

SN 77-204,626, FILED 6-13-2007.

DAVID MURRAY, EXAMINING ATTORNEY

Int. Cls.: 1 and 17

Prior U.S. Cls.: 1, 5, 6, 10, 12, 13, 26, 35, 46, and 50

United States Patent and Trademark Office

Reg. No. 3,521,708

Registered Oct. 21, 2008

**TRADEMARK
PRINCIPAL REGISTER**

PLEXIMER

NATURALNANO, INC. (NEVADA CORPORATION)
15 SCHOEN PLACE
PITTSFORD, NY 14534

FOR: POLYMER BASE COMPOSITIONS USED IN THE MANUFACTURE OF AGRICULTURAL, COMMERCIAL, INDUSTRIAL AND DOMESTIC GOODS, IN CLASS 1 (U.S. CLS. 1, 5, 6, 10, 26 AND 46).

FIRST USE 6-1-2007; IN COMMERCE 6-1-2007.

FOR: PLASTIC COMPOSITE MATERIAL IN THE FORM OF PROFILES, BOARDS, SHEETS, BLOCKS,

RODS, POWDER AND PELLETS FOR USE IN MANUFACTURING, IN CLASS 17 (U.S. CLS. 1, 5, 12, 13, 35 AND 50).

FIRST USE 6-1-2007; IN COMMERCE 6-1-2007.

THE MARK CONSISTS OF STANDARD CHARACTERS WITHOUT CLAIM TO ANY PARTICULAR FONT, STYLE, SIZE, OR COLOR.

SN 77-204,659, FILED 6-13-2007.

JENNIFER VASQUEZ, EXAMINING ATTORNEY

Int. Cl.: 42

Prior U.S. Cls.: 100 and 101

United States Patent and Trademark Office

Reg. No. 3,521,709

Registered Oct. 21, 2008

**SERVICE MARK
PRINCIPAL REGISTER**

DEALOZ

CAMPUSI, INC. (CALIFORNIA CORPORATION)
39111 PASEO PADRE PARKWAY, SUITE #323
FREMONT, CA 94538

THE MARK CONSISTS OF STANDARD CHAR-
ACTERS WITHOUT CLAIM TO ANY PARTICULAR
FONT, STYLE, SIZE, OR COLOR.

FOR: COMPUTER SERVICES, NAMELY, PRO-
VIDING SEARCH ENGINES FOR OBTAINING
DATA ON A GLOBAL COMPUTER NETWORK, IN
CLASS 42 (U.S. CLS. 100 AND 101).

SN 77-204,806, FILED 6-13-2007.

FIRST USE 9-5-2007; IN COMMERCE 9-5-2007.

INGA ERVIN, EXAMINING ATTORNEY

Int. Cl.: 7

Prior U.S. Cls.: 13, 19, 21, 23, 31, 34, and 35

Reg. No. 3,521,710

United States Patent and Trademark Office

Registered Oct. 21, 2008

**TRADEMARK
PRINCIPAL REGISTER**



PATTON'S, INC. (NORTH CAROLINA CORPORATION)
3201 SOUTH BOULEVARD
CHARLOTTE, NC 28209

TRATION, CONDENSATE DRAINS, OIL/WATER SEPARATORS, IN CLASS 7 (U.S. CLS. 13, 19, 21, 23, 31, 34 AND 35).

FOR: ROTARY SCREW AIR COMPRESSORS, ROTARY SCROLL AIR COMPRESSORS, ROTARY VANE AIR COMPRESSORS, VARIABLE SPEED DRIVE AIR COMPRESSORS, VARIABLE FREQUENCY DRIVE AIR COMPRESSORS, RECIPROCATING OR PISTON AIR COMPRESSORS, OIL FREE AIR COMPRESSORS, OILLESS AIR COMPRESSORS, NON LUBRICATED AIR COMPRESSORS, REFRIGERATED COMPRESSED AIR DRYERS, ADSORPTION AND DESICCANT COMPRESSED AIR DRYERS, COMPRESSED AIR FIL-

FIRST USE 6-1-2007; IN COMMERCE 10-0-2007.

NO CLAIM IS MADE TO THE EXCLUSIVE RIGHT TO USE "PERFORMANCE COMPRESSED AIR SYSTEMS", APART FROM THE MARK AS SHOWN.

SN 77-205,127, FILED 6-13-2007.

ALEXANDER L. POWERS, EXAMINING ATTORNEY

Int. Cl.: 25

Prior U.S. Cls.: 22 and 39

United States Patent and Trademark Office

Reg. No. 3,521,711

Registered Oct. 21, 2008

**TRADEMARK
PRINCIPAL REGISTER**

HEXRIDE

REEBOK INTERNATIONAL LTD. (MASSACHU-
SETTS CORPORATION)
1895 J.W. FOSTER BOULEVARD
CANTON, MA 02021

FOR: ATHLETIC FOOTWEAR, IN CLASS 25 (U.S.
CLS. 22 AND 39).

FIRST USE 2-0-2008; IN COMMERCE 2-0-2008.

THE MARK CONSISTS OF STANDARD CHAR-
ACTERS WITHOUT CLAIM TO ANY PARTICULAR
FONT, STYLE, SIZE, OR COLOR.

SN 77-205,208, FILED 6-13-2007.

NORA BUCHANAN WILL, EXAMINING ATTOR-
NEY

Int. Cls.: 5, 29, and 32

Prior U.S. Cls.: 6, 18, 44, 45, 46, 48, 51, and 52

United States Patent and Trademark Office

Reg. No. 3,521,712

Registered Oct. 21, 2008

**TRADEMARK
PRINCIPAL REGISTER**

SIMPLY NUTRILITE

ALTICOR INC. (MICHIGAN CORPORATION)
78-2M
7575 FULTON STREET EAST
ADA, MI 49355

FOR: DIETARY AND FOOD SUPPLEMENTS
COMPRISED OF VITAMINS AND MINERALS, IN
CLASS 5 (U.S. CLS. 6, 18, 44, 46, 51 AND 52).

FIRST USE 9-1-2007; IN COMMERCE 9-1-2007.

FOR: SNACK FOODS, NAMELY, FRUIT-BASED
SNACK BARS AND NUT-BASED SNACK BARS, IN
CLASS 29 (U.S. CL. 46).

FIRST USE 9-1-2007; IN COMMERCE 9-1-2007.

FOR: FRUIT JUICES; PREPARATIONS FOR
MAKING FLAVORED WATERS, IN CLASS 32 (U.S.
CLS. 45, 46 AND 48).

FIRST USE 9-1-2007; IN COMMERCE 9-1-2007.

THE MARK CONSISTS OF STANDARD CHAR-
ACTERS WITHOUT CLAIM TO ANY PARTICULAR
FONT, STYLE, SIZE, OR COLOR.

OWNER OF U.S. REG. NOS. 2,145,912, 2,780,702,
AND OTHERS.

SN 77-205,212, FILED 6-13-2007.

MARGERY A. TIERNEY, EXAMINING ATTORNEY

Int. Cl.: 41

Prior U.S. Cls.: 100, 101, and 107

United States Patent and Trademark Office

Reg. No. 3,521,713

Registered Oct. 21, 2008

**SERVICE MARK
PRINCIPAL REGISTER**

MAKING PAIN HISTORY

NEUROMED PHARMACEUTICALS, LTD. (CANADA LIMITED COMPANY)
301-2389 HEALTH SCIENCES MALL
VANCOUVER, CANADA V6T1Z3

FOR: EDUCATIONAL SERVICES, NAMELY, CONDUCTING CLASSES, SEMINARS, AND CONFERENCES IN THE FIELD OF PHARMACEUTICALS, IN CLASS 41 (U.S. CLS. 100, 101 AND 107).

FIRST USE 2-26-2008; IN COMMERCE 2-26-2008.

THE MARK CONSISTS OF STANDARD CHARACTERS WITHOUT CLAIM TO ANY PARTICULAR FONT, STYLE, SIZE, OR COLOR.

SN 77-205,279, FILED 6-13-2007.

SETH A. RAPPAPORT, EXAMINING ATTORNEY

Int. Cl.: 38

Prior U.S. Cls.: 100, 101, and 104

United States Patent and Trademark Office

Reg. No. 3,521,714

Registered Oct. 21, 2008

**SERVICE MARK
PRINCIPAL REGISTER**

BEAUTY BEYOND WORDS

BEAUTY BEYOND WORDS, LLC (FLORIDA
LIMITED LIABILITY COMPANY)
PO BOX 715
SARASOTA, FL 342300715

THE MARK CONSISTS OF STANDARD CHAR-
ACTERS WITHOUT CLAIM TO ANY PARTICULAR
FONT, STYLE, SIZE, OR COLOR.

FOR: DELIVERY OF PERSONALIZED GREET-
ING CARDS TO OTHERS VIA ELECTRONIC MAIL,
IN CLASS 38 (U.S. CLS. 100, 101 AND 104).

SN 77-205,358, FILED 6-13-2007.

FIRST USE 11-21-2007; IN COMMERCE 11-21-2007.

KOURTNEE HODGES, EXAMINING ATTORNEY

Int. Cl.: 25

Prior U.S. Cls.: 22 and 39

United States Patent and Trademark Office

Reg. No. 3,521,715

Registered Oct. 21, 2008

**TRADEMARK
PRINCIPAL REGISTER**

REVOKE

CARRANZA, HECTOR (UNITED STATES INDIVIDUAL)
3124 VILLA PUERTA
CARLSBAD, CA 92009

FOR: CLOTHING, HEADGEAR, AND FOOTWEAR; NAMELY, SHIRTS, T-SHIRTS, TANK TOPS, JERSEYS, JACKETS, COATS, SWEATERS, SWEATSHIRTS, SWEATPANTS, PANTS, SHORTS, DRESSES, SKIRTS, BATHING SUITS, PAJAMAS, GLOVES, WRISTBANDS, HATS, CAPS, BEANIES, SHOES, SOCKS, SLIPPERS, AND SANDALS, IN CLASS 25 (U.S. CLS. 22 AND 39).

FIRST USE 7-30-2008; IN COMMERCE 7-30-2008.

THE MARK CONSISTS OF STANDARD CHARACTERS WITHOUT CLAIM TO ANY PARTICULAR FONT, STYLE, SIZE, OR COLOR.

SN 77-205,442, FILED 6-13-2007.

BARBARA BROWN, EXAMINING ATTORNEY

Int. Cl.: 36

Prior U.S. Cls.: 100, 101, and 102

United States Patent and Trademark Office

Reg. No. 3,521,716

Registered Oct. 21, 2008

**SERVICE MARK
PRINCIPAL REGISTER**



KAGYU MONLAM LIMITED (BR.VIRGIN IS-
LANDS CORPORATION)
PORTCULLIS TRUSTNET CHAMBERS
P.O. BOX 3444
ROAD TOWN, TORTOLA, BR.VIRGIN ISLANDS

FOR: MEMORIAL FUNDRAISING SERVICES, IN
CLASS 36 (U.S. CLS. 100, 101 AND 102).

FIRST USE 2-1-2008; IN COMMERCE 6-30-2008.

THE COLOR(S) RED, YELLOW, GREEN, BLACK
AND GRAY IS/ARE CLAIMED AS A FEATURE OF
THE MARK.

THE MARK CONSISTS OF A SERIES OF FOUR
SWIRL DESIGNS WITH ONE RED SWIRL, ONE
YELLOW SWIRL, ONE GREEN SWIRL AND ONE
GRAY SWIRL. THERE IS A BLACK CIRCLE IN THE
CENTER OF THE FOUR SWIRL DESIGNS.

SN 77-205,776, FILED 6-14-2007.

KEVIN CORWIN, EXAMINING ATTORNEY

Int. Cl.: 3

Prior U.S. Cls.: 1, 4, 6, 50, 51, and 52

United States Patent and Trademark Office

Reg. No. 3,521,717

Registered Oct. 21, 2008

**TRADEMARK
PRINCIPAL REGISTER**

FOR HEAVEN'S SAKÉ

BATH & BODY WORKS BRAND MANAGEMENT, INC. (DELAWARE CORPORATION)
7 LIMITED PARKWAY EAST
REYNOLDSBURG, OH 43068

THE MARK CONSISTS OF STANDARD CHARACTERS WITHOUT CLAIM TO ANY PARTICULAR FONT, STYLE, SIZE, OR COLOR.

FOR: PERSONAL CARE PRODUCTS, NAMELY, BATH AND SHOWER BODY WASH, IN CLASS 3 (U.S. CLS. 1, 4, 6, 50, 51 AND 52).

SN 77-205,933, FILED 6-14-2007.

FIRST USE 1-28-2008; IN COMMERCE 1-28-2008.

KATHY DE JONGE, EXAMINING ATTORNEY

Int. Cl.: 16

Prior U.S. Cls.: 2, 5, 22, 23, 29, 37, 38, and 50

Reg. No. 3,521,718

United States Patent and Trademark Office

Registered Oct. 21, 2008

**TRADEMARK
PRINCIPAL REGISTER**

L-PRINT

SABIC INNOVATIVE PLASTICS IP B.V. (NETHERLANDS COMPANY)
PLASTICSLAAN 1
4612 PX
BERGEN OP ZOOM, NETHERLANDS

FOR: PRINT SUBSTRATE, NAMELY, TRANSPARENT, OPAQUE AND TRANSLUCENT FILMS FOR USE WITH INK JET PRINTERS, IN CLASS 16 (U.S. CLS. 2, 5, 22, 23, 29, 37, 38 AND 50).

FIRST USE 5-17-2004; IN COMMERCE 7-0-2004.

THE MARK CONSISTS OF STANDARD CHARACTERS WITHOUT CLAIM TO ANY PARTICULAR FONT, STYLE, SIZE, OR COLOR.

SN 77-206,136, FILED 6-14-2007.

HENRY S. ZAK, EXAMINING ATTORNEY

Int. Cl.: 25

Prior U.S. Cls.: 22 and 39

United States Patent and Trademark Office

Reg. No. 3,521,719

Registered Oct. 21, 2008

**TRADEMARK
PRINCIPAL REGISTER**

BLACK WALNUT

KEFFER, PATRICIA S. (UNITED STATES INDIVIDUAL)
P.O. BOX 783
NICEVILLE, FL 32588 AND
KEFFER, TRICIA L. (UNITED STATES INDIVIDUAL)
P.O. BOX 783
NICEVILLE, FL 32588

FOR: CLOTHING AND HEADGEAR, NAMELY, SHIRTS, HATS AND CAPS, IN CLASS 25 (U.S. CLS. 22 AND 39).

FIRST USE 10-12-2007; IN COMMERCE 10-12-2007.

THE MARK CONSISTS OF STANDARD CHARACTERS WITHOUT CLAIM TO ANY PARTICULAR FONT, STYLE, SIZE, OR COLOR.

SN 77-206,171, FILED 6-14-2007.

ALEX KEAM, EXAMINING ATTORNEY

Int. Cl.: 3

Prior U.S. Cls.: 1, 4, 6, 50, 51, and 52

United States Patent and Trademark Office

Reg. No. 3,521,720

Registered Oct. 21, 2008

**TRADEMARK
PRINCIPAL REGISTER**

STATUS

AMIR, INC. (MINNESOTA CORPORATION)
2755 HIGHWAY 55
EAGAN, MN 55121

THE MARK CONSISTS OF STANDARD CHAR-
ACTERS WITHOUT CLAIM TO ANY PARTICULAR
FONT, STYLE, SIZE, OR COLOR.

FOR: HAIR CARE PRODUCTS, NAMELY, SHAM-
POO, CONDITIONERS, GELS, AND HAIR SPRAY,
SOLD ONLY THROUGH PROFESSIONAL BEAUTY
SALONS, IN CLASS 3 (U.S. CLS. 1, 4, 6, 50, 51 AND 52).

SN 77-206,503, FILED 6-14-2007.

FIRST USE 3-31-2008; IN COMMERCE 3-31-2008.

CHARLES L. JENKINS, EXAMINING ATTORNEY

Int. Cl.: 9

Prior U.S. Cls.: 21, 23, 26, 36, and 38

Reg. No. 3,521,721

United States Patent and Trademark Office

Registered Oct. 21, 2008

**TRADEMARK
PRINCIPAL REGISTER**

ACTIONXL

KIONIX, INC. (DELAWARE CORPORATION)
36 THORNWOOD DRIVE
ITHACA, NY 14850

FIRST USE 9-18-2007; IN COMMERCE 9-18-2007.

FOR: COMPUTER GAME CONTROLLERS WITH
ACCELEROMETER-ENABLED TILT CONTROL;
ACCELEROMETER-BASED PLUG-IN MOTION
SENSOR FOR HANDHELD COMPUTER GAMING
SYSTEMS, IN CLASS 9 (U.S. CLS. 21, 23, 26, 36 AND
38).

THE MARK CONSISTS OF STANDARD CHAR-
ACTERS WITHOUT CLAIM TO ANY PARTICULAR
FONT, STYLE, SIZE, OR COLOR.

SN 77-206,543, FILED 6-14-2007.

KAPIL BHANOT, EXAMINING ATTORNEY

Int. Cl.: 11

Prior U.S. Cls.: 13, 21, 23, 31, and 34

United States Patent and Trademark Office

Reg. No. 3,521,722

Registered Oct. 21, 2008

**TRADEMARK
PRINCIPAL REGISTER**

**THE BEST THING TO HAPPEN
TO BBQ SINCE FIRE**

BBQ'N GRILL, LLC (NEVADA LIMITED LIABILITY COMPANY)
3650 S. VIRGINIA STREET, SUITE K-1
RENO, NV 89502

THE MARK CONSISTS OF STANDARD CHARACTERS WITHOUT CLAIM TO ANY PARTICULAR FONT, STYLE, SIZE, OR COLOR.

FOR: BARBECUE GRILLS, IN CLASS 11 (U.S. CLS. 13, 21, 23, 31 AND 34).

SN 77-206,584, FILED 6-14-2007.

FIRST USE 8-3-2007; IN COMMERCE 8-3-2007.

ANGELA GAW, EXAMINING ATTORNEY

Int. Cl.: 25

Prior U.S. Cls.: 22 and 39

United States Patent and Trademark Office

Reg. No. 3,521,723

Registered Oct. 21, 2008

**TRADEMARK
PRINCIPAL REGISTER**



JING, ZHENG (CHINA INDIVIDUAL)
ROOM 2906, BLOCK A7, ZHONGHAIMINGDU
NO. 1 FANGZHI ROAD, HAIZHU DISTRICT
GUANGZHOU, GUANGDONG, CHINA

FOR: CLOTHING, NAMELY, SHIRTS, SHORTS,
TROUSERS, DRESSES, JACKETS, UNIFORMS,
SPORTS SHIRTS, COATS; FOOTWEAR; HEAD-
GEAR, NAMELY, HATS, CAPS; HOSIERY; GLOVES;
NECKTIES; BELTS; WIND-JACKETS; UNDER-
WEAR; LAYETTES; WEDDING GOWNS; SWIM-
SUITS, IN CLASS 25 (U.S. CLS. 22 AND 39).

FIRST USE 3-22-1999; IN COMMERCE 1-1-2007.

THE WORDING "G...VILL" HAS NO MEANING
IN A FOREIGN LANGUAGE.

THE NON-LATIN CHARACTERS IN THE MARK
TRANSLITERATE TO GUI, ZHI, BU AND THESE
MEAN EXPENSIVE, POSSESSIVE PARTICLE OF,
PACE IN ENGLISH.

SN 77-206,800, FILED 6-15-2007.

THEODORE MCBRIDE, EXAMINING ATTORNEY

Int. Cl.: 9

Prior U.S. Cls.: 21, 23, 26, 36, and 38

United States Patent and Trademark Office

Reg. No. 3,521,724

Registered Oct. 21, 2008

**TRADEMARK
PRINCIPAL REGISTER**

**10-MINUTE ANYWHERE,
ANYTIME WORKOUT**

LEWINSKI, BRYAN (UNITED STATES INDIVIDUAL)
APT. A
5347 COLUMBIA ROAD
COLUMBIA, MD 21044

FOR: DOWNLOADABLE VIDEO RECORDINGS FEATURING EXERCISE AND PHYSICAL FITNESS INSTRUCTION, IN CLASS 9 (U.S. CLS. 21, 23, 26, 36 AND 38).

FIRST USE 10-0-2007; IN COMMERCE 10-0-2007.

THE MARK CONSISTS OF STANDARD CHARACTERS WITHOUT CLAIM TO ANY PARTICULAR FONT, STYLE, SIZE, OR COLOR.

NO CLAIM IS MADE TO THE EXCLUSIVE RIGHT TO USE "10 MINUTE" AND "WORKOUT", APART FROM THE MARK AS SHOWN.

SN 77-207,053, FILED 6-15-2007.

VIVIAN MICZNIK FIRST, EXAMINING ATTORNEY

Int. Cl.: 36

Prior U.S. Cls.: 100, 101, and 102

United States Patent and Trademark Office

Reg. No. 3,521,725

Registered Oct. 21, 2008

**SERVICE MARK
PRINCIPAL REGISTER**

DEXTER

DEXTER APACHE HOLDING, INC. (IOWA CORPORATION)
2211 WEST GRIMES AVENUE
FAIRFIELD, IA 52556

THE MARK CONSISTS OF STANDARD CHARACTERS WITHOUT CLAIM TO ANY PARTICULAR FONT, STYLE, SIZE, OR COLOR.

FOR: FINANCIAL SERVICES, NAMELY, MONEY LENDING, IN CLASS 36 (U.S. CLS. 100, 101 AND 102).

SN 77-207,055, FILED 6-15-2007.

FIRST USE 0-0-2001; IN COMMERCE 0-0-2001.

HEATHER BIDDULPH, EXAMINING ATTORNEY

Int. Cl.: 35

Prior U.S. Cls.: 100, 101, and 102

United States Patent and Trademark Office

Reg. No. 3,521,726

Registered Oct. 21, 2008

**SERVICE MARK
PRINCIPAL REGISTER**



Food Perspectives Inc.

FOOD PERSPECTIVES, INC (MINNESOTA CORPORATION)
2880 VICKSBURG LANE
PLYMOUTH, MN 55447

FOR: MARKET RESEARCH, CONSUMER TESTING, AND BUSINESS CONSULTING FOR OTHERS IN THE FOOD AND BEVERAGE INDUSTRY, IN CLASS 35 (U.S. CLS. 100, 101 AND 102).

FIRST USE 4-16-2008; IN COMMERCE 4-16-2008.

NO CLAIM IS MADE TO THE EXCLUSIVE RIGHT TO USE "FOOD" OR "INC.", APART FROM THE MARK AS SHOWN.

THE MARK CONSISTS OF A CIRCLE WITH THE LETTERS "FPI" INSIDE WITH THE LETTER "F" BREAKING THE CIRCLE ON THE LEFT SIDE AND THE LETTER "I" BREAKING THE CIRCLE ON THE RIGHT SIDE AND THE WORDS "FOOD PERSPECTIVES INC." BELOW THE CIRCLE.

SN 77-207,075, FILED 6-15-2007.

SETH A. RAPPAPORT, EXAMINING ATTORNEY

Int. Cl.: 35

Prior U.S. Cls.: 100, 101, and 102

United States Patent and Trademark Office

Reg. No. 3,521,727

Registered Oct. 21, 2008

**SERVICE MARK
PRINCIPAL REGISTER**

CENTURY

CENTURY LAUNDRY DISTRIBUTING, INC.
(IOWA CORPORATION)
2211 WEST GRIMES AVENUE
FAIRFIELD, IA 52556

FOR: DISTRIBUTORSHIP SERVICES FEATUR-
ING LAUNDRY EQUIPMENT, NAMELY, CLOTHES
WASHING MACHINES AND CLOTHES DRYERS,
IN CLASS 35 (U.S. CLS. 100, 101 AND 102).

FIRST USE 0-0-2001; IN COMMERCE 0-0-2001.

THE MARK CONSISTS OF STANDARD CHAR-
ACTERS WITHOUT CLAIM TO ANY PARTICULAR
FONT, STYLE, SIZE, OR COLOR.

OWNER OF U.S. REG. NO. 2,182,644.

SN 77-207,098, FILED 6-15-2007.

HEATHER BIDDULPH, EXAMINING ATTORNEY

Int. Cl.: 35

Prior U.S. Cls.: 100, 101, and 102

United States Patent and Trademark Office

Reg. No. 3,521,728

Registered Oct. 21, 2008

**SERVICE MARK
PRINCIPAL REGISTER**



**CENTURY LAUNDRY DISTRIBUTING, INC.
(IOWA CORPORATION)**

**2211 WEST GRIMES AVENUE
FAIRFIELD, IA 52556**

**FOR: DISTRIBUTORSHIP SERVICES FEATUR-
ING LAUNDRY EQUIPMENT, NAMELY, CLOTHES**

**WASHING MACHINES AND CLOTHES DRYERS,
IN CLASS 35 (U.S. CLS. 100, 101 AND 102).**

FIRST USE 0-0-2001; IN COMMERCE 0-0-2001.

SN 77-207,121, FILED 6-15-2007.

HEATHER BIDDULPH, EXAMINING ATTORNEY

Int. Cls.: 1 and 3

Prior U.S. Cls.: 1, 4, 5, 6, 10, 26, 46, 50, 51, and 52

United States Patent and Trademark Office

Reg. No. 3,521,729

Registered Oct. 21, 2008

**TRADEMARK
PRINCIPAL REGISTER**

BRAKEBEST

O'REILLY AUTOMOTIVE, INC. (MISSOURI CORPORATION)
233 SOUTH PATTERSON
SPRINGFIELD, MO 65802

FOR: BRAKE FLUID, IN CLASS 1 (U.S. CLS. 1, 5, 6, 10, 26 AND 46).

FIRST USE 3-31-2007; IN COMMERCE 3-31-2007.

FOR: BRAKE CLEANER, IN CLASS 3 (U.S. CLS. 1, 4, 6, 50, 51 AND 52).

FIRST USE 4-30-2007; IN COMMERCE 4-30-2007.

THE MARK CONSISTS OF STANDARD CHARACTERS WITHOUT CLAIM TO ANY PARTICULAR FONT, STYLE, SIZE, OR COLOR.

OWNER OF U.S. REG. NO. 1,957,494.

SN 77-207,154, FILED 6-15-2007.

WENDY GOODMAN, EXAMINING ATTORNEY

Int. Cl.: 25

Prior U.S. Cls.: 22 and 39

United States Patent and Trademark Office

Reg. No. 3,521,730

Registered Oct. 21, 2008

**TRADEMARK
PRINCIPAL REGISTER**

Rough, Slow and Expensive

CHRISTENSEN, JES (DENMARK INDIVIDUAL)
3631 S. SEPULVEDA BLVD. #1
LOS ANGELES, CA 90034

FIRST USE 6-1-2007; IN COMMERCE 1-1-2008.

FOR: CLOTHING, NAMELY, T-SHIRTS, CAPS,
TANK TOPS, PANTS, SWEATPANTS, GYM
SHORTS, GYM SHOES, GYM SUITS, SWEATERS,
SHIRTS, SHOES, SCARVES, SOCKS, BELTS, HATS,
BATHING SUITS, BRAS, UNDERWEAR, SKIRTS,
SHORTS, SLEEPWEAR, DRESSES, AND FOOT-
WEAR, IN CLASS 25 (U.S. CLS. 22 AND 39).

THE MARK CONSISTS OF STANDARD CHAR-
ACTERS WITHOUT CLAIM TO ANY PARTICULAR
FONT, STYLE, SIZE, OR COLOR.

SN 77-207,225, FILED 6-15-2007.

JACLYN KIDWELL, EXAMINING ATTORNEY

Int. Cl.: 30

Prior U.S. Cl.: 46

United States Patent and Trademark Office

Reg. No. 3,521,731

Registered Oct. 21, 2008

**TRADEMARK
PRINCIPAL REGISTER**

BUBBA'S BAR-B-Q RUB

REINKE, BERT L (UNITED STATES INDIVIDUAL)
8852 F. M. 621
MARTINDALE, TX 78655 AND
REINKE, KAREN W. (UNITED STATES INDIVIDUAL)
8852 F. M. 621
MARTINDALE, TX 78655

FOR: BAR-B-Q DRY RUB, IN CLASS 30 (U.S. CL. 46).

FIRST USE 8-18-2007; IN COMMERCE 8-18-2007.

THE MARK CONSISTS OF STANDARD CHARACTERS WITHOUT CLAIM TO ANY PARTICULAR FONT, STYLE, SIZE, OR COLOR.

NO CLAIM IS MADE TO THE EXCLUSIVE RIGHT TO USE "BAR-B-Q RUB", APART FROM THE MARK AS SHOWN.

SN 77-207,431, FILED 6-15-2007.

ANDREA K. NADELMAN, EXAMINING ATTORNEY

Int. Cls.: 24 and 25

Prior U.S. Cls.: 22, 39, 42, and 50

United States Patent and Trademark Office

Reg. No. 3,521,732

Registered Oct. 21, 2008

**TRADEMARK
PRINCIPAL REGISTER**

BAMBOO CHIC

COOK, ANNETTE SEFIERT (UNITED STATES
INDIVIDUAL)
5302 DERRY AVENUE, UNIT D
AGOURA HILLS, CA 91301

FOR: BED BLANKETS, BLANKET TROWS,
CHILDREN'S BLANKETS, RECEIVING BLANKETS
AND WOOLLEN BLANKETS ALL MADE AT LEAST
IN PART OF BAMBOO , IN CLASS 24 (U.S. CLS. 42
AND 50).

FIRST USE 4-1-2008; IN COMMERCE 4-1-2008.

FOR: T-SHIRTS, PANTS, ROBES, SWEAT SHIRTS,
SHORTS, DRESSES, SKIRTS, PAJAMAS, TANK
TOPS, COVERUPS, SOCKS, SLIPPERS, SANDALS,
BABY BUNTING, BABY BIBS NOT OF PAPER,
BONNETS, BOOTIES, COVERALLS, CREEPERS,
HEADWEAR, INFANT WEAR, JACKETS, MITTENS,

NIGHT GOWNS, LINGERIE, ROMPERS, SWAD-
DLING CLOTHES, SHOULDER WRAPS AND IN-
FANT SLEEPERS ALL MADE AT LEAST IN PART
OF BAMBOO, IN CLASS 25 (U.S. CLS. 22 AND 39).

FIRST USE 4-1-2008; IN COMMERCE 4-1-2008.

THE MARK CONSISTS OF STANDARD CHAR-
ACTERS WITHOUT CLAIM TO ANY PARTICULAR
FONT, STYLE, SIZE, OR COLOR.

NO CLAIM IS MADE TO THE EXCLUSIVE
RIGHT TO USE "BAMBOO", APART FROM THE
MARK AS SHOWN.

SN 77-207,454, FILED 6-15-2007.

JAMES LOVELACE, EXAMINING ATTORNEY

Int. Cl.: 5

Prior U.S. Cls.: 6, 18, 44, 46, 51, and 52

United States Patent and Trademark Office

Reg. No. 3,521,733

Registered Oct. 21, 2008

**TRADEMARK
PRINCIPAL REGISTER**

ALL-LIPER-OL

FARR LABORATORIES, LLC (DELAWARE LIMITED LIABILITY COMPANY)
SUITE 560
11100 SANTA MONICA BOULEVARD
LOS ANGELES, CA 90025

THE MARK CONSISTS OF STANDARD CHARACTERS WITHOUT CLAIM TO ANY PARTICULAR FONT, STYLE, SIZE, OR COLOR.

FOR: DIETARY SUPPLEMENTS, IN CLASS 5 (U.S. CLS. 6, 18, 44, 46, 51 AND 52).

SN 77-207,606, FILED 6-15-2007.

FIRST USE 9-28-2007; IN COMMERCE 9-28-2007.

SHARON MEIER, EXAMINING ATTORNEY

Int. Cl.: 36

Prior U.S. Cls.: 100, 101, and 102

United States Patent and Trademark Office

Reg. No. 3,521,734

Registered Oct. 21, 2008

**SERVICE MARK
PRINCIPAL REGISTER**

METRO CONNECT

METROPCS WIRELESS, INC. (DELAWARE CORPORATION)
2250 LAKESIDE BOULEVARD
RICHARDSON, TX 75082

FOR: ELECTRONIC PAYMENT SERVICES, NAMELY, ESTABLISHING REOCCURRING FUNDED ACCOUNTS, USED TO PURCHASE ADDITIONAL CELLULAR PHONE SERVICES, IN CLASS 36 (U.S. CLS. 100, 101 AND 102).

FIRST USE 2-0-2002; IN COMMERCE 2-0-2002.

THE MARK CONSISTS OF STANDARD CHARACTERS WITHOUT CLAIM TO ANY PARTICULAR FONT, STYLE, SIZE, OR COLOR.

SN 77-207,635, FILED 6-15-2007.

JOHN WILKE, EXAMINING ATTORNEY

Int. Cl.: 25

Prior U.S. Cls.: 22 and 39

United States Patent and Trademark Office

Reg. No. 3,521,735

Registered Oct. 21, 2008

**TRADEMARK
PRINCIPAL REGISTER**

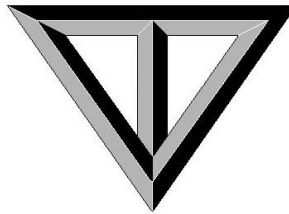

VEST-TECH, INC. (UTAH CORPORATION)
2958 S. 800 W.
SYRACUSE, UT 84075

THE MARK CONSISTS OF TRIANGLE HAVING
A VERTICAL BAR IN THE MIDDLE THEREOF.

FOR: WORK VESTS, IN CLASS 25 (U.S. CLS. 22
AND 39).

SN 77-207,715, FILED 6-15-2007.

FIRST USE 8-18-2008; IN COMMERCE 8-18-2008.

KAPIL BHANOT, EXAMINING ATTORNEY

Int. Cls.: 3, 14, 18, and 21

Prior U.S. Cls.: 1, 2, 3, 4, 6, 13, 22, 23, 27, 28, 29, 30,
33, 40, 41, 50, 51, and 52

Reg. No. 3,521,736

United States Patent and Trademark Office

Registered Oct. 21, 2008

TRADEMARK
PRINCIPAL REGISTER

original
women
celebrating the artistry of human nature

ORIGINAL WOMEN LLC (NEW YORK LIMITED
LIABILITY COMPANY)
SUITE 8A
419 EAST 57TH STREET
NEW YORK, NY 10022

FOR: SOAP, NAMELY, SKIN SOAP, BATH SOAP;
BATH PRODUCTS, NAMELY, BATH POWDER,
BATH OILS, BUBBLE BATH; PERFUME AND ES-
SENTIAL OILS FOR PERSONAL USE; NON-MEDI-
CATED BODY CREAMS AND BODY LOTIONS, IN
CLASS 3 (U.S. CLS. 1, 4, 6, 50, 51 AND 52).

FIRST USE 5-6-2007; IN COMMERCE 10-31-2007.

FOR: JEWELRY, NAMELY, NECKLACES, BRA-
CELETS, ANKLETS, RINGS, EARRINGS, PINS,
BROOCHES, PENDANTS, BELLY RINGS, TOE
RINGS, CHARMS, CHAINS, JEWELRY FOR THE
HEAD, BELLY CHAINS, WAIST CHAINS, HIP
CHAINS, AND LARIATS, IN CLASS 14 (U.S. CLS. 2,
27, 28 AND 50).

FIRST USE 9-26-2006; IN COMMERCE 11-30-2006.

FOR: COSMETIC CASES SOLD EMPTY, HAND
BAGS, KNAPSACKS, ALL PURPOSE SPORTS BAGS,
BACK PACKS, TOTE BAGS, PURSES, WALLETS,
CREDIT CARD CASES, BRIEFCASES-TYPE PORT-
FOLIOS, BRIEF CASES, GYM BAGS, ALL PURPOSE
GEAR CARRYING BAGS, TRAVEL BAGS, DUFFEL
BAGS, LUGGAGE, TRUNKS FOR TRAVELING,
FANNY PACKS, WAIST PACKS, UMBRELLAS, IN
CLASS 18 (U.S. CLS. 1, 2, 3, 22 AND 41).

FIRST USE 9-26-2006; IN COMMERCE 8-30-2007.

FOR: DISHES, PLATES, BOWLS, VASES; COOK-
WARE, NAMELY, POTS, PANS AND NON-ELEC-
TRIC CERAMIC COOKING BOWLS; SERVING
PLATTERS, BREAD BASKETS FOR DOMESTIC
USE; WICKER, STRAW, AND WOOD FRUIT BAS-
KETS FOR DOMESTIC USE, FOOD SERVICE
TRAYS, DRINKING GLASSES, COFFEE MUGS;
HOUSEHOLD AND KITCHEN UTENSILS, NAME-
LY, SALAD SERVERS, SERVING SPOONS, SER-
VING FORKS; NON-ELECTRIC KITCHEN
CONTAINERS NOT OF PRECIOUS METAL OR
COATED THEREWITH, PITCHERS, JUGS AND
GLASS STORAGE JARS, CERAMIC STORAGE
JARS, PORCELAIN STORAGE JARS, EARTHEN-
WARE STORAGE JARS, WIRE METAL DECORA-
TIVE JARS NOT OF PRECIOUS METAL OR
COATED THEREWITH FOR HOUSEHOLD USE,
BEVERAGE GLASSWARE, STATUES AND SCULP-
TURES OF PORCELAIN AND EARTHENWARE,
CANDLE HOLDERS NOT OF PRECIOUS METAL
OR COATED THEREWITH, BRUSHES, NAMELY,
COSMETIC BRUSHES, HAIR BRUSHES, CLOTHES
BRUSHES AND COMBS, IN CLASS 21 (U.S. CLS. 2,
13, 23, 29, 30, 33, 40 AND 50).

FIRST USE 10-31-2006; IN COMMERCE 11-30-2006.

SN 77-207,768, FILED 6-15-2007.

RONALD MCMORROW, EXAMINING ATTORNEY

Int. Cl.: 35

Prior U.S. Cls.: 100, 101, and 102

United States Patent and Trademark Office

Reg. No. 3,521,737

Registered Oct. 21, 2008

**SERVICE MARK
PRINCIPAL REGISTER**

ESSAY MATCH

ESSAY MATCH, LLC (DELAWARE LIMITED
LIABILITY COMPANY)
APT. 318
2 BAYSIDE VILLAGE PLACE
SAN FRANCISCO, CA 94107

FOR: PROVIDING CONSULTING SERVICES IN
THE FIELD OF HIGHER EDUCATION, NAMELY,
FACILITATING THE BUYING AND SELLING OF
SAMPLE COLLEGE ADMISSIONS ESSAYS, GRAD-
UATE SCHOOL ADMISSIONS ESSAYS AND PRO-
FESSIONAL SCHOOL ADMISSIONS ESSAYS, IN
CLASS 35 (U.S. CLS. 100, 101 AND 102).

FIRST USE 6-21-2008; IN COMMERCE 6-21-2008.

THE MARK CONSISTS OF STANDARD CHAR-
ACTERS WITHOUT CLAIM TO ANY PARTICULAR
FONT, STYLE, SIZE, OR COLOR.

NO CLAIM IS MADE TO THE EXCLUSIVE
RIGHT TO USE "ESSAY", APART FROM THE
MARK AS SHOWN.

SN 77-207,911, FILED 6-16-2007.

VIVIAN MICZNIK FIRST, EXAMINING ATTOR-
NEY

Int. Cl.: 18

Prior U.S. Cls.: 1, 2, 3, 22, and 41

United States Patent and Trademark Office

Reg. No. 3,521,738

Registered Oct. 21, 2008

**TRADEMARK
PRINCIPAL REGISTER**

ZIORDIA

ROMAR INTERNATIONAL CORPORATION
(NEW YORK CORPORATION)
4TH FLOOR
1369 BROADWAY
NEW YORK, NY 10018

THE MARK CONSISTS OF STANDARD CHAR-
ACTERS WITHOUT CLAIM TO ANY PARTICULAR
FONT, STYLE, SIZE, OR COLOR.

FOR: HANDBAGS, IN CLASS 18 (U.S. CLS. 1, 2, 3,
22 AND 41).

SN 77-208,165, FILED 6-18-2007.

FIRST USE 11-0-2007; IN COMMERCE 11-0-2007.

DOMINICK J. SALEMI, EXAMINING ATTORNEY

Int. Cl.: 25

Prior U.S. Cls.: 22 and 39

United States Patent and Trademark Office

Reg. No. 3,521,739

Registered Oct. 21, 2008

**TRADEMARK
PRINCIPAL REGISTER**

GANDER MOUNTAIN

GANDER MOUNTAIN COMPANY (MINNESOTA
CORPORATION)
SUITE 1300
180 EAST FIFTH STREET
ST. PAUL, MN 55101

FOR: HEADWEAR, FOOTWEAR AND SPORTS-
WEAR, NAMELY, T-SHIRTS, SHIRTS, SWEATERS,
TURTLENECKS, SWEATSHIRTS, WINDSHIRTS,
COATS, RAINWEAR, JACKETS, VESTS, PANTS,
SHORTS, PARKAS, HATS, CAPS, GLOVES, MIT-
TENS, SOCKS, UNDERWEAR, BOOTS, SHOES, AND
SANDALS, IN CLASS 25 (U.S. CLS. 22 AND 39).

FIRST USE 2-0-2008; IN COMMERCE 2-0-2008.

THE MARK CONSISTS OF STANDARD CHAR-
ACTERS WITHOUT CLAIM TO ANY PARTICULAR
FONT, STYLE, SIZE, OR COLOR.

OWNER OF U.S. REG. NOS. 1,335,489, 2,564,297,
AND OTHERS.

SN 77-208,268, FILED 6-18-2007.

THEODORE MCBRIDE, EXAMINING ATTORNEY

Int. Cl.: 6

Prior U.S. Cls.: 2, 12, 13, 14, 23, 25, and 50

Reg. No. 3,521,740

United States Patent and Trademark Office

Registered Oct. 21, 2008

**TRADEMARK
PRINCIPAL REGISTER**

GANDER MTN.

GANDER MOUNTAIN COMPANY (MINNESOTA
CORPORATION)
SUITE 1300
180 EAST FIFTH STREET
ST. PAUL, MN 55101

FOR: GUN SAFES AND GUN VAULTS PRIMAR-
ILY OF METAL, IN CLASS 6 (U.S. CLS. 2, 12, 13, 14, 23,
25 AND 50).

FIRST USE 10-0-2006; IN COMMERCE 10-0-2006.

THE MARK CONSISTS OF STANDARD CHAR-
ACTERS WITHOUT CLAIM TO ANY PARTICULAR
FONT, STYLE, SIZE, OR COLOR.

OWNER OF U.S. REG. NOS. 1,335,489, 2,864,302,
AND OTHERS.

SN 77-208,323, FILED 6-18-2007.

THEODORE MCBRIDE, EXAMINING ATTORNEY

Int. Cl.: 37

Prior U.S. Cls.: 100, 103, and 106

United States Patent and Trademark Office

Reg. No. 3,521,741

Registered Oct. 21, 2008

**SERVICE MARK
PRINCIPAL REGISTER**

GANDER MTN.

GANDER MOUNTAIN COMPANY (MINNESOTA
CORPORATION)
SUITE 1300
180 EAST FIFTH STREET
ST. PAUL, MN 55101

FOR: GUNSMITHING, NAMELY, REPAIR OR
MAINTENANCE OF FIREARMS; ARCHERY
EQUIPMENT REPAIR AND MAINTENANCE, IN
CLASS 37 (U.S. CLS. 100, 103 AND 106).

FIRST USE 12-0-2005; IN COMMERCE 12-0-2005.

THE MARK CONSISTS OF STANDARD CHAR-
ACTERS WITHOUT CLAIM TO ANY PARTICULAR
FONT, STYLE, SIZE, OR COLOR.

OWNER OF U.S. REG. NOS. 1,335,489, 2,864,302,
AND OTHERS.

SN 77-208,362, FILED 6-18-2007.

THEODORE MCBRIDE, EXAMINING ATTORNEY

Int. Cl.: 39

Prior U.S. Cls.: 100 and 105

United States Patent and Trademark Office

Reg. No. 3,521,742

Registered Oct. 21, 2008

**SERVICE MARK
PRINCIPAL REGISTER**

GANDER MTN.

GANDER MOUNTAIN COMPANY (MINNESOTA CORPORATION)
SUITE 1300
180 EAST FIFTH STREET
ST. PAUL, MN 55101

FOR: ARRANGING AND CONDUCTING HUNTING, FISHING AND ADVENTURE EXPEDITIONS; TRAVEL BOOKING AGENCY SERVICES FOR AIR TRAVEL AND HUNTING, FISHING AND ADVENTURE EXPEDITIONS; PROVIDING TRAVEL INFORMATION AND TRAVEL GUIDE SERVICES; CONDUCTING AND ARRANGING SIGHTSEEING TOURS FOR OTHERS, IN CLASS 39 (U.S. CLS. 100 AND 105).

FIRST USE 4-0-2005; IN COMMERCE 4-0-2005.

THE MARK CONSISTS OF STANDARD CHARACTERS WITHOUT CLAIM TO ANY PARTICULAR FONT, STYLE, SIZE, OR COLOR.

OWNER OF U.S. REG. NOS. 1,335,489, 2,864,302, AND OTHERS.

SN 77-208,367, FILED 6-18-2007.

THEODORE MCBRIDE, EXAMINING ATTORNEY

Int. Cl.: 10

Prior U.S. Cls.: 26, 39, and 44

United States Patent and Trademark Office

Reg. No. 3,521,743

Registered Oct. 21, 2008

**TRADEMARK
PRINCIPAL REGISTER**

FOOTSPA

SKINCARE SYSTEMS, INC. (ILLINOIS CORPORATION)
119 WEST HUBBARD ST., SUITE 300
CHICAGO, IL 60610

THE MARK CONSISTS OF STANDARD CHARACTERS WITHOUT CLAIM TO ANY PARTICULAR FONT, STYLE, SIZE, OR COLOR.

FOR: LIGHT EMITTING DIODE MACHINE FOR ANTI-AGING AND PAIN MANAGEMENT, IN CLASS 10 (U.S. CLS. 26, 39 AND 44).

SN 77-208,466, FILED 6-18-2007.

FIRST USE 1-15-2008; IN COMMERCE 1-15-2008.

MARK PILARO, EXAMINING ATTORNEY

Int. Cl.: 5

Prior U.S. Cls.: 6, 18, 44, 46, 51, and 52

Reg. No. 3,521,744

United States Patent and Trademark Office

Registered Oct. 21, 2008

**TRADEMARK
PRINCIPAL REGISTER**

EZ MOVER

RIDLEY U.S. HOLDINGS, INC. (DELAWARE
CORPORATION)
424 NORTH RIVERFRONT DRIVE
MANKATO, MN 56002

THE MARK CONSISTS OF STANDARD CHAR-
ACTERS WITHOUT CLAIM TO ANY PARTICULAR
FONT, STYLE, SIZE, OR COLOR.

FOR: ANIMAL FEED SUPPLEMENTS, IN CLASS
5 (U.S. CLS. 6, 18, 44, 46, 51 AND 52).

SN 77-208,975, FILED 6-18-2007.

FIRST USE 7-10-2008; IN COMMERCE 8-15-2008.

LESLEY LAMOTHE, EXAMINING ATTORNEY

Int. Cl.: 28

Prior U.S. Cls.: 22, 23, 38, and 50

United States Patent and Trademark Office

Reg. No. 3,521,745

Registered Oct. 21, 2008

**TRADEMARK
PRINCIPAL REGISTER**

Biobait

BIOBAIT, INC. (ALABAMA CORPORATION)
BOX 1138 211 EAST PARK DRIVE
LIVINGSTON, AL 35470

FIRST USE 3-14-2003; IN COMMERCE 3-14-2003.

FOR: ARTIFICIAL FISHING BAIT; ARTIFICIAL FISHING LURES; ARTIFICIAL FISHING WORMS; FISHING LURE PARTS; FISHING LURES; FISHING LURES, NAMELY, LEECHES; FISHING LURES, NAMELY, PLASTIC WORMS; FISHING LURES, NAMELY, SPOONS; LURES FOR FISHING; SCENT LURES FOR HUNTING OR FISHING, IN CLASS 28 (U.S. CLS. 22, 23, 38 AND 50).

THE MARK CONSISTS OF STANDARD CHARACTERS WITHOUT CLAIM TO ANY PARTICULAR FONT, STYLE, SIZE, OR COLOR.

SN 77-209,378, FILED 6-19-2007.

JOHN KELLY, EXAMINING ATTORNEY

Int. Cls.: 19 and 20

Prior U.S. Cls.: 1, 2, 12, 13, 22, 25, 32, 33, and 50

United States Patent and Trademark Office

Reg. No. 3,521,746

Registered Oct. 21, 2008

**TRADEMARK
PRINCIPAL REGISTER**

CHINA GUOYA

GUOYA BAMBOO CANADA INC. (CANADA CORPORATION)
690 PROGRESS AVENUE, UNIT 13-14
SCARBOROUGH, CANADA M1H3A6

FOR: BAMBOO FLOORING; FLOOR BOARDS; FLOOR TILES OF WOOD; PARQUET WOOD FLOORING; WOODEN FLOORING; WOOD TILE FLOORS; WOOD TRIM; WOOD VENEER; WOOD PANELLING; WOOD BOARDS; WOOD BEAMS; WOOD MOLDINGS; BAMBOO BLINDS, IN CLASS 19 (U.S. CLS. 1, 12, 33 AND 50).

FIRST USE 2-8-2008; IN COMMERCE 2-8-2008.

FOR: SEATING FURNITURE; OUTDOOR FURNITURE; CHAIRS, SEATS, TABLES TOY BOXES; FURNITURE; DOORS FOR FURNITURE; FURNITURE CHESTS; FURNITURE, NAMELY, DRESSERS, WARDROBES, LIVING ROOM FURNITURE,

OFFICE FURNITURE, KITCHEN FURNITURE, NAMELY, READY TO ASSEMBLE MOBILE KITCHEN ISLANDS AND KITCHEN CABINETS, IN CLASS 20 (U.S. CLS. 2, 13, 22, 25, 32 AND 50).

FIRST USE 2-8-2008; IN COMMERCE 2-8-2008.

THE MARK CONSISTS OF STANDARD CHARACTERS WITHOUT CLAIM TO ANY PARTICULAR FONT, STYLE, SIZE, OR COLOR.

NO CLAIM IS MADE TO THE EXCLUSIVE RIGHT TO USE "CHINA", APART FROM THE MARK AS SHOWN.

SN 77-209,439, FILED 6-19-2007.

BENJAMIN OKEKE, EXAMINING ATTORNEY

Int. Cls.: 19 and 20

Prior U.S. Cls.: 1, 2, 12, 13, 22, 25, 32, 33, and 50

United States Patent and Trademark Office

Reg. No. 3,521,747

Registered Oct. 21, 2008

**TRADEMARK
PRINCIPAL REGISTER**



GUOYA BAMBOO CANADA INC. (CANADA CORPORATION)
690 PROGRESS AVENUE, UNIT 13-14
SCARBOROUGH, CANADA M1H3A6

FOR: BAMBOO FLOORING; FLOOR BOARDS; FLOOR TILES OF WOOD; PARQUET WOOD FLOORING; WOODEN FLOORING; WOOD TILE FLOORS; WOOD TRIM; WOOD VENEER; WOOD PANELLING; WOOD BOARDS; WOOD BEAMS; WOOD MOLDINGS; BAMBOO BLINDS, IN CLASS 19 (U.S. CLS. 1, 12, 33 AND 50).

FIRST USE 2-8-2008; IN COMMERCE 2-8-2008.

FOR: SEATING FURNITURE; OUTDOOR FURNITURE; CHAIRS, SEATS, TABLES, TOY BOXES;

FURNITURE; DOORS FOR FURNITURE; FURNITURE CHESTS; FURNITURE, NAMELY, DRESSERS, WARDROBES, LIVING ROOM FURNITURE, OFFICE FURNITURE, KITCHEN FURNITURE, NAMELY, READY TO ASSEMBLE MOBILE KITCHEN ISLANDS AND KITCHEN CABINETS, IN CLASS 20 (U.S. CLS. 2, 13, 22, 25, 32 AND 50).

FIRST USE 2-8-2008; IN COMMERCE 2-8-2008.

THE MARK CONSISTS OF AN "I" SHAPED OBJECT INSIDE A CIRCLE.

SN 77-209,492, FILED 6-19-2007.

BENJAMIN OKEKE, EXAMINING ATTORNEY

Int. Cl.: 9

Prior U.S. Cls.: 21, 23, 26, 36, and 38

Reg. No. 3,521,748

United States Patent and Trademark Office

Registered Oct. 21, 2008

**TRADEMARK
PRINCIPAL REGISTER**

RENEGADE

ETI SOUND SYSTEMS, INC. (CALIFORNIA CORPORATION)
3383 E. GAGE AVENUE
HUNTINGTON PARK, CA 90255

THE MARK CONSISTS OF STANDARD CHARACTERS WITHOUT CLAIM TO ANY PARTICULAR FONT, STYLE, SIZE, OR COLOR.

FOR: GUITAR AMPLIFIERS AND SPEAKERS, IN CLASS 9 (U.S. CLS. 21, 23, 26, 36 AND 38).

SN 77-210,046, FILED 6-20-2007.

FIRST USE 7-7-2008; IN COMMERCE 7-7-2008.

KIMBERLY PERRY, EXAMINING ATTORNEY

Int. Cl.: 28

Prior U.S. Cls.: 22, 23, 38, and 50

United States Patent and Trademark Office

Reg. No. 3,521,749

Registered Oct. 21, 2008

**TRADEMARK
PRINCIPAL REGISTER**

**So your pet can play the
organic way**

ECOVATIVE, LLC (CALIFORNIA LIMITED LIABILITY COMPANY)
9903 SANTA MONICA BLVD., #123
BEVERLY HILLS, CA 90212

THE MARK CONSISTS OF STANDARD CHARACTERS WITHOUT CLAIM TO ANY PARTICULAR FONT, STYLE, SIZE, OR COLOR.

FOR: PET TOYS, IN CLASS 28 (U.S. CLS. 22, 23, 38 AND 50).

SN 77-210,240, FILED 6-19-2007.

FIRST USE 8-1-2008; IN COMMERCE 8-1-2008.

GINA FINK, EXAMINING ATTORNEY

Int. Cl.: 5

Prior U.S. Cls.: 6, 18, 44, 46, 51, and 52

United States Patent and Trademark Office

Reg. No. 3,521,750

Registered Oct. 21, 2008

**TRADEMARK
PRINCIPAL REGISTER**

ABOVE & BELOW

THE ANDERSONS, INC. (OHIO CORPORATION)
480 W. DUSSEL DRIVE
MAUMEE, OH 43537

THE MARK CONSISTS OF STANDARD CHAR-
ACTERS WITHOUT CLAIM TO ANY PARTICULAR
FONT, STYLE, SIZE, OR COLOR.

FOR: INSECTICIDES, IN CLASS 5 (U.S. CLS. 6, 18,
44, 46, 51 AND 52).

SN 77-210,434, FILED 6-20-2007.

FIRST USE 3-5-2008; IN COMMERCE 3-5-2008.

ELLEN BURNS, EXAMINING ATTORNEY

Int. Cl.: 14

Prior U.S. Cls.: 2, 27, 28, and 50

United States Patent and Trademark Office

Reg. No. 3,521,751

Registered Oct. 21, 2008

**TRADEMARK
PRINCIPAL REGISTER**



GROSSMAN, DAVID D. (UNITED STATES INDIVIDUAL)
P.O. BOX 15
CALDWELL, NJ 07006 AND
GOLDBERG, DAVID B. (UNITED STATES INDIVIDUAL)
911 LORIEN DRIVE
AMBLER, PA 19002

FOR: JEWELRY, IN CLASS 14 (U.S. CLS. 2, 27, 28 AND 50).

FIRST USE 1-2-2008; IN COMMERCE 1-2-2008.

THE MARK CONSISTS OF STYLIZED LETTERS "DOJO LOGO" WITH TORRI, WHICH IS THE JAPANESE SYMBOL OF A GATEWAY TO A SHRINE, AS THE DESIGN ELEMENT ABOVE THE LETTERS.

SN 77-210,612, FILED 6-20-2007.

LESLEY LAMOTHE, EXAMINING ATTORNEY

Int. Cl.: 29

Prior U.S. Cl.: 46

United States Patent and Trademark Office

Reg. No. 3,521,752

Registered Oct. 21, 2008

**TRADEMARK
PRINCIPAL REGISTER**

**CRUNCHES LIKE AN APPLE,
TASTES LIKE A GRAPE**

RAINIER FRUIT COMPANY (WASHINGTON
CORPORATION)
P.O. BOX 189
SELAH, WA 98942

THE MARK CONSISTS OF STANDARD CHAR-
ACTERS WITHOUT CLAIM TO ANY PARTICULAR
FONT, STYLE, SIZE, OR COLOR.

FOR: FRUIT, NAMELY, APPLES PROCESSED TO
TASTE LIKE GRAPES; FLAVORED FRUIT, NAME-
LY, APPLES FLAVORED WITH GRAPE FLAVOR-
ING, IN CLASS 29 (U.S. CL. 46).

SN 77-210,661, FILED 6-20-2007.

FIRST USE 2-1-2008; IN COMMERCE 2-1-2008.

HEATHER SAPP, EXAMINING ATTORNEY

Int. Cls.: 9 and 42

Prior U.S. Cls.: 21, 23, 26, 36, 38, 100, and 101

United States Patent and Trademark Office

Reg. No. 3,521,753

Registered Oct. 21, 2008

**TRADEMARK
SERVICE MARK
PRINCIPAL REGISTER**

DO THE RIGHT THING, RIGHT

KIT SOLUTIONS, INC. (PENNSYLVANIA CORPORATION)
SUITE 530
5700 CORPORATE DRIVE
PITTSBURGH, PA 15237

FOR: SOFTWARE FOR MONITORING AND MEASURING ACCOUNTABILITY AND PERFORMANCE OUTCOMES AND PROVIDING INFORMATION AND KNOWLEDGE FOR IMPROVED DECISION MAKING AND TO IMPLEMENT BEST PRACTICES, FOR DATA GATHERING AND FOR REPORT GENERATION, ALL IN THE FIELD OF HEALTH AND HUMAN SERVICES, IN CLASS 9 (U.S. CLS. 21, 23, 26, 36 AND 38).

FIRST USE 6-30-2008; IN COMMERCE 6-30-2008.

FOR: APPLICATION SERVICE PROVIDER (ASP) FEATURING SOFTWARE IN THE FIELD OF HEALTH AND HUMAN SERVICES, FOR MONITORING AND MEASURING ACCOUNTABILITY, PERFORMANCE AND OUTCOMES, FOR DATA GATHERING AND FOR REPORT GENERATION, IN CLASS 42 (U.S. CLS. 100 AND 101).

FIRST USE 6-30-2008; IN COMMERCE 6-30-2008.

THE MARK CONSISTS OF STANDARD CHARACTERS WITHOUT CLAIM TO ANY PARTICULAR FONT, STYLE, SIZE, OR COLOR.

SN 77-210,889, FILED 6-20-2007.

ANNE MADDEN, EXAMINING ATTORNEY

Int. Cl.: 9

Prior U.S. Cls.: 21, 23, 26, 36, and 38

United States Patent and Trademark Office

Reg. No. 3,521,754

Registered Oct. 21, 2008

**TRADEMARK
PRINCIPAL REGISTER**

SimUText

SIMBIOTIC SOFTWARE FOR TEACHING & RE-
SEARCH, INC. (NEW YORK CORPORATION)
148 GRANDVIEW COURT
ITHACA, NY 14850

FOR: COMPUTER SOFTWARE PLATFORM
COMPRISING A CUSTOM-BUILT DATABASE AP-
PLICATION, A CLIENT SIDE APPLICATION THAT
REPLACES A WEB BROWSER, AND WEB INTER-
FACES FOR USE BY STUDENTS, TEACHERS, AND
AUTHORS WHICH PROVIDES INTERACTIVE SI-
MULATIONS, ANIMATIONS, AND OTHER INTER-
ACTIVE ELEMENTS, AND THE ABILITY TO
CREATE VIRTUAL TEXTBOOKS AND COMPLETE

ASSIGNMENTS, IN CLASS 9 (U.S. CLS. 21, 23, 26, 36
AND 38).

FIRST USE 6-0-2008; IN COMMERCE 6-0-2008.

THE MARK CONSISTS OF STANDARD CHAR-
ACTERS WITHOUT CLAIM TO ANY PARTICULAR
FONT, STYLE, SIZE, OR COLOR.

SN 77-210,909, FILED 6-20-2007.

ELLEN BURNS, EXAMINING ATTORNEY

Int. Cl.: 10

Prior U.S. Cls.: 26, 39, and 44

United States Patent and Trademark Office

Reg. No. 3,521,755

Registered Oct. 21, 2008

**TRADEMARK
PRINCIPAL REGISTER**

**GET TO THE HEART OF THE
PROBLEM**

CARDIONET, INC. (CALIFORNIA CORPORATION)
1010 SECOND AVENUE
SUITE 700
SAN DIEGO, CA 92101

THE MARK CONSISTS OF STANDARD CHARACTERS WITHOUT CLAIM TO ANY PARTICULAR FONT, STYLE, SIZE, OR COLOR.

FOR: MEDICAL DEVICES, NAMELY, ELECTRONIC CARDIAC MONITORS AND REMOTE SENSORS, IN CLASS 10 (U.S. CLS. 26, 39 AND 44).

SN 77-211,636, FILED 6-21-2007.

FIRST USE 10-9-2007; IN COMMERCE 10-9-2007.

KEVON CHISOLM, EXAMINING ATTORNEY

Int. Cls.: 35 and 36

Prior U.S. Cls.: 100, 101, and 102

United States Patent and Trademark Office

Reg. No. 3,521,756

Registered Oct. 21, 2008

**SERVICE MARK
PRINCIPAL REGISTER**

RELOCATOUR

PALIK, DAVID (UNITED STATES INDIVIDUAL)
3605 W. DALLAS
BROKEN ARROW, OK 74012

FOR: BUSINESS DEVELOPMENT SERVICES,
NAMELY, PROVIDING START-UP SUPPORT FOR
BUSINESSES OF OTHERS, IN CLASS 35 (U.S. CLS.
100, 101 AND 102).

FIRST USE 8-16-2008; IN COMMERCE 8-16-2008.

FOR: REAL ESTATE AGENCIES, IN CLASS 36
(U.S. CLS. 100, 101 AND 102).

FIRST USE 8-16-2008; IN COMMERCE 8-16-2008.

THE MARK CONSISTS OF STANDARD CHAR-
ACTERS WITHOUT CLAIM TO ANY PARTICULAR
FONT, STYLE, SIZE, OR COLOR.

SN 77-211,663, FILED 6-21-2007.

KEVON CHISOLM, EXAMINING ATTORNEY

Int. Cl.: 3

Prior U.S. Cls.: 1, 4, 6, 50, 51, and 52

Reg. No. 3,521,757

United States Patent and Trademark Office

Registered Oct. 21, 2008

**TRADEMARK
PRINCIPAL REGISTER**

SIFTED BLUR

COBALT BALLOON LLC (DELAWARE LIMITED
LIABILITY COMPANY)
10 EAST 53RD STREET, 34TH FLOOR
NEW YORK, NY 10022

THE MARK CONSISTS OF STANDARD CHAR-
ACTERS WITHOUT CLAIM TO ANY PARTICULAR
FONT, STYLE, SIZE, OR COLOR.

FOR: COSMETICS, IN CLASS 3 (U.S. CLS. 1, 4, 6, 50,
51 AND 52).

SN 77-211,795, FILED 6-21-2007.

FIRST USE 4-26-2008; IN COMMERCE 4-26-2008.

ELIZABETH KAJUBI, EXAMINING ATTORNEY

Int. Cl.: 41

Prior U.S. Cls.: 100, 101, and 107

United States Patent and Trademark Office

Reg. No. 3,521,758

Registered Oct. 21, 2008

**SERVICE MARK
PRINCIPAL REGISTER**

IDEAWORKS

ELYNX, LTD. (OHIO LIMITED LIABILITY COMPANY)
SUITE 200
7870 EAST KEMPER ROAD
CINCINNATI, OH 45249

FOR: CONDUCTING WORKSHOPS AND SEMINARS IN THE FIELD OF MORTGAGE INDUSTRY PRACTICES, IN CLASS 41 (U.S. CLS. 100, 101 AND 107).

FIRST USE 3-1-2005; IN COMMERCE 3-1-2005.

THE MARK CONSISTS OF STANDARD CHARACTERS WITHOUT CLAIM TO ANY PARTICULAR FONT, STYLE, SIZE, OR COLOR.

SN 77-211,977, FILED 6-21-2007.

JILL PRATER, EXAMINING ATTORNEY

Int. Cl.: 33

Prior U.S. Cls.: 47 and 49

United States Patent and Trademark Office

Reg. No. 3,521,759

Registered Oct. 21, 2008

**TRADEMARK
PRINCIPAL REGISTER**

BIG HOUSE PINK

THE WINE GROUP LLC (DELAWARE LIMITED
LIABILITY COMPANY)
4596 S. TRACY BOULEVARD
TRACY, CA 95377

THE MARK CONSISTS OF STANDARD CHAR-
ACTERS WITHOUT CLAIM TO ANY PARTICULAR
FONT, STYLE, SIZE, OR COLOR.

FOR: WINE, IN CLASS 33 (U.S. CLS. 47 AND 49).

SN 77-212,347, FILED 6-21-2007.

FIRST USE 8-11-2006; IN COMMERCE 8-11-2006.

CHERYL CLAYTON, EXAMINING ATTORNEY

Int. Cl.: 25

Prior U.S. Cls.: 22 and 39

United States Patent and Trademark Office

Reg. No. 3,521,760

Registered Oct. 21, 2008

**TRADEMARK
PRINCIPAL REGISTER**

N-FERNO

ERGODYNE CORPORATION (MINNESOTA
CORPORATION)
1021 BANDANA BOULEVARD EAST
SUITE 220
ST. PAUL, MN 55108

THE MARK CONSISTS OF STANDARD CHAR-
ACTERS WITHOUT CLAIM TO ANY PARTICULAR
FONT, STYLE, SIZE, OR COLOR.

FOR: HEAD WEAR; HEAD SCARVES; HEAD
SWEATBANDS, IN CLASS 25 (U.S. CLS. 22 AND 39).

SN 77-212,484, FILED 6-21-2007.

FIRST USE 6-1-2008; IN COMMERCE 6-1-2008.

BONNIE LUKEN, EXAMINING ATTORNEY

Int. Cls.: 9, 22, and 25

**Prior U.S. Cls.: 1, 2, 7, 19, 21, 22, 23, 26, 36, 38, 39, 42,
and 50**

Reg. No. 3,521,761

United States Patent and Trademark Office

Registered Oct. 21, 2008

**TRADEMARK
PRINCIPAL REGISTER**

BASIC ISSUE

ERGODYNE CORPORATION (MINNESOTA CORPORATION)
1021 BANDANA BOULEVARD EAST
SUITE 220
ST. PAUL, MN 55108

FOR: HIGHWAY SAFETY CONES; REFLECTIVE AND ILLUMINATED CLOTHING FOR SAFETY PURPOSES; SAFETY PRODUCTS, NAMELY, REFLECTIVE HELMET SKIRTS; SAFETY PRODUCTS, NAMELY, REFLECTIVE SAFETY BANDS TO BE WORN ON THE BODY; PROTECTIVE WORK GLOVES, IN CLASS 9 (U.S. CLS. 21, 23, 26, 36 AND 38).

FIRST USE 7-25-2008; IN COMMERCE 7-25-2008.

FOR: TARPAULINS, IN CLASS 22 (U.S. CLS. 1, 2, 7, 19, 22, 42 AND 50).

FIRST USE 7-25-2008; IN COMMERCE 7-25-2008.

FOR: RAIN BOOTS; RAIN COATS; RAIN JACKETS; RAIN SLICKERS; RAIN SUITS; RAIN TROUSERS; COVERALLS, IN CLASS 25 (U.S. CLS. 22 AND 39).

FIRST USE 7-25-2008; IN COMMERCE 7-25-2008.

THE MARK CONSISTS OF STANDARD CHARACTERS WITHOUT CLAIM TO ANY PARTICULAR FONT, STYLE, SIZE, OR COLOR.

SN 77-212,509, FILED 6-21-2007.

BONNIE LUKEN, EXAMINING ATTORNEY

Int. Cl.: 30

Prior U.S. Cl.: 46

United States Patent and Trademark Office

Reg. No. 3,521,762

Registered Oct. 21, 2008

**TRADEMARK
PRINCIPAL REGISTER**

WRAP ME UPS

FRESH INNOVATIONS CALIFORNIA, LLC (CALIFORNIA LIMITED LIABILITY COMPANY)
920 GARDEN STREET
C/O KOENIG & ASSOCIATES
SANTA BARBARA, CA 93101

FOR: PREPARED FOODS, NAMELY, TORTILLA WRAP SANDWICHES; SANDWICH WRAPS; WRAP SANDWICHES WITH, VEGETABLES, CONDIMENTS, CARROTS, LETTUCE, APPLES, AND SAUCES; STAPLE FOODS, NAMELY TORTILLAS CONTAINING INGREDIENTS OF VEGETABLES AND FRUIT; TORTILLAS AND WRAPS; SANDWICHES; PREPARED SANDWICHES; FOOD ITEMS, NAMELY, SANDWICH WRAPS; SPECIALLY PRE-

PARED TORTILLA FILLED WITH SALAD INGREDIENTS SUCH AS CARROTS, LETTUCE, APPLES, AND SALAD DRESSINGS, IN CLASS 30 (U.S. CL. 46).

FIRST USE 12-31-2007; IN COMMERCE 12-31-2007.

THE MARK CONSISTS OF STANDARD CHARACTERS WITHOUT CLAIM TO ANY PARTICULAR FONT, STYLE, SIZE, OR COLOR.

SN 77-212,659, FILED 6-21-2007.

AMY HELLA, EXAMINING ATTORNEY

Int. Cls.: 39 and 42

Prior U.S. Cls.: 100, 101, and 105

United States Patent and Trademark Office

Reg. No. 3,521,763

Registered Oct. 21, 2008

**SERVICE MARK
PRINCIPAL REGISTER**

QB DAP

QUALITYBUILT.COM (CALIFORNIA CORPORATION)
15330 AVENUE OF SCIENCE
SAN DIEGO, CA 92128

FOR: ELECTRONIC STORAGE OF FILES AND DOCUMENTS, IN CLASS 39 (U.S. CLS. 100 AND 105).

FIRST USE 10-31-2007; IN COMMERCE 10-31-2007.

FOR: PROVIDING ON-LINE NON-DOWNLOADABLE SOFTWARE FOR ACCESSING AND VIEWING ELECTRONIC COPIES OF DOCUMENTS, DOWNLOADING AND PRINTING COPIES OF DOCUMENTS, AND ORDERING COPIES OF DOCUMENTS FOR PHYSICAL DELIVERY, IN CLASS 42 (U.S. CLS. 100 AND 101).

FIRST USE 10-31-2007; IN COMMERCE 10-31-2007.

THE MARK CONSISTS OF STANDARD CHARACTERS WITHOUT CLAIM TO ANY PARTICULAR FONT, STYLE, SIZE, OR COLOR.

NO CLAIM IS MADE TO THE EXCLUSIVE RIGHT TO USE "DAP", APART FROM THE MARK AS SHOWN.

SN 77-212,670, FILED 6-21-2007.

AMY HELLA, EXAMINING ATTORNEY

Int. Cl.: 35

Prior U.S. Cls.: 100, 101, and 102

United States Patent and Trademark Office

Reg. No. 3,521,764

Registered Oct. 21, 2008

**SERVICE MARK
PRINCIPAL REGISTER**

SS

BROWNELLS, INC. (IOWA CORPORATION)
200 SOUTH FRONT
MONTEZUMA, IA 50171

THE MARK CONSISTS OF STANDARD CHAR-
ACTERS WITHOUT CLAIM TO ANY PARTICULAR
FONT, STYLE, SIZE, OR COLOR.

FOR: MAIL ORDER AND ONLINE ORDERING
SERVICES FEATURING GUNSMITHING AND
KNIFE MAKING TOOLS AND SUPPLIES, IN CLASS
35 (U.S. CLS. 100, 101 AND 102).

SN 77-213,423, FILED 6-22-2007.

FIRST USE 5-18-2007; IN COMMERCE 5-18-2007.

JASON TURNER, EXAMINING ATTORNEY

Int. Cls.: 3 and 4

Prior U.S. Cls.: 1, 4, 6, 15, 50, 51, and 52

United States Patent and Trademark Office

Reg. No. 3,521,765

Registered Oct. 21, 2008

**TRADEMARK
PRINCIPAL REGISTER**

RED CHÉRIE

THE THYMES, LLC (MINNESOTA LIMITED
LIABILITY COMPANY)
629 9TH STREET SE
MINNEAPOLIS, MN 55414

FOR: BATH SALTS, LIQUID FOAMING BATH,
BAR SOAP, BODY WASH, BODY SCRUB, BODY
LOTION, COLOGNE, HAND WASH, HAND LO-
TION; AND ROOM FRAGRANCES, NAMELY,
HOME FRAGRANCE MIST, IN CLASS 3 (U.S. CLS.
1, 4, 6, 50, 51 AND 52).

FIRST USE 1-31-2008; IN COMMERCE 1-31-2008.

FOR: CANDLES, NAMELY, POURED CANDLES,
IN CLASS 4 (U.S. CLS. 1, 6 AND 15).

FIRST USE 1-31-2008; IN COMMERCE 1-31-2008.

THE MARK CONSISTS OF STANDARD CHAR-
ACTERS WITHOUT CLAIM TO ANY PARTICULAR
FONT, STYLE, SIZE, OR COLOR.

SN 77-213,475, FILED 6-22-2007.

SHARON MEIER, EXAMINING ATTORNEY

Int. Cls.: 38 and 45

Prior U.S. Cls.: 100, 101, and 104

United States Patent and Trademark Office

Reg. No. 3,521,766

Registered Oct. 21, 2008

**SERVICE MARK
PRINCIPAL REGISTER**

MY.COM

MY ACQUISITION CORPORATION (NEW YORK CORPORATION)
44075 PIPELINE PLAZA, SUITE 320
ASHBURN, VA 20147

FOR: AUDIO AND VIDEO BROADCASTING SERVICES OVER THE INTERNET OR OTHER COMMUNICATIONS NETWORK; PROVIDING ON-LINE CHAT ROOMS AND ELECTRONIC BULLETIN BOARDS FOR TRANSMISSION OF MESSAGES AMONG USERS IN THE FIELD OF GENERAL INTEREST; PROVIDING ACCESS TO COMPUTER DATABASES; ELECTRONIC TRANSMISSION OF INSTANT MESSAGES AND DATA; PROVIDING ONLINE CHAT ROOMS FOR REGISTERED USERS FOR TRANSMISSION OF MESSAGES CONCERNING SOCIAL ACTIVITIES, HOBBIES, CLASSIFIEDS, ONLINE COMMUNITIES AND SOCIAL NETWORKING, IN CLASS 38 (U.S. CLS. 100, 101 AND 104).

FIRST USE 6-20-2007; IN COMMERCE 2-20-2008.

FOR: INTERNET BASED DATING, SOCIAL INTRODUCTION AND SOCIAL NETWORKING SERVICES; COMPUTER DATABASE ON DATING AND SOCIAL NETWORKING, IN CLASS 45 (U.S. CLS. 100 AND 101).

FIRST USE 6-20-2007; IN COMMERCE 2-20-2008.

THE MARK CONSISTS OF STANDARD CHARACTERS WITHOUT CLAIM TO ANY PARTICULAR FONT, STYLE, SIZE, OR COLOR.

SN 77-213,546, FILED 6-22-2007.

DOMINIC J. FERRAIUOLO, EXAMINING ATTORNEY

Int. Cl.: 35

Prior U.S. Cls.: 100, 101, and 102

United States Patent and Trademark Office

Reg. No. 3,521,767

Registered Oct. 21, 2008

**SERVICE MARK
PRINCIPAL REGISTER**



BROWNELLS, INC. (IOWA CORPORATION)
200 SOUTH FRONT
MONTEZUMA, IA 50171

FIRST USE 5-18-2007; IN COMMERCE 5-18-2007.

FOR: MAIL ORDER AND ONLINE ORDERING
SERVICES FEATURING GUNSMITHING AND
KNIFE MAKING TOOLS AND SUPPLIES, IN CLASS
35 (U.S. CLS. 100, 101 AND 102).

SN 77-213,551, FILED 6-22-2007.

JASON TURNER, EXAMINING ATTORNEY

Int. Cl.: 35

Prior U.S. Cls.: 100, 101, and 102

United States Patent and Trademark Office

Reg. No. 3,521,768

Registered Oct. 21, 2008

**SERVICE MARK
PRINCIPAL REGISTER**

Quest Effect

BENSON CONSULTING INC. (WASHINGTON
CORPORATION)
1412 SEACREST DR.
LUMMI ISLAND, WA 98262

THE MARK CONSISTS OF STANDARD CHAR-
ACTERS WITHOUT CLAIM TO ANY PARTICULAR
FONT, STYLE, SIZE, OR COLOR.

FOR: BUSINESS CONSULTATION SERVICES, IN
CLASS 35 (U.S. CLS. 100, 101 AND 102).

SN 77-213,841, FILED 6-23-2007.

FIRST USE 10-10-2006; IN COMMERCE 11-8-2007.

JENNY PARK, EXAMINING ATTORNEY

Int. Cl.: 5

Prior U.S. Cls.: 6, 18, 44, 46, 51, and 52

Reg. No. 3,521,769

United States Patent and Trademark Office

Registered Oct. 21, 2008

**TRADEMARK
PRINCIPAL REGISTER**

MELOZIDE

HMR CORPORATION (VIRGINIA CORPORATION)
P.O.BOX 11442
NORFOLK, VA 23517

THE MARK CONSISTS OF STANDARD CHARACTERS WITHOUT CLAIM TO ANY PARTICULAR FONT, STYLE, SIZE, OR COLOR.

FOR: HEMORRHOIDAL OINTMENTS, IN CLASS 5 (U.S. CLS. 6, 18, 44, 46, 51 AND 52).

SN 77-214,004, FILED 6-24-2007.

FIRST USE 7-20-2008; IN COMMERCE 8-1-2008.

ELIZABETH HUGHITT, EXAMINING ATTORNEY

Int. Cl.: 35

Prior U.S. Cls.: 100, 101, and 102

United States Patent and Trademark Office

Reg. No. 3,521,770

Registered Oct. 21, 2008

**SERVICE MARK
PRINCIPAL REGISTER**



MICHELLE LETENDRE HEDLUND (UNITED STATES INDIVIDUAL)
4337 WILSHIRE BOULEVARD
MOUND, MN 55364

FOR: ADVERTISING AGENCIES; ADVERTISING AND ADVERTISEMENT SERVICES, IN CLASS 35 (U.S. CLS. 100, 101 AND 102).

FIRST USE 6-30-2007; IN COMMERCE 6-30-2007.

NO CLAIM IS MADE TO THE EXCLUSIVE RIGHT TO USE ".COM", APART FROM THE MARK AS SHOWN.

THE COLOR(S) GREEN, WHITE AND GRAY IS/ARE CLAIMED AS A FEATURE OF THE MARK.

THE MARK CONSISTS OF A CIRCLE WHICH IS TWO SHADES OF GREEN WITH THE LOWERCASE LETTER "A" APPEARING IN WHITE INSIDE THE CIRCLE AND THE WORD "YOUR AND "AGENCY" AND ". COM" APPEARING IN GRAY WITH THE WORD "GREEN" APPEARING IN THE COLOR GREEN.

SN 77-214,006, FILED 6-24-2007.

NORA BUCHANAN WILL, EXAMINING ATTORNEY

Int. Cl.: 35

Prior U.S. Cls.: 100, 101, and 102

United States Patent and Trademark Office

Reg. No. 3,521,771

Registered Oct. 21, 2008

**SERVICE MARK
PRINCIPAL REGISTER**

empowerDocs

GLOBAL DOCUMENT SOLUTIONS CORPORATION (DELAWARE CORPORATION)
800 CENTRAL BOULEVARD
CARLSTADT, NJ 07072

FOR: COMPUTERIZED DATA MANAGEMENT FOR THE PRODUCTION OF BUSINESS REPORTS, BILLING AND OTHER RELATED STATEMENTS FOR OTHERS, IN CLASS 35 (U.S. CLS. 100, 101 AND 102).

FIRST USE 3-31-2008; IN COMMERCE 3-31-2008.

THE MARK CONSISTS OF STANDARD CHARACTERS WITHOUT CLAIM TO ANY PARTICULAR FONT, STYLE, SIZE, OR COLOR.

SN 77-214,127, FILED 6-25-2007.

ANNE MADDEN, EXAMINING ATTORNEY

Int. Cl.: 35

Prior U.S. Cls.: 100, 101, and 102

United States Patent and Trademark Office

Reg. No. 3,521,772

Registered Oct. 21, 2008

**SERVICE MARK
PRINCIPAL REGISTER**

RPX

RADAR LOGIC INCORPORATED (DELAWARE
CORPORATION)
379 W. BROADWAY, SUITE 401
NEW YORK, NY 10012

FOR: FINANCIAL SERVICES IN THE NATURE
OF AN INDEX CALCULATED FROM SALES PRICES
AND SQUARE FOOTAGE IN CLOSED REAL
ESTATE TRANSACTIONS, IN CLASS 35 (U.S. CLS.
100, 101 AND 102).

FIRST USE 9-14-2007; IN COMMERCE 9-14-2007.

THE MARK CONSISTS OF STANDARD CHARACTERS
WITHOUT CLAIM TO ANY PARTICULAR
FONT, STYLE, SIZE, OR COLOR.

SN 77-214,167, FILED 6-25-2007.

LESLEY LAMOTHE, EXAMINING ATTORNEY

Int. Cl.: 28

Prior U.S. Cls.: 22, 23, 38, and 50

United States Patent and Trademark Office

Reg. No. 3,521,773

Registered Oct. 21, 2008

**TRADEMARK
PRINCIPAL REGISTER**

TENEEZ

TENEEZ, INC. (FLORIDA CORPORATION)
1902 DREW STREET
CLEARWATER, FL 33765

THE MARK CONSISTS OF STANDARD CHAR-
ACTERS WITHOUT CLAIM TO ANY PARTICULAR
FONT, STYLE, SIZE, OR COLOR.

FOR: POUCH SPECIALLY DESIGNED FOR CAR-
RYING TENNIS BALLS ON PERSON WHILE PLAY-
ING TENNIS, IN CLASS 28 (U.S. CLS. 22, 23, 38 AND
50).

SN 77-214,200, FILED 6-25-2007.

FIRST USE 1-24-2008; IN COMMERCE 1-24-2008.

G. MAYERSCHOFF, EXAMINING ATTORNEY

Int. Cl.: 25

Prior U.S. Cls.: 22 and 39

United States Patent and Trademark Office

Reg. No. 3,521,774

Registered Oct. 21, 2008

**TRADEMARK
PRINCIPAL REGISTER**

THE PURSUIT OF HARMONY

SWEATER.COM APPAREL, INC. (DELAWARE CORPORATION)
1526 C. CLOVERFIELD BLVD.
SANTA MONICA, CA 90401

FOR: BELTS; BLOUSES; CAPS; COATS; COVER-UPS; DRESSES; FOOTWEAR; GLOVES; HATS; HOSIERY; JACKETS; JEANS; JUMPERS; KNIT SHIRTS; LEGGINGS; LINGERIE; LOUNGEWEAR; NECKWEAR; NIGHTWEAR; OVERALLS; PAJAMAS; PANTS; PULLOVERS; ROBES; SCARVES; SHORTS; SKIRTS; SKORTS; SLACKS; SOCKS; SUITS; SWEA-

TERS; SWIMWEAR; T-SHIRTS; TANK TOPS; VESTS; WRAPS; SHIRTS, IN CLASS 25 (U.S. CLS. 22 AND 39).

FIRST USE 1-1-2008; IN COMMERCE 2-1-2008.

THE MARK CONSISTS OF STANDARD CHARACTERS WITHOUT CLAIM TO ANY PARTICULAR FONT, STYLE, SIZE, OR COLOR.

SN 77-214,293, FILED 6-25-2007.

ALICE BENMAMAN, EXAMINING ATTORNEY

Int. Cls.: 9, 11, 12, and 17

Prior U.S. Cls.: 1, 5, 12, 13, 19, 21, 23, 26, 31, 34, 35, 36, 38, 44, and 50

Reg. No. 3,521,775

United States Patent and Trademark Office

Registered Oct. 21, 2008

**TRADEMARK
PRINCIPAL REGISTER**

PBC PRIMA BRAKE COMPONENTS

FLEETPRIDE, INC. (DELAWARE CORPORATION)
8708 TECHNOLOGY FOREST PLACE, SUITE 125
THE WOODLANDS, TX 77381

FOR: AIR BRAKE SYSTEM PARTS FOR LAND VEHICLES, NAMELY, AIR COMPRESSOR GOVERNORS AND AUTOMATIC DRAIN VALVES FOR DRAINING WATER OUT OF COMPRESSED AIR SYSTEMS, IN CLASS 9 (U.S. CLS. 21, 23, 26, 36 AND 38).

FIRST USE 7-9-2007; IN COMMERCE 7-26-2007.

FOR: AIR BRAKE SYSTEM PARTS FOR LAND VEHICLES, NAMELY, DRYER CARTRIDGES FOR THE REMOVAL OF WATER VAPOR FROM COMPRESSED AIR AND GASES; AND DRYERS USED FOR THE REMOVAL OF SOLID, LIQUID AND VAPOR CONTAMINANTS FROM COMPRESSED AIR AND GASES, IN CLASS 11 (U.S. CLS. 13, 21, 23, 31 AND 34).

FIRST USE 7-9-2007; IN COMMERCE 9-26-2007.

FOR: AIR BRAKE SYSTEM PARTS FOR LAND VEHICLES, NAMELY, AIR CYLINDERS FOR VEHICLES; VEHICLE AIR HORNS; LAND VEHICLE BRAKE AIR VALVES; VEHICLE AIR BRAKE

HOSES; TRUCK BRAKE COILED HOSES; GLAD HANDS, GLAD HAND HANDLES AND GLAD HAND SEALS FOR HOSE ASSEMBLIES IN THE NATURE OF COUPLING HOLDERS; AND HANDBRAKE KNOBS, IN CLASS 12 (U.S. CLS. 19, 21, 23, 31, 35 AND 44).

FIRST USE 7-9-2007; IN COMMERCE 7-26-2007.

FOR: AIR BRAKE SYSTEM PARTS FOR LAND VEHICLES, NAMELY, NYLON TUBING FOR USE WITH COMPRESSED AIR SYSTEMS, IN CLASS 17 (U.S. CLS. 1, 5, 12, 13, 35 AND 50).

FIRST USE 7-9-2007; IN COMMERCE 7-26-2007.

THE MARK CONSISTS OF STANDARD CHARACTERS WITHOUT CLAIM TO ANY PARTICULAR FONT, STYLE, SIZE, OR COLOR.

NO CLAIM IS MADE TO THE EXCLUSIVE RIGHT TO USE "BRAKE COMPONENTS", APART FROM THE MARK AS SHOWN.

SN 77-214,294, FILED 6-25-2007.

MARGERY A. TIERNEY, EXAMINING ATTORNEY

Int. Cl.: 25

Prior U.S. Cls.: 22 and 39

United States Patent and Trademark Office

Reg. No. 3,521,776

Registered Oct. 21, 2008

**TRADEMARK
PRINCIPAL REGISTER**



SWEATER.COM APPAREL, INC. (DELAWARE CORPORATION)
1526 C. CLOVERFIELD BLVD.
SANTA MONICA, CA 90401

FOR: BELTS; BLOUSES; CAPS; COATS; COVER-UPS; DRESSES; FOOTWEAR; GLOVES; HATS; HOSIERY; JACKETS; JEANS; JUMPERS; KNIT SHIRTS; LEGGINGS; LINGERIE; LOUNGEWEAR; NECKWEAR; NIGHTWEAR; OVERALLS; PAJAMAS; PANTS; PULLOVERS; ROBES; SCARVES; SHIRTS; SHORTS; SKIRTS; SKORTS; SOCKS; SUITS; SWEATERS; SWIM WEAR; T-SHIRTS; TANK TOPS; VESTS; WRAPS, IN CLASS 25 (U.S. CLS. 22 AND 39).

FIRST USE 1-1-2008; IN COMMERCE 2-1-2008.

THE MARK CONSISTS OF THE WORDS "THE PURSUIT" WRITTEN ABOVE THE WORDS "OF HARMONY" WHERE THE LETTER "O" IN "HARMONY" IS A HEART-SHAPED PEACE SIGN INSIDE A RECTANGLE MADE OF BROKEN LINES.

SN 77-214,318, FILED 6-25-2007.

ALICE BENMAMAN, EXAMINING ATTORNEY

Int. Cl.: 41

Prior U.S. Cls.: 100, 101, and 107

United States Patent and Trademark Office

Reg. No. 3,521,777

Registered Oct. 21, 2008

**SERVICE MARK
PRINCIPAL REGISTER**

SERVENTREPRENEUR

BEAL, MARY (UNITED STATES INDIVIDUAL)
3408 EDGEFIELD RD.
GREENSBORO, NC 27409

FOR: CHARITABLE SERVICES, NAMELY, PROVIDING BOOKS TO PEOPLE; CHARITABLE SERVICES, NAMELY, PROVIDING BOOKS TO PERSONS CONCERNING BUSINESS AND ENTREPRENEURSHIP COMBINED WITH SPIRITUAL OR RELIGIOUS PRINCIPLES AND TEACHINGS; CHARITABLE SERVICES, NAMELY, PROVIDING TRAINING IN THE FIELD OF BUSINESS AND ENTREPRENEURSHIP COMBINED WITH SPIRITUAL OR RELIGIOUS PRINCIPLES AND TEACHINGS; CONDUCTING WORKSHOPS AND SEMINARS IN PERSONAL AWARENESS; CONDUCTING WORKSHOPS AND SEMINARS IN SELF AWARENESS; CONDUCTING WORKSHOPS AND SEMINARS IN SELF-AWARENESS, LEADERSHIP, GROUP DYNAMICS, BUSINESS CONCEPTS, OR ENTREPRENEURSHIP COMBINED WITH SPIRITUAL OR RELIGIOUS PRINCIPLES AND TEACHINGS; EDUCATION SERVICES, NAMELY, PROVIDING WORKSHOPS, RETREATS AND CAMPS INVOLVING NATURE, FARMING, PLANTING, WILDERNESS EXERCISES, MISSIONARY PROJECTS OR SERVICES PROJECTS IN THE FIELD OF SELF-AWARENESS, LEADERSHIP, GROUP DYNAMICS, BUSINESS CONCEPTS, AND ENTREPRE-

NEURSHIP COMBINED WITH SPIRITUAL OR RELIGIOUS PRINCIPLES AND TEACHINGS; EDUCATIONAL SERVICES, NAMELY, CONDUCTING WORKSHOPS, RETREATS AND CAMPS INVOLVING NATURE, FARMING, PLANTING, WILDERNESS EXERCISES, MISSIONARY PROJECTS OR SERVICES PROJECTS IN THE FIELD OF SELF-AWARENESS, LEADERSHIP, GROUP DYNAMICS, BUSINESS CONCEPTS, AND ENTREPRENEURSHIP COMBINED WITH SPIRITUAL OR RELIGIOUS PRINCIPLES AND TEACHINGS AND DISTRIBUTION OF COURSE MATERIAL IN CONNECTION THEREWITH; WORKSHOPS AND SEMINARS IN THE FIELD OF SELF-AWARENESS, LEADERSHIP, GROUP DYNAMICS, BUSINESS CONCEPTS, AND ENTREPRENEURSHIP COMBINED WITH SPIRITUAL OR RELIGIOUS PRINCIPLES AND TEACHINGS, IN CLASS 41 (U.S. CLS. 100, 101 AND 107).

FIRST USE 3-26-2008; IN COMMERCE 3-26-2008.

THE MARK CONSISTS OF STANDARD CHARACTERS WITHOUT CLAIM TO ANY PARTICULAR FONT, STYLE, SIZE, OR COLOR.

SN 77-214,567, FILED 6-25-2007.

GIANCARLO CASTRO, EXAMINING ATTORNEY

Int. Cl.: 35

Prior U.S. Cls.: 100, 101, and 102

United States Patent and Trademark Office

Reg. No. 3,521,778

Registered Oct. 21, 2008

**SERVICE MARK
PRINCIPAL REGISTER**

HARLOW BOUTIQUE

HARLOW ENTERPRISES, LLC (CALIFORNIA
LIMITED LIABILITY COMPANY)
2930 BRISTOL STREET, SUITE A111
COSTA MESA, CA 92626

FOR: RETAIL STORE SERVICES IN THE FIELDS
OF CLOTHING, FASHION ACCESSORIES, SKIN
CARE AND PERSONAL CARE PRODUCTS, IN
CLASS 35 (U.S. CLS. 100, 101 AND 102).

FIRST USE 3-1-2006; IN COMMERCE 3-1-2006.

THE MARK CONSISTS OF STANDARD CHAR-
ACTERS WITHOUT CLAIM TO ANY PARTICULAR
FONT, STYLE, SIZE, OR COLOR.

NO CLAIM IS MADE TO THE EXCLUSIVE
RIGHT TO USE "BOUTIQUE", APART FROM THE
MARK AS SHOWN.

SN 77-214,667, FILED 6-25-2007.

KOURTNEE HODGES, EXAMINING ATTORNEY

Int. Cl.: 9

Prior U.S. Cls.: 21, 23, 26, 36, and 38

United States Patent and Trademark Office

Reg. No. 3,521,779

Registered Oct. 21, 2008

**TRADEMARK
PRINCIPAL REGISTER**

VIDEOSPIN

PINNACLE SYSTEMS, INC. (CALIFORNIA CORPORATION)
ATTN: TRADEMARK ADMINISTRATOR
C/O AVID TECHNOLOGY INC., ONE PARK WEST
TEWKSBURY, MA 01876

THE MARK CONSISTS OF STANDARD CHARACTERS WITHOUT CLAIM TO ANY PARTICULAR FONT, STYLE, SIZE, OR COLOR.

FOR: COMPUTER PROGRAMS FOR EDITING SOUND AND IMAGES, IN CLASS 9 (U.S. CLS. 21, 23, 26, 36 AND 38).

SN 77-214,788, FILED 6-25-2007.

FIRST USE 8-24-2007; IN COMMERCE 8-24-2007.

ODESSA BIBBINS, EXAMINING ATTORNEY

Int. Cl.: 43

Prior U.S. Cls.: 100 and 101

United States Patent and Trademark Office

Reg. No. 3,521,780

Registered Oct. 21, 2008

**SERVICE MARK
PRINCIPAL REGISTER**

Love Tacos

LOVE TACOS, INC. (CALIFORNIA CORPORATION)

5 CAPE DANBURY

NEWPORT BEACH, CA 92660

FOR: RESTAURANT AND BAR SERVICES, IN CLASS 43 (U.S. CLS. 100 AND 101).

FIRST USE 10-22-2007; IN COMMERCE 10-22-2007.

THE MARK CONSISTS OF STANDARD CHARACTERS WITHOUT CLAIM TO ANY PARTICULAR FONT, STYLE, SIZE, OR COLOR.

NO CLAIM IS MADE TO THE EXCLUSIVE RIGHT TO USE "TACOS", APART FROM THE MARK AS SHOWN.

SN 77-214,796, FILED 6-25-2007.

NICHOLAS ALTREE, EXAMINING ATTORNEY

Int. Cl.: 3

Prior U.S. Cls.: 1, 4, 6, 50, 51, and 52

United States Patent and Trademark Office

Reg. No. 3,521,781

Registered Oct. 21, 2008

**TRADEMARK
PRINCIPAL REGISTER**

SUN BREAK

AMIR, INC (MINNESOTA CORPORATION)

2755 HIGHWAY 55

EAGAN, MN 55121

FOR: TANNING LOTION AND SKIN MOISTURIZERS, IN CLASS 3 (U.S. CLS. 1, 4, 6, 50, 51 AND 52).

FIRST USE 11-30-2007; IN COMMERCE 11-30-2007.

THE MARK CONSISTS OF STANDARD CHARACTERS WITHOUT CLAIM TO ANY PARTICULAR FONT, STYLE, SIZE, OR COLOR.

NO CLAIM IS MADE TO THE EXCLUSIVE RIGHT TO USE "SUN", APART FROM THE MARK AS SHOWN.

SN 77-214,822, FILED 6-25-2007.

BENJAMIN ALLEN, EXAMINING ATTORNEY

Int. Cl.: 25

Prior U.S. Cls.: 22 and 39

United States Patent and Trademark Office

Reg. No. 3,521,782

Registered Oct. 21, 2008

**TRADEMARK
PRINCIPAL REGISTER**

W/O

SWELL COMMERCE, INC. (DELAWARE CORPORATION)
140 CALLE IGLESIA
SAN CLEMENTE, CA 92672

FOR: T-SHIRTS, WOVEN SHIRTS, KNIT SHIRTS, THERMAL SHIRTS, FLEECE SWEATSHIRTS, SWEATERS, TANK TOPS, JACKETS, DRESSES, WALK SHORTS, BOARD SHORTS, PANTS, DENIM PANTS, HATS, IN CLASS 25 (U.S. CLS. 22 AND 39).

FIRST USE 11-2-2007; IN COMMERCE 11-2-2007.

THE MARK CONSISTS OF STANDARD CHARACTERS WITHOUT CLAIM TO ANY PARTICULAR FONT, STYLE, SIZE, OR COLOR.

SN 77-215,100, FILED 6-25-2007.

HEATHER BIDDULPH, EXAMINING ATTORNEY

Int. Cl.: 12

Prior U.S. Cls.: 19, 21, 23, 31, 35, and 44

United States Patent and Trademark Office

Reg. No. 3,521,783

Registered Oct. 21, 2008

**TRADEMARK
PRINCIPAL REGISTER**

AERO WAVE

SMITH, TERRY D. (UNITED STATES INDIVIDUAL)
3405 W CHESTNUT
ROGERS, AR 72756

NO CLAIM IS MADE TO THE EXCLUSIVE RIGHT TO USE "AERO", APART FROM THE MARK AS SHOWN.

FOR: SEAPLANES, IN CLASS 12 (U.S. CLS. 19, 21, 23, 31, 35 AND 44).

SN 77-215,177, FILED 6-25-2007.

FIRST USE 8-0-2008; IN COMMERCE 8-0-2008.

THE MARK CONSISTS OF STANDARD CHARACTERS WITHOUT CLAIM TO ANY PARTICULAR FONT, STYLE, SIZE, OR COLOR.

AMOS T. MATTHEWS, JR., EXAMINING ATTORNEY

Int. Cl.: 9

Prior U.S. Cls.: 21, 23, 26, 36, and 38

Reg. No. 3,521,784

United States Patent and Trademark Office

Registered Oct. 21, 2008

**TRADEMARK
PRINCIPAL REGISTER**

SporkNET

BLOCK, BRADLEY (UNITED STATES INDIVIDUAL)
20354 GLEN BRAE DR
SARATOGA, CA 95070

FOR: BACKUP DRIVES FOR COMPUTERS; COMMUNICATIONS SERVERS; COMPUTER SOFTWARE THAT ASSISTS COMPUTERS IN DEPLOYING PARALLEL APPLICATIONS AND PERFORMING PARALLEL COMPUTATIONS; VPN (VIRTUAL PRIVATE NETWORK) OPERATING SOFTWARE, IN CLASS 9 (U.S. CLS. 21, 23, 26, 36 AND 38).

FIRST USE 7-6-1999; IN COMMERCE 7-6-1999.

THE MARK CONSISTS OF STANDARD CHARACTERS WITHOUT CLAIM TO ANY PARTICULAR FONT, STYLE, SIZE, OR COLOR.

SN 77-215,185, FILED 6-26-2007.

WON TEAK OH, EXAMINING ATTORNEY

Int. Cl.: 41

Prior U.S. Cls.: 100, 101, and 107

United States Patent and Trademark Office

Reg. No. 3,521,785

Registered Oct. 21, 2008

**SERVICE MARK
PRINCIPAL REGISTER**

CHILL

COMCAST CORPORATION (PENNSYLVANIA
CORPORATION)
1500 MARKET STREET
PHILADELPHIA, PA 19102

FOR: PROVIDING COMPUTER GAMES TO MO-
BILE PHONES, COMMUNICATION DEVICES AND
COMPUTERS VIA TELECOMMUNICATIONS AND
GLOBAL COMPUTER NETWORKS; PROVIDING
ONLINE COMPUTER GAMES VIA NETWORK BE-
TWEEN COMMUNICATIONS NETWORKS, COM-
PUTERS, MOBILE PHONES AND

COMMUNICATION DEVICES, IN CLASS 41 (U.S.
CLS. 100, 101 AND 107).

FIRST USE 12-20-2007; IN COMMERCE 12-20-2007.

THE MARK CONSISTS OF STANDARD CHAR-
ACTERS WITHOUT CLAIM TO ANY PARTICULAR
FONT, STYLE, SIZE, OR COLOR.

SN 77-215,288, FILED 6-26-2007.

ANNE E. GUSTASON, EXAMINING ATTORNEY

Int. Cl.: 43

Prior U.S. Cls.: 100 and 101

United States Patent and Trademark Office

Reg. No. 3,521,786

Registered Oct. 21, 2008

**SERVICE MARK
PRINCIPAL REGISTER**

Sonrisa

RAM INTERNATIONAL I, L.L.C. (WASHINGTON
LIMITED LIABILITY COMPANY)
10013 59TH AVE. SW
LAKEWOOD, WA 98499

FOR: RESTAURANT AND BAR SERVICES, IN
CLASS 43 (U.S. CLS. 100 AND 101).

FIRST USE 6-27-2007; IN COMMERCE 6-27-2007.

THE MARK CONSISTS OF STANDARD CHAR-
ACTERS WITHOUT CLAIM TO ANY PARTICULAR
FONT, STYLE, SIZE, OR COLOR.

THE ENGLISH TRANSLATION OF THE WORD
"SONRISA" IN THE MARK IS "SMILE."

SN 77-215,582, FILED 6-26-2007.

JULIE GUTTADAURO, EXAMINING ATTORNEY

Int. Cl.: 42

Prior U.S. Cls.: 100 and 101

United States Patent and Trademark Office

Reg. No. 3,521,787

Registered Oct. 21, 2008

**SERVICE MARK
PRINCIPAL REGISTER**

FATHOM CHANGE

KELLER, KRISTIN (UNITED STATES INDIVIDUAL)
10516 SUNLAND BLVD UNIT 7
SUNLAND, CA 91040 AND
REDMON, BRAD (UNITED STATES INDIVIDUAL)
10516 SUNLAND BLVD UNIT 7,
SUNLAND, CA 91040

FOR: DESIGN SERVICES FOR OTHERS IN THE
FIELDS OF INDUSTRIAL DESIGN, GRAPHIC ART
DESIGN, COMPUTER SITE DESIGN, DESIGN OF
CONSUMER PRODUCTS, PACKAGING DESIGN,

AND COMMERCIAL ART DESIGN, IN CLASS 42
(U.S. CLS. 100 AND 101).

FIRST USE 2-15-2007; IN COMMERCE 8-1-2007.

THE MARK CONSISTS OF STANDARD CHARACTERS WITHOUT CLAIM TO ANY PARTICULAR FONT, STYLE, SIZE, OR COLOR.

SN 77-215,699, FILED 6-26-2007.

JEAN IM, EXAMINING ATTORNEY

Int. Cl.: 24

Prior U.S. Cls.: 42 and 50

United States Patent and Trademark Office

Reg. No. 3,521,788

Registered Oct. 21, 2008

**TRADEMARK
PRINCIPAL REGISTER**

TOP TOWELS

THE L.L. CLEAN COMPANY (NEW JERSEY
CORPORATION)

32 ALPINE COURT

VOORHEES, NJ 08043

FOR: CLOTH TOWELS FOR CLEANING AND
POLISHING AUTOMOBILES, IN CLASS 24 (U.S.
CLS. 42 AND 50).

FIRST USE 6-2-2008; IN COMMERCE 6-2-2008.

THE MARK CONSISTS OF STANDARD CHAR-
ACTERS WITHOUT CLAIM TO ANY PARTICULAR
FONT, STYLE, SIZE, OR COLOR.

NO CLAIM IS MADE TO THE EXCLUSIVE
RIGHT TO USE "TOWELS", APART FROM THE
MARK AS SHOWN.

SN 77-215,702, FILED 6-26-2007.

MATTHEW MCDOWELL, EXAMINING ATTOR-
NEY

Int. Cl.: 25

Prior U.S. Cls.: 22 and 39

United States Patent and Trademark Office

Reg. No. 3,521,789

Registered Oct. 21, 2008

**TRADEMARK
PRINCIPAL REGISTER**

EARTH HAPPY

BEGUIRISTAIN, JOSE A. (UNITED STATES IN-
DIVIDUAL)
289 CARABELLA COURT
CORAL GABLES, FL 33143

THE MARK CONSISTS OF STANDARD CHAR-
ACTERS WITHOUT CLAIM TO ANY PARTICULAR
FONT, STYLE, SIZE, OR COLOR.

FOR: MEN'S, WOMEN'S AND CHILDREN'S AP-
PAREL, NAMELY, T-SHIRTS, IN CLASS 25 (U.S.
CLS. 22 AND 39).

SN 77-215,924, FILED 6-26-2007.

FIRST USE 2-19-2008; IN COMMERCE 2-19-2008.

NAKIA HENRY, EXAMINING ATTORNEY

Int. Cl.: 36

Prior U.S. Cls.: 100, 101, and 102

United States Patent and Trademark Office

Reg. No. 3,521,790

Registered Oct. 21, 2008

**SERVICE MARK
PRINCIPAL REGISTER**

SELECT UMA

CITIGROUP INC. (DELAWARE CORPORATION)
399 PARK AVENUE
NEW YORK, NY 10043

FOR: FINANCIAL SERVICES IN THE NATURE OF SECURITIES TRADING, INVESTMENT MANAGEMENT, INVESTMENT CONSULTING, FIDUCIARY MANAGEMENT, PRIVATE BANKING AND RETIREMENT PLANNING SERVICES; AND INSURANCE SERVICES IN THE NATURE OF ANNUITIES, IN CLASS 36 (U.S. CLS. 100, 101 AND 102).

FIRST USE 3-31-2008; IN COMMERCE 3-31-2008.

THE MARK CONSISTS OF STANDARD CHARACTERS WITHOUT CLAIM TO ANY PARTICULAR FONT, STYLE, SIZE, OR COLOR.

NO CLAIM IS MADE TO THE EXCLUSIVE RIGHT TO USE "UMA", APART FROM THE MARK AS SHOWN.

SN 77-215,955, FILED 6-26-2007.

HEATHER SAPP, EXAMINING ATTORNEY

Int. Cl.: 42

Prior U.S. Cls.: 100 and 101

United States Patent and Trademark Office

Reg. No. 3,521,791

Registered Oct. 21, 2008

**SERVICE MARK
PRINCIPAL REGISTER**

LDSJOURNAL

LDSJOURNAL, LTD. (NEVADA LIMITED LIABILITY COMPANY)
7435 S. EASTERN, #5-258
LAS VEGAS, NV 89123

THE MARK CONSISTS OF STANDARD CHARACTERS WITHOUT CLAIM TO ANY PARTICULAR FONT, STYLE, SIZE, OR COLOR.

FOR: HOSTING AND MAINTAINING AN ONLINE WEBSITE FOR OTHERS THAT ENABLES USERS TO KEEP A PRIVATE ONLINE JOURNAL, IN CLASS 42 (U.S. CLS. 100 AND 101).

SN 77-216,150, FILED 6-26-2007.

FIRST USE 3-4-2008; IN COMMERCE 3-4-2008.

JUDITH HELFMAN, EXAMINING ATTORNEY

Int. Cl.: 33

Prior U.S. Cls.: 47 and 49

United States Patent and Trademark Office

Reg. No. 3,521,792

Registered Oct. 21, 2008

**TRADEMARK
PRINCIPAL REGISTER**

FISTICUFFS

HOURLASS WINE COMPANY, INC. (CALIFOR-
NIA CORPORATION)
SUITE 103
1104 ADAMS STREET
ST. HELENA, CA 94574

THE MARK CONSISTS OF STANDARD CHAR-
ACTERS WITHOUT CLAIM TO ANY PARTICULAR
FONT, STYLE, SIZE, OR COLOR.

FOR: WINE, IN CLASS 33 (U.S. CLS. 47 AND 49).

SN 77-216,186, FILED 6-26-2007.

FIRST USE 6-23-2008; IN COMMERCE 6-23-2008.

JILL PRATER, EXAMINING ATTORNEY

Int. Cl.: 42

Prior U.S. Cls.: 100 and 101

United States Patent and Trademark Office

Reg. No. 3,521,793

Registered Oct. 21, 2008

**SERVICE MARK
PRINCIPAL REGISTER**

Life is Worth Recording

LDSJOURNAL, LTD. (NEVADA LIMITED LIABILITY COMPANY)
7435 S. EASTERN, #5-258
LAS VEGAS, NV 89123

FOR: HOSTING AND MAINTAINING AN ONLINE WEBSITE FOR OTHERS THAT ENABLES USERS TO KEEP A PRIVATE ONLINE JOURNAL, IN CLASS 42 (U.S. CLS. 100 AND 101).

FIRST USE 3-4-2008; IN COMMERCE 3-4-2008.

THE MARK CONSISTS OF STANDARD CHARACTERS WITHOUT CLAIM TO ANY PARTICULAR FONT, STYLE, SIZE, OR COLOR.

SN 77-216,212, FILED 6-26-2007.

JUDITH HELFMAN, EXAMINING ATTORNEY

Int. Cl.: 9

Prior U.S. Cls.: 21, 23, 26, 36, and 38

United States Patent and Trademark Office

Reg. No. 3,521,794

Registered Oct. 21, 2008

**TRADEMARK
PRINCIPAL REGISTER**

ROMAN DYNASTY

WMS GAMING INC. (DELAWARE CORPORATION)
800 SOUTH NORTHPOINT BOULEVARD
WAUKEGAN, IL 60085

FOR: GAMING MACHINES THAT GENERATE OR DISPLAY WAGER OUTCOMES; GAMING SOFTWARE THAT GENERATES OR DISPLAYS WAGER OUTCOMES OF GAMING MACHINES, IN CLASS 9 (U.S. CLS. 21, 23, 26, 36 AND 38).

FIRST USE 1-25-2008; IN COMMERCE 1-25-2008.

THE MARK CONSISTS OF STANDARD CHARACTERS WITHOUT CLAIM TO ANY PARTICULAR FONT, STYLE, SIZE, OR COLOR.

SN 77-217,526, FILED 6-28-2007.

ANNE MADDEN, EXAMINING ATTORNEY

Int. Cl.: 5

Prior U.S. Cls.: 6, 18, 44, 46, 51, and 52

United States Patent and Trademark Office

Reg. No. 3,521,795

Registered Oct. 21, 2008

**TRADEMARK
PRINCIPAL REGISTER**

UNICITY OASIS

UNICITY PROPERTIES, INC. (UTAH CORPORATION)
1201 N. 800 E.
OREM, UT 84097

THE MARK CONSISTS OF STANDARD CHARACTERS WITHOUT CLAIM TO ANY PARTICULAR FONT, STYLE, SIZE, OR COLOR.

FOR: DIETARY AND NUTRITIONAL SUPPLEMENTS; DIETARY SUPPLEMENTAL DRINKS, IN CLASS 5 (U.S. CLS. 6, 18, 44, 46, 51 AND 52).

SN 77-217,727, FILED 6-28-2007.

FIRST USE 9-1-2007; IN COMMERCE 10-1-2007.

STEPHANIE ALI, EXAMINING ATTORNEY

Int. Cl.: 11

Prior U.S. Cls.: 13, 21, 23, 31, and 34

United States Patent and Trademark Office

Reg. No. 3,521,796

Registered Oct. 21, 2008

**TRADEMARK
PRINCIPAL REGISTER**

MX

LEUPOLD & STEVENS, INC. (OREGON COR-
PORATION)
PO BOX 688
BEAVERTON, OR 97075

THE MARK CONSISTS OF STANDARD CHAR-
ACTERS WITHOUT CLAIM TO ANY PARTICULAR
FONT, STYLE, SIZE, OR COLOR.

FOR: FLASHLIGHTS, IN CLASS 11 (U.S. CLS. 13,
21, 23, 31 AND 34).

SN 77-218,514, FILED 6-28-2007.

FIRST USE 5-28-2008; IN COMMERCE 5-28-2008.

CHRISTINA SOBRAL, EXAMINING ATTORNEY

Int. Cl.: 35

Prior U.S. Cls.: 100, 101, and 102

United States Patent and Trademark Office

Reg. No. 3,521,797

Registered Oct. 21, 2008

**SERVICE MARK
PRINCIPAL REGISTER**

The Baer's Den

BAER, LESLIE (UNITED STATES INDIVIDUAL)
240 MEADOWGROVE LANE
MEMPHIS, TN 38120 AND
BAER, JEREMY (UNITED STATES INDIVIDUAL)
240 MEADOWGROVE LANE
MEMPHIS, TN 38120

FOR: RETAIL CLOTHING BOUTIQUES; RETAIL
CLOTHING STORES, IN CLASS 35 (U.S. CLS. 100, 101
AND 102).

FIRST USE 10-25-2007; IN COMMERCE 10-25-2007.

THE MARK CONSISTS OF STANDARD CHAR-
ACTERS WITHOUT CLAIM TO ANY PARTICULAR
FONT, STYLE, SIZE, OR COLOR.

SN 77-218,877, FILED 6-29-2007.

KELLY MCCOY, EXAMINING ATTORNEY

Int. Cl.: 21

Prior U.S. Cls.: 2, 13, 23, 29, 30, 33, 40, and 50

United States Patent and Trademark Office

Reg. No. 3,521,798

Registered Oct. 21, 2008

**TRADEMARK
PRINCIPAL REGISTER**

LOVE BOTTLE

MINNA YOO (UNITED STATES INDIVIDUAL)
1359 SILVER AVENUE
SAN FRANCISCO, CA 94134

FOR: HOUSEHOLD WATER AND BEVERAGE
CONTAINERS, NAMELY, BOTTLES SOLD EMPTY,
SPORTS BOTTLES SOLD EMPTY, JUGS, DECAN-
TERS, BOTTLE GOURDS, CUPS, MUGS, GOBLETS,
AND DRINKING GLASSES, IN CLASS 21 (U.S. CLS.
2, 13, 23, 29, 30, 33, 40 AND 50).

FIRST USE 4-22-2008; IN COMMERCE 4-22-2008.

THE MARK CONSISTS OF STANDARD CHAR-
ACTERS WITHOUT CLAIM TO ANY PARTICULAR
FONT, STYLE, SIZE, OR COLOR.

NO CLAIM IS MADE TO THE EXCLUSIVE
RIGHT TO USE "BOTTLE", APART FROM THE
MARK AS SHOWN.

SN 77-219,067, FILED 6-29-2007.

KELLY MCCOY, EXAMINING ATTORNEY

Int. Cl.: 20

Prior U.S. Cls.: 2, 13, 22, 25, 32, and 50

United States Patent and Trademark Office

Reg. No. 3,521,799

Registered Oct. 21, 2008

**TRADEMARK
PRINCIPAL REGISTER**

LONGITUDES

CBT SUPPLY, INC. (MARYLAND CORPORATION)
P.O. BOX
HIBERNIA, NJ 07842

THE MARK CONSISTS OF STANDARD CHARACTERS WITHOUT CLAIM TO ANY PARTICULAR FONT, STYLE, SIZE, OR COLOR.

FOR: OFFICE FURNITURE, IN CLASS 20 (U.S. CLS. 2, 13, 22, 25, 32 AND 50).

SN 77-219,408, FILED 6-29-2007.

FIRST USE 7-16-2008; IN COMMERCE 7-16-2008.

BRIAN NEVILLE, EXAMINING ATTORNEY

Int. Cl.: 20

Prior U.S. Cls.: 2, 13, 22, 25, 32, and 50

United States Patent and Trademark Office

Reg. No. 3,521,800

Registered Oct. 21, 2008

**TRADEMARK
PRINCIPAL REGISTER**

EQUATOR

CBT SUPPLY, INC. (MARYLAND CORPORATION)
P.O. BOX 391
HIBERNIA, NJ 07842

THE MARK CONSISTS OF STANDARD CHARACTERS WITHOUT CLAIM TO ANY PARTICULAR FONT, STYLE, SIZE, OR COLOR.

FOR: OFFICE FURNITURE, IN CLASS 20 (U.S. CLS. 2, 13, 22, 25, 32 AND 50).

SN 77-219,412, FILED 6-29-2007.

FIRST USE 7-16-2008; IN COMMERCE 7-16-2008.

BRIAN NEVILLE, EXAMINING ATTORNEY

Int. Cl.: 39

Prior U.S. Cls.: 100 and 105

United States Patent and Trademark Office

Reg. No. 3,521,801

Registered Oct. 21, 2008

**SERVICE MARK
PRINCIPAL REGISTER**

CELEBRITY GALAXY

CELEBRITY CRUISES INC. (LIBERIA CORPORATION)
1050 CARIBBEAN WAY
MIAMI, FL 33132

FOR: CRUISE SHIP SERVICES, ARRANGING AND CONDUCTING CRUISES FOR OTHERS, AND TRANSPORTATION OF PASSENGERS BY SHIP, IN CLASS 39 (U.S. CLS. 100 AND 105).

FIRST USE 5-15-2007; IN COMMERCE 5-15-2007.

THE MARK CONSISTS OF STANDARD CHARACTERS WITHOUT CLAIM TO ANY PARTICULAR FONT, STYLE, SIZE, OR COLOR.

OWNER OF U.S. REG. NOS. 1,677,067, 2,743,297, AND OTHERS.

SN 77-219,460, FILED 6-29-2007.

LINDA MICKLEBURGH, EXAMINING ATTORNEY

Int. Cl.: 35

Prior U.S. Cls.: 100, 101, and 102

United States Patent and Trademark Office

Reg. No. 3,521,802

Registered Oct. 21, 2008

**SERVICE MARK
PRINCIPAL REGISTER**

Funtastic Cities

SPOONAMORE KARLA A. (UNITED STATES
INDIVIDUAL)
50-701 WASHINGTON ST #513
LA QUINTA, CA 92253

FOR: ADVERTISING AND MARKETING; AD-
VERTISING AND PUBLICITY SERVICES, NAME-
LY, PROMOTING THE GOODS, SERVICES, BRAND
IDENTITY AND COMMERCIAL INFORMATION
AND NEWS OF THIRD PARTIES THROUGH
PRINT, AUDIO, VIDEO, DIGITAL AND ON-LINE
MEDIUM, IN CLASS 35 (U.S. CLS. 100, 101 AND 102).

FIRST USE 8-28-2007; IN COMMERCE 9-1-2007.

THE MARK CONSISTS OF STANDARD CHAR-
ACTERS WITHOUT CLAIM TO ANY PARTICULAR
FONT, STYLE, SIZE, OR COLOR.

SN 77-219,734, FILED 6-29-2007.

DOMINICK J. SALEMI, EXAMINING ATTORNEY

Int. Cl.: 7

Prior U.S. Cls.: 13, 19, 21, 23, 31, 34, and 35

Reg. No. 3,521,803

United States Patent and Trademark Office

Registered Oct. 21, 2008

**TRADEMARK
PRINCIPAL REGISTER**

COASTAL DRAGON

ELLICOTT DREDGES, LLC (MARYLAND LIMITED LIABILITY COMPANY)
1425 WICOMICO STREET
BALTIMORE, MD 21230

FOR: DREDGES, DREDGING MACHINES AND STRUCTURAL PARTS THEREOF, IN CLASS 7 (U.S. CLS. 13, 19, 21, 23, 31, 34 AND 35).

FIRST USE 11-0-2007; IN COMMERCE 11-0-2007.

THE MARK CONSISTS OF STANDARD CHARACTERS WITHOUT CLAIM TO ANY PARTICULAR FONT, STYLE, SIZE, OR COLOR.

OWNER OF U.S. REG. NOS. 586,574 AND 687,887.

SN 77-220,080, FILED 7-2-2007.

ELLEN BURNS, EXAMINING ATTORNEY

Int. Cl.: 25

Prior U.S. Cls.: 22 and 39

United States Patent and Trademark Office

Reg. No. 3,521,804

Registered Oct. 21, 2008

**TRADEMARK
PRINCIPAL REGISTER**

CACHÉ CONTOUR COLLECTION

CACHE, INC. (FLORIDA CORPORATION)
5TH FLOOR
1440 BROADWAY
NEW YORK, NY 10018

FOR: CLOTHING, NAMELY, TOPS, BOTTOMS,
JACKETS AND DRESSES, IN CLASS 25 (U.S. CLS. 22
AND 39).

FIRST USE 8-15-2007; IN COMMERCE 8-15-2007.

THE MARK CONSISTS OF STANDARD CHAR-
ACTERS WITHOUT CLAIM TO ANY PARTICULAR
FONT, STYLE, SIZE, OR COLOR.

OWNER OF U.S. REG. NOS. 1,194,124, 1,351,848,
AND 1,382,406.

NO CLAIM IS MADE TO THE EXCLUSIVE
RIGHT TO USE "COLLECTION", APART FROM
THE MARK AS SHOWN.

THE ENGLISH TRANSLATION OF THE WORD
"CACHÉ" IN THE MARK IS "HIDDEN" OR "CON-
CEALED".

SN 77-220,314, FILED 7-2-2007.

DAVID H. STINE, EXAMINING ATTORNEY

Int. Cl.: 25

Prior U.S. Cls.: 22 and 39

United States Patent and Trademark Office

Reg. No. 3,521,805

Registered Oct. 21, 2008

TRADEMARK
PRINCIPAL REGISTER

cache
contour
collection

CACHE, INC. (FLORIDA CORPORATION)
5TH FLOOR
1440 BROADWAY
NEW YORK, NY 10018

FOR: CLOTHING, NAMELY, TOPS, BOTTOMS,
JACKETS AND DRESSES, IN CLASS 25 (U.S. CLS. 22
AND 39).

FIRST USE 8-15-2007; IN COMMERCE 8-15-2007.

OWNER OF U.S. REG. NOS. 1,194,124, 1,351,848,
AND 1,382,406.

NO CLAIM IS MADE TO THE EXCLUSIVE
RIGHT TO USE "COLLECTION", APART FROM
THE MARK AS SHOWN.

THE ENGLISH TRANSLATION OF THE WORD
"CACHE" IN THE MARK IS "HIDDEN" OR "CON-
CEALED".

SN 77-220,319, FILED 7-2-2007.

DAVID H. STINE, EXAMINING ATTORNEY

Int. Cl.: 35

Prior U.S. Cls.: 100, 101, and 102

United States Patent and Trademark Office

Reg. No. 3,521,806

Registered Oct. 21, 2008

**SERVICE MARK
PRINCIPAL REGISTER**

**EXPRESS EMPLOYMENT
PROFESSIONALS**

EXPRESS FRANCHISE SERVICES, L.P. (TEXAS
LIMITED PARTNERSHIP)
8516 NORTHWEST EXPRESSWAY
OKLAHOMA CITY, OK 73162

FOR: PERSONNEL SERVICES, NAMELY, PROVIDING TEMPORARY EMPLOYMENT AGENCY SERVICES, FULL-TIME EMPLOYMENT AGENCY SERVICES, PROFESSIONAL STAFFING AGENCY SERVICES, CONTRACT STAFFING AGENCY SERVICES, JOB PLACEMENT SERVICES, HUMAN RESOURCE MANAGEMENT AND CONSULTATION SERVICES, EMPLOYMENT SEARCH AND PLACEMENT SERVICES, EXECUTIVE SEARCH AND PLACEMENT SERVICES, ADMINISTRATION OF BUSINESS PAYROLL FOR OTHERS; ACCOUNTING SERVICES; TAX CONSULTATION AND PREPARATION; FRANCHISING, NAMELY, CONSULTATION AND ASSISTANCE IN BUSINESS

MANAGEMENT, ORGANIZATION AND PROMOTION, IN CLASS 35 (U.S. CLS. 100, 101 AND 102).

FIRST USE 2-14-2008; IN COMMERCE 2-14-2008.

THE MARK CONSISTS OF STANDARD CHARACTERS WITHOUT CLAIM TO ANY PARTICULAR FONT, STYLE, SIZE, OR COLOR.

OWNER OF U.S. REG. NOS. 1,708,586, 2,225,130, AND OTHERS.

NO CLAIM IS MADE TO THE EXCLUSIVE RIGHT TO USE "EMPLOYMENT PROFESSIONALS", APART FROM THE MARK AS SHOWN.

SN 77-220,483, FILED 7-2-2007.

BILL DAWE, EXAMINING ATTORNEY

Int. Cl.: 3

Prior U.S. Cls.: 1, 4, 6, 50, 51, and 52

United States Patent and Trademark Office

Reg. No. 3,521,807

Registered Oct. 21, 2008

**TRADEMARK
PRINCIPAL REGISTER**

VERSA-FIX

BEAUTOPIA LLC (MINNESOTA LIMITED LIABILITY COMPANY)
3939 EAST 46TH STREET
MINNEAPOLIS, MN 55406

THE MARK CONSISTS OF STANDARD CHARACTERS WITHOUT CLAIM TO ANY PARTICULAR FONT, STYLE, SIZE, OR COLOR.

FOR: HAIR CARE PRODUCTS, NAMELY, SPRAY STYLING GEL, IN CLASS 3 (U.S. CLS. 1, 4, 6, 50, 51 AND 52).

SN 77-220,574, FILED 7-2-2007.

FIRST USE 1-1-2008; IN COMMERCE 1-1-2008.

CARYN GLASSER, EXAMINING ATTORNEY

Int. Cls.: 9, 16, 37, and 42

**Prior U.S. Cls.: 2, 5, 21, 22, 23, 26, 29, 36, 37, 38, 50,
100, 101, 103, and 106**

Reg. No. 3,521,808

United States Patent and Trademark Office

Registered Oct. 21, 2008

**TRADEMARK
SERVICE MARK
PRINCIPAL REGISTER**

New Town in a Box

WHITTAKER BUILDERS, INC. (MISSOURI CORPORATION)
3333-4 RUE ROYALE
ST. CHARLES, MO 63301

FOR: COMPUTER SOFTWARE FOR USE BY REAL ESTATE DEVELOPERS TO CONDUCT LAND DEVELOPMENT SERVICES, NAMELY, PLANNING AND LAYING OUT RESIDENTIAL AND COMMERCIAL PROPERTIES WITHIN A MULTIUSE COMMUNITY, IN CLASS 9 (U.S. CLS. 21, 23, 26, 36 AND 38).

FIRST USE 4-15-2008; IN COMMERCE 4-15-2008.

FOR: PRINTED MATERIALS, NAMELY, INSTRUCTIONAL MATERIALS, FORMS, BROCHURES, GUIDES, AND BOOKS FOR REAL ESTATE DEVELOPERS RELATING TO PLANNING AND LAYING OUT RESIDENTIAL AND COMMERCIAL PROPERTIES WITHIN A MULTIUSE COMMUNITY, IN CLASS 16 (U.S. CLS. 2, 5, 22, 23, 29, 37, 38 AND 50).

FIRST USE 4-15-2008; IN COMMERCE 4-15-2008.

FOR: PROVIDING CONSULTING SERVICES TO REAL ESTATE DEVELOPERS RELATING TO THE PLANNING AND LAYING OUT OF RESIDENTIAL

AND COMMERCIAL PROPERTIES WITHIN A MULTIUSE COMMUNITY AND CONSULTING SERVICES TO REAL ESTATE DEVELOPERS RELATING TO RESIDENTIAL AND COMMERCIAL REAL ESTATE DEVELOPMENT WITHIN A MULTIUSE COMMUNITY, IN CLASS 37 (U.S. CLS. 100, 103 AND 106).

FIRST USE 12-7-2006; IN COMMERCE 12-7-2006.

FOR: DESIGN OF BUILDING PLANS FOR USE BY OTHERS AND PROVIDING CUSTOMIZED BUILDING PLANS AND SPECIFICATIONS IN THE FIELD OF RESIDENTIAL AND COMMERCIAL DESIGN WITHIN A MULTIUSE COMMUNITY, IN CLASS 42 (U.S. CLS. 100 AND 101).

FIRST USE 4-15-2008; IN COMMERCE 4-15-2008.

THE MARK CONSISTS OF STANDARD CHARACTERS WITHOUT CLAIM TO ANY PARTICULAR FONT, STYLE, SIZE, OR COLOR.

OWNER OF U.S. REG. NO. 2,989,178.

SN 77-220,601, FILED 7-2-2007.

TEJBIR SINGH, EXAMINING ATTORNEY

Int. Cl.: 36

Prior U.S. Cls.: 100, 101, and 102

United States Patent and Trademark Office

Reg. No. 3,521,809

Registered Oct. 21, 2008

**SERVICE MARK
PRINCIPAL REGISTER**

SKISHARE

DICE, MATTHEW P. (UNITED STATES INDIVIDUAL)
5 GLADWYN DRIVE
OCEANVIEW, NJ 08230

FOR: APPRAISAL OF REAL ESTATE; ASSESSMENT AND MANAGEMENT OF REAL ESTATE; ESTATE PLANNING; ESTATE TRUST MANAGEMENT; EVALUATION OF REAL PROPERTY; FINANCIAL INVESTMENT IN THE FIELD OF REAL ESTATE; FINANCIAL SERVICES, NAMELY, ESTATE SETTLEMENT SERVICES; FINANCIAL VALUATION OF PERSONAL PROPERTY AND REAL ESTATE; HOUSING SERVICES, NAMELY, REAL PROPERTY ACQUISITION AND CONSUMER FINANCING TO FACILITATE HOME OWNERSHIP; LAND ACQUISITION, NAMELY, REAL ESTATE BROKERAGE; LEASING OF REAL ESTATE; LEASING OF REAL PROPERTY; PROVIDING INFORMATION IN THE FIELD OF REAL ESTATE BY MEANS OF LINKING THE WEB SITE TO OTHER WEB SITES FEATURING REAL ESTATE INFORMATION; PROVIDING INFORMATION IN THE FIELD OF REAL ESTATE VIA THE INTERNET; PROVIDING REAL ESTATE LISTINGS AND REAL ESTATE INFORMATION VIA THE INTERNET; REAL ESTATE ACQUISITION SERVICES; REAL ESTATE AGENCIES; REAL ESTATE APPRAISAL; REAL ESTATE BROKERAGE; REAL ESTATE CONSULTANCY; REAL ESTATE CONSULTATION; REAL ESTATE EQUITY SHARING, NAMELY, MANAGING AND ARRANGING FOR CO-OWNER-

SHIP OF REAL ESTATE; REAL ESTATE ESCROW SERVICES; REAL ESTATE INVESTMENT; REAL ESTATE INVESTMENT SERVICES IN THE NATURE OF PURCHASING AND SELLING OF REAL ESTATE FOR OTHERS; REAL ESTATE LENDING SERVICES; REAL ESTATE LISTING; REAL ESTATE MANAGEMENT; REAL ESTATE MANAGEMENT CONSULTATION; REAL ESTATE MULTIPLE LISTING SERVICES; REAL ESTATE PROCUREMENT FOR OTHERS; REAL ESTATE SERVICES, NAMELY, RENTAL OF VACATION HOMES, CONDOMINIUMS, CABINS, AND VILLAS USING PAY PER CLICK ADVERTISING ON A GLOBAL COMPUTER NETWORK; REAL ESTATE SYNDICATION; REAL ESTATE TIME-SHARING; REAL ESTATE VALUATION SERVICES; VACATION REAL ESTATE TIME SHARE EXCHANGE SERVICES; VACATION REAL ESTATE TIME-SHARING; VACATION REAL ESTATE TIMESHARE SERVICES, IN CLASS 36 (U.S. CLS. 100, 101 AND 102).

FIRST USE 5-27-2008; IN COMMERCE 5-27-2008.

THE MARK CONSISTS OF STANDARD CHARACTERS WITHOUT CLAIM TO ANY PARTICULAR FONT, STYLE, SIZE, OR COLOR.

SN 77-220,616, FILED 7-2-2007.

TEJBIR SINGH, EXAMINING ATTORNEY

Int. Cl.: 42

Prior U.S. Cls.: 100 and 101

United States Patent and Trademark Office

Reg. No. 3,521,810

Registered Oct. 21, 2008

**SERVICE MARK
PRINCIPAL REGISTER**



AVIX, LLC (MASSACHUSETTS LIMITED LIABILITY COMPANY)
804 MAIN STREET
OSTERVILLE, MA 02655

FOR: DESIGN AND DEVELOPMENT OF NETWORKS FOR THE DELIVERY OF AUDIO/VIDEO MEDIA AND FOR HOME AUTOMATION, IN CLASS 42 (U.S. CLS. 100 AND 101).

THE MARK CONSISTS OF THE WORD AVIX WITH A CRESCENT-LIKE FIGURE EXTENDING ABOVE IT AND FORMING THE DOT ABOVE THE "I" AND ONE STROKE OF THE "X".

SN 77-220,623, FILED 7-2-2007.

FIRST USE 5-31-2005; IN COMMERCE 5-31-2005.

STEVEN R. FOSTER, EXAMINING ATTORNEY

Int. Cl.: 44

Prior U.S. Cls.: 100 and 101

United States Patent and Trademark Office

Reg. No. 3,521,811

Registered Oct. 21, 2008

**SERVICE MARK
PRINCIPAL REGISTER**

PERFUME PERSONALIZED

ARAMIS INC. (DELAWARE CORPORATION)
767 FIFTH AVENUE
NEW YORK, NY 10153

FOR: PROVIDING INFORMATION ABOUT BEAUTY REGARDING THE SELECTION AND USE OF PERFUMERY, FRAGRANCE FOR PERSONAL USE, COLOGNE AND EAU DE TOILETTE; BEAUTY CONSULTATION SERVICES IN THE FIELD OF SELECTION AND USE OF PERFUMERY, FRAGRANCE FOR PERSONAL USE, COLOGNE AND EAU DE TOILETTE, IN CLASS 44 (U.S. CLS. 100 AND 101).

FIRST USE 8-13-2008; IN COMMERCE 8-13-2008.

THE MARK CONSISTS OF STANDARD CHARACTERS WITHOUT CLAIM TO ANY PARTICULAR FONT, STYLE, SIZE, OR COLOR.

NO CLAIM IS MADE TO THE EXCLUSIVE RIGHT TO USE "PERFUME", APART FROM THE MARK AS SHOWN.

SN 77-220,657, FILED 7-2-2007.

SUSAN LESLIE DUBOIS, EXAMINING ATTORNEY

Int. Cl.: 40

Prior U.S. Cls.: 100, 103, and 106

United States Patent and Trademark Office

Reg. No. 3,521,812

Registered Oct. 21, 2008

**SERVICE MARK
PRINCIPAL REGISTER**



SCZECH, MATT (UNITED STATES INDIVIDUAL)
821 KNIGHTS BRIDGE DR.
ISLAND LAKE, IL 60042

FOR: CREATION OF CUSTOM ARTWORK FOR OTHERS FEATURING CUSTOM PAINTINGS AND CUSTOM ARTWORK APPLIED TO SKATEBOARDS AND CLOTHING, IN CLASS 40 (U.S. CLS. 100, 103 AND 106).

FIRST USE 8-17-2008; IN COMMERCE 8-17-2008.

NO CLAIM IS MADE TO THE EXCLUSIVE RIGHT TO USE "CREATIONS", APART FROM THE MARK AS SHOWN.

THE MARK CONSISTS OF THE WORD "SLAPASS" IN BUBBLE LETTERS, POSITIONED ABOVE THE WORD "CREATIONS".

SN 77-220,976, FILED 7-2-2007.

EDWARD NELSON, EXAMINING ATTORNEY

Int. Cl.: 16

Prior U.S. Cls.: 2, 5, 22, 23, 29, 37, 38, and 50

Reg. No. 3,521,813

United States Patent and Trademark Office

Registered Oct. 21, 2008

**TRADEMARK
PRINCIPAL REGISTER**

Know Me Love Me

EADIN COMPANY, LLC (GEORGIA LIMITED
LIABILITY COMPANY)
9122 STONECREST DRIVE
LOUISVILLE, KY 40272

FOR: BLANK CARDS ADAPTED SUCH THAT A
USER CAN ENTER INFORMATION INDICATIVE
OF DESIRED GIFTS AND INFORMATION RELA-
TED TO INDIVIDUALS AND DESIRED GIFTS , IN
CLASS 16 (U.S. CLS. 2, 5, 22, 23, 29, 37, 38 AND 50).

FIRST USE 5-0-2005; IN COMMERCE 8-0-2008.

THE MARK CONSISTS OF STANDARD CHAR-
ACTERS WITHOUT CLAIM TO ANY PARTICULAR
FONT, STYLE, SIZE, OR COLOR.

SN 77-221,551, FILED 7-3-2007.

TEJBIR SINGH, EXAMINING ATTORNEY

Int. Cl.: 44

Prior U.S. Cls.: 100 and 101

United States Patent and Trademark Office

Reg. No. 3,521,814

Registered Oct. 21, 2008

**SERVICE MARK
PRINCIPAL REGISTER**



SMITH, LAWRENCE (UNITED STATES INDIVIDUAL)
SUITE 105
641 UNIVERSITY BLVD
JUPITER, FL 33480

FOR: PHYSICIAN SERVICES, IN CLASS 44 (U.S. CLS. 100 AND 101).

FIRST USE 11-12-2007; IN COMMERCE 11-12-2007.

THE COLOR(S) BLUE, BLACK, WHITE AND RED IS/ARE CLAIMED AS A FEATURE OF THE MARK.

THE COLOR BLUE APPEARS IN THE GRAPH AND THE ANIMATED FACE, THE COLOR BLACK APPEARS IN THE STETHOSCOPE, THE CROSS, AND THE ANIMATED FACE, THE COLOR WHITE APPEARS IN THE CROSS, THE STETHOSCOPE AND THE FACE, THE COLOR RED APPEARS IN THE HEART AND THE FACE.

SN 77-221,780, FILED 7-3-2007.

SHANNON TWOHIG, EXAMINING ATTORNEY

Int. Cl.: 30

Prior U.S. Cl.: 46

United States Patent and Trademark Office

Reg. No. 3,521,815

Registered Oct. 21, 2008

**TRADEMARK
PRINCIPAL REGISTER**

FriendlyCeuticals

OMMAHA, MICHAEL (UNITED STATES INDIVIDUAL)
7825 SANTA MONICA BLVD.
WEST HOLLYWOOD, CA 90046

THE MARK CONSISTS OF STANDARD CHARACTERS WITHOUT CLAIM TO ANY PARTICULAR FONT, STYLE, SIZE, OR COLOR.

FOR: HERBAL FOOD BEVERAGES; PASTRIES; ICE CREAM, IN CLASS 30 (U.S. CL. 46).

SN 77-221,806, FILED 7-3-2007.

FIRST USE 3-0-2007; IN COMMERCE 3-0-2007.

STEPHEN AQUILA, EXAMINING ATTORNEY

Int. Cl.: 19

Prior U.S. Cls.: 1, 12, 33, and 50

Reg. No. 3,521,816

United States Patent and Trademark Office

Registered Oct. 21, 2008

**TRADEMARK
PRINCIPAL REGISTER**



DOLMIT LLC (NEW YORK LIMITED LIABILITY COMPANY)
35 CARLOUGH ROAD, UNIT #3
BOHEMIA, NY 11716

FOR: BRICK SIDING COMPONENTS, NAMELY, BRICK AND MORTAR, IN CLASS 19 (U.S. CLS. 1, 12, 33 AND 50).

FIRST USE 1-7-2004; IN COMMERCE 1-7-2004.

THE COLOR(S) WHITE, COPPER, BROWN AND BLACK IS/ARE CLAIMED AS A FEATURE OF THE MARK.

THE MARK CONSISTS OF THREE ROWS OF RECTANGULAR BLOCKS STACKED INTO THE

SHAPE OF A TRIANGLE; ONE BRICK IS ON THE TOP ROW, TWO BRICKS ON THE MIDDLE ROW AND THREE BRICKS ON THE BOTTOM ROW; THE COLOR OF EACH INDIVIDUAL BRICK INCREASES FROM A FADING LIGHT COPPER ON THE LEFT EDGE TO A BROWN ON THE RIGHT GIVING THE APPEARANCE THAT THE BRICKS ARE MOVING; THE MARK HAS A WHITE BACKGROUND AND WHITE SEPARATES THE INDIVIDUAL BRICKS, ROWS OF BRICKS AND THE LITERAL ELEMENT FROM THE BOTTOM ROW OF BRICKS. THE TERM "BRICKIT" APPEARS IN BLACK TRIMMED IN BROWN.

SN 77-222,111, FILED 7-4-2007.

MARK T. MULLEN, EXAMINING ATTORNEY

Int. Cl.: 3

Prior U.S. Cls.: 1, 4, 6, 50, 51, and 52

United States Patent and Trademark Office

Reg. No. 3,521,817

Registered Oct. 21, 2008

**TRADEMARK
PRINCIPAL REGISTER**

**STRIXADERM-MD S.O.S. DARK
CIRCLES AND BAGS**

PURE SOURCE, INC. (FLORIDA CORPORATION)
9750 NW 17TH STREET
MIAMI, FL 33172

FOR: SKIN CREAMS, IN CLASS 3 (U.S. CLS. 1, 4, 6, 50, 51 AND 52).

FIRST USE 3-3-2008; IN COMMERCE 3-3-2008.

THE MARK CONSISTS OF STANDARD CHARACTERS WITHOUT CLAIM TO ANY PARTICULAR FONT, STYLE, SIZE, OR COLOR.

OWNER OF U.S. REG. NO. 2,911,168.

NO CLAIM IS MADE TO THE EXCLUSIVE RIGHT TO USE "DARK CIRCLES AND BAGS", APART FROM THE MARK AS SHOWN.

SN 77-222,193, FILED 7-5-2007.

GILBERT SWIFT, EXAMINING ATTORNEY

Int. Cl.: 3

Prior U.S. Cls.: 1, 4, 6, 50, 51, and 52

United States Patent and Trademark Office

Reg. No. 3,521,818

Registered Oct. 21, 2008

**TRADEMARK
PRINCIPAL REGISTER**

**STRIXADERM-MD S.O.S.
CELLULITE**

PURE SOURCE, INC. (FLORIDA CORPORATION)
9750 NW 17TH STREET
MIAMI, FL 33172

FOR: SKIN CREAMS, IN CLASS 3 (U.S. CLS. 1, 4, 6, 50, 51 AND 52).

FIRST USE 3-3-2008; IN COMMERCE 3-3-2008.

THE MARK CONSISTS OF STANDARD CHARACTERS WITHOUT CLAIM TO ANY PARTICULAR FONT, STYLE, SIZE, OR COLOR.

OWNER OF U.S. REG. NO. 2,911,168.

NO CLAIM IS MADE TO THE EXCLUSIVE RIGHT TO USE "CELLULITE", APART FROM THE MARK AS SHOWN.

SN 77-222,197, FILED 7-5-2007.

GILBERT SWIFT, EXAMINING ATTORNEY

Int. Cl.: 3

Prior U.S. Cls.: 1, 4, 6, 50, 51, and 52

United States Patent and Trademark Office

Reg. No. 3,521,819

Registered Oct. 21, 2008

**TRADEMARK
PRINCIPAL REGISTER**

STRIXADERM-MD S.O.S.

PURE SOURCE, INC. (FLORIDA CORPORATION)
9750 NW 17TH STREET
MIAMI, FL 33172

FOR: SKIN CREAMS, IN CLASS 3 (U.S. CLS. 1, 4, 6,
50, 51 AND 52).

FIRST USE 3-3-2008; IN COMMERCE 3-3-2008.

THE MARK CONSISTS OF STANDARD CHARACTERS WITHOUT CLAIM TO ANY PARTICULAR FONT, STYLE, SIZE, OR COLOR.

OWNER OF U.S. REG. NO. 2,911,168.

SN 77-222,200, FILED 7-5-2007.

GILBERT SWIFT, EXAMINING ATTORNEY

Int. Cl.: 3

Prior U.S. Cls.: 1, 4, 6, 50, 51, and 52

United States Patent and Trademark Office

Reg. No. 3,521,820

Registered Oct. 21, 2008

**TRADEMARK
PRINCIPAL REGISTER**

STRIXADERM

PURE SOURCE, INC. (FLORIDA CORPORATION)
9750 NW 17TH STREET
MIAMI, FL 33172

FOR: SKIN CREAMS, IN CLASS 3 (U.S. CLS. 1, 4, 6,
50, 51 AND 52).

FIRST USE 3-3-2008; IN COMMERCE 3-3-2008.

THE MARK CONSISTS OF STANDARD CHARACTERS WITHOUT CLAIM TO ANY PARTICULAR FONT, STYLE, SIZE, OR COLOR.

OWNER OF U.S. REG. NO. 2,911,168.

SN 77-222,204, FILED 7-5-2007.

GILBERT SWIFT, EXAMINING ATTORNEY

Int. Cls.: 9, 25, and 41

Prior U.S. Cls.: 21, 22, 23, 26, 36, 38, 39, 100, 101, and 107

Reg. No. 3,521,821

United States Patent and Trademark Office

Registered Oct. 21, 2008

**TRADEMARK
SERVICE MARK
PRINCIPAL REGISTER**

Within The Eddy

RIVER GORGE ENTERPRISES, INCORPORATED
(TENNESSEE CORPORATION)
4116 WESTLIN AVE.
SHERMAN OAKS, CA 91423

FOR: PRE-RECORDED SOUND RECORDINGS AND DOWNLOADABLE PRE-RECORDED SOUND RECORDINGS ALL FEATURING PERFORMANCES OF A MUSICAL GROUP, IN CLASS 9 (U.S. CLS. 21, 23, 26, 36 AND 38).

FIRST USE 5-11-2007; IN COMMERCE 6-10-2007.

FOR: CLOTHING, NAMELY, T-SHIRTS, LONG SLEEVE SHIRTS, TANK TOPS, SHORT SLEEVE SHIRTS, 3/4 SLEEVE SHIRTS, BUTTON DOWN SHIRTS, SWEATSHIRTS, HOODED SWEATSHIRTS, JACKETS, SLEEVELESS JACKETS, PANTS, JEANS, CAPRIS, SWEAT PANTS, CARGO SHORTS, SHORTS, SKIRTS, DRESSES, BRAS, PANTIES, UNDERWEAR, HATS, KNIT HATS, BEANIE CAPS,

BANDANAS, DO RAGS, SWEATBANDS, SOCKS, BELTS AND SHOES , IN CLASS 25 (U.S. CLS. 22 AND 39).

FIRST USE 5-11-2007; IN COMMERCE 1-23-2008.

FOR: ENTERTAINMENT SERVICES, NAMELY, LIVE PERFORMANCES BY A MUSICAL GROUP, IN CLASS 41 (U.S. CLS. 100, 101 AND 107).

FIRST USE 5-11-2007; IN COMMERCE 1-23-2008.

THE MARK CONSISTS OF STANDARD CHARACTERS WITHOUT CLAIM TO ANY PARTICULAR FONT, STYLE, SIZE, OR COLOR.

SN 77-222,477, FILED 7-5-2007.

PAUL CROWLEY, EXAMINING ATTORNEY

Int. Cls.: 41 and 43

Prior U.S. Cls.: 100, 101, and 107

United States Patent and Trademark Office

Reg. No. 3,521,822

Registered Oct. 21, 2008

**SERVICE MARK
PRINCIPAL REGISTER**

THE BANK

DDD HOLDINGS, LLC (DELAWARE LIMITED
LIABILITY COMPANY)
6276 S. RAINBOW BOULEVARD
STE. 120
LAS VEGAS, NV 89118

FOR: NIGHTCLUB SERVICES, IN CLASS 41 (U.S.
CLS. 100, 101 AND 107).

FIRST USE 12-31-2007; IN COMMERCE 12-31-2007.

FOR: RESTAURANT, BAR, AND COCKTAIL
LOUNGE SERVICES, IN CLASS 43 (U.S. CLS. 100
AND 101).

FIRST USE 12-31-2007; IN COMMERCE 12-31-2007.

THE MARK CONSISTS OF STANDARD CHAR-
ACTERS WITHOUT CLAIM TO ANY PARTICULAR
FONT, STYLE, SIZE, OR COLOR.

SN 77-223,040, FILED 7-5-2007.

B. PARADEWELAI, EXAMINING ATTORNEY

Int. Cl.: 7

Prior U.S. Cls.: 13, 19, 21, 23, 31, 34, and 35

Reg. No. 3,521,823

United States Patent and Trademark Office

Registered Oct. 21, 2008

**TRADEMARK
PRINCIPAL REGISTER**



LEE, YU-CHUN (TAIWAN INDIVIDUAL)
DA-AN DISTRICT
B2-13, NO. 225, SEC. 1, DUNHUA S. RD.
TAIPEI, TAIWAN

FOR: INDUSTRIAL ROBOTS, IN CLASS 7 (U.S.
CLS. 13, 19, 21, 23, 31, 34 AND 35).

FIRST USE 3-21-2008; IN COMMERCE 3-21-2008.

THE APPLICANT CLAIMS COLOR AS A FEAT-
URE OF THE MARK, NAMELY, WHITE, GRAY,
BLACK, YELLOW.

THE MARK CONSISTS OF THE WORD "LATTE"
IN WHITE AND BLACK WITH A GRAY SQUARE IN
THE BACKGROUND. "BOX" IS UNDERNEATH
"LATTE" IN GRAY WITH THE COLOR YELLOW
COMING OUT OF THE "O".

SN 77-223,188, FILED 7-6-2007.

THEODORE MCBRIDE, EXAMINING ATTORNEY

Int. Cl.: 38

Prior U.S. Cls.: 100, 101, and 104

United States Patent and Trademark Office

Reg. No. 3,521,824

Registered Oct. 21, 2008

**SERVICE MARK
PRINCIPAL REGISTER**

WATCHOT

LEE, YU-CHUN (TAIWAN INDIVIDUAL)
DA-AN DISTRICT
B2-13, NO. 225, SEC. 1, DUNHUA S. RD.
TAIPEI, TAIWAN

FOR: AUDIO AND VIDEO BROADCASTING
SERVICES OVER THE INTERNET; ELECTRONIC,
ELECTRIC, AND DIGITAL TRANSMISSION OF
VOICE, DATA, IMAGES, SIGNALS, AND MESSA-
GES , IN CLASS 38 (U.S. CLS. 100, 101 AND 104).

FIRST USE 5-1-2008; IN COMMERCE 5-1-2008.

THE MARK CONSISTS OF STANDARD CHAR-
ACTERS WITHOUT CLAIM TO ANY PARTICULAR
FONT, STYLE, SIZE, OR COLOR.

SN 77-223,191, FILED 7-6-2007.

THEODORE MCBRIDE, EXAMINING ATTORNEY

Int. Cl.: 28

Prior U.S. Cls.: 22, 23, 38, and 50

United States Patent and Trademark Office

Reg. No. 3,521,825

Registered Oct. 21, 2008

**TRADEMARK
PRINCIPAL REGISTER**

"NOT!"

NOT! INCORPORATED, LLC (GEORGIA LIMITED LIABILITY COMPANY)
P.O. BOX 857
CARROLLTON, GA 30112

THE MARK CONSISTS OF STANDARD CHARACTERS WITHOUT CLAIM TO ANY PARTICULAR FONT, STYLE, SIZE, OR COLOR.

FOR: CARD GAMES, IN CLASS 28 (U.S. CLS. 22, 23, 38 AND 50).

SN 77-223,373, FILED 7-6-2007.

FIRST USE 4-9-2008; IN COMMERCE 4-9-2008.

GINA FINK, EXAMINING ATTORNEY

Int. Cl.: 30

Prior U.S. Cl.: 46

United States Patent and Trademark Office

Reg. No. 3,521,826

Registered Oct. 21, 2008

**TRADEMARK
PRINCIPAL REGISTER**

COCONUT PLEASURE

THE ALLAN CANDY COMPANY LIMITED (CA-
NADA CORPORATION)

3 ROBERT SPECK PARKWAY

SUITE 250

MISSISSAUGA, ONTARIO L4Z2G5

FOR: CANDY, IN CLASS 30 (U.S. CL. 46).

FIRST USE 10-12-2007; IN COMMERCE 10-12-2007.

THE MARK CONSISTS OF STANDARD CHAR-
ACTERS WITHOUT CLAIM TO ANY PARTICULAR
FONT, STYLE, SIZE, OR COLOR.

NO CLAIM IS MADE TO THE EXCLUSIVE
RIGHT TO USE "COCONUT", APART FROM THE
MARK AS SHOWN.

SN 77-223,470, FILED 7-6-2007.

G. MAYERSCHOFF, EXAMINING ATTORNEY

Int. Cl.: 42

Prior U.S. Cls.: 100 and 101

United States Patent and Trademark Office

Reg. No. 3,521,827

Registered Oct. 21, 2008

**SERVICE MARK
PRINCIPAL REGISTER**

bardom

BARDOM.COM, LLC (FLORIDA LIMITED LIABILITY COMPANY)
1107 KEY PLAZA #300
KEY WEST, FL 33040

FOR: COMPUTER SERVICES, NAMELY, HOSTING AND MAINTAINING AN ONLINE WEBSITE FOR OTHERS TO ORGANIZE AND CONDUCT ONLINE MEETINGS, GATHERINGS, AND INTERACTIVE DISCUSSIONS; AND COMPUTER SERVICES IN THE NATURE OF CUSTOMIZED WEB PAGES FEATURING USER-DEFINED INFORMA-

TION, PERSONAL PROFILES AND INFORMATION, IN CLASS 42 (U.S. CLS. 100 AND 101).

FIRST USE 9-1-2008; IN COMMERCE 9-1-2008.

THE MARK CONSISTS OF STANDARD CHARACTERS WITHOUT CLAIM TO ANY PARTICULAR FONT, STYLE, SIZE, OR COLOR.

SN 77-223,608, FILED 7-6-2007.

RICHARD A. STRASER, EXAMINING ATTORNEY

Int. Cl.: 30

Prior U.S. Cl.: 46

United States Patent and Trademark Office

Reg. No. 3,521,828

Registered Oct. 21, 2008

**TRADEMARK
PRINCIPAL REGISTER**

COOL GHOUL'S

MARS, INCORPORATED (DELAWARE COR-
PORATION)
6885 ELM STREET
MCLEAN, VA 22101

THE MARK CONSISTS OF STANDARD CHAR-
ACTERS WITHOUT CLAIM TO ANY PARTICULAR
FONT, STYLE, SIZE, OR COLOR.

FOR: CONFECTIONERY PRODUCT, NAMELY,
CANDY, IN CLASS 30 (U.S. CL. 46).

SN 77-223,656, FILED 7-6-2007.

FIRST USE 7-7-2008; IN COMMERCE 7-7-2008.

HEATHER THOMPSON, EXAMINING ATTORNEY

Int. Cl.: 9

Prior U.S. Cls.: 21, 23, 26, 36, and 38

United States Patent and Trademark Office

Reg. No. 3,521,829

Registered Oct. 21, 2008

**TRADEMARK
PRINCIPAL REGISTER**

oneClickCGH

INFOQUANT LTD (UNITED KINGDOM COR-
PORATION)
SUITE 326
8 SHEPHERD MARKET
LONDON, UNITED KINGDOM W1J7JY

FOR: COMPUTER SOFTWARE FOR USE IN
BIOTECHNOLOGY, PHARMACEUTICAL AND
MEDICAL DIAGNOSTICS, IN CLASS 9 (U.S. CLS.
21, 23, 26, 36 AND 38).

FIRST USE 10-3-2007; IN COMMERCE 2-1-2008.

THE MARK CONSISTS OF STANDARD CHAR-
ACTERS WITHOUT CLAIM TO ANY PARTICULAR
FONT, STYLE, SIZE, OR COLOR.

SN 77-224,057, FILED 7-7-2007.

SUSAN LESLIE DUBOIS, EXAMINING ATTORNEY

Int. Cl.: 37

Prior U.S. Cls.: 100, 103, and 106

United States Patent and Trademark Office

Reg. No. 3,521,830

Registered Oct. 21, 2008

**SERVICE MARK
PRINCIPAL REGISTER**

JOYOUNG

SHANDONG JOYOUNG HOUSEHOLD ELECTRICAL APPLIANCES CO., LTD. (CHINA CORPORATION)
HUAIYINQU MEILIHU KAIFU GONGYE-CHENG
JINAN CITY, SHANDONG
250021, CHINA

FOR: INSTALLATION OF KITCHEN APPLIANCES; INSTALLATION OF ELECTRICAL APPLIANCES; CONSTRUCTION AND REPAIR OF BUILDINGS; UPHOLSTERING; INSTALLATION, REPAIR AND MAINTENANCE OF HEATING EQUIPMENT; REPAIR OR MAINTENANCE OF OFFICE MACHINES AND APPARATUS; MAINTENANCE AND REPAIR OF COMPUTER HARDWARE; PHOTOGRAPHIC APPARATUS REPAIR;

INSTALLATION AND REPAIR OF AIR CONDITIONING APPARATUS, IN CLASS 37 (U.S. CLS. 100, 103 AND 106).

FIRST USE 4-1-1994; IN COMMERCE 9-10-2000.

THE MARK CONSISTS OF STANDARD CHARACTERS WITHOUT CLAIM TO ANY PARTICULAR FONT, STYLE, SIZE, OR COLOR.

"JOYOUNG" DOES NOT IDENTIFY A LIVING INDIVIDUAL.

SN 77-224,335, FILED 7-9-2007.

MATTHEW PAPPAS, EXAMINING ATTORNEY

Int. Cl.: 7

Prior U.S. Cls.: 13, 19, 21, 23, 31, 34, and 35

Reg. No. 3,521,831

United States Patent and Trademark Office

Registered Oct. 21, 2008

**TRADEMARK
PRINCIPAL REGISTER**

LATTEBOX

LEE, YU-CHUN (TAIWAN INDIVIDUAL)
DA-AN DISTRICT
B2-13, NO. 225, SEC. 1, DUNHUA S. RD.
TAIPEI, TAIWAN

THE MARK CONSISTS OF STANDARD CHAR-
ACTERS WITHOUT CLAIM TO ANY PARTICULAR
FONT, STYLE, SIZE, OR COLOR.

FOR: INDUSTRIAL ROBOTS, IN CLASS 7 (U.S.
CLS. 13, 19, 21, 23, 31, 34 AND 35).

SN 77-224,372, FILED 7-9-2007.

FIRST USE 3-21-2008; IN COMMERCE 3-21-2008.

THEODORE MCBRIDE, EXAMINING ATTORNEY

Int. Cl.: 9

Prior U.S. Cls.: 21, 23, 26, 36, and 38

Reg. No. 3,521,832

United States Patent and Trademark Office

Registered Oct. 21, 2008

**TRADEMARK
PRINCIPAL REGISTER**



SONY CORPORATION (JAPAN CORPORATION)
1-7-1 KONAN, MINATO-KU
TOKYO, JAPAN

FOR: DIGITAL STILL CAMERAS; VIDEO CAM-
ERAS; PHOTOGRAPH PRINTERS, IN CLASS 9 (U.S.
CLS. 21, 23, 26, 36 AND 38).

FIRST USE 2-28-2007; IN COMMERCE 2-28-2007.

NO CLAIM IS MADE TO THE EXCLUSIVE
RIGHT TO USE "FACE DETECTION", APART
FROM THE MARK AS SHOWN.

THE MARK CONSISTS OF THE WORDS "FACE
DETECTION" WITH A HIGHLY STYLIZED DESIGN
OF A FACE WITHIN A RECTANGLE.

SN 77-224,532, FILED 7-9-2007.

KAPIL BHANOT, EXAMINING ATTORNEY

Int. Cl.: 42

Prior U.S. Cls.: 100 and 101

United States Patent and Trademark Office

Reg. No. 3,521,833

Registered Oct. 21, 2008

**SERVICE MARK
PRINCIPAL REGISTER**

**PROTECT YOUR
IDENTITY...DON'T LEAVE A
TRACE**

KEMESA LLC (FLORIDA LIMITED LIABILITY
COMPANY)

#1502

3201 N.E. 183RD STREET

AVENTURA, FL 33160

FOR: ON-LINE SECURITY SERVICES, NAMELY,
PROVIDING PROTECTION AGAINST THEFT OF
PERSONAL IDENTITY INFORMATION DURING
ON-LINE PURCHASE TRANSACTIONS AND PRO-
VIDING PROTECTION AGAINST ANONYMOUS
EMAILS, AND THEFT OF PASSWORDS AND USER

IDS WHEN REGISTERING ON WEBSITES, IN
CLASS 42 (U.S. CLS. 100 AND 101).

FIRST USE 3-31-2008; IN COMMERCE 3-31-2008.

THE MARK CONSISTS OF STANDARD CHAR-
ACTERS WITHOUT CLAIM TO ANY PARTICULAR
FONT, STYLE, SIZE, OR COLOR.

SN 77-224,533, FILED 7-9-2007.

AMY HELLA, EXAMINING ATTORNEY

Int. Cl.: 25

Prior U.S. Cls.: 22 and 39

United States Patent and Trademark Office

Reg. No. 3,521,834

Registered Oct. 21, 2008

**TRADEMARK
PRINCIPAL REGISTER**

TwoBirds.OneStone

WILLIAMS, CLARK (UNITED STATES INDIVIDUAL)
9570 IDEL WEISS
BAINBRIDGE ISLAND, WA 98110

FOR: CASUAL CLOTHING, NAMELY, SHIRTS AND PANTS, IN CLASS 25 (U.S. CLS. 22 AND 39).

FIRST USE 6-21-2008; IN COMMERCE 6-21-2008.

THE MARK CONSISTS OF STANDARD CHARACTERS WITHOUT CLAIM TO ANY PARTICULAR FONT, STYLE, SIZE, OR COLOR.

SN 77-224,561, FILED 7-9-2007.

KATHERINE M. DUBRAY, EXAMINING ATTORNEY

Int. Cls.: 35, 36, 37, 39, and 42

Prior U.S. Cls.: 100, 101, 102, 103, 105, and 106

United States Patent and Trademark Office

Reg. No. 3,521,835

Registered Oct. 21, 2008

**SERVICE MARK
PRINCIPAL REGISTER**



MANHEIM AUCTIONS, INC. (DELAWARE CORPORATION)
6205 PEACHTREE DUNWOODY ROAD
ATLANTA, GA 30328

FOR: AUTOMOBILE AUCTION SERVICES; AUTOMOBILE AUCTION SERVICES PROVIDED VIA THE INTERNET, IN CLASS 35 (U.S. CLS. 100, 101 AND 102).

FIRST USE 6-20-2008; IN COMMERCE 6-20-2008.

FOR: AUTOMOBILE FINANCING SERVICES, IN CLASS 36 (U.S. CLS. 100, 101 AND 102).

FIRST USE 6-20-2008; IN COMMERCE 6-20-2008.

FOR: AUTOMOTIVE DETAILING, RECONDITIONING, REPAIR, CONVERSION AND CUSTOMIZATION SERVICES, IN CLASS 37 (U.S. CLS. 100, 103 AND 106).

FIRST USE 6-20-2008; IN COMMERCE 6-20-2008.

FOR: BUSINESS-TO-BUSINESS AUTOMOTIVE TRANSPORTATION AND STORAGE SERVICES, IN CLASS 39 (U.S. CLS. 100 AND 105).

FIRST USE 6-20-2008; IN COMMERCE 6-20-2008.

FOR: AUTOMOBILE INSPECTION SERVICES, IN CLASS 42 (U.S. CLS. 100 AND 101).

FIRST USE 6-20-2008; IN COMMERCE 6-20-2008.

OWNER OF U.S. REG. NOS. 1,699,332, 3,229,428, AND OTHERS.

NO CLAIM IS MADE TO THE EXCLUSIVE RIGHT TO USE "DALLAS-FORT WORTH", APART FROM THE MARK AS SHOWN.

THE COLOR(S) GOLD, BLUE, GREEN, YELLOW, BROWN, GREY, WHITE AND BLACK IS/ARE CLAIMED AS A FEATURE OF THE MARK.

THE MARK CONSISTS OF A GOLD "M" OVER A BLUE CIRCULAR BACKGROUND AND WITHIN TWO GOLD OUTER RINGS. THE COLOR BROWN OUTLINES THE MARK. TO THE RIGHT OF THE M IS THE WORD "MANHEIM" IN THE COLOR BLACK. A BLACK LINE SEPARATES THE ABOVE DESIGN AND THE WORD "MANHEIM" AND THE WORDS "DALLAS - FORT WORTH" IN THE COLOR BLACK AND DESIGN OF A STAR IN THE COLOR WHITE INSIDE A WHITE CIRCLE WITH A SMALLER YELLOW STAR ON THE WHITE STAR AND TWO YELLOW STARS ON EACH SIDE OF THE WHITE CIRCLE ON A GREEN BACKGROUND, INSIDE CONCENTRIC WHITE AND GREY SQUARES TO THE RIGHT OF THE WORDS "DALLAS - FORT WORTH".

SN 77-224,894, FILED 7-9-2007.

GRETTA YAO, EXAMINING ATTORNEY

Int. Cl.: 30

Prior U.S. Cl.: 46

United States Patent and Trademark Office

Reg. No. 3,521,836

Registered Oct. 21, 2008

**TRADEMARK
PRINCIPAL REGISTER**

CRYSTAL FARMS

CRYSTAL FARMS REFRIGERATED DISTRIBUTION COMPANY (MINNESOTA CORPORATION)

301 CARLSON PARKWAY
SUITE 400
MINNETONKA, MN 55305

FOR: REFRIGERATED ENGLISH MUFFINS FOR RETAIL SALE AT GROCERY STORES, IN CLASS 30 (U.S. CL. 46).

FIRST USE 2-28-1989; IN COMMERCE 2-28-1989.

THE MARK CONSISTS OF STANDARD CHARACTERS WITHOUT CLAIM TO ANY PARTICULAR FONT, STYLE, SIZE, OR COLOR.

OWNER OF U.S. REG. NOS. 1,515,593 AND 2,091,007.

NO CLAIM IS MADE TO THE EXCLUSIVE RIGHT TO USE "FARMS", APART FROM THE MARK AS SHOWN.

SN 77-224,904, FILED 7-9-2007.

BRIAN CALLAGHAN, EXAMINING ATTORNEY

Int. Cl.: 9

Prior U.S. Cls.: 21, 23, 26, 36, and 38

Reg. No. 3,521,837

United States Patent and Trademark Office

Registered Oct. 21, 2008

**TRADEMARK
PRINCIPAL REGISTER**

THUNDERHAWK

WMS GAMING INC. (DELAWARE CORPORATION)
800 SOUTH NORTHPOINT BOULEVARD
WAUKEGAN, IL 60085

FOR: GAMING MACHINES THAT GENERATE OR DISPLAY WAGER OUTCOMES; GAMING SOFTWARE THAT GENERATES OR DISPLAYS WAGER OUTCOMES OF GAMING MACHINES, IN CLASS 9 (U.S. CLS. 21, 23, 26, 36 AND 38).

FIRST USE 11-13-2007; IN COMMERCE 11-13-2007.

THE MARK CONSISTS OF STANDARD CHARACTERS WITHOUT CLAIM TO ANY PARTICULAR FONT, STYLE, SIZE, OR COLOR.

SN 77-225,056, FILED 7-9-2007.

ANNE MADDEN, EXAMINING ATTORNEY

Int. Cl.: 20

Prior U.S. Cls.: 2, 13, 22, 25, 32, and 50

Reg. No. 3,521,838

United States Patent and Trademark Office

Registered Oct. 21, 2008

**TRADEMARK
PRINCIPAL REGISTER**

C-ZEN

C-ZEN, INC. (CALIFORNIA CORPORATION)
14431 VENTURA BLVD., #217
SHERMAN OAKS, CA 91423

FIRST USE 3-1-2005; IN COMMERCE 9-1-2008.

FOR: NECK SUPPORT CUSHIONS; SEAT CUSHIONS; BABY HEAD SUPPORT CUSHIONS; CUSHIONS; HEAD SUPPORTING PILLOWS; NECK-SUPPORTING PILLOWS; PILLOWS, IN CLASS 20 (U.S. CLS. 2, 13, 22, 25, 32 AND 50).

THE MARK CONSISTS OF STANDARD CHARACTERS WITHOUT CLAIM TO ANY PARTICULAR FONT, STYLE, SIZE, OR COLOR.

SN 77-225,181, FILED 7-9-2007.

ANDREA BUTLER, EXAMINING ATTORNEY

Int. Cl.: 31

Prior U.S. Cls.: 1 and 46

United States Patent and Trademark Office

Reg. No. 3,521,839

Registered Oct. 21, 2008

TRADEMARK
PRINCIPAL REGISTER

Calf Max

NOURICHE NUTRITION LTD (MISSOURI CORPORATION)
21 NORMANDY DRIVE
LAKE ST. LOUIS, MO 63367

FOR: LIVESTOCK FEED, IN CLASS 31 (U.S. CLS. 1 AND 46).

FIRST USE 2-22-2008; IN COMMERCE 4-14-2008.

NO CLAIM IS MADE TO THE EXCLUSIVE RIGHT TO USE "CALF" , APART FROM THE MARK AS SHOWN.

THE MARK CONSISTS OF STYLIZED LETTERS FOR "C", "A", "L", "F" AND "M", "A", "X".

SN 77-225,370, FILED 7-9-2007.

ANNE MADDEN, EXAMINING ATTORNEY

Int. Cl.: 31

Prior U.S. Cls.: 1 and 46

United States Patent and Trademark Office

Reg. No. 3,521,840

Registered Oct. 21, 2008

**TRADEMARK
PRINCIPAL REGISTER**

**HEALTHY INSIDE. BEAUTIFUL
OUTSIDE.**

DEL MONTE CORPORATION (DELAWARE
CORPORATION)
ONE MARKET STREET
SAN FRANCISCO, CA 91405

THE MARK CONSISTS OF STANDARD CHAR-
ACTERS WITHOUT CLAIM TO ANY PARTICULAR
FONT, STYLE, SIZE, OR COLOR.

FOR: PET FOOD, IN CLASS 31 (U.S. CLS. 1 AND
46).

SN 77-225,432, FILED 7-10-2007.

FIRST USE 10-4-2007; IN COMMERCE 10-4-2007.

NAAKWAMA ANKRAH, EXAMINING ATTORNEY

Int. Cl.: 10

Prior U.S. Cls.: 26, 39, and 44

Reg. No. 3,521,841

United States Patent and Trademark Office

Registered Oct. 21, 2008

**TRADEMARK
PRINCIPAL REGISTER**

OMNIWAVE

OMNISONICS MEDICAL TECHNOLOGIES, INC.
(DELAWARE CORPORATION)
SUITE A
66 CONCORD STREET
WILMINGTON, MA 01887

FIRST USE 11-26-2007; IN COMMERCE 11-26-2007.

FOR: ULTRASONIC THERAPEUTIC APPARATUS FOR USE IN MEDICAL PROCEDURES SPECIFIC TO SURGICAL, ENDOLUMINAL OR INTERVENTIONAL RADIOLOGY PROCEDURES FOR THE REMOVAL OF INCLUSIONS, BLOOD CLOTS AND PLAQUE, IN CLASS 10 (U.S. CLS. 26, 39 AND 44).

THE MARK CONSISTS OF STANDARD CHARACTERS WITHOUT CLAIM TO ANY PARTICULAR FONT, STYLE, SIZE, OR COLOR.

SN 77-225,447, FILED 7-10-2007.

GIANCARLO CASTRO, EXAMINING ATTORNEY

Int. Cl.: 3

Prior U.S. Cls.: 1, 4, 6, 50, 51, and 52

United States Patent and Trademark Office

Reg. No. 3,521,842

Registered Oct. 21, 2008

**TRADEMARK
PRINCIPAL REGISTER**

BIOELEMENTS VITALIZATION

BIOELEMENTS, INC. (ILLINOIS CORPORATION)
3502 EAST BOULDER
COLORADO SPRINGS, CO 80909

FOR: BODY CREAMS; BODY WASHES, IN CLASS
3 (U.S. CLS. 1, 4, 6, 50, 51 AND 52).

FIRST USE 10-15-2007; IN COMMERCE 10-15-2007.

THE MARK CONSISTS OF STANDARD CHARACTERS WITHOUT CLAIM TO ANY PARTICULAR FONT, STYLE, SIZE, OR COLOR.

OWNER OF U.S. REG. NOS. 1,684,104, 2,548,502, AND OTHERS.

SN 77-225,531, FILED 7-10-2007.

ELLEN BURNS, EXAMINING ATTORNEY

Int. Cl.: 9

Prior U.S. Cls.: 21, 23, 26, 36, and 38

United States Patent and Trademark Office

Reg. No. 3,521,843

Registered Oct. 21, 2008

**TRADEMARK
PRINCIPAL REGISTER**

FORTISPHERE

FORTISPHERE INC. (DELAWARE CORPORATION)
3060 WASHINGTON RD., SUITE 154
GLENWOOD, MD 21738

FOR: COMPUTER SOFTWARE FOR USE IN DEPLOYING, MONITORING AND MANAGING VIRTUAL MACHINES AND VIRTUAL ENVIRONMENTS COMPRISED OF COMPUTERS, COMPUTER OPERATING SYSTEMS, AND COMPUTER SOFTWARE APPLICATIONS IN THE NATURE OF HYPERVISORS; COMPUTER SOFTWARE FOR THE ENFORCEMENT OF AUTHORIZATION AND NETWORK POLICIES IN A VIRTUAL ENVIRONMENT; COMPUTER SOFTWARE FOR THE DETECTION, PREVENTION AND REMEDIATION OF VIRTUAL ENVIRONMENT SECURITY THREATS; COMPU-

TER SOFTWARE FOR USE IN EVALUATING AND MONITORING COMPUTERS, COMPUTER OPERATING SYSTEMS, AND COMPUTER NETWORKS FOR INFORMATION TECHNOLOGY SECURITY RISKS, IN CLASS 9 (U.S. CLS. 21, 23, 26, 36 AND 38).

FIRST USE 1-0-2008; IN COMMERCE 1-0-2008.

THE MARK CONSISTS OF STANDARD CHARACTERS WITHOUT CLAIM TO ANY PARTICULAR FONT, STYLE, SIZE, OR COLOR.

SN 77-225,782, FILED 7-10-2007.

ALICE BENMAMAN, EXAMINING ATTORNEY

Int. Cl.: 10

Prior U.S. Cls.: 26, 39, and 44

United States Patent and Trademark Office

Reg. No. 3,521,844

Registered Oct. 21, 2008

**TRADEMARK
PRINCIPAL REGISTER**

TWIST-N-SHOUT

FINGER-FITTING PRODUCTS, INC. (FLORIDA
CORPORATION)
2102 NE 123RD STREET
NORTH MIAMI, FL 33181

THE MARK CONSISTS OF STANDARD CHAR-
ACTERS WITHOUT CLAIM TO ANY PARTICULAR
FONT, STYLE, SIZE, OR COLOR.

FOR: ELECTRIC MASSAGING APPARATUS, IN
CLASS 10 (U.S. CLS. 26, 39 AND 44).

SN 77-226,011, FILED 7-10-2007.

FIRST USE 2-4-2008; IN COMMERCE 2-4-2008.

WON TEAK OH, EXAMINING ATTORNEY

Int. Cl.: 10

Prior U.S. Cls.: 26, 39, and 44

United States Patent and Trademark Office

Reg. No. 3,521,845

Registered Oct. 21, 2008

**TRADEMARK
PRINCIPAL REGISTER**

ROCKIN' ROLLER

FINGER-FITTING PRODUCTS, INC. (FLORIDA
CORPORATION)
2102 NE 123RD STREET
NORTH MIAMI, FL 33181

THE MARK CONSISTS OF STANDARD CHAR-
ACTERS WITHOUT CLAIM TO ANY PARTICULAR
FONT, STYLE, SIZE, OR COLOR.

FOR: ELECTRIC MASSAGING APPARATUS, IN
CLASS 10 (U.S. CLS. 26, 39 AND 44).

SN 77-226,018, FILED 7-10-2007.

FIRST USE 2-4-2008; IN COMMERCE 2-4-2008.

WON TEAK OH, EXAMINING ATTORNEY

Int. Cl.: 10

Prior U.S. Cls.: 26, 39, and 44

United States Patent and Trademark Office

Reg. No. 3,521,846

Registered Oct. 21, 2008

**TRADEMARK
PRINCIPAL REGISTER**

JUMPIN' JACK

FINGER-FITTING PRODUCTS, INC. (FLORIDA
CORPORATION)
2102 NE 123RD STREET
NORTH MIAMI, FL 33181

THE MARK CONSISTS OF STANDARD CHAR-
ACTERS WITHOUT CLAIM TO ANY PARTICULAR
FONT, STYLE, SIZE, OR COLOR.

FOR: ELECTRIC MASSAGING APPARATUS, IN
CLASS 10 (U.S. CLS. 26, 39 AND 44).

SN 77-226,027, FILED 7-10-2007.

FIRST USE 2-4-2008; IN COMMERCE 2-4-2008.

WON TEAK OH, EXAMINING ATTORNEY

Int. Cls.: 9 and 42

Prior U.S. Cls.: 21, 23, 26, 36, 38, 100, and 101

United States Patent and Trademark Office

Reg. No. 3,521,847

Registered Oct. 21, 2008

**TRADEMARK
SERVICE MARK
PRINCIPAL REGISTER**

LUMENSION

LUMENSION SECURITY, INC. (DELAWARE CORPORATION)
15880 NORTH GREENWAY-HAYDEN LOOP
SCOTTSDALE, AZ 85260

FOR: COMPUTER SOFTWARE USED TO INSTALL AND UPDATE SOFTWARE PATCHES, AND COMPUTER SOFTWARE UPGRADES AND UPDATES TO PRE-INSTALLED SOFTWARE TO RESOLVE SOFTWARE AND IT SECURITY AND VULNERABILITY ISSUES, IN CLASS 9 (U.S. CLS. 21, 23, 26, 36 AND 38).

FIRST USE 9-10-2007; IN COMMERCE 9-10-2007.

FOR: PROVIDING COMPUTER AND IT SECURITY SERVICES, NAMELY, PROVIDING A WEB SITE FEATURING TECHNICAL INFORMATION AND SUPPORT REGARDING SOFTWARE AND VULNERABILITY SOLUTIONS AND REGULATORY

COMPLIANCE, AND PROVIDING COMPUTER SOFTWARE TECHNICAL SUPPORT SERVICES, TECHNICAL INFORMATION AND TECHNICAL SUPPORT REGARDING SOFTWARE PATCHES, UPGRADES AND UPDATES AND UPDATES USED FOR A WIDE VARIETY OF APPLICATIONS, COMPUTER SERVICES, AND REGULATORY COMPLIANCE, IN CLASS 42 (U.S. CLS. 100 AND 101).

FIRST USE 9-10-2007; IN COMMERCE 9-10-2007.

THE MARK CONSISTS OF STANDARD CHARACTERS WITHOUT CLAIM TO ANY PARTICULAR FONT, STYLE, SIZE, OR COLOR.

SN 77-226,293, FILED 7-10-2007.

JENNIFER VASQUEZ, EXAMINING ATTORNEY

Int. Cl.: 42

Prior U.S. Cls.: 100 and 101

United States Patent and Trademark Office

Reg. No. 3,521,848

Registered Oct. 21, 2008

**SERVICE MARK
PRINCIPAL REGISTER**

BLXBID

BOND LOGISTIX, LLC (DELAWARE LIMITED
LIABILITY COMPANY)
777 SOUTH FIGUEROA STREET, SUITE 3200
LOS ANGELES, CA 900175855

FOR: TEMPORARY USE OF NON-DOWNLOAD-
ABLE SOFTWARE THAT ALLOWS USERS TO
PLACE OFFERS ON GUARANTEED INVESTMENT
CONTRACTS FOR MUNICIPALITIES , IN CLASS 42
(U.S. CLS. 100 AND 101).

FIRST USE 4-16-2008; IN COMMERCE 4-16-2008.

THE MARK CONSISTS OF STANDARD CHAR-
ACTERS WITHOUT CLAIM TO ANY PARTICULAR
FONT, STYLE, SIZE, OR COLOR.

NO CLAIM IS MADE TO THE EXCLUSIVE
RIGHT TO USE "BID", APART FROM THE MARK
AS SHOWN.

SN 77-226,368, FILED 7-10-2007.

BENJAMIN ALLEN, EXAMINING ATTORNEY

Int. Cl.: 9

Prior U.S. Cls.: 21, 23, 26, 36, and 38

United States Patent and Trademark Office

Reg. No. 3,521,849

Registered Oct. 21, 2008

**TRADEMARK
PRINCIPAL REGISTER**

CLOSING TABLE

ICLOSINGS.COM, INC. (CALIFORNIA CORPORATION)
201 SANTA MONICA BLVD., SUITE 300
SANTA MONICA, CA 90401

FOR: COMPUTER E-COMMERCE SOFTWARE TO ALLOW USERS TO PERFORM ELECTRONIC BUSINESS TRANSACTIONS VIA A GLOBAL COMPUTER NETWORK, IN CLASS 9 (U.S. CLS. 21, 23, 26, 36 AND 38).

FIRST USE 8-1-2008; IN COMMERCE 8-1-2008.

THE MARK CONSISTS OF STANDARD CHARACTERS WITHOUT CLAIM TO ANY PARTICULAR FONT, STYLE, SIZE, OR COLOR.

SN 77-226,397, FILED 7-10-2007.

NAAKWAMA ANKRAH, EXAMINING ATTORNEY

Int. Cls.: 18, 21, and 25

**Prior U.S. Cls.: 1, 2, 3, 13, 22, 23, 29, 30, 33, 39, 40, 41,
and 50**

Reg. No. 3,521,850

United States Patent and Trademark Office

Registered Oct. 21, 2008

**TRADEMARK
PRINCIPAL REGISTER**

FINRA

FINANCIAL INDUSTRY REGULATORY AU-
THORITY, INC. (DELAWARE NON-PROFIT
CORPORATION)
1735 K STREET, N.W.
WASHINGTON, DC 20006

FOR: TOTE BAGS AND UMBRELLAS, IN CLASS
18 (U.S. CLS. 1, 2, 3, 22 AND 41).

FIRST USE 7-30-2007; IN COMMERCE 7-30-2007.

FOR: MUGS, IN CLASS 21 (U.S. CLS. 2, 13, 23, 29,
30, 33, 40 AND 50).

FIRST USE 7-30-2007; IN COMMERCE 7-30-2007.

FOR: CLOTHING NAMELY, T-SHIRTS, HATS,
SWEATSHIRTS, JACKETS, IN CLASS 25 (U.S. CLS. 22
AND 39).

FIRST USE 7-30-2007; IN COMMERCE 7-30-2007.

THE MARK CONSISTS OF STANDARD CHAR-
ACTERS WITHOUT CLAIM TO ANY PARTICULAR
FONT, STYLE, SIZE, OR COLOR.

SN 77-226,436, FILED 7-10-2007.

BONNIE LUKEN, EXAMINING ATTORNEY

Int. Cls.: 29 and 30

Prior U.S. Cl.: 46

United States Patent and Trademark Office

Reg. No. 3,521,851

Registered Oct. 21, 2008

TRADEMARK
PRINCIPAL REGISTER



CARGILL, INCORPORATED (DELAWARE CORPORATION)
15407 MCGINTY ROAD WEST
WAYZATA, MN 55440

FOR: EGGS; EGG PRODUCTS, NAMELY, PASTEURIZED LIQUID EGGS, SCRAMBLED EGGS, FRIED EGGS, EGG PATTIES, OMELETS, DICED EGGS, HARD COOKED AND PEELED EGGS, IN CLASS 29 (U.S. CL. 46).

FIRST USE 7-31-2008; IN COMMERCE 7-31-2008.

FOR: FRENCH TOAST; WRAP SANDWICHES; AND EGG PATTIES ENROBED IN PANCAKE BATTER, IN CLASS 30 (U.S. CL. 46).

FIRST USE 7-31-2008; IN COMMERCE 7-31-2008.

OWNER OF U.S. REG. NOS. 1,575,282, 1,986,984, AND OTHERS.

NO CLAIM IS MADE TO THE EXCLUSIVE RIGHT TO USE "FRESH", APART FROM THE MARK AS SHOWN.

THE MARK CONSISTS OF THE WORDS "SUNNY FRESH" AND ABSTRACT IMAGES OF HILLS AND A SUN.

SN 77-226,534, FILED 7-11-2007.

RICHARD A. STRASER, EXAMINING ATTORNEY

Int. Cl.: 24

Prior U.S. Cls.: 42 and 50

United States Patent and Trademark Office

Reg. No. 3,521,852

Registered Oct. 21, 2008

**TRADEMARK
PRINCIPAL REGISTER**

XR-MARINER

SEAMAN CORPORATION (OHIO CORPORATION)
1000 VENTURE BOULEVARD
WOOSTER, OH 44691

FOR: COATED FABRICS FOR USE IN THE CONSTRUCTION OF INFLATABLE BOATS, IN CLASS 24 (U.S. CLS. 42 AND 50).

FIRST USE 1-0-2008; IN COMMERCE 1-0-2008.

THE MARK CONSISTS OF STANDARD CHARACTERS WITHOUT CLAIM TO ANY PARTICULAR FONT, STYLE, SIZE, OR COLOR.

OWNER OF U.S. REG. NOS. 1,056,113, 2,303,296, AND 2,386,950.

SN 77-226,575, FILED 7-11-2007.

KATHLEEN M. VANSTON, EXAMINING ATTORNEY

Int. Cl.: 7

Prior U.S. Cls.: 13, 19, 21, 23, 31, 34, and 35

Reg. No. 3,521,853

United States Patent and Trademark Office

Registered Oct. 21, 2008

**TRADEMARK
PRINCIPAL REGISTER**

MICROHONE

KENRIE, INC. (MICHIGAN CORPORATION)
400 136TH AVENUE, BUILDING 100
HOLLAND, MI 49424

HONING, AND FORMING METAL PARTS, IN
CLASS 7 (U.S. CLS. 13, 19, 21, 23, 31, 34 AND 35).

FIRST USE 6-30-2008; IN COMMERCE 6-30-2008.

FOR: POWER-OPERATED MACHINES FOR ASSEMBLING COMPONENTS, NAMELY, WRIST PINS, PISTON RINGS, SEALING RINGS AND BEARING RINGS, POWER-OPERATED MACHINES FOR GRINDING, HONING, AND FORMING METAL PARTS, AND ABRASIVE TOOLS, USED WITH POWER OPERATED MACHINES, FOR GRINDING,

THE MARK CONSISTS OF STANDARD CHARACTERS WITHOUT CLAIM TO ANY PARTICULAR FONT, STYLE, SIZE, OR COLOR.

SN 77-226,925, FILED 7-11-2007.

RENEE MCCRAY, EXAMINING ATTORNEY

Int. Cl.: 20

Prior U.S. Cls.: 2, 13, 22, 25, 32, and 50

United States Patent and Trademark Office

Reg. No. 3,521,854

Registered Oct. 21, 2008

**TRADEMARK
PRINCIPAL REGISTER**

NO-PUCK

WALLACE JR., FRED M. (UNITED STATES IN-
DIVIDUAL)
903 W. MAIN STREET
LOUISVILLE, OH 446411105

THE MARK CONSISTS OF STANDARD CHAR-
ACTERS WITHOUT CLAIM TO ANY PARTICULAR
FONT, STYLE, SIZE, OR COLOR.

FOR: PLASTIC EXTENSIONS FOR USE WITH
CLOTHES HANGERS, IN CLASS 20 (U.S. CLS. 2, 13,
22, 25, 32 AND 50).

SN 77-227,080, FILED 7-11-2007.

FIRST USE 6-10-2007; IN COMMERCE 6-10-2007.

AMY HELLA, EXAMINING ATTORNEY

Int. Cl.: 5

Prior U.S. Cls.: 6, 18, 44, 46, 51, and 52

Reg. No. 3,521,855

United States Patent and Trademark Office

Registered Oct. 21, 2008

**TRADEMARK
PRINCIPAL REGISTER**



GENZYME CORPORATION (MASSACHUSETTS
CORPORATION)
500 KENDALL STREET
CAMBRIDGE, MA 02142

FIRST USE 5-20-2007; IN COMMERCE 5-20-2007.

FOR: MEDICAL DIAGNOSTIC TEST KITS CON-
SISTING PRIMARILY OF MEDICAL DIAGNOSTIC
ANALYTE ASSAY DEVICES HAVING A COLOR
INDICATOR FOR RAPID DIAGNOSIS, AND/OR
REAGENTS FOR USE WITH THE ASSAY DEVICES,
IN CLASS 5 (U.S. CLS. 6, 18, 44, 46, 51 AND 52).

THE MARK CONSISTS OF STYLIZED LETTER
"Q" AND STYLIZED LETTER "C" CONTAINING A
CHECKMARK INSIDE IT.

SN 77-228,159, FILED 7-12-2007.

DOMINICK J. SALEMI, EXAMINING ATTORNEY

Int. Cl.: 42

Prior U.S. Cls.: 100 and 101

United States Patent and Trademark Office

Reg. No. 3,521,856

Registered Oct. 21, 2008

**SERVICE MARK
PRINCIPAL REGISTER**

MANUSCRIPT CENTRAL OPTIMA

THOMSON REUTERS (SCIENTIFIC) INC. (PENNSYLVANIA CORPORATION)
3501 MARKET STREET
PHILADELPHIA, PA 19104

FOR: PROVIDING AN ONLINE DATABASE FEATURING INDEXES TO SCIENTIFIC AND SOCIAL SCIENCE LITERATURE AND BIBLIOGRAPHIC MATERIAL OF JOURNALS; PROVIDING ONLINE NON-DOWNLOADABLE COMPUTER PROGRAMS FOR CREATING REFERENCE DATABASES AND BIBLIOGRAPHIES; APPLICATION SERVICE PROVIDER FEATURING SOFTWARE FOR PROVIDING A WEB-BASED DATABASE TO MANAGE WORK FLOW AND PUBLISHING TASKS RELATED TO MANUSCRIPTS SUBMITTED TO SCHOLARLY JOURNALS, IN CLASS 42 (U.S. CLS. 100 AND 101).

FIRST USE 8-10-2007; IN COMMERCE 8-10-2007.

THE MARK CONSISTS OF STANDARD CHARACTERS WITHOUT CLAIM TO ANY PARTICULAR FONT, STYLE, SIZE, OR COLOR.

NO CLAIM IS MADE TO THE EXCLUSIVE RIGHT TO USE "MANUSCRIPT", APART FROM THE MARK AS SHOWN.

SN 77-228,200, FILED 7-12-2007.

KATINA MISTER, EXAMINING ATTORNEY

Int. Cls.: 5 and 10

Prior U.S. Cls.: 6, 18, 26, 39, 44, 46, 51, and 52

United States Patent and Trademark Office

Reg. No. 3,521,857

Registered Oct. 21, 2008

**TRADEMARK
PRINCIPAL REGISTER**



GENZYME CORPORATION (MASSACHUSETTS CORPORATION)
500 KENDALL STREET
CAMBRIDGE, MA 02142

FOR: PHARMACEUTICALS, NAMELY, PRE-PACKAGED INJECTABLE BIOCHEMICAL SOLUTIONS, NAMELY, SODIUM HYLAN SOLUTIONS, IN CLASS 5 (U.S. CLS. 6, 18, 44, 46, 51 AND 52).

FIRST USE 12-18-2007; IN COMMERCE 12-18-2007.

FOR: MEDICAL APPARATUS, NAMELY, A SELF-CONTAINED SYRINGE FOR DISPENSING PRE-

PACKAGED INJECTABLE SODIUM HYLAN SOLUTIONS FOR USE IN SURGERY, IN CLASS 10 (U.S. CLS. 26, 39 AND 44).

FIRST USE 12-18-2007; IN COMMERCE 12-18-2007.

THE MARK CONSISTS, IN PART, OF THE WORD "ONE" INSIDE A SPHERE.

SN 77-228,235, FILED 7-12-2007.

DOMINICK J. SALEMI, EXAMINING ATTORNEY

Int. Cl.: 32

Prior U.S. Cls.: 45, 46, and 48

United States Patent and Trademark Office

Reg. No. 3,521,858

Registered Oct. 21, 2008

**TRADEMARK
PRINCIPAL REGISTER**

PRINCESS

VITAL PHARMACEUTICALS, INC. (FLORIDA
CORPORATION)
15751 S.W. 41ST STREET, SUITE 300
DAVIE, FL 33331

THE MARK CONSISTS OF STANDARD CHAR-
ACTERS WITHOUT CLAIM TO ANY PARTICULAR
FONT, STYLE, SIZE, OR COLOR.

FOR: ENERGY DRINKS; ISOTONIC DRINKS;
SPORTS DRINKS, IN CLASS 32 (U.S. CLS. 45, 46
AND 48).

SN 77-228,580, FILED 7-12-2007.

FIRST USE 10-25-2007; IN COMMERCE 10-25-2007.

SHANNON TWOHIG, EXAMINING ATTORNEY

Int. Cls.: 35 and 41

Prior U.S. Cls.: 100, 101, 102, and 107

United States Patent and Trademark Office

Reg. No. 3,521,859

Registered Oct. 21, 2008

**SERVICE MARK
PRINCIPAL REGISTER**

KIDZ CREATIONS

KIDZ CREATIONS, LLC (NEW JERSEY LIMITED
LIABILITY COMPANY)
829 BRIGHTON PLACE
OCEAN CITY, NJ 08226

FOR: RETAIL STORE SERVICES FEATURING
MERCHANDISE FOR CHILDREN, IN CLASS 35
(U.S. CLS. 100, 101 AND 102).

FIRST USE 8-0-2007; IN COMMERCE 4-0-2008.

FOR: EDUCATIONAL SERVICES, NAMELY,
CONDUCTING WORKSHOPS IN THE FIELD OF
SCIENCE AND COOKING, IN CLASS 41 (U.S. CLS.
100, 101 AND 107).

FIRST USE 4-3-2007; IN COMMERCE 4-3-2007.

THE MARK CONSISTS OF STANDARD CHAR-
ACTERS WITHOUT CLAIM TO ANY PARTICULAR
FONT, STYLE, SIZE, OR COLOR.

NO CLAIM IS MADE TO THE EXCLUSIVE
RIGHT TO USE "KIDS", APART FROM THE MARK
AS SHOWN.

SN 77-229,068, FILED 7-13-2007.

ROSELLE HERRERA, EXAMINING ATTORNEY

Int. Cl.: 35

Prior U.S. Cls.: 100, 101, and 102

United States Patent and Trademark Office

Reg. No. 3,521,860

Registered Oct. 21, 2008

**SERVICE MARK
PRINCIPAL REGISTER**

EUQUANT

BOSTON RESEARCH GROUP, INC. (GEORGIA CORPORATION)
SUITE 1440
100 GALLERIA PARKWAY, NW
ATLANTA, GA 30339

FOR: BUSINESS CONSULTING SERVICES, NAMELY, ECONOMIC AND STATISTICAL MARKET RESEARCH AND QUANTITATIVE PROGRAM EVALUATIONS; CONDUCTING BUSINESS AND MARKET RESEARCH SURVEYS, NAMELY, CONDUCTING BUSINESS AND MARKET RESEARCH SURVEYS FOR OTHERS BY COLLECTING DATA

FROM INDIVIDUALS AND ANALYZING THE COLLECTED INFORMATION, IN CLASS 35 (U.S. CLS. 100, 101 AND 102).

FIRST USE 1-0-2007; IN COMMERCE 1-0-2007.

THE MARK CONSISTS OF THE STYLIZED WORD "EUQUANT".

SN 77-229,232, FILED 7-13-2007.

MICHAEL TANNER, EXAMINING ATTORNEY

Int. Cl.: 5

Prior U.S. Cls.: 6, 18, 44, 46, 51, and 52

United States Patent and Trademark Office

Reg. No. 3,521,861

Registered Oct. 21, 2008

**TRADEMARK
PRINCIPAL REGISTER**

NUTRITHRIVE

BIORX, LLC (OHIO LIMITED LIABILITY COMPANY)
10828 KENWOOD ROAD
CINCINNATI, OH 45242

THE MARK CONSISTS OF STANDARD CHARACTERS WITHOUT CLAIM TO ANY PARTICULAR FONT, STYLE, SIZE, OR COLOR.

FOR: PHARMACEUTICAL PREPARATIONS FOR ENTERAL THERAPY AND TOTAL PARENTERAL NUTRITION, IN CLASS 5 (U.S. CLS. 6, 18, 44, 46, 51 AND 52).

SN 77-229,266, FILED 7-13-2007.

FIRST USE 6-0-2007; IN COMMERCE 6-0-2007.

DEIRDRE ROBERTSON, EXAMINING ATTORNEY

Int. Cl.: 24

Prior U.S. Cls.: 42 and 50

United States Patent and Trademark Office

Reg. No. 3,521,862

Registered Oct. 21, 2008

**TRADEMARK
PRINCIPAL REGISTER**

MICROFIBRES...NATURALLY

MICROFIBRES, INC. (RHODE ISLAND CORPORATION)
PO BOX 1208
ONE MOSHASSUCK AVENUE
PAWTUCKET, RI 02862

FOR: FABRICS FOR USE IN THE MANUFACTURE OF UPHOLSTERED FURNITURE SOLD TO THE UPHOLSTERY INDUSTRY, IN CLASS 24 (U.S. CLS. 42 AND 50).

FIRST USE 7-15-2007; IN COMMERCE 7-15-2007.

THE MARK CONSISTS OF STANDARD CHARACTERS WITHOUT CLAIM TO ANY PARTICULAR FONT, STYLE, SIZE, OR COLOR.

OWNER OF U.S. REG. NOS. 2,088,459 AND 2,420,344.

SEC. 2(F) AS TO THE WORD "MICROFIBRES".

SN 77-229,352, FILED 7-13-2007.

DAVID H. STINE, EXAMINING ATTORNEY

Int. Cl.: 29

Prior U.S. Cl.: 46

United States Patent and Trademark Office

Reg. No. 3,521,863

Registered Oct. 21, 2008

**TRADEMARK
PRINCIPAL REGISTER**

SIERRA VENTANA

BIO LIVE S.A. (ARGENTINA CORPORATION)
MAIPU 1252 8TH FLOOR
BUENOS AIRES, ARGENTINA C1006ACT

THE ENGLISH TRANSLATION OF THE WORD
SIERRA VENTANA IN THE MARK IS WINDOW
HILLS.

FOR: OLIVE OIL, IN CLASS 29 (U.S. CL. 46).

FIRST USE 1-5-2008; IN COMMERCE 1-5-2008.

SN 77-229,535, FILED 7-13-2007.

THE MARK CONSISTS OF STANDARD CHAR-
ACTERS WITHOUT CLAIM TO ANY PARTICULAR
FONT, STYLE, SIZE, OR COLOR.

LOURDES AYALA, EXAMINING ATTORNEY

Int. Cl.: 42

Prior U.S. Cls.: 100 and 101

United States Patent and Trademark Office

Reg. No. 3,521,864

Registered Oct. 21, 2008

**SERVICE MARK
PRINCIPAL REGISTER**

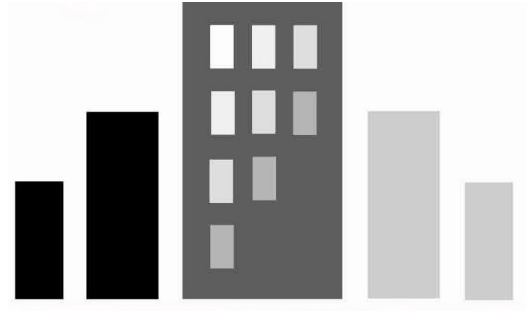

BUILDING MONITOR LLC, THE (WASHINGTON
LIMITED LIABILITY COMPANY)
4720 TREE RIDGE LANE
POULSBO, WA 98370

THE MARK CONSISTS OF DESIGN OF 5 BUILD-
INGS.

FOR: REMOTE MONITORING SERVICES OF
HEATING AND COOLING SYSTEMS IN BUILD-
INGS, IN CLASS 42 (U.S. CLS. 100 AND 101).

SN 77-230,205, FILED 7-16-2007.

FIRST USE 9-5-2008; IN COMMERCE 9-5-2008.

DANNEAN HETZEL, EXAMINING ATTORNEY

Int. Cls.: 5 and 31

Prior U.S. Cls.: 1, 6, 18, 44, 46, 51, and 52

Reg. No. 3,521,865

United States Patent and Trademark Office

Registered Oct. 21, 2008

**TRADEMARK
PRINCIPAL REGISTER**

FRESH EXPRESSIONS

THE CLOROX PET PRODUCTS COMPANY
(TEXAS CORPORATION)
1221 BROADWAY
OAKLAND, CA 94612

FOR: DEODORIZING PREPARATIONS FOR PET
LITTER BOXES, IN CLASS 5 (U.S. CLS. 6, 18, 44, 46, 51
AND 52).

FIRST USE 6-30-2008; IN COMMERCE 6-30-2008.

FOR: CAT LITTER, IN CLASS 31 (U.S. CLS. 1 AND
46).

FIRST USE 6-30-2008; IN COMMERCE 6-30-2008.

THE MARK CONSISTS OF STANDARD CHAR-
ACTERS WITHOUT CLAIM TO ANY PARTICULAR
FONT, STYLE, SIZE, OR COLOR.

SN 77-230,346, FILED 7-16-2007.

THEODORE MCBRIDE, EXAMINING ATTORNEY

Int. Cls.: 5 and 31

Prior U.S. Cls.: 1, 6, 18, 44, 46, 51, and 52

United States Patent and Trademark Office

Reg. No. 3,521,866

Registered Oct. 21, 2008

**TRADEMARK
PRINCIPAL REGISTER**

MOUNTAIN FOREST

CLOROX PET PRODUCTS COMPANY, THE
(TEXAS CORPORATION)
1221 BROADWAY
OAKLAND, CA 94612

FOR: DEODORIZING PREPARATIONS FOR PET
LITTER BOXES, IN CLASS 5 (U.S. CLS. 6, 18, 44, 46, 51
AND 52).

FIRST USE 6-30-2008; IN COMMERCE 6-30-2008.

FOR: CAT LITTER, IN CLASS 31 (U.S. CLS. 1 AND
46).

FIRST USE 6-30-2008; IN COMMERCE 6-30-2008.

THE MARK CONSISTS OF STANDARD CHAR-
ACTERS WITHOUT CLAIM TO ANY PARTICULAR
FONT, STYLE, SIZE, OR COLOR.

SN 77-230,401, FILED 7-16-2007.

THEODORE MCBRIDE, EXAMINING ATTORNEY

Int. Cl.: 39

Prior U.S. Cls.: 100 and 105

United States Patent and Trademark Office

Reg. No. 3,521,867

Registered Oct. 21, 2008

**SERVICE MARK
PRINCIPAL REGISTER**

AVASCEND

AMERICAN VALET PARKING, INC. (KANSAS
CORPORATION)
7734 HEDGE LANE TERRACE
SHAWNEE, KS 66227

FOR: VALET PARKING SERVICES AND THE
TRANSPORTATION OF PASSENGERS AND/OR
GOODS BY AUTOMOBILES, LIMOUSINES, CARS,
VANS AND BUSES, IN CLASS 39 (U.S. CLS. 100 AND
105).

FIRST USE 12-1-2007; IN COMMERCE 12-1-2007.

THE MARK CONSISTS OF STANDARD CHAR-
ACTERS WITHOUT CLAIM TO ANY PARTICULAR
FONT, STYLE, SIZE, OR COLOR.

SN 77-230,518, FILED 7-16-2007.

IRA J. GOODSaid, EXAMINING ATTORNEY

Int. Cl.: 8

Prior U.S. Cls.: 23, 28, and 44

United States Patent and Trademark Office

Reg. No. 3,521,868

Registered Oct. 21, 2008

**TRADEMARK
PRINCIPAL REGISTER**

Cocina al Máximo

HY CITE CORPORATION (WISCONSIN CORPORATION)

333 HOLTZMAN ROAD

MADISON, WI 53713

FOR: CUTLERY, NAMELY, KNIVES WITH STAINLESS STEEL BLADES AND WOODEN HANDLES AND FLATWARE, NAMELY, STAINLESS STEEL FORKS, KNIVES, AND SPOONS, IN CLASS 8 (U.S. CLS. 23, 28 AND 44).

FIRST USE 12-0-2006; IN COMMERCE 12-0-2006.

THE MARK CONSISTS OF STANDARD CHARACTERS WITHOUT CLAIM TO ANY PARTICULAR FONT, STYLE, SIZE, OR COLOR.

NO CLAIM IS MADE TO THE EXCLUSIVE RIGHT TO USE "COCINA", APART FROM THE MARK AS SHOWN.

THE MARK TRANSLATES INTO ENGLISH AS COOK TO THE MAX.

SN 77-230,657, FILED 7-16-2007.

STEVEN PEREZ, EXAMINING ATTORNEY

Int. Cl.: 3

Prior U.S. Cls.: 1, 4, 6, 50, 51, and 52

Reg. No. 3,521,869

United States Patent and Trademark Office

Registered Oct. 21, 2008

**TRADEMARK
PRINCIPAL REGISTER**



HY CITE CORPORATION (WISCONSIN CORPORATION)

333 HOLTZMAN ROAD

MADISON, WI 53713

FOR: FRAGRANCES USED IN VACUUM CLEANERS, IN CLASS 3 (U.S. CLS. 1, 4, 6, 50, 51 AND 52).

FIRST USE 3-0-2006; IN COMMERCE 3-0-2006.

THE COLOR(S) LIGHT BLUE, DARK BLUE AND WHITE IS/ARE CLAIMED AS A FEATURE OF THE MARK.

THE MARK CONSISTS OF AN OVAL SHAPE DIVIDED INTO LEFT AND RIGHT HALVES BY A CENTRAL STAR DESIGN. THE OUTER BORDER OF THE MARK IS DARK BLUE. THE STAR IS WHITE WITH DARK BLUE SHADOWING ON THE LEFT SIDE. THE LEFT SIDE OF THE INNER OVAL IS COLORED IN HORIZONTAL BANDS OF LIGHT BLUE SHADES AND A DOUBLE OUTER BORDER OF LIGHT BLUE. THE RIGHT SIDE OF THE INNER OVAL IS SOLID BLUE WITH AN OUTER BORDER OF DARK AND LIGHT BLUE.

SN 77-230,813, FILED 7-16-2007.

STEVEN PEREZ, EXAMINING ATTORNEY

Int. Cl.: 45

Prior U.S. Cls.: 100 and 101

United States Patent and Trademark Office

Reg. No. 3,521,870

Registered Oct. 21, 2008

**SERVICE MARK
PRINCIPAL REGISTER**

HAZZSPORTS.COM

GAME PLAN HOLDINGS, INC. (NEVADA CORPORATION)
P.O. BOX 777463
HENDERSON, NV 89077

THE MARK CONSISTS OF STANDARD CHARACTERS WITHOUT CLAIM TO ANY PARTICULAR FONT, STYLE, SIZE, OR COLOR.

FOR: INTERNET BASED SOCIAL NETWORKING, INTRODUCTION, AND DATING SERVICES, IN CLASS 45 (U.S. CLS. 100 AND 101).

SN 77-230,877, FILED 7-16-2007.

FIRST USE 7-16-2007; IN COMMERCE 7-16-2007.

DAVID YONTEF, EXAMINING ATTORNEY

Int. Cl.: 8

Prior U.S. Cls.: 23, 28, and 44

Reg. No. 3,521,871

United States Patent and Trademark Office

Registered Oct. 21, 2008

**TRADEMARK
PRINCIPAL REGISTER**

**The Ultimate Culinary
Experience**

HY CITE CORPORATION (WISCONSIN COR-
PORATION)
333 HOLTZMAN ROAD
MADISON, WI 53713

FOR: CUTLERY, NAMELY, KNIVES WITH
STAINLESS STEEL BLADES AND WOODEN HAN-
DLES AND FLATWARE, NAMELY, STAINLESS
STEEL FORKS, KNIVES, AND SPOONS, IN CLASS
8 (U.S. CLS. 23, 28 AND 44).

FIRST USE 12-0-2006; IN COMMERCE 12-0-2006.

THE MARK CONSISTS OF STANDARD CHAR-
ACTERS WITHOUT CLAIM TO ANY PARTICULAR
FONT, STYLE, SIZE, OR COLOR.

SN 77-230,969, FILED 7-16-2007.

STEVEN PEREZ, EXAMINING ATTORNEY

Int. Cl.: 28

Prior U.S. Cls.: 22, 23, 38, and 50

United States Patent and Trademark Office

Reg. No. 3,521,872

Registered Oct. 21, 2008

**TRADEMARK
PRINCIPAL REGISTER**

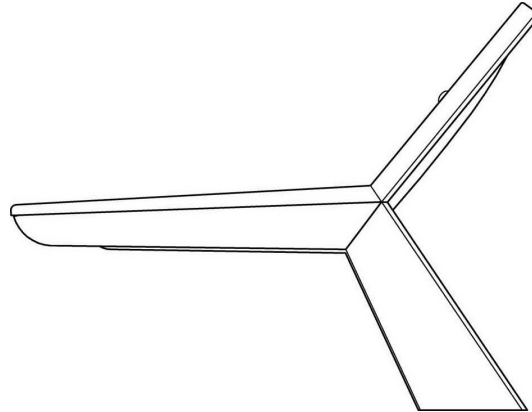

PARAMOUNT FITNESS CORP. (CALIFORNIA CORPORATION)
6450 EAST BANDINI BOULEVARD
LOS ANGELES, CA 90040

THE MARK CONSISTS OF A THREE POINT STAR-LIKE DESIGN WITH EACH POINT HAVING A DIFFERENT LENGTH, WIDTH AND HEIGHT.

FOR: EXERCISE TREADMILLS, IN CLASS 28 (U.S. CLS. 22, 23, 38 AND 50).

SN 77-230,978, FILED 7-16-2007.

FIRST USE 4-29-2008; IN COMMERCE 4-29-2008.

CHRIS WELLS, EXAMINING ATTORNEY

Int. Cl.: 25

Prior U.S. Cls.: 22 and 39

United States Patent and Trademark Office

Reg. No. 3,521,873

Registered Oct. 21, 2008

**TRADEMARK
PRINCIPAL REGISTER**

HOUSE OF MODA

LUKICH, LJUBICA (UNITED STATES INDIVIDUAL)
4708B ELKINS AVE
NASHVILLE, TN 37209 AND
LUKICH, MIRJANA (UNITED STATES INDIVIDUAL)
121 BUCKINGHAM DR UNIT 63
SANTA CLARA, CA 95051

THE MARK CONSISTS OF STANDARD CHARACTERS WITHOUT CLAIM TO ANY PARTICULAR FONT, STYLE, SIZE, OR COLOR.

THE FOREIGN WORDING IN THE MARK TRANSLATES INTO ENGLISH AS FASHION.

FOR: LINGERIE; SHOES; SHIRTS; DRESSES; SKIRTS; PANTS; SCARVES; BELTS; BLOUSES , IN CLASS 25 (U.S. CLS. 22 AND 39).

SN 77-231,024, FILED 7-17-2007.

FIRST USE 9-10-2008; IN COMMERCE 9-10-2008.

CHARISMA HAMPTON, EXAMINING ATTORNEY

Int. Cl.: 35

Prior U.S. Cls.: 100, 101, and 102

United States Patent and Trademark Office

Reg. No. 3,521,874

Registered Oct. 21, 2008

**SERVICE MARK
PRINCIPAL REGISTER**

JustParts

JUST PARTS ONLINE INCORPORATED (CANADA CORPORATION)
520 SQUIER STREET
THUNDER BAY, ONTARIO, CANADA P7B4A8

FOR: ON-LINE RETAIL STORE SERVICES FEATURING AUTOMOTIVE COMPONENTS, SUPPLIES AND ACCESSORIES; ONLINE AUCTION SERVICES; OPERATING ON-LINE MARKETPLACES FOR SELLERS OF GOODS AND/OR SERVICES, IN CLASS 35 (U.S. CLS. 100, 101 AND 102).

FIRST USE 5-15-2008; IN COMMERCE 5-15-2008.

THE MARK CONSISTS OF STANDARD CHARACTERS WITHOUT CLAIM TO ANY PARTICULAR FONT, STYLE, SIZE, OR COLOR.

SN 77-231,069, FILED 7-17-2007.

HANNO RITTNER, EXAMINING ATTORNEY

Int. Cl.: 35

Prior U.S. Cls.: 100, 101, and 102

United States Patent and Trademark Office

Reg. No. 3,521,875

Registered Oct. 21, 2008

**SERVICE MARK
PRINCIPAL REGISTER**



JUST PARTS ONLINE INCORPORATED (CANADA CORPORATION)
520 SQUIER STREET
THUNDER BAY, ONTARIO, CANADA P7B4A8

FOR: ON-LINE RETAIL STORE SERVICES FEATURING AUTOMOTIVE COMPONENTS, SUPPLIES AND ACCESSORIES; OPERATING ON-LINE MARKETPLACES FOR SELLERS OF GOODS AND/OR

SERVICES; ONLINE AUCTION SERVICES, IN CLASS 35 (U.S. CLS. 100, 101 AND 102).

FIRST USE 5-15-2008; IN COMMERCE 5-15-2008.

SN 77-231,141, FILED 7-17-2007.

HANNO RITTNER, EXAMINING ATTORNEY

Int. Cl.: 24

Prior U.S. Cls.: 42 and 50

United States Patent and Trademark Office

Reg. No. 3,521,876

Registered Oct. 21, 2008

**TRADEMARK
PRINCIPAL REGISTER**

CENTRAGARD

SPRINGS CREATIVE PRODUCTS GROUP, LLC
(SOUTH CAROLINA LIMITED LIABILITY
COMPANY)
454 SOUTH ANDERSON ROAD, SUITE 400
ROCK HILL, SC 29730

FOR: FIRE-RETARDANT, FIRE-RESISTANT,
AND FLAME BARRIER FABRICS FOR USE IN
THE MATTRESS, BEDDING, TRANSPORTATION,
AND UPHOLSTERED FURNITURE MARKETS, IN
CLASS 24 (U.S. CLS. 42 AND 50).

FIRST USE 3-31-2004; IN COMMERCE 3-31-2004.

THE MARK CONSISTS OF STANDARD CHAR-
ACTERS WITHOUT CLAIM TO ANY PARTICULAR
FONT, STYLE, SIZE, OR COLOR.

SN 77-231,248, FILED 7-17-2007.

APRIL HESIK, EXAMINING ATTORNEY

Int. Cl.: 35

Prior U.S. Cls.: 100, 101, and 102

United States Patent and Trademark Office

Reg. No. 3,521,877

Registered Oct. 21, 2008

**SERVICE MARK
PRINCIPAL REGISTER**

UPONGREEN

UPONGREEN, LLC (MINNESOTA LIMITED LIABILITY COMPANY)
4337 WILSHIRE BLVD.
MOUND, MN 55364

FOR: PROVIDING AN ON-LINE COMPUTER DATABASE IN THE FIELD OF LOCATING PRODUCTS, DESCRIBING PRODUCTS, RATING PRODUCTS, PRICING PRODUCTS AND COMPARING PRICES OF PRODUCTS; PROVIDING AN ON-LINE SHOWROOM FOR THE GOODS OF OTHERS IN THE FIELD OF ENVIRONMENTALLY RESPONSIBLE PRODUCTS; PROVIDING AN ONLINE DIRECTORY INFORMATION SERVICE FEATURING INFORMATION REGARDING ENVIRONMENTALLY RESPONSIBLE PRODUCTS; PROVIDING CONSUMER INFORMATION IN THE FIELD OF ENVIRONMENTALLY RESPONSIBLE PRODUCTS; PROVIDING CONSUMER PRODUCT INFORMA-

TION VIA THE INTERNET; PROVIDING INFORMATION ABOUT THE GOODS AND SERVICES OF OTHERS VIA THE GLOBAL COMPUTER NETWORK; ON-LINE BUSINESS DIRECTORIES FEATURING ENVIRONMENTALLY RESPONSIBLE PRODUCTS, IN CLASS 35 (U.S. CLS. 100, 101 AND 102).

FIRST USE 7-3-2007; IN COMMERCE 7-3-2007.

THE MARK CONSISTS OF STANDARD CHARACTERS WITHOUT CLAIM TO ANY PARTICULAR FONT, STYLE, SIZE, OR COLOR.

SN 77-231,834, FILED 7-17-2007.

NORA BUCHANAN WILL, EXAMINING ATTORNEY

Int. Cl.: 25

Prior U.S. Cls.: 22 and 39

United States Patent and Trademark Office

Reg. No. 3,521,878

Registered Oct. 21, 2008

**TRADEMARK
PRINCIPAL REGISTER**



LEGER, JEFF (UNITED STATES INDIVIDUAL)
3932 HAWTHORNE
WILSON, WY 83014

THE MARK CONSISTS OF A SNOWFLAKE WITH
A DOLLAR SIGN CENTER.

FOR: BELTS; GLOVES; HATS; PANTS; SHIRTS;
SHOES; UNDERWEAR, IN CLASS 25 (U.S. CLS. 22
AND 39).

SN 77-232,090, FILED 7-17-2007.

FIRST USE 1-1-2007; IN COMMERCE 1-1-2007.

NAAKWAMA ANKRAH, EXAMINING ATTORNEY

Int. Cl.: 3

Prior U.S. Cls.: 1, 4, 6, 50, 51, and 52

United States Patent and Trademark Office

Reg. No. 3,521,879

Registered Oct. 21, 2008

**TRADEMARK
PRINCIPAL REGISTER**

AMAZEMINT

NOXELL CORPORATION (MARYLAND COR-
PORATION)
11050 YORK ROAD
HUNT VALLEY, MD 210302098

THE MARK CONSISTS OF STANDARD CHAR-
ACTERS WITHOUT CLAIM TO ANY PARTICULAR
FONT, STYLE, SIZE, OR COLOR.

FOR: LIP GLOSS, IN CLASS 3 (U.S. CLS. 1, 4, 6, 50,
51 AND 52).

SN 77-232,532, FILED 7-18-2007.

FIRST USE 6-9-2008; IN COMMERCE 6-9-2008.

SHAUNIA CARLYLE, EXAMINING ATTORNEY

Int. Cl.: 16

Prior U.S. Cls.: 2, 5, 22, 23, 29, 37, 38, and 50

United States Patent and Trademark Office

Reg. No. 3,521,880

Registered Oct. 21, 2008

**TRADEMARK
PRINCIPAL REGISTER**

CHATTERCHIX

CHATTERCHIX, INC. (FLORIDA CORPORATION)
3397 CLARINE WAY EAST
DUNEDIN, FL 34698

THE MARK CONSISTS OF STANDARD CHARACTERS WITHOUT CLAIM TO ANY PARTICULAR FONT, STYLE, SIZE, OR COLOR.

FOR: TRADING CARDS, IN CLASS 16 (U.S. CLS. 2, 5, 22, 23, 29, 37, 38 AND 50).

SN 77-232,667, FILED 7-18-2007.

FIRST USE 2-1-2008; IN COMMERCE 2-1-2008.

ALICE BENMAMAN, EXAMINING ATTORNEY

Int. Cl.: 44

Prior U.S. Cls.: 100 and 101

United States Patent and Trademark Office

Reg. No. 3,521,881

Registered Oct. 21, 2008

**SERVICE MARK
PRINCIPAL REGISTER**

ROVER MRI

RICHMAN, TAMA (UNITED STATES INDIVIDUAL)
7100 FAIRWAY DRIVE, SUITES 26-27
PALM BEACH GARDENS, FL 33418 AND
RICHMAN, BRETT (UNITED STATES INDIVIDUAL)
7100 FAIRWAY DRIVE, SUITES 26-27
PALM BEACH GARDENS, FL 33418

FOR: VETERINARY IMAGING SERVICES , IN
CLASS 44 (U.S. CLS. 100 AND 101).

FIRST USE 12-0-2007; IN COMMERCE 12-0-2007.

THE MARK CONSISTS OF STANDARD CHARACTERS WITHOUT CLAIM TO ANY PARTICULAR FONT, STYLE, SIZE, OR COLOR.

NO CLAIM IS MADE TO THE EXCLUSIVE RIGHT TO USE "MRI", APART FROM THE MARK AS SHOWN.

SN 77-232,779, FILED 7-18-2007.

ANGELA GAW, EXAMINING ATTORNEY

Int. Cl.: 30

Prior U.S. Cl.: 46

United States Patent and Trademark Office

Reg. No. 3,521,882

Registered Oct. 21, 2008

**TRADEMARK
PRINCIPAL REGISTER**

L. Frances Caramel Company

L. FRANCES CARAMEL COMPANY, LLC (WIS-
CONSIN LIMITED LIABILITY COMPANY)
1015 S. MASON ST.
APPLETON, WI 54914

FOR: CANDY CARAMEL AND CARAMELS, IN
CLASS 30 (U.S. CL. 46).

FIRST USE 9-10-2007; IN COMMERCE 9-10-2007.

THE MARK CONSISTS OF STANDARD CHAR-
ACTERS WITHOUT CLAIM TO ANY PARTICULAR
FONT, STYLE, SIZE, OR COLOR.

NO CLAIM IS MADE TO THE EXCLUSIVE
RIGHT TO USE "CARAMEL COMPANY", APART
FROM THE MARK AS SHOWN.

THE NAME "L. FRANCES" IDENTIFIES A LIV-
ING INDIVIDUAL WHOSE CONSENT IS OF RE-
CORD.

SN 77-232,807, FILED 7-18-2007.

NATALIE POLZER, EXAMINING ATTORNEY

Int. Cl.: 3

Prior U.S. Cls.: 1, 4, 6, 50, 51, and 52

Reg. No. 3,521,883

United States Patent and Trademark Office

Registered Oct. 21, 2008

**TRADEMARK
PRINCIPAL REGISTER**

MELAMAXX

JONES, DENNIS (UNITED STATES INDIVIDUAL)
STE.112
1025 EXECUTIVE BLVD.
CHESAPEAKE, VA 23320

THE MARK CONSISTS OF STANDARD CHARACTERS WITHOUT CLAIM TO ANY PARTICULAR FONT, STYLE, SIZE, OR COLOR.

FOR: LIPOSOME GELS CONTAINING NATURAL MELANIN FOR COSMETIC LASER HAIR REMOVAL, IN CLASS 3 (U.S. CLS. 1, 4, 6, 50, 51 AND 52).

SN 77-233,133, FILED 7-18-2007.

FIRST USE 11-7-2007; IN COMMERCE 11-7-2007.

ESTHER A. BORSUK, EXAMINING ATTORNEY

Int. Cl.: 41

Prior U.S. Cls.: 100, 101, and 107

United States Patent and Trademark Office

Reg. No. 3,521,884

Registered Oct. 21, 2008

**SERVICE MARK
PRINCIPAL REGISTER**

EKNOW

ENVIRONMENTAL SYSTEMS CORPORATION
(TENNESSEE CORPORATION)
200 TECH CENTER DRIVE
KNOXVILLE, TN 37912

FOR: EDUCATIONAL SERVICES, NAMELY,
PROVIDING WEB-BASED NEW EMPLOYEE
TRAINING AND CONTINUING EDUCATION
LEARNING CLASSES IN THE FIELD OF CONTIN-
UOUS EMISSIONS MONITORING SYSTEMS, IN
CLASS 41 (U.S. CLS. 100, 101 AND 107).

FIRST USE 11-30-2007; IN COMMERCE 3-6-2007.

THE MARK CONSISTS OF STANDARD CHAR-
ACTERS WITHOUT CLAIM TO ANY PARTICULAR
FONT, STYLE, SIZE, OR COLOR.

SN 77-233,506, FILED 7-19-2007.

MATTHEW MCDOWELL, EXAMINING ATTOR-
NEY

Int. Cl.: 32

Prior U.S. Cls.: 45, 46, and 48

United States Patent and Trademark Office

Reg. No. 3,521,885

Registered Oct. 21, 2008

**TRADEMARK
PRINCIPAL REGISTER**

Dark Hollow

BLUE MOUNTAIN BREWERY, INC. (VIRGINIA
CORPORATION)
9585 CRITZERS SHOP ROAD
AFTON, VA 22920

NO CLAIM IS MADE TO THE EXCLUSIVE
RIGHT TO USE "DARK", APART FROM THE
MARK AS SHOWN.

FOR: BEER, IN CLASS 32 (U.S. CLS. 45, 46 AND 48).

FIRST USE 12-1-2007; IN COMMERCE 12-1-2007.

SN 77-233,808, FILED 7-19-2007.

THE MARK CONSISTS OF STANDARD CHAR-
ACTERS WITHOUT CLAIM TO ANY PARTICULAR
FONT, STYLE, SIZE, OR COLOR.

LINDA ORNDORFF, EXAMINING ATTORNEY

Int. Cl.: 25

Prior U.S. Cls.: 22 and 39

United States Patent and Trademark Office

Reg. No. 3,521,886

Registered Oct. 21, 2008

**TRADEMARK
PRINCIPAL REGISTER**

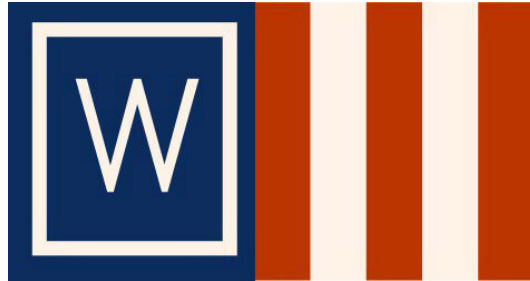

WRANGLER APPAREL CORP. (DELAWARE CORPORATION)
3411 SILVERSIDE RD.
WILMINGTON, DE 19810

FOR: TOPS, IN CLASS 25 (U.S. CLS. 22 AND 39).

FIRST USE 10-24-2007; IN COMMERCE 10-24-2007.

THE COLOR(S) RED, WHITE, AND BLUE IS/ARE CLAIMED AS A FEATURE OF THE MARK.

THE MARK CONSISTS OF THE COLOR WHITE APPEARS ON THE LETTER "W", ON A SQUARE BORDER AROUND THE LETTER "W", AND ON TWO VERTICAL STRIPES TO THE RIGHT OF THE LETTER "W"; THE COLOR RED APPEARS ON THREE VERTICAL STRIPES TO THE RIGHT OF THE LETTER "W"; AND THE COLOR BLUE APPEARS AS SHADING FOR THE BOX CONTAINING THE LETTER "W".

SN 77-234,475, FILED 7-20-2007.

THEODORE MCBRIDE, EXAMINING ATTORNEY

Int. Cl.: 5

Prior U.S. Cls.: 6, 18, 44, 46, 51, and 52

United States Patent and Trademark Office

Reg. No. 3,521,887

Registered Oct. 21, 2008

**TRADEMARK
PRINCIPAL REGISTER**

FEEL THE GOOD

ALACER CORPORATION (CALIFORNIA CORPORATION)
80 ICON
FOOTHILL RANCH, CA 92610

THE MARK CONSISTS OF STANDARD CHARACTERS WITHOUT CLAIM TO ANY PARTICULAR FONT, STYLE, SIZE, OR COLOR.

FOR: BEVERAGES, NAMELY, VITAMIN ENRICHED WATER, IN CLASS 5 (U.S. CLS. 6, 18, 44, 46, 51 AND 52).

SN 77-234,828, FILED 7-20-2007.

FIRST USE 7-26-2006; IN COMMERCE 6-1-2007.

H. M. FISHER, EXAMINING ATTORNEY

Int. Cl.: 16

Prior U.S. Cls.: 2, 5, 22, 23, 29, 37, 38, and 50

Reg. No. 3,521,888

United States Patent and Trademark Office

Registered Oct. 21, 2008

**TRADEMARK
PRINCIPAL REGISTER**

Bizenghast

TOKYOPOP INC. (CALIFORNIA CORPORATION)
5900 WILSHIRE BLVD., SUITE 2000
LEGAL & BUSINESS AFFAIRS
LOS ANGELES, CA 90036

FOR: A SERIES OF BOOKS AND WRITTEN ARTICLES IN THE FIELD OF GRAPHIC NOVELS, COMIC BOOKS; ADVERTISING BOARDS OF PAPER OR CARDBOARD; BOOKMARKS; CALENDARS; CATALOGS IN THE FIELD OF GRAPHIC NOVELS AND ANIMATION MERCHANDISE; COLORING BOOKS; GREETING CARDS; MANUALS IN THE FIELD OF COMIC BOOKS, ANIMATION, DIGITAL PROGRAMS; NEWSPAPER COMIC

STRIPS; NOTEBOOKS; PHOTOGRAPHS; PICTURES; POSTERS; PRINTS; STATIONERY-TYPE PORTFOLIOS; STICKERS; TRADING CARDS, IN CLASS 16 (U.S. CLS. 2, 5, 22, 23, 29, 37, 38 AND 50).

FIRST USE 7-20-2007; IN COMMERCE 1-22-2008.

THE MARK CONSISTS OF STANDARD CHARACTERS WITHOUT CLAIM TO ANY PARTICULAR FONT, STYLE, SIZE, OR COLOR.

SN 77-234,860, FILED 7-20-2007.

NAAKWAMA ANKRAH, EXAMINING ATTORNEY

Int. Cl.: 35

Prior U.S. Cls.: 100, 101, and 102

United States Patent and Trademark Office

Reg. No. 3,521,889

Registered Oct. 21, 2008

**SERVICE MARK
PRINCIPAL REGISTER**

REALTIME HR

REAL TIME HR LLC (OKLAHOMA LIMITED
LIABILITY COMPANY)
SUITE 202
5005 NORTH PENN
OKLAHOMA CITY, OK 73112

FOR: OUTSOURCING IN THE FIELD OF HU-
MAN RESOURCES, IN CLASS 35 (U.S. CLS. 100, 101
AND 102).

FIRST USE 1-1-2008; IN COMMERCE 6-25-2008.

THE MARK CONSISTS OF STANDARD CHAR-
ACTERS WITHOUT CLAIM TO ANY PARTICULAR
FONT, STYLE, SIZE, OR COLOR.

NO CLAIM IS MADE TO THE EXCLUSIVE
RIGHT TO USE "HR", APART FROM THE MARK
AS SHOWN.

SN 77-235,013, FILED 7-20-2007.

ELLEN B. AWRICH, EXAMINING ATTORNEY

Int. Cl.: 36

Prior U.S. Cls.: 100, 101, and 102

United States Patent and Trademark Office

Reg. No. 3,521,890

Registered Oct. 21, 2008

**SERVICE MARK
PRINCIPAL REGISTER**

**Location. Location.
Location.**

SCHAEFFER, MONIQUE (UNITED STATES IN-
DIVIDUAL)
145 PARSELL ST.
KINGSTON, NY 12401

THE MARK CONSISTS OF STANDARD CHAR-
ACTERS WITHOUT CLAIM TO ANY PARTICULAR
FONT, STYLE, SIZE, OR COLOR.

FOR: REAL ESTATE AGENCIES; REAL ESTATE
BROKERAGE, IN CLASS 36 (U.S. CLS. 100, 101 AND
102).

SN 77-235,583, FILED 7-22-2007.

FIRST USE 7-8-2007; IN COMMERCE 3-23-2008.

FRED MANDIR, EXAMINING ATTORNEY

Int. Cl.: 41

Prior U.S. Cls.: 100, 101, and 107

United States Patent and Trademark Office

Reg. No. 3,521,891

Registered Oct. 21, 2008

**SERVICE MARK
PRINCIPAL REGISTER**

BOS

BR CONSULTING, INC. (NEW JERSEY CORPORATION)
340 JORDAN ROAD
SEDONA, AZ 86336

FOR: EDUCATIONAL SERVICES, NAMELY, CONDUCTING CLASSES, SEMINARS AND WORKSHOPS, TO ENHANCE MENTAL, EMOTIONAL AND PHYSICAL CAPABILITIES, IN CLASS 41 (U.S. CLS. 100, 101 AND 107).

FIRST USE 4-10-2006; IN COMMERCE 4-10-2006.

THE MARK CONSISTS OF STANDARD CHARACTERS WITHOUT CLAIM TO ANY PARTICULAR FONT, STYLE, SIZE, OR COLOR.

SN 77-235,831, FILED 7-23-2007.

DAVID TAYLOR, EXAMINING ATTORNEY

Int. Cl.: 19

Prior U.S. Cls.: 1, 12, 33, and 50

United States Patent and Trademark Office

Reg. No. 3,521,892

Registered Oct. 21, 2008

**TRADEMARK
PRINCIPAL REGISTER**

PROSTONE

OWENS CORNING INTELLECTUAL CAPITAL,
LLC (DELAWARE LIMITED LIABILITY COM-
PANY)
ONE OWENS CORNING PARKWAY
TOLEDO, OH 43659

FOR: MANUFACTURED STONE, MANUFAC-
TURED BRICK, MANUFACTURED STONE VE-
NEER AND DECORATIVE STONE ALL IN THE
BUILDING INDUSTRY, IN CLASS 19 (U.S. CLS. 1, 12,
33 AND 50).

FIRST USE 3-24-2008; IN COMMERCE 3-24-2008.

THE MARK CONSISTS OF STANDARD CHAR-
ACTERS WITHOUT CLAIM TO ANY PARTICULAR
FONT, STYLE, SIZE, OR COLOR.

SN 77-235,978, FILED 7-23-2007.

ESTHER A. BORSUK, EXAMINING ATTORNEY

Int. Cls.: 29 and 30

Prior U.S. Cl.: 46

United States Patent and Trademark Office

Reg. No. 3,521,893

Registered Oct. 21, 2008

TRADEMARK
PRINCIPAL REGISTER



QUALITY CANDY SHOPPES/BUDDY SQUIRREL
OF WISCONSIN, INC. (WISCONSIN COR-
PORATION)

1801 E. BOLIVAR AVE
ST. FRANCIS, WI 53235

FOR: FOODS, NAMELY, ROASTED NUTS, SHEL-
LED NUTS, PROCESSED SALTED NUTS AND
PROCESSED MIXED NUTS, IN CLASS 29 (U.S. CL.
46).

FIRST USE 10-15-2007; IN COMMERCE 10-15-2007.

FOR: CANDIES, CHOCOLATE COVERED NUTS
AND CHOCOLATE COVERED RAISINS, IN CLASS
30 (U.S. CL. 46).

FIRST USE 10-15-2007; IN COMMERCE 10-15-2007.

NO CLAIM IS MADE TO THE EXCLUSIVE
RIGHT TO USE "CONFECTIONS", APART FROM
THE MARK AS SHOWN.

THE SCRIPT LETTERS, "J" & "L" APPEAR IN A
RECTANGULAR BLOCK WITH RECTANGULAR
BARS ABOVE AND BELOW; THE WORDS "JOSEPH
" AND "LOTTIE" APPEAR ON THE SIDES OF THE
BLOCK.

SN 77-236,103, FILED 7-23-2007.

SEAN CROWLEY, EXAMINING ATTORNEY

Int. Cls.: 29 and 30

Prior U.S. Cl.: 46

United States Patent and Trademark Office

Reg. No. 3,521,894

Registered Oct. 21, 2008

TRADEMARK
PRINCIPAL REGISTER



QUALITY CANDY SHOPPES/BUDDY SQUIRREL
OF WISCONSIN, INC. (WISCONSIN COR-
PORATION)

1801 E. BOLIVAR AVE
ST. FRANCIS, WI 53235

FOR: SNACK FOODS, NAMELY, ROASTED
NUTS, SHELLED NUTS, PROCESSED SALTED
NUTS AND PROCESSED MIXED NUTS, IN CLASS
29 (U.S. CL. 46).

FIRST USE 10-15-2007; IN COMMERCE 10-15-2007.

FOR: CANDIES, CHOCOLATE COVERED NUTS
AND CHOCOLATE COVERED RAISINS, IN CLASS
30 (U.S. CL. 46).

FIRST USE 10-15-2007; IN COMMERCE 10-15-2007.

THE SCRIPT LETTERS, "J" & "L" APPEAR IN A
RECTANGULAR BLOCK WITH RECTANGULAR
BARS ABOVE AND BELOW.

SN 77-236,113, FILED 7-23-2007.

SEAN CROWLEY, EXAMINING ATTORNEY

Int. Cl.: 28

Prior U.S. Cls.: 22, 23, 38, and 50

United States Patent and Trademark Office

Reg. No. 3,521,895

Registered Oct. 21, 2008

**TRADEMARK
PRINCIPAL REGISTER**

THE ORIGIN OF EXPRESSIONS

DISCOVERY BAY GAMES LLC (WASHINGTON
LIMITED LIABILITY COMPANY)
211 TAYLOR STREET, #401A
PORT TOWNSEND, WA 98368

THE MARK CONSISTS OF STANDARD CHAR-
ACTERS WITHOUT CLAIM TO ANY PARTICULAR
FONT, STYLE, SIZE, OR COLOR.

FOR: BOARD GAMES, IN CLASS 28 (U.S. CLS. 22,
23, 38 AND 50).

SN 77-236,515, FILED 7-23-2007.

FIRST USE 9-1-2007; IN COMMERCE 9-1-2007.

DAVID TOOLEY, EXAMINING ATTORNEY

Int. Cl.: 38

Prior U.S. Cls.: 100, 101, and 104

United States Patent and Trademark Office

Reg. No. 3,521,896

Registered Oct. 21, 2008

**SERVICE MARK
PRINCIPAL REGISTER**

TOTALTEL

COVISTA COMMUNICATIONS, INC. (NEW JERSEY CORPORATION)
4803 HWY 58 NORTH
CHATTANOOGA, TN 37416

FOR: TELECOMMUNICATIONS SERVICES, NAMELY, TRANSMISSION OF VOICE, FACSIMILE, DATA, VIDEO AND INFORMATION; PROVIDING TELECOMMUNICATION SERVICE CONNECTIONS TO GLOBAL COMPUTER NETWORKS; TELECOMMUNICATIONS SERVICES PROVIDED OVER A SWITCHED AND DEDICATED TELECOMMUNICATIONS NETWORK, NAMELY, THE SIMULTANEOUS BI-DIRECTIONAL INTERACTIVE TRANSMISSION OF VOICE, AUDIO, VIDEO, DATA, TEXT, FACSIMILE AND INFORMATION; LOCAL AND LONG DISTANCE VOICE AND DATA ELECTRONIC TRANSMISSION SERVICES; LOCAL AND LONG DISTANCE VOICE AND DATA TELEPHONE COMMUNICATION SERVICES; VOICE AND DATA TRANSMISSION SERVICES PROVIDED VIA IN-

TERNET PROTOCOL, NAMELY VOICE OVER INTERNET PROTOCOL SERVICES, PBX VOICE OVER INTERNET PROTOCOL SERVICES, AND CENTREX VOICE OVER INTERNET PROTOCOL SERVICES; AND VOICE AND DATA TRANSMISSION SERVICES PROVIDED OVER ELECTRICAL LINES, OPTICAL LINES, AND ETHERNET, IN CLASS 38 (U.S. CLS. 100, 101 AND 104).

FIRST USE 10-1-1983; IN COMMERCE 10-1-1983.

THE MARK CONSISTS OF STANDARD CHARACTERS WITHOUT CLAIM TO ANY PARTICULAR FONT, STYLE, SIZE, OR COLOR.

OWNER OF U.S. REG. NO. 1,605,963.

SN 77-236,529, FILED 7-23-2007.

MAUREEN DALL, EXAMINING ATTORNEY

Int. Cl.: 41

Prior U.S. Cls.: 100, 101, and 107

United States Patent and Trademark Office

Reg. No. 3,521,897

Registered Oct. 21, 2008

**SERVICE MARK
PRINCIPAL REGISTER**

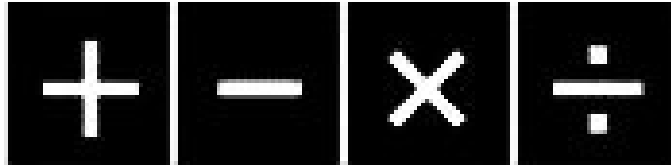

ALEKS CORPORATION (DELAWARE CORPORATION)
SUITE 150
15641 RED HILL AVENUE
TUSTIN, CA 92780

FOR: PROVIDING ONLINE INDIVIDUALIZED LESSONS IN MATH TO STUDENTS AND MONITORING THE PROGRESS OF THE STUDENTS; PERFORMING ONLINE INTERACTIVE ASSES-

MENTS OF THE KNOWLEDGE AND SKILLS OF STUDENTS, IN CLASS 41 (U.S. CLS. 100, 101 AND 107).

FIRST USE 9-24-2007; IN COMMERCE 9-24-2007.

SN 77-236,686, FILED 7-23-2007.

G. MAYERSCHOFF, EXAMINING ATTORNEY

Int. Cl.: 24

Prior U.S. Cls.: 42 and 50

United States Patent and Trademark Office

Reg. No. 3,521,898

Registered Oct. 21, 2008

**TRADEMARK
PRINCIPAL REGISTER**

QUILTEE

ROTHSTEIN, NANCY H. (UNITED STATES IN-
DIVIDUAL)
2737 ILLINOIS ROAD
WILMETTE, IL 60091 AND
MATASAR, LAURIE (UNITED STATES INDIVI-
DUAL)
2737 ILLINOIS ROAD
WILMETTE, IL 60091

FIRST USE 10-0-2007; IN COMMERCE 10-0-2007.

THE MARK CONSISTS OF STANDARD CHAR-
ACTERS WITHOUT CLAIM TO ANY PARTICULAR
FONT, STYLE, SIZE, OR COLOR.

SN 77-237,001, FILED 7-24-2007.

FOR: HAND MADE, CUSTOM-DESIGNED
QUILTS, IN CLASS 24 (U.S. CLS. 42 AND 50).

JILL C. ALT, EXAMINING ATTORNEY

Int. Cl.: 9

Prior U.S. Cls.: 21, 23, 26, 36, and 38

United States Patent and Trademark Office

Reg. No. 3,521,899

Registered Oct. 21, 2008

**TRADEMARK
PRINCIPAL REGISTER**

SUREAUDIT

STEELCLOUD, INC. (VIRGINIA CORPORATION)
SUITE 210
14040 PARK CENTER ROAD
HERNDON, VA 20171

THE MARK CONSISTS OF STANDARD CHAR-
ACTERS WITHOUT CLAIM TO ANY PARTICULAR
FONT, STYLE, SIZE, OR COLOR.

FOR: COMPUTER SOFTWARE ASSET AUDIT-
ING COMPUTER SOFTWARE, IN CLASS 9 (U.S.
CLS. 21, 23, 26, 36 AND 38).

SN 77-237,325, FILED 7-24-2007.

FIRST USE 9-12-2007; IN COMMERCE 9-12-2007.

RICHARD WHITE, EXAMINING ATTORNEY

Int. Cl.: 7

Prior U.S. Cls.: 13, 19, 21, 23, 31, 34, and 35

Reg. No. 3,521,900

United States Patent and Trademark Office

Registered Oct. 21, 2008

**TRADEMARK
PRINCIPAL REGISTER**

DSB BUSINESS MACHINE CO., LTD. (TAIWAN CORPORATION)
1F, NO. 20, MIN SHENG RD., TOU LIU CITY
YU LIN HSIEN, TAIWAN

FIRST USE 11-20-2007; IN COMMERCE 7-20-2008.

FOR: BAG PRODUCTION MACHINES; SEALING MACHINES FOR PACKING BUT EXCLUDING HEAT SEALING MACHINES AND ENVELOPE SEALING MACHINES; PACKAGING MACHINES; MACHINES FOR THE MANUFACTURE OF INFLATABLE PLASTIC PACKAGING AND INFLATABLE PLASTIC VOID FILL, IN CLASS 7 (U.S. CLS. 13, 19, 21, 23, 31, 34 AND 35).

THE MARK CONSISTS OF THE WORD "WIAIR" WITH THE LOWER CASE LETTERS "WI" AND HIGHLY STYLIZED LETTERS "AIR".

SN 77-237,701, FILED 7-24-2007.

DOMINIC FATHY, EXAMINING ATTORNEY

Int. Cl.: 9

Prior U.S. Cls.: 21, 23, 26, 36, and 38

Reg. No. 3,521,901

United States Patent and Trademark Office

Registered Oct. 21, 2008

**TRADEMARK
PRINCIPAL REGISTER**

I-SPEC

PARADIGM SENSORS, LLC (WISCONSIN LIMITED LIABILITY COMPANY)
7255 WEST APPLETON AVENUE, #200
MILWAUKEE, WI 53216

FOR: HANDHELD FLUID MONITORING DEVICES, NAMELY, HANDHELD MONITORING DEVICES USING IMPEDANCE SPECTROSCOPY FOR FLUID ANALYSIS, IN CLASS 9 (U.S. CLS. 21, 23, 26, 36 AND 38).

FIRST USE 2-29-2008; IN COMMERCE 2-29-0208.

THE MARK CONSISTS OF STANDARD CHARACTERS WITHOUT CLAIM TO ANY PARTICULAR FONT, STYLE, SIZE, OR COLOR.

SN 77-237,907, FILED 7-25-2007.

KAREN BRACEY, EXAMINING ATTORNEY

Int. Cl.: 9

Prior U.S. Cls.: 21, 23, 26, 36, and 38

Reg. No. 3,521,902

United States Patent and Trademark Office

Registered Oct. 21, 2008

**TRADEMARK
PRINCIPAL REGISTER**

PARADIGM SENSORS

PARADIGM SENSORS, LLC (WISCONSIN LIMITED LIABILITY COMPANY)
7255 WEST APPLETON AVENUE, #200
MILWAUKEE, WI 53216

FOR: HANDHELD FLUID MONITORING DEVICES, NAMELY, HANDHELD MONITORING DEVICES USING IMPEDANCE SPECTROSCOPY FOR FLUID ANALYSIS, IN CLASS 9 (U.S. CLS. 21, 23, 26, 36 AND 38).

FIRST USE 2-29-2008; IN COMMERCE 2-29-2008.

THE MARK CONSISTS OF STANDARD CHARACTERS WITHOUT CLAIM TO ANY PARTICULAR FONT, STYLE, SIZE, OR COLOR.

NO CLAIM IS MADE TO THE EXCLUSIVE RIGHT TO USE "SENSORS", APART FROM THE MARK AS SHOWN.

SN 77-237,910, FILED 7-25-2007.

KAREN BRACEY, EXAMINING ATTORNEY

Int. Cl.: 41

Prior U.S. Cls.: 100, 101, and 107

United States Patent and Trademark Office

Reg. No. 3,521,903

Registered Oct. 21, 2008

**SERVICE MARK
PRINCIPAL REGISTER**

**Patent Paradise Found by
Milton**

HAROLD W. MILTON, JR. (UNITED STATES
INDIVIDUAL)
2430 WILDBROOK RUN
BLOOMFIELD HILLS, MI 48304

FOR: VOCATIONAL EDUCATION IN THE FIELD
OF PATENT LAW, IN CLASS 41 (U.S. CLS. 100, 101
AND 107).

FIRST USE 8-3-2007; IN COMMERCE 8-3-2007.

THE MARK CONSISTS OF STANDARD CHAR-
ACTERS WITHOUT CLAIM TO ANY PARTICULAR
FONT, STYLE, SIZE, OR COLOR.

NO CLAIM IS MADE TO THE EXCLUSIVE
RIGHT TO USE "PATENT" OR "BY MILTON",
APART FROM THE MARK AS SHOWN.

SN 77-238,066, FILED 7-25-2007.

DORITT L. CARROLL, EXAMINING ATTORNEY

Int. Cl.: 9

Prior U.S. Cls.: 21, 23, 26, 36, and 38

United States Patent and Trademark Office

Reg. No. 3,521,904

Registered Oct. 21, 2008

**TRADEMARK
PRINCIPAL REGISTER**

PRO-GRIP

COOPER TECHNOLOGIES COMPANY (DELA-
WARE CORPORATION)
600 TRAVIS, SUITE 5600
HOUSTON, TX 77002

THE MARK CONSISTS OF STANDARD CHAR-
ACTERS WITHOUT CLAIM TO ANY PARTICULAR
FONT, STYLE, SIZE, OR COLOR.

FOR: ELECTRICAL LOCKING PLUGS, CONNec-
TORS, RECEPTACLES AND FLANGED INLETS, IN
CLASS 9 (U.S. CLS. 21, 23, 26, 36 AND 38).

SN 77-238,157, FILED 7-25-2007.

FIRST USE 12-3-2007; IN COMMERCE 12-3-2007.

CAROLYN CATALDO, EXAMINING ATTORNEY

Int. Cls.: 25 and 41

Prior U.S. Cls.: 22, 39, 100, 101, and 107

United States Patent and Trademark Office

Reg. No. 3,521,905

Registered Oct. 21, 2008

**TRADEMARK
SERVICE MARK
PRINCIPAL REGISTER**



DEVIN, KEVIN (UNITED STATES INDIVIDUAL)
115 EAST 5TH STREET
CHARLOTTE, NC 28202

FOR: T-SHIRTS, IN CLASS 25 (U.S. CLS. 22 AND 39).

FIRST USE 6-1-2008; IN COMMERCE 6-1-2008.

FOR: ENTERTAINMENT IN THE NATURE OF A LOCAL FESTIVAL WITH AN IRISH THEME, NAMELY, THE PROVISION OF IRISH MUSIC, FOOD, DANCE, AND OTHER TRADITIONAL IRISH ACTIVITIES, IN CLASS 41 (U.S. CLS. 100, 101 AND 107).

FIRST USE 6-1-2008; IN COMMERCE 6-1-2008.

NO CLAIM IS MADE TO THE EXCLUSIVE RIGHT TO USE "CHARLOTTE IRISH SUMMER FESTIVAL", APART FROM THE MARK AS SHOWN.

THE MARK CONSISTS OF THE PHRASE "CHARLOTTE IRISH SUMMER FESTIVAL" WITH A CLOVER LEAF DOTTING THE SMALL LETTER "I" AND A CROWN OVER THE CAPITAL LETTER "I".

SN 77-238,487, FILED 7-25-2007.

KAREN K. BUSH, EXAMINING ATTORNEY

Int. Cl.: 16

Prior U.S. Cls.: 2, 5, 22, 23, 29, 37, 38, and 50

Reg. No. 3,521,906

United States Patent and Trademark Office

Registered Oct. 21, 2008

**TRADEMARK
PRINCIPAL REGISTER**

TRANQUILO

DPE LABEL HOLDING CORP. (NEW YORK
CORPORATION)
232 BROADWAY
BROOKLYN, NY 11211

FOR: PRE-PAID TELEPHONE CALLING CARDS,
NOT MAGNETICALLY ENCODED, IN CLASS 16
(U.S. CLS. 2, 5, 22, 23, 29, 37, 38 AND 50).

FIRST USE 12-14-2007; IN COMMERCE 12-14-2007.

THE MARK CONSISTS OF STANDARD CHAR-
ACTERS WITHOUT CLAIM TO ANY PARTICULAR
FONT, STYLE, SIZE, OR COLOR.

THE FOREIGN WORDING IN THE MARK
TRANSLATES INTO ENGLISH AS "TRANQUIL".

SN 77-238,526, FILED 7-25-2007.

JOHN KELLY, EXAMINING ATTORNEY

Int. Cl.: 16

Prior U.S. Cls.: 2, 5, 22, 23, 29, 37, 38, and 50

Reg. No. 3,521,907

United States Patent and Trademark Office

Registered Oct. 21, 2008

**TRADEMARK
PRINCIPAL REGISTER**

BUSCADA

DPE LABEL HOLDING CORP. (NEW YORK
CORPORATION)
232 BROADWAY
BROOKLYN, NY 11211

FOR: PRE-PAID TELEPHONE CALLING CARDS,
NOT MAGNETICALLY ENCODED, IN CLASS 16
(U.S. CLS. 2, 5, 22, 23, 29, 37, 38 AND 50).

FIRST USE 8-6-2007; IN COMMERCE 8-6-2007.

THE MARK CONSISTS OF STANDARD CHAR-
ACTERS WITHOUT CLAIM TO ANY PARTICULAR
FONT, STYLE, SIZE, OR COLOR.

THE FOREIGN WORDING IN THE MARK
TRANSLATES INTO ENGLISH AS "WANTED".

SN 77-238,535, FILED 7-25-2007.

JOHN KELLY, EXAMINING ATTORNEY

Int. Cls.: 41 and 42

Prior U.S. Cls.: 100, 101, and 107

United States Patent and Trademark Office

Reg. No. 3,521,908

Registered Oct. 21, 2008

**SERVICE MARK
PRINCIPAL REGISTER**

TEMENOS

TEMENOS HEADQUARTERS SA (SWITZERLAND CORPORATION)
PLACE DES PHILOSOPHES 18
1205 GENEVA, SWITZERLAND

FOR: EDUCATIONAL SERVICES, NAMELY, ORGANIZING CONFERENCES, CONDUCTING PRACTICAL TRAINING AND DEMONSTRATIONS, AND TEACHING WORKSHOPS FOR USE IN ADMINISTRATION OF BANKING SOFTWARE FOR FINANCIAL INSTITUTIONS, IN CLASS 41 (U.S. CLS. 100, 101 AND 107).

FIRST USE 11-1-2007; IN COMMERCE 11-1-2007.

FOR: COMPUTER PROGRAMMING, MAINTENANCE OF COMPUTER SOFTWARE, UPDATING OF COMPUTER SOFTWARE, COMPUTER SOFT-

WARE DESIGN AND COMPUTER SOFTWARE ANALYSIS, IN CLASS 42 (U.S. CLS. 100 AND 101).

FIRST USE 11-1-2007; IN COMMERCE 11-1-2007.

THE MARK CONSISTS OF STANDARD CHARACTERS WITHOUT CLAIM TO ANY PARTICULAR FONT, STYLE, SIZE, OR COLOR.

OWNER OF U.S. REG. NOS. 2,629,668, 2,854,045, AND 3,151,739.

THE ENGLISH TRANSLATION OF THE WORD "TEMENOS" IN THE MARK IS "SACRED PLACE".

SN 77-238,667, FILED 7-25-2007.

WILLIAM VERHOSEK, EXAMINING ATTORNEY

Int. Cl.: 41

Prior U.S. Cls.: 100, 101, and 107

United States Patent and Trademark Office

Reg. No. 3,521,909

Registered Oct. 21, 2008

**SERVICE MARK
PRINCIPAL REGISTER**

**IT'S A LONG ROAD FROM
GARAGE TO GOLD - OR
PLATINUM.**

MCNALLY SMITH COLLEGE OF MUSIC (MINNESOTA S-CORPORATION)
19 EXCHANGE STREET EAST
SAINT PAUL, MN 55101

FOR: EDUCATION SERVICES, NAMELY, PROVIDING CLASSES, SEMINARS, AND WORKSHOPS IN THE FIELD OF MUSIC AND MUSIC BUSINESS AND DISTRIBUTING COURSE MATERIAL IN CONNECTION THEREWITH; EDUCATIONAL SERVICES, NAMELY, PROVIDING COURSES OF INSTRUCTION AT THE COLLEGE LEVEL AND DISTRIBUTING COURSE MATERIAL IN CONNEC-

TION THEREWITH, IN CLASS 41 (U.S. CLS. 100, 101 AND 107).

FIRST USE 9-5-2007; IN COMMERCE 9-5-2007.

THE MARK CONSISTS OF STANDARD CHARACTERS WITHOUT CLAIM TO ANY PARTICULAR FONT, STYLE, SIZE, OR COLOR.

SN 77-238,715, FILED 7-25-2007.

STEPHEN AQUILA, EXAMINING ATTORNEY

Int. Cls.: 21 and 25

Prior U.S. Cls.: 2, 13, 22, 23, 29, 30, 33, 39, 40, and 50

United States Patent and Trademark Office

Reg. No. 3,521,910

Registered Oct. 21, 2008

**TRADEMARK
PRINCIPAL REGISTER**

EQUATE

WAL-MART STORES, INC. (DELAWARE CORPORATION)
702 S.W. 8TH ST.
BENTONVILLE, AR 727160520

THE MARK CONSISTS OF STANDARD CHARACTERS WITHOUT CLAIM TO ANY PARTICULAR FONT, STYLE, SIZE, OR COLOR.

FOR: DENTAL FLOSS, IN CLASS 21 (U.S. CLS. 2, 13, 23, 29, 30, 33, 40 AND 50).

OWNER OF U.S. REG. NOS. 1,893,879, 3,098,567, AND OTHERS.

FIRST USE 3-31-2006; IN COMMERCE 3-31-2006.

FOR: INSOLES , IN CLASS 25 (U.S. CLS. 22 AND 39).

SN 77-238,723, FILED 7-25-2007.

FIRST USE 4-30-1998; IN COMMERCE 4-30-1998.

KAREN SEVERSON, EXAMINING ATTORNEY

Int. Cl.: 21

Prior U.S. Cls.: 2, 13, 23, 29, 30, 33, 40, and 50

United States Patent and Trademark Office

Reg. No. 3,521,911

Registered Oct. 21, 2008

**TRADEMARK
PRINCIPAL REGISTER**

PERFEC TEMP

CONAIR CORPORATION (DELAWARE CORPORATION)
ONE CUMMINGS POINT ROAD
STAMFORD, CT 06902

FOR: BAKEWARE; COOKWARE, NAMELY, POTS AND PANS; COOKWARE, NAMELY, ROASTING PANS; COOKWARE, NAMELY, STEAMERS; TEA KETTLES, IN CLASS 21 (U.S. CLS. 2, 13, 23, 29, 30, 33, 40 AND 50).

FIRST USE 7-1-2008; IN COMMERCE 7-1-2008.

THE MARK CONSISTS OF STANDARD CHARACTERS WITHOUT CLAIM TO ANY PARTICULAR FONT, STYLE, SIZE, OR COLOR.

SN 77-238,724, FILED 7-25-2007.

ROBERT C. CLARK JR., EXAMINING ATTORNEY

Int. Cl.: 20

Prior U.S. Cls.: 2, 13, 22, 25, 32, and 50

United States Patent and Trademark Office

Reg. No. 3,521,912

Registered Oct. 21, 2008

**TRADEMARK
PRINCIPAL REGISTER**

Palm Shape Technology

C-ZEN, INC. (CALIFORNIA CORPORATION)
14431 VENTURA BLVD.
SHERMAN OAKS, CA 91423

FOR: NECK SUPPORT CUSHIONS; SEAT CUSHIONS; BABY HEAD SUPPORT CUSHIONS; CUSHIONS; HEAD SUPPORTING PILLOWS; NECK-SUPPORTING PILLOWS; PILLOWS, IN CLASS 20 (U.S. CLS. 2, 13, 22, 25, 32 AND 50).

FIRST USE 3-1-2005; IN COMMERCE 9-1-2008.

THE MARK CONSISTS OF STANDARD CHARACTERS WITHOUT CLAIM TO ANY PARTICULAR FONT, STYLE, SIZE, OR COLOR.

NO CLAIM IS MADE TO THE EXCLUSIVE RIGHT TO USE "TECHNOLOGY", APART FROM THE MARK AS SHOWN.

SN 77-238,911, FILED 7-25-2007.

ANDREA BUTLER, EXAMINING ATTORNEY

Int. Cl.: 41

Prior U.S. Cls.: 100, 101, and 107

United States Patent and Trademark Office

Reg. No. 3,521,913

Registered Oct. 21, 2008

**SERVICE MARK
PRINCIPAL REGISTER**

**GEOMATICS ENGINEERING -
SURVEYING AND MAPPING IN A
DIGITAL WORLD**

FLORIDA ATLANTIC UNIVERSITY (FLORIDA
STATE UNIVERSITY)
777 GLADES ROAD
BOCA RATON, FL 33431

FOR: EDUCATION SERVICES, NAMELY, PRO-
VIDING EDUCATION PROGRAMS IN THE FIELD
OF GEOMATICS, IN CLASS 41 (U.S. CLS. 100, 101
AND 107).

FIRST USE 6-0-2008; IN COMMERCE 6-0-2008.

THE MARK CONSISTS OF STANDARD CHAR-
ACTERS WITHOUT CLAIM TO ANY PARTICULAR
FONT, STYLE, SIZE, OR COLOR.

NO CLAIM IS MADE TO THE EXCLUSIVE
RIGHT TO USE "GEOMATICS ENGINEERING",
APART FROM THE MARK AS SHOWN.

SN 77-239,106, FILED 7-26-2007.

NAAKWAMA ANKRAH, EXAMINING ATTORNEY

Int. Cl.: 41

Prior U.S. Cls.: 100, 101, and 107

Reg. No. 3,521,914

United States Patent and Trademark Office

Registered Oct. 21, 2008

**SERVICE MARK
PRINCIPAL REGISTER**

**GEOMATICS ENGINEERING NET
INSTRUCTIONAL ENVIRONMENT
(GENIE)**

FLORIDA ATLANTIC UNIVERSITY (FLORIDA
STATE UNIVERSITY)
777 GLADES ROAD
BOCA RATON, FL 33431

FOR: EDUCATION SERVICES, NAMELY, PRO-
VIDING EDUCATION PROGRAMS IN THE FIELD
OF GEOMATICS, IN CLASS 41 (U.S. CLS. 100, 101
AND 107).

FIRST USE 9-1-2007; IN COMMERCE 9-1-2007.

THE MARK CONSISTS OF STANDARD CHAR-
ACTERS WITHOUT CLAIM TO ANY PARTICULAR
FONT, STYLE, SIZE, OR COLOR.

NO CLAIM IS MADE TO THE EXCLUSIVE
RIGHT TO USE "GEOMATICS ENGINEERING"
AND "INSTRUCTIONAL", APART FROM THE
MARK AS SHOWN.

SN 77-239,141, FILED 7-26-2007.

NAAKWAMA ANKRAH, EXAMINING ATTORNEY

Int. Cl.: 41

Prior U.S. Cls.: 100, 101, and 107

United States Patent and Trademark Office

Reg. No. 3,521,915

Registered Oct. 21, 2008

**SERVICE MARK
PRINCIPAL REGISTER**

**TOUCHING LIVES THROUGH
TECHNOLOGY**

FLORIDA ATLANTIC UNIVERSITY (FLORIDA
STATE UNIVERSITY)
777 GLADES ROAD
BOCA RATON, FL 33431

FOR: EDUCATION SERVICES, NAMELY, PRO-
VIDING CLASSES, PROGRAMS, AND INSTRUC-
TION IN THE FIELD OF ENGINEERING
RESEARCH AND STUDIES, IN CLASS 41 (U.S.
CLS. 100, 101 AND 107).

FIRST USE 3-1-2007; IN COMMERCE 3-1-2007.

THE MARK CONSISTS OF STANDARD CHAR-
ACTERS WITHOUT CLAIM TO ANY PARTICULAR
FONT, STYLE, SIZE, OR COLOR.

NO CLAIM IS MADE TO THE EXCLUSIVE
RIGHT TO USE "TECHNOLOGY", APART FROM
THE MARK AS SHOWN.

SN 77-239,164, FILED 7-26-2007.

NAAKWAMA ANKRAH, EXAMINING ATTORNEY

Int. Cl.: 3

Prior U.S. Cls.: 1, 4, 6, 50, 51, and 52

United States Patent and Trademark Office

Reg. No. 3,521,916

Registered Oct. 21, 2008

**TRADEMARK
PRINCIPAL REGISTER**

EQUATE

WAL-MART STORES, INC. (DELAWARE CORPORATION)
702 S.W. 8TH ST.
BENTONVILLE, AR 727160520

FOR: ANTIBACTERIAL SKIN SOAPS; ANTIBACTERIAL SOAP; BATH SOAPS; BATH SOAPS IN LIQUID OR GEL FORM; CREAM SOAPS; DEODORANT SOAP; HAND SOAPS; LIQUID BATH SOAPS; LIQUID SOAP; LIQUID SOAPS FOR HANDS, FACE AND BODY; PERFUMED SOAP; SKIN SOAP; SOAPS FOR BODY CARE; SOAPS FOR PERSONAL USE; SHOWER AND BATH GEL; BODY WASHES; FACIAL LOTION; FACIAL CLEANSERS; PRE-MOISTENED COSMETIC TOWELETTES; FACE AND BODY CREAMS; NON-MEDICATED ACNE TREATMENT PREPARATIONS; ASTRINGENTS FOR COSMETIC PURPOSES; DISPOSABLE WIPES IMPREGNATED WITH CLEANSING COMPOUNDS FOR USE ON FACE AND BODY; BODY POWDER; TALCUM POWDER; BATH POWDER; FOOT POW-

DER; PERFUMED TALCUM POWDER; NON-MEDICATED BATH PREPARATIONS; BODY OILS; SHAVING GELS; SHAVING PREPARATIONS; PRE-MOISTENED COSMETIC WIPES; TOOTH WHITENING PREPARATIONS; HAIR CONDITIONERS; HAIR STYLING GEL, IN CLASS 3 (U.S. CLS. 1, 4, 6, 50, 51 AND 52).

FIRST USE 5-4-1998; IN COMMERCE 5-4-1998.

THE MARK CONSISTS OF STANDARD CHARACTERS WITHOUT CLAIM TO ANY PARTICULAR FONT, STYLE, SIZE, OR COLOR.

OWNER OF U.S. REG. NOS. 1,893,879, 3,098,567, AND OTHERS.

SN 77-239,554, FILED 7-26-2007.

KAREN SEVERSON, EXAMINING ATTORNEY

Int. Cl.: 35

Prior U.S. Cls.: 100, 101, and 102

United States Patent and Trademark Office

Reg. No. 3,521,917

Registered Oct. 21, 2008

**SERVICE MARK
PRINCIPAL REGISTER**

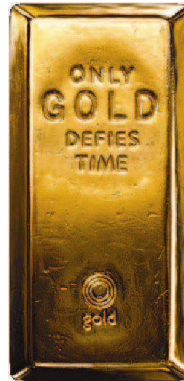

WORLD GOLD COUNCIL (SWITZERLAND ASSOCIATION)
C/O PRICEWATERHOUSECOOPERS DEPT. FISCAL
AVE GIUSEPPE-MOTTA 50, CASE POSTALE 2895
GENEVA 2, SWITZERLAND CH-1211

FOR: ADVERTISING AND PROMOTING THE
USE OF GOLD, IN CLASS 35 (U.S. CLS. 100, 101
AND 102).

FIRST USE 11-0-2007; IN COMMERCE 11-0-2007.

OWNER OF U.S. REG. NO. 2,639,750.

NO CLAIM IS MADE TO THE EXCLUSIVE
RIGHT TO USE "GOLD", APART FROM THE
MARK AS SHOWN.

THE COLOR(S) GOLD IS/ARE CLAIMED AS A
FEATURE OF THE MARK.

THE MARK CONSISTS OF A REPRESENTATION
OF A GOLD BAR UPON THE FACE OF WHICH ARE
THE WORDS "ONLY GOLD DEFIES TIME", TO-
WARD THE TOP, AND THE WORD "GOLD" AND A
CONCENTRIC CIRCLE DESIGN, TOWARD THE
BOTTOM, ALL IN THE COLOR GOLD.

SN 77-240,090, FILED 7-26-2007.

LOURDES AYALA, EXAMINING ATTORNEY

Int. Cl.: 42

Prior U.S. Cls.: 100 and 101

United States Patent and Trademark Office

Reg. No. 3,521,918

Registered Oct. 21, 2008

**SERVICE MARK
PRINCIPAL REGISTER**



INFLEXXION, INC. (MASSACHUSETTS CORPORATION)
320 NEEDHAM STREET
NEWTON, MA 02468

FOR: MEDICAL PRODUCT RESEARCH AND CONSULTING, IN CLASS 42 (U.S. CLS. 100 AND 101).

FIRST USE 12-1-2007; IN COMMERCE 12-1-2007.

OWNER OF U.S. REG. NOS. 2,686,555 AND 2,752,874.

THE MARK CONSISTS OF 4 CONVERGING CRESCENTS, ADJACENT TO STYLIZED LETTERS SPELLING "INFLEXXION" AND THE WORDING "HEALTHY BEHAVIOR THROUGH TECHNOLOGY" IS BELOW.

SN 77-240,655, FILED 7-27-2007.

LINDA ESTRADA, EXAMINING ATTORNEY

Int. Cl.: 9

Prior U.S. Cls.: 21, 23, 26, 36, and 38

Reg. No. 3,521,919

United States Patent and Trademark Office

Registered Oct. 21, 2008

**TRADEMARK
PRINCIPAL REGISTER**

iEvac

ELMRIDGE PROTECTION PRODUCTS, LLC
(FLORIDA LIMITED LIABILITY COMPANY)
6615 W. BOYNTON BEACH BLVD. #320
BOYNTON BEACH, FL 33437

THE MARK CONSISTS OF STANDARD CHARACTERS WITHOUT CLAIM TO ANY PARTICULAR FONT, STYLE, SIZE, OR COLOR.

FOR: RESPIRATORS OTHER THAN FOR ARTIFICIAL RESPIRATION; SAFETY EQUIPMENT, NAMELY, FIRE ESCAPE LADDERS, IN CLASS 9 (U.S. CLS. 21, 23, 26, 36 AND 38).

SN 77-240,944, FILED 7-27-2007.

FIRST USE 8-14-2007; IN COMMERCE 8-15-2007.

APRIL ROACH, EXAMINING ATTORNEY

Int. Cl.: 35

Prior U.S. Cls.: 100, 101, and 102

United States Patent and Trademark Office

Reg. No. 3,521,920

Registered Oct. 21, 2008

**SERVICE MARK
PRINCIPAL REGISTER**

AMRATE

MATRIX LOGISTICS, LLC (OHIO LIMITED LIABILITY COMPANY)
19801 HOLLAND ROAD
BROOK PARK, OH 44142

FOR: TRANSPORTATION LOGISTICS SERVICES, NAMELY, ARRANGING THE TRANSPORTATION OF GOODS FOR OTHERS; TRANSPORTATION LOGISTICS SERVICES, NAMELY, PLANNING AND SCHEDULING SHIPMENTS FOR USERS OF TRANSPORTATION SERVICES, IN CLASS 35 (U.S. CLS. 100, 101 AND 102).

FIRST USE 6-1-2007; IN COMMERCE 6-1-2007.

THE MARK CONSISTS OF STANDARD CHARACTERS WITHOUT CLAIM TO ANY PARTICULAR FONT, STYLE, SIZE, OR COLOR.

SN 77-241,032, FILED 7-27-2007.

THEODORE MCBRIDE, EXAMINING ATTORNEY

Int. Cls.: 35, 36, 37, 39, and 42

Prior U.S. Cls.: 100, 101, 102, 103, 105, and 106

United States Patent and Trademark Office

Reg. No. 3,521,921

Registered Oct. 21, 2008

SERVICE MARK
PRINCIPAL REGISTER



*Southern
California*



MANHEIM AUCTIONS, INC. (DELAWARE CORPORATION)
6205 PEACHTREE DUNWOODY ROAD
ATLANTA, GA 30328

FOR: AUTOMOBILE AUCTION SERVICES; AUTOMOBILE AUCTION SERVICES PROVIDED VIA THE INTERNET, IN CLASS 35 (U.S. CLS. 100, 101 AND 102).

FIRST USE 6-20-2008; IN COMMERCE 6-20-2008.

FOR: AUTOMOBILE FINANCING SERVICES, IN CLASS 36 (U.S. CLS. 100, 101 AND 102).

FIRST USE 6-20-2008; IN COMMERCE 6-20-2008.

FOR: AUTOMOTIVE DETAILING, RECONDITIONING, REPAIR, CONVERSION AND CUSTOMIZATION SERVICES, IN CLASS 37 (U.S. CLS. 100, 103 AND 106).

FIRST USE 6-20-2008; IN COMMERCE 6-20-2008.

FOR: BUSINESS-TO-BUSINESS AUTOMOTIVE TRANSPORTATION AND STORAGE SERVICES, IN CLASS 39 (U.S. CLS. 100 AND 105).

FIRST USE 6-20-2008; IN COMMERCE 6-20-2008.

FOR: AUTOMOBILE INSPECTION SERVICES, IN CLASS 42 (U.S. CLS. 100 AND 101).

FIRST USE 6-20-2008; IN COMMERCE 6-20-2008.

OWNER OF U.S. REG. NOS. 1,699,332, 3,075,304, AND 3,229,428.

NO CLAIM IS MADE TO THE EXCLUSIVE RIGHT TO USE "SOUTHERN CALIFORNIA", APART FROM THE MARK AS SHOWN.

THE COLOR(S) GOLD, DARK BLUE, LIGHT BLUE, YELLOW, BROWN, GREY, BLACK AND WHITE IS/ARE CLAIMED AS A FEATURE OF THE MARK.

THE MARK CONSISTS OF A GOLD "M" OVER A BLUE CIRCULAR BACKGROUND AND WITHIN TWO GOLD OUTER RINGS. THE COLOR BROWN OUTLINES THE MARK. TO THE RIGHT OF THE "M" IS THE WORD "MANHEIM" IN THE COLOR BLACK. A BLACK LINE SEPARATES THE ABOVE DESIGN AND THE WORD "MANHEIM" AND THE WORDS "SOUTHERN CALIFORNIA" IN THE COLOR BLACK AND A DESIGN OF A DARK BLUE PALM TREE, YELLOW BEACH AND SUN WITH WHITE AND DARK BLUE WAVES ON A LIGHT BLUE BACKGROUND, INSIDE CONCENTRIC WHITE AND GREY SQUARES TO THE RIGHT OF THE WORDS "SOUTHERN CALIFORNIA".

SN 77-241,060, FILED 7-27-2007.

GRETTA YAO, EXAMINING ATTORNEY

Int. Cl.: 44

Prior U.S. Cls.: 100 and 101

United States Patent and Trademark Office

Reg. No. 3,521,922

Registered Oct. 21, 2008

**SERVICE MARK
PRINCIPAL REGISTER**

Bless Your Sole

BUCCI, DORINE (UNITED STATES INDIVIDUAL)
4 SORRELWOOD LANE
BLUFFTON, SC 29910

FOR: HEALTH SPA SERVICES FOR HEALTH AND WELLNESS OF THE BODY AND SPIRIT OFFERED AT A HEALTH RESORT; HEALTH SPA SERVICES FOR HEALTH AND WELLNESS OF THE MIND, BODY AND SPIRIT OFFERED IN OR FROM A REMOTE, MOBILE OR TEMPORARY ON-SITE LOCATION; HEALTH SPA SERVICES, NAMELY,

COSMETIC BODY CARE SERVICES, IN CLASS 44 (U.S. CLS. 100 AND 101).

FIRST USE 8-17-2008; IN COMMERCE 8-17-2008.

THE MARK CONSISTS OF STANDARD CHARACTERS WITHOUT CLAIM TO ANY PARTICULAR FONT, STYLE, SIZE, OR COLOR.

SN 77-241,633, FILED 7-30-2007.

MAYUR VAGHANI, EXAMINING ATTORNEY

Int. Cl.: 9

Prior U.S. Cls.: 21, 23, 26, 36, and 38

Reg. No. 3,521,923

United States Patent and Trademark Office

Registered Oct. 21, 2008

**TRADEMARK
PRINCIPAL REGISTER**

ClearView Switch Guard

CLEAR VIEW SWITCH GUARD, LLC (TEXAS
LIMITED LIABILITY COMPANY)
12 BEAVER BROOK ROAD
WEST SIMSBURY, CT 06092

FOR: COVERS FOR ELECTRIC AND EMERGENCY SWITCHES; PROTECTIVE PLATES AND COVERS FOR EMERGENCY SWITCHES, ELECTRIC SWITCHES AND SWITCH PLATE COVERS; SWITCH PLATE COVERS, IN CLASS 9 (U.S. CLS. 21, 23, 26, 36 AND 38).

FIRST USE 8-27-2008; IN COMMERCE 8-27-2008.

THE MARK CONSISTS OF STANDARD CHARACTERS WITHOUT CLAIM TO ANY PARTICULAR FONT, STYLE, SIZE, OR COLOR.

NO CLAIM IS MADE TO THE EXCLUSIVE RIGHT TO USE 'SWITCH GUARD', APART FROM THE MARK AS SHOWN.

SN 77-241,674, FILED 7-30-2007.

KAREN K. BUSH, EXAMINING ATTORNEY

Int. Cl.: 7

Prior U.S. Cls.: 13, 19, 21, 23, 31, 34, and 35

Reg. No. 3,521,924

United States Patent and Trademark Office

Registered Oct. 21, 2008

**TRADEMARK
PRINCIPAL REGISTER**

EdgeMax

MG SYSTEMS & WELDING, INC. (WISCONSIN CORPORATION)
W141 N9427 FOUNTAIN BLVD.
MENOMONEE FALLS, WI 53051

FIRST USE 1-22-2008; IN COMMERCE 1-22-2008.

FOR: POWER OPERATED FABRICATION TOOLS FOR CUTTING METAL, NAMELY, PLASMA CUTTING MACHINES AND REPLACEMENT PARTS THEREFOR ALL FOR CUTTING METAL , IN CLASS 7 (U.S. CLS. 13, 19, 21, 23, 31, 34 AND 35).

THE MARK CONSISTS OF STANDARD CHARACTERS WITHOUT CLAIM TO ANY PARTICULAR FONT, STYLE, SIZE, OR COLOR.

SN 77-242,812, FILED 7-31-2007.

ROBIN CHOSID, EXAMINING ATTORNEY

Int. Cl.: 35

Prior U.S. Cls.: 100, 101, and 102

United States Patent and Trademark Office

Reg. No. 3,521,925

Registered Oct. 21, 2008

**SERVICE MARK
PRINCIPAL REGISTER**



BOSTON RESEARCH GROUP, INC. (GEORGIA CORPORATION)
SUITE 1440
100 GALLERIA PARKWAY, NW
ATLANTA, GA 30339

FOR: BUSINESS CONSULTING SERVICES, NAMELY, ECONOMIC AND STATISTICAL MARKET RESEARCH AND QUANTITATIVE PROGRAM EVALUATIONS; CONDUCTING BUSINESS AND MARKET RESEARCH SURVEYS, NAMELY, CONDUCTING BUSINESS AND MARKET RESEARCH SURVEYS FOR OTHERS BY COLLECTING DATA

FROM INDIVIDUALS AND ANALYZING THE COLLECTED INFORMATION, IN CLASS 35 (U.S. CLS. 100, 101 AND 102).

FIRST USE 1-0-2007; IN COMMERCE 1-0-2007.

THE MARK CONSISTS OF THE STYLIZED LETTER "Q".

SN 77-242,882, FILED 7-31-2007.

MICHAEL TANNER, EXAMINING ATTORNEY

Int. Cl.: 3

Prior U.S. Cls.: 1, 4, 6, 50, 51, and 52

United States Patent and Trademark Office

Reg. No. 3,521,926

Registered Oct. 21, 2008

**TRADEMARK
PRINCIPAL REGISTER**

ABS IN A BOX

KERN, JAMIE (UNITED STATES INDIVIDUAL)
16055 SW WALKER RD. #123
PORTLAND, OR 97006

FIRST USE 6-1-2008; IN COMMERCE 6-1-2008.

FOR: MAKE-UP; BODY CREAMS AND BODY
LOTIONS; NON-MEDICATED SKINCARE PREPAR-
ATIONS; BEAUTY CREAMS FOR BODY CARE;
BODY CARE COSMETICS; COSMETIC PREPARA-
TIONS FOR BODY CARE; LOTIONS, IN CLASS 3
(U.S. CLS. 1, 4, 6, 50, 51 AND 52).

THE MARK CONSISTS OF STANDARD CHAR-
ACTERS WITHOUT CLAIM TO ANY PARTICULAR
FONT, STYLE, SIZE, OR COLOR.

SN 77-243,423, FILED 7-31-2007.

NATALIE POLZER, EXAMINING ATTORNEY

Int. Cl.: 9

Prior U.S. Cls.: 21, 23, 26, 36, and 38

United States Patent and Trademark Office

Reg. No. 3,521,927

Registered Oct. 21, 2008

**TRADEMARK
PRINCIPAL REGISTER**

Clic Stic

RIETVELD, FLOYD L (UNITED STATES INDIVIDUAL)
6831 ROSECLIFF PLACE
DAYTON, OH 45459

THE MARK CONSISTS OF STANDARD CHARACTERS WITHOUT CLAIM TO ANY PARTICULAR FONT, STYLE, SIZE, OR COLOR.

FOR: CAMERA HANDLES, IN CLASS 9 (U.S. CLS. 21, 23, 26, 36 AND 38).

SN 77-243,748, FILED 7-31-2007.

FIRST USE 10-11-2007; IN COMMERCE 10-11-2007.

EMILY CARLSEN, EXAMINING ATTORNEY

Int. Cl.: 6

Prior U.S. Cls.: 2, 12, 13, 14, 23, 25, and 50

Reg. No. 3,521,928

United States Patent and Trademark Office

Registered Oct. 21, 2008

**TRADEMARK
PRINCIPAL REGISTER**

CUPRIUM

QUESTEK INNOVATIONS, LLC (DELAWARE
LIMITED LIABILITY COMPANY)
1820 RIDGE AVENUE
EVANSTON, IL 60201

THE MARK CONSISTS OF STANDARD CHAR-
ACTERS WITHOUT CLAIM TO ANY PARTICULAR
FONT, STYLE, SIZE, OR COLOR.

FOR: COPPER ALLOYS, IN CLASS 6 (U.S. CLS. 2,
12, 13, 14, 23, 25 AND 50).

SN 77-244,126, FILED 8-1-2007.

FIRST USE 8-25-2008; IN COMMERCE 8-25-2008.

KAREN BRACEY, EXAMINING ATTORNEY

Int. Cl.: 4

Prior U.S. Cls.: 1, 6, and 15

United States Patent and Trademark Office

Reg. No. 3,521,929

Registered Oct. 21, 2008

**TRADEMARK
PRINCIPAL REGISTER**

SOLADIESEL

SOLAZYME, INC. (DELAWARE CORPORATION)
561 ECCLES AVENUE
SOUTH SAN FRANCISCO, CA 94080

THE MARK CONSISTS OF STANDARD CHAR-
ACTERS WITHOUT CLAIM TO ANY PARTICULAR
FONT, STYLE, SIZE, OR COLOR.

FOR: FOSSIL FUEL SUBSTITUTES, NAMELY,
BIO-FUELS, IN CLASS 4 (U.S. CLS. 1, 6 AND 15).

SN 77-244,738, FILED 8-1-2007.

FIRST USE 4-10-2008; IN COMMERCE 4-10-2008.

WILLIAM VERHOSEK, EXAMINING ATTORNEY

Int. Cl.: 21

Prior U.S. Cls.: 2, 13, 23, 29, 30, 33, 40, and 50

Reg. No. 3,521,930

United States Patent and Trademark Office

Registered Oct. 21, 2008

**TRADEMARK
PRINCIPAL REGISTER**

Baby Banquet

MEUSER, ELIZABETH (UNITED STATES JOINT APPLICANT)
5603 SPELLMAN ROAD
HOUSTON, TX 77096 AND
MEUSER, JOHN A. (UNITED STATES JOINT APPLICANT)
5603 SPELLMAN ROAD
HOUSTON, TX 77096

FOR: COMBINATION HOUSEHOLD CONTAINER AND DISPENSER, NAMELY, A BABY AND/OR INFANT FOOD STORAGE AND DISPENSER UNIT, IN CLASS 21 (U.S. CLS. 2, 13, 23, 29, 30, 33, 40 AND 50).

FIRST USE 5-17-2008; IN COMMERCE 5-17-2008.

THE MARK CONSISTS OF STANDARD CHARACTERS WITHOUT CLAIM TO ANY PARTICULAR FONT, STYLE, SIZE, OR COLOR.

NO CLAIM IS MADE TO THE EXCLUSIVE RIGHT TO USE "BABY", APART FROM THE MARK AS SHOWN.

SN 77-245,080, FILED 8-2-2007.

MATTHEW MCDOWELL, EXAMINING ATTORNEY

Int. Cl.: 36

Prior U.S. Cls.: 100, 101, and 102

United States Patent and Trademark Office

Reg. No. 3,521,931

Registered Oct. 21, 2008

**SERVICE MARK
PRINCIPAL REGISTER**

DIGNITY PLANNING

SCI MANAGEMENT, L.P. (DELAWARE LIMITED
PARTNERSHIP)
1929 ALLEN PARKWAY
HOUSTON, TX 77019

FOR: PREPAID FUNERAL EXPENSE SERVICES;
PROVIDING UNDERWRITING IN THE FIELDS OF
SAVINGS AND INVESTMENT BONDS AND PER-
SONAL INSURANCE AND ASSURANCE, ALL RE-
LATING TO THE PAYMENT OF FUNERALS AND
RELATED EXPENSES; PREPAID FUNERAL EX-
PENSE SERVICES, NAMELY, PREPAID TRANS-
PORTATION FOR DECEDENT'S REMAINS AND
PREPAID TRAVEL ARRANGEMENT FOR THE
FAMILIES OF DECEASED PERSONS, IN CLASS 36
(U.S. CLS. 100, 101 AND 102).

FIRST USE 7-0-2008; IN COMMERCE 7-0-2008.

THE MARK CONSISTS OF STANDARD CHAR-
ACTERS WITHOUT CLAIM TO ANY PARTICULAR
FONT, STYLE, SIZE, OR COLOR.

OWNER OF U.S. REG. NOS. 2,514,341, 3,113,711,
AND OTHERS.

SN 77-245,110, FILED 8-2-2007.

BRIAN NEVILLE, EXAMINING ATTORNEY

Int. Cl.: 25

Prior U.S. Cls.: 22 and 39

United States Patent and Trademark Office

Reg. No. 3,521,932

Registered Oct. 21, 2008

**TRADEMARK
PRINCIPAL REGISTER**



KOHL'S ILLINOIS, INC. (NEVADA CORPORATION)
NEW YORK SQUARE
4340 FOX VALLEY CENTER
AURORA, IL 60504

FIRST USE 9-0-2007; IN COMMERCE 9-0-2007.

SN 77-245,126, FILED 8-2-2007.

FOR: CLOTHING AND APPAREL PRODUCTS,
NAMELY, TOPS, PANTS, SHORTS, DRESSES, IN
CLASS 25 (U.S. CLS. 22 AND 39).

THOMAS MANOR, EXAMINING ATTORNEY

Int. Cl.: 3

Prior U.S. Cls.: 1, 4, 6, 50, 51, and 52

Reg. No. 3,521,933

United States Patent and Trademark Office

Registered Oct. 21, 2008

**TRADEMARK
PRINCIPAL REGISTER**

TIMER BEADS

PURE & NATURAL COMPANY (ARIZONA CORPORATION)
M.S. 2214
15501 NORTH DIAL BOULEVARD
SCOTTSDALE, AZ 852601619

FOR: ANTIBACTERIAL SOAP; HAND SOAPS; LIQUID SOAP; SKIN SOAP; SOAPS FOR BODY CARE; SOAPS FOR PERSONAL USE, IN CLASS 3 (U.S. CLS. 1, 4, 6, 50, 51 AND 52).

FIRST USE 12-17-2007; IN COMMERCE 12-17-2007.

THE MARK CONSISTS OF STANDARD CHARACTERS WITHOUT CLAIM TO ANY PARTICULAR FONT, STYLE, SIZE, OR COLOR.

NO CLAIM IS MADE TO THE EXCLUSIVE RIGHT TO USE "BEADS", APART FROM THE MARK AS SHOWN.

SN 77-245,983, FILED 8-2-2007.

JORDAN BAKER, EXAMINING ATTORNEY

Int. Cl.: 9

Prior U.S. Cls.: 21, 23, 26, 36, and 38

United States Patent and Trademark Office

Reg. No. 3,521,934

Registered Oct. 21, 2008

TRADEMARK
PRINCIPAL REGISTER



TRIBINIUM CORPORATION (MICHIGAN CORPORATION)
5445 32ND AVE
HUDSONVILLE, MI 49426

FOR: COMPUTER SOFTWARE FOR BLOCKING PORNOGRAPHIC IMAGES AND GRAPHIC LANGUAGE, IN CLASS 9 (U.S. CLS. 21, 23, 26, 36 AND 38).

FIRST USE 1-22-2008; IN COMMERCE 1-22-2008.

THE COLOR(S) BLACK, WHITE AND GREEN IS/ARE CLAIMED AS A FEATURE OF THE MARK.

THE MARK CONSISTS OF A CARTOON IMAGE OF A MONKEY WITH BLACK ARMS, LEGS AND TAIL, AND WHITE CHEST, FACE AND EARS, COVERING ITS EYES, ON A GREEN COMPUTER MONITOR SCREEN WITH THE COMPUTER MONITOR OUTLINED IN BLACK.

SN 77-246,180, FILED 8-3-2007.

DOMINIC J. FERRAIUOLO, EXAMINING ATTORNEY

Int. Cl.: 9

Prior U.S. Cls.: 21, 23, 26, 36, and 38

United States Patent and Trademark Office

Reg. No. 3,521,935

Registered Oct. 21, 2008

**TRADEMARK
PRINCIPAL REGISTER**

LIGHTNING STRIKE

WMS GAMING INC. (DELAWARE CORPORATION)
800 SOUTH NORTHPOINT BOULEVARD
WAUKEGAN, IL 60085

FOR: GAMING MACHINES THAT GENERATE OR DISPLAY WAGER OUTCOMES; GAMING SOFTWARE THAT GENERATES OR DISPLAYS WAGER OUTCOMES OF GAMING MACHINES, IN CLASS 9 (U.S. CLS. 21, 23, 26, 36 AND 38).

FIRST USE 3-25-2008; IN COMMERCE 3-25-2008.

THE MARK CONSISTS OF STANDARD CHARACTERS WITHOUT CLAIM TO ANY PARTICULAR FONT, STYLE, SIZE, OR COLOR.

SN 77-246,277, FILED 8-3-2007.

ANNE MADDEN, EXAMINING ATTORNEY

Int. Cl.: 9

Prior U.S. Cls.: 21, 23, 26, 36, and 38

United States Patent and Trademark Office

Reg. No. 3,521,936

Registered Oct. 21, 2008

**TRADEMARK
PRINCIPAL REGISTER**

PFV

SALT OPTICS, INC. (CALIFORNIA CORPORATION)
1607 MONROVIA AVENUE
COSTA MESA, CA 92627

FOR: CORRECTIVE GLASSES; EYEGLASS CASES; EYEGLASS FRAMES; EYEGLASS LENSES; EYEGLASSES; OPTICAL GLASSES; READING EYEGLASSES; SPORTS GLASSES; SUNGLASS LENSES; SUNGLASSES; CASES FOR SPECTACLES AND SUNGLASSES; FRAMES FOR SPECTACLES AND SUNGLASSES, IN CLASS 9 (U.S. CLS. 21, 23, 26, 36 AND 38).

FIRST USE 3-1-2007; IN COMMERCE 3-1-2007.

THE MARK CONSISTS OF STANDARD CHARACTERS WITHOUT CLAIM TO ANY PARTICULAR FONT, STYLE, SIZE, OR COLOR.

SN 77-246,511, FILED 8-3-2007.

BRIAN NEVILLE, EXAMINING ATTORNEY

Int. Cl.: 25

Prior U.S. Cls.: 22 and 39

United States Patent and Trademark Office

Reg. No. 3,521,937

Registered Oct. 21, 2008

**TRADEMARK
PRINCIPAL REGISTER**

First Edition

BAYER, EARL F. (UNITED STATES INDIVIDUAL)
1001 ABBY WAY
NESHANIC STATION, NJ 08853

FOR: ANGLERS' SHOES; APRES-SKI SHOES; ATHLETIC SHOES; BALLET SHOES; BASEBALL SHOES; BEACH SHOES; BOWLING SHOES; BOXING SHOES; CANVAS SHOES; CLEATS FOR ATTACHMENT TO SPORTS SHOES; CYCLING SHOES; DECK-SHOES; DRIVERS; FOOTBALL SHOES; GOLF SHOES; GYMNAS TIC SHOES; HANDBALL SHOES; HEEL PIECES FOR SHOES; HOCKEY SHOES; INFANTS' SHOES AND BOOTS; INSOLES; LEATHER SHOES; PAPER SHOES USED WHEN GOING THROUGH METAL DETECTORS TO KEEP FEET AND SOCKS CLEAN; PROTECTIVE METAL MEMBERS FOR SHOES AND BOOTS; RUBBER SHOES; RUGBY SHOES; RUNNING SHOES; SHOE DOWELS; SHOE INSERTS FOR PRIMARILY NON-

ORTHOPEDIC PURPOSES; SHOE PEGS; SHOE SOLES; SHOES; SHOES SOLES FOR REPAIR; SKI AND SNOWBOARD SHOES AND PARTS THEREOF; SKIING SHOES; SOCCER SHOES; TAP SHOES; TENNIS SHOES; TONGUE OR PULLSTRAP FOR SHOES AND BOOTS; TRACK AND FIELD SHOES; TRAINING SHOES; VOLLEYBALL SHOES; WOMEN'S SHOES; WORK SHOES AND BOOTS, IN CLASS 25 (U.S. CLS. 22 AND 39).

FIRST USE 8-15-2008; IN COMMERCE 8-15-2008.

THE MARK CONSISTS OF STANDARD CHARACTERS WITHOUT CLAIM TO ANY PARTICULAR FONT, STYLE, SIZE, OR COLOR.

SN 77-247,122, FILED 8-3-2007.

JOHN HWANG, EXAMINING ATTORNEY

Int. Cl.: 43

Prior U.S. Cls.: 100 and 101

United States Patent and Trademark Office

Reg. No. 3,521,938

Registered Oct. 21, 2008

**SERVICE MARK
PRINCIPAL REGISTER**

COPPER ROCK STEAKHOUSE

POKAGON GAMING AUTHORITY, A WHOLLY-
OWNED INSTRUMENTALITY OF THE POKA-
GON BAND OF POTAWATOMI INDIANS OF
MICHIGAN AND INDIANA (UNITED STATES
INSTRUMENTALITY)

58620 SINK ROAD
DOWAGIAC, MI 49047

FOR: RESTAURANT SERVICES, IN CLASS 43
(U.S. CLS. 100 AND 101).

FIRST USE 8-1-2007; IN COMMERCE 8-1-2007.

THE MARK CONSISTS OF STANDARD CHAR-
ACTERS WITHOUT CLAIM TO ANY PARTICULAR
FONT, STYLE, SIZE, OR COLOR.

NO CLAIM IS MADE TO THE EXCLUSIVE
RIGHT TO USE "STEAKHOUSE", APART FROM
THE MARK AS SHOWN.

SN 77-247,541, FILED 8-6-2007.

ROBIN CHOSID, EXAMINING ATTORNEY

Int. Cl.: 43

Prior U.S. Cls.: 100 and 101

United States Patent and Trademark Office

Reg. No. 3,521,939

Registered Oct. 21, 2008

**SERVICE MARK
PRINCIPAL REGISTER**

TIMBERS FAST-FOOD & DELI

POKAGON GAMING AUTHORITY, A WHOLLY-
OWNED INSTRUMENTALITY OF THE POKA-
GON BAND OF POTAWATOMI INDIANS OF
MICHIGAN AND INDIANA (UNITED STATES
INSTRUMENTALITY)

58620 SINK ROAD
DOWAGIAC, MI 49047

FOR: RESTAURANT SERVICES, NAMELY,
FAST-FOOD RESTAURANTS AND DELICATES-
SENS , IN CLASS 43 (U.S. CLS. 100 AND 101).

FIRST USE 8-1-2007; IN COMMERCE 8-1-2007.

THE MARK CONSISTS OF STANDARD CHAR-
ACTERS WITHOUT CLAIM TO ANY PARTICULAR
FONT, STYLE, SIZE, OR COLOR.

NO CLAIM IS MADE TO THE EXCLUSIVE
RIGHT TO USE "FAST-FOOD & DELI", APART
FROM THE MARK AS SHOWN.

SN 77-247,542, FILED 8-6-2007.

ROBIN CHOSID, EXAMINING ATTORNEY

Int. Cl.: 43

Prior U.S. Cls.: 100 and 101

United States Patent and Trademark Office

Reg. No. 3,521,940

Registered Oct. 21, 2008

**SERVICE MARK
PRINCIPAL REGISTER**

SILVER CREEK BISTRO

POKAGON GAMING AUTHORITY, A WHOLLY-
OWNED INSTRUMENTALITY OF THE POKA-
GON BAND OF POTAWATOMI INDIANS OF
MICHIGAN AND INDIANA (UNITED STATES
INSTRUMENTALITY)

58620 SINK ROAD
DOWAGIAC, MI 49047

FOR: RESTAURANT SERVICES, IN CLASS 43
(U.S. CLS. 100 AND 101).

FIRST USE 8-1-2007; IN COMMERCE 8-1-2007.

THE MARK CONSISTS OF STANDARD CHAR-
ACTERS WITHOUT CLAIM TO ANY PARTICULAR
FONT, STYLE, SIZE, OR COLOR.

NO CLAIM IS MADE TO THE EXCLUSIVE
RIGHT TO USE "BISTRO", APART FROM THE
MARK AS SHOWN.

SN 77-247,544, FILED 8-6-2007.

ROBIN CHOSID, EXAMINING ATTORNEY

Int. Cl.: 11

Prior U.S. Cls.: 13, 21, 23, 31, and 34

United States Patent and Trademark Office

Reg. No. 3,521,941

Registered Oct. 21, 2008

**TRADEMARK
PRINCIPAL REGISTER**

ULTRATEMP

PENTAIR WATER POOL AND SPA, INC. (DELA-
WARE CORPORATION)
1620 HAWKINS AVENUE
SANFORD, NC 27330

FOR: HEAT PUMP FOR RESIDENTIAL AND
COMMERCIAL SWIMMING POOLS, SPAS, AND
WATERPARKS, IN CLASS 11 (U.S. CLS. 13, 21, 23,
31 AND 34).

FIRST USE 9-3-2008; IN COMMERCE 9-3-2008.

THE MARK CONSISTS OF STANDARD CHAR-
ACTERS WITHOUT CLAIM TO ANY PARTICULAR
FONT, STYLE, SIZE, OR COLOR.

NO CLAIM IS MADE TO THE EXCLUSIVE
RIGHT TO USE "TEMP", APART FROM THE MARK
AS SHOWN.

SN 77-247,903, FILED 8-6-2007.

MATTHEW EINSTEIN, EXAMINING ATTORNEY

Int. Cl.: 9

Prior U.S. Cls.: 21, 23, 26, 36, and 38

Reg. No. 3,521,942

United States Patent and Trademark Office

Registered Oct. 21, 2008

**TRADEMARK
PRINCIPAL REGISTER**

SYSWAN TECHNOLOGIES

SYSWAN TECHNOLOGIES, INC. (OREGON CORPORATION)
SUITE 101 #388
2050 BEAVERCREEK RD
OREGON CITY, OR 97045

FOR: COMPUTER HARDWARE AND SOFTWARE FOR SETTING UP AND CONFIGURING LOCAL AREA NETWORKS; COMPUTER NETWORK ADAPTERS; COMPUTER NETWORK HUBS, SWITCHES AND ROUTERS; COMPUTER NETWORKING HARDWARE; LAN (LOCAL AREA NETWORK) ACCESS POINTS FOR CONNECTING NETWORK COMPUTER USERS; LAN (LOCAL AREA NETWORK) COMPUTER CARDS FOR CONNECTING PORTABLE COMPUTER DEVICES TO COMPUTER NETWORKS; LAN (LOCAL AREA NETWORK) HARDWARE; LAN (LOCAL AREA NETWORK) OPERATING SOFTWARE; MOBILE COMPUTING AND OPERATING PLATFORMS CONSISTING OF DATA TRANSCEIVERS, WIRELESS NETWORKS AND GATEWAYS FOR COLLECTION AND MANAGEMENT OF DATA; NETWORK ACCESS SERVER HARDWARE; NETWORK ACCESS SERVER OPERATING SOFTWARE; TELECOMMUNICATIONS AND DATA NETWORKING HARDWARE, NAMELY, DEVICES FOR TRANSPORTING AND AGGREGATING VOICE, DATA,

AND VIDEO COMMUNICATIONS ACROSS MULTIPLE NETWORK INFRASTRUCTURES AND COMMUNICATIONS PROTOCOLS; VPN (VIRTUAL PRIVATE NETWORK) HARDWARE; VPN (VIRTUAL PRIVATE NETWORK) OPERATING SOFTWARE; WAN (WIDE AREA NETWORK) HARDWARE; WAN (WIDE AREA NETWORK) OPERATING SOFTWARE; COMPUTER HARDWARE AND SOFTWARE FOR SETTING UP AND CONFIGURING WIDE AREA NETWORKS; COMPUTER SOFTWARE FOR ADMINISTRATION OF COMPUTER LOCAL AREA NETWORKS, IN CLASS 9 (U.S. CLS. 21, 23, 26, 36 AND 38).

FIRST USE 5-1-2007; IN COMMERCE 8-1-2007.

THE MARK CONSISTS OF STANDARD CHARACTERS WITHOUT CLAIM TO ANY PARTICULAR FONT, STYLE, SIZE, OR COLOR.

NO CLAIM IS MADE TO THE EXCLUSIVE RIGHT TO USE "TECHNOLOGIES", APART FROM THE MARK AS SHOWN.

SN 77-248,797, FILED 8-7-2007.

ALLISON HOLTZ, EXAMINING ATTORNEY

Int. Cl.: 9

Prior U.S. Cls.: 21, 23, 26, 36, and 38

United States Patent and Trademark Office

Reg. No. 3,521,943

Registered Oct. 21, 2008

**TRADEMARK
PRINCIPAL REGISTER**

SAMURAI MASTER

WMS GAMING INC. (DELAWARE CORPORATION)
800 SOUTH NORTHPOINT BOULEVARD
WAUKEGAN, IL 60085

FOR: GAMING MACHINES THAT GENERATE OR DISPLAY WAGER OUTCOMES; GAMING SOFTWARE THAT GENERATES OR DISPLAYS WAGER OUTCOMES OF GAMING MACHINES, IN CLASS 9 (U.S. CLS. 21, 23, 26, 36 AND 38).

FIRST USE 11-13-2007; IN COMMERCE 11-13-2007.

THE MARK CONSISTS OF STANDARD CHARACTERS WITHOUT CLAIM TO ANY PARTICULAR FONT, STYLE, SIZE, OR COLOR.

SN 77-249,142, FILED 8-7-2007.

ANNE MADDEN, EXAMINING ATTORNEY

Int. Cl.: 15

Prior U.S. Cls.: 2, 21, and 36

United States Patent and Trademark Office

Reg. No. 3,521,944

Registered Oct. 21, 2008

**TRADEMARK
PRINCIPAL REGISTER**

GTJAMS

PLAYCORE IP SUB, INC. (DELAWARE CORPORATION)
401 CHESTNUT STREET, SUITE 310
CHATTANOOGA, TN 37402

FOR: MUSICAL INSTRUMENTS FOR PLAYGROUND USE, IN CLASS 15 (U.S. CLS. 2, 21 AND 36).

FIRST USE 10-0-2007; IN COMMERCE 10-0-2007.

THE MARK CONSISTS OF STANDARD CHARACTERS WITHOUT CLAIM TO ANY PARTICULAR FONT, STYLE, SIZE, OR COLOR.

OWNER OF U.S. REG. NOS. 2,557,742, 2,726,510, AND OTHERS.

SN 77-249,219, FILED 8-7-2007.

FRED CARL, EXAMINING ATTORNEY

Int. Cl.: 3

Prior U.S. Cls.: 1, 4, 6, 50, 51, and 52

Reg. No. 3,521,945

United States Patent and Trademark Office

Registered Oct. 21, 2008

**TRADEMARK
PRINCIPAL REGISTER**

FREO

FARR LABORATORIES, LLC (CALIFORNIA
LIMITED LIABILITY COMPANY)
SUITE 560
11100 SANTA MONICA BOULEVARD
LOS ANGELES, CA 90025

FOR: COSMETICS; NON-MEDICATED SKIN
CARE PREPARATIONS; SKIN MOISTURIZERS;
SKIN CREAMS; SKIN LOTIONS; SKIN CLEANSERS;
SKIN AND BODY TOPICAL LOTIONS, CREAMS
AND OILS FOR COSMETIC USE; WRINKLE RE-
MOVING SKIN CARE PREPARATIONS; COSMETIC
PREPARATIONS FOR USE TO HELP IMPROVING
THE APPEARANCE OF FIRMER AND MORE

YOUTHFUL SKIN, IN CLASS 3 (U.S. CLS. 1, 4, 6, 50,
51 AND 52).

FIRST USE 7-30-2008; IN COMMERCE 7-30-2008.

THE MARK CONSISTS OF STANDARD CHAR-
ACTERS WITHOUT CLAIM TO ANY PARTICULAR
FONT, STYLE, SIZE, OR COLOR.

SN 77-249,396, FILED 8-7-2007.

SHARON MEIER, EXAMINING ATTORNEY

Int. Cl.: 35

Prior U.S. Cls.: 100, 101, and 102

United States Patent and Trademark Office

Reg. No. 3,521,946

Registered Oct. 21, 2008

**SERVICE MARK
PRINCIPAL REGISTER**

MAKING ART WORK FOR YOU.

THIRD & WALL ART GROUP, LLC (WASHINGTON LIMITED LIABILITY COMPANY)
SUITE 300
2607 SECOND AVENUE
SEATTLE, WA 98121

FOR: PROMOTING THE SALE OF WORKS OF ART, COMMISSIONED ART WORKS, ORIGINAL ART WORKS AND PRINTED ART REPRODUCTIONS OF OTHERS; PROCURING OF CONTRACTS FOR THE PURCHASE AND SALE OF WORKS OF ART, COMMISSIONED ART WORKS, ORIGINAL ART WORKS AND PRINTED ART REPRODUCTIONS; COMMERCIAL ADMINISTRATION OF THE LICENSING OF WORKS OF ART, ORIGINAL ART WORKS AND PRINTED ART REPRODUCTIONS; DISTRIBUTORSHIP SERVICES IN THE FIELD OF WORKS OF ART, COMMISSIONED ART WORKS, ORIGINAL ART WORKS AND PRINTED ART REPRODUCTIONS; ON-LINE ORDERING SERVICES FEATURING WORKS OF ART, COM-

MISSIONED ART WORKS, ORIGINAL ART WORKS AND PRINTED ART REPRODUCTIONS; PROMOTING WORKS OF ART OF THIRD PARTIES THROUGH ON-LINE ORDERING AND CATALOGING OF THOSE WORKS; PROVIDING AN ON-LINE SHOWROOM FOR THE GOODS OF OTHERS IN THE FIELD OF WORKS OF ART, COMMISSIONED ART WORKS, ORIGINAL ART WORKS AND PRINTED ART REPRODUCTIONS, IN CLASS 35 (U.S. CLS. 100, 101 AND 102).

FIRST USE 3-0-2008; IN COMMERCE 3-0-2008.

THE MARK CONSISTS OF STANDARD CHARACTERS WITHOUT CLAIM TO ANY PARTICULAR FONT, STYLE, SIZE, OR COLOR.

SN 77-249,601, FILED 8-7-2007.

SHANNON TWOHIG, EXAMINING ATTORNEY

Int. Cl.: 15

Prior U.S. Cls.: 2, 21, and 36

United States Patent and Trademark Office

Reg. No. 3,521,947

Registered Oct. 21, 2008

**TRADEMARK
PRINCIPAL REGISTER**

SYSTEM BLUE

PRO-MARK CORPORATION (TEXAS CORPORATION)
11550 OLD MAIN STREET LOOP ROAD
HOUSTON, TX 77025

THE MARK CONSISTS OF STANDARD CHARACTERS WITHOUT CLAIM TO ANY PARTICULAR FONT, STYLE, SIZE, OR COLOR.

FOR: PERCUSSION INSTRUMENTS, IN CLASS 15
(U.S. CLS. 2, 21 AND 36).

SN 77-249,640, FILED 8-8-2007.

FIRST USE 6-2-2008; IN COMMERCE 6-2-2008.

ROBIN CHOSID, EXAMINING ATTORNEY

Int. Cl.: 44

Prior U.S. Cls.: 100 and 101

United States Patent and Trademark Office

Reg. No. 3,521,948

Registered Oct. 21, 2008

**SERVICE MARK
PRINCIPAL REGISTER**

Foot Peace

BUCCI, DORINE (UNITED STATES INDIVIDUAL)
4 SORRELWOOD LANE
BLUFFTON, SC 29910

FOR: HEALTH SPA SERVICES FOR HEALTH AND WELLNESS OF THE BODY AND SPIRIT OFFERED AT A HEALTH RESORT; HEALTH SPA SERVICES FOR HEALTH AND WELLNESS OF THE MIND, BODY AND SPIRIT OFFERED IN OR FROM A REMOTE, MOBILE OR TEMPORARY ON-SITE LOCATION; HEALTH SPA SERVICES, NAMELY, COSMETIC BODY CARE SERVICES; MAKING RESERVATIONS AND BOOKINGS FOR OTHERS FOR PHYSICAL AND BEAUTY TREATMENTS AT HEALTH SPAS, IN CLASS 44 (U.S. CLS. 100 AND 101).

FIRST USE 8-17-2008; IN COMMERCE 8-17-2008.

THE MARK CONSISTS OF STANDARD CHARACTERS WITHOUT CLAIM TO ANY PARTICULAR FONT, STYLE, SIZE, OR COLOR.

NO CLAIM IS MADE TO THE EXCLUSIVE RIGHT TO USE "FOOT", APART FROM THE MARK AS SHOWN.

SN 77-249,672, FILED 8-8-2007.

ROBIN CHOSID, EXAMINING ATTORNEY

Int. Cl.: 9

Prior U.S. Cls.: 21, 23, 26, 36, and 38

Reg. No. 3,521,949

United States Patent and Trademark Office

Registered Oct. 21, 2008

**TRADEMARK
PRINCIPAL REGISTER**

BVCOM

BVCOM INC. (ILLINOIS CORPORATION)
4140 W VICTORIA STREET
CHICAGO, IL 60646

FOR: COMPUTERS; DESKTOP COMPUTERS; ELECTRONIC COMPUTERS; COMPUTER SERVERS; CALCULATORS; COMPUTER OPERATING SYSTEMS; COMPUTER PERIPHERALS; COMPUTER SOFTWARE DEVELOPMENT TOOLS; COMPUTER SOFTWARE FOR APPLICATION AND DATABASE INTEGRATION; COMPUTER SOFTWARE FOR CREATING SEARCHABLE DATABASES OF INFORMATION AND DATA; COMPUTER SOFTWARE FOR THE CREATION OF FIREWALLS; COMPUTER SOFTWARE FOR USE IN CUSTOMER RELATIONSHIP MANAGEMENT (CRM); COMPUTER SOFTWARE TO CONTROL AND IMPROVE COMPUTER AND AUDIO EQUIPMENT SOUND QUALITY; DATA PROCESSORS; MICROPROCESSORS; SOFTWARE PROGRAMMABLE MICROPROCESSORS; MICRO-PROCESSORS;

TELECOMMUNICATIONS TRANSMITTERS; TELEVISION TRANSMITTERS; TRANSMITTERS AND RECEIVERS FOR AUDIO AND VIDEO SIGNALS FOR TRANSMISSION OVER TWISTED PAIR CABLES; CABLE MODEMS; MODEMS; COMPUTER HARDWARE AND SOFTWARE FOR SETTING UP AND CONFIGURING WIDE AREA NETWORKS; COMPUTER NETWORK ADAPTERS; TELECOMMUNICATIONS AND DATA NETWORKING HARDWARE, NAMELY, DEVICES FOR TRANSPORTING AND AGGREGATING VOICE, DATA, AND VIDEO COMMUNICATIONS ACROSS MULTIPLE NETWORK INFRASTRUCTURES AND COMMUNICATIONS PROTOCOLS, IN CLASS 9 (U.S. CLS. 21, 23, 26, 36 AND 38).

FIRST USE 9-1-2007; IN COMMERCE 9-1-2007.

SN 77-249,701, FILED 8-8-2007.

MATTHEW PAPPAS, EXAMINING ATTORNEY

Int. Cl.: 36

Prior U.S. Cls.: 100, 101, and 102

United States Patent and Trademark Office

Reg. No. 3,521,950

Registered Oct. 21, 2008

**SERVICE MARK
PRINCIPAL REGISTER**

House Handler

HOUSE HANDLER LLC (INDIANA LIMITED
LIABILITY COMPANY)
730 N LEBANON ST
LEBANON, IN 46052

THE MARK CONSISTS OF STANDARD CHAR-
ACTERS WITHOUT CLAIM TO ANY PARTICULAR
FONT, STYLE, SIZE, OR COLOR.

FOR: REAL ESTATE MANAGEMENT, IN CLASS
36 (U.S. CLS. 100, 101 AND 102).

SN 77-249,737, FILED 8-8-2007.

FIRST USE 6-1-2008; IN COMMERCE 6-1-2008.

JULIE GUTTADAURO, EXAMINING ATTORNEY

Int. Cl.: 10

Prior U.S. Cls.: 26, 39, and 44

United States Patent and Trademark Office

Reg. No. 3,521,951

Registered Oct. 21, 2008

**TRADEMARK
PRINCIPAL REGISTER**



CYTOCORE, INC. (DELAWARE CORPORATION)
414 NORTH ORLEANS, SUITE 502
CHICAGO, IL 60610

FOR: MEDICAL EQUIPMENT, NAMELY, DEVICES FOR IN-VIVO COLLECTION OF A CERVICAL CYTOLOGY SAMPLE FOR EVALUATION, SCREENING AND DIAGNOSIS, IN CLASS 10 (U.S. CLS. 26, 39 AND 44).

FIRST USE 11-0-2007; IN COMMERCE 1-0-2008.

THE MARK CONSISTS OF TWO PARALLEL CURVED VERTICAL LINES.

SN 77-250,424, FILED 8-8-2007.

B. PARADEWELAI, EXAMINING ATTORNEY

Int. Cl.: 6

Prior U.S. Cls.: 2, 12, 13, 14, 23, 25, and 50

United States Patent and Trademark Office

Reg. No. 3,521,952

Registered Oct. 21, 2008

**TRADEMARK
PRINCIPAL REGISTER**



MARKIN TUBING, LP (DELAWARE LIMITED
PARTNERSHIP)
1 MARKIN LANE
WYOMING, NY 14591

THE MARK CONSISTS OF THREE DIAGONAL
LINES FORMING THE LETTER "M".

FOR: STEEL AND METAL TUBING, IN CLASS 6
(U.S. CLS. 2, 12, 13, 14, 23, 25 AND 50).

SN 77-250,872, FILED 8-9-2007.

FIRST USE 8-13-2007; IN COMMERCE 8-13-2007.

KAPIL BHANOT, EXAMINING ATTORNEY

Int. Cl.: 28

Prior U.S. Cls.: 22, 23, 38, and 50

United States Patent and Trademark Office

Reg. No. 3,521,953

Registered Oct. 21, 2008

**TRADEMARK
PRINCIPAL REGISTER**

MAGNEXT

MEGA BRANDS INTERNATIONAL, LUXEM-
BOURG, ZUG BRANCH (LUXEMBOURG
CORPORATION)
POSTSTRASSE 6
ZUG, SWITZERLAND CH-6300

THE MARK CONSISTS OF STANDARD CHAR-
ACTERS WITHOUT CLAIM TO ANY PARTICULAR
FONT, STYLE, SIZE, OR COLOR.

FOR: MULTI-PART CONSTRUCTION TOYS, IN
CLASS 28 (U.S. CLS. 22, 23, 38 AND 50).

SN 77-250,931, FILED 8-9-2007.

FIRST USE 6-1-2008; IN COMMERCE 6-1-2008.

BARBARA BROWN, EXAMINING ATTORNEY

Int. Cl.: 9

Prior U.S. Cls.: 21, 23, 26, 36, and 38

United States Patent and Trademark Office

Reg. No. 3,521,954

Registered Oct. 21, 2008

**TRADEMARK
PRINCIPAL REGISTER**

WILD FLURRY

WMS GAMING INC. (DELAWARE CORPORATION)
800 SOUTH NORTHPOINT BOULEVARD
WAUKEGAN, IL 60085

FOR: GAMING MACHINES THAT GENERATE OR DISPLAY WAGER OUTCOMES; GAMING SOFTWARE THAT GENERATES OR DISPLAYS WAGER OUTCOMES OF GAMING MACHINES, IN CLASS 9 (U.S. CLS. 21, 23, 26, 36 AND 38).

FIRST USE 3-17-2008; IN COMMERCE 3-17-2008.

THE MARK CONSISTS OF STANDARD CHARACTERS WITHOUT CLAIM TO ANY PARTICULAR FONT, STYLE, SIZE, OR COLOR.

SN 77-250,954, FILED 8-9-2007.

ANNE MADDEN, EXAMINING ATTORNEY

Int. Cl.: 9

Prior U.S. Cls.: 21, 23, 26, 36, and 38

United States Patent and Trademark Office

Reg. No. 3,521,955

Registered Oct. 21, 2008

**TRADEMARK
PRINCIPAL REGISTER**

Nettrace

NETPRISE, INC (NEVADA CORPORATION)
SUITE 1
3155 EAST PATRICK LANE
LAS VEGAS, NV 89120

FOR: COMPUTER SOFTWARE FOR APPLICATION AND DATABASE INTEGRATION; COMPUTER SOFTWARE FOR COMPUTER SYSTEM AND APPLICATION DEVELOPMENT, DEPLOYMENT AND MANAGEMENT; COMPUTER SOFTWARE FOR CREATING SEARCHABLE DATABASES OF

INFORMATION AND DATA, IN CLASS 9 (U.S. CLS. 21, 23, 26, 36 AND 38).

FIRST USE 8-9-2007; IN COMMERCE 2-1-2008.

THE MARK CONSISTS OF STANDARD CHARACTERS WITHOUT CLAIM TO ANY PARTICULAR FONT, STYLE, SIZE, OR COLOR.

SN 77-251,217, FILED 8-9-2007.

JOHN WILKE, EXAMINING ATTORNEY

Int. Cl.: 5

Prior U.S. Cls.: 6, 18, 44, 46, 51, and 52

Reg. No. 3,521,956

United States Patent and Trademark Office

Registered Oct. 21, 2008

**TRADEMARK
PRINCIPAL REGISTER**

TotalImmunity

COMPOUND SOLUTIONS, INC. (CALIFORNIA
CORPORATION)
2215 AUTO PARK WAY
ESCONDIDO, CA 92029

THE MARK CONSISTS OF STANDARD CHAR-
ACTERS WITHOUT CLAIM TO ANY PARTICULAR
FONT, STYLE, SIZE, OR COLOR.

FOR: NUTRITIONAL SUPPLEMENT, IN CLASS 5
(U.S. CLS. 6, 18, 44, 46, 51 AND 52).

SN 77-251,377, FILED 8-9-2007.

FIRST USE 8-1-2007; IN COMMERCE 8-1-2007.

JENNIFER MARTIN, EXAMINING ATTORNEY

Int. Cl.: 41

Prior U.S. Cls.: 100, 101, and 107

United States Patent and Trademark Office

Reg. No. 3,521,957

Registered Oct. 21, 2008

**SERVICE MARK
PRINCIPAL REGISTER**

**KEMPO OHANA MARTIAL ARTS
ACADEMY**

RAMOS, JOSEPH (UNITED STATES INDIVIDUAL)

2114-A GERTZ LANE

HONOLULU, HI 96819

FOR: INSTRUCTION IN THE MARTIAL ARTS, NAMELY, INSTRUCTION IN THE DISCIPLINE OF KEMPO, IN CLASS 41 (U.S. CLS. 100, 101 AND 107).

FIRST USE 7-26-2007; IN COMMERCE 9-5-2007.

THE MARK CONSISTS OF STANDARD CHARACTERS WITHOUT CLAIM TO ANY PARTICULAR FONT, STYLE, SIZE, OR COLOR.

NO CLAIM IS MADE TO THE EXCLUSIVE RIGHT TO USE "KEMPO" AND "MARTIAL ARTS ACADEMY", APART FROM THE MARK AS SHOWN.

SN 77-251,855, FILED 8-9-2007.

BILL DAWE, EXAMINING ATTORNEY

Int. Cl.: 14

Prior U.S. Cls.: 2, 27, 28, and 50

United States Patent and Trademark Office

Reg. No. 3,521,958

Registered Oct. 21, 2008

**TRADEMARK
PRINCIPAL REGISTER**

CATHERINE RYDER

GEORGIA DIAMOND CORP. (GEORGIA CORPORATION)
6105 BLUE STONE ROAD, STE. E
ATLANTA, GA 30328

FOR: ANKLE BRACELETS; BRACELETS; BRACELETS OF PRECIOUS METAL; BROOCHES; CHARMS; CHOKERS; CLIP EARRINGS; CUT DIAMONDS; DIAMOND JEWELRY; DIAMONDS; EAR STUDS; EARRINGS; GEMSTONE JEWELRY; JEWEL CHAINS; JEWEL PENDANTS; JEWELLERY CHAINS; JEWELRY; JEWELRY CHAINS; LAPEL PINS; NECKLACES; ORNAMENTAL LAPEL PINS; PENDANTS; PINS BEING JEWELRY; RINGS BEING JEWELRY; WEDDING BANDS, IN CLASS 14 (U.S. CLS. 2, 27, 28 AND 50).

FIRST USE 8-11-2007; IN COMMERCE 8-11-2007.

THE MARK CONSISTS OF STANDARD CHARACTERS WITHOUT CLAIM TO ANY PARTICULAR FONT, STYLE, SIZE, OR COLOR.

THE NAME "CATHERINE RYDER" DOES NOT IDENTIFY A LIVING INDIVIDUAL.

SN 77-252,003, FILED 8-10-2007.

REBECCA SMITH, EXAMINING ATTORNEY

Int. Cl.: 10

Prior U.S. Cls.: 26, 39, and 44

United States Patent and Trademark Office

Reg. No. 3,521,959

Registered Oct. 21, 2008

**TRADEMARK
PRINCIPAL REGISTER**

BATTLE SLING

ARCHANGEL GROUP, LTD. (COLORADO COR-
PORATION)
14855 WEST 54TH AVENUE
GOLDEN, CO 804031217

THE MARK CONSISTS OF STANDARD CHAR-
ACTERS WITHOUT CLAIM TO ANY PARTICULAR
FONT, STYLE, SIZE, OR COLOR.

FOR: STRETCHERS, IN CLASS 10 (U.S. CLS. 26, 39
AND 44).

SN 77-252,931, FILED 8-10-2007.

FIRST USE 10-15-2007; IN COMMERCE 10-15-2007.

PAUL CROWLEY, EXAMINING ATTORNEY

Int. Cls.: 29 and 30

Prior U.S. Cl.: 46

United States Patent and Trademark Office

Reg. No. 3,521,960

Registered Oct. 21, 2008

**TRADEMARK
PRINCIPAL REGISTER**

FOR THE LOVE OF LUNCH

KRAFT FOODS GLOBAL BRANDS LLC (DELA-
WARE CORPORATION)
THREE LAKES DRIVE
NORTHFIELD, IL 60093

FOR: LUNCHEON MEATS, IN CLASS 29 (U.S. CL.
46).

FIRST USE 5-19-2008; IN COMMERCE 5-19-2008.

FOR: HOT DOG SANDWICHES, IN CLASS 30 (U.S.
CL. 46).

FIRST USE 5-19-2008; IN COMMERCE 5-19-2008.

THE MARK CONSISTS OF STANDARD CHAR-
ACTERS WITHOUT CLAIM TO ANY PARTICULAR
FONT, STYLE, SIZE, OR COLOR.

SN 77-253,300, FILED 8-13-2007.

JACLYN KIDWELL, EXAMINING ATTORNEY

Int. Cl.: 44

Prior U.S. Cls.: 100 and 101

United States Patent and Trademark Office

Reg. No. 3,521,961

Registered Oct. 21, 2008

**SERVICE MARK
PRINCIPAL REGISTER**

EZ-SEND

PROSCAN IMAGING, LLC (OHIO LIMITED LIABILITY COMPANY)
5400 KENNEDY AVENUE
CINCINNATI, OH 45213

FOR: PROVIDING A MEDICAL WEBSITE THAT GIVES MEDICAL PROFESSIONALS THE ABILITY TO EXCHANGE MEDICAL INFORMATION BY UPLOADING MEDICAL IMAGES, NAMELY, PROVIDING A WEBSITE IN THE FIELD OF MEDICAL IMAGING, IN CLASS 44 (U.S. CLS. 100 AND 101).

FIRST USE 11-22-2006; IN COMMERCE 11-22-2006.

THE MARK CONSISTS OF STANDARD CHARACTERS WITHOUT CLAIM TO ANY PARTICULAR FONT, STYLE, SIZE, OR COLOR.

SN 77-253,774, FILED 8-13-2007.

SEAN CROWLEY, EXAMINING ATTORNEY

Int. Cl.: 41

Prior U.S. Cls.: 100, 101, and 107

United States Patent and Trademark Office

Reg. No. 3,521,962

Registered Oct. 21, 2008

**SERVICE MARK
PRINCIPAL REGISTER**

DOUBLETOY

LAKE, JIMMIE, JR. (UNITED STATES INDIVIDUAL)
37600 NORTH INDUSTRIAL PARKWAY
UNIT C
WILLOUGHBY, OH 44094

THE MARK CONSISTS OF STANDARD CHARACTERS WITHOUT CLAIM TO ANY PARTICULAR FONT, STYLE, SIZE, OR COLOR.

FOR: LEASING OF TOYS, IN CLASS 41 (U.S. CLS. 100, 101 AND 107).

SN 77-253,800, FILED 8-13-2007.

FIRST USE 10-3-2007; IN COMMERCE 10-3-2007.

MICHAEL SOUDERS, EXAMINING ATTORNEY

Int. Cl.: 42

Prior U.S. Cls.: 100 and 101

United States Patent and Trademark Office

Reg. No. 3,521,963

Registered Oct. 21, 2008

**SERVICE MARK
PRINCIPAL REGISTER**

RESPONSIVE BY DESIGN

BLAKELY JOHNSON & GHUSN, INC. (NEVADA
CORPORATION)
6995 SIERRA CENTER PARKWAY, SUITE 200
RENO, NV 89511

FOR: CONSULTING IN THE FIELDS OF ARCHI-
TECTURE, ENGINEERING AND INTERIOR DE-
SIGN, IN CLASS 42 (U.S. CLS. 100 AND 101).

FIRST USE 7-0-2007; IN COMMERCE 8-0-2007.

THE MARK CONSISTS OF STANDARD CHAR-
ACTERS WITHOUT CLAIM TO ANY PARTICULAR
FONT, STYLE, SIZE, OR COLOR.

SN 77-253,802, FILED 8-13-2007.

LESLIE RICHARDS, EXAMINING ATTORNEY

Int. Cl.: 41

Prior U.S. Cls.: 100, 101, and 107

United States Patent and Trademark Office

Reg. No. 3,521,964

Registered Oct. 21, 2008

**SERVICE MARK
PRINCIPAL REGISTER**

DoubleToy

LAKE, JIMMIE, JR. (UNITED STATES INDIVIDUAL)
37600 NORTH INDUSTRIAL PARKWAY
UNIT C
WILLOUGHBY, OH 44094

THE MARK CONSISTS OF THE WORDS "DOUBLETOY" WITH SMILEY FACES FORMING THE LOWER CASE LETTER "O" IN EACH WORD.

FOR: LEASING OF TOYS, IN CLASS 41 (U.S. CLS. 100, 101 AND 107).

SN 77-253,805, FILED 8-13-2007.

FIRST USE 10-3-2007; IN COMMERCE 10-3-2007.

MICHAEL SOUDERS, EXAMINING ATTORNEY

Int. Cl.: 12

Prior U.S. Cls.: 19, 21, 23, 31, 35, and 44

Reg. No. 3,521,965

United States Patent and Trademark Office

Registered Oct. 21, 2008

**TRADEMARK
PRINCIPAL REGISTER**

MAXONE

MAXWAY CYCLES CO., LTD. (TAIWAN CORPORATION)
NO. 139-3, DONG MING RD., TAICHUNG HSIEN
TACHIA TOWN, TAIWAN ROC

FOR: BICYCLE FRAMES; BICYCLE STANDS; BICYCLES; RIMS FOR BICYCLE WHEELS; HANDLEBARS; ELECTRIC VEHICLES, NAMELY, BICYCLES; BICYCLE PARTS, NAMELY, STANDS FOR BICYCLES AND CYCLES AND BRAKES, IN CLASS 12 (U.S. CLS. 19, 21, 23, 31, 35 AND 44).

FIRST USE 5-15-2008; IN COMMERCE 5-15-2008.

THE MARK CONSISTS OF STANDARD CHARACTERS WITHOUT CLAIM TO ANY PARTICULAR FONT, STYLE, SIZE, OR COLOR.

SN 77-254,012, FILED 8-13-2007.

MELISSA VALLILLO, EXAMINING ATTORNEY

Int. Cl.: 9

Prior U.S. Cls.: 21, 23, 26, 36, and 38

United States Patent and Trademark Office

Reg. No. 3,521,966

Registered Oct. 21, 2008

**TRADEMARK
PRINCIPAL REGISTER**

Personal Pocket Safe

SYSTEMATIC DEVELOPMENT INC. (FLORIDA
CORPORATION)
SUITE 120
350 JIM MORAN BLVD.
DEERFIELD BEACH, FL 33442

FOR: USB (UNIVERSAL SERIAL BUS) OPERAT-
ING SOFTWARE, IN CLASS 9 (U.S. CLS. 21, 23, 26, 36
AND 38).

FIRST USE 1-1-2008; IN COMMERCE 7-31-2008.

THE MARK CONSISTS OF STANDARD CHAR-
ACTERS WITHOUT CLAIM TO ANY PARTICULAR
FONT, STYLE, SIZE, OR COLOR.

NO CLAIM IS MADE TO THE EXCLUSIVE
RIGHT TO USE "PERSONAL POCKET", APART
FROM THE MARK AS SHOWN.

SN 77-255,848, FILED 8-15-2007.

JAY FLOWERS, EXAMINING ATTORNEY

Int. Cl.: 9

Prior U.S. Cls.: 21, 23, 26, 36, and 38

Reg. No. 3,521,967

United States Patent and Trademark Office

Registered Oct. 21, 2008

**TRADEMARK
PRINCIPAL REGISTER**

Dr. Crankenstein

CARNEGIE ACOUSTICS (KENTUCKY CORPORATION)
1001 CARTER AVENUE
ASHLAND, KY 41101

FOR: AUDIO EQUIPMENT FOR VEHICLES, NAMELY, STEREOS, SPEAKERS, AMPLIFIERS, EQUALIZERS, CROSSOVERS AND SPEAKER HOUSINGS; AUDIO SPEAKER ENCLOSURES; AUDIO SPEAKERS; LOUD SPEAKER SYSTEMS; SPEAKER ENCLOSURES; DIGITAL MEDIA, NAMELY, AUDIO CD'S AND DVD'S FEATURING MUSIC, IN CLASS 9 (U.S. CLS. 21, 23, 26, 36 AND 38).

FIRST USE 1-3-1989; IN COMMERCE 1-9-1989.

THE MARK CONSISTS OF STANDARD CHARACTERS WITHOUT CLAIM TO ANY PARTICULAR FONT, STYLE, SIZE, OR COLOR.

SN 77-256,156, FILED 8-15-2007.

H. M. FISHER, EXAMINING ATTORNEY

Int. Cl.: 28

Prior U.S. Cls.: 22, 23, 38, and 50

United States Patent and Trademark Office

Reg. No. 3,521,968

Registered Oct. 21, 2008

**TRADEMARK
PRINCIPAL REGISTER**

HAWAIIAN EYE

L&S BAIT COMPANY OF FLORIDA, INC.
(FLORIDA CORPORATION)
1415 EAST BAY DRIVE
LARGO, FL 33771

THE MARK CONSISTS OF STANDARD CHAR-
ACTERS WITHOUT CLAIM TO ANY PARTICULAR
FONT, STYLE, SIZE, OR COLOR.

FOR: FISHING LURES, IN CLASS 28 (U.S. CLS. 22,
23, 38 AND 50).

SN 77-256,193, FILED 8-15-2007.

FIRST USE 9-9-2008; IN COMMERCE 9-9-2008.

ERNEST SHOSHO, EXAMINING ATTORNEY

Int. Cls.: 35 and 41

Prior U.S. Cls.: 100, 101, 102, and 107

United States Patent and Trademark Office

Reg. No. 3,521,969

Registered Oct. 21, 2008

**SERVICE MARK
PRINCIPAL REGISTER**

CLEAR COUNSEL

SULGRAVE RESOURCES LLC (WASHINGTON
LIMITED LIABILITY COMPANY)
8515 SE 44TH PLACE
MERCER ISLAND, WA 98040

FOR: EMPLOYMENT HIRING, RECRUITING,
PLACEMENT, STAFFING AND CAREER NET-
WORKING SERVICES; EMPLOYMENT OUTPLA-
CEMENT SERVICES, IN CLASS 35 (U.S. CLS. 100, 101
AND 102).

FIRST USE 3-10-2008; IN COMMERCE 3-10-2008.

FOR: LIFE COACHING SERVICES IN THE FIELD
OF LAW, SPECIFICALLY ATTORNEYS; PERSONAL
COACHING SERVICES IN THE FIELD OF LAW,
SPECIFICALLY ATTORNEYS; PROFESSIONAL
COACHING SERVICES IN THE FIELD OF LAW,
SPECIFICALLY ATTORNEYS AND BUSINESSES

WHICH RETAIN ATTORNEYS, IN CLASS 41 (U.S.
CLS. 100, 101 AND 107).

FIRST USE 3-10-2008; IN COMMERCE 3-10-2008.

THE MARK CONSISTS OF STANDARD CHAR-
ACTERS WITHOUT CLAIM TO ANY PARTICULAR
FONT, STYLE, SIZE, OR COLOR.

NO CLAIM IS MADE TO THE EXCLUSIVE
RIGHT TO USE "COUNSEL", APART FROM THE
MARK AS SHOWN.

SN 77-256,323, FILED 8-15-2007.

SAMUEL E. SHARPER JR., EXAMINING ATTOR-
NEY

Int. Cl.: 43

Prior U.S. Cls.: 100 and 101

United States Patent and Trademark Office

Reg. No. 3,521,970

Registered Oct. 21, 2008

**SERVICE MARK
PRINCIPAL REGISTER**

WILLOWBROOK CAFE

POKAGON GAMING AUTHORITY, A WHOLLY-
OWNED UNINCORPORATED INSTRUMENTALITY OF THE POKAGON BAND OF POTAWATOMI INDIANS OF MICHIGAN AND INDIANA (UNITED STATES INSTRUMENTALITY)

58620 SINK ROAD
DOWAGIAC, MI 49047

FOR: RESTAURANT SERVICES, NAMELY, CAFE RESTAURANTS , IN CLASS 43 (U.S. CLS. 100 AND 101).

FIRST USE 8-1-2007; IN COMMERCE 8-1-2007.

THE MARK CONSISTS OF STANDARD CHARACTERS WITHOUT CLAIM TO ANY PARTICULAR FONT, STYLE, SIZE, OR COLOR.

NO CLAIM IS MADE TO THE EXCLUSIVE RIGHT TO USE "CAFE", APART FROM THE MARK AS SHOWN.

SN 77-256,547, FILED 8-16-2007.

ROBIN CHOSID, EXAMINING ATTORNEY

Int. Cls.: 38 and 42

Prior U.S. Cls.: 100, 101, and 104

United States Patent and Trademark Office

Reg. No. 3,521,971

Registered Oct. 21, 2008

**SERVICE MARK
PRINCIPAL REGISTER**

Sportspace

AMERICAN SPORTS LICENSING, INC. (DELAWARE CORPORATION)
300 DELAWARE AVENUE, SUITE 548
WILMINGTON, DE 19801

FOR: PROVIDING ON-LINE FORUMS, CHAT ROOMS AND ELECTRONIC BULLETIN BOARDS FOR TRANSMISSION OF MESSAGES IN THE FIELD OF SPORTS, IN CLASS 38 (U.S. CLS. 100, 101 AND 104).

FIRST USE 5-0-2008; IN COMMERCE 5-0-2008.

FOR: COMPUTER SERVICES, NAMELY, HOSTING ONLINE WEB FACILITIES FOR OTHERS FOR ORGANIZING AND CONDUCTING ONLINE MEETINGS, GATHERINGS, AND INTERACTIVE

DISCUSSIONS; AND COMPUTER SERVICES, NAMELY, PROVIDING CUSTOMIZED WEB PAGES FEATURING USER-DEFINED INFORMATION, PERSONAL PROFILES AND INFORMATION IN THE FIELD OF SPORTS, IN CLASS 42 (U.S. CLS. 100 AND 101).

FIRST USE 5-0-2008; IN COMMERCE 5-0-2008.

THE MARK CONSISTS OF STANDARD CHARACTERS WITHOUT CLAIM TO ANY PARTICULAR FONT, STYLE, SIZE, OR COLOR.

SN 77-256,549, FILED 8-16-2007.

ALEX KEAM, EXAMINING ATTORNEY

Int. Cl.: 9

Prior U.S. Cls.: 21, 23, 26, 36, and 38

United States Patent and Trademark Office

Reg. No. 3,521,972

Registered Oct. 21, 2008

**TRADEMARK
PRINCIPAL REGISTER**

CGH Fusion

INFOQUANT LTD (UNITED KINGDOM CORPORATION)
8 SHEPHERD MARKET, SUITE 326
LONDON, UNITED KINGDOM W1J7JY

FOR: COMPUTER SOFTWARE FOR SCIENTIFIC ANALYSIS OF GENETIC SEQUENCES, IN CLASS 9 (U.S. CLS. 21, 23, 26, 36 AND 38).

FIRST USE 10-3-2007; IN COMMERCE 1-2-2008.

THE MARK CONSISTS OF STANDARD CHARACTERS WITHOUT CLAIM TO ANY PARTICULAR FONT, STYLE, SIZE, OR COLOR.

NO CLAIM IS MADE TO THE EXCLUSIVE RIGHT TO USE "CGH", APART FROM THE MARK AS SHOWN.

SN 77-257,641, FILED 8-17-2007.

SUSAN LESLIE DUBOIS, EXAMINING ATTORNEY

Int. Cl.: 16

Prior U.S. Cls.: 2, 5, 22, 23, 29, 37, 38, and 50

United States Patent and Trademark Office

Reg. No. 3,521,973

Registered Oct. 21, 2008

**TRADEMARK
PRINCIPAL REGISTER**

MY FIRST PERIOD KIT & DVD

HEALTHY CHATS LLC (CALIFORNIA LIMITED
LIABILITY COMPANY)
4680 TARANTELLA LANE
DAN DIEGO, CA 92130

FOR: KITS CONTAINING PRINTED PAMPH-
LETS, GUIDES, BOOKS, DVDS AND INTERACTIVE
ROLE PLAYING GAMES, ALL IN THE FIELD OF
HEALTH EDUCATION, PUBERTY AND CONCEP-
TION, IN CLASS 16 (U.S. CLS. 2, 5, 22, 23, 29, 37, 38
AND 50).

FIRST USE 7-1-2008; IN COMMERCE 7-1-2008.

THE MARK CONSISTS OF STANDARD CHAR-
ACTERS WITHOUT CLAIM TO ANY PARTICULAR
FONT, STYLE, SIZE, OR COLOR.

NO CLAIM IS MADE TO THE EXCLUSIVE
RIGHT TO USE "PERIOD KIT & DVD", APART
FROM THE MARK AS SHOWN.

SN 77-257,690, FILED 8-17-2007.

KELLEY WELLS, EXAMINING ATTORNEY

Int. Cl.: 35

Prior U.S. Cls.: 100, 101, and 102

United States Patent and Trademark Office

Reg. No. 3,521,974

Registered Oct. 21, 2008

**SERVICE MARK
PRINCIPAL REGISTER**

TIPTOPICS

TIPTOPICS LLC (INDIANA LIMITED LIABILITY
COMPANY)
30 GREENWOOD DRIVE
MOORESVILLE, IN 46158

FOR: ADVERTISING SERVICES, NAMELY, PRE-
PARING AND DISSEMINATING, PRIMARILY VIA
EMAIL AND INTERNET CHANNELS, ARTICLES
BASED ON TOPICAL TIPS PROVIDED BY CLIENTS
INCLUDING BUSINESS OWNERS, OPERATORS OR
THEIR REPRESENTATIVES, TO AN AUDIENCE OF
SELECTED TARGETS COMPRISED OF CONTACTS
SUCH AS PROSPECTS AND CUSTOMERS WITH
WHOM EACH CLIENT HAS AN EXISTING COM-

MUNICATION AND/OR PROFESSIONAL RELA-
TIONSHIP, IN CLASS 35 (U.S. CLS. 100, 101 AND 102).

FIRST USE 6-11-2007; IN COMMERCE 10-9-2007.

THE MARK CONSISTS OF STANDARD CHAR-
ACTERS WITHOUT CLAIM TO ANY PARTICULAR
FONT, STYLE, SIZE, OR COLOR.

SN 77-257,832, FILED 8-17-2007.

BRENDAN REGAN, EXAMINING ATTORNEY

Int. Cl.: 16

Prior U.S. Cls.: 2, 5, 22, 23, 29, 37, 38, and 50

Reg. No. 3,521,975

United States Patent and Trademark Office

Registered Oct. 21, 2008

**TRADEMARK
PRINCIPAL REGISTER**

ENTERPRISE MINNESOTA

MINNESOTA TECHNOLOGY, INC. (MINNESOTA CORPORATION), DBA ENTERPRISE MINNESOTA, INC.,
SUITE 7050
310 4TH AVENUE SOUTH
MINNEAPOLIS, MN 55415

FOR: MAGAZINE FEATURING ECONOMIC, TECHNOLOGICAL AND BUSINESS-RELATED ISSUES, IN CLASS 16 (U.S. CLS. 2, 5, 22, 23, 29, 37, 38 AND 50).

FIRST USE 6-0-2008; IN COMMERCE 6-0-2008.

THE MARK CONSISTS OF STANDARD CHARACTERS WITHOUT CLAIM TO ANY PARTICULAR FONT, STYLE, SIZE, OR COLOR.

NO CLAIM IS MADE TO THE EXCLUSIVE RIGHT TO USE "MINNESOTA", APART FROM THE MARK AS SHOWN.

SN 77-258,050, FILED 8-17-2007.

JOHN WILKE, EXAMINING ATTORNEY

Int. Cl.: 35

Prior U.S. Cls.: 100, 101, and 102

United States Patent and Trademark Office

Reg. No. 3,521,976

Registered Oct. 21, 2008

**SERVICE MARK
PRINCIPAL REGISTER**

ENTERPRISE MINNESOTA

MINNESOTA TECHNOLOGY, INC. (MINNESOTA CORPORATION), DBA ENTERPRISE MINNESOTA, INC.,
SUITE 7050
310 4TH AVENUE SOUTH
MINNEAPOLIS, MN 55415

FOR: BUSINESS DEVELOPMENT SERVICES, NAMELY, PROMOTING AND SUPPORTING BUSINESSES IN THE FIELD OF TECHNOLOGY, PRODUCT DEVELOPMENT, SALES AND MARKETING, BUSINESS MANAGEMENT, AND HUMAN RESOURCE MANAGEMENT, IN CLASS 35 (U.S. CLS. 100, 101 AND 102).

FIRST USE 6-0-2008; IN COMMERCE 6-0-2008.

THE MARK CONSISTS OF STANDARD CHARACTERS WITHOUT CLAIM TO ANY PARTICULAR FONT, STYLE, SIZE, OR COLOR.

NO CLAIM IS MADE TO THE EXCLUSIVE RIGHT TO USE "MINNESOTA", APART FROM THE MARK AS SHOWN.

SN 77-258,068, FILED 8-17-2007.

JOHN WILKE, EXAMINING ATTORNEY

Int. Cl.: 11

Prior U.S. Cls.: 13, 21, 23, 31, and 34

United States Patent and Trademark Office

Reg. No. 3,521,977

Registered Oct. 21, 2008

**TRADEMARK
PRINCIPAL REGISTER**

FLIPSTYX

COCHRAN, TONYA RENEE (UNITED STATES
INDIVIDUAL)
652 SKYLINE DRIVE
VILLA RICA, GA 30180

FOR: HEATING UNIT IN THE NATURE OF A
MINI ELECTRIC OVEN USED TO MELT AND
EXTRACT UNUSED LIPSTICK FROM THE ORIGI-
NAL LIPSTICK TUBE, IN CLASS 11 (U.S. CLS. 13, 21,
23, 31 AND 34).

FIRST USE 8-8-2008; IN COMMERCE 8-8-2008.

THE MARK CONSISTS OF STANDARD CHAR-
ACTERS WITHOUT CLAIM TO ANY PARTICULAR
FONT, STYLE, SIZE, OR COLOR.

SN 77-258,217, FILED 8-17-2007.

THOMAS MANOR, EXAMINING ATTORNEY

Int. Cl.: 30

Prior U.S. Cl.: 46

United States Patent and Trademark Office

Reg. No. 3,521,978

Registered Oct. 21, 2008

**TRADEMARK
PRINCIPAL REGISTER**

BON BONA

FLORES, KARLO (CANADA INDIVIDUAL), DBA
KFM FOODS INTERNATIONAL,
2385 BURRARD STREET
VANCOUVER, CANADA V6J3J2

FOR: CHOCOLATE; CHOCOLATE TRUFFLES;
MILK CHOCOLATE; CHOCOLATE CANDIES; CHO-
COLATE COVERED NUTS; CHOCOLATE COV-
ERED RAISINS; CANDY; CANDY BARS; CANDY
WITH COCOA, IN CLASS 30 (U.S. CL. 46).

FIRST USE 8-15-2006; IN COMMERCE 8-15-2006.

THE MARK CONSISTS OF STANDARD CHAR-
ACTERS WITHOUT CLAIM TO ANY PARTICULAR
FONT, STYLE, SIZE, OR COLOR.

SN 77-258,438, FILED 8-17-2007.

JEFF DEFORD, EXAMINING ATTORNEY

Int. Cls.: 38 and 42

Prior U.S. Cls.: 100, 101, and 104

United States Patent and Trademark Office

Reg. No. 3,521,979

Registered Oct. 21, 2008

**SERVICE MARK
PRINCIPAL REGISTER**

NEWTEK TECHNOLOGY SERVICES

NEWTEK BUSINESS SERVICES, INC. (NEW YORK CORPORATION)
1440 BROADWAY
NEW YORK, NY 10018

FOR: PROVIDING ELECTRONIC MAIL SERVICES FOR OTHERS, IN CLASS 38 (U.S. CLS. 100, 101 AND 104).

FIRST USE 5-15-2008; IN COMMERCE 5-15-2008.

FOR: COMPUTER AND BUSINESS SERVICES, NAMELY, HOSTING OF THE WEB SITES OF OTHERS ON A COMPUTER SERVER FOR A GLOBAL COMPUTER NETWORK; PROVIDING INFORMATION ABOUT WEB SITE DEVELOPMENT; WEB SITE HOSTING SERVICES; DESIGNING, DEVELOPING, AND HOSTING WEB SITES FOR OTHERS; COMPUTER NETWORK ADDRESS MANAGEMENT SERVICES, NAMELY, PROVIDING SERVICES ENABLING ENTITIES TO RESERVE, MANAGE

AND SECURE DOMAIN NAMES FOR USE ON A GLOBAL COMPUTER NETWORK AND TO ACCESS, ADD, MODIFY, OR DELETE THEIR DOMAIN NAME INFORMATION, IN CLASS 42 (U.S. CLS. 100 AND 101).

FIRST USE 5-15-2008; IN COMMERCE 5-15-2008.

THE MARK CONSISTS OF STANDARD CHARACTERS WITHOUT CLAIM TO ANY PARTICULAR FONT, STYLE, SIZE, OR COLOR.

NO CLAIM IS MADE TO THE EXCLUSIVE RIGHT TO USE "TECHNOLOGY SERVICES", APART FROM THE MARK AS SHOWN.

SN 77-258,988, FILED 8-20-2007.

JOHN KELLY, EXAMINING ATTORNEY

Int. Cl.: 16

Prior U.S. Cls.: 2, 5, 22, 23, 29, 37, 38, and 50

Reg. No. 3,521,980

United States Patent and Trademark Office

Registered Oct. 21, 2008

**TRADEMARK
PRINCIPAL REGISTER**

SEE HOW FAR A CARD CAN GO

HALLMARK LICENSING, INC. (DELAWARE
CORPORATION)
MD 339
2440 PERSHING ROAD
KANSAS CITY, MO 64108

FOR: GREETING CARDS; GIFT WRAP PAPER;
PAPER BOWS FOR GIFT WRAP; PAPER GIFT
BAGS; PAPER GIFT WRAPPING RIBBONS; BOXES
OF PAPER OR CARDBOARD; TISSUE PAPER;
STATIONERY, IN CLASS 16 (U.S. CLS. 2, 5, 22, 23,
29, 37, 38 AND 50).

FIRST USE 10-8-2007; IN COMMERCE 10-8-2007.

THE MARK CONSISTS OF STANDARD CHAR-
ACTERS WITHOUT CLAIM TO ANY PARTICULAR
FONT, STYLE, SIZE, OR COLOR.

SN 77-260,217, FILED 8-21-2007.

ELLEN B. AWRICH, EXAMINING ATTORNEY

Int. Cl.: 35

Prior U.S. Cls.: 100, 101, and 102

United States Patent and Trademark Office

Reg. No. 3,521,981

Registered Oct. 21, 2008

**SERVICE MARK
PRINCIPAL REGISTER**

SEE HOW FAR A CARD CAN GO

HALLMARK LICENSING, INC. (DELAWARE CORPORATION)

MD 339

2440 PERSHING RD.

KANSAS CITY, MO 64108

FOR: ADVERTISING SERVICES, PUBLIC RELATIONS AND MARKETING SERVICES, NAMELY, PROMOTING AND MARKETING THE GOODS AND SERVICES OF OTHERS THROUGH ALL PUBLIC COMMUNICATION MEANS, IN CLASS 35 (U.S. CLS. 100, 101 AND 102).

FIRST USE 11-1-2007; IN COMMERCE 11-1-2007.

THE MARK CONSISTS OF STANDARD CHARACTERS WITHOUT CLAIM TO ANY PARTICULAR FONT, STYLE, SIZE, OR COLOR.

SN 77-260,222, FILED 8-21-2007.

ELLEN B. AWRICH, EXAMINING ATTORNEY

Int. Cl.: 30

Prior U.S. Cl.: 46

United States Patent and Trademark Office

Reg. No. 3,521,982

Registered Oct. 21, 2008

**TRADEMARK
PRINCIPAL REGISTER**

CREAMY WHEELS

ASSOCIATED WHOLESALE GROCERS, INC.
(KANSAS CORPORATION)
5000 KANSAS AVE
KANSAS CITY, KS 66106

NO CLAIM IS MADE TO THE EXCLUSIVE
RIGHT TO USE "CREAMY", APART FROM THE
MARK AS SHOWN.

FOR: COOKIES, IN CLASS 30 (U.S. CL. 46).

FIRST USE 7-7-2008; IN COMMERCE 7-7-2008.

SN 77-260,683, FILED 8-21-2007.

THE MARK CONSISTS OF STANDARD CHAR-
ACTERS WITHOUT CLAIM TO ANY PARTICULAR
FONT, STYLE, SIZE, OR COLOR.

BRIAN PINO, EXAMINING ATTORNEY

Int. Cl.: 3

Prior U.S. Cls.: 1, 4, 6, 50, 51, and 52

United States Patent and Trademark Office

Reg. No. 3,521,983

Registered Oct. 21, 2008

**TRADEMARK
PRINCIPAL REGISTER**

COSMIC CRITTER CURE

STRAWHUN, KELLI (UNITED STATES INDIVIDUAL)
1815 EAST POINTE AVENUE
CARLSBAD, CA 92008

THE MARK CONSISTS OF STANDARD CHARACTERS WITHOUT CLAIM TO ANY PARTICULAR FONT, STYLE, SIZE, OR COLOR.

FOR: NON-MEDICATED SKIN CARE PREPARATIONS, IN CLASS 3 (U.S. CLS. 1, 4, 6, 50, 51 AND 52).

SN 77-261,017, FILED 8-21-2007.

FIRST USE 9-1-2007; IN COMMERCE 9-1-2007.

KAREN M. STRYZ, EXAMINING ATTORNEY

Int. Cl.: 31

Prior U.S. Cls.: 1 and 46

United States Patent and Trademark Office

Reg. No. 3,521,984

Registered Oct. 21, 2008

**TRADEMARK
PRINCIPAL REGISTER**

WHOLESOME MEDLEY

DEL MONTE CORPORATION (DELAWARE
CORPORATION)

ONE MARKET STREET

SAN FRANCISCO, CA 94105

FOR: PET FOOD, IN CLASS 31 (U.S. CLS. 1 AND
46).

FIRST USE 1-8-2008; IN COMMERCE 1-8-2008.

THE MARK CONSISTS OF STANDARD CHAR-
ACTERS WITHOUT CLAIM TO ANY PARTICULAR
FONT, STYLE, SIZE, OR COLOR.

NO CLAIM IS MADE TO THE EXCLUSIVE
RIGHT TO USE "WHOLESOME", APART FROM
THE MARK AS SHOWN.

SN 77-261,259, FILED 8-22-2007.

NAAKWAMA ANKRAH, EXAMINING ATTORNEY

Int. Cls.: 16 and 41

Prior U.S. Cls.: 2, 5, 22, 23, 29, 37, 38, 50, 100, 101, and 107

Reg. No. 3,521,985

United States Patent and Trademark Office

Registered Oct. 21, 2008

**TRADEMARK
SERVICE MARK
PRINCIPAL REGISTER**

COLUMBIA CASEWORKS

THE TRUSTEES OF COLUMBIA UNIVERSITY IN
THE CITY OF NEW YORK (NEW YORK
CORPORATION)

OFFICE OF THE GENERAL COUNSEL
412 LOW MEMORIAL LIBRARY 535 W. 116TH ST
NEW YORK, NY 10027

FOR: PRINTED CURRICULUM AND EDUCATIONAL COURSE MATERIALS IN THE FIELD OF GRADUATE MANAGEMENT EDUCATION, IN CLASS 16 (U.S. CLS. 2, 5, 22, 23, 29, 37, 38 AND 50).

FIRST USE 8-0-2007; IN COMMERCE 8-0-2007.

FOR: EDUCATIONAL SERVICES, NAMELY, CONDUCTING CLASSES AND DISTRIBUTION OF COURSE MATERIAL IN CONNECTION THEREWITH, CONDUCTING ON-LINE PROGRAMS AND PRINTABLE MATERIALS DISTRIBUTED THEREWITH, AND DEVELOPING EDUCATIONAL AND CURRICULUM MATERIALS FOR OTHERS—ALL IN

THE FIELD OF GRADUATE MANAGEMENT EDUCATION, IN CLASS 41 (U.S. CLS. 100, 101 AND 107).

FIRST USE 8-0-2007; IN COMMERCE 8-0-2007.

THE MARK CONSISTS OF STANDARD CHARACTERS WITHOUT CLAIM TO ANY PARTICULAR FONT, STYLE, SIZE, OR COLOR.

OWNER OF U.S. REG. NOS. 1,524,893, 2,177,115, AND OTHERS.

NO CLAIM IS MADE TO THE EXCLUSIVE RIGHT TO USE "CASEWORKS", APART FROM THE MARK AS SHOWN.

SN 77-261,696, FILED 8-22-2007.

RAUL CORDOVA, EXAMINING ATTORNEY

Int. Cl.: 28

Prior U.S. Cls.: 22, 23, 38, and 50

United States Patent and Trademark Office

Reg. No. 3,521,986

Registered Oct. 21, 2008

**TRADEMARK
PRINCIPAL REGISTER**

HYDRO- BOARD

AQUA-LEISURE INDUSTRIES, INC. (MASSACHUSETTS CORPORATION)

525 BODWELL STREET
AVON, MA 02322

FOR: RECREATIONAL PRODUCTS, NAMELY, WATER TOYS, IN CLASS 28 (U.S. CLS. 22, 23, 38 AND 50).

FIRST USE 1-0-2008; IN COMMERCE 1-0-2008.

THE MARK CONSISTS OF STANDARD CHARACTERS WITHOUT CLAIM TO ANY PARTICULAR FONT, STYLE, SIZE, OR COLOR.

NO CLAIM IS MADE TO THE EXCLUSIVE RIGHT TO USE "BOARD", APART FROM THE MARK AS SHOWN.

SN 77-261,899, FILED 8-22-2007.

JUDITH HELFMAN, EXAMINING ATTORNEY

Int. Cl.: 35

Prior U.S. Cls.: 100, 101, and 102

United States Patent and Trademark Office

Reg. No. 3,521,987

Registered Oct. 21, 2008

**SERVICE MARK
PRINCIPAL REGISTER**

RV FOCUS

BAKER & DANIELS LLP (INDIANA LIMITED
LIABILITY PARTNERSHIP)
SUITE 2700
300 N. MERIDIAN STREET
INDIANAPOLIS, IN 46204

FOR: BUSINESS MANAGEMENT CONSULTING
AND ADVISORY SERVICES, IN CLASS 35 (U.S. CLS.
100, 101 AND 102).

FIRST USE 11-30-2005; IN COMMERCE 11-30-2005.

THE MARK CONSISTS OF STANDARD CHAR-
ACTERS WITHOUT CLAIM TO ANY PARTICULAR
FONT, STYLE, SIZE, OR COLOR.

NO CLAIM IS MADE TO THE EXCLUSIVE
RIGHT TO USE "RV", APART FROM THE MARK
AS SHOWN.

SN 77-261,933, FILED 8-22-2007.

WILLIAM VERHOSEK, EXAMINING ATTORNEY

Int. Cl.: 28

Prior U.S. Cls.: 22, 23, 38, and 50

Reg. No. 3,521,988

United States Patent and Trademark Office

Registered Oct. 21, 2008

**TRADEMARK
PRINCIPAL REGISTER**

AQUA-PEDIC

AQUA-LEISURE INDUSTRIES, INC. (MASSACHUSETTS CORPORATION)
525 BODWELL STREET
AVON, MA 02322

THE MARK CONSISTS OF STANDARD CHARACTERS WITHOUT CLAIM TO ANY PARTICULAR FONT, STYLE, SIZE, OR COLOR.

FOR: FLOATS FOR RECREATIONAL USE ON WATER, IN CLASS 28 (U.S. CLS. 22, 23, 38 AND 50).

SN 77-261,938, FILED 8-22-2007.

FIRST USE 1-0-2008; IN COMMERCE 1-0-2008.

JUDITH HELFMAN, EXAMINING ATTORNEY

Int. Cl.: 41

Prior U.S. Cls.: 100, 101, and 107

United States Patent and Trademark Office

Reg. No. 3,521,989

Registered Oct. 21, 2008

**SERVICE MARK
PRINCIPAL REGISTER**

FORREST WOOD CUP

OPERATION BASS, INC. (KENTUCKY CORPORATION)
30 GAMBLE LANE
BENTON, KY 42025

FOR: ENTERTAINMENT SERVICES, NAMELY, ORGANIZING AND CONDUCTING FISHING COMPETITIONS, IN CLASS 41 (U.S. CLS. 100, 101 AND 107).

FIRST USE 8-0-2006; IN COMMERCE 8-0-2006.

THE MARK CONSISTS OF STANDARD CHARACTERS WITHOUT CLAIM TO ANY PARTICULAR FONT, STYLE, SIZE, OR COLOR.

NO CLAIM IS MADE TO THE EXCLUSIVE RIGHT TO USE "CUP", APART FROM THE MARK AS SHOWN.

THE NAME "FORREST WOOD" IDENTIFIES A LIVING INDIVIDUAL WHOSE CONSENT IS OF RECORD.

SN 77-262,004, FILED 8-22-2007.

KIMBERLY FRYE, EXAMINING ATTORNEY

Int. Cl.: 11

Prior U.S. Cls.: 13, 21, 23, 31, and 34

Reg. No. 3,521,990

United States Patent and Trademark Office

Registered Oct. 21, 2008

**TRADEMARK
PRINCIPAL REGISTER**

Hot TaMollie

HOT TAMOLLIE, LIMITED LIABILITY COMPANY (TEXAS LIMITED LIABILITY COMPANY)
3500 STANFORD AVE.
DALLAS, TX 75225

FOR: COLD AND HEAT CLOTH PACKS, FILLED WITH RICE FOR HEATING AND COOLING THE BODY, HEAD, NECK AND BACK, WHICH CAN BE HEATED OR FROZEN AND THEN APPLIED TO THE BODY OR USED IN BED FOR COMFORT AND RELAXATION AND NOT FOR MEDICAL PURPOSES, IN CLASS 11 (U.S. CLS. 13, 21, 23, 31 AND 34).

FIRST USE 1-12-2007; IN COMMERCE 2-24-2007.

THE MARK CONSISTS OF STANDARD CHARACTERS WITHOUT CLAIM TO ANY PARTICULAR FONT, STYLE, SIZE, OR COLOR.

SN 77-262,077, FILED 8-22-2007.

AMY HELLA, EXAMINING ATTORNEY

Int. Cls.: 35, 36, and 41

Prior U.S. Cls.: 100, 101, 102, and 107

United States Patent and Trademark Office

Reg. No. 3,521,991

Registered Oct. 21, 2008

**SERVICE MARK
PRINCIPAL REGISTER**



SAFE HORIZON, INC. (NEW YORK CHARITABLE, NON-PROFIT CORPORATION)
3RD FLOOR
2 LAFAYETTE STREET
NEW YORK, NY 10007

FOR: PUBLIC ADVOCACY TO PROMOTE AWARENESS OF THE IMPACT OF VIOLENCE AND ABUSE ON CHILDREN; PUBLIC POLICY RESEARCH SERVICES; PROMOTING THE GOODS AND SERVICES OF OTHERS BY ARRANGING FOR SPONSORS TO AFFILIATE THEIR GOODS AND SERVICES WITH CHARITABLE CAMPAIGNS, IN CLASS 35 (U.S. CLS. 100, 101 AND 102).

FIRST USE 3-10-2008; IN COMMERCE 3-10-2008.

FOR: CHARITABLE FUND RAISING, IN CLASS 36 (U.S. CLS. 100, 101 AND 102).

FIRST USE 3-10-2008; IN COMMERCE 3-10-2008.

FOR: EDUCATION SERVICES, NAMELY, PROVIDING LECTURES, CONFERENCES, WORKSHOPS AND SEMINARS FOR THE PUBLIC, CRIME AND ABUSE VICTIMS AND THEIR FAMILIES, LAW ENFORCEMENT, SOCIAL WORK PROFESSIONALS, AND GOVERNMENTAL ORGANIZATIONS IN THE FIELDS OF AWARENESS AND PREVENTION OF THE IMPACT OF VIOLENCE AND ABUSE ON CHILDREN, IN CLASS 41 (U.S. CLS. 100, 101 AND 107).

FIRST USE 3-10-2008; IN COMMERCE 3-10-2008.

THE MARK CONSISTS OF OUTLINE OF A PERSON WITH ONE ARM RAISED TOWARD SOLID CIRCLE, WITH FIVE SOLID SEMI-FORMED TRIANGLES PROTRUDING FROM CIRCLE.

SN 77-262,394, FILED 8-23-2007.

GIANCARLO CASTRO, EXAMINING ATTORNEY

Int. Cl.: 9

Prior U.S. Cls.: 21, 23, 26, 36, and 38

Reg. No. 3,521,992

United States Patent and Trademark Office

Registered Oct. 21, 2008

**TRADEMARK
PRINCIPAL REGISTER**

SCRIPFICIENT

INFINITE TECHNOLOGIES, INC. (ARIZONA
CORPORATION)
2140 EAST BIDWELL STREET
FOLSOM, CA 95630

THE MARK CONSISTS OF STANDARD CHAR-
ACTERS WITHOUT CLAIM TO ANY PARTICULAR
FONT, STYLE, SIZE, OR COLOR.

FOR: COMPUTER SOFTWARE FOR DATA MAN-
AGEMENT AND INVENTORY CONTROL AND
TRACKING, IN CLASS 9 (U.S. CLS. 21, 23, 26, 36
AND 38).

SN 77-262,524, FILED 8-23-2007.

FIRST USE 6-1-2007; IN COMMERCE 6-1-2007.

CHRISTINA SOBRAL, EXAMINING ATTORNEY

Int. Cl.: 32

Prior U.S. Cls.: 45, 46, and 48

United States Patent and Trademark Office

Reg. No. 3,521,993

Registered Oct. 21, 2008

**TRADEMARK
PRINCIPAL REGISTER**



KCV ASSOCIATES INC. (US VIRGIN ISLANDS CORPORATION), DBA ST. JOHN BREWERS, 5000 ESTATE ENIGHED #289 ST. JOHN, US VIRGIN ISLANDS 00830

FOR: BEER; SODA POPS; FRUIT JUICES; FLAVORED WATERS, IN CLASS 32 (U.S. CLS. 45, 46 AND 48).

FIRST USE 7-15-2006; IN COMMERCE 5-15-2007.

THE COLOR(S) GREEN, BROWN, RED, GRAY, AND WHITE IS/ARE CLAIMED AS A FEATURE OF THE MARK.

THE MARK CONSISTS OF A PALM TREE WITH GREEN PALM FRONDS AND BROWN AND WHITE TRUNK WITH GREEN GRASS AT THE BASE OF TRUNK AND A RED BEER TAP HANDLE WITH GRAY SPIGOT PROTRUDING FROM THE TRUNK OF THE TREE.

SN 77-262,722, FILED 8-23-2007.

KAPIL BHANOT, EXAMINING ATTORNEY

Int. Cl.: 42

Prior U.S. Cls.: 100 and 101

United States Patent and Trademark Office

Reg. No. 3,521,994

Registered Oct. 21, 2008

**SERVICE MARK
PRINCIPAL REGISTER**

**BRIGHT SOLUTIONS BRILLIANT
RESULTS**

IPLACEMENT, INC. (FLORIDA CORPORATION)
1516 E. COLONIAL DRIVE
ORLANDO, FL 32803

FOR: EMPLOYMENT CANDIDATE DATABASE SYSTEM, NAMELY, APPLICATION SERVICE PROVIDER (ASP) SYSTEM FEATURING WEB-BASED COMPUTER SOFTWARE FOR APPLICATION AND DATABASE INTEGRATION FOR USE IN THE HUMAN RESOURCES, EMPLOYMENT, RECRUITING, AND STAFFING FIELDS, IN CLASS 42 (U.S. CLS. 100 AND 101).

FIRST USE 7-31-2006; IN COMMERCE 7-31-2006.

THE MARK CONSISTS OF STANDARD CHARACTERS WITHOUT CLAIM TO ANY PARTICULAR FONT, STYLE, SIZE, OR COLOR.

SN 77-262,961, FILED 8-23-2007.

KATHLEEN M. VANSTON, EXAMINING ATTORNEY

Int. Cl.: 25

Prior U.S. Cls.: 22 and 39

United States Patent and Trademark Office

Reg. No. 3,521,995

Registered Oct. 21, 2008

**TRADEMARK
PRINCIPAL REGISTER**

TURF LOCK

AMERICAN SPORTS LICENSING, INC. (DELA-
WARE CORPORATION)
300 DELAWARE AVENUE, SUITE 548
WILMINGTON, DE 19801

THE MARK CONSISTS OF STANDARD CHAR-
ACTERS WITHOUT CLAIM TO ANY PARTICULAR
FONT, STYLE, SIZE, OR COLOR.

FOR: FOOTWEAR, NAMELY, GOLF SHOES, IN
CLASS 25 (U.S. CLS. 22 AND 39).

SN 77-263,383, FILED 8-24-2007.

FIRST USE 1-0-2008; IN COMMERCE 1-0-2008.

ALEX KEAM, EXAMINING ATTORNEY

Int. Cl.: 26

Prior U.S. Cls.: 37, 39, 40, 42, and 50

United States Patent and Trademark Office

Reg. No. 3,521,996

Registered Oct. 21, 2008

**TRADEMARK
PRINCIPAL REGISTER**

TISSUE BOX SOX

GRANDE, DENNIS (UNITED STATES INDIVIDUAL)
4 OLD CRANBERRY ROADS
STERLINGTON, NY 10974

FOR: EXPANDABLE, REUSABLE TISSUE BOX COVER MADE OF STRETCHABLE FABRIC, IN CLASS 26 (U.S. CLS. 37, 39, 40, 42 AND 50).

FIRST USE 6-20-2008; IN COMMERCE 6-20-2008.

THE MARK CONSISTS OF STANDARD CHARACTERS WITHOUT CLAIM TO ANY PARTICULAR FONT, STYLE, SIZE, OR COLOR.

NO CLAIM IS MADE TO THE EXCLUSIVE RIGHT TO USE "TISSUE BOX", APART FROM THE MARK AS SHOWN.

SN 77-263,647, FILED 8-24-2007.

EMILY CARLSEN, EXAMINING ATTORNEY

Int. Cl.: 35

Prior U.S. Cls.: 100, 101, and 102

United States Patent and Trademark Office

Reg. No. 3,521,997

Registered Oct. 21, 2008

**SERVICE MARK
PRINCIPAL REGISTER**



NATIONAL ASSOCIATION OF SPORTING
GOODS WHOLESALERS, INC. (ILLINOIS
NON-PROFIT CORPORATION), DBA NASGW,
362 NW SUNVIEW WAY
PORT ST. LUCIE, FL 34986

FOR: ASSOCIATION SERVICES, NAMELY, PRO-
MOTING THE INTERESTS OF SPORTING GOODS
WHOLESALERS, DISTRIBUTORS, MANUFACTUR-
ERS, SUPPLIERS AND SALES REPRESENTATIVES;
PROVIDING A WEB SITE FEATURING DETAILED
INFORMATION, SPECIFICATIONS, AND DESCRIP-
TIONS OF SPORTING GOODS RELATING TO
THEIR SALE AND PROVIDING A WEB SITE WITH
SPORTING GOODS INFORMATION FACILITAT-
ING PRODUCT CROSS-REFERENCING AND COM-
PARISONS RELATING TO THE SALE OF THE
GOODS, IN CLASS 35 (U.S. CLS. 100, 101 AND 102).

FIRST USE 11-7-2007; IN COMMERCE 11-7-2007.

NO CLAIM IS MADE TO THE EXCLUSIVE
RIGHT TO USE ".COM", APART FROM THE MARK
AS SHOWN.

THE COLOR(S) BLACK AND GREEN IS/ARE
CLAIMED AS A FEATURE OF THE MARK.

THE MARK CONSISTS OF THE WORD "ITEM"
AND ".COM" IN BLACK AND THE ABBREVIATION
"HQ" IN GREEN.

SN 77-263,822, FILED 8-24-2007.

DAVID C. REIHNER, EXAMINING ATTORNEY

Int. Cl.: 35

Prior U.S. Cls.: 100, 101, and 102

United States Patent and Trademark Office

Reg. No. 3,521,998

Registered Oct. 21, 2008

**SERVICE MARK
PRINCIPAL REGISTER**

**ADVANCING SAFETY &
ACTIVITY THROUGH
INNOVATION & EDUCATION**

XENITH, LLC (DELAWARE LIMITED LIABILITY COMPANY)
29 COMMONWEALTH AVENUE
BOSTON, MA 02116

FOR: ASSOCIATION SERVICES, NAMELY, PROMOTING PUBLIC INTEREST IN SAFETY IN SPORTS AND OTHER POTENTIALLY HAZARDOUS ACTIVITIES BY THE PROVISION OF NEW PRODUCTS, TECHNOLOGIES AND INFORMATION TO MINIMIZE INJURIES, IN CLASS 35 (U.S. CLS. 100, 101 AND 102).

FIRST USE 1-0-2008; IN COMMERCE 1-0-2008.

THE MARK CONSISTS OF STANDARD CHARACTERS WITHOUT CLAIM TO ANY PARTICULAR FONT, STYLE, SIZE, OR COLOR.

NO CLAIM IS MADE TO THE EXCLUSIVE RIGHT TO USE "SAFETY AND ACTIVITY", APART FROM THE MARK AS SHOWN.

SN 77-263,952, FILED 8-24-2007.

INGA ERVIN, EXAMINING ATTORNEY

Int. Cl.: 9

Prior U.S. Cls.: 21, 23, 26, 36, and 38

Reg. No. 3,521,999

United States Patent and Trademark Office

Registered Oct. 21, 2008

**TRADEMARK
PRINCIPAL REGISTER**



UPLAY, LLC (CALIFORNIA LIMITED LIABILITY COMPANY)
2185 FARADAY AVENUE, #130
CARLSBAD, CA 92008

THE MARK CONSISTS OF THE GREEK LETTER MU FOLLOWED BY THE TERM "PRO".

FOR: RANGEFINDERS FOR GOLF, IN CLASS 9
(U.S. CLS. 21, 23, 26, 36 AND 38).

SN 77-263,958, FILED 8-24-2007.

FIRST USE 6-4-2008; IN COMMERCE 6-4-2008.

APRIL ROACH, EXAMINING ATTORNEY

Int. Cl.: 28

Prior U.S. Cls.: 22, 23, 38, and 50

Reg. No. 3,522,000

United States Patent and Trademark Office

Registered Oct. 21, 2008

**TRADEMARK
PRINCIPAL REGISTER**

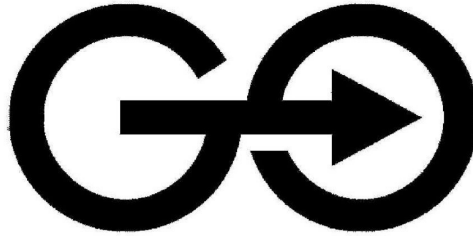

SRI SPORTS KABUSHIKI KAISHA (JAPAN CORPORATION), DBA SRI SPORTS LIMITED, 6-9 WAKINOHAMA-CHO 3-CHOME, CHUO-KU KOBE-SHI, HYOGO, JAPAN

FOR: GOLF BALLS, IN CLASS 28 (U.S. CLS. 22, 23, 38 AND 50).

FIRST USE 12-10-2007; IN COMMERCE 12-10-2007.

THE MARK CONSISTS OF A STYLIZATION OF THE WORD "GO" WITH AN ARROW FORMING THE HORIZONTAL ELEMENT OF THE LETTER "G" AND EXTENDING RIGHTWARD THROUGH THE LETTER "O".

SN 77-264,285, FILED 8-25-2007.

ANN E. SAPPENFIELD, EXAMINING ATTORNEY

Int. Cl.: 28

Prior U.S. Cls.: 22, 23, 38, and 50

Reg. No. 3,522,001

United States Patent and Trademark Office

Registered Oct. 21, 2008

TRADEMARK
PRINCIPAL REGISTER



AMERICAN GATEWAY MARKETING GROUP,
INC. (CALIFORNIA CORPORATION)

2070 ZANKER ROAD
SAN JOSE, CA 95131

FOR: EXERCISE BALLS; EXERCISE EQUIP-
MENT, NAMELY, CHEST PULLS; EXERCISE MA-
CHINES; PERSONAL EXERCISE MATS; YOGA
MATS, IN CLASS 28 (U.S. CLS. 22, 23, 38 AND 50).

FIRST USE 12-0-2006; IN COMMERCE 12-0-2006.

NO CLAIM IS MADE TO THE EXCLUSIVE
RIGHT TO USE "FITNESS", APART FROM THE
MARK AS SHOWN.

THE MARK CONSISTS OF THE STYLIZED
WORD ECOWISE BUTTRESSED BY FLOWERS BE-
LOW WHICH APPEAR THE WORDS FITNESS AND
BECAUSE WE CARE.

SN 77-265,237, FILED 8-27-2007.

ANNE MADDEN, EXAMINING ATTORNEY

Int. Cl.: 16

Prior U.S. Cls.: 2, 5, 22, 23, 29, 37, 38, and 50

Reg. No. 3,522,002

United States Patent and Trademark Office

Registered Oct. 21, 2008

**TRADEMARK
PRINCIPAL REGISTER**



HARPER

HARPERCOLLINS PUBLISHERS L.L.C. (DELA-
WARE LIMITED LIABILITY COMPANY)
10 E. 53RD STREET
NEW YORK, NY 10022

FOR: SERIES OF PRINTED FICTION AND NON-
FICTION BOOKS ON A VARIETY OF SUBJECTS, IN
CLASS 16 (U.S. CLS. 2, 5, 22, 23, 29, 37, 38 AND 50).

FIRST USE 9-0-2007; IN COMMERCE 9-0-2007.

OWNER OF U.S. REG. NOS. 1,133,096, 1,680,146,
AND OTHERS.

NO CLAIM IS MADE TO THE EXCLUSIVE
RIGHT TO USE 1817, APART FROM THE MARK
AS SHOWN.

THE MARK CONSISTS OF A BLACK OVAL WITH
A WHITE TORCH AND THE NUMBERS 1817 WITH-
IN THE OVAL. THE WORD HARPER APPEARS
UNDERNEATH..

SN 77-265,293, FILED 8-27-2007.

INGA ERVIN, EXAMINING ATTORNEY

Int. Cl.: 41

Prior U.S. Cls.: 100, 101, and 107

United States Patent and Trademark Office

Reg. No. 3,522,003

Registered Oct. 21, 2008

**SERVICE MARK
PRINCIPAL REGISTER**

GLOW IN THE PARK

SIX FLAGS THEME PARKS, INC. (DELAWARE
CORPORATION)
924 AVENUE J. EAST
GRAND PRAIRIE, TX 75050

THE MARK CONSISTS OF STANDARD CHAR-
ACTERS WITHOUT CLAIM TO ANY PARTICULAR
FONT, STYLE, SIZE, OR COLOR.

FOR: ENTERTAINMENT SERVICES, NAMELY,
ORGANIZING A PARADE AT AN AMUSEMENT
PARK, IN CLASS 41 (U.S. CLS. 100, 101 AND 107).

SN 77-266,067, FILED 8-28-2007.

FIRST USE 9-27-2007; IN COMMERCE 5-23-2008.

MARGERY A. TIERNEY, EXAMINING ATTORNEY

Int. Cl.: 34

Prior U.S. Cls.: 2, 8, 9, and 17

United States Patent and Trademark Office

Reg. No. 3,522,004

Registered Oct. 21, 2008

**TRADEMARK
PRINCIPAL REGISTER**

SMOO-Z

THOMAS, BENJAMIN P. (UNITED STATES IN-
DIVIDUAL)
1053 CHRIS CROSSING
WOODWORTH, LA 71485

THE MARK CONSISTS OF STANDARD CHAR-
ACTERS WITHOUT CLAIM TO ANY PARTICULAR
FONT, STYLE, SIZE, OR COLOR.

FOR: HOLDER FOR CIGARETTE PACK AND
LIGHTER, IN CLASS 34 (U.S. CLS. 2, 8, 9 AND 17).

SN 77-266,326, FILED 8-28-2007.

FIRST USE 7-29-2008; IN COMMERCE 7-29-2008.

MORGAN WYNNE, EXAMINING ATTORNEY

Int. Cl.: 28

Prior U.S. Cls.: 22, 23, 38, and 50

Reg. No. 3,522,005

United States Patent and Trademark Office

Registered Oct. 21, 2008

**TRADEMARK
PRINCIPAL REGISTER**

ROLL-MASTER

KAF MANUFACTURING COMPANY, INC.
(CONNECTICUT CORPORATION)
14 FAHEY STREET
STAMFORD, CT 06907

THE MARK CONSISTS OF STANDARD CHAR-
ACTERS WITHOUT CLAIM TO ANY PARTICULAR
FONT, STYLE, SIZE, OR COLOR.

FOR: GOLF PUTTERS; GOLF PUTTER COVERS,
IN CLASS 28 (U.S. CLS. 22, 23, 38 AND 50).

SN 77-266,371, FILED 8-28-2007.

FIRST USE 1-3-2008; IN COMMERCE 1-3-2008.

ANN E. SAPPENFIELD, EXAMINING ATTORNEY

Int. Cls.: 35, 36, 37, 39, and 42

Prior U.S. Cls.: 100, 101, 102, 103, 105, and 106

United States Patent and Trademark Office

Reg. No. 3,522,006

Registered Oct. 21, 2008

SERVICE MARK
PRINCIPAL REGISTER



Fort Wayne



MANHEIM AUCTIONS, INC. (DELAWARE CORPORATION)
6205 PEACHTREE DUNWOODY ROAD
ATLANTA, GA 30328

FOR: AUTOMOBILE AUCTION SERVICES; AUTOMOBILE AUCTION SERVICES PROVIDED VIA THE INTERNET, IN CLASS 35 (U.S. CLS. 100, 101 AND 102).

FIRST USE 6-20-2008; IN COMMERCE 6-20-2008.

FOR: AUTOMOBILE FINANCING SERVICES, IN CLASS 36 (U.S. CLS. 100, 101 AND 102).

FIRST USE 6-20-2008; IN COMMERCE 6-20-2008.

FOR: AUTOMOTIVE DETAILING, RECONDITIONING, REPAIR, CONVERSION AND CUSTOMIZATION SERVICES, IN CLASS 37 (U.S. CLS. 100, 103 AND 106).

FIRST USE 6-20-2008; IN COMMERCE 6-20-2008.

FOR: BUSINESS-TO-BUSINESS AUTOMOTIVE TRANSPORTATION AND STORAGE SERVICES, IN CLASS 39 (U.S. CLS. 100 AND 105).

FIRST USE 6-20-2008; IN COMMERCE 6-20-2008.

FOR: AUTOMOBILE INSPECTION SERVICES, IN CLASS 42 (U.S. CLS. 100 AND 101).

FIRST USE 6-20-2008; IN COMMERCE 6-20-2008.

OWNER OF U.S. REG. NOS. 1,699,332, 3,075,304, AND 3,229,428.

NO CLAIM IS MADE TO THE EXCLUSIVE RIGHT TO USE "FORT WAYNE" OR THE DESIGN OF THE STATE OF INDIANA, APART FROM THE MARK AS SHOWN.

THE COLOR(S) GOLD, BLUE, RED, BROWN, GREY, BLACK AND WHITE IS/ARE CLAIMED AS A FEATURE OF THE MARK.

THE MARK CONSISTS OF A GOLD "M" OVER A BLUE CIRCULAR BACKGROUND AND WITHIN TWO GOLD OUTER RINGS. THE COLOR BROWN OUTLINES THE MARK. TO THE RIGHT OF THE "M" IS THE WORD "MANHEIM" IN THE COLOR BLACK. A BLACK LINE SEPARATES THE ABOVE DESIGN AND THE WORD "MANHEIM" AND THE WORDS "FORT WAYNE" IN THE COLOR BLACK AND DESIGN OF A GEOGRAPHICAL OUTLINE OF THE STATE OF INDIANA IN THE COLOR RED WITH STYLIZED CAPITAL LETTERS "F" AND "W" IN THE COLOR WHITE WITH BLACK OUTLINING AND A WHITE STAR ON A BLACK BACKGROUND, INSIDE CONCENTRIC WHITE AND GREY SQUARES TO THE RIGHT OF THE WORDS "FORT WAYNE".

SN 77-266,496, FILED 8-28-2007.

GRETTA YAO, EXAMINING ATTORNEY

Int. Cl.: 12

Prior U.S. Cls.: 19, 21, 23, 31, 35, and 44

Reg. No. 3,522,007

United States Patent and Trademark Office

Registered Oct. 21, 2008

**TRADEMARK
PRINCIPAL REGISTER**

FINESSE

BREEZE, JOSEPH T. (UNITED STATES INDIVIDUAL)
18 MEADOW WAY
FAIRFAX, CA 94930

FOR: BICYCLES; MOUNTAIN BICYCLES; ROAD BICYCLES; FOLDING BICYCLES; TRANSPORTATION BICYCLES; RANGE BICYCLES; TOWN BICYCLES; CRUISER BICYCLES; COMFORT BICYCLES; TANDEM BICYCLES; BICYCLE ACCESSORIES AND STRUCTURAL PARTS THEREFOR, NAMELY, BIKE BASKETS, BIKE FRAMES, BIKE FRAME CRANK BRACKETS, BIKE SEATS, BIKE WARNING BELLS, BIKE CARRIERS IN THE NATURE OF BICYCLE-MOUNTED CARGO CARRYING RACKS, BIKE HANDLEBARS, BIKE BARENDS, BIKE HANDLEBAR STEMS, BIKE FORKS, BIKE

KICK STANDS, BIKE PANNIERS, BIKE FENDERS, BIKE CHAIN GUARDS, BIKE SADDLES, BIKE TIRES, BIKE INNER TUBES, BIKE RIMS, BIKE HANDLEBAR GRIPS, AND BIKE FORK TIPS, IN CLASS 12 (U.S. CLS. 19, 21, 23, 31, 35 AND 44).

FIRST USE 7-9-2008; IN COMMERCE 7-9-2008.

THE MARK CONSISTS OF STANDARD CHARACTERS WITHOUT CLAIM TO ANY PARTICULAR FONT, STYLE, SIZE, OR COLOR.

SN 77-267,208, FILED 8-29-2007.

DOMINIC J. FERRAIUOLO, EXAMINING ATTORNEY

Int. Cl.: 3

Prior U.S. Cls.: 1, 4, 6, 50, 51, and 52

Reg. No. 3,522,008

United States Patent and Trademark Office

Registered Oct. 21, 2008

**TRADEMARK
PRINCIPAL REGISTER**

SHAPER FIERCE

SEBASTIAN INTERNATIONAL, INC. (CALIFORNIA CORPORATION)
6109 DESOTO AVENUE
WOODLAND HILLS, CA 91367

THE MARK CONSISTS OF STANDARD CHARACTERS WITHOUT CLAIM TO ANY PARTICULAR FONT, STYLE, SIZE, OR COLOR.

FOR: HAIR CARE PREPARATIONS; HAIR STYLING PREPARATIONS, IN CLASS 3 (U.S. CLS. 1, 4, 6, 50, 51 AND 52).

SN 77-267,662, FILED 8-29-2007.

FIRST USE 7-1-2008; IN COMMERCE 7-1-2008.

JOHN HWANG, EXAMINING ATTORNEY

Int. Cl.: 9

Prior U.S. Cls.: 21, 23, 26, 36, and 38

Reg. No. 3,522,009

United States Patent and Trademark Office

Registered Oct. 21, 2008

**TRADEMARK
PRINCIPAL REGISTER**

DISNEY PIX JR.

DISNEY ENTERPRISES, INC. (DELAWARE CORPORATION)
500 SOUTH BUENA VISTA STREET
BURBANK, CA 91521

FOR: CAMERAS AND COMPUTER SOFTWARE FOR PHOTO EDITING IN THE FIELDS OF PHOTOGRAPHY AND ART, IN CLASS 9 (U.S. CLS. 21, 23, 26, 36 AND 38).

FIRST USE 11-30-2007; IN COMMERCE 11-30-2007.

THE MARK CONSISTS OF STANDARD CHARACTERS WITHOUT CLAIM TO ANY PARTICULAR FONT, STYLE, SIZE, OR COLOR.

OWNER OF U.S. REG. NOS. 2,888,282, 3,328,009, AND OTHERS.

SN 77-268,217, FILED 8-30-2007.

BRIDGETT SMITH, EXAMINING ATTORNEY

Int. Cl.: 45

Prior U.S. Cls.: 100 and 101

United States Patent and Trademark Office

Reg. No. 3,522,010

Registered Oct. 21, 2008

**SERVICE MARK
PRINCIPAL REGISTER**



WINSTEAD PC (TEXAS CORPORATION), DBA
WINSTEAD SECHREST & MINICK P.C.,
1201 ELM STREET, STE. 5400
DALLAS, TX 75201

FOR: LEGAL SERVICES, IN CLASS 45 (U.S. CLS.
100 AND 101).

FIRST USE 9-5-2007; IN COMMERCE 9-5-2007.

THE COLOR(S) YELLOW, WHITE, BLACK IS/
ARE CLAIMED AS A FEATURE OF THE MARK.

THE MARK CONSISTS OF RECTANGULAR
LOGO FORMED FROM TWO ADJACENT RECTAN-
GLES, A FIRST, YELLOW, ON THE LEFT, A SEC-
OND, WHITE, ON THE RIGHT, WITH THE WORD
"WINSTEAD" IN BLACK PRINT, "WIN" IN THE
YELLOW RECTANGLE, "STEAD" IN THE WHITE
RECTANGLE.

SN 77-268,466, FILED 8-30-2007.

VIVIAN MICZNIK FIRST, EXAMINING ATTOR-
NEY

Int. Cls.: 9 and 42

Prior U.S. Cls.: 21, 23, 26, 36, 38, 100, and 101

United States Patent and Trademark Office

Reg. No. 3,522,011

Registered Oct. 21, 2008

**TRADEMARK
SERVICE MARK
PRINCIPAL REGISTER**

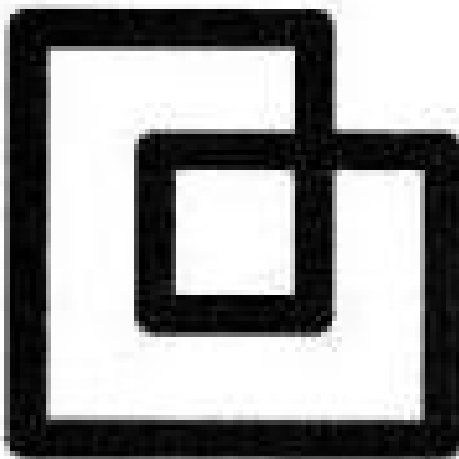

LUMENSION SECURITY, INC. (DELAWARE CORPORATION)
15880 NORTH GREENWAY-HAYDEN LOOP
SCOTTSDALE, AZ 85260

FOR: COMPUTER SOFTWARE USED TO INSTALL AND UPDATE SOFTWARE PATCHES, AND COMPUTER SOFTWARE UPGRADES AND UPDATES TO PRE-INSTALLED SOFTWARE TO RESOLVE SOFTWARE AND IT SECURITY AND VULNERABILITY ISSUES, IN CLASS 9 (U.S. CLS. 21, 23, 26, 36 AND 38).

FIRST USE 9-10-2007; IN COMMERCE 9-10-2007.

FOR: PROVIDING COMPUTER AND IT SECURITY SERVICES, NAMELY, PROVIDING A WEB SITE FEATURING TECHNICAL INFORMATION AND SUPPORT REGARDING SOFTWARE AND VULNERABILITY SOLUTIONS AND REGULATORY

COMPLIANCE, AND PROVIDING COMPUTER SOFTWARE TECHNICAL SUPPORT SERVICES, TECHNICAL INFORMATION AND TECHNICAL SUPPORT REGARDING SOFTWARE PATCHES, UPGRADES AND UPDATES AND UPDATES USED FOR A WIDE VARIETY OF APPLICATIONS, COMPUTER SERVICES, AND REGULATORY COMPLIANCE, IN CLASS 42 (U.S. CLS. 100 AND 101).

FIRST USE 9-10-2007; IN COMMERCE 9-10-2007.

THE MARK CONSISTS OF OF A MISCELLANEOUS DESIGN OF INTERCONNECTING LINES FORMING AN INTERIOR SQUARE AND EXTERIOR INCOMPLETE SQUARE WITH INDENTATION IN UPPER RIGHT CORNER.

SN 77-268,753, FILED 8-30-2007.

DAVID MURRAY, EXAMINING ATTORNEY

Int. Cls.: 36 and 38

Prior U.S. Cls.: 100, 101, 102, and 104

United States Patent and Trademark Office

Reg. No. 3,522,012

Registered Oct. 21, 2008

**SERVICE MARK
PRINCIPAL REGISTER**

CREDO

WORKING ASSETS FUNDING SERVICE, INC.
(CALIFORNIA CORPORATION)
101 MARKET STREET
SUITE 700
SAN FRANCISCO, CA 94105

FOR: TELEPHONE CALLING CARD SERVICES,
IN CLASS 36 (U.S. CLS. 100, 101 AND 102).

FIRST USE 11-4-2007; IN COMMERCE 11-4-2007.

FOR: TELECOMMUNICATIONS SERVICES,
NAMELY, WIRELESS AND CELLULAR TELE-
PHONE SERVICES, LONG DISTANCE SERVICES,
TELEPHONE VOICE MESSAGING, PERSONAL
COMMUNICATIONS SERVICES, ELECTRONIC

MAIL SERVICES, TRANSMISSION OF VOICE AND
DATA, FACSIMILE TRANSMISSION SERVICES
AND PROVIDING ACCESS TO GLOBAL COMPU-
TER NETWORKS, IN CLASS 38 (U.S. CLS. 100, 101
AND 104).

FIRST USE 11-4-2007; IN COMMERCE 11-4-2007.

THE MARK CONSISTS OF STANDARD CHAR-
ACTERS WITHOUT CLAIM TO ANY PARTICULAR
FONT, STYLE, SIZE, OR COLOR.

SN 77-268,762, FILED 8-30-2007.

JILL PRATER, EXAMINING ATTORNEY

Int. Cl.: 41

Prior U.S. Cls.: 100, 101, and 107

United States Patent and Trademark Office

Reg. No. 3,522,013

Registered Oct. 21, 2008

**SERVICE MARK
PRINCIPAL REGISTER**

IT'S ALL ABOUT CHANGE

WILLIAMS, SHIRLEY MEEK (UNITED STATES
INDIVIDUAL)
150 JOANA DRIVE
FAYETTEVILLE, GA 30214

THE MARK CONSISTS OF STANDARD CHAR-
ACTERS WITHOUT CLAIM TO ANY PARTICULAR
FONT, STYLE, SIZE, OR COLOR.

FOR: LIFE COACHING SERVICES FOR WOMEN
FEATURING INSTRUCTION IN THE FIELDS OF
PERSONAL IMPROVEMENT AND SELF IMPROVE-
MENT, IN CLASS 41 (U.S. CLS. 100, 101 AND 107).

SN 77-268,840, FILED 8-30-2007.

FIRST USE 1-10-2008; IN COMMERCE 1-10-2008.

MAUREEN DALL, EXAMINING ATTORNEY

Int. Cl.: 36

Prior U.S. Cls.: 100, 101, and 102

United States Patent and Trademark Office

Reg. No. 3,522,014

Registered Oct. 21, 2008

**SERVICE MARK
PRINCIPAL REGISTER**

TaxSaver Freedom

VANTISLIFE INSURANCE COMPANY (CON-
NECTICUT CORPORATION)
200 DAY HILL ROAD
WINDSOR, CT 06095

FOR: ANNUITY UNDERWRITING; ISSUANCE
AND ADMINISTRATION OF ANNUITIES, IN
CLASS 36 (U.S. CLS. 100, 101 AND 102).

FIRST USE 8-11-2008; IN COMMERCE 8-11-2008.

THE MARK CONSISTS OF STANDARD CHAR-
ACTERS WITHOUT CLAIM TO ANY PARTICULAR
FONT, STYLE, SIZE, OR COLOR.

SEC. 2(F) AS TO "TAXSAVER".

SN 77-269,580, FILED 8-31-2007.

KELLY MCCOY, EXAMINING ATTORNEY

Int. Cl.: 36

Prior U.S. Cls.: 100, 101, and 102

United States Patent and Trademark Office

Reg. No. 3,522,015

Registered Oct. 21, 2008

**SERVICE MARK
PRINCIPAL REGISTER**

TaxSaver Freedom II

VANTISLIFE INSURANCE COMPANY (CON-
NECTICUT CORPORATION)
200 DAY HILL ROAD
WINDSOR, CT 06095

FOR: ANNUITY UNDERWRITING; ISSUANCE
AND ADMINISTRATION OF ANNUITIES, IN
CLASS 36 (U.S. CLS. 100, 101 AND 102).

FIRST USE 8-11-2008; IN COMMERCE 8-11-2008.

THE MARK CONSISTS OF STANDARD CHAR-
ACTERS WITHOUT CLAIM TO ANY PARTICULAR
FONT, STYLE, SIZE, OR COLOR.

SEC. 2(F) AS TO "TAXSAVER".

SN 77-269,621, FILED 8-31-2007.

KELLY MCCOY, EXAMINING ATTORNEY

Int. Cl.: 9

Prior U.S. Cls.: 21, 23, 26, 36, and 38

Reg. No. 3,522,016

United States Patent and Trademark Office

Registered Oct. 21, 2008

**TRADEMARK
PRINCIPAL REGISTER**

POWERCOACH

MERCED SYSTEMS, INC. (DELAWARE CORPORATION)
333 TWIN DOLPHIN DRIVE, SUITE 500
REDWOOD CITY, CA 94065

THE MARK CONSISTS OF STANDARD CHARACTERS WITHOUT CLAIM TO ANY PARTICULAR FONT, STYLE, SIZE, OR COLOR.

FOR: COMPUTER SOFTWARE USED FOR PERFORMANCE MANAGEMENT IN COMMERCIAL AND PUBLIC SECTOR OPERATIONS, IN CLASS 9 (U.S. CLS. 21, 23, 26, 36 AND 38).

SN 77-269,671, FILED 8-31-2007.

FIRST USE 3-1-2007; IN COMMERCE 3-1-2007.

ERIN FALK, EXAMINING ATTORNEY

Int. Cl.: 25

Prior U.S. Cls.: 22 and 39

United States Patent and Trademark Office

Reg. No. 3,522,017

Registered Oct. 21, 2008

TRADEMARK
PRINCIPAL REGISTER

S A C R E D  S U R F

SACRED SURF & SNOW, LLC (COLORADO
LIMITED LIABILITY COMPANY)
115 W. COLORADO AVE., SUITE C
TELLURIDE, CO 81435

FOR: SURF WEAR, IN CLASS 25 (U.S. CLS. 22
AND 39).

FIRST USE 10-29-2007; IN COMMERCE 10-29-2007.

NO CLAIM IS MADE TO THE EXCLUSIVE
RIGHT TO USE "SURF", APART FROM THE MARK
AS SHOWN.

THE MARK CONSISTS OF THE WORDING
"SACRED SURF" IN EUROSTYLE FONT. THE

WORD "SACRED" APPEARS TO THE LEFT OF
THE DESIGN AND THE WORD "SURF" APPEARS
TO THE RIGHT OF THE DESIGN. THE DESIGN
CONSISTS OF A COMBINATION OF A MOUNTAIN
AND OCEAN WAVE WITHIN A DIAMOND WITH A
PALM TREE ON THE RIGHT WITH A HIBISCUS
FLOWER AT THE TOP OF THE PALM TREE; ON
THE LEFT SIDE IS A SINGLE SUN RAY EMER-
GING FROM THE TOP OF THE MOUNTAIN.

SN 77-269,772, FILED 8-31-2007.

SHAILA SETTLES, EXAMINING ATTORNEY

Int. Cl.: 35

Prior U.S. Cls.: 100, 101, and 102

United States Patent and Trademark Office

Reg. No. 3,522,018

Registered Oct. 21, 2008

**SERVICE MARK
PRINCIPAL REGISTER**

Sativa

FIGUEROA, ERIC J (UNITED STATES INDIVIDUAL)
18220 NE 25 PLACE
AVENTURA, FL 33160

THE MARK CONSISTS OF STANDARD CHARACTERS WITHOUT CLAIM TO ANY PARTICULAR FONT, STYLE, SIZE, OR COLOR.

FOR: ADVERTISING AND MARKETING, IN CLASS 35 (U.S. CLS. 100, 101 AND 102).

SN 77-269,801, FILED 8-31-2007.

FIRST USE 8-1-2008; IN COMMERCE 8-1-2008.

ANNE MADDEN, EXAMINING ATTORNEY

Int. Cl.: 3

Prior U.S. Cls.: 1, 4, 6, 50, 51, and 52

Reg. No. 3,522,019

United States Patent and Trademark Office

Registered Oct. 21, 2008

**TRADEMARK
PRINCIPAL REGISTER**

BLUEFORCE

EVONIK STOCKHAUSEN GMBH (FED REP
GERMANY LIMITED LIABILITY COMPANY)
BAKERPFAD 25
KREFELD, FED REP GERMANY

THE MARK CONSISTS OF STANDARD CHAR-
ACTERS WITHOUT CLAIM TO ANY PARTICULAR
FONT, STYLE, SIZE, OR COLOR.

FOR: SKIN CLEANSERS; LIQUID SOAPS, IN
CLASS 3 (U.S. CLS. 1, 4, 6, 50, 51 AND 52).

SN 77-270,626, FILED 9-4-2007.

FIRST USE 9-1-2007; IN COMMERCE 9-1-2007.

MELVIN AXILBUND, EXAMINING ATTORNEY

Int. Cl.: 25

Prior U.S. Cls.: 22 and 39

United States Patent and Trademark Office

Reg. No. 3,522,020

Registered Oct. 21, 2008

**TRADEMARK
PRINCIPAL REGISTER**

ACT OLD LATER

ROYAL, KATHLEEN (UNITED STATES INDIVIDUAL)
1440 CORUNNA STREET
ST. AUGUSTINE, FL 32080

FOR: BANDANAS; BATHING SUITS; BERMUDA SHORTS; BOXER BRIEFS; BRIEFS; CAPS; CAPS WITH VISORS; FLEECE PULLOVERS; HEADBANDS; JACKETS; PANTIES; PANTS; SANDALS; SHIRTS; SHOES; SOCKS; SWEATERS; SWIM TRUNKS; T-SHIRTS; UNDERWEAR; VISORS; WALKING SHORTS; WET SUITS; WIND RESIS-

TANT JACKETS; SURF WEAR, IN CLASS 25 (U.S. CLS. 22 AND 39).

FIRST USE 10-12-2007; IN COMMERCE 10-12-2007.

THE MARK CONSISTS OF STANDARD CHARACTERS WITHOUT CLAIM TO ANY PARTICULAR FONT, STYLE, SIZE, OR COLOR.

SN 77-270,805, FILED 9-4-2007.

THEODORE MCBRIDE, EXAMINING ATTORNEY

Int. Cl.: 9

Prior U.S. Cls.: 21, 23, 26, 36, and 38

Reg. No. 3,522,021

United States Patent and Trademark Office

Registered Oct. 21, 2008

**TRADEMARK
PRINCIPAL REGISTER**

CLEARCURVE

CORNING INCORPORATED (NEW YORK COR-
PORATION)
SP-TI-3-1
ONE RIVERFRONT PLAZA
CORNING, NY 14831

THE MARK CONSISTS OF STANDARD CHAR-
ACTERS WITHOUT CLAIM TO ANY PARTICULAR
FONT, STYLE, SIZE, OR COLOR.

FOR: OPTICAL FIBER; FIBER OPTICS; FIBER
OPTIC CABLE, IN CLASS 9 (U.S. CLS. 21, 23, 26, 36
AND 38).

SN 77-270,928, FILED 9-4-2007.

FIRST USE 11-30-2007; IN COMMERCE 11-30-2007.

BRIAN NEVILLE, EXAMINING ATTORNEY

Int. Cl.: 30

Prior U.S. Cl.: 46

United States Patent and Trademark Office

Reg. No. 3,522,022

Registered Oct. 21, 2008

**TRADEMARK
PRINCIPAL REGISTER**

SPORTSMAN'S GOLD

BERGER, KENNETH J. (UNITED STATES INDIVIDUAL)
1380 W. 15TH STREET
RIVIERA BEACH, FL 33404

THE MARK CONSISTS OF STANDARD CHARACTERS WITHOUT CLAIM TO ANY PARTICULAR FONT, STYLE, SIZE, OR COLOR.

FOR: MARINADES FOR MEATS, IN CLASS 30 (U.S. CL. 46).

SN 77-271,019, FILED 9-4-2007.

FIRST USE 2-3-2008; IN COMMERCE 2-3-2008.

THEODORE MCBRIDE, EXAMINING ATTORNEY

Int. Cls.: 16 and 25

Prior U.S. Cls.: 2, 5, 22, 23, 29, 37, 38, 39, and 50

United States Patent and Trademark Office

Reg. No. 3,522,023

Registered Oct. 21, 2008

**TRADEMARK
PRINCIPAL REGISTER**

rideHI

BERRIER, CONNOR H (UNITED STATES INDIVIDUAL)
2651 KUILEI B-75
HONOLULU, HI 96826

FOR: STICKERS, IN CLASS 16 (U.S. CLS. 2, 5, 22, 23, 29, 37, 38 AND 50).

FIRST USE 7-21-2008; IN COMMERCE 8-1-2008.

FOR: T-SHIRTS; LONG-SLEEVED SHIRTS; SHORT-SLEEVED SHIRTS; SWEAT SHIRTS; JACK-

ETS; UNDERWEAR; HATS, IN CLASS 25 (U.S. CLS. 22 AND 39).

FIRST USE 7-21-2008; IN COMMERCE 8-1-2008.

THE MARK CONSISTS OF STANDARD CHARACTERS WITHOUT CLAIM TO ANY PARTICULAR FONT, STYLE, SIZE, OR COLOR.

SN 77-271,542, FILED 9-5-2007.

PAULA MAHONEY, EXAMINING ATTORNEY

Int. Cl.: 11

Prior U.S. Cls.: 13, 21, 23, 31, and 34

Reg. No. 3,522,024

United States Patent and Trademark Office

Registered Oct. 21, 2008

**TRADEMARK
PRINCIPAL REGISTER**

GLOWTASTIC!

MUELBURY, LTD. (ILLINOIS CORPORATION),
DBA NIGHT LIGHT DESIGNS,
2036 DORSET DRIVE
WHEATON, IL 60187

FIRST USE 11-30-2007; IN COMMERCE 12-4-2007.

FOR: ELECTRIC NIGHT LIGHT KITS CONTAIN-
ING NIGHT LIGHTS AND INTERCHANGEABLE
DISPLAY SHEETS ON WHICH CHILDREN MAY
DRAW AND WHICH ARE INSERTED INTO THE
NIGHT LIGHT TO ILLUMINATE THE DRAWING,
IN CLASS 11 (U.S. CLS. 13, 21, 23, 31 AND 34).

THE MARK CONSISTS OF STANDARD CHAR-
ACTERS WITHOUT CLAIM TO ANY PARTICULAR
FONT, STYLE, SIZE, OR COLOR.

SN 77-272,058, FILED 9-5-2007.

BRIAN NEVILLE, EXAMINING ATTORNEY

Int. Cl.: 36

Prior U.S. Cls.: 100, 101, and 102

United States Patent and Trademark Office

Reg. No. 3,522,025

Registered Oct. 21, 2008

**SERVICE MARK
PRINCIPAL REGISTER**



O'SHAUGHNESSY ASSET MANAGEMENT,
L.L.C. (DELAWARE LIMITED LIABILITY
COMPANY)

6 SUBURBAN AVENUE
STAMFORD, CT 069012012

FOR: INVESTMENT ADVICE; INVESTMENT AD-
VISORY SERVICES; INVESTMENT MANAGE-
MENT; MANAGEMENT OF PORTFOLIOS OF
TRANSFERABLE SECURITIES; PHARMACEUTI-

CAL BENEFIT MANAGEMENT SERVICES, IN
CLASS 36 (U.S. CLS. 100, 101 AND 102).

FIRST USE 2-1-2008; IN COMMERCE 2-1-2008.

THE MARK CONSISTS OF A STYLIZED LETTER
"O".

SN 77-272,569, FILED 9-5-2007.

KELLEY WELLS, EXAMINING ATTORNEY

Int. Cl.: 16

Prior U.S. Cls.: 2, 5, 22, 23, 29, 37, 38, and 50

United States Patent and Trademark Office

Reg. No. 3,522,026

Registered Oct. 21, 2008

**TRADEMARK
PRINCIPAL REGISTER**



GEORGIA-PACIFIC CONSUMER PRODUCTS LP
(DELAWARE LIMITED PARTNERSHIP)
133 PEACHTREE ST., N.E.
ATLANTA, GA 30303

FOR: PAPER TOWELS, IN CLASS 16 (U.S. CLS. 2, 5,
22, 23, 29, 37, 38 AND 50).

FIRST USE 2-4-2008; IN COMMERCE 2-4-2008.

OWNER OF U.S. REG. NOS. 1,062,207, 2,929,823,
AND OTHERS.

THE MARK CONSISTS OF THE WORD "BRAW-
NY" STYLIZED IN ALL CAPITALS AND SHA-
DOWED.

SN 77-272,660, FILED 9-6-2007.

BRIAN CALLAGHAN, EXAMINING ATTORNEY

Int. Cl.: 13

Prior U.S. Cls.: 2 and 9

United States Patent and Trademark Office

Reg. No. 3,522,027

Registered Oct. 21, 2008

TRADEMARK
PRINCIPAL REGISTER

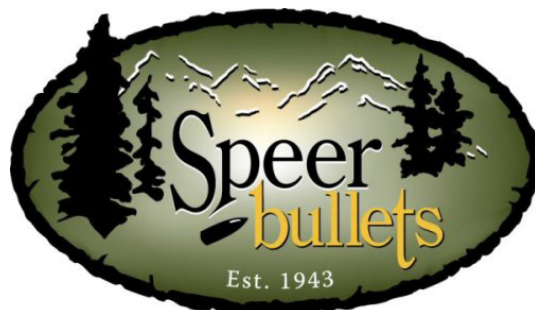

ALLIANT TECHSYSTEMS INC. (DELAWARE CORPORATION)
7480 FLYING CLOUD DRIVE
MINNEAPOLIS, MN 55344

FOR: AMMUNITION COMPONENTS, IN CLASS 13 (U.S. CLS. 2 AND 9).

FIRST USE 11-0-2007; IN COMMERCE 11-0-2007.

OWNER OF U.S. REG. NOS. 1,101,411, 1,102,083, AND 2,501,004.

NO CLAIM IS MADE TO THE EXCLUSIVE RIGHT TO USE "BULLETS" AND "EST. 1943", APART FROM THE MARK AS SHOWN.

THE COLOR(S) GREEN, BLACK, WHITE, YELLOW IS/ARE CLAIMED AS A FEATURE OF THE MARK.

THE MARK CONSISTS OF AN OVAL WITH A JAGGED OUTLINE IN THE COLOR BLACK WITH TREES ON THE LEFT AND RIGHT SIDES IN THE COLOR BLACK AND MOUNTAINS BETWEEN THE TREES IN THE COLOR WHITE WITH THE TERM SPEER IN THE COLOR BLACK POSITIONED BELOW THE MOUNTAINS AND BETWEEN THE TREES AND THE TERM BULLETS IN THE COLOR YELLOW POSITIONED BELOW THE TERM SPEER AND A BULLET IN THE COLOR BLACK POSITIONED TO THE LEFT OF THE B IN BULLETS AND EST. 1943 IN THE COLOR WHITE CENTERED ON THE BOTTOM PORTION OF THE OVAL ALL ON A GREEN BACKGROUND, FADING TO WHITE IN THE CENTER OF THE OVAL.

SN 77-272,686, FILED 9-6-2007.

BRENDAN MCCAULEY, EXAMINING ATTORNEY

Int. Cl.: 25

Prior U.S. Cls.: 22 and 39

United States Patent and Trademark Office

Reg. No. 3,522,028

Registered Oct. 21, 2008

**TRADEMARK
PRINCIPAL REGISTER**



WRANGLER APPAREL CORP. (DELAWARE
CORPORATION)
3411 SILVERSIDE RD.
WILMINGTON, DE 19810

THE MARK CONSISTS OF A STAR IN SPIRAL
ROPE.

FOR: DENIM AND NON-DENIM CASUAL
PANTS AND JEANS, IN CLASS 25 (U.S. CLS. 22
AND 39).

SN 77-272,772, FILED 9-6-2007.

FIRST USE 1-3-2005; IN COMMERCE 1-3-2005.

RONALD MCMORROW, EXAMINING ATTORNEY

Int. Cls.: 35, 38, and 41

Prior U.S. Cls.: 100, 101, 102, 104, and 107

United States Patent and Trademark Office

Reg. No. 3,522,029

Registered Oct. 21, 2008

**SERVICE MARK
PRINCIPAL REGISTER**

Our Green Community

SACRAMENTO MUNICIPAL UTILITY DISTRICT, A POLITICAL SUBDIVISION OF THE STATE OF CALIFORNIA (CALIFORNIA MUNICIPAL CORPORATION)

MS B401

6201 S ST.

SACRAMENTO, CA 958171899

FOR: PROVIDING CONSUMER INFORMATION AND RELATED NEWS IN THE FIELD OF ENVIRONMENTAL ISSUES, IN CLASS 35 (U.S. CLS. 100, 101 AND 102).

FIRST USE 10-24-2007; IN COMMERCE 10-24-2007.

FOR: TRANSMISSION OF NEWS, IN CLASS 38 (U.S. CLS. 100, 101 AND 104).

FIRST USE 10-24-2007; IN COMMERCE 10-24-2007.

FOR: DEVELOPMENT AND DISSEMINATION OF EDUCATIONAL MATERIALS OF OTHERS IN THE FIELD OF ENVIRONMENTAL ISSUES, IN CLASS 41 (U.S. CLS. 100, 101 AND 107).

FIRST USE 10-24-2007; IN COMMERCE 10-24-2007.

THE MARK CONSISTS OF STANDARD CHARACTERS WITHOUT CLAIM TO ANY PARTICULAR FONT, STYLE, SIZE, OR COLOR.

SN 77-273,111, FILED 9-6-2007.

JERI J. FICKES, EXAMINING ATTORNEY

Int. Cl.: 11

Prior U.S. Cls.: 13, 21, 23, 31, and 34

United States Patent and Trademark Office

Reg. No. 3,522,030

Registered Oct. 21, 2008

**TRADEMARK
PRINCIPAL REGISTER**

RIDGEFIELD HOME

HOMEGOODS, INC. (DELAWARE CORPORATION)
770 COCHITUATE ROAD
FRAMINGHAM, MA 01701

FOR: INDOOR AND OUTDOOR ELECTRIC LANTERNS, LAMPS, AND LIGHTING FIXTURES; OUTDOOR HALOGEN LAMPS, IN CLASS 11 (U.S. CLS. 13, 21, 23, 31 AND 34).

FIRST USE 5-8-2008; IN COMMERCE 5-8-2008.

THE MARK CONSISTS OF STANDARD CHARACTERS WITHOUT CLAIM TO ANY PARTICULAR FONT, STYLE, SIZE, OR COLOR.

NO CLAIM IS MADE TO THE EXCLUSIVE RIGHT TO USE "HOME", APART FROM THE MARK AS SHOWN.

SN 77-273,198, FILED 9-6-2007.

AISHA SALEM, EXAMINING ATTORNEY

Int. Cls.: 11 and 24

Prior U.S. Cls.: 13, 21, 23, 31, 34, 42, and 50

United States Patent and Trademark Office

Reg. No. 3,522,031

Registered Oct. 21, 2008

**TRADEMARK
PRINCIPAL REGISTER**

BITTERSWEET INN

HOMEGOODS, INC. (DELAWARE CORPORATION)
770 COCHITUATE ROAD
FRAMINGHAM, MA 01701

FOR: INDOOR AND OUTDOOR ELECTRIC LANTERNS, LAMPS, AND LIGHTING FIXTURES; OUTDOOR HALOGEN LAMPS, IN CLASS 11 (U.S. CLS. 13, 21, 23, 31 AND 34).

FIRST USE 5-8-2008; IN COMMERCE 5-8-2008.

FOR: KITCHEN LINENS, KITCHEN TOWELS, TABLE LINENS, FABRIC PLACEMATS AND FABRIC COASTERS, IN CLASS 24 (U.S. CLS. 42 AND 50).

FIRST USE 4-11-2008; IN COMMERCE 4-11-2008.

THE MARK CONSISTS OF STANDARD CHARACTERS WITHOUT CLAIM TO ANY PARTICULAR FONT, STYLE, SIZE, OR COLOR.

OWNER OF U.S. REG. NO. 3,160,552.

SN 77-273,220, FILED 9-6-2007.

AISHA SALEM, EXAMINING ATTORNEY

Int. Cls.: 11 and 24

Prior U.S. Cls.: 13, 21, 23, 31, 34, 42, and 50

United States Patent and Trademark Office

Reg. No. 3,522,032

Registered Oct. 21, 2008

**TRADEMARK
PRINCIPAL REGISTER**

CITY CHIC

HOMEGOODS, INC. (DELAWARE CORPORATION)
770 COCHITUATE ROAD
FRAMINGHAM, MA 01701

FOR: INDOOR AND OUTDOOR ELECTRIC LANTERNS, LAMPS, AND LIGHTING FIXTURES; OUTDOOR HALOGEN LAMPS, IN CLASS 11 (U.S. CLS. 13, 21, 23, 31 AND 34).

FIRST USE 6-30-2008; IN COMMERCE 6-30-2008.

FOR: KITCHEN LINENS, KITCHEN TOWELS, TABLE LINENS, FABRIC PLACEMATS AND FABRIC COASTERS, IN CLASS 24 (U.S. CLS. 42 AND 50).

FIRST USE 10-31-2006; IN COMMERCE 10-31-2006.

THE MARK CONSISTS OF STANDARD CHARACTERS WITHOUT CLAIM TO ANY PARTICULAR FONT, STYLE, SIZE, OR COLOR.

OWNER OF U.S. REG. NOS. 2,902,450 AND 3,194,890.

SN 77-273,251, FILED 9-6-2007.

AISHA SALEM, EXAMINING ATTORNEY

Int. Cl.: 1

Prior U.S. Cls.: 1, 5, 6, 10, 26, and 46

Reg. No. 3,522,033

United States Patent and Trademark Office

Registered Oct. 21, 2008

**TRADEMARK
PRINCIPAL REGISTER**

TRANSLAM

WILBUR-ELLIS COMPANY (CALIFORNIA CORPORATION)
345 CALIFORNIA STREET, 27TH FLOOR
SAN FRANCISCO, CA 94104

THE MARK CONSISTS OF STANDARD CHARACTERS WITHOUT CLAIM TO ANY PARTICULAR FONT, STYLE, SIZE, OR COLOR.

FOR: ADJUVANTS FOR USE WITH PESTICIDES; SURFACTANTS FOR USE IN CONNECTION WITH AGRICULTURAL PESTICIDES, IN CLASS 1 (U.S. CLS. 1, 5, 6, 10, 26 AND 46).

SN 77-274,598, FILED 9-7-2007.

FIRST USE 3-31-2008; IN COMMERCE 3-31-2008.

CHRIS WELLS, EXAMINING ATTORNEY

Int. Cls.: 18 and 31

Prior U.S. Cls.: 1, 2, 3, 22, 41, and 46

United States Patent and Trademark Office

Reg. No. 3,522,034

Registered Oct. 21, 2008

**TRADEMARK
PRINCIPAL REGISTER**

PET Bistro

PET BISTRO, LLC (DELAWARE LIMITED LIABILITY COMPANY)
108 W. 13TH ST.
WILMINGTON, DE 19801

FOR: PET CLOTHING; PET COLLAR ACCESSORIES, NAMELY, BOWS AND CHARMS, IN CLASS 18 (U.S. CLS. 1, 2, 3, 22 AND 41).

FIRST USE 9-10-2007; IN COMMERCE 9-10-2007.

FOR: PET FOOD; PET TREATS; CONSUMABLE PET CHEWS; PET BEVERAGES, IN CLASS 31 (U.S. CLS. 1 AND 46).

FIRST USE 9-10-2007; IN COMMERCE 9-10-2007.

THE MARK CONSISTS OF STANDARD CHARACTERS WITHOUT CLAIM TO ANY PARTICULAR FONT, STYLE, SIZE, OR COLOR.

NO CLAIM IS MADE TO THE EXCLUSIVE RIGHT TO USE "PET", APART FROM THE MARK AS SHOWN.

SN 77-275,609, FILED 9-10-2007.

JOHN GARTNER, EXAMINING ATTORNEY

Int. Cl.: 43

Prior U.S. Cls.: 100 and 101

United States Patent and Trademark Office

Reg. No. 3,522,035

Registered Oct. 21, 2008

**SERVICE MARK
PRINCIPAL REGISTER**

CAFE SOBANH

CJ FOODVILLE CORP. (REPUBLIC OF KOREA
CORPORATION)
8F, KOO SAN TOWER
3250, BANGBAE-DONG, SEOCHO-KU
SEOUL, REPUBLIC OF KOREA

FOR: RESTAURANT SERVICES; PREPARATION
OF FOOD AND BEVERAGES; BAR SERVICES;
CAFES; CAFETERIAS; KOREAN RESTAURANT
SERVICES, IN CLASS 43 (U.S. CLS. 100 AND 101).

FIRST USE 11-11-2005; IN COMMERCE 11-30-2007.

THE MARK CONSISTS OF STANDARD CHAR-
ACTERS WITHOUT CLAIM TO ANY PARTICULAR
FONT, STYLE, SIZE, OR COLOR.

NO CLAIM IS MADE TO THE EXCLUSIVE
RIGHT TO USE "CAFE", APART FROM THE MARK
AS SHOWN.

SN 77-275,628, FILED 9-10-2007.

CURTIS FRENCH, EXAMINING ATTORNEY

Int. Cl.: 35

Prior U.S. Cls.: 100, 101, and 102

United States Patent and Trademark Office

Reg. No. 3,522,036

Registered Oct. 21, 2008

**SERVICE MARK
PRINCIPAL REGISTER**

THE FOOD IS THE FRANCHISE

HARDEE'S FOOD SYSTEMS, INC. (NORTH CAROLINA CORPORATION)
100 N. BROADWAY, SUITE 1200
ST. LOUIS, MO 63102 AND
CARL KARCHER ENTERPRISES, INC. (CALIFORNIA CORPORATION)
6307 CARPINTERIA AVE., SUITE A
CARPINTERIA, CA 93013

FOR: FRANCHISE AND FRANCHISING SERVICES, NAMELY, OFFERING TECHNICAL, BUSINESS MANAGEMENT, CONSULTATION, ORGANIZATION, AND PROMOTION ASSISTANCE IN THE ESTABLISHMENT AND OPERATION OF

RESTAURANTS, IN CLASS 35 (U.S. CLS. 100, 101 AND 102).

FIRST USE 12-0-2006; IN COMMERCE 12-0-2006.

THE MARK CONSISTS OF STANDARD CHARACTERS WITHOUT CLAIM TO ANY PARTICULAR FONT, STYLE, SIZE, OR COLOR.

SN 77-276,306, FILED 9-11-2007.

KHANH LE, EXAMINING ATTORNEY

Int. Cl.: 21

Prior U.S. Cls.: 2, 13, 23, 29, 30, 33, 40, and 50

Reg. No. 3,522,037

United States Patent and Trademark Office

Registered Oct. 21, 2008

**TRADEMARK
PRINCIPAL REGISTER**

BASSTEK

CRA LABS, INC. (NEBRASKA CORPORATION)
701 S. ANDREASEN DRIVE, SUITE C
ESCONDIDO, CA 92029

THE MARK CONSISTS OF STANDARD CHAR-
ACTERS WITHOUT CLAIM TO ANY PARTICULAR
FONT, STYLE, SIZE, OR COLOR.

FOR: TOOTHBRUSHES, IN CLASS 21 (U.S. CLS. 2,
13, 23, 29, 30, 33, 40 AND 50).

SN 77-276,788, FILED 9-11-2007.

FIRST USE 3-31-2008; IN COMMERCE 3-31-2008.

KELLY MCCOY, EXAMINING ATTORNEY

Int. Cl.: 5

Prior U.S. Cls.: 6, 18, 44, 46, 51, and 52

United States Patent and Trademark Office

Reg. No. 3,522,038

Registered Oct. 21, 2008

**TRADEMARK
PRINCIPAL REGISTER**

LA PANZA ES PRIMERO

SANCHEZ, IRENE (MEXICO INDIVIDUAL)
AV. PATRIA 288
GUADALAJARA, MEXICO 45120

FOR: NUTRITIONAL ENERGY BARS FOR USE
AS A MEAL SUBSTITUTE; NUTRITIONAL SUPPLE-
MENTS, IN CLASS 5 (U.S. CLS. 6, 18, 44, 46, 51 AND
52).

FIRST USE 2-18-2008; IN COMMERCE 2-18-2008.

THE MARK CONSISTS OF STANDARD CHAR-
ACTERS WITHOUT CLAIM TO ANY PARTICULAR
FONT, STYLE, SIZE, OR COLOR.

THE FOREIGN WORDING IN THE MARK
TRANSLATES INTO ENGLISH AS BELLY FIRST.

SN 77-276,829, FILED 9-11-2007.

BARBARA BROWN, EXAMINING ATTORNEY

Int. Cl.: 33

Prior U.S. Cls.: 47 and 49

United States Patent and Trademark Office

Reg. No. 3,522,039

Registered Oct. 21, 2008

**TRADEMARK
PRINCIPAL REGISTER**

WHO NEEDS FAME WHEN YOU
HAVE FORTUNE

WEST COAST WINE AND SPIRITS, INC. (CALI-
FORNIA CORPORATION)
7055 VINELAND AVENUE
NORTH HOLLYWOOD, CA 91605

THE MARK CONSISTS OF STANDARD CHAR-
ACTERS WITHOUT CLAIM TO ANY PARTICULAR
FONT, STYLE, SIZE, OR COLOR.

FOR: ALCOHOLIC BEVERAGES, NAMELY, VOD-
KA, IN CLASS 33 (U.S. CLS. 47 AND 49).

SN 77-276,948, FILED 9-11-2007.

FIRST USE 8-1-2008; IN COMMERCE 8-1-2008.

BRENDAN MCCAULEY, EXAMINING ATTORNEY

Int. Cl.: 12

Prior U.S. Cls.: 19, 21, 23, 31, 35, and 44

Reg. No. 3,522,040

United States Patent and Trademark Office

Registered Oct. 21, 2008

**TRADEMARK
PRINCIPAL REGISTER**

VICTORY

POLARIS INDUSTRIES INC. (DELAWARE CORPORATION)
2100 HIGHWAY 55
MEDINA, MN 553409770

FOR: BICYCLES AND STRUCTURAL PARTS THEREFOR, IN CLASS 12 (U.S. CLS. 19, 21, 23, 31, 35 AND 44).

FIRST USE 8-0-2008; IN COMMERCE 8-0-2008.

THE MARK CONSISTS OF STANDARD CHARACTERS WITHOUT CLAIM TO ANY PARTICULAR FONT, STYLE, SIZE, OR COLOR.

OWNER OF U.S. REG. NOS. 2,206,014, 2,209,340, AND OTHERS.

SN 77-277,432, FILED 9-12-2007.

KATHERINE M. DUBRAY, EXAMINING ATTORNEY

Int. Cl.: 35

Prior U.S. Cls.: 100, 101, and 102

United States Patent and Trademark Office

Reg. No. 3,522,041

Registered Oct. 21, 2008

**SERVICE MARK
PRINCIPAL REGISTER**

BAZAARIO

BAZAARIO INC. (CANADA CORPORATION)
1420, 1122 - 4 ST.
CALGARY, CANADA CAT2R1M1

TELECOMMUNICATION NETWORKS FOR AD-
VERTISING AND SALES PURPOSES, IN CLASS 35
(U.S. CLS. 100, 101 AND 102).

FOR: FACILITATING ON-LINE TRADE AND
EXCHANGE OF GOODS BETWEEN THIRD PARTY
BUYERS AND SELLERS; FACILITATING BUYING
AND SELLING GOODS ONLINE BETWEEN THIRD
PARTY BUYERS AND SELLERS; ONLINE AUC-
TIONS; PROVIDING A WEB SITE THAT ENABLES
USERS TO POST ITEMS FOR SALE THROUGH ON-
LINE CLASSIFIED ADVERTISEMENT; ELECTRO-
NIC COMMERCE SERVICES, NAMELY, PROVID-
ING INFORMATION ABOUT PRODUCTS VIA

FIRST USE 4-0-2006; IN COMMERCE 4-0-2006.

THE MARK CONSISTS OF STANDARD CHAR-
ACTERS WITHOUT CLAIM TO ANY PARTICULAR
FONT, STYLE, SIZE, OR COLOR.

SN 77-277,624, FILED 9-12-2007.

CHARLES L. JENKINS, EXAMINING ATTORNEY

Int. Cl.: 9

Prior U.S. Cls.: 21, 23, 26, 36, and 38

Reg. No. 3,522,042

United States Patent and Trademark Office

Registered Oct. 21, 2008

**TRADEMARK
PRINCIPAL REGISTER**

LIQUID LOTTERY

WEYLER, ED (UNITED STATES INDIVIDUAL)
10815 RABBIT HASH ROAD
ELIZABETH, IN 47117 AND
WEYLER, NELL (UNITED STATES INDIVIDUAL)
10815 RABBIT HASH ROAD
ELIZABETH, IN 47117

FOR: COMPUTER SOFTWARE USED TO TRACK
THE SALE OF LOTTERY TICKETS USED BY LOT-
TERY TICKET RETAILERS FOR AUDIT PURPO-
SES, IN CLASS 9 (U.S. CLS. 21, 23, 26, 36 AND 38).

FIRST USE 8-2-2007; IN COMMERCE 12-12-2007.

THE MARK CONSISTS OF STANDARD CHAR-
ACTERS WITHOUT CLAIM TO ANY PARTICULAR
FONT, STYLE, SIZE, OR COLOR.

NO CLAIM IS MADE TO THE EXCLUSIVE
RIGHT TO USE "LOTTERY", APART FROM THE
MARK AS SHOWN.

SN 77-277,842, FILED 9-12-2007.

STEPHANIE ALI, EXAMINING ATTORNEY

Int. Cl.: 36

Prior U.S. Cls.: 100, 101, and 102

United States Patent and Trademark Office

Reg. No. 3,522,043

Registered Oct. 21, 2008

**SERVICE MARK
PRINCIPAL REGISTER**

**ENRICHMENT FEDERAL CREDIT
UNION**

ENRICHMENT FEDERAL CREDIT UNION (UNITED STATES FEDERALLY CHARTERED CREDIT UNION)
201 SOUTH ILLINOIS AVENUE
OAK RIDGE, TN 378310883

FOR: FINANCIAL SERVICES, NAMELY, CREDIT UNION SERVICES FEATURING CONSUMER LOANS, MORTGAGE LOANS, INSTALLMENT LOANS, SAVINGS ACCOUNT SERVICES, CHECKING ACCOUNT SERVICES, MONEY MARKET DEPOSIT ACCOUNT SERVICES, SHARE CERTIFICATE OF DEPOSIT ACCOUNT SERVICES, INDIVIDUAL RETIREMENT ACCOUNT SERVICES, CREDIT CARD SERVICES, DEBIT CHECK CARD SERVICES, PROVIDING PERSONAL LINES OF CREDIT, PROPRIETARY AUTOMATED TELLER MACHINES SERVICES, TELEPHONE BANKING

AND INTERNET BANKING, IN CLASS 36 (U.S. CLS. 100, 101 AND 102).

FIRST USE 11-5-2007; IN COMMERCE 11-5-2007.

THE MARK CONSISTS OF STANDARD CHARACTERS WITHOUT CLAIM TO ANY PARTICULAR FONT, STYLE, SIZE, OR COLOR.

NO CLAIM IS MADE TO THE EXCLUSIVE RIGHT TO USE "FEDERAL CREDIT UNION", APART FROM THE MARK AS SHOWN.

SN 77-278,348, FILED 9-12-2007.

STEPHANIE ALI, EXAMINING ATTORNEY

Int. Cl.: 36

Prior U.S. Cls.: 100, 101, and 102

United States Patent and Trademark Office

Reg. No. 3,522,044

Registered Oct. 21, 2008

**SERVICE MARK
PRINCIPAL REGISTER**



ENRICHMENT FEDERAL CREDIT UNION (UNI-
TED STATES FEDERALLY CHARTERED
CREDIT UNION)
201 SOUTH ILLINOIS AVENUE
OAK RIDGE, TN 378310883

FOR: FINANCIAL SERVICES, NAMELY, CREDIT
UNION SERVICES FEATURING CONSUMER
LOANS, MORTGAGE LOANS, INSTALLMENT
LOANS, SAVINGS ACCOUNT SERVICES, CHECK-
ING ACCOUNT SERVICES, MONEY MARKET DE-
POSIT ACCOUNT SERVICES, SHARE
CERTIFICATE OF DEPOSIT ACCOUNT SERVICES,
INDIVIDUAL RETIREMENT ACCOUNT SERVICES,
CREDIT CARD SERVICES, DEBIT CHECK CARD
SERVICES, PROVIDING PERSONAL LINES OF

CREDIT, PROPRIETARY AUTOMATED TELLER
MACHINES SERVICES, TELEPHONE BANKING
AND INTERNET BANKING, IN CLASS 36 (U.S.
CLS. 100, 101 AND 102).

FIRST USE 11-5-2007; IN COMMERCE 11-5-2007.

NO CLAIM IS MADE TO THE EXCLUSIVE
RIGHT TO USE "FEDERAL CREDIT UNION",
APART FROM THE MARK AS SHOWN.

SN 77-278,366, FILED 9-12-2007.

STEPHANIE ALI, EXAMINING ATTORNEY

Int. Cl.: 36

Prior U.S. Cls.: 100, 101, and 102

United States Patent and Trademark Office

Reg. No. 3,522,045

Registered Oct. 21, 2008

**SERVICE MARK
PRINCIPAL REGISTER**

**EXCEPTIONAL SERVICE.
EXTRAORDINARY PEOPLE.**

ENRICHMENT FEDERAL CREDIT UNION (UNITED STATES FEDERALLY CHARTERED CREDIT UNION)
201 SOUTH ILLINOIS AVENUE
OAK RIDGE, TN 378310883

FOR: FINANCIAL SERVICES, NAMELY, CREDIT UNION SERVICES FEATURING CONSUMER LOANS, MORTGAGE LOANS, INSTALLMENT LOANS, SAVINGS ACCOUNT SERVICES, CHECKING ACCOUNT SERVICES, MONEY MARKET DEPOSIT ACCOUNT SERVICES, SHARE CERTIFICATE OF DEPOSIT ACCOUNT SERVICES, INDIVIDUAL RETIREMENT ACCOUNT SERVICES, CREDIT CARD SERVICES, DEBIT CHECK CARD SERVICES, PROVIDING PERSONAL LINES OF

CREDIT, PROPRIETARY AUTOMATED TELLER MACHINES SERVICES, TELEPHONE BANKING AND INTERNET BANKING, IN CLASS 36 (U.S. CLS. 100, 101 AND 102).

FIRST USE 11-5-2007; IN COMMERCE 11-5-2007.

THE MARK CONSISTS OF STANDARD CHARACTERS WITHOUT CLAIM TO ANY PARTICULAR FONT, STYLE, SIZE, OR COLOR.

SN 77-278,369, FILED 9-12-2007.

STEPHANIE ALI, EXAMINING ATTORNEY

Int. Cl.: 31

Prior U.S. Cls.: 1 and 46

United States Patent and Trademark Office

Reg. No. 3,522,046

Registered Oct. 21, 2008

**TRADEMARK
PRINCIPAL REGISTER**

CC Ranch

THOMPSON, ROBERTA J (IDAHO LIMITED
LIABILITY COMPANY), DBA COCOLALLA
CREEK RANCH,
550 BUCKING HORSE LANE
COCOLALLA, ID 83813

FOR: HORSES, CATTLE, IN CLASS 31 (U.S. CLS. 1
AND 46).

FIRST USE 1-1-2008; IN COMMERCE 1-1-2008.

NO CLAIM IS MADE TO THE EXCLUSIVE
RIGHT TO USE "RANCH", APART FROM THE
MARK AS SHOWN.

THE MARK CONSISTS OF THE LETTER "C"
SLIGHTLY ABOVE ANOTHER LETTER "C" AND
THE WORD "RANCH".

SN 77-278,433, FILED 9-13-2007.

JOHN WILKE, EXAMINING ATTORNEY

Int. Cl.: 35

Prior U.S. Cls.: 100, 101, and 102

United States Patent and Trademark Office

Reg. No. 3,522,047

Registered Oct. 21, 2008

**SERVICE MARK
PRINCIPAL REGISTER**

CLIMATE CULTURE

CLIMATE CULTURE, INC. (FLORIDA CORPORATION)
1231 CHANTRY PLACE
LAKE MARY, FL 32746

FOR: CONSULTING SERVICES IN THE AREAS OF ENVIRONMENTAL RELATED MARKETING AND BUSINESS PRACTICES, IN CLASS 35 (U.S. CLS. 100, 101 AND 102).

FIRST USE 3-31-2007; IN COMMERCE 3-31-2007.

THE MARK CONSISTS OF STANDARD CHARACTERS WITHOUT CLAIM TO ANY PARTICULAR FONT, STYLE, SIZE, OR COLOR.

NO CLAIM IS MADE TO THE EXCLUSIVE RIGHT TO USE "CLIMATE", APART FROM THE MARK AS SHOWN.

SN 77-278,524, FILED 9-13-2007.

ALLISON HOLTZ, EXAMINING ATTORNEY

Int. Cl.: 17

Prior U.S. Cls.: 1, 5, 12, 13, 35, and 50

Reg. No. 3,522,048

United States Patent and Trademark Office

Registered Oct. 21, 2008

**TRADEMARK
PRINCIPAL REGISTER**



TOM COLARUSSO AND MATT LARGE (CALIFORNIA PARTNERSHIP), DBA BEST PRACTICES ENTERPRISES,

864 ORION WAY
SAN MARCOS, CA 92078

FOR: ACRYLIC SEALANTS, ADHESIVES AND FILLERS FOR REPAIRS, IN CLASS 17 (U.S. CLS. 1, 5, 12, 13, 35 AND 50).

FIRST USE 2-19-2008; IN COMMERCE 2-19-2008.

NO CLAIM IS MADE TO THE EXCLUSIVE RIGHT TO USE "PRODUCTS", APART FROM THE MARK AS SHOWN.

THE MARK CONSISTS OF A DESIGN OF STACKED TRIANGULAR SHAPES PRECEEDING THE COINED TERM "PROCALIBER" AND THE WORD "PRODUCTS".

SN 77-279,216, FILED 9-13-2007.

DOMINIC FATHY, EXAMINING ATTORNEY

Int. Cl.: 9

Prior U.S. Cls.: 21, 23, 26, 36, and 38

Reg. No. 3,522,049

United States Patent and Trademark Office

Registered Oct. 21, 2008

**TRADEMARK
PRINCIPAL REGISTER**

TONAR MUSIC

TONAR, INC. (MARYLAND CORPORATION)
1200 BROADWAY ROAD
LUTHERVILLE, MD 21093

FOR: COMPACT DISCS FEATURING MUSIC
AND SONGS, IN CLASS 9 (U.S. CLS. 21, 23, 26, 36
AND 38).

FIRST USE 2-18-2008; IN COMMERCE 2-18-2008.

THE MARK CONSISTS OF STANDARD CHAR-
ACTERS WITHOUT CLAIM TO ANY PARTICULAR
FONT, STYLE, SIZE, OR COLOR.

NO CLAIM IS MADE TO THE EXCLUSIVE
RIGHT TO USE "MUSIC", APART FROM THE
MARK AS SHOWN.

SN 77-279,407, FILED 9-14-2007.

BENJAMIN OKEKE, EXAMINING ATTORNEY

Int. Cl.: 9

Prior U.S. Cls.: 21, 23, 26, 36, and 38

Reg. No. 3,522,050

United States Patent and Trademark Office

Registered Oct. 21, 2008

**TRADEMARK
PRINCIPAL REGISTER**

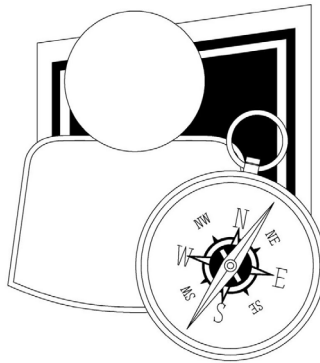

MEDCOM SOLUTIONS, INC. (PENNSYLVANIA CORPORATION)
56 TERMINAL WAY
PITTSBURGH, PA 15219

FOR: COMPUTER DATABASE MANAGEMENT SOFTWARE USED TO MAINTAIN AND MANAGE CHARGEMASTER SOFTWARE AND TO PERMIT USERS TO ACCESS CHARGEMASTER DATABASE SOFTWARE FOR USE BY HEALTHCARE PROFESSIONALS AND HEALTHCARE ORGANIZATIONS, IN CLASS 9 (U.S. CLS. 21, 23, 26, 36 AND 38).

THE MARK CONSISTS OF AN IMAGE OF A COMPASS PLACED ON THE BOTTOM RIGHT IN FRONT OF AN IMAGE OF A SILHOUETTE OF A PERSON, WHICH BOTH IMAGES ARE CENTERED IN FRONT OF AN IMAGE OF A COMPUTER SCREEN.

SN 77-279,860, FILED 9-14-2007.

FIRST USE 7-17-2008; IN COMMERCE 7-17-2008.

PAUL MORENO, EXAMINING ATTORNEY

Int. Cl.: 35

Prior U.S. Cls.: 100, 101, and 102

United States Patent and Trademark Office

Reg. No. 3,522,051

Registered Oct. 21, 2008

**SERVICE MARK
PRINCIPAL REGISTER**

COMPLETE MY ALBUM

APPLE INC. (CALIFORNIA CORPORATION)
1 INFINITE LOOP
CUPERTINO, CA 95014

FOR: RETAIL STORE SERVICES IN THE FIELD OF ENTERTAINMENT, NAMELY, PRE-RECORDED AUDIO, AUDIOVISUAL, VIDEO, MUSIC, AND MULTIMEDIA CONTENT PROVIDED VIA THE INTERNET AND OTHER COMPUTER AND ELECTRONIC COMMUNICATION NETWORKS, IN CLASS 35 (U.S. CLS. 100, 101 AND 102).

FIRST USE 3-29-2007; IN COMMERCE 3-29-2007.

THE MARK CONSISTS OF STANDARD CHARACTERS WITHOUT CLAIM TO ANY PARTICULAR FONT, STYLE, SIZE, OR COLOR.

PRIORITY CLAIMED UNDER SEC. 44(D) ON TRINIDAD/TOBAGO APPLICATION NO. 38317, FILED 3-26-2007.

SN 77-279,915, FILED 9-14-2007.

SKYE YOUNG, EXAMINING ATTORNEY

Int. Cl.: 42

Prior U.S. Cls.: 100 and 101

United States Patent and Trademark Office

Reg. No. 3,522,052

Registered Oct. 21, 2008

**SERVICE MARK
PRINCIPAL REGISTER**

BROADEN

ADVANCED NEUROMODULATION SYSTEMS,
INC. (TEXAS CORPORATION)
6901 PRESTON ROAD
PLANO, TX 75024

THE MARK CONSISTS OF STANDARD CHAR-
ACTERS WITHOUT CLAIM TO ANY PARTICULAR
FONT, STYLE, SIZE, OR COLOR.

FOR: MEDICAL RESEARCH, SPECIFICALLY,
CLINICAL TRIALS IN THE FIELD OF DEPRESSION
TREATMENT, IN CLASS 42 (U.S. CLS. 100 AND 101).

SN 77-280,095, FILED 9-14-2007.

FIRST USE 2-7-2008; IN COMMERCE 2-7-2008.

KATHERINE CHANG, EXAMINING ATTORNEY

Int. Cl.: 30

Prior U.S. Cl.: 46

United States Patent and Trademark Office

Reg. No. 3,522,053

Registered Oct. 21, 2008

TRADEMARK
PRINCIPAL REGISTER



JELLY BELLY CANDY COMPANY (CALIFORNIA CORPORATION)
ONE JELLY BELLY LANE
FAIRFIELD, CA 945336741

THE MARK CONSISTS OF THE WORDS "BEAN BOOZLED" IN YELLOW STYLIZED LETTERS, WITH A BLACK OUTLINE.

FOR: CANDY, IN CLASS 30 (U.S. CL. 46).

SN 77-280,359, FILED 9-14-2007.

FIRST USE 1-4-2008; IN COMMERCE 1-4-2008.

THE COLOR(S) BLACK AND YELLOW IS/ARE CLAIMED AS A FEATURE OF THE MARK.

DANIEL CAPSHAW, EXAMINING ATTORNEY

Int. Cl.: 14

Prior U.S. Cls.: 2, 27, 28, and 50

United States Patent and Trademark Office

Reg. No. 3,522,054

Registered Oct. 21, 2008

**TRADEMARK
PRINCIPAL REGISTER**

**IN AMERICA ONLY THE WIND
BLOWS FREE**

ROZSAVOLGYI, GEORGE (UNITED STATES IN-
DIVIDUAL)
910 W. NEW YORK STREET
AURORA, IL 60506

THE MARK CONSISTS OF STANDARD CHAR-
ACTERS WITHOUT CLAIM TO ANY PARTICULAR
FONT, STYLE, SIZE, OR COLOR.

FOR: BRACELETS, IN CLASS 14 (U.S. CLS. 2, 27, 28
AND 50).

SN 77-280,854, FILED 9-17-2007.

FIRST USE 6-6-2008; IN COMMERCE 6-6-2008.

LESLEY LAMOTHE, EXAMINING ATTORNEY

Int. Cl.: 25

Prior U.S. Cls.: 22 and 39

United States Patent and Trademark Office

Reg. No. 3,522,055

Registered Oct. 21, 2008

TRADEMARK
PRINCIPAL REGISTER



JOHNSON, DANYA R (GEORGIA LIMITED LIABILITY COMPANY)
P.O. BOX 2414
MERRIFIELD, VA 221162414

FOR: CAPRI PANTS; CARGO PANTS; DENIMS; JOGGING PANTS; SWEAT PANTS; WATERPROOF JACKETS AND PANTS; WIND PANTS; JEANS; A-SHIRTS; DRESS SHIRTS; GOLF SHIRTS; KNIT SHIRTS; LONG-SLEEVED SHIRTS; POLO SHIRTS; SHIRTS; SHIRTS FOR SUITS; SHORT-SLEEVED OR LONG-SLEEVED T-SHIRTS; SHORT-SLEEVED SHIRTS; SPORT SHIRTS; SWEAT SHIRTS; T-SHIRTS; TEE SHIRTS; WIND SHIRTS; BELTS;

HOODS; JERSEYS; LEATHER BELTS; SHORT SETS; TIES, IN CLASS 25 (U.S. CLS. 22 AND 39).

FIRST USE 4-29-2008; IN COMMERCE 7-2-2008.

THE MARK CONSISTS OF A DOWNWARD SLANTED "M4" TEARING THROUGH A ROUGH EDGE PIECE OF PAPER WITH A UPWARD SLANTED MASTERING OUR EXISTENCE GOING ACROSS THE TOP.

SN 77-281,035, FILED 9-17-2007.

NAKIA HENRY, EXAMINING ATTORNEY

Int. Cl.: 37

Prior U.S. Cls.: 100, 103, and 106

United States Patent and Trademark Office

Reg. No. 3,522,056

Registered Oct. 21, 2008

**SERVICE MARK
PRINCIPAL REGISTER**

SYSTEM PAVERS

SYSTEMS PAVING, INC. (CALIFORNIA CORPORATION)
1600 DOVE STREET, SUITE 250
NEWPORT BEACH, CA 92660

OWNER OF U.S. REG. NOS. 2,032,512 AND 3,001,779.

FOR: INSTALLATION OF INTERLOCKING PAVING STONES FOR DRIVEWAYS, WALKWAYS, POOL DECKS AND PATIOS, IN CLASS 37 (U.S. CLS. 100, 103 AND 106).

NO CLAIM IS MADE TO THE EXCLUSIVE RIGHT TO USE "PAVERS", APART FROM THE MARK AS SHOWN.

FIRST USE 4-25-2008; IN COMMERCE 4-25-2008.

SN 77-281,724, FILED 9-17-2007.

THE MARK CONSISTS OF STANDARD CHARACTERS WITHOUT CLAIM TO ANY PARTICULAR FONT, STYLE, SIZE, OR COLOR.

LYDIA BELZER, EXAMINING ATTORNEY

Int. Cl.: 35

Prior U.S. Cls.: 100, 101, and 102

United States Patent and Trademark Office

Reg. No. 3,522,057

Registered Oct. 21, 2008

**SERVICE MARK
PRINCIPAL REGISTER**

BALLERINAS AND BRUISERS

ZGENDERS, LLC (INDIANA LIMITED LIABILITY COMPANY)
180 SOUTH MAIN STREET
ZIONSVILLE, IN 46077

FOR: RETAIL STORE SERVICES AND ON-LINE RETAIL STORE SERVICES FEATURING PET SUPPLIES, PET ACCESSORIES, CHILDREN'S CLOTHING, AND CHILDREN'S ACCESSORIES, NAMELY, BOOKS, TOYS, GIFTS AND NOVELTIES, IN CLASS 35 (U.S. CLS. 100, 101 AND 102).

FIRST USE 3-1-2008; IN COMMERCE 3-1-2008.

THE MARK CONSISTS OF STANDARD CHARACTERS WITHOUT CLAIM TO ANY PARTICULAR FONT, STYLE, SIZE, OR COLOR.

SN 77-282,004, FILED 9-18-2007.

ANTHONY RINKER, EXAMINING ATTORNEY

Int. Cl.: 25

Prior U.S. Cls.: 22 and 39

United States Patent and Trademark Office

Reg. No. 3,522,058

Registered Oct. 21, 2008

**TRADEMARK
PRINCIPAL REGISTER**

ECOSENTIALS

TOTES ISOTONER CORPORATION (OHIO CORPORATION)
9655 INTERNATIONAL BOULEVARD
CINCINNATI, OH 45246

THE MARK CONSISTS OF STANDARD CHARACTERS WITHOUT CLAIM TO ANY PARTICULAR FONT, STYLE, SIZE, OR COLOR.

FOR: HATS; SCARVES; GLOVES, IN CLASS 25 (U.S. CLS. 22 AND 39).

SN 77-282,218, FILED 9-18-2007.

FIRST USE 8-25-2008; IN COMMERCE 8-25-2008.

JESSICA FATHY, EXAMINING ATTORNEY

Int. Cl.: 1

Prior U.S. Cls.: 1, 5, 6, 10, 26, and 46

United States Patent and Trademark Office

Reg. No. 3,522,059

Registered Oct. 21, 2008

**TRADEMARK
PRINCIPAL REGISTER**

BECKOSOL AQ

REICHHOLD, INC. (DELAWARE CORPORATION)
2400 ELLIS ROAD
DURHAM, NC 27703

OWNER OF U.S. REG. NOS. 1,131,548 AND
1,132,015.

FOR: WATER-BORNE SYNTHETIC RESINS AS
RAW MATERIALS FOR PAINTS, LACQUERS,
STAINS, SEALANTS, VARNISHES AND COATINGS,
IN CLASS 1 (U.S. CLS. 1, 5, 6, 10, 26 AND 46).

NO CLAIM IS MADE TO THE EXCLUSIVE
RIGHT TO USE "AQ", APART FROM THE MARK
AS SHOWN.

FIRST USE 7-1-2007; IN COMMERCE 7-1-2007.

SN 77-282,993, FILED 9-19-2007.

THE MARK CONSISTS OF STANDARD CHAR-
ACTERS WITHOUT CLAIM TO ANY PARTICULAR
FONT, STYLE, SIZE, OR COLOR.

EDWARD FENNESSY, EXAMINING ATTORNEY

Int. Cl.: 34

Prior U.S. Cls.: 2, 8, 9, and 17

United States Patent and Trademark Office

Reg. No. 3,522,060

Registered Oct. 21, 2008

**TRADEMARK
PRINCIPAL REGISTER**

GURKHA PRIDE

K. HANSOTIA & CO., INC. (FLORIDA CORPORATION)
3705 N.W. 115 AVENUE, BAY, #5
MIAMI, FL 33178

FOR: CIGARS, IN CLASS 34 (U.S. CLS. 2, 8, 9 AND 17).

FIRST USE 2-0-2008; IN COMMERCE 2-0-2008.

THE MARK CONSISTS OF STANDARD CHARACTERS WITHOUT CLAIM TO ANY PARTICULAR FONT, STYLE, SIZE, OR COLOR.

OWNER OF U.S. REG. NO. 2,241,474.

SN 77-283,414, FILED 9-19-2007.

STEPHANIE ALI, EXAMINING ATTORNEY

Int. Cl.: 35

Prior U.S. Cls.: 100, 101, and 102

United States Patent and Trademark Office

Reg. No. 3,522,061

Registered Oct. 21, 2008

**SERVICE MARK
PRINCIPAL REGISTER**

BIBZII

BRODART CO. (NEW YORK PARTNERSHIP)
500 ARCH STREET
WILLIAMSPORT, PA 17705

THE MARK CONSISTS OF STANDARD CHAR-
ACTERS WITHOUT CLAIM TO ANY PARTICULAR
FONT, STYLE, SIZE, OR COLOR.

FOR: DISTRIBUTORSHIP SERVICES IN THE
FIELD OF BOOKS, IN CLASS 35 (U.S. CLS. 100, 101
AND 102).

SN 77-283,726, FILED 9-19-2007.

FIRST USE 9-0-2007; IN COMMERCE 9-0-2007.

CAROL SPILS, EXAMINING ATTORNEY

Int. Cl.: 35

Prior U.S. Cls.: 100, 101, and 102

United States Patent and Trademark Office

Reg. No. 3,522,062

Registered Oct. 21, 2008

**SERVICE MARK
PRINCIPAL REGISTER**

BIBZII.COM

BRODART CO. (NEW YORK PARTNERSHIP)
500 ARCH STREET
WILLIAMSPORT, PA 17705

THE MARK CONSISTS OF STANDARD CHAR-
ACTERS WITHOUT CLAIM TO ANY PARTICULAR
FONT, STYLE, SIZE, OR COLOR.

FOR: DISTRIBUTORSHIP SERVICES IN THE
FIELD OF BOOKS, IN CLASS 35 (U.S. CLS. 100, 101
AND 102).

SN 77-283,751, FILED 9-19-2007.

FIRST USE 9-0-2007; IN COMMERCE 9-0-2007.

CAROL SPILS, EXAMINING ATTORNEY

Int. Cl.: 16

Prior U.S. Cls.: 2, 5, 22, 23, 29, 37, 38, and 50

Reg. No. 3,522,063

United States Patent and Trademark Office

Registered Oct. 21, 2008

**TRADEMARK
PRINCIPAL REGISTER**

**JOURNAL FOR SUCCESS IN
AGING**

DIANE PATTERSON (UNITED STATES INDIVIDUAL)
14 HUGHES, SUITE B104
IRVINE, CA 92618

FOR: PERIODICAL PUBLICATIONS, NAMELY, BROCHURES, MAGAZINES, JOURNALS, AND WORKBOOKS IN THE FIELD OF HEALTH ISSUES AFFECTING AGING POPULATIONS, IN CLASS 16 (U.S. CLS. 2, 5, 22, 23, 29, 37, 38 AND 50).

FIRST USE 5-1-2007; IN COMMERCE 6-15-2007.

THE MARK CONSISTS OF STANDARD CHARACTERS WITHOUT CLAIM TO ANY PARTICULAR FONT, STYLE, SIZE, OR COLOR.

NO CLAIM IS MADE TO THE EXCLUSIVE RIGHT TO USE "JOURNAL", APART FROM THE MARK AS SHOWN.

SN 77-283,773, FILED 9-19-2007.

DANNEAN HETZEL, EXAMINING ATTORNEY

Int. Cl.: 25

Prior U.S. Cls.: 22 and 39

United States Patent and Trademark Office

Reg. No. 3,522,064

Registered Oct. 21, 2008

**TRADEMARK
PRINCIPAL REGISTER**

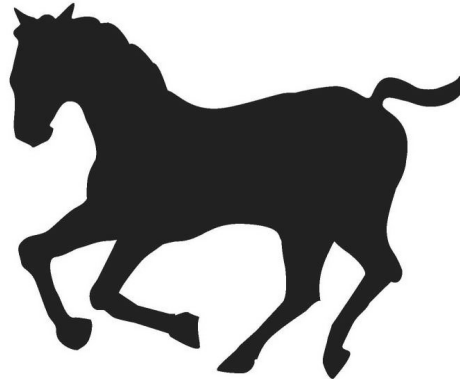

UNITED STATES POLO ASSOCIATION (ILLINOIS CORPORATION)
771 CORPORATE DRIVE, STE. 430
LEXINGTON, KY 40503

FOR: CLOTHING, NAMELY, JACKETS, SHIRTS, PANTS, JEANS; KNITWEAR, NAMELY, T-SHIRTS, POLO SHIRTS, SWEATERS; SLEEPWEAR; SPORTSWEAR, NAMELY, T-SHIRTS, POLO SHIRTS, SWEATSHIRTS, JACKETS; OUTERWEAR, NAMELY, COATS AND JACKETS, IN CLASS 25 (U.S. CLS. 22 AND 39).

FIRST USE 12-1-2005; IN COMMERCE 12-1-2005.

THE MARK CONSISTS OF A STYLIZED DRAWING OF A RUNNING POLO PONY.

SN 77-284,169, FILED 9-20-2007.

ALICE BENMAMAN, EXAMINING ATTORNEY

Int. Cl.: 43

Prior U.S. Cls.: 100 and 101

United States Patent and Trademark Office

Reg. No. 3,522,065

Registered Oct. 21, 2008

**SERVICE MARK
PRINCIPAL REGISTER**



CHOICE HOTELS INTERNATIONAL, INC. (DE-
LAWARE CORPORATION)
10750 COLUMBIA PIKE
SILVER SPRING, MD 20901

FOR: HOTEL AND MOTEL SERVICES, HOTEL
AND MOTEL RESERVATION SERVICES FOR OTH-
ERS, AND ONLINE HOTEL AND MOTEL RESER-
VATION SERVICES FOR OTHERS, IN CLASS 43
(U.S. CLS. 100 AND 101).

FIRST USE 8-22-2007; IN COMMERCE 8-22-2007.

OWNER OF U.S. REG. NOS. 813,642, 1,799,807,
AND 1,799,814.

NO CLAIM IS MADE TO THE EXCLUSIVE
RIGHT TO USE "LODGE", APART FROM THE
MARK AS SHOWN.

THE COLOR(S) RED, YELLOW, AND WHITE IS/
ARE CLAIMED AS A FEATURE OF THE MARK.

THE MARK CONSISTS OF A YELLOW STYLIZED
LETTER "E" INSIDE AN OVAL WITH A WHITE
STAR DESIGN AND THE WORDS ECONO LODGE
IN WHITE, ALL ON A RED BACKGROUND.

SN 77-284,335, FILED 9-20-2007.

GEORGE LORENZO, EXAMINING ATTORNEY

Int. Cl.: 5

Prior U.S. Cls.: 6, 18, 44, 46, 51, and 52

United States Patent and Trademark Office

Reg. No. 3,522,066

Registered Oct. 21, 2008

**TRADEMARK
PRINCIPAL REGISTER**

ACUROX

ACURA PHARMACEUTICALS, INC. (NEW
YORK CORPORATION)
616 N. NORTH COURT, SUITE 120
PALATINE, IL 60067

THE MARK CONSISTS OF STANDARD CHAR-
ACTERS WITHOUT CLAIM TO ANY PARTICULAR
FONT, STYLE, SIZE, OR COLOR.

FOR: PHARMACEUTICAL PREPARATIONS FOR
PAIN RELIEF, IN CLASS 5 (U.S. CLS. 6, 18, 44, 46, 51
AND 52).

SN 77-284,645, FILED 9-20-2007.

FIRST USE 2-0-2008; IN COMMERCE 2-0-2008.

RUDY R. SINGLETON, EXAMINING ATTORNEY

Int. Cl.: 43

Prior U.S. Cls.: 100 and 101

United States Patent and Trademark Office

Reg. No. 3,522,067

Registered Oct. 21, 2008

**SERVICE MARK
PRINCIPAL REGISTER**



CHOICE HOTELS INTERNATIONAL, INC. (DE-
LAWARE CORPORATION)
10750 COLUMBIA PIKE
SILVER SPRING, MD 20901

FOR: HOTEL AND MOTEL SERVICES, HOTEL
AND MOTEL RESERVATION SERVICES FOR OTH-
ERS, AND ONLINE HOTEL AND MOTEL RESER-
VATION SERVICES FOR OTHERS, IN CLASS 43
(U.S. CLS. 100 AND 101).

FIRST USE 8-24-2007; IN COMMERCE 8-24-2007.

OWNER OF U.S. REG. NOS. 813,642, 1,799,807,
AND 1,799,814.

NO CLAIM IS MADE TO THE EXCLUSIVE
RIGHT TO USE "LODGE INN & SUITES", APART
FROM THE MARK AS SHOWN.

THE MARK CONSISTS OF A STYLIZED LETTER
"E" INSIDE AN OVAL WITH A STAR DESIGN AND
THE WORDS "ECONO LODGE INN & SUITES".

SN 77-284,667, FILED 9-20-2007.

GEORGE LORENZO, EXAMINING ATTORNEY

Int. Cl.: 7

Prior U.S. Cls.: 13, 19, 21, 23, 31, 34, and 35

Reg. No. 3,522,068

United States Patent and Trademark Office

Registered Oct. 21, 2008

**TRADEMARK
PRINCIPAL REGISTER**

ECOACTION

BSH HOME APPLIANCES CORPORATION (DE-
LAWARE CORPORATION)
5551 MCFADDEN AVENUE
HUNTINGTON BEACH, CA 92649

FOR: HOUSEHOLD AND KITCHEN MACHINES
AND EQUIPMENT, NAMELY, ELECTRIC KITCH-
EN MACHINES AND EQUIPMENT, NAMELY,
DISHWASHERS; ELECTRIC MACHINES AND AP-
PLIANCES FOR TREATING LAUNDRY AND
CLOTHING, NAMELY, WASHING MACHINES;
STRUCTURAL PARTS OF ALL AFOREMEN-

TIONED GOODS, IN CLASS 7 (U.S. CLS. 13, 19, 21,
23, 31, 34 AND 35).

FIRST USE 7-1-2007; IN COMMERCE 7-1-2007.

THE MARK CONSISTS OF STANDARD CHAR-
ACTERS WITHOUT CLAIM TO ANY PARTICULAR
FONT, STYLE, SIZE, OR COLOR.

SN 77-285,629, FILED 9-21-2007.

DAVID MILLER, EXAMINING ATTORNEY

Int. Cl.: 10

Prior U.S. Cls.: 26, 39, and 44

United States Patent and Trademark Office

Reg. No. 3,522,069

Registered Oct. 21, 2008

**TRADEMARK
PRINCIPAL REGISTER**

HEART IN FOCUS

PACESETTER, INC., DOING BUSINESS AS ST.
JUDE MEDICAL CARDIAC RHYTHM MAN-
AGEMENT DIVISION (DELAWARE COR-
PORATION)
15900 VALLEY VIEW COURT
SYLMAR, CA 91342

FOR: A SOFTWARE MODULE SOLD AS A COM-
PONENT OF A MEDICAL DEVICE PROGRAMMER
WHICH PROVIDES REPORTS, FOR USE WITH AN
IMPLANTED MEDICAL DEVICE, IN CLASS 10 (U.S.
CLS. 26, 39 AND 44).

FIRST USE 11-1-2007; IN COMMERCE 11-1-2007.

THE MARK CONSISTS OF STANDARD CHAR-
ACTERS WITHOUT CLAIM TO ANY PARTICULAR
FONT, STYLE, SIZE, OR COLOR.

NO CLAIM IS MADE TO THE EXCLUSIVE
RIGHT TO USE "HEART", APART FROM THE
MARK AS SHOWN.

SN 77-286,233, FILED 9-21-2007.

PAUL E. FAHRENKOPF, EXAMINING ATTORNEY

Int. Cl.: 25

Prior U.S. Cls.: 22 and 39

United States Patent and Trademark Office

Reg. No. 3,522,070

Registered Oct. 21, 2008

**TRADEMARK
PRINCIPAL REGISTER**



BERRIER, CONNOR H (UNITED STATES INDIVIDUAL)
2651 KUILEI B-75
HONOLULU, HI 96826

FOR: HATS; T-SHIRTS; JACKETS; PULLOVERS; SHORT-SLEEVED OR LONG-SLEEVED T-SHIRTS; BOARD SHORTS; BOXER SHORTS; PANTIES, SHORTS AND BRIEFS; THONGS; LADIES' UNDERWEAR; HEADWEAR; BEANIES , IN CLASS 25 (U.S. CLS. 22 AND 39).

FIRST USE 7-21-2008; IN COMMERCE 8-1-2008.

THE MARK CONSISTS OF A WAVE SYMBOL INSIDE OF A CIRCLE WITH BLACK RAYS GOING OUTWARD INSIDE OF A LARGER TRUNCATED CIRCLE.

SN 77-286,682, FILED 9-24-2007.

PAULA MAHONEY, EXAMINING ATTORNEY

Int. Cl.: 36

Prior U.S. Cls.: 100, 101, and 102

United States Patent and Trademark Office

Reg. No. 3,522,071

Registered Oct. 21, 2008

**SERVICE MARK
PRINCIPAL REGISTER**

KHAKI'S FOR THE CAUSE

THE SUSAN G. KOMEN BREAST CANCER
FOUNDATION, INC. (TEXAS NON-PROFIT
CORPORATION)
5005 LBJ FREEWAY, SUITE 250
DALLAS, TX 75244

FOR: CHARITABLE FUNDRAISING SERVICES,
NAMELY, RAISING MONEY FOR BREAST CAN-
CER RESEARCH AND RAISING MONEY FOR
LOCAL COMMUNITY BREAST HEALTH AWARE-
NESS PROGRAMS, IN CLASS 36 (U.S. CLS. 100, 101
AND 102).

FIRST USE 8-31-2007; IN COMMERCE 8-31-2007.

THE MARK CONSISTS OF STANDARD CHAR-
ACTERS WITHOUT CLAIM TO ANY PARTICULAR
FONT, STYLE, SIZE, OR COLOR.

NO CLAIM IS MADE TO THE EXCLUSIVE
RIGHT TO USE "KHAKI'S", APART FROM THE
MARK AS SHOWN.

SN 77-287,269, FILED 9-24-2007.

SUSAN STIGLITZ, EXAMINING ATTORNEY

Int. Cl.: 7

Prior U.S. Cls.: 13, 19, 21, 23, 31, 34, and 35

Reg. No. 3,522,072

United States Patent and Trademark Office

Registered Oct. 21, 2008

**TRADEMARK
PRINCIPAL REGISTER**

ASCENTA

BSH HOME APPLIANCES CORPORATION (DE-
LAWARE CORPORATION)
5551 MCFADDEN AVENUE
HUNTINGTON BEACH, CA 92649

FIRST USE 5-1-2008; IN COMMERCE 5-1-2008.

FOR: HOUSEHOLD AND KITCHEN MACHINES
AND EQUIPMENT, NAMELY, ELECTRIC KITCH-
EN MACHINES AND EQUIPMENT, NAMELY,
DISHWASHERS; STRUCTURAL PARTS OF ALL
AFOREMENTIONED GOODS, IN CLASS 7 (U.S.
CLS. 13, 19, 21, 23, 31, 34 AND 35).

THE MARK CONSISTS OF STANDARD CHAR-
ACTERS WITHOUT CLAIM TO ANY PARTICULAR
FONT, STYLE, SIZE, OR COLOR.

SN 77-287,294, FILED 9-24-2007.

DAVID MILLER, EXAMINING ATTORNEY

Int. Cl.: 3

Prior U.S. Cls.: 1, 4, 6, 50, 51, and 52

United States Patent and Trademark Office

Reg. No. 3,522,073

Registered Oct. 21, 2008

**TRADEMARK
PRINCIPAL REGISTER**

PRETTY POP

BOOM LLC (DELAWARE LIMITED LIABILITY
COMPANY)
2ND FLOOR
800 THIRD AVENUE
NEW YORK, NY 10022

FOR: COSMETICS, NAMELY, PERFUME, CO-
LOGNE, EAU DE TOILETTE, EAU DE PARFUM,
SKIN SOAPS, LIQUID SOAP, SHOWER GEL, BODY
LOTION, SKIN CREAMS, SKIN LOTIONS, SKIN
MOISTURIZERS, IN CLASS 3 (U.S. CLS. 1, 4, 6, 50, 51
AND 52).

FIRST USE 8-1-2008; IN COMMERCE 8-1-2008.

THE MARK CONSISTS OF STANDARD CHAR-
ACTERS WITHOUT CLAIM TO ANY PARTICULAR
FONT, STYLE, SIZE, OR COLOR.

SN 77-287,876, FILED 9-25-2007.

APRIL HESIK, EXAMINING ATTORNEY

Int. Cls.: 35, 36, and 37

Prior U.S. Cls.: 100, 101, 102, 103, and 106

United States Patent and Trademark Office

Reg. No. 3,522,074

Registered Oct. 21, 2008

**SERVICE MARK
PRINCIPAL REGISTER**

eFuelman

FLEETCOR TECHNOLOGIES OPERATING COMPANY, LLC (GEORGIA LIMITED LIABILITY COMPANY)
SUITE 300
655 ENGINEERING DRIVE
NORCROSS, GA 30092

FOR: RETAIL GASOLINE SUPPLY SERVICES FOR MOTOR VEHICLE FLEET OWNERS; PREPARING BUSINESS REPORTS FOR THE TRANSPORTATION AND VEHICLE FLEET INDUSTRIES; BILLING AND DATA PROCESSING SERVICES FOR THE TRANSPORTATION AND VEHICLE FLEET INDUSTRIES; BUSINESS MANAGEMENT, INVENTORY CONTROL, AND BOOKKEEPING FOR TRANSPORTATION AND VEHICLE FLEET INDUSTRIES; AND WHOLESALE DISTRIBUTORSHIPS FEATURING MOTOR VEHICLE FUELS, LUBRICANTS, AND PETROLEUM PRODUCTS, IN CLASS 35 (U.S. CLS. 100, 101 AND 102).

FIRST USE 1-1-2008; IN COMMERCE 1-1-2008.

FOR: PROVIDING PAYMENT SERVICES FOR PURCHASING MOTOR FUELS, PETROLEUM PRO-

DUCTS AND OTHER VEHICLE RELATED GOODS AND SERVICES, IN CLASS 36 (U.S. CLS. 100, 101 AND 102).

FIRST USE 1-1-2008; IN COMMERCE 1-1-2008.

FOR: MOTOR FUEL AND VEHICLE MAINTENANCE SERVICES TO VEHICLE FLEET OWNERS IN THE NATURE OF AUTOMOBILE SERVICE STATIONS, IN CLASS 37 (U.S. CLS. 100, 103 AND 106).

FIRST USE 1-1-2008; IN COMMERCE 1-1-2008.

THE MARK CONSISTS OF STANDARD CHARACTERS WITHOUT CLAIM TO ANY PARTICULAR FONT, STYLE, SIZE, OR COLOR.

OWNER OF U.S. REG. NOS. 1,363,666, 3,201,086, AND 3,293,718.

SN 77-287,993, FILED 9-25-2007.

DAVID TOOLEY, EXAMINING ATTORNEY

Int. Cl.: 25

Prior U.S. Cls.: 22 and 39

United States Patent and Trademark Office

Reg. No. 3,522,075

Registered Oct. 21, 2008

**TRADEMARK
PRINCIPAL REGISTER**

TECHNICAL COMFORT SYSTEM

HALO INNOVATIONS, INC. (MINNESOTA CORPORATION)
111 CHESHIRE LANE, SUITE 700
MINNETONKA, MN 55305

FOR: CLOTHING, NAMELY, ACTIVE WEAR FOR INFANTS AND CHILDREN, NAMELY, ONE PIECE GARMENTS, BODYSUITS, COVERALLS, PANTS; INFANT AND CHILDREN SLEEPWEAR, IN CLASS 25 (U.S. CLS. 22 AND 39).

FIRST USE 9-7-2007; IN COMMERCE 9-7-2007.

THE MARK CONSISTS OF STANDARD CHARACTERS WITHOUT CLAIM TO ANY PARTICULAR FONT, STYLE, SIZE, OR COLOR.

SN 77-288,174, FILED 9-25-2007.

MARLENE BELL, EXAMINING ATTORNEY

Int. Cl.: 41

Prior U.S. Cls.: 100, 101, and 107

United States Patent and Trademark Office

Reg. No. 3,522,076

Registered Oct. 21, 2008

**SERVICE MARK
PRINCIPAL REGISTER**

FIND&GOSEEK

CALLFLY PRODUCTIONS, LLC (VERMONT
LIMITED LIABILITY COMPANY)
166 SUTTON FARM DRIVE
WILLISTON, VT 05495

FOR: PROVIDING ADVICE AND INFORMATION
IN THE FIELD OF REGIONAL FAMILY EDUCA-
TIONAL AND ENTERTAINMENT ACTIVITIES
AND EVENTS FOR CHILDREN VIA GLOBAL COM-
PUTER NETWORK, PROVIDING A WEB SITE
WHERE USERS CAN POST RATINGS, REVIEWS
AND RECOMMENDATIONS ON EVENTS AND
ACTIVITIES IN THE FIELD OF REGIONAL FA-

MILY ENTERTAINMENT AND EDUCATION, IN
CLASS 41 (U.S. CLS. 100, 101 AND 107).

FIRST USE 3-4-2008; IN COMMERCE 3-4-2008.

THE MARK CONSISTS OF STANDARD CHAR-
ACTERS WITHOUT CLAIM TO ANY PARTICULAR
FONT, STYLE, SIZE, OR COLOR.

SN 77-288,184, FILED 9-25-2007.

JASON TURNER, EXAMINING ATTORNEY

Int. Cls.: 16, 36, and 41

Prior U.S. Cls.: 2, 5, 22, 23, 29, 37, 38, 50, 100, 101, 102, and 107

Reg. No. 3,522,077

United States Patent and Trademark Office

Registered Oct. 21, 2008

**TRADEMARK
SERVICE MARK
PRINCIPAL REGISTER**

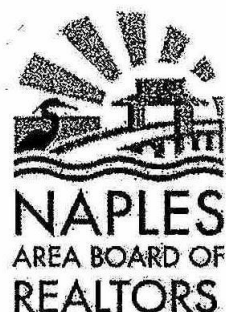

NAPLES AREA BOARD OF REALTORS, INC.
(FLORIDA CORPORATION)
1455 PINE RIDGE ROAD
NAPLES, FL 341092187

FOR: PRINTED MATTER, NAMELY, ASSOCIATION MEMBERSHIP ROSTERS, MAGAZINES FEATURING INFORMATION IN THE AREA OF REAL ESTATE, AND REAL ESTATE TRANSACTION DOCUMENTS, IN CLASS 16 (U.S. CLS. 2, 5, 22, 23, 29, 37, 38 AND 50).

FIRST USE 9-23-2007; IN COMMERCE 9-23-2007.

FOR: REAL ESTATE MULTIPLE LISTING SERVICES ACCESSIBLE VIA THE INTERNET; PROVIDING AN ON-LINE COMPUTER DATABASE OF REAL ESTATE TRANSACTION INFORMATION; PROVIDING INFORMATION ON LOCAL REAL ESTATE NEWS VIA THE INTERNET, IN CLASS 36 (U.S. CLS. 100, 101 AND 102).

FIRST USE 9-23-2007; IN COMMERCE 9-23-2007.

FOR: EDUCATIONAL SERVICES, NAMELY, CONDUCTING SEMINARS AND TRAINING RELATING TO THE PROFESSION OF REAL ESTATE BROKERAGE, IN CLASS 41 (U.S. CLS. 100, 101 AND 107).

FIRST USE 9-23-2007; IN COMMERCE 9-23-2007.

NO CLAIM IS MADE TO THE EXCLUSIVE RIGHT TO USE "NAPLES AREA", APART FROM THE MARK AS SHOWN.

THE MARK CONSISTS OF A BRIDGE WITH AN ARCH OVER A BODY OF WATER, WITH A BIRD ABOUT TO CROSS THE BRIDGE AND THE SUN IN THE BACKGROUND, ALL OVER "NAPLES AREA BOARD OF REALTORS".

SN 77-288,224, FILED 9-25-2007.

BARBARA RUTLAND, EXAMINING ATTORNEY

Int. Cl.: 11

Prior U.S. Cls.: 13, 21, 23, 31, and 34

Reg. No. 3,522,078

United States Patent and Trademark Office

Registered Oct. 21, 2008

**TRADEMARK
PRINCIPAL REGISTER**

nXheat

XALOY INCORPORATED (DELAWARE COR-
PORATION)
1399 COUNTYLINE ROAD
NEW CASTLE, PA 16107

THE MARK CONSISTS OF STANDARD CHAR-
ACTERS WITHOUT CLAIM TO ANY PARTICULAR
FONT, STYLE, SIZE, OR COLOR.

FOR: INDUCTION HEATERS FOR INDUSTRIAL
USE IN THE MOLDING OF PLASTICS, IN CLASS 11
(U.S. CLS. 13, 21, 23, 31 AND 34).

SN 77-288,456, FILED 9-25-2007.

FIRST USE 12-7-2007; IN COMMERCE 12-7-2007.

CHARISMA HAMPTON, EXAMINING ATTORNEY

Int. Cls.: 35, 36, 37, 39, and 42

Prior U.S. Cls.: 100, 101, 102, 103, 105, and 106

United States Patent and Trademark Office

Reg. No. 3,522,079

Registered Oct. 21, 2008

SERVICE MARK
PRINCIPAL REGISTER



MANHEIM AUCTIONS INC. (DELAWARE CORPORATION)
6205 PEACHTREE DUNWOODY ROAD
ATLANTA, GA 30328

FOR: AUTOMOBILE AUCTION SERVICES; AUTOMOBILE AUCTION SERVICES PROVIDED VIA THE INTERNET, IN CLASS 35 (U.S. CLS. 100, 101 AND 102).

FIRST USE 6-20-2008; IN COMMERCE 6-20-2008.

FOR: AUTOMOBILE FINANCING SERVICES, IN CLASS 36 (U.S. CLS. 100, 101 AND 102).

FIRST USE 6-20-2008; IN COMMERCE 6-20-2008.

FOR: AUTOMOTIVE DETAILING, RECONDITIONING, REPAIR, CONVERSION AND CUSTOMIZATION SERVICES, IN CLASS 37 (U.S. CLS. 100, 103 AND 106).

FIRST USE 6-20-2008; IN COMMERCE 6-20-2008.

FOR: BUSINESS-TO-BUSINESS AUTOMOTIVE TRANSPORTATION AND STORAGE SERVICES, IN CLASS 39 (U.S. CLS. 100 AND 105).

FIRST USE 6-20-2008; IN COMMERCE 6-20-2008.

FOR: AUTOMOBILE INSPECTION SERVICES, IN CLASS 42 (U.S. CLS. 100 AND 101).

FIRST USE 6-20-2008; IN COMMERCE 6-20-2008.

OWNER OF U.S. REG. NOS. 1,699,332, 3,075,304, AND 3,229,428.

NO CLAIM IS MADE TO THE EXCLUSIVE RIGHT TO USE "CALIFORNIA", APART FROM THE MARK AS SHOWN.

THE COLOR(S) GOLD, BLUE, YELLOW, BROWN, BLACK, GREY AND WHITE IS/ARE CLAIMED AS A FEATURE OF THE MARK.

THE MARK CONSISTS OF GOLD "M" OVER A BLUE CIRCULAR BACKGROUND AND WITHIN TWO GOLD OUTER RINGS. THE COLOR BROWN OUTLINES THE MARK. TO THE RIGHT OF THE "M" IS THE WORD "MANHEIM" IN THE COLOR BLACK. A BLACK LINE SEPARATES THE ABOVE DESIGN AND THE WORD "MANHEIM" AND THE WORD "CALIFORNIA" IN THE COLOR BLACK AND DESIGN OF A SUN IN THE COLOR WHITE ON A YELLOW BACKGROUND, INSIDE CONCENTRIC WHITE AND GREY SQUARES TO THE RIGHT OF THE WORD "CALIFORNIA".

SN 77-288,593, FILED 9-25-2007.

GRETTA YAO, EXAMINING ATTORNEY

Int. Cl.: 2

Prior U.S. Cls.: 6, 11, and 16

United States Patent and Trademark Office

Reg. No. 3,522,080

Registered Oct. 21, 2008

**TRADEMARK
PRINCIPAL REGISTER**

BARRISURF

IMERYS PIGMENTS INC. (GEORGIA CORPORATION)
100 MANSELL COURT, SUITE 300
ROSWELL, GA 30076

THE MARK CONSISTS OF STANDARD CHARACTERS WITHOUT CLAIM TO ANY PARTICULAR FONT, STYLE, SIZE, OR COLOR.

FOR: PIGMENTS FOR USE IN COATING PAPER AND PAPERBOARD PRODUCTS, IN CLASS 2 (U.S. CLS. 6, 11 AND 16).

SN 77-289,731, FILED 9-26-2007.

FIRST USE 1-0-2008; IN COMMERCE 5-6-2008.

SKYE YOUNG, EXAMINING ATTORNEY

Int. Cls.: 9 and 25

Prior U.S. Cls.: 21, 22, 23, 26, 36, 38, and 39

United States Patent and Trademark Office

Reg. No. 3,522,081

Registered Oct. 21, 2008

**TRADEMARK
PRINCIPAL REGISTER**

RAEN

RAEN EYEWEAR LLC (CALIFORNIA LIMITED
LIABILITY COMPANY)
SUITE 6
364 2ND STREET
ENCINITAS, CA 92024

FOR: EYEWEAR, NAMELY, EYEGLASSES, SUN-
GLASSES, SPECTACLES, SPORT GOGGLES, AND
THEIR PARTS AND ACCESSORIES, NAMELY, RE-
PLACEMENT LENSES, FRAMES, AND CASES SPE-
CIALY ADAPTED FOR EYEWEAR, IN CLASS 9
(U.S. CLS. 21, 23, 26, 36 AND 38).

FIRST USE 2-0-2008; IN COMMERCE 2-0-2008.

FOR: CLOTHING AND ACCESSORIES, NAMELY,
T-SHIRTS, SHIRTS, WOVEN SHIRTS, KNIT SHIRTS,

PANTS, JEANS, SLACKS, SHORTS, JACKETS, HATS,
SWEATSHIRTS, SWEATPANTS, SWIMWEAR,
SOCKS, AND BELTS, IN CLASS 25 (U.S. CLS. 22
AND 39).

FIRST USE 2-0-2008; IN COMMERCE 2-0-2008.

THE MARK CONSISTS OF STANDARD CHAR-
ACTERS WITHOUT CLAIM TO ANY PARTICULAR
FONT, STYLE, SIZE, OR COLOR.

SN 77-289,774, FILED 9-26-2007.

JOHN SCHUYLER YARD, EXAMINING ATTOR-
NEY

Int. Cls.: 9, 10, and 35

Prior U.S. Cls.: 21, 23, 26, 36, 38, 39, 44, 100, 101, and 102

Reg. No. 3,522,082

United States Patent and Trademark Office

Registered Oct. 21, 2008

**TRADEMARK
SERVICE MARK
PRINCIPAL REGISTER**

AttenuTech

K&R MEDICAL, LLC (FLORIDA LIMITED LIABILITY COMPANY)
23110 STATE ROAD 54, #364
LUTZ, FL 33549

FOR: PROTECTIVE EYEWEAR; SAFETY EYEWEAR; SAFETY GOGGLES, IN CLASS 9 (U.S. CLS. 21, 23, 26, 36 AND 38).

FIRST USE 4-15-2008; IN COMMERCE 4-15-2008.

FOR: PROTECTIVE GLOVES FOR MEDICAL USE, IN CLASS 10 (U.S. CLS. 26, 39 AND 44).

FIRST USE 10-4-2007; IN COMMERCE 10-4-2007.

FOR: ON-LINE RETAIL STORE SERVICES FEATURING PERSONAL PROTECTION FOR HEALTHCARE PROFESSIONALS, NAMELY, RADIATION PROTECTIVE EYEWEAR, LASER PROTECTIVE

EYEWEAR, SAFETY EYEWEAR AND GOGGLES, AND RADIATION REDUCING GLOVES; WHOLESALE ORDERING SERVICES IN THE FIELD OF PERSONAL PROTECTION FOR HEALTHCARE PROFESSIONALS, NAMELY, RADIATION PROTECTIVE EYEWEAR, LASER PROTECTIVE EYEWEAR, SAFETY EYEWEAR AND GOGGLES, AND RADIATION REDUCING GLOVES, IN CLASS 35 (U.S. CLS. 100, 101 AND 102).

FIRST USE 9-15-2007; IN COMMERCE 9-15-2007.

THE MARK CONSISTS OF STANDARD CHARACTERS WITHOUT CLAIM TO ANY PARTICULAR FONT, STYLE, SIZE, OR COLOR.

SN 77-290,169, FILED 9-27-2007.

DANIEL CAPSHAW, EXAMINING ATTORNEY

Int. Cl.: 45

Prior U.S. Cls.: 100 and 101

United States Patent and Trademark Office

Reg. No. 3,522,083

Registered Oct. 21, 2008

**SERVICE MARK
PRINCIPAL REGISTER**

WE DO DEALS

RUTTER HOBBS & DAVIDOFF INCORPORATED
(CALIFORNIA CORPORATION)
SUITE 1700
1901 AVENUE OF THE STARS
LOS ANGELES, CA 90067

THE MARK CONSISTS OF STANDARD CHAR-
ACTERS WITHOUT CLAIM TO ANY PARTICULAR
FONT, STYLE, SIZE, OR COLOR.

FOR: LEGAL SERVICES, IN CLASS 45 (U.S. CLS.
100 AND 101).

SN 77-290,453, FILED 9-27-2007.

FIRST USE 8-15-2008; IN COMMERCE 8-15-2008.

JILL PRATER, EXAMINING ATTORNEY

Int. Cl.: 45

Prior U.S. Cls.: 100 and 101

United States Patent and Trademark Office

Reg. No. 3,522,084

Registered Oct. 21, 2008

**SERVICE MARK
PRINCIPAL REGISTER**

**WINNING STRATEGIES IN
BOARDROOMS AND COURTROOMS**

RUTTER HOBBS & DAVIDOFF INCORPORATED
(CALIFORNIA CORPORATION)
SUITE 1700
1901 AVENUE OF THE STARS
LOS ANGELES, CA 90067

THE MARK CONSISTS OF STANDARD CHAR-
ACTERS WITHOUT CLAIM TO ANY PARTICULAR
FONT, STYLE, SIZE, OR COLOR.

FOR: LEGAL SERVICES, IN CLASS 45 (U.S. CLS.
100 AND 101).

SN 77-290,466, FILED 9-27-2007.

FIRST USE 8-15-2008; IN COMMERCE 8-15-2008.

JILL PRATER, EXAMINING ATTORNEY

Int. Cl.: 41

Prior U.S. Cls.: 100, 101, and 107

United States Patent and Trademark Office

Reg. No. 3,522,085

Registered Oct. 21, 2008

**SERVICE MARK
PRINCIPAL REGISTER**

SHOWCASE LIVE

NATIONAL AMUSEMENTS, INC. (MARYLAND
CORPORATION)
200 ELM STREET
DEDHAM, MA 02026

OWNER OF U.S. REG. NOS. 813,680, 2,536,406,
AND 2,946,551.

FOR: PROVIDING FACILITIES FOR ENTERTAINMENT SERVICES, IN CLASS 41 (U.S. CLS. 100, 101 AND 107).

NO CLAIM IS MADE TO THE EXCLUSIVE RIGHT TO USE "LIVE", APART FROM THE MARK AS SHOWN.

FIRST USE 4-0-2008; IN COMMERCE 4-0-2008.

SN 77-290,640, FILED 9-27-2007.

THE MARK CONSISTS OF STANDARD CHARACTERS WITHOUT CLAIM TO ANY PARTICULAR FONT, STYLE, SIZE, OR COLOR.

NICHOLAS ALTREE, EXAMINING ATTORNEY

Int. Cl.: 43

Prior U.S. Cls.: 100 and 101

United States Patent and Trademark Office

Reg. No. 3,522,086

Registered Oct. 21, 2008

**SERVICE MARK
PRINCIPAL REGISTER**

FRANKIE'S SCALOPPINE

LETTUCE ENTERTAIN YOU ENTERPRISES,
INC. (ILLINOIS CORPORATION)
5419 NORTH SHERIDAN ROAD
CHICAGO, IL 60640

FOR: RESTAURANT SERVICES, IN CLASS 43
(U.S. CLS. 100 AND 101).

FIRST USE 2-20-2008; IN COMMERCE 2-20-2008.

THE MARK CONSISTS OF STANDARD CHAR-
ACTERS WITHOUT CLAIM TO ANY PARTICULAR
FONT, STYLE, SIZE, OR COLOR.

NO CLAIM IS MADE TO THE EXCLUSIVE
RIGHT TO USE "SCALOPPINE", APART FROM
THE MARK AS SHOWN.

THE NAME(S), PORTRAIT(S), AND/OR SIGNA-
TURE(S) SHOWN IN THE MARK DOES NOT IDEN-
TIFY A PARTICULAR LIVING INDIVIDUAL.

SN 77-290,668, FILED 9-27-2007.

SEAN CROWLEY, EXAMINING ATTORNEY

Int. Cls.: 1 and 42

Prior U.S. Cls.: 1, 5, 6, 10, 26, 46, 100, and 101

United States Patent and Trademark Office

Reg. No. 3,522,087

Registered Oct. 21, 2008

**TRADEMARK
SERVICE MARK
PRINCIPAL REGISTER**

Drug Discovery Anywhere

CHEMDIV, INC (WISCONSIN CORPORATION),
DBA CHEMICAL DIVERSITY,
6605 NANCY RIDGE DRIVE
SAN DIEGO, CA 92121

FOR: CHEMICAL REAGENTS FOR NON-MEDICAL PURPOSES; REAGENT FOR CHEMICAL ANALYSES; REAGENTS FOR USE IN SCIENTIFIC APPARATUS FOR CHEMICAL OR BIOLOGICAL ANALYSIS, IN CLASS 1 (U.S. CLS. 1, 5, 6, 10, 26 AND 46).

FIRST USE 2-1-2007; IN COMMERCE 2-1-2007.

FOR: ANALYSIS OF THE MODE OF ACTION OF CHEMICAL COMBINATIONS ON ANIMALS; CHEMICAL ANALYSIS; CHEMICAL LABORATORIES; CHEMICAL RESEARCH; CHEMICAL, BIOCHEMICAL, BIOLOGICAL AND BACTERIOLOGICAL RESEARCH AND ANALYSIS; DEVELOPMENT AND TEST OF CHEMICAL PRODUCTION METHODS;

DEVELOPMENT OF PHARMACEUTICAL PREPARATIONS AND MEDICINES; PHARMACEUTICAL DRUG DEVELOPMENT SERVICES; PHARMACEUTICAL RESEARCH AND DEVELOPMENT; PHARMACEUTICAL RESEARCH SERVICES; RESEARCH AND DEVELOPMENT FOR NEW PRODUCTS FOR OTHERS; RESEARCH ON THE SUBJECT OF PHARMACEUTICALS; SCIENTIFIC RESEARCH AND DEVELOPMENT, IN CLASS 42 (U.S. CLS. 100 AND 101).

FIRST USE 2-1-2007; IN COMMERCE 2-1-2007.

THE MARK CONSISTS OF STANDARD CHARACTERS WITHOUT CLAIM TO ANY PARTICULAR FONT, STYLE, SIZE, OR COLOR.

SN 77-290,903, FILED 9-27-2007.

ROSELLE HERRERA, EXAMINING ATTORNEY

Int. Cl.: 32

Prior U.S. Cls.: 45, 46, and 48

United States Patent and Trademark Office

Reg. No. 3,522,088

Registered Oct. 21, 2008

**TRADEMARK
PRINCIPAL REGISTER**

THIS CHANGES JUICE

TROPICANA PRODUCTS, INC. (DELAWARE
CORPORATION)
1001 13TH AVENUE EAST
BRADENTON, FL 34208

THE MARK CONSISTS OF STANDARD CHAR-
ACTERS WITHOUT CLAIM TO ANY PARTICULAR
FONT, STYLE, SIZE, OR COLOR.

FOR: FRUIT JUICES AND FRUIT JUICE
DRINKS, IN CLASS 32 (U.S. CLS. 45, 46 AND 48).

SN 77-291,252, FILED 9-28-2007.

FIRST USE 2-18-2008; IN COMMERCE 2-18-2008.

TERESA M. RUPP, EXAMINING ATTORNEY

Int. Cl.: 10

Prior U.S. Cls.: 26, 39, and 44

United States Patent and Trademark Office

Reg. No. 3,522,089

Registered Oct. 21, 2008

**TRADEMARK
PRINCIPAL REGISTER**

VENTURI

TALLEY GROUP, LTD. (UNITED KINGDOM
PRIVATE LIMITED COMPANY)
ABBAY INDUSTRIAL PARK
1 PREMIER WAY
ROMSEY, HANTS, UNITED KINGDOM SO519DQ

FOR: VACUUM PUMPS FOR APPLYING NEGA-
TIVE PRESSURE TO PATIENTS; DRAINAGE CAN-
ISTERS FOR USE WITH THE VACUUM PUMPS TO
COLLECT EXUDATES, AND CONNECTION TUB-
ING, IN CLASS 10 (U.S. CLS. 26, 39 AND 44).

FIRST USE 6-1-2007; IN COMMERCE 7-18-2008.

THE MARK CONSISTS OF STANDARD CHAR-
ACTERS WITHOUT CLAIM TO ANY PARTICULAR
FONT, STYLE, SIZE, OR COLOR.

SN 77-291,485, FILED 9-28-2007.

LINDA MICKLEBURGH, EXAMINING ATTORNEY

Int. Cls.: 9 and 16

Prior U.S. Cls.: 2, 5, 21, 22, 23, 26, 29, 36, 37, 38, and 50

Reg. No. 3,522,090

United States Patent and Trademark Office

Registered Oct. 21, 2008

**TRADEMARK
PRINCIPAL REGISTER**

FATHER MARTIN

KELLY PRODUCTIONS, INC. (MARYLAND CORPORATION)
218 FULFORD AVENUE
BEL AIR, MD 21014

FOR: AUDIO AND VIDEO RECORDINGS FEATURING INFORMATION ON SUBSTANCE ABUSE EDUCATION, IN CLASS 9 (U.S. CLS. 21, 23, 26, 36 AND 38).

FIRST USE 1-31-1973; IN COMMERCE 1-31-1973.

FOR: PRINTED INSTRUCTIONAL, EDUCATIONAL, AND TEACHING MATERIALS FEATURING INFORMATION ON SUBSTANCE ABUSE EDUCATION, IN CLASS 16 (U.S. CLS. 2, 5, 22, 23, 29, 37, 38 AND 50).

FIRST USE 1-31-1973; IN COMMERCE 1-31-1973.

THE MARK CONSISTS OF STANDARD CHARACTERS WITHOUT CLAIM TO ANY PARTICULAR FONT, STYLE, SIZE, OR COLOR.

THE NAME "FATHER MARTIN" IDENTIFIES A LIVING INDIVIDUAL WHOSE CONSENT IS OF RECORD.

SN 77-291,489, FILED 9-28-2007.

SKYE YOUNG, EXAMINING ATTORNEY

Int. Cl.: 29

Prior U.S. Cl.: 46

United States Patent and Trademark Office

Reg. No. 3,522,091

Registered Oct. 21, 2008

**TRADEMARK
PRINCIPAL REGISTER**

PALAZZINA

SCHRATTER FOODS INCORPORATED (DELA-
WARE CORPORATION)
149 NEW DUTCH LANE
FAIRFIELD, NJ 07004

THE FOREIGN WORDING IN THE MARK
TRANSLATES INTO ENGLISH AS LITTLE PLACE
OR VILLAGE.

FOR: CHEESE, IN CLASS 29 (U.S. CL. 46).

FIRST USE 3-20-2008; IN COMMERCE 3-20-2008.

SN 77-291,684, FILED 9-28-2007.

THE MARK CONSISTS OF STANDARD CHAR-
ACTERS WITHOUT CLAIM TO ANY PARTICULAR
FONT, STYLE, SIZE, OR COLOR.

AMY HELLA, EXAMINING ATTORNEY

Int. Cl.: 36

Prior U.S. Cls.: 100, 101, and 102

United States Patent and Trademark Office

Reg. No. 3,522,092

Registered Oct. 21, 2008

**SERVICE MARK
PRINCIPAL REGISTER**



SHARE OUR STRENGTH (D.C. CORPORATION)
1730 M STREET, NW, SUITE 700
WASHINGTON, DC 20036

FOR: CHARITABLE FUNDRAISING SERVICES,
IN CLASS 36 (U.S. CLS. 100, 101 AND 102).

FIRST USE 10-30-2007; IN COMMERCE 11-19-2007.

THE MARK CONSISTS OF AN APPLE CORE
THAT ALSO FORMS SILHOUETTES OF AN ADULT
AND CHILD FACING ONE ANOTHER.

SN 77-291,762, FILED 9-28-2007.

LINDA E. BLOHM, EXAMINING ATTORNEY

Int. Cl.: 36

Prior U.S. Cls.: 100, 101, and 102

United States Patent and Trademark Office

Reg. No. 3,522,093

Registered Oct. 21, 2008

**SERVICE MARK
PRINCIPAL REGISTER**

THE GREAT AMERICAN DINE OUT

SHARE OUR STRENGTH (D.C. CORPORATION)
1730 M STREET, NW, SUITE 700
WASHINGTON, DC 20036

FOR: CHARITABLE FUNDRAISING SERVICES,
IN CLASS 36 (U.S. CLS. 100, 101 AND 102).

FIRST USE 10-30-2007; IN COMMERCE 4-1-2008.

THE MARK CONSISTS OF STANDARD CHARACTERS WITHOUT CLAIM TO ANY PARTICULAR FONT, STYLE, SIZE, OR COLOR.

NO CLAIM IS MADE TO THE EXCLUSIVE RIGHT TO USE "DINE OUT", APART FROM THE MARK AS SHOWN.

SN 77-291,773, FILED 9-28-2007.

LINDA E. BLOHM, EXAMINING ATTORNEY

Int. Cl.: 25

Prior U.S. Cls.: 22 and 39

United States Patent and Trademark Office

Reg. No. 3,522,094

Registered Oct. 21, 2008

**TRADEMARK
PRINCIPAL REGISTER**

SIGNATURE WRAP DRESS

BUTTER BY NADIA LLC (NEW YORK LIMITED
LIABILITY COMPANY)

405 VAN BRUNT STREET

BROOKLYN, NY 11231

FOR: DRESSES, IN CLASS 25 (U.S. CLS. 22 AND
39).

FIRST USE 9-0-2007; IN COMMERCE 9-0-2007.

THE MARK CONSISTS OF STANDARD CHAR-
ACTERS WITHOUT CLAIM TO ANY PARTICULAR
FONT, STYLE, SIZE, OR COLOR.

NO CLAIM IS MADE TO THE EXCLUSIVE
RIGHT TO USE "WRAP DRESS", APART FROM
THE MARK AS SHOWN.

SN 77-291,843, FILED 9-28-2007.

STEVEN R. FOSTER, EXAMINING ATTORNEY

Int. Cls.: 9 and 41

Prior U.S. Cls.: 21, 23, 26, 36, 38, 100, 101, and 107

United States Patent and Trademark Office

Reg. No. 3,522,095

Registered Oct. 21, 2008

**TRADEMARK
SERVICE MARK
PRINCIPAL REGISTER**

The Starry Eyes

ALEXIS HEBERT (UNITED STATES INDIVIDUAL), DBA ALEX HEBERT,
APT 12
4321 COLFAX AVE
STUDIO CITY, CA 91604

FOR: AUDIO RECORDINGS FEATURING MUSIC; DOWNLOADABLE MP3 FILES, MP3 RECORDINGS, ONLINE DISCUSSION BOARDS, WEBCASTS AND PODCASTS FEATURING MUSIC, AUDIO BOOKS AND NEWS BROADCASTS; DOWNLOADABLE MUSICAL SOUND RECORDINGS; MUSICAL SOUND RECORDINGS; SOUND RECORDINGS FEATURING MUSIC; VIDEO RECORDINGS FEATURING MUSIC; VISUAL RECORDINGS AND AUDIO VISUAL RECORDINGS FEATURING MUSIC AND ANIMATION, IN CLASS 9 (U.S. CLS. 21, 23, 26, 36 AND 38).

FIRST USE 4-11-2008; IN COMMERCE 4-11-2008.

FOR: ENTERTAINMENT, NAMELY, LIVE PERFORMANCES BY A MUSICAL BAND; ENTERTAINMENT SERVICES, NAMELY, AN ONLINE ACTIVITY WHERE YOU CREATE YOUR OWN MUSIC VIDEOS; ENTERTAINMENT SERVICES, NAMELY, PROVIDING A WEB SITE FEATURING MUSICAL PERFORMANCES, MUSICAL VIDEOS,

RELATED FILM CLIPS, PHOTOGRAPHS, AND OTHER MULTIMEDIA MATERIALS; ENTERTAINMENT SERVICES, NAMELY, PROVIDING PRERECORDED MUSIC, INFORMATION IN THE FIELD OF MUSIC, AND COMMENTARY AND ARTICLES ABOUT MUSIC, ALL ON-LINE VIA A GLOBAL COMPUTER NETWORK; ENTERTAINMENT, NAMELY, LIVE MUSIC CONCERTS; ENTERTAINMENT, NAMELY, LIVE PERFORMANCES BY MUSICAL BANDS; ENTERTAINMENT, NAMELY, LIVE PERFORMANCES BY ROCK GROUPS; MUSIC COMPOSITION AND TRANSCRIPTION FOR OTHERS; MUSIC COMPOSITION FOR OTHERS; PRODUCTION OF SOUND AND MUSIC VIDEO RECORDINGS, IN CLASS 41 (U.S. CLS. 100, 101 AND 107).

FIRST USE 4-11-2008; IN COMMERCE 4-11-2008.

THE MARK CONSISTS OF STANDARD CHARACTERS WITHOUT CLAIM TO ANY PARTICULAR FONT, STYLE, SIZE, OR COLOR.

SN 77-292,286, FILED 9-29-2007.

JOHN WILKE, EXAMINING ATTORNEY

Int. Cl.: 35

Prior U.S. Cls.: 100, 101, and 102

United States Patent and Trademark Office

Reg. No. 3,522,096

Registered Oct. 21, 2008

**SERVICE MARK
PRINCIPAL REGISTER**

ARMY OF MOMS

ARMY OF MOMS, INC. (TEXAS CORPORATION)
SUITE 14
5247 BURNET ROAD
AUSTIN, TX 78756

THE MARK CONSISTS OF STANDARD CHAR-
ACTERS WITHOUT CLAIM TO ANY PARTICULAR
FONT, STYLE, SIZE, OR COLOR.

FOR: EMPLOYMENT AGENCIES, IN CLASS 35
(U.S. CLS. 100, 101 AND 102).

SN 77-292,488, FILED 10-1-2007.

FIRST USE 1-30-2008; IN COMMERCE 1-30-2008.

KEVIN DINALLO, EXAMINING ATTORNEY

Int. Cl.: 20

Prior U.S. Cls.: 2, 13, 22, 25, 32, and 50

United States Patent and Trademark Office

Reg. No. 3,522,097

Registered Oct. 21, 2008

TRADEMARK
PRINCIPAL REGISTER



CHRISTMAS PLACE, INC. (TENNESSEE CORPORATION)
2470 PARKWAY, PO BOX 958
PIGEON FORGE, TN 37868

FOR: BEDS, NAMELY, MATTRESSES AND BOX SPRINGS, IN CLASS 20 (U.S. CLS. 2, 13, 22, 25, 32 AND 50).

FIRST USE 8-13-2008; IN COMMERCE 8-13-2008.

OWNER OF U.S. REG. NOS. 2,006,068, 3,328,868, AND OTHERS.

NO CLAIM IS MADE TO THE EXCLUSIVE RIGHT TO USE "ULTIMATE LUXURY CREATED EXCLUSIVELY FOR" AND "PIGEON FORGE, TENNESSEE", APART FROM THE MARK AS SHOWN.

THE MARK CONSISTS OF AN OVAL HAVING AT AN UPPER LOCATION A DRAWING OF A HOTEL, THE WORDS "SLEEP IN HEAVENLY PEACE" UNDER THE DRAWING AND A LOGO OF "THE INN AT CHRISTMAS PLACE" THEREUNDER.

SN 77-292,586, FILED 10-1-2007.

LINDA MICKLEBURGH, EXAMINING ATTORNEY

Int. Cl.: 16

Prior U.S. Cls.: 2, 5, 22, 23, 29, 37, 38, and 50

Reg. No. 3,522,098

United States Patent and Trademark Office

Registered Oct. 21, 2008

**TRADEMARK
PRINCIPAL REGISTER**

BAGABILLIA

LEAKEY, TERESA (UNITED STATES INDIVIDUAL)
6126 HILLSIDE LANE
GARLAND, TX 75043 AND
BARRS, PETRA JO (UNITED STATES INDIVIDUAL)
1449 ALTA MESA
MESQUITE, TX 75150

FIRST USE 1-0-2008; IN COMMERCE 1-0-2008.

THE MARK CONSISTS OF STANDARD CHARACTERS WITHOUT CLAIM TO ANY PARTICULAR FONT, STYLE, SIZE, OR COLOR.

SN 77-292,673, FILED 10-1-2007.

FOR: FABRIC BAGS FOR GIFTS, CARDS, MONEY, LINGERIE AND TOYS, IN CLASS 16 (U.S. CLS. 2, 5, 22, 23, 29, 37, 38 AND 50).

KAREN BRACEY, EXAMINING ATTORNEY

Int. Cl.: 36

Prior U.S. Cls.: 100, 101, and 102

United States Patent and Trademark Office

Reg. No. 3,522,099

Registered Oct. 21, 2008

**SERVICE MARK
PRINCIPAL REGISTER**

Woofminster Dog Show

PLANET VENTURES, INC. (MAINE CORPORATION)

49 YORK ST.

PORTLAND, ME 04101

FOR: CHARITABLE FUND RAISING, IN CLASS
36 (U.S. CLS. 100, 101 AND 102).

FIRST USE 8-1-2005; IN COMMERCE 8-1-2005.

THE MARK CONSISTS OF STANDARD CHARACTERS WITHOUT CLAIM TO ANY PARTICULAR FONT, STYLE, SIZE, OR COLOR.

NO CLAIM IS MADE TO THE EXCLUSIVE RIGHT TO USE "DOG SHOW", APART FROM THE MARK AS SHOWN.

SN 77-292,817, FILED 10-1-2007.

LAURA KOVALSKY, EXAMINING ATTORNEY

Int. Cl.: 19

Prior U.S. Cls.: 1, 12, 33, and 50

United States Patent and Trademark Office

Reg. No. 3,522,100

Registered Oct. 21, 2008

**TRADEMARK
PRINCIPAL REGISTER**

PALAZZO

MASONITE INTERNATIONAL CORPORATION
(CANADA CORPORATION)
1820 MATHESON BOULEVARD, UNIT B4
MISSISSAUGA, CANADA L4W 0B3

FOR: NON-METAL DOORS, IN CLASS 19 (U.S.
CLS. 1, 12, 33 AND 50).

FIRST USE 3-1-2003; IN COMMERCE 9-3-2008.

THE MARK CONSISTS OF STANDARD CHAR-
ACTERS WITHOUT CLAIM TO ANY PARTICULAR
FONT, STYLE, SIZE, OR COLOR.

OWNER OF U.S. REG. NO. 2,861,089.

SN 77-293,055, FILED 10-1-2007.

BRIDGETT SMITH, EXAMINING ATTORNEY

Int. Cl.: 31

Prior U.S. Cls.: 1 and 46

United States Patent and Trademark Office

Reg. No. 3,522,101

Registered Oct. 21, 2008

TRADEMARK
PRINCIPAL REGISTER

before B.G. grain

MERRICK PET CARE, INC. (TEXAS CORPORATION)

P.O. BOX 9800

AMARILLO, TX 79105

FOR: PET FOOD, IN CLASS 31 (U.S. CLS. 1 AND 46).

FIRST USE 2-16-2008; IN COMMERCE 3-15-2008.

NO CLAIM IS MADE TO THE EXCLUSIVE RIGHT TO USE "GRAIN", APART FROM THE MARK AS SHOWN.

THE MARK CONSISTS OF THE WORDS "BEFORE B.G. GRAIN" IN STYLIZED SCRIPT.

SN 77-293,723, FILED 10-2-2007.

INGRID C. EULIN, EXAMINING ATTORNEY

Int. Cl.: 25

Prior U.S. Cls.: 22 and 39

United States Patent and Trademark Office

Reg. No. 3,522,102

Registered Oct. 21, 2008

**TRADEMARK
PRINCIPAL REGISTER**

SLEEK ONE

J. C. PENNEY PRIVATE BRANDS, INC. (DELA-
WARE CORPORATION)
6501 LEGACY DRIVE
PLANO, TX 750243698

THE MARK CONSISTS OF STANDARD CHAR-
ACTERS WITHOUT CLAIM TO ANY PARTICULAR
FONT, STYLE, SIZE, OR COLOR.

FOR: BRAS, IN CLASS 25 (U.S. CLS. 22 AND 39).

SN 77-293,947, FILED 10-2-2007.

FIRST USE 7-1-2008; IN COMMERCE 7-1-2008.

JIM RINGLE, EXAMINING ATTORNEY

Int. Cl.: 28

Prior U.S. Cls.: 22, 23, 38, and 50

United States Patent and Trademark Office

Reg. No. 3,522,103

Registered Oct. 21, 2008

**TRADEMARK
PRINCIPAL REGISTER**

FLIGHTWIRE

FIRSTSTRING, LLC (DELAWARE LIMITED LIABILITY COMPANY)
PO BOX 850965
RICHARDSON, TX 75085

FOR: ARCHERY EQUIPMENT, NAMELY, BOW STRINGS, NON-TELESCOPIC BOW SIGHTS, AND DEVICES FOR REDUCING THE SOUND AND VIBRATION OF A BOW STRING, IN CLASS 28 (U.S. CLS. 22, 23, 38 AND 50).

FIRST USE 4-28-2008; IN COMMERCE 4-28-2008.

THE MARK CONSISTS OF STANDARD CHARACTERS WITHOUT CLAIM TO ANY PARTICULAR FONT, STYLE, SIZE, OR COLOR.

SN 77-294,309, FILED 10-2-2007.

GIANCARLO CASTRO, EXAMINING ATTORNEY

Int. Cl.: 44

Prior U.S. Cls.: 100 and 101

United States Patent and Trademark Office

Reg. No. 3,522,104

Registered Oct. 21, 2008

**SERVICE MARK
PRINCIPAL REGISTER**

**Your Neighborhood Lawn
Care Professional**

SPRING-GREEN LAWN CARE CORP. (DELA-
WARE CORPORATION)
11909 SPAULDING SCHOOL DRIVE
PLAINFIELD, IL 60585

FOR: LANDSCAPING, LAWN CARE AND TREE
CARE SERVICES, NAMELY, LAWN MAINTENANCE,
LAWN FERTILIZATION, TREE FERTILIZATION,
WEED CONTROL, AND SPREADING AGRICULTURAL
CHEMICALS FOR CONTROL OF INSECTS, IN CLASS
44 (U.S. CLS. 100 AND 101).

FIRST USE 8-28-2008; IN COMMERCE 8-28-2008.

THE MARK CONSISTS OF STANDARD CHARACTERS
WITHOUT CLAIM TO ANY PARTICULAR FONT,
STYLE, SIZE, OR COLOR.

OWNER OF U.S. REG. NO. 2,812,235.

NO CLAIM IS MADE TO THE EXCLUSIVE
RIGHT TO USE "LAWN CARE PROFESSIONAL",
APART FROM THE MARK AS SHOWN.

SN 77-294,733, FILED 10-3-2007.

SHARON MEIER, EXAMINING ATTORNEY

Int. Cl.: 37

Prior U.S. Cls.: 100, 103, and 106

United States Patent and Trademark Office

Reg. No. 3,522,105

Registered Oct. 21, 2008

**SERVICE MARK
PRINCIPAL REGISTER**

MYBONEYARD

YOUNG AMERICA CORPORATION (MINNESOTA CORPORATION)
717 FAXON ROAD
YOUNG AMERICA, MN 55397

THE MARK CONSISTS OF STANDARD CHARACTERS WITHOUT CLAIM TO ANY PARTICULAR FONT, STYLE, SIZE, OR COLOR.

FOR: COLLECTION OF COMPUTERS, PHONES, AND ELECTRONIC DEVICES FOR RECYCLING, IN CLASS 37 (U.S. CLS. 100, 103 AND 106).

SN 77-294,754, FILED 10-3-2007.

FIRST USE 1-23-2008; IN COMMERCE 1-23-2008.

STEVEN PEREZ, EXAMINING ATTORNEY

Int. Cl.: 40

Prior U.S. Cls.: 100, 103, and 106

United States Patent and Trademark Office

Reg. No. 3,522,106

Registered Oct. 21, 2008

**SERVICE MARK
PRINCIPAL REGISTER**

MYBONEYARD

YOUNG AMERICA CORPORATION (MINNESOTA CORPORATION)
717 FAXON ROAD
YOUNG AMERICA, MN 55397

THE MARK CONSISTS OF STANDARD CHARACTERS WITHOUT CLAIM TO ANY PARTICULAR FONT, STYLE, SIZE, OR COLOR.

FOR: RECYCLING SERVICES, NAMELY, PROVIDING A RECYCLING PROGRAM FOR COMPUTERS, PHONES, AND ELECTRONIC DEVICES, IN CLASS 40 (U.S. CLS. 100, 103 AND 106).

SN 77-294,761, FILED 10-3-2007.

FIRST USE 1-23-2008; IN COMMERCE 1-23-2008.

STEVEN PEREZ, EXAMINING ATTORNEY

Int. Cls.: 18 and 25

Prior U.S. Cls.: 1, 2, 3, 22, 39, and 41

United States Patent and Trademark Office

Reg. No. 3,522,107

Registered Oct. 21, 2008

**TRADEMARK
PRINCIPAL REGISTER**

GREEN PALMS

CAPPELLI STRAWORLD, INC. (FLORIDA CORPORATION)
5450 N.W. 82ND AVENUE
MIAMI, FL 33166

FOR: HANDBAGS, IN CLASS 18 (U.S. CLS. 1, 2, 3, 22 AND 41).

FIRST USE 7-1-2008; IN COMMERCE 7-1-2008.

FOR: HATS, IN CLASS 25 (U.S. CLS. 22 AND 39).

FIRST USE 7-1-2008; IN COMMERCE 7-1-2008.

THE MARK CONSISTS OF STANDARD CHARACTERS WITHOUT CLAIM TO ANY PARTICULAR FONT, STYLE, SIZE, OR COLOR.

SN 77-294,805, FILED 10-3-2007.

BARBARA BROWN, EXAMINING ATTORNEY

Int. Cl.: 41

Prior U.S. Cls.: 100, 101, and 107

United States Patent and Trademark Office

Reg. No. 3,522,108

Registered Oct. 21, 2008

**SERVICE MARK
PRINCIPAL REGISTER**

JOHNNY ACES

C. B. PRODUCTIONS, LLC (MISSOURI LIMITED
LIABILITY COMPANY)
SUITE 202
118 SOUTHWEST BLVD.
KANSAS CITY, MO 64108

FOR: ENTERTAINMENT SERVICES, NAMELY,
AN ON-GOING SERIES FEATURING CARD PLAY-
ING COMPETITION IN A GAME SHOW FORMAT
BROADCAST THROUGH TELEVISION, SATEL-
LITE, AUDIO AND VIDEO MEDIA, IN CLASS 41
(U.S. CLS. 100, 101 AND 107).

FIRST USE 2-1-2008; IN COMMERCE 2-1-2008.

THE MARK CONSISTS OF STANDARD CHAR-
ACTERS WITHOUT CLAIM TO ANY PARTICULAR
FONT, STYLE, SIZE, OR COLOR.

THE NAME "JOHNNY ACES" DOES NOT IDEN-
TIFY A LIVING INDIVIDUAL.

SN 77-295,331, FILED 10-3-2007.

WILLIAM ROSSMAN, EXAMINING ATTORNEY

Int. Cls.: 9 and 35

Prior U.S. Cls.: 21, 23, 26, 36, 38, 100, 101, and 102

United States Patent and Trademark Office

Reg. No. 3,522,109

Registered Oct. 21, 2008

**TRADEMARK
SERVICE MARK
PRINCIPAL REGISTER**

TOMOPAL

TOMOPAL, INC. (CALIFORNIA CORPORATION)
7485 RUSH RIVER DRIVE, SUITE 710
SACRAMENTO, CA 95831

FOR: DISPENSER SYRINGES FOR LABORATORY USE, IN CLASS 9 (U.S. CLS. 21, 23, 26, 36 AND 38).

FIRST USE 11-19-2007; IN COMMERCE 11-19-2007.

FOR: EXPORT AND IMPORT AGENCIES AND DISTRIBUTORSHIP SERVICES IN THE FIELD OF EQUIPMENT, INSTRUMENTS, AND ACCESSORIES

FOR LABORATORY USE, IN CLASS 35 (U.S. CLS. 100, 101 AND 102).

FIRST USE 9-18-2007; IN COMMERCE 9-18-2007.

THE MARK CONSISTS OF STANDARD CHARACTERS WITHOUT CLAIM TO ANY PARTICULAR FONT, STYLE, SIZE, OR COLOR.

SN 77-295,379, FILED 10-3-2007.

ERNEST SHOSHO, EXAMINING ATTORNEY

Int. Cl.: 11

Prior U.S. Cls.: 13, 21, 23, 31, and 34

United States Patent and Trademark Office

Reg. No. 3,522,110

Registered Oct. 21, 2008

**TRADEMARK
PRINCIPAL REGISTER**

WAVE

FRESH PRODUCTS, LLC (OHIO LIMITED LIABILITY COMPANY)
4010 SOUTH AVENUE
TOLEDO, OH 43615

THE MARK CONSISTS OF STANDARD CHARACTERS WITHOUT CLAIM TO ANY PARTICULAR FONT, STYLE, SIZE, OR COLOR.

FOR: URINAL SCREENS, IN CLASS 11 (U.S. CLS. 13, 21, 23, 31 AND 34).

SN 77-295,756, FILED 10-4-2007.

FIRST USE 11-0-2007; IN COMMERCE 11-0-2007.

MARY MUNSON, EXAMINING ATTORNEY

Int. Cl.: 30

Prior U.S. Cl.: 46

United States Patent and Trademark Office

Reg. No. 3,522,111

Registered Oct. 21, 2008

**TRADEMARK
PRINCIPAL REGISTER**

CRACKER TRAX

FRITO-LAY NORTH AMERICA, INC. (DELA-
WARE CORPORATION)
7701 LEGACY DRIVE
PLANO, TX 75024

NO CLAIM IS MADE TO THE EXCLUSIVE
RIGHT TO USE "CRACKER", APART FROM THE
MARK AS SHOWN.

FOR: CRACKERS, IN CLASS 30 (U.S. CL. 46).

FIRST USE 2-0-2008; IN COMMERCE 2-0-2008.

SN 77-295,987, FILED 10-4-2007.

THE MARK CONSISTS OF STANDARD CHAR-
ACTERS WITHOUT CLAIM TO ANY PARTICULAR
FONT, STYLE, SIZE, OR COLOR.

ELISSA GARBER KON, EXAMINING ATTORNEY

Int. Cl.: 28

Prior U.S. Cls.: 22, 23, 38, and 50

Reg. No. 3,522,112

United States Patent and Trademark Office

Registered Oct. 21, 2008

**TRADEMARK
PRINCIPAL REGISTER**

TICKET BOOM

KABUSHIKI KAISHA SEGA (JAPAN CORPORATION), DBA SEGA CORPORATION,
2-12, HANEDA 1-CHOME
OHTA-KU, TOKYO, JAPAN

THE MARK CONSISTS OF STANDARD CHARACTERS WITHOUT CLAIM TO ANY PARTICULAR FONT, STYLE, SIZE, OR COLOR.

FOR: STAND ALONE VIDEO GAME MACHINES;
ARCADE GAME MACHINES WITH BUILT IN
SCREENS, IN CLASS 28 (U.S. CLS. 22, 23, 38 AND 50).

SN 77-296,132, FILED 10-4-2007.

FIRST USE 5-0-2008; IN COMMERCE 5-0-2008.

GIANCARLO CASTRO, EXAMINING ATTORNEY

Int. Cls.: 41 and 44

Prior U.S. Cls.: 100, 101, and 107

United States Patent and Trademark Office

Reg. No. 3,522,113

Registered Oct. 21, 2008

**SERVICE MARK
PRINCIPAL REGISTER**

Mental Diet Pyramid

HALL, KAREN WHEELER (UNITED STATES
INDIVIDUAL)
12017 SKY WEST DR.
AUSTIN, TX 78758

FOR: EDUCATIONAL SERVICES, NAMELY,
CONDUCTING CLASSES, SEMINARS, WORK-
SHOPS AND LECTURES IN THE FIELD OF LIFE-
STYLE HABITS TO PROMOTE, IMPROVE AND
MAINTAIN MENTAL HEALTH AND WELL-BEING,
IN CLASS 41 (U.S. CLS. 100, 101 AND 107).

FIRST USE 7-11-2008; IN COMMERCE 7-11-2008.

FOR: PROVIDING HEALTH-RELATED INFOR-
MATION ONLINE VIA THE INTERNET IN THE
FIELD OF LIFESTYLE HABITS TO PROMOTE,
IMPROVE AND MAINTAIN MENTAL HEALTH

AND WELL-BEING, IN CLASS 44 (U.S. CLS. 100
AND 101).

FIRST USE 2-14-2008; IN COMMERCE 2-14-2008.

THE MARK CONSISTS OF STANDARD CHAR-
ACTERS WITHOUT CLAIM TO ANY PARTICULAR
FONT, STYLE, SIZE, OR COLOR.

NO CLAIM IS MADE TO THE EXCLUSIVE
RIGHT TO USE "MENTAL", APART FROM THE
MARK AS SHOWN.

SN 77-297,089, FILED 10-5-2007.

JULIE GUTTADAURO, EXAMINING ATTORNEY

Int. Cl.: 36

Prior U.S. Cls.: 100, 101, and 102

United States Patent and Trademark Office

Reg. No. 3,522,114

Registered Oct. 21, 2008

**SERVICE MARK
PRINCIPAL REGISTER**



BOCA GRANDE REALTY, INC. (FLORIDA CORPORATION)
5301 NW 2ND AVE.
#102
BOCA RATON, FL 33487

FOR: REAL ESTATE BROKERAGE, IN CLASS 36
(U.S. CLS. 100, 101 AND 102).

FIRST USE 4-19-2007; IN COMMERCE 4-19-2007.

NO CLAIM IS MADE TO THE EXCLUSIVE
RIGHT TO USE "BOCA GRANDE REALTY", APART
FROM THE MARK AS SHOWN.

THE COLOR(S) RED, GOLD AND GREY IS/ARE
CLAIMED AS A FEATURE OF THE MARK.

THE COLOR RED APPEARS IN THE WORDING
"BOCA GRANDE REALTY"; THE COLOR GREY
APPEARS AS SHADING IN THE WORDING "BOCA
GRANDE"; THE COLOR GOLD APPEARS IN THE
DEPICTION OF THE OVAL, THE CREST EMBLEM
SURROUNDED BY THE OVAL, AS WELL AS THE
LETTERS "B" AND "G" CONTAINED IN THE
CREST EMBLEM.

THE ENGLISH TRANSLATION OF THE SPANISH
WORDING "BOCA GRANDE" IN THE MARK IS
"BIG MOUTH."

SN 77-297,199, FILED 10-5-2007.

MICHAEL TANNER, EXAMINING ATTORNEY

Int. Cls.: 35 and 37

Prior U.S. Cls.: 100, 101, 102, 103, and 106

United States Patent and Trademark Office

Reg. No. 3,522,115

Registered Oct. 21, 2008

**SERVICE MARK
PRINCIPAL REGISTER**

Insidesign
See Beyond the Blueprint.

KOETTER WOODWORKING, INC. (INDIANA CORPORATION)
533 LOUIS SMITH ROAD
BORDEN, IN 47106

FOR: RETAIL STORE SERVICES FEATURING CABINETS, HARDWOOD FLOORING, TRIM, DOORS, STAIR PARTS, AND ACCESSORIES; PROJECT MANAGEMENT SERVICES FOR OTHERS IN THE FIELD OF INSTALLING CABINETS, HARDWOOD FLOORING, TRIM, DOORS, STAIR PARTS, AND ACCESSORIES, IN CLASS 35 (U.S. CLS. 100, 101 AND 102).

FIRST USE 8-13-2008; IN COMMERCE 8-13-2008.

FOR: INSTALLATION OF CABINETS, HARDWOOD FLOORING, TRIM, DOORS, STAIR PARTS AND ACCESSORIES, IN CLASS 37 (U.S. CLS. 100, 103 AND 106).

FIRST USE 1-31-2008; IN COMMERCE 1-31-2008.

THE MARK CONSISTS OF THE WORDS "SEE BEYOND THE BLUEPRINT" APPEARING BELOW THE WORD "INSIDESIGN".

SN 77-297,341, FILED 10-5-2007.

SUSAN LESLIE DUBOIS, EXAMINING ATTORNEY

Int. Cl.: 36

Prior U.S. Cls.: 100, 101, and 102

United States Patent and Trademark Office

Reg. No. 3,522,116

Registered Oct. 21, 2008

**SERVICE MARK
PRINCIPAL REGISTER**

**TOMORROW'S OPPORTUNITY
TODAY**

BANK OF AMERICA CORPORATION (DELA-
WARE CORPORATION)
100 NORTH TRYON STREET
CHARLOTTE, NC 28255

THE MARK CONSISTS OF STANDARD CHAR-
ACTERS WITHOUT CLAIM TO ANY PARTICULAR
FONT, STYLE, SIZE, OR COLOR.

FOR: PROVIDING INFORMATION IN THE
FIELD OF EMPLOYEE BENEFITS; MANAGING
EMPLOYEE BENEFIT PLANS, IN CLASS 36 (U.S.
CLS. 100, 101 AND 102).

SN 77-297,489, FILED 10-5-2007.

FIRST USE 11-6-2007; IN COMMERCE 11-6-2007.

JANET LEE, EXAMINING ATTORNEY

Int. Cl.: 9

Prior U.S. Cls.: 21, 23, 26, 36, and 38

United States Patent and Trademark Office

Reg. No. 3,522,117

Registered Oct. 21, 2008

**TRADEMARK
PRINCIPAL REGISTER**

BrowserObject

HEXASOFT DEVELOPMENT SDN. BHD. (MALAYSIA LIMITED LIABILITY COMPANY)
1-2-15 MAYANG MALL KOMPLEKS
JALAN MAYANG PASIR 1
BAYAN BARU, MALAYSIA 11950

FOR: COMPUTER SOFTWARE DEVELOPMENT TOOLS; WEB SITE DEVELOPMENT SOFTWARE; COMPUTER SOFTWARE, NAMELY, SOFTWARE DEVELOPMENT TOOLS FOR THE CREATION OF MOBILE INTERNET APPLICATIONS AND CLIENT INTERFACES, IN CLASS 9 (U.S. CLS. 21, 23, 26, 36 AND 38).

FIRST USE 11-23-2007; IN COMMERCE 11-23-2007.

THE MARK CONSISTS OF STANDARD CHARACTERS WITHOUT CLAIM TO ANY PARTICULAR FONT, STYLE, SIZE, OR COLOR.

SN 77-298,959, FILED 10-8-2007.

LINDA E. BLOHM, EXAMINING ATTORNEY

Int. Cl.: 42

Prior U.S. Cls.: 100 and 101

United States Patent and Trademark Office

Reg. No. 3,522,118

Registered Oct. 21, 2008

**SERVICE MARK
PRINCIPAL REGISTER**

PISCES

CLEMSON UNIVERSITY (SOUTH CAROLINA
BODY POLITIC AND CORPORATE)
201 SIKES HALL
CLEMSON, SC 296345321

THE MARK CONSISTS OF STANDARD CHAR-
ACTERS WITHOUT CLAIM TO ANY PARTICULAR
FONT, STYLE, SIZE, OR COLOR.

FOR: ENVIRONMENTAL MONITORING SER-
VICE FOR DEVELOPERS OF ENVIRONMENTALLY
FRIENDLY REAL ESTATE DEVELOPMENTS, IN
CLASS 42 (U.S. CLS. 100 AND 101).

SN 77-299,074, FILED 10-9-2007.

FIRST USE 4-18-2007; IN COMMERCE 8-27-2008.

KELLEY WELLS, EXAMINING ATTORNEY

Int. Cl.: 41

Prior U.S. Cls.: 100, 101, and 107

United States Patent and Trademark Office

Reg. No. 3,522,119

Registered Oct. 21, 2008

**SERVICE MARK
PRINCIPAL REGISTER**

FARGO FORCE

URBAN PLAINS HOCKEY CLUB LLC (NORTH
DAKOTA LIMITED LIABILITY COMPANY)
1400 RADISSON TOWER
201 5TH STREET NORTH
FARGO, ND 581024892

FOR: ENTERTAINMENT SERVICES IN THE
NATURE OF HOCKEY GAMES AND EXHIBI-
TIONS, IN CLASS 41 (U.S. CLS. 100, 101 AND 107).

FIRST USE 11-1-2007; IN COMMERCE 11-1-2007.

THE MARK CONSISTS OF STANDARD CHAR-
ACTERS WITHOUT CLAIM TO ANY PARTICULAR
FONT, STYLE, SIZE, OR COLOR.

NO CLAIM IS MADE TO THE EXCLUSIVE
RIGHT TO USE "FARGO", APART FROM THE
MARK AS SHOWN.

SN 77-299,292, FILED 10-9-2007.

WON TEAK OH, EXAMINING ATTORNEY

Int. Cl.: 11

Prior U.S. Cls.: 13, 21, 23, 31, and 34

United States Patent and Trademark Office

Reg. No. 3,522,120

Registered Oct. 21, 2008

**TRADEMARK
PRINCIPAL REGISTER**

**INFRARED GRILLING THAT'S
ALL ABOUT U**

W.C. BRADLEY COMPANY (GEORGIA COR-
PORATION)
1017 FRONT AVENUE
COLUMBUS, GA 31904

THE MARK CONSISTS OF STANDARD CHAR-
ACTERS WITHOUT CLAIM TO ANY PARTICULAR
FONT, STYLE, SIZE, OR COLOR.

FOR: BARBECUE GRILLS AND REPLACEMENT
PARTS THEREFOR, IN CLASS 11 (U.S. CLS. 13, 21, 23,
31 AND 34).

SN 77-299,464, FILED 10-9-2007.

FIRST USE 1-31-2008; IN COMMERCE 1-31-2008.

ALEX KEAM, EXAMINING ATTORNEY

Int. Cl.: 11

Prior U.S. Cls.: 13, 21, 23, 31, and 34

Reg. No. 3,522,121

United States Patent and Trademark Office

Registered Oct. 21, 2008

**TRADEMARK
PRINCIPAL REGISTER**

The Skimmer Angel

GABCO PRODUCTS, INC. (TEXAS CORPORATION)
1540 KELLER PARKWAY - SUITE 108-230
KELLER, TX 76262

FOR: SWIMMING POOL WATER CLEANING AND FILTERING UNITS, IN CLASS 11 (U.S. CLS. 13, 21, 23, 31 AND 34).

FIRST USE 1-18-2008; IN COMMERCE 1-18-2008.

THE MARK CONSISTS OF STANDARD CHARACTERS WITHOUT CLAIM TO ANY PARTICULAR FONT, STYLE, SIZE, OR COLOR.

NO CLAIM IS MADE TO THE EXCLUSIVE RIGHT TO USE "SKIMMER", APART FROM THE MARK AS SHOWN.

SN 77-299,543, FILED 10-9-2007.

THEODORE MCBRIDE, EXAMINING ATTORNEY

Int. Cl.: 25

Prior U.S. Cls.: 22 and 39

United States Patent and Trademark Office

Reg. No. 3,522,122

Registered Oct. 21, 2008

**TRADEMARK
PRINCIPAL REGISTER**

LUCIANO BARONI

SICURA DESIGNS, INC. (NEW YORK CORPORATION)
84 18TH STREET
BROOKLYN, NY 11231

FOR: MEN AND WOMEN JACKETS, COATS, TROUSERS, VESTS; MEN'S SUITS, WOMEN'S SUITS; SKIRTS AND DRESSES; EVENING DRESSES; DRESS SHIRTS, IN CLASS 25 (U.S. CLS. 22 AND 39).

FIRST USE 6-1-2008; IN COMMERCE 6-1-2008.

THE MARK CONSISTS OF STANDARD CHARACTERS WITHOUT CLAIM TO ANY PARTICULAR FONT, STYLE, SIZE, OR COLOR.

THE NAME(S), PORTRAIT(S), AND/OR SIGNATURE(S) SHOWN IN THE MARK DOES NOT IDENTIFY A PARTICULAR LIVING INDIVIDUAL.

SN 77-299,637, FILED 10-9-2007.

JILL C. ALT, EXAMINING ATTORNEY

Int. Cl.: 9

Prior U.S. Cls.: 21, 23, 26, 36, and 38

United States Patent and Trademark Office

Reg. No. 3,522,123

Registered Oct. 21, 2008

TRADEMARK
PRINCIPAL REGISTER



4447 TECHNOLOGIES GROUP, LLC (TEXAS
LIMITED LIABILITY COMPANY)

1901 FOXBOROUGH TRAIL
FLOWER MOUND, TX 75028

FOR: RIFLE SCOPES; SPOTTING SCOPES; LASER
RANGEFINDERS, IN CLASS 9 (U.S. CLS. 21, 23, 26, 36
AND 38).

FIRST USE 9-10-2007; IN COMMERCE 9-10-2007.

THE COLOR(S) BLACK AND RED IS/ARE
CLAIMED AS A FEATURE OF THE MARK.

THE MARK CONSISTS OF A BLACK LETTER "E"
AND A STYLIZED RED LETTER "X" AND THE
TEXT "PLORE" IN BLACK.

SN 77-299,715, FILED 10-9-2007.

ALICE BENMAMAN, EXAMINING ATTORNEY

Int. Cl.: 8

Prior U.S. Cls.: 23, 28, and 44

United States Patent and Trademark Office

Reg. No. 3,522,124

Registered Oct. 21, 2008

**TRADEMARK
PRINCIPAL REGISTER**



INTERNATIONAL EDGE, INC. (NEW JERSEY CORPORATION)
79 TWO BRIDGES ROAD
FAIRFIELD, NJ 07004

THE MARK CONSISTS OF THE LETTERS "PED" FOLLOWED BY A FOOTPRINT APPEARING VERTICALLY FOLLOWED BY THE WORD "EGG".

FOR: PEDICURE IMPLEMENTS, NAMELY, FOOT FILES, IN CLASS 8 (U.S. CLS. 23, 28 AND 44).

SN 77-300,148, FILED 10-10-2007.

FIRST USE 10-29-2007; IN COMMERCE 10-29-2007.

COLLEEN DOMBROW, EXAMINING ATTORNEY

Int. Cl.: 5

Prior U.S. Cls.: 6, 18, 44, 46, 51, and 52

United States Patent and Trademark Office

Reg. No. 3,522,125

Registered Oct. 21, 2008

**TRADEMARK
PRINCIPAL REGISTER**

MediTea

SAFORO, DAVID, K (UNITED STATES INDIVIDUAL)
15024 BIRCHAM RD.
LOUISVILLE, KY 40245

THE MARK CONSISTS OF STANDARD CHARACTERS WITHOUT CLAIM TO ANY PARTICULAR FONT, STYLE, SIZE, OR COLOR.

FOR: HERBAL TEAS FOR MEDICINAL PURPOSES, IN CLASS 5 (U.S. CLS. 6, 18, 44, 46, 51 AND 52).

SN 77-300,185, FILED 10-10-2007.

FIRST USE 6-25-2008; IN COMMERCE 6-25-2008.

DOMINIC FATHY, EXAMINING ATTORNEY

Int. Cl.: 28

Prior U.S. Cls.: 22, 23, 38, and 50

United States Patent and Trademark Office

Reg. No. 3,522,126

Registered Oct. 21, 2008

**TRADEMARK
PRINCIPAL REGISTER**

SHAPE IT UP

MOOSE MOUNTAIN TOYMAKERS LTD. (HONG
KONG CORPORATION)
92 GRANVILLE ROAD TSIMSHATSUI EAST
UNIT 704-6, 7TH FLOOR ENERGY PLAZA
KOWLOON, HONG KONG

THE MARK CONSISTS OF STANDARD CHAR-
ACTERS WITHOUT CLAIM TO ANY PARTICULAR
FONT, STYLE, SIZE, OR COLOR.

FOR: TOYS, NAMELY, AN INTERACTIVE
FLOOR DANCE MAT, IN CLASS 28 (U.S. CLS. 22,
23, 38 AND 50).

SN 77-300,209, FILED 10-10-2007.

FIRST USE 10-1-2007; IN COMMERCE 5-24-2008.

SANJEEV VOHRA, EXAMINING ATTORNEY

Int. Cl.: 3

Prior U.S. Cls.: 1, 4, 6, 50, 51, and 52

Reg. No. 3,522,127

United States Patent and Trademark Office

Registered Oct. 21, 2008

**TRADEMARK
PRINCIPAL REGISTER**

**NO ONE MAKES YOUR HAIR
STRONGER**

LABORATOIRE GARNIER & CIE (FRANCE SOCIÉTÉ EN NOM COLLECTIF (SENC))
281, RUE SAINT HONORE
PARIS, FRANCE 75008

FOR: SHAMPOOS; GELS, SPRAYS, MOUSSES AND BALMS FOR THE HAIR STYLING AND HAIR CARE; HAIR LACQUERS; HAIR COLOURING AND HAIR DECOLORANT PREPARATIONS; PERMANENT WAVING AND CURLING PREPARATIONS; ESSENTIAL OILS FOR PERSONAL USE, IN CLASS 3 (U.S. CLS. 1, 4, 6, 50, 51 AND 52).

FIRST USE 6-0-2007; IN COMMERCE 6-0-2007.

THE MARK CONSISTS OF STANDARD CHARACTERS WITHOUT CLAIM TO ANY PARTICULAR FONT, STYLE, SIZE, OR COLOR.

SN 77-300,226, FILED 10-10-2007.

RONALD MCMORROW, EXAMINING ATTORNEY

Int. Cls.: 35, 36, 37, 39, and 42

Prior U.S. Cls.: 100, 101, 102, 103, 105, and 106

United States Patent and Trademark Office

Reg. No. 3,522,128

Registered Oct. 21, 2008

**SERVICE MARK
PRINCIPAL REGISTER**



New Jersey



MANHEIM AUCTIONS, INC. (DELAWARE CORPORATION)
6205 PEACHTREE DUNWOODY ROAD
ATLANTA, GA 30328

FOR: AUTOMOBILE AUCTION SERVICES; AUTOMOBILE AUCTION SERVICES PROVIDED VIA THE INTERNET, IN CLASS 35 (U.S. CLS. 100, 101 AND 102).

FIRST USE 6-20-2008; IN COMMERCE 6-20-2008.

FOR: AUTOMOBILE FINANCING SERVICES, IN CLASS 36 (U.S. CLS. 100, 101 AND 102).

FIRST USE 6-20-2008; IN COMMERCE 6-20-2008.

FOR: AUTOMOTIVE DETAILING, RECONDITIONING, REPAIR, CONVERSION AND CUSTOMIZATION SERVICES, IN CLASS 37 (U.S. CLS. 100, 103 AND 106).

FIRST USE 6-20-2008; IN COMMERCE 6-20-2008.

FOR: BUSINESS-TO-BUSINESS AUTOMOTIVE TRANSPORTATION AND STORAGE SERVICES, IN CLASS 39 (U.S. CLS. 100 AND 105).

FIRST USE 6-20-2008; IN COMMERCE 6-20-2008.

FOR: AUTOMOBILE INSPECTION SERVICES, IN CLASS 42 (U.S. CLS. 100 AND 101).

FIRST USE 6-20-2008; IN COMMERCE 6-20-2008.

OWNER OF U.S. REG. NOS. 1,699,332, 3,075,304, AND 3,229,428.

NO CLAIM IS MADE TO THE EXCLUSIVE RIGHT TO USE "NEW JERSEY", APART FROM THE MARK AS SHOWN.

THE COLOR(S) GOLD, BLUE, BROWN, BLACK, GREY AND WHITE IS/ARE CLAIMED AS A FEATURE OF THE MARK.

THE MARK CONSISTS OF A GOLD "M" OVER A BLUE CIRCULAR BACKGROUND AND WITHIN TWO GOLD OUTER RINGS. THE COLOR BROWN OUTLINES THE MARK. TO THE RIGHT OF THE "M" IS THE WORD "MANHEIM" IN THE COLOR BLACK. A BLACK LINE SEPARATES THE ABOVE DESIGN AND THE WORD "MANHEIM" AND THE WORDS "NEW JERSEY" IN THE COLOR BLACK AND WHITE STYLIZED CAPITAL LETTERS "NJ" WITH BLACK SHADING ON A BLACK BACKGROUND, INSIDE CONCENTRIC WHITE AND GREY SQUARES TO THE RIGHT OF THE WORDS "NEW JERSEY".

SN 77-300,255, FILED 10-10-2007.

GRETTA YAO, EXAMINING ATTORNEY

Int. Cl.: 33

Prior U.S. Cls.: 47 and 49

United States Patent and Trademark Office

Reg. No. 3,522,129

Registered Oct. 21, 2008

**TRADEMARK
PRINCIPAL REGISTER**

8 SECONDS

FRANK LIN DISTILLERS PRODUCTS, LTD.
(CALIFORNIA CORPORATION)
PO BOX 610877
SAN JOSE, CA 95161

FOR: DISTILLED SPIRITS, NAMELY, CANADIAN WHISKEY, FOR HUMAN CONSUMPTION, IN CLASS 33 (U.S. CLS. 47 AND 49).

FIRST USE 5-30-2008; IN COMMERCE 5-30-2008.

THE MARK CONSISTS OF STANDARD CHARACTERS WITHOUT CLAIM TO ANY PARTICULAR FONT, STYLE, SIZE, OR COLOR.

SN 77-300,473, FILED 10-10-2007.

VIVIAN MICZNIK FIRST, EXAMINING ATTORNEY

Int. Cl.: 16

Prior U.S. Cls.: 2, 5, 22, 23, 29, 37, 38, and 50

Reg. No. 3,522,130

United States Patent and Trademark Office

Registered Oct. 21, 2008

**TRADEMARK
PRINCIPAL REGISTER**

SURCYCLE GREEN

BOLTARON PERFORMANCE PRODUCTS, LLC
(OHIO LIMITED LIABILITY COMPANY)
ONE GENERAL STREET
NEWCOMERSTOWN, OH 43832

FOR: PRINT STOCK, NAMELY, PLASTIC
SHEETS FOR WRITING, PRINTING, AND MARK-
ING, IN CLASS 16 (U.S. CLS. 2, 5, 22, 23, 29, 37, 38 AND
50).

FIRST USE 7-25-2008; IN COMMERCE 7-25-2008.

THE MARK CONSISTS OF STANDARD CHAR-
ACTERS WITHOUT CLAIM TO ANY PARTICULAR
FONT, STYLE, SIZE, OR COLOR.

NO CLAIM IS MADE TO THE EXCLUSIVE
RIGHT TO USE "GREEN", APART FROM THE
MARK AS SHOWN.

SN 77-300,985, FILED 10-10-2007.

APRIL ROACH, EXAMINING ATTORNEY

Int. Cl.: 20

Prior U.S. Cls.: 2, 13, 22, 25, 32, and 50

United States Patent and Trademark Office

Reg. No. 3,522,131

Registered Oct. 21, 2008

**TRADEMARK
PRINCIPAL REGISTER**

ECOTRAC

RTC INDUSTRIES, INC. (ILLINOIS CORPORATION)
2800 GOLF ROAD
ROLLING MEADOWS, IL 60008

FOR: ADJUSTABLE MERCHANDISE RACK OR SHELVING UNIT SYSTEM COMPRISING, NAMELY, A BASE UNIT, RETROFIT PADDLE, PADDLE, RETRACTOR ARM, AND INSERTS AND PARTS THEREFORE, NAMELY, BASE UNIT, RETROFIT PADDLE, PADDLE, RETRACTOR ARM, AND INSERTS, IN CLASS 20 (U.S. CLS. 2, 13, 22, 25, 32 AND 50).

FIRST USE 11-6-2007; IN COMMERCE 11-6-2007.

THE MARK CONSISTS OF STANDARD CHARACTERS WITHOUT CLAIM TO ANY PARTICULAR FONT, STYLE, SIZE, OR COLOR.

SN 77-301,419, FILED 10-11-2007.

LINDA ORNDORFF, EXAMINING ATTORNEY

Int. Cl.: 9

Prior U.S. Cls.: 21, 23, 26, 36, and 38

Reg. No. 3,522,132

United States Patent and Trademark Office

Registered Oct. 21, 2008

**TRADEMARK
PRINCIPAL REGISTER**

PbC

AXION POWER INTERNATIONAL, INC. (DELA-
WARE CORPORATION)
3601 CLOVER LANE
NEW CASTLE, PA 16105

FOR: BATTERIES; ELECTRIC STORAGE BAT-
TERIES; ELECTRICAL CELLS AND BATTERIES;
ELECTRICAL STORAGE BATTERIES; RECHARGE-
ABLE ELECTRIC BATTERIES; RENEWABLE BAT-
TERY SYSTEM TO PROVIDE BACKUP POWER, IN
CLASS 9 (U.S. CLS. 21, 23, 26, 36 AND 38).

FIRST USE 8-22-2008; IN COMMERCE 8-22-2008.

THE MARK CONSISTS OF STANDARD CHAR-
ACTERS WITHOUT CLAIM TO ANY PARTICULAR
FONT, STYLE, SIZE, OR COLOR.

SN 77-301,454, FILED 10-11-2007.

RONALD MCMORROW, EXAMINING ATTORNEY

Int. Cl.: 9

Prior U.S. Cls.: 21, 23, 26, 36, and 38

United States Patent and Trademark Office

Reg. No. 3,522,133

Registered Oct. 21, 2008

**TRADEMARK
PRINCIPAL REGISTER**

LANGUAGE FACTOR

LANGUAGE FACTOR LLC (TEXAS LIMITED
LIABILITY COMPANY)
PO BOX 7902
TYLER, TX 75711

FOR: DIGITAL MEDIA, NAMELY, CDS AND
DVDS FEATURING EDUCATION FOR FOREIGN
LANGUAGE TRANSLATION, IN CLASS 9 (U.S. CLS.
21, 23, 26, 36 AND 38).

FIRST USE 1-9-2007; IN COMMERCE 12-28-2007.

THE MARK CONSISTS OF STANDARD CHAR-
ACTERS WITHOUT CLAIM TO ANY PARTICULAR
FONT, STYLE, SIZE, OR COLOR.

NO CLAIM IS MADE TO THE EXCLUSIVE
RIGHT TO USE "LANGUAGE", APART FROM
THE MARK AS SHOWN.

SN 77-303,521, FILED 10-13-2007.

MICHAEL SOUDERS, EXAMINING ATTORNEY

Int. Cl.: 32

Prior U.S. Cls.: 45, 46, and 48

Reg. No. 3,522,134

United States Patent and Trademark Office

Registered Oct. 21, 2008

**TRADEMARK
PRINCIPAL REGISTER**

Xuni

XUNI BEVERAGE COMPANY, LLC (COLORADO
LIMITED LIABILITY COMPANY)
1555 MAIN STREET, STE. A3-100
WINDSOR, CO 80550

THE MARK CONSISTS OF STANDARD CHAR-
ACTERS WITHOUT CLAIM TO ANY PARTICULAR
FONT, STYLE, SIZE, OR COLOR.

FOR: BEVERAGES, NAMELY, ENERGY
DRINKS, CONTAINING COFFEE, TEA, COCOA
AND/OR ESPRESSO, IN CLASS 32 (U.S. CLS. 45, 46
AND 48).

SN 77-303,540, FILED 10-13-2007.

FIRST USE 6-1-2008; IN COMMERCE 7-15-2008.

MARK SPARACINO, EXAMINING ATTORNEY

Int. Cls.: 10 and 24

Prior U.S. Cls.: 26, 39, 42, 44, and 50

United States Patent and Trademark Office

Reg. No. 3,522,135

Registered Oct. 21, 2008

**TRADEMARK
PRINCIPAL REGISTER**

DcGUARDIAN

GARY YANG (UNITED STATES INDIVIDUAL)
3751 MARTZ ST.
SIMI VALLEY, CA 93063

FIRST USE 6-23-2008; IN COMMERCE 7-5-2008.

FOR: MEDICAL GOWNS; SURGICAL DRAPES;
SURGICAL GOWNS; SURGICAL SCRUB SUITS, IN
CLASS 10 (U.S. CLS. 26, 39 AND 44).

THE MARK CONSISTS OF STANDARD CHAR-
ACTERS WITHOUT CLAIM TO ANY PARTICULAR
FONT, STYLE, SIZE, OR COLOR.

FIRST USE 6-23-2008; IN COMMERCE 7-5-2008.

SN 77-303,578, FILED 10-14-2007.

FOR: FELT AND NON-WOVEN TEXTILE FAB-
RICS; SYNTHETIC FIBER FABRICS, IN CLASS 24
(U.S. CLS. 42 AND 50).

BRIAN NEVILLE, EXAMINING ATTORNEY

Int. Cl.: 5

Prior U.S. Cls.: 6, 18, 44, 46, 51, and 52

United States Patent and Trademark Office

Reg. No. 3,522,136

Registered Oct. 21, 2008

**TRADEMARK
PRINCIPAL REGISTER**

CardioChol

QUALITY OF LIFE LABS (DELAWARE LIMITED
LIABILITY COMPANY)
2975 WESTCHESTER AVENUE
PURCHASE, NY 10577

THE MARK CONSISTS OF STANDARD CHAR-
ACTERS WITHOUT CLAIM TO ANY PARTICULAR
FONT, STYLE, SIZE, OR COLOR.

FOR: DIETARY FOOD SUPPLEMENTS, IN CLASS
5 (U.S. CLS. 6, 18, 44, 46, 51 AND 52).

SN 77-303,793, FILED 10-15-2007.

FIRST USE 4-18-2008; IN COMMERCE 4-18-2008.

TEJBIR SINGH, EXAMINING ATTORNEY

Int. Cl.: 36

Prior U.S. Cls.: 100, 101, and 102

United States Patent and Trademark Office

Reg. No. 3,522,137

Registered Oct. 21, 2008

**SERVICE MARK
PRINCIPAL REGISTER**

GBFGPRESERVATION

THE GB FINANCIAL GROUP INC. (MASSACHU-
SETTS CORPORATION)
11 MAYO ROAD
WELLESLEY, MA 02482

FOR: FINANCIAL SERVICES, NAMELY, FINAN-
CIAL MANAGEMENT, FINANCIAL PLANNING,
ESTATE PLANNING, FINANCIAL CONSULTA-
TION IN THE FIELD OF EXECUTIVE COMPENSA-
TION AND ASSET MANAGEMENT; FINANCIAL
CONSULTATION SERVICES; LIFE INSURANCE
BROKERAGE; INVESTMENT SERVICES, NAMELY,
INVESTMENT CONSULTATION, INVESTMENT
BROKERAGE AND INVESTMENT OF FUNDS

FOR OTHERS, IN CLASS 36 (U.S. CLS. 100, 101
AND 102).

FIRST USE 2-0-2008; IN COMMERCE 2-0-2008.

THE MARK CONSISTS OF STANDARD CHAR-
ACTERS WITHOUT CLAIM TO ANY PARTICULAR
FONT, STYLE, SIZE, OR COLOR.

SN 77-303,820, FILED 10-15-2007.

JILL C. ALT, EXAMINING ATTORNEY

Int. Cl.: 29

Prior U.S. Cl.: 46

United States Patent and Trademark Office

Reg. No. 3,522,138

Registered Oct. 21, 2008

**TRADEMARK
PRINCIPAL REGISTER**

SMART SAUSAGE

CONAGRA FOODS RDM, INC. (DELAWARE
CORPORATION)
ONE CONAGRA DRIVE
OMAHA, NE 68102

OWNER OF U.S. REG. NOS. 2,318,293, 2,773,155,
AND OTHERS.

FOR: SOY BASED FOOD PRODUCTS USED AS
SAUSAGE SUBSTITUTES, IN CLASS 29 (U.S. CL. 46).

NO CLAIM IS MADE TO THE EXCLUSIVE
RIGHT TO USE "SAUSAGE", APART FROM THE
MARK AS SHOWN.

FIRST USE 1-2-2008; IN COMMERCE 1-2-2008.

SN 77-303,906, FILED 10-15-2007.

THE MARK CONSISTS OF STANDARD CHAR-
ACTERS WITHOUT CLAIM TO ANY PARTICULAR
FONT, STYLE, SIZE, OR COLOR.

GINA FINK, EXAMINING ATTORNEY

Int. Cl.: 5

Prior U.S. Cls.: 6, 18, 44, 46, 51, and 52

Reg. No. 3,522,139

United States Patent and Trademark Office

Registered Oct. 21, 2008

**TRADEMARK
PRINCIPAL REGISTER**

NASTY HABIT

NUTRI-VET LLC (IDAHO LIMITED LIABILITY
COMPANY)
495 N. DUPONT AVENUE
BOISE, ID 83713

THE MARK CONSISTS OF STANDARD CHAR-
ACTERS WITHOUT CLAIM TO ANY PARTICULAR
FONT, STYLE, SIZE, OR COLOR.

FOR: NUTRITIONAL SUPPLEMENTS FOR ANI-
MALS, IN CLASS 5 (U.S. CLS. 6, 18, 44, 46, 51 AND 52).

SN 77-304,483, FILED 10-15-2007.

FIRST USE 12-28-2007; IN COMMERCE 12-28-2007.

APRIL ROACH, EXAMINING ATTORNEY

Int. Cl.: 9

Prior U.S. Cls.: 21, 23, 26, 36, and 38

Reg. No. 3,522,140

United States Patent and Trademark Office

Registered Oct. 21, 2008

**TRADEMARK
PRINCIPAL REGISTER**

IMAGENET

MITEK SYSTEMS, INC. (DELAWARE CORPORATION)
8911 BALBOA AVENUE, SUITE B
SAN DIEGO, CA 92123

FOR: COMPUTER SOFTWARE FOR DOCUMENT IMAGING, INTELLIGENT CHARACTER RECOGNITION, AND DOCUMENT ANALYSIS; AND INSTRUCTIONAL BOOKS AND MANUALS SOLD THEREWITH, IN CLASS 9 (U.S. CLS. 21, 23, 26, 36 AND 38).

FIRST USE 8-8-2007; IN COMMERCE 8-8-2007.

THE MARK CONSISTS OF STANDARD CHARACTERS WITHOUT CLAIM TO ANY PARTICULAR FONT, STYLE, SIZE, OR COLOR.

SN 77-305,204, FILED 10-16-2007.

LEIGH LOWRY, EXAMINING ATTORNEY

Int. Cls.: 33 and 35

Prior U.S. Cls.: 47, 49, 100, 101, and 102

United States Patent and Trademark Office

Reg. No. 3,522,141

Registered Oct. 21, 2008

**TRADEMARK
SERVICE MARK
PRINCIPAL REGISTER**

VINTNER'S CIRCLE

VINTNER'S CIRCLE FRANCHISING LLC (NEW
JERSEY LIMITED LIABILITY COMPANY)
40E WEST ROUTE 46
HACKETTSTOWN, NJ 07840

FOR: WINE; KITS FOR MAKING WINE, IN
CLASS 33 (U.S. CLS. 47 AND 49).

FIRST USE 12-26-2005; IN COMMERCE 12-26-2005.

FOR: FRANCHISING, NAMELY, OFFERING
TECHNICAL TRAINING AND ASSISTANCE IN
THE ESTABLISHMENT AND/OR OPERATION OF
RETAIL WINE MAKING SHOPS; RETAIL STORE
SERVICES IN THE FIELD OF WINE AND WINE-
MAKING GOODS, IN CLASS 35 (U.S. CLS. 100, 101
AND 102).

FIRST USE 9-1-2007; IN COMMERCE 9-1-2007.

THE MARK CONSISTS OF STANDARD CHAR-
ACTERS WITHOUT CLAIM TO ANY PARTICULAR
FONT, STYLE, SIZE, OR COLOR.

NO CLAIM IS MADE TO THE EXCLUSIVE
RIGHT TO USE "VINTNER'S", APART FROM THE
MARK AS SHOWN.

SN 77-307,929, FILED 10-18-2007.

MICHAEL TANNER, EXAMINING ATTORNEY

Int. Cls.: 33 and 35

Prior U.S. Cls.: 47, 49, 100, 101, and 102

United States Patent and Trademark Office

Reg. No. 3,522,142

Registered Oct. 21, 2008

TRADEMARK
SERVICE MARK
PRINCIPAL REGISTER



VINTNER'S CIRCLE FRANCHISING LLC (NEW JERSEY LIMITED LIABILITY COMPANY)

40E WEST ROUTE 46

HACKETTSTOWN, NJ 07840

FOR: WINE; KITS FOR MAKING WINE, IN CLASS 33 (U.S. CLS. 47 AND 49).

FIRST USE 12-26-2005; IN COMMERCE 12-26-2005.

FOR: FRANCHISING, NAMELY, OFFERING TECHNICAL TRAINING AND ASSISTANCE IN THE ESTABLISHMENT AND/OR OPERATION OF RETAIL WINE MAKING SHOPS; RETAIL STORE SERVICES IN THE FIELD OF WINE AND WINE-MAKING GOODS, IN CLASS 35 (U.S. CLS. 100, 101 AND 102).

FIRST USE 9-1-2007; IN COMMERCE 9-1-2007.

NO CLAIM IS MADE TO THE EXCLUSIVE RIGHT TO USE "VINTNER'S", APART FROM THE MARK AS SHOWN.

THE COLOR(S) BURGUNDY, GREEN, AND WHITE IS/ARE CLAIMED AS A FEATURE OF THE MARK.

THE MARK CONSISTS OF BURGUNDY COLORED GRAPES WITH GREEN LEAVES WITHIN A BURGUNDY COLORED CIRCLE. THE COLOR BURGUNDY APPEARS IN THE WORDING VINTNER'S AND YOUR WINE. YOUR WAY. THE COLOR GREEN APPEARS IN THE WORDING CIRCLE. THE COLOR WHITE APPEARS AS HIGHLIGHTING ON THE LEAVES AND GRAPES.

SN 77-307,943, FILED 10-18-2007.

MICHAEL TANNER, EXAMINING ATTORNEY

Int. Cl.: 13

Prior U.S. Cls.: 2 and 9

United States Patent and Trademark Office

Reg. No. 3,522,143

Registered Oct. 21, 2008

**TRADEMARK
PRINCIPAL REGISTER**

DISCOVERY

CROSMAN CORPORATION (DELAWARE CORPORATION)
RTES 5 & 20
EAST BLOOMFIELD, NY 14443

THE MARK CONSISTS OF STANDARD CHARACTERS WITHOUT CLAIM TO ANY PARTICULAR FONT, STYLE, SIZE, OR COLOR.

FOR: AIRGUNS, IN CLASS 13 (U.S. CLS. 2 AND 9).

SN 77-308,641, FILED 10-19-2007.

FIRST USE 1-14-2008; IN COMMERCE 3-1-2008.

SUE LAWRENCE, EXAMINING ATTORNEY

Int. Cl.: 28

Prior U.S. Cls.: 22, 23, 38, and 50

United States Patent and Trademark Office

Reg. No. 3,522,144

Registered Oct. 21, 2008

**TRADEMARK
PRINCIPAL REGISTER**

CHAIN GAME

OUT OF THE BOX PUBLISHING, INC. (WISCONSIN CORPORATION)

609 BENNETT ROAD

DODGEVILLE, WI 53533

FOR: PARTY GAMES, IN CLASS 28 (U.S. CLS. 22, 23, 38 AND 50).

FIRST USE 2-17-2008; IN COMMERCE 2-17-2008.

THE MARK CONSISTS OF STANDARD CHARACTERS WITHOUT CLAIM TO ANY PARTICULAR FONT, STYLE, SIZE, OR COLOR.

NO CLAIM IS MADE TO THE EXCLUSIVE RIGHT TO USE "GAME", APART FROM THE MARK AS SHOWN.

SN 77-308,647, FILED 10-19-2007.

MARK SPARACINO, EXAMINING ATTORNEY

Int. Cls.: 35, 36, and 38

Prior U.S. Cls.: 100, 101, 102, and 104

United States Patent and Trademark Office

Reg. No. 3,522,145

Registered Oct. 21, 2008

**SERVICE MARK
PRINCIPAL REGISTER**

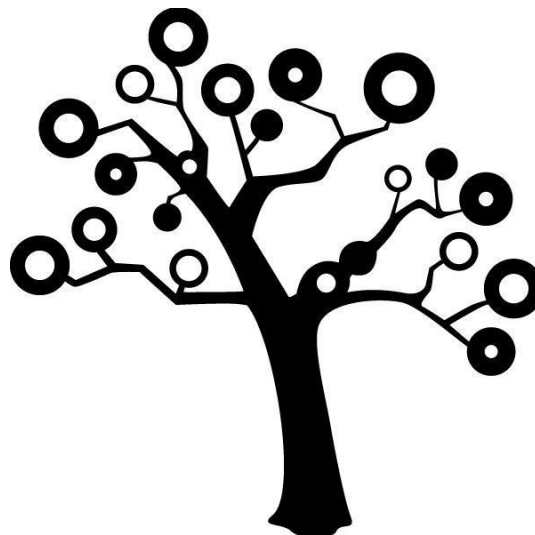

WORKING ASSETS FUNDING SERVICE, INC.
(CALIFORNIA CORPORATION)
101 MARKET STREET, SUITE 700
SAN FRANCISCO, CA 94105

FOR: PROVIDING AN ON-LINE COMPUTER DATABASE IN THE FIELD OF POLITICAL AND SOCIETAL ACTIVISM FEATURING INTERNET ACCESSIBLE, PRE-WRITTEN E-MAILS AND MOBILE TEXT MESSAGING, WHICH CAN BE CUSTOMIZED AND EDITED BY THE USER, ADDRESSED TO PUBLIC POLICY AND OTHER TARGETED DECISION-MAKERS REGARDING TOPICS OF SOCIAL AND POLITICAL CONCERN; PROVIDING A WEBSITE ON GLOBAL COMPUTER NETWORKS FEATURING INFORMATION AND LINKS TO OTHER WEBSITES IN THE FIELDS OF THE BUSINESS OF NONPROFIT ORGANIZATIONS AND POLITICAL ORGANIZATIONS, SELECT ONLINE MERCHANTS, AND PROMOTING VOLUNTEERISM, IN CLASS 35 (U.S. CLS. 100, 101 AND 102).

FIRST USE 11-4-2007; IN COMMERCE 11-4-2007.

FOR: PROVIDING A WEBSITE ON GLOBAL COMPUTER NETWORKS FEATURING INFORMATION AND LINKS TO OTHER WEBSITES IN THE FIELDS OF CHARITABLE DONATIONS AND GIV-

ING FOR NON-PROFIT ORGANIZATIONS AND POLITICAL FUNDRAISING; TELEPHONE CALLING CARD SERVICES, IN CLASS 36 (U.S. CLS. 100, 101 AND 102).

FIRST USE 11-4-2007; IN COMMERCE 11-4-2007.

FOR: TELECOMMUNICATIONS SERVICES, NAMELY, WIRELESS AND CELLULAR TELEPHONE SERVICES, LONG DISTANCE SERVICES, TELEPHONE VOICE MESSAGING, PERSONAL COMMUNICATIONS SERVICES, ELECTRONIC MAIL SERVICES, TRANSMISSION OF VOICE AND DATA, FACSIMILE TRANSMISSION SERVICES AND PROVIDING ACCESS TO GLOBAL COMPUTER NETWORKS, IN CLASS 38 (U.S. CLS. 100, 101 AND 104).

FIRST USE 11-4-2007; IN COMMERCE 11-4-2007.

THE MARK CONSISTS OF A TREE WITH CIRCLES OF VARIOUS SIZES AND APPEARANCES ON ITS BRANCHES.

SN 77-309,043, FILED 10-19-2007.

JILL PRATER, EXAMINING ATTORNEY

Int. Cl.: 13

Prior U.S. Cls.: 2 and 9

United States Patent and Trademark Office

Reg. No. 3,522,146

Registered Oct. 21, 2008

**TRADEMARK
PRINCIPAL REGISTER**

SCCY

SCCY INDUSTRIES, LLC (FLORIDA LIMITED
LIABILITY COMPANY)
3121 OPPORTUNITY COURT BUILDING C
SOUTH DAYTONA, FL 32119

FOR: FIREARMS, IN CLASS 13 (U.S. CLS. 2 AND
9).

FIRST USE 6-1-2008; IN COMMERCE 6-1-2008.

THE MARK CONSISTS OF STANDARD CHAR-
ACTERS WITHOUT CLAIM TO ANY PARTICULAR
FONT, STYLE, SIZE, OR COLOR.

THE WORDING "SCCY" HAS NO MEANING IN A
FOREIGN LANGUAGE.

SN 77-310,685, FILED 10-23-2007.

MICHELE SWAIN, EXAMINING ATTORNEY

Int. Cl.: 36

Prior U.S. Cls.: 100, 101, and 102

United States Patent and Trademark Office

Reg. No. 3,522,147

Registered Oct. 21, 2008

**SERVICE MARK
PRINCIPAL REGISTER**

**WELLS FARGO HEALTH
ADVANTAGE**

WELLS FARGO & COMPANY (DELAWARE
CORPORATION)
1700 WELLS FARGO CENTER, MAC N9305
176 SIXTH & MARQUETTE
MINNEAPOLIS, MN 55479

FOR: CREDIT CARD SERVICES, IN CLASS 36
(U.S. CLS. 100, 101 AND 102).

FIRST USE 11-27-2007; IN COMMERCE 11-27-2007.

THE MARK CONSISTS OF STANDARD CHAR-
ACTERS WITHOUT CLAIM TO ANY PARTICULAR
FONT, STYLE, SIZE, OR COLOR.

OWNER OF U.S. REG. NOS. 2,640,763, 3,197,549,
AND OTHERS.

NO CLAIM IS MADE TO THE EXCLUSIVE
RIGHT TO USE "HEALTH", APART FROM THE
MARK AS SHOWN.

SN 77-311,093, FILED 10-23-2007.

ALEX KEAM, EXAMINING ATTORNEY

Int. Cl.: 36

Prior U.S. Cls.: 100, 101, and 102

United States Patent and Trademark Office

Reg. No. 3,522,148

Registered Oct. 21, 2008

**SERVICE MARK
PRINCIPAL REGISTER**

SMARTSTOPS

ACCIONET, LLC (DELAWARE LIMITED LIABILITY COMPANY), DBA SMARTSTOPS,
323 62ND STREET
NEWPORT BEACH, CA 926631901

THE MARK CONSISTS OF STANDARD CHARACTERS WITHOUT CLAIM TO ANY PARTICULAR FONT, STYLE, SIZE, OR COLOR.

FOR: PROVISION OF FINANCIAL INFORMATION AND INVESTMENT ANALYSIS AND ADVICE BY MEANS OF THE INTERNET, IN CLASS 36 (U.S. CLS. 100, 101 AND 102).

SN 77-311,450, FILED 10-23-2007.

FIRST USE 7-7-2008; IN COMMERCE 7-7-2008.

GILBERT SWIFT, EXAMINING ATTORNEY

Int. Cl.: 5

Prior U.S. Cls.: 6, 18, 44, 46, 51, and 52

Reg. No. 3,522,149

United States Patent and Trademark Office

Registered Oct. 21, 2008

**TRADEMARK
PRINCIPAL REGISTER**

ZODERM HYDRATING WASH

BRADLEY PHARMACEUTICALS, INC. (DELA-
WARE CORPORATION)

60 BAYLIS ROAD

MELVILLE, NY 11747

FOR: MEDICATED SKIN TREATMENT PRO-
DUCTS, NAMELY, CLEANSERS FOR TREATMENT
OF ACNE AND OTHER SKIN CONDITIONS, IN
CLASS 5 (U.S. CLS. 6, 18, 44, 46, 51 AND 52).

FIRST USE 4-13-2008; IN COMMERCE 4-13-2008.

THE MARK CONSISTS OF STANDARD CHAR-
ACTERS WITHOUT CLAIM TO ANY PARTICULAR
FONT, STYLE, SIZE, OR COLOR.

OWNER OF U.S. REG. NO. 2,877,819.

NO CLAIM IS MADE TO THE EXCLUSIVE
RIGHT TO USE "HYDRATING WASH", APART
FROM THE MARK AS SHOWN.

SN 77-312,938, FILED 10-25-2007.

THEODORE MCBRIDE, EXAMINING ATTORNEY

Int. Cl.: 41

Prior U.S. Cls.: 100, 101, and 107

United States Patent and Trademark Office

Reg. No. 3,522,150

Registered Oct. 21, 2008

**SERVICE MARK
PRINCIPAL REGISTER**



GOLDEN, WILLIAM A. (UNITED STATES INDIVIDUAL)
1671 SOUTHWOOD DRIVE
SURFSIDE BEACH, SC 29577

FOR: AMATEUR YOUTH SPORTS SERVICES, NAMELY, ORGANIZING, PROVIDING AND MANAGING YOUTH SPORTS ACTIVITIES, IN CLASS 41 (U.S. CLS. 100, 101 AND 107).

FIRST USE 6-11-2007; IN COMMERCE 1-1-2008.

THE COLOR(S) BLACK, WHITE & GREY IS/ARE CLAIMED AS A FEATURE OF THE MARK.

THE MARK CONSISTS OF A BLACK OVAL SHAPE BACKGROUND OVERLAYED BY RADIANT GREY LETTERS SAYING "MYLOCALSOCCERCLUB.COM". ALSO HAVING A WHITE CATCH PHRASE SAYING WHERE PLAYERS AND CLUBS GET IT. A BLACK AND WHITE SOCCER BALL HOVERS BETWEEN THE WORDS MY AND LOCAL.

SN 77-313,403, FILED 10-25-2007.

WENDY JUN, EXAMINING ATTORNEY

Int. Cl.: 5

Prior U.S. Cls.: 6, 18, 44, 46, 51, and 52

Reg. No. 3,522,151

United States Patent and Trademark Office

Registered Oct. 21, 2008

**TRADEMARK
PRINCIPAL REGISTER**

Novaire

BIOLOGIX HEALTH SCIENCES, LLC (ARIZONA
LIMITED LIABILITY COMPANY), DBA NO-
VAIRE,
9035 N. 15TH PLACE
PHOENIX, AZ 85020

THE MARK CONSISTS OF STANDARD CHAR-
ACTERS WITHOUT CLAIM TO ANY PARTICULAR
FONT, STYLE, SIZE, OR COLOR.

FOR: ANTIBACTERIAL SPRAY; DECONGE-
STANT NASAL SPRAYS; NASAL SPRAY PREPARA-
TIONS, IN CLASS 5 (U.S. CLS. 6, 18, 44, 46, 51 AND 52).

SN 77-313,443, FILED 10-25-2007.

FIRST USE 1-1-2008; IN COMMERCE 1-1-2008.

BRIAN CALLAGHAN, EXAMINING ATTORNEY

Int. Cl.: 11

Prior U.S. Cls.: 13, 21, 23, 31, and 34

United States Patent and Trademark Office

Reg. No. 3,522,152

Registered Oct. 21, 2008

**TRADEMARK
PRINCIPAL REGISTER**

Santa Cruz

HOMER TLC, INC. (DELAWARE CORPORATION)
1404 SOCIETY DRIVE
CLAYMONT, DE 19703

THE MARK CONSISTS OF STANDARD CHARACTERS WITHOUT CLAIM TO ANY PARTICULAR FONT, STYLE, SIZE, OR COLOR.

FOR: CEILING FANS; ELECTRIC LIGHTING FIXTURES, IN CLASS 11 (U.S. CLS. 13, 21, 23, 31 AND 34).

SN 77-313,664, FILED 10-25-2007.

FIRST USE 1-0-2008; IN COMMERCE 1-0-2008.

DANIEL BRODY, EXAMINING ATTORNEY

Int. Cl.: 42

Prior U.S. Cls.: 100 and 101

United States Patent and Trademark Office

Reg. No. 3,522,153

Registered Oct. 21, 2008

**SERVICE MARK
PRINCIPAL REGISTER**

FAMILY HEIRLOOM BEAR

FIT, INC. (GEORGIA CORPORATION)
647 MIMOSA BLVD.
ROSWELL, GA 30075

FOR: CUSTOM DESIGN OF PLUSH TOYS BASED
ON PERSONAL SELECTIONS MADE BY THE CUS-
TOMER, IN CLASS 42 (U.S. CLS. 100 AND 101).

FIRST USE 10-27-2007; IN COMMERCE 10-27-2007.

THE MARK CONSISTS OF STANDARD CHAR-
ACTERS WITHOUT CLAIM TO ANY PARTICULAR
FONT, STYLE, SIZE, OR COLOR.

NO CLAIM IS MADE TO THE EXCLUSIVE
RIGHT TO USE "BEAR", APART FROM THE MARK
AS SHOWN.

SN 77-313,805, FILED 10-25-2007.

GRETTA YAO, EXAMINING ATTORNEY

Int. Cl.: 11

Prior U.S. Cls.: 13, 21, 23, 31, and 34

United States Patent and Trademark Office

Reg. No. 3,522,154

Registered Oct. 21, 2008

**TRADEMARK
PRINCIPAL REGISTER**

NITROGEN 2 U

MILLER CARBONIC, INC. (ILLINOIS CORPORATION)
530 W. ROOT STREET
CHICAGO, IL 60609

FOR: NITROGEN-GENERATION EQUIPMENT AND COMPONENTS, NAMELY, NITROGEN GENERATORS AND ASSOCIATED NOZZLES SOLD AS A UNIT, IN CLASS 11 (U.S. CLS. 13, 21, 23, 31 AND 34).

FIRST USE 2-15-2008; IN COMMERCE 2-15-2008.

THE MARK CONSISTS OF STANDARD CHARACTERS WITHOUT CLAIM TO ANY PARTICULAR FONT, STYLE, SIZE, OR COLOR.

NO CLAIM IS MADE TO THE EXCLUSIVE RIGHT TO USE "NITROGEN", APART FROM THE MARK AS SHOWN.

SN 77-313,860, FILED 10-25-2007.

WILLIAM VERHOSEK, EXAMINING ATTORNEY

Int. Cl.: 18

Prior U.S. Cls.: 1, 2, 3, 22, and 41

Reg. No. 3,522,155

United States Patent and Trademark Office

Registered Oct. 21, 2008

**TRADEMARK
PRINCIPAL REGISTER**



ZIXTRO INC. (MAURITIUS CORPORATION)
ST. DENIS STREET
SUITE 802, ST JAMES COURT
PORT LOUIS, MAURITIUS

FIRST USE 9-6-2007; IN COMMERCE 9-6-2007.

THE MARK INCLUDES THE LETTERS "Z" AND
"I" IN STYLIZED FORM.

FOR: CARRY-ON BAGS; DUFFEL BAGS; ALL
PURPOSE SPORT BAGS; TRAVELING BAGS;
BACKPACKS; FANNY PACKS; HANDBAGS;
BRIEFCASES; LUGGAGE; OVERNIGHT BAGS , IN
CLASS 18 (U.S. CLS. 1, 2, 3, 22 AND 41).

SN 77-314,286, FILED 10-26-2007.

MATTHEW PAPPAS, EXAMINING ATTORNEY

Int. Cl.: 35

Prior U.S. Cls.: 100, 101, and 102

United States Patent and Trademark Office

Reg. No. 3,522,156

Registered Oct. 21, 2008

**SERVICE MARK
PRINCIPAL REGISTER**

SOCIAL BETTY

SOCIALNESS, LLC (CALIFORNIA LIMITED LIABILITY COMPANY), DBA SOCIAL BETTY,
STE. 602, PMB #491
5694 MISSION CENTER RD.
SAN DIEGO, CA 92108

FOR: PROVIDING CONSUMER INFORMATION SERVICES AND MAKING REFERRALS IN THE FIELD OF ENTERTAINMENT SERVICES FOR PRODUCTS, SERVICES, EVENTS, ACTIVITIES, FACILITIES AND LOCATIONS, IN CLASS 35 (U.S. CLS. 100, 101 AND 102).

FIRST USE 4-1-2007; IN COMMERCE 1-16-2008.

THE MARK CONSISTS OF STANDARD CHARACTERS WITHOUT CLAIM TO ANY PARTICULAR FONT, STYLE, SIZE, OR COLOR.

SN 77-314,845, FILED 10-26-2007.

ROBIN MITTLER, EXAMINING ATTORNEY

Int. Cl.: 33

Prior U.S. Cls.: 47 and 49

United States Patent and Trademark Office

Reg. No. 3,522,157

Registered Oct. 21, 2008

**TRADEMARK
PRINCIPAL REGISTER**

XPLORE AFRICA

GOLDEN KAAAN USA, LLC (CALIFORNIA LIMITED LIABILITY COMPANY)
24520 RAMAL RD.
SONOMA, CA 95476

NO CLAIM IS MADE TO THE EXCLUSIVE RIGHT TO USE "AFRICA", APART FROM THE MARK AS SHOWN.

FOR: WINES, IN CLASS 33 (U.S. CLS. 47 AND 49).

FIRST USE 7-18-2008; IN COMMERCE 7-18-2008.

SN 77-314,893, FILED 10-26-2007.

THE MARK CONSISTS OF STANDARD CHARACTERS WITHOUT CLAIM TO ANY PARTICULAR FONT, STYLE, SIZE, OR COLOR.

SUE LAWRENCE, EXAMINING ATTORNEY

Int. Cl.: 42

Prior U.S. Cls.: 100 and 101

United States Patent and Trademark Office

Reg. No. 3,522,158

Registered Oct. 21, 2008

**SERVICE MARK
PRINCIPAL REGISTER**

CITYCENTRAL

INFLUENCE INTERNATIONAL, INC. (UTAH
CORPORATION)
SUITE 2
746 EAST 1910 SOUTH
PROVO, UT 84606

FOR: NON-DOWNLOADABLE COMPUTER PRO-
GRAMS FOR THE COLLECTION, EDITING, ORGA-
NIZING, MODIFYING, BOOK MARKING,
TRANSMISSION, STORAGE AND SHARING OF
DATA AND INFORMATION; NON-DOWNLOAD-
ABLE COMPUTER SOFTWARE FOR THE COLLEC-
TION, EDITING, ORGANIZING, MODIFYING,
BOOK MARKING, TRANSMISSION, STORAGE

AND SHARING OF DATA AND INFORMATION,
IN CLASS 42 (U.S. CLS. 100 AND 101).

FIRST USE 11-1-2007; IN COMMERCE 11-1-2007.

THE MARK CONSISTS OF STANDARD CHAR-
ACTERS WITHOUT CLAIM TO ANY PARTICULAR
FONT, STYLE, SIZE, OR COLOR.

SN 77-315,363, FILED 10-28-2007.

DAVID COLLIER, EXAMINING ATTORNEY

Int. Cl.: 35

Prior U.S. Cls.: 100, 101, and 102

United States Patent and Trademark Office

Reg. No. 3,522,159

Registered Oct. 21, 2008

**SERVICE MARK
PRINCIPAL REGISTER**

**YOUR EMPLOYMENT SOLUTIONS
PARTNER**

FLEXICORPS INC. (ILLINOIS CORPORATION)
1652 E. MAIN STREET, SUITE 150
ST. CHARLES, IL 60174

FOR: CONSULTING SERVICES IN THE FIELD OF HUMAN RESOURCES DEVELOPMENT, NAME-
LY, FOR THE PROMOTION OF EMPLOYEE RE-
TENTION, CAREER GROWTH, AND INCREASED
PRODUCTIVITY FOR EMPLOYEES AND EMPLOY-
ERS; EMPLOYMENT AGENCIES; TEMPORARY
EMPLOYMENT AGENCIES; EMPLOYMENT
COUNSELING AND RECRUITING; EMPLOYMENT
HIRING, RECRUITING, PLACEMENT, STAFFING
AND CAREER NETWORKING SERVICES; EM-

PLOYMENT OUTPLACEMENT SERVICES; EM-
PLOYMENT VERIFICATION, IN CLASS 35 (U.S.
CLS. 100, 101 AND 102).

FIRST USE 1-30-2008; IN COMMERCE 1-30-2008.

THE MARK CONSISTS OF STANDARD CHAR-
ACTERS WITHOUT CLAIM TO ANY PARTICULAR
FONT, STYLE, SIZE, OR COLOR.

SN 77-316,453, FILED 10-29-2007.

ELLEN BURNS, EXAMINING ATTORNEY

Int. Cl.: 28

Prior U.S. Cls.: 22, 23, 38, and 50

United States Patent and Trademark Office

Reg. No. 3,522,160

Registered Oct. 21, 2008

**TRADEMARK
PRINCIPAL REGISTER**

DRIVE THEM ALL!

CASTLINE, INC. (CALIFORNIA CORPORATION)
11837 GOLDRING ROAD
ARCADIA, CA 91006

THE MARK CONSISTS OF STANDARD CHAR-
ACTERS WITHOUT CLAIM TO ANY PARTICULAR
FONT, STYLE, SIZE, OR COLOR.

FOR: TOYS, NAMELY, TOY VEHICLES, COLLEC-
TIBLE MODEL CARS, IN CLASS 28 (U.S. CLS. 22, 23,
38 AND 50).

SN 77-316,847, FILED 10-30-2007.

FIRST USE 6-3-2008; IN COMMERCE 6-8-2008.

DOMINICK J. SALEMI, EXAMINING ATTORNEY

Int. Cl.: 28

Prior U.S. Cls.: 22, 23, 38, and 50

United States Patent and Trademark Office

Reg. No. 3,522,161

Registered Oct. 21, 2008

**TRADEMARK
PRINCIPAL REGISTER**

"IDEAS THAT FLY"

CASTLINE, INC. (CALIFORNIA CORPORATION)
11837 GOLDRING ROAD
ARCADIA, CA 91006

THE MARK CONSISTS OF STANDARD CHAR-
ACTERS WITHOUT CLAIM TO ANY PARTICULAR
FONT, STYLE, SIZE, OR COLOR.

FOR: TOYS, NAMELY, TOY VEHICLES, COLLEC-
TIBLE MODEL CARS, IN CLASS 28 (U.S. CLS. 22, 23,
38 AND 50).

SN 77-316,848, FILED 10-30-2007.

FIRST USE 3-1-2008; IN COMMERCE 5-1-2008.

DOMINICK J. SALEMI, EXAMINING ATTORNEY

Int. Cl.: 45

Prior U.S. Cls.: 100 and 101

United States Patent and Trademark Office

Reg. No. 3,522,162

Registered Oct. 21, 2008

**SERVICE MARK
PRINCIPAL REGISTER**

Elect Home Care

ELECT HOME CARE, LLC (TENNESSEE LIMITED LIABILITY COMPANY)
1862 POPLAR CREST CV
MEMPHIS, TN 38119

FOR: NON-MEDICAL HOME CARE SERVICES, NAMELY, PROVIDING COMPANIONSHIP AND ASSISTANCE WITH DAILY LIVING TO SENIOR CITIZENS, NEW MOTHERS, PEOPLE WITH DISABILITIES AND ANYONE NEEDING SUCH COMPANIONSHIP AND ASSISTANCE IN THEIR DAY TO DAY ACTIVITIES, IN CLASS 45 (U.S. CLS. 100 AND 101).

FIRST USE 11-1-2007; IN COMMERCE 11-1-2007.

THE MARK CONSISTS OF STANDARD CHARACTERS WITHOUT CLAIM TO ANY PARTICULAR FONT, STYLE, SIZE, OR COLOR.

NO CLAIM IS MADE TO THE EXCLUSIVE RIGHT TO USE "HOME CARE", APART FROM THE MARK AS SHOWN.

SN 77-317,320, FILED 10-30-2007.

CURTIS FRENCH, EXAMINING ATTORNEY

Int. Cl.: 41

Prior U.S. Cls.: 100, 101, and 107

United States Patent and Trademark Office

Reg. No. 3,522,163

Registered Oct. 21, 2008

**SERVICE MARK
PRINCIPAL REGISTER**

THE ART OF BALANCE

ALEAGENT HEALTH (NEBRASKA CORPORATION)
12809 WEST DODGE ROAD
OMAHA, NE 68154

FOR: EDUCATION SERVICES, NAMELY, PROVIDING CLASSES AND SEMINARS IN THE FIELD OF LIFE COACHING, IN CLASS 41 (U.S. CLS. 100, 101 AND 107).

FIRST USE 7-31-2007; IN COMMERCE 7-31-2007.

THE MARK CONSISTS OF STANDARD CHARACTERS WITHOUT CLAIM TO ANY PARTICULAR FONT, STYLE, SIZE, OR COLOR.

SN 77-317,352, FILED 10-30-2007.

JENNIFER VASQUEZ, EXAMINING ATTORNEY

Int. Cl.: 41

Prior U.S. Cls.: 100, 101, and 107

United States Patent and Trademark Office

Reg. No. 3,522,164

Registered Oct. 21, 2008

**SERVICE MARK
PRINCIPAL REGISTER**

THE ART OF SUPPORT

ALEAGENT HEALTH (NEBRASKA CORPORATION)
12809 WEST DODGE ROAD
OMAHA, NE 68154

FOR: EDUCATION SERVICES, NAMELY, PROVIDING CLASSES AND SEMINARS IN THE FIELD OF LIFE COACHING, IN CLASS 41 (U.S. CLS. 100, 101 AND 107).

FIRST USE 7-31-2007; IN COMMERCE 7-31-2007.

THE MARK CONSISTS OF STANDARD CHARACTERS WITHOUT CLAIM TO ANY PARTICULAR FONT, STYLE, SIZE, OR COLOR.

SN 77-317,362, FILED 10-30-2007.

JENNIFER VASQUEZ, EXAMINING ATTORNEY

Int. Cl.: 19

Prior U.S. Cls.: 1, 12, 33, and 50

United States Patent and Trademark Office

Reg. No. 3,522,165

Registered Oct. 21, 2008

**TRADEMARK
PRINCIPAL REGISTER**

GO ANYWHERE

KOLCRAFT ENTERPRISES, INC. (DELAWARE
CORPORATION)
1100 W. MONROE STREET
CHICAGO, IL 60607

THE MARK CONSISTS OF STANDARD CHAR-
ACTERS WITHOUT CLAIM TO ANY PARTICULAR
FONT, STYLE, SIZE, OR COLOR.

FOR: NON-METAL GATES, NAMELY, PORTA-
BLE BABY, CHILD SAFETY AND PET GATES, IN
CLASS 19 (U.S. CLS. 1, 12, 33 AND 50).

SN 77-318,243, FILED 10-31-2007.

FIRST USE 9-7-2007; IN COMMERCE 12-7-2007.

MARK T. MULLEN, EXAMINING ATTORNEY

Int. Cl.: 41

Prior U.S. Cls.: 100, 101, and 107

United States Patent and Trademark Office

Reg. No. 3,522,166

Registered Oct. 21, 2008

**SERVICE MARK
PRINCIPAL REGISTER**

GREEN THIRTEEN 13

LISAK, ROB (UNITED STATES INDIVIDUAL)
12343 S 76TH AVE.
PALOS HEIGHTS, IL 60463

FIRST USE 11-1-2007; IN COMMERCE 11-23-2007.

FOR: ENTERTAINMENT SERVICES, NAMELY,
LIVE, TELEVISED AND MOVIE APPEARANCES BY
A PROFESSIONAL ENTERTAINER; ENTERTAIN-
MENT, NAMELY, LIVE MUSIC CONCERTS; EN-
TERTAINMENT, NAMELY, LIVE
PERFORMANCES BY ROCK GROUPS, IN CLASS
41 (U.S. CLS. 100, 101 AND 107).

THE MARK CONSISTS OF STANDARD CHAR-
ACTERS WITHOUT CLAIM TO ANY PARTICULAR
FONT, STYLE, SIZE, OR COLOR.

SN 77-318,661, FILED 10-31-2007.

EMILY CHUO, EXAMINING ATTORNEY

Int. Cl.: 3

Prior U.S. Cls.: 1, 4, 6, 50, 51, and 52

United States Patent and Trademark Office

Reg. No. 3,522,167

Registered Oct. 21, 2008

**TRADEMARK
PRINCIPAL REGISTER**

REVERT ECO

RUE21, INC. (PENNSYLVANIA CORPORATION)
SUITE 100
300 COMMONWEALTH DRIVE
WARRENDALE, PA 15068

FOR: FRAGRANCE FOR PERSONAL USE; PERFUME; COLOGNE; BODY AND BATH PRODUCTS, NAMELY, SOAPS, LOTIONS, BODY SPRAY, BODY SPLASH, BUBBLE BATH; AND GIFT SETS COMPRISED OF COMBINATIONS OF THE ABOVE, SOLD AS A UNIT, IN CLASS 3 (U.S. CLS. 1, 4, 6, 50, 51 AND 52).

FIRST USE 4-17-2008; IN COMMERCE 4-17-2008.

THE MARK CONSISTS OF STANDARD CHARACTERS WITHOUT CLAIM TO ANY PARTICULAR FONT, STYLE, SIZE, OR COLOR.

SN 77-318,759, FILED 11-1-2007.

GIANCARLO CASTRO, EXAMINING ATTORNEY

Int. Cl.: 35

Prior U.S. Cls.: 100, 101, and 102

United States Patent and Trademark Office

Reg. No. 3,522,168

Registered Oct. 21, 2008

**SERVICE MARK
PRINCIPAL REGISTER**

CSI COMMUNICATOR

DOUGLAS WEBB AND ASSOCIATES, INC.
(OHIO CORPORATION)
8080 CORPORATE BLVD.
PLAIN CITY, OH 43064

FOR: BUSINESS SERVICES, NAMELY, CONDUCTING BUSINESS MANAGEMENT AND MARKET RESEARCH SURVEYS, CUSTOMER RESEARCH SURVEYS, CUSTOMER SATISFACTION SURVEYS; PROVIDING EXPERT EVALUATIONS AND REPORTS RELATING TO BUSINESS MATTERS BASED ON BUSINESS MANAGEMENT AND MARKET RESEARCH SURVEYS, CUSTOMER RESEARCH SURVEYS, AND CUSTOMER SATISFACTION SURVEYS, IN CLASS 35 (U.S. CLS. 100, 101 AND 102).

FIRST USE 8-20-2007; IN COMMERCE 10-29-2007.

THE MARK CONSISTS OF STANDARD CHARACTERS WITHOUT CLAIM TO ANY PARTICULAR FONT, STYLE, SIZE, OR COLOR.

OWNER OF U.S. REG. NOS. 2,372,890 AND 2,405,894.

NO CLAIM IS MADE TO THE EXCLUSIVE RIGHT TO USE "CSI" , APART FROM THE MARK AS SHOWN.

SN 77-319,034, FILED 11-1-2007.

MICHAEL TANNER, EXAMINING ATTORNEY

Int. Cl.: 32

Prior U.S. Cls.: 45, 46, and 48

United States Patent and Trademark Office

Reg. No. 3,522,169

Registered Oct. 21, 2008

TRADEMARK
PRINCIPAL REGISTER



BEVERAGE SOLUTIONS GROUP LLC (TENNESSEE LIMITED LIABILITY COMPANY), DBA BEVERAGE SOLUTIONS GROUP, SUITE B
4373 MAYNARDVILLE HIGHWAY
MAYNARDVILLE, TN 37807

FOR: CONCENTRATES, SYRUPS OR POWDERS USED IN THE PREPARATION OF SOFT DRINKS; ENERGY DRINKS; FRUIT DRINKS; PREPARATIONS FOR MAKING BEVERAGES, CONCENTRATES AND POWDERS FOR THE PURPOSE OF MAKING FROZEN DRINKS; FRUIT-FLAVORED DRINKS, IN CLASS 32 (U.S. CLS. 45, 46 AND 48).

FIRST USE 1-15-2008; IN COMMERCE 6-5-2008.

NO CLAIM IS MADE TO THE EXCLUSIVE RIGHT TO USE "NEKTAR" AND "FRUITY AND

FLAVORFUL FROZEN DRINKS", APART FROM THE MARK AS SHOWN.

THE COLOR(S) GREEN, RED, YELLOW, AND ORANGE IS/ARE CLAIMED AS A FEATURE OF THE MARK.

THE MARK CONSISTS OF GREEN AND RED AND ORANGE LETTERING OUTLINED IN YELLOW. THE "E" IN "NEKTAR" IS LOWER CASE AND REVERSED.

SN 77-319,103, FILED 11-1-2007.

ROBERT C. CLARK JR., EXAMINING ATTORNEY

Int. Cl.: 36

Prior U.S. Cls.: 100, 101, and 102

United States Patent and Trademark Office

Reg. No. 3,522,170

Registered Oct. 21, 2008

**SERVICE MARK
PRINCIPAL REGISTER**

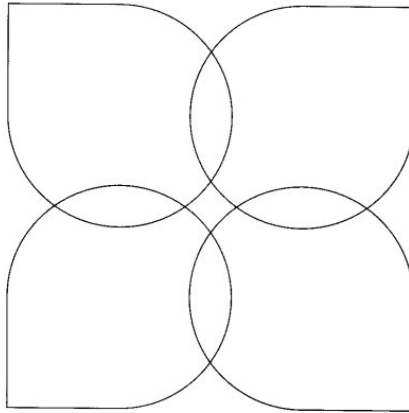

ALLSUP, INC. (ILLINOIS CORPORATION)
300 ALLSUP PLACE
BELLEVILLE, IL 62223

FOR: CLAIMS ADMINISTRATION IN THE FIELD OF SOCIAL SECURITY DISABILITY INSURANCE AND MEDICARE INSURANCE; CONSULTING SERVICES IN THE FIELD OF SOCIAL SECURITY DISABILITY INSURANCE AND MEDICARE INSURANCE RENDERED TO INSURERS, FINAN-

CIAL INSTITUTIONS, AND INDIVIDUALS, IN CLASS 36 (U.S. CLS. 100, 101 AND 102).

FIRST USE 4-8-2008; IN COMMERCE 4-8-2008.

THE MARK CONSISTS OF FOUR OVERLAPPING DROPS.

SN 77-319,718, FILED 11-2-2007.

SETH A. RAPPAPORT, EXAMINING ATTORNEY

Int. Cl.: 28

Prior U.S. Cls.: 22, 23, 38, and 50

United States Patent and Trademark Office

Reg. No. 3,522,171

Registered Oct. 21, 2008

TRADEMARK
PRINCIPAL REGISTER



CHAB ENTERPRISES, LLC (TENNESSEE LIMITED LIABILITY COMPANY)
505 SOUTH PERKINS ROAD, SUITE 1203
MEMPHIS, TN 38117

FOR: TENNIS TRAINING SYSTEMS, NAMELY, APPARATUS HAVING AN ELONGATED ELASTIC CORD THAT ALLOWS A TENNIS PLAYER TO REPETITIVELY HIT A BALL SUCH AS A CONVENTIONAL TENNIS BALL, A FOAM BALL, A SPONGE BALL, A PRESSURELESS TENNIS BALL OR A LOW-COMPRESSION TENNIS BALL; TENNIS RACQUETS HAVING AN ELONGATED ELASTIC CORD AND A TENNIS BALL ATTACHED THERETO, IN CLASS 28 (U.S. CLS. 22, 23, 38 AND 50).

FIRST USE 4-0-2008; IN COMMERCE 4-0-2008.

NO CLAIM IS MADE TO THE EXCLUSIVE RIGHT TO USE "TENNIS TRAINING SYSTEM", APART FROM THE MARK AS SHOWN.

THE MARK CONSISTS OF THE PHRASE "ES" STYLIZED WITH A TENNIS BALL CONNECTED TO THE LETTER "S" ALL WITHIN AN OVAL SHAPE, AND ABOVE THE PHRASE "ELASTI-STROKE", WHICH IS STYLIZED.

SN 77-319,878, FILED 11-2-2007.

KELLEY WELLS, EXAMINING ATTORNEY

Int. Cl.: 44

Prior U.S. Cls.: 100 and 101

United States Patent and Trademark Office

Reg. No. 3,522,172

Registered Oct. 21, 2008

**SERVICE MARK
PRINCIPAL REGISTER**

Organic Alternative

SPRING-GREEN LAWN CARE CORP. (DELA-
WARE CORPORATION)
11909 SPAULDING SCHOOL DRIVE
PLAINFIELD, IL 60585

FOR: ORGANIC LANDSCAPING, ORGANIC
LAWN CARE AND ORGANIC TREE CARE SERVI-
CES, NAMELY, LAWN MAINTENANCE, LAWN
FERTILIZATION, TREE FERTILIZATION, WEED
CONTROL, AND THE SPREADING OF ORGANIC
SUBSTANCES FOR CONTROL OF INSECTS IN
LAWNS AND TREES, IN CLASS 44 (U.S. CLS. 100
AND 101).

FIRST USE 2-6-2008; IN COMMERCE 3-5-2008.

THE MARK CONSISTS OF STANDARD CHAR-
ACTERS WITHOUT CLAIM TO ANY PARTICULAR
FONT, STYLE, SIZE, OR COLOR.

NO CLAIM IS MADE TO THE EXCLUSIVE
RIGHT TO USE "ORGANIC", APART FROM THE
MARK AS SHOWN.

SN 77-319,890, FILED 11-2-2007.

SHARON MEIER, EXAMINING ATTORNEY

Int. Cl.: 33

Prior U.S. Cls.: 47 and 49

United States Patent and Trademark Office

Reg. No. 3,522,173

Registered Oct. 21, 2008

**TRADEMARK
PRINCIPAL REGISTER**

BLACK NOVA

GREAT AMERICAN WINERIES, INC. (CALIFORNIA CORPORATION)
8940 CARMEL VALLEY ROAD
CARMEL, CA 93923

THE MARK CONSISTS OF STANDARD CHARACTERS WITHOUT CLAIM TO ANY PARTICULAR FONT, STYLE, SIZE, OR COLOR.

FOR: WINES, IN CLASS 33 (U.S. CLS. 47 AND 49).

SN 77-320,471, FILED 11-2-2007.

FIRST USE 10-26-2007; IN COMMERCE 1-21-2008.

LINDA M. KING, EXAMINING ATTORNEY

Int. Cls.: 9 and 28

Prior U.S. Cls.: 21, 22, 23, 26, 36, 38, and 50

United States Patent and Trademark Office

Reg. No. 3,522,174

Registered Oct. 21, 2008

**TRADEMARK
PRINCIPAL REGISTER**

MEMORY WORKS

EMERALD INNOVATIONS, LLC (OHIO LIMITED LIABILITY COMPANY)
SUITE 200
245 PITTSBURGH ROAD
BUTLER, PA 16001

FOR: DIGITAL AUDIO PLAYERS; DIGITAL PHOTO FRAMES FOR DISPLAYING DIGITAL PICTURES, VIDEO CLIPS AND MUSIC, IN CLASS 9 (U.S. CLS. 21, 23, 26, 36 AND 38).

FIRST USE 10-1-2007; IN COMMERCE 10-1-2007.

FOR: CHRISTMAS TREE ORNAMENTS; CHRISTMAS TREE ORNAMENTS WITH A MUSIC FEATURE, IN CLASS 28 (U.S. CLS. 22, 23, 38 AND 50).

FIRST USE 10-1-2007; IN COMMERCE 10-1-2007.

THE MARK CONSISTS OF STANDARD CHARACTERS WITHOUT CLAIM TO ANY PARTICULAR FONT, STYLE, SIZE, OR COLOR.

NO CLAIM IS MADE TO THE EXCLUSIVE RIGHT TO USE "MEMORY", APART FROM THE MARK AS SHOWN.

SN 77-320,846, FILED 11-4-2007.

TRACY WHITTAKER-BROWN, EXAMINING ATTORNEY

Int. Cl.: 36

Prior U.S. Cls.: 100, 101, and 102

United States Patent and Trademark Office

Reg. No. 3,522,175

Registered Oct. 21, 2008

**SERVICE MARK
PRINCIPAL REGISTER**

LIFE RECLAIMED

ALLSUP, INC. (ILLINOIS CORPORATION)
300 ALLSUP PLACE
BELLEVILLE, IL 62223

FIRST USE 4-8-2008; IN COMMERCE 4-8-2008.

FOR: CLAIMS ADMINISTRATION IN THE FIELD OF SOCIAL SECURITY DISABILITY INSURANCE AND MEDICARE INSURANCE; CONSULTING SERVICES IN THE FIELD OF SOCIAL SECURITY DISABILITY INSURANCE AND MEDICARE INSURANCE RENDERED TO INSURERS, FINANCIAL INSTITUTIONS, AND INDIVIDUALS, IN CLASS 36 (U.S. CLS. 100, 101 AND 102).

THE MARK CONSISTS OF STANDARD CHARACTERS WITHOUT CLAIM TO ANY PARTICULAR FONT, STYLE, SIZE, OR COLOR.

SN 77-321,241, FILED 11-5-2007.

SETH A. RAPPAPORT, EXAMINING ATTORNEY

Int. Cl.: 35

Prior U.S. Cls.: 100, 101, and 102

United States Patent and Trademark Office

Reg. No. 3,522,176

Registered Oct. 21, 2008

**SERVICE MARK
PRINCIPAL REGISTER**



CEDAR GREY INVESTMENTS, LLC (FLORIDA LIMITED LIABILITY COMPANY), DBA FISH-LADDERHR,
10204 SILVERADO CIRCLE
BRADENTON, FL 34202

FOR: HUMAN CAPITAL MANAGEMENT OUT-SOURCING SERVICES, IN CLASS 35 (U.S. CLS. 100, 101 AND 102).

FIRST USE 11-5-2007; IN COMMERCE 12-11-2007.

THE COLOR(S) GREEN AND BLACK IS/ARE CLAIMED AS A FEATURE OF THE MARK.

THE MARK CONSISTS OF SIX HUMAN STICK FIGURES STACKED ON TOP OF EACH OTHER AS IF IN A HUMAN LADDER. THE LADDER GROWS FROM SMALLER TO LARGER AND IS CURLED INTO A LOOP IMAGE. THE FIRST PERSON IN THE

LADDER IS LIGHT GREEN IN COLOR AND EACH SEQUENTIAL PERSON IN THE LADDER IS A DARKER SHADE OF GREEN RESPECTIVELY UNTIL THE LAST PERSON WHICH IS ON TOP AND IS BLACK. THE WORD "FISHLADDERHR" APPEARS SLIGHTLY UNDERNEATH AND TO THE RIGHT OF THE PEOPLE LADDER IMAGE. THE LEFT-MOST SIDE OF THE "F" IN "FISHLADDERHR", IS DIRECTLY CENTERED BELOW THE CENTER OF THE TOPMOST, BLACK, PERSON IN THE PEOPLE LADDER AND THE BOTTOMMOST RUNG OF THE PEOPLE LADDER IS CENTERED VERTICALLY WITH THE PHRASE "FISHLADDERHR". IN THE PHRASE "FISHLADDERHR", "FISH" IS BLACK, "LADDER" IS GREEN, AND "HR" IS BLACK.

SN 77-321,403, FILED 11-5-2007.

KIMBERLY PERRY, EXAMINING ATTORNEY

Int. Cl.: 14

Prior U.S. Cls.: 2, 27, 28, and 50

United States Patent and Trademark Office

Reg. No. 3,522,177

Registered Oct. 21, 2008

**TRADEMARK
PRINCIPAL REGISTER**

CHERRYPICKDIAMONDS

MENON, LLC (MISSOURI LIMITED LIABILITY
COMPANY), DBA CHERRYPICKDIAMONDS,
230 S. BEMISTON, SUITE 540
ST. LOUIS, MO 63105

THE MARK CONSISTS OF STANDARD CHAR-
ACTERS WITHOUT CLAIM TO ANY PARTICULAR
FONT, STYLE, SIZE, OR COLOR.

FOR: DIAMONDS, IN CLASS 14 (U.S. CLS. 2, 27, 28
AND 50).

SN 77-321,884, FILED 11-5-2007.

FIRST USE 7-0-2008; IN COMMERCE 7-0-2008.

ELLEN PERKINS, EXAMINING ATTORNEY

Int. Cl.: 44

Prior U.S. Cls.: 100 and 101

United States Patent and Trademark Office

Reg. No. 3,522,178

Registered Oct. 21, 2008

**SERVICE MARK
PRINCIPAL REGISTER**

TALKING TRANSPLANT

NATIONAL MARROW DONOR PROGRAM
(COLORADO COLORADO NON-PROFIT COR-
PORATION)

SUITE 500
3001 BROADWAY STREET
MINNEAPOLIS, MN 55413

FOR: PROVIDING AN INTERACTIVE WEBSITE
THAT OFFERS INDIVIDUALS WITH LIMITED
ENGLISH SPEAKING SKILLS INFORMATION ON
MARROW AND CORD BLOOD TRANSPLANTS, IN
CLASS 44 (U.S. CLS. 100 AND 101).

THE MARK CONSISTS OF STANDARD CHAR-
ACTERS WITHOUT CLAIM TO ANY PARTICULAR
FONT, STYLE, SIZE, OR COLOR.

NO CLAIM IS MADE TO THE EXCLUSIVE
RIGHT TO USE "TRANSPLANT", APART FROM
THE MARK AS SHOWN.

SN 77-321,967, FILED 11-5-2007.

FIRST USE 5-9-2008; IN COMMERCE 5-9-2008.

LINDA ORNDORFF, EXAMINING ATTORNEY

Int. Cl.: 18

Prior U.S. Cls.: 1, 2, 3, 22, and 41

United States Patent and Trademark Office

Reg. No. 3,522,179

Registered Oct. 21, 2008

**TRADEMARK
PRINCIPAL REGISTER**

CAVALLO

CROFT, JOSEPH JAMES (CALIFORNIA SOLE PROPRIETORSHIP), DBA HYPERDRIVE INTERNATIONAL,
3501 TRES RIOS
SAN CLEMENTE, CA 92673

FOR: LEATHER BAGS, SUITCASES AND WALLET
LETS; DUFFEL BAGS; LUGGAGE TAGS; TRUNKS;
BRIEFCASE-TYPE PORTFOLIOS; BRIEFCASES;
TOTE BAGS; BACKPACKS , IN CLASS 18 (U.S. CLS.
1, 2, 3, 22 AND 41).

FIRST USE 11-5-2007; IN COMMERCE 6-2-2008.

THE MARK CONSISTS OF STANDARD CHARACTERS WITHOUT CLAIM TO ANY PARTICULAR FONT, STYLE, SIZE, OR COLOR.

THE FOREIGN WORDING IN THE MARK TRANSLATES INTO ENGLISH AS "HORSE".

SN 77-322,074, FILED 11-6-2007.

ANDREA K. NADELMAN, EXAMINING ATTORNEY

Int. Cl.: 36

Prior U.S. Cls.: 100, 101, and 102

United States Patent and Trademark Office

Reg. No. 3,522,180

Registered Oct. 21, 2008

**SERVICE MARK
PRINCIPAL REGISTER**



ALLSUP, INC. (ILLINOIS CORPORATION)
300 ALLSUP PLACE
BELLEVILLE, IL 62223

THE COLOR(S) BLUE, GREEN, PURPLE AND ORANGE IS/ARE CLAIMED AS A FEATURE OF THE MARK.

FOR: CLAIMS ADMINISTRATION IN THE FIELD OF SOCIAL SECURITY DISABILITY INSURANCE AND MEDICARE INSURANCE; CONSULTING SERVICES IN THE FIELD OF SOCIAL SECURITY DISABILITY INSURANCE AND MEDICARE INSURANCE RENDERED TO INSURERS, FINANCIAL INSTITUTIONS, AND INDIVIDUALS, IN CLASS 36 (U.S. CLS. 100, 101 AND 102).

THE MARK CONSISTS OF FOUR OVERLAPPING DROPS; THE COLOR BLUE APPEARS IN THE TOP LEFT DROP, THE COLOR GREEN APPEARS IN THE TOP RIGHT DROP, THE COLOR PURPLE APPEARS IN THE BOTTOM LEFT DROP, AND THE COLOR ORANGE APPEARS IN THE BOTTOM RIGHT DROP.

SN 77-322,206, FILED 11-6-2007.

FIRST USE 4-8-2008; IN COMMERCE 4-8-2008.

SETH A. RAPPAPORT, EXAMINING ATTORNEY

Int. Cl.: 5

Prior U.S. Cls.: 6, 18, 44, 46, 51, and 52

Reg. No. 3,522,181

United States Patent and Trademark Office

Registered Oct. 21, 2008

**TRADEMARK
PRINCIPAL REGISTER**

BUG SHOOTER

ST. GABRIEL LABORATORIES, LLC (VIRGINIA
LIMITED LIABILITY COMPANY), TA ST.
GABRIEL ORGANICS,
14044 LITCHFIELD DRIVE
ORANGE, VA 22960

FOR: INSECTICIDE FOR HOME, GARDEN AND
LAWN USE, FOR PROFESSIONAL USE AND FOR
AGRICULTURAL USE , IN CLASS 5 (U.S. CLS. 6, 18,
44, 46, 51 AND 52).

FIRST USE 2-28-2008; IN COMMERCE 2-28-2008.

THE MARK CONSISTS OF STANDARD CHAR-
ACTERS WITHOUT CLAIM TO ANY PARTICULAR
FONT, STYLE, SIZE, OR COLOR.

NO CLAIM IS MADE TO THE EXCLUSIVE
RIGHT TO USE "BUG", APART FROM THE MARK
AS SHOWN.

SN 77-322,239, FILED 11-6-2007.

DANNEAN HETZEL, EXAMINING ATTORNEY

Int. Cl.: 44

Prior U.S. Cls.: 100 and 101

United States Patent and Trademark Office

Reg. No. 3,522,182

Registered Oct. 21, 2008

**SERVICE MARK
PRINCIPAL REGISTER**



ADVANCED AESTHETICS, L.L.C. (TENNESSEE
LIMITED LIABILITY COMPANY)
SUITE 200
2000 RICHARD JONES ROAD
NASHVILLE, TN 37215

FOR: HEALTH SPA SERVICES, NAMELY, COS-
METIC BODY CARE SERVICES, IN CLASS 44 (U.S.
CLS. 100 AND 101).

FIRST USE 1-1-2006; IN COMMERCE 1-1-2006.

NO CLAIM IS MADE TO THE EXCLUSIVE
RIGHT TO USE "ADVANCED AESTHETICS",
APART FROM THE MARK AS SHOWN.

THE MARK CONSISTS OF A LADY'S ABSTRACT
PROFILE OVER SCRIPTED WORDS "ADVANCED
AESTHETICS".

SN 77-322,347, FILED 11-6-2007.

LINDA MICKLEBURGH, EXAMINING ATTORNEY

Int. Cl.: 12

Prior U.S. Cls.: 19, 21, 23, 31, 35, and 44

Reg. No. 3,522,183

United States Patent and Trademark Office

Registered Oct. 21, 2008

**TRADEMARK
PRINCIPAL REGISTER**

Roadking Shocks

ROADKING SHOCKS LLC (DELAWARE LIMITED LIABILITY COMPANY)
P.O. BOX 277
44542 BRAWLEY AVE.
JACUMBA, CA 91934

FOR: SHOCK ABSORBERS FOR MOTOR HOMES AND HEAVY DUTY TRUCKS, IN CLASS 12 (U.S. CLS. 19, 21, 23, 31, 35 AND 44).

FIRST USE 11-13-2007; IN COMMERCE 11-13-2007.

THE MARK CONSISTS OF STANDARD CHARACTERS WITHOUT CLAIM TO ANY PARTICULAR FONT, STYLE, SIZE, OR COLOR.

NO CLAIM IS MADE TO THE EXCLUSIVE RIGHT TO USE "SHOCKS", APART FROM THE MARK AS SHOWN.

SN 77-323,077, FILED 11-6-2007.

RONALD DELGIZZI, EXAMINING ATTORNEY

Int. Cl.: 39

Prior U.S. Cls.: 100 and 105

United States Patent and Trademark Office

Reg. No. 3,522,184

Registered Oct. 21, 2008

**SERVICE MARK
PRINCIPAL REGISTER**

SCOOTERBELLA

SPERANZA TRAVEL LIMITED (NEW ZEALAND
CORPORATION)
1 JACKSONS ROAD, FENDALTON
CHRISTCHURCH, NEW ZEALAND

FOR: ORGANIZING AND CONDUCTING SIGHT-
SEEING TOURS ON SCOOTERS, IN CLASS 39 (U.S.
CLS. 100 AND 105).

FIRST USE 12-31-2006; IN COMMERCE 12-31-2006.

THE MARK CONSISTS OF STANDARD CHAR-
ACTERS WITHOUT CLAIM TO ANY PARTICULAR
FONT, STYLE, SIZE, OR COLOR.

PRIORITY CLAIMED UNDER SEC. 44(D) ON
NEW ZEALAND APPLICATION NO. 777856, FILED
10-16-2007.

SN 77-323,226, FILED 11-7-2007.

PAUL CROWLEY, EXAMINING ATTORNEY

Int. Cl.: 36

Prior U.S. Cls.: 100, 101, and 102

United States Patent and Trademark Office

Reg. No. 3,522,185

Registered Oct. 21, 2008

**SERVICE MARK
PRINCIPAL REGISTER**



BIZFUNDS (OHIO LIMITED LIABILITY COMPAN-
NY)
4758 RIDGE ROAD #415
CLEVELAND, OH 441443327

FOR: CASH ADVANCE SERVICES FOR BUSI-
NESSES AND MERCHANTS, IN CLASS 36 (U.S. CLS.
100, 101 AND 102).

FIRST USE 11-15-2007; IN COMMERCE 1-1-2008.

NO CLAIM IS MADE TO THE EXCLUSIVE
RIGHT TO USE "BIZFUNDS", APART FROM THE
MARK AS SHOWN.

THE COLOR(S) ORANGE AND GREEN IS/ARE
CLAIMED AS A FEATURE OF THE MARK.

THE MARK CONSISTS OF A COMBINATION OF
A BACKWARDS "B" AND A FORWARD "F" IN
ORANGE CONTAINED IN A GREEN BOX, FOL-
LOWED BY THE WORDING "B" WITH "BIZFUNDS"
IN ORANGE AND THE WORDING "FUNDS" IN
GREEN.

SN 77-323,245, FILED 11-7-2007.

JEAN IM, EXAMINING ATTORNEY

Int. Cl.: 14

Prior U.S. Cls.: 2, 27, 28, and 50

United States Patent and Trademark Office

Reg. No. 3,522,186

Registered Oct. 21, 2008

**TRADEMARK
PRINCIPAL REGISTER**

Dolan·Bullock



COLIBRI CORPORATION (DELAWARE CORPORATION)
25 FAIRMOUNT AVE.
EAST PROVIDENCE, RI 02914

FOR: COSTUME JEWELRY; DIAMOND JEWELRY;
GEMSTONE JEWELRY; JEWELRY; JEWELRY
BOXES; JEWELRY CASES, IN CLASS 14 (U.S. CLS. 2,
27, 28 AND 50).

FIRST USE 2-1-2008; IN COMMERCE 2-1-2008.

OWNER OF U.S. REG. NOS. 1,907,288 AND
2,044,186.

NO CLAIM IS MADE TO THE EXCLUSIVE
RIGHT TO USE "EST. 1917", APART FROM THE
MARK AS SHOWN.

SN 77-323,361, FILED 11-7-2007.

LINDSEY RUBIN, EXAMINING ATTORNEY

Int. Cl.: 36

Prior U.S. Cls.: 100, 101, and 102

United States Patent and Trademark Office

Reg. No. 3,522,187

Registered Oct. 21, 2008

**SERVICE MARK
PRINCIPAL REGISTER**

MEET JACK HEIGHTS

MPC PROPERTIES, LLC (NEW YORK LIMITED LIABILITY COMPANY)
82-11 37TH AVENUE, SUITE 605
JACKSON HEIGHTS, NY 11372

FOR: ASSESSMENT AND MANAGEMENT OF REAL ESTATE; FINANCIAL INVESTMENT IN THE FIELD OF REAL ESTATE; FINANCIAL VALUATION OF REAL ESTATE; LEASING OF REAL ESTATE; OPERATING MARKETPLACES FOR SELLERS OF GOODS AND/OR SERVICES IN CONNECTION WITH REAL ESTATE; PROVIDING INFORMATION IN THE FIELD OF REAL ESTATE BY MEANS OF LINKING THE WEB SITE TO OTHER WEB SITES FEATURING REAL ESTATE INFORMATION; REAL ESTATE ACQUISITION SERVICES; REAL ESTATE AGENCIES; REAL ESTATE BROKERAGE; REAL ESTATE CONSULTATION; REAL ESTATE EQUITY SHARING, NAMELY, MANAGING AND ARRANGING FOR CO-OWNERSHIP OF REAL ESTATE; REAL ESTATE INVEST-

MENT; REAL ESTATE LISTING; REAL ESTATE MANAGEMENT; REAL ESTATE MANAGEMENT CONSULTATION; REAL ESTATE PROCUREMENT FOR OTHERS; REAL ESTATE SYNDICATION; REAL ESTATE VALUATION SERVICES, IN CLASS 36 (U.S. CLS. 100, 101 AND 102).

FIRST USE 11-0-2007; IN COMMERCE 11-0-2007.

THE MARK CONSISTS OF STANDARD CHARACTERS WITHOUT CLAIM TO ANY PARTICULAR FONT, STYLE, SIZE, OR COLOR.

THE NAME "JACK HEIGHTS" DOES NOT IDENTIFY A LIVING INDIVIDUAL.

SN 77-323,812, FILED 11-7-2007.

GILBERT SWIFT, EXAMINING ATTORNEY

Int. Cls.: 16 and 41

Prior U.S. Cls.: 2, 5, 22, 23, 29, 37, 38, 50, 100, 101, and 107

Reg. No. 3,522,188

United States Patent and Trademark Office

Registered Oct. 21, 2008

**TRADEMARK
SERVICE MARK
PRINCIPAL REGISTER**

ANCESTRAL FOLKWAYS

ANCESTRAL FOLKWAYS, LLC (MASSACHUSETTS LIMITED LIABILITY COMPANY)
43 BLAKE RD.
BROOKLINE, MA 02445

FOR: MAGAZINES FEATURING INFORMATION CONCERNING INDO-EUROPEAN MYTHS, CULTURE AND RELIGION; BOOKS IN THE FIELD OF INDO-EUROPEAN MYTHS, CULTURE AND RELIGION, IN CLASS 16 (U.S. CLS. 2, 5, 22, 23, 29, 37, 38 AND 50).

FIRST USE 1-1-2008; IN COMMERCE 1-1-2008.

FOR: PROVIDING NEWSLETTERS IN THE FIELD OF INDO-EUROPEAN MYTHS, CULTURE

AND RELIGION VIA E-MAIL, IN CLASS 41 (U.S. CLS. 100, 101 AND 107).

FIRST USE 1-1-2008; IN COMMERCE 1-1-2008.

THE MARK CONSISTS OF STANDARD CHARACTERS WITHOUT CLAIM TO ANY PARTICULAR FONT, STYLE, SIZE, OR COLOR.

NO CLAIM IS MADE TO THE EXCLUSIVE RIGHT TO USE "ANCESTRAL", APART FROM THE MARK AS SHOWN.

SN 77-323,815, FILED 11-7-2007.

MICHELE SWAIN, EXAMINING ATTORNEY

Int. Cl.: 18

Prior U.S. Cls.: 1, 2, 3, 22, and 41

Reg. No. 3,522,189

United States Patent and Trademark Office

Registered Oct. 21, 2008

**TRADEMARK
PRINCIPAL REGISTER**



BATES, DAVID CHRISTIAN (UNITED STATES
INDIVIDUAL)
3631 NW 64TH STREET
SEATTLE, WA 98107

THE MARK CONSISTS OF THE WORD "DO-
GEAR" IN BLACK BELOW A BLACK STYLIZED
LETTER "D" IN THE SHAPE OF A PROFILE OF A
DOG'S HEAD, ALL ON A WHITE BACKGROUND.

FOR: CLOTHING AND APPAREL FOR DOGS, IN
CLASS 18 (U.S. CLS. 1, 2, 3, 22 AND 41).

SN 77-324,317, FILED 11-8-2007.

FIRST USE 6-1-2008; IN COMMERCE 7-10-2008.

THE COLOR(S) BLACK AND WHITE IS/ARE
CLAIMED AS A FEATURE OF THE MARK.

EDWARD FENNESSY, EXAMINING ATTORNEY

Int. Cl.: 36

Prior U.S. Cls.: 100, 101, and 102

United States Patent and Trademark Office

Reg. No. 3,522,190

Registered Oct. 21, 2008

**SERVICE MARK
PRINCIPAL REGISTER**



MPC PROPERTIES, LLC (NEW YORK LIMITED LIABILITY COMPANY)
82-11 37TH AVENUE, SUITE 605
JACKSON HEIGHTS, NY 11372

FOR: ASSESSMENT AND MANAGEMENT OF REAL ESTATE; FINANCIAL INVESTMENT IN THE FIELD OF REAL ESTATE; FINANCIAL VALUATION OF REAL ESTATE; LEASING OF REAL ESTATE; OPERATING MARKETPLACES FOR SELLERS OF GOODS AND/OR SERVICES IN CONNECTION WITH REAL ESTATE; PROVIDING INFORMATION IN THE FIELD OF REAL ESTATE BY MEANS OF LINKING THE WEB SITE TO OTHER WEB SITES FEATURING REAL ESTATE INFORMATION; REAL ESTATE ACQUISITION SERVICES; REAL ESTATE AGENCIES; REAL ESTATE BROKERAGE; REAL ESTATE CONSULTATION; REAL ESTATE EQUITY SHARING, NAMELY,

MANAGING AND ARRANGING FOR CO-OWNERSHIP OF REAL ESTATE; REAL ESTATE INVESTMENT; REAL ESTATE LISTING; REAL ESTATE MANAGEMENT; REAL ESTATE MANAGEMENT CONSULTATION; REAL ESTATE PROCUREMENT FOR OTHERS; REAL ESTATE SYNDICATION; REAL ESTATE VALUATION SERVICES, IN CLASS 36 (U.S. CLS. 100, 101 AND 102).

FIRST USE 11-0-2007; IN COMMERCE 11-0-2007.

THE MARK CONSISTS OF A STICK FIGURE OF A MAN COMPOSED OF THE LETTERS "J" AND "H", WEARING A TOP HAT.

SN 77-324,384, FILED 11-8-2007.

GILBERT SWIFT, EXAMINING ATTORNEY

Int. Cl.: 41

Prior U.S. Cls.: 100, 101, and 107

United States Patent and Trademark Office

Reg. No. 3,522,191

Registered Oct. 21, 2008

**SERVICE MARK
PRINCIPAL REGISTER**

TEAM BEACHBODY

PRODUCT PARTNERS, LLC (CALIFORNIA LIMITED LIABILITY COMPANY)
SUITE 1050
8383 WILSHIRE BLVD.
BEVERLY HILLS, CA 90211

FOR: PROVIDING A WEB SITE FEATURING ON-LINE INSTRUCTION IN THE FIELD OF PHYSICAL EXERCISE AND NUTRITION AND TRACKING PROGRESS OF WORKOUTS; EDUCATIONAL SERVICES AND ON-LINE EDUCATIONAL SERVICES, NAMELY, PROVIDING INSTRUCTION IN THE FIELDS OF EXERCISE EQUIPMENT, PHYSICAL EXERCISE AND NUTRITION, AND INSTRUCTIONAL MATERIALS DISTRIBUTED IN CONNECTION THEREWITH; PROVIDING INFORMATION IN THE FIELD OF ENTERTAINMENT FEATURING INFORMATION ON REALITY BASED TELEVISION BY MEANS OF A GLOBAL COMPUTER NETWORK; ENTERTAINMENT SERVICES IN THE NATURE OF AN ON-GOING REALITY BASED TELEVISION

PROGRAM; ENTERTAINMENT SERVICES, NAMELY, PROVIDING A REALITY BASED TELEVISION PROGRAM VIA A GLOBAL COMPUTER NETWORK; ENTERTAINMENT SERVICES, NAMELY, CONDUCTING CONTESTS, IN CLASS 41 (U.S. CLS. 100, 101 AND 107).

FIRST USE 3-1-2007; IN COMMERCE 3-1-2007.

THE MARK CONSISTS OF STANDARD CHARACTERS WITHOUT CLAIM TO ANY PARTICULAR FONT, STYLE, SIZE, OR COLOR.

OWNER OF U.S. REG. NOS. 2,862,904, 3,041,368, AND OTHERS.

SN 77-324,434, FILED 11-8-2007.

PATRICIA EVANKO, EXAMINING ATTORNEY

Int. Cl.: 42

Prior U.S. Cls.: 100 and 101

United States Patent and Trademark Office

Reg. No. 3,522,192

Registered Oct. 21, 2008

**SERVICE MARK
PRINCIPAL REGISTER**

**Evaluate, Establish,
Educate, Enforce.**

CONQWEST, INC. (MASSACHUSETTS COR-
PORATION)
615 CONCORD STREET
FRAMINGHAM, MA 01702

FOR: COMPUTER CONSULTATION IN THE
FIELD OF COMPUTER SECURITY, IN CLASS 42
(U.S. CLS. 100 AND 101).

FIRST USE 4-9-2008; IN COMMERCE 4-9-2008.

THE MARK CONSISTS OF STANDARD CHAR-
ACTERS WITHOUT CLAIM TO ANY PARTICULAR
FONT, STYLE, SIZE, OR COLOR.

SN 77-324,536, FILED 11-8-2007.

ESTHER A. BORSUK, EXAMINING ATTORNEY

Int. Cl.: 24

Prior U.S. Cls.: 42 and 50

United States Patent and Trademark Office

Reg. No. 3,522,193

Registered Oct. 21, 2008

**TRADEMARK
PRINCIPAL REGISTER**

Simple Luxury

DIVATEX HOME FASHIONS (NEW YORK CORPORATION)
295 FIFTH AVENUE
NEW YORK, NY 10016

THE MARK CONSISTS OF STANDARD CHARACTERS WITHOUT CLAIM TO ANY PARTICULAR FONT, STYLE, SIZE, OR COLOR.

FOR: SHEETS SET, PILLOWCASES, COMFORTERS, DUVETS AND SHAMS, IN CLASS 24 (U.S. CLS. 42 AND 50).

SN 77-324,543, FILED 11-8-2007.

FIRST USE 1-5-2008; IN COMMERCE 1-5-2008.

DAVID TAYLOR, EXAMINING ATTORNEY

Int. Cl.: 32

Prior U.S. Cls.: 45, 46, and 48

United States Patent and Trademark Office

Reg. No. 3,522,194

Registered Oct. 21, 2008

**TRADEMARK
PRINCIPAL REGISTER**

MOUNTAIN DEW REVOLUTION

PEPSICO, INC. (NORTH CAROLINA CORPORATION)
700 ANDERSON HILL ROAD
PURCHASE, NY 10577

FOR: SOFT DRINKS, AND SYRUPS AND CONCENTRATES FOR MAKING THE SAME, IN CLASS 32 (U.S. CLS. 45, 46 AND 48).

FIRST USE 6-2-2008; IN COMMERCE 6-2-2008.

THE MARK CONSISTS OF STANDARD CHARACTERS WITHOUT CLAIM TO ANY PARTICULAR FONT, STYLE, SIZE, OR COLOR.

OWNER OF U.S. REG. NOS. 820,362, 3,134,243, AND OTHERS.

SN 77-324,720, FILED 11-8-2007.

WON TEAK OH, EXAMINING ATTORNEY

Int. Cl.: 28

Prior U.S. Cls.: 22, 23, 38, and 50

United States Patent and Trademark Office

Reg. No. 3,522,195

Registered Oct. 21, 2008

**TRADEMARK
PRINCIPAL REGISTER**

TETON

CROSMAN CORPORATION (DELAWARE CORPORATION)
RTES 5 & 20
EAST BLOOMFIELD, NY 14443

THE MARK CONSISTS OF STANDARD CHARACTERS WITHOUT CLAIM TO ANY PARTICULAR FONT, STYLE, SIZE, OR COLOR.

FOR: CROSSBOWS, IN CLASS 28 (U.S. CLS. 22, 23, 38 AND 50).

SN 77-324,824, FILED 11-8-2007.

FIRST USE 2-1-2008; IN COMMERCE 7-1-2008.

SUE LAWRENCE, EXAMINING ATTORNEY

Int. Cl.: 33

Prior U.S. Cls.: 47 and 49

United States Patent and Trademark Office

Reg. No. 3,522,196

Registered Oct. 21, 2008

**TRADEMARK
PRINCIPAL REGISTER**

BORN IN RUSSIA

WEST COAST WINE AND SPIRITS, INC. (CALI-
FORNIA CORPORATION)
7055 VINELAND AVENUE
NORTH HOLLYWOOD, CA 91605

THE MARK CONSISTS OF STANDARD CHAR-
ACTERS WITHOUT CLAIM TO ANY PARTICULAR
FONT, STYLE, SIZE, OR COLOR.

FOR: ALCOHOLIC BEVERAGES, NAMELY, VOD-
KA; DISTILLED SPIRITS, IN CLASS 33 (U.S. CLS. 47
AND 49).

SN 77-325,356, FILED 11-8-2007.

FIRST USE 8-1-2008; IN COMMERCE 8-1-2008.

LAURIE MAYES, EXAMINING ATTORNEY

Int. Cl.: 41

Prior U.S. Cls.: 100, 101, and 107

United States Patent and Trademark Office

Reg. No. 3,522,197

Registered Oct. 21, 2008

SERVICE MARK
PRINCIPAL REGISTER



PEBBLE BEACH COMPANY (CALIFORNIA PARTNERSHIP)
2700 17-MILE DRIVE
PEBBLE BEACH, CA 93953

FOR: ENTERTAINMENT SERVICES, NAMELY, WINE AND FOOD TASTINGS; CONDUCTING ENTERTAINMENT EXHIBITIONS IN THE NATURE OF WINE AND FOOD FESTIVALS; ARRANGING AND CONDUCTING CLASSES, SEMINARS AND WORKSHOPS IN THE FIELDS OF WINE, WINERIES, COOKING, CHEFS AND FOOD, AND DISTRIBUTION OF COURSE MATERIALS IN CONNECTION THEREWITH; EDUCATIONAL DEMONSTRATIONS; PROVIDING INFORMATION, NEWS AND COMMENTARY IN THE FIELD OF RECREATION AND LEISURE ACTIVITIES; ENTERTAINMENT SERVICES IN THE NATURE OF AN AUTOMOBILE SHOW AND EXHIBIT; GOLF RESORT SERVICES; GOLF COURSES; GOLF AND TENNIS INSTRUCTION; RENTAL OF GOLF EQUIPMENT; PROVIDING A WEBSITE THROUGH WHICH GOLFERS RESERVE TEE TIMES AT GOLF COURSES; PROVIDING A WEBSITE THROUGH WHICH GOLFERS LOCATE INFORMATION ABOUT GOLF COURSES AND GOLF TOURNAMENTS; PROVIDING INFORMATION IN THE FIELDS OF GOLF, GOLF RESORTS, GOLF INSTRUCTION, GOLF COURSES, AND GOLF TOURNAMENTS; ENTERTAINMENT IN THE NATURE

OF GOLF AND TENNIS TOURNAMENTS; ORGANIZING AND CONDUCTING POLO AND RUGBY CONTESTS AND SAILING REGATTAS; COUNTRY CLUBS; PROVIDING FACILITIES FOR RECREATION ACTIVITIES; RECREATION SERVICES IN THE NATURE OF PROVIDING GOLF AND TENNIS FACILITIES; AND PROVIDING ONLINE NEWSLETTERS IN THE FIELDS OF RECREATION AND LEISURE ACTIVITIES, GOLF RESORTS, SPORTS, ENTERTAINMENT, CULTURE, TOURISM, CUISINE AND HISTORY, IN CLASS 41 (U.S. CLS. 100, 101 AND 107).

FIRST USE 0-0-2000; IN COMMERCE 0-0-2000.

OWNER OF U.S. REG. NOS. 1,597,864, 2,774,463, AND OTHERS.

NO CLAIM IS MADE TO THE EXCLUSIVE RIGHT TO USE "1919", APART FROM THE MARK AS SHOWN.

THE MARK CONSISTS OF A STYLIZED TREE ON TOP OF A ROCK, WITH "1919" LOCATED WITHIN THE ROCK, ALL OF THE FOREGOING SURROUNDED BY TWO CONCENTRIC CIRCLES.

SN 77-326,252, FILED 11-9-2007.

AMY GEARIN, EXAMINING ATTORNEY

Int. Cl.: 41

Prior U.S. Cls.: 100, 101, and 107

United States Patent and Trademark Office

Reg. No. 3,522,198

Registered Oct. 21, 2008

**SERVICE MARK
PRINCIPAL REGISTER**

THE BOAT IS WAITING

FREEDOM FRANCHISE SALES, LLC (FLORIDA
LIMITED LIABILITY COMPANY)
1538 STICKNEY POINT ROAD
SARASOTA, FL 34231

THE MARK CONSISTS OF STANDARD CHAR-
ACTERS WITHOUT CLAIM TO ANY PARTICULAR
FONT, STYLE, SIZE, OR COLOR.

FOR: BOAT CLUB SERVICES, IN CLASS 41 (U.S.
CLS. 100, 101 AND 107).

SN 77-327,349, FILED 11-12-2007.

FIRST USE 2-1-2008; IN COMMERCE 2-1-2008.

LINDA MICKLEBURGH, EXAMINING ATTORNEY

Int. Cl.: 43

Prior U.S. Cls.: 100 and 101

United States Patent and Trademark Office

Reg. No. 3,522,199

Registered Oct. 21, 2008

**SERVICE MARK
PRINCIPAL REGISTER**



CHOICE HOTELS INTERNATIONAL, INC. (DE-
LAWARE CORPORATION)
10750 COLUMBIA PIKE
SILVER SPRING, MD 20901

FOR: HOTEL AND MOTEL SERVICES, HOTEL
AND MOTEL RESERVATION SERVICES FOR OTHERS,
AND ONLINE HOTEL AND MOTEL RESERVATION
SERVICES FOR OTHERS, IN CLASS 43
(U.S. CLS. 100 AND 101).

FIRST USE 8-24-2007; IN COMMERCE 8-24-2007.

OWNER OF U.S. REG. NOS. 813,642, 1,799,807,
AND 1,799,814.

NO CLAIM IS MADE TO THE EXCLUSIVE
RIGHT TO USE "LODGE INN & SUITES", APART
FROM THE MARK AS SHOWN.

THE COLOR(S) RED, YELLOW AND WHITE IS/
ARE CLAIMED AS A FEATURE OF THE MARK.

THE MARK CONSISTS OF A YELLOW STYLIZED
LETTER "E" INSIDE AN OVAL WITH A WHITE
STAR DESIGN AND THE WORDS "ECONO
LODGE" IN WHITE ABOVE THE WORDS "INN &
SUITES" IN YELLOW, ALL ON A RED BACK-
GROUND.

SN 77-327,464, FILED 11-12-2007.

GEORGE LORENZO, EXAMINING ATTORNEY

Int. Cl.: 25

Prior U.S. Cls.: 22 and 39

United States Patent and Trademark Office

Reg. No. 3,522,200

Registered Oct. 21, 2008

**TRADEMARK
PRINCIPAL REGISTER**

BANANA BLUES

GHANIMIAN ENTERPRISES, INC. (CALIFORNIA CORPORATION), DBA TWO LIPS SHOE CO.,
9237 SAN FERNANDO ROAD
SUN VALLEY, CA 91352

THE MARK CONSISTS OF STANDARD CHARACTERS WITHOUT CLAIM TO ANY PARTICULAR FONT, STYLE, SIZE, OR COLOR.

FOR: SHOES, IN CLASS 25 (U.S. CLS. 22 AND 39).

SN 77-327,524, FILED 11-12-2007.

FIRST USE 12-0-2007; IN COMMERCE 12-0-2007.

RONALD DELGIZZI, EXAMINING ATTORNEY

Int. Cls.: 35, 36, 37, 39, and 42

Prior U.S. Cls.: 100, 101, 102, 103, 105, and 106

United States Patent and Trademark Office

Reg. No. 3,522,201

Registered Oct. 21, 2008

SERVICE MARK
PRINCIPAL REGISTER



Fredericksburg



MANHEIM AUCTIONS, INC. (DELAWARE CORPORATION)
6205 PEACHTREE DUNWOODY ROAD
ATLANTA, GA 30328

FOR: AUTOMOBILE AUCTION SERVICES, AUTOMOBILE AUCTION SERVICES PROVIDED VIA THE INTERNET, IN CLASS 35 (U.S. CLS. 100, 101 AND 102).

FIRST USE 6-20-2008; IN COMMERCE 6-20-2008.

FOR: AUTOMOBILE FINANCING SERVICES, IN CLASS 36 (U.S. CLS. 100, 101 AND 102).

FIRST USE 6-20-2008; IN COMMERCE 6-20-2008.

FOR: AUTOMOTIVE DETAILING, RECONDITIONING, REPAIR, CONVERSION AND CUSTOMIZATION SERVICES, IN CLASS 37 (U.S. CLS. 100, 103 AND 106).

FIRST USE 6-20-2008; IN COMMERCE 6-20-2008.

FOR: BUSINESS-TO-BUSINESS AUTOMOTIVE TRANSPORTATION AND STORAGE SERVICES, IN CLASS 39 (U.S. CLS. 100 AND 105).

FIRST USE 6-20-2008; IN COMMERCE 6-20-2008.

FOR: AUTOMOBILE INSPECTION SERVICES, IN CLASS 42 (U.S. CLS. 100 AND 101).

FIRST USE 6-20-2008; IN COMMERCE 6-20-2008.

OWNER OF U.S. REG. NOS. 1,699,332, 3,229,428, AND OTHERS.

NO CLAIM IS MADE TO THE EXCLUSIVE RIGHT TO USE "FREDERICKSBURG", APART FROM THE MARK AS SHOWN.

THE COLOR(S) GOLD, BLUE, BROWN, GREY, BLACK AND WHITE IS/ARE CLAIMED AS A FEATURE OF THE MARK.

THE MARK CONSISTS OF A GOLD "M" OVER A BLUE CIRCULAR BACKGROUND AND WITHIN TWO GOLD OUTER RINGS. THE COLOR BROWN OUTLINES THE MARK. TO THE RIGHT OF THE M IS THE WORD "MANHEIM" IN THE COLOR BLACK. A BLACK LINE SEPARATES THE ABOVE DESIGN AND THE WORD "MANHEIM" AND THE WORD "FREDERICKSBURG" IN THE COLOR BLACK AND A DESIGN OF A CANNON IN THE COLOR WHITE ON A BLUE BACKGROUND, INSIDE CONCENTRIC WHITE AND GREY SQUARES TO THE RIGHT OF THE WORD "FREDERICKSBURG" .

SN 77-327,957, FILED 11-13-2007.

GISELLE AGOSTO, EXAMINING ATTORNEY

Int. Cls.: 35 and 36

Prior U.S. Cls.: 100, 101, and 102

United States Patent and Trademark Office

Reg. No. 3,522,202

Registered Oct. 21, 2008

SERVICE MARK
PRINCIPAL REGISTER



Doral



MANHEIM AUCTIONS, INC. (DELAWARE CORPORATION)
6205 PEACHTREE DUNWOODY ROAD
ATLANTA, GA 30328

FOR: AUTOMOBILE AUCTION SERVICES, AUTOMOBILE AUCTION SERVICES PROVIDED VIA THE INTERNET, IN CLASS 35 (U.S. CLS. 100, 101 AND 102).

FIRST USE 6-20-2008; IN COMMERCE 6-20-2008.

FOR: AUTOMOBILE FINANCING SERVICES, IN CLASS 36 (U.S. CLS. 100, 101 AND 102).

FIRST USE 6-20-2008; IN COMMERCE 6-20-2008.

OWNER OF U.S. REG. NOS. 1,699,332, 3,229,428, AND OTHERS.

NO CLAIM IS MADE TO THE EXCLUSIVE RIGHT TO USE "DORAL", APART FROM THE MARK AS SHOWN.

THE COLOR(S) GOLD, BLUE, BROWN, PINK, GREEN, GREY, BLACK AND WHITE IS/ARE CLAIMED AS A FEATURE OF THE MARK.

THE MARK CONSISTS OF A GOLD "M" OVER A BLUE CIRCULAR BACKGROUND AND WITHIN TWO GOLD OUTER RINGS. THE COLOR BROWN OUTLINES THE MARK. TO THE RIGHT OF THE M IS THE WORD "MANHEIM" IN THE COLOR BLACK. A BLACK LINE SEPARATES THE ABOVE DESIGN AND THE WORD "MANHEIM" AND THE WORD "DORAL" IN THE COLOR BLACK AND A DESIGN OF A FLAMINGO IN THE COLOR PINK WITH A BLACK BEAK AND LEGS ON A GREEN BACKGROUND, INSIDE CONCENTRIC WHITE AND GREY SQUARES TO THE RIGHT OF THE WORD "DORAL" .

SN 77-327,963, FILED 11-13-2007.

GISELLE AGOSTO, EXAMINING ATTORNEY

Int. Cl.: 7

Prior U.S. Cls.: 13, 19, 21, 23, 31, 34, and 35

Reg. No. 3,522,203

United States Patent and Trademark Office

Registered Oct. 21, 2008

**TRADEMARK
PRINCIPAL REGISTER**



BISELL HOMECARE, INC. (MICHIGAN CORPORATION)
32 MARKET AVENUE SW, SUITE 500
GRAND RAPIDS, MI 49503

FOR: ELECTRICAL CLEANING DEVICES; NAMELY, CARPET, BARE FLOOR, AND UPHOLSTERY CLEANING EXTRACTORS AND VACUUM CLEANERS AND ACCESSORIES, IN CLASS 7 (U.S. CLS. 13, 19, 21, 23, 31, 34 AND 35).

FIRST USE 2-18-2008; IN COMMERCE 2-18-2008.

THE MARK CONSISTS OF A HOUSE, LEAF, AND STEM.

SN 77-329,122, FILED 11-14-2007.

MARK T. MULLEN, EXAMINING ATTORNEY

Int. Cls.: 14, 18, 25, and 35

**Prior U.S. Cls.: 1, 2, 3, 22, 27, 28, 39, 41, 50, 100, 101,
and 102**

Reg. No. 3,522,204

United States Patent and Trademark Office

Registered Oct. 21, 2008

**TRADEMARK
SERVICE MARK
PRINCIPAL REGISTER**

HEIDIWOOD

HUB DISTRIBUTING, INC. (DELAWARE COR-
PORATION)
2501 GUASTI ROAD
ONTARIO, CA 91761

FOR: JEWELRY, IN CLASS 14 (U.S. CLS. 2, 27, 28
AND 50).

FIRST USE 4-15-2008; IN COMMERCE 4-15-2008.

FOR: HANDBAGS, IN CLASS 18 (U.S. CLS. 1, 2, 3,
22 AND 41).

FIRST USE 4-15-2008; IN COMMERCE 4-15-2008.

FOR: SHIRTS, T-SHIRTS, TOPS, JACKETS,
PANTS, SHORTS, SKIRTS AND DRESSES, IN CLASS
25 (U.S. CLS. 22 AND 39).

FIRST USE 4-15-2008; IN COMMERCE 4-15-2008.

FOR: RETAIL STORE SERVICES SPECIALIZING
IN CLOTHING, HANDBAGS, FRAGRANCES FOR
PERSONAL USE AND JEWELRY, IN CLASS 35 (U.S.
CLS. 100, 101 AND 102).

FIRST USE 4-15-2008; IN COMMERCE 4-15-2008.

THE MARK CONSISTS OF STANDARD CHAR-
ACTERS WITHOUT CLAIM TO ANY PARTICULAR
FONT, STYLE, SIZE, OR COLOR.

SN 77-329,638, FILED 11-14-2007.

WON TEAK OH, EXAMINING ATTORNEY

Int. Cl.: 41

Prior U.S. Cls.: 100, 101, and 107

United States Patent and Trademark Office

Reg. No. 3,522,205

Registered Oct. 21, 2008

**SERVICE MARK
PRINCIPAL REGISTER**

Beloved Portraits

O'BRIEN SPECIALTIES, INC. (NORTH CAROLINA CORPORATION)

1935 SMITH FARM RD

LINCOLNTON, NC 28092

FOR: PORTRAIT PHOTOGRAPHY, IN CLASS 41
(U.S. CLS. 100, 101 AND 107).

FIRST USE 9-28-2007; IN COMMERCE 1-1-2008.

THE MARK CONSISTS OF STANDARD CHARACTERS WITHOUT CLAIM TO ANY PARTICULAR FONT, STYLE, SIZE, OR COLOR.

NO CLAIM IS MADE TO THE EXCLUSIVE RIGHT TO USE "PORTRAITS", APART FROM THE MARK AS SHOWN.

SN 77-330,174, FILED 11-15-2007.

NANCY CLARKE, EXAMINING ATTORNEY

Int. Cl.: 33

Prior U.S. Cls.: 47 and 49

United States Patent and Trademark Office

Reg. No. 3,522,206

Registered Oct. 21, 2008

**TRADEMARK
PRINCIPAL REGISTER**

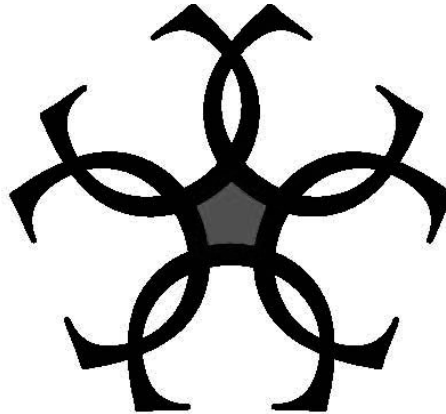

NAGENGAST, DAVID (UNITED STATES INDIVIDUAL)
6404 INDEPENDENCE RANCH PLACE
SAN MIGUEL, CA 93451

FOR: WINE, IN CLASS 33 (U.S. CLS. 47 AND 49).

FIRST USE 5-9-2008; IN COMMERCE 5-9-2008.

THE MARK CONSISTS OF FIVE INTERLOCKING UPPER CASE LETTER "C'S RADIALY SPACED.

SN 77-330,356, FILED 11-15-2007.

JOHN E. MICHOS, EXAMINING ATTORNEY

Int. Cl.: 16

Prior U.S. Cls.: 2, 5, 22, 23, 29, 37, 38, and 50

Reg. No. 3,522,207

United States Patent and Trademark Office

Registered Oct. 21, 2008

**TRADEMARK
PRINCIPAL REGISTER**

SINGULAR

SINGULAR COMMUNICATIONS, LLC (CALIFORNIA LIMITED LIABILITY COMPANY)
1949 FEDERAL AVENUE
LOS ANGELES, CA 90025

THE MARK CONSISTS OF STANDARD CHARACTERS WITHOUT CLAIM TO ANY PARTICULAR FONT, STYLE, SIZE, OR COLOR.

FOR: MAGAZINE ON THE SUBJECT OF THE INTERESTS OF SINGLE ADULTS, IN CLASS 16 (U.S. CLS. 2, 5, 22, 23, 29, 37, 38 AND 50).

SN 77-330,919, FILED 11-15-2007.

FIRST USE 8-19-2008; IN COMMERCE 8-19-2008.

MICHAEL SOUDERS, EXAMINING ATTORNEY

Int. Cl.: 5

Prior U.S. Cls.: 6, 18, 44, 46, 51, and 52

Reg. No. 3,522,208

United States Patent and Trademark Office

Registered Oct. 21, 2008

**TRADEMARK
PRINCIPAL REGISTER**

HUMINO MAAX

PROLAB NUTRITION, INC. (CONNECTICUT
CORPORATION)
21411 PRAIRIE STREET
CHATSWORTH, CA 91311

THE MARK CONSISTS OF STANDARD CHAR-
ACTERS WITHOUT CLAIM TO ANY PARTICULAR
FONT, STYLE, SIZE, OR COLOR.

FOR: DIETARY SUPPLEMENTS, IN CLASS 5 (U.S.
CLS. 6, 18, 44, 46, 51 AND 52).

SN 77-331,286, FILED 11-16-2007.

FIRST USE 4-28-2008; IN COMMERCE 4-28-2008.

MICHAEL TANNER, EXAMINING ATTORNEY

Int. Cl.: 35

Prior U.S. Cls.: 100, 101, and 102

United States Patent and Trademark Office

Reg. No. 3,522,209

Registered Oct. 21, 2008

**SERVICE MARK
PRINCIPAL REGISTER**

LEGAL ESPRESSO

CAREERSEARCHES, LLC (LOUISIANA LIMITED
LIABILITY COMPANY)
10112 FLORIDA BLVD.
WALKER, LA 70785

THE MARK CONSISTS OF STANDARD CHAR-
ACTERS WITHOUT CLAIM TO ANY PARTICULAR
FONT, STYLE, SIZE, OR COLOR.

FOR: EMPLOYMENT HIRING, RECRUITING,
PLACEMENT, STAFFING AND CAREER NET-
WORKING SERVICES, IN CLASS 35 (U.S. CLS. 100,
101 AND 102).

SN 77-331,337, FILED 11-16-2007.

FIRST USE 12-0-2007; IN COMMERCE 12-0-2007.

PAULA MAHONEY, EXAMINING ATTORNEY

Int. Cl.: 5

Prior U.S. Cls.: 6, 18, 44, 46, 51, and 52

United States Patent and Trademark Office

Reg. No. 3,522,210

Registered Oct. 21, 2008

**TRADEMARK
PRINCIPAL REGISTER**



EASY WAY TO GET FIVE A DAY

FIVA ENTERPRISES, INC. (GEORGIA CORPORATION)
SUITE 300
348 COTTON AVE.
MACON, GA 31201

FOR: DIETARY AND NUTRITIONAL SUPPLEMENTS; POWDERED NUTRITIONAL SUPPLE-

MENT DRINK MIX, IN CLASS 5 (U.S. CLS. 6, 18, 44, 46, 51 AND 52).

FIRST USE 4-15-2008; IN COMMERCE 4-15-2008.

SN 77-331,432, FILED 11-16-2007.

RONALD MCMORROW, EXAMINING ATTORNEY

Int. Cl.: 36

Prior U.S. Cls.: 100, 101, and 102

United States Patent and Trademark Office

Reg. No. 3,522,211

Registered Oct. 21, 2008

**SERVICE MARK
PRINCIPAL REGISTER**

PRUDENTIAL ANNUITIES

THE PRUDENTIAL INSURANCE COMPANY OF
AMERICA (NEW JERSEY CORPORATION)
751 BROAD STREET
NEWARK, NJ 07102

FOR: ANNUITIES BROKERAGE SERVICES; UNDERWRITING AND INVESTMENT MANAGEMENT OF ANNUITIES AND DEFINED CONTRIBUTION PLANS; UNDERWRITING INCOME RISKS ARISING FROM OUTLIVING ONE'S ASSETS; INVESTMENT MANAGEMENT AND ADVISORY SERVICES; ADMINISTRATION OF EMPLOYEE RETIREMENT PLANS; RETIREMENT PLANNING SERVICES; ESTATE PLANNING SERVICES; INSURANCE UNDERWRITING, ADMINISTRATION AND AGENCY SERVICES IN THE FIELDS OF LIFE, LONG TERM CARE AND DISABILITY INSURANCE; PROVIDING INSURANCE AND FINANCIAL INFORMATION AND RE-

SEARCH BY MEANS OF A GLOBAL COMPUTER NETWORK, IN CLASS 36 (U.S. CLS. 100, 101 AND 102).

FIRST USE 9-15-2007; IN COMMERCE 9-15-2007.

THE MARK CONSISTS OF STANDARD CHARACTERS WITHOUT CLAIM TO ANY PARTICULAR FONT, STYLE, SIZE, OR COLOR.

NO CLAIM IS MADE TO THE EXCLUSIVE RIGHT TO USE "ANNUITIES", APART FROM THE MARK AS SHOWN.

SN 77-332,669, FILED 11-19-2007.

JENNIFER VASQUEZ, EXAMINING ATTORNEY

Int. Cl.: 44

Prior U.S. Cls.: 100 and 101

United States Patent and Trademark Office

Reg. No. 3,522,212

Registered Oct. 21, 2008

SERVICE MARK
PRINCIPAL REGISTER



N8 TOUCH, INC. (ARIZONA CORPORATION)
9815 NORTH 95TH STREET
SCOTTSDALE, AZ 85258

FOR: MASSAGE, IN CLASS 44 (U.S. CLS. 100 AND 101).

FIRST USE 5-1-2008; IN COMMERCE 5-1-2008.

NO CLAIM IS MADE TO THE EXCLUSIVE RIGHT TO USE "TOUCH" , APART FROM THE MARK AS SHOWN.

THE MARK CONSISTS OF "N8" IN BRACKETS WITH PALMS OF HANDS UNDERNEATH THE "8", WITH "N8 TOUCH" ON THE LINE ABOVE "RELAXSTAT8TIONS" AND ALL LETTERS AND NUMERALS IN A SPECIAL TYPEFACE.

SN 77-332,901, FILED 11-19-2007.

SUSAN LESLIE DUBOIS, EXAMINING ATTORNEY

Int. Cl.: 35

Prior U.S. Cls.: 100, 101, and 102

United States Patent and Trademark Office

Reg. No. 3,522,213

Registered Oct. 21, 2008

**SERVICE MARK
PRINCIPAL REGISTER**



DOMINION ENTERPRISES (VIRGINIA PART-
NERSHIP)
150 GRANBY STREET
NORFOLK, VA 23510

FOR: REAL ESTATE MARKETING SERVICES,
NAMELY, ON-LINE SERVICES FEATURING VIR-
TUAL TOURS OF APARTMENTS, RENTAL PROP-

ERTIES AND RESIDENTIAL COMPLEXES, IN
CLASS 35 (U.S. CLS. 100, 101 AND 102).

FIRST USE 5-1-2007; IN COMMERCE 5-1-2007.

SN 77-334,111, FILED 11-20-2007.

CARYN GLASSER, EXAMINING ATTORNEY

Int. Cls.: 25 and 26

Prior U.S. Cls.: 22, 37, 39, 40, 42, and 50

United States Patent and Trademark Office

Reg. No. 3,522,214

Registered Oct. 21, 2008

**TRADEMARK
PRINCIPAL REGISTER**

ENGUARD

COCONUT GROVE PADS, INC. (CANADA CORPORATION)

UNIT 1

525 DENISON STREET

MARKHAM ONTARIO, CANADA L3R1B8

FOR: BANDANAS, HATS, AND CAPS, IN CLASS 25 (U.S. CLS. 22 AND 39).

FIRST USE 6-11-2008; IN COMMERCE 6-11-2008.

FOR: CLOTH PATCHES FOR CLOTHING; ARM BANDS, IN CLASS 26 (U.S. CLS. 37, 39, 40, 42 AND 50).

FIRST USE 6-11-2008; IN COMMERCE 6-11-2008.

THE MARK CONSISTS OF STANDARD CHARACTERS WITHOUT CLAIM TO ANY PARTICULAR FONT, STYLE, SIZE, OR COLOR.

SN 77-334,356, FILED 11-20-2007.

HEATHER BIDDULPH, EXAMINING ATTORNEY

Int. Cl.: 35

Prior U.S. Cls.: 100, 101, and 102

United States Patent and Trademark Office

Reg. No. 3,522,215

Registered Oct. 21, 2008

**SERVICE MARK
PRINCIPAL REGISTER**

F.A.C.T.S.

FACTUAL PHOTO, INC. (ILLINOIS CORPORATION)
931 W. 75TH ST
NAPERVILLE, IL 60565

FOR: PROVIDING A SECURED ACCESS DATABASE VIA THE INTERNET FOR MANAGING PRIVATE INVESTIGATIONS AND SURVEILLANCE SERVICES, AND THROUGH WHICH PRIVATE INVESTIGATION CLIENTS MAY ACCESS REPORTS AND TRACK INVESTIGATIONS, IN CLASS 35 (U.S. CLS. 100, 101 AND 102).

FIRST USE 11-20-2007; IN COMMERCE 3-1-2008.

THE MARK CONSISTS OF STANDARD CHARACTERS WITHOUT CLAIM TO ANY PARTICULAR FONT, STYLE, SIZE, OR COLOR.

SN 77-334,430, FILED 11-20-2007.

BRIAN NEVILLE, EXAMINING ATTORNEY

Int. Cl.: 3

Prior U.S. Cls.: 1, 4, 6, 50, 51, and 52

Reg. No. 3,522,216

United States Patent and Trademark Office

Registered Oct. 21, 2008

**TRADEMARK
PRINCIPAL REGISTER**

GET YOUR BEAUTY FIX

PRODUCT PARTNERS, LLC (CALIFORNIA LIMITED LIABILITY COMPANY)
SUITE 1050
8383 WILSHIRE BLVD.
BEVERLY HILLS, CA 90211

FOR: SKIN CARE PREPARATIONS, NAMELY, SERUMS, LOTIONS, CREAMS, GELS, MASKS, SKIN EXFOLIANTS AND SPRAYS; EYE MAKE-UP, FACIAL MAKE-UP, MAKE-UP FOUNDATION; MAKE-UP CONCEALERS; MAKE-UP PENCILS, MAKE-UP POWDER; MAKE-UP PRODUCTS FOR THE FACE AND BODY; MAKE-UP REMOVER; EAU DE PERFUME, PERFUME; EAU DE COLOGNE; COLOGNE; OILS; SOAPS; HAIR CARE PREPARATIONS, SHAMPOOS, CONDITIONERS, EXFOLIANTS FOR HAIR, HAIR CREAMS, HAIR SPRAY, HAIR RELAXERS, HAIR STRAIGHTENERS, MOUSSE, HAIR RINSES,

HAIR COLOR, HAIR DYE, HAIR EMOLLIENTS, HAIR FIXERS, IN CLASS 3 (U.S. CLS. 1, 4, 6, 50, 51 AND 52).

FIRST USE 6-25-2008; IN COMMERCE 6-25-2008.

THE MARK CONSISTS OF STANDARD CHARACTERS WITHOUT CLAIM TO ANY PARTICULAR FONT, STYLE, SIZE, OR COLOR.

NO CLAIM IS MADE TO THE EXCLUSIVE RIGHT TO USE "BEAUTY", APART FROM THE MARK AS SHOWN.

SN 77-335,162, FILED 11-21-2007.

PATRICIA EVANKO, EXAMINING ATTORNEY

Int. Cl.: 8

Prior U.S. Cls.: 23, 28, and 44

United States Patent and Trademark Office

Reg. No. 3,522,217

Registered Oct. 21, 2008

**TRADEMARK
PRINCIPAL REGISTER**

nail jack

FOLEY, MICHAEL J. (UNITED STATES INDIVIDUAL)

130 TREASURE LANE

HAILEY, ID 83333

FOR: CARPENTERS' PINNERS, IN CLASS 8 (U.S. CLS. 23, 28 AND 44).

FIRST USE 10-1-2007; IN COMMERCE 8-28-2008.

THE MARK CONSISTS OF STANDARD CHARACTERS WITHOUT CLAIM TO ANY PARTICULAR FONT, STYLE, SIZE, OR COLOR.

NO CLAIM IS MADE TO THE EXCLUSIVE RIGHT TO USE "NAIL", APART FROM THE MARK AS SHOWN.

SN 77-335,919, FILED 11-23-2007.

LINDA LAVACHE, EXAMINING ATTORNEY

Int. Cl.: 42

Prior U.S. Cls.: 100 and 101

United States Patent and Trademark Office

Reg. No. 3,522,218

Registered Oct. 21, 2008

**SERVICE MARK
PRINCIPAL REGISTER**

TAIGA BIOTECHNOLOGIES

TAIGA BIOTECHNOLOGIES, INC. (DELAWARE CORPORATION)
12635 E. MONTVIEW BLVD., SUITE 100
AURORA, CO 80045

FOR: DEVELOPMENT OF NEW TECHNOLOGY FOR OTHERS IN THE FIELD OF PROTEIN, SMALL-MOLECULE, AND CELL-BASED THERAPEUTICS, IN CLASS 42 (U.S. CLS. 100 AND 101).

FIRST USE 7-31-2006; IN COMMERCE 7-1-2007.

THE MARK CONSISTS OF STANDARD CHARACTERS WITHOUT CLAIM TO ANY PARTICULAR FONT, STYLE, SIZE, OR COLOR.

NO CLAIM IS MADE TO THE EXCLUSIVE RIGHT TO USE "BIOTECHNOLOGIES", APART FROM THE MARK AS SHOWN.

SN 77-335,941, FILED 11-23-2007.

JACQUELINE A. LAVINE, EXAMINING ATTORNEY

Int. Cls.: 35, 36, 37, 39, and 42

Prior U.S. Cls.: 100, 101, 102, 103, 105, and 106

United States Patent and Trademark Office

Reg. No. 3,522,219

Registered Oct. 21, 2008

SERVICE MARK
PRINCIPAL REGISTER



MANHEIM AUCTIONS, INC. (DELAWARE CORPORATION)
6205 PEACHTREE DUNWOODY ROAD
ATLANTA, GA 30328

FOR: AUTOMOBILE AUCTION SERVICES; AUTOMOBILE AUCTION SERVICES PROVIDED VIA THE INTERNET, IN CLASS 35 (U.S. CLS. 100, 101 AND 102).

FIRST USE 6-20-2008; IN COMMERCE 6-20-2008.

FOR: AUTOMOBILE FINANCING SERVICES, IN CLASS 36 (U.S. CLS. 100, 101 AND 102).

FIRST USE 6-20-2008; IN COMMERCE 6-20-2008.

FOR: AUTOMOTIVE DETAILING, RECONDITIONING, REPAIR, CONVERSION AND CUSTOMIZATION SERVICES, IN CLASS 37 (U.S. CLS. 100, 103 AND 106).

FIRST USE 6-20-2008; IN COMMERCE 6-20-2008.

FOR: BUSINESS-TO-BUSINESS AUTOMOTIVE TRANSPORTATION AND STORAGE SERVICES, IN CLASS 39 (U.S. CLS. 100 AND 105).

FIRST USE 6-20-2008; IN COMMERCE 6-20-2008.

FOR: AUTOMOBILE INSPECTION SERVICES, IN CLASS 42 (U.S. CLS. 100 AND 101).

FIRST USE 6-20-2008; IN COMMERCE 6-20-2008.

OWNER OF U.S. REG. NOS. 1,699,332, 3,229,428, AND OTHERS.

NO CLAIM IS MADE TO THE EXCLUSIVE RIGHT TO USE "SAN FRANCISCO BAY", APART FROM THE MARK AS SHOWN.

THE COLOR(S) GOLD, BROWN, DARK BLUE, LIGHT BLUE, RED, BLACK, GREY AND WHITE IS/ARE CLAIMED AS A FEATURE OF THE MARK.

THE MARK CONSISTS OF A GOLD "M" OVER A BLUE CIRCULAR BACKGROUND AND WITHIN TWO GOLD OUTER RINGS. THE COLOR BROWN OUTLINES THE MARK. TO THE RIGHT OF THE "M" IS THE WORD "MANHEIM" IN THE COLOR BLACK. A BLACK LINE SEPARATES THE ABOVE DESIGN AND THE WORD "MANHEIM" AND THE WORDS "SAN FRANCISCO BAY" IN THE COLOR BLACK AND A DESIGN OF THE GOLDEN GATE BRIDGE IN THE COLOR RED IN FRONT OF A DARK BLUE SKYLINE ON A LIGHT BLUE BACKGROUND, INSIDE CONCENTRIC WHITE AND GREY SQUARES TO THE RIGHT OF THE WORDS "SAN FRANCISCO BAY".

SN 77-336,692, FILED 11-26-2007.

GISELLE AGOSTO, EXAMINING ATTORNEY

Int. Cl.: 35

Prior U.S. Cls.: 100, 101, and 102

United States Patent and Trademark Office

Reg. No. 3,522,220

Registered Oct. 21, 2008

**SERVICE MARK
PRINCIPAL REGISTER**

RIVETMAKER

RIVETMAKER CONSULTING INC. (FLORIDA
CORPORATION)
1400 VERMONT AVE.
TARPON SPRINGS, FL 34689

THE MARK CONSISTS OF STANDARD CHAR-
ACTERS WITHOUT CLAIM TO ANY PARTICULAR
FONT, STYLE, SIZE, OR COLOR.

FOR: BUSINESS CONSULTING IN THE FIELD
OF EMPLOYEE AND CUSTOMER ENGAGEMENT,
IN CLASS 35 (U.S. CLS. 100, 101 AND 102).

SN 77-337,539, FILED 11-27-2007.

FIRST USE 7-14-2008; IN COMMERCE 7-14-2008.

JAMES STEIN, EXAMINING ATTORNEY

Int. Cl.: 10

Prior U.S. Cls.: 26, 39, and 44

United States Patent and Trademark Office

Reg. No. 3,522,221

Registered Oct. 21, 2008

**TRADEMARK
PRINCIPAL REGISTER**

SUREFIRE

ARTHREX, INC. (DELAWARE CORPORATION)
1370 CREEKSIDE BLVD.
NAPLES, FL 34109

THE MARK CONSISTS OF STANDARD CHAR-
ACTERS WITHOUT CLAIM TO ANY PARTICULAR
FONT, STYLE, SIZE, OR COLOR.

FOR: MEDICAL DEVICES, NAMELY, A SUTURE
PASSING NEEDLE, IN CLASS 10 (U.S. CLS. 26, 39
AND 44).

SN 77-337,627, FILED 11-27-2007.

FIRST USE 2-26-2008; IN COMMERCE 2-26-2008.

DAVID H. STINE, EXAMINING ATTORNEY

Int. Cl.: 28

Prior U.S. Cls.: 22, 23, 38, and 50

United States Patent and Trademark Office

Reg. No. 3,522,222

Registered Oct. 21, 2008

**TRADEMARK
PRINCIPAL REGISTER**



ENLIGHTENED PLAY, LLC (COLORADO LIMITED LIABILITY COMPANY)
10519 WEST WARREN DRIVE
LAKEWOOD, CO 80227

THE MARK CONSISTS OF A TREE, SUN DESIGN, FANCIFUL COW WITH BIRDS ON ITS BACK, AND "ECORANCH".

FOR: EDUCATIONAL BOARD GAME, IN CLASS 28 (U.S. CLS. 22, 23, 38 AND 50).

SN 77-337,842, FILED 11-27-2007.

FIRST USE 10-27-2007; IN COMMERCE 2-23-2008.

BRIAN NEVILLE, EXAMINING ATTORNEY

Int. Cl.: 25

Prior U.S. Cls.: 22 and 39

United States Patent and Trademark Office

Reg. No. 3,522,223

Registered Oct. 21, 2008

**TRADEMARK
PRINCIPAL REGISTER**

SHIMMER BY CINDY

CYNTHIA HOCK (UNITED STATES INDIVIDUAL)
5507 CHANTILLY CIRCLE
LAKE IN THE HILLS, IL 60156

THE MARK CONSISTS OF STANDARD CHARACTERS WITHOUT CLAIM TO ANY PARTICULAR FONT, STYLE, SIZE, OR COLOR.

FOR: SHIRTS, IN CLASS 25 (U.S. CLS. 22 AND 39).

SN 77-338,035, FILED 11-27-2007.

FIRST USE 11-27-2007; IN COMMERCE 12-30-2007.

CHARISMA HAMPTON, EXAMINING ATTORNEY

Int. Cl.: 3

Prior U.S. Cls.: 1, 4, 6, 50, 51, and 52

United States Patent and Trademark Office

Reg. No. 3,522,224

Registered Oct. 21, 2008

**TRADEMARK
PRINCIPAL REGISTER**

FOGOUT

SIDOR, RICARDO (UNITED STATES INDIVIDUAL)
33 VENETIAN WAY NO. 84
MIAMI BEACH, FL 33139

FOR: AUTOMOBILE POLISHES; CLEANING AND POLISHING PREPARATIONS; CLEANSING AND POLISHING PREPARATIONS; GENERAL PURPOSE CLEANING, POLISHING, AND ABRASIVE LIQUIDS AND POWDERS; POLISHING PREPARATIONS, IN CLASS 3 (U.S. CLS. 1, 4, 6, 50, 51 AND 52).

FIRST USE 5-29-2008; IN COMMERCE 5-29-2008.

THE MARK CONSISTS OF STANDARD CHARACTERS WITHOUT CLAIM TO ANY PARTICULAR FONT, STYLE, SIZE, OR COLOR.

SN 77-338,047, FILED 11-27-2007.

SARA THOMAS, EXAMINING ATTORNEY

Int. Cl.: 35

Prior U.S. Cls.: 100, 101, and 102

United States Patent and Trademark Office

Reg. No. 3,522,225

Registered Oct. 21, 2008

**SERVICE MARK
PRINCIPAL REGISTER**

VEN A LA FIESTA

CLARK, CHARLES K. (UNITED STATES INDIVIDUAL)

3500 WEST EXPRESSWAY 83

HARLINGEN, TX 78552

FOR: AUTOMOBILE DEALERSHIP SERVICES, IN CLASS 35 (U.S. CLS. 100, 101 AND 102).

FIRST USE 11-30-2006; IN COMMERCE 11-30-2006.

THE MARK CONSISTS OF STANDARD CHARACTERS WITHOUT CLAIM TO ANY PARTICULAR FONT, STYLE, SIZE, OR COLOR.

THE FOREIGN WORDING IN THE MARK TRANSLATES INTO ENGLISH AS COME TO THE PARTY.

SN 77-338,775, FILED 11-28-2007.

ROSELLE HERRERA, EXAMINING ATTORNEY

Int. Cls.: 35, 36, 37, 39, and 42

Prior U.S. Cls.: 100, 101, 102, 103, 105, and 106

United States Patent and Trademark Office

Reg. No. 3,522,226

Registered Oct. 21, 2008

SERVICE MARK
PRINCIPAL REGISTER



*Imperial
Florida*



MANHEIM AUCTIONS, INC. (DELAWARE CORPORATION)
6205 PEACHTREE DUNWOODY ROAD
ATLANTA, GA 30328

FOR: AUTOMOBILE AUCTION SERVICES; AUTOMOBILE AUCTION SERVICES PROVIDED VIA THE INTERNET, IN CLASS 35 (U.S. CLS. 100, 101 AND 102).

FIRST USE 6-20-2008; IN COMMERCE 6-20-2008.

FOR: AUTOMOBILE FINANCING SERVICES, IN CLASS 36 (U.S. CLS. 100, 101 AND 102).

FIRST USE 6-20-2008; IN COMMERCE 6-20-2008.

FOR: AUTOMOTIVE DETAILING, RECONDITIONING, REPAIR, CONVERSION AND CUSTOMIZATION SERVICES, IN CLASS 37 (U.S. CLS. 100, 103 AND 106).

FIRST USE 6-20-2008; IN COMMERCE 6-20-2008.

FOR: BUSINESS-TO-BUSINESS AUTOMOTIVE TRANSPORTATION AND STORAGE SERVICES, IN CLASS 39 (U.S. CLS. 100 AND 105).

FIRST USE 6-20-2008; IN COMMERCE 6-20-2008.

FOR: AUTOMOBILE INSPECTION SERVICES, IN CLASS 42 (U.S. CLS. 100 AND 101).

FIRST USE 6-20-2008; IN COMMERCE 6-20-2008.

OWNER OF U.S. REG. NOS. 1,699,332, 3,229,428, AND OTHERS.

NO CLAIM IS MADE TO THE EXCLUSIVE RIGHT TO USE "FLORIDA" AND THE REPRESENTATION OF THE OUTLINE OF NORTH AND SOUTH AMERICA, APART FROM THE MARK AS SHOWN.

THE COLOR(S) GOLD, BLUE, LIGHT OLIVE GREEN, BROWN, BLACK, GREY AND WHITE IS/ARE CLAIMED AS A FEATURE OF THE MARK.

THE MARK CONSISTS OF A GOLD "M" OVER A BLUE CIRCULAR BACKGROUND AND WITHIN TWO GOLD OUTER RINGS. THE COLOR BROWN OUTLINES THE MARK. TO THE RIGHT OF THE "M" IS THE WORD "MANHEIM" IN THE COLOR BLACK. A BLACK LINE SEPARATES THE ABOVE DESIGN AND THE WORD "MANHEIM" AND THE WORDS "IMPERIAL FLORIDA" IN THE COLOR BLACK AND A DESIGN OF A LIGHT OLIVE GREEN GLOBE WITH WHITE GRIDS SHOWING A GEOGRAPHICAL OUTLINE OF NORTH AND SOUTH AMERICA IN THE COLOR WHITE ON A BLUE BACKGROUND, INSIDE CONCENTRIC WHITE AND GREY SQUARES TO THE RIGHT OF THE WORDS "IMPERIAL FLORIDA" .

SN 77-339,712, FILED 11-29-2007.

GISELLE AGOSTO, EXAMINING ATTORNEY

Int. Cl.: 35

Prior U.S. Cls.: 100, 101, and 102

United States Patent and Trademark Office

Reg. No. 3,522,227

Registered Oct. 21, 2008

**SERVICE MARK
PRINCIPAL REGISTER**

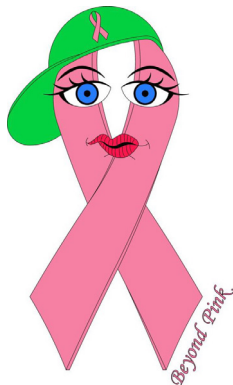

BEYOND PINK LLC (OHIO LIMITED LIABILITY
COMPANY)
2270 OMAHA PLACE
LEWIS CENTER, OH 43035

FOR: PROMOTING PUBLIC AWARENESS OF
BREAST CANCER AND BREAST CANCER TREAT-
MENT OPTIONS, IN CLASS 35 (U.S. CLS. 100, 101
AND 102).

FIRST USE 11-1-2007; IN COMMERCE 1-1-2008.

THE COLOR(S) PINK, RED, BLUE, GREEN,
BLACK AND WHITE IS/ARE CLAIMED AS A
FEATURE OF THE MARK.

THE MARK CONSISTS OF THE WORDS "BE-
YOND PINK" IN PINK WITH A BLACK OUTLINE,
A PINK RIBBON WITH A FACE AND A GREEN
HAT WITH A PINK RIBBON ON THE HAT, RED
LIPS WITH BLACK LINES, BLUE EYES WITH
BLACK CIRCLES AND BLACK IRISES IN WHITE
CORNEAS WITH BLACK EYELASHES AND BLACK
EYEBROWS, THE SPACE BETWEEN THE LARGE
RIBBON IS IN WHITE AND THE DRAWING IS
DEMARKED IN BLACK OUTLINES.

SN 77-339,960, FILED 11-29-2007.

RAUL CORDOVA, EXAMINING ATTORNEY

Int. Cl.: 19

Prior U.S. Cls.: 1, 12, 33, and 50

United States Patent and Trademark Office

Reg. No. 3,522,228

Registered Oct. 21, 2008

**TRADEMARK
PRINCIPAL REGISTER**

True marc

DANNY PHILLIPS (CANADA CORPORATION)
81 MACK AVE
TORONTO, CANADA M1L1M5

IN BUILDING CONSTRUCTION, IN CLASS 19 (U.S.
CLS. 1, 12, 33 AND 50).

FIRST USE 1-12-2008; IN COMMERCE 1-12-2008.

FOR: BUILDING MATERIALS, NAMELY, CEL-
LULAR PVC TRIM; NON-METAL BUILDING MA-
TERIAL, NAMELY, FASCIA; NON-METAL
BUILDING MATERIALS, NAMELY, SOFFITS;
NON-METAL BUILDING PRODUCTS, NAMELY,
SHUTTERS, SHINGLES, SIDING, AND TRIM;
NON-METAL CLADDING FOR CONSTRUCTION
AND BUILDING; NON-METAL DECORATIVE
MOLDINGS AND DECORATIVE TRIM FOR USE

THE MARK CONSISTS OF STANDARD CHAR-
ACTERS WITHOUT CLAIM TO ANY PARTICULAR
FONT, STYLE, SIZE, OR COLOR.

SN 77-341,048, FILED 11-30-2007.

THEODORE MCBRIDE, EXAMINING ATTORNEY

Int. Cl.: 41

Prior U.S. Cls.: 100, 101, and 107

United States Patent and Trademark Office

Reg. No. 3,522,229

Registered Oct. 21, 2008

**SERVICE MARK
PRINCIPAL REGISTER**

Ticket Channel

BRISCOE, TY (CALIFORNIA LIMITED LIABILITY COMPANY), DBA THE TICKET CHANNEL,
400 S. BEVERLY DR. #214
BEVERLY HILLS, CA 90212

FOR: ARRANGING FOR TICKET RESERVATIONS FOR SHOWS AND OTHER ENTERTAINMENT EVENTS, IN CLASS 41 (U.S. CLS. 100, 101 AND 107).

FIRST USE 8-16-2004; IN COMMERCE 2-17-2008.

THE MARK CONSISTS OF STANDARD CHARACTERS WITHOUT CLAIM TO ANY PARTICULAR FONT, STYLE, SIZE, OR COLOR.

NO CLAIM IS MADE TO THE EXCLUSIVE RIGHT TO USE "TICKET", APART FROM THE MARK AS SHOWN.

SN 77-341,720, FILED 11-30-2007.

STEPHANIE ALI, EXAMINING ATTORNEY

Int. Cl.: 5

Prior U.S. Cls.: 6, 18, 44, 46, 51, and 52

Reg. No. 3,522,230

United States Patent and Trademark Office

Registered Oct. 21, 2008

**TRADEMARK
PRINCIPAL REGISTER**

NOBLECROWN

THE ARGEN CORPORATION (CALIFORNIA
CORPORATION)
5855 OBERLIN DRIVE
SAN DIEGO, CA 92121

THE MARK CONSISTS OF STANDARD CHAR-
ACTERS WITHOUT CLAIM TO ANY PARTICULAR
FONT, STYLE, SIZE, OR COLOR.

FOR: DENTAL ALLOYS, IN CLASS 5 (U.S. CLS. 6,
18, 44, 46, 51 AND 52).

SN 77-341,968, FILED 12-2-2007.

FIRST USE 12-19-2007; IN COMMERCE 12-19-2007.

SEAN CROWLEY, EXAMINING ATTORNEY

Int. Cl.: 36

Prior U.S. Cls.: 100, 101, and 102

United States Patent and Trademark Office

Reg. No. 3,522,231

Registered Oct. 21, 2008

**SERVICE MARK
PRINCIPAL REGISTER**

Price with Precision

MARKET RATES INSIGHT, INC. (CALIFORNIA CORPORATION)
P. O. BOX 9107
SAN RAFAEL, CA 94912

FOR: FINANCIAL SERVICES, NAMELY, PROVIDING INFORMATION IN THE FIELDS OF FOREIGN CURRENCY, COMMODITIES, FINANCIAL DERIVATIVES, INTEREST RATE PRODUCTS, AND EQUITIES VIA THE INTERNET AND INTRANET SYSTEMS, IN CLASS 36 (U.S. CLS. 100, 101 AND 102).

FIRST USE 9-2-2008; IN COMMERCE 9-3-2008.

THE MARK CONSISTS OF STANDARD CHARACTERS WITHOUT CLAIM TO ANY PARTICULAR FONT, STYLE, SIZE, OR COLOR.

SN 77-342,033, FILED 12-2-2007.

BRENDAN MCCAULEY, EXAMINING ATTORNEY

Int. Cl.: 35

Prior U.S. Cls.: 100, 101, and 102

United States Patent and Trademark Office

Reg. No. 3,522,232

Registered Oct. 21, 2008

**SERVICE MARK
PRINCIPAL REGISTER**



CURASCRIP, INC. (DELAWARE CORPORATION)
6272 LEE VISTA BLVD
ORLANDO, FL 32822

FOR: ADMINISTERING PHARMACY REIMBURSEMENT PROGRAMS AND SERVICES BY MEANS OF A GLOBAL COMPUTER NETWORK, TELECOMMUNICATIONS CENTERS, AND DISTRIBUTION OF PROPRIETARY INFORMATION; BUSINESS MANAGEMENT SERVICES IN THE PHARMACEUTICAL INDUSTRY, NAMELY, MANAGING PRODUCT DISTRIBUTION OF PHARMA PRODUCTS AND PHARMACEUTICAL SAMPLES IN COMPLIANCE WITH STANDARDS OF THE PHARMACEUTICAL DRUG MANUFACTURER'S ASSOCIATION; ADMINISTRATION OF PRE-PAID DRUG ASSISTANCE PROGRAMS FOR OTHERS TO PROVIDE

PRESCRIPTION DRUGS TO LOW INCOME PATIENTS, IN CLASS 35 (U.S. CLS. 100, 101 AND 102).

FIRST USE 10-1-2007; IN COMMERCE 10-1-2007.

OWNER OF U.S. REG. NOS. 2,585,718, 3,386,549, AND OTHERS.

THE MARK CONSISTS OF STYLIZED LETTER "H" THAT RESEMBLES THE FIGURATIVE DESIGN OF A BRIDGE WITHIN A CIRCLE. TO THE RIGHT OF THE CIRCLE IN PROMINENT STYLIZED TEXT IS THE TERM "HEALTHBRIDGE" WITH A SOLID HORIZONTAL BAR UNDERNEATH.

SN 77-343,266, FILED 12-4-2007.

PAUL CROWLEY, EXAMINING ATTORNEY

Int. Cl.: 33

Prior U.S. Cls.: 47 and 49

United States Patent and Trademark Office

Reg. No. 3,522,233

Registered Oct. 21, 2008

**TRADEMARK
PRINCIPAL REGISTER**

SAVA

FINE ESTATES FROM SPAIN, INC. (MASSACHUSETTS CORPORATION)
745 HIGH STREET
DEDHAM, MA 02026

THE MARK CONSISTS OF STANDARD CHARACTERS WITHOUT CLAIM TO ANY PARTICULAR FONT, STYLE, SIZE, OR COLOR.

FOR: WINE, IN CLASS 33 (U.S. CLS. 47 AND 49).

SN 77-343,524, FILED 12-4-2007.

FIRST USE 8-28-2008; IN COMMERCE 8-28-2008.

LINDA MICKLEBURGH, EXAMINING ATTORNEY

Int. Cls.: 35, 36, 37, 39, and 42

Prior U.S. Cls.: 100, 101, 102, 103, 105, and 106

United States Patent and Trademark Office

Reg. No. 3,522,234

Registered Oct. 21, 2008

**SERVICE MARK
PRINCIPAL REGISTER**



Manheim

Texas Hobby



MANHEIM AUCTIONS, INC. (DELAWARE CORPORATION)
6205 PEACHTREE DUNWOODY ROAD
ATLANTA, GA 30328

FOR: AUTOMOBILE AUCTION SERVICES; AUTOMOBILE AUCTION SERVICES PROVIDED VIA THE INTERNET, IN CLASS 35 (U.S. CLS. 100, 101 AND 102).

FIRST USE 6-20-2008; IN COMMERCE 6-20-2008.

FOR: AUTOMOBILE FINANCING SERVICES, IN CLASS 36 (U.S. CLS. 100, 101 AND 102).

FIRST USE 6-20-2008; IN COMMERCE 6-20-2008.

FOR: AUTOMOTIVE DETAILING, RECONDITIONING, REPAIR, CONVERSION AND CUSTOMIZATION SERVICES, IN CLASS 37 (U.S. CLS. 100, 103 AND 106).

FIRST USE 6-20-2008; IN COMMERCE 6-20-2008.

FOR: BUSINESS-TO-BUSINESS AUTOMOTIVE TRANSPORTATION AND STORAGE SERVICES, IN CLASS 39 (U.S. CLS. 100 AND 105).

FIRST USE 6-20-2008; IN COMMERCE 6-20-2008.

FOR: AUTOMOBILE INSPECTION SERVICES, IN CLASS 42 (U.S. CLS. 100 AND 101).

FIRST USE 6-20-2008; IN COMMERCE 6-20-2008.

OWNER OF U.S. REG. NOS. 1,699,332, 3,229,428, AND OTHERS.

NO CLAIM IS MADE TO THE EXCLUSIVE RIGHT TO USE "TEXAS HOBBY", APART FROM THE MARK AS SHOWN.

THE COLOR(S) GOLD, BLUE, BROWN, BLACK, GREY AND WHITE IS/ARE CLAIMED AS A FEATURE OF THE MARK.

THE MARK CONSISTS OF A GOLD "M" OVER A BLUE CIRCULAR BACKGROUND AND WITHIN TWO GOLD OUTER RINGS. THE COLOR BROWN OUTLINES THE MARK. TO THE RIGHT OF THE M IS THE WORD "MANHEIM" IN THE COLOR BLACK. A BLACK LINE SEPARATES THE ABOVE DESIGN AND THE WORD "MANHEIM" AND THE WORDS "TEXAS HOBBY" IN THE COLOR BLACK AND A DESIGN OF A LONGHORN IN THE COLOR BLACK WITH A WHITE STAR ON A WHITE BACKGROUND, INSIDE A GREY SQUARE TO THE RIGHT OF THE WORDS "TEXAS HOBBY".

SN 77-343,570, FILED 12-5-2007.

GISELLE AGOSTO, EXAMINING ATTORNEY

Int. Cl.: 9

Prior U.S. Cls.: 21, 23, 26, 36, and 38

Reg. No. 3,522,235

United States Patent and Trademark Office

Registered Oct. 21, 2008

**TRADEMARK
PRINCIPAL REGISTER**

10MINUTES

PRICEWATERHOUSECOOPERS LLP (DELA-
WARE LIMITED LIABILITY PARTNERSHIP)
300 MADISON AVENUE
NEW YORK, NY 10017

THE MARK CONSISTS OF STANDARD CHAR-
ACTERS WITHOUT CLAIM TO ANY PARTICULAR
FONT, STYLE, SIZE, OR COLOR.

FOR: DOWNLOADABLE ELECTRONIC NEWS-
LETTER IN THE AREAS OF ACCOUNTING, TAX
AND BUSINESS ADVISORY ISSUES, IN CLASS 9
(U.S. CLS. 21, 23, 26, 36 AND 38).

SN 77-343,824, FILED 12-4-2007.

FIRST USE 11-6-2007; IN COMMERCE 11-6-2007.

KATHERINE CHANG, EXAMINING ATTORNEY

Int. Cl.: 5

Prior U.S. Cls.: 6, 18, 44, 46, 51, and 52

Reg. No. 3,522,236

United States Patent and Trademark Office

Registered Oct. 21, 2008

**TRADEMARK
PRINCIPAL REGISTER**

NUPRO

DENTSPLY INTERNATIONAL INC. (DELA-
WARE CORPORATION)
221 WEST PHILADELPHIA STREET
YORK, PA 174050872

FOR: MEDICATED MOUTH CARE AND TREAT-
MENT PREPARATIONS, IN CLASS 5 (U.S. CLS. 6, 18,
44, 46, 51 AND 52).

FIRST USE 6-30-2008; IN COMMERCE 6-30-2008.

THE MARK CONSISTS OF STANDARD CHAR-
ACTERS WITHOUT CLAIM TO ANY PARTICULAR
FONT, STYLE, SIZE, OR COLOR.

OWNER OF U.S. REG. NOS. 962,204 AND 2,800,464.

SN 77-344,286, FILED 12-5-2007.

AMY ALFIERI, EXAMINING ATTORNEY

Int. Cl.: 41

Prior U.S. Cls.: 100, 101, and 107

United States Patent and Trademark Office

Reg. No. 3,522,237

Registered Oct. 21, 2008

**SERVICE MARK
PRINCIPAL REGISTER**

Mamas Move

MAMAS MOVE, INC. (MASSACHUSETTS CORPORATION)
17 COPLEY STREET
QUINCY, MA 02170

FOR: PROVIDING FITNESS AND EXERCISE FACILITIES; PROVIDING ASSISTANCE, PERSONAL TRAINING AND PHYSICAL FITNESS CONSULTATION TO INDIVIDUALS TO HELP THEM MAKE PHYSICAL FITNESS, STRENGTH, CONDITIONING, AND EXERCISE IMPROVEMENT IN THEIR DAILY LIVING; PHYSICAL FITNESS CONSULTATION; PHYSICAL FITNESS CONDITION CLASS; PHYSICAL FITNESS INSTRUCTION; PROVIDING INFORMATION IN THE FIELD OF EXERCISE TRAINING; PROVIDING AND CONDUCTING PHYSICAL FITNESS AND WELLNESS INSTRUCTION, SEMINARS, WORKSHOPS, CLASSES AND PROGRAMS FOR PRE-NATAL AND POST-PARTUM WOMEN; PROVIDING INSTRUCTION ON A CREATING A HEALTHY LIFESTYLE FOR MOTHERS AND CHILDREN THROUGH EXERCISE

AND PHYSICAL FITNESS; PROVIDING INSTRUCTION AND TRAINING FOR NEW AN EXPECTANT MOTHERS ON NUTRITION AND EXERCISE FOR A HEALTHY WELL-BEING; PROVIDING INSTRUCTION, CLASSES, SEMINARS AND WORKSHOPS IN FITNESS AND LIFESTYLE TRAINING FOR NEW MOTHERS; EDUCATION SERVICES, NAMELY, CONDUCTING CLASSES, SEMINARS AND WORKSHOPS IN THE FIELD OF PRE-NATAL AND POST PARTUM INFANT CARE AND DEVELOPMENT, IN CLASS 41 (U.S. CLS. 100, 101 AND 107).

FIRST USE 2-1-2008; IN COMMERCE 2-1-2008.

THE MARK CONSISTS OF STANDARD CHARACTERS WITHOUT CLAIM TO ANY PARTICULAR FONT, STYLE, SIZE, OR COLOR.

SN 77-344,316, FILED 12-5-2007.

DAVID ELTON, EXAMINING ATTORNEY

Int. Cl.: 2

Prior U.S. Cls.: 6, 11, and 16

United States Patent and Trademark Office

Reg. No. 3,522,238

Registered Oct. 21, 2008

**TRADEMARK
PRINCIPAL REGISTER**

COLOR ON SYSTEMS

STEVENSON, MICHAEL J. (UNITED STATES
INDIVIDUAL)
999 HWY 89A
CLARKDALE, AZ 86324

FOR: COLORANT DISPERSIONS FOR USE IN
SURFACE COATING COMPOSITIONS, IN CLASS 2
(U.S. CLS. 6, 11 AND 16).

FIRST USE 11-30-2007; IN COMMERCE 11-30-2007.

THE MARK CONSISTS OF STANDARD CHAR-
ACTERS WITHOUT CLAIM TO ANY PARTICULAR
FONT, STYLE, SIZE, OR COLOR.

NO CLAIM IS MADE TO THE EXCLUSIVE
RIGHT TO USE "SYSTEMS", APART FROM THE
MARK AS SHOWN.

SN 77-344,521, FILED 12-5-2007.

NICHOLAS ALTREE, EXAMINING ATTORNEY

Int. Cl.: 2

Prior U.S. Cls.: 6, 11, and 16

United States Patent and Trademark Office

Reg. No. 3,522,239

Registered Oct. 21, 2008

**TRADEMARK
PRINCIPAL REGISTER**

COLOR IN SYSTEMS

STEVENSON, MICHAEL J. (UNITED STATES
INDIVIDUAL)
999 HWY 89A
CLARKDALE, AZ 86324

FOR: COLORANTS FOR USE IN THE MANU-
FACTURE OF ROTATIONALLY MOLDED PLAS-
TIC ARTICLES, IN CLASS 2 (U.S. CLS. 6, 11 AND 16).

FIRST USE 11-30-2007; IN COMMERCE 11-30-2007.

THE MARK CONSISTS OF STANDARD CHAR-
ACTERS WITHOUT CLAIM TO ANY PARTICULAR
FONT, STYLE, SIZE, OR COLOR.

NO CLAIM IS MADE TO THE EXCLUSIVE
RIGHT TO USE "SYSTEMS", APART FROM THE
MARK AS SHOWN.

SN 77-344,531, FILED 12-5-2007.

NICHOLAS ALTREE, EXAMINING ATTORNEY

Int. Cl.: 9

Prior U.S. Cls.: 21, 23, 26, 36, and 38

Reg. No. 3,522,240

United States Patent and Trademark Office

Registered Oct. 21, 2008

**TRADEMARK
PRINCIPAL REGISTER**

THE PARLOR MOB

THE PARLOR MOB MUSIC, LLC (NEW JERSEY
LIMITED LIABILITY COMPANY)
C/O IN DE GOOT ENTERTAINMENT
119 WEST 23RD STREET, SUITE 609
NEW YORK, NY 10011

THE MARK CONSISTS OF STANDARD CHAR-
ACTERS WITHOUT CLAIM TO ANY PARTICULAR
FONT, STYLE, SIZE, OR COLOR.

FOR: SERIES OF MUSICAL SOUND RECORD-
INGS, IN CLASS 9 (U.S. CLS. 21, 23, 26, 36 AND 38).

SN 77-344,536, FILED 12-5-2007.

FIRST USE 3-11-2008; IN COMMERCE 3-11-2008.

CHERYL CLAYTON, EXAMINING ATTORNEY

Int. Cl.: 11

Prior U.S. Cls.: 13, 21, 23, 31, and 34

Reg. No. 3,522,241

United States Patent and Trademark Office

Registered Oct. 21, 2008

**TRADEMARK
PRINCIPAL REGISTER**

**BRASSMASTER NORTHWOODS
SERIES**

WATER CONTROL CORPORATION OF MINNE-
SOTA (MINNESOTA CORPORATION)
7150 143RD AVE NW
ANOKA, MN 55303

FOR: WATER SOFTENER UNITS SPECIFICALLY
DESIGNED FOR LIGHT, SEASONAL USAGE IN
CABINS, COTTAGES, RECREATIONAL VEHICLES,
VACATION HOMES, AND OTHER RESIDENTIAL
APPLICATIONS WHERE THERE IS LIGHTER
USAGE AND LESS SOFTENING CAPACITY IS
REQUIRED, IN CLASS 11 (U.S. CLS. 13, 21, 23, 31
AND 34).

FIRST USE 11-27-2007; IN COMMERCE 11-27-2007.

THE MARK CONSISTS OF STANDARD CHAR-
ACTERS WITHOUT CLAIM TO ANY PARTICULAR
FONT, STYLE, SIZE, OR COLOR.

NO CLAIM IS MADE TO THE EXCLUSIVE
RIGHT TO USE "SERIES", APART FROM THE
MARK AS SHOWN.

SN 77-345,492, FILED 12-6-2007.

LINDA LAVACHE, EXAMINING ATTORNEY

Int. Cls.: 9 and 42

Prior U.S. Cls.: 21, 23, 26, 36, 38, 100, and 101

United States Patent and Trademark Office

Reg. No. 3,522,242

Registered Oct. 21, 2008

**TRADEMARK
SERVICE MARK
PRINCIPAL REGISTER**

Vector Magic

JACOB NORDA (SWEDEN INDIVIDUAL)
450 OAK GROVE AVE APT 204
450 OAK GROVE AVE APT 204
MENLO PARK, CA 94025

FOR: COMPUTER GRAPHICS SOFTWARE, IN
CLASS 9 (U.S. CLS. 21, 23, 26, 36 AND 38).

FIRST USE 7-15-2008; IN COMMERCE 7-15-2008.

FOR: CROSS-PLATFORM CONVERSION OF DI-
GITAL CONTENT INTO OTHER FORMS OF DIGI-
TAL CONTENT; GRAPHIC DESIGN; GRAPHIC
DESIGN SERVICES, IN CLASS 42 (U.S. CLS. 100
AND 101).

FIRST USE 4-10-2007; IN COMMERCE 4-10-2007.

THE MARK CONSISTS OF STANDARD CHAR-
ACTERS WITHOUT CLAIM TO ANY PARTICULAR
FONT, STYLE, SIZE, OR COLOR.

NO CLAIM IS MADE TO THE EXCLUSIVE
RIGHT TO USE "VECTOR", APART FROM THE
MARK AS SHOWN.

SN 77-345,663, FILED 12-6-2007.

AMY HELLA, EXAMINING ATTORNEY

Int. Cls.: 35, 36, 37, 39, and 42

Prior U.S. Cls.: 100, 101, 102, 103, 105, and 106

United States Patent and Trademark Office

Reg. No. 3,522,243

Registered Oct. 21, 2008

SERVICE MARK
PRINCIPAL REGISTER



Arena Illinois



MANHEIM AUCTIONS, INC. (DELAWARE CORPORATION)
6205 PEACHTREE DUNWOODY ROAD
ATLANTA, GA 30328

FOR: AUTOMOBILE AUCTION SERVICES; AUTOMOBILE AUCTION SERVICES PROVIDED VIA THE INTERNET, IN CLASS 35 (U.S. CLS. 100, 101 AND 102).

FIRST USE 6-20-2008; IN COMMERCE 6-20-2008.

FOR: AUTOMOBILE FINANCING SERVICES, IN CLASS 36 (U.S. CLS. 100, 101 AND 102).

FIRST USE 6-20-2008; IN COMMERCE 6-20-2008.

FOR: AUTOMOTIVE DETAILING, RECONDITIONING, REPAIR, CONVERSION AND CUSTOMIZATION SERVICES, IN CLASS 37 (U.S. CLS. 100, 103 AND 106).

FIRST USE 6-20-2008; IN COMMERCE 6-20-2008.

FOR: BUSINESS-TO-BUSINESS AUTOMOTIVE TRANSPORTATION AND STORAGE SERVICES, IN CLASS 39 (U.S. CLS. 100 AND 105).

FIRST USE 6-20-2008; IN COMMERCE 6-20-2008.

FOR: AUTOMOBILE INSPECTION SERVICES, IN CLASS 42 (U.S. CLS. 100 AND 101).

FIRST USE 6-20-2008; IN COMMERCE 6-20-2008.

OWNER OF U.S. REG. NOS. 1,699,332, 3,229,428, AND OTHERS.

NO CLAIM IS MADE TO THE EXCLUSIVE RIGHT TO USE "ILLINOIS", APART FROM THE MARK AS SHOWN.

THE COLOR(S) GOLD, BLUE, BROWN, RED, BLACK, GREY AND WHITE IS/ARE CLAIMED AS A FEATURE OF THE MARK.

THE MARK CONSISTS OF A GOLD "M" OVER A BLUE CIRCULAR BACKGROUND AND WITHIN TWO GOLD OUTER RINGS. THE COLOR BROWN OUTLINES THE MARK. TO THE RIGHT OF THE M IS THE WORD "MANHEIM" IN THE COLOR BLACK. A BLACK LINE SEPARATES THE ABOVE DESIGN AND THE WORD "MANHEIM" AND THE WORDS "ARENA ILLINOIS" IN THE COLOR BLACK AND A ZIGZAG DESIGN IN THE COLOR WHITE ON A RED BACKGROUND, INSIDE CONCENTRIC WHITE AND GREY SQUARES TO THE RIGHT OF THE WORDS "ARENA ILLINOIS".

SN 77-345,717, FILED 12-6-2007.

GISELLE AGOSTO, EXAMINING ATTORNEY

Int. Cl.: 28

Prior U.S. Cls.: 22, 23, 38, and 50

United States Patent and Trademark Office

Reg. No. 3,522,244

Registered Oct. 21, 2008

**TRADEMARK
PRINCIPAL REGISTER**

**MY FIRST CRYSTALS AND FIZZ
ADVENTURE KIT**

ELMER'S PRODUCTS, INC. (PENNSYLVANIA
CORPORATION)
ONE EASTON OVAL
COLUMBUS, OH 43219

FOR: TOYS AND PLAYTHINGS, NAMELY, SCI-
ENCE AND ACTIVITY KITS FOR CHILDREN, IN
CLASS 28 (U.S. CLS. 22, 23, 38 AND 50).

FIRST USE 6-1-2008; IN COMMERCE 6-1-2008.

THE MARK CONSISTS OF STANDARD CHAR-
ACTERS WITHOUT CLAIM TO ANY PARTICULAR
FONT, STYLE, SIZE, OR COLOR.

NO CLAIM IS MADE TO THE EXCLUSIVE
RIGHT TO USE "CRYSTALS" AND "KIT", APART
FROM THE MARK AS SHOWN.

SN 77-345,746, FILED 12-6-2007.

MICHELE SWAIN, EXAMINING ATTORNEY

Int. Cl.: 41

Prior U.S. Cls.: 100, 101, and 107

United States Patent and Trademark Office

Reg. No. 3,522,245

Registered Oct. 21, 2008

**SERVICE MARK
PRINCIPAL REGISTER**

STORM STRUCK

FEDERAL ALLIANCE FOR SAFE HOMES -
FLASH, INC. (FLORIDA CORPORATION)
SUITE 2
1427 E. PIEDMONT DRIVE
TALLAHASSEE, FL 32308

FOR: ENTERTAINMENT SERVICES IN THE
NATURE OF AN AMUSEMENT PARK ATTRAC-
TION, NAMELY, A THEMED AREA, IN CLASS 41
(U.S. CLS. 100, 101 AND 107).

FIRST USE 8-11-2008; IN COMMERCE 8-11-2008.

THE MARK CONSISTS OF STANDARD CHAR-
ACTERS WITHOUT CLAIM TO ANY PARTICULAR
FONT, STYLE, SIZE, OR COLOR.

NO CLAIM IS MADE TO THE EXCLUSIVE
RIGHT TO USE "STORM", APART FROM THE
MARK AS SHOWN.

SN 77-346,114, FILED 12-6-2007.

ROBIN CHOSID, EXAMINING ATTORNEY

Int. Cl.: 41

Prior U.S. Cls.: 100, 101, and 107

United States Patent and Trademark Office

Reg. No. 3,522,246

Registered Oct. 21, 2008

**SERVICE MARK
PRINCIPAL REGISTER**

**STORM STRUCK ... A TALE OF
TWO HOMES**

FEDERAL ALLIANCE FOR SAFE HOMES -
FLASH, INC. (FLORIDA CORPORATION)
SUITE 2
1427 E PIEDMONT DRIVE
TALLAHASSEE, FL 32308

FOR: ENTERTAINMENT SERVICES IN THE
NATURE OF AN AMUSEMENT PARK ATTRAC-
TION, NAMELY, A THEMED AREA, IN CLASS 41
(U.S. CLS. 100, 101 AND 107).

FIRST USE 8-11-2008; IN COMMERCE 8-11-2008.

THE MARK CONSISTS OF STANDARD CHAR-
ACTERS WITHOUT CLAIM TO ANY PARTICULAR
FONT, STYLE, SIZE, OR COLOR.

NO CLAIM IS MADE TO THE EXCLUSIVE
RIGHT TO USE "STORM", APART FROM THE
MARK AS SHOWN.

SN 77-346,125, FILED 12-6-2007.

ROBIN CHOSID, EXAMINING ATTORNEY

Int. Cl.: 41

Prior U.S. Cls.: 100, 101, and 107

United States Patent and Trademark Office

Reg. No. 3,522,247

Registered Oct. 21, 2008

**SERVICE MARK
PRINCIPAL REGISTER**

CIRQUE MECHANICS

WHEELWORK ARTS LLC (NEVADA LIMITED
LIABILITY COMPANY)
1301 DESERT HILLS DRIVE
LAS VEGAS, NV 89117

NO CLAIM IS MADE TO THE EXCLUSIVE
RIGHT TO USE "CIRQUE", APART FROM THE
MARK AS SHOWN.

FOR: ENTERTAINMENT IN THE NATURE OF
CIRCUSES; ENTERTAINMENT IN THE NATURE
OF THEATER PRODUCTIONS, IN CLASS 41 (U.S.
CLS. 100, 101 AND 107).

THE ENGLISH TRANSLATION OF THE FRENCH
WORDING "CIRQUE" IN THE MARK IS "CIRCUS."

FIRST USE 10-5-2007; IN COMMERCE 12-16-2007.

SN 77-346,296, FILED 12-7-2007.

THE MARK CONSISTS OF STANDARD CHAR-
ACTERS WITHOUT CLAIM TO ANY PARTICULAR
FONT, STYLE, SIZE, OR COLOR.

STEPHEN AQUILA, EXAMINING ATTORNEY

Int. Cl.: 28

Prior U.S. Cls.: 22, 23, 38, and 50

United States Patent and Trademark Office

Reg. No. 3,522,248

Registered Oct. 21, 2008

**TRADEMARK
PRINCIPAL REGISTER**

BITE THIS

TIGRESS TRADING COMPANY, INC. (FLORIDA
CORPORATION)
2516 S.W. 4TH AVE.
FT. LAUDERDALE, FL 33315

THE MARK CONSISTS OF STANDARD CHAR-
ACTERS WITHOUT CLAIM TO ANY PARTICULAR
FONT, STYLE, SIZE, OR COLOR.

FOR: KITES, IN CLASS 28 (U.S. CLS. 22, 23, 38 AND
50).

SN 77-346,399, FILED 12-7-2007.

FIRST USE 12-7-2007; IN COMMERCE 12-7-2007.

THEODORE MCBRIDE, EXAMINING ATTORNEY

Int. Cl.: 3

Prior U.S. Cls.: 1, 4, 6, 50, 51, and 52

Reg. No. 3,522,249

United States Patent and Trademark Office

Registered Oct. 21, 2008

**TRADEMARK
PRINCIPAL REGISTER**

CUSHIONYTHICK

U.S. NONWOVENS CORPORATION (NEW YORK
CORPORATION)
100 EMJAY BOULEVARD
BRENTWOOD, NY 11717

FIRST USE 8-1-2008; IN COMMERCE 8-1-2008.

FOR: DISPOSABLE WIPES IMPREGNATED
WITH CHEMICALS OR COMPOUNDS FOR PERSONAL
HYGIENE AND ALL-PURPOSE HOUSEHOLD
USE; PRE-MOISTENED COSMETIC WIPES; BABY
WIPES, IN CLASS 3 (U.S. CLS. 1, 4, 6, 50, 51 AND 52).

THE MARK CONSISTS OF STANDARD CHAR-
ACTERS WITHOUT CLAIM TO ANY PARTICULAR
FONT, STYLE, SIZE, OR COLOR.

SN 77-346,622, FILED 12-7-2007.

JOHN HWANG, EXAMINING ATTORNEY

Int. Cl.: 3

Prior U.S. Cls.: 1, 4, 6, 50, 51, and 52

United States Patent and Trademark Office

Reg. No. 3,522,250

Registered Oct. 21, 2008

**TRADEMARK
PRINCIPAL REGISTER**

SOFTSPUN

U.S. NONWOVENS CORPORATION (NEW YORK
CORPORATION)
100 EMJAY BOULEVARD
BRENTWOOD, NY 11717

FOR: DISPOSABLE WIPES IMPREGNATED
WITH CHEMICALS OR COMPOUNDS FOR PERSONAL
HYGIENE AND ALL-PURPOSE HOUSEHOLD
USE; PRE-MOISTENED COSMETIC WIPES; BABY
WIPES, IN CLASS 3 (U.S. CLS. 1, 4, 6, 50, 51 AND 52).

FIRST USE 8-1-2008; IN COMMERCE 8-1-2008.

THE MARK CONSISTS OF STANDARD CHAR-
ACTERS WITHOUT CLAIM TO ANY PARTICULAR
FONT, STYLE, SIZE, OR COLOR.

SN 77-346,636, FILED 12-7-2007.

JOHN HWANG, EXAMINING ATTORNEY

Int. Cl.: 39

Prior U.S. Cls.: 100 and 105

United States Patent and Trademark Office

Reg. No. 3,522,251

Registered Oct. 21, 2008

**SERVICE MARK
PRINCIPAL REGISTER**



LOGISTICS ONE, INC. (DELAWARE CORPORATION)
33 CADY HILL BLVD.
SARATOGA SPRINGS, NY 12866

FOR: RENTAL OF TRUCKS; SUPPLY CHAIN, LOGISTICS AND REVERSE LOGISTICS SERVICES, NAMELY, STORAGE, TRANSPORTATION AND DELIVERY OF DOCUMENTS, PACKAGES, RAW MATERIALS, AND OTHER FREIGHT FOR OTHERS BY AIR, RAIL, SHIP OR TRUCK; TRANSPORTATION OF FURNITURE OF OTHERS BY TRUCKS; TRUCK AND TRAILER RENTAL; TRUCK HAULING; TRUCK TRANSPORT; DELIVERY OF GOODS BY TRUCK; EXPRESS DELIVERY OF GOODS BY TRUCK; FREIGHT TRANSPORTATION BY TRUCK; LEASING OF TRUCKS; RENTAL OF WAREHOUSE SPACE; RENTAL OF WAREHOUSES; WAREHOUSE STORAGE, IN CLASS 39 (U.S. CLS. 100 AND 105).

FIRST USE 5-1-2008; IN COMMERCE 5-1-2008.

THE COLOR(S) RED AND BLACK IS/ARE CLAIMED AS A FEATURE OF THE MARK.

THE MARK CONSISTS OF A SINGLE NON STANDARD CHARACTER BLACK AND RED, BLACK 1/2 LETTER "L" ON THE BOTTOM AND RED 1/2 NUMBER "1" ON TOP, THEN ENCIRCLED IN HALF CIRCLE BLACK ON THE LEFT AND HALF CIRCLE RED ON THE RIGHT; FOLLOWING TO THE LEFT ARE BLACK STANDARD CHARACTERS "LOGISTICS" FOLLOWED BY RED STANDARD CHARACTERS "ONE" WITHOUT A SPACE BETWEEN; IMMEDIATELY BENEATH ARE RIGHT JUSTIFIED BLACK STANDARD CHARACTERS "PERFORMANCE DELIVERED".

SN 77-346,673, FILED 12-7-2007.

NORA BUCHANAN WILL, EXAMINING ATTORNEY

Int. Cl.: 33

Prior U.S. Cls.: 47 and 49

United States Patent and Trademark Office

Reg. No. 3,522,252

Registered Oct. 21, 2008

**TRADEMARK
PRINCIPAL REGISTER**

VOLVER

FINE ESTATES FROM SPAIN, INC. (MASSACHUSETTS CORPORATION)

745 HIGH STREET

DEDHAM, MA 02026

FOR: WINE, IN CLASS 33 (U.S. CLS. 47 AND 49).

FIRST USE 3-20-2008; IN COMMERCE 3-20-2008.

THE MARK CONSISTS OF STANDARD CHARACTERS WITHOUT CLAIM TO ANY PARTICULAR FONT, STYLE, SIZE, OR COLOR.

THE FOREIGN WORDING IN THE MARK TRANSLATES INTO ENGLISH AS TO "RETURN".

SN 77-346,820, FILED 12-7-2007.

LINDA MICKLEBURGH, EXAMINING ATTORNEY

Int. Cl.: 21

Prior U.S. Cls.: 2, 13, 23, 29, 30, 33, 40, and 50

United States Patent and Trademark Office

Reg. No. 3,522,253

Registered Oct. 21, 2008

**TRADEMARK
PRINCIPAL REGISTER**

**AGS/Advanced
Growing
System**

AEROGROW INTERNATIONAL, INC. (NEVADA CORPORATION)
6075 LONGBOW DRIVE SUITE 200
BOULDER, CO 80301

FOR: HYDROPONIC GARDEN KIT FOR HOME USE COMPRISING A PLANT GROWING CONTAINER AND A VARIETY OF THE FOLLOWING GOODS, ALL SOLD AS A UNIT, NAMELY, LIVE PLANTS, SEEDS, HYDROPONIC FERTILIZERS, PLANT NUTRIENTS, PLANT GROWING MEDIA, GERMINATION COVERS, GROWING BASKETS, METAL AND NON-METAL PLANT HANGERS, HORTICULTURAL GROW LAMP FIXTURES, HORTICULTURAL GROW LAMPS, WATER PUMP, AIR PUMP, ELECTRONIC CONTROL UNIT, PRINTED INSTRUCTIONS FOR USING THE KIT, AND BOOKS AND DVDS, ALL DEALING WITH COOKING WITH PLANTS GROWN WITH THE KIT,

GARDENING, HORTICULTURE, FLOWER ARRANGING OR FLOWER ARTS, IN CLASS 21 (U.S. CLS. 2, 13, 23, 29, 30, 33, 40 AND 50).

FIRST USE 5-15-2008; IN COMMERCE 5-15-2008.

NO CLAIM IS MADE TO THE EXCLUSIVE RIGHT TO USE "ADVANCED GROWING SYSTEM", APART FROM THE MARK AS SHOWN.

THE MARK CONSISTS OF STYLIZED "AGS," FORWARD SLASH, "ADVANCED GROWING SYSTEM."

SN 77-347,195, FILED 12-7-2007.

RUSS HERMAN, EXAMINING ATTORNEY

Int. Cl.: 30

Prior U.S. Cl.: 46

United States Patent and Trademark Office

Reg. No. 3,522,254

Registered Oct. 21, 2008

**TRADEMARK
PRINCIPAL REGISTER**

Red Bird Coffee

PENTEL, JEFFREY A. (UNITED STATES INDIVIDUAL)
3130 PRAIRIE SMOKE RD.
BOZEMAN, MT 597158701

FOR: BEVERAGES MADE OF COFFEE; CAFFEINE-FREE COFFEE; COFFEE; COFFEE; COFFEE BASED BEVERAGES; COFFEE BEANS; COFFEE PODS; GROUND COFFEE BEANS; INSTANT COFFEE; MIXTURES OF COFFEE AND CHICORY; ROASTED COFFEE BEANS, IN CLASS 30 (U.S. CL. 46).

FIRST USE 2-1-2008; IN COMMERCE 2-1-2008.

THE MARK CONSISTS OF STANDARD CHARACTERS WITHOUT CLAIM TO ANY PARTICULAR FONT, STYLE, SIZE, OR COLOR.

NO CLAIM IS MADE TO THE EXCLUSIVE RIGHT TO USE "COFFEE", APART FROM THE MARK AS SHOWN.

SN 77-347,617, FILED 12-9-2007.

THEODORE MCBRIDE, EXAMINING ATTORNEY

Int. Cl.: 14

Prior U.S. Cls.: 2, 27, 28, and 50

United States Patent and Trademark Office

Reg. No. 3,522,255

Registered Oct. 21, 2008

**TRADEMARK
PRINCIPAL REGISTER**

D.NEA

D.NEA LLC (MICHIGAN LIMITED LIABILITY
COMPANY)
PO BOX 2401
BATTLE CREEK, MI 490162401

THE MARK CONSISTS OF STANDARD CHAR-
ACTERS WITHOUT CLAIM TO ANY PARTICULAR
FONT, STYLE, SIZE, OR COLOR.

FOR: SYNTHETIC DIAMONDS; DIAMOND JEW-
ELRY; JEWELRY, IN CLASS 14 (U.S. CLS. 2, 27, 28
AND 50).

SN 77-348,076, FILED 12-10-2007.

FIRST USE 12-1-2007; IN COMMERCE 1-1-2008.

NAAKWAMA ANKRAH, EXAMINING ATTORNEY

Int. Cl.: 36

Prior U.S. Cls.: 100, 101, and 102

United States Patent and Trademark Office

Reg. No. 3,522,256

Registered Oct. 21, 2008

**SERVICE MARK
PRINCIPAL REGISTER**

STAY COM

THE COMMERCE INSURANCE COMPANY
(MASSACHUSETTS CORPORATION)
211 MAIN STREET
WEBSTER, MA 01570

FOR: INSURANCE SERVICES, NAMELY, INSURANCE UNDERWRITING AND ADMINISTRATION OF INSURANCE IN THE FIELDS OF AUTOMOBILE, ACCIDENT, LIABILITY, HOMEOWNERS, PROPERTY, FIRE, COMMERCIAL PROPERTY AND LIABILITY, GENERAL LIABILITY, COMMERCIAL AND PERSONAL PROPERTY AND CASUALTY; INSURANCE BROKERAGE AND AGENCY SERVICES; PROPERTY AND CASUALTY LOSS IN-

SURANCE ADMINISTRATION; INSURANCE CLAIMS ADJUSTMENT AND ADMINISTRATION, IN CLASS 36 (U.S. CLS. 100, 101 AND 102).

FIRST USE 3-8-2008; IN COMMERCE 3-8-2008.

THE MARK CONSISTS OF STANDARD CHARACTERS WITHOUT CLAIM TO ANY PARTICULAR FONT, STYLE, SIZE, OR COLOR.

SN 77-348,273, FILED 12-10-2007.

MICHAEL TANNER, EXAMINING ATTORNEY

Int. Cl.: 36

Prior U.S. Cls.: 100, 101, and 102

United States Patent and Trademark Office

Reg. No. 3,522,257

Registered Oct. 21, 2008

**SERVICE MARK
PRINCIPAL REGISTER**

MICROGIVING

JZJ, LLC (GEORGIA LIMITED LIABILITY COMPANY)
80 PEACHTREE PARK DRIVE, N.E.
ATLANTA, GA 303091320

THE MARK CONSISTS OF STANDARD CHARACTERS WITHOUT CLAIM TO ANY PARTICULAR FONT, STYLE, SIZE, OR COLOR.

FOR: CHARITABLE FUNDRAISING SERVICES VIA INTERNET MERCHANTS, IN CLASS 36 (U.S. CLS. 100, 101 AND 102).

SN 77-349,266, FILED 12-11-2007.

FIRST USE 11-8-2007; IN COMMERCE 11-8-2007.

JORDAN BAKER, EXAMINING ATTORNEY

Int. Cl.: 25

Prior U.S. Cls.: 22 and 39

United States Patent and Trademark Office

Reg. No. 3,522,258

Registered Oct. 21, 2008

**TRADEMARK
PRINCIPAL REGISTER**

THE NATURAL SOLUTION

COCONUT GROVE PADS, INC. (CANADA CORPORATION)
UNIT 1
525 DENISON STREET
MARKHAM, ONTARIO, CANADA L3R1B8

FOR: BRASSIERES, IN CLASS 25 (U.S. CLS. 22 AND 39).

FIRST USE 3-24-2008; IN COMMERCE 3-24-2008.

THE MARK CONSISTS OF STANDARD CHARACTERS WITHOUT CLAIM TO ANY PARTICULAR FONT, STYLE, SIZE, OR COLOR.

OWNER OF U.S. REG. NOS. 3,019,285 AND 3,340,487.

SN 77-349,396, FILED 12-11-2007.

HEATHER BIDDULPH, EXAMINING ATTORNEY

Int. Cl.: 29

Prior U.S. Cl.: 46

United States Patent and Trademark Office

Reg. No. 3,522,259

Registered Oct. 21, 2008

**TRADEMARK
PRINCIPAL REGISTER**

CULINARY TOUCH

JOHN B. SANFILIPPO & SON, INC. (DELAWARE CORPORATION)
1703 N. RANDALL ROAD
ELGIN, IL 601237820

FOR: SNACK MIXES CONSISTING PRIMARILY OF PROCESSED NUTS, PROCESSED FRUITS AND/OR UNPROCESSED NUTS; MIXES CONSISTING PRIMARILY OF PROCESSED NUTS, PROCESSED FRUITS AND/OR UNPROCESSED NUTS FOR BAKING OR USE AS CONDIMENTS, IN CLASS 29 (U.S. CL. 46).

FIRST USE 2-20-2008; IN COMMERCE 2-20-2008.

THE MARK CONSISTS OF STANDARD CHARACTERS WITHOUT CLAIM TO ANY PARTICULAR FONT, STYLE, SIZE, OR COLOR.

NO CLAIM IS MADE TO THE EXCLUSIVE RIGHT TO USE "CULINARY", APART FROM THE MARK AS SHOWN.

SN 77-350,455, FILED 12-12-2007.

G. MAYERSCHOFF, EXAMINING ATTORNEY

Int. Cl.: 33

Prior U.S. Cls.: 47 and 49

United States Patent and Trademark Office

Reg. No. 3,522,260

Registered Oct. 21, 2008

**TRADEMARK
PRINCIPAL REGISTER**

DOMINO DE OSAS

FINE ESTATES FROM SPAIN, INC. (MASSACHUSETTS CORPORATION)
745 HIGH STREET
DEDHAM, MA 02109

THE FOREIGN WORDING IN THE MARK
TRANSLATES INTO ENGLISH AS HEAD OF FEMALE BEAR.

FOR: WINE, IN CLASS 33 (U.S. CLS. 47 AND 49).

FIRST USE 3-20-2008; IN COMMERCE 3-20-2008.

SN 77-351,120, FILED 12-13-2007.

THE MARK CONSISTS OF STANDARD CHARACTERS WITHOUT CLAIM TO ANY PARTICULAR FONT, STYLE, SIZE, OR COLOR.

LINDA MICKLEBURGH, EXAMINING ATTORNEY

Int. Cls.: 21 and 43

Prior U.S. Cls.: 2, 13, 23, 29, 30, 33, 40, 50, 100, and 101

United States Patent and Trademark Office

Reg. No. 3,522,261

Registered Oct. 21, 2008

**TRADEMARK
SERVICE MARK
PRINCIPAL REGISTER**

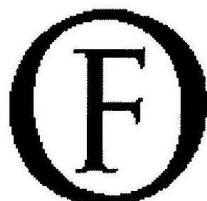

**OLD FORT BAY
CLUB**

BARA ISHIDU INTERNATIONAL CORPORA-
TION (BAHAMAS CORPORATION)
CAY HOUSE
P.O. BOX N7776
LYFORD CAY, BAHAMAS

FOR: BEVERAGE GLASSWARE; PLASTIC CUPS
AND MUGS, IN CLASS 21 (U.S. CLS. 2, 13, 23, 29, 30,
33, 40 AND 50).

FIRST USE 2-28-2003; IN COMMERCE 2-28-2003.

FOR: BAR SERVICES LOCATED WITHIN A RE-
SORT, IN CLASS 43 (U.S. CLS. 100 AND 101).

FIRST USE 2-28-2003; IN COMMERCE 2-28-2003.

OWNER OF U.S. REG. NO. 3,141,399.

NO CLAIM IS MADE TO THE EXCLUSIVE
RIGHT TO USE "CLUB", APART FROM THE MARK
AS SHOWN.

THE MARK CONSISTS OF A CIRCLED "F" WITH
A HORIZONTAL LINE UNDERNEATH AND THE
WORDS "OLD FORT BAY CLUB" UNDERNEATH
THE LINE.

SN 77-351,601, FILED 12-13-2007.

ROBERT C. CLARK JR., EXAMINING ATTORNEY

Int. Cl.: 12

Prior U.S. Cls.: 19, 21, 23, 31, 35, and 44

Reg. No. 3,522,262

United States Patent and Trademark Office

Registered Oct. 21, 2008

**TRADEMARK
PRINCIPAL REGISTER**

BRONX

RUBIO GONZALEZ, JUAN JOSE (MEXICO INDIVIDUAL)
PASEO DE LAS ARAUCARIAS 531, SANTA ANITA
TLAJOMULCO DE ZUÑIGA, MEXICO 45645

FOR: AUTOMOBILE BUMPERS; AUTOMOBILE CHASSIS; AUTOMOBILE DOOR HANDLES; AUTOMOBILE HOODS; AUTOMOBILE ROOF RACKS; AUTOMOBILE SUNROOFS; AUTOMOBILE WINDSHIELD SUNSHADES; MIRRORS FOR VEHICLES, NAMELY, SIDE VIEW MIRRORS; MUDGUARDS; REAR VIEW MIRRORS; REARVIEW MIRRORS; REARVIEW MIRRORS; ROOF RACK STORAGE CONTAINERS FOR LAND VEHICLES; ROOF RACKS; SUN SHIELDS AND VISORS FOR MOTOR

CARS; LICENSE PLATE FRAMES; LICENSE PLATE HOLDERS; LICENSE PLATE FASTENERS, IN CLASS 12 (U.S. CLS. 19, 21, 23, 31, 35 AND 44).

FIRST USE 5-10-2008; IN COMMERCE 5-10-2008.

THE MARK CONSISTS OF STANDARD CHARACTERS WITHOUT CLAIM TO ANY PARTICULAR FONT, STYLE, SIZE, OR COLOR.

SN 77-351,709, FILED 12-13-2007.

AMY MCMENAMIN, EXAMINING ATTORNEY

Int. Cl.: 35

Prior U.S. Cls.: 100, 101, and 102

United States Patent and Trademark Office

Reg. No. 3,522,263

Registered Oct. 21, 2008

**SERVICE MARK
PRINCIPAL REGISTER**

MAN'S NEXT BEST FRIEND

ANSLEY, MICAH (UNITED STATES INDIVIDUAL)
565 KING ROAD
PISGAH FOREST, NC 28768

THE MARK CONSISTS OF STANDARD CHARACTERS WITHOUT CLAIM TO ANY PARTICULAR FONT, STYLE, SIZE, OR COLOR.

FOR: ON-LINE RETAIL STORE SERVICES FEATURING AUTOMOTIVE TOOLS; RETAIL STORE SERVICES FEATURING AUTOMOTIVE TOOLS, IN CLASS 35 (U.S. CLS. 100, 101 AND 102).

SN 77-352,041, FILED 12-14-2007.

FIRST USE 2-19-2007; IN COMMERCE 2-19-2007.

JASON TURNER, EXAMINING ATTORNEY

Int. Cl.: 14

Prior U.S. Cls.: 2, 27, 28, and 50

United States Patent and Trademark Office

Reg. No. 3,522,264

Registered Oct. 21, 2008

**TRADEMARK
PRINCIPAL REGISTER**

Waves of Gratitude

WAVELET PRODUCTIONS, LLC (NEW HAMPSHIRE LIMITED LIABILITY COMPANY)
35 MANCHESTER ROAD, 11A, BOX 250
DERRY, NH 03038

THE MARK CONSISTS OF STANDARD CHARACTERS WITHOUT CLAIM TO ANY PARTICULAR FONT, STYLE, SIZE, OR COLOR.

FOR: JEWELRY, IN CLASS 14 (U.S. CLS. 2, 27, 28 AND 50).

SN 77-353,044, FILED 12-15-2007.

FIRST USE 5-19-2008; IN COMMERCE 5-19-2008.

KAELIE KUNG, EXAMINING ATTORNEY

Int. Cl.: 9

Prior U.S. Cls.: 21, 23, 26, 36, and 38

United States Patent and Trademark Office

Reg. No. 3,522,265

Registered Oct. 21, 2008

**TRADEMARK
PRINCIPAL REGISTER**

LivePresets

ARTLANDIA, INC. (ILLINOIS CORPORATION)
2015 BARBERRY CIR.
2015 BARBERRY CIR.
CHAMPAIGN, IL 61821

THE MARK CONSISTS OF STANDARD CHAR-
ACTERS WITHOUT CLAIM TO ANY PARTICULAR
FONT, STYLE, SIZE, OR COLOR.

FOR: COMPUTER SOFTWARE FOR GRAPHIC
DESIGN, IN CLASS 9 (U.S. CLS. 21, 23, 26, 36 AND 38).

SN 77-353,295, FILED 12-16-2007.

FIRST USE 7-13-2008; IN COMMERCE 7-13-2008.

AHSEN KHAN, EXAMINING ATTORNEY

Int. Cl.: 44

Prior U.S. Cls.: 100 and 101

United States Patent and Trademark Office

Reg. No. 3,522,266

Registered Oct. 21, 2008

**SERVICE MARK
PRINCIPAL REGISTER**



DIAZ VISION CENTER, PA (TEXAS PROFESSIONAL ASSOCIATION)
SUITE 404
124 E. BANDERA
BOERNE, TX 78006

FOR: TREATMENT OF EYE DISEASES AND CONDITIONS, IN CLASS 44 (U.S. CLS. 100 AND 101).

FIRST USE 3-31-2008; IN COMMERCE 3-31-2008.

NO CLAIM IS MADE TO THE EXCLUSIVE RIGHT TO USE "VISION CENTER, PA", APART FROM THE MARK AS SHOWN.

THE MARK CONSISTS OF A STYLIZED PARTIAL OUTLINE OF AN EYE AND THE TEXT OF THE MARK.

SN 77-353,354, FILED 12-17-2007.

AMOS T. MATTHEWS, JR., EXAMINING ATTORNEY

Int. Cls.: 16 and 35

Prior U.S. Cls.: 2, 5, 22, 23, 29, 37, 38, 50, 100, 101, and 102

Reg. No. 3,522,267

United States Patent and Trademark Office

Registered Oct. 21, 2008

**TRADEMARK
SERVICE MARK
PRINCIPAL REGISTER**

TULSA A NEW KIND OF ENERGY

CITY OF TULSA (OKLAHOMA MUNICIPAL CORPORATION)
200 CIVIC CENTER
TULSA, OK 74103

FOR: PRINTED MATTER, NAMELY, FLYERS, BROCHURES, AND ADVERTISING MATERIAL TO PROMOTE THE CITY OF TULSA AND ITS CITIZENS, IN CLASS 16 (U.S. CLS. 2, 5, 22, 23, 29, 37, 38 AND 50).

FIRST USE 11-19-2007; IN COMMERCE 11-19-2007.

FOR: PROVIDING ADVERTISING, MARKETING AND PROMOTIONAL SERVICES, NAMELY, PROMOTING THE CITY OF TULSA AND ITS CITIZENS, IN CLASS 35 (U.S. CLS. 100, 101 AND 102).

FIRST USE 11-19-2007; IN COMMERCE 11-19-2007.

THE MARK CONSISTS OF STANDARD CHARACTERS WITHOUT CLAIM TO ANY PARTICULAR FONT, STYLE, SIZE, OR COLOR.

NO CLAIM IS MADE TO THE EXCLUSIVE RIGHT TO USE "TULSA" , APART FROM THE MARK AS SHOWN.

SN 77-353,925, FILED 12-17-2007.

JUDITH HELFMAN, EXAMINING ATTORNEY

Int. Cl.: 5

Prior U.S. Cls.: 6, 18, 44, 46, 51, and 52

Reg. No. 3,522,268

United States Patent and Trademark Office

Registered Oct. 21, 2008

**TRADEMARK
PRINCIPAL REGISTER**

EXULET

PHARMACIA & UPJOHN COMPANY LLC (DE-
LAWARE LIMITED LIABILITY COMPANY)
7000 PORTAGE ROAD
KALAMAZOO, MI 49001

THE MARK CONSISTS OF STANDARD CHAR-
ACTERS WITHOUT CLAIM TO ANY PARTICULAR
FONT, STYLE, SIZE, OR COLOR.

FOR: PHARMACEUTICAL PREPARATIONS,
NAMELY, ANTIBACTERIAL PREPARATIONS, IN
CLASS 5 (U.S. CLS. 6, 18, 44, 46, 51 AND 52).

SN 77-354,336, FILED 12-18-2007.

FIRST USE 7-24-2008; IN COMMERCE 7-24-2008.

JAMES STEIN, EXAMINING ATTORNEY

Int. Cl.: 36

Prior U.S. Cls.: 100, 101, and 102

United States Patent and Trademark Office

Reg. No. 3,522,269

Registered Oct. 21, 2008

**SERVICE MARK
PRINCIPAL REGISTER**

Quoin

QUOIN FINANCIAL BANK (SOUTH DAKOTA
CORPORATION)
201 NORTH BROADWAY
MILLER, SD 57362

THE MARK CONSISTS OF STANDARD CHAR-
ACTERS WITHOUT CLAIM TO ANY PARTICULAR
FONT, STYLE, SIZE, OR COLOR.

FOR: BANKING SERVICES; CREDIT CARD SER-
VICES; INSURANCE AGENCIES, IN CLASS 36 (U.S.
CLS. 100, 101 AND 102).

SN 77-354,487, FILED 12-18-2007.

FIRST USE 4-1-2008; IN COMMERCE 4-1-2008.

MICHAEL WIENER, EXAMINING ATTORNEY

Int. Cl.: 11

Prior U.S. Cls.: 13, 21, 23, 31, and 34

Reg. No. 3,522,270

United States Patent and Trademark Office

Registered Oct. 21, 2008

**TRADEMARK
PRINCIPAL REGISTER**

FLAIR

WATKINS MANUFACTURING CORPORATION
(CALIFORNIA CORPORATION)
1280 PARK CENTER DRIVE
VISTA, CA 92081

THE MARK CONSISTS OF STANDARD CHAR-
ACTERS WITHOUT CLAIM TO ANY PARTICULAR
FONT, STYLE, SIZE, OR COLOR.

FOR: HOT TUBS AND FREESTANDING SPAS IN
THE NATURE OF HEATED POOLS, IN CLASS 11
(U.S. CLS. 13, 21, 23, 31 AND 34).

SN 77-354,616, FILED 12-18-2007.

FIRST USE 2-19-2008; IN COMMERCE 2-19-2008.

CAROLYN CATALDO, EXAMINING ATTORNEY

Int. Cl.: 36

Prior U.S. Cls.: 100, 101, and 102

United States Patent and Trademark Office

Reg. No. 3,522,271

Registered Oct. 21, 2008

**SERVICE MARK
PRINCIPAL REGISTER**



QUOIN
Financial Bank

QUOIN FINANCIAL BANK (SOUTH DAKOTA
CORPORATION)

201 NORTH BROADWAY

MILLER, SD 57362

FOR: BANKING SERVICES; CREDIT CARD SER-
VICES, IN CLASS 36 (U.S. CLS. 100, 101 AND 102).

FIRST USE 4-0-2008; IN COMMERCE 4-0-2008.

NO CLAIM IS MADE TO THE EXCLUSIVE
RIGHT TO USE "FINANCIAL BANK", APART
FROM THE MARK AS SHOWN.

THE MARK CONSISTS OF THE STYLIZED RE-
PRESENTATION OF THE WORDS "QUOIN FINAN-
CIAL BANK".

SN 77-354,629, FILED 12-18-2007.

MICHAEL WIENER, EXAMINING ATTORNEY

Int. Cl.: 11

Prior U.S. Cls.: 13, 21, 23, 31, and 34

Reg. No. 3,522,272

United States Patent and Trademark Office

Registered Oct. 21, 2008

**TRADEMARK
PRINCIPAL REGISTER**

PULSE

WATKINS MANUFACTURING CORPORATION
(CALIFORNIA CORPORATION)
1280 PARK CENTER DRIVE
VISTA, CA 92081

THE MARK CONSISTS OF STANDARD CHAR-
ACTERS WITHOUT CLAIM TO ANY PARTICULAR
FONT, STYLE, SIZE, OR COLOR.

FOR: HOT TUBS AND FREESTANDING SPAS IN
THE NATURE OF HEATED POOLS, IN CLASS 11
(U.S. CLS. 13, 21, 23, 31 AND 34).

SN 77-354,638, FILED 12-18-2007.

FIRST USE 4-3-2008; IN COMMERCE 4-3-2008.

CAROLYN CATALDO, EXAMINING ATTORNEY

Int. Cl.: 9

Prior U.S. Cls.: 21, 23, 26, 36, and 38

United States Patent and Trademark Office

Reg. No. 3,522,273

Registered Oct. 21, 2008

**TRADEMARK
PRINCIPAL REGISTER**

MEETINGS360

AMERICAN EXPRESS MARKETING & DEVELOPMENT CORP. (DELAWARE CORPORATION)
200 VESEY STREET
NEW YORK, NY 10285

FOR: MEETING AND EVENT SOFTWARE FOR MEETING PLANNERS TO CREATE BUDGETS, MARKET EVENTS, MANAGE MEETING SPENDING AND MEASURE RESULTS , IN CLASS 9 (U.S. CLS. 21, 23, 26, 36 AND 38).

FIRST USE 1-0-2008; IN COMMERCE 1-0-2008.

THE MARK CONSISTS OF STANDARD CHARACTERS WITHOUT CLAIM TO ANY PARTICULAR FONT, STYLE, SIZE, OR COLOR.

SN 77-354,716, FILED 12-18-2007.

NAPOLEON SHARMA, EXAMINING ATTORNEY

Int. Cl.: 36

Prior U.S. Cls.: 100, 101, and 102

United States Patent and Trademark Office

Reg. No. 3,522,274

Registered Oct. 21, 2008

**SERVICE MARK
PRINCIPAL REGISTER**

**The Cornerstone Of Quality
Banking**

QUOIN FINANCIAL BANK (SOUTH DAKOTA
CORPORATION)
201 NORTH BROADWAY
MILLER, SD 57362

THE MARK CONSISTS OF STANDARD CHAR-
ACTERS WITHOUT CLAIM TO ANY PARTICULAR
FONT, STYLE, SIZE, OR COLOR.

FOR: BANKING SERVICES; CREDIT CARD SER-
VICES, IN CLASS 36 (U.S. CLS. 100, 101 AND 102).

SN 77-355,086, FILED 12-18-2007.

FIRST USE 4-0-2008; IN COMMERCE 4-0-2008.

MICHAEL WIENER, EXAMINING ATTORNEY

Int. Cl.: 33

Prior U.S. Cls.: 47 and 49

Reg. No. 3,522,275

United States Patent and Trademark Office

Registered Oct. 21, 2008

**TRADEMARK
PRINCIPAL REGISTER**

■ ■ ■ KU DÉ TA

LATITUDE BEVERAGE COMPANY (MASSACHUSETTS CORPORATION)
8 FANEUIL HALL - 3RD FLOOR
BOSTON, MA 02109

FOR: WINE, IN CLASS 33 (U.S. CLS. 47 AND 49).

FIRST USE 4-1-2008; IN COMMERCE 4-1-2008.

PRIORITY CLAIMED UNDER SEC. 44(D) ON CANADA APPLICATION NO. 1373465, FILED 11-26-2007.

THE MARK CONSISTS OF AN OVERALL SQUARED SHAPE COMPOSED BY SEVERAL SMALL SQUARES JUXTAPOSED (THREE PER SIDE), AND THE STYLIZED WORD "KU DÉ TA". THE WORDING "KU DE TA" IS THE PHONETIC EQUIVALENT OF "COUP D'ETAT."

SN 77-355,396, FILED 12-19-2007.

GINA FINK, EXAMINING ATTORNEY

Int. Cl.: 35

Prior U.S. Cls.: 100, 101, and 102

United States Patent and Trademark Office

Reg. No. 3,522,276

Registered Oct. 21, 2008

**SERVICE MARK
PRINCIPAL REGISTER**

DIGITAL MUSIC LIVE!

NIelsen BUSINESS MEDIA, INC. (DELAWARE
CORPORATION)
770 BROADWAY
NEW YORK, NY 100039595

THE MARK CONSISTS OF STANDARD CHAR-
ACTERS WITHOUT CLAIM TO ANY PARTICULAR
FONT, STYLE, SIZE, OR COLOR.

FOR: ARRANGING AND CONDUCTING BUSI-
NESS CONFERENCES, IN CLASS 35 (U.S. CLS. 100,
101 AND 102).

SN 77-355,649, FILED 12-19-2007.

FIRST USE 1-9-2008; IN COMMERCE 1-9-2008.

ANNE E. GUSTASON, EXAMINING ATTORNEY

Int. Cl.: 43

Prior U.S. Cls.: 100 and 101

United States Patent and Trademark Office

Reg. No. 3,522,277

Registered Oct. 21, 2008

**SERVICE MARK
PRINCIPAL REGISTER**



TODD WENDELL MORAW LARSON (UNITED STATES INDIVIDUAL)
N9633 TYVAND ROAD
BLANCHARDVILLE, WI 53516

FOR: HOTELS; RESIDENTIAL HOTELS; RESORT HOTELS, IN CLASS 43 (U.S. CLS. 100 AND 101).

FIRST USE 1-1-2008; IN COMMERCE 6-1-2008.

THE MARK CONSISTS OF A SIMPLE RECTANGLE FRAME (SUCH AS A SQUARE) WITH A HALF ROUND FRAME ON TOP, AND FACSIMILES OF TWO HINGES TO ONE SIDE OF THE RECTANGLE, SUCH THAT IT RESEMBLES A SHUTTER WINDOW ON A BARN.

SN 77-355,938, FILED 12-19-2007.

CHRISTINA SOBRAL, EXAMINING ATTORNEY

Int. Cl.: 43

Prior U.S. Cls.: 100 and 101

United States Patent and Trademark Office

Reg. No. 3,522,278

Registered Oct. 21, 2008

**SERVICE MARK
PRINCIPAL REGISTER**

MESA VERDE

THE QUIZNO'S MASTER LLC (COLORADO LIMITED LIABILITY COMPANY)
1475 LAWRENCE STREET
SUITE 400
DENVER, CO 80202

FOR: RESTAURANT SERVICES; TAKE OUT RESTAURANT SERVICES, IN CLASS 43 (U.S. CLS. 100 AND 101).

FIRST USE 11-1-2006; IN COMMERCE 11-1-2006.

THE MARK CONSISTS OF STANDARD CHARACTERS WITHOUT CLAIM TO ANY PARTICULAR FONT, STYLE, SIZE, OR COLOR.

THE ENGLISH TRANSLATION OF THE WORD "MESA VERDE" IN THE MARK IS GREEN TABLE.

SN 77-356,191, FILED 12-19-2007.

ELLEN PERKINS, EXAMINING ATTORNEY

Int. Cl.: 38

Prior U.S. Cls.: 100, 101, and 104

United States Patent and Trademark Office

Reg. No. 3,522,279

Registered Oct. 21, 2008

**SERVICE MARK
PRINCIPAL REGISTER**

JNEIGHBOR

JNEIGHBOR, LLC (OHIO LIMITED LIABILITY
COMPANY)
5140 LONGTON ROAD
CLEVELAND, OH 44124

FOR: PROVIDING ON-LINE CHAT ROOMS AND
ELECTRONIC BULLETIN BOARDS FOR TRANS-
MISSION OF MESSAGES AMONG USERS IN THE
FIELD OF GENERAL INTEREST; VIDEO-ON-DE-
MAND TRANSMISSION SERVICES; INTERNET
TELEPHONY SERVICES; PROVIDING ON-LINE
ELECTRONIC BULLETIN BOARDS FOR TRANS-
MISSION OF MESSAGES AMONG COMPUTER
USERS CONCERNING CLASSIFIED LISTINGS
AND LISTINGS FOR ANNOUNCEMENTS, EVENTS,
CLASSES, MEETINGS, ACTIVITIES, HOUSING,

REAL ESTATE, ROOMMATES, RENTALS, FOR
SALE ADVERTISEMENTS, WANT ADS, EMPLOY-
MENT, RESUMES, VOLUNTEERISM, SERVICES,
COMMUNITY, PERSONALS, POLITICS, AND FA-
MILY, IN CLASS 38 (U.S. CLS. 100, 101 AND 104).

FIRST USE 7-24-2007; IN COMMERCE 7-24-2007.

THE MARK CONSISTS OF STANDARD CHAR-
ACTERS WITHOUT CLAIM TO ANY PARTICULAR
FONT, STYLE, SIZE, OR COLOR.

SN 77-356,509, FILED 12-20-2007.

KATINA MISTER, EXAMINING ATTORNEY

Int. Cl.: 38

Prior U.S. Cls.: 100, 101, and 104

United States Patent and Trademark Office

Reg. No. 3,522,280

Registered Oct. 21, 2008

**SERVICE MARK
PRINCIPAL REGISTER**

FEEL AT HOME WHEREVER YOU
ARE

JNEIGHBOR, LLC (OHIO LIMITED LIABILITY
COMPANY)
5140 LONGTON ROAD
CLEVELAND, OH 44124

FOR: PROVIDING ON-LINE CHAT ROOMS AND
ELECTRONIC BULLETIN BOARDS FOR TRANS-
MISSION OF MESSAGES AMONG USERS IN THE
FIELD OF GENERAL INTEREST; VIDEO-ON-DE-
MAND TRANSMISSION SERVICES; INTERNET
TELEPHONY SERVICES; PROVIDING ON-LINE
ELECTRONIC BULLETIN BOARDS FOR TRANS-
MISSION OF MESSAGES AMONG COMPUTER
USERS CONCERNING CLASSIFIED LISTINGS
AND LISTINGS FOR ANNOUNCEMENTS, EVENTS,
CLASSES, MEETINGS, ACTIVITIES, HOUSING,

REAL ESTATE, ROOMMATES, RENTALS, FOR
SALE ADVERTISEMENTS, WANT ADS, EMPLOY-
MENT, RESUMES, VOLUNTEERISM, SERVICES,
COMMUNITY, PERSONALS, POLITICS, AND FA-
MILY, IN CLASS 38 (U.S. CLS. 100, 101 AND 104).

FIRST USE 7-24-2007; IN COMMERCE 7-24-2007.

THE MARK CONSISTS OF STANDARD CHAR-
ACTERS WITHOUT CLAIM TO ANY PARTICULAR
FONT, STYLE, SIZE, OR COLOR.

SN 77-356,513, FILED 12-20-2007.

KATINA MISTER, EXAMINING ATTORNEY

Int. Cl.: 36

Prior U.S. Cls.: 100, 101, and 102

United States Patent and Trademark Office

Reg. No. 3,522,281

Registered Oct. 21, 2008

**SERVICE MARK
PRINCIPAL REGISTER**

AIG ASSURED CHOICE ANNUITY

AMERICAN INTERNATIONAL GROUP, INC.
(DELAWARE CORPORATION)
70 PINE STREET
NEW YORK, NY 10270

OWNER OF U.S. REG. NOS. 1,151,229, 1,273,845,
AND OTHERS.

FOR: ANNUITY UNDERWRITING; ISSUANCE
AND ADMINISTRATION OF ANNUITIES, IN
CLASS 36 (U.S. CLS. 100, 101 AND 102).

NO CLAIM IS MADE TO THE EXCLUSIVE
RIGHT TO USE "ANNUITY", APART FROM THE
MARK AS SHOWN.

FIRST USE 6-1-2008; IN COMMERCE 6-1-2008.

SN 77-356,760, FILED 12-20-2007.

THE MARK CONSISTS OF STANDARD CHAR-
ACTERS WITHOUT CLAIM TO ANY PARTICULAR
FONT, STYLE, SIZE, OR COLOR.

ROBIN CHOSID, EXAMINING ATTORNEY

Int. Cl.: 33

Prior U.S. Cls.: 47 and 49

United States Patent and Trademark Office

Reg. No. 3,522,282

Registered Oct. 21, 2008

**TRADEMARK
PRINCIPAL REGISTER**

CYCLE BUFF BEAUTY

MISFIT WINE COMPANY, LLC (PENNSYLVANIA LIMITED LIABILITY COMPANY)
ARSENAL BUSINESS CENTER, BLDG. 124
5301 TACONY STREET, BOX 228
PHILADELPHIA, PA 19137

THE MARK CONSISTS OF STANDARD CHARACTERS WITHOUT CLAIM TO ANY PARTICULAR FONT, STYLE, SIZE, OR COLOR.

FOR: WINE, IN CLASS 33 (U.S. CLS. 47 AND 49).

SN 77-357,094, FILED 12-20-2007.

FIRST USE 9-5-2008; IN COMMERCE 9-5-2008.

JORDAN BAKER, EXAMINING ATTORNEY

Int. Cls.: 16 and 41

Prior U.S. Cls.: 2, 5, 22, 23, 29, 37, 38, 50, 100, 101, and 107

Reg. No. 3,522,283

United States Patent and Trademark Office

Registered Oct. 21, 2008

**TRADEMARK
SERVICE MARK
PRINCIPAL REGISTER**



AMERICAN READING COMPANY (PENNSYLVANIA CORPORATION)

201 S. GULPH ROAD
KING OF PRUSSIA, PA 19406

FOR: PRINTED INSTRUCTIONAL, EDUCATIONAL AND TEACHING MATERIALS FOR SCHOOL ADMINISTRATORS, TEACHERS AND ADULTS TO CONDUCT A READING PROGRAM AND TO TEACH READING TO STUDENTS FROM PRE-KINDERGARTEN THROUGH SECONDARY SCHOOL; PRINTED EDUCATIONAL MATERIALS, NAMELY, A SERIES OF BOOKS IN THE FIELD OF FICTION, HISTORY, GEOGRAPHY, ART, MUSIC, GOVERNMENT, POLITICS, SPORTS, ENTERTAINMENT, MATH AND SCIENCE, IN CLASS 16 (U.S. CLS. 2, 5, 22, 23, 29, 37, 38 AND 50).

FIRST USE 10-25-2007; IN COMMERCE 10-25-2007.

FOR: EDUCATIONAL SERVICES, NAMELY, A READING PROGRAM FOR PRE-KINDERGARTEN THROUGH SECONDARY SCHOOL STUDENTS AND DISTRIBUTION OF PRINTED BOOKS IN CONNECTION THEREWITH; A PROGRAM FOR ASSESSING THE LEVEL OF DIFFICULTY OF BOOKS AS PART OF A READING PROGRAM, IN CLASS 41 (U.S. CLS. 100, 101 AND 107).

FIRST USE 10-25-2007; IN COMMERCE 10-25-2007.

OWNER OF U.S. REG. NO. 3,263,891.

THE COLOR(S) YELLOW, GREEN, BLUE, RED, WHITE, BLACK, ORANGE, PURPLE, BROWN, SILVER, GOLD IS/ARE CLAIMED AS A FEATURE OF THE MARK.

THE MARK CONSISTS OF A SHOE SIZING DEVICE. THE COLOR YELLOW APPEARS IN THE RECTANGULAR BOXES IN THE DESIGN OF THE SHOE SIZING DEVICE; THE COLOR GREEN APPEARS IN THE RECTANGULAR BOXES IN THE DESIGN OF THE SHOE SIZING DEVICE; THE COLOR BLUE APPEARS IN THE RECTANGULAR BOXES IN THE DESIGN OF THE SHOE SIZING DEVICE; THE COLOR RED APPEARS IN THE RECTANGULAR BOXES IN THE DESIGN OF THE SHOE SIZING DEVICE; THE COLOR WHITE APPEARS IN THE RECTANGULAR BOX IN THE DESIGN OF THE SHOE SIZING DEVICE; THE COLOR BLACK APPEARS IN THE RECTANGULAR BOX IN THE DESIGN OF THE SHOE SIZING DEVICE; THE COLOR ORANGE APPEARS IN THE RECTANGULAR BOX IN THE DESIGN OF THE SHOE SIZING DEVICE; THE COLOR PURPLE APPEARS IN THE RECTANGULAR BOX IN THE DESIGN OF THE SHOE SIZING DEVICE; THE COLOR BROWN APPEARS IN THE RECTANGULAR BOX IN THE DESIGN OF THE SHOE SIZING DEVICE; THE COLOR SILVER APPEARS IN THE

RECTANGULAR BOX IN THE DESIGN OF THE SHOE SIZING DEVICE; THE COLOR GOLD APPEARS IN THE RECTANGULAR BOX IN THE DESIGN OF THE SHOE SIZING DEVICE.

SN 77-357,150, FILED 12-20-2007.

NAPOLEON SHARMA, EXAMINING ATTORNEY

Int. Cl.: 33

Prior U.S. Cls.: 47 and 49

United States Patent and Trademark Office

Reg. No. 3,522,284

Registered Oct. 21, 2008

**TRADEMARK
PRINCIPAL REGISTER**

SURF POINT

WINERY EXCHANGE, INC. (CALIFORNIA CORPORATION)
35 LEVERONI COURT, SUITE 100
NOVATO, CA 94949

THE MARK CONSISTS OF STANDARD CHARACTERS WITHOUT CLAIM TO ANY PARTICULAR FONT, STYLE, SIZE, OR COLOR.

FOR: WINES, IN CLASS 33 (U.S. CLS. 47 AND 49).

SN 77-357,528, FILED 12-20-2007.

FIRST USE 4-0-2008; IN COMMERCE 4-0-2008.

MELISSA VALLILLO, EXAMINING ATTORNEY

Int. Cl.: 16

Prior U.S. Cls.: 2, 5, 22, 23, 29, 37, 38, and 50

United States Patent and Trademark Office

Reg. No. 3,522,285

Registered Oct. 21, 2008

**TRADEMARK
PRINCIPAL REGISTER**

EPASSPORT

ESCREEN, INC (DELAWARE CORPORATION)
P.O. BOX 25902
OVERLAND PARK, KS 662255902

FIRST USE 3-4-2002; IN COMMERCE 4-5-2008.

FOR: PRINTED MATTER, NAMELY, PRINTED
FORMS, INSTRUCTIONS, AND FACT SHEETS, ALL
CONTAINING INFORMATION RELATING TO
DRUG TESTING FOR EMPLOYEES AND POTEN-
TIAL EMPLOYEES, IN CLASS 16 (U.S. CLS. 2, 5, 22,
23, 29, 37, 38 AND 50).

THE MARK CONSISTS OF STANDARD CHAR-
ACTERS WITHOUT CLAIM TO ANY PARTICULAR
FONT, STYLE, SIZE, OR COLOR.

SN 77-357,826, FILED 12-21-2007.

JAMES A. RAUEN, EXAMINING ATTORNEY

Int. Cl.: 35

Prior U.S. Cls.: 100, 101, and 102

United States Patent and Trademark Office

Reg. No. 3,522,286

Registered Oct. 21, 2008

**SERVICE MARK
PRINCIPAL REGISTER**

REPUTATION MOMENTUM

EDELMAN, INC. (DELAWARE CORPORATION)
63RD FLOOR
200 EAST RANDOLPH STREET
CHICAGO, IL 60601

THE MARK CONSISTS OF STANDARD CHAR-
ACTERS WITHOUT CLAIM TO ANY PARTICULAR
FONT, STYLE, SIZE, OR COLOR.

FOR: PUBLIC RELATIONS, IN CLASS 35 (U.S.
CLS. 100, 101 AND 102).

SN 77-358,421, FILED 12-21-2007.

FIRST USE 7-13-2008; IN COMMERCE 7-13-2008.

IRA J. GOODSaid, EXAMINING ATTORNEY

Int. Cl.: 36

Prior U.S. Cls.: 100, 101, and 102

United States Patent and Trademark Office

Reg. No. 3,522,287

Registered Oct. 21, 2008

**SERVICE MARK
PRINCIPAL REGISTER**



AMERICANAIRMANHOMES.com
A Dedication To Service, Surpassed Only By Your Own

MURPHY, JOHN (UNITED STATES INDIVIDUAL)
1743 SUN-GAZER DRIVE
ROCKLEDGE, FL 32955

FOR: REAL ESTATE BROKERAGE, IN CLASS 36
(U.S. CLS. 100, 101 AND 102).

FIRST USE 1-14-2008; IN COMMERCE 1-14-2008.

THE MARK CONSISTS OF A CIRCULAR CENTER WITH THREE REPRESENTATIONS OF

HOUSES INSIDE. THE CIRCLE HAS THE SWOOPING, TWO RIBBON WINGS, COMING OUT FROM EACH SIDE. WITH THE STYLIZED TEXT OF "AMERICANAIRMANHOMES.COM A DEDICATION TO SERVICE, SURPASSED ONLY BY YOUR OWN".

SN 77-358,509, FILED 12-21-2007.

STEVEN R. FOSTER, EXAMINING ATTORNEY

Int. Cl.: 9

Prior U.S. Cls.: 21, 23, 26, 36, and 38

Reg. No. 3,522,288

United States Patent and Trademark Office

Registered Oct. 21, 2008

**TRADEMARK
PRINCIPAL REGISTER**

MANTIS

COHERENT, INC. (DELAWARE CORPORATION)
5100 PATRICK HENRY DRIVE
SANTA CLARA, CA 95054

THE MARK CONSISTS OF STANDARD CHAR-
ACTERS WITHOUT CLAIM TO ANY PARTICULAR
FONT, STYLE, SIZE, OR COLOR.

FOR: LASERS NOT FOR MEDICAL USE, IN
CLASS 9 (U.S. CLS. 21, 23, 26, 36 AND 38).

SN 77-358,582, FILED 12-21-2007.

FIRST USE 3-26-2008; IN COMMERCE 3-26-2008.

DAVID I, EXAMINING ATTORNEY

Int. Cl.: 45

Prior U.S. Cls.: 100 and 101

United States Patent and Trademark Office

Reg. No. 3,522,289

Registered Oct. 21, 2008

**SERVICE MARK
PRINCIPAL REGISTER**



MEET ME NOW INC. (NEW JERSEY CORPORATION)
SUITE 11S
1530 PALISADES AVENUE
FORT LEE, NJ 07024

FOR: MATCHMAKING SERVICES; ONLINE SOCIAL NETWORKING SERVICES; PROVIDING A WEBSITE FEATURING INFORMATION AND CONTENT IN THE FIELDS OF PERSONAL RELATIONSHIPS, DATING AND FASHION, IN CLASS 45 (U.S. CLS. 100 AND 101).

FIRST USE 2-14-2008; IN COMMERCE 2-14-2008.

THE COLOR(S) RED, BLUE, BLACK, GRAY AND BLUE-GRAY IS/ARE CLAIMED AS A FEATURE OF THE MARK.

THE MARK CONSISTS OF TWO HIGHLY STYLIZED RACE CARS ON A STYLIZED ROAD TO THE LEFT OF THE WORDS "MEET ME AT THE RACES.COM". THE COLOR RED APPEARS IN THE OUTLINE OF THE LOWER CAR, THE COLOR BLUE APPEARS IN THE OUTLINE OF THE UPPER CAR, THE COLOR BLACK APPEARS IN THE OUTLINE OF THE ROAD AND IN THE WORDS "MEET ME AT THE RACES.COM", THE COLOR GRAY APPEARS IN THE CENTER IN THE ROAD AND IN THE LINE UNDER THE WORDS, AND THE COLOR BLUE-GRAY APPEARS IN THE BACKGROUND.

SN 77-359,099, FILED 12-24-2007.

ESTHER BELENKER, EXAMINING ATTORNEY

Int. Cls.: 41 and 43

Prior U.S. Cls.: 100, 101, and 107

United States Patent and Trademark Office

Reg. No. 3,522,290

Registered Oct. 21, 2008

**SERVICE MARK
PRINCIPAL REGISTER**



HOUNDS TOWN (NEW YORK CORPORATION)
12 GARRITY AVENUE
RONKONKOMA, NY 11779

FOR: ANIMAL TRAINING, IN CLASS 41 (U.S. CLS. 100, 101 AND 107).

FIRST USE 10-8-2007; IN COMMERCE 10-8-2007.

FOR: PET BOARDING SERVICES; PET DAY CARE SERVICES, IN CLASS 43 (U.S. CLS. 100 AND 101).

FIRST USE 10-8-2007; IN COMMERCE 10-8-2007.

NO CLAIM IS MADE TO THE EXCLUSIVE RIGHT TO USE "HOUNDS" AND "USA", APART FROM THE MARK AS SHOWN.

THE MARK CONSISTS OF A DOG HOUSE WITH A PAW PRINT AND THE WORDS "HOUNDS TOWN USA".

SN 77-359,290, FILED 12-26-2007.

ANDREA K. NADELMAN, EXAMINING ATTORNEY

Int. Cl.: 32

Prior U.S. Cls.: 45, 46, and 48

Reg. No. 3,522,291

United States Patent and Trademark Office

Registered Oct. 21, 2008

TRADEMARK
PRINCIPAL REGISTER



YAKIMA CRAFT BREWING COMPANY LLC
(WASHINGTON LIMITED LIABILITY COM-
PANY)

#6

2920 RIVER ROAD
YAKIMA, WA 98902

FOR: BEER; BEER, ALE, LAGER, STOUT AND
PORTER; PALE BEER; PORTER; ALE; ALE AND
PORTER; ALES; BEER, ALE AND LAGER; BEER,
ALE AND PORTER; LAGER; LAGERS, IN CLASS 32
(U.S. CLS. 45, 46 AND 48).

FIRST USE 11-27-2007; IN COMMERCE 5-1-2008.

NO CLAIM IS MADE TO THE EXCLUSIVE
RIGHT TO USE "YAKIMA CRAFT BREWING
CO.", APART FROM THE MARK AS SHOWN.

SN 77-360,846, FILED 12-28-2007.

NICHOLAS ALTREE, EXAMINING ATTORNEY

Int. Cl.: 28

Prior U.S. Cls.: 22, 23, 38, and 50

United States Patent and Trademark Office

Reg. No. 3,522,292

Registered Oct. 21, 2008

**TRADEMARK
PRINCIPAL REGISTER**

BLACK SERIES i

CALLAWAY GOLF COMPANY (DELAWARE
CORPORATION)
2180 RUTHERFORD ROAD
CARLSBAD, CA 92008

OWNER OF U.S. REG. NO. 3,300,186.

FOR: GOLF CLUBS; GOLF PUTTER COVERS;
GOLF PUTTERS, IN CLASS 28 (U.S. CLS. 22, 23, 38
AND 50).

NO CLAIM IS MADE TO THE EXCLUSIVE
RIGHT TO USE "SERIES", APART FROM THE
MARK AS SHOWN.

FIRST USE 9-13-2007; IN COMMERCE 9-13-2007.

SN 77-360,988, FILED 12-28-2007.

THE MARK CONSISTS OF STANDARD CHAR-
ACTERS WITHOUT CLAIM TO ANY PARTICULAR
FONT, STYLE, SIZE, OR COLOR.

SETH A. RAPPAPORT, EXAMINING ATTORNEY

Int. Cl.: 36

Prior U.S. Cls.: 100, 101, and 102

United States Patent and Trademark Office

Reg. No. 3,522,293

Registered Oct. 21, 2008

**SERVICE MARK
PRINCIPAL REGISTER**

**WELLS FARGO SMART PAYMENT
PLAN**

WELLS FARGO & COMPANY (DELAWARE
CORPORATION)
1700 WELLS FARGO CENTER, MAC N9305-176
SIXTH AND MARQUETTE
MINNEAPOLIS, MN 55479

FOR: DEBT CANCELLATION AND DEFERMENT
SERVICES, NAMELY, OFFERING A DEBT DEFER-
MENT AND CANCELLATION PROGRAM THAT
PERMITS CUSTOMERS TO CANCEL OR DEFER
PAYMENTS IN THE EVENT OF A TRIGGERING
OCCURRENCE, NAMELY, DEATH, DISABILITY,
INVOLUNTARY UNEMPLOYMENT, MILITARY
SERVICE ACTIVATION, FAMILY LEAVE, MEDI-
CAL LEAVE AND OTHER EMERGENCY SITUA-
TIONS, IN CLASS 36 (U.S. CLS. 100, 101 AND 102).

FIRST USE 8-16-2008; IN COMMERCE 8-16-2008.

THE MARK CONSISTS OF STANDARD CHAR-
ACTERS WITHOUT CLAIM TO ANY PARTICULAR
FONT, STYLE, SIZE, OR COLOR.

OWNER OF U.S. REG. NOS. 779,187, 2,457,743,
AND OTHERS.

NO CLAIM IS MADE TO THE EXCLUSIVE
RIGHT TO USE "PAYMENT PLAN", APART FROM
THE MARK AS SHOWN.

SN 77-361,105, FILED 12-28-2007.

MARY CRAWFORD, EXAMINING ATTORNEY

Int. Cl.: 9

Prior U.S. Cls.: 21, 23, 26, 36, and 38

Reg. No. 3,522,294

United States Patent and Trademark Office

Registered Oct. 21, 2008

TRADEMARK
PRINCIPAL REGISTER

The word "chirp" is written in a red, cursive, lowercase font. The letters are connected and have a slight shadow or glow effect around them. The background is white.

TANAGER AUDIOWORKS, INC. (NEW JERSEY CORPORATION)
17 DOLLY BRIDGE ROAD
RANDOLPH, NJ 07869

FOR: COMPUTER SOFTWARE FOR PROCESSING DIGITAL MUSIC FILES, IN CLASS 9 (U.S. CLS. 21, 23, 26, 36 AND 38).

FIRST USE 2-25-2008; IN COMMERCE 2-25-2008.

THE COLOR(S) RED IS/ARE CLAIMED AS A FEATURE OF THE MARK.

THE MARK CONSISTS OF THE STYLIZED WORD "CHIRP". THE COLOR RED APPEARS IN THE WORD "CHIRP" IN THE MARK. THE WHITE IN THE DRAWING REPRESENTS BACKGROUND AREAS AND IS NOT PART OF THE MARK.

SN 77-361,713, FILED 12-31-2007.

MAUREEN DALL, EXAMINING ATTORNEY

Int. Cl.: 45

Prior U.S. Cls.: 100 and 101

United States Patent and Trademark Office

Reg. No. 3,522,295

Registered Oct. 21, 2008

**SERVICE MARK
PRINCIPAL REGISTER**

RESOLUTION STRATEGIES

RESOLUTION STRATEGIES, LLP (OREGON
LIMITED PARTNERSHIP)
1500 SW TAYLOR STREET
PORTLAND, OR 97205

THE MARK CONSISTS OF STANDARD CHAR-
ACTERS WITHOUT CLAIM TO ANY PARTICULAR
FONT, STYLE, SIZE, OR COLOR.

FOR: LEGAL SERVICES, IN CLASS 45 (U.S. CLS.
100 AND 101).

SN 77-362,061, FILED 12-31-2007.

FIRST USE 1-28-2008; IN COMMERCE 1-28-2008.

MELVIN AXILBUND, EXAMINING ATTORNEY

Int. Cl.: 9

Prior U.S. Cls.: 21, 23, 26, 36, and 38

Reg. No. 3,522,296

United States Patent and Trademark Office

Registered Oct. 21, 2008

**TRADEMARK
PRINCIPAL REGISTER**

SUNCLUB

U.S. VISION, INC. (DELAWARE CORPORATION)
GLEN OAKS INDUSTRIAL PARK
1 HARMON DRIVE
GLEN DORA, NJ 08029

FIRST USE 6-16-2008; IN COMMERCE 6-16-2008.

FOR: EYEWEAR; EYEWEAR ACCESSORIES,
NAMELY, STRAPS, NECK CORDS AND HEAD
STRAPS WHICH RESTRAIN EYEWEAR FROM
MOVEMENT ON A WEARER; SUNGLASSES; EYE-
GLASS CASES; EYEGLASS FRAMES; EYEGLASSES,
IN CLASS 9 (U.S. CLS. 21, 23, 26, 36 AND 38).

THE MARK CONSISTS OF STANDARD CHAR-
ACTERS WITHOUT CLAIM TO ANY PARTICULAR
FONT, STYLE, SIZE, OR COLOR.

SN 77-362,320, FILED 1-2-2008.

ELLEN B. AWRICH, EXAMINING ATTORNEY

Int. Cl.: 9

Prior U.S. Cls.: 21, 23, 26, 36, and 38

Reg. No. 3,522,297

United States Patent and Trademark Office

Registered Oct. 21, 2008

**TRADEMARK
PRINCIPAL REGISTER**

GUARDENER

AIMERTECH (MARYLAND CORPORATION)
6325 WOODSIDE COURT
COLUMBIA, MD 21046

FIRST USE 3-1-2008; IN COMMERCE 4-15-2008.

FOR: SOLAR-POWERED GARDENING DEVICE WHICH WILL PROTECT A GARDEN FROM UNWANTED ANIMALS USING ULTRASONIC SOUND AND WATER DISPERSION THAT PHYSICALLY REPELS, IN CLASS 9 (U.S. CLS. 21, 23, 26, 36 AND 38).

THE MARK CONSISTS OF STANDARD CHARACTERS WITHOUT CLAIM TO ANY PARTICULAR FONT, STYLE, SIZE, OR COLOR.

SN 77-362,361, FILED 1-2-2008.

CURTIS FRENCH, EXAMINING ATTORNEY

Int. Cl.: 37

Prior U.S. Cls.: 100, 103, and 106

United States Patent and Trademark Office

Reg. No. 3,522,298

Registered Oct. 21, 2008

**SERVICE MARK
PRINCIPAL REGISTER**

FIX IT FORCE

EURKEA! INSTITUTE, INC. (OHIO CORPORATION)
3849 EDWARDS ROAD
CINCINNATI, OH 45244

FOR: HOME IMPROVEMENT SERVICES, NAME-
LY, REPAIR, IMPROVEMENT, AND CONSTRUCTION OF RESIDENTIAL REAL PROPERTY, IN CLASS 37 (U.S. CLS. 100, 103 AND 106).

FIRST USE 2-27-2008; IN COMMERCE 2-27-2008.

THE MARK CONSISTS OF STANDARD CHARACTERS WITHOUT CLAIM TO ANY PARTICULAR FONT, STYLE, SIZE, OR COLOR.

SN 77-362,676, FILED 1-2-2008.

THEODORE MCBRIDE, EXAMINING ATTORNEY

Int. Cl.: 11

Prior U.S. Cls.: 13, 21, 23, 31, and 34

United States Patent and Trademark Office

Reg. No. 3,522,299

Registered Oct. 21, 2008

**TRADEMARK
PRINCIPAL REGISTER**

JETBOIL HELIOS

JETBOIL, INC. (DELAWARE CORPORATION)
540 NORTH COMMERCIAL STREET
MANCHESTER, NH 03101

FOR: COOKING APPLIANCES, NAMELY, PORTABLE GAS COOKING UNITS AND REPLACEMENT PARTS THEREFOR, IN CLASS 11 (U.S. CLS. 13, 21, 23, 31 AND 34).

FIRST USE 3-31-2008; IN COMMERCE 3-31-2008.

THE MARK CONSISTS OF STANDARD CHARACTERS WITHOUT CLAIM TO ANY PARTICULAR FONT, STYLE, SIZE, OR COLOR.

OWNER OF U.S. REG. NO. 2,957,651.

SN 77-362,682, FILED 1-2-2008.

NORA BUCHANAN WILL, EXAMINING ATTORNEY

Int. Cl.: 35

Prior U.S. Cls.: 100, 101, and 102

United States Patent and Trademark Office

Reg. No. 3,522,300

Registered Oct. 21, 2008

**SERVICE MARK
PRINCIPAL REGISTER**

Who's Your Estimator?

ELECTRICAL ENLIGHTENMENT, INC. (OHIO CORPORATION)
26765 ROYALTON ROAD
COLUMBIA STATION, OH 44028

FOR: ESTIMATING CONTRACTING WORK; BUSINESS CONSULTING SERVICES IN THE FIELD OF ADVISING BUILDING CONTRACTORS AND ELECTRICAL CONTRACTORS AND PLUMBING CONTRACTORS ON PRICING FOR JOBS AND PREPARING BIDS FOR ELECTRICAL AND PLUMBING JOBS, IN CLASS 35 (U.S. CLS. 100, 101 AND 102).

FIRST USE 1-2-2008; IN COMMERCE 1-2-2008.

THE MARK CONSISTS OF STANDARD CHARACTERS WITHOUT CLAIM TO ANY PARTICULAR FONT, STYLE, SIZE, OR COLOR.

SN 77-363,493, FILED 1-3-2008.

SUSAN LESLIE DUBOIS, EXAMINING ATTORNEY

Int. Cl.: 36

Prior U.S. Cls.: 100, 101, and 102

United States Patent and Trademark Office

Reg. No. 3,522,301

Registered Oct. 21, 2008

**SERVICE MARK
PRINCIPAL REGISTER**

**PREDICTABILITY...IN
UNPREDICTABLE TIMES.**

AMERICAN INTERNATIONAL GROUP, INC.
(DELAWARE CORPORATION)
70 PINE STREET
NEW YORK, NY 10270

THE MARK CONSISTS OF STANDARD CHAR-
ACTERS WITHOUT CLAIM TO ANY PARTICULAR
FONT, STYLE, SIZE, OR COLOR.

FOR: INSURANCE UNDERWRITING IN THE
FIELD OF MORTGAGE GUARANTY INSURANCE,
IN CLASS 36 (U.S. CLS. 100, 101 AND 102).

SN 77-363,536, FILED 1-3-2008.

FIRST USE 6-25-2008; IN COMMERCE 6-25-2008.

THOMAS MANOR, EXAMINING ATTORNEY

Int. Cl.: 41

Prior U.S. Cls.: 100, 101, and 107

United States Patent and Trademark Office

Reg. No. 3,522,302

Registered Oct. 21, 2008

**SERVICE MARK
PRINCIPAL REGISTER**

JOOKT

JOOKT, LLC (COLORADO LIMITED LIABILITY COMPANY)
360 SOUTH MONROE STREET, SUITE 600
DENVER, CO 80209

FOR: ENTERTAINMENT SERVICES, NAMELY, PROVIDING AN INTERACTIVE WEBSITE FEATURING SPORTING EVENTS AND ATHLETES, AND VIDEOS, RELATED FILM CLIPS, PHOTOGRAPHS, AND OTHER MULTIMEDIA MATERIALS IN THE FIELD OF SPORTS; PROVIDING INFORMATION IN THE FIELD OF SPORTS VIA AN ONLINE COMPUTER NETWORK; ON-LINE LIBRARY SERVICES, NAMELY, PROVIDING ELECTRONIC LIBRARY SERVICES WHICH FEATURE STATISTICS, NEWS, VIDEO, PHOTOGRAPHS AND PICTURES VIA AN ON-LINE COMPUTER NETWORK; FILM AND VIDEO PRODUCTION;

PROVISION OF NON-DOWNLOADABLE FILMS AND TELEVISION PROGRAMS VIA A VIDEO-ON-DEMAND SERVICE; ONLINE JOURNALS, NAMELY, BLOGS FEATURING SPORTING EVENTS AND ATHLETES, IN CLASS 41 (U.S. CLS. 100, 101 AND 107).

FIRST USE 9-8-2008; IN COMMERCE 9-8-2008.

THE MARK CONSISTS OF STANDARD CHARACTERS WITHOUT CLAIM TO ANY PARTICULAR FONT, STYLE, SIZE, OR COLOR.

SN 77-363,581, FILED 1-3-2008.

STEVEN JACKSON, EXAMINING ATTORNEY

Int. Cl.: 9

Prior U.S. Cls.: 21, 23, 26, 36, and 38

Reg. No. 3,522,303

United States Patent and Trademark Office

Registered Oct. 21, 2008

**TRADEMARK
PRINCIPAL REGISTER**

BLUE OCEAN

TECHNOLOGY SOLUTIONS COMPANY (DELA-
WARE CORPORATION)
SUITE 2600
55 EAST MONROE
CHICAGO, IL 60603

FOR: SOFTWARE INTENDED FOR USE BY
HEALTHCARE PROVIDERS AS A COMPUTERIZED
VISUAL DASHBOARD THAT DISPLAYS THE OP-
ERATIONAL METRICS OF A HEALTHCARE EN-
TERPRISE , IN CLASS 9 (U.S. CLS. 21, 23, 26, 36 AND
38).

FIRST USE 1-31-2007; IN COMMERCE 1-31-2007.

THE MARK CONSISTS OF STANDARD CHAR-
ACTERS WITHOUT CLAIM TO ANY PARTICULAR
FONT, STYLE, SIZE, OR COLOR.

SN 77-364,343, FILED 1-4-2008.

CHRIS WELLS, EXAMINING ATTORNEY

Int. Cl.: 36

Prior U.S. Cls.: 100, 101, and 102

United States Patent and Trademark Office

Reg. No. 3,522,304

Registered Oct. 21, 2008

**SERVICE MARK
PRINCIPAL REGISTER**

Can you think of a better
return in life than saving
one?

FANARO, MARY (UNITED STATES INDIVIDUAL)
3306 COY ST.
SHERMAN OAKS, CA 91423

THE MARK CONSISTS OF STANDARD CHARACTERS WITHOUT CLAIM TO ANY PARTICULAR FONT, STYLE, SIZE, OR COLOR.

FOR: CHARITABLE FUND RAISING SERVICES,
IN CLASS 36 (U.S. CLS. 100, 101 AND 102).

SN 77-364,583, FILED 1-4-2008.

FIRST USE 3-9-2007; IN COMMERCE 3-9-2007.

MICHAEL ENGEL, EXAMINING ATTORNEY

Int. Cl.: 28

Prior U.S. Cls.: 22, 23, 38, and 50

United States Patent and Trademark Office

Reg. No. 3,522,305

Registered Oct. 21, 2008

**TRADEMARK
PRINCIPAL REGISTER**

HYPER JUMP

WILD PLANET ENTERTAINMENT, INC. (CALI-
FORNIA CORPORATION)
13TH FLOOR
225 BUSH STREET
SAN FRANCISCO, CA 94104

FOR: TOYS, GAMES, AND PLAYTHINGS, NAME-
LY, AN ACTIVE GAME WHERE THE PLAYER
FOLLOWS SPOKEN COMMANDS OF AN ELEC-
TRONIC FLOOR UNIT, TOUCHING HANDS OR
FEET TO TOUCHPADS, IN CLASS 28 (U.S. CLS. 22,
23, 38 AND 50).

FIRST USE 6-2-2008; IN COMMERCE 6-2-2008.

THE MARK CONSISTS OF STANDARD CHAR-
ACTERS WITHOUT CLAIM TO ANY PARTICULAR
FONT, STYLE, SIZE, OR COLOR.

SN 77-364,919, FILED 1-5-2008.

JEAN IM, EXAMINING ATTORNEY

Int. Cl.: 35

Prior U.S. Cls.: 100, 101, and 102

United States Patent and Trademark Office

Reg. No. 3,522,306

Registered Oct. 21, 2008

**SERVICE MARK
PRINCIPAL REGISTER**



SMITHKLINE BEECHAM CORPORATION
(PENNSYLVANIA CORPORATION)
ONE FRANKLIN PLAZA
PHILADELPHIA, PA 19102

FIRST USE 6-2-2008; IN COMMERCE 6-2-2008.

OWNER OF U.S. REG. NO. 2,718,146.

FOR: CONSUMER LOYALTY INCENTIVE PROGRAM FOR COMMERCIAL, PROMOTIONAL AND/OR ADVERTISING PURPOSES WHEREBY PARTICIPANTS ACCUMULATE VALUE FROM PURCHASES WHICH CAN BE REDEEMED FOR MERCHANDISE, DISCOUNTS AND CASH PRIZES, IN CLASS 35 (U.S. CLS. 100, 101 AND 102).

THE MARK CONSISTS OF THE STYLIZED WORDS "MY COMMIT REWARDS\$".

SN 77-365,522, FILED 1-7-2008.

MARK PILARO, EXAMINING ATTORNEY

Int. Cl.: 14

Prior U.S. Cls.: 2, 27, 28, and 50

United States Patent and Trademark Office

Reg. No. 3,522,307

Registered Oct. 21, 2008

**TRADEMARK
PRINCIPAL REGISTER**

txt-abls

THE BELL GROUP, INC. (NEW MEXICO CORPORATION), DBA RIO GRANDE,
7500 BLUEWATER RD NW
ALBUQUERQUE, NM 87121

THE MARK CONSISTS OF STANDARD CHARACTERS WITHOUT CLAIM TO ANY PARTICULAR FONT, STYLE, SIZE, OR COLOR.

FOR: JEWELRY, IN CLASS 14 (U.S. CLS. 2, 27, 28 AND 50).

SN 77-367,222, FILED 1-9-2008.

FIRST USE 2-1-2008; IN COMMERCE 2-1-2008.

RUSS HERMAN, EXAMINING ATTORNEY

Int. Cls.: 37 and 45

Prior U.S. Cls.: 100, 101, 103, and 106

United States Patent and Trademark Office

Reg. No. 3,522,308

Registered Oct. 21, 2008

**SERVICE MARK
PRINCIPAL REGISTER**

FORTIFIRE

LUSE THERMAL TECHNOLOGIES, LLC (ILLINOIS LIMITED LIABILITY COMPANY)
3990 ENTERPRISE CT.
AURORA, IL 60504

FOR: INSTALLATION OF FIRE MITIGATION SYSTEMS, IN CLASS 37 (U.S. CLS. 100, 103 AND 106).

FIRST USE 5-31-2008; IN COMMERCE 5-31-2008.

FOR: FIRE PREVENTION CONSULTATION, IN CLASS 45 (U.S. CLS. 100 AND 101).

FIRST USE 5-31-2008; IN COMMERCE 5-31-2008.

THE MARK CONSISTS OF STANDARD CHARACTERS WITHOUT CLAIM TO ANY PARTICULAR FONT, STYLE, SIZE, OR COLOR.

SN 77-367,241, FILED 1-9-2008.

RUSS HERMAN, EXAMINING ATTORNEY

Int. Cl.: 17

Prior U.S. Cls.: 1, 5, 12, 13, 35, and 50

Reg. No. 3,522,309

United States Patent and Trademark Office

Registered Oct. 21, 2008

**TRADEMARK
PRINCIPAL REGISTER**

ARROW-FLO

EATON CORPORATION (OHIO CORPORATION)
1111 SUPERIOR AVENUE
CLEVELAND, OH 44114

FIRST USE 12-31-1989; IN COMMERCE 12-31-1989.

FOR: ELASTOMERIC HOSES, THERMOPLASTIC TUBING, REINFORCED THERMOPLASTIC HOSES, AND THERMOPLASTIC HOSES REINFORCED WITH POLYESTER, ALL FOR USE IN PNEUMATIC CONVEYANCE APPLICATIONS, AND WATER SUCTION AND DISCHARGE APPLICATIONS, IN CLASS 17 (U.S. CLS. 1, 5, 12, 13, 35 AND 50).

THE MARK CONSISTS OF STANDARD CHARACTERS WITHOUT CLAIM TO ANY PARTICULAR FONT, STYLE, SIZE, OR COLOR.

SN 77-367,338, FILED 1-9-2008.

AMEETA JORDAN, EXAMINING ATTORNEY

Int. Cl.: 44

Prior U.S. Cls.: 100 and 101

United States Patent and Trademark Office

Reg. No. 3,522,310

Registered Oct. 21, 2008

SERVICE MARK
PRINCIPAL REGISTER

[n8] touch
relaxst8tion2go

N8 TOUCH, INC. (ARIZONA CORPORATION)
9815 NORTH 95TH STREET
SCOTTSDALE, AZ 85258

FOR: MASSAGE, IN CLASS 44 (U.S. CLS. 100 AND 101).

FIRST USE 5-1-2008; IN COMMERCE 5-1-2008.

NO CLAIM IS MADE TO THE EXCLUSIVE RIGHT TO USE "TOUCH" , APART FROM THE MARK AS SHOWN.

THE MARK CONSISTS OF "N8" IN BRACKETS WITH PALMS OF HANDS UNDERNEATH THE "8", WITH "N8 TOUCH" ON THE LINE ABOVE "RELAXST8TION2GO", THE NUMBERS "8" AND "2" IN THE BOTTOM LINE RAISED ABOVE THE LETTERS IN THE LINE, AND ALL LETTERS AND NUMERALS IN A SPECIAL TYPEFACE.

SN 77-367,339, FILED 1-9-2008.

SUSAN LESLIE DUBOIS, EXAMINING ATTORNEY

Int. Cl.: 33

Prior U.S. Cls.: 47 and 49

United States Patent and Trademark Office

Reg. No. 3,522,311

Registered Oct. 21, 2008

**TRADEMARK
PRINCIPAL REGISTER**

ACTEA

FINE ESTATES FROM SPAIN, INC. (MASSACHUSETTS CORPORATION)
745 HIGH STREET
DEDHAM, MA 02026

THE MARK CONSISTS OF STANDARD CHARACTERS WITHOUT CLAIM TO ANY PARTICULAR FONT, STYLE, SIZE, OR COLOR.

FOR: WINE, IN CLASS 33 (U.S. CLS. 47 AND 49).

SN 77-367,607, FILED 1-9-2008.

FIRST USE 3-20-2008; IN COMMERCE 3-20-2008.

LINDA MICKLEBURGH, EXAMINING ATTORNEY

Int. Cl.: 33

Prior U.S. Cls.: 47 and 49

United States Patent and Trademark Office

Reg. No. 3,522,312

Registered Oct. 21, 2008

**TRADEMARK
PRINCIPAL REGISTER**

AMATHIA

FINE ESTATES FROM SPAIN, INC. (MASSACHUSETTS CORPORATION)

745 HIGH STREET

DEDHAM, MA 02026

FOR: WINE, IN CLASS 33 (U.S. CLS. 47 AND 49).

FIRST USE 3-20-2008; IN COMMERCE 3-20-2008.

THE MARK CONSISTS OF STANDARD CHARACTERS WITHOUT CLAIM TO ANY PARTICULAR FONT, STYLE, SIZE, OR COLOR.

THE WORDING "AMATHIA" HAS NO MEANING IN A FOREIGN LANGUAGE.

SN 77-367,659, FILED 1-9-2008.

LINDA MICKLEBURGH, EXAMINING ATTORNEY

Int. Cls.: 9 and 38

Prior U.S. Cls.: 21, 23, 26, 36, 38, 100, 101, and 104

United States Patent and Trademark Office

Reg. No. 3,522,313

Registered Oct. 21, 2008

**TRADEMARK
SERVICE MARK
PRINCIPAL REGISTER**

WALKINGHOTPOT

TAPROOT SYSTEMS, INC (DELAWARE CORPORATION)
3000 AERIAL CENTER PKWY, #103
MORRISVILLE, NC 27560

FOR: COMPUTER SOFTWARE FOR ACCESSING A GLOBAL COMPUTER NETWORK AND INTERACTIVE COMPUTER COMMUNICATIONS NETWORKS, ESPECIALLY FOR CONFIGURATION, ACCESS CONTROL, SECURITY, BILLING, AND ROAMING SETTLEMENT, IN CLASS 9 (U.S. CLS. 21, 23, 26, 36 AND 38).

FIRST USE 12-8-2006; IN COMMERCE 3-26-2008.

FOR: TELECOMMUNICATIONS GATEWAY SERVICES, NAMELY, PROVIDING AD HOC, HIGH-

SPEED WIRELESS ACCESS TO A GLOBAL COMPUTER NETWORK AT VARIABLE GEOGRAPHIC LOCATIONS, IN CLASS 38 (U.S. CLS. 100, 101 AND 104).

FIRST USE 12-8-2006; IN COMMERCE 3-26-2008.

THE MARK CONSISTS OF STANDARD CHARACTERS WITHOUT CLAIM TO ANY PARTICULAR FONT, STYLE, SIZE, OR COLOR.

SN 77-367,692, FILED 1-9-2008.

BRIAN NEVILLE, EXAMINING ATTORNEY

Int. Cl.: 42

Prior U.S. Cls.: 100 and 101

United States Patent and Trademark Office

Reg. No. 3,522,314

Registered Oct. 21, 2008

**SERVICE MARK
PRINCIPAL REGISTER**

POLYMATHIC ANALYTICAL LABS

ZEUS INDUSTRIAL PRODUCTS, INC. (NEW
JERSEY CORPORATION)
3737 INDUSTRIAL BLVD.
ORANGEBURG, SC 29118

FOR: SCIENTIFIC RESEARCH, NAMELY, ANALYSIS AND TESTING OF POLYMERS AND OTHER ADVANCED MATERIALS, AND PROVIDING CONSULTING AND INFORMATION IN CONNECTION THEREWITH, IN CLASS 42 (U.S. CLS. 100 AND 101).

FIRST USE 4-30-2008; IN COMMERCE 4-30-2008.

THE MARK CONSISTS OF STANDARD CHARACTERS WITHOUT CLAIM TO ANY PARTICULAR FONT, STYLE, SIZE, OR COLOR.

NO CLAIM IS MADE TO THE EXCLUSIVE RIGHT TO USE "ANALYTICAL LABS", APART FROM THE MARK AS SHOWN.

SN 77-367,971, FILED 1-9-2008.

RENEE MCCRAY, EXAMINING ATTORNEY

Int. Cl.: 28

Prior U.S. Cls.: 22, 23, 38, and 50

United States Patent and Trademark Office

Reg. No. 3,522,315

Registered Oct. 21, 2008

**TRADEMARK
PRINCIPAL REGISTER**



E-Z SPIN DISCS, INC. (WISCONSIN CORPORATION)
P.O. BOX 262
HALES CORNERS, WI 531300262

FOR: DISC TOSS TOYS, IN CLASS 28 (U.S. CLS. 22, 23, 38 AND 50).

FIRST USE 1-9-2008; IN COMMERCE 1-9-2008.

NO CLAIM IS MADE TO THE EXCLUSIVE RIGHT TO USE "FREESTYLE DISCS", APART FROM THE MARK AS SHOWN.

THE MARK CONSISTS OF A BLACK COLORED SOLID AREA DEPICTING A MAN CATCHING A DISC UNDER HIS LEG AND BLACK STYLIZED LETTERING BELOW WITH A WHITE BACKGROUND.

SN 77-368,134, FILED 1-9-2008.

JULIE WATSON, EXAMINING ATTORNEY

Int. Cls.: 39 and 43

Prior U.S. Cls.: 100, 101, and 105

United States Patent and Trademark Office

Reg. No. 3,522,316

Registered Oct. 21, 2008

**SERVICE MARK
PRINCIPAL REGISTER**

APPLE LEISURE GROUP

THE CORYN GROUP, LLC II (DELAWARE LIMITED LIABILITY COMPANY)

NO. 100

7 CAMPUS BOULEVARD

NEWTOWN SQUARE, PA 190733295

FOR: ARRANGING AND PROVIDING TRAVEL VACATION PACKAGES, NAMELY, MAKING RESERVATIONS AND BOOKINGS FOR TRANSPORTATION, IN CLASS 39 (U.S. CLS. 100 AND 105).

FIRST USE 12-14-2007; IN COMMERCE 12-14-2007.

FOR: ARRANGING AND PROVIDING TRAVEL VACATION PACKAGES, NAMELY, MAKING RESERVATIONS AND BOOKINGS FOR TEMPORARY LODGING, IN CLASS 43 (U.S. CLS. 100 AND 101).

FIRST USE 12-14-2007; IN COMMERCE 12-14-2007.

THE MARK CONSISTS OF STANDARD CHARACTERS WITHOUT CLAIM TO ANY PARTICULAR FONT, STYLE, SIZE, OR COLOR.

OWNER OF U.S. REG. NOS. 1,462,268, 3,258,063, AND OTHERS.

NO CLAIM IS MADE TO THE EXCLUSIVE RIGHT TO USE "LEISURE GROUP", APART FROM THE MARK AS SHOWN.

SN 77-368,506, FILED 1-10-2008.

KOURTNEE HODGES, EXAMINING ATTORNEY

Int. Cl.: 5

Prior U.S. Cls.: 6, 18, 44, 46, 51, and 52

United States Patent and Trademark Office

Reg. No. 3,522,317

Registered Oct. 21, 2008

**TRADEMARK
PRINCIPAL REGISTER**

**INTEGRATIVE METABOLIC
FORMULA**

ECONUGENICS, INC. (CALIFORNIA CORPORATION)
2208 NORTHPOINT PARKWAY
SANTA ROSA, CA 95407

FOR: DIETARY SUPPLEMENTS, IN CLASS 5 (U.S. CLS. 6, 18, 44, 46, 51 AND 52).

FIRST USE 5-0-2008; IN COMMERCE 6-0-2008.

THE MARK CONSISTS OF STANDARD CHARACTERS WITHOUT CLAIM TO ANY PARTICULAR FONT, STYLE, SIZE, OR COLOR.

OWNER OF U.S. REG. NOS. 3,085,179 AND 3,140,497.

NO CLAIM IS MADE TO THE EXCLUSIVE RIGHT TO USE "METABOLIC FORMULA", APART FROM THE MARK AS SHOWN.

SN 77-368,540, FILED 1-10-2008.

MORGAN WYNNE, EXAMINING ATTORNEY

Int. Cl.: 41

Prior U.S. Cls.: 100, 101, and 107

United States Patent and Trademark Office

Reg. No. 3,522,318

Registered Oct. 21, 2008

SERVICE MARK
PRINCIPAL REGISTER



ZIPERMAN, CINDY (UNITED STATES INDIVIDUAL)
8635 VINTNER COURT
INDIANAPOLIS, IN 46256

FOR: PRODUCTION OF PERSONALIZED, PROFESSIONAL DVD'S FEATURING CLIENTS' PERSONAL PHOTOGRAPHS AND VIDEOS AND RELATED SPECIAL EFFECTS, NARRATION, MUSIC TRACKS, TRANSITIONS, AND CREDITS, IN CLASS 41 (U.S. CLS. 100, 101 AND 107).

FIRST USE 3-21-2008; IN COMMERCE 6-13-2008.

NO CLAIM IS MADE TO THE EXCLUSIVE RIGHT TO USE "STUDIOS", APART FROM THE MARK AS SHOWN.

THE MARK CONSISTS OF AN IMAGE OF A "DVD" WITH THE STYLIZED LETTERS "DS". TO THE RIGHT OF THE "DVD" IMAGE ARE THE STYLIZED WORDS "DOLMEN STUDIOS".

SN 77-368,894, FILED 1-10-2008.

PAUL CROWLEY, EXAMINING ATTORNEY

Int. Cl.: 43

Prior U.S. Cls.: 100 and 101

United States Patent and Trademark Office

Reg. No. 3,522,319

Registered Oct. 21, 2008

**SERVICE MARK
PRINCIPAL REGISTER**

5 10 20

MARRIOTT INTERNATIONAL, INC. (DELA-
WARE CORPORATION)
10400 FERNWOOD ROAD
BETHESDA, MD 20817

THE MARK CONSISTS OF STANDARD CHAR-
ACTERS WITHOUT CLAIM TO ANY PARTICULAR
FONT, STYLE, SIZE, OR COLOR.

FOR: RESTAURANT AND BAR SERVICES, IN
CLASS 43 (U.S. CLS. 100 AND 101).

SN 77-369,199, FILED 1-11-2008.

FIRST USE 9-17-2007; IN COMMERCE 9-17-2007.

MARIAM MAHMOUDI, EXAMINING ATTORNEY

Int. Cl.: 3

Prior U.S. Cls.: 1, 4, 6, 50, 51, and 52

United States Patent and Trademark Office

Reg. No. 3,522,320

Registered Oct. 21, 2008

**TRADEMARK
PRINCIPAL REGISTER**

GREEN KEY

DIAMOND CHEMICAL COMPANY, INC. (NEW
JERSEY CORPORATION)
UNION AVENUE AND DUBOIS STREET
EAST RUTHERFORD, NJ 07073

FOR: CLEANING PREPARATIONS FOR HOUSE-
HOLD PURPOSES, IN CLASS 3 (U.S. CLS. 1, 4, 6, 50, 51
AND 52).

FIRST USE 6-10-2008; IN COMMERCE 6-10-2008.

THE MARK CONSISTS OF STANDARD CHAR-
ACTERS WITHOUT CLAIM TO ANY PARTICULAR
FONT, STYLE, SIZE, OR COLOR.

NO CLAIM IS MADE TO THE EXCLUSIVE
RIGHT TO USE "GREEN", APART FROM THE
MARK AS SHOWN.

SN 77-369,534, FILED 1-11-2008.

SARA THOMAS, EXAMINING ATTORNEY

Int. Cl.: 30

Prior U.S. Cl.: 46

United States Patent and Trademark Office

Reg. No. 3,522,321

Registered Oct. 21, 2008

TRADEMARK
PRINCIPAL REGISTER



KOA CHOCOLATES (HAWAII PARTNERSHIP)
3476 AKALA DR., B
KIHEI, HI 96753

FOR: CHOCOLATE AND CHOCOLATES, IN
CLASS 30 (U.S. CL. 46).

FIRST USE 7-1-2008; IN COMMERCE 7-1-2008.

NO CLAIM IS MADE TO THE EXCLUSIVE
RIGHT TO USE "FINE CHOCOLATES", APART
FROM THE MARK AS SHOWN.

THE COLOR(S) BROWN, WHITE AND BLACK IS/
ARE CLAIMED AS A FEATURE OF THE MARK.

THE MARK CONSISTS OF THE WORDS "KOA
FINE CHOCOLATES" IN THE COLOR WHITE,
WITH A WHITE LINE UNDERLINING THE WORDS
"FINE CHOCOLATES", ALL ON A SQUARE BACK-
GROUND HAVING THE APPEARANCE OF A KOA
WOOD TEXTURE IN VARYING SHADES OF
BROWN WITH BLACK STRIATIONS. THE BACK-
GROUND SQUARE ALSO FEATURES AN INTER-
IOR SQUARE IN THE COLOR WHITE ALONG ITS
BORDER.

SN 77-369,984, FILED 1-11-2008.

ZHALEH DELANEY, EXAMINING ATTORNEY

Int. Cl.: 25

Prior U.S. Cls.: 22 and 39

United States Patent and Trademark Office

Reg. No. 3,522,322

Registered Oct. 21, 2008

TRADEMARK
PRINCIPAL REGISTER



BUECHLER, KIMBERLY M. (UNITED STATES
INDIVIDUAL)
1ST FLOOR
36 WEST 17TH STREET
BAYONNE, NJ 07002

FOR: BLOUSES; CAPS; CHILDREN'S AND IN-
FANTS' CLOTH BIBS; INFANT AND TODDLER
ONE PIECE CLOTHING; COATS; JACKETS; PANTS;
SHORT TROUSERS; SKIRTS AND DRESSES; KNIT
SHIRTS; LONG-SLEEVED SHIRTS; SHIRTS;
SHORT-SLEEVED OR LONG-SLEEVED T-SHIRTS;
SWEAT SHIRTS; T-SHIRTS; CROP TOPS; HALTER
TOPS; MUSCLE TOPS; TANK-TOPS; TOPS; LADIES'
SUITS, IN CLASS 25 (U.S. CLS. 22 AND 39).

FIRST USE 9-9-2008; IN COMMERCE 9-9-2008.

THE MARK CONSISTS OF A STYLIZED SKETCH
OF A FEMALE FIGURE POSING, THE TORSO OF
THE FIGURE BECOMES A FLOWER AT THE
WAISTLINE, THE WORD, "PRILLA", IS PRINTED
TO THE RIGHT OF THE FIGURE, WITH DOTS
PLACED AT THE BEGINNING AND ENDING
POINT OF EACH LETTER.

SN 77-370,008, FILED 1-11-2008.

TEJBIR SINGH, EXAMINING ATTORNEY

Int. Cl.: 30

Prior U.S. Cl.: 46

United States Patent and Trademark Office

Reg. No. 3,522,323

Registered Oct. 21, 2008

**TRADEMARK
PRINCIPAL REGISTER**

THE TEA NATION

SOUTHERNSUN TEAS (PRIVATE) LIMITED (SRI
LANKA CORPORATION)

5, BUCHANAN STREET

COLOMBO 4, SRI LANKA 40000

FOR: COFFEE AND TEA, IN CLASS 30 (U.S. CL.
46).

FIRST USE 3-1-2008; IN COMMERCE 6-1-2008.

THE MARK CONSISTS OF STANDARD CHAR-
ACTERS WITHOUT CLAIM TO ANY PARTICULAR
FONT, STYLE, SIZE, OR COLOR.

NO CLAIM IS MADE TO THE EXCLUSIVE
RIGHT TO USE "TEA", APART FROM THE MARK
AS SHOWN.

SN 77-370,191, FILED 1-11-2008.

JILL PRATER, EXAMINING ATTORNEY

Int. Cl.: 33

Prior U.S. Cls.: 47 and 49

United States Patent and Trademark Office

Reg. No. 3,522,324

Registered Oct. 21, 2008

**TRADEMARK
PRINCIPAL REGISTER**

ALISIOS

FINE ESTATES FROM SPAIN, INC. (MASSACHUSETTS CORPORATION)

745 HIGH STREET

DEDHAM, MA 02026

FOR: WINE, IN CLASS 33 (U.S. CLS. 47 AND 49).

FIRST USE 3-20-2008; IN COMMERCE 3-20-2008.

THE MARK CONSISTS OF STANDARD CHARACTERS WITHOUT CLAIM TO ANY PARTICULAR FONT, STYLE, SIZE, OR COLOR.

THE FOREIGN WORDING IN THE MARK TRANSLATES INTO ENGLISH AS TRADEWINDS.

SN 77-370,598, FILED 1-14-2008.

LINDA MICKLEBURGH, EXAMINING ATTORNEY

Int. Cl.: 40

Prior U.S. Cls.: 100, 103, and 106

United States Patent and Trademark Office

Reg. No. 3,522,325

Registered Oct. 21, 2008

**SERVICE MARK
PRINCIPAL REGISTER**

OMEGAFRAC

HALLIBURTON ENERGY SERVICES, INC. (DE-
LAWARE CORPORATION)
1-B-121
2601 BELTLINE ROAD
CARROLLTON, TX 75006

THE MARK CONSISTS OF STANDARD CHAR-
ACTERS WITHOUT CLAIM TO ANY PARTICULAR
FONT, STYLE, SIZE, OR COLOR.

FOR: OIL AND GAS WELL FRACTURING SER-
VICES USED FOR STIMULATING RESERVOIRS, IN
CLASS 40 (U.S. CLS. 100, 103 AND 106).

SN 77-370,633, FILED 1-14-2008.

FIRST USE 4-30-2008; IN COMMERCE 4-30-2008.

JAMES LOVELACE, EXAMINING ATTORNEY

Int. Cl.: 36

Prior U.S. Cls.: 100, 101, and 102

United States Patent and Trademark Office

Reg. No. 3,522,326

Registered Oct. 21, 2008

**SERVICE MARK
PRINCIPAL REGISTER**

SOLID SECURE SMART

KEYSTONE MUTUAL INSURANCE COMPANY
(MISSOURI CORPORATION)
SUITE 400
400 CHESTERFIELD CENTER
CHESTERFIELD, MO 63017

FOR: INSURANCE UNDERWRITING AND ADMINISTRATION IN THE FIELD OF MEDICAL AND DENTAL PROFESSIONAL LIABILITY INSURANCE, IN CLASS 36 (U.S. CLS. 100, 101 AND 102).

FIRST USE 4-15-2008; IN COMMERCE 4-15-2008.

THE MARK CONSISTS OF STANDARD CHARACTERS WITHOUT CLAIM TO ANY PARTICULAR FONT, STYLE, SIZE, OR COLOR.

SN 77-371,350, FILED 1-14-2008.

MICHAEL LITZAU, EXAMINING ATTORNEY

Int. Cls.: 35, 36, 37, 39, and 42

Prior U.S. Cls.: 100, 101, 102, 103, 105, and 106

United States Patent and Trademark Office

Reg. No. 3,522,327

Registered Oct. 21, 2008

SERVICE MARK
PRINCIPAL REGISTER



Houston



MANHEIM AUCTIONS, INC. (DELAWARE CORPORATION)
6205 PEACHTREE DUNWOODY ROAD
ATLANTA, GA 30328

FOR: AUTOMOBILE AUCTION SERVICES; AUTOMOBILE AUCTION SERVICES PROVIDED VIA THE INTERNET, IN CLASS 35 (U.S. CLS. 100, 101 AND 102).

FIRST USE 6-20-2008; IN COMMERCE 6-20-2008.

FOR: AUTOMOBILE FINANCING SERVICES, IN CLASS 36 (U.S. CLS. 100, 101 AND 102).

FIRST USE 6-20-2008; IN COMMERCE 6-20-2008.

FOR: AUTOMOTIVE DETAILING, RECONDITIONING, REPAIR, CONVERSION AND CUSTOMIZATION SERVICES, IN CLASS 37 (U.S. CLS. 100, 103 AND 106).

FIRST USE 6-20-2008; IN COMMERCE 6-20-2008.

FOR: BUSINESS-TO-BUSINESS AUTOMOTIVE TRANSPORTATION AND STORAGE SERVICES, IN CLASS 39 (U.S. CLS. 100 AND 105).

FIRST USE 6-20-2008; IN COMMERCE 6-20-2008.

FOR: AUTOMOBILE INSPECTION SERVICES, IN CLASS 42 (U.S. CLS. 100 AND 101).

FIRST USE 6-20-2008; IN COMMERCE 6-20-2008.

OWNER OF U.S. REG. NOS. 1,699,332, 3,229,428, AND OTHERS.

NO CLAIM IS MADE TO THE EXCLUSIVE RIGHT TO USE "HOUSTON", APART FROM THE MARK AS SHOWN.

THE COLOR(S) GOLD, BROWN, DARK BLUE, RED, WHITE IS/ARE CLAIMED AS A FEATURE OF THE MARK.

THE MARK CONSISTS OF A GOLD "M" OVER A BLUE CIRCULAR BACKGROUND AND WITHIN TWO GOLD OUTER RINGS. THE COLOR BROWN OUTLINES THE MARK. TO THE RIGHT OF THE M IS THE WORD "MANHEIM" IN THE COLOR BLACK. A BLACK LINE SEPARATES THE ABOVE DESIGN AND THE WORD "MANHEIM" AND THE WORDS "HOUSTON" IN THE COLOR BLACK AND A STYLIZED SPACE SHUTTLE IN THE COLOR WHITE IN FRONT OF A CAPITAL LETTER "H" IN THE COLOR RED ON A DARK BLUE BACKGROUND, INSIDE CONCENTRIC WHITE AND GREY SQUARES TO THE RIGHT OF THE WORD "HOUSTON".

SN 77-371,370, FILED 1-14-2008.

GISELLE AGOSTO, EXAMINING ATTORNEY

Int. Cl.: 9

Prior U.S. Cls.: 21, 23, 26, 36, and 38

United States Patent and Trademark Office

Reg. No. 3,522,328

Registered Oct. 21, 2008

**TRADEMARK
PRINCIPAL REGISTER**

MACBOOK AIR

APPLE INC. (CALIFORNIA CORPORATION)
1 INFINITE LOOP
CUPERTINO, CA 95014

FOR: COMPUTERS, NOTEBOOK COMPUTERS,
COMPUTER HARDWARE, COMPUTER OPERAT-
ING SYSTEM SOFTWARE, COMPUTER PERIPH-
ERALS, IN CLASS 9 (U.S. CLS. 21, 23, 26, 36 AND 38).

FIRST USE 1-15-2008; IN COMMERCE 1-15-2008.

THE MARK CONSISTS OF STANDARD CHAR-
ACTERS WITHOUT CLAIM TO ANY PARTICULAR
FONT, STYLE, SIZE, OR COLOR.

OWNER OF U.S. REG. NOS. 1,968,965 AND
3,222,089.

SN 77-371,650, FILED 1-15-2008.

CHERYL CLAYTON, EXAMINING ATTORNEY

Int. Cl.: 5

Prior U.S. Cls.: 6, 18, 44, 46, 51, and 52

United States Patent and Trademark Office

Reg. No. 3,522,329

Registered Oct. 21, 2008

**TRADEMARK
PRINCIPAL REGISTER**

TRIPLE SHOT

WILBUR-ELLIS COMPANY (CALIFORNIA CORPORATION)
345 CALIFORNIA STREET, 27TH FLOOR
SAN FRANCISCO, CA 94104

FOR: PESTICIDES, IN CLASS 5 (U.S. CLS. 6, 18, 44, 46, 51 AND 52).

FIRST USE 4-29-2008; IN COMMERCE 4-29-2008.

THE MARK CONSISTS OF STANDARD CHARACTERS WITHOUT CLAIM TO ANY PARTICULAR FONT, STYLE, SIZE, OR COLOR.

THE WORDING "TRIPLE SHOT" HAS NO MEANING AS APPLIED TO THE IDENTIFIED GOODS OTHER THAN TRADEMARK SIGNIFICANCE.

SN 77-374,036, FILED 1-17-2008.

MATTHEW MCDOWELL, EXAMINING ATTORNEY

Int. Cl.: 4

Prior U.S. Cls.: 1, 6, and 15

United States Patent and Trademark Office

Reg. No. 3,522,330

Registered Oct. 21, 2008

TRADEMARK
PRINCIPAL REGISTER



HEAVEN TO HOME, LLC (ARIZONA LIMITED
LIABILITY COMPANY)
1493 EAST MESQUITE STREET
GILBERT, AZ 85296

THE MARK CONSISTS OF "ANIMALS POSI-
TIONED ALONG A SEMI-CIRCLE".

FOR: CANDLES, IN CLASS 4 (U.S. CLS. 1, 6 AND
15).

SN 77-374,083, FILED 1-17-2008.

FIRST USE 6-13-2008; IN COMMERCE 6-13-2008.

KRISTIN DAHLING, EXAMINING ATTORNEY

Int. Cl.: 4

Prior U.S. Cls.: 1, 6, and 15

United States Patent and Trademark Office

Reg. No. 3,522,331

Registered Oct. 21, 2008

TRADEMARK
PRINCIPAL REGISTER



HEAVEN TO HOME, LLC (ARIZONA LIMITED LIABILITY COMPANY)
1493 EAST MESQUITE STREET
GILBERT, AZ 85296

FOR: CANDLES, IN CLASS 4 (U.S. CLS. 1, 6 AND 15).

FIRST USE 6-13-2008; IN COMMERCE 6-13-2008.

THE COLOR(S) BROWN, TURQUOISE, AND WHITE IS/ARE CLAIMED AS A FEATURE OF THE MARK.

THE MARK CONSISTS OF THE COLOR BROWN APPEARS IN THE GROUND AND THE OUTLINE OF THE HOUSE, THE COLOR TURQUOISE APPEARS IN THE SKY, AND THE COLOR WHITE APPEARS IN THE WORDING "HEAVEN TO HOME", THE WINDOWS, AND THE STARS.

SN 77-374,092, FILED 1-17-2008.

KRISTIN DAHLING, EXAMINING ATTORNEY

Int. Cl.: 37

Prior U.S. Cls.: 100, 103, and 106

United States Patent and Trademark Office

Reg. No. 3,522,332

Registered Oct. 21, 2008

**SERVICE MARK
PRINCIPAL REGISTER**

MIDAS SECURE STOP

MIDAS INTERNATIONAL CORPORATION (DE-
LAWARE CORPORATION)
1300 ARLINGTON HEIGHTS ROAD
ITASCA, IL 60143

FOR: REPAIR, ADJUSTMENT AND INSTALLA-
TION OF BRAKE SYSTEM COMPONENTS; VEHI-
CLE MAINTENANCE AND REPAIR SERVICES, IN
CLASS 37 (U.S. CLS. 100, 103 AND 106).

FIRST USE 4-2-2007; IN COMMERCE 4-2-2007.

THE MARK CONSISTS OF STANDARD CHAR-
ACTERS WITHOUT CLAIM TO ANY PARTICULAR
FONT, STYLE, SIZE, OR COLOR.

SN 77-374,144, FILED 1-17-2008.

BRENDAN MCCAULEY, EXAMINING ATTORNEY

Int. Cl.: 37

Prior U.S. Cls.: 100, 103, and 106

United States Patent and Trademark Office

Reg. No. 3,522,333

Registered Oct. 21, 2008

**SERVICE MARK
PRINCIPAL REGISTER**

SECURE STOP

MIDAS INTERNATIONAL CORPORATION (DE-
LAWARE CORPORATION)
1300 ARLINGTON HEIGHTS ROAD
ITASCA, IL 60143

FOR: REPAIR, ADJUSTMENT AND INSTALLA-
TION OF BRAKE SYSTEM COMPONENTS; VEHI-
CLE MAINTENANCE AND REPAIR SERVICES, IN
CLASS 37 (U.S. CLS. 100, 103 AND 106).

FIRST USE 4-2-2007; IN COMMERCE 4-2-2007.

THE MARK CONSISTS OF STANDARD CHAR-
ACTERS WITHOUT CLAIM TO ANY PARTICULAR
FONT, STYLE, SIZE, OR COLOR.

SN 77-374,149, FILED 1-17-2008.

BRENDAN MCCAULEY, EXAMINING ATTORNEY

Int. Cl.: 31

Prior U.S. Cls.: 1 and 46

United States Patent and Trademark Office

Reg. No. 3,522,334

Registered Oct. 21, 2008

**TRADEMARK
PRINCIPAL REGISTER**

DOUBLE CROSS

WHITETAIL INSTITUTE OF NORTH AMERICA
(ALABAMA CORPORATION)
P.O. BOX 3006 ROUTE 1
PINTLALA, AL 36043

THE MARK CONSISTS OF STANDARD CHAR-
ACTERS WITHOUT CLAIM TO ANY PARTICULAR
FONT, STYLE, SIZE, OR COLOR.

FOR: WILDLIFE SEED MIXTURES, IN CLASS 31
(U.S. CLS. 1 AND 46).

SN 77-374,175, FILED 1-17-2008.

FIRST USE 5-14-2008; IN COMMERCE 5-14-2008.

ALEX KEAM, EXAMINING ATTORNEY

Int. Cl.: 12

Prior U.S. Cls.: 19, 21, 23, 31, 35, and 44

Reg. No. 3,522,335

United States Patent and Trademark Office

Registered Oct. 21, 2008

**TRADEMARK
PRINCIPAL REGISTER**

FORTY FOUR

HENRY, KRISTOFER E. (UNITED STATES IN-
DIVIDUAL)
62 OLD TEMPLE RD.
LYNDEBOROUGH, NH 03082

THE MARK CONSISTS OF STANDARD CHAR-
ACTERS WITHOUT CLAIM TO ANY PARTICULAR
FONT, STYLE, SIZE, OR COLOR.

FOR: BICYCLE FRAMES, IN CLASS 12 (U.S. CLS.
19, 21, 23, 31, 35 AND 44).

SN 77-375,367, FILED 1-18-2008.

FIRST USE 5-17-2004; IN COMMERCE 7-1-2008.

CHARISMA HAMPTON, EXAMINING ATTORNEY

Int. Cl.: 12

Prior U.S. Cls.: 19, 21, 23, 31, 35, and 44

Reg. No. 3,522,336

United States Patent and Trademark Office

Registered Oct. 21, 2008

**TRADEMARK
PRINCIPAL REGISTER**

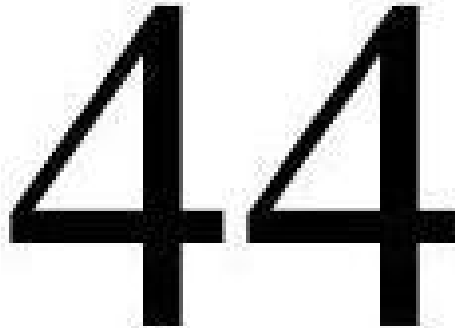

HENRY, KRISTOFER E. (UNITED STATES IN-
DIVIDUAL)
62 OLD TEMPLE RD.
LYNDEBOROUGH, NH 03082

THE MARK CONSISTS OF STANDARD CHAR-
ACTERS WITHOUT CLAIM TO ANY PARTICULAR
FONT, STYLE, SIZE, OR COLOR.

FOR: BICYCLE FRAMES, IN CLASS 12 (U.S. CLS.
19, 21, 23, 31, 35 AND 44).

SN 77-376,207, FILED 1-20-2008.

FIRST USE 5-17-2004; IN COMMERCE 7-1-2008.

CHARISMA HAMPTON, EXAMINING ATTORNEY

Int. Cl.: 44

Prior U.S. Cls.: 100 and 101

United States Patent and Trademark Office

Reg. No. 3,522,337

Registered Oct. 21, 2008

**SERVICE MARK
PRINCIPAL REGISTER**

PHYLOMICS

ABU-ASAB, MONES S (UNITED STATES INDIVIDUAL)
5314 POOKS HILL ROAD
BETHESDA, MD 20814

FOR: MEDICAL SERVICES, NAMELY, SOFTWARE ANALYSIS OF GENOMIC, PROTEOMIC, AND METABOLOMIC DATA, AND PREDICTION MODELS FOR DISEASE RISK AND PROGNOSIS, IN CLASS 44 (U.S. CLS. 100 AND 101).

FIRST USE 3-1-2008; IN COMMERCE 3-1-2008.

THE MARK CONSISTS OF STANDARD CHARACTERS WITHOUT CLAIM TO ANY PARTICULAR FONT, STYLE, SIZE, OR COLOR.

SN 77-376,211, FILED 1-20-2008.

NAAKWAMA ANKRAH, EXAMINING ATTORNEY

Int. Cl.: 3

Prior U.S. Cls.: 1, 4, 6, 50, 51, and 52

Reg. No. 3,522,338

United States Patent and Trademark Office

Registered Oct. 21, 2008

**TRADEMARK
PRINCIPAL REGISTER**

LA VILY

TANG, VIVIAN (UNITED STATES INDIVIDUAL)
3330 ONSLOW WAY
SAN JOSE, CA 95132

FIRST USE 9-9-2008; IN COMMERCE 9-9-2008.

FOR: BODY AND BEAUTY CARE COSMETICS;
COSMETIC CREAMS FOR SKIN CARE; SKIN AND
BODY TOPICAL LOTIONS, CREAMS AND OILS
FOR COSMETIC USE, IN CLASS 3 (U.S. CLS. 1, 4, 6,
50, 51 AND 52).

THE MARK CONSISTS OF STANDARD CHAR-
ACTERS WITHOUT CLAIM TO ANY PARTICULAR
FONT, STYLE, SIZE, OR COLOR.

SN 77-376,292, FILED 1-21-2008.

TOBY BULLOFF, EXAMINING ATTORNEY

Int. Cls.: 32 and 33

Prior U.S. Cls.: 45, 46, 47, 48, and 49

United States Patent and Trademark Office

Reg. No. 3,522,339

Registered Oct. 21, 2008

**TRADEMARK
PRINCIPAL REGISTER**

Work Truck

CONTADINI, LLC (WASHINGTON LIMITED
LIABILITY COMPANY)
PO BOX 523
VASHON, WA 98070

FOR: BEER, IN CLASS 32 (U.S. CLS. 45, 46 AND 48).

FIRST USE 8-30-2008; IN COMMERCE 8-30-2008.

FOR: ALCOHOLIC BEVERAGES, NAMELY,
WINE; DISTILLED ALCOHOLIC BEVERAGES; FLA-
VOR-BREWED ALCOHOLIC MALT BEVERAGES,
IN CLASS 33 (U.S. CLS. 47 AND 49).

FIRST USE 8-30-2008; IN COMMERCE 8-30-2008.

THE MARK CONSISTS OF STANDARD CHAR-
ACTERS WITHOUT CLAIM TO ANY PARTICULAR
FONT, STYLE, SIZE, OR COLOR.

SN 77-376,721, FILED 1-21-2008.

JILL C. ALT, EXAMINING ATTORNEY

Int. Cl.: 5

Prior U.S. Cls.: 6, 18, 44, 46, 51, and 52

Reg. No. 3,522,340

United States Patent and Trademark Office

Registered Oct. 21, 2008

**TRADEMARK
PRINCIPAL REGISTER**

PECTASOL-C

ECONUGENICS, INC. (CALIFORNIA CORPORATION)
2208 NORTHPOINT PARKWAY
SANTA ROSA, CA 95407

FOR: DIETARY SUPPLEMENTS, IN CLASS 5 (U.S. CLS. 6, 18, 44, 46, 51 AND 52).

FIRST USE 5-0-2008; IN COMMERCE 6-0-2008.

THE MARK CONSISTS OF STANDARD CHARACTERS WITHOUT CLAIM TO ANY PARTICULAR FONT, STYLE, SIZE, OR COLOR.

OWNER OF U.S. REG. NO. 1,991,417.

SN 77-376,922, FILED 1-22-2008.

MORGAN WYNNE, EXAMINING ATTORNEY

Int. Cl.: 10

Prior U.S. Cls.: 26, 39, and 44

United States Patent and Trademark Office

Reg. No. 3,522,341

Registered Oct. 21, 2008

**TRADEMARK
PRINCIPAL REGISTER**



INSPRI, LLC (COLORADO LIMITED LIABILITY
COMPANY)
16016 W. ELLSWORTH LANE
GOLDEN, CO 80401

FOR: PRESSURE MANAGEMENT SEATING
CUSHION FOR THE TREATMENT AND RELIEF
OF PRESSURE ON THE SCIATIC NERVE AND
COCCYX, IN CLASS 10 (U.S. CLS. 26, 39 AND 44).

FIRST USE 1-24-2008; IN COMMERCE 1-24-2008.

THE MARK CONSISTS OF A STYLIZED SWISH
TERMINATING WITH A FANCIFUL STAR.

SN 77-377,099, FILED 1-22-2008.

WON TEAK OH, EXAMINING ATTORNEY

Int. Cl.: 11

Prior U.S. Cls.: 13, 21, 23, 31, and 34

Reg. No. 3,522,342

United States Patent and Trademark Office

Registered Oct. 21, 2008

**TRADEMARK
PRINCIPAL REGISTER**

AMPHORA

CRAFTMADE INTERNATIONAL INC (DELA-
WARE CORPORATION)
650 S. ROYAL LANE
COPPELL, TX 75019

THE MARK CONSISTS OF STANDARD CHAR-
ACTERS WITHOUT CLAIM TO ANY PARTICULAR
FONT, STYLE, SIZE, OR COLOR.

FOR: CEILING FANS, IN CLASS 11 (U.S. CLS. 13,
21, 23, 31 AND 34).

SN 77-378,864, FILED 1-23-2008.

FIRST USE 1-1-2008; IN COMMERCE 4-1-2008.

MICHAEL ENGEL, EXAMINING ATTORNEY

Int. Cl.: 11

Prior U.S. Cls.: 13, 21, 23, 31, and 34

Reg. No. 3,522,343

United States Patent and Trademark Office

Registered Oct. 21, 2008

**TRADEMARK
PRINCIPAL REGISTER**

SILO

CRAFTMADE INTERNATIONAL INC (DELA-
WARE CORPORATION)
650 S. ROYAL LANE
COPPELL, TX 75019

THE MARK CONSISTS OF STANDARD CHAR-
ACTERS WITHOUT CLAIM TO ANY PARTICULAR
FONT, STYLE, SIZE, OR COLOR.

FOR: CEILING FANS, IN CLASS 11 (U.S. CLS. 13,
21, 23, 31 AND 34).

SN 77-378,895, FILED 1-23-2008.

FIRST USE 1-1-2008; IN COMMERCE 4-1-2008.

MICHAEL ENGEL, EXAMINING ATTORNEY

Int. Cl.: 9

Prior U.S. Cls.: 21, 23, 26, 36, and 38

Reg. No. 3,522,344

United States Patent and Trademark Office

Registered Oct. 21, 2008

**TRADEMARK
PRINCIPAL REGISTER**

AUDIO SKY

SOUNDGOD CO. LTD. (TAIWAN CORPORATION)
SANCHUNG
2F, #178 CHIMEI STREET
TAIPEI, TAIWAN

FOR: AUDIO EQUIPMENT, NAMELY, KARAOKE AMPLIFIER; COMBINATION SPEAKER AND MICROPHONE PA AMPLIFIER; MIXER; COMBINATION SPEAKER AND MICROPHONE, IN CLASS 9 (U.S. CLS. 21, 23, 26, 36 AND 38).

FIRST USE 8-15-2008; IN COMMERCE 8-15-2008.

THE MARK CONSISTS OF STANDARD CHARACTERS WITHOUT CLAIM TO ANY PARTICULAR FONT, STYLE, SIZE, OR COLOR.

NO CLAIM IS MADE TO THE EXCLUSIVE RIGHT TO USE "AUDIO", APART FROM THE MARK AS SHOWN.

SN 77-378,970, FILED 1-23-2008.

JOHN HWANG, EXAMINING ATTORNEY

Int. Cl.: 16

Prior U.S. Cls.: 2, 5, 22, 23, 29, 37, 38, and 50

Reg. No. 3,522,345

United States Patent and Trademark Office

Registered Oct. 21, 2008

**TRADEMARK
PRINCIPAL REGISTER**

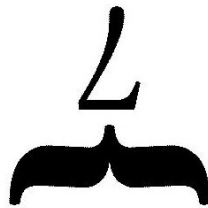

Old Tom Foolery

GRYNIEWSKI & WEINBLATT, PARTNERS (CALIFORNIA PARTNERSHIP), DBA OLD TOM FOOLERY'S BRIC-A-BRAC,
101 PARNASSUS AVE., APT. 2
SAN FRANCISCO, CA 94117

THE MARK CONSISTS OF A STYLIZED MALE FACE AND THE WORDS "OLD TOM FOOLERY". AN UPSIDE-DOWN NUMBER "7" FORMS THE MAN'S NOSE. A BRACKET TURNED SIDEWAYS FORMS THE MAN'S MUSTACHE.

FOR: STATIONERY, IN CLASS 16 (U.S. CLS. 2, 5, 22, 23, 29, 37, 38 AND 50).

SN 77-379,050, FILED 1-23-2008.

FIRST USE 5-18-2008; IN COMMERCE 5-18-2008.

HELENE LIWINSKI, EXAMINING ATTORNEY

Int. Cl.: 9

Prior U.S. Cls.: 21, 23, 26, 36, and 38

United States Patent and Trademark Office

Reg. No. 3,522,346

Registered Oct. 21, 2008

**TRADEMARK
PRINCIPAL REGISTER**

Restaurant Rush

GAMENAUTS, INC. (CALIFORNIA CORPORATION)
5602 RUDY DRIVE
SAN JOSE, CA 95124

FOR: COMPUTER GAME CARTRIDGES; COMPUTER GAME CARTRIDGES AND DISCS; COMPUTER GAME CASSETTES; COMPUTER GAME DISCS; COMPUTER GAME PROGRAMS; COMPUTER GAME PROGRAMS, CARTRIDGES, AND CASSETTES; COMPUTER GAME SOFTWARE; DOWNLOADABLE GAMES VIA THE INTERNET AND WIRELESS DEVICES; ELECTRONIC GAME PROGRAMS; ELECTRONIC GAME SOFTWARE; ELECTRONIC GAME SOFTWARE FOR CELLULAR TELEPHONES; ELECTRONIC GAME SOFTWARE FOR HANDHELD ELECTRONIC DEVICES; ELECTRONIC GAME SOFTWARE FOR WIRELESS DEVICES; GAME SOFTWARE; INTERACTIVE MULTIMEDIA COMPUTER GAME PROGRAM; INTERACTIVE VIDEO GAME PROGRAMS; VIDEO

AND COMPUTER GAME PROGRAMS; VIDEO GAME CARTRIDGES; VIDEO GAME CARTRIDGES AND CASSETTES; VIDEO GAME CARTRIDGES AND DISCS; VIDEO GAME DISCS; VIDEO GAME SOFTWARE; VIDEO GAME TAPE CASSETTES, IN CLASS 9 (U.S. CLS. 21, 23, 26, 36 AND 38).

FIRST USE 8-15-2008; IN COMMERCE 8-15-2008.

THE MARK CONSISTS OF STANDARD CHARACTERS WITHOUT CLAIM TO ANY PARTICULAR FONT, STYLE, SIZE, OR COLOR.

NO CLAIM IS MADE TO THE EXCLUSIVE RIGHT TO USE "RESTAURANT", APART FROM THE MARK AS SHOWN.

SN 77-379,136, FILED 1-24-2008.

CYNTHIA SLOAN, EXAMINING ATTORNEY

Int. Cl.: 44

Prior U.S. Cls.: 100 and 101

United States Patent and Trademark Office

Reg. No. 3,522,347

Registered Oct. 21, 2008

**SERVICE MARK
PRINCIPAL REGISTER**

SENS

HE, FRANK (CHINA INDIVIDUAL)
1288 KIFER ROAD, SUITE 202
SUNNYVALE, CA 94086

THE MARK CONSISTS OF STANDARD CHAR-
ACTERS WITHOUT CLAIM TO ANY PARTICULAR
FONT, STYLE, SIZE, OR COLOR.

FOR: ACUPUNCTURE SERVICES, IN CLASS 44
(U.S. CLS. 100 AND 101).

SN 77-380,170, FILED 1-24-2008.

FIRST USE 11-15-1998; IN COMMERCE 11-19-1998.

AMEETA JORDAN, EXAMINING ATTORNEY

Int. Cl.: 44

Prior U.S. Cls.: 100 and 101

United States Patent and Trademark Office

Reg. No. 3,522,348

Registered Oct. 21, 2008

**SERVICE MARK
PRINCIPAL REGISTER**

MCT

HE, FRANK (CHINA INDIVIDUAL)
1288 KIFER ROAD, SUITE 202
SUNNYVALE, CA 94086

THE MARK CONSISTS OF STANDARD CHAR-
ACTERS WITHOUT CLAIM TO ANY PARTICULAR
FONT, STYLE, SIZE, OR COLOR.

FOR: ACUPUNCTURE SERVICES, IN CLASS 44
(U.S. CLS. 100 AND 101).

SN 77-380,174, FILED 1-24-2008.

FIRST USE 11-15-1998; IN COMMERCE 11-15-1998.

AMEETA JORDAN, EXAMINING ATTORNEY

Int. Cl.: 3

Prior U.S. Cls.: 1, 4, 6, 50, 51, and 52

Reg. No. 3,522,349

United States Patent and Trademark Office

Registered Oct. 21, 2008

**TRADEMARK
PRINCIPAL REGISTER**

Gorify

FAHS, TERESA L. (UNITED STATES INDIVIDUAL)
SUITE #D154
3651 LINDELL ROAD
LAS VEGAS, NV 89103

FOR: MAKE-UP KITS COMPRISED OF THEATRICAL COLOR CREAMS, MOLDING WAX, LATEX, FOUNDATIONS, POWDERS, FAKE BLOOD, FAKE FLESH, ACCESSORIES, APPLICATORS, PROTHETICS, ADHESIVES, AND REMOVERS FOR FACE AND BODY; MAKE UP REMOVING PREPARATIONS; MAKE-UP; MAKE-UP FOR THE FACE AND BODY; MAKE-UP FOUNDATIONS; MAKE-UP POWDER; MAKE-UP REMOVER; THEATRICAL MAKE-UP; COSMETICS AND MAKE-UP; EYE MAKE-UP; EYE MAKE-UP REMOVER; FACE PAINTING KITS; FACIAL MAKE-UP; FAKE BLOOD; FOUNDATION MAKE-UP; MAKE UP

FOUNDATIONS; ADHESIVES FOR COSMETIC USE; COSMETIC PADS; COSMETICS; COSMETICS AND COSMETIC PREPARATIONS; PRE-MOISTENED COSMETIC TISSUES; PRE-MOISTENED COSMETIC TOWELETTES; PRE-MOISTENED COSMETIC WIPES, IN CLASS 3 (U.S. CLS. 1, 4, 6, 50, 51 AND 52).

FIRST USE 2-20-2008; IN COMMERCE 5-15-2008.

THE MARK CONSISTS OF STANDARD CHARACTERS WITHOUT CLAIM TO ANY PARTICULAR FONT, STYLE, SIZE, OR COLOR.

SN 77-380,228, FILED 1-25-2008.

MELVIN AXILBUND, EXAMINING ATTORNEY

Int. Cl.: 36

Prior U.S. Cls.: 100, 101, and 102

United States Patent and Trademark Office

Reg. No. 3,522,350

Registered Oct. 21, 2008

**SERVICE MARK
PRINCIPAL REGISTER**



QUOIN FINANCIAL BANK (SOUTH DAKOTA
CORPORATION)
201 NORTH BROADWAY
MILLER, SD 57362

THE MARK CONSISTS OF A SQUARE WITH ONE
CORNER ELEVATED.

FOR: BANKING SERVICES; CREDIT CARD SER-
VICES; INSURANCE AGENCIES, IN CLASS 36 (U.S.
CLS. 100, 101 AND 102).

SN 77-381,325, FILED 1-26-2008.

FIRST USE 4-0-2008; IN COMMERCE 4-0-2008.

MICHAEL WIENER, EXAMINING ATTORNEY

Int. Cl.: 10

Prior U.S. Cls.: 26, 39, and 44

United States Patent and Trademark Office

Reg. No. 3,522,351

Registered Oct. 21, 2008

**TRADEMARK
PRINCIPAL REGISTER**

RESTORIS

MAKO SURGICAL CORP. (FLORIDA CORPORATION)
SUITE 110
2555 DAVIE ROAD
DAVIE, FL 33317

THE MARK CONSISTS OF STANDARD CHARACTERS WITHOUT CLAIM TO ANY PARTICULAR FONT, STYLE, SIZE, OR COLOR.

FOR: ORTHOPEDIC JOINT IMPLANTS, IN CLASS 10 (U.S. CLS. 26, 39 AND 44).

SN 77-382,822, FILED 1-29-2008.

FIRST USE 8-13-2008; IN COMMERCE 8-13-2008.

DAVID I, EXAMINING ATTORNEY

Int. Cl.: 36

Prior U.S. Cls.: 100, 101, and 102

United States Patent and Trademark Office

Reg. No. 3,522,352

Registered Oct. 21, 2008

**SERVICE MARK
PRINCIPAL REGISTER**

AVALOPA

AVALOPA INC. (MASSACHUSETTS CORPORATION)
12 TENNYSON ROAD
WELLESLEY, MA 02481

FOR: BUSINESS FINANCE PROCUREMENT SERVICES; CAPITAL INVESTMENT SERVICES; COMMERCIAL LENDING SERVICES; EQUIPMENT FINANCING SERVICES; FINANCING SERVICES; LEASE-PURCHASE FINANCING, IN CLASS 36 (U.S. CLS. 100, 101 AND 102).

FIRST USE 1-17-2007; IN COMMERCE 2-4-2008.

THE MARK CONSISTS OF STANDARD CHARACTERS WITHOUT CLAIM TO ANY PARTICULAR FONT, STYLE, SIZE, OR COLOR.

SN 77-383,321, FILED 1-29-2008.

ZACHARY BELLO, EXAMINING ATTORNEY

Int. Cl.: 35

Prior U.S. Cls.: 100, 101, and 102

United States Patent and Trademark Office

Reg. No. 3,522,353

Registered Oct. 21, 2008

**SERVICE MARK
PRINCIPAL REGISTER**

RVBARGAINPARTS

BOB COX CAMPER COUNTRY, INC. (TENNESSEE CORPORATION)
6014 CLINTON HWY.
KNOXVILLE, TN 37912

FOR: RETAIL STORES FEATURING RECREATIONAL VEHICLE PARTS AND SUPPLIES, MOTORHOME AND TRAVEL TRAILER PARTS AND SUPPLIES, MARINE PARTS, HIKING AND CAMPING PARTS AND SUPPLIES, IN CLASS 35 (U.S. CLS. 100, 101 AND 102).

FIRST USE 10-23-2007; IN COMMERCE 10-23-2007.

THE MARK CONSISTS OF STANDARD CHARACTERS WITHOUT CLAIM TO ANY PARTICULAR FONT, STYLE, SIZE, OR COLOR.

SN 77-383,713, FILED 1-29-2008.

JOHN HWANG, EXAMINING ATTORNEY

Int. Cls.: 9, 18, 25, 35, 41, and 42

Prior U.S. Cls.: 1, 2, 3, 21, 22, 23, 26, 36, 38, 39, 41,
100, 101, 102, and 107

Reg. No. 3,522,354

United States Patent and Trademark Office

Registered Oct. 21, 2008

TRADEMARK
SERVICE MARK
PRINCIPAL REGISTER

BIBHU MOHAPATRA

BIBHUDUTTA MOHAPATRA (INDIA INDIVIDUAL), DBA BIBHU MOHAPATRA,

5M

344 WEST 72ND STREET
NEW YORK, NY 10023

FOR: EYEWEAR ACCESSORIES, NAMELY, STRAPS, NECK CORDS AND HEAD STRAPS WHICH RESTRAIN EYEWEAR FROM MOVEMENT ON A WEARER; MESSENGER BAGS ESPECIALLY ADAPTED FOR HOLDING LAPTOPS, IN CLASS 9 (U.S. CLS. 21, 23, 26, 36 AND 38).

FIRST USE 8-5-2007; IN COMMERCE 6-5-2008.

FOR: FUR; ATHLETIC BAGS; CARRY-ALL BAGS; CARRY-ON BAGS; CLUTCH BAGS; DUFFEL BAGS; FLEXIBLE BAGS FOR GARMENTS; GARMENT BAGS FOR TRAVEL; GYM BAGS; LEATHER AND IMITATION LEATHER BAGS; LEATHER BAGS FOR MERCHANDISE PACKAGING; LEATHER BAGS, SUITCASES AND WALLETS; MEN'S CLUTCH BAGS; MESSENGER BAGS; OVERNIGHT BAGS; SADDLE HORN BAGS; SHOULDER BAGS; SLING BAGS; SMALL BAGS FOR MEN; SPORTSMAN'S HUNTING BAGS; SUIT BAGS; CHAIN MESH PURSES; CHANGE PURSES; CLUTCH PURSES; CLUTCHES; HANDBAGS, PURSES AND WALLETS; LEATHER PURSES; MULTI-PURPOSE PURSES; PURSES; PURSES; PURSES AND WALLETS; PURSES AND WALLETS OF PRECIOUS METAL; PURSES MADE OF PRECIOUS METAL; PURSES NOT MADE OF PRECIOUS METAL; PURSES OF PRECIOUS METAL; PURSES, NOT OF PRECIOUS METAL; SMALL CLUTCH PURSES; SMALL PURSES; WRIST MOUNTED PURSES, IN CLASS 18 (U.S. CLS. 1, 2, 3, 22 AND 41).

FIRST USE 8-5-2007; IN COMMERCE 2-5-2008.

FOR: BATHING COSTUMES FOR WOMEN; COATS FOR MEN AND WOMEN; FOOTWEAR FOR MEN AND WOMEN; FOOTWEAR FOR WOMEN; MEN AND WOMEN JACKETS, COATS, TROUSERS, VESTS; MEN'S SUITS, WOMEN'S SUITS; SWIM WEAR; TENNIS WEAR; FUR CLOAKS; FUR COATS; FUR COATS AND JACKETS; FUR JACKETS; FUR STOLE; WEDDING GOWNS; EVENING DRESSES; EVENING GOWNS; LADIES' BOOTS; LADIES' SUITS; LEOTARDS AND TIGHTS FOR WOMEN, MEN AND CHILDREN OF NYLON, COTTON OR OTHER TEXTILE FIBERS; WOMEN'S CEREMONIAL DRESSES; WOMEN'S UNDERWEAR; LEATHER PANTS; SKI PANTS; SNOW PANTS; PLEATED SKIRTS FOR FORMAL KIMONOS (HAKAMA); SKIRT SUITS; SKIRTS; SKIRTS AND DRESSES; BRIDESMAID DRESSES; DRESS SUITS; DRESSES; DRESSES MADE FROM SKINS; DRESSING GOWNS; WEDDING DRESSES; GOWNS; NIGHT GOWNS; BLOUSES; RAIN BOOTS; RAIN COATS; RAIN JACKETS; RAIN SLICKERS; RAIN SUITS; RAIN TROUSERS, IN CLASS 25 (U.S. CLS. 22 AND 39).

FIRST USE 8-5-2007; IN COMMERCE 2-5-2008.

FOR: FASHION SHOW EXHIBITIONS FOR COMMERCIAL PURPOSES, IN CLASS 35 (U.S. CLS. 100, 101 AND 102).

FIRST USE 8-5-2007; IN COMMERCE 7-5-2008.

FOR: ORGANIZATION OF FASHION SHOWS; PHOTOGRAPHY; PHOTOGRAPHY SERVICES, IN CLASS 41 (U.S. CLS. 100, 101 AND 107).

FIRST USE 8-5-2007; IN COMMERCE 4-7-2008.

FOR: DRESS DESIGN; DRESS DESIGNING, IN
CLASS 42 (U.S. CLS. 100 AND 101).

THE MARK CONSISTS OF STANDARD CHAR-
ACTERS WITHOUT CLAIM TO ANY PARTICULAR
FONT, STYLE, SIZE, OR COLOR.

SN 77-385,627, FILED 1-31-2008.

FIRST USE 8-5-2007; IN COMMERCE 5-3-2008.

JOHN HWANG, EXAMINING ATTORNEY

Int. Cl.: 36

Prior U.S. Cls.: 100, 101, and 102

United States Patent and Trademark Office

Reg. No. 3,522,355

Registered Oct. 21, 2008

**SERVICE MARK
PRINCIPAL REGISTER**

GEAR GUARD

BASS PRO INTELLECTUAL PROPERTY, L.L.C
(MISSOURI LIMITED LIABILITY COMPANY)
2500 EAST KEARNEY
SPRINGFIELD, MO 65898

FOR: PROVIDING EXTENDED WARRANTIES
ON CAMPING GEAR AND ACCESSORIES, HUNT-
ING EQUIPMENT AND ACCESSORIES, FISHING
TACKLE AND ACCESSORIES, MARINE ARTICLES
AND ACCESSORIES, AND ELECTRONIC DEVICES
AND ACCESSORIES, IN CLASS 36 (U.S. CLS. 100, 101
AND 102).

FIRST USE 2-2-2008; IN COMMERCE 2-2-2008.

THE MARK CONSISTS OF STANDARD CHAR-
ACTERS WITHOUT CLAIM TO ANY PARTICULAR
FONT, STYLE, SIZE, OR COLOR.

NO CLAIM IS MADE TO THE EXCLUSIVE
RIGHT TO USE "GEAR", APART FROM THE
MARK AS SHOWN.

SN 77-386,761, FILED 2-1-2008.

SAMUEL E. SHARPER JR., EXAMINING ATTOR-
NEY

Int. Cl.: 1

Prior U.S. Cls.: 1, 5, 6, 10, 26, and 46

United States Patent and Trademark Office

Reg. No. 3,522,356

Registered Oct. 21, 2008

**TRADEMARK
PRINCIPAL REGISTER**

BIOVERT

HALLIBURTON ENERGY SERVICES, INC.
(TEXAS CORPORATION)
1-B-121
2601 BELTLINE ROAD
CARROLLTON, TX 75006

FOR: ORGANIC CHEMICAL ADDITIVES USED
IN OIL AND GAS WELL TREATMENT OPERA-
TIONS, INCLUDING ACIDIFYING, SCALE INHI-
BITING AND FLUID LOSS IN PERFORATIONS , IN
CLASS 1 (U.S. CLS. 1, 5, 6, 10, 26 AND 46).

FIRST USE 7-31-2004; IN COMMERCE 7-31-2004.

THE MARK CONSISTS OF STANDARD CHAR-
ACTERS WITHOUT CLAIM TO ANY PARTICULAR
FONT, STYLE, SIZE, OR COLOR.

SN 77-387,528, FILED 2-4-2008.

JAMES LOVELACE, EXAMINING ATTORNEY

Int. Cl.: 45

Prior U.S. Cls.: 100 and 101

United States Patent and Trademark Office

Reg. No. 3,522,357

Registered Oct. 21, 2008

**SERVICE MARK
PRINCIPAL REGISTER**

BEARTOPIA

TOPIA, LLC (NEW JERSEY LIMITED LIABILITY
COMPANY)
APT #22J
80 N MOORE STREET
NEW YORK, NY 10013

THE MARK CONSISTS OF STANDARD CHAR-
ACTERS WITHOUT CLAIM TO ANY PARTICULAR
FONT, STYLE, SIZE, OR COLOR.

FOR: ONLINE SOCIAL NETWORKING SERVI-
CES, IN CLASS 45 (U.S. CLS. 100 AND 101).

SN 77-387,531, FILED 2-4-2008.

FIRST USE 5-17-2008; IN COMMERCE 5-17-2008.

RAUL CORDOVA, EXAMINING ATTORNEY

Int. Cl.: 1

Prior U.S. Cls.: 1, 5, 6, 10, 26, and 46

Reg. No. 3,522,358

United States Patent and Trademark Office

Registered Oct. 21, 2008

**TRADEMARK
PRINCIPAL REGISTER**

MONOPROP

HALLIBURTON ENERGY SERVICES, INC. (DE-
LAWARE CORPORATION)

1-B-121

2601 BELTLINE ROAD
CARROLLTON, TX 75006

FOR: SYNTHETIC CHEMICAL ADDITIVES
MIXED WITH FRACTURING FLUID FOR USE IN
PROVIDING A CONDUIT FOR PRODUCTION OF
FLUID FROM THE RESERVOIR TO THE WELL-
BORE DURING OIL AND GAS WELL DRILLING
OPERATIONS, IN CLASS 1 (U.S. CLS. 1, 5, 6, 10, 26
AND 46).

FIRST USE 4-30-2008; IN COMMERCE 4-30-2008.

THE MARK CONSISTS OF STANDARD CHAR-
ACTERS WITHOUT CLAIM TO ANY PARTICULAR
FONT, STYLE, SIZE, OR COLOR.

SN 77-398,498, FILED 2-15-2008.

JAMES LOVELACE, EXAMINING ATTORNEY

Int. Cl.: 25

Prior U.S. Cls.: 22 and 39

United States Patent and Trademark Office

Reg. No. 3,522,359

Registered Oct. 21, 2008

**TRADEMARK
PRINCIPAL REGISTER**

RUN LUCKY

NIKE, INC. (OREGON CORPORATION)
ONE BOWERMAN DRIVE
BEAVERTON, OR 97005

THE MARK CONSISTS OF STANDARD CHAR-
ACTERS WITHOUT CLAIM TO ANY PARTICULAR
FONT, STYLE, SIZE, OR COLOR.

FOR: SHIRTS, T-SHIRTS, HEADWEAR, ALL RE-
LATED TO RUNNING RACE EVENTS, IN CLASS 25
(U.S. CLS. 22 AND 39).

SN 77-400,842, FILED 2-19-2008.

FIRST USE 3-11-2008; IN COMMERCE 3-11-2008.

GRETTA YAO, EXAMINING ATTORNEY

Int. Cl.: 36

Prior U.S. Cls.: 100, 101, and 102

United States Patent and Trademark Office

Reg. No. 3,522,360

Registered Oct. 21, 2008

**SERVICE MARK
PRINCIPAL REGISTER**

AIG ELITE GLOBAL SURVIVOR

AMERICAN INTERNATIONAL GROUP, INC.
(DELAWARE CORPORATION)
70 PINE STREET
NEW YORK, NY 10270

OWNER OF U.S. REG. NOS. 1,151,229, 3,215,821,
AND OTHERS.

FOR: INSURANCE UNDERWRITING IN THE
FIELD OF UNIVERSAL LIFE INSURANCE, IN
CLASS 36 (U.S. CLS. 100, 101 AND 102).

NO CLAIM IS MADE TO THE EXCLUSIVE
RIGHT TO USE "GLOBAL SURVIVOR", APART
FROM THE MARK AS SHOWN.

FIRST USE 8-13-2008; IN COMMERCE 8-13-2008.

SN 77-405,126, FILED 2-25-2008.

THE MARK CONSISTS OF STANDARD CHAR-
ACTERS WITHOUT CLAIM TO ANY PARTICULAR
FONT, STYLE, SIZE, OR COLOR.

BRIDGETT SMITH, EXAMINING ATTORNEY

Int. Cl.: 36

Prior U.S. Cls.: 100, 101, and 102

United States Patent and Trademark Office

Reg. No. 3,522,361

Registered Oct. 21, 2008

**SERVICE MARK
PRINCIPAL REGISTER**

AIG ELITE GLOBAL PLUS

AMERICAN INTERNATIONAL GROUP, INC.
(DELAWARE CORPORATION)
70 PINE STREET
NEW YORK, NY 10270

OWNER OF U.S. REG. NOS. 1,151,229, 3,215,821,
AND OTHERS.

FOR: INSURANCE UNDERWRITING IN THE
FIELD OF UNIVERSAL LIFE INSURANCE, IN
CLASS 36 (U.S. CLS. 100, 101 AND 102).

NO CLAIM IS MADE TO THE EXCLUSIVE
RIGHT TO USE "GLOBAL", APART FROM THE
MARK AS SHOWN.

FIRST USE 8-13-2008; IN COMMERCE 8-13-2008.

SN 77-405,180, FILED 2-25-2008.

THE MARK CONSISTS OF STANDARD CHAR-
ACTERS WITHOUT CLAIM TO ANY PARTICULAR
FONT, STYLE, SIZE, OR COLOR.

BRIDGETT SMITH, EXAMINING ATTORNEY

Int. Cls.: 3, 35, and 41

Prior U.S. Cls.: 1, 4, 6, 50, 51, 52, 100, 101, 102, and 107

United States Patent and Trademark Office

Reg. No. 3,522,362

Registered Oct. 21, 2008

**TRADEMARK
SERVICE MARK
PRINCIPAL REGISTER**

King of Curls

CURL CONNECTION CORPORATION (NEW YORK CORPORATION)
FIFTH FLOOR
574 FIFTH AVENUE
NEW YORK, NY 10036

FOR: HAIR CARE PREPARATIONS, IN CLASS 3 (U.S. CLS. 1, 4, 6, 50, 51 AND 52).

FIRST USE 6-1-2008; IN COMMERCE 7-10-2008.

FOR: ADVERTISING PARTICULARLY SERVICES FOR THE PROMOTION OF GOODS, IN CLASS 35 (U.S. CLS. 100, 101 AND 102).

FIRST USE 2-1-2008; IN COMMERCE 3-1-2008.

FOR: WORKSHOPS AND SEMINARS IN THE FIELD OF COSMETOLOGY, IN CLASS 41 (U.S. CLS. 100, 101 AND 107).

FIRST USE 5-1-2008; IN COMMERCE 5-1-2008.

THE MARK CONSISTS OF STANDARD CHARACTERS WITHOUT CLAIM TO ANY PARTICULAR FONT, STYLE, SIZE, OR COLOR.

SN 77-407,383, FILED 2-27-2008.

THEODORE MCBRIDE, EXAMINING ATTORNEY

Int. Cl.: 3

Prior U.S. Cls.: 1, 4, 6, 50, 51, and 52

Reg. No. 3,522,363

United States Patent and Trademark Office

Registered Oct. 21, 2008

**TRADEMARK
PRINCIPAL REGISTER**

BOOST UP

CELEBRITY SIGNATURES INTERNATIONAL,
INC. (DELAWARE CORPORATION)
5900 EQUITABLE ROAD
KANSAS CITY, MO 64120

THE MARK CONSISTS OF STANDARD CHAR-
ACTERS WITHOUT CLAIM TO ANY PARTICULAR
FONT, STYLE, SIZE, OR COLOR.

FOR: TEMPORARY HAIR COLOR, IN CLASS 3
(U.S. CLS. 1, 4, 6, 50, 51 AND 52).

SN 77-413,403, FILED 3-5-2008.

FIRST USE 6-25-2008; IN COMMERCE 6-25-2008.

ERNEST SHOSHO, EXAMINING ATTORNEY

Int. Cl.: 40

Prior U.S. Cls.: 100, 103, and 106

United States Patent and Trademark Office

Reg. No. 3,522,364

Registered Oct. 21, 2008

**SERVICE MARK
PRINCIPAL REGISTER**

VERISTIM

HALLIBURTON ENERGY SERVICES, INC. (DE-
LAWARE CORPORATION)
1-B-121
2601 BELTLINE ROAD
CARROLLTON, TX 75006

THE MARK CONSISTS OF STANDARD CHAR-
ACTERS WITHOUT CLAIM TO ANY PARTICULAR
FONT, STYLE, SIZE, OR COLOR.

FOR: OIL AND GAS WELL STIMULATION AND
FRACTURING SERVICES, IN CLASS 40 (U.S. CLS.
100, 103 AND 106).

SN 77-417,222, FILED 3-10-2008.

FIRST USE 3-30-2008; IN COMMERCE 3-30-2008.

JAMES LOVELACE, EXAMINING ATTORNEY

Int. Cl.: 36

Prior U.S. Cls.: 100, 101, and 102

United States Patent and Trademark Office

Reg. No. 3,522,365

Registered Oct. 21, 2008

**SERVICE MARK
PRINCIPAL REGISTER**

AIG ROP SELECT-A-TERM

AMERICAN INTERNATIONAL GROUP, INC.
(DELAWARE CORPORATION)
70 PINE STREET
NEW YORK, NY 10270

OWNER OF U.S. REG. NOS. 1,273,845, 3,351,909,
AND OTHERS.

FOR: INSURANCE UNDERWRITING IN THE
FIELD OF TERM LIFE INSURANCE, IN CLASS 36
(U.S. CLS. 100, 101 AND 102).

NO CLAIM IS MADE TO THE EXCLUSIVE
RIGHT TO USE "ROP SELECT-A-TERM ", APART
FROM THE MARK AS SHOWN.

FIRST USE 5-16-2008; IN COMMERCE 5-16-2008.

SN 77-422,528, FILED 3-14-2008.

THE MARK CONSISTS OF STANDARD CHAR-
ACTERS WITHOUT CLAIM TO ANY PARTICULAR
FONT, STYLE, SIZE, OR COLOR.

BRIDGETT SMITH, EXAMINING ATTORNEY

Int. Cl.: 44

Prior U.S. Cls.: 100 and 101

United States Patent and Trademark Office

Reg. No. 3,522,366

Registered Oct. 21, 2008

**SERVICE MARK
PRINCIPAL REGISTER**

NUTRIFILTER

AHOLD LICENSING SA (SWITZERLAND COR-
PORATION)
2 RUE JEAN-PETITOT
GENEVA, SWITZERLAND 1204

THE MARK CONSISTS OF STANDARD CHAR-
ACTERS WITHOUT CLAIM TO ANY PARTICULAR
FONT, STYLE, SIZE, OR COLOR.

FOR: PROVIDING AN ONLINE SEARCHABLE
COMPUTER DATABASE OF NUTRITIONAL IN-
FORMATION, IN CLASS 44 (U.S. CLS. 100 AND 101).

SN 77-432,816, FILED 3-27-2008.

FIRST USE 3-0-2008; IN COMMERCE 3-0-2008.

ELLEN B. AWRICH, EXAMINING ATTORNEY

Int. Cl.: 28

Prior U.S. Cls.: 22, 23, 38, and 50

United States Patent and Trademark Office

Reg. No. 3,522,367

Registered Oct. 21, 2008

**TRADEMARK
PRINCIPAL REGISTER**



E-Z SPIN DISCS, INC. (WISCONSIN CORPORATION)
P.O. BOX 262
HALES CORNERS, WI 531300262

FOR: FLYING DISCS, IN CLASS 28 (U.S. CLS. 22, 23, 38 AND 50).

FIRST USE 3-28-2008; IN COMMERCE 3-28-2008.

NO CLAIM IS MADE TO THE EXCLUSIVE RIGHT TO USE "FREESTYLE DISCS", APART FROM THE MARK AS SHOWN.

THE MARK CONSISTS OF SOLID AREA OF BLACK DEPICTING A MAN CATCHING A FLYING DISC UNDER HIS LEG AND SPINNING IT ON HIS FINGER WITH STYLIZED LETTERING IN BLACK AS WELL ON A WHITE BACKGROUND.

SN 77-434,866, FILED 3-28-2008.

JULIE WATSON, EXAMINING ATTORNEY

Int. Cl.: 19

Prior U.S. Cls.: 1, 12, 33, and 50

United States Patent and Trademark Office

Reg. No. 3,522,368

Registered Oct. 21, 2008

**TRADEMARK
PRINCIPAL REGISTER**

PICASSO MOULDINGS INC.

PICASSO MOULDINGS INC. (CANADA CORPORATION)
UNIT 103 - 14772 - 64TH
SURREY, BRITISH COLUMBIA, CANADA V3S1X7

FOR: WOOD MOLDINGS, NAMELY, CASINGS, CROWN MOULDINGS, BASE MOULDINGS, BACK BANDS, CHAIR RAILS, HAND RAILS, WAINSCOTING CAPS, RABBETED PANEL MOULDINGS, BAND MOULDINGS, INSIDE AND OUTSIDE CORNER MOULDINGS, HALF ROUNDS, ASTRAGALS AND BATTENS, HEADERS AND DOOR JAMS, IN CLASS 19 (U.S. CLS. 1, 12, 33 AND 50).

FIRST USE 12-11-2004; IN COMMERCE 6-8-2007.

THE MARK CONSISTS OF STANDARD CHARACTERS WITHOUT CLAIM TO ANY PARTICULAR FONT, STYLE, SIZE, OR COLOR.

OWNER OF CANADA REG. NO. TMA672,542, DATED 9-12-2006, EXPIRES 9-12-2021.

NO CLAIM IS MADE TO THE EXCLUSIVE RIGHT TO USE "MOULDINGS INC.", APART FROM THE MARK AS SHOWN.

SN 77-975,714, FILED 10-10-2006.

ANDREA K. NADELMAN, EXAMINING ATTORNEY

Int. Cl.: 21

Prior U.S. Cls.: 2, 13, 23, 29, 30, 33, 40, and 50

United States Patent and Trademark Office

Reg. No. 3,522,369

Registered Oct. 21, 2008

**TRADEMARK
PRINCIPAL REGISTER**

Emeshel

EMESHEL LLC (FLORIDA LIMITED LIABILITY
COMPANY)
3930 NE 2ND AVE., SUITE 204
MIAMI, FL 33137

FOR: HANDMADE GLASS AND CRYSTAL
HOUSEWARES, DESIGN PRODUCTS AND DEC-
ORATIVE ITEMS, NAMELY, DRINKING GLASSES,
GLASS AND CRYSTAL BEVERAGEWARE, GLASS
AND CRYSTAL CARAFES, CRYSTAL DECAN-
TERS, GLASS DISHES, GLASS BOWLS, CRYSTAL
VASES, CRYSTAL PASTRY TRAYS, SCULPTURES
OF CRYSTAL, STATUETTES OF CRYSTAL, WORKS
OF ART OF CRYSTAL, FIGURINES OF CRYSTAL,

ORNAMENTS OF CRYSTAL, IN CLASS 21 (U.S. CLS.
2, 13, 23, 29, 30, 33, 40 AND 50).

FIRST USE 8-31-2007; IN COMMERCE 4-24-2008.

THE MARK CONSISTS OF STANDARD CHAR-
ACTERS WITHOUT CLAIM TO ANY PARTICULAR
FONT, STYLE, SIZE, OR COLOR.

SN 77-975,778, FILED 8-13-2007.

ANNE E. GUSTASON, EXAMINING ATTORNEY

Int. Cl.: 3

Prior U.S. Cls.: 1, 4, 6, 50, 51, and 52

Reg. No. 3,522,370

United States Patent and Trademark Office

Registered Oct. 21, 2008

**TRADEMARK
PRINCIPAL REGISTER**



S. C. JOHNSON & SON, INC. (WISCONSIN CORPORATION)
1525 HOWE STREET
RACINE, WI 53403

THE MARK CONSISTS OF THE WORD "GREENLIST" AND TWO LEAVES AND A LINE INSIDE A LARGER LEAF.

FOR: GLASS CLEANER, IN CLASS 3 (U.S. CLS. 1, 4, 6, 50, 51 AND 52).

SN 77-975,784, FILED 3-28-2007.

FIRST USE 2-18-2008; IN COMMERCE 2-18-2008.

LESLEY LAMOTHE, EXAMINING ATTORNEY

Int. Cl.: 41

Prior U.S. Cls.: 100, 101, and 107

United States Patent and Trademark Office

Reg. No. 3,522,371

Registered Oct. 21, 2008

**SERVICE MARK
PRINCIPAL REGISTER**

WAMU LIVE!

WASHINGTON MUTUAL, INC. (WASHINGTON CORPORATION)
WMC 3501
1301 SECOND AVENUE
SEATTLE, WA 98101

FOR: ENTERTAINMENT SERVICES, NAMELY, PROVIDING A WEBSITE FEATURING NEWS, ENTERTAINMENT INFORMATION, ENTERTAINMENT VENUES, SCHEDULES AND TICKET INFORMATION FOR ARTS AND ENTERTAINMENT EVENTS AND PROGRAMS, NAMELY, THEATRE PERFORMANCES, MUSICAL PERFORMANCES AND CONCERTS, AND SPORTING EVENTS; ENTERTAINMENT SERVICES, NAMELY, PROVIDING ON-LINE REVIEWS OF CONCERTS; ENTERTAINMENT SERVICES, NAMELY, CONDUCTING CONTESTS; ENTERTAINMENT TICKET

AGENCY SERVICES; ENTERTAINMENT TICKET AGENCY SERVICES PROVIDED VIA THE INTERNET, IN CLASS 41 (U.S. CLS. 100, 101 AND 107).

FIRST USE 4-30-2007; IN COMMERCE 4-30-2007.

THE MARK CONSISTS OF STANDARD CHARACTERS WITHOUT CLAIM TO ANY PARTICULAR FONT, STYLE, SIZE, OR COLOR.

OWNER OF U.S. REG. NOS. 2,315,782, 2,879,308, AND OTHERS.

SN 77-975,813, FILED 2-23-2007.

LINDA ESTRADA, EXAMINING ATTORNEY

Int. Cl.: 35

Prior U.S. Cls.: 100, 101, and 102

United States Patent and Trademark Office

Reg. No. 3,522,372

Registered Oct. 21, 2008

**SERVICE MARK
PRINCIPAL REGISTER**

WAMU LIVE!

WASHINGTON MUTUAL, INC. (WASHINGTON CORPORATION)
WMC 3501
1301 SECOND AVENUE
SEATTLE, WA 98101

FOR: DISTRIBUTION OF ADVERTISEMENTS AND COMMERCIAL ANNOUNCEMENTS FOR OTHERS FEATURING NEWS, INFORMATION, ENTERTAINMENT VENUES, SCHEDULES, TICKET INFORMATION, AND CONTESTS RELATED TO ARTS AND ENTERTAINMENT EVENTS AND PROGRAMS, NAMELY, THEATRE PERFORMANCES, MUSICAL PERFORMANCES AND CONCERTS, SPORTING EVENTS; DISTRIBUTION OF ADVERTISEMENTS AND COMMERCIAL ANNOUNCEMENTS FOR ENTERTAINMENT TICKET

AGENCIES, IN CLASS 35 (U.S. CLS. 100, 101 AND 102).

FIRST USE 4-30-2007; IN COMMERCE 4-30-2007.

THE MARK CONSISTS OF STANDARD CHARACTERS WITHOUT CLAIM TO ANY PARTICULAR FONT, STYLE, SIZE, OR COLOR.

OWNER OF U.S. REG. NOS. 2,315,782, 2,879,308, AND OTHERS.

SN 77-975,815, FILED 2-23-2007.

LINDA ESTRADA, EXAMINING ATTORNEY

Int. Cl.: 29

Prior U.S. Cl.: 46

United States Patent and Trademark Office

Reg. No. 3,522,373

Registered Oct. 21, 2008

**TRADEMARK
PRINCIPAL REGISTER**

TRUENORTH

FRITO-LAY NORTH AMERICA, INC. (DELA-
WARE CORPORATION)
7701 LEGACY DRIVE
PLANO, TX 75024

FOR: PROCESSED NUTS; SHELLED NUTS; PRO-
CESSED NUTS IN CLUSTER FORM; PROCESSED
NUTS IN CRISP FORM; PROCESSED NUT-BASED
SNACKS; SEASONED NUTS; ROASTED NUTS; NUT
BASED SNACK FOODS , IN CLASS 29 (U.S. CL. 46).

FIRST USE 2-3-2008; IN COMMERCE 2-3-2008.

THE MARK CONSISTS OF STANDARD CHAR-
ACTERS WITHOUT CLAIM TO ANY PARTICULAR
FONT, STYLE, SIZE, OR COLOR.

SN 77-975,836, FILED 1-4-2007.

CAROLYN CATALDO, EXAMINING ATTORNEY

Int. Cl.: 24

Prior U.S. Cls.: 42 and 50

United States Patent and Trademark Office

Reg. No. 3,522,374

Registered Oct. 21, 2008

**TRADEMARK
PRINCIPAL REGISTER**



COTEMINAS S.A. (BRAZIL CORPORATION)
PLANALTO, MONTES CLAROS
AV MAGALHAES PINTO NO. 4000
MINAS GERAIS, CEP: 39404166, BRAZIL

FOR: FABRICS, NAMELY, COTTON FABRICS AND COTTON BASE MIXED FABRICS; HOUSEHOLD LINEN MADE WITH COTTON; COMFORTERS MADE OF COTTON; CURTAINS MADE OF COTTON; UNFITTED COTTON COVERS FOR SOFAS; MATTRESS COVERS MADE OF COTTON; COTTON COVERS FOR CUSHIONS, IN CLASS 24 (U.S. CLS. 42 AND 50).

FIRST USE 2-1-2007; IN COMMERCE 2-1-2007.

NO CLAIM IS MADE TO THE EXCLUSIVE RIGHT TO USE "PURE BRAZIL COTTON" AND "EARTH'S RICHEST COTTON", APART FROM THE MARK AS SHOWN.

THE MARK CONSISTS OF TWO SQUARES PLACED SIDE BY SIDE, WITH A DISTINCTIVE, STYLIZED COTTON DESIGN IN THE LEFT-HAND SQUARE, AND THE WORDS PURE BRAZIL COTTON IN THE RIGHT-HAND SQUARE; THE WORDS EARTH'S RICHEST COTTON APPEARS BELOW THE SQUARES.

SN 77-975,851, FILED 9-26-2006.

SANDRA MANIOS, EXAMINING ATTORNEY

Int. Cl.: 14

Prior U.S. Cls.: 2, 27, 28, and 50

United States Patent and Trademark Office

Reg. No. 3,522,375

Registered Oct. 21, 2008

**TRADEMARK
PRINCIPAL REGISTER**

**PARKMADISON BY LEO
SCHACHTER**

MY DIAMOND PLACE, LTD. (BAHAMAS COR-
PORATION)

BRITISH COLONIAL CENTER OF COMMERCE

ONE BAY STREET

NASSAU, BAHAMAS

FOR: JEWELRY AND DIAMONDS, IN CLASS 14
(U.S. CLS. 2, 27, 28 AND 50).

FIRST USE 10-22-2007; IN COMMERCE 10-22-2007.

THE MARK CONSISTS OF STANDARD CHAR-
ACTERS WITHOUT CLAIM TO ANY PARTICULAR
FONT, STYLE, SIZE, OR COLOR.

THE NAME "LEO SCHACHTER" IDENTIFIES A
LIVING INDIVIDUAL WHOSE CONSENT IS OF
RECORD.

SN 77-975,865, FILED 6-8-2007.

NORA BUCHANAN WILL, EXAMINING ATTOR-
NEY

Int. Cl.: 5

Prior U.S. Cls.: 6, 18, 44, 46, 51, and 52

United States Patent and Trademark Office

Reg. No. 3,522,376

Registered Oct. 21, 2008

**TRADEMARK
PRINCIPAL REGISTER**

DERMWORX

DERMWORX INCORPORATED (DELAWARE
CORPORATION)
1835 E. HALLANDALE BEACH BLVD.
SUITE 612
HALLANDALE, FL 33009

FOR: TOPICAL COMPOUNDS AND DERMATO-
LOGICAL PREPARATIONS FOR MEDICAL USE,
NAMELY, MEDICATED LOTIONS AND CREAMS
FOR SKIN AND FACE FOR TREATMENT OF
DERMATOLOGICAL CONDITIONS, IN CLASS 5
(U.S. CLS. 6, 18, 44, 46, 51 AND 52).

FIRST USE 3-24-2008; IN COMMERCE 3-24-2008.

THE MARK CONSISTS OF STANDARD CHAR-
ACTERS WITHOUT CLAIM TO ANY PARTICULAR
FONT, STYLE, SIZE, OR COLOR.

SN 77-975,866, FILED 3-21-2007.

KIMBERLY FRYE, EXAMINING ATTORNEY

Int. Cls.: 9 and 41

Prior U.S. Cls.: 21, 23, 26, 36, 38, 100, 101, and 107

United States Patent and Trademark Office

Reg. No. 3,522,377

Registered Oct. 21, 2008

**TRADEMARK
SERVICE MARK
PRINCIPAL REGISTER**

PEGGLE

POPCAP GAMES, INC. (WASHINGTON CORPORATION)
SUITE 810
2401 4TH AVENUE
SEATTLE, WA 98121

FOR: INTERACTIVE GAME SOFTWARE; COMPUTER GAME SOFTWARE; ELECTRONIC GAME PROGRAMS; DOWNLOADABLE INTERACTIVE, COMPUTER, VIDEO AND ELECTRONIC GAME PROGRAMS, IN CLASS 9 (U.S. CLS. 21, 23, 26, 36 AND 38).

FIRST USE 2-28-2007; IN COMMERCE 2-28-2007.

FOR: ENTERTAINMENT SERVICES, NAMELY, PROVIDING ON-LINE INTERACTIVE, COMPUTER, VIDEO AND ELECTRONIC GAMES; PROVIDING WEBSITES FEATURING CONTENT AND INFORMATION IN THE FIELD OF GAMES, INTER-

ACTIVE GAME CONTENT, ELECTRONIC GAME CONTENT, COMPUTER GAME CONTENT OR VIDEO GAME CONTENT; PROVIDING TEMPORARY USE OF NON-DOWNLOADABLE INTERACTIVE GAMES, ELECTRONIC GAMES, COMPUTER GAMES OR VIDEO GAMES; PROVIDING INTERACTIVE, COMPUTER, VIDEO AND ELECTRONIC GAMES THROUGH COMPUTER NETWORKS, IN CLASS 41 (U.S. CLS. 100, 101 AND 107).

FIRST USE 2-28-2007; IN COMMERCE 2-28-2007.

THE MARK CONSISTS OF STANDARD CHARACTERS WITHOUT CLAIM TO ANY PARTICULAR FONT, STYLE, SIZE, OR COLOR.

SN 77-975,873, FILED 1-2-2007.

DAVID ELTON, EXAMINING ATTORNEY

Int. Cls.: 16, 35, 36, 39, 41, 44, and 45

Prior U.S. Cls.: 2, 5, 22, 23, 29, 37, 38, 50, 100, 101, 102, 105, and 107

Reg. No. 3,522,378

United States Patent and Trademark Office

Registered Oct. 21, 2008

TRADEMARK
SERVICE MARK
PRINCIPAL REGISTER



THE BIG IDEA COMPANY, LLC (NORTH CAROLINA LIMITED LIABILITY COMPANY)
3924 CAMBRIDGE HILL LANE
CHARLOTTE, NC 28270

FOR: PAPER PRODUCTS, NAMELY, BROCHURES, HANDBOOKS, PAMPHLETS AND WRITTEN LITERATURE IN THE FIELDS OF ANIMAL WELFARE, ANIMAL ADOPTION AND PLACEMENT, AND ANIMAL CARE, IN CLASS 16 (U.S. CLS. 2, 5, 22, 23, 29, 37, 38 AND 50).

FIRST USE 7-1-2007; IN COMMERCE 7-1-2007.

FOR: PROMOTING PUBLIC AWARENESS OF THE NEED FOR ANIMAL WELFARE ACTION, ANIMAL REHABILITATION, ANIMAL ADOPTION AND PLACEMENT, VETERINARY SERVICES AND ANIMAL CARE; PUBLIC ADVOCACY TO PROMOTE AWARENESS OF ANIMAL RIGHTS, IN CLASS 35 (U.S. CLS. 100, 101 AND 102).

FIRST USE 7-1-2007; IN COMMERCE 7-1-2007.

FOR: TRUST SERVICES, NAMELY, INVESTMENT AND TRUST COMPANY SERVICES; CHARITABLE FUND RAISING SERVICES FOR ANIMAL WELFARE; CHARITABLE SERVICES, NAMELY, PROVIDING GRANTS, DONATIONS AND FUNDING TO ORGANIZATIONS AND INDIVIDUALS FOR USE IN THE FIELD OF ANIMAL WELFARE; ESTATE TRUST MANAGEMENT PROVIDED FOR THE CARE AND SUPPORT OF PETS, IN CLASS 36 (U.S. CLS. 100, 101 AND 102).

FIRST USE 7-1-2007; IN COMMERCE 7-1-2007.

FOR: ANIMAL RESCUE SERVICES, IN CLASS 39 (U.S. CLS. 100 AND 105).

FIRST USE 7-1-2007; IN COMMERCE 7-1-2007.

FOR: EDUCATIONAL SERVICES IN THE NATURE OF PROVIDING PODCASTS IN THE FIELDS OF ANIMAL WELFARE, ANIMAL ADOPTION AND PLACEMENT, AND ANIMAL CARE, IN CLASS 41 (U.S. CLS. 100, 101 AND 107).

FIRST USE 7-1-2007; IN COMMERCE 7-1-2007.

FOR: PET CARE SERVICES, NAMELY, DOG WALKING, DOG BATHING, NON-MEDICATED PET GROOMING AND IN-HOME MEDICAL CARE; VETERINARY SERVICES; VETERINARY SURGERIES; EMERGENCY VETERINARY SERVICES, IN CLASS 44 (U.S. CLS. 100 AND 101).

FIRST USE 7-1-2007; IN COMMERCE 7-1-2007.

FOR: ANIMAL ADOPTION SERVICES, NAMELY, ARRANGING FOR COMPANION ANIMALS FROM SHELTERS TO BE PLACED IN HOMES; PROVIDING INFORMATION IN THE FIELDS OF ANIMAL ADOPTION AND PLACEMENT; PLACEMENT SERVICES FOR PETS WHEN THE OWNER DIES AND THERE IS NO ONE TO CARE FOR THE PET AND SUBSEQUENT MONITORING OF THE CARE PROVIDED FOR THE PET, IN CLASS 45 (U.S. CLS. 100 AND 101).

FIRST USE 7-1-2007; IN COMMERCE 7-1-2007.

NO CLAIM IS MADE TO THE EXCLUSIVE RIGHT TO USE "AMERICAN PET", APART FROM THE MARK AS SHOWN.

THE COLOR(S) PURPLE, BLUE, GREEN, YELLOW, RED, WHITE AND BLACK IS/ARE CLAIMED AS A FEATURE OF THE MARK.

THE MARK CONSISTS OF A CROSS WHICH IS COMPOSED OF FIVE SQUARES WITH A WHITE

PAW PRINT IMPOSED OVER THE CROSS, AND THE WORDING "AMERICAN PET CROSS" IN BLACK TO THE RIGHT OF THE CROSS. THE TOP SQUARE OF THE CROSS IS PURPLE; THE LEFT SQUARE IS BLUE; THE RIGHT SQUARE IS YELLOW; THE BOTTOM SQUARE IS GREEN; AND THE MIDDLE SQUARE IS RED.

SN 77-975,892, FILED 1-24-2007.

SUNG IN, EXAMINING ATTORNEY

Int. Cls.: 16, 35, and 41

Prior U.S. Cls.: 2, 5, 22, 23, 29, 37, 38, 50, 100, 101, 102, and 107

Reg. No. 3,522,379

United States Patent and Trademark Office

Registered Oct. 21, 2008

**TRADEMARK
SERVICE MARK
PRINCIPAL REGISTER**

TMFORUM

TELEMANAGEMENT FORUM (NEW JERSEY
NON-PROFIT CORPORATION)
240 HEADQUARTERS PLAZA
EAST TOWER - 10TH FLOOR
MORRISTOWN, NJ 079606628

FOR: PRINTED MATERIALS, NAMELY, BOOKS, PAMPHLETS, BROCHURES, BOOKLETS, AND FORMS CONTAINING DEVELOPMENT SPECIFICATIONS, STRATEGIES AND IMPLEMENTATION GUIDES THAT DEFINE AND PROMOTE THE USE OF INTEGRATED TECHNICAL STANDARDS TO DEVELOP OR PROCURE NETWORK SYSTEMS MANAGEMENT APPLICATION INTERFACES, IN CLASS 16 (U.S. CLS. 2, 5, 22, 23, 29, 37, 38 AND 50).

FIRST USE 1-2-2008; IN COMMERCE 1-2-2008.

FOR: PROMOTION OF SERVICES OF OTHERS IN THE FIELD OF THE MANAGEMENT OF NETWORKED INFORMATION SYSTEMS AND BUSINESS MANAGEMENT CONSULTATION SERVICES IN THE FIELD OF NETWORKED INFORMATION SYSTEMS; PROMOTION OF SERVICES OF OTHERS IN THE FIELD OF THE MANAGEMENT OF NETWORKED INFORMATION SYSTEMS THROUGH

EXHIBITIONS, TRADE SHOWS AND CONFERENCES, IN CLASS 35 (U.S. CLS. 100, 101 AND 102).

FIRST USE 7-1-2007; IN COMMERCE 7-1-2007.

FOR: EDUCATIONAL SERVICES, NAMELY, CONDUCTING SEMINARS, EXHIBITIONS, TRADE SHOWS, CONFERENCES, ONLINE TRAINING, WEBINARS AND WORKSHOPS ON TECHNICAL ISSUES IN THE FIELD OF TELECOMMUNICATIONS AND COMPUTERS FOR TELECOMMUNICATIONS, CABLE, SATELLITE AND COMPUTER SERVICE PROVIDERS AND SUPPLIERS, AND DEVELOPING AND DISTRIBUTING PRINTED MATERIAL IN CONNECTION THEREWITH, IN CLASS 41 (U.S. CLS. 100, 101 AND 107).

FIRST USE 7-1-2007; IN COMMERCE 7-1-2007.

THE MARK CONSISTS OF STANDARD CHARACTERS WITHOUT CLAIM TO ANY PARTICULAR FONT, STYLE, SIZE, OR COLOR.

SN 77-975,896, FILED 7-18-2007.

CHRIS WELLS, EXAMINING ATTORNEY

Int. Cl.: 30

Prior U.S. Cl.: 46

United States Patent and Trademark Office

Reg. No. 3,522,380

Registered Oct. 21, 2008

**TRADEMARK
PRINCIPAL REGISTER**

MASTERFRY

ONTIVEROS, PABLO IGNACIO MICHEL (MEX-
ICO INDIVIDUAL)
COL. GUADALUPANA, S.H.
ANDRES QUINTANA ROO NO. 1611
GUADALAJARA, JALISCO, MEXICO CP44260

THE MARK CONSISTS OF STANDARD CHAR-
ACTERS WITHOUT CLAIM TO ANY PARTICULAR
FONT, STYLE, SIZE, OR COLOR.

FOR: WHEAT-BASED SNACK FOODS, IN CLASS
30 (U.S. CL. 46).

SN 77-975,897, FILED 10-2-2006.

FIRST USE 7-31-2008; IN COMMERCE 7-31-2008.

CHRIS WELLS, EXAMINING ATTORNEY

Int. Cl.: 21

Prior U.S. Cls.: 2, 13, 23, 29, 30, 33, 40, and 50

Reg. No. 3,522,381

United States Patent and Trademark Office

Registered Oct. 21, 2008

**TRADEMARK
PRINCIPAL REGISTER**

GREEN AND IT'S CLEAN

QUICKIE MANUFACTURING CORPORATION
(NEW JERSEY CORPORATION)
1150 TAYLORS LANE
P.O. BOX 156
CINNAMINSON, NJ 08077

FIRST USE 5-14-2008; IN COMMERCE 7-31-2008.

FOR: POT SCOURERS, DUST PANS, TOILET
PLUNGERS AND HOLDERS FOR TOILET PLUN-
GERS; BRUSHES FOR HOUSEHOLD USE, NAME-
LY, SCRUB BRUSHES, TOILET BRUSHES, DISH
BRUSHES, POT CLEANING BRUSHES BATH AND
SHOWER BRUSHES, IN CLASS 21 (U.S. CLS. 2, 13, 23,
29, 30, 33, 40 AND 50).

THE MARK CONSISTS OF STANDARD CHAR-
ACTERS WITHOUT CLAIM TO ANY PARTICULAR
FONT, STYLE, SIZE, OR COLOR.

SN 77-975,903, FILED 8-14-2007.

KIMBERLY FRYE, EXAMINING ATTORNEY

Int. Cls.: 16, 35, and 41

Prior U.S. Cls.: 2, 5, 22, 23, 29, 37, 38, 50, 100, 101, 102, and 107

Reg. No. 3,522,382

United States Patent and Trademark Office

Registered Oct. 21, 2008

**TRADEMARK
SERVICE MARK
PRINCIPAL REGISTER**



TELEMANAGEMENT FORUM (NEW JERSEY
NON-PROFIT CORPORATION)
240 HEADQUARTERS PLAZA, EAST TOWER
MORRISTOWN, NJ 079606628

FOR: PRINTED MATERIALS, NAMELY, BOOKS, PAMPHLETS, BROCHURES, BOOKLETS, AND FORMS CONTAINING DEVELOPMENT SPECIFICATIONS, STRATEGIES AND IMPLEMENTATION GUIDES THAT DEFINE AND PROMOTE THE USE OF INTEGRATED TECHNICAL STANDARDS TO DEVELOP OR PROCURE NETWORK SYSTEMS MANAGEMENT APPLICATION INTERFACES, IN CLASS 16 (U.S. CLS. 2, 5, 22, 23, 29, 37, 38 AND 50).

FIRST USE 1-2-2008; IN COMMERCE 1-2-2008.

FOR: PROMOTION OF SERVICES OF OTHERS IN THE FIELD OF THE MANAGEMENT OF NETWORKED INFORMATION SYSTEMS AND BUSINESS MANAGEMENT CONSULTATION SERVICES IN THE FIELD OF NETWORKED INFORMATION SYSTEMS; PROMOTION OF SERVICES OF OTHERS IN THE FIELD OF THE MANAGEMENT OF NETWORKED INFORMATION SYSTEMS THROUGH EXHIBITIONS, TRADE SHOWS AND CONFERENCES, IN CLASS 35 (U.S. CLS. 100, 101 AND 102).

FIRST USE 7-1-2007; IN COMMERCE 7-1-2007.

FOR: EDUCATIONAL SERVICES, NAMELY, CONDUCTING SEMINARS, EXHIBITIONS, CON-

FERENCES, ONLINE TRAINING, WEBINARS AND WORKSHOPS ON TECHNICAL ISSUES IN THE FIELD OF TELECOMMUNICATIONS AND COMPUTERS FOR TELECOMMUNICATIONS, CABLE, SATELLITE AND COMPUTER SERVICE PROVIDERS AND SUPPLIERS, AND DEVELOPING AND DISTRIBUTING PRINTED MATERIAL IN CONNECTION THEREWITH, IN CLASS 41 (U.S. CLS. 100, 101 AND 107).

FIRST USE 7-1-2007; IN COMMERCE 7-1-2007.

THE COLOR(S) BLUE, ORANGE AND BLACK IS/ARE CLAIMED AS A FEATURE OF THE MARK.

THE MARK CONSISTS OF THE LETTERS "TM" AND THE WORD "FORUM" WITH THE LETTERS "TM" APPEARING IN THE COLOR BLUE, THE LETTERS "F", "R", "U" AND THE SECOND "M" IN THE WORD "FORUM" APPEARING IN THE COLOR ORANGE; AND THE LETTER "O" IN THE WORD "FORUM" REPRESENTED BY TWO CURLING ARROWS, ONE IN THE COLORS ORANGE AND BLACK AND ONE IN THE COLORS BLUE AND BLACK.

SN 77-975,904, FILED 8-2-2007.

CHRIS WELLS, EXAMINING ATTORNEY

Int. Cls.: 20 and 24

Prior U.S. Cls.: 2, 13, 22, 25, 32, 42, and 50

United States Patent and Trademark Office

Reg. No. 3,522,383

Registered Oct. 21, 2008

**TRADEMARK
PRINCIPAL REGISTER**

ANNA'S HOME

ANNA'S LINENS, INC. (DELAWARE CORPORATION)
3550 HYLAND AVENUE
COSTA MESA, CA 92626

FOR: BED PILLOWS, NON-METALLIC SHOWER CURTAIN HOOKS, DECORATIVE PILLOWS, FITTED FABRIC FURNITURE SLIPCOVERS; MIRRORS; HAMPERS; WINDOW SHADES; FLOOR CUSHIONS, IN CLASS 20 (U.S. CLS. 2, 13, 22, 25, 32 AND 50).

FIRST USE 10-30-2007; IN COMMERCE 10-30-2007.

FOR: LINENS, WINDOW COVERINGS, NAMELY, DRAPERIES, CURTAINS, WINDOW TREATMENTS IN THE NATURE OF WINDOW PANELS OF POLYESTER, AND COTTON, FABRIC VALANCES; TEXTILE TABLECLOTHS, TEXTILE PLACEMATS, TEXTILE NAPKINS, MATTRESS PADS, COMFORTERS, BED SKIRTS, SHAMS, BED BLANKETS, PILLOW PROTECTORS IN THE NATURE OF DECORATIVE PILLOW COVERS, BED SHEETS, PIL-

LOWCASES, BATH TOWELS, SHOWER CURTAINS, FURNITURE THROWS, DECORATIVE THROWS, KITCHEN LINENS, KITCHEN TOWELS, POT HOLDERS, OVEN MITTS; SHEET SETS COMPRISED OF BED SHEETS, LINEN AND PILLOWCASES, IN CLASS 24 (U.S. CLS. 42 AND 50).

FIRST USE 11-30-2007; IN COMMERCE 11-30-2007.

THE MARK CONSISTS OF STANDARD CHARACTERS WITHOUT CLAIM TO ANY PARTICULAR FONT, STYLE, SIZE, OR COLOR.

OWNER OF U.S. REG. NO. 3,022,503.

NO CLAIM IS MADE TO THE EXCLUSIVE RIGHT TO USE "HOME", APART FROM THE MARK AS SHOWN.

SN 77-975,924, FILED 5-2-2007.

WON TEAK OH, EXAMINING ATTORNEY

Int. Cl.: 5

Prior U.S. Cls.: 6, 18, 44, 46, 51, and 52

Reg. No. 3,522,384

United States Patent and Trademark Office

Registered Oct. 21, 2008

**TRADEMARK
PRINCIPAL REGISTER**

DANDRUFFSCALPCURE

PUREOLOGY RESEARCH, LLC (DELAWARE
LIMITED LIABILITY COMPANY)
575 FIFTH AVENUE
NEW YORK, NY 10017

THE MARK CONSISTS OF STANDARD CHAR-
ACTERS WITHOUT CLAIM TO ANY PARTICULAR
FONT, STYLE, SIZE, OR COLOR.

FOR: HAIR CARE PRODUCTS, NAMELY, DAN-
DRUFF SHAMPOO, DANDRUFF CONDITIONER,
IN CLASS 5 (U.S. CLS. 6, 18, 44, 46, 51 AND 52).

SN 77-975,930, FILED 11-29-2007.

FIRST USE 7-0-2008; IN COMMERCE 7-0-2008.

MORGAN WYNNE, EXAMINING ATTORNEY

Int. Cl.: 3

Prior U.S. Cls.: 1, 4, 6, 50, 51, and 52

United States Patent and Trademark Office

Reg. No. 3,522,385

Registered Oct. 21, 2008

**TRADEMARK
PRINCIPAL REGISTER**

SOLUTIONIST

L'OREAL USA CREATIVE, INC. (DELAWARE
CORPORATION)
575 FIFTH AVENUE
NEW YORK, NY 10017

FOR: HAIR CARE PREPARATIONS, HAIR STY-
LING PREPARATIONS AND NON-MEDICATED
HAIR TREATMENT PREPARATIONS, IN CLASS 3
(U.S. CLS. 1, 4, 6, 50, 51 AND 52).

FIRST USE 8-1-2008; IN COMMERCE 8-1-2008.

THE MARK CONSISTS OF STANDARD CHAR-
ACTERS WITHOUT CLAIM TO ANY PARTICULAR
FONT, STYLE, SIZE, OR COLOR.

SN 77-975,937, FILED 12-4-2007.

CHRIS WELLS, EXAMINING ATTORNEY

Int. Cls.: 36 and 41

Prior U.S. Cls.: 100, 101, 102, and 107

United States Patent and Trademark Office

Reg. No. 3,522,386

Registered Oct. 21, 2008

**SERVICE MARK
PRINCIPAL REGISTER**

CENTSABLES

NORM HILL ENTERTAINMENT LTD. (NEW YORK CORPORATION)
1 HUNTINGTON BAY ROAD
HUNTINGTON, NY 11743

FOR: PROVIDING A WEBSITE FEATURING INFORMATION FOR CHILDREN AND YOUNG PEOPLE ABOUT COUNTING, SAVING AND SPENDING MONEY, IN CLASS 36 (U.S. CLS. 100, 101 AND 102).

FIRST USE 7-1-2008; IN COMMERCE 7-1-2008.

FOR: EDUCATIONAL SERVICES, NAMELY, PROVIDING INSTRUCTION AND TRAINING TO

CHILDREN AND YOUNG PEOPLE ABOUT HOW TO EARN, COUNT, SAVE AND SPEND MONEY, IN CLASS 41 (U.S. CLS. 100, 101 AND 107).

FIRST USE 7-1-2008; IN COMMERCE 7-1-2008.

THE MARK CONSISTS OF STANDARD CHARACTERS WITHOUT CLAIM TO ANY PARTICULAR FONT, STYLE, SIZE, OR COLOR.

SN 77-975,947, FILED 3-15-2007.

G. MAYERSCHOFF, EXAMINING ATTORNEY

Int. Cl.: 30

Prior U.S. Cl.: 46

United States Patent and Trademark Office

Reg. No. 3,522,387

Registered Oct. 21, 2008

**TRADEMARK
PRINCIPAL REGISTER**

TRIDENT XTRA CARE

CADBURY ADAMS USA LLC (DELAWARE LIMITED LIABILITY COMPANY)

389 INTERPACE PARKWAY

PARSIPPANY, NJ 07054

FOR: CHEWING GUM, IN CLASS 30 (U.S. CL. 46).

FIRST USE 4-28-2008; IN COMMERCE 4-28-2008.

THE MARK CONSISTS OF STANDARD CHARACTERS WITHOUT CLAIM TO ANY PARTICULAR FONT, STYLE, SIZE, OR COLOR.

OWNER OF U.S. REG. NOS. 591,356, 2,644,031, AND OTHERS.

SN 77-975,949, FILED 11-14-2006.

KATHY DE JONGE, EXAMINING ATTORNEY

Int. Cl.: 25

Prior U.S. Cls.: 22 and 39

United States Patent and Trademark Office

Reg. No. 3,522,388

Registered Oct. 21, 2008

**TRADEMARK
PRINCIPAL REGISTER**

DISCOVER THE ALTERNATIVE

VIBRAM FIVEFINGERS, LLC (MASSACHU-
SETTS LIMITED LIABILITY COMPANY)
SUITE H3, DAMONMILL SQUARE
CONCORD, MA 01742

FOR: FOOTWEAR; CLOTHING, NAMELY, T-
SHIRTS, SHIRTS, SOCKS, IN CLASS 25 (U.S. CLS.
22 AND 39).

FIRST USE 4-1-2007; IN COMMERCE 4-1-2007.

THE MARK CONSISTS OF STANDARD CHAR-
ACTERS WITHOUT CLAIM TO ANY PARTICULAR
FONT, STYLE, SIZE, OR COLOR.

SN 77-975,962, FILED 3-23-2007.

MICHAEL KEATING, EXAMINING ATTORNEY

Int. Cl.: 42

Prior U.S. Cls.: 100 and 101

United States Patent and Trademark Office

Reg. No. 3,522,389

Registered Oct. 21, 2008

**SERVICE MARK
PRINCIPAL REGISTER**

ME.DIUM

ME.DIUM, INC. (DELAWARE CORPORATION)
1050 WALNUT STREET
SUITE 202
BOULDER, CO 80302

FOR: COMPUTER SERVICES, NAMELY, PROVIDING AN INTERNET SEARCH ENGINE FOR OBTAINING DATA ON A GLOBAL COMPUTER NETWORK; PROVIDING INDEXES OF INFORMATION, SITES AND OTHER INFORMATION AVAILABLE ON COMPUTER NETWORKS, IN CLASS 42 (U.S. CLS. 100 AND 101).

FIRST USE 4-0-2006; IN COMMERCE 4-0-2006.

THE MARK CONSISTS OF STANDARD CHARACTERS WITHOUT CLAIM TO ANY PARTICULAR FONT, STYLE, SIZE, OR COLOR.

SN 77-975,967, FILED 1-19-2007.

LINDA E. BLOHM, EXAMINING ATTORNEY

Int. Cl.: 5

Prior U.S. Cls.: 6, 18, 44, 46, 51, and 52

Reg. No. 3,522,390

United States Patent and Trademark Office

Registered Oct. 21, 2008

**TRADEMARK
PRINCIPAL REGISTER**

CLEAR SPRINGS

S. C. JOHNSON & SON, INC. (WISCONSIN CORPORATION)
1525 HOWE STREET
RACINE, WI 53403

THE MARK CONSISTS OF STANDARD CHARACTERS WITHOUT CLAIM TO ANY PARTICULAR FONT, STYLE, SIZE, OR COLOR.

FOR: AIR FRESHENERS, IN CLASS 5 (U.S. CLS. 6, 18, 44, 46, 51 AND 52).

SN 77-975,970, FILED 2-22-2007.

FIRST USE 7-17-2008; IN COMMERCE 7-17-2008.

SETH A. RAPPAPORT, EXAMINING ATTORNEY

Int. Cl.: 9

Prior U.S. Cls.: 21, 23, 26, 36, and 38

Reg. No. 3,522,391

United States Patent and Trademark Office

Registered Oct. 21, 2008

**TRADEMARK
PRINCIPAL REGISTER**

MEDIA EXCEL

MEDIA EXCEL, INC. (TEXAS CORPORATION)
3536 BEES CAVE RD.
SUITE 204
AUSTIN, TX 78746

FOR: COMPUTER SOFTWARE AND HARDWARE USED TO ENCODE AND DECODE DIGITAL AUDIO-VISUAL SIGNALS IN THE FIELD OF STREAMING MEDIA VIEWABLE ON A VIDEO DISPLAY INCLUDING VIDEO COMPRESSION AND MOTION ESTIMATION, FORMAT TRANSLA-

TION, AND PLATFORM-SPECIFIC IMPLEMENTATIONS, IN CLASS 9 (U.S. CLS. 21, 23, 26, 36 AND 38).

FIRST USE 2-0-2000; IN COMMERCE 2-0-2000.

NO CLAIM IS MADE TO THE EXCLUSIVE RIGHT TO USE "MEDIA", APART FROM THE MARK AS SHOWN.

SN 78-016,274, FILED 7-11-2000.

ARETHA SOMERVILLE, EXAMINING ATTORNEY

Int. Cl.: 9

Prior U.S. Cls.: 21, 23, 26, 36, and 38

Reg. No. 3,522,392

United States Patent and Trademark Office

Registered Oct. 21, 2008

**TRADEMARK
PRINCIPAL REGISTER**

AMOS

SPECTEC GROUP HOLDINGS LTD (CYPRUS
PRIVATE LIMITED LIABILITY COMPANY)
ANAXAGOROU 16
AGIA ZONI
P.C. 3031, LIMASSOL, CYPRUS

FOR: SOFTWARE FOR USE IN RELATION TO
TELECOMMUNICATION SERVICES, NAMELY,
COMPUTER SOFTWARE FOR MANAGING SHIP
AND FLEET TELECOMMUNICATIONS; COMPU-
TER COMMUNICATION SOFTWARE FOR USE IN
DATA AND MESSAGE COMMUNICATION RELA-
TED TO SHIP AND FLEET MANAGEMENT; COM-
MUNICATION SOFTWARE FOR USE IN SHIP AND
FLEET MANAGEMENT; APPARATUS, NAMELY,
COMPUTER HARDWARE FOR RECORDING,
TRANSMISSION AND REPRODUCTION OF
SOUND, DATA AND IMAGES; DATA PROCESSOR;

COMPUTERS; BLANK AND ENCODED CHIP
CARDS FOR USE FOR IDENTIFYING USERS OF
COMPUTERS FOR TELECOMMUNICATIONS;
COMPUTER CHIPS; COMPUTER PROGRAMS,
NAMELY, COMPUTER PROGRAMS FOR DATA-
BASE CREATION, MANAGEMENT AND MAINTEN-
ANCE FOR USE IN SHIP AND FLEET
MANAGEMENT; PROVIDING DOWNLOADABLE
SOFTWARE FOR PROCESSING, STORING AND
RETRIEVAL OF INFORMATION, IN CLASS 9 (U.S.
CLS. 21, 23, 26, 36 AND 38).

FIRST USE 1-1-1986; IN COMMERCE 7-7-1987.

SN 78-110,001, FILED 2-20-2002.

AMY HELLA, EXAMINING ATTORNEY

Int. Cls.: 9, 35, 36, and 38

Prior U.S. Cls.: 21, 23, 26, 36, 38, 100, 101, 102, and 104

Reg. No. 3,522,393

United States Patent and Trademark Office

Registered Oct. 21, 2008

**TRADEMARK
SERVICE MARK
PRINCIPAL REGISTER**

AXEUS

AXEUS, INC. (CALIFORNIA CORPORATION)
P. O. BOX 130026
CARLSBAD, CA 92013

FOR: COMPUTER HARDWARE AND SOFTWARE SYSTEM FOR FACILITATING BUSINESS TRANSACTIONS, NAMELY, ELECTRONIC AND NON-ELECTRONIC CASH REGISTERS, TIME CLOCKS, AUTOMATED TELLER MACHINES AND POINT-OF-SALE TERMINALS FOR USE IN DISPENSING CASH AND NON-CASH ITEMS, DEPOSITING OF FUNDS, PAYMENTS OF CHECKS, AND CONSUMMATING A VARIETY OF ELECTRONIC TRANSFERS OF FUNDS; CALCULATING MACHINES; DATA PROCESSING EQUIPMENT, NAMELY, DATA PROCESSORS AND COMPUTERS; MAGNETIC ENCODED CARDS; MAGNETIC IDENTITY CARDS; MAGNETIC DATA CARRIERS CONTAINING RECORDED INFORMATION AND DATA RELATED TO ELECTRONIC PAYMENTS; COMPUTER SOFTWARE FOR THE MANAGEMENT OF SCANNABLE PRODUCT FILES AND DATA; NAMELY, FILE MAINTENANCE AND PRICING SOFTWARE FOR CASH REGISTERS; COMPUTER SOFTWARE FOR USE IN CASH REGISTERS, INVENTORY MANAGEMENT, AND ACCOUNTING, COMPUTER SOFTWARE UTILITIES, COMPUTER SOFTWARE FOR TEXT PROCESSING; COMPUTER SOFTWARE PROVIDING INTERFACES TO A VARIETY OF POINT-OF-SALE DEVICES FOR AUTOMATICALLY TRANSFERRING SALES DATA FROM THE POINT-OF-SALE TO A CENTRAL COMPUTER, FOR GENERATING REPORTS, FOR SENDING PLUS, UPCS, DEPARTMENTS AND PRICES TO

CASH REGISTERS, AND FOR MONITORING SALES, PURCHASE AND INVENTORY, FOR USE IN AUTOMATING A STORE AND THE STORE MANAGER'S DAILY ACTIVITIES, IN CLASS 9 (U.S. CLS. 21, 23, 26, 36 AND 38).

FIRST USE 6-8-1999; IN COMMERCE 6-8-1999.

FOR: PAYROLL SERVICES, NAMELY, PAYROLL PREPARATION SERVICES, PAYROLL PROCESSING SERVICES, IN CLASS 35 (U.S. CLS. 100, 101 AND 102).

FIRST USE 11-22-2004; IN COMMERCE 11-22-2004.

FOR: PAYROLL TAX DEBITING SERVICES, IN CLASS 36 (U.S. CLS. 100, 101 AND 102).

FIRST USE 11-22-2004; IN COMMERCE 11-22-2004.

FOR: ELECTRONIC TRANSMISSION OF BANKING AND FINANCIAL INFORMATION, COMMUNICATIONS BY TELEPHONE BY RECEPTION OR BY EMISSION, BY VOICE RESPONSE AND BY ELECTRONIC MEANS; ELECTRONIC TRANSMISSION OF SECURED MESSAGES AND IMAGES BY COMPUTER TERMINALS, IN CLASS 38 (U.S. CLS. 100, 101 AND 104).

FIRST USE 6-8-1999; IN COMMERCE 6-8-1999.

SN 78-187,096, FILED 11-20-2002.

SUE LAWRENCE, EXAMINING ATTORNEY

Int. Cl.: 1

Prior U.S. Cls.: 1, 5, 6, 10, 26, and 46

United States Patent and Trademark Office

Reg. No. 3,522,394

Registered Oct. 21, 2008

**TRADEMARK
PRINCIPAL REGISTER**

ECOGUARD

CHEMGUARD, INC. (TEXAS CORPORATION)
204 S. 6TH AVENUE
MANSFIELD, TX 76063

FIRST USE 8-4-2008; IN COMMERCE 8-4-2008.

SN 78-212,586, FILED 2-8-2003.

FOR: CHEMICALS FOR USE IN CONTROLLING
AND EXTINGUISHING FIRES, IN CLASS 1 (U.S.
CLS. 1, 5, 6, 10, 26 AND 46).

KEVON CHISOLM, EXAMINING ATTORNEY

Int. Cl.: 21

Prior U.S. Cls.: 2, 13, 23, 29, 30, 33, 40, and 50

United States Patent and Trademark Office

Reg. No. 3,522,395

Registered Oct. 21, 2008

**TRADEMARK
PRINCIPAL REGISTER**

EUROCLASSIQUE

RISEN, PAUL, M. (UNITED STATES INDIVIDUAL)
P.O. BOX 77577
GREENSBORO, NC 27417

FIRST USE 2-1-2008; IN COMMERCE 2-1-2008.

SN 78-222,194, FILED 3-5-2003.

FOR: TOWEL BARS AND RINGS AND TOILET PAPER HOLDERS, IN CLASS 21 (U.S. CLS. 2, 13, 23, 29, 30, 33, 40 AND 50).

DAVID HOFFMAN, EXAMINING ATTORNEY

Prior U.S. Cl.: 200

United States Patent and Trademark Office

Reg. No. 3,522,396

Registered Oct. 21, 2008

**COLLECTIVE MEMBERSHIP
PRINCIPAL REGISTER**



THE MARMON GROUP LLC (DELAWARE LIMITED LIABILITY COMPANY)
26TH FLOOR
181 WEST MADISON STREET
CHICAGO, IL 60602

FOR: TO INDICATE MEMBERSHIP IN AN ORGANIZATION COMPOSED OF MANUFACTURERS AND DISTRIBUTORS OF ORIGINAL EQUIPMENT MANUFACTURER AND AFTERMARKET TRUCK AND AUTOMOTIVE PARTS AND COMPONENTS, TRUCK TRAILERS AND RELATED GOODS, IN CLASS 200 (U.S. CL. 200).

FIRST USE 7-17-2008; IN COMMERCE 7-17-2008.

THE MARK CONSISTS OF THREE VERTICAL SHADED RECTANGLES WHICH ARE SLANTED, TO THE LEFT TO THE LETTERS "MHT" IN ALL CAPS.

SN 78-274,029, FILED 7-14-2003.

ODESSA BIBBINS, EXAMINING ATTORNEY

Int. Cls.: 18 and 20

Prior U.S. Cls.: 1, 2, 3, 13, 22, 25, 32, 41, and 50

United States Patent and Trademark Office

Reg. No. 3,522,397

Registered Oct. 21, 2008

**TRADEMARK
PRINCIPAL REGISTER**

TECTONA

TECTONA (FRANCE JOINT STOCK COMPANY)
36 RUE DU BAC
PARIS, FRANCE 75007

FOR: PARASOLS, IN CLASS 18 (U.S. CLS. 1, 2, 3, 22 AND 41).

FIRST USE 8-31-1981; IN COMMERCE 4-30-1990.

FOR: NON-METAL DUCKBOARDS, NON-METAL BINS, BINS OF WOOD AND/OR PLASTIC, CASES OF WOOD AND/OR PLASTIC FOR STORAGE OR TRANSPORT; CASES OF WOOD AND/OR PLASTIC FOR PLANTS AND/OR FLOWERS, TABLES, SEATS, EASY CHAIRS, ARMCHAIRS,

BENCHES, CUSHIONS, MATTRESSES, KENNELS FOR DOGS, NON METAL FLOWER-STANDS, FLOWER-STANDS OF WOOD AND/OR PLASTIC, SCREENS, OUTDOOR FURNITURE, FURNITURE, IN CLASS 20 (U.S. CLS. 2, 13, 22, 25, 32 AND 50).

FIRST USE 8-31-1981; IN COMMERCE 4-30-1990.

OWNER OF U.S. REG. NO. 2,352,729.

SN 78-278,483, FILED 7-24-2003.

CHRISTOPHER BUONGIORNO, EXAMINING ATTORNEY

Int. Cl.: 12

Prior U.S. Cls.: 19, 21, 23, 31, 35, and 44

Reg. No. 3,522,398

United States Patent and Trademark Office

Registered Oct. 21, 2008

**TRADEMARK
PRINCIPAL REGISTER**

PREMA

PREMA PRODUCTS, INC. (DELAWARE CORPORATION)
119 ROCKLAND AVENUE
NORTHVALE, NJ 07647

FOR: STRUCTURAL VEHICLE PARTS, NAMELY, TIRE PATCHES, PLASTERS, GAITERS, STRIPS, FOILS, INSERTS AND PLUGS WITH OR WITHOUT VALVES, FOR REPAIRING RUBBER VEHICLE GOODS SUCH AS TIRES, TUBES, PONTOONS, AND BELTS; VALVES FOR VEHICLE TIRES AND TUBES, NAMELY, METAL VALVES, PLASTIC VALVES AND SNAP-ON VALVES, AND ACCESSORIES THEREFORE, NAMELY, RUBBER VALVE BASES, VALVE CAPS, VALVE EXTENSIONS, DEFLATION CONNECTORS AND SNAP-ON VALVE ADAPTERS; BALANCING WEIGHTS FOR VEHICLE WHEELS; REPAIR KITS FOR CONTAINING

FOR REPAIRING RUBBER VEHICLE GOODS SUCH AS TIRES, TUBES, PONTOONS, AND BELTS COMPRISED OF TIRE PATCHES, PATCHES, PLASTERS, GAITERS, STRIPS, FOILS, INSERTS, PLUGS, BALANCING BEADS, HAND OPERATED APPLICATOR AND RETREADING TOOLS, AND ABRASIVE, ADHESIVE AND VULCANIZING MATERIALS, IN CLASS 12 (U.S. CLS. 19, 21, 23, 31, 35 AND 44).

FIRST USE 7-28-2004; IN COMMERCE 7-28-2004.

SN 78-289,036, FILED 8-19-2003.

JOHN SCHUYLER YARD, EXAMINING ATTORNEY

Int. Cl.: 17

Prior U.S. Cls.: 1, 5, 12, 13, 35, and 50

Reg. No. 3,522,399

United States Patent and Trademark Office

Registered Oct. 21, 2008

**TRADEMARK
PRINCIPAL REGISTER**

PREMA

PREMA PRODUCTS, INC. (DELAWARE CORPORATION)
119 ROCKLAND AVENUE
NORTHVALE, NJ 07647

FOR: REPAIR MATERIAL COMPOSED OF RUBBER AND SYNTHETIC RUBBER IN THE FORM OF STRIPS, BLANKS, INSERTS, PATCHES, PLUGS, GAITERS, STRINGS, SHEETS, FOILS, SLEEVES AND INLETS, ALL SOLD SEPARATELY AND IN KITS WITH ONE OR MORE OF VULCANIZING FLUIDS, BONDING FLUIDS, PASTES, CEMENTS, COMPOUNDS AND TOOLS FOR USE IN REPAIRING PUNCTURES AND RIPS IN ARTICLES MADE OF RUBBER AND SYNTHETIC MATERIALS, NAMELY, TIRES, TUBES, CONVEYOR BELTS, DINGHIES, COLLAPSIBLE BOATS, PONTOONS, RUBBER AND PVC CABLES, AIR-BEDS, TENTS, TENT SQUARES, CANVAS HOODS, TARPAULINS, INDUSTRIAL CLOTHING, SPORTSWEAR, CLOTHING FOR BAD WEATHER, PROTECTIVE CLOTHING, CURING TUBES, AIR BAGS, AND FIRE HOSES; RUBBER AND SYNTHETIC RUBBER IN THE FORM OF SHEETINGS, FOILS, BARS, CLEATS, STRINGS, INSERTS, COVERS, COATINGS, SLEEVES, CUT-OUTS, LAGGINGS, LININGS AND CYLINDERS, ALL FOR USE AS PROTECTION AGAINST WEAR, ABRASION, CORROSION AND

NOISE FOR STORAGE BINS, HOPPERS, SILOS, BUNKERS, WASHING DRUMS, IDLERS, PULLEYS, THE INNER AND OUTER SURFACES OF PIPES, BALL MILLS, ROD MILLS, AUTOGENOUS MILLS, CHUTES, CRUSHERS, ELEVATOR BUCKETS, CONVEYOR BUCKETS, BUCKET LOADERS, TRUCK LOADING AREAS, SCREENING MACHINES AND CONCRETE MIXERS; SIFTING SCREENS AND SCREEN MATS OF RUBBER AND SYNTHETIC MATERIAL; RUBBER CLEATS, RUBBER SKIRTINGS AND RUBBER SCRAPERS FOR USE ON CONVEYOR BELTS; RUBBER PLATES EMBEDDED WITH CERAMICS, POLYETHYLENE, POLYURETHANE AND POLYTETRAFLUOROETHYLENE TO BE USED AS LINING AND LAGGING MATERIAL FOR CONTAINERS, STORAGE BINS, PIPES, PULLEYS, VIBRATORY FEEDERS, SKIPS, AND DEDUSTING CYCLONES, IN CLASS 17 (U.S. CLS. 1, 5, 12, 13, 35 AND 50).

FIRST USE 9-15-2004; IN COMMERCE 9-15-2004.

SN 78-289,044, FILED 8-19-2003.

JOHN SCHUYLER YARD, EXAMINING ATTORNEY

Int. Cl.: 25

Prior U.S. Cls.: 22 and 39

United States Patent and Trademark Office

Reg. No. 3,522,400

Registered Oct. 21, 2008

**TRADEMARK
PRINCIPAL REGISTER**

WALT DISNEY WORLD

DISNEY ENTERPRISES, INC. (DELAWARE CORPORATION)
500 SOUTH BUENA VISTA STREET
BURBANK, CA 91521

FOR: CLOTH BIBS FOR BABIES; SWEATERS; DRESSES; INFANT WEAR; PAJAMAS; PANTS; SWEAT PANTS; SWEAT SHIRTS; SHIRTS; SHOES; SHORTS; SLEEPERS; SOCKS; TANK TOPS; JERSEYS; SCARVES; NECKTIES; NIGHT GOWNS; HEAD BANDS; SKIRTS; COATS; SLIPPERS; SANDALS; RAINWEAR, IN CLASS 25 (U.S. CLS. 22 AND 39).

FIRST USE 12-0-1976; IN COMMERCE 12-0-1976.

OWNER OF U.S. REG. NOS. 980,995, 1,189,727, AND 2,189,177.

THE NAME IN THE MARK DOES NOT IDENTIFY A PARTICULAR LIVING INDIVIDUAL.

SN 78-316,594, FILED 10-21-2003.

PAUL F. GAST, EXAMINING ATTORNEY

Int. Cl.: 28

Prior U.S. Cls.: 22, 23, 38, and 50

United States Patent and Trademark Office

Reg. No. 3,522,401

Registered Oct. 21, 2008

**TRADEMARK
PRINCIPAL REGISTER**

WALT DISNEY WORLD

DISNEY ENTERPRISES, INC. (DELAWARE CORPORATION)
500 SOUTH BUENA VISTA STREET
BURBANK, CA 91521

FOR: RUBBER ACTION BALLS; ACTION SKILL GAMES; BEAN BAG DOLLS; BATH TOYS; CHRISTMAS TREE ORNAMENTS; BOARD GAMES; EQUIPMENT SOLD AS A UNIT FOR PLAYING CARD GAMES; PLAYING CARDS; DOLLS AND DOLL CLOTHING; DOLL PLAYSETS; CHILDREN'S PLAY COSMETICS; ELECTRIC ACTION TOYS; MANIPULATIVE GAMES; JIGSAW PUZZLES; PARTY FAVORS IN THE NATURE OF SMALL TOYS; INFLATABLE POOL TOYS; TARGET GAMES; TOY BOWS AND ARROWS; MODEL TOY CARS; MODEL TOY TRUCKS; TOY GUNS; TOY HOLSTERS; MU-

SICAL TOYS; HAND-HELD UNIT FOR PLAYING ELECTRONIC GAMES; TALKING TOYS, IN CLASS 28 (U.S. CLS. 22, 23, 38 AND 50).

FIRST USE 8-0-1993; IN COMMERCE 8-0-1993.

OWNER OF U.S. REG. NOS. 980,995, 1,189,727, AND 2,189,177.

THE NAME IN THE MARK DOES NOT IDENTIFY A PARTICULAR LIVING INDIVIDUAL.

SN 78-316,597, FILED 10-21-2003.

PAUL F. GAST, EXAMINING ATTORNEY

Int. Cl.: 29

Prior U.S. Cl.: 46

United States Patent and Trademark Office

Reg. No. 3,522,402

Registered Oct. 21, 2008

**TRADEMARK
PRINCIPAL REGISTER**

WALT DISNEY WORLD

DISNEY ENTERPRISES, INC. (DELAWARE CORPORATION)
500 SOUTH BUENA VISTA STREET
BURBANK, CA 91521

FOR: CANDIED, ROASTED AND SHELLED
NUTS, IN CLASS 29 (U.S. CL. 46).

FIRST USE 3-0-2005; IN COMMERCE 3-0-2005.

OWNER OF U.S. REG. NOS. 980,995, 1,189,727,
AND 2,189,177.

THE NAME IN THE MARK DOES NOT IDENTIFY
A PARTICULAR LIVING INDIVIDUAL.

SN 78-316,600, FILED 10-21-2003.

PAUL F. GAST, EXAMINING ATTORNEY

Int. Cl.: 42

Prior U.S. Cls.: 100 and 101

United States Patent and Trademark Office

Reg. No. 3,522,403

Registered Oct. 21, 2008

**SERVICE MARK
PRINCIPAL REGISTER**

POCKETREP

DATAFORCE, INC. (COLORADO CORPORATION)
246 W. WALNUT STREET
LOUISVILLE, CO 80027

FOR: PROVIDING TEMPORARY USE OF ONLINE NON-DOWNLOADABLE SOFTWARE THAT ALLOWS SALES FORCE PERSONNEL TO GATHER, STORE, AND INDEX INFORMATION AND PREPARE REPORTS IN THE FIELDS OF CUSTOMER RELATIONSHIP MANAGEMENT AND SALES FORCE AUTOMATION; AND APPLICATION SERVICE PROVIDER FEATURING SOFTWARE THAT ALLOWS SALES FORCE PERSONNEL TO GATHER, STORE, AND INDEX INFORMATION AND PRE-

PARE REPORTS IN THE FIELDS OF CUSTOMER RELATIONSHIP MANAGEMENT AND SALES FORCE AUTOMATION, IN CLASS 42 (U.S. CLS. 100 AND 101).

FIRST USE 12-9-1999; IN COMMERCE 12-9-1999.

THE MARK CONSISTS OF STANDARD CHARACTERS WITHOUT CLAIM TO ANY PARTICULAR FONT, STYLE, SIZE, OR COLOR.

SN 78-318,615, FILED 10-25-2003.

LOURDES AYALA, EXAMINING ATTORNEY

Int. Cl.: 41

Prior U.S. Cls.: 100, 101, and 107

United States Patent and Trademark Office

Reg. No. 3,522,404

Registered Oct. 21, 2008

**SERVICE MARK
PRINCIPAL REGISTER**

**PERISCOPE
ENTERTAINMENT**

LEVY, DAVID G. (UNITED STATES INDIVIDUAL)
ROOM 1610 655 THIRD AVENUE
NEW YORK, NY 10017

FOR: MOTION PICTURE FILM PRODUCTION SERVICES, IN CLASS 41 (U.S. CLS. 100, 101 AND 107).

FIRST USE 1-22-2008; IN COMMERCE 1-22-2008.

THE MARK CONSISTS OF STANDARD CHARACTERS WITHOUT CLAIM TO ANY PARTICULAR FONT, STYLE, SIZE, OR COLOR.

NO CLAIM IS MADE TO THE EXCLUSIVE RIGHT TO USE "ENTERTAINMENT", APART FROM THE MARK AS SHOWN.

SN 78-331,499, FILED 11-21-2003.

GEORGIA CARTY, EXAMINING ATTORNEY

Int. Cl.: 42

Prior U.S. Cls.: 100 and 101

United States Patent and Trademark Office

Reg. No. 3,522,405

Registered Oct. 21, 2008

**SERVICE MARK
PRINCIPAL REGISTER**

GENSTRUCT

GENSTRUCT, INC. (DELAWARE CORPORATION)
ONE ALEWIFE CENTER
CAMBRIDGE, MA 02140

FOR: BIOLOGICAL AND CHEMICAL RESEARCH IN THE LIFE SCIENCES FIELD, INCLUDING PRIMARILY THE FIELDS OF BIOLOGY, GENOMICS, PROTEOMICS AND PHARMACEUTICALS; DEVELOPMENT, VALIDATION AND TESTING OF RESEARCH RESULTS AND RELATED THEORIES IN THE LIFE SCIENCES FIELD, INCLUDING PRIMARILY THE FIELDS OF BIOLOGY, GENOMICS, PROTEOMICS AND PHARMACEUTICALS; PHARMACEUTICAL DRUG DISCOVERY, DESIGN, TESTING AND FORMULATION FOR OTHERS; COMPUTER SERVICES, NAMELY, DA-

TABASE DESIGN AND DEVELOPMENT SERVICES FOR OTHERS AND DESIGN AND DEVELOPMENT OF COMPUTER PRODUCTS IN THE FIELDS OF ARTIFICIAL INTELLIGENCE AND ARTIFICIAL REASONING; DATA MINING, IN CLASS 42 (U.S. CLS. 100 AND 101).

FIRST USE 1-22-2007; IN COMMERCE 1-22-2007.

THE MARK CONSISTS OF STANDARD CHARACTERS WITHOUT CLAIM TO ANY PARTICULAR FONT, STYLE, SIZE, OR COLOR.

SN 78-340,870, FILED 12-15-2003.

JERI J. FICKES, EXAMINING ATTORNEY

Int. Cl.: 7

Prior U.S. Cls.: 13, 19, 21, 23, 31, 34, and 35

United States Patent and Trademark Office

Reg. No. 3,522,406

Registered Oct. 21, 2008

**TRADEMARK
PRINCIPAL REGISTER**

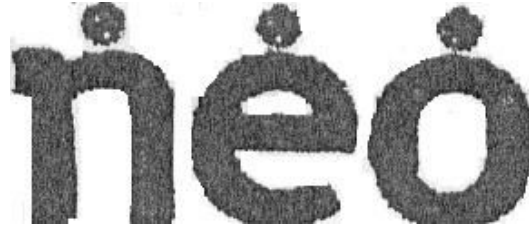

MARCONI, GABRIEL MAXIMILIANO (ARGENTINA INDIVIDUAL)
15200 GRAL. PAZ AVENUE, 1* FLOOR
BUENOS AIRES CITY, ARGENTINA ARGENTINA

FOR: POWER-OPERATED MACHINE TOOLS, NAMELY, ROUTERS, SAWS, DRILLS, AND GRINDERS, EXCLUDING POSTAL, MAILING OR SORTING MACHINES, IN CLASS 7 (U.S. CLS. 13, 19, 21, 23, 31, 34 AND 35).

FIRST USE 7-1-2003; IN COMMERCE 12-31-2003.

PRIORITY CLAIMED UNDER SEC. 44(D) ON ARGENTINA APPLICATION NO. 2441330, FILED 7-1-2003.

THE TRANSLATION OF NEO IS "RECENT".

SN 78-346,821, FILED 12-31-2003.

MARILYN IZZI, EXAMINING ATTORNEY

Int. Cl.: 9

Prior U.S. Cls.: 21, 23, 26, 36, and 38

Reg. No. 3,522,407

United States Patent and Trademark Office

Registered Oct. 21, 2008

**TRADEMARK
PRINCIPAL REGISTER**

STRATEGY SPORTS

SONY PICTURES DIGITAL PRODUCTION INC.
(DELAWARE CORPORATION)
10202 W. WASHINGTON BLVD.
CULVER CITY, CA 90232

FOR: DOWNLOADABLE WIRELESS GAME
SOFTWARE THAT CAN BE PLAYED ON HAND-
HELD ELECTRONIC GAME UNITS; AND COMPU-
TER GAME SOFTWARE, IN CLASS 9 (U.S. CLS. 21,
23, 26, 36 AND 38).

FIRST USE 6-30-2004; IN COMMERCE 6-30-2004.

THE MARK CONSISTS OF STANDARD CHAR-
ACTERS WITHOUT CLAIM TO ANY PARTICULAR
FONT, STYLE, SIZE, OR COLOR.

SN 78-350,577, FILED 1-12-2004.

ELISSA GARBER KON, EXAMINING ATTORNEY

Int. Cls.: 30 and 43

Prior U.S. Cls.: 46, 100, and 101

United States Patent and Trademark Office

Reg. No. 3,522,408

Registered Oct. 21, 2008

TRADEMARK
SERVICE MARK
PRINCIPAL REGISTER



Arthemia

CPQ BRASIL S.A. (BRAZIL COMPANY)
RODOVIA AKZO NOBEL
2250 - SAO ROQUE DA CHAVE
ITUPEVA, SP, BRAZIL 13295-470

FOR: DIFFERENT FLAVORS OF SALTED AND SWEET FOOD PREPARED WITH PUFF PASTRY, NAMELY, BAKERY GOODS ;DIFFERENT FLAVORS OF SALTED AND SWEET PIES;PIES;COCOA-BASED BEVERAGES; TEA; TEA-BASED BEVERAGES, NAMELY, BEVERAGES MADE OF TEA; ICED TEA; CHOCOLATE-BASED BEVERAGES, NAMELY, CHOCOLATE FOOD BEVERAGES NOT BEING DAIRY OR VEGETABLE BASED; COOKIES; CAKES, BROWNIES; COFFEE; PREPARED COFFEE AND COFFEE-BASED BEVERAGES; COFFEE BEVERAGES WITH MILK;EDIBLE ICES; CANDY; FROZEN YOGURT; PASTE AND POWDER FOR CHEESE BREAD; CHEESE BREAD; BREAD ROLLS; BREAD; PASTRY; POWDERS FOR ICE CREAM, IN CLASS 30 (U.S. CL. 46).

FIRST USE 1-7-2008; IN COMMERCE 1-7-2008.

FOR: CONTRACT FOOD SERVICES; BAR SERVICES; RESTAURANTS; SNACK-BARS; FOOD AND DRINK CATERING; CAFES; CAFETERIAS; CANTEENS, IN CLASS 43 (U.S. CLS. 100 AND 101).

FIRST USE 1-7-2008; IN COMMERCE 1-7-2008.

THE PORTRAIT IN THE MARK DOES NOT IDENTIFY A LIVING INDIVIDUAL.

THE COLOR(S) DARK GREEN, YELLOW AND WHITE IS/ARE CLAIMED AS A FEATURE OF THE MARK.

THE MARK CONSISTS OF AN ILLUSTRATION IN DARK GREEN AND WHITE OF A WOMAN WEARING GLASSES HOLDING A MIXING BOWL, WITH A YELLOW BACKGROUND.

SN 78-375,544, FILED 2-27-2004.

SAMUEL E. SHARPER JR., EXAMINING ATTORNEY

Int. Cl.: 5

Prior U.S. Cls.: 6, 18, 44, 46, 51, and 52

United States Patent and Trademark Office

Reg. No. 3,522,409

Registered Oct. 21, 2008

**TRADEMARK
PRINCIPAL REGISTER**

**METABOLIC
TARGETING**

THRESHOLD PHARMACEUTICALS, INC. (DE-
LAWARE CORPORATION)
1300 SEAPORT BOULEVARD
5TH FLOOR
REDWOOD CITY, CA 94063

FOR: PHARMACEUTICAL PREPARATIONS FOR
THE TREATMENT OF CANCER; HOUSEMARK
FOR A FULL LINE OF PHARMACEUTICAL PRO-
DUCTS, IN CLASS 5 (U.S. CLS. 6, 18, 44, 46, 51 AND
52).

FIRST USE 7-31-2007; IN COMMERCE 7-31-2007.

THE MARK CONSISTS OF STANDARD CHAR-
ACTERS WITHOUT CLAIM TO ANY PARTICULAR
FONT, STYLE, SIZE, OR COLOR.

SN 78-389,595, FILED 3-23-2004.

CAROLYN GRAY, EXAMINING ATTORNEY

Int. Cl.: 16

Prior U.S. Cls.: 2, 5, 22, 23, 29, 37, 38, and 50

Reg. No. 3,522,410

United States Patent and Trademark Office

Registered Oct. 21, 2008

**TRADEMARK
PRINCIPAL REGISTER**

CASE CLOSED

SHOGAKUKAN PRODUCTIONS CO., LTD. (JAPAN CORPORATION)
SHOWA BUILDING, 2-30 KANDA JINBOCHO
CHIYODA-KU, TOKYO, JAPAN 101-8415

FOR: PAPER GOODS AND PRINTED MATTER, NAMELY, COMIC BOOKS FEATURING COMIC STRIPS AND SCIENCE FICTION THEMES, STORIES AND CHARACTERS; A SERIES OF FICTION BOOKS FEATURING STORIES ON COMIC STRIPS AND SCIENCE FICTION THEMES, STORIES AND CHARACTERS IN ILLUSTRATED FORMS; NOVELS FEATURING GRAPHICAL ILLUSTRATIONS; GRAPHIC NOVELS; TRADING CARDS AND COLLECTORS CARDS FEATURING COMIC BOOK,

COMIC STRIP, CARTOON CHARACTERS; CALENDARS, IN CLASS 16 (U.S. CLS. 2, 5, 22, 23, 29, 37, 38 AND 50).

FIRST USE 8-4-2004; IN COMMERCE 8-4-2004.

THE MARK CONSISTS OF STANDARD CHARACTERS WITHOUT CLAIM TO ANY PARTICULAR FONT, STYLE, SIZE, OR COLOR.

SN 78-394,448, FILED 3-31-2004.

DAVID MURRAY, EXAMINING ATTORNEY

Int. Cl.: 28

Prior U.S. Cls.: 22, 23, 38, and 50

Reg. No. 3,522,411

United States Patent and Trademark Office

Registered Oct. 21, 2008

**TRADEMARK
PRINCIPAL REGISTER**

CASE CLOSED

SHOGAKUKAN PRODUCTIONS CO., LTD. (JAPAN CORPORATION)
SHOWA BUILDING, 2-30 KANDA JINBOCHO
CHIYODA-KU, TOKYO, JAPAN 101-8415

THE MARK CONSISTS OF STANDARD CHARACTERS WITHOUT CLAIM TO ANY PARTICULAR FONT, STYLE, SIZE, OR COLOR.

FOR: TOYS, NAMELY, CARD GAMES, IN CLASS 28 (U.S. CLS. 22, 23, 38 AND 50).

SN 78-394,451, FILED 3-31-2004.

FIRST USE 6-20-2005; IN COMMERCE 6-20-2005.

DAVID MURRAY, EXAMINING ATTORNEY

Int. Cl.: 33

Prior U.S. Cls.: 47 and 49

United States Patent and Trademark Office

Reg. No. 3,522,412

Registered Oct. 21, 2008

**TRADEMARK
PRINCIPAL REGISTER**

JAMAICAN COWBOY

TEXAS ROADHOUSE DELAWARE LLC (DELA-
WARE LIMITED LIABILITY COMPANY)
6040 DUTCHMANS LANE, SUITE 400
LOUISVILLE, KY 40205

FOR: ALCOHOLIC BEVERAGES, NAMELY, PRE-
PARED COCKTAILS, IN CLASS 33 (U.S. CLS. 47 AND
49).

FIRST USE 12-31-2002; IN COMMERCE 12-31-2002.

THE MARK CONSISTS OF STANDARD CHAR-
ACTERS WITHOUT CLAIM TO ANY PARTICULAR
FONT, STYLE, SIZE, OR COLOR.

SN 78-400,099, FILED 4-12-2004.

CHRISTOPHER BUONGIORNO, EXAMINING AT-
TORNEY

Int. Cl.: 9

Prior U.S. Cls.: 21, 23, 26, 36, and 38

Reg. No. 3,522,413

United States Patent and Trademark Office

Registered Oct. 21, 2008

**TRADEMARK
PRINCIPAL REGISTER**

BOTTLELOX

PLESCON LIMITED (UNITED KINGDOM CORPORATION)
UNIT 9, SPROUGHTON BUSINESS PARK
FARTHING ROAD
IPSWICH, SUFFOLK IPI 5AP, UNITED KINGDOM

FOR: ANTI-THEFT SECURITY DEVICES AND ACCESS RESTRICTING DEVICES FOR USE WITH CONTAINERS AND BOTTLES, NAMELY, AN ELECTRONIC TRIGGERING DEVICE FOR PROTECTING AND SECURING CONTAINERS AND BOTTLES FROM THEFT AND RELEASE DEVICES FOR USE THEREWITH, IN CLASS 9 (U.S. CLS. 21, 23, 26, 36 AND 38).

FIRST USE 4-10-2008; IN COMMERCE 4-10-2008.

THE MARK CONSISTS OF STANDARD CHARACTERS WITHOUT CLAIM TO ANY PARTICULAR FONT, STYLE, SIZE, OR COLOR.

PRIORITY CLAIMED UNDER SEC. 44(D) ON ERPN CMNTY TM OFC APPLICATION NO. 003601242, FILED 1-22-2004, REG. NO. 003601242, DATED 5-25-2005, EXPIRES 1-22-2014.

SN 78-401,427, FILED 4-14-2004.

JENNY PARK, EXAMINING ATTORNEY

Int. Cl.: 9

Prior U.S. Cls.: 21, 23, 26, 36, and 38

Reg. No. 3,522,414

United States Patent and Trademark Office

Registered Oct. 21, 2008

TRADEMARK
PRINCIPAL REGISTER



A-DATA TECHNOLOGY CO., LTD. (TAIWAN CORPORATION)
18F, NO. 258, LIAN CHENG RD.
CHUNG HO CITY, TAIPEI, TAIWAN

FOR: COMPUTER HARDWARE, NAMELY, COMPUTER MEMORIES AND COMPUTER MEMORY MODULES, MEMORY CARDS, COMPACT DISC READ ONLY MEMORY DRIVES, DISC DRIVES FOR COMPUTERS, MAGNETIC DISK DRIVES, FLASH MEMORIES, USB FLASH MEMORY DRIVES, INTERFACE CARDS FOR COMPUTERS, INTEGRATED CIRCUITS, INTEGRATED CIRCUIT BOARDS, SEMICONDUCTORS, CAMERAS, DIGI-

TAL CAMERAS, VIDEO CAMERAS, IN CLASS 9 (U.S. CLS. 21, 23, 26, 36 AND 38).

FIRST USE 6-0-2003; IN COMMERCE 4-30-2004.

THE MARK CONSISTS OF "MY FLASH MY FLASH, MY LIFE" STYLIZED WITH A BLACK BACKGROUND DESIGN.

SN 78-401,493, FILED 4-14-2004.

SOPHIA S. KIM, EXAMINING ATTORNEY

Int. Cl.: 44

Prior U.S. Cls.: 100 and 101

United States Patent and Trademark Office

Reg. No. 3,522,415

Registered Oct. 21, 2008

**SERVICE MARK
PRINCIPAL REGISTER**

**SYSCO HEALTHY AND
POSITIVE EATING**

SYSCO CORPORATION (DELAWARE CORPORATION)
1390 ENCLAVE PARKWAY
HOUSTON, TX 770771390

FOR: CONSULTING SERVICES RELATED TO MENU PLANNING, HEALTHY EATING AND HEALTHY COOKING; PROVIDING INFORMATION ON FOOD NUTRITION, HEALTHY EATING AND HEALTHY COOKING, IN CLASS 44 (U.S. CLS. 100 AND 101).

FIRST USE 1-1-2004; IN COMMERCE 1-1-2004.

THE MARK CONSISTS OF STANDARD CHARACTERS WITHOUT CLAIM TO ANY PARTICULAR FONT, STYLE, SIZE, OR COLOR.

OWNER OF U.S. REG. NOS. 2,804,989, 2,810,655, AND OTHERS.

NO CLAIM IS MADE TO THE EXCLUSIVE RIGHT TO USE "HEALTHY AND POSITIVE EATING", APART FROM THE MARK AS SHOWN.

SN 78-402,100, FILED 4-15-2004.

BRIDGETT SMITH, EXAMINING ATTORNEY

Int. Cls.: 1, 2, 3, 9, 16, and 20

**Prior U.S. Cls.: 1, 2, 4, 5, 6, 10, 11, 13, 16, 21, 22, 23,
25, 26, 29, 32, 36, 37, 38, 46, 50, 51, and 52**

Reg. No. 3,522,416

Registered Oct. 21, 2008

United States Patent and Trademark Office

**TRADEMARK
PRINCIPAL REGISTER**

WOODSMART

BEHR PROCESS CORPORATION (CALIFORNIA
CORPORATION)
3400 W. SEGERSTROM AVENUE
SANTA ANA, CA 92704

FOR: WATERPROOFING CHEMICAL COMPOSITIONS FOR USE ON WOOD, IN CLASS 1 (U.S. CLS. 1, 5, 6, 10, 26 AND 46).

FIRST USE 6-0-2004; IN COMMERCE 6-0-2004.

FOR: COATINGS IN THE NATURE OF STAINS, AND SEALERS FOR USE ON WOOD, IN CLASS 2 (U.S. CLS. 6, 11 AND 16).

FIRST USE 6-0-2004; IN COMMERCE 6-0-2004.

FOR: WOOD STRIPPING AND CLEANING PREPARATIONS, IN CLASS 3 (U.S. CLS. 1, 4, 6, 50, 51 AND 52).

FIRST USE 6-0-2004; IN COMMERCE 6-0-2004.

FOR: INTERACTIVE COMPUTER TERMINALS AND PROGRAMS FOR DISPLAYING INSTRUCTIONAL VIDEOS ON WOOD STAINING AND WA-

TERPROOFING TECHNIQUES, IN CLASS 9 (U.S. CLS. 21, 23, 26, 36 AND 38).

FIRST USE 6-0-2004; IN COMMERCE 6-0-2004.

FOR: PRINTED CARDS FEATURING STAIN COLOR SAMPLES, IN CLASS 16 (U.S. CLS. 2, 5, 22, 23, 29, 37, 38 AND 50).

FIRST USE 6-0-2004; IN COMMERCE 6-0-2004.

FOR: FURNITURE, NAMELY, KIOSKS FOR DISPLAYING WOOD STAIN COLOR SAMPLES, IN CLASS 20 (U.S. CLS. 2, 13, 22, 25, 32 AND 50).

FIRST USE 6-0-2004; IN COMMERCE 6-0-2004.

THE MARK CONSISTS OF STANDARD CHARACTERS WITHOUT CLAIM TO ANY PARTICULAR FONT, STYLE, SIZE, OR COLOR.

SN 78-421,592, FILED 5-19-2004.

ASMAT KHAN, EXAMINING ATTORNEY

Int. Cl.: 5

Prior U.S. Cls.: 6, 18, 44, 46, 51, and 52

Reg. No. 3,522,417

United States Patent and Trademark Office

Registered Oct. 21, 2008

**TRADEMARK
PRINCIPAL REGISTER**

ARMAGEN

ARMAGEN TECHNOLOGIES, INC. (DELAWARE CORPORATION)
914 COLORADO BOULEVARD
SANTA MONICA, CA 90401

FIRST USE 4-15-2005; IN COMMERCE 4-15-2005.

FOR: PHARMACEUTICAL PREPARATIONS AND DRUG DELIVERY COMPOSITIONS FOR THE TREATMENT OF NEUROLOGICAL, OCULAR, LIVER, SPLEEN, LUNG AND RESPIRATORY DISEASES AND DISORDERS, IN CLASS 5 (U.S. CLS. 6, 18, 44, 46, 51 AND 52).

THE MARK CONSISTS OF STANDARD CHARACTERS WITHOUT CLAIM TO ANY PARTICULAR FONT, STYLE, SIZE, OR COLOR.

SN 78-422,170, FILED 5-20-2004.

CAROLYN GRAY, EXAMINING ATTORNEY

Int. Cl.: 6

Prior U.S. Cls.: 2, 12, 13, 14, 23, 25, and 50

Reg. No. 3,522,418

United States Patent and Trademark Office

Registered Oct. 21, 2008

**TRADEMARK
PRINCIPAL REGISTER**

BULL'S-EYE

BESSEMER METAL PRODUCTS, INC. (ALABAMA CORPORATION)
3491 MARY TAYLOR ROAD
BIRMINGHAM, AL 35235

THE MARK CONSISTS OF STANDARD CHARACTERS WITHOUT CLAIM TO ANY PARTICULAR FONT, STYLE, SIZE, OR COLOR.

FOR: KIT FOR MAKING A PREFABRICATED METAL BUILDING, IN CLASS 6 (U.S. CLS. 2, 12, 13, 14, 23, 25 AND 50).

SN 78-422,293, FILED 5-20-2004.

FIRST USE 5-6-2008; IN COMMERCE 7-8-2008.

COLLEEN KEARNEY, EXAMINING ATTORNEY

Int. Cl.: 1

Prior U.S. Cls.: 1, 5, 6, 10, 26, and 46

United States Patent and Trademark Office

Reg. No. 3,522,419

Registered Oct. 21, 2008

**TRADEMARK
PRINCIPAL REGISTER**

AOPLUS

CELANESE INTERNATIONAL CORPORATION
(DELAWARE CORPORATION)
1601 LBJ FREEWAY
DALLAS, TX 75234

THE MARK CONSISTS OF STANDARD CHARACTERS WITHOUT CLAIM TO ANY PARTICULAR FONT, STYLE, SIZE, OR COLOR.

FOR: ACETIC ACID FOR INDUSTRIAL APPLICATIONS, IN CLASS 1 (U.S. CLS. 1, 5, 6, 10, 26 AND 46).

SN 78-437,019, FILED 6-17-2004.

FIRST USE 4-19-2001; IN COMMERCE 8-14-2007.

LAURA KOVALSKY, EXAMINING ATTORNEY

Int. Cl.: 29

Prior U.S. Cl.: 46

United States Patent and Trademark Office

Reg. No. 3,522,420

Registered Oct. 21, 2008

**TRADEMARK
PRINCIPAL REGISTER**

BELLA GIANA

CACIQUE, INC. (CALIFORNIA CORPORATION)
14940 PROCTOR AVENUE
CITY OF INDUSTRY, CA 91744

FOR: DAIRY PRODUCTS, EXCLUDING ICE
CREAM, ICE MILK AND FROZEN YOGURT, IN
CLASS 29 (U.S. CL. 46).

FIRST USE 8-28-2008; IN COMMERCE 8-28-2008.

THE MARK CONSISTS OF STANDARD CHAR-
ACTERS WITHOUT CLAIM TO ANY PARTICULAR
FONT, STYLE, SIZE, OR COLOR.

THE NAME "GIANA" DOES NOT IDENTIFY A
LIVING INDIVIDUAL.

THE ENGLISH TRANSLATION OF "BELLA" IS
"BEAUTIFUL".

SN 78-446,220, FILED 7-6-2004.

MELVIN AXILBUND, EXAMINING ATTORNEY

Int. Cl.: 12

Prior U.S. Cls.: 19, 21, 23, 31, 35, and 44

Reg. No. 3,522,421

United States Patent and Trademark Office

Registered Oct. 21, 2008

**TRADEMARK
PRINCIPAL REGISTER**

FORCE A.I.R.

KALIL, ANTHONY (UNITED STATES INDIVIDUAL)
4034 S.W. OSPREY CREEK WAY
PALM CITY, FL 34990

FOR: STRUCTURAL PARTS OF BOATS, NAMELY, PERFORMANCE ENHANCING DEVICES PLACED UNDERNEATH VESSEL HULLS TO REDUCE WET SURFACE AND THE DRAG OF THE BOATS, IN CLASS 12 (U.S. CLS. 19, 21, 23, 31, 35 AND 44).

FIRST USE 5-23-2008; IN COMMERCE 5-23-2008.

THE MARK CONSISTS OF STANDARD CHARACTERS WITHOUT CLAIM TO ANY PARTICULAR FONT, STYLE, SIZE, OR COLOR.

SN 78-447,903, FILED 7-8-2004.

BRIDGETT SMITH, EXAMINING ATTORNEY

Int. Cls.: 35 and 42

Prior U.S. Cls.: 100, 101, and 102

United States Patent and Trademark Office

Reg. No. 3,522,422

Registered Oct. 21, 2008

**SERVICE MARK
PRINCIPAL REGISTER**

SPACEID

SPACE ID, INC. (TEXAS CORPORATION)
SUITE 120
2651 N. HARWOOD
DALLAS, TX 75201

FOR: PROCUREMENT, NAMELY, PURCHASING FOR OTHERS; RETAIL AND WHOLESALE STORE SERVICES FEATURING FURNITURE, IN CLASS 35 (U.S. CLS. 100, 101 AND 102).

FIRST USE 8-24-2007; IN COMMERCE 8-24-2007.

FOR: CONSULTING SERVICES IN THE FIELD OF DESIGN, SELECTION, IMPLEMENTATION AND USE OF COMPUTER HARDWARE AND SOFTWARE SYSTEMS FOR OTHERS; SPACE PLANNING AND WORKPLACE DESIGN SERVICES;

COMPUTER PROJECT MANAGEMENT SERVICES; DESIGNING AND PLANNING THE LAYOUT, FURNISHING AND DECORATION OF OFFICES AND OF OFFICE SPACE; INTERIOR DESIGN SERVICES; OFFICE SPACE PLANNING, IN CLASS 42 (U.S. CLS. 100 AND 101).

FIRST USE 8-24-2007; IN COMMERCE 8-24-2007.

THE MARK CONSISTS OF STANDARD CHARACTERS WITHOUT CLAIM TO ANY PARTICULAR FONT, STYLE, SIZE, OR COLOR.

SN 78-447,983, FILED 7-8-2004.

ROBERT C. CLARK JR., EXAMINING ATTORNEY

Int. Cl.: 16

Prior U.S. Cls.: 2, 5, 22, 23, 29, 37, 38, and 50

Reg. No. 3,522,423

United States Patent and Trademark Office

Registered Oct. 21, 2008

**TRADEMARK
PRINCIPAL REGISTER**

**YOUR DATES
BUTTONED UP**

BUTTONED UP, INC. (CALIFORNIA CORPORATION)
3365 WASHTENAW AVE
ANN ARBOR, MI 48104

FOR: PAPER GOODS AND PRINTED MATTER, NAMELY, STATIONERY, NOTE CARDS, ORGANIZERS FOR STATIONERY USE, PRINTED CALENDARS, PRINTED APPOINTMENT BOOKS, AND PRINTED ADDRESS BOOKS, IN CLASS 16 (U.S. CLS. 2, 5, 22, 23, 29, 37, 38 AND 50).

FIRST USE 1-15-2008; IN COMMERCE 1-15-2008.

THE MARK CONSISTS OF STANDARD CHARACTERS WITHOUT CLAIM TO ANY PARTICULAR FONT, STYLE, SIZE, OR COLOR.

SN 78-461,226, FILED 8-3-2004.

ANDREA BUTLER, EXAMINING ATTORNEY

Int. Cl.: 20

Prior U.S. Cls.: 2, 13, 22, 25, 32, and 50

Reg. No. 3,522,424

United States Patent and Trademark Office

Registered Oct. 21, 2008

**TRADEMARK
PRINCIPAL REGISTER**



THE CARTOON NETWORK, INC. (DELAWARE CORPORATION)
C/O TURNER BROADCASTING SYSTEM, INC.
ONE CNN CENTER
ATLANTA, GA 30303

CHAINS, PILLOWS, IN CLASS 20 (U.S. CLS. 2, 13, 22, 25, 32 AND 50).

FIRST USE 9-1-2005; IN COMMERCE 9-1-2005.

SN 78-464,489, FILED 8-9-2004.

FOR: FIGURINES, PLASTIC CAKE DECORATIONS, NON-METAL AND NON-LEATHER KEY

ROBIN CHOSID, EXAMINING ATTORNEY

Int. Cl.: 31

Prior U.S. Cls.: 1 and 46

United States Patent and Trademark Office

Reg. No. 3,522,425

Registered Oct. 21, 2008

TRADEMARK
PRINCIPAL REGISTER

TUXEDO

ANTHONY TESSELAAR PLANTS PTY LTD.
(AUSTRALIA CORPORATION)

327 MONBULK ROAD

SILVAN, AUSTRALIA

FOR: LIVE PLANTS, IN CLASS 31 (U.S. CLS. 1
AND 46).

FIRST USE 7-12-2008; IN COMMERCE 7-12-2008.

THE MARK CONSISTS OF STANDARD CHAR-
ACTERS WITHOUT CLAIM TO ANY PARTICULAR
FONT, STYLE, SIZE, OR COLOR.

PRIORITY CLAIMED UNDER SEC. 44(D) ON
AUSTRALIA APPLICATION NO. 1010102, FILED 7-
9-2004.

SN 78-466,712, FILED 8-12-2004.

SUSAN STIGLITZ, EXAMINING ATTORNEY

Int. Cl.: 9

Prior U.S. Cls.: 21, 23, 26, 36, and 38

Reg. No. 3,522,426

United States Patent and Trademark Office

Registered Oct. 21, 2008

**TRADEMARK
PRINCIPAL REGISTER**

SQUIDBILLIES

THE CARTOON NETWORK, INC. (DELAWARE
CORPORATION)
ONE CNN CENTER, 10 NORTH
C/O TURNER BROADCASTING SYSTEM, INC.
ATLANTA, GA 303032762

FOR: DIGITAL VERSATILE DISCS FEATURING
MUSIC, COMEDY, DRAMA, ACTION, ADVEN-
TURE, AND/OR ANIMATION , IN CLASS 9 (U.S.
CLS. 21, 23, 26, 36 AND 38).

FIRST USE 10-16-2007; IN COMMERCE 10-16-2007.

THE MARK CONSISTS OF STANDARD CHAR-
ACTERS WITHOUT CLAIM TO ANY PARTICULAR
FONT, STYLE, SIZE, OR COLOR.

SN 78-475,975, FILED 8-30-2004.

RICHARD A. STRASER, EXAMINING ATTORNEY

Int. Cl.: 5

Prior U.S. Cls.: 6, 18, 44, 46, 51, and 52

Reg. No. 3,522,427

United States Patent and Trademark Office

Registered Oct. 21, 2008

**TRADEMARK
PRINCIPAL REGISTER**

ZYGENERICS

ZYDUS PHARMACEUTICALS (USA) INC. (NEW
JERSEY CORPORATION)
210 CARNEGIE CENTER, SUITE 103
PRINCETON, NJ 08540

THE MARK CONSISTS OF STANDARD CHAR-
ACTERS WITHOUT CLAIM TO ANY PARTICULAR
FONT, STYLE, SIZE, OR COLOR.

FOR: HOUSE MARK FOR A FULL LINE OF
PHARMACEUTICAL PREPARATIONS, IN CLASS 5
(U.S. CLS. 6, 18, 44, 46, 51 AND 52).

SN 78-496,742, FILED 10-8-2004.

FIRST USE 8-11-2005; IN COMMERCE 8-11-2005.

AISHA CLARKE, EXAMINING ATTORNEY

Int. Cl.: 41

Prior U.S. Cls.: 100, 101, and 107

United States Patent and Trademark Office

Reg. No. 3,522,428

Registered Oct. 21, 2008

**SERVICE MARK
PRINCIPAL REGISTER**

MAKE LEARNING PART OF THE
GRADE

PEARSON EDUCATION, INC. (DELAWARE
CORPORATION)
ONE LAKE STREET
UPPER SADDLE RIVER, NJ 07458

FOR: EDUCATIONAL SERVICES, NAMELY,
PROVIDING ONLINE INSTRUCTIONAL MATERI-
ALS NAMELY, STUDY GUIDES, TUTORIALS AND
TESTING MATERIALS FOR USE BY STUDENTS
AND INSTRUCTORS IN CONJUNCTION WITH
HIGHER EDUCATION TEXTBOOKS IN THE FIELD
OF SCIENCE, IN CLASS 41 (U.S. CLS. 100, 101 AND
107).

FIRST USE 8-31-2003; IN COMMERCE 8-31-2003.

THE MARK CONSISTS OF STANDARD CHAR-
ACTERS WITHOUT CLAIM TO ANY PARTICULAR
FONT, STYLE, SIZE, OR COLOR.

SN 78-497,077, FILED 10-8-2004.

RAMONA ORTIGA, EXAMINING ATTORNEY

Int. Cl.: 37

Prior U.S. Cls.: 100, 103, and 106

United States Patent and Trademark Office

Reg. No. 3,522,429

Registered Oct. 21, 2008

**SERVICE MARK
PRINCIPAL REGISTER**

CRITERION

CRITERION PROPERTY COMPANY, L.P. (DELA-
WARE LIMITED PARTNERSHIP)
14160 NORTH DALLAS PARKWAY
PACIFIC CENTER II, SUITE 750
DALLAS, TX 75254

THE MARK CONSISTS OF STANDARD CHAR-
ACTERS WITHOUT CLAIM TO ANY PARTICULAR
FONT, STYLE, SIZE, OR COLOR.

FOR: REAL ESTATE DEVELOPMENT OF MULTI-
FAMILY REAL ESTATE PROPERTIES, IN CLASS 37
(U.S. CLS. 100, 103 AND 106).

SN 78-497,786, FILED 10-11-2004.

FIRST USE 9-3-2008; IN COMMERCE 9-3-2008.

SHARON MEIER, EXAMINING ATTORNEY

Int. Cl.: 34

Prior U.S. Cls.: 2, 8, 9, and 17

United States Patent and Trademark Office

Reg. No. 3,522,430

Registered Oct. 21, 2008

**TRADEMARK
PRINCIPAL REGISTER**

BUTT CUP

INTELLECTUAL SOLUTIONS, INC. (DELA-
WARE CORPORATION)

41 JAMES WAY

EATONTOWN, NJ 07724

FOR: ASH TRAYS, IN CLASS 34 (U.S. CLS. 2, 8, 9
AND 17).

FIRST USE 5-2-2008; IN COMMERCE 5-2-2008.

THE MARK CONSISTS OF STANDARD CHAR-
ACTERS WITHOUT CLAIM TO ANY PARTICULAR
FONT, STYLE, SIZE, OR COLOR.

NO CLAIM IS MADE TO THE EXCLUSIVE
RIGHT TO USE "BUTT", APART FROM THE MARK
AS SHOWN.

SN 78-500,693, FILED 10-15-2004.

LESLEY LAMOTHE, EXAMINING ATTORNEY

Int. Cl.: 14

Prior U.S. Cls.: 2, 27, 28, and 50

Reg. No. 3,522,431

United States Patent and Trademark Office

Registered Oct. 21, 2008

**TRADEMARK
PRINCIPAL REGISTER**

CONCHO CRAZY

DOSSEY, LINDA DIANE NORCROSS (UNITED STATES INDIVIDUAL)
24061 NUTHATCH LANE
LAGUNA NIGUEL, CA 92677

THE MARK CONSISTS OF STANDARD CHARACTERS WITHOUT CLAIM TO ANY PARTICULAR FONT, STYLE, SIZE, OR COLOR.

FOR: JEWELRY; JEWELRY FOR USE ON PANTS, PURSES, BELTS, CLOTHING, HEADWEAR AND FOOTWEAR, IN CLASS 14 (U.S. CLS. 2, 27, 28 AND 50).

SN 78-503,217, FILED 10-20-2004.

FIRST USE 6-16-2008; IN COMMERCE 6-16-2008.

MICHAEL WEBSTER, EXAMINING ATTORNEY

Int. Cl.: 5

Prior U.S. Cls.: 6, 18, 44, 46, 51, and 52

United States Patent and Trademark Office

Reg. No. 3,522,432

Registered Oct. 21, 2008

**TRADEMARK
PRINCIPAL REGISTER**

**AnaMantle HC
GEL**

NYCOMED US INC. (NEW YORK CORPORATION)
60 BAYLIS ROAD
MELVILLE, NY 11747

FOR: MEDICAL KIT CONTAINING AN APPLICATOR, WIPES AND AN ANTI-INFLAMMATORY ANESTHETIC; AND DERMATOLOGICAL PREPARATIONS, NAMELY, AN ANTI-INFLAMMATORY ANESTHETIC FOR RELIEF OF PAIN, SORENESS AND DISCOMFORT DUE TO PRURITUS ANI, PRURITUS VULVAE, HEMORRHOIDS, ANAL FISSURES, AND SIMILAR CONDITIONS OF THE SKIN AND MUCOUS MEMBRANES, IN CLASS 5 (U.S. CLS. 6, 18, 44, 46, 51 AND 52).

FIRST USE 8-0-2006; IN COMMERCE 8-0-2006.

OWNER OF U.S. REG. NOS. 721,545, 721,546, AND 2,791,296.

NO CLAIM IS MADE TO THE EXCLUSIVE RIGHT TO USE "HC GEL", APART FROM THE MARK AS SHOWN.

SN 78-513,581, FILED 11-9-2004.

KIMBERLY FRYE, EXAMINING ATTORNEY

Int. Cl.: 26

Prior U.S. Cls.: 37, 39, 40, 42, and 50

Reg. No. 3,522,433

United States Patent and Trademark Office

Registered Oct. 21, 2008

TRADEMARK
PRINCIPAL REGISTER

Ribbon Candy

PALM BEACH BOTANICALS, INC. (FLORIDA CORPORATION)
25 IRONWOOD WAY N.
PALM BEACH GARDENS, FL 33418

FOR: HAIR RIBBONS, ORNAMENTAL RIBBONS MADE OF TEXTILES, RIBBONS, RIBBONS FOR WRAPPING, RIBBONS FOR GIFT WRAPPING, IN CLASS 26 (U.S. CLS. 37, 39, 40, 42 AND 50).

FIRST USE 6-18-2008; IN COMMERCE 6-18-2008.

THE COLOR(S) HOT PINK & BLACK IS/ARE CLAIMED AS A FEATURE OF THE MARK.

THE MARK CONSISTS OF CURLZ FONT, THE BODY OF THE LETTER IS HOT PINK OUTLINED WITH BLACK.

SN 78-516,417, FILED 11-12-2004.

CHRIS WELLS, EXAMINING ATTORNEY

Int. Cls.: 14, 18, and 25

Prior U.S. Cls.: 1, 2, 3, 22, 27, 28, 39, 41, and 50

United States Patent and Trademark Office

Reg. No. 3,522,434

Registered Oct. 21, 2008

**TRADEMARK
PRINCIPAL REGISTER**

SSAM

SSAMZIE CO., LTD (REPUBLIC OF KOREA CORPORATION)
177-14 BANGYI-DONG, SONGPA-GU
SEOUL, REPUBLIC OF KOREA

FOR: JEWELRY, NAMELY, BRACELETS, BROOCHES, STOPWATCHES, CUPS OF PRECIOUS METALS, EARRINGS, HAT ORNAMENTS OF PRECIOUS METAL, PASTE JEWELRY, CUFF LINKS, MEDALS, NECKLACES, TIE PINS, PURSES OF PRECIOUS METAL, RINGS, TRINKET RINGS, CLOCKS, WRISTWATCHES, ORNAMENTS OF PRECIOUS METAL, ORNAMENTAL PINS, BUCKLES OF PRECIOUS METAL, AND KEY RINGS OF PRECIOUS METAL, IN CLASS 14 (U.S. CLS. 2, 27, 28 AND 50).

FIRST USE 6-18-2008; IN COMMERCE 6-18-2008.

FOR: BACKPACKS, LEATHER STRAPS, BEACH BAGS, BRIEFCASES, BUSINESS CARD CASES, CREDIT CARD CASES, ENVELOPES OF LEATHER FOR MERCHANDISE PACKAGING, FUR PELTS, HANDBAGS, HAVERSACKS, LEATHER BAGS, IMITATION LEATHER BAGS, LEATHER LEASHES FOR ANIMALS, PURSES, SCHOOL BAGS, TEXTILE SHOPPING BAGS, LEATHER SHOPPING BAGS,

TRAVELING BAGS, UMBRELLAS, WALKING STICKS, IN CLASS 18 (U.S. CLS. 1, 2, 3, 22 AND 41).

FIRST USE 6-18-2008; IN COMMERCE 6-18-2008.

FOR: CLOTHING, NAMELY, BABIES' PANTS, SWIMSUITS, BELTS, SUSPENDERS, CAPS, HATS, LEATHER CLOTHING, NAMELY, LEATHER COATS, LEATHER JACKETS FOR SAFARI EXPEDITION, FOOTWEAR, GLOVES, JACKETS, JUMPERS, KNITWEAR, NAMELY, PULLOVERS, CARDIGANS, NECKTIES, PANTS, PARKAS, SANDALS, SHAWLS, SCARVES, SOCKS, SKIRTS, SPORTS JERSEYS, SUITS, SWEATERS, T-SHIRTS, UNDERWEAR, VESTS, SLIPPERS, IN CLASS 25 (U.S. CLS. 22 AND 39).

FIRST USE 1-1-2005; IN COMMERCE 1-1-2005.

THE MARK CONSISTS OF STANDARD CHARACTERS WITHOUT CLAIM TO ANY PARTICULAR FONT, STYLE, SIZE, OR COLOR.

SN 78-519,491, FILED 11-18-2004.

LESLEY LAMOTHE, EXAMINING ATTORNEY

Int. Cl.: 36

Prior U.S. Cls.: 100, 101, and 102

United States Patent and Trademark Office

Reg. No. 3,522,435

Registered Oct. 21, 2008

**SERVICE MARK
PRINCIPAL REGISTER**

UTOPIA FOUNDATION

FINANCIAL INVESTMENT MANAGEMENT
GROUP, LTD. (MICHIGAN CORPORATION)
111 CASS STREET
TRAVERSE CITY, MI 49684

THE MARK CONSISTS OF STANDARD CHAR-
ACTERS WITHOUT CLAIM TO ANY PARTICULAR
FONT, STYLE, SIZE, OR COLOR.

FOR: MUTUAL FUND INVESTMENT SERVICES,
IN CLASS 36 (U.S. CLS. 100, 101 AND 102).

SN 78-521,572, FILED 11-23-2004.

FIRST USE 3-24-2008; IN COMMERCE 3-24-2008.

DARRYL SPRUILL, EXAMINING ATTORNEY

Int. Cl.: 9

Prior U.S. Cls.: 21, 23, 26, 36, and 38

Reg. No. 3,522,436

United States Patent and Trademark Office

Registered Oct. 21, 2008

**TRADEMARK
PRINCIPAL REGISTER**

REGENERATION TAP

NET OPTICS, INC. (CALIFORNIA CORPORATION)
1130 MOUNTAIN VIEW ALVISO ROAD
SUNNYVALE, CA 94089

FOR: TELECOMMUNICATIONS AND DATA NETWORKING HARDWARE, NAMELY, DEVICES FOR TRANSPORTING AND AGGREGATING VOICE, DATA, AND VIDEO COMMUNICATIONS ACROSS MULTIPLE NETWORK INFRASTRUCTURES AND COMMUNICATIONS PROTOCOLS; ELECTRONIC TEST AND MEASUREMENT DEVICES FOR USE IN THE FIELDS OF NETWORKS AND TELECOMMUNICATIONS, NAMELY, INSTRUMENTATION USED TO TEST AND MONITOR TELECOMMUNICATIONS NETWORKS; HARDWARE FOR USE IN TELECOMMUNICATIONS NETWORKS, NAMELY, COUPLERS, HUBS, SWITCHES, ROUTERS, TRANSCEIVERS AND TAPS; HARDWARE FOR MONITORING, TROUBLESHOOTING, SECURING AND ACCESSING

TELECOMMUNICATIONS NETWORKS; AND SOFTWARE FOR CONTROLLING, MONITORING, SECURING AND ACCESSING TELECOMMUNICATIONS AND DATA NETWORKING HARDWARE, IN CLASS 9 (U.S. CLS. 21, 23, 26, 36 AND 38).

FIRST USE 3-31-2001; IN COMMERCE 9-30-2001.

THE MARK CONSISTS OF STANDARD CHARACTERS WITHOUT CLAIM TO ANY PARTICULAR FONT, STYLE, SIZE, OR COLOR.

NO CLAIM IS MADE TO THE EXCLUSIVE RIGHT TO USE "TAP", APART FROM THE MARK AS SHOWN.

SN 78-529,184, FILED 12-8-2004.

JANICE L. MCMORROW, EXAMINING ATTORNEY

Int. Cl.: 25

Prior U.S. Cls.: 22 and 39

United States Patent and Trademark Office

Reg. No. 3,522,437

Registered Oct. 21, 2008

**TRADEMARK
PRINCIPAL REGISTER**

AGENTS OF TERROR

DE'EPEY, ZACH (UNITED STATES INDIVIDUAL)
SUITE 5C
25-54 12TH STREET
ASTORIA, NY 11102

FOR: CLOTHING, NAMELY, T-SHIRTS AND CAPS, IN CLASS 25 (U.S. CLS. 22 AND 39).

FIRST USE 3-8-2008; IN COMMERCE 3-8-2008.

THE MARK CONSISTS OF STANDARD CHARACTERS WITHOUT CLAIM TO ANY PARTICULAR FONT, STYLE, SIZE, OR COLOR.

SN 78-534,421, FILED 12-17-2004.

COLLEEN KEARNEY, EXAMINING ATTORNEY

Int. Cl.: 9

Prior U.S. Cls.: 21, 23, 26, 36, and 38

United States Patent and Trademark Office

Reg. No. 3,522,438

Registered Oct. 21, 2008

**TRADEMARK
PRINCIPAL REGISTER**



CENTRIC GROUP, LLC (MISSOURI LIMITED
LIABILITY COMPANY)
1260 ANDES BOULEVARD
ST. LOUIS, MO 63132

THE MARK CONSISTS OF THE LETTERS "ION"
WITH THE "3" IN SUPERScript POSITION.

FOR: BATTERIES, IN CLASS 9 (U.S. CLS. 21, 23, 26,
36 AND 38).

SN 78-536,230, FILED 12-21-2004.

FIRST USE 2-17-2005; IN COMMERCE 2-17-2005.

LYDIA BELZER, EXAMINING ATTORNEY

Int. Cl.: 29

Prior U.S. Cl.: 46

United States Patent and Trademark Office

Reg. No. 3,522,439

Registered Oct. 21, 2008

**TRADEMARK
PRINCIPAL REGISTER**



DISNEY ENTERPRISES, INC. (DELAWARE CORPORATION)
500 SOUTH BUENA VISTA STREET
BURBANK, CA 91521

FOR: FRUIT-BASED SNACK FOOD; CANDIED FRUIT SNACKS; MILK AND DAIRY-BASED DIPS, SNACK DIPS, MILK BEVERAGES WITH HIGH MILK CONTENT, AND YOGURT, IN CLASS 29 (U.S. CL. 46).

FIRST USE 8-1-2007; IN COMMERCE 7-30-2008.

THE MARK CONSISTS OF THE WORD CARS IN STYLIZED LETTERING, SURROUNDED BY A DARK OBLONG AND SUPERIMPOSED OVER A STYLIZED "V".

SN 78-538,943, FILED 12-28-2004.

GEOFFREY FOSDICK, EXAMINING ATTORNEY

Int. Cl.: 5

Prior U.S. Cls.: 6, 18, 44, 46, 51, and 52

Reg. No. 3,522,440

United States Patent and Trademark Office

Registered Oct. 21, 2008

**TRADEMARK
PRINCIPAL REGISTER**

Catocyanic Complex

HEM CORPORATION PRIVATE LIMITED (INDIA CORPORATION)
MITHAGAR 'X' ROAD, MULAND (EAST)
G-5+, RIDDHI - SIDDHI APARTMENTS
MUMBAI, INDIA

FOR: DIETETIC FOODS ADAPTED FOR MEDICAL USE, HYGIENIC PRODUCTS, NAMELY, DISINFECTANTS FOR HYGIENIC PURPOSES; NUTRACEUTICALS FOR USE AS A DIETARY SUPPLEMENT, NAMELY, VASCULAR PROTECTORS AND VISION NUTRIENTS, IN CLASS 5 (U.S. CLS. 6, 18, 44, 46, 51 AND 52).

FIRST USE 1-12-2006; IN COMMERCE 1-12-2006.

THE MARK CONSISTS OF STANDARD CHARACTERS WITHOUT CLAIM TO ANY PARTICULAR FONT, STYLE, SIZE, OR COLOR.

NO CLAIM IS MADE TO THE EXCLUSIVE RIGHT TO USE "COMPLEX", APART FROM THE MARK AS SHOWN.

SN 78-539,379, FILED 12-29-2004.

BARNEY CHARLON, EXAMINING ATTORNEY

Int. Cl.: 35

Prior U.S. Cls.: 100, 101, and 102

United States Patent and Trademark Office

Reg. No. 3,522,441

Registered Oct. 21, 2008

**SERVICE MARK
PRINCIPAL REGISTER**

CCE

VISA U.S.A. INC. (DELAWARE CORPORATION)
900 METRO CENTER BOULEVARD, M1-11A
FOSTER CITY, CA 94404

FOR: BUSINESS SERVICES, NAMELY, PROVIDING INFORMATION AND ANALYSIS REGARDING TRENDS IN THE FINANCIAL INDUSTRY FOR THE PURPOSE OF MEASURING AND FORECASTING PAYMENT TRENDS; COLLECTION, PREPARATION, COMPOSITION, PROCESSING, COMPILATION AND PROVISION OF FINANCIAL BUSINESS INFORMATION, DATA, STATISTICS

AND INDICES, IN CLASS 35 (U.S. CLS. 100, 101 AND 102).

FIRST USE 9-0-2004; IN COMMERCE 9-0-2004.

THE MARK CONSISTS OF STANDARD CHARACTERS WITHOUT CLAIM TO ANY PARTICULAR FONT, STYLE, SIZE, OR COLOR.

SN 78-542,178, FILED 1-4-2005.

MARK SPARACINO, EXAMINING ATTORNEY

Int. Cl.: 37

Prior U.S. Cls.: 100, 103, and 106

United States Patent and Trademark Office

Reg. No. 3,522,442

Registered Oct. 21, 2008

**SERVICE MARK
PRINCIPAL REGISTER**

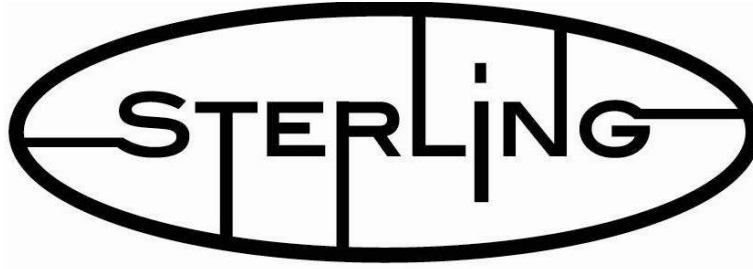

STERLING BUILDING GROUP, INC. (NORTH
CAROLINA CORPORATION)
4089 BATTLEGROUND AVENUE
GREENSBORO, NC 27410

FIRST USE 11-0-2004; IN COMMERCE 11-0-2004.

FOR: GENERAL CONTRACTOR SERVICES,
NAMELY, BUILDING CONSTRUCTION AND RE-
NOVATION, IN CLASS 37 (U.S. CLS. 100, 103 AND
106).

SN 78-542,371, FILED 1-5-2005.

MAUREEN DALL, EXAMINING ATTORNEY

Int. Cl.: 9

Prior U.S. Cls.: 21, 23, 26, 36, and 38

Reg. No. 3,522,443

United States Patent and Trademark Office

Registered Oct. 21, 2008

**TRADEMARK
PRINCIPAL REGISTER**

**MAKING ACCESS
EASIER**

THE CHAMBERLAIN GROUP, INC. (CONNECTI-
CUT CORPORATION)
845 LARCH AVENUE
ELMHURST, IL 601261196

FOR: AUTOMATIC GARAGE DOOR OPENERS,
ELECTRIC GATE OPERATORS, AUTOMATIC
COMMERCIAL DOOR OPERATORS, TELEPHONE
ENTRY SYSTEMS FOR USE WITH DOORS, GATES,
AND ENTRANCE AND EXIT BARRIERS, ELEC-
TRONIC CONTROLS FOR GRANTING ACCESS
AND EGRESS THROUGH DOORS OR GATES,
AND REMOTE AND RADIO CONTROLS FOR

THE FOREGOING, IN CLASS 9 (U.S. CLS. 21, 23, 26,
36 AND 38).

FIRST USE 1-1-2007; IN COMMERCE 1-3-2007.

THE MARK CONSISTS OF STANDARD CHAR-
ACTERS WITHOUT CLAIM TO ANY PARTICULAR
FONT, STYLE, SIZE, OR COLOR.

SN 78-548,137, FILED 1-14-2005.

JASON LOTT, EXAMINING ATTORNEY

Int. Cl.: 19

Prior U.S. Cls.: 1, 12, 33, and 50

United States Patent and Trademark Office

Reg. No. 3,522,444

Registered Oct. 21, 2008

**TRADEMARK
PRINCIPAL REGISTER**

Xtrulinear Lengths

FLEX TRIM HOLDING CO (DELAWARE CORPORATION)
1015 BRANDIDGE BLVD.
TROY, AL 36081

FOR: NON-METAL DECORATIVE TRIM, MOLDING ON SPOOLS, EMULATING WOOD OR WOOD-FINISHED PRODUCTS, COMPOSED OF PLASTIC AND POLYMER MATERIALS FOR USE IN BUILDING CONSTRUCTION, IN CLASS 19 (U.S. CLS. 1, 12, 33 AND 50).

FIRST USE 8-1-2008; IN COMMERCE 8-1-2008.

THE MARK CONSISTS OF STANDARD CHARACTERS WITHOUT CLAIM TO ANY PARTICULAR FONT, STYLE, SIZE, OR COLOR.

NO CLAIM IS MADE TO THE EXCLUSIVE RIGHT TO USE "LENGTHS", APART FROM THE MARK AS SHOWN.

SN 78-550,982, FILED 1-20-2005.

SUSAN STIGLITZ, EXAMINING ATTORNEY

Int. Cl.: 29

Prior U.S. Cl.: 46

United States Patent and Trademark Office

Reg. No. 3,522,445

Registered Oct. 21, 2008

**TRADEMARK
PRINCIPAL REGISTER**

**LAY'S GET YOUR
SMILE ON!**

FRITO-LAY NORTH AMERICA, INC. (DELA-
WARE CORPORATION)
7701 LEGACY DRIVE
PLANO, TX 75024

FOR: POTATO-BASED SNACK FOODS, NAME-
LY, POTATO CHIPS AND POTATO CRISPS, IN
CLASS 29 (U.S. CL. 46).

FIRST USE 1-1-2005; IN COMMERCE 1-1-2005.

THE MARK CONSISTS OF STANDARD CHAR-
ACTERS WITHOUT CLAIM TO ANY PARTICULAR
FONT, STYLE, SIZE, OR COLOR.

OWNER OF U.S. REG. NOS. 905,919, 2,607,894,
AND OTHERS.

SN 78-555,200, FILED 1-27-2005.

CHRISTOPHER BUONGIORNO, EXAMINING AT-
TORNEY

Int. Cl.: 9

Prior U.S. Cls.: 21, 23, 26, 36, and 38

Reg. No. 3,522,446

United States Patent and Trademark Office

Registered Oct. 21, 2008

**TRADEMARK
PRINCIPAL REGISTER**

UNDERCOVER

PUPO, MICHAEL S. (UNITED STATES INDIVIDUAL)
17410 BEAR CREEK ROAD
BOULDER CREEK, CA 95006

THE MARK CONSISTS OF STANDARD CHARACTERS WITHOUT CLAIM TO ANY PARTICULAR FONT, STYLE, SIZE, OR COLOR.

FOR: PRERECORDED CD'S FEATURING MUSIC, IN CLASS 9 (U.S. CLS. 21, 23, 26, 36 AND 38).

SN 78-558,386, FILED 2-1-2005.

FIRST USE 1-10-2005; IN COMMERCE 1-10-2005.

JASON TURNER, EXAMINING ATTORNEY

Int. Cl.: 12

Prior U.S. Cls.: 19, 21, 23, 31, 35, and 44

Reg. No. 3,522,447

United States Patent and Trademark Office

Registered Oct. 21, 2008

**TRADEMARK
PRINCIPAL REGISTER**

LoveBike

STALLER, ERIC (UNITED STATES INDIVIDUAL)
STALLER STUDIO
NEDERLAND HERENGRACHT 1015BS
AMSTERDAM, NETHERLANDS

FOR: PLURAL-PASSENGER PEDALED VEHICLE IN WHICH RIDERS ARE SEATED ON THE VEHICLE, AND IN WHICH ONE RIDER STEERS AND BRAKES AND THE OTHER RIDER(S) MAY ASSIST IN PEDALING, IN CLASS 12 (U.S. CLS. 19, 21, 23, 31, 35 AND 44).

FIRST USE 8-4-2008; IN COMMERCE 8-4-2008.

THE MARK CONSISTS OF STANDARD CHARACTERS WITHOUT CLAIM TO ANY PARTICULAR FONT, STYLE, SIZE, OR COLOR.

SN 78-560,497, FILED 2-4-2005.

DOMINICK J. SALEMI, EXAMINING ATTORNEY

Int. Cl.: 32

Prior U.S. Cls.: 45, 46, and 48

United States Patent and Trademark Office

Reg. No. 3,522,448

Registered Oct. 21, 2008

**TRADEMARK
PRINCIPAL REGISTER**

**FERMENTUS
INTERRUPTUS**

GRANITE CITY FOOD & BREWERY LTD. (MIN-
NESOTA CORPORATION)
5402 PARKDALE DRIVE, SUITE 101
MINNEAPOLIS, MN 55416

FOR: BEER, IN CLASS 32 (U.S. CLS. 45, 46 AND 48).

FIRST USE 8-6-2008; IN COMMERCE 8-6-2008.

THE MARK CONSISTS OF STANDARD CHAR-
ACTERS WITHOUT CLAIM TO ANY PARTICULAR
FONT, STYLE, SIZE, OR COLOR.

SN 78-567,953, FILED 2-15-2005.

ELISSA GARBER KON, EXAMINING ATTORNEY

Int. Cl.: 35

Prior U.S. Cls.: 100, 101, and 102

United States Patent and Trademark Office

Reg. No. 3,522,449

Registered Oct. 21, 2008

**SERVICE MARK
PRINCIPAL REGISTER**

**SNOOZE YOU LOSE
SALE**

ARITZIA, LP (CANADA LIMITED PARTNER-
SHIP)
NO. 327 - 611 ALEXANDER STREET
VANCOUVER, B.C., CANADA V6A 1E1

FOR: RETAIL STORE SERVICES FEATURING
CLOTHING, SHOES, ACCESSORIES AND JEWEL-
RY, IN CLASS 35 (U.S. CLS. 100, 101 AND 102).

FIRST USE 2-7-2008; IN COMMERCE 2-7-2008.

THE MARK CONSISTS OF STANDARD CHAR-
ACTERS WITHOUT CLAIM TO ANY PARTICULAR
FONT, STYLE, SIZE, OR COLOR.

NO CLAIM IS MADE TO THE EXCLUSIVE
RIGHT TO USE "SALE", APART FROM THE MARK
AS SHOWN.

SN 78-568,508, FILED 2-16-2005.

RUDY R. SINGLETON, EXAMINING ATTORNEY

Int. Cls.: 37 and 42

Prior U.S. Cls.: 100, 101, 103, and 106

United States Patent and Trademark Office

Reg. No. 3,522,450

Registered Oct. 21, 2008

**SERVICE MARK
PRINCIPAL REGISTER**

SIGNACERT

SIGNACERT, INC. (DELAWARE CORPORATION)
707 SW WASHINGTON
7TH FLOOR
PORTLAND, OR 97205

FOR: PROVIDING ONLINE COMPUTER DATABASE AND INFORMATION FOR USE BY ORGANIZATIONS, BUSINESSES AND INDIVIDUALS TO EXAMINE AND EVALUATE THE CURRENT STATUS OF THE USER'S COMPUTER HARDWARE SYSTEM, IN CLASS 37 (U.S. CLS. 100, 103 AND 106).

FIRST USE 4-0-2007; IN COMMERCE 3-31-2008.

FOR: PROVIDING ONLINE COMPUTER DATABASE AND INFORMATION FOR USE BY ORGANI-

ZATIONS, BUSINESSES AND INDIVIDUALS TO EXAMINE AND EVALUATE THE CURRENT STATUS OF THE USER'S COMPUTER SOFTWARE SYSTEM, IN CLASS 42 (U.S. CLS. 100 AND 101).

FIRST USE 4-0-2007; IN COMMERCE 3-31-2008.

THE MARK CONSISTS OF STANDARD CHARACTERS WITHOUT CLAIM TO ANY PARTICULAR FONT, STYLE, SIZE, OR COLOR.

SN 78-568,834, FILED 2-16-2005.

VIVIAN MICZNIK FIRST, EXAMINING ATTORNEY

Int. Cl.: 16

Prior U.S. Cls.: 2, 5, 22, 23, 29, 37, 38, and 50

Reg. No. 3,522,451

United States Patent and Trademark Office

Registered Oct. 21, 2008

**TRADEMARK
PRINCIPAL REGISTER**

THE LEMONADE STAND

ZINDA, GAYLE M. (UNITED STATES INDIVIDUAL)
3294 BROOKLYN DRIVE
STOUGHTON, WI 53589 AND
ZINDA, MICHAEL W. (UNITED STATES INDIVIDUAL)
3294 BROOKLYN DRIVE
STOUGHTON, WI 53589

FOR: PRINTED MATTER, NAMELY, BOOKLETS, BROCHURES, HANDBOOKS, JOURNALS, LEAFLETS, NEWSLETTERS, MAGAZINES AND TRAINING MANUALS ALL FEATURING DIET, EMOTIONAL STRESSES, EXERCISE, HEALTH, LIFESTYLE, PHYSICAL CHALLENGES AND PHYSICAL FITNESS, RELATIONSHIPS, SPIRITUALITY AND CHARITABLE FUND RAISING ACTIVITIES; CALENDARS, DIARIES; GREETINGS CARDS; POSTCARDS; SERIES OF BOOKS IN THE FIELD

OF DIET, EMOTIONAL STRESSES, EXERCISE, HEALTH, LIFESTYLE, PHYSICAL CHALLENGES AND PHYSICAL FITNESS, RELATIONSHIPS, SPIRITUALITY, AND CHARITABLE FUNDRAISING ACTIVITIES; MOUNTED AND UNMOUNTED PHOTOGRAPHS; STICKERS, IN CLASS 16 (U.S. CLS. 2, 5, 22, 23, 29, 37, 38 AND 50).

FIRST USE 11-22-2005; IN COMMERCE 11-22-2005.

THE MARK CONSISTS OF STANDARD CHARACTERS WITHOUT CLAIM TO ANY PARTICULAR FONT, STYLE, SIZE, OR COLOR.

SN 78-569,990, FILED 2-17-2005.

AMY GEARIN, EXAMINING ATTORNEY

Int. Cl.: 9

Prior U.S. Cls.: 21, 23, 26, 36, and 38

United States Patent and Trademark Office

Reg. No. 3,522,452

Registered Oct. 21, 2008

**TRADEMARK
PRINCIPAL REGISTER**



TRINITY COMPUTER SERVICES, INC. (CALI-
FORNIA CORPORATION)
500 WALL STREET
AUBURN, CA 95603

FOR: COMPUTER SOFTWARE FOR MEDICAL
MANAGEMENT OF PATIENT CARE USED FOR
ORGANIZING, MANAGING, TRACKING AND
ANALYZING MEDICAL TREATMENT AND MED-
ICAL INFORMATION, IN CLASS 9 (U.S. CLS. 21, 23,
26, 36 AND 38).

FIRST USE 8-1-2005; IN COMMERCE 10-17-2005.

THE COLORS TEAL, WHITE AND BLACK ARE
CLAIMED AS A FEATURE OF THE MARK.

THE COLOR TEAL APPEARS IN THE CIRCLE
DESIGN, THE COLORS WHITE APPEARS IN THE
STYLIZED "A" IN THE DESIGN, AND THE COLOR
BLACK APPEARS IN THE WORDING.

SN 78-570,623, FILED 2-18-2005.

KAREN K. BUSH, EXAMINING ATTORNEY

Int. Cl.: 13

Prior U.S. Cls.: 2 and 9

United States Patent and Trademark Office

Reg. No. 3,522,453

Registered Oct. 21, 2008

**TRADEMARK
PRINCIPAL REGISTER**

Securiflame

CHIMNEY SWEEPING LOG, LLC (NEVADA
LIMITED LIABILITY CORPORATION)
SUITE 170-A
3763 HOWARD HUGHES PARKWAY
LAS VEGAS, NV 89109

FOR: FIRE IGNITERS, NAMELY, PACKETS
COMPRISED OF VOLATILE AND NON-VOLATILE
COMPOUNDS USED FOR STARTING FIRES IN
FIREPLACES, WOOD STOVES, CHARCOAL
GRILLS AND CAMPFIRES, IN CLASS 13 (U.S. CLS.
2 AND 9).

FIRST USE 5-29-2008; IN COMMERCE 5-29-2008.

THE MARK CONSISTS OF STANDARD CHAR-
ACTERS WITHOUT CLAIM TO ANY PARTICULAR
FONT, STYLE, SIZE, OR COLOR.

SN 78-574,635, FILED 2-24-2005.

ELLEN B. AWRICH, EXAMINING ATTORNEY

Int. Cls.: 5 and 10

Prior U.S. Cls.: 6, 18, 26, 39, 44, 46, 51, and 52

United States Patent and Trademark Office

Reg. No. 3,522,454

Registered Oct. 21, 2008

**TRADEMARK
PRINCIPAL REGISTER**

DISCOVERYLABS

DISCOVERY LABORATORIES, INC. (DELA-
WARE CORPORATION)
2600 KELLY ROAD
WARRINGTON, PA 18976

FOR: PHARMACEUTICAL PREPARATIONS
AND SUBSTANCES FOR TREATMENT OF UPPER
AND LOWER RESPIRATORY DISEASES AND DIS-
ORDERS; SURFACTANT REPLACEMENT THERA-
PIES FOR RESPIRATORY DISEASES;
PULMONARY LUNG SURFACTANTS; INHALED
PHARMACEUTICAL PRODUCTS FOR ALL HU-
MAN RESPIRATORY INDICATIONS; RESPIRA-
TORY STIMULANTS, IN CLASS 5 (U.S. CLS. 6, 18,
44, 46, 51 AND 52).

FIRST USE 7-28-2008; IN COMMERCE 7-28-2008.

FOR: ELECTRIC WARMING UNITS FOR HEAT-
ING MEDICATION, IN CLASS 10 (U.S. CLS. 26, 39
AND 44).

FIRST USE 4-14-2005; IN COMMERCE 6-30-2005.

THE MARK CONSISTS OF STANDARD CHAR-
ACTERS WITHOUT CLAIM TO ANY PARTICULAR
FONT, STYLE, SIZE, OR COLOR.

SN 78-577,412, FILED 3-1-2005.

VIVIAN MICZNIK FIRST, EXAMINING ATTOR-
NEY

Int. Cl.: 5

Prior U.S. Cls.: 6, 18, 44, 46, 51, and 52

United States Patent and Trademark Office

Reg. No. 3,522,455

Registered Oct. 21, 2008

**TRADEMARK
PRINCIPAL REGISTER**

**INSPIRED
INNOVATION**

DISCOVERY LABORATORIES, INC. (DELA-
WARE CORPORATION)
2600 KELLY ROAD
WARRINGTON, PA 18976

FOR: PHARMACEUTICAL PREPARATIONS
AND SUBSTANCES FOR TREATMENT OF UPPER
AND LOWER RESPIRATORY DISEASES AND DIS-
ORDERS; SURFACTANT REPLACEMENT THERA-
PIES FOR RESPIRATORY DISEASES;
PULMONARY LUNG SURFACTANTS; INHALED
PHARMACEUTICAL PRODUCTS FOR ALL HU-
MAN RESPIRATORY INDICATIONS; RESPIRA-

TORY STIMULANTS, IN CLASS 5 (U.S. CLS. 6, 18,
44, 46, 51 AND 52).

FIRST USE 7-27-2008; IN COMMERCE 7-27-2008.

THE MARK CONSISTS OF STANDARD CHAR-
ACTERS WITHOUT CLAIM TO ANY PARTICULAR
FONT, STYLE, SIZE, OR COLOR.

SN 78-577,978, FILED 3-2-2005.

VIVIAN MICZNIK FIRST, EXAMINING ATTOR-
NEY

Int. Cls.: 16 and 41

Prior U.S. Cls.: 2, 5, 22, 23, 29, 37, 38, 50, 100, 101, and 107

Reg. No. 3,522,456

United States Patent and Trademark Office

Registered Oct. 21, 2008

TRADEMARK
SERVICE MARK
PRINCIPAL REGISTER



BELLVIEW MEDIA LLC (CALIFORNIA LIMITED LIABILITY COMPANY)
8826 CLIFTON WAY
BEVERLY HILLS, CA 90211

FOR: SERIES OF PUBLICATIONS, NAMELY, COOK BOOKS, IN CLASS 16 (U.S. CLS. 2, 5, 22, 23, 29, 37, 38 AND 50).

FIRST USE 12-1-2006; IN COMMERCE 12-1-2006.

FOR: ENTERTAINMENT IN THE NATURE OF ON-GOING TELEVISION AND RADIO PROGRAMS IN THE FIELD OF FOOD, COOKING AND FOOD RELATED TOPICS AND PERSONALITIES, IN CLASS 41 (U.S. CLS. 100, 101 AND 107).

FIRST USE 6-1-2004; IN COMMERCE 6-1-2004.

NO CLAIM IS MADE TO THE EXCLUSIVE RIGHT TO USE "A LA COCINA", APART FROM THE MARK AS SHOWN.

THE NAME "GINA" IN THE MARK IDENTIFIES GINA PACHECO A LIVING INDIVIDUAL WHOSE CONSENT IS OF RECORD.

THE COLORS YELLOW, GREEN, RED AND WHITE ARE CLAIMED AS FEATURES OF THE MARK.

THE WORDING "A LA COCINA" AND THE MIDDLE RECTANGLE DESIGN APPEAR IN YELLOW. THE FIRST RECTANGLE IS SHADED GREEN. THE THIRD RECTANGLE AND THE WORDS "CON GINA" ARE IN RED. THE MARK BACKGROUND AND THE OUTLINES OF FRUIT/VEGETABLES WITHIN THE COLOR SHADED RECTANGLES ARE WHITE.

THE MARK CONSISTS OF THE WORDS "A LA COCINA CON GINA" ABOVE THREE FIGURES, A GREEN PEPPER, A PEAR, AND A TOMATO.

THE FOREIGN WORDING IN THE MARK TRANSLATES INTO ENGLISH AS THE KITCHEN WITH "GINA" OR COOK WITH "GINA".

SN 78-578,862, FILED 3-2-2005.

STEVEN PEREZ, EXAMINING ATTORNEY

Int. Cl.: 41

Prior U.S. Cls.: 100, 101, and 107

United States Patent and Trademark Office

Reg. No. 3,522,457

Registered Oct. 21, 2008

**SERVICE MARK
PRINCIPAL REGISTER**

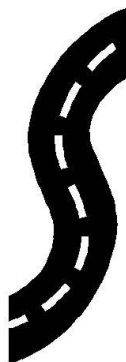

STORYHIGHWAY, INC. (VIRGINIA CORPORATION)
P.O. BOX 9589
NORFOLK, VA 23505

FOR: EDUCATION AND ENTERTAINMENT IN THE NATURE OF COMPETITIONS IN THE FIELDS OF READING AND CREATIVE WRITING; AND EDUCATION AND ENTERTAINMENT IN THE NATURE OF COMPETITIONS IN THE FIELDS OF READING AND CREATIVE WRITING BY MEANS OF A GLOBAL COMPUTER INFORMATION NETWORK; AND EDUCATIONAL AND ENTERTAINMENT SERVICES BY MEANS OF A GLOBAL COMPUTER INFORMATION NETWORK, NAMELY, PROVIDING A WEB-SITE FEATURING, IN WHOLE OR IN PART, STORIES, POETRY, LYRICS, ESSAYS, PUZZLES, GAMES, AND HUMOR AND PROVIDING, IN WHOLE OR IN PART, ON-LINE LITERARY REVIEWS, ON-LINE INTERVIEWS WITH AUTHORS, AND ON-LINE INFORMATION RELATING TO AUTHORS, READERS, AND LITERARY WORKS; AND EDUCATIONAL AND ENTERTAINMENT SERVICES, NAMELY, THE PUBLICATION OF LITERARY WORKS, IN WHOLE OR IN PART, IN THE NATURE OF BOOKS, STORIES, POETRY, LYRICS, ESSAYS, PUZZLES, GAMES,

AND HUMOR; AND EDUCATIONAL AND ENTERTAINMENT SERVICES, NAMELY, THE PUBLICATION OF LITERARY WORKS, IN WHOLE OR IN PART, IN THE NATURE OF BOOKS, STORIES, POETRY, LYRICS, ESSAYS, PUZZLES, GAMES, AND HUMOR BY MEANS OF A GLOBAL COMPUTER INFORMATION NETWORK; AND PROVIDING EDUCATIONAL AND ENTERTAINMENT SERVICES BY MEANS OF A GLOBAL COMPUTER INFORMATION NETWORK, NAMELY, PROVIDING A WEB-SITE FEATURING A GAME OR GAMES THAT MAY BE ACCESSED NETWORK-WIDE BY NETWORK USERS, IN CLASS 41 (U.S. CLS. 100, 101 AND 107).

FIRST USE 6-26-2008; IN COMMERCE 6-26-2008.

THE MARK CONSISTS OF A FANCIFUL, STYLIZED HIGHWAY AND/OR "S". THE LINING IN THE MARK IS A FEATURE OF THE MARK AND DOES NOT INDICATE COLOR.

SN 78-580,067, FILED 3-4-2005.

SUE LAWRENCE, EXAMINING ATTORNEY

Int. Cl.: 36

Prior U.S. Cls.: 100, 101, and 102

United States Patent and Trademark Office

Reg. No. 3,522,458

Registered Oct. 21, 2008

**SERVICE MARK
PRINCIPAL REGISTER**

SLEEPWELL

COOPER, FRANK E. III (UNITED STATES IN-
DIVIDUAL)
1511 W. SWANN AVENUE
TAMPA, FL 33606

FOR: FINANCIAL SERVICES, NAMELY, MONEY
MANAGEMENT SERVICES, IN CLASS 36 (U.S. CLS.
100, 101 AND 102).

FIRST USE 2-0-2005; IN COMMERCE 2-0-2005.

THE MARK CONSISTS OF STANDARD CHAR-
ACTERS WITHOUT CLAIM TO ANY PARTICULAR
FONT, STYLE, SIZE, OR COLOR.

SN 78-581,565, FILED 3-7-2005.

MARILYN IZZI, EXAMINING ATTORNEY

Int. Cl.: 20

Prior U.S. Cls.: 2, 13, 22, 25, 32, and 50

United States Patent and Trademark Office

Reg. No. 3,522,459

Registered Oct. 21, 2008

**TRADEMARK
PRINCIPAL REGISTER**

VERSAPRO

HAGEMEYER NORTH AMERICA, INC. (DELA-
WARE CORPORATION)
1460 TOBIAS GADSON BLVD.
CHARLESTON, SC 29407

FOR: NON-METAL BROOM HANDLES, IN
CLASS 20 (U.S. CLS. 2, 13, 22, 25, 32 AND 50).

FIRST USE 9-0-2007; IN COMMERCE 9-0-2007.

THE MARK CONSISTS OF STANDARD CHAR-
ACTERS WITHOUT CLAIM TO ANY PARTICULAR
FONT, STYLE, SIZE, OR COLOR.

SN 78-582,393, FILED 3-8-2005.

KATHLEEN M. VANSTON, EXAMINING ATTOR-
NEY

Int. Cls.: 35 and 43

Prior U.S. Cls.: 100, 101, and 102

United States Patent and Trademark Office

Reg. No. 3,522,460

Registered Oct. 21, 2008

**SERVICE MARK
PRINCIPAL REGISTER**

ESSENCHA

ESSENCHA TEA HOUSE & FINE TEAS, INC.
(OHIO CORPORATION)
3212 MADISON ROAD
CINCINNATI, OH 45209

FOR: RETAIL STORE, ONLINE-RETAIL STORE SERVICES, SPECIALIZING IN AND FOCUSING PRIMARILY ON THE SALE OF TEA, AND ALSO FEATURING PASTRIES, CHOCOLATES, CANDY, BOXED LUNCHES, TEA POTS, COFFEE AND TEA CUPS, TEAPOT BURNERS AND WARMERS, TEA SETS AND ACCESSORIES, POTTERY, CERAMICS, BOOKS, GIFT BASKETS, GIFT CARDS, AND GIFT ITEMS, IN CLASS 35 (U.S. CLS. 100, 101 AND 102).

FIRST USE 11-1-2005; IN COMMERCE 11-1-2005.

FOR: TEA ROOMS; RESTAURANT AND CATERING SERVICES, IN CLASS 43 (U.S. CLS. 100 AND 101).

FIRST USE 11-1-2005; IN COMMERCE 11-1-2005.

THE MARK CONSISTS OF STANDARD CHARACTERS WITHOUT CLAIM TO ANY PARTICULAR FONT, STYLE, SIZE, OR COLOR.

SN 78-587,724, FILED 3-15-2005.

BRENDAN REGAN, EXAMINING ATTORNEY

Int. Cl.: 9

Prior U.S. Cls.: 21, 23, 26, 36, and 38

United States Patent and Trademark Office

Reg. No. 3,522,461

Registered Oct. 21, 2008

**TRADEMARK
PRINCIPAL REGISTER**

FLASHCOUNT

DE LA RUE CASH SYSTEMS, INC. (DELAWARE
CORPORATION)
1209 ORANGE STREET
WILMINGTON, DE 19801

FOR: APPARATUS, INSTRUMENTS AND MA-
CHINES FOR HOLDING AND HANDLING MON-
EY, COINS, BANK NOTES AND CURRENCY,
NAMELY, MACHINES WHICH WEIGH AND CON-
VERT THE WEIGHT OF CURRENCY TO ITS
MONETARY VALUE, IN CLASS 9 (U.S. CLS. 21, 23,
26, 36 AND 38).

FIRST USE 8-0-2006; IN COMMERCE 8-0-2006.

THE MARK CONSISTS OF STANDARD CHAR-
ACTERS WITHOUT CLAIM TO ANY PARTICULAR
FONT, STYLE, SIZE, OR COLOR.

SN 78-590,348, FILED 3-18-2005.

ANDREA K. NADELMAN, EXAMINING ATTOR-
NEY

Int. Cl.: 35

Prior U.S. Cls.: 100, 101, and 102

United States Patent and Trademark Office

Reg. No. 3,522,462

Registered Oct. 21, 2008

**SERVICE MARK
PRINCIPAL REGISTER**

FIRST AND STILL THE BEST...

GIFTCO, INC. (ILLINOIS CORPORATION)
700 WOODLANDS PARKWAY
VERNON HILLS, IL 60061

FOR: BUSINESS CONSULTING SERVICES IN THE FIELD OF CHARITABLE FUNDRAISING, NAMELY, PROVIDING BUSINESS GUIDANCE TO OTHERS REGARDING MERCHANDISE, EQUIPMENT, FACILITIES, PROGRAMS AND PROMOTIONAL MATERIALS FOR FUNDRAISING, IN CLASS 35 (U.S. CLS. 100, 101 AND 102).

FIRST USE 1-0-2005; IN COMMERCE 1-0-2005.

THE MARK CONSISTS OF STANDARD CHARACTERS WITHOUT CLAIM TO ANY PARTICULAR FONT, STYLE, SIZE, OR COLOR.

SN 78-592,722, FILED 3-22-2005.

ZHALEH DELANEY, EXAMINING ATTORNEY

Int. Cl.: 29

Prior U.S. Cl.: 46

United States Patent and Trademark Office

Reg. No. 3,522,463

Registered Oct. 21, 2008

**TRADEMARK
PRINCIPAL REGISTER**

100% NUESTRO SABOR

IBE BUSINESS ENTERPRISE AG (SWITZER-
LAND CORPORATION)
BAARERSTRASSE 86
ZUG, SWITZERLAND 6300

FOR: MILK AND MILK PRODUCTS, NAMELY,
WHOLE MILK AND LOW FAT MILK; NATURAL
AND FLAVORED YOGHURTS; PASTEURIZED
CREAM, IN CLASS 29 (U.S. CL. 46).

FIRST USE 9-15-2005; IN COMMERCE 9-15-2005.

THE MARK CONSISTS OF STANDARD CHAR-
ACTERS WITHOUT CLAIM TO ANY PARTICULAR
FONT, STYLE, SIZE, OR COLOR.

THE FOREIGN WORDING IN THE MARK
TRANSLATES INTO ENGLISH AS OUR FLAVOR.

SN 78-601,379, FILED 4-4-2005.

ASMAT KHAN, EXAMINING ATTORNEY

Int. Cl.: 16

Prior U.S. Cls.: 2, 5, 22, 23, 29, 37, 38, and 50

United States Patent and Trademark Office

Reg. No. 3,522,464

Registered Oct. 21, 2008

**TRADEMARK
PRINCIPAL REGISTER**

SPA CLUB

CR LICENSE, LLC (ARIZONA LIMITED LIABILITY COMPANY)
8600 EAST ROCKCLIFF ROAD
TUCSON, AZ 85750

FOR: GIFT CARDS; PENS; ENVELOPES; MEMO PADS; STATIONERY, IN CLASS 16 (U.S. CLS. 2, 5, 22, 23, 29, 37, 38 AND 50).

FIRST USE 7-8-2008; IN COMMERCE 7-8-2008.

THE MARK CONSISTS OF STANDARD CHARACTERS WITHOUT CLAIM TO ANY PARTICULAR FONT, STYLE, SIZE, OR COLOR.

OWNER OF U.S. REG. NOS. 2,498,670, 2,893,272, AND OTHERS.

SN 78-601,584, FILED 4-4-2005.

ANDREA K. NADELMAN, EXAMINING ATTORNEY

Int. Cl.: 41

Prior U.S. Cls.: 100, 101, and 107

United States Patent and Trademark Office

Reg. No. 3,522,465

Registered Oct. 21, 2008

**SERVICE MARK
PRINCIPAL REGISTER**

OSBC LEGAL

INTERNATIONAL DATA GROUP, INC. (MASSACHUSETTS CORPORATION)
5 SPEEN STREET
FRAMINGHAM, MA 01701

FOR: EDUCATIONAL SERVICES, NAMELY, CONDUCTING SEMINARS AND DISCUSSION GROUPS, COLLOQUIUMS AND SYMPOSIUMS IN THE FIELD OF THE INFORMATION TECHNOLOGY INDUSTRY , IN CLASS 41 (U.S. CLS. 100, 101 AND 107).

FIRST USE 6-1-2005; IN COMMERCE 6-1-2005.

THE MARK CONSISTS OF STANDARD CHARACTERS WITHOUT CLAIM TO ANY PARTICULAR FONT, STYLE, SIZE, OR COLOR.

OWNER OF U.S. REG. NO. 2,992,367.

NO CLAIM IS MADE TO THE EXCLUSIVE RIGHT TO USE "LEGAL", APART FROM THE MARK AS SHOWN.

SN 78-601,663, FILED 4-5-2005.

LINDA ORNDORFF, EXAMINING ATTORNEY

Int. Cl.: 44

Prior U.S. Cls.: 100 and 101

United States Patent and Trademark Office

Reg. No. 3,522,466

Registered Oct. 21, 2008

**SERVICE MARK
PRINCIPAL REGISTER**

**THE HAUTE COUTURE
OF ALL TREATMENTS**

TRACIE MARTYN, INC. (NEW YORK CORPORATION)
59 FIFTH AVENUE
NEW YORK, NY 10003

FOR: SKIN CARE SERVICES, NAMELY, PROVIDING FACIAL, SKIN AND BODY CARE TREATMENTS AND MASSAGE, IN CLASS 44 (U.S. CLS. 100 AND 101).

FIRST USE 7-29-2008; IN COMMERCE 7-29-2008.

THE MARK CONSISTS OF STANDARD CHARACTERS WITHOUT CLAIM TO ANY PARTICULAR FONT, STYLE, SIZE, OR COLOR.

SN 78-601,693, FILED 4-5-2005.

KEVIN DINALLO, EXAMINING ATTORNEY

Int. Cls.: 7 and 12

Prior U.S. Cls.: 13, 19, 21, 23, 31, 34, 35, and 44

United States Patent and Trademark Office

Reg. No. 3,522,467

Registered Oct. 21, 2008

**TRADEMARK
PRINCIPAL REGISTER**

OX3

ADVANCED ENGINE TECHNOLOGIES, INC.
(COLORADO CORPORATION)
19021 S. FIGUEROA STREET
GARDENA, CA 90248

FOR: MACHINERY, NAMELY, GASOLINE POWERED GENERATORS FOR LAND VEHICLES, ENGINES FOR AIRPLANES AND BOATS, PARTS FOR ENGINES FOR AIRPLANES, BOATS AND AUTOMOBILES, NAMELY, PISTONS, ENGINE SHAFTS, CYLINDER HEADS, PORT PLATES AND PORT SEALS, IN CLASS 7 (U.S. CLS. 13, 19, 21, 23, 31, 34 AND 35).

FIRST USE 4-6-2005; IN COMMERCE 7-1-2008.

FOR: ENGINES FOR AUTOMOBILES AND OTHER LAND VEHICLES, IN CLASS 12 (U.S. CLS. 19, 21, 23, 31, 35 AND 44).

FIRST USE 4-6-2005; IN COMMERCE 7-1-2008.

THE MARK CONSISTS OF STANDARD CHARACTERS WITHOUT CLAIM TO ANY PARTICULAR FONT, STYLE, SIZE, OR COLOR.

SN 78-603,253, FILED 4-6-2005.

COURTNEY MCCORMICK, EXAMINING ATTORNEY

Int. Cls.: 29 and 30

Prior U.S. Cl.: 46

United States Patent and Trademark Office

Reg. No. 3,522,468

Registered Oct. 21, 2008

TRADEMARK
PRINCIPAL REGISTER



FRITO-LAY NORTH AMERICA, INC. (DELAWARE CORPORATION)
7701 LEGACY DRIVE
PLANO, TX 75024

FOR: FRIED PORK RINDS; POTATO-BASED SNACK FOODS, NAMELY, POTATO CHIPS, POTATO CRISPS AND PUFFED POTATO SNACKS; PROCESSED EDIBLE SEEDS; PROCESSED NUTS; SNACK DIPS, NAMELY, CHEESE-BASED SNACK DIPS, BEAN-BASED SNACK DIPS AND DAIRY-BASED SNACK DIPS; MEAT SNACKS, NAMELY, PROCESSED MEATS AND BEEF JERKY; CANDY-COATED NUTS; PLANTAIN CHIPS, IN CLASS 29 (U.S. CL. 46).

FIRST USE 5-0-2005; IN COMMERCE 5-0-2005.

FOR: CORN-BASED SNACK FOODS, NAMELY, CORN CHIPS, TORTILLA CHIPS AND PUFFED CORN SNACKS; READY-TO-EAT POPCORN; CARAMEL COATED READY-TO-EAT POPCORN; SALSA AND HOT SAUCES; TRAIL MIX CONSISTING PRIMARILY OF CRACKERS, PRETZELS, AND PROCESSED NUTS; COOKIES; CRACKERS; FILLED CRACKERS; SNACK MIX COMPRISED OF TORTILLA CHIPS, MULTIGRAIN SNACK CHIPS, CHEESE-FLAVORED PUFFED CORN SNACKS,

PRETZELS, READY-TO-EAT CEREAL, BAGEL PIECES, AND/OR CRACKERS; PRETZELS; MULTIGRAIN SNACK CHIPS; WHEAT-BASED SNACK FOODS, NAMELY PUFFED WHEAT SNACKS, IN CLASS 30 (U.S. CL. 46).

FIRST USE 5-0-2005; IN COMMERCE 5-0-2005.

OWNER OF U.S. REG. NOS. 2,464,128, 2,607,912, AND OTHERS.

THE COLOR(S) RED, WHITE AND YELLOW IS/ARE CLAIMED AS A FEATURE OF THE MARK.

THE MARK CONSISTS OF A RED BANNER CONTAINING THE TEXT FRITO LAY IN WHITE, THE WORDING GOOD FOOD FOR THE FUN OF IT! APPEARING BELOW THE BANNER IN RED, AND A CIRCLE APPEARING BEHIND THE BANNER IN YELLOW.

SN 78-603,766, FILED 4-7-2005.

BARBARA GAYNOR, EXAMINING ATTORNEY

Int. Cl.: 9

Prior U.S. Cls.: 21, 23, 26, 36, and 38

Reg. No. 3,522,469

United States Patent and Trademark Office

Registered Oct. 21, 2008

**TRADEMARK
PRINCIPAL REGISTER**



SMART PRODUCTIONS, LLC (ARIZONA LIMITED LIABILITY COMPANY)
2024 SOUTH BALDWIN #46
MESA, AZ 85212

FOR: SERIES OF PRE-RECORDED CD'S, VIDEO TAPES, LASER DISKS, AND DVD'S FEATURING A DOCUMENTARY ABOUT THE CHICAGO SPRING BASEBALL TRAINING CAMP, IN CLASS 9 (U.S. CLS. 21, 23, 26, 36 AND 38).

FIRST USE 2-20-2005; IN COMMERCE 3-2-2006.

THE COLOR(S) RED AND BLUE IS/ARE CLAIMED AS A FEATURE OF THE MARK.

THE MARK CONSISTS OF PALM TREE'S, CACTUS AND BASEBALL PLAYERS IN NAVY BLUE. LETTERING IN RED.

SN 78-607,895, FILED 4-13-2005.

INGRID C. EULIN, EXAMINING ATTORNEY

Int. Cl.: 9

Prior U.S. Cls.: 21, 23, 26, 36, and 38

Reg. No. 3,522,470

United States Patent and Trademark Office

Registered Oct. 21, 2008

**TRADEMARK
PRINCIPAL REGISTER**



SUZUKI MUSICAL INSTRUMENT MFG. CO.,
LTD. (JAPAN CORPORATION)
25-12, 2-CHOME, RYOUKE
HAMAMATSU-SHI, SHIZUOKA-KEN, JAPAN

OWNER OF JAPAN REG. NO. 2136315, DATED 5-30-1989, EXPIRES 5-30-2009.

FOR: PUBLIC ADDRESS SYSTEMS AND INSTRUMENTS; LOUDSPEAKERS; HEADPHONES; MICROPHONES FOR TELECOMMUNICATIONS APPARATUS; METRONOMES , IN CLASS 9 (U.S. CLS. 21, 23, 26, 36 AND 38).

OWNER OF U.S. REG. NO. 1,190,631.

SN 78-609,445, FILED 4-15-2005.

FIRST USE 2-0-1992; IN COMMERCE 10-0-1999.

MAYUR VAGHANI, EXAMINING ATTORNEY

Int. Cl.: 9

Prior U.S. Cls.: 21, 23, 26, 36, and 38

Reg. No. 3,522,471

United States Patent and Trademark Office

Registered Oct. 21, 2008

TRADEMARK
PRINCIPAL REGISTER

EzMONY \$

BAL MARAJ (UNITED STATES INDIVIDUAL)
SUITE 610
1400 N HARBOR BLVD.
FULLERTON, CA 92835

FOR: FULL LINE OF COMPUTER SOFTWARE FOR GAMING AND FOR PROVIDING GRAPHICAL ANIMATIONS, VIDEO GAME SOFTWARE AND INTERACTIVE COMPUTER GAME SOFTWARE; COMPUTER GAME SOFTWARE FOR USE WITH ELECTRONIC DEVICES SUCH AS WIRELESS/WIRED TABLET COMPUTERS, PERSONAL DIGITAL ASSISTANTS, LAPTOPS, DESKTOP COMPUTERS, COMPUTERIZED CELLULAR PHONES, AND RADIO PAGERS, DIGITAL VIDEO DISC DRIVES AND PORTABLE COMPUTER DEVICES, NAMELY, WIRELESS AND WIRED TABLET COMPUTERS, PERSONAL DIGITAL ASSISTANTS, LAPTOPS, DESKTOPS, COMPUTERIZED CELLULAR PHONES, WALKIE TALKIES, RADIO PAGERS, DIGITAL VIDEO DISCS AND DIGITAL AUDIO

HARDWARE; PORTABLE COMPUTER HARDWARE; PORTABLE DIGITAL AUDIO AND VIDEO HARDWARE FOR GAMES AND GAMING MACHINES; COMPUTER GAME AND GAMING DEVICES, NAMELY, WIRELESS AND WIRED TABLET COMPUTERS, PERSONAL DIGITAL ASSISTANTS, LAPTOPS, DESKTOPS, COMPUTERIZED CELLULAR PHONES, WALKIE TALKIES, RADIO PAGERS, POCKET COMPUTERS, DIGITAL VIDEO DISCS AND DIGITAL AUDIO HARDWARE; PORTABLE COMPUTER HARDWARE; PORTABLE DIGITAL AUDIO AND VIDEO HARDWARE CONTAINING MEMORY FOR SCORE KEEPING, IN CLASS 9 (U.S. CLS. 21, 23, 26, 36 AND 38).

FIRST USE 6-19-2006; IN COMMERCE 6-19-2006.

SN 78-610,328, FILED 4-15-2005.

ALICE BENMAMAN, EXAMINING ATTORNEY

Int. Cl.: 25

Prior U.S. Cls.: 22 and 39

United States Patent and Trademark Office

Reg. No. 3,522,472

Registered Oct. 21, 2008

**TRADEMARK
PRINCIPAL REGISTER**



HONGRUIXING (JINJIANG) GARMENTS CO.,
LTD (CHINA CORPORATION)
NO. 20 MEILING INDUSTRY ESTATE
QINGYANG TOWN
JINJIANG, FUJIAN, CHINA CN362200

FOR: CLOTHING, NAMELY, SHIRTS, PANTS,
SHORTS, DRESSES, UNDERWEAR; LAYETTES
BEING CLOTHING; SWIMSUITS; RAINCOATS;
FOOTWEAR; HEADGEAR FOR WEAR, NAMELY,
CAPS AND HATS; HOSIERY; GLOVES BEING
CLOTHING; NECKTIES; BELTS BEING CLOTHING,
IN CLASS 25 (U.S. CLS. 22 AND 39).

FIRST USE 11-15-2001; IN COMMERCE 4-30-2006.

THE MARK CONSISTS OF THE WORD "HOPE-
RISE" AND A DESIGN.

THE WORD "HOPERISE" IS AN INVENTED
WORD AND HAS NO MEANING OR SIGNIFI-
CANCE IN THE RELEVANT TRADE OR IN ANY
LANGUAGES.

SN 78-611,478, FILED 4-19-2005.

MARLENE BELL, EXAMINING ATTORNEY

Int. Cl.: 16

Prior U.S. Cls.: 2, 5, 22, 23, 29, 37, 38, and 50

United States Patent and Trademark Office

Reg. No. 3,522,473

Registered Oct. 21, 2008

**TRADEMARK
PRINCIPAL REGISTER**



COX, STEPHAN L. (UNITED STATES INDIVIDUAL)
5640 RIVERSIDE DRIVE #9
CHINO, CA 91710

FIRST USE 7-15-2006; IN COMMERCE 7-15-2006.

SN 78-614,346, FILED 4-21-2005.

FOR: MAGAZINES IN THE FIELD OF MOTORCYCLE RACING AND MOTORCYCLE PRODUCTS, IN CLASS 16 (U.S. CLS. 2, 5, 22, 23, 29, 37, 38 AND 50).

BENJAMIN OKEKE, EXAMINING ATTORNEY

Int. Cls.: 16 and 38

Prior U.S. Cls.: 2, 5, 22, 23, 29, 37, 38, 50, 100, 101, and 104

United States Patent and Trademark Office

Reg. No. 3,522,474

Registered Oct. 21, 2008

**TRADEMARK
SERVICE MARK
PRINCIPAL REGISTER**

FreeConferenceCall



Standard Edition

FREE CONFERENCING CORPORATION OF
AMERICA (CALIFORNIA CORPORATION)
SUITE C
110 W. OCEAN BLVD.
LONG BEACH, CA 90802

FOR: CALLING CARDS FOR USE IN TELECON-
FERENCING NOT MAGNETICALLY ENCODED,
IN CLASS 16 (U.S. CLS. 2, 5, 22, 23, 29, 37, 38 AND 50).

FIRST USE 6-1-2008; IN COMMERCE 6-1-2008.

FOR: TELECOMMUNICATION SERVICES,
NAMELY, CONFERENCE CALLING SERVICES, IN
CLASS 38 (U.S. CLS. 100, 101 AND 104).

FIRST USE 10-14-2004; IN COMMERCE 10-14-2004.

NO CLAIM IS MADE TO THE EXCLUSIVE
RIGHT TO USE "FREE CONFERENCE CALL",
APART FROM THE MARK AS SHOWN.

THE COLOR GRAY IN THE MARK MERELY
INDICATES SHADING.

THE MARK CONSISTS OF "FREECONFERENCE-
CALL" CENTERED AT THE TOP. CENTERED BE-
NEATH "FREECONFERENCECALL" IS A
TELEPHONE POSITIONED DIAGONALLY. CEN-
TERED BENEATH THE TELEPHONE IS THE
WORDING "STANDARD EDITION".

SN 78-621,206, FILED 5-2-2005.

JANICE L. MCMORROW, EXAMINING ATTOR-
NEY

Int. Cls.: 14 and 35

Prior U.S. Cls.: 2, 27, 28, 50, 100, 101, and 102

United States Patent and Trademark Office

Reg. No. 3,522,475

Registered Oct. 21, 2008

**TRADEMARK
SERVICE MARK
PRINCIPAL REGISTER**

HYDE PARK FINALE

HYDE PARK, INC. (COLORADO CORPORATION)
SUITE 243
3000 E. 1ST AVE.
DENVER, CO 80206

FOR: JEWELRY, IN CLASS 14 (U.S. CLS. 2, 27, 28 AND 50).

FIRST USE 7-10-2007; IN COMMERCE 7-10-2007.

FOR: RETAIL JEWELRY STORE SERVICES AND ON-LINE RETAIL JEWELRY STORE SERVICES, IN CLASS 35 (U.S. CLS. 100, 101 AND 102).

FIRST USE 7-10-2007; IN COMMERCE 7-10-2007.

THE MARK CONSISTS OF STANDARD CHARACTERS WITHOUT CLAIM TO ANY PARTICULAR FONT, STYLE, SIZE, OR COLOR.

OWNER OF U.S. REG. NO. 2,212,142.

SN 78-626,132, FILED 5-9-2005.

GIANCARLO CASTRO, EXAMINING ATTORNEY

Int. Cls.: 9 and 42

Prior U.S. Cls.: 21, 23, 26, 36, 38, 100, and 101

United States Patent and Trademark Office

Reg. No. 3,522,476

Registered Oct. 21, 2008

**TRADEMARK
SERVICE MARK
PRINCIPAL REGISTER**

ZXTECH

ZX TECHNOLOGIES, INC. (TEXAS CORPORATION)

420 NORTH CARROLL AVENUE, SUITE 150

SOUTHLAKE, TX 76092

FOR: EMBEDDABLE COMPUTER HARDWARE;
AND OPERATING SYSTEM SOFTWARE FOR USE
WITH SUCH COMPUTER HARDWARE, IN CLASS 9
(U.S. CLS. 21, 23, 26, 36 AND 38).

FIRST USE 1-15-2006; IN COMMERCE 0-0-2005.

FOR: DESIGN AND DEVELOPMENT OF COMPUTER SOFTWARE AND HARDWARE FOR OTHERS, IN CLASS 42 (U.S. CLS. 100 AND 101).

FIRST USE 1-15-2006; IN COMMERCE 0-0-2005.

THE MARK CONSISTS OF STANDARD CHARACTERS WITHOUT CLAIM TO ANY PARTICULAR FONT, STYLE, SIZE, OR COLOR.

SN 78-629,931, FILED 5-13-2005.

KRISTIN DAHLING, EXAMINING ATTORNEY

Int. Cl.: 30

Prior U.S. Cl.: 46

United States Patent and Trademark Office

Reg. No. 3,522,477

Registered Oct. 21, 2008

TRADEMARK
PRINCIPAL REGISTER



MOSHER, JILL A. (UNITED STATES INDIVIDUAL)
88 OAK ROAD
FAIRFAX, CA 949302124

FOR: CHOCOLATE, IN CLASS 30 (U.S. CL. 46).

FIRST USE 0-0-2006; IN COMMERCE 0-0-2006.

NO CLAIM IS MADE TO THE EXCLUSIVE RIGHT TO USE "CHOCOLATIER" AND "BON BON", APART FROM THE MARK AS SHOWN.

THE COLOR(S) BLUE, WHITE AND BROWN IS/ARE CLAIMED AS A FEATURE OF THE MARK.

THE MARK CONSISTS OF A BLUE RECTANGULAR BACKGROUND WITH A LIGHTER BLUE "B" DESIGN, THE REMAINING WORDING IN THE MARK IS IN BROWN, WITH TWO WHITE HORIZONTAL LINES.

THE FOREIGN WORDING IN THE MARK TRANSLATES INTO ENGLISH AS BEAUTIFUL.

SN 78-630,612, FILED 5-16-2005.

AMY HELLA, EXAMINING ATTORNEY

Int. Cl.: 9

Prior U.S. Cls.: 21, 23, 26, 36, and 38

United States Patent and Trademark Office

Reg. No. 3,522,478

Registered Oct. 21, 2008

**TRADEMARK
PRINCIPAL REGISTER**

Tom Cody

NY2LA INC. (CALIFORNIA CORPORATION)
5516 VIA OLAS
THOUSAND OAKS, CA 91320

FOR: EYEGLASS CASES; EYEGLASS CHAINS; EYEGLASS CLEANING CLOTHS; EYEGLASS FRAMES; EYEGLASS LENSES; EYEGLASSES; PROTECTIVE EYEGLASSES; READING EYEGLASSES; SIDE GUARDS FOR EYEGLASSES; SPECTACLES; SPORTS TRAINING EYEGLASSES; CHILDREN'S EYEGLASSES; CASES FOR CHILDREN'S EYEGLASSES; MAGNIFYING GLASSES; OPTICAL GLASSES; PROTECTIVE GLASSES; READING GLASSES; SKI GLASSES; SPECTACLE GLASSES; SPORTS GLASSES; SUNGLASSES; SUNGLASS LENSES; LENSES FOR SUNGLASSES; FRAMES FOR SPECTACLES AND SUNGLASSES; CASES FOR SPECTACLES AND SUNGLASSES; EYEWARE AC-

CESSORIES NAMELY, CASES, CLEANING CLOTHS AND CHAINS, IN CLASS 9 (U.S. CLS. 21, 23, 26, 36 AND 38).

FIRST USE 6-1-2006; IN COMMERCE 6-1-2006.

THE MARK CONSISTS OF STANDARD CHARACTERS WITHOUT CLAIM TO ANY PARTICULAR FONT, STYLE, SIZE, OR COLOR.

THE NAME(S), PORTRAIT(S), AND/OR SIGNATURE(S) SHOWN IN THE MARK IDENTIFIES "TOM CODY", WHOSE CONSENT(S) TO REGISTER IS SUBMITTED.

SN 78-635,620, FILED 5-24-2005.

JOHN KELLY, EXAMINING ATTORNEY

Int. Cl.: 14

Prior U.S. Cls.: 2, 27, 28, and 50

United States Patent and Trademark Office

Reg. No. 3,522,479

Registered Oct. 21, 2008

**TRADEMARK
PRINCIPAL REGISTER**

Tom Cody

NY2LA INC. (CALIFORNIA CORPORATION)
5516 VIA OLAS
THOUSAND OAKS, CA 91320

FOR: ALARM CLOCKS; APPARATUS FOR TIMING SPORTS EVENTS; BELT BUCKLES OF PRECIOUS METAL; BUCKLES FOR WATCHSTRAPS; CASES FOR WATCHES AND CLOCKS; DIAMOND BELTS; PARTS FOR WATCHES; POCKET WATCHES; SMALL CLOCKS; STOP WATCHES; TIMEPIECES; WATCH BRACELETS; WATCH CASES; WATCH CHAINS; WATCH GLASSES; WATCH PARTS; WATCHES; WRISTWATCHES; WATCH BANDS; WATCH BOXES; WATCH STRAPS; WATCH STRAPS MADE OF METAL OR LEATHER OR PLASTIC; WATCHES FOR OUTDOOR USE, IN CLASS 14 (U.S. CLS. 2, 27, 28 AND 50).

FIRST USE 6-1-2006; IN COMMERCE 6-1-2006.

THE MARK CONSISTS OF STANDARD CHARACTERS WITHOUT CLAIM TO ANY PARTICULAR FONT, STYLE, SIZE, OR COLOR.

THE NAME(S), PORTRAIT(S), AND/OR SIGNATURE(S) SHOWN IN THE MARK IDENTIFIES "TOM CODY", WHOSE CONSENT(S) TO REGISTER IS SUBMITTED."

SN 78-636,648, FILED 5-25-2005.

JOHN KELLY, EXAMINING ATTORNEY

Int. Cl.: 10

Prior U.S. Cls.: 26, 39, and 44

United States Patent and Trademark Office

Reg. No. 3,522,480

Registered Oct. 21, 2008

**TRADEMARK
PRINCIPAL REGISTER**

ONETOUCH AST

JOHNSON & JOHNSON (NEW JERSEY CORPORATION)
ONE JOHNSON & JOHNSON PLAZA
NEW BRUNSWICK, NJ 089337001

FOR: LANCETS, IN CLASS 10 (U.S. CLS. 26, 39 AND 44).

FIRST USE 1-0-2007; IN COMMERCE 1-0-2007.

THE MARK CONSISTS OF STANDARD CHARACTERS WITHOUT CLAIM TO ANY PARTICULAR FONT, STYLE, SIZE, OR COLOR.

OWNER OF U.S. REG. NOS. 1,484,999, 2,863,393, AND OTHERS.

NO CLAIM IS MADE TO THE EXCLUSIVE RIGHT TO USE "AST", APART FROM THE MARK AS SHOWN.

SN 78-637,778, FILED 5-26-2005.

MICHAEL SOUDERS, EXAMINING ATTORNEY

Int. Cl.: 18

Prior U.S. Cls.: 1, 2, 3, 22, and 41

United States Patent and Trademark Office

Reg. No. 3,522,481

Registered Oct. 21, 2008

**TRADEMARK
PRINCIPAL REGISTER**

Tom Cody

NY2LA INC. (CALIFORNIA CORPORATION)
5516 VIA OLAS
THOUSAND OAKS, CA 91320

FOR: ALL PURPOSE SPORT BAGS; ALL-PURPOSE ATHLETIC BAGS; ALL-PURPOSE CARRYING BAGS; ATHLETIC BAGS; ATTACHE CASES; BACKPACKS; BRIEFCASES; BRIEFCASE-TYPE PORTFOLIOS; BUSINESS CARD CASES; CREDIT CARD CASES; GYM BAGS; HANDBAGS; KEY CASES; LEATHER BAGS, SUITCASES AND WALLETS; LEATHER CASES; LEATHER HANDBAGS; LEATHER KEY CASES; LEATHER KEY CHAINS; NAME CARD CASES; POCKETBOOKS; SPORTS BAGS; TRAVEL BAGS; WALLETS; WALLETS WITH CARD COMPARTMENTS, IN CLASS 18 (U.S. CLS. 1, 2, 3, 22 AND 41).

FIRST USE 6-1-2006; IN COMMERCE 6-1-2006.

THE MARK CONSISTS OF STANDARD CHARACTERS WITHOUT CLAIM TO ANY PARTICULAR FONT, STYLE, SIZE, OR COLOR.

THE NAME(S), PORTRAIT(S), AND/OR SIGNATURE(S) SHOWN IN THE MARK IDENTIFIES "TOM CODY", WHOSE CONSENT(S) TO REGISTER IS SUBMITTED.

SN 78-639,573, FILED 5-30-2005.

JOHN KELLY, EXAMINING ATTORNEY

Int. Cl.: 33

Prior U.S. Cls.: 47 and 49

United States Patent and Trademark Office

Reg. No. 3,522,482

Registered Oct. 21, 2008

**TRADEMARK
PRINCIPAL REGISTER**

GONO

ASAHI-SHUZO SAKE BREWING CO., LTD. (JAPAN CORPORATION)

880-1, ASAHI, NAGAOKA-SHI

NIIGATA, JAPAN

FOR: SAKE, IN CLASS 33 (U.S. CLS. 47 AND 49).

FIRST USE 7-0-2001; IN COMMERCE 7-0-2001.

THE MARK CONSISTS OF STANDARD CHARACTERS WITHOUT CLAIM TO ANY PARTICULAR FONT, STYLE, SIZE, OR COLOR.

THE TRANSLATION OF "GONO" IS OF THE FIFTH.

SN 78-639,862, FILED 5-31-2005.

PATRICIA EVANKO, EXAMINING ATTORNEY

Int. Cl.: 42

Prior U.S. Cls.: 100 and 101

United States Patent and Trademark Office

Reg. No. 3,522,483

Registered Oct. 21, 2008

**SERVICE MARK
PRINCIPAL REGISTER**

MYCREDITQUOTE

RLI CREDIT DATA, INC. (CALIFORNIA CORPORATION)
24881 ALICIA PKWY. SUITE E290
LAGUNA HILLS, CA 92653

FOR: PROVIDING TEMPORARY USE OF ON-LINE NON-DOWNLOADABLE COMPUTER SOFTWARE FOR CALCULATING CREDIT SCORES FOR CONSUMERS, FOR USE IN THE FIELD OF PERSONAL AND BUSINESS FINANCE, ACCOUNTING AND CREDIT SCORING AND PROVIDING ON-LINE USER MANUALS FOR USE THEREWITH, IN CLASS 42 (U.S. CLS. 100 AND 101).

FIRST USE 4-28-2005; IN COMMERCE 4-28-2005.

THE MARK CONSISTS OF STANDARD CHARACTERS WITHOUT CLAIM TO ANY PARTICULAR FONT, STYLE, SIZE, OR COLOR.

SN 78-643,437, FILED 6-3-2005.

ATTIYA MALIK, EXAMINING ATTORNEY

Int. Cl.: 36

Prior U.S. Cls.: 100, 101, and 102

United States Patent and Trademark Office

Reg. No. 3,522,484

Registered Oct. 21, 2008

**SERVICE MARK
PRINCIPAL REGISTER**

ISoldMyHouse.com

STERLING LION, LLC (MASSACHUSETTS LIMITED LIABILITY COMPANY)
SUITE 102
171 LOCKE DRIVE
MARLBOROUGH, MA 01752

FOR: REAL ESTATE BROKERAGE SERVICES, IN CLASS 36 (U.S. CLS. 100, 101 AND 102).

FIRST USE 8-4-2008; IN COMMERCE 8-4-2008.

THE MARK CONSISTS OF STANDARD CHARACTERS WITHOUT CLAIM TO ANY PARTICULAR FONT, STYLE, SIZE, OR COLOR.

SN 78-651,939, FILED 6-16-2005.

JENNY PARK, EXAMINING ATTORNEY

Int. Cl.: 41

Prior U.S. Cls.: 100, 101, and 107

United States Patent and Trademark Office

Reg. No. 3,522,485

Registered Oct. 21, 2008

**SERVICE MARK
PRINCIPAL REGISTER**

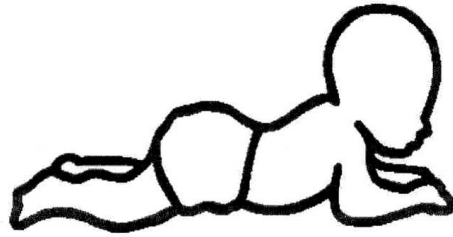

PATHWAYS FOUNDATION (ILLINOIS NON-PROFIT CORPORATION), DBA PATHWAYS AWARENESS,
150 N. MICHIGAN AVENUE, SUITE 2100
CHICAGO, IL 60601

FOR: EDUCATIONAL SERVICES, NAMELY, DEVELOPMENT AND DISSEMINATION OF EDUCATION MATERIALS OF OTHERS IN THE FIELDS OF INFANT PHYSICAL DEVELOPMENT, DETECTION OF MOVEMENT DIFFICULTIES IN CHILDREN, EARLY INTERVENTION, INCLUSION, AND SERVICES FOR CHILDREN WITH SPECIAL NEEDS,

AND CAREER OPPORTUNITIES IN THE FIELD OF PEDIATRIC THERAPY; AND CONDUCTING SEMINARS, CONFERENCES, AND WORKSHOPS ON INCLUSION FOR CHILDREN WITH SPECIAL NEEDS, IN CLASS 41 (U.S. CLS. 100, 101 AND 107).

FIRST USE 3-0-2000; IN COMMERCE 3-0-2000.

SN 78-653,214, FILED 6-17-2005.

STEVEN PEREZ, EXAMINING ATTORNEY

Int. Cl.: 9

Prior U.S. Cls.: 21, 23, 26, 36, and 38

United States Patent and Trademark Office

Reg. No. 3,522,486

Registered Oct. 21, 2008

TRADEMARK
PRINCIPAL REGISTER

FormaTone

FORMATO, RICHARD (UNITED STATES INDIVIDUAL)
761 W. MONTROSE STREET
CLERMONT, FL 34711

FOR: GUITAR AMPLIFIERS, BASS GUITAR AMPLIFIERS, MUSICAL INSTRUMENTS AMPLIFIERS, GUITAR EFFECTS PEDALS, NAMELY, ELECTRONIC EFFECT PEDALS FOR USE WITH SOUND AMPLIFIERS; GUITAR CABLES, MUSICAL IN-

STRUMENT SPEAKER CABINETS, IN CLASS 9 (U.S. CLS. 21, 23, 26, 36 AND 38).

FIRST USE 8-1-2007; IN COMMERCE 8-1-2007.

SN 78-662,143, FILED 6-30-2005.

SALLY SHIH, EXAMINING ATTORNEY

Int. Cls.: 9 and 41

Prior U.S. Cls.: 21, 23, 26, 36, 38, 100, 101, and 107

United States Patent and Trademark Office

Reg. No. 3,522,487

Registered Oct. 21, 2008

**TRADEMARK
SERVICE MARK
PRINCIPAL REGISTER**



LUCASFILM LTD. (CALIFORNIA CORPORATION)
PO BOX 29901
SAN FRANCISCO, CA 94129

FOR: PRE-RECORDED CD-ROMS, COMPACT DISCS, VIDEO DISCS, VIDEO CASSETTES, VIDEO TAPES AND DVDS FEATURING PRE-RECORDED FILM, VIDEO MATERIAL, GAMES, MUSIC, COMPUTER GAME SOFTWARE AND VIDEO GAME SOFTWARE; PRE-RECORDED AUDIO AND PRE-RECORDED VIDEO TAPES FEATURING FILMS AND VIDEO MATERIAL; PRE-RECORDED AUDIO AND PRE-RECORDED VIDEO TAPES FEATURING GAMES; PRE-RECORDED AUDIO AND PRE-RECORDED VIDEO TAPES FEATURING MUSIC; DOWNLOADABLE COMPUTER GAME SOFTWARE; DOWNLOADABLE INTERACTIVE ENTERTAINMENT SOFTWARE FOR PLAYING COMPUTER GAMES AND VIDEO GAMES; VIDEO GAME SOFTWARE AND MANUALS SOLD AS A UNIT; INTERACTIVE VIDEO GAME PROGRAMS; INTERACTIVE COMPUTER GAME PROGRAMS FEATURING SCIENCE FICTION, ACTION, ADVENTURE, ANIMATION, DRAMA, OR MUSIC; FILM CLIPS FEATURING SCIENCE FICTION, ACTION, ADVENTURE, ANIMATION, DRAMA, OR MUSIC; INTERACTIVE MULTIMEDIA SOFTWARE; INTERACTIVE MULTIMEDIA GAME SOFTWARE, IN CLASS 9 (U.S. CLS. 21, 23, 26, 36 AND 38).

FIRST USE 10-0-2005; IN COMMERCE 10-0-2005.

FOR: PRODUCTION OF MOTION PICTURES AND TELEVISION; PROVIDING TELEVISION AND MOTION PICTURE AUDIO AND VISUAL SPECIAL EFFECTS; PROVIDING NEWS AND INFORMATION IN THE FIELD OF ENTERTAINMENT PROVIDED ONLINE, VIA CABLE, VIA TELEVISION BROADCASTS, VIA SATELLITE AND VIA WIRELESS COMMUNICATIONS; FAN CLUB SERVICES; AND CONSULTING SERVICES IN FIELD OF ENTERTAINMENT PRODUCTS AND SERVICES, IN CLASS 41 (U.S. CLS. 100, 101 AND 107).

FIRST USE 10-0-2005; IN COMMERCE 10-0-2005.

OWNER OF U.S. REG. NOS. 2,565,990, 2,698,216, AND OTHERS.

NO CLAIM IS MADE TO THE EXCLUSIVE RIGHT TO USE "LTD", APART FROM THE MARK AS SHOWN.

THE MARK CONSISTS OF THE WORDS "LUCASFILM LTD" IN A STYLIZED DESIGN.

SN 78-662,806, FILED 7-1-2005.

ROBIN CHOSID, EXAMINING ATTORNEY

Int. Cl.: 28

Prior U.S. Cls.: 22, 23, 38, and 50

Reg. No. 3,522,488

United States Patent and Trademark Office

Registered Oct. 21, 2008

**TRADEMARK
PRINCIPAL REGISTER**

PLAY SAFE

PACIFIC CYCLE, LLC (DELAWARE LIMITED
LIABILITY COMPANY)
4902 HAMMERSLEY RD
MADISON, WI 53711

THE MARK CONSISTS OF STANDARD CHAR-
ACTERS WITHOUT CLAIM TO ANY PARTICULAR
FONT, STYLE, SIZE, OR COLOR.

FOR: SLIDES, SWINGS AND SWING SETS,
CLIMBING FRAMES, LADDERS, SOLD AT RETAIL
FOR RESIDENTIAL USE, IN CLASS 28 (U.S. CLS. 22,
23, 38 AND 50).

SN 78-662,890, FILED 7-1-2005.

FIRST USE 7-1-2008; IN COMMERCE 7-1-2008.

VERNA BETH RIRIE, EXAMINING ATTORNEY

Int. Cl.: 9

Prior U.S. Cls.: 21, 23, 26, 36, and 38

United States Patent and Trademark Office

Reg. No. 3,522,489

Registered Oct. 21, 2008

**TRADEMARK
PRINCIPAL REGISTER**

MORAL OREL

THE CARTOON NETWORK, INC. (DELAWARE
CORPORATION)
ONE CNN CENTER, 10 NORTH
C/O TURNER BROADCASTING SYSTEM, INC.
ATLANTA, GA 303032762

FOR: DIGITAL VERSATILE DISCS FEATURING
MUSIC, COMEDY, DRAMA, ACTION, ADVEN-
TURE, AND ANIMATION , IN CLASS 9 (U.S. CLS.
21, 23, 26, 36 AND 38).

FIRST USE 4-24-2007; IN COMMERCE 4-24-2007.

THE MARK CONSISTS OF STANDARD CHAR-
ACTERS WITHOUT CLAIM TO ANY PARTICULAR
FONT, STYLE, SIZE, OR COLOR.

SN 78-665,152, FILED 7-7-2005.

H. M. FISHER, EXAMINING ATTORNEY

Int. Cls.: 8 and 20

Prior U.S. Cls.: 2, 13, 22, 23, 25, 28, 32, 44, and 50

United States Patent and Trademark Office

Reg. No. 3,522,490

Registered Oct. 21, 2008

**TRADEMARK
PRINCIPAL REGISTER**



MENARD, INC. (WISCONSIN CORPORATION)
4777 MENARD DRIVE
EAU CLAIRE, WI 54703

FOR: FIREPLACE TOOL SETS SOLD AS A UNIT,
FIREPLACE BELLOWS, FIREPLACE TONGS,
NAMELY, LOG GRABBERS, IN CLASS 8 (U.S. CLS.
23, 28 AND 44).

FIRST USE 7-0-2008; IN COMMERCE 8-7-2008.

FOR: FLOOR AND WALL SHIELDS, IN THE
NATURE OF FIREGUARDS, FIREPLACE
SCREENS, IN CLASS 20 (U.S. CLS. 2, 13, 22, 25, 32
AND 50).

FIRST USE 7-0-2008; IN COMMERCE 8-7-2008.

NO CLAIM IS MADE TO THE EXCLUSIVE
RIGHT TO USE "HEARTH PRODUCTS", APART
FROM THE MARK AS SHOWN.

THE COLOR(S) GREEN, BEIGE, BROWN AND
WHITE IS/ARE CLAIMED AS A FEATURE OF THE
MARK.

THE MARK CONSISTS OF EXTERIOR BEIGE
CIRCLE OUTLINED IN BROWN, SURROUNDING
GREEN INTERIOR CIRCLE WITH BEIGE EVER-
GREEN TREES; WAVY BROWN BANNER, OUT-
LINED IN BEIGE IN WHITE, INTERSECTING
CIRCLES HORIZONTALLY WITH BEIGE AND
WHITE STYLIZED "NORTHWOODS" CHARAC-
TERS, INSIDE LOWER PORTION OF EXTERIOR
BEIGE CIRCLE, STYLIZED "HEARTH PRODUCTS"
IN BROWN LETTERING.

SN 78-667,252, FILED 7-11-2005.

KAREN K. BUSH, EXAMINING ATTORNEY

Int. Cls.: 36, 41, and 42

Prior U.S. Cls.: 100, 101, 102, and 107

United States Patent and Trademark Office

Reg. No. 3,522,491

Registered Oct. 21, 2008

**SERVICE MARK
PRINCIPAL REGISTER**



ARROWHEAD GENERAL INSURANCE AGENCY, INC. (MINNESOTA CORPORATION)

SUITE 2100

701 B STREET

SAN DIEGO, CA 92101

FOR: INSURANCE SERVICES, NAMELY, INSURANCE BROKERAGE SERVICES; INSURANCE GENERAL AGENCY SERVICES IN THE FIELDS OF PERSONAL AND COMMERCIAL PROPERTY AND LIABILITY INSURANCE; INSURANCE AGENCY SERVICES IN THE FIELDS OF HOME, MOBILE HOME, MOTORCYCLE, AUTOMOBILE, AND COMMERCIAL PROPERTY AND LIABILITY COVERAGES; FINANCING INSURANCE PREMIUMS, IN CLASS 36 (U.S. CLS. 100, 101 AND 102).

FIRST USE 11-15-2007; IN COMMERCE 11-15-2007.

FOR: TRAINING IN THE FIELD OF INSURANCE SOFTWARE, IN CLASS 41 (U.S. CLS. 100, 101 AND 107).

FIRST USE 11-15-2007; IN COMMERCE 11-15-2007.

FOR: MAINTENANCE AND TECHNICAL SUPPORT SERVICES, NAMELY, TROUBLESHOOTING, INSTALLING AND UPDATING IN THE FIELD OF INSURANCE SOFTWARE, IN CLASS 42 (U.S. CLS. 100 AND 101).

FIRST USE 11-15-2007; IN COMMERCE 11-15-2007.

THE MARK CONSISTS OF A GENERALLY TRIANGULAR SHAPE WITH A CUTOUT.

SN 78-668,733, FILED 7-12-2005.

BONNIE LUKEN, EXAMINING ATTORNEY

Int. Cl.: 30

Prior U.S. Cl.: 46

United States Patent and Trademark Office

Reg. No. 3,522,492

Registered Oct. 21, 2008

**TRADEMARK
PRINCIPAL REGISTER**

FUTURE CEUTICALS

VDF FUTURECEUTICALS, INC. (ILLINOIS CORPORATION)
300 WEST SIXTH STREET
MOMENCE, IL 60954

FOR: HOUSE MARK FOR PROCESSED FOOD PRODUCTS AND INGREDIENTS, NAMELY, PROCESSED HERBS AND GRAINS; FREEZE-DRIED, INDIVIDUALLY QUICK FROZEN, AND AIR DRIED HERBS; FREEZE-DRIED GRAINS; FLAVOURINGS OF NON-ESSENTIAL OILS, NAMELY, FRUIT FLAVOURINGS, FLAVOURINGS FOR CHEESES; FLAVORING ADDITIVES FOR NON-NUTRITIONAL PURPOSES; VEGETABLE CONCENTRATES USED FOR SEASONING; AND EX-

TRACTS USED AS FLAVORING, BEING NON-ESSENTIAL OILS, IN CLASS 30 (U.S. CL. 46).

FIRST USE 4-15-1999; IN COMMERCE 11-2-1999.

THE MARK CONSISTS OF STANDARD CHARACTERS WITHOUT CLAIM TO ANY PARTICULAR FONT, STYLE, SIZE, OR COLOR.

OWNER OF U.S. REG. NOS. 2,424,872 AND 2,895,123.

SN 78-669,801, FILED 7-13-2005.

ROBIN CHOSID, EXAMINING ATTORNEY

Int. Cl.: 5

Prior U.S. Cls.: 6, 18, 44, 46, 51, and 52

Reg. No. 3,522,493

United States Patent and Trademark Office

Registered Oct. 21, 2008

**TRADEMARK
PRINCIPAL REGISTER**

FUTURE CEUTICALS

VDF FUTURECEUTICALS, INC. (ILLINOIS CORPORATION)
300 WEST SIXTH STREET
MOMENCE, IL 60954

FOR: HOUSEMARK FOR NUTRACEUTICALS, NUTRITIONAL NUTRACEUTICAL INGREDIENTS, DIETARY AND NUTRITIONAL SUPPLEMENTS; DIETARY SUPPLEMENTS; NUTRICEUTICALS FOR USE AS DIETARY SUPPLEMENTS AND AS DIETARY SUPPLEMENT INGREDIENTS; AND NUTRITIONAL SUPPLEMENTS, IN CLASS 5 (U.S. CLS. 6, 18, 44, 46, 51 AND 52).

FIRST USE 11-15-1999; IN COMMERCE 11-15-1999.

THE MARK CONSISTS OF STANDARD CHARACTERS WITHOUT CLAIM TO ANY PARTICULAR FONT, STYLE, SIZE, OR COLOR.

OWNER OF U.S. REG. NOS. 2,424,872 AND 2,895,123.

SN 78-669,816, FILED 7-13-2005.

ROBIN CHOSID, EXAMINING ATTORNEY

Int. Cl.: 29

Prior U.S. Cl.: 46

Reg. No. 3,522,494

United States Patent and Trademark Office

Registered Oct. 21, 2008

**TRADEMARK
PRINCIPAL REGISTER**

FUTURE CEUTICALS

VDF FUTURECEUTICALS, INC. (ILLINOIS CORPORATION)
300 WEST SIXTH STREET
MOMENCE, IL 60954

FOR: HOUSE MARK FOR PROCESSED FOOD AND BEVERAGE PRODUCTS AND INGREDIENTS, PROCESSED FRUITS, VEGETABLES, AND BEANS; FREEZE-DRIED AND DEHYDRATED FRUITS AND VEGETABLES; FREEZE-DRIED TOFU PIECES; PROCESSED CHEESE; FREEZE-DRIED AND DEHYDRATED CHEESE; PROCESSED BEANS; FREEZE-DRIED AND DEHYDRATED BEANS; DAIRY PRODUCTS EXCLUDING ICE CREAM, ICE MILK AND FROZEN YOGURT; FREEZE-DRIED DAIRY PRODUCTS, EXCLUDING ICE CREAM, ICE MILK AND FROZEN YOGURT; PRESERVED, DRIED, COOKED AND GRILLED VEGETABLES; DRIED BEANS; DRIED EGGS; DRIED FRUITS; DRIED VEGETABLES; FREEZE-DRIED, DRUM-DRIED, INDIVIDUALLY QUICK FROZEN, AIR-

DRIED, FREEZE-DRIED ROASTED, IQF ROASTED, AND SUN-DRIED VEGETABLES; FREEZE-DRIED, DRUM-DRIED, AIR-DRIED, AND SUGAR-INFUSED FRUITS; FREEZE-DRIED SPECIALTY FOOD ITEMS, NAMELY, SOUPS, SHRIMP, SURIMI AND TOFU, IN CLASS 29 (U.S. CL. 46).

FIRST USE 4-15-1999; IN COMMERCE 11-2-1999.

THE MARK CONSISTS OF STANDARD CHARACTERS WITHOUT CLAIM TO ANY PARTICULAR FONT, STYLE, SIZE, OR COLOR.

OWNER OF U.S. REG. NOS. 2,424,872 AND 2,895,123.

SN 78-669,827, FILED 7-13-2005.

ROBIN CHOSID, EXAMINING ATTORNEY

Int. Cl.: 3

Prior U.S. Cls.: 1, 4, 6, 50, 51, and 52

United States Patent and Trademark Office

Reg. No. 3,522,495

Registered Oct. 21, 2008

**TRADEMARK
PRINCIPAL REGISTER**

SIRA DES INDES

THE PROCTER & GAMBLE COMPANY (OHIO
CORPORATION)
ONE PROCTER & GAMBLE PLAZA
CINCINNATI, OH 45202

FOR: PERFUMES, EAU DE PARFUM, FRA-
GRANCES FOR PERSONAL USE, NON-MEDICA-
TED SKIN CARE PREPARATIONS, IN CLASS 3 (U.S.
CLS. 1, 4, 6, 50, 51 AND 52).

FIRST USE 2-28-2006; IN COMMERCE 2-28-2006.

THE MARK CONSISTS OF STANDARD CHAR-
ACTERS WITHOUT CLAIM TO ANY PARTICULAR
FONT, STYLE, SIZE, OR COLOR.

THE ENGLISH TRANSLATION FOR DES INDES
IS "FROM INDIA."

SN 78-670,144, FILED 7-14-2005.

LESLEY LAMOTHE, EXAMINING ATTORNEY

Int. Cl.: 9

Prior U.S. Cls.: 21, 23, 26, 36, and 38

United States Patent and Trademark Office

Reg. No. 3,522,496

Registered Oct. 21, 2008

**TRADEMARK
PRINCIPAL REGISTER**

Audio-Out

BUCLATIN, EMMANUEL (UNITED STATES IN-
DIVIDUAL)
31877 CORTE MENDOZA
TEMECULA, CA 92592

THE MARK CONSISTS OF STANDARD CHAR-
ACTERS WITHOUT CLAIM TO ANY PARTICULAR
FONT, STYLE, SIZE, OR COLOR.

FOR: PRE-RECORDED COMPACT DISCS FEATURING PERFORMANCES BY A MUSICAL BAND, IN CLASS 9 (U.S. CLS. 21, 23, 26, 36 AND 38).

SN 78-679,216, FILED 7-27-2005.

FIRST USE 3-3-2008; IN COMMERCE 3-3-2008.

ALEX KEAM, EXAMINING ATTORNEY

Int. Cl.: 3

Prior U.S. Cls.: 1, 4, 6, 50, 51, and 52

United States Patent and Trademark Office

Reg. No. 3,522,497

Registered Oct. 21, 2008

**TRADEMARK
PRINCIPAL REGISTER**

FANTASY BRITNEY SPEARS

BRITNEY BRANDS, INC. (LOUISIANA CORPORATION)
C/O DAVIS SHAPIRO LEWIT MONTONE & HAYES
689 FIFTH AVENUE
NEW YORK, NY 10022

FOR: COSMETICS; FACIAL MAKEUP, BLUSHERS, FACIAL POWDERS, EYE MAKEUP, FACE AND BODY GLITTER, COSMETIC COMPACTS, LIPSTICK, LIP GLOSS, LOTIONS AND SCRUBS; SKIN MOISTURIZERS, SKIN CONDITIONERS, BATH GELS, SKIN HIGHLIGHTER, BODY FRAGRANCE SPRAYS, BODY AND HAND LOTIONS, BODY GELS, SHOWER GELS, BODY POWDERS, PERFUME, COLOGNE, EAU DE TOILETTE, EAU DE PERFUME, EAU DE COLOGNE AND TOILETTE WATER, IN CLASS 3 (U.S. CLS. 1, 4, 6, 50, 51 AND 52).

FIRST USE 9-5-2005; IN COMMERCE 9-5-2005.

THE MARK CONSISTS OF STANDARD CHARACTERS WITHOUT CLAIM TO ANY PARTICULAR FONT, STYLE, SIZE, OR COLOR.

THE NAME "BRITNEY SPEARS" IDENTIFIES A LIVING INDIVIDUAL WHOSE CONSENT IS OF RECORD.

SN 78-680,794, FILED 7-28-2005.

JAMES MACFARLANE, EXAMINING ATTORNEY

Int. Cls.: 16 and 41

Prior U.S. Cls.: 2, 5, 22, 23, 29, 37, 38, 50, 100, 101, and 107

Reg. No. 3,522,498

United States Patent and Trademark Office

Registered Oct. 21, 2008

**TRADEMARK
SERVICE MARK
PRINCIPAL REGISTER**

Safe Voyage

QSE PUBLISHING (WASHINGTON CORPORATION)
23112 NE 144TH STREET
WOODINVILLE, WA 98077

FOR: BROCHURES ABOUT MARITIME QUALITY, HEALTH, SAFETY, AND ENVIRONMENTAL AWARENESS; EDUCATIONAL PUBLICATIONS ABOUT MARITIME QUALITY, HEALTH, SAFETY, AND ENVIRONMENTAL AWARENESS; TRAINING MANUALS IN THE FIELD OF MARITIME QUALITY, HEALTH, SAFETY, AND ENVIRONMENTAL AWARENESS; GENERAL FEATURE MAGAZINES PROMOTING MARITIME QUALITY, HEALTH, SAFETY, AND ENVIRONMENTAL AWARENESS; INFORMATIONAL FLYERS FEATURING MARITIME QUALITY, HEALTH, SAFETY, AND ENVIRONMENTAL AWARENESS; MAGAZINE COLUMNS ABOUT MARITIME QUALITY, HEALTH, SAFETY, AND ENVIRONMENTAL AWARENESS; MAGAZINE DEPARTMENTS IN THE FIELD OF MARITIME QUALITY, HEALTH, SAFETY, AND ENVIRONMENTAL AWARENESS; MAGAZINE PAPER ABOUT MARITIME QUALITY, HEALTH, SAFETY, AND ENVIRONMENTAL AWARENESS; MAGAZINE SECTIONS IN THE FIELD OF MARITIME QUALITY, HEALTH, SAFETY, AND ENVIRONMENTAL AWARENESS; MAGAZINE SUPPLEMENTS TO NEWSPAPERS IN THE FIELD OF MARITIME QUALITY, HEALTH, SAFETY, AND ENVIRONMENTAL AWARENESS; MAGAZINES FEATURING MARITIME QUALITY, HEALTH, SAFETY, AND ENVIRONMENTAL AWARENESS; MANUALS IN THE FIELD OF MARITIME QUALITY, HEALTH, SAFETY, AND ENVIRONMENTAL AWARENESS; NEWSLETTERS IN THE FIELD OF MARITIME QUALITY, HEALTH, SAFETY, AND ENVIRONMENTAL AWARENESS;

SYNDICATED MAGAZINE SECTIONS DEALING WITH MARITIME QUALITY, HEALTH, SAFETY, AND ENVIRONMENTAL AWARENESS, IN CLASS 16 (U.S. CLS. 2, 5, 22, 23, 29, 37, 38 AND 50).

FIRST USE 4-30-2005; IN COMMERCE 4-30-2005.

FOR: ENTERTAINMENT SERVICES, NAMELY, PROVIDING A WEB SITE FEATURING MUSICAL PERFORMANCES, MUSICAL VIDEOS, RELATED FILM CLIPS, PHOTOGRAPHS, AND OTHER MULTIMEDIA MATERIALS; MAGAZINE PUBLISHING; MULTIMEDIA ENTERTAINMENT SOFTWARE PRODUCTION SERVICES; ON-LINE LIBRARY SERVICES, NAMELY, PROVIDING ELECTRONIC LIBRARY SERVICES WHICH FEATURE NEWSPAPERS, MAGAZINES, PHOTOGRAPHS AND PICTURES VIA AN ON-LINE COMPUTER NETWORK; PROVIDING NEWSLETTERS IN THE FIELD OF MARITIME QUALITY, HEALTH, SAFETY AND ENVIRONMENTAL AWARENESS VIA E-MAIL; PUBLICATION OF ALMANACS; PUBLICATION OF BOOKS, OF MAGAZINES, OR JOURNALS, OF NEWSPAPERS, OF PERIODICALS, OF CATALOGS, OF BROCHURES; PUBLICATION OF MANUALS, IN CLASS 41 (U.S. CLS . 100, 101 AND 107).

FIRST USE 2-1-2008; IN COMMERCE 2-1-2008.

THE MARK CONSISTS OF STANDARD CHARACTERS WITHOUT CLAIM TO ANY PARTICULAR FONT, STYLE, SIZE, OR COLOR.

SN 78-681,729, FILED 7-29-2005.

GIANCARLO CASTRO, EXAMINING ATTORNEY

Int. Cl.: 35

Prior U.S. Cls.: 100, 101, and 102

United States Patent and Trademark Office

Reg. No. 3,522,499

Registered Oct. 21, 2008

**SERVICE MARK
PRINCIPAL REGISTER**

KCLC

KANSAS COALITION FOR LIFESAVING CURES
INC. (KANSAS NON-PROFIT CORPORATION)
P. O. BOX 394
6201 COLLEGE BLVD.
TOPEKA, KS 666010394

FOR: PROMOTING PUBLIC AWARENESS OF
THE NEED FOR AND AVAILABILITY OF SCIENTIFIC
RESEARCH, TREATMENT, AND EDUCATION
IN THE FIELD OF STEM CELL RESEARCH
AND PROVIDING INFORMATION IN CONNEC-
TION THEREWITH; PUBLIC AWARENESS SERVI-
CES, NAMELY, PROMOTING THE NEED FOR
SCIENTIFIC RESEARCH, TREATMENT AND EDU-

CATION IN THE FIELD OF STEM CELLS, IN CLASS
35 (U.S. CLS. 100, 101 AND 102).

FIRST USE 7-26-2008; IN COMMERCE 7-26-2008.

THE MARK CONSISTS OF STANDARD CHAR-
ACTERS WITHOUT CLAIM TO ANY PARTICULAR
FONT, STYLE, SIZE, OR COLOR.

SN 78-682,995, FILED 8-1-2005.

ELLEN PERKINS, EXAMINING ATTORNEY

Int. Cl.: 3

Prior U.S. Cls.: 1, 4, 6, 50, 51, and 52

United States Patent and Trademark Office

Reg. No. 3,522,500

Registered Oct. 21, 2008

**TRADEMARK
PRINCIPAL REGISTER**



TOPCO ASSOCIATES, LLC (DELAWARE LIMITED LIABILITY COMPANY)
7711 GROSS POINT ROAD
SKOKIE, IL 60077

FIRST USE 8-1-2006; IN COMMERCE 8-1-2006.

THE MARK CONSISTS OF "CV CLEAR VALUE".

FOR: LAUNDRY BLEACH, LAUNDRY DETERGENT, DISH DETERGENT, FABRIC SOFTENER FOR LAUNDRY USE, BABY WIPES, GLASS CLEANERS, IN CLASS 3 (U.S. CLS. 1, 4, 6, 50, 51 AND 52).

SN 78-684,037, FILED 8-2-2005.

MORGAN WYNNE, EXAMINING ATTORNEY

Int. Cl.: 6

Prior U.S. Cls.: 2, 12, 13, 14, 23, 25, and 50

Reg. No. 3,522,501

United States Patent and Trademark Office

Registered Oct. 21, 2008

**TRADEMARK
PRINCIPAL REGISTER**



TOPCO ASSOCIATES, LLC (DELAWARE LIMITED LIABILITY COMPANY)
7711 GROSS POINT ROAD
SKOKIE, IL 60077

THE MARK CONSISTS OF "CV CLEAR VALUE"

FOR: ALUMINUM FOIL, IN CLASS 6 (U.S. CLS. 2, 12, 13, 14, 23, 25 AND 50).

SN 78-684,050, FILED 8-2-2005.

FIRST USE 8-1-2006; IN COMMERCE 8-1-2006.

MORGAN WYNNE, EXAMINING ATTORNEY

Int. Cl.: 31

Prior U.S. Cls.: 1 and 46

United States Patent and Trademark Office

Reg. No. 3,522,502

Registered Oct. 21, 2008

**TRADEMARK
PRINCIPAL REGISTER**



TOPCO ASSOCIATES, LLC (DELAWARE LIMITED LIABILITY COMPANY)
7711 GROSS POINT ROAD
SKOKIE, IL 60077

FOR: CAT LITTER, DRY CAT FOOD, DRY DOG FOOD, DOG BISCUITS, IN CLASS 31 (U.S. CLS. 1 AND 46).

FIRST USE 8-1-2006; IN COMMERCE 8-1-2006.

THE MARK CONSISTS OF "CV CLEAR VALUE"

SN 78-684,095, FILED 8-2-2005.

MORGAN WYNNE, EXAMINING ATTORNEY

Int. Cl.: 32

Prior U.S. Cls.: 45, 46, and 48

United States Patent and Trademark Office

Reg. No. 3,522,503

Registered Oct. 21, 2008

**TRADEMARK
PRINCIPAL REGISTER**



TOPCO ASSOCIATES, LLC (DELAWARE LIMITED LIABILITY COMPANY)
7711 GROSS POINT ROAD
SKOKIE, IL 60077

FOR: FRUIT JUICES, NAMELY, ORANGE, APPLE, TOMATO, CRANBERRY, CRANBERRY-APPLE; DRINKING WATER, IN CLASS 32 (U.S. CLS. 45, 46 AND 48).

FIRST USE 8-1-2006; IN COMMERCE 8-1-2006.

THE MARK CONSISTS OF "CV CLEAR VALUE"

SN 78-684,100, FILED 8-2-2005.

MORGAN WYNNE, EXAMINING ATTORNEY

Int. Cl.: 35

Prior U.S. Cls.: 100, 101, and 102

United States Patent and Trademark Office

Reg. No. 3,522,504

Registered Oct. 21, 2008

**SERVICE MARK
PRINCIPAL REGISTER**

THE OUTDOOR COMPANY

THE COLEMAN COMPANY, INC. (DELAWARE
CORPORATION)
IP LEGAL DEPT. - 11702
3600 NORTH HYDRAULIC
WICHITA, KS 67219

FOR: RETAIL DEPARTMENT STORE SERVICES,
IN CLASS 35 (U.S. CLS. 100, 101 AND 102).

FIRST USE 6-0-2006; IN COMMERCE 6-0-2006.

THE MARK CONSISTS OF STANDARD CHAR-
ACTERS WITHOUT CLAIM TO ANY PARTICULAR
FONT, STYLE, SIZE, OR COLOR.

NO CLAIM IS MADE TO THE EXCLUSIVE
RIGHT TO USE "COMPANY", APART FROM THE
MARK AS SHOWN.

SN 78-684,520, FILED 8-3-2005.

JEFF DEFORD, EXAMINING ATTORNEY

Int. Cls.: 9, 35, and 42

Prior U.S. Cls.: 21, 23, 26, 36, 38, 100, 101, and 102

United States Patent and Trademark Office

Reg. No. 3,522,505

Registered Oct. 21, 2008

**TRADEMARK
SERVICE MARK
PRINCIPAL REGISTER**

VENDOR CENTRAL

AMAZON TECHNOLOGIES, INC. (NEVADA CORPORATION)
TRADEMARKS
PO BOX 8102
RENO, NV 89507

FOR: DOWNLOADABLE COMPUTER SOFTWARE, ACCESSIBLE OVER A GLOBAL COMPUTER NETWORK, FOR MANAGING THE SALE OF GOODS AND SERVICES, NAMELY, MANAGING PURCHASE ORDER AND FULFILLMENT WORKFLOW, PUBLISHING AND MANAGING PRODUCT AND SERVICE OFFERINGS, TRACKING OF SALES AND INVENTORY, CATEGORIZING OF MERCHANDISE, MERCHANDISING AND PRESENTATION OF PRODUCT AND SERVICE OFFERINGS, ANALYZING AND REPORTING DATA RELATING TO MANAGING THE SALE OF GOODS AND SERVICES, IN CLASS 9 (U.S. CLS. 21, 23, 26, 36 AND 38).

FIRST USE 3-31-2006; IN COMMERCE 3-31-2006.

FOR: BUSINESS MANAGEMENT SERVICES RELATED TO THE MANAGEMENT OF THE SALE OF GOODS AND SERVICES, NAMELY, MANAGING PURCHASE ORDER AND FULFILLMENT WORKFLOW, PUBLISHING AND MANAGING PRODUCT AND SERVICE OFFERINGS, TRACKING OF SALES AND INVENTORY, CATEGORIZING OF MERCHANDISE, MERCHANDISING AND PRESENTATION OF PRODUCT AND SERVICE OFFERINGS, ANALYZING AND REPORTING DATA RELATED TO MANAGEMENT OF THE SALE OF GOODS AND SERVICES; BUSINESS CONSULTATION REGARDING THE MANAGEMENT OF THE SALE OF

GOODS AND SERVICES, IN CLASS 35 (U.S. CLS. 100, 101 AND 102).

FIRST USE 3-31-2006; IN COMMERCE 3-31-2006.

FOR: TECHNICAL SUPPORT SERVICES, NAMELY, TROUBLESHOOTING COMPUTER HARDWARE AND COMPUTER SOFTWARE PROBLEMS VIA EMAIL AND TELEPHONE; PROVIDING ONLINE TEMPORARY USE OF NONDOWNLOADABLE COMPUTER SOFTWARE FOR MANAGING THE SALE OF GOODS AND SERVICES, NAMELY, MANAGING PURCHASE ORDER AND FULFILLMENT WORKFLOW, PUBLISHING AND MANAGING PRODUCT AND SERVICES OFFERINGS, TRACKING OF SALES AND INVENTORY, CATEGORIZING OF MERCHANDISE, MERCHANDISING AND PRESENTATION OF PRODUCT AND SERVICE OFFERINGS, ANALYZING AND REPORTING DATA RELATING TO MANAGING THE SALE OF GOODS AND SERVICES, IN CLASS 42 (U.S. CLS. 100 AND 101).

FIRST USE 3-31-2006; IN COMMERCE 3-31-2006.

THE MARK CONSISTS OF STANDARD CHARACTERS WITHOUT CLAIM TO ANY PARTICULAR FONT, STYLE, SIZE, OR COLOR.

NO CLAIM IS MADE TO THE EXCLUSIVE RIGHT TO USE "VENDOR", APART FROM THE MARK AS SHOWN.

SN 78-685,002, FILED 8-3-2005.

PATRICIA EVANKO, EXAMINING ATTORNEY

Int. Cl.: 5

Prior U.S. Cls.: 6, 18, 44, 46, 51, and 52

Reg. No. 3,522,506

United States Patent and Trademark Office

Registered Oct. 21, 2008

**TRADEMARK
PRINCIPAL REGISTER**

HARDISTRAIN

VDF FUTURECEUTICALS, INC. (ILLINOIS CORPORATION)
300 WEST SIXTH STREET
MOMENCE, IL 60954

FOR: NUTRACEUTICAL INGREDIENTS, NAME-
LY, PROBIOTIC BACTERIA ALONE OR IN COMBI-
NATION WITH NUTRACEUTICAL OR
FUNCTIONAL FOOD INGREDIENTS, FOR THE
TREATMENT OF CORONARY HEALTH, MAINTEN-
NANCE OF HEALTHY WEIGHT, LIPID HEALTH,
GASTROINTESTINAL HEALTH, IMMUNE
HEALTH, HEALTHY OXIDATIVE AND ANTIOXI-
DATIVE STATUS, HEALTHY AGING, NEUROLO-
GICAL HEALTH, BONE AND JOINT/OSTEO
HEALTH, HEALTHY OXALIC ACID STATUS, ME-
TABOLIC HEALTH AND HEALTHY GLUCOSE
METABOLISM, HEALTHY TRIGLYCERIDE STA-
TUS, RENAL HEALTH, HEPATIC HEALTH, DER-
MAL HEALTH, WOMEN'S HEALTH, NAMELY,
MAINTENANCE OF HEALTHY URINARY
TRACTS, ESTROGEN, SERUM CALCIUM, OXA-
LATES, AND VITAMIN D LEVELS, AND THE

MAINTENANCE AND IMPROVEMENT OF HEAL-
THY PRE- AND POST-MENOPAUSAL STATUS,
MEN'S HEALTH, NAMELY, MAINTENANCE OF
HEALTHY TESTOSTERONE, VITAMIN D, PARA-
THYROID, OXALATES AND SERUM CALCIUM
LEVELS, HEALTHY VITAMIN STATUS, HEALTHY
MINERAL STATUS, VASCULAR HEALTH, MUS-
CULAR HEALTH, CELLULAR HEALTH; DIETARY
AND NUTRITIONAL SUPPLEMENTS; NUTRACEU-
TICALS FOR USE AS DIETARY SUPPLEMENTS
AND AS DIETARY SUPPLEMENT INGREDIENTS,
IN CLASS 5 (U.S. CLS. 6, 18, 44, 46, 51 AND 52).

FIRST USE 2-0-2005; IN COMMERCE 6-14-2005.

THE MARK CONSISTS OF STANDARD CHAR-
ACTERS WITHOUT CLAIM TO ANY PARTICULAR
FONT, STYLE, SIZE, OR COLOR.

SN 78-688,374, FILED 8-9-2005.

KAREN K. BUSH, EXAMINING ATTORNEY

Int. Cl.: 16

Prior U.S. Cls.: 2, 5, 22, 23, 29, 37, 38, and 50

United States Patent and Trademark Office

Reg. No. 3,522,507

Registered Oct. 21, 2008

**TRADEMARK
PRINCIPAL REGISTER**

Le Big Boss

STREETWISE MAPS INC. (FLORIDA CORPORATION)
4376 INDEPENDENCE COURT
SARASOTA, FL 34234

FOR: MAPS, MAPS WITH INDICES, PRINTED EDUCATIONAL MATERIAL IN THE FIELDS OF GEOGRAPHY AND TRAVEL; GUIDE BOOKS FOR TRAVEL, INCLUDING MAPS AND INDICES , IN CLASS 16 (U.S. CLS. 2, 5, 22, 23, 29, 37, 38 AND 50).

FIRST USE 8-28-2008; IN COMMERCE 8-28-2008.

THE MARK CONSISTS OF STANDARD CHARACTERS WITHOUT CLAIM TO ANY PARTICULAR FONT, STYLE, SIZE, OR COLOR.

SN 78-689,642, FILED 8-10-2005.

PAUL F. GAST, EXAMINING ATTORNEY

Int. Cl.: 35

Prior U.S. Cls.: 100, 101, and 102

United States Patent and Trademark Office

Reg. No. 3,522,508

Registered Oct. 21, 2008

**SERVICE MARK
PRINCIPAL REGISTER**

STREETSMART

STREETWISE MAPS INC. (FLORIDA CORPORATION)
4376 INDEPENDENCE COURT
SARASOTA, FL 34243

FOR: RETAILING SERVICES, NAMELY, MAIL ORDER SERVICES, TELEPHONE ORDERING SERVICES, ONLINE RETAIL ORDERING SERVICES VIA THE INTERNET, ELECTRONIC RETAIL ORDERING SERVICES VIA COMPUTER, FEATURING MAPS, MAPS WITH INDICES, AND RELATED TRAVEL MATERIAL; WHOLESALE DISTRIBUTORSHIPS FEATURING MAPS, MAPS WITH INDICES, AND RELATED TRAVEL MATERIAL, AND WHOLESALE ORDERING SERVICES IN THE FIELD OF MAPS, MAPS WITH INDICES, AND

RELATED TRAVEL MATERIAL, IN CLASS 35 (U.S. CLS. 100, 101 AND 102).

FIRST USE 8-8-2008; IN COMMERCE 8-8-2008.

THE MARK CONSISTS OF STANDARD CHARACTERS WITHOUT CLAIM TO ANY PARTICULAR FONT, STYLE, SIZE, OR COLOR.

OWNER OF U.S. REG. NO. 2,976,904.

SN 78-691,084, FILED 8-11-2005.

EDWARD NELSON, EXAMINING ATTORNEY

Int. Cls.: 2, 9, 37, 41, and 42

Prior U.S. Cls.: 6, 11, 16, 21, 23, 26, 36, 38, 100, 101, 103, 106, and 107

Reg. No. 3,522,509

United States Patent and Trademark Office

Registered Oct. 21, 2008

**TRADEMARK
SERVICE MARK
PRINCIPAL REGISTER**

JDSU

JDS UNIPHASE CORPORATION (DELAWARE CORPORATION)
430 N. MCCARTHY BLVD.
MILPITAS, CA 95035

FOR: OPTICAL COATINGS; PIGMENTS; FLEXOGRAPHIC, INTAGLIO, AND GRAVURE INKS, AND HIGH PERFORMANCE COATINGS AND DISPERSIONS TO PROVIDE SECURITY AND BRAND PROTECTION, AUTHENTICATION, AND DIFFERENTIATION, IN CLASS 2 (U.S. CLS. 6, 11 AND 16).

FIRST USE 4-20-2006; IN COMMERCE 4-20-2006.

FOR: COMMUNICATIONS HARDWARE AND SOFTWARE FOR CONNECTING ELECTRONIC COMMUNICATIONS NETWORKS; TELECOMMUNICATIONS AND DATA NETWORKING HARDWARE AND SOFTWARE, NAMELY DEVICES FOR TRANSMITTING, ROUTING, AND RECEIVING AUDIO, VIDEO, AND OTHER DATA ACROSS NETWORKS; COMPUTER HARDWARE FOR TELECOMMUNICATIONS; COMPUTER HARDWARE; HARDWARE, SOFTWARE AND SYSTEMS, NAMELY TELECOMMUNICATIONS AND DATA NETWORKING HARDWARE, SOFTWARE, AND COMPONENTS FOR TESTING AND MEASUREMENT OF TELECOMMUNICATIONS AND NETWORKING HARDWARE, SOFTWARE AND SYSTEMS; COMPUTER IMAGING HARDWARE; LASERS NOT FOR MEDICAL USE; SEMICONDUCTORS; COMMUNICATIONS, TELECOMMUNICATIONS, OPTICAL AND COMPUTING SWITCHES, ADAPTORS, CONNECTORS, SPLITTERS, COUPLERS, METERS, MODULATORS, RECEIVERS, AMPLIFIERS, TRANSMITTERS, MONITORS, TEST SYSTEMS; TRANSCEIVERS; TRANSPONDERS; MULTIPLEXERS; SCIENTIFIC AND TECHNICAL APPARATUS, NAMELY, OPTICAL MIRRORS; OPTICAL FILTERS; OPTICAL LENSES; POWER CON-

VERTERS; POWER SUPPLIES; LIQUID CRYSTAL DISPLAYS; LIQUID CRYSTAL DISPLAY PROJECTORS; IMAGE PROJECTORS; INTERNALLY ILLUMINATED SIGN AND LIGHT ENGINES; MOUNTING RACKS FOR COMMUNICATIONS OR COMPUTER HARDWARE, TELECOMMUNICATIONS HARDWARE OR COMPUTER HARDWARE, IN CLASS 9 (U.S. CLS. 21, 23, 26, 36 AND 38).

FIRST USE 8-0-2006; IN COMMERCE 8-0-2006.

FOR: REPAIR AND MAINTENANCE OF COMPUTER AND COMMUNICATIONS HARDWARE AND SOFTWARE AND MEDICAL DEVICES, IN CLASS 37 (U.S. CLS. 100, 103 AND 106).

FIRST USE 11-0-2005; IN COMMERCE 11-0-2005.

FOR: EDUCATION SERVICES, NAMELY, PROVIDING CLASSES, SEMINARS, AND WORKSHOPS IN THE FIELDS OF THE DESIGN, SELECTION, IMPLEMENTATION, INSTALLATION, USE, AND TESTING OF COMMUNICATIONS SYSTEMS AND EQUIPMENT FOR OTHERS AND IN THE FIELDS OF PRODUCT SECURITY, COMMUNICATIONS NETWORKS, OPTICAL NETWORKS, OPTICAL HARDWARE, COMMUNICATIONS HARDWARE AND FIBER OPTICS; TRAINING SERVICES IN THE FIELDS OF THE DESIGN, SELECTION, IMPLEMENTATION, INSTALLATION, USE, AND TESTING OF COMMUNICATIONS SYSTEMS AND EQUIPMENT FOR OTHERS AND IN THE FIELDS OF PRODUCT SECURITY, COMMUNICATIONS NETWORKS, OPTICAL HARDWARE, COMMUNICATIONS HARDWARE, AND FIBER OPTICS, IN CLASS 41 (U.S. CLS. 100, 101 AND 107).

FIRST USE 3-0-2006; IN COMMERCE 3-0-2006.

FOR: CONSULTATION SERVICES IN THE FIELDS OF THE DESIGN, SELECTION, IMPLEMENTATION, INSTALLATION, USE, AND TESTING OF COMMUNICATIONS SYSTEMS AND EQUIPMENT FOR OTHERS; CONSULTATION SERVICES IN THE FIELDS OF PRODUCT SECURITY, COMMUNICATIONS HARDWARE, COMMUNICATIONS NETWORKS, OPTICAL NETWORKS, OPTICAL HARDWARE, FIBER OPTICS; ENGINEERING; DESIGN FOR OTHERS IN THE FIELDS OF PRINTING, PRODUCT SECURITY, COMMUNICATIONS HARDWARE, COMPUTER HARDWARE, OPTICAL

HARDWARE, FIBER OPTICS, IN CLASS 42 (U.S. CLS. 100 AND 101).

FIRST USE 10-0-2005; IN COMMERCE 10-0-2005.

THE MARK CONSISTS OF STANDARD CHARACTERS WITHOUT CLAIM TO ANY PARTICULAR FONT, STYLE, SIZE, OR COLOR.

SN 78-692,958, FILED 8-15-2005.

ANNE E. GUSTASON, EXAMINING ATTORNEY

Int. Cls.: 2, 9, 37, 41, and 42

Prior U.S. Cls.: 6, 11, 16, 21, 23, 26, 36, 38, 100, 101, 103, 106, and 107

Reg. No. 3,522,510

United States Patent and Trademark Office

Registered Oct. 21, 2008

**TRADEMARK
SERVICE MARK
PRINCIPAL REGISTER**

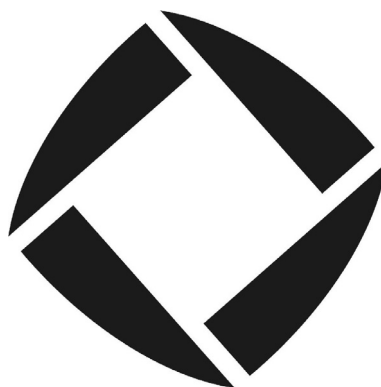

JDS UNIPHASE CORPORATION (DELAWARE CORPORATION)
430 NORTH MCCARTHY BLVD.
MILPITAS, CA 95035

FOR: OPTICAL COATINGS; PIGMENTS; FLEXOGRAPHIC, INTAGLIO, AND GRAVURE INKS, AND HIGH PERFORMANCE COATINGS AND DISPERSIONS TO PROVIDE SECURITY AND BRAND PROTECTION, AUTHENTICATION, AND DIFFERENTIATION, IN CLASS 2 (U.S. CLS. 6, 11 AND 16).

FIRST USE 4-20-2006; IN COMMERCE 4-20-2006.

FOR: COMMUNICATIONS HARDWARE AND SOFTWARE FOR CONNECTING ELECTRONIC COMMUNICATIONS NETWORKS; TELECOMMUNICATIONS AND DATA NETWORKING HARDWARE AND SOFTWARE, NAMELY, DEVICES FOR TRANSMITTING, ROUTING, AND RECEIVING AUDIO, VIDEO, AND OTHER DATA ACROSS NETWORKS; COMPUTER HARDWARE FOR TELECOMMUNICATIONS; COMPUTER HARDWARE; HARDWARE, SOFTWARE AND SYSTEMS, NAMELY, TELECOMMUNICATIONS AND DATA NETWORKING HARDWARE, SOFTWARE, AND COMPONENTS FOR TESTING AND MEASUREMENT OF TELECOMMUNICATIONS AND NETWORKING HARDWARE, SOFTWARE AND SYSTEMS; COMPUTER IMAGING HARDWARE; LASERS NOT FOR MEDICAL USE; SEMICONDUCTORS; COMMUNICATIONS, TELECOMMUNICATIONS, OPTICAL AND COMPUTING SWITCHES, ADAPTORS, CONNECTORS, SPLITTERS, COU-

PLERS, METERS, MODULATORS, RECEIVERS, AMPLIFIERS, TRANSMITTERS, MONITORS, TEST SYSTEMS; TRANSCIVERS; TRANSPONDERS; MULTIPLEXERS; SCIENTIFIC AND TECHNICAL APPARATUS, NAMELY, OPTICAL MIRRORS; OPTICAL FILTERS; OPTICAL LENSES; POWER CONVERTERS; POWER SUPPLIES; LIQUID CRYSTAL DISPLAYS; LIQUID CRYSTAL DISPLAY PROJECTORS; IMAGE PROJECTORS; INTERNALLY ILLUMINATED SIGN AND LIGHT ENGINES; MOUNTING RACKS FOR COMMUNICATIONS OR COMPUTER HARDWARE, TELECOMMUNICATIONS HARDWARE OR COMPUTER HARDWARE, IN CLASS 9 (U.S. CLS. 21, 23, 26, 36 AND 38).

FIRST USE 8-0-2006; IN COMMERCE 8-0-2006.

FOR: REPAIR AND MAINTENANCE OF COMPUTER AND COMMUNICATIONS HARDWARE AND SOFTWARE AND MEDICAL DEVICES, IN CLASS 37 (U.S. CLS. 100, 103 AND 106).

FIRST USE 11-0-2005; IN COMMERCE 11-0-2005.

FOR: EDUCATION SERVICES, NAMELY, PROVIDING CLASSES, SEMINARS, AND WORKSHOPS IN THE FIELDS OF THE DESIGN, SELECTION, IMPLEMENTATION, INSTALLATION, USE, AND TESTING OF COMMUNICATIONS SYSTEMS AND EQUIPMENT FOR OTHERS, AND IN THE FIELDS OF PRODUCT SECURITY, COMMUNICATIONS NETWORKS, OPTICAL NETWORKS, OPTICAL HARDWARE, COMMUNICATIONS HARDWARE

AND FIBER OPTICS; TRAINING SERVICES IN THE FIELDS OF THE DESIGN, SELECTION, IMPLEMENTATION, INSTALLATION, USE, AND TESTING OF COMMUNICATIONS SYSTEMS AND EQUIPMENT FOR OTHERS, AND IN THE FIELDS OF PRODUCT SECURITY, COMMUNICATIONS NETWORKS, OPTICAL HARDWARE, COMMUNICATIONS HARDWARE, AND FIBER OPTICS, IN CLASS 41 (U.S. CLS. 100, 101 AND 107).

FIRST USE 3-0-2006; IN COMMERCE 3-0-2006.

FOR: CONSULTATION SERVICES IN THE FIELDS OF THE DESIGN, SELECTION, IMPLEMENTATION, INSTALLATION, USE, AND TESTING OF COMMUNICATIONS SYSTEMS AND

EQUIPMENT FOR OTHERS; CONSULTATION SERVICES IN THE FIELDS OF PRODUCT SECURITY, COMMUNICATIONS HARDWARE, COMMUNICATIONS NETWORKS, OPTICAL NETWORKS, OPTICAL HARDWARE, FIBER OPTICS; ENGINEERING; DESIGN FOR OTHERS IN THE FIELDS OF PRINTING, PRODUCT SECURITY, COMMUNICATIONS HARDWARE, COMPUTER HARDWARE, OPTICAL HARDWARE, FIBER OPTICS, IN CLASS 42 (U.S. CLS. 100 AND 101).

FIRST USE 10-0-2005; IN COMMERCE 10-0-2005.

SN 78-692,980, FILED 8-15-2005.

ANNE E. GUSTASON, EXAMINING ATTORNEY

Int. Cls.: 2 and 9

Prior U.S. Cls.: 6, 11, 16, 21, 23, 26, 36, and 38

United States Patent and Trademark Office

Reg. No. 3,522,511

Registered Oct. 21, 2008

**TRADEMARK
PRINCIPAL REGISTER**



JDS UNIPHASE CORPORATION (DELAWARE CORPORATION)
430 NORTH MCCARTHY BLVD.
MILPITAS, CA 95035

FOR: OPTICAL COATINGS; PIGMENTS; FLEXOGRAPHIC, INTAGLIO, AND GRAVURE INKS, AND HIGH PERFORMANCE COATINGS AND DISPERSIONS TO PROVIDE SECURITY AND BRAND PROTECTION, AUTHENTICATION, AND DIFFERENTIATION, IN CLASS 2 (U.S. CLS. 6, 11 AND 16).

FIRST USE 4-20-2006; IN COMMERCE 4-20-2006.

FOR: COMMUNICATIONS HARDWARE AND SOFTWARE FOR CONNECTING ELECTRONIC COMMUNICATIONS NETWORKS; TELECOMMUNICATIONS AND DATA NETWORKING HARDWARE AND SOFTWARE, NAMELY DEVICES FOR TRANSMITTING, ROUTING, AND RECEIVING AUDIO, VIDEO, AND OTHER DATA ACROSS NETWORKS; COMPUTER HARDWARE FOR TELECOMMUNICATIONS; COMPUTER HARDWARE; HARDWARE, SOFTWARE AND SYSTEMS, NAMELY TELECOMMUNICATIONS AND DATA NETWORKING HARDWARE, SOFTWARE, AND COMPONENTS FOR TESTING AND MEASUREMENT OF TELECOMMUNICATIONS AND NET-

WORKING HARDWARE, SOFTWARE AND SYSTEMS; COMPUTER IMAGING HARDWARE; LASERS NOT FOR MEDICAL USE; SEMICONDUCTORS; COMMUNICATIONS, TELECOMMUNICATIONS, OPTICAL AND COMPUTING SWITCHES, ADAPTORS, CONNECTORS, SPLITTERS, COUPLERS, METERS, MODULATORS, RECEIVERS, AMPLIFIERS, TRANSMITTERS, MONITORS, TEST SYSTEMS; TRANSCEIVERS; TRANSPONDERS; MULTIPLEXERS; SCIENTIFIC AND TECHNICAL APPARATUS, NAMELY, OPTICAL MIRRORS; OPTICAL FILTERS; OPTICAL LENSES; POWER CONVERTERS; POWER SUPPLIES; LIQUID CRYSTAL DISPLAYS; LIQUID CRYSTAL DISPLAY PROJECTORS; IMAGE PROJECTORS; INTERNALLY ILLUMINATED SIGN AND LIGHT ENGINES; MOUNTING RACKS FOR COMMUNICATIONS OR COMPUTER HARDWARE, TELECOMMUNICATIONS HARDWARE OR COMPUTER HARDWARE, IN CLASS 9 (U.S. CLS. 21, 23, 26, 36 AND 38).

FIRST USE 8-0-2006; IN COMMERCE 8-0-2006.

SN 78-692,990, FILED 8-15-2005.

ANNE E. GUSTASON, EXAMINING ATTORNEY

Int. Cl.: 36

Prior U.S. Cls.: 100, 101, and 102

United States Patent and Trademark Office

Reg. No. 3,522,512

Registered Oct. 21, 2008

**SERVICE MARK
PRINCIPAL REGISTER**

COMFORT EXPRESS

GOODMAN MANUFACTURING COMPANY,
L.P. (TEXAS LIMITED PARTNERSHIP)
5151 SAN FELIPE, SUITE 500
HOUSTON, TX 77056

THE MARK CONSISTS OF STANDARD CHAR-
ACTERS WITHOUT CLAIM TO ANY PARTICULAR
FONT, STYLE, SIZE, OR COLOR.

FOR: FINANCING SERVICES IN THE FIELD OF
HEATING AND AIR CONDITIONING EQUIP-
MENT, IN CLASS 36 (U.S. CLS. 100, 101 AND 102).

SN 78-699,398, FILED 8-24-2005.

FIRST USE 8-7-2008; IN COMMERCE 8-7-2008.

JAMES MACFARLANE, EXAMINING ATTORNEY

Int. Cl.: 41

Prior U.S. Cls.: 100, 101, and 107

United States Patent and Trademark Office

Reg. No. 3,522,513

Registered Oct. 21, 2008

**SERVICE MARK
PRINCIPAL REGISTER**

KIDZ WALK

MCKEITHAN, WILLIAM RAY (UNITED STATES
INDIVIDUAL)
217 N. MARKET STREET
WASHINGTON, DC 27889

FOR: COLUMNS ON THE SUBJECT OF RELI-
GIOUS-BASED CHILDREN'S STORIES, IN CLASS 41
(U.S. CLS. 100, 101 AND 107).

FIRST USE 11-27-2005; IN COMMERCE 11-27-2005.

THE MARK CONSISTS OF STANDARD CHAR-
ACTERS WITHOUT CLAIM TO ANY PARTICULAR
FONT, STYLE, SIZE, OR COLOR.

NO CLAIM IS MADE TO THE EXCLUSIVE
RIGHT TO USE "KIDS", APART FROM THE MARK
AS SHOWN.

SN 78-700,442, FILED 8-25-2005.

CHERYL CLAYTON, EXAMINING ATTORNEY

Int. Cl.: 16

Prior U.S. Cls.: 2, 5, 22, 23, 29, 37, 38, and 50

United States Patent and Trademark Office

Reg. No. 3,522,514

Registered Oct. 21, 2008

**TRADEMARK
PRINCIPAL REGISTER**

{eurostyle}

REZIDOR SAS HOSPITALITY A/S (DENMARK
JOINT STOCK COMPANY)
AMAGER BOULEVARD 70,
KOPENHAMN S, DENMARK DK-2300

FIRST USE 9-1-2005; IN COMMERCE 9-1-2005.

SN 78-702,371, FILED 8-29-2005.

FOR: GENERAL FEATURE MAGAZINES, IN
CLASS 16 (U.S. CLS. 2, 5, 22, 23, 29, 37, 38 AND 50).

JOSETTE BEVERLY, EXAMINING ATTORNEY

Int. Cls.: 25 and 41

Prior U.S. Cls.: 22, 39, 100, 101, and 107

United States Patent and Trademark Office

Reg. No. 3,522,515

Registered Oct. 21, 2008

**TRADEMARK
SERVICE MARK
PRINCIPAL REGISTER**

Dirt Bowl

HUFFMAN, KERRY W. (UNITED STATES INDIVIDUAL)
116 SYCAMORE AVENUE
MILL VALLEY, CA 94941

FOR: SPORTS SHIRTS, IN CLASS 25 (U.S. CLS. 22 AND 39).

FIRST USE 6-1-2005; IN COMMERCE 6-1-2005.

FOR: SPORTS CAMP , IN CLASS 41 (U.S. CLS. 100, 101 AND 107).

FIRST USE 6-1-2005; IN COMMERCE 6-1-2005.

THE MARK CONSISTS OF STANDARD CHARACTERS WITHOUT CLAIM TO ANY PARTICULAR FONT, STYLE, SIZE, OR COLOR.

SN 78-704,594, FILED 8-31-2005.

STEVEN PEREZ, EXAMINING ATTORNEY

Int. Cl.: 16

Prior U.S. Cls.: 2, 5, 22, 23, 29, 37, 38, and 50

United States Patent and Trademark Office

Reg. No. 3,522,516

Registered Oct. 21, 2008

**TRADEMARK
PRINCIPAL REGISTER**



AOL LLC (DELAWARE LIMITED LIABILITY
COMPANY)
22000 AOL WAY
DULLES, VA 20166

FIRST USE 1-10-2008; IN COMMERCE 1-10-2008.

SN 78-707,011, FILED 9-6-2005.

FOR: DECALS, IN CLASS 16 (U.S. CLS. 2, 5, 22, 23,
29, 37, 38 AND 50).

ALEXANDER L. POWERS, EXAMINING ATTOR-
NEY

Int. Cl.: 35

Prior U.S. Cls.: 100, 101, and 102

United States Patent and Trademark Office

Reg. No. 3,522,517

Registered Oct. 21, 2008

**SERVICE MARK
PRINCIPAL REGISTER**

SNOWOVERSTOCK

DIRTOVERSTOCK, LLC (NEVADA LIMITED
LIABILITY COMPANY)

318 N. CARSON STREET, #208

CARSON CITY, NV 89701

FOR: RETAIL STORES FEATURING SNOW MO-
BILE VEHICLE PARTS AND ACCESSORIES, IN
CLASS 35 (U.S. CLS. 100, 101 AND 102).

FIRST USE 4-22-2005; IN COMMERCE 5-17-2005.

THE MARK CONSISTS OF STANDARD CHAR-
ACTERS WITHOUT CLAIM TO ANY PARTICULAR
FONT, STYLE, SIZE, OR COLOR.

NO CLAIM IS MADE TO THE EXCLUSIVE
RIGHT TO USE "OVERSTOCK", APART FROM
THE MARK AS SHOWN.

SN 78-709,444, FILED 9-8-2005.

ELLEN B. AWRICH, EXAMINING ATTORNEY

Int. Cl.: 28

Prior U.S. Cls.: 22, 23, 38, and 50

United States Patent and Trademark Office

Reg. No. 3,522,518

Registered Oct. 21, 2008

**TRADEMARK
PRINCIPAL REGISTER**

TELLMEOMUSE

TELLMEOMUSE LLC (NEW YORK LIMITED
LIABILITY COMPANY)
88 CHARLES STREET
#5B
NEW YORK, NY 10014

THE MARK CONSISTS OF STANDARD CHAR-
ACTERS WITHOUT CLAIM TO ANY PARTICULAR
FONT, STYLE, SIZE, OR COLOR.

FOR: CARD GAMES, IN CLASS 28 (U.S. CLS. 22,
23, 38 AND 50).

SN 78-709,725, FILED 9-9-2005.

FIRST USE 5-25-2007; IN COMMERCE 5-25-2007.

ANGELA M. MICHELI, EXAMINING ATTORNEY

Int. Cl.: 40

Prior U.S. Cls.: 100, 103, and 106

United States Patent and Trademark Office

Reg. No. 3,522,519

Registered Oct. 21, 2008

**SERVICE MARK
PRINCIPAL REGISTER**

Sprint R2

SPRINT COMMUNICATIONS COMPANY L.P.
(DELAWARE LIMITED PARTNERSHIP)
KSOPHT0101-Z2100
6391 SPRINT PARKWAY
OVERLAND PARK, KS 66251

FOR: TELECOMMUNICATIONS EQUIPMENT
RECYCLING PROGRAM SERVICES, IN CLASS 40
(U.S. CLS. 100, 103 AND 106).

FIRST USE 2-1-2007; IN COMMERCE 9-30-2007.

THE MARK CONSISTS OF STANDARD CHAR-
ACTERS WITHOUT CLAIM TO ANY PARTICULAR
FONT, STYLE, SIZE, OR COLOR.

OWNER OF U.S. REG. NOS. 1,104,943, 2,987,454,
AND OTHERS.

SN 78-711,982, FILED 9-13-2005.

JAY BESCH, EXAMINING ATTORNEY

Int. Cl.: 11

Prior U.S. Cls.: 13, 21, 23, 31, and 34

United States Patent and Trademark Office

Reg. No. 3,522,520

Registered Oct. 21, 2008

**TRADEMARK
PRINCIPAL REGISTER**

SNSAFE

S & N PUMP CO., INC. (TEXAS CORPORATION)
7545 BREEN STREET
HOUSTON, TX 77086

FOR: ENVIRONMENTALLY SENSITIVE ANTI-FOULING EQUIPMENT TO INHIBIT MARINE GROWTH FOULING IN PUMP SYSTEMS, NAME- LY, ION GENERATORS FOR OFFSHORE OPERA- TORS, USED TO CREATE METALLIC IONS FOR LIMITING AQUATIC GROWTH, IN CLASS 11 (U.S. CLS. 13, 21, 23, 31 AND 34).

FIRST USE 4-18-2008; IN COMMERCE 4-18-2008.

THE MARK CONSISTS OF STANDARD CHAR- ACTERS WITHOUT CLAIM TO ANY PARTICULAR FONT, STYLE, SIZE, OR COLOR.

SN 78-712,758, FILED 9-14-2005.

SAMUEL E. SHARPER JR., EXAMINING ATTOR- NEY

Int. Cl.: 33

Prior U.S. Cls.: 47 and 49

United States Patent and Trademark Office

Reg. No. 3,522,521

Registered Oct. 21, 2008

**TRADEMARK
PRINCIPAL REGISTER**

CHAMBLUE

FROST INCORPORATED (MICHIGAN CORPORATION)
2020 BRISTOL AVENUE, N.W.
GRAND RAPIDS, MI 49504

FOR: SPARKLING WINE, NAMELY, CHAMPAGNE, IN CLASS 33 (U.S. CLS. 47 AND 49).

FIRST USE 12-31-2007; IN COMMERCE 12-31-2007.

THE MARK CONSISTS OF STANDARD CHARACTERS WITHOUT CLAIM TO ANY PARTICULAR FONT, STYLE, SIZE, OR COLOR.

SN 78-713,954, FILED 9-15-2005.

JANICE L. MCMORROW, EXAMINING ATTORNEY

Int. Cls.: 38 and 41

Prior U.S. Cls.: 100, 101, 104, and 107

United States Patent and Trademark Office

Reg. No. 3,522,522

Registered Oct. 21, 2008

**SERVICE MARK
PRINCIPAL REGISTER**

OUR AUDIENCE MEANS BUSINESS

BLOOMBERG L.P. (DELAWARE LIMITED PART-
NERSHIP)
731 LEXINGTON AVENUE
NEW YORK, NY 10022

FOR: RADIO AND TELEVISION BROADCAST-
ING, IN CLASS 38 (U.S. CLS. 100, 101 AND 104).

FIRST USE 1-31-2006; IN COMMERCE 1-31-2006.

FOR: NEWS REPORTING SERVICES; NEWS
AGENCIES, NAMELY, GATHERING AND DISSE-
MINATION OF NEWS BY COMPUTER; COMPUTER
SERVICES, NAMELY, PROVIDING ON-LINE PUB-
LICATIONS IN THE NATURE OF REPORTS, BRO-
CHURES, BOOKLETS, AND MAGAZINES IN THE
FIELDS OF NEWS, BUSINESS, FINANCE, CUR-

RENT EVENTS, ENTERTAINMENT, SPORTS, HU-
MAN INTEREST STORIES, SECURITIES,
SECURITIES MARKETS AND THE ENERGY AND
ASPHALT INDUSTRIES, IN CLASS 41 (U.S. CLS. 100,
101 AND 107).

FIRST USE 1-31-2006; IN COMMERCE 1-31-2006.

THE MARK CONSISTS OF STANDARD CHAR-
ACTERS WITHOUT CLAIM TO ANY PARTICULAR
FONT, STYLE, SIZE, OR COLOR.

SN 78-717,908, FILED 9-21-2005.

DAVID MILLER, EXAMINING ATTORNEY

Int. Cl.: 16

Prior U.S. Cls.: 2, 5, 22, 23, 29, 37, 38, and 50

Reg. No. 3,522,523

United States Patent and Trademark Office

Registered Oct. 21, 2008

**TRADEMARK
PRINCIPAL REGISTER**

IGOR

EXODUS FILM FUND I, LLC (DELAWARE LIMITED LIABILITY COMPANY)
1201 ELECTRIC AVENUE
VENICE, CA 90291

FIRST USE 6-16-2008; IN COMMERCE 6-16-2008.

FOR: PRINTED MATERIALS, NAMELY, BOOKS, POSTERS, PRESS RELEASES, BROCHURES, FLYERS ALL FEATURING INFORMATION RELATING TO MOTION PICTURES AND MOTION PICTURE RELATED PRODUCT MERCHANDISING, IN CLASS 16 (U.S. CLS. 2, 5, 22, 23, 29, 37, 38 AND 50).

THE MARK CONSISTS OF STANDARD CHARACTERS WITHOUT CLAIM TO ANY PARTICULAR FONT, STYLE, SIZE, OR COLOR.

SN 78-717,952, FILED 9-21-2005.

G. MAYERSCHOFF, EXAMINING ATTORNEY

Int. Cls.: 28 and 31

Prior U.S. Cls.: 1, 22, 23, 38, 46, and 50

Reg. No. 3,522,524

United States Patent and Trademark Office

Registered Oct. 21, 2008

**TRADEMARK
PRINCIPAL REGISTER**

TOOF

MARKEL ENTERPRISES LLC (CALIFORNIA
LIMITED LIABILITY COMPANY)
4444 MISSISSIPPI STREET #B
SAN DIEGO, CA 92116

FIRST USE 5-7-2008; IN COMMERCE 5-7-2008.

FOR: DOG CHEW TOY SHAPED LIKE A TOOTH,
IN CLASS 28 (U.S. CLS. 22, 23, 38 AND 50).

THE MARK CONSISTS OF STANDARD CHAR-
ACTERS WITHOUT CLAIM TO ANY PARTICULAR
FONT, STYLE, SIZE, OR COLOR.

FIRST USE 5-7-2008; IN COMMERCE 5-7-2008.

SN 78-719,831, FILED 9-23-2005.

FOR: DOG FOOD TREAT SHAPED LIKE A
TOOTH, IN CLASS 31 (U.S. CLS. 1 AND 46).

CHERYL CLAYTON, EXAMINING ATTORNEY

Int. Cl.: 25

Prior U.S. Cls.: 22 and 39

United States Patent and Trademark Office

Reg. No. 3,522,525

Registered Oct. 21, 2008

**TRADEMARK
PRINCIPAL REGISTER**



PIGG, MARTIN K. (UNITED STATES INDIVIDUAL)
10830 EPHRAIM DRIVE
OWINGS MILLS, MD 21117

FOR: CLOTHING, NAMELY, CAPS, SHIRTS, T-SHIRTS, SWEATSHIRTS, AND TIES, IN CLASS 25 (U.S. CLS. 22 AND 39).

FIRST USE 11-1-2006; IN COMMERCE 11-1-2006.

THE COLOR(S) PINK, BLUE, WHITE IS/ARE CLAIMED AS A FEATURE OF THE MARK.

THE MARK CONSISTS OF A PIG WITH A PINK BODY, BLUE SCARF, AND WHITE WINGS.

SN 78-722,985, FILED 9-29-2005.

SHANNON TWOHIG, EXAMINING ATTORNEY

Int. Cl.: 9

Prior U.S. Cls.: 21, 23, 26, 36, and 38

Reg. No. 3,522,526

United States Patent and Trademark Office

Registered Oct. 21, 2008

TRADEMARK
PRINCIPAL REGISTER

VICTOR COMPANY OF JAPAN, LIMITED (JAPAN JOINT STOCK COMPANY)
12, 3-CHOME, MORIYA-CHO, KANAGAWA-KU
YOKOHAMA-CITY, JAPAN

FOR: DIGITAL AUDIO RECORDERS/PLAYERS, MEDIA CARD VIDEO RECORDERS/PLAYERS, NAMELY, INTEGRATED CIRCUIT MEMORY CARD FOR DIGITAL VIDEO AND AUDIO, HARD DISC RECORDERS/PLAYERS; AUDIO DISC RECORDERS/PLAYERS; AUDIO TAPE RECORDERS/PLAYERS; RADIO RECEIVERS; RADIO TRANSMITTERS; SPEAKERS; AMPLIFIERS; DIGITAL STILL CAMERAS; VIDEO CAMERAS; VIDEO DISC RECORDERS/PLAYERS; VIDEO TAPE RECORDERS/PLAYERS; COMBINED VIDEO CAMERAS WITH DIGITAL STILL CAMERAS; COMBINED VIDEO TAPE RECORDERS/PLAYERS WITH DISC RECORDERS/PLAYERS; COMBINED VIDEO CAMERAS WITH VIDEO DISC RECORDERS/PLAYERS; COMBINED VIDEO CAMERAS WITH VIDEO TAPE RECORDERS/PLAYERS; COMBINED DIGITAL STILL CAMERAS WITH HARD DISC DRIVES; PERSONAL DIGITAL ASSISTANTS (PDA); PRERECORDED COMPUTER SOFTWARE FOR USE IN VIDEO AND IMAGE PROCESSING, EDITING AND AUTHORING; BLANK COMPUTER DISC; PRERECORDED COMPUTER DISC FEATURING MOTION

PICTURES, AND MUSIC; SMART MEDIA CARDS, NAMELY, DIGITAL TRADING CARDS IN THE NATURE OF MULTIMEDIA SOFTWARE RECORDED ON MAGNETIC MEDIA FEATURING AUDIO AND VIDEO SHOWS; HARD DISC DRIVES FOR COMPUTERS; DIGITAL VOICE RECORDERS; PARTS AND FITTINGS FOR THE AFORESAID GOODS, NAMELY, BATTERIES, BATTERY CHARGERS, AC ADAPTERS, AV CABLES, CASES, REMOTE CONTROLS FOR AUDIO AND VIDEO EQUIPMENT, NAMELY, VIDEO DISC RECORDER/PLAYERS, VIDEO-TAPE RECORDER-PLAYERS, COMPACT DISC PLAYERS, AUDIO DISC RECORDER/PLAYERS, AUDIO-TAPE RECORDER/PLAYERS; EARPHONES, HEADPHONES, ELECTRICAL CONNECTORS, POWER AND ELECTRICAL WIRES, IN CLASS 9 (U.S. CLS. 21, 23, 26, 36 AND 38).

FIRST USE 9-0-2005; IN COMMERCE 9-0-2005.

PRIORITY CLAIMED UNDER SEC. 44(D) ON JAPAN APPLICATION NO. 75361, FILED 8-11-2005.

SN 78-724,054, FILED 9-30-2005.

SHANNON TWOHIG, EXAMINING ATTORNEY

Int. Cl.: 5

Prior U.S. Cls.: 6, 18, 44, 46, 51, and 52

United States Patent and Trademark Office

Reg. No. 3,522,527

Registered Oct. 21, 2008

**TRADEMARK
PRINCIPAL REGISTER**

STAYHEALTHY

DIAMOND, GEORGE (UNITED STATES INDIVIDUAL)
62 ANTHONY ROAD
GLEN GARDNER, NJ 08826

FOR: INSECT REPELLENTS, INSECTICIDES, ANTIMICROBIAL SKIN SANITIZERS IN GEL, FOAM OR LIQUID FORM; TOPICAL OR SURFACE DISINFECTANTS FOR SANITARY PURPOSES; SPRAYABLE ROOM AIR SANITIZERS; ROOM DEODORANTS; SANITARY STERILIZING PREPARATIONS, IN CLASS 5 (U.S. CLS. 6, 18, 44, 46, 51 AND 52).

FIRST USE 3-5-2008; IN COMMERCE 3-5-2008.

THE MARK CONSISTS OF STANDARD CHARACTERS WITHOUT CLAIM TO ANY PARTICULAR FONT, STYLE, SIZE, OR COLOR.

SN 78-724,283, FILED 9-30-2005.

AMY GEARIN, EXAMINING ATTORNEY

Int. Cl.: 5

Prior U.S. Cls.: 6, 18, 44, 46, 51, and 52

Reg. No. 3,522,528

United States Patent and Trademark Office

Registered Oct. 21, 2008

**TRADEMARK
PRINCIPAL REGISTER**

DALBAK

VICURON PHARMACEUTICALS INC. (DELA-
WARE CORPORATION)
455 SOUTH GULPH ROAD
KING OF PRUSSIA, PA 19406

THE MARK CONSISTS OF STANDARD CHAR-
ACTERS WITHOUT CLAIM TO ANY PARTICULAR
FONT, STYLE, SIZE, OR COLOR.

FOR: ANTIBIOTIC PREPARATIONS, IN CLASS 5
(U.S. CLS. 6, 18, 44, 46, 51 AND 52).

SN 78-730,857, FILED 10-11-2005.

FIRST USE 7-23-2008; IN COMMERCE 7-23-2008.

ANDREA BUTLER, EXAMINING ATTORNEY

Int. Cl.: 36

Prior U.S. Cls.: 100, 101, and 102

United States Patent and Trademark Office

Reg. No. 3,522,529

Registered Oct. 21, 2008

**SERVICE MARK
PRINCIPAL REGISTER**

QUATRIN CAPITAL PARTNERS

HUNTER, BRIAN A. (UNITED STATES INDIVIDUAL)
24TH FLOOR
800 BOYLSTON STREET
BOSTON, MA 02199

FOR: FINANCIAL SERVICES, NAMELY, ASSET MANAGEMENT SERVICES, INVESTMENT MANAGEMENT SERVICES AND INVESTMENT ADVISORY SERVICES, IN CLASS 36 (U.S. CLS. 100, 101 AND 102).

FIRST USE 3-0-2006; IN COMMERCE 3-0-2006.

THE MARK CONSISTS OF STANDARD CHARACTERS WITHOUT CLAIM TO ANY PARTICULAR FONT, STYLE, SIZE, OR COLOR.

NO CLAIM IS MADE TO THE EXCLUSIVE RIGHT TO USE "CAPITAL PARTNERS", APART FROM THE MARK AS SHOWN.

SN 78-731,365, FILED 10-12-2005.

KEVIN DINALLO, EXAMINING ATTORNEY

Int. Cl.: 9

Prior U.S. Cls.: 21, 23, 26, 36, and 38

United States Patent and Trademark Office

Reg. No. 3,522,530

Registered Oct. 21, 2008

**TRADEMARK
PRINCIPAL REGISTER**

MSX-BOX

ADDI-DATA GMBH MESS-UND STEUERUNG-
STECHNIK (FED REP GERMANY CORPORA-
TION)
DIESELSTRASSE 3
OTTERSWEIER, FED REP GERMANY 77833

FOR: COMPUTERS, COMPUTER HARDWARE
AND COMPUTER SOFTWARE FOR USE IN NET-
WORK CONTROLLING, MEASURING AND DATA
ACQUISITION IN INDUSTRIAL AUTOMATION
PROCESSES, IN CLASS 9 (U.S. CLS. 21, 23, 26, 36
AND 38).

FIRST USE 2-18-2003; IN COMMERCE 10-1-2004.

THE MARK CONSISTS OF STANDARD CHAR-
ACTERS WITHOUT CLAIM TO ANY PARTICULAR
FONT, STYLE, SIZE, OR COLOR.

OWNER OF FED REP GERMANY REG. NO.
30263142, DATED 4-30-2003, EXPIRES 12-30-2012.

OWNER OF FED REP GERMANY REG. NO.
30263143, DATED 4-30-2003, EXPIRES 12-30-2012.

SN 78-734,031, FILED 10-15-2005.

G. MAYERSCHOFF, EXAMINING ATTORNEY

Int. Cl.: 7

Prior U.S. Cls.: 13, 19, 21, 23, 31, 34, and 35

Reg. No. 3,522,531

United States Patent and Trademark Office

Registered Oct. 21, 2008

**TRADEMARK
PRINCIPAL REGISTER**

US-FIP

MCFINN TECHNOLOGIES, LLC (WISCONSIN
LIMITED LIABILITY COMPANY)
7910 7TH AVENUE
KENOSHA, WI 53143

THE MARK CONSISTS OF STANDARD CHAR-
ACTERS WITHOUT CLAIM TO ANY PARTICULAR
FONT, STYLE, SIZE, OR COLOR.

FOR: IMPELLER PUMPS, IN CLASS 7 (U.S. CLS.
13, 19, 21, 23, 31, 34 AND 35).

SN 78-736,970, FILED 10-20-2005.

FIRST USE 3-22-2007; IN COMMERCE 3-22-2007.

G. MAYERSCHOFF, EXAMINING ATTORNEY

Int. Cls.: 9, 36, and 45

Prior U.S. Cls.: 21, 23, 26, 36, 38, 100, 101, and 102

United States Patent and Trademark Office

Reg. No. 3,522,532

Registered Oct. 21, 2008

**TRADEMARK
SERVICE MARK
PRINCIPAL REGISTER**

SAFETY GAUGE

BALDWIN AVIATION, INC. (SOUTH CAROLINA CORPORATION)
9 SAILWING LANE SUITE 300
HILTON HEAD ISLAND, SC 29926

FOR: SOFTWARE IN THE FIELD OF AVIATION MANAGEMENT, NAMELY, SOFTWARE FOR PROVIDING AVIATION OPERATING STANDARDS, OPERATIONAL GUIDELINES, SAFETY MANAGEMENT, AND RISK ANALYSIS, IN CLASS 9 (U.S. CLS. 21, 23, 26, 36 AND 38).

FIRST USE 1-15-2008; IN COMMERCE 1-15-2008.

FOR: RISK MANAGEMENT SERVICES IN THE FIELD OF TRANSPORTATION, AVIATION, MARINE TRANSPORTATION, RAILROAD AND INDUSTRIAL, MANUFACTURING AND POWER PLANTS, IN CLASS 36 (U.S. CLS. 100, 101 AND 102).

FIRST USE 1-17-2008; IN COMMERCE 1-17-2008.

FOR: CONSULTATION SERVICES IN THE FIELD OF THE SAFETY NEEDS OF COMMERCIAL AND INDUSTRIAL COMPANIES, NAMELY, PROVIDING SAFETY MANAGEMENT IN THE FIELD OF TRANSPORTATION, AVIATION, MARINE TRANSPORTATION, RAILROAD AND INDUSTRIAL, MANUFACTURING AND POWER PLANTS, IN CLASS 45 (U.S. CLS. 100 AND 101).

FIRST USE 1-17-2008; IN COMMERCE 1-17-2008.

THE MARK CONSISTS OF STANDARD CHARACTERS WITHOUT CLAIM TO ANY PARTICULAR FONT, STYLE, SIZE, OR COLOR.

NO CLAIM IS MADE TO THE EXCLUSIVE RIGHT TO USE "SAFETY", APART FROM THE MARK AS SHOWN.

SN 78-740,934, FILED 10-26-2005.

ROBERT STRUCK, EXAMINING ATTORNEY

Int. Cl.: 41

Prior U.S. Cls.: 100, 101, and 107

United States Patent and Trademark Office

Reg. No. 3,522,533

Registered Oct. 21, 2008

**SERVICE MARK
PRINCIPAL REGISTER**

**Instituto de Superacion
Latina**

INSTITUTO DE SUPERACION LATINA, INC.
(ILLINOIS CORPORATION)
P.O. BOX 597789
CHICAGO, IL 60659

FOR: DEVELOPMENT AND DISSEMINATION
OF EDUCATIONAL MATERIALS IN THE FIELD
OF BUSINESS, IN CLASS 41 (U.S. CLS. 100, 101 AND
107).

FIRST USE 2-2-2008; IN COMMERCE 2-2-2008.

THE MARK CONSISTS OF STANDARD CHAR-
ACTERS WITHOUT CLAIM TO ANY PARTICULAR
FONT, STYLE, SIZE, OR COLOR.

NO CLAIM IS MADE TO THE EXCLUSIVE
RIGHT TO USE "SUPERACION LATINA", APART
FROM THE MARK AS SHOWN.

THE ENGLISH TRANSLATION OF "INSTITUTO
DE SUPERACION LATINA" IS "INSTITUTE OF
LATINO ADVANCEMENT."

SN 78-741,654, FILED 10-27-2005.

GEOFFREY FOSDICK, EXAMINING ATTORNEY

Int. Cl.: 9

Prior U.S. Cls.: 21, 23, 26, 36, and 38

Reg. No. 3,522,534

United States Patent and Trademark Office

Registered Oct. 21, 2008

**TRADEMARK
PRINCIPAL REGISTER**

VELOCITY VECTOR IMAGING

SIEMENS MEDICAL SOLUTIONS USA, INC.
(DELAWARE CORPORATION)
51 VALLEY STREAM PARKWAY
MALVERN, PA 19355

FOR: COMPUTER SOFTWARE FOR USE IN
IMAGING SYSTEMS IN THE MEDICAL FIELD, IN
CLASS 9 (U.S. CLS. 21, 23, 26, 36 AND 38).

FIRST USE 5-1-2007; IN COMMERCE 5-1-2007.

THE MARK CONSISTS OF STANDARD CHAR-
ACTERS WITHOUT CLAIM TO ANY PARTICULAR
FONT, STYLE, SIZE, OR COLOR.

NO CLAIM IS MADE TO THE EXCLUSIVE
RIGHT TO USE "IMAGING", APART FROM THE
MARK AS SHOWN.

SN 78-743,123, FILED 10-29-2005.

GIANCARLO CASTRO, EXAMINING ATTORNEY

Int. Cl.: 9

Prior U.S. Cls.: 21, 23, 26, 36, and 38

United States Patent and Trademark Office

Reg. No. 3,522,535

Registered Oct. 21, 2008

**TRADEMARK
PRINCIPAL REGISTER**

RAD-CZT

RFTRAX, INC. (WASHINGTON CORPORATION)
14100 S.W. FREEWAY
SUGAR LAND, TX 77478

FIRST USE 6-0-2005; IN COMMERCE 6-0-2005.

FOR: SECURITY, MONITORING, AND TRACKING EQUIPMENT COMPRISED OF ENERGY SENSORS FOR CARGO AND CARGO CONTAINERS IN THE FREIGHT TRANSPORT INDUSTRY; ELECTRICAL ENERGY SENSORS FOR MONITORING AND TRACKING OF CARGO AND CARGO CONTAINERS IN THE FREIGHT TRANSPORT INDUSTRY, IN CLASS 9 (U.S. CLS. 21, 23, 26, 36 AND 38).

THE MARK CONSISTS OF STANDARD CHARACTERS WITHOUT CLAIM TO ANY PARTICULAR FONT, STYLE, SIZE, OR COLOR.

SN 78-743,457, FILED 10-31-2005.

RONALD DELGIZZI, EXAMINING ATTORNEY

Int. Cl.: 36

Prior U.S. Cls.: 100, 101, and 102

United States Patent and Trademark Office

Reg. No. 3,522,536

Registered Oct. 21, 2008

**SERVICE MARK
PRINCIPAL REGISTER**

HelpBuySell

CATBAGAN, CHRISTIAN (UNITED STATES IN-
DIVIDUAL)
97 LAKEWOOD CIR.
SAN MATEO, CA 94402

THE MARK CONSISTS OF STANDARD CHAR-
ACTERS WITHOUT CLAIM TO ANY PARTICULAR
FONT, STYLE, SIZE, OR COLOR.

FOR: REAL ESTATE BROKERAGE SERVICES, IN
CLASS 36 (U.S. CLS. 100, 101 AND 102).

SN 78-748,664, FILED 11-7-2005.

FIRST USE 11-1-2005; IN COMMERCE 6-25-2008.

JASON TURNER, EXAMINING ATTORNEY

Int. Cls.: 16, 18, 24, 25, and 28

**Prior U.S. Cls.: 1, 2, 3, 5, 22, 23, 29, 37, 38, 39, 41, 42,
and 50**

Reg. No. 3,522,537

United States Patent and Trademark Office

Registered Oct. 21, 2008

**TRADEMARK
PRINCIPAL REGISTER**

VANISH ARID

VANISH CAMO, LLC (COLORADO LIMITED
LIABILITY COMPANY)
104 S. FIRST STREET
MONTROSE, CO 81401

FOR: PRINTED CAMOUFLAGE PATTERNS FOR
HARD OR SOFT SURFACES AND FOR VARIOUS
OTHER CAMOUFLAGE-DECORATED PRODUCTS
, IN CLASS 16 (U.S. CLS. 2, 5, 22, 23, 29, 37, 38 AND 50).

FIRST USE 3-0-2005; IN COMMERCE 3-0-2005.

FOR: DAY PACKS, FANNY PACKS, IN CLASS 18
(U.S. CLS. 1, 2, 3, 22 AND 41).

FIRST USE 5-0-2005; IN COMMERCE 5-0-2005.

FOR: FABRICS, NAMELY, COTTON AND
POLYESTER FABRIC, AND FABRIC FOR THE
MANUFACTURE OF COATS AND JACKETS,
HUNTING VESTS, SHIRTS, AND PANTS, IN CLASS
24 (U.S. CLS. 42 AND 50).

FIRST USE 7-0-2005; IN COMMERCE 7-0-2005.

FOR: CLOTHING, NAMELY, SPORTS SHIRTS,
AND SPORTS RAINWEAR, INCLUDING, CAPS
AND HEADWEAR CONSISTING OF HATS AND
FACE MASKS, SHIRTS, JACKETS, COATS, HUNT-
ING VESTS, AND PANTS, IN CLASS 25 (U.S. CLS. 22
AND 39).

FIRST USE 6-0-2005; IN COMMERCE 6-0-2005.

FOR: ARCHERY EQUIPMENT, NAMELY, AR-
ROW POINTS, IN CLASS 28 (U.S. CLS. 22, 23, 38 AND
50).

FIRST USE 2-0-2007; IN COMMERCE 2-0-2007.

THE MARK CONSISTS OF STANDARD CHAR-
ACTERS WITHOUT CLAIM TO ANY PARTICULAR
FONT, STYLE, SIZE, OR COLOR.

SN 78-749,318, FILED 11-8-2005.

KRISTIN DAHLING, EXAMINING ATTORNEY

Int. Cl.: 42

Prior U.S. Cls.: 100 and 101

United States Patent and Trademark Office

Reg. No. 3,522,538

Registered Oct. 21, 2008

**SERVICE MARK
PRINCIPAL REGISTER**

LEAN PROCUREMENT

CONSUMERS INTERSTATE CORPORATION
(CONNECTICUT CORPORATION)
2 CONSUMERS AVENUE
NORWICH, CT 06360

FOR: ON-LINE NON-DOWNLOADABLE SOFTWARE FOR USE IN DATABASE MANAGEMENT, MAINTENANCE, INVENTORY TRACKING AND THE ORDERING OF GOODS SPECIFIC TO PARTICULAR USERS, IN THE FIELD OF PAPER PRODUCTS AND PRODUCTS FOR THE MAINTENANCE AND OPERATION OF OFFICE, COMMERCIAL AND INDUSTRIAL BUILDINGS, IN CLASS 42 (U.S. CLS. 100 AND 101).

FIRST USE 2-15-2006; IN COMMERCE 2-15-2006.

THE MARK CONSISTS OF STANDARD CHARACTERS WITHOUT CLAIM TO ANY PARTICULAR FONT, STYLE, SIZE, OR COLOR.

NO CLAIM IS MADE TO THE EXCLUSIVE RIGHT TO USE "PROCUREMENT", APART FROM THE MARK AS SHOWN.

SN 78-750,642, FILED 11-9-2005.

ROBIN CHOSID, EXAMINING ATTORNEY

Int. Cl.: 3

Prior U.S. Cls.: 1, 4, 6, 50, 51, and 52

Reg. No. 3,522,539

United States Patent and Trademark Office

Registered Oct. 21, 2008

**TRADEMARK
PRINCIPAL REGISTER**



THE PROCTER & GAMBLE COMPANY (OHIO CORPORATION)
ONE PROCTER & GAMBLE PLAZA
CINCINNATI, OH 45202

THE COLOR(S) LIGHT GOLD AND DARK GOLD IS/ARE CLAIMED AS A FEATURE OF THE MARK.

FOR: SKIN CARE PRODUCTS, NAMELY, LOTIONS, SKIN CREAMS, FACIAL SKIN CLEANSERS, EYE GELS, MOISTURIZERS, TOILET SOAP, BATH SOAP, BODY WASH, NON-MEDICATED TOWEL-ETTES IMPREGNATED WITH SKIN CLEANSER, IN CLASS 3 (U.S. CLS. 1, 4, 6, 50, 51 AND 52).

THE MARK CONSISTS OF A PRIMARILY OVAL-SHAPED DESIGN WITH A LIGHT GOLD BACKGROUND AND DARK GOLD CONTRASTING ROUNDED LINES CREATING THE DETAILS OF A WOMAN'S FACE.

FIRST USE 1-23-2006; IN COMMERCE 1-23-2006.

SN 78-754,923, FILED 11-16-2005.

OWNER OF U.S. REG. NOS. 825,080, 3,040,896, AND OTHERS.

MAYUR VAGHANI, EXAMINING ATTORNEY

Int. Cls.: 36 and 45

Prior U.S. Cls.: 100, 101, and 102

United States Patent and Trademark Office

Reg. No. 3,522,540

Registered Oct. 21, 2008

**SERVICE MARK
PRINCIPAL REGISTER**



CAPTAIN HOPE'S KIDS (TEXAS CORPORATION)

SUITE 319

1499 REGAL ROW

DALLAS, TX 75247

FOR: CHARITABLE FUNDRAISING SERVICES IN THE NATURE OF CONDUCTING ENTERTAINMENT EVENTS SUCH AS GOLF TOURNAMENTS, WALKS, AND RUNS FOR FUNDRAISING PURPOSES; PROVIDING ON-LINE DONATION COLLECTION INFORMATION FOR THE BENEFIT OF HOMELESS CHILDREN, IN CLASS 36 (U.S. CLS. 100, 101 AND 102).

FIRST USE 9-26-2005; IN COMMERCE 9-26-2005.

FOR: CHARITABLE SERVICES, NAMELY, PROVIDING FOR THE CRITICAL NEEDS OF HOMELESS CHILDREN BY COLLECTING AND DISTRIBUTING CLOTHING, DIAPERS, PERSONAL CARE ITEMS, AND TOILETRIES, AND PROVIDING INFORMATION RELATED THERETO, IN CLASS 45 (U.S. CLS. 100 AND 101).

FIRST USE 9-26-2005; IN COMMERCE 9-26-2005.

THE MARK CONSISTS OF CARTOON CHARACTER WEARING A CAPE AND HAVING AN "H" ON ITS CHEST.

SN 78-756,245, FILED 11-17-2005.

DANIEL CAPSHAW, EXAMINING ATTORNEY

Int. Cl.: 19

Prior U.S. Cls.: 1, 12, 33, and 50

United States Patent and Trademark Office

Reg. No. 3,522,541

Registered Oct. 21, 2008

**TRADEMARK
PRINCIPAL REGISTER**

POLYSTRONG

CRANE COMPOSITES, INC. (DELAWARE CORPORATION)
23525 W. EAMES STREET
CHANNAHON, IL 60410

THE MARK CONSISTS OF STANDARD CHARACTERS WITHOUT CLAIM TO ANY PARTICULAR FONT, STYLE, SIZE, OR COLOR.

FOR: POLYCARBONATE PANELS FOR USE IN BUILDING STRUCTURES, IN CLASS 19 (U.S. CLS. 1, 12, 33 AND 50).

SN 78-756,855, FILED 11-18-2005.

FIRST USE 12-8-2005; IN COMMERCE 12-8-2005.

LINDA MICKLEBURGH, EXAMINING ATTORNEY

Int. Cl.: 17

Prior U.S. Cls.: 1, 5, 12, 13, 35, and 50

United States Patent and Trademark Office

Reg. No. 3,522,542

Registered Oct. 21, 2008

**TRADEMARK
PRINCIPAL REGISTER**

ECO-CARD

CORTEC CORPORATION (MINNESOTA CORPORATION)
4119 WHITE BEAR PARKWAY
ST. PAUL, MN 55110

FOR: BIODEGRADABLE PLASTIC SHEETS FOR USE IN MANUFACTURING CREDIT CARDS AND OTHER COMMERCIAL USE CARDS; BIODEGRADABLE PLASTIC CARDS IN SHEET FORM FOR USE IN MAKING CREDIT CARDS AND OTHER COMMERCIAL CARDS, IN CLASS 17 (U.S. CLS. 1, 5, 12, 13, 35 AND 50).

FIRST USE 7-30-2008; IN COMMERCE 7-30-2008.

THE MARK CONSISTS OF STANDARD CHARACTERS WITHOUT CLAIM TO ANY PARTICULAR FONT, STYLE, SIZE, OR COLOR.

SN 78-756,877, FILED 11-18-2005.

CAROLYN CATALDO, EXAMINING ATTORNEY

Int. Cls.: 35, 36, and 44

Prior U.S. Cls.: 100, 101, and 102

United States Patent and Trademark Office

Reg. No. 3,522,543

Registered Oct. 21, 2008

**SERVICE MARK
PRINCIPAL REGISTER**

ACCESS FOR LIFE

UNIPRISE, INC. (DELAWARE CORPORATION)
450 COLUMBUS BOULEVARD
HARTFORD, CT 06115

FOR: HEALTH CARE COST MANAGEMENT SERVICES FOR HEALTH CARE BENEFIT PLANS OF OTHERS, IN CLASS 35 (U.S. CLS. 100, 101 AND 102).

FIRST USE 2-0-2007; IN COMMERCE 2-0-2007.

FOR: ORGANIZING AND ADMINISTERING HEALTH CARE PLANS, WHICH CONSIST OF A NETWORK OF HEALTH CARE PROVIDERS; ADMINISTRATION OF EMPLOYEE BENEFITS PLANS, UNDER WHICH EMPLOYEES PRE-QUALIFY, THROUGH FUNDING AND ADVANCED UNDERWRITING, FOR HEALTH CARE COVERAGE AT FUTURE POINTS IN THEIR LIFE; ADMINISTRATION OF PREPAID HEALTH CARE PLANS; AD-

MINISTRATION OF HEALTH CARE BENEFIT PLANS; AND INSURANCE SERVICES, NAMELY, CLAIMS ADMINISTRATION SERVICES FOR HEALTH CARE BENEFIT PLANS, IN CLASS 36 (U.S. CLS. 100, 101 AND 102).

FIRST USE 2-0-2007; IN COMMERCE 2-0-2007.

FOR: MANAGED HEALTH CARE SERVICES, IN CLASS 44 (U.S. CLS. 100 AND 101).

FIRST USE 2-0-2007; IN COMMERCE 2-0-2007.

THE MARK CONSISTS OF STANDARD CHARACTERS WITHOUT CLAIM TO ANY PARTICULAR FONT, STYLE, SIZE, OR COLOR.

SN 78-757,088, FILED 11-18-2005.

ROBIN CHOSID, EXAMINING ATTORNEY

Int. Cl.: 25

Prior U.S. Cls.: 22 and 39

United States Patent and Trademark Office

Reg. No. 3,522,544

Registered Oct. 21, 2008

**TRADEMARK
PRINCIPAL REGISTER**

THAT BALL DON'T LIE

KBA ENTERPRISES, INC. (TEXAS CORPORATION)
1905 OVERCUP DRIVE
ROUND ROCK, TX 78681

THE MARK CONSISTS OF STANDARD CHARACTERS WITHOUT CLAIM TO ANY PARTICULAR FONT, STYLE, SIZE, OR COLOR.

FOR: ATHLETIC APPAREL, NAMELY, SHIRTS, SHORTS, HATS, SHOES, SOCKS, PANTS, JACKETS, IN CLASS 25 (U.S. CLS. 22 AND 39).

SN 78-760,667, FILED 11-23-2005.

FIRST USE 9-12-2007; IN COMMERCE 9-12-2007.

RENEE MCCRAY, EXAMINING ATTORNEY

Int. Cl.: 9

Prior U.S. Cls.: 21, 23, 26, 36, and 38

United States Patent and Trademark Office

Reg. No. 3,522,545

Registered Oct. 21, 2008

**TRADEMARK
PRINCIPAL REGISTER**

Soulah

MUSSER, JAMES, ALLEN (UNITED STATES IN-
DIVIDUAL)
24725 PENNSYLVANIA AVE., #C20
LOMITA, CA 90717

THE MARK CONSISTS OF STANDARD CHAR-
ACTERS WITHOUT CLAIM TO ANY PARTICULAR
FONT, STYLE, SIZE, OR COLOR.

FOR: COMPUTER SOFTWARE FOR LEARNING
HARMONY, IN CLASS 9 (U.S. CLS. 21, 23, 26, 36 AND
38).

SN 78-760,980, FILED 11-25-2005.

FIRST USE 1-18-2007; IN COMMERCE 6-20-2007.

ROBERT STRUCK, EXAMINING ATTORNEY

Int. Cl.: 41

Prior U.S. Cls.: 100, 101, and 107

United States Patent and Trademark Office

Reg. No. 3,522,546

Registered Oct. 21, 2008

**SERVICE MARK
PRINCIPAL REGISTER**

NIKOLI

NIKOLI CO., LTD. (JAPAN CORPORATION)
4-17-10, KURAMAE, TAITO-KU
TOKYO, JAPAN 111-0051

THE MARK CONSISTS OF STANDARD CHAR-
ACTERS WITHOUT CLAIM TO ANY PARTICULAR
FONT, STYLE, SIZE, OR COLOR.

FOR: ENTERTAINMENT SERVICES, NAMELY,
PROVIDING ON-LINE COMPUTER GAMES, IN
CLASS 41 (U.S. CLS. 100, 101 AND 107).

SN 78-761,057, FILED 11-26-2005.

FIRST USE 10-17-2000; IN COMMERCE 10-27-2006.

CHARLES L. JENKINS, EXAMINING ATTORNEY

Int. Cl.: 9

Prior U.S. Cls.: 21, 23, 26, 36, and 38

United States Patent and Trademark Office

Reg. No. 3,522,547

Registered Oct. 21, 2008

**TRADEMARK
PRINCIPAL REGISTER**

eneloop

SANYO ELECTRIC CO., LTD. (JAPAN CORPORATION)
5-5, KEIHAN-HONDORI 2-CHOME
MORIGUCHI CITY
OSAKA, JAPAN 570-8677

FOR: BATTERIES; ELECTRIC BATTERY CHARGERS, IN CLASS 9 (U.S. CLS. 21, 23, 26, 36 AND 38).

FIRST USE 11-14-2005; IN COMMERCE 7-31-2006.

THE MARK CONSISTS OF STANDARD CHARACTERS WITHOUT CLAIM TO ANY PARTICULAR FONT, STYLE, SIZE, OR COLOR.

PRIORITY CLAIMED UNDER SEC. 44(D) ON ERPN CMNTY TM OFC APPLICATION NO. 004620225, FILED 9-28-2005.

SN 78-761,676, FILED 11-28-2005.

STEVEN JACKSON, EXAMINING ATTORNEY

Int. Cls.: 9 and 37

Prior U.S. Cls.: 21, 23, 26, 36, 38, 100, 103, and 106

United States Patent and Trademark Office

Reg. No. 3,522,548

Registered Oct. 21, 2008

**TRADEMARK
SERVICE MARK
PRINCIPAL REGISTER**

The logo for ECONOLITE features a stylized blue icon of a traffic light on the left, followed by the word "ECONOLITE" in a bold, blue, sans-serif font.

ECONOLITE CONTROL PRODUCTS, INC. (CALIFORNIA CORPORATION)
3360 EAST LA PALMA AVENUE
ANAHEIM, CA 92806

FOR: TRAFFIC CONTROL EQUIPMENT, NAME-
LY, ACTUATED AND PRETIMED TRAFFIC SIG-
NAL CONTROLLERS; TRAFFIC MANAGEMENT
EQUIPMENT COMPRISING DISPLAY MONITORS,
COMPUTERS, AUTO COMPASSES, SOFTWARE TO
MANAGE TRAFFIC, VEHICLE DETECTION
EQUIPMENT COMPRISING DISPLAY MONITORS,
COMPUTERS, IMAGE SENSORS, VIDEO CAM-
ERAS, AND OPERATING SYSTEM AND APPLICA-
TION SOFTWARE TO DETECT VEHICLE
LOCATION; AND CONTROL CABINETS FOR
TRAFFIC CONTROL EQUIPMENT, NAMELY,
TRAFFIC SIGNAL CONTROLLERS, IN CLASS 9
(U.S. CLS. 21, 23, 26, 36 AND 38).

FIRST USE 12-28-1977; IN COMMERCE 1-25-1978.

FOR: MAINTENANCE OF TRAFFIC CONTROL
EQUIPMENT; CONSULTING SERVICES IN THE
FIELD OF TRAFFIC CONTROL EQUIPMENT, IN
CLASS 37 (U.S. CLS. 100, 103 AND 106).

FIRST USE 1-1-2000; IN COMMERCE 1-1-2000.

OWNER OF U.S. REG. NOS. 622,978 AND 2,156,026.

"THE COLOR(S) BLUE IS/ARE CLAIMED AS A
FEATURE OF THE MARK."

THE COLOR BLUE APPEARS IN THE WORDING
"ECONOLITE" AND IN THE SIGN DESIGN.

SN 78-765,957, FILED 12-2-2005.

TEJBIR SINGH, EXAMINING ATTORNEY

Int. Cl.: 3

Prior U.S. Cls.: 1, 4, 6, 50, 51, and 52

Reg. No. 3,522,549

United States Patent and Trademark Office

Registered Oct. 21, 2008

**TRADEMARK
PRINCIPAL REGISTER**

PERFECT 10

THE PROCTER & GAMBLE COMPANY (OHIO
CORPORATION)
ONE PROCTER & GAMBLE PLAZA
CINCINNATI, OH 45202

THE MARK CONSISTS OF STANDARD CHAR-
ACTERS WITHOUT CLAIM TO ANY PARTICULAR
FONT, STYLE, SIZE, OR COLOR.

FOR: HAIR COLOR, IN CLASS 3 (U.S. CLS. 1, 4, 6,
50, 51 AND 52).

SN 78-771,557, FILED 12-12-2005.

FIRST USE 1-2-2008; IN COMMERCE 1-2-2008.

NAKIA HENRY, EXAMINING ATTORNEY

Int. Cls.: 42 and 45

Prior U.S. Cls.: 100 and 101

United States Patent and Trademark Office

Reg. No. 3,522,550

Registered Oct. 21, 2008

**SERVICE MARK
PRINCIPAL REGISTER**

WATCHWIRE

AMERICAN ALARM & COMMUNICATIONS,
INC. (MASSACHUSETTS CORPORATION)
297 BROADWAY
ARLINGTON, MA 02474

FOR: TECHNICAL SUPPORT, NAMELY, MONITORING OF NETWORK SYSTEMS FOR BOTH LOCAL AND WIDE AREA NETWORKS; AND SERVICES DESIGNED TO SUPPORT MONITORING SERVICES, NAMELY, DESIGN OF COMPUTER PROGRAMS FOR OTHERS, SOFTWARE CONSULTING, COMPUTER PROGRAMMING FOR OTHERS, INSTALLATION OF COMPUTER SOFTWARE, TECHNICAL COMPUTER SUPPORT, NAMELY, TELEPHONE AND ON-SITE COMPUTER CONSULTATION IN CONNECTION WITH OPERATION AND MAINTENANCE OF COMPUTER HARDWARE AND SOFTWARE, UPDATING COMPUTER PROGRAMS FOR OTHERS, AND MANAGING WEB SITES FOR OTHERS, IN CLASS 42 (U.S. CLS. 100 AND 101).

FIRST USE 4-6-2000; IN COMMERCE 8-19-2008.

FOR: MONITORING SERVICES IMPLEMENTED THROUGH A WEBSITE ON A GLOBAL COMPUTER NETWORK FOR MONITORING OF COMPUTER HARDWARE AND SOFTWARE SYSTEMS, TELEPHONE SYSTEMS, AND FACSIMILE SYSTEMS FOR SECURITY PURPOSES; ON-LINE MONITORING, NAMELY, VIDEO MONITORING OF FACILITIES, VIEWABLE THROUGH A GLOBAL COMPUTER NETWORK; MONITORING SECURITY SYSTEMS; MONITORING FIRE ALARMS, IN CLASS 45 (U.S. CLS. 100 AND 101).

FIRST USE 4-6-2000; IN COMMERCE 8-19-2008.

THE MARK CONSISTS OF STANDARD CHARACTERS WITHOUT CLAIM TO ANY PARTICULAR FONT, STYLE, SIZE, OR COLOR.

SN 78-772,516, FILED 12-13-2005.

JERI J. FICKES, EXAMINING ATTORNEY

Int. Cl.: 41

Prior U.S. Cls.: 100, 101, and 107

United States Patent and Trademark Office

Reg. No. 3,522,551

Registered Oct. 21, 2008

**SERVICE MARK
PRINCIPAL REGISTER**

FLY SPICE

SPICE ENTERTAINMENT, INC. (DELAWARE
CORPORATION)
680 NORTH LAKE SHORE DRIVE
CHICAGO, IL 60611

FOR: ENTERTAINMENT SERVICES, NAMELY,
PROVISION OF NON-DOWNLOADABLE ADULT
ENTERTAINMENT FILMS AND TV PROGRAMS
VIA A VIDEO-ON-DEMAND SERVICE; ENTER-
TAINMENT, NAMELY, AN ADULT ENTERTAIN-
MENT PROGRAM SHOW BROADCAST VIA
SATELLITE; PRODUCTION OF ADULT CABLE
TELEVISION PROGRAMS; PRODUCTION AND
DISTRIBUTION OF MOTION PICTURES FEATUR-
ING ADULT ENTERTAINMENT, IN CLASS 41 (U.S.
CLS. 100, 101 AND 107).

FIRST USE 5-5-2006; IN COMMERCE 5-5-2006.

THE MARK CONSISTS OF STANDARD CHAR-
ACTERS WITHOUT CLAIM TO ANY PARTICULAR
FONT, STYLE, SIZE, OR COLOR.

OWNER OF U.S. REG. NOS. 1,690,906, 2,729,537,
AND OTHERS.

SN 78-779,834, FILED 12-22-2005.

INGA ERVIN, EXAMINING ATTORNEY

Int. Cl.: 10

Prior U.S. Cls.: 26, 39, and 44

United States Patent and Trademark Office

Reg. No. 3,522,552

Registered Oct. 21, 2008

**TRADEMARK
PRINCIPAL REGISTER**

ELECTROCEUTICALS

IVIVI TECHNOLOGIES, INC. (NEW JERSEY
CORPORATION)
224-S PEGASUS AVENUE
NORTHVALE, NJ 07647

FOR: ELECTROMAGNETIC THERAPY APPARA-
TUS FOR MEDICAL PURPOSES THAT USE
PULSED SIGNALS IN CONNECTION WITH PHY-
SIO THERAPEUTIC TREATMENT OF HUMANS,
ANIMALS, PLANTS, LIVING CELLS, AND MOLE-
CULES, IN CLASS 10 (U.S. CLS. 26, 39 AND 44).

FIRST USE 12-27-2005; IN COMMERCE 12-27-2005.

THE MARK CONSISTS OF STANDARD CHAR-
ACTERS WITHOUT CLAIM TO ANY PARTICULAR
FONT, STYLE, SIZE, OR COLOR.

SN 78-780,953, FILED 12-27-2005.

AISHA CLARKE, EXAMINING ATTORNEY

Int. Cl.: 45

Prior U.S. Cls.: 100 and 101

United States Patent and Trademark Office

Reg. No. 3,522,553

Registered Oct. 21, 2008

**SERVICE MARK
PRINCIPAL REGISTER**

CLICK FRAUD INDEX

CLICK FORENSICS, INC. (DELAWARE CORPORATION)
4301 WESTBANK DR.
BUILDING A, SUITE 301
AUSTIN, TX 78746

FOR: PROVIDING INFORMATION ONLINE IN THE FIELD OF DETECTING FRAUD IN PAY-PER-CLICK ADVERTISING PROGRAMS OVER A GLOBAL COMMUNICATIONS NETWORK VIA A GLOBAL COMMUNICATIONS NETWORK, IN CLASS 45 (U.S. CLS. 100 AND 101).

FIRST USE 2-28-2006; IN COMMERCE 2-28-2006.

THE MARK CONSISTS OF STANDARD CHARACTERS WITHOUT CLAIM TO ANY PARTICULAR FONT, STYLE, SIZE, OR COLOR.

NO CLAIM IS MADE TO THE EXCLUSIVE RIGHT TO USE "FRAUD INDEX", APART FROM THE MARK AS SHOWN.

SN 78-781,898, FILED 12-28-2005.

BRIAN NEVILLE, EXAMINING ATTORNEY

Int. Cls.: 9 and 37

Prior U.S. Cls.: 21, 23, 26, 36, 38, 100, 103, and 106

United States Patent and Trademark Office

Reg. No. 3,522,554

Registered Oct. 21, 2008

**TRADEMARK
SERVICE MARK
PRINCIPAL REGISTER**



ECONOLITE CONTROL PRODUCTS, INC. (CALIFORNIA CORPORATION)
3360 EAST LA PALMA AVENUE
ANAHEIM, CA 92806

FOR: TRAFFIC CONTROL EQUIPMENT, NAME-
LY, ACTUATED AND PRETIMED TRAFFIC SIG-
NAL CONTROLLERS; TRAFFIC MANAGEMENT
EQUIPMENT COMPRISING DISPLAY MONITORS,
COMPUTERS, AUTO COMPASSES, SOFTWARE TO
MANAGE TRAFFIC, AND ANTENNAS, RADIO
TRANSMITTERS, AND RADIO RECEIVERS TO
COMMUNICATE TRAFFIC INFORMATION; VEHI-
CLE DETECTION EQUIPMENT COMPRISING DIS-
PLAY MONITORS, COMPUTERS, IMAGE
SENSORS, VIDEO CAMERAS, AND OPERATING
SYSTEM AND APPLICATION SOFTWARE TO DE-
TECT VEHICLE LOCATION; AND CONTROL CA-
BINETS FOR TRAFFIC CONTROL EQUIPMENT,
NAMELY, TRAFFIC SIGNAL CONTROLLERS, IN
CLASS 9 (U.S. CLS. 21, 23, 26, 36 AND 38).

FIRST USE 12-28-1977; IN COMMERCE 1-25-1978.

FOR: MAINTENANCE OF TRAFFIC CONTROL
EQUIPMENT; CONSULTING SERVICES IN THE
FIELD OF TRAFFIC CONTROL EQUIPMENT, IN
CLASS 37 (U.S. CLS. 100, 103 AND 106).

FIRST USE 1-1-2000; IN COMMERCE 1-1-2000.

OWNER OF U.S. REG. NOS. 622,978 AND 2,156,026.

THE COLOR(S) BLUE IS/ARE CLAIMED AS A
FEATURE OF THE MARK.

THE COLOR BLUE APPEARS IN THE BARS AND
GLOBE DESIGN.

SN 78-785,049, FILED 1-4-2006.

TEJBIR SINGH, EXAMINING ATTORNEY

Int. Cl.: 42

Prior U.S. Cls.: 100 and 101

United States Patent and Trademark Office

Reg. No. 3,522,555

Registered Oct. 21, 2008

**SERVICE MARK
PRINCIPAL REGISTER**



DEFENSE ADVANCED RESEARCH PROJECTS
AGENCY (UNITED STATES FEDERAL AGENCY)

LEGAL SCIENCES OFFICE
3701 NORTH FAIRFAX DRIVE
ARLINGTON, VA 222031714

FOR: DEVELOPMENT OF NEW TECHNOLOGY FOR OTHERS IN THE FIELDS OF ADVANCED WEAPONS TECHNOLOGY, DEFENSE SCIENCES, INFORMATION PROCESSING AND EXPLOITATION TECHNOLOGY, MICROSYSTEMS TECHNOLOGY, TACTICAL TECHNOLOGIES RELATING TO AERONAUTICS, SPACE, LAND VEHICLES, AND WEAPONS SYSTEMS, AND SPECIAL MILITARY AND SPACE TECHNOLOGIES; SCIENTIFIC RESEARCH AND DEVELOPMENT; TECHNICAL RESEARCH IN THE FIELD OF AERONAUTICS, IN CLASS 42 (U.S. CLS. 100 AND 101).

FIRST USE 6-7-1999; IN COMMERCE 6-7-1999.

THE COLOR(S) BLUE, SILVER, AND GRAY IS/ ARE CLAIMED AS A FEATURE OF THE MARK.

THE MARK CONSISTS OF A BLUE GLOBE-LIKE SHAPE OUTLINED IN GRAY WITH SIX CURVED HORIZONTAL LINES; A HALF CIRCLE AT THE TOP AND BOTTOM OF THE GLOBE-LIKE SHAPE; A STRAIGHT LINE IN THE CENTER OF THE GLOBE-LIKE SHAPE, WITH A CURVED VERTICAL LINE ABOVE AND BELOW THE STRAIGHT LINE; ALL GRAY IN COLOR. THE LETTERS "DARPA" APPEAR IN THE FRONT OF THE LINES WITHIN THE GLOBE-LIKE SHAPE. THE TOP OF THE LETTERS ARE LIGHT SILVER TURNING TO A DARKER GRAY TOWARDS THE BOTTOM OF THE LETTERS.

SN 78-786,534, FILED 1-6-2006.

NELSON SNYDER, EXAMINING ATTORNEY

Int. Cl.: 9

Prior U.S. Cls.: 21, 23, 26, 36, and 38

Reg. No. 3,522,556

United States Patent and Trademark Office

Registered Oct. 21, 2008

**TRADEMARK
PRINCIPAL REGISTER**

INFINITY

DIGITAL CHECK CORPORATION (DELAWARE
CORPORATION)
SUITE 31
466 CENTRAL AVENUE
NORTHFIELD, IL 60093

FIRST USE 7-0-2007; IN COMMERCE 7-0-2007.

THE MARK CONSISTS OF STANDARD CHAR-
ACTERS WITHOUT CLAIM TO ANY PARTICULAR
FONT, STYLE, SIZE, OR COLOR.

FOR: A DEVICE IN THE NATURE OF AN AUTO-
MATIC FEEDER FOR SENDING A CONTINUOUS
NUMBER OF CHECKS INTO A CHECK SCANNER
SOLD AS AN INTEGRAL COMPONENT OF CHECK
SCANNERS, IN CLASS 9 (U.S. CLS. 21, 23, 26, 36 AND
38).

SN 78-787,117, FILED 1-8-2006.

ALEX KEAM, EXAMINING ATTORNEY

Int. Cls.: 36 and 44

Prior U.S. Cls.: 100, 101, and 102

United States Patent and Trademark Office

Reg. No. 3,522,557

Registered Oct. 21, 2008

**SERVICE MARK
PRINCIPAL REGISTER**

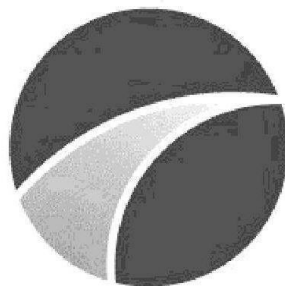

Protocols

MEDICAL SETTLEMENT PROTOCOLS, LLC
(COLORADO LIMITED LIABILITY COMPAN-
NY)

P.O. BOX 13068
DENVER, CO 80202

FOR: FINANCIAL COORDINATION OF FINAN-
CIAL BENEFITS DERIVED FROM MEDICAL
CLAIMS, NAMELY, INSURANCE CLAIMS ADMIN-
ISTRATION AND PROCESSING; CONSULTATION
SERVICES IN THE FIELD OF MEDICAL CLAIMS
SETTLEMENTS, IN CLASS 36 (U.S. CLS. 100, 101
AND 102).

FIRST USE 6-0-2007; IN COMMERCE 6-0-2001.

FOR: MEDICAL EVALUATION SERVICES,
NAMELY, FUNCTIONAL ASSESSMENT PRO-
GRAM FOR PATIENTS RECEIVING MEDICAL
REHABILITATION SERVICES FOR PURPOSES OF

GUIDING TREATMENT, ASSESSING PROGRAM
EFFECTIVENESS, AND EVALUATION OF FUTURE
MEDICAL NEEDS, IN CLASS 44 (U.S. CLS. 100 AND
101).

FIRST USE 6-0-2001; IN COMMERCE 6-0-2001.

NO CLAIM IS MADE TO THE EXCLUSIVE
RIGHT TO USE "PROTOCOLS", APART FROM
THE MARK AS SHOWN.

THE MARK CONSISTS OF A CIRCULAR DESIGN
WITH A WAVE RUNNING THROUGH IT. UNDER-
NEATH THIS DESIGN IS THE WORDING "PROTO-
COLS".

SN 78-787,604, FILED 1-9-2006.

RICHARD A. STRASER, EXAMINING ATTORNEY

Int. Cl.: 18

Prior U.S. Cls.: 1, 2, 3, 22, and 41

United States Patent and Trademark Office

Reg. No. 3,522,558

Registered Oct. 21, 2008

**TRADEMARK
PRINCIPAL REGISTER**

SILVER FACTORY

THE ANDY WARHOL FOUNDATION FOR THE
VISUAL ARTS, INC. (NEW YORK CORPORATION)
65 BLEECKER STREET, 7TH FLOOR
NEW YORK, NY 10012

FOR: WALLETS, TOTE BAGS, MESSENGER
BAGS, OVERNIGHT BAGS, IN CLASS 18 (U.S. CLS.
1, 2, 3, 22 AND 41).

FIRST USE 1-0-2007; IN COMMERCE 1-0-2007.

THE MARK CONSISTS OF STANDARD CHAR-
ACTERS WITHOUT CLAIM TO ANY PARTICULAR
FONT, STYLE, SIZE, OR COLOR.

SN 78-789,329, FILED 1-11-2006.

KATHERINE M. DUBRAY, EXAMINING ATTOR-
NEY

Int. Cls.: 9 and 16

Prior U.S. Cls.: 2, 5, 21, 22, 23, 26, 29, 36, 37, 38, and 50

Reg. No. 3,522,559

United States Patent and Trademark Office

Registered Oct. 21, 2008

**TRADEMARK
PRINCIPAL REGISTER**

APPLIANCE TODAY

MARKETSHARE SYSTEMS, INC. (FLORIDA CORPORATION)
396 N. HARBOR CITY BLVD.
MELBOURNE, FL 32935

FOR: DOWNLOADABLE PERIODICAL PUBLICATIONS IN THE FIELD OF APPLIANCES AND THE RETAIL SALES OF APPLIANCES, IN CLASS 9 (U.S. CLS. 21, 23, 26, 36 AND 38).

FIRST USE 0-0-2006; IN COMMERCE 0-0-2006.

FOR: PERIODICAL PUBLICATIONS, NAMELY, NEWSLETTERS AND MAGAZINES IN THE FIELD OF APPLIANCES AND THE RETAIL SALES OF APPLIANCES, IN CLASS 16 (U.S. CLS. 2, 5, 22, 23, 29, 37, 38 AND 50).

FIRST USE 0-0-2006; IN COMMERCE 0-0-2006.

THE MARK CONSISTS OF STANDARD CHARACTERS WITHOUT CLAIM TO ANY PARTICULAR FONT, STYLE, SIZE, OR COLOR.

NO CLAIM IS MADE TO THE EXCLUSIVE RIGHT TO USE "APPLIANCE", APART FROM THE MARK AS SHOWN.

SN 78-790,112, FILED 1-12-2006.

STEVEN PEREZ, EXAMINING ATTORNEY

Int. Cl.: 28

Prior U.S. Cls.: 22, 23, 38, and 50

United States Patent and Trademark Office

Reg. No. 3,522,560

Registered Oct. 21, 2008

**TRADEMARK
PRINCIPAL REGISTER**

Caboodle!

CABOODLE! TOYS LLC (NEW YORK LIMITED
LIABILITY COMPANY)
SUITE 907
1140 BROADWAY
NEW YORK, NY 10001

FOR: COLLECTABLE TOY FIGURES; MODELED
PLASTIC TOY FIGURINES; MOLDED TOY FIG-
URES; TOY ANIMALS AND ACCESSORIES THERE-
FORE; TOY FIGURES, IN CLASS 28 (U.S. CLS. 22, 23,
38 AND 50).

FIRST USE 1-26-2007; IN COMMERCE 1-26-2007.

THE MARK CONSISTS OF STANDARD CHAR-
ACTERS WITHOUT CLAIM TO ANY PARTICULAR
FONT, STYLE, SIZE, OR COLOR.

SN 78-791,278, FILED 1-13-2006.

BARBARA BROWN, EXAMINING ATTORNEY

Int. Cls.: 35, 37, and 40

Prior U.S. Cls.: 100, 101, 102, 103, and 106

United States Patent and Trademark Office

Reg. No. 3,522,561

Registered Oct. 21, 2008

**SERVICE MARK
PRINCIPAL REGISTER**

CARERETURN

HILL-ROM SERVICES, INC. (DELAWARE CORPORATION)
1069 STATE ROUTE 46 EAST
BATESVILLE, IN 47006

FOR: HEALTHCARE FACILITY MANAGEMENT AND CONSULTING SERVICES TO IMPROVE MEDICAL EQUIPMENT UTILIZATION; MEDICAL EQUIPMENT MANAGEMENT SERVICES , IN CLASS 35 (U.S. CLS. 100, 101 AND 102).

FIRST USE 6-1-2006; IN COMMERCE 6-1-2006.

FOR: MAINTENANCE AND REPAIR SERVICES FOR MOVEABLE MEDICAL EQUIPMENT AND PICKUP AND DELIVERY SERVICES SOLD THEREWITH, IN CLASS 37 (U.S. CLS. 100, 103 AND 106).

FIRST USE 6-1-2006; IN COMMERCE 6-1-2006.

FOR: DECONTAMINATION SERVICES IN THE FIELD OF MOVEABLE MEDICAL EQUIPMENT, IN CLASS 40 (U.S. CLS. 100, 103 AND 106).

FIRST USE 6-1-2006; IN COMMERCE 6-1-2006.

THE MARK CONSISTS OF STANDARD CHARACTERS WITHOUT CLAIM TO ANY PARTICULAR FONT, STYLE, SIZE, OR COLOR.

SN 78-795,591, FILED 1-20-2006.

ZACHARY BELLO, EXAMINING ATTORNEY

Int. Cls.: 1 and 5

Prior U.S. Cls.: 1, 5, 6, 10, 18, 26, 44, 46, 51, and 52

United States Patent and Trademark Office

Reg. No. 3,522,562

Registered Oct. 21, 2008

**TRADEMARK
PRINCIPAL REGISTER**

MITOPROFILE

MITOSCIENCE LLC (OREGON LIMITED LIABILITY COMPANY)
1850 MILLRACE DR., SUITE 3A
EUGENE, OR 97403

FOR: REAGENTS FOR SCIENTIFIC, PHARMACEUTICAL AND MEDICAL RESEARCH; CHEMICAL PREPARATIONS FOR SCIENTIFIC PURPOSES; TESTING KITS CONSISTING PRIMARILY OF MONOCLONAL ANTIBODIES, BUFFERS, AND REAGENTS FOR MEASURING AMOUNTS OR ACTIVITIES OF TARGET PROTEINS FOR RESEARCH PURPOSES; DIAGNOSTIC KITS CONSISTING PRIMARILY OF MONOCLONAL ANTIBODIES, BUFFERS, AND REAGENTS FOR USE TO MONITOR TOXICITY OF DRUGS, IN CLASS 1 (U.S. CLS. 1, 5, 6, 10, 26 AND 46).

FIRST USE 5-1-2006; IN COMMERCE 5-8-2006.

FOR: TESTING KITS CONSISTING PRIMARILY OF MONOCLONAL ANTIBODIES, BUFFERS, AND REAGENTS FOR MEASURING AMOUNTS OR ACTIVITIES OF TARGET PROTEINS FOR MEDICAL USE; DIAGNOSTIC KITS CONSISTING PRIMARILY OF MONOCLONAL ANTIBODIES, BUFFERS, AND REAGENTS FOR USE IN TESTING FOR DISEASES, IN CLASS 5 (U.S. CLS. 6, 18, 44, 46, 51 AND 52).

FIRST USE 5-1-2006; IN COMMERCE 5-8-2006.

THE MARK CONSISTS OF STANDARD CHARACTERS WITHOUT CLAIM TO ANY PARTICULAR FONT, STYLE, SIZE, OR COLOR.

SN 78-796,254, FILED 1-20-2006.

DOMINIC FATHY, EXAMINING ATTORNEY

Int. Cl.: 30

Prior U.S. Cl.: 46

United States Patent and Trademark Office

Reg. No. 3,522,563

Registered Oct. 21, 2008

**TRADEMARK
PRINCIPAL REGISTER**

**Peter The Mark Of
Distinction**

WILBUR CHOCOLATE CO., INC. (DELAWARE
CORPORATION)
20 NORTH BROAD STREET
LITITZ, PA 17543

FOR: CHOCOLATE, CARAMEL, COCOA, COCOA
BASED INGREDIENTS FOR CONFECTIONERY
PRODUCTS AND WHITE AND COCOA BASED
CONFECTIONERY COATINGS USED AS AN IN-
GREDIENT IN CONFECTIONERY, FUDGE,
ICINGS, TOPPINGS, SYRUP, ICE CREAM AND
BAKERY GOODS, IN CLASS 30 (U.S. CL. 46).

FIRST USE 1-20-2006; IN COMMERCE 1-20-2006.

THE MARK CONSISTS OF STANDARD CHAR-
ACTERS WITHOUT CLAIM TO ANY PARTICULAR
FONT, STYLE, SIZE, OR COLOR.

OWNER OF U.S. REG. NO. 532,689.

SN 78-797,949, FILED 1-24-2006.

GIANCARLO CASTRO, EXAMINING ATTORNEY

Int. Cls.: 9 and 38

Prior U.S. Cls.: 21, 23, 26, 36, 38, 100, 101, and 104

United States Patent and Trademark Office

Reg. No. 3,522,564

Registered Oct. 21, 2008

**TRADEMARK
SERVICE MARK
PRINCIPAL REGISTER**

FANVIEW

NEXTEL COMMUNICATIONS, INC. (DELA-
WARE CORPORATION)
6200 SPRINT PARKWAY
OVERLAND PARK, KS 66251

FOR: WIRELESS DEVICES FOR RECEIVING
AND VIEWING LIVE AND RECORDED SPORTING
AND ENTERTAINMENT EVENTS AND RELATED
AUDIO, VIDEO AND MULTIMEDIA CONTENT, IN
CLASS 9 (U.S. CLS. 21, 23, 26, 36 AND 38).

FIRST USE 2-9-2007; IN COMMERCE 2-9-2007.

FOR: TELECOMMUNICATIONS SERVICES,
NAMELY, TRANSMISSION OF LIVE AND RECOR-

DED AUDIO, VIDEO AND MULTIMEDIA CON-
TENT IN THE FIELD OF SPORTING AND
ENTERTAINMENT EVENTS, IN CLASS 38 (U.S.
CLS. 100, 101 AND 104).

FIRST USE 2-9-2007; IN COMMERCE 2-9-2007.

THE MARK CONSISTS OF STANDARD CHAR-
ACTERS WITHOUT CLAIM TO ANY PARTICULAR
FONT, STYLE, SIZE, OR COLOR.

SN 78-798,388, FILED 1-24-2006.

HENRY S. ZAK, EXAMINING ATTORNEY

Int. Cl.: 35

Prior U.S. Cls.: 100, 101, and 102

United States Patent and Trademark Office

Reg. No. 3,522,565

Registered Oct. 21, 2008

**SERVICE MARK
PRINCIPAL REGISTER**

CITY OF GREENSBORO



NORTH CAROLINA

THE CITY OF GREENSBORO (NORTH CAROLINA CORPORATION)
300 WEST WASHINGTON STREET
GREENSBORO, NC 27401

FOR: MUNICIPAL SERVICES, NAMELY, BUSINESS MARKETING AND PROMOTING ECONOMIC DEVELOPMENT AND GROWTH OF THE CITY OF GREENSBORO, NORTH CAROLINA, IN CLASS 35 (U.S. CLS. 100, 101 AND 102).

NO CLAIM IS MADE TO THE EXCLUSIVE RIGHT TO USE "CITY OF GREENSBORO" AND "1808" AND "NORTH CAROLINA", APART FROM THE MARK AS SHOWN.

SN 78-800,986, FILED 1-27-2006.

FIRST USE 5-0-2007; IN COMMERCE 5-0-2007.

DAVID COLLIER, EXAMINING ATTORNEY

Int. Cls.: 16 and 25

Prior U.S. Cls.: 2, 5, 22, 23, 29, 37, 38, 39, and 50

United States Patent and Trademark Office

Reg. No. 3,522,566

Registered Oct. 21, 2008

**TRADEMARK
PRINCIPAL REGISTER**

**ROCKY MOUNTAIN
RAGE**

BROOMFIELD ICE, LLC (COLORADO LIMITED
LIABILITY COMPANY)

555 ELDORADO BOULEVARD

BROOMFIELD, CO 80021

FOR: POSTERS, PHOTOGRAPHS, SPORTS TEAM
AND PLAYER TRADING CARDS, AND GAME
EVENT PROGRAMS, IN CLASS 16 (U.S. CLS. 2, 5,
22, 23, 29, 37, 38 AND 50).

FIRST USE 10-26-2007; IN COMMERCE 10-26-2007.

FOR: CLOTHING, NAMELY, SWEAT SHIRTS,
BASEBALL CAPS, KNIT CAPS, AND SKI CAPS, IN
CLASS 25 (U.S. CLS. 22 AND 39).

FIRST USE 7-27-2006; IN COMMERCE 7-27-2006.

NO CLAIM IS MADE TO THE EXCLUSIVE
RIGHT TO USE "ROCKY MOUNTAIN", APART
FROM THE MARK AS SHOWN.

SN 78-803,831, FILED 1-31-2006.

KIMBERLY FRYE, EXAMINING ATTORNEY

Int. Cl.: 25

Prior U.S. Cls.: 22 and 39

United States Patent and Trademark Office

Reg. No. 3,522,567

Registered Oct. 21, 2008

**TRADEMARK
PRINCIPAL REGISTER**



MATTHEW HENDERSON (NEW ZEALAND INDIVIDUAL)

56 RAYMOND STREET

HAMILTON, NEW ZEALAND 3214 AND

WILLIAMS, ADAM, J. (NEW ZEALAND INDIVIDUAL)

3 KATHERINE PLACE

HAMILTON, NEW ZEALAND

FOR: CAPS; DENIM JACKETS; DOWN JACKETS; HEAVY JACKETS; HOODS; JACKETS; JERSEYS; LEATHER BELTS; POLO SHIRTS; SHORT-SLEEVED OR LONG-SLEEVED T-SHIRTS; SPORT SHIRTS; SPORTS SHIRTS; SPORTS SHIRTS WITH SHORT

SLEEVES; SWEAT PANTS; SWEAT SHIRTS; T-SHIRTS, IN CLASS 25 (U.S. CLS. 22 AND 39).

FIRST USE 10-26-2005; IN COMMERCE 12-1-2005.

THE MARK CONSISTS OF THE WORDING "BRAWLA," THE STYLIZED DESIGN OF A SILHOUETTED FACE, AND THE STYLIZED DESIGN OF A FIST APPEARING IN THE LETTER "W" IN THE WORDING "BRAWLA."

SN 78-804,397, FILED 2-1-2006.

SEAN CROWLEY, EXAMINING ATTORNEY

Int. Cls.: 35 and 45

Prior U.S. Cls.: 100, 101, and 102

United States Patent and Trademark Office

Reg. No. 3,522,568

Registered Oct. 21, 2008

**SERVICE MARK
PRINCIPAL REGISTER**

SAMPLESURE

UNITED PARCEL SERVICE OF AMERICA, INC.
(DELAWARE CORPORATION)
55 GLENLAKE PARKWAY, NE
ATLANTA, GA 30328

FOR: COMPUTERIZED TRACKING AND TRACING OF PACKAGES IN TRANSIT; PROVIDING INFORMATION IN THE FIELD OF TRACKING ORDERS OF PHARMACEUTICAL SAMPLE PRODUCTS, NAMELY, DATA COLLECTION AND REPORTING SERVICES RELATING TO PHARMACEUTICAL SAMPLES ORDERING, SHIPPING AND DELIVERY STATUS; COMPUTERIZED TRACKING OF SHIPMENTS, NAMELY, TRACKING DISTRIBUTION OF SAMPLE PHARMACEUTICAL PRODUCTS; AND INVENTORY MANAGEMENT IN THE FIELD OF PHARMACEUTICAL SAMPLES AND PRODUCTS, IN CLASS 35 (U.S. CLS. 100, 101 AND 102).

FIRST USE 5-0-2006; IN COMMERCE 5-0-2006.

FOR: PROVIDING REGULATORY INFORMATION ON-LINE, NAMELY, PROVIDING ONLINE INFORMATION REGARDING RULES AND REGULATIONS RELATING TO DISTRIBUTION OF PHARMACEUTICAL PRODUCTS, IN CLASS 45 (U.S. CLS. 100 AND 101).

FIRST USE 5-0-2006; IN COMMERCE 5-0-2006.

THE MARK CONSISTS OF STANDARD CHARACTERS WITHOUT CLAIM TO ANY PARTICULAR FONT, STYLE, SIZE, OR COLOR.

SN 78-804,831, FILED 2-1-2006.

SEAN CROWLEY, EXAMINING ATTORNEY

Int. Cl.: 28

Prior U.S. Cls.: 22, 23, 38, and 50

United States Patent and Trademark Office

Reg. No. 3,522,569

Registered Oct. 21, 2008

**TRADEMARK
PRINCIPAL REGISTER**

KULL

KULL PRODUCTIONS INC. (DELAWARE COR-
PORATION)
8484 WILSHIRE BOULEVARD
STE. 870
BEVERLY HILLS, CA 90211

FOR: COLLECTABLE TOY FIGURES, IN CLASS
28 (U.S. CLS. 22, 23, 38 AND 50).

FIRST USE 6-11-2008; IN COMMERCE 6-11-2008.

THE MARK CONSISTS OF STANDARD CHAR-
ACTERS WITHOUT CLAIM TO ANY PARTICULAR
FONT, STYLE, SIZE, OR COLOR.

OWNER OF U.S. REG. NO. 1,347,678.

SN 78-807,118, FILED 2-3-2006.

LAURA HAMMEL, EXAMINING ATTORNEY

Int. Cl.: 16

Prior U.S. Cls.: 2, 5, 22, 23, 29, 37, 38, and 50

Reg. No. 3,522,570

United States Patent and Trademark Office

Registered Oct. 21, 2008

**TRADEMARK
PRINCIPAL REGISTER**

GALAXY GOONS

BOHANNON, REGINA M (UNITED STATES IN-
DIVIDUAL)
1130 BERDOVA DRIVE
MILFORD, OH 45150

THE MARK CONSISTS OF STANDARD CHAR-
ACTERS WITHOUT CLAIM TO ANY PARTICULAR
FONT, STYLE, SIZE, OR COLOR.

FOR: CHILDREN'S BOOKS, IN CLASS 16 (U.S.
CLS. 2, 5, 22, 23, 29, 37, 38 AND 50).

SN 78-807,468, FILED 2-5-2006.

FIRST USE 5-1-2008; IN COMMERCE 5-1-2008.

EVELYN BRADLEY, EXAMINING ATTORNEY

Int. Cls.: 16 and 30

Prior U.S. Cls.: 2, 5, 22, 23, 29, 37, 38, 46, and 50

United States Patent and Trademark Office

Reg. No. 3,522,571

Registered Oct. 21, 2008

**TRADEMARK
PRINCIPAL REGISTER**

TUNG TOOS

LJMC, LLC (KENTUCKY LIMITED LIABILITY
COMPANY)
36 HENRY AVENUE
FORT THOMAS, KY 41075

FOR: TEMPORARY TATTOOS, IN CLASS 16 (U.S.
CLS. 2, 5, 22, 23, 29, 37, 38 AND 50).

FIRST USE 6-30-2006; IN COMMERCE 6-30-2006.

FOR: CANDY, NAMELY, FLAVORED TEMPOR-
ARY TATOOS, IN CLASS 30 (U.S. CL. 46).

FIRST USE 6-30-2006; IN COMMERCE 6-30-2006.

THE MARK CONSISTS OF STANDARD CHAR-
ACTERS WITHOUT CLAIM TO ANY PARTICULAR
FONT, STYLE, SIZE, OR COLOR.

SN 78-811,210, FILED 2-9-2006.

DAVID TOOLEY, EXAMINING ATTORNEY

Int. Cl.: 11

Prior U.S. Cls.: 13, 21, 23, 31, and 34

United States Patent and Trademark Office

Reg. No. 3,522,572

Registered Oct. 21, 2008

**TRADEMARK
PRINCIPAL REGISTER**

NANOPLEAT

BHA GROUP, INC. (DELAWARE CORPORATION)
8800 EAST 63RD STREET
KANSAS CITY, MO 64133

FOR: FILTERS FOR PARTICULATE COLLECTION OF INDUSTRIAL FUME AND DUST APPLICATIONS, IN CLASS 11 (U.S. CLS. 13, 21, 23, 31 AND 34).

FIRST USE 3-23-2006; IN COMMERCE 3-23-2006.

THE MARK CONSISTS OF STANDARD CHARACTERS WITHOUT CLAIM TO ANY PARTICULAR FONT, STYLE, SIZE, OR COLOR.

OWNER OF U.S. REG. NOS. 2,373,340 AND 2,437,355.

SN 78-811,339, FILED 2-9-2006.

DAVID TAYLOR, EXAMINING ATTORNEY

Int. Cl.: 11

Prior U.S. Cls.: 13, 21, 23, 31, and 34

United States Patent and Trademark Office

Reg. No. 3,522,573

Registered Oct. 21, 2008

**TRADEMARK
PRINCIPAL REGISTER**

FUSION

RTR GROUP, INC. (TENNESSEE CORPORATION)
1405 WINCHESTER HIGHWAY
FAYETTEVILLE, TN 37334

FOR: IN-GROUND SPAS IN THE NATURE OF HEATED POOLS AND PARTS THEREOF, NAMELY, SPA SHELLS, SWIM SPA SHELLS, AND IN-GROUND SWIM SPA SHELLS, IN CLASS 11 (U.S. CLS. 13, 21, 23, 31 AND 34).

FIRST USE 2-28-2005; IN COMMERCE 2-28-2005.

THE MARK CONSISTS OF STANDARD CHARACTERS WITHOUT CLAIM TO ANY PARTICULAR FONT, STYLE, SIZE, OR COLOR.

SN 78-811,488, FILED 2-9-2006.

BRIAN PINO, EXAMINING ATTORNEY

Int. Cls.: 21 and 28

Prior U.S. Cls.: 2, 13, 22, 23, 29, 30, 33, 38, 40, and 50

United States Patent and Trademark Office

Reg. No. 3,522,574

Registered Oct. 21, 2008

**TRADEMARK
PRINCIPAL REGISTER**

Precious Memory

PRECIOUS MEMORY, INC. (DELAWARE CORPORATION)
100 CORPORATE WOODS PARKWAY
VERNON HILLS, IL 60061

FOR: FINE PORCELAIN FIGURINES, IN CLASS 21 (U.S. CLS. 2, 13, 23, 29, 30, 33, 40 AND 50).

FIRST USE 3-2-2000; IN COMMERCE 3-11-2004.

FOR: FINE PORCELAIN DOLLS, IN CLASS 28 (U.S. CLS. 22, 23, 38 AND 50).

FIRST USE 2-2-2006; IN COMMERCE 2-2-2006.

THE MARK CONSISTS OF STANDARD CHARACTERS WITHOUT CLAIM TO ANY PARTICULAR FONT, STYLE, SIZE, OR COLOR.

SN 78-813,290, FILED 2-13-2006.

MARIA-VICTORIA SUAREZ, EXAMINING ATTORNEY

Int. Cls.: 9 and 35

Prior U.S. Cls.: 21, 23, 26, 36, 38, 100, 101, and 102

United States Patent and Trademark Office

Reg. No. 3,522,575

Registered Oct. 21, 2008

**TRADEMARK
SERVICE MARK
PRINCIPAL REGISTER**

YPA CO-OP

YELLOW PAGES INTEGRATED MEDIA ASSOCIATION (DELAWARE NON-PROFIT CORPORATION), DBA YELLOW PAGES ASSOCIATION,
TWO CONNELL DRIVE, FIRST FLOOR
BERKELEY HEIGHTS, NJ 07922

FOR: DOWNLOADABLE ELECTRONIC PUBLICATIONS IN THE NATURE OF CATALOGS IN THE FIELD OF YELLOW PAGES ADVERTISING; ELECTRONIC PUBLICATIONS, NAMELY, CATALOGS FEATURING INFORMATION IN THE FIELD OF YELLOW PAGES ADVERTISING RECORDED ON COMPUTER MEDIA, IN CLASS 9 (U.S. CLS. 21, 23, 26, 36 AND 38).

FIRST USE 4-30-2007; IN COMMERCE 4-30-2007.

FOR: ADVERTISING AND ADVERTISEMENT SERVICES; ADVERTISING AND PROMOTION SERVICES AND RELATED CONSULTING; ASSOCIATION SERVICES, NAMELY, PROMOTING THE INTERESTS OF YELLOW PAGES DIRECTORY PUBLISHERS AND ADVERTISERS; COOPERATIVE ADVERTISING AND MARKETING; COOPERATIVE ADVERTISING AND MARKETING SERVICES BY WAY OF SOLICITATION, CUSTOMER SERVICE AND PROVIDING MARKETING INFORMATION

VIA WEB SITES ON A GLOBAL COMPUTER NETWORK; ON-LINE BUSINESS DIRECTORIES FEATURING CONTACT INFORMATION AND BUSINESS HOURS FOR YELLOW PAGES PUBLISHERS AND WHITE PAGES PUBLISHERS, AS WELL AS CERTIFIED MARKETING REPRESENTATIVES IN THE FIELD OF YELLOW PAGES ADVERTISING AND WHITE PAGES ADVERTISING; ON-LINE BUSINESS DIRECTORIES FEATURING TELEPHONE DIRECTORY HEADINGS, IN CLASS 35 (U.S. CLS. 100, 101 AND 102).

FIRST USE 4-30-2007; IN COMMERCE 4-30-2007.

THE MARK CONSISTS OF STANDARD CHARACTERS WITHOUT CLAIM TO ANY PARTICULAR FONT, STYLE, SIZE, OR COLOR.

OWNER OF U.S. REG. NO. 3,012,726.

NO CLAIM IS MADE TO THE EXCLUSIVE RIGHT TO USE "CO-OP", APART FROM THE MARK AS SHOWN.

SN 78-814,272, FILED 2-14-2006.

SHAILA SETTLES, EXAMINING ATTORNEY

Int. Cl.: 7

Prior U.S. Cls.: 13, 19, 21, 23, 31, 34, and 35

United States Patent and Trademark Office

Reg. No. 3,522,576

Registered Oct. 21, 2008

**TRADEMARK
PRINCIPAL REGISTER**

TREE KING POWERSTROKE

FOREST EQ AB (SWEDEN CORPORATION)
BOX 284
KARLSKOGA, SWEDEN 69125

OWNER OF U.S. REG. NO. 2,641,962.

FOR: TIMBER HARVESTING MACHINERY, IN
CLASS 7 (U.S. CLS. 13, 19, 21, 23, 31, 34 AND 35).

NO CLAIM IS MADE TO THE EXCLUSIVE
RIGHT TO USE "TREE", APART FROM THE MARK
AS SHOWN.

FIRST USE 8-0-1995; IN COMMERCE 8-0-1995.

SN 78-819,949, FILED 2-21-2006.

THE MARK CONSISTS OF STANDARD CHAR-
ACTERS WITHOUT CLAIM TO ANY PARTICULAR
FONT, STYLE, SIZE, OR COLOR.

DARRYL SPRUILL, EXAMINING ATTORNEY

Int. Cls.: 9, 10, and 11

Prior U.S. Cls.: 13, 21, 23, 26, 31, 34, 36, 38, 39, and 44

Reg. No. 3,522,577

United States Patent and Trademark Office

Registered Oct. 21, 2008

**TRADEMARK
PRINCIPAL REGISTER**

LUMATEC

LUMATEC GESELLSCHAFT FÜR MEDIZINISCH-TECHNISCHE GERÄTE MIT BESCHRÄNKTER HAFTUNG (FED REP GERMANY CORPORATION)
LINIENSTRASSE 9-13
DEISENHOFEN, FED REP GERMANY 82041

FOR: LIGHTGUIDES, NAMELY, LIQUID CORE LIGHTGUIDES USED FOR PHOTOPOLYMERIZATION, FLUORESCENCE EXCITATION, MICROSCOPE AND BORESCOPE ILLUMINATION, SPECTROSCOPIC ANALYSIS, 3D DIGITIZING, SURFACE INSPECTION, AND WAFER MANUFACTURING; ACCESSORIES FOR LIGHTGUIDES USED FOR PHOTOPOLYMERIZATION, FLUORESCENCE EXCITATION, MICROSCOPE AND BORESCOPE ILLUMINATION, SPECTROSCOPIC ANALYSIS, 3D DIGITIZING, SURFACE INSPECTION, AND WAFER MANUFACTURING, NAMELY, ADAPTERS AND CONNECTORS; ILLUMINATION APPARATUS, NAMELY, LAMPS FOR USE IN CRIME SCENE FORENSIC ANALYSIS, IN CLASS 9 (U.S. CLS. 21, 23, 26, 36 AND 38).

FIRST USE 5-0-1981; IN COMMERCE 5-0-1981.

FOR: LIGHTGUIDES, NAMELY, LIQUID CORE LIGHTGUIDES FOR MEDICAL PURPOSES; MEDICAL APPARATUS AND INSTRUMENTS, NAMELY,

INFRARED CONTACT COAGULATORS FOR USE IN PERFORMING PROCTOLOGICAL, GYNECOLOGICAL, OTOLARYNGOLOGICAL, DERMATOLOGICAL, SURGICAL, AND DENTAL PROCEDURES; ACCESSORIES FOR LIGHTGUIDES USED FOR MEDICAL PURPOSES, NAMELY, ADAPTERS AND CONNECTORS, IN CLASS 10 (U.S. CLS. 26, 39 AND 44).

FIRST USE 5-0-1981; IN COMMERCE 5-0-1981.

FOR: ILLUMINATION APPARATUS, NAMELY, UV-LAMPS, IN CLASS 11 (U.S. CLS. 13, 21, 23, 31 AND 34).

FIRST USE 1-0-1990; IN COMMERCE 1-0-1990.

THE MARK CONSISTS OF STANDARD CHARACTERS WITHOUT CLAIM TO ANY PARTICULAR FONT, STYLE, SIZE, OR COLOR.

OWNER OF FED REP GERMANY REG. NO. 30519796, DATED 5-31-2005, EXPIRES 4-5-2015.

SN 78-820,556, FILED 2-22-2006.

DANNEAN HETZEL, EXAMINING ATTORNEY

Int. Cl.: 10

Prior U.S. Cls.: 26, 39, and 44

Reg. No. 3,522,578

United States Patent and Trademark Office

Registered Oct. 21, 2008

**TRADEMARK
PRINCIPAL REGISTER**

Roma

IVIVI TECHNOLOGIES, INC. (NEW JERSEY
CORPORATION)
224-S PEGASUS AVENUE
NORTHVALE, NJ 07647

THE MARK CONSISTS OF STANDARD CHAR-
ACTERS WITHOUT CLAIM TO ANY PARTICULAR
FONT, STYLE, SIZE, OR COLOR.

FOR: ELECTROMAGNETIC THERAPY APPARA-
TUS FOR CLINICAL MEDICAL USE IN THE
TREATMENT OF TISSUE GROWTH AND REPAIR,
IN CLASS 10 (U.S. CLS. 26, 39 AND 44).

SN 78-820,732, FILED 2-22-2006.

FIRST USE 2-22-2006; IN COMMERCE 2-22-2006.

AISHA CLARKE, EXAMINING ATTORNEY

Int. Cl.: 12

Prior U.S. Cls.: 19, 21, 23, 31, 35, and 44

Reg. No. 3,522,579

United States Patent and Trademark Office

Registered Oct. 21, 2008

**TRADEMARK
PRINCIPAL REGISTER**

ROGUE

NISSAN JIDOSHA KABUSHIKI KAISHA (JAPAN
CORPORATION)
NO. 2 TAKARACHO, KANAGAWA-KU
YOKOHAMA-SHI
KANAGAWA-KEN, JAPAN

FOR: AUTOMOBILES AND STRUCTURAL
PARTS FOR AUTOMOBILES EXCLUDING TIRES,
IN CLASS 12 (U.S. CLS. 19, 21, 23, 31, 35 AND 44).

FIRST USE 9-18-2007; IN COMMERCE 9-18-2007.

THE MARK CONSISTS OF STANDARD CHAR-
ACTERS WITHOUT CLAIM TO ANY PARTICULAR
FONT, STYLE, SIZE, OR COLOR.

PRIORITY CLAIMED UNDER SEC. 44(D) ON
CANADA APPLICATION NO. 1,287,975, FILED 1-30-
2006.

SN 78-820,802, FILED 2-22-2006.

DEBRA LEE, EXAMINING ATTORNEY

Int. Cl.: 35

Prior U.S. Cls.: 100, 101, and 102

United States Patent and Trademark Office

Reg. No. 3,522,580

Registered Oct. 21, 2008

**SERVICE MARK
PRINCIPAL REGISTER**

IMAGINE GREAT PEOPLE

PROFILES INTERNATIONAL, INC. (TEXAS
CORPORATION)
4525 LAKE SHORE DRIVE
WACO, TX 76710

FOR: PERSONNEL MANAGEMENT SERVICES,
NAMELY, EMPLOYEE EVALUATION, ASSESS-
MENT AND TESTING TO DETERMINE EMPLOY-
MENT SKILLS AND PROFESSIONAL
COMPETENCY, IN CLASS 35 (U.S. CLS. 100, 101
AND 102).

FIRST USE 2-0-2006; IN COMMERCE 2-0-2006.

THE MARK CONSISTS OF STANDARD CHAR-
ACTERS WITHOUT CLAIM TO ANY PARTICULAR
FONT, STYLE, SIZE, OR COLOR.

SN 78-824,807, FILED 2-28-2006.

KAPIL BHANOT, EXAMINING ATTORNEY

Int. Cl.: 19

Prior U.S. Cls.: 1, 12, 33, and 50

United States Patent and Trademark Office

Reg. No. 3,522,581

Registered Oct. 21, 2008

**TRADEMARK
PRINCIPAL REGISTER**

ThermaProof

SERIOUS MATERIALS, LLC (DELAWARE LIMITED LIABILITY COMPANY)
522 ALMANOR AVENUE
SUNNYVALE, CA 94085

THE MARK CONSISTS OF STANDARD CHARACTERS WITHOUT CLAIM TO ANY PARTICULAR FONT, STYLE, SIZE, OR COLOR.

FOR: NON-METAL WINDOWS; VINYL WINDOWS; WINDOW GLASS; WINDOW PANES, IN CLASS 19 (U.S. CLS. 1, 12, 33 AND 50).

SN 78-824,826, FILED 2-28-2006.

FIRST USE 2-8-2008; IN COMMERCE 8-19-2008.

WON TEAK OH, EXAMINING ATTORNEY

Int. Cl.: 30

Prior U.S. Cl.: 46

United States Patent and Trademark Office

Reg. No. 3,522,582

Registered Oct. 21, 2008

**TRADEMARK
PRINCIPAL REGISTER**

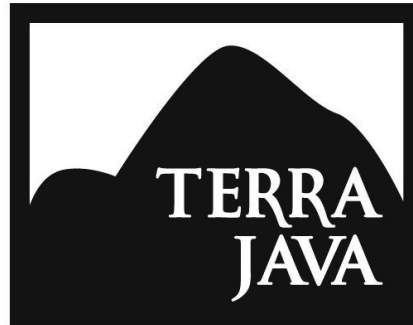

HAND-ROASTED COFFEE

HOMER TLC, INC. (DELAWARE CORPORATION)
1404 SOCIETY DRIVE
CLAYMONT, DE 19703

FOR: COFFEE, IN CLASS 30 (U.S. CL. 46).

FIRST USE 1-31-2006; IN COMMERCE 1-31-2006.

NO CLAIM IS MADE TO THE EXCLUSIVE RIGHT TO USE "JAVA" AND "HAND-ROASTED COFFEE", APART FROM THE MARK AS SHOWN.

THE MARK CONSISTS OF A MOUNTAIN PEAK.

THE ENGLISH TRANSLATION OF THE ITALIAN WORD "TERRA" IN THE MARK IS EARTH OR LAND.

SN 78-826,814, FILED 3-1-2006.

MICHAEL TANNER, EXAMINING ATTORNEY

Int. Cl.: 9

Prior U.S. Cls.: 21, 23, 26, 36, and 38

United States Patent and Trademark Office

Reg. No. 3,522,583

Registered Oct. 21, 2008

**TRADEMARK
PRINCIPAL REGISTER**



ANXO TECNOLOGIAS SA DE CV (MEXICO CORPORATION)
ONTARIO 1500
GUADALAJARA, MEXICO 44630

FOR: ANTI-SPYWARE SOFTWARE; COMPILER SOFTWARE; COMPUTER GAME SOFTWARE; COMPUTER GRAPHICS SOFTWARE; COMPUTER PROGRAMS RECORDED ON DATA MEDIA (SOFTWARE) DESIGNED FOR USE IN CONSTRUCTION AND AUTOMATED MANUFACTURING (CAD/CAM); COMPUTER SCREEN SAVER SOFTWARE; COMPUTER SOFTWARE DEVELOPMENT TOOLS; COMPUTER SOFTWARE FOR ADMINISTRATION OF COMPUTER LOCAL AREA NETWORKS; COMPUTER SOFTWARE FOR APPLICATION AND DATABASE INTEGRATION, IN CLASS 9 (U.S. CLS. 21, 23, 26, 36 AND 38).

FIRST USE 7-20-2007; IN COMMERCE 7-20-2007.

THE COLOR(S) BLACK, BLUE AND WHITE IS/ARE CLAIMED AS A FEATURE OF THE MARK.

THE MARK CONSISTS OF TWO SEMI-CIRCLES IN BLUE SURROUNDING A COMPLETE CIRCLE IN THE MIDDLE CONTAINS THREE WHITE STRIPES AND A LITTLE WHITE DOT IN THE UPPER LEFT SIDE. IN THE BOTTOM APPEARS THE WORD "ANXO" IN THE LETTER "O" CONTAINS A DOT IN THE MIDDLE.

SN 78-827,431, FILED 3-2-2006.

KATHERINE CHANG, EXAMINING ATTORNEY

Int. Cls.: 35 and 42

Prior U.S. Cls.: 100, 101, and 102

United States Patent and Trademark Office

Reg. No. 3,522,584

Registered Oct. 21, 2008

**SERVICE MARK
PRINCIPAL REGISTER**



HORNE, TIM (UNITED STATES INDIVIDUAL)
1391 MILLINGTON ROAD
COLUMBUS, GA 31904 AND
COLEMAN, BRIAN (UNITED STATES INDIVIDUAL)
6643 WOODBERRY ROAD
COLUMBUS, GA 31904

FOR: MARKETING, NAMELY, MARKETING
CONSULTING, IN CLASS 35 (U.S. CLS. 100, 101
AND 102).

FIRST USE 4-0-2006; IN COMMERCE 4-0-2006.

FOR: PRODUCT DEVELOPMENT, DESIGN SERVICES,
NAMELY, DESIGN OF NEW PRODUCTS FOR OTHERS,
IN CLASS 42 (U.S. CLS. 100 AND 101).

FIRST USE 4-0-2006; IN COMMERCE 4-0-2006.

SN 78-828,084, FILED 3-2-2006.

CARYN GLASSER, EXAMINING ATTORNEY

Int. Cl.: 41

Prior U.S. Cls.: 100, 101, and 107

United States Patent and Trademark Office

Reg. No. 3,522,585

Registered Oct. 21, 2008

**SERVICE MARK
PRINCIPAL REGISTER**

EXALTED

BLACK ENTERTAINMENT TELEVISION LLC
(D.C. LIMITED LIABILITY COMPANY)
ONE BET PLAZA, 1235 W STREET, N.E.
LEGAL AFFAIRS
WASHINGTON, DC 20018

FOR: ENTERTAINMENT SERVICES, NAMELY,
PROVIDING A TELEVISION PROGRAM IN THE
FIELD OF RELIGION VIA THE TELEVISION,
CABLE AND WIRELESS; DISTRIBUTION OF TELE-
VISION PROGRAMS VIA BROADCAST, CABLE,
SATELLITE TELEVISION, AND THE INTERNET,
IN CLASS 41 (U.S. CLS. 100, 101 AND 107).

FIRST USE 10-2-2007; IN COMMERCE 10-2-2007.

THE MARK CONSISTS OF STANDARD CHAR-
ACTERS WITHOUT CLAIM TO ANY PARTICULAR
FONT, STYLE, SIZE, OR COLOR.

SN 78-829,750, FILED 3-6-2006.

DOMINIC FATHY, EXAMINING ATTORNEY

Int. Cl.: 42

Prior U.S. Cls.: 100 and 101

United States Patent and Trademark Office

Reg. No. 3,522,586

Registered Oct. 21, 2008

**SERVICE MARK
PRINCIPAL REGISTER**

COOL

FUTURE MEDIA ARCHITECTS, INC. (BR.VIR-
GIN ISLANDS CORPORATION)
P.O. BOX 71, ROAD TOWN
TORTOLA, BR.VIRGIN ISLANDS

FOR: PROVIDING CUSTOMIZED ON-LINE WEB
PAGES FEATURING USER-DEFINED INFORMA-
TION, WHICH INCLUDES SEARCH ENGINES AND
ON-LINE WEB LINKS TO OTHER WEB SITES;
HOSTING OF DIGITAL CONTENT ON THE INTER-
NET, NAMELY, THE DIGITAL DATA, IMAGES,
AUDIO AND VIDEO CONTENT OF OTHERS, IN
CLASS 42 (U.S. CLS. 100 AND 101).

FIRST USE 3-0-2006; IN COMMERCE 3-0-2006.

THE MARK CONSISTS OF STANDARD CHAR-
ACTERS WITHOUT CLAIM TO ANY PARTICULAR
FONT, STYLE, SIZE, OR COLOR.

SN 78-830,245, FILED 3-6-2006.

ASMAT KHAN, EXAMINING ATTORNEY

Int. Cl.: 33

Prior U.S. Cls.: 47 and 49

United States Patent and Trademark Office

Reg. No. 3,522,587

Registered Oct. 21, 2008

TRADEMARK
PRINCIPAL REGISTER

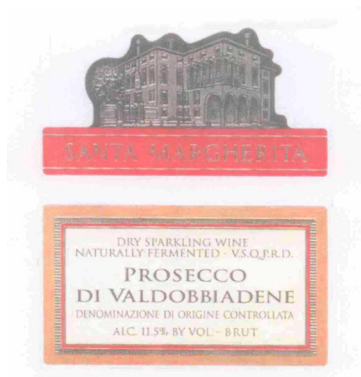

S. MARGHERITA S.P.A. (ITALY CORPORATION)
VIA ITA MARZOTTO 8
FOSSALTA DIPORTOGRUARO, ITALY

FOR: ALCOHOLIC BEVERAGES, NAMELY,
WINES AND SPARKLING WINES, IN CLASS 33
(U.S. CLS. 47 AND 49).

FIRST USE 4-30-2002; IN COMMERCE 5-31-2002.

OWNER OF U.S. REG. NOS. 1,300,876 AND
1,556,014.

NO CLAIM IS MADE TO THE EXCLUSIVE
RIGHT TO USE "DRY SPARKLING WINE," "NATU-
RALLY FERMENTED - V.S.Q.P.R.D.," "PROSECCO
DI VALDOBBIADENE," "DENOMINAZIONE DI
ORIGINE CONTROLLATA" AND "ALC. 11.5% BY
VOL. - BRUT", APART FROM THE MARK AS
SHOWN.

THE COLOR(S) GRAY, BLACK, GOLD, RED,
CREAM, TAN AND BROWN IS/ARE CLAIMED AS
A FEATURE OF THE MARK.

THE MARK CONSISTS OF A GRAY BUILDING
OUTLINED IN BLACK OVER A RED RECTANGLE

AROUND THE WORDING "SANTA MARGHERITA"
IN GOLD WITH A GOLD LINE ABOVE AND A
GOLD LINE BELOW THE WORDING, AND A
RECTANGLE WITH THE WORDING "DRY SPARK-
LING WINE, NATURALLY FERMENTED
V.S.Q.P.R.D., PROSECCO DI VALDOBBIADENE, DE-
NOMINAZIONE DI ORIGINE CONTROLLATA,
ALC. 11.5% BY VOL. BRUT" IN BROWN ON A
CREAM RECTANGLE THAT IS OUTLINED WITH A
SINGLE LINE BROWN RECTANGLE, THEN A RED
SINGLE LINE RECTANGLE, THEN A BROWN AND
CREAM RECTANGLE, THEN A TAN BROWN
RECTANGULAR BORDER .

THE FOREIGN WORDING IN THE MARK
TRANSLATES INTO ENGLISH AS "SANTA MAR-
GHERITA" IS SAINT MARGHERITA, THE ENG-
LISH TRANSLATION OF THE WORDING
"PROSECCO DI VALDOBBIADENE" IS PROSECCO
OF VALDOBBIADENE AND THE ENGLISH
TRANSLATION OF "DENOMINAZIONE DI ORI-
GINE CONTROLLATA" IS DENOMINATION OF
CONTROLLED ORIGIN.

SN 78-831,424, FILED 3-7-2006.

SARA THOMAS, EXAMINING ATTORNEY

Int. Cl.: 3

Prior U.S. Cls.: 1, 4, 6, 50, 51, and 52

United States Patent and Trademark Office

Reg. No. 3,522,588

Registered Oct. 21, 2008

**TRADEMARK
PRINCIPAL REGISTER**

UNBEATABLE

FAWAZ, MOHAMAD-HILAL (FRANCE INDIVIDUAL)
C/O MS ROSALIE ALLIE
1854 LAKEWOOD DR
TROY, MI 48083

THE MARK CONSISTS OF STANDARD CHARACTERS WITHOUT CLAIM TO ANY PARTICULAR FONT, STYLE, SIZE, OR COLOR.

FOR: PERFUMERY, IN CLASS 3 (U.S. CLS. 1, 4, 6, 50, 51 AND 52).

SN 78-831,528, FILED 3-7-2006.

FIRST USE 6-27-2008; IN COMMERCE 6-27-2008.

BRENDAN MCCAULEY, EXAMINING ATTORNEY

Int. Cl.: 32

Prior U.S. Cls.: 45, 46, and 48

United States Patent and Trademark Office

Reg. No. 3,522,589

Registered Oct. 21, 2008

**TRADEMARK
PRINCIPAL REGISTER**

ACCELERADE

MOTT'S LLP (DELAWARE LIMITED PARTNER-
SHIP)
900 KING STREET
RYE BROOK, NY 10573

FOR: NON-ALCOHOLIC, NON-CARBONATED
FRUIT FLAVORED DRINKS, SPORTS DRINKS,
ENERGY DRINKS AND SYRUPS AND CONCEN-
TRATES FOR MAKING SAME, IN CLASS 32 (U.S.
CLS. 45, 46 AND 48).

FIRST USE 3-0-2007; IN COMMERCE 3-0-2007.

THE MARK CONSISTS OF STANDARD CHAR-
ACTERS WITHOUT CLAIM TO ANY PARTICULAR
FONT, STYLE, SIZE, OR COLOR.

OWNER OF U.S. REG. NOS. 2,586,338, 2,873,953,
AND OTHERS.

SN 78-834,585, FILED 3-10-2006.

GISELLE AGOSTO, EXAMINING ATTORNEY

Int. Cl.: 9

Prior U.S. Cls.: 21, 23, 26, 36, and 38

Reg. No. 3,522,590

United States Patent and Trademark Office

Registered Oct. 21, 2008

**TRADEMARK
PRINCIPAL REGISTER**

STRENDURANCE

TROY JACOBSON MULTI-SPORT, LLC (MARY-
LAND LIMITED LIABILITY COMPANY)
19840 GRAYSTONE ROAD
WHITE HALL, MD 21161

FOR: DVDS AND CDS AND DIGITAL DOWN-
LOADABLE AUDIO AND VIDEO RECORDINGS,
ALL FEATURING EDUCATIONAL MATERIALS,
INFORMATION, TRAINING MATERIALS, PRE-RE-
CORDED CLASSES, PRE-RECORDED SPORTING
AND ENDURANCE CONTESTS AND PRE-RECOR-
DED EVENTS IN THE FIELD OF EXERCISE AND

PHYSICAL FITNESS, IN CLASS 9 (U.S. CLS. 21, 23, 26,
36 AND 38).

FIRST USE 10-1-2006; IN COMMERCE 10-1-2006.

THE MARK CONSISTS OF STANDARD CHAR-
ACTERS WITHOUT CLAIM TO ANY PARTICULAR
FONT, STYLE, SIZE, OR COLOR.

SN 78-835,508, FILED 3-13-2006.

SANDRA MANIOS, EXAMINING ATTORNEY

Int. Cl.: 18

Prior U.S. Cls.: 1, 2, 3, 22, and 41

United States Patent and Trademark Office

Reg. No. 3,522,591

Registered Oct. 21, 2008

TRADEMARK
PRINCIPAL REGISTER

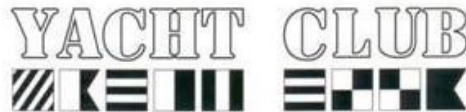

YACHT CLUB ENTERPRISES, LTD. (DELA-
WARE CORPORATION)
73 PIPERS POND ROAD
BLUFFTON, SC 29910

FOR: BAGS, NAMELY, DUFFLE BAGS, BACK-
PACKS, BRIEFCASES AND LUGGAGE; DOG COL-
LARS; DOG LEASHES, IN CLASS 18 (U.S. CLS. 1, 2, 3,
22 AND 41).

FIRST USE 3-1-2006; IN COMMERCE 3-1-2006.

SN 78-835,595, FILED 3-13-2006.

SETH A. RAPPAPORT, EXAMINING ATTORNEY

Int. Cl.: 25

Prior U.S. Cls.: 22 and 39

United States Patent and Trademark Office

Reg. No. 3,522,592

Registered Oct. 21, 2008

TRADEMARK
PRINCIPAL REGISTER

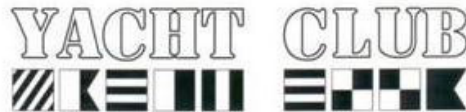

YACHT CLUB ENTERPRISES, LTD. (DELA-
WARE CORPORATION)
73 PIPERS POND ROAD
BLUFFTON, SC 29910

FOR: HATS, SHIRTS, SWEATERS, SWEAT
SHIRTS, BELTS, BLAZERS, JACKETS, BLOUSES,
TIES, CHILDREN'S CLOTHING, NAMELY, HATS,
SHIRTS, SWEATERS, SWEAT SHIRTS, BELTS, BLA-
ZERS, JACKETS, BLOUSES, DRESSES, SHORTS,

SKIRTS, SWIMWEAR AND SHOES, IN CLASS 25
(U.S. CLS. 22 AND 39).

FIRST USE 3-1-2006; IN COMMERCE 3-1-2006.

SN 78-835,604, FILED 3-13-2006.

SETH A. RAPPAPORT, EXAMINING ATTORNEY

Int. Cl.: 25

Prior U.S. Cls.: 22 and 39

United States Patent and Trademark Office

Reg. No. 3,522,593

Registered Oct. 21, 2008

**TRADEMARK
PRINCIPAL REGISTER**



YACHT CLUB ENTERPRISES, LTD. (DELA-
WARE CORPORATION)
73 PIPERS POND ROAD
BLUFFTON, SC 29910

FOR: HATS, SHIRTS, SWEATERS, SWEAT
SHIRTS, BELTS, BLAZERS, JACKETS, BLOUSES,
TIES, CHILDREN'S CLOTHING, NAMELY, HATS,
SHIRTS, SWEATERS, SWEAT SHIRTS, BELTS, BLA-
ZERS, JACKETS, BLOUSES, DRESSES, SHORTS,
SKIRTS, SWIMWEAR AND SHOES, IN CLASS 25
(U.S. CLS. 22 AND 39).

FIRST USE 3-1-2006; IN COMMERCE 3-1-2006.

THE SIGNIFICANCE OF THE DESIGN ELEMENT
OF THE MARK IS THAT THE INTERNATIONAL
SIGNALING FLAGS TRANSLATE INTO THE
WORDING YACHT CLUB.

SN 78-836,795, FILED 3-14-2006.

SETH A. RAPPAPORT, EXAMINING ATTORNEY

Int. Cl.: 19

Prior U.S. Cls.: 1, 12, 33, and 50

United States Patent and Trademark Office

Reg. No. 3,522,594

Registered Oct. 21, 2008

TRADEMARK
PRINCIPAL REGISTER



AMERICAN CEMENT COMPANY, LLC (DELA-
WARE LIMITED LIABILITY COMPANY)
4750 E C 470
SUMTERVILLE, FL 33585

FOR: PORTLAND CEMENT AND PORTLAND
CEMENT PRODUCTS, NAMELY, GRAY HYDRAU-
LIC PORTLAND CEMENT, MASONRY CEMENT
AND STUCCO CEMENT, IN CLASS 19 (U.S. CLS. 1,
12, 33 AND 50).

FIRST USE 5-30-2008; IN COMMERCE 5-30-2008.

NO CLAIM IS MADE TO THE EXCLUSIVE
RIGHT TO USE "AMERICAN CEMENT COMPA-
NY", APART FROM THE MARK AS SHOWN.

THE COLOR(S) RED, WHITE AND BLUE IS/ARE
CLAIMED AS A FEATURE OF THE MARK.

THE MARK CONSISTS OF THE WORD AMER-
ICAN IN THE COLOR BLUE, THE WORDS "CE-
MENT COMPANY" IN THE COLOR RED AND A
WHITE STAR IN THE MIDDLE OF THE FIRST "A"
IN "AMERICAN".

SN 78-838,138, FILED 3-15-2006.

ANNE MADDEN, EXAMINING ATTORNEY

Int. Cl.: 45

Prior U.S. Cls.: 100 and 101

United States Patent and Trademark Office

Reg. No. 3,522,595

Registered Oct. 21, 2008

**SERVICE MARK
PRINCIPAL REGISTER**



NETWORK MULTI-FAMILY SECURITY COR-
PORATION (DELAWARE CORPORATION)
4221 W. JOHN CARPENTER FREEWAY
IRVING, TX 75063

FOR: SECURITY ALARM MONITORING SERVI-
CES, NAMELY, INTRUSION DETECTION, FIRE
DETECTION, VIDEO SURVEILLANCE VIA
CLOSED CIRCUIT TV AND BUILDING ACCESS
CONTROL; SECURITY ALARM RESPONSE SERVI-
CES, IN CLASS 45 (U.S. CLS. 100 AND 101).

FIRST USE 2-28-2008; IN COMMERCE 2-28-2008.

OWNER OF U.S. REG. NO. 2,927,429.

SEC. 2(F) AS TO "MULTIFAMILY".

SN 78-839,696, FILED 3-17-2006.

RUDY R. SINGLETON, EXAMINING ATTORNEY

Int. Cl.: 9

Prior U.S. Cls.: 21, 23, 26, 36, and 38

United States Patent and Trademark Office

Reg. No. 3,522,596

Registered Oct. 21, 2008

**TRADEMARK
PRINCIPAL REGISTER**

ATRIUM WIZARD

ATRIUM COMPANIES, INC. (DELAWARE CORPORATION)

SUITE 500

3890 WEST NORTHWEST HIGHWAY

DALLAS, TX 75220

FOR: COMPUTER SOFTWARE FOR CALCULATING AND PLACING ORDERS FOR BUILDING PRODUCTS, NAMELY, WINDOWS AND DOORS, IN CLASS 9 (U.S. CLS. 21, 23, 26, 36 AND 38).

FIRST USE 7-0-2003; IN COMMERCE 7-0-2003.

THE MARK CONSISTS OF STANDARD CHARACTERS WITHOUT CLAIM TO ANY PARTICULAR FONT, STYLE, SIZE, OR COLOR.

OWNER OF U.S. REG. NOS. 2,497,434, 3,025,701, AND OTHERS.

NO CLAIM IS MADE TO THE EXCLUSIVE RIGHT TO USE "WIZARD", APART FROM THE MARK AS SHOWN.

SN 78-839,958, FILED 3-17-2006.

KALIE KUNG, EXAMINING ATTORNEY

Int. Cls.: 9 and 42

Prior U.S. Cls.: 21, 23, 26, 36, 38, 100, and 101

Reg. No. 3,522,597

United States Patent and Trademark Office

Registered Oct. 21, 2008

**TRADEMARK
SERVICE MARK
PRINCIPAL REGISTER**

KASTLE

3I INFOTECH LIMITED (INDIA CORPORATION)
TOWER #5, 3RD-6TH FLOORS
INTERNATIONAL INFOTECH PARK
VASHI, NAVI MUMBAI, INDIA 400 705

FOR: COMPUTER SOFTWARE AND COMPUTER SYSTEMS FOR USE IN DATABASE MANAGEMENT IN THE FIELDS OF FINANCE, ASSET AND PORTFOLIO MANAGEMENT, TREASURY MANAGEMENT, AND BANKING; COMPUTER SOFTWARE AND COMPUTER SYSTEMS FOR USE IN IDENTIFYING, EVALUATING, AND MANAGING MARKET RISKS, ASSETS AND FINANCIAL LIABILITIES, MANAGING DIVERSIFICATION OF FINANCIAL PORTFOLIOS, FINANCIAL ANALYSIS, LOAN ORIGINATION, MANAGEMENT AND COLLECTION, ORGANIZING, MANAGING AND BALANCING BANK ACCOUNT DATA, TRANSACTION PROCESSING, AND ACCOUNTING, IN CLASS 9 (U.S. CLS. 21, 23, 26, 36 AND 38).

FIRST USE 5-31-2005; IN COMMERCE 10-31-2006.

FOR: COMPUTER PROGRAMMING SERVICES, COMPUTER SOFTWARE AND COMPUTER DATABASE DESIGN, ANALYSIS, MANAGEMENT, MAINTENANCE AND UPGRADE SERVICES, AND CONSULTING SERVICES IN THE FIELDS OF COMPUTER SOFTWARE PROGRAMS FOR USE IN THE FIELDS OF FINANCE, ASSET AND PORTFOLIO MANAGEMENT, TREASURY MANAGEMENT, AND BANKING; COMPUTER PROGRAMMING SERVICES, COMPUTER SOFTWARE AND COMPUTER DATABASE DESIGN, ANALYSIS, MANAGEMENT, MAINTENANCE AND UPGRADE SERVICES, AND CONSULTING SERVICES IN THE FIELDS OF COMPUTER SOFTWARE AND COM-

PUTER DATABASES FOR USE IN EVALUATING, IDENTIFYING, AND MANAGING MARKET RISKS, ASSETS AND FINANCIAL LIABILITIES, MANAGING DIVERSIFICATION OF FINANCIAL PORTFOLIOS, FINANCIAL ANALYSIS, FINANCIAL PLANNING, LOAN ORIGINATION, MANAGEMENT, SERVICING AND COLLECTION, ORGANIZING, MANAGING AND BALANCING BANK ACCOUNT DATA, TRANSACTION PROCESSING, AND ACCOUNTING; APPLICATION SERVICE PROVIDER FEATURING SOFTWARE FOR PROVIDING AN ON-LINE DATABASE IN THE FIELDS OF FINANCE, ASSET AND PORTFOLIO MANAGEMENT, TREASURY MANAGEMENT, AND BANKING; COMPUTER SOFTWARE TECHNICAL CONSULTING AND SUPPORT SERVICES, NAMELY, TROUBLESHOOTING IN PERSON, VIA TELEPHONE AND VIA ELECTRONIC AND OPTICAL COMMUNICATIONS NETWORKS, PROVIDING BACK UP AND RECOVERY SERVICES AND PROVIDING NETWORK OPERATIONS SUPPORT SERVICES FOR COMPUTER SOFTWARE, COMPUTER DATABASES AND COMPUTER SYSTEMS FOR USES IN THE FIELDS OF FINANCE, ASSET AND PORTFOLIO MANAGEMENT, TREASURY MANAGEMENT, AND BANKING, IN CLASS 42 (U.S. CLS. 100 AND 101).

FIRST USE 5-31-2005; IN COMMERCE 10-31-2006.

THE MARK CONSISTS OF STANDARD CHARACTERS WITHOUT CLAIM TO ANY PARTICULAR FONT, STYLE, SIZE, OR COLOR.

SN 78-841,553, FILED 3-20-2006.

DAVID MURRAY, EXAMINING ATTORNEY

Int. Cl.: 39

Prior U.S. Cls.: 100 and 105

United States Patent and Trademark Office

Reg. No. 3,522,598

Registered Oct. 21, 2008

**SERVICE MARK
PRINCIPAL REGISTER**

GEOLINK AVIATION

NEW CENTURY AVIATION, LLC (DELAWARE
LIMITED LIABILITY COMPANY)
1080 WISCONSIN AVE., NW, SUITE 3019
WASHINGTON, DC 200076135

FOR: TRANSPORTATION SERVICES, NAMELY,
TRANSPORTATION OF PASSENGERS BY AIR, IN
CLASS 39 (U.S. CLS. 100 AND 105).

FIRST USE 9-4-2008; IN COMMERCE 9-4-2008.

THE MARK CONSISTS OF STANDARD CHAR-
ACTERS WITHOUT CLAIM TO ANY PARTICULAR
FONT, STYLE, SIZE, OR COLOR.

NO CLAIM IS MADE TO THE EXCLUSIVE
RIGHT TO USE "AVIATION", APART FROM THE
MARK AS SHOWN.

SN 78-841,622, FILED 3-20-2006.

SUSAN LESLIE DUBOIS, EXAMINING ATTORNEY

Int. Cl.: 25

Prior U.S. Cls.: 22 and 39

United States Patent and Trademark Office

Reg. No. 3,522,599

Registered Oct. 21, 2008

TRADEMARK
PRINCIPAL REGISTER



BLUE ICE UNDER FIRE (ARIZONA PARTNER-SHIP)
11666 N 28TH DR #151
PHOENIX, AZ 85029

FOR: SHIRTS, IN CLASS 25 (U.S. CLS. 22 AND 39).

FIRST USE 5-1-2006; IN COMMERCE 5-1-2006.

NO CLAIM IS MADE TO THE EXCLUSIVE RIGHT TO USE "CLOTHING", APART FROM THE MARK AS SHOWN.

THE COLOR(S) YELLOW, ORANGE, RED, BLACK, BLUE AND WHITE IS/ARE CLAIMED AS A FEATURE OF THE MARK.

THE MARK CONSISTS OF OVAL SHAPED LOGO WITH BLACK BRANCHES AT THE TOP OF THE LOGO, "BLUE ICE UNDER FIRE" WRITTEN ACROSS THE MIDDLE IN THE COLORS WHITE, RED, BLUE, YELLOW, BLACK AND ORANGE, THE DESIGN OF BLUE ICE IN BLUE WITH YELLOW, ORANGE AND RED FLAMES ABOVE THE WRITING, THE WORD "CLOTHING" WRITTEN AT THE BOTTOM OF THE LOGO WITHIN THE BLACK ROCK DESIGN ELEMENT.

SN 78-841,831, FILED 3-20-2006.

KATHERINE STOIDES, EXAMINING ATTORNEY

Int. Cl.: 5

Prior U.S. Cls.: 6, 18, 44, 46, 51, and 52

Reg. No. 3,522,600

United States Patent and Trademark Office

Registered Oct. 21, 2008

**TRADEMARK
PRINCIPAL REGISTER**

GENOPAUSE

GENCOR PACIFIC, INC. (TEXAS CORPORATION)
10025 CIRCLEVIEW DRIVE
AUSTIN, TX 78733

THE MARK CONSISTS OF STANDARD CHARACTERS WITHOUT CLAIM TO ANY PARTICULAR FONT, STYLE, SIZE, OR COLOR.

FOR: DIETARY SUPPLEMENTS, IN CLASS 5 (U.S. CLS. 6, 18, 44, 46, 51 AND 52).

SN 78-842,439, FILED 3-21-2006.

FIRST USE 3-21-2006; IN COMMERCE 8-10-2007.

SUE LAWRENCE, EXAMINING ATTORNEY

Int. Cl.: 9

Prior U.S. Cls.: 21, 23, 26, 36, and 38

Reg. No. 3,522,601

United States Patent and Trademark Office

Registered Oct. 21, 2008

**TRADEMARK
PRINCIPAL REGISTER**

SITESCROLL

KOPPERT, ERIK (CANADA INDIVIDUAL)
16 MUNRO STREET
KEW EAST, VIC, AUSTRALIA 3102

FIRST USE 12-5-2006; IN COMMERCE 12-5-2006.

FOR: COMPUTER SOFTWARE, NAMELY, INFORMATION MANAGEMENT SOFTWARE; COMPUTER SOFTWARE FOR ACCESSING, MANIPULATING, SORTING, CATEGORIZING AND PRESENTING INFORMATION, IN CLASS 9 (U.S. CLS. 21, 23, 26, 36 AND 38).

THE MARK CONSISTS OF STANDARD CHARACTERS WITHOUT CLAIM TO ANY PARTICULAR FONT, STYLE, SIZE, OR COLOR.

SN 78-842,887, FILED 3-22-2006.

CHERYL CLAYTON, EXAMINING ATTORNEY

Int. Cl.: 40

Prior U.S. Cls.: 100, 103, and 106

United States Patent and Trademark Office

Reg. No. 3,522,602

Registered Oct. 21, 2008

**SERVICE MARK
PRINCIPAL REGISTER**

SERVING YOU, SERVING YOUR
CUSTOMERS.

SOLO CUP OPERATING CORPORATION (DELA-
WARE CORPORATION)
1700 OLD DEERFIELD ROAD
HIGHLAND PARK, IL 60035

FOR: CUSTOM MANUFACTURE OF DISPOSABLE AND REUSABLE DISPOSABLE PRODUCTS, NAMELY, CUPS, PLATES, BOWLS, CONTAINERS, CUTLERY, NAPKINS, STRAWS, LIDS AND DINERWARE, IN CLASS 40 (U.S. CLS. 100, 103 AND 106).

FIRST USE 3-13-2007; IN COMMERCE 3-13-2007.

THE MARK CONSISTS OF STANDARD CHARACTERS WITHOUT CLAIM TO ANY PARTICULAR FONT, STYLE, SIZE, OR COLOR.

SN 78-842,934, FILED 3-22-2006.

SARA THOMAS, EXAMINING ATTORNEY

Int. Cl.: 9

Prior U.S. Cls.: 21, 23, 26, 36, and 38

United States Patent and Trademark Office

Reg. No. 3,522,603

Registered Oct. 21, 2008

**TRADEMARK
PRINCIPAL REGISTER**



LUXOTTICA S.R.L. (ITALY LIMITED LIABILITY COMPANY)
VIA VALCOZZENA, 10
32021 AGORDO (BL), ITALY

FOR: SUNGLASSES, EYEGLASSES, LENSES FOR EYEGLASSES, EYEGLASSES FRAMES, CASES FOR EYEGLASSES, IN CLASS 9 (U.S. CLS. 21, 23, 26, 36 AND 38).

FIRST USE 6-27-1999; IN COMMERCE 6-27-1999.

PRIORITY CLAIMED UNDER SEC. 44(D) ON ITALY APPLICATION NO. BO2006C00012, FILED 1-31-2006.

OWNER OF U.S. REG. NOS. 361,875, 1,093,658, AND OTHERS.

THE COLOR(S) RED AND WHITE IS/ARE CLAIMED AS A FEATURE OF THE MARK.

THE MARK CONSISTS OF THE WORDS "RAY-BAN" IN STYLIZED WHITE LETTERING ON A RED BACKGROUND RECTANGLE.

SN 78-843,120, FILED 3-22-2006.

NORA BUCHANAN WILL, EXAMINING ATTORNEY

Int. Cl.: 35

Prior U.S. Cls.: 100, 101, and 102

United States Patent and Trademark Office

Reg. No. 3,522,604

Registered Oct. 21, 2008

**SERVICE MARK
PRINCIPAL REGISTER**

BROWN SHOE CLOSET

BROWN SHOE COMPANY, INC. (NEW YORK CORPORATION)
8300 MARYLAND AVENUE
ST. LOUIS, MO 63105

FOR: RETAIL STORE SERVICES AND WHOLESALE DISTRIBUTORSHIP SERVICES FEATURING FOOTWEAR AND HANDBAGS, IN CLASS 35 (U.S. CLS. 100, 101 AND 102).

FIRST USE 8-23-2008; IN COMMERCE 8-23-2008.

THE MARK CONSISTS OF STANDARD CHARACTERS WITHOUT CLAIM TO ANY PARTICULAR FONT, STYLE, SIZE, OR COLOR.

OWNER OF U.S. REG. NO. 2,555,540.

NO CLAIM IS MADE TO THE EXCLUSIVE RIGHT TO USE "SHOE", APART FROM THE MARK AS SHOWN.

SEC. 2(F) "BROWN".

SN 78-843,313, FILED 3-22-2006.

MARLENE BELL, EXAMINING ATTORNEY

Int. Cls.: 9, 25, and 35

Prior U.S. Cls.: 21, 22, 23, 26, 36, 38, 39, 100, 101, and 102

United States Patent and Trademark Office

Reg. No. 3,522,605

Registered Oct. 21, 2008

**TRADEMARK
SERVICE MARK
PRINCIPAL REGISTER**



RICARDO, MENDOZA PIÑA (MEXICO INDIVIDUAL)
STA MONICA 1734 SAN MARTIN DE PORRES
IRAPUATO, GUANAJUATO, MEXICO 36557

FOR: SHOES FOR PROTECTION AGAINST ACCIDENTS AND FIRE, IN CLASS 9 (U.S. CLS. 21, 23, 26, 36 AND 38).

FIRST USE 3-22-2006; IN COMMERCE 3-22-2006.

FOR: FOOTWEAR; HEADGEAR, NAMELY, CAPS; JERSEYS; JOGGING PANTS; PANTS; SHORT-SLEEVED OR LONG-SLEEVED T-SHIRTS; SWEAT PANTS; T-SHIRTS, IN CLASS 25 (U.S. CLS. 22 AND 39).

FIRST USE 3-22-2006; IN COMMERCE 3-22-2006.

FOR: RETAIL CLOTHING STORES; RETAIL STORE SERVICES FEATURING A WIDE VARIETY OF CONSUMER GOODS OF OTHERS; RETAIL STORES FEATURING SHOES FOR PROTECTION AGAINST FIRE AND ACCIDENTS, FOOTWEAR, IN CLASS 35 (U.S. CLS. 100, 101 AND 102).

FIRST USE 3-22-2006; IN COMMERCE 3-22-2006.

NO CLAIM IS MADE TO THE EXCLUSIVE RIGHT TO USE "ERGONOMIC", APART FROM THE MARK AS SHOWN.

THE COLOR(S) BLACK, ORANGE AND GRAY IS/ ARE CLAIMED AS A FEATURE OF THE MARK.

THE MARK CONSISTS OF THE STYLIZED WORDING "RIVERLINE ERGONOMIC" IN SILVER GRAY, WHERE THE LETTER "I" IN "ERGONOMIC" IS REPRESENTED BY A SILVER GRAY SILHOUETTE OF A WALKING MAN; ALL OF THE FOREGOING IS CENTERED WITHIN A RECTANGLE SHADED IN BLACK AND OUTLINED IN ORANGE.

SN 78-843,317, FILED 3-22-2006.

MATTHEW PAPPAS, EXAMINING ATTORNEY

Int. Cl.: 21

Prior U.S. Cls.: 2, 13, 23, 29, 30, 33, 40, and 50

United States Patent and Trademark Office

Reg. No. 3,522,606

Registered Oct. 21, 2008

**TRADEMARK
PRINCIPAL REGISTER**

Tight Lips

KNOWLES, RONALD R. (UNITED STATES IN-
DIVIDUAL)
5711 RICHMOND AVE
GARDEN GROVE, CA 92845

FOR: PLASTIC ATTACHMENT FOR SQUEEZ-
ABLE TUBES CONTAINING TOOTHPASTE,
CREAMS, OINTMENTS OR BEAUTY AIDS, THE
ATTACHMENT SLIDES ONTO THE BOTTOM OF
THE TUBE, IN CLASS 21 (U.S. CLS. 2, 13, 23, 29, 30, 33,
40 AND 50).

FIRST USE 7-15-2008; IN COMMERCE 7-15-2008.

THE MARK CONSISTS OF STANDARD CHAR-
ACTERS WITHOUT CLAIM TO ANY PARTICULAR
FONT, STYLE, SIZE, OR COLOR.

SN 78-845,436, FILED 3-24-2006.

ANNE E. GUSTASON, EXAMINING ATTORNEY

Int. Cl.: 28

Prior U.S. Cls.: 22, 23, 38, and 50

United States Patent and Trademark Office

Reg. No. 3,522,607

Registered Oct. 21, 2008

**TRADEMARK
PRINCIPAL REGISTER**

POCKETZOO

ROB NELSON COMPANY, THE (WASHINGTON
CORPORATION)
1701 BROADWAY
VANCOUVER, WA 98663

THE MARK CONSISTS OF STANDARD CHAR-
ACTERS WITHOUT CLAIM TO ANY PARTICULAR
FONT, STYLE, SIZE, OR COLOR.

FOR: STUFFED TOY ANIMALS, IN CLASS 28
(U.S. CLS. 22, 23, 38 AND 50).

SN 78-845,889, FILED 3-24-2006.

FIRST USE 7-1-2008; IN COMMERCE 7-1-2008.

BONNIE LUKEN, EXAMINING ATTORNEY

Int. Cl.: 36

Prior U.S. Cls.: 100, 101, and 102

United States Patent and Trademark Office

Reg. No. 3,522,608

Registered Oct. 21, 2008

**SERVICE MARK
PRINCIPAL REGISTER**

Wise Investor Group

BEEMAN, RANDY (UNITED STATES INDIVIDUAL)
SUITE 400
11710 PLAZA AMERICA DRIVE
RESTON, VA 20190

FOR: INVESTMENT MANAGEMENT, IN CLASS
36 (U.S. CLS. 100, 101 AND 102).

FIRST USE 3-31-2006; IN COMMERCE 3-31-2006.

THE MARK CONSISTS OF STANDARD CHARACTERS WITHOUT CLAIM TO ANY PARTICULAR FONT, STYLE, SIZE, OR COLOR.

NO CLAIM IS MADE TO THE EXCLUSIVE RIGHT TO USE "INVESTOR GROUP", APART FROM THE MARK AS SHOWN.

SN 78-846,278, FILED 3-26-2006.

SKYE YOUNG, EXAMINING ATTORNEY

Int. Cl.: 3

Prior U.S. Cls.: 1, 4, 6, 50, 51, and 52

Reg. No. 3,522,609

United States Patent and Trademark Office

Registered Oct. 21, 2008

**TRADEMARK
PRINCIPAL REGISTER**

INU

BATH AND BODY WORKS BRAND MANAGEMENT, INC. (DELAWARE CORPORATION)
7 LIMITED PARWAY EAST
REYNOLDSBURG, OH 43068

FOR: PERSONAL CARE PRODUCTS, NAMELY, BODY LOTION, IN CLASS 3 (U.S. CLS. 1, 4, 6, 50, 51 AND 52).

FIRST USE 1-31-2007; IN COMMERCE 1-31-2007.

THE MARK CONSISTS OF STANDARD CHARACTERS WITHOUT CLAIM TO ANY PARTICULAR FONT, STYLE, SIZE, OR COLOR.

THE FOREIGN WORDING IN THE MARK TRANSLATES INTO ENGLISH AS DRINK.

SN 78-846,896, FILED 3-27-2006.

SIMON TENG, EXAMINING ATTORNEY

Int. Cl.: 3

Prior U.S. Cls.: 1, 4, 6, 50, 51, and 52

Reg. No. 3,522,610

United States Patent and Trademark Office

Registered Oct. 21, 2008

**TRADEMARK
PRINCIPAL REGISTER**

HUA'I

BATH & BODY WORK BRAND MANAGEMENT,
INC. (DELAWARE CORPORATION)
7 LIMITED PARKWAY EAST
REYNOLDSBURG, OH 43068

FOR: PERSONAL CARE PRODUCTS, NAMELY,
BODY SCRUBS, IN CLASS 3 (U.S. CLS. 1, 4, 6, 50, 51
AND 52).

FIRST USE 1-31-2007; IN COMMERCE 1-31-2007.

THE MARK CONSISTS OF STANDARD CHAR-
ACTERS WITHOUT CLAIM TO ANY PARTICULAR
FONT, STYLE, SIZE, OR COLOR.

THE FOREIGN WORDING IN THE MARK
TRANSLATES INTO ENGLISH AS TO REVEAL.

SN 78-846,969, FILED 3-27-2006.

CHARLOTTE CORWIN, EXAMINING ATTORNEY

Int. Cls.: 29 and 30

Prior U.S. Cl.: 46

United States Patent and Trademark Office

Reg. No. 3,522,611

Registered Oct. 21, 2008

**TRADEMARK
PRINCIPAL REGISTER**

GIVE YOUR CHIPS SOME DIP!

FRITO-LAY NORTH AMERICA, INC. (DELA-
WARE CORPORATION)
7701 LEGACY DRIVE
PLANO, TX 75024

FOR: BEAN DIP; DAIRY-BASED DIPS; DIPS;
SNACK DIPS; SNACK FOOD DIPS, IN CLASS 29
(U.S. CL. 46).

FIRST USE 8-0-2007; IN COMMERCE 8-0-2007.

FOR: HOT SAUCE; PICANTE SAUCE; SALSA;
SAUCES, IN CLASS 30 (U.S. CL. 46).

FIRST USE 8-0-2007; IN COMMERCE 8-0-2007.

THE MARK CONSISTS OF STANDARD CHAR-
ACTERS WITHOUT CLAIM TO ANY PARTICULAR
FONT, STYLE, SIZE, OR COLOR.

SN 78-848,224, FILED 3-28-2006.

ELLEN PERKINS, EXAMINING ATTORNEY

Int. Cl.: 21

Prior U.S. Cls.: 2, 13, 23, 29, 30, 33, 40, and 50

United States Patent and Trademark Office

Reg. No. 3,522,612

Registered Oct. 21, 2008

TRADEMARK
PRINCIPAL REGISTER



FLOWERS, INC. (GEORGIA CORPORATION)
325 CLEVELAND ROAD
BOGART, GA 30622

FIRST USE 12-1-2006; IN COMMERCE 2-1-2007.

FOR: JEWELRY DECORATIONS FOR VASES
AND OTHER HOME DECOR ITEMS, NAMELY,
BRACELETS FOR VASES, IN CLASS 21 (U.S. CLS. 2,
13, 23, 29, 30, 33, 40 AND 50).

SN 78-849,131, FILED 3-29-2006.

GRETTA YAO, EXAMINING ATTORNEY

Int. Cl.: 33

Prior U.S. Cls.: 47 and 49

United States Patent and Trademark Office

Reg. No. 3,522,613

Registered Oct. 21, 2008

TRADEMARK
PRINCIPAL REGISTER

THACHER



W I N E R Y

WESTSIDE WINERY (CALIFORNIA LIMITED
LIABILITY COMPANY)
8355 VINEYARD DRIVE
PASO ROBLES, CA 93446

FOR: WINE, IN CLASS 33 (U.S. CLS. 47 AND 49).

FIRST USE 11-1-2006; IN COMMERCE 11-1-2006.

NO CLAIM IS MADE TO THE EXCLUSIVE
RIGHT TO USE "WINERY" , APART FROM THE
MARK AS SHOWN.

THE COLOR(S) RED AND BLACK IS/ARE
CLAIMED AS A FEATURE OF THE MARK.

THE COLOR RED APPEARS IN THE CRICKET
DESIGN AND THE COLOR BLACK APPEARS IN
THE WORDS "THACHER WINERY".

SN 78-850,669, FILED 3-30-2006.

ANNE FARRELL, EXAMINING ATTORNEY

Int. Cl.: 30

Prior U.S. Cl.: 46

United States Patent and Trademark Office

Reg. No. 3,522,614

Registered Oct. 21, 2008

**TRADEMARK
PRINCIPAL REGISTER**

SIP-N-CHEW

AMERICAN LICORICE CO. (DELAWARE COR-
PORATION)
2796 NW CLEARWATER DRIVE
BEND, OR 97701

THE MARK CONSISTS OF STANDARD CHAR-
ACTERS WITHOUT CLAIM TO ANY PARTICULAR
FONT, STYLE, SIZE, OR COLOR.

FOR: CANDY, IN CLASS 30 (U.S. CL. 46).

SN 78-851,128, FILED 3-31-2006.

FIRST USE 6-9-2006; IN COMMERCE 6-9-2006.

ATTIYA MALIK, EXAMINING ATTORNEY

Int. Cl.: 25

Prior U.S. Cls.: 22 and 39

United States Patent and Trademark Office

Reg. No. 3,522,615

Registered Oct. 21, 2008

**TRADEMARK
PRINCIPAL REGISTER**

BOONDOCK SAINTS

BOONDOCK SAINTS, LLC (CALIFORNIA LIMITED LIABILITY COMPANY)
732 N. DIAMOND BAR BLVD.
SUITE 224
DIAMOND BAR, CA 91765

FOR: CLOTHING, NAMELY, SHIRTS, T-SHIRTS, FOOTWEAR, HEADWEAR, BASEBALL CAPS, SHORTS, SWIMWEAR, LINGERIE, SWEAT SHIRTS, UNDERWEAR, JACKETS, COATS, SCARVES AND GLOVES, IN CLASS 25 (U.S. CLS. 22 AND 39).

FIRST USE 1-1-2002; IN COMMERCE 1-1-2002.

THE MARK CONSISTS OF STANDARD CHARACTERS WITHOUT CLAIM TO ANY PARTICULAR FONT, STYLE, SIZE, OR COLOR.

SN 78-852,769, FILED 4-3-2006.

ELLEN PERKINS, EXAMINING ATTORNEY

Int. Cl.: 9

Prior U.S. Cls.: 21, 23, 26, 36, and 38

Reg. No. 3,522,616

United States Patent and Trademark Office

Registered Oct. 21, 2008

**TRADEMARK
PRINCIPAL REGISTER**

HID GLOBAL

HID GLOBAL CORPORATION (DELAWARE CORPORATION)
9292 JERONIMO ROAD
IRVINE, CA 92618

FOR: RADIO FREQUENCY IDENTIFICATION (RFID) SYSTEMS AND THEIR INDIVIDUAL COMPONENTS, NAMELY, RFID CREDENTIALS, READERS AND WRITERS FOR COMMUNICATING WITH THE RFID CREDENTIALS, AND PROGRAMMERS FOR PROGRAMMING THE RFID CREDENTIALS, WHEREIN THE RFID CREDENTIALS ARE IN THE FORM OF CARDS, TAGS, OR KEY FOBS; MAGNETIC STRIPE SYSTEMS AND THEIR INDIVIDUAL COMPONENTS, NAMELY, MAGNETIC STRIPE CARDS AND READERS FOR COMMUNICATING WITH THE MAGNETIC STRIPE CARDS; MAGNETIC ALLOY WIRE SYSTEMS AND THEIR INDIVIDUAL COMPONENTS, NAMELY, MAGNETIC ALLOY WIRE CARDS AND READERS FOR COMMUNICATING WITH THE MAGNETIC ALLOY WIRE CARDS; RFID READER AND WRITER MODULES FOR ORIGINAL EQUIPMENT MANUFACTURERS (OEM'S); CONTACT SMART CHIPS; MULTIPLE TECHNOLOGY-BASED RFID CARDS WHICH COMBINE RFID TECHNOLOGY WITH MAGNETIC STRIPE TECHNOLOGY, MAGNETIC ALLOY WIRE TECHNOLOGY, CONTACT SMART CHIP TECHNOLOGY, BAR CODE TECHNOLOGY,

ANTI-COUNTERFEITING TECHNOLOGY, OR PHOTO IDENTIFICATION TECHNOLOGY; MULTIPLE TECHNOLOGY-BASED RFID READERS WHICH COMBINE RFID TECHNOLOGY WITH MAGNETIC STRIPE TECHNOLOGY, MAGNETIC ALLOY WIRE TECHNOLOGY, CONTACT SMART CHIP TECHNOLOGY, KEY PAD TECHNOLOGY, BAR CODE TECHNOLOGY, OR BIOMETRIC TECHNOLOGY; DATA ROUTERS FOR COMPUTER NETWORKS USED IN THE FIELDS OF SECURITY AND ACCESS CONTROL; AND COMPUTER SOFTWARE FOR ISSUING AND MANAGING RFID CREDENTIALS, IN CLASS 9 (U.S. CLS. 21, 23, 26, 36 AND 38).

FIRST USE 8-1-2008; IN COMMERCE 8-1-2008.

THE MARK CONSISTS OF STANDARD CHARACTERS WITHOUT CLAIM TO ANY PARTICULAR FONT, STYLE, SIZE, OR COLOR.

NO CLAIM IS MADE TO THE EXCLUSIVE RIGHT TO USE "GLOBAL", APART FROM THE MARK AS SHOWN.

SN 78-853,856, FILED 4-4-2006.

KIM MONINGHOFF, EXAMINING ATTORNEY

Int. Cl.: 41

Prior U.S. Cls.: 100, 101, and 107

United States Patent and Trademark Office

Reg. No. 3,522,617

Registered Oct. 21, 2008

**SERVICE MARK
PRINCIPAL REGISTER**

MÉLANGE MAGAZINE

BROWN, KEDMA (UNITED STATES INDIVIDUAL)

192 WASHINGTON PARK, 2B

BROOKLYN, NY 11205

FOR: PUBLISHING OF WEB MAGAZINES, IN CLASS 41 (U.S. CLS. 100, 101 AND 107).

FIRST USE 4-16-2006; IN COMMERCE 7-16-2006.

THE MARK CONSISTS OF STANDARD CHARACTERS WITHOUT CLAIM TO ANY PARTICULAR FONT, STYLE, SIZE, OR COLOR.

NO CLAIM IS MADE TO THE EXCLUSIVE RIGHT TO USE "MAGAZINE", APART FROM THE MARK AS SHOWN.

SN 78-855,137, FILED 4-5-2006.

DOMINICK J. SALEMI, EXAMINING ATTORNEY

Int. Cl.: 11

Prior U.S. Cls.: 13, 21, 23, 31, and 34

United States Patent and Trademark Office

Reg. No. 3,522,618

Registered Oct. 21, 2008

**TRADEMARK
PRINCIPAL REGISTER**

MONOSCREEN

NORDIC WATER PRODUCTS AB (SWEDEN
CORPORATION)
PO BOX 1004
NYNASHAMN, SWEDEN S-149 25

FOR: WATER FILTERS AND SCREENS FOR
SEPARATION OF PARTICLES FROM LIQUIDS, IN
CLASS 11 (U.S. CLS. 13, 21, 23, 31 AND 34).

FIRST USE 0-0-1998; IN COMMERCE 0-0-1998.

THE MARK CONSISTS OF STANDARD CHAR-
ACTERS WITHOUT CLAIM TO ANY PARTICULAR
FONT, STYLE, SIZE, OR COLOR.

SN 78-855,726, FILED 4-6-2006.

TRACY WHITTAKER-BROWN, EXAMINING AT-
TORNEY

Int. Cl.: 35

Prior U.S. Cls.: 100, 101, and 102

United States Patent and Trademark Office

Reg. No. 3,522,619

Registered Oct. 21, 2008

**SERVICE MARK
PRINCIPAL REGISTER**

WHAT DO YOU THINK?

COLLEGENET, INC. (DELAWARE CORPORATION)
SUITE 1600
805 SW BROADWAY
PORTLAND, OR 97205

FOR: CONDUCTING PUBLIC OPINION, CUSTOMER OPINION, AND MARKET OPINION SURVEYS AND POLLS, AND PROVIDING THE RESULTS OF THESE SURVEYS AND POLLS TO BUSINESSES IN THE FORM OF PROVIDING BUSINESS CONSULTATION; CONDUCTING PUBLIC OPINION SURVEYS AND POLLS; CONDUCTING PUBLIC OPINION, CUSTOMER OPINION, AND MARKET OPINION SURVEYS AND POLLS FOR CUSTOMERS, EMPLOYEES, STUDENTS, COLLEGES, UNIVERSITIES, GOVERNMENT ENTITIES, AND BUSINESS; ANALYSIS REGARDING PUBLIC OPINION, CUSTOMER OPINION, AND MARKET OPINION SURVEYS AND POLLS; PROVIDING DATABASES FEATURING AGGREGATED PUBLIC OPINION, CUSTOMER OPINION, AND MARKET OPINION SURVEY RESULTS, STANDARDS FOR JUDGING BUSINESS PERFORMANCE, AND

BENCHMARKS; BENCHMARK ANALYSIS OF PUBLIC OPINION, CUSTOMER OPINION, AND MARKET OPINION SURVEY AND POLL RESULTS; BUSINESS ANALYSIS, NAMELY IDENTIFYING STANDARDS FOR JUDGING BUSINESS PERFORMANCE FROM PUBLIC OPINION, CUSTOMER OPINION, AND MARKET OPINION SURVEY AND POLL RESULTS, AND COMPARING PERFORMANCE AGAINST THAT OF OTHERS FROM PUBLIC OPINION, CUSTOMER OPINION, AND MARKET OPINION SURVEY AND POLL RESULTS, IN CLASS 35 (U.S. CLS. 100, 101 AND 102).

FIRST USE 4-17-2006; IN COMMERCE 4-17-2006.

THE MARK CONSISTS OF STANDARD CHARACTERS WITHOUT CLAIM TO ANY PARTICULAR FONT, STYLE, SIZE, OR COLOR.

SN 78-856,907, FILED 4-7-2006.

SEAN CROWLEY, EXAMINING ATTORNEY

Int. Cls.: 35 and 36

Prior U.S. Cls.: 100, 101, and 102

United States Patent and Trademark Office

Reg. No. 3,522,620

Registered Oct. 21, 2008

**SERVICE MARK
PRINCIPAL REGISTER**

**WHERE THE WORLD FINDS
HOMES ONLINE**

HOMES & LAND AFFILIATES, LLC (DELA-
WARE LIMITED LIABILITY COMPANY)
1830 EAST PARK AVENUE
TALLAHASSEE, FL 32301

FOR: DISSEMINATION OF ADVERTISING FOR
REAL ESTATE AGENCIES AND OTHERS
THROUGH PRINTED PUBLICATIONS AND VIA A
GLOBAL COMMUNICATIONS NETWORK , IN
CLASS 35 (U.S. CLS. 100, 101 AND 102).

FIRST USE 7-0-2007; IN COMMERCE 7-0-2007.

FOR: PROVIDING REAL ESTATE LISTINGS
THROUGH PRINTED PUBLICATIONS AND VIA A

GLOBAL COMMUNICATIONS NETWORK, IN
CLASS 36 (U.S. CLS. 100, 101 AND 102).

FIRST USE 7-0-2007; IN COMMERCE 7-0-2007.

THE MARK CONSISTS OF STANDARD CHAR-
ACTERS WITHOUT CLAIM TO ANY PARTICULAR
FONT, STYLE, SIZE, OR COLOR.

OWNER OF U.S. REG. NO. 2,301,988.

SN 78-857,478, FILED 4-10-2006.

WILLIAM VERHOSEK, EXAMINING ATTORNEY

Int. Cl.: 9

Prior U.S. Cls.: 21, 23, 26, 36, and 38

Reg. No. 3,522,621

United States Patent and Trademark Office

Registered Oct. 21, 2008

**TRADEMARK
PRINCIPAL REGISTER**

BLUGIRL

BLUFIN S.P.A. (ITALY CORPORATION)
VIA G. FERRARIS 13, 15, 15/A
CARPI (MO), ITALY I-42010

FIRST USE 12-13-1987; IN COMMERCE 4-14-1992.

FOR: SUNGLASSES; SPECTACLES; ACCESSORIES FOR SUNGLASSES AND SPECTACLES, NAME-
LY, CASES, CHAINS, FRAMES, LENSES AND
TWIST STRINGS, IN CLASS 9 (U.S. CLS. 21, 23, 26,
36 AND 38).

THE MARK CONSISTS OF STANDARD CHAR-
ACTERS WITHOUT CLAIM TO ANY PARTICULAR
FONT, STYLE, SIZE, OR COLOR.

SN 78-857,712, FILED 4-10-2006.

SEAN CROWLEY, EXAMINING ATTORNEY

Int. Cl.: 30

Prior U.S. Cl.: 46

United States Patent and Trademark Office

Reg. No. 3,522,622

Registered Oct. 21, 2008

**TRADEMARK
PRINCIPAL REGISTER**

**m
Dark**

MARS, INCORPORATED (DELAWARE CORPORATION)
6885 ELM STREET
MCLEAN, VA 221013883

NO CLAIM IS MADE TO THE EXCLUSIVE
RIGHT TO USE "DARK" , APART FROM THE
MARK AS SHOWN.

FOR: CONFECTIONERY, NAMELY, CANDY, IN
CLASS 30 (U.S. CL. 46).

SN 78-860,962, FILED 4-13-2006.

FIRST USE 7-3-2006; IN COMMERCE 7-3-2006.

OWNER OF U.S. REG. NO. 418,332.

ESTHER A. BORSUK, EXAMINING ATTORNEY

Int. Cl.: 8

Prior U.S. Cls.: 23, 28, and 44

United States Patent and Trademark Office

Reg. No. 3,522,623

Registered Oct. 21, 2008

**TRADEMARK
PRINCIPAL REGISTER**

C.U.B.

5.11, INC. (CALIFORNIA CORPORATION)
4300 SPYRES WAY
MODESTO, CA 95356

THE MARK CONSISTS OF STANDARD CHAR-
ACTERS WITHOUT CLAIM TO ANY PARTICULAR
FONT, STYLE, SIZE, OR COLOR.

FOR: KNIVES, IN CLASS 8 (U.S. CLS. 23, 28 AND
44).

SN 78-861,859, FILED 4-14-2006.

FIRST USE 10-0-2007; IN COMMERCE 10-0-2007.

CAROLYN CATALDO, EXAMINING ATTORNEY

Int. Cl.: 10

Prior U.S. Cls.: 26, 39, and 44

United States Patent and Trademark Office

Reg. No. 3,522,624

Registered Oct. 21, 2008

**TRADEMARK
PRINCIPAL REGISTER**

RECOVERYWRAP

VITALWEAR, INC. (CALIFORNIA CORPORATION)
384 OYSTER POINT BLVD, SUITE 16
SOUTH SAN FRANCISCO, CA 94080

THE MARK CONSISTS OF STANDARD CHARACTERS WITHOUT CLAIM TO ANY PARTICULAR FONT, STYLE, SIZE, OR COLOR.

FOR: MEDICAL INSTRUMENTS FOR INTERSTITIAL THERMOTHERAPY OF BIOLOGICAL TISSUE, IN CLASS 10 (U.S. CLS. 26, 39 AND 44).

SN 78-862,346, FILED 4-16-2006.

FIRST USE 7-1-2006; IN COMMERCE 7-1-2006.

ANNE MADDEN, EXAMINING ATTORNEY

Int. Cl.: 9

Prior U.S. Cls.: 21, 23, 26, 36, and 38

United States Patent and Trademark Office

Reg. No. 3,522,625

Registered Oct. 21, 2008

**TRADEMARK
PRINCIPAL REGISTER**

INCITE!

DON JOHNSTON INCORPORATED (ILLINOIS
CORPORATION)
26799 COMMERCE DRIVE
VOLO, IL 60073

FOR: PRE-RECORDED CD'S, VIDEO TAPES,
AND DVD'S FEATURING LITERACY TRAINING
INFORMATION, AND HISTORICAL, SOCIAL SCI-
ENCE AND SCIENCE INSTRUCTION FOR STU-
DENTS IN THE PRIMARY AND SECONDARY
GRADES, IN CLASS 9 (U.S. CLS. 21, 23, 26, 36 AND
38).

FIRST USE 9-26-2006; IN COMMERCE 9-26-2006.

THE MARK CONSISTS OF STANDARD CHAR-
ACTERS WITHOUT CLAIM TO ANY PARTICULAR
FONT, STYLE, SIZE, OR COLOR.

SN 78-863,904, FILED 4-18-2006.

MAUREEN DALL, EXAMINING ATTORNEY

Int. Cls.: 9 and 16

Prior U.S. Cls.: 2, 5, 21, 22, 23, 26, 29, 36, 37, 38, and 50

Reg. No. 3,522,626

United States Patent and Trademark Office

Registered Oct. 21, 2008

TRADEMARK
PRINCIPAL REGISTER



EDUCATIONAL ADVENTURES, LLC (DELAWARE LIMITED LIABILITY COMPANY)
SUITE 106
3426 TORINGDON WAY
CHARLOTTE, NC 28277

FOR: PRE-RECORDED VIDEO DISKS, CASSETTES, AND TAPES FEATURING EDUCATIONAL PROGRAMMING FOR CHILDREN, IN CLASS 9 (U.S. CLS. 21, 23, 26, 36 AND 38).

FIRST USE 1-1-2007; IN COMMERCE 1-1-2007.

FOR: CHILDREN'S BOOKS, IN CLASS 16 (U.S. CLS. 2, 5, 22, 23, 29, 37, 38 AND 50).

FIRST USE 1-1-2007; IN COMMERCE 1-1-2007.

OWNER OF U.S. REG. NOS. 3,094,444, 3,102,342, AND OTHERS.

THE COLOR(S) BLUE, LIGHT BLUE, RED, ORANGE, BEIGE, WHITE, AND YELLOW IS/ARE CLAIMED AS A FEATURE OF THE MARK.

THE COLORS RED, ORANGE, AND YELLOW APPEAR IN THE LETTERS OF THE MARK'S WORDING "DANGER RANGERS"; THE COLORS BLUE, LIGHT BLUE, AND WHITE APPEAR IN THE BORDER OF THE LETTERS IN THE MARK'S WORDING "DANGER RANGERS"; THE COLORS YELLOW, BEIGE, AND WHITE APPEAR IN THE RECTANGLE UNDERNEATH THE MARK'S WORDING "DANGER RANGERS"; THE COLOR BLUE APPEARS IN THE BORDER OF THE RECTANGLE.

SN 78-864,107, FILED 4-18-2006.

STEVEN JACKSON, EXAMINING ATTORNEY

Int. Cl.: 12

Prior U.S. Cls.: 19, 21, 23, 31, 35, and 44

Reg. No. 3,522,627

United States Patent and Trademark Office

Registered Oct. 21, 2008

**TRADEMARK
PRINCIPAL REGISTER**

FX50

NISSAN JIDOSHA KABUSHIKI KAISHA (JAPAN CORPORATION), TA NISSAN MOTOR CO., LTD., NO. 2 TAKARACHO, KANAGAWA-KU YOKOHAMA-SHI, KANAGAWA, JAPAN

FOR: MOTOR VEHICLES, NAMELY AUTOMOBILES AND SPORT UTILITY VEHICLES AND STRUCTURAL PARTS THEREFOR , IN CLASS 12 (U.S. CLS. 19, 21, 23, 31, 35 AND 44).

FIRST USE 6-24-2008; IN COMMERCE 6-24-2008.

THE MARK CONSISTS OF STANDARD CHARACTERS WITHOUT CLAIM TO ANY PARTICULAR FONT, STYLE, SIZE, OR COLOR.

SN 78-865,217, FILED 4-19-2006.

JULIE GUTTADAURO, EXAMINING ATTORNEY

Int. Cl.: 39

Prior U.S. Cls.: 100 and 105

United States Patent and Trademark Office

Reg. No. 3,522,628

Registered Oct. 21, 2008

SERVICE MARK
PRINCIPAL REGISTER

myair

SHANGHAI YIN JIA HUI CAPITAL MANAGEMENT CO., LTD (CHINA CORPORATION)
10-127 ROOM, 3050 GONGHEXIN ROAD
SHANGHAI, CHINA

FOR: TRANSPORTATION RESERVATION SERVICES; TRANSPORT BROKERAGE; TRAFFIC INFORMATION SERVICES; TRAVEL INFORMATION SERVICES; TRANSPORT OF PASSENGERS; TRANSPORT BY FERRY; AIR TRANSPORT; COURIER SERVICES; TRAVEL AND TOUR TICKET RESERVATION SERVICE; TRAVEL AGENCY SERVICES, NAMELY, MAKING RESERVATIONS AND BOOKINGS FOR TRANSPORTATION; ARRANGING TRAVEL TOURS; STORAGE IN GENERAL; SHIP BROKERAGE; REMOVAL SERVICES, NAMELY, FURNITURE MOVING; GLOBAL TRANSPORTATION OF FREIGHT FOR OTHERS BY ALL AVAILABLE MEANS; CAR PARKING; RENTAL OF BOATS; RENTAL OF WAREHOUSE SPACE; WATER

SUPPLYING; ELECTRICITY DISTRIBUTION; TOURIST AGENCY SERVICES; TRANSPORTATION OF FURNITURE OF OTHERS BY TRUCKS; STEVEDORING SERVICES; CAR TRANSPORT; RAILWAY TRANSPORT; RENTAL OF VEHICLES; RENTAL OF DEEP WATER DIVING SUITS; GAS SUPPLYING; PARCEL DELIVERY; MESSAGE DELIVERY; DELIVERY OF GOODS BY MAIL ORDER BY TRUCK, AIR; TRANSMISSION OF OIL OR GAS THROUGH PIPELINES; LAUNCH AND PLACEMENT IN PRESCRIBED ORBIT OF SATELLITES OF OTHERS, IN CLASS 39 (U.S. CLS. 100 AND 105).

FIRST USE 5-5-2004; IN COMMERCE 6-8-2006.

SN 78-865,437, FILED 4-20-2006.

THOMAS MANOR, EXAMINING ATTORNEY

Int. Cl.: 35

Prior U.S. Cls.: 100, 101, and 102

United States Patent and Trademark Office

Reg. No. 3,522,629

Registered Oct. 21, 2008

**SERVICE MARK
PRINCIPAL REGISTER**

**WEEKLY SPECIALS IN 60
SECONDS**

PEREZ, HECTOR (UNITED STATES INDIVIDUAL)
SUITE 505
800 S. WELLS
CHICAGO, IL 60607

FOR: ADVERTISING AND PROMOTING THE GOODS AND SERVICES OF BUSINESSES BY PREPARING AND DISSEMINATING ADVERTISEMENTS VIA ON-DEMAND VIDEO, VIDEO BROADCASTS, PODCASTS, MOBILE PHONE MESSAGES AND VIDEO STREAMING ALL ON WEB SITES ACCESSED THROUGH COMPUTER NETWORKS; ADVERTISING AND PROMOTING THE

GOODS AND SERVICES OF BUSINESSES VIA GLOBAL COMPUTER NETWORKS, IN CLASS 35 (U.S. CLS. 100, 101 AND 102).

FIRST USE 8-13-2008; IN COMMERCE 8-13-2008.

THE MARK CONSISTS OF STANDARD CHARACTERS WITHOUT CLAIM TO ANY PARTICULAR FONT, STYLE, SIZE, OR COLOR.

SN 78-865,610, FILED 4-20-2006.

BONNIE LUKEN, EXAMINING ATTORNEY

Int. Cl.: 42

Prior U.S. Cls.: 100 and 101

United States Patent and Trademark Office

Reg. No. 3,522,630

Registered Oct. 21, 2008

**SERVICE MARK
PRINCIPAL REGISTER**

Inventing The Future Now

NANOSOURCE, INC. (DELAWARE CORPORATION)
43087 LAGO GALLERIE COURT
ASHBURN, VA 20148

FOR: RESEARCH, DEVELOPMENT, AND CONSULTING IN THE FIELD OF NANOTECHNOLOGY, IN CLASS 42 (U.S. CLS. 100 AND 101).

FIRST USE 2-25-2008; IN COMMERCE 2-25-2008.

THE MARK CONSISTS OF STANDARD CHARACTERS WITHOUT CLAIM TO ANY PARTICULAR FONT, STYLE, SIZE, OR COLOR.

SN 78-867,913, FILED 4-24-2006.

CHRIS WELLS, EXAMINING ATTORNEY

Int. Cls.: 41 and 44

Prior U.S. Cls.: 100, 101, and 107

United States Patent and Trademark Office

Reg. No. 3,522,631

Registered Oct. 21, 2008

**SERVICE MARK
PRINCIPAL REGISTER**

PROACTIVE PARTNERS

TENNIS CORPORATION OF AMERICA (DELA-
WARE CORPORATION)
3611 N. KEDZIE AVE.
CHICAGO, IL 60618

FOR: EDUCATIONAL PROGRAMS, NAMELY,
CONDUCTING WORKSITE PHYSICAL ACTIVITY
SEMINARS, IN CLASS 41 (U.S. CLS. 100, 101 AND
107).

FIRST USE 6-0-2006; IN COMMERCE 6-0-2006.

FOR: WORKSITE HEALTH ENHANCEMENT
SERVICES, NAMELY, WELLNESS PROGRAMS DI-
RECTED TOWARDS CORPORATIONS AND BUSI-
NESSES TO BENEFIT THE HEALTH OF THEIR
EMPLOYEES, IN CLASS 44 (U.S. CLS. 100 AND 101).

FIRST USE 6-0-2006; IN COMMERCE 6-0-2006.

THE MARK CONSISTS OF STANDARD CHAR-
ACTERS WITHOUT CLAIM TO ANY PARTICULAR
FONT, STYLE, SIZE, OR COLOR.

NO CLAIM IS MADE TO THE EXCLUSIVE
RIGHT TO USE "PARTNERS", APART FROM THE
MARK AS SHOWN.

SN 78-868,706, FILED 4-25-2006.

KYLE PEETE, EXAMINING ATTORNEY

Int. Cl.: 9

Prior U.S. Cls.: 21, 23, 26, 36, and 38

United States Patent and Trademark Office

Reg. No. 3,522,632

Registered Oct. 21, 2008

**TRADEMARK
PRINCIPAL REGISTER**



DEVTEK, INC. (ALABAMA CORPORATION)
220 CEDAR STREET NE
HARTSELLE, AL 35640

NO CLAIM IS MADE TO THE EXCLUSIVE
RIGHT TO USE "WHERE THE SPORTS ACTION
IS", APART FROM THE MARK AS SHOWN.

FOR: APPARATUS FOR TRANSMISSION OF
COMMUNICATION, NAMELY, DISPOSABLE
RADIO RECEIVERS, IN CLASS 9 (U.S. CLS. 21, 23,
26, 36 AND 38).

SN 78-869,637, FILED 4-26-2006.

FIRST USE 7-31-2006; IN COMMERCE 9-30-2007.

SKYE YOUNG, EXAMINING ATTORNEY

Int. Cl.: 25

Prior U.S. Cls.: 22 and 39

United States Patent and Trademark Office

Reg. No. 3,522,633

Registered Oct. 21, 2008

TRADEMARK
PRINCIPAL REGISTER

The trademark consists of the word "Sexable" written in a cursive, flowing script. The letter "S" is stylized with a female symbol (a circle with a cross) at its base. The word "able" is written in a similar cursive style. A thick, black, stylized graphic of a female leg, including the thigh, calf, and foot, is positioned below the word "Sexable", starting under the "S" and extending under the "able".

SEXABLE, INC. (CALIFORNIA CORPORATION)
686 S. ARROYO PARKWAY, #6
PASADENA, CA 91105

FOR: NIGHT SHIRTS; NON-DISPOSABLE CLOTH TRAINING PANTS; OPEN-NECKED SHIRTS; PANTS; SHIRT FRONTS; SHIRTS; SHORT-SLEEVED SHIRTS; SLEEP SHIRTS; SPORT SHIRTS; SPORTS SHIRTS WITH SHORT SLEEVES; SWEAT PANTS; SWEAT SHIRTS; T-SHIRTS; TRACK PANTS; BOXER SHORTS; GYM SHORTS; PANTIES, SHORTS AND BRIEFS; SHORT SETS; SHORT TROUSERS; SHORTS; SHORT-SLEEVED OR LONG-SLEEVED T-SHIRTS; SWEAT SHORTS; WALKING SHORTS; TANK TOPS, IN CLASS 25 (U.S. CLS. 22 AND 39).

FIRST USE 2-24-2008; IN COMMERCE 2-24-2008.

THE MARK CONSISTS OF THE WORD "SEX-ABLE" ALONG WITH A CROSS AND ARROW ATTACHED TO THE LOWER PORTION OF THE LETTER "S" SIMILAR TO AN MALE AND FEMALE GENDER SIGNS SUPERIMPOSED ON EACH OTHER. IN ADDITION, THE LETTERS "EXABLE" IS UNDERScoreD WITH AN IMAGE OF A FEMALE LEG THAT INCLUDES THE THIGH, CALF AND FOOT PORTION. THE FOOT BLENDS IN WITH THE LAST LETTER "E".

SN 78-871,735, FILED 4-28-2006.

LINDA ORNDORFF, EXAMINING ATTORNEY

Int. Cl.: 25

Prior U.S. Cls.: 22 and 39

United States Patent and Trademark Office

Reg. No. 3,522,634

Registered Oct. 21, 2008

**TRADEMARK
PRINCIPAL REGISTER**

OPERA ROCK

VERSATTI INDUSTRIA E COMERCIO DE CONFECÇÕES LTDA. (BRAZIL LIMITED PARTNERSHIP)
RUA MAJOR SAMPAIO, Nº 52, SANTANA
SAO PAULO, BRAZIL

FOR: CLOTHING, NAMELY, JEANS, TROUSERS, PANTS, SHIRTS, OVERALLS, UNDERWEAR, JACKETS, SHORTS, BERMUDA SHORTS, SUITS, COATS, BATHING SUITS, SOCKS, T-SHIRTS, JUMPERS, BLOUSES, TOPS, DRESSES, SKIRTS, NECK BANDS, CORSETS, BODY TIGHTS, FUR CLOAKS, FUR COATS, FUR JACKETS, FUR STOLEES, UNDERPANTS, PULLOVERS AND TRICOT SHIRTS; AND ACCESSORIES, NAMELY, SCARVES, STOLEES, SILK

NECKERCHIEFS, HATS, CAPS, ATHLETIC FOOTWEAR, TENNIS SHOES AND BELTS, IN CLASS 25 (U.S. CLS. 22 AND 39).

FIRST USE 5-18-2006; IN COMMERCE 8-14-2006.

THE MARK CONSISTS OF STANDARD CHARACTERS WITHOUT CLAIM TO ANY PARTICULAR FONT, STYLE, SIZE, OR COLOR.

SN 78-871,912, FILED 4-28-2006.

NICHOLAS ALTREE, EXAMINING ATTORNEY

Int. Cl.: 25

Prior U.S. Cls.: 22 and 39

United States Patent and Trademark Office

Reg. No. 3,522,635

Registered Oct. 21, 2008

**TRADEMARK
PRINCIPAL REGISTER**



ESOLES, L.L.C. (ARIZONA CORPORATION)
9376 EAST BAHIA DRIVE
SUITE D-101
SCOTTSDALE, AZ 85260

FOR: INNER SOLES; INSOLES; SHOE INSERTS
FOR PRIMARILY NON-ORTHOPEDIC PURPOSES,
IN CLASS 25 (U.S. CLS. 22 AND 39).

FIRST USE 1-6-2006; IN COMMERCE 1-6-2006.

NO CLAIM IS MADE TO THE EXCLUSIVE
RIGHT TO USE "CUSTOM", APART FROM THE
MARK AS SHOWN.

THE MARK CONSISTS OF THE WORD "ESOLES"
WITH A GRAPHIC REPRESENTATION OF THE
LETTER "S".

SN 78-872,229, FILED 4-28-2006.

CHERYL CLAYTON, EXAMINING ATTORNEY

Int. Cl.: 30

Prior U.S. Cl.: 46

United States Patent and Trademark Office

Reg. No. 3,522,636

Registered Oct. 21, 2008

**TRADEMARK
PRINCIPAL REGISTER**

CHOCOLATE WITH BENEFITS

MOSKAL/MCCORD, INC. (NEW YORK COR-
PORATION)
12 W. 27TH STREET
NEW YORK, NY 10001

FOR: CONFECTIONERY PRODUCTS, NAMELY,
CHOCOLATES AND CANDY, IN CLASS 30 (U.S. CL.
46).

FIRST USE 8-8-2007; IN COMMERCE 8-8-2007.

THE MARK CONSISTS OF STANDARD CHAR-
ACTERS WITHOUT CLAIM TO ANY PARTICULAR
FONT, STYLE, SIZE, OR COLOR.

NO CLAIM IS MADE TO THE EXCLUSIVE
RIGHT TO USE "CHOCOLATE", APART FROM
THE MARK AS SHOWN.

SN 78-873,114, FILED 5-1-2006.

JIM RINGLE, EXAMINING ATTORNEY

Int. Cl.: 21

Prior U.S. Cls.: 2, 13, 23, 29, 30, 33, 40, and 50

United States Patent and Trademark Office

Reg. No. 3,522,637

Registered Oct. 21, 2008

**TRADEMARK
PRINCIPAL REGISTER**



THE PROCTER & GAMBLE COMPANY (OHIO CORPORATION)
ONE PROCTER & GAMBLE PLAZA
CINCINNATI, OH 45202

FOR: MICRO-FIBER CLEANING MITTS OF FABRIC, IN CLASS 21 (U.S. CLS. 2, 13, 23, 29, 30, 33, 40 AND 50).

FIRST USE 1-31-2007; IN COMMERCE 1-31-2007.

OWNER OF U.S. REG. NO. 2,945,048.

THE STIPLING IS FOR SHADING PURPOSES.

THE MARK CONSISTS OF A MAN'S HEAD WITH SMILING FACE AND BUSHY EYEBROWS, AN EARRING IN HIS LEFT EAR, WEARING A WHITE T-SHIRT WITH HIS ARMS FOLDED.

SN 78-875,598, FILED 5-3-2006.

JOHN SCHUYLER YARD, EXAMINING ATTORNEY

Int. Cl.: 42

Prior U.S. Cls.: 100 and 101

United States Patent and Trademark Office

Reg. No. 3,522,638

Registered Oct. 21, 2008

**SERVICE MARK
PRINCIPAL REGISTER**

5SQUARE.COM

5 SQUARE SYSTEMS, INC. (CALIFORNIA CORPORATION)
4360 PARK TERRACE DRIVE, SUITE 100
WESTLAKE VILLAGE, CA 91361

FOR: APPLICATION SERVICE PROVIDER (ASP) FEATURING SOFTWARE IN THE FIELD OF AUTOMATING AND INTEGRATING THE PROCESSES INVOLVED IN MOTOR VEHICLE PURCHASING AND LEASING, IN CLASS 42 (U.S. CLS. 100 AND 101).

FIRST USE 8-1-2005; IN COMMERCE 8-1-2005.

THE MARK CONSISTS OF STANDARD CHARACTERS WITHOUT CLAIM TO ANY PARTICULAR FONT, STYLE, SIZE, OR COLOR.

SN 78-876,105, FILED 5-4-2006.

BARNEY CHARLON, EXAMINING ATTORNEY

Int. Cls.: 7 and 40

Prior U.S. Cls.: 13, 19, 21, 23, 31, 34, 35, 100, 103, and 106

Reg. No. 3,522,639

United States Patent and Trademark Office

Registered Oct. 21, 2008

**TRADEMARK
SERVICE MARK
PRINCIPAL REGISTER**

SURFACE ACTIVATION

SURFACE ACTIVATION TECHNOLOGIES, LLC.
(MICHIGAN LIMITED LIABILITY COMPANY)
977 YARMOUTH ROAD
BLOOMFIELD VILLAGE, MI 48301

FOR: MACHINERY COMPRISING GENERATOR
AND TREATMENT CHAMBER FOR SULFONAT-
ING ARTICLES, IN CLASS 7 (U.S. CLS. 13, 19, 21, 23,
31, 34 AND 35).

FIRST USE 4-0-2006; IN COMMERCE 4-0-2006.

FOR: SERVICES FOR SULFONATING PLASTIC
ARTICLES TO THE ORDER AND SPECIFICATION

OF OTHERS, IN CLASS 40 (U.S. CLS. 100, 103 AND
106).

FIRST USE 4-0-2006; IN COMMERCE 4-0-2006.

THE MARK CONSISTS OF STANDARD CHAR-
ACTERS WITHOUT CLAIM TO ANY PARTICULAR
FONT, STYLE, SIZE, OR COLOR.

SN 78-877,520, FILED 5-5-2006.

GRETTA YAO, EXAMINING ATTORNEY

Int. Cl.: 35

Prior U.S. Cls.: 100, 101, and 102

United States Patent and Trademark Office

Reg. No. 3,522,640

Registered Oct. 21, 2008

SERVICE MARK
PRINCIPAL REGISTER

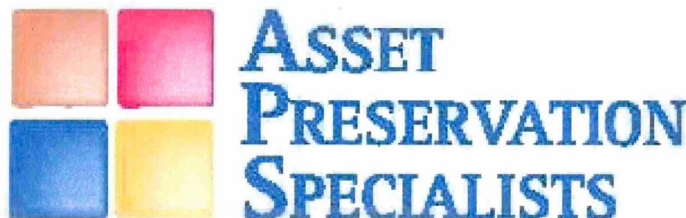

ASSET PRESERVATION SPECIALISTS, INC. (INDIANA CORPORATION)
900 PARKER PLACE
SCHERERVILLE, IN 46375

FOR: ADVERTISING AND COMMERCIAL INFORMATION SERVICES FOR THIRD PARTIES ENGAGED IN FINANCIAL PLANNING, CONSULTING AND MANAGEMENT, THROUGH THE DISTRIBUTION OF INFORMATIONAL AND PROMOTIONAL MATERIALS VIA THE INTERNET AND OTHER MEDIA, IN CLASS 35 (U.S. CLS. 100, 101 AND 102).

FIRST USE 5-8-2006; IN COMMERCE 5-8-2006.

NO CLAIM IS MADE TO THE EXCLUSIVE RIGHT TO USE "ASSET PRESERVATION SPECIALISTS", APART FROM THE MARK AS SHOWN.

THE COLOR(S) PINK, YELLOW, BLUE AND ORANGE IS/ARE CLAIMED AS A FEATURE OF THE MARK.

THE MARK CONSISTS OF FOUR COLORED SQUARES IN A SQUARE ARRAY, THE COLORS OF THE SQUARES (PROCEEDING CLOCKWISE BEGINNING IN THE UPPER RIGHT) BEING PINK, YELLOW, BLUE, AND ORANGE. THE ARRAY OF SQUARES ARE LOCATED TO THE LEFT OF THE WORD PORTION OF THE MARK WHICH IS IN BLUE.

SN 78-879,034, FILED 5-8-2006.

GIANCARLO CASTRO, EXAMINING ATTORNEY

Int. Cls.: 3, 30, and 31

Prior U.S. Cls.: 1, 4, 6, 46, 50, 51, and 52

United States Patent and Trademark Office

Reg. No. 3,522,641

Registered Oct. 21, 2008

TRADEMARK
PRINCIPAL REGISTER



ASHLEY
LAVENDER
E S T A T E

A & K RANCHES (OREGON PARTNERSHIP),
DBA ASHLEY LAVENDER ESTATE,
3633 WASHINGTON STREET
SAN FRANCISCO, CA 94118

FOR: AROMATHERAPY CREAMS; AROMATHERAPY LOTIONS; AROMATHERAPY OILS; ESSENTIAL OILS; FACE AND BODY LOTIONS; HAND LOTIONS; LAVENDER OIL; LIP BALM; PERFUMED SOAPS; POTPOURRI; SCENTED LINEN SPRAYS; SCENTED LINEN WATER; SHOWER AND BATH GEL; SOAPS FOR PERSONAL USE; SUN SCREEN, IN CLASS 3 (U.S. CLS. 1, 4, 6, 50, 51 AND 52).

FIRST USE 5-30-2007; IN COMMERCE 5-30-2007.

FOR: HONEY, IN CLASS 30 (U.S. CL. 46).

FIRST USE 6-15-2008; IN COMMERCE 6-15-2008.

FOR: DRIED PLANTS; LIVING PLANTS, IN CLASS 31 (U.S. CLS. 1 AND 46).

FIRST USE 7-27-2007; IN COMMERCE 7-27-2007.

NO CLAIM IS MADE TO THE EXCLUSIVE RIGHT TO USE "LAVENDER ESTATE", APART FROM THE MARK AS SHOWN.

SN 78-879,523, FILED 5-9-2006.

JENNY PARK, EXAMINING ATTORNEY

Int. Cls.: 16 and 25

Prior U.S. Cls.: 2, 5, 22, 23, 29, 37, 38, 39, and 50

United States Patent and Trademark Office

Reg. No. 3,522,642

Registered Oct. 21, 2008

**TRADEMARK
PRINCIPAL REGISTER**

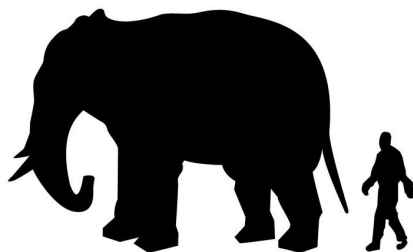

DANG, SHIN REN J. (UNITED STATES INDIVIDUAL)
12135 MISSION RIDGE WAY
GRANADA HILLS, CA 91344

FOR: STATIONERY, OFFICE PAPER STATIONERY, ENVELOPES FOR STATIONERY USE, FILE POCKETS FOR STATIONERY USE, PAPER STATIONERY, STATIONERY, STATIONERY BOXES, STATIONERY FOLDERS, STICKERS, STATIONERY WRITING PAPER AND ENVELOPES, IN CLASS 16 (U.S. CLS. 2, 5, 22, 23, 29, 37, 38 AND 50).

FIRST USE 2-1-2005; IN COMMERCE 4-15-2006.

FOR: POLO SHIRTS, SHORT SLEEVED T-SHIRTS, LONG SLEEVED T-SHIRTS, SPORT SHIRTS IN BOTH SHORT AND LONG SLEEVES, SWEAT-

SHIRTS, T-SHIRTS, BOWTIES, TIES, LADIES UNDERWEAR, WOMEN'S UNDERWEAR, BOXER BRIEFS, BOXER SHORTS, IN CLASS 25 (U.S. CLS. 22 AND 39).

FIRST USE 8-1-2006; IN COMMERCE 8-1-2006.

THE MARK CONSISTS OF A SILHOUETTED ELEPHANT FOLLOWED BY A SILHOUETTED MAN. THE MAN FALLS BEHIND THE ELEPHANT AND BOTH ELEMENTS WALK FACING TO THE LEFT (IF LOOKING AT THE MARK HEAD ON).

SN 78-882,092, FILED 5-12-2006.

CURTIS FRENCH, EXAMINING ATTORNEY

Int. Cl.: 10

Prior U.S. Cls.: 26, 39, and 44

United States Patent and Trademark Office

Reg. No. 3,522,643

Registered Oct. 21, 2008

**TRADEMARK
PRINCIPAL REGISTER**

ESVS

KIPS BAY MEDICAL, INC. (DELAWARE COR-
PORATION)
3405 ANNAPOLIS LANE
SUITE 200
MINNEAPOLIS, MN 55447

THE MARK CONSISTS OF STANDARD CHAR-
ACTERS WITHOUT CLAIM TO ANY PARTICULAR
FONT, STYLE, SIZE, OR COLOR.

FOR: SYNTHETIC STENT GRAFTS, IN CLASS 10
(U.S. CLS. 26, 39 AND 44).

SN 78-883,502, FILED 5-15-2006.

FIRST USE 8-15-2008; IN COMMERCE 8-15-2008.

ROBIN CHOSID, EXAMINING ATTORNEY

Int. Cl.: 21

Prior U.S. Cls.: 2, 13, 23, 29, 30, 33, 40, and 50

Reg. No. 3,522,644

United States Patent and Trademark Office

Registered Oct. 21, 2008

**TRADEMARK
PRINCIPAL REGISTER**

PET PLANT

KASATSHKO, VICTOR (UNITED STATES INDIVIDUAL)
40347 U.S. HIGHWAY 19 N., SUITE 222
TARPON SPRINGS, FL 34689

FOR: LIVE PLANTS SOLD AS A COMPONENT PART OF A MINIATURE TERRARIUM FOR PLANTS, IN CLASS 21 (U.S. CLS. 2, 13, 23, 29, 30, 33, 40 AND 50).

FIRST USE 8-22-2008; IN COMMERCE 8-22-2008.

THE MARK CONSISTS OF STANDARD CHARACTERS WITHOUT CLAIM TO ANY PARTICULAR FONT, STYLE, SIZE, OR COLOR.

NO CLAIM IS MADE TO THE EXCLUSIVE RIGHT TO USE "PLANT", APART FROM THE MARK AS SHOWN.

SN 78-883,935, FILED 5-15-2006.

LINDA LAVACHE, EXAMINING ATTORNEY

Int. Cls.: 9 and 28

Prior U.S. Cls.: 21, 22, 23, 26, 36, 38, and 50

United States Patent and Trademark Office

Reg. No. 3,522,645

Registered Oct. 21, 2008

**TRADEMARK
PRINCIPAL REGISTER**

F4F WILDCAT

NORTHROP GRUMMAN CORPORATION (DE-
LAWARE CORPORATION)
1840 CENTURY PARK EAST
LOS ANGELES, CA 90067

FOR: VIDEO GAMES FOR USE WITH TELEVI-
SIONS, IN CLASS 9 (U.S. CLS. 21, 23, 26, 36 AND 38).

FIRST USE 10-1-1988; IN COMMERCE 10-1-1988.

FOR: TOY AIRPLANES; SCALE MODEL AIR-
PLANES; ARCADE GAMES; AND STAND ALONE
VIDEO GAME MACHINES, IN CLASS 28 (U.S. CLS.
22, 23, 38 AND 50).

FIRST USE 10-1-1988; IN COMMERCE 10-1-1988.

THE MARK CONSISTS OF STANDARD CHAR-
ACTERS WITHOUT CLAIM TO ANY PARTICULAR
FONT, STYLE, SIZE, OR COLOR.

NO CLAIM IS MADE TO THE EXCLUSIVE
RIGHT TO USE "F4F", APART FROM THE MARK
AS SHOWN.

SN 78-884,021, FILED 5-15-2006.

SALLY SHIH, EXAMINING ATTORNEY

Int. Cl.: 29

Prior U.S. Cl.: 46

United States Patent and Trademark Office

Reg. No. 3,522,646

Registered Oct. 21, 2008

**TRADEMARK
PRINCIPAL REGISTER**

FAST CAR NUGGETS

ACA CO-OPERATIVE LIMITED (CANADA COR-
PORATION)

11 CALKIN DRIVE, UNIT 1

KENTVILLE, NOVA SCOTIA, CANADA B4N 3V7

FOR: CHICKEN NUGGETS, IN CLASS 29 (U.S. CL.
46).

FIRST USE 9-0-2006; IN COMMERCE 10-10-2006.

THE MARK CONSISTS OF STANDARD CHAR-
ACTERS WITHOUT CLAIM TO ANY PARTICULAR
FONT, STYLE, SIZE, OR COLOR.

NO CLAIM IS MADE TO THE EXCLUSIVE
RIGHT TO USE "NUGGETS", APART FROM THE
MARK AS SHOWN.

SN 78-884,738, FILED 5-16-2006.

MARK T. MULLEN, EXAMINING ATTORNEY

Int. Cls.: 6 and 7

**Prior U.S. Cls.: 2, 12, 13, 14, 19, 21, 23, 25, 31, 34, 35,
and 50**

Reg. No. 3,522,647

United States Patent and Trademark Office

Registered Oct. 21, 2008

**TRADEMARK
PRINCIPAL REGISTER**

QUADX

SONNY'S ENTERPRISES, INC. (DELAWARE
CORPORATION)
5605 HIATUS ROAD
TAMARAC, FL 33321

FOR: ALUMINUM TUBING; AND METAL TUB-
ING, IN CLASS 6 (U.S. CLS. 2, 12, 13, 14, 23, 25 AND
50).

FIRST USE 3-7-2006; IN COMMERCE 3-7-2006.

FOR: MACHINE FRAMES FOR CARWASH MA-
CHINES; AND CARWASH MACHINES CONTAIN-

ING METAL TUBING OR ALUMINUM TUBING, IN
CLASS 7 (U.S. CLS. 13, 19, 21, 23, 31, 34 AND 35).

FIRST USE 3-7-2006; IN COMMERCE 3-7-2006.

THE MARK CONSISTS OF STANDARD CHAR-
ACTERS WITHOUT CLAIM TO ANY PARTICULAR
FONT, STYLE, SIZE, OR COLOR.

SN 78-885,747, FILED 5-17-2006.

DORITT L. CARROLL, EXAMINING ATTORNEY

Int. Cl.: 3

Prior U.S. Cls.: 1, 4, 6, 50, 51, and 52

United States Patent and Trademark Office

Reg. No. 3,522,648

Registered Oct. 21, 2008

**TRADEMARK
PRINCIPAL REGISTER**

HEALTHY SKIN GLOW SHEERS

NEUTROGENA CORPORATION (DELAWARE
CORPORATION)
5760 WEST 96TH STREET
LOS ANGELES, CA 90045

FOR: COSMETICS AND MAKEUP; SKIN CARE
PRODUCTS FOR THE FACE, BODY, HANDS AND
FEET; NAMELY, NON-MEDICATED SKIN CARE
PREPARATIONS; COSMETIC SUNLESS TANNING
PREPARATIONS AND SUN PROTECTION PRO-
DUCTS, NAMELY, COSMETIC SUN-PROTECTING
PREPARATIONS, IN CLASS 3 (U.S. CLS. 1, 4, 6, 50, 51
AND 52).

FIRST USE 12-28-2006; IN COMMERCE 12-28-2006.

THE MARK CONSISTS OF STANDARD CHAR-
ACTERS WITHOUT CLAIM TO ANY PARTICULAR
FONT, STYLE, SIZE, OR COLOR.

OWNER OF U.S. REG. NOS. 1,974,300, 2,302,969,
AND 2,952,695.

NO CLAIM IS MADE TO THE EXCLUSIVE
RIGHT TO USE "HEALTHY SKIN" AND "SHEERS",
APART FROM THE MARK AS SHOWN.

SN 78-886,583, FILED 5-18-2006.

RUDY R. SINGLETON, EXAMINING ATTORNEY

Int. Cls.: 6 and 20

Prior U.S. Cls.: 2, 12, 13, 14, 22, 23, 25, 32, and 50

United States Patent and Trademark Office

Reg. No. 3,522,649

Registered Oct. 21, 2008

**TRADEMARK
PRINCIPAL REGISTER**

Everbilt

HOMER TLC, INC. (DELAWARE CORPORATION)
1404 SOCIETY DRIVE
CLAYMONT, DE 19703

FOR: METAL HOOKS, IN CLASS 6 (U.S. CLS. 2, 12, 13, 14, 23, 25 AND 50).

FIRST USE 12-31-2006; IN COMMERCE 12-31-2006.

FOR: NON-METAL HOOKS , IN CLASS 20 (U.S. CLS. 2, 13, 22, 25, 32 AND 50).

FIRST USE 12-31-2006; IN COMMERCE 12-31-2006.

THE MARK CONSISTS OF STANDARD CHARACTERS WITHOUT CLAIM TO ANY PARTICULAR FONT, STYLE, SIZE, OR COLOR.

SN 78-886,709, FILED 5-18-2006.

MICHAEL TANNER, EXAMINING ATTORNEY

Int. Cls.: 9, 16, and 41

**Prior U.S. Cls.: 2, 5, 21, 22, 23, 26, 29, 36, 37, 38, 50,
100, 101, and 107**

Reg. No. 3,522,650

United States Patent and Trademark Office

Registered Oct. 21, 2008

**TRADEMARK
SERVICE MARK
PRINCIPAL REGISTER**



COASTAL TRAINING TECHNOLOGIES CORP
(VIRGINIA CORPORATION)
500 STUDIO DRIVE
VIRGINIA BEACH, VA 23452 AND
GELLER, E. SCOTT (UNITED STATES INDIVIDUAL)
P.O. BOX 73
161 MAKE-A-DIFF DRIVE
NEWPORT, VA 24128

FOR: PRE-RECORDED VIDEOTAPES AND DIGITAL VIDEO DISKS AND PRINTED INSTRUCTIONAL MANUALS, SOLD AS A UNIT, CONTAINING WORKPLACE TRAINING TO PREVENT MEDICAL ERRORS AND PATIENT HARM IN THE HEALTHCARE SETTING, IN CLASS 9 (U.S. CLS. 21, 23, 26, 36 AND 38).

FIRST USE 12-31-2005; IN COMMERCE 12-31-2005.

FOR: PRINTED INSTRUCTIONAL MANUALS CONTAINING WORKPLACE TRAINING TO PREVENT MEDICAL ERRORS AND PATIENT HARM

IN THE HEALTHCARE SETTING, IN CLASS 16 (U.S. CLS. 2, 5, 22, 23, 29, 37, 38 AND 50).

FIRST USE 12-31-2005; IN COMMERCE 12-31-2005.

FOR: EDUCATIONAL LECTURES IN THE FIELD OF WORKPLACE TRAINING TO PREVENT MEDICAL ERRORS AND PATIENT HARM IN THE HEALTHCARE SETTING, IN CLASS 41 (U.S. CLS. 100, 101 AND 107).

FIRST USE 11-10-2005; IN COMMERCE 11-10-2005.

OWNER OF U.S. REG. NO. 3,265,735.

NO CLAIM IS MADE TO THE EXCLUSIVE RIGHT TO USE "PATIENT SAFETY", APART FROM THE MARK AS SHOWN.

SN 78-887,008, FILED 5-18-2006.

MARY CRAWFORD, EXAMINING ATTORNEY

Int. Cls.: 9, 14, 16, 25, and 41

Prior U.S. Cls.: 2, 5, 21, 22, 23, 26, 27, 28, 29, 36, 37, 38, 39, 50, 100, 101, and 107

Reg. No. 3,522,651

United States Patent and Trademark Office

Registered Oct. 21, 2008

**TRADEMARK
SERVICE MARK
PRINCIPAL REGISTER**



K.K. SHOGAKUKAN PRODUCTION (JAPAN CORPORATION)
CHIYODA-KU
SHOWA BUILDING 6F 2-30 KANDA JINBOCHO
TOKYO, JAPAN 101-8415

FOR: PRE-RECORDED TELEVISION PROGRAMS FEATURING ANIMATED PERFORMANCES RECORDED ON VIDEO AND AUDIO DISCS, CD ROMS, COMPACT DISCS, AND DVDS, IN CLASS 9 (U.S. CLS. 21, 23, 26, 36 AND 38).

FIRST USE 4-24-2007; IN COMMERCE 4-24-2007.

FOR: JEWELRY, IN CLASS 14 (U.S. CLS. 2, 27, 28 AND 50).

FIRST USE 9-30-2007; IN COMMERCE 9-30-2007.

FOR: PUBLICATIONS, NAMELY, GRAPHIC NOVELS, FICTION BOOKS, COMIC BOOKS; POSTERS, IN CLASS 16 (U.S. CLS. 2, 5, 22, 23, 29, 37, 38 AND 50).

FIRST USE 4-1-2005; IN COMMERCE 4-1-2005.

FOR: MEN'S, WOMEN'S, AND CHILDREN'S CLOTHING, NAMELY, SHIRTS AND T-SHIRTS, IN CLASS 25 (U.S. CLS. 22 AND 39).

FIRST USE 3-1-2007; IN COMMERCE 3-1-2007.

FOR: ENTERTAINMENT SERVICES, NAMELY, PRODUCTION AND DISTRIBUTION OF TELEVI-

SION PROGRAMS IN THE FIELDS OF ANIMATED ENTERTAINMENT; ENTERTAINMENT SERVICES, NAMELY, DISTRIBUTION OF ANIMATED AUDIO-VISUAL WORKS VIA THE INTERNET AND TELEVISION; PROVIDING INFORMATION ONLINE REGARDING ANIMATED ENTERTAINMENT, AND COMICS, IN CLASS 41 (U.S. CLS. 100, 101 AND 107).

FIRST USE 7-14-2006; IN COMMERCE 7-14-2006.

THE STIPLING IS FOR SHADING PURPOSES ONLY.

THE MARK CONSISTS OF STYLIZED WORDING "MÄR" WHERE THE "Ä" IS A LARGER ELEMENT AND "MÄRCHEN AWAKENS ROMANCE" IS IN SMALLER BLOCK LETTERS BELOW THE STYLIZED WORDING AND RIGHT JUSTIFIED.

THE ENGLISH TRANSLATION OF THE GERMAN WORD MARCHEN IN THE MARK IS "FAIRY TALE".

THE NON-LATIN CHARACTERS IN THE MARK transliterate to "MERU-HEN" AND MEAN "FAIRY TALE" IN ENGLISH.

SN 78-888,085, FILED 5-19-2006.

DANIEL BRODY, EXAMINING ATTORNEY

Int. Cl.: 44

Prior U.S. Cls.: 100 and 101

United States Patent and Trademark Office

Reg. No. 3,522,652

Registered Oct. 21, 2008

**SERVICE MARK
PRINCIPAL REGISTER**

**ABRAXIS ONCOLOGY RESOURCE
CENTER**

ABRAXIS BIOSCIENCE, LLC (DELAWARE LIMITED LIABILITY COMPANY)

11755 WILSHIRE BLVD.

20TH FLOOR

LOS ANGELES, CA 90025

FOR: MEDICAL INFORMATION AND MEDICAL CONSULTATION IN THE FIELD OF PHARMACEUTICALS FOR THE TREATMENT OF CANCER, IN CLASS 44 (U.S. CLS. 100 AND 101).

FIRST USE 8-28-2008; IN COMMERCE 8-28-2008.

THE MARK CONSISTS OF STANDARD CHARACTERS WITHOUT CLAIM TO ANY PARTICULAR FONT, STYLE, SIZE, OR COLOR.

OWNER OF U.S. REG. NOS. 3,077,449 AND 3,088,534.

NO CLAIM IS MADE TO THE EXCLUSIVE RIGHT TO USE "ONCOLOGY RESOURCE CENTER", APART FROM THE MARK AS SHOWN.

SN 78-888,954, FILED 5-22-2006.

PAUL F. GAST, EXAMINING ATTORNEY

Int. Cl.: 36

Prior U.S. Cls.: 100, 101, and 102

United States Patent and Trademark Office

Reg. No. 3,522,653

Registered Oct. 21, 2008

**SERVICE MARK
PRINCIPAL REGISTER**

**SUN PRIME SURVIVORSHIP
UNIVERSAL LIFE**

SUN LIFE ASSURANCE COMPANY OF CANADA (CANADA CORPORATION)
150 KING STREET WEST, SUITE 1400
TORONTO, ONTARIO, CANADA M5H 1J9

FOR: FINANCIAL SERVICES, NAMELY, UNDERWRITING, ISSUING AND ADMINISTRATION OF LIFE INSURANCE, IN CLASS 36 (U.S. CLS. 100, 101 AND 102).

FIRST USE 6-0-2007; IN COMMERCE 6-0-2007.

THE MARK CONSISTS OF STANDARD CHARACTERS WITHOUT CLAIM TO ANY PARTICULAR FONT, STYLE, SIZE, OR COLOR.

NO CLAIM IS MADE TO THE EXCLUSIVE RIGHT TO USE "SURVIVORSHIP UNIVERSAL LIFE", APART FROM THE MARK AS SHOWN.

SN 78-889,028, FILED 5-22-2006.

KIMBERLY PERRY, EXAMINING ATTORNEY

Int. Cl.: 28

Prior U.S. Cls.: 22, 23, 38, and 50

United States Patent and Trademark Office

Reg. No. 3,522,654

Registered Oct. 21, 2008

**TRADEMARK
PRINCIPAL REGISTER**

STAR TRAC INSTINCT

UNISEN, INC. (CALIFORNIA CORPORATION)
14410 MYFORD ROAD
IRVINE, CA 92606

FOR: EXERCISE MACHINES AND EQUIPMENT,
NAMELY, SINGLE AND DUAL FUNCTION EXER-
CISE STATIONS WITH WEIGHTLIFTING BENCHES
AND RACKS FOR CARDIOVASCULAR, CIRCUIT,
OR STRENGTH TRAINING , IN CLASS 28 (U.S. CLS.
22, 23, 38 AND 50).

FIRST USE 5-0-2006; IN COMMERCE 5-0-2006.

THE MARK CONSISTS OF STANDARD CHAR-
ACTERS WITHOUT CLAIM TO ANY PARTICULAR
FONT, STYLE, SIZE, OR COLOR.

OWNER OF U.S. REG. NOS. 1,618,917, 2,409,352,
AND 2,848,300.

SN 78-890,459, FILED 5-23-2006.

AMY MCMENAMIN, EXAMINING ATTORNEY

Int. Cl.: 35

Prior U.S. Cls.: 100, 101, and 102

United States Patent and Trademark Office

Reg. No. 3,522,655

Registered Oct. 21, 2008

**SERVICE MARK
PRINCIPAL REGISTER**

Forecast-ability

JOHN GALT DEVELOPMENT, INC. (ILLINOIS
CORPORATION)
SUITE 1950
125 SOUTH CLARK STREET
CHICAGO, IL 60603

THE MARK CONSISTS OF STANDARD CHAR-
ACTERS WITHOUT CLAIM TO ANY PARTICULAR
FONT, STYLE, SIZE, OR COLOR.

FOR: BUSINESS CONSULTATION IN THE FIELD
OF ENTERPRISE PLANNING FOR SOFTWARE
CLIENTS, IN CLASS 35 (U.S. CLS. 100, 101 AND 102).

SN 78-891,316, FILED 5-24-2006.

FIRST USE 10-20-2002; IN COMMERCE 10-20-2002.

DOMINIC FATHY, EXAMINING ATTORNEY

Int. Cl.: 9

Prior U.S. Cls.: 21, 23, 26, 36, and 38

Reg. No. 3,522,656

United States Patent and Trademark Office

Registered Oct. 21, 2008

**TRADEMARK
PRINCIPAL REGISTER**



WIZARD PRODUCTIVITY SYSTEMS, L.P.
(TEXAS LIMITED PARTNERSHIP)
2083 HUNTERS CREST WAY
VIENNA, VA 22181

DATABASE MANAGEMENT, AND NOT FOR USE
IN THE ADMINISTRATION OF LANS, IN CLASS 9
(U.S. CLS. 21, 23, 26, 36 AND 38).

FIRST USE 4-0-2006; IN COMMERCE 4-0-2006.

FOR: COMPUTER SOFTWARE FOR USE BY
DATABASE ADMINSTRATORS TO AUTOMATE
THE SET-UP AND CONFIGURATION OF DATA-
BASES AND CONVERSION OF DATA WITHIN
THOSE DATABASES, AND TO PROVIDE CONFIG-
URATION AUDIT TRAILS FOR SOFTWARE UTI-
LIZING DATABASES, ALL FOR USE IN THE FIELD
OF ADMINISTERING AND IMPLEMENTING EN-
TERPRISE WIDE SOFTWARE APPLICATIONS FOR

NO CLAIM IS MADE TO THE EXCLUSIVE
RIGHT TO USE "PRODUCTIVITY SUITE", APART
FROM THE MARK AS SHOWN.

SN 78-893,922, FILED 5-26-2006.

ELISSA GARBER KON, EXAMINING ATTORNEY

Int. Cl.: 9

Prior U.S. Cls.: 21, 23, 26, 36, and 38

United States Patent and Trademark Office

Reg. No. 3,522,657

Registered Oct. 21, 2008

**TRADEMARK
PRINCIPAL REGISTER**

PicoSensor

BOSTON MICROSYSTEMS, INC (DELAWARE CORPORATION)
30-H SIXTH AVENUE
WOBURN, MA 01801

FIRST USE 10-15-2007; IN COMMERCE 10-15-2007.

FOR: ELECTRONIC DETECTION INSTRUMENTS FOR DETECTING, ANALYZING, AND MEASURING CHEMICAL, BIOLOGICAL, AND RADIOLOGICAL SUBSTANCES IN GASEOUS, VAPOR, FLUID, AND PARTICLE FORM, AS WELL AS AIR TEMPERATURE AND PRESSURE AND FLUID VISCOSITY AND DENSITY, IN CLASS 9 (U.S. CLS. 21, 23, 26, 36 AND 38).

THE MARK CONSISTS OF STANDARD CHARACTERS WITHOUT CLAIM TO ANY PARTICULAR FONT, STYLE, SIZE, OR COLOR.

SN 78-894,028, FILED 5-26-2006.

WANDA KAY PRICE, EXAMINING ATTORNEY

Int. Cl.: 9

Prior U.S. Cls.: 21, 23, 26, 36, and 38

Reg. No. 3,522,658

United States Patent and Trademark Office

Registered Oct. 21, 2008

**TRADEMARK
PRINCIPAL REGISTER**

DrivTrac

ROCK ENTERPRISES, INC. (CALIFORNIA CORPORATION)
1250 E. 223RD ST., SUITE 104
CARSON, CA 90745

FOR: ELECTRICAL CONTROLLING DEVICES; ENGINE CUT-OUT DEVICES; SATELLITE NAVIGATIONAL SYSTEM, NAMELY, A GLOBAL POSITIONING SYSTEM (GPS); SECURITY LIGHTING SYSTEM FOR VEHICLES USING RADIO FREQUENCY DEVICE; TELECOMMUNICATIONS AND DATA NETWORKING HARDWARE, NAMELY, DEVICES FOR TRANSPORTING AND AGGREGATING VOICE, DATA, AND VIDEO COMMUNICATIONS ACROSS MULTIPLE NETWORK INFRASTRUCTURES AND COMMUNICATIONS PROTOCOLS; VEHICLE LOCATING, TRACKING AND SECURITY SYSTEM COMPRISED OF AN ANTENNA AND RADIO TRANSMITTER TO BE PLACED IN A VEHICLE; VEHICLE LOCATOR

AND RECOVERY DEVICE PROGRAMMED TO USE GLOBAL POSITIONING SYSTEMS (GPS) AND CELLULAR TELECOMMUNICATIONS; VEHICLE MOUNTED GPS SENSOR FOR DETERMINING THE RATE OF MOTION FOR A VEHICLE; WARNING DEVICES, NAMELY, BELLS; WIRELESS POS (POINT OF SERVICE) DEVICES, IN CLASS 9 (U.S. CLS. 21, 23, 26, 36 AND 38).

FIRST USE 7-19-2006; IN COMMERCE 5-30-2006.

THE MARK CONSISTS OF STANDARD CHARACTERS WITHOUT CLAIM TO ANY PARTICULAR FONT, STYLE, SIZE, OR COLOR.

SN 78-894,155, FILED 5-26-2006.

GIANCARLO CASTRO, EXAMINING ATTORNEY

Int. Cls.: 1, 3, 5, and 40

**Prior U.S. Cls.: 1, 4, 5, 6, 10, 18, 26, 44, 46, 50, 51, 52,
100, 103, and 106**

Reg. No. 3,522,659

United States Patent and Trademark Office

Registered Oct. 21, 2008

**TRADEMARK
SERVICE MARK
PRINCIPAL REGISTER**



Bionetix

BIONETIX INTERNATIONAL CORP. (CANADA CORPORATION)
2286 CHEMIN SAINT FRANCOIS
DORVAL, QUEBEC, CANADA H9P 1K9

FOR: PREPARATIONS COMPOSED OF BACTERIA AND ENZYMES USED FOR BIOREMEDIATION OF CONTAMINATED SOILS; BIO-AUGMENTATION PRODUCTS FOR MUNICIPAL AND INDUSTRIAL WASTE WATER TREATMENT PLANTS, NAMELY, BACTERIA AND ENZYMES FOR WASTE WATER TREATMENT, IN CLASS 1 (U.S. CLS. 1, 5, 6, 10, 26 AND 46).

FIRST USE 10-14-2005; IN COMMERCE 10-14-2005.

FOR: BIOLOGICAL CLEANING PRODUCTS FOR HARD SURFACES, NAMELY, SOAP DETERGENTS FOR INDUSTRIAL CONCRETE FLOORS, IN CLASS 3 (U.S. CLS. 1, 4, 6, 50, 51 AND 52).

FIRST USE 10-14-2005; IN COMMERCE 10-14-2005.

FOR: ODOR CONTROL PRODUCTS, NAMELY, ODOR NEUTRALIZING PREPARATIONS FOR USE ON CARPETS, TEXTILES, AND GARBAGE CANS; ODOR NEUTRALIZING PREPARATIONS FOR

DEODORIZING THE AIR AT MUNICIPAL WASTE WATER TREATMENT FACILITIES AND HOG AND POULTRY PROCESSING OPERATIONS, IN CLASS 5 (U.S. CLS. 6, 18, 44, 46, 51 AND 52).

FIRST USE 5-30-2007; IN COMMERCE 5-30-2007.

FOR: MANUFACTURE OF ENVIRONMENTAL PRODUCTS IN THE NATURE OF PREPARATIONS COMPOSED OF BACTERIA AND ENZYMES USED FOR BIOREMEDIATION OF CONTAMINATED SOILS, BACTERIA AND ENZYMES USED FOR WASTE WATER TREATMENT, BIOLOGICAL CLEANING PRODUCTS FOR HARD SURFACES, ODOR CONTROL PRODUCTS, BIOLOGICAL PRODUCTS USED IN AGRICULTURE, NATURAL SOIL STIMULANTS AND SOIL AMENDMENTS, TO THE ORDER AND/OR SPECIFICATION OF OTHERS, IN CLASS 40 (U.S. CLS. 100, 103 AND 106).

FIRST USE 10-14-2005; IN COMMERCE 10-14-2005.

SN 78-897,379, FILED 5-31-2006.

ROBERT LAVACHE, EXAMINING ATTORNEY

Int. Cl.: 25

Prior U.S. Cls.: 22 and 39

United States Patent and Trademark Office

Reg. No. 3,522,660

Registered Oct. 21, 2008

TRADEMARK
PRINCIPAL REGISTER



JACQUES, JENNIFER L. (ARIZONA PARTNER-
SHIP)

208 E. BETH DRIVE
PHOENIX, AZ 85042 AND

JACQUES, DANIELLE C. (ARIZONA PARTNER-
SHIP)

22619 N. 54TH PLACE
PHOENIX, AZ 85054

FOR: WOMEN'S UNDERWEAR AND TANK
TOPS, IN CLASS 25 (U.S. CLS. 22 AND 39).

FIRST USE 5-1-2007; IN COMMERCE 8-1-2007.

THE COLOR(S) PINK, BLACK, BLUE AND
WHITE IS/ARE CLAIMED AS A FEATURE OF
THE MARK.

THE COLORS PINK AND BLACK APPEAR IN
THE WORDING "SNATCHIES" AND IN THE CAT
FACE ILLUSTRATION; THE COLOR BLUE AP-
PEARS IN THE CAT'S EYES; THE COLOR WHITE
APPEARS IN THE BACKGROUND.

SN 78-897,448, FILED 5-31-2006.

JORDAN BAKER, EXAMINING ATTORNEY

Int. Cl.: 38

Prior U.S. Cls.: 100, 101, and 104

United States Patent and Trademark Office

Reg. No. 3,522,661

Registered Oct. 21, 2008

**SERVICE MARK
PRINCIPAL REGISTER**

WHO'S IN YOUR FAVE 5?

T-MOBILE USA, INC. (DELAWARE CORPORATION)
12920 S.E. 38TH STREET
BELLEVUE, WA 98006

FOR: TELECOMMUNICATIONS SERVICES, NAMELY, WIRELESS VOICE AND DATA TRANSMISSION, TWO WAY WIRELESS TRANSMISSION OF EMAIL AND TEXT BETWEEN WIRELESS TELECOMMUNICATIONS TERMINALS AND COMPUTERS, AND PROVIDING MULTIPLE-USER ACCESS TO A GLOBAL COMPUTER NETWORK, IN CLASS 38 (U.S. CLS. 100, 101 AND 104).

FIRST USE 10-2-2006; IN COMMERCE 10-2-2006.

THE MARK CONSISTS OF STANDARD CHARACTERS WITHOUT CLAIM TO ANY PARTICULAR FONT, STYLE, SIZE, OR COLOR.

SN 78-898,022, FILED 6-1-2006.

BARBARA RUTLAND, EXAMINING ATTORNEY

Int. Cl.: 25

Prior U.S. Cls.: 22 and 39

United States Patent and Trademark Office

Reg. No. 3,522,662

Registered Oct. 21, 2008

**TRADEMARK
PRINCIPAL REGISTER**

WCT WORK COMFORT TECHNOLOGY

DAN POST BOOT COMPANY (TENNESSEE CORPORATION)
C/O MCRAE INDUSTRIES
400 N. MAIN STREET
MT. GILEAD, NC 27306

FOR: AN INSOLE AND OUTSOLE COMBINATION FOR BOOTS, IN CLASS 25 (U.S. CLS. 22 AND 39).

FIRST USE 2-0-2007; IN COMMERCE 2-0-2007.

THE MARK CONSISTS OF STANDARD CHARACTERS WITHOUT CLAIM TO ANY PARTICULAR FONT, STYLE, SIZE, OR COLOR.

NO CLAIM IS MADE TO THE EXCLUSIVE RIGHT TO USE "TECHNOLOGY", APART FROM THE MARK AS SHOWN.

SN 78-898,026, FILED 6-1-2006.

LOURDES AYALA, EXAMINING ATTORNEY

Int. Cl.: 41

Prior U.S. Cls.: 100, 101, and 107

United States Patent and Trademark Office

Reg. No. 3,522,663

Registered Oct. 21, 2008

**SERVICE MARK
PRINCIPAL REGISTER**

PROTECT ME IF YOU CAN

PATIRE, THOMAS (UNITED STATES INDIVIDUAL)
24 WAMPUM ROAD, UNIT A
PARK RIDGE, NJ 07656

FOR: ENTERTAINMENT SERVICES IN THE NATURE OF AN ONGOING TELEVISION SERIES IN THE FIELD OF REALITY TELEVISION, IN CLASS 41 (U.S. CLS. 100, 101 AND 107).

FIRST USE 2-1-2008; IN COMMERCE 2-1-2008.

THE MARK CONSISTS OF STANDARD CHARACTERS WITHOUT CLAIM TO ANY PARTICULAR FONT, STYLE, SIZE, OR COLOR.

SN 78-899,284, FILED 6-2-2006.

ELLEN PERKINS, EXAMINING ATTORNEY

Int. Cl.: 9

Prior U.S. Cls.: 21, 23, 26, 36, and 38

United States Patent and Trademark Office

Reg. No. 3,522,664

Registered Oct. 21, 2008

**TRADEMARK
PRINCIPAL REGISTER**

SECUREBRANCH

NIPPON DENKI KABUSHIKI KAISHA D/B/A
NEC CORPORATION (JAPAN CORPORATION)
7-1, SHIBA 5 - CHOME, MINATO KU
TOKYO, JAPAN

FOR: COMPUTER SOFTWARE FOR OPERATING
PRIVATE COMPUTER NETWORKS; COMPUTER
HARDWARE AND COMPUTER SOFTWARE THAT
ALLOWS A USER TO REMOTELY ACCESS A
COMPUTER OR COMPUTER NETWORKS USING
A VARIETY OF ACCESS DEVICES; COMPUTER
SOFTWARE FOR SECURE ACCESS TO, FIREWALL
PROTECTION OF, AND DATA ENCRYPTION OF
COMMUNICATIONS OVER COMPUTER NET-

WORKS; VPN HARDWARE; VPN OPERATING
SOFTWARE, IN CLASS 9 (U.S. CLS. 21, 23, 26, 36
AND 38).

FIRST USE 6-12-2008; IN COMMERCE 6-12-2008.

THE MARK CONSISTS OF STANDARD CHAR-
ACTERS WITHOUT CLAIM TO ANY PARTICULAR
FONT, STYLE, SIZE, OR COLOR.

SN 78-900,304, FILED 6-5-2006.

AMY HELLA, EXAMINING ATTORNEY

Int. Cls.: 35 and 41

Prior U.S. Cls.: 100, 101, 102, and 107

United States Patent and Trademark Office

Reg. No. 3,522,665

Registered Oct. 21, 2008

**SERVICE MARK
PRINCIPAL REGISTER**

ISCe  Satellite Investment Symposium

HANNOVER FAIRS USA, INC. (NEW JERSEY CORPORATION)
212 CARNEGIE CENTER, SUITE 203
PRINCETON, NJ 08540

FOR: ORGANIZING AND CONDUCTING CONFERENCES IN THE FIELD OF SATELLITE FINANCE, IN CLASS 35 (U.S. CLS. 100, 101 AND 102).

FIRST USE 11-28-2006; IN COMMERCE 11-28-2006.

FOR: ORGANIZING AND CONDUCTING SYMPOSIUMS AND SEMINARS IN THE FIELD OF

SATELLITE FINANCE, IN CLASS 41 (U.S. CLS. 100, 101 AND 107).

FIRST USE 11-28-2006; IN COMMERCE 11-28-2006.

NO CLAIM IS MADE TO THE EXCLUSIVE RIGHT TO USE "SATELLITE INVESTMENT SYMPOSIUM", APART FROM THE MARK AS SHOWN.

SN 78-902,555, FILED 6-7-2006.

RONALD DELGIZZI, EXAMINING ATTORNEY

Int. Cl.: 28

Prior U.S. Cls.: 22, 23, 38, and 50

Reg. No. 3,522,666

United States Patent and Trademark Office

Registered Oct. 21, 2008

**TRADEMARK
PRINCIPAL REGISTER**

HUMANSPORT

UNISEN, INC. (CALIFORNIA CORPORATION)
14410 MYFORD ROAD
IRVINE, CA 92606

FIRST USE 3-0-2005; IN COMMERCE 3-0-2006.

FOR: EXERCISE MACHINES AND EQUIPMENT,
NAMELY, A DUAL FUNCTION CABLE BASED
SYSTEM USED FOR WEIGHTLIFTING,
STRENGTH AND RESISTANCE TRAINING, IN
CLASS 28 (U.S. CLS. 22, 23, 38 AND 50).

THE MARK CONSISTS OF STANDARD CHAR-
ACTERS WITHOUT CLAIM TO ANY PARTICULAR
FONT, STYLE, SIZE, OR COLOR.

SN 78-902,618, FILED 6-7-2006.

AMY MCMENAMIN, EXAMINING ATTORNEY

Int. Cl.: 41

Prior U.S. Cls.: 100, 101, and 107

United States Patent and Trademark Office

Reg. No. 3,522,667

Registered Oct. 21, 2008

**SERVICE MARK
PRINCIPAL REGISTER**

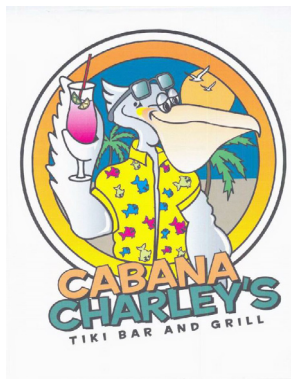

ALWAYS 5 O'CLOCK, INC. (ILLINOIS CORPORATION)
20 W 427 ELIZABETH DRIVE
DOWNERS GROVE, IL 60516

FOR: RESTAURANT AND BAR SERVICES, IN CLASS 41 (U.S. CLS. 100, 101 AND 107).

FIRST USE 0-0-2007; IN COMMERCE 0-0-2007.

NO CLAIM IS MADE TO THE EXCLUSIVE RIGHT TO USE "TIKI BAR AND GRILL", APART FROM THE MARK AS SHOWN.

THE COLOR(S) TAN, GREEN, YELLOW, GRAY, BLUE, PINK, BROWN, BEIGE, BLACK, ORANGE, AND WHITE IS/ARE CLAIMED AS A FEATURE OF THE MARK.

THE MARK CONSISTS OF THE COLOR GRAY REPRESENTS THE PELICAN, WHICH HAS A BEIGE

BEAK; THE PELICAN IS OUTLINED IN BLACK, HIGHLIGHTED IN WHITE, AND IS WEARING A YELLOW SHIRT WITH YELLOW, RED AND BLUE FISH ON IT; THE PELICAN IS WEARING BLUE AND GRAY SUNGLASSES ON ITS HEAD AND IS HOLDING A PINK DRINK; THE PELICAN IS IN FRONT OF A TAN SAND BEACH, GREEN PALM TREES, WITH BROWN TRUNKS, AND AN ORANGE SUN WITH WHITE BIRDS THAT ARE OUTLINED IN BLACK FLYING IN FRONT OF THE SUN OVER A BLUE SKY; THE ENTIRE DESIGN IS WITHIN A WHITE, ORANGE AND YELLOW CARRIER THAT IS OUTLINED WITH A THIN WHITE LINE AND BLACK OUTLINE; "CABANA" IS IN ORANGE WITH BLACK OUTLINING AND "CHARLEY'S" IS IN GREEN WITH BLACK OUTLINING; "TIKI BAR AND GRILL" IS IN BLACK.

SN 78-902,692, FILED 6-7-2006.

NAKIA HENRY, EXAMINING ATTORNEY

Int. Cls.: 5 and 10

Prior U.S. Cls.: 6, 18, 26, 39, 44, 46, 51, and 52

United States Patent and Trademark Office

Reg. No. 3,522,668

Registered Oct. 21, 2008

**TRADEMARK
PRINCIPAL REGISTER**

PROPATEN

W. L. GORE & ASSOCIATES, INC. (DELAWARE
CORPORATION)
555 PAPER MILL ROAD, P. O. BOX 9329
NEWARK, DE 19714

FOR: VASCULAR GRAFTS, IN CLASS 5 (U.S. CLS.
6, 18, 44, 46, 51 AND 52).

FIRST USE 5-1-2008; IN COMMERCE 5-1-2008.

FOR: SURGICAL IMPLANTS COMPRISING OF
ARTIFICIAL MATERIAL, IN CLASS 10 (U.S. CLS. 26,
39 AND 44).

FIRST USE 5-30-2008; IN COMMERCE 5-30-2008.

THE MARK CONSISTS OF STANDARD CHAR-
ACTERS WITHOUT CLAIM TO ANY PARTICULAR
FONT, STYLE, SIZE, OR COLOR.

SN 78-903,026, FILED 6-7-2006.

MARY MUNSON, EXAMINING ATTORNEY

Int. Cl.: 3

Prior U.S. Cls.: 1, 4, 6, 50, 51, and 52

Reg. No. 3,522,669

United States Patent and Trademark Office

Registered Oct. 21, 2008

**TRADEMARK
PRINCIPAL REGISTER**

BIO-SUN NETWORK

LANCOME PARFUMS ET BEAUTE & CIE
(FRANCE SOCIETE EN NOM COLLECTIF)
29, RUE DU FAUBOURG SAINT-HONORE
PARIS, FRANCE 75008

THE MARK CONSISTS OF STANDARD CHAR-
ACTERS WITHOUT CLAIM TO ANY PARTICULAR
FONT, STYLE, SIZE, OR COLOR.

FOR: SUN TANNING AND AFTER-SUN MILKS,
CREAMS, GELS AND OILS, IN CLASS 3 (U.S. CLS. 1,
4, 6, 50, 51 AND 52).

SN 78-905,078, FILED 6-9-2006.

FIRST USE 3-15-2008; IN COMMERCE 3-15-2008.

MATTHEW MCDOWELL, EXAMINING ATTOR-
NEY

Int. Cl.: 42

Prior U.S. Cls.: 100 and 101

United States Patent and Trademark Office

Reg. No. 3,522,670

Registered Oct. 21, 2008

**SERVICE MARK
PRINCIPAL REGISTER**

DENTIGRAM

PLANET DDS, INC. (DELAWARE CORPORATION)
2967 MICHELSON DR., SUITE G-115
IRVINE, CA 92612

THE MARK CONSISTS OF STANDARD CHARACTERS WITHOUT CLAIM TO ANY PARTICULAR FONT, STYLE, SIZE, OR COLOR.

FOR: APPLICATION SERVICE PROVIDER FEATURING SOFTWARE IN THE FIELD OF PROMOTION AND MARKETING OF DENTAL PRACTICES, IN CLASS 42 (U.S. CLS. 100 AND 101).

SN 78-905,569, FILED 6-12-2006.

FIRST USE 2-1-2005; IN COMMERCE 1-5-2006.

ROBERT C. CLARK JR., EXAMINING ATTORNEY

Int. Cl.: 42

Prior U.S. Cls.: 100 and 101

United States Patent and Trademark Office

Reg. No. 3,522,671

Registered Oct. 21, 2008

**SERVICE MARK
PRINCIPAL REGISTER**

DENTIGRAM.COM

PLANET DDS, INC. (DELAWARE CORPORATION)
2967 MICHELSON DR., SUITE G-115
IRVINE, CA 92612

FOR: APPLICATION SERVICE PROVIDER FEATURING SOFTWARE IN THE FIELD OF PROMOTION AND MARKETING OF DENTAL PRACTICES, IN CLASS 42 (U.S. CLS. 100 AND 101).

FIRST USE 2-1-2005; IN COMMERCE 1-5-2006.

THE MARK CONSISTS OF STANDARD CHARACTERS WITHOUT CLAIM TO ANY PARTICULAR FONT, STYLE, SIZE, OR COLOR.

SN 78-905,571, FILED 6-12-2006.

ROBERT C. CLARK JR., EXAMINING ATTORNEY

Int. Cl.: 35

Prior U.S. Cls.: 100, 101, and 102

United States Patent and Trademark Office

Reg. No. 3,522,672

Registered Oct. 21, 2008

**SERVICE MARK
PRINCIPAL REGISTER**

FARMER JONES

THE CHEF'S GARDEN, INC. (OHIO CORPORATION)
9009 HURON-AVERY ROAD
HURON, OH 44839

FOR: ON-LINE ORDERING SERVICES FEATURING FRESH VEGETABLES, PLANTS, HERBS AND EDIBLE FLOWERS; RETAIL SERVICES BY DIRECT SOLICITATION BY SALES AGENTS IN THE FIELD OF FRESH VEGETABLES, PLANTS, HERBS AND EDIBLE FLOWERS; EXCLUDING NUTS, IN CLASS 35 (U.S. CLS. 100, 101 AND 102).

FIRST USE 7-29-1981; IN COMMERCE 8-14-2008.

THE MARK CONSISTS OF STANDARD CHARACTERS WITHOUT CLAIM TO ANY PARTICULAR FONT, STYLE, SIZE, OR COLOR.

OWNER OF U.S. REG. NOS. 2,798,381 AND 3,042,576.

SN 78-906,600, FILED 6-13-2006.

JESSICA A. POWERS, EXAMINING ATTORNEY

Prior U.S. Cl.: 200

United States Patent and Trademark Office

Reg. No. 3,522,673

Registered Oct. 21, 2008

COLLECTIVE MEMBERSHIP
PRINCIPAL REGISTER

AMCA

THE ANTIQUE MOTORCYCLE CLUB OF AMERICA, INC. (FLORIDA CORPORATION)
225 E LEMON STREET SUITE 351
LAKELAND, FL 33801

FOR: INDICATING MEMBERSHIP IN A(N) ASSOCIATION OF INDIVIDUALS INTERESTED IN MOTORCYCLES, MOTORCYCLE SAFETY, MOTORCYCLE SHOWS AND SUBJECT MATTER DIRECT TO MOTORCYCLE ENTHUSIASTS, IN CLASS 200 (U.S. CL. 200).

FIRST USE 1-1-2008; IN COMMERCE 1-1-2008.

THE MARK CONSISTS OF STANDARD CHARACTERS WITHOUT CLAIM TO ANY PARTICULAR FONT, STYLE, SIZE, OR COLOR.

SN 78-906,732, FILED 6-13-2006.

ALICE BENMAMAN, EXAMINING ATTORNEY

Int. Cl.: 16

Prior U.S. Cls.: 2, 5, 22, 23, 29, 37, 38, and 50

Reg. No. 3,522,674

United States Patent and Trademark Office

Registered Oct. 21, 2008

**TRADEMARK
PRINCIPAL REGISTER**

SIMPLY COOKING

THE GLAD PRODUCTS COMPANY (DELA-
WARE CORPORATION)

1221 BROADWAY

OAKLAND, CA 94612

FOR: PLASTIC MICROWAVE STEAMING BAGS,
IN CLASS 16 (U.S. CLS. 2, 5, 22, 23, 29, 37, 38 AND 50).

FIRST USE 7-30-2007; IN COMMERCE 7-30-2007.

THE MARK CONSISTS OF STANDARD CHAR-
ACTERS WITHOUT CLAIM TO ANY PARTICULAR
FONT, STYLE, SIZE, OR COLOR.

NO CLAIM IS MADE TO THE EXCLUSIVE
RIGHT TO USE "COOKING", APART FROM THE
MARK AS SHOWN.

SN 78-907,439, FILED 6-13-2006.

STEVEN R. FOSTER, EXAMINING ATTORNEY

Int. Cl.: 9

Prior U.S. Cls.: 21, 23, 26, 36, and 38

United States Patent and Trademark Office

Reg. No. 3,522,675

Registered Oct. 21, 2008

**TRADEMARK
PRINCIPAL REGISTER**

BLESSINGS UNLIMITED

DAYSPRING CARDS, INC. (ILLINOIS CORPORATION)
21154 HIGHWAY 16 EAST
SILOAM SPRINGS, AR 72761

FOR: DECORATIVE MAGNETS, IN CLASS 9 (U.S. CLS. 21, 23, 26, 36 AND 38).

FIRST USE 8-31-2007; IN COMMERCE 8-31-2007.

THE MARK CONSISTS OF STANDARD CHARACTERS WITHOUT CLAIM TO ANY PARTICULAR FONT, STYLE, SIZE, OR COLOR.

OWNER OF U.S. REG. NO. 2,597,520.

SN 78-908,291, FILED 6-14-2006.

MICHAEL ENGEL, EXAMINING ATTORNEY

Int. Cls.: 14, 18, 25, and 26

Prior U.S. Cls.: 1, 2, 3, 22, 27, 28, 37, 39, 40, 41, 42, and 50

Reg. No. 3,522,676

United States Patent and Trademark Office

Registered Oct. 21, 2008

TRADEMARK
PRINCIPAL REGISTER

Scena D'uno

KURAUDIA CO., LTD (JAPAN CORPORATION)
22-1 MINAMI TAKADA-CHO SAIIN
UKYO-KU KYOTO-SHI, JAPAN 615-0041

FOR: JEWELRY, BRACELETS, BROOCHES, BUCKLES OF PRECIOUS METAL, CLOCKS AND WATCHES, CUFF LINKS, EARRINGS, HAT ORNAMENTS OF PRECIOUS METAL, JEWELRY CASES OF PRECIOUS METAL, JEWELRY BOXES OF PRECIOUS METAL, NECKLACES, PENDANTS, ORNAMENTAL PINS, PERSONAL ORNAMENTS OF PRECIOUS METAL, PEARLS, POWDER COMPACTS OF PRECIOUS METAL, PURSES OF PRECIOUS METAL, RINGS, SHOE ORNAMENTS OF PRECIOUS METAL, SILVER ORNAMENTS, TIE CLIPS, TIE PINS, TRINKETS, WATCH BANDS, MEDALLIONS, TIARAS, IN CLASS 14 (U.S. CLS. 2, 27, 28 AND 50).

FIRST USE 10-1-2001; IN COMMERCE 10-1-2001.

FOR: BAGS, POUCHES, HANDBAGS, ATTACHE CASES, BACKPACKS, BRIEFCASES, BUSINESS CARD CASES, NAME CARD CASES, GARMENT BAGS FOR TRAVEL, POCKET WALLETS, PURSES, NOT OF PRECIOUS METAL, SHOPPING BAGS MADE OF LEATHER OR TEXTILE, SUITCASES, TRAVELING BAGS, TRAVELING TRUNKS, VALISES, VANITY CASES SOLD EMPTY, HAT BOXES OF LEATHER, KEY CASES, PARASOLS, UMBRELLAS, CANES, IN CLASS 18 (U.S. CLS. 1, 2, 3, 22 AND 41).

FIRST USE 10-1-2001; IN COMMERCE 10-1-2001.

FOR: FORMAL CLOTHING, NAMELY, CUMMERBUNDS, TUXEDO SHIRTS, WEDDING DRESSES, TUXEDOS, GARTERS, SOCK SUSPENDERS, SUSPENDERS, BANDS, BELTS, FOOTWEAR, FANCY CLOTHES, NAMELY EVENING GOWNS, EVENING DRESSES, WOMEN'S CEREMONIAL DRESSES, DRESSES, SPECIALLY DESIGNED ATHLETIC CLOTHING, NAMELY, ATHLETIC UNIFORMS, SPECIALLY DESIGNED ATHLETIC FOOTWEAR, CAPS, HEADWEAR, SCARVES, SHAWLS, SUITS, SHIRTS, SKIRTS, SOCKS, CAMISOLES, CORSETS, PETTICOATS, MASQUERADE COSTUMES, VEILS, GLOVES, IN CLASS 25 (U.S. CLS. 22 AND 39).

FIRST USE 10-1-2001; IN COMMERCE 10-1-2001.

FOR: HAIR ORNAMENTS, BARRETTES, FALSE HAIR, ARTIFICIAL FLOWERS, ARTIFICIAL FLOWERS OF TEXTILE, ARTIFICIAL FLOWERS OF PAPER, CORSAGE, RIBBONS, HAIR RIBBONS, HAIR NETS, HAIR BANDS, HAIR PINS AND GRIPS, BROOCHES FOR CLOTHING, BUTTONS, SHOE ORNAMENTS NOT OF PRECIOUS METAL, HAT ORNAMENTS NOT OF PRECIOUS METAL, IN CLASS 26 (U.S. CLS. 37, 39, 40, 42 AND 50).

FIRST USE 10-1-2001; IN COMMERCE 10-1-2001.

THE FOREIGN WORDING IN THE MARK TRANSLATES INTO ENGLISH AS SCENE OF ONE.

SN 78-911,189, FILED 6-19-2006.

MICHAEL ENGEL, EX AMINING ATTORNEY

Int. Cl.: 35

Prior U.S. Cls.: 100, 101, and 102

United States Patent and Trademark Office

Reg. No. 3,522,677

Registered Oct. 21, 2008

**SERVICE MARK
PRINCIPAL REGISTER**

CULT WINE CENTRAL

NAPA WINE COMPANY, LLC (CALIFORNIA
LIMITED LIABILITY COMPANY)

7830 ST. HELENA HIGHWAY

OAKVILLE, CA 94562

FOR: RETAIL STORE SERVICES, AVAILABLE
THROUGH THE INTERNET, FEATURING WINE,
IN CLASS 35 (U.S. CLS. 100, 101 AND 102).

FIRST USE 9-30-2006; IN COMMERCE 9-30-2006.

THE MARK CONSISTS OF STANDARD CHAR-
ACTERS WITHOUT CLAIM TO ANY PARTICULAR
FONT, STYLE, SIZE, OR COLOR.

NO CLAIM IS MADE TO THE EXCLUSIVE
RIGHT TO USE "WINE", APART FROM THE MARK
AS SHOWN.

SN 78-911,279, FILED 6-19-2006.

JANICE L. MCMORROW, EXAMINING ATTOR-
NEY

Int. Cls.: 7, 12, and 37

**Prior U.S. Cls.: 13, 19, 21, 23, 31, 34, 35, 44, 100, 103,
and 106**

Reg. No. 3,522,678

United States Patent and Trademark Office

Registered Oct. 21, 2008

**TRADEMARK
SERVICE MARK
PRINCIPAL REGISTER**

BOCKER

ALBERT BOCKER GMBH & CO. KG (FED REP
GERMANY KOMMANDITGESELLSCHAFT
(KG))

LIPPESTRASSE 69

WERNE, FED REP GERMANY 59368

FOR: HOISTING DEVICES, NAMELY, CRANES; RACK AND PINION ELEVATORS, FURNITURE ELEVATORS, GARBAGE COMPACTORS, ANCHOR WINCHES, STARTERS FOR MOTORS, ANTI-FRICTION BEARINGS FOR MACHINES, DRIVE CHAINS, WITH THE EXCEPTION OF THOSE FOR LAND VEHICLES, DRIVE SHAFTS, WITH THE EXCEPTION OF THOSE FOR LAND VEHICLES, ELEVATORS, BELT CONVEYORS, TORQUE CONVERTERS, WITH THE EXCEPTION OF THOSE FOR LAND VEHICLES, SPEED OF ROTATION REGULATORS FOR MACHINES AND MOTORS, COMPRESSED AIR CONVEYORS, COMPRESSED AIR MACHINES, COMPRESSED AIR MOTORS, PRESSURE REDUCTION VALVES AS MACHINE PARTS, PRESSURE REGULATORS AS MACHINE PARTS, PRESSURE VALVES AS MACHINE PARTS, PRESSURE CYLINDERS, ELECTRIC GENERATORS, ELECTRIC MOTORS, WITH THE EXCEPTION OF THOSE FOR LAND VEHICLES, ELEVATORS, ELEVATOR BELTS, ELEVATOR CHAINS AS MACHINE PARTS, BLOCK AND TACKLE SETS, MACHINE-DRIVEN, CONVEYOR BELTS, CONVEYOR MACHINES, HOUSINGS FOR MACHINES AND MOTORS, TRANSMISSIONS, WITH THE EXCEPTION OF THOSE FOR LAND VEHICLES, HOISTS, MECHANICAL HOIST WINCHES, HYDRAULIC MOTORS, HYDRAULIC DRIVES FOR MACHINES AND MOTORS, CARDANIC JOINTS, COOLERS FOR MOTORS, CLUTCHES, WITH THE EXCEPTION OF THOSE FOR LAND VEHICLES, CRANKS AS MACHINE PARTS, CRANKSHAFTS, LOADING APPARATUSES, NAMELY, LOADING BOOMS, LOADING BRIDGES, BEARINGS AS MACHINE

PARTS, FREIGHT ELEVATORS, MOBILE CRANES, LIFTS, AIR FILTERS FOR MOTORS, MATERIAL ELEVATORS, MOTORS, WITH THE EXCEPTION OF THOSE FOR LAND VEHICLES, CONNECTING RODS FOR MACHINES AND MOTORS, PNEUMATIC DRIVES FOR MACHINES AND MOTORS, WHEEL TRANSMISSIONS, WITH THE EXCEPTION OF THOSE FOR LAND VEHICLES, REDUCTION TRANSMISSIONS, OTHER THAN THOSE FOR LAND VEHICLES, REGULATORS AS MACHINE PARTS, BELTS FOR MACHINES, GEAR-CHANGE CLUTCHES WITH THE EXCEPTION OF THOSE FOR LAND VEHICLES, FLYWHEELS FOR MACHINES, CONTROL ROPES FOR MACHINES OR MOTORS, TRANSPORT BELTS, DRIVE CHAINS, WITH THE EXCEPTION OF THOSE FOR LAND VEHICLES, DRIVE BELTS FOR MOTORS, DRIVE MECHANISMS FOR VEHICLES, WITH THE EXCEPTION OF THOSE FOR LAND VEHICLES, STEP-DOWN TRANSMISSIONS, WITH THE EXCEPTION OF THOSE FOR LAND VEHICLES, FANS FOR MOTORS, FAN BELTS FOR MOTORS, VALVES, CARBURETORS, WAGON ELEVATORS, SHAFT COUPLINGS AS MACHINE PARTS, TOOLS AS MACHINE PARTS, TOOL HOLDERS AS MACHINE PARTS, WINCHES, RACK AND PINION WINCHES, IGNITION MAGNETS FOR MOTORS, CYLINDERS FOR MACHINES, CYLINDERS FOR MOTORS, CYLINDER PISTONS, CYLINDER HEADS FOR MOTORS; MECHANICAL LIFTING DEVICES IN THE FORM OF ARTICULATED TELESCOPES, TRUCK WORKING PLATFORMS, TRAILER WORKING PLATFORMS, SCISSOR-TYPE WORKING PLATFORMS, SPECIAL WORKING PLATFORMS, PASSENGER ELEVATORS, ROPE ELEVATORS, SLANTED ELEVATORS WITH ROPES, FREIGHT ELEVATORS, HOIST WORKING PLATFORMS, ELEVATORS, STAIR LIFTS, DRILLING MA-

CHINES, SLANTED ELEVATORS, IN CLASS 7 (U.S. CLS. 13, 19, 21, 23, 31, 34 AND 35).

FIRST USE 0-0-1989; IN COMMERCE 0-0-1989.

FOR: CAR CRANES, ALUMINUM CRANES, COVER HOODS FOR VEHICLES, AXLE SHANKS, AIRBAGS, VEHICLE TRAILERS, TRAILER COUPLINGS FOR VEHICLES, DRIVE CHAINS FOR LAND VEHICLES, DRIVE MACHINES FOR LAND VEHICLES, DRIVE SHAFTS FOR LAND VEHICLES, BRAKE BLOCKS FOR VEHICLES, BRAKE SHOES FOR VEHICLES, CHASSIS FOR VEHICLES, CHASSIS FOR MOTOR VEHICLES, WIRE CABLE CONVEYOR DEVICES AND SYSTEMS, TORQUE CONVERTERS FOR LAND VEHICLES, ELECTRIC MOTORS FOR LAND VEHICLES, CHASSIS FOR VEHICLES, CHASSIS FOR MOTOR VEHICLES, VEHICLES, VEHICLE BODIES, IDLE WHEELS FOR LAND VEHICLES, HOUSINGS FOR PARTS OF LAND VEHICLES, TRANSMISSIONS FOR LAND VEHICLES, FORKLIFTS, HORNS AND SIGNALING ACCESSORIES FOR VEHICLES, HYDRAULIC CIRCUITS FOR VEHICLES, BODIES FOR MOTOR VEHICLES, MOTOR VEHICLES, CLUTCHES FOR LAND VEHICLES, LOADING BOARD WALLS AS VEHICLE PARTS, MOTOR TRUCKS, TRUCKS, TRUCK SUPERSTRUCTURES, MOTORS FOR LAND VEHICLES, MOTOR HOODS FOR VEHICLES, AUTOMOBILE HOODS FOR MOTOR VEHICLES, CONNECTING RODS FOR LAND VEHICLES, WITH THE EXCEPTION OF THOSE USED AS ENGINE PARTS, WHEEL AXLES, WHEEL TRANSMISSIONS FOR LAND VEHICLES, CATERPILLAR CHAINS FOR VEHICLES, REDUCTION TRANSMISSIONS FOR LAND VEHICLES, BACK-UP WARNING DEVICES FOR VEHICLES, GEAR-CHANGE CLUTCHES FOR LAND VEHICLES, PUSH SLEDS AS VEHICLES, SUSPENDED CONVEYORS, SHOCK ABSORBERS FOR VEHICLES, SHOCK ABSORBERS FOR MOTOR VEHICLES, SHOCK ABSORBER SPRINGS FOR VEHICLES, BUMPERS FOR VEHICLES, BUMPERS FOR MOTOR VEHICLES, TRANSPORT SUSPENDED RAILWAYS, TRANSPORT CARTS, DRIVE CHAINS FOR LAND VEHICLES, DRIVE MECHANISMS FOR LAND VEHICLES, RUNNING BOARDS FOR VEHICLES, TURBINES FOR LAND VEHICLES, TRANSMISSION MECHANISMS FOR LAND VEHICLES, STEP-DOWN TRANSMISSIONS FOR LAND VEHICLES, WAGONS AS VEHICLES, WAGON CHASSIS, IN CLASS 12 (U.S. CLS. 19, 21, 23, 31, 35 AND 44).

FIRST USE 0-0-1989; IN COMMERCE 0-0-1989.

FOR: VEHICLE AND MACHINE MAINTENANCE, NAMELY, LUBRICATION OF VEHICLES, VEHICLE MAINTENANCE, VEHICLE SERVICE REPAIR, SERVICING, MAINTENANCE, INSTALLATION AND REPAIR OF ELEVATORS, INSTALLATION, SERVICING, AND REPAIR OF MACHINES, OVERHAULING OF WORN OR PARTIALLY DESTROYED MACHINES, RENTAL OF CONSTRUCTION EQUIPMENT, RENTAL OF CONSTRUCTION EQUIPMENT, NAMELY, CRANES, SERVICING AND REPAIR OF MOTOR VEHICLES, INSTALLATION, SERVICING, REPAIR, MAINTENANCE, AND OVERHAULING OF CRANES, ELEVATORS, LIFTS, WORKING PLATFORMS, ARTICULATED TELESCOPES, ROPE ELEVATORS, SLANTED ELEVATORS, FURNITURE ELEVATORS, ROOFERS' ELEVATORS, MATERIAL AND PASSENGER ELEVATORS, STAIR LIFTS AND CAR CRANES; RENTAL OF CRANES, NAMELY, HOIST DEVICES; RENTAL OF RACK AND PINION ELEVATORS, RENTAL OF FURNITURE ELEVATORS, RENTAL OF TRUCK WORKING PLATFORMS, RENTAL OF TRAILER WORKING PLATFORMS, RENTAL OF SCISSOR-TYPE WORKING PLATFORMS, RENTAL OF ARTICULATED TELESCOPES, RENTAL OF SPECIAL WORKING PLATFORMS, RENTAL OF PASSENGER ELEVATORS, RENTAL OF MATERIAL ELEVATORS, RENTAL OF ROPE ELEVATORS, RENTAL OF SLANTED ELEVATORS WITH ROPES, RENTAL OF FREIGHT ELEVATORS, RENTAL OF HOIST WORKING PLATFORMS, RENTAL OF PARTS FOR FREIGHT ELEVATORS, RENTAL OF PARTS FOR PASSENGER ELEVATORS, RENTAL OF ELEVATORS, RENTAL OF STAIR LIFTS, RENTAL OF CAR CRANES, RENTAL OF LIFTS, IN CLASS 37 (U.S. CLS. 100, 103 AND 106).

FIRST USE 0-0-1989; IN COMMERCE 0-0-1989.

THE MARK CONSISTS OF STANDARD CHARACTERS WITHOUT CLAIM TO ANY PARTICULAR FONT, STYLE, SIZE, OR COLOR.

SEC. 2(F).

SN 78-914,021, FILED 6-22-2006.

NAAKWAMA ANKRAH, EXAMINING ATTORNEY

Int. Cl.: 39

Prior U.S. Cls.: 100 and 105

United States Patent and Trademark Office

Reg. No. 3,522,679

Registered Oct. 21, 2008

SERVICE MARK
PRINCIPAL REGISTER



KOREAN AIRLINES CO., LTD. (REPUBLIC OF KOREA CORPORATION)
41-3, SEOSOMUN-DONG, CHUNG-KU
SEOUL, REPUBLIC OF KOREA

FOR: TRANSPORTATION OF TRAVELERS BY AIR; INTERNATIONAL COMPLEX TRANSPORTATION, NAMELY, TRANSPORTATION OF PASSENGERS AND/OR GOODS BY AIR; TRANSPORTATION RESERVATION SERVICES; TRANSPORTATION INFORMATION SERVICES; AIR TRANSPORT AGENCY, NAMELY, MAKING RESERVATIONS AND BOOKING FOR TRANSPORTATION OF PASSENGERS AND GOODS BY AIR; AIR TRANSPORT; TOUR ESCORTING OF TRAVELERS, NAMELY, TRAVEL GUIDE SERVICES; ARRANGING AND ORGANIZING OF EXCURSIONS, SIGHTSEEING TOURS, HOLIDAY EXCURSIONS, TRAVEL TOURS AND TRAVEL; TRAVEL RESERVATION SERVICES; BOOKING OF SEATS FOR TRAVEL; TRAVEL AGENCY SERVICES, NAMELY, MAKING RESERVATIONS AND BOOKINGS FOR TRANSPORTATION; AND TOURIST OFFICES, NAMELY, TRAVEL AND TOUR INFORMATION SERVICES, TOUR GUIDE SERVICES, AND TRAVEL AND TOUR TICKET RESERVATION SERVICES, IN CLASS 39 (U.S. CLS. 100 AND 105).

FIRST USE 3-1-2004; IN COMMERCE 11-0-2004.

PRIORITY CLAIMED UNDER SEC. 44(D) ON REPUBLIC OF KOREA APPLICATION NO. 2006-3683, FILED 2-15-2006, REG. NO. 140973, DATED 11-30-2006, EXPIRES 11-30-2016.

OWNER OF U.S. REG. NOS. 1,379,608, 2,177,744, AND OTHERS.

THE COLOR(S) WHITE, BLUE AND RED IS/ARE CLAIMED AS A FEATURE OF THE MARK.

THE MARK CONSISTS OF "EXCELLENCE IN FLIGHT" IN BLUE ABOVE THE WORDS "KOREAN AIR" IN BLUE, WITH A YIN-YANG SYMBOL FOR THE LETTER "O" IN RED, WHITE AND BLUE.

SEC. 2(F) AS TO "KOREAN AIR".

SN 78-918,418, FILED 6-28-2006.

LAURA HAMMEL, EXAMINING ATTORNEY

Int. Cl.: 25

Prior U.S. Cls.: 22 and 39

United States Patent and Trademark Office

Reg. No. 3,522,680

Registered Oct. 21, 2008

**TRADEMARK
PRINCIPAL REGISTER**



LORD WILLY'S LLC (NEW YORK LIMITED
LIABILITY CORPORATION)
121 LAKOTA DRIVE
P.O. BOX 212
DENVER, NY 12421

FIRST USE 11-14-2005; IN COMMERCE 11-14-2005.

SN 78-919,318, FILED 6-28-2006.

FOR: JACKETS, SHIRTS AND SHORTS, IN CLASS
25 (U.S. CLS. 22 AND 39).

ESTHER A. BORSUK, EXAMINING ATTORNEY

Int. Cls.: 1 and 5

Prior U.S. Cls.: 1, 5, 6, 10, 18, 26, 44, 46, 51, and 52

United States Patent and Trademark Office

Reg. No. 3,522,681

Registered Oct. 21, 2008

**TRADEMARK
PRINCIPAL REGISTER**

NATURAL GARDENING SOLUTIONS

THE ESPOMA COMPANY (NEW JERSEY CORPORATION)
6 ESPOMA ROAD
MILLVILLE, NJ 08332

FOR: PLANT FOODS, POTTING SOILS, PLANTING MIXES, NAMELY, SOIL CONDITIONERS FOR DOMESTIC USE, GROWING MEDIA FOR PLANTS, PEAT, COMPOST, HUMUS, LOAMS AND MANURE, NATURAL ORGANIC MATERIALS CONSISTING OF LOAM, FIBROUS ORGANICS, COMPOST AND SAND, GROWING MEDIA FOR PLANTS AND GROWING MEDIA FOR PLANTS WITH ADDED FERTILIZER FOR HORTICULTURAL AND DOMESTIC USE, IN CLASS 1 (U.S. CLS. 1, 5, 6, 10, 26 AND 46).

FIRST USE 6-0-2008; IN COMMERCE 6-0-2008.

FOR: PESTICIDES, IN CLASS 5 (U.S. CLS. 6, 18, 44, 46, 51 AND 52).

FIRST USE 6-0-2008; IN COMMERCE 6-0-2008.

THE MARK CONSISTS OF STANDARD CHARACTERS WITHOUT CLAIM TO ANY PARTICULAR FONT, STYLE, SIZE, OR COLOR.

NO CLAIM IS MADE TO THE EXCLUSIVE RIGHT TO USE "NATURAL GARDENING", APART FROM THE MARK AS SHOWN.

SN 78-920,647, FILED 6-30-2006.

LINDA MICKLEBURGH, EXAMINING ATTORNEY

Int. Cls.: 7 and 12

Prior U.S. Cls.: 13, 19, 21, 23, 31, 34, 35, and 44

United States Patent and Trademark Office

Reg. No. 3,522,682

Registered Oct. 21, 2008

**TRADEMARK
PRINCIPAL REGISTER**

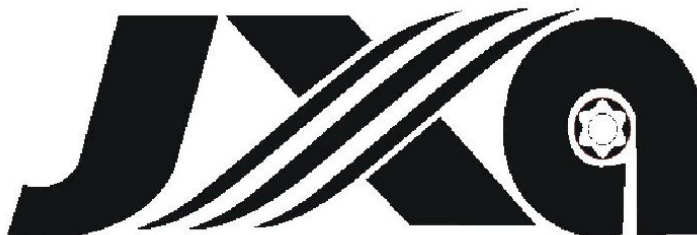

TAIZHOU JIAXIAN INDUSTRIAL CO., LTD.
(CHINA CORPORATION)
JIANZHOU ROAD, DONGFENG INDUSTRIAL
ZONE
KANMEN, YUHUAN COUNTY
ZHEJIANG PROVINCE, CHINA

FOR: SHAFT COUPLINGS FOR MACHINES; VA-
CUUM PUMPS; SHOCK ABSORBERS FOR MA-
CHINES; BALL BEARINGS BEING PARTS OF
MACHINES; ROLLER BEARINGS FOR MACHINES;
OIL PUMPS FOR LAND VEHICLES; WATER PUMPS
FOR LAND VEHICLES; RADIATORS FOR VEHI-
CLES, IN CLASS 7 (U.S. CLS. 13, 19, 21, 23, 31, 34 AND
35).

FIRST USE 11-21-2004; IN COMMERCE 6-26-2008.

FOR: CONSTANT VELOCITY JOINT FOR VEHI-
CLES; COMPLETE DRIVE SHAFT FOR VEHICLES,
IN CLASS 12 (U.S. CLS. 19, 21, 23, 31, 35 AND 44).

FIRST USE 11-21-2004; IN COMMERCE 6-26-2008.

SN 78-922,274, FILED 7-5-2006.

ROBIN CHOSID, EXAMINING ATTORNEY

Int. Cls.: 41 and 45

Prior U.S. Cls.: 100, 101, and 107

United States Patent and Trademark Office

Reg. No. 3,522,683

Registered Oct. 21, 2008

**SERVICE MARK
PRINCIPAL REGISTER**

Pandemic 101

THE PANDEMIC 101 CORPORATION (CANADA CORPORATION), DBA THE PANDEMIC 101 CORPORATION,
829 SOUTHGATE DRIVE
GUELPH, ONTARIO, CANADA N1G 4W6

FOR: PANDEMIC AWARENESS TRAINING, IN CLASS 41 (U.S. CLS. 100, 101 AND 107).

FIRST USE 1-1-2007; IN COMMERCE 1-1-2007.

FOR: PROVIDING CONSULTATION, AND INFORMATION IN THE CREATION OF PANDEMIC EMERGENCY PLANS, CHECKLISTS, AND CONTINUITY PLANNING, IN CLASS 45 (U.S. CLS. 100 AND 101).

FIRST USE 1-1-2007; IN COMMERCE 1-1-2007.

THE MARK CONSISTS OF STANDARD CHARACTERS WITHOUT CLAIM TO ANY PARTICULAR FONT, STYLE, SIZE, OR COLOR.

PRIORITY CLAIMED UNDER SEC. 44(D) ON CANADA APPLICATION NO. 1306415, FILED 6-22-2006, REG. NO. 1306415, DATED 1-4-2007, EXPIRES 1-4-2027.

NO CLAIM IS MADE TO THE EXCLUSIVE RIGHT TO USE "PANDEMIC", APART FROM THE MARK AS SHOWN.

SN 78-923,626, FILED 7-6-2006.

BRIAN NEVILLE, EXAMINING ATTORNEY

Int. Cl.: 41

Prior U.S. Cls.: 100, 101, and 107

United States Patent and Trademark Office

Reg. No. 3,522,684

Registered Oct. 21, 2008

**SERVICE MARK
PRINCIPAL REGISTER**

LIEBERMAN LEARNING LABS

LIEBERMAN RESEARCH WORLDWIDE, INC.
(CALIFORNIA CORPORATION)

1900 AVENUE OF THE STARS, 15TH FLOOR

LOS ANGELES, CA 90067

FOR: WORKSHOPS AND SEMINARS IN THE
FIELD OF BUSINESS TO ENABLE BUSINESSES TO
UTILIZE RESULTS OF MARKET RESEARCH, IN
CLASS 41 (U.S. CLS. 100, 101 AND 107).

FIRST USE 3-31-2006; IN COMMERCE 3-31-2006.

THE MARK CONSISTS OF STANDARD CHAR-
ACTERS WITHOUT CLAIM TO ANY PARTICULAR
FONT, STYLE, SIZE, OR COLOR.

OWNER OF U.S. REG. NO. 2,575,089.

NO CLAIM IS MADE TO THE EXCLUSIVE
RIGHT TO USE "LEARNING LABS", APART FROM
THE MARK AS SHOWN.

SN 78-923,979, FILED 7-6-2006.

WILLIAM VERHOSEK, EXAMINING ATTORNEY

Int. Cl.: 9

Prior U.S. Cls.: 21, 23, 26, 36, and 38

Reg. No. 3,522,685

United States Patent and Trademark Office

Registered Oct. 21, 2008

**TRADEMARK
PRINCIPAL REGISTER**

vimak

HUANG, JIAQUN (CHINA INDIVIDUAL)
RM 1001, UNIT 1, B BLOCK
BIAN FANG FEN JU, MEI LIN 2 CUN
SHENZHEN, GUANGDONG, CHINA 518000

FOR: AUDIO AMPLIFIERS; AUDIO SPEAKERS;
CAMCORDERS; COMPUTER PERIPHERALS; DVD
RECORDING APPARATUS; DVD-PLAYERS; DVDS
FEATURING SOUND AND/OR VIDEO RECORD-
INGS IN THE FIELD OF MOTION PICTURE SOUND
TRACKS, MUSICAL CONCERTS, MUSIC, TECH-
NOLOGY, COMPUTERS, AND LEASURE INTER-
ESTS; BLANK RECORDABLE DVDS;
MICROPHONES; VIDEO GAME MACHINES FOR
USE WITH TELEVISIONS; VOLTAGE STABILIZERS;

VOLTAGE STABILIZING POWER SUPPLY, IN
CLASS 9 (U.S. CLS. 21, 23, 26, 36 AND 38).

FIRST USE 6-30-2006; IN COMMERCE 10-25-2007.

THE MARK CONSISTS OF STANDARD CHAR-
ACTERS WITHOUT CLAIM TO ANY PARTICULAR
FONT, STYLE, SIZE, OR COLOR.

PRIORITY CLAIMED UNDER SEC. 44(D) ON
CHINA APPLICATION NO. 5118418, FILED 1-16-2006.

SN 78-925,324, FILED 7-10-2006.

INGA ERVIN, EXAMINING ATTORNEY

Int. Cl.: 35

Prior U.S. Cls.: 100, 101, and 102

United States Patent and Trademark Office

Reg. No. 3,522,686

Registered Oct. 21, 2008

**SERVICE MARK
PRINCIPAL REGISTER**

Otomobil.com

HYPER LINK INTERNATIONAL, LTD (MASSACHUSETTS CORPORATION)
MCKINLEY BUILDING
177B STATE STREET
BOSTON, MA 02109

FOR: PROMOTING, ADVERTISING, AND MARKETING OF INTERNET WEBSITES, NAMELY, DENTAL WEBSITES, IN CLASS 35 (U.S. CLS. 100, 101 AND 102).

FIRST USE 2-15-2006; IN COMMERCE 3-1-2006.

THE MARK CONSISTS OF STANDARD CHARACTERS WITHOUT CLAIM TO ANY PARTICULAR FONT, STYLE, SIZE, OR COLOR.

SN 78-925,412, FILED 7-10-2006.

ROSELLE HERRERA, EXAMINING ATTORNEY

Int. Cl.: 35

Prior U.S. Cls.: 100, 101, and 102

United States Patent and Trademark Office

Reg. No. 3,522,687

Registered Oct. 21, 2008

**SERVICE MARK
PRINCIPAL REGISTER**

Profilo.com

HYPER LINK INTERNATIONAL, LTD (MASSACHUSETTS CORPORATION)
MCKINLEY BUILDING
177B STATE STREET
BOSTON, MA 02109

FOR: PROMOTING, ADVERTISING AND MARKETING OF THE ON-LINE WEBSITES OF DENTAL WEBSITES, IN CLASS 35 (U.S. CLS. 100, 101 AND 102).

FIRST USE 2-15-2006; IN COMMERCE 3-1-2006.

THE MARK CONSISTS OF STANDARD CHARACTERS WITHOUT CLAIM TO ANY PARTICULAR FONT, STYLE, SIZE, OR COLOR.

THE ENGLISH TRANSLATION OF "PROFILO" IS PROFILE.

SN 78-925,447, FILED 7-10-2006.

ROSELLE HERRERA, EXAMINING ATTORNEY

Int. Cl.: 41

Prior U.S. Cls.: 100, 101, and 107

United States Patent and Trademark Office

Reg. No. 3,522,688

Registered Oct. 21, 2008

**SERVICE MARK
PRINCIPAL REGISTER**

**BRINGING THE SHOWROOM TO
YOUR LIVING ROOM**

DRIVERTV LLC (NEW YORK LIMITED LIABILITY COMPANY)
435 HUDSON STREET
NEW YORK, NY 10014

FOR: ENTERTAINMENT AND EDUCATIONAL SERVICES, NAMELY, PRODUCTION OF VIDEO PROGRAMMING FEATURING INFORMATION ABOUT THE ATTRIBUTES, FEATURES AND SPECIFICATIONS OF MODEL AUTOMOBILES FROM ALL MAJOR MANUFACTURERS AS WELL AS OTHER INFORMATION THAT WILL HELP CONSUMERS MAKE INFORMED PURCHASING DECISIONS REGARDING AUTOMOBILES AND ANCILLARY AUTOMOTIVE PRODUCTS, WHICH

IS DISTRIBUTED TO VIDEO-ON-DEMAND TELEVISION CHANNELS, WEB SITES, IN-ROOM HOTEL NETWORKS, AND WIRELESS NETWORKS, IN CLASS 41 (U.S. CLS. 100, 101 AND 107).

FIRST USE 11-0-2006; IN COMMERCE 11-0-2006.

THE MARK CONSISTS OF STANDARD CHARACTERS WITHOUT CLAIM TO ANY PARTICULAR FONT, STYLE, SIZE, OR COLOR.

SN 78-927,625, FILED 7-12-2006.

ESTHER A. BORSUK, EXAMINING ATTORNEY

Int. Cl.: 36

Prior U.S. Cls.: 100, 101, and 102

United States Patent and Trademark Office

Reg. No. 3,522,689

Registered Oct. 21, 2008

SERVICE MARK
PRINCIPAL REGISTER



Member FDIC

Tennessee
State Bank
"Your Kind of Bank"

TENNESSEE STATE BANK (TENNESSEE CORPORATION)

2210 PARKWAY

PIGEON FORGE, TN 37863

FOR: BANKING AND FINANCIAL SERVICES, NAMELY, ASSUMING FINANCIAL RISK OF OTHERS BY ENTERING INTO OPTIONS AND SWAPS, CREDIT AND FINANCIAL CONSULTATION, ELECTRONIC FINANCIAL SERVICES FOR THE PURCHASE OF SAVINGS BONDS, FINANCIAL ANALYSIS AND CONSULTATION, FINANCIAL CLEARING HOUSES, FINANCIAL CONSULTATION, FINANCIAL DUE DILIGENCE, FINANCIAL EVALUATION FOR INSURANCE PURPOSES, FINANCIAL EXCHANGE, FINANCIAL FORECASTING, FINANCIAL GUARANTEE AND SURETY, FINANCIAL INFORMATION IN THE NATURE OF RATES OF EXCHANGE, FINANCIAL INFORMATION PROVIDED BY ELECTRONIC MEANS, FINANCIAL INFORMATION PROCESSING, FINANCIAL LOAN CONSULTATION, FINANCIAL MANAGEMENT, FINANCIAL PLANNING, FINANCIAL PLANNING CONSULTATION, FINANCIAL PORTFOLIO MANAGEMENT, FINANCIAL RESEARCH, FINANCIAL RISK MANAGEMENT, FINANCIAL SERVICES IN THE NATURE OF AN INVESTMENT SECURITY, FINANCIAL SERVICES IN THE FIELD OF MONEY LENDING, FINANCIAL SERVICES, NAMELY, PROVIDING ON-LINE STORED VALUE ACCOUNTS IN AN ELECTRONIC ENVIRONMENT, INVESTMENT FUND TRANSFER AND TRANSACTION SERVICES, ASSISTING OTHERS WITH THE COMPLETION OF FINANCIAL TRANSACTIONS FOR STOCKS, BONDS, SECURITIES AND EQUITIES, ISSUANCE AND MANAGEMENT OF CERTIFICATES BACKED BY LOAN PORTFOLIOS WHICH ARE SUBSEQUENTLY MANAGED TO INSURE THE INTEGRITY OF THE

CERTIFICATES, FINANCIAL SERVICES, NAMELY, A TOTAL PORTFOLIO OFFERING FOR HIGH NET WORTH CLIENTS CONSISTING OF BOTH SEPARATE ACCOUNTS AND MUTUAL FUNDS FOR EQUITY AND FIXED INCOME INVESTMENTS, FINANCIAL SERVICES, NAMELY, SAVINGS PROGRAMS FOR YOUTHS, PURCHASE OF RESIDENTIAL MORTGAGES ON BEHALF OF OTHERS AND THE ISSUANCE OF MORTGAGE-BACKED SECURITIES, FINANCIAL TRUST OPERATIONS, FINANCIAL VALUATION OF PERSONAL PROPERTY AND REAL ESTATE; ORGANIZATION OF STOCK EXCHANGES FOR THE BENEFIT OF THE TRADE OF STOCKS AND OTHER FINANCIAL VALUES, PROVIDING ON-LINE FINANCIAL CALCULATORS, IN CLASS 36 (U.S. CLS. 100, 101 AND 102).

FIRST USE 5-22-2008; IN COMMERCE 5-22-2008.

NO CLAIM IS MADE TO THE EXCLUSIVE RIGHT TO USE "TENNESSEE STATE BANK" AND "MEMBER FDIC", APART FROM THE MARK AS SHOWN.

THE COLOR(S) ORANGE, BLACK AND WHITE IS/ARE CLAIMED AS A FEATURE OF THE MARK.

THE MARK CONSISTS OF THE CAPITAL LETTER "T" WITHIN A SQUARE DESIGN, AND THE LINE WHICH CREATES THE CROSS OF THE CAPITAL LETTER "T" IS A REPRESENTATION OF THE OUTLINE OF THE STATE OF TENNESSEE. THE MARK ALSO CONSISTS OF THE WORDING "TENNESSEE STATE BANK", "YOUR KIND OF BANK" AND "MEMBER FDIC". THE COLOR ORANGE APPEARS IN THE BACKGROUND OF THE SQUARE DESIGN AND IN THE WORDING "TENNESSEE STATE BANK"; THE COLOR WHITE AP-

PEARS IN THE STYLIZED LETTER "T" WITHIN THE SQUARE DESIGN; AND THE COLOR BLACK APPEARS IN THE OUTLINING OF THE SQUARE DESIGN AND LETTER "T" DESIGN AND IN THE WORDING "YOUR KIND OF BANK" AND "MEMBER FDIC" OF THE MARK.

SN 78-927,759, FILED 7-12-2006.

ANDREW RHIM, EXAMINING ATTORNEY

Int. Cl.: 10

Prior U.S. Cls.: 26, 39, and 44

United States Patent and Trademark Office

Reg. No. 3,522,690

Registered Oct. 21, 2008

**TRADEMARK
PRINCIPAL REGISTER**

MICROFLOW^{II}

The logo for MICROFLOW II features the word "MICRO" in a bold, sans-serif font, followed by a circular emblem containing a grid of dots with the letters "M" and "F" positioned above and below the grid respectively. To the right of the emblem is the word "FLOW" in a bold, sans-serif font, followed by two vertical bars of varying heights, representing the Roman numeral "II".

LEICA BIOSYSTEMS ST. LOUIS LLC (DELA-
WARE LIMITED LIABILITY COMPANY)
5918 EVERGREEN BOULEVARD
ST. LOUIS, MO 63134

FIRST USE 10-29-2005; IN COMMERCE 10-29-2005.

FOR: MEDICAL CONTAINERS, NAMELY, CAS-
SETTES FOR PROCESSING OF HISTOLOGICAL
SPECIMENS FOR CLINICAL MEDICAL USE, IN
CLASS 10 (U.S. CLS. 26, 39 AND 44).

SN 78-927,854, FILED 7-12-2006.

KHANH LE, EXAMINING ATTORNEY

Int. Cl.: 5

Prior U.S. Cls.: 6, 18, 44, 46, 51, and 52

Reg. No. 3,522,691

United States Patent and Trademark Office

Registered Oct. 21, 2008

**TRADEMARK
PRINCIPAL REGISTER**

GALA

DEPARTMENT OF VETERANS AFFAIRS (UNI-
TED STATES FEDERAL AGENCY)
103 SOUTH GAY STREET
BALTIMORE, MD 21202

THE MARK CONSISTS OF STANDARD CHAR-
ACTERS WITHOUT CLAIM TO ANY PARTICULAR
FONT, STYLE, SIZE, OR COLOR.

FOR: ORGAN AND TISSUE PERFUSION AND
PRESERVATION SOLUTIONS, IN CLASS 5 (U.S.
CLS. 6, 18, 44, 46, 51 AND 52).

SN 78-928,321, FILED 7-12-2006.

FIRST USE 8-2-2006; IN COMMERCE 8-2-2006.

DOMINIC FATHY, EXAMINING ATTORNEY

Int. Cl.: 41

Prior U.S. Cls.: 100, 101, and 107

United States Patent and Trademark Office

Reg. No. 3,522,692

Registered Oct. 21, 2008

**SERVICE MARK
PRINCIPAL REGISTER**

TRELG

THE REAL ESTATE LEARNING GROUP, LLC
(MAINE LIMITED LIABILITY COMPANY)
P.O. BOX 3831
PORTLAND, ME 04104

THE MARK CONSISTS OF STANDARD CHAR-
ACTERS WITHOUT CLAIM TO ANY PARTICULAR
FONT, STYLE, SIZE, OR COLOR.

FOR: PROVIDING EDUCATIONAL WORKSHOPS
AND PROGRAMS IN THE FIELD OF REAL ES-
TATE, IN CLASS 41 (U.S. CLS. 100, 101 AND 107).

SN 78-928,827, FILED 7-13-2006.

FIRST USE 12-31-2007; IN COMMERCE 12-31-2007.

BARBARA RUTLAND, EXAMINING ATTORNEY

Int. Cl.: 25

Prior U.S. Cls.: 22 and 39

United States Patent and Trademark Office

Reg. No. 3,522,693

Registered Oct. 21, 2008

**TRADEMARK
PRINCIPAL REGISTER**

FANDINI

CBS RADIO EAST INC. (DELAWARE CORPORATION)
1515 BROADWAY
NEW YORK, NY 10036

FOR: ARTICLES OF CLOTHING FOR WOMEN, MEN AND CHILDREN, NAMELY, MULTIPURPOSE WRAPS MADE OF TEXTILES FOR USE AS A DECORATIVE HEADWEAR, HEAD BANDS, ARM BANDS, WRIST BANDS AND LEG BANDS , IN CLASS 25 (U.S. CLS. 22 AND 39).

FIRST USE 9-25-2006; IN COMMERCE 9-25-2006.

THE MARK CONSISTS OF STANDARD CHARACTERS WITHOUT CLAIM TO ANY PARTICULAR FONT, STYLE, SIZE, OR COLOR.

SN 78-930,731, FILED 7-17-2006.

AMOS T. MATTHEWS, JR., EXAMINING ATTORNEY

Int. Cl.: 35

Prior U.S. Cls.: 100, 101, and 102

United States Patent and Trademark Office

Reg. No. 3,522,694

Registered Oct. 21, 2008

**SERVICE MARK
PRINCIPAL REGISTER**

Yozen Frogurt

YOZEN FROGURT (CALIFORNIA CORPORATION)

90 DAPPLEGRAY RD.

BELL CANYON, CA 91307

FOR: RETAIL STORES FEATURING FROZEN YOGURT AND TOPPINGS, IN CLASS 35 (U.S. CLS. 100, 101 AND 102).

FIRST USE 3-25-2007; IN COMMERCE 3-25-2007.

THE MARK CONSISTS OF STANDARD CHARACTERS WITHOUT CLAIM TO ANY PARTICULAR FONT, STYLE, SIZE, OR COLOR.

NO CLAIM IS MADE TO THE EXCLUSIVE RIGHT TO USE "FROGURT", APART FROM THE MARK AS SHOWN.

SN 78-930,734, FILED 7-17-2006.

AMOS T. MATTHEWS, JR., EXAMINING ATTORNEY

Int. Cl.: 10

Prior U.S. Cls.: 26, 39, and 44

United States Patent and Trademark Office

Reg. No. 3,522,695

Registered Oct. 21, 2008

**TRADEMARK
PRINCIPAL REGISTER**

INFANT HEAD BED

WARNOCK, STEVEN H. M.D. (UNITED STATES
INDIVIDUAL)

9829 SOUTH 1300 EAST, SUITE 200

SANDY, UT 84094

FOR: PILLOWS FOR TREATING CRANIAL DE-
FORMATION, IN CLASS 10 (U.S. CLS. 26, 39 AND 44).

FIRST USE 6-1-2008; IN COMMERCE 6-1-2008.

THE MARK CONSISTS OF STANDARD CHAR-
ACTERS WITHOUT CLAIM TO ANY PARTICULAR
FONT, STYLE, SIZE, OR COLOR.

NO CLAIM IS MADE TO THE EXCLUSIVE
RIGHT TO USE "INFANT", APART FROM THE
MARK AS SHOWN.

SN 78-932,093, FILED 7-18-2006.

STEVEN PEREZ, EXAMINING ATTORNEY

Int. Cl.: 42

Prior U.S. Cls.: 100 and 101

United States Patent and Trademark Office

Reg. No. 3,522,696

Registered Oct. 21, 2008

**SERVICE MARK
PRINCIPAL REGISTER**

**PALOMA PHARMACEUTICALS,
INC.**

PALOMA PHARMACEUTICALS, INC. (DELA-
WARE CORPORATION)
37 NEILLIAN CRESCENT
JAMAICA PLAIN, MA 02130

FOR: PHARMACEUTICAL RESEARCH AND DE-
VELOPMENT, IN CLASS 42 (U.S. CLS. 100 AND 101).

FIRST USE 0-0-2005; IN COMMERCE 0-0-2005.

THE MARK CONSISTS OF STANDARD CHAR-
ACTERS WITHOUT CLAIM TO ANY PARTICULAR
FONT, STYLE, SIZE, OR COLOR.

NO CLAIM IS MADE TO THE EXCLUSIVE
RIGHT TO USE "PHARMACEUTICALS, INC.",
APART FROM THE MARK AS SHOWN.

THE FOREIGN WORDING IN THE MARK
TRANSLATES INTO ENGLISH AS DOVE.

SN 78-932,809, FILED 7-19-2006.

IRA J. GOODSaid, EXAMINING ATTORNEY

Int. Cl.: 11

Prior U.S. Cls.: 13, 21, 23, 31, and 34

United States Patent and Trademark Office

Reg. No. 3,522,697

Registered Oct. 21, 2008

**TRADEMARK
PRINCIPAL REGISTER**

ACTIVE PYRO

CHALABI, RIFAT AL. (UNITED STATES INDIVIDUAL)
93 CHETWOOD TERRACE
FANWOOD, NJ 07023 AND
PERRY, OPHNEIL H. (UNITED KINGDOM INDIVIDUAL)
11 BLENCATHRA CLOSE, GAMSTON
NOTTINGHAM, UNITED KINGDOM NG2 6RL

FOR: CONVECTION OVENS; DOMESTIC COOKING OVENS; ELECTRIC COOKING OVENS, ELECTRIC DUTCH OVENS; GAS COOKING OVENS, IN CLASS 11 (U.S. CLS. 13, 21, 23, 31 AND 34).

FIRST USE 3-1-2007; IN COMMERCE 3-1-2007.

THE MARK CONSISTS OF STANDARD CHARACTERS WITHOUT CLAIM TO ANY PARTICULAR FONT, STYLE, SIZE, OR COLOR.

SN 78-933,228, FILED 7-19-2006.

SHAUNIA CARLYLE, EXAMINING ATTORNEY

Int. Cl.: 44

Prior U.S. Cls.: 100 and 101

United States Patent and Trademark Office

Reg. No. 3,522,698

Registered Oct. 21, 2008

**SERVICE MARK
PRINCIPAL REGISTER**



TAKE CARE HEALTH SYSTEMS, LLC (DELA-
WARE LIMITED LIABILITY COMPANY)
SUITE 1400
EIGHT TOWER BRIDGE, 161 WASHINGTON ST
CONSHOHOCKEN, PA 19428

FOR: MANAGED HEALTH CARE SERVICES,
NAMELY, PROVIDING MEDICAL AND PHARMA-
CEUTICAL CONSULTATION, PERFORMING DI-
AGNOSIS AND TREATMENT OF DISEASES,
MEDICAL TESTING, AND PROVIDING HEALTH
CARE INFORMATION BY PHONE AND THE IN-
TERNET; MEDICAL CLINICS; HOME HEALTH
CARE SERVICES; AND MOBILE HEALTHCARE
CENTERS, IN CLASS 44 (U.S. CLS. 100 AND 101).

FIRST USE 8-31-2007; IN COMMERCE 8-31-2007.

NO CLAIM IS MADE TO THE EXCLUSIVE
RIGHT TO USE "HEALTH CLINIC" AND THE
REPRESENTATION OF THE CADUCEUS SYMBOL,
APART FROM THE MARK AS SHOWN.

THE STIPPLING IS FOR SHADING PURPOSES
ONLY.

THE MARK CONSISTS OF A CADUCEUS SYM-
BOL WITHIN A CIRCLE NEXT TO THE WORDS
"TAKE CARE HEALTH CLINIC".

SN 78-935,629, FILED 7-24-2006.

PAUL CROWLEY, EXAMINING ATTORNEY

Int. Cl.: 41

Prior U.S. Cls.: 100, 101, and 107

United States Patent and Trademark Office

Reg. No. 3,522,699

Registered Oct. 21, 2008

**SERVICE MARK
PRINCIPAL REGISTER**

**QUINCEANERA: MAMA, QUIERO
SER ARTISTA**

NOSTROMO AMERICA, LLC (FLORIDA LIMITED LIABILITY COMPANY)
1680 MICHIGAN AVENUE, SUITE 1013
MIAMI BEACH, FL 33139

FOR: ENTERTAINMENT SERVICES, NAMELY, AN ON-GOING TELEVISION PROGRAM IN THE FIELD OF REALITY SHOWS, IN CLASS 41 (U.S. CLS. 100, 101 AND 107).

FIRST USE 8-26-2006; IN COMMERCE 8-26-2006.

THE MARK CONSISTS OF STANDARD CHARACTERS WITHOUT CLAIM TO ANY PARTICULAR FONT, STYLE, SIZE, OR COLOR.

NO CLAIM IS MADE TO THE EXCLUSIVE RIGHT TO USE "QUINCEANERA", APART FROM THE MARK AS SHOWN.

THE ENGLISH TRANSLATION OF "QUINCEANERA" IS FIFTEEN-YEAR OLD FEMALE, AND THE ENGLISH TRANSLATION OF "MAMA QUIERO SER ARTISTA" IS MAMA I WANT TO BE AN ACTRESS.

SN 78-937,214, FILED 7-25-2006.

JENNIFER MARTIN, EXAMINING ATTORNEY

Int. Cl.: 30

Prior U.S. Cl.: 46

United States Patent and Trademark Office

Reg. No. 3,522,700

Registered Oct. 21, 2008

**TRADEMARK
PRINCIPAL REGISTER**

Glancy's Popcorn

GLANCY, PERRY B. (UNITED STATES INDIVIDUAL)

2891 E. 700 N.

DECATUR, IN 46733

FOR: POPCORN; PROCESSED UNPOPPED POPCORN, IN CLASS 30 (U.S. CL. 46).

FIRST USE 5-10-1941; IN COMMERCE 8-10-2006.

THE MARK CONSISTS OF STANDARD CHARACTERS WITHOUT CLAIM TO ANY PARTICULAR FONT, STYLE, SIZE, OR COLOR.

NO CLAIM IS MADE TO THE EXCLUSIVE RIGHT TO USE "POPCORN", APART FROM THE MARK AS SHOWN.

SN 78-940,680, FILED 7-30-2006.

JULIE GUTTADAURO, EXAMINING ATTORNEY

Int. Cl.: 25

Prior U.S. Cls.: 22 and 39

United States Patent and Trademark Office

Reg. No. 3,522,701

Registered Oct. 21, 2008

**TRADEMARK
PRINCIPAL REGISTER**

Profeisional

ENO, DANA (UNITED STATES INDIVIDUAL)
10065 154TH RD. N
JUPITER, FL 33478

THE MARK CONSISTS OF STANDARD CHAR-
ACTERS WITHOUT CLAIM TO ANY PARTICULAR
FONT, STYLE, SIZE, OR COLOR.

FOR: DRESSES; HATS; JACKETS; PANTS;
SHIRTS; SHORTS; SKIRTS; SOCKS, IN CLASS 25
(U.S. CLS. 22 AND 39).

SN 78-942,053, FILED 8-1-2006.

FIRST USE 5-25-2007; IN COMMERCE 8-1-2008.

GRETTA YAO, EXAMINING ATTORNEY

Int. Cls.: 30 and 35

Prior U.S. Cls.: 46, 100, 101, and 102

United States Patent and Trademark Office

Reg. No. 3,522,702

Registered Oct. 21, 2008

**TRADEMARK
SERVICE MARK
PRINCIPAL REGISTER**



SANTUCCI'S SQUARE PIZZA & PASTA IV, INC.
(PENNSYLVANIA CORPORATION)
4006 WOODHAVEN RD.-KNIGHTS RD. SHP. CTR.
PHILADELPHIA, PA 19154

FOR: FRESH PIZZA, IN CLASS 30 (U.S. CL. 46).

FIRST USE 2-28-2006; IN COMMERCE 2-28-2006.

FOR: RETAIL SHOPS FEATURING PIZZA AND
OTHER FOOD ITEMS, IN CLASS 35 (U.S. CLS. 100,
101 AND 102).

FIRST USE 2-28-2006; IN COMMERCE 2-28-2006.

NO CLAIM IS MADE TO THE EXCLUSIVE
RIGHT TO USE "ORIGINAL SQUARE PIZZA",
APART FROM THE MARK AS SHOWN.

THE NAME SHOWN IN THE MARK IDENTIFIES
"JOE SANTUCCI" WHOSE CONSENT IS OF RE-
CORD.

THE COLOR(S) GREEN, RED AND BLACK IS/
ARE CLAIMED AS A FEATURE OF THE MARK.

THE MARK CONSISTS OF A RED SQUARE BOX
WITH THE STYLIZED LETTERS "JS" IN GREEN
WITH WHITE OUTLINE, THESE STYLIZED LET-
TERS ARE PARTIALLY OUTSIDE OF THE BOX
THE AND BUSINESS NAME ON TWO LINES IN
BLACK.

SN 78-943,262, FILED 8-2-2006.

SAMUEL E. SHARPER JR., EXAMINING ATTOR-
NEY

Int. Cl.: 16

Prior U.S. Cls.: 2, 5, 22, 23, 29, 37, 38, and 50

Reg. No. 3,522,703

United States Patent and Trademark Office

Registered Oct. 21, 2008

**TRADEMARK
PRINCIPAL REGISTER**

Anmar

ANMAR PARTY COORDINATORS, INC. (FLOR-
IDA CORPORATION)
20041 NW 65TH CT.
HIALEAH, FL 330152138

FIRST USE 11-30-2006; IN COMMERCE 11-30-2006.

FOR: MAGAZINES FEATURING ADVERTISE-
MENTS, EDITORIALS, AND INFORMATION RE-
LATING TO FORMAL AND INFORMAL SOCIAL
EVENTS, RECEPTIONS, PARTIES, AND BANQUETS
, IN CLASS 16 (U.S. CLS. 2, 5, 22, 23, 29, 37, 38 AND 50).

THE MARK CONSISTS OF STANDARD CHAR-
ACTERS WITHOUT CLAIM TO ANY PARTICULAR
FONT, STYLE, SIZE, OR COLOR.

SN 78-943,723, FILED 8-3-2006.

RUDY R. SINGLETON, EXAMINING ATTORNEY

Int. Cl.: 44

Prior U.S. Cls.: 100 and 101

United States Patent and Trademark Office

Reg. No. 3,522,704

Registered Oct. 21, 2008

**SERVICE MARK
PRINCIPAL REGISTER**

Zen Massage

KOON, KEVIN L. (UNITED STATES INDIVIDUAL)

1021 EAST BOULEVARD

CHARLOTTE, NC 28203 AND

KOON, LEA P. (UNITED STATES INDIVIDUAL)

1021 EAST BOULEVARD

CHARLOTTE, NC 28203

FOR: MASSAGE THERAPY, IN CLASS 44 (U.S. CLS. 100 AND 101).

FIRST USE 1-31-2008; IN COMMERCE 1-31-2005.

THE MARK CONSISTS OF STANDARD CHARACTERS WITHOUT CLAIM TO ANY PARTICULAR FONT, STYLE, SIZE, OR COLOR.

OWNER OF U.S. REG. NOS. 2,991,288 AND 3,195,423.

NO CLAIM IS MADE TO THE EXCLUSIVE RIGHT TO USE "MASSAGE", APART FROM THE MARK AS SHOWN.

SN 78-943,734, FILED 8-3-2006.

ELI HELLMAN, EXAMINING ATTORNEY

Int. Cl.: 11

Prior U.S. Cls.: 13, 21, 23, 31, and 34

United States Patent and Trademark Office

Reg. No. 3,522,705

Registered Oct. 21, 2008

**TRADEMARK
PRINCIPAL REGISTER**



RSGA INTERNATIONAL, INC. (UTAH CORPORATION)
1309 16TH STREET, SUITE A
OGDEN, UT 84404

FIRST USE 3-1-2007; IN COMMERCE 3-1-2007.

SN 78-945,118, FILED 8-4-2006.

FOR: LOW VOLTAGE ELECTRIC LIGHTS FOR USE IN TENTS, BATHROOMS, VEHICLES, OUTDOOR SHELTERS, AND OUTDOOR STRUCTURES, IN CLASS 11 (U.S. CLS. 13, 21, 23, 31 AND 34).

ANTHONY RINKER, EXAMINING ATTORNEY

Int. Cl.: 42

Prior U.S. Cls.: 100 and 101

United States Patent and Trademark Office

Reg. No. 3,522,706

Registered Oct. 21, 2008

**SERVICE MARK
PRINCIPAL REGISTER**



VERITOX, INC. (WASHINGTON CORPORATION)
18372 REDMOND FALL CITY ROAD
REDMOND, WA 98052

FOR: ANALYSIS SERVICES OF AIR SAMPLES
FOR MOLD, BACTERIA, CHEMICALS AND OTHER
AGENTS, IN CLASS 42 (U.S. CLS. 100 AND 101).

FIRST USE 8-4-2006; IN COMMERCE 8-4-2006.

NO CLAIM IS MADE TO THE EXCLUSIVE
RIGHT TO USE "INDOOR ENVIRONMENTAL HY-
GIENE LABORATORY", APART FROM THE MARK
AS SHOWN.

SN 78-945,541, FILED 8-4-2006.

KAREN SEVERSON, EXAMINING ATTORNEY

Int. Cl.: 25

Prior U.S. Cls.: 22 and 39

United States Patent and Trademark Office

Reg. No. 3,522,707

Registered Oct. 21, 2008

**TRADEMARK
PRINCIPAL REGISTER**

Sexable

SEXABLE, INC. (CALIFORNIA CORPORATION)
686 S. ARROYO PARKWAY, #6
PASADENA, CA 91105

FOR: BOARD SHORTS; BOXER SHORTS; BRIEFS;
FLEECE SHORTS; GYM SHORTS; GYM SUITS;
JOGGING PANTS; JOGGING SUITS; LADIES' UN-
DERWEAR; MUSCLE TOPS; NIGHT SHIRTS; NON-
DISPOSABLE CLOTH TRAINING PANTS; OPEN-
NECKED SHIRTS; PANTIES, SHORTS AND BRIEFS;
PANTS; SHIRTS; SHORT SETS; SHORT TROUSERS;
SHORT-SLEEVED OR LONG-SLEEVED T-SHIRTS;
SHORT-SLEEVED SHIRTS; SHORTS; SLEEP
SHIRTS; SPORT SHIRTS; SPORTS SHIRTS; SPORTS
SHIRTS WITH SHORT SLEEVES; SWEAT PANTS;

SWEAT SHIRTS; SWEAT SHORTS; SWEAT SUITS; T-
SHIRTS; TANK TOPS; TOPS; TRACK PANTS;
TRACK SUITS; TRAINING SUITS; UNDERWEAR;
WALKING SHORTS; WARM UP SUITS; WOMEN'S
UNDERWEAR, IN CLASS 25 (U.S. CLS. 22 AND 39).

FIRST USE 2-24-2008; IN COMMERCE 2-24-2008.

THE MARK CONSISTS OF STANDARD CHAR-
ACTERS WITHOUT CLAIM TO ANY PARTICULAR
FONT, STYLE, SIZE, OR COLOR.

SN 78-945,724, FILED 8-5-2006.

LINDA ORNDORFF, EXAMINING ATTORNEY

Int. Cl.: 41

Prior U.S. Cls.: 100, 101, and 107

United States Patent and Trademark Office

Reg. No. 3,522,708

Registered Oct. 21, 2008

**SERVICE MARK
PRINCIPAL REGISTER**

POWERBLOCK

RTM PRODUCTIONS, INC. (TENNESSEE CORPORATION)
130 SOUTHEAST PARKWAY COURT
FRANKLIN, TN 37064

FOR: ENTERTAINMENT SERVICES, NAMELY, A GROUP OF TELEVISION PROGRAMS AIRING CONSECUTIVELY WITH RELATED CONTENT OR A RELATED THEME OF AUTOMOBILES, IN CLASS 41 (U.S. CLS. 100, 101 AND 107).

FIRST USE 1-4-2003; IN COMMERCE 1-4-2003.

THE MARK CONSISTS OF STANDARD CHARACTERS WITHOUT CLAIM TO ANY PARTICULAR FONT, STYLE, SIZE, OR COLOR.

OWNER OF U.S. REG. NOS. 2,982,794 AND 2,984,460.

SN 78-947,550, FILED 8-8-2006.

SAIMA MAKHDOOM, EXAMINING ATTORNEY

Int. Cl.: 30

Prior U.S. Cl.: 46

United States Patent and Trademark Office

Reg. No. 3,522,709

Registered Oct. 21, 2008

**TRADEMARK
PRINCIPAL REGISTER**

HARMONY FOR BODY & SOUL

R. SEELIG & HILLE OHG (FED REP GERMANY
PARTNERSHIP)
KEVELAERER STRASSE 21-23
DUESSELDORF, FED REP GERMANY 40549

THE MARK CONSISTS OF STANDARD CHAR-
ACTERS WITHOUT CLAIM TO ANY PARTICULAR
FONT, STYLE, SIZE, OR COLOR.

FOR: TEA, HERBAL TEA FOR FOOD PURPOSES;
HERBAL INFUSIONS; BEVERAGES MADE OF TEA,
HERBAL TEA, FRUIT TEA, OR A COMBINATION
THEREOF, IN CLASS 30 (U.S. CL. 46).

SN 78-948,458, FILED 8-9-2006.

FIRST USE 8-0-2003; IN COMMERCE 6-17-2008.

KAPIL BHANOT, EXAMINING ATTORNEY

Int. Cl.: 12

Prior U.S. Cls.: 19, 21, 23, 31, 35, and 44

Reg. No. 3,522,710

United States Patent and Trademark Office

Registered Oct. 21, 2008

**TRADEMARK
PRINCIPAL REGISTER**

ROGUE

BOMBARDIER RECREATIONAL PRODUCTS
INC. (CANADA CORPORATION)
726 ST-JOSEPH STREET
VALCOURT, CANADA J0E2L0

THE MARK CONSISTS OF STANDARD CHAR-
ACTERS WITHOUT CLAIM TO ANY PARTICULAR
FONT, STYLE, SIZE, OR COLOR.

FOR: MARINE PROPELLERS, IN CLASS 12 (U.S.
CLS. 19, 21, 23, 31, 35 AND 44).

SN 78-949,416, FILED 8-10-2006.

FIRST USE 4-13-2007; IN COMMERCE 4-13-2007.

ESTHER BELENKER, EXAMINING ATTORNEY

Int. Cl.: 5

Prior U.S. Cls.: 6, 18, 44, 46, 51, and 52

United States Patent and Trademark Office

Reg. No. 3,522,711

Registered Oct. 21, 2008

**TRADEMARK
PRINCIPAL REGISTER**

OMEGAFORCE

WHOLE FOODS MARKET IP, L.P. (DELAWARE
LIMITED PARTNERSHIP)
550 BOWIE STREET, 6TH FLOOR
AUSTIN, TX 78703

FOR: NUTRITIONAL AND DIETARY SUPPLE-
MENTS, IN CLASS 5 (U.S. CLS. 6, 18, 44, 46, 51 AND
52).

FIRST USE 9-30-2007; IN COMMERCE 9-30-2007.

THE MARK CONSISTS OF STANDARD CHAR-
ACTERS WITHOUT CLAIM TO ANY PARTICULAR
FONT, STYLE, SIZE, OR COLOR.

OWNER OF U.S. REG. NO. 2,375,892.

SN 78-949,750, FILED 8-10-2006.

GRETTA YAO, EXAMINING ATTORNEY

Int. Cl.: 36

Prior U.S. Cls.: 100, 101, and 102

United States Patent and Trademark Office

Reg. No. 3,522,712

Registered Oct. 21, 2008

**SERVICE MARK
PRINCIPAL REGISTER**

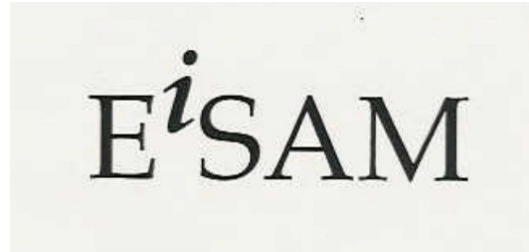

TROXLER, MICHAEL E. (UNITED STATES IN-
DIVIDUAL)
P.O. BOX 129
HEISSON, WA 986220129

FOR: FINANCIAL SERVICES, NAMELY, ASSET
MANAGEMENT, CAPITAL INVESTMENT FOR
OTHERS; FINANCIAL PLANNING; INVESTMENT
CONSULTATION; MORTGAGE BANKING SERVI-
CES, NAMELY, ORIGINATION, ACQUISITION,
SERVICING, SECURITIZATION AND BROKER-

AGE OF MORTGAGE LOANS; MORTGAGE CON-
SULTATION; INSURANCE CONSULTATION, IN
CLASS 36 (U.S. CLS. 100, 101 AND 102).

FIRST USE 4-0-2008; IN COMMERCE 4-0-2008.

SN 78-950,781, FILED 8-11-2006.

DAVID I, EXAMINING ATTORNEY

Int. Cl.: 9

Prior U.S. Cls.: 21, 23, 26, 36, and 38

United States Patent and Trademark Office

Reg. No. 3,522,713

Registered Oct. 21, 2008

**TRADEMARK
PRINCIPAL REGISTER**

V THERE PLAYER

SENTILLION, INC. (DELAWARE CORPORATION)
40 SHATTUCK ROAD
ANDOVER, MA 01810

FOR: COMPUTER SOFTWARE FOR PROVIDING, MANAGING AND ADMINISTERING REMOTE ACCESS TO APPLICATION SOFTWARE IN THE FIELDS OF HEALTHCARE, EDUCATION, FINANCE, AND CALL CENTERS , IN CLASS 9 (U.S. CLS. 21, 23, 26, 36 AND 38).

FIRST USE 11-0-2006; IN COMMERCE 11-0-2006.

THE MARK CONSISTS OF STANDARD CHARACTERS WITHOUT CLAIM TO ANY PARTICULAR FONT, STYLE, SIZE, OR COLOR.

NO CLAIM IS MADE TO THE EXCLUSIVE RIGHT TO USE "PLAYER", APART FROM THE MARK AS SHOWN.

SN 78-951,231, FILED 8-14-2006.

PAUL CROWLEY, EXAMINING ATTORNEY

Int. Cl.: 11

Prior U.S. Cls.: 13, 21, 23, 31, and 34

United States Patent and Trademark Office

Reg. No. 3,522,714

Registered Oct. 21, 2008

**TRADEMARK
PRINCIPAL REGISTER**

HYDRA SAUNA

P.I. INC. (TENNESSEE CORPORATION)
1712 CONGRESS PARKWAY
ATHENS, TN 373710669

FOR: SAUNAS, SAUNA HEATERS, SAUNA CONTROLS AND STEAM GENERATORS, IN CLASS 11 (U.S. CLS. 13, 21, 23, 31 AND 34).

FIRST USE 2-1-2008; IN COMMERCE 2-1-2008.

THE MARK CONSISTS OF STANDARD CHARACTERS WITHOUT CLAIM TO ANY PARTICULAR FONT, STYLE, SIZE, OR COLOR.

NO CLAIM IS MADE TO THE EXCLUSIVE RIGHT TO USE "SAUNA", APART FROM THE MARK AS SHOWN.

SN 78-951,428, FILED 8-14-2006.

GIANCARLO CASTRO, EXAMINING ATTORNEY

Int. Cl.: 41

Prior U.S. Cls.: 100, 101, and 107

United States Patent and Trademark Office

Reg. No. 3,522,715

Registered Oct. 21, 2008

SERVICE MARK
PRINCIPAL REGISTER



DELL, JEFFERY S. (TENNESSEE SOLE PROPRIETORSHIP)
215 QUIET LANE
LAVERGNE, TN 37086

FOR: MUSIC PRODUCTION SERVICES, IN CLASS 41 (U.S. CLS. 100, 101 AND 107).

FIRST USE 11-14-2007; IN COMMERCE 11-23-2007.

NO CLAIM IS MADE TO THE EXCLUSIVE RIGHT TO USE "RECORDS", APART FROM THE MARK AS SHOWN.

THE COLOR(S) BLACK, WHITE, GRAY AND BLUE IS/ARE CLAIMED AS A FEATURE OF THE MARK.

THE COLOR BLUE APPEARS IN THE WORDING "DREAM LINE", THE COLOR BLACK APPEARS IN THE OUTLINE OF THE TERM "DREAM LINE", THE OUTLINE OF THE TERM "RECORDS", IN THE DESIGN OF THE HEADPHONES AND IN THE RECTANGULAR BACKGROUND, THE COLOR WHITE APPEARS IN THE TERM "RECORDS" AND IN THE LIGHTENING, THE COLOR GRAY APPEARS IN THE SHADED AREA SURROUNDING THE LIGHTENING AND IN THE HEADPHONES.

SN 78-951,824, FILED 8-14-2006.

AMY MCMENAMIN, EXAMINING ATTORNEY

Int. Cls.: 7, 9, and 11

Prior U.S. Cls.: 13, 19, 21, 23, 26, 31, 34, 35, 36, and 38

Reg. No. 3,522,716

United States Patent and Trademark Office

Registered Oct. 21, 2008

**TRADEMARK
PRINCIPAL REGISTER**

SYSTEC

RHEODYNE, LLC (DELAWARE LIMITED LIABILITY COMPANY)
600 PARK COURT
ROHNERT PARK, CA 94927

FOR: VACUUM PUMPS FOR EVACUATING CHAMBERS USED IN FLUID DEGASSING OPERATIONS, IN CLASS 7 (U.S. CLS. 13, 19, 21, 23, 31, 34 AND 35).

FIRST USE 1-15-2000; IN COMMERCE 1-15-2000.

FOR: PRINTED CIRCUIT BOARDS; COMPUTER SOFTWARE AND FIRMWARE FOR CONTROLLING THE OPERATION OF PUMPS USED IN FLUID DEGASSING OPERATIONS; ELECTRICAL TRANSFORMERS; PRESSURE SENSORS; FILTERS FOR LIQUIDS USED IN CHROMATOGRAPHIC ANALYSES; PRESSURE REGULATORS FOR LIQUIDS USED IN CHROMATOGRAPHIC ANALYSES; AND CHROMATOGRAPHY EQUIPMENT, NAMELY, LIQUID SAMPLE CELLS IN THE NATURE OF CONTAINERS FOR SPECTROANALYSIS OF LIQUIDS, IN CLASS 9 (U.S. CLS. 21, 23, 26, 36 AND 38).

FIRST USE 1-15-2000; IN COMMERCE 1-15-2000.

FOR: MEMBRANE CONTACTOR UNITS IN THE NATURE OF CARTRIDGES FOR USE IN DEGASSING FLUID STREAMS USED IN CHROMATOGRAPHIC ANALYSES; SEMI-PERMEABLE LIQUID CONVEYANCE TUBING AND PARTS AND FITTINGS THEREFORE FOR USE IN DEGASSING FLUID STREAMS USED IN CHROMATOGRAPHIC ANALYSES, IN CLASS 11 (U.S. CLS. 13, 21, 23, 31 AND 34).

FIRST USE 1-1-2004; IN COMMERCE 1-1-2004.

THE MARK CONSISTS OF STANDARD CHARACTERS WITHOUT CLAIM TO ANY PARTICULAR FONT, STYLE, SIZE, OR COLOR.

SN 78-953,616, FILED 8-16-2006.

MARIAM MAHMOUDI, EXAMINING ATTORNEY

Int. Cl.: 9

Prior U.S. Cls.: 21, 23, 26, 36, and 38

Reg. No. 3,522,717

United States Patent and Trademark Office

Registered Oct. 21, 2008

**TRADEMARK
PRINCIPAL REGISTER**

COSTOPTIMIZER

FORMING TECHNOLOGIES INCORPORATED
(CANADA CORPORATION)
1075 NORTH SERVICE ROAD WEST
SUITE #6
OAKVILLE, ONTARIO, CANADA L6M 2G2

FOR: COMPUTER AIDED ENGINEERING SOFTWARE USED PRIMARILY IN THE METAL STAMPING AND FORMING INDUSTRIES AND IN AUTOMOTIVE STYLING , IN CLASS 9 (U.S. CLS. 21, 23, 26, 36 AND 38).

FIRST USE 2-28-2007; IN COMMERCE 2-28-2007.

THE MARK CONSISTS OF STANDARD CHARACTERS WITHOUT CLAIM TO ANY PARTICULAR FONT, STYLE, SIZE, OR COLOR.

PRIORITY CLAIMED UNDER SEC. 44(D) ON CANADA APPLICATION NO. 1313004, FILED 8-15-2006, REG. NO. TMA693141, DATED 7-31-2007, EXPIRES 7-31-2022.

SN 78-953,638, FILED 8-16-2006.

JENNIFER VASQUEZ, EXAMINING ATTORNEY

Int. Cls.: 35, 41, and 42

Prior U.S. Cls.: 100, 101, 102, and 107

United States Patent and Trademark Office

Reg. No. 3,522,718

Registered Oct. 21, 2008

**SERVICE MARK
PRINCIPAL REGISTER**

TWIST NEW BRAND VENTURE

TWIST, NEW.BRAND.VENTURE, LLC (DELAWARE LIMITED LIABILITY COMPANY)

#6F

310 E. 74 STREET

NEW YORK, NY 10021

FOR: MARKETING SERVICES, NAMELY, BRAND BUILDING, WEBSITE AND E-MAIL MARKETING, VIRAL MARKETING AND DIRECT MARKETING FOR BUSINESS TO CONSUMER AND BUSINESS TO BUSINESS; PUBLIC RELATION SERVICES, NAMELY, PUBLIC RELATIONS STRATEGY AND EXECUTION; BRAND BUILDING, NAMELY, SERVICES RELATING TO THE ANALYSIS, EVALUATION, CREATION AND BRAND ESTABLISHMENT, AND DEVELOPMENT OF BRAND AND CORPORATE IDENTITY; PUBLIC RELATION SERVICES; ADVERTISING SERVICES, NAMELY, DEVELOPING BRAND IDENTITY OF OTHERS; MARKET ANALYSIS IN THE NATURE OF DISTRIBUTION CHANNEL IDENTIFICATION; DEVELOPING BRAND IDENTITY FOR OTHERS THROUGH THE DEVELOPMENT OF IN-STORE STRATEGIES AND MARKETING PROGRAMS, PRODUCT FORECASTING, IN-STORE PRODUCT MERCHANDISING; DEVELOPMENT AND EXECUTION AND RETAIL PROMOTION FOR OTHERS THROUGH DISTRIBUTION OF MARKETING AND SALES MATERIALS, NAMELY, BROCHURES, SAMPLES, TRAINING MATERIALS, PRODUCT ENDORSEMENT; BUSINESS ADVISORY AND CONSULTATION SERVICES IN THE FIELDS OF MARKETING, PUBLIC RELATIONS, DEVELOPING BRAND IDENTITY, PRODUCT DEVELOPMENT, ADVERTISING, BUSINESS AND SALES PROMOTION AND DISTRIBUTION OF PRODUCTS AND ADVERTISING; ADVISORY AND CONSULTATION SERVICES WITH RESPECT TO PROMOTING PRODUCT ENDORSEMENTS, IN CLASS 35 (U.S. CLS. 100, 101 AND 102).

FIRST USE 1-0-2007; IN COMMERCE 1-0-2007.

FOR: EDUCATIONAL SERVICES, NAMELY, PROVIDING CUSTOMIZED CONSULTATIONS, INTERNAL STAFF TRAINING THROUGH WORKSHOPS, SEMINARS OR TUTORIALS IN THE FIELD OF MARKETING, BRANDING AND SALES; EDUCATIONAL SERVICES, NAMELY, PROVIDING EXTERNAL STAFF TRAINING IN THE FIELDS OF MARKETING, PUBLIC RELATIONS, DEVELOPING BRAND IDENTITY, ADVERTISING, BUSINESS CONSULTING AND SALES PROMOTION, PRODUCT TRAINING AT POINTS OF DISTRIBUTION AND DISTRIBUTION OF PRODUCTS AND ADVERTISING THROUGH WORKSHOPS, SEMINARS OR TUTORIALS, MOTIVATIONAL OR EDUCATIONAL SPEAKERS, WEBINARS, INTERACTIVE PROGRAMS OVER THE INTERNET, TELEVISION APPEARANCES, RADIO BROADCASTS, PRINT MATERIALS AND EDUCATIONAL MATERIALS DISTRIBUTED IN ASSOCIATION THEREWITH; AND DISTRIBUTION OF COURSE MATERIALS IN CONNECTION THEREWITH; EDUCATIONAL SERVICES, NAMELY, PROVIDING CLASSES, SEMINARS, WORKSHOPS AND LECTURES IN THE FIELD OF DEVELOPING BRAND IDENTITY FOR OTHERS THROUGH THE DEVELOPMENT OF IN-STORE BRAND STRATEGIES, IN CLASS 41 (U.S. CLS. 100, 101 AND 107).

FIRST USE 1-0-2007; IN COMMERCE 1-0-2007.

FOR: PRODUCT DEVELOPMENT FOR OTHERS; PRODUCT DEVELOPMENT AND PACKAGING NAMELY DEVELOPMENT OF A PRODUCT'S STRUCTURAL PACKAGING, PHOTOGRAPHY, GUIDELINES AND POSITIONING, IN CLASS 42 (U.S. CLS. 100 AND 101).

FIRST USE 1-0-2007; IN COMMERCE 1-0-2007.

THE MARK CONSISTS OF STANDARD CHARACTERS WITHOUT CLAIM TO ANY PARTICULAR FONT, STYLE, SIZE, OR COLOR.

SN 78-954,074, FILED 8-17-2006.

RONALD DELGIZZI, EXAMINING ATTORNEY

Int. Cls.: 6, 7, 9, 12, and 42

**Prior U.S. Cls.: 2, 12, 13, 14, 19, 21, 23, 25, 26, 31, 34,
35, 36, 38, 44, 50, 100, and 101**

Reg. No. 3,522,719

United States Patent and Trademark Office

Registered Oct. 21, 2008

**TRADEMARK
SERVICE MARK
PRINCIPAL REGISTER**

KAREM AIRCRAFT, INC.

ABE KAREM (UNITED STATES INDIVIDUAL)
1018 TIMBERLINE LANE
TUSTIN, CA 92705

FOR: HIGH STRENGTH, LOW-WEIGHT METAL AND METAL COMPOSITE FOR USE IN AIRCRAFT, NAMELY, ALUMINUM AND TITANIUM, IN CLASS 6 (U.S. CLS. 2, 12, 13, 14, 23, 25 AND 50).

FIRST USE 10-3-2005; IN COMMERCE 10-3-2005.

FOR: ELECTRIC MOTORS FOR MACHINES, AIRCRAFT ENGINES; MACHINES FOR THE MANUFACTURE AND CONSTRUCTION OF AIRCRAFT; JET ENGINES FOR THE PROPULSION OF AIRCRAFT, IN CLASS 7 (U.S. CLS. 13, 19, 21, 23, 31, 34 AND 35).

FIRST USE 10-3-2005; IN COMMERCE 10-3-2005.

FOR: FLIGHT CONTROL ELECTRONICS, NAMELY, INTEGRATED FLIGHT CONTROL, NAVIGATION AND GUIDANCE COMPUTERS FOR MANNED AND UNMANNED AIRCRAFT; COMPUTER SOFTWARE AND HARDWARE FOR AIRCRAFT OPERATION AND NAVIGATION, IN CLASS 9 (U.S. CLS. 21, 23, 26, 36 AND 38).

FIRST USE 10-3-2005; IN COMMERCE 10-3-2005.

FOR: AIRCRAFT, NAMELY, AIRPLANES AND HELICOPTERS AND STRUCTURAL PARTS

THEREFORE, IN CLASS 12 (U.S. CLS. 19, 21, 23, 31, 35 AND 44).

FIRST USE 10-3-2005; IN COMMERCE 10-3-2005.

FOR: DESIGN OF ELECTRONICS, COMPUTER PROGRAMS AND SOFTWARE RELATING TO AIRCRAFT; TECHNOLOGY AND TECHNICAL CONSULTATION AND RESEARCH IN THE FIELDS OF AEROSPACE ENGINEERING, SOFTWARE DEVELOPMENT, COMPUTER ENGINEERING AND ELECTRICAL ENGINEERING, ALL PERTAINING TO AIRCRAFT AND AIRCRAFT SYSTEMS; TECHNICAL PROJECT MANAGEMENT PERTAINING TO AIRCRAFT AND AIRCRAFT SYSTEMS, IN CLASS 42 (U.S. CLS. 100 AND 101).

FIRST USE 10-3-2005; IN COMMERCE 10-3-2005.

THE MARK CONSISTS OF STANDARD CHARACTERS WITHOUT CLAIM TO ANY PARTICULAR FONT, STYLE, SIZE, OR COLOR.

NO CLAIM IS MADE TO THE EXCLUSIVE RIGHT TO USE "AIRCRAFT, INC.", APART FROM THE MARK AS SHOWN.

SN 78-954,719, FILED 8-17-2006.

MICHAEL SOUDERS, EXAMINING ATTORNEY

Int. Cls.: 35, 38, 41, and 42

Prior U.S. Cls.: 100, 101, 102, 104, and 107

United States Patent and Trademark Office

Reg. No. 3,522,720

Registered Oct. 21, 2008

**SERVICE MARK
PRINCIPAL REGISTER**



WEB2 CORP (DELAWARE CORPORATION)
SUITE 600
100 W. LUCERNE CIRCLE
ORLANDO, FL 32801

FOR: BUSINESS CONSULTATION; ADVERTISING AND MARKETING FOR OTHERS, NAMELY, DISSEMINATION OF ADVERTISING FOR OTHERS VIA THE INTERNET, PROVIDING ADVERTISING SPACE ON THE INTERNET; E-COMMERCE SERVICES, NAMELY, PROMOTING THE GOODS AND SERVICES OF OTHERS BY MEANS OF OPERATING AN ONLINE SHOPPING MALL WITH LINKS TO THE RETAIL WEB SITES OF OTHERS; ONLINE AUCTION SERVICES; ONLINE TRADING SERVICES, NAMELY, ONLINE TRADING SERVICES IN WHICH SELLERS POST PRODUCTS TO BE AUCTIONED AND BIDDING IS DONE VIA THE INTERNET; PROVIDING ON-LINE DIRECTORY INFORMATION SERVICES ALSO FEATURING HYPERLINKS TO OTHER WEB SITES, IN CLASS 35 (U.S. CLS. 100, 101 AND 102).

FIRST USE 3-1-2008; IN COMMERCE 3-1-2008.

FOR: PROVIDING ONLINE CHAT ROOMS AND ELECTRONIC BULLETIN BOARD FOR THE TRANSMISSION OF MESSAGES IN THE FIELD OF BUSINESS AND CONSUMER INTEREST TOPICS AND GENERAL INTEREST; E-MAIL SERVICES; PROVIDING ELECTRONIC TRANSMISSION OF DATA, IMAGES, AND SOUND VIA THE INTERNET, ONLINE ELECTRONIC BULLETIN BOARDS AND CHAT ROOMS FOR TRANSMISSION OF MESSAGES, PHOTOS AND NOTES AMONG A GROUP OF COMPUTER USERS CONCERNING USER-DEFINED TOPICS OF BUSINESS AND CON-

SUMER INTEREST TOPICS AND GENERAL INTEREST; PROVIDING ONLINE COMPUTER NETWORK FACILITIES FOR REAL-TIME INTERACTION AND COMMUNICATION AMONG COMPUTER USERS IN THE FIELDS OF BUSINESS AND CONSUMER INTEREST TOPICS AND GENERAL INTEREST, IN CLASS 38 (U.S. CLS. 100, 101 AND 104).

FIRST USE 3-1-2008; IN COMMERCE 3-1-2008.

FOR: ENTERTAINMENT AND EDUCATION SERVICES, NAMELY, ONGOING TELEVISION, RADIO AND INDEPENDENTLY PRODUCED VIDEO AND AUDIO PROGRAMS BROADCAST OVER THE INTERNET IN THE FIELDS OF NEWS, WEATHER, SPORTS, TRAVEL, CURRENT EVENTS, REFERENCE INFORMATION, CAREER, COMPUTING, SHOPPING, AUCTIONS, MOVIES, THEATER, MUSIC, HEALTH, EDUCATION, SCIENCE, FINANCE AND INVESTING; PROVIDING LINKS TO THE WEBSITES OF OTHERS FEATURING NEWS, SPORTS, CURRENT EVENTS, ONLINE REFERENCE LIBRARIES OF LITERATURE AND TO OTHER ENTERTAINMENT AND EDUCATIONAL DATA, IN CLASS 41 (U.S. CLS. 100, 101 AND 107).

FIRST USE 3-1-2008; IN COMMERCE 3-1-2008.

FOR: PROVIDING TEMPORARY USE OF ONLINE NONDOWNLOADABLE SOFTWARE FOR USE BY ONLINE RETAIL MERCHANTS TO FACILITATE ONLINE ORDERING OF SUCH MERCHANTS' GOODS BY THEIR CUSTOMERS, AND ELECTRONIC TRANSACTION PROCESSING VIA AN INTEGRATED ONLINE SHOPPING CART PROVIDED BY SUCH ONLINE SOFTWARE; DESIGNING AND CREATING WEBSITES FOR OTHER,

WEBSITE HOSTING FOR OTHERS, MANAGING WEBSITE CONTENT AND ELECTRONIC MESSAGING SYSTEMS AND APPLICATIONS FOR OTHERS; PROVIDING CUSTOMIZED ONLINE WEB PAGES FEATURING USER-DEFINED INFORMATION, WHICH INCLUDES SEARCH ENGINES AND ONLINE WEB LINKS TO OTHER WEB SITES; COMPUTER SERVICES, NAMELY, PROVIDING TEMPORARY USE OF ON-LINE NONDOWNLOADABLE SOFTWARE TO PROVIDE OTHERS WITH A SEARCH ENGINE FOR OBTAINING DATA ON THE INTERNET; SEARCHING AND RETRIEVING INFORMATION, SITES AND OTHER RESOURCES AVAILABLE ON THE INTERNET FOR OTHERS; CREATING INDEXES OF INFORMATION, SITES AND OTHER RESOURCES AVAILABLE ON THE INTERNET, IN CLASS 42 (U.S. CLS. 100 AND 101).

FIRST USE 3-1-2008; IN COMMERCE 3-1-2008.

"THE COLOR(S) WHITE, GRAY, DARK BLUE AND LIGHT BLUE IS/ARE CLAIMED AS A FEATURE OF THE MARK."

"THE MARK CONSISTS OF THE CHARACTERS 2.0 AND) FORMED AS STYLIZED SMILING FACE SET ABOVE THE WORDING WEB2CORP; THE COLOR DARK BLUE APPEARS IN THE WORDING WEB2 AND IN THE EDGES OF A STYLIZED RECTANGLE; THE COLOR LIGHT BLUE APPEARS IN THE WORDING CORP AND IN THE CENTER OF THE RECTANGLE; THE COLOR WHITE APPEARS IN THE STYLIZED DESIGN OF A FACE CONSISTING OF THE CHARACTERS 2.0) AND IN THE OUTER BORDER OF THE RECTANGLE; THE COLOR GRAY APPEARS AT THE TOP RIGHT AND BOTTOM LEFT EDGES OF THE BORDER OF THE RECTANGLE."

SN 78-954,739, FILED 8-17-2006.

SEAN CROWLEY, EXAMINING ATTORNEY

Int. Cl.: 35

Prior U.S. Cls.: 100, 101, and 102

United States Patent and Trademark Office

Reg. No. 3,522,721

Registered Oct. 21, 2008

**SERVICE MARK
PRINCIPAL REGISTER**

Gshop

HERTEL, ANDREW (UNITED STATES INDIVIDUAL)
P.O. BOX 753
MAPLE VALLEY, WA 98038

FOR: ELECTRONIC COMMERCE SERVICES, NAMELY, PROVIDING INFORMATION ABOUT PRODUCTS VIA TELECOMMUNICATION NETWORKS FOR ADVERTISING AND SALES PURPOSES, IN CLASS 35 (U.S. CLS. 100, 101 AND 102).

FIRST USE 9-21-2004; IN COMMERCE 8-6-2008.

THE MARK CONSISTS OF STANDARD CHARACTERS WITHOUT CLAIM TO ANY PARTICULAR FONT, STYLE, SIZE, OR COLOR.

SN 78-955,677, FILED 8-18-2006.

ANDREA K. NADELMAN, EXAMINING ATTORNEY

Int. Cl.: 5

Prior U.S. Cls.: 6, 18, 44, 46, 51, and 52

Reg. No. 3,522,722

United States Patent and Trademark Office

Registered Oct. 21, 2008

**TRADEMARK
PRINCIPAL REGISTER**

Nutri Shield

NUTRITEK INC. (OREGON CORPORATION)
2928 MAPLELEAF COURT, NW
SALEM, OR 97304

THE MARK CONSISTS OF STANDARD CHAR-
ACTERS WITHOUT CLAIM TO ANY PARTICULAR
FONT, STYLE, SIZE, OR COLOR.

FOR: INSECT REPELLENTS, IN CLASS 5 (U.S.
CLS. 6, 18, 44, 46, 51 AND 52).

SN 78-955,721, FILED 8-18-2006.

FIRST USE 7-15-2006; IN COMMERCE 12-31-2006.

TINA BROWN, EXAMINING ATTORNEY

Int. Cl.: 37

Prior U.S. Cls.: 100, 103, and 106

United States Patent and Trademark Office

Reg. No. 3,522,723

Registered Oct. 21, 2008

**SERVICE MARK
PRINCIPAL REGISTER**

CLEANOLOGY

CLEANOLOGY, INC. (CALIFORNIA CORPORATION)
SUITE 107
4682 IOWA STREET
SAN DIEGO, CA 92116

THE MARK CONSISTS OF STANDARD CHARACTERS WITHOUT CLAIM TO ANY PARTICULAR FONT, STYLE, SIZE, OR COLOR.

FOR: CLEANING OF RESIDENTIAL HOUSES AND BUSINESSES, IN CLASS 37 (U.S. CLS. 100, 103 AND 106).

SN 78-955,771, FILED 8-18-2006.

FIRST USE 6-30-2006; IN COMMERCE 1-31-2007.

JAMES GRIFFIN, EXAMINING ATTORNEY

Int. Cl.: 25

Prior U.S. Cls.: 22 and 39

United States Patent and Trademark Office

Reg. No. 3,522,724

Registered Oct. 21, 2008

**TRADEMARK
PRINCIPAL REGISTER**

Have a whale of a time

TOGOZ, INC. (MAINE CORPORATION)
166 RIVERSIDE INDUSTRIAL PARKWAY
PORTLAND, ME 04103

THE MARK CONSISTS OF STANDARD CHAR-
ACTERS WITHOUT CLAIM TO ANY PARTICULAR
FONT, STYLE, SIZE, OR COLOR.

FOR: HEADBANDS; SANDALS; WAIST BELTS,
IN CLASS 25 (U.S. CLS. 22 AND 39).

SN 78-956,655, FILED 8-21-2006.

FIRST USE 1-30-2007; IN COMMERCE 1-30-2007.

HOWARD B. LEVINE, EXAMINING ATTORNEY

Int. Cls.: 35 and 36

Prior U.S. Cls.: 100, 101, and 102

United States Patent and Trademark Office

Reg. No. 3,522,725

Registered Oct. 21, 2008

**SERVICE MARK
PRINCIPAL REGISTER**

BRIDGING THE POSSIBILITIES

SILO FINANCIAL CORP. (CONNECTICUT CORPORATION)
SUITE #208
2 LANDMARK SQUARE
STAMFORD, CT 06901

FOR: BUSINESS MANAGEMENT CONSULTATION SERVICES; PROVIDING BUSINESS INFORMATION BY ELECTRONIC MEANS; ECONOMIC FORECASTING; RELOCATION SERVICES FOR INDIVIDUALS AND BUSINESSES; PROVIDING ONLINE COMPUTER DATABASES VIA THE INTERNET IN THE FIELD OF BUSINESS, IN CLASS 35 (U.S. CLS. 100, 101 AND 102).

FIRST USE 9-1-2006; IN COMMERCE 9-1-2006.

FOR: FINANCIAL LENDING SERVICES, NAMELY, PRIMARY, SECONDARY AND INVESTMENT LENDING; LOAN FINANCING OF MORTGAGE LOANS, REAL ESTATE LOANS, CONSTRUCTION LOANS, HOME EQUITY LOANS AND BRIDGE LOANS; FINANCIAL SERVICES, NAMELY, FINANCIAL GUARANTEE UNDERWRITING, MANAGEMENT OF CAPITAL INVESTMENT FUNDS, FUNDS AND TRUST INVESTMENTS; FACTORING AGENCIES; MORTGAGE PROCUREMENT FOR OTHERS; MORTGAGE SERVICES, NAMELY, ORIGINATION,

ACQUISITION, SERVICING, SECURITIZATION AND BROKERAGE OF MORTGAGE FOR INDIVIDUALS, BANKS AND MORTGAGE BROKERS; MORTGAGE BROKERAGE; PROVIDING FINANCIAL COUNSELING, EVALUATION AND INFORMATION IN THE FIELDS OF MORTGAGES AND REAL ESTATE; AND FINANCIAL INFORMATION PROVIDED BY ELECTRONIC MEANS; REAL ESTATE APPRAISALS AND VALUATIONS; LEASING OF REAL ESTATE; REAL ESTATE ACQUISITION AND INVESTMENT; FINANCIAL AND REAL ESTATE CONSULTATION SERVICES; PROVIDING FINANCIAL AND REAL ESTATE INFORMATION BY ELECTRONIC MEANS; PROVIDING ONLINE COMPUTER DATABASES VIA THE INTERNET IN THE FIELD OF FINANCES AND REAL ESTATE, IN CLASS 36 (U.S. CLS. 100, 101 AND 102).

FIRST USE 9-1-2006; IN COMMERCE 9-1-2006.

THE MARK CONSISTS OF STANDARD CHARACTERS WITHOUT CLAIM TO ANY PARTICULAR FONT, STYLE, SIZE, OR COLOR.

SN 78-958,460, FILED 8-23-2006.

SEAN CROWLEY, EXAMINING ATTORNEY

Int. Cl.: 14

Prior U.S. Cls.: 2, 27, 28, and 50

United States Patent and Trademark Office

Reg. No. 3,522,726

Registered Oct. 21, 2008

**TRADEMARK
PRINCIPAL REGISTER**

KWITSMOWKIN!

DRUSKOCZI, SUE (UNITED STATES INDIVIDUAL)

#335

2490 BLACK ROCK TURNPIKE

FAIRFIELD, CT 06825

THE MARK CONSISTS OF STANDARD CHARACTERS WITHOUT CLAIM TO ANY PARTICULAR FONT, STYLE, SIZE, OR COLOR.

FOR: RUBBER OR SILICONE WRISTBANDS IN THE NATURE OF A BRACELET, IN CLASS 14 (U.S. CLS. 2, 27, 28 AND 50).

SN 78-958,468, FILED 8-23-2006.

FIRST USE 10-1-2006; IN COMMERCE 10-1-2006.

MARGARET POWER, EXAMINING ATTORNEY

Int. Cls.: 9 and 21

**Prior U.S. Cls.: 2, 13, 21, 23, 26, 29, 30, 33, 36, 38, 40,
and 50**

Reg. No. 3,522,727

United States Patent and Trademark Office

Registered Oct. 21, 2008

**TRADEMARK
PRINCIPAL REGISTER**

**Creme Brulee 101 by
Tabletops**

TABLETOPS UNLIMITED INC. (CALIFORNIA
CORPORATION)
23000 AVALON BLVD
CARSON, CA 90745

FOR: MEASURING CUP, MEASURING SPOONS,
IN CLASS 9 (U.S. CLS. 21, 23, 26, 36 AND 38).

FIRST USE 2-12-2007; IN COMMERCE 2-12-2007.

FOR: BAKEWARE, NAMELY, BAKING PAN,
BOWL, WHISK, CULINARY BLOW TORCH;
HOUSEHOLD UTENSILS, NAMELY, SPATULAS,
IN CLASS 21 (U.S. CLS. 2, 13, 23, 29, 30, 33, 40 AND 50).

FIRST USE 2-12-2007; IN COMMERCE 2-12-2007.

THE MARK CONSISTS OF STANDARD CHAR-
ACTERS WITHOUT CLAIM TO ANY PARTICULAR
FONT, STYLE, SIZE, OR COLOR.

NO CLAIM IS MADE TO THE EXCLUSIVE
RIGHT TO USE "CREME BRULEE", APART FROM
THE MARK AS SHOWN.

SN 78-958,976, FILED 8-23-2006.

REGINA DRUMMOND, EXAMINING ATTORNEY

Int. Cl.: 25

Prior U.S. Cls.: 22 and 39

United States Patent and Trademark Office

Reg. No. 3,522,728

Registered Oct. 21, 2008

**TRADEMARK
PRINCIPAL REGISTER**

Hellz Bellz

CLOAK & DAGGER LLC (NEW JERSEY LIMITED LIABILITY COMPANY)
31-421 RIVER COURT
JERSEY CITY, NJ 07310

FOR: MENS, WOMENS, AND CHILDRENS SHOES, SHIRTS, HATS, PANTS, DRESSES, AND SHORTS, IN CLASS 25 (U.S. CLS. 22 AND 39).

FIRST USE 11-1-2005; IN COMMERCE 11-1-2005.

THE MARK CONSISTS OF STANDARD CHARACTERS WITHOUT CLAIM TO ANY PARTICULAR FONT, STYLE, SIZE, OR COLOR.

SN 78-959,556, FILED 8-24-2006.

KATHERINE M. DUBRAY, EXAMINING ATTORNEY

Int. Cl.: 9

Prior U.S. Cls.: 21, 23, 26, 36, and 38

United States Patent and Trademark Office

Reg. No. 3,522,729

Registered Oct. 21, 2008

**TRADEMARK
PRINCIPAL REGISTER**



IDEAL INDUSTRIES, INC. (DELAWARE CORPORATION)
BECKER PLACE
SYCAMORE, IL 60178

FOR: ELECTRICAL WIRE CONNECTORS, IN CLASS 9 (U.S. CLS. 21, 23, 26, 36 AND 38).

FIRST USE 10-31-2006; IN COMMERCE 10-31-2006.

THE MARK CONSISTS OF THE TERM "POWER-PLUG" WITH THE TERM "POWER" IN A FIRST COLOR WITH A FIRST CONTRASTING BACKGROUND AND THE TERM "PLUG" IN A SECOND COLOR WITH A SECOND CONTRASTING BACKGROUND.

SN 78-960,855, FILED 8-25-2006.

GIANCARLO CASTRO, EXAMINING ATTORNEY

Int. Cl.: 7

Prior U.S. Cls.: 13, 19, 21, 23, 31, 34, and 35

Reg. No. 3,522,730

United States Patent and Trademark Office

Registered Oct. 21, 2008

**TRADEMARK
PRINCIPAL REGISTER**

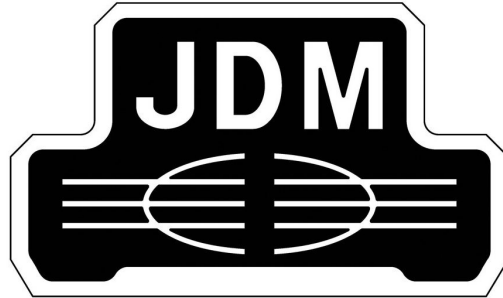

ZHENG, LIANGCAI (CHINA INDIVIDUAL)
ROOM110, NO.6
35LANE, YUNSHI STREET, HAISHU DISTRICT
NINGBO CITY, CHINA 315000

FOR: PUNCHING PRESSES; SEMICONDUCTOR
WAFER PROCESSING MACHINES; METALWORK-
ING MACHINE TOOLS; MANIPULATORS FOR
FORGING PRESSES AND FOR FORGING MA-
CHINES; BENDING MACHINES; CUTTING MA-
CHINES; AUTOMATIC ELECTRIC OR GAS
WELDING MACHINES; WASHING MACHINE
FOR INDUSTRIAL PARTS; HIGH-PRESSURE

PUMPS FOR WASHING APPLIANCES AND IN-
STALLATIONS, IN CLASS 7 (U.S. CLS. 13, 19, 21, 23,
31, 34 AND 35).

FIRST USE 10-10-2006; IN COMMERCE 10-10-2006.

THE MARK CONSISTS OF PARTIALLY SHADED
POLYGONS WITH "JDM" AND OVALS DIVIDED IN
THE MIDDLE AND HORIZONTAL LINES.

SN 78-961,369, FILED 8-28-2006.

IRA J. GOODSaid, EXAMINING ATTORNEY

Int. Cl.: 41

Prior U.S. Cls.: 100, 101, and 107

United States Patent and Trademark Office

Reg. No. 3,522,731

Registered Oct. 21, 2008

**SERVICE MARK
PRINCIPAL REGISTER**

PHOEBE FONTAINE

GEORGIA-PACIFIC CONSUMER PRODUCTS LP
(DELAWARE LIMITED PARTNERSHIP)
GA030-41N
133 PEACHTREE STREET NE
ATLANTA, GA 30303

FOR: PROVIDING ADVICE AND INFORMATION
IN THE FIELD OF PARTY PLANNING FEATUR-
ING A SPOKESPERSON AND PROMOTIONAL
CHARACTER, IN CLASS 41 (U.S. CLS. 100, 101
AND 107).

FIRST USE 1-31-2007; IN COMMERCE 1-31-2007.

THE MARK CONSISTS OF STANDARD CHAR-
ACTERS WITHOUT CLAIM TO ANY PARTICULAR
FONT, STYLE, SIZE, OR COLOR.

THE NAME "PHOEBE FONTAINE" DOES NOT
IDENTIFY A LIVING INDIVIDUAL.

SN 78-961,746, FILED 8-28-2006.

MICHELE SWAIN, EXAMINING ATTORNEY

Int. Cls.: 9, 17, 23, and 26

**Prior U.S. Cls.: 1, 5, 12, 13, 21, 23, 26, 35, 36, 37, 38,
39, 40, 42, 43, and 50**

Reg. No. 3,522,732

United States Patent and Trademark Office

Registered Oct. 21, 2008

**TRADEMARK
PRINCIPAL REGISTER**

FILZ-IT!

J. & P. COATS, LIMITED (GREAT BRITAIN
CORPORATION)
155 ST. VINCENT STREET
GLASGOW G2 5PA, SCOTLAND

FOR: PRE-RECORDED CDS, CD ROMS, AND
DVDS FEATURING TEXTILE CRAFTS, IN CLASS 9
(U.S. CLS. 21, 23, 26, 36 AND 38).

FIRST USE 12-27-2005; IN COMMERCE 12-27-2005.

FOR: PLASTICS IN EXTRUDED FORM FOR
CRAFT USE, IN CLASS 17 (U.S. CLS. 1, 5, 12, 13, 35
AND 50).

FIRST USE 12-27-2005; IN COMMERCE 12-27-2005.

FOR: YARNS, IN CLASS 23 (U.S. CL. 43).

FIRST USE 12-27-2005; IN COMMERCE 12-27-2005.

FOR: NEEDLES AND FELTING NEEDLES, IN
CLASS 26 (U.S. CLS. 37, 39, 40, 42 AND 50).

FIRST USE 12-27-2005; IN COMMERCE 12-27-2005.

THE MARK CONSISTS OF STANDARD CHAR-
ACTERS WITHOUT CLAIM TO ANY PARTICULAR
FONT, STYLE, SIZE, OR COLOR.

THE FOREIGN WORDING IN THE MARK
TRANSLATES INTO ENGLISH AS FELT.

SN 78-961,871, FILED 8-28-2006.

INGA ERVIN, EXAMINING ATTORNEY

Int. Cl.: 30

Prior U.S. Cl.: 46

United States Patent and Trademark Office

Reg. No. 3,522,733

Registered Oct. 21, 2008

**TRADEMARK
PRINCIPAL REGISTER**

Tahoe Trip Mint Chip

TCIP, LLC (WYOMING LIMITED LIABILITY
COMPANY)
60 EAST SIMPSON AVE.
JACKSON, WY 83001

FOR: ICE CREAM; ICE MILK; CONFECTIONERY
ICES, NAMELY, FROZEN YOGURT; FROZEN CON-
FECTIONS; SORBET; SHERBET; TOPPINGS FOR
ICE CREAM IN THE NATURE OF CHOCOLATE
TOPPINGS, FUDGE TOPPINGS, CARAMEL TOP-
PINGS, MARSHMALLOW TOPPING, BUTTERS-
COTCH TOPPING, CANDY TOPPINGS AND
CANDY SPRINKLE TOPPING, IN CLASS 30 (U.S.
CL. 46).

FIRST USE 8-1-2007; IN COMMERCE 8-1-2007.

THE MARK CONSISTS OF STANDARD CHAR-
ACTERS WITHOUT CLAIM TO ANY PARTICULAR
FONT, STYLE, SIZE, OR COLOR.

NO CLAIM IS MADE TO THE EXCLUSIVE
RIGHT TO USE "MINT CHIP", APART FROM THE
MARK AS SHOWN.

SN 78-962,975, FILED 8-29-2006.

DEIRDRE ROBERTSON, EXAMINING ATTORNEY

Int. Cl.: 9

Prior U.S. Cls.: 21, 23, 26, 36, and 38

Reg. No. 3,522,734

United States Patent and Trademark Office

Registered Oct. 21, 2008

**TRADEMARK
PRINCIPAL REGISTER**

FXPERT

GLOBAL POSITIONING SOLUTIONS, INC.
(UTAH CORPORATION)
10653 S. RIVERFRONT PARKWAY, SUITE 190
SOUTH JORDAN, UT 84095

THE MARK CONSISTS OF STANDARD CHAR-
ACTERS WITHOUT CLAIM TO ANY PARTICULAR
FONT, STYLE, SIZE, OR COLOR.

FOR: COMPUTER SOFTWARE FOR USE IN
DATABASE MANAGEMENT IN THE FIELD OF
CURRENCY EXCHANGE, IN CLASS 9 (U.S. CLS. 21,
23, 26, 36 AND 38).

SN 78-964,042, FILED 8-30-2006.

FIRST USE 10-0-2006; IN COMMERCE 10-0-2006.

SHANNON TWOHIG, EXAMINING ATTORNEY

Int. Cl.: 25

Prior U.S. Cls.: 22 and 39

United States Patent and Trademark Office

Reg. No. 3,522,735

Registered Oct. 21, 2008

**TRADEMARK
PRINCIPAL REGISTER**

URBANACID

DI GIANNANTONIO, KEITH W. (UNITED STATES INDIVIDUAL)
61-42 69TH LANE
MIDDLE VILLAGE, NY 11379

FIRST USE 6-25-2008; IN COMMERCE 6-25-2008.

FOR: APPAREL, NAMELY, TOPS, BOTTOMS, FOOTWEAR, HEADWEAR, UNDERWEAR, BEACHWEAR, SWIMWEAR, BELTS, COATS, JACKETS, DRESSES, SUITS, NECKWEAR, GLOVES, HOSIERY, LINGERIE, UNIFORMS, JERSEYS, MUFFS, ROBES, SASHES, PONCHOS, IN CLASS 25 (U.S. CLS. 22 AND 39).

THE MARK CONSISTS OF STANDARD CHARACTERS WITHOUT CLAIM TO ANY PARTICULAR FONT, STYLE, SIZE, OR COLOR.

SN 78-964,410, FILED 8-30-2006.

JAY BESCH, EXAMINING ATTORNEY

Int. Cl.: 9

Prior U.S. Cls.: 21, 23, 26, 36, and 38

Reg. No. 3,522,736

United States Patent and Trademark Office

Registered Oct. 21, 2008

**TRADEMARK
PRINCIPAL REGISTER**

Propelling Innovation

INTEC INC. (FLORIDA CORPORATION)
7600 CORPORATE CENTER DRIVE
SUITE 400
MIAMI, FL 33126

FOR: ELECTRONIC VIDEO GAMES ACCESSORIES, NAMELY, VIDEO GAME CONTROLLERS, HAND HELD CONTROLLERS, DANCE MAT VIDEO GAME CONTROLLERS, VIDEO GAME INTERACTIVE REMOTE CONTROL UNITS, AUDIO AND VIDEO CABLES, AUDIO AND VIDEO CONNECTORS, DIGITAL VIDEO DEVICE PROTECTORS, NAMELY, DVD CASES, CARRYING CASES FOR VIDEO DISC PLAYERS, CARRYING CASES FOR PORTABLE VIDEO GAME PLAYERS, ELECTRICAL CABLES, MULTIPLAYER LINK CABLES FOR VIDEO GAME UNITS, STANDS FOR SUPPORTING VIDEO GAME CONSOLES AND STANDS FOR SUPPORTING VIDEO GAMES, PROTECTIVE CASES FOR VIDEO GAME UNITS, PROTECTIVE CASES FOR VIDEO GAMING COMPACT DISCS AND DIGITAL VIDEO DEVICES, AUDIO VIDEO SWITCH SELECTORS, SOUND SYSTEMS COMPRISED OF AUDIO AMPLIFIERS, AUDIO TUNERS AND AUDIO SPEAKERS, AUDIO SPEAKERS AND AUDIO SPEAKER ENCLOSURES, AMPLIFIERS, EARPHONES, EAR BUDS, PERSONAL HEADPHONES, HEADSETS FOR VIDEO GAME PLAYER, AUDIO VIDEO SCREEN EQUIPMENT FOR VIDEO GAMES, NAMELY, FLAT PANEL DISPLAY SCREENS AND LIQUID CRYSTAL DISPLAYS FOR VIDEO GAMES, ELECTRONIC VIDEO GAME

SCREEN DISPLAYS COMPRISED OF LIQUID CRYSTAL DISPLAYS FOR USE WITH VIDEO GAME UNITS, MEMORY CARDS FOR VIDEO GAME UNITS, AUDIO AND VIDEO SPLITTERS, VIDEO ADAPTERS, AUDIO VIDEO EXTENSION CABLES, LIGHTS, NAMELY, LIGHT-EMITTING DIODES (LEDS) FOR ILLUMINATING VIDEO GAME DISPLAYS, MAGNIFIER FOR MAGNIFYING VIDEO GAME DISPLAY, PROTECTIVE SHIELDS FOR PROTECTING VIDEO GAME DISPLAYS, POWER SUPPLIES FOR VIDEO GAME DEVICES, NAMELY, AC/DC ADAPTERS, AUTOMOBILE ADAPTERS, BATTERIES, RECHARGEABLE BATTERIES, CHARGING UNITS FOR RECHARGING BATTERIES, AC/DC CONVERTERS, CLEANING KITS COMPRISED OF CD/DVD ROTATING MECHANICAL CLEANERS, CD/DVD LENS CLEANING DISCS, AND CD/DVD CLEANING FLUID FOR CLEANING COMPACT DISCS AND VIDEO GAME UNITS, IN CLASS 9 (U.S. CLS. 21, 23, 26, 36 AND 38).

FIRST USE 4-4-2006; IN COMMERCE 4-4-2006.

THE MARK CONSISTS OF STANDARD CHARACTERS WITHOUT CLAIM TO ANY PARTICULAR FONT, STYLE, SIZE, OR COLOR.

SN 78-965,392, FILED 8-31-2006.

KATHY DE JONGE, EXAMINING ATTORNEY

Int. Cl.: 9

Prior U.S. Cls.: 21, 23, 26, 36, and 38

Reg. No. 3,522,737

United States Patent and Trademark Office

Registered Oct. 21, 2008

**TRADEMARK
PRINCIPAL REGISTER**

It's a gamers life for me

INTEC INC. (FLORIDA CORPORATION)
7600 CORPORATE CENTER DRIVE
SUITE 400
MIAMI, FL 33126

FOR: ELECTRONIC VIDEO GAMES ACCESSORIES, NAMELY, VIDEO GAME CONTROLLERS, HAND HELD CONTROLLERS, DANCE MAT VIDEO GAME CONTROLLERS, VIDEO GAME INTERACTIVE REMOTE CONTROL UNITS, AUDIO AND VIDEO CABLES, AUDIO AND VIDEO CONNECTORS, DIGITAL VIDEO DEVICE PROTECTORS, NAMELY, DVD CASES, CARRYING CASES FOR VIDEO DISC PLAYERS, CARRYING CASES FOR PORTABLE VIDEO GAME PLAYERS, ELECTRICAL CABLES, MULTIPLAYER LINK CABLES FOR VIDEO GAME UNITS, STANDS FOR SUPPORTING VIDEO GAME CONSOLES AND STANDS FOR SUPPORTING VIDEO GAMES, PROTECTIVE CASES FOR VIDEO GAME UNITS, PROTECTIVE CASES FOR VIDEO GAMING COMPACT DISCS AND DIGITAL VIDEO DEVICES, AUDIO VIDEO SWITCH SELECTORS, SOUND SYSTEMS COMPRISED OF AUDIO AMPLIFIERS, AUDIO TUNERS AND AUDIO SPEAKERS, AUDIO SPEAKERS AND AUDIO SPEAKER ENCLOSURES, AMPLIFIERS, EARPHONES, EAR BUDS, PERSONAL HEADPHONES, HEADSETS FOR VIDEO GAME PLAYER, AUDIO VIDEO SCREEN EQUIPMENT FOR VIDEO GAMES, NAMELY, FLAT PANEL DISPLAY SCREENS AND LIQUID CRYSTAL DISPLAYS FOR VIDEO GAMES, ELECTRONIC VIDEO GAME

SCREEN DISPLAYS COMPRISED OF LIQUID CRYSTAL DISPLAYS FOR USE WITH VIDEO GAME UNITS, MEMORY CARDS FOR VIDEO GAME UNITS, AUDIO AND VIDEO SPLITTERS, VIDEO ADAPTERS, AUDIO VIDEO EXTENSION CABLES, LIGHTS, NAMELY, LIGHT-EMITTING DIODES (LEDS) FOR ILLUMINATING VIDEO GAME DISPLAYS, MAGNIFIER FOR MAGNIFYING VIDEO GAME DISPLAY, PROTECTIVE SHIELDS FOR PROTECTING VIDEO GAME DISPLAYS, POWER SUPPLIES FOR VIDEO GAME DEVICES, NAMELY, AC/DC ADAPTERS, AUTOMOBILE ADAPTERS, BATTERIES, RECHARGEABLE BATTERIES, CHARGING UNITS FOR RECHARGING BATTERIES, AC/DC CONVERTERS, CLEANING KITS COMPRISED OF CD/DVD ROTATING MECHANICAL CLEANERS, CD/DVD LENS CLEANING DISCS, AND CD/DVD CLEANING FLUID FOR CLEANING COMPACT DISCS AND VIDEO GAME UNITS, IN CLASS 9 (U.S. CLS. 21, 23, 26, 36 AND 38).

FIRST USE 4-4-2006; IN COMMERCE 4-4-2006.

THE MARK CONSISTS OF STANDARD CHARACTERS WITHOUT CLAIM TO ANY PARTICULAR FONT, STYLE, SIZE, OR COLOR.

SN 78-965,403, FILED 8-31-2006.

KATHY DE JONGE, EXAMINING ATTORNEY

Int. Cl.: 7

Prior U.S. Cls.: 13, 19, 21, 23, 31, 34, and 35

Reg. No. 3,522,738

United States Patent and Trademark Office

Registered Oct. 21, 2008

**TRADEMARK
PRINCIPAL REGISTER**

VARIQUIK

M&A THOMSON LITHO LIMITED (UNITED
KINGDOM CORPORATION)
KELVIN INDUSTRIAL ESTATE
10-16 COLVILLES PLACE
EAST KILBRIDE, UNITED KINGDOM G75 OSN

FOR: OFFSET LITHO PRINTING MACHINES
AND PRINTING PRESSES, AND STRUCTURAL
AND REPLACEMENT PARTS FOR THE AFORE-
SAID GOODS, IN CLASS 7 (U.S. CLS. 13, 19, 21, 23, 31,
34 AND 35).

FIRST USE 6-30-2000; IN COMMERCE 6-30-2000.

THE MARK CONSISTS OF STANDARD CHAR-
ACTERS WITHOUT CLAIM TO ANY PARTICULAR
FONT, STYLE, SIZE, OR COLOR.

OWNER OF UNITED KINGDOM REG. NO.
1527390, DATED 1-21-1994, EXPIRES 2-19-2010.

SN 78-966,058, FILED 9-1-2006.

BONNIE LUKEN, EXAMINING ATTORNEY

Int. Cl.: 16

Prior U.S. Cls.: 2, 5, 22, 23, 29, 37, 38, and 50

United States Patent and Trademark Office

Reg. No. 3,522,739

Registered Oct. 21, 2008

**TRADEMARK
PRINCIPAL REGISTER**



IZAJ, THOMAS N. (UNITED STATES INDIVIDUAL)
511 FLORENCE DRIVE
BETHEL PARK, PA 15102

FOR: CARDBOARD CONTAINERS FOR DOCUMENT AND RECORD STORAGE IN THE FIELD OF GOVERNMENTAL REGULATORY COMPLIANCE INCLUDING THE SARBANES-OXLEY ACT OF 2002, IN CLASS 16 (U.S. CLS. 2, 5, 22, 23, 29, 37, 38 AND 50).

FIRST USE 11-1-2007; IN COMMERCE 11-1-2007.

THE MARK CONSISTS OF THE WORD "S O X" HORIZONTALLY POSITIONED INSIDE A RECTANGLE AND THE WORD "B O X" VERTICALLY POSITIONED INSIDE A LARGER SQUARE WITH THE LETTER "O" CONNECTING THE TWO WORDS.

SN 78-966,927, FILED 9-5-2006.

EMILY CARLSEN, EXAMINING ATTORNEY

Int. Cl.: 36

Prior U.S. Cls.: 100, 101, and 102

United States Patent and Trademark Office

Reg. No. 3,522,740

Registered Oct. 21, 2008

**SERVICE MARK
PRINCIPAL REGISTER**



REALM PROPERTIES, LLC (TEXAS LIMITED
LIABILITY COMPANY)
810 HIGHWAY 6 SOUTH, #100
HOUSTON, TX 77079

FIRST USE 3-1-2001; IN COMMERCE 3-1-2001.

SN 78-969,345, FILED 9-7-2006.

FOR: REAL ESTATE AGENCY, BROKERAGE
AND LISTING SERVICES, IN CLASS 36 (U.S. CLS.
100, 101 AND 102).

ROBIN MITTLER, EXAMINING ATTORNEY

Int. Cl.: 28

Prior U.S. Cls.: 22, 23, 38, and 50

Reg. No. 3,522,741

United States Patent and Trademark Office

Registered Oct. 21, 2008

**TRADEMARK
PRINCIPAL REGISTER**

FOREST FRESH

CINDEX HOLDINGS LIMITED (HONG KONG CORPORATION)
8/F ENTERPRISE SQUARE 3
39 WANG CHIU ROAD
KOWLOON BAY, HONG KONG

FOR: ARTIFICIAL CHRISTMAS ITEMS, NAME-
LY, TREES MADE OF POLY VINYL CHLORIDE;
ARTIFICIAL CHRISTMAS ITEMS, NAME-
LY, TREES, GARLAND AND WREATHS MADE OF
TINSEL; ARTIFICIAL CHRISTMAS ITEMS, NAME-
LY, TREES, GARLAND AND WREATHS MADE OF
FIBER OPTIC; ARTIFICIAL CHRISTMAS TREES;
CHRISTMAS TREES MADE OF COMPOSITE MA-

TERIALS; CHRISTMAS TREE STANDS, IN CLASS 28
(U.S. CLS. 22, 23, 38 AND 50).

FIRST USE 10-12-2007; IN COMMERCE 10-12-2007.

THE MARK CONSISTS OF STANDARD CHAR-
ACTERS WITHOUT CLAIM TO ANY PARTICULAR
FONT, STYLE, SIZE, OR COLOR.

SN 78-969,767, FILED 9-8-2006.

VIVIAN MICZNIK FIRST, EXAMINING ATTOR-
NEY

Int. Cls.: 35 and 37

Prior U.S. Cls.: 100, 101, 102, 103, and 106

United States Patent and Trademark Office

Reg. No. 3,522,742

Registered Oct. 21, 2008

**SERVICE MARK
PRINCIPAL REGISTER**

FLOORS FOR YOU

FLOORS FOR YOU, INC. (INDIANA CORPORATION)
1485 N. GREEN STREET
BROWNSBURG, IN 46112

FOR: RETAIL AND WHOLESALE STORE SERVICES FEATURING CARPET, HARDWOOD, LAMINATE, VINYL, CORK, BAMBOO, CERAMIC TILE, VINYL COMPOSITE TILE, AREA RUGS, STONE TILE, CONCRETE BOARD, SUBFLOOR FOR VINYL, PLYWOOD, TURF CARPETING, CARPET PADDING, LAMINATE PADDING, TACK STRIPS, CARPET METALS, METAL THRESHOLDS, CARPET SEAM TAPE, GROUT, SEAM SEALER, VINYL SEALER, NAILS, SCREWS, MORTAR, CERAMIC GROUT SEALER, CERAMIC GROUT CLEANER, VINYL POLISH SOLUTION, VINYL STRIPPER SOLUTION, VINYL CLEANING SOLUTION, CARPET CLEANER, CARPET SPOT SOLUTION, HARDWOOD CLEANER SOLUTION, LAMINATE CLEANER SOLUTION; COMPUTERIZED ONLINE RETAIL STORE SERVICES FEATURING CARPET, HARDWOOD, LAMINATE, VINYL, CORK, BAMBOO, CERAMIC TILE, VINYL COMPOSITE TILE, AREA RUGS, STONE TILE, CONCRETE BOARD, SUBFLOOR FOR VINYL, PLYWOOD, TURF CARPETING, CARPET PADDING, LAMINATE PADDING, TACK STRIPS, CARPET METALS, METAL THRESHOLDS, CARPET SEAM TAPE, GROUT, SEAM SEALER, VINYL SEALER, NAILS, SCREWS, MORTAR, CERAMIC GROUT SEALER, CERAMIC GROUT CLEANER, VINYL POLISH SOLUTION, VINYL STRIPPER SOLUTION, VINYL CLEANING

SOLUTION, CARPET CLEANER, CARPET SPOT SOLUTION, HARDWOOD CLEANER SOLUTION, LAMINATE CLEANER SOLUTION; PROVIDING CONSUMER INFORMATION VIA THE INTERNET IN THE FIELD OF INSTALLATION AND MAINTENANCE OF FLOORING, IN CLASS 35 (U.S. CLS. 100, 101 AND 102).

FIRST USE 6-30-1994; IN COMMERCE 6-30-1994.

FOR: INSTALLATION AND MAINTENANCE OF FLOOR COVERINGS, NAMELY, CARPET, HARDWOOD, LAMINATE, VINYL, CORK, BAMBOO, CERAMIC TILE, VINYL COMPOSITE TILE, AREA RUGS, STONE TILE, CONCRETE BOARD, SUBFLOOR FOR VINYL, PLYWOOD, TURF CARPETING, CARPET PADDING AND LAMINATE PADDING, IN CLASS 37 (U.S. CLS. 100, 103 AND 106).

FIRST USE 6-30-1994; IN COMMERCE 6-30-1994.

THE MARK CONSISTS OF STANDARD CHARACTERS WITHOUT CLAIM TO ANY PARTICULAR FONT, STYLE, SIZE, OR COLOR.

NO CLAIM IS MADE TO THE EXCLUSIVE RIGHT TO USE "FLOORS", APART FROM THE MARK AS SHOWN.

SN 78-970,263, FILED 9-8-2006.

DOMINIC FATHY, EXAMINING ATTORNEY

Int. Cls.: 5 and 25

Prior U.S. Cls.: 6, 18, 22, 39, 44, 46, 51, and 52

United States Patent and Trademark Office

Reg. No. 3,522,743

Registered Oct. 21, 2008

**TRADEMARK
PRINCIPAL REGISTER**

Footcare Pharmacy

DR. BROOKS INNOVATIONS, LLC (MISSOURI
LIMITED LIABILITY COMPANY)
304
680 CRAIG ROAD
ST. LOUIS, MO 63141

FOR: ATHLETES' FOOT POWDERS, IN CLASS 5
(U.S. CLS. 6, 18, 44, 46, 51 AND 52).

FIRST USE 6-1-2007; IN COMMERCE 6-1-2007.

FOR: HEEL INSERTS, IN CLASS 25 (U.S. CLS. 22
AND 39).

FIRST USE 2-15-2007; IN COMMERCE 2-15-2007.

THE MARK CONSISTS OF STANDARD CHAR-
ACTERS WITHOUT CLAIM TO ANY PARTICULAR
FONT, STYLE, SIZE, OR COLOR.

NO CLAIM IS MADE TO THE EXCLUSIVE
RIGHT TO USE "FOOTCARE", APART FROM THE
MARK AS SHOWN.

SN 78-970,897, FILED 9-10-2006.

DAVID C. REIHNER, EXAMINING ATTORNEY

Int. Cls.: 9, 11, and 12

Prior U.S. Cls.: 13, 19, 21, 23, 26, 31, 34, 35, 36, 38, and 44

Reg. No. 3,522,744

United States Patent and Trademark Office

Registered Oct. 21, 2008

**TRADEMARK
PRINCIPAL REGISTER**

PRIMATRONICS

FLEETPRIDE, INC. (TEXAS CORPORATION)
SUITE 125
8708 TECHNOLOGY FOREST PLACE
THE WOODLANDS, TX 77381

FOR: LIGHTING CONTROL PANELS; ELECTRICAL WIRE ACCESSORIES, NAMELY, WIRING HARNESSSES AND PIGTAILS; FLASHING SAFETY LIGHTS, IN CLASS 9 (U.S. CLS. 21, 23, 26, 36 AND 38).

FIRST USE 3-19-2007; IN COMMERCE 5-4-2007.

FOR: ELECTRICAL LIGHTING FIXTURES FOR VEHICLES, NAMELY, ELECTRIC LIGHT BULBS, HALOGEN LIGHT BULBS, INCANDESCENT LIGHT BULBS, MINIATURE LIGHT BULBS; LIGHT REFLECTORS; FLASHING STROBE LIGHT APPARATUS; BACK-UP LIGHTS; TAIL LIGHTS; AND RUNNING LIGHTS, IN CLASS 11 (U.S. CLS. 13, 21, 23, 31 AND 34).

FIRST USE 3-19-2007; IN COMMERCE 5-4-2007.

FOR: MIRRORS FOR VEHICLES, NAMELY, INTERIOR REARVIEW AND EXTERIOR SIDEVIEW MIRRORS AND MOUNTING ASSEMBLIES SOLD IN CONNECTION THEREWITH, IN CLASS 12 (U.S. CLS. 19, 21, 23, 31, 35 AND 44).

FIRST USE 3-19-2007; IN COMMERCE 5-4-2007.

THE MARK CONSISTS OF STANDARD CHARACTERS WITHOUT CLAIM TO ANY PARTICULAR FONT, STYLE, SIZE, OR COLOR.

SN 78-973,644, FILED 9-13-2006.

SUSAN LESLIE DUBOIS, EXAMINING ATTORNEY

Int. Cl.: 41

Prior U.S. Cls.: 100, 101, and 107

United States Patent and Trademark Office

Reg. No. 3,522,745

Registered Oct. 21, 2008

**SERVICE MARK
PRINCIPAL REGISTER**

DRESS YOUR WEDDING

DBD, INC. (DELAWARE CORPORATION)
1001 WASHINGTON STREET
CONSHOHOCKEN, PA 19428

FOR: PROVIDING ON-LINE INFORMATION ABOUT SPECIAL EVENT PLANNING, NAMELY, ALLOWING USERS TO CREATE AND SAVE ALTERNATE SPECIAL EVENT SCENARIOS BY CHOOSING VARIOUS COMBINATIONS OF WOMEN'S AND GIRLS' FORMAL WEAR, BRIDAL GOWNS, BRIDESMAID DRESSES, FLOWER GIRL DRESSES, ACCESSORIES, SHOES, HANDBAGS, VEILS, HATS, HEADBANDS, GLOVES, SASHES, RIBBONS, JEWELRY, TIARAS, NECKLACES, BRACELETS, EARRINGS, BROOCHES, MEN'S AND BOYS' FORMAL WEAR, TUXEDOS, VESTS, SHIRTS, CUMMERBUNDS, TIES, BOW-TIES, SHOES, BOUQUETS AND BOUTONNIERES MADE OF LIVE FLOWERS, AND SPECIAL EVENT LOCATION/

BACKDROPS; CREATE A SHOPPING LIST FOR THE COMPONENTS OF EACH SCENARIO; ALLOW USERS TO SEND INFORMATION ABOUT THE SCENARIO VIA WEBSITE LINK TO THIRD PARTIES; AND ALLOW THIRD PARTIES TO VIEW THE VARIOUS SPECIAL EVENT SCENARIOS CREATED BY THE USER AND PROVIDE THE USER WITH FEEDBACK VIA E-MAIL, IN CLASS 41 (U.S. CLS. 100, 101 AND 107).

FIRST USE 12-20-2006; IN COMMERCE 12-20-2006.

THE MARK CONSISTS OF STANDARD CHARACTERS WITHOUT CLAIM TO ANY PARTICULAR FONT, STYLE, SIZE, OR COLOR.

SN 78-974,131, FILED 9-14-2006.

ROSELLE HERRERA, EXAMINING ATTORNEY

Int. Cl.: 4

Prior U.S. Cls.: 1, 6, and 15

United States Patent and Trademark Office

Reg. No. 3,522,746

Registered Oct. 21, 2008

**TRADEMARK
PRINCIPAL REGISTER**

PROMETHEUS ENERGY

PROMETHEUS ENERGY COMPANY (WA-
SHINGTON CORPORATION)

9675 S.E. 36TH ST.

MERCER ISLAND, WA 98040

FOR: LIQUEFIED NATURAL GAS, IN CLASS 4
(U.S. CLS. 1, 6 AND 15).

FIRST USE 9-14-2006; IN COMMERCE 9-14-2006.

THE MARK CONSISTS OF STANDARD CHAR-
ACTERS WITHOUT CLAIM TO ANY PARTICULAR
FONT, STYLE, SIZE, OR COLOR.

NO CLAIM IS MADE TO THE EXCLUSIVE
RIGHT TO USE "ENERGY", APART FROM THE
MARK AS SHOWN.

SN 78-974,294, FILED 9-14-2006.

PRISCILLA MILTON, EXAMINING ATTORNEY

Int. Cl.: 4

Prior U.S. Cls.: 1, 6, and 15

United States Patent and Trademark Office

Reg. No. 3,522,747

Registered Oct. 21, 2008

TRADEMARK
PRINCIPAL REGISTER



PROMETHEUS*energy*

PROMETHEUS ENERGY COMPANY (WA-
SHINGTON CORPORATION)
9675 S.E. 36TH ST.
MERCER ISLAND, WA 98040

NO CLAIM IS MADE TO THE EXCLUSIVE
RIGHT TO USE "ENERGY" , APART FROM THE
MARK AS SHOWN.

FOR: LIQUEFIED NATURAL GAS, IN CLASS 4
(U.S. CLS. 1, 6 AND 15).

SN 78-974,298, FILED 9-14-2006.

FIRST USE 9-14-2006; IN COMMERCE 9-14-2006.

PRISCILLA MILTON, EXAMINING ATTORNEY

Int. Cl.: 35

Prior U.S. Cls.: 100, 101, and 102

United States Patent and Trademark Office

Reg. No. 3,522,748

Registered Oct. 21, 2008

**SERVICE MARK
PRINCIPAL REGISTER**



AUTONATION HOLDING CORP. (DELAWARE CORPORATION)
110 S.E. 6TH STREET, 20TH FLOOR
FT. LAUDERDALE, FL 33301

OWNER OF U.S. REG. NOS. 2,568,292, 2,767,218,
AND OTHERS.

FOR: AUTOMOBILE DEALERSHIP SERVICES, IN
CLASS 35 (U.S. CLS. 100, 101 AND 102).

SN 78-974,369, FILED 9-14-2006.

FIRST USE 7-0-2001; IN COMMERCE 7-0-2001.

PAUL CROWLEY, EXAMINING ATTORNEY

Int. Cl.: 43

Prior U.S. Cls.: 100 and 101

United States Patent and Trademark Office

Reg. No. 3,522,749

Registered Oct. 21, 2008

**SERVICE MARK
PRINCIPAL REGISTER**

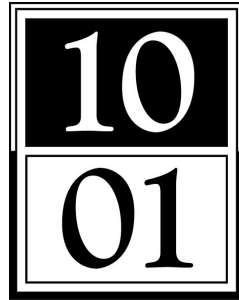

ten 01

TENTH & COUCH, LLC (OREGON LIMITED
LIABILITY COMPANY)
1001 NW COUCH ST
PORTLAND, OR 97209

FIRST USE 11-7-2006; IN COMMERCE 11-7-2006.

SN 78-974,389, FILED 9-14-2006.

FOR: CATERING OF FOOD AND DRINKS; RES-
TAURANT AND BAR SERVICES, IN CLASS 43 (U.S.
CLS. 100 AND 101).

GISELLE AGOSTO, EXAMINING ATTORNEY

Int. Cl.: 30

Prior U.S. Cl.: 46

United States Patent and Trademark Office

Reg. No. 3,522,750

Registered Oct. 21, 2008

**TRADEMARK
PRINCIPAL REGISTER**

QUAKER COFFEE

QUAKER COFFEE COMPANY INC. (DELA-
WARE CORPORATION)
333 EAST LANCASTER AVENUE
#316
WYNNEWOOD, PA 19096

FOR: BEVERAGES MADE FROM COFFEE BASE;
ESPRESSO; COFFEE BEANS; AND DRY ROASTED
COFFEE AVAILABLE FROM A COFFEE SHOP, IN
CLASS 30 (U.S. CL. 46).

FIRST USE 1-26-2005; IN COMMERCE 1-26-2005.

THE MARK CONSISTS OF STANDARD CHAR-
ACTERS WITHOUT CLAIM TO ANY PARTICULAR
FONT, STYLE, SIZE, OR COLOR.

NO CLAIM IS MADE TO THE EXCLUSIVE
RIGHT TO USE "COFFEE", APART FROM THE
MARK AS SHOWN.

SN 78-976,794, FILED 8-11-2004.

KAPIL BHANOT, EXAMINING ATTORNEY

Int. Cl.: 35

Prior U.S. Cls.: 100, 101, and 102

United States Patent and Trademark Office

Reg. No. 3,522,751

Registered Oct. 21, 2008

**SERVICE MARK
PRINCIPAL REGISTER**

DMAIL

PITNETY BOWES MANAGEMENT SERVICES,
INC. (DELAWARE CORPORATION)
WORLD HEADQUARTERS ONE ELMCROFT
ROAD
STAMFORD, CT 069260700

FIRST USE 7-11-2005; IN COMMERCE 7-11-2005.

SN 78-976,875, FILED 7-16-2003.

FOR: MAIL SORTING, HANDLING, AND RE-
CEIVING INCOMING PHYSICAL MAIL PIECES, IN
CLASS 35 (U.S. CLS. 100, 101 AND 102).

JOHN SCHUYLER YARD, EXAMINING ATTOR-
NEY

Int. Cl.: 44

Prior U.S. Cls.: 100 and 101

United States Patent and Trademark Office

Reg. No. 3,522,752

Registered Oct. 21, 2008

**SERVICE MARK
PRINCIPAL REGISTER**



SOCIETE ANONYME DES EAUX MINERALES
D'EVIAN (FRANCE JOINT STOCK COMPAN-
NY)

22, AVENUE DES SOURCES
EVIAN, FRANCE 74500

FOR: HEALTH SPA SERVICES, NAMELY, COS-
METIC BODY CARE SERVICES; BEAUTY SALON
SERVICES; TANNING SALONS; SKIN CARE SAL-
ONS, IN CLASS 44 (U.S. CLS. 100 AND 101).

FIRST USE 2-22-2006; IN COMMERCE 2-22-2006.

OWNER OF U.S. REG. NOS. 848,243, 2,822,102,
AND OTHERS.

THE COLOR(S) WHITE, PINK, RED AND BLUE
IS/ARE CLAIMED AS A FEATURE OF THE MARK.

THE MARK CONSISTS OF A BLUE MOUNTAIN
RANGE OVER A PINK BACKGROUND; BENEATH
THE MOUNTAIN RANGE IS THE WORD "EVIAN"
IN RED PLAIN BLOCK LETTERS; THE COLOR
WHITE APPEARS SURROUNDING THE MOUN-
TAIN RANGE AND THE WORD "EVIAN".

SN 78-979,805, FILED 6-3-2005.

DOMINICK J. SALEMI, EXAMINING ATTORNEY

Int. Cl.: 33

Prior U.S. Cls.: 47 and 49

United States Patent and Trademark Office

Reg. No. 3,522,753

Registered Oct. 21, 2008

**TRADEMARK
PRINCIPAL REGISTER**

JONATA

COOL HAND VINEYARDS, LLC (CALIFORNIA
LIMITED LIABILITY COMPANY)
110 EL PASEO
SANTA BARBARA, CA 93101

THE MARK CONSISTS OF STANDARD CHAR-
ACTERS WITHOUT CLAIM TO ANY PARTICULAR
FONT, STYLE, SIZE, OR COLOR.

FOR: WINE, IN CLASS 33 (U.S. CLS. 47 AND 49).

SN 78-980,235, FILED 6-21-2006.

FIRST USE 4-16-2007; IN COMMERCE 4-16-2007.

JOHN GARTNER, EXAMINING ATTORNEY

Int. Cl.: 41

Prior U.S. Cls.: 100, 101, and 107

United States Patent and Trademark Office

Reg. No. 3,522,754

Registered Oct. 21, 2008

**SERVICE MARK
PRINCIPAL REGISTER**

REAL PEOPLE. REAL CHANGE.

WALDEN UNIVERSITY, INC. (FLORIDA CORPORATION)
155 FIFTH AVENUE SOUTH
MINNEAPOLIS, MN 55401

FOR: EDUCATIONAL SERVICES AND ONLINE EDUCATIONAL SERVICES, NAMELY, PROVIDING COURSES OF INSTRUCTION AT THE COLLEGE AND GRADUATE SCHOOL LEVELS, IN CLASS 41 (U.S. CLS. 100, 101 AND 107).

FIRST USE 3-0-2006; IN COMMERCE 3-0-2006.

THE MARK CONSISTS OF STANDARD CHARACTERS WITHOUT CLAIM TO ANY PARTICULAR FONT, STYLE, SIZE, OR COLOR.

SN 78-980,373, FILED 3-17-2006.

DAVID YONTEF, EXAMINING ATTORNEY

Int. Cl.: 5

Prior U.S. Cls.: 6, 18, 44, 46, 51, and 52

United States Patent and Trademark Office

Reg. No. 3,522,755

Registered Oct. 21, 2008

**TRADEMARK
PRINCIPAL REGISTER**

YOU'RE THE MAN

CCA INDUSTRIES, INC. (DELAWARE CORPORATION)
200 MURRAY HILL PARKWAY
EAST RUTHERFORD, NJ 07073

FOR: MEDICATED SKIN GELS, IN CLASS 5 (U.S. CLS. 6, 18, 44, 46, 51 AND 52).

FIRST USE 1-24-2006; IN COMMERCE 1-24-2006.

THE MARK CONSISTS OF STANDARD CHARACTERS WITHOUT CLAIM TO ANY PARTICULAR FONT, STYLE, SIZE, OR COLOR.

SN 78-980,492, FILED 5-18-2005.

VIVIAN MICZNIK FIRST, EXAMINING ATTORNEY

Int. Cl.: 25

Prior U.S. Cls.: 22 and 39

United States Patent and Trademark Office

Reg. No. 3,522,756

Registered Oct. 21, 2008

**TRADEMARK
PRINCIPAL REGISTER**

Wii

NINTENDO OF AMERICA INC. (WASHINGTON CORPORATION)
4820 150TH AVENUE NE
REDMOND, WA 98052

FOR: CLOTHING, NAMELY, CAPS; HATS; HEADWEAR; JACKETS; JERSEYS; PAJAMAS; SHIRTS; SLEEPWEAR; SWEATSHIRTS; SWEAT BANDS; T-SHIRTS; UNDERWEAR; VESTS AND WRIST BANDS, IN CLASS 25 (U.S. CLS. 22 AND 39).

FIRST USE 11-19-2006; IN COMMERCE 11-19-2006.

THE MARK CONSISTS OF STANDARD CHARACTERS WITHOUT CLAIM TO ANY PARTICULAR FONT, STYLE, SIZE, OR COLOR.

SN 78-980,519, FILED 4-27-2006.

KRISTINA MORRIS, EXAMINING ATTORNEY

Int. Cls.: 9 and 41

Prior U.S. Cls.: 21, 23, 26, 36, 38, 100, 101, and 107

United States Patent and Trademark Office

Reg. No. 3,522,757

Registered Oct. 21, 2008

**TRADEMARK
SERVICE MARK
PRINCIPAL REGISTER**

CORDLESS

WARNER-ELEKTRA-ATLANTIC CORPORATION
(NEW YORK CORPORATION)
75 ROCKEFELLER PLAZA
NEW YORK, NY 10019

FOR: MUSICAL SOUND RECORDINGS, IN
CLASS 9 (U.S. CLS. 21, 23, 26, 36 AND 38).

FIRST USE 11-8-2005; IN COMMERCE 11-8-2005.

FOR: ENTERTAINMENT SERVICES, NAMELY,
PROVIDING PRERECORDED MUSIC, ONLINE VIA
A GLOBAL COMPUTER NETWORK OR WIRELESS

NETWORK, IN CLASS 41 (U.S. CLS. 100, 101 AND
107).

FIRST USE 11-8-2005; IN COMMERCE 11-8-2005.

THE MARK CONSISTS OF STANDARD CHAR-
ACTERS WITHOUT CLAIM TO ANY PARTICULAR
FONT, STYLE, SIZE, OR COLOR.

SN 78-980,529, FILED 8-18-2005.

ANNE E. GUSTASON, EXAMINING ATTORNEY

Int. Cl.: 25

Prior U.S. Cls.: 22 and 39

United States Patent and Trademark Office

Reg. No. 3,522,758

Registered Oct. 21, 2008

**TRADEMARK
PRINCIPAL REGISTER**

MARY ELLEN

FRESH PRODUCE SPORTSWEAR, INC. (COLOR-
ADO CORPORATION)

2885 WILDERNESS PLACE

BOULDER, CO 80301

FOR: CLOTHING, NAMELY, TANK TOPS, T-
SHIRTS, SHIRTS, DRESSES, SKIRTS, SHORTS,
AND PANTS, IN CLASS 25 (U.S. CLS. 22 AND 39).

FIRST USE 11-12-2007; IN COMMERCE 11-12-2007.

THE MARK CONSISTS OF STANDARD CHAR-
ACTERS WITHOUT CLAIM TO ANY PARTICULAR
FONT, STYLE, SIZE, OR COLOR.

THE NAME(S), PORTRAIT(S), AND/OR SIGNA-
TURE(S) SHOWN IN THE MARK IDENTIFIES
"MARY ELLEN VERNON", WHOSE CONSENT(S)
TO REGISTER IS SUBMITTED.

SN 78-980,544, FILED 5-6-2005.

MICHAEL GAAFAR, EXAMINING ATTORNEY

Int. Cls.: 9, 38, and 41

Prior U.S. Cls.: 21, 23, 26, 36, 38, 100, 101, 104, and 107

Reg. No. 3,522,759

United States Patent and Trademark Office

Registered Oct. 21, 2008

**TRADEMARK
SERVICE MARK
PRINCIPAL REGISTER**

G POTATO

GALA-NET, INC. (CALIFORNIA CORPORATION)
SUITE 200
995 STEWART DRIVE
SUNNYVALE, CA 94085

FOR: COMPUTER SOFTWARE FOR BROWSING AND NAVIGATING THROUGH WEBSITES ON GLOBAL COMMUNICATION NETWORKS; COMPUTER SOFTWARE FOR SENDING AND RECEIVING MESSAGES AND ELECTRONIC MAIL; DOWNLOADABLE COMPUTER GRAPHICS SOFTWARE, NAMELY, DOWNLOADABLE WALLPAPERS OR DOWNLOADABLE SCREENSAVERS FOR THE SCREENS OF COMPUTER DISPLAYS OR MOBILE PHONE DISPLAYS; DOWNLOADABLE VIDEO RECORDINGS FEATURING CARTOON CHARACTERS AND/OR VIDEO GAME CHARACTERS; DOWNLOADABLE COMPUTER PROGRAMS FOR PLAYING COMPUTER GAMES AND VIDEO GAMES OVER THE INTERNET; DOWNLOADABLE ELECTRONIC PUBLICATIONS IN THE NATURE OF MAGAZINES, JOURNALS, NEWSLETTERS AND MANUALS IN THE FIELDS OF COMPUTER GAMES, VIDEO GAMES AND GENERAL ENTERTAINMENT, IN CLASS 9 (U.S. CLS. 21, 23, 26, 36 AND 38).

FIRST USE 11-0-2007; IN COMMERCE 11-0-2007.

FOR: PROVIDING ON-LINE CHAT ROOMS FOR TRANSMISSION OF MESSAGES AMONG COMPUTER USERS CONCERNING A WIDE VARIETY OF TOPICS AND FIELDS, VIA A GLOBAL COMPUTER NETWORK; PROVIDING ON-LINE ELECTRONIC BULLETIN BOARDS AND FORUMS FOR TRANSMISSION OF MESSAGES AMONG COMPUTER USERS CONCERNING A WIDE VARIETY OF TOPICS AND FIELDS, VIA A GLOBAL COMPUTER NETWORK; ELECTRONIC TRANSMISSION OF

AUDIO AND VIDEO DATA AND DOCUMENTS VIA A GLOBAL COMPUTER NETWORK; PROVIDING MULTIPLE-USER ACCESS TO A GLOBAL COMPUTER NETWORK FOR THE TRANSFER AND DISSEMINATION OF A WIDE RANGE OF INFORMATION AND SERVICES, AND FOR ACCESSING THIRD PARTY AND PROPRIETARY WEB SITES; PROVIDING ON-LINE CHAT ROOMS, FORUMS, ON-LINE ELECTRONIC BULLETIN BOARDS AND POLLING PAGES FOR TRANSMISSION OF MESSAGES AMONG COMPUTER USERS CONCERNING GAMES, COMPUTER GAMES, VIDEO GAMES, MOVIES, MOTION PICTURES, MUSIC, VIDEOS, AND ALSO CONTAINING INTERACTIVE POLLING PAGES ABOUT GAMES AND OTHER ENTERTAINMENT RELATED TOPICS, IN CLASS 38 (U.S. CLS. 100, 101 AND 104).

FIRST USE 10-0-2007; IN COMMERCE 10-0-2007.

FOR: ENTERTAINMENT AND LEISURE SERVICES, NAMELY, PROVIDING GAMES, ON-LINE GAMES, VIDEO GAMES, INTERACTIVE GAMES, AVATARS, REALITY SIMULATION, SPORTS GAMES, CONTESTS, COMPETITIONS, AND LOTTERY SERVICES; PROVIDING INFORMATION REGARDING ENTERTAINMENT AND LEISURE SERVICES, NAMELY, GAMES, ON-LINE GAMES, VIDEO GAMES, INTERACTIVE GAMES, AVATARS, REALITY SIMULATION, SPORTS GAMES, CONTESTS, COMPETITIONS, AND LOTTERY SERVICES; ON-LINE JOURNALS, NAMELY, BLOGS FEATURING MESSAGES AMONG COMPUTER USERS CONCERNING COMPUTER AND VIDEO GAMING, MUSIC AND GAMING CULTURE; PROVIDING INFORMATION TO GAME PLAYERS ABOUT THE RANKINGS OF THEIR SCORES, ALL BY MEANS OF A GLOBAL COMPUTER NETWORK, IN CLASS 41 (U.S. CLS. 100, 101 AND 107).

FIRST USE 11-3-2005; IN COMMERCE 11-3-2005.

THE MARK CONSISTS OF STANDARD CHARACTERS WITHOUT CLAIM TO ANY PARTICULAR FONT, STYLE, SIZE, OR COLOR.

THE WORDING "GPOTATO" HAS NO MEANING IN A FOREIGN LANGUAGE.

SN 78-980,545, FILED 12-12-2005.

DOMINICK J. SALEMI, EXAMINING ATTORNEY

Int. Cl.: 25

Prior U.S. Cls.: 22 and 39

United States Patent and Trademark Office

Reg. No. 3,522,760

Registered Oct. 21, 2008

**TRADEMARK
PRINCIPAL REGISTER**

POP SODA

SODA CONCEPTS, INC. (NEW YORK CORPORATION)
641 LEXINGTON AVENUE, 20TH FLOOR
NEW YORK, NY 10022

THE MARK CONSISTS OF STANDARD CHARACTERS WITHOUT CLAIM TO ANY PARTICULAR FONT, STYLE, SIZE, OR COLOR.

FOR: T-SHIRTS, JACKETS, SHIRTS, SHORTS, JEANS, PANTS, LADIES' BLOUSES, SKIRTS AND BELTS, IN CLASS 25 (U.S. CLS. 22 AND 39).

SN 78-980,562, FILED 4-20-2006.

FIRST USE 8-1-2008; IN COMMERCE 8-1-2008.

JEFF DEFORD, EXAMINING ATTORNEY

Int. Cl.: 25

Prior U.S. Cls.: 22 and 39

United States Patent and Trademark Office

Reg. No. 3,522,761

Registered Oct. 21, 2008

**TRADEMARK
PRINCIPAL REGISTER**

MIXTERMAX

MISS MATCHED, INC. (DELAWARE CORPORATION)
307 SEVENTH AVENUE, SUITE 501
NEW YORK, NY 10001

THE MARK CONSISTS OF STANDARD CHARACTERS WITHOUT CLAIM TO ANY PARTICULAR FONT, STYLE, SIZE, OR COLOR.

FOR: FOOTWEAR; SOCKS, IN CLASS 25 (U.S. CLS. 22 AND 39).

SN 78-980,563, FILED 4-26-2005.

FIRST USE 7-20-2007; IN COMMERCE 7-20-2007.

ESTHER A. BORSUK, EXAMINING ATTORNEY

Int. Cl.: 25

Prior U.S. Cls.: 22 and 39

United States Patent and Trademark Office

Reg. No. 3,522,762

Registered Oct. 21, 2008

**TRADEMARK
PRINCIPAL REGISTER**

DCMA COLLECTIVE

DCMA COLLECTIVE, LLC (DELAWARE LIMITED LIABILITY COMPANY)
C/O PS BUSINESS MANAGEMENT
140 W 57TH STREET, SUITE 2-A
NEW YORK, NY 10019

FOR: CLOTHING, NAMELY, SHIRTS, T-SHIRTS, SWEAT SHIRTS, JACKETS, INFANTWEAR, BANDANNAS, HATS, HEADWEAR, FOOTWEAR AND SHOES, IN CLASS 25 (U.S. CLS. 22 AND 39).

FIRST USE 6-1-2005; IN COMMERCE 3-15-2008.

THE MARK CONSISTS OF STANDARD CHARACTERS WITHOUT CLAIM TO ANY PARTICULAR FONT, STYLE, SIZE, OR COLOR.

NO CLAIM IS MADE TO THE EXCLUSIVE RIGHT TO USE "COLLECTIVE", APART FROM THE MARK AS SHOWN.

SN 78-980,571, FILED 5-25-2005.

ESTHER BELENKER, EXAMINING ATTORNEY

Int. Cls.: 25 and 35

Prior U.S. Cls.: 22, 39, 100, 101, and 102

United States Patent and Trademark Office

Reg. No. 3,522,763

Registered Oct. 21, 2008

**TRADEMARK
SERVICE MARK
PRINCIPAL REGISTER**

SEED

STEAMBROOK PTY LTD. (AUSTRALIA CORPORATION)
LEVEL 53
101 COLLINS ST.
MELBOURNE, VICTORIA, AUSTRALIA 3000

FOR: CLOTHING, NAMELY, SHIRTS, T-SHIRTS, POLO TOPS, TANK TOPS, SWEATSHIRTS, BLOUSES, VESTS, SWEATERS, JUMPERS, PULLOVERS, HOODED KNITWEAR TOPS, FLEECE TOPS, CARDIGANS, PAJAMAS, SLEEPWEAR, TRACKSUITS, SWEAT PANTS, SWEAT SHIRTS, LOUNGEWEAR, LEGGINGS, BEACHWEAR, ROMPERS AND INFANT AND TODDLER ONE-PIECE CLOTHING, NEWBORN, BABY AND INFANT WEAR, GLOVES, MITTENS, SOCKS, BELTS, SHORTS, GYM SHORT, SKIRTS, DRESSES, PANTS, KHAKI PANTS, CARGO PANTS, JEANS, TROUSERS, JACKETS, OVERALLS, COATS, RAINWEAR, ANORAKS, SUITS, UNDERWEAR, UNDERGARMENTS, HOSIERY, TIGHTS, SCARVES, TIES, SCHOOL UNIFORMS, SWIMWEAR, BODYSUITS, APRONS, CLOTH BIBS, NIGHT GOWNS, ROBES, BONNETS, FOOTWEAR,

SLIPPERS, CAPS, HATS AND HEADWEAR, IN CLASS 25 (U.S. CLS. 22 AND 39).

FIRST USE 2-28-2001; IN COMMERCE 6-30-2006.

FOR: ONLINE RETAIL STORES FEATURING CLOTHING, FOOTWEAR AND HEADGEAR, CLOTHING AND FASHION ACCESSORIES, LEATHER AND LEATHER IMITATION PRODUCTS INCLUDING BELTS, HANDBAGS, AND TOYS, IN CLASS 35 (U.S. CLS. 100, 101 AND 102).

FIRST USE 2-28-2001; IN COMMERCE 6-30-2006.

THE MARK CONSISTS OF STANDARD CHARACTERS WITHOUT CLAIM TO ANY PARTICULAR FONT, STYLE, SIZE, OR COLOR.

SN 78-980,598, FILED 2-17-2006.

KAREN K. BUSH, EXAMINING ATTORNEY

Int. Cl.: 3

Prior U.S. Cls.: 1, 4, 6, 50, 51, and 52

Reg. No. 3,522,764

United States Patent and Trademark Office

Registered Oct. 21, 2008

**TRADEMARK
PRINCIPAL REGISTER**

MÉXICO SALUDABLE Y QUERIDO

INDUSTRIAS ALEN, S.A. DE C.V. (MEXICO CORPORATION)
BLVD. DIAZ ORDAZ NO. 1000
COL. LOS TREVINO
SANTA CATARINA, N.L., MEXICO C.P.66350

FOR: BLEACHING PREPARATIONS FOR HOUSEHOLD USE AND LIQUID HOUSEHOLD CLEANING PREPARATIONS , IN CLASS 3 (U.S. CLS. 1, 4, 6, 50, 51 AND 52).

FIRST USE 5-15-2008; IN COMMERCE 5-15-2008.

NO CLAIM IS MADE TO THE EXCLUSIVE RIGHT TO USE "MEXICO", APART FROM THE MARK AS SHOWN.

THE FOREIGN WORDING IN THE MARK TRANSLATES INTO ENGLISH AS HEALTHY AND LOVABLE MEXICO.

SN 78-980,602, FILED 7-21-2006.

IRA J. GOODSID, EXAMINING ATTORNEY

Int. Cl.: 42

Prior U.S. Cls.: 100 and 101

United States Patent and Trademark Office

Reg. No. 3,522,765

Registered Oct. 21, 2008

**SERVICE MARK
PRINCIPAL REGISTER**



ASPREVA INTERNATIONAL LTD. (CANADA
LIMITED LIABILITY COMPANY)
4464 MARKHAM STREET
#1203
VICTORIA, BRITISH COLOMBIA, CANADA

FOR: RESEARCH AND DEVELOPMENT OF
PHARMACEUTICAL PREPARATIONS, IN CLASS
42 (U.S. CLS. 100 AND 101).

FIRST USE 6-0-2007; IN COMMERCE 6-0-2007.

OWNER OF U.S. REG. NO. 2,939,943.

NO CLAIM IS MADE TO THE EXCLUSIVE
RIGHT TO USE "PHARMACEUTICALS", APART
FROM THE MARK AS SHOWN.

THE MARK CONSISTS OF A DESIGN ELEMENT
RESEMBLING A FLOWER, WHICH APPEARS
OVER THE "E" IN THE LITERAL ELEMENT OF
THE MARK, "ASPREVA PHARMACEUTICALS".

SN 78-980,609, FILED 4-14-2006.

JIM RINGLE, EXAMINING ATTORNEY

Int. Cl.: 11

Prior U.S. Cls.: 13, 21, 23, 31, and 34

United States Patent and Trademark Office

Reg. No. 3,522,766

Registered Oct. 21, 2008

**TRADEMARK
PRINCIPAL REGISTER**

TRISPRAY

AVILION LIMITED (UNITED KINGDOM COMPANY)
GATEWAY XIII FERRY LANE RAINHAM
ESSEX, UNITED KINGDOM RM13 9JY

FOR: WATER TAP FAUCETS, IN CLASS 11 (U.S. CLS. 13, 21, 23, 31 AND 34).

FIRST USE 4-0-2007; IN COMMERCE 4-0-2007.

THE MARK CONSISTS OF STANDARD CHARACTERS WITHOUT CLAIM TO ANY PARTICULAR FONT, STYLE, SIZE, OR COLOR.

OWNER OF UNITED KINGDOM REG. NO. 2288017, DATED 5-31-2002, EXPIRES 12-12-2011.

SN 78-980,611, FILED 2-14-2006.

DAVID MURRAY, EXAMINING ATTORNEY

Int. Cl.: 25

Prior U.S. Cls.: 22 and 39

United States Patent and Trademark Office

Reg. No. 3,522,767

Registered Oct. 21, 2008

**TRADEMARK
PRINCIPAL REGISTER**

UNISENS

FAWAZ, MOHAMAD-HILAL (FRANCE INDIVIDUAL)
C/O MS ROSALIE ALLIE
1854 LAKEWOOD DR
TROY, MI 48083

FOR: MEN'S AND WOMEN'S APPAREL, NAME-
LY, JACKETS, COATS, SCARVES, NECKTIES, PA-
JAMAS, UNDERWEAR, HATS, TEE SHIRTS AND
PANTS, IN CLASS 25 (U.S. CLS. 22 AND 39).

FIRST USE 6-27-2008; IN COMMERCE 6-27-2008.

THE MARK CONSISTS OF STANDARD CHAR-
ACTERS WITHOUT CLAIM TO ANY PARTICULAR
FONT, STYLE, SIZE, OR COLOR.

SN 78-980,623, FILED 3-9-2006.

BRENDAN MCCAULEY, EXAMINING ATTORNEY

Int. Cl.: 16

Prior U.S. Cls.: 2, 5, 22, 23, 29, 37, 38, and 50

United States Patent and Trademark Office

Reg. No. 3,522,768

Registered Oct. 21, 2008

**TRADEMARK
PRINCIPAL REGISTER**

JETBLUE

JETBLUE AIRWAYS CORPORATION (DELA-
WARE CORPORATION)
118-29 QUEENS BLVD.
FOREST HILLS, NY 11375

FOR: PRINTED PUBLICATIONS, NAMELY, MA-
GAZINES, BOOKLETS AND PAMPHLETS IN THE
FIELDS OF TRANSPORTATION AND TRAVEL;
PENS, CALENDARS, NOTE BOOKS, POSTCARDS ,
IN CLASS 16 (U.S. CLS. 2, 5, 22, 23, 29, 37, 38 AND 50).

FIRST USE 12-3-1999; IN COMMERCE 12-3-1999.

THE MARK CONSISTS OF STANDARD CHAR-
ACTERS WITHOUT CLAIM TO ANY PARTICULAR
FONT, STYLE, SIZE, OR COLOR.

OWNER OF U.S. REG. NOS. 2,449,988, 2,896,785,
AND OTHERS.

SN 78-980,624, FILED 8-29-2005.

G. MAYERSCHOFF, EXAMINING ATTORNEY

Int. Cls.: 9 and 42

Prior U.S. Cls.: 21, 23, 26, 36, 38, 100, and 101

United States Patent and Trademark Office

Reg. No. 3,522,769

Registered Oct. 21, 2008

**TRADEMARK
SERVICE MARK
PRINCIPAL REGISTER**

CLICKFREE

STORAGE APPLIANCE CORPORATION (CANADA CORPORATION)
SUITE 115-30 WEST BEAVER CREEK RD.
RICHMOND HILL, CANADA L4B 3K1

FOR: COMPUTER HARDWARE; COMPUTER PERIPHERALS; COMPUTER UTILITY SOFTWARE; COMPUTER HARDWARE, SOFTWARE AND PERIPHERALS FOR BACKUP, STORAGE, ORGANIZATION AND RETRIEVAL OF DATA; COMPUTER HARDWARE, SOFTWARE AND PERIPHERALS FOR LAUNCHING SOFTWARE APPLICATIONS; COMPUTER HARD DISCS; COMPUTER HARDWARE AND PERIPHERALS FOR USE IN DATA BACKUP, RECOVERY, ORGANIZATION AND RETRIEVAL, IN CLASS 9 (U.S. CLS. 21, 23, 26, 36 AND 38).

FIRST USE 5-8-2006; IN COMMERCE 5-8-2006.

FOR: PROVISION OF TECHNICAL SUPPORT SERVICES, NAMELY, DATA BACKUP, STORAGE,

ARCHIVING AND RECOVERY SERVICES; PROVISION OF INFORMATION RELATING TO COMPUTER HARDWARE, COMPUTER SOFTWARE, COMPUTER PERIPHERALS, TECHNICAL SUPPORT, AND DATA BACKUP, STORAGE, ARCHIVING AND RECOVERY SERVICES; TECHNICAL SUPPORT SERVICES, NAMELY, TROUBLESHOOTING OF COMPUTER HARDWARE, SOFTWARE AND PERIPHERAL PROBLEMS, IN CLASS 42 (U.S. CLS. 100 AND 101).

FIRST USE 5-8-2006; IN COMMERCE 5-8-2006.

THE MARK CONSISTS OF STANDARD CHARACTERS WITHOUT CLAIM TO ANY PARTICULAR FONT, STYLE, SIZE, OR COLOR.

SN 78-980,630, FILED 8-9-2006.

BRIDGETT SMITH, EXAMINING ATTORNEY

Int. Cl.: 16

Prior U.S. Cls.: 2, 5, 22, 23, 29, 37, 38, and 50

Reg. No. 3,522,770

United States Patent and Trademark Office

Registered Oct. 21, 2008

**TRADEMARK
SUPPLEMENTAL REGISTER**

DRA. ISABEL

BASSOLS, ISABEL GOMEZ (UNITED STATES
INDIVIDUAL)
5851 N. BAYSHORE DRIVE
MIAMI, FL 33137

FOR: NEWSLETTERS, MAGAZINES AND
OTHER PUBLICATIONS, NAMELY, BOOKS, LET-
TERS REQUESTING ADVICE, JOURNALS FEAT-
URING SOCIAL AND MEDICAL EVENTS
RELATED TO RELATIONSHIPS, SOCIAL BEHA-
VIOR, EDUCATION AS WELL AS MENTAL, PHY-
SICAL, EMOTIONAL, SEXUAL AND SOCIAL
HEALTH ISSUES, IN CLASS 16 (U.S. CLS. 2, 5, 22,
23, 29, 37, 38 AND 50).

FIRST USE 9-0-2001; IN COMMERCE 9-0-2001.

THE MARK CONSISTS OF STANDARD CHAR-
ACTERS WITHOUT CLAIM TO ANY PARTICULAR
FONT, STYLE, SIZE, OR COLOR.

THE NAME "DRA. ISABEL" IDENTIFIES A LIV-
ING INDIVIDUAL WHOSE CONSENT IS OF RE-
CORD.

SER. NO. 76-560,632, FILED P.R. 11-18-2003; AM.
S.R. 5-15-2008.

SUSAN STIGLITZ, EXAMINING ATTORNEY

Int. Cl.: 36

Prior U.S. Cls.: 100, 101, and 102

United States Patent and Trademark Office

Reg. No. 3,522,771

Registered Oct. 21, 2008

**SERVICE MARK
SUPPLEMENTAL REGISTER**

SUPERIOR FINANCIAL SERVICES

SUPERIOR BANCORP (DELAWARE CORPORATION)
17 NORTH 20TH STREET
BIRMINGHAM, AL 35203

FOR: FINANCIAL SERVICES, NAMELY, MAKING ADMINISTERING AND COLLECTING LOANS, IN CLASS 36 (U.S. CLS. 100, 101 AND 102).

FIRST USE 8-15-2006; IN COMMERCE 8-15-2006.

THE MARK CONSISTS OF STANDARD CHARACTERS WITHOUT CLAIM TO ANY PARTICULAR FONT, STYLE, SIZE, OR COLOR.

OWNER OF U.S. REG. NOS. 2,760,576 AND 2,760,577.

NO CLAIM IS MADE TO THE EXCLUSIVE RIGHT TO USE "FINANCIAL SERVICES", APART FROM THE MARK AS SHOWN.

SER. NO. 76-659,420, FILED P.R. 5-2-2006; AM. S.R. 4-17-2007.

SUSAN RICHARDS, EXAMINING ATTORNEY

Int. Cl.: 44

Prior U.S. Cl.: A

United States Patent and Trademark Office

Reg. No. 3,522,772

Registered Oct. 21, 2008

**CERTIFICATION MARK
GOODS
SUPPLEMENTAL REGISTER**

LEGAL VERIFIED WITH CHAIN OF CUSTODY

TROPICAL FOREST FOUNDATION (VIRGINIA
NON-STOCK CORPORATION)
2121 EISENHOWER AVE., #200
ALEXANDRIA, VA 22314

FOR: FORESTRY PRODUCTS, NAMELY, LOGS,
IN CLASS A (U.S. CL. A).

FIRST USE 6-0-2007; IN COMMERCE 6-0-2007.

THE MARK CONSISTS OF STANDARD CHAR-
ACTERS WITHOUT CLAIM TO ANY PARTICULAR
FONT, STYLE, SIZE, OR COLOR.

THE CERTIFICATION MARK, AS USED BY
AUTHORIZED PERSONS, CERTIFIES THAT THE
GOODS HAVE BEEN TRANSPORTED, PROCES-
SED, AND STORED IN CONFORMANCE WITH
APPLICABLE CHAIN OF CUSTODY LEGAL STAND-
ARDS.

SER. NO. 76-680,560, FILED P.R. 8-10-2007; AM. S.R.
12-7-2007.

MICHAEL LITZAU, EXAMINING ATTORNEY

Int. Cl.: 42

Prior U.S. Cls.: 100 and 101

United States Patent and Trademark Office

Reg. No. 3,522,773

Registered Oct. 21, 2008

**SERVICE MARK
SUPPLEMENTAL REGISTER**

DEFENSE HOLDINGS

DEFENSE HOLDINGS, INC. (VIRGINIA CORPORATION)
1005 N. GLEBE ROAD, SUITE 500
ARLINGTON, VA 22201

FOR: TECHNOLOGY CONSULTATION, ENGINEERING AND RESEARCH SERVICES FEATURING INNOVATION IN THE FIELD OF NATIONAL DEFENSE; RESEARCH SERVICES, NAMELY, INDUSTRIAL, MECHANICAL, PHYSICS AND PRODUCT RESEARCH IN THE FIELD OF NATIONAL DEFENSE; ENGINEERING SERVICES, NAMELY, SPECIFICATION OF PRODUCT DESIGN REQUIREMENTS OF OTHERS, NAMELY, COMMERCIAL AND GOVERNMENT CLIENTS; AND DEVELOP-

ING NEW PRODUCTS FOR OTHERS, NAMELY, COMMERCIAL AND GOVERNMENT CLIENTS, IN CLASS 42 (U.S. CLS. 100 AND 101).

FIRST USE 12-20-2005; IN COMMERCE 12-20-2005.

THE MARK CONSISTS OF STANDARD CHARACTERS WITHOUT CLAIM TO ANY PARTICULAR FONT, STYLE, SIZE, OR COLOR.

SER. NO. 76-683,111, FILED P.R. 10-18-2007; AM. S.R. 9-8-2008.

WILLIAM ROSSMAN, EXAMINING ATTORNEY

Int. Cl.: 16

Prior U.S. Cls.: 2, 5, 22, 23, 29, 37, 38, and 50

United States Patent and Trademark Office

Reg. No. 3,522,774

Registered Oct. 21, 2008

**TRADEMARK
SUPPLEMENTAL REGISTER**

CHASE YOUR STARRY DREAMS

CAHALAN, STACY LYNN (UNITED STATES
INDIVIDUAL)
6509 WEST 101ST TERRACE
OVERLAND PARK, KS 66212

FOR: PAPER PRODUCTS, NAMELY, PAPER
HANG TAGS, NOTE PAPER, BLANK JOURNALS,
BLANK PAPER NOTEBOOKS, PAPER STATION-
ERY AND PAPER ENVELOPES , IN CLASS 16 (U.S.
CLS. 2, 5, 22, 23, 29, 37, 38 AND 50).

FIRST USE 1-15-2003; IN COMMERCE 1-15-2003.

THE MARK CONSISTS OF STANDARD CHAR-
ACTERS WITHOUT CLAIM TO ANY PARTICULAR
FONT, STYLE, SIZE, OR COLOR.

SER. NO. 76-684,057, FILED P.R. 11-15-2007; AM.
S.R. 9-5-2008.

KRISTINA MORRIS, EXAMINING ATTORNEY

Int. Cl.: 16

Prior U.S. Cls.: 2, 5, 22, 23, 29, 37, 38, and 50

United States Patent and Trademark Office

Reg. No. 3,522,775

Registered Oct. 21, 2008

**TRADEMARK
SUPPLEMENTAL REGISTER**

LIVE A DAMN JUICY LIFE

CAHALAN, STACY LYNN (UNITED STATES
INDIVIDUAL)
6509 WEST 101ST TERRACE
OVERLAND PARK, KS 66212

FOR: PAPER PRODUCTS, NAMELY, PAPER
HANG TAGS, NOTE PAPER, BLANK JOURNALS,
BLANK PAPER NOTEBOOKS, PAPER STATION-
ERY AND PAPER ENVELOPES , IN CLASS 16 (U.S.
CLS. 2, 5, 22, 23, 29, 37, 38 AND 50).

FIRST USE 1-15-2003; IN COMMERCE 1-15-2003.

THE MARK CONSISTS OF STANDARD CHAR-
ACTERS WITHOUT CLAIM TO ANY PARTICULAR
FONT, STYLE, SIZE, OR COLOR.

SER. NO. 76-684,063, FILED P.R. 11-15-2007; AM.
S.R. 9-5-2008.

KRISTINA MORRIS, EXAMINING ATTORNEY

Int. Cl.: 13

Prior U.S. Cls.: 2 and 9

United States Patent and Trademark Office

Reg. No. 3,522,776

Registered Oct. 21, 2008

**TRADEMARK
SUPPLEMENTAL REGISTER**

IRON FRAME

A. UBERTI S.R.L. (ITALY COMPANY)
VIA VITTORIO EMANUELE II
NO. 1, BRESCIA, ITALY

FIRST USE 11-30-2007; IN COMMERCE 11-30-2007.

SER. NO. 76-684,543, FILED P.R. 12-3-2007; AM. S.R.
9-4-2008.

FOR: REPLICA FIREARMS, IN CLASS 13 (U.S.
CLS. 2 AND 9).

JENNIFER HETU, EXAMINING ATTORNEY

Int. Cl.: 9

Prior U.S. Cls.: 21, 23, 26, 36, and 38

United States Patent and Trademark Office

Reg. No. 3,522,777

Registered Oct. 21, 2008

TRADEMARK
SUPPLEMENTAL REGISTER



SONY ERICSSON MOBILE COMMUNICATIONS
AB (SWEDEN CORPORATION)
NYA VATTENTORNET
LUND, SWEDEN SE-22188

FOR: AUDIO SPEAKERS FOR USE WITH CEL-
LULAR OR MOBILE PHONES AND COMPUTERS,
IN CLASS 9 (U.S. CLS. 21, 23, 26, 36 AND 38).

FIRST USE 10-0-2007; IN COMMERCE 2-0-2008.

THE MARK CONSISTS OF A THREE-DIMEN-
SIONAL DESIGN OF AN AUDIO SPEAKER IN
WHICH THE SPHERICAL SHAPE AND THE CRA-
TER-LIKE INDENTATIONS, WHICH COVER AP-
PROXIMATELY HALF OF THE SPHERICAL

SHAPE, ARE CLAIMED AS FEATURES OF THE
MARK; AND THE BASE OF THE SPEAKER, WHICH
IS DEPICTED IN BROKEN LINES, PROVIDES CON-
TEXT AND IS NOT CLAIMED AS A FEATURE OF
THE MARK. THE DRAWING SHOWS ONLY ONE
VIEW OF THE DESIGN. THE DESIGN WOULD
LOOK THE SAME IF VIEWED FROM THE OPPO-
SITE SIDE OF THE SPEAKER; ONE WOULD JUST
SEE A MIRROR-IMAGE OF THE VIEW SHOWN IN
THE DRAWING.

SER. NO. 76-687,899, FILED 3-19-2008.

ZACHARY BELLO, EXAMINING ATTORNEY

Int. Cl.: 31

Prior U.S. Cls.: 1 and 46

United States Patent and Trademark Office

Reg. No. 3,522,778

Registered Oct. 21, 2008

**TRADEMARK
SUPPLEMENTAL REGISTER**

CHICKEN BARZ

SMOKEHOUSE PET PRODUCTS, INC. (CALI-
FORNIA CORPORATION)
11850 SHELDON STREET
SUN VALLEY, CA 91352

FIRST USE 8-9-2006; IN COMMERCE 8-9-2006.

SER. NO. 76-688,006, FILED P.R. 3-24-2008; AM. S.R.
7-15-2008.

FOR: MEAT PRODUCTS FOR PETS, NAMELY,
EDIBLE TREATS FOR DOGS AND CATS, IN CLASS
31 (U.S. CLS. 1 AND 46).

DEZMONA MIZELLE, EXAMINING ATTORNEY

Int. Cl.: 35

Prior U.S. Cls.: 100, 101, and 102

United States Patent and Trademark Office

Reg. No. 3,522,779

Registered Oct. 21, 2008

**SERVICE MARK
SUPPLEMENTAL REGISTER**

AMERICAN DEBT SPECIALISTS

LG TECHNOLOGIES OF CALIFORNIA (DELA-
WARE CORPORATION)
32836 WOLF STORE ROAD, SUITE A
TEMECULA, CA 925928274

FOR: PROVIDING REFERRALS IN THE FIELDS
OF DEBT MANAGEMENT, DEBT REDUCTION,
DEBT CONSULTING AND DEBT CONSOLIDA-
TION, IN CLASS 35 (U.S. CLS. 100, 101 AND 102).

FIRST USE 6-15-2008; IN COMMERCE 6-15-2008.

THE MARK CONSISTS OF STANDARD CHAR-
ACTERS WITHOUT CLAIM TO ANY PARTICULAR
FONT, STYLE, SIZE, OR COLOR.

NO CLAIM IS MADE TO THE EXCLUSIVE
RIGHT TO USE "DEBT SPECIALISTS", APART
FROM THE MARK AS SHOWN.

SER. NO. 76-688,613, FILED P.R. 4-14-2008; AM. S.R.
8-25-2008.

LINDA LAVACHE, EXAMINING ATTORNEY

Int. Cl.: 9

Prior U.S. Cls.: 21, 23, 26, 36, and 38

United States Patent and Trademark Office

Reg. No. 3,522,780

Registered Oct. 21, 2008

**TRADEMARK
SUPPLEMENTAL REGISTER**

AdTracker

DATABASE PUBLISHING SYSTEMS, INC. (DPS,
INC.) (CONNECTICUT CORPORATION)
784 OLD MAIN STREET
ROCKY HILL, CT 06067

FOR: COMPUTER SOFTWARE FOR TRACKING
AND PRODUCTION OF PRINT AND ONLINE
ADVERTISEMENTS, IN CLASS 9 (U.S. CLS. 21, 23,
26, 36 AND 38).

FIRST USE 7-18-2002; IN COMMERCE 7-18-2002.

THE MARK CONSISTS OF STANDARD CHAR-
ACTERS WITHOUT CLAIM TO ANY PARTICULAR
FONT, STYLE, SIZE, OR COLOR.

SER. NO. 76-688,729, FILED P.R. 4-18-2008; AM. S.R.
9-2-2008.

RONALD MCMORROW, EXAMINING ATTORNEY

Int. Cl.: 31

Prior U.S. Cls.: 1 and 46

United States Patent and Trademark Office

Reg. No. 3,522,781

Registered Oct. 21, 2008

**TRADEMARK
SUPPLEMENTAL REGISTER**

**Family Owned & Florida
Grown**

UNCLE MATT'S ORGANIC, INC. (FLORIDA
CORPORATION)
SUITE B
1000 E. HIGHWAY 50
CLERMONT, FL 34711

FOR: ORGANIC CITRUS PRODUCTS, NAMELY,
FRESH ORGANIC ORANGES, LEMONS, TANGER-
INES, GRAPEFRUITS, LIMES AND TANGELOS, IN
CLASS 31 (U.S. CLS. 1 AND 46).

FIRST USE 12-1-2002; IN COMMERCE 12-1-2002.

THE MARK CONSISTS OF STANDARD CHAR-
ACTERS WITHOUT CLAIM TO ANY PARTICULAR
FONT, STYLE, SIZE, OR COLOR.

SER. NO. 77-024,575, FILED P.R. 10-19-2006; AM.
S.R. 5-14-2008.

JAMES LOVELACE, EXAMINING ATTORNEY

Int. Cl.: 41

Prior U.S. Cls.: 100, 101, and 107

United States Patent and Trademark Office

Reg. No. 3,522,782

Registered Oct. 21, 2008

**SERVICE MARK
SUPPLEMENTAL REGISTER**

**PONCA CITY GRAND NATIONAL
CHAMPIONSHIP MOTOCROSS**

HENRICKSEN, RONALD J. (UNITED STATES
INDIVIDUAL)

P.O. BOX 759

PERRIS, CA 92572

FOR: ENTERTAINMENT SERVICES, NAMELY,
ARRANGING AND CONDUCTING MOTOCROSS
COMPETITIONS, IN CLASS 41 (U.S. CLS. 100, 101
AND 107).

FIRST USE 1-1-1978; IN COMMERCE 1-1-1978.

THE MARK CONSISTS OF STANDARD CHAR-
ACTERS WITHOUT CLAIM TO ANY PARTICULAR
FONT, STYLE, SIZE, OR COLOR.

NO CLAIM IS MADE TO THE EXCLUSIVE
RIGHT TO USE "GRAND NATIONAL CHAMPION-
SHIP MOTOCROSS", APART FROM THE MARK AS
SHOWN.

SER. NO. 77-032,692, FILED P.R. 10-30-2006; AM.
S.R. 4-9-2008.

JASON TURNER, EXAMINING ATTORNEY

Int. Cl.: 16

Prior U.S. Cls.: 2, 5, 22, 23, 29, 37, 38, and 50

United States Patent and Trademark Office

Reg. No. 3,522,783

Registered Oct. 21, 2008

**TRADEMARK
SUPPLEMENTAL REGISTER**

LOS CHAPINES

T & T, LLC (ST.CHRIST-NEVIS LIMITED LIABILITY COMPANY)

P.O. BOX 556

CHARLESTOWN, ST.CHRIST-NEVIS

FOR: PRE-PAID TELEPHONE CALLING CARDS,
NOT MAGNETICALLY ENCODED, IN CLASS 16
(U.S. CLS. 2, 5, 22, 23, 29, 37, 38 AND 50).

FIRST USE 10-2-2006; IN COMMERCE 10-2-2006.

THE MARK CONSISTS OF STANDARD CHARACTERS WITHOUT CLAIM TO ANY PARTICULAR FONT, STYLE, SIZE, OR COLOR.

THE FOREIGN WORDING IN THE MARK TRANSLATES INTO ENGLISH AS THE GUATEMALANS.

SER. NO. 77-050,971, FILED P.R. 11-27-2006; AM. S.R. 1-26-2007.

LINDA ORNDORFF, EXAMINING ATTORNEY

Int. Cls.: 14 and 18

Prior U.S. Cls.: 1, 2, 3, 22, 27, 28, 41, and 50

United States Patent and Trademark Office

Reg. No. 3,522,784

Registered Oct. 21, 2008

**TRADEMARK
SUPPLEMENTAL REGISTER**

HONIGMAN

HONIGMAN AND SONS LTD. (ISRAEL LIMITED
COMPANY)
58 SALME STREET
TEL-AVIV, ISRAEL 66074

FOR: (BASED ON 44(E) PURSUANT TO ISRAEL
REGISTRATION NUMBER 177707) JEWELRY, IN
CLASS 14 (U.S. CLS. 2, 27, 28 AND 50).

FOR: (BASED ON 44(E) PURSUANT TO ISRAEL
REGISTRATION NUMBER 177708) BACK PACKS,
TOTE BAGS TO BE WORN ON THE SIDE, CARRY-
ING CASES TO BE WORN ON THE BACK, CARRY-
ING CASES TO BE WORN ON THE SIDE, SPORT
PACKS, SPORT BAGS, SHOULDER BAGS, CLUTCH
BAGS, ALL-PURPOSE CARRYING BAGS, BEACH
BAGS, CARRYING CASES FOR BOOKS, RUCK-
SACKS, WALLETS, WAIST BAGS, BRIEFCASES,

WASH BAGS FOR CARRYING TOILETRIES, POU-
CHES OF LEATHER, SUITCASES, UMBRELLAS,
UMBRELLA COVERS, LEATHER AND IMITATION
LEATHER, LEATHER BOXES FOR STORING
GREETING CARDS, AND TRAVELING BAGS, IN
CLASS 18 (U.S. CLS. 1, 2, 3, 22 AND 41).

OWNER OF ISRAEL REG. NO. 177708, DATED 1-
16-2005, EXPIRES 1-16-2015.

OWNER OF ISRAEL REG. NO. 177707, DATED 1-
16-2005, EXPIRES 1-16-2015.

SER. NO. 77-056,116, FILED P.R. 12-4-2006; AM. S.R.
3-12-2008.

NELSON SNYDER, EXAMINING ATTORNEY

Int. Cl.: 35

Prior U.S. Cls.: 100, 101, and 102

United States Patent and Trademark Office

Reg. No. 3,522,785

Registered Oct. 21, 2008

**SERVICE MARK
SUPPLEMENTAL REGISTER**

CENTRAL FLORIDA PARTNERSHIP

GREATER ORLANDO CHAMBER OF COMMERCE, INC. (FLORIDA NON-PROFIT CORPORATION)
75 SOUTH IVANHOE BLVD
ORLANDO, FL 32804

FOR: CHAMBER OF COMMERCE SERVICES, NAMELY, PROMOTING BUSINESS, ENTREPRENEURSHIP AND TOURISM IN CENTRAL FLORIDA; PUBLIC ADVOCACY TO PROMOTE INCREASED QUALITY OF LIFE AND ECONOMIC AND BUSINESS PROSPERITY IN CENTRAL FLORIDA; ORGANIZING AND CONDUCTING BUSINESS NETWORKING AND LEADERSHIP

DEVELOPMENT PROGRAMS AND EVENTS, IN CLASS 35 (U.S. CLS. 100, 101 AND 102).

FIRST USE 12-12-2007; IN COMMERCE 12-12-2007.

THE MARK CONSISTS OF STANDARD CHARACTERS WITHOUT CLAIM TO ANY PARTICULAR FONT, STYLE, SIZE, OR COLOR.

SER. NO. 77-063,065, FILED P.R. 12-13-2006; AM. S.R. 10-15-2007.

ROBIN MITTLER, EXAMINING ATTORNEY

Int. Cls.: 35 and 36

Prior U.S. Cls.: 100, 101, and 102

United States Patent and Trademark Office

Reg. No. 3,522,786

Registered Oct. 21, 2008

**SERVICE MARK
SUPPLEMENTAL REGISTER**

CAPEX VaR

WESTNEY CONSULTING GROUP, INC. (TEXAS CORPORATION)
2200 WEST LOOP SOUTH, SUITE 500
HOUSTON, TX 77027 AND
INDEPENDENT EXECUTIVE VIEW, INC. (TEXAS CORPORATION)
P. O. BOX 56024
HOUSTON, TX 77256

FOR: BUSINESS MANAGEMENT , IN CLASS 35 (U.S. CLS. 100, 101 AND 102).

FIRST USE 6-27-2006; IN COMMERCE 6-27-2006.

FOR: FINANCIAL ANALYSIS AND CONSULTATION, IN CLASS 36 (U.S. CLS. 100, 101 AND 102).

FIRST USE 6-27-2006; IN COMMERCE 6-27-2006.

THE MARK CONSISTS OF STANDARD CHARACTERS WITHOUT CLAIM TO ANY PARTICULAR FONT, STYLE, SIZE, OR COLOR.

SER. NO. 77-077,050, FILED P.R. 1-5-2007; AM. S.R. 9-16-2008.

SUE LAWRENCE, EXAMINING ATTORNEY

Int. Cl.: 11

Prior U.S. Cls.: 13, 21, 23, 31, and 34

United States Patent and Trademark Office

Reg. No. 3,522,787

Registered Oct. 21, 2008

**TRADEMARK
SUPPLEMENTAL REGISTER**

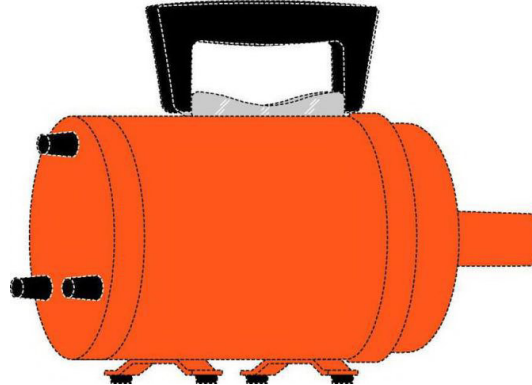

METROPOLITAN VACUUM CLEANER CO., INC.
(NEW YORK CORPORATION)
ONE RAMAPO AVE.
SUFFERN, NY 10901

FOR: PORTABLE ELECTRIC AIR POWER DRYER FOR USE IN DRYING PETS SOLD TO PROFESSIONAL PET GROOMERS, IN CLASS 11 (U.S. CLS. 13, 21, 23, 31 AND 34).

FIRST USE 6-1-1988; IN COMMERCE 6-1-1988.

THE COLOR(S) ORANGE, BLACK AND SILVER IS/ARE CLAIMED AS A FEATURE OF THE MARK.

THE MARK CONSISTS OF A THREE DIMENSIONAL REPRESENTATION OF THE MARK IS PRESENTED. THE BROKEN LINES ARE NOT PART OF THE MARK AND SERVE ONLY TO SHOW THE PLACEMENT OF THE COLORS. THE COLOR ORANGE APPEARS IN THE CANISTER AND LEGS, THE COLOR BLACK APPEARS IN THE HANDLE AND FEET, AND THE COLOR SILVER APPEARS IN THE HANDLE ATTACHMENT.

SER. NO. 77-080,230, FILED P.R. 1-10-2007; AM. S.R. 9-8-2008.

KRISTINA MORRIS, EXAMINING ATTORNEY

Int. Cl.: 41

Prior U.S. Cls.: 100, 101, and 107

United States Patent and Trademark Office

Reg. No. 3,522,788

Registered Oct. 21, 2008

**SERVICE MARK
SUPPLEMENTAL REGISTER**

**The American Academy of
Personal Training**

AMERICAN ACADEMY OF PERSONAL TRAIN-
ING (AAPT), LLC (NEW YORK LIMITED
LIABILITY COMPANY)
138 WEST 14TH STREET
NEW YORK, NY 10011

FOR: EDUCATIONAL SERVICES IN THE NAT-
URE OF PERSONAL FITNESS TRAINING
SCHOOLS, IN CLASS 41 (U.S. CLS. 100, 101 AND 107).

FIRST USE 11-30-2006; IN COMMERCE 11-30-2006.

THE MARK CONSISTS OF STANDARD CHAR-
ACTERS WITHOUT CLAIM TO ANY PARTICULAR
FONT, STYLE, SIZE, OR COLOR.

SER. NO. 77-084,811, FILED P.R. 1-17-2007; AM. S.R.
8-7-2008.

BERNICE MIDDLETON, EXAMINING ATTORNEY

Int. Cl.: 25

Prior U.S. Cls.: 22 and 39

United States Patent and Trademark Office

Reg. No. 3,522,789

Registered Oct. 21, 2008

**TRADEMARK
SUPPLEMENTAL REGISTER**

BIGALLI

YANAPI S.A. (ECUADOR CORPORATION)
SECTOR CHIMBACALLE, TRAS DEL FERROCAR-
RIL
LLANGANATES E2-22 Y TOMBAMBA
QUITO, ECUADOR

FOR: HATS AND HAT BODIES, IN CLASS 25 (U.S.
CLS. 22 AND 39).

FIRST USE 2-0-2007; IN COMMERCE 5-7-2007.

THE MARK CONSISTS OF STANDARD CHAR-
ACTERS WITHOUT CLAIM TO ANY PARTICULAR
FONT, STYLE, SIZE, OR COLOR.

SER. NO. 77-094,563, FILED P.R. 1-30-2007; AM. S.R.
8-28-2008.

ANGELA GAW, EXAMINING ATTORNEY

Int. Cl.: 42

Prior U.S. Cls.: 100 and 101

United States Patent and Trademark Office

Reg. No. 3,522,790

Registered Oct. 21, 2008

**SERVICE MARK
SUPPLEMENTAL REGISTER**

**GREEN STANDARD
SUSTAINABILITY PROGRAM**

A GREENER SOLUTION, LLC (ILLINOIS LIMITED LIABILITY COMPANY)
19989 S. LAGRANGE ROAD, NMB 222
FRANKFURT, IL 60423

FOR: PERFORMING ENVIRONMENTAL AUDITS AND CONSULTING, NAMELY, TECHNICAL ANALYSIS OF A PRODUCT OR PROCESS TO DETERMINE HOW TO MAKE IT MORE ENVIRONMENTALLY SOUND AND PREPARING ENVIRONMENTAL COMPLIANCE REPORTS, IN CLASS 42 (U.S. CLS. 100 AND 101).

FIRST USE 9-1-2006; IN COMMERCE 9-1-2006.

THE MARK CONSISTS OF STANDARD CHARACTERS WITHOUT CLAIM TO ANY PARTICULAR FONT, STYLE, SIZE, OR COLOR.

SER. NO. 77-095,780, FILED P.R. 1-31-2007; AM. S.R. 6-8-2008.

EUGENIA MARTIN, EXAMINING ATTORNEY

Int. Cl.: 23

Prior U.S. Cl.: 43

United States Patent and Trademark Office

Reg. No. 3,522,791

Registered Oct. 21, 2008

**TRADEMARK
SUPPLEMENTAL REGISTER**

ECO-DYED

BLANCHARD, C. DOUGLAS (UNITED STATES
INDIVIDUAL)
P O BOX 609
KINGS MOUNTAIN, NC 28086

FOR: THREADS AND YARNS FOR TEXTILE
USE, IN CLASS 23 (U.S. CL. 43).

FIRST USE 8-31-2007; IN COMMERCE 8-31-2007.

THE MARK CONSISTS OF STANDARD CHAR-
ACTERS WITHOUT CLAIM TO ANY PARTICULAR
FONT, STYLE, SIZE, OR COLOR.

SER. NO. 77-105,040, FILED P.R. 2-12-2007; AM. S.R.
12-6-2007.

RENEE SERVANCE, EXAMINING ATTORNEY

Int. Cl.: 35

Prior U.S. Cls.: 100, 101, and 102

United States Patent and Trademark Office

Reg. No. 3,522,792

Registered Oct. 21, 2008

**SERVICE MARK
SUPPLEMENTAL REGISTER**

DESIGNERS MARKETPLACE

CAPRIUS, LLC (NEW MEXICO LIMITED LIABILITY COMPANY)
4201 CARLISLE NE
ALBUQUERQUE, NM 87107

FOR: WHOLESALE DISTRIBUTORSHIP SERVICES FEATURING FURNITURE, FABRICS, TEXTILES, MIRRORS AND WINDOW TREATMENTS, AND CASE GOODS, IN CLASS 35 (U.S. CLS. 100, 101 AND 102).

FIRST USE 8-28-1997; IN COMMERCE 8-28-1997.

THE MARK CONSISTS OF STANDARD CHARACTERS WITHOUT CLAIM TO ANY PARTICULAR FONT, STYLE, SIZE, OR COLOR.

NO CLAIM IS MADE TO THE EXCLUSIVE RIGHT TO USE "MARKETPLACE", APART FROM THE MARK AS SHOWN.

SER. NO. 77-106,151, FILED P.R. 2-13-2007; AM. S.R. 6-22-2008.

ASMAT KHAN, EXAMINING ATTORNEY

Int. Cl.: 36

Prior U.S. Cls.: 100, 101, and 102

United States Patent and Trademark Office

Reg. No. 3,522,793

Registered Oct. 21, 2008

**SERVICE MARK
SUPPLEMENTAL REGISTER**

MILMO LOFTS

MILMO, ALBERTO F. (UNITED STATES INDIVIDUAL)

514 EL PASO STREET

SAN ANTONIO, TX 78207

FOR: LEASING OF APARTMENTS; RENTAL OF APARTMENTS, IN CLASS 36 (U.S. CLS. 100, 101 AND 102).

FIRST USE 1-1-2005; IN COMMERCE 1-1-2005.

THE MARK CONSISTS OF STANDARD CHARACTERS WITHOUT CLAIM TO ANY PARTICULAR FONT, STYLE, SIZE, OR COLOR.

NO CLAIM IS MADE TO THE EXCLUSIVE RIGHT TO USE "LOFTS", APART FROM THE MARK AS SHOWN.

SER. NO. 77-106,263, FILED P.R. 2-13-2007; AM. S.R. 8-12-2008.

GENE MACIOL, EXAMINING ATTORNEY

Int. Cl.: 37

Prior U.S. Cls.: 100, 103, and 106

United States Patent and Trademark Office

Reg. No. 3,522,794

Registered Oct. 21, 2008

**SERVICE MARK
SUPPLEMENTAL REGISTER**

MILMO GROUP

MILMO, ALBERTO F. (UNITED STATES INDIVIDUAL)

514 EL PASO STREET

SAN ANTONIO, TX 78207

FOR: REAL ESTATE DEVELOPMENT, IN CLASS 37 (U.S. CLS. 100, 103 AND 106).

FIRST USE 1-1-2005; IN COMMERCE 1-1-2005.

THE MARK CONSISTS OF STANDARD CHARACTERS WITHOUT CLAIM TO ANY PARTICULAR FONT, STYLE, SIZE, OR COLOR.

NO CLAIM IS MADE TO THE EXCLUSIVE RIGHT TO USE "GROUP", APART FROM THE MARK AS SHOWN.

SER. NO. 77-106,281, FILED P.R. 2-13-2007; AM. S.R. 8-12-2008.

GENE MACIOL, EXAMINING ATTORNEY

Int. Cls.: 9 and 42

Prior U.S. Cls.: 21, 23, 26, 36, 38, 100, and 101

Reg. No. 3,522,795

United States Patent and Trademark Office

Registered Oct. 21, 2008

**TRADEMARK
SERVICE MARK
SUPPLEMENTAL REGISTER**

BAUMER

BAUMER HOLDING AG (SWITZERLAND AK-
TIENGESELLSCHAFT)
HUMMELSTRASSE 17
FRAUENFELD, SWITZERLAND CH-8501

FOR: COMPUTERS; MEASURING TECHNIQUE, NAMELY, PRESSURE MEASURING, NAMELY, PRESSURE SENSORS, DIFFERENTIAL PRESSURE TRANSMITTERS, PRESSURE TRANSMITTERS, SUBMERSIBLE PRESSURE TRANSMITTERS, MECHANICAL AND ELECTRONIC PRESSURE SWITCHES, PRESSURE GAUGES, CHEMICAL SEALS, ACCESSORIES SUCH AS PRESSURE LIMITERS, FLANGES, NEEDLE VALVES, MANIFOLDS, IN-LINE PIPES, DAMPENING CONNECTIONS, SIPHONS, CAPILLARIES, NUTS AND NOZZLES, TEMPERATURE MEASURING, NAMELY, THERMOMETERS, TEMPERATURE SENSORS, TEMPERATURE TRANSMITTERS, MECHANICAL AND ELECTRONIC TEMPERATURE SWITCHES, THERMOWELLS, SYSTEM COMPONENTS FOR MEASURING, NAMELY, LEVEL MEASUREMENT, NAMELY, LEVEL SENSORS, LEVEL SWITCHES, LEVEL INDICATORS, LEAKAGE SENSORS, PROCESS ANALYSIS MEASURING, NAMELY, CONDUCTIVITY SENSORS, CONDUCTIVITY SWITCHES, HUMIDITY SENSORS, GAS ANALYSIS SENSORS, PH-ANALYSIS SENSORS, TEST AND CALIBRATION MEASURING, NAMELY, MECHANICAL AND ELECTRONIC CALIBRATION DEVICES, FLOW MEASUREMENT, NAMELY, FLOW SENSORS, FLOW TRANSMITTERS, FLOW SWITCHES, DISPLAYS, PROGRAMMING TOOLS, TRANSVERSE MEASURING, STRAIN MEASURING DEVICES, NAMELY, STRAIN GAUGES AND APPARATUS FOR PHOTOELASTICITY; ANGULAR AND LINEAR ENCODERS; ELECTRICAL POSITIONING DRIVES, NAMELY, ROTARY DRIVES, SWIVEL DRIVES, SPINDLE DRIVES AND LINEAR ACTUATORS FOR CHANGING THE ADJUSTMENTS OF MACHINES; COUNTERS, NAMELY,

ELECTRICAL AND MECHANICAL COUNTERS FOR COUNTING ROTATIONS; TACHOMETERS; GLUING SYSTEMS NOT ELECTRIC GLUING GUNS, NAMELY, GLUE INJECTORS, GLUE PUMPS, GLUE-VALVES, PRESSURE RESERVOIRS, GLUE MELTING DEVICES, CONTROL MODULES FOR GLUING SYSTEMS AND SIZE PREPARATION DEVICES; DIGITAL CAMERAS; DATA PROCESSERS; POI INTERFACE BOARDS, COMPUTER SOFTWARE FOR RECORDING AND PROCESSING MEASURED DATA AND THE SUBSEQUENT PROVISION TO A CONTROL MODULE IN THE FIELD OF CONTROL ENGINEERING, MEASURING TECHNIQUE, TELECOMMUNICATIONS, DRIVERS, IN PARTICULAR FOR SENSORS AND ACTUATORS, CONTROLLING SOFTWARE FOR MACHINES AND ROBOTS IN THE FIELD OF CONTROL ENGINEERING, MEASURING TECHNIQUE, DRIVERS, IN PARTICULAR FOR SENSORS AND ACTUATORS, SOFTWARE FOR TRANSMISSION OF ELECTRICAL SIGNALS, OPERATING SYSTEM PROGRAMS FOR MACHINES; SENSOR TECHNOLOGY, NAMELY, ANALOG AND DIGITAL SENSORS, IN PARTICULAR PRESSURE SENSORS, FORCE SENSORS, STRAIN SENSORS, SENSORS FOR DRIVE TECHNOLOGY, SURFACE STRAIN SENSORS, PIEZOELECTRIC SENSORS, PIEZORESISTIVE SENSORS, INDUCTIVE SENSORS, MAGNETIC FIELD SENSORS, HALL SENSORS, HIGH TEMPERATURE SENSORS, DISPLACEMENT SENSORS, DISTANCE SENSORS, CAPACITIVE LEVEL SENSORS, CAPACITIVE HIGH TEMPERATURE SENSORS, OPTICAL SENSORS, LASER SENSORS, COLOR SENSORS, LINE SENSORS, ANGLE SENSORS, MAGNETIC SENSORS; ELECTRIC STRAIN TRANSFORMERS; PRESSURE TRANSDUCERS; PRESSURE TRANSMITTERS; ELECTRIC PRESSURE AND TEMPERATURE SWITCHES; EXTENSIMETERS; BRIDGE AMPLIFIERS; ELECTRIC PROXIMITY SWITCHES; INDUCTIVE CODE READERS; DISPLACEMENT

TRANSDUCERS, DISPLACEMENT TRANSMITTERS; INDUCTIVE DISPLACEMENT TRANSDUCERS; CAPACITIVE PROXIMITY SWITCHES; ACTUATORS, NAMELY, ELECTRIC ACTUATORS; PRESSURE GAUGES; PHOTOELECTRIC SENSORS, NAMELY, ANALOG AND DIGITAL SENSORS IN PARTICULAR, LIGHT ARRAY BARRIERS, DIFFUSE SENSORS, DIFFUSE SENSOR ARRAY, RETROREFLECTIVE SENSORS, RETROREFLECTIVE SENSOR ARRAY FIBER OPTIC SENSORS, LEVEL MONITORING AND LEAK DETECTION SENSORS, DISTANCE MEASURING SENSORS, DISTANCE MEASURING SCANNERS, PHOTOELECTRIC AREA SCANNER, COLOR DETECTION SENSORS, COLOR MEASURING SENSORS, COLOR MARK SENSORS, LASER SENSORS, LINE SENSORS, VISION SENSORS, SMART VISION SENSORS, LUMINESCENCE SENSORS, LIGHT GAUGING SENSORS, INFRARED LIGHT SENSORS, RADAR SENSORS, ULTRASONIC SENSORS, ULTRASONIC SCANNERS, ULTRASONIC DISTANCE MEASURING SENSORS, THROUGH BEAM LIGHT BARRIERS OR FORKED LIGHT BARRIERS USED TO DETECT AND PREVENT DISRUPTION FROM EXTRANEOUS LIGHT SOURCES; LIGHT GUIDE APPARATUS, FIBER-OPTIC LIGHT GUIDES, PLASTIC FIBERS LIGHT GUIDES, MEASURING LIGHT GUIDES, USED FOR SAFETY AND WARNING PURPOSES; LASER COPY COUNTERS; ELECTRIC SHAPE CONVERTERS; ROTARY ENCODERS; MAGNETIC ROTARY ENCODERS; MULTI-TURN ROTARY ENCODERS; ABSOLUTE ROTARY ENCODERS; HOLLOW SHAFT ROTARY ENCODERS; SHAFT ROTARY ENCODERS; LINEAR DISPLACEMENT TRANSDUCERS; ELECTRONIC INTERPOLATION SYSTEMS, NAMELY, FOR SENSORS AND ACTUATOR DRIVES; METERING EQUIPMENT, NAMELY, ELECTRICAL AND POWER CONTROL-

TERS, NAMELY, ELECTRICAL, POWER, BRAKE; PRECISION SWITCHES, NAMELY, ELECTRICAL AND POWER; PRECISION SCANNERS; IDENTIFICATION SENSORS FOR RECORDING THE LOCATION, POSITION, MOVEMENT OR SIZE OF PERSONS OR OBJECTS; IDENTIFICATION SENSORS FOR RECORDING ENCODED DATA AND INFORMATION; IDENTIFICATION DEVICES FOR RECORDING CHARACTERS AND IMAGES, NAMELY, PHOTOELECTRIC BARCODE READERS, PHOTOELECTRIC 2D CODE READERS, INDUCTIVE, MICROWAVE CODE READERS, MAGNETIC CODE READERS, MICROWAVE AND INDUCTIVE TAGS, IN CLASS 9 (U.S. CLS. 21, 23, 26, 36 AND 38).

FOR: SCIENTIFIC AND INDUSTRIAL RESEARCH AND DEVELOPMENT IN THE FIELD OF SENSOR TECHNOLOGY AND OPTICAL INFORMATION CAPTURE AND PROCESSING; COMPUTER PROGRAMMING, IN PARTICULAR FOR DIGITAL INFORMATION CAPTURE BY MEANS OF SENSORS AND THE ACTIVATION OF ACTUATORS; TECHNICAL CONSULTATION SERVICES , IN CLASS 42 (U.S. CLS. 100 AND 101).

THE MARK CONSISTS OF STANDARD CHARACTERS WITHOUT CLAIM TO ANY PARTICULAR FONT, STYLE, SIZE, OR COLOR.

OWNER OF ERPN CMNTY TM OFC REG. NO. 003321023, DATED 1-18-2005, EXPIRES 8-20-2013.

SER. NO. 77-106,880, FILED P.R. 2-14-2007; AM. S.R. 7-28-2008.

ANGELA M. MICHELI, EXAMINING ATTORNEY

Int. Cl.: 42

Prior U.S. Cls.: 100 and 101

United States Patent and Trademark Office

Reg. No. 3,522,796

Registered Oct. 21, 2008

**SERVICE MARK
SUPPLEMENTAL REGISTER**

SOUTHEAST TEXAS HEART STUDY

SOUTHEAST TEXAS BIOMEDICAL RESEARCH
INSTITUTE (TEXAS NON-PROFIT CORPORATION)
SUITE 390
7789 SOUTHWEST FWY
HOUSTON, TX 77074

FOR: MEDICAL RESEARCH, NAMELY, PROVIDING MULTI-SITE PROSPECTIVE EPIDEMIOLOGICAL INVESTIGATION OF CARDIOVASCULAR DISEASE AMONG AFRICAN AMERICANS, ANGLO-AMERICANS, HISPANIC AMERICANS, AND NATIVE AMERICANS IN UNDERSERVED POPULATIONS IN RURAL, SUBURBAN AND URBAN AREAS, IN CLASS 42 (U.S. CLS. 100 AND 101).

FIRST USE 1-0-2006; IN COMMERCE 1-0-2006.

THE MARK CONSISTS OF STANDARD CHARACTERS WITHOUT CLAIM TO ANY PARTICULAR FONT, STYLE, SIZE, OR COLOR.

NO CLAIM IS MADE TO THE EXCLUSIVE RIGHT TO USE "HEART STUDY", APART FROM THE MARK AS SHOWN.

SER. NO. 77-115,436, FILED P.R. 2-24-2007; AM. S.R. 8-28-2008.

TASHIA BUNCH, EXAMINING ATTORNEY

Int. Cls.: 7, 8, 9, 18, and 20

Prior U.S. Cls.: 1, 2, 3, 13, 19, 21, 22, 23, 25, 26, 28, 31, 32, 34, 35, 36, 38, 41, 44, and 50

Reg. No. 3,522,797

United States Patent and Trademark Office

Registered Oct. 21, 2008

**TRADEMARK
SUPPLEMENTAL REGISTER**

Garant

HOFFMANN GMBH QUALITÄTSWERKZEUGE
(FED REP GERMANY LIMITED LIABILITY
COMPANY)

HABERLANDSTR. 55

MÜNCHEN, FED REP GERMANY D-81241

FOR: MACHINE OPERATED TOOLS FOR ALL KINDS OF MATERIALS, NAMELY, TWIST DRILLS, CENTER DRILLS, STEP DRILLS, HOLE CUTTERS, SOLID CARBIDE DRILLS, STONE DRILLS, TAPS, DIES FOR USE WITH MACHINE TOOLS, HOLDERS FOR USE WITH DIES, COUNTERBORES, COUNTERSINKS, REAMERS, SAW BLADES, SHELL ENDMILLS, ROUGHING ENDMILLS AND ENDMILLS WITH SHANKS; POWER OPERATED MILLING TOOLS AND PARTS THEREFOR, NAMELY, MILLING CUTTERS, HEADS AND TREADMILLS AND INDEXABLE INSERTS THEREFOR; POWER OPERATED CLAMPING TOOLS AND PARTS THEREFOR, NAMELY, FASTENER COLLETS, LATHE CHUCKS, DRIVING CENTERS, NAMELY, MACHINING CENTERS FOR METAL WORKING MACHINES, AND LATHE CHUCKS FOR TURNING AND DRIVING STOCK, METAL REPLACEMENT NUTS FOR ADJUSTING MACHINING OF WORK PIECES FOR POWER OPERATED TOOLS, METAL SPACERS FOR ADJUSTING MACHINING OF WORK PIECES FOR POWER OPERATED TOOLS, SPINDLES FOR POWER BORING HEADS FOR MACHINING WORK PIECES, POWER OPERATED METAL VICE JAWS FOR HOLDING MACHINING WORK PIECES, COLLET FIXTURES, MACHINE VISES, DRILL CHUCKS, MILLING CHUCKS, MAGNETIC CHUCKS, PARALLELS, ARBORS, METAL CLAMPS USED FOR HOLDING PIECE PARTS ON MACHINE TOOL TABLES, V-BLOCKS; POWER OPERATED TOOL PRESETTERS FOR POSITIONING WORK PIECES ON MACHINE TOOL TABLES; POWER OPERATED FILING, GRINDING AND SAWING TOOLS AND PARTS THEREFOR, NAMELY, HIGH SPEED STEEL ENGRAVING SCRIBERS,

MILLING PINS, GRINDING PINS, ABRASIVE DISCS, SAW BLADES AND SAWS; ABRASIVES CUP BRUSHES; WHEEL BRUSHES; POWER OPERATED HAND TOOLS, NAMELY, SCREW DRIVERS, WRENCHES, POWER SOCKETS AND BITS FOR POWER DRILLING AND DRIVING TOOLS; TOOL BITS FOR MACHINES, IN CLASS 7 (U.S. CLS. 13, 19, 21, 23, 31, 34 AND 35).

FOR: HAND TOOLS FOR ALL KINDS OF MATERIALS, NAMELY, TWIST DRILLS, CENTER DRILLS, HOLE CUTTERS, REAMERS; HAND OPERATED CLAMPING TOOLS AND PARTS THEREFOR, NAMELY, FASTENER COLLETS, LATHE CHUCKS; COLLET FIXTURES; MANUALLY OPERATED METAL VISES, DRILL CHUCKS, MILLING CHUCKS, MAGNETIC CHUCKS, PARALLELS, ARBORS, CLAMPS, V-BLOCKS; MANUALLY OPERATED PRESETTERS AND PARALLELS FOR MANUALLY OPERATED POSITIONING OF WORK PIECES ON MACHINE TOOL TABLES; MANUALLY OPERATED FILING, GRINDING AND SAWING HAND TOOLS AND PARTS THEREFOR, NAMELY, FILES, WOOD RASPS, ENGRAVING PINS, CUP BRUSHES, HAND SCRATCH WIRE BRUSHES, ABRASIVE DISCS, SAW BLADES; MANUALLY OPERATED HAND TOOLS, NAMELY, WRENCHES, TORQUE SOCKETS, TORQUE SOCKET AND RATCHET WRENCH SETS, EXTENSIONS, SCREWDRIVERS, BITS FOR HAND DRILLS, AND PLIERS, SIDE CUTTERS, WIRE STRIPPERS, ELECTRICIAN PLIERS, BOLT AND CABLE CUTTERS, CHISELS, HAMMERS, SCISSORS, RIVETING PLIERS; FORGE ANVILS; WOOD WORKING HAND TOOLS AND PARTS THEREFOR, NAMELY, WOOD PLANERS, WOOD-BORING BITS, WOODEN HAMMERS, WOOD MARKING GAGES, RIPPING CHISELS; WATER INSTALLATION HAND TOOLS, NAMELY, PIPE CUTTERS AND PIPE BENDING DEVICES; ELECTRICIAN KNIVES, KNIVES; HAND TOOLS, NAMELY, SHEET METAL PUNCHES; ADJUSTA-

BLE CLAMPS; METAL VISES; SHEET METAL CUTTERS; ANGLE BENDING HAND TOOLS, IN CLASS 8 (U.S. CLS. 23, 28 AND 44).

FOR: MEASURING EQUIPMENT AND HAND MEASURING DEVICES, NAMELY, ELECTRONIC NON-LASER GAUGES FOR MEASURING PRODUCTION PARAMETERS, CALIPERS, MICROMETERS, DIAL INDICATORS, GAUGE BLOCKS, SQUARES AND LEVELS; INSTRUMENTS FOR MEASURING LENGTH, MEASURING TAPES, RULERS, HEIGHT AND DEPTH GAUGES, WAVEMETER, SLIDE RULERS; TORQUEMETER AND TEMPERATURE SENSORS AND INDICATORS; APPARATUS FOR OPTICAL INSPECTION FOR INDUSTRIAL USE AND SURVEYING MEASUREMENT, INSTRUMENTS FOR MEASURING THICKNESS; SURFACE COMPARISON PLATES FOR COMPARATIVE CHECKING OF SURFACE FINISHES USING VISUAL AND TACTILE METHODS, MICROSCOPES; SURFACE ROUGHNESS TESTING MACHINES AND INSTRUMENTS, PROFILOMETER, IN CLASS 9 (U.S. CLS. 21, 23, 26, 36 AND 38).

FOR: TOOL BAGS OF LEATHER AND IMITATIONS OF LEATHER SOLD EMPTY, IN CLASS 18 (U.S. CLS. 1, 2, 3, 22 AND 41).

FOR: WORK BENCHES; TOOL STORAGE CABINETS, NAMELY, CHESTS OF DRAWERS FOR STORING TOOLS AND TECHNICAL EQUIPMENT, IN CLASS 20 (U.S. CLS. 2, 13, 22, 25, 32 AND 50).

THE MARK CONSISTS OF STANDARD CHARACTERS WITHOUT CLAIM TO ANY PARTICULAR FONT, STYLE, SIZE, OR COLOR.

OWNER OF FED REP GERMANY REG. NO. 30361252, DATED 1-21-2003, EXPIRES 11-30-2013.

OWNER OF FED REP GERMANY REG. NO. 39620607, DATED 9-27-1996, RENEWED AS REG. NO. 39620607, DATED 5-31-2006, EXPIRES 5-31-2016.

OWNER OF U.S. REG. NO. 3,239,937.

THE FOREIGN WORDING IN THE MARK TRANSLATES INTO ENGLISH AS GUARANTOR.

SER. NO. 77-121,005, FILED P.R. 3-2-2007; AM. S.R. 9-11-2008.

WANDA KAY PRICE, EXAMINING ATTORNEY

Int. Cl.: 25

Prior U.S. Cls.: 22 and 39

United States Patent and Trademark Office

Reg. No. 3,522,798

Registered Oct. 21, 2008

TRADEMARK
SUPPLEMENTAL REGISTER



NOR NEV (NEVADA PARTNERSHIP)
1555 SKY VALLEY DR., APT. Z102
RENO, NV 89523

FOR: CLOTHING, NAMELY, SHIRTS, SWEATERS AND HATS, IN CLASS 25 (U.S. CLS. 22 AND 39).

FIRST USE 7-19-2008; IN COMMERCE 7-19-2008.

THE STIPLING IS A FEATURE OF THE MARK.

THE MARK CONSISTS OF A BLACK STAR WITH WHITE SKULLS ON EACH CORNER AND ONE

LARGE SKULL IN THE CENTER OF THE STAR, WITH THE WORD "NOR" ABOVE THE LEFT HAND SIDE OF THE STAR AND THE WORD NEV ABOVE THE RIGHT HAND SIDE OF THE STAR, WITH STIPLING AROUND THE WORDS "NOR" AND "NEV". THE WORDS "NOR" AND "NEV" HAVE SOME STIPLING RUNNING THROUGH THEM SO THAT THE LETTERS APPEAR TO BE BLURRED.

SER. NO. 77-122,965, FILED P.R. 3-6-2007; AM. S.R. 9-12-2008.

B. PARADEWELAI, EXAMINING ATTORNEY

Int. Cl.: 41

Prior U.S. Cls.: 100, 101, and 107

United States Patent and Trademark Office

Reg. No. 3,522,799

Registered Oct. 21, 2008

**SERVICE MARK
SUPPLEMENTAL REGISTER**

DETROIT MEDIA PARTNERSHIP

DETROIT MEDIA PARTNERSHIP. L.P. (DELA-
WARE LIMITED PARTNERSHIP)
615 WEST LAFAYETTE BOULEVARD
DETROIT, MI 48231

FOR: PUBLISHING SERVICES, NAMELY, MA-
GAZINES, NEWSPAPERS AND ELECTRONIC PUB-
LICATIONS, IN CLASS 41 (U.S. CLS. 100, 101 AND
107).

FIRST USE 4-23-2007; IN COMMERCE 4-23-2007.

THE MARK CONSISTS OF STANDARD CHAR-
ACTERS WITHOUT CLAIM TO ANY PARTICULAR
FONT, STYLE, SIZE, OR COLOR.

SER. NO. 77-126,916, FILED P.R. 3-9-2007; AM. S.R.
10-22-2007.

ALLISON HOLTZ, EXAMINING ATTORNEY

Int. Cls.: 9, 35, and 39

Prior U.S. Cls.: 21, 23, 26, 36, 38, 100, 101, 102, and 105

Reg. No. 3,522,800

United States Patent and Trademark Office

Registered Oct. 21, 2008

**TRADEMARK
SERVICE MARK
SUPPLEMENTAL REGISTER**

SMART EXPLOSIVE

EXPLOTRACK, INC. (DELAWARE CORPORATION)
2080 DETWILER ROAD
MIDWAY BUSINESS CENTER, SUITE 3
HARLEYSVILLE, PA 19438

FOR: SENSORS AND TRACKING EQUIPMENT, NAMELY, RADIO FREQUENCY IDENTIFICATION TAGS AND READERS, ELECTRICAL AND ELECTRONIC DETECTORS, INFRARED SENSORS, MOTION SENSORS, TEMPERATURE SENSORS, ELECTROMAGNETIC TAGS, ACOUSTOMAGNETIC TAGS, AND MAGNETICALLY CODED MICROWIRE FOR IDENTIFYING, TRACKING AND TRACING EXPLOSIVES; INFRARED SIGNAL TRANSMITTERS; SCANNERS; VIDEO EQUIPMENT, NAMELY, VIDEO RECORDERS, ELECTRONIC VIDEO SURVEILLANCE INSTALLATIONS, VIDEO MONITORS, VIDEO PROCESSORS, VIDEO RECEIVERS, VIDEO TRANSMISSION APPARATUS, AND CLOSED-CIRCUIT TELEVISION CAMERAS; COMPUTER HARDWARE AND SOFTWARE FOR RETRIEVING, MONITORING, ENCRYPTING AND PUBLISHING DATA RECEIVED FROM SENSORS AND TRACKING EQUIPMENT; ELECTRONIC DEVICES FOR LOCATING AND TRACKING EXPLOSIVES PROGRAMMED TO USE GLOBAL POSITIONING SYSTEMS AND CELLULAR COMMUNICATIONS, NAMELY, COMPUTERS, COMPUTER SOFTWARE, TRANSMITTERS, RECEIVERS, AND NETWORK INTERFACE DEVICES; MOBILE COMPUTING AND OPERATING PLATFORMS CONSISTING OF DATA TRANSCEIVERS, WIRELESS NETWORKS AND GATEWAYS FOR COLLECTION AND MANAGEMENT OF DATA; COMPUTER HARDWARE, NAMELY, WIRELESS ACCESS POINT DEVICES; GLOBAL RADIO PACKET SERVICE DEVICES, NAMELY GPRS MODEMS, GPRS ROUTERS AND GPRS TELEMETRY SYSTEMS, IN CLASS 9 (U.S. CLS. 21, 23, 26, 36 AND 38).

FIRST USE 7-3-2008; IN COMMERCE 7-3-2008.

FOR: TRACKING AND MONITORING OF PACKAGE SHIPMENTS, NAMELY, EXPLOSIVES, IN CLASS 35 (U.S. CLS. 100, 101 AND 102).

FIRST USE 7-3-2008; IN COMMERCE 7-3-2008.

FOR: TRANSPORTATION AND DISTRIBUTION, DELIVERY OF EXPLOSIVES BY LAND, WATER AND AIR; TRANSPORT OF EXPLOSIVES BY LAND, WATER AND AIR; CARGO HANDLING SERVICES FOR EXPLOSIVES; PACKING, CRATING AND WAREHOUSING SERVICES OF EXPLOSIVES FOR TRANSPORTATION; TRANSPORTATION AND STORAGE OF EXPLOSIVES; FREIGHT FORWARDING SERVICES; EXPLOSIVES CARGO LOADING AND UNLOADING; SUPPLY CHAIN, LOGISTICS AND REVERSE LOGISTICS SERVICES, NAMELY, STORAGE, TRANSPORTATION AND DELIVERY OF EXPLOSIVES, IN CLASS 39 (U.S. CLS. 100 AND 105).

FIRST USE 7-3-2008; IN COMMERCE 7-3-2008.

THE MARK CONSISTS OF STANDARD CHARACTERS WITHOUT CLAIM TO ANY PARTICULAR FONT, STYLE, SIZE, OR COLOR.

NO CLAIM IS MADE TO THE EXCLUSIVE RIGHT TO USE "EXPLOSIVE", APART FROM THE MARK AS SHOWN.

SER. NO. 77-127,347, FILED P.R. 3-9-2007; AM. S.R. 7-10-2008.

STEVEN JACKSON, EXAMINING ATTORNEY

Int. Cls.: 9, 35, and 39

Prior U.S. Cls.: 21, 23, 26, 36, 38, 100, 101, 102, and 105

Reg. No. 3,522,801

United States Patent and Trademark Office

Registered Oct. 21, 2008

**TRADEMARK
SERVICE MARK
SUPPLEMENTAL REGISTER**

SMART DETONATOR

EXPLOTRACK, INC. (DELAWARE CORPORATION)
2080 DETWILER ROAD
MIDWAY BUSINESS CENTER, SUITE 3
HARLEYSVILLE, PA 19438

FOR: SENSORS AND TRACKING EQUIPMENT, NAMELY, RADIO FREQUENCY IDENTIFICATION TAGS AND READERS, ELECTRICAL AND ELECTRONIC DETECTORS, INFRARED SENSORS, MOTION SENSORS, TEMPERATURE SENSORS, ELECTROMAGNETIC TAGS, ACOUSTOMAGNETIC TAGS, AND MAGNETICALLY CODED MICROWIRE FOR IDENTIFYING, TACKING AND TRACING EXPLOSIVES; INFRARED SIGNAL TRANSMITTERS; SCANNERS; VIDEO EQUIPMENT, NAMELY, VIDEO RECORDERS, ELECTRONIC VIDEO SURVEILLANCE INSTALLATIONS, VIDEO MONITORS, VIDEO PROCESSORS, VIDEO RECEIVERS, VIDEO TRANSMISSION APPARATUS, AND CLOSED-CIRCUIT TELEVISION CAMERAS; COMPUTER HARDWARE AND SOFTWARE FOR RETRIEVING, MONITORING, ENCRYPTING AND PUBLISHING DATA RECEIVED FROM SENSORS AND TRACKING EQUIPMENT; ELECTRONIC DEVICES FOR LOCATING AND TRACKING EXPLOSIVES PROGRAMMED TO USE GLOBAL POSITIONING SYSTEMS (GPS) AND CELLULAR COMMUNICATIONS, NAMELY, COMPUTERS, COMPUTER SOFTWARE, TRANSMITTERS, RECEIVERS, AND NETWORK INTERFACE DEVICES; MOBILE COMPUTING AND OPERATING PLATFORMS CONSISTING OF DATA TRANSCEIVERS, WIRELESS NETWORKS AND GATEWAYS FOR COLLECTION AND MANAGEMENT OF DATA; COMPUTER HARDWARE, NAMELY, WIRELESS ACCESS POINT DEVICES; GLOBAL RADIO PACK-

ET SERVICE DEVICES, NAMELY, GPRS MODEMS, GPRS ROUTERS AND GPRS TELEMETRY SYSTEMS, IN CLASS 9 (U.S. CLS. 21, 23, 26, 36 AND 38).

FIRST USE 7-3-2008; IN COMMERCE 7-3-2008.

FOR: TRACKING AND MONITORING OF PACKAGE SHIPMENTS, NAMELY, EXPLOSIVES, IN CLASS 35 (U.S. CLS. 100, 101 AND 102).

FIRST USE 7-3-2008; IN COMMERCE 7-3-2008.

FOR: TRANSPORTATION AND DISTRIBUTION, DELIVERY OF EXPLOSIVES BY LAND, WATER AND AIR; TRANSPORT OF EXPLOSIVES BY LAND, WATER AND AIR; CARGO HANDLING SERVICES FOR EXPLOSIVES; PACKING, CRATING AND WAREHOUSING SERVICES OF EXPLOSIVES FOR TRANSPORTATION; TRANSPORTATION AND STORAGE OF EXPLOSIVES; FREIGHT FORWARDING SERVICES; EXPLOSIVES CARGO LOADING AND UNLOADING; SUPPLY CHAIN, LOGISTICS AND REVERSE LOGISTICS SERVICES, NAMELY, STORAGE, TRANSPORTATION AND DELIVERY OF EXPLOSIVES, IN CLASS 39 (U.S. CLS. 100 AND 105).

FIRST USE 7-3-2008; IN COMMERCE 7-3-2008.

THE MARK CONSISTS OF STANDARD CHARACTERS WITHOUT CLAIM TO ANY PARTICULAR FONT, STYLE, SIZE, OR COLOR.

SER. NO. 77-127,362, FILED P.R. 3-9-2007; AM. S.R. 7-9-2008.

STEVEN JACKSON, EXAMINING ATTORNEY

Int. Cls.: 35 and 36

Prior U.S. Cls.: 100, 101, and 102

United States Patent and Trademark Office

Reg. No. 3,522,802

Registered Oct. 21, 2008

**SERVICE MARK
SUPPLEMENTAL REGISTER**

**INSTITUTIONAL LIABILITY
MANAGEMENT**

INSTITUTIONAL LIABILITY MANAGEMENT,
LLC (DELAWARE LIMITED LIABILITY COM-
PANY)
9715 BUSINESSPARK AVENUE, SUITE 100
SAN DIEGO, CA 92131

FOR: CONNECTING BUYERS AND SELLERS OF
FINANCIAL ASSETS, IN CLASS 35 (U.S. CLS. 100, 101
AND 102).

FIRST USE 1-1-2007; IN COMMERCE 1-1-2007.

FOR: FINANCIAL CONSULTATION; FINAN-
CIAL SERVICES, NAMELY, ASSISTING OTHERS
WITH THE COMPLETION OF FINANCIAL TRANS-

ACTIONS FOR STOCKS, BONDS, SECURITIES AND
EQUITIES, IN CLASS 36 (U.S. CLS. 100, 101 AND 102).

FIRST USE 1-1-2007; IN COMMERCE 1-1-2007.

THE MARK CONSISTS OF STANDARD CHAR-
ACTERS WITHOUT CLAIM TO ANY PARTICULAR
FONT, STYLE, SIZE, OR COLOR.

SER. NO. 77-132,469, FILED P.R. 3-15-2007; AM. S.R.
9-4-2008.

TOBY BULLOFF, EXAMINING ATTORNEY

Int. Cls.: 41 and 45

Prior U.S. Cls.: 100, 101, and 107

United States Patent and Trademark Office

Reg. No. 3,522,803

Registered Oct. 21, 2008

**SERVICE MARK
SUPPLEMENTAL REGISTER**

**EXCELLENCE IN TECHNOLOGY
TRAINING AND SERVICE**

NATIONAL INSTITUTE FOR TRUTH VERIFICATION, LLC (FLORIDA LIMITED LIABILITY COMPANY)

11400 FORTUNE CIRCLE
WEST PALM BEACH, FL 33410

FOR: EDUCATION SERVICES, NAMELY, CONDUCTING TRAINING PROGRAMS IN THE FIELDS OF TRUTH DETECTION, VOICE ANALYSIS AND THE USE OF COMPUTER VOICE ANALYSIS SYSTEMS, IN CLASS 41 (U.S. CLS. 100, 101 AND 107).

FIRST USE 6-1-2006; IN COMMERCE 6-1-2006.

FOR: CONSULTING SERVICES IN THE FIELDS OF TRUTH DETECTION AND VOICE ANALYSIS FOR SECURITY PURPOSES, IN CLASS 45 (U.S. CLS. 100 AND 101).

FIRST USE 6-1-2006; IN COMMERCE 6-1-2006.

THE MARK CONSISTS OF STANDARD CHARACTERS WITHOUT CLAIM TO ANY PARTICULAR FONT, STYLE, SIZE, OR COLOR.

NO CLAIM IS MADE TO THE EXCLUSIVE RIGHT TO USE "TECHNOLOGY TRAINING AND SERVICE", APART FROM THE MARK AS SHOWN.

SER. NO. 77-135,076, FILED P.R. 3-20-2007; AM. S.R. 12-31-2007.

REBECCA POVARCHUK, EXAMINING ATTORNEY

Int. Cl.: 20

Prior U.S. Cls.: 2, 13, 22, 25, 32, and 50

Reg. No. 3,522,804

United States Patent and Trademark Office

Registered Oct. 21, 2008

**TRADEMARK
SUPPLEMENTAL REGISTER**

**The
Peroba
Collection**

ENVIRONMENT FURNITURE, INC. (CALIFORNIA CORPORATION)

7257 BEVERLY BLVD.

SUITE 244

LOS ANGELES, CA 90036

FOR: FURNITURE, IN CLASS 20 (U.S. CLS. 2, 13, 22, 25, 32 AND 50).

FIRST USE 2-0-2003; IN COMMERCE 2-0-2003.

THE MARK CONSISTS OF STANDARD CHARACTERS WITHOUT CLAIM TO ANY PARTICULAR FONT, STYLE, SIZE, OR COLOR.

NO CLAIM IS MADE TO THE EXCLUSIVE RIGHT TO USE "COLLECTION", APART FROM THE MARK AS SHOWN.

SER. NO. 77-138,694, FILED P.R. 3-23-2007; AM. S.R. 5-9-2008.

JACQUELINE A. LAVINE, EXAMINING ATTORNEY

Int. Cl.: 36

Prior U.S. Cls.: 100, 101, and 102

United States Patent and Trademark Office

Reg. No. 3,522,805

Registered Oct. 21, 2008

**SERVICE MARK
SUPPLEMENTAL REGISTER**

BABY BOND

TUNBRIDGE WELLS EQUITABLE FRIENDLY
SOCIETY LIMITED ABBEY COURT (UNITED
KINGDOM CORPORATION)
ST JOHN'S ROAD
TUNBRIDGE WELLS, KENT, UNITED KINGDOM
TN49TE

FOR: FINANCIAL SERVICES, NAMELY, ASSIST-
ING OTHERS WITH THE COMPLETION OF FINAN-
CIAL TRANSACTIONS FOR STOCKS, BONDS,
SECURITIES, EQUITIES AND PROVIDING FINAN-
CIAL ADVICE AND INFORMATION TO THIRD
PARTIES IN RELATION TO LONG TERM SAVINGS
BONDS AND SAVINGS SCHEMES; INSURANCE
SERVICES, NAMELY, PROVISION OF CONTRACTS
OF LIFE INSURANCE IN CONNECTION WITH
SAVINGS POLICIES; INVESTMENT SERVICES,
NAMELY, INVESTMENT CONSULTATION; SAV-
INGS ACCOUNT SERVICES; ADVISORY AND IN-
FORMATION SERVICES RELATING TO ALL THE

AFORESAID SERVICES, IN CLASS 36 (U.S. CLS. 100,
101 AND 102).

THE MARK CONSISTS OF STANDARD CHAR-
ACTERS WITHOUT CLAIM TO ANY PARTICULAR
FONT, STYLE, SIZE, OR COLOR.

OWNER OF ERPN CMNTY TM OFC REG. NO.
002585552, DATED 6-21-2004, EXPIRES 2-20-2012.

NO CLAIM IS MADE TO THE EXCLUSIVE
RIGHT TO USE "BOND", APART FROM THE
MARK AS SHOWN.

SER. NO. 77-147,830, FILED P.R. 4-3-2007; AM. S.R.
8-7-2008.

EMILY CARLSEN, EXAMINING ATTORNEY

Int. Cl.: 32

Prior U.S. Cls.: 45, 46, and 48

United States Patent and Trademark Office

Reg. No. 3,522,806

Registered Oct. 21, 2008

**TRADEMARK
SUPPLEMENTAL REGISTER**

VALAIS

FEDERATION OF MIGROS COOPERATIVES
(SWITZERLAND CORPORATION)

LIMMATSTRASSE 152

CH-8005 ZURICH, SWITZERLAND

FOR: MINERAL WATER, IN CLASS 32 (U.S. CLS.
45, 46 AND 48).

FIRST USE 8-0-2008; IN COMMERCE 8-0-2008.

THE MARK CONSISTS OF STANDARD CHAR-
ACTERS WITHOUT CLAIM TO ANY PARTICULAR
FONT, STYLE, SIZE, OR COLOR.

"VALAIS" IS THE NAME OF A CANTON OR
PROVINCE IN "SWITZERLAND".

SER. NO. 77-148,533, FILED P.R. 4-4-2007; AM. S.R.
9-15-2008.

HANNO RITTNER, EXAMINING ATTORNEY

Int. Cl.: 9

Prior U.S. Cls.: 21, 23, 26, 36, and 38

Reg. No. 3,522,807

United States Patent and Trademark Office

Registered Oct. 21, 2008

**TRADEMARK
SUPPLEMENTAL REGISTER**

VINCI

NACT TELECOMMUNICATIONS, INC. (DELA-
WARE CORPORATION)
191 WEST 5200 NORTH
PROVO, UT 84604

FOR: COMPUTER TELEPHONY SOFTWARE EN-
ABLING PREPAID TELEPHONE ACTIVITIES TO BE
PERFORMED THROUGH A COMPUTER; TELE-
PHONY HARDWARE, NAMELY, CHANGE-OVER
SWITCHES, IN CLASS 9 (U.S. CLS. 21, 23, 26, 36 AND
38).

FIRST USE 6-30-2008; IN COMMERCE 6-30-2008.

THE MARK CONSISTS OF STANDARD CHAR-
ACTERS WITHOUT CLAIM TO ANY PARTICULAR
FONT, STYLE, SIZE, OR COLOR.

SER. NO. 77-152,749, FILED P.R. 4-10-2007; AM. S.R.
9-10-2008.

BARNEY CHARLON, EXAMINING ATTORNEY

Int. Cl.: 36

Prior U.S. Cls.: 100, 101, and 102

United States Patent and Trademark Office

Reg. No. 3,522,808

Registered Oct. 21, 2008

**SERVICE MARK
SUPPLEMENTAL REGISTER**

AMERICAN FARMERS & RANCHERS

AMERICAN FARMERS & RANCHERS MUTUAL
INSURANCE COMPANY (OKLAHOMA COR-
PORATION)
P.O. BOX 24000
OKLAHOMA CITY, OK 73124

FOR: INSURANCE SERVICES, NAMELY, WRIT-
ING AND UNDERWRITING OF LIFE INSURANCE,
CASUALTY INSURANCE AND PROPERTY INSUR-
ANCE, AND PROVIDING ANCILLARY SERVICES
THERE TO, NAMELY, ADMINISTRATION, CLAIMS
ADJUSTMENT AND BROKERAGE, IN CLASS 36
(U.S. CLS. 100, 101 AND 102).

FIRST USE 2-9-2007; IN COMMERCE 11-26-2007.

THE MARK CONSISTS OF STANDARD CHAR-
ACTERS WITHOUT CLAIM TO ANY PARTICULAR
FONT, STYLE, SIZE, OR COLOR.

SER. NO. 77-154,281, FILED P.R. 4-11-2007; AM. S.R.
8-28-2008.

DAVID TOOLEY, EXAMINING ATTORNEY

Int. Cl.: 42

Prior U.S. Cls.: 100 and 101

United States Patent and Trademark Office

Reg. No. 3,522,809

Registered Oct. 21, 2008

**SERVICE MARK
SUPPLEMENTAL REGISTER**

CORPORATE ART

CORPORATE ART, LLC (NEW JERSEY LIMITED
LIABILITY COMPANY)
33 CLINTON ROAD, SUITE 107
WEST CALDWELL, NJ 07006

FOR: PROVIDING CONSULTING SERVICES FOR
SELECTION, PLACEMENT AND INSTALLATION
OF ARTWORK IN INDUSTRIAL, BUSINESS, RE-
TAIL AND RESIDENTIAL SPACES , IN CLASS 42
(U.S. CLS. 100 AND 101).

FIRST USE 3-11-2002; IN COMMERCE 3-11-2002.

THE MARK CONSISTS OF STANDARD CHAR-
ACTERS WITHOUT CLAIM TO ANY PARTICULAR
FONT, STYLE, SIZE, OR COLOR.

NO CLAIM IS MADE TO THE EXCLUSIVE
RIGHT TO USE "ART", APART FROM THE MARK
AS SHOWN.

SER. NO. 77-157,956, FILED P.R. 4-16-2007; AM. S.R.
8-27-2008.

KAREN SEVERSON, EXAMINING ATTORNEY

Int. Cl.: 42

Prior U.S. Cls.: 100 and 101

United States Patent and Trademark Office

Reg. No. 3,522,810

Registered Oct. 21, 2008

**SERVICE MARK
SUPPLEMENTAL REGISTER**

SITE LOGISTICS

TIMMONS GROUP, INC. (VIRGINIA CORPORATION)
#303
117 SOUTH 14TH STREET
RICHMOND, VA 23219

FOR: PROVIDING TEMPORARY USE OF ONLINE, NON-DOWNLOADABLE COMPUTER SOFTWARE FOR LOCAL ECONOMIC DEVELOPMENT OFFICIALS FOR USE IN ECONOMIC DEVELOPMENT ACTIVITIES, NAMELY, LOCATION SELECTION AND BUSINESS PLANNING SERVICES, NAMELY, SOFTWARE THAT PROVIDES CUSTOMIZED SITE AND BUILDING QUERIES, INTEGRATED DEMOGRAPHIC REPORTING, COMPARATIVE ANALYSIS OF MULTIPLE SITES

AND THEIR SURROUNDING DEMOGRAPHICS, REPORTS WITH CUSTOMIZED DEMOGRAPHIC ANALYSIS, AND AERIAL PHOTOS, IN CLASS 42 (U.S. CLS. 100 AND 101).

FIRST USE 10-18-2007; IN COMMERCE 10-18-2007.

THE MARK CONSISTS OF STANDARD CHARACTERS WITHOUT CLAIM TO ANY PARTICULAR FONT, STYLE, SIZE, OR COLOR.

SER. NO. 77-160,038, FILED P.R. 4-18-2007; AM. S.R. 2-1-2008.

SARA THOMAS, EXAMINING ATTORNEY

Int. Cls.: 7 and 11

Prior U.S. Cls.: 13, 19, 21, 23, 31, 34, and 35

United States Patent and Trademark Office

Reg. No. 3,522,811

Registered Oct. 21, 2008

**TRADEMARK
SUPPLEMENTAL REGISTER**

MABE

EXINMEX, S.A. DE C.V. (MEXICO CORPORATION)
AVENIDA INSURGENTES SUR NO. 664
COLONIA DE VALLE
MEXICO, MEXICO 03110

FOR: CLOTHES WASHING MACHINES; ELECTRIC MOTORS FOR WASHING MACHINES, IN CLASS 7 (U.S. CLS. 13, 19, 21, 23, 31, 34 AND 35).

FOR: REFRIGERATORS; FREEZERS; WATER COOLERS AND WATER HEATERS, NAMELY, GAS WATER HEATERS, HOT WATER HEATERS, SOLAR WATER HEATERS, WATER HEATERS FOR DOMESTIC USE; AIR CONDITIONERS, CLOTHES DRYERS; STOVES, NAMELY, GAS STOVES AND ELECTRIC STOVES; MICROWAVE OVENS, IN CLASS 11 (U.S. CLS. 13, 21, 23, 31 AND 34).

THE MARK CONSISTS OF STANDARD CHARACTERS WITHOUT CLAIM TO ANY PARTICULAR FONT, STYLE, SIZE, OR COLOR.

OWNER OF MEXICO REG. NO. 620499, DATED 8-31-1999, EXPIRES 12-7-2014.

OWNER OF MEXICO REG. NO. 641424, DATED 2-21-2000, EXPIRES 12-7-2014.

THE WORDING "MABE" HAS NO MEANING IN A FOREIGN LANGUAGE.

SER. NO. 77-160,065, FILED P.R. 4-18-2007; AM. S.R. 8-19-2008.

AMY ALFIERI, EXAMINING ATTORNEY

Int. Cl.: 14

Prior U.S. Cls.: 2, 27, 28, and 50

United States Patent and Trademark Office

Reg. No. 3,522,812

Registered Oct. 21, 2008

**TRADEMARK
SUPPLEMENTAL REGISTER**

In Memory Of . . .

MILLS, JAMES L. (UNITED STATES INDIVIDUAL)
APARTMENT E13
100 MCDONALD STREET
LAFAYETTE, LA 70506

FOR: RUBBER OR SILICON WRISTBANDS IN THE NATURE OF A BRACELET, IN CLASS 14 (U.S. CLS. 2, 27, 28 AND 50).

FIRST USE 7-23-2007; IN COMMERCE 7-23-2007.

THE MARK CONSISTS OF STANDARD CHARACTERS WITHOUT CLAIM TO ANY PARTICULAR FONT, STYLE, SIZE, OR COLOR.

SER. NO. 77-160,401, FILED P.R. 4-19-2007; AM. S.R. 8-18-2008.

SUNG IN, EXAMINING ATTORNEY

Int. Cl.: 35

Prior U.S. Cls.: 100, 101, and 102

United States Patent and Trademark Office

Reg. No. 3,522,813

Registered Oct. 21, 2008

**SERVICE MARK
SUPPLEMENTAL REGISTER**

QUALITY RECRUITMENT PROCESS

TALENT PLUS, INC. (NEBRASKA CORPORATION)
ONE TALENT PLUS WAY
LINCOLN, NE 68506

FOR: BUSINESS MANAGEMENT, PERSONNEL AND HUMAN RESOURCES CONSULTING SERVICES IN THE FIELD OF RECRUITMENT, STAFF AND SUCCESSION PLANNING, PERFORMANCE MANAGEMENT AND EVALUATION, SKILL ASSESSMENT AND COMPETENCY EVALUATION OF CURRENT AND FUTURE PERSONNEL; PROVIDING AN ONLINE DATABASE WHERE EMPLOYERS HAVE ACCESS TO INFORMATION FOR PURPOSES

OF CONDUCTING SCREENING OF PROSPECTIVE PERSONNEL, IN CLASS 35 (U.S. CLS. 100, 101 AND 102).

FIRST USE 5-0-2006; IN COMMERCE 5-0-2006.

THE MARK CONSISTS OF STANDARD CHARACTERS WITHOUT CLAIM TO ANY PARTICULAR FONT, STYLE, SIZE, OR COLOR.

SER. NO. 77-160,571, FILED P.R. 4-19-2007; AM. S.R. 9-8-2008.

WENDY JUN, EXAMINING ATTORNEY

Int. Cl.: 35

Prior U.S. Cls.: 100, 101, and 102

United States Patent and Trademark Office

Reg. No. 3,522,814

Registered Oct. 21, 2008

**SERVICE MARK
SUPPLEMENTAL REGISTER**

QUALITY INVESTMENT PROCESS

TALENT PLUS, INC. (NEBRASKA CORPORATION)
ONE TALENT PLUS WAY
LINCOLN, NE 68506

FOR: BUSINESS MANAGEMENT, PERSONNEL AND HUMAN RESOURCES CONSULTING SERVICES IN THE FIELD OF RECRUITMENT, STAFF AND SUCCESSION PLANNING, PERFORMANCE MANAGEMENT AND EVALUATION, SKILL ASSESSMENT AND COMPETENCY EVALUATION OF CURRENT AND FUTURE PERSONNEL; PROVIDING AN ONLINE DATABASE WHERE EMPLOYERS HAVE ACCESS TO INFORMATION USED FOR

PURPOSES OF PERSONNEL MENTORING, RETENTION, ENHANCEMENT AND SUCCESSION PLANNING, IN CLASS 35 (U.S. CLS. 100, 101 AND 102).

FIRST USE 5-0-2006; IN COMMERCE 5-0-2006.

THE MARK CONSISTS OF STANDARD CHARACTERS WITHOUT CLAIM TO ANY PARTICULAR FONT, STYLE, SIZE, OR COLOR.

SER. NO. 77-160,881, FILED P.R. 4-19-2007; AM. S.R. 9-8-2008.

WENDY JUN, EXAMINING ATTORNEY

Int. Cls.: 35 and 37

Prior U.S. Cls.: 100, 101, 102, 103, and 106

United States Patent and Trademark Office

Reg. No. 3,522,815

Registered Oct. 21, 2008

**SERVICE MARK
SUPPLEMENTAL REGISTER**

EURO AND EXOTIC GARAGE

EURO END EXOTIC GARAGE, INC. (WASHINGTON CORPORATION)
6505 233RD PL S.E.
WOODINVILLE, WA 98072

FOR: WHOLESALE DISTRIBUTORSHIPS FEATURING AUTOMOBILES, IN CLASS 35 (U.S. CLS. 100, 101 AND 102).

FIRST USE 3-1-2004; IN COMMERCE 3-1-2004.

FOR: AUTOMOBILE BODY REPAIR AND FINISHING FOR OTHERS; AUTOMOBILE REPAIR

AND MAINTENANCE FOR ANY VEHICLE, IN CLASS 37 (U.S. CLS. 100, 103 AND 106).

FIRST USE 3-1-2004; IN COMMERCE 3-1-2004.

THE MARK CONSISTS OF STANDARD CHARACTERS WITHOUT CLAIM TO ANY PARTICULAR FONT, STYLE, SIZE, OR COLOR.

SER. NO. 77-162,482, FILED P.R. 4-21-2007; AM. S.R. 9-6-2008.

CHERYL CLAYTON, EXAMINING ATTORNEY

Int. Cls.: 35 and 41

Prior U.S. Cls.: 100, 101, 102, and 107

United States Patent and Trademark Office

Reg. No. 3,522,816

Registered Oct. 21, 2008

**SERVICE MARK
SUPPLEMENTAL REGISTER**

**Voluntary System of
Accountability Program**

NATIONAL ASSOCIATION OF STATE UNIVERSITIES AND LAND-GRANT COLLEGES (D.C. NON-PROFIT CORPORATION)

SUITE 400
1307 NEW YORK AVENUE, N.W.
WASHINGTON, DC 20005

FOR: PROMOTING THE INTERESTS AND ENCOURAGING THE ACCOUNTABILITY OF COLLEGES AND UNIVERSITIES, IN CLASS 35 (U.S. CLS. 100, 101 AND 102).

FIRST USE 8-1-2006; IN COMMERCE 8-1-2006.

FOR: EDUCATIONAL SERVICES, NAMELY, THE DEVELOPMENT AND DISSEMINATION OF WRITTEN EDUCATIONAL MATERIALS ENCOURAGING THE ACCOUNTABILITY OF COLLEGES

AND UNIVERSITIES, IN CLASS 41 (U.S. CLS. 100, 101 AND 107).

FIRST USE 8-1-2006; IN COMMERCE 8-1-2006.

THE MARK CONSISTS OF STANDARD CHARACTERS WITHOUT CLAIM TO ANY PARTICULAR FONT, STYLE, SIZE, OR COLOR.

NO CLAIM IS MADE TO THE EXCLUSIVE RIGHT TO USE "PROGRAM", APART FROM THE MARK AS SHOWN.

SER. NO. 77-171,606, FILED P.R. 5-3-2007; AM. S.R. 9-17-2008.

TOBY BULLOFF, EXAMINING ATTORNEY

Int. Cls.: 30 and 35

Prior U.S. Cls.: 46, 100, 101, and 102

United States Patent and Trademark Office

Reg. No. 3,522,817

Registered Oct. 21, 2008

TRADEMARK
SERVICE MARK
SUPPLEMENTAL REGISTER

YARROWS

YARROWS (THE BAKERS) LIMITED (NEW ZEALAND LIMITED LIABILITY COMPANY)
MAIN STREET
MANAIA, TARANAKI, NEW ZEALAND

FOR: BAKED, UNBAKED, FROZEN AND UNFROZEN, BREAD, BISCUITS, CAKES, SPONGE CAKES, PASTRIES, YEAST RAISED PASTRIES, CONFECTIONS, NAMELY, FROZEN CONFECTIONS, CONFECTIONERY CHIPS FOR BAKING, ICING AND FUDGE, MEAT PIES, FRUIT PIES, SAUSAGE ROLLS, MERINGUE, PROCESSED CEREALS, CHOCOLATE BASED AND CUSTARD BASED FILLINGS FOR CAKES AND PIES, CAKE MIXES, PUDDINGS, FROZEN DOUGH AND YEAST BAKED GOODS, NAMELY, BREADS, ROLLS, SCONES, CROISSANTS, DANISH PUFF PASTRIES, DONUTS AND BISCUITS, IN CLASS 30 (U.S. CL. 46).

FIRST USE 12-31-2000; IN COMMERCE 12-31-2000.

FOR: RETAIL AND WHOLESALE STORE SERVICES, FEATURING BAKED, UNBAKED, FROZEN AND UNFROZEN, BREAD, BISCUITS, CAKES,

SPONGE CAKES, PASTRIES, YEAST RAISED PASTRIES, CONFECTIONS, NAMELY, CONFECTIONERY CHIPS FOR BAKING, FROZEN CONFECTION, ICING AND FUDGE, MEAT PIES, FRUIT PIES, SAUSAGE ROLLS, MERINGUE, PROCESSED CEREALS, CHOCOLATE-BASED AND CUSTARD BASED FILLINGS FOR CAKES AND PIES, CAKE MIXES, PUDDINGS, FROZEN DOUGH AND YEAST BAKED GOODS, NAMELY, BREADS, ROLLS, SCONES, CROISSANTS, DANISH, PUFF PASTRIES, DONUTS, AND BISCUITS, IN CLASS 35 (U.S. CLS. 100, 101 AND 102).

FIRST USE 1-30-1998; IN COMMERCE 1-30-1998.

THE MARK CONSISTS OF STANDARD CHARACTERS WITHOUT CLAIM TO ANY PARTICULAR FONT, STYLE, SIZE, OR COLOR.

SER. NO. 77-177,324, FILED P.R. 5-10-2007; AM. S.R. 2-22-2008.

ERNEST SHOSHO, EXAMINING ATTORNEY

Int. Cl.: 35

Prior U.S. Cls.: 100, 101, and 102

United States Patent and Trademark Office

Reg. No. 3,522,818

Registered Oct. 21, 2008

**SERVICE MARK
SUPPLEMENTAL REGISTER**

CAROLINAS WALK OF FAME

THE TOWN OF CHESTERFIELD (SOUTH CAROLINA BODY POLITIC AND CORPORATE)
POST OFFICE BOX 350
CHESTERFIELD, SC 29709

FOR: PROMOTING TOURISM IN THE TOWN OF CHESTERFIELD BY DISPLAYS AND EXHIBITS HONORING FAMOUS PERSONS FROM NORTH AND SOUTH CAROLINA , IN CLASS 35 (U.S. CLS. 100, 101 AND 102).

FIRST USE 2-29-2008; IN COMMERCE 2-29-2008.

THE MARK CONSISTS OF STANDARD CHARACTERS WITHOUT CLAIM TO ANY PARTICULAR FONT, STYLE, SIZE, OR COLOR.

NO CLAIM IS MADE TO THE EXCLUSIVE RIGHT TO USE "WALK OF FAME", APART FROM THE MARK AS SHOWN.

SER. NO. 77-180,283, FILED P.R. 5-14-2007; AM. S.R. 8-20-2008.

KRISTIN DAHLING, EXAMINING ATTORNEY

Int. Cl.: 9

Prior U.S. Cls.: 21, 23, 26, 36, and 38

United States Patent and Trademark Office

Reg. No. 3,522,819

Registered Oct. 21, 2008

**TRADEMARK
SUPPLEMENTAL REGISTER**

WEBCARD CENTER

THE CBORD GROUP, INC. (DELAWARE CORPORATION)
61 BROWN ROAD
ITHACA, NY 14850

FOR: PRERECORDED COMPUTER SOFTWARE FOR CUSTOMER-HOSTED WEB-BASED COMPUTER APPLICATION THAT ALLOWS USERS TO CHECK CURRENT BALANCES, VIEW SPENDING HISTORY, REPORT LOST ID CARDS, AND REQUEST NEW ID CARDS, IN CLASS 9 (U.S. CLS. 21, 23, 26, 36 AND 38).

FIRST USE 2-28-2007; IN COMMERCE 3-22-2007.

THE MARK CONSISTS OF STANDARD CHARACTERS WITHOUT CLAIM TO ANY PARTICULAR FONT, STYLE, SIZE, OR COLOR.

NO CLAIM IS MADE TO THE EXCLUSIVE RIGHT TO USE "CENTER", APART FROM THE MARK AS SHOWN.

SER. NO. 77-186,743, FILED P.R. 5-22-2007; AM. S.R. 7-9-2008.

LINDA POWELL, EXAMINING ATTORNEY

Int. Cl.: 35

Prior U.S. Cls.: 100, 101, and 102

United States Patent and Trademark Office

Reg. No. 3,522,820

Registered Oct. 21, 2008

**SERVICE MARK
SUPPLEMENTAL REGISTER**

GREENAUTO.COM

GREENAUTO.COM (NEW JERSEY LIMITED
LIABILITY COMPANY)
127 CHESNUT ST.
EMERSON, NJ 07630

FOR: ADVERTISING AND ADVERTISEMENT SERVICES; ADVERTISING AND COMMERCIAL INFORMATION SERVICES, VIA THE INTERNET; ADVERTISING AND PUBLICITY SERVICES; ADVERTISING AND PUBLICITY SERVICES, NAMELY, PROMOTING THE GOODS, SERVICES, BRAND IDENTITY AND COMMERCIAL INFORMATION AND NEWS OF THIRD PARTIES THROUGH PRINT, AUDIO, VIDEO, DIGITAL AND ON-LINE MEDIUM; ADVERTISING PARTICULARLY SERVICES FOR THE PROMOTION OF GOODS; ADVERTISING SERVICES; ADVERTISING SERVICES, NAMELY, PROMOTING AND MARKETING THE GOODS AND SERVICES OF OTHERS THROUGH ALL PUBLIC COMMUNICATION MEANS; ADVERTISING SERVICES, NAMELY, PROVIDING INFORMATION AS TO THE AVAILABILITY OF VEHICLES FOR RENT OR PURCHASE; ADVERTISING, INCLUDING PROMOTION RELATING TO THE SALE OF ARTICLES AND SERVICES FOR THIRD PARTIES BY THE TRANSMISSION OF ADVERTISING MATERIAL AND THE DISSEMINATION OF ADVERTISING MESSAGES ON COMPUTER NETWORKS; ADVERTISING, MARKETING AND PROMOTION SERVICES; ADVICE AND INFORMATION ABOUT CUSTOMER SERVICES AND PRODUCT MANAGEMENT AND PRICES ON INTERNET SITES IN CONNECTION WITH PURCHASES MADE OVER THE INTERNET; BUSINESS INFORMATION SERVICES AND APPRAISALS; BUSINESS INTERMEDIARY AND ADVISORY SERVICES IN THE FIELD OF SELLING PRODUCTS AND RENDERING SERVICES; BUSINESS SERVICES, NAMELY, PROVIDING COMPUTER DATABASES REGARDING THE PURCHASE AND SALE OF A WIDE VARIETY OF PRODUCTS AND SERVICES OF OTHERS; COMPUTERIZED ON-LINE

ORDERING SERVICES IN THE FIELD OF VEHICLES; ELECTRONIC COMMERCE SERVICES, NAMELY, PROVIDING INFORMATION ABOUT PRODUCTS VIA TELECOMMUNICATION NETWORKS FOR ADVERTISING AND SALES PURPOSES; ON-LINE ADVERTISING AND MARKETING SERVICES; ON-LINE ORDERING SERVICES FEATURING VEHICLES; PROMOTING THE GOODS AND SERVICES OF OTHERS THROUGH ON-LINE ORDERING AND CATALOGING OF THOSE GOODS AND SERVICES; PROVIDING A WEB SITE WHERE USERS CAN POST RATINGS, REVIEWS AND RECOMMENDATIONS ON PRODUCTS AND SERVICES; PROVIDING A WEB SITE WHEREBY BUYERS OF GOODS OR SERVICES LOCATE AND RECEIVE QUOTATIONS FROM MULTIPLE COMPETITIVE SOURCES AND SELLERS OF GOODS OR SERVICES IDENTIFY AND BID ON MULTIPLE NEW SALES OPPORTUNITIES; PROVIDING A WEB SITE WHICH FEATURES ADVERTISEMENTS FOR THE GOODS AND SERVICES OF OTHERS ON A GLOBAL COMPUTER NETWORK; PROVIDING A WEBSITE FEATURING PRODUCT RATINGS OF THE CONSUMER GOODS AND SERVICES OF OTHERS IN THE FIELD OF VEHICLES; PROVIDING ON-LINE FACILITIES FEATURING TRANSACTION ORDER ENTRY, ORDER DIRECTING AND ORDER CONFIRMATION SERVICES TO CUSTOMERS IN THE FIELD OF INVESTING; WHOLESALE DISTRIBUTORSHIPS FEATURING VEHICLES; AUTOMOBILE DEALERSHIPS; DEALERSHIPS IN THE FIELD OF AUTOMOTIVE VEHICLES, IN CLASS 35 (U.S. CLS. 100, 101 AND 102).

FIRST USE 3-20-2008; IN COMMERCE 3-20-2008.

THE MARK CONSISTS OF STANDARD CHARACTERS WITHOUT CLAIM TO ANY PARTICULAR FONT, STYLE, SIZE, OR COLOR.

SER. NO. 77-193,982, FILED P.R. 5-31-2007; AM. S.R.
9-4-2008.

LEIGH CAROLINE CASE, EXAMINING ATTOR-
NEY

Int. Cl.: 23

Prior U.S. Cl.: 43

United States Patent and Trademark Office

Reg. No. 3,522,821

Registered Oct. 21, 2008

**TRADEMARK
SUPPLEMENTAL REGISTER**

CAREFREE COTTON

J. & P. COATS, LIMITED (UNITED KINGDOM
CORPORATION)

155 ST. VINCENT STREET

GLASGOW G2 5PA, SCOTLAND

FOR: HANDKNITTING YARNS MADE IN
WHOLE OR IN PART OF COTTON, IN CLASS 23
(U.S. CL. 43).

FIRST USE 8-23-2007; IN COMMERCE 8-23-2007.

THE MARK CONSISTS OF STANDARD CHAR-
ACTERS WITHOUT CLAIM TO ANY PARTICULAR
FONT, STYLE, SIZE, OR COLOR.

NO CLAIM IS MADE TO THE EXCLUSIVE
RIGHT TO USE "COTTON", APART FROM THE
MARK AS SHOWN.

SER. NO. 77-195,187, FILED P.R. 6-1-2007; AM. S.R.
2-25-2008.

JULIE WATSON, EXAMINING ATTORNEY

Int. Cl.: 9

Prior U.S. Cls.: 21, 23, 26, 36, and 38

United States Patent and Trademark Office

Reg. No. 3,522,822

Registered Oct. 21, 2008

**TRADEMARK
SUPPLEMENTAL REGISTER**

RETENTION MODULES

DRB LIT, LTD. (TEXAS LIMITED PARTNER-
SHIP)
4401 WINDSOR RIDGE DRIVE
IRVING, TX 75038

FOR: COMPUTER SOFTWARE THAT ACTS AS A
PERSONAL LEARNING TOOL TO ENHANCE
MEMORIZATION AND ASSIMILATION OF NEW
INFORMATION THAT MAY BE DOWNLOADED
FROM A GLOBAL COMPUTER NETWORK, IN
CLASS 9 (U.S. CLS. 21, 23, 26, 36 AND 38).

FIRST USE 5-1-2006; IN COMMERCE 5-1-2006.

THE MARK CONSISTS OF STANDARD CHAR-
ACTERS WITHOUT CLAIM TO ANY PARTICULAR
FONT, STYLE, SIZE, OR COLOR.

NO CLAIM IS MADE TO THE EXCLUSIVE
RIGHT TO USE "MODULES", APART FROM THE
MARK AS SHOWN.

SER. NO. 77-203,654, FILED P.R. 6-12-2007; AM. S.R.
9-16-2008.

DAVID I, EXAMINING ATTORNEY

Int. Cl.: 35

Prior U.S. Cls.: 100, 101, and 102

United States Patent and Trademark Office

Reg. No. 3,522,823

Registered Oct. 21, 2008

**SERVICE MARK
SUPPLEMENTAL REGISTER**

AMERICA'S ENERGY FUTURE

GREATER HOUSTON PARTNERSHIP, INC.
(TEXAS CORPORATION)
1200 SMITH, SUITE #700
HOUSTON, TX 77002

THE MARK CONSISTS OF STANDARD CHARACTERS WITHOUT CLAIM TO ANY PARTICULAR FONT, STYLE, SIZE, OR COLOR.

FOR: PROMOTING PUBLIC AWARENESS OF POLICY ISSUES AND CONSIDERATIONS REGARDING A NATIONAL ENERGY POLICY, IN CLASS 35 (U.S. CLS. 100, 101 AND 102).

SER. NO. 77-208,354, FILED P.R. 6-18-2007; AM. S.R. 7-31-2008.

FIRST USE 12-0-2007; IN COMMERCE 12-0-2007.

JIM RINGLE, EXAMINING ATTORNEY

Int. Cl.: 16

Prior U.S. Cls.: 2, 5, 22, 23, 29, 37, 38, and 50

Reg. No. 3,522,824

United States Patent and Trademark Office

Registered Oct. 21, 2008

**TRADEMARK
SUPPLEMENTAL REGISTER**

TOP TEN SELLING

NORMAN, DANIEL P. (UNITED STATES INDIVIDUAL)
1105 OAK POND DRIVE
CELEBRATION, FL 34747

THE MARK CONSISTS OF STANDARD CHARACTERS WITHOUT CLAIM TO ANY PARTICULAR FONT, STYLE, SIZE, OR COLOR.

FOR: SERIES OF BOOKS, WRITTEN ARTICLES, HANDOUTS AND WORKSHEETS IN THE FIELD OF SALES TECHNIQUES, IN CLASS 16 (U.S. CLS. 2, 5, 22, 23, 29, 37, 38 AND 50).

SER. NO. 77-217,078, FILED P.R. 6-27-2007; AM. S.R. 3-26-2008.

FIRST USE 7-21-2007; IN COMMERCE 7-21-2007.

STEVEN JACKSON, EXAMINING ATTORNEY

Int. Cl.: 16

Prior U.S. Cls.: 2, 5, 22, 23, 29, 37, 38, and 50

United States Patent and Trademark Office

Reg. No. 3,522,825

Registered Oct. 21, 2008

**TRADEMARK
SUPPLEMENTAL REGISTER**

MEDPRESS

ORIGIN BIOMED INC. (CANADA CORPORATION)
SUITE 520 5162 DUKE STREET
HALIFAX, NOVA SCOTIA, CANADA B3J1N7

FOR: PRINTED MATERIALS, NAMELY, BOOKS PROVIDING INFORMATION IN THE FIELD OF NEUROPATHY, CHRONIC PAIN, DIABETES AND GENERAL PERSONAL HEALTH, IN CLASS 16 (U.S. CLS. 2, 5, 22, 23, 29, 37, 38 AND 50).

FIRST USE 7-10-2008; IN COMMERCE 7-10-2008.

THE MARK CONSISTS OF STANDARD CHARACTERS WITHOUT CLAIM TO ANY PARTICULAR FONT, STYLE, SIZE, OR COLOR.

SER. NO. 77-222,378, FILED P.R. 7-5-2007; AM. S.R. 5-15-2008.

FRED CARL, EXAMINING ATTORNEY

Int. Cl.: 42

Prior U.S. Cls.: 100 and 101

United States Patent and Trademark Office

Reg. No. 3,522,826

Registered Oct. 21, 2008

**SERVICE MARK
SUPPLEMENTAL REGISTER**

THE BUILDING MONITOR

THE BUILDING MONITOR LLC (WASHINGTON
LIMITED LIABILITY COMPANY)
4720 TREE RIDGE LANE
POULSBO, WA 98370

THE MARK CONSISTS OF STANDARD CHAR-
ACTERS WITHOUT CLAIM TO ANY PARTICULAR
FONT, STYLE, SIZE, OR COLOR.

FOR: REMOTE MONITORING SERVICES OF
HEATING AND COOLING SYSTEMS IN BUILD-
INGS, IN CLASS 42 (U.S. CLS. 100 AND 101).

SER. NO. 77-230,162, FILED P.R. 7-16-2007; AM. S.R.
9-11-2008.

FIRST USE 9-5-2008; IN COMMERCE 9-5-2008.

DANNEAN HETZEL, EXAMINING ATTORNEY

Int. Cl.: 5

Prior U.S. Cls.: 6, 18, 44, 46, 51, and 52

United States Patent and Trademark Office

Reg. No. 3,522,827

Registered Oct. 21, 2008

**TRADEMARK
SUPPLEMENTAL REGISTER**

BETA K

ULTIMATE NUTRITION, INC. (CONNECTICUT
CORPORATION)
21 HYDE ROAD
FARMINGTON, CT 06034

FOR: DIETARY SUPPLEMENTS, NAMELY,
DIETARY SUPPLEMENTS CONTAINING BETA
ALANINE AND CREATINE, IN CLASS 5 (U.S. CLS.
6, 18, 44, 46, 51 AND 52).

FIRST USE 7-18-2007; IN COMMERCE 7-18-2007.

THE MARK CONSISTS OF STANDARD CHAR-
ACTERS WITHOUT CLAIM TO ANY PARTICULAR
FONT, STYLE, SIZE, OR COLOR.

SER. NO. 77-236,732, FILED P.R. 7-23-2007; AM. S.R.
9-15-2008.

LINDSEY RUBIN, EXAMINING ATTORNEY

Int. Cl.: 44

Prior U.S. Cls.: 100 and 101

United States Patent and Trademark Office

Reg. No. 3,522,828

Registered Oct. 21, 2008

**SERVICE MARK
SUPPLEMENTAL REGISTER**

Rent A Ruminant

RENT-A- RUMINANT LLC (WASHINGTON LIMITED LIABILITY COMPANY)
PO BOX 1345
VASHON, WA 98070

FOR: WEED CONTROL, IN CLASS 44 (U.S. CLS. 100 AND 101).

FIRST USE 8-15-2003; IN COMMERCE 3-1-2004.

THE MARK CONSISTS OF STANDARD CHARACTERS WITHOUT CLAIM TO ANY PARTICULAR FONT, STYLE, SIZE, OR COLOR.

SER. NO. 77-249,180, FILED P.R. 8-7-2007; AM. S.R. 1-2-2008.

PAUL MORENO, EXAMINING ATTORNEY

Int. Cl.: 29

Prior U.S. Cl.: 46

United States Patent and Trademark Office

Reg. No. 3,522,829

Registered Oct. 21, 2008

**TRADEMARK
SUPPLEMENTAL REGISTER**

wild forest products

WILD FOREST PRODUCTS LLC (NEW YORK
LIMITED LIABILITY COMPANY)

954 3RD AVENUE #733

NEW YORK, NY 10022

FOR: OILS AND FATS FOR FOOD; BLENDED
OIL, IN CLASS 29 (U.S. CL. 46).

FIRST USE 9-1-2004; IN COMMERCE 9-1-2004.

THE MARK CONSISTS OF STANDARD CHAR-
ACTERS WITHOUT CLAIM TO ANY PARTICULAR
FONT, STYLE, SIZE, OR COLOR.

NO CLAIM IS MADE TO THE EXCLUSIVE
RIGHT TO USE "WILD" OR "FOREST" OR "PRO-
DUCTS", APART FROM THE MARK AS SHOWN.

SER. NO. 77-258,672, FILED P.R. 8-18-2007; AM. S.R.
9-6-2008.

KELLEY WELLS, EXAMINING ATTORNEY

Int. Cl.: 25

Prior U.S. Cls.: 22 and 39

United States Patent and Trademark Office

Reg. No. 3,522,830

Registered Oct. 21, 2008

**TRADEMARK
SUPPLEMENTAL REGISTER**

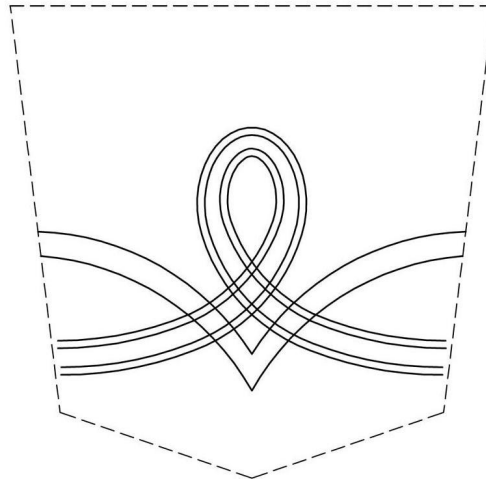

88 INTERNATIONAL, INC. (CALIFORNIA CORPORATION)
332 S. PALM AVENUE
ALHAMBRA, CA 91803

FOR: CLOTHING, NAMELY, MEN, WOMEN AND CHILDREN'S SHIRTS, VESTS, JACKETS, SKIRTS AND PANTS, IN CLASS 25 (U.S. CLS. 22 AND 39).

FIRST USE 12-4-2006; IN COMMERCE 12-4-2006.

THE MARK CONSISTS OF POCKET STITCHING IN THE PATTERN OF A MULTIPLE-LINED SINGLE LOOP SUPERIMPOSED OVER A DOUBLE-LINED CHEVRON.

SER. NO. 77-259,665, FILED P.R. 8-20-2007; AM. S.R. 7-1-2008.

BENJAMIN ALLEN, EXAMINING ATTORNEY

Int. Cl.: 35

Prior U.S. Cls.: 100, 101, and 102

United States Patent and Trademark Office

Reg. No. 3,522,831

Registered Oct. 21, 2008

**SERVICE MARK
SUPPLEMENTAL REGISTER**

**HUMAN CAPITAL FOR THE
CAPITAL MARKETS**

RJ, MAKAY & ASSOCIATES, LLC (COLORADO
LIMITED LIABILITY COMPANY)
1360 AMBERGATE COURT
MONUMENT, CO 81230

FOR: EMPLOYMENT COUNSELING AND RE-
CRUITING; EMPLOYMENT HIRING, RECRUIT-
ING, PLACEMENT, STAFFING AND CAREER
NETWORKING SERVICES; EMPLOYMENT OUT-
PLACEMENT SERVICES, IN CLASS 35 (U.S. CLS.
100, 101 AND 102).

FIRST USE 3-1-2004; IN COMMERCE 3-1-2004.

THE MARK CONSISTS OF STANDARD CHAR-
ACTERS WITHOUT CLAIM TO ANY PARTICULAR
FONT, STYLE, SIZE, OR COLOR.

SER. NO. 77-271,789, FILED P.R. 9-5-2007; AM. S.R.
9-8-2008.

ELISSA GARBER KON, EXAMINING ATTORNEY

Int. Cls.: 35 and 36

Prior U.S. Cls.: 100, 101, and 102

United States Patent and Trademark Office

Reg. No. 3,522,832

Registered Oct. 21, 2008

**SERVICE MARK
SUPPLEMENTAL REGISTER**

Risk Resolution

WESTNEY CONSULTING GROUP, INC. (TEXAS CORPORATION)
2200 WEST LOOP SOUTH, SUITE 500
HOUSTON, TX 77027 AND
INDEPENDENT EXECUTIVE VIEW, INC. (TEXAS CORPORATION)
P.O. BOX 56024
HOUSTON, TX 77256

FOR: BUSINESS MANAGEMENT , IN CLASS 35 (U.S. CLS. 100, 101 AND 102).

FIRST USE 12-19-2003; IN COMMERCE 12-19-2003.

FOR: FINANCIAL ANALYSIS AND CONSULTATION, IN CLASS 36 (U.S. CLS. 100, 101 AND 102).

FIRST USE 12-19-2003; IN COMMERCE 12-19-2003.

THE MARK CONSISTS OF STANDARD CHARACTERS WITHOUT CLAIM TO ANY PARTICULAR FONT, STYLE, SIZE, OR COLOR.

SER. NO. 77-273,102, FILED P.R. 9-6-2007; AM. S.R. 6-18-2008.

LINDSEY RUBIN, EXAMINING ATTORNEY

Int. Cl.: 41

Prior U.S. Cls.: 100, 101, and 107

United States Patent and Trademark Office

Reg. No. 3,522,833

Registered Oct. 21, 2008

**SERVICE MARK
SUPPLEMENTAL REGISTER**

**BATTLE ROYAL THE ULTIMATE
FITNESS PROGRAM**

LEIGHTON, GARY P. (UNITED STATES INDIVIDUAL)
2413 TWINFLOWER CT.
MARTINEZ, CA 94553

FOR: ARRANGING AND CONDUCTING ATHLETIC COMPETITIONS, IN CLASS 41 (U.S. CLS. 100, 101 AND 107).

FIRST USE 9-13-2001; IN COMMERCE 3-31-2004.

THE MARK CONSISTS OF STANDARD CHARACTERS WITHOUT CLAIM TO ANY PARTICULAR FONT, STYLE, SIZE, OR COLOR.

NO CLAIM IS MADE TO THE EXCLUSIVE RIGHT TO USE "ULTIMATE FITNESS PROGRAM", APART FROM THE MARK AS SHOWN.

SER. NO. 77-273,698, FILED 9-6-2007.

LINDSEY RUBIN, EXAMINING ATTORNEY

Int. Cl.: 35

Prior U.S. Cls.: 100, 101, and 102

United States Patent and Trademark Office

Reg. No. 3,522,834

Registered Oct. 21, 2008

**SERVICE MARK
SUPPLEMENTAL REGISTER**

GREEN SOURCE SOLUTIONS

WILLIAM BLASEK, LTD (MASSACHUSETTS
CORPORATION)
20 STEARNS ROAD, #23
BROOKLINE, MA 02146 AND
WALTERSSOLUTIONS, INC. (MASSACHUSETTS
CORPORATION)
93 LOWELL STREET
ANDOVER, MA 01810

FOR: BUSINESS CONSULTING SERVICES IN
THE FIELD OF USE OF ENVIRONMENTALLY
FRIENDLY CONSTRUCTION PRODUCTS AND IN-
TERIOR DESIGN, NAMELY, FLOORING AND

SURFACING PRODUCTS, IN CLASS 35 (U.S. CLS.
100, 101 AND 102).

FIRST USE 7-12-2007; IN COMMERCE 7-12-2007.

THE MARK CONSISTS OF STANDARD CHAR-
ACTERS WITHOUT CLAIM TO ANY PARTICULAR
FONT, STYLE, SIZE, OR COLOR.

SER. NO. 77-278,954, FILED P.R. 9-13-2007; AM. S.R.
8-29-2008.

RAUL CORDOVA, EXAMINING ATTORNEY

Int. Cl.: 25

Prior U.S. Cls.: 22 and 39

United States Patent and Trademark Office

Reg. No. 3,522,835

Registered Oct. 21, 2008

**TRADEMARK
SUPPLEMENTAL REGISTER**

spank me pink 

PREMIER BUSINESS ENTERPRISES, INC. (NE-
VADA CORPORATION)
4814 CON CARNE CT.
N. LAS VEGAS, NV 89031

FOR: CLOTHING, NAMELY, BASEBALL CAPS,
CAMISOLES, CAPRI PANTS, DRESSES, G-STRINGS,
PANTIES, SHORTS, BRIEFS, LADIES UNDER-
WEAR, SPORTS JACKET, SPORTS BRA, BOY
SHORTS, T-SHIRTS, TANK TOP, TANKINI, SWEAT-
PANTS, SWEAT SHIRTS, YOGA PANTS, JOGGING
PANTS, JACKETS, LINGERIE, SKIRTS AND TED-
DIES AND HALTER TOPS, BEACH FOOTWEAR,
BOXER SHORTS, BOXER BRIEFS, SANDAL CLOGS,
SUNVISOR, HEAD SWEATBANDS, WRIST SWEAT
BANDS, JOGGING SUIT, JOGGING PANTS, SKULL-
CAPS, THONG FOOTWEAR, SWIMWEAR, PAJA-

MAS, CHILDRENS AND INFANTS CLOTH BIBS,
BABY BODYSUITS, BABY BOTTOMS, INFANT
AND TODDLER ONE PIECE CLOTHING, JERSEYS,
SHORT SETS, SWADDLING CLOTHES, CAPS AND
CLOTHING, IN CLASS 25 (U.S. CLS. 22 AND 39).

FIRST USE 3-8-2006; IN COMMERCE 3-8-2006.

THE MARK CONSISTS OF, "SPANK ME PINK"
WITH A HAND PRINT DOTTING THE "I" IN THE
WORD PINK.

SER. NO. 77-282,808, FILED P.R. 9-18-2007; AM. S.R.
6-2-2008.

LESLIE RICHARDS, EXAMINING ATTORNEY

Int. Cl.: 43

Prior U.S. Cls.: 100 and 101

United States Patent and Trademark Office

Reg. No. 3,522,836

Registered Oct. 21, 2008

**SERVICE MARK
SUPPLEMENTAL REGISTER**

MCNELLIE'S

MCNELLIE'S RESTAURANT GROUP, L.L.C.
(OKLAHOMA LIMITED LIABILITY COMPAN-
NY)
409 EAST 1ST STREET
TULSA, OK 74120

FOR: RESTAURANT AND BAR SERVICES, IN
CLASS 43 (U.S. CLS. 100 AND 101).

FIRST USE 3-11-2004; IN COMMERCE 3-11-2004.

THE MARK CONSISTS OF STANDARD CHAR-
ACTERS WITHOUT CLAIM TO ANY PARTICULAR
FONT, STYLE, SIZE, OR COLOR.

SER. NO. 77-283,923, FILED P.R. 9-19-2007; AM. S.R.
9-9-2008.

LANA PHAM, EXAMINING ATTORNEY

Int. Cl.: 41

Prior U.S. Cls.: 100, 101, and 107

United States Patent and Trademark Office

Reg. No. 3,522,837

Registered Oct. 21, 2008

**SERVICE MARK
SUPPLEMENTAL REGISTER**

WORLD BUSINESS DIGEST

QUORUM PRODUCTIONS II, INC. (FLORIDA CORPORATION)

2001 WEST SAMPLE ROAD, SUITE 101

POMPANO BEACH, FL 33064

FOR: EDUCATIONAL TELEVISION PROGRAMMING IN THE FIELD OF BUSINESS, IN CLASS 41 (U.S. CLS. 100, 101 AND 107).

FIRST USE 2-0-2003; IN COMMERCE 2-0-2003.

THE MARK CONSISTS OF STANDARD CHARACTERS WITHOUT CLAIM TO ANY PARTICULAR FONT, STYLE, SIZE, OR COLOR.

NO CLAIM IS MADE TO THE EXCLUSIVE RIGHT TO USE "BUSINESS", APART FROM THE MARK AS SHOWN.

SER. NO. 77-287,236, FILED P.R. 9-24-2007; AM. S.R. 8-13-2008.

DOMINIC J. FERRAIUOLO, EXAMINING ATTORNEY

Int. Cl.: 37

Prior U.S. Cls.: 100, 103, and 106

United States Patent and Trademark Office

Reg. No. 3,522,838

Registered Oct. 21, 2008

**SERVICE MARK
SUPPLEMENTAL REGISTER**

GREAT CAMPS OF THE SMOKIES

IBEX FIELD & STREAM CORP. (FLORIDA CORPORATION)
95 MERRICK WAY, SUITE 610
CORAL GABLES, FL 33134

FOR: REAL ESTATE DEVELOPMENT SERVICES AND PLANNING, DEVELOPMENT AND LAYING OUT OF RESIDENTIAL COMMUNITIES, IN CLASS 37 (U.S. CLS. 100, 103 AND 106).

FIRST USE 5-3-2005; IN COMMERCE 5-3-2005.

THE MARK CONSISTS OF STANDARD CHARACTERS WITHOUT CLAIM TO ANY PARTICULAR FONT, STYLE, SIZE, OR COLOR.

SER. NO. 77-288,484, FILED P.R. 9-25-2007; AM. S.R. 8-18-2008.

PAUL E. FAHRENKOPF, EXAMINING ATTORNEY

Int. Cls.: 41 and 42

Prior U.S. Cls.: 100, 101, and 107

United States Patent and Trademark Office

Reg. No. 3,522,839

Registered Oct. 21, 2008

**SERVICE MARK
SUPPLEMENTAL REGISTER**

Advisor

TAMARAC INC. (WASHINGTON CORPORATION)
811 FIRST AVE., SUITE 340
SEATTLE, WA 98104

FOR: EDUCATIONAL SERVICES IN THE FIELD OF TRAINING IN THE USE AND IMPLEMENTATION OF INVESTMENT STRATEGY MANAGEMENT AND SOFTWARE USE, IN CLASS 41 (U.S. CLS. 100, 101 AND 107).

FIRST USE 9-1-2005; IN COMMERCE 9-1-2005.

FOR: APPLICATION SERVICE PROVIDER FEATURING SOFTWARE FOR USE IN FINANCIAL

ACCOUNT BALANCING AND MONITORING IN THE FIELD OF INVESTMENTS MANAGEMENT, IN CLASS 42 (U.S. CLS. 100 AND 101).

FIRST USE 9-1-2005; IN COMMERCE 9-1-2005.

THE MARK CONSISTS OF STANDARD CHARACTERS WITHOUT CLAIM TO ANY PARTICULAR FONT, STYLE, SIZE, OR COLOR.

SER. NO. 77-298,596, FILED P.R. 10-8-2007; AM. S.R. 8-29-2008.

LINDA ORNDORFF, EXAMINING ATTORNEY

Int. Cl.: 30

Prior U.S. Cl.: 46

United States Patent and Trademark Office

Reg. No. 3,522,840

Registered Oct. 21, 2008

TRADEMARK
SUPPLEMENTAL REGISTER

CAFÉ VENEZUELA, S.A. (VENEZUELA SOCIEDAD ANONIMA (SA))
CERRETERA PRINCIPAL, EL CRUCE, MONAY
SECTOR TABOR, LOCAL S/N
MUNICIPIO PANPAN EDO., VENEZUELA

FOR: COFFEE, IN CLASS 30 (U.S. CL. 46).

FIRST USE 3-24-2008; IN COMMERCE 3-24-2008.

NO CLAIM IS MADE TO THE EXCLUSIVE RIGHT TO USE "CAFÉ", APART FROM THE MARK AS SHOWN.

THE MARK CONSISTS OF THE WORDS "CAFÉ VENEZUELA" WITH THREE DIAGONAL LINES, WHERE THE WORD "CAFÉ" APPEARS AS BREAKING ONE DIAGONAL LINE INTO TWO.

THE FOREIGN WORDING IN THE MARK TRANSLATES INTO ENGLISH AS "COFFEE".

SER. NO. 77-305,202, FILED P.R. 10-16-2007; AM. S.R. 8-13-2008.

SARA THOMAS, EXAMINING ATTORNEY

Int. Cl.: 16

Prior U.S. Cls.: 2, 5, 22, 23, 29, 37, 38, and 50

Reg. No. 3,522,841

United States Patent and Trademark Office

Registered Oct. 21, 2008

**TRADEMARK
SUPPLEMENTAL REGISTER**

ROUNDER

ROUNDER ENTERPRISES, INC. (SOUTH CAROLINA CORPORATION)
2640 LAURENS ROAD
GREENVILLE, SC 29607

FOR: MAGAZINES ABOUT POKER, POKER RELATED ENTERTAINMENT, FOOD AND WOMEN, BUT NOT COMPUTER GAMES NOR TELEVISION SHOWS, IN CLASS 16 (U.S. CLS. 2, 5, 22, 23, 29, 37, 38 AND 50).

FIRST USE 12-1-2006; IN COMMERCE 12-1-2006.

THE MARK CONSISTS OF STANDARD CHARACTERS WITHOUT CLAIM TO ANY PARTICULAR FONT, STYLE, SIZE, OR COLOR.

SER. NO. 77-307,292, FILED P.R. 10-18-2007; AM. S.R. 9-8-2008.

G. MAYERSCHOFF, EXAMINING ATTORNEY

Int. Cl.: 25

Prior U.S. Cls.: 22 and 39

United States Patent and Trademark Office

Reg. No. 3,522,842

Registered Oct. 21, 2008

**TRADEMARK
SUPPLEMENTAL REGISTER**

Party Like A Cockstar

BUNDRICK, JOHN DANIEL (UNITED STATES INDIVIDUAL), DBA SHOP ROAD BOYZ, 120 HICKORY KNOB HILL ROAD IRMO, SC 29063

THE MARK CONSISTS OF STANDARD CHARACTERS WITHOUT CLAIM TO ANY PARTICULAR FONT, STYLE, SIZE, OR COLOR.

FOR: HATS; SHORT-SLEEVED OR LONG-SLEEVED T-SHIRTS; T-SHIRTS, ALL USED IN CONNECTION WITH A SPORTS TEAM MASCOT, IN CLASS 25 (U.S. CLS. 22 AND 39).

SER. NO. 77-312,851, FILED P.R. 10-25-2007; AM. S.R. 7-27-2008.

FIRST USE 9-24-2007; IN COMMERCE 10-1-2007.

ANDREA BUTLER, EXAMINING ATTORNEY

Int. Cl.: 4

Prior U.S. Cls.: 1, 6, and 15

United States Patent and Trademark Office

Reg. No. 3,522,843

Registered Oct. 21, 2008

**TRADEMARK
SUPPLEMENTAL REGISTER**

GREEN-TECH

COMERCIAL IMPORTADORA, S.A. DE C.V.
(MEXICO CORPORATION)
COL. CENTRO CIUDAD SANTE FE,
GONZALEZ CAMARENA NO. 400,
DELEGACION ALVARO OBRE, MEXICO

FOR: INDUSTRIAL OILS AND GREASES; INDUSTRIAL LUBRICANTS; PETROLEUM BASED DUST ABSORBING, DUST-WETTING AND DUST-BINDING COMPOSITIONS FOR USE IN ROAD BUILDING, SWEEPING ROADS, AND DUSTLAYING; FUELS; MOTOR SPIRITS, NAMELY, GASOLINE AND ETHANOL FUELS; ILLUMINANTS, NAMELY, PARAFFIN WAX; CANDLES; WICKS FOR LAMPS AND CANDLES, IN CLASS 4 (U.S. CLS. 1, 6 AND 15).

THE MARK CONSISTS OF STANDARD CHARACTERS WITHOUT CLAIM TO ANY PARTICULAR FONT, STYLE, SIZE, OR COLOR.

OWNER OF MEXICO REG. NO. 1006627, DATED 10-15-2007, EXPIRES 9-28-2017.

OWNER OF MEXICO REG. NO. 997149, DATED 8-8-2007, EXPIRES 6-28-2017.

SER. NO. 77-314,353, FILED P.R. 10-26-2007; AM. S.R. 8-7-2008.

HANNO RITTNER, EXAMINING ATTORNEY

Int. Cls.: 35 and 41

Prior U.S. Cls.: 100, 101, 102, and 107

United States Patent and Trademark Office

Reg. No. 3,522,844

Registered Oct. 21, 2008

**SERVICE MARK
SUPPLEMENTAL REGISTER**

**INVESTOR PROTECTION
INSTITUTE**

THE TRUSTEES OF THE INVESTOR PROTECTION TRUST (WISCONSIN CHARITABLE TRUST)
919 EIGHTEENTH STREET NW, SUITE 300
WASHINGTON, DC 200065517

FOR: PROMOTING PUBLIC AWARENESS OF THE NEED TO MAKE WISE AND SAFE INVESTMENT DECISIONS; PRODUCTION OF PUBLIC SERVICE ANNOUNCEMENTS IN THE FIELD OF MAKING WISE AND SAFE INVESTMENT DECISIONS, IN CLASS 35 (U.S. CLS. 100, 101 AND 102).

FIRST USE 8-11-2008; IN COMMERCE 8-11-2008.

FOR: EDUCATIONAL SERVICES, NAMELY, SEMINARS AND CLASSES TO TEACH INVESTORS HOW TO MAKE WISE AND SAFE INVESTMENT DECISIONS; DISSEMINATION OF EDUCATIONAL MATERIALS OF OTHERS IN THE FIELD OF

TEACHING INVESTORS HOW TO MAKE WISE AND SAFE INVESTMENT DECISIONS, IN CLASS 41 (U.S. CLS. 100, 101 AND 107).

FIRST USE 8-11-2008; IN COMMERCE 8-11-2008.

THE MARK CONSISTS OF STANDARD CHARACTERS WITHOUT CLAIM TO ANY PARTICULAR FONT, STYLE, SIZE, OR COLOR.

NO CLAIM IS MADE TO THE EXCLUSIVE RIGHT TO USE "INSTITUTE", APART FROM THE MARK AS SHOWN.

SER. NO. 77-315,601, FILED P.R. 10-29-2007; AM. S.R. 8-14-2008.

DAVID YONTEF, EXAMINING ATTORNEY

Int. Cl.: 5

Prior U.S. Cls.: 6, 18, 44, 46, 51, and 52

United States Patent and Trademark Office

Reg. No. 3,522,845

Registered Oct. 21, 2008

**TRADEMARK
SUPPLEMENTAL REGISTER**

YOUR DAILY NUTRITION

COUNTRY LIFE, LLC (NEW YORK LIMITED
LIABILITY COMPANY)

180 VANDERBILT MOTOR PARKWAY

HAUPPAUGE, NY 11788

FOR: DIETARY SUPPLEMENTS, IN CLASS 5 (U.S.
CLS. 6, 18, 44, 46, 51 AND 52).

FIRST USE 2-28-2008; IN COMMERCE 2-28-2008.

THE MARK CONSISTS OF STANDARD CHAR-
ACTERS WITHOUT CLAIM TO ANY PARTICULAR
FONT, STYLE, SIZE, OR COLOR.

NO CLAIM IS MADE TO THE EXCLUSIVE
RIGHT TO USE "DAILY NUTRITION", APART
FROM THE MARK AS SHOWN.

SER. NO. 77-316,729, FILED P.R. 10-30-2007; AM.
S.R. 8-8-2008.

DAYNA BROWNE, EXAMINING ATTORNEY

Int. Cl.: 5

Prior U.S. Cls.: 6, 18, 44, 46, 51, and 52

United States Patent and Trademark Office

Reg. No. 3,522,846

Registered Oct. 21, 2008

**TRADEMARK
SUPPLEMENTAL REGISTER**

REAL FOOD ORGANICS

COUNTRY LIFE, LLC (NEW YORK LIMITED
LIABILITY COMPANY)

180 VANDERBILT MOTOR PARKWAY

HAUPPAUGE, NY 11788

FOR: ORGANIC NUTRITIONAL SUPPLEMENTS,
IN CLASS 5 (U.S. CLS. 6, 18, 44, 46, 51 AND 52).

FIRST USE 2-28-2008; IN COMMERCE 2-28-2008.

THE MARK CONSISTS OF STANDARD CHAR-
ACTERS WITHOUT CLAIM TO ANY PARTICULAR
FONT, STYLE, SIZE, OR COLOR.

NO CLAIM IS MADE TO THE EXCLUSIVE
RIGHT TO USE "FOOD ORGANICS", APART FROM
THE MARK AS SHOWN.

SER. NO. 77-316,756, FILED P.R. 10-30-2007; AM.
S.R. 8-7-2008.

DAYNA BROWNE, EXAMINING ATTORNEY

Int. Cl.: 5

Prior U.S. Cls.: 6, 18, 44, 46, 51, and 52

United States Patent and Trademark Office

Reg. No. 3,522,847

Registered Oct. 21, 2008

**TRADEMARK
SUPPLEMENTAL REGISTER**

ESSENTIAL-8

COUNTRY LIFE, LLC (NEW YORK LIMITED
LIABILITY COMPANY)
180 VANDERBILT MOTOR PARKWAY
HAUPPAUGE, NY 11788

FOR: DIETARY SUPPLEMENTS, IN CLASS 5 (U.S.
CLS. 6, 18, 44, 46, 51 AND 52).

FIRST USE 2-21-2008; IN COMMERCE 2-21-2008.

THE MARK CONSISTS OF STANDARD CHAR-
ACTERS WITHOUT CLAIM TO ANY PARTICULAR
FONT, STYLE, SIZE, OR COLOR.

SER. NO. 77-316,824, FILED P.R. 10-30-2007; AM.
S.R. 9-9-2008.

DAYNA BROWNE, EXAMINING ATTORNEY

Int. Cl.: 36

Prior U.S. Cls.: 100, 101, and 102

United States Patent and Trademark Office

Reg. No. 3,522,848

Registered Oct. 21, 2008

**SERVICE MARK
SUPPLEMENTAL REGISTER**

GUARANTEE INSURANCE COMPANY

PATRIOT RISK MANAGEMENT, INC. (DELA-
WARE CORPORATION)
401 EAST LAS OLAS BOULEVARD
SUITE 1540
F. LAUDERDALE, FL 33301

FOR: INSURANCE SERVICES, NAMELY, INSUR-
ANCE AGENCY SERVICES, INSURANCE UNDER-
WRITING, INSURANCE BROKERAGE, AND
INSURANCE CONSULTATION SERVICES, ALL IN
THE FIELD OF WORKER'S COMPENSATION IN-
SURANCE, IN CLASS 36 (U.S. CLS. 100, 101 AND 102).

FIRST USE 9-30-2003; IN COMMERCE 9-30-2003.

THE MARK CONSISTS OF STANDARD CHAR-
ACTERS WITHOUT CLAIM TO ANY PARTICULAR
FONT, STYLE, SIZE, OR COLOR.

NO CLAIM IS MADE TO THE EXCLUSIVE
RIGHT TO USE "INSURANCE COMPANY", APART
FROM THE MARK AS SHOWN.

SER. NO. 77-317,668, FILED P.R. 10-31-2007; AM.
S.R. 8-13-2008.

ROBIN CHOSID, EXAMINING ATTORNEY

Int. Cls.: 41 and 44

Prior U.S. Cls.: 100, 101, and 107

United States Patent and Trademark Office

Reg. No. 3,522,849

Registered Oct. 21, 2008

**SERVICE MARK
SUPPLEMENTAL REGISTER**

THE DIET DOC

GENESIS HEALTH SYSTEMS, INC. (INDIANA CORPORATION)
222 MAIN STREET, SUITE 202
EVANSVILLE, IN 47708

FOR: PROVIDING CONSULTATION IN THE FIELD OF FITNESS, IN CLASS 41 (U.S. CLS. 100, 101 AND 107).

FIRST USE 9-1-2007; IN COMMERCE 9-1-2007.

FOR: PROVIDING CONSULTATION IN THE FIELD OF DIET AND NUTRITION, IN CLASS 44 (U.S. CLS. 100 AND 101).

FIRST USE 9-1-2007; IN COMMERCE 9-1-2007.

THE MARK CONSISTS OF STANDARD CHARACTERS WITHOUT CLAIM TO ANY PARTICULAR FONT, STYLE, SIZE, OR COLOR.

SER. NO. 77-319,226, FILED P.R. 11-1-2007; AM. S.R. 4-1-2008.

DEZMONA MIZELLE, EXAMINING ATTORNEY

Int. Cl.: 35

Prior U.S. Cls.: 100, 101, and 102

United States Patent and Trademark Office

Reg. No. 3,522,850

Registered Oct. 21, 2008

**SERVICE MARK
SUPPLEMENTAL REGISTER**

Cavage

INDÚSTRIA DE CALÇADOS CAVAGE (BRAZIL CORPORATION)
BAIRRO OPERÁRIO
RUA AFONSO CELSO, NO. 459
NOVO HAMBURGO, BRAZIL 93.315-20

FOR: GOODS IMPORT-EXPORT AGENCIES; DISTRIBUTORSHIP SERVICES IN THE FIELD OF SHOES AND FOOTWEAR; WHOLESALE DISTRIBUTORSHIPS FEATURING SHOES AND FOOTWEAR; ON-LINE RETAIL STORE SERVICES FEATURING SHOES AND FOOTWEAR; RETAIL

STORE SERVICES FEATURING SHOES AND FOOTWEAR, IN CLASS 35 (U.S. CLS. 100, 101 AND 102).

FIRST USE 12-31-1999; IN COMMERCE 12-31-2002.

THE MARK CONSISTS OF THE WORD "CAVAGE" IN STYLIZED LETTERS.

SER. NO. 77-320,891, FILED P.R. 11-4-2007; AM. S.R. 8-12-2008.

TRACY CROSS, EXAMINING ATTORNEY

Int. Cl.: 25

Prior U.S. Cls.: 22 and 39

United States Patent and Trademark Office

Reg. No. 3,522,851

Registered Oct. 21, 2008

**TRADEMARK
SUPPLEMENTAL REGISTER**

Good Father's Only

ENCOURAGE ME I'M YOUNG, INC. (MICHIGAN CORPORATION)
15475 MURRAY HILL
DETROIT, MI 48227

FOR: T-SHIRTS; SWEAT SHIRTS, IN CLASS 25 (U.S. CLS. 22 AND 39).

FIRST USE 8-4-2006; IN COMMERCE 8-4-2006.

THE MARK CONSISTS OF STANDARD CHARACTERS WITHOUT CLAIM TO ANY PARTICULAR FONT, STYLE, SIZE, OR COLOR.

SER. NO. 77-322,228, FILED P.R. 11-6-2007; AM. S.R. 8-21-2008.

LAURA HAMMEL, EXAMINING ATTORNEY

Int. Cl.: 41

Prior U.S. Cls.: 100, 101, and 107

United States Patent and Trademark Office

Reg. No. 3,522,852

Registered Oct. 21, 2008

**SERVICE MARK
SUPPLEMENTAL REGISTER**

BEBOP PARTIES

JANA D. LLC (NEW JERSEY LIMITED LIABILITY COMPANY)
980 SHREWSBURY AVENUE
TINTON FALLS, NJ 07724

FOR: PARTY AND ENTERTAINMENT SERVICES, NAMELY, CONDUCTING PARTIES, PROVIDING RECREATION AND AMUSEMENT FACILITIES, AND PROVIDING PARAPHERNALIA IN CONNECTION THEREWITH, IN CLASS 41 (U.S. CLS. 100, 101 AND 107).

FIRST USE 6-4-2007; IN COMMERCE 6-4-2007.

THE MARK CONSISTS OF STANDARD CHARACTERS WITHOUT CLAIM TO ANY PARTICULAR FONT, STYLE, SIZE, OR COLOR.

NO CLAIM IS MADE TO THE EXCLUSIVE RIGHT TO USE "PARTIES", APART FROM THE MARK AS SHOWN.

SER. NO. 77-324,282, FILED 11-8-2007.

ANN E. SAPPENFIELD, EXAMINING ATTORNEY

Int. Cl.: 6

Prior U.S. Cls.: 2, 12, 13, 14, 23, 25, and 50

Reg. No. 3,522,853

United States Patent and Trademark Office

Registered Oct. 21, 2008

**TRADEMARK
SUPPLEMENTAL REGISTER**

KAZTERS

ARC AMERICA, INC. (GEORGIA CORPORATION)
1509 HENDRY AVENUE
SAVANNAH, GA 31406

FOR: METAL BRACKET SYSTEM COMPRISING
BASE AND WHEEL ASSEMBLIES THAT PROVIDES
MOBILITY TO A SKID OR PALLET OR THE LIKE
FOR USE IN TRANSPORTING LOADS OF VAR-
IOUS SIZE AND SHAPE, IN CLASS 6 (U.S. CLS. 2, 12,
13, 14, 23, 25 AND 50).

FIRST USE 4-20-2005; IN COMMERCE 8-18-2008.

THE MARK CONSISTS OF STANDARD CHAR-
ACTERS WITHOUT CLAIM TO ANY PARTICULAR
FONT, STYLE, SIZE, OR COLOR.

SER. NO. 77-324,571, FILED P.R. 11-8-2007; AM. S.R.
8-28-2008.

BENJAMIN ALLEN, EXAMINING ATTORNEY

Int. Cl.: 9

Prior U.S. Cls.: 21, 23, 26, 36, and 38

United States Patent and Trademark Office

Reg. No. 3,522,854

Registered Oct. 21, 2008

TRADEMARK
SUPPLEMENTAL REGISTER

BIKE
IMMOBILIZER
SECURITY FOR YOUR BIKE!

EDWARD M. FILES (UNITED STATES INDIVIDUAL)
4818 NE PEBBLE BEACH ST.
LEE'S SUMMIT, MO 64064

FOR: MOTORCYCLE SECURITY DEVICE, NAMELY, ENGINE STARTER IMMOBILIZER, IN CLASS 9 (U.S. CLS. 21, 23, 26, 36 AND 38).

FIRST USE 11-1-2007; IN COMMERCE 11-1-2007.

NO CLAIM IS MADE TO THE EXCLUSIVE RIGHT TO USE "IMMOBILIZER", APART FROM THE MARK AS SHOWN.

THE COLOR(S) BLACK AND ORANGE IS/ARE CLAIMED AS A FEATURE OF THE MARK.

THE MARK CONSISTS OF THE WORD "BIKE" IS IN BLACK LETTERING, THE WORD "IMMOBILIZER" IS IN ORANGE LETTERING AND THE PHRASE "SECURITY FOR YOUR BIKE!" IS IN BLACK LETTERING.

SER. NO. 77-328,643, FILED P.R. 11-13-2007; AM. S.R. 9-5-2008.

MICHELE SWAIN, EXAMINING ATTORNEY

Int. Cl.: 35

Prior U.S. Cls.: 100, 101, and 102

United States Patent and Trademark Office

Reg. No. 3,522,855

Registered Oct. 21, 2008

**SERVICE MARK
SUPPLEMENTAL REGISTER**

GEMCONTROL

DGA SECURITY SYSTEMS, INC. (NEW YORK
CORPORATION)
20 WEST 47TH STREET
NEW YORK, NY 10036

FOR: INVENTORY CONTROL, IN CLASS 35 (U.S.
CLS. 100, 101 AND 102).

FIRST USE 1-0-2007; IN COMMERCE 1-0-2007.

THE MARK CONSISTS OF STANDARD CHAR-
ACTERS WITHOUT CLAIM TO ANY PARTICULAR
FONT, STYLE, SIZE, OR COLOR.

SER. NO. 77-332,674, FILED P.R. 11-19-2007; AM.
S.R. 8-20-2008.

ADA HAN, EXAMINING ATTORNEY

Int. Cl.: 43

Prior U.S. Cls.: 100 and 101

United States Patent and Trademark Office

Reg. No. 3,522,856

Registered Oct. 21, 2008

**SERVICE MARK
SUPPLEMENTAL REGISTER**



MACCHIATO, INC. (NEW YORK CORPORATION)

141 EAST 44TH STREET

NEW YORK, NY 10017

FOR: COFFEE-HOUSE AND SNACK-BAR SERVICES, IN CLASS 43 (U.S. CLS. 100 AND 101).

FIRST USE 1-31-2006; IN COMMERCE 1-31-2006.

NO CLAIM IS MADE TO THE EXCLUSIVE RIGHT TO USE "ESPRESSO BAR", APART FROM THE MARK AS SHOWN.

THE MARK CONSISTS OF THE WORD "MACCHIATO" PLACED ABOVE THE PHRASE "ESPRESSO BAR".

SER. NO. 77-333,675, FILED P.R. 11-19-2007; AM. S.R. 9-10-2008.

SOPHIA S. KIM, EXAMINING ATTORNEY

Int. Cl.: 45

Prior U.S. Cls.: 100 and 101

United States Patent and Trademark Office

Reg. No. 3,522,857

Registered Oct. 21, 2008

**SERVICE MARK
SUPPLEMENTAL REGISTER**

CASE-A-DAY LEGAL

CASE A DAY CORPORATION (INDIANA COR-
PORATION)

2630 RYAN DRIVE

INDIANAPOLIS, IN 46220

FOR: PROVIDING SUMMARIES OF LEGAL
CASES VIA A GLOBAL COMPUTER NETWORK,
IN CLASS 45 (U.S. CLS. 100 AND 101).

FIRST USE 9-1-2008; IN COMMERCE 9-1-2008.

THE MARK CONSISTS OF STANDARD CHAR-
ACTERS WITHOUT CLAIM TO ANY PARTICULAR
FONT, STYLE, SIZE, OR COLOR.

NO CLAIM IS MADE TO THE EXCLUSIVE
RIGHT TO USE "LEGAL", APART FROM THE
MARK AS SHOWN.

SER. NO. 77-334,298, FILED P.R. 11-20-2007; AM.
S.R. 9-3-2008.

KRISTIN DAHLING, EXAMINING ATTORNEY

Int. Cl.: 25

Prior U.S. Cls.: 22 and 39

United States Patent and Trademark Office

Reg. No. 3,522,858

Registered Oct. 21, 2008

**TRADEMARK
SUPPLEMENTAL REGISTER**

Pretty Dangerous

PAT MILETICH (UNITED STATES INDIVIDUAL)
325 16TH ST.
BETTENDORF, IA 52722

FOR: CLOTHING, NAMELY, COATS, JACKETS,
JERSEYS, PANTS, RAINWEAR, SHIRTS, SHORTS,
SWEAT PANTS, SWEAT SHIRTS, SWEATERS, T-
SHIRTS, TANK TOPS, WIND-RESISTANT JACKETS;
FOOTWEAR AND HEADWEAR , IN CLASS 25 (U.S.
CLS. 22 AND 39).

FIRST USE 6-1-1997; IN COMMERCE 6-1-2001.

THE MARK CONSISTS OF STANDARD CHAR-
ACTERS WITHOUT CLAIM TO ANY PARTICULAR
FONT, STYLE, SIZE, OR COLOR.

SER. NO. 77-334,785, FILED P.R. 11-20-2007; AM.
S.R. 9-3-2008.

MARY MUNSON, EXAMINING ATTORNEY

Int. Cl.: 35

Prior U.S. Cls.: 100, 101, and 102

United States Patent and Trademark Office

Reg. No. 3,522,859

Registered Oct. 21, 2008

**SERVICE MARK
SUPPLEMENTAL REGISTER**

VISATAXES

VISATAXES, INC. (DELAWARE CORPORATION)
16192 COASTAL HWY
LEWES, DE 19958

FOR: INCOME TAX PREPARATION; TAX PRE-
PARATION, IN CLASS 35 (U.S. CLS. 100, 101 AND
102).

FIRST USE 5-0-2006; IN COMMERCE 5-0-2006.

THE MARK CONSISTS OF STANDARD CHAR-
ACTERS WITHOUT CLAIM TO ANY PARTICULAR
FONT, STYLE, SIZE, OR COLOR.

SER. NO. 77-334,833, FILED P.R. 11-21-2007; AM.
S.R. 9-2-2008.

BRIAN PINO, EXAMINING ATTORNEY

Int. Cl.: 35

Prior U.S. Cls.: 100, 101, and 102

United States Patent and Trademark Office

Reg. No. 3,522,860

Registered Oct. 21, 2008

**SERVICE MARK
SUPPLEMENTAL REGISTER**

BODYSHAPEWEAR

DAN & DAVE ENGINEERING, CORP. (FLORIDA
CORPORATION)
20532 N.E. 6TH COURT
MIAMI, FL 33179

FOR: ON-LINE RETAIL STORE SERVICES FEATURING WOMEN'S OUTER GARMENTS AND UNDERGARMENTS, IN CLASS 35 (U.S. CLS. 100, 101 AND 102).

FIRST USE 3-11-2004; IN COMMERCE 3-11-2004.

THE MARK CONSISTS OF STANDARD CHARACTERS WITHOUT CLAIM TO ANY PARTICULAR FONT, STYLE, SIZE, OR COLOR.

SER. NO. 77-335,356, FILED P.R. 11-21-2007; AM. S.R. 9-9-2008.

BRIAN NEVILLE, EXAMINING ATTORNEY

Int. Cl.: 28

Prior U.S. Cls.: 22, 23, 38, and 50

Reg. No. 3,522,861

United States Patent and Trademark Office

Registered Oct. 21, 2008

**TRADEMARK
SUPPLEMENTAL REGISTER**

HEALTHY CIRCUIT

MIRACLE RECREATION EQUIPMENT COMPA-
NY (IOWA CORPORATION)
878 HIGHWAY 60
MONETT, MO 65708

FOR: EXERCISE AND FITNESS EQUIPMENT,
NAMELY, PUSH-UP UNITS, PULL-UP UNITS,
STRETCHING UNITS, STEPPING UNITS, WAIST
TWISTING UNITS, SIT-UP UNITS, AND PEDALING
UNITS, IN CLASS 28 (U.S. CLS. 22, 23, 38 AND 50).

FIRST USE 2-25-2008; IN COMMERCE 2-25-2008.

THE MARK CONSISTS OF STANDARD CHAR-
ACTERS WITHOUT CLAIM TO ANY PARTICULAR
FONT, STYLE, SIZE, OR COLOR.

SER. NO. 77-336,467, FILED P.R. 11-26-2007; AM.
S.R. 9-3-2008.

CORY BOONE, EXAMINING ATTORNEY

Int. Cl.: 30

Prior U.S. Cl.: 46

United States Patent and Trademark Office

Reg. No. 3,522,862

Registered Oct. 21, 2008

**TRADEMARK
SUPPLEMENTAL REGISTER**

Honey Berry

UNIGREEN, INC. (CALIFORNIA CORPORATION)
3488 EL CAMINO REAL
SANTA CLARA, CA 95051

FOR: FROZEN CONFECTIONS; FROZEN YOGURT; GELATO; BAKERY DESSERTS; ICE-CREAM CAKES; CAKES; CUP CAKES; ICED CAKES, IN CLASS 30 (U.S. CL. 46).

FIRST USE 8-5-2008; IN COMMERCE 8-5-2008.

THE MARK CONSISTS OF STANDARD CHARACTERS WITHOUT CLAIM TO ANY PARTICULAR FONT, STYLE, SIZE, OR COLOR.

SER. NO. 77-337,039, FILED P.R. 11-26-2007; AM. S.R. 9-3-2008.

PAUL F. GAST, EXAMINING ATTORNEY

Int. Cl.: 43

Prior U.S. Cls.: 100 and 101

United States Patent and Trademark Office

Reg. No. 3,522,863

Registered Oct. 21, 2008

**SERVICE MARK
SUPPLEMENTAL REGISTER**

KILBURN'S TAVERN & GRILLE

EDWARD ANTHONY ENTERTAINMENT, INC.
(TEXAS CORPORATION)

11808 BARKER CYPRESS

CYPRESS, TX 77433

FOR: TAVERN SERVICES, IN CLASS 43 (U.S. CLS.
100 AND 101).

FIRST USE 8-0-2005; IN COMMERCE 8-0-2005.

THE MARK CONSISTS OF STANDARD CHAR-
ACTERS WITHOUT CLAIM TO ANY PARTICULAR
FONT, STYLE, SIZE, OR COLOR.

NO CLAIM IS MADE TO THE EXCLUSIVE
RIGHT TO USE "TAVERN & GRILLE", APART
FROM THE MARK AS SHOWN.

SER. NO. 77-337,623, FILED P.R. 11-27-2007; AM.
S.R. 9-8-2008.

JOHN E. MICHOS, EXAMINING ATTORNEY

Int. Cl.: 41

Prior U.S. Cls.: 100, 101, and 107

United States Patent and Trademark Office

Reg. No. 3,522,864

Registered Oct. 21, 2008

**SERVICE MARK
SUPPLEMENTAL REGISTER**

MATHTV.COM

MATHTV.COM (CALIFORNIA CORPORATION)
615 CLARION COURT
SAN LUIS OBISPO, CA 93401

FOR: EDUCATION SERVICES, NAMELY, PROVIDING INTERNET INSTRUCTION IN THE FIELD OF MATHEMATICS, IN CLASS 41 (U.S. CLS. 100, 101 AND 107).

FIRST USE 2-7-1999; IN COMMERCE 1-1-2000.

THE MARK CONSISTS OF STANDARD CHARACTERS WITHOUT CLAIM TO ANY PARTICULAR FONT, STYLE, SIZE, OR COLOR.

SER. NO. 77-339,512, FILED P.R. 11-28-2007; AM. S.R. 9-9-2008.

RENEE MCCRAY, EXAMINING ATTORNEY

Int. Cl.: 16

Prior U.S. Cls.: 2, 5, 22, 23, 29, 37, 38, and 50

United States Patent and Trademark Office

Reg. No. 3,522,865

Registered Oct. 21, 2008

TRADEMARK
SUPPLEMENTAL REGISTER



I AM
My Sister's Keeper

VANCE, NANCY ELLEN (UNITED STATES INDIVIDUAL)
1112 MORELAND COURT
ROCHESTER HILLS, MI 48307

FOR: PRINTED MATTER, NAMELY, BUMPER STICKERS, IN CLASS 16 (U.S. CLS. 2, 5, 22, 23, 29, 37, 38 AND 50).

FIRST USE 11-10-2007; IN COMMERCE 11-10-2007.

THE MARK CONSISTS OF A CIRCULAR DESIGN OF THE WORDS "DOMESTIC VIOLENCE" WITH A

"/" THROUGH IT IN MIDDLE OF THE CIRCLE WHICH IS OUTLINED BY HANDS BEING HELD TOGETHER ALSO FORMING AN OUTSIDE CIRCLE, WITH THE WORDS "I AM MY SISTER'S KEEPER" TO THE RIGHT OF THE CIRCLULAR DESIGN.

SER. NO. 77-339,797, FILED P.R. 11-29-2007; AM. S.R. 9-5-2008.

JESSICA A. POWERS, EXAMINING ATTORNEY

Int. Cl.: 25

Prior U.S. Cls.: 22 and 39

United States Patent and Trademark Office

Reg. No. 3,522,866

Registered Oct. 21, 2008

TRADEMARK
SUPPLEMENTAL REGISTER



VANCE, NANCY ELLEN (UNITED STATES INDIVIDUAL)
1112 MORELAND COURT
ROCHESTER HILLS, MI 48307

FOR: CLOTHING, NAMELY, T-SHIRTS, IN CLASS 25 (U.S. CLS. 22 AND 39).

FIRST USE 5-24-2007; IN COMMERCE 5-24-2007.

THE MARK CONSISTS OF A CIRCULAR DESIGN OF THE WORDS "DOMESTIC VIOLENCE" WITH A

"/" THROUGH THE MIDDLE OF THE CIRCLE WHICH IS OUTLINED BY HANDS BEING HELD TOGETHER ALSO FORMING AN OUTSIDE CIRCLE, WITH THE WORDS "I AM" LOCATED DIRECTLY ABOVE THE CIRCULAR DESIGN AND THE WORDS "MY SISTER'S KEEPER" DIRECTLY BENEATH THE CIRCULAR DESIGN.

SER. NO. 77-339,871, FILED P.R. 11-29-2007; AM. S.R. 9-5-2008.

JESSICA A. POWERS, EXAMINING ATTORNEY

Int. Cl.: 36

Prior U.S. Cls.: 100, 101, and 102

United States Patent and Trademark Office

Reg. No. 3,522,867

Registered Oct. 21, 2008

**SERVICE MARK
SUPPLEMENTAL REGISTER**

THE REIMBURSEMENT GROUP

THE REIMBURSEMENT GROUP (ILLINOIS
CORPORATION)
15469 WEST ROCKLAND LANE
LIBERTYVILLE, IL 60048

FOR: CONSULTATION SERVICES IN THE FIELD
OF MEDICAL PROVIDER FINANCIAL REIMBUR-
SEMENT FOR PHARMACEUTICAL COMPANIES,
MEDICAL DEVICE MANUFACTURERS, HEALTH
SYSTEMS, AND BIOTECHNOLOGY FIRMS; INSUR-
ANCE MANAGEMENT SERVICES, NAMELY, PRO-
VIDING INSURANCE BILLING AND CODING
INFORMATION TO PHARMACEUTICAL COMPA-
NIES, MEDICAL DEVICE MANUFACTURERS,
HEALTHY SYSTEMS, AND BIOTECHNOLOGY
FIRMS FOR USE IN BILLING AND RECEIVING
REIMBURSEMENT PAYMENTS FOR MEDICAL

GOODS AND SERVICES, IN CLASS 36 (U.S. CLS.
100, 101 AND 102).

FIRST USE 2-6-2007; IN COMMERCE 2-6-2007.

THE MARK CONSISTS OF STANDARD CHAR-
ACTERS WITHOUT CLAIM TO ANY PARTICULAR
FONT, STYLE, SIZE, OR COLOR.

NO CLAIM IS MADE TO THE EXCLUSIVE
RIGHT TO USE "GROUP", APART FROM THE
MARK AS SHOWN.

SER. NO. 77-339,913, FILED P.R. 11-29-2007; AM.
S.R. 9-5-2008.

JEFF DEFORD, EXAMINING ATTORNEY

Int. Cl.: 9

Prior U.S. Cls.: 21, 23, 26, 36, and 38

United States Patent and Trademark Office

Reg. No. 3,522,868

Registered Oct. 21, 2008

**TRADEMARK
SUPPLEMENTAL REGISTER**

CORPORATION TOOLBOX

SYNCOMER SOLUTIONS, INC. (NEVADA CORPORATION)
12 WEST MESQUITE BLVD. SUITE 108
MESQUITE, NV 89027

FOR: SOFTWARE PROGRAM FOR USE IN A PERSONAL COMPUTER TO PRODUCE LEGAL FORMS AND INSTRUCTIONS, IN CLASS 9 (U.S. CLS. 21, 23, 26, 36 AND 38).

FIRST USE 1-17-2006; IN COMMERCE 1-17-2006.

THE MARK CONSISTS OF STANDARD CHARACTERS WITHOUT CLAIM TO ANY PARTICULAR FONT, STYLE, SIZE, OR COLOR.

SER. NO. 77-342,721, FILED P.R. 12-3-2007; AM. S.R. 9-9-2008.

MICHAEL KEATING, EXAMINING ATTORNEY

Int. Cl.: 44

Prior U.S. Cls.: 100 and 101

United States Patent and Trademark Office

Reg. No. 3,522,869

Registered Oct. 21, 2008

**SERVICE MARK
SUPPLEMENTAL REGISTER**

NeuroVascular Release

WELLNESS CONCEPTS OF FLORIDA, L.L.C.
(FLORIDA LIMITED LIABILITY COMPANY),
DBA WELLNESS CONCEPTS,
9070 58TH DRIVE EAST STE 103
BRADENTON, FL 34202

FOR: BODYWORK THERAPY, IN CLASS 44 (U.S.
CLS. 100 AND 101).

FIRST USE 4-20-2006; IN COMMERCE 11-15-2006.

THE MARK CONSISTS OF STANDARD CHAR-
ACTERS WITHOUT CLAIM TO ANY PARTICULAR
FONT, STYLE, SIZE, OR COLOR.

SER. NO. 77-348,651, FILED P.R. 12-11-2007; AM.
S.R. 5-27-2008.

ODESSA BIBBINS, EXAMINING ATTORNEY

Int. Cls.: 35 and 41

Prior U.S. Cls.: 100, 101, 102, and 107

United States Patent and Trademark Office

Reg. No. 3,522,870

Registered Oct. 21, 2008

**SERVICE MARK
SUPPLEMENTAL REGISTER**

HR DECISION SUPPORT NETWORK

THE BUREAU OF NATIONAL AFFAIRS, INC.
(DELAWARE CORPORATION)
ROOM 11211
1801 S. BELL STREET
ARLINGTON, VA 22202

FOR: PROVIDING A WEB SITE FEATURING CUSTOM BUSINESS RESEARCH IN THE FIELD OF HUMAN RESOURCES, COMPENSATION, AND BENEFITS, IN CLASS 35 (U.S. CLS. 100, 101 AND 102).

FIRST USE 10-23-2006; IN COMMERCE 10-23-2006.

FOR: PROVIDING ONLINE PUBLICATIONS IN THE NATURE OF REPORTS, HANDBOOKS, GUIDES, WHITE PAPERS, AND STUDIES FEATURING NEWS, INFORMATION AND DEVELOPMENTS, LEGAL ANALYSIS, COMPLIANCE TOPICS, POLICIES, LAWS AND REGULATIONS, AND FORMS AND SAMPLE DOCUMENTS, ALL IN THE FIELD OF HUMAN RESOURCES, COMPEN-

SATION AND BENEFITS; PROVIDING REPORTS FEATURING NEWS, INFORMATION, AND DEVELOPMENTS IN THE FIELD OF HUMAN RESOURCES, COMPENSATION AND BENEFITS VIA E-MAIL; ARRANGING AND CONDUCTING EDUCATIONAL CONFERENCES VIA THE INTERNET, NAMELY, ONLINE CONFERENCES IN THE FIELD OF HUMAN RESOURCES, COMPENSATION AND BENEFITS, IN CLASS 41 (U.S. CLS. 100, 101 AND 107).

FIRST USE 10-23-2006; IN COMMERCE 10-23-2006.

THE MARK CONSISTS OF STANDARD CHARACTERS WITHOUT CLAIM TO ANY PARTICULAR FONT, STYLE, SIZE, OR COLOR.

SER. NO. 77-354,357, FILED P.R. 12-18-2007; AM. S.R. 9-5-2008.

DORITT L. CARROLL, EXAMINING ATTORNEY

Int. Cl.: 5

Prior U.S. Cls.: 6, 18, 44, 46, 51, and 52

Reg. No. 3,522,871

United States Patent and Trademark Office

Registered Oct. 21, 2008

**TRADEMARK
SUPPLEMENTAL REGISTER**

ULTIMATE DAILY NUTRITION

COUNTRY LIFE, LLC (NEW YORK LIMITED
LIABILITY COMPANY)

180 VANDERBILT MOTOR PARKWAY

HAUPPAUGE, NY 11788

FOR: DIETARY SUPPLEMENTS, IN CLASS 5 (U.S.
CLS. 6, 18, 44, 46, 51 AND 52).

FIRST USE 2-28-2008; IN COMMERCE 2-28-2008.

THE MARK CONSISTS OF STANDARD CHAR-
ACTERS WITHOUT CLAIM TO ANY PARTICULAR
FONT, STYLE, SIZE, OR COLOR.

NO CLAIM IS MADE TO THE EXCLUSIVE
RIGHT TO USE "DAILY NUTRITION", APART
FROM THE MARK AS SHOWN.

SER. NO. 77-356,005, FILED P.R. 12-19-2007; AM.
S.R. 8-7-2008.

DAYNA BROWNE, EXAMINING ATTORNEY

Int. Cl.: 5

Prior U.S. Cls.: 6, 18, 44, 46, 51, and 52

United States Patent and Trademark Office

Reg. No. 3,522,872

Registered Oct. 21, 2008

**TRADEMARK
SUPPLEMENTAL REGISTER**

YOUR DAILY PROBIOTIC

COUNTRY LIFE, LLC (NEW YORK LIMITED
LIABILITY COMPANY)

180 VANDERBILT MOTOR PARKWAY

HAUPPAUGE, NY 11788

FOR: DIETARY SUPPLEMENTS, IN CLASS 5 (U.S.
CLS. 6, 18, 44, 46, 51 AND 52).

FIRST USE 3-31-2008; IN COMMERCE 3-31-2008.

THE MARK CONSISTS OF STANDARD CHAR-
ACTERS WITHOUT CLAIM TO ANY PARTICULAR
FONT, STYLE, SIZE, OR COLOR.

NO CLAIM IS MADE TO THE EXCLUSIVE
RIGHT TO USE "PROBIOTIC", APART FROM THE
MARK AS SHOWN.

SER. NO. 77-356,023, FILED P.R. 12-19-2007; AM.
S.R. 8-7-2008.

DAYNA BROWNE, EXAMINING ATTORNEY

Int. Cl.: 36

Prior U.S. Cls.: 100, 101, and 102

United States Patent and Trademark Office

Reg. No. 3,522,873

Registered Oct. 21, 2008

**SERVICE MARK
SUPPLEMENTAL REGISTER**

I-BUSINESSPAY

WINTRUST FINANCIAL CORPORATION (ILLI-
NOIS CORPORATION)
727 N. BANK LANE
LAKE FOREST, IL 60045

FOR: BANKING SERVICES, IN CLASS 36 (U.S.
CLS. 100, 101 AND 102).

FIRST USE 3-0-2008; IN COMMERCE 3-0-2008.

THE MARK CONSISTS OF STANDARD CHAR-
ACTERS WITHOUT CLAIM TO ANY PARTICULAR
FONT, STYLE, SIZE, OR COLOR.

SER. NO. 77-363,664, FILED P.R. 1-3-2008; AM. S.R.
9-11-2008.

MICHAEL ENGEL, EXAMINING ATTORNEY

Int. Cl.: 36

Prior U.S. Cls.: 100, 101, and 102

United States Patent and Trademark Office

Reg. No. 3,522,874

Registered Oct. 21, 2008

**SERVICE MARK
SUPPLEMENTAL REGISTER**

PRICECAP

NICOR INC. (ILLINOIS CORPORATION)
1844 FERRY ROAD
NAPERVILLE, IL 60563

FIRST USE 12-6-2007; IN COMMERCE 12-6-2007.

FOR: ENERGY MANAGEMENT SERVICES, NAMELY, A VARIABLE-RATE BILLING PROGRAM THAT FEATURES AN UPPER LIMIT AMOUNT IN WHICH BUYERS PURCHASE NATURAL GAS BASED ON THE PREVAILING DAILY MARKET PRICES WITH A CONTRACTED UPPER LIMIT AMOUNT, IN CLASS 36 (U.S. CLS. 100, 101 AND 102).

THE MARK CONSISTS OF STANDARD CHARACTERS WITHOUT CLAIM TO ANY PARTICULAR FONT, STYLE, SIZE, OR COLOR.

SER. NO. 77-369,619, FILED P.R. 1-11-2008; AM. S.R. 9-4-2008.

JAMES A. RAUEN, EXAMINING ATTORNEY

Int. Cl.: 42

Prior U.S. Cls.: 100 and 101

United States Patent and Trademark Office

Reg. No. 3,522,875

Registered Oct. 21, 2008

**SERVICE MARK
SUPPLEMENTAL REGISTER**

**THE INSTANT LINK PAGE
SYSTEM**

REVIXIO SOFTWARE, LLC (PENNSYLVANIA
LIMITED LIABILITY COMPANY)
7 GREAT VALLEY PARKWAY
SUITE 210
MALVERN, PA 19355

FOR: PROVIDING AN ONLINE SALES TOOL IN
THE NATURE OF ON-LINE NON-DOWNLOAD-
ABLE SOFTWARE FOR CREATING CUSTOMIZED
PRIVATE WEB PAGES , IN CLASS 42 (U.S. CLS. 100
AND 101).

FIRST USE 4-7-2008; IN COMMERCE 4-24-2008.

THE MARK CONSISTS OF STANDARD CHAR-
ACTERS WITHOUT CLAIM TO ANY PARTICULAR
FONT, STYLE, SIZE, OR COLOR.

SER. NO. 77-375,272, FILED P.R. 1-18-2008; AM. S.R.
9-3-2008.

GINA FINK, EXAMINING ATTORNEY

Int. Cls.: 16 and 41

Prior U.S. Cls.: 2, 5, 22, 23, 29, 37, 38, 50, 100, 101, and 107

Reg. No. 3,522,876

United States Patent and Trademark Office

Registered Oct. 21, 2008

**TRADEMARK
SERVICE MARK
SUPPLEMENTAL REGISTER**

Journal of Nursing

AMERICAN SOCIETY OF REGISTERED NURSES, INC. (CALIFORNIA CORPORATION),
DBA AMERICAN SOCIETY OF REGISTERED NURSES,

1001 BRIDGEWAY, SUITE 411

SAUSALITO, CA 94965

FOR: NEWSLETTERS IN THE FIELD OF NURSING, IN CLASS 16 (U.S. CLS. 2, 5, 22, 23, 29, 37, 38 AND 50).

FIRST USE 2-1-2007; IN COMMERCE 2-1-2007.

FOR: PROVIDING NEWSLETTERS IN THE FIELD OF NURSING VIA E-MAIL, IN CLASS 41 (U.S. CLS. 100, 101 AND 107).

FIRST USE 2-1-2007; IN COMMERCE 2-1-2007.

THE MARK CONSISTS OF STANDARD CHARACTERS WITHOUT CLAIM TO ANY PARTICULAR FONT, STYLE, SIZE, OR COLOR.

SER. NO. 77-376,257, FILED P.R. 1-20-2008; AM. S.R. 9-10-2008.

DEZMONA MIZELLE, EXAMINING ATTORNEY

Int. Cl.: 25

Prior U.S. Cls.: 22 and 39

United States Patent and Trademark Office

Reg. No. 3,522,877

Registered Oct. 21, 2008

**TRADEMARK
SUPPLEMENTAL REGISTER**

**WORLD'S MOST COMFORTABLE
THONG**

HANKY PANKY, LTD. (NEW YORK CORPORATION)
373 PARK AVENUE SOUTH
NEW YORK, NY 10016

FOR: LINGERIE AND UNDERWEAR, IN CLASS
25 (U.S. CLS. 22 AND 39).

FIRST USE 8-22-2008; IN COMMERCE 8-22-2008.

THE MARK CONSISTS OF STANDARD CHARACTERS WITHOUT CLAIM TO ANY PARTICULAR FONT, STYLE, SIZE, OR COLOR.

OWNER OF U.S. REG. NO. 3,074,963.

NO CLAIM IS MADE TO THE EXCLUSIVE RIGHT TO USE "THONG", APART FROM THE MARK AS SHOWN.

SER. NO. 77-379,365, FILED P.R. 1-24-2008; AM. S.R. 9-5-2008.

MICHAEL KAZAZIAN, EXAMINING ATTORNEY

Int. Cl.: 41

Prior U.S. Cls.: 100, 101, and 107

United States Patent and Trademark Office

Reg. No. 3,522,878

Registered Oct. 21, 2008

**SERVICE MARK
SUPPLEMENTAL REGISTER**

AMERICA'S STRONGEST MAN

AMERICAN STRONGMAN CORPORATION
(MISSOURI CORPORATION)
11676 MARK TWAIN LN
BRIDGETON, MO 63044

THE MARK CONSISTS OF STANDARD CHAR-
ACTERS WITHOUT CLAIM TO ANY PARTICULAR
FONT, STYLE, SIZE, OR COLOR.

FOR: ENTERTAINMENT IN THE NATURE OF
COMPETITIONS IN THE FIELD OF STRENGTH
ATHLETICS AND STRENGTH ENTERTAINMENT,
IN CLASS 41 (U.S. CLS. 100, 101 AND 107).

SER. NO. 77-387,835, FILED 2-4-2008.

FIRST USE 10-15-2004; IN COMMERCE 3-16-2005.

WENDY JUN, EXAMINING ATTORNEY

Int. Cl.: 30

Prior U.S. Cl.: 46

United States Patent and Trademark Office

Reg. No. 3,522,879

Registered Oct. 21, 2008

**TRADEMARK
SUPPLEMENTAL REGISTER**

S'MORECONES

CERTERRA, INC. (CALIFORNIA CORPORATION)
26741 PORTOLA PKWY, #1E-429
FOOTHILL RANCH, CA 92610

FOR: COOKIES AND CRACKERS; CRACKERS;
CONES FOR ICE CREAM, IN CLASS 30 (U.S. CL. 46).

FIRST USE 12-7-2007; IN COMMERCE 12-7-2007.

THE MARK CONSISTS OF STANDARD CHARACTERS WITHOUT CLAIM TO ANY PARTICULAR FONT, STYLE, SIZE, OR COLOR.

SER. NO. 77-388,283, FILED P.R. 2-4-2008; AM. S.R. 9-2-2008.

RONALD DELGIZZI, EXAMINING ATTORNEY

Int. Cl.: 16

Prior U.S. Cls.: 2, 5, 22, 23, 29, 37, 38, and 50

Reg. No. 3,522,880

United States Patent and Trademark Office

Registered Oct. 21, 2008

**TRADEMARK
SUPPLEMENTAL REGISTER**

GREAT PLACES TO LIVE

INTEGRATED MEDIA GROUP, INC. (ALABAMA
CORPORATION)
133 GOLDEN DELICIOUS DRIVE
OXFORD, AL 36203

FOR: PUBLICATIONS, NAMELY, A MAGAZINE
COVERING TOPICS PERTAINING TO AFFLUENT
NEIGHBORHOODS AND DESIRABLE LIVING LO-
CALES; MAGAZINES FOR HOME OWNERS IN
AFFLUENT NEIGHBORHOODS IN THE FIELD OF
AFFLUENT NEIGHBORHOODS AND DESIRABLE
LIVING LOCALES, IN CLASS 16 (U.S. CLS. 2, 5, 22, 23,
29, 37, 38 AND 50).

FIRST USE 2-25-2008; IN COMMERCE 2-25-2008.

THE MARK CONSISTS OF STANDARD CHAR-
ACTERS WITHOUT CLAIM TO ANY PARTICULAR
FONT, STYLE, SIZE, OR COLOR.

SER. NO. 77-388,684, FILED P.R. 2-5-2008; AM. S.R.
9-5-2008.

MARK T. MULLEN, EXAMINING ATTORNEY

Int. Cl.: 43

Prior U.S. Cls.: 100 and 101

United States Patent and Trademark Office

Reg. No. 3,522,881

Registered Oct. 21, 2008

**SERVICE MARK
SUPPLEMENTAL REGISTER**

PASILLA MEXICAN GRILL

SAMIM SALEMI (UNITED STATES INDIVIDUAL)

359 KEARNY STREET

SAN FRANCISCO, CA 94108

FOR: CAFE-RESTAURANTS; CARRY-OUT RESTAURANTS; FAST-FOOD RESTAURANTS, IN CLASS 43 (U.S. CLS. 100 AND 101).

FIRST USE 3-20-2008; IN COMMERCE 3-20-2008.

THE MARK CONSISTS OF STANDARD CHARACTERS WITHOUT CLAIM TO ANY PARTICULAR FONT, STYLE, SIZE, OR COLOR.

NO CLAIM IS MADE TO THE EXCLUSIVE RIGHT TO USE "MEXICAN GRILL", APART FROM THE MARK AS SHOWN.

SER. NO. 77-388,751, FILED P.R. 2-5-2008; AM. S.R. 9-8-2008.

GEOFFREY FOSDICK, EXAMINING ATTORNEY

Int. Cl.: 41

Prior U.S. Cls.: 100, 101, and 107

United States Patent and Trademark Office

Reg. No. 3,522,882

Registered Oct. 21, 2008

**SERVICE MARK
SUPPLEMENTAL REGISTER**

STATE TAX RESEARCH DIGEST

THE BUREAU OF NATIONAL AFFAIRS, INC.
(DELAWARE CORPORATION)
SUITE 11211
1801 S. BELL STREET
ARLINGTON, VA 22202

FOR: PROVIDING ONLINE PUBLICATIONS IN THE NATURE OF DIGESTS AND REFERENCE MATERIALS FEATURING INFORMATION IN THE FIELD OF STATE BUSINESS AND INDIVIDUAL TAX SYSTEMS, SUMMARIES OF CORPORATE AND INDIVIDUAL INCOME TAX ISSUES, AND STATE TAX STATUTES AND REGULATIONS, IN CLASS 41 (U.S. CLS. 100, 101 AND 107).

FIRST USE 12-10-2007; IN COMMERCE 12-10-2007.

THE MARK CONSISTS OF STANDARD CHARACTERS WITHOUT CLAIM TO ANY PARTICULAR FONT, STYLE, SIZE, OR COLOR.

NO CLAIM IS MADE TO THE EXCLUSIVE RIGHT TO USE "DIGEST", APART FROM THE MARK AS SHOWN.

SER. NO. 77-390,366, FILED P.R. 2-6-2008; AM. S.R. 9-5-2008.

DORITT L. CARROLL, EXAMINING ATTORNEY

Int. Cl.: 33

Prior U.S. Cls.: 47 and 49

United States Patent and Trademark Office

Reg. No. 3,522,883

Registered Oct. 21, 2008

TRADEMARK
SUPPLEMENTAL REGISTER

CHAIKEN

CHAIKEN, BARRY P (UNITED STATES INDIVIDUAL)

14 DURHAM STREET
BOSTON, MA 02115

FOR: APERITIF WINES; APERITIFS WITH A WINE BASE; COOKING WINE; FRUIT WINE; GRAPE WINE; NATURAL SPARKLING WINES; PORT WINES; PREPARED WINE COCKTAILS; RED WINE; SPARKLING FRUIT WINE; SPARKLING GRAPE WINE; SPARKLING WINES; STRAWBERRY WINE; SWEET WINES; TABLE WINES; WHITE WINE; WINE; WINE COOLERS; WINE PUNCH; WINE PUNCHES; WINES; WINES AND FORTIFIED WINES; WINES AND LIQUEURS;

WINES AND SPARKLING WINES, IN CLASS 33 (U.S. CLS. 47 AND 49).

FIRST USE 2-8-2008; IN COMMERCE 2-8-2008.

THE MARK CONSISTS OF STANDARD CHARACTERS WITHOUT CLAIM TO ANY PARTICULAR FONT, STYLE, SIZE, OR COLOR.

THE NAME "CHAIKEN" IDENTIFIES A LIVING INDIVIDUAL WHOSE CONSENT IS OF RECORD.

SER. NO. 77-393,102, FILED P.R. 2-9-2008; AM. S.R. 9-10-2008.

MARGERY A. TIERNEY, EXAMINING ATTORNEY

Int. Cl.: 35

Prior U.S. Cls.: 100, 101, and 102

United States Patent and Trademark Office

Reg. No. 3,522,884

Registered Oct. 21, 2008

**SERVICE MARK
SUPPLEMENTAL REGISTER**

PAYMENT ADVISOR SUITE

SEARCH AMERICA, INC. (MINNESOTA CORPORATION)
7001 E. FISH LAKE ROAD
MAPLE GROVE, MN 55311

FOR: PROVIDING BUSINESS INFORMATION VIA THE INTERNET TO HEALTHCARE PROVIDERS AND FACILITIES; TO PREDICT PAYMENT CAPABILITIES OF PATIENTS; TO PROVIDE DATA AS TO THIRD PARTY FINANCIAL ASSISTANCE TO HEALTHCARE PATIENTS; AND TO PROVIDE INFORMATION WITH RESPECT TO THE IDENTITY AND LOCATION OF PATIENTS BASED ON A CREDIT SCREENING AND SCORING SERVICE, IN CLASS 35 (U.S. CLS. 100, 101 AND 102).

FIRST USE 4-1-2008; IN COMMERCE 4-1-2008.

THE MARK CONSISTS OF STANDARD CHARACTERS WITHOUT CLAIM TO ANY PARTICULAR FONT, STYLE, SIZE, OR COLOR.

OWNER OF U.S. REG. NO. 3,321,719.

SER. NO. 77-393,824, FILED P.R. 2-11-2008; AM. S.R. 9-4-2008.

JILL C. ALT, EXAMINING ATTORNEY

Int. Cl.: 16

Prior U.S. Cls.: 2, 5, 22, 23, 29, 37, 38, and 50

United States Patent and Trademark Office

Reg. No. 3,522,885

Registered Oct. 21, 2008

**TRADEMARK
SUPPLEMENTAL REGISTER**

**THE ORIGINAL TREEHUGGER
50% PCW RECYCLED TAB**

TICEHURST BROTHERS, INC. (CALIFORNIA
CORPORATION)

16102 ORANGE AVENUE

PARAMOUNT, CA 90723

FOR: RECYCLED LEGAL EXHIBIT TABS, IN
CLASS 16 (U.S. CLS. 2, 5, 22, 23, 29, 37, 38 AND 50).

FIRST USE 2-25-2008; IN COMMERCE 5-1-2008.

THE MARK CONSISTS OF STANDARD CHAR-
ACTERS WITHOUT CLAIM TO ANY PARTICULAR
FONT, STYLE, SIZE, OR COLOR.

NO CLAIM IS MADE TO THE EXCLUSIVE
RIGHT TO USE "RECYCLED TAB", APART FROM
THE MARK AS SHOWN.

SER. NO. 77-394,651, FILED P.R. 2-12-2008; AM. S.R.
8-21-2008.

DARRYL SPRUILL, EXAMINING ATTORNEY

Int. Cl.: 30

Prior U.S. Cl.: 46

United States Patent and Trademark Office

Reg. No. 3,522,886

Registered Oct. 21, 2008

**TRADEMARK
SUPPLEMENTAL REGISTER**

**AMERICA'S COFFEE PROVIDER
SINCE 1859**

THE GREAT ATLANTIC & PACIFIC TEA COM-
PANY, INC. (MARYLAND CORPORATION)
2 PARAGON DRIVE
MONTVALE, NJ 07645

FOR: COFFEE, IN CLASS 30 (U.S. CL. 46).

FIRST USE 7-0-2008; IN COMMERCE 7-0-2008.

THE MARK CONSISTS OF STANDARD CHAR-
ACTERS WITHOUT CLAIM TO ANY PARTICULAR
FONT, STYLE, SIZE, OR COLOR.

SER. NO. 77-398,541, FILED P.R. 2-15-2008; AM. S.R.
9-9-2008.

WENDY JUN, EXAMINING ATTORNEY

Int. Cl.: 9

Prior U.S. Cls.: 21, 23, 26, 36, and 38

United States Patent and Trademark Office

Reg. No. 3,522,887

Registered Oct. 21, 2008

**TRADEMARK
SUPPLEMENTAL REGISTER**

Tenant File

W G SOFTWARE, INC. (TEXAS CORPORATION)
POB 90218
AUSTIN, TX 78709

FOR: COMPUTER PROGRAMS FOR PROPERTY
MANAGEMENT THAT MAINTAINS ACCOUNT-
ING FOR OWNERS OR MANAGERS OF RENTAL
PROPERTIES, IN CLASS 9 (U.S. CLS. 21, 23, 26, 36
AND 38).

FIRST USE 2-1-1988; IN COMMERCE 2-1-1988.

THE MARK CONSISTS OF STANDARD CHAR-
ACTERS WITHOUT CLAIM TO ANY PARTICULAR
FONT, STYLE, SIZE, OR COLOR.

SER. NO. 77-398,976, FILED P.R. 2-16-2008; AM. S.R.
9-8-2008.

FRANK LATTUCA, EXAMINING ATTORNEY

Int. Cls.: 36 and 37

Prior U.S. Cls.: 100, 101, 102, 103, and 106

United States Patent and Trademark Office

Reg. No. 3,522,888

Registered Oct. 21, 2008

**SERVICE MARK
SUPPLEMENTAL REGISTER**

KINGS & QUEENS PROPERTIES

LEFRAK ORGANIZATION, INC. (NEW YORK CORPORATION)
40 WEST 57TH STREET
NEW YORK, NY 10019

FOR: REAL ESTATE SERVICES, NAMELY, COMMERCIAL AND RESIDENTIAL REAL ESTATE INVESTMENT, CONSULTATION AND MANAGEMENT; REAL ESTATE RENTAL SERVICES, NAMELY, RENTAL OF RESIDENTIAL HOUSING, VACATION HOMES, AND SHORT-TERM FURNISHED APARTMENTS, IN CLASS 36 (U.S. CLS. 100, 101 AND 102).

FIRST USE 5-7-2008; IN COMMERCE 5-7-2008.

FOR: REAL ESTATE SERVICES, NAMELY, COMMERCIAL AND RESIDENTIAL REAL ESTATE DE-

VELOPMENT, IN CLASS 37 (U.S. CLS. 100, 103 AND 106).

FIRST USE 5-7-2008; IN COMMERCE 5-7-2008.

THE MARK CONSISTS OF STANDARD CHARACTERS WITHOUT CLAIM TO ANY PARTICULAR FONT, STYLE, SIZE, OR COLOR.

NO CLAIM IS MADE TO THE EXCLUSIVE RIGHT TO USE "PROPERTIES", APART FROM THE MARK AS SHOWN.

SER. NO. 77-406,153, FILED P.R. 2-26-2008; AM. S.R. 9-8-2008.

ELISSA GARBER KON, EXAMINING ATTORNEY

Int. Cl.: 30

Prior U.S. Cl.: 46

United States Patent and Trademark Office

Reg. No. 3,522,889

Registered Oct. 21, 2008

**TRADEMARK
SUPPLEMENTAL REGISTER**

ULTIMATE GREEN TEA

CHI TEA INC (NEW YORK CORPORATION)
84 HEDGEROW LANE
COMMACK, NY 11725

FOR: GREEN TEA; TEA; TEA EXTRACTS; HER-
BAL INFUSIONS, IN CLASS 30 (U.S. CL. 46).

FIRST USE 4-10-2008; IN COMMERCE 4-10-2008.

THE MARK CONSISTS OF STANDARD CHAR-
ACTERS WITHOUT CLAIM TO ANY PARTICULAR
FONT, STYLE, SIZE, OR COLOR.

NO CLAIM IS MADE TO THE EXCLUSIVE
RIGHT TO USE "GREEN TEA", APART FROM
THE MARK AS SHOWN.

SER. NO. 77-408,971, FILED P.R. 2-28-2008; AM. S.R.
9-2-2008.

JIM RINGLE, EXAMINING ATTORNEY

Int. Cl.: 35

Prior U.S. Cls.: 100, 101, and 102

United States Patent and Trademark Office

Reg. No. 3,522,890

Registered Oct. 21, 2008

**SERVICE MARK
SUPPLEMENTAL REGISTER**

GOLF APPAREL BRANDS

GOLF APPAREL BRANDS, INC. (CALIFORNIA CORPORATION)
13301 S. MAIN STREET
LOS ANGELES, CA 90061

FOR: WHOLESALER DISTRIBUTORSHIPS FEATURING CLOTHING, HEADGEAR, GOLF GLOVES, GOLF TOWELS, AND TOTE BAGS, IN CLASS 35 (U.S. CLS. 100, 101 AND 102).

FIRST USE 2-5-1999; IN COMMERCE 2-5-1999.

THE MARK CONSISTS OF STANDARD CHARACTERS WITHOUT CLAIM TO ANY PARTICULAR FONT, STYLE, SIZE, OR COLOR.

NO CLAIM IS MADE TO THE EXCLUSIVE RIGHT TO USE "GOLF APPAREL", APART FROM THE MARK AS SHOWN.

SER. NO. 77-412,560, FILED P.R. 3-4-2008; AM. S.R. 8-16-2008.

SONYA STEPHENS, EXAMINING ATTORNEY

Int. Cl.: 41

Prior U.S. Cls.: 100, 101, and 107

United States Patent and Trademark Office

Reg. No. 3,522,891

Registered Oct. 21, 2008

**SERVICE MARK
SUPPLEMENTAL REGISTER**

OILMAN'S ARCHERY CLASSIC

HOOVER, JASON (UNITED STATES INDIVIDUAL)

21815 HANNOVER VILLAGE

SPRING, TX 77388

FOR: ORGANIZING SPORTING EVENTS, NAME-
LY, ARCHERY COMPETITIONS, IN CLASS 41 (U.S.
CLS. 100, 101 AND 107).

FIRST USE 6-1-2007; IN COMMERCE 6-1-2007.

THE MARK CONSISTS OF STANDARD CHAR-
ACTERS WITHOUT CLAIM TO ANY PARTICULAR
FONT, STYLE, SIZE, OR COLOR.

NO CLAIM IS MADE TO THE EXCLUSIVE
RIGHT TO USE "ARCHERY", APART FROM THE
MARK AS SHOWN.

SER. NO. 77-416,169, FILED P.R. 3-7-2008; AM. S.R.
8-28-2008.

MARY BOAGNI, EXAMINING ATTORNEY

Int. Cl.: 36

Prior U.S. Cls.: 100, 101, and 102

United States Patent and Trademark Office

Reg. No. 3,522,892

Registered Oct. 21, 2008

**SERVICE MARK
SUPPLEMENTAL REGISTER**

**FLORIDA DISASTER RECOVERY
FUND**

THE FLORIDA COMMISSION ON COMMUNITY SERVICE (FLORIDA A COMMISSION ON THE EXECUTIVE BRANCH OF FLORIDA GOVERNMENT), DBA THE GOVERNOR'S COMMISSION ON VOLUNTEERISM AND COMMUNITY SERVICE, VOLUNTEER FLORIDA,

THE ELLIOT BUILDING, 401 SOUTH MONROE ST
TALLAHASSEE, FL 32301

FOR: CHARITABLE SERVICES, NAMELY, FUND RAISING FROM PRIVATE AND CORPORATE DONORS; ACCEPTING AND ADMINISTERING MONETARY CHARITABLE CONTRIBUTIONS FOR USE IN THE ASSISTANCE OF THE REBUILDING OF COMMUNITIES IN FURTHERANCE OF THE FLORIDA VOLUNTEER AND COMMUNITY SERVICE, IN CLASS 36 (U.S. CLS. 100, 101 AND 102).

FIRST USE 2-8-2007; IN COMMERCE 2-8-2007.

THE MARK CONSISTS OF STANDARD CHARACTERS WITHOUT CLAIM TO ANY PARTICULAR FONT, STYLE, SIZE, OR COLOR.

NO CLAIM IS MADE TO THE EXCLUSIVE RIGHT TO USE "FLORIDA" OR "FUND", APART FROM THE MARK AS SHOWN.

SER. NO. 77-429,259, FILED P.R. 3-24-2008; AM. S.R. 8-13-2008.

SANJEEV VOHRA, EXAMINING ATTORNEY

Int. Cls.: 16, 37, and 45

**Prior U.S. Cls.: 2, 5, 22, 23, 29, 37, 38, 50, 100, 101,
103, and 106**

Reg. No. 3,522,893

United States Patent and Trademark Office

Registered Oct. 21, 2008

**TRADEMARK
SERVICE MARK
SUPPLEMENTAL REGISTER**

INDUSTRIAL LIFT AND HOIST

MAXIMUM CAPACITY MEDIA, L.L.C. (IOWA
LIMITED LIABILITY COMPANY)
P.O. BOX 1052, 1003 CENTRAL AVENUE
FORT DODGE, IA 50501

FOR: MAGAZINE FEATURING COMPREHEN-
SIVE INFORMATION ON THE SELECTION, MAIN-
TENANCE AND SAFE USE OF INDUSTRIAL
LIFTING EQUIPMENT, IN CLASS 16 (U.S. CLS. 2,
5, 22, 23, 29, 37, 38 AND 50).

FIRST USE 2-6-2008; IN COMMERCE 2-6-2008.

FOR: A WEBSITE FEATURING INFORMATION,
NAMELY, SELECTING AND MAINTENANCE OF
INDUSTRIAL LIFTING EQUIPMENT NEEDED
FOR SPECIFIC PURPOSES/JOBS, IN CLASS 37 (U.S.
CLS. 100, 103 AND 106).

FIRST USE 7-7-2008; IN COMMERCE 7-7-2008.

FOR: A WEBSITE FEATURING INFORMATION
ON THE SAFE USE OF INDUSTRIAL LIFTING
EQUIPMENT, IN CLASS 45 (U.S. CLS. 100 AND 101).

FIRST USE 7-7-2008; IN COMMERCE 7-7-2008.

THE MARK CONSISTS OF STANDARD CHAR-
ACTERS WITHOUT CLAIM TO ANY PARTICULAR
FONT, STYLE, SIZE, OR COLOR.

SER. NO. 77-429,902, FILED P.R. 3-24-2008; AM. S.R.
8-21-2008.

KATHERINE STOIDES, EXAMINING ATTORNEY

Int. Cl.: 16

Prior U.S. Cls.: 2, 5, 22, 23, 29, 37, 38, and 50

United States Patent and Trademark Office

Reg. No. 3,522,894

Registered Oct. 21, 2008

TRADEMARK
SUPPLEMENTAL REGISTER

VOLUNTEERISM
THE GIVER
IS
THE RECEIVER

VANCE, NANCY ELLEN (UNITED STATES IN-
DIVIDUAL)

1112 MORELAND COURT
ROCHESTER HILLS, MI 48307

FOR: BUMPER STICKERS, IN CLASS 16 (U.S. CLS.
2, 5, 22, 23, 29, 37, 38 AND 50).

FIRST USE 3-3-2008; IN COMMERCE 3-3-2008.

THE MARK CONSISTS OF THE WORD "VOLUN-
TEERISM" APPEARING IN A CURVE DIRECTLY
ABOVE THE WORDS "THE GIVER" WHICH AP-
PEARS DIRECTLY ABOVE THE WORD "IS" WHICH
APPEARS DIRECTLY ABOVE THE WORDS "THE
RECEIVER".

SER. NO. 77-431,932, FILED P.R. 3-26-2008; AM. S.R.
9-5-2008.

RUDY R. SINGLETON, EXAMINING ATTORNEY

Int. Cl.: 25

Prior U.S. Cls.: 22 and 39

United States Patent and Trademark Office

Reg. No. 3,522,895

Registered Oct. 21, 2008

TRADEMARK
SUPPLEMENTAL REGISTER

VOLUNTEERISM
THE GIVER
IS
THE RECEIVER

VANCE, NANCY ELLEN (UNITED STATES IN-
DIVIDUAL)

1112 MORELAND COURT
ROCHESTER HILLS, MI 48307

FOR: CLOTHING, NAMELY, T-SHIRTS, IN
CLASS 25 (U.S. CLS. 22 AND 39).

FIRST USE 2-29-2008; IN COMMERCE 2-29-2008.

THE MARK CONSISTS OF THE WORD "VOLUN-
TEERISM" APPEARING IN A CURVE DIRECTLY
ABOVE THE WORDS "THE GIVER" WHICH AP-
PEARS DIRECTLY ABOVE THE WORD "IS" WHICH
APPEARS DIRECTLY ABOVE THE WORDS "THE
RECEIVER".

SER. NO. 77-432,023, FILED P.R. 3-26-2008; AM. S.R.
9-5-2008.

RUDY R. SINGLETON, EXAMINING ATTORNEY

Int. Cl.: 41

Prior U.S. Cls.: 100, 101, and 107

United States Patent and Trademark Office

Reg. No. 3,522,896

Registered Oct. 21, 2008

**SERVICE MARK
SUPPLEMENTAL REGISTER**

Fog City Wrestling

NXS ENTERTAINMENT (CALIFORNIA LIMITED PARTNERSHIP)
1019 COLE STREET #2
SAN FRANCISCO, CA 94117

FOR: ENTERTAINMENT IN THE NATURE OF WRESTLING CONTESTS; ENTERTAINMENT SERVICES, NAMELY, WRESTLING EXHIBITS AND PERFORMANCES BY A PROFESSIONAL WRESTLER AND ENTERTAINER; PROVIDING WRESTLING NEWS AND INFORMATION VIA A GLOBAL COMPUTER NETWORK, IN CLASS 41 (U.S. CLS. 100, 101 AND 107).

FIRST USE 11-1-2007; IN COMMERCE 11-30-2007.

THE MARK CONSISTS OF STANDARD CHARACTERS WITHOUT CLAIM TO ANY PARTICULAR FONT, STYLE, SIZE, OR COLOR.

NO CLAIM IS MADE TO THE EXCLUSIVE RIGHT TO USE "WRESTLING", APART FROM THE MARK AS SHOWN.

SER. NO. 77-432,657, FILED P.R. 3-26-2008; AM. S.R. 8-13-2008.

HEATHER BIDDULPH, EXAMINING ATTORNEY

Int. Cl.: 41

Prior U.S. Cls.: 100, 101, and 107

United States Patent and Trademark Office

Reg. No. 3,522,897

Registered Oct. 21, 2008

**SERVICE MARK
SUPPLEMENTAL REGISTER**

ANIME WEEKEND ATLANTA

ANIME WEEKEND ATLANTA, INC. (GEORGIA CORPORATION)

2151 LENOX ROAD, D-2

ATLANTA, GA 30324

FOR: ORGANIZATION OF CONVENTION FEATURING JAPANESE ANIMATION AND COMICS, IN CLASS 41 (U.S. CLS. 100, 101 AND 107).

FIRST USE 4-1-1995; IN COMMERCE 4-1-1995.

THE MARK CONSISTS OF STANDARD CHARACTERS WITHOUT CLAIM TO ANY PARTICULAR FONT, STYLE, SIZE, OR COLOR.

NO CLAIM IS MADE TO THE EXCLUSIVE RIGHT TO USE "ANIME", APART FROM THE MARK AS SHOWN.

SER. NO. 77-433,070, FILED P.R. 3-27-2008; AM. S.R. 9-5-2008.

ANTHONY RINKER, EXAMINING ATTORNEY

Int. Cl.: 35

Prior U.S. Cls.: 100, 101, and 102

United States Patent and Trademark Office

Reg. No. 3,522,898

Registered Oct. 21, 2008

**SERVICE MARK
SUPPLEMENTAL REGISTER**

DISCOUNT CYCLE SUPPLY

MONAHAN TERENCE S. (CONNECTICUT SOLE PROPRIETORSHIP)
61 CEMETERY RD
HARWINTON, CT 06791

FOR: RETAIL STORE SERVICES FEATURING NEW AND USED PARTS, ACCESSORIES, APPAREL, AND MANUALS FOR MOTORCYCLES, ALL TERRAIN VEHICLES, ALSO KNOWN AS ATV, SNOWMOBILES, AND POWER AND RECREATIONAL WATERCRAFT, NAMELY, BOATS, JET BOATS, AND PERSONAL WATERCRAFT, PROVIDED OVER A GLOBAL COMMUNICATION INFORMATION NETWORK; ADVERTISING SERVICES; PROVIDING MAIL ORDER CATALOG SERVICES FEATURING NEW AND USED PARTS, ACCESSORIES, APPAREL, AND MANUALS FOR MOTORCYCLES, ALL TERRAIN VEHICLES, ALSO KNOWN AS ATV, SNOWMOBILES, AND POWER AND RECREATIONAL WATERCRAFT, NAMELY, BOATS, JET BOATS, AND PERSONAL WATERCRAFT; RETAIL AND ONLINE RETAIL STORE SERVICES AND COMPUTERIZED ON-LINE ORDERING AND MAIL ORDER SERVICES FEATURING NEW AND USED PARTS, ACCESSORIES, APPAREL, AND MANUALS FOR MOTORCYCLES, ALL TERRAIN VEHICLES, ALSO KNOWN AS ATV, SNOWMOBILES, AND POWER AND RECREATIONAL WATERCRAFT, NAMELY, BOATS, JET BOATS, AND PERSONAL WATERCRAFT; PROVIDING AN ON-LINE COMMERCIAL INFORMATION DIRECTORY ON THE INTERNET REGARDING MOTORCYCLES, ALL TERRAIN VEHICLES, ALSO KNOWN AS ATV, SNOWMOBILES, AND POWER AND RECREATIONAL WATERCRAFT, NAMELY, BOATS, JET BOATS, AND PERSONAL WATERCRAFT AND PARTS, ACCESSORIES, TOOLS, POW-

ER TOOLS, APPAREL, AND MANUALS THEREFOR; PROVIDING A SEARCHABLE DATABASE AVAILABLE VIA A GLOBAL COMPUTER NETWORK FEATURING CONSUMER INFORMATION IN THE FIELD OF MOTORCYCLES, ALL TERRAIN VEHICLES, ALSO KNOWN AS ATV, SNOWMOBILES, AND POWER AND RECREATIONAL WATERCRAFT, NAMELY, BOATS, JET BOATS, AND PERSONAL WATERCRAFT AND PARTS, ACCESSORIES, TOOLS, POWER TOOLS, APPAREL, AND MANUALS THEREFOR; PROVIDING A SEARCHABLE ON-LINE ADVERTISING GUIDE FEATURING THE GOODS AND SERVICES OF OTHER ON-LINE VENDORS IN THE FIELD OF MOTORCYCLES, ALL TERRAIN VEHICLES, ALSO KNOWN AS ATV, SNOWMOBILES, AND POWER AND RECREATIONAL WATERCRAFT, NAMELY, BOATS, JET BOATS, AND PERSONAL WATERCRAFT AND PARTS, ACCESSORIES, TOOLS, POWER TOOLS, APPAREL, AND MANUALS THEREFOR, IN CLASS 35 (U.S. CLS. 100, 101 AND 102).

FIRST USE 10-12-2001; IN COMMERCE 10-12-2001.

THE MARK CONSISTS OF STANDARD CHARACTERS WITHOUT CLAIM TO ANY PARTICULAR FONT, STYLE, SIZE, OR COLOR.

NO CLAIM IS MADE TO THE EXCLUSIVE RIGHT TO USE "CYCLE SUPPLY", APART FROM THE MARK AS SHOWN.

SER. NO. 77-441,788, FILED P.R. 4-7-2008; AM. S.R. 7-18-2008.

ESTHER BELENKER, EXAMINING ATTORNEY

Int. Cl.: 29

Prior U.S. Cl.: 46

United States Patent and Trademark Office

Reg. No. 3,522,899

Registered Oct. 21, 2008

**TRADEMARK
SUPPLEMENTAL REGISTER**

CALF'S CHOICE

CLAVA PRODUCTS CO., INC (CALIFORNIA CORPORATION)
4351 E. WINERY RD
ACAMPO, CA 95220

THE COLOR(S) BLUE IS/ARE CLAIMED AS A FEATURE OF THE MARK.

FOR: CALF MILK FOR USE AS WHOLE MILK SUBSTITUTE, IN CLASS 29 (U.S. CL. 46).

THE MARK CONSISTS OF THE WORDING "CALF'S CHOICE" IS THE COLOR BLUE.

FIRST USE 1-1-1980; IN COMMERCE 1-1-1980.

SER. NO. 77-444,164, FILED 4-9-2008.

NO CLAIM IS MADE TO THE EXCLUSIVE RIGHT TO USE "CALF'S" , APART FROM THE MARK AS SHOWN.

INGRID C. EULIN, EXAMINING ATTORNEY

Int. Cl.: 3

Prior U.S. Cls.: 1, 4, 6, 50, 51, and 52

United States Patent and Trademark Office

Reg. No. 3,522,900

Registered Oct. 21, 2008

**TRADEMARK
SUPPLEMENTAL REGISTER**

LIPSCREEN

SCREEN, INC. (NEVADA CORPORATION)
PO BOX 17417
12306 VIKING WAY
RENO, NV 89511

THE MARK CONSISTS OF STANDARD CHAR-
ACTERS WITHOUT CLAIM TO ANY PARTICULAR
FONT, STYLE, SIZE, OR COLOR.

FOR: LIP CREAM, IN CLASS 3 (U.S. CLS. 1, 4, 6, 50,
51 AND 52).

SER. NO. 77-450,298, FILED P.R. 4-16-2008; AM. S.R.
9-9-2008.

FIRST USE 4-1-2008; IN COMMERCE 4-1-2008.

MARK T. MULLEN, EXAMINING ATTORNEY

Int. Cl.: 42

Prior U.S. Cls.: 100 and 101

United States Patent and Trademark Office

Reg. No. 3,522,901

Registered Oct. 21, 2008

**SERVICE MARK
SUPPLEMENTAL REGISTER**

ECOMPILE

NEWSSTAND, INC. (DELAWARE CORPORATION)
1835-B KRAMER LANE, SUITE 150
AUSTIN, TX 78758

FOR: PROVIDING ON-LINE NON-DOWNLOADABLE SOFTWARE FOR USE IN PRODUCING ELECTRONIC VERSIONS OF BOOKS, IN CLASS 42 (U.S. CLS. 100 AND 101).

FIRST USE 8-17-2007; IN COMMERCE 8-17-2007.

THE MARK CONSISTS OF STANDARD CHARACTERS WITHOUT CLAIM TO ANY PARTICULAR FONT, STYLE, SIZE, OR COLOR.

SER. NO. 77-452,155, FILED P.R. 4-18-2008; AM. S.R. 9-10-2008.

KELLY BOULTON, EXAMINING ATTORNEY

Int. Cl.: 43

Prior U.S. Cls.: 100 and 101

United States Patent and Trademark Office

Reg. No. 3,522,902

Registered Oct. 21, 2008

**SERVICE MARK
SUPPLEMENTAL REGISTER**

Brick City Bar & Grill

BRICK CITY BAR AND GRILL (NEW JERSEY
LIMITED LIABILITY COMPANY)

500 RT. 17 SOUTH

HASBROUCK HEIGHTS, NJ 07604

FOR: BAR AND RESTAURANT SERVICES, IN
CLASS 43 (U.S. CLS. 100 AND 101).

FIRST USE 3-25-2008; IN COMMERCE 3-27-2008.

THE MARK CONSISTS OF STANDARD CHAR-
ACTERS WITHOUT CLAIM TO ANY PARTICULAR
FONT, STYLE, SIZE, OR COLOR.

NO CLAIM IS MADE TO THE EXCLUSIVE
RIGHT TO USE "BAR AND GRILL", APART FROM
THE MARK AS SHOWN.

SER. NO. 77-455,676, FILED P.R. 4-23-2008; AM. S.R.
9-4-2008.

MEGHAN REINHART, EXAMINING ATTORNEY

Int. Cl.: 36

Prior U.S. Cls.: 100, 101, and 102

United States Patent and Trademark Office

Reg. No. 3,522,903

Registered Oct. 21, 2008

**SERVICE MARK
SUPPLEMENTAL REGISTER**

buyorrentrealestate.com

DEYCH, MIKHAIL (UNITED STATES INDIVIDUAL)

#209

4975 WASHINGTON STREET
WEST ROXBURY, MA 02132

FOR: REAL ESTATE AGENCIES; REAL ESTATE BROKERAGE; REAL ESTATE MANAGEMENT; REAL ESTATE RENTAL SERVICES, NAMELY, RENTAL OF RESIDENTIAL HOUSING , IN CLASS 36 (U.S. CLS. 100, 101 AND 102).

FIRST USE 1-9-2003; IN COMMERCE 1-9-2003.

THE MARK CONSISTS OF STANDARD CHARACTERS WITHOUT CLAIM TO ANY PARTICULAR FONT, STYLE, SIZE, OR COLOR.

SER. NO. 77-457,996, FILED P.R. 4-25-2008; AM. S.R. 8-22-2008.

JEFF DEFORD, EXAMINING ATTORNEY

Int. Cl.: 33

Prior U.S. Cls.: 47 and 49

United States Patent and Trademark Office

Reg. No. 3,522,904

Registered Oct. 21, 2008

**TRADEMARK
SUPPLEMENTAL REGISTER**

O'MALLEYS

INTERCONTINENTAL PACKAGING CO. (MIN-
NESOTA CORPORATION)
1999 SHEPARD ROAD
ST. PAUL, MN 55116

FOR: CREAM LIQUEURS, IN CLASS 33 (U.S. CLS.
47 AND 49).

FIRST USE 10-31-2007; IN COMMERCE 11-30-2007.

THE MARK CONSISTS OF STANDARD CHAR-
ACTERS WITHOUT CLAIM TO ANY PARTICULAR
FONT, STYLE, SIZE, OR COLOR.

SER. NO. 77-459,243, FILED P.R. 4-28-2008; AM. S.R.
9-5-2008.

ROBERT LAVACHE, EXAMINING ATTORNEY

Int. Cl.: 41

Prior U.S. Cls.: 100, 101, and 107

United States Patent and Trademark Office

Reg. No. 3,522,905

Registered Oct. 21, 2008

**SERVICE MARK
SUPPLEMENTAL REGISTER**

babies2sleep

DOUBLETALK, LLC (CALIFORNIA LIMITED
LIABILITY COMPANY)
774 FAIR OAKS DRIVE
ALAMO, CA 94507

FOR: EDUCATION SERVICES, NAMELY, PRO-
VIDING MENTORING, TUTORING, CLASSES,
SEMINARS AND WORKSHOPS IN THE FIELD OF
INFANT AND TODDLER SLEEP COACHING, IN
CLASS 41 (U.S. CLS. 100, 101 AND 107).

FIRST USE 10-6-2006; IN COMMERCE 10-6-2006.

THE MARK CONSISTS OF STANDARD CHAR-
ACTERS WITHOUT CLAIM TO ANY PARTICULAR
FONT, STYLE, SIZE, OR COLOR.

SER. NO. 77-465,291, FILED P.R. 5-4-2008; AM. S.R.
9-4-2008.

LINDA POWELL, EXAMINING ATTORNEY

Int. Cls.: 9 and 16

Prior U.S. Cls.: 2, 5, 21, 22, 23, 26, 29, 36, 37, 38, and 50

United States Patent and Trademark Office

Reg. No. 3,522,906

Registered Oct. 21, 2008

TRADEMARK
SUPPLEMENTAL REGISTER

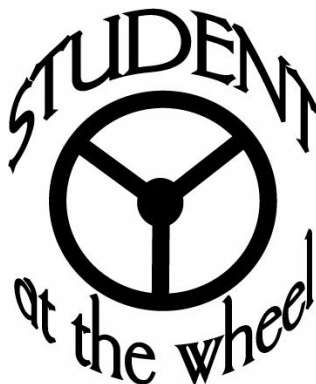

KLAYMAN, ALAN L (UNITED STATES INDIVIDUAL)
309 LYON CIRCLE
DOYLESTOWN, PA 18902

FOR: DECORATIVE MAGNETS, IN CLASS 9 (U.S. CLS. 21, 23, 26, 36 AND 38).

FIRST USE 4-22-2008; IN COMMERCE 4-24-2008.

FOR: DECALS, IN CLASS 16 (U.S. CLS. 2, 5, 22, 23, 29, 37, 38 AND 50).

FIRST USE 4-22-2008; IN COMMERCE 4-24-2008.

THE MARK CONSISTS OF THE WORDING "STUDENT AT THE WHEEL" FORMING THE PERIMETER AROUND A DESIGN OF A STEERING WHEEL.

SER. NO. 77-465,719, FILED P.R. 5-5-2008; AM. S.R. 9-11-2008.

NICHOLAS ALTREE, EXAMINING ATTORNEY

Int. Cl.: 35

Prior U.S. Cls.: 100, 101, and 102

United States Patent and Trademark Office

Reg. No. 3,522,907

Registered Oct. 21, 2008

**SERVICE MARK
SUPPLEMENTAL REGISTER**

National Crib Campaign

SUDDEN INFANT DEATH SYNDROME ALLIANCE, INC. (MARYLAND NON-PROFIT CORPORATION)

SUITE 210
1314 BEDFORD AVENUE
BALTIMORE, MD 21208

FOR: PUBLIC ADVOCACY TO PROMOTE AWARENESS OF INFANT MORTALITY, IN CLASS 35 (U.S. CLS. 100, 101 AND 102).

FIRST USE 11-5-2007; IN COMMERCE 11-5-2007.

THE MARK CONSISTS OF STANDARD CHARACTERS WITHOUT CLAIM TO ANY PARTICULAR FONT, STYLE, SIZE, OR COLOR.

NO CLAIM IS MADE TO THE EXCLUSIVE RIGHT TO USE "CAMPAIGN", APART FROM THE MARK AS SHOWN.

SER. NO. 77-467,150, FILED P.R. 5-6-2008; AM. S.R. 9-4-2008.

CORY BOONE, EXAMINING ATTORNEY

Int. Cl.: 1

Prior U.S. Cls.: 1, 5, 6, 10, 26, and 46

United States Patent and Trademark Office

Reg. No. 3,522,908

Registered Oct. 21, 2008

**TRADEMARK
SUPPLEMENTAL REGISTER**

NATURALLY ENRICHED

SURFATECH CORPORATION (GEORGIA CORPORATION)
2170 LUKE EDWARD ROAD
DACULA, GA 30019

FOR: CHEMICALS FOR USE IN THE MANUFACTURE OF COSMETIC AND PERSONAL CARE PRODUCTS, IN CLASS 1 (U.S. CLS. 1, 5, 6, 10, 26 AND 46).

FIRST USE 4-15-2008; IN COMMERCE 4-15-2008.

THE MARK CONSISTS OF STANDARD CHARACTERS WITHOUT CLAIM TO ANY PARTICULAR FONT, STYLE, SIZE, OR COLOR.

SER. NO. 77-469,364, FILED P.R. 5-8-2008; AM. S.R. 9-10-2008.

WENDY GOODMAN, EXAMINING ATTORNEY

Int. Cl.: 25

Prior U.S. Cls.: 22 and 39

United States Patent and Trademark Office

Reg. No. 3,522,909

Registered Oct. 21, 2008

TRADEMARK
SUPPLEMENTAL REGISTER

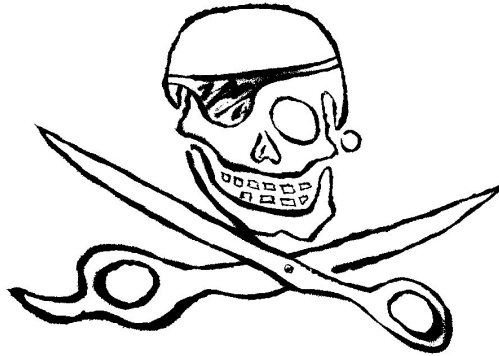

SCHWARZ, ERICH (UNITED STATES INDIVIDUAL)
5950 ESTES STREET
ARVADA, CO 80004

FOR: APRONS; BANDANAS; HATS; JACKETS;
POLO SHIRTS; PULLOVERS; SHIRTS; SHOES;
SKULL CAPS; SWEAT SHIRTS; T-SHIRTS, IN CLASS
25 (U.S. CLS. 22 AND 39).

FIRST USE 1-27-2006; IN COMMERCE 1-27-2006.

SER. NO. 77-472,899, FILED P.R. 5-13-2008; AM. S.R.
9-12-2008.

REBECCA POVARCHUK, EXAMINING ATTORNEY

Int. Cl.: 38

Prior U.S. Cls.: 100, 101, and 104

United States Patent and Trademark Office

Reg. No. 3,522,910

Registered Oct. 21, 2008

**SERVICE MARK
SUPPLEMENTAL REGISTER**

Military Brats Online

VANN BAKER (UNITED STATES INDIVIDUAL),
DBA MILITARY BRATS ONLINE,
2641 WOODSIDE DRIVE
DULUTH, GA 30096

FOR: PROVIDING ON-LINE CHAT ROOMS FOR
TRANSMISSION OF MESSAGES AMONG COMPU-
TER USERS CONCERNING EXPERIENCES GROW-
ING UP IN A MILITARY FAMILY , IN CLASS 38
(U.S. CLS. 100, 101 AND 104).

FIRST USE 5-1-1995; IN COMMERCE 5-1-1995.

THE MARK CONSISTS OF STANDARD CHAR-
ACTERS WITHOUT CLAIM TO ANY PARTICULAR
FONT, STYLE, SIZE, OR COLOR.

NO CLAIM IS MADE TO THE EXCLUSIVE
RIGHT TO USE "ONLINE", APART FROM THE
MARK AS SHOWN.

SER. NO. 77-475,183, FILED P.R. 5-15-2008; AM. S.R.
5-15-2008.

DAVID TOOLEY, EXAMINING ATTORNEY

Int. Cl.: 37

Prior U.S. Cls.: 100, 103, and 106

United States Patent and Trademark Office

Reg. No. 3,522,911

Registered Oct. 21, 2008

**SERVICE MARK
SUPPLEMENTAL REGISTER**

DESIGN+BUILD GROUP

DESIGN+BUILD GROUP, LLC (OKLAHOMA
LIMITED LIABILITY COMPANY)

816 N. BROADWAY

OKLAHOMA CITY, OK 73102

FOR: BUILDING CONSTRUCTION MANAGE-
MENT AND CONSULTING, IN CLASS 37 (U.S.
CLS. 100, 103 AND 106).

FIRST USE 9-5-2007; IN COMMERCE 9-5-2007.

THE MARK CONSISTS OF STANDARD CHAR-
ACTERS WITHOUT CLAIM TO ANY PARTICULAR
FONT, STYLE, SIZE, OR COLOR.

NO CLAIM IS MADE TO THE EXCLUSIVE
RIGHT TO USE "GROUP", APART FROM THE
MARK AS SHOWN.

SER. NO. 77-476,497, FILED P.R. 5-16-2008; AM. S.R.
9-5-2008.

RENEE MCCRAY, EXAMINING ATTORNEY

Int. Cl.: 41

Prior U.S. Cls.: 100, 101, and 107

United States Patent and Trademark Office

Reg. No. 3,522,912

Registered Oct. 21, 2008

**SERVICE MARK
SUPPLEMENTAL REGISTER**



NEW JERSEY STATE LIBRARY (NEW JERSEY CORPORATION)
185 WEST STATE STREET, PO BOX 520
TRENTON, NJ 08625

FOR: LIBRARIES, IN CLASS 41 (U.S. CLS. 100, 101 AND 107).

FIRST USE 9-24-2003; IN COMMERCE 9-24-2003.

THE COLOR(S) BLACK, PURPLE, BEIGE, WHITE, ORANGE AND GREEN IS/ARE CLAIMED AS A FEATURE OF THE MARK.

THE MARK CONSISTS OF A STYLIZED WOMAN WITH BLACK AND PURPLE HAIR, A BEIGE FACE AND PURPLE GLASSES WEARING A PURPLE SUIT WITH THE WHITE LETTERS "SL" WRITTEN WITHIN AN ORANGE CREST ON THE SUIT AND AN ORANGE CAPE OUTLINED IN BLACK HOLDING GREEN BOOKS OUTLINED IN BLACK WITH WHITE PAGES.

SER. NO. 77-477,966, FILED P.R. 5-19-2008; AM. S.R. 9-4-2008.

DAVID YONTEF, EXAMINING ATTORNEY

Int. Cl.: 41

Prior U.S. Cls.: 100, 101, and 107

United States Patent and Trademark Office

Reg. No. 3,522,913

Registered Oct. 21, 2008

**SERVICE MARK
SUPPLEMENTAL REGISTER**

SUPER LIBRARIAN

NEW JERSEY STATE LIBRARY (NEW JERSEY
CORPORATION)
185 WEST STATE STREET, PO BOX 520
TRENTON, NJ 08625

FOR: LIBRARIES, IN CLASS 41 (U.S. CLS. 100, 101
AND 107).

FIRST USE 9-23-2003; IN COMMERCE 9-23-2003.

THE MARK CONSISTS OF STANDARD CHAR-
ACTERS WITHOUT CLAIM TO ANY PARTICULAR
FONT, STYLE, SIZE, OR COLOR.

SER. NO. 77-478,002, FILED P.R. 5-19-2008; AM. S.R.
9-4-2008.

DAVID YONTEF, EXAMINING ATTORNEY

Int. Cl.: 9

Prior U.S. Cls.: 21, 23, 26, 36, and 38

Reg. No. 3,522,914

United States Patent and Trademark Office

Registered Oct. 21, 2008

**TRADEMARK
SUPPLEMENTAL REGISTER**

Athletic Trainer System

KEFFER DEVELOPMENT SERVICES, LLC
(PENNSYLVANIA LIMITED LIABILITY COMPANY)
24 VILLAGE PARK DRIVE
GROVE CITY, PA 16127

FOR: COMPUTER PROGRAMS FOR TRACKING INJURIES AND TREATMENTS TO ATHLETES AND MONITORING REHABILITATION AND MEDICAL PROCEDURES FOR USE BY HEALTH CARE PROFESSIONALS IN THE SPORTS INDUSTRY, IN CLASS 9 (U.S. CLS. 21, 23, 26, 36 AND 38).

FIRST USE 11-1-2006; IN COMMERCE 11-1-2006.

THE MARK CONSISTS OF STANDARD CHARACTERS WITHOUT CLAIM TO ANY PARTICULAR FONT, STYLE, SIZE, OR COLOR.

NO CLAIM IS MADE TO THE EXCLUSIVE RIGHT TO USE "SYSTEM", APART FROM THE MARK AS SHOWN.

SER. NO. 77-478,004, FILED P.R. 5-19-2008; AM. S.R. 9-10-2008.

DAVID YONTEF, EXAMINING ATTORNEY

Int. Cl.: 3

Prior U.S. Cls.: 1, 4, 6, 50, 51, and 52

United States Patent and Trademark Office

Reg. No. 3,522,915

Registered Oct. 21, 2008

**TRADEMARK
SUPPLEMENTAL REGISTER**

REJUVENATE DEEP CLEAN!

FOR LIFE PRODUCTS, INC. (FLORIDA CORPORATION)

2301 SW 145TH AVENUE

MIRAMAR, FL 33027

FOR: ALL PURPOSE CLEANER, IN CLASS 3 (U.S. CLS. 1, 4, 6, 50, 51 AND 52).

FIRST USE 11-29-2002; IN COMMERCE 12-5-2002.

THE MARK CONSISTS OF STANDARD CHARACTERS WITHOUT CLAIM TO ANY PARTICULAR FONT, STYLE, SIZE, OR COLOR.

NO CLAIM IS MADE TO THE EXCLUSIVE RIGHT TO USE "CLEAN", APART FROM THE MARK AS SHOWN.

SER. NO. 77-478,330, FILED 5-19-2008.

KIM SAITO, EXAMINING ATTORNEY

Int. Cl.: 41

Prior U.S. Cls.: 100, 101, and 107

United States Patent and Trademark Office

Reg. No. 3,522,916

Registered Oct. 21, 2008

**SERVICE MARK
SUPPLEMENTAL REGISTER**

Topics in Oncology

PLEXUS COMMUNICATIONS (NEW JERSEY
LIMITED LIABILITY COMPANY)
SUITE #250
2150 HIGHWAY 35
SEA GIRT, NJ 08750

FOR: EDUCATION SERVICES, NAMELY, PRO-
VIDING MEETINGS, LECTURES IN THE FIELD OF
ONCOLOGY, IN CLASS 41 (U.S. CLS. 100, 101 AND
107).

FIRST USE 6-1-2006; IN COMMERCE 8-2-2006.

THE MARK CONSISTS OF STANDARD CHAR-
ACTERS WITHOUT CLAIM TO ANY PARTICULAR
FONT, STYLE, SIZE, OR COLOR.

NO CLAIM IS MADE TO THE EXCLUSIVE
RIGHT TO USE "ONCOLOGY", APART FROM
THE MARK AS SHOWN.

SER. NO. 77-478,839, FILED P.R. 5-20-2008; AM. S.R.
9-9-2008.

DAVID COLLIER, EXAMINING ATTORNEY

Int. Cl.: 35

Prior U.S. Cls.: 100, 101, and 102

United States Patent and Trademark Office

Reg. No. 3,522,917

Registered Oct. 21, 2008

**SERVICE MARK
SUPPLEMENTAL REGISTER**

TRIBECA TREATS

TRIBECA TREATS, LLC (NEW YORK LIMITED
LIABILITY COMPANY)
94 READE STREET
NEW YORK, NY 10013

FOR: RETAIL STORE AND ON-LINE RETAIL
STORE SERVICES FEATURING CONFECTIONERY
GOODS AND BAKED GOODS, NAMELY, CHOCO-
LATES, CANDIES, COOKIES, AND CAKES , IN
CLASS 35 (U.S. CLS. 100, 101 AND 102).

FIRST USE 10-15-2003; IN COMMERCE 3-16-2004.

THE MARK CONSISTS OF STANDARD CHAR-
ACTERS WITHOUT CLAIM TO ANY PARTICULAR
FONT, STYLE, SIZE, OR COLOR.

SER. NO. 77-479,581, FILED 5-20-2008.

DAVID TOOLEY, EXAMINING ATTORNEY

Int. Cl.: 35

Prior U.S. Cls.: 100, 101, and 102

United States Patent and Trademark Office

Reg. No. 3,522,918

Registered Oct. 21, 2008

**SERVICE MARK
SUPPLEMENTAL REGISTER**

**NATIONAL REGISTRY OF DANCE
STUDIOS**

NATIONAL REGISTRY OF DANCE STUDIOS,
INC. (DELAWARE CORPORATION)

6 BEECHWOOD AVENUE

SUDBURY, MA 01776

FOR: MAINTAINING A REGISTRY OF DANCE
STUDIOS, IN CLASS 35 (U.S. CLS. 100, 101 AND 102).

FIRST USE 5-19-2008; IN COMMERCE 5-19-2008.

THE MARK CONSISTS OF STANDARD CHAR-
ACTERS WITHOUT CLAIM TO ANY PARTICULAR
FONT, STYLE, SIZE, OR COLOR.

NO CLAIM IS MADE TO THE EXCLUSIVE
RIGHT TO USE "REGISTRY OF DANCE STUDIOS",
APART FROM THE MARK AS SHOWN.

SER. NO. 77-480,253, FILED 5-21-2008.

HELENE LIWINSKI, EXAMINING ATTORNEY

Int. Cl.: 14

Prior U.S. Cls.: 2, 27, 28, and 50

United States Patent and Trademark Office

Reg. No. 3,522,919

Registered Oct. 21, 2008

**TRADEMARK
SUPPLEMENTAL REGISTER**

**AUTISM - Would you know if
you saw it?**

AUTISM GEAR (FLORIDA SOLE PROPRIETOR-
SHIP)
P.O. BOX 121021
CLERMONT, FL 34712

FOR: BRACELETS; CHARITY BRACELETS;
PLASTIC BRACELETS IN THE NATURE OF JEW-
ELRY; RUBBER OR SILICON WRISTBANDS IN
THE NATURE OF A BRACELET, IN CLASS 14
(U.S. CLS. 2, 27, 28 AND 50).

FIRST USE 3-11-2005; IN COMMERCE 2-14-2006.

THE MARK CONSISTS OF STANDARD CHAR-
ACTERS WITHOUT CLAIM TO ANY PARTICULAR
FONT, STYLE, SIZE, OR COLOR.

OWNER OF U.S. REG. NO. 3,243,698.

SER. NO. 77-480,985, FILED P.R. 5-22-2008; AM. S.R.
9-8-2008.

DAVID YONTEF, EXAMINING ATTORNEY

Int. Cls.: 16, 18, and 21

**Prior U.S. Cls.: 1, 2, 3, 5, 13, 22, 23, 29, 30, 33, 37, 38,
40, 41, and 50**

Reg. No. 3,522,920

United States Patent and Trademark Office

Registered Oct. 21, 2008

**TRADEMARK
SUPPLEMENTAL REGISTER**

AUTISM
Would you know if you saw
it?

AUTISM GEAR (FLORIDA SOLE PROPRIETOR-
SHIP)
P.O. BOX 121021
CLERMONT, FL 34712

FOR: WRITING IMPLEMENTS; PENS; PENCILS,
IN CLASS 16 (U.S. CLS. 2, 5, 22, 23, 29, 37, 38 AND 50).

FIRST USE 3-11-2005; IN COMMERCE 11-27-2006.

FOR: BACKPACKS; BACKPACKS, BOOK BAGS,
SPORTS BAGS, BUM BAGS, WALLETS AND HAND-
BAGS; SCHOOLCHILDREN'S BACKPACKS; TOTE
BAGS, IN CLASS 18 (U.S. CLS. 1, 2, 3, 22 AND 41).

FIRST USE 3-11-2005; IN COMMERCE 5-5-2005.

FOR: SPORTS BOTTLES SOLD EMPTY; BOTTLES,
SOLD EMPTY; PLASTIC WATER BOTTLES SOLD
EMPTY; SQUEEZE BOTTLE SOLD EMPTY, IN
CLASS 21 (U.S. CLS. 2, 13, 23, 29, 30, 33, 40 AND 50).

FIRST USE 3-11-2005; IN COMMERCE 5-13-2005.

THE MARK CONSISTS OF STANDARD CHAR-
ACTERS WITHOUT CLAIM TO ANY PARTICULAR
FONT, STYLE, SIZE, OR COLOR.

OWNER OF U.S. REG. NO. 3,243,698.

SER. NO. 77-481,020, FILED P.R. 5-22-2008; AM. S.R.
9-8-2008.

DAVID YONTEF, EXAMINING ATTORNEY

Int. Cls.: 41 and 44

Prior U.S. Cls.: 100, 101, and 107

United States Patent and Trademark Office

Reg. No. 3,522,921

Registered Oct. 21, 2008

**SERVICE MARK
SUPPLEMENTAL REGISTER**

FitnessCoachPro.com

AMERICAN SPECIALTY HEALTH INCORPORATED (DELAWARE CORPORATION)
LIZ HORTON, MAIL STOP #4H
777 FRONT STREET
SAN DIEGO, CA 92101

FOR: PROVIDING A WEBSITE FOR PERSONAL TRAINERS FEATURING INFORMATION ON EXERCISE AND FITNESS, IN CLASS 41 (U.S. CLS. 100, 101 AND 107).

FIRST USE 1-16-2007; IN COMMERCE 8-1-2007.

FOR: PROVIDING A WEBSITE FOR HEALTH CARE PROFESSIONALS, NAMELY, MEDICAL

DOCTORS, PHYSICAL THERAPISTS, AND CHIROPRACTORS, FEATURING INFORMATION ON HEALTH AND NUTRITION, IN CLASS 44 (U.S. CLS. 100 AND 101).

FIRST USE 1-16-2007; IN COMMERCE 8-1-2007.

OWNER OF U.S. REG. NOS. 3,361,066 AND 3,478,364.

SER. NO. 77-481,688, FILED P.R. 5-22-2008; AM. S.R. 9-10-2008.

BENJAMIN ALLEN, EXAMINING ATTORNEY

Int. Cls.: 41 and 44

Prior U.S. Cls.: 100, 101, and 107

United States Patent and Trademark Office

Reg. No. 3,522,922

Registered Oct. 21, 2008

**SERVICE MARK
SUPPLEMENTAL REGISTER**

FitnessCoach.com

AMERICAN SPECIALTY HEALTH INCORPORATED (DELAWARE CORPORATION)

LIZ HORTON, MAIL STOP #4H

777 FRONT STREET

SAN DIEGO, CA 92101

FOR: PROVIDING A WEB SITE FEATURING INFORMATION ON EXERCISE AND FITNESS, IN CLASS 41 (U.S. CLS. 100, 101 AND 107).

FIRST USE 12-6-2006; IN COMMERCE 9-1-2007.

FOR: PROVIDING A WEB SITE FEATURING INFORMATION ON HEALTH AND NUTRITION, IN CLASS 44 (U.S. CLS. 100 AND 101).

FIRST USE 12-6-2006; IN COMMERCE 9-1-2007.

OWNER OF U.S. REG. NOS. 3,361,066 AND 3,478,364.

SER. NO. 77-481,724, FILED P.R. 5-22-2008; AM. S.R. 9-10-2008.

BENJAMIN ALLEN, EXAMINING ATTORNEY

Int. Cl.: 16

Prior U.S. Cls.: 2, 5, 22, 23, 29, 37, 38, and 50

United States Patent and Trademark Office

Reg. No. 3,522,923

Registered Oct. 21, 2008

**TRADEMARK
SUPPLEMENTAL REGISTER**

Family Care Series

LINDA B. FINDLAY (UNITED STATES INDIVIDUAL), DBA MOURNING DISCOVERIES,
114 GARRETT'S GROVE
WHITESBORO, NY 13492

FOR: SERIES OF NON-FICTION BOOKS IN THE FIELD OF GRIEF AND BEREAVEMENT, IN CLASS 16 (U.S. CLS. 2, 5, 22, 23, 29, 37, 38 AND 50).

FIRST USE 5-1-2008; IN COMMERCE 5-1-2008.

THE MARK CONSISTS OF STANDARD CHARACTERS WITHOUT CLAIM TO ANY PARTICULAR FONT, STYLE, SIZE, OR COLOR.

NO CLAIM IS MADE TO THE EXCLUSIVE RIGHT TO USE "SERIES", APART FROM THE MARK AS SHOWN.

SER. NO. 77-483,196, FILED P.R. 5-25-2008; AM. S.R. 9-10-2008.

BARBARA GAYNOR, EXAMINING ATTORNEY

Int. Cl.: 36

Prior U.S. Cls.: 100, 101, and 102

United States Patent and Trademark Office

Reg. No. 3,522,924

Registered Oct. 21, 2008

**SERVICE MARK
SUPPLEMENTAL REGISTER**

**ALTERNATIVE INVESTMENTS
ADVISOR**

J.J. HILLIARD, W.L. LYONS, LLC (KENTUCKY
LIMITED LIABILITY COMPANY), DBA HIL-
LIARD LYONS,
P.O BOX 32760
LOUISVILLE, KY 402322760

FOR: FINANCIAL ANALYSIS AND CONSULTA-
TION; FINANCIAL AND INVESTMENT SERVICES,
NAMELY, MANAGEMENT AND BROKERAGE IN
THE FIELDS OF STOCKS, BONDS, OPTIONS, COM-
MODITIES, FUTURES AND OTHER SECURITIES,
AND THE INVESTMENT OF FUNDS OF OTHERS;
FINANCIAL PORTFOLIO ANALYSIS SERVICES;

FINANCIAL PORTFOLIO MANAGEMENT, IN
CLASS 36 (U.S. CLS. 100, 101 AND 102).

FIRST USE 5-27-2008; IN COMMERCE 5-27-2008.

THE MARK CONSISTS OF STANDARD CHAR-
ACTERS WITHOUT CLAIM TO ANY PARTICULAR
FONT, STYLE, SIZE, OR COLOR.

SER. NO. 77-484,940, FILED 5-28-2008.

MARY CRAWFORD, EXAMINING ATTORNEY

Int. Cl.: 39

Prior U.S. Cls.: 100 and 105

United States Patent and Trademark Office

Reg. No. 3,522,925

Registered Oct. 21, 2008

**SERVICE MARK
SUPPLEMENTAL REGISTER**

**AMERICAS FIRST TRAVEL
YELLOW PAGES**

YELLOWPAGES.TRAVEL, LLC (NEVADA LIMITED LIABILITY COMPANY)

#245

3395 SOUTH JONES BLVD.
LAS VEGAS, NV 89146

FOR: TRAVEL AGENCY SERVICES, NAMELY, MAKING RESERVATIONS AND BOOKINGS FOR TRANSPORTATION; TRAVEL INFORMATION SERVICES, NAMELY, PROVIDING TRAVEL INFORMATION FROM VARIOUS TRAVEL WEBSITES OF OTHERS FOR COMPARISON PURPOSES, IN CLASS 39 (U.S. CLS. 100 AND 105).

FIRST USE 5-20-2008; IN COMMERCE 5-20-2008.

THE MARK CONSISTS OF STANDARD CHARACTERS WITHOUT CLAIM TO ANY PARTICULAR FONT, STYLE, SIZE, OR COLOR.

NO CLAIM IS MADE TO THE EXCLUSIVE RIGHT TO USE "TRAVEL YELLOW PAGES", APART FROM THE MARK AS SHOWN.

SER. NO. 77-487,110, FILED P.R. 5-30-2008; AM. S.R. 9-4-2008.

DAVID TOOLEY, EXAMINING ATTORNEY

Int. Cl.: 25

Prior U.S. Cls.: 22 and 39

United States Patent and Trademark Office

Reg. No. 3,522,926

Registered Oct. 21, 2008

**TRADEMARK
SUPPLEMENTAL REGISTER**



The image shows the word "LADY" in a stylized, outlined font. The letters "LA" are positioned above the letters "DY", creating a layered effect. The letters are bold and have a consistent thickness throughout.

RAAM BERKOWITZ (UNITED STATES INDIVIDUAL)
245 NORTH STREET
WILLITS, CA 95490

THE MARK CONSISTS OF THE LETTERS "LA" WRITTEN OVER THE LETTERS "DY", IN LARGE, STYLIZED LETTERS.

FOR: BATHING SUITS; SHIRTS; SHORT TROUSERS; SWEATERS; TROUSERS, IN CLASS 25 (U.S. CLS. 22 AND 39).

SER. NO. 77-491,267, FILED P.R. 6-4-2008; AM. S.R. 9-5-2008.

FIRST USE 12-7-2007; IN COMMERCE 12-7-2007.

AMY GEARIN, EXAMINING ATTORNEY

Int. Cl.: 35

Prior U.S. Cls.: 100, 101, and 102

United States Patent and Trademark Office

Reg. No. 3,522,927

Registered Oct. 21, 2008

**SERVICE MARK
SUPPLEMENTAL REGISTER**

National Campaign for Cribs

SUDDEN INFANT DEATH SYNDROME ALLIANCE, INC. (MARYLAND NON-PROFIT CORPORATION)

SUITE 210
1314 BEDFORD AVENUE
BALTIMORE, MD 21208

FOR: PUBLIC ADVOCACY TO PROMOTE AWARENESS OF INFANT MORTALITY, IN CLASS 35 (U.S. CLS. 100, 101 AND 102).

FIRST USE 9-15-2005; IN COMMERCE 9-15-2005.

THE MARK CONSISTS OF STANDARD CHARACTERS WITHOUT CLAIM TO ANY PARTICULAR FONT, STYLE, SIZE, OR COLOR.

NO CLAIM IS MADE TO THE EXCLUSIVE RIGHT TO USE "CAMPAIGN", APART FROM THE MARK AS SHOWN.

SER. NO. 77-517,756, FILED P.R. 7-9-2008; AM. S.R. 9-4-2008.

CORY BOONE, EXAMINING ATTORNEY

Int. Cl.: 25

Prior U.S. Cls.: 22 and 39

United States Patent and Trademark Office

Reg. No. 3,522,928

Registered Oct. 21, 2008

**TRADEMARK
SUPPLEMENTAL REGISTER**

Cheers To Life

LABLANC, PAUL G (WASHINGTON LIMITED
LIABILITY COMPANY), DBA CHEERS TO
LIFE,
20722 33RD AVE W
LYNNWOOD, WA 98036

THE MARK CONSISTS OF STANDARD CHAR-
ACTERS WITHOUT CLAIM TO ANY PARTICULAR
FONT, STYLE, SIZE, OR COLOR.

FOR: SHORT-SLEEVED OR LONG-SLEEVED T-
SHIRTS; TANK TOPS; VISORS, IN CLASS 25 (U.S.
CLS. 22 AND 39).

SER. NO. 77-525,527, FILED P.R. 7-18-2008; AM. S.R.
9-2-2008.

FIRST USE 4-22-2008; IN COMMERCE 5-1-2008.

MARILYN IZZI, EXAMINING ATTORNEY

Int. Cl.: 25

Prior U.S. Cls.: 22 and 39

United States Patent and Trademark Office

Reg. No. 3,522,929

Registered Oct. 21, 2008

**TRADEMARK
SUPPLEMENTAL REGISTER**

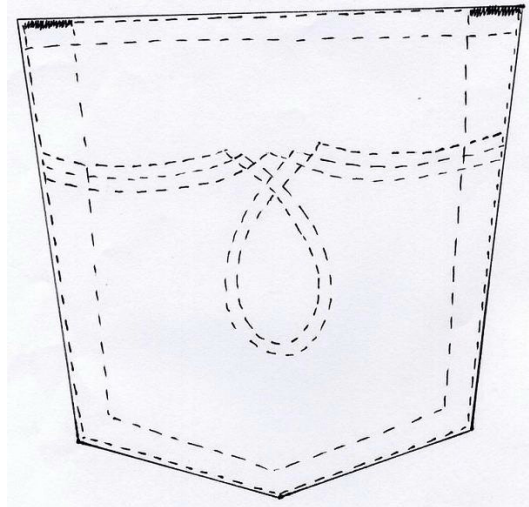

LUCKY BRAND DUNGAREES, INC. (CALIFORNIA CORPORATION)
5233 ALCOA AVENUE
VERNON, CA 90058

FOR: JEANS, IN CLASS 25 (U.S. CLS. 22 AND 39).

FIRST USE 1-0-2006; IN COMMERCE 1-0-2006.

NO CLAIM IS MADE TO THE EXCLUSIVE RIGHT TO USE A STANDARD POCKET DESIGN OR THE DESIGN OF DOUBLE STITCHING

AROUND THE PERIMETER OF THE POCKET, APART FROM THE MARK AS SHOWN.

THE MARK CONSISTS OF A TRIPLE LINE OF STITCHES HORIZONTALLY ACROSS A POCKET, AND CONVERGING INTO A DOUBLE STITCHED LOOP.

SER. NO. 77-536,894, FILED P.R. 8-1-2008; AM. S.R. 9-5-2008.

IRA J. GOODSaid, EXAMINING ATTORNEY

Int. Cl.: 41

Prior U.S. Cls.: 100, 101, and 107

United States Patent and Trademark Office

Reg. No. 3,522,930

Registered Oct. 21, 2008

**SERVICE MARK
SUPPLEMENTAL REGISTER**

World Air League

WORLD AIR LEAGUE LLC (DELAWARE LIMITED LIABILITY COMPANY)
875 PROSPECT
LA JOLLA, CA 92037

THE MARK CONSISTS OF STANDARD CHARACTERS WITHOUT CLAIM TO ANY PARTICULAR FONT, STYLE, SIZE, OR COLOR.

FOR: ORGANIZING SPORTING EVENTS, NAMELY, AERIAL COMPETITIONS, IN CLASS 41 (U.S. CLS. 100, 101 AND 107).

SER. NO. 77-975,803, FILED P.R. 4-14-2007; AM. S.R. 2-11-2008.

FIRST USE 1-2-2007; IN COMMERCE 1-2-2007.

SOPHIA S. KIM, EXAMINING ATTORNEY

Int. Cls.: 21, 25, and 28

Prior U.S. Cls.: 2, 13, 22, 23, 29, 30, 33, 38, 39, 40, and 50

Reg. No. 3,522,931

United States Patent and Trademark Office

Registered Oct. 21, 2008

**TRADEMARK
SUPPLEMENTAL REGISTER**

RUN LIGHTNING

RUN LIGHTNING PRODUCTIONS, LLC
(NORTH CAROLINA CORPORATION)
36 CHILES AVENUE
ASHEVILLE, NC 28803

FOR: MUGS, PLATES, BOWLS, LUNCH BOXES, DRINKING GLASSES AND CUPS, PAPER CUPS, PLASTIC CUPS, PAPER PLATES, PAPER BOWLS, NON-ELECTRIC TOOTHBRUSHES; TOOTHBRUSH HOLDERS, COMMEMORATIVE PLATES, COOKIE JARS, NON-METAL COIN BANKS, CHILDREN'S DINNERWARE, IN CLASS 21 (U.S. CLS. 2, 13, 23, 29, 30, 33, 40 AND 50).

FIRST USE 4-19-2007; IN COMMERCE 4-19-2007.

FOR: MEN'S, WOMEN'S, AND CHILDREN'S CLOTHING AND ATHLETIC WEAR, NAMELY, UNDERWEAR, RAINWEAR, SLEEPWEAR, HOSIERY, FOOTWEAR, BELTS, SUSPENDERS, CAPS, HEAD WEAR, KNIT CAPS, BATHROBES, BELTS, COATS, SHIRTS, GLOVES, HATS, JACKETS, JOGGING SUITS, LEATHER JACKETS, MITTENS, PAJAMAS, SCARVES, SHORTS, PANTS, SKIRTS, DRESSES, SLIPPERS, SOCKS, SWEATERS, SWIM WEAR, TANK TOPS, TIES, VESTS, MASQUERADE COSTUMES AND MASKS SOLD IN CONNECTION THEREWITH; BOXER SHORTS; LONG UNDERWEAR; HEADBANDS, WRISTBANDS, LEOTARDS, SINGLETs, UNITARDS, VISORS, WARM-UP SUITS, OVERALLS, WIND-RESISTANT JACKETS, PARKAS, JUMPSUITS, CROP TOPS, FITNESS TOPS, TIGHTS, TENNIS WEAR, ANORAKS, SWEAT-SHIRTS, SWEATPANTS, AND T-SHIRTS, IN CLASS 25 (U.S. CLS. 22 AND 39).

FIRST USE 4-19-2007; IN COMMERCE 4-19-2007.

FOR: TOYS, GAMES AND PLAYTHINGS, NAME-
LY, BALLOONS; BOARD GAMES; TOY CANDY
DISPENSERS AND HOLDERS; CARD GAMES; TOY
VEHICLES; DOLLS; STAND ALONE VIDEO GAME
MACHINES; HAND HELD UNITS FOR PLAYING
ELECTRONIC GAMES; HI BOUNCE BALLS; COS-
TUME MASKS; PAPER FACE MASKS; TOY MODEL
VEHICLES AND RELATED ACCESSORIES THERE-
FOR SOLD AS UNITS; TOY PEDAL CARS; PLAY-
SETS FOR ACTION FIGURES; PLAYSETS FOR TOY
VEHICLES; SKATEBOARDS; THREE-DIMENSION-
AL PUZZLES; TOY BANKS; TOY MODEL HOBBY
CRAFT KITS; TOY MODEL ROCKETS AND AC-
CESSORIES THEREFOR SOLD AS UNIT; TOY
WEAPONS; JIGSAW PUZZLES; TOY ACTION FIG-
URES AND ACCESSORIES THEREFOR; PLUSH
TOYS; ROLLER SKATES; IN-LINE SKATES;
CHRISTMAS TREE ORNAMENTS; AMUSEMENT
PARK RIDES; TOY VEHICLES MADE OF NON-
PRECIOUS METALS; BEACH TOYS, NAMELY, IN-
FLATABLE TOYS; WATER SQUIRTING TOYS;
CONSTRUCTION TOYS; TOY BUILDING BLOCKS
AND CONNECTING LINKS FOR THE SAME; PRO-
TECTIVE PADS AND PADDING FOR SKATE-
BOARDING, IN-LINE SKATING, AND ROLLER
SKATING; TOY COIN BANKS; PINBALL MA-
CHINES; INFLATABLE SWIMMING POOLS; IN-
FLATABLE POOL TOYS; TOY SNOW GLOBES;
TOY FOAM WEAPONS, IN CLASS 28 (U.S. CLS. 22,
23, 38 AND 50).

FIRST USE 4-19-2007; IN COMMERCE 4-19-2007.

SER. NO. 78-180,067, FILED P.R. 10-30-2002; AM.
S.R. 8-14-2008.

KATHRYN COWARD, EXAMINING ATTORNEY

Int. Cls.: 40 and 42

Prior U.S. Cls.: 100, 101, 103, and 106

United States Patent and Trademark Office

Reg. No. 3,522,932

Registered Oct. 21, 2008

**SERVICE MARK
SUPPLEMENTAL REGISTER**

PEDESTAL DESIGNS

PEDESTAL DESIGNS, INC. (CALIFORNIA CORPORATION)
931 HAMILTON AVENUE
MENLO PARK, CA 94025

FOR: MANUFACTURE OF PEDESTALS AND PEDESTAL SYSTEMS TO THE ORDER AND/OR SPECIFICATION OF OTHERS, IN CLASS 40 (U.S. CLS. 100, 103 AND 106).

FIRST USE 2-0-2000; IN COMMERCE 2-0-2000.

FOR: DESIGN OF PEDESTALS AND PEDESTAL SYSTEMS FOR COMMERCIAL, CATERING AND RESIDENTIAL APPLICATIONS, IN CLASS 42 (U.S. CLS. 100 AND 101).

FIRST USE 2-0-2000; IN COMMERCE 2-0-2000.

THE MARK CONSISTS OF STANDARD CHARACTERS WITHOUT CLAIM TO ANY PARTICULAR FONT, STYLE, SIZE, OR COLOR.

OWNER OF U.S. REG. NO. 2,755,484.

SER. NO. 78-592,825, FILED P.R. 3-22-2005; AM. S.R. 8-20-2008.

MARIA-VICTORIA SUAREZ, EXAMINING ATTORNEY

Int. Cls.: 6, 9, and 20

**Prior U.S. Cls.: 2, 12, 13, 14, 21, 22, 23, 25, 26, 32, 36,
38, and 50**

Reg. No. 3,522,933

United States Patent and Trademark Office

Registered Oct. 21, 2008

**TRADEMARK
SUPPLEMENTAL REGISTER**

LIVEBOLT

STRAGITEK CORP (CANADA CORPORATION)
425 FORGE ROAD S.E.
CALGARY, CANADA T2H 0S9

FOR: METAL LOCKS, IN CLASS 6 (U.S. CLS. 2, 12,
13, 14, 23, 25 AND 50).

FOR: ELECTRONIC SECURITY LOCKS AND
ELECTRONIC LOCKING PRODUCTS, NAMELY,
ELECTRONIC LOCKBOXES, ELECTRONICALLY
OPERATED HIGH SECURITY LOCK CYLINDERS,
ELECTRONICALLY OPERATED DOOR LATCHES,
ELECTRONICALLY OPERATED LOCKS; LOCKS
WITH ELECTRONIC CONTROLLERS TO RECEIVE
AND TRANSMIT ELECTRONIC SIGNALS TO AC-
CESS, TRACK, LOCATE, CREATE, IDENTIFY, RE-
CEIVE AND TRANSMIT INFORMATION
RESPECTING GOODS AND ASSETS;ELECTRONIC
SECURITY LOCKS THAT INTERACT WITH CLI-
ENT AND SERVER SOFTWARE USING A DISTRIB-

UTED NETWORK, IN CLASS 9 (U.S. CLS. 21, 23, 26,
36 AND 38).

FOR: NON-METALLIC LOCKS, IN CLASS 20 (U.S.
CLS. 2, 13, 22, 25, 32 AND 50).

THE MARK CONSISTS OF STANDARD CHAR-
ACTERS WITHOUT CLAIM TO ANY PARTICULAR
FONT, STYLE, SIZE, OR COLOR.

PRIORITY CLAIMED UNDER SEC. 44(D) ON
CANADA APPLICATION NO. 1243841, FILED 1-17-
2005, REG. NO. TMA672012, DATED 9-5-2006, EX-
PIRES 9-5-2021.

SER. NO. 78-669,812, FILED P.R. 7-13-2005; AM. S.R.
9-11-2008.

LINDA ORNDORFF, EXAMINING ATTORNEY

Int. Cl.: 16

Prior U.S. Cls.: 2, 5, 22, 23, 29, 37, 38, and 50

United States Patent and Trademark Office

Reg. No. 3,522,934

Registered Oct. 21, 2008

**TRADEMARK
SUPPLEMENTAL REGISTER**

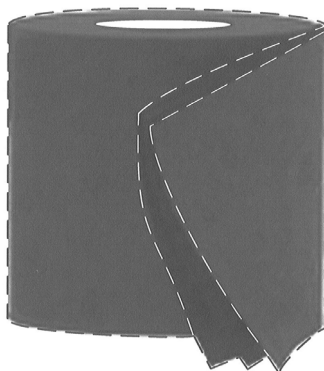

RENOVA - FABRICA DE PAPEL DO ALMONDA,
S.A. (PORTUGAL CORPORATION)
P-2354-001 TORRES NOVAS
ZIBREIRA, PORTUGAL

FOR: BATHROOM TISSUE, IN CLASS 16 (U.S.
CLS. 2, 5, 22, 23, 29, 37, 38 AND 50).

FIRST USE 3-24-2005; IN COMMERCE 8-15-2005.

THE COLOR(S) BLACK IS/ARE CLAIMED AS A
FEATURE OF THE MARK.

THE MARK CONSISTS OF THE COLOR BLACK
AS APPLIED TO THE GOODS. THE DOTTED OUT-
LINE OF THE GOODS IS INTENDED TO SHOW THE
POSITION OF THE MARK ON THE GOODS AND IS
NOT PART OF THE MARK.

SER. NO. 78-737,982, FILED P.R. 10-21-2005; AM.
S.R. 9-4-2008.

PAUL E. FAHRENKOPF, EXAMINING ATTORNEY

Int. Cls.: 29 and 32

Prior U.S. Cls.: 45, 46, and 48

United States Patent and Trademark Office

Reg. No. 3,522,935

Registered Oct. 21, 2008

**TRADEMARK
SUPPLEMENTAL REGISTER**

STIEBS POMEGRANATE PRODUCTS

STIEBS POMEGRANATE PRODUCTS (CALIFORNIA CORPORATION)
11767 ROAD 27 1/2
MADERA, CA 93637

FOR: DRIED POMEGRANATE FRUIT, IN CLASS 29 (U.S. CL. 46).

FIRST USE 9-1-2005; IN COMMERCE 9-1-2005.

FOR: POMEGRANATE JUICE CONCENTRATE, IN CLASS 32 (U.S. CLS. 45, 46 AND 48).

FIRST USE 9-1-2005; IN COMMERCE 9-1-2005.

THE MARK CONSISTS OF STANDARD CHARACTERS WITHOUT CLAIM TO ANY PARTICULAR FONT, STYLE, SIZE, OR COLOR.

NO CLAIM IS MADE TO THE EXCLUSIVE RIGHT TO USE "POMEGRANATE PRODUCTS", APART FROM THE MARK AS SHOWN.

SER. NO. 78-780,294, FILED P.R. 12-23-2005; AM. S.R. 12-0-2007.

STEPHANIE ALI, EXAMINING ATTORNEY

Int. Cl.: 36

Prior U.S. Cls.: 100, 101, and 102

United States Patent and Trademark Office

Reg. No. 3,522,936

Registered Oct. 21, 2008

**SERVICE MARK
SUPPLEMENTAL REGISTER**

BUY & TRY 30 DAY GUARANTEE

BFS BRANDS, LLC (DELAWARE LIMITED LIABILITY COMPANY)
535 MARRIOTT DRIVE
NASHVILLE, TN 37214

PRIORITY CLAIMED UNDER SEC. 44(D) ON CANADA APPLICATION NO. 1282753, FILED 12-13-2005.

FOR: PROVIDING EXTENDED WARRANTIES ON AUTOMOTIVE AND TRUCK TIRES, IN CLASS 36 (U.S. CLS. 100, 101 AND 102).

NO CLAIM IS MADE TO THE EXCLUSIVE RIGHT TO USE "30 DAY GUARANTEE", APART FROM THE MARK AS SHOWN.

FIRST USE 1-31-2006; IN COMMERCE 1-31-2006.

SER. NO. 78-789,174, FILED P.R. 1-11-2006; AM. S.R. 9-5-2008.

THE MARK CONSISTS OF STANDARD CHARACTERS WITHOUT CLAIM TO ANY PARTICULAR FONT, STYLE, SIZE, OR COLOR.

JANICE KIM, EXAMINING ATTORNEY

Int. Cl.: 9

Prior U.S. Cls.: 21, 23, 26, 36, and 38

Reg. No. 3,522,937

United States Patent and Trademark Office

Registered Oct. 21, 2008

**TRADEMARK
SUPPLEMENTAL REGISTER**

BABYCAM

ROSTRA PRECISION CONTROLS, INC. (CON-
NECTICUT CORPORATION)
2519 DANA DRIVE
LAURINBURG, NC 28352

THE MARK CONSISTS OF STANDARD CHAR-
ACTERS WITHOUT CLAIM TO ANY PARTICULAR
FONT, STYLE, SIZE, OR COLOR.

FOR: CAMERAS AND VIDEO DISPLAY MONI-
TORS FOR USE ON VEHICLES, IN CLASS 9 (U.S.
CLS. 21, 23, 26, 36 AND 38).

SER. NO. 78-797,774, FILED P.R. 1-24-2006; AM. S.R.
8-20-2008.

FIRST USE 12-6-2005; IN COMMERCE 12-6-2005.

LAURA HAMMEL, EXAMINING ATTORNEY

Int. Cls.: 16 and 35

Prior U.S. Cls.: 2, 5, 22, 23, 29, 37, 38, 50, 100, 101, and 102

Reg. No. 3,522,938

United States Patent and Trademark Office

Registered Oct. 21, 2008

**TRADEMARK
SERVICE MARK
SUPPLEMENTAL REGISTER**

**YELLOW PAGES CREATING
BRAND DEMAND**

YELLOW PAGES INTEGRATED MEDIA ASSOCIATION (DELAWARE NON-PROFIT CORPORATION), DBA YELLOW PAGES ASSOCIATION,
TWO CONNELL DRIVE, FIRST FLOOR
BERKELEY HEIGHTS, NJ 07922

FOR: ADDRESS LISTS; BOOKS IN THE FIELD OF YELLOW PAGES ADVERTISING; BROCHURES ABOUT YELLOW PAGES ADVERTISING; CATALOGS IN THE FIELD OF YELLOW PAGES ADVERTISING; DIRECTORIES OF ADVERTISING RATES IN YELLOW PAGES DIRECTORIES; EDUCATIONAL PUBLICATIONS, NAMELY, TRAINING MANUALS IN THE FIELD OF YELLOW PAGES ADVERTISING; MANUALS IN THE FIELD OF YELLOW PAGES ADVERTISING; MANUALS IN THE FIELD OF WHITE PAGES ADVERTISING; NEWSLETTERS IN THE FIELD OF YELLOW PAGES ADVERTISING; PRINTED FORMS; PRINTED PRODUCTS, NAMELY, LISTS FEATURING CONTACT INFORMATION AND BUSINESS HOURS FOR YELLOW PAGES PUBLISHERS AND WHITE PAGES PUBLISHERS, AS WELL AS CONTACT INFORMATION AND BUSINESS HOURS FOR CERTIFIED MARKETING REPRESENTATIVES IN THE FIELD OF YELLOW PAGES ADVERTISING AND WHITE PAGES ADVERTISING; PRINTED PRODUCTS, NAMELY, LISTS FEATURING YELLOW PAGES HEADINGS, IN CLASS 16 (U.S. CLS. 2, 5, 22, 23, 29, 37, 38 AND 50).

FIRST USE 12-31-2007; IN COMMERCE 12-31-2007.

FOR: ADVERTISING AND ADVERTISEMENT SERVICES; ADVERTISING AND PROMOTION SERVICES AND RELATED CONSULTING; ASSOCIATION SERVICES, NAMELY, PROMOTING THE

INTERESTS OF YELLOW PAGES DIRECTORY PUBLISHERS AND ADVERTISERS; COOPERATIVE ADVERTISING AND MARKETING; COOPERATIVE ADVERTISING AND MARKETING SERVICES BY WAY OF SOLICITATION, CUSTOMER SERVICE AND PROVIDING MARKETING INFORMATION VIA WEBSITES ON A GLOBAL COMPUTER NETWORK; LICENSING OF TELEPHONE DIRECTORY COOPERATIVE ADVERTISING RATES AND DATA; ON-LINE BUSINESS DIRECTORIES FEATURING CONTACT INFORMATION AND BUSINESS HOURS FOR YELLOW PAGES PUBLISHERS AND WHITE PAGES PUBLISHERS, AS WELL AS CERTIFIED MARKETING REPRESENTATIVES IN THE FIELD OF YELLOW PAGES ADVERTISING AND WHITE PAGES ADVERTISING; ON-LINE BUSINESS DIRECTORIES FEATURING YELLOW PAGES HEADINGS, IN CLASS 35 (U.S. CLS. 100, 101 AND 102).

FIRST USE 8-31-2008; IN COMMERCE 8-31-2008.

THE MARK CONSISTS OF STANDARD CHARACTERS WITHOUT CLAIM TO ANY PARTICULAR FONT, STYLE, SIZE, OR COLOR.

OWNER OF U.S. REG. NOS. 2,713,294, 3,012,726, AND OTHERS.

NO CLAIM IS MADE TO THE EXCLUSIVE RIGHT TO USE "YELLOW PAGES", APART FROM THE MARK AS SHOWN.

SER. NO. 78-851,670, FILED P.R. 3-31-2006; AM. S.R. 9-9-2008.

ALICIA COLLINS, EXAMINING ATTORNEY

Int. Cl.: 16

Prior U.S. Cls.: 2, 5, 22, 23, 29, 37, 38, and 50

United States Patent and Trademark Office

Reg. No. 3,522,939

Registered Oct. 21, 2008

**TRADEMARK
SUPPLEMENTAL REGISTER**

Bonus Days

IBASIS, INC. (DELAWARE CORPORATION)
20 SECOND AVENUE
BURLINGTON, MA 01803

FOR: PRE-PAID TELEPHONE CALLING CARDS,
NOT MAGNETICALLY ENCODED, IN CLASS 16
(U.S. CLS. 2, 5, 22, 23, 29, 37, 38 AND 50).

FIRST USE 5-29-2008; IN COMMERCE 5-29-2008.

THE MARK CONSISTS OF STANDARD CHAR-
ACTERS WITHOUT CLAIM TO ANY PARTICULAR
FONT, STYLE, SIZE, OR COLOR.

SER. NO. 78-858,358, FILED P.R. 4-10-2006; AM. S.R.
9-4-2008.

LINDA LAVACHE, EXAMINING ATTORNEY

Int. Cl.: 9

Prior U.S. Cls.: 21, 23, 26, 36, and 38

United States Patent and Trademark Office

Reg. No. 3,522,940

Registered Oct. 21, 2008

**TRADEMARK
SUPPLEMENTAL REGISTER**



QWICK KURB, INC. (FLORIDA CORPORATION)
1916 U.S. 41 SOUTH
RUSKIN, FL 33570

FOR: HIGHWAY SAFETY MARKERS; HIGH-
WAY SAFETY TRAFFIC CONTROL DELINEATORS
IN THE NATURE OF SAFETY MARKERS, IN
CLASS 9 (U.S. CLS. 21, 23, 26, 36 AND 38).

FIRST USE 9-6-2000; IN COMMERCE 9-6-2000.

THE MARK CONSISTS OF A CONFIGURATION
OF A TAPERED CYLINDRICAL SHAPED MAR-
KER HAVING AN ENLARGED CYLINDRICAL TOP
PORTION AND AN ENLARGED FLATTEN BOT-
TOM PORTION.

SER. NO. 78-884,111, FILED P.R. 5-15-2006; AM. S.R.
8-7-2008.

SANI KHOURI, EXAMINING ATTORNEY

Int. Cl.: 9

Prior U.S. Cls.: 21, 23, 26, 36, and 38

United States Patent and Trademark Office

Reg. No. 3,522,941

Registered Oct. 21, 2008

TRADEMARK
SUPPLEMENTAL REGISTER

RECON XT

GAMROTH, VIRGIL J. (NEVADA CORPORATION)
5301 LONGLEY LANE D-154
RENO, NV 89511

FOR: INFRARED CAMERA, IN CLASS 9 (U.S. CLS. 21, 23, 26, 36 AND 38).

FIRST USE 7-0-2003; IN COMMERCE 7-0-2003.

NO CLAIM IS MADE TO THE EXCLUSIVE RIGHT TO USE "XT" , APART FROM THE MARK AS SHOWN.

THE COLOR(S) RED AND WHITE ARE CLAIMED AS FEATURES OF THE MARK IS/ARE CLAIMED AS A FEATURE OF THE MARK.

THE MARK CONSISTS OF A WHITE RECTANGULAR BACKGROUND AND THE WORD "RECON XT" IN RED LETTERING WITH WHITE LINES THROUGHOUT THE TEXT.

SER. NO. 78-904,752, FILED P.R. 6-9-2006; AM. S.R. 8-18-2008.

SANJEEV VOHRA, EXAMINING ATTORNEY

Int. Cl.: 41

Prior U.S. Cls.: 100, 101, and 107

United States Patent and Trademark Office

Reg. No. 3,522,942

Registered Oct. 21, 2008

**SERVICE MARK
SUPPLEMENTAL REGISTER**

CARIBFEST

FORDE, MICHAEL C. (UNITED STATES INDIVIDUAL)
22 HENRYS FORK DRIVE
HAMPTON, VA 23666

FOR: ORGANIZING COMMUNITY FESTIVALS FEATURING A VARIETY OF ACTIVITIES, NAMELY, HANDMADE ARTS AND CRAFTS EXHIBITIONS, ETHNIC DANCES, LIVE CULTURAL PERFORMANCES, AND EXHIBITIONS FEATURING CARIBBEAN HISTORY AND DIASPORAS, IN CLASS 41 (U.S. CLS. 100, 101 AND 107).

FIRST USE 2-1-2006; IN COMMERCE 2-1-2006.

THE MARK CONSISTS OF STANDARD CHARACTERS WITHOUT CLAIM TO ANY PARTICULAR FONT, STYLE, SIZE, OR COLOR.

SER. NO. 78-904,947, FILED P.R. 6-9-2006; AM. S.R. 9-5-2008.

MARK SPARACINO, EXAMINING ATTORNEY

Int. Cl.: 25

Prior U.S. Cls.: 22 and 39

United States Patent and Trademark Office

Reg. No. 3,522,943

Registered Oct. 21, 2008

**TRADEMARK
SUPPLEMENTAL REGISTER**

The logo consists of the word "HONIGMAN" in a bold, white, sans-serif font, centered within a solid black rectangular background.

HONIGMAN AND SONS LTD (ISRAEL LIMITED
COMPANY)
58 SALAME STR.
TEL-AVIV, ISRAEL 66074

FOR: CLOTHING, NAMELY, JACKETS, PARKAS,
BLOUSES, SUITS, SKIRTS, PANTS, TROUSERS,
BREECHES, COATS, SWEATERS, VESTS, CARDI-
GANS, TEE-SHIRTS, SHIRTS, HATS, CAPS, STOCK-
INGS, DRESSES FOR WOMEN, CAMISOLES;
SPATS, UNIFORMS; CLOTHING OF LEATHER,
NAMELY, SKIRTS, COATS, JACKETS, TROUSERS,
APRONS, VESTS, SHIRTS AND GLOVES; BODICES,
SWEAT SHIRTS, APRONS, BABY'S PANTS, BATH-

ROBES, PAJAMAS, BATHING CAPS, BATHING
DRAWERS, BATHING SUITS, BANDANAS, SOCKS,
GLOVES, SCARVES, SHAWLS, BOAS, MUFFLERS,
NECKTIES, EAR MUFFS, BELTS, HEAD WEAR,
FOOTWEAR, SHOES, SANDALS, AND BOOTS, IN
CLASS 25 (U.S. CLS. 22 AND 39).

OWNER OF ISRAEL REG. NO. 177709, DATED 1-
16-2005, EXPIRES 1-16-2015.

SER. NO. 78-924,321, FILED P.R. 7-7-2006; AM. S.R.
3-12-2008.

CHRISTINE COOPER, EXAMINING ATTORNEY

Int. Cl.: 36

Prior U.S. Cls.: 100, 101, and 102

United States Patent and Trademark Office

Reg. No. 3,522,944

Registered Oct. 21, 2008

**SERVICE MARK
SUPPLEMENTAL REGISTER**

**THE CAPTIVE SOLUTION FOR
THE STAFFING INDUSTRY**

BARROW GROUP, LLC (GEORGIA LIMITED
LIABILITY COMPANY)
110 EAST CROGAN STREET
LAWRENCEVILLE, GA 30045

FOR: ADMINISTRATION OF EMPLOYEE BENE-
FIT PLANS; INSURANCE BROKERAGE; INSUR-
ANCE CONSULTATION, IN CLASS 36 (U.S. CLS. 100,
101 AND 102).

FIRST USE 7-0-2008; IN COMMERCE 7-0-2008.

THE MARK CONSISTS OF STANDARD CHAR-
ACTERS WITHOUT CLAIM TO ANY PARTICULAR
FONT, STYLE, SIZE, OR COLOR.

SER. NO. 78-931,441, FILED P.R. 7-18-2006; AM. S.R.
9-8-2008.

JASON LOTT, EXAMINING ATTORNEY

Int. Cl.: 38

Prior U.S. Cls.: 100, 101, and 104

United States Patent and Trademark Office

Reg. No. 3,522,945

Registered Oct. 21, 2008

**SERVICE MARK
SUPPLEMENTAL REGISTER**

TV SHOPPERS NETWORK

CPO INTERACTIVE, LLC (DELAWARE LIMITED
LIABILITY COMPANY)
2710 STURGES HIGHWAY
WESTPORT, CT 06880

FOR: STREAMING VIDEO OF INFOMERCIALS
AND DIRECT RESPONSE ADVERTISING ON THE
INTERNET, IN CLASS 38 (U.S. CLS. 100, 101 AND
104).

FIRST USE 9-0-2006; IN COMMERCE 9-0-2006.

THE MARK CONSISTS OF STANDARD CHAR-
ACTERS WITHOUT CLAIM TO ANY PARTICULAR
FONT, STYLE, SIZE, OR COLOR.

SER. NO. 78-941,299, FILED P.R. 7-31-2006; AM. S.R.
9-12-2008.

ANNE E. GUSTASON, EXAMINING ATTORNEY

Int. Cl.: 16

Prior U.S. Cls.: 2, 5, 22, 23, 29, 37, 38, and 50

United States Patent and Trademark Office

Reg. No. 3,522,946

Registered Oct. 21, 2008

**TRADEMARK
SUPPLEMENTAL REGISTER**

ART DECO DESIGNS

DEFLECTO CORPORATION (DELAWARE CORPORATION)
11937 EXIT FIVE PARKWAY
FISHERS, IN 46038

FOR: DESK AND OFFICE ACCESSORIES, NAME-
LY, FRONT LOADABLE LETTER TRAYS, FRONT
LOADABLE LEGAL TRAYS, SIDE LOADABLE LET-
TER TRAYS, SIDE LOADABLE LEGAL TRAYS,
PENCIL CUPS, DESKTOP BUSINESS CARD HOLD-
ERS, PLANNER STANDS IN THE FORM OF DIS-
PLAYS, LEAFLET HOLDERS, PAPER SIGN
HOLDERS, MAGAZINE FILE HOLDERS, FILE SOR-
TERS AND ELECTRONIC ORGANIZERS, IN CLASS
16 (U.S. CLS. 2, 5, 22, 23, 29, 37, 38 AND 50).

FIRST USE 6-30-2007; IN COMMERCE 6-30-2007.

THE MARK CONSISTS OF STANDARD CHAR-
ACTERS WITHOUT CLAIM TO ANY PARTICULAR
FONT, STYLE, SIZE, OR COLOR.

NO CLAIM IS MADE TO THE EXCLUSIVE
RIGHT TO USE "ART DECO", APART FROM THE
MARK AS SHOWN.

SER. NO. 78-950,089, FILED P.R. 8-11-2006; AM. S.R.
12-21-2007.

CAROL SPILS, EXAMINING ATTORNEY

Int. Cl.: 42

Prior U.S. Cls.: 100 and 101

United States Patent and Trademark Office

Reg. No. 3,522,947

Registered Oct. 21, 2008

**SERVICE MARK
SUPPLEMENTAL REGISTER**

MANAGED GLOBAL DELIVERY

SUN GRACE INC (MICHIGAN CORPORATION)
4661 HICKORY POINTE BLVD
PITTSFIELD TWP, MI 48197

THE MARK CONSISTS OF STANDARD CHAR-
ACTERS WITHOUT CLAIM TO ANY PARTICULAR
FONT, STYLE, SIZE, OR COLOR.

FOR: COMPUTER SOFTWARE DESIGN, COM-
PUTER PROGRAMMING, OR MAINTENANCE OF
COMPUTER SOFTWARE, IN CLASS 42 (U.S. CLS.
100 AND 101).

SER. NO. 78-951,632, FILED P.R. 8-14-2006; AM. S.R.
9-4-2008.

FIRST USE 6-14-2005; IN COMMERCE 6-14-2005.

ANDREA BUTLER, EXAMINING ATTORNEY

Int. Cl.: 9

Prior U.S. Cls.: 21, 23, 26, 36, and 38

Reg. No. 3,522,948

United States Patent and Trademark Office

Registered Oct. 21, 2008

**TRADEMARK
SUPPLEMENTAL REGISTER**

PullaChart

CLYDE, DEAN J. (UNITED STATES INDIVIDUAL)
6813 SW 45TH AVE
GAINESVILLE, FL 32608

THE MARK CONSISTS OF STANDARD CHARACTERS WITHOUT CLAIM TO ANY PARTICULAR FONT, STYLE, SIZE, OR COLOR.

FOR: COMPUTER SOFTWARE FOR CONTROLLING AND MANAGING PATIENT MEDICAL INFORMATION, IN CLASS 9 (U.S. CLS. 21, 23, 26, 36 AND 38).

SER. NO. 78-958,258, FILED P.R. 8-23-2006; AM. S.R. 8-18-2008.

FIRST USE 12-4-2007; IN COMMERCE 12-4-2007.

DORITT L. CARROLL, EXAMINING ATTORNEY

Int. Cls.: 20 and 24

Prior U.S. Cls.: 2, 13, 22, 25, 32, 42, and 50

United States Patent and Trademark Office

Reg. No. 3,522,949

Registered Oct. 21, 2008

**TRADEMARK
SUPPLEMENTAL REGISTER**

TECHNICAL BEDDING

QUIXOTE DESIGN, INC. (WASHINGTON CORPORATION)
SUITE A
4119 FREMONT AVENUE NORTH
SEATTLE, WA 98103

FOR: PILLOWS, IN CLASS 20 (U.S. CLS. 2, 13, 22, 25, 32 AND 50).

FIRST USE 8-31-2008; IN COMMERCE 8-31-2008.

FOR: PILLOW CASES , IN CLASS 24 (U.S. CLS. 42 AND 50).

FIRST USE 8-31-2008; IN COMMERCE 8-31-2008.

THE MARK CONSISTS OF STANDARD CHARACTERS WITHOUT CLAIM TO ANY PARTICULAR FONT, STYLE, SIZE, OR COLOR.

NO CLAIM IS MADE TO THE EXCLUSIVE RIGHT TO USE "BEDDING", APART FROM THE MARK AS SHOWN.

SER. NO. 78-961,980, FILED P.R. 8-28-2006; AM. S.R. 9-8-2008.

ANDREW RHIM, EXAMINING ATTORNEY

Int. Cl.: 36

Prior U.S. Cls.: 100, 101, and 102

United States Patent and Trademark Office

Reg. No. 3,522,950

Registered Oct. 21, 2008

**SERVICE MARK
SUPPLEMENTAL REGISTER**

GAP ANALYSIS

CHOICE PERFORMANCE, INC. (NEVADA CORPORATION)
1135 TERMINAL WAY
SUITE 209
RENO, NV 89502

FOR: PERSONAL FINANCIAL REVIEW SERVICES, IN CLASS 36 (U.S. CLS. 100, 101 AND 102).

FIRST USE 0-0-2005; IN COMMERCE 0-0-2005.

THE MARK CONSISTS OF STANDARD CHARACTERS WITHOUT CLAIM TO ANY PARTICULAR FONT, STYLE, SIZE, OR COLOR.

SER. NO. 78-963,136, FILED P.R. 8-29-2006; AM. S.R. 9-8-2008.

KATHY DE JONGE, EXAMINING ATTORNEY