

**Int. Cls.: 29 and 30**

**Prior U.S. Cl.: 46**

**United States Patent and Trademark Office**

**Reg. No. 3,503,351**

**Registered Sep. 23, 2008**

**TRADEMARK  
PRINCIPAL REGISTER**

**SAN ZENONE**

PRAIRIE HARVEST CANADA LIMITED (CANADA CORPORATION)  
BOX 1120 108 MAIN STREET  
ALTONA, MANITOBA, CANADA T0G 0B0

FOR: TOMATO PASTE; SOUPS AND ITALIAN SOUPS, NAMELY, MINISTRONE, LENTILS, BEANS, VEGETABLES, AND NOODLE SOUPS; PROCESSED WHOLE AND CRUSHED TOMATOES; PROCESSED VEGETABLES AND PROCESSED MIXED VEGETABLES; ITALIAN FOOD PRODUCTS, NAMELY, PROCESSED TOMATOES AND VEGETABLES, AND CHEESES, IN CLASS 29 (U.S. CL. 46).

FOR: PASTA AND PASTA RELATED PRODUCTS, NAMELY, SPAGHETTI, SPAGHETTINI, VERMICELLI, LINGUINI, FETTUCINE, LASAGNA, RIGATONI, MEZZI RIGATONI, PENNE LISCE, PENNE, ZITI CUT, BABY PASTINI, DITALI ELBOWS, BABY

SHELLS, SMALL SHELLS, LARGE SHELLS, ROTINI, ALPHABETS, NOODLES, MACARONI, TORTELLINI, RAVIOLI, CAPPELLINI, TWISTS, NESTS, ANGEL HAIR; TOMATO SAUCES; RICE; ITALIAN FOOD PRODUCTS, NAMELY, PASTAS AND PIZZA SAUCE; CARBONATED, NON-CARBONATED, AND NON-ALCOHOLIC BEVERAGES, NAMELY, TEA, ICED TEA, AND COFFEE, IN CLASS 30 (U.S. CL. 46).

OWNER OF CANADA REG. NO. TMA650859, DATED 10-20-2005, EXPIRES 10-20-2019.

THE ENGLISH TRANSLATION OF "SAN" AS "SAINT".

SER. NO. 75-324,795, FILED 7-15-1997.

SHARON MEIER, EXAMINING ATTORNEY

**Int. Cl.: 36**

**Prior U.S. Cls.: 100, 101 and 102**

**United States Patent and Trademark Office**

**Reg. No. 3,503,352**

**Registered Sep. 23, 2008**

**SERVICE MARK  
PRINCIPAL REGISTER**

**DYNAMIC CANADIAN RESOURCE FUND**

DUNDEE CORPORATION (CANADA CORPORATION)  
SCOTIA PLAZA 40 KING STREET WEST  
TORONTO, ONTARIO, CANADA M5H 4A9

FOR: MANAGEMENT OF MUTUAL FUNDS, IN  
CLASS 36 (U.S. CLS. 100, 101 AND 102).

PRIORITY CLAIMED UNDER SEC. 44(D) ON  
CANADA APPLICATION NO. 877304, FILED 5-5-

1998, REG. NO. TMA702487, DATED 12-6-2007, EX-  
PIRES 12-6-2022.

NO CLAIM IS MADE TO THE EXCLUSIVE  
RIGHT TO USE "CANADIAN RESOURCE FUND",  
APART FROM THE MARK AS SHOWN.

SER. NO. 75-514,130, FILED 7-7-1998.

RICHARD A. STRASER, EXAMINING ATTORNEY

**Int. Cl.: 31**

**Prior U.S. Cls.: 1 and 46**

**United States Patent and Trademark Office**

**Reg. No. 3,503,353**

**Registered Sep. 23, 2008**

**TRADEMARK  
PRINCIPAL REGISTER**

**DOGGY DELI**

KRAMER, ALLAN CARL (UNITED STATES IN-  
DIVIDUAL)  
5950 QUAAS AVE  
MAYER, MN 55360

NO CLAIM IS MADE TO THE EXCLUSIVE  
RIGHT TO USE "DOGGY" , APART FROM THE  
MARK AS SHOWN.

FOR: GOURMET EDIBLE DOG TREATS, IN  
CLASS 31 (U.S. CLS. 1 AND 46).

SER. NO. 75-647,712, FILED 2-25-1999.

FIRST USE 8-31-1998; IN COMMERCE 8-31-1998.

AMY GEARIN, EXAMINING ATTORNEY

**Int. Cl.: 14**

**Prior U.S. Cls.: 2, 27, 28 and 50**

**United States Patent and Trademark Office**

**Reg. No. 3,503,354**

**Registered Sep. 23, 2008**

---

**TRADEMARK  
PRINCIPAL REGISTER**

**STARLIGHT**

SELECT JEWELRY, INC. (NEW YORK COR-  
PORATION)  
37-02 48TH AVENUE  
LONG ISLAND CITY, NY 11101

FIRST USE 11-1-1998; IN COMMERCE 11-1-1998.

SER. NO. 76-107,284, FILED 8-10-2000.

FOR: JEWELRY, IN CLASS 14 (U.S. CLS. 2, 27, 28  
AND 50).

ANDREA SAUNDERS, EXAMINING ATTORNEY

**Int. Cls.: 5, 10, 40 and 42**

**Prior U.S. Cls.: 6, 18, 26, 39, 44, 46, 51, 52, 100, 101,  
103 and 106**

**Reg. No. 3,503,355**

**United States Patent and Trademark Office**

**Registered Sep. 23, 2008**

**TRADEMARK  
SERVICE MARK  
PRINCIPAL REGISTER**

**SKYESTABE**

JAGOTEC AG (SWITZERLAND CORPORATION)  
EPTINGERSTRASSE 51  
CH-4132 MUTTENZ, SWITZERLAND

FOR: PHARMACEUTICAL PREPARATIONS FOR USE IN THE TREATMENT OF RESPIRATORY DISEASES, NAMELY, ASTHMA AND CHRONIC OBSTRUCTIVE PULMONARY DISEASE; PHARMACEUTICAL PREPARATIONS DELIVERED IN AEROSOL FORM FOR USE IN THE TREATMENT OF RESPIRATORY DISEASES; VETERINARY PREPARATIONS FOR USE IN THE TREATMENT OF RESPIRATORY DISEASES IN LIVESTOCK AND DOMESTICATED PETS; TOPICAL PHARMACEUTICAL CARRIERS FOR STABILIZATION AND ENHANCING DELIVERY OF DELICATELY STABILIZED DRUGS USED IN THE TREATMENT OF RESPIRATORY DISEASES, CANCER, DISEASES OF THE CENTRAL NERVOUS SYSTEM; FOODS FOR MEDICALLY RESTRICTIVE DIETS; PREPARATIONS FOR DESTROYING VERMIN; INHALERS FILLED WITH PHARMACEUTICAL PREPARATIONS FOR TREATMENT OF CONDITIONS OF THE LUNGS AND PARTS AND FITTINGS THEREFOR, IN CLASS 5 (U.S. CLS. 6, 18, 44, 46, 51 AND 52).

FOR: INHALERS FOR THERAPEUTIC USE, SOLD EMPTY, AND PARTS AND FITTINGS THEREFOR, IN CLASS 10 (U.S. CLS. 26, 39 AND 44).

FOR: CUSTOM MANUFACTURE OF PHARMACEUTICALS TO THE ORDER AND SPECIFICATION OF OTHERS; CUSTOM MANUFACTURE OF MEDICAL GOODS, NAMELY INHALERS, TO THE ORDER AND SPECIFICATION OF OTHERS, IN CLASS 40 (U.S. CLS. 100, 103 AND 106).

FOR: DESIGN OF MEDICAL GOODS IN THE NATURE OF INHALERS FOR OTHERS, IN CLASS 42 (U.S. CLS. 100 AND 101).

THE MARK CONSISTS OF STANDARD CHARACTERS WITHOUT CLAIM TO ANY PARTICULAR FONT, STYLE, SIZE, OR COLOR.

PRIORITY CLAIMED UNDER SEC. 44(D) ON ERPN CMNTY TM OFC APPLICATION NO. 2984417, FILED 12-11-2002, REG. NO. 002984417, DATED 3-24-2004, EXPIRES 12-11-2012.

SER. NO. 76-505,672, FILED 4-9-2003.

REBECCA POVARCHUK, EXAMINING ATTORNEY

**Int. Cls.: 9, 16, 28, 30 and 41**

**Prior U.S. Cls.: 2, 5, 21, 22, 23, 26, 29, 36, 37, 38, 46,  
50, 100, 101 and 107**

**Reg. No. 3,503,356**

**United States Patent and Trademark Office**

**Registered Sep. 23, 2008**

**TRADEMARK  
SERVICE MARK  
PRINCIPAL REGISTER**



TRANSPORT FOR LONDON (UNITED KING-  
DOM PUBLIC UTILITY ESTABLISHED BY  
STATUTE)

WINDSOR HOUSE

42-50 VICTORIA STREET

LONDON SW1H 0TL ENGLAND, UNITED KING-  
DOM

FOR: COMPUTER SOFTWARE AND DOWN-  
LOADABLE SOFTWARE FOR USE IN TRAVEL  
PLANNING AND ROUTE PLANNING, AND COM-  
PUTER SOFTWARE FOR USE IN GENERATING  
TYPE FONTS; DOWNLOADABLE ELECTRONIC  
PUBLICATIONS, NAMELY, BOOKS, COMICS, MA-  
GAZINES FEATURING INFORMATION ON ART,  
POETRY, TRAVEL, HISTORY, CITY GUIDES,  
TOURISM, TRANSPORT AND CARTOONS; MO-  
BILE TELEPHONES; MAGNETICALLY CODED  
CREDIT CARDS; VENDING MACHINES; TICKET  
CANCELING MACHINES; MULTIMEDIA SOFT-  
WARE RECORDED ON CD-ROM FEATURING IN-  
FORMATION ON TRAVEL, TRANSPORT,  
HISTORY, CITY GUIDES, ART, POETRY AND  
TOURISM; PRERECORDED VIDEO DISCS FEAT-  
URING INFORMATION AND ENTERTAINMENT  
IN RELATION TO HISTORY, TRAVEL, TRANS-  
PORT, ART, CHILDREN'S STORY BOOKS, POET-  
RY, CARTOONS, CITY GUIDES AND TOURISM;  
PRERECORDED VIDEO TAPES, AUDIO TAPES,  
DISCS, VIDEO CASSETTES AND DVD'S FEATU-  
RING ANIMATED FILMS, DOCUMENTARIES,  
STORY BOOKS; MOUSE PADS; FILMS, NAMELY,

MOTION PICTURE FILMS FEATURING ANIMA-  
TED CARTOONS, IN CLASS 9 (U.S. CLS. 21, 23, 26, 36  
AND 38).

FOR: PRINTED PUBLICATIONS, NAMELY,  
BOOKS, MAGAZINES, COMICS, LEAFLETS AND  
BROCHURES FEATURING INFORMATION ON  
HISTORY, CITY GUIDES, TOURISM, TRAVEL,  
CARTOONS, ARTS, POETRY; DIARIES, CALEN-  
DARS, NOTEBOOKS, ADDRESS BOOKS, COAST-  
ERS MADE OF PAPER, BEER COASTERS MADE OF  
PAPER, STATIONERY, PENS, PENCILS, FOLDERS,  
RING BINDERS, WRITING PAPER, ENVELOPES,  
POSTCARDS, STICKERS, PHOTOGRAPHS, POS-  
TERS, BROCHURES, LEAFLETS, MAPS, GREET-  
ING CARDS, PRINTED TICKETS, PAPER LABELS,  
PAPER TAGS, PRINTED INSTRUCTIONAL AND  
TEACHING MATERIALS FEATURING INFORMA-  
TION ON HISTORY, TRAVEL, TRANSPORT, TOUR-  
ISM, ART, AND POETRY, IN CLASS 16 (U.S. CLS. 2,  
5, 22, 23, 29, 37, 38 AND 50).

FOR: PLAYING CARDS; BOARD GAMES; TOYS,  
NAMELY, SOFT SCULPTURE TOYS, CUDDLY  
TOYS IN THE NATURE OF PLUSH TOYS, SOFT  
SCULPTURE TOYS, STUFFED TOYS, DOLLS, TOY  
MODEL TRAIN SETS AND TRAIN SET ACCESSOR-  
IES, IN THE NATURE OF TOY MODEL STATIONS,  
BUILDINGS, BRIDGES, AND SCENERY; BALLS  
FOR SPORTS; FLYING DISCS, JIGSAW PUZZLES,  
BALLOONS, IN CLASS 28 (U.S. CLS. 22, 23, 38 AND  
50).

FOR: COFFEE, TEA; COCOA, SUGAR, RICE, FLOUR, BREAD, PASTRIES; CONFECTIONERY, NAMELY, CHOCOLATES, TOFFEES AND CANDIES; ICES, NAMELY, FRUIT ICE, ICE LOLLIES, FLAVOURED ICE; HONEY, TREACLE, MUSTARD, SAUCES, SPICES, IN CLASS 30 (U.S. CL. 46).

FOR: ENTERTAINMENT IN THE NATURE OF ON-GOING TELEVISION PROGRAMS IN THE FIELD OF ANIMATED CARTOONS AND DOCU-

MENTARIES, IN CLASS 41 (U.S. CLS. 100, 101 AND 107).

OWNER OF ERPN CMNTY TM OFC REG. NO. 003219268, DATED 2-21-2005, EXPIRES 10-6-2013.

SER. NO. 76-535,108, FILED 8-7-2003.

AMY ALFIERI, EXAMINING ATTORNEY

**Int. Cl.: 36**

**Prior U.S. Cls.: 100, 101 and 102**

**United States Patent and Trademark Office**

**Reg. No. 3,503,357**

**Registered Sep. 23, 2008**

**SERVICE MARK  
PRINCIPAL REGISTER**

**MASTR**

UBS AG (SWITZERLAND CORPORATION)  
BAHNHOFSTRASSE 45  
ZURICH, SWITZERLAND CH-8098

FOR: MORTGAGE BROKERAGE; LOAN AND ASSET SECURITIZATION; RESECURITIZATION OF MORTGAGE-BACKED AND ASSET-BACKED SECURITIES; ISSUANCE OF MORTGAGE-BACKED AND ASSET-BACKED SECURITIES; FINANCIAL RESEARCH; FINANCIAL SERVICES, NAMELY, PURCHASE, SECURITY BROKERAGE, TRANSFER, EXCHANGE, PLEDGE, FINANCE, REPURCHASE AND REVERSE REPURCHASE OF SECURITIES OR FINANCIAL OBLIGATIONS; AND FINANCIAL SERVICES, NAMELY, OFFERING FORWARD CONTRACTS, STANDBY CONTRACTS, FUTURES AND LISTED OR OVER-THE-COUNTER OPTIONS ON ANY OF THE FOREGOING OR ANY SWAP OR OTHER DERIVATIVE TRANSACTION ON ANY INDEX, RATE, SECURITY OR INSTRUMENT OR ANY DERIVATIVE THEREOF TO OTHERS; EXCLUDING FROM ALL

OF THE FOREGOING, BANK CARD, DEBIT CARD, CREDIT CARD, CHARGE CARD, MAGNETIC ENCODED CARD, SMART CARDS, STORED VALUE CARD AND/OR PREPAID CARD SERVICES, AUTOMATED TELLER MACHINE ("ATM") SERVICES, THE MARKETING, DISTRIBUTION, PROVISION AND ISSUANCE OF CARDS FOR SUCH SERVICES, ATM'S TRANSACTION AUTHORIZATION AND SETTLEMENT SERVICES, MONEY EXCHANGE SERVICES, AND ELECTRONIC SETTLEMENT SERVICES, IN CLASS 36 (U.S. CLS. 100, 101 AND 102).

FIRST USE 8-0-2001; IN COMMERCE 8-0-2001.

THE MARK CONSISTS OF STANDARD CHARACTERS WITHOUT CLAIM TO ANY PARTICULAR FONT, STYLE, SIZE, OR COLOR.

SER. NO. 76-569,716, FILED 1-13-2004.

GEOFFREY FOSDICK, EXAMINING ATTORNEY



Int. Cl.: 43

Prior U.S. Cls.: 100 and 101

United States Patent and Trademark Office

Reg. No. 3,503,358

Registered Sep. 23, 2008

SERVICE MARK  
PRINCIPAL REGISTER



BOYD GAMING CORPORATION (NEVADA  
CORPORATION)

2950 INDUSTRIAL ROAD

LAS VEGAS, NV 89109

FOR: RESTAURANT SERVICES, IN CLASS 43  
(U.S. CLS. 100 AND 101).

FIRST USE 3-22-1979; IN COMMERCE 3-22-1979.

NO CLAIM IS MADE TO THE EXCLUSIVE  
RIGHT TO USE "CAFE & MARKET", APART FROM  
THE MARK AS SHOWN.

THE LIKENESS (OR, "PORTRAIT") IN THE  
MARK DOES NOT IDENTIFY A LIVING INDIVI-  
DUAL.

SER. NO. 76-591,313, FILED 5-6-2004.

WON TEAK OH, EXAMINING ATTORNEY

**Int. Cl.: 43**

**Prior U.S. Cls.: 100 and 101**

**United States Patent and Trademark Office**

**Reg. No. 3,503,359**

**Registered Sep. 23, 2008**

**SERVICE MARK  
PRINCIPAL REGISTER**

**SMOKEY JOE'S**

BOYD GAMING CORPORATION (NEVADA  
CORPORATION)  
2950 INDUSTRIAL ROAD  
LAS VEGAS, NV 89109

THE MARK CONSISTS OF STANDARD CHAR-  
ACTERS WITHOUT CLAIM TO ANY PARTICULAR  
FONT, STYLE, SIZE, OR COLOR.

FOR: RESTAURANT SERVICES, IN CLASS 43  
(U.S. CLS. 100 AND 101).

SER. NO. 76-591,314, FILED 5-6-2004.

FIRST USE 3-22-1979; IN COMMERCE 3-22-1979.

WON TEAK OH, EXAMINING ATTORNEY

**Int. Cls.: 3 and 5**

**Prior U.S. Cls.: 1, 4, 6, 18, 44, 46, 50, 51 and 52**

**United States Patent and Trademark Office**

**Reg. No. 3,503,360**

**Registered Sep. 23, 2008**

**TRADEMARK  
PRINCIPAL REGISTER**

**POWER ONE**

TOPCO HOLDINGS, INC. (WISCONSIN COOP-  
ERATIVE CORPORATION)  
7711 GROSS POINT ROAD  
SKOKIE, IL 60073

FOR: ENZYME-BASED LAUNDRY DETERGENTS, ALL-PURPOSE LIQUID CLEANSERS, ALL-PURPOSE POWDERED CLEANSERS, SOAP IN THE FORM OF PADS FOR CLEANING PURPOSES, ALL-PURPOSE CLEANERS, AMMONIA FOR CLEANING PURPOSES, GLASS CLEANERS, DRAIN OPENERS, AEROSOL FURNITURE POLISH, FABRIC-CARE PREPARATION IN THE NATURE OF LAUNDRY PRE-WASH, ALL-FABRIC LAUNDRY BLEACH, DISH DETERGENT, AUTO DISH DETERGENTS, POWDERED AND LIQUID LAUNDRY DETERGENTS; CHLORINE, NAMELY, BLEACH-CHLORINE FOR CLEANING, HOUSEHOLD AND LAUNDRY PURPOSES, IN CLASS 3 (U.S. CLS. 1, 4, 6, 50, 51 AND 52).

FIRST USE 9-12-1995; IN COMMERCE 9-12-1995.

FOR: ALL-PURPOSE AEROSOL DISINFECTANT SPRAYS, DISINFECTANT TOILET BOWL CLEANERS, AEROSOL DISINFECTANT BATHROOM CLEANER SPRAY, IN CLASS 5 (U.S. CLS. 6, 18, 44, 46, 51 AND 52).

FIRST USE 9-12-1995; IN COMMERCE 9-12-1995.

THE MARK CONSISTS OF STANDARD CHARACTERS WITHOUT CLAIM TO ANY PARTICULAR FONT, STYLE, SIZE, OR COLOR.

OWNER OF U.S. REG. NOS. 1,951,960 AND 2,021,240.

SER. NO. 76-595,300, FILED 6-1-2004.

BRENDAN REGAN, EXAMINING ATTORNEY

**Int. Cls.: 6, 7 and 8**

**Prior U.S. Cls.: 2, 12, 13, 14, 19, 21, 23, 25, 28, 31, 34,  
35, 44 and 50**

**Reg. No. 3,503,361**

**United States Patent and Trademark Office**

**Registered Sep. 23, 2008**

**TRADEMARK  
PRINCIPAL REGISTER**

**SUREBONDER**

FPC CORPORATION (ILLINOIS CORPORATION)  
355 HOLLOW HILL DRIVE  
WAUCONDA, IL 60084

FOR: METAL FASTENERS, NAMELY BRADS,  
WIRE NAILS, STAPLES AND BRAD NAILS, RIVETS;  
METAL HARDWARE, NAMELY, WASHERS AND  
NUTS, IN CLASS 6 (U.S. CLS. 2, 12, 13, 14, 23, 25 AND  
50).

FIRST USE 11-15-1997; IN COMMERCE 11-15-1997.

FOR: HOT MELT GLUE GUNS; POWER-OPER-  
ATED STAPLE GUNS; AIR POWERED TOOLS,  
NAMELY, PNEUMATIC RIVET GUNS, IN CLASS 7  
(U.S. CLS. 13, 19, 21, 23, 31, 34 AND 35).

FIRST USE 1-1-1992; IN COMMERCE 1-1-1992.

FOR: HAND-POWERED STAPLE GUNS AND  
RIVET GUNS, IN CLASS 8 (U.S. CLS. 23, 28 AND 44).

FIRST USE 11-15-1997; IN COMMERCE 11-15-1997.

THE MARK CONSISTS OF STANDARD CHAR-  
ACTERS WITHOUT CLAIM TO ANY PARTICULAR  
FONT, STYLE, SIZE, OR COLOR.

SER. NO. 76-606,799, FILED 8-10-2004.

EDWARD NELSON, EXAMINING ATTORNEY

**Int. Cl.: 25**

**Prior U.S. Cls.: 22 and 39**

**United States Patent and Trademark Office**

**Reg. No. 3,503,362**

**Registered Sep. 23, 2008**

**TRADEMARK  
PRINCIPAL REGISTER**



ZIER, INC. (FLORIDA CORPORATION)  
P.O. BOX 268778  
WESTON, FL 333268778

OWNER OF U.S. REG. NO. 3,072,368.

FOR: SHOES, SANDALS, SLIPPERS, SHOE COVERINGS IN THE NATURE OF CLOTH COVERINGS SPECIFICALLY FITTED FOR SHOES NOT FOR MEDICAL PURPOSES, BOOTS AND SOCKS, IN CLASS 25 (U.S. CLS. 22 AND 39).

NO CLAIM IS MADE TO THE EXCLUSIVE RIGHT TO USE "FOOTWEAR", APART FROM THE MARK AS SHOWN.

SER. NO. 76-614,420, FILED 10-1-2004.

FIRST USE 6-3-2005; IN COMMERCE 6-7-2005.

CHARLOTTE CORWIN, EXAMINING ATTORNEY

**Int. Cl.: 5**

**Prior U.S. Cls.: 6, 18, 44, 46, 51 and 52**

**United States Patent and Trademark Office**

**Reg. No. 3,503,363**

**Registered Sep. 23, 2008**

**TRADEMARK  
PRINCIPAL REGISTER**

**PROTIBRION**

ASTELLAS PHARMA INC. (JAPAN CORPORATION)  
3-11 NIHONBASHI-HONCHO 2-CHOME, CHUO-KU  
TOKYO, JAPAN

OWNER OF JAPAN REG. NO. 4904182, DATED 10-28-2005, EXPIRES 10-28-2015.

FOR: DERMATOLOGICAL PREPARATIONS, IN  
CLASS 5 (U.S. CLS. 6, 18, 44, 46, 51 AND 52).

SER. NO. 76-617,260, FILED 10-21-2004.

THE MARK CONSISTS OF STANDARD CHARACTERS WITHOUT CLAIM TO ANY PARTICULAR FONT, STYLE, SIZE, OR COLOR.

CHRISTOPHER BUONGIORNO, EXAMINING ATTORNEY

Int. Cl.: 27

Prior U.S. Cls.: 19, 20, 37, 42 and 50

United States Patent and Trademark Office

Reg. No. 3,503,364

Registered Sep. 23, 2008

TRADEMARK  
PRINCIPAL REGISTER

FUSION

TO MARKET, LLC (DELAWARE LIMITED LIABILITY COMPANY)  
2347 BRONSON ROAD  
FAIRFIELD, CT 068242061

FOR: CARPETS, RUGS, MATS AND MATTING,  
LINOLEUM FOR COVERING EXISTING FLOORS,  
IN CLASS 27 (U.S. CLS. 19, 20, 37, 42 AND 50).

FIRST USE 6-1-2004; IN COMMERCE 6-1-2004.

OWNER OF U.S. REG. NOS. 2,641,756 AND  
2,742,605.

THE MARK CONSISTS OF STYLIZED LOWER  
CASE FONT USING BEZIER CURVES.

SER. NO. 76-627,270, FILED 1-6-2005.

GIANCARLO CASTRO, EXAMINING ATTORNEY

**Int. Cls.: 6, 9, 16, 20, 21, 24, 25, 26, 28, 30 and 41**

**Prior U.S. Cls.: 2, 5, 12, 13, 14, 21, 22, 23, 25, 26, 29, 30, 32, 33, 36, 37, 38, 39, 40, 42, 46, 50, 100, 101 and 107**

**Reg. No. 3,503,365**

**United States Patent and Trademark Office**

**Registered Sep. 23, 2008**

**TRADEMARK  
SERVICE MARK  
PRINCIPAL REGISTER**

**TALON THE GRIP OF FEAR**

CEDAR FAIR, L.P. (DELAWARE LIMITED PARTNERSHIP)  
ONE CEDAR POINT DRIVE  
SANDUSKY, OH 448705259

FOR: METAL KEY CHAINS , IN CLASS 6 (U.S. CLS. 2, 12, 13, 14, 23, 25 AND 50).

FIRST USE 5-0-2001; IN COMMERCE 5-0-2001.

FOR: SOUVENIR MAGNETS, IN CLASS 9 (U.S. CLS. 21, 23, 26, 36 AND 38).

FIRST USE 5-0-2001; IN COMMERCE 5-0-2001.

FOR: POSTERS, POSTCARDS, PENS AND PENCILS, NEWSLETTERS IN THE FIELD OF AMUSEMENT PARKS AND GAMES; CALENDERS, IN CLASS 16 (U.S. CLS. 2, 5, 22, 23, 29, 37, 38 AND 50).

FIRST USE 5-0-2001; IN COMMERCE 5-0-2001.

FOR: NON-METAL KEY CHAINS, PICTURE FRAMES, IN CLASS 20 (U.S. CLS. 2, 13, 22, 25, 32 AND 50).

FIRST USE 5-0-2001; IN COMMERCE 5-0-2001.

FOR: SOUVENIR SPORTS BOTTLES SOLD EMPTY; SOUVENIR BEVERAGWARE; SOUVENIR SHOT GLASSES; SOUVENIR MUGS; SOUVENIR STEINS, IN CLASS 21 (U.S. CLS. 2, 13, 23, 29, 30, 33, 40 AND 50).

FIRST USE 5-0-2001; IN COMMERCE 5-0-2001.

FOR: FELT PENNANTS; TOWELS, IN CLASS 24 (U.S. CLS. 42 AND 50).

FIRST USE 5-0-2001; IN COMMERCE 5-0-2001.

FOR: CLOTHING, NAMELY, T-SHIRTS, SHIRTS, HATS AND CAPS TO BE SOLD EXCLUSIVELY AS SOUVENIR MERCHANDISE ASSOCIATED WITH AMUSEMENT PARKS, IN CLASS 25 (U.S. CLS. 22 AND 39).

FIRST USE 5-0-2001; IN COMMERCE 5-0-2001.

FOR: ORNAMENTAL NOVELTY PINS; SOUVENIR BUTTONS; ORNAMENTAL SOUVENIR CLOTH PATCHES, IN CLASS 26 (U.S. CLS. 37, 39, 40, 42 AND 50).

FIRST USE 5-0-2001; IN COMMERCE 5-0-2001.

FOR: AMUSEMENT PARK RIDE; TOYS, NAMELY, BASEBALLS, CHRISTMAS TREE ORNAMENTS, FLASH BALLS, MICRO MINI BALLS, SNOW GLOBES, IN CLASS 28 (U.S. CLS. 22, 23, 38 AND 50).

FIRST USE 5-0-2001; IN COMMERCE 5-0-2001.

FOR: CANDY, IN CLASS 30 (U.S. CL. 46).

FIRST USE 5-0-2004; IN COMMERCE 5-0-2004.

FOR: ENTERTAINMENT SERVICES IN THE NATURE OF AN AMUSEMENT PARK RIDE; PROVIDING ONLINE NEWSLETTERS IN THE FIELD OF AMUSEMENT PARKS AND GAMES; PROVIDING ONLINE VIDEO AND TRIVIA GAMES, IN CLASS 41 (U.S. CLS. 100, 101 AND 107).

FIRST USE 5-0-2001; IN COMMERCE 5-0-2001.

THE MARK CONSISTS OF STANDARD CHARACTERS WITHOUT CLAIM TO ANY PARTICULAR FONT, STYLE, SIZE, OR COLOR.

OWNER OF U.S. REG. NO. 2,952,021.



SER. NO. 76-628,173, FILED 1-19-2005.

YONG KIM, EXAMINING ATTORNEY

Int. Cls.: 6, 9, 16, 20, 21, 25, 26, 28, 30 and 41

Prior U.S. Cls.: 2, 5, 12, 13, 14, 21, 22, 23, 25, 26, 29, 30, 32, 33, 36, 37, 38, 39, 40, 42, 46, 50, 100, 101 and 107

Reg. No. 3,503,366

United States Patent and Trademark Office

Registered Sep. 23, 2008

TRADEMARK  
SERVICE MARK  
PRINCIPAL REGISTER



CEDAR FAIR, L.P. (DELAWARE LIMITED PARTNERSHIP)

ONE CEDAR POINT DRIVE  
SANDUSKY, OH 448705259

FOR: METAL KEY CHAINS, IN CLASS 6 (U.S. CLS. 2, 12, 13, 14, 23, 25 AND 50).

FIRST USE 5-0-2001; IN COMMERCE 5-0-2001.

FOR: SOUVENIR MAGNETS, IN CLASS 9 (U.S. CLS. 21, 23, 26, 36 AND 38).

FIRST USE 5-1-2001; IN COMMERCE 5-1-2001.

FOR: POSTERS, POSTCARDS, PENS AND PENCILS, NEWSLETTERS IN THE FIELD OF AMUSEMENT PARKS AND GAMES, IN CLASS 16 (U.S. CLS. 2, 5, 22, 23, 29, 37, 38 AND 50).

FIRST USE 5-0-2001; IN COMMERCE 5-0-2001.

FOR: NON-METAL KEY CHAINS, IN CLASS 20 (U.S. CLS. 2, 13, 22, 25, 32 AND 50).

FIRST USE 5-0-2001; IN COMMERCE 5-0-2001.

FOR: SOUVENIR SPORTS BOTTLES SOLD EMPTY AND SOUVENIR BEVERAGEWARE, IN CLASS 21 (U.S. CLS. 2, 13, 23, 29, 30, 33, 40 AND 50).

FIRST USE 5-1-2001; IN COMMERCE 5-1-2001.

FOR: CLOTHING, NAMELY, T-SHIRTS, SHIRTS, HATS, AND CAPS TO BE SOLD EXCLUSIVELY AS SOUVENIR MERCHANDISE ASSOCIATED WITH AMUSEMENT PARKS, IN CLASS 25 (U.S. CLS. 22 AND 39).

FIRST USE 5-0-2001; IN COMMERCE 5-0-2001.

FOR: ORNAMENTAL NOVELTY PINS, IN CLASS 26 (U.S. CLS. 37, 39, 40, 42 AND 50).

FIRST USE 5-1-2001; IN COMMERCE 5-1-2001.

FOR: AMUSEMENT PARK RIDE; TOYS, NAMELY, BASEBALLS, CHRISTMAS TREE ORNAMENTS, SNOW GLOBES, TOY BALLS, IN CLASS 28 (U.S. CLS. 22, 23, 38 AND 50).

FIRST USE 5-0-2001; IN COMMERCE 5-0-2001.

FOR: CANDY, IN CLASS 30 (U.S. CL. 46).

FIRST USE 5-0-2004; IN COMMERCE 5-0-2004.

FOR: ENTERTAINMENT SERVICES IN THE NATURE OF AN AMUSEMENT PARK RIDE; PROVIDING ONLINE NEWSLETTERS IN THE FIELD OF AMUSEMENT PARKS AND GAMES; PROVID-

ING ONLINE VIDEO AND TRIVIA GAMES, IN  
CLASS 41 (U.S. CLS. 100, 101 AND 107).

SER. NO. 76-628,174, FILED 1-19-2005.

FIRST USE 5-0-2001; IN COMMERCE 5-0-2001.

OWNER OF U.S. REG. NO. 2,952,021.

YONG KIM, EXAMINING ATTORNEY

Int. Cl.: 44

Prior U.S. Cls.: 100 and 101

United States Patent and Trademark Office

Reg. No. 3,503,367

Registered Sep. 23, 2008

SERVICE MARK  
PRINCIPAL REGISTER

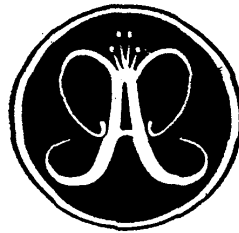

ANASTASIA  
*Beverly Hills*

ANASTASIA BEVERLY HILLS, INC. (CALIFORNIA CORPORATION)  
438 N. BEDFORD DRIVE  
BEVERLY HILLS, CA 90210

FOR: BEAUTY SALON SERVICES, NAMELY, HAIR REMOVAL, DRESSING AND STYLING, IN CLASS 44 (U.S. CLS. 100 AND 101).

FIRST USE 9-0-1999; IN COMMERCE 9-0-1999.

OWNER OF U.S. REG. NOS. 2,798,069 AND 2,821,892.

NO CLAIM IS MADE TO THE EXCLUSIVE RIGHT TO USE "BEVERLY HILLS", APART FROM THE MARK AS SHOWN.

SER. NO. 76-632,127, FILED 2-25-2005.

REBECCA EISINGER, EXAMINING ATTORNEY

Int. Cl.: 10

Prior U.S. Cls.: 26, 39 and 44

United States Patent and Trademark Office

Reg. No. 3,503,368

Registered Sep. 23, 2008

TRADEMARK  
PRINCIPAL REGISTER



ADVANCED SPINE

ENCORE MEDICAL ASSET CORPORATION (NE-  
VADA CORPORATION)  
PO BOX 530759  
HENDERSON, NV 890530759

FOR: ORTHOPEDIC PROSTHESES, NAMELY,  
SPINAL IMPLANTS CONSISTING OF ARTIFICIAL  
MATERIALS AND SURGICAL AND MEDICAL  
APPARATUS AND INSTRUMENTS FOR SPINAL  
SURGERY, IN CLASS 10 (U.S. CLS. 26, 39 AND 44).

FIRST USE 2-23-2005; IN COMMERCE 2-23-2005.

NO CLAIM IS MADE TO THE EXCLUSIVE  
RIGHT TO USE "SPINE", APART FROM THE MARK  
AS SHOWN.

THE STIPPLING IS FOR SHADING PURPOSES  
ONLY.

SER. NO. 76-635,767, FILED 4-14-2005.

WILLIAM VERHOSEK, EXAMINING ATTORNEY

**Int. Cl.: 10**

**Prior U.S. Cls.: 26, 39 and 44**

**United States Patent and Trademark Office**

**Reg. No. 3,503,369**

**Registered Sep. 23, 2008**

**TRADEMARK  
PRINCIPAL REGISTER**

**ADVANCED SPINE**

ENCORE MEDICAL ASSET CORPORATION (NE-  
VADA CORPORATION)  
PO BOX 530759  
HENDERSON, NV 890530759

FOR: ORTHOPEDIC PROSTHESES, NAMELY  
SPINAL IMPLANTS CONSISTING OF ARTIFICIAL  
MATERIALS AND SURGICAL AND MEDICAL  
APPARATUS AND INSTRUMENTS FOR SPINAL  
SURGERY, IN CLASS 10 (U.S. CLS. 26, 39 AND 44).

FIRST USE 2-23-2005; IN COMMERCE 2-23-2005.

THE MARK CONSISTS OF STANDARD CHAR-  
ACTERS WITHOUT CLAIM TO ANY PARTICULAR  
FONT, STYLE, SIZE, OR COLOR.

NO CLAIM IS MADE TO THE EXCLUSIVE  
RIGHT TO USE "SPINE", APART FROM THE MARK  
AS SHOWN.

SER. NO. 76-635,768, FILED 4-14-2005.

WILLIAM VERHOSEK, EXAMINING ATTORNEY

**Int. Cls.: 1 and 2**

**Prior U.S. Cls.: 1, 5, 6, 10, 11, 16, 26 and 46**

**United States Patent and Trademark Office**

**Reg. No. 3,503,370**

**Registered Sep. 23, 2008**

**TRADEMARK  
PRINCIPAL REGISTER**

**ULTIMATTE**

ENGELHARD CORPORATION (DELAWARE  
CORPORATION)  
101 WOOD AVENUE  
ISELIN, NJ 08830

FIRST USE 12-13-2002; IN COMMERCE 12-13-2002.

FOR: CLAY FOR COATING AND FILLING USED  
IN THE MANUFACTURE OF PAPER AND PAPER-  
BOARD, IN CLASS 1 (U.S. CLS. 1, 5, 6, 10, 26 AND 46).

THE MARK CONSISTS OF STANDARD CHAR-  
ACTERS WITHOUT CLAIM TO ANY PARTICULAR  
FONT, STYLE, SIZE, OR COLOR.

FIRST USE 12-13-2002; IN COMMERCE 12-13-2002.

SER. NO. 76-636,509, FILED 4-19-2005.

FOR: CLAY COATINGS IN THE NATURE OF  
PIGMENTATION FOR PAPER AND PAPERBOARD,  
IN CLASS 2 (U.S. CLS. 6, 11 AND 16).

DAVID C. REIHNER, EXAMINING ATTORNEY

Int. Cl.: 33

Prior U.S. Cls.: 47 and 49

United States Patent and Trademark Office

Reg. No. 3,503,371

Registered Sep. 23, 2008

TRADEMARK  
PRINCIPAL REGISTER

*Chunghwa*

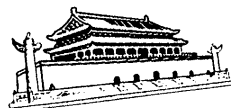

SHANGHAI TOBACCO (GROUP) CORPORATION  
(CHINA CORPORATION)  
1062 XU CHANG ROAD  
SHANGHAI, CHINA

FOR: WINE, GRAPE WINE AND OTHER KINDS OF ALCOHOLIC BEVERAGES OF FRUITS, BRANDY, COGNAC, WHISKY, DISTILLED SPIRITS OF ALCOHOL, DISTILLED SPIRITS, AND ALCOHOLIC BEVERAGES OTHER THAN BEER, NAMELY, UNSTRAINED RICE WINE (TAG-JU), CLEAR COMPOUND RICE WINE, PEPPERMINT LIQUEURS, TRADITIONAL RICE WINE, REFINED RICE WINE (YAG-JU), RUM, YELLOW WINE, CHINESE LIQUEUR (LAO LIQUOR), FLAVORED TONIC LIQUORS, WINE COOLERS, IN CLASS 33 (U.S. CLS. 47 AND 49).

FIRST USE 2-9-2005; IN COMMERCE 3-3-2005.

OWNER OF U.S. REG. NOS. 2,221,208 AND 2,434,448.

NO CLAIM IS MADE TO THE EXCLUSIVE RIGHT TO USE "CHUNGHWA", APART FROM THE MARK AS SHOWN.

THE MARK CONSISTS, IN PART, OF THE WORD "CHUNGHWA" AND THE DESIGN OF THE TIANAN MEN PALACE.

THE ENGLISH TRANSLATION OF THE WORD "CHUNGHWA" IN THE MARK IS MIDDLE CHINA.

SER. NO. 76-643,729, FILED 7-28-2005.

VIVIAN MICZNIK FIRST, EXAMINING ATTORNEY



**Int. Cl.: 25**

**Prior U.S. Cls.: 22 and 39**

**United States Patent and Trademark Office**

**Reg. No. 3,503,372**

**Registered Sep. 23, 2008**

**TRADEMARK  
PRINCIPAL REGISTER**

**I'M A TOY TESTER**

TOY TIPS, INC. (WISCONSIN CORPORATION)  
3611 JERELIN DR  
FRANKLIN, WI 53132

FOR: CLOTHING, NAMELY, SHIRTS, PANTS,  
INFANT AND TODDLER ONE PIECE CLOTHING,  
INFANT SLEEPERS, RAINWEAR, BABY SHOES,  
CHILDREN'S AND INFANTS' CLOTH BIBS, ROM-  
PERS AND SHORT SETS , IN CLASS 25 (U.S. CLS. 22  
AND 39).

FIRST USE 9-1-1994; IN COMMERCE 9-1-1994.

THE MARK CONSISTS OF STANDARD CHAR-  
ACTERS WITHOUT CLAIM TO ANY PARTICULAR  
FONT, STYLE, SIZE, OR COLOR.

SER. NO. 76-645,999, FILED 8-29-2005.

CIMMERIAN COLEMAN, EXAMINING ATTOR-  
NEY

**Int. Cls.: 16 and 17**

**Prior U.S. Cls.: 1, 2, 5, 12, 13, 22, 23, 29, 35, 37, 38 and 50**

**Reg. No. 3,503,373**

**United States Patent and Trademark Office**

**Registered Sep. 23, 2008**

**TRADEMARK  
PRINCIPAL REGISTER**

**KURARISTER**

KURARAY CO., LTD. (JAPAN CORPORATION)  
1621, SAKAZU, KURASHIKI CITY  
OKAYAMA PREFECTURE, JAPAN

FOR: PLASTIC MATERIALS FOR PACKAGING AND WRAPPING, NAMELY, FOOD WRAPPING PLASTIC FILM AND FOOD WRAPPING PLASTIC WRAP FOR HOUSEHOLD USE; PLASTIC GARBAGE BAGS FOR HOUSEHOLD USE; AND INDUSTRIAL PACKAGING PLASTIC FILM IN THE NATURE OF PLASTIC BUBBLE PACKS, IN CLASS 16 (U.S. CLS. 2, 5, 22, 23, 29, 37, 38 AND 50).

FOR: PLASTICS SEMI-WORKED PRODUCTS, NAMELY, EXTRUDED PLASTICS AND CASTED PLASTICS IN THE FORM OF FIBERS, THREADS, YARNS, STRIPS, BARS, BLOCKS, PELLETS, RODS, FILMS, SHEETS, TUBES AND ADHESIVE COATED PLASTIC SHEETS, FOR USE IN MANUFACTURING; PLASTIC SHEETING FOR AGRICULTURAL PURPOSES, NAMELY, PLASTIC FILM USED AS PACKAGING FOR AGRICULTURAL PRODUCTS; PLASTIC FILMS FOR INDUSTRIAL AND COM-

MERCIAL PACKING USE; CHEMICAL FIBER NOT FOR TEXTILE USE; CHEMICAL FIBER YARN AND THREAD NOT FOR TEXTILE USE, IN CLASS 17 (U.S. CLS. 1, 5, 12, 13, 35 AND 50).

THE MARK CONSISTS OF STANDARD CHARACTERS WITHOUT CLAIM TO ANY PARTICULAR FONT, STYLE, SIZE, OR COLOR.

PRIORITY CLAIMED UNDER SEC. 44(D) ON JAPAN APPLICATION NO. 2005-074640, FILED 8-10-2005, REG. NO. 4935865, DATED 3-10-2006, EXPIRES 3-10-2016.

PRIORITY CLAIMED UNDER SEC. 44(D) ON JAPAN APPLICATION NO. 2005-074639, FILED 8-10-2005, REG. NO. 4935864, DATED 3-10-2006, EXPIRES 3-10-2016.

SER. NO. 76-646,730, FILED 9-13-2005.

KATHERINE M. DUBRAY, EXAMINING ATTORNEY

**Int. Cls.: 35 and 41**

**Prior U.S. Cls.: 100, 101, 102 and 107**

**United States Patent and Trademark Office**

**Reg. No. 3,503,374**

**Registered Sep. 23, 2008**

**SERVICE MARK  
PRINCIPAL REGISTER**

**PSYCCAREERS . COM**

AMERICAN PSYCHOLOGICAL ASSOCIATION  
(D.C. NOT-FOR-PROFIT CORPORATION)  
750 FIRST STREET, N.W.  
WASHINGTON, DC 200024242

FOR: INTERACTIVE WEBSITE PROVIDING INFORMATION CONCERNING CAREER OPPORTUNITIES AND PROVIDING INFORMATION ABOUT SUBSCRIPTIONS TO ELECTRONIC JOURNALS IN THE FIELD OF PSYCHOLOGY AND THE SOCIAL SCIENCES; NETWORKING IN THE FIELD OF CAREER OPPORTUNITIES RELATED TO PSYCHOLOGY AND THE SOCIAL SCIENCES, IN CLASS 35 (U.S. CLS. 100, 101 AND 102).

FIRST USE 11-0-1999; IN COMMERCE 11-0-1999.

FOR: PROVIDING ON-LINE PUBLICATIONS IN THE NATURE OF ADVERTISEMENTS AND RE-

SUMES IN THE FIELD OF PSYCHOLOGY AND THE SOCIAL SCIENCES; PROVIDING INFORMATION ABOUT THE PUBLICATIONS OF OTHERS IN THE FIELDS OF PSYCHOLOGY AND THE SOCIAL SCIENCES VIA AN INTERACTIVE WEBSITE, IN CLASS 41 (U.S. CLS. 100, 101 AND 107).

FIRST USE 11-0-1999; IN COMMERCE 11-0-1999.

THE MARK CONSISTS OF STANDARD CHARACTERS WITHOUT CLAIM TO ANY PARTICULAR FONT, STYLE, SIZE, OR COLOR.

SEC. 2(F).

SER. NO. 76-653,770, FILED 1-20-2006.

SHANNON TWOHIG, EXAMINING ATTORNEY

**Int. Cls.: 9 and 16**

**Prior U.S. Cls.: 2, 5, 21, 22, 23, 26, 29, 36, 37, 38 and 50**

**United States Patent and Trademark Office**

**Reg. No. 3,503,375**

**Registered Sep. 23, 2008**

**TRADEMARK  
PRINCIPAL REGISTER**

**SIMPLE START**

JOHNSON & JOHNSON (NEW JERSEY CORPORATION)

ONE JOHNSON & JOHNSON PLAZA

NEW BRUNSWICK, NJ 089337001

FOR: PRERECORDED CD-ROMS AND DVDS FEATURING INFORMATIONAL PROGRAMMING REGARDING MANAGING DIABETES, IN CLASS 9 (U.S. CLS. 21, 23, 26, 36 AND 38).

FIRST USE 3-22-2005; IN COMMERCE 3-22-2005.

FOR: PRINTED BOOKLET FEATURING INFORMATION ON MANAGING DIABETES, IN CLASS 16 (U.S. CLS. 2, 5, 22, 23, 29, 37, 38 AND 50).

FIRST USE 3-22-2005; IN COMMERCE 3-22-2005.

THE MARK CONSISTS OF STANDARD CHARACTERS WITHOUT CLAIM TO ANY PARTICULAR FONT, STYLE, SIZE, OR COLOR.

SER. NO. 76-657,333, FILED 3-24-2006.

STEVEN PEREZ, EXAMINING ATTORNEY

**Int. Cl.: 15**

**Prior U.S. Cls.: 2, 21 and 36**

**United States Patent and Trademark Office**

**Reg. No. 3,503,376**

**Registered Sep. 23, 2008**

**TRADEMARK  
PRINCIPAL REGISTER**

# Monoposto

RANDALL MAY INTERNATIONAL, INC. (CALIFORNIA CORPORATION)  
1402 MCGAW AVENUE  
IRVINE, CA 92614

FOR: SHOULDER MOUNTED INSTRUMENT CARRIER FOR USE WITH MUSICAL INSTRUMENTS, IN CLASS 15 (U.S. CLS. 2, 21 AND 36).

FIRST USE 12-12-2004; IN COMMERCE 12-1-2005.

THE MARK CONSISTS OF STANDARD CHARACTERS WITHOUT CLAIM TO ANY PARTICULAR FONT, STYLE, SIZE, OR COLOR.

THE ENGLISH TRANSLATION OF THE WORD "MONOPOSTO" IN THE MARK IS SINGLE-SEATER.

SER. NO. 76-661,260, FILED 6-2-2006.

JOHN DALIER, EXAMINING ATTORNEY

**Int. Cl.: 35**

**Prior U.S. Cls.: 100, 101 and 102**

**United States Patent and Trademark Office**

**Reg. No. 3,503,377**

**Registered Sep. 23, 2008**

**SERVICE MARK  
PRINCIPAL REGISTER**

**MEDIMINE**

BACKE COMMUNICATIONS, INC. (DELAWARE CORPORATION)  
35 CRICKET TERRACE CENTER  
ARDMORE, PA 19003

FOR: ADVERTISING AGENCY SERVICES, NAMELY, PROVIDING INFORMATION RELATING TO BRAND DEVELOPMENT SERVICES; INTERACTIVE BUSINESS MARKETING SERVICES; CONDUCTING BUSINESS AND MARKET RESEARCH SURVEYS, NAMELY, ONLINE SURVEYS VIA A SEARCH ENGINE, IN CLASS 35 (U.S. CLS. 100, 101 AND 102).

FIRST USE 1-19-2006; IN COMMERCE 1-19-2006.

THE MARK CONSISTS OF STANDARD CHARACTERS WITHOUT CLAIM TO ANY PARTICULAR FONT, STYLE, SIZE, OR COLOR.

SER. NO. 76-664,344, FILED 8-9-2006.

JENNIFER VASQUEZ, EXAMINING ATTORNEY

**Int. Cl.: 7**

**Prior U.S. Cls.: 13, 19, 21, 23, 31, 34 and 35**

**Reg. No. 3,503,378**

**United States Patent and Trademark Office**

**Registered Sep. 23, 2008**

**TRADEMARK  
PRINCIPAL REGISTER**

**BEAMRIDER**

FLEET (LINE MARKERS) LIMITED (ENGLAND CORPORATION)  
SPRING LANE SOUTH, SPRING LANE INDUSTRIAL ESTATE, MALVERN  
WORCESTERSHIRE WR14 1AJ, UNITED KINGDOM

FOR: LINE MARKING MACHINES; EARTH MOVING SCARIFIERS; LAWN MOWERS; POWER OPERATED TURF AERATORS; POWER OPERATED RAKES; AND STRUCTURAL AND REPLACEMENT PARTS FOR ALL THE AFORESAID GOODS, IN CLASS 7 (U.S. CLS. 13, 19, 21, 23, 31, 34 AND 35).

THE MARK CONSISTS OF STANDARD CHARACTERS WITHOUT CLAIM TO ANY PARTICULAR FONT, STYLE, SIZE, OR COLOR.

PRIORITY CLAIMED UNDER SEC. 44(D) ON UNITED KINGDOM APPLICATION NO. 2414896, FILED 2-24-2006, REG. NO. 2414896, DATED 2-24-2006, EXPIRES 2-24-2016.

SER. NO. 76-664,572, FILED 8-14-2006.

KAREN BRACEY, EXAMINING ATTORNEY

**Int. Cl.: 16**

**Prior U.S. Cls.: 2, 5, 22, 23, 29, 37, 38 and 50**

**United States Patent and Trademark Office**

**Reg. No. 3,503,379**

**Registered Sep. 23, 2008**

**TRADEMARK  
PRINCIPAL REGISTER**

**BRIDES NORTHERN CALIFORNIA**

ADVANCE MAGAZINE PUBLISHER, INC. (NEW  
YORK CORPORATION)  
FOUR TIMES SQUARE  
NEW YORK, NY 10036

FOR: MAGAZINES FEATURING INFORMATION CONCERNING WEDDINGS, FASHION, TRAVEL AND ENTERTAINMENT, IN CLASS 16 (U.S. CLS. 2, 5, 22, 23, 29, 37, 38 AND 50).

FIRST USE 6-27-2006; IN COMMERCE 6-27-2006.

THE MARK CONSISTS OF STANDARD CHARACTERS WITHOUT CLAIM TO ANY PARTICULAR FONT, STYLE, SIZE, OR COLOR.

OWNER OF U.S. REG. NOS. 2,443,575, 2,750,084 AND OTHERS.

NO CLAIM IS MADE TO THE EXCLUSIVE RIGHT TO USE "NORTHERN CALIFORNIA", APART FROM THE MARK AS SHOWN.

SEC. 2(F).

SER. NO. 76-666,133, FILED 9-15-2006.

BRIAN PINO, EXAMINING ATTORNEY



**Int. Cls.: 35 and 42**

**Prior U.S. Cls.: 100, 101 and 102**

**United States Patent and Trademark Office**

**Reg. No. 3,503,380**

**Registered Sep. 23, 2008**

**SERVICE MARK  
PRINCIPAL REGISTER**

# Agilis Solutions

COSOURCE TECHNOLOGY GROUP, INC. (OREGON CORPORATION)

#201

14795 SW MURRAY SCHOLLS DR  
BEAVERTON, OR 97007

FOR: BUSINESS CONSULTATION SERVICES IN THE FIELDS OF MARKETING, INVESTOR RELATIONS, PUBLIC RELATIONS, CUSTOMER RELATIONSHIP MANAGEMENT, COLLECTING MARKETING DATA, MANAGING VENDOR RELATIONSHIPS, MANAGING SUPPLIER RELATIONSHIPS, INTERNAL COMPANY COMMUNICATIONS AND SYSTEMS, AND HOW TO MARKET, OFFER AND SELL PRODUCTS AND SERVICES USING A GLOBAL COMPUTER NETWORK; DATABASE MANAGEMENT, IN CLASS 35 (U.S. CLS. 100, 101 AND 102).

FIRST USE 12-1-2004; IN COMMERCE 4-22-2005.

FOR: NETWORK OPERATING SYSTEMS DEVELOPMENT; COMPUTER CONSULTATION IN THE FIELD OF HARDWARE AND SOFTWARE SELECTION, IN CLASS 42 (U.S. CLS. 100 AND 101).

FIRST USE 12-1-2004; IN COMMERCE 4-22-2005.

THE MARK CONSISTS OF STANDARD CHARACTERS WITHOUT CLAIM TO ANY PARTICULAR FONT, STYLE, SIZE, OR COLOR.

NO CLAIM IS MADE TO THE EXCLUSIVE RIGHT TO USE "SOLUTIONS", APART FROM THE MARK AS SHOWN.

THE ENGLISH TRANSLATION OF THE WORD "AGILIS" IN THE MARK IS AGILE.

SER. NO. 76-667,575, FILED 10-16-2006.

MICHAEL WIENER, EXAMINING ATTORNEY

**Int. Cls.: 35 and 42**

**Prior U.S. Cls.: 100, 101 and 102**

**United States Patent and Trademark Office**

**Reg. No. 3,503,381**

**Registered Sep. 23, 2008**

**SERVICE MARK  
PRINCIPAL REGISTER**



COSOURCE TECHNOLOGY GROUP, INC. (OREGON CORPORATION)

#201

14795 SW MURRAY SCHOLLS DR  
BEAVERTON, OR 97007

FOR: BUSINESS CONSULTATION SERVICES IN THE FIELDS OF MARKETING, INVESTOR RELATIONS, PUBLIC RELATIONS, CUSTOMER RELATIONSHIP MANAGEMENT, COLLECTING MARKETING DATA, MANAGING VENDOR RELATIONSHIPS, MANAGING SUPPLIER RELATIONSHIPS, INTERNAL COMPANY COMMUNICATIONS AND SYSTEMS, AND HOW TO MARKET, OFFER AND SELL PRODUCTS AND SERVICES USING A GLOBAL COMPUTER NETWORK; DATABASE MANAGEMENT, IN CLASS 35 (U.S. CLS. 100, 101 AND 102).

FIRST USE 3-1-2005; IN COMMERCE 4-22-2005.

FOR: NETWORK OPERATING SYSTEMS DEVELOPMENT; COMPUTER CONSULTATION IN THE FIELD OF HARDWARE AND SOFTWARE SELECTION, IN CLASS 42 (U.S. CLS. 100 AND 101).

FIRST USE 3-1-2005; IN COMMERCE 3-1-2005.

NO CLAIM IS MADE TO THE EXCLUSIVE RIGHT TO USE "SOLUTIONS", APART FROM THE MARK AS SHOWN.

THE ENGLISH TRANSLATION OF THE WORD "AGILIS" IN THE MARK IS AGILE.

SER. NO. 76-667,576, FILED 10-16-2006.

MICHAEL WIENER, EXAMINING ATTORNEY

Int. Cl.: 29

Prior U.S. Cl.: 46

United States Patent and Trademark Office

Reg. No. 3,503,382

Registered Sep. 23, 2008

TRADEMARK  
PRINCIPAL REGISTER

おいしさにまごころこめて……



SK FOODS CO., LTD. (JAPAN CORPORATION)  
1110 JUNNA, IGAWADANI-CHO  
NISHI-KU, KOBE, JAPAN

FOR: FROZEN UNCOOKED SHRIMP AND PRAWN; FROZEN COOKED SHRIMP AND PRAWN; FROZEN PACKAGED PREPARED ENTREES CONSISTING PRIMARILY OF SEAFOOD OR VEGETABLES, BUT ALSO CONTAINING RICE; FROZEN BREADED UNCOOKED PRAWN FOR DEEP FRYING; FROZEN TENJU, NAMELY, ENTREES CONSISTING PRIMARILY OF TEMPURA OF PRAWN, CUTTLEFISH, PUMPKIN, AUBERGINE AND GREEN BEANS, BUT ALSO CONTAINING RICE AND SAUCE, WITH EACH COMPONENT OF THE ENTREE SEPARATELY PACKED; FROZEN COOKED TEMPURA OF PRAWN; FROZEN TEMPURA OF PRAWN, CUTTLEFISH, PUMPKIN, AUBERGINE AND GREEN BEANS, WITH SAUCE; FROZEN DEEP-FRIED SEAFOOD; FROZEN SEAFOOD TEMPURA; FROZEN PACKAGED MEAL CONSISTING PRIMARILY OF SEAFOOD, VEGETABLES AND MUSHROOMS, BUT ALSO CONTAIN-

ING COOKED RICE; FROZEN PACKAGED TEMPURA MEAL CONSISTING PRIMARILY OF FROZEN TEMPURA OF PRAWN, CUTTLEFISH, PUMPKIN, AUBERGINE AND GREEN BEANS, BUT ALSO CONTAINING SAUCE, COOKED RICE, VEGETABLES AND MUSHROOMS; AND FROZEN SHRIMP, PRAWN, SEAFOOD, VEGETABLES, AND PREPARED ENTREES CONSISTING OF FROZEN SHRIMP, PRAWN, SEAFOOD AND VEGETABLES, IN CLASS 29 (U.S. CL. 46).

FIRST USE 12-0-2003; IN COMMERCE 12-0-2003.

THE NON-LATIN CHARACTERS IN THE MARK TRANSLITERATE TO "OISHISANI MAGOKORO KOMETE ES KEH," AND THIS MEANS "PUTTING SINCERITY INTO DELICIOUSNESS SK" IN ENGLISH.

SER. NO. 76-668,603, FILED 11-6-2006.

NICHOLAS ALTREE, EXAMINING ATTORNEY

**Int. Cls.: 6, 7, 8, 12, 20 and 22**

**Prior U.S. Cls.: 1, 2, 7, 12, 13, 14, 19, 21, 22, 23, 25, 28, 31, 32, 34, 35, 42, 44 and 50**

**Reg. No. 3,503,383**

**United States Patent and Trademark Office**

**Registered Sep. 23, 2008**

**TRADEMARK  
PRINCIPAL REGISTER**



TUCKER-ROCKY CORPORATION, INC. (DELAWARE CORPORATION)  
103 FOULK ROAD, SUITE 202  
WILMINGTON, DE 19803

FOR: METAL BIKE RAMP AND SAFETY WIRE; METAL MOTORCYCLE STAND THAT MAY BE RAISED AND LOWERED BY NON-POWERED MEANS, IN CLASS 6 (U.S. CLS. 2, 12, 13, 14, 23, 25 AND 50).

FIRST USE 7-0-2004; IN COMMERCE 7-0-2004.

FOR: ENGINE PARTS, NAMELY, FUEL MIXTURE SCREWS; AXLE PULLS FOR MOTORCYCLES, AIR FILTER SKINS FOR VEHICLE MOTORS AND ENGINES, SILENCERS AS PART OF VEHICLE EXHAUST SYSTEM, ENGINE BEARING; MOTORCYCLE ENGINE PARTS, NAMELY, FLY-WHEEL BALANCING WEIGHTS FOR ENGINES, IN CLASS 7 (U.S. CLS. 13, 19, 21, 23, 31, 34 AND 35).

FIRST USE 7-0-2004; IN COMMERCE 7-0-2004.

FOR: HAND TOOLS, NAMELY, LEVER SCREW DRIVERS AND WRENCHES; WIRE TWISTER PLIERS, IN CLASS 8 (U.S. CLS. 23, 28 AND 44).

FIRST USE 7-0-2004; IN COMMERCE 7-0-2004.

FOR: MOTORCYCLE PARTS AND ACCESSORIES, NAMELY, SHORT HAND LEVERS, ALUMINUM SIDE STANDS, CLUTCHES FOR LAND VEHICLES, ENGINE POWER TRANSMISSION DRIVE CHAINS, CHAIN ROLLERS, CHAIN GUIDES, WHEEL SPROCKETS, PARTS OF MOTORCYCLES, NAMELY, HANDLE BAR CONTROL LE-

VERS, CLUTCH PERCHES, FORK SEAL KIT, FORK SKINS, HANDLEBARS, HANDLE BAR GRIPS, FOAM SAFETY PADS, HAND SHIELDS FOR USE WITH MOTORCYCLE HANDLE BARS, MOUNT KITS FOR ELECTRONIC DEVICES, HAND DEFLECTORS, BRAKE ROTORS, BRAKE LINES, RADIATOR PROTECTIVE GUARDS; SKID PLATES; BRAKE LEVER PROTECTIVE GUARDS, BRAKE DISC GUARD, UNIVERSAL COMPUTER MOUNT, MIRRORS FOR VEHICLES, NAMELY, REAR VIEW AND VANITY MIRRORS, IN CLASS 12 (U.S. CLS. 19, 21, 23, 31, 35 AND 44).

FIRST USE 7-0-2004; IN COMMERCE 7-0-2004.

FOR: PLASTIC PENNANTS; PLASTIC BANNERS; HARD PART DISPLAY RACKING SYSTEM USED TO DISPLAY MOTORCYCLE HARD PARTS IN STORES, IN CLASS 20 (U.S. CLS. 2, 13, 22, 25, 32 AND 50).

FIRST USE 7-0-2004; IN COMMERCE 7-0-2004.

FOR: TOWING STRAPS FOR VEHICLES; TIE DOWN STRAPS, CABLE TIES FOR FASTENING AND SECURING OBJECTS SUCH AS BUNDLES OF WIRE TOGETHER, IN CLASS 22 (U.S. CLS. 1, 2, 7, 19, 22, 42 AND 50).

FIRST USE 7-0-2004; IN COMMERCE 7-0-2004.

OWNER OF U.S. REG. NO. 2,002,789.

SER. NO. 76-669,031, FILED 11-13-2006.

JAMES LOVELACE, EXAMINING ATTORNEY

**Int. Cls.: 35 and 42**

**Prior U.S. Cls.: 100, 101 and 102**

**United States Patent and Trademark Office**

**Reg. No. 3,503,384**

**Registered Sep. 23, 2008**

**SERVICE MARK  
PRINCIPAL REGISTER**



AMERICA'S HEALTH INSURANCE PLANS, INC.  
(DELAWARE CORPORATION)  
601 PENNSYLVANIA AVENUE NW  
SUITE 500  
WASHINGTON, DC 20004

FOR: PREPARING REPORTS FOR THE HEALTH CARE INDUSTRY AND THE PUBLIC REGARDING PHYSICIAN COMPLIANCE OR RATING BASED ON PERFORMANCE STANDARDS, IN CLASS 35 (U.S. CLS. 100, 101 AND 102).

FIRST USE 11-7-2006; IN COMMERCE 11-7-2006.

FOR: SERVICES TO OTHERS IN THE FIELD OF HEALTH CARE INFORMATION, NAMELY, IDENTIFYING AND DEVELOPING STANDARDS TO MEASURE PHYSICIAN PERFORMANCE IN THE AREAS OF QUALITY AND COST OF SERVICES PROVIDED, IN CLASS 42 (U.S. CLS. 100 AND 101).

FIRST USE 11-7-2006; IN COMMERCE 11-7-2006.

SER. NO. 76-669,196, FILED 11-17-2006.

ELLEN PERKINS, EXAMINING ATTORNEY

**Int. Cl.: 32**

**Prior U.S. Cls.: 45, 46 and 48**

**United States Patent and Trademark Office**

**Reg. No. 3,503,385**

**Registered Sep. 23, 2008**

**TRADEMARK  
PRINCIPAL REGISTER**



PRODUCTORA DE JUGOS S.A. (COLOMBIA CORPORATION)  
CLL. 48 # 21-100  
TULUA, VALLE, COLOMBIA

THE COLOR(S) YELLOW, RED AND GREEN IS/ARE CLAIMED AS A FEATURE OF THE MARK.

FOR: MINERAL AND AERATED WATERS AND OTHER BEVERAGES, NAMELY, CARBONATED BEVERAGES, ENERGY DRINKS, FRUIT BEVERAGES, FRUIT DRINKS, FRUIT FLAVORED BEVERAGES, FRUIT JUICES, SMOOTHIES; SOFT DRINKS AND SPORTS DRINKS; DRINKING WATER; NON-ALCOHOLIC BEVERAGES CONTAINING FRUIT JUICES; NON-ALCOHOLIC BEVERAGES WITH TEA FLAVOR; SOFT DRINKS, IN CLASS 32 (U.S. CLS. 45, 46 AND 48).

THE MARK CONSISTS OF THE TERMS TUTTI FRUTTI IN YELLOW STYLIZED LETTERS WITH GREEN DOTS IN THE LETTER "I." THE TERMS ARE DISPLAYED AGAINST A RED RECTANGULAR BACKGROUND WITH A NARROW YELLOW BORDER AND AN OUTER WIDER GREEN BORDER. A STYLIZED GREEN LEAF WITH A YELLOW BORDER IS POSITIONED IN A HORIZONTAL FASHION ABOVE THE LETTERS "UTTI" IN "TUTTI".

OWNER OF COLOMBIA REG. NO. 305887, DATED 9-21-2005, EXPIRES 9-21-2015.

SER. NO. 76-669,464, FILED 11-24-2006.

NO CLAIM IS MADE TO THE EXCLUSIVE RIGHT TO USE "TUTTI FRUTTI", APART FROM THE MARK AS SHOWN.

GIANCARLO CASTRO, EXAMINING ATTORNEY

Int. Cl.: 31

Prior U.S. Cls.: 1 and 46

United States Patent and Trademark Office

Reg. No. 3,503,386

Registered Sep. 23, 2008

TRADEMARK  
PRINCIPAL REGISTER



POSTIER, MARK (UNITED STATES INDIVIDUAL), DBA HOOD CANAL EVERGREENS  
431 N.E. MISSION CREEK ROAD  
BELFAIR, WA 98528 AND  
POSTIER, MICKIE (UNITED STATES INDIVIDUAL), DBA HOOD CANAL EVERGREENS  
431 N.E. MISSION CREEK ROAD  
BELFAIR, WA 98528

FOR: HORTICULTURAL AND FORESTRY PRODUCTS, NAMELY, CUT FOLIAGE AND ORNAMENTAL FOLIAGE, IN CLASS 31 (U.S. CLS. 1 AND 46).

FIRST USE 3-1-2003; IN COMMERCE 3-1-2003.

NO CLAIM IS MADE TO THE EXCLUSIVE RIGHT TO USE "HAND PICKED FLORAL GREENERY", APART FROM THE MARK AS SHOWN.

THE COLOR(S) ORANGE, BROWN, GREEN AND GRAY IS/ARE CLAIMED AS A FEATURE OF THE MARK.

THE MARK CONSISTS OF THE STYLIZED WORDING "MYSTIC FOREST HAND PICKED FLORAL GREENERY" AND DESIGN ELEMENTS, ALL OF WHICH ARE SUPERIMPOSED OVER AN ORANGE RECTANGULAR BACKGROUND ON PACKAGING FOR THE GOODS. ALL WORDING IN THE MARK IS BROWN, AND THE WORDING "MYSTIC FOREST" HAS PARTIAL THIN BROWN OUTLINES TO CREATE A RAISED EFFECT. AN

INCOMPLETE BROWN-LINED INNER OVAL WITH AN INCOMPLETE THIN BROWN OUTLINE APPEARS BETWEEN THE TERMS "MYSTIC" AND "FOREST". THE INCOMPLETE OVALS CONTAIN A GRAY MOUNTAIN RANGE, THREE BROWN TREE TRUNKS, AND THE SILHOUETTE OF A PERSON IN BROWN STANDING ON GROUND THAT IS ALSO BROWN. THE PERSON IS CARRYING THREE GREEN BRANCHES. THE ORANGE BACKGROUND THAT APPEARS THROUGHOUT THE MARK EXTENDS TO FORM AN ORANGE OUTLINE AROUND EACH OF THE BRANCHES. THE TWO UPPER GREEN BRANCHES BEING CARRIED BY THE PERSON AND A SMALL BROWN ROOT FROM THE LEFTMOST TREE TRUNK EXTEND OUTSIDE THE INCOMPLETE OVALS. THE WORDING "HAND PICKED GREENERY" IS CURVED IN AN ARC AROUND THE TOP PORTION OF THE OUTER INCOMPLETE OVAL. THE WORDS AND DESIGN ELEMENTS ARE CONTAINED WITHIN TWO CURVED BROWN BORDER LINES, ONE ON THE TOP AND THE OTHER ON THE BOTTOM. THE WORDING AND DESIGN ARE SHOWN ON THE SIDE OF THE PACKAGING, WHICH IS SHOWN IN DOTTED LINES; THE DOTTED LINES MERELY REPRESENT PLACEMENT OF THE MARK, AND NEITHER THE DOTTED LINES NOR THE PACKAGE ARE CLAIMED AS PART OF THE MARK.

SER. NO. 76-669,642, FILED 11-29-2006.

NELSON SNYDER, EXAMINING ATTORNEY

**Int. Cl.: 12**

**Prior U.S. Cls.: 19, 21, 23, 31, 35 and 44**

**Reg. No. 3,503,387**

**United States Patent and Trademark Office**

**Registered Sep. 23, 2008**

---

**TRADEMARK  
PRINCIPAL REGISTER**

# Stellar

THE HOFFMAN GROUP LLC (OREGON LIMITED LIABILITY COMPANY)  
201 SE OAK STREET  
PORTLAND, OR 97214

FIRST USE 9-4-1995; IN COMMERCE 9-4-1995.

SER. NO. 76-669,715, FILED 11-30-2006.

FOR: AUTOMOBILE PARTS NAMELY, MOTOR VEHICLE ALARM SYSTEMS AND PARTS THEREFOR, IN CLASS 12 (U.S. CLS. 19, 21, 23, 31, 35 AND 44).

DOMINIC J. FERRAIUOLO, EXAMINING ATTORNEY



Int. Cl.: 31

Prior U.S. Cls.: 1 and 46

United States Patent and Trademark Office

Reg. No. 3,503,388

Registered Sep. 23, 2008

TRADEMARK  
PRINCIPAL REGISTER

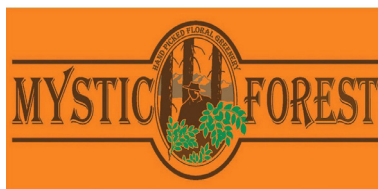

POSTIER, MARK (UNITED STATES INDIVIDUAL)  
431 N.E. MISSION CREEK ROAD  
BELFAIR, WA 98528 AND  
POSTIER, MICKIE (UNITED STATES INDIVIDUAL)  
431 N.E. MISSION CREEK ROAD  
BELFAIR, WA 98528  
DBA HOOD CANAL EVERGREENS

FOR: HORTICULTURAL AND FORESTRY PRODUCTS, NAMELY, CUT FOLIAGE AND ORNAMENTAL FOLIAGE, IN CLASS 31 (U.S. CLS. 1 AND 46).

FIRST USE 3-1-2003; IN COMMERCE 3-1-2003.

NO CLAIM IS MADE TO THE EXCLUSIVE RIGHT TO USE "HAND PICKED FLORAL GREENERY", APART FROM THE MARK AS SHOWN.

THE COLOR(S) ORANGE, BROWN, GREEN AND GRAY IS/ARE CLAIMED AS A FEATURE OF THE MARK.

THE MARK CONSISTS OF THE STYLIZED WORDING "MYSTIC FOREST HAND PICKED FLORAL GREENERY" AND DESIGN ELEMENTS, ALL OF WHICH ARE SUPERIMPOSED OVER AN ORANGE RECTANGULAR BACKGROUND. ALL WORDING IN THE MARK IS BROWN, AND THE

WORDING "MYSTIC FOREST" HAS PARTIAL THIN BROWN OUTLINES TO CREATE A RAISED EFFECT. AN INCOMPLETE BROWN-LINED INNER OVAL WITH AN INCOMPLETE THIN BROWN OUTLINE APPEARS BETWEEN THE TERMS "MYSTIC" AND "FOREST". THE INCOMPLETE OVALS CONTAIN A GRAY MOUNTAIN RANGE, THREE BROWN TREE TRUNKS, AND THE SILHOUETTE OF A PERSON IN BROWN STANDING ON GROUND THAT IS ALSO BROWN. THE PERSON IS CARRYING THREE GREEN BRANCHES. THE ORANGE BACKGROUND THAT APPEARS THROUGHOUT THE MARK EXTENDS TO FORM AN ORANGE OUTLINE AROUND EACH OF THE BRANCHES. THE TWO UPPER GREEN BRANCHES BEING CARRIED BY THE PERSON AND A SMALL BROWN ROOT FROM THE LEFTMOST TREE TRUNK EXTEND OUTSIDE THE INCOMPLETE OVALS. THE WORDING "HAND PICKED GREENERY" IS CURVED IN AN ARC AROUND THE TOP PORTION OF THE OUTER INCOMPLETE OVAL. THE WORDS AND DESIGN ELEMENTS ARE CONTAINED WITHIN TWO CURVED BROWN BORDER LINES, ONE ON THE TOP AND THE OTHER ON THE BOTTOM.

SER. NO. 76-669,787, FILED 12-1-2006.

NELSON SNYDER, EXAMINING ATTORNEY

**Int. Cl.: 14**

**Prior U.S. Cls.: 2, 27, 28 and 50**

**United States Patent and Trademark Office**

**Reg. No. 3,503,389**

**Registered Sep. 23, 2008**

**TRADEMARK  
PRINCIPAL REGISTER**

**I REISS**

I. REISS CO. INC. (NEW YORK CORPORATION)  
45 NORTH STATION PLAZA, SUITE 406  
GREAT NECK, NY 11021

FOR: JEWELRY AND WATCHES, IN CLASS 14  
(U.S. CLS. 2, 27, 28 AND 50).

FIRST USE 6-0-1997; IN COMMERCE 6-0-1997.

THE MARK CONSISTS OF STANDARD CHAR-  
ACTERS WITHOUT CLAIM TO ANY PARTICULAR  
FONT, STYLE, SIZE, OR COLOR.

SEC. 2(F).

SER. NO. 76-670,116, FILED 12-8-2006.

LOURDES AYALA, EXAMINING ATTORNEY

**Int. Cls.: 9 and 35**

**Prior U.S. Cls.: 21, 23, 26, 36, 38, 100, 101 and 102**

**United States Patent and Trademark Office**

**Reg. No. 3,503,390**

**Registered Sep. 23, 2008**

**TRADEMARK  
SERVICE MARK  
PRINCIPAL REGISTER**

**GJORGI**

ANGELA LUDWIG, LLC (NEW YORK LIMITED  
LIABILITY COMPANY)  
2440 BRONX PARK EAST  
BRONX, NY 10467

FOR: COMPACT DISKS FEATURING MUSIC;  
DVDS FEATURING MUSIC, SOUND, IMAGES  
AND/OR ANIMATION; CASSETTES FEATURING  
MUSIC, IN CLASS 9 (U.S. CLS. 21, 23, 26, 36 AND 38).

FIRST USE 9-0-2006; IN COMMERCE 9-0-2006.

FOR: WEB SITE SERVICES, NAMELY, PROVID-  
ING AN ONLINE RETAIL STORE FEATURING  
DOWNLOADABLE MUSIC AND VIDEO, IN CLASS  
35 (U.S. CLS. 100, 101 AND 102).

FIRST USE 8-15-2006; IN COMMERCE 8-15-2006.

THE MARK CONSISTS OF STANDARD CHAR-  
ACTERS WITHOUT CLAIM TO ANY PARTICULAR  
FONT, STYLE, SIZE, OR COLOR.

THE NAME "GJORGI" IDENTIFIES A LIVING  
INDIVIDUAL WHOSE CONSENT IS OF RECORD.

SER. NO. 76-670,270, FILED 12-13-2006.

ELLEN PERKINS, EXAMINING ATTORNEY

**Int. Cl.: 3**

**Prior U.S. Cls.: 1, 4, 6, 50, 51 and 52**

**Reg. No. 3,503,391**

**United States Patent and Trademark Office**

**Registered Sep. 23, 2008**

**TRADEMARK  
PRINCIPAL REGISTER**

**WIG NET**

DEMERT BRANDS, INC. (FLORIDA CORPORATION)  
15402 N. NEBRASKA AVENUE  
LUTZ, FL 33549

FOR: HOLDING SPRAYS FOR NATURAL AND SYNTHETIC WIGS, FALLS, HAIR PIECES, EXTENSIONS AND ADD-ONS, IN CLASS 3 (U.S. CLS. 1, 4, 6, 50, 51 AND 52).

FIRST USE 1-0-1980; IN COMMERCE 1-0-1980.

THE MARK CONSISTS OF STANDARD CHARACTERS WITHOUT CLAIM TO ANY PARTICULAR FONT, STYLE, SIZE, OR COLOR.

NO CLAIM IS MADE TO THE EXCLUSIVE RIGHT TO USE "WIG", APART FROM THE MARK AS SHOWN.

SER. NO. 76-670,657, FILED 12-21-2006.

LINDA ORNDORFF, EXAMINING ATTORNEY

**Int. Cl.: 9**

**Prior U.S. Cls.: 21, 23, 26, 36 and 38**

**Reg. No. 3,503,392**

**United States Patent and Trademark Office**

**Registered Sep. 23, 2008**

**TRADEMARK  
PRINCIPAL REGISTER**



SHINEI GROUP, INC. (JAPAN CORPORATION)  
HONKOMAGOME 6-15-8  
BUNKYO-KU, TOKYO, JAPAN

13-2006, REG. NO. 5094353, DATED 11-22-2007, EX-  
PIRES 11-22-2017.

OWNER OF U.S. REG. NO. 3,096,046.

FOR: BINOCULARS, TELESCOPES, TELESCOPIC  
SIGHTS FOR FIREARMS, LENS CAPS, MOUNTS  
AND BASES FOR TELESCOPIC SIGHTS; EYE GLAS-  
SES, SPECTACLES AND SUNGLASSES, IN CLASS 9  
(U.S. CLS. 21, 23, 26, 36 AND 38).

THE LINING SHOWN IN THE DRAWING IS A  
FEATURE OF THE MARK.

SER. NO. 76-672,467, FILED 2-8-2007.

PRIORITY CLAIMED UNDER SEC. 44(D) ON  
JAPAN APPLICATION NO. 2006-115227, FILED 12-

TINA L. SNAPP, EXAMINING ATTORNEY

**Int. Cl.: 39**

**Prior U.S. Cls.: 100 and 105**

**United States Patent and Trademark Office**

**Reg. No. 3,503,393**

**Registered Sep. 23, 2008**

**SERVICE MARK  
PRINCIPAL REGISTER**

# VisitRussia

OPTIMA TOURS LTD. (NEW YORK CORPORATION)  
257 WEST 39TH ST., STUDIO 39  
NEW YORK, NY 10018

FOR: ORGANIZING TRAVEL TOURS FOR OTHERS; TRAVEL AND TOUR INFORMATION SERVICES IN THE FIELD OF TOURISM; PROVIDING INFORMATION ON TRAVEL ARRANGEMENTS, IN CLASS 39 (U.S. CLS. 100 AND 105).

FIRST USE 1-9-2006; IN COMMERCE 1-9-2006.

THE MARK CONSISTS OF STANDARD CHARACTERS WITHOUT CLAIM TO ANY PARTICULAR FONT, STYLE, SIZE, OR COLOR.

SER. NO. 76-673,569, FILED 3-5-2007.

ALICIA COLLINS, EXAMINING ATTORNEY

**Int. Cl.: 41**

**Prior U.S. Cls.: 100, 101 and 107**

**United States Patent and Trademark Office**

**Reg. No. 3,503,394**

**Registered Sep. 23, 2008**

**SERVICE MARK  
PRINCIPAL REGISTER**

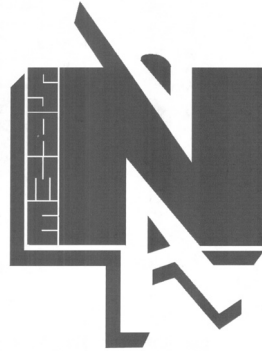

T. WOODARD ENTERPRISES LLC (PENNSYLVANIA LIMITED LIABILITY COMPANY)  
514 N. 57TH STREET  
PHILADELPHIA, PA 19131

FIRST USE 10-20-2004; IN COMMERCE 10-20-2004.

SER. NO. 76-673,975, FILED 3-12-2007.

FOR: ENTERTAINMENT SERVICES, NAMELY,  
LIVE PERFORMANCES BY A VOCAL MUSIC  
GROUP, IN CLASS 41 (U.S. CLS. 100, 101 AND 107).

ARETHA SOMERVILLE, EXAMINING ATTORNEY

**Int. Cl.: 42**

**Prior U.S. Cls.: 100 and 101**

**United States Patent and Trademark Office**

**Reg. No. 3,503,395**

**Registered Sep. 23, 2008**

**SERVICE MARK  
PRINCIPAL REGISTER**



AMERICAN HOSPITAL ASSOCIATION (ILLINOIS NON-PROFIT CORPORATION)  
ONE NORTH FRANKLIN  
CHICAGO, IL 60610

FOR: TESTING, ANALYSIS AND EVALUATION OF THE KNOWLEDGE AND SKILL OF OTHERS FOR THE PURPOSE OF CERTIFICATION IN THE FIELD OF HEALTHCARE ADMINISTRATION AND MANAGEMENT, IN CLASS 42 (U.S. CLS. 100 AND 101).

FIRST USE 1-1-2002; IN COMMERCE 1-1-2002.

OWNER OF U.S. REG. NOS. 1,348,716, 3,032,690 AND OTHERS.

NO CLAIM IS MADE TO THE EXCLUSIVE RIGHT TO USE "CERTIFICATION" AND "HOSPITAL ASSOCIATION", APART FROM THE MARK AS SHOWN.

SEC. 2(F).

SER. NO. 76-674,665, FILED 3-27-2007.

BRIAN NEVILLE, EXAMINING ATTORNEY



**Int. Cls.: 9, 35 and 42**

**Prior U.S. Cls.: 21, 23, 26, 36, 38, 100, 101 and 102**

**Reg. No. 3,503,396**

**United States Patent and Trademark Office**

**Registered Sep. 23, 2008**

**TRADEMARK  
SERVICE MARK  
PRINCIPAL REGISTER**

# ESTHALTO

PHOTOALTO (FRANCE CORPORATION)  
9 RUE PIERRE DUPONT  
75010 PARIS, FRANCE

FOR: CD-ROMS, DVDS, FLASH MEMORY CARDS AND COMPUTER HARD DISCS, CARRYING DIGITIZED PHOTOGRAPHS TO FORM A DIGITAL PHOTOLIBRARY; DOWNLOADABLE ELECTRONIC MAGAZINES AND CATALOGS IN THE FIELD OF ART, FASHION, BEAUTY, DESIGN, FOOD, ARCHITECTURE, HEALTH, LIFESTYLE, PHOTOGRAPHY, ENTERTAINMENT, GEOGRAPHY AND/OR HUMAN CULTURES; CD-ROMS, DVDS, FLASH MEMORY CARDS AND COMPUTER HARD DISCS, FEATURING DIGITIZED IMAGE DATABASES AND DOWNLOADABLE DIGITIZED IMAGE DATABASES, IN CLASS 9 (U.S. CLS. 21, 23, 26, 36 AND 38).

FOR: COMMERCIAL MANAGEMENT OF IMAGE DATABASES FOR PROFESSIONAL USE, DESIGNED FOR MEDIA PROFESSIONALS, AND MORE ESPECIALLY FOR MEMBERS OF THE PRESS, AND FOR ADVERTISING AND COMMU-

NICATION PROFESSIONALS, IN CLASS 35 (U.S. CLS. 100, 101 AND 102).

FOR: STOCK PHOTOGRAPHY SERVICES, NAMELY, LEASING PRODUCTION RIGHTS OF PHOTOGRAPHS AND TRANSPARENCIES TO ADVERTISING PROFESSIONALS, AND TO MEDIA AND COMMUNICATION PROFESSIONALS, IN CLASS 42 (U.S. CLS. 100 AND 101).

THE MARK CONSISTS OF STANDARD CHARACTERS WITHOUT CLAIM TO ANY PARTICULAR FONT, STYLE, SIZE, OR COLOR.

PRIORITY CLAIMED UNDER SEC. 44(D) ON FRANCE APPLICATION NO. 073490077, FILED 3-23-2007, REG. NO. 073490077, DATED 3-23-2007, EXPIRES 3-23-2017.

THE TERM ESTHALTO HAS NO MEANING IN A FOREIGN LANGUAGE.

SER. NO. 76-675,173, FILED 4-5-2007.

DEIRDRE ROBERTSON, EXAMINING ATTORNEY

**Int. Cl.: 28**

**Prior U.S. Cls.: 22, 23, 38 and 50**

**United States Patent and Trademark Office**

**Reg. No. 3,503,397**

**Registered Sep. 23, 2008**

**TRADEMARK  
PRINCIPAL REGISTER**

# **The Pitcher's Eye**

4 SEAM, INC. (PENNSYLVANIA CORPORATION)  
35 DAVIS AVENUE  
BROOMALL, PA 19008

FOR: SPORTS TRAINING EQUIPMENT, NAME-  
LY, DEVICES DEPLOYED ON A BASEBALL FIELD  
TO ASSIST IN VISUALIZING THE PATH OF A  
BASEBALL FOR USE IN TRAINING BASEBALL  
PITCHERS, CATCHERS AND BATTERS , IN CLASS  
28 (U.S. CLS. 22, 23, 38 AND 50).

FIRST USE 12-19-2006; IN COMMERCE 12-19-2006.

THE MARK CONSISTS OF STANDARD CHAR-  
ACTERS WITHOUT CLAIM TO ANY PARTICULAR  
FONT, STYLE, SIZE, OR COLOR.

NO CLAIM IS MADE TO THE EXCLUSIVE  
RIGHT TO USE "PITCHER'S", APART FROM THE  
MARK AS SHOWN.

SER. NO. 76-675,395, FILED 4-12-2007.

TINA L. SNAPP, EXAMINING ATTORNEY

**Int. Cl.: 16**

**Prior U.S. Cls.: 2, 5, 22, 23, 29, 37, 38 and 50**

**Reg. No. 3,503,398**

**United States Patent and Trademark Office**

**Registered Sep. 23, 2008**

**TRADEMARK  
PRINCIPAL REGISTER**

**BOOKMATE**

HIGHTOWER ASSOCIATES, INC. (FLORIDA  
CORPORATION)  
P.O. BOX 740146  
BOYNTON BEACH, FL 334740146

THE MARK CONSISTS OF STANDARD CHAR-  
ACTERS WITHOUT CLAIM TO ANY PARTICULAR  
FONT, STYLE, SIZE, OR COLOR.

FOR: A PROTECTIVE COVER FOR PAPERBACK  
BOOKS THAT HOLDS A BOOK OPEN WHEN  
READING, IN CLASS 16 (U.S. CLS. 2, 5, 22, 23, 29,  
37, 38 AND 50).

SER. NO. 76-675,565, FILED 4-16-2007.

FIRST USE 1-0-1990; IN COMMERCE 1-0-1990.

ANGELA M. MICHELI, EXAMINING ATTORNEY

**Int. Cl.: 9**

**Prior U.S. Cls.: 21, 23, 26, 36 and 38**

**United States Patent and Trademark Office**

**Reg. No. 3,503,399**

**Registered Sep. 23, 2008**

**TRADEMARK  
PRINCIPAL REGISTER**



HANFLING, ISSAC GABRIEL (ARGENTINA IN-  
DIVIDUAL)  
MURCIA 1558 (1414) CAPITAL FEDERAL  
BUENOS AIRES, ARGENTINA

FIRST USE 9-15-1997; IN COMMERCE 2-7-1998.

SER. NO. 76-675,926, FILED 4-24-2007.

FOR: SUNGLASSES AND OPTICAL FRAMES, IN  
CLASS 9 (U.S. CLS. 21, 23, 26, 36 AND 38).

JESSICA A. POWERS, EXAMINING ATTORNEY

**Int. Cl.: 42**

**Prior U.S. Cls.: 100 and 101**

**United States Patent and Trademark Office**

**Reg. No. 3,503,400**

**Registered Sep. 23, 2008**

**SERVICE MARK  
PRINCIPAL REGISTER**

**OM DESIGNS**

ORGANIC METHOD, LLC (NEW JERSEY LIMITED LIABILITY COMPANY)

212 BRIGHTON AVENUE

NEPTUNE, NJ 07753

FOR: INTERIOR DESIGN SERVICES, IN CLASS 42 (U.S. CLS. 100 AND 101).

FIRST USE 11-0-2006; IN COMMERCE 5-16-2007.

THE MARK CONSISTS OF STANDARD CHARACTERS WITHOUT CLAIM TO ANY PARTICULAR FONT, STYLE, SIZE, OR COLOR.

NO CLAIM IS MADE TO THE EXCLUSIVE RIGHT TO USE "DESIGNS", APART FROM THE MARK AS SHOWN.

SER. NO. 76-676,271, FILED 4-30-2007.

JENNIFER VASQUEZ, EXAMINING ATTORNEY

**Int. Cl.: 25**

**Prior U.S. Cls.: 22 and 39**

**United States Patent and Trademark Office**

**Reg. No. 3,503,401**

**Registered Sep. 23, 2008**

**TRADEMARK  
PRINCIPAL REGISTER**

**TURQUOISE N BLUE**

LAM, WINNIE (UNITED STATES INDIVIDUAL)  
110 E. NINTH STREET, SUITE # A1147  
LOS ANGELES, CA 90079

THE MARK CONSISTS OF STANDARD CHAR-  
ACTERS WITHOUT CLAIM TO ANY PARTICULAR  
FONT, STYLE, SIZE, OR COLOR.

FOR: LADIES' AND MEN'S APPAREL, NAMELY,  
PANTS, SHIRTS, JACKETS, SHOES AND SWEA-  
TERS, IN CLASS 25 (U.S. CLS. 22 AND 39).

SER. NO. 76-676,833, FILED 5-14-2007.

FIRST USE 5-1-2007; IN COMMERCE 5-1-2007.

GIANCARLO CASTRO, EXAMINING ATTORNEY

**Int. Cls.: 9, 16, 35 and 41**

**Prior U.S. Cls.: 2, 5, 21, 22, 23, 26, 29, 36, 37, 38, 50,  
100, 101, 102 and 107**

**Reg. No. 3,503,402**

**United States Patent and Trademark Office**

**Registered Sep. 23, 2008**

**TRADEMARK  
SERVICE MARK  
PRINCIPAL REGISTER**

**TOPSS**

AMERICAN PSYCHOLOGICAL ASSOCIATION  
(D.C. NOT-FOR-PROFIT CORPORATION)  
750 FIRST STREET N.E.  
WASHINGTON, DC 200024242

FOR: DOWNLOADABLE EDUCATIONAL LESSON PLANS DIRECTED TO PSYCHOLOGY TEACHERS IN THE FIELD OF PSYCHOLOGY AND THE SOCIAL SCIENCES, IN CLASS 9 (U.S. CLS. 21, 23, 26, 36 AND 38).

FIRST USE 0-0-2003; IN COMMERCE 0-0-2003.

FOR: PRINTED EDUCATIONAL LESSON PLANS DIRECTED TO PSYCHOLOGY TEACHERS IN THE FIELD OF PSYCHOLOGY AND THE SOCIAL SCIENCES, IN CLASS 16 (U.S. CLS. 2, 5, 22, 23, 29, 37, 38 AND 50).

FIRST USE 0-0-2003; IN COMMERCE 0-0-2003.

FOR: PROMOTING THE PUBLIC AWARENESS AND PUBLIC INTEREST FOR THE NEED OF PSYCHOLOGY AWARENESS IN HIGH SCHOOLS; PROVIDING OPPORTUNITIES FOR HIGH SCHOOL TEACHERS AND STUDENTS TO BE RECOGNIZED AND TO BE AWARDED FOR ACADEMIC EXCELLENCE, IN CLASS 35 (U.S. CLS. 100, 101 AND 102).

FIRST USE 0-0-1994; IN COMMERCE 0-0-1994.

FOR: PROVIDING PROFESSIONAL DEVELOPMENT OPPORTUNITIES, NAMELY, WORKSHOPS IN THE FIELD OF PSYCHOLOGY AND THE SOCIAL SCIENCES FOR PSYCHOLOGY TEACHERS; PROVIDING EDUCATIONAL WORKSHOPS IN THE AREA OF PSYCHOLOGY AND THE SOCIAL SCIENCES; ARRANGING AND CONDUCTING EDUCATIONAL CONFERENCES; PROVIDING RECOGNITION AND INCENTIVES BY WAY OF AWARDS TO DEMONSTRATE EXCELLENCE IN THE FIELD OF EDUCATION; PROVIDING ONLINE CONTINUING EDUCATIONAL PSYCHOLOGY COURSES, IN CLASS 41 (U.S. CLS. 100, 101 AND 107).

FIRST USE 0-0-1994; IN COMMERCE 0-0-1994.

THE MARK CONSISTS OF STANDARD CHARACTERS WITHOUT CLAIM TO ANY PARTICULAR FONT, STYLE, SIZE, OR COLOR.

SER. NO. 76-677,004, FILED 5-17-2007.

KEVON CHISOLM, EXAMINING ATTORNEY

**Int. Cls.: 9, 16, 35 and 41**

**Prior U.S. Cls.: 2, 5, 21, 22, 23, 26, 29, 36, 37, 38, 50, 100, 101, 102 and 107**

**Reg. No. 3,503,403**

**United States Patent and Trademark Office**

**Registered Sep. 23, 2008**

**TRADEMARK  
SERVICE MARK  
PRINCIPAL REGISTER**



AMERICAN PSYCHOLOGICAL ASSOCIATION  
(D.C. NOT-FOR-PROFIT CORPORATION)  
750 FIRST STREET N.E.  
WASHINGTON, DC 200024242

FOR: DOWNLOADABLE EDUCATIONAL LESSON PLANS DIRECTED TO PSYCHOLOGY TEACHERS IN THE FIELD OF PSYCHOLOGY AND THE SOCIAL SCIENCES, IN CLASS 9 (U.S. CLS. 21, 23, 26, 36 AND 38).

FIRST USE 0-0-2003; IN COMMERCE 0-0-2003.

FOR: PRINTED EDUCATIONAL LESSON PLANS DIRECTED TO PSYCHOLOGY TEACHERS IN THE FIELD OF PSYCHOLOGY AND THE SOCIAL SCIENCES, IN CLASS 16 (U.S. CLS. 2, 5, 22, 23, 29, 37, 38 AND 50).

FIRST USE 0-0-2003; IN COMMERCE 0-0-2003.

FOR: PROMOTING PUBLIC AWARENESS OF AND PUBLIC INTEREST IN THE NEED OF PSYCHOLOGY AWARENESS IN HIGH SCHOOLS , IN CLASS 35 (U.S. CLS. 100, 101 AND 102).

FIRST USE 0-0-1994; IN COMMERCE 0-0-1994.

FOR: PROVIDING PROFESSIONAL DEVELOPMENT OPPORTUNITIES, NAMELY, WORKSHOPS

IN THE FIELD PSYCHOLOGY AND THE SOCIAL SCIENCES FOR PSYCHOLOGY TEACHERS; PROVIDING EDUCATIONAL WORKSHOPS IN THE AREA OF PSYCHOLOGY AND THE SOCIAL SCIENCES; ARRANGING AND CONDUCTING EDUCATIONAL CONFERENCES; PROVIDING RECOGNITION AND INCENTIVES BY WAY OF AWARDS TO DEMONSTRATE EXCELLENCE IN THE FIELD OF EDUCATION; PROVIDING ONLINE CONTINUING EDUCATIONAL PSYCHOLOGY COURSES; EDUCATIONAL SERVICES, NAMELY, PROVIDING OPPORTUNITIES FOR HIGH SCHOOL TEACHERS AND STUDENTS TO BE RECOGNIZED AND TO BE AWARDED FOR ACADEMIC EXCELLENCE, IN CLASS 41 (U.S. CLS. 100, 101 AND 107).

FIRST USE 0-0-1994; IN COMMERCE 0-0-1994.

THE COLOR(S) BLACK AND RED IS/ARE CLAIMED AS A FEATURE OF THE MARK.

THE COLOR BLACK APPEARS IN THE LETTERING "TPSS". THE COLOR RED APPEARS IN THE DESIGN OF THE APPLE.

SER. NO. 76-677,005, FILED 5-17-2007.

KEVON CHISOLM, EXAMINING ATTORNEY



**Int. Cl.: 29**

**Prior U.S. Cl.: 46**

**United States Patent and Trademark Office**

**Reg. No. 3,503,404**

**Registered Sep. 23, 2008**

**TRADEMARK  
PRINCIPAL REGISTER**

**HAVE NUTS? HAVE A PARTY!**

SAFeway INC. (DELAWARE CORPORATION)  
5918 STONERDIGE MALL ROAD  
PLEASANTON, CA 945882322

THE MARK CONSISTS OF STANDARD CHARACTERS WITHOUT CLAIM TO ANY PARTICULAR FONT, STYLE, SIZE, OR COLOR.

FOR: PROCESSED NUTS, ROASTED NUTS, SHELLED NUTS, IN CLASS 29 (U.S. CL. 46).

SER. NO. 76-677,677, FILED 5-31-2007.

FIRST USE 10-1-2007; IN COMMERCE 10-1-2007.

ALYSSA PALADINO, EXAMINING ATTORNEY

Int. Cl.: 21

Prior U.S. Cls.: 2, 13, 23, 29, 30, 33, 40 and 50

United States Patent and Trademark Office

Reg. No. 3,503,405

Registered Sep. 23, 2008

TRADEMARK  
PRINCIPAL REGISTER

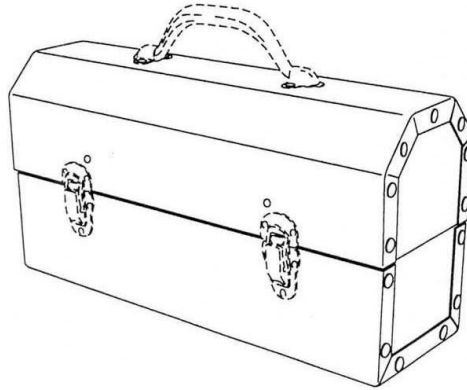

L. MAY METAL FABRICATORS LTD. (CANADA CORPORATION)  
122 RIDGEMOUNT AVENUE  
SUDBURY, ONTARIO, CANADA P3B 3W5

FOR: LUNCH BOXES, IN CLASS 21 (U.S. CLS. 2, 13, 23, 29, 30, 33, 40 AND 50).

FIRST USE 1-22-1974; IN COMMERCE 1-22-1974.

OWNER OF CANADA REG. NO. TMA343,395, DATED 8-5-1988, RENEWED AS REG. NO. TMA343,395, DATED 8-5-2003, EXPIRES 8-5-2018.

THE MARK CONSISTS OF THE CONFIGURATION OF A LUNCH BOX. THE LUNCH BOX FEATURES A LID PORTION WITH PLURALITY OF PANELS THAT, IN COMBINATION WITH THE LOWER PORTION, HAS AN OVERALL SHAPE THAT RESEMBLES A BARN. A SERIES OF RIVETS ARE VISIBLE AT EACH END.

SEC. 2(F).

SER. NO. 76-677,847, FILED 6-6-2007.

JOHN E. MICHOS, EXAMINING ATTORNEY

**Int. Cl.: 41**

**Prior U.S. Cls.: 100, 101 and 107**

**United States Patent and Trademark Office**

**Reg. No. 3,503,406**

**Registered Sep. 23, 2008**

**SERVICE MARK  
PRINCIPAL REGISTER**

**DUNHILL VACATIONS**

DUNHILL VACATIONS, INC. (FLORIDA CORPORATION)  
1802 N. UNIVERSITY DRIVE SUITE 102-325  
PLANTATION, FL 33322

FOR: PROVIDING INFORMATION ON TRAVEL, TOURISM, CULTURE FOOD AND BEVERAGE TO OTHERS VIA A GLOBAL COMPUTER NETWORK, IN CLASS 41 (U.S. CLS. 100, 101 AND 107).

FIRST USE 0-0-2001; IN COMMERCE 0-0-2001.

THE MARK CONSISTS OF STANDARD CHARACTERS WITHOUT CLAIM TO ANY PARTICULAR FONT, STYLE, SIZE, OR COLOR.

NO CLAIM IS MADE TO THE EXCLUSIVE RIGHT TO USE "VACATIONS", APART FROM THE MARK AS SHOWN.

SER. NO. 76-677,912, FILED 6-7-2007.

LOURDES AYALA, EXAMINING ATTORNEY

**Int. Cls.: 16, 35 and 44**

**Prior U.S. Cls.: 2, 5, 22, 23, 29, 37, 38, 50, 100, 101, 102  
and 200**

**Reg. No. 3,503,407**

**Registered Sep. 23, 2008**

**United States Patent and Trademark Office**

---

**TRADEMARK  
SERVICE MARK  
COLLECTIVE MEMBERSHIP  
PRINCIPAL REGISTER**



MICHIGAN DENTAL ASSOCIATION (MICHIGAN CORPORATION)  
230 N. WASHINGTON SQUARE, SUITE 208  
LANSING, MI 48933

FOR: PERIODICALS, NAMELY, A PROFESSIONAL DENTAL JOURNAL, IN CLASS 16 (U.S. CLS. 2, 5, 22, 23, 29, 37, 38 AND 50).

FIRST USE 1-9-1995; IN COMMERCE 1-9-1995.

FOR: PROMOTING THE PUBLIC AWARENESS OF THE NEED FOR SCIENCE, ART AND PRACTICE OF DENTISTRY, IN CLASS 35 (U.S. CLS. 100, 101 AND 102).

FIRST USE 10-30-1994; IN COMMERCE 10-30-1994.

FOR: PROVIDING INFORMATION TO THE PUBLIC ABOUT DENTAL CARE SERVICE, DENTAL CARE NEEDS OF THE PUBLIC, AND QUALIFICATIONS OF DENTAL PRACTITIONERS, IN CLASS 44 (U.S. CLS. 100 AND 101).

FIRST USE 10-30-1994; IN COMMERCE 10-30-1994.

FOR: INDICATING MEMBERSHIP IN A PROFESSIONAL ORGANIZATION OF DENTISTS AND DENTAL PRACTITIONERS IN THE STATE OF MICHIGAN, IN CLASS 200 (U.S. CL. 200).

FIRST USE 10-30-1994; IN COMMERCE 10-30-1994.

SER. NO. 76-679,514, FILED 7-13-2007.

DEIRDRE ROBERTSON, EXAMINING ATTORNEY

**Int. Cl.: 17**

**Prior U.S. Cls.: 1, 5, 12, 13, 35 and 50**

**Reg. No. 3,503,408**

**United States Patent and Trademark Office**

**Registered Sep. 23, 2008**

**TRADEMARK  
PRINCIPAL REGISTER**



A REEL TAPE CORPORATION (ILLINOIS CORPORATION)  
707 THOMAS DRIVE  
P.O. BOX 812  
BENSENVILLE, IL 60106

FOR: INDUSTRIAL PRESSURE SENSITIVE AND GUMMED TAPE, IN CLASS 17 (U.S. CLS. 1, 5, 12, 13, 35 AND 50).

FIRST USE 4-1-1960; IN COMMERCE 4-1-1960.

NO CLAIM IS MADE TO THE EXCLUSIVE RIGHT TO USE "TAPE", APART FROM THE MARK AS SHOWN.

THE COLOR(S) RED, WHITE, AND BLACK IS/ARE CLAIMED AS A FEATURE OF THE MARK.

THE COLOR RED APPEARS ON THE FRONT SURFACES OF THE LETTERS COMPRISING THE WORD "REEL" AND IN THE WORDS "A TAPE". THE COLOR WHITE APPEARS ON THE TOP AND SIDE SURFACES OF THE LETTERS COMPRISING THE WORD "REEL". THE COLOR WHITE ALSO APPEARS ON THE TOP AND INNER SURFACES OF THE CIRCULAR DESIGN. THE COLOR BLACK APPEARS IN THE OUTER SIDE SURFACE OF THE CIRCULAR DESIGN.

SER. NO. 76-679,746, FILED 7-20-2007.

RUSS HERMAN, EXAMINING ATTORNEY

Int. Cl.: 16

Prior U.S. Cls.: 2, 5, 22, 23, 29, 37, 38 and 50

Reg. No. 3,503,409

United States Patent and Trademark Office

Registered Sep. 23, 2008

TRADEMARK  
PRINCIPAL REGISTER

SPIRIT

VOLUNTEERS OF AMERICA, INC. (NEW YORK CORPORATION)  
1660 DUKE STREET  
ALEXANDRIA, VA 22314

FOR: MAGAZINE FEATURING THE ACTIVITIES AND SERVICES OF NON-PROFIT HUMAN SERVICES ORGANIZATION DEVOTED TO PROVIDING HOUSING AND GROUP HOMES FOR LOW INCOME FAMILIES, THE ELDERLY AND THE DISABLED, INDIVIDUAL AND FAMILY COUNSELING, DAY CARE FOR CHILDREN AND ADULTS, SENIOR CITIZEN CENTERS, ADOPTION AND FOSTER CARE, RESIDENTIAL, CLINIC AND HOME HEALTH CARE AND PHYSICAL/MENTAL TREATMENT, NURSING HOMES, DRUG AND ALCOHOL PREVENTION AND TREATMENT, PERSONAL ASSISTANCE IN DISASTER RELIEF AND LIFE CRISIS MANAGEMENT, EMERGENCY AND

HOMELESS SHELTERS AND ASSISTANCE, FAMILY DEVELOPMENT, DELINQUENCY PREVENTION, PRISON, PAROLE AND OFFENDER TRANSITION/WORK RELEASE PROGRAMS, AND DISTRIBUTING AND SERVING MEALS, FOOD AND HOUSEHOLD GOODS, IN CLASS 16 (U.S. CLS. 2, 5, 22, 23, 29, 37, 38 AND 50).

FIRST USE 12-31-1993; IN COMMERCE 12-31-1993.

THE MARK CONSISTS OF STANDARD CHARACTERS WITHOUT CLAIM TO ANY PARTICULAR FONT, STYLE, SIZE, OR COLOR.

SER. NO. 76-679,964, FILED 7-26-2007.

AMY MCMENAMIN, EXAMINING ATTORNEY

**Int. Cl.: 44**

**Prior U.S. Cls.: 100 and 101**

**United States Patent and Trademark Office**

**Reg. No. 3,503,410**

**Registered Sep. 23, 2008**

**SERVICE MARK  
PRINCIPAL REGISTER**

# **TMI SPORTS MEDICINE**

MEISTER, KEITH (UNITED STATES INDIVIDUAL)  
515 MAYFIELD RD.  
STE. 116  
ARLINGTON, TX 76014

FOR: MEDICAL SERVICES, IN CLASS 44 (U.S. CLS. 100 AND 101).

FIRST USE 7-1-2004; IN COMMERCE 7-1-2004.

THE MARK CONSISTS OF STANDARD CHARACTERS WITHOUT CLAIM TO ANY PARTICULAR FONT, STYLE, SIZE, OR COLOR.

NO CLAIM IS MADE TO THE EXCLUSIVE RIGHT TO USE "SPORTS MEDICINE", APART FROM THE MARK AS SHOWN.

SER. NO. 76-680,036, FILED 7-30-2007.

INGA ERVIN, EXAMINING ATTORNEY

**Int. Cl.: 9**

**Prior U.S. Cls.: 21, 23, 26, 36 and 38**

**Reg. No. 3,503,411**

**United States Patent and Trademark Office**

**Registered Sep. 23, 2008**

**TRADEMARK  
PRINCIPAL REGISTER**

**VUEMETRIX**

VUEMETRIX, INC. (CALIFORNIA CORPORATION)  
960 HAMLIN COURT  
SUNNYVALE, CA 94089

THE MARK CONSISTS OF STANDARD CHARACTERS WITHOUT CLAIM TO ANY PARTICULAR FONT, STYLE, SIZE, OR COLOR.

FOR: LASER DIODE CONTROL DEVICE, NAME-  
LY, FAULT MONITORING AND LASER DIODE  
CONTROL ELECTRONICS, IN CLASS 9 (U.S. CLS.  
21, 23, 26, 36 AND 38).

SER. NO. 76-680,074, FILED 7-30-2007.

FIRST USE 8-0-2003; IN COMMERCE 8-0-2003.

DAVID YONTEF, EXAMINING ATTORNEY



**Int. Cl.: 16**

**Prior U.S. Cls.: 2, 5, 22, 23, 29, 37, 38 and 50**

**United States Patent and Trademark Office**

**Reg. No. 3,503,412**

**Registered Sep. 23, 2008**

**TRADEMARK  
PRINCIPAL REGISTER**

**FANCLAPPER**

MAX IMPACT, LLC (DELAWARE LIMITED LIABILITY COMPANY)  
1405 OLD WINTER BEACH ROAD  
VERO BEACH, FL 32963

THE MARK CONSISTS OF STANDARD CHARACTERS WITHOUT CLAIM TO ANY PARTICULAR FONT, STYLE, SIZE, OR COLOR.

FOR: CARDBOARD ADVERTISING AND PROMOTIONAL SIGNS, IN CLASS 16 (U.S. CLS. 2, 5, 22, 23, 29, 37, 38 AND 50).

SER. NO. 76-680,103, FILED 7-30-2007.

FIRST USE 2-21-2007; IN COMMERCE 3-15-2007.

DANIEL CAPSHAW, EXAMINING ATTORNEY

Int. Cl.: 45

Prior U.S. Cls.: 100 and 101

United States Patent and Trademark Office

Reg. No. 3,503,413

Registered Sep. 23, 2008

SERVICE MARK  
PRINCIPAL REGISTER



CHRISTIAN MOTORCYCLISTS ASSOCIATION,  
INC. (ARKANSAS CORPORATION)  
P.O. BOX 9  
HATFIELD, AR 71945

NO CLAIM IS MADE TO THE EXCLUSIVE  
RIGHT TO USE "CHRISTIAN MOTORCYCLISTS  
ASSOCIATION", APART FROM THE MARK AS  
SHOWN.

FOR: MINISTERIAL SERVICES, IN CLASS 45 (U.S.  
CLS. 100 AND 101).

SER. NO. 76-680,388, FILED 8-6-2007.

FIRST USE 6-21-1991; IN COMMERCE 6-21-1991.

OWNER OF U.S. REG. NOS. 1,186,227 AND  
1,702,308.

JOHN GARTNER, EXAMINING ATTORNEY

**Int. Cl.: 35**

**Prior U.S. Cls.: 100, 101 and 102**

**United States Patent and Trademark Office**

**Reg. No. 3,503,414**

**Registered Sep. 23, 2008**

**SERVICE MARK  
PRINCIPAL REGISTER**

**DISCOUNT DAVE**

HALL'S SALVAGE, LLC (TENNESSEE LIMITED  
LIABILITY COMPANY)  
720 HIGHWAY 68  
SWEETWATER, TN 37874

FOR: RETAIL AND WHOLESALE STORE SERVI-  
CES IN THE FIELD OF HOME IMPROVEMENT  
SUPPLIES, IN CLASS 35 (U.S. CLS. 100, 101 AND 102).

FIRST USE 12-26-2002; IN COMMERCE 12-26-2002.

NO CLAIM IS MADE TO THE EXCLUSIVE  
RIGHT TO USE DISCOUNT, APART FROM THE  
MARK AS SHOWN.

SER. NO. 76-680,692, FILED 8-15-2007.

WILLIAM BRECKENFELD, EXAMINING ATTOR-  
NEY

Int. Cl.: 19

Prior U.S. Cls.: 1, 12, 33 and 50

United States Patent and Trademark Office

Reg. No. 3,503,415

Registered Sep. 23, 2008

TRADEMARK  
PRINCIPAL REGISTER



ELITE VINYL WINDOWS LLC (PENNSYLVANIA  
LIMITED LIABILITY COMPANY)  
620 NORTH SHIRK ROAD  
NEW HOLLAND, PA 17557

FOR: VINYL WINDOWS, IN CLASS 19 (U.S. CLS. 1,  
12, 33 AND 50).

FIRST USE 6-1-2007; IN COMMERCE 6-1-2007.

NO CLAIM IS MADE TO THE EXCLUSIVE  
RIGHT TO USE "VINYL WINDOWS", APART FROM  
THE MARK AS SHOWN.

THE COLOR(S) ORANGE AND BROWN IS/ARE  
CLAIMED AS A FEATURE OF THE MARK.

THE MARK CONSISTS OF THE COLORS OR-  
ANGE AND BROWN. THE WORD "ELITE" AP-  
PEARS IN BROWN; THE WORDING "VINYL  
WINDOWS" AND THE 4 SQUARES DESIGN AP-  
PEAR IN ORANGE.

SER. NO. 76-680,858, FILED 8-20-2007.

ANGELA M. MICHELI, EXAMINING ATTORNEY

**Int. Cls.: 29 and 30**

**Prior U.S. Cl.: 46**

**United States Patent and Trademark Office**

**Reg. No. 3,503,416**

**Registered Sep. 23, 2008**

**TRADEMARK  
PRINCIPAL REGISTER**

**CLOVER STORNETTA**

CLOVER-STORNETTA FARMS, INC. (CALIFORNIA CORPORATION)  
91 LAKEVILLE STREET  
PETALUMA, CA 94952

FOR: MILK; EGGS; AND OTHER DAILY PRODUCTS, NAMELY, CHEESE, IN CLASS 29 (U.S. CL. 46).

FIRST USE 1-1-1980; IN COMMERCE 1-1-1980.

FOR: ICE CREAM , IN CLASS 30 (U.S. CL. 46).

FIRST USE 1-1-1980; IN COMMERCE 1-1-1980.

THE MARK CONSISTS OF STANDARD CHARACTERS WITHOUT CLAIM TO ANY PARTICULAR FONT, STYLE, SIZE, OR COLOR.

SER. NO. 76-680,930, FILED 8-20-2007.

AMY GEARIN, EXAMINING ATTORNEY

**Int. Cl.: 32**

**Prior U.S. Cls.: 45, 46 and 48**

**United States Patent and Trademark Office**

**Reg. No. 3,503,417**

**Registered Sep. 23, 2008**

**TRADEMARK  
PRINCIPAL REGISTER**



CERVECERIA CENTRO AMERICANA, S.A.  
(GUATEMALA CORPORATION)  
3A. AVE. NORTE FINAL  
FINCA EL ZAPOTE, ZONA 2  
GUATEMALA CITY, GUATEMALA

THE MARK CONSISTS OF THE STYLIZED  
WORDS, "MONTE CARLO", UPON RECTANGU-  
LAR BACKGROUND AS SHOWN IN THE AT-  
TACHED DRAWING PAGE.

FOR: BEER, ALE AND PORTER, IN CLASS 32  
(U.S. CLS. 45, 46 AND 48).

SER. NO. 76-681,035, FILED 8-23-2007.

FIRST USE 3-31-2006; IN COMMERCE 11-12-2006.

OWNER OF U.S. REG. NO. 2,446,456.

H. M. FISHER, EXAMINING ATTORNEY

**Int. Cl.: 32**

**Prior U.S. Cls.: 45, 46 and 48**

**United States Patent and Trademark Office**

**Reg. No. 3,503,418**

**Registered Sep. 23, 2008**

**TRADEMARK  
PRINCIPAL REGISTER**

**MONTE CARLO**

CERVECERIA CENTRO AMERICANA, S.A.  
(GUATEMALA CORPORATION)  
3A. AVE. NORTE FINAL  
FINCA EL ZAPOTE, ZONA 2  
GUATEMALA CITY, GUATEMALA

FOR: BEER, ALE AND PORTER, IN CLASS 32  
(U.S. CLS. 45, 46 AND 48).

FIRST USE 5-0-1950; IN COMMERCE 10-0-1986.

THE MARK CONSISTS OF STANDARD CHAR-  
ACTERS WITHOUT CLAIM TO ANY PARTICULAR  
FONT, STYLE, SIZE, OR COLOR.

OWNER OF U.S. REG. NO. 2,446,456.

SER. NO. 76-681,036, FILED 8-23-2007.

H. M. FISHER, EXAMINING ATTORNEY

**Int. Cl.: 35**

**Prior U.S. Cls.: 100, 101 and 102**

**United States Patent and Trademark Office**

**Reg. No. 3,503,419**

**Registered Sep. 23, 2008**

**SERVICE MARK  
PRINCIPAL REGISTER**

**Simply  
Successful**

"Moving Forward Together"

SIMPLY SUCCESSFUL, L.L.C. (MISSOURI LIMITED LIABILITY COMPANY)  
1311 CHERRY GLEN  
CHESTERFIELD, MO 63017

THE MARK CONSISTS OF STANDARD CHARACTERS WITHOUT CLAIM TO ANY PARTICULAR FONT, STYLE, SIZE, OR COLOR.

FOR: BUSINESS MANAGEMENT CONSULTING WITH RELATION TO STRATEGY, MARKETING, PRODUCTION, PERSONNEL AND RETAIL SALE MATTERS, IN CLASS 35 (U.S. CLS. 100, 101 AND 102).

SER. NO. 76-681,354, FILED 8-31-2007.

FIRST USE 4-18-2004; IN COMMERCE 4-18-2004.

JEFFERY COWARD, EXAMINING ATTORNEY



**Int. Cl.: 35**

**Prior U.S. Cls.: 100, 101 and 102**

**United States Patent and Trademark Office**

**Reg. No. 3,503,420**

**Registered Sep. 23, 2008**

**SERVICE MARK  
PRINCIPAL REGISTER**

**NQ. JEWELLERS**

NQ. JEWELLERS, INC. (CALIFORNIA CORPORATION)

16041 BROOKHURST STREET

FOUNTAIN VALLEY, CA 92708

FOR: RETAIL JEWELRY STORES, IN CLASS 35  
(U.S. CLS. 100, 101 AND 102).

FIRST USE 8-15-2007; IN COMMERCE 8-15-2007.

THE MARK CONSISTS OF STANDARD CHARACTERS WITHOUT CLAIM TO ANY PARTICULAR FONT, STYLE, SIZE, OR COLOR.

NO CLAIM IS MADE TO THE EXCLUSIVE RIGHT TO USE "JEWELLERS", APART FROM THE MARK AS SHOWN.

SER. NO. 76-681,649, FILED 9-7-2007.

MICHAEL WIENER, EXAMINING ATTORNEY

**Int. Cl.: 35**

**Prior U.S. Cls.: 100, 101 and 102**

**United States Patent and Trademark Office**

**Reg. No. 3,503,421**

**Registered Sep. 23, 2008**

**SERVICE MARK  
PRINCIPAL REGISTER**

**HMS  
MOTORSPORT**

HMS MOTORSPORT, LTD. (MASSACHUSETTS  
CORPORATION)  
3 FIRST AVENUE  
PEABODY, MA 01960

FOR: RETAIL STORE SERVICES FEATURING  
AUTO PARTS AND SAFETY EQUIPMENT, IN  
CLASS 35 (U.S. CLS. 100, 101 AND 102).

FIRST USE 1-1-1995; IN COMMERCE 1-1-1995.

THE MARK CONSISTS OF STANDARD CHAR-  
ACTERS WITHOUT CLAIM TO ANY PARTICULAR  
FONT, STYLE, SIZE, OR COLOR.

NO CLAIM IS MADE TO THE EXCLUSIVE  
RIGHT TO USE "MOTORSPORT", APART FROM  
THE MARK AS SHOWN.

SER. NO. 76-682,023, FILED 9-18-2007.

LINDA ORNDORFF, EXAMINING ATTORNEY

**Int. Cl.: 35**

**Prior U.S. Cls.: 100, 101 and 102**

**United States Patent and Trademark Office**

**Reg. No. 3,503,422**

**Registered Sep. 23, 2008**

**SERVICE MARK  
PRINCIPAL REGISTER**

**99¢ FLOOR STORE**

SANBERG, DONALD A. (UNITED STATES IN-  
DIVIDUAL)  
5503 FM 2920  
SPRING, TX 77388

FOR: RETAIL STORE SERVICES FEATURING  
FLOORS AND FLOOR COVERINGS INCLUDING  
LAMINATE, HARD WOOD, VINYL, STONE, TILE,  
CARPET, RUGS, POLYMERTILE, MATS AND  
WALL COVERINGS INCLUDING WALL PAPER,  
IN CLASS 35 (U.S. CLS. 100, 101 AND 102).

FIRST USE 4-0-2007; IN COMMERCE 4-0-2007.

THE MARK CONSISTS OF STANDARD CHAR-  
ACTERS WITHOUT CLAIM TO ANY PARTICULAR  
FONT, STYLE, SIZE, OR COLOR.

NO CLAIM IS MADE TO THE EXCLUSIVE  
RIGHT TO USE "FLOOR STORE", APART FROM  
THE MARK AS SHOWN.

SER. NO. 76-682,167, FILED 9-21-2007.

HOWARD B. LEVINE, EXAMINING ATTORNEY

**Int. Cl.: 9**

**Prior U.S. Cls.: 21, 23, 26, 36 and 38**

**Reg. No. 3,503,423**

**United States Patent and Trademark Office**

**Registered Sep. 23, 2008**

**TRADEMARK  
PRINCIPAL REGISTER**

**AlgoSec**

ALGORITHMIC SECURITY INC. (DELAWARE  
CORPORATION)  
59 FOREST STREET  
ALPINE, NJ 07620

THE MARK CONSISTS OF STANDARD CHAR-  
ACTERS WITHOUT CLAIM TO ANY PARTICULAR  
FONT, STYLE, SIZE, OR COLOR.

FOR: COMPUTER SOFTWARE FOR MANAGE-  
MENT OF COMPLEX NETWORK SECURITY, IN  
CLASS 9 (U.S. CLS. 21, 23, 26, 36 AND 38).

SER. NO. 76-682,458, FILED 10-1-2007.

FIRST USE 1-4-2004; IN COMMERCE 1-4-2004.

MARTHA FROMM, EXAMINING ATTORNEY

**Int. Cls.: 9, 16 and 18**

**Prior U.S. Cls.: 1, 2, 3, 5, 21, 22, 23, 26, 29, 36, 37, 38,  
41 and 50**

**Reg. No. 3,503,424**

**United States Patent and Trademark Office**

**Registered Sep. 23, 2008**

**TRADEMARK  
PRINCIPAL REGISTER**

**STEBCO**

BRY-MEL HOLDING INC. (CANADA CORPORATION)  
9255 HENRI BOURASSA WEST  
MONTREAL, QUEBEC H4S 1X1, CANADA

FOR: COMPUTER CARRYING CASES, IN CLASS  
9 (U.S. CLS. 21, 23, 26, 36 AND 38).

FIRST USE 12-31-1996; IN COMMERCE 12-31-1996.

FOR: WRITING CASES AND PADFOLIOS, IN  
CLASS 16 (U.S. CLS. 2, 5, 22, 23, 29, 37, 38 AND 50).

FIRST USE 10-1-1937; IN COMMERCE 10-1-1937.

FOR: BUSINESS CASES, CATALOG CASES,  
BRIEF-CASE TYPE PORTFOLIOS, LUGGAGE  
CARTS, DUFFEL BAGS, SPORTS BAGS, IN CLASS  
18 (U.S. CLS. 1, 2, 3, 22 AND 41).

FIRST USE 10-1-1937; IN COMMERCE 10-1-1937.

THE MARK CONSISTS OF STANDARD CHAR-  
ACTERS WITHOUT CLAIM TO ANY PARTICULAR  
FONT, STYLE, SIZE, OR COLOR.

SER. NO. 76-682,513, FILED 10-2-2007.

GINA HAYES, EXAMINING ATTORNEY

**Int. Cl.: 25**

**Prior U.S. Cls.: 22 and 39**

**United States Patent and Trademark Office**

**Reg. No. 3,503,425**

**Registered Sep. 23, 2008**

**TRADEMARK  
PRINCIPAL REGISTER**

**REVERSIBLE - ROLLOVERS**

HANSON HOLDINGS, INC. (NEW YORK CORPORATION)

P.O. BOX 163

PLAINVIEW, NY 11803

FOR: BEACH FOOTWEAR, FOOTWEAR, FOOTWEAR FOR MEN AND WOMEN AND CHILDREN SLIPPERS FOOTWEAR, IN CLASS 25 (U.S. CLS. 22 AND 39).

FIRST USE 6-25-2007; IN COMMERCE 6-25-2007.

THE MARK CONSISTS OF STANDARD CHARACTERS WITHOUT CLAIM TO ANY PARTICULAR FONT, STYLE, SIZE, OR COLOR.

OWNER OF U.S. REG. NO. 3,020,274.

NO CLAIM IS MADE TO THE EXCLUSIVE RIGHT TO USE "REVERSIBLE", APART FROM THE MARK AS SHOWN.

SER. NO. 76-682,969, FILED 10-15-2007.

RENEE SERVANCE, EXAMINING ATTORNEY

**Int. Cl.: 45**

**Prior U.S. Cls.: 100 and 101**

**United States Patent and Trademark Office**

**Reg. No. 3,503,426**

**Registered Sep. 23, 2008**

**SERVICE MARK  
PRINCIPAL REGISTER**

**THE MUSIC IS IN**

MICHAEL WELSH PRODUCTIONS, INC. (CALI-  
FORNIA CORPORATION)  
2215 LAMBERT DRIVE  
PASADENA, CA 91107

THE MARK CONSISTS OF STANDARD CHAR-  
ACTERS WITHOUT CLAIM TO ANY PARTICULAR  
FONT, STYLE, SIZE, OR COLOR.

FOR: MUSIC LICENSING, IN CLASS 45 (U.S. CLS.  
100 AND 101).

SER. NO. 76-683,321, FILED 10-23-2007.

FIRST USE 10-0-2006; IN COMMERCE 10-0-2006.

MICHAEL LITZAU, EXAMINING ATTORNEY

**Int. Cl.: 41**

**Prior U.S. Cls.: 100, 101 and 107**

**United States Patent and Trademark Office**

**Reg. No. 3,503,427**

**Registered Sep. 23, 2008**

**SERVICE MARK  
PRINCIPAL REGISTER**

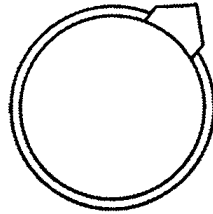

**CTT**

CTT CENTER OF TECHNOLOGY TRANSFER  
CORPORATION (PANAMA CORPORATION)  
1690 SOUTH BAYSHORE DRIVE, UNIT 6B  
COCONUT GROVE, FL 33133

FOR: EDUCATIONAL SERVICES, NAMELY,  
CLASSES, SEMINARS, AND WORKSHOPS FOR  
BUSINESSES AND INDIVIDUALS IN THE FIELD  
OF COMPUTER INFORMATION, SYSTEMS AND

NETWORK TECHNOLOGY, IN CLASS 41 (U.S. CLS.  
100, 101 AND 107).

FIRST USE 12-31-1990; IN COMMERCE 12-31-1998.

SER. NO. 76-683,578, FILED 11-2-2007.

KEVIN DINALLO, EXAMINING ATTORNEY



**Int. Cl.: 35**

**Prior U.S. Cls.: 100, 101 and 102**

**United States Patent and Trademark Office**

**Reg. No. 3,503,428**

**Registered Sep. 23, 2008**

**SERVICE MARK  
PRINCIPAL REGISTER**

**DRASPECIALISTS**

HMC MEDICAL IMAGING CONSULTANTS LLC  
(COLORADO LIMITED LIABILITY COMPAN-  
NY)

3286 CHERRY PLUM WAY  
CASTLE ROCK, CO 80104

FOR: BUSINESS MANAGEMENT AND CONSULTATION PROVIDED TO COMPANIES IN THE FIELD OF DIAGNOSTIC MEDICAL IMAGING, IN CLASS 35 (U.S. CLS. 100, 101 AND 102).

FIRST USE 7-0-2007; IN COMMERCE 7-0-2007.

THE MARK CONSISTS OF STANDARD CHARACTERS WITHOUT CLAIM TO ANY PARTICULAR FONT, STYLE, SIZE, OR COLOR.

SER. NO. 76-683,650, FILED 11-5-2007.

KAREN BRACEY, EXAMINING ATTORNEY

**Int. Cl.: 35**

**Prior U.S. Cls.: 100, 101 and 102**

**United States Patent and Trademark Office**

**Reg. No. 3,503,429**

**Registered Sep. 23, 2008**

**SERVICE MARK  
PRINCIPAL REGISTER**

**THE DRA SURVIVAL PROGRAM**

HMC MEDICAL IMAGING CONSULTANTS LLC  
(COLORADO LIMITED LIABILITY COMPAN-  
NY)  
3286 CHERRY PLUM WAY  
CASTLE ROCK, CO 80104

FOR: ASSISTANCE, ADVISORY SERVICES AND  
CONSULTANCY WITH REGARD TO BUSINESS  
MANAGEMENT IN THE FIELD OF MEDICAL  
IMAGING, IN CLASS 35 (U.S. CLS. 100, 101 AND 102).

FIRST USE 7-0-2007; IN COMMERCE 7-0-2007.

THE MARK CONSISTS OF STANDARD CHAR-  
ACTERS WITHOUT CLAIM TO ANY PARTICULAR  
FONT, STYLE, SIZE, OR COLOR.

NO CLAIM IS MADE TO THE EXCLUSIVE  
RIGHT TO USE "PROGRAM", APART FROM THE  
MARK AS SHOWN.

SER. NO. 76-683,652, FILED 11-5-2007.

KAREN BRACEY, EXAMINING ATTORNEY

**Int. Cl.: 29**

**Prior U.S. Cl.: 46**

**United States Patent and Trademark Office**

**Reg. No. 3,503,430**

**Registered Sep. 23, 2008**

**TRADEMARK  
PRINCIPAL REGISTER**

**ZARAGOZA**

UNION DE GANADEROS LECHEROS DE JUAREZ, S.A. DE C.V. (MEXICO CORPORATION)  
C. RAMON RAYON # 1351  
NUEVO ZARAGOZA, DISRITO DE BRAVO  
CIUDAD JUAREZ, CHIHUAHUA, MEXICO

FOR: DAIRY PRODUCTS AND DAIRY BY-PRODUCTS, NAMELY, MILK, CREAM, CHEESE, BUTTER; YOGURT, DAIRY BASED BEVERAGES, PASTEURIZED AND ULTRA-PASTEURIZED WHOLE MILK; PASTEURIZED AND ULTRA-PASTEURIZED LOW FAT MILK; PASTEURIZED AND ULTRA-PASTEURIZED MILK FORMULA, NAMELY, MILK BEVERAGES WITH HIGH MILK CONTENT; PASTEURIZED AND ULTRA-

PASTEURIZED COMBINED DAIRY PRODUCTS, NAMELY, DAIRY PRODUCTS EXCLUDING ICE CREAM, ICE MILK AND FROZEN YOGURT, IN CLASS 29 (U.S. CL. 46).

FIRST USE 11-30-2006; IN COMMERCE 11-30-2006.

THE MARK CONSISTS OF STANDARD CHARACTERS WITHOUT CLAIM TO ANY PARTICULAR FONT, STYLE, SIZE, OR COLOR.

SER. NO. 76-683,807, FILED 11-8-2007.

ROBERT STRUCK, EXAMINING ATTORNEY

**Int. Cl.: 41**

**Prior U.S. Cls.: 100, 101 and 107**

**United States Patent and Trademark Office**

**Reg. No. 3,503,431**

**Registered Sep. 23, 2008**

**SERVICE MARK  
PRINCIPAL REGISTER**

**OUR WORD, YOUR PEACE OF MIND.**

CETRA, INC. (PENNSYLVANIA CORPORATION)  
7804 MONTGOMERY AVENUE; SUITE 8  
ELKINS PARK, PA 19027

FOR: LANGUAGE SERVICES PROVIDER,  
NAMELY, PROVIDER OF LANGUAGE TRANSLA-  
TION AND LANGUAGE INTERPRETATION SER-  
VICES; LANGUAGE TRANSLATION SERVICES;  
LANGUAGE INTERPRETATION SERVICES; PRO-  
VIDING VOICE OVERS FOR TAPES, RECORDS  
AND OTHER RECORDED MEDIA; DOCUMENT  
TRANSLATION SERVICES; PROVIDING ON-SITE  
LANGUAGE TRANSLATION AND LANGUAGE

INTERPRETATION SERVICES, IN CLASS 41 (U.S.  
CLS. 100, 101 AND 107).

FIRST USE 9-12-2007; IN COMMERCE 9-12-2007.

THE MARK CONSISTS OF STANDARD CHAR-  
ACTERS WITHOUT CLAIM TO ANY PARTICULAR  
FONT, STYLE, SIZE, OR COLOR.

SER. NO. 76-684,304, FILED 11-26-2007.

JAMES LOVELACE, EXAMINING ATTORNEY

**Int. Cl.: 7**

**Prior U.S. Cls.: 13, 19, 21, 23, 31, 34 and 35**

**United States Patent and Trademark Office**

**Reg. No. 3,503,432**

**Registered Sep. 23, 2008**

**TRADEMARK  
PRINCIPAL REGISTER**

**CENTRI-MAXX**

CENTRUM FORCE LLC (MICHIGAN LIMITED  
LIABILITY COMPANY)  
3425 STONE SCHOOL ROAD  
ANN ARBOR, MI 48108

THE MARK CONSISTS OF STANDARD CHAR-  
ACTERS WITHOUT CLAIM TO ANY PARTICULAR  
FONT, STYLE, SIZE, OR COLOR.

FOR: MACHINERY, NAMELY, RUG DRYING  
MACHINES, IN CLASS 7 (U.S. CLS. 13, 19, 21, 23, 31, 34  
AND 35).

SER. NO. 76-684,346, FILED 11-26-2007.

FIRST USE 2-15-2007; IN COMMERCE 2-21-2007.

SARA THOMAS, EXAMINING ATTORNEY

**Int. Cl.: 30**

**Prior U.S. Cl.: 46**

**United States Patent and Trademark Office**

**Reg. No. 3,503,433**

**Registered Sep. 23, 2008**

**TRADEMARK  
PRINCIPAL REGISTER**



UNIQUE INDUSTRIES, INC. (PENNSYLVANIA  
CORPORATION)  
4750 LEAGUE ISLAND BLVD.  
PHILADELPHIA, PA 191121222

NO CLAIM IS MADE TO THE EXCLUSIVE  
RIGHT TO USE "PARTY MINTS" , APART FROM  
THE MARK AS SHOWN.

FOR: CANDY, IN CLASS 30 (U.S. CL. 46).

SER. NO. 76-684,753, FILED 12-10-2007.

FIRST USE 1-31-2008; IN COMMERCE 1-31-2008.

JESSICA A. POWERS, EXAMINING ATTORNEY

**Int. Cl.: 5**

**Prior U.S. Cls.: 6, 18, 44, 46, 51 and 52**

**Reg. No. 3,503,434**

**United States Patent and Trademark Office**

**Registered Sep. 23, 2008**

**TRADEMARK  
PRINCIPAL REGISTER**

The image shows the word "Parent" in a stylized, serif font. The letter "R" is replaced by a dark, stylized leaf shape that extends upwards and to the right, with a stem that forms the vertical part of the "R". The rest of the letters "P", "a", "e", "n", and "t" are in a classic serif typeface.

BIO KING, INC. (CALIFORNIA CORPORATION)  
1541 WILSHIRE BOULEVARD, #502  
LOS ANGELES, CA 90017

FOR: NUTRITION SUPPLEMENT, IN CLASS 5  
(U.S. CLS. 6, 18, 44, 46, 51 AND 52).

FIRST USE 10-15-2007; IN COMMERCE 10-15-2007.

NO CLAIM IS MADE TO THE EXCLUSIVE  
RIGHT TO USE "PARENT", APART FROM THE  
MARK AS SHOWN.

THE MARK CONSISTS OF THE WORD "PAR-  
ENT" IN STYLIZED FONT WITH A STYLIZED  
LETTER "R" FORMING THE REPRESENTATION  
OF A LEAF.

SER. NO. 76-684,760, FILED 12-10-2007.

PRISCILLA MILTON, EXAMINING ATTORNEY

**Int. Cls.: 41 and 44**

**Prior U.S. Cls.: 100, 101 and 107**

**United States Patent and Trademark Office**

**Reg. No. 3,503,435**

**Registered Sep. 23, 2008**

**SERVICE MARK  
PRINCIPAL REGISTER**

**ADVANCED ATHLETICS**

ADVANCED ATHLETICS, INC. (CALIFORNIA CORPORATION)  
PMB#1027  
1223 WILSHIRE BLVD.  
SANTA MONICA, CA 90403

FOR: PROVIDING PHYSICAL FITNESS CONSULTATION, INSTRUCTION AND TRAINING FOR INDIVIDUALS AND ORGANIZATIONS; KEY NOTE SPEAKING, NAMELY, EDUCATIONAL SERVICES IN THE NATURE OF PROVIDING MOTIVATIONAL AND EDUCATIONAL SPEAKERS FOR SMALL GROUPS, ORGANIZATIONS, AND CORPORATIONS; EDUCATIONAL SERVICES IN THE NATURE OF CLASSES AND SEMINARS FOR PERSONAL TRAINERS, IN CLASS 41 (U.S. CLS. 100, 101 AND 107).

FIRST USE 11-0-1998; IN COMMERCE 11-0-1998.

FOR: PROVIDING WELLNESS SERVICES, NAMELY, PERSONAL ASSESSMENTS IN THE NATURE OF NUTRITION AND HEALTH ASSESSMENT

FOR INDIVIDUALS AND ORGANIZATIONS; NUTRITION COUNSELING; PROVIDING ONLINE INFORMATION ON NUTRITION, NAMELY, INFORMATION ON NUTRITIONAL PROGRAMS AND NUTRITIONAL SUPPLEMENTATION; SPORTS SOFT-TISSUE THERAPY, NAMELY, PHYSICAL THERAPY, IN CLASS 44 (U.S. CLS. 100 AND 101).

FIRST USE 12-1-2007; IN COMMERCE 12-1-2007.

THE MARK CONSISTS OF STANDARD CHARACTERS WITHOUT CLAIM TO ANY PARTICULAR FONT, STYLE, SIZE, OR COLOR.

NO CLAIM IS MADE TO THE EXCLUSIVE RIGHT TO USE "ATHLETICS", APART FROM THE MARK AS SHOWN.

SER. NO. 76-684,921, FILED 12-13-2007.

AMY ALFIERI, EXAMINING ATTORNEY



**Int. Cl.: 43**

**Prior U.S. Cls.: 100 and 101**

**United States Patent and Trademark Office**

**Reg. No. 3,503,436**

**Registered Sep. 23, 2008**

**SERVICE MARK  
PRINCIPAL REGISTER**

**RED CLOUD CABIN**

TALISKER MOUNTAIN INCORPORATED (DE-  
LAWARE CORPORATION)

900 MAIN STREET, SUITE 6111

PARK CITY, UT 84060

FOR: RESTAURANT AND BAR SERVICES; COFFEE-HOUSE AND SNACK-BAR SERVICES; COCKTAIL LOUNGES, IN CLASS 43 (U.S. CLS. 100 AND 101).

FIRST USE 12-0-2006; IN COMMERCE 12-0-2006.

THE MARK CONSISTS OF STANDARD CHARACTERS WITHOUT CLAIM TO ANY PARTICULAR FONT, STYLE, SIZE, OR COLOR.

OWNER OF U.S. REG. NO. 3,172,958.

NO CLAIM IS MADE TO THE EXCLUSIVE RIGHT TO USE "CABIN", APART FROM THE MARK AS SHOWN.

SER. NO. 76-685,294, FILED 12-26-2007.

PETER B. BROMAGHIM, EXAMINING ATTORNEY

Int. Cl.: 36

Prior U.S. Cls.: 100, 101 and 102

United States Patent and Trademark Office

Reg. No. 3,503,437

Registered Sep. 23, 2008

SERVICE MARK  
PRINCIPAL REGISTER



EPISCOPAL MINISTRIES OF THE DIOCESE OF  
BETHLEHEM, INC. (PENNSYLVANIA COR-  
PORATION)  
337 WYANDOTTE STREET  
BETHLEHEM, PA 18015

FOR: CHARITABLE FUNDRAISING EVENT IN  
WHICH CANDLE KITS ARE SOLD AND DISTRIB-  
UTED THROUGHOUT THE COMMUNITY, IN  
CLASS 36 (U.S. CLS. 100, 101 AND 102).

FIRST USE 12-0-1997; IN COMMERCE 12-0-1997.

NO CLAIM IS MADE TO THE EXCLUSIVE  
RIGHT TO USE "LUMINARIA", APART FROM  
THE MARK AS SHOWN.

SER. NO. 76-685,312, FILED 12-26-2007.

DEZMONA MIZELLE, EXAMINING ATTORNEY

**Int. Cl.: 9**

**Prior U.S. Cls.: 21, 23, 26, 36 and 38**

**Reg. No. 3,503,438**

**United States Patent and Trademark Office**

**Registered Sep. 23, 2008**

**TRADEMARK  
PRINCIPAL REGISTER**

**ERMCO**

ELECTRIC RESEARCH & MANUFACTURING  
COOPERATIVE, INC. (DELAWARE COR-  
PORATION), AKA ERMCO  
P.O. BOX 1228  
DYERSBURG, TN 380251228

FOR: VOLTAGE REGULATING AND TRANS-  
FORMING APPARATUS, NAMELY, VOLTAGE  
REGULATORS AND TRANSFORMERS, AND CIR-  
CUIT SWITCHING AND FUSING CABINETS,  
NAMELY, HOUSING CABINETS FOR ELECTRI-  
CAL SWITCHES AND FUSES, USED IN THE  
TRANSMISSION AND DISTRIBUTION OF ELEC-

TRIC POWER, IN CLASS 9 (U.S. CLS. 21, 23, 26, 36  
AND 38).

FIRST USE 2-12-1985; IN COMMERCE 2-12-1985.

THE MARK CONSISTS OF STANDARD CHAR-  
ACTERS WITHOUT CLAIM TO ANY PARTICULAR  
FONT, STYLE, SIZE, OR COLOR.

SER. NO. 76-685,357, FILED 12-28-2007.

RONALD DELGIZZI, EXAMINING ATTORNEY

**Int. Cl.: 9**

**Prior U.S. Cls.: 21, 23, 26, 36 and 38**

**United States Patent and Trademark Office**

**Reg. No. 3,503,439**

**Registered Sep. 23, 2008**

**TRADEMARK  
PRINCIPAL REGISTER**

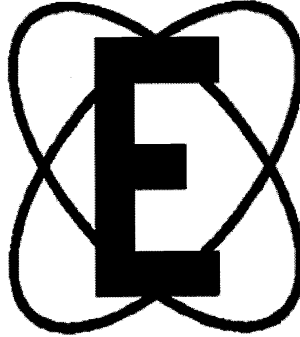

ELECTRIC RESEARCH & MANUFACTURING  
COOPERATIVE, INC. (DELAWARE COR-  
PORATION), AKA ERMCO  
P.O. BOX 1228  
DYERSBURG, TN 380251228

FOR: VOLTAGE REGULATING AND TRANS-  
FORMING APPARATUS, NAMELY, VOLTAGE  
REGULATORS AND TRANSFORMERS, AND CIR-  
CUIT SWITCHING AND FUSING CABINETS,  
NAMELY, HOUSING CABINETS FOR ELECTRICAL  
SWITCHES AND FUSES, USED IN THE  
TRANSMISSION AND DISTRIBUTION OF ELEC-

TRIC POWER, IN CLASS 9 (U.S. CLS. 21, 23, 26, 36  
AND 38).

FIRST USE 2-12-1985; IN COMMERCE 2-12-1985.

THE MARK CONSISTS OF THE LETTER "E"  
SUPERIMPOSED UPON TWO OVALS REPRESENT-  
ING AN ATOM.

SER. NO. 76-685,358, FILED 12-28-2007.

RONALD DELGIZZI, EXAMINING ATTORNEY

**Int. Cl.: 43**

**Prior U.S. Cls.: 100 and 101**

**United States Patent and Trademark Office**

**Reg. No. 3,503,440**

**Registered Sep. 23, 2008**

**SERVICE MARK  
PRINCIPAL REGISTER**

**THE ROCKWELL GROUP**

THE ROCKWELL GROUP, INC. (CALIFORNIA  
CORPORATION)  
10432 GARDEN GROVE AVENUE  
NORTHRIDGE, CA 91326

FOR: MAKING HOTEL RESERVATIONS FOR  
OTHERS; RESERVATION OF RESTAURANTS, IN  
CLASS 43 (U.S. CLS. 100 AND 101).

FIRST USE 7-0-1981; IN COMMERCE 7-0-1981.

THE MARK CONSISTS OF STANDARD CHAR-  
ACTERS WITHOUT CLAIM TO ANY PARTICULAR  
FONT, STYLE, SIZE, OR COLOR.

NO CLAIM IS MADE TO THE EXCLUSIVE  
RIGHT TO USE "GROUP", APART FROM THE  
MARK AS SHOWN.

SER. NO. 76-685,365, FILED 12-28-2007.

RUDY R. SINGLETON, EXAMINING ATTORNEY

**Int. Cl.: 41**

**Prior U.S. Cls.: 100, 101 and 107**

**United States Patent and Trademark Office**

**Reg. No. 3,503,441**

**Registered Sep. 23, 2008**

**SERVICE MARK  
PRINCIPAL REGISTER**



DAVIS, JACQUI (UNITED STATES INDIVIDUAL), AKA INGRID J. DAVIS  
22347 HOBSON ROAD S.E.  
YELM, WA 98597

FOR: EDUCATIONAL SERVICES, NAMELY, INSTRUCTION IN THE FIELD OF DANCING; INSTRUCTION IN THE FIELD OF SHAMANIC DANCING, WHEREIN THE PARTICIPANTS WEAR FACE MASKS AND VISUALIZE AND SPEAK OF THEIR DESIRES AND DREAMS WHILE DANCING, IN CLASS 41 (U.S. CLS. 100, 101 AND 107).

FIRST USE 8-15-2007; IN COMMERCE 8-15-2007.

NO CLAIM IS MADE TO THE EXCLUSIVE RIGHT TO USE "DANCE", APART FROM THE MARK AS SHOWN.

THE COLOR(S) BLUE, WHITE, DARK BLUE IS/ARE CLAIMED AS A FEATURE OF THE MARK.

THE MARK COMPRISES A RECTANGULAR PATCH OF BLUE SKY WITH PUFFS OF WHITE CLOUDS, THE WORDS "DANCE N CREATE" WRITTEN HORIZONTALLY JUST ABOVE THE LOWER LEFT MARGIN THEREOF, AND A SERIES OF DARK BLUE, SEMICIRCULAR ARCHES, OPEN AT THEIR LOWER ENDS, WHICH TRAIL OFF FROM THE, FOREGROUND INTO THE DISTANT, BACKGROUND SKY.

SER. NO. 76-685,573, FILED 1-7-2008.

EDWARD FENNESSY, EXAMINING ATTORNEY

**Int. Cl.: 35**

**Prior U.S. Cls.: 100, 101 and 102**

**United States Patent and Trademark Office**

**Reg. No. 3,503,442**

**Registered Sep. 23, 2008**

**SERVICE MARK  
PRINCIPAL REGISTER**

**HELPING GOLF BUSINESSES SUCCEED**

NATIONAL GOLF FOUNDATION, INC. (ILLINOIS CORPORATION)  
1150 S. U.S. HWY. # 1  
JUPITER, FL 33477

THE MARK CONSISTS OF STANDARD CHARACTERS WITHOUT CLAIM TO ANY PARTICULAR FONT, STYLE, SIZE, OR COLOR.

FOR: ASSOCIATION SERVICES, NAMELY, PROMOTING THE INTERESTS OF GOLF ENTHUSIASTS; MARKET RESEARCH SERVICES, IN CLASS 35 (U.S. CLS. 100, 101 AND 102).

SER. NO. 76-685,691, FILED 1-11-2008.

FIRST USE 8-30-2007; IN COMMERCE 8-30-2007.

STEPHEN AQUILA, EXAMINING ATTORNEY

Int. Cls.: 35 and 41

Prior U.S. Cls.: 100, 101, 102 and 107

United States Patent and Trademark Office

Reg. No. 3,503,443

Registered Sep. 23, 2008

SERVICE MARK  
PRINCIPAL REGISTER



PATTON MUSEUM FOUNDATION, INC. (KENTUCKY NON-PROFIT CORPORATION)  
4554 FAYETTE AVENUE  
P. O. BOX 25  
FT. KNOX, KY 40121

FOR: MUSEUM GIFT SHOP RETAIL SERVICES,  
IN CLASS 35 (U.S. CLS. 100, 101 AND 102).

FIRST USE 9-1-2007; IN COMMERCE 9-1-2007.

FOR: MILITARY HISTORY MUSEUM AND EDUCATIONAL SERVICES, NAMELY, CONDUCTING LECTURES, EXHIBITIONS, SEMINARS AND VIDEO PRESENTATIONS ALL IN THE FIELD OF MILITARY HISTORY; PROVIDING GUIDED

TOURS OF A MUSEUM, IN CLASS 41 (U.S. CLS. 100, 101 AND 107).

FIRST USE 9-1-2007; IN COMMERCE 9-1-2007.

NO CLAIM IS MADE TO THE EXCLUSIVE RIGHT TO USE "MUSEUM", APART FROM THE MARK AS SHOWN.

THE NAME "GEORGE PATTON" IDENTIFIES THE NAME OF A DECEASED INDIVIDUAL.

SER. NO. 76-685,831, FILED 1-16-2008.

LINDA ESTRADA, EXAMINING ATTORNEY



**Int. Cl.: 43**

**Prior U.S. Cls.: 100 and 101**

**United States Patent and Trademark Office**

**Reg. No. 3,503,444**

**Registered Sep. 23, 2008**

**SERVICE MARK  
PRINCIPAL REGISTER**



ROBERT WIEDMAIER LLC (D.C. LIMITED LIABILITY COMPANY)  
2401 PENNSYLVANIA AVENUE  
WASHINGTON, DC 20037

FIRST USE 5-1-2007; IN COMMERCE 5-1-2007.

SER. NO. 76-686,041, FILED 1-23-2008.

FOR: RESTAURANT AND BAR SERVICES, IN CLASS 43 (U.S. CLS. 100 AND 101).

AMEETA JORDAN, EXAMINING ATTORNEY

**Int. Cl.: 40**

**Prior U.S. Cls.: 100, 103 and 106**

**United States Patent and Trademark Office**

**Reg. No. 3,503,445**

**Registered Sep. 23, 2008**

**SERVICE MARK  
PRINCIPAL REGISTER**



APPLIED COATINGS & LININGS INC. (CALI-  
FORNIA CORPORATION)  
3224 NORTH ROSEMEAD BOULEVARD  
EL MONTE, CA 91731

OWNER OF U.S. REG. NO. 2,056,858.

FOR: APPLICATION OF PROTECTIVE COAT-  
INGS, IN CLASS 40 (U.S. CLS. 100, 103 AND 106).

SER. NO. 76-686,062, FILED 1-11-2008.

FIRST USE 1-0-2002; IN COMMERCE 1-0-2002.

HEATHER BIDDULPH, EXAMINING ATTORNEY

**Int. Cl.: 9**

**Prior U.S. Cls.: 21, 23, 26, 36 and 38**

**United States Patent and Trademark Office**

**Reg. No. 3,503,446**

**Registered Sep. 23, 2008**

**TRADEMARK  
PRINCIPAL REGISTER**



TRIGON COMPONENTS INC. (CALIFORNIA CORPORATION)  
939 MARINER STREET  
BREA, CA 92821

FOR: ELECTRICAL APPARATUS, NAMELY, RESISTORS, CAPACITORS, INDUCTORS AND EMI PRODUCTS, NAMELY, TRANSFORMERS, DIRECTIONAL COUPLERS, DISTRIBUTORS, MULTI-LAYER FERRITE CHIPS, FREQUENCY MIXERS, DOUBLE BALANCE MIXERS, SWITCHES, CONNECTORS AND CABLE ASSEMBLIES, IN CLASS 9 (U.S. CLS. 21, 23, 26, 36 AND 38).

FIRST USE 1-2-1998; IN COMMERCE 1-2-1998.

NO CLAIM IS MADE TO THE EXCLUSIVE RIGHT TO USE "COMPONENTS", APART FROM THE MARK AS SHOWN.

SER. NO. 76-686,376, FILED 1-24-2008.

BRIAN NEVILLE, EXAMINING ATTORNEY

**Int. Cl.: 29**

**Prior U.S. Cl.: 46**

**United States Patent and Trademark Office**

**Reg. No. 3,503,447**

**Registered Sep. 23, 2008**

**TRADEMARK  
PRINCIPAL REGISTER**

**QUEEN CITY SAUSAGE**

QUEEN CITY SAUSAGE AND PROVISION, INC.  
(OHIO CORPORATION)

1136 STRAIGHT STREET

CINCINNATI, OH 452141787

FOR: MEAT, CHEESE, HAM, BOLOGNA, SAUSAGES, TURKEY, LIVER PUDDING, HOT DOGS, AND GOETTA, NAMELY, A SAUSAGE-LIKE BLEND OF PORK, BEEF, OATS AND SEASONINGS, IN CLASS 29 (U.S. CL. 46).

FIRST USE 12-31-1965; IN COMMERCE 12-31-1965.

THE MARK CONSISTS OF STANDARD CHARACTERS WITHOUT CLAIM TO ANY PARTICULAR FONT, STYLE, SIZE, OR COLOR.

NO CLAIM IS MADE TO THE EXCLUSIVE RIGHT TO USE "SAUSAGE", APART FROM THE MARK AS SHOWN.

SEC. 2(F).

SER. NO. 76-686,380, FILED 1-31-2008.

NORA BUCHANAN WILL, EXAMINING ATTORNEY

**Int. Cl.: 16**

**Prior U.S. Cls.: 2, 5, 22, 23, 29, 37, 38 and 50**

**United States Patent and Trademark Office**

**Reg. No. 3,503,448**

**Registered Sep. 23, 2008**

**TRADEMARK  
PRINCIPAL REGISTER**

**LA MALDITA TARJETA de LLAMADAS**

ABC TELECOM INC. (NEW YORK CORPORATION)  
251-61 JERICHO TURNPIKE  
2ND FLOOR  
BELLEROSE, NY 11426

FOR: PREPAID TELEPHONE CALLING CARDS  
NOT MAGNETICALLY ENCODED, IN CLASS 16  
(U.S. CLS. 2, 5, 22, 23, 29, 37, 38 AND 50).

FIRST USE 8-24-2007; IN COMMERCE 9-12-2007.

THE MARK CONSISTS OF STANDARD CHARACTERS WITHOUT CLAIM TO ANY PARTICULAR FONT, STYLE, SIZE, OR COLOR.

NO CLAIM IS MADE TO THE EXCLUSIVE RIGHT TO USE "TARJETA DE LLAMADAS", APART FROM THE MARK AS SHOWN.

THE FOREIGN WORDING IN THE MARK "LA MALDITA TARJETA DE LLAMADAS" TRANSLATES INTO ENGLISH AS THE BAD ONE CALLING CARD.

SER. NO. 76-686,476, FILED 2-4-2008.

JAY BESCH, EXAMINING ATTORNEY

**Int. Cl.: 7**

**Prior U.S. Cls.: 13, 19, 21, 23, 31, 34 and 35**

**United States Patent and Trademark Office**

**Reg. No. 3,503,449**

**Registered Sep. 23, 2008**

**TRADEMARK  
PRINCIPAL REGISTER**

**SIMPL-TRACK**

PARTNERPAK, INC. (CALIFORNIA CORPORATION)  
5770 RESEARCH DRIVE  
HUNTINGTON BEACH, CA 92649

OWNER OF U.S. REG. NO. 3,367,462.

FOR: PACKAGING MACHINES, IN CLASS 7 (U.S. CLS. 13, 19, 21, 23, 31, 34 AND 35).

SER. NO. 76-686,715, FILED 2-11-2008.

FIRST USE 9-24-2007; IN COMMERCE 9-24-2007.

MICHELE SWAIN, EXAMINING ATTORNEY

**Int. Cl.: 35**

**Prior U.S. Cls.: 100, 101 and 102**

**United States Patent and Trademark Office**

**Reg. No. 3,503,450**

**Registered Sep. 23, 2008**

**SERVICE MARK  
PRINCIPAL REGISTER**



FUGENT, INC. (DELAWARE CORPORATION)  
5131 POST ROAD, SUITE 210  
DUBLIN, OH 43017

OWNER OF U.S. REG. NOS. 2,592,752, 2,716,228  
AND OTHERS.

FOR: BUSINESS CONSULTATION SERVICES  
AND TELEPHONE ANSWERING SERVICES, IN  
CLASS 35 (U.S. CLS. 100, 101 AND 102).

SER. NO. 76-686,833, FILED 2-15-2008.

FIRST USE 5-1-2004; IN COMMERCE 5-1-2004.

KIMBERLY FRYE, EXAMINING ATTORNEY

**Int. Cl.: 9**

**Prior U.S. Cls.: 21, 23, 26, 36 and 38**

**United States Patent and Trademark Office**

**Reg. No. 3,503,451**

**Registered Sep. 23, 2008**

**TRADEMARK  
PRINCIPAL REGISTER**

**FUGENT**

FUGENT, INC. (DELAWARE CORPORATION)  
5131 POST ROAD, SUITE 210  
DUBLIN, OH 43017

FOR: COMPUTER SOFTWARE FOR USE IN THE  
PRODUCTION OF WEB CAST TRANSMISSIONS OF  
SOUND AND VIDEO VIA A GLOBAL COMPUTER  
NETWORK, IN CLASS 9 (U.S. CLS. 21, 23, 26, 36 AND  
38).

FIRST USE 11-1-2001; IN COMMERCE 11-1-2001.

THE MARK CONSISTS OF STANDARD CHAR-  
ACTERS WITHOUT CLAIM TO ANY PARTICULAR  
FONT, STYLE, SIZE, OR COLOR.

OWNER OF U.S. REG. NOS. 2,592,752, 2,716,228  
AND OTHERS.

SER. NO. 76-686,835, FILED 2-15-2008.

KIMBERLY FRYE, EXAMINING ATTORNEY



**Int. Cl.: 35**

**Prior U.S. Cls.: 100, 101 and 102**

**United States Patent and Trademark Office**

**Reg. No. 3,503,452**

**Registered Sep. 23, 2008**

**SERVICE MARK  
PRINCIPAL REGISTER**

**TUMBLEROOS**

TUMBLEROOS, LLC (MINNESOTA LIMITED  
LIABILITY COMPANY)  
15670 EDGEWOOD DRIVE  
BAXTER, MN 56425

THE MARK CONSISTS OF STANDARD CHAR-  
ACTERS WITHOUT CLAIM TO ANY PARTICULAR  
FONT, STYLE, SIZE, OR COLOR.

FOR: RETAIL STORE SERVICES IN THE FIELD  
OF CHILDREN'S CLOTHING AND FOOTWEAR, IN  
CLASS 35 (U.S. CLS. 100, 101 AND 102).

SER. NO. 76-686,849, FILED 2-15-2008.

FIRST USE 10-0-2003; IN COMMERCE 10-0-2003.

SALLY SHIH, EXAMINING ATTORNEY

**Int. Cl.: 42**

**Prior U.S. Cls.: 100 and 101**

**United States Patent and Trademark Office**

**Reg. No. 3,503,453**

**Registered Sep. 23, 2008**

**SERVICE MARK  
PRINCIPAL REGISTER**

**LewisStyle**

LEWIS, NATALIE (UNITED STATES INDIVIDUAL)  
931 UTICA DRIVE  
CASTLE ROCK, CO 80108

FOR: HOME STAGING CONSULTATION, NAME-  
LY, TEMPORARY INTERIOR AND EXTERIOR  
HOME DECORATION CONSULTATION FOR THE  
PURPOSE OF MAKING HOMES MORE APPEAL-  
ING TO PROSPECTIVE BUYERS; INTERIOR DE-  
SIGN SERVICES; INTERIOR DECORATION  
CONSULTATION, IN CLASS 42 (U.S. CLS. 100 AND  
101).

FIRST USE 1-23-2008; IN COMMERCE 1-23-2008.

THE MARK CONSISTS OF STANDARD CHAR-  
ACTERS WITHOUT CLAIM TO ANY PARTICULAR  
FONT, STYLE, SIZE, OR COLOR.

SER. NO. 76-686,886, FILED 2-19-2008.

SANDRA MANIOS, EXAMINING ATTORNEY

**Int. Cl.: 10**

**Prior U.S. Cls.: 26, 39 and 44**

**United States Patent and Trademark Office**

**Reg. No. 3,503,454**

**Registered Sep. 23, 2008**

**TRADEMARK  
PRINCIPAL REGISTER**

**SURESAMPLE**

GYNEX CORPORATION (WASHINGTON COR-  
PORATION)  
2789 152ND AVENUE N.E.  
REDMOND, WA 98052

THE MARK CONSISTS OF STANDARD CHAR-  
ACTERS WITHOUT CLAIM TO ANY PARTICULAR  
FONT, STYLE, SIZE, OR COLOR.

FOR: MEDICAL INSTRUMENT, NAMELY, AN  
ENDOMETRIAL SAMPLER, IN CLASS 10 (U.S. CLS.  
26, 39 AND 44).

SER. NO. 76-686,941, FILED 2-19-2008.

FIRST USE 9-13-2000; IN COMMERCE 9-13-2000.

GRETTA YAO, EXAMINING ATTORNEY

Int. Cl.: 25

Prior U.S. Cls.: 22 and 39

United States Patent and Trademark Office

Reg. No. 3,503,455

Registered Sep. 23, 2008

TRADEMARK  
PRINCIPAL REGISTER

**THE BRAVE EDGE**

HAYNES, MAURICE A. (UNITED STATES INDIVIDUAL)

10207 MERRIDITH CIRCLE # 107

BURKE, VA 22015

FOR: CLOTHING, NAMELY, T-SHIRTS, HATS, HEADBANDS, SWEATBANDS, WRISTBANDS, GLOVES, JACKETS, SKI JACKETS, SWEATSHIRTS,

SWEATPANTS, AND SHIRTS, IN CLASS 25 (U.S. CLS. 22 AND 39).

FIRST USE 2-5-2008; IN COMMERCE 2-5-2008.

SER. NO. 76-686,944, FILED 2-20-2008.

RONALD MCMORROW, EXAMINING ATTORNEY

Int. Cl.: 16

Prior U.S. Cls.: 2, 5, 22, 23, 29, 37, 38 and 50

United States Patent and Trademark Office

Reg. No. 3,503,456

Registered Sep. 23, 2008

TRADEMARK  
PRINCIPAL REGISTER

Nearly Normal  
Cooking

NEARLY NORMAL COOKING, LLC (MARY-  
LAND LIMITED LIABILITY COMPANY)  
5907 FOXHALL MANOR DRIVE  
CATONSVILLE, MD 21228

FIRST USE 11-0-2006; IN COMMERCE 11-0-2006.

SER. NO. 76-686,963, FILED 2-20-2008.

FOR: SERIES OF BOOKS AND WRITTEN ARTI-  
CLES IN THE FIELD OF GLUTEN-FREE FOOD TO  
ACCOMMODATE SPECIAL MEDICAL AND  
HEALTH CONDITIONS, IN CLASS 16 (U.S. CLS. 2,  
5, 22, 23, 29, 37, 38 AND 50).

JACQUELINE A. LAVINE, EXAMINING ATTOR-  
NEY

**Int. Cl.: 31**

**Prior U.S. Cls.: 1 and 46**

**United States Patent and Trademark Office**

**Reg. No. 3,503,457**

**Registered Sep. 23, 2008**

**TRADEMARK  
PRINCIPAL REGISTER**

**PAM-12**

ENCAP, LLC (WISCONSIN LIMITED LIABILITY  
COMPANY)  
3921 ALGOMA ROAD  
GREEN BAY, WI 54311

THE MARK CONSISTS OF STANDARD CHAR-  
ACTERS WITHOUT CLAIM TO ANY PARTICULAR  
FONT, STYLE, SIZE, OR COLOR.

FOR: NON AQUEOUS PRODUCT, NAMELY, A  
MULCH, THAT CARRIES A SOIL AMENDMENT,  
IN CLASS 31 (U.S. CLS. 1 AND 46).

SER. NO. 76-687,004, FILED 2-19-2008.

FIRST USE 1-0-2002; IN COMMERCE 1-0-2002.

ALLISON HOLTZ, EXAMINING ATTORNEY

**Int. Cl.: 6**

**Prior U.S. Cls.: 2, 12, 13, 14, 23, 25 and 50**

**Reg. No. 3,503,458**

**United States Patent and Trademark Office**

**Registered Sep. 23, 2008**

**TRADEMARK  
PRINCIPAL REGISTER**

**MAXIMO**

PERI FORMWORK SYSTEMS, INC. (MARY-  
LAND CORPORATION)  
7141 DORSEY RUN ROAD  
ELKRIDGE, MD 21075

THE MARK CONSISTS OF STANDARD CHAR-  
ACTERS WITHOUT CLAIM TO ANY PARTICULAR  
FONT, STYLE, SIZE, OR COLOR.

FOR: CONSTRUCTION ELEMENTS MADE OF  
METAL, NAMELY, FORM WORK, IN CLASS 6 (U.S.  
CLS. 2, 12, 13, 14, 23, 25 AND 50).

SER. NO. 76-687,009, FILED 2-21-2008.

FIRST USE 10-0-2007; IN COMMERCE 10-0-2007.

FRED MANDIR, EXAMINING ATTORNEY

**Int. Cl.: 6**

**Prior U.S. Cls.: 2, 12, 13, 14, 23, 25 and 50**

**Reg. No. 3,503,459**

**United States Patent and Trademark Office**

**Registered Sep. 23, 2008**

**TRADEMARK  
PRINCIPAL REGISTER**

**BEAMDECK**

PERI FORMWORK SYSTEMS, INC. (MARY-  
LAND CORPORATION)  
7141 DORSEY RUN ROAD  
ELKRIDGE, MD 21075

THE MARK CONSISTS OF STANDARD CHAR-  
ACTERS WITHOUT CLAIM TO ANY PARTICULAR  
FONT, STYLE, SIZE, OR COLOR.

FOR: CONSTRUCTION ELEMENTS MADE OF  
METAL, NAMELY, FORM WORK, IN CLASS 6 (U.S.  
CLS. 2, 12, 13, 14, 23, 25 AND 50).

SER. NO. 76-687,010, FILED 2-21-2008.

FIRST USE 1-23-2008; IN COMMERCE 1-23-2008.

FRED MANDIR, EXAMINING ATTORNEY



**Int. Cl.: 7**

**Prior U.S. Cls.: 13, 19, 21, 23, 31, 34 and 35**

**United States Patent and Trademark Office**

**Reg. No. 3,503,460**

**Registered Sep. 23, 2008**

**TRADEMARK  
PRINCIPAL REGISTER**

**SPOTNAILS**



PEACE INDUSTRIES, LTD. (DELAWARE CORPORATION)  
1100 HICKS ROAD  
ROLLING MEADOWS, IL 60008

FOR: MACHINES FOR DRIVING SECURING ELEMENTS IN THE NATURE OF NAILS, NAMELY, PNEUMATIC HAMMERS, IN CLASS 7 (U.S. CLS. 13, 19, 21, 23, 31, 34 AND 35).

FIRST USE 8-29-1941; IN COMMERCE 8-29-1941.

OWNER OF U.S. REG. NOS. 836,195 AND 844,379.

SER. NO. 76-687,100, FILED 2-21-2008.

JULIE WATSON, EXAMINING ATTORNEY

**Int. Cl.: 28**

**Prior U.S. Cls.: 22, 23, 38 and 50**

**United States Patent and Trademark Office**

**Reg. No. 3,503,461**

**Registered Sep. 23, 2008**

**TRADEMARK  
PRINCIPAL REGISTER**

**DUAL-START DRAGWAY**

HASBRO, INC. (RHODE ISLAND CORPORATION)  
1027 NEWPORT AVENUE  
PAWTUCKET, RI 02862

THE MARK CONSISTS OF STANDARD CHARACTERS WITHOUT CLAIM TO ANY PARTICULAR FONT, STYLE, SIZE, OR COLOR.

FOR: TOY VEHICLES, TOY VEHICLE PLAYSETS AND ACCESSORIES FOR USE THEREWITH, IN CLASS 28 (U.S. CLS. 22, 23, 38 AND 50).

SER. NO. 76-687,236, FILED 2-29-2008.

FIRST USE 2-14-2007; IN COMMERCE 2-14-2007.

ELISSA GARBER KON, EXAMINING ATTORNEY

**Int. Cl.: 43**

**Prior U.S. Cls.: 100 and 101**

**United States Patent and Trademark Office**

**Reg. No. 3,503,462**

**Registered Sep. 23, 2008**

**SERVICE MARK  
PRINCIPAL REGISTER**



LEE, DOOHI (UNITED STATES INDIVIDUAL)  
5508 ASHCREEK LANE  
PLANO, TX 75093

FOR: BAR AND RESTAURANT SERVICES, IN  
CLASS 43 (U.S. CLS. 100 AND 101).

FIRST USE 3-1-2007; IN COMMERCE 3-1-2007.

THE PATTERN OF THE STITCHING ON THE  
BASEBALL IS NOT THE TRADITIONAL BASEBALL  
STITCHING PATTERN, BUT IS IN THE SHAPE OF A  
WOMAN'S FIGURE.

SER. NO. 76-687,522, FILED 3-10-2008.

KIMBERLY FRYE, EXAMINING ATTORNEY

**Int. Cl.: 9**

**Prior U.S. Cls.: 21, 23, 26, 36 and 38**

**United States Patent and Trademark Office**

**Reg. No. 3,503,463**

**Registered Sep. 23, 2008**

**TRADEMARK  
PRINCIPAL REGISTER**

**BULLETIN DIRECTOR**

PERFTECH, INC. (DELAWARE CORPORATION)  
613 NW LOOP 410, SUITE 520  
SAN ANTONIO, TX 78216

THE MARK CONSISTS OF STANDARD CHAR-  
ACTERS WITHOUT CLAIM TO ANY PARTICULAR  
FONT, STYLE, SIZE, OR COLOR.

FOR: COMPUTER HARDWARE FOR USE IN  
THE ENHANCEMENT OF THE OPERATIONS OF  
INTERNET PROVIDERS, IN CLASS 9 (U.S. CLS. 21,  
23, 26, 36 AND 38).

SER. NO. 76-687,713, FILED 3-14-2008.

FIRST USE 10-15-2001; IN COMMERCE 2-11-2002.

SANJEEV VOHRA, EXAMINING ATTORNEY

**Int. Cl.: 28**

**Prior U.S. Cls.: 22, 23, 38 and 50**

**United States Patent and Trademark Office**

**Reg. No. 3,503,464**

**Registered Sep. 23, 2008**

**TRADEMARK  
PRINCIPAL REGISTER**



HASBRO, INC. (RHODE ISLAND CORPORATION)  
1027 NEWPORT AVENUE  
PAWTUCKET, RI 02862

FIRST USE 9-8-2005; IN COMMERCE 9-8-2005.

SER. NO. 76-688,351, FILED 4-4-2008.

FOR: TOYS, NAMELY, TOY VEHICLES AND ACCESSORIES FOR USE THEREWITH, IN CLASS 28 (U.S. CLS. 22, 23, 38 AND 50).

TRACY WHITTAKER-BROWN, EXAMINING ATTORNEY

**Int. Cl.: 28**

**Prior U.S. Cls.: 22, 23, 38 and 50**

**United States Patent and Trademark Office**

**Reg. No. 3,503,465**

**Registered Sep. 23, 2008**

**TRADEMARK  
PRINCIPAL REGISTER**

**NITRO XRC**

HASBRO, INC. (RHODE ISLAND CORPORATION)  
1027 NEWPORT AVENUE  
PAWTUCKET, RI 02862

THE MARK CONSISTS OF STANDARD CHARACTERS WITHOUT CLAIM TO ANY PARTICULAR FONT, STYLE, SIZE, OR COLOR.

FOR: TOY VEHICLES, TOYS, NAMELY, TOY VEHICLES AND ACCESSORIES FOR USE THEREWITH, IN CLASS 28 (U.S. CLS. 22, 23, 38 AND 50).

SER. NO. 76-688,353, FILED 4-4-2008.

FIRST USE 9-8-2005; IN COMMERCE 9-8-2005.

ELI HELLMAN, EXAMINING ATTORNEY

**Int. Cl.: 28**

**Prior U.S. Cls.: 22, 23, 38 and 50**

**United States Patent and Trademark Office**

**Reg. No. 3,503,466**

**Registered Sep. 23, 2008**

**TRADEMARK  
PRINCIPAL REGISTER**

**AUTOBOT CAMSHAFT**

HASBRO, INC. (RHODE ISLAND CORPORATION)  
1027 NEWPORT AVENUE  
PAWTUCKET, RI 02862

FOR: TOY ACTION FIGURES, TOY VEHICLES  
AND TOY ROBOTS CONVERTIBLE INTO OTHER  
VISUAL TOY FORMS, IN CLASS 28 (U.S. CLS. 22, 23,  
38 AND 50).

FIRST USE 5-23-2005; IN COMMERCE 5-23-2005.

THE MARK CONSISTS OF STANDARD CHARACTERS WITHOUT CLAIM TO ANY PARTICULAR FONT, STYLE, SIZE, OR COLOR.

OWNER OF U.S. REG. NOS. 1,348,233, 2,985,989  
AND OTHERS.

SER. NO. 76-688,901, FILED 4-21-2008.

ELI HELLMAN, EXAMINING ATTORNEY

**Int. Cl.: 28**

**Prior U.S. Cls.: 22, 23, 38 and 50**

**United States Patent and Trademark Office**

**Reg. No. 3,503,467**

**Registered Sep. 23, 2008**

**TRADEMARK  
PRINCIPAL REGISTER**

**OPTIMUS PRIMAL**

HASBRO, INC. (RHODE ISLAND CORPORATION)  
1027 NEWPORT AVENUE  
PAWTUCKET, RI 02862

FOR: TOY ACTION FIGURES, TOY VEHICLES  
AND TOY ROBOTS CONVERTIBLE INTO OTHER  
VISUAL TOY FORMS, IN CLASS 28 (U.S. CLS. 22, 23,  
38 AND 50).

FIRST USE 10-4-2004; IN COMMERCE 10-4-2004.

THE MARK CONSISTS OF STANDARD CHARACTERS WITHOUT CLAIM TO ANY PARTICULAR FONT, STYLE, SIZE, OR COLOR.

OWNER OF U.S. REG. NO. 1,329,850.

SER. NO. 76-689,205, FILED 5-1-2008.

THEODORE MCBRIDE, EXAMINING ATTORNEY



**Int. Cl.: 24**

**Prior U.S. Cls.: 42 and 50**

**United States Patent and Trademark Office**

**Reg. No. 3,503,468**

**Registered Sep. 23, 2008**

**TRADEMARK  
PRINCIPAL REGISTER**

**CONNOISSEUR**

STROHEIM & ROMANN, INC. (DELAWARE  
CORPORATION)  
30-30 47TH AVENUE  
LONG ISLAND CITY, NY 11101

THE MARK CONSISTS OF STANDARD CHAR-  
ACTERS WITHOUT CLAIM TO ANY PARTICULAR  
FONT, STYLE, SIZE, OR COLOR.

FOR: DRAPERY, UPHOLSTERY FABRICS AND  
TEXTILE WALL COVERINGS, IN CLASS 24 (U.S.  
CLS. 42 AND 50).

SER. NO. 76-978,750, FILED 9-29-2005.

FIRST USE 1-25-2000; IN COMMERCE 1-25-2000.

DANIEL BRODY, EXAMINING ATTORNEY

**Int. Cl.: 35**

**Prior U.S. Cls.: 100, 101 and 102**

**United States Patent and Trademark Office**

**Reg. No. 3,503,469**

**Registered Sep. 23, 2008**

**SERVICE MARK  
PRINCIPAL REGISTER**

**BETTERSEX.COM**

TOWNSEND ENTERPRISES, INC. (NORTH CAROLINA CORPORATION)  
402 MILLSTONE DRIVE  
HILLSBOROUGH, NC 27278

FOR: ONLINE RETAIL STORE SERVICES FEATURING BODY AND BEAUTY CARE PREPARATIONS, BODY LOTIONS, MASSAGE OILS, SHAVERS AND SHAVING PRODUCTS, PERSONAL LUBRICANTS, ANESTHETICS FOR NON-SURGICAL USE, ADULT SEXUAL AIDS, TOYS AND GAMES, CLEANING PRODUCTS, TATTOOS, CONDOMS, AND AUDIO, VISUAL, AND MULTI-MEDIA RECORDINGS FEATURING MUSIC, ADULT ENTERTAINMENT OR INFORMATION IN THE FIELD OF HUMAN SEXUALITY; CATALOG ORDERING SERVICES FEATURING BODY AND BEAUTY CARE PREPARATIONS, BODY LOTIONS, MASSAGE OILS, SHAVERS AND SHAVING PRODUCTS, PERSONAL LUBRICANTS, ANESTHETICS FOR NON-SURGICAL USE, ADULT SEXUAL AIDS, TOYS AND GAMES, CLEANING PRODUCTS, TAT-

TOOS, CONDOMS, AND AUDIO, VISUAL, AND MULTI-MEDIA RECORDINGS FEATURING MUSIC, ADULT ENTERTAINMENT OR INFORMATION IN THE FIELD OF HUMAN SEXUALITY, IN CLASS 35 (U.S. CLS. 100, 101 AND 102).

FIRST USE 5-1-1996; IN COMMERCE 5-1-1996.

THE MARK CONSISTS OF STANDARD CHARACTERS WITHOUT CLAIM TO ANY PARTICULAR FONT, STYLE, SIZE, OR COLOR.

OWNER OF U.S. REG. NOS. 1,641,091 AND 3,107,809.

SEC. 2(F).

SER. NO. 77-000,159, FILED 9-15-2006.

DOMINIC FATHY, EXAMINING ATTORNEY

**Int. Cl.: 3**

**Prior U.S. Cls.: 1, 4, 6, 50, 51 and 52**

**Reg. No. 3,503,470**

**United States Patent and Trademark Office**

**Registered Sep. 23, 2008**

**TRADEMARK  
PRINCIPAL REGISTER**

**BERKELEY SQUARE**

THE BERKELEY SQUARE COSMETICS COMPANY LTD. (GREAT BRITAIN CORPORATION)  
UNIT 13, WATFORD METRO CENTRE, DWIGHT RD  
WATFORD, GREAT BRITAIN WD189SB

FOR: SOAPS; LIQUID SOAP; SHOWER AND BATH ADDITIVES IN THE NATURE OF FOAMS, CRYSTALS, BEADS, OILS AND SALTS NOT FOR MEDICAL PURPOSES; PERFUMES; COSMETICS; ESSENTIAL OILS; NON-MEDICATED PREPARATIONS FOR THE CARE OF SKIN AND HAIR; SHAMPOOS; DENTIFRICES; TOILET WATER; COLOGNES; DEODORANTS AND ANTI-PERSPIRANTS FOR PERSONAL USE; TALCUM POWDER; NON-MEDICATED PREPARATIONS FOR USE BEFORE, DURING AND AFTER SHAVING; NON-MEDICATED TOILET PREPARATIONS, NAMELY, COSMETIC CREAMS, SKIN CARE LOTIONS, BODY AND FACE MOISTURIZERS; COSMETIC SUN-TANNING AND AFTER-SUN PREPARATIONS; NAIL-POLISH, NAIL-VARNISH FOR COSMETIC PURPOSES, FACIAL CLEANSERS AND SCRUBS; SKIN MOISTURIZERS; PREPARATIONS FOR THE

SCALP, NAMELY, NON-MEDICATED SCALP TREATMENT CREAM AND SCALP CONDITIONERS; HAIR COLOURANTS; HAIR CONDITIONERS; HAIR DYES; NON-MEDICATED MASSAGE OILS; DEPILATORIES; COTTON STICKS FOR COSMETIC PURPOSES; COTTON-WOOL FOR NON-MEDICAL PURPOSES; SCENTED ARTICLES ALL FOR PERFUMERY PURPOSES, NAMELY, SACHETS AND SCENTED CERAMIC STONES; BARRIER CREAMS, PROTECTIVE CREAMS FOR THE SKIN AND HANDS, IN CLASS 3 (U.S. CLS. 1, 4, 6, 50, 51 AND 52).

FIRST USE 11-30-2006; IN COMMERCE 11-30-2006.

THE MARK CONSISTS OF STANDARD CHARACTERS WITHOUT CLAIM TO ANY PARTICULAR FONT, STYLE, SIZE, OR COLOR.

SER. NO. 77-001,500, FILED 9-18-2006.

AMOS T. MATTHEWS, JR., EXAMINING ATTORNEY

**Int. Cl.: 9**

**Prior U.S. Cls.: 21, 23, 26, 36 and 38**

**Reg. No. 3,503,471**

**United States Patent and Trademark Office**

**Registered Sep. 23, 2008**

---

**TRADEMARK  
PRINCIPAL REGISTER**

**TLA**

JEDA TECHNOLOGIES, INC. (CALIFORNIA  
CORPORATION)  
2440 W. EL CAMINO  
MOUNTAIN VIEW, CA 94040

FIRST USE 9-1-2006; IN COMMERCE 9-1-2006.

FOR: DOWNLOADABLE COMPUTER SOFTWARE FOR PERFORMING QUALITY CONTROL CHECKS IN THE DESIGN OF SEMICONDUCTORS AND/OR ELECTRONIC SYSTEMS, IN CLASS 9 (U.S. CLS. 21, 23, 26, 36 AND 38).

THE MARK CONSISTS OF STANDARD CHARACTERS WITHOUT CLAIM TO ANY PARTICULAR FONT, STYLE, SIZE, OR COLOR.

SER. NO. 77-001,791, FILED 9-18-2006.

ADA HAN, EXAMINING ATTORNEY

**Int. Cl.: 30**

**Prior U.S. Cl.: 46**

**United States Patent and Trademark Office**

**Reg. No. 3,503,472**

**Registered Sep. 23, 2008**

**TRADEMARK  
PRINCIPAL REGISTER**

**GOURMEDAS**

GOURMEDAS, INC. (CANADA CORPORATION)

17 DU MANOIR

LAC DELAGE, CANADA G0A4P0

FOR: CHOCOLATE PRODUCTS, NAMELY, CHOCOLATE BARS, CHOCOLATE CANDIES, CHOCOLATE SAUCE, CHOCOLATE TOPPING, AND CHOCOLATE PREPARATIONS FOR CHOCOLATE FONDUE, IN CLASS 30 (U.S. CL. 46).

THE MARK CONSISTS OF STANDARD CHARACTERS WITHOUT CLAIM TO ANY PARTICULAR FONT, STYLE, SIZE, OR COLOR.

PRIORITY CLAIMED UNDER SEC. 44(D) ON CANADA APPLICATION NO. 1304970, FILED 6-9-2006, REG. NO. TMA709586, DATED 3-17-2008, EXPIRES 3-17-2023.

SER. NO. 77-007,534, FILED 9-26-2006.

SARA THOMAS, EXAMINING ATTORNEY

**Int. Cl.: 9**

**Prior U.S. Cls.: 21, 23, 26, 36 and 38**

**Reg. No. 3,503,473**

**United States Patent and Trademark Office**

**Registered Sep. 23, 2008**

**TRADEMARK  
PRINCIPAL REGISTER**

**GOLDFIRE INNOVATOR**

INVENTION MACHINE CORPORATION (DELA-  
WARE CORPORATION)  
133 PORTLAND STREET  
BOSTON, MA 02114

FOR: SOFTWARE FOR PROBLEM-SOLVING,  
IDEATION, SOLUTION GENERATION, AND TO  
ACCELERATE INNOVATION IN THE FIELDS OF  
PRODUCT DEVELOPMENT AND MANUFACTUR-  
ING, NAMELY, SOFTWARE FOR PROBLEM-SOL-  
VING DEFINITION AND ANALYSIS, FOR SYSTEM  
DEVELOPMENT AND ANALYSIS, AND FOR RISK  
ANALYSIS; SOFTWARE FOR KNOWLEDGE EX-  
TRACTION AND RETRIEVAL SEARCHING AND  
QUERY SEARCHING INCLUDING NATURAL  
LANGUAGE SEARCHES IN DATA BASES AND  
KNOWLEDGE BASES; SOFTWARE FOR CREAT-  
ING DATA BASES AND KNOWLEDGE BASES;

SOFTWARE FOR PROBLEM-SOLVING ANALYSIS;  
SOFTWARE FOR NATURAL LANGUAGE QUERY  
PROCESSING; SEARCH ENGINE SOFTWARE, IN  
CLASS 9 (U.S. CLS. 21, 23, 26, 36 AND 38).

FIRST USE 1-20-2004; IN COMMERCE 1-20-2004.

THE MARK CONSISTS OF STANDARD CHAR-  
ACTERS WITHOUT CLAIM TO ANY PARTICULAR  
FONT, STYLE, SIZE, OR COLOR.

OWNER OF U.S. REG. NO. 3,050,490.

SER. NO. 77-008,353, FILED 9-27-2006.

REBECCA EISINGER, EXAMINING ATTORNEY

**Int. Cl.: 7**

**Prior U.S. Cls.: 13, 19, 21, 23, 31, 34 and 35**

**United States Patent and Trademark Office**

**Reg. No. 3,503,474**

**Registered Sep. 23, 2008**

**TRADEMARK  
PRINCIPAL REGISTER**

**RAZOR TOOTH**

EXCHANGE-A-BLADE LTD. (CANADA CORPORATION)  
584 EBURY PLACE, ANNACIS ISLAND  
DELTA, CANADA V3M6M8

FOR: CIRCULAR SAW BLADES, IN CLASS 7 (U.S. CLS. 13, 19, 21, 23, 31, 34 AND 35).

FIRST USE 2-28-2004; IN COMMERCE 2-28-2004.

THE MARK CONSISTS OF STANDARD CHARACTERS WITHOUT CLAIM TO ANY PARTICULAR FONT, STYLE, SIZE, OR COLOR.

OWNER OF U.S. REG. NO. 2,420,396.

NO CLAIM IS MADE TO THE EXCLUSIVE RIGHT TO USE "TOOTH", APART FROM THE MARK AS SHOWN.

SER. NO. 77-009,772, FILED 9-28-2006.

LINDA ORNDORFF, EXAMINING ATTORNEY

**Int. Cl.: 9**

**Prior U.S. Cls.: 21, 23, 26, 36 and 38**

**United States Patent and Trademark Office**

**Reg. No. 3,503,475**

**Registered Sep. 23, 2008**

**TRADEMARK  
PRINCIPAL REGISTER**

# Spb Diary

SPB SOFTWARE HOUSE (RUSSIAN FED. CORPORATION)  
4, UL. VOZROZHDENIA  
SAINT PETERSBURG, RUSSIAN FED. 198097

FOR: COMPUTER SOFTWARE FOR CREATING SEARCHABLE DATABASES OF INFORMATION AND DATA; COMPUTER SOFTWARE FOR SYNCHRONIZATION OF DATA, INFORMATION AND FILES, FOR MOBILE COMMUNICATIONS AND COMPUTING, FOR PERSONAL INFORMATION MANAGEMENT, DATABASE MANAGEMENT AND SYNCHRONIZATION, IN CLASS 9 (U.S. CLS. 21, 23, 26, 36 AND 38).

FIRST USE 4-26-2005; IN COMMERCE 4-26-2005.

THE MARK CONSISTS OF STANDARD CHARACTERS WITHOUT CLAIM TO ANY PARTICULAR FONT, STYLE, SIZE, OR COLOR.

NO CLAIM IS MADE TO THE EXCLUSIVE RIGHT TO USE "DIARY", APART FROM THE MARK AS SHOWN.

THE WORDING "SPB DIARY" HAS NO MEANING IN A FOREIGN LANGUAGE.

SER. NO. 77-011,167, FILED 9-30-2006.

FRANK LATTUCA, EXAMINING ATTORNEY



**Int. Cl.: 36**

**Prior U.S. Cls.: 100, 101 and 102**

**United States Patent and Trademark Office**

**Reg. No. 3,503,476**

**Registered Sep. 23, 2008**

**SERVICE MARK  
PRINCIPAL REGISTER**



COMPUFOREX INC (NEVADA CORPORATION)  
711 S.CARSON STREET, SUITE 4  
CARSON CITY, NV 89701

FIRST USE 7-1-2005; IN COMMERCE 7-1-2005.

FOR: FINANCIAL SERVICES, NAMELY, PROVIDING FOR THE EXCHANGE OF FOREIGN CURRENCY, COMMODITIES, FINANCIAL DERIVATIVES, INTEREST RATE PRODUCTS, AND EQUITIES VIA THE INTERNET AND INTRANET SYSTEMS, IN CLASS 36 (U.S. CLS. 100, 101 AND 102).

THE MARK CONSISTS OF STYLIZED TEXT OF THE WORDING "4XFINDME".

SER. NO. 77-012,013, FILED 10-2-2006.

LINDA E. BLOHM, EXAMINING ATTORNEY

**Int. Cl.: 9**

**Prior U.S. Cls.: 21, 23, 26, 36 and 38**

**United States Patent and Trademark Office**

**Reg. No. 3,503,477**

**Registered Sep. 23, 2008**

**TRADEMARK  
PRINCIPAL REGISTER**

**MTP**

US CONEC LTD. (DELAWARE CORPORATION)  
1555 4TH AVENUE, SE  
HICKORY, NC 28602

FOR: FIBER OPTIC CONNECTORS, IN CLASS 9  
(U.S. CLS. 21, 23, 26, 36 AND 38).

FIRST USE 8-31-1993; IN COMMERCE 8-31-1993.

THE MARK CONSISTS OF STANDARD CHAR-  
ACTERS WITHOUT CLAIM TO ANY PARTICULAR  
FONT, STYLE, SIZE, OR COLOR.

OWNER OF U.S. REG. NO. 2,748,033.

SEC. 2(F).

SER. NO. 77-015,758, FILED 10-6-2006.

DAVID YONTEF, EXAMINING ATTORNEY

**Int. Cl.: 41**

**Prior U.S. Cls.: 100, 101 and 107**

**United States Patent and Trademark Office**

**Reg. No. 3,503,478**

**Registered Sep. 23, 2008**

**SERVICE MARK  
PRINCIPAL REGISTER**

**BARCODE TO BOTTOMLINE**

THE BENNETT GROUP (NEW YORK CORPORATION)  
71 GOODWAY DR. S.  
ROCHESTER, NY 146232718

FOR: EDUCATIONAL SERVICES, NAMELY, PROVIDING TRAINING IN DIRECT MAIL AND FULFILLMENT PRODUCTION AND DISTRIBUTING PRINTED MATERIALS IN CONNECTION THEREWITH, IN CLASS 41 (U.S. CLS. 100, 101 AND 107).

FIRST USE 4-1-1993; IN COMMERCE 4-1-1993.

THE MARK CONSISTS OF STANDARD CHARACTERS WITHOUT CLAIM TO ANY PARTICULAR FONT, STYLE, SIZE, OR COLOR.

SER. NO. 77-017,751, FILED 10-10-2006.

ANGELA M. MICHELI, EXAMINING ATTORNEY

Int. Cl.: 9

Prior U.S. Cls.: 21, 23, 26, 36 and 38

United States Patent and Trademark Office

Reg. No. 3,503,479

Registered Sep. 23, 2008

TRADEMARK  
PRINCIPAL REGISTER

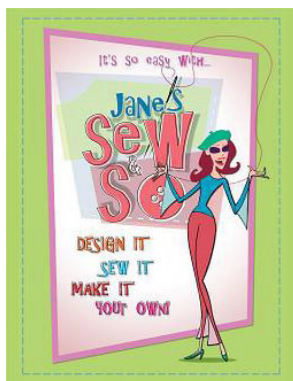

JANE SAMSON (CALIFORNIA CORPORATION),  
DBA EMERALD LIGHT PICTURES  
421 SOUTH FAIRVIEW STREET  
BURBANK, CA 91505

FOR: VIDEO RECORDINGS FEATURING SELF-  
IMPROVEMENT HELP, IN CLASS 9 (U.S. CLS. 21, 23,  
26, 36 AND 38).

FIRST USE 12-2-2005; IN COMMERCE 9-12-2006.

THE COLOR(S) BLUE, LIGHT BLUE, RED, PINK,  
WHITE, GREEN, PURPLE, AND BLACK IS/ARE  
CLAIMED AS A FEATURE OF THE MARK.

THE COLOR GREEN APPEARS IN THE BACK-  
GROUND OF THE DESIGN, AND A RECTANGLE  
IN THE DESIGN. THE COLORS BLUE, PINK, RED,  
GREEN, WHITE, PURPLE AND BLACK APPEAR IN  
THE DESIGN OF THE WOMAN. THE COLORS  
PINK, BLUE, GREEN, RED, AND WHITE, APPEAR  
IN THE WORDING. THE COLORS PINK, WHITE  
AND BLUE APPEAR IN THE RECTANGLE WITHIN  
THE DESIGN. THE NEEDLE DESIGN IS IN BLACK  
AND THE COLOR RED APPEARS IN THE THREAD  
IN THE DESIGN.

SER. NO. 77-024,260, FILED 10-18-2006.

GRETТА YAO, EXAMINING ATTORNEY

**Int. Cl.: 35**

**Prior U.S. Cls.: 100, 101 and 102**

**United States Patent and Trademark Office**

**Reg. No. 3,503,480**

**Registered Sep. 23, 2008**

**SERVICE MARK  
PRINCIPAL REGISTER**

**VICAN**

VICAN PRODUCT DISTRIBUTION CANADA  
INC. (CANADA CORPORATION)  
6600 DECARIE BLVD., SUITE 220  
MONTREAL, QUEBEC, CANADA H3X2K4

FOR: WHOLESALE DISTRIBUTORSHIPS, ALL OF THE FIELD OF NON-FERROUS AND FERROUS SCRAP METAL TO THIRD PARTIES AT THE WHOLESALE AND RETAIL LEVELS FOR RECYCLING; OPERATION OF THE BUSINESS FOR OTHERS, NAMELY, THE ADMINISTRATION, MANAGEMENT AND COORDINATION OF TRANSPORTATION DISTRICTS, PRODUCT MOVEMENT, SUPPLY CHAIN RELATIONSHIPS AND CLIENT RELATIONSHIPS FOR THIRD PARTIES; WHOLESALE AND RETAIL STORE SERVICES, ALL IN THE FIELD OF MOTORSPORT AND MARINE VEHICLES, NAMELY, AUTOMOBILES, CARS, TRUCKS, VANS, BOATS, RECREATIONAL JET

BOATS, SNOW MOBILES, ALL TERRAIN VEHICLES, MOTORCYCLES, TRACTORS, TRAILERS AND HELICOPTERS TO THIRD PARTIES , IN CLASS 35 (U.S. CLS. 100, 101 AND 102).

THE MARK CONSISTS OF STANDARD CHARACTERS WITHOUT CLAIM TO ANY PARTICULAR FONT, STYLE, SIZE, OR COLOR.

PRIORITY CLAIMED UNDER SEC. 44(D) ON CANADA APPLICATION NO. 1318216, FILED 9-27-2006, REG. NO. TMA700,415, DATED 11-7-2007, EXPIRES 11-7-2022.

SER. NO. 77-027,014, FILED 10-23-2006.

ERNEST SHOSHO, EXAMINING ATTORNEY

**Int. Cl.: 9**

**Prior U.S. Cls.: 21, 23, 26, 36 and 38**

**Reg. No. 3,503,481**

**United States Patent and Trademark Office**

**Registered Sep. 23, 2008**

**TRADEMARK  
PRINCIPAL REGISTER**

**SYTELINE**

INFOR GLOBAL SOLUTIONS (MICHIGAN), INC.  
(MICHIGAN CORPORATION)  
SUITE 4100  
13560 MORRIS ROAD  
ALPHARETTA, GA 30004

FOR: MANUFACTURING MANAGEMENT COMPUTER SOFTWARE, NAMELY, ENTERPRISE RESOURCE PLANNING (ERP) SOFTWARE APPLICATIONS FOR USE BY MANUFACTURERS FOR ENTERING AND MAINTAINING DATA, RUNNING TRANSACTIONS, GATHERING AND REPORTING INFORMATION AND AUTOMATING FUNCTIONS FOR SUPPLIER MANAGEMENT, SALES MANAGEMENT, SALES FORCE AUTOMATION, WAREHOUSING, DISTRIBUTION, LOGISTICS, CUSTOMER SERVICE, CUSTOMER ASSET MANAGEMENT, CUSTOMER RELATIONSHIP MANAGEMENT, PRODUCT LIFECYCLE MANAGEMENT, TRANSPORTATION LOGISTICS MANAGEMENT, TRANSPORTATION RESOURCE PLANNING, SUPPLIER RELATIONSHIP MANAGEMENT, ORDER ENTRY, INVENTORY AND PRODUCTION PLANNING, PRODUCT DESIGN, PROCUREMENT ORDER MANAGEMENT, SUPPLY CHAIN MANAGEMENT, FACILITY PLANNING, TAX PLANNING, ACCOUNTING, FINANCIAL AND BUSINESS ANALYSIS, BUSINESS ADMINISTRATION AND FORECASTING, TECHNICAL SUPPORT SERVICES, SUPPLY CHAIN COLLABORATION, HUMAN RESOURCE ADMINISTRATION AND RESOURCE PLANNING,

DISTRIBUTION RESOURCE PLANNING, RETAIL RESOURCE PLANNING, ELECTRONIC DATA INTERCHANGE, MANAGEMENT OF ACCOUNTS PAYABLE AND RECEIVABLE, ORDERING, INVOICING, TELEMARKETING, SHIPPING CUSTOMER ORDERS, MANAGEMENT OF FIELD CUSTOMER SUPPORT SERVICES, QUALITY MANAGEMENT OF MANUFACTURED GOODS, MANAGEMENT OF MANUFACTURING EXECUTION SYSTEMS, PRODUCT AND SALES ORDER CONFIGURATION, ENTERPRISE RESOURCE PLANNING, AND FOR PERFORMING BUSINESS TRANSACTIONS OVER THE INTERNET, NAMELY, ORDERING AND THE FULFILLING ORDERS FOR PRODUCTS, TRACKING PRODUCT ORDER STATUS AND MANAGING INFORMATION RELATING TO BUSINESS TRANSACTIONS, IN CLASS 9 (U.S. CLS. 21, 23, 26, 36 AND 38).

FIRST USE 8-6-1996; IN COMMERCE 8-6-1996.

THE MARK CONSISTS OF STANDARD CHARACTERS WITHOUT CLAIM TO ANY PARTICULAR FONT, STYLE, SIZE, OR COLOR.

OWNER OF U.S. REG. NOS. 1,611,920 AND 2,594,594.

SER. NO. 77-027,198, FILED 10-23-2006.

PAUL CROWLEY, EXAMINING ATTORNEY

**Int. Cl.: 37**

**Prior U.S. Cls.: 100, 103 and 106**

**United States Patent and Trademark Office**

**Reg. No. 3,503,482**

**Registered Sep. 23, 2008**

**SERVICE MARK  
PRINCIPAL REGISTER**



CONROY, MICHAEL, P (ALABAMA SOLE PROPRIETORSHIP)  
15740 BISHOP TRACE  
LILLIAN, AL 36549

FOR: BUILDING RESTORATION; CARPET AND RUG CLEANING; CARPET CLEANING, IN CLASS 37 (U.S. CLS. 100, 103 AND 106).

FIRST USE 1-1-2003; IN COMMERCE 1-1-2003.

NO CLAIM IS MADE TO THE EXCLUSIVE RIGHT TO USE "EXPERT DRY", APART FROM THE MARK AS SHOWN.

THE COLOR(S) BLUE, BLACK, GRAY, AND WHITE IS/ARE CLAIMED AS A FEATURE OF THE MARK.

THE WORDING "EXPERT DRY", AND THE LETTERS "HO" AND THE HORIZONTAL LINES APPEAR IN BLACK. THE LETTERS "UT" APPEAR IN BLUE, THE WATER DROPLET APPEARS IN BLUE AND WHITE, AND THE NUMERAL "2" IS BLUE AND OUTLINED IN WHITE AND GRAY.

SER. NO. 77-029,634, FILED 10-26-2006.

AMY ALFIERI, EXAMINING ATTORNEY

**Int. Cls.: 6, 19 and 37**

**Prior U.S. Cls.: 1, 2, 12, 13, 14, 23, 25, 33, 50, 100, 103  
and 106**

**Reg. No. 3,503,483**

**United States Patent and Trademark Office**

**Registered Sep. 23, 2008**

**TRADEMARK  
SERVICE MARK  
PRINCIPAL REGISTER**

**ANEETA**

ANEETA WINDOW SYSTEMS (VIC) PTY LTD  
(AUSTRALIA LIMITED LIABILITY COMPAN-  
NY)

UNIT 2, 170-180 ROOKS ROAD  
NUNAWADING, AUSTRALIA 3131

FOR: WINDOWS AND SASHLESS WINDOWS OF  
METAL OR PREDOMINANTLY OF METAL; WIN-  
DOW FRAMES AND WINDOW STILES OF METAL  
OR PREDOMINANTLY OF METAL; WINDOW FAS-  
TENERS OF METAL OR PREDOMINANTLY OF  
METAL; METAL WINDOW PULLEYS; WINDOW  
LOCKS OF METAL OR PREDOMINANTLY OF  
METAL; WINDOW HANDLES OF METAL, IN  
CLASS 6 (U.S. CLS. 2, 12, 13, 14, 23, 25 AND 50).

FOR: NON-METALLIC WINDOW FRAMES;  
NON-METALLIC WINDOW SILLS; WINDOW  
GLASS EXCEPT GLASS FOR VEHICLE WINDOWS;

WINDOW PANES FOR BUILDINGS, IN CLASS 19  
(U.S. CLS. 1, 12, 33 AND 50).

FOR: WINDOW INSTALLATION; WINDOW RE-  
PAIR AND MAINTENANCE, IN CLASS 37 (U.S. CLS.  
100, 103 AND 106).

THE MARK CONSISTS OF STANDARD CHAR-  
ACTERS WITHOUT CLAIM TO ANY PARTICULAR  
FONT, STYLE, SIZE, OR COLOR.

PRIORITY CLAIMED UNDER SEC. 44(D) ON  
AUSTRALIA APPLICATION NO. 1126496, FILED 7-  
27-2006, REG. NO. 1126496, DATED 3-12-2007, EX-  
PIRES 7-27-2016.

SER. NO. 77-030,539, FILED 10-26-2006.

MARLENE BELL, EXAMINING ATTORNEY



**Int. Cl.: 25**

**Prior U.S. Cls.: 22 and 39**

**United States Patent and Trademark Office**

**Reg. No. 3,503,484**

**Registered Sep. 23, 2008**

**TRADEMARK  
PRINCIPAL REGISTER**

**BEDROOM ATHLETICS**

AMBER DUDES LIMITED (UNITED KINGDOM  
LIMITED LIABILITY COMPANY)

CELTIC SPRINGS BUSINESS PARK

CLAMPETT HOUSE, HAZELL DRIVE

NEWPORT, UNITED KINGDOM NP108FY

FOR: BATHROBES; BEACHWEAR; BELTS; BODY SUITS; COATS; CRAVATS; DRESSES; DRESSING GOWNS; FLIP FLOPS; FOOTWEAR; GLOVES; HEADWEAR; HOSIERY; JACKETS; JEANS; JUMPERS; LEG WARMERS; LINGERIE; MITTENS; MOCCASINS; NIGHTWEAR; PANTS; POLO SHIRTS; PYJAMAS; RAINWEAR; SANDALS; SARONGS; SASHES; SCARVES; SHAWLS; SHIRTS; SHOES; SHORTS; SKIRTS; SLACKS; SLEEPWEAR; SLIPPERS; SNEAKERS; SOCKS; STOCKINGS; SUITS; SWEAT SHIRTS; T-SHIRTS; TIES; TOPS; TRAINING SHOES; TROUSERS; UNDERWEAR; VESTS, IN CLASS 25 (U.S. CLS. 22 AND 39).

THE MARK CONSISTS OF STANDARD CHARACTERS WITHOUT CLAIM TO ANY PARTICULAR FONT, STYLE, SIZE, OR COLOR.

PRIORITY CLAIMED UNDER SEC. 44(D) ON UNITED KINGDOM APPLICATION NO. 4947586, FILED 8-3-2006, REG. NO. 2309519, DATED 2-21-2003, EXPIRES 2-21-2016.

PRIORITY CLAIMED UNDER SEC. 44(D) ON ERPN CMNTY TM OFC APPLICATION NO. 4947586, FILED 8-3-2006, REG. NO. 4947586, DATED 4-10-2007, EXPIRES 3-8-2016.

NO CLAIM IS MADE TO THE EXCLUSIVE RIGHT TO USE "ATHLETICS", APART FROM THE MARK AS SHOWN.

SER. NO. 77-030,668, FILED 10-27-2006.

HOWARD SMIGA, EXAMINING ATTORNEY

**Int. Cl.: 42**

**Prior U.S. Cls.: 100 and 101**

**United States Patent and Trademark Office**

**Reg. No. 3,503,485**

**Registered Sep. 23, 2008**

**SERVICE MARK  
PRINCIPAL REGISTER**

**FABRACADABRA**

VODRA, LISA (UNITED STATES INDIVIDUAL)  
18 PARK LANE  
JAMAICA PLAIN, MA 02130

FIRST USE 9-1-2006; IN COMMERCE 10-10-2006.

FOR: COMPUTER SERVICES, NAMELY, HOSTING ON-LINE WEB FACILITIES FOR OTHERS FOR ORGANIZING AND CONDUCTING ONLINE MEETINGS, GATHERINGS, AND INTERACTIVE DISCUSSIONS, IN CLASS 42 (U.S. CLS. 100 AND 101).

THE MARK CONSISTS OF STANDARD CHARACTERS WITHOUT CLAIM TO ANY PARTICULAR FONT, STYLE, SIZE, OR COLOR.

SER. NO. 77-031,567, FILED 10-27-2006.

JAY FLOWERS, EXAMINING ATTORNEY

**Int. Cl.: 35**

**Prior U.S. Cls.: 100, 101 and 102**

**United States Patent and Trademark Office**

**Reg. No. 3,503,486**

**Registered Sep. 23, 2008**

**SERVICE MARK  
PRINCIPAL REGISTER**



ENHANCA LLC (MARYLAND LIMITED LIABILITY COMPANY)  
601 N. EUTAW STREET  
SUITE 704  
BALTIMORE, MD 21201

FOR: MARKETING AGENCY SERVICES; ORGANIZING MARKETING PROMOTIONAL EVENTS FOR OTHERS; CREATING BRAND IDENTITY FOR OTHERS; CONSULTING SERVICES IN THE FIELD OF CREATING BRAND IDENTITY; ADVERTISING AND PROMOTION SERVICES THROUGH THE CREATION AND DISTRIBUTION OF PRINTED, PHOTOGRAPHIC, INTERACTIVE, AND AUDIO PROMOTIONAL MATERIALS, IN CLASS 35 (U.S. CLS. 100, 101 AND 102).

FIRST USE 7-3-2003; IN COMMERCE 7-3-2003.

THE COLOR(S) GRAY AND ORANGE IS/ARE CLAIMED AS A FEATURE OF THE MARK.

THE MARK CONSISTS OF A GRAY CAPITAL "E" WITH AN ORANGE LINE ABOVE THE "E".

SER. NO. 77-031,990, FILED 10-30-2006.

KELLY CHOE, EXAMINING ATTORNEY

**Int. Cl.: 16**

**Prior U.S. Cls.: 2, 5, 22, 23, 29, 37, 38 and 50**

**Reg. No. 3,503,487**

**United States Patent and Trademark Office**

**Registered Sep. 23, 2008**

**TRADEMARK  
PRINCIPAL REGISTER**

**JC LEYENDECKER**

ARTSHOWS AND PRODUCTS, CORP. (NEW  
HAMPSHIRE CORPORATION)  
492 BELLEVUE AVENUE  
NEWPORT, RI 02840

FOR: ARTICLES MADE OF OR PRINTED ON  
PAPER OR CARDBOARD, NAMELY, REPRODUC-  
TIONS IN THE FORM OF ART PRINTS, LIMITED  
EDITION FINE ART PRINTS AND OTHER REPRO-  
DUCTIONS, NAMELY, POSTERS, STATIONERY,  
STATIONARY TYPE PORTFOLIOS, NOTE CARDS,  
GREETING CARDS, POSTCARDS, CALENDARS;  
GIFTWRAPPING PAPER, STAMPS; BOOKS, NAME-  
LY, ART BOOKS, AND DIARIES, IN CLASS 16 (U.S.  
CLS. 2, 5, 22, 23, 29, 37, 38 AND 50).

FIRST USE 1-31-1990; IN COMMERCE 1-31-1990.

THE MARK CONSISTS OF STANDARD CHAR-  
ACTERS WITHOUT CLAIM TO ANY PARTICULAR  
FONT, STYLE, SIZE, OR COLOR.

THE NAME(S), PORTRAIT(S), AND/OR SIGNA-  
TURE(S) SHOWN IN THE MARK DOES NOT IDEN-  
TIFY A PARTICULAR LIVING INDIVIDUAL.

SEC. 2(F).

SER. NO. 77-032,674, FILED 10-30-2006.

NICHOLAS ALTREE, EXAMINING ATTORNEY

Int. Cl.: 16

Prior U.S. Cls.: 2, 5, 22, 23, 29, 37, 38 and 50

United States Patent and Trademark Office

Reg. No. 3,503,488

Registered Sep. 23, 2008

TRADEMARK  
PRINCIPAL REGISTER



ARTSHOWS AND PRODUCTS, CORP. (NEW HAMPSHIRE CORPORATION)  
492 BELLEVUE AVENUE  
NEWPORT, RI 02840

FOR: ARTICLES MADE OF OR PRINTED ON PAPER OR CARDBOARD, NAMELY, REPRODUCTIONS IN THE FORM OF ART PRINTS, LIMITED EDITION FINE ART PRINTS AND OTHER REPRODUCTIONS, NAMELY, POSTERS, STATIONERY, STATIONERY TYPE PORTFOLIOS, NOTE CARDS, GREETING CARDS, POSTCARDS, CALENDARS; GIFTWRAPPING PAPER, COMMEMORATIVE STAMP SHEETS; BOOKS, NAMELY, ART BOOKS, AND DIARIES, IN CLASS 16 (U.S. CLS. 2, 5, 22, 23, 29, 37, 38 AND 50).

FIRST USE 1-31-1990; IN COMMERCE 1-31-1990.

THE NAME AND/OR SIGNATURE SHOWN IN THE MARK DOES NOT IDENTIFY A PARTICULAR LIVING INDIVIDUAL.

THE MARK DISPLAYS THE SIGNATURE OF THE LATE ARTIST "JC LEYENDECKER".

SEC. 2(F).

SER. NO. 77-032,684, FILED 10-30-2006.

NICHOLAS ALTREE, EXAMINING ATTORNEY

**Int. Cls.: 9, 16 and 41**

**Prior U.S. Cls.: 2, 5, 21, 22, 23, 26, 29, 36, 37, 38, 50,  
100, 101 and 107**

**Reg. No. 3,503,489**

**United States Patent and Trademark Office**

**Registered Sep. 23, 2008**

**TRADEMARK  
SERVICE MARK  
PRINCIPAL REGISTER**



RAISING MORE MONEY INC. (WASHINGTON CORPORATION)  
2100 NORTH PACIFIC STREET  
SEATTLE, WA 98103

FOR: COMPUTER SOFTWARE FOR MANAGING DONOR DATABASES IN FUNDRAISING AND FUNDRAISING MANAGEMENT; COMPACT DISCS FEATURING TOPICS IN FUNDRAISING AND FUNDRAISING MANAGEMENT; DIGITAL VIDEO DISCS FEATURING TOPICS IN FUNDRAISING AND FUNDRAISING MANAGEMENT; PRE-RECORDED AUDIO AND VIDEO TAPES FEATURING TOPICS IN FUNDRAISING AND FUNDRAISING MANAGEMENT; ELECTRONIC STORAGE MEDIA, NAMELY, FLASH DRIVES, DISK DRIVES, AND COMPUTER DISCS FEATURING TOPICS IN FUNDRAISING AND FUNDRAISING MANAGEMENT, IN CLASS 9 (U.S. CLS. 21, 23, 26, 36 AND 38).

FIRST USE 7-18-2001; IN COMMERCE 7-18-2001.

FOR: BOOKS, MAGAZINES, AND NEWSLETTERS FEATURING TOPICS IN FUNDRAISING

AND FUNDRAISING MANAGEMENT, IN CLASS 16 (U.S. CLS. 2, 5, 22, 23, 29, 37, 38 AND 50).

FIRST USE 7-18-2001; IN COMMERCE 7-18-2001.

FOR: EDUCATIONAL SERVICES, NAMELY, TRAINING IN FUNDRAISING AND FUNDRAISING MANAGEMENT; PROVIDING WORKSHOPS AND SEMINARS IN FUNDRAISING AND FUNDRAISING MANAGEMENT; PRODUCTION OF VIDEO CASSETTES, COMPACT DISCS, DIGITAL VIDEO DISCS, AUDIO TAPES, AND VIDEO TAPES, IN CLASS 41 (U.S. CLS. 100, 101 AND 107).

FIRST USE 7-18-2001; IN COMMERCE 7-18-2001.

THE MARK CONSISTS OF A COIN DESIGN FEATURING A SUN SHINING OVER A FLOWER IN THE CENTER OF THE COIN. TWO SPRIGS FRAME THE FLOWER DESIGN.

SER. NO. 77-032,711, FILED 10-30-2006.

LAURIE KAUFMAN, EXAMINING ATTORNEY

**Int. Cl.: 42**

**Prior U.S. Cls.: 100 and 101**

**United States Patent and Trademark Office**

**Reg. No. 3,503,490**

**Registered Sep. 23, 2008**

**SERVICE MARK  
PRINCIPAL REGISTER**

**ProCarCareZone**

AUTOZONE PARTS, INC. (NEVADA CORPORATION)  
123 SOUTH FRONT STREET  
MEMPHIS, TN 38103

FOR: PROVIDING WEB-BASED TOOLS, NAME-  
LY, PROVIDING TEMPORARY USE OF ON-LINE  
NON-DOWNLOADABLE SOFTWARE FOR AUTO-  
MOTIVE SERVICE CENTERS TO CREATE WEB-  
SITES, PROMOTE AND MARKET SERVICES, FIND  
AND RETAIN CUSTOMERS, SCHEDULE APPOINT-  
MENTS AND MANAGE BUSINESS INFORMA-  
TION, IN CLASS 42 (U.S. CLS. 100 AND 101).

FIRST USE 12-16-2004; IN COMMERCE 12-16-2004.

THE MARK CONSISTS OF STANDARD CHAR-  
ACTERS WITHOUT CLAIM TO ANY PARTICULAR  
FONT, STYLE, SIZE, OR COLOR.

OWNER OF U.S. REG. NOS. 1,550,569, 2,855,757  
AND OTHERS.

SER. NO. 77-032,957, FILED 10-31-2006.

COLLEEN DOMBROW, EXAMINING ATTORNEY

**Int. Cl.: 20**

**Prior U.S. Cls.: 2, 13, 22, 25, 32 and 50**

**United States Patent and Trademark Office**

**Reg. No. 3,503,491**

**Registered Sep. 23, 2008**

**TRADEMARK  
PRINCIPAL REGISTER**



AKERUE INDUSTRIES, LLC D/B/A KAY HOME  
PRODUCTS (OHIO LIMITED LIABILITY  
COMPANY)  
90 MCMILLEN ROAD  
ANTIOCH, IL 60002

FOR: FURNITURE, NAMELY, TRAY TABLES  
AND DECORATOR STANDS; PATIO FURNITURE,  
IN CLASS 20 (U.S. CLS. 2, 13, 22, 25, 32 AND 50).

FIRST USE 8-15-2006; IN COMMERCE 8-15-2006.

NO CLAIM IS MADE TO THE EXCLUSIVE  
RIGHT TO USE "HOME PRODUCTS", APART  
FROM THE MARK AS SHOWN.

THE MARK CONSISTS OF THE WORDS "KAY"  
AND "HOME" DISPLAYED OVER THE DRAWING  
OF A HOUSE WITH THE WORD "PRODUCTS"  
BELOW THE HOUSE. ALL ELEMENTS BEING  
OUTLINED BY A SQUARE WITHIN A LARGER  
SQUARE.

SER. NO. 77-035,325, FILED 11-2-2006.

THEODORE MCBRIDE, EXAMINING ATTORNEY



Prior U.S. Cl.: A

United States Patent and Trademark Office

Reg. No. 3,503,492

Registered Sep. 23, 2008

CERTIFICATION MARK  
PRINCIPAL REGISTER



ANIMAL WELFARE INSTITUTE (DELAWARE  
NON-PROFIT ORGANIZATION)

1007 QUEEN STREET  
ALEXANDRIA, VA 22314

FOR: MEAT, POULTRY AND EGGS DERIVED  
FROM FAMILY FARMS CONFORMING TO ANI-  
MAL WELFARE STANDARDS DEVELOPED BY A  
NON-PROFIT ORGANIZATION, IN CLASS A (U.S.  
CL. A).

FIRST USE 11-20-2006; IN COMMERCE 11-20-2006.

NO CLAIM IS MADE TO THE EXCLUSIVE  
RIGHT TO USE "ANIMAL WELFARE APPROVED",  
APART FROM THE MARK AS SHOWN.

THE COLOR(S) BLUE, GREEN AND WHITE IS/  
ARE CLAIMED AS A FEATURE OF THE MARK.

THE MARK CONSISTS OF A BLUE SKY BEHIND  
A WHITE SUN CONTAINING THIN WHITE RAYS  
EXTENDING FROM THE CENTER OF THE SUN,  
WHICH IS RISING OVER A GREEN SLOPED HILL  
OR LAND MASS. THE WORDING "ANIMAL WEL-  
FARE" APPEARS IN GREEN ON A WHITE BACK-  
GROUND ABOVE THE SUN. THE WORDING  
"APPROVED" APPEARS IN WHITE ON THE GREEN  
HILL DESIGN.

THE CERTIFICATION MARK, AS USED BY  
PERSONS AUTHORIZED BY THE CERTIFIER,  
CERTIFIES THAT THE GOODS PROVIDED HAVE  
ORIGINATED FROM FAMILY FARMS THAT  
MEET THE STANDARDS FOR THE HUMANE  
TREATMENT OF ANIMALS AS SET BY THE CER-  
TIFIER.

SER. NO. 77-035,478, FILED 11-2-2006.

CHRISTINE COOPER, EXAMINING ATTORNEY

**Int. Cls.: 10 and 16**

**Prior U.S. Cls.: 2, 5, 22, 23, 26, 29, 37, 38, 39, 44 and 50**

**Reg. No. 3,503,493**

**United States Patent and Trademark Office**

**Registered Sep. 23, 2008**

**TRADEMARK  
PRINCIPAL REGISTER**

**MEGAFIBRE**

KARL STORZ GMBH & CO. KG (FED REP  
GERMANY LIMITED PARTNERSHIP)  
MITTELSTRASSE 8  
D-78532 TUTTLINGEN, FED REP GERMANY

FOR: MEDICAL INSTRUMENTS AND APPARATUS AND SURGICAL APPARATUS, NAMELY, SURGICAL AND MEDICAL APPARATUS AND INSTRUMENTS FOR USE IN GENERAL SURGERY AND ENDOSCOPIC SURGERY; IMPLANTS CONSISTING OF ARTIFICIAL MATERIAL, SURGICAL SUTURE MATERIAL, IN CLASS 10 (U.S. CLS. 26, 39 AND 44).

FOR: BROCHURES AND PRINTED MATERIAL, NAMELY, BROCHURES AND INFORMATIONAL FLYERS, NEWSLETTERS, AND SHEETS IN THE

FIELD OF MEDICAL TECHNOLOGY AND INDUSTRIAL ENDOSCOPY, IN CLASS 16 (U.S. CLS. 2, 5, 22, 23, 29, 37, 38 AND 50).

THE MARK CONSISTS OF STANDARD CHARACTERS WITHOUT CLAIM TO ANY PARTICULAR FONT, STYLE, SIZE, OR COLOR.

PRIORITY CLAIMED UNDER SEC. 44(D) ON FED REP GERMANY APPLICATION NO. 306302934, FILED 5-9-2006, REG. NO. 30630293, DATED 1-30-2008, EXPIRES 5-9-2016.

SER. NO. 77-038,480, FILED 11-7-2006.

JUSTINE D. PARKER, EXAMINING ATTORNEY

**Int. Cls.: 36 and 37**

**Prior U.S. Cls.: 100, 101, 102, 103 and 106**

**United States Patent and Trademark Office**

**Reg. No. 3,503,494**

**Registered Sep. 23, 2008**

**SERVICE MARK  
PRINCIPAL REGISTER**

# KeyPoint Partners

KEYPOINT PARTNERS, LLC (MASSACHUSETTS  
LIMITED LIABILITY COMPANY)  
ONE BURLINGTON WOODS DRIVE  
BURLINGTON, MA 01803

FOR: COMMERCIAL REAL ESTATE SERVICES,  
NAMELY, PROPERTY MANAGEMENT, ASSET  
MANAGEMENT, REAL ESTATE BROKERAGE  
FOR SALES AND LEASING, REAL ESTATE RE-  
SEARCH, REAL ESTATE FINANCING, AND CON-  
SULTING RELATED THERETO, IN CLASS 36 (U.S.  
CLS. 100, 101 AND 102).

FIRST USE 12-4-2006; IN COMMERCE 12-4-2006.

FOR: REAL ESTATE CONSTRUCTION AND DE-  
VELOPMENT SERVICES FOR COMMERCIAL  
PROPERTIES, NAMELY, PLANNING, LAYING

OUT AND CONSTRUCTION OF COMMERCIAL  
PROPERTY, IN CLASS 37 (U.S. CLS. 100, 103 AND  
106).

FIRST USE 12-4-2006; IN COMMERCE 12-4-2006.

THE MARK CONSISTS OF STANDARD CHAR-  
ACTERS WITHOUT CLAIM TO ANY PARTICULAR  
FONT, STYLE, SIZE, OR COLOR.

NO CLAIM IS MADE TO THE EXCLUSIVE  
RIGHT TO USE "PARTNERS", APART FROM THE  
MARK AS SHOWN.

SER. NO. 77-040,515, FILED 11-9-2006.

JANET LEE, EXAMINING ATTORNEY

**Int. Cls.: 9 and 38**

**Prior U.S. Cls.: 21, 23, 26, 36, 38, 100, 101 and 104**

**United States Patent and Trademark Office**

**Reg. No. 3,503,495**

**Registered Sep. 23, 2008**

**TRADEMARK  
SERVICE MARK  
PRINCIPAL REGISTER**



MICROSOFT CORPORATION (WASHINGTON CORPORATION)  
ONE MICROSOFT WAY  
REDMOND, WA 980526399

FOR: COMPUTER SOFTWARE FOR CONNECTING USERS TO WEB MESSAGING SERVICES AND FOR VOICE AND VIDEO TRANSMISSIONS OVER THE INTERNET AND WIRELESS NETWORKS, IN CLASS 9 (U.S. CLS. 21, 23, 26, 36 AND 38).

FIRST USE 12-31-1997; IN COMMERCE 12-31-1997.

FOR: WEB MESSAGING SERVICES, INCLUDING VOICE AND VIDEO CAPABILITIES, IN CLASS 38 (U.S. CLS. 100, 101 AND 104).

FIRST USE 12-31-1997; IN COMMERCE 12-31-1997.

OWNER OF U.S. REG. NOS. 2,378,045 AND 2,451,379.

SER. NO. 77-041,860, FILED 11-10-2006.

KELLY CHOE, EXAMINING ATTORNEY

**Int. Cls.: 9 and 38**

**Prior U.S. Cls.: 21, 23, 26, 36, 38, 100, 101 and 104**

**United States Patent and Trademark Office**

**Reg. No. 3,503,496**

**Registered Sep. 23, 2008**

**TRADEMARK  
SERVICE MARK  
PRINCIPAL REGISTER**



MICROSOFT CORPORATION (WASHINGTON CORPORATION)  
ONE MICROSOFT WAY  
REDMOND, WA 980526399

FOR: COMPUTER SOFTWARE FOR CONNECTING USERS TO WEB MESSAGING SERVICES AND FOR VOICE AND VIDEO TRANSMISSIONS OVER THE INTERNET AND WIRELESS NETWORKS, IN CLASS 9 (U.S. CLS. 21, 23, 26, 36 AND 38).

FIRST USE 12-31-1997; IN COMMERCE 12-31-1997.

FOR: WEB MESSAGING SERVICES, INCLUDING VOICE AND VIDEO CAPABILITIES, IN CLASS 38 (U.S. CLS. 100, 101 AND 104).

FIRST USE 12-31-1997; IN COMMERCE 12-31-1997.

OWNER OF U.S. REG. NOS. 2,378,045 AND 2,451,379.

SER. NO. 77-041,883, FILED 11-10-2006.

KELLY CHOE, EXAMINING ATTORNEY

**Int. Cl.: 25**

**Prior U.S. Cls.: 22 and 39**

**United States Patent and Trademark Office**

**Reg. No. 3,503,497**

**Registered Sep. 23, 2008**

**TRADEMARK  
PRINCIPAL REGISTER**

**THE LEGENDARY CONVERTIBLE  
BERTT**

THE LENGENDARY CONVERTIBLE BERT  
(GEORGIA LIMITED LIABILITY COMPANY)  
SUITE 7104  
1709 WILMA DR  
ATLANTA, GA 30318

FOR: CAMP SHIRTS; DRESS SHIRTS; FUR HATS;  
HATS; JEANS; MEN AND WOMEN JACKETS,  
COATS, TROUSERS, VESTS; POLO SHIRTS; SHIRTS;  
SHORT-SLEEVED SHIRTS; SPORT SHIRTS; SPORTS  
SHIRTS WITH SHORT SLEEVES; T-SHIRTS; TO-  
BOGGAN HATS, PANTS AND CAPS; VESTS, IN  
CLASS 25 (U.S. CLS. 22 AND 39).

FIRST USE 10-8-2003; IN COMMERCE 10-8-2003.

THE MARK CONSISTS OF STANDARD CHAR-  
ACTERS WITHOUT CLAIM TO ANY PARTICULAR  
FONT, STYLE, SIZE, OR COLOR.

SER. NO. 77-041,897, FILED 11-10-2006.

MARILYN IZZI, EXAMINING ATTORNEY

**Int. Cl.: 35**

**Prior U.S. Cls.: 100, 101 and 102**

**United States Patent and Trademark Office**

**Reg. No. 3,503,498**

**Registered Sep. 23, 2008**

**SERVICE MARK  
PRINCIPAL REGISTER**



CORPORATE PLANNERS, INC. (NEW YORK CORPORATION)  
271 MADISON AVENUE  
NEW YORK, NY 10016

FOR: CONSULTING SERVICES IN THE FIELD OF INCREASING PUBLIC AWARENESS OF ORGAN DONATION THROUGH A CORPORATE MARKETING PROGRAM CONDUCTED AT COLLEGE AND PROFESSIONAL FOOTBALL VENUES TO ENCOURAGE SPORTS FANS TO HELP INCREASE NATIONAL ORGAN DONATION STATISTICS AND BECOME ORGAN DONORS BY SIGNING DONOR CARDS OR REGISTERING THROUGH THEIR LOCAL DONOR REGISTRIES

OR MOTOR VEHICLE DEPARTMENTS, IN CLASS 35 (U.S. CLS. 100, 101 AND 102).

FIRST USE 10-31-2002; IN COMMERCE 2-2-2003.

THE MARK CONSISTS OF A BASKETBALL WITH A RIBBON AROUND IT CENTERED OVER THE WORDS "GET GAME", WHICH APPEAR ABOVE THE WORDS "GIVE LIFE".

SER. NO. 77-042,499, FILED 11-13-2006.

PAUL E. FAHRENKOPF, EXAMINING ATTORNEY

**Int. Cl.: 35**

**Prior U.S. Cls.: 100, 101 and 102**

**United States Patent and Trademark Office**

**Reg. No. 3,503,499**

**Registered Sep. 23, 2008**

**SERVICE MARK  
PRINCIPAL REGISTER**

**GET GAME GIVE LIFE**

CORPORATE PLANNERS, INC. (NEW YORK CORPORATION)  
271 MADISON AVENUE  
NEW YORK, NY 10016

FOR: CONSULTING SERVICES IN THE FIELD OF INCREASING PUBLIC AWARENESS OF ORGAN DONATION THROUGH A CORPORATE MARKETING PROGRAM CONDUCTED AT COLLEGE AND PROFESSIONAL FOOTBALL VENUES TO ENCOURAGE SPORTS FANS TO HELP INCREASE NATIONAL ORGAN DONATION STATISTICS AND BECOME ORGAN DONORS BY SIGNING DONOR CARDS OR REGISTERING

THROUGH THEIR LOCAL DONOR REGISTRIES OR MOTOR VEHICLE DEPARTMENTS, IN CLASS 35 (U.S. CLS. 100, 101 AND 102).

FIRST USE 10-31-2002; IN COMMERCE 2-2-2003.

THE MARK CONSISTS OF STANDARD CHARACTERS WITHOUT CLAIM TO ANY PARTICULAR FONT, STYLE, SIZE, OR COLOR.

SER. NO. 77-042,505, FILED 11-13-2006.

PAUL E. FAHRENKOPF, EXAMINING ATTORNEY



**Int. Cls.: 9, 38, 41 and 42**

**Prior U.S. Cls.: 21, 23, 26, 36, 38, 100, 101, 104 and 107**

**Reg. No. 3,503,500**

**United States Patent and Trademark Office**

**Registered Sep. 23, 2008**

**TRADEMARK  
SERVICE MARK  
PRINCIPAL REGISTER**

# EIGHT DAYS

SONY COMPUTER ENTERTAINMENT EUROPE  
LIMITED (ENGLAND LIMITED LIABILITY  
COMPANY)

10 GREAT MARLBOROUGH STREET  
LONDON, ENGLAND W1F7LP

FOR: VIDEO GAME SOFTWARE; ELECTRONIC GAME SOFTWARE; GAMING APPARATUS FOR USE WITH TELEVISION RECEIVERS AND/OR MONITORS, NAMELY, COMPUTER JOYSTICKS, ELECTRONIC CABLES; COMPUTER GAMES SOFTWARE; COMPUTER GAMES CARTRIDGES; INTERACTIVE EDUCATIONAL GAME SOFTWARE FOR USE WITH TELEVISION RECEIVERS AND/OR MONITORS; COMPUTER SCREENSAVER SOFTWARE; COMPUTER SOFTWARE FOR CREATING BACKGROUND WALLPAPER ON COMPUTER SCREENS; SOUND AND/OR VIDEO RECORDINGS FEATURING IMAGES AND AUDIO TRACKS FOR USE AS PART OF A COMPUTER GAME; DOWNLOADABLE DIGITAL SOUND AND/OR VIDEO RECORDINGS FEATURING IMAGES AND AUDIO TRACKS FOR USE AS PART OF A COMPUTER GAME, IN CLASS 9 (U.S. CLS. 21, 23, 26, 36 AND 38).

FOR: PROVIDING ELECTRONIC ACCESS TO GAMING, DIGITAL MUSIC AND/OR VIDEO WEB SITES; DELIVERY OF GAMES, DIGITAL MUSIC AND/OR VIDEO BY ELECTRONIC TRANSMISSION; PROVIDING ELECTRONIC TELECOMMUNICATIONS CONNECTIONS TO THE INTERNET OR DATABASES; PROVIDING ELECTRONIC WIRELESS TRANSMISSION OF DATA AND MESSAGES; VIDEO AND AUDIO STREAMING SERVICES; ELECTRONIC BULLETIN BOARD SERVICES, NAMELY, PROVIDING AN ONLINE ELECTRONIC BULLETIN BOARD FOR TRANSMISSION OF MESSAGES AMONG COMPUTER USERS CONCERNING ENTERTAINMENT, MUSIC, CONCERTS, VIDEOS, RADIO, TELEVISION, FILM, NEWS, SPORTS, GAMES AND CULTURAL EVENTS; ELEC-

TRONIC TRANSMISSION OF IMAGES, AUDIO, VIDEO, AND DOCUMENTS, INCLUDING TEXT, CARDS, LETTERS, MESSAGES, MAIL, AND ELECTRONIC MAIL, OVER LOCAL OR GLOBAL COMMUNICATIONS NETWORKS, INCLUDING THE INTERNET, INTRANETS, EXTRANETS, TELEVISION, CELLULAR, AND SATELLITE NETWORKS; PROVIDING ON-LINE ELECTRONIC BULLETIN BOARDS FOR THE TRANSMISSION OF MESSAGES AMONG COMPUTER USERS CONCERNING ENTERTAINMENT, MUSIC, CONCERTS, VIDEOS, RADIO, TELEVISION, FILM, NEWS, SPORTS, GAMES AND CULTURAL EVENTS; PROVIDING SECURE REAL TIME ELECTRONIC COMMUNICATION BETWEEN USERS REGARDING THE TRANSFER OF MUSIC, VIDEO AND AUDIO RECORDINGS VIA A COMPUTER NETWORK; INFORMATION, ADVISORY AND CONSULTANCY SERVICES RELATING TO ALL THE AFORESAID, IN CLASS 38 (U.S. CLS. 100, 101 AND 104).

FOR: GAMING SERVICES, NAMELY, THE PROVISION OF ONLINE COMPUTER AND VIDEO GAMES; MULTIMEDIA PUBLISHING OF WEB MAGAZINES REGARDING GAMES; ONLINE ELECTRONIC NEWSLETTERS AND MAGAZINES IN THE FIELD OF COMPUTER GAMES; INFORMATION SERVICES AND ON-LINE INFORMATION SERVICES IN THE FIELD OF ENTERTAINMENT, NAMELY, COMPUTER GAMING, VIA THE INTERNET; DIGITAL IMAGING SERVICES; PROVIDING A WEBSITE FEATURING AUDIO, VIDEO, GRAPHICS, TEXT AND OTHER MULTIMEDIA CONTENT IN THE FIELDS OF MUSIC, VIDEO ENTERTAINMENT, RADIO ENTERTAINMENT, TELEVISION ENTERTAINMENT, FILM ENTERTAINMENT, ENTERTAINMENT NEWS, SPORTS GAMES, CULTURAL EVENTS, ENTERTAINMENT AND ARTS AND LEISURE VIA COMMUNICATIONS NETWORKS, IN CLASS 41 (U.S. CLS. 100, 101 AND 107).

FOR: PROVIDING A WEBSITE FEATURING TEMPORARY USE OF NONDOWNLOADABLE SOFTWARE THAT ALLOWS COMPUTER USERS TO UPLOAD AND DOWNLOAD ENTERTAINMENT DATA, MUSIC, ENTERTAINMENT VIDEOS, GAMES, RINGTONES, ENTERTAINMENT GRAPHICS, ENTERTAINMENT INFORMATION, AND ENTERTAINMENT NEWS VIA THE INTERNET; TEMPORARY USE OF ON-LINE NONDOWNLOADABLE SOFTWARE IN THE FIELD OF COMPUTER GAMING, IN CLASS 42 (U.S. CLS. 100 AND 101).

THE MARK CONSISTS OF STANDARD CHARACTERS WITHOUT CLAIM TO ANY PARTICULAR FONT, STYLE, SIZE, OR COLOR.

PRIORITY CLAIMED UNDER SEC. 44(D) ON UNITED KINGDOM APPLICATION NO. 2422173, FILED 5-18-2006, REG. NO. 2422173, DATED 8-17-2007, EXPIRES 5-18-2016.

SER. NO. 77-044,661, FILED 11-15-2006.

ANGELA M. MICHELI, EXAMINING ATTORNEY

**Int. Cls.: 37 and 40**

**Prior U.S. Cls.: 100, 103 and 106**

**United States Patent and Trademark Office**

**Reg. No. 3,503,501**

**Registered Sep. 23, 2008**

**SERVICE MARK  
PRINCIPAL REGISTER**

**UNI-CRETE**

CANADIAN ROCKPORT HOMES INTERNATIONAL INC. (CANADA CORPORATION)  
2317 WALL STREET  
VANCOUVER, CANADA V5L1B8

FOR: CONSTRUCTION OF MONOLITHIC CONCRETE HOUSING USING A MOLDING TECHNOLOGY; CONSTRUCTION OF MULTIPLE FACTORY-FINISHED CONCRETE HOUSING MODULES INTO HOMES AND OTHER TYPES OF BUILDINGS, IN CLASS 37 (U.S. CLS. 100, 103 AND 106).

FOR: MANUFACTURE OF MULTIPLE FACTORY-FINISHED CONCRETE HOUSING MODULES INTO HOMES AND OTHER TYPES OF BUILDINGS TO THE ORDER AND/OR SPECIFICA-

TION OF OTHERS, IN CLASS 40 (U.S. CLS. 100, 103 AND 106).

THE MARK CONSISTS OF STANDARD CHARACTERS WITHOUT CLAIM TO ANY PARTICULAR FONT, STYLE, SIZE, OR COLOR.

PRIORITY CLAIMED UNDER SEC. 44(D) ON CANADA APPLICATION NO. 1320717, FILED 10-18-2006, REG. NO. 704702, DATED 1-15-2008, EXPIRES 1-15-2023.

SER. NO. 77-044,992, FILED 11-15-2006.

WANDA KAY PRICE, EXAMINING ATTORNEY

**Int. Cl.: 36**

**Prior U.S. Cls.: 100, 101 and 102**

**United States Patent and Trademark Office**

**Reg. No. 3,503,502**

**Registered Sep. 23, 2008**

**SERVICE MARK  
PRINCIPAL REGISTER**

**WORLD ELITE MASTERCARD FOR  
BUSINESS**

MASTERCARD INTERNATIONAL INCORPORATED (DELAWARE CORPORATION)  
2000 PURCHASE STREET  
PURCHASE, NY 105772509

FOR: FINANCIAL SERVICES, NAMELY, CREDIT CARD SERVICES; PROVIDING CREDIT CARD, DEBIT CARD AND CHARGE CARD SERVICES; PROVIDING ELECTRONIC FUNDS AND CURRENCY TRANSFER SERVICES, ELECTRONIC BILL PAYMENTS SERVICES, CASH DISBURSEMENT SERVICES, AND TRANSACTION AUTHORIZATION AND SETTLEMENT SERVICES; TRAVEL INSURANCE UNDERWRITING SERVICES; CHEQUE VERIFICATION SERVICES; FINANCIAL SERVICES, NAMELY, BANKING AND PAYMENT CARD SERVICES, PROVIDED BY MEANS OF A GLOBAL COMPUTER NETWORK OR THE INTERNET, IN CLASS 36 (U.S. CLS. 100, 101 AND 102).

FIRST USE 9-7-2006; IN COMMERCE 9-7-2006.

THE MARK CONSISTS OF STANDARD CHARACTERS WITHOUT CLAIM TO ANY PARTICULAR FONT, STYLE, SIZE, OR COLOR.

OWNER OF U.S. REG. NOS. 1,257,853, 3,114,790 AND OTHERS.

NO CLAIM IS MADE TO THE EXCLUSIVE RIGHT TO USE "FOR BUSINESS", APART FROM THE MARK AS SHOWN.

SER. NO. 77-045,547, FILED 11-16-2006.

GENE MACIOL, EXAMINING ATTORNEY

**Int. Cls.: 5 and 44**

**Prior U.S. Cls.: 6, 18, 44, 46, 51, 52, 100 and 101**

**United States Patent and Trademark Office**

**Reg. No. 3,503,503**

**Registered Sep. 23, 2008**

**TRADEMARK  
SERVICE MARK  
PRINCIPAL REGISTER**



A2 CORPORATION LIMITED (NEW ZEALAND CORPORATION)  
LEVEL 5, 235 BROADWAY, NEWMARKET  
AUCKLAND, NEW ZEALAND

FOR: ANIMAL SEMEN, ANIMAL BREEDING MATERIALS, NAMELY, DNA AND OVUM, NAMELY, UNFERTILIZED EGGS; INFANT FOODS; MILK POWDER FOR INFANTS; READY TO DRINK INFANT MILK POWDER, IN CLASS 5 (U.S. CLS. 6, 18, 44, 46, 51 AND 52).

FOR: VETERINARY SERVICES; ANIMAL BREEDING SERVICES; ANIMAL TESTING SERVI-

CES FOR BREEDING PURPOSES, IN CLASS 44 (U.S. CLS. 100 AND 101).

PRIORITY CLAIMED UNDER SEC. 44(D) ON NEW ZEALAND APPLICATION NO. 754206, FILED 8-30-2006, REG. NO. 754206, DATED 8-30-2006, EXPIRES 8-30-2013.

OWNER OF U.S. REG. NO. 2,885,528.

SER. NO. 77-045,933, FILED 11-16-2006.

ANDREA HACK, EXAMINING ATTORNEY

**Int. Cls.: 18, 25 and 35**

**Prior U.S. Cls.: 1, 2, 3, 22, 39, 41, 100, 101 and 102**

**United States Patent and Trademark Office**

**Reg. No. 3,503,504**

**Registered Sep. 23, 2008**

**TRADEMARK  
SERVICE MARK  
PRINCIPAL REGISTER**

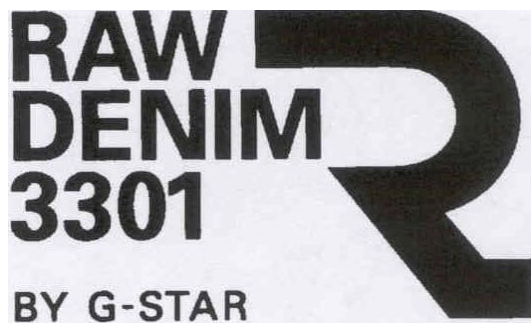

G-STAR RAW DENIM KFT (HUNGARY LIMITED LIABILITY COMPANY)  
APÁCZAI CSERE JÁNOS UTCA 11  
BUDAPEST, HUNGARY 1052

FOR: LEATHER AND IMITATION LEATHER AND GOODS MADE OF LEATHER AND IMITATION LEATHER AND NOT INCLUDED IN OTHER CLASSES, NAMELY, BAGS OF LEATHER FOR CARRYING PACKAGES, POCKET WALLETS AND SUITCASES; TRUNKS AND TRAVELING BAGS; UMBRELLAS, IN CLASS 18 (U.S. CLS. 1, 2, 3, 22 AND 41).

FIRST USE 0-0-1999; IN COMMERCE 6-0-2000.

FOR: CLOTHING, NAMELY, JEANS, TROUSERS AND PANTS, SHIRTS, POLO SHIRTS, T-SHIRTS, SOCKS, STOCKINGS, JACKETS, COATS, SHORTS, BLOUSES, SWEATERS, BABY ONE PIECE CLOTHING, RAINWEAR, WARM-UP SUITS, SKI-WEAR, SWIMMING WEAR, UNDERGARMENTS, SHOES AND BELTS; FOOTWEAR, HEADGEAR, NAMELY, HATS AND CAPS; LEATHER BELTS FOR CLOTHING, IN CLASS 25 (U.S. CLS. 22 AND 39).

FIRST USE 0-0-1999; IN COMMERCE 6-0-2000.

FOR: ADVERTISING, WHETHER OR NOT PROVIDED VIA THE INTERNET, IN THE NATURE OF PROMOTION ACTIVITIES AND PROMOTION EVENTS; BUSINESS MANAGEMENT, WHETHER OR NOT PROVIDED VIA THE INTERNET, IN THE NATURE OF FRANCHISE SERVICES RELATING TO THE COMMERCIAL EXPLOITATION OF SHOPS SELLING FASHION ACCESSORIES, INCLUDING CLOTHING, FOOTWEAR, HEADGEAR, HOROLO-

GICAL INSTRUMENTS, SPECTACLES, SUNGLASSES AND JEWELRY; BUSINESS ADMINISTRATION CONSULTANCY, WHETHER OR NOT PROVIDED VIA THE INTERNET; PROVIDING OFFICE FUNCTIONS, WHETHER OR NOT PROVIDED VIA THE INTERNET, INCLUDING THOSE RELATING TO THE CLOSING OF FRANCHISE AGREEMENTS AMONGST OTHERS FOR SOAPS, NAMELY, ALMOND SOAPS, ANTIBACTERIAL SOAPS, BATH SOAPS IN LIQUID, SOLID OR GEL FORM, COSMETIC SOAPS, CREAM SOAPS, DEODORANT SOAPS, DISINFECTING PERFUMED SOAPS, HAND SOAPS, LIQUID SOAPS FOR HANDS, FACE AND/OR BODY, PERFUMED SOAPS, TOILET SOAPS AND SKIN SOAPS, PERFUME, ESSENTIAL OILS FOR PERSONAL USE, COSMETICS, NAMELY, AFTER-SHAVE GEL AND LOTION, ALL PURPOSE COTTON SWABS FOR PERSONAL USE, ANTIPERSPIRANTS, AROMATHERAPY CREAMS, LOTIONS AND OILS, ARTIFICIAL EYELASHES AND FINGERNAILS, BATH CRYSTALS, FOAMS, GELS, OILS, AND PEARLS, NON-MEDICATED BATH SALTS, BLUSH, BLUSHER, BODY CREAM, BODY OIL, COMPACTS, COTTON BALLS, PUFFS AND SWABS, DEPILATORY CREAMS, EYE PENCILS, EYE SHADOW, EYE MAKE-UP REMOVER, EYE BROW PENCILS, EYELINERS, FOUNDATION, LIP BALM, CREAM, GLOSS AND LINER, LIPSTICK, MAKE-UP REMOVER, MASCARA, MASSAGE OIL, MAKE-UP POWDER, SUN-TANNING PREPARATIONS, HAIR SHAMPOO, MOUSSE, AND CONDITIONERS, HAIR LOTIONS, LEATHER AND IMITATION LEATHER AND GOODS MADE OF LEATHER AND IMITATION LEATHER, NAMELY, BAGS OF LEATHER FOR CARRYING PACKAGES, BRIEFCASES, RUCKSACKS, KEY CASES, POCKET WALLETS AND SUITCASES, TRUNKS AND TRA-

VELING BAGS, ATHLETIC BAGS, UMBRELLAS; CLOTHING, NAMELY, JEANS, TROUSERS, PANTS, SHIRTS, POLO SHIRTS, T-SHIRTS, SOCKS, STOCKINGS, JACKETS, COATS, SHORTS, BLOUSES, SWEATERS, BABY ONE PIECE CLOTHING, RAINWEAR, WARM-UP SUITS, SKI-WEAR, SWIMMING WEAR, UNDERGARMENTS, SHOES AND BELTS, FOOTWEAR, HEADGEAR, NAMELY, HATS AND CAPS, LEATHER BELTS FOR CLOTHING, BABY CLOTHING, NAMELY, SWADDLING CLOTHES, LAYETTES, CLOTH BIBS, JUMPERS, HATS, T-SHIRTS, ROMPER CLOTHING, BELTS, CAPS, HOODS, JERSEYS, MANTLES, MUFFLERS, FOU-LARDS, SHORTS, TOPS, UNDERWEAR, JEANS, SHIRTS, SOCKS, STOCKINGS, JACKETS, COATS, BLOUSES, SWEATERS, RAINWEAR, WARM-UP SUITS, SKI-WEAR, SWIMMING WEAR, UNDER-GARMENTS AND SHOES; RETAIL STORE SERVI-CES IN THE FIELD OF LEATHER AND IMITATION LEATHER AND GOODS MADE OF LEATHER AND IMITATION LEATHER, NAMELY, BAGS OF LEA-THER FOR CARRYING PACKAGES, POCKET WALLETS AND SUITCASES, TRUNKS AND TRA-VELING BAGS, UMBRELLAS, CLOTHING, NAME-LY, JEANS, TROUSERS AND PANTS, SHIRTS, POLO SHIRTS, T-SHIRTS, SOCKS, STOCKINGS,

JACKETS, COATS, SHORTS, BLOUSES, SWEATERS, BABY ONE PIECE CLOTHING, RAINWEAR, WARM-UP SUITS, SKI-WEAR, SWIMMING WEAR, UNDERGARMENTS, SHOES AND BELTS, FOOT-WEAR, HEADGEAR, NAMELY, HATS AND CAPS, LEATHER BELTS FOR CLOTHING, HOROLOGI-CAL GOODS, NAMELY, WATCHES AND ACCES-SORIES THEREFOR, SPECTACLES, SUNGLASSES AND JEWELRY, IN CLASS 35 (U.S. CLS. 100, 101 AND 102).

FIRST USE 4-10-2003; IN COMMERCE 7-0-2004.

OWNER OF ERPN CMNTY TM OFC REG. NO. 001659945, DATED 7-3-2001, EXPIRES 5-17-2010.

OWNER OF U.S. REG. NOS. 1,976,206, 3,219,357 AND OTHERS.

NO CLAIM IS MADE TO THE EXCLUSIVE RIGHT TO USE "RAW DENIM" IN CLASS 025, APART FROM THE MARK AS SHOWN.

SER. NO. 77-046,946, FILED 11-17-2006.

JESSICA A. POWERS, EXAMINING ATTORNEY

**Int. Cl.: 35**

**Prior U.S. Cls.: 100, 101 and 102**

**United States Patent and Trademark Office**

**Reg. No. 3,503,505**

**Registered Sep. 23, 2008**

**SERVICE MARK  
PRINCIPAL REGISTER**



DEUTCH, RONI LYNN (UNITED STATES INDIVIDUAL)  
4815 WATT AVENUE  
NORTH HIGHLANDS, CA 95660

FOR: INCOME TAX PREPARATION; TAX CONSULTATION; TAX FILING SERVICES; TAX PREPARATION; ALL OF THE FOREGOING EXCLUDING CREDIT CARD, DEBIT CARD, PAYMENT CARD, ATM, BANKING AND OTHER BILL PAYMENT SERVICES AND RELATED BILL PAYMENT PRODUCTS, IN CLASS 35 (U.S. CLS. 100, 101 AND 102).

FIRST USE 11-1-2006; IN COMMERCE 11-1-2006.

NO CLAIM IS MADE TO THE EXCLUSIVE RIGHT TO USE "TAX CENTER", APART FROM THE MARK AS SHOWN.

THE NAME "RONI DEUTCH" IDENTIFIES A LIVING INDIVIDUAL WHOSE CONSENT IS OF RECORD.

THE COLOR(S) ORANGE, PURPLE, BLUE AND WHITE ARE CLAIMED AS A FEATURE OF THE MARK. IS/ARE CLAIMED AS A FEATURE OF THE MARK.

THE MARK CONSISTS OF A WHITE LETTER R ENCLOSED IN AN ORANGE CIRCLE INTERLOCKED WITH A WHITE LETTER D IN A BLUE CIRCLE WITH THE PURPLE APPEARING WHERE THE TWO CIRCLES JOIN TO THE LEFT OF THE WORDING RONI DEUTCH APPEARING IN LARGE ORANGE LETTERING ABOVE THE WORDING TAX CENTER IN SMALLER BLUE LETTERING..

SER. NO. 77-047,304, FILED 11-18-2006.

BARBARA BROWN, EXAMINING ATTORNEY



**Int. Cls.: 26, 35 and 44**

**Prior U.S. Cls.: 37, 39, 40, 42, 50, 100, 101 and 102**

**Reg. No. 3,503,506**

**United States Patent and Trademark Office**

**Registered Sep. 23, 2008**

**TRADEMARK  
SERVICE MARK  
PRINCIPAL REGISTER**

## Hair Comes the Bride

LUDWIG, GINA M. (CALIFORNIA SOLE PROPRIETORSHIP)  
SUITE 14  
27601 FORBES RD.  
LAGUNA NIGUEL, CA 92677

FOR: HAIR ORNAMENTS, IN CLASS 26 (U.S. CLS. 37, 39, 40, 42 AND 50).

FIRST USE 11-1-1996; IN COMMERCE 2-1-1997.

FOR: WHOLESALE ORDERING SERVICES IN THE FIELD OF BRIDAL ACCESSORIES, IN CLASS 35 (U.S. CLS. 100, 101 AND 102).

FIRST USE 11-1-1996; IN COMMERCE 2-1-1997.

FOR: HAIR STYLING SERVICES AND SERVICES OF A PROFESSIONAL MAKEUP ARTIST, IN CLASS 44 (U.S. CLS. 100 AND 101).

FIRST USE 11-1-1996; IN COMMERCE 2-1-1996.

THE MARK CONSISTS OF STANDARD CHARACTERS WITHOUT CLAIM TO ANY PARTICULAR FONT, STYLE, SIZE, OR COLOR.

SER. NO. 77-051,593, FILED 11-27-2006.

DORITT L. CARROLL, EXAMINING ATTORNEY

**Int. Cl.: 36**

**Prior U.S. Cls.: 100, 101 and 102**

**United States Patent and Trademark Office**

**Reg. No. 3,503,507**

**Registered Sep. 23, 2008**

**SERVICE MARK  
PRINCIPAL REGISTER**

**ZAAM**

ZURICH INSURANCE COMPANY (SWITZER-  
LAND COMPANY)  
MYTHENQUAI 2  
ZURICH, SWITZERLAND 8002

THE MARK CONSISTS OF STANDARD CHAR-  
ACTERS WITHOUT CLAIM TO ANY PARTICULAR  
FONT, STYLE, SIZE, OR COLOR.

FOR: FINANCIAL SERVICES, NAMELY, INVEST-  
MENT AND INVESTMENT FUND MANAGEMENT,  
FINANCIAL ADVISORY AND ASSET MANAGE-  
MENT, IN CLASS 36 (U.S. CLS. 100, 101 AND 102).

SER. NO. 77-052,639, FILED 11-29-2006.

FIRST USE 1-1-2006; IN COMMERCE 7-6-2006.

LESLIE RICHARDS, EXAMINING ATTORNEY

**Int. Cls.: 36, 40 and 42**

**Prior U.S. Cls.: 100, 101, 102, 103 and 106**

**United States Patent and Trademark Office**

**Reg. No. 3,503,508**

**Registered Sep. 23, 2008**

**SERVICE MARK  
PRINCIPAL REGISTER**

**CANO PETROLEUM**

CANO PETROLEUM, INC. (DELAWARE CORPORATION)  
801 CHERRY STREET, UNIT 3  
FORT WORTH, TX 761026882

FOR: ACQUISITION OF OIL AND GAS ASSETS, NAMELY, ACQUIRING OIL AND GAS ASSETS ON BEHALF OF SHAREHOLDERS, IN CLASS 36 (U.S. CLS. 100, 101 AND 102).

FIRST USE 6-30-2004; IN COMMERCE 6-30-2004.

FOR: OIL AND NATURAL GAS PRODUCTION SERVICES, IN CLASS 40 (U.S. CLS. 100, 103 AND 106).

FIRST USE 6-4-2004; IN COMMERCE 6-4-2004.

FOR: EXPLORATION, SEARCHING, AND PROSPECTING OF OIL AND GAS; ANALYSIS SERVICES

FOR OIL AND GAS EXPLORATION, IN CLASS 42 (U.S. CLS. 100 AND 101).

FIRST USE 6-4-2004; IN COMMERCE 6-4-2004.

THE MARK CONSISTS OF STANDARD CHARACTERS WITHOUT CLAIM TO ANY PARTICULAR FONT, STYLE, SIZE, OR COLOR.

NO CLAIM IS MADE TO THE EXCLUSIVE RIGHT TO USE "PETROLEUM", APART FROM THE MARK AS SHOWN.

SEC. 2(F) AS TO "CANO".

SER. NO. 77-052,717, FILED 11-29-2006.

WANDA KAY PRICE, EXAMINING ATTORNEY

**Int. Cls.: 7 and 9**

**Prior U.S. Cls.: 13, 19, 21, 23, 26, 31, 34, 35, 36 and 38**

**United States Patent and Trademark Office**

**Reg. No. 3,503,509**

**Registered Sep. 23, 2008**

**TRADEMARK  
PRINCIPAL REGISTER**

**EMERSON MOTOR TECHNOLOGIES**

EMERSON ELECTRIC CO. (MISSOURI CORPORATION)  
8000 WEST FLORISSANT AVENUE  
ST. LOUIS, MO 63136

FOR: ELECTRIC MOTORS FOR MACHINES, APPLIANCES, HEATING, VENTILATING, AIR CONDITIONING AND REFRIGERATION EQUIPMENT AND COOLING TOWERS; ELECTRIC GENERATORS; WATER PUMPS FOR SPAS, BATHS AND WHIRLPOOLS; DRIVES FOR ELECTRIC MOTORS; MACHINE PARTS FOR ELECTRIC MOTORS FOR MACHINES, NAMELY, MOUNTING KITS COMPRISED PRIMARILY OF MOUNTING BRACKETS AND HARDWARE FOR MOTORS AND BRAKE CONVERSION KITS COMPRISED PRIMARILY OF BRAKES, BRAKE MOUNTING FLANGES, SHAFT STUBS, COUPLINGS, FANS, AND HARDWARE PACKAGED TOGETHER FOR BRAKE CONVERSIONS; PARTS FOR ELECTRIC MOTORS FOR MACHINES, NAMELY, ENDSHIELDS AND FAN COVER KITS COMPRISED PRIMARILY OF FANS, FAN COVERS, AND HARDWARE PACKAGED TOGETHER FOR FAN COVER CONVERSIONS, IN CLASS 7 (U.S. CLS. 13, 19, 21, 23, 31, 34 AND 35).

FIRST USE 10-1-2002; IN COMMERCE 10-1-2002.

FOR: CAPACITORS, CAPACITOR COVERS, ELECTRICAL CONDUIT BOXES, ELECTRICAL OVERLOAD RESET BUTTONS IN THE NATURE OF ELECTRICAL SWITCHES, ALL FOR USE WITH ELECTRIC MOTORS, IN CLASS 9 (U.S. CLS. 21, 23, 26, 36 AND 38).

FIRST USE 10-1-2002; IN COMMERCE 10-1-2002.

THE MARK CONSISTS OF STANDARD CHARACTERS WITHOUT CLAIM TO ANY PARTICULAR FONT, STYLE, SIZE, OR COLOR.

OWNER OF U.S. REG. NOS. 111,931, 2,834,971 AND OTHERS.

NO CLAIM IS MADE TO THE EXCLUSIVE RIGHT TO USE "MOTOR TECHNOLOGIES", APART FROM THE MARK AS SHOWN.

SER. NO. 77-053,224, FILED 11-29-2006.

HANNO RITTNER, EXAMINING ATTORNEY

**Int. Cl.: 9**

**Prior U.S. Cls.: 21, 23, 26, 36 and 38**

**Reg. No. 3,503,510**

**United States Patent and Trademark Office**

**Registered Sep. 23, 2008**

**TRADEMARK  
PRINCIPAL REGISTER**

**FREEZE ✓**

AMERICAN THERMAL INSTRUMENTS, INC.  
(DELAWARE CORPORATION)  
9 HUFFMAN AVE.  
DAYTON, OH 45403

THE MARK CONSISTS OF THE MARK CONSISTS  
OF THE WORD "FREEZE" WITH A CHECK SYM-  
BOL TRAILING.

FOR: TEMPERATURE INDICATORS; TEMPERA-  
TURE SENSORS, IN CLASS 9 (U.S. CLS. 21, 23, 26, 36  
AND 38).

SER. NO. 77-053,375, FILED 11-29-2006.

FIRST USE 8-28-2006; IN COMMERCE 8-28-2006.

JILL C. ALT, EXAMINING ATTORNEY

Int. Cls.: 9 and 41

Prior U.S. Cls.: 21, 23, 26, 36, 38, 100, 101 and 107

United States Patent and Trademark Office

Reg. No. 3,503,511

Registered Sep. 23, 2008

TRADEMARK  
SERVICE MARK  
PRINCIPAL REGISTER



JAVIER SANTOS GARNICA (MEXICO INDIVIDUAL)  
AV. 16 DE SEPTIEMBRE 730-303-B, CENTRO  
GUADALAJARA, MEXICO 44100

FOR: AUDIO RECORDINGS FEATURING MUSIC; PRERECORDED CD'S, VIDEOTAPES, LASER DISKS AND DVD'S FEATURING MUSIC, IN CLASS 9 (U.S. CLS. 21, 23, 26, 36 AND 38).

FIRST USE 5-13-1997; IN COMMERCE 5-13-1997.

FOR: ENTERTAINMENT IN THE NATURE OF LIVE PERFORMANCES BY A VOCAL AND INSTRUMENTAL MUSICAL GROUP, IN CLASS 41 (U.S. CLS. 100, 101 AND 107).

FIRST USE 5-13-1997; IN COMMERCE 5-13-1997.

NO CLAIM IS MADE TO THE EXCLUSIVE RIGHT TO USE "BANDA", APART FROM THE MARK AS SHOWN.

THE MARK CONSISTS OF THE WORD "BANDA" OVER A CIRCLE. INSIDE THERE IS A SPINNING MEXICAN TRADITIONAL TOY DESIGN AND BELOW ARE THE WORDS "LA PIRINOLA" ACROSS THE CIRCLE.

SER. NO. 77-054,034, FILED 11-30-2006.

CHARLES L. JENKINS, EXAMINING ATTORNEY

**Int. Cl.: 28**

**Prior U.S. Cls.: 22, 23, 38 and 50**

**United States Patent and Trademark Office**

**Reg. No. 3,503,512**

**Registered Sep. 23, 2008**

**TRADEMARK  
PRINCIPAL REGISTER**

**BANDED MALLARD COMPANY**

BANDED MALLARD CO. (ARKANSAS CORPORATION)

310 ORANGE STREET

AUSTIN, AR 72007

FOR: DUCK BLINDS; FIELD BLINDS USED IN HUNTING; FISHING FLOATS, IN CLASS 28 (U.S. CLS. 22, 23, 38 AND 50).

FIRST USE 11-15-2004; IN COMMERCE 9-15-2006.

THE MARK CONSISTS OF STANDARD CHARACTERS WITHOUT CLAIM TO ANY PARTICULAR FONT, STYLE, SIZE, OR COLOR.

NO CLAIM IS MADE TO THE EXCLUSIVE RIGHT TO USE "MALLARD COMPANY", APART FROM THE MARK AS SHOWN.

SER. NO. 77-054,627, FILED 11-30-2006.

STEVEN PEREZ, EXAMINING ATTORNEY

Int. Cls.: 9, 35 and 36

Prior U.S. Cls.: 21, 23, 26, 36, 38, 100, 101 and 102

Reg. No. 3,503,513

United States Patent and Trademark Office

Registered Sep. 23, 2008

**TRADEMARK  
SERVICE MARK  
PRINCIPAL REGISTER**



TULLETT PREBON LIMITED (UNITED KINGDOM CORPORATION)  
54-62 NEW BROAD STREET  
LONDON, UNITED KINGDOM EC2M1ST

FOR: COMPUTER SOFTWARE FOR USE IN OPERATING AN ELECTRONIC TRADING SYSTEM FOR FACILITATING TRADES OF FINANCIAL INSTRUMENTS; COMPUTER SOFTWARE FOR ACCESSING, REVIEWING, INTERACTING WITH, RETRIEVING, PROCESSING AND DISPLAYING AUDIO, VIDEO, TEXT, DATA, GRAPHICS AND IMAGES VIA A COMPUTER OR COMMUNICATIONS NETWORK; COMPUTER SOFTWARE FOR ACCESSING COMPUTER COMMUNICATIONS NETWORKS; COMPUTER SOFTWARE FOR USE IN DATABASE CREATION AND DATABASE MANAGEMENT; INTERACTIVE COMPUTER SOFTWARE FOR USE IN OPERATING ELECTRONIC TRADING SYSTEMS FOR USE IN THE FINANCIAL FIELD; COMPUTER SOFTWARE COMPUTER DATABASES IN THE FIELD OF FINANCE; DOWNLOADABLE ELECTRONIC PUBLICATIONS IN THE NATURE OF ELECTRONIC NEWSLETTERS AND OTHER PERIODIC PUBLICATIONS, NAMELY, LEAFLETS, PAMPHLETS, CATALOGUES, BROCHURES, INFORMATION SHEETS AND DATA SHEETS IN THE FIELD OF FINANCE, IN CLASS 9 (U.S. CLS. 21, 23, 26, 36 AND 38).

FOR: COMPILATION OF INFORMATION INTO COMPUTER DATABASES; UPDATING AND MANAGEMENT OF DATABASES; DATA PROCESSING SERVICES; ALL THE AFORESAID RELATING TO FINANCIAL INFORMATION, DATA OR DATABASES, IN CLASS 35 (U.S. CLS. 100, 101 AND 102).

FOR: FINANCIAL BROKERAGE SERVICES RELATING TO FOREIGN EXCHANGE, CURRENCIES,

MONEY MARKET INSTRUMENTS, DERIVATIVES, OPTIONS, SWAPS, TREASURY BILLS, FUTURES, BONDS, SECURITIES, EQUITIES, ENERGY PRODUCTS, NAMELY, OIL, COAL AND NATURAL GAS, WEATHER DERIVATIVES, PRECIOUS AND NON-PRECIOUS METALS, STOCKS, CASH, COMMODITIES, FORWARDS AND REPURCHASE AGREEMENTS; INTER-DEALER BROKERAGE SERVICES RELATING TO FOREIGN EXCHANGE, CURRENCIES, MONEY MARKET INSTRUMENTS, DERIVATIVES, OPTIONS, SWAPS, TREASURY BILLS, FUTURES, BONDS, SECURITIES, EQUITIES, ENERGY PRODUCTS, NAMELY, OIL, COAL AND NATURAL GAS, WEATHER DERIVATIVES, PRECIOUS AND NON-PRECIOUS METALS, STOCKS, CASH, COMMODITIES, FORWARDS AND REPURCHASE AGREEMENTS; TRANSACTING AND TRADING OF FINANCIAL INSTRUMENTS, NAMELY, TRANSACTING AND TRADING FOREIGN EXCHANGE, CURRENCIES, MONEY MARKET INSTRUMENTS, DERIVATIVES, OPTIONS, SWAPS, TREASURY BILLS, FUTURES, BONDS, SECURITIES, EQUITIES, ENERGY PRODUCTS, NAMELY, OIL, COAL AND NATURAL GAS, WEATHER DERIVATIVES, PRECIOUS AND NON-PRECIOUS METALS, STOCKS, CASH, COMMODITIES, FORWARDS AND REPURCHASE AGREEMENTS; PROVIDING AN ELECTRONIC PLATFORM FOR TRANSACTIONS IN FINANCIAL INSTRUMENTS, NAMELY, PROVIDING ON-LINE FACILITIES ENABLING THE PURCHASE, SALE AND EXCHANGE OF FOREIGN EXCHANGE, CURRENCIES, MONEY MARKET INSTRUMENTS, DERIVATIVES, OPTIONS, SWAPS, TREASURY BILLS, FUTURES, BONDS, SECURITIES, EQUITIES, ENERGY PRODUCTS, NAMELY, OIL, COAL AND NATURAL GAS, WEATHER DERIVATIVES, PRECIOUS AND NON-PRECIOUS METALS, STOCKS, CASH, COMMODITIES, FORWARDS AND REPURCHASE AGREEMENTS; PROVIDING AN ELECTRONIC PLATFORM FOR TRANSACTIONS IN FINANCIAL INSTRUMENTS, NAMELY, PROVIDING ON-LINE FACILITIES ENABLING THE PURCHASE, SALE AND EXCHANGE OF FOREIGN EXCHANGE, CURRENCIES, MONEY MARKET INSTRUMENTS, DERIVATIVES, OPTIONS, SWAPS, TREASURY BILLS, FUTURES, BONDS, SECURITIES, EQUITIES, ENERGY PRODUCTS, NAMELY, OIL, COAL AND NATURAL GAS, WEATHER DERIVATIVES, PRECIOUS AND NON-PRECIOUS METALS, STOCKS, CASH, COMMODITIES, FORWARDS AND REPURCHASE



AGREEMENTS BY OTHERS; FINANCIAL ANALYSIS; PROVISION OF FINANCIAL DATA AND INFORMATION; ADVISORY AND CONSULTANCY SERVICES RELATING TO THE AFORESAID, IN CLASS 36 (U.S. CLS. 100, 101 AND 102).

PRIORITY CLAIMED UNDER SEC. 44(D) ON UNITED KINGDOM APPLICATION NO. 2436225,

FILED 10-19-2006, REG. NO. 2436225, DATED 6-15-2007, EXPIRES 10-19-2016.

THE MARK CONSISTS OF A STYLIZED CIRCLE.

SER. NO. 77-055,867, FILED 12-2-2006.

DAVID TAYLOR, EXAMINING ATTORNEY

**Int. Cl.: 19**

**Prior U.S. Cls.: 1, 12, 33 and 50**

**United States Patent and Trademark Office**

**Reg. No. 3,503,514**

**Registered Sep. 23, 2008**

**TRADEMARK  
PRINCIPAL REGISTER**



FLAKEBOARD COMPANY LIMITED (CANADA  
CORPORATION)  
80 TIVERTON COURT, SUITE 701  
MARKHAM, CANADA L3R0G4

FOR: FIBRE BOARD, WOOD PANELS, IN CLASS  
19 (U.S. CLS. 1, 12, 33 AND 50).

PRIORITY CLAIMED UNDER SEC. 44(D) ON  
CANADA APPLICATION NO. 1325999, FILED 11-28-  
2006, REG. NO. TMA712660, DATED 4-24-2008, EX-  
PIRES 4-24-2023.

SER. NO. 77-056,950, FILED 12-5-2006.

WENDY JUN, EXAMINING ATTORNEY

**Int. Cls.: 35 and 37**

**Prior U.S. Cls.: 100, 101, 102, 103 and 106**

**United States Patent and Trademark Office**

**Reg. No. 3,503,515**

**Registered Sep. 23, 2008**

**SERVICE MARK  
PRINCIPAL REGISTER**



THE GARLAND COMPANY, INC. (OHIO CORPORATION)  
3800 EAST 91ST STREET  
CLEVELAND, OH 44105

FOR: DOCUMENTATION, NAMELY, BUSINESS RECORDS MANAGEMENT WITH REGARD TO ROOFING MAINTENANCE; DATABASE MANAGEMENT IN THE FIELD OF ROOFING MAINTENANCE, IN CLASS 35 (U.S. CLS. 100, 101 AND 102).

FIRST USE 2-2-2006; IN COMMERCE 2-1-2006.

FOR: ROOFING EVALUATION, NAMELY, ROOFING CONSULTATION SERVICES; ROOFING INSPECTION, NAMELY, BUILDING INSPECTION

WITH REGARD TO ROOFS ROOF INSTALLATION OR ROOF REPAIR ON BUILDINGS OR OTHER STRUCTURES; ROOFING INSTALLATION AND MAINTENANCE; AND ROOF CONSTRUCTION MANAGEMENT SERVICES WITH REGARD TO ROOFING; PROVIDING A DATABASE FEATURING INFORMATION REGARDING ROOFING MAINTENANCE, IN CLASS 37 (U.S. CLS. 100, 103 AND 106).

FIRST USE 2-1-2006; IN COMMERCE 2-1-2006.

SER. NO. 77-059,791, FILED 12-8-2006.

BRIAN PINO, EXAMINING ATTORNEY

**Int. Cl.: 35**

**Prior U.S. Cls.: 100, 101 and 102**

**United States Patent and Trademark Office**

**Reg. No. 3,503,516**

**Registered Sep. 23, 2008**

**SERVICE MARK  
PRINCIPAL REGISTER**

**HEART TO HEART**

MEDTRONIC, INC. (MINNESOTA CORPORATION)  
710 MEDTRONIC PARKWAY  
MINNEAPOLIS, MN 554325604

FOR: CHARITABLE SERVICES, NAMELY, ORGANIZING AND CONDUCTING VOLUNTEER PROGRAMS FOR PROVIDING PATIENT ADVOCATE SERVICES FOR PATIENTS WHO REQUIRE IMPLANTED CARDIAC DEVICES , IN CLASS 35 (U.S. CLS. 100, 101 AND 102).

FIRST USE 4-30-2007; IN COMMERCE 4-30-2007.

THE MARK CONSISTS OF STANDARD CHARACTERS WITHOUT CLAIM TO ANY PARTICULAR FONT, STYLE, SIZE, OR COLOR.

SER. NO. 77-062,161, FILED 12-12-2006.

MARK SPARACINO, EXAMINING ATTORNEY

**Int. Cl.: 42**

**Prior U.S. Cls.: 100 and 101**

**United States Patent and Trademark Office**

**Reg. No. 3,503,517**

**Registered Sep. 23, 2008**

**SERVICE MARK  
PRINCIPAL REGISTER**

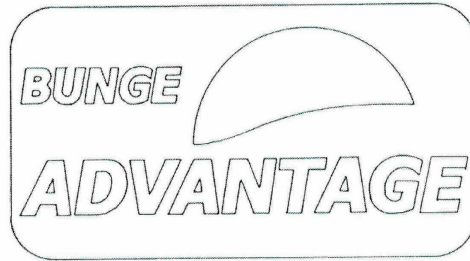

BUNGE NORTH AMERICA, INC. (NEW YORK CORPORATION)  
11720 BORMAN DRIVE  
ST. LOUIS, MO 63146

FOR: AGRICULTURAL RESEARCH, NAMELY, COLLECTING AND ANALYZING INFORMATION ON AGRICULTURAL AND FARM PRODUCTION, IN CLASS 42 (U.S. CLS. 100 AND 101).

FIRST USE 9-1-2006; IN COMMERCE 9-1-2006.

OWNER OF U.S. REG. NOS. 2,036,787 AND 2,682,682.

THE MARK CONSISTS OF CURVED LINES BETWEEN "BUNGE" AND "ADVANTAGE" AND TO THE RIGHT OF "BUNGE".

SER. NO. 77-065,295, FILED 12-15-2006.

MARK T. MULLEN, EXAMINING ATTORNEY

**Int. Cl.: 41**

**Prior U.S. Cls.: 100, 101 and 107**

**United States Patent and Trademark Office**

**Reg. No. 3,503,518**

**Registered Sep. 23, 2008**

**SERVICE MARK  
PRINCIPAL REGISTER**

**BRAIN INTEGRATING**

BR CONSULTING, INC. (NEW JERSEY CORPORATION)  
340 JORDAN ROAD  
SEDONA, AZ 86336

FOR: EDUCATION SERVICES, NAMELY, CONDUCTING CLASSES, SEMINARS AND WORKSHOPS TO ENHANCE MENTAL, EMOTIONAL AND PHYSICAL CAPABILITIES, IN CLASS 41 (U.S. CLS. 100, 101 AND 107).

FIRST USE 1-9-2003; IN COMMERCE 1-9-2003.

THE MARK CONSISTS OF STANDARD CHARACTERS WITHOUT CLAIM TO ANY PARTICULAR FONT, STYLE, SIZE, OR COLOR.

OWNER OF U.S. REG. NOS. 2,411,603, 3,073,257 AND OTHERS.

SER. NO. 77-066,792, FILED 12-18-2006.

PAUL CROWLEY, EXAMINING ATTORNEY

**Int. Cl.: 41**

**Prior U.S. Cls.: 100, 101 and 107**

**United States Patent and Trademark Office**

**Reg. No. 3,503,519**

**Registered Sep. 23, 2008**

**SERVICE MARK  
PRINCIPAL REGISTER**

**BRAIN MASTERING**

BR CONSULTING, INC. (NEW JERSEY CORPORATION)  
340 JORDAN ROAD  
SEDONA, AZ 86336

FOR: EDUCATION SERVICES, NAMELY, CONDUCTING CLASSES, SEMINARS AND WORKSHOPS TO ENHANCE MENTAL, EMOTIONAL AND PHYSICAL CAPABILITIES, IN CLASS 41 (U.S. CLS. 100, 101 AND 107).

FIRST USE 1-9-2003; IN COMMERCE 1-9-2003.

THE MARK CONSISTS OF STANDARD CHARACTERS WITHOUT CLAIM TO ANY PARTICULAR FONT, STYLE, SIZE, OR COLOR.

OWNER OF U.S. REG. NOS. 2,411,603, 3,073,257 AND OTHERS.

SER. NO. 77-066,799, FILED 12-18-2006.

PAUL CROWLEY, EXAMINING ATTORNEY

**Int. Cl.: 25**

**Prior U.S. Cls.: 22 and 39**

**United States Patent and Trademark Office**

**Reg. No. 3,503,520**

**Registered Sep. 23, 2008**

**TRADEMARK  
PRINCIPAL REGISTER**

**SUBWAY**

DOCTOR'S ASSOCIATES INC. (FLORIDA CORPORATION)  
300 SOUTH PINE ISLAND ROAD  
SUITE 306  
PLANTATION, FL 33324

FOR: CLOTHING WITH COMPANY LOGO, NAMELY, CAPS, HATS, VISORS, LONG AND SHORT SLEEVE T-SHIRTS, DENIM SHIRTS, COLLARED SHIRTS, POLO SHIRTS, SWEAT SHIRTS, TWILL SHIRTS, WIND SHIRTS, FLANNEL SHORTS, FLANNEL PANTS, SWEAT PANTS, FLEECE JACKETS, INFANT BIBS NOT OF PAPER, INFANT ONE-PIECE GARMENTS, SOCKS, IN CLASS 25 (U.S. CLS. 22 AND 39).

FIRST USE 9-18-2001; IN COMMERCE 9-18-2001.

THE MARK CONSISTS OF STANDARD CHARACTERS WITHOUT CLAIM TO ANY PARTICULAR FONT, STYLE, SIZE, OR COLOR.

OWNER OF U.S. REG. NOS. 1,174,608, 1,307,341 AND OTHERS.

SEC. 2(F).

SER. NO. 77-067,038, FILED 12-19-2006.

ELIZABETH KAJUBI, EXAMINING ATTORNEY



**Int. Cl.: 25**

**Prior U.S. Cls.: 22 and 39**

**United States Patent and Trademark Office**

**Reg. No. 3,503,521**

**Registered Sep. 23, 2008**

**TRADEMARK  
PRINCIPAL REGISTER**



DOCTOR'S ASSOCIATES INC. (FLORIDA CORPORATION)  
SUITE 306  
300 SOUTH PINE ISLAND ROAD  
PLANTATION, FL 33324

FOR: CLOTHING WITH COMPANY LOGO, NAMELY, CAPS, HATS, VISORS, LONG AND SHORT SLEEVE T-SHIRTS, DENIM SHIRTS, COLLARED SHIRTS, POLO SHIRTS, SWEAT SHIRTS, TWILL SHIRTS, WIND SHIRTS, FLANNEL SHORTS, FLANNEL PANTS, SWEAT PANTS, FLEECE JACKETS, INFANT BIBS NOT OF PAPER, INFANT ONE-

PIECE GARMENTS, SOCKS, IN CLASS 25 (U.S. CLS. 22 AND 39).

FIRST USE 9-18-2001; IN COMMERCE 9-18-2001.

OWNER OF U.S. REG. NOS. 1,174,608, 1,307,341 AND OTHERS.

SEC. 2(F).

SER. NO. 77-067,476, FILED 12-19-2006.

ELIZABETH KAJUBI, EXAMINING ATTORNEY

**Int. Cls.: 3, 18 and 25**

**Prior U.S. Cls.: 1, 2, 3, 4, 6, 22, 39, 41, 50, 51 and 52**

**United States Patent and Trademark Office**

**Reg. No. 3,503,522**

**Registered Sep. 23, 2008**

**TRADEMARK  
PRINCIPAL REGISTER**

**ENRICO COVERI**

ENRICO COVERI S.R.L. (ITALY LIMITED LIABILITY COMPANY)  
VIA ALESSANDRO MANZONI 43  
MILAN, ITALY

FOR: PERFUMES, EAU DE PARFUM, COLOGNE, TOILET WATER, ESSENTIAL OILS, COLD CREAM, PERSONAL DEODORANTS, ANTIPERSPIRANTS, FACIAL AND SKIN CLEANSING LOTIONS, SKIN MOISTURIZER, BODY OIL, SKIN EMOLLIENT, BATH AND SHOWER GEL, BODY LOTIONS, SKIN LOTIONS, DENTIFRICES, LIPSTICKS, EYE MAKE-UP, BLUSHERS, EYELINER, LIP PENCILS, EYE-SHADOW, FOUNDATION MAKEUP, FACE POWDER, IN CLASS 3 (U.S. CLS. 1, 4, 6, 50, 51 AND 52).

FOR: HANDBAGS, SHOULDER BAGS, BRIEF-CASES, DUFFLE BAGS, TOTE BAGS, CLUTCH BAGS, ATTACHE-CASES, SUITCASES, GARMENT BAGS FOR TRAVEL, RUCKSACKS, TRUNKS, TRAVELING BAGS, WALLETS, PURSES, CREDIT CARD CASES, KEYCASES, COSMETIC BAGS SOLD EMPTY, UMBRELLAS, IN CLASS 18 (U.S. CLS. 1, 2, 3, 22 AND 41).

FOR: ARTICLES OF CLOTHING FOR MEN, WOMEN AND CHILDREN, NAMELY, PULL-OVERS, CARDIGANS, SWEATERS, JERSEYS, JUM-

PERS, JACKETS, SWEATSHIRTS, PARKAS, BATHING SUITS, BLOUSES, SHIRTS, TROUSERS, JEANS, WAISTCOATS, SKIRTS, SHORTS, T-SHIRTS, DRESSES, MEN'S SUITS, COATS, RAINCOATS, OVERCOATS, OVERALLS, UNDERWEAR, VESTS, HOSIERY AND PANTY-HOSES, BATHROBES, SHAWLS, SCARVES, NECKTIES, GLOVES, BELTS FOR CLOTHING, SHOES, BOOTS, SANDALS, SLIPPERS, CLOGS, HATS AND CAPS, IN CLASS 25 (U.S. CLS. 22 AND 39).

THE MARK CONSISTS OF STANDARD CHARACTERS WITHOUT CLAIM TO ANY PARTICULAR FONT, STYLE, SIZE, OR COLOR.

OWNER OF ERPN CMNTY TM OFC REG. NO. 2239747, DATED 3-11-2004, EXPIRES 5-31-2011.

OWNER OF U.S. REG. NOS. 1,410,041 AND 2,227,541.

"ENRICO COVERI" DOES NOT IDENTIFY A LIVING INDIVIDUAL.

SER. NO. 77-068,170, FILED 12-20-2006.

NAAKWAMA ANKRAH, EXAMINING ATTORNEY

**Int. Cl.: 43**

**Prior U.S. Cls.: 100 and 101**

**United States Patent and Trademark Office**

**Reg. No. 3,503,523**

**Registered Sep. 23, 2008**

**SERVICE MARK  
PRINCIPAL REGISTER**

**Focused On Fresh**

JDS RESTAURANT GROUP, INC. (CALIFORNIA  
CORPORATION)  
3717 E. THOUSAND OAKS BLVD.  
WESTLAKE VILLAGE, CA 91362

THE MARK CONSISTS OF STANDARD CHAR-  
ACTERS WITHOUT CLAIM TO ANY PARTICULAR  
FONT, STYLE, SIZE, OR COLOR.

FOR: RESTAURANT SERVICES, IN CLASS 43  
(U.S. CLS. 100 AND 101).

SER. NO. 77-068,897, FILED 12-20-2006.

FIRST USE 4-21-2006; IN COMMERCE 4-21-2006.

MICHAEL ENGEL, EXAMINING ATTORNEY

**Int. Cls.: 5, 6, 9, 11 and 19**

**Prior U.S. Cls.: 1, 2, 6, 12, 13, 14, 18, 21, 23, 25, 26, 31, 33, 34, 36, 38, 44, 46, 50, 51 and 52**

**Reg. No. 3,503,524**

**United States Patent and Trademark Office**

**Registered Sep. 23, 2008**

**TRADEMARK  
PRINCIPAL REGISTER**

**AIRDOC**

ANTHONY FARRUGIA (AUSTRALIA INDIVIDUAL)  
6 WHITE LODGE COURT  
DONVALE, VICTORIA, AUSTRALIA 3111

FOR: GAS-SCRUBBING CHEMICAL PREPARATIONS FOR SANITARY PURPOSES IN MAINTAINING RESPIRABLE AIR WITHIN A CLOSED SPACE, IN CLASS 5 (U.S. CLS. 6, 18, 44, 46, 51 AND 52).

FOR: PORTABLE METAL BUILDINGS THAT DEFINE A SUBSTANTIALLY CLOSED SPACE FOR CONTAINING RESPIRABLE AIR FOR COMMERCIAL USE; ACCESSORIES FOR THE ABOVE-MENTIONED GOODS, NAMELY, METAL DOORS AND STRUCTURAL PARTS THEREOF FOR STRUCTURES DEFINING THE SUBSTANTIALLY CLOSED SPACE FOR MAINTAINING RESPIRABLE AIR, IN CLASS 6 (U.S. CLS. 2, 12, 13, 14, 23, 25 AND 50).

FOR: ACCESSORIES FOR APPARATUS FOR MAINTAINING RESPIRABLE AIR WITHIN A CLOSED SPACE, NAMELY, AIR QUALITY MEASUREMENT UNITS CONSISTING OF PARTICLE COUNTERS, ELECTROCHEMICAL MONITORS, ABSORPTION SPECTROPHOTOMETERS AND GAS CHROMATOGRAPHS, FOR MEASURING THE RELATIVE PROPORTION OF TOXIC GASES IN AMBIENT AIR, INDUSTRIAL AUTOMATION CONTROLS FOR ACTIVATING AIR PURGING UNITS UPON DETECTION OF NON-RESPIRABLE, IN CLASS 9 (U.S. CLS. 21, 23, 26, 36 AND 38).

FOR: APPARATUS FOR MAINTAINING RESPIRABLE AIR WITHIN A CLOSED SPACE, NAMELY, VENTILATORS, AIR PURIFICATION UNITS, AIR CLEANING UNITS, AIR-CONDITIONING UNITS, GAS SCRUBBERS AND ELECTRO-CHEMICAL

FLUE GAS SCRUBBING MACHINES, AIR FILTERING INSTALLATIONS AND AIR PURGING UNITS TO FLUSH AIR FROM A SUBSTANTIALLY CLOSED SPACE; ACCESSORIES FOR VENTILATORS, AIR PURIFICATION UNITS, AIR CLEANING UNITS, AIR-CONDITIONING UNITS, GAS SCRUBBERS, ELECTRO-CHEMICAL FLUE GAS SCRUBBING MACHINES, AIR FILTERING INSTALLATIONS, AIR PURGING UNITS, NAMELY, REPLACEMENT AIR FILTERS FOR INDUSTRIAL INSTALLATIONS, IN CLASS 11 (U.S. CLS. 13, 21, 23, 31 AND 34).

FOR: PORTABLE NON-METAL BUILDINGS THAT DEFINE A SUBSTANTIALLY CLOSED SPACE FOR CONTAINING RESPIRABLE AIR FOR COMMERCIAL USE; ACCESSORIES FOR PORTABLE NON-METAL BUILDINGS, NAMELY, NON-METAL DOORS AND STRUCTURAL PARTS THEREOF FOR PORTABLE NON-METAL STRUCTURES FOR DEFINING A SUBSTANTIALLY CLOSED SPACE FOR MAINTAINING RESPIRABLE AIR, IN CLASS 19 (U.S. CLS. 1, 12, 33 AND 50).

THE MARK CONSISTS OF STANDARD CHARACTERS WITHOUT CLAIM TO ANY PARTICULAR FONT, STYLE, SIZE, OR COLOR.

PRIORITY CLAIMED UNDER SEC. 44(D) ON AUSTRALIA APPLICATION NO. 1120081, FILED 6-21-2006, REG. NO. 1120081, DATED 6-21-2006, EXPIRES 6-21-2016.

SER. NO. 77-069,079, FILED 12-21-2006.

DAWN HAN, EXAMINING ATTORNEY

**Int. Cls.: 7 and 8**

**Prior U.S. Cls.: 13, 19, 21, 23, 28, 31, 34, 35 and 44**

**United States Patent and Trademark Office**

**Reg. No. 3,503,525**

**Registered Sep. 23, 2008**

**TRADEMARK  
PRINCIPAL REGISTER**

**MEGA LUBE**

WEEMS INDUSTRIES, INC. (IOWA CORPORATION)  
6281 NORTH GATEWAY DRIVE  
MARION, IA 52302

FOR: BATTERY POWERED GREASE GUNS; AIR OPERATED PUMPS AND POWER OPERATED PUMPS, IN CLASS 7 (U.S. CLS. 13, 19, 21, 23, 31, 34 AND 35).

FIRST USE 8-1-2005; IN COMMERCE 8-1-2005.

FOR: MANUAL POWERED GREASE GUNS; HAND-OPERATED PUMPS, IN CLASS 8 (U.S. CLS. 23, 28 AND 44).

FIRST USE 12-20-2006; IN COMMERCE 12-20-2006.

THE MARK CONSISTS OF STANDARD CHARACTERS WITHOUT CLAIM TO ANY PARTICULAR FONT, STYLE, SIZE, OR COLOR.

NO CLAIM IS MADE TO THE EXCLUSIVE RIGHT TO USE "LUBE", APART FROM THE MARK AS SHOWN.

SER. NO. 77-069,093, FILED 12-21-2006.

KELLY CHOE, EXAMINING ATTORNEY

**Int. Cls.: 35, 36 and 41**

**Prior U.S. Cls.: 100, 101, 102 and 107**

**United States Patent and Trademark Office**

**Reg. No. 3,503,526**

**Registered Sep. 23, 2008**

**SERVICE MARK  
PRINCIPAL REGISTER**

**OPEN2AMERICA**

MAUDUIT, JEROME (FRANCE INDIVIDUAL)  
11 AVENUE DU PARC  
COURBEVOIE, FRANCE 92400

FOR: PUBLIC RELATIONS REGARDING LEGISLATION AND GOVERNMENTAL MATTERS; PUBLIC RELATIONS FEATURING CONSULTATION IN PRESS RELATIONS; STRATEGIC CONSULTING SERVICES WITH REGARDS TO THE DEVELOPMENT OF ALL TYPES OF BUSINESSES AND PUBLIC RELATIONS ACTIVITIES IN THE UNITED STATES; PERSONNEL PLACEMENT AND RECRUITMENT; BUSINESS CONSULTING AND STRATEGIC PLANNING SERVICES IN THE DEVELOPMENT OF AMERICAN MARKETS; DEVELOPMENT OF STRATEGIC BUSINESS AND PUBLIC RELATIONS NETWORKS; ARRANGING AND CONDUCTING BUSINESS AND PUBLIC RELATIONS EVENTS, NAMELY, TRADE-SHOWS AND EXHIBITIONS FEATURING PRODUCTS AND SERVICES IN THE FIELD OF BUSINESS AND PUBLIC RELATIONS; MEDIATION OF TRADE BUSINESS FOR THIRD PARTIES FEATURING BUSINESS REFERRALS TO AND ON BEHALF OF RESELLERS, WHOLESALERS AND BUSINESS PROFESSIONALS IN THE INTERNATIONAL BUSINESS COMMUNITY FOR A WIDE VARIETY OF PRODUCTS AND SERVICES; ADVERTISING AND BUSINESS MANAGEMENT CONSULTATION SERVICES;

CONDUCTING BUSINESS RESEARCH AND SURVEYS; CONDUCTING BUSINESS AND MARKET RESEARCH SURVEYS; ADVICE ON THE ANALYSIS OF AMERICAN CONSUMER BUYING HABITS AND NEEDS PROVIDED WITH THE HELP OF SENSORY, QUALITY AND QUANTITY RELATED DATA; AND BUSINESS CONSULTING IN THE FIELD OF IMPORTATION, IN CLASS 35 (U.S. CLS. 100, 101 AND 102).

FOR: DEBT RECOVERY AND COLLECTION AGENCY SERVICES, IN CLASS 36 (U.S. CLS. 100, 101 AND 102).

FOR: TRANSLATION SERVICES, IN CLASS 41 (U.S. CLS. 100, 101 AND 107).

THE MARK CONSISTS OF STANDARD CHARACTERS WITHOUT CLAIM TO ANY PARTICULAR FONT, STYLE, SIZE, OR COLOR.

PRIORITY CLAIMED UNDER SEC. 44(D) ON CANADA APPLICATION NO. 1328012, FILED 12-13-2006, REG. NO. TMA709212, DATED 3-10-2008, EXPIRES 3-10-2023.

SER. NO. 77-069,741, FILED 12-21-2006.

ELISSA GARBER KON, EXAMINING ATTORNEY

**Int. Cl.: 42**

**Prior U.S. Cls.: 100 and 101**

**United States Patent and Trademark Office**

**Reg. No. 3,503,527**

**Registered Sep. 23, 2008**

**SERVICE MARK  
PRINCIPAL REGISTER**

**MD PRESENCE**

IHEALTHSPOT INC. (FLORIDA CORPORATION)  
SUITE 18  
767 SOUTH STATE ROAD 7  
MARGATE, FL 33068

FOR: COMPUTER PROGRAMMING FOR OTHERS; CREATING OR MAINTAINING WEB SITES FOR OTHERS; DESIGN AND DEVELOPMENT OF DATA BASES; DESIGN, DEVELOPMENT AND IMPLEMENTATION OF SOFTWARE , IN CLASS 42 (U.S. CLS. 100 AND 101).

FIRST USE 9-19-2006; IN COMMERCE 9-19-2006.

THE MARK CONSISTS OF STANDARD CHARACTERS WITHOUT CLAIM TO ANY PARTICULAR FONT, STYLE, SIZE, OR COLOR.

NO CLAIM IS MADE TO THE EXCLUSIVE RIGHT TO USE "MD", APART FROM THE MARK AS SHOWN.

SER. NO. 77-069,875, FILED 12-21-2006.

MICHELLE DUBOIS, EXAMINING ATTORNEY

**Int. Cls.: 9, 11 and 20**

**Prior U.S. Cls.: 2, 13, 21, 22, 23, 25, 26, 31, 32, 34, 36,  
38 and 50**

**Reg. No. 3,503,528**

**United States Patent and Trademark Office**

**Registered Sep. 23, 2008**

**TRADEMARK  
PRINCIPAL REGISTER**

# DIGITURE

SAMSUNG ELECTRONICS CO., LTD. (REPUBLIC OF KOREA CORPORATION)  
416, MAETAN-DONG, YEONGTONG-GU, SUWON-SI  
GYEONGGI-DO, REPUBLIC OF KOREA

FOR: AUDIO AND VIDEO SYSTEMS SOLD AS A UNIT AND COMPRISED OF SOME OR ALL OF THE FOLLOWING, NAMELY, LIQUID CRYSTAL DISPLAY SCREENS, DIGITAL LIGHT PROCESSING SCREENS, LASER PROJECTORS, LED PROJECTORS AND COMPUTERS AND TELEVISIONS, FLAT PANEL DISPLAYS PROJECTION SCREENS, MOVIE/HOME THEATER PROJECTORS, PLASMA DISPLAYS, CEILING AND WALL MOUNT BRACKETS OF METAL AND NON-METAL NOT SOLD SEPARATELY, DVD SYSTEMS CONSISTING OF DVD/CD PLAYERS AND RADIO TUNERS AND DIGITAL SURROUND SOUND AMPLIFIER WITH SPEAKERS, AUDIO SPEAKERS, BATTERY RECHARGERS, CAMCORDERS, COMPACT DISK PLAYERS, COMPUTER Mouses, COMPUTER SERVERS, COMPUTER SOFTWARE THAT ENABLES THE CAPTURE OF HANDWRITING, COMPUTER SOFTWARE THAT ENABLES DECISION RECORDING, ASSIGNMENT OF PERSONALIZED TASKS AND THE DELIVERY OF A MEETING SUMMARY TO PARTICIPANTS VIA ELECTRONIC MAIL, COMPUTER SOFTWARE TO ENABLE SCHEDULING THE USE OF MEETING ROOMS, INFORMING PARTICIPANTS IN MEETINGS OF MEETING AGENDAS, AND DISTRIBUTING MEETING MATERIALS TO MEETING PARTICIPANTS, COMPUTER SOFTWARE TO ENABLE CONTROL OF WORKSPACE ENVIRONMENT, NAMELY, THE COLOR OF LIGHTING, THE BRIGHTNESS OF LIGHTS, TEMPERATURE AND VENTILATION, COMPUTER SOFTWARE FOR MEETING ROOMS WHICH ELECTRONICALLY RECOGNIZES HANDWRITING AND DISPLAYS SUCH HANDWRITING ON A SCREEN, COMPUTER WHITEBOARDS, COM-

PUTER HARDWARE, DIGITAL CAMERAS, DVD PLAYERS, ELECTRIC STORAGE BATTERIES, ELECTRONIC CONTROL BOX FOR CONTROLLING TELEPHONES, VIDEO PROJECTORS, ELECTRONIC WHITEBOARDS, ELECTRIC LAMPS AND LIGHTS, VIDEO-CONFERENCE SYSTEMS AND AUDIO AND VIDEO SYSTEMS INSTALLED IN A CONFERENCE ROOM OR OFFICE, FLASH MEMORY CARDS, HARD DISK DRIVES, HEADSETS FOR AUDIO AND VIDEO SYSTEMS, HEADSETS FOR COMPUTERS, HEADSETS FOR TELEPHONES, JUKE BOXES, JUNCTION BOXES, LCD SCREENS, MOBILE TELEPHONES, MONITORS FOR COMPUTERS, MOUSE PADS, MP3 PLAYERS, OPTICAL CABLES, OPTICAL DISK DRIVES, PDAS, PORTABLE COMPUTERS, PORTABLE MULTIMEDIA PLAYERS, POWER DISTRIBUTING BOXES, PRINTERS FOR CAMERAS, PRINTERS FOR COMPUTERS, RECHARGEABLE ELECTRIC BATTERIES, SEMICONDUCTOR DEVICES, SET-TOP BOXES, SWITCH BOXES, TABLET MONITORS; TELECOMMUNICATION EQUIPMENT, NAMELY, ETHERNET PASSIVE OPTICAL NETWORK (E-PON) FOR APPLICATIONS IN LOCAL AREA NETWORK (LAN) AND METRO AREA NETWORK (MAN), TELEPHONES, TELEVISION SETS, USB (UNIVERSAL SERIAL BUS) HARDWARE, VIDEO CAMERAS, VIDEO DISK PLAYERS, VIDEO PROJECTORS, VIDEO SURVEILLANCE CAMERAS, VIDEO TELEPHONES; VIDEOCONFERENCING EQUIPMENT AND SOFTWARE, SOLD AS SEPARATE COMPONENTS AND AS A SYSTEM, NAMELY, VIDEO CAMERAS, DOCUMENT CAMERAS, LOUD SPEAKERS, SPEAKER TELEPHONES, MICROPHONES, VIDEO MONITORS, KEYPADS, VIDEO CASSETTE RECORDERS, MEDIA CONVERTERS, ELECTRICAL AND COMPUTER CABLES, AND COMPUTER HARDWARE AND PROGRAMS FOR OPERATING THE ABOVE VIDEOCONFERENCING EQUIPMENT, FOR ESTABLISHING NETWORK CONNECTIONS, FOR CONFERENCE SCHEDUL-



ING AND ADMINISTRATION AND FOR DATA COMPRESSION; AND MODEMS, IN CLASS 9 (U.S. CLS. 21, 23, 26, 36 AND 38).

FOR: DENTAL OVENS, WATER PURIFIERS FOR HOUSEHOLD PURPOSES, ICE-COOLING REFRIGERATORS, GAS RANGES, BIDETS, GAS STOVES, AIR CONDITIONERS, VENTILATING FANS FOR COMMERCIAL AND INDUSTRIAL USE, GAS LAMPS, DECORATIVE WATER FOUNTAINS, PORTABLE ELECTRIC HEATERS, AIR CONDITIONERS FOR VEHICLES, AIR FILTERS FOR INDUSTRIAL INSTALLATIONS OR DOMESTIC USE, AIR PURIFICATION UNITS, HOT BLAST FURNACES, FLUORESCENT LAMPS, INFRARED LAMPS, ELECTRIC FANS, REFRIGERATORS, HUMIDIFIERS, HAIR DRYERS, ELECTRIC RANGES, ELECTRIC CLOTHES DRYERS, ELECTRIC TOASTERS, ELECTRICALLY HEATED CARPETS, MICROWAVE OVENS FOR COOKING, LIGHTERS PRIMARILY FOR LIGHTING GRILLS, FIREPLACES AND CANDLES, KIMCHI REFRIGERATORS, IN CLASS 11 (U.S. CLS. 13, 21, 23, 31 AND 34).

FOR: BOOKCASES, BOOKSHELVES, CABINETS (FURNITURE), CHAIRS, TEA TABLES, COMPUTER FURNITURE, CREDENZAS, DRAWERS, FILING CABINETS, FREE STANDING OFFICE PARTITIONS, FURNITURE CHESTS, INDOOR WINDOW BLINDS, MOVABLE OFFICE PARTITIONS, OFFICE TABLES, PICTURE FRAMES, STOOLS, CONFERENCE TABLES, IN CLASS 20 (U.S. CLS. 2, 13, 22, 25, 32 AND 50).

THE MARK CONSISTS OF STANDARD CHARACTERS WITHOUT CLAIM TO ANY PARTICULAR FONT, STYLE, SIZE, OR COLOR.

PRIORITY CLAIMED UNDER SEC. 44(D) ON REPUBLIC OF KOREA APPLICATION NO. 40-2006-0063, FILED 12-12-2006, REG. NO. 0728889, DATED 11-22-2007, EXPIRES 11-22-2017.

SER. NO. 77-071,275, FILED 12-26-2006.

REBECCA EISINGER, EXAMINING ATTORNEY

**Int. Cl.: 36**

**Prior U.S. Cls.: 100, 101 and 102**

**United States Patent and Trademark Office**

**Reg. No. 3,503,529**

**Registered Sep. 23, 2008**

**SERVICE MARK  
PRINCIPAL REGISTER**



LYFORD GROUP INTERNATIONAL LTD. (BA-  
HAMAS LIMITED LIABILITY COMPANY)  
375 PARK AVENUE  
SUITE 3302  
NEW YORK, NY 10152

FOR: HEDGE FUND MANAGEMENT AND  
HEDGE FUND INVESTMENT SERVICES, IN CLASS  
36 (U.S. CLS. 100, 101 AND 102).

FIRST USE 8-30-2004, THE MARK WAS FIRST  
USED ANYWHERE IN A DIFFERENT FORM

OTHER THAN THAT SOUGHT TO BE  
REGISTERED ON 06/30/2002.; IN COMMERCE  
8-30-2004, THE MARK WAS FIRST USED IN  
COMMERCE IN A DIFFERENT FORM OTHER  
THAN THAT SOUGHT TO BE REGISTERED ON  
06/30/2002..

SER. NO. 77-073,810, FILED 12-30-2006.

LINDSEY RUBIN, EXAMINING ATTORNEY

**Int. Cl.: 7**

**Prior U.S. Cls.: 13, 19, 21, 23, 31, 34 and 35**

**United States Patent and Trademark Office**

**Reg. No. 3,503,530**

**Registered Sep. 23, 2008**

**TRADEMARK  
PRINCIPAL REGISTER**

**WINTER**

WINTER EQUIPMENT COMPANY, INC. (OHIO CORPORATION)  
1900 JOSEPH LLOYD PARKWAY  
WILLOUGHBY, OH 44094

FOR: PLOW EDGE GUARDS AND PLOW BLADE WEAR GUARDS, NAMELY, FOR EXTENDING THE LIFE OF COMMERCIAL/HIGHWAY PLOW BLADES, IN CLASS 7 (U.S. CLS. 13, 19, 21, 23, 31, 34 AND 35).

FIRST USE 10-1-1989; IN COMMERCE 10-1-1989.

THE MARK CONSISTS OF STANDARD CHARACTERS WITHOUT CLAIM TO ANY PARTICULAR FONT, STYLE, SIZE, OR COLOR.

SEC. 2(F).

SER. NO. 77-074,168, FILED 1-2-2007.

SETH A. RAPPAPORT, EXAMINING ATTORNEY

**Int. Cl.: 41**

**Prior U.S. Cls.: 100, 101 and 107**

**United States Patent and Trademark Office**

**Reg. No. 3,503,531**

**Registered Sep. 23, 2008**

**SERVICE MARK  
PRINCIPAL REGISTER**

**cheat code**

CHEATCODES.COM LLC. (WASHINGTON LIMITED LIABILITY COMPANY)  
24430 SE 179TH ST  
MAPLE VALLEY, WA 98038

FOR: PROVIDING A WEBSITE FEATURING VIDEO GAME CHEATS, VIDEO GAME INFORMATION AND NEWS, GAME PLAY STRATEGIES AND FREQUENTLY ASKED QUESTIONS ABOUT VIDEO GAMES , IN CLASS 41 (U.S. CLS. 100, 101 AND 107).

FIRST USE 10-31-1996; IN COMMERCE 10-31-1996.

THE MARK CONSISTS OF STANDARD CHARACTERS WITHOUT CLAIM TO ANY PARTICULAR FONT, STYLE, SIZE, OR COLOR.

SEC. 2(F).

SER. NO. 77-074,309, FILED 1-2-2007.

LOURDES AYALA, EXAMINING ATTORNEY

**Int. Cls.: 36 and 37**

**Prior U.S. Cls.: 100, 101, 102, 103 and 106**

**United States Patent and Trademark Office**

**Reg. No. 3,503,532**

**Registered Sep. 23, 2008**

**SERVICE MARK  
PRINCIPAL REGISTER**

**REAL PROPERTY SPECIALISTS**

REAL PROPERTY SPECIALISTS, INC. (FLORIDA  
CORPORATION)  
SUITE 230  
6700 CONROY ROAD  
ORLANDO, FL 32835

FOR: REAL ESTATE APPRAISAL, BROKERAGE,  
PROPERTY MANAGEMENT AND CONSULTING  
SERVICES, IN CLASS 36 (U.S. CLS. 100, 101 AND 102).

FIRST USE 8-7-1992; IN COMMERCE 8-7-1992.

FOR: REAL ESTATE DEVELOPMENT, IN CLASS  
37 (U.S. CLS. 100, 103 AND 106).

FIRST USE 8-7-1992; IN COMMERCE 8-7-1992.

THE MARK CONSISTS OF STANDARD CHAR-  
ACTERS WITHOUT CLAIM TO ANY PARTICULAR  
FONT, STYLE, SIZE, OR COLOR.

NO CLAIM IS MADE TO THE EXCLUSIVE  
RIGHT TO USE "REAL PROPERTY", APART FROM  
THE MARK AS SHOWN.

SEC. 2(F).

SER. NO. 77-078,585, FILED 1-9-2007.

BERNICE MIDDLETON, EXAMINING ATTORNEY

**Int. Cls.: 38, 40 and 41**

**Prior U.S. Cls.: 100, 101, 103, 104, 106 and 107**

**United States Patent and Trademark Office**

**Reg. No. 3,503,533**

**Registered Sep. 23, 2008**

**SERVICE MARK  
PRINCIPAL REGISTER**

# ARABVISION

MIDDLE EAST BROADCASTING CORPORATION (CANADA CORPORATION)  
C/O 112 FOREST HILL ROAD  
TORONTO, CANADA M4V2L7

FOR: BROADCASTING OF RADIO AND TELEVISION PROGRAMS; BROADCASTING OF RADIO PROGRAMS AND TELEVISION PROGRAMS VIA THE INTERNET AND A GLOBAL COMPUTER NETWORK, IN CLASS 38 (U.S. CLS. 100, 101 AND 104).

FOR: REPRODUCTION OF RADIO AND TELEVISION PROGRAMS RECORDED ON AUDIO TAPES, VIDEO TAPES, COMPACT DISCS AND DIGITAL VIDEO DISCS; REPRODUCTION OF RADIO PROGRAMS AND TELEVISION PROGRAMS RECORDED ON AUDIO TAPES, VIDEO TAPES, COMPACT DISCS AND DIGITAL VIDEO

DISCS VIA THE INTERNET AND A GLOBAL COMPUTER NETWORK, IN CLASS 40 (U.S. CLS. 100, 103 AND 106).

FOR: PRODUCTION AND DISTRIBUTION OF RADIO AND TELEVISION PROGRAMS, IN CLASS 41 (U.S. CLS. 100, 101 AND 107).

THE MARK CONSISTS OF STANDARD CHARACTERS WITHOUT CLAIM TO ANY PARTICULAR FONT, STYLE, SIZE, OR COLOR.

OWNER OF CANADA REG. NO. TMA447546, DATED 9-15-1995, EXPIRES 9-15-2010.

SER. NO. 77-078,935, FILED 1-9-2007.

BARBARA GAYNOR, EXAMINING ATTORNEY

Int. Cl.: 35

Prior U.S. Cls.: 100, 101 and 102

United States Patent and Trademark Office

Reg. No. 3,503,534

Registered Sep. 23, 2008

**SERVICE MARK  
PRINCIPAL REGISTER**



DEFELICE, PAUL A. (UNITED STATES INDIVIDUAL)

P.O. BOX 131

KENSINGTON, CT 06037

FOR: INTERNET ONLINE AUCTION SERVICES PROVIDED VIA APPLICANT'S WEBSITE, IN CLASS 35 (U.S. CLS. 100, 101 AND 102).

FIRST USE 11-8-2006; IN COMMERCE 0-0-2006.

THE COLOR(S) BLUE, GREEN, ORANGE AND WHITE IS/ARE CLAIMED AS A FEATURE OF THE MARK.

THE COLOR ORANGE IS LOCATED IN THE UPPER RIGHT PORTION OF THE CIRCULAR "Z" DESIGN AND IN THE TERM "ZLOT". THE COLOR GREEN IS IN THE LOWER LEFT CORNER OF THE CIRCULAR "Z" DESIGN, THE TERM "THE", THE DOT IN ".COM", AND IN THE UNDERLINE OF "BETTER". THE COLOR BLUE APPEARS IN BOTH THE TOP LOWER PORTION OF THE CIRCULAR "Z" DESIGN, IN THE TERM "COM" AND IN THE WORDING "WHERE THE BIG STUFF SELLS BETTER".

SER. NO. 77-080,679, FILED S.R. 1-11-2007 AM. P.R. 5-23-2008.

TRACY WHITTAKER-BROWN, EXAMINING ATTORNEY

**Int. Cl.: 41**

**Prior U.S. Cls.: 100, 101 and 107**

**United States Patent and Trademark Office**

**Reg. No. 3,503,535**

**Registered Sep. 23, 2008**

**SERVICE MARK  
PRINCIPAL REGISTER**

**RAW SPIRIT FESTIVAL**

RAW SPIRIT FESTIVAL, INC. (ARIZONA CORPORATION)  
SUITE C  
4395 LAKE FORK LANE  
PRESCOTT, AZ 863018416

FOR: CONDUCTING EDUCATIONAL EXHIBITIONS IN THE NATURE OF AN ANNUAL EVENT TO RAISE PUBLIC AWARENESS IN THE FIELD OF RAW VEGANISM AND HEALTHY LIVING; SPECIAL EVENT PLANNING OF AN ANNUAL EVENT TO RAISE PUBLIC AWARENESS IN THE FIELD OF RAW VEGANISM AND HEALTHY LIVING, IN CLASS 41 (U.S. CLS. 100, 101 AND 107).

FIRST USE 5-15-2005; IN COMMERCE 5-15-2005.

THE MARK CONSISTS OF STANDARD CHARACTERS WITHOUT CLAIM TO ANY PARTICULAR FONT, STYLE, SIZE, OR COLOR.

NO CLAIM IS MADE TO THE EXCLUSIVE RIGHT TO USE "RAW" AND "FESTIVAL", APART FROM THE MARK AS SHOWN.

SER. NO. 77-082,912, FILED 1-15-2007.

ROBERT C. CLARK JR., EXAMINING ATTORNEY



**Int. Cl.: 3**

**Prior U.S. Cls.: 1, 4, 6, 50, 51 and 52**

**United States Patent and Trademark Office**

**Reg. No. 3,503,536**

**Registered Sep. 23, 2008**

**TRADEMARK  
PRINCIPAL REGISTER**

**GLOW AFTER DARK BY JLO**

JLO HOLDING COMPANY, LLC (DELAWARE  
LIMITED LIABILITY COMPANY)  
2401 MAIN STREET  
C/O MURPHY & KRESS, INC.  
SANTA MONICA, CA 90405

FOR: PERFUMERY PRODUCTS, NAMELY, PER-  
FUMES AND EAU DE TOILETTE; BODY LOTIONS,  
AND SHOWER GEL, IN CLASS 3 (U.S. CLS. 1, 4, 6, 50,  
51 AND 52).

FIRST USE 12-1-2006; IN COMMERCE 12-1-2006.

THE MARK CONSISTS OF STANDARD CHAR-  
ACTERS WITHOUT CLAIM TO ANY PARTICULAR  
FONT, STYLE, SIZE, OR COLOR.

OWNER OF U.S. REG. NO. 2,878,296.

THE NAME "JLO" IDENTIFIES A LIVING INDI-  
VIDUAL WHOSE CONSENT IS OF RECORD.

SER. NO. 77-085,850, FILED 1-18-2007.

KELLEY WELLS, EXAMINING ATTORNEY

Prior U.S. Cl.: B

United States Patent and Trademark Office

Reg. No. 3,503,537

Registered Sep. 23, 2008

CERTIFICATION MARK  
PRINCIPAL REGISTER

CERTIFIED CLINICAL  
ESTHETICIAN

PROFESSIONAL SKIN CARE, INC. (CALIFORNIA CORPORATION)  
25028 AVENUE KEARNEY  
VALENCIA, CA 91355

FOR: SKIN CARE ESTHETIC SERVICES, IN CLASS B (U.S. CL. B).

FIRST USE 1-1-1993; IN COMMERCE 1-1-1993.

THE MARK CONSISTS OF STANDARD CHARACTERS WITHOUT CLAIM TO ANY PARTICULAR FONT, STYLE, SIZE, OR COLOR.

NO CLAIM IS MADE TO THE EXCLUSIVE RIGHT TO USE "CERTIFIED", APART FROM THE MARK AS SHOWN.

THE CERTIFICATION MARK, AS INTENDED TO BE USED BY PERSONS AUTHORIZED BY THE CERTIFIER, CERTIFIES THAT THE CORRECTIVE SKIN CARE TECHNIQUES USED BY THE SKIN CARE PROFESSIONALS IS PERFORMED BY USING TECHNICALLY PROVEN METHODS AND MATERIALS FOR SAFETY AND EFFICIENCY.

SEC. 2(F).

SER. NO. 77-088,301, FILED 1-22-2007.

JAMES MACFARLANE, EXAMINING ATTORNEY

**Int. Cl.: 44**

**Prior U.S. Cls.: 100 and 101**

**United States Patent and Trademark Office**

**Reg. No. 3,503,538**

**Registered Sep. 23, 2008**

**SERVICE MARK  
PRINCIPAL REGISTER**

**SWALLOW'S**

SWALLOW, JACK (UNITED STATES INDIVIDUAL)  
POST OFFICE BOX 41040  
BRECKSVILLE, OH 441410040

THE MARK CONSISTS OF STANDARD CHARACTERS WITHOUT CLAIM TO ANY PARTICULAR FONT, STYLE, SIZE, OR COLOR.

FOR: BARBERING SERVICES, IN CLASS 44 (U.S. CLS. 100 AND 101).

SER. NO. 77-088,438, FILED 1-22-2007.

FIRST USE 12-31-1974; IN COMMERCE 12-31-1974.

DAVID C. REIHNER, EXAMINING ATTORNEY

Int. Cl.: 33

Prior U.S. Cls.: 47 and 49

United States Patent and Trademark Office

Reg. No. 3,503,539

Registered Sep. 23, 2008

TRADEMARK  
PRINCIPAL REGISTER



GEKKEIKAN SAKE COMPANY, LTD. (JAPAN  
JOINT STOCK COMPANY)  
MINAMIHAMA-CHO  
MFRS. AND MERCHANTS OF NO. 247  
FUSHIMI-KU, KYOTO, JAPAN

FOR: WINE; LIQUEURS; DISTILLED SPIRITS;  
SAKE; SHOCHU, NAMELY, JAPANESE WHITE  
LIQUOR; MIRIN, NAMELY, JAPANESE SHOCHU-  
BASED MIXED LIQUOR, IN CLASS 33 (U.S. CLS. 47  
AND 49).

FIRST USE 6-3-2002; IN COMMERCE 6-3-2002.

OWNER OF U.S. REG. NOS. 1,019,725, 1,255,493  
AND OTHERS.

NO CLAIM IS MADE TO THE EXCLUSIVE  
RIGHT TO USE "SAKE", APART FROM THE MARK  
AS SHOWN.

THE ENGLISH TRANSLATION OF "HORIN" IS  
"PHOENIX" OR "PEGASUS" IN ASIAN MYTHOL-  
OGY; THE ENGLISH TRANSLATION OF "GEKKEI-  
KAN" IS "LAUREL CROWN."

THE NON-LATIN CHARACTER(S) IN THE  
MARK TRANSLITERATES INTO "GEKKEIKAN"  
AND "HORIN", AND THIS MEANS LAUREL  
CROWN, AND PHOENIX/PEGASUS, RESPECTIVE-  
LY, IN ENGLISH.

SER. NO. 77-089,621, FILED 1-24-2007.

DAVID I, EXAMINING ATTORNEY

**Int. Cls.: 9 and 16**

**Prior U.S. Cls.: 2, 5, 21, 22, 23, 26, 29, 36, 37, 38 and 50**

**Reg. No. 3,503,540**

**United States Patent and Trademark Office**

**Registered Sep. 23, 2008**

**TRADEMARK  
PRINCIPAL REGISTER**

**Star**   
**graphics**

SKINNER, PAUL (UNITED STATES INDIVIDUAL)  
4785 EASTEX FREEWAY  
BEAUMONT, TX 77706

FIRST USE 10-31-1982; IN COMMERCE 10-31-1982.

FOR: COMPUTER HARDWARE; FACSIMILE MACHINES, IN CLASS 9 (U.S. CLS. 21, 23, 26, 36 AND 38).

NO CLAIM IS MADE TO THE EXCLUSIVE RIGHT TO USE "GRAPHICS", APART FROM THE MARK AS SHOWN.

FIRST USE 10-31-1982; IN COMMERCE 10-31-1982.

SER. NO. 77-089,937, FILED 1-24-2007.

FOR: DUPLICATING MACHINES; ELECTRIC AND ELECTRONIC FRANKING MACHINES, IN CLASS 16 (U.S. CLS. 2, 5, 22, 23, 29, 37, 38 AND 50).

WENDY GOODMAN, EXAMINING ATTORNEY

**Int. Cls.: 10, 12, 20 and 22**

**Prior U.S. Cls.: 1, 2, 7, 13, 19, 21, 22, 23, 25, 26, 31, 32, 35, 39, 42, 44 and 50**

**Reg. No. 3,503,541**

**United States Patent and Trademark Office**

**Registered Sep. 23, 2008**

**TRADEMARK  
PRINCIPAL REGISTER**

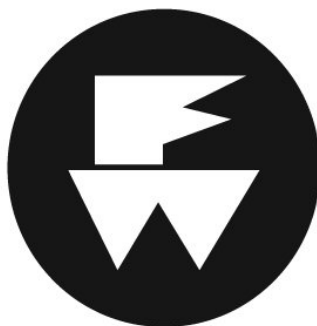

FERNO-WASHINGTON, INC. (OHIO CORPORATION)  
70 WEIL WAY  
WILMINGTON, OH 451779371

FOR: AMBULANCE COTS, FASTENERS AND RELATED HARDWARE USED TO FASTEN THE PATIENT, AND RELATED EQUIPMENT, NAMELY IV POLES; FASTENERS AND RELATED HARDWARE USED TO FASTEN IV POLES TO AMBULANCE COTS; AMBULANCE AND EMERGENCY STRETCHERS; CPR MATTRESSES; AMBULANCE COT AND STRETCHER MATTRESSES AND BEDDING FOR USE THEREWITH; BATHS EQUIPPED WITH UNDERWATER TREADMILLS, WATER JETS AND CURRENT SYSTEMS FOR USE IN PHYSICAL THERAPY; FASTENERS AND HARDWARE FOR FASTENING PATIENTS TO EMERGENCY COTS, STRETCHERS, EMERGENCY PATIENT BENCHES AND SEATS, SPINE BOARDS AND BACKBOARDS, AND PATIENT RESCUE, HANDLING AND TRANSFER EQUIPMENT; PATIENT RESCUE, HANDLING AND TRANSFER EQUIPMENT, NAMELY, EMERGENCY RESCUE SLEDS, EMERGENCY RESCUE BASKET STRETCHERS AND EMERGENCY RESCUE TOBOGGANS; PATIENT IMMOBILIZING AND SAFETY EQUIPMENT, NAMELY, SAFETY RESTRAINTS USED TO IMMOBILIZE A PATIENT'S HEAD, NECK, SPINE, LIMBS AND JOINTS; MORTUARY OPERATING TABLES; WHIRLPOOLS FOR USE IN HOSPITALS OR THERAPEUTIC USE; HIGH-LOW BATHS FOR THERAPEUTIC USE; SPINE BOARDS AND BACKBOARDS FOR SAFETY, RESCUE AND EMERGENCY MEDICAL SITUATIONS, AND BRIDLE STRAPS AND FASTENERS THERE-

FOR, NAMELY, STRAPS FOR USE IN SECURING THE PATIENT ONTO SPINE BOARDS AND BACKBOARDS, STRAPS FOR USE IN LIFTING SPINE BOARDS AND BACKBOARDS, AND HARDWARE FOR FASTENING BRIDLE STRAPS TO SPINE BOARDS AND BACKBOARDS; LITTERS FOR THE TRANSPORTATION OF SICK, INJURED OR WOUNDED PERSONS, IN CLASS 10 (U.S. CLS. 26, 39 AND 44).

FIRST USE 0-0-1962; IN COMMERCE 0-0-1962.

FOR: WHEELED CARTS FOR USE IN TRANSPORTING EQUIPMENT, FASTENERS, HARDWARE AND ACCESSORIES THEREFOR; CHURCH, UTILITY AND SHOWROOM TRUCKS FOR CASKETS; EMERGENCY VEHICLE PATIENT BENCHES AND SEATS, IN CLASS 12 (U.S. CLS. 19, 21, 23, 31, 35 AND 44).

FIRST USE 0-0-1962; IN COMMERCE 0-0-1962.

FOR: CASKET TABLES FOR HOSPITAL USE; COTS, SEATS AND CHAIRS, IN CLASS 20 (U.S. CLS. 2, 13, 22, 25, 32 AND 50).

FIRST USE 0-0-1962; IN COMMERCE 0-0-1962.

FOR: BODY BAGS, IN CLASS 22 (U.S. CLS. 1, 2, 7, 19, 22, 42 AND 50).

FIRST USE 5-0-1966; IN COMMERCE 5-0-1966.

THE MARK CONSISTS OF THE LETTERS "FW"  
IN STYLIZED FORM, AGAINST A CIRCULAR  
GROUND.

SER. NO. 77-089,945, FILED 1-24-2007.

WENDY GOODMAN, EXAMINING ATTORNEY

**Int. Cl.: 16**

**Prior U.S. Cls.: 2, 5, 22, 23, 29, 37, 38 and 50**

**United States Patent and Trademark Office**

**Reg. No. 3,503,542**

**Registered Sep. 23, 2008**

**TRADEMARK  
PRINCIPAL REGISTER**



**MetricNet**  
Performance Benchmarking

METRICNET, LLC (VIRGINIA LIMITED LIABILITY COMPANY)

1431 MAYHURST BLVD  
MCLEAN, VA 22102

FOR: RESEARCH REPORTS FEATURING BENCHMARKS, PERFORMANCE METRICS, SCORECARDS, SALARY AND BUSINESS DATA, IN CLASS 16 (U.S. CLS. 2, 5, 22, 23, 29, 37, 38 AND 50).

FIRST USE 12-1-2006; IN COMMERCE 1-1-2007.

NO CLAIM IS MADE TO THE EXCLUSIVE RIGHT TO USE "PERFORMANCE BENCHMARKING", APART FROM THE MARK AS SHOWN.

THE COLOR(S) BLUE, GREEN, ORANGE, BLACK AND GRAY IS/ARE CLAIMED AS A FEATURE OF THE MARK.

THE MARK CONSISTS OF THE COLOR BLUE APPEARS WITHIN THE FIRST OF THREE VERTICAL BARS WHICH APPEARS WITHIN A GRAY GLOBE/SPHERE. THE COLOR GREEN APPEARS WITHIN THE SECOND OF THREE VERTICAL BARS. THE COLOR ORANGE APPEARS WITHIN THE THIRD OF THREE VERTICAL BARS; THE WORDING "METRICNET" APPEARS IN BLACK.

SER. NO. 77-091,464, FILED 1-25-2007.

GINA HAYES, EXAMINING ATTORNEY



**Int. Cl.: 35**

**Prior U.S. Cls.: 100, 101 and 102**

**United States Patent and Trademark Office**

**Reg. No. 3,503,543**

**Registered Sep. 23, 2008**

**SERVICE MARK  
PRINCIPAL REGISTER**

**BUZZ NAVIGATORS**

INTELLIGENCE NAVIGATORS CORP. (NEVADA CORPORATION)  
SUITE 430  
5190 NEIL ROAD  
RENO, NV 89502

FOR: BUSINESS PROCESS RE-ENGINEERING SERVICES; EMPLOYMENT COUNSELING AND RECRUITING, EMPLOYMENT HIRING, RECRUITING, PLACEMENT, STAFFING, AND CAREER NETWORKING SERVICES, IN CLASS 35 (U.S. CLS. 100, 101 AND 102).

FIRST USE 1-1-2005; IN COMMERCE 1-1-2005.

THE MARK CONSISTS OF STANDARD CHARACTERS WITHOUT CLAIM TO ANY PARTICULAR FONT, STYLE, SIZE, OR COLOR.

"BUZZ" HAS NO MEANING IN A FOREIGN LANGUAGE.

SER. NO. 77-092,026, FILED 1-26-2007.

ROBERT C. CLARK JR., EXAMINING ATTORNEY

**Int. Cl.: 41**

**Prior U.S. Cls.: 100, 101 and 107**

**United States Patent and Trademark Office**

**Reg. No. 3,503,544**

**Registered Sep. 23, 2008**

**SERVICE MARK  
PRINCIPAL REGISTER**

**THE ARTIST PROJECT**

MERCHANDISE MART PROPERTIES, INC. (DE-  
LAWARE CORPORATION)  
SUITE 470  
222 MERCHANDISE MART PLAZA  
CHICAGO, IL 60654

FOR: ORGANIZING AND CONDUCTING ART  
EXHIBITIONS, IN CLASS 41 (U.S. CLS. 100, 101 AND  
107).

FIRST USE 10-25-2006; IN COMMERCE 10-25-2006.

THE MARK CONSISTS OF STANDARD CHAR-  
ACTERS WITHOUT CLAIM TO ANY PARTICULAR  
FONT, STYLE, SIZE, OR COLOR.

NO CLAIM IS MADE TO THE EXCLUSIVE  
RIGHT TO USE "ARTIST", APART FROM THE  
MARK AS SHOWN.

SER. NO. 77-092,103, FILED 1-26-2007.

DAVID I, EXAMINING ATTORNEY

**Int. Cls.: 35, 36 and 37**

**Prior U.S. Cls.: 100, 101, 102, 103 and 106**

**United States Patent and Trademark Office**

**Reg. No. 3,503,545**

**Registered Sep. 23, 2008**

**SERVICE MARK  
PRINCIPAL REGISTER**



THE REINVESTMENT FUND, INC. (PENNSYLVANIA CORPORATION)  
SUITE 3N 718 ARCH STREET,  
PHILADELPHIA, PA 19106

FOR: PUBLIC POLICY ANALYSIS, ADVICE AND CONSULTING PERTAINING TO ALLOCATION OF FINANCIAL RESOURCES TO SERVE PUBLIC PURPOSES, IN CLASS 35 (U.S. CLS. 100, 101 AND 102).

FIRST USE 6-0-1999; IN COMMERCE 6-0-1999.

FOR: FINANCIAL SERVICES IN THE NATURE OF LOAN FINANCING, PROJECT GRANTS AND EQUITY CAPITAL INVESTMENTS FOR RESIDENTIAL REAL ESTATE, COMMUNITY FACILITIES, CHILD CARE CENTERS, SCHOOLS AND HEALTH CENTERS, BUSINESSES AND COMMERCIAL REAL ESTATE IN DISTRESSED COMMUNITIES, AND DEVELOPMENT AND APPLICATION OF RENEWABLE ENERGY TECHNOLOGIES; FINAN-

CIAL INTERMEDIARY SERVICES BETWEEN INVESTORS AND BORROWERS AND GRANTEES, NAMELY, SECURING AND MANAGING INVESTMENTS, IN CLASS 36 (U.S. CLS. 100, 101 AND 102).

FIRST USE 6-0-1999; IN COMMERCE 6-0-1999.

FOR: REAL ESTATE DEVELOPMENT SERVICES FOR POTENTIAL RESIDENTIAL AND COMMERCIAL DEVELOPMENT, IN CLASS 37 (U.S. CLS. 100, 103 AND 106).

FIRST USE 6-0-1999; IN COMMERCE 6-0-1999.

THE MARK CONSISTS OF THE LETTERS TRF WITH A GEOMETRICAL DESIGN.

SER. NO. 77-092,137, FILED 1-26-2007.

INGA ERVIN, EXAMINING ATTORNEY

**Int. Cl.: 3**

**Prior U.S. Cls.: 1, 4, 6, 50, 51 and 52**

**United States Patent and Trademark Office**

**Reg. No. 3,503,546**

**Registered Sep. 23, 2008**

**TRADEMARK  
PRINCIPAL REGISTER**

**DENTIBLANC**

LABORATORIOS VIÑAS, S.A. (SPAIN CORPORATION)  
PROVENZA, 386 - 5A PLANTA  
BARCELONA, SPAIN 08025

FOR: DENTIFRICES, IN CLASS 3 (U.S. CLS. 1, 4, 6, 50, 51 AND 52).

THE MARK CONSISTS OF STANDARD CHARACTERS WITHOUT CLAIM TO ANY PARTICULAR FONT, STYLE, SIZE, OR COLOR.

OWNER OF SPAIN REG. NO. 1.918.390, DATED 10-5-1995, RENEWED AS REG. NO. 1.918.390, DATED 8-7-2004, EXPIRES 8-17-2014.

OWNER OF U.S. REG. NO. 2,442,119.

THE MARK HAS NO MEANING IN ANY FOREIGN LANGUAGE.

SER. NO. 77-092,547, FILED 1-26-2007.

TARAH HARDY, EXAMINING ATTORNEY

**Int. Cls.: 17 and 40**

**Prior U.S. Cls.: 1, 5, 12, 13, 35, 50, 100, 103 and 106**

**United States Patent and Trademark Office**

**Reg. No. 3,503,547**

**Registered Sep. 23, 2008**

**TRADEMARK  
SERVICE MARK  
PRINCIPAL REGISTER**

# BreathSaver

FRE COMPOSITES (2005) INC. (CANADA CORPORATION)  
75 WALES  
ST.-ANDRE-D'ARGENTEUIL, CANADA J0V1X0

FOR: REINFORCED FIBERGLASS PHENOL-BASED RESIN CONDUITS, FITTINGS AND ADAPTERS FOR CARRYING ELECTRICAL AND TELECOMMUNICATION CABLES UNDERWATER, UNDERGROUND AND ABOVE GROUND, IN CLASS 17 (U.S. CLS. 1, 5, 12, 13, 35 AND 50).

FIRST USE 0-0-1993; IN COMMERCE 0-0-1993.

FOR: CUSTOM MANUFACTURE OF ADVANCED COMPOSITE PRODUCTS FOR USE IN PUBLIC UTILITIES AND ELECTRICAL SYSTEMS INFRASTRUCTURE EQUIPMENT AND NET-

WORKS, NAMELY, REINFORCED FIBERGLASS PHENOL-BASED RESIN CONDUITS, FITTINGS AND ADAPTERS FOR CARRYING ELECTRICAL AND TELECOMMUNICATION CABLES UNDERWATER, UNDERGROUND AND ABOVE GROUND, IN CLASS 40 (U.S. CLS. 100, 103 AND 106).

FIRST USE 0-0-1993; IN COMMERCE 0-0-1993.

THE MARK CONSISTS OF STANDARD CHARACTERS WITHOUT CLAIM TO ANY PARTICULAR FONT, STYLE, SIZE, OR COLOR.

SER. NO. 77-092,851, FILED 1-27-2007.

DAVID COLLIER, EXAMINING ATTORNEY

**Int. Cls.: 38 and 41**

**Prior U.S. Cls.: 100, 101, 104 and 107**

**United States Patent and Trademark Office**

**Reg. No. 3,503,548**

**Registered Sep. 23, 2008**

**SERVICE MARK  
PRINCIPAL REGISTER**



SMALL BUSINESS NETWORK, INC. (ALABAMA CORPORATION)  
503 E. TUSCALOOSA ST.  
FLORENCE, AL 35630

FOR: BROADCASTING RADIO PROGRAMS IN THE FIELD OF SMALL BUSINESS CONCERNS VIA A GLOBAL COMPUTER NETWORK, IN CLASS 38 (U.S. CLS. 100, 101 AND 104).

FIRST USE 1-0-2003; IN COMMERCE 1-0-2003.

FOR: ENTERTAINMENT SERVICES, NAMELY, RADIO PROGRAMS FEATURING A RADIO PERSONALITY, PRODUCTION OF SUCH RADIO PROGRAMS, AND PROVIDING SUCH RADIO PROGRAMS IN THE FIELD OF SMALL BUSINESS CONCERNS VIA A GLOBAL COMPUTER NETWORK; ON-LINE LIBRARY ARCHIVE SERVICES, NAMELY, PROVIDING ELECTRONIC LIBRARY ARCHIVE SERVICES WHICH FEATURE RADIO PROGRAMS IN THE FIELD OF SMALL BUSINESS

CONCERNS VIA A GLOBAL COMPUTER NETWORK, IN CLASS 41 (U.S. CLS. 100, 101 AND 107).

FIRST USE 1-0-2003; IN COMMERCE 1-0-2003.

OWNER OF U.S. REG. NO. 3,144,305.

THE NAME(S), PORTRAIT(S), AND/OR SIGNATURE(S) SHOWN IN THE MARK IDENTIFIES JIM BLASINGAME, WHOSE CONSENT(S) TO REGISTER IS SUBMITTED.

THE MARK CONSISTS OF A GLOBE AND THE LITERAL ELEMENTS "JIM BLASINGAME" AND "THE SMALL BUSINESS ADVOCATE" OVERLYING A PORTION OF THE GLOBE.

SEC. 2(F) AS TO "SMALL BUSINESS ADVOCATE".

SER. NO. 77-093,844, FILED 1-29-2007.

JAMES STEIN, EXAMINING ATTORNEY

**Int. Cl.: 14**

**Prior U.S. Cls.: 2, 27, 28 and 50**

**United States Patent and Trademark Office**

**Reg. No. 3,503,549**

**Registered Sep. 23, 2008**

**TRADEMARK  
PRINCIPAL REGISTER**

**MOISSANITE CREATED BY  
CHARLES & COLVARD**

CHARLES & COLVARD, LTD. (NORTH CAROLINA CORPORATION)  
300 PERIMETER PARK DRIVE, SUITE A  
MORRISVILLE, NC 27560

FOR: JEWELRY; PRECIOUS GEMSTONES; SEMI-PRECIOUS GEMSTONES, IN CLASS 14 (U.S. CLS. 2, 27, 28 AND 50).

FIRST USE 1-24-2003; IN COMMERCE 1-24-2003.

THE MARK CONSISTS OF STANDARD CHARACTERS WITHOUT CLAIM TO ANY PARTICULAR FONT, STYLE, SIZE, OR COLOR.

OWNER OF U.S. REG. NOS. 2,462,691 AND 2,493,475.

NO CLAIM IS MADE TO THE EXCLUSIVE RIGHT TO USE "MOISSANITE CREATED BY", APART FROM THE MARK AS SHOWN.

SER. NO. 77-094,876, FILED 1-30-2007.

JAMES LOVELACE, EXAMINING ATTORNEY

**Int. Cl.: 25**

**Prior U.S. Cls.: 22 and 39**

**United States Patent and Trademark Office**

**Reg. No. 3,503,550**

**Registered Sep. 23, 2008**

**TRADEMARK  
PRINCIPAL REGISTER**

**NEXT LEVEL**

NEXT LEVEL SPORTSYSTEMS, INC. (PENNSYLVANIA CORPORATION)  
26 ERICA DRIVE  
LANGHORNE, PA 19047

FOR: ATHLETIC FOOTWEAR; BATHING SUITS; CLEATS FOR ATTACHMENT TO SPORTS SHOES; FOOTWEAR; FOOTWEAR FOR MEN AND WOMEN; GLOVES; GOLF CLEATS; GOLF SPIKES; GYM SUITS; HEADWEAR; JACKETS; JOGGING SUITS; LADIES' SUITS; MEN'S SUITS; MITTENS; PANTS; RAINPROOF JACKETS; SHORTS; SKIRTS; SOCKS; SPORT COATS; SPORTS SHIRTS; SPORTS SHIRTS WITH SHORT SLEEVES; SWEAT SHIRTS; SWEAT SHORTS; SWEAT SUITS; SWEATERS; T-SHIRTS; TIGHTS; TOPS; TRACK SUITS; TRAINING

SUITS; TROUSERS; UNDERWEAR; UNITARDS; VESTS; WAIST BELTS; WARM UP SUITS; WATER-PROOF JACKETS AND PANTS, IN CLASS 25 (U.S. CLS. 22 AND 39).

FIRST USE 9-0-1998; IN COMMERCE 9-0-1998.

THE MARK CONSISTS OF STANDARD CHARACTERS WITHOUT CLAIM TO ANY PARTICULAR FONT, STYLE, SIZE, OR COLOR.

SER. NO. 77-095,045, FILED 1-30-2007.

JAY BESCH, EXAMINING ATTORNEY



**Int. Cls.: 9, 38, 39, 41, 42 and 45**

**Prior U.S. Cls.: 21, 23, 26, 36, 38, 100, 101, 104, 105  
and 107**

**Reg. No. 3,503,551**

**United States Patent and Trademark Office**

**Registered Sep. 23, 2008**

**TRADEMARK  
SERVICE MARK  
PRINCIPAL REGISTER**

**itsmy**

GOFRESH GMBH (FED REP GERMANY CORPORATION)  
LILIENSTRASSE 7  
MUNCHEN, FED REP GERMANY 81669

FOR: DOWNLOADABLE ELECTRONIC PUBLICATIONS IN THE NATURE OF MAGAZINES AND NEWSLETTERS IN THE FIELDS OF TELECOMMUNICATIONS, SOCIAL NETWORKING AND ENTERTAINMENT; INTERACTIVE COMPUTER SOFTWARE FOR THE CREATION, PERSONALIZATION AND STORAGE OF WEBSITES, BLOGS AND ACOUSTIC, VISUAL AND TEXT CONTENT FOR INTERNET AND MOBILE INTERNET; SOFTWARE TO ENABLE THE PRODUCTION AND DISTRIBUTION OF MULTIMEDIA CONTENT; INTERNET OPERATING SOFTWARE FOR THE CREATION, ADMINISTRATION AND PUBLICATION OF ACOUSTIC AND VISUAL DATA; OPERATING SYSTEM SOFTWARE FOR THE SEARCH, LOCALIZATION AND NETWORKING OF DIGITAL DATA, IN CLASS 9 (U.S. CLS. 21, 23, 26, 36 AND 38).

FOR: TELECOMMUNICATIONS SERVICES, NAMELY, PROVIDING ACCESS TO DATA ON TELECOMMUNICATIONS NETWORKS; PROVIDING TELECOMMUNICATION ACCESS TO VIDEO AND AUDIO CONTENT VIA THE INTERNET; PROVIDING MOBILE TELEPHONE AND MOBILE INTERNET COMPUTER USERS WITH THE ABILITY TO TRANSMIT AND EXCHANGE ACOUSTIC AND VISUAL DATA; PROVIDING MOBILE TELEPHONE AND MOBILE INTERNET COMPUTER USERS WITH THE ABILITY TO CREATE, MANAGE AND PUBLISH ACOUSTIC AND VISUAL DATA; PROVIDING MOBILE TELEPHONE AND MOBILE INTERNET COMPUTER USERS WITH THE ABILITY TO SEARCH AND LINK DIGITAL DATA; PROVIDING MOBILE TELEPHONE AND MOBILE INTERNET COMPUTER USERS WITH THE ABIL-

ITY TO SEARCH, LOCALIZE AND LINK DIGITAL DATA; PROVIDING MOBILE TELEPHONE AND MOBILE INTERNET COMPUTER USERS WITH THE ABILITY TO EXCHANGE AUDIO, VIDEO AND TEXT CONTENT WITH ONE ANOTHER; PROVIDING ONLINE CONTENT IN THE FIELD OF COMMUNICATIONS, IN CLASS 38 (U.S. CLS. 100, 101 AND 104).

FOR: ELECTRONIC STORAGE OF DATA , IN CLASS 39 (U.S. CLS. 100 AND 105).

FOR: ENTERTAINMENT, NAMELY, PUBLISHING OF ELECTRONIC PUBLICATIONS; ON-LINE JOURNALS, NAMELY, BLOGS IN THE FIELD OF COMMUNICATIONS, ENTERTAINMENT AND SOCIAL NETWORKING; PROVIDING MOBILE TELEVISION ENTERTAINMENT; PROVIDING ON-LINE CONTENT IN THE FIELD OF ENTERTAINMENT; PROVIDING ON-LINE JOURNALS, NAMELY, BLOGS FEATURING USER-CREATED CONTENT; DIGITAL IMAGING SERVICES; PROVISION OF NON-DOWNLOADABLE FILMS VIA A VIDEO-ON-DEMAND SERVICE, IN CLASS 41 (U.S. CLS. 100, 101 AND 107).

FOR: COMPUTER PROGRAMMING FOR OTHERS, IN CLASS 42 (U.S. CLS. 100 AND 101).

FOR: INTERNET AND MOBILE INTERNET-BASED SOCIAL NETWORKING SERVICES; PROVIDING ONLINE CONTENT IN THE FIELD OF SOCIAL NETWORKING, IN CLASS 45 (U.S. CLS. 100 AND 101).

THE MARK CONSISTS OF STANDARD CHARACTERS WITHOUT CLAIM TO ANY PARTICULAR FONT, STYLE, SIZE, OR COLOR.

OWNER OF FED REP GERMANY REG. NO.  
30616799, DATED 7-14-2006, EXPIRES 3-31-2016.

SER. NO. 77-095,113, FILED 1-30-2007.

OWNER OF FED REP GERMANY REG. NO.  
30616799, DATED 7-14-2006, EXPIRES 3-31-2016.

MARGERY A. TIERNEY, EXAMINING ATTORNEY

Int. Cl.: 25

Prior U.S. Cls.: 22 and 39

United States Patent and Trademark Office

Reg. No. 3,503,552

Registered Sep. 23, 2008

TRADEMARK  
PRINCIPAL REGISTER

Sugarfly 

RUNWAY GLOBAL LIMITED (HONG KONG  
PRIVATE COMPANY LIMITED BY SHARES)  
PARK BUILDING, 14TH FLOOR  
476 CASTLE PEAK ROAD  
CHEUNG SHA WAN, KOWLOO, HONG KONG 3

FOR: CLOTHING, NAMELY, WOMEN'S AND  
GIRL'S KNIT JACKETS, KNIT AND WOVEN  
PANTS, WOOL JACKETS, WOOL COATS, CASUAL  
WOVEN COATS, CASUAL WOVEN JACKETS, OUT-  
DOOR VESTS, WOVEN TRENCH COATS, T-SHIRTS,  
SHORTS, AND SKIRTS, IN CLASS 25 (U.S. CLS. 22  
AND 39).

FIRST USE 1-8-2004; IN COMMERCE 1-8-2004.

THE MARK CONSISTS OF THE WORD "SUGAR-  
FLY" AND A STYLIZED FEMALE FLY TO THE  
RIGHT OF THE WORD.

SER. NO. 77-095,137, FILED 1-30-2007.

YAT SYE, LEE, EXAMINING ATTORNEY

Int. Cl.: 14

Prior U.S. Cls.: 2, 27, 28 and 50

United States Patent and Trademark Office

Reg. No. 3,503,553

Registered Sep. 23, 2008

TRADEMARK  
PRINCIPAL REGISTER

MOISSANITE  
— *Created By* —  
CHARLES & COLVARD

CHARLES & COLVARD, LTD. (NORTH CAROLINA CORPORATION)  
300 PERIMETER PARK DRIVE, SUITE A  
MORRISVILLE, NC 27560

FOR: JEWELRY; PRECIOUS GEMSTONES; SEMI-PRECIOUS GEMSTONES, IN CLASS 14 (U.S. CLS. 2, 27, 28 AND 50).

FIRST USE 1-24-2003; IN COMMERCE 1-24-2003.

OWNER OF U.S. REG. NOS. 2,462,691 AND 2,493,475.

NO CLAIM IS MADE TO THE EXCLUSIVE RIGHT TO USE "MOISSANITE CREATED BY", APART FROM THE MARK AS SHOWN.

SER. NO. 77-095,413, FILED 1-31-2007.

JAMES LOVELACE, EXAMINING ATTORNEY

Int. Cl.: 35

Prior U.S. Cls.: 100, 101 and 102

United States Patent and Trademark Office

Reg. No. 3,503,554

Registered Sep. 23, 2008

SERVICE MARK  
PRINCIPAL REGISTER



PITNEY BOWES INC. (DELAWARE CORPORATION)  
WORLD HEADQUARTERS  
ONE ELMCROFT ROAD  
STAMFORD, CT 069260700

FOR: TRANSPORTATION LOGISTICS SERVICES, NAMELY, PROVIDING ON-LINE SHIPPING AND CUSTOMS CLEARANCE INFORMATION FEATURING CALCULATIONS OF LOGISTICS AND REVERSE LOGISTICS COSTS FOR SHIPPING AND HANDLING, CALCULATIONS OF TAXES, CUSTOMS DUTIES AND REVERSE LOGISTICS PROCESS; PROVIDING INFORMATION ABOUT CUSTOMS CLEARANCE IN THE NATURE OF INFORMATION ABOUT COMPLETION AND CLEARANCE OF CUSTOMS FORMS, PAYMENT OF TAXES, DUTIES, PAYMENT OF SHIPPERS AND

HANDLERS; COMPUTERIZED TRACKING OF SHIPMENTS AND PACKAGES IN TRANSIT, IN CLASS 35 (U.S. CLS. 100, 101 AND 102).

FIRST USE 4-30-2006; IN COMMERCE 4-30-2006.

OWNER OF U.S. REG. NOS. 899,476, 2,693,398 AND OTHERS.

NO CLAIM IS MADE TO THE EXCLUSIVE RIGHT TO USE "CROSS BORDER SERVICES", APART FROM THE MARK AS SHOWN.

SER. NO. 77-096,568, FILED 2-1-2007.

SANDRA MANIOS, EXAMINING ATTORNEY

**Int. Cls.: 9 and 11**

**Prior U.S. Cls.: 13, 21, 23, 26, 31, 34, 36 and 38**

**United States Patent and Trademark Office**

**Reg. No. 3,503,555**

**Registered Sep. 23, 2008**

**TRADEMARK  
PRINCIPAL REGISTER**

**SMARTD**

SMARTD, INC. (CANADA CORPORATION)  
1800 TRANSCANADA HIGHWAY  
DORVAL, CANADA H9P1H7

FOR: MICROPROCESSOR CONTROLLERS FOR  
AIR CONDITIONERS AND COOLING SYSTEMS, IN  
CLASS 9 (U.S. CLS. 21, 23, 26, 36 AND 38).

FIRST USE 9-1-2004; IN COMMERCE 9-1-2004.

FOR: COMPONENTS FOR AIR CONDITIONING  
AND COOLING SYSTEMS, NAMELY, HEAT EX-  
CHANGERS, CHILLERS, VALVES, CENTRAL AIR-

CONDITIONING INSTALLATIONS, IN CLASS 11  
(U.S. CLS. 13, 21, 23, 31 AND 34).

FIRST USE 9-1-2004; IN COMMERCE 9-1-2004.

THE MARK CONSISTS OF STANDARD CHAR-  
ACTERS WITHOUT CLAIM TO ANY PARTICULAR  
FONT, STYLE, SIZE, OR COLOR.

SER. NO. 77-096,692, FILED 2-1-2007.

ROBIN CHOSID, EXAMINING ATTORNEY

**Int. Cls.: 9 and 36**

**Prior U.S. Cls.: 21, 23, 26, 36, 38, 100, 101 and 102**

**Reg. No. 3,503,556**

**United States Patent and Trademark Office**

**Registered Sep. 23, 2008**

**TRADEMARK  
SERVICE MARK  
PRINCIPAL REGISTER**

**MONIMAX**

NAUTILUS HYOSUNG INC. (REPUBLIC OF  
KOREA CORPORATION)  
52, CHUNGDAM-DONG, KANGNAM-GU  
SEOUL, REPUBLIC OF KOREA

FOR: AUTOMATED TELLER MACHINES; PASS-  
BOOK PRINTERS; CARD READERS AND WRI-  
TERS, NAMELY, MAGNETIC ENCODED CARD  
READERS AND WRITERS, IN CLASS 9 (U.S. CLS.  
21, 23, 26, 36 AND 38).

FOR: BANKING AND FINANCIAL SERVICES,  
NAMELY, AUTOMATED TELLER MACHINE SER-  
VICES, IN CLASS 36 (U.S. CLS. 100, 101 AND 102).

THE MARK CONSISTS OF STANDARD CHAR-  
ACTERS WITHOUT CLAIM TO ANY PARTICULAR  
FONT, STYLE, SIZE, OR COLOR.

PRIORITY CLAIMED UNDER SEC. 44(D) ON  
REPUBLIC OF KOREA APPLICATION NO. 41-2007-  
0002, FILED 1-25-2007, REG. NO. 160987, DATED 2-12-  
2008, EXPIRES 2-12-2018.

PRIORITY CLAIMED UNDER SEC. 44(D) ON  
REPUBLIC OF KOREA APPLICATION NO. 40-2007-  
0004, FILED 1-25-2007, REG. NO. 736989, DATED 2-12-  
2008, EXPIRES 2-12-2018.

SER. NO. 77-096,741, FILED 2-1-2007.

ANGELA GAW, EXAMINING ATTORNEY

**Int. Cl.: 9**

**Prior U.S. Cls.: 21, 23, 26, 36 and 38**

**United States Patent and Trademark Office**

**Reg. No. 3,503,557**

**Registered Sep. 23, 2008**

**TRADEMARK  
PRINCIPAL REGISTER**

**DJ THRILL**

MCNEILL, AARON M. (UNITED STATES INDIVIDUAL)  
3406 BEACON BEND CT.  
PEARLAND, TX 77584

FOR: MUSICAL SOUND RECORDINGS; MUSICAL VIDEO RECORDINGS, IN CLASS 9 (U.S. CLS. 21, 23, 26, 36 AND 38).

FIRST USE 9-18-2002; IN COMMERCE 9-18-2002.

THE MARK CONSISTS OF STANDARD CHARACTERS WITHOUT CLAIM TO ANY PARTICULAR FONT, STYLE, SIZE, OR COLOR.

NO CLAIM IS MADE TO THE EXCLUSIVE RIGHT TO USE "DJ", APART FROM THE MARK AS SHOWN.

THE NAME "DJ THRILL" IDENTIFIES A LIVING INDIVIDUAL WHOSE CONSENT IS OF RECORD.

SER. NO. 77-097,192, FILED 2-1-2007.

JEFFERY COWARD, EXAMINING ATTORNEY



**Int. Cls.: 9 and 36**

**Prior U.S. Cls.: 21, 23, 26, 36, 38, 100, 101 and 102**

**Reg. No. 3,503,558**

**United States Patent and Trademark Office**

**Registered Sep. 23, 2008**

**TRADEMARK  
SERVICE MARK  
PRINCIPAL REGISTER**

**MONIWELL**

NAUTILUS HYOSUNG INC. (REPUBLIC OF  
KOREA CORPORATION)  
52, CHUNGDAM-DONG, KANGNAM-GU  
SEOUL, REPUBLIC OF KOREA

FOR: AUTOMATED TELLER MACHINES; PASS-  
BOOK PRINTERS; CARD READERS AND WRI-  
TERS, NAMELY, MAGNETIC ENCODED CARD  
READERS AND WRITERS, IN CLASS 9 (U.S. CLS.  
21, 23, 26, 36 AND 38).

FOR: BANKING AND FINANCIAL SERVICES,  
NAMELY, AUTOMATED TELLER MACHINE SER-  
VICES, IN CLASS 36 (U.S. CLS. 100, 101 AND 102).

THE MARK CONSISTS OF STANDARD CHAR-  
ACTERS WITHOUT CLAIM TO ANY PARTICULAR  
FONT, STYLE, SIZE, OR COLOR.

PRIORITY CLAIMED UNDER SEC. 44(D) ON  
REPUBLIC OF KOREA APPLICATION NO. 41-2007-  
0002, FILED 1-31-2007, REG. NO. 158796, DATED 12-  
31-2007, EXPIRES 12-31-2017.

PRIORITY CLAIMED UNDER SEC. 44(D) ON  
REPUBLIC OF KOREA APPLICATION NO. 40-2007-  
0005, FILED 1-31-2007, REG. NO. 736991, DATED 2-12-  
2008, EXPIRES 2-12-2018.

SER. NO. 77-097,608, FILED 2-2-2007.

ANGELA GAW, EXAMINING ATTORNEY

**Int. Cls.: 9 and 36**

**Prior U.S. Cls.: 21, 23, 26, 36, 38, 100, 101 and 102**

**Reg. No. 3,503,559**

**United States Patent and Trademark Office**

**Registered Sep. 23, 2008**

**TRADEMARK  
SERVICE MARK  
PRINCIPAL REGISTER**

**MONIAD**

NAUTILUS HYOSUNG INC. (REPUBLIC OF  
KOREA CORPORATION)  
52, CHUNGDAM-DONG, KANGNAM-GU  
SEOUL, REPUBLIC OF KOREA

FOR: AUTOMATED TELLER MACHINES; PASS-  
BOOK PRINTERS; CARD READERS AND WRI-  
TERS, NAMELY, MAGNETIC ENCODED CARD  
READERS AND WRITERS, IN CLASS 9 (U.S. CLS.  
21, 23, 26, 36 AND 38).

FOR: BANKING AND FINANCIAL SERVICES,  
NAMELY, AUTOMATED TELLER MACHINE SER-  
VICES, IN CLASS 36 (U.S. CLS. 100, 101 AND 102).

THE MARK CONSISTS OF STANDARD CHAR-  
ACTERS WITHOUT CLAIM TO ANY PARTICULAR  
FONT, STYLE, SIZE, OR COLOR.

PRIORITY CLAIMED UNDER SEC. 44(D) ON  
REPUBLIC OF KOREA APPLICATION NO. 41-2007-  
0002, FILED 1-31-2007, REG. NO. 158795, DATED 12-  
31-2007, EXPIRES 12-31-2017.

PRIORITY CLAIMED UNDER SEC. 44(D) ON  
REPUBLIC OF KOREA APPLICATION NO. 40-2007-  
0005, FILED 1-31-2007, REG. NO. 736990, DATED 2-12-  
2008, EXPIRES 2-12-2018.

SER. NO. 77-097,628, FILED 2-2-2007.

ANGELA GAW, EXAMINING ATTORNEY

**Int. Cls.: 35, 41 and 42**

**Prior U.S. Cls.: 100, 101, 102 and 107**

**United States Patent and Trademark Office**

**Reg. No. 3,503,560**

**Registered Sep. 23, 2008**

**SERVICE MARK  
PRINCIPAL REGISTER**

**TOOLS FOR SHAPING  
CHILDREN'S LIVES**

CIVITAS INITIATIVE (ILLINOIS NON-PROFIT CORPORATION)  
2210 W. NORTH AVENUE  
CHICAGO, IL 60647

FOR: PROMOTING PUBLIC AWARENESS OF THE NEED FOR THE CARE AND WELL-BEING OF CHILDREN, IN CLASS 35 (U.S. CLS. 100, 101 AND 102).

FIRST USE 9-1-1999; IN COMMERCE 9-1-1999.

FOR: DEVELOPMENT AND DISSEMINATION OF EDUCATIONAL MATERIALS FOR OTHERS IN THE FIELD OF THE CARE AND WELL-BEING OF CHILDREN; PROVIDING ON-LINE PUBLICATIONS IN THE NATURE OF RESOURCE GUIDES IN THE FIELD OF THE EDUCATION, CARE AND WELL-BEING OF CHILDREN; PROVIDING A WEBSITE FEATURING NON-DOWNLOADABLE INSTRUCTIONAL VIDEOS IN THE FIELD OF THE

EDUCATION, CARE AND WELL-BEING OF CHILDREN, IN CLASS 41 (U.S. CLS. 100, 101 AND 107).

FIRST USE 9-1-1999; IN COMMERCE 9-1-1999.

FOR: RESEARCH IN THE FIELD OF EARLY CHILDHOOD DEVELOPMENT TO CREATE EDUCATIONAL TOOLS TO TEACH ADULTS HOW TO PROTECT, NURTURE, EDUCATE AND CARE FOR AND ENRICH CHILDREN, IN CLASS 42 (U.S. CLS. 100 AND 101).

FIRST USE 9-1-1999; IN COMMERCE 9-1-1999.

THE MARK CONSISTS OF STANDARD CHARACTERS WITHOUT CLAIM TO ANY PARTICULAR FONT, STYLE, SIZE, OR COLOR.

SER. NO. 77-098,244, FILED 2-2-2007.

TARAH HARDY, EXAMINING ATTORNEY

**Int. Cl.: 5**

**Prior U.S. Cls.: 6, 18, 44, 46, 51 and 52**

**Reg. No. 3,503,561**

**United States Patent and Trademark Office**

**Registered Sep. 23, 2008**

**TRADEMARK  
PRINCIPAL REGISTER**

**H.O.P.E.**

ITV GLOBAL, INC. (NEVADA CORPORATION)  
55 CHERRY HILL DRIVE  
BEVERLY, MA 01915

THE MARK CONSISTS OF STANDARD CHAR-  
ACTERS WITHOUT CLAIM TO ANY PARTICULAR  
FONT, STYLE, SIZE, OR COLOR.

FOR: ANIMAL FEED SUPPLEMENTS; DIETARY  
SUPPLEMENTS FOR ANIMALS; FEED SUPPLE-  
MENTS FOR DOGS AND CATS, IN CLASS 5 (U.S.  
CLS. 6, 18, 44, 46, 51 AND 52).

SER. NO. 77-099,994, FILED 2-6-2007.

FIRST USE 1-15-2007; IN COMMERCE 1-15-2007.

ELIZABETH KAJUBI, EXAMINING ATTORNEY

**Int. Cl.: 45**

**Prior U.S. Cls.: 100 and 101**

**United States Patent and Trademark Office**

**Reg. No. 3,503,562**

**Registered Sep. 23, 2008**

**SERVICE MARK  
PRINCIPAL REGISTER**

**NV.COM**

NV.COM REGISTRY, LLC (KANSAS LIMITED  
LIABILITY COMPANY)  
13725 W 121ST TERRACE  
OLATHE, KS 660626093

THE MARK CONSISTS OF STANDARD CHAR-  
ACTERS WITHOUT CLAIM TO ANY PARTICULAR  
FONT, STYLE, SIZE, OR COLOR.

FOR: REGISTRATION OF DOMAIN NAMES FOR  
IDENTIFICATION OF USERS ON A GLOBAL COM-  
PUTER NETWORK, IN CLASS 45 (U.S. CLS. 100 AND  
101).

SER. NO. 77-101,240, FILED 2-7-2007.

FIRST USE 3-21-2000; IN COMMERCE 3-21-2000.

DANNEAN HETZEL, EXAMINING ATTORNEY

**Int. Cls.: 16, 25, 35, 38, 39, 41, 42 and 45**

**Prior U.S. Cls.: 2, 5, 22, 23, 29, 37, 38, 39, 50, 100, 101, 102, 104, 105 and 107**

**Reg. No. 3,503,563**

**United States Patent and Trademark Office**

**Registered Sep. 23, 2008**

**TRADEMARK  
SERVICE MARK  
PRINCIPAL REGISTER**

# 3Gay

3GAY PTY LTD ATF 3GAY.MOBI TRUST (AUSTRALIA TRUST)  
LOT 7 KOONYUM RANGE ROAD  
KOONYUM RANGE, AUSTRALIA 2482

FOR: PRINTED MATTER, NAMELY, NEWSLETTERS AND MAGAZINES IN THE FIELD OF NEWS, GENERAL INTEREST, ENTERTAINMENT, TRAVEL, FASHION, SPORTS AND DATING FOR A GAY AND LESBIAN AUDIENCE; PHOTOGRAPHS FOR A GAY AND LESBIAN AUDIENCE, IN CLASS 16 (U.S. CLS. 2, 5, 22, 23, 29, 37, 38 AND 50).

FOR: CLOTHING, NAMELY, SINGLETS, UNDERWEAR, SWIMMING COSTUMES, TEE-SHIRTS, SHIRTS, JEANS, PANTS, SKIRTS, JACKETS, SHORTS; FOOTWEAR; HEADGEAR, NAMELY, HATS, CAPS, HEADWEAR, IN CLASS 25 (U.S. CLS. 22 AND 39).

FOR: COMPILATION OF ADVERTISEMENTS FOR USE AS WEB PAGES ON THE INTERNET SPECIFICALLY FOR A GAY AND LESBIAN AUDIENCE, NAMELY, PROVIDING A WEB SITE WHICH FEATURES ADVERTISEMENTS FOR THE GOODS AND SERVICES OF OTHERS ON A GLOBAL COMPUTER NETWORK; PROVIDING AN ONLINE COMMERCIAL INFORMATION DIRECTORY ON THE INTERNET; ADVERTISING AND PROMOTION SERVICES IN THE FIELD OF GAY AND LESBIAN INTEREST, IN CLASS 35 (U.S. CLS. 100, 101 AND 102).

FOR: INTERNET SERVICE PROVIDER (ISP) FOR A GAY AND LESBIAN MARKET; PROVIDING MULTIPLE-USER ACCESS TO A GLOBAL COMPUTER INFORMATION NETWORK SPECIFICALLY FOR A GAY AND LESBIAN MARKET; MOBILE TELEPHONE COMMUNICATION SERVICES SPE-

CIFICALLY FOR A GAY AND LESBIAN MARKET, IN CLASS 38 (U.S. CLS. 100, 101 AND 104).

FOR: TRAVEL AGENCY SERVICES SPECIFICALLY FOR A GAY AND LESBIAN MARKET, NAMELY, MAKING RESERVATIONS AND BOOKINGS FOR TRANSPORTATION; ARRANGING TRAVEL TOURS, COORDINATING TRAVEL ARRANGEMENTS FOR INDIVIDUALS AND GROUPS SPECIFICALLY FOR A GAY AND LESBIAN MARKET; TRAVEL INFORMATION SERVICES SPECIFICALLY FOR A GAY AND LESBIAN MARKET; TRAVEL BOOKING AGENCIES SPECIFICALLY FOR A GAY AND LESBIAN MARKET, IN CLASS 39 (U.S. CLS. 100 AND 105).

FOR: PUBLISHING OF BOOKS, MAGAZINES AND ELECTRONIC DIGITAL PUBLICATIONS SPECIFICALLY FOR A GAY AND LESBIAN AUDIENCE, IN CLASS 41 (U.S. CLS. 100, 101 AND 107).

FOR: CREATING AND DESIGNING WEB PAGES FOR OTHERS; CREATING AND MAINTAINING WEB SITES FOR OTHERS; WEB SITE HOSTING SERVICES; HOSTING THE WEB SITES OF OTHERS ON A COMPUTER SERVER FOR A GLOBAL COMPUTER NETWORK; APPLICATION SERVICE PROVIDER, NAMELY, HOSTING COMPUTER SOFTWARE APPLICATIONS OF OTHERS; PROVIDING ON-LINE NON-DOWNLOADABLE SOFTWARE FOR USE IN MANAGING LINKS TO THIRD PARTY WEBSITES FEATURING NEWS, ENTERTAINMENT, GENERAL INTEREST, TRAVEL, FASHION, SPORTS AND DATING FOR A GAY AND LESBIAN AUDIENCE; DESIGN OF HOMEPAGES AND WEB SITES, IN CLASS 42 (U.S. CLS. 100 AND 101).

FOR: COMPUTER DATING SERVICES SPECIFICALLY FOR A GAY AND LESBIAN AUDIENCE; DATING AGENCY SERVICES AND DATING SERVICES SPECIFICALLY FOR A GAY AND LESBIAN AUDIENCE, IN CLASS 45 (U.S. CLS. 100 AND 101).

THE MARK CONSISTS OF STANDARD CHARACTERS WITHOUT CLAIM TO ANY PARTICULAR FONT, STYLE, SIZE, OR COLOR.

PRIORITY CLAIMED UNDER SEC. 44(D) ON AUSTRALIA APPLICATION NO. 1159405, FILED 2-5-2007, REG. NO. 1159405, DATED 2-5-2007, EXPIRES 2-5-2017.

SER. NO. 77-102,177, FILED 2-8-2007.

KATHERINE M. DUBRAY, EXAMINING ATTORNEY

**Int. Cl.: 30**

**Prior U.S. Cl.: 46**

**United States Patent and Trademark Office**

**Reg. No. 3,503,564**

**Registered Sep. 23, 2008**

**TRADEMARK  
PRINCIPAL REGISTER**

**MADE BY ITALIANS. ENJOYED  
BY EVERYONE!**

LIDESTRI FOODS, INC. (NEW YORK CORPORATION)  
815 WEST WHITNEY ROAD  
FAIRPORT, NY 14450

THE MARK CONSISTS OF STANDARD CHARACTERS WITHOUT CLAIM TO ANY PARTICULAR FONT, STYLE, SIZE, OR COLOR.

FOR: SAUCES; PASTA SAUCE; TOMATO SAUCE; SPAGHETTI SAUCE; VODKA SAUCE, IN CLASS 30 (U.S. CL. 46).

SER. NO. 77-102,301, FILED 2-8-2007.

FIRST USE 7-1-1999; IN COMMERCE 7-1-1999.

DORITT L. CARROLL, EXAMINING ATTORNEY



**Int. Cl.: 41**

**Prior U.S. Cls.: 100, 101 and 107**

**United States Patent and Trademark Office**

**Reg. No. 3,503,565**

**Registered Sep. 23, 2008**

**SERVICE MARK  
PRINCIPAL REGISTER**

**Hebni Nutrition  
Consultants, Inc.**

HEBNI NUTRITION CONSULTANTS, INC.  
(FLORIDA CORPORATION)  
4630 S. KIRKMAN ROAD, SUITE 201  
ORLANDO, FL 32811

FOR: EDUCATIONAL SERVICES, NAMELY,  
CONDUCTING PROGRAMS IN THE FIELD OF  
HEALTH AND NUTRITION EDUCATION, IN  
CLASS 41 (U.S. CLS. 100, 101 AND 107).

FIRST USE 1-15-1998; IN COMMERCE 1-15-1998.

THE MARK CONSISTS OF STANDARD CHAR-  
ACTERS WITHOUT CLAIM TO ANY PARTICULAR  
FONT, STYLE, SIZE, OR COLOR.

NO CLAIM IS MADE TO THE EXCLUSIVE  
RIGHT TO USE "NUTRITION CONSULTANTS,  
INC.", APART FROM THE MARK AS SHOWN.

THE FOREIGN WORDING IN THE MARK  
TRANSLATES INTO ENGLISH AS EBONY.

SER. NO. 77-102,520, FILED 2-8-2007.

LINDA POWELL, EXAMINING ATTORNEY

Int. Cl.: 37

Prior U.S. Cls.: 100, 103 and 106

United States Patent and Trademark Office

Reg. No. 3,503,566

Registered Sep. 23, 2008

**SERVICE MARK  
PRINCIPAL REGISTER**



DECORATING ELVES INC. (FLORIDA CORPORATION)  
10460 ROOSEVELT BLVD.  
SUITE 292  
ST. PETERSBURG, FL 33716

FOR: HOLIDAY LIGHTING INSTALLATION, MAINTENANCE AND REMOVAL SERVICES, ON RESIDENTIAL AND COMMERCIAL BUILDINGS AND/OR OUTSIDE LANDSCAPING, IN CLASS 37 (U.S. CLS. 100, 103 AND 106).

FIRST USE 11-30-2002; IN COMMERCE 12-1-2003.

THE MARK CONSISTS OF THE WORDING "AVOID THE HOLIDAY HASSLE!" IN BLACK; THE TANGLED LIGHTS CONSIST OF BLACK AND WHITE LIGHT BULBS.

SER. NO. 77-104,578, FILED 2-11-2007.

DAWN FELDMAN, EXAMINING ATTORNEY

Int. Cl.: 15

Prior U.S. Cls.: 2, 21 and 36

United States Patent and Trademark Office

Reg. No. 3,503,567

Registered Sep. 23, 2008

TRADEMARK  
PRINCIPAL REGISTER

**Blackbird**  
  
**guitars**

LUTTWAK, JOSEPH (UNITED STATES INDIVIDUAL)  
4510 DRUMMOND AVENUE  
CHEVY CHASE, MD 20815

FOR: GUITARS; MUSICAL INSTRUMENTS, IN CLASS 15 (U.S. CLS. 2, 21 AND 36).

FIRST USE 1-12-2007; IN COMMERCE 1-18-2007.

NO CLAIM IS MADE TO THE EXCLUSIVE RIGHT TO USE "GUITARS" , APART FROM THE MARK AS SHOWN.

THE MARK CONSISTS OF A STYLIZED BIRD IN FLIGHT.

SER. NO. 77-104,634, FILED 2-11-2007.

ANNE E. GUSTASON, EXAMINING ATTORNEY

Int. Cls.: 3, 16 and 22

Prior U.S. Cls.: 1, 2, 4, 5, 6, 7, 19, 22, 23, 29, 37, 38, 42,  
50, 51 and 52

Reg. No. 3,503,568

United States Patent and Trademark Office

Registered Sep. 23, 2008

TRADEMARK  
PRINCIPAL REGISTER



HONEYWELL INTERNATIONAL INC. (DELA-  
WARE CORPORATION)  
101 COLUMBIA ROAD  
MORRISTOWN, NJ 07962

FOR: CLEANING PREPARATIONS, NAMELY,  
DISPOSABLE DRY AND WET WIPES IMPREGNA-  
TED WITH CHEMICALS OR COMPOUNDS FOR  
AUTOMOTIVE CLEANING USE AND DISPOSABLE  
CLEANING CLOTHS PRE-MOISTENED WITH  
CLEANING SOLUTION FOR CLEANING WIN-  
DOWS, IN CLASS 3 (U.S. CLS. 1, 4, 6, 50, 51 AND 52).

FIRST USE 4-1-2006; IN COMMERCE 1-7-2007.

FOR: TRASH BAGS, IN CLASS 16 (U.S. CLS. 2, 5,  
22, 23, 29, 37, 38 AND 50).

FIRST USE 4-1-2006; IN COMMERCE 1-7-2007.

FOR: MESH BAGS FOR STORAGE, IN CLASS 22  
(U.S. CLS. 1, 2, 7, 19, 22, 42 AND 50).

FIRST USE 4-1-2006; IN COMMERCE 1-7-2007.

OWNER OF U.S. REG. NOS. 3,276,869 AND  
3,337,872.

THE NAME(S), PORTRAIT(S), AND/OR SIGNA-  
TURE(S) SHOWN IN THE MARK DOES NOT IDEN-  
TIFY A PARTICULAR LIVING INDIVIDUAL.

SER. NO. 77-105,235, FILED 2-12-2007.

JESSICA FATHY, EXAMINING ATTORNEY

**Int. Cls.: 9, 16 and 41**

**Prior U.S. Cls.: 2, 5, 21, 22, 23, 26, 29, 36, 37, 38, 50,  
100, 101 and 107**

**Reg. No. 3,503,569**

**United States Patent and Trademark Office**

**Registered Sep. 23, 2008**

**TRADEMARK  
SERVICE MARK  
PRINCIPAL REGISTER**

**EWI**

MULTIPLE STREAMS OF INCOME INTERNATIONAL, INC. (UTAH CORPORATION)  
5072 NORTH 300 WEST  
PROVO, UT 84604

FOR: PRE-RECORDED CD-ROMS AND DVDS FEATURING TRAINING MATERIALS AND PRESENTATIONS IN THE FIELDS OF WEALTH BUILDING, WEALTH MANAGEMENT, WEALTH PROTECTION, ASSET MANAGEMENT, ASSET PROTECTION, REAL ESTATE, ENTREPRENEURSHIP AND PERSONAL FINANCE, IN CLASS 9 (U.S. CLS. 21, 23, 26, 36 AND 38).

FIRST USE 11-0-2004; IN COMMERCE 11-0-2004.

FOR: PUBLICATIONS, NAMELY, BOOKS, TEXTBOOKS, PAMPHLETS, BROCHURES, NEWSLETTERS, JOURNALS AND CATALOGS IN THE FIELDS OF WEALTH BUILDING, WEALTH MANAGEMENT, WEALTH PROTECTION, ASSET MANAGEMENT, ASSET PROTECTION, REAL ESTATE, ENTREPRENEURSHIP AND PERSONAL FINANCE, IN CLASS 16 (U.S. CLS. 2, 5, 22, 23, 29, 37, 38 AND 50).

FIRST USE 11-0-2004; IN COMMERCE 11-0-2004.

FOR: EDUCATIONAL SERVICES, NAMELY, ARRANGING AND CONDUCTING TRAINING CLASSES, SEMINARS, WORKSHOPS, RETREATS AND BOOTCAMPS IN THE FIELDS OF WEALTH BUILDING, WEALTH MANAGEMENT, WEALTH PRO-

TECTION, ASSET MANAGEMENT, ASSET PROTECTION, REAL ESTATE, ENTREPRENEURSHIP AND PERSONAL FINANCE; ONLINE EDUCATIONAL SERVICES, NAMELY, ARRANGING AND CONDUCTING ONLINE TRAINING CLASSES AND SEMINARS IN THE FIELDS OF WEALTH BUILDING, WEALTH MANAGEMENT, WEALTH PROTECTION, ASSET MANAGEMENT, ASSET PROTECTION, REAL ESTATE, ENTREPRENEURSHIP AND PERSONAL FINANCE; PERSONAL COACHING IN THE FIELDS OF WEALTH BUILDING, WEALTH MANAGEMENT, WEALTH PROTECTION, ASSET MANAGEMENT, ASSET PROTECTION, REAL ESTATE, ENTREPRENEURSHIP AND PERSONAL FINANCE; PUBLICATION OF E-ZINES IN THE FIELDS OF WEALTH BUILDING, WEALTH MANAGEMENT, WEALTH PROTECTION, ASSET MANAGEMENT, ASSET PROTECTION, REAL ESTATE, ENTREPRENEURSHIP AND PERSONAL FINANCE, IN CLASS 41 (U.S. CLS. 100, 101 AND 107).

FIRST USE 11-0-2004; IN COMMERCE 11-0-2004.

THE MARK CONSISTS OF STANDARD CHARACTERS WITHOUT CLAIM TO ANY PARTICULAR FONT, STYLE, SIZE, OR COLOR.

SER. NO. 77-107,420, FILED 2-14-2007.

CHRISTINA SOBRAL, EXAMINING ATTORNEY

**Int. Cls.: 9, 16 and 41**

**Prior U.S. Cls.: 2, 5, 21, 22, 23, 26, 29, 36, 37, 38, 50,  
100, 101 and 107**

**Reg. No. 3,503,570**

**United States Patent and Trademark Office**

**Registered Sep. 23, 2008**

**TRADEMARK  
SERVICE MARK  
PRINCIPAL REGISTER**

**ENLIGHTENED WEALTH  
INSTITUTE**

MULTIPLE STREAMS OF INCOME INTERNATIONAL, INC. (UTAH CORPORATION)  
5072 NORTH 300 WEST  
PROVO, UT 84604

FOR: PRE-RECORDED CD-ROMS AND DVDS FEATURING TRAINING MATERIALS AND PRESENTATIONS IN THE FIELDS OF WEALTH BUILDING, WEALTH MANAGEMENT, WEALTH PROTECTION, ASSET MANAGEMENT, ASSET PROTECTION, REAL ESTATE, ENTREPRENEURSHIP AND PERSONAL FINANCE, IN CLASS 9 (U.S. CLS. 21, 23, 26, 36 AND 38).

FIRST USE 11-0-2004; IN COMMERCE 11-0-2004.

FOR: PUBLICATIONS, NAMELY, BOOKS, TEXTBOOKS, PAMPHLETS, BROCHURES, NEWSLETTERS, JOURNALS AND CATALOGS IN THE FIELDS OF WEALTH BUILDING, WEALTH MANAGEMENT, WEALTH PROTECTION, ASSET MANAGEMENT, ASSET PROTECTION, REAL ESTATE, ENTREPRENEURSHIP AND PERSONAL FINANCE, IN CLASS 16 (U.S. CLS. 2, 5, 22, 23, 29, 37, 38 AND 50).

FIRST USE 11-0-2004; IN COMMERCE 11-0-2004.

FOR: EDUCATIONAL SERVICES, NAMELY, ARRANGING AND CONDUCTING TRAINING CLASSES, SEMINARS, WORKSHOPS, RETREATS AND BOOTCAMPS IN THE FIELDS OF WEALTH BUILDING, WEALTH MANAGEMENT, WEALTH PROTECTION, ASSET MANAGEMENT, ASSET PROTECTION, REAL ESTATE, ENTREPRENEUR-

SHIP AND PERSONAL FINANCE; ON-LINE EDUCATIONAL SERVICES, NAMELY, ARRANGING AND CONDUCTING ONLINE TRAINING CLASSES AND SEMINARS IN THE FIELDS OF WEALTH BUILDING, WEALTH MANAGEMENT, WEALTH PROTECTION, ASSET MANAGEMENT, ASSET PROTECTION, REAL ESTATE, ENTREPRENEURSHIP AND PERSONAL FINANCE; PERSONAL COACHING IN THE FIELDS OF WEALTH BUILDING, WEALTH MANAGEMENT, WEALTH PROTECTION, ASSET MANAGEMENT, ASSET PROTECTION, REAL ESTATE, ENTREPRENEURSHIP AND PERSONAL FINANCE; PUBLICATION OF E-ZINES IN THE FIELDS OF WEALTH BUILDING, WEALTH MANAGEMENT, WEALTH PROTECTION, ASSET MANAGEMENT, ASSET PROTECTION, REAL ESTATE, ENTREPRENEURSHIP AND PERSONAL FINANCE, IN CLASS 41 (U.S. CLS. 100, 101 AND 107).

FIRST USE 11-0-2004; IN COMMERCE 11-0-2004.

THE MARK CONSISTS OF STANDARD CHARACTERS WITHOUT CLAIM TO ANY PARTICULAR FONT, STYLE, SIZE, OR COLOR.

NO CLAIM IS MADE TO THE EXCLUSIVE RIGHT TO USE "WEALTH INSTITUTE", APART FROM THE MARK AS SHOWN.

SER. NO. 77-107,428, FILED 2-14-2007.

CHRISTINA SOBRAL, EXAMINING ATTORNEY

**Int. Cl.: 41**

**Prior U.S. Cls.: 100, 101 and 107**

**United States Patent and Trademark Office**

**Reg. No. 3,503,571**

**Registered Sep. 23, 2008**

**SERVICE MARK  
PRINCIPAL REGISTER**

**BIG CHEF LITTLE CHEF**

BLM PRODUCTIONS, INC. (FLORIDA CORPORATION)  
SUITE 1400  
701 BRICKELL AVENUE  
MIAMI, FL 33131

FOR: EDUCATIONAL SERVICES, NAMELY, CONDUCTING CLASSES, SEMINARS, CONFERENCES AND WORKSHOPS IN THE FIELD OF DIET, NUTRITION AND FOOD PREPARATION; PROVIDING INFORMATION ABOUT NUTRITION, RECIPES AND COOKING INFORMATION TO SECONDARY AND ELEMENTARY SCHOOL AGED

CHILDREN, IN CLASS 41 (U.S. CLS. 100, 101 AND 107).

FIRST USE 8-26-2004; IN COMMERCE 8-26-2004.

THE MARK CONSISTS OF STANDARD CHARACTERS WITHOUT CLAIM TO ANY PARTICULAR FONT, STYLE, SIZE, OR COLOR.

SER. NO. 77-108,327, FILED 2-15-2007.

BRENDAN REGAN, EXAMINING ATTORNEY

**Int. Cl.: 39**

**Prior U.S. Cls.: 100 and 105**

**United States Patent and Trademark Office**

**Reg. No. 3,503,572**

**Registered Sep. 23, 2008**

**SERVICE MARK  
PRINCIPAL REGISTER**

**Best Valet Parking  
Corporation**

BEST VALET PARKING CORPORATION (CALIFORNIA CORPORATION)

SUITE 205

12792 VALLEY VIEW STREET

GARDEN GROVE, CA 92845

FOR: VALET PARKING SERVICES, CAR PARKING CONSULTING, IN CLASS 39 (U.S. CLS. 100 AND 105).

FIRST USE 10-1-1985; IN COMMERCE 10-1-1985.

THE MARK CONSISTS OF STANDARD CHARACTERS WITHOUT CLAIM TO ANY PARTICULAR FONT, STYLE, SIZE, OR COLOR.

NO CLAIM IS MADE TO THE EXCLUSIVE RIGHT TO USE "VALET PARKING CORPORATION", APART FROM THE MARK AS SHOWN.

SEC. 2(F).

SER. NO. 77-108,789, FILED 2-15-2007.

TANYA AMOS, EXAMINING ATTORNEY



**Int. Cls.: 35, 36, 39 and 41**

**Prior U.S. Cls.: 100, 101, 102, 105 and 107**

**United States Patent and Trademark Office**

**Reg. No. 3,503,573**

**Registered Sep. 23, 2008**

**SERVICE MARK  
PRINCIPAL REGISTER**

**KEEPERS OF THE WILD**

KEEPERS OF THE WILD INC. (NEVADA CORPORATION)  
13441 E. HWY 66  
VALENTINE, AZ 86437

FOR: PROMOTING PUBLIC AWARENESS OF THE NEED FOR ANIMAL CONSERVATION, IN CLASS 35 (U.S. CLS. 100, 101 AND 102).

FIRST USE 2-21-1996; IN COMMERCE 2-21-1996.

FOR: CHARITABLE FUNDRAISING SERVICES, NAMELY, FINANCIAL SPONSORSHIP OF SPECIFIED ANIMALS BY COLLECTING FUNDS FOR THE DIRECT SUPPORT OF SAID ANIMAL, IN CLASS 36 (U.S. CLS. 100, 101 AND 102).

FIRST USE 2-21-1996; IN COMMERCE 2-21-1996.

FOR: ANIMAL RESCUE SERVICES, NAMELY, RECEIVING WILD, EXOTIC AND DOMESTIC ANIMALS IN A SAFE AND SECURE HABITAT, IN CLASS 39 (U.S. CLS. 100 AND 105).

FIRST USE 2-21-1996; IN COMMERCE 2-21-1996.

FOR: ANIMAL EXHIBITION; EDUCATIONAL SERVICES, NAMELY, PROVIDING GUIDED EDUCATIONAL TOURS OF ANIMALS RESCUED FROM ABUSIVE OR NEGLECTFUL ENVIRONMENTS, PROVIDING EDUCATIONAL PRESENTATIONS IN THE FIELD OF ANIMAL CONSERVATION AND PROTECTION, AND DISSEMINATING EDUCATIONAL PAMPHLETS AND BROCHURES OF OTHERS THEREWITH, IN CLASS 41 (U.S. CLS. 100, 101 AND 107).

FIRST USE 2-21-1996; IN COMMERCE 2-21-1996.

THE MARK CONSISTS OF STANDARD CHARACTERS WITHOUT CLAIM TO ANY PARTICULAR FONT, STYLE, SIZE, OR COLOR.

SER. NO. 77-109,467, FILED 2-16-2007.

ALLISON SCHRODY, EXAMINING ATTORNEY

**Int. Cls.: 9 and 40**

**Prior U.S. Cls.: 21, 23, 26, 36, 38, 100, 103 and 106**

**United States Patent and Trademark Office**

**Reg. No. 3,503,574**

**Registered Sep. 23, 2008**

**TRADEMARK  
SERVICE MARK  
PRINCIPAL REGISTER**

# DRAGONWAVE

DRAGONWAVE, INC. (CANADA CORPORATION)  
600-411 LEGGET DRIVE  
KANATA, ON K2K 3C9, CANADA

FOR: MICROWAVE ETHERNET RADIOS FOR THE DELIVERY OF INTERNET PROTOCOL AND ETHERNET DATA, NAMELY, AUDIO, TEXT, VOICE OVER INTERNET PROTOCOL (VOIP) AND GRAPHICS SIGNALS; COMPUTER HARDWARE AND SOFTWARE, NAMELY, A DATA INFRASTRUCTURE COMPUTER SOFTWARE PLATFORM TO FACILITATE DELIVERY OF AUDIO, TEXT, VOICE OVER INTERNET PROTOCOL (VOIP) AND GRAPHICS SIGNALS IN THE PROVISION OF TELECOMMUNICATIONS SERVICES; HARDWARE AND SOFTWARE PROGRAMS FOR THE MANAGEMENT OF MICROWAVE RADIOS FOR THE DELIVERY OF PACKET BASED AND CIRCUIT SWITCHED SIGNALS; HARDWARE AND SOFTWARE PROGRAMS, NAMELY, A DATA INFRASTRUCTURE PLATFORM FOR USE IN THE

PROVISION OF TELECOMMUNICATION SERVICES, IN CLASS 9 (U.S. CLS. 21, 23, 26, 36 AND 38).

FIRST USE 5-0-2002; IN COMMERCE 5-0-2002.

FOR: CUSTOM MANUFACTURE OF WIRELESS EQUIPMENT, NAMELY, MICROWAVE RADIOS FOR THE DELIVERY OF PACKET BASED AND CIRCUIT SWITCHED SIGNALS, IN CLASS 40 (U.S. CLS. 100, 103 AND 106).

FIRST USE 5-0-2002; IN COMMERCE 5-0-2002.

THE MARK CONSISTS OF STANDARD CHARACTERS WITHOUT CLAIM TO ANY PARTICULAR FONT, STYLE, SIZE, OR COLOR.

SER. NO. 77-110,825, FILED 2-19-2007.

KELLY BOULTON, EXAMINING ATTORNEY

**Int. Cl.: 41**

**Prior U.S. Cls.: 100, 101 and 107**

**United States Patent and Trademark Office**

**Reg. No. 3,503,575**

**Registered Sep. 23, 2008**

**SERVICE MARK  
PRINCIPAL REGISTER**

**GREATER ATLANTIC  
MULTISPORT SERIES**

SEMMELE, NEIL S. (UNITED STATES INDIVIDUAL)  
230 MARINERS WAY  
BEAR, DE 19701

FOR: ORGANIZING AND OPERATING COMMUNITY SPORTING AND CULTURAL EVENTS, IN CLASS 41 (U.S. CLS. 100, 101 AND 107).

FIRST USE 10-0-2002; IN COMMERCE 10-0-2002.

THE MARK CONSISTS OF STANDARD CHARACTERS WITHOUT CLAIM TO ANY PARTICULAR FONT, STYLE, SIZE, OR COLOR.

NO CLAIM IS MADE TO THE EXCLUSIVE RIGHT TO USE "MULTISPORT SERIES", APART FROM THE MARK AS SHOWN.

SEC. 2(F).

SER. NO. 77-112,663, FILED 2-21-2007.

AMEETA JORDAN, EXAMINING ATTORNEY

**Int. Cls.: 35 and 42**

**Prior U.S. Cls.: 100, 101 and 102**

**Reg. No. 3,503,576**

**United States Patent and Trademark Office**

**Registered Sep. 23, 2008**

**SERVICE MARK  
PRINCIPAL REGISTER**

The logo for Local.com features the word "Local.com" in a bold, black, sans-serif font. The letter "o" in "Local" is replaced by a stylized microphone icon, consisting of a circular head and a vertical stem with a small circle at the top.

LOCAL.COM CORPORATION (DELAWARE CORPORATION)  
BUILDING G  
ONE TECHNOLOGY DRIVE  
IRVINE, CA 92618

FOR: COMPUTER SERVICES, NAMELY, PROVIDING BUSINESS INFORMATION ON A GLOBAL COMPUTER NETWORK; ON-LINE TELEPHONE AND ADDRESS DIRECTORY INFORMATION SERVICES; PROVIDING AN ON-LINE SEARCHABLE DATABASE FEATURING CLASSIFIED AD LISTINGS AND EMPLOYMENT OPPORTUNITIES; PROVIDING A WEB SITE THAT ENABLES USERS TO POST ITEMS FOR SALE THROUGH ON-LINE CLASSIFIED ADVERTISEMENTS, IN CLASS 35 (U.S. CLS. 100, 101 AND 102).

FIRST USE 8-9-2005; IN COMMERCE 8-9-2005.

FOR: COMPUTER SERVICES, NAMELY, PROVIDING SEARCH ENGINES FOR OBTAINING DATA ON A GLOBAL COMPUTER NETWORK; COMPUTER SERVICES, NAMELY, CREATING INDEXES OF INFORMATION, WEB SITES, AND OTHER RESOURCES AVAILABLE ON COMPUTER NETWORKS; COMPUTER SERVICE, NAMELY, ACTING AS AN APPLICATION SERVICE PROVIDER IN THE FIELD OF KNOWLEDGE MANAGEMENT TO HOST COMPUTER APPLICATION SOFTWARE FOR SEARCHING AND RETRIEVING

INFORMATION FROM DATABASES AND COMPUTER NETWORKS; COMPUTER SERVICES, NAMELY, ACTING AS AN APPLICATION SERVICE PROVIDER IN THE FIELD OF KNOWLEDGE MANAGEMENT TO HOST COMPUTER APPLICATION SOFTWARE FOR CREATING SEARCHABLE DATABASES OF INFORMATION AND DATA; COMPUTER SERVICES, NAMELY, ACTING AS AN APPLICATION SERVICE PROVIDER IN THE FIELD OF KNOWLEDGE MANAGEMENT TO HOST COMPUTER APPLICATION SOFTWARE FOR THE COLLECTION, EDITING, ORGANIZING, MODIFYING, TRANSMISSION, STORAGE AND SHARING OF DATA AND INFORMATION; ELECTRONIC NAVIGATION SERVICES, NAMELY, PROVIDING SEARCH ENGINE SERVICES FOR OBTAINING DATA VIA A GLOBAL COMPUTER NETWORK; PROVIDING CUSTOMIZED ONLINE WEB PAGES FEATURING USER-DEFINED INFORMATION, WHICH INCLUDES SEARCH ENGINES AND ON-LINE WEB LINKS TO OTHER WEBSITES, IN CLASS 42 (U.S. CLS. 100 AND 101).

FIRST USE 8-9-2005; IN COMMERCE 8-9-2005.

SEC. 2(F) AS TO LOCAL.COM.

SER. NO. 77-112,860, FILED 2-21-2007.

PAUL E. FAHRENKOPF, EXAMINING ATTORNEY

**Int. Cls.: 35 and 42**

**Prior U.S. Cls.: 100, 101 and 102**

**United States Patent and Trademark Office**

**Reg. No. 3,503,577**

**Registered Sep. 23, 2008**

**SERVICE MARK  
PRINCIPAL REGISTER**

**PICA9**

PICA9, INC. (NEW YORK CORPORATION)  
410 WYNNEWOOD ROAD  
PELHAM, NY 10803

FOR: ONLINE MEDIA PLANNING, NAMELY,  
BUYING, AND DESIGNING OF ADVERTISING  
MATERIALS FOR OTHERS, IN CLASS 35 (U.S.  
CLS. 100, 101 AND 102).

FIRST USE 4-1-2001; IN COMMERCE 4-1-2001.

FOR: PROVIDING A WEBSITE FEATURING  
DOCUMENT GENERATION AND DIGITAL ASSET  
MANAGEMENT PROGRAMS, NAMELY, PRE-AP-

PROVED NON-DOWNLOADABLE MARKETING  
PROGRAMS FOR CUSTOMIZATION AND ADAP-  
TATION OF ADVERTISEMENTS, IN CLASS 42 (U.S.  
CLS. 100 AND 101).

FIRST USE 4-1-2001; IN COMMERCE 4-1-2001.

THE MARK CONSISTS OF STANDARD CHAR-  
ACTERS WITHOUT CLAIM TO ANY PARTICULAR  
FONT, STYLE, SIZE, OR COLOR.

SER. NO. 77-112,961, FILED 2-21-2007.

KEVON CHISOLM, EXAMINING ATTORNEY

**Int. Cl.: 25**

**Prior U.S. Cls.: 22 and 39**

**United States Patent and Trademark Office**

**Reg. No. 3,503,578**

**Registered Sep. 23, 2008**

**TRADEMARK  
PRINCIPAL REGISTER**

**SHOWERFRESH**

MAGELLAN TEXTILE HOLDINGS LIMITED  
(HONG KONG CORPORATION)  
UNIT 1001, 10TH FLOOR, STAR HOUSE  
3 SALISBURY ROAD, TSIMSHATSUI  
KOWLOON, HONG KONG

FOR: CLOTHING, NAMELY, UNDERWEAR,  
HOSIERY, LINGERIE, IN CLASS 25 (U.S. CLS. 22  
AND 39).

THE MARK CONSISTS OF STANDARD CHAR-  
ACTERS WITHOUT CLAIM TO ANY PARTICULAR  
FONT, STYLE, SIZE, OR COLOR.

PRIORITY CLAIMED UNDER SEC. 44(D) ON  
UNITED KINGDOM APPLICATION NO. 2446371,  
FILED 2-12-2007, REG. NO. 2446371, DATED 7-27-  
2007, EXPIRES 2-12-2017.

SER. NO. 77-113,715, FILED 2-22-2007.

FRANK LATTUCA, EXAMINING ATTORNEY

**Int. Cl.: 9**

**Prior U.S. Cls.: 21, 23, 26, 36 and 38**

**United States Patent and Trademark Office**

**Reg. No. 3,503,579**

**Registered Sep. 23, 2008**

**TRADEMARK  
PRINCIPAL REGISTER**

**MARGARITA ROSE**

ARISTOCRAT TECHNOLOGIES AUSTRALIA  
PTY LTD (AUSTRALIA CORPORATION)  
71 LONGUEVILLE ROAD  
LANE COVE, NSW, AUSTRALIA 2066

FOR: GAMING MACHINES; COMPUTER HARD-  
WARE; DOWNLOADABLE GAME SOFTWARE;  
ELECTRONIC GAME SOFTWARE, IN CLASS 9  
(U.S. CLS. 21, 23, 26, 36 AND 38).

THE MARK CONSISTS OF STANDARD CHAR-  
ACTERS WITHOUT CLAIM TO ANY PARTICULAR  
FONT, STYLE, SIZE, OR COLOR.

OWNER OF AUSTRALIA REG. NO. 1135569,  
DATED 9-14-2006, EXPIRES 9-14-2016.

SER. NO. 77-114,099, FILED 2-22-2007.

WILLIAM ROSSMAN, EXAMINING ATTORNEY

**Int. Cl.: 33**

**Prior U.S. Cls.: 47 and 49**

**United States Patent and Trademark Office**

**Reg. No. 3,503,580**

**Registered Sep. 23, 2008**

**TRADEMARK  
PRINCIPAL REGISTER**

**A F CRICKETER'S**

BODEGAS WILLIAMS & HUMBERT, S.A. (SPAIN  
CORPORATION)  
CTRA. NACIONAL IV, KM.641,75  
11408 JEREZ DE LA FRONTERA  
(CADIZ), SPAIN

PRIORITY CLAIMED UNDER SEC. 44(D) ON  
ERPNTY TM OFC APPLICATION NO.  
5708698, FILED 2-22-2007, REG. NO. 005708698, DA-  
TED 1-31-2008, EXPIRES 2-22-2017.

FOR: GIN, IN CLASS 33 (U.S. CLS. 47 AND 49).

SER. NO. 77-115,958, FILED 2-26-2007.

THE MARK CONSISTS OF STANDARD CHAR-  
ACTERS WITHOUT CLAIM TO ANY PARTICULAR  
FONT, STYLE, SIZE, OR COLOR.

CAROLYN GRAY, EXAMINING ATTORNEY



**Int. Cl.: 44**

**Prior U.S. Cls.: 100 and 101**

**United States Patent and Trademark Office**

**Reg. No. 3,503,581**

**Registered Sep. 23, 2008**

**SERVICE MARK  
PRINCIPAL REGISTER**



PERMACULTURE DESIGN, LLC (TEXAS LIMITED LIABILITY COMPANY)  
4407 JANE STREET  
BELLAIRE, TX 77401

FOR: LANDSCAPE DESIGN; LANDSCAPE GARDENING, IN CLASS 44 (U.S. CLS. 100 AND 101).

FIRST USE 10-31-2001; IN COMMERCE 10-31-2001.

NO CLAIM IS MADE TO THE EXCLUSIVE RIGHT TO USE "PERMACULTURE DESIGN", APART FROM THE MARK AS SHOWN.

THE COLOR(S) WHITE, GREEN, MAGNETA AND BLACK IS/ARE CLAIMED AS A FEATURE OF THE MARK.

THE MARK CONSISTS OF A GREEN BANANA TREE WITH A MAGENTA FLOWER ON A WHITE BACKGROUND BELOW THE WORDING "PERMACULTURE DESIGN" IN BLACK.

SER. NO. 77-116,109, FILED 2-26-2007.

DAVID ELTON, EXAMINING ATTORNEY

**Int. Cl.: 39**

**Prior U.S. Cls.: 100 and 105**

**United States Patent and Trademark Office**

**Reg. No. 3,503,582**

**Registered Sep. 23, 2008**

**SERVICE MARK  
PRINCIPAL REGISTER**



GLOBAL MOTION LIMITED (UNITED KING-  
DOM LIMITED COMPANY)  
UNIT D  
NORTHUMBERLAND CLOSE  
STANWELL, UNITED KINGDOM TW197LN

FOR: TRANSPORT OF PASSENGERS AND  
FREIGHT; PACKAGING OF GOODS FOR TRANS-  
PORT AND STORAGE OF GOODS; COORDINAT-  
ING TRAVEL ARRANGEMENTS FOR  
INDIVIDUALS AND FOR GROUPS; FREIGHT  
TRANSPORTATION BY MEANS OF TRAIN,  
TRUCK, SHIP AND AIR; FORWARDING OF  
FREIGHT; GLOBAL TRANSPORTATION OF  
FREIGHT FOR OTHERS BY ALL AVAILABLE  
MEANS; AIRCRAFT CHARTERING; GROUND  
TRANSPORTATION FOR PASSENGERS AND  
FREIGHT; COURIER SERVICES; COURIER SERVI-  
CES FOR THE TRANSPORTATION OF CARGO;  
DELIVERY OF GOODS BY COURIER; TRANSPOR-

TATION BY COURIER; STORAGE OF GOODS, IN  
CLASS 39 (U.S. CLS. 100 AND 105).

PRIORITY CLAIMED UNDER SEC. 44(D) ON  
UNITED KINGDOM APPLICATION NO. 2445940,  
FILED 2-7-2007, REG. NO. 2445940, DATED 2-7-2007,  
EXPIRES 2-7-2017.

NO CLAIM IS MADE TO THE EXCLUSIVE  
RIGHT TO USE "GLOBAL", APART FROM THE  
MARK AS SHOWN.

THE MARK CONSISTS OF THE WORDS "GLO-  
BAL MOTION" IN WHITE WITH A BLACK CEN-  
TRAL STRIPE ON A CIRCULAR BLACK  
BACKGROUND.

SER. NO. 77-116,776, FILED 2-27-2007.

LINDA MICKLEBURGH, EXAMINING ATTORNEY

**Int. Cl.: 9**

**Prior U.S. Cls.: 21, 23, 26, 36 and 38**

**Reg. No. 3,503,583**

**United States Patent and Trademark Office**

**Registered Sep. 23, 2008**

**TRADEMARK  
PRINCIPAL REGISTER**

**SPECTRA-TECH**

THERMO ELECTRON SCIENTIFIC INSTRUMENTS LLC (DELAWARE LIMITED LIABILITY COMPANY)  
5225 VERONA ROAD  
MADISON, WI 53711

FOR: ACCESSORIES FOR USE WITH SPECTROPHOTOMETERS AND SPECTROMETERS, NAMELY, REFLECTIVE AND TRANSMITTANCE MICROSCOPES AND THEIR PARTS, OPTICAL INSTRUMENTS FOR MEASURING SPECTRAL DATA AND MOLECULAR COMPOSITION USING SPECULAR REFLECTANCE, OPTICAL INSTRUMENTS FOR MEASURING SPECTRAL DATA AND MOLECULAR COMPOSITION USING DIFFUSE REFLECTANCE, OPTICAL INSTRUMENTS FOR MEASURING SPECTRAL DATA AND MOLECULAR COMPOSITION USING ATTENUATED TOTAL REFLECTANCE, LIGHT INTEGRATING SPHERES FOR MEASUREMENT OF SAMPLE REFLECTANCE, FIBER OPTIC INTEGRATING SPHERES FOR MEASUREMENT OF SAMPLE REFLECTANCE, FIBER OPTIC PROBES, MICRO-SAMPLING BEAM CONDENSERS, GAS CHROMATOGRAPHY COLLECTORS AND CELLS, SPECTROPHOTOM-

ETER AND SPECTROMETER CELLS FOR USE IN LIQUID SAMPLING, SPECTROPHOTOMETER AND SPECTROMETER CELLS FOR USE IN GAS SAMPLING; LABORATORY APPARATUS AND INSTRUMENTS FOR MEASURING SPECTRAL DATA AND MOLECULAR COMPOSITION, NAMELY, CUVETTES, SAMPLE HOLDERS AND DYES, AND PELLET SAMPLE AND TRANSMISSION FILM HOLDERS FOR USE DURING SPECTROSCOPIC AND SPECTROPHOTOMETRIC ANALYSIS, IN CLASS 9 (U.S. CLS. 21, 23, 26, 36 AND 38).

FIRST USE 11-0-1981; IN COMMERCE 11-0-1981.

THE MARK CONSISTS OF STANDARD CHARACTERS WITHOUT CLAIM TO ANY PARTICULAR FONT, STYLE, SIZE, OR COLOR.

OWNER OF U.S. REG. NO. 1,437,808.

SER. NO. 77-118,369, FILED 2-28-2007.

CHARISMA HAMPTON, EXAMINING ATTORNEY

**Int. Cl.: 17**

**Prior U.S. Cls.: 1, 5, 12, 13, 35 and 50**

**Reg. No. 3,503,584**

**United States Patent and Trademark Office**

**Registered Sep. 23, 2008**

**TRADEMARK  
PRINCIPAL REGISTER**

**DURAPLEAT**

FAIRBORN USA, INC. (OHIO CORPORATION)  
P.O. BOX 151  
UPPER SANDUSKY, OH 43351

FIRST USE 12-10-1979; IN COMMERCE 12-10-1979.

FOR: SHEETS OF REINFORCED VINYL OR NEOPRENE COATED FABRIC TO PROVIDE A SEAL BETWEEN A LOADING DOCK OPENING AND A TRUCK TO PROTECT AGAINST WEAR AND WEATHER DAMAGE WHILE LOADING AND UNLOADING GOODS, IN CLASS 17 (U.S. CLS. 1, 5, 12, 13, 35 AND 50).

THE MARK CONSISTS OF STANDARD CHARACTERS WITHOUT CLAIM TO ANY PARTICULAR FONT, STYLE, SIZE, OR COLOR.

SER. NO. 77-118,512, FILED 2-28-2007.

ZHALEH DELANEY, EXAMINING ATTORNEY

**Int. Cls.: 9 and 14**

**Prior U.S. Cls.: 2, 21, 23, 26, 27, 28, 36, 38 and 50**

**United States Patent and Trademark Office**

**Reg. No. 3,503,585**

**Registered Sep. 23, 2008**

**TRADEMARK  
PRINCIPAL REGISTER**

**CAROLINA PANTHERS**

PANTHERS FOOTBALL LLC (NORTH CAROLINA LIMITED LIABILITY COMPANY)  
800 SOUTH MINT ROAD  
CHARLOTTE, NC 28202

FOR: FOOTBALL HELMETS, CELL PHONE COVERS, MAGNETICALLY ENCODED CREDIT CARDS, DECORATIVE MAGNETS, PRERECORDED DVD'S FEATURING THE SPORT OF FOOTBALL, COMPUTER GAME SOFTWARE AND DISCS, MOUSE PADS AND VIDEO GAME CARTRIDGES, IN CLASS 9 (U.S. CLS. 21, 23, 26, 36 AND 38).

FIRST USE 9-30-1995; IN COMMERCE 9-30-1995.

FOR: JEWELRY, WATCHES, CLOCKS, PINS, EARRINGS, BRACELETS, CHARMS, COMMEMORATIVE AND COLLECTIBLE COINS MADE OF PRECIOUS METAL, PENDANTS AND KEY CHAINS

MADE OF PRECIOUS METAL, IN CLASS 14 (U.S. CLS. 2, 27, 28 AND 50).

FIRST USE 9-30-1995; IN COMMERCE 9-30-1995.

THE MARK CONSISTS OF STANDARD CHARACTERS WITHOUT CLAIM TO ANY PARTICULAR FONT, STYLE, SIZE, OR COLOR.

OWNER OF U.S. REG. NO. 2,120,117.

NO CLAIM IS MADE TO THE EXCLUSIVE RIGHT TO USE "CAROLINA", APART FROM THE MARK AS SHOWN.

SER. NO. 77-119,462, FILED 3-1-2007.

MAUREEN DALL, EXAMINING ATTORNEY

**Int. Cl.: 42**

**Prior U.S. Cls.: 100 and 101**

**United States Patent and Trademark Office**

**Reg. No. 3,503,586**

**Registered Sep. 23, 2008**

**SERVICE MARK  
PRINCIPAL REGISTER**

**GELTECH SOLUTIONS**

GEL TECH SOLUTIONS, INC. (FLORIDA CORPORATION)  
SUITE 1  
1460 PARK LANE SOUTH  
JUPITER, FL 33458

FOR: NEW PRODUCT RESEARCH SERVICES IN THE FIELD OF FORMULATED POLYMERS; DESIGN AND DEVELOPMENT SERVICES IN THE FIELD OF FORMULATED POLYMERS, IN CLASS 42 (U.S. CLS. 100 AND 101).

FIRST USE 7-31-2006; IN COMMERCE 7-31-2006.

THE MARK CONSISTS OF STANDARD CHARACTERS WITHOUT CLAIM TO ANY PARTICULAR FONT, STYLE, SIZE, OR COLOR.

NO CLAIM IS MADE TO THE EXCLUSIVE RIGHT TO USE "SOLUTIONS", APART FROM THE MARK AS SHOWN.

SER. NO. 77-121,260, FILED 3-2-2007.

MAUREEN DALL, EXAMINING ATTORNEY

Int. Cl.: 30

Prior U.S. Cl.: 46

United States Patent and Trademark Office

Reg. No. 3,503,587

Registered Sep. 23, 2008

**TRADEMARK  
PRINCIPAL REGISTER**



PIADINA MIA, INC. (MICHIGAN CORPORATION)

3485 JOHN R.

ROCHESTER HILLS, MI 48307

FOR: UNLEAVENED BREAD IN THIN SHEETS,  
IN CLASS 30 (U.S. CL. 46).

FIRST USE 12-1-2006; IN COMMERCE 1-1-2007.

NO CLAIM IS MADE TO THE EXCLUSIVE RIGHT TO USE "PIADINA," "THE ORIGINAL TRADITIONAL, REGIONAL ITALIAN PIADINA," AND "FIRST PRODUCER IN THE USA", APART FROM THE MARK AS SHOWN.

THE COLOR(S) RED, ORANGE, YELLOW, BLUE AND BLACK IS/ARE CLAIMED AS A FEATURE OF THE MARK.

THE MARK CONSISTS OF RED LOCATED ON THE TOP AND BOTTOM OF BACKGROUND. ORANGE IS LOCATED IN THE MIDDLE OF THE BACKGROUND. YELLOW WHEAT STALKS ARE IN THE BACKGROUND. THE WORDS "PIADINA MIA" ARE IN BLUE AND ARE LOCATED IN THE TOP CENTER OF THE MARK. THE WORDS "THE ORIGINAL TRADITIONAL, REGIONAL ITALIAN PIADINA" ARE IN BLACK AND APPEAR IN THE CENTER OF THE MARK. THE WORDS "FIRST PRODUCER IN USA" ARE IN BLACK AND APPEAR ON THE BOTTOM CENTER OF THE MARK.

THE ENGLISH TRANSLATION OF "PIADINA MIA" AND "PIADINA" IN THE MARK IS MY UNLEAVENED FLAT BREAD AND UNLEAVENED FLAT BREAD.

SER. NO. 77-123,362, FILED 3-6-2007.

BRIAN PINO, EXAMINING ATTORNEY

**Int. Cl.: 9**

**Prior U.S. Cls.: 21, 23, 26, 36 and 38**

**Reg. No. 3,503,588**

**United States Patent and Trademark Office**

**Registered Sep. 23, 2008**

**TRADEMARK  
PRINCIPAL REGISTER**

**SAFECELL**

FRONT EDGE TECHNOLOGY, INC. (CALIFORNIA CORPORATION)  
13455 BROOKS DRIVE  
BALDWIN PARK, CA 91706

FOR: BATTERIES, NAMELY, THIN FILM BATTERIES AND BATTERY PACKS, ELECTRICAL STORAGE BATTERIES, RECHARGEABLE ELECTRIC BATTERIES, DRY CELLS, AND FUEL CELLS, IN CLASS 9 (U.S. CLS. 21, 23, 26, 36 AND 38).

FIRST USE 11-3-2006; IN COMMERCE 2-26-2007.

THE MARK CONSISTS OF STANDARD CHARACTERS WITHOUT CLAIM TO ANY PARTICULAR FONT, STYLE, SIZE, OR COLOR.

SER. NO. 77-125,044, FILED 3-7-2007.

MICHAEL WIENER, EXAMINING ATTORNEY



**Int. Cl.: 35**

**Prior U.S. Cls.: 100, 101 and 102**

**United States Patent and Trademark Office**

**Reg. No. 3,503,589**

**Registered Sep. 23, 2008**

**SERVICE MARK  
PRINCIPAL REGISTER**

**ALWAYS SOMETHING NEW**

CAFEPRESS.COM, INC. (DELAWARE CORPORATION)  
1850 GATEWAY DRIVE, STE. 300  
SAN MATEO, CA 94404

FOR: SPECIALTY MERCHANDISING SERVICES, NAMELY, PROMOTING THE GOODS AND SERVICES OF OTHERS THROUGH THE DISTRIBUTION OF CUSTOMIZED ADVERTISING MATERIALS; COMPUTERIZED ONLINE RETAIL STORES FEATURING CUSTOMIZED CLOTHING, TOYS, PUBLICATIONS, SOUND RECORDINGS, VIDEO AND DVD RECORDINGS, STATIONERY, JEWELRY, CLOCKS, COMPUTER PERIPHERALS, BEVERAGEWARE, BAGS FOR CARRYING PERSONAL ITEMS, COASTERS, PICTURE FRAMES, BUMPER STICKERS, HEADWEAR, AND LICENSE PLATE FRAMES AND OTHER NOVELTY ITEMS; MANAGEMENT SERVICES, NAMELY, ONLINE BUSINESS DEVELOPMENT SERVICES, NAMELY, PROVIDING START-UP SUPPORT FOR BUSINESSES OF OTHERS; BUSINESS MANAGEMENT SERVICES; ORDER FULFILLMENT SERVICES; PROVIDING CONSUMER PRODUCT INFORMATION VIA TELEPHONE AND EMAIL FOR OTHERS, IN CLASS 35 (U.S. CLS. 100, 101 AND 102).

OPMENT SERVICES, NAMELY, PROVIDING START-UP SUPPORT FOR BUSINESSES OF OTHERS; BUSINESS MANAGEMENT SERVICES; ORDER FULFILLMENT SERVICES; PROVIDING CONSUMER PRODUCT INFORMATION VIA TELEPHONE AND EMAIL FOR OTHERS, IN CLASS 35 (U.S. CLS. 100, 101 AND 102).

FIRST USE 5-1-2007; IN COMMERCE 5-1-2007.

THE MARK CONSISTS OF STANDARD CHARACTERS WITHOUT CLAIM TO ANY PARTICULAR FONT, STYLE, SIZE, OR COLOR.

SER. NO. 77-125,459, FILED 3-8-2007.

STEVEN R. FOSTER, EXAMINING ATTORNEY

**Int. Cl.: 41**

**Prior U.S. Cls.: 100, 101 and 107**

**United States Patent and Trademark Office**

**Reg. No. 3,503,590**

**Registered Sep. 23, 2008**

**SERVICE MARK  
PRINCIPAL REGISTER**

**ISLANDWOOD**

ISLANDWOOD (WASHINGTON NON-PROFIT  
CORPORATION)  
4450 BLAKELY AVENUE NE  
BAINBRIDGE ISLAND, WA 98110

FOR: EDUCATIONAL SERVICES, NAMELY,  
PROVIDING CLASSES, SEMINARS, WORKSHOPS  
AND MENTORING IN THE FIELD OF ENVIRON-  
MENTAL EDUCATION , IN CLASS 41 (U.S. CLS. 100,  
101 AND 107).

FIRST USE 9-0-2002; IN COMMERCE 9-0-2002.

THE MARK CONSISTS OF STANDARD CHAR-  
ACTERS WITHOUT CLAIM TO ANY PARTICULAR  
FONT, STYLE, SIZE, OR COLOR.

SER. NO. 77-126,264, FILED 3-8-2007.

SAIMA MAKHDOOM, EXAMINING ATTORNEY

**Int. Cls.: 16, 35 and 41**

**Prior U.S. Cls.: 2, 5, 22, 23, 29, 37, 38, 50, 100, 101, 102  
and 107**

**Reg. No. 3,503,591**

**United States Patent and Trademark Office**

**Registered Sep. 23, 2008**

**TRADEMARK  
SERVICE MARK  
PRINCIPAL REGISTER**

# MYGUIDE

THE MCGRAW-HILL COMPANIES, INC. (NEW  
YORK CORPORATION)  
1221 AVENUE OF THE AMERICAS  
NEW YORK, NY 10020

FOR: PERSONALIZED STUDY GUIDES FOR  
GRADES 3-12, IN ENGLISH/LANGUAGE ARTS,  
WRITING, MATH, SCIENCE AND SOCIAL STU-  
DIES, IN CLASS 16 (U.S. CLS. 2, 5, 22, 23, 29, 37, 38  
AND 50).

FIRST USE 8-0-2006; IN COMMERCE 8-0-2006.

FOR: PROVIDING A WEB SITE FEATURING  
CAREER INFORMATION FOR STUDENTS IN  
GRADES 6-12, IN CLASS 35 (U.S. CLS. 100, 101 AND  
102).

FIRST USE 8-0-2006; IN COMMERCE 8-0-2006.

FOR: PROVIDING A WEB SITE FEATURING  
INTERACTIVE TUTORIALS AND INFORMATION  
ABOUT EDUCATIONAL OPPORTUNITIES FOR  
STUDENTS IN GRADES 3-12; PROVIDING A WEB  
SITE FEATURING INFORMATION ABOUT COL-  
LEGES FOR GRADES 6-12, IN CLASS 41 (U.S. CLS.  
100, 101 AND 107).

FIRST USE 8-0-2006; IN COMMERCE 8-0-2006.

THE MARK CONSISTS OF STANDARD CHAR-  
ACTERS WITHOUT CLAIM TO ANY PARTICULAR  
FONT, STYLE, SIZE, OR COLOR.

SER. NO. 77-132,988, FILED 3-16-2007.

LINDA M. KING, EXAMINING ATTORNEY

**Int. Cl.: 16**

**Prior U.S. Cls.: 2, 5, 22, 23, 29, 37, 38 and 50**

**United States Patent and Trademark Office**

**Reg. No. 3,503,592**

**Registered Sep. 23, 2008**

**TRADEMARK  
PRINCIPAL REGISTER**

**Joan Marie The Gift**

JOAN MARIE WHELAN (UNITED STATES IN-  
DIVIDUAL)  
P.O.BOX 1173  
CORONA DEL MAR, CA 92625

THE MARK CONSISTS OF STANDARD CHAR-  
ACTERS WITHOUT CLAIM TO ANY PARTICULAR  
FONT, STYLE, SIZE, OR COLOR.

FOR: A SERIES OF BOOKS, WRITTEN ARTICLES,  
HANDOUTS AND WORKSHEETS IN THE FIELD  
OF SELF-HELP, SELF-IMPROVEMENT, HEALING  
ARTS, TV AND FILM WORK, IN CLASS 16 (U.S. CLS.  
2, 5, 22, 23, 29, 37, 38 AND 50).

SER. NO. 77-134,177, FILED 3-19-2007.

FIRST USE 2-14-2007; IN COMMERCE 3-1-2007.

KATHERINE M. DUBRAY, EXAMINING ATTOR-  
NEY

Int. Cl.: 9

Prior U.S. Cls.: 21, 23, 26, 36 and 38

Reg. No. 3,503,593

United States Patent and Trademark Office

Registered Sep. 23, 2008

TRADEMARK  
PRINCIPAL REGISTER

SyNIRgi

MALVERN INSTRUMENTS LIMITED (UNITED KINGDOM LIMITED LIABILITY COMPANY)  
ENIGMA BUSINESS PARK, GROVEWOOD ROAD  
MALVERN WORCESTERSHIRE, UNITED KINGDOM WR141XZ

FOR: ELECTRICAL, OPTICAL, ACOUSTICAL, ULTRASONIC AND/OR LASER SCIENTIFIC AND LABORATORY INSTRUMENTS FOR COUNTING, SIZING, CLASSIFYING, DIFFERENTIATING AND IDENTIFYING PARTICLES IN SOLIDS, LIQUIDS OR GASES, FOR USE IN CLINICAL, BIOLOGICAL, INDUSTRIAL, MEDICAL, ENVIRONMENTAL, ACADEMIC AND/OR SCIENTIFIC RESEARCH AND COMMERCIAL LABORATORIES; INSTRUMENTS FOR MEASURING RHEOLOGICAL PROPERTIES, NAMELY, VISCOMETERS, ROTARY AND CAPILLARY RHEOMETERS; INSTRUMENTS FOR MEASURING DIMENSIONAL INFORMATION OF PARTICLES THROUGH IMAGE FORMATION AND ANALYSIS, NAMELY, PARTICLE SIZE, SHAPE, STRUCTURE AND COMPOSITION ANALYSERS; PARTICLE SIZE AND SHAPE DISTRIBUTION AND CONCENTRATION MEASURING INSTRUMENTS, NAMELY, PARTICLE COUNTING INSTRUMENTS, AIR AND LIQUID PARTICLE COUNTERS, PHOTOCORRELATION SPECTROSCOPY INSTRUMENTS, INSTRUMENTS FOR PRODUCING ZIMM PLOTS TO DETERMINE THE MOLECULAR WEIGHT OF POLYMERS, ACOUSTIC SPECTROSCOPY INSTRUMENTS, LASER DIFFRACTION MEASURING INSTRUMENTS, ALL FOR USE IN CLINICAL, BIOLOGICAL, INDUSTRIAL, MEDICAL, ACADEMIC AND/OR SCIENTIFIC RESEARCH AND COMMERCIAL LABORATORIES; PARTICLE CHARGE MEASURING INSTRUMENTS, NAMELY, ZETA POTENTIAL MEASURING INSTRUMENTS, ELECTROPHORETIC MOBILITY MEASURING INSTRUMENTS, PARTICLE MOBILITY MEASURING INSTRUMENTS,

PH MEASURING INSTRUMENTS, MICRO ELECTROPHORESIS MEASURING INSTRUMENTS, ALL FOR USE IN CLINICAL, BIOLOGICAL, INDUSTRIAL, MEDICAL, ACADEMIC AND/OR SCIENTIFIC RESEARCH AND COMMERCIAL LABORATORIES; APPARATUS FOR PREPARING SAMPLES, SUSPENSIONS, SPRAYS, AND EMULSIONS OF PARTICLES FOR USE WITH ANY OF THE AFORESAID GOODS, NAMELY, SAMPLE DISPERSION UNITS, STIRRED CELLS, AUTOSAMPLERS, DRY POWDER FEEDERS, DISPENSERS, AUTO TITRATORS, NEBULIZERS, ULTRASONIC BATHS, AND TEMPERATURE CONTROLLERS; INSTRUMENT CONTROLLERS, NAMELY, COMPUTERS, DIGITAL SIGNAL PROCESSORS AND MICROPROCESSORS, COMPUTER PRINTERS, COMPUTER SOFTWARE FOR CONTROLLING AND OPERATING ALL OF THE AFORESAID GOODS; MACHINE READABLE DATA CARRIERS, NAMELY, SOLID STATE MEMORY DEVICES, OPTICAL AND/OR MAGNETIC STORAGE MEDIA DISKS, MAGNETIC TAPES, ALL SOLD PRE-PROGRAMMED WITH CONTROL OR ANALYSIS PROGRAMS FOR USE WITH THE FOREGOING GOODS, IN CLASS 9 (U.S. CLS. 21, 23, 26, 36 AND 38).

THE MARK CONSISTS OF STANDARD CHARACTERS WITHOUT CLAIM TO ANY PARTICULAR FONT, STYLE, SIZE, OR COLOR.

PRIORITY CLAIMED UNDER SEC. 44(D) ON ERPN CMNTY TM OFC APPLICATION NO. 5670112, FILED 1-22-2007, REG. NO. 005670112, DATED 3-13-2008, EXPIRES 1-22-2017.

SER. NO. 77-134,209, FILED 3-19-2007.

DAVID I, EXAMINING ATTORNEY

**Int. Cl.: 35**

**Prior U.S. Cls.: 100, 101 and 102**

**United States Patent and Trademark Office**

**Reg. No. 3,503,594**

**Registered Sep. 23, 2008**

**SERVICE MARK  
PRINCIPAL REGISTER**



INTERMODAL ASSOCIATION OF NORTH  
AMERICA (DELAWARE CORPORATION)  
SUITE 1100  
11785 BELTSVILLE DRIVE  
CALVERTON, MD 20705

FOR: ARRANGING AND CONDUCTING TRADE  
SHOWS IN THE FIELD OF INTERMODAL  
FREIGHT TRANSPORTATION, IN CLASS 35 (U.S.  
CLS. 100, 101 AND 102).

FIRST USE 1-1-1990; IN COMMERCE 1-1-1990.

NO CLAIM IS MADE TO THE EXCLUSIVE  
RIGHT TO USE "INTERMODAL EXPO", APART  
FROM THE MARK AS SHOWN.

THE MARK CONSISTS OF A TRIANGLE MADE  
UP OF THREE PARALLELOGRAMS. THE BOTTOM  
PARALLELOGRAM HAS A WAVE DESIGN IN IT,  
THE PARALLELOGRAM ON THE LEFT SIDE HAS  
A RAILROAD TRACK DESIGN IN IT, AND THE  
PARALLELOGRAM ON THE RIGHT SIDE HAS A  
ROAD DESIGN IN IT. THE WORDING "IANA'S  
INTERMODAL EXPO" APPEARS IN STYLIZED  
FORM UNDERNEATH THE TRIANGLE.

SER. NO. 77-137,612, FILED 3-22-2007.

ANDREA BUTLER, EXAMINING ATTORNEY

Int. Cl.: 9

Prior U.S. Cls.: 21, 23, 26, 36 and 38

United States Patent and Trademark Office

Reg. No. 3,503,595

Registered Sep. 23, 2008

TRADEMARK  
PRINCIPAL REGISTER



ESPINOSA, JAVIER GUTIERREZ (MEXICO IN-  
DIVIDUAL)  
COL. CONDESA  
CUERNAVACA NO. 35 INT. 5  
MEXICO DF 6140, MEXICO

FOR: IMPRESSED MOVIES AND FILMS, NAME-  
LY, MOTION PICTURE FILMS IN THE FIELD OF  
DOCUMENTARIES, HORROR, COMEDY, DRAMA  
AND MUSICALS; IMPRESSED MOVIES AND  
FILMS, NAMELY, PRE-RECORDED DVDS AND

VIDEOTAPES IN THE FIELD OF DOCUMENTAR-  
IES, HORROR, COMEDY, DRAMA AND MUSI-  
CALS, IN CLASS 9 (U.S. CLS. 21, 23, 26, 36 AND 38).

OWNER OF MEXICO REG. NO. 958198, DATED 5-  
9-2006, EXPIRES 5-9-2016.

SER. NO. 77-137,695, FILED 3-22-2007.

KELLEY WELLS, EXAMINING ATTORNEY

**Int. Cls.: 9, 16, 25 and 41**

**Prior U.S. Cls.: 2, 5, 21, 22, 23, 26, 29, 36, 37, 38, 39,  
50, 100, 101 and 107**

**Reg. No. 3,503,596**

**United States Patent and Trademark Office**

**Registered Sep. 23, 2008**

**TRADEMARK  
SERVICE MARK  
PRINCIPAL REGISTER**



ROBBINS RESEARCH INTERNATIONAL, INC.  
(NEVADA CORPORATION)  
9888 CARROLL CENTRE ROAD SUITE 100  
SAN DIEGO, CA 92126

FOR: AUDIO AND VIDEO RECORDINGS IN THE  
FIELD OF PERSONAL IMPROVEMENT , IN CLASS  
9 (U.S. CLS. 21, 23, 26, 36 AND 38).

FIRST USE 5-30-2004; IN COMMERCE 5-30-2004.

FOR: PRINTED MATERIALS, NAMELY, WORK-  
BOOKS AND FLASHCARDS IN THE FIELD OF  
PERSONAL IMPROVEMENT, IN CLASS 16 (U.S.  
CLS. 2, 5, 22, 23, 29, 37, 38 AND 50).

FIRST USE 5-30-2004; IN COMMERCE 5-30-2004.

FOR: CLOTHING, NAMELY, SHIRTS, TOPS, BOT-  
TOMS, HATS AND VISORS, SOLD EXCLUSIVELY

THROUGH OWNER'S WEBSITE AND AT LEC-  
TURES OR EVENTS SPONSORED BY OWNER, IN  
CLASS 25 (U.S. CLS. 22 AND 39).

FIRST USE 12-18-2006; IN COMMERCE 12-18-2006.

FOR: EDUCATIONAL SERVICES, NAMELY  
CONDUCTING CLASSES AND SEMINARS IN THE  
FIELD OF PERSONAL AND FINANCIAL IM-  
PROVEMENT AND SALES TRAINING, IN CLASS  
41 (U.S. CLS. 100, 101 AND 107).

FIRST USE 5-30-2004; IN COMMERCE 5-30-2004.

SER. NO. 77-137,810, FILED 3-22-2007.

BENJAMIN OKEKE, EXAMINING ATTORNEY



**Int. Cl.: 35**

**Prior U.S. Cls.: 100, 101 and 102**

**United States Patent and Trademark Office**

**Reg. No. 3,503,597**

**Registered Sep. 23, 2008**

**SERVICE MARK  
PRINCIPAL REGISTER**

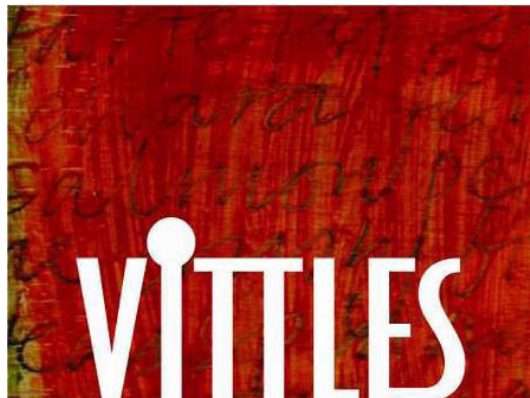

VITTLES, INC. (VIRGINIA CORPORATION)  
141 SANTA ROSA AVENUE  
SAUSALITO, CA 94965

FOR: ADVERTISING AND MARKETING SERVICES, NAMELY, PROMOTING THE GOODS AND SERVICES OF OTHERS THROUGH MARKET RESEARCH, PREPARING AND PLACING ADVERTISEMENTS OF OTHERS, SALES PROMOTION SERVICES, DIRECT MARKETING SERVICES AND CONCEPT AND BRAND DEVELOPMENT; PROMOTION SERVICES, NAMELY, PROMOTING THE GOODS AND SERVICES OF OTHERS THROUGH ALL PUBLIC COMMUNICATION MEANS; PRODUCT MERCHANDISING; PUBLIC RELATIONS SERVICES; BUSINESS CONSULTING SERVICES IN THE FIELDS OF ADVERTISING, MARKETING, PROMOTIONS AND PUBLIC RELATIONS, IN CLASS 35 (U.S. CLS. 100, 101 AND 102).

FIRST USE 11-0-2006; IN COMMERCE 11-0-2006.

THE COLOR(S) RED, WHITE, BLACK AND GREEN IS/ARE CLAIMED AS A FEATURE OF THE MARK.

THE COLOR WHITE APPEARS IN THE WORDING VITTLES, THE COLOR RED APPEARS IN THE DESIGN OF THE BACKGROUND, THE COLOR GREEN APPEARS IN THE BACKGROUND OF THE MARK, AND THE COLOR BLACK APPEARS IN THE WORDING TARTE, PER, AWARD, FEN, SALMON, PE, RE, HAPPY, BR, TEAS, SPINACH IN THE BACKGROUND OF THE MARK

SER. NO. 77-139,197, FILED 3-23-2007.

SHANNON TWOHIG, EXAMINING ATTORNEY

**Int. Cls.: 35 and 41**

**Prior U.S. Cls.: 100, 101, 102 and 107**

**United States Patent and Trademark Office**

**Reg. No. 3,503,598**

**Registered Sep. 23, 2008**

**SERVICE MARK  
PRINCIPAL REGISTER**

**VERGE RECORDS**

VERGE RECORDS INTERNATIONAL LLC (NEW  
YORK CORPORATION)  
200 HOPKINS STREET, APT. B  
BROOKLYN, NY 11206

FOR: DISTRIBUTORSHIPS IN THE FIELD OF  
MUSICAL SOUND AND VIDEO RECORDINGS, IN  
CLASS 35 (U.S. CLS. 100, 101 AND 102).

FIRST USE 1-1-2006; IN COMMERCE 1-1-2006.

FOR: PRODUCTION OF MUSICAL SOUND AND  
VIDEO RECORDINGS, IN CLASS 41 (U.S. CLS. 100,  
101 AND 107).

FIRST USE 5-1-2006; IN COMMERCE 1-23-2007.

THE MARK CONSISTS OF STANDARD CHAR-  
ACTERS WITHOUT CLAIM TO ANY PARTICULAR  
FONT, STYLE, SIZE, OR COLOR.

NO CLAIM IS MADE TO THE EXCLUSIVE  
RIGHT TO USE "RECORDS", APART FROM THE  
MARK AS SHOWN.

SER. NO. 77-142,283, FILED 3-28-2007.

ESTHER A. BORSUK, EXAMINING ATTORNEY

Int. Cl.: 16

Prior U.S. Cls.: 2, 5, 22, 23, 29, 37, 38 and 50

Reg. No. 3,503,599

United States Patent and Trademark Office

Registered Sep. 23, 2008

TRADEMARK  
PRINCIPAL REGISTER



INTERMODAL ASSOCIATION OF NORTH  
AMERICA (DELAWARE CORPORATION)  
SUITE 1100  
11785 BELTSVILLE DRIVE  
CALVERTON, MD 20705

FOR: NEWSLETTERS IN THE FIELD OF INTER-  
MODAL FREIGHT TRANSPORTATION, IN CLASS  
16 (U.S. CLS. 2, 5, 22, 23, 29, 37, 38 AND 50).

FIRST USE 11-1-1989; IN COMMERCE 11-1-1989.

NO CLAIM IS MADE TO THE EXCLUSIVE  
RIGHT TO USE "INTERMODAL", APART FROM  
THE MARK AS SHOWN.

THE MARK CONSISTS OF THE WORDING  
"IANA". TO THE RIGHT OF "IANA" IS A CIRCLE  
DESIGN WITH A WAVE DESIGN ENTERING

FROM THE LEFT, A RAILROAD DESIGN COMING  
FROM THE BOTTOM LEFT AND ENDING AT A  
POINT IN THE CIRCLE, AND A ROAD DESIGN  
ENTERING THE CIRCLE FROM THE BOTTOM  
RIGHT AND ENDING AT A POINT IN THE CIRCLE.  
THERE ARE TWO HORIZONTAL LINES IN THE  
MARK, ONE TO THE LEFT OF WORDING "IANA"  
AND THE OTHER TO THE RIGHT OF THE CIRCLE  
DESIGN. THE WORD "INTERMODAL" IN ALL  
CAPITAL LETTERS IS STACKED BELOW THE  
WORDING "IANA", THE CIRCLE DESIGN AND  
THE HORIZONTAL LINES. BELOW "INTERMO-  
DAL" IS THE WORD "INSIGHTS", ENCLOSED IN-  
SIDE A RECTANGULAR DESIGN.

SER. NO. 77-142,494, FILED 3-28-2007.

ANDREA BUTLER, EXAMINING ATTORNEY

**Int. Cl.: 41**

**Prior U.S. Cls.: 100, 101 and 107**

**United States Patent and Trademark Office**

**Reg. No. 3,503,600**

**Registered Sep. 23, 2008**

**SERVICE MARK  
PRINCIPAL REGISTER**

**WISETO**

THE GALE GROUP, INC. (DELAWARE COR-  
PORATION)  
SUITE 400  
2711 CENTERVILLE ROAD  
WILMINGTON, DE 483313535

FOR: PROVIDING AN ON-LINE COMPUTER  
DATABASE FEATURING EDUCATIONAL RE-  
SEARCH MATERIAL ON THE TOPIC OF SOCIAL  
ISSUES VIA THE INTERNET , IN CLASS 41 (U.S.  
CLS. 100, 101 AND 107).

FIRST USE 10-25-2006; IN COMMERCE 10-25-2006.

THE MARK CONSISTS OF STANDARD CHAR-  
ACTERS WITHOUT CLAIM TO ANY PARTICULAR  
FONT, STYLE, SIZE, OR COLOR.

SER. NO. 77-142,538, FILED 3-28-2007.

TASNEEM HUSSAIN, EXAMINING ATTORNEY

**Int. Cl.: 41**

**Prior U.S. Cls.: 100, 101 and 107**

**United States Patent and Trademark Office**

**Reg. No. 3,503,601**

**Registered Sep. 23, 2008**

**SERVICE MARK  
PRINCIPAL REGISTER**

**ACCESS MY LIBRARY**

THE GALE GROUP, INC. (DELAWARE CORPORATION)  
27500 DRAKE ROAD  
FARMINGTON HILLS, MI 483313535

FOR: PROVIDING AN ON-LINE COMPUTER DATABASE FEATURING EDUCATIONAL ARTICLES AND REFERENCE WORKS FROM A VARIETY OF PUBLICATIONS AVAILABLE AT LIBRARIES VIA THE INTERNET, IN CLASS 41 (U.S. CLS. 100, 101 AND 107).

FIRST USE 7-1-2005; IN COMMERCE 7-1-2005.

THE MARK CONSISTS OF STANDARD CHARACTERS WITHOUT CLAIM TO ANY PARTICULAR FONT, STYLE, SIZE, OR COLOR.

NO CLAIM IS MADE TO THE EXCLUSIVE RIGHT TO USE "ACCESS" AND "LIBRARY", APART FROM THE MARK AS SHOWN.

SER. NO. 77-142,586, FILED 3-28-2007.

TASNEEM HUSSAIN, EXAMINING ATTORNEY

**Int. Cl.: 5**

**Prior U.S. Cls.: 6, 18, 44, 46, 51 and 52**

**United States Patent and Trademark Office**

**Reg. No. 3,503,602**

**Registered Sep. 23, 2008**

**TRADEMARK  
PRINCIPAL REGISTER**

# Maca-GO

NHI, INC. (BR.VIRGIN ISLANDS BVI BUSINESS  
COMPANY)  
C/O OVERSEAS MANAGEMENT COMPANY  
TRUST  
P.O. BOX 3152  
ROAD TOWN TORTOLA, BR.VIRGIN ISLANDS

FOR: PROPRIETARY COMBINATION AND RA-  
TIO, FORMULATED SPECIFICALLY FOR WOMEN,  
OF FOUR MAJOR PHENOTYPES OF LEPIDIUM  
PERUVIANUM CHACON, ALSO KNOWN AS LEPI-  
DIUM MEYENII, IN A HIGH QUALITY AND  
ENHANCED WATER SOLUBILITY PRODUCT,  
SOLD AS AN INTEGRAL AND PRIMARY COMPO-

NENT OF DIETARY SUPPLEMENTS, IN CLASS 5  
(U.S. CLS. 6, 18, 44, 46, 51 AND 52).

FIRST USE 5-19-2004; IN COMMERCE 5-19-2004.

THE MARK CONSISTS OF STANDARD CHAR-  
ACTERS WITHOUT CLAIM TO ANY PARTICULAR  
FONT, STYLE, SIZE, OR COLOR.

SER. NO. 77-143,220, FILED 3-28-2007.

BRIAN PINO, EXAMINING ATTORNEY

**Int. Cls.: 35, 38, 41 and 42**

**Prior U.S. Cls.: 100, 101, 102, 104 and 107**

**United States Patent and Trademark Office**

**Reg. No. 3,503,603**

**Registered Sep. 23, 2008**

**SERVICE MARK  
PRINCIPAL REGISTER**

**MEMBERCENTRAL**

TRIALSMITH, INC. (TEXAS CORPORATION)  
SUITE 285  
5113 SOUTHWEST PARKWAY  
AUSTIN, TX 78735

FOR: MARKETING SERVICES FOR OTHERS ON INTERNET WEBSITES; ONLINE RETAIL STORE SERVICES VIA THE INTERNET AND EMAIL BUSINESS SOLICITATION IN THE FIELD OF LEGAL DOCUMENTS; DATA PROCESSING AND DATABASE MANAGEMENT; PROVIDING AN ON-LINE COMMERCIAL INFORMATION DIRECTORY ON THE INTERNET, IN CLASS 35 (U.S. CLS. 100, 101 AND 102).

FIRST USE 7-11-2006; IN COMMERCE 7-11-2006.

FOR: COMMUNICATIONS SERVICES, NAMELY, TRANSMITTING STREAMED SOUND AND AUDIO-VISUAL RECORDINGS VIA THE INTERNET; PROVIDING INTERNET CHAT ROOMS; TRANSMITTING LIST SERVER MESSAGES; TRANSMISSION OF NEWS, IN CLASS 38 (U.S. CLS. 100, 101 AND 104).

FIRST USE 7-11-2006; IN COMMERCE 7-11-2006.

FOR: EDUCATIONAL SERVICES, NAMELY, CONDUCTING DISTANCE LEARNING FOR POST-SECONDARY, COLLEGE, POST-COLLEGE, GRADUATE AND POST-GRADUATE LEVELS, IN CLASS 41 (U.S. CLS. 100, 101 AND 107).

FIRST USE 7-11-2006; IN COMMERCE 7-11-2006.

FOR: CONSULTING SERVICES, NAMELY, DEVELOPING WEBSITES FOR OTHERS, WEBSITE HOSTING, IN CLASS 42 (U.S. CLS. 100 AND 101).

FIRST USE 7-11-2006; IN COMMERCE 7-11-2006.

THE MARK CONSISTS OF STANDARD CHARACTERS WITHOUT CLAIM TO ANY PARTICULAR FONT, STYLE, SIZE, OR COLOR.

SER. NO. 77-143,340, FILED 3-29-2007.

JOHN HWANG, EXAMINING ATTORNEY

**Int. Cl.: 41**

**Prior U.S. Cls.: 100, 101 and 107**

**United States Patent and Trademark Office**

**Reg. No. 3,503,604**

**Registered Sep. 23, 2008**

**SERVICE MARK  
PRINCIPAL REGISTER**

**WORLD BODY**

SAME SEEDS DIFFERENT WINDS FOUNDATION, INC. (VIRGINIA CORPORATION)  
35 LAUREL ROAD  
POUND RIDGE, NY 10576

FOR: EDUCATION AND TRAINING, NAMELY, PROVIDING LECTURES, CLASSES, SEMINARS AND WORKSHOPS, IN THE FIELDS OF RELIGION, SCIENCE, MYTHOLOGY, ART, LANGUAGE, EASTERN PRACTICES, MEDICINE AND THERAPY, IN CLASS 41 (U.S. CLS. 100, 101 AND 107).

FIRST USE 9-12-2005; IN COMMERCE 9-12-2005.

THE MARK CONSISTS OF STANDARD CHARACTERS WITHOUT CLAIM TO ANY PARTICULAR FONT, STYLE, SIZE, OR COLOR.

SER. NO. 77-143,676, FILED 3-29-2007.

LINDA ORNDORFF, EXAMINING ATTORNEY



Int. Cl.: 36

Prior U.S. Cls.: 100, 101 and 102

United States Patent and Trademark Office

Reg. No. 3,503,605

Registered Sep. 23, 2008

**SERVICE MARK  
PRINCIPAL REGISTER**



THE UNWANTED, LLC (PENNSYLVANIA LIMITED LIABILITY COMPANY)  
725 CHARETTE RD.  
PHILADELPHIA, PA 19115

FOR: CHARITABLE FUNDRAISING SERVICES BY MEANS OF RAISING FUNDS FROM PROFITS OBTAINED THROUGH MOTORCYCLE RIDING EVENTS, IN CLASS 36 (U.S. CLS. 100, 101 AND 102).

FIRST USE 4-0-2006; IN COMMERCE 4-0-2006.

NO CLAIM IS MADE TO THE EXCLUSIVE RIGHT TO USE "PENNSYLVANIA", APART FROM THE MARK AS SHOWN.

THE MARK CONSISTS OF A CREST WITH A PITCHFORK WITH THREE POINTS ON IT, HAV-

ING AN IMAGE OF FLAMES IN THE BACKGROUND, AND A HUMAN SKULL CENTERED IN THE BOTTOM PORTION. THE SKULL HAS VAMPIRE-LIKE FRONT TEETH, AND A CRACK IN IT WITH A HANDCUFF CHAIN COMING THROUGH IT. THE SKULL IS HANDCUFFED TO ONE OF THE DEVIL-TAILS ON EITHER SIDE OF IT. ABOVE THE CREST IS THE STYLIZED WORDING "THE UNWANTED" APPEARING IN A BANNER; BELOW THE CREST THE STYLIZED WORDING "PENNSYLVANIA" APPEARS IN ANOTHER BANNER.

SER. NO. 77-144,549, FILED 3-30-2007.

LYDIA BELZER, EXAMINING ATTORNEY

**Int. Cls.: 41 and 44**

**Prior U.S. Cls.: 100, 101 and 107**

**United States Patent and Trademark Office**

**Reg. No. 3,503,606**

**Registered Sep. 23, 2008**

**SERVICE MARK  
PRINCIPAL REGISTER**

**MH FIT**

RODALE INC. (PENNSYLVANIA CORPORATION)  
33 EAST MINOR STREET  
EMMAUS, PA 180980099

FOR: PROVIDING INFORMATION IN THE FIELDS OF FITNESS AND EXERCISE ON THE INTERNET; PROVIDING CUSTOMIZED PHYSICAL FITNESS CONSULTATION SERVICES, IN CLASS 41 (U.S. CLS. 100, 101 AND 107).

FIRST USE 4-10-2007; IN COMMERCE 4-10-2007.

FOR: PROVIDING INFORMATION IN THE FIELDS OF HEALTH, DIET AND A HEALTHY LIFESTYLE VIA A WEBSITE ON THE INTERNET, IN CLASS 44 (U.S. CLS. 100 AND 101).

FIRST USE 4-10-2007; IN COMMERCE 4-10-2007.

THE MARK CONSISTS OF STANDARD CHARACTERS WITHOUT CLAIM TO ANY PARTICULAR FONT, STYLE, SIZE, OR COLOR.

OWNER OF U.S. REG. NOS. 2,689,733, 2,849,828, AND 2,855,359.

NO CLAIM IS MADE TO THE EXCLUSIVE RIGHT TO USE "FIT" , APART FROM THE MARK AS SHOWN.

SER. NO. 77-144,745, FILED 3-30-2007.

GEORGIA CARTY, EXAMINING ATTORNEY

**Int. Cl.: 42**

**Prior U.S. Cls.: 100 and 101**

**United States Patent and Trademark Office**

**Reg. No. 3,503,607**

**Registered Sep. 23, 2008**

**SERVICE MARK  
PRINCIPAL REGISTER**



DRV HOLDINGS, LLC (NEW JERSEY LIMITED  
LIABILITY COMPANY)  
SUITE 310  
2001 ROUTE 46  
PARSIPPANY, NJ 07054

FOR: DESIGN OF HOMEPAGES AND WEB-  
SITES, IN CLASS 42 (U.S. CLS. 100 AND 101).

FIRST USE 1-1-2000; IN COMMERCE 1-1-2003.

NO CLAIM IS MADE TO THE EXCLUSIVE  
RIGHT TO USE "LODGING INTERACTIVE",  
APART FROM THE MARK AS SHOWN.

THE MARK CONSISTS, IN PART, OF THE LET-  
TERS "L","I" IN STYLIZED FORM.

SER. NO. 77-146,862, FILED 4-2-2007.

JOHN E. MICHOS, EXAMINING ATTORNEY

**Int. Cl.: 36**

**Prior U.S. Cls.: 100, 101 and 102**

**United States Patent and Trademark Office**

**Reg. No. 3,503,608**

**Registered Sep. 23, 2008**

**SERVICE MARK  
PRINCIPAL REGISTER**

**RACING FOR A REASON**

RACING FOR A REASON (NORTH CAROLINA  
NON-PROFIT CORPORATION)  
320 AVIATION DRIVE  
STATESVILLE, NC 28677

FOR: CHARITABLE FUND RAISING, IN CLASS  
36 (U.S. CLS. 100, 101 AND 102).

FIRST USE 1-15-2007; IN COMMERCE 1-15-2007.

THE MARK CONSISTS OF STANDARD CHAR-  
ACTERS WITHOUT CLAIM TO ANY PARTICULAR  
FONT, STYLE, SIZE, OR COLOR.

SER. NO. 77-147,202, FILED 4-3-2007.

AMOS T. MATTHEWS, JR., EXAMINING ATTOR-  
NEY

**Int. Cl.: 42**

**Prior U.S. Cls.: 100 and 101**

**United States Patent and Trademark Office**

**Reg. No. 3,503,609**

**Registered Sep. 23, 2008**

**SERVICE MARK  
PRINCIPAL REGISTER**

**DocumNIC Document Network  
Information Center**

MARKO, ANASTASOV (CYPRUS INDIVIDUAL)  
38 ANDREA ARAOUZOU  
NICOSIA, CYPRUS 1687

FOR: COMPUTER SERVICES, NAMELY, PROVIDING SEARCH ENGINES FOR OBTAINING DATA ON A GLOBAL COMPUTER NETWORK, IN CLASS 42 (U.S. CLS. 100 AND 101).

FIRST USE 3-27-2007; IN COMMERCE 3-27-2007.

THE MARK CONSISTS OF STANDARD CHARACTERS WITHOUT CLAIM TO ANY PARTICULAR FONT, STYLE, SIZE, OR COLOR.

NO CLAIM IS MADE TO THE EXCLUSIVE RIGHT TO USE "DOCUMENT NETWORK INFORMATION CENTER", APART FROM THE MARK AS SHOWN.

SER. NO. 77-147,909, FILED 4-3-2007.

KAREN K. BUSH, EXAMINING ATTORNEY

**Int. Cl.: 37**

**Prior U.S. Cls.: 100, 103 and 106**

**United States Patent and Trademark Office**

**Reg. No. 3,503,610**

**Registered Sep. 23, 2008**

**SERVICE MARK  
PRINCIPAL REGISTER**

**OMEGA ELECTRIC**

BETOSSIB, RON (UNITED STATES INDIVIDUAL)

P.O. BOX 26834

SAN JOSE, CA 95159

FOR: ELECTRICAL CONTRACTOR SERVICES,  
IN CLASS 37 (U.S. CLS. 100, 103 AND 106).

FIRST USE 12-2-2004; IN COMMERCE 12-2-2004.

THE MARK CONSISTS OF STANDARD CHARACTERS WITHOUT CLAIM TO ANY PARTICULAR FONT, STYLE, SIZE, OR COLOR.

NO CLAIM IS MADE TO THE EXCLUSIVE RIGHT TO USE "ELECTRIC", APART FROM THE MARK AS SHOWN.

SER. NO. 77-148,034, FILED 4-4-2007.

DOMINICK J. SALEMI, EXAMINING ATTORNEY

Int. Cl.: 36

Prior U.S. Cls.: 100, 101 and 102

United States Patent and Trademark Office

Reg. No. 3,503,611

Registered Sep. 23, 2008

SERVICE MARK  
PRINCIPAL REGISTER



FLOORPLAN XPRESS LLC-OK (OKLAHOMA  
LIMITED LIABILITY COMPANY)  
2615 S. MAY AVE  
OKLAHOMA CITY, OK 73108

NO CLAIM IS MADE TO THE EXCLUSIVE  
RIGHT TO USE "FLOORPLAN", APART FROM  
THE MARK AS SHOWN.

FOR: FINANCIAL SERVICES IN THE FIELD OF  
MONEY LENDING FOR AUTOMOBILE DEALER-  
SHIPS, IN CLASS 36 (U.S. CLS. 100, 101 AND 102).

SER. NO. 77-148,677, FILED 4-4-2007.

FIRST USE 3-30-2006; IN COMMERCE 3-30-2006.

LESLEY LAMOTHE, EXAMINING ATTORNEY

**Int. Cls.: 9 and 42**

**Prior U.S. Cls.: 21, 23, 26, 36, 38, 100 and 101**

**United States Patent and Trademark Office**

**Reg. No. 3,503,612**

**Registered Sep. 23, 2008**

**TRADEMARK  
SERVICE MARK  
PRINCIPAL REGISTER**

# ViewCenter

ICM CONVERSIONS, INC (ARIZONA CORPORATION)  
SUITE 12  
2850 S. 36TH ST.  
PHOENIX, AZ 85034

FOR: DOWNLOADABLE SOFTWARE FOR SEARCHING, VIEWING AND RETRIEVAL OF DIGITAL DOCUMENTS, NAMELY, BUSINESS CRITICAL DOCUMENTATION, ACCOUNTING RECORDS, HUMAN RESOURCE DOCUMENTS AND ENGINEERING DRAWINGS, IN CLASS 9 (U.S. CLS. 21, 23, 26, 36 AND 38).

FIRST USE 4-0-1992; IN COMMERCE 4-0-1992.

FOR: PROVIDING ONLINE, NON-DOWNLOADABLE SOFTWARE FOR SEARCHING, VIEWING

AND RETRIEVAL OF DIGITAL DOCUMENTS, NAMELY, BUSINESS CRITICAL DOCUMENTATION, ACCOUNTING RECORDS, HUMAN RESOURCE DOCUMENTS AND ENGINEERING DRAWINGS, IN CLASS 42 (U.S. CLS. 100 AND 101).

FIRST USE 4-0-1992; IN COMMERCE 4-0-1992.

THE MARK CONSISTS OF STANDARD CHARACTERS WITHOUT CLAIM TO ANY PARTICULAR FONT, STYLE, SIZE, OR COLOR.

SER. NO. 77-149,858, FILED 4-5-2007.

DAVID C. REIHNER, EXAMINING ATTORNEY



**Int. Cl.: 39**

**Prior U.S. Cls.: 100 and 105**

**United States Patent and Trademark Office**

**Reg. No. 3,503,613**

**Registered Sep. 23, 2008**

**SERVICE MARK  
PRINCIPAL REGISTER**

# Quick Trip Express

QUICK TRIP EXPRESS (ILLINOIS CORPORATION)  
2623 N. TEXAS ROAD  
TRIVOLI, IL 61569

FOR: FREIGHT TRANSPORTATION BY TRUCK, INCLUDING, CONSUMER GOODS, NAMELY, BEVERAGES, RAW MATERIALS, NAMELY, WIRE, AND LANDSCAPE MATERIALS, INCLUDING, MULCH, IN CLASS 39 (U.S. CLS. 100 AND 105).

FIRST USE 10-8-1983; IN COMMERCE 10-8-1983.

THE MARK CONSISTS OF STANDARD CHARACTERS WITHOUT CLAIM TO ANY PARTICULAR FONT, STYLE, SIZE, OR COLOR.

NO CLAIM IS MADE TO THE EXCLUSIVE RIGHT TO USE "EXPRESS", APART FROM THE MARK AS SHOWN.

SER. NO. 77-150,195, FILED 4-5-2007.

JENNIFER VASQUEZ, EXAMINING ATTORNEY

**Int. Cl.: 43**

**Prior U.S. Cls.: 100 and 101**

**United States Patent and Trademark Office**

**Reg. No. 3,503,614**

**Registered Sep. 23, 2008**

**SERVICE MARK  
PRINCIPAL REGISTER**

**APPLE KISS**

EROM INC (CALIFORNIA CORPORATION)  
6131 ORANGETHORPE AVE #115  
BUENA PARK, CA 90620

FOR: CAFE-RESTAURANTS; RESTAURANT  
SERVICES; RESTAURANT AND BAR SERVICES,  
IN CLASS 43 (U.S. CLS. 100 AND 101).

FIRST USE 5-1-2006; IN COMMERCE 10-1-2006.

THE MARK CONSISTS OF STANDARD CHAR-  
ACTERS WITHOUT CLAIM TO ANY PARTICULAR  
FONT, STYLE, SIZE, OR COLOR.

NO CLAIM IS MADE TO THE EXCLUSIVE  
RIGHT TO USE "APPLE", APART FROM THE  
MARK AS SHOWN.

SER. NO. 77-151,148, FILED 4-6-2007.

PRISCILLA MILTON, EXAMINING ATTORNEY

**Int. Cl.: 16**

**Prior U.S. Cls.: 2, 5, 22, 23, 29, 37, 38 and 50**

**United States Patent and Trademark Office**

**Reg. No. 3,503,615**

**Registered Sep. 23, 2008**

**TRADEMARK  
PRINCIPAL REGISTER**

**ANALYTICA CHIMICA ACTA**

ELSEVIER BV (NETHERLANDS CORPORATION)  
RADARWEG 29  
1043 NX AMSTERDAM, NETHERLANDS 1043NX

FOR: PRINTED PUBLICATIONS, NAMELY,  
JOURNALS IN THE FIELDS OF SCIENCE AND  
CHEMISTRY, IN CLASS 16 (U.S. CLS. 2, 5, 22, 23, 29,  
37, 38 AND 50).

FIRST USE 12-31-1947; IN COMMERCE 12-31-1947.

THE MARK CONSISTS OF STANDARD CHAR-  
ACTERS WITHOUT CLAIM TO ANY PARTICULAR  
FONT, STYLE, SIZE, OR COLOR.

SER. NO. 77-151,415, FILED 4-8-2007.

MARLENE BELL, EXAMINING ATTORNEY

**Int. Cl.: 9**

**Prior U.S. Cls.: 21, 23, 26, 36 and 38**

**United States Patent and Trademark Office**

**Reg. No. 3,503,616**

**Registered Sep. 23, 2008**

**TRADEMARK  
PRINCIPAL REGISTER**

**ANALYTICA CHIMICA ACTA**

ELSEVIER BV (NETHERLANDS CORPORATION)  
RADARWEG 29  
AMSTERDAM, NETHERLANDS 1043NX

THE MARK CONSISTS OF STANDARD CHAR-  
ACTERS WITHOUT CLAIM TO ANY PARTICULAR  
FONT, STYLE, SIZE, OR COLOR.

FOR: ELECTRONIC DOWNLOADABLE PUBLI-  
CATIONS, NAMELY, JOURNALS IN THE FIELDS  
OF SCIENCE AND CHEMISTRY, IN CLASS 9 (U.S.  
CLS. 21, 23, 26, 36 AND 38).

SER. NO. 77-153,269, FILED 4-10-2007.

FIRST USE 3-26-1998; IN COMMERCE 3-26-1998.

MARLENE BELL, EXAMINING ATTORNEY

**Int. Cl.: 41**

**Prior U.S. Cls.: 100, 101 and 107**

**United States Patent and Trademark Office**

**Reg. No. 3,503,617**

**Registered Sep. 23, 2008**

**SERVICE MARK  
PRINCIPAL REGISTER**

**ANALYTICA CHIMICA ACTA**

ELSEVIER BV (NETHERLANDS CORPORATION)  
RADARWEG 29  
AMSTERDAM, NETHERLANDS 1043NX

THE MARK CONSISTS OF STANDARD CHAR-  
ACTERS WITHOUT CLAIM TO ANY PARTICULAR  
FONT, STYLE, SIZE, OR COLOR.

FOR: PROVIDING ON-LINE PUBLICATIONS,  
NAMELY, JOURNALS IN THE FIELDS OF SCIENCE  
AND CHEMISTRY, IN CLASS 41 (U.S. CLS. 100, 101  
AND 107).

SER. NO. 77-153,619, FILED 4-11-2007.

FIRST USE 3-31-1998; IN COMMERCE 3-31-1998.

MARLENE BELL, EXAMINING ATTORNEY

Int. Cls.: 35 and 42

Prior U.S. Cls.: 100, 101 and 102

United States Patent and Trademark Office

Reg. No. 3,503,618

Registered Sep. 23, 2008

SERVICE MARK  
PRINCIPAL REGISTER



*BenTyler Enterprises, Inc.*

BENTYLER ENTERPRISES, INC. (CALIFORNIA CORPORATION)  
830 W. EVELYN AVE.  
SUNNYVALE, CA 94086

FOR: BUSINESS CONSULTATION SERVICES, IN CLASS 35 (U.S. CLS. 100, 101 AND 102).

FIRST USE 9-2-1993; IN COMMERCE 9-2-1993.

FOR: ENGINEERING; ENGINEERING SERVICES FOR BUILDING AND PROPERTY CONDITION ASSESSMENT, FACILITY MANAGEMENT, REPAIR AND RESTORATION, BUILDING INSTRUMENTATION AND MONITORING, AND ENVIRONMENTAL CONSULTING; CONSULTING SERVICES IN THE FIELD OF ENVIRONMENTAL ASSESSMENT, COMPLIANCE AND PLANNING, IN CLASS 42 (U.S. CLS. 100 AND 101).

FIRST USE 9-2-1993; IN COMMERCE 9-2-1993.

NO CLAIM IS MADE TO THE EXCLUSIVE RIGHT TO USE "ENTERPRISES, INC.", APART FROM THE MARK AS SHOWN.

THE NAME BENTYLER IDENTIFIES A LIVING INDIVIDUAL WHOSE CONSENT IS OF RECORD.

THE MARK CONSISTS OF 5 POINTED STAR SURROUNDED BY 5 PARALLELOGRAMS. EACH PARALLELOGRAM HAS 4 PARALLEL LINES INSIDE. EACH PARALLELOGRAM IS ADJACENT TO ONE SIDE OF THE STAR.

SER. NO. 77-154,917, FILED 4-12-2007.

JOHN DALIER, EXAMINING ATTORNEY

Int. Cl.: 42

Prior U.S. Cls.: 100 and 101

United States Patent and Trademark Office

Reg. No. 3,503,619

Registered Sep. 23, 2008

SERVICE MARK  
PRINCIPAL REGISTER



AGRI-EDUCATION, INC. (IOWA CORPORATION)  
801 SHAKESPEARE AVE.  
STRATFORD, IA 50249

FOR: TESTING, INSPECTION AND RESEARCH  
ON LIVESTOCK, NAMELY, DAIRY ANIMALS, IN  
CLASS 42 (U.S. CLS. 100 AND 101).

FIRST USE 1-0-2001; IN COMMERCE 1-0-2001.

NO CLAIM IS MADE TO THE EXCLUSIVE  
RIGHT TO USE "DAIRY QUALITY ASSURANCE",  
APART FROM THE MARK AS SHOWN.

THE MARK CONSISTS OF THE WORDING "5  
STAR DAIRY QUALITY ASSURANCE" AND A 5  
POINTED STAR.

SER. NO. 77-155,955, FILED 4-13-2007.

DAVID TAYLOR, EXAMINING ATTORNEY

Int. Cl.: 42

Prior U.S. Cls.: 100 and 101

United States Patent and Trademark Office

Reg. No. 3,503,620

Registered Sep. 23, 2008

**SERVICE MARK  
PRINCIPAL REGISTER**



AGRI-EDUCATION, INC. (IOWA CORPORATION)  
801 SHAKESPEARE AVE.  
STRATFORD, IA 50249

FOR: TESTING, INSPECTION AND RESEARCH  
ON LIVESTOCK, NAMELY, DAIRY ANIMALS, IN  
CLASS 42 (U.S. CLS. 100 AND 101).

FIRST USE 1-0-2000; IN COMMERCE 1-0-2000.

NO CLAIM IS MADE TO THE EXCLUSIVE  
RIGHT TO USE "MILK & DAIRY BEEF QUALITY

ASSURANCE CENTER, INC.", APART FROM THE  
MARK AS SHOWN.

THE MARK CONSISTS OF THE WORDS "MILK &  
DAIRY BEEF QUALITY ASSURANCE CENTER,  
INC." WITH A FANCIFUL "Q" AND IMAGES OF  
FOOD ITEMS THEREBETWEEN.

SER. NO. 77-155,972, FILED 4-13-2007.

DAVID TAYLOR, EXAMINING ATTORNEY



Int. Cls.: 35 and 36

Prior U.S. Cls.: 100, 101 and 102

United States Patent and Trademark Office

Reg. No. 3,503,621

Registered Sep. 23, 2008

SERVICE MARK  
PRINCIPAL REGISTER



FNF INTELLECTUAL PROPERTY HOLDINGS,  
INC. (DELAWARE CORPORATION)  
11TH FLOOR  
601 RIVERSIDE AVENUE  
JACKSONVILLE, FL 32204

FOR: REAL ESTATE SALES MANAGEMENT, IN  
CLASS 35 (U.S. CLS. 100, 101 AND 102).

FIRST USE 4-11-2007; IN COMMERCE 4-11-2007.

FOR: REAL ESTATE AGENCIES; REAL ESTATE  
BROKERAGE; REAL ESTATE CONSULTATION;  
REAL ESTATE LISTING; REAL ESTATE PROCURE-  
MENT FOR OTHERS, IN CLASS 36 (U.S. CLS. 100, 101  
AND 102).

FIRST USE 4-11-2007; IN COMMERCE 4-11-2007.

NO CLAIM IS MADE TO THE EXCLUSIVE  
RIGHT TO USE "REALTORS", APART FROM THE  
MARK AS SHOWN.

THE MARK CONSISTS OF "J. ROCKCLIFF RE-  
ALTORS JR" (STYLIZED) AND DESIGN.

SER. NO. 77-156,528, FILED 4-13-2007.

SUSAN RICHARDS, EXAMINING ATTORNEY

**Int. Cl.: 45**

**Prior U.S. Cls.: 100 and 101**

**United States Patent and Trademark Office**

**Reg. No. 3,503,622**

**Registered Sep. 23, 2008**

**SERVICE MARK  
PRINCIPAL REGISTER**

**MarriageMentors**  
Prepare, Enrich & Restore

MARRIAGE MENTORS (TEXAS NON-PROFIT CORPORATION)  
2071 COLLINS BLVD, STE 101  
RICHARDSON, TX 75080

FOR: MARRIAGE COUNSELING, IN CLASS 45 (U.S. CLS. 100 AND 101).

FIRST USE 1-1-2003; IN COMMERCE 1-1-2003.

NO CLAIM IS MADE TO THE EXCLUSIVE RIGHT TO USE "MARRIAGEMENTORS", APART FROM THE MARK AS SHOWN.

THE COLOR(S) BLACK AND MAROON IS/ARE CLAIMED AS A FEATURE OF THE MARK.

THE MARK CONSISTS OF THE PHRASE "MARRIAGEMENTORS" WITH "MARRIAGE" IN MAROON AND "MENTORS" IN BLACK ABOVE THE PHRASE "PREPARE, ENRICH & RESTORE" IN MAROON.

SER. NO. 77-157,916, FILED 4-16-2007.

KATHERINE CHANG, EXAMINING ATTORNEY

**Int. Cls.: 7, 37 and 42**

**Prior U.S. Cls.: 13, 19, 21, 23, 31, 34, 35, 100, 101, 103  
and 106**

**Reg. No. 3,503,623**

**Registered Sep. 23, 2008**

**United States Patent and Trademark Office**

---

**TRADEMARK  
SERVICE MARK  
PRINCIPAL REGISTER**

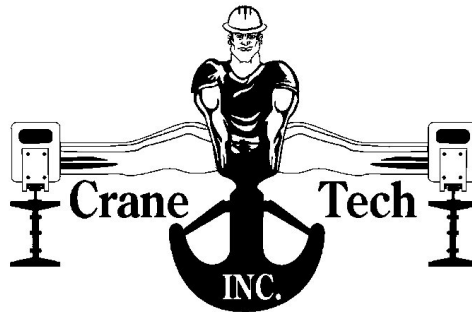

CRANETECH INC. (CALIFORNIA CORPORATION)  
610 COMMERCE COURT  
MANTECA, CA 95336

FIRST USE 4-1-2004; IN COMMERCE 4-1-2004.

FOR: OVERHEAD TRAVELLING CRANES, IN CLASS 7 (U.S. CLS. 13, 19, 21, 23, 31, 34 AND 35).

NO CLAIM IS MADE TO THE EXCLUSIVE RIGHT TO USE "CRANE" AND "INC.", APART FROM THE MARK AS SHOWN.

FIRST USE 4-1-2004; IN COMMERCE 4-1-2004.

FOR: MAINTENANCE AND/OR REPAIR OF CRANES, IN CLASS 37 (U.S. CLS. 100, 103 AND 106).

THE MARK CONSISTS OF PICTURE OF A HALF MAN / HALF CRANE. THE MAN IS HOLDING A LIFTING HOOK USED IN THE CRANE INDUSTRY.

FIRST USE 4-1-2004; IN COMMERCE 4-1-2004.

SER. NO. 77-158,994, FILED 4-17-2007.

FOR: INSPECTIONS OF CRANES, IN CLASS 42 (U.S. CLS. 100 AND 101).

JENNIFER DIXON, EXAMINING ATTORNEY

**Int. Cls.: 35, 41 and 44**

**Prior U.S. Cls.: 100, 101, 102 and 107**

**United States Patent and Trademark Office**

**Reg. No. 3,503,624**

**Registered Sep. 23, 2008**

**SERVICE MARK  
PRINCIPAL REGISTER**

# DRUG TOPICS

ADVANSTAR COMMUNICATIONS INC. (NEW YORK CORPORATION)  
131 WEST FIRST STREET  
DULUTH, MN 55802

FOR: PROVIDING A WEBSITE ON A GLOBAL COMPUTER NETWORK REGARDING RETAIL AND HOSPITAL PHARMACY BUSINESS MANAGEMENT AND CLINICAL PRACTICE , IN CLASS 35 (U.S. CLS. 100, 101 AND 102).

FIRST USE 1-1-1997; IN COMMERCE 1-1-1997.

FOR: ELECTRONIC PUBLICATION, NAMELY, AN ONLINE MAGAZINE OFFERED ON A GLOBAL COMPUTER NETWORK ABOUT THE PHARMACEUTICAL INDUSTRY, IN CLASS 41 (U.S. CLS. 100, 101 AND 107).

FIRST USE 1-1-1997; IN COMMERCE 1-1-1997.

FOR: PROVIDING A WEBSITE ON A GLOBAL COMPUTER NETWORK FEATURING MEDICAL INFORMATION ABOUT PHARMACEUTICALS, IN CLASS 44 (U.S. CLS. 100 AND 101).

FIRST USE 1-1-1997; IN COMMERCE 1-1-1997.

THE MARK CONSISTS OF STANDARD CHARACTERS WITHOUT CLAIM TO ANY PARTICULAR FONT, STYLE, SIZE, OR COLOR.

OWNER OF U.S. REG. NO. 1,198,723.

SEC. 2(F).

SER. NO. 77-160,442, FILED 4-19-2007.

DAYNA BROWNE, EXAMINING ATTORNEY

**Int. Cl.: 30**

**Prior U.S. Cl.: 46**

**United States Patent and Trademark Office**

**Reg. No. 3,503,625**

**Registered Sep. 23, 2008**

**TRADEMARK  
PRINCIPAL REGISTER**



TUAN, THAI (VIETNAM INDIVIDUAL)  
11/16 NGUYEN DU ST., WARD 9  
SOC TRAN PROVINCE, VIETNAM 848

FOR: PASTRIES, IN CLASS 30 (U.S. CL. 46).

FIRST USE 6-1-1985; IN COMMERCE 6-1-1985.

THE COLOR(S) RED AND YELLOW IS/ARE  
CLAIMED AS A FEATURE OF THE MARK.

THE MARK CONSISTS OF A RED RECTANGLE  
WITH THE WORDS "TÂN HUÊ VIÊN" IN YELLOW  
INSIDE THE RECTANGLE.

THE FOREIGN WORDING IN THE MARK  
TRANSLATES INTO ENGLISH AS "NEW", "FLOW-  
ER", AND "GARDEN".

SER. NO. 77-161,096, FILED 4-19-2007.

JAY FLOWERS, EXAMINING ATTORNEY

**Int. Cl.: 9**

**Prior U.S. Cls.: 21, 23, 26, 36 and 38**

**Reg. No. 3,503,626**

**United States Patent and Trademark Office**

**Registered Sep. 23, 2008**

**TRADEMARK  
PRINCIPAL REGISTER**



ONNET USA, INC. (CALIFORNIA CORPORATION)  
3003 NORTH FIRST STREET  
SAN JOSE, CA 95134

FOR: DOWNLOADABLE COMPUTER GAME SOFTWARE, IN CLASS 9 (U.S. CLS. 21, 23, 26, 36 AND 38).

FIRST USE 3-19-2007; IN COMMERCE 3-19-2007.

THE COLOR(S) BLACK, WHITE, GRAY, RED, ORANGE, YELLOW, AND BLUE IS/ARE CLAIMED AS A FEATURE OF THE MARK.

THE MARK CONSISTS OF THE WORDS "BOMB" AND "DASH" ARE SHADED IN ORANGE TO YELLOW RUNNING FROM LEFT TO RIGHT. THE LETTER "N" IS SHADED IN YELLOW TO ORANGE RUNNING LEFT TO RIGHT. THE WORDING IN THE MARK AND THE BOMB ARE OUTLINED IN BLUE. THE BOMB FACE AND FUSE ARE BLACK. THE FOREHEAD IN THE BOMB FACE IS GRAY. THE EYES ARE WHITE AND BLACK. THE SPARKS ON THE FUSE ARE RED.

SER. NO. 77-162,399, FILED 4-20-2007.

PAUL F. GAST, EXAMINING ATTORNEY

Int. Cl.: 25

Prior U.S. Cls.: 22 and 39

United States Patent and Trademark Office

Reg. No. 3,503,627

Registered Sep. 23, 2008

TRADEMARK  
PRINCIPAL REGISTER



EASTERN KENTUCKY UNIVERSITY (KEN-  
TUCKY CORPORATION)  
521 LANCASTER AVENUE  
RICHMOND, KY 40475

FOR: COLLEGIATE CLOTHING, NAMELY, T-SHIRTS, SWEATSHIRTS, SWEATPANTS, SPORT SHIRTS, GOLF SHIRTS, POLO SHIRTS, SWEATERS, BELTS, TIES, NIGHT SHIRTS, COATS, HATS, HEADBANDS, WRISTBANDS, PANTS, SOCKS, JERSEYS, JACKETS, WARM-UP SUITS, SCARVES, AND CLOTH BIBS SOLD EXCLUSIVELY THROUGH APPLICANT'S WEBSITE, CAMPUS BOOKSTORE, AND LICENSED COLLEGIATE OUTLETS, IN CLASS 25 (U.S. CLS. 22 AND 39).

FIRST USE 3-31-2006; IN COMMERCE 3-31-2006.

NO CLAIM IS MADE TO THE EXCLUSIVE RIGHT TO USE "EASTERN KENTUCKY", APART FROM THE MARK AS SHOWN.

THE MARK CONSISTS OF THE LITERAL ELEMENT TO THE RIGHT OF THE DESIGN ELEMENT, WHICH CONSISTS OF A BUST OF A MAN WITH FACIAL HAIR WEARING A HAT AND TIE.

SER. NO. 77-164,052, FILED 4-24-2007.

MIDGE BUTLER, EXAMINING ATTORNEY

**Int. Cls.: 16, 25, 35 and 42**

**Prior U.S. Cls.: 2, 5, 22, 23, 29, 37, 38, 39, 50, 100, 101  
and 102**

**Reg. No. 3,503,628**

**United States Patent and Trademark Office**

**Registered Sep. 23, 2008**

**TRADEMARK  
SERVICE MARK  
PRINCIPAL REGISTER**

**NEXOPIA**

NEXOPIA.COM INC. (CANADA CORPORATION)  
SUITE 400  
10150 - 100 STREET, NW  
EDMONTON, CANADA T5J0P6

FOR: PAPER GOODS, NAMELY, VOUCHER  
BOOKS, STICKERS, STENCILS AND PAPER BAN-  
NERS, IN CLASS 16 (U.S. CLS. 2, 5, 22, 23, 29, 37, 38  
AND 50).

FOR: CLOTHING, NAMELY, T-SHIRTS, HATS  
AND CAPS, IN CLASS 25 (U.S. CLS. 22 AND 39).

FOR: ADVERTISING VIA AN ONLINE ELECTRO-  
NIC COMMUNICATIONS NETWORK, IN CLASS 35  
(U.S. CLS. 100, 101 AND 102).

FOR: COMPUTER SERVICES, NAMELY, HOST-  
ING ON-LINE WEB FACILITIES FOR OTHERS FOR  
ORGANIZING AND CONDUCTING ONLINE  
MEETINGS, GATHERINGS, AND INTERACTIVE  
DISCUSSIONS, IN CLASS 42 (U.S. CLS. 100 AND 101).

THE MARK CONSISTS OF STANDARD CHAR-  
ACTERS WITHOUT CLAIM TO ANY PARTICULAR  
FONT, STYLE, SIZE, OR COLOR.

PRIORITY CLAIMED UNDER SEC. 44(D) ON  
CANADA APPLICATION NO. 1322976, FILED 10-27-  
2006, REG. NO. TMA714063, DATED 5-9-2008, EX-  
PIRES 5-9-2023.

SER. NO. 77-164,342, FILED 4-24-2007.

SALLY SHIH, EXAMINING ATTORNEY



**Int. Cl.: 41**

**Prior U.S. Cls.: 100, 101 and 107**

**United States Patent and Trademark Office**

**Reg. No. 3,503,629**

**Registered Sep. 23, 2008**

**SERVICE MARK  
PRINCIPAL REGISTER**



POINT PARK UNIVERSITY (PENNSYLVANIA  
NON-PROFIT CORPORATION)

POINT PARK UNIVERSITY  
201 WOOD STREET  
PITTSBURGH, PA 152221984

FOR: ENTERTAINMENT IN THE NATURE OF  
ON-GOING ON-CAMPUS CABLE TELEVISION  
PROGRAMS IN THE FIELD OF NEWS AND GEN-  
ERAL INTEREST, IN CLASS 41 (U.S. CLS. 100, 101  
AND 107).

FIRST USE 2-1-2007; IN COMMERCE 2-1-2007.

THE MARK CONSISTS OF THE FOREGROUND:  
STYLIZED LETTERS COMPRISING "U-VIEW"; THE  
BACKGROUND: A FILLED OVAL IS BEHIND THE  
"U-VIEW" LETTERS; THE FILLED OVAL IS ENCIR-  
CLED FURTHER BY A THICK OVAL BORDER;  
THE "U-VIEW" LETTERING IS SHOWN IN THE  
FOREGROUND AND CUTS THROUGH - ALONG  
THE HORIZONTAL AXIS - A CENTER PORTION OF  
THE FILLED OVAL AND THE THICK OVAL BOR-  
DER WHICH ENCIRCLES IT.

SER. NO. 77-164,609, FILED 4-24-2007.

BONNIE LUKEN, EXAMINING ATTORNEY

Int. Cl.: 37

Prior U.S. Cls.: 100, 103 and 106

United States Patent and Trademark Office

Reg. No. 3,503,630

Registered Sep. 23, 2008

**SERVICE MARK  
PRINCIPAL REGISTER**



**Green Clean**  
SERVICES INC.

CALLANT, JANICE (UNITED STATES INDIVIDUAL)  
1121 RACHEL CIRCLE  
ESCONDIDO, CA 92026

FOR: JANITORIAL SERVICES; MAINTENANCE AND/OR REPAIR OF RESIDENTIAL AND COMMERCIAL BUILDINGS; WINDOW CLEANING; CLEANING OF STORM DRAINS, IN CLASS 37 (U.S. CLS. 100, 103 AND 106).

FIRST USE 2-12-2007; IN COMMERCE 2-12-2007.

NO CLAIM IS MADE TO THE EXCLUSIVE RIGHT TO USE "GREEN CLEAN SERVICES, INC.", APART FROM THE MARK AS SHOWN.

THE MARK CONSISTS OF THE WORDS "A GREEN APPROACH FOR A CLEAN TOMORROW" AROUND A PLANET WITH THE WORDS "GREEN CLEAN SERVICES, INC." UNDERNEATH IT.

SER. NO. 77-165,273, FILED 4-25-2007.

MICHAEL SOUDERS, EXAMINING ATTORNEY

**Int. Cls.: 6 and 19**

**Prior U.S. Cls.: 1, 2, 12, 13, 14, 23, 25, 33 and 50**

**United States Patent and Trademark Office**

**Reg. No. 3,503,631**

**Registered Sep. 23, 2008**

**TRADEMARK  
PRINCIPAL REGISTER**

**MACRES**

OFFICINE MACCAFERRI S.P.A. (ITALY CORPORATION)  
VIA AGRESTI, 6  
BOLOGNA, ITALY

FOR: METAL REINFORCING MATERIALS FOR BUILDING PURPOSES, IN CLASS 6 (U.S. CLS. 2, 12, 13, 14, 23, 25 AND 50).

FOR: STEEL BAR REINFORCED CONCRETE PANELS AND STRIP POLYMERIC REINFORCEMENTS FOR BUILDING PURPOSES, IN CLASS 19 (U.S. CLS. 1, 12, 33 AND 50).

THE MARK CONSISTS OF STANDARD CHARACTERS WITHOUT CLAIM TO ANY PARTICULAR FONT, STYLE, SIZE, OR COLOR.

OWNER OF ITALY REG. NO. 0001093024, DATED 3-7-2006, EXPIRES 3-7-2016.

SER. NO. 77-166,036, FILED 4-26-2007.

KELLEY WELLS, EXAMINING ATTORNEY

**Int. Cl.: 35**

**Prior U.S. Cls.: 100, 101 and 102**

**United States Patent and Trademark Office**

**Reg. No. 3,503,632**

**Registered Sep. 23, 2008**

**SERVICE MARK  
PRINCIPAL REGISTER**

**DIRT DIRECTORY.COM**

DIGITAL PERFORMANCE, INC. (CALIFORNIA CORPORATION)  
2700 CHERRY AVENUE  
SIGNAL HILL, CA 90755

THE MARK CONSISTS OF STANDARD CHARACTERS WITHOUT CLAIM TO ANY PARTICULAR FONT, STYLE, SIZE, OR COLOR.

FOR: PROVIDING AN ON-LINE SEARCHABLE DATABASE WITH LINKS TO RETAIL WEBSITES OF OTHERS IN THE AUTOMOTIVE INDUSTRY; ONLINE RETAIL STORE FEATURING AUTOMOTIVE PRODUCTS WITH LINKS TO THE WEBSITES OF OTHER AUTOMOTIVE RETAIL WEBSITES, IN CLASS 35 (U.S. CLS. 100, 101 AND 102).

NO CLAIM IS MADE TO THE EXCLUSIVE RIGHT TO USE "DIRECTORY.COM", APART FROM THE MARK AS SHOWN.

SER. NO. 77-167,031, FILED 4-26-2007.

FIRST USE 11-0-2003; IN COMMERCE 11-0-2003.

DAVID TOOLEY, EXAMINING ATTORNEY

**Int. Cls.: 35 and 43**

**Prior U.S. Cls.: 100, 101 and 102**

**United States Patent and Trademark Office**

**Reg. No. 3,503,633**

**Registered Sep. 23, 2008**

**SERVICE MARK  
PRINCIPAL REGISTER**

**IT'S TIME FOR THE POCONO  
MOUNTAINS.**

POCONO MOUNTAINS VACATION BUREAU,  
INC. (PENNSYLVANIA NON-PROFIT COR-  
PORATION)  
1004 MAIN STREET  
STROUDSBURG, PA 18360

FOR: CHAMBER OF COMMERCE SERVICES,  
NAMELY, PROMOTING TOURISM AND OPERAT-  
ING VISITOR CENTERS FOR PROMOTING TOUR-  
ISM, IN CLASS 35 (U.S. CLS. 100, 101 AND 102).

FIRST USE 2-0-2007; IN COMMERCE 2-0-2007.

FOR: MAKING HOTEL RESERVATIONS FOR  
OTHERS, IN CLASS 43 (U.S. CLS. 100 AND 101).

FIRST USE 2-0-2007; IN COMMERCE 2-0-2007.

THE MARK CONSISTS OF STANDARD CHAR-  
ACTERS WITHOUT CLAIM TO ANY PARTICULAR  
FONT, STYLE, SIZE, OR COLOR.

NO CLAIM IS MADE TO THE EXCLUSIVE  
RIGHT TO USE "POCONO MOUNTAINS", APART  
FROM THE MARK AS SHOWN.

SER. NO. 77-167,593, FILED 4-27-2007.

STEVEN R. FINE, EXAMINING ATTORNEY

Int. Cl.: 35

Prior U.S. Cls.: 100, 101 and 102

United States Patent and Trademark Office

Reg. No. 3,503,634

Registered Sep. 23, 2008

**SERVICE MARK  
PRINCIPAL REGISTER**

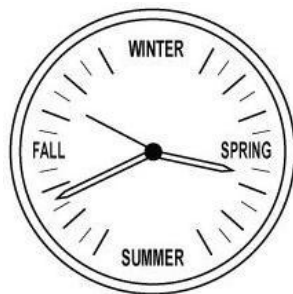

**IT'S TIME  
FOR THE POCONO MOUNTAINS.**

POCONO MOUNTAINS VACATION BUREAU,  
INC. (PENNSYLVANIA NON-PROFIT COR-  
PORATION)  
1004 MAIN STREET  
STROUDSBURG, PA 18360

FOR: CHAMBER OF COMMERCE SERVICES,  
NAMELY, PROMOTING TOURISM AND OPERAT-  
ING VISITOR CENTERS FOR PROMOTING TOUR-  
ISM, IN CLASS 35 (U.S. CLS. 100, 101 AND 102).

FIRST USE 2-0-2007; IN COMMERCE 2-0-2007.

NO CLAIM IS MADE TO THE EXCLUSIVE  
RIGHT TO USE "WINTER", "FALL", "SPRING",

"SUMMER", AND "POCONO MOUNTAINS", APART  
FROM THE MARK AS SHOWN.

THE MARK CONSISTS OF A REPRESENTATION  
OF A CLOCK WITH THE WORD "WINTER" RE-  
PLACING THE NUMBER 12, THE WORD "SPRING"  
REPLACING THE NUMBER 3, THE WORD "SUM-  
MER" REPLACING THE NUMBER 6, AND THE  
WORD "FALL" REPLACING THE NUMBER 9 ON  
THE CLOCK DIAL AND THE WORDING "IT'S  
TIME FOR THE POCONO MOUNTAINS".

SER. NO. 77-167,600, FILED 4-27-2007.

STEVEN R. FINE, EXAMINING ATTORNEY

**Int. Cl.: 35**

**Prior U.S. Cls.: 100, 101 and 102**

**United States Patent and Trademark Office**

**Reg. No. 3,503,635**

**Registered Sep. 23, 2008**

**SERVICE MARK  
PRINCIPAL REGISTER**



COLORFUL ARTS SOCIETY, INC. (GEORGIA CORPORATION)  
P.O. BOX 142863  
FAYETTEVILLE, GA 30214

FIRST USE 11-1-2001; IN COMMERCE 11-1-2001.

FOR: PROMOTING PUBLIC AWARENESS OF THE NEED FOR ART APPRECIATION AND INVOLVEMENT IN THE ARTS, IN CLASS 35 (U.S. CLS. 100, 101 AND 102).

SER. NO. 77-168,524, FILED 4-29-2007.

MARY CRAWFORD, EXAMINING ATTORNEY

**Int. Cl.: 9**

**Prior U.S. Cls.: 21, 23, 26, 36 and 38**

**Reg. No. 3,503,636**

**United States Patent and Trademark Office**

**Registered Sep. 23, 2008**

**TRADEMARK  
PRINCIPAL REGISTER**



WINDY CITY WIRE CABLE AND TECHNOLOGY PRODUCTS, LLC (DELAWARE LIMITED LIABILITY COMPANY)

386 INTERNATIONALE DRIVE  
BOLINGBROOK, IL 60440

FOR: ELECTRICAL WIRE AND CABLE, IN CLASS 9 (U.S. CLS. 21, 23, 26, 36 AND 38).

FIRST USE 0-0-1996; IN COMMERCE 0-0-1996.

OWNER OF U.S. REG. NO. 2,509,204.

NO CLAIM IS MADE TO THE EXCLUSIVE RIGHT TO USE "WIRE", APART FROM THE MARK AS SHOWN.

THE MARK CONSISTS OF A LINE FORMING A CITYSCAPE IN ASSOCIATION WITH THE WORDS "WINDY CITY WIRE."

SEC. 2(F) AS TO WINDY CITY.

SER. NO. 77-169,418, FILED 4-30-2007.

HEATHER THOMPSON, EXAMINING ATTORNEY



**Int. Cl.: 36**

**Prior U.S. Cls.: 100, 101 and 102**

**United States Patent and Trademark Office**

**Reg. No. 3,503,637**

**Registered Sep. 23, 2008**

**SERVICE MARK  
PRINCIPAL REGISTER**



ACCORD FINANCIAL, INC. (DELAWARE CORPORATION)  
SUITE 102  
25 WOODS LAKE ROAD, P.O. BOX 6704  
GREENVILLE, SC 29606

FIRST USE 12-31-1992; IN COMMERCE 8-30-2002.

NO CLAIM IS MADE TO THE EXCLUSIVE RIGHT TO USE "FINANCIAL, INC.", APART FROM THE MARK AS SHOWN.

FOR: COMMERCIAL LENDING SERVICES TO PROVIDE WORKING CAPITAL FINANCING, NAMELY, FACTORING, ASSET-BASED LOANS, ACCOUNTS RECEIVABLE PURCHASES AND MANAGEMENT, INVENTORY LOANS, TERM LOANS, EQUIPMENT LOANS AND INTERIM REAL ESTATE LOANS; THE PRECEDING SERVICES SPECIFICALLY EXCLUDING ELECTRONIC PROCESSING OF FOREIGN FINANCIAL EXCHANGE AND MONEY MARKET TRADING TRANSACTIONS, AND ELECTRONIC MESSAGE TRANSMISSION OF FINANCIAL INFORMATION, IN CLASS 36 (U.S. CLS. 100, 101 AND 102).

THE MARK CONSISTS OF THE WORDS "ACCORD FINANCIAL, INC." IN ALL CAPITAL LETTERS AND STYLIZED SCRIPT, WITH THE LETTER "A" FORMED FROM AN INVERTED, NON-SYMMETRICAL "V" WITH THREE SLASH MARKS CROSSING THE RIGHT SIDE.

SER. NO. 77-169,640, FILED 5-1-2007.

ANDREA SAUNDERS, EXAMINING ATTORNEY

**Int. Cl.: 36**

**Prior U.S. Cls.: 100, 101 and 102**

**United States Patent and Trademark Office**

**Reg. No. 3,503,638**

**Registered Sep. 23, 2008**

**SERVICE MARK  
PRINCIPAL REGISTER**

**ACCORD FINANCIAL, INC.**

ACCORD FINANCIAL, INC. (DELAWARE CORPORATION)  
SUITE 102  
25 WOODS LAKE ROAD, P.O. BOX 6704  
GREENVILLE, SC 29606

FOR: COMMERCIAL LENDING SERVICES TO PROVIDE WORKING CAPITAL FINANCING, NAMELY, FACTORING, ASSET-BASED LOANS, ACCOUNTS RECEIVABLE PURCHASES AND MANAGEMENT, INVENTORY LOANS, TERM LOANS, EQUIPMENT LOANS AND INTERIM REAL ESTATE LOANS; THE PRECEDING SERVICES SPECIFICALLY EXCLUDING ELECTRONIC PROCESSING OF FOREIGN FINANCIAL EXCHANGE AND MONEY MARKET TRADING TRANSACTIONS, AND ELECTRONIC MESSAGE TRANSMISSION

OF FINANCIAL INFORMATION, IN CLASS 36 (U.S. CLS. 100, 101 AND 102).

FIRST USE 12-31-1992; IN COMMERCE 8-30-2002.

THE MARK CONSISTS OF STANDARD CHARACTERS WITHOUT CLAIM TO ANY PARTICULAR FONT, STYLE, SIZE, OR COLOR.

NO CLAIM IS MADE TO THE EXCLUSIVE RIGHT TO USE "FINANCIAL, INC.", APART FROM THE MARK AS SHOWN.

SER. NO. 77-169,787, FILED 5-1-2007.

ANDREA SAUNDERS, EXAMINING ATTORNEY

**Int. Cls.: 35 and 44**

**Prior U.S. Cls.: 100, 101 and 102**

**United States Patent and Trademark Office**

**Reg. No. 3,503,639**

**Registered Sep. 23, 2008**

**SERVICE MARK  
PRINCIPAL REGISTER**

A LIFE CHANGING EXPERIENCE

ADAPTIVE MARKETING LLC (DELAWARE  
LIMITED LIABILITY COMPANY)  
20 GLOVER AVENUE  
NORWALK, CT 06850

FOR: REFERRAL SERVICES TO CONSUMERS IN  
THE AREA OF PLASTIC SURGERY, COSMETIC  
DENTISTRY, HAIR RESTORATION, LASER HAIR  
REMOVAL, MED SPA THERAPIES, ANTI-AGING  
AND SKINCARE, VIA A GLOBAL COMPUTER  
NETWORK, IN CLASS 35 (U.S. CLS. 100, 101 AND  
102).

FIRST USE 10-23-2006; IN COMMERCE 10-23-2006.

FOR: IMAGE-ENHANCEMENT CONSULTING  
TO CONSUMERS IN THE AREA OF PLASTIC

SURGERY, COSMETIC DENTISTRY, HAIR RE-  
STORATION, LASER HAIR REMOVAL, MED SPA  
THERAPIES, ANTI-AGING AND SKINCARE, VIA A  
GLOBAL COMPUTER NETWORK, IN CLASS 44  
(U.S. CLS. 100 AND 101).

FIRST USE 10-23-2006; IN COMMERCE 10-23-2006.

THE MARK CONSISTS OF STANDARD CHAR-  
ACTERS WITHOUT CLAIM TO ANY PARTICULAR  
FONT, STYLE, SIZE, OR COLOR.

SER. NO. 77-169,795, FILED 5-1-2007.

ESTHER A. BORSUK, EXAMINING ATTORNEY

**Int. Cl.: 36**

**Prior U.S. Cls.: 100, 101 and 102**

**United States Patent and Trademark Office**

**Reg. No. 3,503,640**

**Registered Sep. 23, 2008**

**SERVICE MARK  
PRINCIPAL REGISTER**

**ACCORD FINANCIAL**

ACCORD FINANCIAL, INC. (DELAWARE CORPORATION)  
SUITE 102  
25 WOODS LAKE ROAD, P.O. BOX 6704  
GREENVILLE, SC 29606

FOR: COMMERCIAL LENDING SERVICES TO PROVIDE WORKING CAPITAL FINANCING, NAMELY, FACTORING, ASSET-BASED LOANS, ACCOUNTS RECEIVABLE PURCHASES AND MANAGEMENT, INVENTORY LOANS, TERM LOANS, EQUIPMENT LOANS AND INTERIM REAL ESTATE LOANS; THE PRECEDING SERVICES SPECIFICALLY EXCLUDING ELECTRONIC PROCESSING OF FOREIGN FINANCIAL EXCHANGE AND MONEY MARKET TRADING TRANSACTIONS, AND ELECTRONIC MESSAGE TRANSMISSION

OF FINANCIAL INFORMATION, IN CLASS 36 (U.S. CLS. 100, 101 AND 102).

FIRST USE 12-31-1992; IN COMMERCE 8-30-2002.

THE MARK CONSISTS OF STANDARD CHARACTERS WITHOUT CLAIM TO ANY PARTICULAR FONT, STYLE, SIZE, OR COLOR.

NO CLAIM IS MADE TO THE EXCLUSIVE RIGHT TO USE "FINANCIAL", APART FROM THE MARK AS SHOWN.

SER. NO. 77-170,065, FILED 5-1-2007.

ANDREA SAUNDERS, EXAMINING ATTORNEY

Int. Cl.: 29

Prior U.S. Cl.: 46

United States Patent and Trademark Office

Reg. No. 3,503,641

Registered Sep. 23, 2008

TRADEMARK  
PRINCIPAL REGISTER



BOWERS, HAROLD W. (UNITED STATES INDIVIDUAL)

24781 SH 35 S.

PALACIOS, TX 77465

FOR: SHELLFISH; SHRIMP, IN CLASS 29 (U.S. CL. 46).

FIRST USE 1-2-1995; IN COMMERCE 1-2-1995.

NO CLAIM IS MADE TO THE EXCLUSIVE RIGHT TO USE "SHRIMP", APART FROM THE MARK AS SHOWN.

THE MARK CONSISTS OF AN IMAGE OF A SHRIMP (FARMER) USED TO REPRESENT AND IDENTIFY BOWERS FARM RAISED SHRIMP.

SER. NO. 77-170,250, FILED 5-1-2007.

DAVID I, EXAMINING ATTORNEY

**Int. Cl.: 41**

**Prior U.S. Cls.: 100, 101 and 107**

**United States Patent and Trademark Office**

**Reg. No. 3,503,642**

**Registered Sep. 23, 2008**

**SERVICE MARK  
PRINCIPAL REGISTER**

**WHO'S HOOMAN**

HOOMAN KHALILI (UNITED STATES INDIVIDUAL)  
1395 GOLDEN GATE AVENUE, #407  
SAN FRANCISCO, CA 94115

THE MARK CONSISTS OF STANDARD CHARACTERS WITHOUT CLAIM TO ANY PARTICULAR FONT, STYLE, SIZE, OR COLOR.

FOR: PERFORMANCES BY A COMEDIAN, NAMELY, COMEDY SKITS INVOLVING HUMOROUS INTERVIEWS, IN CLASS 41 (U.S. CLS. 100, 101 AND 107).

SER. NO. 77-172,566, FILED 5-3-2007.

FIRST USE 1-17-2005; IN COMMERCE 1-17-2005.

MARK SPARACINO, EXAMINING ATTORNEY

**Int. Cl.: 39**

**Prior U.S. Cls.: 100 and 105**

**United States Patent and Trademark Office**

**Reg. No. 3,503,643**

**Registered Sep. 23, 2008**

**SERVICE MARK  
PRINCIPAL REGISTER**

**EASYBIZ**

ALASKA AIRLINES, INC. (ALASKA CORPORATION)  
19300 INTERNATIONAL BOULEVARD  
SEATTLE, WA 98188

FOR: TRAVEL INFORMATION SERVICES; PROVIDING AN ONLINE COMPUTER DATABASE IN THE FIELD OF TRAVEL INFORMATION SERVICES; PROVIDING AN INTERACTIVE WEBSITE CONTAINING TRAVEL INFORMATION, NAMELY, AIRLINE FLIGHT SCHEDULES, RESERVATIONS, BOOKINGS, AND AIRLINE FLIGHT STATUS, IN CLASS 39 (U.S. CLS. 100 AND 105).

FIRST USE 1-30-2000; IN COMMERCE 1-30-2000.

THE MARK CONSISTS OF STANDARD CHARACTERS WITHOUT CLAIM TO ANY PARTICULAR FONT, STYLE, SIZE, OR COLOR.

SER. NO. 77-173,575, FILED 5-4-2007.

KELLEY WELLS, EXAMINING ATTORNEY

**Int. Cl.: 9**

**Prior U.S. Cls.: 21, 23, 26, 36 and 38**

**Reg. No. 3,503,644**

**United States Patent and Trademark Office**

**Registered Sep. 23, 2008**

---

**TRADEMARK  
PRINCIPAL REGISTER**

**SUNS**

SUNS INTERNATIONAL, LLC (DELAWARE  
LIMITED LIABILITY COMPANY)  
34 CALVIN STREET  
LEXINGTON, MA 02420

FOR: FOOT SWITCHES, NAMELY, FOOT OPER-  
ATED ELECTRIC SWITCHES FOR INDUSTRIAL  
AUTOMATION AND CONTROL, IN CLASS 9 (U.S.  
CLS. 21, 23, 26, 36 AND 38).

FIRST USE 10-1-1997; IN COMMERCE 10-1-1998.

THE MARK CONSISTS OF STANDARD CHAR-  
ACTERS WITHOUT CLAIM TO ANY PARTICULAR  
FONT, STYLE, SIZE, OR COLOR.

OWNER OF U.S. REG. NOS. 2,834,294 AND  
3,255,837.

SER. NO. 77-173,890, FILED 5-6-2007.

MARCIE MILONE, EXAMINING ATTORNEY



**Int. Cl.: 12**

**Prior U.S. Cls.: 19, 21, 23, 31, 35 and 44**

**Reg. No. 3,503,645**

**United States Patent and Trademark Office**

**Registered Sep. 23, 2008**

**TRADEMARK  
PRINCIPAL REGISTER**

# EVOLUTION

VANGUARD NATIONAL TRAILER CORPORATION (DELAWARE CORPORATION)  
289 EAST WATER TOWER DR.  
MONON, IN 47959

FOR: SEMI-TRACTOR TRAILER PARTS, COMPONENTS AND ACCESSORIES, NAMELY, DOORS FOR SEMI-TRACTOR TRAILERS, FLOOR PANELS FOR SEMI-TRACTOR TRAILERS, REAR FRAMES FOR SEMI-TRACTOR TRAILERS, ROOF PANELS FOR SEMI-TRACTOR TRAILERS, EXTERIOR SIDE PANELS AND INTERIOR SIDE PANELS FOR SEMI-TRACTOR TRAILERS, BRAKING SYSTEMS FOR SEMI-TRACTOR TRAILERS AND PARTS THEREFOR, TRAILER COUPLINGS, LANDING GEAR, NAMELY, STANDS AND CRANKS FOR SEMI-TRACTOR TRAILERS, SUSPENSION SYSTEMS FOR SEMI-TRACTOR TRAILERS, UNDER

FRAMES FOR SEMI-TRACTOR TRAILERS, WHEELS AND WHEEL COMPONENTS, NAMELY, RIMS, BEARINGS AND SEALANTS, REAR VIEW MIRRORS FOR SEMI-TRACTOR TRAILERS AND MUD FLAPS FOR SEMI-TRACTOR TRAILERS, IN CLASS 12 (U.S. CLS. 19, 21, 23, 31, 35 AND 44).

FIRST USE 2-0-2006; IN COMMERCE 2-0-2006.

THE MARK CONSISTS OF STANDARD CHARACTERS WITHOUT CLAIM TO ANY PARTICULAR FONT, STYLE, SIZE, OR COLOR.

SER. NO. 77-174,127, FILED 5-7-2007.

JAY FLOWERS, EXAMINING ATTORNEY

**Int. Cls.: 9 and 41**

**Prior U.S. Cls.: 21, 23, 26, 36, 38, 100, 101 and 107**

**United States Patent and Trademark Office**

**Reg. No. 3,503,646**

**Registered Sep. 23, 2008**

**TRADEMARK  
SERVICE MARK  
PRINCIPAL REGISTER**

**FLO RIDA**

DILLARD, TRAMAR (UNITED STATES INDIVIDUAL)  
200 PARK AVENUE SUITE 1408  
C/O SEDLMAYR & ASSOCIATES, P.C.  
NEW YORK, NY 10003

FOR: SERIES OF MUSICAL SOUND RECORDINGS FEATURING HIP HOP, RAP, AND POPULAR MUSIC; MUSICAL VIDEO RECORDINGS FEATURING HIP HOP, RAP, AND POPULAR MUSIC; DOWNLOADABLE MUSICAL SOUND RECORDINGS FEATURING HIP HOP, RAP, AND POPULAR MUSIC, IN CLASS 9 (U.S. CLS. 21, 23, 26, 36 AND 38).

FIRST USE 10-0-2006; IN COMMERCE 10-0-2006.

FOR: ENTERTAINMENT SERVICES IN THE NATURE OF LIVE MUSICAL PERFORMANCES BY A RAP AND HIP HOP MUSICAL AND PER-

FORMING ARTIST; ENTERTAINMENT SERVICES, NAMELY, PROVIDING A WEB SITE FEATURING MUSICAL PERFORMANCES, MUSICAL VIDEOS, RELATED FILM CLIPS, PHOTOGRAPHS, AND OTHER MULTIMEDIA MATERIALS IN THE FIELD OF RAP, HIP HOP, AND POPULAR MUSIC, IN CLASS 41 (U.S. CLS. 100, 101 AND 107).

FIRST USE 0-0-2000; IN COMMERCE 0-0-2000.

THE MARK CONSISTS OF STANDARD CHARACTERS WITHOUT CLAIM TO ANY PARTICULAR FONT, STYLE, SIZE, OR COLOR.

SER. NO. 77-174,277, FILED 5-7-2007.

JAMES LOVELACE, EXAMINING ATTORNEY

**Int. Cl.: 10**

**Prior U.S. Cls.: 26, 39 and 44**

**United States Patent and Trademark Office**

**Reg. No. 3,503,647**

**Registered Sep. 23, 2008**

**TRADEMARK  
PRINCIPAL REGISTER**

**NEOPEEP**

MARSHALL PRODUCTS LTD (UNITED KING-  
DOM CORPORATION)  
CHARTER HOUSE  
THE SQUARE, LOWER BRISTOL ROAD  
BATH, UNITED KINGDOM BA23BH

FOR: PROTECTIVE BREATHING MASKS AND  
SHIELDS FOR SURGICAL AND MEDICAL USE;  
LARYNGEAL MASKS; LARYNGOSCOPES; NASO-  
PHARYNGEAL AIRWAYS; OROPHARYNGEAL  
AIRWAYS; TRACHEAL TUBES; TRACHEAL  
GUIDES AND INTRODUCERS; TUBES AND TUB-  
ING FOR MEDICAL PURPOSES, TUBING CON-  
NECTORS FOR MEDICAL USE; FORCEPS; PARTS  
AND FITTINGS FOR ALL THE AFORESAID  
GOODS, IN CLASS 10 (U.S. CLS. 26, 39 AND 44).

THE MARK CONSISTS OF STANDARD CHAR-  
ACTERS WITHOUT CLAIM TO ANY PARTICULAR  
FONT, STYLE, SIZE, OR COLOR.

PRIORITY CLAIMED UNDER SEC. 44(D) ON  
UNITED KINGDOM APPLICATION NO. 2441296,  
FILED 12-12-2006.

OWNER OF GREAT BRITAIN REG. NO. 2441296,  
DATED 12-12-2006, EXPIRES 12-12-2016.

SER. NO. 77-175,575, FILED 5-8-2007.

KEVON CHISOLM, EXAMINING ATTORNEY

Int. Cl.: 13

Prior U.S. Cls.: 2 and 9

United States Patent and Trademark Office

Reg. No. 3,503,648

Registered Sep. 23, 2008

TRADEMARK  
PRINCIPAL REGISTER

Webley

WEBLEY LTD. (ENGLAND CORPORATION)  
2 WINDLEY CLOSE  
6 WINDLEY MANOR  
SUTTON, COLDFIELD, ENGLAND B744JD

FOR: FIREARMS, IN CLASS 13 (U.S. CLS. 2 AND 9).

FIRST USE 1-1-1850; IN COMMERCE 1-1-1850.

THE MARK CONSISTS OF STANDARD CHARACTERS WITHOUT CLAIM TO ANY PARTICULAR FONT, STYLE, SIZE, OR COLOR.

OWNER OF ENGLAND REG. NO. UK394799, DATED 3-8-1919, EXPIRES 3-9-2013.

SEC. 2(F).

SER. NO. 77-176,367, FILED 5-9-2007.

PRISCILLA MILTON, EXAMINING ATTORNEY

**Int. Cl.: 9**

**Prior U.S. Cls.: 21, 23, 26, 36 and 38**

**Reg. No. 3,503,649**

**United States Patent and Trademark Office**

**Registered Sep. 23, 2008**

**TRADEMARK  
PRINCIPAL REGISTER**

**INTELLIGENTINSITES**

INTELLIGENT INSITES, INC. (NORTH DAKOTA CORPORATION)  
SUITE 100  
1120 COLLEGE DRIVE  
BISMARCK, ND 58501

FOR: REAL-TIME WIRELESS MONITORING AND COMMUNICATION SYSTEM COMPRISED PRIMARILY OF LOCATION-SENSING HARDWARE, NAMELY, TAGS, TRANSMITTERS, RECEIVERS, AND MOTION DETECTORS UTILIZING RADIO FREQUENCY IDENTIFICATION (RFID), INFRARED, ULTRA-WIDEBAND (UWB), ULTRASOUND (US), AND/OR WI-FI TECHNOLOGIES FOR USE IN THE FIELD OF HEALTH INFORMATION MANAGEMENT (HIM) AND ALSO CONTAINING NON-DOWNLOADABLE COMPUTER SOFTWARE FOR USE IN PATIENT FLOW, ASSET MANAGEMENT, INVENTORY MANAGEMENT, SKILLED NURSING HOME MANAGEMENT, ASSISTED LIVING COMMUNITY MANAGEMENT, NURSE CALL,

WANDER PREVENTION, SECURITY AND ACCESS CONTROL, STAFF DURESS, PATIENT AND STAFF LOCATING, WORKFLOW AUTOMATION AND HEALTHCARE OPERATIONS MANAGEMENT IN THE FIELD OF HEALTH INFORMATION MANAGEMENT (HIM) ACCESSED THROUGH AN ONLINE WEB PORTAL OR A PERSONAL DIGITAL ASSISTANT (PDA) AS PART OF THE SYSTEM, IN CLASS 9 (U.S. CLS. 21, 23, 26, 36 AND 38).

FIRST USE 5-1-2007; IN COMMERCE 5-1-2007.

THE MARK CONSISTS OF STANDARD CHARACTERS WITHOUT CLAIM TO ANY PARTICULAR FONT, STYLE, SIZE, OR COLOR.

SER. NO. 77-177,248, FILED 5-10-2007.

SETH A. RAPPAPORT, EXAMINING ATTORNEY

**Int. Cl.: 41**

**Prior U.S. Cls.: 100, 101 and 107**

**United States Patent and Trademark Office**

**Reg. No. 3,503,650**

**Registered Sep. 23, 2008**

**SERVICE MARK  
PRINCIPAL REGISTER**



POINT PARK UNIVERSITY (PENNSYLVANIA  
NON-PROFIT CORPORATION)  
201 WOOD STREET  
PITTSBURGH, PA 15222

FOR: ENTERTAINMENT IN THE NATURE OF  
ON-GOING ON-CAMPUS TELEVISION PRO-  
GRAMS IN THE FIELD OF NEWS AND GENERAL  
INTEREST, IN CLASS 41 (U.S. CLS. 100, 101 AND 107).

FIRST USE 2-1-2007; IN COMMERCE 2-1-2007.

THE MARK CONSISTS OF A FILLED OVAL IN  
THE BACKGROUND; THE FILLED OVAL IS EN-

CIRCLED FURTHER BY A FIRST OVAL BORDER;  
THE FIRST OVAL BORDER IS FURTHER ENCIR-  
CLED BY A SECOND OVAL BORDER; AND, THE  
STYLIZED "U-VIEW" LETTERING IS SHOWN IN  
THE FOREGROUND AND CUTS THROUGH -  
ALONG THE HORIZONTAL AXIS - A CENTER  
PORTION OF THE FILLED OVAL, THE FIRST  
OVAL BORDER, AND THE SECOND OVAL BOR-  
DER.

SER. NO. 77-177,383, FILED 5-10-2007.

BONNIE LUKEN, EXAMINING ATTORNEY

Int. Cl.: 30

Prior U.S. Cl.: 46

United States Patent and Trademark Office

Reg. No. 3,503,651

Registered Sep. 23, 2008

TRADEMARK  
PRINCIPAL REGISTER



ADMINISTRADORA DE MARCAS, LICENCIAS  
Y DISEÑOS, S.A. DE C.V. (MEXICO COR-  
PORATION)  
COLONIA MEZQUITAN COUNTRY  
PRIVADA SINALOA #1569 A  
GUADALAJARA, JALISCO, MEXICO C.P.44206

FOR: CANDY, CANDY, NAMELY, MARZIPAN,  
CHOCOLATES, CHEWING GUM, IN CLASS 30 (U.S.  
CL. 46).

FIRST USE 0-0-2002; IN COMMERCE 0-0-2002.

OWNER OF U.S. REG. NOS. 1,902,902, 2,775,810  
AND OTHERS.

NO CLAIM IS MADE TO THE EXCLUSIVE  
RIGHT TO USE "PINATA MIX," "JUMBO," AND "  
SAL Y CHILE", APART FROM THE MARK AS  
SHOWN.

THE COLOR(S) RED, YELLOW, PURPLE, WHITE,  
BLUE, GREEN, BROWN, TAN AND PINK IS/ARE  
CLAIMED AS A FEATURE OF THE MARK.

THE MARK CONSIST OF THE APPEARANCE  
AND DESIGN OF THE PRODUCT PACKAGING,  
NAMELY, A RED BACKGROUND WITH PURPLE  
PIÑATAS ON IT; A YELLOW SQUARE OUTLINED  
IN RED CONTAINING THE WORDS "DE LA ROSA"  
IN RED STYLIZED LETTERS UNDERNEATH A  
RED ROSE WITH GREEN LEAVES, A YELLOW  
BACKGROUND AND OUTLINED IN RED; THE

WORD "PIÑATA" IN YELLOW STYLIZED LETTERS  
WHICH ARE OUTLINED IN PURPLE, THEN  
WHITE, THEN PINK; THE WORD "MIX" IS DI-  
RECTLY BELOW "PIÑATA" AND IS IN RED STY-  
LIZED LETTERS WHICH ARE OUTLINED IN  
WHITE, THEN PURPLE; THE ENTIRE WORDING  
"PIÑATA MIX" IS OUTLINED IN BLUE; UNDER-  
NEATH AND BELOW THE WORDING "PIÑATA  
MIX" ARE THE IMAGES OF VARIOUS WRAPPED  
CANDIES, LOLLIPOPS IN GREEN, PURPLE AND  
PINK WRAPPERS WITH THE WORDING "MINI  
JUMBO"; PULPARINDO CANDIES WITH BROWN  
LETTERING OUTLINED IN RED AND THE WRAP-  
PER IN YELLOW, BROWN AND GREEN WITH THE  
WORDS "SAL Y CHILE" IN RED LETTERING OUT-  
LINED IN WHITE AND RED; MILKARAMEL CAN-  
DIES IN BLACK LETTERING IN TAN WRAPPER;  
MEGAGUM CANDIES WITH YELLOW AND  
GREEN LETTERING IN RED WRAPPER; VARIOUS  
CANDIES IN WRAPPERS OF RED, GREEN, AND  
YELLOW THAT APPEAR TO BE BURSTING OUT  
OF THE PACKAGING.

THERE IS NO TRANSLATION OF THE WORDS  
"PINATA" AND "PULPARINDO". THE TRANSLA-  
TION OF "DULCE DE TAMARINDO" IS "TAMAR-  
IND CANDY" AND THE TRANSLATION OF "SAL Y  
CHILE" IS "SALT" AND "CHILE".

SER. NO. 77-178,119, FILED 5-10-2007.

AMY HELLA, EXAMINING ATTORNEY

**Int. Cls.: 35 and 41**

**Prior U.S. Cls.: 100, 101, 102 and 107**

**United States Patent and Trademark Office**

**Reg. No. 3,503,652**

**Registered Sep. 23, 2008**

**SERVICE MARK  
PRINCIPAL REGISTER**

# Foodpreneur

PSARAKIS, ESTHER LUONGO (UNITED STATES INDIVIDUAL)  
50 CLAIRE DRIVE  
BRIDGEWATER, NJ 08807

FOR: MARKETING CONSULTING AND PUBLIC RELATIONS IN THE FIELD OF SPECIALTY/NATURAL/FOOD COMPANY MANAGEMENT AND DEVELOPMENT, IN CLASS 35 (U.S. CLS. 100, 101 AND 102).

FIRST USE 4-29-2007; IN COMMERCE 4-29-2007.

FOR: ARRANGING OF EXHIBITIONS, SEMINARS AND CONFERENCES; CONDUCTING WORKSHOPS AND SEMINARS IN SMALL BUSINESS SPECIALTY/GOURMET FOOD COMPANY DEVELOPMENT/MANAGEMENT; EDUCATION SERVICES, NAMELY, PROVIDING LIVE AND ON-LINE SEMINARS, WORKSHOPS, TRAINING CLASSES IN THE FIELD OF SPECIALTY/NATURAL/FOOD COMPANY MANAGEMENT AND DEVELOPMENT; EDUCATION SERVICES, NAMELY PROVIDING SEMINARS, WORKSHOPS, TRAINING CLASSES IN THE FIELD OF FOOD COMPANY DEVELOPMENT AND MANAGEMENT; EDUCATION SERVICES, NAMELY, CONDUCTING SEMINARS, WORKSHOPS, TRAINING CLASSES IN THE FIELD OF FOOD COMPANY DEVELOPMENT AND MANAGEMENT AND DISTRIBUTION OF COURSE MATERIAL IN CONNECTION THEREWITH; EDU-

CATIONAL SERVICES, NAMELY, CONDUCTING SEMINARS, WORKSHOPS, TRAINING CLASSES IN THE FIELD OF FOOD COMPANY DEVELOPMENT AND SUPPORT, ALONG WITH THE DISTRIBUTION OF APPROPRIATE COURSE MATERIALS IN CONNECTION THEREWITH; MEETING AND SEMINAR ARRANGING; PROVIDING ON-LINE TRAINING SEMINARS, WORKSHOPS, TRAINING CLASSES IN THE FIELD OF FOOD COMPANY DEVELOPMENT AND MANAGEMENT; WORKSHOPS AND SEMINARS IN THE FIELD OF SPECIALTY AND GOURMET FOOD COMPANY ENTREPRENEURSHIP; PUBLICATION OF MANUALS AND BROCHURES FOR USE AS RESOURCE MATERIALS IN THE FIELD OF SPECIALTY/NATURAL/FOOD COMPANY MANAGEMENT AND DEVELOPMENT, IN CLASS 41 (U.S. CLS. 100, 101 AND 107).

FIRST USE 7-15-2006; IN COMMERCE 4-29-2007.

THE MARK CONSISTS OF STANDARD CHARACTERS WITHOUT CLAIM TO ANY PARTICULAR FONT, STYLE, SIZE, OR COLOR.

SER. NO. 77-178,398, FILED 5-11-2007.

VIVIAN MICZNIK FIRST, EXAMINING ATTORNEY



**Int. Cl.: 25**

**Prior U.S. Cls.: 22 and 39**

**United States Patent and Trademark Office**

**Reg. No. 3,503,653**

**Registered Sep. 23, 2008**

**TRADEMARK  
PRINCIPAL REGISTER**

**RIMBA**

RIMBA BV (NETHERLANDS CORPORATION)

POTTENBAKKERSTRAAT 14

ETTEN-LEUR 4871 EP, NETHERLANDS

FOR: CORSETS; HOODS; LEATHER BELTS;  
PARTS OF CLOTHING, NAMELY, GUSSETS FOR  
TIGHTS, GUSSETS FOR STOCKINGS, GUSSETS  
FOR BATHING SUITS, GUSSETS FOR UNDER-  
WEAR, GUSSETS FOR LEOTARDS AND GUSSETS  
FOR FOOTLETS; TOPS, IN CLASS 25 (U.S. CLS. 22  
AND 39).

THE MARK CONSISTS OF STANDARD CHAR-  
ACTERS WITHOUT CLAIM TO ANY PARTICULAR  
FONT, STYLE, SIZE, OR COLOR.

OWNER OF NETHERLANDS REG. NO. 426296,  
DATED 11-12-1976, EXPIRES 11-12-2016.

THE ENGLISH TRANSLATION, FROM THE MA-  
LAY LANGUAGE, OF "RIMBA" IN THE MARK IS  
FOREST OR JUNGLE.

SER. NO. 77-178,477, FILED 5-11-2007.

MARK SPARACINO, EXAMINING ATTORNEY

**Int. Cls.: 8, 20 and 21**

**Prior U.S. Cls.: 2, 13, 22, 23, 25, 28, 29, 30, 32, 33, 40,  
44 and 50**

**Reg. No. 3,503,654**

**United States Patent and Trademark Office**

**Registered Sep. 23, 2008**

**TRADEMARK  
PRINCIPAL REGISTER**

**SCANWOOD**

MÖLLER, JENS PETER (DENMARK INDIVIDUAL)  
RYTTERVEJEN 13  
ODENSE NØ, DENMARK 5240

FOR: CUTLERY AND SILVER-PLATED CUTLERY, NAMELY, KNIVES, FORKS AND SPOONS; TABLE FORKS; NUTCRACKERS, NOT OF PRECIOUS METAL; SCISSORS; AND BUTTER KNIVES, IN CLASS 8 (U.S. CLS. 23, 28 AND 44).

FOR: SALE DISPLAY STANDS FOR HOLDING KITCHEN IMPLEMENTS, NAMELY, STIRRING SPOONS, PASTRY SPATULAS, WHISKS AND WOODEN FORKS; AND FLOWER POT PEDESTALS, IN CLASS 20 (U.S. CLS. 2, 13, 22, 25, 32 AND 50).

FOR: CONTAINERS FOR HOUSEHOLD OR KITCHEN USE NOT OF PRECIOUS METAL; GRILL BRUSHES, NAMELY, BRUSHES FOR BASTING MEAT ON GRILLS; SPAGHETTI SERVING FORKS; CONDIMENT GRINDERS, NAMELY, PEPPER AND SALT SHAKERS AND PEPPER AND SALT MILLS; TRIVETS; JELLY JAR STANDS; CANDLE HOLDERS; WOODEN PAPER-ROLL HOLDERS AND PORCELAIN PAPER-ROLL HOLDERS, NAMELY, DISPENSERS FOR PAPER TOWELS; HONEY SERVING SPOONS; HOUSEHOLD AND KITCHEN UTENSILS AND IMPLEMENTS, NAMELY, MIXING SPOONS, STIRRING SPOONS AND SPATULAS, MADE OF WOOD OR PORCELAIN, HAND-HELD TOOLS AND BAKING IMPLEMENTS, NAMELY, ROLLING PINS AND CUTTING BOARDS, AND BAKING MOULDS, NAMELY, CAKE MOULDS, PASTRY MOULDS AND CONFECTIONERS'

MOULDS; FEEDING TROUGHS, FEEDING BOWLS AND TROUGHS FOR LIVESTOCK; WOODEN BIRD CAGES FOR DOMESTIC ANIMALS; FLOWER POTS, FLOWER URNS, AND FLOWER BOXES FOR PLANTING, NAMELY, WOODEN PLANTERS AND PORCELAIN PLANTERS; PANS; BREAD BOXES; COOKING POT SETS; SAUCEPANS; CAULDRONS; SALT AND PEPPER POTS, NOT OF PRECIOUS METAL; WHISKS, OTHER THAN ELECTRIC, FOR HOUSEHOLD PURPOSES; POT LIDS; TART SCOOPS; DRINKING TROUGHS; DRINKING VESSELS; BIRD BATHS; NON-ELECTRIC KETTLES; SUPER BOWLS, NAMELY, BAMBOO SERVING BOWLS; VASES, NOT OF PRECIOUS METALS; DISHES AND FRUIT BOWLS, NOT OF METAL; COOKERY MOULDS, IN CLASS 21 (U.S. CLS. 2, 13, 23, 29, 30, 33, 40 AND 50).

THE MARK CONSISTS OF STANDARD CHARACTERS WITHOUT CLAIM TO ANY PARTICULAR FONT, STYLE, SIZE, OR COLOR.

PRIORITY CLAIMED UNDER SEC. 44(D) ON ERPN CMNTY TM OFC APPLICATION NO. 005493821, FILED 11-14-2006, REG. NO. 005493821, DATED 9-14-2007, EXPIRES 11-14-2016.

PRIORITY CLAIMED UNDER SEC. 44(D) ON ERPN CMNTY TM OFC APPLICATION NO. 005493821, FILED 11-14-2006.

SER. NO. 77-178,695, FILED 5-11-2007.

TANYA AMOS, EXAMINING ATTORNEY

**Int. Cl.: 9**

**Prior U.S. Cls.: 21, 23, 26, 36 and 38**

**United States Patent and Trademark Office**

**Reg. No. 3,503,655**

**Registered Sep. 23, 2008**

**TRADEMARK  
PRINCIPAL REGISTER**

**1-800-PREPARE**

FAUST, PAUL (UNITED STATES INDIVIDUAL)  
44 LOOMIS DRIVE  
BALDWIN PLACE, NY 10505

FIRST USE 5-11-2007; IN COMMERCE 5-11-2007.

FOR: A KIT FOR EMERGENCY SITUATIONS  
CONSISTING OF FIRST AID AND HYGIENE PRO-  
DUCTS, NAMELY, EMERGENCY WARNING  
LIGHTS, DIRECTIONAL COMPASS, WOOLEN  
BLANKETS, FACIAL TISSUES, AND DISPOSABLE  
WIPES NOT IMPREGNATED WITH CHEMICALS  
OR COMPOUNDS, IN CLASS 9 (U.S. CLS. 21, 23, 26, 36  
AND 38).

THE MARK CONSISTS OF STANDARD CHAR-  
ACTERS WITHOUT CLAIM TO ANY PARTICULAR  
FONT, STYLE, SIZE, OR COLOR.

SER. NO. 77-179,104, FILED 5-11-2007.

TOBY BULLOFF, EXAMINING ATTORNEY

**Int. Cls.: 35 and 42**

**Prior U.S. Cls.: 100, 101 and 102**

**United States Patent and Trademark Office**

**Reg. No. 3,503,656**

**Registered Sep. 23, 2008**

**SERVICE MARK  
PRINCIPAL REGISTER**

**MERINCORE**

MERINCORE, INC. (D.C. CORPORATION)  
SUITE 300  
1814 TAYLOR STREET NE  
WASHINGTON, DC 20018

FOR: BUSINESS ORGANIZATION AND MANAGEMENT CONSULTING SERVICES, NAMELY, PROVIDING BUSINESS MANAGEMENT AND ADVICE IN THE FIELDS OF BUSINESS MANAGEMENT, STRATEGIC PLANNING, ORGANIZATIONAL TRANSFORMATION; IMPLEMENTATION OF SPECIALIZED MANAGEMENT PROCESS; BUSINESS PROCESS IMPROVEMENT; BALANCED SCORECARD REPORTING; INDEPENDENT VERIFICATION AND VALIDATION (IV AND V) OF BUSINESS PROCESSES; AND PROGRAM AND PROJECT MANAGEMENT, NAMELY, RISK MANAGEMENT, CHANGE MANAGEMENT, PROGRAM MANAGEMENT AND PROJECT MANAGEMENT, IN CLASS 35 (U.S. CLS. 100, 101 AND 102).

FIRST USE 1-9-2007; IN COMMERCE 5-7-2007.

FOR: INFORMATION TECHNOLOGY SERVICES IN THE FIELD OF NETWORK ENGINEERING, NAMELY, NETWORK MANAGEMENT AND ADMINISTRATION, ASSET, INFRASTRUCTURE AND CONFIGURATION MANAGEMENT, PERFOR-

MANCE MANAGEMENT AND REPORTING, TECHNOLOGY AND REFRESHMENT SERVICES, CONTINGENCY PLANNING SERVICES, INFORMATION SECURITY SERVICES; HELP DESK/CALL CENTER AND END-USER TECHNICAL SUPPORT, NAMELY, DESK SIDE SUPPORT; AND SYSTEMS ENGINEERING SERVICES IN THE FIELD OF COMPUTER SYSTEMS, NAMELY, REQUIREMENTS ANALYSIS, FACILITIES MANAGEMENT, SYSTEMS ANALYSIS AND DESIGN, SYSTEM INSTALLATION, TESTING AND DEPLOYMENT, APPLICATION DEVELOPMENT, CONTENT AND KNOWLEDGE MANAGEMENT, AND SYSTEMS ACQUISITION MANAGEMENT; INDEPENDENT VERIFICATION AND VALIDATION IN THE FIELD OF COMPUTER SYSTEM DEVELOPMENT, IN CLASS 42 (U.S. CLS. 100 AND 101).

FIRST USE 1-9-2007; IN COMMERCE 5-7-2007.

THE MARK CONSISTS OF STANDARD CHARACTERS WITHOUT CLAIM TO ANY PARTICULAR FONT, STYLE, SIZE, OR COLOR.

SER. NO. 77-179,760, FILED 5-14-2007.

ANNE MADDEN, EXAMINING ATTORNEY

**Int. Cls.: 35, 36, 42 and 45**

**Prior U.S. Cls.: 100, 101 and 102**

**United States Patent and Trademark Office**

**Reg. No. 3,503,657**

**Registered Sep. 23, 2008**

**SERVICE MARK  
PRINCIPAL REGISTER**



CALIFORNIA CAPITAL INSURANCE COMPANY  
(CALIFORNIA CORPORATION)  
2300 GARDEN ROAD  
MONTEREY, CA 93940

FOR: ADMINISTRATION OF A CONSUMER DISCOUNT PROGRAM FOR ENABLING MEMBERS TO OBTAIN COMPLIMENTARY OR DISCOUNTED GOODS AND SERVICES FROM PARTICIPATING THIRD PARTY PROVIDERS; PROVIDING LINKS TO WEB SITES OF OTHERS FEATURING GOODS AND SERVICES IN THE FIELDS OF COMPUTER DISASTER RECOVERY AND DATA RECOVERY; PROVIDING LINKS TO WEB SITES OF OTHERS FEATURING PRODUCTS AND SERVICES IN THE FIELD OF EMERGENCY PREPAREDNESS, DATA THEFT AND IDENTITY THEFT, CHILD SAFETY, HOME SAFETY, FIREPLACE SAFETY, ACCIDENT PREVENTION, AUTO THEFT PREVENTION, DRIVING SAFETY, FIRE SAFETY, EMERGENCY NOTIFICATION AND RECOVERY; PROVIDING LINKS TO WEB SITES OF OTHERS FEATURING GOODS AND SERVICES IN THE LEGAL FIELD, IN CLASS 35 (U.S. CLS. 100, 101 AND 102).

FIRST USE 1-26-2007; IN COMMERCE 3-26-2007.

FOR: PROVIDING INFORMATION IN THE FIELD OF INSURANCE MATTERS, IN CLASS 36 (U.S. CLS. 100, 101 AND 102).

FIRST USE 1-26-2007; IN COMMERCE 3-1-2007.

FOR: PROVIDING INFORMATION IN THE FIELD OF DATA RECOVERY AND COMPUTER DISASTER RECOVERY PLANNING, IN CLASS 42 (U.S. CLS. 100 AND 101).

FIRST USE 1-26-2007; IN COMMERCE 3-26-2007.

FOR: PROVIDING INFORMATION IN THE FIELD OF EMERGENCY PREPAREDNESS, DATA THEFT AND IDENTITY THEFT, CHILD SAFETY, HOME SAFETY, FIREPLACE SAFETY, ACCIDENT PREVENTION, AUTO THEFT PREVENTION, DRIVING SAFETY, FIRE SAFETY, EMERGENCY NOTIFICATION AND RECOVERY, AND OTHER SAFETY AND SECURITY GOODS AND SERVICES; PROVIDING INFORMATION IN THE FIELD OF LEGAL SERVICE MATTERS, IN CLASS 45 (U.S. CLS. 100 AND 101).

FIRST USE 1-26-2007; IN COMMERCE 3-26-2007.

NO CLAIM IS MADE TO THE EXCLUSIVE RIGHT TO USE "NETWORK", APART FROM THE MARK AS SHOWN.

THE MARK CONSISTS OF DESIGN OF AN EAGLE WITH WINGS SPREAD OVER THE WORDS "THE PROTECTOR NETWORK".

SER. NO. 77-180,026, FILED 5-14-2007.

JOHN HWANG, EXAMINING ATTORNEY

**Int. Cl.: 36**

**Prior U.S. Cls.: 100, 101 and 102**

**United States Patent and Trademark Office**

**Reg. No. 3,503,658**

**Registered Sep. 23, 2008**

**SERVICE MARK  
PRINCIPAL REGISTER**

# NTS CAPITAL

ABN AMRO MANAGEMENT SERVICES LIMITED (UNITED KINGDOM PRIVATE LIMITED COMPANY)  
250 BISHOPSGATE  
LONDON, EC2M 4AA, UNITED KINGDOM

FOR: BANKING SERVICES; HEDGE FUND INVESTMENT SERVICES, PRIVATE PLACEMENTS OF HEDGE FUNDS, PRIVATE EQUITY FUNDS, SECURITIES AND DERIVATIVES FOR OTHERS, PRIVATE EQUITY FUNDS INVESTMENT SERVICES, MANAGEMENT OF PRIVATE EQUITY FUNDS, PUBLIC EQUITY INVESTMENT MANAGEMENT, FINANCIAL PLANNING CONSULTATION, INVESTMENT AND ADVISORY SERVICES, RETIREMENT PLANNING; REAL ESTATE AFFAIRS, NAMELY, MORTGAGE PLANNING AND ESTATE PLANNING; INSURANCE ADMINISTRATION AND CONSULTANCY; INVESTMENT BANKING SERVICES; SECURITY, STOCK AND BOND BROKERAGE SERVICES; CAPITAL AND FUND INVESTMENT SERVICES; UNIT TRUST MANAGEMENT ACCOUNTS; INVESTMENT MANAGEMENT; MUTUAL FUND BROKERAGE AND INVESTMENT; ASSET MANAGEMENT, NAMELY, ASSET ACQUISITION, CONSULTATION, DEVELOPMENT AND MANAGEMENT SERVICES; FACTORING AGENCY SERVICES; FINANCING, LOAN AND CREDIT CARD SERVICES; LEASE SERVICES, NAMELY, BEING ADVISORY AND FINANCES SERVICES RELATING TO LEASING OF CAPITAL GOODS, PLANTS AND EQUIPMENT, TRANSPORT AND INFRASTRUCTURES, FILMS AND INTELLECTUAL PROPERTY RIGHTS; INSURANCE BROKERAGE AND INSURANCE UNDERWRITING SERVICES; FUND TRANSFER SERVICES; FOREIGN EXCHANGE SERVICES; FINANCIAL GUARANTEE AND SURETY; MUTUAL FUND SERVICES;

FINANCIAL ADVISORY, CONSULTANCY AND INFORMATION SERVICES; FINANCIAL PLANNING, ANALYSIS, MANAGEMENT, ADVICE AND CONSULTANCY; FINANCIAL SURVEYS, APPRAISALS, INQUIRIES AND RESEARCH, NAMELY, APPRAISAL OF REAL ESTATE AND PERSONAL PROPERTY; CONDUCT OF FINANCIAL STUDIES AND PREPARATION OF FINANCIAL REPORTS; COLLECTION, PREPARATION, COMPILATION, STORAGE, PROCESSING AND RETRIEVAL OF FINANCIAL INFORMATION; MARKET ANALYSIS, RESEARCH AND MONITORING SERVICES FOR FINANCIAL PURPOSES; ADVISORY AND CONSULTANCY SERVICES IN RESPECT OF ALL THE AFORESAID SERVICES, IN CLASS 36 (U.S. CLS. 100, 101 AND 102).

THE MARK CONSISTS OF STANDARD CHARACTERS WITHOUT CLAIM TO ANY PARTICULAR FONT, STYLE, SIZE, OR COLOR.

PRIORITY CLAIMED UNDER SEC. 44(D) ON UNITED KINGDOM APPLICATION NO. 2449357, FILED 3-8-2007, REG. NO. 2449357, DATED 3-8-2007, EXPIRES 3-8-2017.

NO CLAIM IS MADE TO THE EXCLUSIVE RIGHT TO USE "CAPITAL", APART FROM THE MARK AS SHOWN.

THE WORDING "NTS" HAS NO MEANING IN A FOREIGN LANGUAGE.

SER. NO. 77-180,460, FILED 5-14-2007.

ANNE MADDEN, EXAMINING ATTORNEY

Int. Cl.: 27

Prior U.S. Cls.: 19, 20, 37, 42 and 50

United States Patent and Trademark Office

Reg. No. 3,503,659

Registered Sep. 23, 2008

TRADEMARK  
PRINCIPAL REGISTER



FAZE THREE LIMITED (INDIA CORPORATION)  
1-2, SHIV SMRITI CHAMBERS, 49-A  
DR. ANNIE BESANT ROAD, WORLI  
MUMBAI-INDIA, INDIA 400 018

FOR: BATHMAT, IN CLASS 27 (U.S. CLS. 19, 20, 37,  
42 AND 50).

FIRST USE 4-2-2007; IN COMMERCE 4-2-2007.

THE COLOR(S) GREEN AND LIGHT BLUE IS/  
ARE CLAIMED AS A FEATURE OF THE MARK.

THE MARK CONSISTS OF THE COLOR GREEN  
APPEARING IN THE WORD "EAZYLN" AND IN  
TWO OF THE WAVY LINES UNDERLINING THE  
WORD, AND THE COLOR LIGHT BLUE APPEARS  
IN THE OTHER TWO WAVY LINES UNDERLINING  
THE WORD "EAZYLN"

THE WORDING "EAZYLN" HAS NO MEANING  
IN A FOREIGN LANGUAGE.

SER. NO. 77-180,912, FILED S.R. 5-15-2007 AM. P.R.  
3-26-2008.

CARYN GLASSER, EXAMINING ATTORNEY

**Int. Cl.: 9**

**Prior U.S. Cls.: 21, 23, 26, 36 and 38**

**United States Patent and Trademark Office**

**Reg. No. 3,503,660**

**Registered Sep. 23, 2008**

**TRADEMARK  
PRINCIPAL REGISTER**

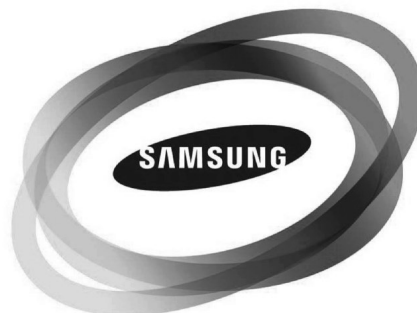

SAMSUNG ELECTRONICS CO., LTD. (REPUBLIC OF KOREA CORPORATION)  
416, MAETAN-DONG, YEONGTONG-GU  
SUWON-SI, GYEONGGI-DO, REPUBLIC OF KOREA

FOR: HEADPHONES; CELLULAR PHONES, BATTERIES; BATTERY CHARGERS; DRY CELL BATTERIES; MP3 PLAYERS; VIDEO CAMERAS; DIGITAL CAMERAS; PERSONAL DIGITAL ASSISTANTS (PDA), IN CLASS 9 (U.S. CLS. 21, 23, 26, 36 AND 38).

PRIORITY CLAIMED UNDER SEC. 44(D) ON REPUBLIC OF KOREA APPLICATION NO. 40-2007-0025, FILED 5-11-2007, REG. NO. 0737551, DATED 2-18-2008, EXPIRES 2-18-2018.

OWNER OF U.S. REG. NO. 2,751,708 AND OTHERS.

THE MARK CONSISTS OF A DESIGN MARK OF OVERLAPPING OVALS WITH THE WORD "SAMSUNG" INSIDE THE OVALS.

THE ENGLISH TRANSLATION OF THE WORD "SAMSUNG" IN THE MARK IS THREE STARS.

SER. NO. 77-181,015, FILED 5-15-2007.

DORITT L. CARROLL, EXAMINING ATTORNEY



Int. Cl.: 5

Prior U.S. Cls.: 6, 18, 44, 46, 51 and 52

Reg. No. 3,503,661

United States Patent and Trademark Office

Registered Sep. 23, 2008

TRADEMARK  
PRINCIPAL REGISTER



ULTIMATE NUTRITION, INC. (CONNECTICUT CORPORATION)  
21 HYDE ROAD  
FARMINGTON, CT 06032

THE COLOR(S) GOLD AND WHITE AND GRAY IS/ARE CLAIMED AS A FEATURE OF THE MARK.

FOR: VITAMINS, AND NUTRITIONAL FOOD SUPPLEMENTS, IN CLASS 5 (U.S. CLS. 6, 18, 44, 46, 51 AND 52).

THE MARK CONSISTS OF THE LITERAL ELEMENT "ULTIMATE NUTRITION" IN GOLD, THE LITERAL ELEMENT "THE FUTURE OF SPORTS NUTRITION" IN WHITE, AND A GRAY BACKGROUND.

FIRST USE 7-1-2004; IN COMMERCE 7-1-2004.

OWNER OF U.S. REG. NO. 3,088,065.

SER. NO. 77-181,067, FILED 5-15-2007.

NO CLAIM IS MADE TO THE EXCLUSIVE RIGHT TO USE "NUTRITION" AND "SPORTS NUTRITION", APART FROM THE MARK AS SHOWN.

LINDSEY RUBIN, EXAMINING ATTORNEY

**Int. Cls.: 25 and 41**

**Prior U.S. Cls.: 22, 39, 100, 101 and 107**

**United States Patent and Trademark Office**

**Reg. No. 3,503,662**

**Registered Sep. 23, 2008**

**TRADEMARK  
SERVICE MARK  
PRINCIPAL REGISTER**



NAESA INTERNATIONAL (ARIZONA CORPORATION)  
SUITE A  
6957 LITTLEROCK ROAD  
TUMWATER, WA 98512

FOR: SHIRTS, IN CLASS 25 (U.S. CLS. 22 AND 39).

FIRST USE 8-1-2001; IN COMMERCE 8-1-2001.

FOR: EDUCATION SERVICES, NAMELY, PROVIDING TRAINING AND TESTING TO QUALIFIED INDIVIDUALS FOR THE PURPOSE OF CERTIFICATION AS QUALIFIED ELEVATOR INSPECTORS, CONDUCTING WORKSHOPS TO INFORM, EDUCATE AND PROVIDE A FORUM FOR INDIVIDUALS TO DISCUSS ELEVATOR TOPICS, PROVIDING CLASSROOM TRAINING ON A VARIETY OF TOPICAL ELEVATOR SUBJECTS IN THE

FIELDS OF ELEVATORS AND ESCALATORS, IN CLASS 41 (U.S. CLS. 100, 101 AND 107).

FIRST USE 8-1-2001; IN COMMERCE 8-1-2001.

THE MARK CONSISTS OF A "GLOBE" CONSISTING OF CONTINENTS SURROUNDED BY WATER. AN "EAGLE" WITH TALONS, WINGS OUTSTRETCHED STANDING ON A BUFFER ON TOP OF A SHEAVE EXTENDS ACROSS THE FRONT OF THE GLOBE. THE WORD "NAESA" IN STYLIZED LETTERS EXTENDS ACROSS THE BASE OF THE SHEAVE.

SER. NO. 77-184,141, FILED 5-17-2007.

LESLIE RICHARDS, EXAMINING ATTORNEY

**Int. Cl.: 36**

**Prior U.S. Cls.: 100, 101 and 102**

**United States Patent and Trademark Office**

**Reg. No. 3,503,663**

**Registered Sep. 23, 2008**

**SERVICE MARK  
PRINCIPAL REGISTER**

# Bay and River

BAY AND RIVER REAL ESTATE, LLC (VIRGINIA LIMITED LIABILITY COMPANY)  
P.O. BOX 85  
32 CHURCH STREET  
MATHEWS, VA 23109

THE MARK CONSISTS OF STANDARD CHARACTERS WITHOUT CLAIM TO ANY PARTICULAR FONT, STYLE, SIZE, OR COLOR.

FOR: REAL ESTATE AGENCIES; REAL ESTATE BROKERAGE; REAL ESTATE LISTING, IN CLASS 36 (U.S. CLS. 100, 101 AND 102).

SER. NO. 77-185,835, FILED 5-21-2007.

FIRST USE 7-1-2003; IN COMMERCE 7-1-2003.

ANNE MADDEN, EXAMINING ATTORNEY

Int. Cl.: 11

Prior U.S. Cls.: 13, 21, 23, 31 and 34

United States Patent and Trademark Office

Reg. No. 3,503,664

Registered Sep. 23, 2008

TRADEMARK  
PRINCIPAL REGISTER



TIMBERLAND DESIGNS INCORPORATED (ARIZONA CORPORATION)  
6516 WAGON WHEEL LANE  
LAKESIDE, AZ 85929

FOR: LIGHTING FIXTURES, IN CLASS 11 (U.S. CLS. 13, 21, 23, 31 AND 34).

FIRST USE 6-1-2002; IN COMMERCE 6-1-2002.

NO CLAIM IS MADE TO THE EXCLUSIVE RIGHT TO USE "DESIGNS INC.", APART FROM THE MARK AS SHOWN.

THE MARK CONSISTS OF A CIRCULAR LINE WITH THE WORDS "TIMBERLAND DESIGNS INC." IN THE LOWER HALF CIRCLE AND GRASS AND TREES IN THE UPPER HALF, OVER WHICH AN ELK APPEARS STANDING, HEAD FACING FORWARD AND RIGHT, AND PROTRUDING OUTSIDE THE CIRCLE FROM THE MID-CHEST UP THROUGH THE ANTLERS.

SER. NO. 77-186,624, FILED 5-21-2007.

LINDSEY RUBIN, EXAMINING ATTORNEY

**Int. Cl.: 41**

**Prior U.S. Cls.: 100, 101 and 107**

**United States Patent and Trademark Office**

**Reg. No. 3,503,665**

**Registered Sep. 23, 2008**

**SERVICE MARK  
PRINCIPAL REGISTER**



OHIO STATE UNIVERSITY, THE (OHIO EDUCATIONAL INSTITUTION)  
190 NORTH OVAL MALL  
COLUMBUS, OH 43210

FOR: PROVIDING EDUCATIONAL INFORMATION ABOUT COLLEGE LEVEL COURSES OF INSTRUCTION VIA A GLOBAL COMPUTER NETWORK, IN CLASS 41 (U.S. CLS. 100, 101 AND 107).

FIRST USE 7-0-2003; IN COMMERCE 7-0-2003.

OWNER OF U.S. REG. NO. 2,452,639.

NO CLAIM IS MADE TO THE EXCLUSIVE RIGHT TO USE "OHIO LEARNING NETWORK"

AND THE REPRESENTATION OF THE OUTLINE OF THE STATE OF OHIO, APART FROM THE MARK AS SHOWN.

THE MARK CONSISTS OF LITERAL ELEMENT "OHIO LEARNING NETWORK" IN TITLE CASE, OF WHICH "OHIO" OVERLAYS A FIGURE IN THE SHAPE OF THE STATE OF OHIO AROUND WHICH IS A DIAGONAL ARC. SHADING IS A FEATURE OF THE MARK AND DOES NOT INDICATE COLOR.

SER. NO. 77-187,327, FILED 5-22-2007.

ANGELA M. MICHELI, EXAMINING ATTORNEY

**Int. Cls.: 1, 3 and 5**

**Prior U.S. Cls.: 1, 4, 5, 6, 10, 18, 26, 44, 46, 50, 51 and 52**

**Reg. No. 3,503,666**

**United States Patent and Trademark Office**

**Registered Sep. 23, 2008**

**TRADEMARK  
PRINCIPAL REGISTER**

**SPA CM**

AURORA SKIN CARE CENTER, P.C. (COLOR-ADO CORPORATION)  
SUITE 100  
9570 KINGSTON COURT  
ENGLEWOOD, CO 80112

FOR: ANTIOXIDANTS USED IN THE MANUFACTURE OF COSMETICS, IN CLASS 1 (U.S. CLS. 1, 5, 6, 10, 26 AND 46).

FIRST USE 7-0-2006; IN COMMERCE 7-0-2006.

FOR: NON-MEDICATED SKIN CARE PRODUCTS, NAMELY, ANTI-AGING CREAMS, ASTRINGENTS, BATH GELS, BATH OILS, BATH POWDERS, BODY CREAMS, BODY SCRUBS, CLEANSERS, CREAMS FOR CELLULITE REDUCTION, SKIN PEELING CREAMS, BODY CREAMS, EXFOLIANTS, FACIAL SCRUBS, FACIAL MASKS, FACIAL, HAND AND FOOT CREAMS, LIQUID SOAPS, MOISTURIZERS, SHAVING BALMS, SHAVING GELS, SHOWER GELS, SKIN ABRASIVE PREPARATIONS, SKIN CLARIFIERS, SKIN CLEANSERS AND CREAMS, SKIN CREAMS FOR DRY, OILY AND ACNE FACIAL CONDITIONS, SKIN EMOLLIENTS, SKIN LIGHTENING CREAMS, SKIN LOTIONS, SKIN MASKS, SKIN MOISTURIZERS, SKIN AND BODY TONERS, SKIN WHITENERS, SOAPS, SPOT REMOVERS, TONERS; NON-MEDICATED HAIR CARE PRODUCTS, NAMELY, SHAMPOOS AND CONDITIONERS; NON-MEDICATED NAIL CARE PRODUCTS, NAMELY, NAIL STRENGTHENING CREAMS AND LIQUIDS; NON-MEDICATED SUN PROTECTION PRODUCTS, NAMELY, SUN BLOCKERS, SUN SCREENS, SHAMPOOS, AND LIP BALMS, IN CLASS 3 (U.S. CLS. 1, 4, 6, 50, 51 AND 52).

FIRST USE 7-0-2006; IN COMMERCE 7-0-2006.

FOR: MEDICATED SKIN CARE PRODUCTS, NAMELY, ANTI-AGING CREAMS, ASTRINGENTS, BATH GELS, BATH OILS, BATH POWDERS, BODY CREAMS, BODY SCRUBS, CLEANSERS, CREAMS FOR CELLULITE REDUCTION, SKIN PEELING CREAMS, BODY CREAMS, EXFOLIANTS, FACIAL SCRUBS, FACIAL MASKS, FACIAL, HAND AND FOOT CREAMS, MOISTURIZERS, SHAVING BALMS, SHAVING GELS, SHOWER GELS, SKIN ABRASIVE PREPARATIONS, SKIN CLARIFIERS, SKIN CLEANSERS AND CREAMS, SKIN CREAMS FOR DRY, OILY AND ACNE FACIAL CONDITIONS, SKIN EMOLLIENTS, SKIN LIGHTENING CREAMS, SKIN LOTIONS, SKIN MASKS, SKIN MOISTURIZERS, SKIN AND BODY TONERS, SKIN WHITENERS, SOAPS, SPOT REMOVERS, TONERS; MEDICATED HAIR CARE PRODUCTS, NAMELY, SHAMPOOS AND CONDITIONERS; MEDICATED SUN PROTECTION PRODUCTS, NAMELY, SUN BLOCKERS, SUN SCREENS, SHAMPOOS, AND LIP BALMS, IN CLASS 5 (U.S. CLS. 6, 18, 44, 46, 51 AND 52).

FIRST USE 7-0-2006; IN COMMERCE 7-0-2006.

THE MARK CONSISTS OF STANDARD CHARACTERS WITHOUT CLAIM TO ANY PARTICULAR FONT, STYLE, SIZE, OR COLOR.

NO CLAIM IS MADE TO THE EXCLUSIVE RIGHT TO USE "SPA", APART FROM THE MARK AS SHOWN.

SER. NO. 77-187,681, FILED 5-22-2007.

CAROLYN GRAY, EXAMINING ATTORNEY

**Int. Cls.: 1, 3 and 5**

**Prior U.S. Cls.: 1, 4, 5, 6, 10, 18, 26, 44, 46, 50, 51 and 52**

**Reg. No. 3,503,667**

**United States Patent and Trademark Office**

**Registered Sep. 23, 2008**

**TRADEMARK  
PRINCIPAL REGISTER**



AURORA SKIN CARE CENTER, P.C. (COLORADO CORPORATION)  
SUITE 100  
9570 KINGSTON COURT  
ENGLEWOOD, CO 80112

STRENGTHENING CREAMS AND LIQUIDS; NON-MEDICATED SUN PROTECTION PRODUCTS, NAMELY, SUN BLOCKERS, SUN SCREENS, SHAMPOOS, AND LIP BALMS, IN CLASS 3 (U.S. CLS. 1, 4, 6, 50, 51 AND 52).

FOR: ANTIOXIDANTS USED IN THE MANUFACTURE OF COSMETICS, IN CLASS 1 (U.S. CLS. 1, 5, 6, 10, 26 AND 46).

FIRST USE 7-0-2006; IN COMMERCE 7-0-2006.

FIRST USE 7-0-2006; IN COMMERCE 7-0-2006.

FOR: NON-MEDICATED SKIN CARE PRODUCTS, NAMELY, ANTI-AGING CREAMS, ASTRINGENTS, BATH GELS, BATH OILS, BATH POWDERS, BODY CREAMS, BODY SCRUBS, CLEANSERS, CREAMS FOR CELLULITE REDUCTION, SKIN PEELING CREAMS, BODY CREAMS, EXFOLIANTS, FACIAL SCRUBS, FACIAL MASKS, FACIAL, HAND AND FOOT CREAMS, LIQUID SOAPS, MOISTURIZERS, SHAVING BALMS, SHAVING GELS, SHOWER GELS, SKIN ABRASIVE PREPARATIONS, SKIN CLARIFIERS, SKIN CLEANSERS AND CREAMS, SKIN CREAMS FOR DRY, OILY AND ACNE FACIAL CONDITIONS, SKIN EMOLLIENTS, SKIN LIGHTENING CREAMS, SKIN LOTIONS, SKIN MASKS, SKIN MOISTURIZERS, SKIN AND BODY TONERS, SKIN WHITENERS, SOAPS, SPOT REMOVERS, TONERS; NON-MEDICATED HAIR CARE PRODUCTS, NAMELY, SHAMPOOS AND CONDITIONERS; NON-MEDICATED NAIL CARE PRODUCTS, NAMELY, NAIL

FOR: MEDICATED SKIN CARE PRODUCTS, NAMELY, ANTI-AGING CREAMS, ASTRINGENTS, BATH GELS, BATH OILS, BATH POWDERS, BODY CREAMS, BODY SCRUBS, CLEANSERS, CREAMS FOR CELLULITE REDUCTION, SKIN PEELING CREAMS, BODY CREAMS, EXFOLIANTS, FACIAL SCRUBS, FACIAL MASKS, FACIAL, HAND AND FOOT CREAMS, MOISTURIZERS, SHAVING BALMS, SHAVING GELS, SHOWER GELS, SKIN ABRASIVE PREPARATIONS, SKIN CLARIFIERS, SKIN CLEANSERS AND CREAMS, SKIN CREAMS FOR DRY, OILY AND ACNE FACIAL CONDITIONS, SKIN EMOLLIENTS, SKIN LIGHTENING CREAMS, SKIN LOTIONS, SKIN MASKS, SKIN MOISTURIZERS, SKIN AND BODY TONERS, SKIN WHITENERS, SOAPS, SPOT REMOVERS, TONERS; MEDICATED HAIR CARE PRODUCTS, NAMELY, SHAMPOOS AND CONDITIONERS; MEDICATED SUN PROTECTION PRODUCTS, NAMELY, SUN BLOCKERS, SUN SCREENS, SHAMPOOS, AND LIP BALMS, IN CLASS 5 (U.S. CLS. 6, 18, 44, 46, 51 AND 52).

FIRST USE 7-0-2006; IN COMMERCE 7-0-2006.

NO CLAIM IS MADE TO THE EXCLUSIVE RIGHT TO USE "SPA", APART FROM THE MARK AS SHOWN.

THE MARK CONSISTS OF THE STYLIZED WORD "SPA" WITH A CONTRASTING WAVY BAND THROUGH IT SUCH THAT THE WAVY BAND ALSO FORMS THE BAR FOR THE LETTER "A" APPEARING OVER THE STYLIZED LETTERS "CM" WITH THE LETTER "C" HAVING WITHIN IT A STYLIZED HUMAN FIGURE OF AN ANDROGY-

NOUS ADULT WITH UPRAISED ARMS AGAINST AN OVAL BACKGROUND THAT IS VERTICALLY DIVIDED INTO EQUAL PARTS BY CONTRASTING COLORS OR SHADING AND A VERTICAL BAR WITHOUT COLOR OR SHADING ABOVE THE HEAD OF THE HUMAN FIGURE.

SER. NO. 77-187,721, FILED 5-22-2007.

CAROLYN GRAY, EXAMINING ATTORNEY



**Int. Cl.: 35**

**Prior U.S. Cls.: 100, 101 and 102**

**United States Patent and Trademark Office**

**Reg. No. 3,503,668**

**Registered Sep. 23, 2008**

**SERVICE MARK  
PRINCIPAL REGISTER**

**WOODLAND DIRECT**

WOODLAND DIRECT, INC. (MICHIGAN CORPORATION)  
UNIT 1  
13420 WEST STAR  
SHELBY TWP., MI 48308

FOR: ON-LINE RETAIL STORE SERVICES FEATURING ALL OF THE FOLLOWING: HOME ACCENTS, NAMELY, BOOT SCRAPERS, SHOE BRUSHES, METAL AND BRONZE SCULPTURES, MANTELS; OUTDOOR PRODUCTS, NAMELY, ARBORS, BENCHES, BIRDBATHS AND FEEDERS, BELLS, DOOR BELLS AND KNOCKERS, FLAG-POLE TOPPERS, WALL ART, GARDEN ORNAMENTS, FAUCETS, FIREGLASS; WROUGHT IRON GARDEN ACCESSORIES, NAMELY, HANGING BASKETS, WINDOW BOXES, FLOWER POT STANDS, LANTERNS, BASKETS, HOOKS, CALDRONS, VASES, CROCKS, BOWLS, BOOT SCRAPERS; BRACKETS, NAMELY, HANGING BRACKETS, WINDOW BOX BRACKETS, SIGN BRACKETS, SHELF BRACKETS, MAIL BOX BRACKETS, WALL BRACKETS, AND LANTERN

BRACKETS; CERAMIC BOWLS, CONE-SHAPED PLANT WATERING UNITS FOR USE IN GARDENS, GARDEN CARTS, HOSE HOLDERS, OUTDOOR CLOCKS, OUTDOOR SIGNS, PATIO HEATERS, PATIO UMBRELLAS, SUNDIALS, TEAK FURNITURE, AND WEATHERVANES, IN CLASS 35 (U.S. CLS. 100, 101 AND 102).

FIRST USE 9-1-2004; IN COMMERCE 9-1-2004.

THE MARK CONSISTS OF STANDARD CHARACTERS WITHOUT CLAIM TO ANY PARTICULAR FONT, STYLE, SIZE, OR COLOR.

NO CLAIM IS MADE TO THE EXCLUSIVE RIGHT TO USE "DIRECT", APART FROM THE MARK AS SHOWN.

SER. NO. 77-188,348, FILED 5-23-2007.

JENNIFER VASQUEZ, EXAMINING ATTORNEY

**Int. Cl.: 5**

**Prior U.S. Cls.: 6, 18, 44, 46, 51 and 52**

**United States Patent and Trademark Office**

**Reg. No. 3,503,669**

**Registered Sep. 23, 2008**

**TRADEMARK  
PRINCIPAL REGISTER**

**ZIMCOSA**

SCHWARZ PHARMA AG (FED REP GERMANY  
CORPORATION)  
ALFRED-NOBEL-STRASSE 10  
D-40789 MONHEIM, FED REP GERMANY

FOR: PHARMACEUTICAL PREPARATIONS  
AND SUBSTANCES FOR THE TREATMENT OF  
CENTRAL AND PERIPHERAL NERVOUS SYSTEM  
DISEASES, HEART AND CIRCULATORY DISEASES,  
HYPERTENSION, CARDIOVASCULAR DISEASES,  
UROLOGICAL DISEASES,  
GASTROINTESTINAL DISORDERS, METABOLIC  
DISEASES, CHRONIC PERIPHERAL ARTERIAL  
OCCLUSIVE DISEASES, CANCER AND INFLAMMATORY  
DISEASES; PHARMACEUTICAL PRE-

PARATIONS, NAMELY, ANTIALLERGIC  
PREPARATIONS, IN CLASS 5 (U.S. CLS. 6, 18, 44,  
46, 51 AND 52).

THE MARK CONSISTS OF STANDARD CHARACTERS  
WITHOUT CLAIM TO ANY PARTICULAR  
FONT, STYLE, SIZE, OR COLOR.

OWNER OF FED REP GERMANY REG. NO.  
30668505, DATED 11-8-2006, EXPIRES 11-30-2016.

SER. NO. 77-188,593, FILED 5-23-2007.

MARGERY A. TIERNEY, EXAMINING ATTORNEY

**Int. Cl.: 5**

**Prior U.S. Cls.: 6, 18, 44, 46, 51 and 52**

**Reg. No. 3,503,670**

**United States Patent and Trademark Office**

**Registered Sep. 23, 2008**

**TRADEMARK  
PRINCIPAL REGISTER**

**LONFOR**

SCHWARZ PHARMA AG (FED REP GERMANY  
CORPORATION)  
ALFRED-NOBEL-STRASSE 10  
D-40789 MONHEIM, FED REP GERMANY

FOR: PHARMACEUTICAL PREPARATIONS  
AND SUBSTANCES FOR THE TREATMENT OF  
CENTRAL AND PERIPHERAL NERVOUS SYSTEM  
DISEASES, HEART AND CIRCULATORY DISEASES,  
HYPERTENSION, CARDIOVASCULAR DISEASES,  
UROLOGICAL DISEASES,  
GASTROINTESTINAL DISORDERS, METABOLIC  
DISEASES, CHRONIC PERIPHERAL ARTERIAL  
OCCLUSIVE DISEASES, CANCER AND INFLAMMATORY  
DISEASES; PHARMACEUTICAL PRE-

PARATIONS, NAMELY, ANTIALLERGIC  
PREPARATIONS, IN CLASS 5 (U.S. CLS. 6, 18, 44,  
46, 51 AND 52).

THE MARK CONSISTS OF STANDARD CHARACTERS  
WITHOUT CLAIM TO ANY PARTICULAR  
FONT, STYLE, SIZE, OR COLOR.

OWNER OF FED REP GERMANY REG. NO.  
30668503, DATED 11-8-2006, EXPIRES 11-30-2016.

SER. NO. 77-188,653, FILED 5-23-2007.

MARGERY A. TIERNEY, EXAMINING ATTORNEY

**Int. Cl.: 42**

**Prior U.S. Cls.: 100 and 101**

**United States Patent and Trademark Office**

**Reg. No. 3,503,671**

**Registered Sep. 23, 2008**

**SERVICE MARK  
PRINCIPAL REGISTER**



LOCKLINK COMMUNICATIONS INC (NEVADA CORPORATION)  
PO BOX 610607  
SAN JOSE, CA 95161

FOR: APPLICATION SERVICE PROVIDER (ASP) FEATURING SOFTWARE FOR USE IN FACILITATING SECURE COMMUNICATIONS WITH APPLICATIONS AND WEB SITES OF OTHERS HOSTED ON A COMPUTER SERVER FOR A GLOBAL COMPUTER NETWORK, IN CLASS 42 (U.S. CLS. 100 AND 101).

FIRST USE 4-4-1999; IN COMMERCE 4-4-1999.

THE COLOR(S) BLUE IS/ARE CLAIMED AS A FEATURE OF THE MARK.

THE MARK CONSISTS OF A BLUE STYLIZED LOCK INSIDE A BLUE CIRCLE

SER. NO. 77-191,047, FILED 5-25-2007.

STEVEN PEREZ, EXAMINING ATTORNEY

**Int. Cl.: 42**

**Prior U.S. Cls.: 100 and 101**

**United States Patent and Trademark Office**

**Reg. No. 3,503,672**

**Registered Sep. 23, 2008**

**SERVICE MARK  
PRINCIPAL REGISTER**

# Planet PDF

BINARYTHING.COM PTY LTD (AUSTRALIA  
CORPORATION)  
LEVEL 3, 370 LITTLE BOURKE STREET  
MELBOURNE, AUSTRALIA

FOR: PROVIDING INFORMATION REGARDING  
PORTABLE DOCUMENT FORMAT (PDF) TECH-  
NOLOGY VIA A GLOBAL COMPUTER NETWORK,  
IN CLASS 42 (U.S. CLS. 100 AND 101).

FIRST USE 10-1-1998; IN COMMERCE 10-1-1998.

THE MARK CONSISTS OF STANDARD CHAR-  
ACTERS WITHOUT CLAIM TO ANY PARTICULAR  
FONT, STYLE, SIZE, OR COLOR.

NO CLAIM IS MADE TO THE EXCLUSIVE  
RIGHT TO USE "PDF", APART FROM THE MARK  
AS SHOWN.

SER. NO. 77-192,660, FILED 5-30-2007.

DAWN FELDMAN, EXAMINING ATTORNEY

**Int. Cl.: 35**

**Prior U.S. Cls.: 100, 101 and 102**

**United States Patent and Trademark Office**

**Reg. No. 3,503,673**

**Registered Sep. 23, 2008**

**SERVICE MARK  
PRINCIPAL REGISTER**

**STREET PERFORMANCE.COM**

DIGITAL PERFORMANCE, INC. (CALIFORNIA CORPORATION)  
2700 CHERRY AVENUE  
SIGNAL HILL, CA 90755

FIRST USE 5-0-2003; IN COMMERCE 5-0-2003.

FOR: PROVIDING AN ON-LINE SEARCHABLE DATABASE WITH LINKS TO THE RETAIL WEB SITES OF OTHERS IN THE AUTOMOTIVE INDUSTRY; ONLINE RETAIL STORE FEATURING AUTOMOTIVE PRODUCTS WITH LINKS TO THE WEB SITES OF OTHER AUTOMOTIVE RETAIL WEBSITES, IN CLASS 35 (U.S. CLS. 100, 101 AND 102).

THE MARK CONSISTS OF STANDARD CHARACTERS WITHOUT CLAIM TO ANY PARTICULAR FONT, STYLE, SIZE, OR COLOR.

SER. NO. 77-193,222, FILED 5-30-2007.

DAVID TOOLEY, EXAMINING ATTORNEY

**Int. Cl.: 5**

**Prior U.S. Cls.: 6, 18, 44, 46, 51 and 52**

**United States Patent and Trademark Office**

**Reg. No. 3,503,674**

**Registered Sep. 23, 2008**

**TRADEMARK  
PRINCIPAL REGISTER**

**SERGEANT'S**

SERGEANT'S PET CARE PRODUCTS, INC. (NE-  
VADA CORPORATION)  
2625 S 158TH PLAZA  
OMAHA, NE 681301770

FOR: ANIMAL REPELLANTS, IN CLASS 5 (U.S.  
CLS. 6, 18, 44, 46, 51 AND 52).

FIRST USE 12-0-1990; IN COMMERCE 12-0-1990.

THE MARK CONSISTS OF STANDARD CHAR-  
ACTERS WITHOUT CLAIM TO ANY PARTICULAR  
FONT, STYLE, SIZE, OR COLOR.

OWNER OF U.S. REG. NOS. 3,081,652, 3,109,005,  
AND 3,270,277.

SER. NO. 77-193,853, FILED 5-31-2007.

NELSON SNYDER, EXAMINING ATTORNEY

Int. Cl.: 30

Prior U.S. Cl.: 46

**United States Patent and Trademark Office**

**Reg. No. 3,503,675**

Registered Sep. 23, 2008

**TRADEMARK  
PRINCIPAL REGISTER**

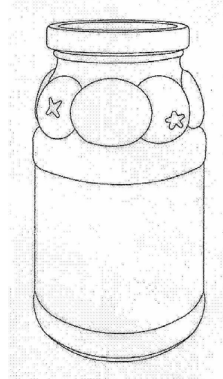

LIDESTRI FOODS, INC. (NEW YORK CORPORATION)  
815 WEST WHITNEY ROAD  
FAIRPORT, NY 14450

GOODS, THE JAR CONFIGURATION CONSISTING OF A "TOMATO" DECORATION APPEARING ON BOTH SIDES OF THE SHOULDER OF THE JAR.

FOR: PASTA SAUCE, IN CLASS 30 (U.S. CL. 46).

SEC. 2(F).

FIRST USE 1-0-1996; IN COMMERCE 1-0-1996.

SER. NO. 77-196,643, FILED 6-4-2007.

THE MARK CONSISTS OF A CONFIGURATION OF A JAR USED AS THE CONTAINER FOR THE

ANNE E. GUSTASON, EXAMINING ATTORNEY



**Int. Cl.: 25**

**Prior U.S. Cls.: 22 and 39**

**United States Patent and Trademark Office**

**Reg. No. 3,503,676**

**Registered Sep. 23, 2008**

**TRADEMARK  
PRINCIPAL REGISTER**

# Just Racing

JUST RACING, LTD (MINNESOTA CORPORATION)  
4 WISHBONE LANE  
NORTH OAKS, MN 55127

THE MARK CONSISTS OF STANDARD CHARACTERS WITHOUT CLAIM TO ANY PARTICULAR FONT, STYLE, SIZE, OR COLOR.

FOR: CLOTHING, NAMELY, T-SHIRTS, PANTS, SHORTS, HATS, JACKETS, SOCKS, SHOES, GLOVES, HEAD WEAR, AND SUSPENDERS, IN CLASS 25 (U.S. CLS. 22 AND 39).

SER. NO. 77-197,500, FILED 6-5-2007.

FIRST USE 1-15-2007; IN COMMERCE 1-15-2007.

JENNIFER VASQUEZ, EXAMINING ATTORNEY

**Int. Cl.: 36**

**Prior U.S. Cls.: 100, 101 and 102**

**United States Patent and Trademark Office**

**Reg. No. 3,503,677**

**Registered Sep. 23, 2008**

**SERVICE MARK  
PRINCIPAL REGISTER**

**DISTRIBUTED CAPITAL**

DISTRIBUTED CAPITAL GROUP, INC. (DELA-  
WARE CORPORATION)  
200 W. 60TH STREET, APT. 23G  
NEW YORK, NY 10023

FOR: GLOBAL FINANCIAL INVESTMENT AD-  
VISORY, PRICING, RISK, EXECUTION, CLEARING  
AND TRANSACTION SERVICES, NAMELY, AS-  
SISTING OTHERS WITH THE ASSESSMENT AND  
COMPLETION OF FINANCIAL TRANSACTIONS  
INVOLVING FINANCIAL INSTRUMENTS AND  
STRUCTURES ON A GLOBAL BASIS; FINANCIAL  
ANALYSIS AND CONSULTATION; FINANCIAL  
RISK ANALYSIS SERVICES; AND FINANCIAL  
RISK MANAGEMENT SERVICES, NAMELY,  
STRUCTURE, DESIGN, PRICING AND TRANSFER

OF FINANCIAL RISK, IN CLASS 36 (U.S. CLS. 100,  
101 AND 102).

FIRST USE 0-0-1999; IN COMMERCE 1-22-2000.

THE MARK CONSISTS OF STANDARD CHAR-  
ACTERS WITHOUT CLAIM TO ANY PARTICULAR  
FONT, STYLE, SIZE, OR COLOR.

SEC. 2(F).

SER. NO. 77-197,787, FILED 6-5-2007.

MARTHA FROMM, EXAMINING ATTORNEY

**Int. Cls.: 16, 41 and 44**

**Prior U.S. Cls.: 2, 5, 22, 23, 29, 37, 38, 50, 100, 101 and 107**

**Reg. No. 3,503,678**

**United States Patent and Trademark Office**

**Registered Sep. 23, 2008**

**TRADEMARK  
SERVICE MARK  
PRINCIPAL REGISTER**

**EQUINE EQUATIONS**

JANSEN, CALI (UNITED STATES INDIVIDUAL)  
9100 MEADOW LANE  
NEWCASTLE, CA 95658

FOR: A SERIES OF BOOKS, WRITTEN ARTICLES, HANDOUTS AND WORKSHEETS IN THE FIELD OF EQUINE CARE, IN CLASS 16 (U.S. CLS. 2, 5, 22, 23, 29, 37, 38 AND 50).

FIRST USE 9-15-1996; IN COMMERCE 9-15-1996.

FOR: EDUCATING AT UNIVERSITY OR COLLEGES; EDUCATION SERVICES, NAMELY, MENTORING IN THE FIELD OF EQUINE CARE; EDUCATION SERVICES, NAMELY, ONE-ON-ONE MENTORING IN THE FIELD OF EQUINE CARE.; EDUCATION SERVICES, NAMELY, PROVIDING LIVE AND ON-LINE CLASSES, SEMINARS, WORKSHOPS, CLASSES IN THE FIELD OF EQUINE CARE.; EDUCATION SERVICES, NAMELY, PROVIDING TUTORIAL SESSIONS IN THE FIELD(S) OF EQUINE CARE.; EDUCATION SERVICES, NAMELY, PROVIDING SEMINARS, WORKSHOPS, AND CLASSES IN THE FIELD OF EQUINE CARE.; EDUCATIONAL AND ENTERTAINMENT SERVICES, NAMELY, A CONTINUING PROGRAM ABOUT EQUINE CARE ACCESSIBLE BY RADIO, TELEVISION, SATELLITE, AUDIO, VIDEO AND COMPUTER NETWORKS; EDUCATIONAL RESEARCH; EDUCATIONAL SERVICES, NAMELY, CONDUCTING DISTANCE LEARNING INSTRUCTION AT THE SECONDARY, COLLEGE AND GRADUATE LEVELS; EDUCATIONAL SERVICES, NAMELY, CONDUCTING INFORMAL ON-LINE PROGRAMS IN THE FIELDS OF EQUINE CARE, AND PRINTABLE MATERIALS DISTRIBUTED THEREWITH; EDUCATIONAL SERVICES, NAMELY, CONDUCTING INFORMAL PROGRAMS IN THE FIELDS OF EQUINE CARE, USING ON-LINE ACTIVITIES AND

INTERACTIVE EXHIBITS, AND PRINTABLE MATERIALS DISTRIBUTED THEREWITH; EDUCATIONAL SERVICES, NAMELY, CONDUCTING ON-LINE EXHIBITIONS AND DISPLAYS AND INTERACTIVE EXHIBITS IN THE FIELD OF EQUINE CARE; EDUCATIONAL SERVICES, NAMELY, CONDUCTING SEMINARS, CLASSES, AND WORKSHOPS IN THE FIELD OF EQUINE CARE AND DISTRIBUTION OF COURSE MATERIAL IN CONNECTION THEREWITH; EDUCATIONAL SERVICES, NAMELY, PROVIDING COURSES OF INSTRUCTION AT THE SECONDARY AND COLLEGE LEVEL AND DISTRIBUTION OF COURSE MATERIAL IN CONNECTION THEREWITH; VOCATIONAL EDUCATION IN THE FIELD OF EQUINE CARE.; WRITING OF ARTICLES FOR JOURNALS OTHER THAN FOR ADVERTISING OR PUBLICITY; WRITING OF ARTICLES FOR PERIODICALS OTHER THAN FOR ADVERTISING OR PUBLICITY; WRITING OF ARTICLES FOR PROFESSIONAL JOURNALS OTHER THAN FOR ADVERTISING OR PUBLICITY, IN CLASS 41 (U.S. CLS. 100, 101 AND 107).

FIRST USE 8-10-1995; IN COMMERCE 8-10-1995.

FOR: PROVIDING CONSULTATION IN THE FIELD OF EQUINE CARE, IN CLASS 44 (U.S. CLS. 100 AND 101).

FIRST USE 8-10-1995; IN COMMERCE 8-10-1995.

THE MARK CONSISTS OF STANDARD CHARACTERS WITHOUT CLAIM TO ANY PARTICULAR FONT, STYLE, SIZE, OR COLOR.

NO CLAIM IS MADE TO THE EXCLUSIVE RIGHT TO USE "EQUINE", APART FROM THE MARK AS SHOWN.

SER. NO. 77-198,602, FILED 6-5-2007.

ANN E. SAPPENFIELD, EXAMINING ATTORNEY

**Int. Cl.: 35**

**Prior U.S. Cls.: 100, 101 and 102**

**United States Patent and Trademark Office**

**Reg. No. 3,503,679**

**Registered Sep. 23, 2008**

**SERVICE MARK  
PRINCIPAL REGISTER**

**APPARELSPIDER.COM**

137, LLC. (CONNECTICUT LIMITED LIABILITY  
COMPANY)  
P.O. BOX 158  
MYSTIC, CT 06355

FOR: BUSINESS SERVICES, NAMELY, PROVIDING COMPUTER DATABASES IN THE FIELD OF PROCUREMENT INFORMATION AND GOODS AND SERVICES PRICE QUOTATIONS REGARDING THE PURCHASE AND SALE OF A WIDE VARIETY OF PRODUCTS AND SERVICES OF OTHERS; PROVIDING A WEB SITE WHEREBY BUYERS OF GOODS OR SERVICES LOCATE AND RECEIVE QUOTATIONS FROM MULTIPLE COMPETITIVE SOURCES AND SELLERS OF GOODS OR SERVICES

IDENTIFY AND BID ON MULTIPLE NEW SALES OPPORTUNITIES, IN CLASS 35 (U.S. CLS. 100, 101 AND 102).

FIRST USE 11-25-2006; IN COMMERCE 11-25-2006.

THE MARK CONSISTS OF STANDARD CHARACTERS WITHOUT CLAIM TO ANY PARTICULAR FONT, STYLE, SIZE, OR COLOR.

SER. NO. 77-200,481, FILED 6-7-2007.

JESSICA FATHY, EXAMINING ATTORNEY

**Int. Cl.: 11**

**Prior U.S. Cls.: 13, 21, 23, 31 and 34**

**United States Patent and Trademark Office**

**Reg. No. 3,503,680**

**Registered Sep. 23, 2008**

**TRADEMARK  
PRINCIPAL REGISTER**

**NUMBER EIGHT LIGHTING**

NUMBER EIGHT LIGHTING COMPANY INCORPORATED (CALIFORNIA CORPORATION)  
418 PETALUMA AVE.  
SEBASTOPOL, CA 95472

NO CLAIM IS MADE TO THE EXCLUSIVE RIGHT TO USE "LIGHTING", APART FROM THE MARK AS SHOWN.

FOR: ELECTRIC LIGHTING FIXTURES, IN CLASS 11 (U.S. CLS. 13, 21, 23, 31 AND 34).

SER. NO. 77-201,437, FILED 6-8-2007.

FIRST USE 7-1-2006; IN COMMERCE 7-1-2006.

THE MARK CONSISTS OF STANDARD CHARACTERS WITHOUT CLAIM TO ANY PARTICULAR FONT, STYLE, SIZE, OR COLOR.

WILLIAM BRECKENFELD, EXAMINING ATTORNEY

**Int. Cl.: 41**

**Prior U.S. Cls.: 100, 101 and 107**

**United States Patent and Trademark Office**

**Reg. No. 3,503,681**

**Registered Sep. 23, 2008**

**SERVICE MARK  
PRINCIPAL REGISTER**



BUSINESS TRAINING WORKS, INC. (MARY-  
LAND CORPORATION)  
9015 KATIE COURT  
PORT TOBACCO, MD 20677

FOR: PROVIDING ON-LINE TRAINING COURSES IN THE FIELD OF BUSINESS; ARRANGING PROFESSIONAL WORKSHOP AND TRAINING COURSES; BUSINESS TRAINING; PUBLICATION OF DOCUMENTS IN THE FIELD OF TRAINING, SCIENCE, PUBLIC LAW AND SOCIAL AFFAIRS; ARRANGEMENT OF TRAINING COURSES IN TEACHING INSTITUTES, IN CLASS 41 (U.S. CLS. 100, 101 AND 107).

FIRST USE 8-1-2005; IN COMMERCE 8-1-2005.

NO CLAIM IS MADE TO THE EXCLUSIVE RIGHT TO USE "BUSINESS TRAINING" AND "LEARN", APART FROM THE MARK AS SHOWN.

THE MARK CONSISTS OF THREE INTERLOCKING COGS ARRANGED WITH A TOP COG, A MIDDLE COG, AND A LOWER COG; THE WORDING "BUSINESS TRAINING WORKS" TO THE RIGHT OF THE THREE-COG DESIGN; AND THE WORDING "INSPIRE, ENERGIZE, LEARN" TO THE RIGHT THEREOF.

SER. NO. 77-202,595, FILED 6-11-2007.

ELIZABETH KAJUBI, EXAMINING ATTORNEY

**Int. Cl.: 16**

**Prior U.S. Cls.: 2, 5, 22, 23, 29, 37, 38 and 50**

**Reg. No. 3,503,682**

**United States Patent and Trademark Office**

**Registered Sep. 23, 2008**

**TRADEMARK  
PRINCIPAL REGISTER**

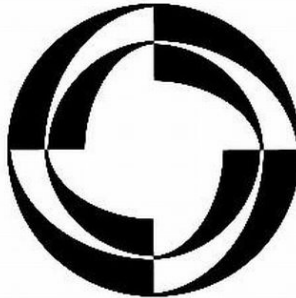

PINAL COUNTY COMMUNITY COLLEGE DISTRICT (ARIZONA POLITICAL SUBDIVISION OF THE STATE OF ARIZONA)  
8470 NORTH OVERFIELD ROAD  
COOLIDGE, AZ 85228

FOR: PUBLICATIONS, NAMELY, COMMUNITY REPORTS, NEWSLETTERS AND COURSE CATALOGS, ALL IN THE FIELD OF EDUCATION; APPOINTMENT BOOKS, GIFT WRAPPING PAPER, PRINTED ART REPRODUCTIONS, PRINTED CALENDARS; PENCILS AND PENS; BUMPER STICK-

ERS; ALBUMS FOR PHOTOGRAPHS, IN CLASS 16 (U.S. CLS. 2, 5, 22, 23, 29, 37, 38 AND 50).

FIRST USE 2-28-2007; IN COMMERCE 2-28-2007.

THE MARK CONSISTS OF A STYLIZED CIRCLE WITHIN A STYLIZED CIRCLE.

SER. NO. 77-204,301, FILED 6-12-2007.

SONYA STEPHENS, EXAMINING ATTORNEY



**Int. Cl.: 5**

**Prior U.S. Cls.: 6, 18, 44, 46, 51 and 52**

**United States Patent and Trademark Office**

**Reg. No. 3,503,683**

**Registered Sep. 23, 2008**

**TRADEMARK  
PRINCIPAL REGISTER**

**EURARTIN**

SIGMA-TAU INDUSTRIE FARMACEUTICHE  
RIUNITE S.P.A. (ITALY SOCIETA PER AZIO-  
NI)  
VIALE SHAKESPEARE, 47  
ROMA, ITALY 00144

FOR: ANTIMALARIAL PHARMACEUTICAL  
PREPARATIONS FOR ORAL USE OR INJECTABLE,  
IN CLASS 5 (U.S. CLS. 6, 18, 44, 46, 51 AND 52).

THE MARK CONSISTS OF STANDARD CHAR-  
ACTERS WITHOUT CLAIM TO ANY PARTICULAR  
FONT, STYLE, SIZE, OR COLOR.

PRIORITY CLAIMED UNDER SEC. 44(D) ON  
ERPNTY CMNTY TM OFC APPLICATION NO.  
5996673, FILED 6-13-2007, REG. NO. 005996673, DA-  
TED 3-10-2008, EXPIRES 6-13-2017.

SER. NO. 77-205,090, FILED 6-13-2007.

H. M. FISHER, EXAMINING ATTORNEY

**Int. Cls.: 9 and 10**

**Prior U.S. Cls.: 21, 23, 26, 36, 38, 39 and 44**

**Reg. No. 3,503,684**

**United States Patent and Trademark Office**

**Registered Sep. 23, 2008**

**TRADEMARK  
PRINCIPAL REGISTER**

# HYPERMED

HYPERMED, INC. (DELAWARE CORPORATION)  
305 SECOND AVE  
WALTHAM, MA 02451

FOR: LABORATORY RESEARCH SYSTEMS COMPRISED OF MEDICAL APPARATUS, NAMELY, SPECTRAL IMAGING DEVICES FOR USE IN ANALYZING BIOLOGICAL, HUMAN, ANIMAL, MEDICAL OR FORENSIC TISSUE, REMOTE CONTROL UNITS FOR USE WITH THE SPECTRAL IMAGING DEVICES, ACCESSORIES, NAMELY, CALIBRATION PADS, REGISTRATION TARGETS, IMMOBILIZATION PILLOWS, PILLOW COVERS, SHADED EYEWEAR, MEDICAL PRE-MOISTENED WIPES, LENS CLEANER PACKS EQUIPMENT REMOTE CONTROL UNITS, PRINTER, SOFTWARE PACKAGE FOR REMOTE DATA ACCESS AND ANALYSIS AND ASSOCIATED DOCUMENTATION AND INSTRUCTIONAL MATERIALS ALL SOLD AS A UNIT THEREWITH, IN CLASS 9 (U.S. CLS. 21, 23, 26, 36 AND 38).

FIRST USE 12-31-2002; IN COMMERCE 12-31-2002.

FOR: MEDICAL DIAGNOSTIC SYSTEM COMPRISED OF MEDICAL APPARATUS, NAMELY, SPECTRAL IMAGING DEVICES FOR USE IN ANA-

LYZING BIOLOGICAL, HUMAN, ANIMAL, MEDICAL OR FORENSIC TISSUE, REMOTE CONTROL UNITS FOR USE WITH THE SPECTRAL IMAGING DEVICES, ACCESSORIES, NAMELY, CALIBRATION PADS, REGISTRATION TARGETS, IMMOBILIZATION PILLOWS, PILLOW COVERS, SHADED EYEWEAR, MEDICAL PRE-MOISTENED WIPES, LENS CLEANER PACKS EQUIPMENT REMOTE CONTROL UNITS, PRINTER, SOFTWARE PACKAGE FOR REMOTE DATA ACCESS AND ANALYSIS AND ASSOCIATED DOCUMENTATION AND INSTRUCTIONAL MATERIALS ALL SOLD AS A UNIT THEREWITH, IN CLASS 10 (U.S. CLS. 26, 39 AND 44).

FIRST USE 12-31-2002; IN COMMERCE 12-31-2002.

THE MARK CONSISTS OF STANDARD CHARACTERS WITHOUT CLAIM TO ANY PARTICULAR FONT, STYLE, SIZE, OR COLOR.

OWNER OF U.S. REG. NO. 2,617,713.

SER. NO. 77-206,546, FILED 6-14-2007.

CHRISTINA SOBRAL, EXAMINING ATTORNEY

**Int. Cl.: 43**

**Prior U.S. Cls.: 100 and 101**

**United States Patent and Trademark Office**

**Reg. No. 3,503,685**

**Registered Sep. 23, 2008**

**SERVICE MARK  
PRINCIPAL REGISTER**

# Gone Wild Cafe

ALDEN, JOHN (UNITED STATES INDIVIDUAL)  
PO BOX 81  
LEAGUE CITY, TX 77574

FOR: CAFE-RESTAURANTS, IN CLASS 43 (U.S.  
CLS. 100 AND 101).

FIRST USE 12-16-2003; IN COMMERCE 1-16-2004.

THE MARK CONSISTS OF STANDARD CHAR-  
ACTERS WITHOUT CLAIM TO ANY PARTICULAR  
FONT, STYLE, SIZE, OR COLOR.

NO CLAIM IS MADE TO THE EXCLUSIVE  
RIGHT TO USE "CAFE", APART FROM THE MARK  
AS SHOWN.

SER. NO. 77-206,870, FILED 6-15-2007.

REGINA DRUMMOND, EXAMINING ATTORNEY

**Int. Cls.: 35 and 36**

**Prior U.S. Cls.: 100, 101 and 102**

**United States Patent and Trademark Office**

**Reg. No. 3,503,686**

**Registered Sep. 23, 2008**

**SERVICE MARK  
PRINCIPAL REGISTER**

**GCAAPS**

HR INNOVATIONS, INC. (DELAWARE CORPORATION)  
SUITE 1380  
35 EAST WACKER DRIVE  
CHICAGO, IL 60601

FOR: WAGE GARNISHMENT MANAGEMENT AND PROCESSING SERVICES, NAMELY, DATA CAPTURE AND CASE MANAGEMENT, IN CLASS 35 (U.S. CLS. 100, 101 AND 102).

FIRST USE 0-0-2005; IN COMMERCE 0-0-2005.

FOR: WAGE GARNISHMENT SERVICES, NAMELY, ADMINISTRATION AND PAYMENT OF CLAIMS, IN CLASS 36 (U.S. CLS. 100, 101 AND 102).

FIRST USE 0-0-2005; IN COMMERCE 0-0-2005.

THE MARK CONSISTS OF STANDARD CHARACTERS WITHOUT CLAIM TO ANY PARTICULAR FONT, STYLE, SIZE, OR COLOR.

SER. NO. 77-207,031, FILED 6-15-2007.

JEFFERY COWARD, EXAMINING ATTORNEY

**Int. Cl.: 43**

**Prior U.S. Cls.: 100 and 101**

**United States Patent and Trademark Office**

**Reg. No. 3,503,687**

**Registered Sep. 23, 2008**

**SERVICE MARK  
PRINCIPAL REGISTER**

**RIPOSO**

ALOTTA, PHILIP (UNITED STATES INDIVIDUAL)  
128 AUSTIN AVENUE  
TAPPAN, NY 10983

FOR: RESTAURANT SERVICES, IN CLASS 43  
(U.S. CLS. 100 AND 101).

FIRST USE 3-31-2006; IN COMMERCE 3-31-2006.

THE MARK CONSISTS OF STANDARD CHARACTERS WITHOUT CLAIM TO ANY PARTICULAR FONT, STYLE, SIZE, OR COLOR.

THE ENGLISH TRANSLATION OF THE WORD "RIPOSO" IN THE MARK IS RELAX.

SER. NO. 77-208,775, FILED 6-18-2007.

KELLY MCCOY, EXAMINING ATTORNEY

**Int. Cl.: 31**

**Prior U.S. Cls.: 1 and 46**

**United States Patent and Trademark Office**

**Reg. No. 3,503,688**

**Registered Sep. 23, 2008**

**TRADEMARK  
PRINCIPAL REGISTER**

**Calusa**

ALL NATIVE, LLC (FLORIDA LIMITED LIABILITY COMPANY)

PO BOX 1045

SAN ANTONIO, FL 335761045

FOR: LIVING PLANTS, NAMELY, FIREBUSH, IN CLASS 31 (U.S. CLS. 1 AND 46).

FIRST USE 7-6-2006; IN COMMERCE 7-6-2006.

THE MARK CONSISTS OF STANDARD CHARACTERS WITHOUT CLAIM TO ANY PARTICULAR FONT, STYLE, SIZE, OR COLOR.

THE WORDING "CALUSA" HAS NO MEANING IN A FOREIGN LANGUAGE.

SER. NO. 77-209,561, FILED 6-19-2007.

YONG KIM, EXAMINING ATTORNEY

**Int. Cl.: 9**

**Prior U.S. Cls.: 21, 23, 26, 36 and 38**

**Reg. No. 3,503,689**

**United States Patent and Trademark Office**

**Registered Sep. 23, 2008**

**TRADEMARK  
PRINCIPAL REGISTER**

# GEN-PROBE

GEN-PROBE INCORPORATED (DELAWARE CORPORATION)  
10210 GENETIC CENTER DRIVE  
SAN DIEGO, CA 92121

FOR: HOUSEMARK FOR SCIENTIFIC APPARATUS AND INSTRUMENTS, AND PARTS THEREFOR, ALL FOR USE IN BIOMEDICAL RESEARCH OR CLINICAL LABORATORIES, NAMELY, PHOTOMETERS, ASSAY TUBE WASH STATIONS, LABORATORY INCUBATORS, DRY HEAT BATHS, ASSAY TUBE VORTEX MIXERS, ULTRASONIC APPARATUS FOR DISRUPTING CELLS, ASSAY REACTION TUBES, NAMELY, TEST TUBES AND TEST TUBE CAPS, PIPETTORS, LIQUID SAMPLE PROCESSORS FOR HANDLING LIQUIDS, AND AUTOMATED IN VITRO DIAGNOSTIC SPECIMEN TEST ANALYZERS COMPRISED OF ASSAY PROCESSING UNIT, CONTROL UNIT, AND POWER SUPPLY; HOUSEMARK FOR COMPUTER SOFTWARE FOR THE OPERATION OF SCIENTIFIC AND CLINICAL LABORATORY INSTRUMENTS, NAMELY, AUTOMATED IN VITRO DIAGNOSTIC SPECIMEN TEST ANALYZERS, PHOTOMETERS, AND SAMPLE PROCESSORS; HOUSEMARK FOR COMPUTER SOFTWARE FOR THE ORGANIZATION,

ANALYSIS AND REPORTING OF IN VITRO DIAGNOSTIC SPECIMEN TEST DATA, NAMELY, DATA PROCESSING SOFTWARE; HOUSEMARK FOR ELECTRONIC PUBLICATIONS, NAMELY, LABORATORY PROCEDURE GUIDES, INSTRUMENT OPERATING MANUALS, SOFTWARE MANUALS, AND QUICK REFERENCE GUIDES ALL IN THE FIELD OF BIOMEDICAL RESEARCH AND CLINICAL LABORATORIES, RECORDED ON COMPUTER MEDIA, IN CLASS 9 (U.S. CLS. 21, 23, 26, 36 AND 38).

FIRST USE 1-8-1985; IN COMMERCE 1-8-1985.

THE MARK CONSISTS OF STANDARD CHARACTERS WITHOUT CLAIM TO ANY PARTICULAR FONT, STYLE, SIZE, OR COLOR.

OWNER OF U.S. REG. NOS. 1,984,980 AND 1,990,678.

SER. NO. 77-209,721, FILED 6-19-2007.

ELIZABETH KAJUBI, EXAMINING ATTORNEY

**Int. Cl.: 9**

**Prior U.S. Cls.: 21, 23, 26, 36 and 38**

**Reg. No. 3,503,690**

**United States Patent and Trademark Office**

**Registered Sep. 23, 2008**

**TRADEMARK  
PRINCIPAL REGISTER**



GEN-PROBE INCORPORATED (DELAWARE CORPORATION)  
10210 GENETIC CENTER DRIVE  
SAN DIEGO, CA 92121

FOR: HOUSEMARK FOR SCIENTIFIC APPARATUS AND INSTRUMENTS, AND PARTS THEREFOR, ALL FOR USE IN BIOMEDICAL RESEARCH OR CLINICAL LABORATORIES, NAMELY, PHOTOMETERS, ASSAY TUBE WASH STATIONS, LABORATORY INCUBATORS, DRY HEAT BATHS, ASSAY TUBE VORTEX MIXERS, ULTRASONIC APPARATUS FOR DISRUPTING CELLS, ASSAY REACTION TUBES, NAMELY, TEST TUBES AND TEST TUBE CAPS, PIPETTORS, LIQUID SAMPLE PROCESSORS FOR HANDLING LIQUIDS, AND AUTOMATED IN VITRO DIAGNOSTIC SPECIMEN TEST ANALYZERS COMPRISED OF ASSAY PROCESSING UNIT, CONTROL UNIT, AND POWER SUPPLY; HOUSEMARK FOR COMPUTER SOFTWARE FOR THE OPERATION OF SCIENTIFIC AND CLINICAL LABORATORY INSTRUMENTS, NAMELY, AUTOMATED IN VITRO DIAGNOSTIC SPECIMEN TEST ANALYZERS, PHOTOMETERS, AND

SAMPLE PROCESSORS; HOUSEMARK FOR COMPUTER SOFTWARE FOR THE ORGANIZATION, ANALYSIS AND REPORTING OF IN VITRO DIAGNOSTIC SPECIMEN TEST DATA, NAMELY, DATA PROCESSING SOFTWARE; HOUSEMARK FOR ELECTRONIC PUBLICATIONS, NAMELY, LABORATORY PROCEDURE GUIDES, INSTRUMENT OPERATING MANUALS, SOFTWARE MANUALS, AND QUICK REFERENCE GUIDES ALL IN THE FIELD OF BIOMEDICAL RESEARCH AND CLINICAL LABORATORIES, RECORDED ON COMPUTER MEDIA, IN CLASS 9 (U.S. CLS. 21, 23, 26, 36 AND 38).

FIRST USE 1-8-1985; IN COMMERCE 1-8-1985.

OWNER OF U.S. REG. NOS. 1,984,980 AND 1,990,678.

SER. NO. 77-209,733, FILED 6-19-2007.

ELIZABETH KAJUBI, EXAMINING ATTORNEY



**Int. Cl.: 1**

**Prior U.S. Cls.: 1, 5, 6, 10, 26 and 46**

**United States Patent and Trademark Office**

**Reg. No. 3,503,691**

**Registered Sep. 23, 2008**

**TRADEMARK  
PRINCIPAL REGISTER**

**OFF THE VINE**

2077333 ONTARIO INC. (CANADA CORPORATION)  
121 EARL THOMPSON ROAD  
AYRE, CANADA N0B1B0

FOR: FERTILIZER, IN CLASS 1 (U.S. CLS. 1, 5, 6,  
10, 26 AND 46).

THE MARK CONSISTS OF STANDARD CHARACTERS  
WITHOUT CLAIM TO ANY PARTICULAR FONT,  
STYLE, SIZE, OR COLOR.

PRIORITY CLAIMED UNDER SEC. 44(D) ON  
CANADA APPLICATION NO. 1350739, FILED 6-7-  
2007, REG. NO. 712837, DATED 4-25-2008, EXPIRES 4-  
25-2023.

SER. NO. 77-209,756, FILED 6-19-2007.

AMEETA JORDAN, EXAMINING ATTORNEY

**Int. Cl.: 1**

**Prior U.S. Cls.: 1, 5, 6, 10, 26 and 46**

**United States Patent and Trademark Office**

**Reg. No. 3,503,692**

**Registered Sep. 23, 2008**

**TRADEMARK  
PRINCIPAL REGISTER**

**GREEN EVOLUTION**

2077333 ONTARIO INC. (CANADA CORPORATION)  
121 EARL THOMPSON ROAD  
AYRE, CANADA N0B1E0

FOR: FERTILIZER, IN CLASS 1 (U.S. CLS. 1, 5, 6,  
10, 26 AND 46).

THE MARK CONSISTS OF STANDARD CHARACTERS WITHOUT CLAIM TO ANY PARTICULAR FONT, STYLE, SIZE, OR COLOR.

PRIORITY CLAIMED UNDER SEC. 44(D) ON CANADA APPLICATION NO. 1350741, FILED 6-7-

2007, REG. NO. 714300, DATED 5-14-2008, EXPIRES 5-14-2023.

OWNER OF U.S. REG. NOS. 3,196,318 AND 3,196,319.

NO CLAIM IS MADE TO THE EXCLUSIVE RIGHT TO USE "GREEN", APART FROM THE MARK AS SHOWN.

SER. NO. 77-209,762, FILED 6-19-2007.

AMEETA JORDAN, EXAMINING ATTORNEY

**Int. Cl.: 19**

**Prior U.S. Cls.: 1, 12, 33 and 50**

**United States Patent and Trademark Office**

**Reg. No. 3,503,693**

**Registered Sep. 23, 2008**

**TRADEMARK  
PRINCIPAL REGISTER**

**DECO CER**

DECO CER, S.A. (SPAIN CORPORATION)  
CARRETERA ONDA-VILLARREAL  
KM. 3,500  
ONDA (CASTELLON), SPAIN 12200

FOR: WALL TILES, FLOOR TILES, WALL COVERING MATERIALS AND FLOOR PAVING, NAMELY TILES, BLOCKS AND STONES, ALL THE AFOREMENTIONED GOODS MADE OF CERAMIC, STONEWARE AND PORCELAIN MATERIALS, IN CLASS 19 (U.S. CLS. 1, 12, 33 AND 50).

OWNER OF SPAIN REG. NO. 2.620.832, DATED 11-4-2004, EXPIRES 11-4-2014.

OWNER OF U.S. REG. NOS. 2,715,401 AND 2,818,924.

THE COLOR(S) PINK AND GRAY IS/ARE CLAIMED AS A FEATURE OF THE MARK.

THE MARK CONSISTS OF THE WORD "DECO CER" IN STYLIZED LETTERING; THE LETTERS "DECO" ARE IN GRAY AND THE LETTERS "CER" ARE WRITTEN IN PINK.

SER. NO. 77-209,883, FILED 6-19-2007.

KEVON CHISOLM, EXAMINING ATTORNEY

**Int. Cl.: 14**

**Prior U.S. Cls.: 2, 27, 28 and 50**

**United States Patent and Trademark Office**

**Reg. No. 3,503,694**

**Registered Sep. 23, 2008**

**TRADEMARK  
PRINCIPAL REGISTER**

**PIECES OF ME BY CINDY**

MPASIAKOS, CINDY (UNITED STATES INDIVIDUAL)  
16 WILLARD PL  
MONROE, NY 10950

THE MARK CONSISTS OF STANDARD CHARACTERS WITHOUT CLAIM TO ANY PARTICULAR FONT, STYLE, SIZE, OR COLOR.

FOR: JEWELRY, IN CLASS 14 (U.S. CLS. 2, 27, 28 AND 50).

SER. NO. 77-213,748, FILED 6-22-2007.

FIRST USE 5-7-2007; IN COMMERCE 5-7-2007.

SETH A. RAPPAPORT, EXAMINING ATTORNEY

**Int. Cl.: 7**

**Prior U.S. Cls.: 13, 19, 21, 23, 31, 34 and 35**

**United States Patent and Trademark Office**

**Reg. No. 3,503,695**

**Registered Sep. 23, 2008**

**TRADEMARK  
PRINCIPAL REGISTER**

**WATER SPOUT-I**

P.E.P. TECHNOLOGIES, INTERNATIONAL, LLC  
(FLORIDA LIMITED LIABILITY COMPANY),  
AKA PROACTIVE ENVIRONMENTAL PRO-  
DUCTS

1767 LAKEWOOD RANCH BOULEVARD, SUITE 113  
BRADENTON, FL 34211

FOR: SUBMERSIBLE ELECTRIC WATER PUMPS  
FOR GROUNDWATER TESTING , IN CLASS 7 (U.S.  
CLS. 13, 19, 21, 23, 31, 34 AND 35).

FIRST USE 1-0-2005; IN COMMERCE 1-0-2005.

THE MARK CONSISTS OF STANDARD CHAR-  
ACTERS WITHOUT CLAIM TO ANY PARTICULAR  
FONT, STYLE, SIZE, OR COLOR.

NO CLAIM IS MADE TO THE EXCLUSIVE  
RIGHT TO USE "WATER", APART FROM THE  
MARK AS SHOWN.

SER. NO. 77-213,883, FILED 6-23-2007.

SHAUNIA CARLYLE, EXAMINING ATTORNEY

**Int. Cl.: 7**

**Prior U.S. Cls.: 13, 19, 21, 23, 31, 34 and 35**

**United States Patent and Trademark Office**

**Reg. No. 3,503,696**

**Registered Sep. 23, 2008**

**TRADEMARK  
PRINCIPAL REGISTER**

**WATER SPOUT-II**

P.E.P. TECHNOLOGIES, INTERNATIONAL, LLC  
(FLORIDA LIMITED LIABILITY COMPANY),  
AKA PROACTIVE ENVIRONMENTAL PRO-  
DUCTS

1767 LAKEWOOD RANCH BOULEVARD, SUITE 113  
BRADENTON, FL 34211

FOR: SUBMERSIBLE ELECTRIC WATER PUMPS  
FOR GROUNDWATER TESTING , IN CLASS 7 (U.S.  
CLS. 13, 19, 21, 23, 31, 34 AND 35).

FIRST USE 1-0-2005; IN COMMERCE 1-0-2005.

THE MARK CONSISTS OF STANDARD CHAR-  
ACTERS WITHOUT CLAIM TO ANY PARTICULAR  
FONT, STYLE, SIZE, OR COLOR.

NO CLAIM IS MADE TO THE EXCLUSIVE  
RIGHT TO USE "WATER", APART FROM THE  
MARK AS SHOWN.

SER. NO. 77-213,884, FILED 6-23-2007.

SHAUNIA CARLYLE, EXAMINING ATTORNEY

**Int. Cl.: 3**

**Prior U.S. Cls.: 1, 4, 6, 50, 51 and 52**

**United States Patent and Trademark Office**

**Reg. No. 3,503,697**

**Registered Sep. 23, 2008**

**TRADEMARK  
PRINCIPAL REGISTER**

**MANCARE**

SUNFEATHER NATURAL SOAP COMPANY,  
INC. (NEW YORK CORPORATION)  
1551 STATE HWY 172  
POTSDAM, NY 13676

FOR: COSMETICS AND PERSONAL CARE PRODUCTS, NAMELY, SOAP IN LIQUID OR SOLID BAR FORM FOR USE ON HANDS, FACE, HAIR AND BODY; FACE AND BODY SPRAY COMPOSED OF ESSENTIAL OILS IN AN OIL OR ALCOHOL/ETHANOL BASE, FACE AND BODY BALMS AND CREAMS COMPOSED OF OILS, WAXES AND ESSENTIAL OILS AND ESSENTIAL OILS FOR PERSONAL USE, SUNSCREEN BODY SPRAYS AND

CREAMS, IN CLASS 3 (U.S. CLS. 1, 4, 6, 50, 51 AND 52).

FIRST USE 10-0-2006; IN COMMERCE 10-0-2006.

THE MARK CONSISTS OF STANDARD CHARACTERS WITHOUT CLAIM TO ANY PARTICULAR FONT, STYLE, SIZE, OR COLOR.

SER. NO. 77-214,572, FILED 6-25-2007.

GIANCARLO CASTRO, EXAMINING ATTORNEY

**Int. Cl.: 36**

**Prior U.S. Cls.: 100, 101 and 102**

**United States Patent and Trademark Office**

**Reg. No. 3,503,698**

**Registered Sep. 23, 2008**

**SERVICE MARK  
PRINCIPAL REGISTER**



NEW ZEALAND EXCHANGE LIMITED (NEW  
ZEALAND CORPORATION)  
LEVEL 2, NZX CENTRE, 11 CABLE STREET  
WELLINGTON, NEW ZEALAND

FOR: CARBON, ELECTRICITY, GAS, AND RE-  
LATED COMMODITY EXCHANGE SERVICES,  
NAMELY, FACILITATING THE TRADING, CLEAR-  
ING AND SETTLEMENT OF UNITS, ALLOWAN-  
CES, OFFSETS, FUTURES, OPTIONS, SWAPS, SPOT  
CONTRACTS AND OTHER SUCH INSTRUMENTS  
FOR CARBON DIOXIDE, OTHER GREENHOUSE  
GAS EMISSIONS, ELECTRICITY AND GAS;  
BROKERAGE SERVICES IN THE FIELD OF COM-  
MODITIES AND ENERGY, NAMELY, GAS AND  
ELECTRICITY; ISSUING, TRADING, BROKERAGE  
AND ADMINISTRATION OF FINANCIAL INSTRU-  
MENTS IN THE FIELD OF COMMODITIES AND

ENERGY; PROVIDING INVESTMENT ADVISORY  
SERVICES AND FINANCIAL INFORMATION IN  
THE FIELD OF COMMODITIES AND ENERGY, IN  
CLASS 36 (U.S. CLS. 100, 101 AND 102).

PRIORITY CLAIMED UNDER SEC. 44(D) ON  
NEW ZEALAND APPLICATION NO. 764675, FILED  
3-7-2007, REG. NO. 769546, DATED 6-1-2007, EXPIRES  
6-1-2017.

"TZ" HAS NO MEANING IN A FOREIGN LAN-  
GUAGE.

SER. NO. 77-214,965, FILED 6-25-2007.

MARLENE BELL, EXAMINING ATTORNEY



**Int. Cl.: 36**

**Prior U.S. Cls.: 100, 101 and 102**

**United States Patent and Trademark Office**

**Reg. No. 3,503,699**

**Registered Sep. 23, 2008**

**SERVICE MARK  
PRINCIPAL REGISTER**

**TZ1 PLATINUM CREDIT**

NEW ZEALAND EXCHANGE LIMITED (NEW  
ZEALAND CORPORATION)  
LEVEL 2, NZX CENTRE, 11 CABLE STREET  
WELLINGTON, NEW ZEALAND

FOR: CARBON, ELECTRICITY, GAS, AND RE-  
LATED COMMODITY EXCHANGE SERVICES,  
NAMELY, FACILITATING THE TRADING, CLEAR-  
ING AND SETTLEMENT OF UNITS, ALLOWAN-  
CES, OFFSETS, FUTURES, OPTIONS, SWAPS, SPOT  
CONTRACTS AND OTHER SUCH INSTRUMENTS  
FOR CARBON DIOXIDE, OTHER GREENHOUSE  
GAS EMISSIONS, ELECTRICITY AND GAS;  
BROKERAGE SERVICES IN THE FIELD OF COM-  
MODITIES AND ENERGY, NAMELY, GAS AND  
ELECTRICITY; ISSUING, TRADING, BROKERAGE  
AND ADMINISTRATION OF FINANCIAL INSTRU-  
MENTS IN THE FIELD OF COMMODITIES AND  
ENERGY; PROVIDING INVESTMENT ADVISORY  
SERVICES AND FINANCIAL INFORMATION IN

THE FIELD OF COMMODITIES AND ENERGY, IN  
CLASS 36 (U.S. CLS. 100, 101 AND 102).

THE MARK CONSISTS OF STANDARD CHAR-  
ACTERS WITHOUT CLAIM TO ANY PARTICULAR  
FONT, STYLE, SIZE, OR COLOR.

PRIORITY CLAIMED UNDER SEC. 44(D) ON  
NEW ZEALAND APPLICATION NO. 764675, FILED  
3-7-2007, REG. NO. 764675, DATED 3-7-2007, EXPIRES  
3-7-2017.

NO CLAIM IS MADE TO THE EXCLUSIVE  
RIGHT TO USE "PLATINUM CREDIT", APART  
FROM THE MARK AS SHOWN.

SER. NO. 77-214,977, FILED 6-25-2007.

MARLENE BELL, EXAMINING ATTORNEY

**Int. Cls.: 15, 25 and 40**

**Prior U.S. Cls.: 2, 21, 22, 36, 39, 100, 103 and 106**

**United States Patent and Trademark Office**

**Reg. No. 3,503,700**

**Registered Sep. 23, 2008**

**TRADEMARK  
SERVICE MARK  
PRINCIPAL REGISTER**



ORANGE COUNTY DRUM & PERCUSSION, INC.  
(CALIFORNIA CORPORATION)  
UNIT D  
1609 E. MCFADDEN  
SANTA ANA, CA 92705

FOR: DRUMS, IN CLASS 15 (U.S. CLS. 2, 21 AND 36).

FIRST USE 10-31-1991; IN COMMERCE 10-31-1991.

FOR: CLOTHING, NAMELY, HEADWEAR, T-SHIRTS, SHIRTS AND SWEATSHIRTS, IN CLASS 25 (U.S. CLS. 22 AND 39).

FIRST USE 10-31-1991; IN COMMERCE 10-31-1991.

FOR: CUSTOM MANUFACTURE OF MUSICAL DRUMS FOR OTHERS, IN CLASS 40 (U.S. CLS. 100, 103 AND 106).

FIRST USE 10-31-1991; IN COMMERCE 10-31-1991.

THE MARK CONSISTS OF CONCENTRIC CIRCULAR FEATURES FORMED BY THE LETTERS OCDP.

SER. NO. 77-214,985, FILED 6-25-2007.

MARLENE BELL, EXAMINING ATTORNEY

**Int. Cl.: 24**

**Prior U.S. Cls.: 42 and 50**

**United States Patent and Trademark Office**

**Reg. No. 3,503,701**

**Registered Sep. 23, 2008**

**TRADEMARK  
PRINCIPAL REGISTER**

**BUSCH GARDENS**

ANHEUSER-BUSCH, INCORPORATED (MIS-  
SOURI CORPORATION)

202-6

ONE BUSCH PLACE

ST. LOUIS, MO 63118

FOR: CLOTH PENNANTS; FELT PENNANTS;  
BLANKET THROWS, IN CLASS 24 (U.S. CLS. 42  
AND 50).

FIRST USE 4-4-2004; IN COMMERCE 4-4-2004.

THE MARK CONSISTS OF STANDARD CHAR-  
ACTERS WITHOUT CLAIM TO ANY PARTICULAR  
FONT, STYLE, SIZE, OR COLOR.

OWNER OF U.S. REG. NOS. 925,302, 3,256,146 AND  
OTHERS.

SER. NO. 77-215,259, FILED 6-26-2007.

LOURDES AYALA, EXAMINING ATTORNEY

**Int. Cl.: 44**

**Prior U.S. Cls.: 100 and 101**

**United States Patent and Trademark Office**

**Reg. No. 3,503,702**

**Registered Sep. 23, 2008**

**SERVICE MARK  
PRINCIPAL REGISTER**



OHIOHEALTH CORPORATION (OHIO CORPORATION)  
180 E. BROAD STREET  
COLUMBUS, OH 43215

FOR: HOSPITAL SERVICES, HEALTH CARE IN THE NATURE OF HOME HEALTH AGENCIES, NURSING HOMES, PHYSICIAN SERVICES, AND AMBULATORY CARE CENTERS, IN CLASS 44 (U.S. CLS. 100 AND 101).

FIRST USE 4-11-1997; IN COMMERCE 4-11-1997.

SEC. 2(F) AS TO "OHIOHEALTH".

SER. NO. 77-215,968, FILED 6-26-2007.

ALICE SUE CARRUTHERS, EXAMINING ATTORNEY

**Int. Cls.: 16 and 41**

**Prior U.S. Cls.: 2, 5, 22, 23, 29, 37, 38, 50, 100, 101 and 107**

**Reg. No. 3,503,703**

**United States Patent and Trademark Office**

**Registered Sep. 23, 2008**

**TRADEMARK  
SERVICE MARK  
PRINCIPAL REGISTER**

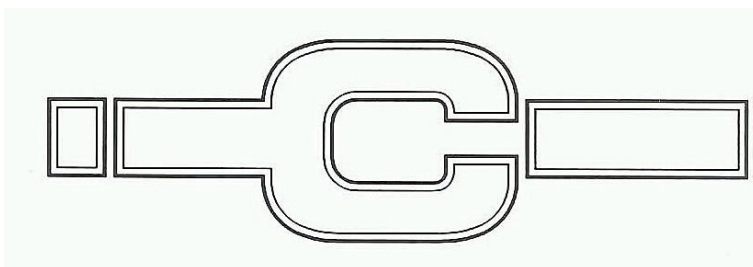

INTERNAL CONTROL INSTITUTE (FLORIDA CORPORATION)  
SUITE 200  
2101 PARK CENTER DRIVE  
ORLANDO, FL 328357614

FOR: PRINTED INSTRUCTIONAL MATERIALS, PAMPHLETS AND REPORTS IN THE FIELD OF INTERNAL BUSINESS CONTROL , IN CLASS 16 (U.S. CLS. 2, 5, 22, 23, 29, 37, 38 AND 50).

FIRST USE 10-1-2002; IN COMMERCE 10-1-2002.

FOR: PROVIDING EDUCATIONAL TRAINING AND TESTING IN THE FIELD OF INTERNAL

BUSINESS MANAGEMENT BY MANNER OF LECTURES, SEMINARS, AND WORKSHOPS, IN CLASS 41 (U.S. CLS. 100, 101 AND 107).

FIRST USE 10-1-2002; IN COMMERCE 10-1-2002.

THE MARK CONSISTS OF THE LETTER "C" WITH PERIOD AND HYPHEN SYMBOLS.

SER. NO. 77-217,146, FILED 6-27-2007.

TIMOTHY FINNEGAN, EXAMINING ATTORNEY

**Int. Cl.: 41**

**Prior U.S. Cls.: 100, 101 and 107**

**United States Patent and Trademark Office**

**Reg. No. 3,503,704**

**Registered Sep. 23, 2008**

**SERVICE MARK  
PRINCIPAL REGISTER**



THE LIONHEART SCHOOL (GEORGIA CORPORATION)  
180 ACADEMY ST.  
ALPHARETTA, GA 30004

FOR: CHARITABLE SERVICES, NAMELY, ACADEMIC MENTORING OF SCHOOL AGE CHILDREN; EDUCATIONAL SERVICES IN THE NATURE OF SPECIAL NEEDS SCHOOLS; EDUCATIONAL SERVICES, NAMELY, CONDUCTING PROGRAMS IN THE FIELD OF SPECIAL NEEDS; EDUCATIONAL SERVICES, NAMELY, CLASSES, SEMINARS, CONFERENCES AND WORKSHOPS IN THE FIELDS OF YOGA, SCIENCE, HISTORY, SOCIAL STUDIES, OCCUPATIONAL THERAPY, SPEECH, LANGUAGE, READING, WRITING, MATH, PHYSICAL EDUCATION, ART, MUSIC, DRAMA, COMMUNICATION SKILLS, THERAPEUTIC INTERVENTIONS, ASSISTIVE TECHNOLOGY, LIFE THINKING CURRICULUM AND PRE-VOCATIONAL AND VOCATIONAL SKILLS, ALL PROVIDED TO CHILDREN WITH SPECIAL NEEDS, IN CLASS 41 (U.S. CLS. 100, 101 AND 107).

FIRST USE 1-1-2001; IN COMMERCE 1-1-2001.

NO CLAIM IS MADE TO THE EXCLUSIVE RIGHT TO USE "SCHOOL", APART FROM THE MARK AS SHOWN.

THE COLOR(S) WHITE, GREY AND RED IS/ARE CLAIMED AS A FEATURE OF THE MARK.

THE MARK CONSISTS OF THE WORDING "THE LIONHEART SCHOOL" IN GREY LETTERING AND THE DESIGN OF A HEART SHAPED LION'S HEAD. THE FACE AND EARS OF THE LION IS WHITE, THE HEART IS RED AND THE LION'S EYES, NOSE AND MOUTH ARE RED.

SER. NO. 77-217,343, FILED 6-27-2007.

WENDY GOODMAN, EXAMINING ATTORNEY

**Int. Cl.: 5**

**Prior U.S. Cls.: 6, 18, 44, 46, 51 and 52**

**United States Patent and Trademark Office**

**Reg. No. 3,503,705**

**Registered Sep. 23, 2008**

**TRADEMARK  
PRINCIPAL REGISTER**

**LT-ONE**

COMPOUND SOLUTIONS, INC. (CALIFORNIA  
CORPORATION)  
2215 VINEYARD AVENUE  
ESCONDIDO, CA 92029

FOR: DIETARY SUPPLEMENTS, NAMELY, L-  
TRYPTOPHAN, IN CLASS 5 (U.S. CLS. 6, 18, 44, 46, 51  
AND 52).

FIRST USE 2-8-2007; IN COMMERCE 2-8-2007.

THE MARK CONSISTS OF STANDARD CHAR-  
ACTERS WITHOUT CLAIM TO ANY PARTICULAR  
FONT, STYLE, SIZE, OR COLOR.

OWNER OF U.S. REG. NOS. 3,311,328, 3,382,594,  
AND 3,395,546.

SER. NO. 77-217,351, FILED 6-27-2007.

MONIQUE MILLER, EXAMINING ATTORNEY

**Int. Cl.: 6**

**Prior U.S. Cls.: 2, 12, 13, 14, 23, 25 and 50**

**Reg. No. 3,503,706**

**United States Patent and Trademark Office**

**Registered Sep. 23, 2008**

**TRADEMARK  
PRINCIPAL REGISTER**



**Romac Industries, Inc.**

ROMAC INDUSTRIES, INC. (WASHINGTON CORPORATION)  
21919 29TH AVE. S.E., SUITE 100  
BOTHELL, WA 980214446

NO CLAIM IS MADE TO THE EXCLUSIVE RIGHT TO USE "INDUSTRIES, INC.", APART FROM THE MARK AS SHOWN.

FOR: METAL PIPE FITTINGS, METAL PIPE REPAIR CLAMPS AND METAL PIPE COUPLINGS, IN CLASS 6 (U.S. CLS. 2, 12, 13, 14, 23, 25 AND 50).

SER. NO. 77-217,990, FILED 6-28-2007.

FIRST USE 6-30-1969; IN COMMERCE 6-30-1969.

JESSICA A. POWERS, EXAMINING ATTORNEY



**Int. Cl.: 35**

**Prior U.S. Cls.: 100, 101 and 102**

**United States Patent and Trademark Office**

**Reg. No. 3,503,707**

**Registered Sep. 23, 2008**

**SERVICE MARK  
PRINCIPAL REGISTER**

**RATE AND REVIEW THE PET  
WORLD**

ZOO TOO LLC (DELAWARE LIMITED LIABILITY COMPANY)  
400 PLAZA DRIVE, 1ST FLOOR  
SECAUCUS, NJ 07094

FOR: PROVIDING A WEBSITE FEATURING PRODUCT RATINGS SUBMITTED BY THE PUBLIC OF THE CONSUMER GOODS AND SERVICES OF OTHERS IN THE FIELD OF PET PRODUCTS AND PET CARE SERVICES, IN CLASS 35 (U.S. CLS. 100, 101 AND 102).

FIRST USE 6-25-2007; IN COMMERCE 6-25-2007.

THE MARK CONSISTS OF STANDARD CHARACTERS WITHOUT CLAIM TO ANY PARTICULAR FONT, STYLE, SIZE, OR COLOR.

SER. NO. 77-218,047, FILED 6-28-2007.

DANNEAN HETZEL, EXAMINING ATTORNEY

Int. Cl.: 36

Prior U.S. Cls.: 100, 101 and 102

United States Patent and Trademark Office

Reg. No. 3,503,708

Registered Sep. 23, 2008

SERVICE MARK  
PRINCIPAL REGISTER



JAKKS PACIFIC, INC. (DELAWARE CORPORATION)  
22619 PACIFIC COAST HIGHWAY  
MALIBU, CA 90265

FOR: CHARITABLE FUND RAISING, IN CLASS  
36 (U.S. CLS. 100, 101 AND 102).

FIRST USE 5-31-2007; IN COMMERCE 5-31-2007.

THE MARK CONSISTS OF THE WORDS "JAKKS  
CARES SMILE PLAY SUCCEED" SURROUNDED

BY A CIRCLE; THE WORDS "JAKKS CARES" ARE  
ABOVE AN INNER CIRCLE SHOWING TWO FIG-  
URES HOLDING HANDS TO FORM A HEART;  
BELOW THE INNER CIRCLE ARE THE WORDS  
"SMILE PLAY SUCCEED" WHICH ARE SEPARA-  
TED BY A TINY HEART.

SER. NO. 77-218,308, FILED 6-28-2007.

MARY CRAWFORD, EXAMINING ATTORNEY

**Int. Cl.: 36**

**Prior U.S. Cls.: 100, 101 and 102**

**United States Patent and Trademark Office**

**Reg. No. 3,503,709**

**Registered Sep. 23, 2008**

**SERVICE MARK  
PRINCIPAL REGISTER**

**JAKKS CARES SMILE PLAY  
SUCCEED**

JAKKS PACIFIC, INC. (DELAWARE CORPORATION)  
22619 PACIFIC COAST HIGHWAY  
MALIBU, CA 90265

THE MARK CONSISTS OF STANDARD CHARACTERS WITHOUT CLAIM TO ANY PARTICULAR FONT, STYLE, SIZE, OR COLOR.

FOR: CHARITABLE FUND RAISING, IN CLASS 36 (U.S. CLS. 100, 101 AND 102).

SER. NO. 77-218,322, FILED 6-28-2007.

FIRST USE 5-31-2007; IN COMMERCE 5-31-2007.

MARY CRAWFORD, EXAMINING ATTORNEY

**Int. Cl.: 42**

**Prior U.S. Cls.: 100 and 101**

**United States Patent and Trademark Office**

**Reg. No. 3,503,710**

**Registered Sep. 23, 2008**

**SERVICE MARK  
PRINCIPAL REGISTER**

**THE DECO GUYZ**

INTERIORS BY DECORATING DEN (TEXAS  
PARTNERSHIP)

11011 PEMBRIDGE DR.

HOUSTON, TX 77071

FOR: INTERIOR DECORATING, IN CLASS 42  
(U.S. CLS. 100 AND 101).

FIRST USE 4-1-2004; IN COMMERCE 4-1-2004.

THE MARK CONSISTS OF STANDARD CHAR-  
ACTERS WITHOUT CLAIM TO ANY PARTICULAR  
FONT, STYLE, SIZE, OR COLOR.

NO CLAIM IS MADE TO THE EXCLUSIVE  
RIGHT TO USE "DECO", APART FROM THE MARK  
AS SHOWN.

SER. NO. 77-218,479, FILED 6-28-2007.

BARBARA A. GOLD, EXAMINING ATTORNEY

**Int. Cl.: 30**

**Prior U.S. Cl.: 46**

**United States Patent and Trademark Office**

**Reg. No. 3,503,711**

**Registered Sep. 23, 2008**

**TRADEMARK  
PRINCIPAL REGISTER**

**LEONETTI'S FROZEN FOODS**

LEONETTI FOOD DISTRIBUTORS, INC. (PENNSYLVANIA CORPORATION)  
5935 WOODLAND AVE.  
PHILADELPHIA, PA 19143

FOR: CALZONES; SANDWICHES, NAMELY, STROMBOLIS, IN CLASS 30 (U.S. CL. 46).

FIRST USE 1-2-1981; IN COMMERCE 1-2-1981.

THE MARK CONSISTS OF STANDARD CHARACTERS WITHOUT CLAIM TO ANY PARTICULAR FONT, STYLE, SIZE, OR COLOR.

NO CLAIM IS MADE TO THE EXCLUSIVE RIGHT TO USE "FROZEN FOODS", APART FROM THE MARK AS SHOWN.

THE NAME(S), PORTRAIT(S), AND/OR SIGNATURE(S) SHOWN IN THE MARK DOES NOT IDENTIFY A PARTICULAR LIVING INDIVIDUAL.

SEC. 2(F).

SER. NO. 77-219,998, FILED 7-1-2007.

SUSAN LESLIE DUBOIS, EXAMINING ATTORNEY

**Int. Cls.: 3 and 5**

**Prior U.S. Cls.: 1, 4, 6, 18, 44, 46, 50, 51 and 52**

**United States Patent and Trademark Office**

**Reg. No. 3,503,712**

**Registered Sep. 23, 2008**

**TRADEMARK  
PRINCIPAL REGISTER**

**INTEGRALE ANTI-AGE**

LANCÔME PARFUMS ET BEAUTE & CIE  
(FRANCE SOCIETE EN NOM COLLECTIF)  
29, RUE DU FAUBOURG SAINT-HONORE  
PARIS, FRANCE 75008

FOR: PERFUME, TOILET WATER; GELS, SALTS FOR THE BATH AND THE SHOWER NOT FOR MEDICAL PURPOSE; TOILET SOAPS, BODY DEODORANTS; COSMETICS, NAMELY, CREAMS, MILKS, LOTIONS, GELS AND POWDERS FOR THE FACE, THE BODY AND THE HANDS; NON-MEDICATED SUN CARE PREPARATIONS; MAKE-UP PREPARATIONS; SHAMPOOS; GELS, SPRAYS, MOUSSES AND BALMS FOR HAIR STYLING AND HAIR CARE; HAIR LACQUERS; HAIR COLOURING AND HAIR DECOLORANT PREPARATIONS; PERMANENT WAVING AND CURLING PREPARATIONS; ESSENTIAL OILS FOR PERSONAL USE, IN CLASS 3 (U.S. CLS. 1, 4, 6, 50, 51 AND 52).

FOR: NUTRACEUTICALS FOR USE AS A DIETARY SUPPLEMENT, DIETARY SUPPLEMENTS, DIETARY FOOD SUPPLEMENTS AND NUTRITIONAL SUPPLEMENTS FOR NUTRITIONAL

AND COSMETIC PURPOSES, FOOD FOR BABIES, IN CLASS 5 (U.S. CLS. 6, 18, 44, 46, 51 AND 52).

THE MARK CONSISTS OF STANDARD CHARACTERS WITHOUT CLAIM TO ANY PARTICULAR FONT, STYLE, SIZE, OR COLOR.

PRIORITY CLAIMED UNDER SEC. 44(D) ON FRANCE APPLICATION NO. 073504450, FILED 6-5-2007, REG. NO. 073504450, DATED 6-5-2007, EXPIRES 6-5-2017.

NO CLAIM IS MADE TO THE EXCLUSIVE RIGHT TO USE "ANTI-AGE", APART FROM THE MARK AS SHOWN.

THE FOREIGN WORDING IN THE MARK TRANSLATES INTO ENGLISH AS INTEGRAL.

SER. NO. 77-220,148, FILED 7-2-2007.

JENNIFER VASQUEZ, EXAMINING ATTORNEY

**Int. Cl.: 39**

**Prior U.S. Cls.: 100 and 105**

**United States Patent and Trademark Office**

**Reg. No. 3,503,713**

**Registered Sep. 23, 2008**

**SERVICE MARK  
PRINCIPAL REGISTER**

**DREAMMAKER**

PATRICK, GREGORY L. (UNITED STATES INDIVIDUAL)  
4511 YOKUM BLVD  
HOUSTON, TX 77006

FOR: ARRANGING TRAVEL TOURS; COORDINATING TRAVEL ARRANGEMENTS FOR INDIVIDUALS AND FOR GROUPS; ORGANISATION OF TRAVEL; ORGANIZATION OF EXCURSIONS, SIGHTSEEING TOURS, HOLIDAYS, TOURS AND TRAVEL; ORGANIZATION OF TRAVEL AND BOAT TRIPS, IN CLASS 39 (U.S. CLS. 100 AND 105).

FIRST USE 1-1-2001; IN COMMERCE 1-1-2001.

THE MARK CONSISTS OF STANDARD CHARACTERS WITHOUT CLAIM TO ANY PARTICULAR FONT, STYLE, SIZE, OR COLOR.

SER. NO. 77-220,170, FILED 7-2-2007.

BONNIE LUKEN, EXAMINING ATTORNEY

**Int. Cl.: 35**

**Prior U.S. Cls.: 100, 101 and 102**

**United States Patent and Trademark Office**

**Reg. No. 3,503,714**

**Registered Sep. 23, 2008**

**SERVICE MARK  
PRINCIPAL REGISTER**

# Home for the Brand

KORMAN MARKETING GROUP L.P. (TEXAS  
LIMITED PARTNERSHIP)  
SUITE 200  
16800 DALLAS PKWY  
DALLAS, TX 75248

THE MARK CONSISTS OF STANDARD CHAR-  
ACTERS WITHOUT CLAIM TO ANY PARTICULAR  
FONT, STYLE, SIZE, OR COLOR.

FOR: ADVERTISING, MARKETING AND PRO-  
MOTION SERVICES, IN CLASS 35 (U.S. CLS. 100, 101  
AND 102).

SER. NO. 77-220,551, FILED 7-2-2007.

FIRST USE 6-1-2007; IN COMMERCE 6-1-2007.

LINDA E. BLOHM, EXAMINING ATTORNEY



**Int. Cl.: 16**

**Prior U.S. Cls.: 2, 5, 22, 23, 29, 37, 38 and 50**

**United States Patent and Trademark Office**

**Reg. No. 3,503,715**

**Registered Sep. 23, 2008**

**TRADEMARK  
PRINCIPAL REGISTER**



AQUARIUS PRESS COMPANY (ILLINOIS CORPORATION)  
P.O. BOX 906  
MORTON GROVE, IL 60053

FOR: SCHOLARLY BOOKS ON VARIOUS TOPICS, NAMELY, HISTORY, IN CLASS 16 (U.S. CLS. 2, 5, 22, 23, 29, 37, 38 AND 50).

FIRST USE 12-4-2006; IN COMMERCE 12-20-2006.

NO CLAIM IS MADE TO THE EXCLUSIVE RIGHT TO USE "PRESS", APART FROM THE MARK AS SHOWN.

THE COLOR(S) BLACK AND BLUE IS/ARE CLAIMED AS A FEATURE OF THE MARK.

THE COLOR BLACK APPEARS IN THE WORDING "AQUARIUS PRESS" AND IN THE DESIGN OF THE HORIZONTAL LINE BETWEEN THE "A" AND "PRESS"; THE COLOR BLUE APPEARS IN THE DESIGN OF THE WAVES EMBEDDED IN THE LETTER "A" OF "AQUARIUS".

SER. NO. 77-221,644, FILED 7-3-2007.

MARLENE BELL, EXAMINING ATTORNEY

**Int. Cl.: 11**

**Prior U.S. Cls.: 13, 21, 23, 31 and 34**

**United States Patent and Trademark Office**

**Reg. No. 3,503,716**

**Registered Sep. 23, 2008**

**TRADEMARK  
PRINCIPAL REGISTER**

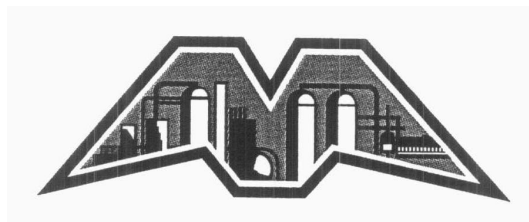

MERICHEM COMPANY (DELAWARE CORPORATION)  
5455 OLD SPANISH TRAIL  
HOUSTON, TX 77023

FOR: PROCESS EQUIPMENT, NAMELY, REACTORS AND SEPARATORS FOR USE IN THE TREATMENT OF HYDROCARBONS, SPENT CAUSTIC AND OTHER CHEMICALS, IN CLASS 11 (U.S. CLS. 13, 21, 23, 31 AND 34).

FIRST USE 1-0-1970; IN COMMERCE 1-0-1970.

THE MARK IS PRESENTED WITHOUT CLAIM TO ANY PARTICULAR SIZE OR COLOR AND CONSISTS OF A STYLIZED "M" WITH A REPRESENTATION OF VARIOUS CHEMICAL PROCESS EQUIPMENT.

SER. NO. 77-223,404, FILED 7-6-2007.

AMY ALFIERI, EXAMINING ATTORNEY

**Int. Cl.: 42**

**Prior U.S. Cls.: 100 and 101**

**United States Patent and Trademark Office**

**Reg. No. 3,503,717**

**Registered Sep. 23, 2008**

**SERVICE MARK  
PRINCIPAL REGISTER**

**VOICE PARTNERS**

VOICE PARTNERS LLC (DELAWARE LIMITED  
LIABILITY COMPANY)  
655 MONTGOMERY STREET, 5TH FLOOR  
SAN FRANCISCO, CA 94111

FOR: RESEARCH, DESIGN, DEVELOPMENT,  
AND IMPLEMENTATION OF SOFTWARE APPLI-  
CATIONS FOR VOICE CONTROLLED COMMUNI-  
CATIONS VIA COMPUTERS, THE INTERNET,  
LOCAL AREA NETWORKS, AND TELECOMMUNI-  
CATIONS NETWORKS; COMPUTER PROGRAM-  
MING FOR OTHERS, AND INSTALLATION AND  
MAINTENANCE OF COMPUTER NETWORK  
SOFTWARE AND VOICE USER INTERFACE COM-  
PUTER SOFTWARE; CONSULTING SERVICES IN

THE FIELD OF DESIGN, SELECTION, IMPLEMEN-  
TATION AND USE OF COMPUTER HARDWARE  
AND SOFTWARE SYSTEMS FOR OTHERS, IN  
CLASS 42 (U.S. CLS. 100 AND 101).

FIRST USE 9-0-2002; IN COMMERCE 9-0-2002.

THE MARK CONSISTS OF STANDARD CHAR-  
ACTERS WITHOUT CLAIM TO ANY PARTICULAR  
FONT, STYLE, SIZE, OR COLOR.

SER. NO. 77-223,426, FILED 7-6-2007.

KYLE PEETE, EXAMINING ATTORNEY

Int. Cls.: 24 and 25

Prior U.S. Cls.: 22, 39, 42 and 50

United States Patent and Trademark Office

Reg. No. 3,503,718

Registered Sep. 23, 2008

TRADEMARK  
PRINCIPAL REGISTER



GENEX BRANDS LTD (UNITED KINGDOM LIMITED COMPANY)  
29 MARYLEBONE ROAD  
LONDON, UNITED KINGDOM NW11JD

FOR: TEXTILES AND TEXTILE GOODS, NAME-  
LY, BED, TABLE, DINING, HOUSEHOLD AND  
BATH LINEN, BED SHEETS, EIDERDOWNS AND  
QUILTS, BEDSPREADS, WALL HANGINGS OF  
TEXTILE, CURTAINS MADE OF TEXTILE FAB-  
RICS, FABRICS FOR TEXTILE USE, PLACE MATS  
OF TEXTILE, QUILTS OF TEXTILE, SERVIETTES  
OF TEXTILE, TABLE NAPKINS OF TEXTILE, TA-  
BLECLOTHS OF TEXTILE, TAPESTRIES OF TEX-  
TILE, TEXTILE FABRICS FOR THE  
MANUFACTURE OF CLOTHING, TEXTILE USED  
AS LINING FOR CLOTHING, TEXTILE LABELS,  
TEXTILE WALL HANGINGS, HANDKERCHIEFS  
OF TEXTILE, COTTON FABRICS; FABRICS MADE  
FROM COTTON; FABRICS FOR TEXTILE USE; BED  
BLANKETS; BLANKET TROWS; BLANKETS FOR  
OUTDOOR USE; CHILDREN'S BLANKETS; PETS  
BLANKETS; COTTON BLANKETS; COTTON  
CLOTHS, NAMELY, WASH CLOTHS; BATH  
SHEETS; CLOTH LABELS; TOWELS; CURTAINS;  
BEDDING, NAMELY, BLANKETS, COMFORTERS  
AND SHEETS; FURNITURE COVERINGS OF COT-  
TON; COVERS FOR CUSHIONS; PILLOW CASES;  
ALL OF THE FOREGOING GOODS COMPOSED  
WHOLLY OF ORGANIC COTTON, IN CLASS 24  
(U.S. CLS. 42 AND 50).

FOR: CLOTHING, NAMELY, BELTS, SHIRTS,  
DRESS SHIRTS, NIGHT SHIRTS, LONG SLEEVED  
SHIRTS, RUGBY SHIRTS, SHIRT FRONTS, SHIRT  
YOKES, SHIRTS FOR SUITS, SHORT SLEEVED OR

LONG SLEEVED SHIRTS, SPORTS SHIRTS, T  
SHIRTS, TROUSERS AND VESTS, JUMPERS, PULL-  
OVERS, BLOUSES, SKIRTS AND DRESSES, SKIRT  
SUITS, SKIRTS, DRESS SUITS, SUITS, PARTS OF  
CLOTHING, NAMELY, GUSSETS FOR TIGHTS,  
GUSSETS FOR STOCKINGS, GUSSETS FOR BATH-  
ING SUITS, GUSSETS FOR UNDERWEAR, GUS-  
SETS FOR LEOTARDS AND GUSSETS FOR  
FOOTLETS, TRACK SUITS, TRAINING SUITS,  
COATS AND JACKETS, COATS AND JACKETS OF  
COTTON, HEAVY COATS AND JACKETS, MORN-  
ING COATS, OVER COATS, SPORTS COATS, TOP  
COATS, TRENCH COATS, WIND COATS, JACKETS,  
JACKET LINERS, LONG JACKETS, REVERSIBLE  
JACKETS, SLEEVED OR SLEEVELESS JACKETS,  
SPORTS JACKETS, SCARVES, HEAD SCARVES,  
SHOULDER SCARVES, GLOVES, CUFFS, UNDER-  
WEAR, SOCKS; HEADGEAR, NAMELY, HATS,  
CAPS, BASEBALL CAPS; ALL OF THE FOREGOING  
GOODS FOR MEN, WOMEN AND CHILDREN AND  
COMPOSED WHOLLY OF ORGANIC COTTON, IN  
CLASS 25 (U.S. CLS. 22 AND 39).

PRIORITY CLAIMED UNDER SEC. 44(D) ON  
ERPNTY TM OFC APPLICATION NO.  
5606314, FILED 1-10-2007, REG. NO. 5606314, DATED  
2-12-2008, EXPIRES 1-10-2017.

NO CLAIM IS MADE TO THE EXCLUSIVE  
RIGHT TO USE "ORGANIC COTTON," "100% OR-  
GANIC COTTON" AND "COMPANY", APART  
FROM THE MARK AS SHOWN.

THE LINING IS A FEATURE OF THE MARK.  
THE STIPPLING IS A FEATURE OF THE MARK.

SER. NO. 77-223,841, FILED 7-6-2007.

ANDREW RHIM, EXAMINING ATTORNEY

**Int. Cl.: 16**

**Prior U.S. Cls.: 2, 5, 22, 23, 29, 37, 38 and 50**

**United States Patent and Trademark Office**

**Reg. No. 3,503,719**

**Registered Sep. 23, 2008**

**TRADEMARK  
PRINCIPAL REGISTER**

**SUPERNANNY**

RICOCHET PRODUCTIONS LIMITED (UNITED  
KINGDOM CORPORATION)  
PACIFIC HOUSE  
126 DYKE ROAD  
BRIGHTON, UNITED KINGDOM BN13TE

FOR: PRINTED CHARTS, NAMELY, COLOR  
CHARTS, WALL CHARTS, STICKER CHARTS,  
AND REWARD CHARTS, IN CLASS 16 (U.S. CLS. 2,  
5, 22, 23, 29, 37, 38 AND 50).

THE MARK CONSISTS OF STANDARD CHAR-  
ACTERS WITHOUT CLAIM TO ANY PARTICULAR  
FONT, STYLE, SIZE, OR COLOR.

PRIORITY CLAIMED UNDER SEC. 44(D) ON  
UNITED KINGDOM APPLICATION NO. 2456155,  
FILED 5-21-2007, REG. NO. 2456155, DATED 10-26-  
2007, EXPIRES 5-21-2017.

OWNER OF U.S. REG. NO. 3,147,001.

SER. NO. 77-223,926, FILED 7-6-2007.

DAVID YONTEF, EXAMINING ATTORNEY

**Int. Cl.: 35**

**Prior U.S. Cls.: 100, 101 and 102**

**United States Patent and Trademark Office**

**Reg. No. 3,503,720**

**Registered Sep. 23, 2008**

**SERVICE MARK  
PRINCIPAL REGISTER**

**COMPUTRABAJO**

DGNET LTD. (UNITED KINGDOM CORPORATION)  
OFFICE 19  
12 SOUTH BRIDGE  
EDINBURGH, UNITED KINGDOM EH11DD

FOR: PROVIDING AN ON-LINE SEARCHABLE DATABASE FEATURING CLASSIFIED LISTINGS OF EMPLOYMENT OPPORTUNITIES AND RESUMES, IN CLASS 35 (U.S. CLS. 100, 101 AND 102).

FIRST USE 10-5-1998; IN COMMERCE 10-5-1998.

THE MARK CONSISTS OF STANDARD CHARACTERS WITHOUT CLAIM TO ANY PARTICULAR FONT, STYLE, SIZE, OR COLOR.

THE ENGLISH TRANSLATION OF THE WORD "TRABAJO" IN THE MARK IS WORK OR EMPLOYMENT.

SER. NO. 77-224,917, FILED 7-9-2007.

EVELYN BRADLEY, EXAMINING ATTORNEY

**Int. Cls.: 41 and 45**

**Prior U.S. Cls.: 100, 101 and 107**

**United States Patent and Trademark Office**

**Reg. No. 3,503,721**

**Registered Sep. 23, 2008**

**SERVICE MARK  
PRINCIPAL REGISTER**



BIG BROTHERS BIG SISTERS OF CENTRAL OHIO, INC. (OHIO NON-PROFIT CORPORATION)  
1855 E. DUBLIN-GRANVILLE ROAD  
COLUMBUS, OH 43229

FOR: ONE-ON-ONE ADULT MENTORING OF YOUTH IN THE FIELDS OF LIFE SKILLS, LIFE ACHIEVEMENT, CAREER COUNSELING AND POST-SECONDARY EDUCATION, IN CLASS 41 (U.S. CLS. 100, 101 AND 107).

FIRST USE 9-25-2007; IN COMMERCE 9-25-2007.

FOR: YOUTH COUNSELING SERVICES FOCUSED ON ONE-ON-ONE ADULT-CHILD MENTORING, IN CLASS 45 (U.S. CLS. 100 AND 101).

FIRST USE 9-25-2007; IN COMMERCE 9-25-2007.

NO CLAIM IS MADE TO THE EXCLUSIVE RIGHT TO USE "PROJECT MENTOR COLUMBUS CITY SCHOOLS", APART FROM THE MARK AS SHOWN.

THE MARK CONSISTS OF A SMALLER PARTIAL STAR SHAPE WITH A CIRCLE ON TOP AND A GRADUATION CAP SYMBOLIZING A CHILD TO THE LEFT OF A LARGER PARTIAL STAR SHAPE WITH A CIRCLE ON TOP SYMBOLIZING AN ADULT. THE WORDS "PROJECT", "MENTOR" AND "COLUMBUS CITY SCHOOLS" APPEAR DIRECTLY BELOW THE STAR SHAPES ON THREE SEPARATE LINES.

SER. NO. 77-226,147, FILED 7-10-2007.

LINDA ESTRADA, EXAMINING ATTORNEY



**Int. Cls.: 29 and 30**

**Prior U.S. Cl.: 46**

**United States Patent and Trademark Office**

**Reg. No. 3,503,722**

**Registered Sep. 23, 2008**

**TRADEMARK  
PRINCIPAL REGISTER**



LOG HOUSE FOODS, INC. (MINNESOTA CORPORATION)  
700 NORTH BERKSHIRE LANE  
PLYMOUTH, MN 55441

FOR: PROCESSED COCONUT, IN CLASS 29 (U.S. CL. 46).

FIRST USE 12-31-2005; IN COMMERCE 12-31-2005.

FOR: CONFECTIONARY COATINGS, NAMELY, VANILLA AND ALMOND BARK, BAKING CHIPS AND CHUNKS, COOKIES AND PRODUCE COATINGS, IN CLASS 30 (U.S. CL. 46).

FIRST USE 12-31-2005; IN COMMERCE 12-31-2005.

NO CLAIM IS MADE TO THE EXCLUSIVE RIGHT TO USE "MARKET", APART FROM THE MARK AS SHOWN.

THE MARK CONSISTS OF THE WORDS "MILL CITY MARKET" SUPERIMPOSED ON TWO RECTANGLES INSIDE A SQUARE BACKGROUND.

SER. NO. 77-227,019, FILED 7-11-2007.

ALEX KEAM, EXAMINING ATTORNEY

**Int. Cls.: 8 and 19**

**Prior U.S. Cls.: 1, 12, 23, 28, 33, 44 and 50**

**United States Patent and Trademark Office**

**Reg. No. 3,503,723**

**Registered Sep. 23, 2008**

**TRADEMARK  
PRINCIPAL REGISTER**

**MARBLE LINO**

KHM MANAGEMENT AG (SWITZERLAND  
CORPORATION)  
SUDQUAISTRASSE 12  
BASEL, SWITZERLAND CH-4019

FOR: TROWELS, IN CLASS 8 (U.S. CLS. 23, 28 AND  
44).

FIRST USE 7-0-2006; IN COMMERCE 7-0-2006.

FOR: DECORATIVE PLASTER FINISHES MADE  
PRIMARILY FROM MARBLE AND CONTAINING  
OTHER NATURAL STONE MATERIALS, IN CLASS  
19 (U.S. CLS. 1, 12, 33 AND 50).

FIRST USE 7-0-2006; IN COMMERCE 7-0-2006.

THE MARK CONSISTS OF STANDARD CHAR-  
ACTERS WITHOUT CLAIM TO ANY PARTICULAR  
FONT, STYLE, SIZE, OR COLOR.

NO CLAIM IS MADE TO THE EXCLUSIVE  
RIGHT TO USE "MARBLE", APART FROM THE  
MARK AS SHOWN.

SER. NO. 77-227,125, FILED 7-11-2007.

CAROLINE WOOD, EXAMINING ATTORNEY

**Int. Cl.: 34**

**Prior U.S. Cls.: 2, 8, 9 and 17**

**United States Patent and Trademark Office**

**Reg. No. 3,503,724**

**Registered Sep. 23, 2008**

**TRADEMARK  
PRINCIPAL REGISTER**

**KENNY'S BAD BOYS**

WESTMINSTER CIGAR COMPANY (MARY-  
LAND CORPORATION)  
23 E. MAIN STREET  
WESTMINSTER, MD 21157

FOR: CIGARS, NAMELY, UNIQUELY FLA-  
VORED AND AROMATIC 100% NATURAL TOBAC-  
CO LEAF SMOKING ROLLS, IN CLASS 34 (U.S. CLS.  
2, 8, 9 AND 17).

FIRST USE 11-0-1996; IN COMMERCE 11-0-1996.

THE MARK CONSISTS OF STANDARD CHAR-  
ACTERS WITHOUT CLAIM TO ANY PARTICULAR  
FONT, STYLE, SIZE, OR COLOR.

SER. NO. 77-228,667, FILED 7-12-2007.

MELVIN AXILBUND, EXAMINING ATTORNEY

**Int. Cl.: 38**

**Prior U.S. Cls.: 100, 101 and 104**

**United States Patent and Trademark Office**

**Reg. No. 3,503,725**

**Registered Sep. 23, 2008**

**SERVICE MARK  
PRINCIPAL REGISTER**

**DEBTORBOARDS**

KATZ, STEVEN (UNITED STATES INDIVIDUAL)  
12899 S EVENING SUN TRAIL  
VAIL, AZ 85641

FOR: PROVIDING ON-LINE CHAT ROOMS AND  
ELECTRONIC BULLETIN BOARDS FOR TRANS-  
MISSION OF MESSAGES AMONG USERS IN THE  
FIELD OF GENERAL INTEREST, IN CLASS 38 (U.S.  
CLS. 100, 101 AND 104).

FIRST USE 10-1-2005; IN COMMERCE 10-1-2005.

THE MARK CONSISTS OF STANDARD CHAR-  
ACTERS WITHOUT CLAIM TO ANY PARTICULAR  
FONT, STYLE, SIZE, OR COLOR.

SEC. 2(F).

SER. NO. 77-228,669, FILED 7-12-2007.

JENNIFER VASQUEZ, EXAMINING ATTORNEY

**Int. Cl.: 25**

**Prior U.S. Cls.: 22 and 39**

**United States Patent and Trademark Office**

**Reg. No. 3,503,726**

**Registered Sep. 23, 2008**

**TRADEMARK  
PRINCIPAL REGISTER**

**CORE HEAT TRANSFER SYSTEM**

GERBING'S HEATED CLOTHING INC. (WA-  
SHINGTON CORPORATION)  
750 EAST DALBY ROAD  
UNION, WA 98592

FOR: CLOTHING, NAMELY, PANTS, JACKETS,  
BIB OVERALLS, GLOVES, SOCKS, MITTENS,  
CLOTH BIBS AND JACKETS, PANT AND VEST  
LINERS, IN CLASS 25 (U.S. CLS. 22 AND 39).

FIRST USE 10-1-2006; IN COMMERCE 1-11-2007.

THE MARK CONSISTS OF STANDARD CHAR-  
ACTERS WITHOUT CLAIM TO ANY PARTICULAR  
FONT, STYLE, SIZE, OR COLOR.

NO CLAIM IS MADE TO THE EXCLUSIVE  
RIGHT TO USE "HEAT TRANSFER SYSTEM",  
APART FROM THE MARK AS SHOWN.

SER. NO. 77-228,729, FILED 7-12-2007.

EDWARD NELSON, EXAMINING ATTORNEY

**Int. Cl.: 9**

**Prior U.S. Cls.: 21, 23, 26, 36 and 38**

**Reg. No. 3,503,727**

**United States Patent and Trademark Office**

**Registered Sep. 23, 2008**

**TRADEMARK  
PRINCIPAL REGISTER**



PIONEER KABUSHIKI KAISHA (JAPAN CORPORATION), DBA PIONEER CORPORATION  
4-1, MEGURO 1-CHOME  
MEGURO-KU, TOKYO, JAPAN

FOR: AUDIO COMPONENT EQUIPMENTS, NAMELY, AMPLIFIERS, STEREO AND TELEVISION TUNERS, RECEIVERS, PHONOGRAPH TURNTABLES, CD PLAYERS AND RECORDERS, AUDIO CASSETTE PLAYERS AND RECORDERS, SUPER AUDIO CD PLAYERS, DIGITAL AUDIO PLAYERS, LOUDSPEAKERS, AUDIO CABLES, HEADPHONES; RADIOS; DIGITAL RADIO RECEIVERS; DVD PLAYERS; DVD RECORDERS; HARD DISC DRIVE PLAYERS AND RECORDERS; OPTICAL DISC PLAYERS AND RECORDERS FOR AUDIO, VIDEO AND COMPUTER DATA; TELEVISION SETS; FLAT DISPLAY PANEL SCREENS AND MONITORS; PLASMA DISPLAY PANELS; VIDEO MONITORS; COMPUTER MONITORS; HOME

THEATER SYSTEM COMPRISING OF ONE OR MORE OF AUDIO SPEAKERS, RECEIVERS, DVD PLAYERS, CD PLAYERS, AND TELEVISION SETS; AUDIO RACKS FOR BUILT-IN LOUDSPEAKERS; REMOTE CONTROLS FOR EACH OF AFORESAID GOODS, IN CLASS 9 (U.S. CLS. 21, 23, 26, 36 AND 38).

PRIORITY CLAIMED UNDER SEC. 44(D) ON JAPAN APPLICATION NO. 2007-75552, FILED 7-4-2007, REG. NO. 5117622, DATED 3-7-2007, EXPIRES 3-7-2017.

OWNER OF U.S. REG. NOS. 1,128,556 AND 1,614,718.

SER. NO. 77-228,941, FILED 7-13-2007.

JENNIFER VASQUEZ, EXAMINING ATTORNEY

**Int. Cl.: 9**

**Prior U.S. Cls.: 21, 23, 26, 36 and 38**

**Reg. No. 3,503,728**

**United States Patent and Trademark Office**

**Registered Sep. 23, 2008**

---

**TRADEMARK  
PRINCIPAL REGISTER**

**CHOCLOTTIE**

MATTEL, INC. (DELAWARE CORPORATION)  
M1-1518  
333 CONTINENTAL BLVD.  
EL SEGUNDO, CA 90245

FIRST USE 6-2-2003; IN COMMERCE 6-2-2003.

FOR: PROVIDING DOWNLOADABLE SOFTWARE, AVAILABLE ON AN INTERACTIVE WEB SITE FOR CHILDREN'S ENTERTAINMENT, FOR CREATING AND USING DESKTOP WALLPAPER AND DOWNLOADABLE IMAGES FOR COLORING, IN CLASS 9 (U.S. CLS. 21, 23, 26, 36 AND 38).

THE MARK CONSISTS OF STANDARD CHARACTERS WITHOUT CLAIM TO ANY PARTICULAR FONT, STYLE, SIZE, OR COLOR.

SER. NO. 77-229,154, FILED 7-13-2007.

ANGELA M. MICHELI, EXAMINING ATTORNEY

**Int. Cl.: 9**

**Prior U.S. Cls.: 21, 23, 26, 36 and 38**

**Reg. No. 3,503,729**

**United States Patent and Trademark Office**

**Registered Sep. 23, 2008**

**TRADEMARK  
PRINCIPAL REGISTER**

**BANANCY**

MATTEL, INC. (DELAWARE CORPORATION)  
M1-1518  
333 CONTINENTAL BLVD.  
EL SEGUNDO, CA 90245

FIRST USE 6-2-2003; IN COMMERCE 6-2-2003.

FOR: PROVIDING DOWNLOADABLE SOFTWARE, AVAILABLE ON AN INTERACTIVE WEB SITE FOR CHILDREN'S ENTERTAINMENT, FOR CREATING AND USING DESKTOP WALLPAPER AND DOWNLOADABLE IMAGES FOR COLORING, IN CLASS 9 (U.S. CLS. 21, 23, 26, 36 AND 38).

THE MARK CONSISTS OF STANDARD CHARACTERS WITHOUT CLAIM TO ANY PARTICULAR FONT, STYLE, SIZE, OR COLOR.

SER. NO. 77-229,158, FILED 7-13-2007.

ANGELA M. MICHELI, EXAMINING ATTORNEY



**Int. Cl.: 35**

**Prior U.S. Cls.: 100, 101 and 102**

**United States Patent and Trademark Office**

**Reg. No. 3,503,730**

**Registered Sep. 23, 2008**

**SERVICE MARK  
PRINCIPAL REGISTER**

# DMX MUSIC

DMX, INC. (TEXAS CORPORATION)  
600 CONGRESS AVE.  
SUITE 1400  
AUSTIN, TX 78701

FOR: DISTRIBUTORSHIP SERVICES IN THE FIELD OF CONSUMER AND COMMERCIAL ELECTRONICS, COMPUTER SYSTEMS, COMPUTER HARDWARE AND COMPUTER SOFTWARE FOR THE BROADCASTING, DOWNLOAD, STORAGE, MANIPULATION AND PLAYBACK OF MUSIC, SOUND RECORDINGS AND AUDIO AND VISUAL ENTERTAINMENT, EDUCATIONAL AND INFORMATIONAL PROGRAMS; DISTRIBUTORSHIP SERVICES IN THE FIELD OF MUSIC, SOUND RECORDINGS AND AUDIO AND VISUAL ENTERTAINMENT, EDUCATIONAL AND INFORMATIONAL PROGRAMS; DISTRIBUTORSHIP SERVICES IN THE FIELD OF SATELLITE AND DIGITAL TUNERS, SATELLITE DISHES, TRANSMITTERS AND RECEIVERS AND SATELLITE, TELEPHONIC, TELEVISION AND CABLE BROADCASTING AND RECEIVING EQUIPMENT AND SYSTEMS; MESSAGE MARKETING SERVICES FOR OTHERS, NAMELY, PROVIDING CUSTOMIZED RECORDED MESSAGES TO BE PLAYED WHILE TELEPHONE CALLERS ARE PLACED ON HOLD AND CUSTOMIZED RECORDED MESSAGES TO BE PLAYED OVER IN-STORE AND ON-SITE AUDIO AND VISUAL EQUIPMENT TO PROMOTE THE GOODS AND SERVICES OF OTHERS; ADVERTISING AND MARKETING SERVICES FOR OTHERS; ON LINE RETAIL STORE SERVICES FEATURING CONSUMER AND COMMERCIAL

ELECTRONICS, COMPUTER SYSTEMS, COMPUTER HARDWARE AND COMPUTER SOFTWARE FOR THE BROADCASTING, DOWNLOAD, STORAGE, MANIPULATION AND PLAYBACK OF MUSIC, SOUND RECORDINGS, AUDIO AND VISUAL ENTERTAINMENT, SATELLITE AND DIGITAL TUNERS, SATELLITE DISHES, TRANSMITTERS AND RECEIVERS AND SATELLITE, TELEPHONIC, TELEVISION AND CABLE BROADCASTING AND RECEIVING EQUIPMENT AND SYSTEMS; COMMERCIAL ADMINISTRATION OF THE LICENSING OF MUSIC, SOUND RECORDING AND AUDIO AND VIDEO CONTENT OF OTHERS, IN CLASS 35 (U.S. CLS. 100, 101 AND 102).

FIRST USE 2-0-2000; IN COMMERCE 2-0-2000.

THE MARK CONSISTS OF STANDARD CHARACTERS WITHOUT CLAIM TO ANY PARTICULAR FONT, STYLE, SIZE, OR COLOR.

OWNER OF ERPN CMNTY TM OFC REG. NO. 3506623, DATED 4-20-2005, EXPIRES 10-31-2013.

OWNER OF U.S. REG. NOS. 1,736,237, 2,565,797, AND 2,568,018.

NO CLAIM IS MADE TO THE EXCLUSIVE RIGHT TO USE "MUSIC", APART FROM THE MARK AS SHOWN.

SER. NO. 77-229,414, FILED 7-13-2007.

INGA ERVIN, EXAMINING ATTORNEY

**Int. Cl.: 38**

**Prior U.S. Cls.: 100, 101 and 104**

**United States Patent and Trademark Office**

**Reg. No. 3,503,731**

**Registered Sep. 23, 2008**

**SERVICE MARK  
PRINCIPAL REGISTER**

# DMX MUSIC

DMX, INC. (TEXAS CORPORATION)  
600 CONGRESS AVE.  
SUITE 1400  
AUSTIN, TX 78701

FOR: MUSIC BROADCASTING; TELEVISION, CABLE, SATELLITE AND ELECTRONIC TRANSMISSION AND BROADCAST OF MUSIC, SOUND RECORDINGS AND AUDIO AND VISUAL ENTERTAINMENT, EDUCATIONAL AND INFORMATIONAL PROGRAMS; RENTAL OF CUSTOMIZED CONSUMER AND COMMERCIAL ELECTRONICS EQUIPMENT AND SYSTEMS FOR THE BROADCAST AND DOWNLOAD OF MUSIC, SOUND RECORDINGS AND AUDIO AND VISUAL ENTERTAINMENT, EDUCATIONAL AND INFORMATIONAL PROGRAMS; RENTAL OF SATELLITE AND DIGITAL TUNERS, SATELLITE DISHES, TRANSMITTERS AND RECEIVERS, AND SATELLITE, TELEPHONIC, TELEVISION AND CABLE BROADCASTING AND RECEIVING EQUIPMENT SYSTEMS; TELEPHONE MESSAGING VOICE SERVICES; ELECTRONIC VOICE MESSAGING, NAMELY, THE RECORDING AND SUBSEQUENT TRANSMISSION OF VOICE MESSAGES BY TELEPHONE; ELECTRONIC STORAGE AND FORWARDING SERVICES; RENTAL OF COMMUNICATION SYSTEMS, NAMELY, RENTAL

OF MESSAGING SYSTEMS AND EQUIPMENT USED IN CONNECTION WITH TELEPHONE ON-HOLD MUSIC AND MESSAGE SERVICES AND IN-STORE AND ON-SITE MESSAGE SERVICES FOR THE PLAYING OF PRE-RECORDED MESSAGES IN BUSINESSES, IN CLASS 38 (U.S. CLS. 100, 101 AND 104).

FIRST USE 2-0-2000; IN COMMERCE 2-0-2000.

THE MARK CONSISTS OF STANDARD CHARACTERS WITHOUT CLAIM TO ANY PARTICULAR FONT, STYLE, SIZE, OR COLOR.

OWNER OF ERPN CMNTY TM OFC REG. NO. 3506623, DATED 4-20-2005, EXPIRES 10-31-2013.

OWNER OF U.S. REG. NOS. 1,736,237, 2,565,797, AND 2,568,018.

NO CLAIM IS MADE TO THE EXCLUSIVE RIGHT TO USE "MUSIC", APART FROM THE MARK AS SHOWN.

SER. NO. 77-229,435, FILED 7-13-2007.

INGA ERVIN, EXAMINING ATTORNEY

**Int. Cl.: 20**

**Prior U.S. Cls.: 2, 13, 22, 25, 32 and 50**

**Reg. No. 3,503,732**

**United States Patent and Trademark Office**

**Registered Sep. 23, 2008**

**TRADEMARK  
PRINCIPAL REGISTER**



FHD UNLIMITED, INC. (OHIO CORPORATION),  
DBA FINEHOMEDISPLAYS.COM & FINEHOMEDESIGNS.COM  
P.O. BOX 2491  
COLUMBUS, OH 43216

FOR: PLATE RACKS, IN CLASS 20 (U.S. CLS. 2, 13, 22, 25, 32 AND 50).

FIRST USE 12-29-2004; IN COMMERCE 1-1-2005.

THE MARK CONSISTS OF A SQUARE DESIGN WITH A STYLIZED FLOWER AND SCROLLWORK

DESIGN INSIDE THE SQUARE. THE STYLIZED FLOWER AND SCROLLWORK DESIGN EXTENDS BEYOND THE LEFT AND RIGHT BORDERS OF THE SQUARE. THE WORD "F H D" APPEARS ABOVE THE SQUARE AND THE WORD "UNLIMITED" APPEARS BELOW THE SQUARE.

SER. NO. 77-230,532, FILED 7-16-2007.

EDWARD NELSON, EXAMINING ATTORNEY

**Int. Cls.: 16, 25 and 41**

**Prior U.S. Cls.: 2, 5, 22, 23, 29, 37, 38, 39, 50, 100, 101 and 107**

**Reg. No. 3,503,733**

**United States Patent and Trademark Office**

**Registered Sep. 23, 2008**

**TRADEMARK  
SERVICE MARK  
PRINCIPAL REGISTER**



UNIVERSITY OF SAN DIEGO (CALIFORNIA CORPORATION)  
5998 ALCALA PARK  
SAN DIEGO, CA 92110

FOR: FOLDERS; BINDERS; NOTE BOOKS; NOTE PADS AND HOLDERS; DECALS; STICKERS; POSTERS; DAY PLANNERS; POSTCARDS; BOOKMARKS; CALENDARS; MONEY CLIPS; PENCILS; PENS; NEWSLETTERS FEATURING COLLEGE LIFE, CAMPUS ACTIVITIES, ACADEMIC, EDUCATIONAL AND ATHLETIC PROGRAMS, VISUAL, LITERARY AND PERFORMING ARTS PRESENTATIONS; PAMPHLETS FEATURING COLLEGE LIFE, CAMPUS ACTIVITIES, ACADEMIC, EDUCATIONAL AND ATHLETIC PROGRAMS, VISUAL, LITERARY AND PERFORMING ARTS PRESENTATIONS; PERIODIC BROCHURES FEATURING COLLEGE LIFE, CAMPUS ACTIVITIES, ACADEMIC, EDUCATIONAL AND ATHLETIC PROGRAMS, VISUAL, LITERARY AND PERFORMING ARTS PRESENTATIONS, IN CLASS 16 (U.S. CLS. 2, 5, 22, 23, 29, 37, 38 AND 50).

FIRST USE 2-1-2007; IN COMMERCE 2-1-2007.

FOR: CLOTHING, NAMELY, TOPS, BOTTOMS, SHIRTS, T-SHIRTS, POLO SHIRTS, SPORTS SHIRTS, TANK TOPS, SHORTS, SWEAT PANTS, SWEAT SHIRTS, WARM UP SUITS, COATS, SOCKS, HEADWEAR, VISORS AND CAPS, IN CLASS 25 (U.S. CLS. 22 AND 39).

FIRST USE 1-1-2007; IN COMMERCE 1-1-2007.

FOR: EDUCATIONAL SERVICES, NAMELY, PROVIDING UNDERGRADUATE, GRADUATE, AND DOCTORAL EDUCATION SERVICES AT THE UNIVERSITY LEVEL; CONTINUING EDUCATION SERVICES IN THE AREAS OF ARTS, SCIENCES, HUMANITIES, EDUCATION, ECONOMICS, BUSINESS, HEALTH, NURSING, LAW, ENGINEERING, COMPUTER TECHNOLOGY, LANGUAGES, LEADERSHIP, AND GOVERNMENT; EDUCATIONAL SEMINARS IN THE FIELDS OF ARTS, SCIENCES, HUMANITIES, EDUCATION, ECONOMICS, BUSINESS, HEALTH, NURSING, LAW, ENGINEERING, COMPUTER TECHNOLOGY, LANGUAGES, LEADERSHIP, AND GOVERNMENT, IN CLASS 41 (U.S. CLS. 100, 101 AND 107).

FIRST USE 1-1-2007; IN COMMERCE 1-1-2007.

OWNER OF U.S. REG. NOS. 1,756,753 AND 3,034,356.

NO CLAIM IS MADE TO THE EXCLUSIVE RIGHT TO USE "UNIVERSITY", APART FROM THE MARK AS SHOWN.

SEC. 2(F) AS TO "UNIVERSITY OF SAN DIEGO".

SER. NO. 77-230,856, FILED 7-16-2007.

WILLIAM P. SHANAHAN, EXAMINING ATTORNEY

**Int. Cls.: 35, 40 and 45**

**Prior U.S. Cls.: 100, 101, 102, 103 and 106**

**United States Patent and Trademark Office**

**Reg. No. 3,503,734**

**Registered Sep. 23, 2008**

**SERVICE MARK  
PRINCIPAL REGISTER**

**BOWNE ePOD**

BOWNE OF LOS ANGELES, INC. (CALIFORNIA CORPORATION)  
2013 EAST UNIVERSITY DRIVE  
DOMINGUEZ HILLS, CA 90220

FOR: PROVIDING NOTIFICATION SERVICES VIA PAPER, FOR BUSINESSES, INFORMING SHAREHOLDERS OF THE AVAILABILITY OF PRINTED OR ON-LINE PROXY MATERIALS; PROVIDING BUSINESS INFORMATION ONLINE IN THE NATURE OF PROXY MATERIALS CONCERNING A PARTICULAR BUSINESS OR ENTERPRISE; VOTING SERVICES, NAMELY, SERVICE ALLOWING USERS TO CAST SHAREHOLDER VOTES AND REQUEST PROXY BALLOTS ONLINE, VIA TELEPHONE AND VIA PAPER; BUSINESS ADMINISTRATION SERVICES PROVIDED FOR THIRD PARTIES, NAMELY, DISTRIBUTION OF A BUSINESS'S PROXY MATERIALS BY MAIL, IN CLASS 35 (U.S. CLS. 100, 101 AND 102).

FIRST USE 8-1-2007; IN COMMERCE 8-1-2007.

FOR: PRINTING OF PROXY MATERIALS, IN CLASS 40 (U.S. CLS. 100, 103 AND 106).

FIRST USE 8-1-2007; IN COMMERCE 8-1-2007.

FOR: REVIEW OF A COMPANY'S DATA, POLICIES AND PROCESS IN ORDER TO PROVIDE REPORTS VERIFYING COMPLIANCE WITH SEC RULES, IN CLASS 45 (U.S. CLS. 100 AND 101).

FIRST USE 8-1-2007; IN COMMERCE 8-1-2007.

OWNER OF U.S. REG. NOS. 1,306,990, 2,339,685 AND OTHERS.

SER. NO. 77-231,240, FILED 7-17-2007.

JENNIFER VASQUEZ, EXAMINING ATTORNEY

**Int. Cl.: 31**

**Prior U.S. Cls.: 1 and 46**

**United States Patent and Trademark Office**

**Reg. No. 3,503,735**

**Registered Sep. 23, 2008**

**TRADEMARK  
PRINCIPAL REGISTER**

**HAZERA BOUTIQUE**

HAZERA GENETICS LTD. (ISRAEL CORPORATION)  
BRURIM, M. P.  
SHIKMIM, ISRAEL 79837

FOR: LIVING PLANTS, PLANT PROPAGATING MATERIAL, NAMELY, SEEDS, AND FRESH FRUITS, IN CLASS 31 (U.S. CLS. 1 AND 46).

THE MARK CONSISTS OF STANDARD CHARACTERS WITHOUT CLAIM TO ANY PARTICULAR FONT, STYLE, SIZE, OR COLOR.

OWNER OF ERPN CMNTY TM OFC REG. NO. 5657739, DATED 1-29-2008, EXPIRES 1-22-2017.

OWNER OF U.S. REG. NO. 2,182,060.

NO CLAIM IS MADE TO THE EXCLUSIVE RIGHT TO USE "HAZERA", APART FROM THE MARK AS SHOWN.

THE FOREIGN WORDING IN THE MARK TRANSLATES INTO ENGLISH AS THE SEED.

SER. NO. 77-231,947, FILED 7-17-2007.

ESTHER A. BORSUK, EXAMINING ATTORNEY

**Int. Cl.: 41**

**Prior U.S. Cls.: 100, 101 and 107**

**United States Patent and Trademark Office**

**Reg. No. 3,503,736**

**Registered Sep. 23, 2008**

**SERVICE MARK  
PRINCIPAL REGISTER**

**BOB WILLS DAY**

THE ESTATE OF BOB WILLS, INC. (TEXAS CORPORATION), DBA THE BOB WILLS ESTATE

P. O. BOX 448  
C/O TWIN FIDDLE RANCH  
ALVARADO, TX 760090448

FOR: ENTERTAINMENT SERVICES, NAMELY, THE STAGING AND PROMOTION OF MUSICAL PERFORMANCES BY INSTRUMENTAL AND VOCAL GROUPS; THE STAGING AND PROMOTION OF MUSIC FESTIVALS, IN CLASS 41 (U.S. CLS. 100, 101 AND 107).

FIRST USE 4-1-1972; IN COMMERCE 4-1-1972.

THE MARK CONSISTS OF STANDARD CHARACTERS WITHOUT CLAIM TO ANY PARTICULAR FONT, STYLE, SIZE, OR COLOR.

THE NAME "BOB WILLS" DOES NOT IDENTIFY A LIVING INDIVIDUAL.

SER. NO. 77-233,501, FILED 7-19-2007.

ALICIA COLLINS, EXAMINING ATTORNEY

**Int. Cl.: 21**

**Prior U.S. Cls.: 2, 13, 23, 29, 30, 33, 40 and 50**

**United States Patent and Trademark Office**

**Reg. No. 3,503,737**

**Registered Sep. 23, 2008**

**TRADEMARK  
PRINCIPAL REGISTER**

**FOH Porcelain...your first  
ingredient.**

FOH, INC. (FLORIDA CORPORATION)  
9315 PARK DRIVE  
MIAMI SHORES, FL 33138

FOR: BOWLS; CERAMIC SCULPTURES, VASES, VESSELS, BOWLS, PLATES AND POTS; FINGER BOWLS; FLOWER BOWLS; FLOWER VASES AND BOWLS; FRUIT BOWLS; JAPANESE RICE BOWLS (CHAWAN); JAPANESE RICE BOWLS NOT OF PRECIOUS METAL (CHAWAN); JAPANESE STYLE SOUP SERVING BOWLS (WAN); PEPPER POTS, SUGAR BOWLS AND SALT SHAKERS; RINSING BOWLS; SALAD BOWLS; SALAD BOWLS; SERVING BOWLS (HACHI); SHALLOW BOWLS; SUGAR BOWLS; DECORATIVE PLATES; DINNERWARE, NAMELY, BOWLS, PLATES, SERVERS, PLATTERS, SAUCERS, MUGS, CREAMERS, TEAPOTS, CUPS, DISHES, SWEETENER PACKET HOLDERS, GLASSES, SUGAR POTS, POURERS, RAMEKINS, SUGAR AND CREAMER SETS, SALT AND PEPPER SHAKERS, TASTING SPOONS; DISHES AND PLATES; PLATES; PLATES FOR HORS D'OEUVRE; SOUVENIR PLATES; CAKE SERVERS; COFFEE SERVERS; NON-ELECTRIC COFFEE SERVERS NOT OF PRECIOUS METAL; PIE SERVERS; SERVING PLATTERS; SERVING PLATTERS NOT OF PRECIOUS METAL; SAUCERS; SAUCERS NOT OF PRECIOUS METALS; MUG TREES; MUGS; PORCELAIN MUGS; CREAMER PITCHERS; COFFEE CUPS; CUPS; DRINKING CUPS; EGG CUPS; MIXING CUPS; SAKE CUPS; BAKING DISHES; BUTTER DISHES; BUTTER-DISH AND CHEESE-DISH COV-

ERS; CASSEROLES; DISH COVERS; DISHES; POT-POURRI DISHES; SERVING DISHES; STANDS FOR DISHES; TABLE PLACE CARD HOLDERS NOT OF PRECIOUS METAL; TOOTHPICK HOLDERS; MENU CARD HOLDERS; NAPKIN HOLDERS; SERVIETTE HOLDERS; CANDLE HOLDERS; CANDLE HOLDERS NOT OF PRECIOUS METAL; DRINKING GLASSES; SHOT GLASSES; COFFEE POTS; COFFEE POTS NOT OF PRECIOUS METAL; JAPANESE STYLE TEA-SERVING POTS (KYUSU); NON-ELECTRIC COFFEE POTS; POT LIDS; TEA POTS; TEA POTS NOT OF PRECIOUS METAL; WINE POURERS; TEA SETS; COCKTAIL SHAKERS; PEPPER GRINDERS; PEPPER MILLS; SALT AND PEPPER MILLS; SALT AND PEPPER SHAKERS; SALT CELLARS; SALT SHAKERS; MIXING SPOONS; SERVING SPOONS; SLOTTED SPOONS; SPOON RESTS, IN CLASS 21 (U.S. CLS. 2, 13, 23, 29, 30, 33, 40 AND 50).

FIRST USE 10-1-2006; IN COMMERCE 10-1-2006.

THE MARK CONSISTS OF STANDARD CHARACTERS WITHOUT CLAIM TO ANY PARTICULAR FONT, STYLE, SIZE, OR COLOR.

NO CLAIM IS MADE TO THE EXCLUSIVE RIGHT TO USE "PORCELAIN", APART FROM THE MARK AS SHOWN.

SER. NO. 77-233,855, FILED 7-19-2007.

LINDA M. KING, EXAMINING ATTORNEY



**Int. Cls.: 37, 41, 42, 43 and 44**

**Prior U.S. Cls.: 100, 101, 103, 106 and 107**

**United States Patent and Trademark Office**

**Reg. No. 3,503,738**

**Registered Sep. 23, 2008**

**SERVICE MARK  
PRINCIPAL REGISTER**

**BETTER HOMES AND GARDENS**

MEREDITH CORPORATION (IOWA CORPORATION)  
1716 LOCUST STREET  
DES MOINES, IA 503093023

FOR: PROVIDING INFORMATION VIA A WEBSITE ABOUT HOME BUILDING, REMODELING, PROPER INSTALLATION OF APPLIANCES AND PRODUCTS FOR USE IN THE HOME, IN CLASS 37 (U.S. CLS. 100, 103 AND 106).

FIRST USE 6-26-2000; IN COMMERCE 6-26-2000.

FOR: PROVIDING INFORMATION VIA A WEBSITE IN THE FIELD OF CRAFTS, FAMILY ENTERTAINMENT, LEISURE ACTIVITIES, EXERCISE AND FITNESS, IN CLASS 41 (U.S. CLS. 100, 101 AND 107).

FIRST USE 6-26-2000; IN COMMERCE 6-26-2000.

FOR: PROVIDING INFORMATION VIA A WEBSITE IN THE FIELDS OF INTERIOR AND EXTERIOR DECORATING, ARCHITECTURAL DESIGN, LANDSCAPE ARCHITECTURAL DESIGN AND LANDSCAPE LIGHTING DESIGN, IN CLASS 42 (U.S. CLS. 100 AND 101).

FIRST USE 6-26-2000; IN COMMERCE 6-26-2000.

FOR: PROVIDING INFORMATION VIA A WEBSITE IN THE FIELDS OF FOOD, COOKING AND THE ART OF FOOD PREPARATION, IN CLASS 43 (U.S. CLS. 100 AND 101).

FIRST USE 6-26-2000; IN COMMERCE 6-26-2000.

FOR: PROVIDING INFORMATION VIA A WEBSITE IN THE FIELDS OF GARDENING, LANDSCAPE DESIGN, HEALTH AND NUTRITION, IN CLASS 44 (U.S. CLS. 100 AND 101).

FIRST USE 6-26-2000; IN COMMERCE 6-26-2000.

THE MARK CONSISTS OF STANDARD CHARACTERS WITHOUT CLAIM TO ANY PARTICULAR FONT, STYLE, SIZE, OR COLOR.

OWNER OF U.S. REG. NOS. 754,656, 2,979,393 AND OTHERS.

SER. NO. 77-234,146, FILED 7-19-2007.

MYRIAH HABEEB, EXAMINING ATTORNEY

**Int. Cls.: 9, 41 and 42**

**Prior U.S. Cls.: 21, 23, 26, 36, 38, 100, 101 and 107**

**Reg. No. 3,503,739**

**United States Patent and Trademark Office**

**Registered Sep. 23, 2008**

**TRADEMARK  
SERVICE MARK  
PRINCIPAL REGISTER**

# STARREZ

STARREZ, INC. (DELAWARE CORPORATION)  
5340 S. QUEBEC STREET, SUITE 250-S  
GREENWOOD VILLAGE, CO 80111

FOR: COMPUTER SOFTWARE FOR HOUSING AND CONFERENCE FACILITY MANAGEMENT AND ADMINISTRATION IN THE FIELD OF EDUCATIONAL INSTITUTIONS; COMPUTER SOFTWARE FOR MANAGING AND ADMINISTERING HOUSING APPLICATIONS, ROOM SELECTION AND BILLING FOR HOUSING FACILITIES IN THE FIELD OF EDUCATIONAL INSTITUTIONS; COMPUTER SOFTWARE FOR SCHEDULING AND MANAGING CONFERENCES AND EVENTS IN THE FIELD OF EDUCATIONAL INSTITUTIONS; COMPUTER SOFTWARE FOR INTEGRATING COMPUTER SYSTEMS FOR HOUSING AND CONFERENCE FACILITY MANAGEMENT WITH OTHER CAMPUS INFORMATION SYSTEMS, NAMELY, COMPUTER SYSTEMS FOR SINGLE SIGN-ON, CAMPUS SECURITY AND MEAL PLANS; COMPUTER SOFTWARE FOR COMPILING SECURITY-RELATED ACCOUNTING AND RECORD-KEEPING, NAMELY, INCIDENT REPORTS AND SECURITY-RELATED STATISTICS, IN THE FIELD OF EDUCATIONAL INSTITUTIONS; COMPUTER SOFTWARE FOR MANAGING MAINTENANCE AND INVENTORY RECORD-KEEPING FOR HOUSING AND CONFERENCE FACILITIES IN THE FIELD OF EDUCATIONAL INSTITUTIONS, IN CLASS 9 (U.S. CLS. 21, 23, 26, 36 AND 38).

FIRST USE 5-0-2003; IN COMMERCE 5-0-2003.

FOR: PROVIDING TRAINING IN THE USE AND OPERATION OF COMPUTER SYSTEMS, IN CLASS 41 (U.S. CLS. 100, 101 AND 107).

FIRST USE 5-0-2003; IN COMMERCE 5-0-2003.

FOR: CONSULTING SERVICES IN FIELD OF COMPUTER SYSTEMS AND SYSTEMS IMPLEMENTATION FOR HOUSING AND CONFERENCE FACILITIES; COMPUTER SYSTEMS INTEGRATION FOR STUDENT HOUSING AND CONFERENCE FACILITY MANAGEMENT SOFTWARE WITH OTHER CAMPUS INFORMATION SOFTWARE, NAMELY, SECURITY ACCESS CARDS, SINGLE SIGN-ON AND MEAL PLANS; CONFIGURATION AND CUSTOMIZATION OF COMPUTER SOFTWARE FOR MANAGING AND ADMINISTERING HOUSING AND CONFERENCE FACILITIES IN THE FIELD OF EDUCATIONAL INSTITUTIONS; CONFIGURATION AND CUSTOMIZATION OF COMPUTER SOFTWARE FOR MANAGING AND ADMINISTERING HOUSING APPLICATIONS, ROOM SELECTION AND BILLING FOR HOUSING FACILITIES IN THE FIELD OF EDUCATIONAL INSTITUTIONS; CONFIGURATION AND CUSTOMIZATION OF COMPUTER SOFTWARE FOR SCHEDULING AND MANAGING CONFERENCES AND EVENTS IN THE FIELD OF EDUCATIONAL INSTITUTIONS; CONFIGURATION AND CUSTOMIZATION OF COMPUTER SOFTWARE FOR COMPILING SECURITY-RELATED ACCOUNTING AND RECORD-KEEPING, NAMELY, INCIDENT REPORTS AND SECURITY-RELATED STATISTICS, IN THE FIELD OF EDUCATIONAL INSTITUTIONS; CONFIGURATION AND CUSTOMIZATION OF COMPUTER SOFTWARE FOR MANAGING MAINTENANCE AND INVENTORY RECORD-KEEPING FOR HOUSING AND CONFERENCE FACILITIES IN THE FIELD OF EDUCATIONAL INSTITUTIONS, IN CLASS 42 (U.S. CLS. 100 AND 101).

FIRST USE 5-0-2003; IN COMMERCE 5-0-2003.

THE MARK CONSISTS OF STANDARD CHARACTERS WITHOUT CLAIM TO ANY PARTICULAR FONT, STYLE, SIZE, OR COLOR.

SER. NO. 77-235,191, FILED 7-20-2007.

MARLENE BELL, EXAMINING ATTORNEY

**Int. Cls.: 9, 41 and 42**

**Prior U.S. Cls.: 21, 23, 26, 36, 38, 100, 101 and 107**

**Reg. No. 3,503,740**

**United States Patent and Trademark Office**

**Registered Sep. 23, 2008**

**TRADEMARK  
SERVICE MARK  
PRINCIPAL REGISTER**



STARREZ, INC. (DELAWARE CORPORATION)  
5340 S. QUEBEC STREET, SUITE 250-S  
GREENWOOD VILLAGE, CO 80111

FOR: COMPUTER SOFTWARE FOR HOUSING AND CONFERENCE FACILITY MANAGEMENT AND ADMINISTRATION IN THE FIELD OF EDUCATIONAL INSTITUTIONS; COMPUTER SOFTWARE FOR MANAGING AND ADMINISTERING HOUSING APPLICATIONS, ROOM SELECTION AND BILLING FOR HOUSING FACILITIES IN THE FIELD OF EDUCATIONAL INSTITUTIONS; COMPUTER SOFTWARE FOR SCHEDULING AND MANAGING CONFERENCES AND EVENTS IN THE FIELD OF EDUCATIONAL INSTITUTIONS; COMPUTER SOFTWARE FOR INTEGRATING COMPUTER SYSTEMS FOR HOUSING AND CONFERENCE FACILITY MANAGEMENT WITH OTHER CAMPUS INFORMATION SYSTEMS, NAMELY, COMPUTER SYSTEMS FOR SINGLE SIGN-ON, CAMPUS SECURITY AND MEAL PLANS; COMPUTER SOFTWARE FOR COMPILING SECURITY-RELATED ACCOUNTING AND RECORD-KEEPING, NAMELY, INCIDENT REPORTS AND SECURITY-RELATED STATISTICS, IN THE FIELD OF EDUCATIONAL INSTITUTIONS; COMPUTER SOFTWARE FOR MANAGING MAINTENANCE AND INVENTORY RECORD-KEEPING FOR HOUSING AND CONFERENCE FACILITIES IN THE FIELD OF EDUCATIONAL INSTITUTIONS, IN CLASS 9 (U.S. CLS. 21, 23, 26, 36 AND 38).

FIRST USE 5-0-2003; IN COMMERCE 6-0-2003.

FOR: PROVIDING TRAINING IN THE USE AND OPERATION OF COMPUTER SYSTEMS, IN CLASS 41 (U.S. CLS. 100, 101 AND 107).

FIRST USE 5-0-2003; IN COMMERCE 5-0-2003.

FOR: CONSULTING SERVICES IN FIELD OF COMPUTER SYSTEMS AND SYSTEMS IMPLEMENTATION FOR HOUSING AND CONFERENCE FACILITIES; COMPUTER SYSTEMS INTEGRATION FOR STUDENT HOUSING AND CONFERENCE FACILITY MANAGEMENT SOFTWARE WITH OTHER CAMPUS INFORMATION SOFTWARE, NAMELY, SECURITY ACCESS CARDS, SINGLE SIGN-ON AND MEAL PLANS; CONFIGURATION AND CUSTOMIZATION OF COMPUTER SOFTWARE FOR MANAGING AND ADMINISTERING HOUSING AND CONFERENCE FACILITIES IN THE FIELD OF EDUCATIONAL INSTITUTIONS; CONFIGURATION AND CUSTOMIZATION OF COMPUTER SOFTWARE FOR MANAGING AND ADMINISTERING HOUSING APPLICATIONS, ROOM SELECTION AND BILLING FOR HOUSING FACILITIES IN THE FIELD OF EDUCATIONAL INSTITUTIONS; CONFIGURATION AND CUSTOMIZATION OF COMPUTER SOFTWARE FOR SCHEDULING AND MANAGING CONFERENCES AND EVENTS IN THE FIELD OF EDUCATIONAL INSTITUTIONS; CONFIGURATION AND CUSTO-

MIZATION OF COMPUTER SOFTWARE FOR COMPILING SECURITY-RELATED ACCOUNTING AND RECORD-KEEPING, NAMELY, INCIDENT REPORTS AND SECURITY-RELATED STATISTICS, IN THE FIELD OF EDUCATIONAL INSTITUTIONS; CONFIGURATION AND CUSTOMIZATION OF COMPUTER SOFTWARE FOR MANAGING MAINTENANCE AND INVENTORY RECORD-KEEPING FOR HOUSING AND CONFERENCE FACILITIES

IN THE FIELD OF EDUCATIONAL INSTITUTIONS, IN CLASS 42 (U.S. CLS. 100 AND 101).

FIRST USE 5-0-2003; IN COMMERCE 5-0-2003.

SER. NO. 77-235,215, FILED 7-20-2007.

MARLENE BELL, EXAMINING ATTORNEY

**Int. Cls.: 35, 41 and 42**

**Prior U.S. Cls.: 100, 101, 102 and 107**

**United States Patent and Trademark Office**

**Reg. No. 3,503,741**

**Registered Sep. 23, 2008**

**SERVICE MARK  
PRINCIPAL REGISTER**

**BOUNDLESS NETWORK**

BOUNDLESS NETWORK, INC. (DELAWARE CORPORATION)  
200 EAST 6TH STREET, SUITE 300  
AUSTIN, TX 78701

FOR: BRAND MARKETING CONSULTING IN THE PROMOTIONAL ADVERTISING INDUSTRY AND ON-LINE RETAIL STORE SERVICES FEATURING PROMOTIONAL ADVERTISING PRODUCTS , IN CLASS 35 (U.S. CLS. 100, 101 AND 102).

FIRST USE 11-30-2006; IN COMMERCE 11-30-2006.

FOR: BUSINESS TRAINING IN THE FIELD OF SALES, ADVERTISING, PROMOTION AND MARKETING OF PROMOTIONAL ASSETS, IN CLASS 41 (U.S. CLS. 100, 101 AND 107).

FIRST USE 11-30-2006; IN COMMERCE 11-30-2006.

FOR: SOFTWARE DEVELOPMENT SERVICES FOR USE IN THE PROMOTIONAL ADVERTISING INDUSTRY, IN CLASS 42 (U.S. CLS. 100 AND 101).

FIRST USE 11-30-2006; IN COMMERCE 11-30-2006.

THE MARK CONSISTS OF STANDARD CHARACTERS WITHOUT CLAIM TO ANY PARTICULAR FONT, STYLE, SIZE, OR COLOR.

NO CLAIM IS MADE TO THE EXCLUSIVE RIGHT TO USE "NETWORK", APART FROM THE MARK AS SHOWN.

SER. NO. 77-235,563, FILED 7-22-2007.

KELLY BOULTON, EXAMINING ATTORNEY

**Int. Cls.: 35, 41 and 42**

**Prior U.S. Cls.: 100, 101, 102 and 107**

**United States Patent and Trademark Office**

**Reg. No. 3,503,742**

**Registered Sep. 23, 2008**

**SERVICE MARK  
PRINCIPAL REGISTER**



BOUNDLESS NETWORK, INC. (DELAWARE CORPORATION)  
200 EAST 6TH STREET, SUITE 300  
AUSTIN, TX 78701

FOR: MARKETING CONSULTING IN THE PROMOTIONAL ADVERTISING INDUSTRY AND ON-LINE RETAIL STORE SERVICES FEATURING PROMOTIONAL ADVERTISING PRODUCTS, IN CLASS 35 (U.S. CLS. 100, 101 AND 102).

FIRST USE 11-30-2006; IN COMMERCE 11-30-2006.

FOR: BUSINESS TRAINING IN THE FIELD OF SALES, ADVERTISING, PROMOTION AND MARKETING OF PROMOTIONAL PRODUCTS, IN CLASS 41 (U.S. CLS. 100, 101 AND 107).

FIRST USE 11-30-2006; IN COMMERCE 11-30-2006.

FOR: SOFTWARE DEVELOPMENT SERVICES FOR USE IN THE PROMOTIONAL ADVERTISING INDUSTRY, IN CLASS 42 (U.S. CLS. 100 AND 101).

FIRST USE 11-30-2006; IN COMMERCE 11-30-2006.

NO CLAIM IS MADE TO THE EXCLUSIVE RIGHT TO USE "NETWORK", APART FROM THE MARK AS SHOWN.

THE MARK CONSISTS OF STYLIZED CIRCLE.

SER. NO. 77-235,567, FILED 7-22-2007.

KELLY BOULTON, EXAMINING ATTORNEY

**Int. Cl.: 18**

**Prior U.S. Cls.: 1, 2, 3, 22 and 41**

**United States Patent and Trademark Office**

**Reg. No. 3,503,743**

**Registered Sep. 23, 2008**

**TRADEMARK  
PRINCIPAL REGISTER**

**Icybag**

COHEN, KATHLEEN, R (UNITED STATES INDIVIDUAL), DBA ICYBAG  
14 HOUPERTS WAY  
CLINTON, CT 06413

THE MARK CONSISTS OF STANDARD CHARACTERS WITHOUT CLAIM TO ANY PARTICULAR FONT, STYLE, SIZE, OR COLOR.

FOR: COSMETIC BAGS SOLD EMPTY, IN CLASS 18 (U.S. CLS. 1, 2, 3, 22 AND 41).

SER. NO. 77-235,600, FILED 7-22-2007.

FIRST USE 10-1-2006; IN COMMERCE 10-1-2006.

EDWARD FENNESSY, EXAMINING ATTORNEY



**Int. Cls.: 37 and 45**

**Prior U.S. Cls.: 100, 101, 103 and 106**

**United States Patent and Trademark Office**

**Reg. No. 3,503,744**

**Registered Sep. 23, 2008**

**SERVICE MARK  
PRINCIPAL REGISTER**



WEST COAST PROPERTY CONSULTANTS INC.  
(CALIFORNIA CORPORATION)  
8801 KENAMAR DRIVE  
SAN DIEGO, CA 92121

THE COLOR(S) DARK BLUE CMYK VALUE C-100, M-72, Y-0, K-6 #00529F LIGHT BLUE C-60, M-43, Y-0, K-4 #6982BC BLACK IS/ARE CLAIMED AS A FEATURE OF THE MARK.

FOR: BUILDING INSPECTION; CONSTRUCTION CONSULTANCY; CONSTRUCTION CONSULTATION; CONSULTING IN THE FIELD OF BUILDING CONSTRUCTION, IN CLASS 37 (U.S. CLS. 100, 103 AND 106).

THE MARK CONSISTS OF A LOGO GRAPHIC ABSTRACTLY REPRESENTING A SERIES OF ROOFS AND CHIMNEYS OVER THE CAPITAL LETTERS "WCPC", WITH UNDERLINING BELOW. THE FIRST ROOFLINE IS BLACK WITH A TRIANGLE INSIDE IN LIGHT BLUE. THE SECOND ROOF AND CHIMNEY ARE DARK BLUE AND THE THIRD IS LIGHT BLUE. THE LETTERS ARE BLACK. UNDERLINING IS ONE THIN LINE OF LIGHT BLUE OVER A THICKER LINE OF BLACK.

FIRST USE 5-1-2005; IN COMMERCE 5-1-2005.

SER. NO. 77-235,612, FILED 7-22-2007.

FOR: SAFETY INSPECTION AUDITS TO IMPROVE SAFETY OF CONSTRUCTION WORKERS ON RESIDENTIAL CONSTRUCTION SITES, IN CLASS 45 (U.S. CLS. 100 AND 101).

FIRST USE 5-1-2005; IN COMMERCE 5-1-2005.

MICHAEL KAZAZIAN, EXAMINING ATTORNEY

**Int. Cl.: 25**

**Prior U.S. Cls.: 22 and 39**

**United States Patent and Trademark Office**

**Reg. No. 3,503,745**

**Registered Sep. 23, 2008**

**TRADEMARK  
PRINCIPAL REGISTER**

**EXPLOIT THE EARTH OR DIE**

GLEN ALLEN PRESS, LLC (VIRGINIA LIMITED  
LIABILITY COMPANY)  
SUITE D  
4036-D COX ROAD  
GLEN ALLEN, VA 23060

THE MARK CONSISTS OF STANDARD CHAR-  
ACTERS WITHOUT CLAIM TO ANY PARTICULAR  
FONT, STYLE, SIZE, OR COLOR.

FOR: CLOTHING, NAMELY, T-SHIRTS, GOLF  
SHIRTS, AND BALL CAPS, IN CLASS 25 (U.S. CLS. 22  
AND 39).

SER. NO. 77-235,938, FILED 7-23-2007.

FIRST USE 8-30-2007; IN COMMERCE 8-30-2007.

JENNIFER VASQUEZ, EXAMINING ATTORNEY

**Int. Cl.: 9**

**Prior U.S. Cls.: 21, 23, 26, 36 and 38**

**United States Patent and Trademark Office**

**Reg. No. 3,503,746**

**Registered Sep. 23, 2008**

**TRADEMARK  
PRINCIPAL REGISTER**

**OLIVE TREE**

OLIVE TREE BIBLE SOFTWARE, INC. (OREGON  
CORPORATION)  
PO BOX 48271  
SPOKANE, WA 99228

FOR: COMPUTER APPLICATION SOFTWARE  
FOR MOBILE PHONES; COMPUTER APPLICATION  
SOFTWARE FOR PDAS; COMPUTER SOFTWARE  
FOR USE IN BROWSING, SEARCHING OR STUDY-  
ING THE BIBLE, IN CLASS 9 (U.S. CLS. 21, 23, 26, 36  
AND 38).

FIRST USE 1-15-1999; IN COMMERCE 1-15-1999.

THE MARK CONSISTS OF STANDARD CHAR-  
ACTERS WITHOUT CLAIM TO ANY PARTICULAR  
FONT, STYLE, SIZE, OR COLOR.

SER. NO. 77-235,987, FILED 7-23-2007.

WILLIAM P. SHANAHAN, EXAMINING ATTOR-  
NEY

**Int. Cl.: 33**

**Prior U.S. Cls.: 47 and 49**

**United States Patent and Trademark Office**

**Reg. No. 3,503,747**

**Registered Sep. 23, 2008**

**TRADEMARK  
PRINCIPAL REGISTER**

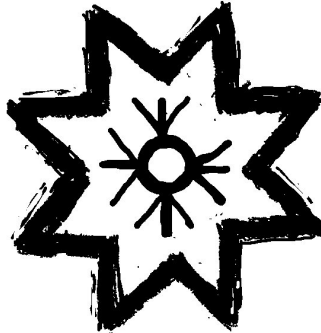

VIÑA UNDURRAGA S.A. (CHILE CORPORATION)  
VITACURA 2939, PISO 21, LAS CONDES  
SANTIAGO, CHILE

REG. NO. 803768, DATED 12-17-2007, EXPIRES 12-17-2017.

FOR: WINES, IN CLASS 33 (U.S. CLS. 47 AND 49).

SER. NO. 77-236,135, FILED 7-23-2007.

PRIORITY CLAIMED UNDER SEC. 44(D) ON  
CHILE APPLICATION NO. 780746, FILED 7-11-2007,

ANTHONY RINKER, EXAMINING ATTORNEY

**Int. Cl.: 9**

**Prior U.S. Cls.: 21, 23, 26, 36 and 38**

**Reg. No. 3,503,748**

**United States Patent and Trademark Office**

**Registered Sep. 23, 2008**

**TRADEMARK  
PRINCIPAL REGISTER**



WEB SEARCH + DESIGN, LLC (CALIFORNIA  
LIMITED LIABILITY COMPANY)  
4924 WILMA WAY  
SAN JOSE, CA 95124

THE COLOR(S) GREEN AND BLUE IS/ARE  
CLAIMED AS A FEATURE OF THE MARK.

FOR: COMPUTER SOFTWARE FOR USE IN ON-  
LINE SALES, DATABASE MANAGEMENT, ORDER  
PROCESSING, INVENTORY AND MEMBERSHIP  
MANAGEMENT IN THE WINE INDUSTRY , IN  
CLASS 9 (U.S. CLS. 21, 23, 26, 36 AND 38).

THE MARK CONSISTS OF "GREEN" GRAPES  
HANGING ABOVE BLUE LETTERING OF "VINES"  
"ONLINE SOLUTION", GREEN BAR BETWEEN  
WORDS "ONLINE SOLUTION".

FIRST USE 4-15-2005; IN COMMERCE 4-15-2005.

SER. NO. 77-236,709, FILED 7-23-2007.

NO CLAIM IS MADE TO THE EXCLUSIVE  
RIGHT TO USE "ONLINE SOLUTION", APART  
FROM THE MARK AS SHOWN.

GIANCARLO CASTRO, EXAMINING ATTORNEY

Int. Cl.: 9

Prior U.S. Cls.: 21, 23, 26, 36 and 38

United States Patent and Trademark Office

Reg. No. 3,503,749

Registered Sep. 23, 2008

TRADEMARK  
PRINCIPAL REGISTER



OLIVE TREE BIBLE SOFTWARE, INC. (OREGON CORPORATION)  
PO BOX 48271  
SPOKANE, WA 99228

FOR: COMPUTER APPLICATION SOFTWARE FOR MOBILE PHONES; COMPUTER APPLICATION SOFTWARE FOR PDAS; COMPUTER SOFTWARE FOR USE IN BROWSING, SEARCHING OR STUDYING THE BIBLE, IN CLASS 9 (U.S. CLS. 21, 23, 26, 36 AND 38).

FIRST USE 9-14-2005; IN COMMERCE 9-14-2005.

NO CLAIM IS MADE TO THE EXCLUSIVE RIGHT TO USE "BIBLE SOFTWARE", APART FROM THE MARK AS SHOWN.

THE MARK CONSISTS OF A TREE WITH THE WORDS "OLIVE TREE BIBLE SOFTWARE" NEXT TO IT.

SER. NO. 77-237,275, FILED 7-24-2007.

WILLIAM P. SHANAHAN, EXAMINING ATTORNEY

**Int. Cl.: 9**

**Prior U.S. Cls.: 21, 23, 26, 36 and 38**

**United States Patent and Trademark Office**

**Reg. No. 3,503,750**

**Registered Sep. 23, 2008**

**TRADEMARK  
PRINCIPAL REGISTER**

**MPR: Profiles of Urban  
Entrepreneurs**

SANDIFER, JON MARC (UNITED STATES INDIVIDUAL)  
5270 WEST CENTINELA AVENUE #326  
LOS ANGELES, CA 90045

FOR: ENTERTAINMENT, NAMELY, PRERECORDED MULTIMEDIA PROGRAM FEATURING STORIES ABOUT SUCCESSFUL PEOPLE, IN CLASS 9 (U.S. CLS. 21, 23, 26, 36 AND 38).

FIRST USE 0-0-1998; IN COMMERCE 0-0-1998.

THE MARK CONSISTS OF STANDARD CHARACTERS WITHOUT CLAIM TO ANY PARTICULAR FONT, STYLE, SIZE, OR COLOR.

SER. NO. 77-238,362, FILED 7-25-2007.

INGRID C. EULIN, EXAMINING ATTORNEY

**Int. Cl.: 12**

**Prior U.S. Cls.: 19, 21, 23, 31, 35 and 44**

**Reg. No. 3,503,751**

**United States Patent and Trademark Office**

**Registered Sep. 23, 2008**

**TRADEMARK  
PRINCIPAL REGISTER**

**IRD**

INTERLOC, INC. (CALIFORNIA CORPORATION)  
1415 SAN MATEO AVE.  
SOUTH SAN FRANCISCO, CA 94080

FOR: BICYCLE PARTS, NAMELY, FRAMES, BRAKES, BRAKE LEVERS, HANDLEBARS, HEADSETS, STEMS, SEATPOSTS, SEAT CLAMPS, BOTTOM BRACKETS, CHAINS, CASSETTES, CHAINRINGS, CRANK SETS, DERAILLEURS, RIMS, WHEELSETS CONSISTING PRIMARILY OF WHEEL RIMS AND SPOKES, FREEWHEELS, TIRES, FORKS, PANNIER RACKS FOR BICYCLES, BI-

CYCLE WATER BOTTLE CAGES, IN CLASS 12 (U.S. CLS. 19, 21, 23, 31, 35 AND 44).

FIRST USE 9-1-1985; IN COMMERCE 9-1-1985.

THE MARK CONSISTS OF STANDARD CHARACTERS WITHOUT CLAIM TO ANY PARTICULAR FONT, STYLE, SIZE, OR COLOR.

SER. NO. 77-238,366, FILED 7-25-2007.

ANGELA M. MICHELI, EXAMINING ATTORNEY



**Int. Cl.: 42**

**Prior U.S. Cls.: 100 and 101**

**United States Patent and Trademark Office**

**Reg. No. 3,503,752**

**Registered Sep. 23, 2008**

**SERVICE MARK  
PRINCIPAL REGISTER**

**ADA**

ELECTRIC POWER RESEARCH INSTITUTE,  
INC. (D.C. CORPORATION)  
3420 HILLVIEW AVENUE  
PALO ALTO, CA 94304

FOR: CONDUCTING RESEARCH AND DEVELOPMENT FOR OTHERS AND PROVIDING CONSULTING SERVICES, ALL WITH RESPECT TO PROVIDING A COLLECTIVE BODY OF INTELLIGENT ELECTRONIC DEVICES AND INFORMATION TECHNOLOGY FOR USE IN POWER DISTRIBUTION SYSTEMS, DISTRIBUTED CONTROL TECHNOLOGY, AND ADVANCED DISTRI-

BUTION SYSTEM CONFIGURATION CONCEPTS, IN CLASS 42 (U.S. CLS. 100 AND 101).

FIRST USE 9-29-2003; IN COMMERCE 9-29-2003.

THE MARK CONSISTS OF STANDARD CHARACTERS WITHOUT CLAIM TO ANY PARTICULAR FONT, STYLE, SIZE, OR COLOR.

SER. NO. 77-239,049, FILED 7-26-2007.

MELVIN AXILBUND, EXAMINING ATTORNEY

**Int. Cl.: 44**

**Prior U.S. Cls.: 100 and 101**

**United States Patent and Trademark Office**

**Reg. No. 3,503,753**

**Registered Sep. 23, 2008**

**SERVICE MARK  
PRINCIPAL REGISTER**

**GREAT CARE. EXPECT IT.**

TALBERT MEDICAL GROUP, INC. (CALIFORNIA CORPORATION)  
1665 SCENIC AVENUE  
SUITE 100  
COSTA MESA, CA 92626

FOR: MEDICAL CARE SERVICES, NAMELY, PRIMARY MEDICAL CARE SERVICES AND SPECIALIZED MEDICAL CARE SERVICES IN THE FIELDS OF CARDIOLOGY, DERMATOLOGY, ENDOCRINOLOGY, GASTROENTEROLOGY, GYNECOLOGY, NEUROLOGY, OBSTETRICS, ORTHOPEDICS, ONCOLOGY, PODIATRY, PULMONOLOGY, RADIOLOGY, RHEUMATOLOGY AND UROLOGY, AND MEDICAL CARE SERVICES FOR

THE TREATMENT OF ALLERGIES AND MEDICAL CONDITIONS OF THE EARS, NOSE AND THROAT, IN CLASS 44 (U.S. CLS. 100 AND 101).

FIRST USE 5-0-2005; IN COMMERCE 5-0-2005.

THE MARK CONSISTS OF STANDARD CHARACTERS WITHOUT CLAIM TO ANY PARTICULAR FONT, STYLE, SIZE, OR COLOR.

SER. NO. 77-239,414, FILED 7-26-2007.

ARETHA SOMERVILLE, EXAMINING ATTORNEY

**Int. Cls.: 39 and 41**

**Prior U.S. Cls.: 100, 101, 105 and 107**

**United States Patent and Trademark Office**

**Reg. No. 3,503,754**

**Registered Sep. 23, 2008**

**SERVICE MARK  
PRINCIPAL REGISTER**



CLOUD 9 ADVENTURES, LLC (FLORIDA LIMITED LIABILITY COMPANY)  
STE. 216  
320 PLAZA REAL,  
BOCA RATON, FL 33432

FOR: ARRANGING OF CRUISES; BOAT CRUISES; PLEASURE BOAT CRUISES; TRAVEL, EXCURSION AND CRUISE ARRANGEMENT; COORDINATING TRAVEL ARRANGEMENTS FOR INDIVIDUALS AND FOR GROUPS; ORGANIZATION OF EXCURSIONS, IN CLASS 39 (U.S. CLS. 100 AND 105).

FIRST USE 5-0-2004; IN COMMERCE 5-0-2004.

FOR: ENTERTAINMENT IN THE NATURE OF LIVE PERFORMANCES BY MUSICAL GROUPS AND PERFORMING ARTISTS; ENTERTAINMENT IN THE NATURE OF FESTIVALS FEATURING LIVE PERFORMANCES BY MULTIPLE MUSICAL

PERFORMING ARTISTS; CONCERT BOOKING; CONDUCTING ENTERTAINMENT EXHIBITIONS IN THE NATURE OF LIVE MUSIC FESTIVALS, IN CLASS 41 (U.S. CLS. 100, 101 AND 107).

FIRST USE 5-0-2004; IN COMMERCE 5-0-2004.

NO CLAIM IS MADE TO THE EXCLUSIVE RIGHT TO USE "CRUISE", APART FROM THE MARK AS SHOWN.

THE MARK CONSISTS OF THE WORDS JAM CRUISE BELOW AN IMAGE OF A CRUISE SHIP WITH MUSICAL NOTES COMING OUT OF ITS SMOKE STACK.

SER. NO. 77-239,611, FILED 7-26-2007.

CAROLYN GRAY, EXAMINING ATTORNEY

**Int. Cls.: 25, 36 and 41**

**Prior U.S. Cls.: 22, 39, 100, 101, 102 and 107**

**United States Patent and Trademark Office**

**Reg. No. 3,503,755**

**Registered Sep. 23, 2008**

**TRADEMARK  
SERVICE MARK  
PRINCIPAL REGISTER**

**CHALLENGED ATHLETES  
FOUNDATION**

CHALLENGED ATHLETES, INC. (CALIFORNIA CORPORATION)  
SUITE C  
11199 SORRENTO VALLEY ROAD  
SAN DIEGO, CA 92121

FOR: CLOTHING, NAMELY, T-SHIRTS, SWEAT-SHIRTS, CYCLING JERSEYS, TRIATHLON SING-LETS, BICYCLE SHORTS, TRIATHLON SHORTS, POLO SHIRTS, TECHNICAL RUNNING SHIRTS, RUNNING SHORTS, SWEATS, JACKETS, RACE BELTS AND WARM-UPS; HEADGEAR, NAMELY, HATS, VISORS, SWIM CAPS AND BEANIES, IN CLASS 25 (U.S. CLS. 22 AND 39).

FIRST USE 3-31-1997; IN COMMERCE 3-31-1997.

FOR: CHARITABLE FUND RAISING SERVICES FOR PHYSICALLY CHALLENGED AND NON-PHYSICALLY CHALLENGED ATHLETES BY MEANS OF TRIATHLONS, BICYCLE CHALLENGES, AND STATIONARY CYCLE CHALLENGES, IN CLASS 36 (U.S. CLS. 100, 101 AND 102).

FIRST USE 3-31-1997; IN COMMERCE 3-31-1997.

FOR: PROVIDING EDUCATIONAL CLASSES IN HEALTH, LIFESTYLE, MEDICAL SUPPORT, AND POST REHABILITATION SUPPORT FOR CHALLENGED ATHLETES AND DISTRIBUTING EDUCATIONAL MATERIALS THEREWITH, IN CLASS 41 (U.S. CLS. 100, 101 AND 107).

FIRST USE 3-31-1997; IN COMMERCE 3-31-1997.

THE MARK CONSISTS OF STANDARD CHARACTERS WITHOUT CLAIM TO ANY PARTICULAR FONT, STYLE, SIZE, OR COLOR.

SEC. 2(F).

SER. NO. 77-239,619, FILED 7-26-2007.

RICHARD A. STRASER, EXAMINING ATTORNEY

**Int. Cl.: 9**

**Prior U.S. Cls.: 21, 23, 26, 36 and 38**

**United States Patent and Trademark Office**

**Reg. No. 3,503,756**

**Registered Sep. 23, 2008**

**TRADEMARK  
PRINCIPAL REGISTER**

**FORZA POWER TECHNOLOGIES**

SOFTWARE BROKERS OF AMERICA INC.  
(FLORIDA CORPORATION), DBA INTCOMEX  
9835 N.W. 14TH STREET  
MIAMI, FL 33172

FOR: AUTOMATIC VOLTAGE REGULATORS,  
UNINTERRUPTIBLE POWER SUPPLIES, SURGE  
PROTECTORS, RECHARGEABLE BATTERIES,  
AND BATTERY CHARGERS, ALL FOR HOME  
AND OFFICE USE ONLY, IN CLASS 9 (U.S. CLS.  
21, 23, 26, 36 AND 38).

FIRST USE 4-0-2005; IN COMMERCE 4-0-2005.

THE MARK CONSISTS OF STANDARD CHAR-  
ACTERS WITHOUT CLAIM TO ANY PARTICULAR  
FONT, STYLE, SIZE, OR COLOR.

NO CLAIM IS MADE TO THE EXCLUSIVE  
RIGHT TO USE "POWER TECHNOLOGIES", APART  
FROM THE MARK AS SHOWN.

THE FOREIGN WORDING IN THE MARK  
TRANSLATES INTO ENGLISH AS FORCE.

SER. NO. 77-240,230, FILED 7-27-2007.

ANDREW RHIM, EXAMINING ATTORNEY

**Int. Cl.: 39**

**Prior U.S. Cls.: 100 and 105**

**United States Patent and Trademark Office**

**Reg. No. 3,503,757**

**Registered Sep. 23, 2008**

**SERVICE MARK  
PRINCIPAL REGISTER**



MAIL SERVICES, INC. (MARYLAND CORPORATION)

16 WHITFIELD PLACE  
BALTIMORE, MD 21210

FOR: TRANSPORT OF GOODS, IN CLASS 39 (U.S. CLS. 100 AND 105).

FIRST USE 5-4-2006; IN COMMERCE 5-15-2006.

NO CLAIM IS MADE TO THE EXCLUSIVE RIGHT TO USE "MAIL SERVICES, INC." , APART FROM THE MARK AS SHOWN.

THE STIPPLING IS FOR SHADING PURPOSES ONLY.

THE MARK CONSISTS OF THE STYLIZED LETTERS "MSI" ABOVE THE STYLIZED WORDING "MAIL SERVICES INC.", ALL WORDING INSIDE THE OUTLINE OF A SQUARE AND THE DESIGN OF A SHADED RECTANGLE AROUND THE LETTERS "MSI" AND THE DESIGN OF RECTANGLE AROUND THE WORDING "MAIL SERVICES INC."

SER. NO. 77-240,405, FILED 7-27-2007.

JAY BESCH, EXAMINING ATTORNEY

**Int. Cl.: 37**

**Prior U.S. Cls.: 100, 103 and 106**

**Reg. No. 3,503,758**

**United States Patent and Trademark Office**

**Registered Sep. 23, 2008**

---

**SERVICE MARK  
PRINCIPAL REGISTER**



GREAT WHITE ENERGY SERVICES LLC (DE-  
LAWARE LIMITED LIABILITY COMPANY)  
14313 NORTH MAY AVENUE, SUITE 100  
OKLAHOMA CITY, OK 73134

NO CLAIM IS MADE TO THE EXCLUSIVE  
RIGHT TO USE "TUBULAR REPAIR", APART  
FROM THE MARK AS SHOWN.

FOR: REPAIR OF OILFIELD PIPE, IN CLASS 37  
(U.S. CLS. 100, 103 AND 106).

SER. NO. 77-240,437, FILED 7-27-2007.

FIRST USE 12-27-2006; IN COMMERCE 12-27-2006.

GINA HAYES, EXAMINING ATTORNEY

**Int. Cls.: 37 and 40**

**Prior U.S. Cls.: 100, 103 and 106**

**United States Patent and Trademark Office**

**Reg. No. 3,503,759**

**Registered Sep. 23, 2008**

**SERVICE MARK  
PRINCIPAL REGISTER**



GREAT WHITE ENERGY SERVICES LLC (DE-  
LAWARE LIMITED LIABILITY COMPANY)  
14313 NORTH MAY AVENUE, SUITE 100  
OKLAHOMA CITY, OK 73134

FOR: CEMENTING SERVICES FOR OIL AND  
GAS WELLS, IN CLASS 37 (U.S. CLS. 100, 103 AND  
106).

FIRST USE 5-1-2007; IN COMMERCE 5-1-2007.

FOR: OIL AND GAS WELL ACIDIZING; OIL AND  
GAS WELL FRACTURING, IN CLASS 40 (U.S. CLS.  
100, 103 AND 106).

FIRST USE 5-1-2007; IN COMMERCE 5-1-2007.

NO CLAIM IS MADE TO THE EXCLUSIVE  
RIGHT TO USE "PRESSURE PUMPING", APART  
FROM THE MARK AS SHOWN.

SER. NO. 77-240,474, FILED 7-27-2007.

GINA HAYES, EXAMINING ATTORNEY



**Int. Cls.: 37 and 40**

**Prior U.S. Cls.: 100, 103 and 106**

**United States Patent and Trademark Office**

**Reg. No. 3,503,760**

**Registered Sep. 23, 2008**

**SERVICE MARK  
PRINCIPAL REGISTER**

**GREAT WHITE PRESSURE  
PUMPING**

GREAT WHITE ENERGY SERVICES LLC (DE-  
LAWARE LIMITED LIABILITY COMPANY)  
14313 NORTH MAY AVENUE, SUITE 100  
OKLAHOMA CITY, OK 73134

FOR: CEMENTING SERVICES FOR OIL AND  
GAS WELLS, IN CLASS 37 (U.S. CLS. 100, 103 AND  
106).

FIRST USE 5-1-2007; IN COMMERCE 5-1-2007.

FOR: OIL AND GAS WELL ACIDIZING; OIL AND  
GAS WELL FRACTURING, IN CLASS 40 (U.S. CLS.  
100, 103 AND 106).

FIRST USE 5-1-2007; IN COMMERCE 5-1-2007.

THE MARK CONSISTS OF STANDARD CHAR-  
ACTERS WITHOUT CLAIM TO ANY PARTICULAR  
FONT, STYLE, SIZE, OR COLOR.

NO CLAIM IS MADE TO THE EXCLUSIVE  
RIGHT TO USE "PRESSURE PUMPING", APART  
FROM THE MARK AS SHOWN.

SER. NO. 77-240,488, FILED 7-27-2007.

GINA HAYES, EXAMINING ATTORNEY

**Int. Cl.: 35**

**Prior U.S. Cls.: 100, 101 and 102**

**United States Patent and Trademark Office**

**Reg. No. 3,503,761**

**Registered Sep. 23, 2008**

**SERVICE MARK  
PRINCIPAL REGISTER**

**GSAMEDIA**

BRITE MEDIA GROUP LLC (DELAWARE LIMITED LIABILITY COMPANY)  
SUITE 512  
735 STATE STREET  
SANTA BARBARA, CA 93101

FOR: ADVERTISING AND PUBLICITY SERVICES, NAMELY, PROMOTING THE GOODS, SERVICES, BRAND IDENTITY AND COMMERCIAL INFORMATION AND NEWS OF THIRD PARTIES THROUGH PRINT, AUDIO, VIDEO, DIGITAL AND ON-LINE MEDIA, IN CLASS 35 (U.S. CLS. 100, 101 AND 102).

FIRST USE 7-1-2007; IN COMMERCE 7-1-2007.

THE MARK CONSISTS OF STANDARD CHARACTERS WITHOUT CLAIM TO ANY PARTICULAR FONT, STYLE, SIZE, OR COLOR.

SER. NO. 77-240,955, FILED 7-27-2007.

ANGELA GAW, EXAMINING ATTORNEY

**Int. Cl.: 41**

**Prior U.S. Cls.: 100, 101 and 107**

**United States Patent and Trademark Office**

**Reg. No. 3,503,762**

**Registered Sep. 23, 2008**

**SERVICE MARK  
PRINCIPAL REGISTER**

**S<sup>b</sup> ScienceBlogs**

SCIENCEBLOGS, LLC (DELAWARE LIMITED  
LIABILITY COMPANY)  
12 W. 21ST STREET  
NEW YORK, NY 10010

FOR: ONLINE JOURNALS, NAMELY, BLOGS  
FEATURING SCIENCE; ONLINE ELECTRONIC  
PUBLISHING AND WEBLOG SERVICES, NAMELY  
PUBLICATION OF ONLINE JOURNALS, BLOGS,  
COMMENTARY, TEXT, GRAPHICS, AND VIDEO  
MATERIALS OF OTHERS IN THE FIELD OF SCI-  
ENCE, IN CLASS 41 (U.S. CLS. 100, 101 AND 107).

FIRST USE 1-31-2006; IN COMMERCE 1-31-2006.

NO CLAIM IS MADE TO THE EXCLUSIVE  
RIGHT TO USE "SCIENCEBLOGS", APART FROM  
THE MARK AS SHOWN.

THE MARK CONSISTS OF STYLIZED LETTERS.

SER. NO. 77-241,212, FILED 7-27-2007.

TINA KUAN, EXAMINING ATTORNEY

**Int. Cl.: 11**

**Prior U.S. Cls.: 13, 21, 23, 31 and 34**

**United States Patent and Trademark Office**

**Reg. No. 3,503,763**

**Registered Sep. 23, 2008**

**TRADEMARK  
PRINCIPAL REGISTER**

**MicroCSP**

SOPOGY INC. (DELAWARE CORPORATION)  
2660 WAIWAI LOOP  
HONOLULU, HI 96819

FOR: POWER PLANTS; SOLAR COLLECTORS;  
SOLAR HEAT COLLECTION PANELS; SOLAR  
THERMAL INSTALLATIONS, NAMELY, SOLAR  
THERMAL MODULES; SOLAR WATER HEATERS,  
IN CLASS 11 (U.S. CLS. 13, 21, 23, 31 AND 34).

FIRST USE 7-21-2007; IN COMMERCE 7-21-2007.

THE MARK CONSISTS OF STANDARD CHAR-  
ACTERS WITHOUT CLAIM TO ANY PARTICULAR  
FONT, STYLE, SIZE, OR COLOR.

SER. NO. 77-241,333, FILED 7-28-2007.

KATHERINE E. HALMEN, EXAMINING ATTOR-  
NEY

Int. Cl.: 36

Prior U.S. Cls.: 100, 101 and 102

United States Patent and Trademark Office

Reg. No. 3,503,764

Registered Sep. 23, 2008

SERVICE MARK  
PRINCIPAL REGISTER



SECOND SOURCE FUNDING, LLC (NEW YORK  
LIMITED LIABILITY COMPANY)  
55 BROAD STREET, 2ND FLOOR  
NEW YORK, NY 10004

FOR: ELECTRONIC PAYMENT, CREDIT AND DEBIT CARD TRANSACTION PROCESSING SERVICES, NAMELY, CREDIT AND DEBIT CARD PROCESSING; CHECK VERIFICATION, GUARANTEE, AND CONVERSION; ELECTRONIC FUNDS TRANSFER SERVICES; ISSUING AND PROCESSING GIFT, STORED VALUE, AND PRE-PAID CARDS; PROVIDING ELECTRONIC PROCESSING OF CREDIT CARD TRANSACTIONS AND ELECTRONIC PAYMENTS VIA A GLOBAL COMPUTER NETWORK; ACCOUNTS RECEIVABLES FINANCING; CREDIT CARD SERVICES; ELECTRONIC CREDIT CARD TRANSACTION, IN CLASS 36 (U.S. CLS. 100, 101 AND 102).

FIRST USE 2-1-2006; IN COMMERCE 2-1-2006.

NO CLAIM IS MADE TO THE EXCLUSIVE RIGHT TO USE "2ND SOURCE FUNDING", APART FROM THE MARK AS SHOWN.

THE MARK CONSISTS OF TWO VERTICALLY PLACED BOXES WITH A CHECK MARK THROUGH THE BOTTOM BOX AND THE WORDS "2ND SOURCE" IMMEDIATELY TO THE RIGHT OF THE BOXES AND THE WORD "FUNDING" BELOW THE WORDS "2ND SOURCE".

SER. NO. 77-241,966, FILED 7-30-2007.

SANI KHOURI, EXAMINING ATTORNEY

**Int. Cls.: 16, 25 and 41**

**Prior U.S. Cls.: 2, 5, 22, 23, 29, 37, 38, 39, 50, 100, 101 and 107**

**Reg. No. 3,503,765**

**United States Patent and Trademark Office**

**Registered Sep. 23, 2008**

**TRADEMARK  
SERVICE MARK  
PRINCIPAL REGISTER**



LUCASFILM LTD. (CALIFORNIA CORPORATION)  
P.O. BOX 29901  
SAN FRANCISCO, CA 94129

FOR: PAPER GOODS AND PRINTED MATTER, NAMELY, ADDRESS BOOKS; COMIC BOOKS; NOTEBOOKS; CHILDREN'S BOOKS; BOOKS CONTAINING SCREENPLAYS; SCRIPT BOOKS; DIARIES; PAPER DOORKNOB HANGERS; PRINTED INVITATIONS; PERSONAL ORGANIZERS; PAPER TABLE CLOTHS; TRADING CARDS; WALLET CARDS IN THE NATURE OF A BILL HOLDER, POSTERS; BOOK PLATES; BOOK MARKS; CHECKBOOK HOLDERS AND COVERS; NON-ELECTRONIC PERSONAL DAILY PLANNERS AND ORGANIZERS; ARTIST'S MATERIALS, NAMELY, PENCILS, PENS; PAPER GIFT WRAP; PAPER GIFT TAGS; PAPER GIFT BAGS; GREETING CARDS, PAPER PARTY DECORATIONS; PAPER NAPKINS; PAPER PARTY BAGS; PAPER PARTY HATS; POSTCARDS; STICKERS; STICKER ALBUMS; CALENDARS; CARDBOARD FIGURES; TEMPORARY TATTOOS; SCHOOL AND OFFICE SUPPLIES, NAMELY, ERASERS, PENCILS, PENS, MARKERS, PENCIL CASES; PENCIL SHARPENERS; SHEET MUSIC; ADULT NOVELIZATIONS; NOVELS; PAPER CAKE DECORATIONS; BANK CHECKS; SERIES OF FICTION BOOKS; JUVENILE BOOKS; REFERENCE BOOKS IN THE FIELD OF SCIENCE FICTION; COMIC MAGAZINES; ROLE PLAYING EQUIPMENT IN THE NATURE OF GAME BOOK MANUALS; ART BOOKS; COFFEE TABLE BOOKS IN THE FIELD OF FANTASY AND SCIENCE FICTION, IN CLASS 16 (U.S. CLS. 2, 5, 22, 23, 29, 37, 38 AND 50).

FIRST USE 1-3-1977; IN COMMERCE 1-3-1977.

FOR: ATHLETIC SHOES, SLIPPERS, BOXER SHORTS, CAPS, CHILDREN'S FOOTWEAR, HATS, HEAD WEAR, KNIT CAPS, MASQUERADE COSTUMES, MASKS, PAJAMAS, RAINWEAR, SHIRTS, SLEEPWEAR, SLIPPERS, SOCKS, SWEATPANTS, SWEATSHIRTS, TIES, T-SHIRTS, UNDERWEAR, WRISTBANDS AND SUSPENDERS, IN CLASS 25 (U.S. CLS. 22 AND 39).

FIRST USE 6-3-1977; IN COMMERCE 6-3-1977.

FOR: ENTERTAINMENT SERVICES, NAMELY, THE PRODUCTION AND DISTRIBUTION OF MOTION PICTURES; PROVIDING NEWS AND INFORMATION IN THE FIELD OF ENTERTAINMENT RELATING TO MOTION PICTURE FILMS, SCIENCE FICTION TOPICS VIA GLOBAL COMPUTER NETWORKS; PROVIDING NEWS IN THE FIELD OF ENTERTAINMENT RELATING TO COMPUTER GAMES VIA GLOBAL COMPUTER NETWORKS; PROVIDING NEWS AND INFORMATION IN THE FIELD OF ENTERTAINMENT RELATING TO MOTION PICTURE FILMS, SCIENCE FICTION TOPICS VIA OTHER ELECTRONIC COMPUTER NETWORKS, IN CLASS 41 (U.S. CLS. 100, 101 AND 107).

FIRST USE 5-25-1977; IN COMMERCE 5-25-1977.

OWNER OF U.S. REG. NOS. 1,279,481, 2,402,644 AND OTHERS.

THE MARK CONSISTS OF STYLIZED "STAR WARS".

SER. NO. 77-242,000, FILED 7-30-2007.

WON TEAK OH, EXAMINING ATTORNEY

**Int. Cl.: 28**

**Prior U.S. Cls.: 22, 23, 38 and 50**

**United States Patent and Trademark Office**

**Reg. No. 3,503,766**

**Registered Sep. 23, 2008**

**TRADEMARK  
PRINCIPAL REGISTER**

**AIR FORCE GOLF**

GERARDO, MARTIN (UNITED STATES INDIVIDUAL)

RR1 BOX 1779A

SAYLORSBURG, PA 18353

FOR: AIR POWERED GOLF BALL LAUNCHER,  
IN CLASS 28 (U.S. CLS. 22, 23, 38 AND 50).

FIRST USE 7-16-2007; IN COMMERCE 7-16-2007.

THE MARK CONSISTS OF STANDARD CHARACTERS WITHOUT CLAIM TO ANY PARTICULAR FONT, STYLE, SIZE, OR COLOR.

NO CLAIM IS MADE TO THE EXCLUSIVE RIGHT TO USE "GOLF", APART FROM THE MARK AS SHOWN.

SER. NO. 77-242,046, FILED 7-30-2007.

RON FAIRBANKS, EXAMINING ATTORNEY

**Int. Cl.: 42**

**Prior U.S. Cls.: 100 and 101**

**United States Patent and Trademark Office**

**Reg. No. 3,503,767**

**Registered Sep. 23, 2008**

**SERVICE MARK  
PRINCIPAL REGISTER**

**MEDIAPROOF**

BRITE MEDIA GROUP LLC (DELAWARE LIMITED LIABILITY COMPANY)  
SUITE 512  
735 STATET STREET  
SANTA BARBARA, CA 93101

FOR: PROVIDING TEMPORARY USE OF ON-LINE NON-DOWNLOADABLE SOFTWARE FOR REPORTING ON ADVERTISING SERVICES PROVIDED TO THIRD PARTIES BY ADVERTISING ENTITIES, IN CLASS 42 (U.S. CLS. 100 AND 101).

FIRST USE 7-1-2007; IN COMMERCE 7-1-2007.

THE MARK CONSISTS OF STANDARD CHARACTERS WITHOUT CLAIM TO ANY PARTICULAR FONT, STYLE, SIZE, OR COLOR.

SER. NO. 77-242,887, FILED 7-31-2007.

ANGELA GAW, EXAMINING ATTORNEY



**Int. Cl.: 12**

**Prior U.S. Cls.: 19, 21, 23, 31, 35 and 44**

**Reg. No. 3,503,768**

**United States Patent and Trademark Office**

**Registered Sep. 23, 2008**

**TRADEMARK  
PRINCIPAL REGISTER**

**STS**

E. THIRTEEN INCORPORATED (MAINE CORPORATION)  
PO BOX 2724  
11 BOLDT FARMS RD  
EDGARTOWN, MA 02539

FIRST USE 1-1-2003; IN COMMERCE 1-1-2003.

THE MARK CONSISTS OF STANDARD CHARACTERS WITHOUT CLAIM TO ANY PARTICULAR FONT, STYLE, SIZE, OR COLOR.

FOR: BICYCLE PARTS, NAMELY, SINGLE RING CHAIN RETENTION SYSTEMS COMPRISING BACK PLATES, SLIDERS, BOLTS, AND BASHGUARDS, IN CLASS 12 (U.S. CLS. 19, 21, 23, 31, 35 AND 44).

SER. NO. 77-243,755, FILED 7-31-2007.

MICHAEL ENGEL, EXAMINING ATTORNEY

**Int. Cl.: 12**

**Prior U.S. Cls.: 19, 21, 23, 31, 35 and 44**

**Reg. No. 3,503,769**

**United States Patent and Trademark Office**

**Registered Sep. 23, 2008**

**TRADEMARK  
PRINCIPAL REGISTER**

**LG1**

E. THIRTEEN INCORPORATED (MAINE CORPORATION)  
PO BOX 2724  
11 BOLDT FARMS RD  
EDGARTOWN, MA 02539

FIRST USE 1-1-2005; IN COMMERCE 1-1-2005.

THE MARK CONSISTS OF STANDARD CHARACTERS WITHOUT CLAIM TO ANY PARTICULAR FONT, STYLE, SIZE, OR COLOR.

FOR: BICYCLE PARTS, NAMELY, SINGLE RING CHAIN RETENTION SYSTEMS COMPRISING BACK PLATES, SLIDERS, BOLTS, AND BASHGUARDS, IN CLASS 12 (U.S. CLS. 19, 21, 23, 31, 35 AND 44).

SER. NO. 77-243,760, FILED 7-31-2007.

MICHAEL ENGEL, EXAMINING ATTORNEY

**Int. Cl.: 12**

**Prior U.S. Cls.: 19, 21, 23, 31, 35 and 44**

**United States Patent and Trademark Office**

**Reg. No. 3,503,770**

**Registered Sep. 23, 2008**

**TRADEMARK  
PRINCIPAL REGISTER**

# Security

E. THIRTEEN INCORPORATED (MAINE CORPORATION)  
PO BOX 2724  
11 BOLDT FARMS RD  
EDGARTOWN, MA 02539

FOR: BICYCLE PARTS, NAMELY, SINGLE RING CHAIN RETENTION SYSTEMS COMPRISING BACK PLATES, SLIDERS, BOLTS, AND BASH-GUARDS, IN CLASS 12 (U.S. CLS. 19, 21, 23, 31, 35 AND 44).

FIRST USE 1-1-2001; IN COMMERCE 1-1-2001.

THE MARK CONSISTS OF STANDARD CHARACTERS WITHOUT CLAIM TO ANY PARTICULAR FONT, STYLE, SIZE, OR COLOR.

SER. NO. 77-243,786, FILED 7-31-2007.

MICHAEL ENGEL, EXAMINING ATTORNEY

**Int. Cl.: 43**

**Prior U.S. Cls.: 100 and 101**

**United States Patent and Trademark Office**

**Reg. No. 3,503,771**

**Registered Sep. 23, 2008**

**SERVICE MARK  
PRINCIPAL REGISTER**



TWO COUSINS, LLC (WASHINGTON LIMITED LIABILITY COMPANY)  
8516 GREENWOOD AVENUE N.  
SEATTLE, WA 98103

FOR: RESTAURANT SERVICES, NAMELY, SERVICE OF SPECIALTY FOODS FROM THE MEDITERRANEAN, IN CLASS 43 (U.S. CLS. 100 AND 101).

FIRST USE 1-1-2004; IN COMMERCE 1-1-2004.

NO CLAIM IS MADE TO THE EXCLUSIVE RIGHT TO USE "SPECIALTY FOODS FROM THE MEDITERRANEAN", APART FROM THE MARK AS SHOWN.

THE MARK CONSISTS OF THE WORDS "OLIVE YOU SPECIALTY FOODS FROM THE MEDITERRANEAN" POSITIONED BETWEEN TWO OLIVE BRANCHES. A HORIZONTAL BAR IN A DARKER SHADE APPEARS ABOVE THE WORDING. A HEART DESIGN APPEARS OVER THE LETTER "I" IN OLIVE. AN IMAGE OF THE SEA APPEARS AS THE BACKGROUND TO THE RIGHT OF THE OLIVE BRANCH ON THE RIGHT SIDE.

SER. NO. 77-244,142, FILED 8-1-2007.

EMILY CHUO, EXAMINING ATTORNEY

**Int. Cl.: 39**

**Prior U.S. Cls.: 100 and 105**

**United States Patent and Trademark Office**

**Reg. No. 3,503,772**

**Registered Sep. 23, 2008**

**SERVICE MARK  
PRINCIPAL REGISTER**

**SHIP-N-STORE**

FESCO INTERNATIONAL LLC (DELAWARE  
LIMITED LIABILITY COMPANY)  
2711 CENTERVILLE ROAD, SUITE 400  
WILMINGTON, DE 19808

THE MARK CONSISTS OF STANDARD CHAR-  
ACTERS WITHOUT CLAIM TO ANY PARTICULAR  
FONT, STYLE, SIZE, OR COLOR.

FOR: ELECTRONIC STORAGE OF FILES AND  
DOCUMENTS, IN CLASS 39 (U.S. CLS. 100 AND 105).

SER. NO. 77-244,154, FILED 8-1-2007.

FIRST USE 1-1-2007; IN COMMERCE 1-1-2007.

PAUL F. GAST, EXAMINING ATTORNEY

**Int. Cl.: 45**

**Prior U.S. Cls.: 100 and 101**

**United States Patent and Trademark Office**

**Reg. No. 3,503,773**

**Registered Sep. 23, 2008**

**SERVICE MARK  
PRINCIPAL REGISTER**

**DEBIX**

DEBIX ONE INCORPORATED (TEXAS CORPORATION)  
900 CONGRESS, SUITE 402  
AUSTIN, TX 78701

THE MARK CONSISTS OF STANDARD CHARACTERS WITHOUT CLAIM TO ANY PARTICULAR FONT, STYLE, SIZE, OR COLOR.

FOR: FRAUD DETECTION SERVICES IN THE FIELD OF CREDIT CARDS FOR ON-LINE PURCHASING, IN CLASS 45 (U.S. CLS. 100 AND 101).

SER. NO. 77-244,236, FILED 8-1-2007.

FIRST USE 3-0-2006; IN COMMERCE 3-0-2006.

JAMES LOVELACE, EXAMINING ATTORNEY

**Int. Cl.: 16**

**Prior U.S. Cls.: 2, 5, 22, 23, 29, 37, 38 and 50**

**United States Patent and Trademark Office**

**Reg. No. 3,503,774**

**Registered Sep. 23, 2008**

**TRADEMARK  
PRINCIPAL REGISTER**

**CARING FOR PETS SINCE 1868**

SERGEANT'S PET CARE PRODUCTS, INC. (NE-  
VADA CORPORATION)

2625 S 158TH PLAZA

OMAHA, NE 681301770

FOR: DISPOSABLE HOUSEBREAKING PADS  
FOR PETS, IN CLASS 16 (U.S. CLS. 2, 5, 22, 23, 29,  
37, 38 AND 50).

FIRST USE 5-0-2004; IN COMMERCE 5-0-2004.

THE MARK CONSISTS OF STANDARD CHAR-  
ACTERS WITHOUT CLAIM TO ANY PARTICULAR  
FONT, STYLE, SIZE, OR COLOR.

OWNER OF U.S. REG. NOS. 3,421,922, 3,425,866  
AND OTHERS.

SEC. 2(F).

SER. NO. 77-244,325, FILED 8-1-2007.

ADA HAN, EXAMINING ATTORNEY

**Int. Cl.: 25**

**Prior U.S. Cls.: 22 and 39**

**United States Patent and Trademark Office**

**Reg. No. 3,503,775**

**Registered Sep. 23, 2008**

**TRADEMARK  
PRINCIPAL REGISTER**

**CHRISTOPHER FIT**

ROBINSON WEBSTER (HOLDINGS) LIMITED  
(UNITED KINGDOM COMPANY)  
159 MORTLAKE ROAD  
KEW, UNITED KINGDOM TW94AW

FOR: CLOTHING, NAMELY, TROUSERS, PANTS  
SUITS, SKIRT SUITS, SKIRTS, SHIRTS AND JACK-  
ETS, IN CLASS 25 (U.S. CLS. 22 AND 39).

THE MARK CONSISTS OF STANDARD CHAR-  
ACTERS WITHOUT CLAIM TO ANY PARTICULAR  
FONT, STYLE, SIZE, OR COLOR.

PRIORITY CLAIMED UNDER SEC. 44(D) ON  
UNITED KINGDOM APPLICATION NO. 2457677,

FILED 6-6-2007, REG. NO. 2457677, DATED 11-30-  
2007, EXPIRES 6-6-2017.

NO CLAIM IS MADE TO THE EXCLUSIVE  
RIGHT TO USE "FIT", APART FROM THE MARK  
AS SHOWN.

THE NAME SHOWN IN THE MARK DOES NOT  
IDENTIFY A PARTICULAR LIVING INDIVIDUAL.

SER. NO. 77-244,485, FILED 8-1-2007.

LINDA POWELL, EXAMINING ATTORNEY



**Int. Cl.: 25**

**Prior U.S. Cls.: 22 and 39**

**United States Patent and Trademark Office**

**Reg. No. 3,503,776**

**Registered Sep. 23, 2008**

**TRADEMARK  
PRINCIPAL REGISTER**

**HAMPSTEAD FIT**

ROBINSON WEBSTER (HOLDINGS) LIMITED  
(UNITED KINGDOM COMPANY)  
159 MORTLAKE ROAD  
KEW, UNITED KINGDOM TW94AW

FOR: CLOTHING, NAMELY, TROUSERS, PANTS  
SUITS, SKIRT SUITS, SKIRTS, SHIRTS AND JACK-  
ETS, IN CLASS 25 (U.S. CLS. 22 AND 39).

THE MARK CONSISTS OF STANDARD CHAR-  
ACTERS WITHOUT CLAIM TO ANY PARTICULAR  
FONT, STYLE, SIZE, OR COLOR.

PRIORITY CLAIMED UNDER SEC. 44(D) ON  
UNITED KINGDOM APPLICATION NO. 2457676,  
FILED 6-6-2007, REG. NO. 2457676, DATED 11-30-  
2007, EXPIRES 6-6-2017.

NO CLAIM IS MADE TO THE EXCLUSIVE  
RIGHT TO USE "FIT", APART FROM THE MARK  
AS SHOWN.

SER. NO. 77-244,510, FILED 8-1-2007.

LINDA POWELL, EXAMINING ATTORNEY

**Int. Cl.: 16**

**Prior U.S. Cls.: 2, 5, 22, 23, 29, 37, 38 and 50**

**Reg. No. 3,503,777**

**United States Patent and Trademark Office**

**Registered Sep. 23, 2008**

**TRADEMARK  
PRINCIPAL REGISTER**

**BAO TRE**

PHAM, KRYSTAL (UNITED STATES INDIVIDUAL)  
3433 DUVAL DRIVE  
PLANO, TX 75025

FOR: MAGAZINE FEATURING TOPICS OF GENERAL INTEREST IN THE ASIAN COMMUNITY IN THE FIELDS OF ASIAN CULTURE, FAMILY, SCIENCE AND SPORTS, IN CLASS 16 (U.S. CLS. 2, 5, 22, 23, 29, 37, 38 AND 50).

FIRST USE 7-7-2007; IN COMMERCE 7-7-2007.

THE MARK CONSISTS OF STANDARD CHARACTERS WITHOUT CLAIM TO ANY PARTICULAR FONT, STYLE, SIZE, OR COLOR.

OWNER OF U.S. REG. NO. 3,417,435.

NO CLAIM IS MADE TO THE EXCLUSIVE RIGHT TO USE "BAO", APART FROM THE MARK AS SHOWN.

THE ENGLISH TRANSLATION OF THE MARK IS "YOUTH MAGAZINE."

SEC. 2(F) AS TO "TRE".

SER. NO. 77-244,730, FILED 8-1-2007.

ALICE SUE CARRUTHERS, EXAMINING ATTORNEY

**Int. Cl.: 25**

**Prior U.S. Cls.: 22 and 39**

**United States Patent and Trademark Office**

**Reg. No. 3,503,778**

**Registered Sep. 23, 2008**

**TRADEMARK  
PRINCIPAL REGISTER**

**ZPZ**

ZAPPA FAMILY TRUST, THE (CALIFORNIA  
TRUST)  
SUITE 802  
11684 VENTURA BOULEVARD  
STUDIO CITY, CA 91604

THE MARK CONSISTS OF STANDARD CHAR-  
ACTERS WITHOUT CLAIM TO ANY PARTICULAR  
FONT, STYLE, SIZE, OR COLOR.

FOR: CLOTHING, NAMELY, T-SHIRTS, IN  
CLASS 25 (U.S. CLS. 22 AND 39).

SER. NO. 77-244,809, FILED 8-1-2007.

FIRST USE 7-1-2007; IN COMMERCE 7-1-2007.

CHARLES L. JENKINS, EXAMINING ATTORNEY

**Int. Cl.: 30**

**Prior U.S. Cl.: 46**

**United States Patent and Trademark Office**

**Reg. No. 3,503,779**

**Registered Sep. 23, 2008**

**TRADEMARK  
PRINCIPAL REGISTER**

**TASTY MEDS**

SOUTHEASTERN PHARMCEUTICALS, INC.  
(FLORIDA CORPORATION)  
1140 CRYSTAL DRIVE  
PALM BEACH, FL 33418

FOR: FLAVORING ADDITIVES FOR NON-NU-  
TRITIONAL PURPOSES, IN CLASS 30 (U.S. CL. 46).

FIRST USE 6-6-2002; IN COMMERCE 6-6-2002.

THE MARK CONSISTS OF STANDARD CHAR-  
ACTERS WITHOUT CLAIM TO ANY PARTICULAR  
FONT, STYLE, SIZE, OR COLOR.

SEC. 2(F).

SER. NO. 77-245,145, FILED 8-2-2007.

VERNA BETH RIRIE, EXAMINING ATTORNEY

**Int. Cl.: 28**

**Prior U.S. Cls.: 22, 23, 38 and 50**

**United States Patent and Trademark Office**

**Reg. No. 3,503,780**

**Registered Sep. 23, 2008**

**TRADEMARK  
PRINCIPAL REGISTER**

# RESPONSE

RAWLINGS SPORTING GOODS COMPANY,  
INC. (DELAWARE CORPORATION)  
5 NORMANDY DR.  
ALTAMONT, NY 12009

THE MARK CONSISTS OF STANDARD CHAR-  
ACTERS WITHOUT CLAIM TO ANY PARTICULAR  
FONT, STYLE, SIZE, OR COLOR.

FOR: LACROSSE EQUIPMENT, NAMELY, LA-  
CROSSE HEADS, LACROSSE STICKS, LACROSSE  
POCKETS, IN CLASS 28 (U.S. CLS. 22, 23, 38 AND 50).

SER. NO. 77-245,297, FILED 8-2-2007.

FIRST USE 6-0-2001; IN COMMERCE 6-0-2001.

ALLISON HOLTZ, EXAMINING ATTORNEY

**Int. Cls.: 9 and 12**

**Prior U.S. Cls.: 19, 21, 23, 26, 31, 35, 36, 38 and 44**

**United States Patent and Trademark Office**

**Reg. No. 3,503,781**

**Registered Sep. 23, 2008**

**TRADEMARK  
PRINCIPAL REGISTER**

**RACESTART**

DAIMLER AG (FED REP GERMANY CORPORATION)  
MERCEDSSTRASSE 137  
STUTTGART, FED REP GERMANY 70327

FOR: ELECTRONIC TRANSMISSION CONTROL SYSTEMS COMPRISED PRIMARILY OF ELECTRONIC CONTROL UNITS TO CONTROL THE SHIFTING ACTION IN MANUAL GEARS IN VEHICLE TRANSMISSIONS, IN CLASS 9 (U.S. CLS. 21, 23, 26, 36 AND 38).

FOR: TRANSMISSION AND THEIR PARTS FOR LAND VEHICLES, IN CLASS 12 (U.S. CLS. 19, 21, 23, 31, 35 AND 44).

THE MARK CONSISTS OF STANDARD CHARACTERS WITHOUT CLAIM TO ANY PARTICULAR FONT, STYLE, SIZE, OR COLOR.

PRIORITY CLAIMED UNDER SEC. 44(D) ON FED REP GERMANY APPLICATION NO. 30708190.712, FILED 2-6-2007, REG. NO. 30708190, DATED 4-10-2007, EXPIRES 2-7-2017.

SER. NO. 77-245,393, FILED 8-2-2007.

BENJAMIN ALLEN, EXAMINING ATTORNEY

**Int. Cl.: 10**

**Prior U.S. Cls.: 26, 39 and 44**

**United States Patent and Trademark Office**

**Reg. No. 3,503,782**

**Registered Sep. 23, 2008**

**TRADEMARK  
PRINCIPAL REGISTER**

**ALCO-SENSOR FST**

INTOXIMETERS, INC. (MISSOURI CORPORATION)  
8110 LACKLAND  
ST. LOUIS, MO 63114

FOR: BREATH ALCOHOL ANALYZERS AND RELATED ACCESSORIES AND SUPPLIES SOLD AS A UNIT THEREWITH, NAMELY, MOUTH PIECES, PASSIVE SAMPLE CUPS, CD MANUALS, RUBBERIZED GRIPS, RUBBER DISPLAY BEZELS, CASE WINDOW PROTECTOR LENS, CD-ROM IN SERVICE TRAINING, IN CLASS 10 (U.S. CLS. 26, 39 AND 44).

FIRST USE 3-6-2004; IN COMMERCE 3-6-2004.

THE MARK CONSISTS OF STANDARD CHARACTERS WITHOUT CLAIM TO ANY PARTICULAR FONT, STYLE, SIZE, OR COLOR.

OWNER OF U.S. REG. NO. 1,444,931.

SER. NO. 77-245,548, FILED 8-2-2007.

KELLY BOULTON, EXAMINING ATTORNEY

**Int. Cl.: 31**

**Prior U.S. Cls.: 1 and 46**

**United States Patent and Trademark Office**

**Reg. No. 3,503,783**

**Registered Sep. 23, 2008**

**TRADEMARK  
PRINCIPAL REGISTER**

**BERBERIAN NUT COMPANY**

BERBERIAN NUT COMPANY, LLC (CALIFORNIA LIMITED LIABILITY COMPANY)  
SUITE 110  
139 EAST SOUTH TEMPLE  
SALT LAKE CITY, UT 84111

NO CLAIM IS MADE TO THE EXCLUSIVE RIGHT TO USE "NUT COMPANY", APART FROM THE MARK AS SHOWN.

FOR: UNPROCESSED, RAW, AND FRESH NUTS, IN CLASS 31 (U.S. CLS. 1 AND 46).

SEC. 2(F).

FIRST USE 8-0-1984; IN COMMERCE 8-0-1984.

SER. NO. 77-245,876, FILED 8-2-2007.

THE MARK CONSISTS OF STANDARD CHARACTERS WITHOUT CLAIM TO ANY PARTICULAR FONT, STYLE, SIZE, OR COLOR.

GRETTA YAO, EXAMINING ATTORNEY



**Int. Cl.: 42**

**Prior U.S. Cls.: 100 and 101**

**United States Patent and Trademark Office**

**Reg. No. 3,503,784**

**Registered Sep. 23, 2008**

**SERVICE MARK  
PRINCIPAL REGISTER**

**part prefab all custom**

SANDER ARCHITECTS, LLC (CALIFORNIA  
LIMITED LIABILITY COMPANY)  
2434 LINCOLN BLVD.  
VENICE, CA 90291

FOR: ARCHITECTURAL DESIGN, IN CLASS 42  
(U.S. CLS. 100 AND 101).

FIRST USE 2-28-2006; IN COMMERCE 2-28-2006.

THE MARK CONSISTS OF STANDARD CHAR-  
ACTERS WITHOUT CLAIM TO ANY PARTICULAR  
FONT, STYLE, SIZE, OR COLOR.

NO CLAIM IS MADE TO THE EXCLUSIVE  
RIGHT TO USE "PART PREFAB", APART FROM  
THE MARK AS SHOWN.

SER. NO. 77-245,917, FILED 8-2-2007.

ALICE SUE CARRUTHERS, EXAMINING ATTOR-  
NEY

**Int. Cl.: 41**

**Prior U.S. Cls.: 100, 101 and 107**

**United States Patent and Trademark Office**

**Reg. No. 3,503,785**

**Registered Sep. 23, 2008**

**SERVICE MARK  
PRINCIPAL REGISTER**

**GOLDEN STATE**

DISNEY ENTERPRISES, INC. (DELAWARE COR-  
PORATION)

500 SOUTH BUENA

BURBANK, CA 915210643

FOR: AMUSEMENT PARK SERVICES, IN CLASS  
41 (U.S. CLS. 100, 101 AND 107).

FIRST USE 2-8-2001; IN COMMERCE 2-8-2001.

THE MARK CONSISTS OF STANDARD CHAR-  
ACTERS WITHOUT CLAIM TO ANY PARTICULAR  
FONT, STYLE, SIZE, OR COLOR.

OWNER OF U.S. REG. NO. 2,526,342.

SEC. 2(F).

SER. NO. 77-246,219, FILED 8-3-2007.

STEPHEN AQUILA, EXAMINING ATTORNEY

**Int. Cl.: 35**

**Prior U.S. Cls.: 100, 101 and 102**

**United States Patent and Trademark Office**

**Reg. No. 3,503,786**

**Registered Sep. 23, 2008**

**SERVICE MARK  
PRINCIPAL REGISTER**

**WIV INC.  
see:change:create**

WIV INC. (MASSACHUSETTS CORPORATION)  
15 TALBOT ROAD  
HINGHAM, MA 02043

FOR: MANAGEMENT AND BUSINESS CONSULTING SERVICES IN THE FIELD OF CORPORATE CREATIVITY, IN CLASS 35 (U.S. CLS. 100, 101 AND 102).

FIRST USE 7-10-2007; IN COMMERCE 7-10-2007.

THE MARK CONSISTS OF STANDARD CHARACTERS WITHOUT CLAIM TO ANY PARTICULAR FONT, STYLE, SIZE, OR COLOR.

NO CLAIM IS MADE TO THE EXCLUSIVE RIGHT TO USE "INC.", APART FROM THE MARK AS SHOWN.

SER. NO. 77-246,625, FILED 8-3-2007.

ARETHA SOMERVILLE, EXAMINING ATTORNEY

**Int. Cl.: 6**

**Prior U.S. Cls.: 2, 12, 13, 14, 23, 25 and 50**

**Reg. No. 3,503,787**

**United States Patent and Trademark Office**

**Registered Sep. 23, 2008**

---

**TRADEMARK  
PRINCIPAL REGISTER**

**STARNAIL**

EVERHOLD GROUP CORPORATION, THE  
(FLORIDA CORPORATION)  
2014 FOURTH STREET  
SARASOTA, FL 34237

FOR: NAILS USED IN CONSTRUCTION, IN  
CLASS 6 (U.S. CLS. 2, 12, 13, 14, 23, 25 AND 50).

FIRST USE 6-30-2007; IN COMMERCE 6-30-2007.

THE MARK CONSISTS OF STANDARD CHAR-  
ACTERS WITHOUT CLAIM TO ANY PARTICULAR  
FONT, STYLE, SIZE, OR COLOR.

SER. NO. 77-246,771, FILED 8-3-2007.

ANDREA K. NADELMAN, EXAMINING ATTOR-  
NEY

Int. Cl.: 6

Prior U.S. Cls.: 2, 12, 13, 14, 23, 25 and 50

Reg. No. 3,503,788

United States Patent and Trademark Office

Registered Sep. 23, 2008

**TRADEMARK  
PRINCIPAL REGISTER**

**STRONGER · LIGHTER · BETTER**

THE EVERHOLD GROUP CORPORATION  
(FLORIDA CORPORATION)  
2014 FOURTH STREET  
SARASOTA, FL 34237

FIRST USE 6-30-2007; IN COMMERCE 6-30-2007.

SER. NO. 77-246,869, FILED 8-3-2007.

FOR: NAILS, IN CLASS 6 (U.S. CLS. 2, 12, 13, 14, 23,  
25 AND 50).

ANDREA K. NADELMAN, EXAMINING ATTOR-  
NEY

Int. Cl.: 44

Prior U.S. Cls.: 100 and 101

United States Patent and Trademark Office

Reg. No. 3,503,789

Registered Sep. 23, 2008

SERVICE MARK  
PRINCIPAL REGISTER



AARON M. HARDY (NEVADA SOLE PROPRIETORSHIP), DBA INTEGRATED HEALTH & WELLNESS

#115-311

10580 N. MCCARRAN BLVD  
RENO, NV 89503

FIRST USE 6-10-2007; IN COMMERCE 6-10-2007.

NO CLAIM IS MADE TO THE EXCLUSIVE RIGHT TO USE "HEALTH MATTERS", APART FROM THE MARK AS SHOWN.

FOR: CONSULTING SERVICES IN THE FIELD OF MENTAL HEALTH AND WELLNESS; HEALTH CARE SERVICES, NAMELY WELLNESS PROGRAMS; PROVIDING A WEBSITE FEATURING INFORMATION IN THE FIELD OF MENTAL HEALTH AND WELLNESS; PROVIDING ASSISTANCE, FITNESS EVALUATION AND CONSULTATION TO CORPORATE CLIENTS TO HELP THEIR EMPLOYEES MAKE HEALTH, WELLNESS AND NUTRITIONAL CHANGES IN THEIR DAILY LIVING TO IMPROVE HEALTH; PROVIDING WELLNESS SERVICES, NAMELY, PERSONAL ASSESSMENTS, PERSONALIZED ROUTINES, MAINTENANCE SCHEDULES, AND COUNSELING, IN CLASS 44 (U.S. CLS. 100 AND 101).

THE MARK CONSISTS OF LOWER-CASE ARIAL BLACK FONT "HEALTH" WITH A ROUNDED UNDERLINE BAR WITH "EDUCATE ENGAGE EMPOWER" CENTERED IN ALL-CAPS ARIAL BLACK FONT AND LOWER-CASE ARIAL BLACK FONT "MATTERS" WITH A ROUNDED UNDERLINE BAR WITH "CREATING A CULTURE OF WELLNESS" CENTERED IN ALL-CAPS ARIAL BLACK FONT.

SER. NO. 77-247,337, FILED 8-4-2007.

CAROLINE WOOD, EXAMINING ATTORNEY

**Int. Cl.: 29**

**Prior U.S. Cl.: 46**

**United States Patent and Trademark Office**

**Reg. No. 3,503,790**

**Registered Sep. 23, 2008**

**TRADEMARK  
PRINCIPAL REGISTER**

**CITRI-FI**

FIBERSTAR, INC. (MINNESOTA CORPORATION)  
3023 15TH STREET SW  
WILLMAR, MN 562019670

FOR: DRIED CITRUS FRUIT PULP IN POWDERED FORM FOR USE AS A FILLER, FOR MANAGING MOISTURE CONTENT, FOR REPLACING FAT, AS A STRENGTHENING AGENT, OR AS A THICKENER IN FOOD FOR HUMAN AND ANIMAL CONSUMPTION, IN CLASS 29 (U.S. CL. 46).

FIRST USE 3-10-2004; IN COMMERCE 3-10-2004.

THE MARK CONSISTS OF STANDARD CHARACTERS WITHOUT CLAIM TO ANY PARTICULAR FONT, STYLE, SIZE, OR COLOR.

OWNER OF U.S. REG. NOS. 2,986,457 AND 3,079,524.

SER. NO. 77-247,459, FILED 8-5-2007.

NELSON SNYDER, EXAMINING ATTORNEY

**Int. Cl.: 20**

**Prior U.S. Cls.: 2, 13, 22, 25, 32 and 50**

**United States Patent and Trademark Office**

**Reg. No. 3,503,791**

**Registered Sep. 23, 2008**

**TRADEMARK  
PRINCIPAL REGISTER**

**ROLLABANA**

MAX IMPACT, LLC (DELAWARE LIMITED LIABILITY COMPANY)  
1405 OLD WINTER BEACH ROAD  
VERO BEACH, FL 32963

THE MARK CONSISTS OF STANDARD CHARACTERS WITHOUT CLAIM TO ANY PARTICULAR FONT, STYLE, SIZE, OR COLOR.

FOR: PLASTIC PROMOTIONAL AND ADVERTISING SIGNS, IN CLASS 20 (U.S. CLS. 2, 13, 22, 25, 32 AND 50).

SER. NO. 77-247,644, FILED 8-6-2007.

FIRST USE 9-6-2006; IN COMMERCE 9-6-2006.

DANIEL CAPSHAW, EXAMINING ATTORNEY



**Int. Cl.: 4**

**Prior U.S. Cls.: 1, 6 and 15**

**United States Patent and Trademark Office**

**Reg. No. 3,503,792**

**Registered Sep. 23, 2008**

**TRADEMARK  
PRINCIPAL REGISTER**

**F & L RACING FUEL**

M.O. DION & SONS, INC. (CALIFORNIA CORPORATION)  
1543 WEST 16TH STREET  
LONG BEACH, CA 90813

FOR: GASOLINE FUEL FOR RACING CARS, GOKARTS, JET SKIS, MOTORCYCLES, BOATS, SNOW MOBILES, AND ATVS, IN CLASS 4 (U.S. CLS. 1, 6 AND 15).

FIRST USE 0-0-1982; IN COMMERCE 0-0-1982.

THE MARK CONSISTS OF STANDARD CHARACTERS WITHOUT CLAIM TO ANY PARTICULAR FONT, STYLE, SIZE, OR COLOR.

NO CLAIM IS MADE TO THE EXCLUSIVE RIGHT TO USE "RACING FUEL", APART FROM THE MARK AS SHOWN.

SER. NO. 77-247,896, FILED 8-6-2007.

AMOS T. MATTHEWS, JR., EXAMINING ATTORNEY

**Int. Cl.: 35**

**Prior U.S. Cls.: 100, 101 and 102**

**United States Patent and Trademark Office**

**Reg. No. 3,503,793**

**Registered Sep. 23, 2008**

**SERVICE MARK  
PRINCIPAL REGISTER**

**GOLDEN CIRCLE**

SHANGRI-LA INTERNATIONAL HOTEL MAN-  
AGEMENT LIMITED (BR.VIRGIN ISLANDS  
CORPORATION)  
P.O. BOX 146  
TRIDENT CHAMBERS  
ROAD TOWN TORTOLA, BR.VIRGIN ISLANDS

FOR: CUSTOMER LOYALTY SERVICES AND  
CUSTOMER CLUB SERVICES FOR PROMOTIONAL  
AND ADVERTISING PURPOSES , IN CLASS 35 (U.S.  
CLS. 100, 101 AND 102).

FIRST USE 8-28-1992; IN COMMERCE 8-28-1997.

THE MARK CONSISTS OF STANDARD CHAR-  
ACTERS WITHOUT CLAIM TO ANY PARTICULAR  
FONT, STYLE, SIZE, OR COLOR.

OWNER OF U.S. REG. NO. 2,643,117.

SER. NO. 77-248,102, FILED 8-6-2007.

RONALD MCMORROW, EXAMINING ATTORNEY

**Int. Cl.: 35**

**Prior U.S. Cls.: 100, 101 and 102**

**United States Patent and Trademark Office**

**Reg. No. 3,503,794**

**Registered Sep. 23, 2008**

**SERVICE MARK  
PRINCIPAL REGISTER**

**High School Highlights**



**The Starting Place for Legends of the Future**

JOHNSON, MISHAEL AYINDE (UNITED STATES  
INDIVIDUAL)  
2042 THOUSAND OAKS BLVD  
INDIANAPOLIS, IN 46214

FOR: SPORTS RECRUITING SERVICES FOR  
HIGH SCHOOL ATHLETES, IN CLASS 35 (U.S.  
CLS. 100, 101 AND 102).

FIRST USE 0-0-2003; IN COMMERCE 11-12-2004.

NO CLAIM IS MADE TO THE EXCLUSIVE  
RIGHT TO USE "HIGH SCHOOL" & "SPORTS",  
APART FROM THE MARK AS SHOWN.

THE MARK CONSISTS OF AN IMAGE THAT  
LOOKS LIKE A PERSON WITH ONE ARM UP  
SITTING ABOVE THE LETTERS "HSH SPORTS".  
OVER THE TOP OF THE IMAGE ARE THE WORDS  
"HIGH SCHOOL HIGHLIGHTS" AT THE BOTTOM  
OF THE IMAGE ARE THE WORDS "THE START-  
ING PLACE FOR LEGENDS OF THE FUTURE".

SER. NO. 77-248,110, FILED 8-6-2007.

KARANENDRA S. CHHINA, EXAMINING ATTOR-  
NEY

**Int. Cls.: 29 and 30**

**Prior U.S. Cl.: 46**

**United States Patent and Trademark Office**

**Reg. No. 3,503,795**

**Registered Sep. 23, 2008**

**TRADEMARK  
PRINCIPAL REGISTER**

The logo for the trademark 'PROTIQUE' is written in a bold, black, cursive script. The letters are thick and interconnected, with a prominent 'P' and 'Q'. A thick, curved underline sweeps under the word from the 'P' to the 'E'.

BARIATRIX NUTRITION, INC. (CANADA CORPORATION)  
4905 FAIRWAY STREET  
LACHINE H8T 1B7, CANADA

FOR: HIGH PROTEIN FORMULATED PREPARED MEALS CONSISTING PRIMARILY OF MEAT, FISH, POULTRY OR VEGETABLES; HIGH PROTEIN FORMULATED SOUPS, IN CLASS 29 (U.S. CL. 46).

FIRST USE 8-9-2005; IN COMMERCE 8-9-2005.

FOR: HIGH PROTEIN FORMULATED PUD-  
DINGS, IN CLASS 30 (U.S. CL. 46).

FIRST USE 8-9-2005; IN COMMERCE 8-9-2005.

THE MARK CONSISTS OF THE WORD "PRO-  
TIQUE" IN STYLIZED FONT.

SER. NO. 77-248,121, FILED 8-6-2007.

MICHAEL TANNER, EXAMINING ATTORNEY

**Int. Cl.: 30**

**Prior U.S. Cl.: 46**

**United States Patent and Trademark Office**

**Reg. No. 3,503,796**

**Registered Sep. 23, 2008**

**TRADEMARK  
PRINCIPAL REGISTER**

# Johnny's Hots

JOHNNY'S LUNCH FRANCHISE, LLC (OHIO  
LIMITED LIABILITY COMPANY)  
9TH FLOOR  
ONE SEAGATE  
TOLEDO, OH 43604

FOR: HOT DOG SANDWICHES, IN CLASS 30 (U.S.  
CL. 46).

FIRST USE 0-0-1972; IN COMMERCE 0-0-1972.

THE MARK CONSISTS OF STANDARD CHAR-  
ACTERS WITHOUT CLAIM TO ANY PARTICULAR  
FONT, STYLE, SIZE, OR COLOR.

NO CLAIM IS MADE TO THE EXCLUSIVE  
RIGHT TO USE "HOTS", APART FROM THE MARK  
AS SHOWN.

SER. NO. 77-248,130, FILED 8-6-2007.

SANJEEV VOHRA, EXAMINING ATTORNEY

**Int. Cl.: 9**

**Prior U.S. Cls.: 21, 23, 26, 36 and 38**

**United States Patent and Trademark Office**

**Reg. No. 3,503,797**

**Registered Sep. 23, 2008**

**TRADEMARK  
PRINCIPAL REGISTER**

**THE TRUTH IS IN YOUR HANDS**

OLIVE TREE BIBLE SOFTWARE, INC. (OREGON  
CORPORATION)  
PO BOX 48271  
SPOKANE, WA 99228

FOR: COMPUTER APPLICATION SOFTWARE  
FOR MOBILE PHONES; COMPUTER APPLICATION  
SOFTWARE FOR PDAS; COMPUTER SOFTWARE  
FOR USE IN BROWSING, SEARCHING OR STUDY-  
ING THE BIBLE, IN CLASS 9 (U.S. CLS. 21, 23, 26, 36  
AND 38).

FIRST USE 1-15-1999; IN COMMERCE 1-15-1999.

THE MARK CONSISTS OF STANDARD CHAR-  
ACTERS WITHOUT CLAIM TO ANY PARTICULAR  
FONT, STYLE, SIZE, OR COLOR.

SER. NO. 77-248,169, FILED 8-6-2007.

WILLIAM P. SHANAHAN, EXAMINING ATTOR-  
NEY

**Int. Cl.: 20**

**Prior U.S. Cls.: 2, 13, 22, 25, 32 and 50**

**Reg. No. 3,503,798**

**United States Patent and Trademark Office**

**Registered Sep. 23, 2008**

**TRADEMARK  
PRINCIPAL REGISTER**

**FIELD OF FRAMES**

VJC LLC (WASHINGTON LIMITED LIABILITY  
COMPANY)  
10030 200TH PL SE  
SNOHOMISH, WA 98296

FOR: PICTURE FRAMES NOT OF PRECIOUS  
METALS; WALL FRAMES NOT OF PRECIOUS  
METALS FOR THE DISPLAY OF A COLLAGE OF  
PICTURE FRAMES, IN CLASS 20 (U.S. CLS. 2, 13, 22,  
25, 32 AND 50).

FIRST USE 12-26-2005; IN COMMERCE 6-24-2006.

THE MARK CONSISTS OF STANDARD CHAR-  
ACTERS WITHOUT CLAIM TO ANY PARTICULAR  
FONT, STYLE, SIZE, OR COLOR.

NO CLAIM IS MADE TO THE EXCLUSIVE  
RIGHT TO USE "FRAMES", APART FROM THE  
MARK AS SHOWN.

SER. NO. 77-248,232, FILED 8-6-2007.

CARYN GLASSER, EXAMINING ATTORNEY

**Int. Cl.: 36**

**Prior U.S. Cls.: 100, 101 and 102**

**United States Patent and Trademark Office**

**Reg. No. 3,503,799**

**Registered Sep. 23, 2008**

**SERVICE MARK  
PRINCIPAL REGISTER**

**PPI**

PAYMENT PROCESSING, INC. (CALIFORNIA CORPORATION)  
8200 CENTRAL AVENUE  
NEWARK, CA 94560

FOR: PROVIDING ELECTRONIC PROCESSING OF CREDIT CARD TRANSACTION DATA AND ELECTRONIC PAYMENT DATA VIA A GLOBAL COMPUTER NETWORK, IN CLASS 36 (U.S. CLS. 100, 101 AND 102).

FIRST USE 6-12-1995; IN COMMERCE 6-12-1995.

THE MARK CONSISTS OF STANDARD CHARACTERS WITHOUT CLAIM TO ANY PARTICULAR FONT, STYLE, SIZE, OR COLOR.

OWNER OF U.S. REG. NOS. 3,027,432, 3,074,722, AND 3,074,723.

THE WORDING "PPI" HAS NO MEANING IN A FOREIGN LANGUAGE.

SER. NO. 77-248,245, FILED 8-6-2007.

ANGELA GAW, EXAMINING ATTORNEY



**Int. Cl.: 35**

**Prior U.S. Cls.: 100, 101 and 102**

**United States Patent and Trademark Office**

**Reg. No. 3,503,800**

**Registered Sep. 23, 2008**

**SERVICE MARK  
PRINCIPAL REGISTER**

**HOME LUXURY**

MUSICOM CORPORATION (VIRGINIA CORPORATION)

2545 EAST SUNRISE BLVD 207

FORT LAUDERDALE, FL 33304

FOR: OPERATING AN ONLINE SHOPPING SITE IN THE FIELD OF BEAUTY CARE COSMETIC PRODUCTS AND HOME DÉCOR, IN CLASS 35 (U.S. CLS. 100, 101 AND 102).

FIRST USE 4-9-2002; IN COMMERCE 4-9-2002.

THE MARK CONSISTS OF STANDARD CHARACTERS WITHOUT CLAIM TO ANY PARTICULAR FONT, STYLE, SIZE, OR COLOR.

NO CLAIM IS MADE TO THE EXCLUSIVE RIGHT TO USE "HOME", APART FROM THE MARK AS SHOWN.

SEC. 2(F).

SER. NO. 77-248,527, FILED 8-6-2007.

JOHN E. MICHOS, EXAMINING ATTORNEY

**Int. Cl.: 10**

**Prior U.S. Cls.: 26, 39 and 44**

**United States Patent and Trademark Office**

**Reg. No. 3,503,801**

**Registered Sep. 23, 2008**

**TRADEMARK  
PRINCIPAL REGISTER**

**INNOVATIONS IN UROLOGY**

PERCUTANEOUS SYSTEMS, INC. (DELAWARE CORPORATION)  
1300 CRITTENDEN LANE, SUITE 101  
MOUNTAIN VIEW, CA 94043

FOR: SURGICAL CATHETERS; ENDOSCOPIC EQUIPMENT; MEDICAL INSTRUMENTS FOR PERCUTANEOUS TRACHEOSTOMY; RESILIENT, SLICK, BIOCOMPATIBLE FILMS FOR ATRAUMATIC INTRODUCTION USED ON CATHETERS AND ENDOSCOPIC EQUIPMENT IN THE FIELDS OF UROLOGY AND GYNECOLOGY; VASCULAR CATHETERS HAVING AN INTRODUCER SHEATH; CATHETER GUIDE WIRES FOR RENAL OR UTERAL USE; EVERTING UTERAL CATHETERS; URETHRAL INTRODUCER SHEATHS FOR CATHETERS, IN CLASS 10 (U.S. CLS. 26, 39 AND 44).

FIRST USE 0-0-2005; IN COMMERCE 0-0-2005.

THE MARK CONSISTS OF STANDARD CHARACTERS WITHOUT CLAIM TO ANY PARTICULAR FONT, STYLE, SIZE, OR COLOR.

NO CLAIM IS MADE TO THE EXCLUSIVE RIGHT TO USE "UROLOGY", APART FROM THE MARK AS SHOWN.

SER. NO. 77-248,896, FILED 8-7-2007.

KYLE PEETE, EXAMINING ATTORNEY

**Int. Cl.: 10**

**Prior U.S. Cls.: 26, 39 and 44**

**Reg. No. 3,503,802**

**United States Patent and Trademark Office**

**Registered Sep. 23, 2008**

**TRADEMARK  
PRINCIPAL REGISTER**

**IT'S ABOUT TIME!**

PERCUTANEOUS SYSTEMS, INC. (DELAWARE  
CORPORATION)  
1300 CRITTENDEN LANE, SUITE 101  
MOUNTAIN VIEW, CA 94043

THE MARK CONSISTS OF STANDARD CHAR-  
ACTERS WITHOUT CLAIM TO ANY PARTICULAR  
FONT, STYLE, SIZE, OR COLOR.

FOR: CATHETER GUIDE WIRES FOR RENAL  
OR URETERAL USE; MICRO-CATHETERS, IN  
CLASS 10 (U.S. CLS. 26, 39 AND 44).

SER. NO. 77-248,929, FILED 8-7-2007.

FIRST USE 4-0-2007; IN COMMERCE 4-0-2007.

KYLE PEETE, EXAMINING ATTORNEY

**Int. Cl.: 20**

**Prior U.S. Cls.: 2, 13, 22, 25, 32 and 50**

**United States Patent and Trademark Office**

**Reg. No. 3,503,803**

**Registered Sep. 23, 2008**

**TRADEMARK  
PRINCIPAL REGISTER**

**EASY CARE**

ENCOMPASS GROUP, LLC (DELAWARE LIMITED LIABILITY COMPANY)  
615 MACON STREET  
MCDONOUGH, GA 30253

THE MARK CONSISTS OF STANDARD CHARACTERS WITHOUT CLAIM TO ANY PARTICULAR FONT, STYLE, SIZE, OR COLOR.

FOR: PILLOWS, IN CLASS 20 (U.S. CLS. 2, 13, 22, 25, 32 AND 50).

SER. NO. 77-248,949, FILED 8-7-2007.

FIRST USE 2-2-1993; IN COMMERCE 2-2-1993.

KELLY BOULTON, EXAMINING ATTORNEY

**Int. Cls.: 41 and 44**

**Prior U.S. Cls.: 100, 101 and 107**

**United States Patent and Trademark Office**

**Reg. No. 3,503,804**

**Registered Sep. 23, 2008**

**SERVICE MARK  
PRINCIPAL REGISTER**

**WORLD CONGRESS ON  
PREVENTIVE DENTISTRY**

INTERNATIONAL ASSOCIATION FOR DENTAL  
RESEARCH (VIRGINIA CORPORATION)  
1619 DUKE STREET  
ALEXANDRIA, VA 22314

FOR: SCIENTIFIC EDUCATIONAL SERVICES,  
NAMELY, COURSES, LECTURES AND SEMINARS  
FEATURING INFORMATION IN THE FIELDS OF  
ORAL HEALTH OF INDIVIDUALS AND COMMU-  
NITIES THROUGHOUT THE WORLD, IN CLASS 41  
(U.S. CLS. 100, 101 AND 107).

FIRST USE 1-1-1994; IN COMMERCE 1-1-1994.

FOR: PROVIDING HEALTH INFORMATION,  
NAMELY, THE DISSEMINATION OF INFORMA-  
TION IN THE FIELD OF DENTISTRY AND ORAL  
HEALTH OF INDIVIDUALS AND COMMUNITIES  
THROUGHOUT THE WORLD, IN CLASS 44 (U.S.  
CLS. 100 AND 101).

FIRST USE 1-1-1994; IN COMMERCE 1-1-1994.

THE MARK CONSISTS OF STANDARD CHAR-  
ACTERS WITHOUT CLAIM TO ANY PARTICULAR  
FONT, STYLE, SIZE, OR COLOR.

OWNER OF U.S. REG. NO. 2,143,649.

NO CLAIM IS MADE TO THE EXCLUSIVE  
RIGHT TO USE "PREVENTIVE DENTISTRY",  
APART FROM THE MARK AS SHOWN.

SEC. 2(F).

SER. NO. 77-249,278, FILED 8-7-2007.

JESSICA A. POWERS, EXAMINING ATTORNEY

**Int. Cls.: 15, 20 and 21**

**Prior U.S. Cls.: 2, 13, 21, 22, 23, 25, 29, 30, 32, 33, 36,  
40 and 50**

**United States Patent and Trademark Office**

**Reg. No. 3,503,805**

**Registered Sep. 23, 2008**

**TRADEMARK  
PRINCIPAL REGISTER**

# **GOLD LABEL**

MR. CHRISTMAS INCORPORATED (NEW YORK CORPORATION)  
41 MADISON AVENUE, 38TH FLOOR  
NEW YORK, NY 10010

FOR: MUSIC BOXES FEATURING ILLUMINATED CHRISTMAS MOTIFS, IN CLASS 15 (U.S. CLS. 2, 21 AND 36).

FIRST USE 12-17-1999; IN COMMERCE 12-17-1999.

FOR: ELECTRIC AND BATTERY-OPERATED HOLIDAY ANIMATED FIGURES MADE OF WOOD AND PLASTIC, IN CLASS 20 (U.S. CLS. 2, 13, 22, 25, 32 AND 50).

FIRST USE 12-17-1999; IN COMMERCE 12-17-1999.

FOR: ELECTRIC AND BATTERY-OPERATED HOLIDAY ANIMATED FIGURES MADE OF CERAMIC AND GLASS, IN CLASS 21 (U.S. CLS. 2, 13, 23, 29, 30, 33, 40 AND 50).

FIRST USE 12-17-1999; IN COMMERCE 12-17-1999.

THE MARK CONSISTS OF STANDARD CHARACTERS WITHOUT CLAIM TO ANY PARTICULAR FONT, STYLE, SIZE, OR COLOR.

OWNER OF U.S. REG. NO. 2,785,325.

SER. NO. 77-249,279, FILED 8-7-2007.

JESSICA A. POWERS, EXAMINING ATTORNEY

**Int. Cl.: 12**

**Prior U.S. Cls.: 19, 21, 23, 31, 35 and 44**

**Reg. No. 3,503,806**

**United States Patent and Trademark Office**

**Registered Sep. 23, 2008**

---

**TRADEMARK  
PRINCIPAL REGISTER**

**CONDOR**

AMERICAN SPORTWORKS LLC (DELAWARE  
LIMITED LIABILITY COMPANY)  
4404 ENGLE RIDGE DRIVE  
FORT WAYNE, IN 46804

THE MARK CONSISTS OF STANDARD CHAR-  
ACTERS WITHOUT CLAIM TO ANY PARTICULAR  
FONT, STYLE, SIZE, OR COLOR.

FOR: MOTORIZED-OFF ROAD VEHICLES,  
NAMELY, ALL-TERRAIN VEHICLES, MOTORIZED  
MINIBIKES, GO-KARTS, AND UTILITY VEHICLES,  
IN CLASS 12 (U.S. CLS. 19, 21, 23, 31, 35 AND 44).

OWNER OF U.S. REG. NO. 2,338,981.

SER. NO. 77-250,133, FILED 8-8-2007.

FIRST USE 8-0-2006; IN COMMERCE 8-0-2006.

BARBARA A. GOLD, EXAMINING ATTORNEY

**Int. Cl.: 41**

**Prior U.S. Cls.: 100, 101 and 107**

**United States Patent and Trademark Office**

**Reg. No. 3,503,807**

**Registered Sep. 23, 2008**

**SERVICE MARK  
PRINCIPAL REGISTER**

**LONE STAR CLASSIC**

ST. MARY'S UNIVERSITY OF SAN ANTONIO,  
TEXAS (TEXAS NON-PROFIT CORPORATION)

ONE CAMINO SANTA MARIA  
SAN ANTONIO, TX 78284

FOR: EDUCATIONAL SERVICES IN THE NATURE OF CONDUCTING MOCK TRIAL COMPETITIONS FOR LAW SCHOOL STUDENTS, IN CLASS 41 (U.S. CLS. 100, 101 AND 107).

FIRST USE 9-0-2001; IN COMMERCE 9-0-2001.

THE MARK CONSISTS OF STANDARD CHARACTERS WITHOUT CLAIM TO ANY PARTICULAR FONT, STYLE, SIZE, OR COLOR.

NO CLAIM IS MADE TO THE EXCLUSIVE RIGHT TO USE "CLASSIC", APART FROM THE MARK AS SHOWN.

SEC. 2(F) AS TO "LONE STAR".

SER. NO. 77-250,378, FILED 8-8-2007.

KATHLEEN M. VANSTON, EXAMINING ATTORNEY



**Int. Cl.: 21**

**Prior U.S. Cls.: 2, 13, 23, 29, 30, 33, 40 and 50**

**United States Patent and Trademark Office**

**Reg. No. 3,503,808**

**Registered Sep. 23, 2008**

**TRADEMARK  
PRINCIPAL REGISTER**

**ORGANIZED BY DESIGN**

VENTURE PRODUCTS, LLC (NEW JERSEY LIMITED LIABILITY COMPANY)  
SUITE 209  
376 HOLLYWOOD AVENUE  
FAIRFIELD, NJ 07004

FOR: STORAGE CONTAINERS, STORAGE BASKETS, PORTABLE STORAGE CONTAINERS, STACKABLE STORAGE CONTAINERS, STORAGE BINS, DRAWER ORGANIZERS, ALL OF FOAM CONSTRUCTION FOR HOUSEHOLD, KITCHEN, DOMESTIC GARAGE, AND DOMESTIC CONSU-

MER USES, IN CLASS 21 (U.S. CLS. 2, 13, 23, 29, 30, 33, 40 AND 50).

FIRST USE 10-11-2007; IN COMMERCE 10-11-2007.

THE MARK CONSISTS OF STANDARD CHARACTERS WITHOUT CLAIM TO ANY PARTICULAR FONT, STYLE, SIZE, OR COLOR.

SER. NO. 77-250,434, FILED 8-8-2007.

B. PARADEWELAI, EXAMINING ATTORNEY

**Int. Cls.: 9 and 36**

**Prior U.S. Cls.: 21, 23, 26, 36, 38, 100, 101 and 102**

**Reg. No. 3,503,809**

**United States Patent and Trademark Office**

**Registered Sep. 23, 2008**

**TRADEMARK  
SERVICE MARK  
PRINCIPAL REGISTER**

# CARDEX ICARD

CARD EXPRESS, INC. (CALIFORNIA CORPORATION)  
13766 ALTON PARKWAY, SUITE 150  
IRVINE, CA 92618

FOR: MAGNETICALLY ENCODED PREPAID DEBIT CARDS, IN CLASS 9 (U.S. CLS. 21, 23, 26, 36 AND 38).

FIRST USE 4-0-2000; IN COMMERCE 4-0-2000.

FOR: DEBIT CARD SERVICES AND DEBIT CARD TRANSACTION PROCESSING SERVICES, IN CLASS 36 (U.S. CLS. 100, 101 AND 102).

FIRST USE 4-0-2000; IN COMMERCE 4-0-2000.

THE MARK CONSISTS OF STANDARD CHARACTERS WITHOUT CLAIM TO ANY PARTICULAR FONT, STYLE, SIZE, OR COLOR.

NO CLAIM IS MADE TO THE EXCLUSIVE RIGHT TO USE "ICARD", APART FROM THE MARK AS SHOWN.

SER. NO. 77-250,455, FILED 8-8-2007.

TASHIA BUNCH, EXAMINING ATTORNEY

**Int. Cl.: 11**

**Prior U.S. Cls.: 13, 21, 23, 31 and 34**

**Reg. No. 3,503,810**

**United States Patent and Trademark Office**

**Registered Sep. 23, 2008**

**TRADEMARK  
PRINCIPAL REGISTER**

**PULSEOX**

APPLIED PROCESS TECHNOLOGY, INC. (CALI-  
FORNIA CORPORATION)  
3333 VINCENT ROAD, SUITE 222  
PLEASANT HILL, CA 94523

FIRST USE 11-1-2004; IN COMMERCE 11-1-2004.

FOR: WATER TREATMENT EQUIPMENT FOR  
INJECTING HYDROGEN PEROXIDE, OZONE AND  
OTHER CHEMICALS AND COMPOUNDS INTO  
CONTAMINATED WATERS AND SUBSURFACES  
FOR THE TREATMENT THEREFOR; WATER  
TREATMENT UNITS USING OXIDATION FOR  
DOMESTIC, COMMERCIAL AND INDUSTRIAL  
USE, IN CLASS 11 (U.S. CLS. 13, 21, 23, 31 AND 34).

THE MARK CONSISTS OF STANDARD CHAR-  
ACTERS WITHOUT CLAIM TO ANY PARTICULAR  
FONT, STYLE, SIZE, OR COLOR.

SER. NO. 77-250,516, FILED 8-8-2007.

CHRIS DONINGER, EXAMINING ATTORNEY

**Int. Cl.: 28**

**Prior U.S. Cls.: 22, 23, 38 and 50**

**United States Patent and Trademark Office**

**Reg. No. 3,503,811**

**Registered Sep. 23, 2008**

**TRADEMARK  
PRINCIPAL REGISTER**

**FLYSTART**

ROSS OUTDOOR SPORTS SPECIALTIES, LLC  
(COLORADO LIMITED LIABILITY COMPA-  
NY)  
ONE PONDEROSA COURT  
MONTROSE, CO 81401

THE MARK CONSISTS OF STANDARD CHAR-  
ACTERS WITHOUT CLAIM TO ANY PARTICULAR  
FONT, STYLE, SIZE, OR COLOR.

FOR: FISHING RODS AND FISHING REELS, IN  
CLASS 28 (U.S. CLS. 22, 23, 38 AND 50).

SER. NO. 77-250,594, FILED 8-8-2007.

FIRST USE 1-2-2006; IN COMMERCE 1-2-2006.

CARYN GLASSER, EXAMINING ATTORNEY

Int. Cl.: 44

Prior U.S. Cls.: 100 and 101

United States Patent and Trademark Office

Reg. No. 3,503,812

Registered Sep. 23, 2008

SERVICE MARK  
PRINCIPAL REGISTER



RECKITT BENCKISER HEALTHCARE (UK) LIMITED (ENGLAND LIMITED LIABILITY COMPANY)

DANSOM LANE  
HULL, UNITED KINGDOM HU87DS

FOR: PROVISION OF HEALTHCARE ADVICE; PROVIDING INFORMATION RELATING TO OPIOID DEPENDENCE, IN CLASS 44 (U.S. CLS. 100 AND 101).

FIRST USE 9-1-2005; IN COMMERCE 9-1-2005.

OWNER OF U.S. REG. NOS. 2,169,133, 2,917,297, AND 3,434,688.

NO CLAIM IS MADE TO THE EXCLUSIVE RIGHT TO USE "BUPRENORPHINE HCl/NALOXONE HCl DIHYDRATE" AND THE STYLIZED "C" WITH THREE VERTICAL LINES INSIDE AND "SUBLINGUAL TABLETS", APART FROM THE MARK AS SHOWN.

THE COLOR(S) BLUE, GREEN, AND BLACK IS/ ARE CLAIMED AS A FEATURE OF THE MARK.

THE MARK CONSISTS OF THE WORD "SUBOXONE" IN BLUE WITH A GREEN PETAL OVER THE "ON" IN "SUBOXONE". THE CHEMICAL NAME OF THE MARK ("BUPRENORPHINE HCl/NALOXONE HCl DIHYDRATE") APPEARS IN BLACK UNDERNEATH THE WORD "SUBOXONE". TO THE RIGHT OF THE CHEMICAL NAME IS A STYLIZED "C" WITH THREE VERTICAL LINES INSIDE, FOLLOWED BY THE WORDS "SUBLINGUAL TABLETS" ALL IN BLACK.

SER. NO. 77-250,843, FILED 8-9-2007.

JEFFERY COWARD, EXAMINING ATTORNEY

**Int. Cl.: 32**

**Prior U.S. Cls.: 45, 46 and 48**

**Reg. No. 3,503,813**

**United States Patent and Trademark Office**

**Registered Sep. 23, 2008**

**TRADEMARK  
PRINCIPAL REGISTER**

**GLOJI**

GLOJI INC. (CALIFORNIA CORPORATION)  
1427 E. 4TH ST., SUITE 7  
LOS ANGELES, CA 90033

LY, WOLFBERRY, ROSELLE, BLACK MULBERRY,  
PASSION FRUIT, MINT AND LEMON JUICES, IN  
CLASS 32 (U.S. CLS. 45, 46 AND 48).

FOR: FRUIT JUICES; FRUIT JUICE CONCENTRATES; NON-ALCOHOLIC FRUIT EXTRACTS USED IN THE PREPARATION OF BEVERAGES, NAMELY, WOLFBERRY, ROSELLE, BLACK MULBERRY, PASSION FRUIT, MINT AND LEMON BEVERAGES; NON-ALCOHOLIC FRUIT-FLAVORED BEVERAGES, NAMELY, WOLFBERRY, ROSELLE, BLACK MULBERRY, PASSION FRUIT, MINT AND LEMON FLAVORS; NON-ALCOHOLIC BEVERAGES CONTAINING FRUIT JUICES, NAME-

FIRST USE 5-19-2007; IN COMMERCE 5-19-2007.

THE MARK CONSISTS OF STANDARD CHARACTERS WITHOUT CLAIM TO ANY PARTICULAR FONT, STYLE, SIZE, OR COLOR.

SER. NO. 77-250,889, FILED 8-9-2007.

MELVIN AXILBUND, EXAMINING ATTORNEY

**Int. Cl.: 41**

**Prior U.S. Cls.: 100, 101 and 107**

**United States Patent and Trademark Office**

**Reg. No. 3,503,814**

**Registered Sep. 23, 2008**

**SERVICE MARK  
PRINCIPAL REGISTER**

**BIG DOG BIG LOSER**

VETERINARY NEURO SERVICES, LLC (FLOR-  
IDA LIMITED LIABILITY COMPANY)  
BUILDING M, UNIT 4  
3900 CLARK ROAD  
SARASOTA, FL 34233

FOR: CONDUCTING A CONTEST IN THE NAT-  
URE OF AN INCENTIVE AWARD PROGRAM DE-  
SIGNATED TO REWARD PARTICIPATES, NAMELY,  
DOGS AND THEIR OWNERS, FOR LOSS OF  
WEIGHT BY THE DOG OVER A PREDETERMINED  
PERIOD OF TIME, IN CLASS 41 (U.S. CLS. 100, 101  
AND 107).

FIRST USE 1-19-2007; IN COMMERCE 1-19-2007.

THE MARK CONSISTS OF STANDARD CHAR-  
ACTERS WITHOUT CLAIM TO ANY PARTICULAR  
FONT, STYLE, SIZE, OR COLOR.

NO CLAIM IS MADE TO THE EXCLUSIVE  
RIGHT TO USE "DOG", APART FROM THE MARK  
AS SHOWN.

SER. NO. 77-251,236, FILED 8-9-2007.

ADA HAN, EXAMINING ATTORNEY

**Int. Cl.: 16**

**Prior U.S. Cls.: 2, 5, 22, 23, 29, 37, 38 and 50**

**United States Patent and Trademark Office**

**Reg. No. 3,503,815**

**Registered Sep. 23, 2008**

**TRADEMARK  
PRINCIPAL REGISTER**

**Kids' Acting for Brain  
Surgeons**

HOLLYWOOD OPERATING SYSTEM, LLC (CALIFORNIA LIMITED LIABILITY COMPANY)  
3108 W. MAGNOLIA BLVD.  
BURBANK, CA 91505

OWNER OF U.S. REG. NO. 2,648,743.

FOR: REFERENCE BOOKS IN THE FIELD OF ENTERTAINMENT, IN CLASS 16 (U.S. CLS. 2, 5, 22, 23, 29, 37, 38 AND 50).

NO CLAIM IS MADE TO THE EXCLUSIVE RIGHT TO USE "KIDS' ACTING", APART FROM THE MARK AS SHOWN.

FIRST USE 1-23-2003; IN COMMERCE 1-23-2003.

SER. NO. 77-251,934, FILED 8-10-2007.

THE MARK CONSISTS OF STANDARD CHARACTERS WITHOUT CLAIM TO ANY PARTICULAR FONT, STYLE, SIZE, OR COLOR.

NATALIE POLZER, EXAMINING ATTORNEY



**Int. Cls.: 37 and 44**

**Prior U.S. Cls.: 100, 101, 103 and 106**

**United States Patent and Trademark Office**

**Reg. No. 3,503,816**

**Registered Sep. 23, 2008**

**SERVICE MARK  
PRINCIPAL REGISTER**

**LUXURY OF NATURE**

BACK TO NATURE LANDSCAPE ASSOCIATES,  
INC., (NEW JERSEY CORPORATION)  
152 OLDWICK ROAD  
OLDWICK, NJ 08858

FOR: REGENERATIVE AND TRADITIONAL  
REAL ESTATE DEVELOPMENT SERVICES AND  
RESIDENTIAL AND COMMERCIAL BUILDING  
AND CONSTRUCTION SERVICES; LANDSCAPE  
CONSTRUCTION, NAMELY, INSTALLATION OF  
NON-LIVING LANDSCAPING MATERIALS, IN  
CLASS 37 (U.S. CLS. 100, 103 AND 106).

FIRST USE 1-15-2007; IN COMMERCE 5-1-2007.

FOR: LANDSCAPE DESIGN; LANDSCAPE GAR-  
DENING; GARDEN DESIGN, IN CLASS 44 (U.S.  
CLS. 100 AND 101).

FIRST USE 1-15-2007; IN COMMERCE 5-1-2007.

THE MARK CONSISTS OF STANDARD CHAR-  
ACTERS WITHOUT CLAIM TO ANY PARTICULAR  
FONT, STYLE, SIZE, OR COLOR.

SER. NO. 77-251,962, FILED 8-10-2007.

HANNO RITTNER, EXAMINING ATTORNEY

**Int. Cl.: 36**

**Prior U.S. Cls.: 100, 101 and 102**

**United States Patent and Trademark Office**

**Reg. No. 3,503,817**

**Registered Sep. 23, 2008**

**SERVICE MARK  
PRINCIPAL REGISTER**

**Change Point Analytics**

WILLIAM RORY CROWDER (UNITED STATES  
INDIVIDUAL)  
2300 LAS FLORES CANYON ROAD  
MALIBU, CA 90265

FOR: PROVIDING STOCK/SECURITIES MAR-  
KET INFORMATION, IN CLASS 36 (U.S. CLS. 100,  
101 AND 102).

FIRST USE 9-1-2006; IN COMMERCE 9-1-2006.

THE MARK CONSISTS OF STANDARD CHAR-  
ACTERS WITHOUT CLAIM TO ANY PARTICULAR  
FONT, STYLE, SIZE, OR COLOR.

NO CLAIM IS MADE TO THE EXCLUSIVE  
RIGHT TO USE "ANALYTICS", APART FROM  
THE MARK AS SHOWN.

SER. NO. 77-252,381, FILED 8-10-2007.

RICHARD WHITE, EXAMINING ATTORNEY

**Int. Cl.: 18**

**Prior U.S. Cls.: 1, 2, 3, 22 and 41**

**United States Patent and Trademark Office**

**Reg. No. 3,503,818**

**Registered Sep. 23, 2008**

**TRADEMARK  
PRINCIPAL REGISTER**

**puparazzi**

NAPOLI, DAVID V (UNITED STATES INDIVIDUAL)  
25 THOMPSON ST. APT # 25  
NEW YORK, NY 10013

THE MARK CONSISTS OF STANDARD CHARACTERS WITHOUT CLAIM TO ANY PARTICULAR FONT, STYLE, SIZE, OR COLOR.

FOR: CLOTHING FOR DOMESTIC PETS, IN CLASS 18 (U.S. CLS. 1, 2, 3, 22 AND 41).

SER. NO. 77-252,535, FILED 8-10-2007.

FIRST USE 8-10-2007; IN COMMERCE 8-10-2007.

TRACY CROSS, EXAMINING ATTORNEY

**Int. Cl.: 11**

**Prior U.S. Cls.: 13, 21, 23, 31 and 34**

**United States Patent and Trademark Office**

**Reg. No. 3,503,819**

**Registered Sep. 23, 2008**

**TRADEMARK  
PRINCIPAL REGISTER**

**KAISER idell**

STEEN LYHNE-JOHANSEN (DENMARK INDIVIDUAL)

SKOVVANG 14

VEJLE, DENMARK 7100

FOR: LUMINARIES AND REPLACEMENT PARTS THEREFOR; AND LIGHTS, NAMELY, TABLE LIGHTS, WALL LIGHTS, PENDANT LIGHTS AND REPLACEMENT PARTS THEREFOR, IN CLASS 11 (U.S. CLS. 13, 21, 23, 31 AND 34).

THE MARK CONSISTS OF STANDARD CHARACTERS WITHOUT CLAIM TO ANY PARTICULAR FONT, STYLE, SIZE, OR COLOR.

PRIORITY CLAIMED UNDER SEC. 44(D) ON ERPN CMNTY TM OFC APPLICATION NO. 005710207, FILED 2-13-2007, REG. NO. 005710207, DATED 2-11-2008, EXPIRES 2-13-2017.

SER. NO. 77-252,546, FILED 8-10-2007.

TRACY CROSS, EXAMINING ATTORNEY

**Int. Cls.: 35 and 41**

**Prior U.S. Cls.: 100, 101, 102 and 107**

**United States Patent and Trademark Office**

**Reg. No. 3,503,820**

**Registered Sep. 23, 2008**

**SERVICE MARK  
PRINCIPAL REGISTER**

**JOBSINTHEMONEY**

JOBSINTHEMONEY.COM, INC. (DELAWARE CORPORATION)  
THREE PARK AVENUE, 33RD FLOOR  
NEW YORK, NY 10016

FOR: PROVIDING AN ONLINE SEARCHABLE DATABASE FEATURING EMPLOYMENT OPPORTUNITIES; PROVIDING INFORMATION AND ARTICLES IN THE FIELDS OF EMPLOYMENT, RECRUITMENT, CAREERS, JOB RESOURCES, JOB LISTINGS AND RESUMES, AND PROVIDING CAREER INFORMATION, IN CLASS 35 (U.S. CLS. 100, 101 AND 102).

FIRST USE 10-15-1998; IN COMMERCE 10-15-1998.

FOR: PROVIDING ONLINE PUBLICATIONS IN THE NATURE OF NEWSLETTERS IN THE FIELDS OF EMPLOYMENT, RECRUITMENT, CAREERS, JOB RESOURCES, JOB LISTINGS AND RESUMES; CAREER COUNSELING, IN CLASS 41 (U.S. CLS. 100, 101 AND 107).

FIRST USE 10-15-1998; IN COMMERCE 10-15-1998.

THE MARK CONSISTS OF STANDARD CHARACTERS WITHOUT CLAIM TO ANY PARTICULAR FONT, STYLE, SIZE, OR COLOR.

SER. NO. 77-252,873, FILED 8-10-2007.

KELLEY WELLS, EXAMINING ATTORNEY

**Int. Cl.: 30**

**Prior U.S. Cl.: 46**

**Reg. No. 3,503,821**

**United States Patent and Trademark Office**

**Registered Sep. 23, 2008**

**TRADEMARK  
PRINCIPAL REGISTER**

**Spice Rack Chocolates**

MY EXTRA HANDS, LLC (VIRGINIA LIMITED LIABILITY COMPANY), DBA SPICE RACK CHOCOLATES  
10908 COURTHOUSE RD. SUITE 264 #102  
FREDERICKSBURG, VA 22408

FOR: CANDY, CHOCOLATE, CHOCOLATE CANDY, CHOCOLATES FLAVORED WITH ASSORTED SPICES, CANDY COATED POPCORN, CARAMEL POPCORN, CHOCOLATE POPCORN, IN CLASS 30 (U.S. CL. 46).

FIRST USE 6-1-2006; IN COMMERCE 6-1-2006.

THE MARK CONSISTS OF STANDARD CHARACTERS WITHOUT CLAIM TO ANY PARTICULAR FONT, STYLE, SIZE, OR COLOR.

NO CLAIM IS MADE TO THE EXCLUSIVE RIGHT TO USE "SPICE" AND "CHOCOLATES", APART FROM THE MARK AS SHOWN.

SER. NO. 77-253,343, FILED 8-13-2007.

INGA ERVIN, EXAMINING ATTORNEY

**Int. Cl.: 35**

**Prior U.S. Cls.: 100, 101 and 102**

**United States Patent and Trademark Office**

**Reg. No. 3,503,822**

**Registered Sep. 23, 2008**

**SERVICE MARK  
PRINCIPAL REGISTER**

**10 GRAIN**

STAR INTERNATIONAL FURNITURE, INC. (CALIFORNIA CORPORATION)  
30322 ESPERANZA, SUITE 100  
RANCHO SANTA MARGARITA, CA 926882138

FOR: DISTRIBUTORSHIP OF FURNITURE, IN CLASS 35 (U.S. CLS. 100, 101 AND 102).

FIRST USE 7-0-2007; IN COMMERCE 7-0-2007.

THE MARK CONSISTS OF STANDARD CHARACTERS WITHOUT CLAIM TO ANY PARTICULAR FONT, STYLE, SIZE, OR COLOR.

THE WORDING "GRAIN" AND "10" HAS NO MEANING IN A FOREIGN LANGUAGE.

SER. NO. 77-253,484, FILED 8-13-2007.

SEAN CROWLEY, EXAMINING ATTORNEY

**Int. Cl.: 35**

**Prior U.S. Cls.: 100, 101 and 102**

**United States Patent and Trademark Office**

**Reg. No. 3,503,823**

**Registered Sep. 23, 2008**

**SERVICE MARK  
PRINCIPAL REGISTER**

**ESSENTIALS FOR LIVING**

STAR INTERNATIONAL FURNITURE, INC. (CALIFORNIA CORPORATION)  
30322 ESPERANZA, SUITE 100  
RANCHO SANTA MARGARITA, CA 926882138

THE MARK CONSISTS OF STANDARD CHARACTERS WITHOUT CLAIM TO ANY PARTICULAR FONT, STYLE, SIZE, OR COLOR.

FOR: DISTRIBUTORSHIP OF FURNITURE, IN CLASS 35 (U.S. CLS. 100, 101 AND 102).

SER. NO. 77-253,611, FILED 8-13-2007.

FIRST USE 7-0-2007; IN COMMERCE 7-0-2007.

SEAN CROWLEY, EXAMINING ATTORNEY



**Int. Cl.: 9**

**Prior U.S. Cls.: 21, 23, 26, 36 and 38**

**Reg. No. 3,503,824**

**United States Patent and Trademark Office**

**Registered Sep. 23, 2008**

**TRADEMARK  
PRINCIPAL REGISTER**

**DAVID BENJAMIN**

EUROPA EYEWEAR CORP. (ILLINOIS CORPORATION), DBA EUROPA INTERNATIONAL  
730 HASTINGS LANE  
BUFFALO GROVE, IL 60089

FOR: EYEGLASSES, SUNGLASSES, READING GLASSES, AND RELATED ACCESSORIES, NAMELY, EYEGLASS CASES AND FRAMES, IN CLASS 9 (U.S. CLS. 21, 23, 26, 36 AND 38).

FIRST USE 4-0-2006; IN COMMERCE 4-0-2006.

THE MARK CONSISTS OF STANDARD CHARACTERS WITHOUT CLAIM TO ANY PARTICULAR FONT, STYLE, SIZE, OR COLOR.

THE NAME "DAVID BENJAMIN" SHOWN IN THE MARK DOES NOT IDENTIFY A PARTICULAR LIVING INDIVIDUAL.

SER. NO. 77-253,615, FILED 8-13-2007.

ARETHA SOMERVILLE, EXAMINING ATTORNEY

**Int. Cl.: 9**

**Prior U.S. Cls.: 21, 23, 26, 36 and 38**

**Reg. No. 3,503,825**

**United States Patent and Trademark Office**

**Registered Sep. 23, 2008**

**TRADEMARK  
PRINCIPAL REGISTER**

The logo for 'Tagan' features the word 'Tagan' in a bold, sans-serif font. A thick, black, curved line starts under the 'T', loops under the 'a' and 'g', and ends under the 'n', resembling a stylized underline or a swoosh.

TAGAN TECHNOLOGY CO. (CALIFORNIA CORPORATION)  
1307 JOHN REED COURT  
CITY OF INDUSTRY, CA 91745

FOR: POWER SUPPLIES, IN PARTICULAR COMBINATIONAL CIRCUIT PARTS, POWER SUPPLY UNITS, TRANSFORMERS AND CONTINUOUS POWER SUPPLIES FOR COMPUTER SYSTEMS AND COMPUTER PERIPHERAL DEVICES; TEMPERATURE REGULATORS AND SENSORS, FANS AND HEAT SINKS FOR COMPUTERS AND COMPUTER PERIPHERAL DEVICES; VOLTAGE REGULATORS; ACCUMULATORS, IN PARTICULAR RECHARGEABLE NICKEL BATTERIES; DATA PROCESSING EQUIPMENT AND COMPUTERS; MOTHERBOARDS, ALSO KNOWN AS MAINBOARDS; COMPUTER SCREENS AND INPUT APPARATUS, IN PARTICULAR KEYBOARDS AND MOUSE DEVICES; HOUSINGS FOR DATA PROCES-

SING EQUIPMENT, NAMELY, COMPUTER HOUSINGS, COMPUTERS, MAGNETIC AND OPTICAL DATA STORAGE APPARATUS, IN PARTICULAR HARD DISC DRIVES, CD/DVD DRIVES, FLOPPY DISC DRIVES, EXCHANGEABLE DISC DRIVES; CABLES FOR DATA, SOUND AND VIDEO TRANSMISSION, FIBERGLASS CONNECTOR CABLES; HOUSINGS FOR AUDIO APPARATUS, NAMELY, SPEAKER HOUSINGS; ELECTRONIC REVERSING SWITCHES FOR INPUT AND OUTPUT APPARATUS, ALSO KNOWN AS KVM KEYBOARD VIDEO MOUSE SWITCHES, IN CLASS 9 (U.S. CLS. 21, 23, 26, 36 AND 38).

FIRST USE 8-30-2003; IN COMMERCE 8-31-2003.

SER. NO. 77-253,975, FILED 8-13-2007.

BRIAN CALLAGHAN, EXAMINING ATTORNEY

**Int. Cls.: 37 and 42**

**Prior U.S. Cls.: 100, 101, 103 and 106**

**United States Patent and Trademark Office**

**Reg. No. 3,503,826**

**Registered Sep. 23, 2008**

**SERVICE MARK  
PRINCIPAL REGISTER**

 **e+** design and construction

EARL'S RESTAURANTS LTD. (CANADA CORPORATION)  
SUITE 108B, 949 WEST THIRD STREET  
NORTH VANCOUVER, BC, CANADA V7P3P7

FOR: CONSTRUCTION MANAGEMENT SERVICES, IN CLASS 37 (U.S. CLS. 100, 103 AND 106).

FIRST USE 3-0-2006; IN COMMERCE 3-0-2006.

FOR: RESTAURANT DESIGN, NAMELY, ARCHITECTURAL DESIGN AND INTERIOR DESIGN SERVICES, IN CLASS 42 (U.S. CLS. 100 AND 101).

FIRST USE 3-0-2006; IN COMMERCE 3-0-2006.

PRIORITY CLAIMED UNDER SEC. 44(D) ON CANADA APPLICATION NO. 1335122, FILED 2-13-2007.

NO CLAIM IS MADE TO THE EXCLUSIVE RIGHT TO USE "DESIGN AND CONSTRUCTION", APART FROM THE MARK AS SHOWN.

THE MARK CONSISTS OF "E" AND PLUS SIGN AND "DESIGN AND CONSTRUCTION" ALL IN SMALL LETTERING.

SER. NO. 77-254,005, FILED 8-13-2007.

DAVID I, EXAMINING ATTORNEY

**Int. Cl.: 35**

**Prior U.S. Cls.: 100, 101 and 102**

**United States Patent and Trademark Office**

**Reg. No. 3,503,827**

**Registered Sep. 23, 2008**

**SERVICE MARK  
PRINCIPAL REGISTER**



SENIORDIRECTORY.COM, LLC (COLORADO  
LIMITED LIABILITY COMPANY)  
141 SOUTH JASMINE ST.  
DENVER, CO 80224

FOR: PROVIDING A SEARCHABLE ONLINE  
ADVERTISING GUIDE FEATURING THE GOODS  
AND SERVICES OF OTHER ONLINE VENDORS ON  
THE INTERNET, IN CLASS 35 (U.S. CLS. 100, 101  
AND 102).

FIRST USE 11-0-2001; IN COMMERCE 11-0-2001.

THE MARK CONSISTS OF THE WORDS "SE-  
NIORDIRECTORY.COM" WITH A DIAMOND  
SHAPE IN THE BACKGROUND.

SER. NO. 77-254,132, FILED 8-13-2007.

TEJBIR SINGH, EXAMINING ATTORNEY

**Int. Cl.: 7**

**Prior U.S. Cls.: 13, 19, 21, 23, 31, 34 and 35**

**United States Patent and Trademark Office**

**Reg. No. 3,503,828**

**Registered Sep. 23, 2008**

**TRADEMARK  
PRINCIPAL REGISTER**



GORSKI, LINDSAY (UNITED STATES INDIVIDUAL)  
13833 LAKEWOOD HTS. BLVD.  
CLEVELAND, OH 44107

THE MARK CONSISTS OF THE LETTERING IN THE SOFACHROME FONT AND THE "50" IS A SUBSCRIPT ON THE BOTTOM RIGHT.

FOR: CUSTOM FIT HIGH PERFORMANCE IGNITION SPARK PLUG WIRES, IN CLASS 7 (U.S. CLS. 13, 19, 21, 23, 31, 34 AND 35).

SER. NO. 77-254,221, FILED 8-13-2007.

FIRST USE 3-0-2007; IN COMMERCE 3-0-2007.

DOMINICK J. SALEMI, EXAMINING ATTORNEY

**Int. Cl.: 9**

**Prior U.S. Cls.: 21, 23, 26, 36 and 38**

**United States Patent and Trademark Office**

**Reg. No. 3,503,829**

**Registered Sep. 23, 2008**

**TRADEMARK  
PRINCIPAL REGISTER**



CENTRAL TECHNOLOGY, INC. (INDIANA CORPORATION)  
614 CASEY COURT  
DANVILLE, IN 46122

FOR: SELF-SERVICE ELECTRONIC CHECKOUT STATION FOR USE IN LIBRARIES, COMPRISING COMPUTER HARDWARE, COMPUTER SOFTWARE AND A CABINET FEATURING A DESKTOP, SOLD AS A UNIT, USED BY LIBRARY PATRONS TO CHECKOUT THEIR OWN LIBRARY MATERIALS, IN CLASS 9 (U.S. CLS. 21, 23, 26, 36 AND 38).

FIRST USE 1-1-2003; IN COMMERCE 1-1-2003.

OWNER OF U.S. REG. NO. 3,103,488.

THE COLOR(S) RED, LIGHT GRAY, AND DARK GRAY IS/ARE CLAIMED AS A FEATURE OF THE MARK.

THE MARK CONSISTS OF LOWERCASE LETTERS SPELLING "I-CIRC" IN DARK GRAY. IN THE BACKGROUND IS AN OUTLINE OF A BOX WITH ROUNDED CORNERS IN LIGHT GRAY AND A LARGE RED CHECKMARK IN THE CENTER OF THE BOX. THE TIP OF THE CHECKMARK EXITS THE UPPER RIGHT CORNER OF THE BOX AND THE "V" PART OF THE CHECKMARK EXITS THE BOTTOM BORDER OF THE BOX.

SER. NO. 77-254,730, FILED 8-14-2007.

ELLEN BURNS, EXAMINING ATTORNEY

**Int. Cls.: 35 and 36**

**Prior U.S. Cls.: 100, 101 and 102**

**United States Patent and Trademark Office**

**Reg. No. 3,503,830**

**Registered Sep. 23, 2008**

**SERVICE MARK  
PRINCIPAL REGISTER**



BEASON & NALLEY, INC. (ALABAMA CORPORATION)  
101 MONROE STREET  
HUNTSVILLE, AL 35801

FOR: ACCOUNT AUDIT SERVICES; BUSINESS ADVISORY SERVICES, CONSULTANCY AND INFORMATION; BUSINESS REPORTING SERVICES, NAMELY, PREPARING BUSINESS REPORTS, PREPARING FINANCIAL REPORTS FOR OTHERS; GOVERNMENT CONTRACT CONSULTING SERVICES, NAMELY CONSULTATION FOR THE PROCUREMENT OF GOVERNMENT CONTRACTS FOR THE PURCHASE AND SALES OF GOODS AND SERVICES; TAX ADVISORY SERVICES AND CONSULTATIONS; TAX PREPARATION SERVICES; FINANCIAL STATEMENT PREPARATION AND ANALYSIS FOR BUSINESS; FORENSIC ACCOUNTING SERVICES; BOOKKEEPING ASSISTANCE, NAMELY, BOOKKEEPING; BUSINESS APPRAISAL SERVICES; HUMAN RESOURCES CONSULTING, IN CLASS 35 (U.S. CLS. 100, 101 AND 102).

FIRST USE 1-31-1998; IN COMMERCE 1-31-1998.

FOR: FINANCIAL DUE DILIGENCE; BUSINESS VALUATION; FINANCIAL PLANNING, IN CLASS 36 (U.S. CLS. 100, 101 AND 102).

FIRST USE 1-31-1998; IN COMMERCE 1-31-1998.

THE NAME(S), PORTRAIT(S), AND/OR SIGNATURE(S) SHOWN IN THE MARK IDENTIFIES "DONALD WOODROW NALLEY, JR." AND "ROBERT THOMAS BEASON", WHOSE CONSENT(S) TO REGISTER IS SUBMITTED.

THE MARK CONSISTS OF THE WORDS "BEASON & NALLEY" IN LOWERCASE LETTERS WITH THE WORD "BEASON" ABOVE THE WORDS "& NALLEY" AND WITH A LINE UNDERNEATH. TWO SWIRL SHAPES ARE TO THE LEFT OF THE WORDS.

SER. NO. 77-254,912, FILED 8-14-2007.

NAKIA HENRY, EXAMINING ATTORNEY

**Int. Cl.: 37**

**Prior U.S. Cls.: 100, 103 and 106**

**United States Patent and Trademark Office**

**Reg. No. 3,503,831**

**Registered Sep. 23, 2008**

**SERVICE MARK  
PRINCIPAL REGISTER**

**Now That's A Capitol Idea**

CAPITOL HOMES, INC. (TENNESSEE CORPORATION)  
SUITE 320  
475 METROPLEX DR.  
NASHVILLE, TN 37211

THE MARK CONSISTS OF STANDARD CHARACTERS WITHOUT CLAIM TO ANY PARTICULAR FONT, STYLE, SIZE, OR COLOR.

FOR: GENERAL CONSTRUCTION CONTRACTING, IN CLASS 37 (U.S. CLS. 100, 103 AND 106).

SER. NO. 77-255,184, FILED 8-14-2007.

FIRST USE 12-17-2003; IN COMMERCE 1-1-2004.

JENNIFER DIXON, EXAMINING ATTORNEY



**Int. Cl.: 25**

**Prior U.S. Cls.: 22 and 39**

**United States Patent and Trademark Office**

**Reg. No. 3,503,832**

**Registered Sep. 23, 2008**

**TRADEMARK  
PRINCIPAL REGISTER**

**ENERGY VAMPIRES BITE**

MIKOLAJCZYK, DAVID, JAY (UNITED STATES  
INDIVIDUAL)  
768 BRAYTON AVE.  
CLEVELAND, OH 44113

THE MARK CONSISTS OF STANDARD CHAR-  
ACTERS WITHOUT CLAIM TO ANY PARTICULAR  
FONT, STYLE, SIZE, OR COLOR.

FOR: T-SHIRTS, LONG SLEEVE T-SHIRTS, BOX-  
ERS, SWEAT SHIRTS WITH HOOD, HATS, SWEAT  
SHIRTS, IN CLASS 25 (U.S. CLS. 22 AND 39).

SER. NO. 77-255,425, FILED 8-15-2007.

FIRST USE 6-4-2006; IN COMMERCE 6-10-2006.

MARCIE MILONE, EXAMINING ATTORNEY

**Int. Cl.: 25**

**Prior U.S. Cls.: 22 and 39**

**United States Patent and Trademark Office**

**Reg. No. 3,503,833**

**Registered Sep. 23, 2008**

**TRADEMARK  
PRINCIPAL REGISTER**

**ENERGY VAMPIRES SUCK**

MIKOLAJCZYK, DAVID, JAY (UNITED STATES  
INDIVIDUAL)  
768 BRAYTON AVE.  
CLEVELAND, OH 44113

THE MARK CONSISTS OF STANDARD CHAR-  
ACTERS WITHOUT CLAIM TO ANY PARTICULAR  
FONT, STYLE, SIZE, OR COLOR.

FOR: T-SHIRTS, LONG SLEEVE T-SHIRTS,  
SWEAT SHIRTS WITH HOODS, SWEAT SHIRT-  
S, HATS, BOXERS, JOGGING PANTS, IN CLASS 25  
(U.S. CLS. 22 AND 39).

SER. NO. 77-255,429, FILED 8-15-2007.

FIRST USE 6-4-2006; IN COMMERCE 6-9-2006.

MARCIE MILONE, EXAMINING ATTORNEY

Int. Cl.: 44

Prior U.S. Cls.: 100 and 101

United States Patent and Trademark Office

Reg. No. 3,503,834

Registered Sep. 23, 2008

SERVICE MARK  
PRINCIPAL REGISTER



GreenDentistry

PATEL, NAMRATA (UNITED STATES INDIVIDUAL)  
360 POST STREET, SUITE 704  
SAN FRANCISCO, CA 94108

FOR: DENTIST SERVICES, IN CLASS 44 (U.S. CLS. 100 AND 101).

FIRST USE 11-1-2006; IN COMMERCE 11-1-2006.

NO CLAIM IS MADE TO THE EXCLUSIVE RIGHT TO USE "GREEN DENTISTRY", APART FROM THE MARK AS SHOWN.

THE COLOR(S) WHITE, DARK GREEN, BLUE, LIGHT GREEN IS/ARE CLAIMED AS A FEATURE OF THE MARK.

THE MARK CONSISTS OF A DARK GREEN LEAF OVER A TOOTH. THE TOOTH IS WHITE WITH A BLUE BORDER. THIS GRAPHIC IS ABOVE THE WORDS "GREEN DENTISTRY". THE WORD "GREEN" IS IN DARK GREEN AND THE WORD "DENTISTRY" IS IN LIGHT GREEN. THE WHITE BACKGROUND IS NOT CLAIMED AS A FEATURE OF THE MARK.

SER. NO. 77-255,782, FILED 8-15-2007.

JOHN HWANG, EXAMINING ATTORNEY

**Int. Cl.: 1**

**Prior U.S. Cls.: 1, 5, 6, 10, 26 and 46**

**United States Patent and Trademark Office**

**Reg. No. 3,503,835**

**Registered Sep. 23, 2008**

**TRADEMARK  
PRINCIPAL REGISTER**

# Sportstem

WAJCHMAN, HOWARD (UNITED STATES INDIVIDUAL)

5700 LAKE MANOR TRACE  
ALPHARETTA, GA 30022 AND

BRUBAKER, RICHARD LANCE (UNITED STATES INDIVIDUAL)

5700 LAKE MANOR TRACE  
ALPHARETTA, GA 30022

FOR: BIOLOGICAL TISSUE, NAMELY, BLOOD, STEM CELLS, UMBILICAL CORDS AND PLACENTAS FOR SCIENTIFIC AND MEDICAL RESEARCH USE, IN CLASS 1 (U.S. CLS. 1, 5, 6, 10, 26 AND 46).

FIRST USE 5-25-2007; IN COMMERCE 5-25-2007.

THE MARK CONSISTS OF STANDARD CHARACTERS WITHOUT CLAIM TO ANY PARTICULAR FONT, STYLE, SIZE, OR COLOR.

THE WORDING "SPORTSTEM" HAS NO MEANING IN A FOREIGN LANGUAGE.

SER. NO. 77-255,800, FILED 8-15-2007.

ANNE MADDEN, EXAMINING ATTORNEY

**Int. Cl.: 36**

**Prior U.S. Cls.: 100, 101 and 102**

**United States Patent and Trademark Office**

**Reg. No. 3,503,836**

**Registered Sep. 23, 2008**

**SERVICE MARK  
PRINCIPAL REGISTER**



CITYWIDE BANKS OF COLORADO, INC. (COL-  
ORADO CORPORATION)  
SUITE 203  
6500 E HAMPDEN AVE  
DENVER, CO 80224

THE MARK CONSISTS OF THE WORDS "CITY-  
WIDE BANKS" BELOW A LINE DRAWING OF A  
SUNBURST IMAGE.

FOR: BANKING, IN CLASS 36 (U.S. CLS. 100, 101  
AND 102).

SEC. 2(F) AS TO "CITYWIDE".

FIRST USE 6-1-1985; IN COMMERCE 6-15-1985.

SER. NO. 77-255,819, FILED 8-15-2007.

NO CLAIM IS MADE TO THE EXCLUSIVE  
RIGHT TO USE "BANKS", APART FROM THE  
MARK AS SHOWN.

BARBARA RUTLAND, EXAMINING ATTORNEY

**Int. Cl.: 35**

**Prior U.S. Cls.: 100, 101 and 102**

**United States Patent and Trademark Office**

**Reg. No. 3,503,837**

**Registered Sep. 23, 2008**

**SERVICE MARK  
PRINCIPAL REGISTER**

**THE JWT SWARM**

J. WALTER THOMPSON COMPANY (NEW YORK CORPORATION)  
466 LEXINGTON AVENUE  
NEW YORK, NY 10017

FOR: ADVERTISING AGENCY SERVICES; PUBLIC RELATIONS SERVICES; PUBLICITY SERVICES; DIRECT MARKETING ADVERTISING SERVICES FOR OTHERS; RECRUITMENT ADVERTISING AGENCY SERVICES; MARKETING CONSULTING; MARKET RESEARCH; MEDIA PLANNING, NAMELY, ADVISING THE CLIENT ON THE CORRECT TIMES AND STATIONS TO ADVERTISE BASED ON MEDIA ANALYSIS OF THE MARKET FOR THAT MEDIA; SALES PROMOTION SERVICES, NAMELY, PROMOTING THE GOODS AND SERVICES OF VARIOUS INDUSTRIES THROUGH THE DISTRIBUTION OF PROMOTIONAL MATERIALS AND BY RENDERING SALES PROMOTION ADVICE; CUS-

TOMER RELATIONSHIP MARKETING SERVICES; BUSINESS AND MARKETING CONSULTING SERVICES RELATED TO ADVERTISING, MARKETING AND BRAND DEVELOPMENT, IN CLASS 35 (U.S. CLS. 100, 101 AND 102).

FIRST USE 5-31-2005; IN COMMERCE 5-31-2005.

THE MARK CONSISTS OF STANDARD CHARACTERS WITHOUT CLAIM TO ANY PARTICULAR FONT, STYLE, SIZE, OR COLOR.

OWNER OF U.S. REG. NOS. 2,045,699, 2,629,031, AND 2,873,477.

SER. NO. 77-255,834, FILED 8-15-2007.

WON TEAK OH, EXAMINING ATTORNEY

**Int. Cl.: 30**

**Prior U.S. Cl.: 46**

**United States Patent and Trademark Office**

**Reg. No. 3,503,838**

**Registered Sep. 23, 2008**

**TRADEMARK  
PRINCIPAL REGISTER**

**PURE GOODNESS**

SMALL PLANET FOODS, INC. (WASHINGTON  
CORPORATION)  
719 METCALF STREET  
SEDRO-WOOLLEY, WA 98284

FOR: FROZEN FRUIT NOVELTIES, NAMELY,  
FROZEN FRUIT JUICE BARS; SHERBET, IN CLASS  
30 (U.S. CL. 46).

FIRST USE 6-4-2007; IN COMMERCE 6-4-2007.

THE MARK CONSISTS OF STANDARD CHAR-  
ACTERS WITHOUT CLAIM TO ANY PARTICULAR  
FONT, STYLE, SIZE, OR COLOR.

OWNER OF U.S. REG. NO. 3,206,886.

SER. NO. 77-255,872, FILED 8-15-2007.

INGA ERVIN, EXAMINING ATTORNEY

**Int. Cl.: 41**

**Prior U.S. Cls.: 100, 101 and 107**

**Reg. No. 3,503,839**

**United States Patent and Trademark Office**

**Registered Sep. 23, 2008**

**SERVICE MARK  
PRINCIPAL REGISTER**

**NILA**

NATIONAL INDEPENDENT LIFESTYLE ASSOCIATION (FLORIDA CORPORATION)  
15 PALM HARBOR VILLAGE WAY, SUITE E  
PALM COAST, FL 32137

FOR: PROVIDING ONLINE NON-DOWNLOADABLE MAGAZINES AND NEWSLETTERS PROMOTING THE INTERESTS OF MATURE INDIVIDUALS AND IN THE FIELDS OF CARE GIVING, CHILDCARE, EDUCATION, MEDICAL SERVICES, ELDERCARE, EMPLOYMENT, ASSISTED CARE FACILITIES, LEGAL ASSISTANCE, BUSINESS, INSURANCE, REAL ESTATE, TRAVEL, ELDER ASSISTANCE, RETIREMENT, MATURE OR RETIRED LIFESTYLES, FINANCE, HEALTH, AGING, FAMILY RELATIONSHIPS, VOLUNTEER ACTIVITIES, CONSUMER ISSUES, ECONOMIC SECURITY, WORK, INDEPENDENT LIVING, EXERCISE AND FITNESS, EDUCATIONAL SERVICES, NAMELY, SEMINARS, CONFERENCES AND WORKSHOPS IN THE FIELDS OF CARE GIVING, CHILDCARE, EDUCATION, MEDICAL SERVICES, ELDERCARE, EMPLOYMENT, ASSISTED CARE FACILITIES, LEGAL ASSISTANCE, BUSINESS, INSURANCE, REAL ESTATE, TRAVEL, ELDER ASSISTANCE, RETIREMENT, MATURE OR RETIRED LIFESTYLES, FINANCE, HEALTH, AGING, FAMILY RELATIONSHIPS, VOLUNTEER ACTIVITIES, CONSUMER ISSUES, ECONOMIC SECURITY, WORK, INDEPENDENT LIVING, EXERCISE, FITNESS, AND THE DISTRIBUTION OF COURSE MATERIALS IN CONNECTION THEREWITH, PROVIDING RECOGNITION AND INCENTIVES BY THE WAY OF AWARDS TO DEMONSTRATE EXCELLENCE IN THE FIELDS OF PUBLIC SERVICE, SIGNIFICANT ACHIEVEMENTS, MILESTONES AND CHARITABLE CONTRIBUTIONS IN THE FIELDS OF RETIREMENT, MATURE OR RETIRED

LIFESTYLES, FINANCE, HEALTH, AGING, FAMILY RELATIONSHIPS, CONSUMER ISSUES, ECONOMIC SECURITY, WORK, INDEPENDENT LIVING, AND ELDER ISSUES, ENTERTAINMENT SERVICES, NAMELY, CONDUCTING CONTESTS IN MAGAZINES FOR RECOGNITION IN THE FIELDS OF PUBLIC SERVICE, SIGNIFICANT ACHIEVEMENTS AND MILESTONES, ARRANGING AND CONDUCTING EXERCISE, FITNESS, ATHLETIC AND SPORTS COMPETITIONS, CONTESTS, RACES AND EVENTS, AND CONSULTATION SERVICES PROVIDED IN CONNECTION THEREWITH, PROVIDING ONGOING RADIO PROGRAMS FEATURING AND PROMOTING THE INTERESTS OF MATURE INDIVIDUALS IN THE FIELDS OF CARE GIVING, CHILDCARE, EDUCATION, MEDICAL SERVICES, ELDERCARE, EMPLOYMENT, ASSISTED CARE FACILITIES, LEGAL ASSISTANCE, BUSINESS, INSURANCE, REAL ESTATE, TRAVEL, ELDER ASSISTANCE, RETIREMENT, MATURE OR RETIRED LIFESTYLES, FINANCE, HEALTH, AGING, FAMILY RELATIONSHIPS, VOLUNTEER ACTIVITIES, CONSUMER ISSUES, WORK, INDEPENDENT LIVING, EXERCISE, AND FITNESS, IN CLASS 41 (U.S. CLS. 100, 101 AND 107).

FIRST USE 4-6-2007; IN COMMERCE 4-6-2007.

THE MARK CONSISTS OF STANDARD CHARACTERS WITHOUT CLAIM TO ANY PARTICULAR FONT, STYLE, SIZE, OR COLOR.

SER. NO. 77-255,978, FILED 8-15-2007.

DOMINIC J. FERRAIUOLO, EXAMINING ATTORNEY



**Int. Cl.: 12**

**Prior U.S. Cls.: 19, 21, 23, 31, 35 and 44**

**Reg. No. 3,503,840**

**United States Patent and Trademark Office**

**Registered Sep. 23, 2008**

---

**TRADEMARK  
PRINCIPAL REGISTER**

**AERO-TRED**

RADIO FLYER INC. (ILLINOIS CORPORATION)  
6515 WEST GRAND AVENUE  
CHICAGO, IL 60707

THE MARK CONSISTS OF STANDARD CHAR-  
ACTERS WITHOUT CLAIM TO ANY PARTICULAR  
FONT, STYLE, SIZE, OR COLOR.

FOR: WHEELS FOR TRICYCLES, IN CLASS 12  
(U.S. CLS. 19, 21, 23, 31, 35 AND 44).

SER. NO. 77-256,046, FILED 8-15-2007.

FIRST USE 8-31-2005; IN COMMERCE 8-31-2005.

SIMON TENG, EXAMINING ATTORNEY

**Int. Cl.: 7**

**Prior U.S. Cls.: 13, 19, 21, 23, 31, 34 and 35**

**United States Patent and Trademark Office**

**Reg. No. 3,503,841**

**Registered Sep. 23, 2008**

**TRADEMARK  
PRINCIPAL REGISTER**

**THE POWER OF WATER**

REXAIR LLC (DELAWARE LIMITED LIABILITY  
COMPANY)  
SUITE 350  
50 W. BIG BEAVER ROAD  
TROY, MI 48084

FOR: VACUUM CLEANERS, POWER-OPERATED  
FLOOR SCRUBBERS, POWER-OPERATED CARPET  
AND UPHOLSTERY CLEANING MACHINES, POW-  
ER-OPERATED WATER EXTRACTORS, AND  
PARTS AND ATTACHMENTS THEREOF, ALL  
FOR HOUSEHOLD USE, IN CLASS 7 (U.S. CLS. 13,  
19, 21, 23, 31, 34 AND 35).

FIRST USE 6-0-1998; IN COMMERCE 6-0-1998.

THE MARK CONSISTS OF STANDARD CHAR-  
ACTERS WITHOUT CLAIM TO ANY PARTICULAR  
FONT, STYLE, SIZE, OR COLOR.

SER. NO. 77-256,233, FILED 8-15-2007.

JANET LEE, EXAMINING ATTORNEY

**Int. Cl.: 10**

**Prior U.S. Cls.: 26, 39 and 44**

**United States Patent and Trademark Office**

**Reg. No. 3,503,842**

**Registered Sep. 23, 2008**

**TRADEMARK  
PRINCIPAL REGISTER**



DISC DYNAMICS, INC. (MINNESOTA CORPORATION)  
9600 WEST 76TH STREET, SUITE T  
EDEN PRAIRIE, MN 55344

FOR: MEDICAL AND SURGICAL INSTRUMENTS AND APPARATUS USED FOR ARTHROPLASTY, SPINAL SURGERY, SPINAL TREATMENT, OR TISSUE REPAIR, AND REPLACEMENT PARTS, STRUCTURAL PARTS AND COMPONENTS THEREFOR; MEDICAL AND SURGICAL IMPLANTS MADE PRIMARILY OF ARTIFICIAL MATERIALS; OVENS FOR MEDICAL USE, IN CLASS 10 (U.S. CLS. 26, 39 AND 44).

FIRST USE 9-9-2005; IN COMMERCE 9-9-2005.

OWNER OF U.S. REG. NO. 3,261,364.

NO CLAIM IS MADE TO THE EXCLUSIVE RIGHT TO USE "DISC", APART FROM THE MARK AS SHOWN.

THE MARK CONSISTS OF THE WORDING "DISC DYNAMICS" AND A STYLIZED REPRESENTATION OF A PORTION OF A SPINE.

SER. NO. 77-256,764, FILED 8-16-2007.

ANDREW RHIM, EXAMINING ATTORNEY

Int. Cl.: 36

Prior U.S. Cls.: 100, 101 and 102

United States Patent and Trademark Office

Reg. No. 3,503,843

Registered Sep. 23, 2008

**SERVICE MARK  
PRINCIPAL REGISTER**

**WORLD ELITE MASTERCARD  
UNIQUE EXPERIENCES**

MASTERCARD INTERNATIONAL INCORPORATED (DELAWARE CORPORATION)  
LAW DEPARTMENT  
2000 PURCHASE STREET  
PURCHASE, NY 105772509

FOR: FINANCIAL SERVICES, NAMELY, BANKING AND CREDIT CARD SERVICES; DEBIT CARD, CHARGE CARD AND STORED VALUE PREPAID CARD SERVICES; REMOTE BILL PAYMENT SERVICES; STORED VALUE ELECTRONIC PURSE SERVICES, NAMELY, PROVIDING ON-LINE STORED VALUE ACCOUNTS IN AN ELECTRONIC ENVIRONMENT; PROVIDING ELECTRONIC FUNDS AND CURRENCY TRANSFER SERVICES, ELECTRONIC BILL PAYMENT SERVICES, PREPAID TELEPHONE CALLING CARD SERVICES, CASH MANAGEMENT SERVICES, NAMELY, CASH DISBURSEMENT SERVICES IN THE NATURE OF AUTOMATED TELLER SERVICES; PROVISION OF DEBIT AND CREDIT SERVICES BY MEANS OF RADIO FREQUENCY IDENTIFICATION DEVICES KNOWN AS TRANSPONDERS; TRAVEL INSURANCE UNDERWRITING SERVICES; CHEQUE VER-

IFICATION SERVICES; ISSUING AND REDEMPTION SERVICES ALL RELATING TO TRAVELERS CHEQUES; BILL PAYMENT SERVICES PROVIDED THROUGH A WEBSITE; ON-LINE BANKING; FINANCIAL SERVICES, NAMELY, BANKING AND PAYMENT CARD SERVICES, PROVIDED BY MEANS OF A GLOBAL COMPUTER NETWORK OR THE INTERNET, IN CLASS 36 (U.S. CLS. 100, 101 AND 102).

FIRST USE 1-30-2007; IN COMMERCE 1-30-2007.

THE MARK CONSISTS OF STANDARD CHARACTERS WITHOUT CLAIM TO ANY PARTICULAR FONT, STYLE, SIZE, OR COLOR.

OWNER OF U.S. REG. NOS. 1,186,117, 2,213,329, AND 2,400,578.

SER. NO. 77-256,769, FILED 8-16-2007.

LINDA POWELL, EXAMINING ATTORNEY

Int. Cl.: 45

Prior U.S. Cls.: 100 and 101

United States Patent and Trademark Office

Reg. No. 3,503,844

Registered Sep. 23, 2008

SERVICE MARK  
PRINCIPAL REGISTER



MASTER'S PLAN WORLD OUTREACH, INC.  
(TEXAS CORPORATION)

11400 S. SAM HOUSTON PARKWAY W.  
HOUSTON, TX 77031

FOR: CLERGY AND MINISTERIAL SERVICES;  
CHARITABLE SERVICES, NAMELY, PROVIDING  
CLOTHING TO NEEDY PERSONS; RELIGIOUS  
AND SPIRITUAL SERVICES, NAMELY, PROVID-  
ING GATHERINGS AND RETREATS TO DEVELOP  
AND ENHANCE THE SPIRITUAL LIVES OF INDI-  
VIDUAL, IN CLASS 45 (U.S. CLS. 100 AND 101).

FIRST USE 1-1-2006; IN COMMERCE 1-1-2006.

NO CLAIM IS MADE TO THE EXCLUSIVE  
RIGHT TO USE "WORLD OUTREACH, INC",  
APART FROM THE MARK AS SHOWN.

THE STIPPLING IS FOR SHADING PURPOSES  
ONLY.

THE MARK CONSISTS OF AN ABSTRACT DE-  
SIGN IN THE FORM OF A GLOBE WITH A BIRD,  
AND THE STYLIZED TEXT "MASTER'S PLAN  
WORLD OUTREACH, INC."

SER. NO. 77-256,782, FILED 8-16-2007.

KATHLEEN M. VANSTON, EXAMINING ATTOR-  
NEY

**Int. Cl.: 35**

**Prior U.S. Cls.: 100, 101 and 102**

**United States Patent and Trademark Office**

**Reg. No. 3,503,845**

**Registered Sep. 23, 2008**

**SERVICE MARK  
PRINCIPAL REGISTER**

**WHERE CONTENT COMES TO LIFE**

NATIONAL ASSOCIATION OF BROADCASTERS  
(DELAWARE CORPORATION)  
1771 N STREET, NW  
WASHINGTON, DC 20036

FOR: ARRANGING, ORGANIZING AND CONDUCTING CONVENTIONS, CONFERENCES, EXPOSITIONS, TRADE SHOWS AND SYMPOSIA IN THE FIELDS OF BROADCASTING AND ELECTRONIC MEDIA ALL FOR BUSINESS AND ADVERTISING PURPOSES, IN CLASS 35 (U.S. CLS. 100, 101 AND 102).

FIRST USE 4-30-2007; IN COMMERCE 4-30-2007.

THE MARK CONSISTS OF STANDARD CHARACTERS WITHOUT CLAIM TO ANY PARTICULAR FONT, STYLE, SIZE, OR COLOR.

SER. NO. 77-256,862, FILED 8-16-2007.

WILLIAM VERHOSEK, EXAMINING ATTORNEY

**Int. Cl.: 35**

**Prior U.S. Cls.: 100, 101 and 102**

**United States Patent and Trademark Office**

**Reg. No. 3,503,846**

**Registered Sep. 23, 2008**

**SERVICE MARK  
PRINCIPAL REGISTER**

**NABSHOW**

NATIONAL ASSOCIATION OF BROADCASTERS  
(DELAWARE CORPORATION)  
1771 N STREET, NW  
WASHINGTON, DC 20036

FOR: ARRANGING, ORGANIZING AND CONDUCTING CONVENTIONS, CONFERENCES, EXPOSITIONS, TRADE SHOWS AND SYMPOSIA IN THE FIELDS OF BROADCASTING AND ELECTRONIC MEDIA ALL FOR BUSINESS AND ADVERTISING PURPOSES, IN CLASS 35 (U.S. CLS. 100, 101 AND 102).

FIRST USE 7-31-2007; IN COMMERCE 7-31-2007.

THE MARK CONSISTS OF STANDARD CHARACTERS WITHOUT CLAIM TO ANY PARTICULAR FONT, STYLE, SIZE, OR COLOR.

OWNER OF U.S. REG. NOS. 1,488,869, 1,817,521, AND 2,653,603.

SER. NO. 77-256,884, FILED 8-16-2007.

WILLIAM VERHOSEK, EXAMINING ATTORNEY

**Int. Cl.: 35**

**Prior U.S. Cls.: 100, 101 and 102**

**United States Patent and Trademark Office**

**Reg. No. 3,503,847**

**Registered Sep. 23, 2008**

**SERVICE MARK  
PRINCIPAL REGISTER**



NATIONAL ASSOCIATION OF BROADCASTERS  
(DELAWARE CORPORATION)  
1771 N STREET, NW  
WASHINGTON, DC 20036

FOR: ARRANGING, ORGANIZING AND CONDUCTING CONVENTIONS, CONFERENCES, EXPOSITIONS, TRADE SHOWS AND SYMPOSIA IN THE FIELDS OF BROADCASTING AND ELECTRONIC MEDIA ALL FOR BUSINESS AND ADVERTISING PURPOSES, IN CLASS 35 (U.S. CLS. 100, 101 AND 102).

FIRST USE 12-31-1991; IN COMMERCE 12-31-1991.

OWNER OF U.S. REG. NOS. 1,488,869, 1,817,521, AND 2,653,603.

SER. NO. 77-256,913, FILED 8-16-2007.

WILLIAM VERHOSEK, EXAMINING ATTORNEY



**Int. Cl.: 30**

**Prior U.S. Cl.: 46**

**United States Patent and Trademark Office**

**Reg. No. 3,503,848**

**Registered Sep. 23, 2008**

**TRADEMARK  
PRINCIPAL REGISTER**

# Chocolate 2 Die 4

CASSIDY, SUZAN E (UNITED STATES INDIVIDUAL), DBA CHOCOLATE 2 DIE 4  
P. O. BOX 486  
NORTH BEND, WA 98045

FOR: CHOCOLATE; CHOCOLATE BARS; CHOCOLATE CANDIES; CHOCOLATE COVERED NUTS; CHOCOLATE FOOD BEVERAGES NOT BEING DAIRY-BASED OR VEGETABLE BASED; CHOCOLATE POWDER; CHOCOLATE SYRUP; CHOCOLATE TOPPING; CHOCOLATE TRUFFLES; FILLED CHOCOLATE, IN CLASS 30 (U.S. CL. 46).

FIRST USE 4-14-2004; IN COMMERCE 2-10-2005.

THE MARK CONSISTS OF STANDARD CHARACTERS WITHOUT CLAIM TO ANY PARTICULAR FONT, STYLE, SIZE, OR COLOR.

NO CLAIM IS MADE TO THE EXCLUSIVE RIGHT TO USE "CHOCOLATE", APART FROM THE MARK AS SHOWN.

SER. NO. 77-257,085, FILED 8-16-2007.

ANDREA BUTLER, EXAMINING ATTORNEY

**Int. Cl.: 11**

**Prior U.S. Cls.: 13, 21, 23, 31 and 34**

**United States Patent and Trademark Office**

**Reg. No. 3,503,849**

**Registered Sep. 23, 2008**

**TRADEMARK  
PRINCIPAL REGISTER**

# Free Rain

BOST CONSTRUCTION COMPANY (NORTH  
CAROLINA CORPORATION)  
219 EAST CHATHAM STREET, SUITE 205  
CARY, NC 27511

FOR: RAINWATER HARVESTING SYSTEM  
COMPRISED OF A WATER STORAGE TANK, PUR-  
IFICATION FILTER, PUMP FOR DELIVERY OF  
WATER, AND CONNECTION COMPONENT PART  
THEREFORE, IN CLASS 11 (U.S. CLS. 13, 21, 23, 31  
AND 34).

FIRST USE 8-23-2003; IN COMMERCE 8-23-2003.

THE MARK CONSISTS OF STANDARD CHAR-  
ACTERS WITHOUT CLAIM TO ANY PARTICULAR  
FONT, STYLE, SIZE, OR COLOR.

SER. NO. 77-257,200, FILED 8-16-2007.

JEAN IM, EXAMINING ATTORNEY

**Int. Cl.: 38**

**Prior U.S. Cls.: 100, 101 and 104**

**United States Patent and Trademark Office**

**Reg. No. 3,503,850**

**Registered Sep. 23, 2008**

**SERVICE MARK  
PRINCIPAL REGISTER**

**THE BIG SWITCH**

RAYCOM MEDIA, INC. (DELAWARE CORPORATION)  
201 MONROE STREET, 20TH FLOOR  
MONTGOMERY, AL 36104

FOR: TELEVISION BROADCASTING OF SPECIFIC INFORMATION TO VIEWERS, NAMELY, INFORMATION RELATING TO THE TRANSITION TO DIGITAL TELEVISION, IN CLASS 38 (U.S. CLS. 100, 101 AND 104).

FIRST USE 4-13-2007; IN COMMERCE 4-13-2007.

THE MARK CONSISTS OF STANDARD CHARACTERS WITHOUT CLAIM TO ANY PARTICULAR FONT, STYLE, SIZE, OR COLOR.

SER. NO. 77-257,218, FILED 8-16-2007.

BARBARA A. GOLD, EXAMINING ATTORNEY

**Int. Cl.: 45**

**Prior U.S. Cls.: 100 and 101**

**United States Patent and Trademark Office**

**Reg. No. 3,503,851**

**Registered Sep. 23, 2008**

**SERVICE MARK  
PRINCIPAL REGISTER**

**THE TEXAS HAMMER**

JIM S. ADLER, P.C. (TEXAS CORPORATION)  
1900 WEST LOOP SOUTH, 20TH FLOOR  
HOUSTON, TX 770273214

FOR: LEGAL SERVICES, IN CLASS 45 (U.S. CLS.  
100 AND 101).

FIRST USE 8-2-2002; IN COMMERCE 8-2-2002.

THE MARK CONSISTS OF STANDARD CHAR-  
ACTERS WITHOUT CLAIM TO ANY PARTICULAR  
FONT, STYLE, SIZE, OR COLOR.

NO CLAIM IS MADE TO THE EXCLUSIVE  
RIGHT TO USE "TEXAS", APART FROM THE  
MARK AS SHOWN.

SER. NO. 77-257,396, FILED 8-16-2007.

MARK RADEMACHER, EXAMINING ATTORNEY

**Int. Cl.: 45**

**Prior U.S. Cls.: 100 and 101**

**United States Patent and Trademark Office**

**Reg. No. 3,503,852**

**Registered Sep. 23, 2008**

**SERVICE MARK  
PRINCIPAL REGISTER**

**EL MARTILLO TEJANO**

JIM S. ADLER, P.C. (TEXAS CORPORATION)  
1900 WEST LOOP SOUTH, 20TH FLOOR  
HOUSTON, TX 770273214

FOR: LEGAL SERVICES, IN CLASS 45 (U.S. CLS.  
100 AND 101).

FIRST USE 8-2-2002; IN COMMERCE 8-2-2002.

THE MARK CONSISTS OF STANDARD CHAR-  
ACTERS WITHOUT CLAIM TO ANY PARTICULAR  
FONT, STYLE, SIZE, OR COLOR.

NO CLAIM IS MADE TO THE EXCLUSIVE  
RIGHT TO USE "TEJANO", APART FROM THE  
MARK AS SHOWN.

THE FOREIGN WORDING IN THE MARK  
TRANSLATES INTO ENGLISH AS THE TEXAS  
HAMMER.

SER. NO. 77-257,407, FILED 8-16-2007.

MARK RADEMACHER, EXAMINING ATTORNEY

Int. Cl.: 29

Prior U.S. Cl.: 46

United States Patent and Trademark Office

Reg. No. 3,503,853

Registered Sep. 23, 2008

TRADEMARK  
PRINCIPAL REGISTER



DD FOOD SOLUTIONS, INC (FLORIDA CORPORATION)  
6575 NOVA DRIVE  
DAVIE, FL 33317

THE COLOR(S) LIGHT AND DARK GREEN IS/ARE CLAIMED AS A FEATURE OF THE MARK.

FOR: SOUPS; PRE-PACKAGED DINNERS CONSISTING OF MEAT, SEAFOOD OR POULTRY; CHICKEN, MEAT, FISH CROQUETTES; FROZEN ENTREES CONSISTING PRIMARILY OF MEAT, FISH, POULTRY OR VEGETABLES; FROZEN MEALS CONSISTING PRIMARILY OF MEAT, FISH, POULTRY OR VEGETABLES, IN CLASS 29 (U.S. CL. 46).

THE MARK CONSISTS OF TWO WORDS "SIMPLY - NATURAL" WITH TWO OVERLAPPING LEAVES IN BETWEEN THE TWO WORDS. LETTERS ARE LIGHT GREEN, OUTLINED WITH DARK GREEN. LEAVES ARE LIGHT AND DARK GREEN, OUTLINED WITH DARK GREEN.

FIRST USE 5-1-2007; IN COMMERCE 6-1-2007.

SER. NO. 77-257,457, FILED 8-16-2007.

NO CLAIM IS MADE TO THE EXCLUSIVE RIGHT TO USE "NATURAL", APART FROM THE MARK AS SHOWN.

VIVIAN MICZNIK FIRST, EXAMINING ATTORNEY

**Int. Cl.: 35**

**Prior U.S. Cls.: 100, 101 and 102**

**United States Patent and Trademark Office**

**Reg. No. 3,503,854**

**Registered Sep. 23, 2008**

**SERVICE MARK  
PRINCIPAL REGISTER**

**BUILDERS GREENSOURCE INC.**

BUILDERS' GREENSOURCE, INC. (CALIFORNIA CORPORATION)  
2405 MIRA MAR AVE.  
LONG BEACH, CA 90815

FOR: WHOLESALE DISTRIBUTORSHIPS FEATURING BUILDING MATERIALS; RETAIL STORE SERVICES FEATURING BUILDING MATERIALS, IN CLASS 35 (U.S. CLS. 100, 101 AND 102).

FIRST USE 6-30-2005; IN COMMERCE 4-1-2006.

THE MARK CONSISTS OF STANDARD CHARACTERS WITHOUT CLAIM TO ANY PARTICULAR FONT, STYLE, SIZE, OR COLOR.

NO CLAIM IS MADE TO THE EXCLUSIVE RIGHT TO USE "BUILDERS" AND "INC.", APART FROM THE MARK AS SHOWN.

THE WORDING "GREENSOURCE" HAS NO MEANING IN A FOREIGN LANGUAGE.

SER. NO. 77-257,470, FILED 8-16-2007.

SAIMA MAKHDOOM, EXAMINING ATTORNEY

**Int. Cl.: 9**

**Prior U.S. Cls.: 21, 23, 26, 36 and 38**

**United States Patent and Trademark Office**

**Reg. No. 3,503,855**

**Registered Sep. 23, 2008**

**TRADEMARK  
PRINCIPAL REGISTER**

**KNOXWARE**

KNOX ASSOCIATES, INC. (CALIFORNIA CORPORATION)  
1601 WEST DEER VALLEY ROAD  
PHOENIX, AZ 85027

THE MARK CONSISTS OF STANDARD CHARACTERS WITHOUT CLAIM TO ANY PARTICULAR FONT, STYLE, SIZE, OR COLOR.

FOR: COMPUTER SOFTWARE, NAMELY, SOFTWARE FOR USE ON KEY RETENTION DEVICES, IN CLASS 9 (U.S. CLS. 21, 23, 26, 36 AND 38).

SER. NO. 77-257,560, FILED 8-16-2007.

FIRST USE 2-0-2005; IN COMMERCE 2-0-2005.

ALLISON SCHRODY, EXAMINING ATTORNEY



**Int. Cl.: 16**

**Prior U.S. Cls.: 2, 5, 22, 23, 29, 37, 38 and 50**

**Reg. No. 3,503,856**

**United States Patent and Trademark Office**

**Registered Sep. 23, 2008**

**TRADEMARK  
PRINCIPAL REGISTER**

**MS. GROW-IT-ALL**

POSTSCRIPT PUBLISHING, LLC (FLORIDA LIMITED LIABILITY COMPANY)  
1514 COOMBS DRIVE  
TALLAHASSEE, FL 32308

FOR: SYNDICATED COLUMNS DEALING WITH GARDENING AND OUTDOOR LIVING ADVICE, IN CLASS 16 (U.S. CLS. 2, 5, 22, 23, 29, 37, 38 AND 50).

FIRST USE 5-12-2005; IN COMMERCE 5-12-2005.

THE MARK CONSISTS OF STANDARD CHARACTERS WITHOUT CLAIM TO ANY PARTICULAR FONT, STYLE, SIZE, OR COLOR.

THE NAME IN THE MARK IDENTIFIES A LIVING INDIVIDUAL WHOSE CONSENT IS OF RECORD.

SER. NO. 77-257,717, FILED 8-17-2007.

HENRY S. ZAK, EXAMINING ATTORNEY

Int. Cl.: 7

Prior U.S. Cls.: 13, 19, 21, 23, 31, 34 and 35

**United States Patent and Trademark Office**

**Reg. No. 3,503,857**

Registered Sep. 23, 2008

**TRADEMARK  
PRINCIPAL REGISTER**



***"Infused with teeth that just won't quit."***

GENESIS III, INC. (ILLINOIS CORPORATION)  
HAMMER PLANT  
5575 LYNDON ROAD  
PROPHETSTOWN, IL 61277

THE MARK CONSISTS OF HAMMERHEAD  
SHARK.

FOR: HAMMERMILL HAMMERS, IN CLASS 7  
(U.S. CLS. 13, 19, 21, 23, 31, 34 AND 35).

SER. NO. 77-257,876, FILED 8-17-2007.

FIRST USE 5-1-1997; IN COMMERCE 12-1-2001.

JOHN GARTNER, EXAMINING ATTORNEY

**Int. Cl.: 6**

**Prior U.S. Cls.: 2, 12, 13, 14, 23, 25 and 50**

**Reg. No. 3,503,858**

**United States Patent and Trademark Office**

**Registered Sep. 23, 2008**

---

**TRADEMARK  
PRINCIPAL REGISTER**

**Jimmy Shipper**

VASCULAR TRANSPLANT SERVICES, INC. (ILLINOIS CORPORATION)  
2122 PALMER DRIVE  
SCHAUMBURG, IL 60173

FOR: METAL INSULATED SHIPPING CONTAINERS FOR TRANSPORTING HUMAN TISSUE, IN CLASS 6 (U.S. CLS. 2, 12, 13, 14, 23, 25 AND 50).

FIRST USE 7-25-2005; IN COMMERCE 7-25-2005.

THE MARK CONSISTS OF STANDARD CHARACTERS WITHOUT CLAIM TO ANY PARTICULAR FONT, STYLE, SIZE, OR COLOR.

NO CLAIM IS MADE TO THE EXCLUSIVE RIGHT TO USE "SHIPPER", APART FROM THE MARK AS SHOWN.

SER. NO. 77-257,955, FILED 8-17-2007.

PAUL E. FAHRENKOPF, EXAMINING ATTORNEY

**Int. Cl.: 35**

**Prior U.S. Cls.: 100, 101 and 102**

**United States Patent and Trademark Office**

**Reg. No. 3,503,859**

**Registered Sep. 23, 2008**

**SERVICE MARK  
PRINCIPAL REGISTER**

**Techshowcase A Technology  
Experience and Retail Store**

APW HOLDINGS, LLC (PENNSYLVANIA LIMITED LIABILITY COMPANY)  
3141 FAIRLANE FARMS ROAD, UNIT 8  
WELLINGTON, FL 33414

FOR: RETAIL STORE SERVICES IN THE FIELDS OF PHOTOGRAPHIC AND VIDEO EQUIPMENT, AUDIO EQUIPMENT AND TELECOMMUNICATION EQUIPMENT, INCLUDING CELLULAR TELEPHONES, HANDHELD PERSONAL DIGITAL ASSISTANTS, TRAVEL SPEAKERS, PORTABLE COMPACT DISC AND PORTABLE DIGITAL VIDEO DISK PLAYERS, MP3 PLAYERS, HEADPHONES, SATELLITE RADIOS, DIGITAL CAMERAS AND THEIR ACCESSORIES AND RELATED MERCHANDISE, IN CLASS 35 (U.S. CLS. 100, 101 AND 102).

FIRST USE 4-27-2007; IN COMMERCE 4-27-2007.

THE MARK CONSISTS OF STANDARD CHARACTERS WITHOUT CLAIM TO ANY PARTICULAR FONT, STYLE, SIZE, OR COLOR.

NO CLAIM IS MADE TO THE EXCLUSIVE RIGHT TO USE "TECHNOLOGY" OR "RETAIL STORE", APART FROM THE MARK AS SHOWN.

SER. NO. 77-257,980, FILED 8-17-2007.

ANDREW RHIM, EXAMINING ATTORNEY

**Int. Cls.: 35 and 36**

**Prior U.S. Cls.: 100, 101 and 102**

**United States Patent and Trademark Office**

**Reg. No. 3,503,860**

**Registered Sep. 23, 2008**

**SERVICE MARK  
PRINCIPAL REGISTER**



CHARLES SCHWAB & CO., INC. (CALIFORNIA CORPORATION)  
101 MONTGOMERY STREET  
SAN FRANCISCO, CA 94104

FOR: COLLECTION, PREPARATION, AND PROVISION OF BUSINESS DATA AND INDICES, IN CLASS 35 (U.S. CLS. 100, 101 AND 102).

FIRST USE 0-0-2001; IN COMMERCE 0-0-2001.

FOR: CONSULTATION AND ADVISORY SERVICES AND PROVISION OF INVESTMENT INFORMATION IN THE FIELD OF COMMERCIAL REAL ESTATE INVESTMENT, IN CLASS 36 (U.S. CLS. 100, 101 AND 102).

FIRST USE 0-0-2001; IN COMMERCE 0-0-2001.

THE COLOR(S) GREEN AND BLACK IS/ARE CLAIMED AS A FEATURE OF THE MARK.

THE MARK CONSISTS OF THE LETTERS "GRA" IN STYLIZED FORM, WITH THE "G" AND "A" IN BLACK, AND THE "R" IN GREEN.

SER. NO. 77-258,033, FILED 8-17-2007.

KIMBERLY FRYE, EXAMINING ATTORNEY

**Int. Cl.: 35**

**Prior U.S. Cls.: 100, 101 and 102**

**United States Patent and Trademark Office**

**Reg. No. 3,503,861**

**Registered Sep. 23, 2008**

**SERVICE MARK  
PRINCIPAL REGISTER**

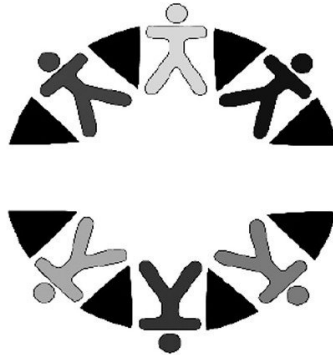

YES! OF AMERICA UNITED, INC. (FLORIDA  
NON-PROFIT CORPORATION)  
2142 WEST BUSCH BLVD.  
TAMPA, FL 33612

FOR: PROMOTING PUBLIC AND SOCIAL  
AWARENESS OF THE NEEDS AND CAPABILITIES  
OF PEOPLE WITH DISABILITIES TO ENCOURAGE  
POSITIVE CHANGES IN THE COMMUNITY AS A  
WHOLE; CHARITABLE SERVICES, NAMELY, PRO-  
MOTING AND ENCOURAGING VOLUNTEERISM  
ON INDIVIDUAL AND GROUP BASES, ORGANIZ-  
ING AND CONDUCTING VOLUNTEER PRO-  
GRAMS AND COMMUNITY SERVICE PROJECTS

AND PROVIDING ADMINISTRATION AND MAN-  
AGEMENT OF LIFE-ENRICHMENT PROGRAMS  
FOR PEOPLE WITH DISABILITIES, IN CLASS 35  
(U.S. CLS. 100, 101 AND 102).

FIRST USE 3-0-2002; IN COMMERCE 3-0-2005.

THE MARK CONSISTS OF A CIRCLE COM-  
PRISED OF FIGURES IN THE SHAPE OF PEOPLE.

SER. NO. 77-258,076, FILED 8-17-2007.

KELLEY WELLS, EXAMINING ATTORNEY

**Int. Cl.: 44**

**Prior U.S. Cls.: 100 and 101**

**United States Patent and Trademark Office**

**Reg. No. 3,503,862**

**Registered Sep. 23, 2008**

**SERVICE MARK  
PRINCIPAL REGISTER**

**BEHAVIORAL HEALTH OF THE  
PALM BEACHES**

BEHAVIORAL HEALTH OF THE PALM BEACHES, INC. (FLORIDA CORPORATION)  
631 U.S. HIGHWAY 1  
SUITE 304  
NORTH PALM BEACH, FL 33408

FOR: PROVIDING SUBSTANCE ABUSE, DETOX AND REHABILITATION TREATMENT, IN CLASS 44 (U.S. CLS. 100 AND 101).

FIRST USE 11-30-1999; IN COMMERCE 11-30-1999.

THE MARK CONSISTS OF STANDARD CHARACTERS WITHOUT CLAIM TO ANY PARTICULAR FONT, STYLE, SIZE, OR COLOR.

SEC. 2(F).

SER. NO. 77-258,114, FILED 8-17-2007.

MARGERY A. TIERNEY, EXAMINING ATTORNEY

**Int. Cl.: 14**

**Prior U.S. Cls.: 2, 27, 28 and 50**

**United States Patent and Trademark Office**

**Reg. No. 3,503,863**

**Registered Sep. 23, 2008**

**TRADEMARK  
PRINCIPAL REGISTER**

**BLACK IS BACK**

GEMORO, INC. (NEW YORK CORPORATION)  
SUITE 1102  
48 WEST 48TH STREET  
NEW YORK, NY 10036

THE MARK CONSISTS OF STANDARD CHAR-  
ACTERS WITHOUT CLAIM TO ANY PARTICULAR  
FONT, STYLE, SIZE, OR COLOR.

FOR: PRECIOUS AND SEMI-PRECIOUS GEM-  
STONES AND JEWELRY, IN CLASS 14 (U.S. CLS. 2,  
27, 28 AND 50).

SER. NO. 77-258,264, FILED 8-17-2007.

FIRST USE 11-1-2006; IN COMMERCE 11-1-2006.

SALLY SHIH, EXAMINING ATTORNEY



**Int. Cls.: 16, 35, 41, 42 and 44**

**Prior U.S. Cls.: 2, 5, 22, 23, 29, 37, 38, 50, 100, 101, 102  
and 107**

**Reg. No. 3,503,864**

**United States Patent and Trademark Office**

**Registered Sep. 23, 2008**

**TRADEMARK  
SERVICE MARK  
PRINCIPAL REGISTER**

**DMAA**

DISEASE MANAGEMENT ASSOCIATION OF AMERICA, INC. (MASSACHUSETTS CORPORATION)  
SUITE 700  
701 PENNSYLVANIA AVENUE, NW  
WASHINGTON, DC 20004

FOR: PUBLICATIONS, NAMELY, NEWSLETTERS, BROCHURES, BOOKLETS, JOURNALS, WHITE PAPERS, AND PRINTED EDUCATIONAL MATERIALS IN THE FIELD OF POPULATION HEALTH IMPROVEMENT INCLUDING WELLNESS, DISEASE MANAGEMENT, CARE COORDINATION, AND PATIENT SELF-CARE, IN CLASS 16 (U.S. CLS. 2, 5, 22, 23, 29, 37, 38 AND 50).

FIRST USE 8-31-2002; IN COMMERCE 8-31-2002.

FOR: ASSOCIATION SERVICES, NAMELY, PROMOTING THE INTERESTS OF THE HEALTH CARE INDUSTRY IN THE FIELD OF POPULATION HEALTH IMPROVEMENT INCLUDING WELLNESS, DISEASE MANAGEMENT, CARE COORDINATION, AND PATIENT SELF-CARE; LOBBYING SERVICES, NAMELY, PROMOTING THE INTERESTS OF THE HEALTH CARE INDUSTRY IN THE FIELDS OF LEGISLATION AND REGULATION, IN CLASS 35 (U.S. CLS. 100, 101 AND 102).

FIRST USE 3-31-1999; IN COMMERCE 3-31-1999.

FOR: EDUCATIONAL SERVICES, NAMELY, PROVIDING CLASSES, SEMINARS, WORKSHOPS, AND CONFERENCES IN THE FIELD OF POPULATION HEALTH IMPROVEMENT, INCLUDING WELLNESS, DISEASE MANAGEMENT, CARE COORDINATION, AND PATIENT SELF-CARE AND THE DISTRIBUTION OF COURSE MATERIAL IN

CONNECTION THEREWITH; PROVIDING ONLINE PUBLICATIONS, NAMELY, NEWSLETTERS, BROCHURES, BOOKLETS, JOURNALS, WHITE PAPERS, AND EDUCATIONAL MATERIALS IN THE FIELD OF POPULATION HEALTH IMPROVEMENT, INCLUDING WELLNESS, DISEASE MANAGEMENT, CARE COORDINATION, AND PATIENT SELF-CARE, IN CLASS 41 (U.S. CLS. 100, 101 AND 107).

FIRST USE 10-31-2001; IN COMMERCE 10-31-2001.

FOR: MEDICAL RESEARCH SERVICES IN THE FIELD OF POPULATION HEALTH IMPROVEMENT, INCLUDING WELLNESS, DISEASE MANAGEMENT, CARE COORDINATION, AND PATIENT SELF-CARE, IN CLASS 42 (U.S. CLS. 100 AND 101).

FIRST USE 3-31-2003; IN COMMERCE 3-31-2003.

FOR: PROVIDING A WEBSITE IN THE FIELDS OF POPULATION HEALTH IMPROVEMENT, INCLUDING WELLNESS, DISEASE MANAGEMENT, CARE COORDINATION, AND PATIENT SELF-CARE, IN CLASS 44 (U.S. CLS. 100 AND 101).

FIRST USE 3-31-2003; IN COMMERCE 3-31-2003.

THE MARK CONSISTS OF STANDARD CHARACTERS WITHOUT CLAIM TO ANY PARTICULAR FONT, STYLE, SIZE, OR COLOR.

SER. NO. 77-258,313, FILED 8-17-2007.

PRISCILLA MILTON, EXAMINING ATTORNEY

**Int. Cls.: 18 and 20**

**Prior U.S. Cls.: 1, 2, 3, 13, 22, 25, 32, 41 and 50**

**United States Patent and Trademark Office**

**Reg. No. 3,503,865**

**Registered Sep. 23, 2008**

**TRADEMARK  
PRINCIPAL REGISTER**

**FOR NOW AND FOREVER**

SUMMER CLASSICS (ALABAMA CORPORATION)  
7000 HIGHWAY 25  
MONTEVALLO, AL 35115

FOR: MARKET UMBRELLAS, IN CLASS 18 (U.S. CLS. 1, 2, 3, 22 AND 41).

FIRST USE 7-1-2005; IN COMMERCE 7-1-2005.

FOR: FURNITURE FOR HOUSE, OUTDOORS, AND GARDEN , IN CLASS 20 (U.S. CLS. 2, 13, 22, 25, 32 AND 50).

FIRST USE 7-1-2005; IN COMMERCE 7-1-2005.

THE MARK CONSISTS OF STANDARD CHARACTERS WITHOUT CLAIM TO ANY PARTICULAR FONT, STYLE, SIZE, OR COLOR.

SER. NO. 77-258,355, FILED 8-17-2007.

GEOFFREY FOSDICK, EXAMINING ATTORNEY

**Int. Cl.: 44**

**Prior U.S. Cls.: 100 and 101**

**United States Patent and Trademark Office**

**Reg. No. 3,503,866**

**Registered Sep. 23, 2008**

**SERVICE MARK  
PRINCIPAL REGISTER**

**SNEAK PEEK ULTRASOUND**

SNEAK PEEK ULTRASOUND, INC. (NEVADA CORPORATION)

1820 E. WARM SPRINGS ROAD, SUITE 105

LAS VEGAS, NV 891194680

FOR: MEDICAL IMAGING SERVICES, NAMELY, PRE-NATAL NON-DIAGNOSTIC ULTRASOUND IMAGING SERVICES, IN CLASS 44 (U.S. CLS. 100 AND 101).

FIRST USE 10-1-2003; IN COMMERCE 11-1-2003.

THE MARK CONSISTS OF STANDARD CHARACTERS WITHOUT CLAIM TO ANY PARTICULAR FONT, STYLE, SIZE, OR COLOR.

OWNER OF U.S. REG. NO. 2,748,520.

NO CLAIM IS MADE TO THE EXCLUSIVE RIGHT TO USE "ULTRASOUND", APART FROM THE MARK AS SHOWN.

SER. NO. 77-258,519, FILED 8-17-2007.

AHSEN KHAN, EXAMINING ATTORNEY

**Int. Cl.: 28**

**Prior U.S. Cls.: 22, 23, 38 and 50**

**United States Patent and Trademark Office**

**Reg. No. 3,503,867**

**Registered Sep. 23, 2008**

**TRADEMARK  
PRINCIPAL REGISTER**

**THE #1 SKI CONDITIONER IN  
THE WORLD**

LOANE, R. JOEL (UNITED STATES INDIVIDUAL)  
P.O. BOX 2700  
PARK CITY, UT 84060

FOR: MANUALLY OPERATED EXERCISE MACHINES FOR LATERAL MOVEMENT SIMULATING A DOWNHILL SKIING MOTION, IN CLASS 28 (U.S. CLS. 22, 23, 38 AND 50).

FIRST USE 1-31-1989; IN COMMERCE 1-31-1989.

THE MARK CONSISTS OF STANDARD CHARACTERS WITHOUT CLAIM TO ANY PARTICULAR FONT, STYLE, SIZE, OR COLOR.

SEC. 2(F).

SER. NO. 77-258,533, FILED 8-17-2007.

JAMES A. RAUEN, EXAMINING ATTORNEY

Int. Cl.: 35

Prior U.S. Cls.: 100, 101 and 102

United States Patent and Trademark Office

Reg. No. 3,503,868

Registered Sep. 23, 2008

**SERVICE MARK  
PRINCIPAL REGISTER**



PROFESSIONAL RETAIL STORE MAINTENANCE ASSOCIATION (TEXAS UNINCORPORATED ASSOCIATION)

SUITE 160  
14285 MIDWAY ROAD  
ADDISON, TX 75001

FOR: ASSOCIATION SERVICES, NAMELY, PROMOTING THE IMPROVEMENT OF BUSINESS CONDITIONS, PROMOTING IMPLEMENTING UNIFORM AND HIGHER BUSINESS STANDARDS IN THE RETAIL STORE MAINTENANCE INDUSTRY, PROMOTING THE CREATION OF AN ENVIRONMENT TO CONTINUALLY IMPROVE THE BUSINESS PROCESSES, PROMOTING ACTIVE PARTICIPATION IN INDUSTRY AFFAIRS AND ADVANCING AWARENESS OF RETAIL FACILITIES FOR ALL INDUSTRIES, IN CLASS 35 (U.S. CLS. 100, 101 AND 102).

FIRST USE 9-1-1995; IN COMMERCE 9-1-1995.

THE MARK CONSISTS OF IN PART, CIRCLES ON TOP OF PRISMS TO FORM A REPRESENTATION OF PERSONS. THE WORDS "PRSM PROFESSIONAL RETAIL STORE MAINTENANCE ASSOCIATION" SURROUNDS THE REPRESENTATION OF PERSON. SHADING ALSO SURROUNDS THE PERSONS AND WORKING.

SEC. 2(F) AS TO PROFESSIONAL RETAIL STORE MAINTENANCE.

SER. NO. 77-259,080, FILED 8-20-2007.

TRACY CROSS, EXAMINING ATTORNEY

**Int. Cl.: 35**

**Prior U.S. Cls.: 100, 101 and 102**

**United States Patent and Trademark Office**

**Reg. No. 3,503,869**

**Registered Sep. 23, 2008**

**SERVICE MARK  
PRINCIPAL REGISTER**

**SMUGGLER'S HOLD**

MARGARITAVILLE ENTERPRISES, LLC (DELA-  
WARE LIMITED LIABILITY COMPANY)  
256 WORTH AVENUE, SUITE Q-R  
PALM BEACH, FL 33480

FOR: RETAIL STORE SERVICES AND MAIL  
ORDER AND ON-LINE RETAIL SERVICES FEATURING A WIDE ARRAY OF MERCHANDISE IN THE NATURE OF NOVELTY ITEMS, SOUVENIRS, CLOTHING, HEADWEAR, BOOKS, HOUSEWARES, SOUND AND VIDEO RECORDINGS, BEVERAGE WARE AND PRINTED MATERIALS, IN CLASS 35 (U.S. CLS. 100, 101 AND 102).

FIRST USE 12-8-2003; IN COMMERCE 12-8-2003.

THE MARK CONSISTS OF STANDARD CHARACTERS WITHOUT CLAIM TO ANY PARTICULAR FONT, STYLE, SIZE, OR COLOR.

SER. NO. 77-259,127, FILED 8-20-2007.

RICHARD A. STRASER, EXAMINING ATTORNEY

Int. Cl.: 35

Prior U.S. Cls.: 100, 101 and 102

United States Patent and Trademark Office

Reg. No. 3,503,870

Registered Sep. 23, 2008

SERVICE MARK  
PRINCIPAL REGISTER



MARGARITAVILLE ENTERPRISES, LLC (DELAWARE LIMITED LIABILITY COMPANY)  
256 WORTH AVENUE, SUITE Q-R  
PALM BEACH, FL 33480

FOR: RETAIL STORE SERVICES AND MAIL ORDER AND ON-LINE RETAIL SERVICES FEATURING A WIDE ARRAY OF MERCHANDISE IN THE NATURE OF NOVELTY ITEMS, SOUVENIRS, CLOTHING, HEADWEAR, BOOKS, HOUSEWARES, SOUND AND VIDEO RECORDINGS, BEVERAGE WARE AND PRINTED MATERIALS, IN CLASS 35 (U.S. CLS. 100, 101 AND 102).

FIRST USE 12-8-2003; IN COMMERCE 12-8-2003.

OWNER OF U.S. REG. NOS. 2,463,238, 3,192,551 AND OTHERS.

THE NAME(S), PORTRAIT(S), AND/OR SIGNATURE(S) SHOWN IN THE MARK IDENTIFIES "JIMMY BUFFETT" WHOSE CONSENT IS OF RECORD.

THE MARK CONSISTS OF THE WORDS "JIMMY BUFFETT'S MARGARITAVILLE SMUGGLER'S HOLD" ALL IN STYLIZED LETTERING WITHIN RECTANGLES TOGETHER WITH THE DESIGNS OF THE TREE LEAVES AND THE DESIGN OF A PARROT WITH AN EXTENDED TAIL.

SER. NO. 77-259,129, FILED 8-20-2007.

RICHARD A. STRASER, EXAMINING ATTORNEY

**Int. Cl.: 20**

**Prior U.S. Cls.: 2, 13, 22, 25, 32 and 50**

**United States Patent and Trademark Office**

**Reg. No. 3,503,871**

**Registered Sep. 23, 2008**

**TRADEMARK  
PRINCIPAL REGISTER**

**PLASTIQUARIUM**

EDGAR, DAVID (UNITED STATES INDIVIDUAL)  
5919 LAKEVIEW DRIVE  
CHARLOTTE, NC 28270

FOR: WORKS OF ART OF RECYCLED PLASTIC,  
IN CLASS 20 (U.S. CLS. 2, 13, 22, 25, 32 AND 50).

FIRST USE 6-21-2004; IN COMMERCE 11-2-2004.

THE MARK CONSISTS OF STANDARD CHARACTERS WITHOUT CLAIM TO ANY PARTICULAR FONT, STYLE, SIZE, OR COLOR.

SER. NO. 77-259,259, FILED 8-20-2007.

WILLIAM P. SHANAHAN, EXAMINING ATTORNEY



**Int. Cl.: 9**

**Prior U.S. Cls.: 21, 23, 26, 36 and 38**

**Reg. No. 3,503,872**

**United States Patent and Trademark Office**

**Registered Sep. 23, 2008**

**TRADEMARK  
PRINCIPAL REGISTER**

**EPENCIL**

THE CARDONE GROUP OF CENTRAL FLORIDA, INC. (FLORIDA CORPORATION)  
4241 N. JOHN YOUNG PARKWAY, SUITE 1500  
ORLANDO, FL 32804

THE MARK CONSISTS OF STANDARD CHARACTERS WITHOUT CLAIM TO ANY PARTICULAR FONT, STYLE, SIZE, OR COLOR.

FOR: COMPUTER SOFTWARE, NAMELY, FINANCIAL AND DATA MANAGEMENT SOFTWARE FOR AUTOMOTIVE DEALERSHIPS, IN CLASS 9 (U.S. CLS. 21, 23, 26, 36 AND 38).

SER. NO. 77-259,345, FILED 8-20-2007.

FIRST USE 4-6-2001; IN COMMERCE 4-6-2001.

CARYN GLASSER, EXAMINING ATTORNEY

**Int. Cl.: 41**

**Prior U.S. Cls.: 100, 101 and 107**

**United States Patent and Trademark Office**

**Reg. No. 3,503,873**

**Registered Sep. 23, 2008**

**SERVICE MARK  
PRINCIPAL REGISTER**

# CIGAR DAVE

CIGAR CONNOISSEUR RADIO NETWORK, INC.  
(FLORIDA CORPORATION)  
4002 GANDY BOULEVARD  
TAMPA, FL 33611

FOR: ENTERTAINMENT SERVICES, NAMELY,  
AN ONGOING TALK SHOW BROADCAST OVER  
TELEVISION, RADIO AND WEBCAST FEATURING  
FOOD, CIGARS, SPIRITS AND MEN'S LIFESTYLE  
RELATED ACTIVITIES, IN CLASS 41 (U.S. CLS. 100,  
101 AND 107).

FIRST USE 7-0-1995; IN COMMERCE 12-0-1995.

THE MARK CONSISTS OF STANDARD CHAR-  
ACTERS WITHOUT CLAIM TO ANY PARTICULAR  
FONT, STYLE, SIZE, OR COLOR.

NO CLAIM IS MADE TO THE EXCLUSIVE  
RIGHT TO USE "CIGAR", APART FROM THE  
MARK AS SHOWN.

THE NAME(S), PORTRAIT(S), AND/OR SIGNA-  
TURE(S) SHOWN IN THE MARK IDENTIFIES  
"DAVID ZEPLOWITZ", WHOSE CONSENT(S) TO  
REGISTER IS SUBMITTED.

SER. NO. 77-259,361, FILED 8-20-2007.

PATRICIA EVANKO, EXAMINING ATTORNEY

**Int. Cl.: 35**

**Prior U.S. Cls.: 100, 101 and 102**

**United States Patent and Trademark Office**

**Reg. No. 3,503,874**

**Registered Sep. 23, 2008**

**SERVICE MARK  
PRINCIPAL REGISTER**

# HRI

VEDIOR NORTH AMERICA LLC (DELAWARE  
LIMITED LIABILITY COMPANY)  
60 HARVARD MILL SQUARE  
WAKEFIELD, MA 01880

FOR: EMPLOYMENT AGENCY SERVICES; EM-  
PLOYMENT RECRUITING AND PLACEMENT  
CONSULTANCY SERVICES; EMPLOYMENT  
COUNSELING; INFORMATION SERVICES RELAT-  
ING TO JOB PLACEMENT; PROVIDING CAREER  
INFORMATION; JOB ADVERTISING; PERSONNEL  
MANAGEMENT SERVICES; PERSONNEL RE-  
CRUITMENT; TESTING AND ASSESSMENT FOR  
THE SELECTION OF PERSONNEL; PSYCHOLOGI-  
CAL TESTING FOR THE SELECTION OF PERSON-  
NEL; INFORMATION AND ADVISORY SERVICES

RELATING TO THE AFORESAID, IN CLASS 35 (U.S.  
CLS. 100, 101 AND 102).

FIRST USE 1-26-1998; IN COMMERCE 1-26-1998.

THE MARK CONSISTS OF STANDARD CHAR-  
ACTERS WITHOUT CLAIM TO ANY PARTICULAR  
FONT, STYLE, SIZE, OR COLOR.

OWNER OF U.S. REG. NO. 2,262,526.

SER. NO. 77-259,378, FILED 8-20-2007.

LINDA LAVACHE, EXAMINING ATTORNEY

**Int. Cl.: 35**

**Prior U.S. Cls.: 100, 101 and 102**

**United States Patent and Trademark Office**

**Reg. No. 3,503,875**

**Registered Sep. 23, 2008**

**SERVICE MARK  
PRINCIPAL REGISTER**

**FLOP TURN RIVER**

PWNMARKETING (CALIFORNIA CORPORATION)  
ESPRAGUE@GMAIL.COM  
1134 18TH STREET  
MANHATTAN BEACH, CA 90266

THE MARK CONSISTS OF STANDARD CHARACTERS WITHOUT CLAIM TO ANY PARTICULAR FONT, STYLE, SIZE, OR COLOR.

FOR: ADVERTISING VIA ELECTRONIC MEDIA AND SPECIFICALLY THE INTERNET, IN CLASS 35 (U.S. CLS. 100, 101 AND 102).

SER. NO. 77-259,484, FILED 8-20-2007.

FIRST USE 12-1-2003; IN COMMERCE 12-1-2003.

SANI KHOURI, EXAMINING ATTORNEY

**Int. Cl.: 41**

**Prior U.S. Cls.: 100, 101 and 107**

**United States Patent and Trademark Office**

**Reg. No. 3,503,876**

**Registered Sep. 23, 2008**

**SERVICE MARK  
PRINCIPAL REGISTER**

**COORDINATION PATTERN**

WETZIG, ELIZABETH M. (UNITED STATES INDIVIDUAL)  
1335 RUSSET RD  
ALLENTOWN, PA 18104

FOR: PROVIDING ASSISTANCE, PERSONAL TRAINING AND PHYSICAL FITNESS CONSULTATION TO INDIVIDUALS TO HELP THEM MAKE PHYSICAL FITNESS, STRENGTH, CONDITIONING, AND EXERCISE IMPROVEMENT IN THEIR DAILY LIVING; PHYSICAL FITNESS CONDITIONING CLASSES; PHYSICAL FITNESS CONSULTATION; PHYSICAL FITNESS INSTRUCTION; EDUCATION SERVICES, NAMELY, PROVIDING TRAINING WORKSHOPS IN THE FIELDS OF FITNESS, BODY MECHANICS, SOMATIC AWARENESS, HANDLING STRESS, PREVENTING

INJURY AND INCREASING MOBILITY OF JOINTS, IN CLASS 41 (U.S. CLS. 100, 101 AND 107).

FIRST USE 0-0-1996; IN COMMERCE 0-0-1996.

THE MARK CONSISTS OF STANDARD CHARACTERS WITHOUT CLAIM TO ANY PARTICULAR FONT, STYLE, SIZE, OR COLOR.

NO CLAIM IS MADE TO THE EXCLUSIVE RIGHT TO USE "COORDINATION", APART FROM THE MARK AS SHOWN.

SER. NO. 77-259,501, FILED 8-20-2007.

BRENDAN REGAN, EXAMINING ATTORNEY

**Int. Cls.: 35, 38, 41 and 42**

**Prior U.S. Cls.: 100, 101, 102, 104 and 107**

**United States Patent and Trademark Office**

**Reg. No. 3,503,877**

**Registered Sep. 23, 2008**

**SERVICE MARK  
PRINCIPAL REGISTER**

**IT'S WHAT'S ON THE WEB**

OVGUIDE.COM, INC. (DELAWARE CORPORATION)  
144 SOUTH BEVERLY DRIVE  
BEVERLY HILLS, CA 90212

FOR: ADVERTISING AND ADVERTISEMENT SERVICES, IN CLASS 35 (U.S. CLS. 100, 101 AND 102).

FIRST USE 7-13-2006; IN COMMERCE 7-13-2006.

FOR: PROVIDING ONLINE DISCUSSION FORUMS CONCERNING AUDIOVISUAL CONTENT ON THE INTERNET IN THE FIELDS OF GENERAL INTEREST ENTERTAINMENT, ADULT ENTERTAINMENT, CURRENT EVENT NEWS, MUSIC, EDUCATIONAL INFORMATION, AND INTERNATIONAL CULTURE AND ENTERTAINMENT, IN CLASS 38 (U.S. CLS. 100, 101 AND 104).

FIRST USE 7-13-2006; IN COMMERCE 7-13-2006.

FOR: ENTERTAINMENT SERVICES IN THE NATURE OF AN INTERACTIVE ONLINE DATABASE FEATURING ENTERTAINMENT CONTENT; PROVIDING A COMPREHENSIVE DATABASE AND SEARCHABLE INDEX OF WEBSITES AND DATASTREAMS FEATURING AUDIOVISUAL

CONTENT ON THE INTERNET IN THE FIELDS OF GENERAL INTEREST ENTERTAINMENT, ADULT ENTERTAINMENT, CURRENT EVENT NEWS, MUSIC, EDUCATION INFORMATION, AND INTERNATIONAL CULTURE AND ENTERTAINMENT, IN CLASS 41 (U.S. CLS. 100, 101 AND 107).

FIRST USE 7-13-2006; IN COMMERCE 7-13-2006.

FOR: COMPUTER SERVICES, NAMELY, CREATING CUSTOMIZED INDEXES OF INFORMATION, SITES AND OTHER RESOURCES AVAILABLE ON COMPUTER NETWORKS, IN CLASS 42 (U.S. CLS. 100 AND 101).

FIRST USE 7-13-2006; IN COMMERCE 7-13-2006.

THE MARK CONSISTS OF STANDARD CHARACTERS WITHOUT CLAIM TO ANY PARTICULAR FONT, STYLE, SIZE, OR COLOR.

SER. NO. 77-259,506, FILED 8-20-2007.

KARANENDRA S. CHHINA, EXAMINING ATTORNEY

**Int. Cls.: 35, 38, 41 and 42**

**Prior U.S. Cls.: 100, 101, 102, 104 and 107**

**United States Patent and Trademark Office**

**Reg. No. 3,503,878**

**Registered Sep. 23, 2008**

**SERVICE MARK  
PRINCIPAL REGISTER**

# OVGUIDE

OVGUIDE.COM, INC. (DELAWARE CORPORATION)  
144 SOUTH BEVERLY DRIVE  
BEVERLY HILLS, CA 90212

FOR: ADVERTISING AND ADVERTISEMENT SERVICES, IN CLASS 35 (U.S. CLS. 100, 101 AND 102).

FIRST USE 7-13-2006; IN COMMERCE 7-13-2006.

FOR: PROVIDING ONLINE DISCUSSION FORUMS CONCERNING AUDIOVISUAL CONTENT ON THE INTERNET IN THE FIELDS OF GENERAL INTEREST ENTERTAINMENT, ADULT ENTERTAINMENT, CURRENT EVENT NEWS, MUSIC, EDUCATIONAL INFORMATION, AND INTERNATIONAL CULTURE AND ENTERTAINMENT, IN CLASS 38 (U.S. CLS. 100, 101 AND 104).

FIRST USE 7-13-2006; IN COMMERCE 7-13-2006.

FOR: ENTERTAINMENT SERVICES IN THE NATURE OF AN INTERACTIVE ONLINE DATABASE FEATURING ENTERTAINMENT CONTENT; PROVIDING A COMPREHENSIVE DATABASE AND SEARCHABLE INDEX OF WEBSITES AND DATASTREAMS FEATURING AUDIOVISUAL

CONTENT ON THE INTERNET IN THE FIELDS OF GENERAL INTEREST ENTERTAINMENT, ADULT ENTERTAINMENT, CURRENT EVENT NEWS, MUSIC, EDUCATIONAL INFORMATION, AND INTERNATIONAL CULTURE AND ENTERTAINMENT, IN CLASS 41 (U.S. CLS. 100, 101 AND 107).

FIRST USE 7-13-2006; IN COMMERCE 7-13-2006.

FOR: COMPUTER SERVICES, NAMELY, CREATING CUSTOMIZED INDEXES OF INFORMATION, SITES AND OTHER RESOURCES AVAILABLE ON COMPUTER NETWORKS, IN CLASS 42 (U.S. CLS. 100 AND 101).

FIRST USE 7-13-2006; IN COMMERCE 7-13-2006.

THE MARK CONSISTS OF STANDARD CHARACTERS WITHOUT CLAIM TO ANY PARTICULAR FONT, STYLE, SIZE, OR COLOR.

SER. NO. 77-259,522, FILED 8-20-2007.

KARANENDRA S. CHHINA, EXAMINING ATTORNEY

**Int. Cls.: 35, 38, 41 and 42**

**Prior U.S. Cls.: 100, 101, 102, 104 and 107**

**United States Patent and Trademark Office**

**Reg. No. 3,503,879**

**Registered Sep. 23, 2008**

**SERVICE MARK  
PRINCIPAL REGISTER**



OVGUIDE.COM, INC. (DELAWARE CORPORATION)  
144 SOUTH BEVERLY DRIVE  
BEVERLY HILLS, CA 90212

FOR: ADVERTISING AND ADVERTISEMENT SERVICES, IN CLASS 35 (U.S. CLS. 100, 101 AND 102).

FIRST USE 7-13-2006; IN COMMERCE 7-13-2006.

FOR: PROVIDING ONLINE DISCUSSION FORUMS CONCERNING AUDIOVISUAL CONTENT ON THE INTERNET IN THE FIELDS OF GENERAL INTEREST ENTERTAINMENT, ADULT ENTERTAINMENT, CURRENT EVENT NEWS, MUSIC, EDUCATIONAL INFORMATION, AND INTERNATIONAL CULTURE AND ENTERTAINMENT, IN CLASS 38 (U.S. CLS. 100, 101 AND 104).

FIRST USE 7-13-2006; IN COMMERCE 7-13-2006.

FOR: ENTERTAINMENT SERVICES IN THE NATURE OF AN INTERACTIVE ONLINE DATABASE FEATURING ENTERTAINMENT CONTENT; PROVIDING A COMPREHENSIVE DATABASE AND SEARCHABLE INDEX OF WEBSITES AND DATASTREAMS FEATURING AUDIOVISUAL CONTENT ON THE INTERNET IN THE FIELDS OF GENERAL INTEREST ENTERTAINMENT,

ADULT ENTERTAINMENT, CURRENT EVENT NEWS, MUSIC, EDUCATION INFORMATION, AND INTERNATIONAL CULTURE AND ENTERTAINMENT, IN CLASS 41 (U.S. CLS. 100, 101 AND 107).

FIRST USE 7-13-2006; IN COMMERCE 7-13-2006.

FOR: COMPUTER SERVICES, NAMELY, CREATING CUSTOMIZED INDEXES OF INFORMATION, SITES AND OTHER RESOURCES AVAILABLE ON COMPUTER NETWORKS, IN CLASS 42 (U.S. CLS. 100 AND 101).

FIRST USE 7-13-2006; IN COMMERCE 7-13-2006.

NO CLAIM IS MADE TO THE EXCLUSIVE RIGHT TO USE "ONLINE VIDEO GUIDE", APART FROM THE MARK AS SHOWN.

THE MARK CONSISTS OF THE TERM "OV-GUIDE" ABOVE THE WORDS "ONLINE VIDEO GUIDE" WITHIN A BOX.

SER. NO. 77-259,543, FILED 8-20-2007.

KARANENDRA S. CHHINA, EXAMINING ATTORNEY



**Int. Cl.: 41**

**Prior U.S. Cls.: 100, 101 and 107**

**United States Patent and Trademark Office**

**Reg. No. 3,503,880**

**Registered Sep. 23, 2008**

**SERVICE MARK  
PRINCIPAL REGISTER**

**EASY ENTERTAINING**

TELEVISION FOOD NETWORK, G.P. (DELA-  
WARE PARTNERSHIP)  
1180 AVENUE OF THE AMERICAS  
NEW YORK, NY 10036

FOR: ENTERTAINMENT SERVICES, NAMELY,  
AN ONGOING AUDIO AND VISUAL PROGRAM IN  
THE FIELDS OF COOKING DISTRIBUTED OVER  
TELEVISION, SATELLITE, WIRELESS, AUDIO AND  
VIDEO MEDIA, FIBER OPTICS, CABLE AND A  
GLOBAL COMPUTER NETWORK, IN CLASS 41  
(U.S. CLS. 100, 101 AND 107).

FIRST USE 10-12-2003; IN COMMERCE 10-12-2003.

THE MARK CONSISTS OF STANDARD CHAR-  
ACTERS WITHOUT CLAIM TO ANY PARTICULAR  
FONT, STYLE, SIZE, OR COLOR.

NO CLAIM IS MADE TO THE EXCLUSIVE  
RIGHT TO USE "ENTERTAINING", APART FROM  
THE MARK AS SHOWN.

SER. NO. 77-259,551, FILED 8-20-2007.

JOHN E. MICHOS, EXAMINING ATTORNEY

**Int. Cl.: 16**

**Prior U.S. Cls.: 2, 5, 22, 23, 29, 37, 38 and 50**

**Reg. No. 3,503,881**

**United States Patent and Trademark Office**

**Registered Sep. 23, 2008**

**TRADEMARK  
PRINCIPAL REGISTER**

**PLAY 'N WASH**

MILLIKEN & COMPANY (DELAWARE COR-  
PORATION)  
M495  
920 MILLIKEN ROAD  
SPARTANBURG, SC 29303

THE MARK CONSISTS OF STANDARD CHAR-  
ACTERS WITHOUT CLAIM TO ANY PARTICULAR  
FONT, STYLE, SIZE, OR COLOR.

FOR: ART PRODUCTS, NAMELY, MARKERS  
AND CRAYONS, IN CLASS 16 (U.S. CLS. 2, 5, 22, 23,  
29, 37, 38 AND 50).

SER. NO. 77-259,640, FILED 8-20-2007.

FIRST USE 5-19-2006; IN COMMERCE 5-19-2006.

DEIRDRE ROBERTSON, EXAMINING ATTORNEY

**Int. Cl.: 35**

**Prior U.S. Cls.: 100, 101 and 102**

**United States Patent and Trademark Office**

**Reg. No. 3,503,882**

**Registered Sep. 23, 2008**

**SERVICE MARK  
PRINCIPAL REGISTER**

**NATIONAL ECZEMA ASSOCIATION**

NATIONAL ECZEMA ASSOCIATION FOR SCIENCE & EDUCATION (OREGON CHARITABLE, NON-PROFIT CORPORATION)

4460 REDWOOD HIGHWAY, SUITE 16D  
SAN RAFAEL, CA 94903

FOR: PROMOTING PUBLIC AWARENESS OF ECZEMA AND ISSUES RELATING TO ITS TREATMENT AND CURE TO THE GENERAL PUBLIC, PATIENTS AND MEMBERS OF THE MEDICAL COMMUNITY, IN CLASS 35 (U.S. CLS. 100, 101 AND 102).

FIRST USE 3-0-1995; IN COMMERCE 3-0-1995.

THE MARK CONSISTS OF STANDARD CHARACTERS WITHOUT CLAIM TO ANY PARTICULAR FONT, STYLE, SIZE, OR COLOR.

OWNER OF U.S. REG. NO. 2,174,101.

NO CLAIM IS MADE TO THE EXCLUSIVE RIGHT TO USE "ECZEMA ASSOCIATION", APART FROM THE MARK AS SHOWN.

SEC. 2(F).

SER. NO. 77-259,799, FILED 8-20-2007.

LAURA HAMMEL, EXAMINING ATTORNEY

**Int. Cl.: 41**

**Prior U.S. Cls.: 100, 101 and 107**

**United States Patent and Trademark Office**

**Reg. No. 3,503,883**

**Registered Sep. 23, 2008**

---

**SERVICE MARK  
PRINCIPAL REGISTER**

**TYRESE GIBSON**

TYRESE GIBSON (UNITED STATES INDIVIDUAL)  
1635 N. CAHUENGA BLVD., 2ND FLOOR  
LOS ANGELES, CA 90028

FOR: ENTERTAINMENT SERVICES, NAMELY, LIVE, TELEVISED AND MOVIE APPEARANCES BY A PROFESSIONAL ENTERTAINER AND DRAMATIC AND COMEDIC PERFORMANCES ASSOCIATED THEREWITH , IN CLASS 41 (U.S. CLS. 100, 101 AND 107).

FIRST USE 6-29-2001; IN COMMERCE 6-29-2001.

THE MARK CONSISTS OF STANDARD CHARACTERS WITHOUT CLAIM TO ANY PARTICULAR FONT, STYLE, SIZE, OR COLOR.

THE NAME "TYRESE GIBSON" IDENTIFIES A LIVING INDIVIDUAL WHOSE CONSENT IS OF RECORD.

SER. NO. 77-259,810, FILED 8-20-2007.

ELIZABETH HUGHITT, EXAMINING ATTORNEY

**Int. Cl.: 41**

**Prior U.S. Cls.: 100, 101 and 107**

**United States Patent and Trademark Office**

**Reg. No. 3,503,884**

**Registered Sep. 23, 2008**

**SERVICE MARK  
PRINCIPAL REGISTER**

**UNITED STATES MEDICAL  
LICENSING EXAMINATION**

NATIONAL BOARD OF MEDICAL EXAMINERS  
(D.C. NON-PROFIT CORPORATION)  
3750 MARKET STREET  
PHILADELPHIA, PA 19104

FOR: LICENSING EXAMINATION SERVICES, NAMELY, DEVELOPING, PREPARATION, SCORING, AND ANALYSIS OF EXAMINATIONS DEVELOPED TO MAINTAIN HIGH STANDARDS OF PROFESSIONAL COMPETENCE IN THE MEDICAL PROFESSION TO PROTECT THE HEALTH, SAFETY, AND WELFARE OF THE PUBLIC; ADMINISTERING OF PROFESSIONAL COMPETENCY EXAMINATIONS FOR TESTING STUDENTS AND GRADUATES OF MEDICAL SCHOOLS TO ASCERTAIN THEIR COMPETENCE TO BE LICENSED TO PRACTICE MEDICINE; PROVIDING RESULTS AND PERFORMANCE REPORTS FOR PROFES-

SIONAL COMPETENCY EXAMINATIONS TO EXAMINEES AND TO EXAMINING AND LICENSING BOARDS IN THE FIELD OF MEDICINE, IN CLASS 41 (U.S. CLS. 100, 101 AND 107).

FIRST USE 9-1-1990; IN COMMERCE 9-1-1990.

THE MARK CONSISTS OF STANDARD CHARACTERS WITHOUT CLAIM TO ANY PARTICULAR FONT, STYLE, SIZE, OR COLOR.

SEC. 2(F).

SER. NO. 77-260,175, FILED 8-21-2007.

SALLY SHIH, EXAMINING ATTORNEY

**Int. Cl.: 41**

**Prior U.S. Cls.: 100, 101 and 107**

**United States Patent and Trademark Office**

**Reg. No. 3,503,885**

**Registered Sep. 23, 2008**

**SERVICE MARK  
PRINCIPAL REGISTER**

**USMLE**

NATIONAL BOARD OF MEDICAL EXAMINERS  
(D.C. NON-PROFIT CORPORATION)  
3750 MARKET STREET  
PHILADELPHIA, PA 19104

FOR: LICENSING EXAMINATION SERVICES, NAMELY, DEVELOPING, PREPARATION, SCORING, AND ANALYSIS OF EXAMINATIONS DEVELOPED TO MAINTAIN HIGH STANDARDS OF PROFESSIONAL COMPETENCE IN THE MEDICAL PROFESSION TO PROTECT THE HEALTH, SAFETY, AND WELFARE OF THE PUBLIC; ADMINISTERING OF PROFESSIONAL COMPETENCY EXAMINATIONS FOR TESTING STUDENTS AND GRADUATES OF MEDICAL SCHOOLS TO ASCERTAIN THEIR COMPETENCE TO BE LICENSED TO PRACTICE MEDICINE; PROVIDING RESULTS

AND PERFORMANCE REPORTS FOR PROFESSIONAL COMPETENCY EXAMINATIONS TO EXAMINEES AND TO EXAMINING AND LICENSING BOARDS IN THE FIELD OF MEDICINE, IN CLASS 41 (U.S. CLS. 100, 101 AND 107).

FIRST USE 9-1-1990; IN COMMERCE 9-1-1990.

THE MARK CONSISTS OF STANDARD CHARACTERS WITHOUT CLAIM TO ANY PARTICULAR FONT, STYLE, SIZE, OR COLOR.

SER. NO. 77-260,177, FILED 8-21-2007.

SALLY SHIH, EXAMINING ATTORNEY

**Int. Cl.: 41**

**Prior U.S. Cls.: 100, 101 and 107**

**United States Patent and Trademark Office**

**Reg. No. 3,503,886**

**Registered Sep. 23, 2008**

**SERVICE MARK  
PRINCIPAL REGISTER**



NATIONAL BOARD OF MEDICAL EXAMINERS  
(D.C. NON-PROFIT CORPORATION)  
3750 MARKET STREET  
PHILADELPHIA, PA 19104

FOR: LICENSING EXAMINATION SERVICES, NAMELY, DEVELOPING, PREPARATION, SCORING, AND ANALYSIS OF EXAMINATIONS DEVELOPED TO MAINTAIN HIGH STANDARDS OF PROFESSIONAL COMPETENCE IN THE MEDICAL PROFESSION TO PROTECT THE HEALTH, SAFETY, AND WELFARE OF THE PUBLIC; ADMINISTERING OF PROFESSIONAL COMPETENCY EXAMINATIONS FOR TESTING STUDENTS AND GRADUATES OF MEDICAL SCHOOLS TO ASCERTAIN THEIR COMPETENCE TO BE LICENSED TO PRACTICE MEDICINE; PROVIDING RESULTS AND PERFORMANCE REPORTS FOR PROFESSIONAL COMPETENCY EXAMINATIONS TO EXAMINEES AND TO EXAMINING AND LICENSING BOARDS IN THE FIELD OF MEDICINE, IN CLASS 41 (U.S. CLS. 100, 101 AND 107).

FIRST USE 3-1-1991; IN COMMERCE 3-1-1991.

NO CLAIM IS MADE TO THE EXCLUSIVE RIGHT TO USE "US" AND "UNITED STATES MEDICAL LICENSING EXAMINATION", APART FROM THE MARK AS SHOWN.

THE COLOR(S) RED, WHITE, BLUE AND LIGHT BLUE IS/ARE CLAIMED AS A FEATURE OF THE MARK.

THE COLOR RED APPEARS IN THE DIAMOND, LINES AND THE RECTANGULAR CARRIER, THE COLOR WHITE APPEARS IN THE RECTANGULAR BACKGROUND, THE COLOR BLUE APPEARS IN THE WORDING "MLE UNITED STATES MEDICAL LICENSING EXAMINATION" AND THE COLOR LIGHT BLUE APPEARS IN THE LETTERS "US".

SER. NO. 77-260,178, FILED 8-21-2007.

SALLY SHIH, EXAMINING ATTORNEY

**Int. Cls.: 5 and 10**

**Prior U.S. Cls.: 6, 18, 26, 39, 44, 46, 51 and 52**

**United States Patent and Trademark Office**

**Reg. No. 3,503,887**

**Registered Sep. 23, 2008**

**TRADEMARK  
PRINCIPAL REGISTER**

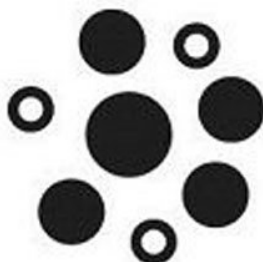

ORTHOVITA, INC. (PENNSYLVANIA CORPORATION)  
77 GREAT VALLEY PARKWAY  
MALVERN, PA 19355

FOR: BONE COMPOSITIONS, CONSISTING OF CALCIUM PHOSPHATE, IN CLASS 5 (U.S. CLS. 6, 18, 44, 46, 51 AND 52).

FIRST USE 12-6-2005; IN COMMERCE 12-6-2005.

FOR: SYNTHETIC BONE GRAFT IMPLANT MATERIAL FOR REPAIR OF BONES; PLASTIC CANISTERS FILLED WITH BONE COMPOSITION, AND RELATED PUSHROD ASSEMBLY AND DISPOSABLE SYRINGES FOR THE DELIVERY OF BIOMA-

THERIAL PREPARATIONS FOR ORTHOPEDIC, MEDICAL, AND SURGICAL USE, IN CLASS 10 (U.S. CLS. 26, 39 AND 44).

FIRST USE 12-6-2005; IN COMMERCE 12-6-2005.

THE MARK CONSISTS OF 5 LARGER CIRCLE DESIGNS SURROUNDED BY 3 SMALLER CIRCLE DESIGNS IN AN OVERALL ROUND DISPLAY FORMAT.

SER. NO. 77-260,190, FILED 8-21-2007.

FLORENTINA BLANDU, EXAMINING ATTORNEY



**Int. Cl.: 41**

**Prior U.S. Cls.: 100, 101 and 107**

**United States Patent and Trademark Office**

**Reg. No. 3,503,888**

**Registered Sep. 23, 2008**

**SERVICE MARK  
PRINCIPAL REGISTER**



NATIONAL BOARD OF MEDICAL EXAMINERS  
(D.C. NON-PROFIT CORPORATION)  
3750 MARKET STREET  
PHILADELPHIA, PA 19104

FOR: LICENSING EXAMINATION SERVICES, NAMELY, DEVELOPING, PREPARATION, SCORING, AND ANALYSIS OF EXAMINATIONS DEVELOPED TO MAINTAIN HIGH STANDARDS OF PROFESSIONAL COMPETENCE IN THE MEDICAL PROFESSION TO PROTECT THE HEALTH, SAFETY, AND WELFARE OF THE PUBLIC; ADMINISTERING OF PROFESSIONAL COMPETENCY EXAMINATIONS FOR TESTING STUDENTS AND GRADUATES OF MEDICAL SCHOOLS TO ASCERTAIN THEIR COMPETENCE TO BE LICENSED TO PRACTICE MEDICINE; PROVIDING RESULTS

AND PERFORMANCE REPORTS FOR PROFESSIONAL COMPETENCY EXAMINATIONS TO EXAMINEES AND TO EXAMINING AND LICENSING BOARDS IN THE FIELD OF MEDICINE, IN CLASS 41 (U.S. CLS. 100, 101 AND 107).

FIRST USE 3-1-1991; IN COMMERCE 3-1-1991.

NO CLAIM IS MADE TO THE EXCLUSIVE RIGHT TO USE "US" AND "UNITED STATES MEDICAL LICENSING EXAMINATION", APART FROM THE MARK AS SHOWN.

SER. NO. 77-260,332, FILED 8-21-2007.

SALLY SHIH, EXAMINING ATTORNEY

**Int. Cl.: 9**

**Prior U.S. Cls.: 21, 23, 26, 36 and 38**

**United States Patent and Trademark Office**

**Reg. No. 3,503,889**

**Registered Sep. 23, 2008**

**TRADEMARK  
PRINCIPAL REGISTER**

# DUNGEON HERO

FIREFLY HOLDINGS LIMITED (UNITED KINGDOM CORPORATION)  
SHAKESPEARE HOUSE, 168 LAVENDER HILL  
LONDON, UNITED KINGDOM SW115TG

FOR: COMPUTER GAME SOFTWARE; COMPUTER GAME CARTRIDGES AND DISCS; COMPUTER GAME JOYSTICKS; COMPUTER AND VIDEO GAME CONSOLES FOR USE WITH AN EXTERNAL DISPLAY SCREEN OR MONITOR; GAMES ADAPTED FOR USE WITH TELEVISION RECEIVERS; VIDEO GAME MACHINES FOR USE WITH TELEVISIONS; VIDEO GAME CARTRIDGES, DISCS, JOYSTICKS AND SOFTWARE, IN CLASS 9 (U.S. CLS. 21, 23, 26, 36 AND 38).

THE MARK CONSISTS OF STANDARD CHARACTERS WITHOUT CLAIM TO ANY PARTICULAR FONT, STYLE, SIZE, OR COLOR.

PRIORITY CLAIMED UNDER SEC. 44(D) ON UNITED KINGDOM APPLICATION NO. 2448649, FILED 3-7-2007.

PRIORITY CLAIMED UNDER SEC. 44(D) ON UNITED KINGDOM APPLICATION NO. 2448000, FILED 2-28-2007.

OWNER OF UNITED KINGDOM REG. NO. 2448000, DATED 9-21-2007, EXPIRES 2-28-2017.

SER. NO. 77-260,335, FILED 8-21-2007.

IRA J. GOODSaid, EXAMINING ATTORNEY

Int. Cl.: 41

Prior U.S. Cls.: 100, 101 and 107

United States Patent and Trademark Office

Reg. No. 3,503,890

Registered Sep. 23, 2008

SERVICE MARK  
PRINCIPAL REGISTER



ELITE BUSINESS PEOPLE'S ACCESS TO THE INACCESSIBLE

ANNE MCKEVITT (UNITED KINGDOM INDIVIDUAL)  
LEVEL 20, TOWER 2  
201 SUSSEX STREET  
SYDNEY, AUSTRALIA NSW2060

FOR: EDUCATIONAL SERVICES, NAMELY, PROVIDING A WEBSITE TO PROVIDE ON-LINE CLASSES, SEMINARS, AND LECTURES IN THE FIELD OF PROFESSIONAL COACHING; EDUCATIONAL SERVICES, NAMELY, PROVIDING EDUCATIONAL INFORMATION IN THE FORMAT OF CLASSES, LECTURES, AND SEMINARS, IN THE FIELD OF BUSINESS, AND DISTRIBUTING COURSE MATERIAL IN THE NATURE OF TEXTBOOKS AND MANUALS THEREWITH; PROVIDING CONTINUING BUSINESS EDUCATION COURSES AND DISTRIBUTING COURSE MATERIAL IN THE NATURE OF TEXTBOOKS, PRERECORDED CDS AND DVDS, MANUALS, BUSINESS NEWSLETTERS AND MAGAZINES, IN CONNECTION THEREWITH; AND PROFESSIONAL COACH-

ING SERVICES IN THE FIELD OF BUSINESS; AND ENTERTAINMENT, NAMELY, PRODUCTION OF TELEVISION SHOWS IN THE FIELD OF BUSINESS, IN CLASS 41 (U.S. CLS. 100, 101 AND 107).

FIRST USE 10-0-2006; IN COMMERCE 10-0-2006.

NO CLAIM IS MADE TO THE EXCLUSIVE RIGHT TO USE "MILLION DOLLAR PLUS CLUB", APART FROM THE MARK AS SHOWN.

THE MARK CONSISTS OF THE WORD "MILLION" IN LARGE STYLIZED FONT, ABOVE THE WORDS "DOLLAR PLUS CLUB", WHICH ARE ABOVE THE WORDS "ELITE BUSINESS PEOPLE'S ACCESS TO THE INACCESSIBLE".

SER. NO. 77-260,401, FILED 8-21-2007.

ADA HAN, EXAMINING ATTORNEY

**Int. Cl.: 28**

**Prior U.S. Cls.: 22, 23, 38 and 50**

**Reg. No. 3,503,891**

**United States Patent and Trademark Office**

**Registered Sep. 23, 2008**

---

**TRADEMARK  
PRINCIPAL REGISTER**

**DEAD ZONE**

STEVEN SIMS, INC. (WASHINGTON CORPORATION), DBA SIMS VIBRATION LABORATORY  
50 W. ROSE NYE WAY  
N/A  
SHELTON, WA 98584

THE MARK CONSISTS OF STANDARD CHARACTERS WITHOUT CLAIM TO ANY PARTICULAR FONT, STYLE, SIZE, OR COLOR.

FOR: ARCHERY BOWS, IN CLASS 28 (U.S. CLS. 22, 23, 38 AND 50).

SER. NO. 77-260,625, FILED 8-21-2007.

FIRST USE 12-28-2007; IN COMMERCE 12-28-2007.

AMY HELLA, EXAMINING ATTORNEY

**Int. Cl.: 35**

**Prior U.S. Cls.: 100, 101 and 102**

**United States Patent and Trademark Office**

**Reg. No. 3,503,892**

**Registered Sep. 23, 2008**

**SERVICE MARK  
PRINCIPAL REGISTER**

**ENDOSCOPY.MD**

INNOVATIVE ENDOSCOPY COMPONENTS, LLC  
(FLORIDA LIMITED LIABILITY COMPANY)  
733 SHOTGUN ROAD  
FORT LAUDERDALE, FL 33326

FOR: ON-LINE RETAIL STORE SERVICES AND  
DISTRIBUTORSHIP SERVICES FEATURING MED-  
ICAL EQUIPMENT, NAMELY, FLEXIBLE AND  
RIGID ENDOSCOPE SYSTEMS, ENDOSCOPE  
EQUIPMENT AND PARTS, CARTS AND CABINETS  
FOR STORAGE AND TRANSPORT OF ENDO-  
SCOPE EQUIPMENT, IN CLASS 35 (U.S. CLS. 100,  
101 AND 102).

FIRST USE 8-31-2002; IN COMMERCE 8-31-2002.

THE MARK CONSISTS OF STANDARD CHAR-  
ACTERS WITHOUT CLAIM TO ANY PARTICULAR  
FONT, STYLE, SIZE, OR COLOR.

SEC. 2(F).

SER. NO. 77-260,903, FILED 8-21-2007.

KELLEY WELLS, EXAMINING ATTORNEY

**Int. Cl.: 41**

**Prior U.S. Cls.: 100, 101 and 107**

**United States Patent and Trademark Office**

**Reg. No. 3,503,893**

**Registered Sep. 23, 2008**

**SERVICE MARK  
PRINCIPAL REGISTER**

**MASTERS OF MARKETING**

ASSOCIATION OF NATIONAL ADVERTISERS,  
INC. (NEW YORK NON-PROFIT CORPORATION)

708 THIRD AVENUE  
NEW YORK, NY 10017

FOR: EDUCATIONAL SERVICES, NAMELY, ORGANIZING AND CONDUCTING FORUMS AND CONFERENCES IN THE FIELD OF MARKETING, IN CLASS 41 (U.S. CLS. 100, 101 AND 107).

FIRST USE 6-0-2003; IN COMMERCE 6-0-2003.

THE MARK CONSISTS OF STANDARD CHARACTERS WITHOUT CLAIM TO ANY PARTICULAR FONT, STYLE, SIZE, OR COLOR.

OWNER OF U.S. REG. NO. 2,283,082.

NO CLAIM IS MADE TO THE EXCLUSIVE RIGHT TO USE "MARKETING", APART FROM THE MARK AS SHOWN.

SER. NO. 77-261,064, FILED 8-21-2007.

JOHN DWYER, EXAMINING ATTORNEY

**Int. Cl.: 9**

**Prior U.S. Cls.: 21, 23, 26, 36 and 38**

**United States Patent and Trademark Office**

**Reg. No. 3,503,894**

**Registered Sep. 23, 2008**

**TRADEMARK  
PRINCIPAL REGISTER**

# Mythania

CHASE, MARK W. (UNITED STATES INDIVIDUAL)  
8833 KIRCHENBAUM DRIVE  
CHARLOTTE, NC 28210

FOR: DOWNLOADABLE ELECTRONIC PUBLICATIONS IN THE NATURE OF A SERIES OF SHORT STORIES AND BOOKS FEATURING FANTASY ADVENTURE, IN CLASS 9 (U.S. CLS. 21, 23, 26, 36 AND 38).

FIRST USE 3-14-2007; IN COMMERCE 3-14-2007.

THE MARK CONSISTS OF STANDARD CHARACTERS WITHOUT CLAIM TO ANY PARTICULAR FONT, STYLE, SIZE, OR COLOR.

THE WORDING "MYTHANIA" HAS NO MEANING IN ANY FOREIGN LANGUAGE.

SER. NO. 77-261,087, FILED 8-21-2007.

LINDA E. BLOHM, EXAMINING ATTORNEY

**Int. Cl.: 25**

**Prior U.S. Cls.: 22 and 39**

**United States Patent and Trademark Office**

**Reg. No. 3,503,895**

**Registered Sep. 23, 2008**

**TRADEMARK  
PRINCIPAL REGISTER**

**ANTHONY SICARI**

ACE INTERNATIONAL ENTERPSISE LTD (NEW  
YORK CORPORATION)  
PO BOX 3003  
KINGSTON, NY 12402

FOR: LADIES' BOOTS; LADIES' SUITS; BLOUSES;  
CAPRI PANTS; CARGO PANTS; DENIMS; JOGGING  
PANTS; SWIM WEAR FOR GENTLEMEN AND  
LADIES; CROP TOPS; TANK TOPS; TOP COATS;  
TOPS; DRESS SHIRTS; DRESS SUITS; DRESSES;  
DRESSES MADE FROM SKINS; DRESSING  
GOWNS; EVENING DRESSES; LADIES' UNDER-  
WEAR; PLEATED SKIRTS FOR FORMAL KIMO-  
NOS (HAKAMA); SKIRT SUITS; SKIRTS; SKIRTS  
AND DRESSES; WEDDING DRESSES, IN CLASS 25  
(U.S. CLS. 22 AND 39).

FIRST USE 4-25-1988; IN COMMERCE 4-25-1988.

THE MARK CONSISTS OF STANDARD CHAR-  
ACTERS WITHOUT CLAIM TO ANY PARTICULAR  
FONT, STYLE, SIZE, OR COLOR.

OWNER OF U.S. REG. NOS. 1,513,695 AND  
3,224,652.

THE NAME SHOWN IN THE MARK IDENTIFIES  
A LIVING INDIVIDUAL WHOSE CONSENT IS OF  
RECORD.

SER. NO. 77-261,347, FILED 8-22-2007.

JOHN WILKE, EXAMINING ATTORNEY



**Int. Cl.: 37**

**Prior U.S. Cls.: 100, 103 and 106**

**United States Patent and Trademark Office**

**Reg. No. 3,503,896**

**Registered Sep. 23, 2008**

**SERVICE MARK  
PRINCIPAL REGISTER**

**BALLANTYNE VILLAGE**

HARRIS, JOHN W. (UNITED STATES INDIVIDUAL)

2700 RICHARDSON DRIVE  
CHARLOTTE, NC 28211 AND

HARRIS, CAMERON M. (UNITED STATES INDIVIDUAL)

3247 SEVEN EAGLES  
CHARLOTTE, NC 28210 AND

BISSELL, SARA H. (UNITED STATES INDIVIDUAL)  
2526 RICHARDSON DRIVE  
CHARLOTTE, NC 28211

FOR: RESIDENTIAL AND COMMERCIAL REAL ESTATE DEVELOPMENT, IN CLASS 37 (U.S. CLS. 100, 103 AND 106).

FIRST USE 12-0-2003; IN COMMERCE 12-0-2003.

THE MARK CONSISTS OF STANDARD CHARACTERS WITHOUT CLAIM TO ANY PARTICULAR FONT, STYLE, SIZE, OR COLOR.

OWNER OF U.S. REG. NO. 2,035,774.

NO CLAIM IS MADE TO THE EXCLUSIVE RIGHT TO USE "VILLAGE", APART FROM THE MARK AS SHOWN.

SER. NO. 77-261,388, FILED 8-22-2007.

PRISCILLA MILTON, EXAMINING ATTORNEY

Int. Cl.: 40

Prior U.S. Cls.: 100, 103 and 106

United States Patent and Trademark Office

Reg. No. 3,503,897

Registered Sep. 23, 2008

**SERVICE MARK  
PRINCIPAL REGISTER**



U SEW NICE (MISSISSIPPI PARTNERSHIP)  
370 FAIRFIELD DR  
JACKSON, MS 39206

FOR: EMBROIDERY, MONOGRAMMING AND  
SEWING, IN CLASS 40 (U.S. CLS. 100, 103 AND 106).

FIRST USE 1-1-2005; IN COMMERCE 1-1-2005.

NO CLAIM IS MADE TO THE EXCLUSIVE  
RIGHT TO USE "CUSTOM EMBROIDERY &  
MONOGRAMMING", APART FROM THE MARK  
AS SHOWN.

THE MARK CONSISTS OF A TWO PART COM-  
BINED LOGO WITH A CIRCLE AT THE TOP WITH  
CUSTOM DESIGN FONT "USN". LOWER BOTTOM  
IS A BANNER WITH THE WORDS "U SEW NICE" IN  
EASY STREET COSTA FONT. BELOW BANNER  
ARE THE WORDS "CUSTOM EMBROIDERY &  
MONOGRAMMING" IN THE SAME EASY STREET  
COSTA FONT.

SER. NO. 77-261,563, FILED 8-22-2007.

JEFFERY COWARD, EXAMINING ATTORNEY

**Int. Cl.: 25**

**Prior U.S. Cls.: 22 and 39**

**United States Patent and Trademark Office**

**Reg. No. 3,503,898**

**Registered Sep. 23, 2008**

**TRADEMARK  
PRINCIPAL REGISTER**

**ANTONIO SICARI**

ACE INTERNATIONAL ENTERPRISE LTD (NEW  
YORK CORPORATION)  
PO BOX 3003  
KINGSTON, NY 12402

FOR: A-SHIRTS; BATHING SUITS; BODY SUITS;  
CAPRI PANTS; CARGO PANTS; CROP TOPS; DEN-  
IMS; DRESS SHIRTS; DRESS SUITS; DRESSES;  
DRESSES MADE FROM SKINS; DRESSING  
GOWNS; EVENING DRESSES; JEANS; JOGGING  
SUITS; KNIT SHIRTS; LADIES' BOOTS; LADIES'  
SUITS; LEATHER PANTS; MEN'S SUITS; MEN'S  
SUITS, WOMEN'S SUITS; PANTS; POLO SHIRTS;  
SHIRTS; SPORT SHIRTS; SUITS; T-SHIRTS; TANK-  
TOPS; TEE SHIRTS; TOP COATS; TOPS; VESTED  
SUITS; WEDDING DRESSES; WOMEN'S CEREMO-  
NIAL DRESSES, IN CLASS 25 (U.S. CLS. 22 AND 39).

FIRST USE 8-1-2007; IN COMMERCE 8-1-2007.

THE MARK CONSISTS OF STANDARD CHAR-  
ACTERS WITHOUT CLAIM TO ANY PARTICULAR  
FONT, STYLE, SIZE, OR COLOR.

OWNER OF U.S. REG. NOS. 1,513,695 AND  
3,224,652.

THE NAME "ANTONIO SICARI" SHOWN IN THE  
MARK IDENTIFIES A LIVING INDIVIDUAL  
WHOSE CONSENT TO REGISTER IS OF RECORD.

THE ENGLISH TRANSLATION OF THE WORD  
"ANTONIO" IN THE MARK IS "ANTHONY".

SER. NO. 77-261,573, FILED 8-22-2007.

ZHALEH DELANEY, EXAMINING ATTORNEY

**Int. Cl.: 36**

**Prior U.S. Cls.: 100, 101 and 102**

**United States Patent and Trademark Office**

**Reg. No. 3,503,899**

**Registered Sep. 23, 2008**

**SERVICE MARK  
PRINCIPAL REGISTER**



CITYWIDE BANKS OF COLORADO, INC. (COL-  
ORADO CORPORATION)  
SUITE 203  
6500 E HAMPDEN AVE  
DENVER, CO 80224

THE MARK CONSISTS OF WORDS "CITYWIDE  
EXCHANGE" BELOW LINE DRAWING OF SUN-  
RISE.

FOR: BANKING, IN CLASS 36 (U.S. CLS. 100, 101  
AND 102).

SEC. 2(F) AS TO "CITYWIDE".

FIRST USE 7-12-2007; IN COMMERCE 7-12-2007.

SER. NO. 77-261,852, FILED 8-22-2007.

NO CLAIM IS MADE TO THE EXCLUSIVE  
RIGHT TO USE "EXCHANGE", APART FROM  
THE MARK AS SHOWN.

BARBARA RUTLAND, EXAMINING ATTORNEY

**Int. Cl.: 41**

**Prior U.S. Cls.: 100, 101 and 107**

**United States Patent and Trademark Office**

**Reg. No. 3,503,900**

**Registered Sep. 23, 2008**

**SERVICE MARK  
PRINCIPAL REGISTER**

# SWEAT EQUITY

SCRIPPS NETWORKS, LLC (DELAWARE LIMITED LIABILITY COMPANY)  
9721 SHERRILL BOULEVARD  
KNOXVILLE, TN 37932

FOR: EDUCATIONAL AND ENTERTAINMENT SERVICES, NAMELY, A CONTINUING PROGRAM ABOUT ARCHITECTURE AND HOME DESIGN, BUILDING, IMPROVEMENT, REPAIR, AND RENOVATION, ACCESSIBLE BY RADIO, TELEVISION, CABLE, FIBER OPTIC NETWORKS, WIRELESS NETWORKS, SATELLITE, AUDIO, VIDEO AND

COMPUTER NETWORKS, IN CLASS 41 (U.S. CLS. 100, 101 AND 107).

FIRST USE 6-15-2007; IN COMMERCE 6-15-2007.

THE MARK CONSISTS OF STANDARD CHARACTERS WITHOUT CLAIM TO ANY PARTICULAR FONT, STYLE, SIZE, OR COLOR.

SER. NO. 77-262,478, FILED 8-23-2007.

CORY BOONE, EXAMINING ATTORNEY

**Int. Cls.: 35, 36 and 44**

**Prior U.S. Cls.: 100, 101 and 102**

**United States Patent and Trademark Office**

**Reg. No. 3,503,901**

**Registered Sep. 23, 2008**

**SERVICE MARK  
PRINCIPAL REGISTER**

# REGENCE ENGINE

THE REGENCE GROUP (OREGON NON-PROFIT CORPORATION)  
100 SW MARKET STREET  
PORTLAND, OR 97207

FOR: PROVIDING MEMBER INCENTIVE AWARDS PROGRAMS FOR CUSTOMERS OF A HEALTH INSURANCE PLAN FOR THE PURPOSE OF PROMOTING HEALTHY BEHAVIOR, IN CLASS 35 (U.S. CLS. 100, 101 AND 102).

FIRST USE 10-0-2005; IN COMMERCE 10-0-2005.

FOR: PROVIDING A WEB SITE FEATURING INFORMATION IN HEALTH INSURANCE MATTERS; CONDUCTING HEALTH INSURANCE UNDERWRITING FEATURING MEMBER INCENTIVE AWARDS PROGRAMS TO PROMOTE HEALTHY BEHAVIOR, IN CLASS 36 (U.S. CLS. 100, 101 AND 102).

FIRST USE 10-0-2005; IN COMMERCE 10-0-2005.

FOR: PROVIDING A WEB SITE FEATURING INFORMATION ABOUT HEALTH AND HEALTHY BEHAVIOR, IN CLASS 44 (U.S. CLS. 100 AND 101).

FIRST USE 10-0-2005; IN COMMERCE 10-0-2005.

THE MARK CONSISTS OF STANDARD CHARACTERS WITHOUT CLAIM TO ANY PARTICULAR FONT, STYLE, SIZE, OR COLOR.

OWNER OF U.S. REG. NOS. 2,204,585, 2,206,267, AND 2,209,549.

SER. NO. 77-262,629, FILED 8-23-2007.

BRENDAN REGAN, EXAMINING ATTORNEY

**Int. Cls.: 6 and 11**

**Prior U.S. Cls.: 2, 12, 13, 14, 21, 23, 25, 31, 34 and 50**

**United States Patent and Trademark Office**

**Reg. No. 3,503,902**

**Registered Sep. 23, 2008**

**TRADEMARK  
PRINCIPAL REGISTER**



T&S BRASS AND BRONZE WORKS, INC. (DE-  
LAWARE CORPORATION)

2 SADDLEBACK COVE

TRAVELERS REST, SC 296901088

FOR: METAL COMPONENT PIECES USED IN  
THE FABRICATION OF STAINLESS STEEL TABLES  
AND OTHER STAINLESS STEEL EQUIPMENT  
USED IN THE FOODSERVICE INDUSTRY, NAME-  
LY, BULLET FEET, CASTERS, DRAWER SLIDES,  
HINGES AND PULLS; METAL HOSES FOR USE  
WITH GAS, IN CLASS 6 (U.S. CLS. 2, 12, 13, 14, 23, 25  
AND 50).

FIRST USE 12-0-2005; IN COMMERCE 12-0-2005.

FOR: GREASE FILTERS FOR USE IN OVENS,  
COOKTOPS AND VENTILATION HOODS; FAU-  
CETS; PRE-RINSE FAUCET SPRAY UNITS; PLUMB-  
ING FITTINGS, NAMELY, DRAINS, IN CLASS 11  
(U.S. CLS. 13, 21, 23, 31 AND 34).

FIRST USE 12-0-2005; IN COMMERCE 12-0-2005.

OWNER OF U.S. REG. NOS. 2,014,935 AND  
2,571,948.

THE STIPLING IS A FEATURE OF THE MARK.

SER. NO. 77-262,783, FILED 8-23-2007.

RUSS HERMAN, EXAMINING ATTORNEY

Int. Cl.: 31

Prior U.S. Cls.: 1 and 46

United States Patent and Trademark Office

Reg. No. 3,503,903

Registered Sep. 23, 2008

TRADEMARK  
PRINCIPAL REGISTER



CANADIAN AGRA INC. (CANADA CORPORATION)  
2091 HWY #21  
KINCARDINE, ONTARIO, CANADA N2Z2Y9

FOR: ANIMAL FEED, IN CLASS 31 (U.S. CLS. 1 AND 46).

FIRST USE 7-0-1991; IN COMMERCE 7-0-1991.

NO CLAIM IS MADE TO THE EXCLUSIVE RIGHT TO USE "AGRICULTURAL PRODUCTS" , APART FROM THE MARK AS SHOWN.

THE MARK CONSISTS OF TWO CONCENTRIC CIRCLES, THE STYLIZED LETTERS "CA" APPEAR

IN THE CENTER WITH LINES INSIDE OF THEM FOR THE APPEARANCE OF VISUAL DEPTH, THE WORDING "AGRA" APPEARING IN LARGER LETTERING BELOW THIS, THE WORDING "VALUE ADDED AGRICULTURAL PRODUCTS" APPEARING AROUND THE BORDER BETWEEN THE CIRCLES AND THE DESIGN OF A LEAF AT THE BOTTOM BETWEEN THE TWO CIRCLES.

SEC. 2(F).

SER. NO. 77-262,816, FILED 8-23-2007.

GENE MACIOL, EXAMINING ATTORNEY



**Int. Cls.: 35 and 41**

**Prior U.S. Cls.: 100, 101, 102 and 107**

**United States Patent and Trademark Office**

**Reg. No. 3,503,904**

**Registered Sep. 23, 2008**

**SERVICE MARK  
PRINCIPAL REGISTER**



MILITARY FORCES FEATURES, INC. (NEW YORK CORPORATION)  
370 OLD COUNTRY ROAD  
SUITE C20  
GARDEN CITY, NY 11530

FOR: PROMOTING THE GOODS AND SERVICES OF OTHERS THROUGH THE DISTRIBUTION OF DISCOUNT COUPONS FOR UNITED STATES MILITARY COMMISSARIES , IN CLASS 35 (U.S. CLS. 100, 101 AND 102).

FIRST USE 1-1-1997; IN COMMERCE 5-29-1997.

FOR: MAGAZINE PUBLISHING; ELECTRONIC PUBLISHING SERVICES, NAMELY, ON-LINE PUBLICATION OF TEXT AND GRAPHIC WORKS OF OTHERS FEATURING ARTICLES AND INFORMATION CONCERNING TOPICS OF INTEREST TO PERSONS SERVING IN THE UNITED STATES MILITARY WORLDWIDE, IN CLASS 41 (U.S. CLS. 100, 101 AND 107).

FIRST USE 1-1-1997; IN COMMERCE 5-29-1997.

NO CLAIM IS MADE TO THE EXCLUSIVE RIGHT TO USE "MEDIA AND GROUP" , APART FROM THE MARK AS SHOWN.

THE COLOR(S) RED, WHITE, BLACK, AND BLUE IS/ARE CLAIMED AS A FEATURE OF THE MARK.

THE MARK CONSISTS OF THE LETTERS "F" AND "M" IN RED. THE LETTERS "AMILY" AND "EDIA" ARE WHITE AND OUTLINED IN BLACK. THE WORD "GROUP" IS DARK BLUE.

SER. NO. 77-262,828, FILED 8-23-2007.

RICHARD A. STRASER, EXAMINING ATTORNEY

**Int. Cl.: 31**

**Prior U.S. Cls.: 1 and 46**

**United States Patent and Trademark Office**

**Reg. No. 3,503,905**

**Registered Sep. 23, 2008**

**TRADEMARK  
PRINCIPAL REGISTER**

**CANADIAN AGRA**

CANADIAN AGRA INC. (CANADA CORPORATION)  
2091 HWY #21  
KINCARDINE, ONTARIO, CANADA N2Z2Y9

FOR: ANIMAL FEED, IN CLASS 31 (U.S. CLS. 1 AND 46).

FIRST USE 0-0-1983; IN COMMERCE 0-0-1983.

THE MARK CONSISTS OF STANDARD CHARACTERS WITHOUT CLAIM TO ANY PARTICULAR FONT, STYLE, SIZE, OR COLOR.

SEC. 2(F).

SER. NO. 77-262,865, FILED 8-23-2007.

GENE MACIOL, EXAMINING ATTORNEY

**Int. Cl.: 16**

**Prior U.S. Cls.: 2, 5, 22, 23, 29, 37, 38 and 50**

**United States Patent and Trademark Office**

**Reg. No. 3,503,906**

**Registered Sep. 23, 2008**

**TRADEMARK  
PRINCIPAL REGISTER**

**ALPHA**

INSTITUTIONAL INVESTOR, INC. (DELAWARE  
CORPORATION)  
225 PARK AVENUE SOUTH  
NEW YORK, NY 10003

FOR: MAGAZINES RELATING TO THE FINAN-  
CIAL AND HEDGE FUND INDUSTRY, IN CLASS 16  
(U.S. CLS. 2, 5, 22, 23, 29, 37, 38 AND 50).

FIRST USE 7-1-2003; IN COMMERCE 7-1-2003.

THE MARK CONSISTS OF STANDARD CHAR-  
ACTERS WITHOUT CLAIM TO ANY PARTICULAR  
FONT, STYLE, SIZE, OR COLOR.

OWNER OF U.S. REG. NO. 3,020,452.

SER. NO. 77-262,895, FILED 8-23-2007.

STEPHEN AQUILA, EXAMINING ATTORNEY

Int. Cl.: 35

Prior U.S. Cls.: 100, 101 and 102

United States Patent and Trademark Office

Reg. No. 3,503,907

Registered Sep. 23, 2008

SERVICE MARK  
PRINCIPAL REGISTER



SUGARBUNS, LLC (MARYLAND LIMITED LIABILITY COMPANY)  
601 S. TALBOT STREET  
ST. MICHAELS, MD 21663

FOR: RETAIL BAKERY SHOPS, IN CLASS 35 (U.S. CLS. 100, 101 AND 102).

FIRST USE 5-21-2007; IN COMMERCE 5-21-2007.

NO CLAIM IS MADE TO THE EXCLUSIVE RIGHT TO USE "SUGAR BUNS", APART FROM THE MARK AS SHOWN.

THE MARK CONSISTS OF THE LETTER "B" IN THE WORD "BUNS" IS COMPOSED OF TWO BAKERY ROLL SHAPED OBJECTS. THE WORD "SUGAR" HAS A CURSIVE FONT. THE LETTERS "U", "N", "S" IN THE WORD "BUNS" HAS A BUBBLE STYLE FONT.

SER. NO. 77-262,978, FILED 8-23-2007.

FRED MANDIR, EXAMINING ATTORNEY

**Int. Cls.: 35 and 44**

**Prior U.S. Cls.: 100, 101 and 102**

**United States Patent and Trademark Office**

**Reg. No. 3,503,908**

**Registered Sep. 23, 2008**

**SERVICE MARK  
PRINCIPAL REGISTER**



MEDICAL REIMBURSEMENT SYSTEMS, INC  
(MASSACHUSETTS CORPORATION)  
12 GILL STREET, SUITE 3000  
WOBURN, MA 01801

FOR: BILLING, NAMELY, HOSPITAL EMERGENCY DEPARTMENT MEDICAL BILLING AND BILLING SUPPORT SERVICES; ADMINISTRATION, BILLING, AND RECONCILIATION OF ACCOUNTS ON BEHALF OF HOSPITAL EMERGENCY DEPARTMENTS, RECORDS MANAGEMENT SERVICES, NAMELY, DOCUMENT INDEXING FOR HOSPITAL EMERGENCY DEPARTMENTS; HOSPITAL EMERGENCY DEPARTMENT ADMINISTRATION SERVICES; HOSPITAL EMERGENCY DEPARTMENT MANAGEMENT, IN CLASS 35 (U.S. CLS. 100, 101 AND 102).

FIRST USE 9-21-2001; IN COMMERCE 9-21-2001.

FOR: MAINTAINING HOSPITAL EMERGENCY DEPARTMENT ELECTRONIC FILES AND RECORDS CONCERNING THE MEDICAL CONDITION OF INDIVIDUALS; EMERGENCY ROOM HOSPITAL SERVICES, IN CLASS 44 (U.S. CLS. 100 AND 101).

FIRST USE 9-29-2001; IN COMMERCE 9-29-2001.

THE MARK CONSISTS OF THE STYLIZED LETTERS "MRSI" WITH TWO ARCS BELOW THE LETTERS.

SER. NO. 77-263,017, FILED 8-23-2007.

ANDREA HACK, EXAMINING ATTORNEY

**Int. Cl.: 35**

**Prior U.S. Cls.: 100, 101 and 102**

**United States Patent and Trademark Office**

**Reg. No. 3,503,909**

**Registered Sep. 23, 2008**

**SERVICE MARK  
PRINCIPAL REGISTER**



JIM KOONS MANAGEMENT COMPANY  
(MARYLAND CORPORATION)  
2000 CHAIN BRIDGE ROAD  
VIENNA, VA 22182

FOR: RETAIL STORE SERVICES FEATURING  
VEHICLES, AUTOMOBILES AND TRUCKS; RE-  
TAIL STORE SERVICES FEATURING VEHICLE  
TIRES, OIL, PETROLEUM PRODUCTS, LUBRI-

CANTS AND VEHICLE PARTS AND ACCESSORIES,  
IN CLASS 35 (U.S. CLS. 100, 101 AND 102).

FIRST USE 9-0-1999; IN COMMERCE 9-0-1999.

SER. NO. 77-263,105, FILED 8-23-2007.

JENNY PARK, EXAMINING ATTORNEY

**Int. Cl.: 20**

**Prior U.S. Cls.: 2, 13, 22, 25, 32 and 50**

**Reg. No. 3,503,910**

**United States Patent and Trademark Office**

**Registered Sep. 23, 2008**

**TRADEMARK  
PRINCIPAL REGISTER**

The logo for Hilker features the word "Hilker" in a bold, italicized, sans-serif font. A thick, black, curved line arches over the letters, starting above the 'H' and ending above the 'r'.

HILKER FAR EAST LIMITED (HONG KONG CORPORATION)  
29TH FLOOR, WING ON CENTRE  
111 CONNAUGHT ROAD  
CENTRAL, HONG KONG

FOR: FURNITURE; MIRRORS; PAPER PHOTO FRAMES; PICTURE FRAMES; ART WORKS OF WOOD, WAX, PLASTER OR PLASTIC; BEDDING, EXCEPT LINEN, NAMELY, MATTRESSES; CUSH-

IONS; PILLOWS; DOWN LEATHER PILLOW; MAGNETIC PILLOW, IN CLASS 20 (U.S. CLS. 2, 13, 22, 25, 32 AND 50).

FIRST USE 5-17-2005; IN COMMERCE 12-25-2006.

SER. NO. 77-263,735, FILED 8-24-2007.

CHRISTINA SOBRAL, EXAMINING ATTORNEY

**Int. Cls.: 35 and 42**

**Prior U.S. Cls.: 100, 101 and 102**

**United States Patent and Trademark Office**

**Reg. No. 3,503,911**

**Registered Sep. 23, 2008**

**SERVICE MARK  
PRINCIPAL REGISTER**



CONTENT DIRECTIONS, INC. (NEW YORK CORPORATION)  
558 NINTH AVENUE  
BROOKLYN, NY 11215

FOR: PROVIDING ONLINE ADVERTISING AND MARKETING TOOLS, NAMELY, A NAVIGATION TOOL THAT ENABLES LINKING OF INFORMATION AND CONTENT WITH MULTIPLE NAVIGATION PATHS FOR USE IN ONLINE ADVERTISEMENTS AND ON WEBSITES, IN CLASS 35 (U.S. CLS. 100, 101 AND 102).

FIRST USE 11-0-2005; IN COMMERCE 11-0-2005.

FOR: PROVIDING ONLINE NON-DOWNLOADABLE COMPUTER SOFTWARE, NAMELY, AN ONLINE ADVERTISING AND MARKETING NAVIGATION TOOL THAT ENABLES LINKING OF INFORMATION AND CONTENT WITH MULTIPLE NAVIGATION PATHS FOR USE IN ONLINE ADVERTISEMENTS AND ON WEBSITES; COMPU-

TER SERVICES, NAMELY, DESIGNING, INSTALLING AND MAINTAINING A NAVIGATION SOFTWARE TOOL THAT ENABLES LINKING OF INFORMATION AND CONTENT WITH MULTIPLE NAVIGATION PATHS FOR USE IN ONLINE ADVERTISEMENTS AND WEBSITES, IN CLASS 42 (U.S. CLS. 100 AND 101).

FIRST USE 11-0-2005; IN COMMERCE 11-0-2005.

OWNER OF U.S. REG. NOS. 3,228,763, 3,254,210, AND 3,280,612.

THE MARK CONSISTS OF THE WORDING "LINKSTORM" WITH THE DESIGN OF ARROWS FACING INWARD IN AN OVAL SHAPE TO THE LEFT OF THE WORDING.

SER. NO. 77-263,773, FILED 8-24-2007.

AMY HELLA, EXAMINING ATTORNEY



**Int. Cl.: 19**

**Prior U.S. Cls.: 1, 12, 33 and 50**

**United States Patent and Trademark Office**

**Reg. No. 3,503,912**

**Registered Sep. 23, 2008**

**TRADEMARK  
PRINCIPAL REGISTER**



BAY TREE TECHNOLOGIES USA, LLC (DELA-  
WARE LIMITED LIABILITY COMPANY)

8700 TRAIL LAKE DRIVE WEST

SUITE 102

MEMPHIS, TN 38125

FOR: NON-METAL BUILDING MATERIALS,  
NAMELY, DECKING BOARDS; NON-METAL  
FLOATING DOCKS, NON-METAL GATES AND  
FENCING, NON-METAL LATTICES , IN CLASS 19  
(U.S. CLS. 1, 12, 33 AND 50).

NO CLAIM IS MADE TO THE EXCLUSIVE  
RIGHT TO USE "PUREWOOD" AND "LINEA",  
APART FROM THE MARK AS SHOWN.

THE MARK CONSISTS OF A BLACK RECTAN-  
GLE WITH ROUNDED CORNERS DIVIDED BY A  
WHITE LINE BENT TO THE RIGHT WITH THE  
WORD "PUREWOOD" IN WHITE IN THE LEFT  
PORTION AND THE WORD "LINEA" IN WHITE IN  
THE RIGHT PORTION, THE RIGHT PORTION  
BEING LARGER THAN THE LEFT.

SER. NO. 77-263,978, FILED 8-24-2007.

FIRST USE 12-13-2007; IN COMMERCE 12-13-2007.

TOBY BULLOFF, EXAMINING ATTORNEY

**Int. Cl.: 19**

**Prior U.S. Cls.: 1, 12, 33 and 50**

**United States Patent and Trademark Office**

**Reg. No. 3,503,913**

**Registered Sep. 23, 2008**

**TRADEMARK  
PRINCIPAL REGISTER**



BAY TREE TECHNOLOGIES USA, LLC (DELA-  
WARE LIMITED LIABILITY COMPANY)

8700 TRAIL LAKE DRIVE WEST

SUITE 102

MEMPHIS, TN 38125

FOR: NON-METAL BUILDING MATERIALS,  
NAMELY, DECKING BOARDS; NON-METAL  
GATES AND FENCING; NON-METAL LATTICES;  
NON-METAL FLOATING DOCKS , IN CLASS 19  
(U.S. CLS. 1, 12, 33 AND 50).

FIRST USE 12-13-2007; IN COMMERCE 12-13-2007.

NO CLAIM IS MADE TO THE EXCLUSIVE  
RIGHT TO USE "PUREWOOD", APART FROM  
THE MARK AS SHOWN.

THE MARK CONSISTS OF A BLACK RECTAN-  
GLE WITH ROUNDED CORNERS DIVIDED BY A  
WHITE LINE BENT TO THE RIGHT WITH THE  
WORD "PUREWOOD" IN WHITE IN THE LEFT  
PORTION AND THE WORD "SAHARA" IN WHITE  
IN THE RIGHT PORTION, THE RIGHT PORTION  
BEING LARGER THAN THE LEFT.

SER. NO. 77-263,993, FILED 8-24-2007.

TOBY BULLOFF, EXAMINING ATTORNEY

**Int. Cl.: 19**

**Prior U.S. Cls.: 1, 12, 33 and 50**

**United States Patent and Trademark Office**

**Reg. No. 3,503,914**

**Registered Sep. 23, 2008**

**TRADEMARK  
PRINCIPAL REGISTER**



BAY TREE TECHNOLOGIES USA, LLC (DELA-  
WARE LIMITED LIABILITY COMPANY)  
8700 TRAIL LAKE DRIVE WEST  
SUITE 102  
MEMPHIS, TN 38125

FOR: NON-METAL BUILDING MATERIALS,  
NAMELY, DECKING BOARDS; NON-METAL  
FLOATING DOCKS, NON-METAL GATES AND  
FENCING, NON-METAL LATTICES , IN CLASS 19  
(U.S. CLS. 1, 12, 33 AND 50).

FIRST USE 12-13-2007; IN COMMERCE 12-13-2007.

NO CLAIM IS MADE TO THE EXCLUSIVE  
RIGHT TO USE "PUREWOOD", APART FROM  
THE MARK AS SHOWN.

THE MARK CONSISTS OF A BLACK RECTAN-  
GLE WITH ROUNDED CORNERS DIVIDED BY A  
WHITE LINE BENT TO THE RIGHT WITH A  
DEPICTION OF A GROVE OF CONICAL SHAPED  
TREES IN WHITE IN THE LEFT PORTION AND  
THE WORD PUREWOOD IN WHITE IN THE LEFT  
PORTION, THE RIGHT PORTION BEING LARGER  
THAN THE LEFT.

SER. NO. 77-264,035, FILED 8-24-2007.

TOBY BULLOFF, EXAMINING ATTORNEY

**Int. Cl.: 36**

**Prior U.S. Cls.: 100, 101 and 102**

**United States Patent and Trademark Office**

**Reg. No. 3,503,915**

**Registered Sep. 23, 2008**

**SERVICE MARK  
PRINCIPAL REGISTER**

# Wall Street Greek

MARKOS N. KAMINIS (UNITED STATES INDIVIDUAL)  
APT. 3C  
341 EAST 81ST STREET  
NEW YORK, NY 10028

FOR: FINANCIAL INFORMATION PROVIDED BY ELECTRONIC MEANS, SPECIFICALLY, BY THE OPERATION OF WEBSITES, IN CONJUNCTION WITH PARTNERED WEBSITES, AND THROUGH PODCAST OR OTHERWISE REACHING WEB ENABLED MOBILE DEVICES OR OTHER WEB ENABLED DEVICES, AND IN SO DOING, OFFERING FINANCIAL MARKET CONTENT, THAT INCLUDES ANALYSIS AND ADVICE ON FINANCIAL MARKET TOPICS INCLUDING, BUT NOT LIMITED TO, GLOBAL AND DOMESTIC FINANCIAL MARKET AND ECONOMIC ACTIVITY AND FORECASTING, FIXED INCOME AND EQUITY SECURITIES AND MARKETS, COMMODITY MARKETS,

CURRENCY MARKETS, DERIVATIVE FINANCIAL INSTRUMENTS, GEOPOLITICAL FACTORS THAT CAN IMPACT FINANCIAL INSTRUMENTS, AND ALSO OFFERING OTHER RELATED FINANCIAL NEWS AND INFORMATION EITHER DIRECTLY OR THROUGH THE WEBSITE LINKS OF OTHER NEWS PROVIDERS, IN CLASS 36 (U.S. CLS. 100, 101 AND 102).

FIRST USE 9-6-2006; IN COMMERCE 9-15-2006.

THE MARK CONSISTS OF STANDARD CHARACTERS WITHOUT CLAIM TO ANY PARTICULAR FONT, STYLE, SIZE, OR COLOR.

SER. NO. 77-264,276, FILED 8-25-2007.

KARANENDRA S. CHHINA, EXAMINING ATTORNEY

**Int. Cls.: 9 and 42**

**Prior U.S. Cls.: 21, 23, 26, 36, 38, 100 and 101**

**United States Patent and Trademark Office**

**Reg. No. 3,503,916**

**Registered Sep. 23, 2008**

**TRADEMARK  
SERVICE MARK  
PRINCIPAL REGISTER**

# MEDIA CHASE

MEDIACHASE, LTD. (DELAWARE CORPORATION)  
7411 BEVERLY BOULEVARD  
LOS ANGELES, CA 90036

FOR: COMPUTER SOFTWARE FOR THE COLLECTION, EDITING, ORGANIZING, MODIFYING, BOOK MARKING, TRANSMISSION, STORAGE AND SHARING OF DATA AND INFORMATION; COMPUTER SOFTWARE, NAMELY, SOFTWARE DEVELOPMENT TOOLS FOR THE CREATION OF MOBILE INTERNET APPLICATIONS AND CLIENT INTERFACES; COMPUTER SOFTWARE DEVELOPMENT TOOLS; COMPUTER SOFTWARE FOR ADMINISTRATION OF COMPUTER NETWORKS; COMPUTER E-COMMERCE SOFTWARE TO ALLOW USERS TO PERFORM ELECTRONIC BUSINESS TRANSACTIONS VIA A GLOBAL COMPUTER NETWORK; COMPUTER SOFTWARE FOR UPLOADING DATA; COMPUTER SOFTWARE, NAMELY, COMPUTER SOFTWARE FOR CALENDAR APPLICATIONS, IN CLASS 9 (U.S. CLS. 21, 23, 26, 36 AND 38).

FIRST USE 4-16-2003; IN COMMERCE 4-16-2003.

FOR: CUSTOM DESIGN OF SOFTWARE AND BUSINESS COMMUNICATION SOLUTIONS FOR OTHERS; CONSULTING SERVICES, NAMELY, DESIGN AND IMPLEMENTATION OF SOFTWARE AND COMMUNICATIONS SOLUTIONS FOR OTHERS; TECHNICAL SUPPORT SERVICES, NAMELY, TROUBLESHOOTING OF COMPUTER COMMUNICATIONS HARDWARE AND SOFTWARE PROBLEMS, IN CLASS 42 (U.S. CLS. 100 AND 101).

FIRST USE 4-16-2003; IN COMMERCE 4-16-2003.

THE MARK CONSISTS OF STANDARD CHARACTERS WITHOUT CLAIM TO ANY PARTICULAR FONT, STYLE, SIZE, OR COLOR.

OWNER OF U.S. REG. NO. 2,491,915.

NO CLAIM IS MADE TO THE EXCLUSIVE RIGHT TO USE "MEDIA", APART FROM THE MARK AS SHOWN.

SER. NO. 77-264,377, FILED 8-25-2007.

KELLEY WELLS, EXAMINING ATTORNEY

**Int. Cl.: 24**

**Prior U.S. Cls.: 42 and 50**

**United States Patent and Trademark Office**

**Reg. No. 3,503,917**

**Registered Sep. 23, 2008**

**TRADEMARK  
PRINCIPAL REGISTER**

**BALLET**

COMFORTEX CORPORATION (NEW YORK  
CORPORATION)  
21 ELM STREET  
WATERVLIET, NY 12189

THE MARK CONSISTS OF STANDARD CHAR-  
ACTERS WITHOUT CLAIM TO ANY PARTICULAR  
FONT, STYLE, SIZE, OR COLOR.

FOR: FABRIC WINDOW TREATMENTS, NAME-  
LY, DRAPERIES AND SHEERS, IN CLASS 24 (U.S.  
CLS. 42 AND 50).

SER. NO. 77-264,800, FILED 8-27-2007.

FIRST USE 7-10-2006; IN COMMERCE 7-10-2006.

AHSEN KHAN, EXAMINING ATTORNEY

**Int. Cl.: 7**

**Prior U.S. Cls.: 13, 19, 21, 23, 31, 34 and 35**

**Reg. No. 3,503,918**

**United States Patent and Trademark Office**

**Registered Sep. 23, 2008**

**TRADEMARK  
PRINCIPAL REGISTER**

# BUFFERS

BUFFERS USA, INC. (FLORIDA CORPORATION)  
10180 NEW BERLIN ROAD  
JACKSONVILLE, FL 32226

ASSEMBLIES, IN CLASS 7 (U.S. CLS. 13, 19, 21, 23,  
31, 34 AND 35).

FIRST USE 1-1-1990; IN COMMERCE 1-1-1990.

FOR: MACHINE PARTS, NAMELY, SUSPENSION  
PARTS, FIFTH WHEEL AND DOLLY WHEEL COM-  
PONENTS AND ASSEMBLIES, TWISTLOCK AND  
PINLOCK ASSEMBLIES AND PARTS, STEEL PA-  
NELS AND STRUCTURAL STEEL COMPONENTS,  
SANDSHOES, CRANK HANDLES AND KEEPERS,  
CRANK HANDLE SHAFTS, GEARS AND BUSH-  
ING, TURNING SHAFTS, FIXED AND ADJUSTA-  
BLE BRACES, COUPLINGS AND DRAWBAR

THE MARK CONSISTS OF STANDARD CHAR-  
ACTERS WITHOUT CLAIM TO ANY PARTICULAR  
FONT, STYLE, SIZE, OR COLOR.

SER. NO. 77-265,046, FILED 8-27-2007.

JILL C. ALT, EXAMINING ATTORNEY

**Int. Cls.: 35 and 36**

**Prior U.S. Cls.: 100, 101 and 102**

**United States Patent and Trademark Office**

**Reg. No. 3,503,919**

**Registered Sep. 23, 2008**

**SERVICE MARK  
PRINCIPAL REGISTER**

**LIVEHOBOKEN.COM**

GORILLA MARKETING GROUP, INC. (NEW JERSEY CORPORATION)  
1000 BLOOMFIELD ST.  
HOBOKEN, NJ 07030

FOR: ADVERTISING AND COMMERCIAL INFORMATION SERVICES, VIA THE INTERNET, ADVERTISING VIA ELECTRONIC MEDIA AND SPECIFICALLY THE INTERNET, ADVICE AND INFORMATION ABOUT CUSTOMER SERVICES AND PRODUCT MANAGEMENT AND PRICES ON INTERNET SITES IN CONNECTION WITH PURCHASES MADE OVER THE INTERNET, COMPUTER SERVICES, NAMELY, ADDRESS CHANGE NOTIFICATION SERVICES IN THE NATURE OF POSTING NOTIFICATIONS OF CHANGES OF ADDRESSES FOR BUSINESSES VIA THE INTERNET, DESIGN OF INTERNET ADVERTISING, DISSEMINATION OF ADVERTISING FOR OTHERS VIA THE INTERNET, DISSEMINATION OF ADVERTISING FOR OTHERS VIA AN ON-LINE COMMUNICATIONS NETWORK ON THE INTERNET, FACILITATING THE EXCHANGE OF NEEDED INFORMATION FOR FINANCIAL COMPENSATION VIA THE INTERNET, INFORMATION MANAGEMENT SERVICES, NAMELY, SHIPMENT PROCESSING, PREPARING SHIPPING DOCUMENTS AND INVOICES, TRACKING DOCUMENTS, PACKAGES AND FREIGHT OVER COMPUTER NETWORKS, INTRANETS AND INTERNETS, INFORMATION, ADVISORY AND CONSULTANCY SERVICES RELATING TO BUSINESS AND MANAGEMENT OR BUSINESS ADMINISTRATION, INCLUDING SUCH SERVICES PROVIDED ON LINE OR VIA THE INTERNET, INSURANCE LEAD COLLECTION AND MATCHING SERVICES, NAMELY, MATCHING CONSUMER REQUESTS FOR INSURANCE POLICY

QUOTES COLLECTED OVER THE INTERNET TO PRE-QUALIFIED INSURANCE BROKERS, AGENTS AND AGENCIES INTERESTED IN THOSE REQUESTS, INTERNET ADVERTISING SERVICES, PROVIDING A SEARCHABLE ONLINE ADVERTISING GUIDE FEATURING THE GOODS AND SERVICES OF OTHER ON-LINE VENDORS ON THE INTERNET, PROVIDING AN ON-LINE COMMERCIAL INFORMATION DIRECTORY ON THE INTERNET, PROVIDING AND RENTAL OF ADVERTISING SPACE ON THE INTERNET, PROVIDING BUSINESS INFORMATION, ALSO VIA INTERNET, THE CABLE NETWORK OR OTHER FORMS OF DATA TRANSFER, AND PROVIDING INFORMATION IN THE FIELD OF MARKETING AND ON-LINE MARKETING MEDIA VIA THE INTERNET, IN CLASS 35 (U.S. CLS. 100, 101 AND 102).

FIRST USE 1-16-2007; IN COMMERCE 11-16-2007.

FOR: PROVIDING INFORMATION IN THE FIELD OF REAL ESTATE VIA THE INTERNET AND PROVIDING REAL ESTATE LISTINGS AND REAL ESTATE INFORMATION VIA THE INTERNET, IN CLASS 36 (U.S. CLS. 100, 101 AND 102).

FIRST USE 1-16-2007; IN COMMERCE 11-16-2007.

THE MARK CONSISTS OF STANDARD CHARACTERS WITHOUT CLAIM TO ANY PARTICULAR FONT, STYLE, SIZE, OR COLOR.

SER. NO. 77-265,066, FILED 8-27-2007.

SUSAN STIGLITZ, EXAMINING ATTORNEY



**Int. Cls.: 35 and 36**

**Prior U.S. Cls.: 100, 101 and 102**

**United States Patent and Trademark Office**

**Reg. No. 3,503,920**

**Registered Sep. 23, 2008**

**SERVICE MARK  
PRINCIPAL REGISTER**

**LUCKY CREDIT CARD**

LUCKY CREDIT CARD LLC (NEVADA LIMITED  
LIABILITY COMPANY)  
5084 ISLEWORTH COUNTRY CLUB DRIVE  
WINDEMERE, FL 34786

FOR: (BASED ON USE IN COMMERCE) PRO-  
MOTING THE SALE OF GOODS AND SERVICES OF  
OTHERS BY AWARDED PURCHASE POINTS FOR  
CREDIT CARD USE , IN CLASS 35 (U.S. CLS. 100, 101  
AND 102).

FIRST USE 8-21-2007; IN COMMERCE 8-21-2007.

FOR: (BASED ON USE IN COMMERCE) CREDIT  
CARD SERVICES, IN CLASS 36 (U.S. CLS. 100, 101  
AND 102).

FIRST USE 8-21-2007; IN COMMERCE 8-21-2007.

THE MARK CONSISTS OF STANDARD CHAR-  
ACTERS WITHOUT CLAIM TO ANY PARTICULAR  
FONT, STYLE, SIZE, OR COLOR.

NO CLAIM IS MADE TO THE EXCLUSIVE  
RIGHT TO USE "CREDIT CARD", APART FROM  
THE MARK AS SHOWN.

SER. NO. 77-265,127, FILED 8-27-2007.

JACQUELINE A. LAVINE, EXAMINING ATTOR-  
NEY

Int. Cl.: 16

Prior U.S. Cls.: 2, 5, 22, 23, 29, 37, 38 and 50

United States Patent and Trademark Office

Reg. No. 3,503,921

Registered Sep. 23, 2008

TRADEMARK  
PRINCIPAL REGISTER

MANJARES

CASIANO COMMUNICATIONS, INC. (PUERTO  
RICO CORPORATION)  
1700 FERNANDEZ JUNCOS AVENUE  
SAN JUAN, PUERTO RICO 00909

FOR: MAGAZINE FEATURING GASTRONOMY,  
COOKING AND RECIPES, IN CLASS 16 (U.S. CLS. 2,  
5, 22, 23, 29, 37, 38 AND 50).

FIRST USE 3-0-2006; IN COMMERCE 3-0-2006.

THE MARK CONSISTS OF STANDARD CHAR-  
ACTERS WITHOUT CLAIM TO ANY PARTICULAR  
FONT, STYLE, SIZE, OR COLOR.

THE ENGLISH TRANSLATION OF MANJARES  
IN THE MARK IS "DELICACIES."

SER. NO. 77-265,289, FILED 8-27-2007.

CHARLOTTE CORWIN, EXAMINING ATTORNEY

**Int. Cls.: 9 and 41**

**Prior U.S. Cls.: 21, 23, 26, 36, 38, 100, 101 and 107**

**United States Patent and Trademark Office**

**Reg. No. 3,503,922**

**Registered Sep. 23, 2008**

**TRADEMARK  
SERVICE MARK  
PRINCIPAL REGISTER**

**FURIOUS STYLES**

MARSHALL, STEPHEN V. (UNITED STATES  
INDIVIDUAL)  
P.O. BOX 753242  
MEMPHIS, TN 38175

FOR: DOWNLOADABLE MUSICAL SOUND RE-  
CORDINGS; MUSICAL SOUND RECORDINGS;  
MUSICAL VIDEO RECORDINGS; AUDIO TAPES  
FEATURING MUSIC; PRERECORDED AUDIO  
TAPES FEATURING MUSIC; VIDEO TAPES FEAT-  
URING MUSIC; PRERECORDED VIDEO TAPES  
FEATURING MUSIC; COMPACT DISCS FEATUR-  
ING MUSIC; PHONOGRAPH RECORDS FEATUR-  
ING MUSIC; PRERECORDED VIDEO CASSETTES  
FEATURING MUSIC; PRERECORDED AUDIO  
CASSETTES FEATURING MUSIC; DVDS FEATUR-  
ING MUSIC, IN CLASS 9 (U.S. CLS. 21, 23, 26, 36 AND  
38).

FIRST USE 0-0-1998; IN COMMERCE 8-28-2007.

FOR: ENTERTAINMENT, NAMELY, LIVE PER-  
FORMANCES BY A MUSICAL ARTIST, IN CLASS 41  
(U.S. CLS. 100, 101 AND 107).

FIRST USE 0-0-1998; IN COMMERCE 8-28-2007.

THE MARK CONSISTS OF STANDARD CHAR-  
ACTERS WITHOUT CLAIM TO ANY PARTICULAR  
FONT, STYLE, SIZE, OR COLOR.

SER. NO. 77-265,659, FILED 8-28-2007.

KELLY BOULTON, EXAMINING ATTORNEY

**Int. Cl.: 36**

**Prior U.S. Cls.: 100, 101 and 102**

**United States Patent and Trademark Office**

**Reg. No. 3,503,923**

**Registered Sep. 23, 2008**

**SERVICE MARK  
PRINCIPAL REGISTER**

**DVFG Advisors, LLC**

DVFG ADVISORS, LLC (PENNSYLVANIA LIMITED LIABILITY COMPANY)  
3200 HORIZON DR. SUITE 100  
KING OF PRUSSIA, PA 19406

FOR: FINANCING SERVICES; LIFE INSURANCE BROKERAGE; LIFE INSURANCE UNDERWRITING; ANNUITY UNDERWRITING; INVESTMENT MANAGEMENT OF AND DISTRIBUTION OF ANNUITIES; INVESTMENT MANAGEMENT OF AND DISTRIBUTION OF VARIABLE ANNUITIES; ISSUANCE AND ADMINISTRATION OF ANNUITIES, IN CLASS 36 (U.S. CLS. 100, 101 AND 102).

FIRST USE 12-29-2004; IN COMMERCE 12-29-2004.

THE MARK CONSISTS OF STANDARD CHARACTERS WITHOUT CLAIM TO ANY PARTICULAR FONT, STYLE, SIZE, OR COLOR.

NO CLAIM IS MADE TO THE EXCLUSIVE RIGHT TO USE "ADVISORS, LLC", APART FROM THE MARK AS SHOWN.

SER. NO. 77-265,718, FILED 8-28-2007.

MICHAEL KAZAZIAN, EXAMINING ATTORNEY

**Int. Cl.: 11**

**Prior U.S. Cls.: 13, 21, 23, 31 and 34**

**United States Patent and Trademark Office**

**Reg. No. 3,503,924**

**Registered Sep. 23, 2008**

**TRADEMARK  
PRINCIPAL REGISTER**

**YOUR BODY WILL SAY...  
"THANK YOU"**

SAISEIKO, LLC (GEORGIA LIMITED LIABILITY  
COMPANY)  
SUITE 28  
3731 NORTHCREST ROAD  
DORAVILLE, GA 30340

FOR: SHOWER HEADS AND ENVIRONMENTAL  
CONTROL APPARATUS, NAMELY, WATER PAR-  
TICLE ACTIVATORS FOR USE IN DRINKING  
WATER TREATMENT AND SHOWERS , IN CLASS  
11 (U.S. CLS. 13, 21, 23, 31 AND 34).

FIRST USE 4-1-2007; IN COMMERCE 4-1-2007.

THE MARK CONSISTS OF STANDARD CHAR-  
ACTERS WITHOUT CLAIM TO ANY PARTICULAR  
FONT, STYLE, SIZE, OR COLOR.

SER. NO. 77-265,776, FILED 8-28-2007.

WARREN L. OLANDRIA, EXAMINING ATTOR-  
NEY

**Int. Cls.: 3 and 35**

**Prior U.S. Cls.: 1, 4, 6, 50, 51, 52, 100, 101 and 102**

**United States Patent and Trademark Office**

**Reg. No. 3,503,925**

**Registered Sep. 23, 2008**

**TRADEMARK  
SERVICE MARK  
PRINCIPAL REGISTER**

**INNATE YOU**

NUDE NATURAL SKIN CARE LIMITED (NEW  
ZEALAND COMPANY)  
18 ANDERSON GROVE  
LOWER HUTT, NEW ZEALAND

FOR: SKIN CARE PRODUCTS, NAMELY, SKIN  
LOTIONS AND BODY CREAMS; COSMETICS;  
SOAPS FOR PERSONAL USE, IN CLASS 3 (U.S.  
CLS. 1, 4, 6, 50, 51 AND 52).

FOR: RETAIL STORE SERVICES FEATURING  
SOAPS, PERFUMERY, ESSENTIAL OILS, SKIN  
CARE PRODUCTS, COSMETICS; HAIR LOTIONS  
AND MEDICATED PREPARATIONS, IN CLASS 35  
(U.S. CLS. 100, 101 AND 102).

THE MARK CONSISTS OF STANDARD CHAR-  
ACTERS WITHOUT CLAIM TO ANY PARTICULAR  
FONT, STYLE, SIZE, OR COLOR.

PRIORITY CLAIMED UNDER SEC. 44(D) ON  
NEW ZEALAND APPLICATION NO. 774463, FILED  
8-22-2007, REG. NO. 774463, DATED 8-22-2007, EX-  
PIRES 8-22-2014.

SER. NO. 77-265,870, FILED 8-28-2007.

JOHN DALIER, EXAMINING ATTORNEY

Int. Cl.: 29

Prior U.S. Cl.: 46

United States Patent and Trademark Office

Reg. No. 3,503,926

Registered Sep. 23, 2008

TRADEMARK  
PRINCIPAL REGISTER



SCALA PACKING COMPANY, INC. (ILLINOIS CORPORATION)  
351 W. HURON STREET  
CHICAGO, IL 60610

FOR: CHEESE; VEGETABLE SALADS; PROCESSED PEPPERS; SAUSAGES; BEEF; BEEF PATTIES; PREPARED BEEF; MEATBALLS, IN CLASS 29 (U.S. CL. 46).

FIRST USE 0-0-1949; IN COMMERCE 0-0-1949.

NO CLAIM IS MADE TO THE EXCLUSIVE RIGHT TO USE "PREFERRED", APART FROM THE MARK AS SHOWN.

THE MARK CONSISTS OF THE TERM "SCALA'S" IN FANCIFUL SCRIPT WITH THE WORD "PREFERRED" APPEARING IN BLOCK LETTERS WITHIN A BAND BELOW.

SER. NO. 77-265,928, FILED 8-28-2007.

PAULA MAHONEY, EXAMINING ATTORNEY

**Int. Cl.: 35**

**Prior U.S. Cls.: 100, 101 and 102**

**United States Patent and Trademark Office**

**Reg. No. 3,503,927**

**Registered Sep. 23, 2008**

**SERVICE MARK  
PRINCIPAL REGISTER**

**invenioIP**

UNIVERSITY OF MARYLAND, BALTIMORE  
(MARYLAND STATE AGENCY)  
OFFICE OF RESEARCH AND DEVELOPMENT  
110 SOUTH PACA STREET, 4TH FLOOR  
BALTIMORE, MD 21201

FOR: SEARCHABLE ONLINE DATABASE OF  
LICENSABLE TECHNOLOGIES FROM HIGHER  
EDUCATION INSTITUTIONS, RESEARCH INSTI-  
TUTIONS, COMPANIES, AND OTHER PUBLIC  
AND PRIVATE SECTOR ENTITIES, IN CLASS 35  
(U.S. CLS. 100, 101 AND 102).

FIRST USE 5-7-2007; IN COMMERCE 5-7-2007.

THE MARK CONSISTS OF STANDARD CHAR-  
ACTERS WITHOUT CLAIM TO ANY PARTICULAR  
FONT, STYLE, SIZE, OR COLOR.

THE ENGLISH TRANSLATION OF THE WORD  
"INVENIO" IN THE MARK IS "INVENT".

SER. NO. 77-265,960, FILED 8-28-2007.

WARREN L. OLANDRIA, EXAMINING ATTOR-  
NEY



**Int. Cl.: 7**

**Prior U.S. Cls.: 13, 19, 21, 23, 31, 34 and 35**

**United States Patent and Trademark Office**

**Reg. No. 3,503,928**

**Registered Sep. 23, 2008**

**TRADEMARK  
PRINCIPAL REGISTER**



ILMOR ENGINEERING, INC. (MICHIGAN CORPORATION)  
43939 PLYMOUTH OAKS BOULEVARD  
PLYMOUTH, MI 48170

FOR: MARINE, AIRCRAFT AND INDUSTRIAL  
INTERNAL COMBUSTION ENGINES AND PARTS  
AND FITTINGS THEREFOR, IN CLASS 7 (U.S. CLS.  
13, 19, 21, 23, 31, 34 AND 35).

FIRST USE 2-28-2001; IN COMMERCE 2-28-2001.

THE MARK CONSISTS OF THE STYLIZED LETTERS "I", "L", "M", "O" AND "R".

SER. NO. 77-266,037, FILED 8-28-2007.

VERNA BETH RIRIE, EXAMINING ATTORNEY

**Int. Cl.: 7**

**Prior U.S. Cls.: 13, 19, 21, 23, 31, 34 and 35**

**Reg. No. 3,503,929**

**United States Patent and Trademark Office**

**Registered Sep. 23, 2008**

**TRADEMARK  
PRINCIPAL REGISTER**

**ILMOR**

ILMOR ENGINEERING, INC. (MICHIGAN CORPORATION)  
43939 PLYMOUTH OAKS BOULEVARD  
PLYMOUTH, MI 48170

THE MARK CONSISTS OF STANDARD CHARACTERS WITHOUT CLAIM TO ANY PARTICULAR FONT, STYLE, SIZE, OR COLOR.

FOR: MARINE, AIRCRAFT AND INDUSTRIAL MACHINE INTERNAL COMBUSTION ENGINES AND PARTS AND FITTINGS THEREFOR, IN CLASS 7 (U.S. CLS. 13, 19, 21, 23, 31, 34 AND 35).

SER. NO. 77-266,038, FILED 8-28-2007.

FIRST USE 2-28-2001; IN COMMERCE 2-28-2001.

VERNA BETH RIRIE, EXAMINING ATTORNEY

**Int. Cl.: 27**

**Prior U.S. Cls.: 19, 20, 37, 42 and 50**

**Reg. No. 3,503,930**

**United States Patent and Trademark Office**

**Registered Sep. 23, 2008**

---

**TRADEMARK  
PRINCIPAL REGISTER**

# FORMIS

TO MARKET, LLC (DELAWARE LIMITED LIABILITY COMPANY)  
3844 NW 8TH STREET  
OKLAHOMA CITY, OK 73107

THE MARK CONSISTS OF STANDARD CHARACTERS WITHOUT CLAIM TO ANY PARTICULAR FONT, STYLE, SIZE, OR COLOR.

FOR: SOLID SURFACE FLOOR COVERINGS, IN CLASS 27 (U.S. CLS. 19, 20, 37, 42 AND 50).

SER. NO. 77-266,066, FILED 8-28-2007.

FIRST USE 7-15-2007; IN COMMERCE 7-15-2007.

RENEE SERVANCE, EXAMINING ATTORNEY

**Int. Cl.: 41**

**Prior U.S. Cls.: 100, 101 and 107**

**United States Patent and Trademark Office**

**Reg. No. 3,503,931**

**Registered Sep. 23, 2008**

**SERVICE MARK  
PRINCIPAL REGISTER**



TWIN PEAKS INCORPORATED (CALIFORNIA CORPORATION)  
445 WEST 7TH ST  
SAN PEDRO, CA 90731

FOR: ENTERTAINMENT SERVICES, NAMELY, PROVIDING A WEBSITE FEATURING, PHOTOGRAPHIC, AUDIO, VIDEO AND PROSE PRESENTATIONS FEATURING SPORTS, REALITY-BASED TELEVISION PROGRAMS, CURRENT EVENTS NEWS, DOCUMENTARIES, CHILDREN'S ANIMATED AND NON-ANIMATED TELEVISION PROGRAMS, AND AMBIENT RELAXATION MEDIA IN THE FORM OF VIDEOS FEATURING RELAXING MUSIC AND SOUND EFFECTS, IN CLASS 41 (U.S. CLS. 100, 101 AND 107).

FIRST USE 9-1-2005; IN COMMERCE 9-1-2005.

THE COLOR(S) GRAY, RED AND BLACK IS/ARE CLAIMED AS A FEATURE OF THE MARK.

THE COLOR GRAY APPEARS IN THE WORDING "STABLE", THE COLOR RED APPEARS IN THE WORDING "ROAD", AND THE COLOR BLACK APPEARS IN THE SOLID RECTANGULAR BACKGROUND.

SER. NO. 77-266,655, FILED S.R. 8-28-2007 AM. P.R. 12-5-2007.

ESTHER A. BORSUK, EXAMINING ATTORNEY

**Int. Cl.: 1**

**Prior U.S. Cls.: 1, 5, 6, 10, 26 and 46**

**Reg. No. 3,503,932**

**United States Patent and Trademark Office**

**Registered Sep. 23, 2008**

**TRADEMARK  
PRINCIPAL REGISTER**

# CardioStem

WAJCHMAN, HOWARD (UNITED STATES IN-  
DIVIDUAL)  
5700 LAKE MANOR TRACE  
ALPHARETTA, GA 30022 AND  
BRUBAKER, RICHARD LANCE (UNITED STATES  
INDIVIDUAL)  
5700 LAKE MANOR TRACE  
ALPHARETTA, GA 30022

FIRST USE 5-25-2007; IN COMMERCE 5-25-2007.

THE MARK CONSISTS OF STANDARD CHAR-  
ACTERS WITHOUT CLAIM TO ANY PARTICULAR  
FONT, STYLE, SIZE, OR COLOR.

FOR: BIOLOGICAL TISSUE, NAMELY, BLOOD,  
STEM CELLS, UMBILICAL CORDS AND PLACEN-  
TAS FOR SCIENTIFIC AND MEDICAL RESEARCH  
USE, IN CLASS 1 (U.S. CLS. 1, 5, 6, 10, 26 AND 46).

SER. NO. 77-266,839, FILED 8-29-2007.

ANNE MADDEN, EXAMINING ATTORNEY

**Int. Cl.: 42**

**Prior U.S. Cls.: 100 and 101**

**United States Patent and Trademark Office**

**Reg. No. 3,503,933**

**Registered Sep. 23, 2008**

**SERVICE MARK  
PRINCIPAL REGISTER**

**INTEGRATED CONDITION  
ASSESSMENT SYSTEM**

GENERAL ELECTRIC COMPANY (NEW YORK CORPORATION)  
1 RIVER ROAD  
SCHENECTADY, NY 12345

FOR: ENGINEERING AND COMPUTER PROGRAMMING FOR OTHERS IN THE FIELD OF INTEGRATED CONDITION ASSESSMENT SYSTEMS FOR PLANT OPERATING MACHINERY, IN CLASS 42 (U.S. CLS. 100 AND 101).

FIRST USE 6-27-1994; IN COMMERCE 7-8-1994.

THE MARK CONSISTS OF STANDARD CHARACTERS WITHOUT CLAIM TO ANY PARTICULAR FONT, STYLE, SIZE, OR COLOR.

NO CLAIM IS MADE TO THE EXCLUSIVE RIGHT TO USE "SYSTEM", APART FROM THE MARK AS SHOWN.

SEC. 2(F).

SER. NO. 77-266,886, FILED 8-29-2007.

KATHERINE CHANG, EXAMINING ATTORNEY

**Int. Cl.: 3**

**Prior U.S. Cls.: 1, 4, 6, 50, 51 and 52**

**Reg. No. 3,503,934**

**United States Patent and Trademark Office**

**Registered Sep. 23, 2008**

**TRADEMARK  
PRINCIPAL REGISTER**

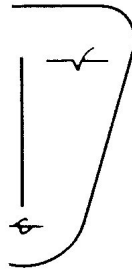

SYDELL, INC. (GEORGIA CORPORATION), DBA  
SPA SYDELL  
4100 PERIMETER PARK SOUTH  
ATLANTA, GA 30341

FOR: BATH CARE PRODUCTS, NAMELY, BATH  
BEADS, BATH OILS, BODY CARE PRODUCTS,  
NAMELY, MASSAGE OILS, CREAMS AND LO-  
TIONS, BATH SOAPS, BATH SALTS, BATH CRYSTALS,  
SKIN CONDITIONERS, SKIN  
EXFOLIATORS, SKIN CLEANERS AND SKIN

MOISTURIZERS, IN CLASS 3 (U.S. CLS. 1, 4, 6, 50,  
51 AND 52).

FIRST USE 10-0-2001; IN COMMERCE 10-0-2001.

OWNER OF U.S. REG. NO. 1,461,410.

SER. NO. 77-266,916, FILED 8-29-2007.

KATHERINE CHANG, EXAMINING ATTORNEY

**Int. Cl.: 16**

**Prior U.S. Cls.: 2, 5, 22, 23, 29, 37, 38 and 50**

**United States Patent and Trademark Office**

**Reg. No. 3,503,935**

**Registered Sep. 23, 2008**

**TRADEMARK  
PRINCIPAL REGISTER**

**THE BARITONIOS**

THE BARITONIOS (ILLINOIS LIMITED LIABILITY COMPANY)  
55 LAURA DRIVE  
ADDISON, IL 60101

THE MARK CONSISTS OF STANDARD CHARACTERS WITHOUT CLAIM TO ANY PARTICULAR FONT, STYLE, SIZE, OR COLOR.

FOR: PRINTED PUBLICATIONS NAMELY, COMIC BOOKS AND MAGAZINES IN THE FIELD OF COMIC BOOKS AND FICTIONAL STORIES, IN CLASS 16 (U.S. CLS. 2, 5, 22, 23, 29, 37, 38 AND 50).

SER. NO. 77-267,054, FILED 8-29-2007.

FIRST USE 11-17-2006; IN COMMERCE 11-17-2006.

JOHN HWANG, EXAMINING ATTORNEY



**Int. Cls.: 37 and 44**

**Prior U.S. Cls.: 100, 101, 103 and 106**

**United States Patent and Trademark Office**

**Reg. No. 3,503,936**

**Registered Sep. 23, 2008**

**SERVICE MARK  
PRINCIPAL REGISTER**



HENRY'S LANDSCAPING LLC (CALIFORNIA  
LIMITED LIABILITY COMPANY)  
28991 LAVATERA AVE.  
MURRIETA, CA 92563

FIRST USE 6-1-1999; IN COMMERCE 5-1-2007.

FOR: LANDSCAPE CONTRACTOR SERVICES, IN  
CLASS 37 (U.S. CLS. 100, 103 AND 106).

NO CLAIM IS MADE TO THE EXCLUSIVE  
RIGHT TO USE "LANDSCAPING LLC", APART  
FROM THE MARK AS SHOWN.

FIRST USE 6-1-1999; IN COMMERCE 5-1-2007.

SER. NO. 77-267,057, FILED 8-29-2007.

FOR: LANDSCAPE GARDENING SERVICES, IN  
CLASS 44 (U.S. CLS. 100 AND 101).

ANNE MADDEN, EXAMINING ATTORNEY

**Int. Cls.: 9, 41 and 42**

**Prior U.S. Cls.: 21, 23, 26, 36, 38, 100, 101 and 107**

**United States Patent and Trademark Office**

**Reg. No. 3,503,937**

**Registered Sep. 23, 2008**

**TRADEMARK  
SERVICE MARK  
PRINCIPAL REGISTER**

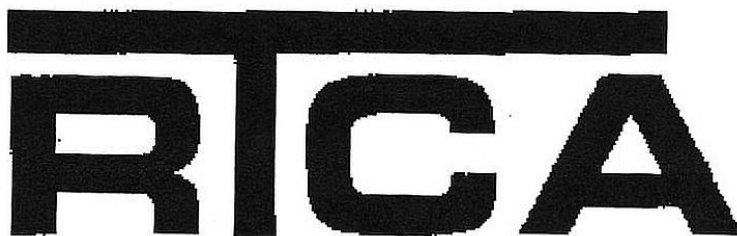
The logo for RTICA consists of the letters 'RTICA' in a bold, black, sans-serif font. A thick horizontal bar is positioned above the letters, extending across the width of the 'R' and 'T'.

RADON TESTING CORPORATION OF AMERICA, INC. (NEW YORK CORPORATION)  
2 HAYES STREET  
ELMSFORD, NY 10523

FOR: RADON DETECTORS; RADON TEST KITS CONSISTING PRIMARILY OF SEALABLE CONTAINERS FOR COLLECTING RADON AND SEALS FOR STOPPING RADON TESTS PACKAGED WITH TEST INFORMATION CARDS AND RETURN MAILERS; RADON MONITORS, IN CLASS 9 (U.S. CLS. 21, 23, 26, 36 AND 38).

FIRST USE 6-0-1986; IN COMMERCE 6-0-1986.

FOR: TRAINING SERVICES IN THE FIELD OF RADON DETECTION, TESTING AND MITIGATION, IN CLASS 41 (U.S. CLS. 100, 101 AND 107).

FIRST USE 4-23-1998; IN COMMERCE 4-23-1998.

FOR: RADON DETECTING; RADON MONITORING; LABORATORY SERVICES, NAMELY, ANALYSIS OF RESULTS OF RADON MEASUREMENT; CALIBRATION OF RADON MONITORS, IN CLASS 42 (U.S. CLS. 100 AND 101).

FIRST USE 6-0-1986; IN COMMERCE 6-0-1986.

SER. NO. 77-267,270, FILED 8-29-2007.

DAVID TOOLEY, EXAMINING ATTORNEY

**Int. Cl.: 30**

**Prior U.S. Cl.: 46**

**Reg. No. 3,503,938**

**United States Patent and Trademark Office**

**Registered Sep. 23, 2008**

---

**TRADEMARK  
PRINCIPAL REGISTER**

**Ah' roma**

RALSTON UNLIMITED NUTS COMPANY (NE-  
BRASKA CORPORATION), DBA AH'ROMA  
SPECIALTY COFFEE  
134 HARWOOD COURT  
LINCOLN, NE 68502

FOR: COFFEE; COFFEE; COFFEE BEANS;  
GROUND COFFEE BEANS; PREPARED COFFEE  
AND COFFEE-BASED BEVERAGES; ROASTED  
COFFEE BEANS, IN CLASS 30 (U.S. CL. 46).

FIRST USE 4-1-1997; IN COMMERCE 4-1-1997.

THE MARK CONSISTS OF STANDARD CHAR-  
ACTERS WITHOUT CLAIM TO ANY PARTICULAR  
FONT, STYLE, SIZE, OR COLOR.

SER. NO. 77-267,369, FILED 8-29-2007.

ANDREW RHIM, EXAMINING ATTORNEY

**Int. Cls.: 35 and 42**

**Prior U.S. Cls.: 100, 101 and 102**

**United States Patent and Trademark Office**

**Reg. No. 3,503,939**

**Registered Sep. 23, 2008**

**SERVICE MARK  
PRINCIPAL REGISTER**



INTECH HEALTH VENTURES (ARIZONA CORPORATION)  
405 E. WETMORE, 117-510  
TUCSON, AZ 85705

FOR: BUSINESS MANAGEMENT AND CONSULTATION ; INTERACTIVE RECORD-KEEPING SERVICES FOR USE IN RISK MANAGEMENT AND REGULATORY COMPLIANCE BY INSURERS AND PROFESSIONALS IN THE MEDICAL FIELD ; MANAGED CARE SERVICES, NAMELY, ELECTRONIC PROCESSING OF HEALTH CARE INFORMATION, IN CLASS 35 (U.S. CLS. 100, 101 AND 102).

FIRST USE 10-15-2006; IN COMMERCE 10-15-2006.

FOR: CONSULTING SERVICES IN THE FIELD OF OFFICE AND WORKPLACE AUTOMATION ; INFORMATION TECHNOLOGY CONSULTATION ; COMPUTER PROGRAMMING IN THE MEDICAL FIELD, IN CLASS 42 (U.S. CLS. 100 AND 101).

FIRST USE 10-15-2006; IN COMMERCE 10-15-2006.

NO CLAIM IS MADE TO THE EXCLUSIVE RIGHT TO USE "HEALTH VENTURES", APART FROM THE MARK AS SHOWN.

THE STIPPLING IS FOR SHADING PURPOSES ONLY.

THE MARK CONSISTS OF THE WORDS "INTECH HEALTH VENTURES" IN LARGE TEXT ON TOP OF THE WORDS "TRANSFORMING HEALTHCARE THROUGH INNOVATIVE TECHNOLOGY" IN SMALLER TEXT. THERE IS A LOGO TO THE LEFT OF THE PRINT THAT IS A SQUARE DIAMOND WITH A STYLIZED "EKG" HEARTBEAT.

SER. NO. 77-267,631, FILED 8-29-2007.

STEVEN PEREZ, EXAMINING ATTORNEY

**Int. Cl.: 35**

**Prior U.S. Cls.: 100, 101 and 102**

**United States Patent and Trademark Office**

**Reg. No. 3,503,940**

**Registered Sep. 23, 2008**

**SERVICE MARK  
PRINCIPAL REGISTER**

# Caretagious

SOMEBODY CARES TAMPA BAY (FLORIDA  
CORPORATION)  
2140 RANGE RD A  
CLEARWATER, FL 33765

FOR: CHARITABLE SERVICES, NAMELY, ORGANIZING YOUTH GROUPS TO UNDERTAKE PROJECTS TO BENEFIT THE NEEDY AND THE COMMUNITY TO ENCOURAGE LEADERSHIP, CHARACTER, COMPASSION, AND GOOD CITIZENSHIP, IN CLASS 35 (U.S. CLS. 100, 101 AND 102).

FIRST USE 12-1-2007; IN COMMERCE 12-1-2007.

THE MARK CONSISTS OF STANDARD CHARACTERS WITHOUT CLAIM TO ANY PARTICULAR FONT, STYLE, SIZE, OR COLOR.

SER. NO. 77-267,968, FILED 8-30-2007.

PAM WILLIS, EXAMINING ATTORNEY

**Int. Cl.: 43**

**Prior U.S. Cls.: 100 and 101**

**United States Patent and Trademark Office**

**Reg. No. 3,503,941**

**Registered Sep. 23, 2008**

**SERVICE MARK  
PRINCIPAL REGISTER**

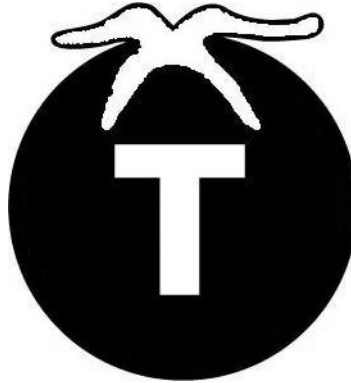

TOMASO'S HOLDING COMPANY, INC. (IOWA CORPORATION)  
1061 NORTH CENTER POINT ROAD  
HIAWATHA, IA 52233

THE MARK CONSISTS OF CAPITAL T WITHIN A TOMATO.

FOR: RESTAURANT SERVICES; CARRY-OUT RESTAURANT SERVICES, IN CLASS 43 (U.S. CLS. 100 AND 101).

SER. NO. 77-268,032, FILED 8-30-2007.

FIRST USE 10-1-1996; IN COMMERCE 10-1-1996.

MICHAEL SOUDERS, EXAMINING ATTORNEY

**Int. Cl.: 44**

**Prior U.S. Cls.: 100 and 101**

**United States Patent and Trademark Office**

**Reg. No. 3,503,942**

**Registered Sep. 23, 2008**

**SERVICE MARK  
PRINCIPAL REGISTER**

**BRAVEHEARTS**

BRAVEHEARTS THERAPEUTIC RIDING AND  
EDUCATIONAL CENTER (ILLINOIS COR-  
PORATION)  
3011 SUNNYSIDE AVENUE  
BROOKFIELD, IL 60513

FOR: PHYSICAL ACTIVITY BASED THERAPY  
FOR PSYCHOLOGICAL, COGNITIVE AND MEN-  
TAL HEALTH PURPOSES, IN CLASS 44 (U.S. CLS.  
100 AND 101).

FIRST USE 8-21-2002; IN COMMERCE 8-21-2002.

THE MARK CONSISTS OF STANDARD CHAR-  
ACTERS WITHOUT CLAIM TO ANY PARTICULAR  
FONT, STYLE, SIZE, OR COLOR.

SER. NO. 77-268,617, FILED 8-30-2007.

MAUREEN DALL, EXAMINING ATTORNEY

**Int. Cl.: 30**

**Prior U.S. Cl.: 46**

**United States Patent and Trademark Office**

**Reg. No. 3,503,943**

**Registered Sep. 23, 2008**

**TRADEMARK  
PRINCIPAL REGISTER**

**SWEET CHRISTINE'S**

SWEET CHRISTINE'S LLC (PENNSYLVANIA  
LIMITED LIABILITY COMPANY)  
417 RED CLAY DRIVE  
KENNETT SQUARE, PA 19348

FOR: BAKERY GOODS, COOKIES, BROWNIES,  
BISCOTTI AND GLUTEN-FREE SWEETS, IN CLASS  
30 (U.S. CL. 46).

FIRST USE 10-31-2005; IN COMMERCE 10-31-2005.

THE MARK CONSISTS OF STANDARD CHAR-  
ACTERS WITHOUT CLAIM TO ANY PARTICULAR  
FONT, STYLE, SIZE, OR COLOR.

NO CLAIM IS MADE TO THE EXCLUSIVE  
RIGHT TO USE "SWEET", APART FROM THE  
MARK AS SHOWN.

THE NAME "CHRISTINE" IDENTIFIES A LIVING  
INDIVIDUAL WHOSE CONSENT IS OF RECORD.

SER. NO. 77-269,757, FILED 8-31-2007.

MAUREEN DALL, EXAMINING ATTORNEY



**Int. Cl.: 35**

**Prior U.S. Cls.: 100, 101 and 102**

**United States Patent and Trademark Office**

**Reg. No. 3,503,944**

**Registered Sep. 23, 2008**

**SERVICE MARK  
PRINCIPAL REGISTER**

GLOBAL HEALTHCARE RESOURCES

LIGHT, DENNIS S. (UNITED STATES INDIVIDUAL)  
11715 BOWMAN GREEN DR., STE. 200  
RESTON, VA 20190

FOR: PERSONNEL PLACEMENT AND RECRUITMENT, IN CLASS 35 (U.S. CLS. 100, 101 AND 102).

FIRST USE 3-29-2001; IN COMMERCE 5-18-2001.

THE MARK CONSISTS OF STANDARD CHARACTERS WITHOUT CLAIM TO ANY PARTICULAR FONT, STYLE, SIZE, OR COLOR.

SEC. 2(F).

SER. NO. 77-269,824, FILED 8-31-2007.

KATINA MISTER, EXAMINING ATTORNEY

**Int. Cl.: 41**

**Prior U.S. Cls.: 100, 101 and 107**

**United States Patent and Trademark Office**

**Reg. No. 3,503,945**

**Registered Sep. 23, 2008**

**SERVICE MARK  
PRINCIPAL REGISTER**

**GREEN ROCKS**

E TOWN (COLORADO NON-PROFIT CORPORATION)  
207 CANYON, SUITE 302  
BOULDER, CO 80302

FOR: ENTERTAINMENT IN THE NATURE OF  
LIVE MUSIC CONCERTS, IN CLASS 41 (U.S. CLS.  
100, 101 AND 107).

FIRST USE 6-30-2007; IN COMMERCE 6-30-2007.

THE MARK CONSISTS OF STANDARD CHARACTERS WITHOUT CLAIM TO ANY PARTICULAR FONT, STYLE, SIZE, OR COLOR.

SER. NO. 77-269,944, FILED 8-31-2007.

KEVIN CORWIN, EXAMINING ATTORNEY

**Int. Cl.: 9**

**Prior U.S. Cls.: 21, 23, 26, 36 and 38**

**United States Patent and Trademark Office**

**Reg. No. 3,503,946**

**Registered Sep. 23, 2008**

**TRADEMARK  
PRINCIPAL REGISTER**

**Don't Waste Another Minute!**

DREWS, TOM J (UNITED STATES INDIVIDUAL)  
1885 GREEN STREET  
SAN FRANCISCO, CA 94123

FOR: PRE-RECORDED COMPACT DISCS, DIGITAL VIDEO DISCS, MULTIMEDIA FILES, DOWNLOADABLE AUDIO AND AUDIOVISUAL FILES, NAMELY, MP3, WAM, WAV, RM AND WMV FILES, ALL FEATURING VALUABLE INFORMATION ON THE TOPICS OF BUSINESS, LEADERSHIP, SALES, TRAINING, PERSONAL GROWTH AND DEVELOPMENT, MOTIVATION, SUCCESS, HEALTH AND WELLNESS, TIME MANAGEMENT, PERSONAL PRODUCTIVITY, EFFICIENT WORK HABITS, PLANNING AND ORGANIZATIONAL TECHNIQUES, STRESS RELIEF, RELATIONSHIPS, EDUCA-

TION, PHILOSOPHY AND PSYCHOLOGY; COMPUTER SOFTWARE PROGRAMS PROVIDING INFORMATION AND GUIDANCE IN TIME MANAGEMENT, SCHEDULING, AND PERSONAL AND BUSINESS PRODUCTIVITY, IN CLASS 9 (U.S. CLS. 21, 23, 26, 36 AND 38).

FIRST USE 9-25-2005; IN COMMERCE 4-20-2007.

THE MARK CONSISTS OF STANDARD CHARACTERS WITHOUT CLAIM TO ANY PARTICULAR FONT, STYLE, SIZE, OR COLOR.

SER. NO. 77-270,487, FILED 9-3-2007.

WENDY GOODMAN, EXAMINING ATTORNEY

**Int. Cl.: 16**

**Prior U.S. Cls.: 2, 5, 22, 23, 29, 37, 38 and 50**

**United States Patent and Trademark Office**

**Reg. No. 3,503,947**

**Registered Sep. 23, 2008**

**TRADEMARK  
PRINCIPAL REGISTER**

**Don't Waste Another Minute!**

DREWS, TOM J (UNITED STATES INDIVIDUAL)  
1885 GREEN STREET  
SAN FRANCISCO, CA 94123

FOR: PUBLICATIONS, NAMELY, BOOKS, BROCHURES, WORKBOOKS, NEWSLETTERS, PAPER BOOKMARKS, POSTERS, PRINTED SEMINAR COURSE MATERIALS AND PAMPHLETS IN THE FIELD OF PERSONAL GROWTH, BUSINESS SKILLS, TIME MANAGEMENT, PERSONAL PRODUCTIVITY, PLANNING AND ORGANIZATIONAL TECHNIQUES, EFFICIENT WORK HABITS, SALES, PRESENTATION SKILLS, NEGOTIATION SKILLS,

STRESS RELIEF, CAREER DEVELOPMENT AND DECISION MAKING, IN CLASS 16 (U.S. CLS. 2, 5, 22, 23, 29, 37, 38 AND 50).

FIRST USE 9-25-2005; IN COMMERCE 4-20-2007.

THE MARK CONSISTS OF STANDARD CHARACTERS WITHOUT CLAIM TO ANY PARTICULAR FONT, STYLE, SIZE, OR COLOR.

SER. NO. 77-270,490, FILED 9-3-2007.

WENDY GOODMAN, EXAMINING ATTORNEY

**Int. Cls.: 29 and 30**

**Prior U.S. Cl.: 46**

**United States Patent and Trademark Office**

**Reg. No. 3,503,948**

**Registered Sep. 23, 2008**

**TRADEMARK  
PRINCIPAL REGISTER**

**Bombay Bakery Baked  
Delights**

INDIA'S FINEST, LTD. (CALIFORNIA CORPORATION)  
2733 MCCONE AVE  
HAYWARD, CA 94545

FOR: SOY-BASED SNACK FOODS; SOY CHIPS; POTATO-BASED SNACK FOODS; PUFFED SOY SNACKS; POTATO CHIPS, IN CLASS 29 (U.S. CL. 46).

FIRST USE 8-13-2004; IN COMMERCE 8-13-2004.

FOR: GRAIN-BASED SNACK FOODS, NAMELY, ROASTED WHEAT SNACKS, RICE-BASED SNACK FOODS; MULTI GRAIN BASED SNACK FOODS, CORN-BASED SNACK FOODS; FLOUR-BASED CHIPS; EDIBLE WAFERS; COOKIES AND CRACKERS, IN CLASS 30 (U.S. CL. 46).

FIRST USE 8-13-2004; IN COMMERCE 8-13-2004.

THE MARK CONSISTS OF STANDARD CHARACTERS WITHOUT CLAIM TO ANY PARTICULAR FONT, STYLE, SIZE, OR COLOR.

NO CLAIM IS MADE TO THE EXCLUSIVE RIGHT TO USE "BOMBAY BAKERY BAKED", APART FROM THE MARK AS SHOWN.

SER. NO. 77-270,512, FILED 9-4-2007.

INGA ERVIN, EXAMINING ATTORNEY

**Int. Cl.: 41**

**Prior U.S. Cls.: 100, 101 and 107**

**United States Patent and Trademark Office**

**Reg. No. 3,503,949**

**Registered Sep. 23, 2008**

**SERVICE MARK  
PRINCIPAL REGISTER**

# SANDS EXPO

LAS VEGAS SANDS CORP. (NEVADA CORPORATION)  
3355 LAS VEGAS BOULEVARD SOUTH  
LAS VEGAS, NV 89109

FOR: ENTERTAINMENT SERVICES IN THE NATURE OF THEATER PRODUCTIONS AND BOXING CONTESTS; ART EXHIBITION AND MUSEUM SERVICES; ARRANGING OF SEMINARS AND CONFERENCES; RENTAL OF AUDIO-VISUAL EQUIPMENT; RENTAL OF PORTABLE STAGES; PREPARATION OF SPECIAL EFFECTS FOR TRADE SHOW BOOTHS AND EXHIBITIONS; ENTERTAINMENT NAMELY, LIGHTING PRODUCTION, IN CLASS 41 (U.S. CLS. 100, 101 AND 107).

FIRST USE 9-4-2007; IN COMMERCE 9-4-2007.

THE MARK CONSISTS OF STANDARD CHARACTERS WITHOUT CLAIM TO ANY PARTICULAR FONT, STYLE, SIZE, OR COLOR.

OWNER OF U.S. REG. NO. 1,209,102.

NO CLAIM IS MADE TO THE EXCLUSIVE RIGHT TO USE "EXPO", APART FROM THE MARK AS SHOWN.

SER. NO. 77-270,584, FILED 9-4-2007.

PATRICIA EVANKO, EXAMINING ATTORNEY

**Int. Cl.: 43**

**Prior U.S. Cls.: 100 and 101**

**United States Patent and Trademark Office**

**Reg. No. 3,503,950**

**Registered Sep. 23, 2008**

**SERVICE MARK  
PRINCIPAL REGISTER**

# SANDS EXPO

LAS VEGAS SANDS CORP. (NEVADA CORPORATION)  
3355 LAS VEGAS BOULEVARD SOUTH  
LAS VEGAS, NV 89109

FOR: ARENA SERVICES, NAMELY, PROVIDING FACILITIES FOR SPORTS, CONCERTS, CONVENTIONS AND EXHIBITIONS; PROVISION OF CONFERENCE, EXHIBITION AND MEETING FACILITIES; PROVIDING CONVENTION FACILITIES; PROVIDING FACILITIES FOR EXHIBITIONS; CATERING SERVICES, IN CLASS 43 (U.S. CLS. 100 AND 101).

FIRST USE 9-4-2007; IN COMMERCE 9-4-2007.

THE MARK CONSISTS OF STANDARD CHARACTERS WITHOUT CLAIM TO ANY PARTICULAR FONT, STYLE, SIZE, OR COLOR.

OWNER OF U.S. REG. NO. 1,209,102.

NO CLAIM IS MADE TO THE EXCLUSIVE RIGHT TO USE "EXPO", APART FROM THE MARK AS SHOWN.

SER. NO. 77-270,586, FILED 9-4-2007.

PATRICIA EVANKO, EXAMINING ATTORNEY

**Int. Cl.: 42**

**Prior U.S. Cls.: 100 and 101**

**United States Patent and Trademark Office**

**Reg. No. 3,503,951**

**Registered Sep. 23, 2008**

**SERVICE MARK  
PRINCIPAL REGISTER**

**SANDS EXPO**

LAS VEGAS SANDS CORP. (NEVADA CORPORATION)  
3355 LAS VEGAS BOULEVARD SOUTH  
LAS VEGAS, NV 89109

FOR: RENTAL OF COMPUTERS AND SOFTWARE; DECORATION SERVICES FOR TRADE SHOW BOOTHS AND EXHIBITIONS, NAMELY, INTERIOR DECORATION OF TRADE SHOW BOOTHS AND EXHIBITION SPACES, IN CLASS 42 (U.S. CLS. 100 AND 101).

FIRST USE 9-4-2007; IN COMMERCE 9-4-2007.

THE MARK CONSISTS OF STANDARD CHARACTERS WITHOUT CLAIM TO ANY PARTICULAR FONT, STYLE, SIZE, OR COLOR.

OWNER OF U.S. REG. NO. 1,209,102.

NO CLAIM IS MADE TO THE EXCLUSIVE RIGHT TO USE "EXPO", APART FROM THE MARK AS SHOWN.

SER. NO. 77-270,589, FILED 9-4-2007.

PATRICIA EVANKO, EXAMINING ATTORNEY



**Int. Cl.: 35**

**Prior U.S. Cls.: 100, 101 and 102**

**United States Patent and Trademark Office**

**Reg. No. 3,503,952**

**Registered Sep. 23, 2008**

**SERVICE MARK  
PRINCIPAL REGISTER**

# SANDS EXPO

LAS VEGAS SANDS CORP. (NEVADA CORPORATION)  
3355 LAS VEGAS BOULEVARD SOUTH  
LAS VEGAS, NV 89109

FOR: PROVIDING AND RENTAL OF EXHIBITION STANDS AND BOOTHS INCLUDING RESPECTIVE EQUIPMENT; ORGANIZING EXHIBITIONS FOR COMMERCIAL OR ADVERTISING PURPOSES; PLANNING AND CONDUCTING OF TRADE FAIRS, EXHIBITIONS AND PRESENTATIONS FOR ECONOMIC OR ADVERTISING PURPOSES; CONSULTATION RELATING TO TRADE FAIRS; RENTAL OF ADVERTISING SPACE; RENTAL OF OFFICE MACHINERY AND EQUIPMENT, IN CLASS 35 (U.S. CLS. 100, 101 AND 102).

FIRST USE 9-4-2007; IN COMMERCE 9-4-2007.

THE MARK CONSISTS OF STANDARD CHARACTERS WITHOUT CLAIM TO ANY PARTICULAR FONT, STYLE, SIZE, OR COLOR.

OWNER OF U.S. REG. NO. 1,209,102.

NO CLAIM IS MADE TO THE EXCLUSIVE RIGHT TO USE "EXPO", APART FROM THE MARK AS SHOWN.

SER. NO. 77-270,601, FILED 9-4-2007.

PATRICIA EVANKO, EXAMINING ATTORNEY

**Prior U.S. Cl.: B**

**United States Patent and Trademark Office**

**Reg. No. 3,503,953**

**Registered Sep. 23, 2008**

**CERTIFICATION MARK  
PRINCIPAL REGISTER**

**CALT**

INTERNATIONAL ASSOCIATION OF LIGHTING  
MANAGEMENT COMPANIES (IOWA NON-  
PROFIT CORPORATION)  
100 EAST GRAND AVENUE, SUITE 330  
DES MOINES, IA 50309

FOR: TECHNICAL OR CONSULTING SERVICES  
IN THE LIGHTING INDUSTRY, IN CLASS B (U.S.  
CL. B).

FIRST USE 7-0-1996; IN COMMERCE 7-0-1996.

THE MARK CONSISTS OF STANDARD CHAR-  
ACTERS WITHOUT CLAIM TO ANY PARTICULAR  
FONT, STYLE, SIZE, OR COLOR.

THIS CERTIFICATION MARK AS, USED BY  
AUTHORIZED PERSONS, CERTIFIES THAT THE  
LIGHTING TECHNICIAN OR CONSULTANT  
MEETS THE PERSONS AUTHORIZED BY THE  
CERTIFIER, CERTIFIES THAT SERVICES PROVI-  
DED HAVE BEEN PERFORMED BY A LIGHTING  
TECHNICIAN OR CONSULTANT WHO MEETS  
THE CERTIFIER'S SET OF DEVELOPED STAN-  
DARDS OR GOOD PRACTICES.

SER. NO. 77-270,652, FILED 9-4-2007.

HEATHER THOMPSON, EXAMINING ATTORNEY

**Int. Cl.: 25**

**Prior U.S. Cls.: 22 and 39**

**United States Patent and Trademark Office**

**Reg. No. 3,503,954**

**Registered Sep. 23, 2008**

**TRADEMARK  
PRINCIPAL REGISTER**

**DE NOVO DAHL**

DE NOVO DAHL, LLC (TENNESSEE LIMITED  
LIABILITY COMPANY)  
1019 HORSESHOE DRIVE  
NASHVILLE, TN 37216

THE FOREIGN WORDING IN THE MARK  
TRANSLATES INTO ENGLISH AS "THE NEW  
DAHL".

FOR: SHIRTS, IN CLASS 25 (U.S. CLS. 22 AND 39).

FIRST USE 6-15-2003; IN COMMERCE 6-15-2003.

SER. NO. 77-270,671, FILED 9-4-2007.

THE MARK CONSISTS OF STANDARD CHAR-  
ACTERS WITHOUT CLAIM TO ANY PARTICULAR  
FONT, STYLE, SIZE, OR COLOR.

KEVIN CORWIN, EXAMINING ATTORNEY

**Prior U.S. Cl.: B**

**United States Patent and Trademark Office**

**Reg. No. 3,503,955**

**Registered Sep. 23, 2008**

**CERTIFICATION MARK  
PRINCIPAL REGISTER**

**CLMC**

INTERNATIONAL ASSOCIATION OF LIGHTING  
MANAGEMENT COMPANIES (IOWA NON-  
PROFIT CORPORATION)  
100 EAST GRAND AVENUE, SUITE 330  
DES MOINES, IA 50309

FOR: TECHNICAL OR CONSULTING SERVICES  
IN THE LIGHTING INDUSTRY, IN CLASS B (U.S.  
CL. B).

FIRST USE 12-0-1987; IN COMMERCE 12-0-1987.

THE MARK CONSISTS OF STANDARD CHAR-  
ACTERS WITHOUT CLAIM TO ANY PARTICULAR  
FONT, STYLE, SIZE, OR COLOR.

THIS CERTIFICATION MARK, AS USED BY  
AUTHORIZED PERSONS, CERTIFIES THAT THE  
LIGHTING TECHNICIAN OR CONSULTANT  
MEETS THE PERSONS AUTHORIZED BY THE  
CERTIFIER, CERTIFIES THAT SERVICES PROVI-  
DED HAVE BEEN PERFORMED BY A LIGHTING  
TECHNICIAN OR CONSULTANT WHO MEETS  
THE CERTIFIER'S SET OF DEVELOPED STAN-  
DARDS OR GOOD PRACTICES.

SER. NO. 77-270,685, FILED 9-4-2007.

HEATHER THOMPSON, EXAMINING ATTORNEY

**Int. Cl.: 41**

**Prior U.S. Cls.: 100, 101 and 107**

**United States Patent and Trademark Office**

**Reg. No. 3,503,956**

**Registered Sep. 23, 2008**

**SERVICE MARK  
PRINCIPAL REGISTER**

**DE NOVO DAHL**

DE NOVO DAHL, LLC (TENNESSEE LIMITED  
LIABILITY COMPANY)  
1019 HORSESHOE DRIVE  
NASHVILLE, TN 37216

FOR: ENTERTAINMENT IN THE NATURE OF  
LIVE PERFORMANCES BY A MUSICAL GROUP, IN  
CLASS 41 (U.S. CLS. 100, 101 AND 107).

FIRST USE 4-19-2002; IN COMMERCE 4-19-2002.

THE MARK CONSISTS OF STANDARD CHAR-  
ACTERS WITHOUT CLAIM TO ANY PARTICULAR  
FONT, STYLE, SIZE, OR COLOR.

THE FOREIGN WORDING IN THE MARK  
TRANSLATES INTO ENGLISH AS "THE NEW  
DAHL".

SER. NO. 77-270,690, FILED 9-4-2007.

KEVIN CORWIN, EXAMINING ATTORNEY

**Int. Cl.: 41**

**Prior U.S. Cls.: 100, 101 and 107**

**United States Patent and Trademark Office**

**Reg. No. 3,503,957**

**Registered Sep. 23, 2008**

**SERVICE MARK  
PRINCIPAL REGISTER**

**QUICK ACTION DEPLOYMENT**

NORTH AMERICAN S.W.A.T. TRAINING ASSO-  
CIATION, LTD. (OHIO LIMITED LIABILITY  
COMPANY)  
55 WEST STAFFORD AVENUE  
WORTHINGTON, OH 43085

FOR: INSTRUCTION IN THE FIELD OF SPECIAL  
WEAPONS AND TACTICS TRAINING, IN CLASS 41  
(U.S. CLS. 100, 101 AND 107).

FIRST USE 11-30-1999; IN COMMERCE 11-30-1999.

THE MARK CONSISTS OF STANDARD CHAR-  
ACTERS WITHOUT CLAIM TO ANY PARTICULAR  
FONT, STYLE, SIZE, OR COLOR.

SEC. 2(F).

SER. NO. 77-270,715, FILED 9-4-2007.

MARK T. MULLEN, EXAMINING ATTORNEY

**Prior U.S. Cl.: B**

**United States Patent and Trademark Office**

**Reg. No. 3,503,958**

**Registered Sep. 23, 2008**

**CERTIFICATION MARK  
PRINCIPAL REGISTER**

**CSLT**

INTERNATIONAL ASSOCIATION OF LIGHTING  
MANAGEMENT COMPANIES (IOWA NON-  
PROFIT CORPORATION)  
100 EAST GRAND AVENUE, SUITE 330  
DES MOINES, IA 50309

FOR: TECHNICAL OR CONSULTING SERVICES  
IN THE LIGHTING INDUSTRY, IN CLASS B (U.S.  
CL. B).

FIRST USE 7-0-1997; IN COMMERCE 7-0-1997.

THE MARK CONSISTS OF STANDARD CHAR-  
ACTERS WITHOUT CLAIM TO ANY PARTICULAR  
FONT, STYLE, SIZE, OR COLOR.

THIS CERTIFICATION MARK, AS USED BY  
AUTHORIZED PERSONS, CERTIFIES THAT THE  
LIGHTING TECHNICIAN OR CONSULTANT  
MEETS THE PERSONS AUTHORIZED BY THE  
CERTIFIER, CERTIFIES THAT THE SERVICES  
PROVIDED HAVE BEEN PERFORMED BY A  
LIGHTING TECHNICIAN OR CONSULTANT WHO  
MEETS THE CERTIFIER'S SET OF DEVELOPED  
STANDARDS OR GOOD PRACTICES.

SER. NO. 77-270,735, FILED 9-4-2007.

HEATHER THOMPSON, EXAMINING ATTORNEY

**Int. Cl.: 42**

**Prior U.S. Cls.: 100 and 101**

**United States Patent and Trademark Office**

**Reg. No. 3,503,959**

**Registered Sep. 23, 2008**

**SERVICE MARK  
PRINCIPAL REGISTER**

**FIRE**

BECOME, INC. (DELAWARE CORPORATION)  
1300 CRITTENDEN LANE  
SUITE 403  
MOUNTAIN VIEW, CA 94043

FIRST USE 10-0-2007; IN COMMERCE 10-0-2007.

FOR: COMPUTER SERVICES, NAMELY, CREATING CUSTOMIZED WEB PAGES OF INFORMATION, SITES AND OTHER RESOURCES AVAILABLE ON COMPUTER NETWORKS, BASED ON PERCEIVED IMPORTANCE OR RELEVANCE TO THE USER, IN CLASS 42 (U.S. CLS. 100 AND 101).

THE MARK CONSISTS OF STANDARD CHARACTERS WITHOUT CLAIM TO ANY PARTICULAR FONT, STYLE, SIZE, OR COLOR.

SER. NO. 77-270,887, FILED 9-4-2007.

RICHARD A. STRASER, EXAMINING ATTORNEY



**Int. Cl.: 41**

**Prior U.S. Cls.: 100, 101 and 107**

**United States Patent and Trademark Office**

**Reg. No. 3,503,960**

**Registered Sep. 23, 2008**

**SERVICE MARK  
PRINCIPAL REGISTER**

**WHAT YOU WANT MATTERS**

PEOPLE BUILDERS, INC. (ILLINOIS CORPORATION)  
PO BOX 515  
LAKE GENEVA, WI 53147

FOR: EDUCATIONAL SERVICES, NAMELY, CONDUCTING COACHING, TRAINING, SEMINARS, RETREATS, AND WORKSHOPS IN THE FIELDS OF LEADERSHIP, PERSONAL EMPOWERMENT, PERSONAL PRODUCTIVITY, DECISION MAKING AND THE COACHING OF OTHERS, AND CONSULTING IN CONNECTION WITH EDUCATIONAL SERVICES IN THE FIELDS OF LEADERSHIP, PERSONAL EMPOWERMENT, PERSONAL PRODUCTIVITY, DECISION MAKING

AND THE COACHING OF OTHERS; CONSULTING REGARDING COACHING OF OTHERS, IN CLASS 41 (U.S. CLS. 100, 101 AND 107).

FIRST USE 9-0-2004; IN COMMERCE 1-0-2005.

THE MARK CONSISTS OF STANDARD CHARACTERS WITHOUT CLAIM TO ANY PARTICULAR FONT, STYLE, SIZE, OR COLOR.

SER. NO. 77-270,901, FILED 9-4-2007.

SUE LAWRENCE, EXAMINING ATTORNEY

**Int. Cl.: 9**

**Prior U.S. Cls.: 21, 23, 26, 36 and 38**

**Reg. No. 3,503,961**

**United States Patent and Trademark Office**

**Registered Sep. 23, 2008**

**TRADEMARK  
PRINCIPAL REGISTER**

**QUADCOOL**

AUGMENTIX CORPORATION (TEXAS CORPORATION)  
4616 HOWARD LANE, SUITE 150  
AUSTIN, TX 78728

FOR: A THERMAL MANAGEMENT SYSTEM, NAMELY, VARIABLE SPEED BLOWER AND HIGH EFFICIENCY HEAT DISSIPATION MODULES, AS PART OF AN INTEGRAL COMPONENT OF COMPUTER HARDWARE, IN CLASS 9 (U.S. CLS. 21, 23, 26, 36 AND 38).

FIRST USE 8-31-2007; IN COMMERCE 8-31-2007.

THE MARK CONSISTS OF STANDARD CHARACTERS WITHOUT CLAIM TO ANY PARTICULAR FONT, STYLE, SIZE, OR COLOR.

SER. NO. 77-270,907, FILED 9-4-2007.

LOURDES AYALA, EXAMINING ATTORNEY

**Int. Cl.: 9**

**Prior U.S. Cls.: 21, 23, 26, 36 and 38**

**Reg. No. 3,503,962**

**United States Patent and Trademark Office**

**Registered Sep. 23, 2008**

**TRADEMARK  
PRINCIPAL REGISTER**

**BROWSER DEFENDER**

PC TOOLS TECHNOLOGY PTY LTD (AUSTRALIA COMPANY)  
LEVEL 6  
620 BOURKE STREET  
MELBOURNE, AUSTRALIA 3000

PRIORITY CLAIMED UNDER SEC. 44(D) ON AUSTRALIA APPLICATION NO. 1165635, FILED 3-13-2007, REG. NO. 1165635, DATED 3-13-2007, EXPIRES 3-13-2017.

FOR: COMPUTER SOFTWARE AND DOWNLOADABLE COMPUTER SOFTWARE FOR THE DETECTION, BLOCKING, FILTERING OR REMOVAL OF VIRUSES, SPYWARE, MALWARE AND OTHER MALICIOUS SOFTWARE; ELECTRONIC USER MANUALS SUPPLIED WITH ALL THE FOREGOING, IN CLASS 9 (U.S. CLS. 21, 23, 26, 36 AND 38).

NO CLAIM IS MADE TO THE EXCLUSIVE RIGHT TO USE "BROWSER", APART FROM THE MARK AS SHOWN.

SER. NO. 77-270,970, FILED 9-4-2007.

THE MARK CONSISTS OF STANDARD CHARACTERS WITHOUT CLAIM TO ANY PARTICULAR FONT, STYLE, SIZE, OR COLOR.

TINA KUAN, EXAMINING ATTORNEY

**Int. Cl.: 16**

**Prior U.S. Cls.: 2, 5, 22, 23, 29, 37, 38 and 50**

**United States Patent and Trademark Office**

**Reg. No. 3,503,963**

**Registered Sep. 23, 2008**

**TRADEMARK  
PRINCIPAL REGISTER**

**DIABETIC LIVING**

MEREDITH CORPORATION (IOWA CORPORATION)

1716 LOCUST STREET

DES MOINES, IA 503093023

FOR: PRINTED PUBLICATIONS, NAMELY, A SERIES OF COOKBOOKS CONTAINING INFORMATION AND RECIPES DESIGNED FOR CONSUMERS WITH DIABETES, IN CLASS 16 (U.S. CLS. 2, 5, 22, 23, 29, 37, 38 AND 50).

FIRST USE 9-6-2005; IN COMMERCE 9-6-2005.

THE MARK CONSISTS OF STANDARD CHARACTERS WITHOUT CLAIM TO ANY PARTICULAR FONT, STYLE, SIZE, OR COLOR.

OWNER OF U.S. REG. NOS. 2,956,266 AND 3,172,706.

NO CLAIM IS MADE TO THE EXCLUSIVE RIGHT TO USE "DIABETIC", APART FROM THE MARK AS SHOWN.

SER. NO. 77-271,342, FILED 9-4-2007.

ELLEN B. AWRICH, EXAMINING ATTORNEY

**Int. Cl.: 30**

**Prior U.S. Cl.: 46**

**United States Patent and Trademark Office**

**Reg. No. 3,503,964**

**Registered Sep. 23, 2008**

**TRADEMARK  
PRINCIPAL REGISTER**

**SWEETHEART BOUQUET**

EDIBLE ARRANGEMENTS, LLC (CONNECTI-  
CUT LIMITED LIABILITY COMPANY)  
95 BARNES ROAD  
WALLINGFORD, CT 064921800

FOR: FRESH FRUIT CUT INTO FLOWER  
SHAPES AND COATED WITH CHOCOLATE;  
FRESH FRUIT CUT INTO FLOWER SHAPES AND  
COATED WITH CHOCOLATE AND ARRANGED IN  
CONTAINERS AS FLORAL DESIGNS; PROCESSED  
FRUITS COATED WITH CHOCOLATE; ARRANGE-  
MENTS MADE OF FRESH PROCESSED FRUIT  
COATED WITH CHOCOLATE, IN CLASS 30 (U.S.  
CL. 46).

FIRST USE 4-30-2002; IN COMMERCE 4-30-2002.

THE MARK CONSISTS OF STANDARD CHAR-  
ACTERS WITHOUT CLAIM TO ANY PARTICULAR  
FONT, STYLE, SIZE, OR COLOR.

SEC. 2(F) AS TO "BOUQUET".

SER. NO. 77-271,455, FILED 9-4-2007.

LINDA M. KING, EXAMINING ATTORNEY

**Int. Cls.: 10, 21 and 24**

**Prior U.S. Cls.: 2, 13, 23, 26, 29, 30, 33, 39, 40, 42, 44  
and 50**

**Reg. No. 3,503,965**

**United States Patent and Trademark Office**

**Registered Sep. 23, 2008**

**TRADEMARK  
PRINCIPAL REGISTER**

**BOTANICAL BATH**

SCHROEDER & TREMAYNE, INC. (MISSOURI  
CORPORATION)  
8500 VALCOUR  
ST. LOUIS, MO 63123

FOR: NON-POWERED HAND-HELD THERA-  
PEUTIC MASSAGER, IN CLASS 10 (U.S. CLS. 26, 39  
AND 44).

FIRST USE 6-30-2007; IN COMMERCE 6-30-2007.

FOR: LOOFAH BODY SPONGES, NAIL BRU-  
SHES, BACK BRUSHES AND LOOFAHS; FACE  
AND BODY BRUSHES, BUFFS AND EXFOLIATING  
MITTS, IN CLASS 21 (U.S. CLS. 2, 13, 23, 29, 30, 33, 40  
AND 50).

FIRST USE 6-30-2007; IN COMMERCE 6-30-2007.

FOR: WASHCLOTHS; WASHING MITTS, IN  
CLASS 24 (U.S. CLS. 42 AND 50).

FIRST USE 6-30-2007; IN COMMERCE 6-30-2007.

THE MARK CONSISTS OF STANDARD CHAR-  
ACTERS WITHOUT CLAIM TO ANY PARTICULAR  
FONT, STYLE, SIZE, OR COLOR.

NO CLAIM IS MADE TO THE EXCLUSIVE  
RIGHT TO USE "BATH", APART FROM THE MARK  
AS SHOWN.

SER. NO. 77-271,650, FILED 9-5-2007.

MICHELE SWAIN, EXAMINING ATTORNEY

**Int. Cls.: 41 and 42**

**Prior U.S. Cls.: 100, 101 and 107**

**United States Patent and Trademark Office**

**Reg. No. 3,503,966**

**Registered Sep. 23, 2008**

**SERVICE MARK  
PRINCIPAL REGISTER**

**RedCape**

THE RED CAPE COMPANY, LLC (TEXAS LIMITED LIABILITY COMPANY)  
P.O. BOX 1115  
GRAPEVINE, TX 76099

FOR: COMPUTER SOFTWARE TRAINING SERVICES FEATURING COACHING IN THE IMPROVEMENT OF COMPUTER SKILLS, PRODUCTIVITY AND BEST PRACTICES; EDUCATIONAL SERVICES, NAMELY, THE OFFERING OF WEB BASED AND CLASSROOM TRAINING FOR CERTIFICATION IN THE USE OF COMPUTER SOFTWARE; EDUCATIONAL ASSESSMENT OF COMPUTER SOFTWARE SKILLS, IN CLASS 41 (U.S. CLS. 100, 101 AND 107).

FIRST USE 8-24-2007; IN COMMERCE 8-24-2007.

FOR: COMPUTER SOFTWARE CONSULTATION; CONSULTATION SERVICES IN THE FIELDS OF

SELECTION, IMPLEMENTATION AND USE OF COMPUTER SOFTWARE SYSTEMS FOR OTHERS, IN CLASS 42 (U.S. CLS. 100 AND 101).

FIRST USE 8-24-2007; IN COMMERCE 8-24-2007.

THE COLOR(S) RED AND GRAYSCALE IS/ARE CLAIMED AS A FEATURE OF THE MARK.

THE WORD "RED" IS IN THE COLOR RED. THE WORD "CAPE" IS GRAYSCALE AND THE ENTIRE MARK HAS AN EMBOSSED EFFECT.

SER. NO. 77-271,691, FILED 9-5-2007.

DANIEL BRODY, EXAMINING ATTORNEY

**Int. Cl.: 35**

**Prior U.S. Cls.: 100, 101 and 102**

**United States Patent and Trademark Office**

**Reg. No. 3,503,967**

**Registered Sep. 23, 2008**

**SERVICE MARK  
PRINCIPAL REGISTER**



HEALTH CAREERS FOUNDATION (MISSOURI  
NON-PROFIT CORPORATION)  
100 NORTH POINT CENTER EAST, SUITE 200  
ALPHARETTA, GA 30022

FOR: EMPLOYMENT HIRING, RECRUITING,  
PLACEMENT, STAFFING AND CAREER NET-  
WORKING SERVICES, IN CLASS 35 (U.S. CLS. 100,  
101 AND 102).

FIRST USE 6-1-2007; IN COMMERCE 6-1-2007.

NO CLAIM IS MADE TO THE EXCLUSIVE  
RIGHT TO USE "HIRE" AND "USA", APART FROM  
THE MARK AS SHOWN.

THE MARK CONSISTS OF SHIELD DESIGN  
WITH THE WORDS "HIRE HEROES USA" IN A  
STYLIZED TEXT.

SER. NO. 77-271,803, FILED 9-5-2007.

ANDREA K. NADELMAN, EXAMINING ATTOR-  
NEY



**Int. Cl.: 33**

**Prior U.S. Cls.: 47 and 49**

**United States Patent and Trademark Office**

**Reg. No. 3,503,968**

**Registered Sep. 23, 2008**

**TRADEMARK  
PRINCIPAL REGISTER**

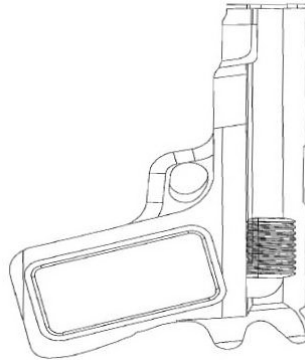

LICORES VERACRUZ, S.A. DE C.V. (MEXICO CORPORATION)  
KM. 341.5 CARRETERA CORDOBA-VERACRUZ  
CORDOBA, VERACRUZ, MEXICO 94500

FOR: ALCOHOLIC BEVERAGES EXCEPT BEERS,  
IN CLASS 33 (U.S. CLS. 47 AND 49).

OWNER OF MEXICO REG. NO. 825753, DATED 3-22-2004, EXPIRES 12-1-2013.

THE MARK CONSISTS OF A THREE DIMENSIONAL DESIGN FOR A BEVERAGE BOTTLE IN THE SHAPE OF A PISTOL.

SER. NO. 77-271,993, FILED 9-5-2007.

BARBARA A. GOLD, EXAMINING ATTORNEY

**Int. Cl.: 33**

**Prior U.S. Cls.: 47 and 49**

**United States Patent and Trademark Office**

**Reg. No. 3,503,969**

**Registered Sep. 23, 2008**

**TRADEMARK  
PRINCIPAL REGISTER**

**IXEL**

LA MADRILEÑA, S.A. DE C.V. (MEXICO CORPORATION)  
PISO 17  
INSURGENTES SUR NÚMERO 800  
COL. DEL VALLE, MEXICO C.P.03100

FOR: ALCOHOLIC BEVERAGES, NAMELY, TEQUILA, IN CLASS 33 (U.S. CLS. 47 AND 49).

THE MARK CONSISTS OF STANDARD CHARACTERS WITHOUT CLAIM TO ANY PARTICULAR FONT, STYLE, SIZE, OR COLOR.

PRIORITY CLAIMED UNDER SEC. 44(D) ON MEXICO APPLICATION NO. 874779, FILED 8-13-2007, REG. NO. 100268, DATED 9-14-2007, EXPIRES 9-14-2017.

THE WORDING "IXEL" HAS NO MEANING IN A FOREIGN LANGUAGE.

SER. NO. 77-273,331, FILED 9-6-2007.

MARLENE BELL, EXAMINING ATTORNEY

**Int. Cl.: 35**

**Prior U.S. Cls.: 100, 101 and 102**

**United States Patent and Trademark Office**

**Reg. No. 3,503,970**

**Registered Sep. 23, 2008**

**SERVICE MARK  
PRINCIPAL REGISTER**

**DISCOVER ORGANIZING INC.**

REVITSKY, JILL N (PENNSYLVANIA CORPORATION)  
366 ATLANTA DRIVE  
PITTSBURGH, PA 15228

FOR: PROVIDING ORGANIZING SERVICES FOR INDIVIDUALS AT HOME, IN HOME OFFICES AND IN BUSINESS OFFICES, THAT PROVIDES HELP WITH TIME AND PAPER MANAGEMENT, IN CLASS 35 (U.S. CLS. 100, 101 AND 102).

FIRST USE 4-1-2005; IN COMMERCE 4-1-2005.

THE MARK CONSISTS OF STANDARD CHARACTERS WITHOUT CLAIM TO ANY PARTICULAR FONT, STYLE, SIZE, OR COLOR.

NO CLAIM IS MADE TO THE EXCLUSIVE RIGHT TO USE "ORGANIZING INC.", APART FROM THE MARK AS SHOWN.

SER. NO. 77-273,891, FILED 9-7-2007.

KAPIL BHANOT, EXAMINING ATTORNEY

**Int. Cl.: 28**

**Prior U.S. Cls.: 22, 23, 38 and 50**

**United States Patent and Trademark Office**

**Reg. No. 3,503,971**

**Registered Sep. 23, 2008**

**TRADEMARK  
PRINCIPAL REGISTER**

**MAXMO**

PARADISE GOLF EQUIPMENT, INC. (GEORGIA CORPORATION)

1331 LYNNAH AVE.

GARDEN CITY, GA 31408

FOR: GOLF CLUBS; HEAD COVERS FOR GOLF CLUBS, IN CLASS 28 (U.S. CLS. 22, 23, 38 AND 50).

FIRST USE 2-0-2007; IN COMMERCE 2-0-2007.

THE MARK CONSISTS OF STANDARD CHARACTERS WITHOUT CLAIM TO ANY PARTICULAR FONT, STYLE, SIZE, OR COLOR.

THE WORDING "MAXMO" HAS NO MEANING IN A FOREIGN LANGUAGE.

SER. NO. 77-274,065, FILED 9-7-2007.

AMOS T. MATTHEWS, JR., EXAMINING ATTORNEY

**Int. Cls.: 39 and 43**

**Prior U.S. Cls.: 100, 101 and 105**

**United States Patent and Trademark Office**

**Reg. No. 3,503,972**

**Registered Sep. 23, 2008**

**SERVICE MARK  
PRINCIPAL REGISTER**

**MAYALAND RESORTS**

MAYALAND, S.A. DE C.V. (MEXICO CORPORATION)  
CALLE ROBALO #30, SUPER MANZANA 3, CANCUN  
QUINTANA ROO, C.P. 77500, MEXICO

FOR: TRAVEL TOURS, NAMELY, ARRANGING AND CONDUCTING TRAVEL TOURS, IN CLASS 39 (U.S. CLS. 100 AND 105).

FIRST USE 0-0-1930; IN COMMERCE 1-1-1990.

FOR: RESORT HOTEL SERVICES, IN CLASS 43 (U.S. CLS. 100 AND 101).

FIRST USE 0-0-1930; IN COMMERCE 1-1-1990.

THE MARK CONSISTS OF STANDARD CHARACTERS WITHOUT CLAIM TO ANY PARTICULAR FONT, STYLE, SIZE, OR COLOR.

NO CLAIM IS MADE TO THE EXCLUSIVE RIGHT TO USE "RESORTS", APART FROM THE MARK AS SHOWN.

SER. NO. 77-274,603, FILED 9-7-2007.

HOWARD B. LEVINE, EXAMINING ATTORNEY

**Int. Cl.: 35**

**Prior U.S. Cls.: 100, 101 and 102**

**United States Patent and Trademark Office**

**Reg. No. 3,503,973**

**Registered Sep. 23, 2008**

**SERVICE MARK  
PRINCIPAL REGISTER**

**VOLTAIRE BOOKS**

KUSH, CHRISTOPHER (UNITED STATES INDIVIDUAL)  
5225 WISCONSIN AVENUE N.W. SUITE 501  
WASHINGTON, DC 20015

FOR: RETAIL STORE SERVICES FEATURING BOOKS, BOOKLETS, NEWSLETTERS, MAGAZINES, CALENDARS, BOOKMARKS, POSTERS, NOTECARDS, POSTCARDS, GAMES, JOURNALS, FINE ART, GIFTS, APPAREL, AND OTHER ITEMS COMMONLY FOUND IN BOOKSTORES, IN CLASS 35 (U.S. CLS. 100, 101 AND 102).

FIRST USE 2-1-2007; IN COMMERCE 2-1-2007.

THE MARK CONSISTS OF STANDARD CHARACTERS WITHOUT CLAIM TO ANY PARTICULAR FONT, STYLE, SIZE, OR COLOR.

NO CLAIM IS MADE TO THE EXCLUSIVE RIGHT TO USE "BOOKS", APART FROM THE MARK AS SHOWN.

THE WORDING "VOLTAIRE" HAS NO MEANING IN A FOREIGN LANGUAGE.

SER. NO. 77-274,730, FILED 9-7-2007.

PAUL E. FAHRENKOPF, EXAMINING ATTORNEY

**Int. Cl.: 7**

**Prior U.S. Cls.: 13, 19, 21, 23, 31, 34 and 35**

**United States Patent and Trademark Office**

**Reg. No. 3,503,974**

**Registered Sep. 23, 2008**

**TRADEMARK  
PRINCIPAL REGISTER**



LHR TECHNOLOGIES, INC. (TEXAS CORPORATION)

4930 ALLEN GENOA  
PASADENA, TX 77504

FOR: WOODWORKING MACHINE FOR CARVING, SAWING, PLANING AND ROUTING WOOD, PLASTIC, LAMINATE, POLYMER RESINS AND FORM BOARD, IN CLASS 7 (U.S. CLS. 13, 19, 21, 23, 31, 34 AND 35).

FIRST USE 12-0-2005; IN COMMERCE 12-0-2005.

THE COLOR(S) YELLOW-GOLD AND BLACK IS/ARE CLAIMED AS A FEATURE OF THE MARK.

THE COLOR BLACK APPEARS IN THE WORDING AND AS EDGING TO THE DESIGN ELEMENTS; THE COLOR YELLOW-GOLD APPEARS AS A BACKGROUND FOR THE MARK.

SER. NO. 77-275,229, FILED 9-10-2007.

VIVIAN MICZNIK FIRST, EXAMINING ATTORNEY

**Int. Cl.: 9**

**Prior U.S. Cls.: 21, 23, 26, 36 and 38**

**United States Patent and Trademark Office**

**Reg. No. 3,503,975**

**Registered Sep. 23, 2008**

**TRADEMARK  
PRINCIPAL REGISTER**

# TurboCredit

GONZALES, ROY (UNITED STATES INDIVIDUAL)  
1501 BLUE HERON DRIVE  
SARASOTA, FL 34236

THE MARK CONSISTS OF STANDARD CHARACTERS WITHOUT CLAIM TO ANY PARTICULAR FONT, STYLE, SIZE, OR COLOR.

FOR: MULTIMEDIA SOFTWARE RECORDED ON CD-ROM FEATURING DO-IT-YOURSELF CONSUMER CREDIT REPAIR, IN CLASS 9 (U.S. CLS. 21, 23, 26, 36 AND 38).

SER. NO. 77-275,393, FILED 9-10-2007.

FIRST USE 10-31-2006; IN COMMERCE 5-31-2007.

KATHLEEN LORENZO, EXAMINING ATTORNEY



Int. Cl.: 41

Prior U.S. Cls.: 100, 101 and 107

United States Patent and Trademark Office

Reg. No. 3,503,976

Registered Sep. 23, 2008

SERVICE MARK  
PRINCIPAL REGISTER



NAEMT (MISSISSIPPI NON-PROFIT ASSOCIATION)

P.O. BOX 1400  
CLINTON, MS 39060

FOR: PROVIDING CONTINUING MEDICAL EDUCATION COURSES; PROVIDING CONTINUING NURSING EDUCATION COURSES; PROVIDING COURSES OF INSTRUCTION AT THE COLLEGE LEVEL; EDUCATIONAL SERVICES, NAMELY, DEVELOPING, ARRANGING, AND CONDUCTING EDUCATIONAL CONFERENCES AND PROGRAMS AND PROVIDING COURSES OF INSTRUCTION IN THE FIELD OF EMERGENCY MEDICAL SERVICES; EDUCATIONAL DEMONSTRATIONS; EDUCATION SERVICES, NAMELY, PROVIDING LIVE AND ON-LINE CLASSES, WORKSHOPS IN THE FIELD OF PEDIATRIC CARE; EDUCATION SERVICES, NAMELY, PROVIDING CLASSES, WORKSHOPS IN THE FIELD OF PEDIATRIC CARE; ARRANGING AND CONDUCTING EDUCATIONAL CONFERENCES; PROVIDING FACILITIES FOR EDUCATIONAL CONVENTIONS, IN CLASS 41 (U.S. CLS. 100, 101 AND 107).

FIRST USE 12-1-2006; IN COMMERCE 12-1-2006.

OWNER OF U.S. REG. NOS. 2,795,011 AND 2,800,437.

NO CLAIM IS MADE TO THE EXCLUSIVE RIGHT TO USE "EMERGENCY PEDIATRIC CARE", APART FROM THE MARK AS SHOWN.

THE COLOR(S) GREEN, ORANGE, WHITE IS/ ARE CLAIMED AS A FEATURE OF THE MARK.

THE MARK CONSISTS OF DARK GREEN BOLD CAPITAL LETTERS WITH THE CAPITAL LETTERS "NAEMT" EMBOSSED IN THE LETTER "E" IN WHITE AND AN IMAGE OF A LITTLE GIRL IN A DRESS HOLDING 3 BALLOONS AND HER HAND REACHING UPWARDS AS IF SHE IS REACHING FOR AN ADULT'S HAND. THE LITTLE GIRL IMAGE IS IN DARK ORANGE ALONG WITH THE 3 BALLOONS. THE IMAGE ALSO HAS THE WORDS "EMERGENCY PEDIATRIC CARE" IN BOLD DARK GREEN BELOW THE BOLD DARK GREEN CAPITALIZED LETTERS, "EPC".

SER. NO. 77-275,408, FILED 9-10-2007.

AHSEN KHAN, EXAMINING ATTORNEY

Int. Cl.: 25

Prior U.S. Cls.: 22 and 39

United States Patent and Trademark Office

Reg. No. 3,503,977

Registered Sep. 23, 2008

TRADEMARK  
PRINCIPAL REGISTER



INGENUITY EXPRESS CORP. (DELAWARE CORPORATION)  
204 HAMILTON STREET  
NEW BRUNSWICK, NJ 08901

FOR: SHOES, SOCKS, FOOTWEAR AND FOOTWEAR COMPONENTS, NAMELY, SHOE OUTSOLES, INSOLES, SHOE UPPERS, SHOE TONGUES AND HARDWARE AND STRAPS FOR HOLDING FOOTWEAR COMPONENTS TOGETHER, STRAPS, PULLSTRAPS, LACES, AGLETS, EYELETS, RIVETS, GROMMETS, SHOE FASTENERS, SHOE FASTENER HOOKS, SHOE BUCKLES, SHOE ORNAMENTS

NOT OF PRECIOUS METAL, ALL SOLD AS INTEGRAL COMPONENTS OF FOOTWEAR, IN CLASS 25 (U.S. CLS. 22 AND 39).

FIRST USE 2-1-2007; IN COMMERCE 2-1-2007.

THE MARK CONSISTS OF A SPIRAL-SHAPED FIGURE.

SER. NO. 77-275,521, FILED 9-10-2007.

ANGELA M. MICHELI, EXAMINING ATTORNEY

**Int. Cl.: 44**

**Prior U.S. Cls.: 100 and 101**

**United States Patent and Trademark Office**

**Reg. No. 3,503,978**

**Registered Sep. 23, 2008**

**SERVICE MARK  
PRINCIPAL REGISTER**

**EVEREST**

WRIGHT MEDICAL TECHNOLOGY, INC. (DE-  
LAWARE CORPORATION)  
5677 AIRLINE ROAD  
ARLINGTON, TN 38002

FOR: PROVIDING PHYSICIAN SERVICES VIA  
THE INTERNET, NAMELY, AN INTERNET ACCE-  
SSIBLE DATABASE THAT ENABLES ORTHOPEDIC  
SURGEONS TO INPUT POSTOPERATIVE DATA  
FOR USE IN DATA REPORTING, IN CLASS 44  
(U.S. CLS. 100 AND 101).

FIRST USE 9-10-2007; IN COMMERCE 9-10-2007.

THE MARK CONSISTS OF STANDARD CHAR-  
ACTERS WITHOUT CLAIM TO ANY PARTICULAR  
FONT, STYLE, SIZE, OR COLOR.

SER. NO. 77-275,741, FILED 9-10-2007.

DAVID I, EXAMINING ATTORNEY

**Int. Cl.: 20**

**Prior U.S. Cls.: 2, 13, 22, 25, 32 and 50**

**Reg. No. 3,503,979**

**United States Patent and Trademark Office**

**Registered Sep. 23, 2008**

---

**TRADEMARK  
PRINCIPAL REGISTER**

**WOOD IMAGES**

SPRINGS WINDOW FASHIONS, LLC (DELA-  
WARE LIMITED LIABILITY COMPANY)  
7549 GRABER ROAD  
MIDDLETON, WI 53562

FOR: WINDOW BLINDS AND WINDOW  
SHADES, IN CLASS 20 (U.S. CLS. 2, 13, 22, 25, 32  
AND 50).

FIRST USE 8-6-2001; IN COMMERCE 8-6-2001.

THE MARK CONSISTS OF STANDARD CHAR-  
ACTERS WITHOUT CLAIM TO ANY PARTICULAR  
FONT, STYLE, SIZE, OR COLOR.

NO CLAIM IS MADE TO THE EXCLUSIVE  
RIGHT TO USE "WOOD", APART FROM THE  
MARK AS SHOWN.

SER. NO. 77-275,788, FILED 9-10-2007.

GEORGE LORENZO, EXAMINING ATTORNEY

**Int. Cls.: 7, 9 and 16**

**Prior U.S. Cls.: 2, 5, 13, 19, 21, 22, 23, 26, 29, 31, 34,  
35, 36, 37, 38 and 50**

**Reg. No. 3,503,980**

**United States Patent and Trademark Office**

**Registered Sep. 23, 2008**

**TRADEMARK  
PRINCIPAL REGISTER**



VSM GROUP AB (SWEDEN AKTIEBOLAG (AB))  
SE-561 84  
HUSKVARNA, SWEDEN

FOR: SEWING MACHINES; EMBROIDERY MACHINES, IN CLASS 7 (U.S. CLS. 13, 19, 21, 23, 31, 34 AND 35).

FIRST USE 1-1-1998; IN COMMERCE 1-1-1998.

FOR: COMPUTER SOFTWARE FOR CONTROLLING THE OPERATION OF SEWING MACHINES, EMBROIDERY MACHINES AND PARTS THEREOF; DVDS FEATURING INSTRUCTION IN THE FIELD OF SEWING AND EMBROIDERY; AND DOWNLOADABLE ELECTRONIC PUBLICATIONS IN THE NATURE OF INSTRUCTION MANUALS AND PATTERNS IN THE FIELD OF SEWING AND EMBROIDERY, IN CLASS 9 (U.S. CLS. 21, 23, 26, 36 AND 38).

FIRST USE 1-1-2000; IN COMMERCE 1-1-2000.

FOR: BOOKS FEATURING SEWING AND SEWING MACHINES, IN CLASS 16 (U.S. CLS. 2, 5, 22, 23, 29, 37, 38 AND 50).

FIRST USE 1-1-2000; IN COMMERCE 1-1-2000.

OWNER OF U.S. REG. NO. 2,746,835.

THE STIPPLING IS FOR SHADING PURPOSES ONLY.

THE MARK CONSISTS OF THE LITERAL ELEMENT "KEEPING THE WORLD SEWING" AND THREE HEARTS APPEAR IN A CIRCLE BAND AROUND A STYLIZED REPRESENTATION OF THE GLOBE WITH A SEWING MACHINE SUPERIMPOSED.

SER. NO. 77-275,891, FILED 9-10-2007.

PAM WILLIS, EXAMINING ATTORNEY

**Int. Cl.: 3**

**Prior U.S. Cls.: 1, 4, 6, 50, 51 and 52**

**United States Patent and Trademark Office**

**Reg. No. 3,503,981**

**Registered Sep. 23, 2008**

**TRADEMARK  
PRINCIPAL REGISTER**

**DUST DESTROYER**

FALCON SAFETY PRODUCTS, INC. (NEW JERSEY CORPORATION)  
25 IMCLONE DRIVE  
BRANCBURG, NJ 08876

FOR: GAS BLAST DUSTER IN A PRESSURIZED CAN FOR CLEANING COMPUTERS, ARTICLES OF A SCIENTIFIC AND PHOTOGRAPHIC NATURE, NAMELY, CAMERAS, PHOTOGRAPHIC AND OPTICAL LENSES, LABORATORY EQUIPMENT CONTAINING OPTICAL LENSES, ELECTRONIC LABORATORY EQUIPMENT, AND HOME AND OFFICE ELECTRONIC EQUIPMENT, IN CLASS 3 (U.S. CLS. 1, 4, 6, 50, 51 AND 52).

FIRST USE 8-1-2007; IN COMMERCE 8-1-2007.

THE MARK CONSISTS OF STANDARD CHARACTERS WITHOUT CLAIM TO ANY PARTICULAR FONT, STYLE, SIZE, OR COLOR.

NO CLAIM IS MADE TO THE EXCLUSIVE RIGHT TO USE "DUST", APART FROM THE MARK AS SHOWN.

SER. NO. 77-276,398, FILED 9-11-2007.

GIANCARLO CASTRO, EXAMINING ATTORNEY

**Int. Cl.: 35**

**Prior U.S. Cls.: 100, 101 and 102**

**United States Patent and Trademark Office**

**Reg. No. 3,503,982**

**Registered Sep. 23, 2008**

**SERVICE MARK  
PRINCIPAL REGISTER**

**EXSTARE FEDERAL SERVICES  
GROUP, LLC**

EXSTARE FEDERAL SERVICES GROUP, LLC  
(VIRGINIA LIMITED LIABILITY COMPANY)

6915 STONEYBROOKE LANE

ALEXANDRIA, VA 22306

FOR: BUSINESS CONSULTING SERVICES, IN  
CLASS 35 (U.S. CLS. 100, 101 AND 102).

FIRST USE 5-31-2005; IN COMMERCE 5-31-2005.

THE MARK CONSISTS OF STANDARD CHAR-  
ACTERS WITHOUT CLAIM TO ANY PARTICULAR  
FONT, STYLE, SIZE, OR COLOR.

NO CLAIM IS MADE TO THE EXCLUSIVE  
RIGHT TO USE "FEDERAL SERVICES GROUP,  
LLC", APART FROM THE MARK AS SHOWN.

SER. NO. 77-277,809, FILED 9-12-2007.

AMY GEARIN, EXAMINING ATTORNEY

**Int. Cl.: 9**

**Prior U.S. Cls.: 21, 23, 26, 36 and 38**

**Reg. No. 3,503,983**

**United States Patent and Trademark Office**

**Registered Sep. 23, 2008**

**TRADEMARK  
PRINCIPAL REGISTER**

# OPTIMUS

TRS QUALITY, INC. (DELAWARE CORPORATION)  
MAIL STOP # CF4-101  
300 RADIOSHACK CIRCLE  
FORT WORTH, TX 76102

FOR: AUDIO/VIDEO EQUIPMENT, NAMELY, TUNERS, AMPLIFIERS, RECEIVERS, SPEAKERS, HOME SPEAKER SYSTEMS COMPRISED OF AUDIO/VIDEO SURROUND SPEAKERS, COMPACT SPEAKERS, SWIVEL SPEAKERS, MINI SPEAKERS, STEREO SPEAKERS, BOOKSHELF SPEAKERS, AMPLIFIED SPEAKERS, WIRELESS SPEAKERS, CEILING-MOUNT SPEAKERS, IN-WALL SPEAKERS, SPEAKER GRILLES, STEREO AND MICROPHONE CABLES, MOUNTING BRACKETS AND HOUSING STANDS; MUSIC SYSTEMS COMPRISED OF SPEAKERS, TURNTABLES, TIMERS, CASSETTE TAPE PLAYERS/RECORDERS, COMPACT DISC PLAYERS/RECORDERS, MICROPHONES, REMOTE CONTROLLERS, AND INCORPORATING CLOCKS; KEYBOARDS; DIGITAL COMPACT AND VIDEO DISC PLAYERS; PORTABLE DIGITAL COMPACT AND VIDEO DISC PLAYERS; TURNTABLES; MAGNETIC PHONOGRAPH CARTRIDGES FEATURING REPLACEMENT STYLII; TAPE PLAYERS/RECORDERS; CASSETTE DECKS; DIGITAL TAPE PLAYERS/RECORDERS; CASSETTE PLAYERS/RECORDERS; CAR RADIOS; CAR RADIOS WITH CASSETTE PLAYERS; CAR

RADIOS WITH DIGITAL DISK PLAYERS; CAR RADIOS WITH DIGITAL TAPE PLAYERS; CD-ROM PLAYERS; CAR RADIOS WITH CD-ROM PLAYERS; PORTABLE CD-ROM PLAYERS; CAR SPEAKERS; PORTABLE KARAOKE MACHINES AND MICROPHONES; HEADPHONES AND MICROPHONES; VIDEO CASSETTE RECORDERS; CAMCORDERS; MOVIE CAMERAS; TELEVISIONS; SATELLITE SYSTEMS COMPRISED OF SATELLITE DISH, SATELLITE RECEIVER, REMOTE CONTROLLER, ANTENNA CONNECTORS, DATA ACCESS PORT FOR USE WITH ELECTRICAL CONTROL PANELS FOR CONNECTING MULTIPLE DATA AND ELECTRONIC DEVICES AND VIDEO OUTPUT RECEIVERS AND VIDEO EDITORS, IN CLASS 9 (U.S. CLS. 21, 23, 26, 36 AND 38).

FIRST USE 6-30-1967; IN COMMERCE 6-30-1967.

THE MARK CONSISTS OF STANDARD CHARACTERS WITHOUT CLAIM TO ANY PARTICULAR FONT, STYLE, SIZE, OR COLOR.

OWNER OF U.S. REG. NOS. 865,669 AND 3,277,745.

SER. NO. 77-277,867, FILED 9-12-2007.

JOHN GARTNER, EXAMINING ATTORNEY



**Int. Cl.: 9**

**Prior U.S. Cls.: 21, 23, 26, 36 and 38**

**United States Patent and Trademark Office**

**Reg. No. 3,503,984**

**Registered Sep. 23, 2008**

**TRADEMARK  
PRINCIPAL REGISTER**



ENERGY RECOVERY, INC. (VIRGINIA CORPORATION)  
1908 DOOLITTLE DRIVE  
SAN LEANDRO, CA 94577

FIRST USE 3-30-2007; IN COMMERCE 3-30-2007.

OWNER OF U.S. REG. NOS. 3,053,713 AND 3,075,798.

FOR: PRESSURE TRANSFERORS, NAMELY, ENERGY TRANSFER MACHINES HAVING A MULTI-CHANNEL ROTOR FOR THE TRANSFER OF PRESSURE BETWEEN HIGH AND LOW PRESSURE FLUIDS, PARTICULARLY FOR THE WATER TREATMENT INDUSTRY, INCLUDING COMPONENT PARTS AND INSTRUCTION MANUALS SOLD AS A UNIT THEREWITH, IN CLASS 9 (U.S. CLS. 21, 23, 26, 36 AND 38).

THE MARK CONSISTS OF THE LETTERING "ERI" AND THE DESIGN OF TWO WAVY OR BENT RECTANGULAR SHAPES SURROUNDING THE LETTERING.

SER. NO. 77-278,196, FILED 9-12-2007.

ESTHER A. BORSUK, EXAMINING ATTORNEY

**Int. Cl.: 3**

**Prior U.S. Cls.: 1, 4, 6, 50, 51 and 52**

**United States Patent and Trademark Office**

**Reg. No. 3,503,985**

**Registered Sep. 23, 2008**

**TRADEMARK  
PRINCIPAL REGISTER**

**BACK 2  
NATURAL**

IAN MALCOLM GAVET (GREAT BRITAIN IN-  
DIVIDUAL)  
408 GREENFIELD AVE  
SAN ANSELMO, CA 94960

FOR: HAIR CARE CREAMS; HAIR CARE LO-  
TIONS; HAIR CARE PREPARATIONS; HAIR COL-  
OR; HAIR COLOR REMOVERS; HAIR  
COLORANTS; HAIR CONDITIONER; HAIR GELS;  
HAIR RINSES; HAIR STYLING PREPARATIONS;  
HAIR STYLING SPRAY; LOTIONS FOR FACE AND  
BODY CARE; NAIL CARE PREPARATIONS; NON-  
MEDICATED LIP CARE PREPARATIONS; NON-  
MEDICATED SKIN CARE PREPARATIONS; NON-  
MEDICATED SKIN CARE PREPARATIONS, NAME-  
LY, CREAMS, LOTIONS, GELS, TONERS, CLEA-  
NERS AND PEELS; 3-IN-1 HAIR CONDITIONERS; 3-

IN-1 HAIR SHAMPOOS; COSMETIC CREAMS FOR  
SKIN CARE; COSMETIC PREPARATIONS FOR  
BODY CARE; HAIR BALSAM, IN CLASS 3 (U.S.  
CLS. 1, 4, 6, 50, 51 AND 52).

FIRST USE 1-31-2007; IN COMMERCE 9-4-2007.

THE MARK CONSISTS OF STANDARD CHAR-  
ACTERS WITHOUT CLAIM TO ANY PARTICULAR  
FONT, STYLE, SIZE, OR COLOR.

SER. NO. 77-278,411, FILED 9-12-2007.

LEIGH CAROLINE CASE, EXAMINING ATTOR-  
NEY

**Int. Cl.: 25**

**Prior U.S. Cls.: 22 and 39**

**United States Patent and Trademark Office**

**Reg. No. 3,503,986**

**Registered Sep. 23, 2008**

**TRADEMARK  
PRINCIPAL REGISTER**



EJR INC. (NEW YORK CORPORATION)  
99 MAIN STREET  
WESTHAMPTON BEACH, NY 11978

FOR: CLOTHING, NAMELY, SHIRTS, T-SHIRTS,  
SWEATSHIRTS, PANTS, SWEATPANTS, HATS,  
BATHING SUITS, ACTIVE WEAR IN THE NATURE  
OF SURF WEAR, BODY SUITS AND WET SUITS  
AND FOOTWEAR, IN CLASS 25 (U.S. CLS. 22 AND  
39).

FIRST USE 7-1-2007; IN COMMERCE 8-25-2007.

THE MARK CONSISTS OF GRAPHIC DEPICTIONS OF AN EYE WITH BROW, A SURFER ON A SURF BOARD, THE NUMERAL 4 AND A PEACE SIGN ABOVE THE TEXT EYESURFFORPEACE.-COM.

SER. NO. 77-278,834, FILED 9-13-2007.

DAVID YONTEF, EXAMINING ATTORNEY

**Int. Cl.: 5**

**Prior U.S. Cls.: 6, 18, 44, 46, 51 and 52**

**United States Patent and Trademark Office**

**Reg. No. 3,503,987**

**Registered Sep. 23, 2008**

**TRADEMARK  
PRINCIPAL REGISTER**

**LASERSKIN**

FIDIA FARMACEUTICI SPA (ITALY JOINT  
STOCK COMPANY)  
VIA PONTE DELLA FABBRICA 3/A  
I-35031 ABANO TERME, ITALY

FOR: PHARMACEUTICAL PREPARATIONS FOR  
DERMATOLOGICAL USE, IN CLASS 5 (U.S. CLS. 6,  
18, 44, 46, 51 AND 52).

THE MARK CONSISTS OF STANDARD CHAR-  
ACTERS WITHOUT CLAIM TO ANY PARTICULAR  
FONT, STYLE, SIZE, OR COLOR.

OWNER OF ITALY REG. NO. 600048, DATED 7-5-  
1993, EXPIRES 12-23-2012.

OWNER OF U.S. REG. NO. 2,481,072.

SER. NO. 77-278,962, FILED 9-13-2007.

LOURDES AYALA, EXAMINING ATTORNEY

**Int. Cl.: 14**

**Prior U.S. Cls.: 2, 27, 28 and 50**

**United States Patent and Trademark Office**

**Reg. No. 3,503,988**

**Registered Sep. 23, 2008**

**TRADEMARK  
PRINCIPAL REGISTER**



ROBERT PAUL FINE JEWELRY (CALIFORNIA CORPORATION), DBA PAULING BLUE FIRE DIAMONDS  
5620 PASEO DEL NORTE, SUITE 105  
CARLSBAD, CA 92008

FIRST USE 6-1-1953; IN COMMERCE 6-1-1953.

THE MARK CONSISTS OF DIAMOND SYMBOL WITH TRADE NAME "BLUE FIRE".

FOR: CULTURED PEARL RINGS, DIAMOND PENDANTS, DIAMOND RINGS, GENUINE STONE FASHION RINGS, GENUINE STONE FASHION PENDANTS, GOLD WEDDING BANDS, IN CLASS 14 (U.S. CLS. 2, 27, 28 AND 50).

SER. NO. 77-279,353, FILED 9-14-2007.

TEJBIR SINGH, EXAMINING ATTORNEY

**Int. Cl.: 35**

**Prior U.S. Cls.: 100, 101 and 102**

**United States Patent and Trademark Office**

**Reg. No. 3,503,989**

**Registered Sep. 23, 2008**

**SERVICE MARK  
PRINCIPAL REGISTER**

**OSO ECO**

NEW WORLD EXCHANGE, LLC (OREGON LIMITED LIABILITY COMPANY)  
SUITE 290  
115 W. 8TH AVENUE  
EUGENE, OR 97401

FOR: OPERATING AN ON-LINE SOCIAL MARKETPLACE FEATURING SUSTAINABLE GOODS AND SERVICES; PROVIDING A WEBSITE FEATURING PRODUCT RATINGS, CONSUMER REVIEWS AND RECOMMENDATIONS OF SUSTAINABLE GOODS AND SERVICES OF OTHERS, IN CLASS 35 (U.S. CLS. 100, 101 AND 102).

FIRST USE 1-1-2007; IN COMMERCE 1-1-2007.

THE MARK CONSISTS OF STANDARD CHARACTERS WITHOUT CLAIM TO ANY PARTICULAR FONT, STYLE, SIZE, OR COLOR.

SER. NO. 77-279,701, FILED 9-14-2007.

ZACHARY BELLO, EXAMINING ATTORNEY

**Int. Cl.: 9**

**Prior U.S. Cls.: 21, 23, 26, 36 and 38**

**Reg. No. 3,503,990**

**United States Patent and Trademark Office**

**Registered Sep. 23, 2008**

**TRADEMARK  
PRINCIPAL REGISTER**

**ARGUS AIR DAILY**

ARGUS MEDIA LIMITED (UNITED KINGDOM  
LIMITED COMPANY (LTD.))  
93 SHEPPERTON ROAD  
LONDON, UNITED KINGDOM N13DF

FOR: ELECTRONIC PUBLICATIONS, NAMELY,  
NEWSLETTERS AND REPORTS PROVIDING  
NEWS, COMMENTARY AND ANALYSIS ABOUT  
THE U.S. EMISSIONS MARKET AND FACTORS  
AFFECTING THE U.S. EMISSIONS MARKET AND  
FACTORS AFFECTING PRICING IN THE U.S.  
EMISSIONS MARKET, AND NOT INCLUDING IN-  
FORMATION CONCERNING ASSET MANAGE-  
MENT AND INVESTMENT ADVICE RELATING  
TO STOCKS AND BONDS, IN ELECTRONIC FOR-  
MAT DOWNLOADABLE FROM AND MADE  
AVAILABLE VIA A GLOBAL COMPUTER NET-  
WORK ON A SUBSCRIPTION BASIS, IN CLASS 9  
(U.S. CLS. 21, 23, 26, 36 AND 38).

FIRST USE 9-13-2004; IN COMMERCE 9-13-2004.

THE MARK CONSISTS OF STANDARD CHAR-  
ACTERS WITHOUT CLAIM TO ANY PARTICULAR  
FONT, STYLE, SIZE, OR COLOR.

OWNER OF U.S. REG. NOS. 2,501,377 AND  
2,562,712.

NO CLAIM IS MADE TO THE EXCLUSIVE  
RIGHT TO USE "DAILY", APART FROM THE  
MARK AS SHOWN.

SEC. 2(F) AS TO "AIR DAILY".

SER. NO. 77-279,887, FILED 9-14-2007.

KEVON CHISOLM, EXAMINING ATTORNEY

**Int. Cl.: 41**

**Prior U.S. Cls.: 100, 101 and 107**

**United States Patent and Trademark Office**

**Reg. No. 3,503,991**

**Registered Sep. 23, 2008**

**SERVICE MARK  
PRINCIPAL REGISTER**

**INTEGRAL LEADERSHIP**

INTEGRAL LEADERSHIP, LLC (CALIFORNIA  
LIMITED LIABILITY COMPANY)  
3502 GEARY BLVD., 2ND FLOOR  
SAN FRANCISCO, CA 94118

FOR: TRAINING SERVICES IN THE FIELD OF  
PROFESSIONAL DEVELOPMENT FOCUSED ON  
SELF-KNOWLEDGE, COMMUNICATIONS, AND  
RELATIONSHIPS, IN CLASS 41 (U.S. CLS. 100, 101  
AND 107).

FIRST USE 5-17-2004; IN COMMERCE 5-17-2004.

THE MARK CONSISTS OF STANDARD CHAR-  
ACTERS WITHOUT CLAIM TO ANY PARTICULAR  
FONT, STYLE, SIZE, OR COLOR.

NO CLAIM IS MADE TO THE EXCLUSIVE  
RIGHT TO USE "LEADERSHIP", APART FROM  
THE MARK AS SHOWN.

SER. NO. 77-280,108, FILED 9-14-2007.

INGA ERVIN, EXAMINING ATTORNEY



**Int. Cl.: 41**

**Prior U.S. Cls.: 100, 101 and 107**

**United States Patent and Trademark Office**

**Reg. No. 3,503,992**

**Registered Sep. 23, 2008**

**SERVICE MARK  
PRINCIPAL REGISTER**

**DON'T SWEAT IT**

SCRIPPS NETWORKS, LLC (DELAWARE LIMITED LIABILITY COMPANY)  
9721 SHERRILL BOULEVARD  
KNOXVILLE, TX 37932

FOR: EDUCATIONAL AND ENTERTAINMENT SERVICES, NAMELY, A CONTINUING PROGRAM ABOUT INTERIOR DESIGN AND DECORATING AND BUILDING, IMPROVEMENT, REPAIR AND RENOVATION OF REAL ESTATE, ACCESSIBLE BY RADIO, TELEVISION, CABLE, FIBER OPTIC NETWORKS, WIRELESS NETWORKS, SATELLITE,

AUDIO, VIDEO AND COMPUTER NETWORKS, IN CLASS 41 (U.S. CLS. 100, 101 AND 107).

FIRST USE 11-4-2006; IN COMMERCE 11-4-2006.

THE MARK CONSISTS OF STANDARD CHARACTERS WITHOUT CLAIM TO ANY PARTICULAR FONT, STYLE, SIZE, OR COLOR.

SER. NO. 77-280,111, FILED 9-14-2007.

CORY BOONE, EXAMINING ATTORNEY

**Int. Cl.: 37**

**Prior U.S. Cls.: 100, 103 and 106**

**United States Patent and Trademark Office**

**Reg. No. 3,503,993**

**Registered Sep. 23, 2008**

**SERVICE MARK  
PRINCIPAL REGISTER**

# The Termite Man

BARNETT, KEVIN M. (UNITED STATES INDIVIDUAL)

3605 ALHAMBRA LANE

PERRIS, CA 92571

FOR: TERMITE AND PEST CONTROL, IN CLASS 37 (U.S. CLS. 100, 103 AND 106).

FIRST USE 2-9-1999; IN COMMERCE 2-9-1999.

THE MARK CONSISTS OF STANDARD CHARACTERS WITHOUT CLAIM TO ANY PARTICULAR FONT, STYLE, SIZE, OR COLOR.

NO CLAIM IS MADE TO THE EXCLUSIVE RIGHT TO USE "TERMITE", APART FROM THE MARK AS SHOWN.

SER. NO. 77-280,464, FILED 9-15-2007.

DORITT L. CARROLL, EXAMINING ATTORNEY

**Int. Cl.: 35**

**Prior U.S. Cls.: 100, 101 and 102**

**United States Patent and Trademark Office**

**Reg. No. 3,503,994**

**Registered Sep. 23, 2008**

**SERVICE MARK  
PRINCIPAL REGISTER**

**BLUE ADVOCACY**

BLUE CROSS AND BLUE SHIELD ASSOCIATION  
(ILLINOIS NON-PROFIT CORPORATION)  
6TH FLOOR  
225 NORTH MICHIGAN AVENUE  
CHICAGO, IL 60601

FOR: PROVIDING A NATIONAL ADVOCACY NETWORK VIA A WEBSITE FOR PUBLIC ADVOCACY TO PROMOTE AWARENESS OF NATIONAL HEALTHCARE POLICY VIA ACCESS TO POLICY STATEMENTS TESTIMONY, ACTION ALERTS AND FACT SHEETS, AND COMMUNICATION WITH LAWMAKERS IN THE FIELD OF NATIONAL HEALTHCARE POLICY, IN CLASS 35 (U.S. CLS. 100, 101 AND 102).

FIRST USE 7-31-2004; IN COMMERCE 7-31-2004.

THE MARK CONSISTS OF STANDARD CHARACTERS WITHOUT CLAIM TO ANY PARTICULAR FONT, STYLE, SIZE, OR COLOR.

OWNER OF U.S. REG. NOS. 1,426,942, 3,219,611 AND OTHERS.

NO CLAIM IS MADE TO THE EXCLUSIVE RIGHT TO USE "ADVOCACY", APART FROM THE MARK AS SHOWN.

SER. NO. 77-280,800, FILED 9-17-2007.

CYNTHIA SLOAN, EXAMINING ATTORNEY

**Int. Cl.: 41**

**Prior U.S. Cls.: 100, 101 and 107**

**United States Patent and Trademark Office**

**Reg. No. 3,503,995**

**Registered Sep. 23, 2008**

**SERVICE MARK  
PRINCIPAL REGISTER**

EXPECT THE UNEXPECTED WITH  
MATH

THE ACTUARIAL FOUNDATION (ILLINOIS  
NONPROFIT CORPORATION)  
475 NORTH MARTINGALE RD., SUITE 600  
SCHAUMBURG, IL 60173

FOR: CHARITABLE SERVICES, NAMELY, PRO-  
VIDING SUPPLEMENTAL MATERIALS TO TEA-  
CHERS FOR TEACHING MATHEMATICS TO  
THEIR STUDENTS, IN CLASS 41 (U.S. CLS. 100, 101  
AND 107).

FIRST USE 10-2-2006; IN COMMERCE 10-2-2006.

THE MARK CONSISTS OF STANDARD CHAR-  
ACTERS WITHOUT CLAIM TO ANY PARTICULAR  
FONT, STYLE, SIZE, OR COLOR.

SER. NO. 77-281,147, FILED 9-17-2007.

ALICE SUE CARRUTHERS, EXAMINING ATTOR-  
NEY

**Int. Cl.: 39**

**Prior U.S. Cls.: 100 and 105**

**United States Patent and Trademark Office**

**Reg. No. 3,503,996**

**Registered Sep. 23, 2008**

**SERVICE MARK  
PRINCIPAL REGISTER**

**TRAFFIX**

TRANSPORTATION DISTRICT COMMISSION  
OF HAMPTON ROADS (VIRGINIA BODY  
CORPORATE AND POLITIC CREATED PUR-  
SUANT TO SECTION 15.2-4505 CODE OF VA.,  
1950 AS AMENDED)  
3400 VICTORIA BOULEVARD  
HAMPTON, VA 23661

FOR: TRAFFIC CONSULTATION SERVICES,  
NAMELY, PROVIDING FREE CONSULTATIONS  
PROMOTING THE USE OF TRANSPORTATION  
ALTERNATIVES; TRAFFIC INFORMATION SER-  
VICES, NAMELY, PROVIDING FREE INFORMA-  
TION PROMOTING THE USE OF  
TRANSPORTATION ALTERNATIVES, IN CLASS 39  
(U.S. CLS. 100 AND 105).

FIRST USE 10-0-1995; IN COMMERCE 10-0-1995.

THE MARK CONSISTS OF STANDARD CHAR-  
ACTERS WITHOUT CLAIM TO ANY PARTICULAR  
FONT, STYLE, SIZE, OR COLOR.

OWNER OF U.S. REG. NOS. 2,394,560 AND  
2,473,899.

SER. NO. 77-281,457, FILED 9-17-2007.

WILLIAM ROSSMAN, EXAMINING ATTORNEY

Int. Cl.: 16

Prior U.S. Cls.: 2, 5, 22, 23, 29, 37, 38 and 50

United States Patent and Trademark Office

Reg. No. 3,503,997

Registered Sep. 23, 2008

TRADEMARK  
PRINCIPAL REGISTER



American Society for  
Clinical Pathology  
Press

AMERICAN SOCIETY OF CLINICAL PATHOLOGISTS, INC. (ILLINOIS CORPORATION)  
SUITE 1600  
33 W. MONROE  
CHICAGO, IL 60603

FOR: PRINTED PUBLICATIONS, NAMELY, BOOKS, MAGAZINES, NEWSLETTERS AND JOURNALS ALL OF THE FOREGOING FEATURING INFORMATION IN THE FIELD OF CLINICAL PATHOLOGY, IN CLASS 16 (U.S. CLS. 2, 5, 22, 23, 29, 37, 38 AND 50).

FIRST USE 1-1-2007; IN COMMERCE 1-1-2007.

OWNER OF U.S. REG. NOS. 2,918,458, 2,990,985 AND OTHERS.

NO CLAIM IS MADE TO THE EXCLUSIVE RIGHT TO USE "AMERICAN SOCIETY FOR CLIN-

ICAL PATHOLOGY AND PRESS", APART FROM THE MARK AS SHOWN.

THE STIPPLING IS A FEATURE OF THE MARK AND DOES NOT INDICATE COLOR.

THE MARK CONSISTS OF THE LETTERS "ASCP" IN THE TOP PORTION OF A CIRCLE WITH SLANTED LINES BELOW THE LETTERS, THE WORDS "AMERICAN SOCIETY FOR" IS TO THE RIGHT OF THE CIRCLE, BELOW THE WORDS "AMERICAN SOCIETY FOR" ARE THE WORDS "CLINICAL PATHOLOGY" AND BELOW THE WORDS "CLINICAL PATHOLOGY" IS THE WORD "PRESS".

SER. NO. 77-282,029, FILED 9-18-2007.

BERYL GARDNER, EXAMINING ATTORNEY

**Int. Cl.: 39**

**Prior U.S. Cls.: 100 and 105**

**United States Patent and Trademark Office**

**Reg. No. 3,503,998**

**Registered Sep. 23, 2008**

**SERVICE MARK  
PRINCIPAL REGISTER**



HUSKY EXPRESS (MASSACHUSETTS CORPORATION)  
977-979 TREMONT STREET  
BOSTON, MA 02120

FOR: EXPRESS DELIVERY OF GOODS BY TRUCK, IN CLASS 39 (U.S. CLS. 100 AND 105).

FIRST USE 3-13-2000; IN COMMERCE 3-13-2000.

NO CLAIM IS MADE TO THE EXCLUSIVE RIGHT TO USE "SINCE 1999", APART FROM THE MARK AS SHOWN.

THE COLOR(S) RED, BLACK, BLUE AND WHITE IS/ARE CLAIMED AS A FEATURE OF THE MARK.

THE MARK CONSISTS OF A SOLID RED BODIED FIGURE WITH A SEPARATE RED CIRCLE HEAD AND A BLACK BACK FOOT. IT IS CARRYING A BAG ON ITS BACK THAT IS BLACK AND OUTLINED IN BLACK. COMING FROM THAT BAG ON ITS BACK IS A CORD WHICH EXTENDS OVER ITS SHOULDER AND INTO THE LEFT ARM. ON THE BLACK BAG WITH THE BLACK OUTLINE IS THE WORDING "SINCE 1999" IN WHITE. THE ENTIRE DESIGN IS ENCLOSED IN A SHADED BLUE AND WHITE CIRCLE WITH A DARK BLUE OUTLINE.

SER. NO. 77-282,694, FILED 9-18-2007.

RENEE MCCRAY, EXAMINING ATTORNEY

**Int. Cls.: 35, 43 and 44**

**Prior U.S. Cls.: 100, 101 and 102**

**United States Patent and Trademark Office**

**Reg. No. 3,503,999**

**Registered Sep. 23, 2008**

**SERVICE MARK  
PRINCIPAL REGISTER**



BAPTIST GLOBAL RESPONSE, INC. (VIRGINIA CORPORATION)  
SUITE 411  
402 BNA DRIVE  
NASHVILLE, TN 37217

FOR: PROMOTION AND COORDINATION OF ASSISTANCE IN THE FIELD OF INTERNATIONAL DEVELOPMENT AND RELIEF, NAMELY, DEVELOPING AND COORDINATING VOLUNTEER PROJECTS FOR CHARITABLE ORGANIZATIONS, IN CLASS 35 (U.S. CLS. 100, 101 AND 102).

FIRST USE 7-1-2007; IN COMMERCE 7-1-2007.

FOR: PROVIDING ASSISTANCE TO REFUGEES, INTERNALLY DISPLACED PERSONS AND PEOPLE IN NEED IN AREAS RAVAGED BY CIVIL WAR, CONFLICT OR NATURAL DISASTER, NAMELY, PROVIDING FOOD AND EMERGENCY SHELTER IN THE NATURE OF TEMPORARY HOUSING, IN CLASS 43 (U.S. CLS. 100 AND 101).

FIRST USE 7-1-2007; IN COMMERCE 7-1-2007.

FOR: EMERGENCY RELIEF, NAMELY, PROVIDING EMERGENCY MEDICAL ASSISTANCE, IN CLASS 44 (U.S. CLS. 100 AND 101).

FIRST USE 7-1-2007; IN COMMERCE 7-1-2007.

NO CLAIM IS MADE TO THE EXCLUSIVE RIGHT TO USE "BAPTIST GLOBAL RESPONSE", APART FROM THE MARK AS SHOWN.

THE COLOR(S) GREEN AND BLACK IS/ARE CLAIMED AS A FEATURE OF THE MARK.

THE MARK CONSISTS OF THE LETTERS "BGR" IN STYLIZED BLACK TYPE SURROUNDED BY GREEN, WITH A STYLIZED BLACK AND GREEN GLOBE TO THE RIGHT OF THE LETTERS "BGR," WITH THE WORDS "BAPTIST GLOBAL RESPONSE" IN BLACK IMMEDIATELY BELOW THE LETTERS "BGR", AND A "TAIL" IN BLACK COMING RIGHT TO LEFT FROM THE GLOBE TO UNDERLINE THE WORDS "BAPTIST GLOBAL RESPONSE".

SER. NO. 77-283,682, FILED 9-19-2007.

BARBARA BROWN, EXAMINING ATTORNEY



**Int. Cl.: 40**

**Prior U.S. Cls.: 100, 103 and 106**

**United States Patent and Trademark Office**

**Reg. No. 3,504,000**

**Registered Sep. 23, 2008**

**SERVICE MARK  
PRINCIPAL REGISTER**

**NUCLEAR EARTH**

NAC INTERNATIONAL, INC. (DELAWARE CORPORATION)  
3930 EAST JONES BRIDGE ROAD  
NORCROSS, GA 30092

FOR: PROVIDING INFORMATION IN THE FIELD OF NUCLEAR POWER GENERATION, INCLUDING SATELLITE IMAGERY AND OTHER FACILITY INFORMATION, TO NUCLEAR INDUSTRY SUBSCRIBERS VIA THE INTERNET, IN CLASS 40 (U.S. CLS. 100, 103 AND 106).

FIRST USE 9-5-2007; IN COMMERCE 9-5-2007.

THE MARK CONSISTS OF STANDARD CHARACTERS WITHOUT CLAIM TO ANY PARTICULAR FONT, STYLE, SIZE, OR COLOR.

NO CLAIM IS MADE TO THE EXCLUSIVE RIGHT TO USE "NUCLEAR", APART FROM THE MARK AS SHOWN.

SER. NO. 77-284,194, FILED 9-20-2007.

MICHAEL WIENER, EXAMINING ATTORNEY

**Int. Cl.: 40**

**Prior U.S. Cls.: 100, 103 and 106**

**United States Patent and Trademark Office**

**Reg. No. 3,504,001**

**Registered Sep. 23, 2008**

**SERVICE MARK  
PRINCIPAL REGISTER**



NAC INTERNATIONAL, INC. (DELAWARE CORPORATION)  
3930 EAST JONES BRIDGE ROAD  
NORCROSS, GA 30092

FOR: PROVIDING INFORMATION IN THE FIELD OF NUCLEAR POWER GENERATION, INCLUDING SATELLITE IMAGERY AND OTHER FACILITY INFORMATION, TO NUCLEAR INDUSTRY SUBSCRIBERS VIA THE INTERNET, IN CLASS 40 (U.S. CLS. 100, 103 AND 106).

FIRST USE 9-5-2007; IN COMMERCE 9-5-2007.

NO CLAIM IS MADE TO THE EXCLUSIVE RIGHT TO USE "NUCLEAR", APART FROM THE MARK AS SHOWN.

THE COLOR(S) GREEN, BLUE, BLACK AND WHITE IS/ARE CLAIMED AS A FEATURE OF THE MARK.

"THE MARK CONSISTS OF A RECTANGLE. THE LEFT HALF OF THE RECTANGLE APPEARS IN THE COLOR WHITE. THE TERM "NUCLEAR" APPEARS IN THIS HALF OF THE RECTANGLE IN GREEN LETTERS. THE RIGHT HALF OF THE RECTANGLE APPEARS IN THE COLOR GREEN. THE TERM "EARTH" APPEARS IN THIS HALF OF THE RECTANGLE IN WHITE LETTERS. IN THE CENTER OF THE RECTANGLE A DESIGN OF THE PLANET EARTH APPEARS, WITH THE OCEANS APPEARING IN THE COLOR BLUE AND THE CONTINENTS APPEARING IN THE COLOR GREEN. SURROUNDING THE DESIGN OF THE PLANET EARTH APPEARS AN ATOMIC MODEL IN THE COLOR BLACK."

SER. NO. 77-284,206, FILED 9-20-2007.

MICHAEL WIENER, EXAMINING ATTORNEY

**Int. Cl.: 12**

**Prior U.S. Cls.: 19, 21, 23, 31, 35 and 44**

**Reg. No. 3,504,002**

**United States Patent and Trademark Office**

**Registered Sep. 23, 2008**

---

**TRADEMARK  
PRINCIPAL REGISTER**

**Pro-Line**

PRO-LINE PERFORMANCE, INC. (VIRGINIA  
CORPORATION)  
3021 FLEMING AVENUE  
ROANOKE, VA 24012

FOR: CAR HAULERS, NAMELY, TRAILERS  
USED TO TRANSPORT VEHICLES; TRAILERS;  
MOTOR HOMES; HORSE TRAILERS; CATTLE  
TRAILERS; TRUCKS; EQUIPMENT HAULERS,  
NAMELY, TRAILERS USED TO TRANSPORT  
EQUIPMENT, IN CLASS 12 (U.S. CLS. 19, 21, 23, 31,  
35 AND 44).

FIRST USE 1-1-1995; IN COMMERCE 1-1-1995.

THE MARK CONSISTS OF STANDARD CHAR-  
ACTERS WITHOUT CLAIM TO ANY PARTICULAR  
FONT, STYLE, SIZE, OR COLOR.

SER. NO. 77-284,233, FILED 9-20-2007.

SANJEEV VOHRA, EXAMINING ATTORNEY

**Int. Cl.: 36**

**Prior U.S. Cls.: 100, 101 and 102**

**United States Patent and Trademark Office**

**Reg. No. 3,504,003**

**Registered Sep. 23, 2008**

**SERVICE MARK  
PRINCIPAL REGISTER**



CITYWIDE BANKS OF COLORADO, INC. (COL-  
ORADO CORPORATION)  
SUITE 203  
6500 EAST HAMPDEN AVE  
DENVER, CO 80224

FOR: BANKING, IN CLASS 36 (U.S. CLS. 100, 101  
AND 102).

FIRST USE 7-31-2007; IN COMMERCE 7-31-2007.

NO CLAIM IS MADE TO THE EXCLUSIVE  
RIGHT TO USE "WEALTH MANAGEMENT",  
APART FROM THE MARK AS SHOWN.

THE MARK CONSISTS OF LINE DRAWING OF A  
SUNRISE IMAGE CENTERED ABOVE THE WORDS  
"CITYWIDE WEALTH MANAGEMENT".

SEC. 2(F) "CITYWIDE HAS BECOME DISTINC-  
TIVE OF THE GOODS/SERVICES THROUGH THE  
APPLICANT'S SUBSTANTIALLY EXCLUSIVE AND  
CONTINUOUS USE IN COMMERCE FOR AT  
LEAST THE FIVE YEARS IMMEDIATELY BEFORE  
THE DATE OF THIS STATEMENT".

SER. NO. 77-284,760, FILED 9-20-2007.

BARBARA RUTLAND, EXAMINING ATTORNEY

**Int. Cl.: 41**

**Prior U.S. Cls.: 100, 101 and 107**

**United States Patent and Trademark Office**

**Reg. No. 3,504,004**

**Registered Sep. 23, 2008**

**SERVICE MARK  
PRINCIPAL REGISTER**

**INDIEVELOPMENT**

CNET NETWORKS, INC. (DELAWARE CORPORATION)  
FOURTH FLOOR  
235 SECOND STREET  
SAN FRANCISCO, CA 94105

FOR: ENTERTAINMENT SERVICES, NAMELY, PROVIDING A CONTINUING REALITY-BASED TELEVISION SHOW DELIVERED OVER THE INTERNET; ENTERTAINMENT SERVICES, NAMELY, PROVIDING A WEB SITE FEATURING ONGOING REALITY-BASED VIDEO PROGRAMS; ENTERTAINMENT SERVICES, NAMELY, PROVIDING WEBCASTS IN THE NATURE OF AN ON-GOING

REALITY-BASED PROGRAM, IN CLASS 41 (U.S. CLS. 100, 101 AND 107).

FIRST USE 3-31-2007; IN COMMERCE 3-31-2007.

THE MARK CONSISTS OF STANDARD CHARACTERS WITHOUT CLAIM TO ANY PARTICULAR FONT, STYLE, SIZE, OR COLOR.

SER. NO. 77-285,080, FILED 9-20-2007.

JEFFERY COWARD, EXAMINING ATTORNEY

**Int. Cls.: 9, 16, 41 and 42**

**Prior U.S. Cls.: 2, 5, 21, 22, 23, 26, 29, 36, 37, 38, 50,  
100, 101 and 107**

**Reg. No. 3,504,005**

**United States Patent and Trademark Office**

**Registered Sep. 23, 2008**

**TRADEMARK  
SERVICE MARK  
PRINCIPAL REGISTER**

# MediaLit Kit

JOLLS, TESSA (UNITED STATES INDIVIDUAL)  
SUITE 472  
23852 PACIFIC COAST HIGHWAY  
MALIBU, CA 90265

FOR: CDS, DVDS, AND VIDEOTAPES OF CLIPS, LESSON PLANS, AND PRESENTATIONS IN THE FIELD OF MEDIA COMMUNICATIONS, NAMELY, PROVIDING METHODS FOR ANALYZING AND EVALUATING THE DISSEMINATION OF INFORMATION, IN CLASS 9 (U.S. CLS. 21, 23, 26, 36 AND 38).

FIRST USE 2-7-2002; IN COMMERCE 1-1-2003.

FOR: ARTICLES, BOOKS, AND NEWSLETTERS IN THE FIELD OF MEDIA COMMUNICATIONS, NAMELY, PROVIDING METHODS FOR ANALYZING AND EVALUATING THE DISSEMINATION OF INFORMATION, IN CLASS 16 (U.S. CLS. 2, 5, 22, 23, 29, 37, 38 AND 50).

FIRST USE 2-7-2002; IN COMMERCE 1-1-2003.

FOR: EDUCATIONAL SERVICES, NAMELY, PROVIDING SEMINARS, DEVELOPING LESSON PLANS, CONDUCTING CASE STUDIES, AND PROVIDING EDITORIAL CONSULTATION ON THE

CONTENT OF TEACHING MATERIALS, IN CLASS 41 (U.S. CLS. 100, 101 AND 107).

FIRST USE 2-7-2002; IN COMMERCE 1-1-2003.

FOR: RESEARCH, DESIGN, AND DEVELOPMENT OF ADVANCED LEARNING TECHNOLOGIES IN THE FIELD OF MEDIA COMMUNICATIONS, NAMELY, PROVIDING METHODS FOR ANALYZING AND EVALUATING THE DISSEMINATION OF INFORMATION, IN CLASS 42 (U.S. CLS. 100 AND 101).

FIRST USE 2-7-2002; IN COMMERCE 1-1-2003.

THE MARK CONSISTS OF STANDARD CHARACTERS WITHOUT CLAIM TO ANY PARTICULAR FONT, STYLE, SIZE, OR COLOR.

NO CLAIM IS MADE TO THE EXCLUSIVE RIGHT TO USE "KIT", APART FROM THE MARK AS SHOWN.

SEC. 2(F).

SER. NO. 77-285,082, FILED 9-20-2007.

JILL C. ALT, EXAMINING ATTORNEY

**Int. Cl.: 41**

**Prior U.S. Cls.: 100, 101 and 107**

**United States Patent and Trademark Office**

**Reg. No. 3,504,006**

**Registered Sep. 23, 2008**

**SERVICE MARK  
PRINCIPAL REGISTER**

**IT'S EASIER TO GET AHEAD  
THAN TO CATCH UP**

OLDE TYME TUTORS, LLC (ARKANSAS LIMITED LIABILITY COMPANY)  
14596 HIGHWAY 12 E.  
ROGERS, AR 72756

FOR: EDUCATION SERVICES, NAMELY, CLASSES, WORKSHOPS, INDIVIDUAL GROUP INSTRUCTION AND SMALL GROUP INSTRUCTION IN THE NATURE OF COURSES AT THE GRADE SCHOOL LEVEL AND UNIVERSITY LEVEL, IN CLASS 41 (U.S. CLS. 100, 101 AND 107).

FIRST USE 3-1-2006; IN COMMERCE 3-1-2006.

THE MARK CONSISTS OF STANDARD CHARACTERS WITHOUT CLAIM TO ANY PARTICULAR FONT, STYLE, SIZE, OR COLOR.

SER. NO. 77-285,094, FILED 9-20-2007.

ARETHA SOMERVILLE, EXAMINING ATTORNEY

**Int. Cl.: 5**

**Prior U.S. Cls.: 6, 18, 44, 46, 51 and 52**

**United States Patent and Trademark Office**

**Reg. No. 3,504,007**

**Registered Sep. 23, 2008**

**TRADEMARK  
PRINCIPAL REGISTER**

**Power-X**

KIM, JONG S (UNITED STATES INDIVIDUAL)  
1620 S. 312TH ST. # E  
FEDERAL WAY, WA 98003

THE MARK CONSISTS OF STANDARD CHAR-  
ACTERS WITHOUT CLAIM TO ANY PARTICULAR  
FONT, STYLE, SIZE, OR COLOR.

FOR: HERBAL SUPPLEMENTS, IN CLASS 5 (U.S.  
CLS. 6, 18, 44, 46, 51 AND 52).

SER. NO. 77-285,134, FILED 9-20-2007.

FIRST USE 9-20-2007; IN COMMERCE 9-20-2007.

DAVID ELTON, EXAMINING ATTORNEY



**Int. Cls.: 35 and 41**

**Prior U.S. Cls.: 100, 101, 102 and 107**

**United States Patent and Trademark Office**

**Reg. No. 3,504,008**

**Registered Sep. 23, 2008**

---

**SERVICE MARK  
PRINCIPAL REGISTER**

**MEDi**

BEACON (CONNECTICUT NON-PROFIT ASSO-  
CIATION)

1 CONGRESS STREET, SUITE 201  
HARTFORD, CT 06114

FOR: ARRANGING AND CONDUCTING BUSI-  
NESS CONFERENCES AND TRADE SHOWS IN THE  
FIELDS OF MEDICAL DEVICES AND BIOMEDI-  
CAL ENGINEERING , IN CLASS 35 (U.S. CLS. 100,  
101 AND 102).

FIRST USE 1-5-2005; IN COMMERCE 1-5-2005.

FOR: ARRANGING AND CONDUCTING EDU-  
CATIONAL CONFERENCES, IN CLASS 41 (U.S. CLS.  
100, 101 AND 107).

FIRST USE 1-5-2005; IN COMMERCE 1-5-2005.

THE MARK CONSISTS OF STANDARD CHAR-  
ACTERS WITHOUT CLAIM TO ANY PARTICULAR  
FONT, STYLE, SIZE, OR COLOR.

SER. NO. 77-285,315, FILED 9-21-2007.

REBECCA EISINGER, EXAMINING ATTORNEY

**Int. Cl.: 9**

**Prior U.S. Cls.: 21, 23, 26, 36 and 38**

**United States Patent and Trademark Office**

**Reg. No. 3,504,009**

**Registered Sep. 23, 2008**

**TRADEMARK  
PRINCIPAL REGISTER**

**ccflowcam**

CONSISTACOM, INC. (MICHIGAN CORPORATION)  
P.O. BOX 293  
HOUGHTON, MI 49931

FOR: COMPUTER SOFTWARE FOR MAKING, EDITING, DIAGRAMMING AND PRINTING CUSTOMER CALL CENTER FLOW CHART TELEPHONE SYSTEM PROGRAMMING AND CUSTOMER CALL CENTER FLOW CHART PROGRAMMING BUSINESS RELATIONSHIPS, IN CLASS 9 (U.S. CLS. 21, 23, 26, 36 AND 38).

FIRST USE 9-12-2007; IN COMMERCE 9-18-2007.

THE MARK CONSISTS OF STANDARD CHARACTERS WITHOUT CLAIM TO ANY PARTICULAR FONT, STYLE, SIZE, OR COLOR.

SER. NO. 77-285,474, FILED 9-21-2007.

G. MAYERSCHOFF, EXAMINING ATTORNEY

**Int. Cl.: 44**

**Prior U.S. Cls.: 100 and 101**

**United States Patent and Trademark Office**

**Reg. No. 3,504,010**

**Registered Sep. 23, 2008**

**SERVICE MARK  
PRINCIPAL REGISTER**

**TEXOMA MEDICAL CENTER**

UHS OF DELAWARE, INC. (DELAWARE CORPORATION)  
367 SOUTH GULPH ROAD  
KING OF PRUSSIA, PA 19406

NO CLAIM IS MADE TO THE EXCLUSIVE RIGHT TO USE "MEDICAL CENTER", APART FROM THE MARK AS SHOWN.

FOR: MEDICAL, HOSPITAL AND HEALTHCARE SERVICES, IN CLASS 44 (U.S. CLS. 100 AND 101).

SEC. 2(F).

FIRST USE 9-16-1976; IN COMMERCE 9-16-1976.

SER. NO. 77-285,513, FILED 9-21-2007.

THE MARK CONSISTS OF STANDARD CHARACTERS WITHOUT CLAIM TO ANY PARTICULAR FONT, STYLE, SIZE, OR COLOR.

ALICE SUE CARRUTHERS, EXAMINING ATTORNEY

**Int. Cl.: 39**

**Prior U.S. Cls.: 100 and 105**

**United States Patent and Trademark Office**

**Reg. No. 3,504,011**

**Registered Sep. 23, 2008**

**SERVICE MARK  
PRINCIPAL REGISTER**

**SANDS EXPO**

LAS VEGAS SANDS CORP. (NEVADA CORPORATION)  
3355 LAS VEGAS BOULEVARD SOUTH  
LAS VEGAS, NV 89109

FOR: SHIPPING AND DELIVERY SERVICES, NAMELY, PICKUP, TRANSPORTATION, AND DELIVERY OF PACKAGES AND LETTERS BY VARIOUS MODES OF TRANSPORTATION; COAT CHECK SERVICES; COORDINATING TRAVEL ARRANGEMENTS FOR INDIVIDUALS AND FOR GROUPS, IN CLASS 39 (U.S. CLS. 100 AND 105).

FIRST USE 9-21-2007; IN COMMERCE 9-21-2007.

THE MARK CONSISTS OF STANDARD CHARACTERS WITHOUT CLAIM TO ANY PARTICULAR FONT, STYLE, SIZE, OR COLOR.

OWNER OF U.S. REG. NO. 1,209,102.

NO CLAIM IS MADE TO THE EXCLUSIVE RIGHT TO USE "EXPO", APART FROM THE MARK AS SHOWN.

SER. NO. 77-285,579, FILED 9-21-2007.

PATRICIA EVANKO, EXAMINING ATTORNEY

**Int. Cl.: 35**

**Prior U.S. Cls.: 100, 101 and 102**

**United States Patent and Trademark Office**

**Reg. No. 3,504,012**

**Registered Sep. 23, 2008**

**SERVICE MARK  
PRINCIPAL REGISTER**

**INTERNATIONAL ASSOCIATION  
OF HOME STAGING  
PROFESSIONALS**

BARB, INC. (WASHINGTON CORPORATION),  
DBA STAGED HOMES  
4807 CLAYTON RD. SUITE #200  
CONCORD, CA 94521

OWNER OF U.S. REG. NOS. 3,251,204 AND  
3,286,268.

FOR: ASSOCIATION SERVICES, NAMELY, PROMOTING THE INTERESTS OF REAL ESTATE PROFESSIONALS, DECORATORS AND HOME STAGERS IN THE FIELD OF HOME RENOVATION, DESIGN AND DECORATION, IN CLASS 35 (U.S. CLS. 100, 101 AND 102).

NO CLAIM IS MADE TO THE EXCLUSIVE RIGHT TO USE "ASSOCIATION OF HOME STAGING PROFESSIONALS", APART FROM THE MARK AS SHOWN.

SEC. 2(F).

FIRST USE 12-31-1999; IN COMMERCE 12-31-1999.

SER. NO. 77-285,638, FILED 9-21-2007.

THE MARK CONSISTS OF STANDARD CHARACTERS WITHOUT CLAIM TO ANY PARTICULAR FONT, STYLE, SIZE, OR COLOR.

DAWN HAN, EXAMINING ATTORNEY

**Int. Cl.: 20**

**Prior U.S. Cls.: 2, 13, 22, 25, 32 and 50**

**United States Patent and Trademark Office**

**Reg. No. 3,504,013**

**Registered Sep. 23, 2008**

**TRADEMARK  
PRINCIPAL REGISTER**

**RJONES**

R. JONES AND ASSOCIATES, INC. (TEXAS CORPORATION)  
3054 IRVING BOULEVARD  
DALLAS, TX 75247

THE NAME IN THE MARK IDENTIFIES A LIVING INDIVIDUAL WHOSE CONSENT IS OF RECORD.

FOR: FURNITURE, IN CLASS 20 (U.S. CLS. 2, 13, 22, 25, 32 AND 50).

SEC. 2(F).

FIRST USE 3-1-1979; IN COMMERCE 3-1-1979.

SER. NO. 77-286,437, FILED 9-22-2007.

THE MARK CONSISTS OF STANDARD CHARACTERS WITHOUT CLAIM TO ANY PARTICULAR FONT, STYLE, SIZE, OR COLOR.

SUSAN RICHARDS, EXAMINING ATTORNEY

**Int. Cl.: 35**

**Prior U.S. Cls.: 100, 101 and 102**

**United States Patent and Trademark Office**

**Reg. No. 3,504,014**

**Registered Sep. 23, 2008**

**SERVICE MARK  
PRINCIPAL REGISTER**

**F!NDS DALLAS TEMP SHOW**

WTC-TRADE MART, L.P. (DELAWARE LIMITED  
PARTNERSHIP)  
2100 STEMMONS FREEWAY  
DALLAS, TX 75207

FOR: ARRANGING, CONDUCTING AND PRO-  
MOTING GIFT AND HOME TEMPORARY TRADE  
SHOWS HELD MULITPLE TIMES EACH YEAR IN  
DALLAS FOR WHOLESALE BUYERS, IN CLASS 35  
(U.S. CLS. 100, 101 AND 102).

FIRST USE 10-0-2005; IN COMMERCE 10-0-2005.

THE MARK CONSISTS OF STANDARD CHAR-  
ACTERS WITHOUT CLAIM TO ANY PARTICULAR  
FONT, STYLE, SIZE, OR COLOR.

OWNER OF U.S. REG. NO. 3,299,124.

NO CLAIM IS MADE TO THE EXCLUSIVE  
RIGHT TO USE "DALLAS TEMP SHOW", APART  
FROM THE MARK AS SHOWN.

SER. NO. 77-286,487, FILED 9-22-2007.

JAMES GRIFFIN, EXAMINING ATTORNEY

**Int. Cl.: 42**

**Prior U.S. Cls.: 100 and 101**

**United States Patent and Trademark Office**

**Reg. No. 3,504,015**

**Registered Sep. 23, 2008**

**SERVICE MARK  
PRINCIPAL REGISTER**

**SEARCH + BRAINPOWER**

CHACHA SEARCH, INC. (DELAWARE CORPORATION)  
SUITE 130  
14550 CLAY TERRACE BLVD.  
CARMEL, IN 46032

FOR: PROVIDING SEARCH ENGINE SERVICES FOR OBTAINING SPECIFIC USER-REQUESTED INFORMATION VIA THE INTERNET, TELEPHONE, TEXT MESSAGING, MEDIA MESSAGING, INSTANT MESSAGING, MOBILE INTERNET, E-MAIL, VOICE MESSAGING, AND WIRELESS DEVICES, IN CLASS 42 (U.S. CLS. 100 AND 101).

FIRST USE 6-15-2007; IN COMMERCE 6-15-2007.

THE MARK CONSISTS OF STANDARD CHARACTERS WITHOUT CLAIM TO ANY PARTICULAR FONT, STYLE, SIZE, OR COLOR.

NO CLAIM IS MADE TO THE EXCLUSIVE RIGHT TO USE "SEARCH", APART FROM THE MARK AS SHOWN.

SER. NO. 77-287,423, FILED 9-24-2007.

ALICE SUE CARRUTHERS, EXAMINING ATTORNEY



Int. Cls.: 35 and 36

Prior U.S. Cls.: 100, 101 and 102

United States Patent and Trademark Office

Reg. No. 3,504,016

Registered Sep. 23, 2008

SERVICE MARK  
PRINCIPAL REGISTER



JOHNSTON, RICHARD W (NEW YORK SOLE PROPRIETORSHIP), DBA FRENCH COUNTRY DREAMS

APT. 6C

817 WEST END AVENUE

NEW YORK, NY 100255319

FOR: MATCHING CONSUMERS WITH REAL ESTATE PROFESSIONALS IN THE FIELD OF REAL ESTATE SERVICES VIA COMPUTER NETWORK; PROVIDING REAL ESTATE LEADS FOR PROSPECTIVE PURCHASERS, IN CLASS 35 (U.S. CLS. 100, 101 AND 102).

FIRST USE 6-1-1991; IN COMMERCE 6-1-1991.

FOR: REAL ESTATE PROCUREMENT FOR OTHERS, IN CLASS 36 (U.S. CLS. 100, 101 AND 102).

FIRST USE 6-1-1991; IN COMMERCE 6-1-1991.

NO CLAIM IS MADE TO THE EXCLUSIVE RIGHT TO USE "FRENCH COUNTRY", APART FROM THE MARK AS SHOWN.

THE MARK CONSISTS OF "FRENCH COUNTRY DREAMS" NAME SURROUNDING AN IMAGE OF A FRENCH COTTAGE.

SER. NO. 77-287,679, FILED 9-24-2007.

KYLE PEETE, EXAMINING ATTORNEY

**Int. Cl.: 35**

**Prior U.S. Cls.: 100, 101 and 102**

**United States Patent and Trademark Office**

**Reg. No. 3,504,017**

**Registered Sep. 23, 2008**

**SERVICE MARK  
PRINCIPAL REGISTER**

**LUV MIA**

GIBBS, GILBERT A. (UNITED STATES INDIVIDUAL)  
5501 NW 72ND AVENUE  
MIAMI, FL 33166

FOR: PROMOTING TOURISM IN THE MIAMI-DADE COUNTY AREA, IN CLASS 35 (U.S. CLS. 100, 101 AND 102).

FIRST USE 9-6-2007; IN COMMERCE 9-6-2007.

THE MARK CONSISTS OF STANDARD CHARACTERS WITHOUT CLAIM TO ANY PARTICULAR FONT, STYLE, SIZE, OR COLOR.

NO CLAIM IS MADE TO THE EXCLUSIVE RIGHT TO USE "MIA", APART FROM THE MARK AS SHOWN.

SER. NO. 77-287,880, FILED 9-25-2007.

CAROLYN CATALDO, EXAMINING ATTORNEY

**Int. Cl.: 25**

**Prior U.S. Cls.: 22 and 39**

**United States Patent and Trademark Office**

**Reg. No. 3,504,018**

**Registered Sep. 23, 2008**

**TRADEMARK  
PRINCIPAL REGISTER**



STARR WESTERN WEAR, INC. (TEXAS CORPORATION)  
P.O. BOX 1022  
EL PASO, TX 79946

FOR: BASEBALL CAPS; BLOUSES; COATS; DRESS SHIRTS; DRESSES; HATS; JACKETS; JEANS; OVERALLS; PANTS; POLO SHIRTS; PULLOVERS; SHIRTS; SHORTS; SKIRTS; T-SHIRTS; TANK TOPS; TOP COATS; VESTS, IN CLASS 25 (U.S. CLS. 22 AND 39).

FIRST USE 10-1-2003; IN COMMERCE 10-1-2003.

OWNER OF U.S. REG. NO. 2,996,865.

THE MARK CONSISTS OF AN OUTLINE OF A COWBOY FIGURE.

SER. NO. 77-287,962, FILED 9-25-2007.

JEFFERY COWARD, EXAMINING ATTORNEY

**Int. Cl.: 45**

**Prior U.S. Cls.: 100 and 101**

**United States Patent and Trademark Office**

**Reg. No. 3,504,019**

**Registered Sep. 23, 2008**

**SERVICE MARK  
PRINCIPAL REGISTER**

**SANDS EXPO**

LAS VEGAS SANDS CORP. (NEVADA CORPORATION)  
3355 LAS VEGAS BOULEVARD SOUTH  
LAS VEGAS, NV 89109

FOR: SECURITY GUARD SERVICES, IN CLASS  
45 (U.S. CLS. 100 AND 101).

FIRST USE 9-25-2007; IN COMMERCE 9-25-2007.

THE MARK CONSISTS OF STANDARD CHARACTERS WITHOUT CLAIM TO ANY PARTICULAR FONT, STYLE, SIZE, OR COLOR.

OWNER OF U.S. REG. NO. 1,209,102.

NO CLAIM IS MADE TO THE EXCLUSIVE RIGHT TO USE "EXPO", APART FROM THE MARK AS SHOWN.

SER. NO. 77-288,294, FILED 9-25-2007.

PATRICIA EVANKO, EXAMINING ATTORNEY

**Int. Cl.: 36**

**Prior U.S. Cls.: 100, 101 and 102**

**United States Patent and Trademark Office**

**Reg. No. 3,504,020**

**Registered Sep. 23, 2008**

**SERVICE MARK  
PRINCIPAL REGISTER**



CITYWIDE BANKS OF COLORADO, INC. (COL-  
ORADO CORPORATION)  
SUITE 203  
6500 EAST HAMPDEN AVE  
DENVER, CO 80224

FOR: BANKING, IN CLASS 36 (U.S. CLS. 100, 101  
AND 102).

FIRST USE 7-11-1974; IN COMMERCE 7-11-1974.

THE MARK CONSISTS OF LINE DRAWING OF A  
SUNBURST IMAGE TO THE LEFT OF THE WORD  
"CITYWIDE". THE BOTTOM RIGHT SUNBURST  
LINE RUNS HORIZONTALLY TO THE RIGHT AND  
UNDERNEATH THE WORD "CITYWIDE".

SEC. 2(F) AS TO "CITYWIDE".

SER. NO. 77-288,295, FILED 9-25-2007.

BARBARA RUTLAND, EXAMINING ATTORNEY

**Int. Cl.: 35**

**Prior U.S. Cls.: 100, 101 and 102**

**United States Patent and Trademark Office**

**Reg. No. 3,504,021**

**Registered Sep. 23, 2008**

**SERVICE MARK  
PRINCIPAL REGISTER**

**FLOORZ TO YOUR DOORZ**

FLOORZ TO YOUR DOORZ, LLC (NORTH CAROLINA LIMITED LIABILITY COMPANY)  
P. O. BOX 15671  
WILMINGTON, NC 28405

FOR: RETAIL STORE SERVICES FEATURING FLOOR COVERINGS THROUGH A MOBILE VAN AT THE BUYER'S RESIDENCE, IN CLASS 35 (U.S. CLS. 100, 101 AND 102).

FIRST USE 4-1-2006; IN COMMERCE 4-1-2006.

THE MARK CONSISTS OF STANDARD CHARACTERS WITHOUT CLAIM TO ANY PARTICULAR FONT, STYLE, SIZE, OR COLOR.

NO CLAIM IS MADE TO THE EXCLUSIVE RIGHT TO USE "FLOORS", APART FROM THE MARK AS SHOWN.

SER. NO. 77-288,363, FILED 9-25-2007.

SHAUNIA CARLYLE, EXAMINING ATTORNEY

Int. Cl.: 35

Prior U.S. Cls.: 100, 101 and 102

United States Patent and Trademark Office

Reg. No. 3,504,022

Registered Sep. 23, 2008

SERVICE MARK  
PRINCIPAL REGISTER



DYNASTY IRON DOORS, LLC (ARIZONA LIMITED LIABILITY COMPANY)  
C-102  
1522 WEST TODD DR.  
TEMPE, AZ 85283

FOR: WHOLESALE DISTRIBUTORSHIPS FEATURING ORNATE WROUGHT IRON PRODUCTS, IN CLASS 35 (U.S. CLS. 100, 101 AND 102).

FIRST USE 2-1-2006; IN COMMERCE 2-1-2006.

NO CLAIM IS MADE TO THE EXCLUSIVE RIGHT TO USE "IRON DOORS", APART FROM THE MARK AS SHOWN.

THE MARK CONSISTS OF THE STYLIZED WORDS "D DYNASTY IRON DOORS".

SER. NO. 77-288,700, FILED 9-25-2007.

ANNE MADDEN, EXAMINING ATTORNEY

**Int. Cls.: 41 and 42**

**Prior U.S. Cls.: 100, 101 and 107**

**United States Patent and Trademark Office**

**Reg. No. 3,504,023**

**Registered Sep. 23, 2008**

**SERVICE MARK  
PRINCIPAL REGISTER**

**COMPUTER HISTORY MUSEUM**

COMPUTER HISTORY MUSEUM (CALIFORNIA  
NON-PROFIT CORPORATION)  
1401 N. SHORELINE BLVD.  
MOUNTAIN VIEW, CA 94043

FOR: MUSEUM SERVICES; EDUCATIONAL SERVICES, NAMELY, CONDUCTING SEMINARS, WORKSHOPS AND CONFERENCES IN THE FIELD OF HISTORY; EDUCATIONAL AND ENTERTAINMENT SERVICES, NAMELY, ORGANIZING AND CONDUCTING COMPUTER TRIVIA CONTESTS AND TOURNAMENTS; PROVIDING INFORMATION IN THE FIELD OF HISTORY VIA ELECTRONIC GLOBAL COMMUNICATIONS NETWORKS, IN CLASS 41 (U.S. CLS. 100, 101 AND 107).

FIRST USE 0-0-2001; IN COMMERCE 0-0-2001.

FOR: PROVIDING INFORMATION IN THE FIELD OF TECHNOLOGY VIA ELECTRONIC GLO-

BAL COMMUNICATIONS NETWORKS, IN CLASS 42 (U.S. CLS. 100 AND 101).

FIRST USE 0-0-2001; IN COMMERCE 0-0-2001.

THE MARK CONSISTS OF STANDARD CHARACTERS WITHOUT CLAIM TO ANY PARTICULAR FONT, STYLE, SIZE, OR COLOR.

NO CLAIM IS MADE TO THE EXCLUSIVE RIGHT TO USE "MUSEUM", APART FROM THE MARK AS SHOWN.

SEC. 2(F).

SER. NO. 77-288,863, FILED 9-25-2007.

PAUL E. FAHRENKOPF, EXAMINING ATTORNEY



**Int. Cl.: 35**

**Prior U.S. Cls.: 100, 101 and 102**

**United States Patent and Trademark Office**

**Reg. No. 3,504,024**

**Registered Sep. 23, 2008**

**SERVICE MARK  
PRINCIPAL REGISTER**

# Perfect Transcription

PERFECT TRANSCRIPTION, INC. (TEXAS CORPORATION)

4501 UPVALLEY CT.

AUSTIN, TX 78731

FOR: MEDICAL TRANSCRIPTION SERVICES, IN CLASS 35 (U.S. CLS. 100, 101 AND 102).

FIRST USE 7-1-2000; IN COMMERCE 7-1-2000.

THE MARK CONSISTS OF STANDARD CHARACTERS WITHOUT CLAIM TO ANY PARTICULAR FONT, STYLE, SIZE, OR COLOR.

NO CLAIM IS MADE TO THE EXCLUSIVE RIGHT TO USE "TRANSCRIPTION", APART FROM THE MARK AS SHOWN.

SER. NO. 77-288,936, FILED 9-26-2007.

TRACY CROSS, EXAMINING ATTORNEY

**Int. Cl.: 16**

**Prior U.S. Cls.: 2, 5, 22, 23, 29, 37, 38 and 50**

**Reg. No. 3,504,025**

**United States Patent and Trademark Office**

**Registered Sep. 23, 2008**

**TRADEMARK  
PRINCIPAL REGISTER**

# Kure Punch

KABUSHIKI KAISHA KURETAKE (JAPAN  
JOINT-STOCK COMPAY), DBA KURETAKE  
CO., LTD

576, 7-CHOME, MINAMIKYOBATE-CHO  
NARA-SHI, NARA-KEN, JAPAN

FOR: PUNCHES FOR CRAFT PAPER FOR  
SCRAPBOOKING, IN CLASS 16 (U.S. CLS. 2, 5, 22,  
23, 29, 37, 38 AND 50).

FIRST USE 8-1-2005; IN COMMERCE 8-1-2006.

THE MARK CONSISTS OF STANDARD CHAR-  
ACTERS WITHOUT CLAIM TO ANY PARTICULAR  
FONT, STYLE, SIZE, OR COLOR.

NO CLAIM IS MADE TO THE EXCLUSIVE  
RIGHT TO USE "PUNCH", APART FROM THE  
MARK AS SHOWN.

SER. NO. 77-289,375, FILED 9-26-2007.

ARETHA SOMERVILLE, EXAMINING ATTORNEY

**Int. Cl.: 35**

**Prior U.S. Cls.: 100, 101 and 102**

**United States Patent and Trademark Office**

**Reg. No. 3,504,026**

**Registered Sep. 23, 2008**

**SERVICE MARK  
PRINCIPAL REGISTER**

**BEDA**

BINGHAM MCHALE LLP (INDIANA LIMITED  
PARTNERSHIP)  
2700 MARKET TOWER  
10 WEST MARKET STREET  
INDIANAPOLIS, IN 46204

FOR: BUSINESS CONSULTATION AND DEVELOPMENT SERVICES IN THE FIELD OF ECONOMIC DEVELOPMENT RELATING TO SITE-SELECTION ANALYSIS, INCENTIVE PROCUREMENT AND COMPLIANCE, AND COMMUNITY DEVELOPMENT AND PLANNING, IN CLASS 35 (U.S. CLS. 100, 101 AND 102).

FIRST USE 5-28-2007; IN COMMERCE 5-28-2007.

THE MARK CONSISTS OF STANDARD CHARACTERS WITHOUT CLAIM TO ANY PARTICULAR FONT, STYLE, SIZE, OR COLOR.

SER. NO. 77-290,098, FILED 9-27-2007.

ESTHER A. BORSUK, EXAMINING ATTORNEY

**Int. Cl.: 9**

**Prior U.S. Cls.: 21, 23, 26, 36 and 38**

**Reg. No. 3,504,027**

**United States Patent and Trademark Office**

**Registered Sep. 23, 2008**

---

**TRADEMARK  
PRINCIPAL REGISTER**

**RHOZET**

HARMONIC INC. (DELAWARE CORPORATION)  
549 BALTIC WAY  
SUNNYVALE, CA 94089

THE MARK CONSISTS OF STANDARD CHAR-  
ACTERS WITHOUT CLAIM TO ANY PARTICULAR  
FONT, STYLE, SIZE, OR COLOR.

FOR: COMPUTER SOFTWARE FOR CONVERT-  
ING VIDEO AND AUDIO FROM ONE DIGITAL  
FORMAT TO ANOTHER, IN CLASS 9 (U.S. CLS. 21,  
23, 26, 36 AND 38).

SER. NO. 77-290,567, FILED 9-27-2007.

FIRST USE 10-1-2004; IN COMMERCE 2-15-2005.

BARBARA A. GOLD, EXAMINING ATTORNEY

**Int. Cl.: 35**

**Prior U.S. Cls.: 100, 101 and 102**

**United States Patent and Trademark Office**

**Reg. No. 3,504,028**

**Registered Sep. 23, 2008**

**SERVICE MARK  
PRINCIPAL REGISTER**

**PERSONNEL CONNECTION**

SPENCER REED GROUP, LLC (KANSAS LIMITED LIABILITY COMPANY)  
6900 COLLEGE BLVD, SUITE 1  
OVERLAND PARK, KS 66211

FOR: EMPLOYMENT AGENCY SERVICES, NAMELY, STAFFING SERVICES FOR TEMPORARY AND DIRECT HIRE IN THE FIELDS OF OFFICE ADMINISTRATION, ACCOUNTING, INFORMATION TECHNOLOGY, LAW, PROFESSIONAL, LIGHT INDUSTRIAL AND SKILLED TRADES, IN CLASS 35 (U.S. CLS. 100, 101 AND 102).

FIRST USE 11-30-1991; IN COMMERCE 11-30-1991.

THE MARK CONSISTS OF STANDARD CHARACTERS WITHOUT CLAIM TO ANY PARTICULAR FONT, STYLE, SIZE, OR COLOR.

NO CLAIM IS MADE TO THE EXCLUSIVE RIGHT TO USE "PERSONNEL", APART FROM THE MARK AS SHOWN.

SER. NO. 77-290,700, FILED 9-27-2007.

DEZMONA MIZELLE, EXAMINING ATTORNEY

**Int. Cl.: 35**

**Prior U.S. Cls.: 100, 101 and 102**

**United States Patent and Trademark Office**

**Reg. No. 3,504,029**

**Registered Sep. 23, 2008**

**SERVICE MARK  
PRINCIPAL REGISTER**

**ENCORE STAFFING SERVICES**

SPENCER REED GROUP, LLC (KANSAS LIMITED LIABILITY COMPANY)  
6900 COLLEGE BLVD, SUITE 1  
OVERLAND PARK, KS 66211

FOR: EMPLOYMENT AGENCY SERVICES, NAMELY, STAFFING SERVICES FOR TEMPORARY AND DIRECT HIRE IN THE FIELDS OF OFFICE ADMINISTRATION, ACCOUNTING, INFORMATION TECHNOLOGY, LAW, PROFESSIONAL, LIGHT INDUSTRIAL AND SKILLED TRADES, IN CLASS 35 (U.S. CLS. 100, 101 AND 102).

FIRST USE 8-31-1994; IN COMMERCE 8-31-1994.

THE MARK CONSISTS OF STANDARD CHARACTERS WITHOUT CLAIM TO ANY PARTICULAR FONT, STYLE, SIZE, OR COLOR.

NO CLAIM IS MADE TO THE EXCLUSIVE RIGHT TO USE "STAFFING SERVICES", APART FROM THE MARK AS SHOWN.

SER. NO. 77-290,702, FILED 9-27-2007.

DEZMONA MIZELLE, EXAMINING ATTORNEY

**Int. Cl.: 35**

**Prior U.S. Cls.: 100, 101 and 102**

**United States Patent and Trademark Office**

**Reg. No. 3,504,030**

**Registered Sep. 23, 2008**

**SERVICE MARK  
PRINCIPAL REGISTER**

**SPENCER REED GROUP**

SPENCER REED GROUP, LLC (KANSAS LIMITED LIABILITY COMPANY)  
6900 COLLEGE BLVD, SUITE 1  
OVERLAND PARK, KS 66211

FOR: EMPLOYMENT AGENCY SERVICES, NAMELY, STAFFING SERVICES FOR TEMPORARY AND DIRECT HIRE IN THE FIELDS OF OFFICE ADMINISTRATION, ACCOUNTING, INFORMATION TECHNOLOGY, LAW, PROFESSIONAL, LIGHT INDUSTRIAL AND SKILLED TRADES, IN CLASS 35 (U.S. CLS. 100, 101 AND 102).

FIRST USE 12-31-1990; IN COMMERCE 12-31-1990.

THE MARK CONSISTS OF STANDARD CHARACTERS WITHOUT CLAIM TO ANY PARTICULAR FONT, STYLE, SIZE, OR COLOR.

NO CLAIM IS MADE TO THE EXCLUSIVE RIGHT TO USE "GROUP", APART FROM THE MARK AS SHOWN.

THE NAME "SPENCER REED" DOES NOT IDENTIFY A LIVING INDIVIDUAL.

SER. NO. 77-290,705, FILED 9-27-2007.

DEZMONA MIZELLE, EXAMINING ATTORNEY

**Int. Cls.: 29, 30 and 32**

**Prior U.S. Cls.: 45, 46 and 48**

**Reg. No. 3,504,031**

**United States Patent and Trademark Office**

**Registered Sep. 23, 2008**

**TRADEMARK  
PRINCIPAL REGISTER**



VIETNAM AIRLINES CORPORATION (VIETNAM CORPORATION)  
GIA LAM AIRPORT  
HANOI, VIETNAM

FOR: PROCESSED, CANNED, DRIED AND PRESERVED FRUITS; CANNED COOKED MEAT; MEAT, FISH AND VEGETABLE CHOW MEIN; COMPOTES; CUT, BAGGED, CANNED, BOTTLED VEGETABLES; DAIRY PRODUCTS EXCLUDING ICE CREAM, ICE MILK AND FROZEN YOGURT; DRIED EGGS; DRINKING YOGURTS; EGG YOLKS; EGGS; FISH NOT LIVE; FISH SAUSAGES; FISH-MEAL FOR HUMAN CONSUMPTION; FRIED MEAT; FROZEN EGGS; FRUIT CONSERVES; MARINATED MEAT, SEAFOOD, FISH, POULTRY AND VEGETABLES; MEAT JELLIES; MEAT PASTE; MEATBALLS; MILK; MILK CURD; MILK DRINKS CONTAINING FRUITS; MILK-BASED BEVERAGE CONTAINING COFFEE; MILK POWDER; OMELETS; PROCESSED FISH ROE; PROCESSED MEAT, NAMELY, HAM, TURKEY, LAMB, VEAL; PROCES-

SED VEGETABLES; SMOKED FISH; FROZEN, PRESERVED VEGETABLES, IN CLASS 29 (U.S. CL. 46).

FOR: BREAD; CAKES, IN CLASS 30 (U.S. CL. 46).

FOR: MINERAL WATER, IN CLASS 32 (U.S. CLS. 45, 46 AND 48).

OWNER OF VIETNAM REG. NO. 30628, DATED 4-3-1999, EXPIRES 11-17-2017.

NO CLAIM IS MADE TO THE EXCLUSIVE RIGHT TO USE "VIETNAM", APART FROM THE MARK AS SHOWN.

THE MARK CONSISTS OF WORD PART IS "VIETNAM AIRLINES" AND DEVICE PART IS A LOTUS.

SER. NO. 77-291,034, FILED 9-27-2007.

CAROLYN CATALDO, EXAMINING ATTORNEY



Int. Cl.: 16

Prior U.S. Cls.: 2, 5, 22, 23, 29, 37, 38 and 50

Reg. No. 3,504,032

United States Patent and Trademark Office

Registered Sep. 23, 2008

TRADEMARK  
PRINCIPAL REGISTER



UNITED STATES POSTAL SERVICE (UNITED STATES INDEPENDENT ESTABLISHMENT OF THE EXECUTIVE BRANCH OF THE GOVERNMENT OF THE UNITED STATES)

475 L'ENFANT PLAZA WEST SW  
WASHINGTON, DC 20260

FOR: MAILING MATERIALS, NAMELY, PLASTIC OR PAPER ENVELOPES AND POUCHES AND CARDBOARD AND CORRUGATED BOXES FOR SHIPPING AND PACKAGING; ADHESIVE TAPE AND LABELS FOR PACKAGING, IN CLASS 16 (U.S. CLS. 2, 5, 22, 23, 29, 37, 38 AND 50).

FIRST USE 5-31-2007; IN COMMERCE 5-31-2007.

OWNER OF U.S. REG. NOS. 1,155,532, 3,202,186 AND OTHERS.

NO CLAIM IS MADE TO THE EXCLUSIVE RIGHT TO USE "MAIL", AND "EXTREMELY URGENT PLEASE RUSH TO ADDRESSEE", AND THE RECTANGULAR SHAPE OF THE ENVELOPE, APART FROM THE MARK AS SHOWN.

THE COLOR(S) BLUE AND WHITE IS/ARE CLAIMED AS A FEATURE OF THE MARK.

THE MARK CONSISTS OF THE DESIGN OF A RECTANGULAR MAIL ENVELOPE. BLUE STRIPS ARE PLACED ALONG THE TOP AND BOTTOM EDGES OF THE ENVELOPE. THE BACKGROUND OF THE ENVELOPE IS WHITE. IN THE UPPER LEFT HAND CORNER OF THE ENVELOPE IS A BLUE AND WHITE STYLIZED EAGLE HEAD WITH THE BLUE WORDING "EXPRESS MAIL" DIVIDED BY A BLUE LINE OVER THE WORDING "UNITED STATES POSTAL SERVICE" IN THE COLOR BLUE. IN THE UPPER RIGHT HAND CORNER OF THE ENVELOPE IS THE STYLIZED WORDING "EMS" WITH GEOMETRIC SHAPES ON EITHER SIDE AND WITH VERTICAL LINES RUNNING THROUGH IT ALL IN THE COLOR BLUE. ON THE LEFT IN THE CENTER OF THE ENVELOPE IN BLUE ARE THE WORDS "EXTREMELY URGENT PLEASE RUSH TO ADDRESSEE" WITH BLUE LINES OVER AND UNDER THE WORDING "EXTREMELY URGENT".

SEC. 2(F) AS TO "EXPRESS MAIL" AND "UNITED STATES POSTAL SERVICE".

SER. NO. 77-291,657, FILED 9-28-2007.

JEFFERY COWARD, EXAMINING ATTORNEY

Int. Cl.: 39

Prior U.S. Cls.: 100 and 105

United States Patent and Trademark Office

Reg. No. 3,504,033

Registered Sep. 23, 2008

**SERVICE MARK  
PRINCIPAL REGISTER**



UNITED STATES POSTAL SERVICE (UNITED STATES INDEPENDENT ESTABLISHMENT OF THE EXECUTIVE BRANCH OF THE GOVERNMENT OF THE UNITED STATES)

475 L'ENFANT PLAZA WEST SW  
WASHINGTON, DC 20260

FOR: PICKUP, TRANSPORTATION, AND DELIVERY OF PACKAGES, LETTERS AND DOCUMENTS BY VARIOUS MODES OF TRANSPORTATION, IN CLASS 39 (U.S. CLS. 100 AND 105).

FIRST USE 5-31-2007; IN COMMERCE 5-31-2007.

OWNER OF U.S. REG. NOS. 2,132,892, 3,202,187 AND OTHERS.

NO CLAIM IS MADE TO THE EXCLUSIVE RIGHT TO USE "MAIL", AND "EXTREMELY URGENT PLEASE RUSH TO ADDRESSEE", AND THE RECTANGULAR SHAPE OF THE ENVELOPE, APART FROM THE MARK AS SHOWN.

THE COLOR(S) BLUE AND WHITE IS/ARE CLAIMED AS A FEATURE OF THE MARK.

THE MARK CONSISTS OF THE DESIGN OF A RECTANGULAR MAIL ENVELOPE. BLUE STRIPS ARE PLACED ALONG THE TOP AND BOTTOM EDGES OF THE ENVELOPE. THE BACKGROUND OF THE ENVELOPE IS WHITE. IN THE UPPER LEFT HAND CORNER OF THE ENVELOPE IS A BLUE AND WHITE STYLIZED EAGLE HEAD WITH THE BLUE WORDING "EXPRESS MAIL" DIVIDED BY A BLUE LINE OVER THE WORDING "UNITED STATES POSTAL SERVICE" IN THE COLOR BLUE. IN THE UPPER RIGHT HAND CORNER OF THE ENVELOPE IS THE STYLIZED WORDING "EMS" WITH GEOMETRIC SHAPES ON EITHER SIDE AND WITH VERTICAL LINES RUNNING THROUGH IT ALL IN THE COLOR BLUE. ON THE LEFT IN THE CENTER OF THE ENVELOPE IN BLUE ARE THE WORDS "EXTREMELY URGENT PLEASE RUSH TO ADDRESSEE" WITH BLUE LINES OVER AND UNDER THE WORDING "EXTREMELY URGENT".

SEC. 2(F) AS TO EXPRESS MAIL AND UNITED STATES POSTAL SERVICE.

SER. NO. 77-291,842, FILED 9-28-2007.

JEFFERY COWARD, EXAMINING ATTORNEY

Int. Cl.: 35

Prior U.S. Cls.: 100, 101 and 102

United States Patent and Trademark Office

Reg. No. 3,504,034

Registered Sep. 23, 2008

SERVICE MARK  
PRINCIPAL REGISTER



UNITED STATES POSTAL SERVICE (UNITED STATES INDEPENDENT ESTABLISHMENT OF THE EXECUTIVE BRANCH OF THE GOVERNMENT OF THE UNITED STATES)  
475 L'ENFANT PLAZA WEST SW  
WASHINGTON, DC 20260

FOR: SORTING, HANDLING, AND RECEIVING PACKAGES AND LETTERS, IN CLASS 35 (U.S. CLS. 100, 101 AND 102).

FIRST USE 5-31-2007; IN COMMERCE 5-31-2007.

OWNER OF U.S. REG. NOS. 2,132,892, 3,202,187 AND OTHERS.

NO CLAIM IS MADE TO THE EXCLUSIVE RIGHT TO USE "MAIL", "BY AIR MAIL", "PAR AVION" AND THE RECTANGULAR SHAPE OF THE ENVELOPE, APART FROM THE MARK AS SHOWN.

THE COLOR(S) RED, WHITE AND BLUE IS/ARE CLAIMED AS A FEATURE OF THE MARK.

THE MARK CONSISTS OF THE DESIGN OF A RECTANGULAR MAIL ENVELOPE. RED STRIPS ARE PLACED ALONG THE TOP AND BOTTOM EDGES OF THE ENVELOPE. THE BACKGROUND OF THE ENVELOPE IS WHITE. IN THE UPPER LEFT-HAND QUARTER OF THE ENVELOPE IS A BLUE AND WHITE STYLIZED EAGLE HEAD WITH THE BLUE WORDING "PRIORITY MAIL" DIVIDED BY A THIN RED LINE OVER THE WORDING "UNITED STATES POSTAL SERVICE" IN THE COL-

OR BLUE. IN THE UPPER RIGHT-HAND CORNER OF THE ENVELOPE IS A GEOMETRIC SHIELD-LIKE DESIGN OUTLINED IN RED WITH A WHITE BACKGROUND. AT THE TOP LEFT OF THE SHIELD DESIGN THE RED WORDING "BY AIR MAIL" APPEARS OVER THE RED WORDING "PAR AVION" INSIDE A RED OUTLINED RECTANGLE. AT THE TOP RIGHT OF THE SHIELD DESIGN THE RED WORDING "PRIORITY" APPEARS OVER THE RED WORDING "PRIORITAIRE" INSIDE A RED OUTLINED RECTANGLE. BELOW THE TWO RECTANGLES, THE TERM "INTERNATIONAL" APPEARS IN WHITE INSIDE A RED CURVED BAND. IN THE CENTER OF THE SHIELD APPEARS A RED AND WHITE GLOBE DESIGN INCLUDING RED CONTINENTS IN THE MIDDLE. THE TERM "EXPRES" APPEARS IN WHITE INSIDE A RED CURVED BAND OVER THE GLOBE DESIGN, AND THE TERM "PRIORITY" APPEARS IN WHITE INSIDE A RED CURVED BAND BELOW THE GLOBE DESIGN. THE BANDS ARE SEPARATED BY THREE RED QUADRILATERALS ON THE LEFT AND THE RIGHT OF THE GLOBE. (THE SHIELD DESIGN IS DEPICTED IN U.S. REGISTRATION NO. 2619946)

THE ENGLISH TRANSLATION OF THE FOREIGN WORDING "PAR AVION", "PRIORITAIRE" AND "EXPRES" IS "BY AIR MAIL", "PRIORITY" AND "EXPRESS" RESPECTIVELY.

SEC. 2(F) AS TO "PRIORITY MAIL", "UNITED STATES POSTAL SERVICE", "PRIORITY", "PRIORITAIRE" AND "INTERNATIONAL EXPRES PRIORITY" .

SER. NO. 77-291,850, FILED 9-28-2007.

JEFFERY COWARD, EXAMINING ATTORNEY

**Int. Cl.: 35**

**Prior U.S. Cls.: 100, 101 and 102**

**United States Patent and Trademark Office**

**Reg. No. 3,504,035**

**Registered Sep. 23, 2008**

**SERVICE MARK  
PRINCIPAL REGISTER**

**ACCOUNTPROS**

VEDIOR NORTH AMERICA LLC (DELAWARE  
LIMITED LIABILITY COMPANY)  
60 HARVARD MILL SQUARE  
WAKEFIELD, MA 01880

FOR: EMPLOYMENT AGENCY SERVICES; EM-  
PLOYMENT RECRUITING AND PLACEMENT  
CONSULTANCY SERVICES; EMPLOYMENT  
COUNSELING; INFORMATION SERVICES RELAT-  
ING TO JOB PLACEMENT; PROVIDING CAREER  
INFORMATION; JOB ADVERTISING; PERSONNEL  
MANAGEMENT SERVICES; PERSONNEL RE-  
CRUITMENT; TESTING AND ASSESSMENT FOR  
THE SELECTION OF PERSONNEL; PSYCHOLOGI-  
CAL TESTING FOR THE SELECTION OF PERSON-  
NEL; INFORMATION AND ADVISORY SERVICES

RELATING TO THE AFORESAID, IN CLASS 35 (U.S.  
CLS. 100, 101 AND 102).

FIRST USE 10-13-1988; IN COMMERCE 12-1-1988.

THE MARK CONSISTS OF STANDARD CHAR-  
ACTERS WITHOUT CLAIM TO ANY PARTICULAR  
FONT, STYLE, SIZE, OR COLOR.

OWNER OF U.S. REG. NO. 1,622,801.

SER. NO. 77-292,200, FILED 9-28-2007.

LINDA LAVACHE, EXAMINING ATTORNEY

**Int. Cl.: 35**

**Prior U.S. Cls.: 100, 101 and 102**

**United States Patent and Trademark Office**

**Reg. No. 3,504,036**

**Registered Sep. 23, 2008**

**SERVICE MARK  
PRINCIPAL REGISTER**



NATIONAL ASSOCIATION OF BROADCASTERS  
(DELAWARE CORPORATION)  
1771 N STREET, NW  
WASHINGTON, DC 20036

FOR: PROVIDING AN ONLINE COMMUNITY DATABASE IN THE FIELD OF TRADE INFORMATION FEATURING BROADCASTING AND MULTIMEDIA EQUIPMENT; PROMOTING THE GOODS AND SERVICES OF OTHERS BY PROVIDING A COMMUNITY-DRIVEN WEBSITE FEATURING USER-SUBMITTED CONTENT IN THE NATURE OF PRODUCT REVIEWS, JOB OPPORTUNITIES, AND LINKS TO THE WEBSITES OF OTHERS;

OPERATING ON-LINE MARKETPLACE FOR SELLERS OF GOODS AND SERVICES, IN CLASS 35 (U.S. CLS. 100, 101 AND 102).

FIRST USE 6-30-2007; IN COMMERCE 6-30-2007.

OWNER OF U.S. REG. NOS. 1,488,869, 1,817,521, AND 2,653,603.

SER. NO. 77-292,553, FILED 10-1-2007.

WILLIAM VERHOSEK, EXAMINING ATTORNEY

**Int. Cl.: 35**

**Prior U.S. Cls.: 100, 101 and 102**

**United States Patent and Trademark Office**

**Reg. No. 3,504,037**

**Registered Sep. 23, 2008**

**SERVICE MARK  
PRINCIPAL REGISTER**



BINGHAM MCHALE LLP (INDIANA LIMITED  
PARTNERSHIP)  
2700 MARKET TOWER  
10 WEST MARKET STREET  
INDIANAPOLIS, IN 46204

FOR: BUSINESS CONSULTATION AND DEVELOPMENT SERVICES IN THE FIELD OF ECONOMIC DEVELOPMENT RELATING TO SITE-SELECTION ANALYSIS, INCENTIVE PROCUREMENT AND

COMPLIANCE, AND COMMUNITY DEVELOPMENT AND PLANNING, IN CLASS 35 (U.S. CLS. 100, 101 AND 102).

FIRST USE 5-28-2007; IN COMMERCE 5-28-2007.

SER. NO. 77-292,805, FILED 10-1-2007.

ESTHER A. BORSUK, EXAMINING ATTORNEY

**Int. Cl.: 43**

**Prior U.S. Cls.: 100 and 101**

**United States Patent and Trademark Office**

**Reg. No. 3,504,038**

**Registered Sep. 23, 2008**

**SERVICE MARK  
PRINCIPAL REGISTER**



LAS VEGAS SANDS CORP. (NEVADA CORPORATION)  
3355 LAS VEGAS BOULEVARD SOUTH  
LAS VEGAS, NV 89109

FOR: ARENA SERVICES, NAMELY, PROVIDING FACILITIES FOR SPORTS, CONCERTS, CONVENTIONS AND EXHIBITIONS; PROVISION OF CONFERENCE, EXHIBITION AND MEETING FACILITIES; PROVIDING CONVENTION FACILITIES; PROVIDING FACILITIES FOR EXHIBITIONS; CATERING SERVICES, IN CLASS 43 (U.S. CLS. 100 AND 101).

FIRST USE 10-1-2007; IN COMMERCE 10-1-2007.

OWNER OF U.S. REG. NO. 1,209,102.

NO CLAIM IS MADE TO THE EXCLUSIVE RIGHT TO USE "EXPO", APART FROM THE MARK AS SHOWN.

THE MARK CONSISTS OF THE STYLIZED WORD "SANDS" DIRECTLY ON TOP OF THE WORD "EXPO", WITH A SUNBURST TO THE IMMEDIATE LEFT OF SUCH WORDS.

SER. NO. 77-292,814, FILED 10-1-2007.

PATRICIA EVANKO, EXAMINING ATTORNEY



**Int. Cl.: 41**

**Prior U.S. Cls.: 100, 101 and 107**

**United States Patent and Trademark Office**

**Reg. No. 3,504,039**

**Registered Sep. 23, 2008**

**SERVICE MARK  
PRINCIPAL REGISTER**



LAS VEGAS SANDS CORP. (NEVADA CORPORATION)  
3355 LAS VEGAS BOULEVARD SOUTH  
LAS VEGAS, NV 89109

OWNER OF U.S. REG. NO. 1,209,102.

FOR: ENTERTAINMENT SERVICES IN THE NATURE OF THEATER PRODUCTIONS AND BOXING CONTESTS; ART EXHIBITION AND MUSEUM SERVICES; ARRANGING OF SEMINARS AND CONFERENCES; RENTAL OF AUDIO-VISUAL EQUIPMENT; RENTAL OF PORTABLE STAGES; PREPARATION OF SPECIAL EFFECTS FOR TRADE SHOW BOOTHS AND EXHIBITIONS; ENTERTAINMENT, NAMELY, LIGHTING PRODUCTION, IN CLASS 41 (U.S. CLS. 100, 101 AND 107).

NO CLAIM IS MADE TO THE EXCLUSIVE RIGHT TO USE "EXPO", APART FROM THE MARK AS SHOWN.

THE MARK CONSISTS OF THE STYLIZED WORD "SANDS" DIRECTLY ON TOP OF THE WORD "EXPO," WITH A SUNBURST TO THE IMMEDIATE LEFT OF SUCH WORDS.

SER. NO. 77-292,824, FILED 10-1-2007.

FIRST USE 10-1-2007; IN COMMERCE 10-1-2007.

PATRICIA EVANKO, EXAMINING ATTORNEY

**Int. Cl.: 39**

**Prior U.S. Cls.: 100 and 105**

**United States Patent and Trademark Office**

**Reg. No. 3,504,040**

**Registered Sep. 23, 2008**

**SERVICE MARK  
PRINCIPAL REGISTER**



LAS VEGAS SANDS CORP. (NEVADA CORPORATION)  
3355 LAS VEGAS BOULEVARD SOUTH  
LAS VEGAS, NV 89109

FOR: SHIPPING AND DELIVERY SERVICES, NAMELY, PICKUP, TRANSPORTATION, AND DELIVERY OF PACKAGES AND LETTERS BY VARIOUS MODES OF TRANSPORTATION; COAT CHECK SERVICES; COORDINATING TRAVEL ARRANGEMENTS FOR INDIVIDUALS AND FOR GROUPS, IN CLASS 39 (U.S. CLS. 100 AND 105).

FIRST USE 10-1-2007; IN COMMERCE 10-1-2007.

OWNER OF U.S. REG. NO. 1,209,102.

NO CLAIM IS MADE TO THE EXCLUSIVE RIGHT TO USE "EXPO", APART FROM THE MARK AS SHOWN.

THE MARK CONSISTS OF THE STYLIZED WORD SANDS DIRECTLY ON TOP OF THE WORD EXPO, WITH A SUNBURST TO THE IMMEDIATE LEFT OF SUCH WORDS.

SER. NO. 77-292,831, FILED 10-1-2007.

PATRICIA EVANKO, EXAMINING ATTORNEY

**Int. Cl.: 38**

**Prior U.S. Cls.: 100, 101 and 104**

**United States Patent and Trademark Office**

**Reg. No. 3,504,041**

**Registered Sep. 23, 2008**

**SERVICE MARK  
PRINCIPAL REGISTER**



LAS VEGAS SANDS CORP. (NEVADA CORPORATION)  
3355 LAS VEGAS BOULEVARD SOUTH  
LAS VEGAS, NV 89109

FOR: INFORMATION TRANSMISSION SERVICES VIA DIGITAL NETWORKS; PAY-PER-VIEW TELEVISION TRANSMISSION SERVICES; PROVIDING FACILITIES AND EQUIPMENT FOR VIDEO CONFERENCING; PROVIDING ACCESS TO TELECOMMUNICATION NETWORKS; COMMUNICATION SERVICES, NAMELY, ELECTRONIC TRANSMISSION OF DATA AND DOCUMENTS AMONG USERS OF COMPUTERS; TELECOMMUNICATION CONSULTATION IN THE NATURE OF TECHNICAL CONSULTING IN THE FIELD OF AUDIO, TEXT AND VISUAL DATA TRANSMISSION AND COMMUNICATION; LOCAL AND LONG DISTANCE TELEPHONE SERVICES; PROVIDING TELEPHONE CONFERENCING SERVICES; TELEPHONE VOICE MESSAGING SERVICES; FACSIMILE TRANSMISSION AND RETRIEVAL SERVICES; PROVIDING E-MAIL FAX SERVICES; WIRELESS BROADBAND COMMUNICATION SERVICES; RENTAL OF EQUIPMENT FOR TELECOMMUNICATIONS; TELECOMMUNICATION

SERVICES, NAMELY, LOCAL AND LONG DISTANCE TRANSMISSION OF VOICE, DATA, GRAPHICS BY MEANS OF TELEPHONE, TELEGRAPHIC, CABLE, AND SATELLITE TRANSMISSIONS; VOICE MAIL SERVICES; TELECOMMUNICATIONS SERVICES, NAMELY, ISDN SERVICES, IN CLASS 38 (U.S. CLS. 100, 101 AND 104).

FIRST USE 10-1-2007; IN COMMERCE 10-1-2007.

OWNER OF U.S. REG. NO. 1,209,102.

NO CLAIM IS MADE TO THE EXCLUSIVE RIGHT TO USE "EXPO", APART FROM THE MARK AS SHOWN.

THE MARK CONSISTS OF THE STYLIZED WORD "SANDS" DIRECTLY ON TOP OF THE WORD "EXPO", WITH A SUNBURST TO THE IMMEDIATE LEFT OF SUCH WORDS.

SER. NO. 77-292,844, FILED 10-1-2007.

PATRICIA EVANKO, EXAMINING ATTORNEY

Int. Cl.: 37

Prior U.S. Cls.: 100, 103 and 106

**United States Patent and Trademark Office**

**Reg. No. 3,504,042**

Registered Sep. 23, 2008

**SERVICE MARK  
PRINCIPAL REGISTER**



LAS VEGAS SANDS CORP. (NEVADA CORPORATION)  
3355 LAS VEGAS BOULEVARD SOUTH  
LAS VEGAS, NV 89109

FOR: JANITORIAL SERVICES; ELECTRICAL CONTRACTOR SERVICES; REPAIR OR MAINTENANCE OF ELECTRIC LIGHTING APPARATUS; PLUMBING SERVICES, IN CLASS 37 (U.S. CLS. 100, 103 AND 106).

FIRST USE 10-1-2007; IN COMMERCE 10-1-2007.

OWNER OF U.S. REG. NO. 1,209,102.

NO CLAIM IS MADE TO THE EXCLUSIVE RIGHT TO USE "EXPO", APART FROM THE MARK AS SHOWN.

THE MARK CONSISTS OF THE STYLIZED WORD "SANDS" DIRECTLY ON TOP OF THE WORD "EXPO", WITH A SUNBURST TO THE IMMEDIATE LEFT OF SUCH WORDS.

SER. NO. 77-292,853, FILED 10-1-2007.

PATRICIA EVANKO, EXAMINING ATTORNEY

**Int. Cl.: 35**

**Prior U.S. Cls.: 100, 101 and 102**

**United States Patent and Trademark Office**

**Reg. No. 3,504,043**

**Registered Sep. 23, 2008**

**SERVICE MARK  
PRINCIPAL REGISTER**



LAS VEGAS SANDS CORP. (NEVADA CORPORATION)  
3355 LAS VEGAS BOULEVARD SOUTH  
LAS VEGAS, NV 89109

FOR: PROVIDING AND RENTAL OF EXHIBITION STANDS AND BOOTHS INCLUDING RESPECTIVE EQUIPMENT; ORGANIZING EXHIBITIONS FOR COMMERCIAL OR ADVERTISING PURPOSES; PLANNING AND CONDUCTING OF TRADE FAIRS, EXHIBITIONS AND PRESENTATIONS FOR ECONOMIC OR ADVERTISING PURPOSES; CONSULTATION RELATING TO TRADE FAIRS; RENTAL OF ADVERTISING SPACE; RENTAL OF OFFICE MACHINERY AND EQUIPMENT, IN CLASS 35 (U.S. CLS. 100, 101 AND 102).

FIRST USE 10-1-2007; IN COMMERCE 10-1-2007.

OWNER OF U.S. REG. NO. 1,209,102.

NO CLAIM IS MADE TO THE EXCLUSIVE RIGHT TO USE "EXPO", APART FROM THE MARK AS SHOWN.

THE MARK CONSISTS OF THE STYLIZED WORD "SANDS" DIRECTLY ON TOP OF THE WORD "EXPO", WITH A SUNBURST TO THE IMMEDIATE LEFT OF SUCH WORDS.

SER. NO. 77-292,868, FILED 10-1-2007.

PATRICIA EVANKO, EXAMINING ATTORNEY

Int. Cl.: 30

Prior U.S. Cl.: 46

United States Patent and Trademark Office

Reg. No. 3,504,044

Registered Sep. 23, 2008

TRADEMARK  
PRINCIPAL REGISTER



DRAGON PEARL WHOLE TEAS (CALIFORNIA CORPORATION)

1030 HUSTON STREET, SUITE A

GROVER BEACH, CA 93433

FOR: TEA, IN CLASS 30 (U.S. CL. 46).

FIRST USE 1-1-2005; IN COMMERCE 5-5-2005.

NO CLAIM IS MADE TO THE EXCLUSIVE RIGHT TO USE "DRAGON PEARL WHOLE TEAS", APART FROM THE MARK AS SHOWN.

THE MARK CONSISTS OF A DRAGON INSIDE A CIRCLE WITH THE WORDS "DRAGON PEARL" WRITTEN ABOVE AND "WHOLE TEAS" BELOW.

SER. NO. 77-292,875, FILED 10-1-2007.

REBECCA SMITH, EXAMINING ATTORNEY

**Int. Cl.: 25**

**Prior U.S. Cls.: 22 and 39**

**United States Patent and Trademark Office**

**Reg. No. 3,504,045**

**Registered Sep. 23, 2008**

**TRADEMARK  
PRINCIPAL REGISTER**

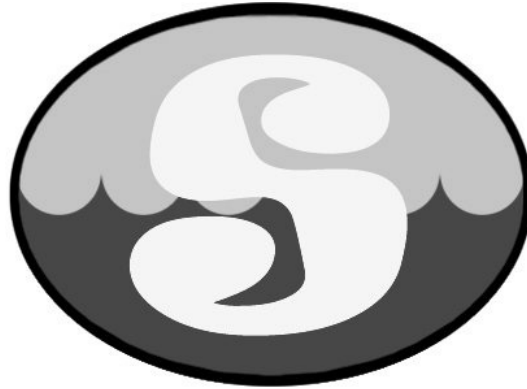

SPLASHGEAR LLC (CALIFORNIA LIMITED  
LIABILITY COMPANY)  
7445 SEASTAR DRIVE, UNIT 8  
HUNTINGTON BEACH, CA 92648

FOR: SWIMWEAR, IN CLASS 25 (U.S. CLS. 22  
AND 39).

FIRST USE 6-1-2007; IN COMMERCE 6-1-2007.

THE MARK CONSISTS OF A STYLIZED LETTER  
"S" SUPERIMPOSED ON A BACKGROUND COM-  
PRISING AN OVAL DIVIDED INTO AN UPPER  
AND LOWER HALF BY A LINE OF WAVES.

SER. NO. 77-293,430, FILED 10-2-2007.

TEJBIR SINGH, EXAMINING ATTORNEY

**Int. Cl.: 42**

**Prior U.S. Cls.: 100 and 101**

**United States Patent and Trademark Office**

**Reg. No. 3,504,046**

**Registered Sep. 23, 2008**

**SERVICE MARK  
PRINCIPAL REGISTER**

# Think2Build

THINK2BUILD (CALIFORNIA LIMITED LIABILITY COMPANY), DBA THINK 2 BUILD  
546-B PRESIDIO BLVD  
SAN FRANCISCO, CA 94129

THE MARK CONSISTS OF STANDARD CHARACTERS WITHOUT CLAIM TO ANY PARTICULAR FONT, STYLE, SIZE, OR COLOR.

FOR: PRODUCT DEVELOPMENT CONSULTATION, IN CLASS 42 (U.S. CLS. 100 AND 101).

SER. NO. 77-293,450, FILED 10-2-2007.

FIRST USE 9-19-2005; IN COMMERCE 9-19-2005.

RONALD MCMORROW, EXAMINING ATTORNEY



**Int. Cls.: 9 and 35**

**Prior U.S. Cls.: 21, 23, 26, 36, 38, 100, 101 and 102**

**United States Patent and Trademark Office**

**Reg. No. 3,504,047**

**Registered Sep. 23, 2008**

**TRADEMARK  
SERVICE MARK  
PRINCIPAL REGISTER**

**DELOITTE INTERNATIONAL TAX  
SOURCE**

DELOITTE TOUCHE TOHMATSU (SWITZERLAND ASSOCIATION)  
ZOLLIKERSTRASSE 225  
ZURICH CH-8008, SWITZERLAND

FOR: COMPUTER APPLICATION SOFTWARE FOR GLOBAL CORPORATE TAX RATES, INDIRECT TAX RATES AND WITHHOLDING TAX RATES, BOTH DOMESTIC AND UNDER TAX TREATIES, FOR PROVIDING A BROAD RANGE OF INTERNATIONAL TAX, INVESTMENT AND BUSINESS INFORMATION, AND FOR COMPARING TAX, INVESTMENT AND BUSINESS DATA; DOWNLOADABLE ELECTRONIC PUBLICATIONS IN THE NATURE OF GUIDES, NEWSLETTERS, ALERTS AND MATRICES IN THE FIELDS OF INTERNATIONAL TAX, INVESTMENT AND BUSINESS, IN CLASS 9 (U.S. CLS. 21, 23, 26, 36 AND 38).

FIRST USE 10-15-2007; IN COMMERCE 10-15-2007.

FOR: PROVIDING A DATABASE FEATURING GLOBAL CORPORATE, INDIRECT AND WITHHOLDING TAX RATE INFORMATION; THE PROVISION OF INFORMATION VIA THE INTERNET ON GLOBAL CORPORATE TAX RATES, INDIRECT TAX RATES AND WITHHOLDING TAX RATES,

BOTH DOMESTIC AND UNDER TAX TREATIES; THE PROVISION OF INFORMATION ON GENERAL TAX, INVESTMENT AND BUSINESS ISSUES; AND THE PROVISION OF INFORMATION ON INFORMATION TECHNOLOGY AND TRANSMISSION PROTOCOL ISSUES RELATED TO THE TAX, INVESTMENT AND BUSINESS FIELDS, IN CLASS 35 (U.S. CLS. 100, 101 AND 102).

FIRST USE 10-15-2007; IN COMMERCE 10-15-2007.

THE MARK CONSISTS OF STANDARD CHARACTERS WITHOUT CLAIM TO ANY PARTICULAR FONT, STYLE, SIZE, OR COLOR.

OWNER OF U.S. REG. NOS. 1,602,793, 2,052,869, AND 3,002,108.

NO CLAIM IS MADE TO THE EXCLUSIVE RIGHT TO USE "INTERNATIONAL TAX SOURCE", APART FROM THE MARK AS SHOWN.

SER. NO. 77-294,026, FILED 10-2-2007.

HENRY S. ZAK, EXAMINING ATTORNEY

**Int. Cl.: 7**

**Prior U.S. Cls.: 13, 19, 21, 23, 31, 34 and 35**

**United States Patent and Trademark Office**

**Reg. No. 3,504,048**

**Registered Sep. 23, 2008**

**TRADEMARK  
PRINCIPAL REGISTER**

**TRANSCAR**

SWISSLOG TELELIFT GMBH (FED REP GER-  
MANY LIMITED LIABILITY COMPANY)  
SIEMENSSTRASSE 1  
PUCHHEIM, FED REP GERMANY D-82178

FOR: AUTOMATIC CONVEYOR SYSTEMS CON-  
SISTING OF CONVEYORS, COMPUTER HARD-  
WARE, AND COMPUTER SOFTWARE FOR  
OPERATING CONVEYORS, SOLD AS A UNIT FOR  
OFFICES, ARCHIVES, WAREHOUSES, HOSPITALS  
AND NURSING HOMES, IN CLASS 7 (U.S. CLS. 13,  
19, 21, 23, 31, 34 AND 35).

FIRST USE 0-0-1975; IN COMMERCE 0-0-1975.

THE MARK CONSISTS OF STANDARD CHAR-  
ACTERS WITHOUT CLAIM TO ANY PARTICULAR  
FONT, STYLE, SIZE, OR COLOR.

SER. NO. 77-294,105, FILED 10-2-2007.

DOMINIC FATHY, EXAMINING ATTORNEY

**Int. Cl.: 9**

**Prior U.S. Cls.: 21, 23, 26, 36 and 38**

**United States Patent and Trademark Office**

**Reg. No. 3,504,049**

**Registered Sep. 23, 2008**

**TRADEMARK  
PRINCIPAL REGISTER**

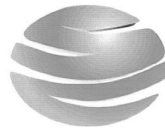

NEST TECHNOLOGIES, INC. (DELAWARE CORPORATION)  
4511 SINGER COURT, SUITE 201  
CHANTILLY, VA 20151

FOR: FIBER OPTIC NETWORKING HARDWARE FOR THE AGGREGATION, ROUTING, SWITCHING, AND TRANSMISSION OF VOICE, DATA AND VIDEO SIGNALS, IN CLASS 9 (U.S. CLS. 21, 23, 26, 36 AND 38).

FIRST USE 6-6-2002; IN COMMERCE 6-6-2002.

THE MARK CONSISTS OF STYLIZED SPHERE CONTAINING THE LETTERS "S" AND "C".

SER. NO. 77-294,330, FILED 10-2-2007.

KATHLEEN LORENZO, EXAMINING ATTORNEY

**Int. Cl.: 37**

**Prior U.S. Cls.: 100, 103 and 106**

**United States Patent and Trademark Office**

**Reg. No. 3,504,050**

**Registered Sep. 23, 2008**

**SERVICE MARK  
PRINCIPAL REGISTER**

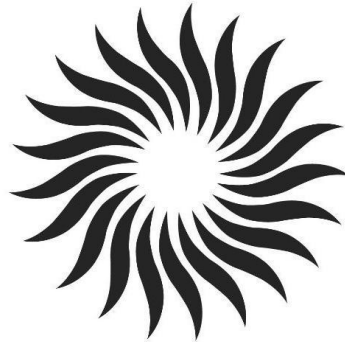

LAS VEGAS SANDS CORP. (NEVADA CORPORATION)  
3355 LAS VEGAS BOULEVARD SOUTH  
LAS VEGAS, NV 89109

FOR: JANITORIAL SERVICES; ELECTRICAL CONTRACTOR SERVICES; REPAIR OR MAINTENANCE OF ELECTRIC LIGHTING APPARATUS; PLUMBING SERVICES, IN CLASS 37 (U.S. CLS. 100, 103 AND 106).

FIRST USE 10-3-2007; IN COMMERCE 10-3-2007.

THE MARK CONSISTS OF A SUNBURST.

SER. NO. 77-295,069, FILED 10-3-2007.

PATRICIA EVANKO, EXAMINING ATTORNEY

**Int. Cl.: 35**

**Prior U.S. Cls.: 100, 101 and 102**

**United States Patent and Trademark Office**

**Reg. No. 3,504,051**

**Registered Sep. 23, 2008**

**SERVICE MARK  
PRINCIPAL REGISTER**

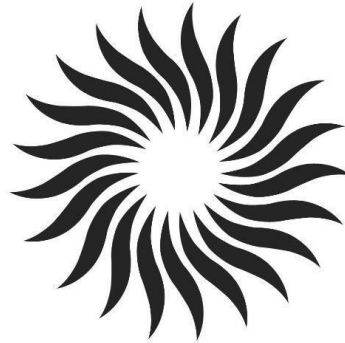

LAS VEGAS SANDS CORP. (NEVADA CORPORATION)  
3355 LAS VEGAS BOULEVARD SOUTH  
LAS VEGAS, NV 89109

FOR: PROVIDING AND RENTAL OF EXHIBITION STANDS AND BOOTHS INCLUDING RESPECTIVE EQUIPMENT; ORGANIZING EXHIBITIONS FOR COMMERCIAL OR ADVERTISING PURPOSES; PLANNING AND CONDUCTING OF TRADE FAIRS, EXHIBITIONS AND PRESENTATIONS FOR ECONOMIC OR ADVERTISING PURPOSES; CONSULTATION RELATING TO TRADE

FAIRS; RENTAL OF ADVERTISING SPACE; RENTAL OF OFFICE MACHINERY AND EQUIPMENT, IN CLASS 35 (U.S. CLS. 100, 101 AND 102).

FIRST USE 10-3-2007; IN COMMERCE 10-3-2007.

THE MARK CONSISTS OF A SUNBURST.

SER. NO. 77-295,073, FILED 10-3-2007.

PATRICIA EVANKO, EXAMINING ATTORNEY

**Int. Cl.: 38**

**Prior U.S. Cls.: 100, 101 and 104**

**United States Patent and Trademark Office**

**Reg. No. 3,504,052**

**Registered Sep. 23, 2008**

**SERVICE MARK  
PRINCIPAL REGISTER**



LAS VEGAS SANDS CORP. (NEVADA CORPORATION)  
3355 LAS VEGAS BOULEVARD SOUTH  
LAS VEGAS, NV 89109

FOR: INFORMATION TRANSMISSION SERVICES VIA DIGITAL NETWORKS; PAY-PER-VIEW TELEVISION TRANSMISSION SERVICES; PROVIDING FACILITIES AND EQUIPMENT FOR VIDEO CONFERENCING; PROVIDING ACCESS TO TELECOMMUNICATION NETWORKS; COMMUNICATION SERVICES, NAMELY, ELECTRONIC TRANSMISSION OF DATA AND DOCUMENTS AMONG USERS OF COMPUTERS; TELECOMMUNICATION CONSULTATION IN THE NATURE OF TECHNICAL CONSULTING IN THE FIELD OF AUDIO, TEXT AND VISUAL DATA TRANSMISSION AND COMMUNICATION; LOCAL AND LONG DISTANCE TELEPHONE SERVICES; PROVIDING TELEPHONE CONFERENCING SERVICES; TELEPHONE VOICE MESSAGING SERVICES; FAC-

SIMILE TRANSMISSION AND RETRIEVAL SERVICES; PROVIDING E-MAIL FAX SERVICES; WIRELESS BROADBAND COMMUNICATION SERVICES; RENTAL OF EQUIPMENT FOR TELECOMMUNICATIONS; TELECOMMUNICATION SERVICES, NAMELY, LOCAL AND LONG DISTANCE TRANSMISSION OF VOICE, DATA, GRAPHICS BY MEANS OF TELEPHONE, TELEGRAPHIC, CABLE, AND SATELLITE TRANSMISSIONS; VOICE MAIL SERVICES; TELECOMMUNICATIONS SERVICES, NAMELY, ISDN SERVICES, IN CLASS 38 (U.S. CLS. 100, 101 AND 104).

FIRST USE 10-3-2007; IN COMMERCE 10-3-2007.

THE MARK CONSISTS OF A SUNBURST.

SER. NO. 77-295,096, FILED 10-3-2007.

PATRICIA EVANKO, EXAMINING ATTORNEY

**Int. Cl.: 41**

**Prior U.S. Cls.: 100, 101 and 107**

**United States Patent and Trademark Office**

**Reg. No. 3,504,053**

**Registered Sep. 23, 2008**

**SERVICE MARK  
PRINCIPAL REGISTER**

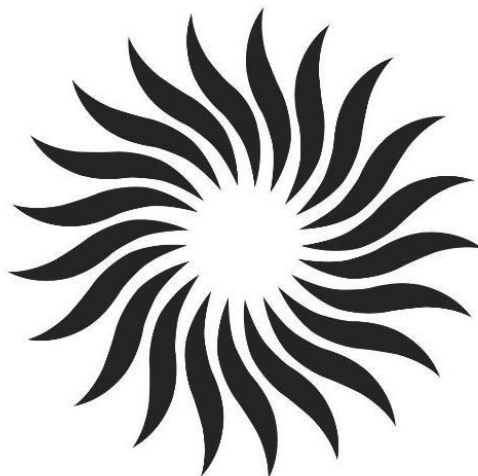

LAS VEGAS SANDS CORP. (NEVADA CORPORATION)  
3355 LAS VEGAS BOULEVARD SOUTH  
LAS VEGAS, NV 89109

FOR: ENTERTAINMENT SERVICES IN THE NATURE OF THEATER PRODUCTIONS AND BOXING CONTESTS; ART EXHIBITION AND MUSEUM SERVICES; ARRANGING OF SEMINARS AND CONFERENCES; RENTAL OF AUDIO-VISUAL EQUIPMENT; RENTAL OF PORTABLE STAGES; PREPARATION OF SPECIAL EFFECTS FOR

TRADE SHOW BOOTHS AND EXHIBITIONS; ENTERTAINMENT NAMELY, LIGHTING PRODUCTION, IN CLASS 41 (U.S. CLS. 100, 101 AND 107).

FIRST USE 10-3-2007; IN COMMERCE 10-3-2007.

THE MARK CONSISTS OF A SUNBURST.

SER. NO. 77-295,107, FILED 10-3-2007.

PATRICIA EVANKO, EXAMINING ATTORNEY

**Int. Cl.: 43**

**Prior U.S. Cls.: 100 and 101**

**United States Patent and Trademark Office**

**Reg. No. 3,504,054**

**Registered Sep. 23, 2008**

**SERVICE MARK  
PRINCIPAL REGISTER**

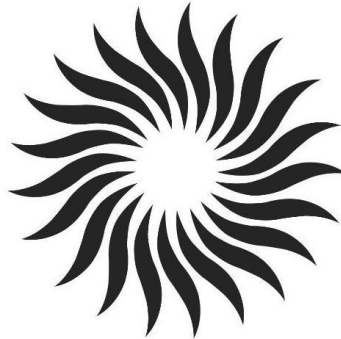

LAS VEGAS SANDS CORP. (NEVADA CORPORATION)  
3355 LAS VEGAS BOULEVARD SOUTH  
LAS VEGAS, NV 89109

FOR: ARENA SERVICES, NAMELY, PROVIDING FACILITIES FOR SPORTS, CONCERTS, CONVENTIONS AND EXHIBITIONS; PROVISION OF CONFERENCE, EXHIBITION AND MEETING FACILITIES; PROVIDING CONVENTION FACILITIES; PROVIDING FACILITIES FOR EXHIBI-

TIONS; CATERING SERVICES, IN CLASS 43 (U.S. CLS. 100 AND 101).

FIRST USE 10-3-2007; IN COMMERCE 10-3-2007.

THE MARK CONSISTS OF A SUNBURST.

SER. NO. 77-295,120, FILED 10-3-2007.

PATRICIA EVANKO, EXAMINING ATTORNEY



**Int. Cl.: 42**

**Prior U.S. Cls.: 100 and 101**

**United States Patent and Trademark Office**

**Reg. No. 3,504,055**

**Registered Sep. 23, 2008**

**SERVICE MARK  
PRINCIPAL REGISTER**

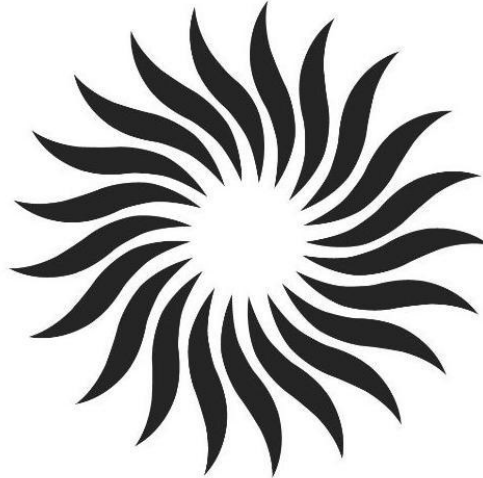

LAS VEGAS SANDS CORP. (NEVADA CORPORATION)

3355 LAS VEGAS BOULEVARD SOUTH  
LAS VEGAS, NV 89109

FOR: RENTAL OF COMPUTERS AND SOFTWARE; DECORATION SERVICES FOR TRADE SHOW BOOTHS AND EXHIBITIONS, NAMELY, PROVIDING INTERIOR DECORATING OF TRADE

SHOW BOOTHS AND EXHIBITION SPACES, IN CLASS 42 (U.S. CLS. 100 AND 101).

FIRST USE 10-3-2007; IN COMMERCE 10-3-2007.

THE MARK CONSISTS OF A "SUNBURST"

SER. NO. 77-295,135, FILED 10-3-2007.

PATRICIA EVANKO, EXAMINING ATTORNEY

**Int. Cl.: 39**

**Prior U.S. Cls.: 100 and 105**

**United States Patent and Trademark Office**

**Reg. No. 3,504,056**

**Registered Sep. 23, 2008**

**SERVICE MARK  
PRINCIPAL REGISTER**

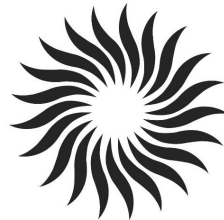

LAS VEGAS SANDS CORP. (NEVADA CORPORATION)  
3355 LAS VEGAS BOULEVARD SOUTH  
LAS VEGAS, NV 89109

FOR: SHIPPING AND DELIVERY SERVICES, NAMELY, PICKUP, TRANSPORTATION, AND DELIVERY OF PACKAGES AND LETTERS BY VARIOUS MODES OF TRANSPORTATION; COAT CHECK SERVICES; COORDINATING TRAVEL AR-

RANGEMENTS FOR INDIVIDUALS AND FOR GROUPS, IN CLASS 39 (U.S. CLS. 100 AND 105).

FIRST USE 10-3-2007; IN COMMERCE 10-3-2007.

THE MARK CONSISTS OF A SUNBURST.

SER. NO. 77-295,162, FILED 10-3-2007.

PATRICIA EVANKO, EXAMINING ATTORNEY

**Int. Cl.: 1**

**Prior U.S. Cls.: 1, 5, 6, 10, 26 and 46**

**Reg. No. 3,504,057**

**United States Patent and Trademark Office**

**Registered Sep. 23, 2008**

**TRADEMARK  
PRINCIPAL REGISTER**

**RHEO-LINE**

BAKER HUGHES INCORPORATED (DELA-  
WARE CORPORATION)  
2929 ALLEN PARKWAY, SUITE 2100  
HOUSTON, TX 770192118

FOR: AN EMULSION-BASED DRILLING FLUID  
ADDITIVE USED AS A RHEOLOGY MODIFIER TO  
ENHANCE VISCOSITY AND GEL STRUCTURES IN  
DEEP WATER APPLICATIONS , IN CLASS 1 (U.S.  
CLS. 1, 5, 6, 10, 26 AND 46).

FIRST USE 4-27-2006; IN COMMERCE 4-27-2006.

THE MARK CONSISTS OF STANDARD CHAR-  
ACTERS WITHOUT CLAIM TO ANY PARTICULAR  
FONT, STYLE, SIZE, OR COLOR.

SER. NO. 77-295,461, FILED 10-3-2007.

LINDA MICKLEBURGH, EXAMINING ATTORNEY

**Int. Cl.: 16**

**Prior U.S. Cls.: 2, 5, 22, 23, 29, 37, 38 and 50**

**United States Patent and Trademark Office**

**Reg. No. 3,504,058**

**Registered Sep. 23, 2008**

---

**TRADEMARK  
PRINCIPAL REGISTER**

**PIGMA SENSEI**

SAKURA COLOR PRODUCTS CORPORATION  
(JAPAN CORPORATION)  
10-17, NAKAMICHI 1-CHOME, HIGASHINARI-KU  
OSAKA-SHI, JAPAN

FOR: WRITING INSTRUMENTS, IN CLASS 16  
(U.S. CLS. 2, 5, 22, 23, 29, 37, 38 AND 50).

FIRST USE 10-1-2007; IN COMMERCE 10-1-2007.

THE MARK CONSISTS OF STANDARD CHAR-  
ACTERS WITHOUT CLAIM TO ANY PARTICULAR  
FONT, STYLE, SIZE, OR COLOR.

THE WORD "SENSEI" MEANS "TEACHER" IN  
JAPANESE.

SER. NO. 77-295,639, FILED 10-3-2007.

DAVID C. REIHNER, EXAMINING ATTORNEY

Int. Cl.: 25

Prior U.S. Cls.: 22 and 39

United States Patent and Trademark Office

Reg. No. 3,504,059

Registered Sep. 23, 2008

TRADEMARK  
PRINCIPAL REGISTER



GRUPO ROSE 555, C.A. (VENEZUELA CORPORATION)  
AV. CAJIGAL Y JOSE MARIA VARGAS  
EDIFICIOA MIRANDA, LOCAL 2, ENTRE  
SAN BERNADINO, CARACAS, VENEZUELA

FOR: LINGERIE, NAMELY, LINGERIE FOR WOMEN, MEN AND CHILDREN, IN CLASS 25 (U.S. CLS. 22 AND 39).

FIRST USE 1-16-2007; IN COMMERCE 3-16-2007.

NO CLAIM IS MADE TO THE EXCLUSIVE RIGHT TO USE "LINGERIE", APART FROM THE MARK AS SHOWN.

THE NAME "HAIHAH" DOES NOT IDENTIFY A LIVING INDIVIDUAL.

THE MARK CONSISTS OF A RECTANGULAR DESIGN WITH AN ORNAMENTAL BORDER INSIDE OF WHICH THE EXPRESSION "HAIHAH EN ROSE LINGERIE" APPEARS WITH EACH WORD APPEARING ONE BELOW THE OTHER IN STYLIZED CHARACTERS. THE WORD "ROSE" IS UNDERLINED BY A ROSE.

THE ENGLISH TRANSLATION OF THE WORD "HAIHAH" IN THE MARK IS ROSE LINGERIE.

SER. NO. 77-296,107, FILED 10-4-2007.

MARK PILARO, EXAMINING ATTORNEY

**Int. Cl.: 35**

**Prior U.S. Cls.: 100, 101 and 102**

**United States Patent and Trademark Office**

**Reg. No. 3,504,060**

**Registered Sep. 23, 2008**

**SERVICE MARK  
PRINCIPAL REGISTER**

**LIFERETURNS**

JC MOTORS (CALIFORNIA CORPORATION)  
16591 NOYES AVENUE  
IRVINE, CA 92606

FOR: ONLINE RETAIL STORE SERVICES AND  
RETAIL STORE SERVICES FEATURING MOTOR-  
CYCLES, MOTORCYCLE PARTS, MOTORCYCLE  
ACCESSORIES AND MOTORCYCLE TRANSPOR-  
TATION, IN CLASS 35 (U.S. CLS. 100, 101 AND 102).

FIRST USE 10-1-2007; IN COMMERCE 10-1-2007.

THE MARK CONSISTS OF STANDARD CHAR-  
ACTERS WITHOUT CLAIM TO ANY PARTICULAR  
FONT, STYLE, SIZE, OR COLOR.

SER. NO. 77-296,909, FILED 10-5-2007.

LINDSEY RUBIN, EXAMINING ATTORNEY

**Int. Cl.: 19**

**Prior U.S. Cls.: 1, 12, 33 and 50**

**United States Patent and Trademark Office**

**Reg. No. 3,504,061**

**Registered Sep. 23, 2008**

**TRADEMARK  
PRINCIPAL REGISTER**

# ClearCast

MCCOLL STUDIO INC (WASHINGTON CORPORATION), DBA SCULPTURAL GLASS DOORS INC  
4716 FREMONT AVE  
BELLINGHAM, WA 982292626

FOR: DECORATIVE GLASS; GLASS PANELS FOR BUILDING CONSTRUCTION PURPOSES; GLASS PANES; INSULATED GLASS; MODIFIED SHEET GLASS; SAFETY GLASS FOR BUILDING PURPOSES; WINDOW GLASS, IN CLASS 19 (U.S. CLS. 1, 12, 33 AND 50).

FIRST USE 1-1-1999; IN COMMERCE 7-27-2007.

THE MARK CONSISTS OF STANDARD CHARACTERS WITHOUT CLAIM TO ANY PARTICULAR FONT, STYLE, SIZE, OR COLOR.

SER. NO. 77-297,638, FILED 10-5-2007.

PAUL E. FAHRENKOPF, EXAMINING ATTORNEY

**Int. Cl.: 25**

**Prior U.S. Cls.: 22 and 39**

**United States Patent and Trademark Office**

**Reg. No. 3,504,062**

**Registered Sep. 23, 2008**

**TRADEMARK  
PRINCIPAL REGISTER**

**I do that.**

DAVID LUPPINO (UNITED STATES INDIVIDUAL)  
P. O. BOX 340862  
TAMPA, FL 33694

THE MARK CONSISTS OF STANDARD CHARACTERS WITHOUT CLAIM TO ANY PARTICULAR FONT, STYLE, SIZE, OR COLOR.

FOR: T-SHIRTS, IN CLASS 25 (U.S. CLS. 22 AND 39).

SER. NO. 77-298,098, FILED 10-7-2007.

FIRST USE 1-21-2004; IN COMMERCE 1-21-2004.

AMY GEARIN, EXAMINING ATTORNEY



**Int. Cl.: 38**

**Prior U.S. Cls.: 100, 101 and 104**

**United States Patent and Trademark Office**

**Reg. No. 3,504,063**

**Registered Sep. 23, 2008**

**SERVICE MARK  
PRINCIPAL REGISTER**



NEWARK PUBLIC RADIO, INC. (NEW JERSEY CORPORATION)  
54 PARK PLACE  
NEWARK, NJ 07102

FOR: RADIO BROADCASTING SERVICES, IN CLASS 38 (U.S. CLS. 100, 101 AND 104).

FIRST USE 1-1-2006; IN COMMERCE 1-1-2006.

NO CLAIM IS MADE TO THE EXCLUSIVE RIGHT TO USE "88.3 FM", APART FROM THE MARK AS SHOWN.

THE MARK CONSISTS OF A SILHOUETTE OF A FIGURE PLAYING A SAXAPHONE. TO THE LEFT OF THE FIGURE ARE THE WORDS "JAZZ 88 WBGO.ORG 88.3 FM".

SER. NO. 77-298,602, FILED 10-8-2007.

BARBARA BROWN, EXAMINING ATTORNEY

**Int. Cl.: 33**

**Prior U.S. Cls.: 47 and 49**

**United States Patent and Trademark Office**

**Reg. No. 3,504,064**

**Registered Sep. 23, 2008**

**TRADEMARK  
PRINCIPAL REGISTER**



**O•S WINERY**

O. S. WINERY LLC (WASHINGTON LIMITED  
LIABILITY COMPANY)  
1501 SOUTH 92ND PLACE, SUITE B  
SEATTLE, WA 98108

FOR: WINES, IN CLASS 33 (U.S. CLS. 47 AND 49).

FIRST USE 12-21-2004; IN COMMERCE 1-31-2005.

OWNER OF U.S. REG. NO. 3,083,772.

NO CLAIM IS MADE TO THE EXCLUSIVE  
RIGHT TO USE "WINERY", APART FROM THE  
MARK AS SHOWN.

THE MARK CONSISTS OF STYLIZED LETTERS  
"O" AND "S" WITHIN A SQUARE BACKGROUND,  
THE LETTERS "O" AND "S", AND THE WORD  
"WINERY".

SER. NO. 77-299,849, FILED 10-9-2007.

KYLE PEETE, EXAMINING ATTORNEY

**Int. Cls.: 35 and 37**

**Prior U.S. Cls.: 100, 101, 102, 103 and 106**

**United States Patent and Trademark Office**

**Reg. No. 3,504,065**

**Registered Sep. 23, 2008**

**SERVICE MARK  
PRINCIPAL REGISTER**



MDI, INC. (DELAWARE CORPORATION)  
SUITE 200  
10226 SAN PEDRO AVENUE  
SAN ANTONIO, TX 78216

FOR: CONTRACT REVIEWING, NAMELY, BUSINESS RISK MANAGEMENT CONSULTATION, IN CLASS 35 (U.S. CLS. 100, 101 AND 102).

FIRST USE 5-0-1997; IN COMMERCE 5-0-1997.

FOR: BUILDING PROJECT MONITORING, NAMELY, CONSTRUCTION SUPERVISION, IN CLASS 37 (U.S. CLS. 100, 103 AND 106).

FIRST USE 5-0-1997; IN COMMERCE 5-0-1997.

THE MARK CONSISTS OF THE LETTERS "FAS" WITH A RECTANGLE AND A SEMI-CIRCULAR CUTOUT AND AN ORBITAL RING.

SER. NO. 77-299,935, FILED 10-9-2007.

JOHN DWYER, EXAMINING ATTORNEY

**Int. Cls.: 35 and 37**

**Prior U.S. Cls.: 100, 101, 102, 103 and 106**

**United States Patent and Trademark Office**

**Reg. No. 3,504,066**

**Registered Sep. 23, 2008**

**SERVICE MARK  
PRINCIPAL REGISTER**

**FAS**

MDI, INC. (DELAWARE CORPORATION)  
SUITE 200  
10226 SAN PEDRO AVENUE  
SAN ANTONIO, TX 78216

FOR: CONTRACT REVIEWING, NAMELY, BUSINESS RISK MANAGEMENT CONSULTATION, IN CLASS 35 (U.S. CLS. 100, 101 AND 102).

FIRST USE 5-0-1997; IN COMMERCE 5-0-1997.

FOR: BUILDING PROJECT MONITORING, NAMELY, CONSTRUCTION SUPERVISION, IN CLASS 37 (U.S. CLS. 100, 103 AND 106).

FIRST USE 5-0-1997; IN COMMERCE 5-0-1997.

THE MARK CONSISTS OF STANDARD CHARACTERS WITHOUT CLAIM TO ANY PARTICULAR FONT, STYLE, SIZE, OR COLOR.

SER. NO. 77-299,940, FILED 10-9-2007.

JOHN DWYER, EXAMINING ATTORNEY

**Int. Cl.: 28**

**Prior U.S. Cls.: 22, 23, 38 and 50**

**United States Patent and Trademark Office**

**Reg. No. 3,504,067**

**Registered Sep. 23, 2008**

**TRADEMARK  
PRINCIPAL REGISTER**

**FAN-IE**

GRINDSTAFF, JANICE R. (UNITED STATES  
INDIVIDUAL)  
126 CLAREMONT ROAD  
OAK RIDGE, TN 37830

THE MARK CONSISTS OF STANDARD CHAR-  
ACTERS WITHOUT CLAIM TO ANY PARTICULAR  
FONT, STYLE, SIZE, OR COLOR.

FOR: DOLLS, IN CLASS 28 (U.S. CLS. 22, 23, 38  
AND 50).

SER. NO. 77-301,312, FILED 10-11-2007.

FIRST USE 7-30-2007; IN COMMERCE 7-30-2007.

MELISSA VALLILLO, EXAMINING ATTORNEY

Int. Cl.: 35

Prior U.S. Cls.: 100, 101 and 102

United States Patent and Trademark Office

Reg. No. 3,504,068

Registered Sep. 23, 2008

**SERVICE MARK  
PRINCIPAL REGISTER**



MOUNT VERNON ATHLETIC CLUB (VIRGINIA LIMITED LIABILITY COMPANY), DBA MOUNT VERNON HEALTH AND RACQUET CLUB  
7950 AUDUBON AVENUE  
ALEXANDRIA, VA 22306

FOR: ORGANIZING AND CONDUCTING CHARITY AUCTIONS FOR CHARITABLE FUNDRAISING PURPOSES, IN CLASS 35 (U.S. CLS. 100, 101 AND 102).

FIRST USE 9-24-2007; IN COMMERCE 10-4-2007.

THE COLOR(S) LIGHT PINK, PINK, MAGENTA, BLACK, LIGHT GREEN AND WHITE IS/ARE CLAIMED AS A FEATURE OF THE MARK.

THE MARK CONSISTS OF THE WORDING, "SWING FOR PINK" WITH THE WORDS "SWING

AND "PINK" IN PINK AND THE WORD "FOR" IN BLACK ABOVE THE WORDING "OUR FIGHT AGAINST BREAST CANCER" IN BLACK. ABOVE THE ALL THE WORDING IS A TENNIS BALL IN THREE SHADES OF LIGHT GREEN WITH A WHITE CURVE RUNNING THROUGH; THE WORDING "MT. VERNON ATHLETIC CLUB" IS ON THE BALL IN BLACK. TO THE RIGHT OF THE BALL IS A RIBBON OUTLINED IN THE COLOR BLACK; THE INTERIOR OF THE RIBBON HAVING THE COLORS WHITE, LIGHT PINK, PINK AND MAGENTA. BEHIND THE RIBBON IS A PINK OVAL SHADOW. TO THE LEFT OF THE BALL ARE THREE PINK TRIANGLES.

SER. NO. 77-301,851, FILED 10-11-2007.

JULIE GUTTADAURO, EXAMINING ATTORNEY

**Int. Cl.: 35**

**Prior U.S. Cls.: 100, 101 and 102**

**United States Patent and Trademark Office**

**Reg. No. 3,504,069**

**Registered Sep. 23, 2008**

**SERVICE MARK  
PRINCIPAL REGISTER**

**RITEQUIK**

HARPER ENTERPRISES, LLC (TENNESSEE LIMITED LIABILITY COMPANY)  
P.O. BOX 1742  
MORRISTOWN, TN 37816

THE MARK CONSISTS OF STANDARD CHARACTERS WITHOUT CLAIM TO ANY PARTICULAR FONT, STYLE, SIZE, OR COLOR.

FOR: RETAIL CONVENIENCE STORES, IN CLASS 35 (U.S. CLS. 100, 101 AND 102).

SER. NO. 77-301,950, FILED 10-11-2007.

FIRST USE 11-0-2005; IN COMMERCE 11-0-2005.

GIANCARLO CASTRO, EXAMINING ATTORNEY

**Int. Cl.: 45**

**Prior U.S. Cls.: 100 and 101**

**United States Patent and Trademark Office**

**Reg. No. 3,504,070**

**Registered Sep. 23, 2008**

**SERVICE MARK  
PRINCIPAL REGISTER**

# Guaranteed ID

RIPROK (NEVADA LIMITED LIABILITY COMPANY)

6787 W TROPICANA, #247

LAS VEGAS, NV 89103

FOR: IDENTITY THEFT RESTORATION AND RECOVERY SERVICES, IN CLASS 45 (U.S. CLS. 100 AND 101).

FIRST USE 1-1-2007; IN COMMERCE 1-1-2007.

THE MARK CONSISTS OF STANDARD CHARACTERS WITHOUT CLAIM TO ANY PARTICULAR FONT, STYLE, SIZE, OR COLOR.

NO CLAIM IS MADE TO THE EXCLUSIVE RIGHT TO USE "ID", APART FROM THE MARK AS SHOWN.

SER. NO. 77-302,180, FILED 10-11-2007.

LINDA POWELL, EXAMINING ATTORNEY



**Int. Cls.: 30 and 31**

**Prior U.S. Cls.: 1 and 46**

**United States Patent and Trademark Office**

**Reg. No. 3,504,071**

**Registered Sep. 23, 2008**

**TRADEMARK  
PRINCIPAL REGISTER**



KETTLE SANCHEZ INDUSTRIAL, S. A. (DOMINICAN REP CORPORATION)  
AV. 27 DE FEBRERO, ESQ. CALLE H, HERRERA  
SANTO DOMINGO OESTE, DOMINICAN REP

FOR: PROCESSED OATS, IN CLASS 30 (U.S. CL. 46).

FIRST USE 10-5-1980; IN COMMERCE 10-5-1980.

FOR: FRESH OATS , IN CLASS 31 (U.S. CLS. 1 AND 46).

FIRST USE 10-5-1980; IN COMMERCE 10-5-1980.

NO CLAIM IS MADE TO THE EXCLUSIVE RIGHT TO USE "AVENA RAPIDA AMERICANA", APART FROM THE MARK AS SHOWN.

THE COLOR(S) RED, WHITE, BLUE AND BLACK IS/ARE CLAIMED AS A FEATURE OF THE MARK.

THE MARK CONSISTS OF THE WORDS "AVENA AMERICA" IN RED COLOR WITHIN A HOOKED STYLE SPOON IN BLUE COLOR ABOVE A WHITE BACKGROUND.

THE FOREIGN WORDING IN THE MARK TRANSLATES INTO ENGLISH AS AMERICAN RAPID OATS.

SER. NO. 77-302,248, FILED 10-11-2007.

JILL C. ALT, EXAMINING ATTORNEY

**Int. Cls.: 9, 16 and 41**

**Prior U.S. Cls.: 2, 5, 21, 22, 23, 26, 29, 36, 37, 38, 50,  
100, 101 and 107**

**Reg. No. 3,504,072**

**United States Patent and Trademark Office**

**Registered Sep. 23, 2008**

**TRADEMARK  
SERVICE MARK  
PRINCIPAL REGISTER**

# PORN NATION

BRAVEHEARTS, LLC (GEORGIA LIMITED LIABILITY COMPANY)  
SUITE 140  
1080 HOLCOMB BRIDGE RD., BUILDING 200  
ROSWELL, GA 30076

FOR: PRE-RECORDED COMPACT DISKS FEATURING AUDIO LECTURES AND PRESENTATIONS ON ANTI-PORNOGRAPHY; PRE-DIGITAL VIDEO DISKS FEATURING LECTURES AND PRESENTATIONS ON ANTI-PORNOGRAPHY, IN CLASS 9 (U.S. CLS. 21, 23, 26, 36 AND 38).

FIRST USE 0-0-2007; IN COMMERCE 0-0-2007.

FOR: PUBLICATIONS, NAMELY, PAMPHLETS, BROCHURES, NEWSLETTERS AND BOOKLETS IN THE FIELD OF ANTI-PORNOGRAPHY, IN CLASS 16 (U.S. CLS. 2, 5, 22, 23, 29, 37, 38 AND 50).

FIRST USE 0-0-2007; IN COMMERCE 0-0-2007.

FOR: EDUCATIONAL SERVICES, NAMELY, A SERIES OF INSPIRATIONAL LECTURES AND PRESENTATION OF INSPIRATIONAL ANTI-PORNOGRAPHIC TALKS RELATING THERETO, IN CLASS 41 (U.S. CLS. 100, 101 AND 107).

FIRST USE 0-0-2007; IN COMMERCE 0-0-2007.

THE MARK CONSISTS OF STANDARD CHARACTERS WITHOUT CLAIM TO ANY PARTICULAR FONT, STYLE, SIZE, OR COLOR.

NO CLAIM IS MADE TO THE EXCLUSIVE RIGHT TO USE "PORN", APART FROM THE MARK AS SHOWN.

SER. NO. 77-302,523, FILED 10-12-2007.

WILLIAM BRECKENFELD, EXAMINING ATTORNEY

**Int. Cl.: 35**

**Prior U.S. Cls.: 100, 101 and 102**

**United States Patent and Trademark Office**

**Reg. No. 3,504,073**

**Registered Sep. 23, 2008**

**SERVICE MARK  
PRINCIPAL REGISTER**



TIRETRENDS.COM ENTERPRISES LTD (CANADA CORPORATION)  
10-20295 113B AVENUE  
MAPLE RIDGE, B.C., CANADA V2X6E9

FOR: ON-LINE RETAIL STORE SERVICES FEATURING AUTOMOTIVE PRODUCTS; RETAIL STORE SERVICES FEATURING AUTOMOTIVE PRODUCTS; RETAIL TIRE STORES; MAIL ORDER SERVICES FEATURING AUTOMOTIVE PRODUCTS; WHOLESALE DISTRIBUTORSHIPS FEATURING AUTOMOTIVE PRODUCTS, IN CLASS 35 (U.S. CLS. 100, 101 AND 102).

FIRST USE 8-11-2000; IN COMMERCE 8-11-2000.

PRIORITY CLAIMED UNDER SEC. 44(D) ON CANADA APPLICATION NO. 1344513, FILED 4-23-2007.

THE MARK CONSISTS OF THE LETTERS "T" AND "T" WITHIN A CIRCLE.

SER. NO. 77-302,875, FILED 10-12-2007.

JILL C. ALT, EXAMINING ATTORNEY

**Int. Cl.: 3**

**Prior U.S. Cls.: 1, 4, 6, 50, 51 and 52**

**Reg. No. 3,504,074**

**United States Patent and Trademark Office**

**Registered Sep. 23, 2008**

**TRADEMARK  
PRINCIPAL REGISTER**

**el Forte'**

EVOLVING SOLUTIONS, INC. (PENNSYLVANIA CORPORATION)  
204 EAST BROAD STREET  
TAMAQUA, PA 18252

FOR: CLEANING PREPARATIONS FOR HOUSEHOLD PURPOSES, NAMELY, CLEANING, POLISHING, ABRASIVE LIQUIDS AND POWDERS; ROOM FRAGRANCES, IN CLASS 3 (U.S. CLS. 1, 4, 6, 50, 51 AND 52).

FIRST USE 10-12-2007; IN COMMERCE 10-12-2007.

THE MARK CONSISTS OF STANDARD CHARACTERS WITHOUT CLAIM TO ANY PARTICULAR FONT, STYLE, SIZE, OR COLOR.

THE ENGLISH TRANSLATION OF THE WORD "EL FORTÉ" IN THE MARK IS "STRONG" OR "POWERFUL".

SER. NO. 77-303,064, FILED 10-12-2007.

JASON BLAIR, EXAMINING ATTORNEY

**Int. Cl.: 3**

**Prior U.S. Cls.: 1, 4, 6, 50, 51 and 52**

**United States Patent and Trademark Office**

**Reg. No. 3,504,075**

**Registered Sep. 23, 2008**

**TRADEMARK  
PRINCIPAL REGISTER**



EVOLVING SOLUTIONS, INC. (PENNSYLVANIA  
CORPORATION)  
204 EAST BROAD STREET  
TAMAQUA, PA 18252

FOR: CLEANING PREPARATIONS FOR HOUSE-  
HOLD PURPOSES, NAMELY, CLEANING, POLISH-  
ING, ABRASIVE LIQUIDS AND POWDERS; ROOM  
FRAGRANCES, IN CLASS 3 (U.S. CLS. 1, 4, 6, 50, 51  
AND 52).

FIRST USE 10-12-2007; IN COMMERCE 10-12-2007.

THE ENGLISH TRANSLATION OF THE WORD-  
ING IN THE MARK IS "STRONG" OR "POWER-  
FUL".

SER. NO. 77-303,161, FILED 10-12-2007.

JASON BLAIR, EXAMINING ATTORNEY

**Int. Cl.: 29**

**Prior U.S. Cl.: 46**

**United States Patent and Trademark Office**

**Reg. No. 3,504,076**

**Registered Sep. 23, 2008**

**TRADEMARK  
PRINCIPAL REGISTER**

# PureMega

SANMARK, LLC (NORTH CAROLINA LIMITED LIABILITY COMPANY), DBA SANMARK, LTD.

2007 YANCEYVILLE STREET, BOX 31  
GREENSBORO, NC 27405

FOR: COOKING OIL; EDIBLE OIL; NUTRITIONAL OILS FOR FOOD PURPOSES; OIL, NAMELY, BORAGE, EVENING PRIMROSE, PUMPKINSEED, FLAXSEED, BLACK CURRANT; OILS AND FATS FOR FOOD; POWDERED OILS AND FATS; PROCESSED OILS AND FATS; VEGETABLE OILS; VE-

GETABLE OILS AND FATS, IN CLASS 29 (U.S. CL. 46).

FIRST USE 8-16-2007; IN COMMERCE 8-16-2007.

THE MARK CONSISTS OF STANDARD CHARACTERS WITHOUT CLAIM TO ANY PARTICULAR FONT, STYLE, SIZE, OR COLOR.

SER. NO. 77-303,189, FILED 10-12-2007.

LINDSEY RUBIN, EXAMINING ATTORNEY

**Int. Cl.: 44**

**Prior U.S. Cls.: 100 and 101**

**United States Patent and Trademark Office**

**Reg. No. 3,504,077**

**Registered Sep. 23, 2008**

**SERVICE MARK  
PRINCIPAL REGISTER**

Vision care that's focused  
on you

KRISTEN LANGNER EYE CARE PC (ILLINOIS CORPORATION), DBA LANGNER EYE CARE  
46 E. IRVING PARK RD  
ROSELLE, IL 60172

THE MARK CONSISTS OF STANDARD CHARACTERS WITHOUT CLAIM TO ANY PARTICULAR FONT, STYLE, SIZE, OR COLOR.

FOR: OPTOMETRY SERVICES, IN CLASS 44 (U.S. CLS. 100 AND 101).

SER. NO. 77-303,620, FILED 10-14-2007.

FIRST USE 9-1-2005; IN COMMERCE 12-15-2005.

SUE LAWRENCE, EXAMINING ATTORNEY

**Int. Cl.: 28**

**Prior U.S. Cls.: 22, 23, 38 and 50**

**Reg. No. 3,504,078**

**United States Patent and Trademark Office**

**Registered Sep. 23, 2008**

**TRADEMARK  
PRINCIPAL REGISTER**

**GRID**

LIFE WEAR TECHNOLOGIES, INC. (FLORIDA CORPORATION)  
4031 N.E.12TH TERRACE  
OAKLAND PARK, FL 33334

FIRST USE 12-31-1974; IN COMMERCE 12-31-1974.

FOR: ATHLETIC PROTECTIVE WEAR, NAMELY, ARM PADS, ELBOW PADS, HAND PADS, KNEE-PADS, SHIN PADS, ATHLETIC SUPPORTERS AND SUPPORTER CUPS FOR USE IN TEAM SPORTS, CONTACT SPORTS AND FITNESS TRAINING; ATHLETIC ANKLE BRACES, ELBOW BRACES, KNEE BRACES, WRIST BRACES NOT FOR MEDICAL USE, IN CLASS 28 (U.S. CLS. 22, 23, 38 AND 50).

THE MARK CONSISTS OF STANDARD CHARACTERS WITHOUT CLAIM TO ANY PARTICULAR FONT, STYLE, SIZE, OR COLOR.

SER. NO. 77-303,855, FILED 10-15-2007.

WILLIAM VERHOSEK, EXAMINING ATTORNEY



**Int. Cls.: 35, 38, 41, 42 and 45**

**Prior U.S. Cls.: 100, 101, 102, 104 and 107**

**United States Patent and Trademark Office**

**Reg. No. 3,504,079**

**Registered Sep. 23, 2008**

**SERVICE MARK  
PRINCIPAL REGISTER**

**JUDGE-O-RAMA**

JUDGE-O-RAMA, LLC (ARIZONA LIMITED LIABILITY COMPANY)  
5343 EAST NISBET ROAD  
SCOTTSDALE, AZ 85254

FOR: ADVERTISING AND INFORMATION DISTRIBUTION SERVICES, NAMELY, PROVIDING ADVERTISING SPACE VIA THE GLOBAL COMPUTER NETWORK; PROMOTING THE GOODS AND SERVICES OF OTHERS OVER THE INTERNET, IN CLASS 35 (U.S. CLS. 100, 101 AND 102).

FIRST USE 8-7-2007; IN COMMERCE 8-7-2007.

FOR: PROVIDING ONLINE BULLETIN BOARDS AND CHAT ROOMS FOR REGISTERED USERS FOR TRANSMISSION OF MESSAGES, OPINIONS, AND POPULARITY VOTES IN THE FIELDS OF GENERAL ENTERTAINMENT, GENERAL INTEREST, TRANSMITTED PHOTOGRAPHIC IMAGES, SOCIAL NETWORKING, AND USER-CREATED CONTESTS AND DISPUTES, IN CLASS 38 (U.S. CLS. 100, 101 AND 104).

FIRST USE 8-7-2007; IN COMMERCE 8-7-2007.

FOR: PUBLISHING OF ONLINE WORKS OF OTHERS FEATURING USER-CREATED TEXT, AUDIO, VIDEO, AND GRAPHICS; PROVIDING ONLINE JOURNALS AND WEB LOGS FEATURING USER-CREATED CONTENT; PROVIDING ON-LINE COMPUTER DATABASES AND ONLINE SEARCHABLE DATABASES IN THE FIELD OF POPULAR CULTURE; PROVIDING ON-LINE COMPUTER DATABASES AND ONLINE SEARCHABLE DATA-

SES IN THE FIELD OF GENERAL ENTERTAINMENT, IN CLASS 41 (U.S. CLS. 100, 101 AND 107).

FIRST USE 8-7-2007; IN COMMERCE 8-7-2007.

FOR: COMPUTER SERVICES, NAMELY, HOSTING ONLINE WEB FACILITIES FOR OTHERS FOR ORGANIZING AND CONDUCTING ONLINE CONTESTS, DISPUTE RESOLUTION, AND OTHER INTERACTIVE DISCUSSIONS; AND COMPUTER SERVICES IN THE NATURE OF CUSTOMIZED WEB PAGES FEATURING USER-DEFINED INFORMATION, AND PERSONAL PROFILES AND INFORMATION, IN CLASS 42 (U.S. CLS. 100 AND 101).

FIRST USE 8-7-2007; IN COMMERCE 8-7-2007.

FOR: ALTERNATIVE DISPUTE RESOLUTION SERVICES; PROVIDING ON-LINE COMPUTER DATABASES AND ONLINE SEARCHABLE DATABASES IN THE FIELD SOCIAL NETWORKING, IN CLASS 45 (U.S. CLS. 100 AND 101).

FIRST USE 8-7-2007; IN COMMERCE 8-7-2007.

THE MARK CONSISTS OF STANDARD CHARACTERS WITHOUT CLAIM TO ANY PARTICULAR FONT, STYLE, SIZE, OR COLOR.

SER. NO. 77-304,301, FILED 10-15-2007.

JENNY PARK, EXAMINING ATTORNEY

**Int. Cl.: 36**

**Prior U.S. Cls.: 100, 101 and 102**

**United States Patent and Trademark Office**

**Reg. No. 3,504,080**

**Registered Sep. 23, 2008**

**SERVICE MARK  
PRINCIPAL REGISTER**

**Randolph Brooks Federal  
Credit Union**

RANDOLPH-BROOKS FEDERAL CREDIT UNION (UNITED STATES FEDERALLY CHARTERED CREDIT UNION)  
CHIEF FINANCIAL OFFICER  
ONE RANDOLPH BROOKS PARKWAY  
LIVE OAK, TX 78233

FOR: CREDIT UNIONS, IN CLASS 36 (U.S. CLS. 100, 101 AND 102).

FIRST USE 10-15-1961; IN COMMERCE 10-15-1961.

THE MARK CONSISTS OF STANDARD CHARACTERS WITHOUT CLAIM TO ANY PARTICULAR FONT, STYLE, SIZE, OR COLOR.

THE NAME SHOWN IN THE MARK DOES NOT IDENTIFY A PARTICULAR LIVING INDIVIDUAL.

SER. NO. 77-305,466, FILED 10-16-2007.

ROBERT C. CLARK JR., EXAMINING ATTORNEY

**Int. Cl.: 41**

**Prior U.S. Cls.: 100, 101 and 107**

**United States Patent and Trademark Office**

**Reg. No. 3,504,081**

**Registered Sep. 23, 2008**

---

**SERVICE MARK  
PRINCIPAL REGISTER**

**THE LISTING MACHINE**

HILTON JOHNSON PRODUCTIONS, INC.  
(FLORIDA CORPORATION)  
224 COMMERCIAL BLVD, #304  
FORT LAUDERDALE, FL 33308

FOR: EDUCATIONAL SERVICES, NAMELY,  
CONDUCTING CLASSES, SEMINARS AND TRAIN-  
ING COURSES IN THE ART OF SELLING REAL  
ESTATE; EDUCATIONAL SERVICES, NAMELY,  
CONDUCTING CLASSES, SEMINARS, AND TRAIN-  
ING COURSES FOR MARKETING COACHES IN  
THE FIELD OF SELLING REAL ESTATE, IN CLASS  
41 (U.S. CLS. 100, 101 AND 107).

FIRST USE 2-1-1989; IN COMMERCE 2-22-1990.

THE MARK CONSISTS OF STANDARD CHAR-  
ACTERS WITHOUT CLAIM TO ANY PARTICULAR  
FONT, STYLE, SIZE, OR COLOR.

SER. NO. 77-305,599, FILED 10-16-2007.

JANICE KIM, EXAMINING ATTORNEY

**Int. Cl.: 43**

**Prior U.S. Cls.: 100 and 101**

**United States Patent and Trademark Office**

**Reg. No. 3,504,082**

**Registered Sep. 23, 2008**

**SERVICE MARK  
PRINCIPAL REGISTER**

# Hi Ho Mongolian Grill

HI HO MONGOLIAN GRILL WORLDWIDE LLC  
(IOWA LIMITED LIABILITY COMPANY)  
6420 FOREST RD  
DAVENPORT, IA 52807

FOR: DINE-IN AND TAKE OUT RESTAURANT  
SERVICES FEATURING MONGOLIAN BARBECUE,  
IN CLASS 43 (U.S. CLS. 100 AND 101).

FIRST USE 2-14-2004; IN COMMERCE 2-14-2004.

THE MARK CONSISTS OF STANDARD CHAR-  
ACTERS WITHOUT CLAIM TO ANY PARTICULAR  
FONT, STYLE, SIZE, OR COLOR.

NO CLAIM IS MADE TO THE EXCLUSIVE  
RIGHT TO USE "MONGOLIAN GRILL", APART  
FROM THE MARK AS SHOWN.

SER. NO. 77-306,003, FILED 10-17-2007.

DAWN FELDMAN, EXAMINING ATTORNEY

**Int. Cl.: 42**

**Prior U.S. Cls.: 100 and 101**

**United States Patent and Trademark Office**

**Reg. No. 3,504,083**

**Registered Sep. 23, 2008**

**SERVICE MARK  
PRINCIPAL REGISTER**

**CONVERSION SUITE**

ELOQUA CORPORATION (CANADA CORPORATION)  
553 RICHARD STREET WEST, SUITE 214  
TORONTO, ONTARIO, CANADA M5M1Y6

FOR: PROVIDING ON-LINE NON-DOWNLOADABLE ADAPTIVE COMPUTER SOFTWARE DESIGNED TO AUTOMATE AND INTEGRATE DEMAND GENERATION FOR OTHERS' PRODUCTS AND SERVICES BY INTEGRATING EMAIL, DIRECT MAIL, TELEPHONY, INSTANT MESSAGING, AUTOMATION OF FORMS, WEBSITE ANALYTICS, WEBSITE LANDING PAGES, EVENT-TRIGGERED AUTOMATION AND SALES FORCE AUTOMATION; PROVIDING ON-LINE NON-DOWNLOADABLE ADAPTIVE COMPUTER SOFTWARE DESIGNED TO MONITOR WEBSITE TRAFFIC; PROVIDING ON-LINE NON-DOWNLOADABLE ADAPTIVE COMPUTER SOFTWARE DESIGNED TO MONITOR USERS OF WEBSITES OF OTHERS AND AUTOMATICALLY OFFER ONLINE COMMUNICATION IF USER MATCHES PRE-EXISTING PROFILE; PROVIDING ON-LINE NON-DOWNLOADABLE ADAPTIVE COMPUTER SOFTWARE DESIGNED TO ROUTE WEBSITE USERS TO PERSONNEL OF OTHERS FOR THE INITIATION OF A DISCUSSION VIA EMAIL OR TELEPHONE; PROVIDING ON-LINE NON-DOWNLOADABLE ADAPTIVE COMPUTER SOFTWARE DESIGNED TO PREPARE TEXT FOR PERSONNEL OF OTHERS TO USE WITH PROSPECTIVE OR ACTUAL CUSTOMERS; PROVIDING ON-LINE NON-DOWNLOADABLE ADAPTIVE COMPUTER

SOFTWARE DESIGNED TO PREPARE CUSTOMER PROFILES FOR OTHERS; PROVIDING ON-LINE NON-DOWNLOADABLE ADAPTIVE COMPUTER SOFTWARE DESIGNED TO ADVISE PERSONNEL OF OTHERS THAT WEBSITE USERS HAVE REQUESTED A DISCUSSION; PROVIDING ON-LINE NON-DOWNLOADABLE ADAPTIVE COMPUTER SOFTWARE DESIGNED TO CREATE AND HOST INDIVIDUALIZED WEB PAGES OF OTHERS WHERE THE CONTENT OF THE WEB PAGE IS BASED UPON SPECIFIC INFORMATION RECEIVED BY OTHERS REGARDING THE INDIVIDUAL, ALL FOR MARKETING AND SALES PURPOSES, IN CLASS 42 (U.S. CLS. 100 AND 101).

FIRST USE 1-1-2003; IN COMMERCE 1-1-2003.

THE MARK CONSISTS OF STANDARD CHARACTERS WITHOUT CLAIM TO ANY PARTICULAR FONT, STYLE, SIZE, OR COLOR.

NO CLAIM IS MADE TO THE EXCLUSIVE RIGHT TO USE "SUITE", APART FROM THE MARK AS SHOWN.

SEC. 2(F).

SER. NO. 77-306,427, FILED 10-17-2007.

KATHERINE E. HALMEN, EXAMINING ATTORNEY

**Int. Cl.: 42**

**Prior U.S. Cls.: 100 and 101**

**United States Patent and Trademark Office**

**Reg. No. 3,504,084**

**Registered Sep. 23, 2008**

**SERVICE MARK  
PRINCIPAL REGISTER**

**MyTechnicalAssistant**

LAING, JAMES A (UNITED STATES INDIVIDUAL)  
1508 HIGH HOLLY LANE  
RALEIGH, NC 27614

FOR: PERSONALIZED TECHNICAL SUPPORT SERVICES, NAMELY, TROUBLESHOOTING OF COMPUTER HARDWARE AND SOFTWARE PROBLEMS FOR INDIVIDUALS; TECHNICAL CONSULTING AND ASSISTANCE WITH COMPUTER-BASED INFORMATION SYSTEMS AND COMPONENTS, IN CLASS 42 (U.S. CLS. 100 AND 101).

FIRST USE 10-16-2007; IN COMMERCE 10-16-2007.

THE MARK CONSISTS OF STANDARD CHARACTERS WITHOUT CLAIM TO ANY PARTICULAR FONT, STYLE, SIZE, OR COLOR.

SER. NO. 77-307,033, FILED 10-18-2007.

KELLY MCCOY, EXAMINING ATTORNEY

**Int. Cl.: 10**

**Prior U.S. Cls.: 26, 39 and 44**

**United States Patent and Trademark Office**

**Reg. No. 3,504,085**

**Registered Sep. 23, 2008**

**TRADEMARK  
PRINCIPAL REGISTER**

**CELLAID**

JMS CO., LTD. (JAPAN LIMITED LIABILITY  
COMPANY)  
12-17 KAKO-MACHI, NAKA-KU, HIROSHIMA-SHI  
HIROSHIMA, JAPAN 730-8652

FOR: MEDICAL APPARATUS AND INSTRU-  
MENTS, NAMELY, SERUM COLLECTION BAGS  
SPECIALLY DESIGNED FOR PREPARING AUTO-  
LOGOUS SERUM AND HUMAN SERUM, IN CLASS  
10 (U.S. CLS. 26, 39 AND 44).

THE MARK CONSISTS OF STANDARD CHAR-  
ACTERS WITHOUT CLAIM TO ANY PARTICULAR  
FONT, STYLE, SIZE, OR COLOR.

OWNER OF JAPAN REG. NO. 4860628, DATED 4-  
28-2005, EXPIRES 4-28-2015.

SER. NO. 77-307,153, FILED 10-18-2007.

BARBARA GAYNOR, EXAMINING ATTORNEY

**Int. Cls.: 16 and 40**

**Prior U.S. Cls.: 2, 5, 22, 23, 29, 37, 38, 50, 100, 103 and 106**

**Reg. No. 3,504,086**

**United States Patent and Trademark Office**

**Registered Sep. 23, 2008**

**TRADEMARK  
SERVICE MARK  
PRINCIPAL REGISTER**



BLOCK GRAPHICS, INC. (OREGON CORPORATION)  
2441 PRESIDENTIAL PARKWAY  
MIDLOTHIAN, TX 76065

FOR: PRINTED MATTER, NAMELY, CUSTOM FORMS PRINTED TO CUSTOMER SPECIFICATIONS, IN CLASS 16 (U.S. CLS. 2, 5, 22, 23, 29, 37, 38 AND 50).

FIRST USE 7-1-1990; IN COMMERCE 7-1-1990.

FOR: PRINTING CUSTOM FORMS TO CUSTOMER SPECIFICATIONS, IN CLASS 40 (U.S. CLS. 100, 103 AND 106).

FIRST USE 7-1-1990; IN COMMERCE 7-1-1990.

NO CLAIM IS MADE TO THE EXCLUSIVE RIGHT TO USE "GRAPHICS", APART FROM THE MARK AS SHOWN.

THE MARK CONSISTS OF A "THREE-DIMENSIONAL BLOCK" WITH A CAPITAL LETTER "B" ON THE FRONT OF THE BLOCK. TO THE RIGHT OF THE BLOCK ARE THE WORDS "BLOCK GRAPHICS", WITH THE WORD "BLOCK" ON TOP OF THE WORD "GRAPHICS".

SEC. 2(F) "BLOCK GRAPHICS".

SER. NO. 77-307,479, FILED 10-18-2007.

MICHAEL LITZAU, EXAMINING ATTORNEY



**Int. Cl.: 36**

**Prior U.S. Cls.: 100, 101 and 102**

**United States Patent and Trademark Office**

**Reg. No. 3,504,087**

**Registered Sep. 23, 2008**

**SERVICE MARK  
PRINCIPAL REGISTER**

**Randolph-Brooks Federal  
Credit Union**

RANDOLPH-BROOKS FEDERAL CREDIT UNION (UNITED STATES FEDERALLY CHARTERED CREDIT UNION)  
CHIEF FINANCIAL OFFICER  
ONE RANDOLPH BROOKS PARKWAY  
LIVE OAK, TX 78233

FOR: CREDIT UNIONS, IN CLASS 36 (U.S. CLS. 100, 101 AND 102).

FIRST USE 10-15-1961; IN COMMERCE 10-15-1961.

THE MARK CONSISTS OF STANDARD CHARACTERS WITHOUT CLAIM TO ANY PARTICULAR FONT, STYLE, SIZE, OR COLOR.

NO CLAIM IS MADE TO THE EXCLUSIVE RIGHT TO USE "FEDERAL CREDIT UNION", APART FROM THE MARK AS SHOWN.

THE NAME "RANDOLPH BROOKS" DOES NOT IDENTIFY A LIVING INDIVIDUAL.

SER. NO. 77-308,286, FILED 10-19-2007.

ROBERT C. CLARK JR., EXAMINING ATTORNEY

**Int. Cl.: 16**

**Prior U.S. Cls.: 2, 5, 22, 23, 29, 37, 38 and 50**

**United States Patent and Trademark Office**

**Reg. No. 3,504,088**

**Registered Sep. 23, 2008**

---

**TRADEMARK  
PRINCIPAL REGISTER**

**WAR IS HELL**

MARVEL CHARACTERS, INC. (DELAWARE  
CORPORATION)  
9242 BEVERLY BLVD.  
BEVERLY HILLS, CA 90210

THE MARK CONSISTS OF STANDARD CHAR-  
ACTERS WITHOUT CLAIM TO ANY PARTICULAR  
FONT, STYLE, SIZE, OR COLOR.

FOR: COMIC BOOKS; PRINTED PERIODICALS  
IN THE FIELD OF COMIC BOOK STORIES AND  
ARTWORK, IN CLASS 16 (U.S. CLS. 2, 5, 22, 23, 29, 37,  
38 AND 50).

SER. NO. 77-308,607, FILED 10-19-2007.

FIRST USE 3-19-2008; IN COMMERCE 3-19-2008.

PAUL CROWLEY, EXAMINING ATTORNEY

**Int. Cl.: 16**

**Prior U.S. Cls.: 2, 5, 22, 23, 29, 37, 38 and 50**

**United States Patent and Trademark Office**

**Reg. No. 3,504,089**

**Registered Sep. 23, 2008**

**TRADEMARK  
PRINCIPAL REGISTER**

**DEAD OF NIGHT**

MARVEL CHARACTERS, INC. (DELAWARE  
CORPORATION)  
9242 BEVERLY BLVD.  
BEVERLY HILLS, CA 90210

THE MARK CONSISTS OF STANDARD CHAR-  
ACTERS WITHOUT CLAIM TO ANY PARTICULAR  
FONT, STYLE, SIZE, OR COLOR.

FOR: COMIC BOOKS; PRINTED PERIODICALS  
IN THE FIELD OF COMIC BOOK STORIES AND  
ARTWORK, IN CLASS 16 (U.S. CLS. 2, 5, 22, 23, 29, 37,  
38 AND 50).

SER. NO. 77-308,625, FILED 10-19-2007.

FIRST USE 2-15-2008; IN COMMERCE 2-15-2008.

PAUL CROWLEY, EXAMINING ATTORNEY

**Int. Cl.: 42**

**Prior U.S. Cls.: 100 and 101**

**United States Patent and Trademark Office**

**Reg. No. 3,504,090**

**Registered Sep. 23, 2008**

**SERVICE MARK  
PRINCIPAL REGISTER**

**O2 SCAN**

EDCO GROUP, INC. (MISSOURI CORPORATION)  
1351 N. BELCREST AVE.  
SPRINGFIELD, MO 65802

FOR: CONVERSION OF DATA OR DOCUMENTS  
FROM PHYSICAL TO ELECTRONIC MEDIA, IN  
CLASS 42 (U.S. CLS. 100 AND 101).

FIRST USE 7-1-2007; IN COMMERCE 7-1-2007.

THE MARK CONSISTS OF STANDARD CHARACTERS WITHOUT CLAIM TO ANY PARTICULAR FONT, STYLE, SIZE, OR COLOR.

NO CLAIM IS MADE TO THE EXCLUSIVE RIGHT TO USE "SCAN", APART FROM THE MARK AS SHOWN.

SER. NO. 77-308,765, FILED 10-19-2007.

MARY CRAWFORD, EXAMINING ATTORNEY

**Int. Cl.: 9**

**Prior U.S. Cls.: 21, 23, 26, 36 and 38**

**United States Patent and Trademark Office**

**Reg. No. 3,504,091**

**Registered Sep. 23, 2008**

**TRADEMARK  
PRINCIPAL REGISTER**



ARIES INSTITUTE OF TECHNOLOGY, INC. (ARIZONA CORPORATION)  
1445 WEST 12TH PLACE  
TEMPE, AZ 85281

FOR: COMPUTER DISCS IN THE FIELDS OF EDUCATION AND TRAINING RELATING TO COMPUTER HARDWARE AND SOFTWARE, IN CLASS 9 (U.S. CLS. 21, 23, 26, 36 AND 38).

FIRST USE 8-30-2007; IN COMMERCE 8-30-2007.

THE MARK CONSISTS OF A SPIRAL WITH STRAIGHT TAIL.

SER. NO. 77-308,904, FILED 10-19-2007.

LINDA E. BLOHM, EXAMINING ATTORNEY

**Int. Cl.: 45**

**Prior U.S. Cls.: 100 and 101**

**United States Patent and Trademark Office**

**Reg. No. 3,504,092**

**Registered Sep. 23, 2008**

**SERVICE MARK  
PRINCIPAL REGISTER**

# Liosta

FRANKLIN, BRIAN (UNITED STATES INDIVIDUAL)  
12 WEDGEWOOD DRIVE  
WINCHESTER, NH 03470

FOR: ONLINE SOCIAL NETWORKING SERVICES, IN CLASS 45 (U.S. CLS. 100 AND 101).

FIRST USE 2-15-2007; IN COMMERCE 2-15-2007.

THE MARK CONSISTS OF STANDARD CHARACTERS WITHOUT CLAIM TO ANY PARTICULAR FONT, STYLE, SIZE, OR COLOR.

THE ENGLISH TRANSLATION OF THE IRISH GAELIC WORD "LIOSTA" IN THE MARK IS LIST.

SER. NO. 77-309,176, FILED 10-20-2007.

KIMBERLY FRYE, EXAMINING ATTORNEY

**Int. Cl.: 16**

**Prior U.S. Cls.: 2, 5, 22, 23, 29, 37, 38 and 50**

**United States Patent and Trademark Office**

**Reg. No. 3,504,093**

**Registered Sep. 23, 2008**

**TRADEMARK  
PRINCIPAL REGISTER**

**DOODLECITY**

WESLER, KAREN J. (UNITED STATES INDIVIDUAL)  
525 LEWIS AVENUE  
SAN LEANDRO, CA 94577

FOR: ART PRINTS; BLANK OR PARTIALLY PRINTED POSTCARDS; COFFEE TABLE BOOKS FEATURING GRAPHIC DESIGN; PICTORIAL PRINTS; PRINTED PATTERNS, IN CLASS 16 (U.S. CLS. 2, 5, 22, 23, 29, 37, 38 AND 50).

FIRST USE 1-1-1999; IN COMMERCE 12-1-2006.

THE MARK CONSISTS OF STANDARD CHARACTERS WITHOUT CLAIM TO ANY PARTICULAR FONT, STYLE, SIZE, OR COLOR.

SER. NO. 77-309,201, FILED 10-20-2007.

MICHAEL GAAFAR, EXAMINING ATTORNEY

**Int. Cls.: 7 and 42**

**Prior U.S. Cls.: 13, 19, 21, 23, 31, 34, 35, 100 and 101**

**United States Patent and Trademark Office**

**Reg. No. 3,504,094**

**Registered Sep. 23, 2008**

**TRADEMARK  
SERVICE MARK  
PRINCIPAL REGISTER**

**SOLO**

REDZONE ROBOTICS, INC. (PENNSYLVANIA  
CORPORATION)  
91 43RD STREET  
SUITE 250  
PITTSBURGH, PA 15201

FOR: ROBOTIC SYSTEM COMPRISED OF A  
HYDRAULICALLY POWERED ROBOT WITH ON-  
BOARD SENSORS AND A COMPUTER THAT CON-  
TROLS THE OPERATION OF THE ROBOT AND  
SENSORS, USED FOR CONDUCTING PIPELINE  
INSPECTIONS, IN CLASS 7 (U.S. CLS. 13, 19, 21, 23,  
31, 34 AND 35).

FIRST USE 12-5-2007; IN COMMERCE 12-5-2007.

FOR: PIPELINE INSPECTION SERVICES, IN  
CLASS 42 (U.S. CLS. 100 AND 101).

FIRST USE 10-25-2007; IN COMMERCE 10-25-2007.

THE MARK CONSISTS OF STANDARD CHAR-  
ACTERS WITHOUT CLAIM TO ANY PARTICULAR  
FONT, STYLE, SIZE, OR COLOR.

SER. NO. 77-309,849, FILED 10-22-2007.

RENEE SERVANCE, EXAMINING ATTORNEY



**Int. Cl.: 7**

**Prior U.S. Cls.: 13, 19, 21, 23, 31, 34 and 35**

**United States Patent and Trademark Office**

**Reg. No. 3,504,095**

**Registered Sep. 23, 2008**

**TRADEMARK  
PRINCIPAL REGISTER**

**FROZEN CONCOCTIONS, THAT  
HELP ME HANG ON**

MARGARITAVILLE ENTERPRISES, LLC (DELA-  
WARE LIMITED LIABILITY COMPANY)  
256 WORTH AVENUE, SUITE Q-R  
PALM BEACH, FL 33480

THE MARK CONSISTS OF STANDARD CHAR-  
ACTERS WITHOUT CLAIM TO ANY PARTICULAR  
FONT, STYLE, SIZE, OR COLOR.

FOR: ELECTRIC FOOD AND DRINK BLENDERS,  
IN CLASS 7 (U.S. CLS. 13, 19, 21, 23, 31, 34 AND 35).

SER. NO. 77-310,605, FILED 10-23-2007.

FIRST USE 6-14-2006; IN COMMERCE 6-14-2006.

RICHARD A. STRASER, EXAMINING ATTORNEY

**Int. Cl.: 38**

**Prior U.S. Cls.: 100, 101 and 104**

**United States Patent and Trademark Office**

**Reg. No. 3,504,096**

**Registered Sep. 23, 2008**

**SERVICE MARK  
PRINCIPAL REGISTER**

**TEM**

CONFERENCE AMERICA, INC. (ALABAMA  
CORPORATION)  
7079 UNIVERSITY COURT  
MONTGOMERY, AL 36117

THE MARK CONSISTS OF STANDARD CHAR-  
ACTERS WITHOUT CLAIM TO ANY PARTICULAR  
FONT, STYLE, SIZE, OR COLOR.

FOR: TELECONFERENCING AND VIDEO CON-  
FERENCING SERVICES BY TELEPHONE AND THE  
INTERNET FOR TRAINING, IN CLASS 38 (U.S. CLS.  
100, 101 AND 104).

SER. NO. 77-310,736, FILED 10-23-2007.

FIRST USE 10-22-2007; IN COMMERCE 10-22-2007.

KIMBERLY PERRY, EXAMINING ATTORNEY

**Int. Cl.: 38**

**Prior U.S. Cls.: 100, 101 and 104**

**United States Patent and Trademark Office**

**Reg. No. 3,504,097**

**Registered Sep. 23, 2008**

**SERVICE MARK  
PRINCIPAL REGISTER**

TOTAL EVENT MANAGEMENT

CONFERENCE AMERICA, INC. (ALABAMA  
CORPORATION)  
7079 UNIVERSITY COURT  
MONTGOMERY, AL 36117

THE MARK CONSISTS OF STANDARD CHAR-  
ACTERS WITHOUT CLAIM TO ANY PARTICULAR  
FONT, STYLE, SIZE, OR COLOR.

FOR: TELECONFERENCING AND VIDEO CON-  
FERENCING SERVICES BY TELEPHONE AND THE  
INTERNET FOR TRAINING, IN CLASS 38 (U.S. CLS.  
100, 101 AND 104).

SER. NO. 77-310,863, FILED 10-23-2007.

FIRST USE 10-22-2007; IN COMMERCE 10-22-2007.

KIMBERLY PERRY, EXAMINING ATTORNEY

**Int. Cls.: 9 and 43**

**Prior U.S. Cls.: 21, 23, 26, 36, 38, 100 and 101**

**United States Patent and Trademark Office**

**Reg. No. 3,504,098**

**Registered Sep. 23, 2008**

**TRADEMARK  
SERVICE MARK  
PRINCIPAL REGISTER**

**KIMPTON RESERVATOR**

KIMPTON HOTEL & RESTAURANT GROUP,  
LLC (DELAWARE LIMITED LIABILITY COM-  
PANY)  
222 KEARNY STREET, SUITE 200  
SAN FRANCISCO, CA 94108

FOR: DOWNLOADABLE COMPUTER SOFT-  
WARE FOR DELIVERING PERSONALIZED HO-  
TELS AND TEMPORARY ACCOMMODATIONS  
INFORMATION OVER THE INTERNET, IN CLASS  
9 (U.S. CLS. 21, 23, 26, 36 AND 38).

FIRST USE 10-22-2007; IN COMMERCE 10-22-2007.

FOR: PROVIDING PERSONALIZED INFORMA-  
TION ABOUT HOTELS AND TEMPORARY AC-

COMMODATIONS FOR TRAVEL VIA THE  
INTERNET, IN CLASS 43 (U.S. CLS. 100 AND 101).

FIRST USE 10-22-2007; IN COMMERCE 10-22-2007.

THE MARK CONSISTS OF STANDARD CHAR-  
ACTERS WITHOUT CLAIM TO ANY PARTICULAR  
FONT, STYLE, SIZE, OR COLOR.

OWNER OF U.S. REG. NOS. 2,905,415, 3,065,302  
AND OTHERS.

SER. NO. 77-310,927, FILED 10-23-2007.

CURTIS FRENCH, EXAMINING ATTORNEY

**Int. Cl.: 10**

**Prior U.S. Cls.: 26, 39 and 44**

**Reg. No. 3,504,099**

**United States Patent and Trademark Office**

**Registered Sep. 23, 2008**

**TRADEMARK  
PRINCIPAL REGISTER**



SURGICAL INNOVATIONS LIMITED (UNITED  
KINGDOM LIMITED COMPANY (LTD.))  
CLAYTON PARK  
CLAYTON WOOD RISE  
LEEDS, UNITED KINGDOM LS166RF

PRIORITY CLAIMED UNDER SEC. 44(D) ON  
ERPNTY CMNTY TM OFC APPLICATION NO.  
006012058, FILED 6-18-2007, REG. NO. 006012058,  
DATED 4-7-2008, EXPIRES 6-18-2017.

FOR: SURGICAL APPARATUS AND INSTRU-  
MENTS; MEDICAL APPARATUS AND INSTRU-  
MENTS AND PARTS AND FITTINGS FOR ALL  
THE AFORESAID GOODS, IN CLASS 10 (U.S. CLS.  
26, 39 AND 44).

THE MARK CONSISTS OF STYLIZED LETTERS  
"S" AND "I".

SER. NO. 77-311,043, FILED 10-23-2007.

FIRST USE 4-16-1995; IN COMMERCE 12-31-1998.

MARGERY A. TIERNEY, EXAMINING ATTORNEY

Int. Cl.: 41

Prior U.S. Cls.: 100, 101 and 107

United States Patent and Trademark Office

Reg. No. 3,504,100

Registered Sep. 23, 2008

**SERVICE MARK  
PRINCIPAL REGISTER**

NEW YORK SHOCK EXCHANGE

BAKER, RALPH W., JR. (UNITED STATES IN-  
DIVIDUAL)  
112 SOUTH ELLIOT PLACE  
BROOKLYN, NY 11217

FOR: BASKETBALL CAMPS; ENTERTAINMENT  
IN THE NATURE OF BASKETBALL GAMES;  
CHARITABLE SERVICES, NAMELY, ACADEMIC  
MENTORING OF SCHOOL AGE CHILDREN; EDU-  
CATION SERVICES NAMELY, MENTORING IN  
THE FIELD OF BUSINESS, SAVING AND INVEST-  
ING, IN CLASS 41 (U.S. CLS. 100, 101 AND 107).

FIRST USE 9-1-2005; IN COMMERCE 11-1-2005.

NO CLAIM IS MADE TO THE EXCLUSIVE  
RIGHT TO USE "NEW YORK", APART FROM THE  
MARK AS SHOWN.

THE MARK CONSISTS OF THE WORDS "NEW  
YORK SHOCK EXCHANGE" WITH THE LETTER  
"O" IN THE WORD "SHOCK" REPLACED BY A  
BASKETBALL.

SER. NO. 77-311,639, FILED 10-23-2007.

AMY MCMENAMIN, EXAMINING ATTORNEY

**Int. Cl.: 25**

**Prior U.S. Cls.: 22 and 39**

**United States Patent and Trademark Office**

**Reg. No. 3,504,101**

**Registered Sep. 23, 2008**

**TRADEMARK  
PRINCIPAL REGISTER**

**ANKA**

ANKA FASHION, INC (NEW YORK CORPORATION)  
77 DIXON AVENUE  
STATEN ISLAND, NY 10302

FOR: CAPRI PANTS; CARGO PANTS; LEATHER PANTS; PANTS; STRETCH PANTS; BATHING SUITS; DRESS SUITS; LADIES' SUITS; SHIRTS FOR SUITS; SUIT COATS; SUITS; SUITS OF LEATHER; DRESS SHIRTS; DRESSES; DRESSES MADE FROM SKINS; DRESSING GOWNS; EVENING DRESSES; SKIRTS AND DRESSES; WEDDING DRESSES; DENIM JACKETS; DOWN JACKETS; FUR COATS AND JACKETS; FUR JACKETS; HEAVY JACKETS; JACKET LINERS; JACKETS; LEATHER JACKETS; LONG JACKETS; MEN AND WOMEN JACKETS, COATS, TROUSERS, VESTS; RAIN JACKETS; REVERSIBLE JACKETS; SLEEVED OR SLEEVELESS JACKETS; SPORTS JACKETS; SUEDE JACKETS; BLOUSES; BELTS; CORSETS; FABRIC SOLD AS AN INTEGRAL COMPONENT OF FINISHED CLOTHING ITEMS, NAMELY, D; LEATHER BELTS; PARTS OF CLOTHING, NAMELY, GUSSETS FOR TIGHTS, GUSSETS FOR STOCKINGS, GUSSETS FOR BATHING SUITS, GUSSETS

FOR UNDERWEAR, GUSSETS FOR LEOTARDS AND GUSSETS FOR FOOTLETS; SHOULDER WRAPS; TIES; TOPS; WRAPS; BRIEFS; THONGS; UNDERWEAR; WOMEN'S UNDERWEAR; WOVEN OR KNITTED UNDERWEAR; BRAS; FITTED SWIMMING COSTUMES WITH BRA CUPS; LINGERIE ACCESSORIES, NAMELY, REMOVABLE SILICONE BREAST ENHANCER PADS USED IN A BRA; SPORTS BRA; SPORTS BRAS; STRAPLESS BRAS; EVENING GOWNS; GOWNS; NIGHT GOWNS; WEDDING GOWNS; CROP TOPS; HALTER TOPS; TANK TOPS; TANK-TOPS; SKIRT SUITS; SKIRTS; CREWNECK SWEATERS; MOCK TURTLENECK SWEATERS; SWEATERS; TURTLENECK SWEATERS; V-NECK SWEATERS; TRENCH COATS; SLIPS, IN CLASS 25 (U.S. CLS. 22 AND 39).

FIRST USE 8-25-2005; IN COMMERCE 8-25-2005.

OWNER OF U.S. REG. NO. 3,282,885.

SER. NO. 77-311,829, FILED 10-24-2007.

REBECCA EISINGER, EXAMINING ATTORNEY

**Int. Cl.: 39**

**Prior U.S. Cls.: 100 and 105**

**United States Patent and Trademark Office**

**Reg. No. 3,504,102**

**Registered Sep. 23, 2008**

**SERVICE MARK  
PRINCIPAL REGISTER**

**A WORLD OF DIFFERENCE**

CAREY INTERNATIONAL, INC. (DELAWARE CORPORATION)  
4530 WISCONSIN AVENUE, N.W.  
WASHINGTON, DC 20016

FOR: TRANSPORTATION RESERVATION SERVICES FOR CHAUFFEUR DRIVEN LIMOUSINES AND MINI-BUSES; ONLINE TRANSPORTATION RESERVATION SERVICES FOR CHAUFFEUR DRIVEN LIMOUSINES AND MINI-BUSES; TRANSPORTATION RESERVATION SERVICES FOR CHAUFFEUR DRIVEN LIMOUSINES AND MINI-BUSES, NAMELY, PROVIDING CHAUFFEUR DRIVEN GROUND TRANSPORTATION SERVICES FEATURING A FREQUENT CUSTOMER BONUS PROGRAM; COORDINATING TRAVEL ARRANGEMENTS IN THE FIELD OF CHAUFFEUR DRIVEN LIMOUSINES AND MINI-BUSES FOR INDIVIDUALS AND FOR GROUPS; PROVIDING AN ON-LINE COMPUTER DATABASE IN THE FIELD

OF TRAVEL INFORMATION FEATURING CHAUFFEUR DRIVEN LIMOUSINES AND MINI-BUSES; TRANSPORTATION SERVICES, NAMELY, PASSENGER TRANSPORTATION BY CARS, LIMOUSINES, VANS AND BUSES CONDUCTED BY DRIVERS; TRANSPORTING PASSENGERS IN CHAUFFEUR DRIVEN AUTOMOBILES, IN CLASS 39 (U.S. CLS. 100 AND 105).

FIRST USE 7-31-2007; IN COMMERCE 7-31-2007.

THE MARK CONSISTS OF STANDARD CHARACTERS WITHOUT CLAIM TO ANY PARTICULAR FONT, STYLE, SIZE, OR COLOR.

SER. NO. 77-311,858, FILED 10-24-2007.

ALYSSA PALADINO, EXAMINING ATTORNEY



**Int. Cl.: 1**

**Prior U.S. Cls.: 1, 5, 6, 10, 26 and 46**

**United States Patent and Trademark Office**

**Reg. No. 3,504,103**

**Registered Sep. 23, 2008**

**TRADEMARK  
PRINCIPAL REGISTER**

**MILES AHEAD**

O'REILLY AUTOMOTIVE, INC. (MISSOURI  
CORPORATION)  
233 SOUTH PATTERSON  
SPRINGFIELD, MO 65802

THE MARK CONSISTS OF STANDARD CHAR-  
ACTERS WITHOUT CLAIM TO ANY PARTICULAR  
FONT, STYLE, SIZE, OR COLOR.

FOR: CHEMICAL FUEL ADDITIVES, IN CLASS 1  
(U.S. CLS. 1, 5, 6, 10, 26 AND 46).

SER. NO. 77-312,529, FILED 10-24-2007.

FIRST USE 1-1-2007; IN COMMERCE 1-1-2007.

JASON BLAIR, EXAMINING ATTORNEY

**Int. Cl.: 44**

**Prior U.S. Cls.: 100 and 101**

**United States Patent and Trademark Office**

**Reg. No. 3,504,104**

**Registered Sep. 23, 2008**

**SERVICE MARK  
PRINCIPAL REGISTER**

**Tx vision**

360 IMAGING, INC. (DELAWARE CORPORATION)  
STE 870  
5605 GLENRIDGE DR NE  
ATLANTA, GA 303424974

FOR: MEDICAL TREATMENT PLANNING SERVICES, NAMELY, CONSULTING SERVICES IN THE FIELD OF RESTORATIVE DENTISTRY, DENTAL IMPLANTS, AND DENTAL SURGERY, IN CLASS 44 (U.S. CLS. 100 AND 101).

FIRST USE 8-1-2007; IN COMMERCE 10-11-2007.

THE MARK CONSISTS OF STANDARD CHARACTERS WITHOUT CLAIM TO ANY PARTICULAR FONT, STYLE, SIZE, OR COLOR.

SER. NO. 77-312,713, FILED 10-24-2007.

MICHAEL ENGEL, EXAMINING ATTORNEY

**Int. Cl.: 44**

**Prior U.S. Cls.: 100 and 101**

**United States Patent and Trademark Office**

**Reg. No. 3,504,105**

**Registered Sep. 23, 2008**

**SERVICE MARK  
PRINCIPAL REGISTER**



**WEST COAST FERTILITY CENTERS**

DAVID G. DIAZ, M.D. (CALIFORNIA CORPORATION), DBA DAVID G. DIAZ, INC  
11160 WARNER AVE. STE 411  
FOUNTAIN VALLEY, CA 92708

FOR: MEDICAL SERVICES, NAMELY, IN VITRO FERTILIZATION AND RELATED INFERTILITY TREATMENTS, IN CLASS 44 (U.S. CLS. 100 AND 101).

FIRST USE 10-17-1991; IN COMMERCE 10-17-1991.

NO CLAIM IS MADE TO THE EXCLUSIVE RIGHT TO USE "WEST COAST FERTILITY CENTERS", APART FROM THE MARK AS SHOWN.

THE COLOR(S) TEAL, WHITE AND BLACK IS/ ARE CLAIMED AS A FEATURE OF THE MARK.

THE MARK CONSISTS OF A TEAL CIRCLE REPRESENTING A HUMAN EGG WITH A WHITE SPERM INSIDE AND WHITE STRIPES WITHIN AS WELL. BELOW THAT IS THE WORDING "WEST COAST FERTILITY CENTERS" IN BLACK.

SER. NO. 77-313,928, FILED 10-25-2007.

JESSICA A. POWERS, EXAMINING ATTORNEY

**Int. Cls.: 29 and 30**

**Prior U.S. Cl.: 46**

**United States Patent and Trademark Office**

**Reg. No. 3,504,106**

**Registered Sep. 23, 2008**

**TRADEMARK  
PRINCIPAL REGISTER**

**BE KIND TO YOUR BODY, YOUR  
TASTE BUDS AND THE WORLD**

PEACEWORKS (DELAWARE CORPORATION)  
OLD CHELSEA STATION  
P.O. BOX 1393  
NEW YORK, NY 10022

FOR: HEALTHY SNACKS, NAMELY, PROCESSED FRUIT- AND NUT-BASED FOOD BARS, PROCESSED NUT BASED SNACK FOOD BARS, FRUIT-BASED ORGANIC FOOD BARS, ALSO CONTAINING NUTS AND SEEDS; HEALTHY SNACKS, NAMELY, DRIED FRUIT MIXES, SNACK MIXES CONSISTING PRIMARILY OF PROCESSED FRUITS AND PROCESSED NUTS; HEALTHY SNACKS, NAMELY, PROCESSED EDIBLE SEEDS, PROCESSED EDIBLE NUTS, FRESH CUT-BAGGED VEGETABLES; READY TO EAT VEGETABLES, NAMELY, DRIED VEGETABLES, FREEZE DRIED VEGETABLES, CUT AND PACKAGED VEGETABLES ALSO CONTAINING SNACK AND/OR VEGETABLE DIPS; HEALTHY SNACKS, NAMELY, FRESH CUT-BAGGED FRUITS, FROZEN FRUITS, FROZEN VEGETABLES, READY TO EAT FRUITS, NAMELY, FREEZE DRIED FRUITS, CUT AND PACKAGED FRUIT ALSO CONTAINING SNACK AND/OR VEGETABLE DIPS, IN CLASS 29 (U.S. CL. 46).

FIRST USE 3-15-2007; IN COMMERCE 3-15-2007.

FOR: HEALTHY SNACKS, NAMELY, GRANOLA BASED SNACK FOOD, CEREAL BASED SNACK FOOD, RICE BASED SNACK FOOD, WHOLE GRAIN BASED SNACK FOOD, WHEAT BASED SNACK FOOD; HEALTHY SNACKS, NAMELY, GRANOLA BASED SNACK FOOD BARS ALSO CONTAINING FRUITS, NUTS, SEEDS, SOY AND/OR ENROBED WITH CHOCOLATE OR YOGHURT COATING, WHOLE GRAIN BASED SNACK FOOD BARS ALSO CONTAINING FRUITS, NUTS, SEEDS, SOY AND/OR ENROBED WITH CHOCOLATE OR YOGHURT COATING, IN CLASS 30 (U.S. CL. 46).

FIRST USE 3-15-2007; IN COMMERCE 3-15-2007.

THE MARK CONSISTS OF STANDARD CHARACTERS WITHOUT CLAIM TO ANY PARTICULAR FONT, STYLE, SIZE, OR COLOR.

SER. NO. 77-314,217, FILED 10-26-2007.

KELLY BOULTON, EXAMINING ATTORNEY

**Int. Cl.: 14**

**Prior U.S. Cls.: 2, 27, 28 and 50**

**United States Patent and Trademark Office**

**Reg. No. 3,504,107**

**Registered Sep. 23, 2008**

**TRADEMARK  
PRINCIPAL REGISTER**

**Traci Lynn**

TRACI LYNN FASHION JEWELRY, LLC (DELA-  
WARE LIMITED LIABILITY COMPANY)  
34 BLEVENS  
BEAR, DE 19720

FOR: JEWELRY, IN CLASS 14 (U.S. CLS. 2, 27, 28  
AND 50).

FIRST USE 10-16-1989; IN COMMERCE 10-16-1989.

THE MARK CONSISTS OF STANDARD CHAR-  
ACTERS WITHOUT CLAIM TO ANY PARTICULAR  
FONT, STYLE, SIZE, OR COLOR.

THE NAME(S), PORTRAIT(S), AND/OR SIGNA-  
TURE(S) SHOWN IN THE MARK IDENTIFIES  
"TRACI LYNN", WHOSE CONSENT(S) TO REGIS-  
TER IS SUBMITTED.

SER. NO. 77-314,751, FILED 10-26-2007.

LESLEY LAMOTHE, EXAMINING ATTORNEY

**Int. Cl.: 9**

**Prior U.S. Cls.: 21, 23, 26, 36 and 38**

**United States Patent and Trademark Office**

**Reg. No. 3,504,108**

**Registered Sep. 23, 2008**

**TRADEMARK  
PRINCIPAL REGISTER**

# Multigressiv MyView

RODENSTOCK GMBH (FED REP GERMANY  
GESELLSCHAFT MIT BESCHRÄNKTER HAF-  
TUNG (GMBH))  
PATENTE MARKEN NORMEN  
ISARTALSTR. 43  
MÜNCHEN, FED REP GERMANY 80469

FOR: SPECTACLES; SPECTACLE LENSES;  
BLANKS, NAMELY, SPECTACLE LENSES FIN-  
ISHED ON ONE SIDE , IN CLASS 9 (U.S. CLS. 21,  
23, 26, 36 AND 38).

THE MARK CONSISTS OF STANDARD CHAR-  
ACTERS WITHOUT CLAIM TO ANY PARTICULAR  
FONT, STYLE, SIZE, OR COLOR.

PRIORITY CLAIMED UNDER SEC. 44(D) ON FED  
REP GERMANY APPLICATION NO. 30738060.2/0,  
FILED 6-12-2007, REG. NO. 30738060, DATED 7-31-  
2007, EXPIRES 6-12-2017.

THE WORDING "MULTIGRESSIV MYVIEW" HAS  
NO MEANING IN A FOREIGN LANGUAGE.

SER. NO. 77-314,792, FILED 10-26-2007.

SETH A. RAPPAPORT, EXAMINING ATTORNEY

Int. Cl.: 42

Prior U.S. Cls.: 100 and 101

United States Patent and Trademark Office

Reg. No. 3,504,109

Registered Sep. 23, 2008

SERVICE MARK  
PRINCIPAL REGISTER



KUMAR, PRAVEEN (INDIA INDIVIDUAL)  
2945 NW MODA WAY # 221  
HILLSBORO, OR 97124

FOR: COMPUTER SOFTWARE CONSULTANCY; COMPUTER SOFTWARE DEVELOPMENT; COMPUTER PROGRAMMING; COMPUTER PROJECT MANAGEMENT SERVICES; COMPUTER SERVICES, NAMELY, DATABASE DEVELOPMENT SERVICES, NAMELY, CONFIGURATION AND CUSTOMIZATION OF COMPUTER DATABASES CONTAINING INFORMATION REGARDING PUBLIC HEALTH CARE ELIGIBILITY; COMPUTER SERVICES, NAMELY, DESIGNING AND IMPLEMENTING WEB SITES FOR OTHERS; COMPUTER SERVICES, NAMELY, MANAGING WEB SITES FOR OTHERS; COMPUTER SERVICES, NAMELY, REMOTE MANAGEMENT OF COMPUTER APPLICATIONS FOR OTHERS; COMPUTER SOFTWARE CONSULTATION; COMPUTER SOFTWARE DESIGN FOR OTHERS; COMPUTER SOFTWARE DESIGN, COMPUTER PROGRAMMING, OR MAINTENANCE OF COMPUTER SOFTWARE; COMPUTER SYSTEMS ANALYSIS; CUSTOMIZATION OF COMPUTER HARDWARE AND SOFTWARE; DATA CONVERSION OF COMPUTER PROGRAM DATA OR INFORMATION; DATABASE DEVELOPMENT SERVICES; DESIGN AND DEVELOPMENT OF INFORMATION AND DATA BASES; DESIGN AND TESTING FOR NEW PRODUCT DEVELOPMENT; DESIGN OF HOME PAGES, COMPUTER SOFTWARE AND WEB SITES; DESIGN, DEVELOPMENT AND IMPLEMENTATION OF SOFTWARE; DEVELOPMENT, DESIGN AND UPDATING OF HOME PAGES; DOCUMENT DATA TRANSFER FROM ONE COMPUTER FORMAT TO ANOTHER; DUPLICATING COMPUTER PROGRAMS; INFORMATION TECHNOLOGY CONSULTATION; INSTALLATION OF COMPUTER SOFTWARE; MAINTENANCE OF COMPUTER

SOFTWARE; PRODUCT DEVELOPMENT; PRODUCT DEVELOPMENT CONSULTATION; PRODUCT DEVELOPMENT FOR OTHERS; PRODUCT RESEARCH AND DEVELOPMENT; PROVIDING A WEBSITE THAT FEATURES INFORMATION ON COMPUTER TECHNOLOGY AND PROGRAMMING; RESEARCH AND DEVELOPMENT AND CONSULTATION RELATED THERETO IN THE FIELD OF HEALTHCARE PAYER AND PROVIDER INDUSTRIES; RESEARCH AND DEVELOPMENT FOR NEW PRODUCTS FOR OTHERS; TECHNOLOGICAL CONSULTATION IN THE TECHNOLOGY FIELD OF COMPUTER HARDWARE AND SOFTWARE SYSTEMS IN THE HEALTH INSURANCE INDUSTRY; UPDATING OF COMPUTER SOFTWARE FOR OTHERS; WEBSITE DEVELOPMENT FOR OTHERS, IN CLASS 42 (U.S. CLS. 100 AND 101).

FIRST USE 9-26-2007; IN COMMERCE 9-26-2007.

NO CLAIM IS MADE TO THE EXCLUSIVE RIGHT TO USE "SOLUTIONS LLC", APART FROM THE MARK AS SHOWN.

THE COLOR(S) BLUE, ORANGE IS/ARE CLAIMED AS A FEATURE OF THE MARK.

THE MARK CONSISTS OF THE LOGO IS OVAL SHAPED MADE UP OF A STYLIZED LETTER "X" IN BLUE ON THE LEFT, A STYLIZED LETTER "T" IN ORANGE ON THE RIGHT AND AN ORANGE COLORED SWOOSH ON THE BOTTOM. IT IS FOLLOWED BY THE LETTERS "XT SOLUTIONS LLC" IN BLUE.

SER. NO. 77-314,881, FILED 10-26-2007.

ERNEST SHOSHO, EXAMINING ATTORNEY

**Int. Cl.: 41**

**Prior U.S. Cls.: 100, 101 and 107**

**United States Patent and Trademark Office**

**Reg. No. 3,504,110**

**Registered Sep. 23, 2008**

**SERVICE MARK  
PRINCIPAL REGISTER**

**COMFORT DENTAL JUNIOR  
STARTING LINEUP**

KUSHNER, RICK A. (UNITED STATES INDIVIDUAL)  
9990 WEST 26TH AVENUE, SUITE 300  
LAKEWOOD, CO 80215

FOR: ENTERTAINMENT SERVICES, NAMELY, CONDUCTING CONTESTS; ENTERTAINMENT SERVICES, NAMELY, CONDUCTING CONTESTS FOR CHILDREN TO ATTEND PROFESSIONAL SPORT GAMES AND TO TAKE THE FIELD AT PROFESSIONAL SPORT GAMES, IN CLASS 41 (U.S. CLS. 100, 101 AND 107).

FIRST USE 7-0-2003; IN COMMERCE 7-0-2003.

THE MARK CONSISTS OF STANDARD CHARACTERS WITHOUT CLAIM TO ANY PARTICULAR FONT, STYLE, SIZE, OR COLOR.

SER. NO. 77-315,688, FILED 10-29-2007.

JENNIFER MARTIN, EXAMINING ATTORNEY



**Int. Cl.: 41**

**Prior U.S. Cls.: 100, 101 and 107**

**United States Patent and Trademark Office**

**Reg. No. 3,504,111**

**Registered Sep. 23, 2008**

**SERVICE MARK  
PRINCIPAL REGISTER**

**POST MORTEM**

WASHINGTONPOST.NEWSWEEK INTERACTIVE  
COMPANY, LLC (DELAWARE LIMITED LIA-  
BILITY COMPANY)  
1515 N. COURTHOUSE ROAD  
ARLINGTON, VA 22201

FOR: ONLINE JOURNALS, NAMELY, BLOGS  
FEATURING TOPICS IN THE FIELDS OF OBITU-  
ARIES AND OTHER END-OF-LIFE EVENTS SUCH  
AS FUNERALS, CREMATION, AND GRIEF, IN  
CLASS 41 (U.S. CLS. 100, 101 AND 107).

FIRST USE 9-5-2007; IN COMMERCE 9-5-2007.

THE MARK CONSISTS OF STANDARD CHAR-  
ACTERS WITHOUT CLAIM TO ANY PARTICULAR  
FONT, STYLE, SIZE, OR COLOR.

SER. NO. 77-315,771, FILED 10-29-2007.

DOMINIC FATHY, EXAMINING ATTORNEY

**Int. Cl.: 36**

**Prior U.S. Cls.: 100, 101 and 102**

**United States Patent and Trademark Office**

**Reg. No. 3,504,112**

**Registered Sep. 23, 2008**

**SERVICE MARK  
PRINCIPAL REGISTER**

**FailSafe GIGA**

HARTFORD FIRE INSURANCE COMPANY  
(CONNECTICUT CORPORATION)  
LAW DEPT.-TECH/IP TRADEMARK UNIT-HO109  
ONE HARTFORD PLAZA  
HARTFORD, CT 06155

FOR: TECHNOLOGY PROFESSIONAL LIABILITY  
INSURANCE UNDERWRITING SERVICES, IN  
CLASS 36 (U.S. CLS. 100, 101 AND 102).

FIRST USE 11-0-2001; IN COMMERCE 11-0-2001.

THE MARK CONSISTS OF STANDARD CHAR-  
ACTERS WITHOUT CLAIM TO ANY PARTICULAR  
FONT, STYLE, SIZE, OR COLOR.

OWNER OF U.S. REG. NOS. 1,953,361 AND  
2,654,167.

SER. NO. 77-315,823, FILED 10-29-2007.

BRENDAN REGAN, EXAMINING ATTORNEY

**Int. Cl.: 36**

**Prior U.S. Cls.: 100, 101 and 102**

**United States Patent and Trademark Office**

**Reg. No. 3,504,113**

**Registered Sep. 23, 2008**

**SERVICE MARK  
PRINCIPAL REGISTER**

**FailSafe TERA**

HARTFORD FIRE INSURANCE COMPANY  
(CONNECTICUT CORPORATION)  
LAW DEPT.-TECH/IP TRADEMARK UNIT-HO109  
ONE HARTFORD PLAZA  
HARTFORD, CT 06155

FOR: TECHNOLOGY PROFESSIONAL LIABILITY  
INSURANCE UNDERWRITING SERVICES, IN  
CLASS 36 (U.S. CLS. 100, 101 AND 102).

FIRST USE 11-0-2001; IN COMMERCE 11-0-2001.

THE MARK CONSISTS OF STANDARD CHAR-  
ACTERS WITHOUT CLAIM TO ANY PARTICULAR  
FONT, STYLE, SIZE, OR COLOR.

OWNER OF U.S. REG. NOS. 1,953,361 AND  
2,654,167.

SER. NO. 77-315,827, FILED 10-29-2007.

BRENDAN REGAN, EXAMINING ATTORNEY

**Int. Cl.: 36**

**Prior U.S. Cls.: 100, 101 and 102**

**United States Patent and Trademark Office**

**Reg. No. 3,504,114**

**Registered Sep. 23, 2008**

**SERVICE MARK  
PRINCIPAL REGISTER**

**FailSafe MEGA**

HARTFORD FIRE INSURANCE COMPANY  
(CONNECTICUT CORPORATION)  
LAW DEPT.-TECH/IP TRADEMARK UNIT-H01-09  
ONE HARTFORD PLAZA  
HARTFORD, CT 06155

FOR: TECHNOLOGY PROFESSIONAL LIABILITY  
INSURANCE UNDERWRITING SERVICES, IN  
CLASS 36 (U.S. CLS. 100, 101 AND 102).

FIRST USE 5-0-2002; IN COMMERCE 5-0-2002.

THE MARK CONSISTS OF STANDARD CHAR-  
ACTERS WITHOUT CLAIM TO ANY PARTICULAR  
FONT, STYLE, SIZE, OR COLOR.

OWNER OF U.S. REG. NOS. 1,953,361 AND  
2,654,167.

SER. NO. 77-315,832, FILED 10-29-2007.

BRENDAN REGAN, EXAMINING ATTORNEY

**Int. Cl.: 3**

**Prior U.S. Cls.: 1, 4, 6, 50, 51 and 52**

**United States Patent and Trademark Office**

**Reg. No. 3,504,115**

**Registered Sep. 23, 2008**

**TRADEMARK  
PRINCIPAL REGISTER**

**LIERAC**

LABORATOIRES LIERAC S.A. (FRANCE SOCI-  
ETE ANONYME (SA))  
99, RUE DU FAUBOURG SAINT-HONORÉ  
75008 PARIS, FRANCE

THE MARK CONSISTS OF STANDARD CHAR-  
ACTERS WITHOUT CLAIM TO ANY PARTICULAR  
FONT, STYLE, SIZE, OR COLOR.

FOR: COSMETIC PRODUCTS FOR SKIN CARE,  
NAMELY, FACE CREAMS AND BODY CREAMS,  
IN CLASS 3 (U.S. CLS. 1, 4, 6, 50, 51 AND 52).

SER. NO. 77-315,888, FILED 10-29-2007.

FIRST USE 12-31-1974; IN COMMERCE 10-1-1989.

ANTHONY RINKER, EXAMINING ATTORNEY

**Int. Cl.: 38**

**Prior U.S. Cls.: 100, 101 and 104**

**United States Patent and Trademark Office**

**Reg. No. 3,504,116**

**Registered Sep. 23, 2008**

**SERVICE MARK  
PRINCIPAL REGISTER**



ENCYCLOPAEDIA BRITANNICA, INC. (DELA-  
WARE CORPORATION)  
331 NORTH LASALLE  
CHICAGO, IL 60610

FOR: COMPUTER SERVICES, NAMELY, PRO-  
VIDING ACCESS TO COMPUTER DATABASES OF  
INFORMATION DEALING WITH REFERENCE  
MATERIALS FOR ADULTS AND CHILDREN IN  
THE FIELDS OF ENCYCLOPEDIAS, YEARBOOKS,  
DICTIONARIES AND OTHER REFERENCE MATE-  
RIALS, IN CLASS 38 (U.S. CLS. 100, 101 AND 104).

FIRST USE 10-26-2007; IN COMMERCE 10-26-2007.

NO CLAIM IS MADE TO THE EXCLUSIVE  
RIGHT TO USE EDITOR'S, APART FROM THE  
MARK AS SHOWN.

THE MARK CONSISTS OF THE STYLIZED  
WORDING "THE EDITOR'S TOUCH" WITH THE  
DESIGN OF A STYLIZED THUMB PRINT FORMED  
BY OUTLINES OF OVALS AND CURVED BANDS,  
ALL WITHIN A SHADED RECTANGLE.

SER. NO. 77-315,972, FILED 10-29-2007.

JAY BESCH, EXAMINING ATTORNEY

**Int. Cl.: 36**

**Prior U.S. Cls.: 100, 101 and 102**

**United States Patent and Trademark Office**

**Reg. No. 3,504,117**

**Registered Sep. 23, 2008**

**SERVICE MARK  
PRINCIPAL REGISTER**

**STELLARONE**

VIRGINIA FINANCIAL GROUP, INC. (VIRGINIA  
CORPORATION)  
102 SOUTH MAIN STREET  
CULPEPER, VA 22701

THE MARK CONSISTS OF STANDARD CHAR-  
ACTERS WITHOUT CLAIM TO ANY PARTICULAR  
FONT, STYLE, SIZE, OR COLOR.

FOR: BANKING SERVICES, IN CLASS 36 (U.S.  
CLS. 100, 101 AND 102).

SER. NO. 77-316,118, FILED 10-29-2007.

FIRST USE 5-27-2008; IN COMMERCE 5-27-2008.

JULIE WATSON, EXAMINING ATTORNEY

**Int. Cls.: 6, 11 and 17**

**Prior U.S. Cls.: 1, 2, 5, 12, 13, 14, 21, 23, 25, 31, 34, 35  
and 50**

**Reg. No. 3,504,118**

**United States Patent and Trademark Office**

**Registered Sep. 23, 2008**

**TRADEMARK  
PRINCIPAL REGISTER**

# QUICK FITTING

QUICK FITTING, INC. (RHODE ISLAND COR-  
PORATION)  
P.O. BOX 164  
TIVERTON, RI 02878

FOR: METAL PIPE FITTINGS FOR COPPER  
PIPES, PVC PIPES, PEX TUBING AND STAINLESS  
STEEL TUBING, AND METAL PARTS THEREFOR,  
IN CLASS 6 (U.S. CLS. 2, 12, 13, 14, 23, 25 AND 50).

FIRST USE 6-1-2005; IN COMMERCE 6-15-2006.

FOR: PLUMBING FITTINGS, NAMELY, VALVES,  
COUPLERS, REDUCER PIPE FITTINGS, PLUMB-  
ING T-PIPE FITTINGS BEING COUPLERS AND  
VALVES, PLASTIC PLUMBING PIPE FITTING  
END RETAINING CAPS, INSERT SLEEVES,  
THREADED END FITTINGS AND SOLDERED  
END FITTINGS, IN CLASS 11 (U.S. CLS. 13, 21, 23,  
31 AND 34).

FIRST USE 6-1-2005; IN COMMERCE 6-15-2006.

FOR: PLASTIC INSERTS FOR USE WITH METAL  
PIPE FITTINGS AND PLUMBING FITTINGS,

NAMELY, PIPE GASKETS, O-RING PIPE SEALS,  
PACKING GLANDS FOR SEALING PIPES; KITS  
COMPOSED OF PIPE FITTINGS CONSISTING OF  
PIPE GASKETS, O-RING PIPE SEALS, PACKING  
GLANDS FOR SEALING PIPES, PIPE FITTING END  
RETAINING CAPS AND REMOVAL TOOLS FOR  
REMOVING PIPE INSERTS FROM PIPE FITTINGS,  
IN CLASS 17 (U.S. CLS. 1, 5, 12, 13, 35 AND 50).

FIRST USE 6-1-2005; IN COMMERCE 6-15-2006.

THE MARK CONSISTS OF STANDARD CHAR-  
ACTERS WITHOUT CLAIM TO ANY PARTICULAR  
FONT, STYLE, SIZE, OR COLOR.

NO CLAIM IS MADE TO THE EXCLUSIVE  
RIGHT TO USE "FITTING", APART FROM THE  
MARK AS SHOWN.

SER. NO. 77-317,648, FILED 10-31-2007.

KATHERINE CHANG, EXAMINING ATTORNEY



**Int. Cl.: 41**

**Prior U.S. Cls.: 100, 101 and 107**

**United States Patent and Trademark Office**

**Reg. No. 3,504,119**

**Registered Sep. 23, 2008**

**SERVICE MARK  
PRINCIPAL REGISTER**

**KNOXNEWS.COM**

KNOXVILLE NEWS-SENTINEL COMPANY  
(TENNESSEE CORPORATION)  
208 WEST CHURCH AVENUE  
KNOXVILLE, TN 37902

FOR: PROVIDING AN INTERACTIVE COMPU-  
TER DATABASE CONTAINING INFORMATION IN  
THE FIELDS OF SPORTS, ENTERTAINMENT, FINE  
ARTS, AND LOCAL AND NATIONAL NEWS , IN  
CLASS 41 (U.S. CLS. 100, 101 AND 107).

FIRST USE 4-26-1995; IN COMMERCE 4-26-1995.

THE MARK CONSISTS OF STANDARD CHAR-  
ACTERS WITHOUT CLAIM TO ANY PARTICULAR  
FONT, STYLE, SIZE, OR COLOR.

SEC. 2(F).

SER. NO. 77-317,698, FILED 10-31-2007.

BRIAN NEVILLE, EXAMINING ATTORNEY

**Int. Cl.: 9**

**Prior U.S. Cls.: 21, 23, 26, 36 and 38**

**Reg. No. 3,504,120**

**United States Patent and Trademark Office**

**Registered Sep. 23, 2008**

**TRADEMARK  
PRINCIPAL REGISTER**

**AMVONET**

AVE INTERVISION LLC (OHIO LIMITED LIABILITY COMPANY)  
640 WEST STATE STREET  
ALLIANCE, OH 44601

FOR: COMMUNICATIONS SOFTWARE FOR CONNECTING COMPUTER NETWORK USERS AND GLOBAL COMPUTER NETWORKS WITH USAGE OF AUDIO/VIDEO AND MULTIMEDIA INFORMATION; COMPUTER E-COMMERCE SOFTWARE TO ALLOW USERS TO PERFORM ELECTRONIC BUSINESS TRANSACTIONS VIA A GLOBAL COMPUTER NETWORK; DOWNLOADABLE FILMS AND TELEVISION PROGRAMS

ABOUT EDUCATION AND TRAINING PROVIDED VIA A VIDEO-ON-DEMAND SERVICE, IN CLASS 9 (U.S. CLS. 21, 23, 26, 36 AND 38).

FIRST USE 7-19-2000; IN COMMERCE 7-19-2000.

THE MARK CONSISTS OF STANDARD CHARACTERS WITHOUT CLAIM TO ANY PARTICULAR FONT, STYLE, SIZE, OR COLOR.

SER. NO. 77-318,017, FILED 10-31-2007.

COLLEEN DOMBROW, EXAMINING ATTORNEY

**Int. Cl.: 29**

**Prior U.S. Cl.: 46**

**United States Patent and Trademark Office**

**Reg. No. 3,504,121**

**Registered Sep. 23, 2008**

**TRADEMARK  
PRINCIPAL REGISTER**

**AUSTIN WINGS**

AUSTIN GRILL LLC (DELAWARE LIMITED  
LIABILITY COMPANY)  
505 HUNTMAR PARK DRIVE, SUITE 350  
HERNDON, VA 20170 AND  
THOMPSON HOSPITALITY CORPORATION (DE-  
LAWARE CORPORATION)  
505 HUNTMAR PARK DRIVE, SUITE 350  
HERNDON, VA 20170

FOR: GRILLED MARINATED CHICKEN WINGS,  
IN CLASS 29 (U.S. CL. 46).

FIRST USE 6-1-1988; IN COMMERCE 6-1-1988.

THE MARK CONSISTS OF STANDARD CHAR-  
ACTERS WITHOUT CLAIM TO ANY PARTICULAR  
FONT, STYLE, SIZE, OR COLOR.

NO CLAIM IS MADE TO THE EXCLUSIVE  
RIGHT TO USE "WINGS", APART FROM THE  
MARK AS SHOWN.

SER. NO. 77-318,657, FILED 10-31-2007.

REBECCA SMITH, EXAMINING ATTORNEY

**Int. Cl.: 11**

**Prior U.S. Cls.: 13, 21, 23, 31 and 34**

**United States Patent and Trademark Office**

**Reg. No. 3,504,122**

**Registered Sep. 23, 2008**

**TRADEMARK  
PRINCIPAL REGISTER**

**HUMIDIHEAT**

ITW FOOD EQUIPMENT GROUP LLC (DELA-  
WARE LIMITED LIABILITY COMPANY)  
701 SOUTH RIDGE AVENUE  
TROY, OH 45374

THE MARK CONSISTS OF STANDARD CHAR-  
ACTERS WITHOUT CLAIM TO ANY PARTICULAR  
FONT, STYLE, SIZE, OR COLOR.

FOR: CABINETS USED TO CONTROL TEMPERA-  
TURE AND HUMIDITY FOR HEATING FOOD  
GOODS, IN CLASS 11 (U.S. CLS. 13, 21, 23, 31 AND 34).

SER. NO. 77-319,212, FILED 11-1-2007.

FIRST USE 10-11-2007; IN COMMERCE 10-11-2007.

JOHN DWYER, EXAMINING ATTORNEY

**Int. Cls.: 9, 16, 41 and 42**

**Prior U.S. Cls.: 2, 5, 21, 22, 23, 26, 29, 36, 37, 38, 50,  
100, 101 and 107**

**Reg. No. 3,504,123**

**United States Patent and Trademark Office**

**Registered Sep. 23, 2008**

**TRADEMARK  
SERVICE MARK  
PRINCIPAL REGISTER**

**CML**

JOLLS, TESSA (UNITED STATES INDIVIDUAL)  
SUITE 472  
23852 PACIFIC COAST HIGHWAY  
MALIBU, CA 90265

FOR: CDS, DVDS, AND VIDEOTAPES OF CLIPS,  
LESSON PLANS, AND PRESENTATIONS IN THE  
FIELD OF MEDIA COMMUNICATIONS, NAMELY,  
PROVIDING METHODS FOR ANALYZING AND  
EVALUATING THE DISSEMINATION OF INFOR-  
MATION, IN CLASS 9 (U.S. CLS. 21, 23, 26, 36 AND  
38).

FIRST USE 9-20-2000; IN COMMERCE 9-20-2000.

FOR: ARTICLES, BOOKS, AND NEWSLETTERS  
IN THE FIELD OF MEDIA COMMUNICATIONS,  
NAMELY, PROVIDING METHODS FOR ANALYZ-  
ING AND EVALUATING THE DISSEMINATION OF  
INFORMATION, IN CLASS 16 (U.S. CLS. 2, 5, 22, 23,  
29, 37, 38 AND 50).

FIRST USE 9-20-2000; IN COMMERCE 9-20-2000.

FOR: EDUCATIONAL SERVICES, NAMELY,  
PROVIDING SEMINARS, DEVELOPING LESSON

PLANS, CONDUCTING CASE STUDIES, AND PRO-  
VIDING EDITORIAL CONSULTATION ON THE  
CONTENT OF TEACHING MATERIALS, IN CLASS  
41 (U.S. CLS. 100, 101 AND 107).

FIRST USE 9-20-2000; IN COMMERCE 9-20-2000.

FOR: RESEARCH, DESIGN, AND DEVELOP-  
MENT OF ADVANCED LEARNING TECHNOLO-  
GIES IN THE FIELD OF MEDIA  
COMMUNICATIONS, NAMELY, PROVIDING  
METHODS FOR ANALYZING AND EVALUATING  
THE DISSEMINATION OF INFORMATION, IN  
CLASS 42 (U.S. CLS. 100 AND 101).

FIRST USE 9-20-2000; IN COMMERCE 9-20-2000.

THE MARK CONSISTS OF STANDARD CHAR-  
ACTERS WITHOUT CLAIM TO ANY PARTICULAR  
FONT, STYLE, SIZE, OR COLOR.

SEC. 2(F).

SER. NO. 77-319,491, FILED 11-1-2007.

JILL C. ALT, EXAMINING ATTORNEY

**Int. Cl.: 36**

**Prior U.S. Cls.: 100, 101 and 102**

**United States Patent and Trademark Office**

**Reg. No. 3,504,124**

**Registered Sep. 23, 2008**

**SERVICE MARK  
PRINCIPAL REGISTER**

**TenPoint Insurance  
Solutions**

TENPOINT INSURANCE SOLUTIONS, LLC  
(OHIO LIMITED LIABILITY COMPANY)  
ATTN: BRAD JOHNSTON  
400 TECHNECENTER DRIVE, SUITE 402  
MILFORD, OH 45150

FOR: CLAIMS ADJUSTMENT IN THE FIELD OF  
INSURANCE; INSURANCE ADMINISTRATION;  
INSURANCE CLAIMS ADMINISTRATION; INSUR-  
ANCE CLAIMS PROCESSING; INSURANCE CON-  
SULTATION; INSURANCE SUBROGATION;  
INSURANCE SUBROGATION AND SALVAGE;  
PROVIDING INFORMATION IN INSURANCE  
MATTERS, IN CLASS 36 (U.S. CLS. 100, 101 AND 102).

FIRST USE 9-11-2007; IN COMMERCE 10-22-2007.

THE MARK CONSISTS OF STANDARD CHAR-  
ACTERS WITHOUT CLAIM TO ANY PARTICULAR  
FONT, STYLE, SIZE, OR COLOR.

NO CLAIM IS MADE TO THE EXCLUSIVE  
RIGHT TO USE "INSURANCE SOLUTIONS",  
APART FROM THE MARK AS SHOWN.

"TENPOINT" APPEARING IN THE MARK HAS  
NO MEANING IN A FOREIGN LANGUAGE.

SER. NO. 77-319,791, FILED 11-2-2007.

STEVEN R. FINE, EXAMINING ATTORNEY

**Int. Cl.: 35**

**Prior U.S. Cls.: 100, 101 and 102**

**United States Patent and Trademark Office**

**Reg. No. 3,504,125**

**Registered Sep. 23, 2008**

**SERVICE MARK  
PRINCIPAL REGISTER**

**Motivation Made Easy**

AIRPOINTS, INC. (NEVADA CORPORATION)  
1015 GAYLEY AVE., STE. 200  
LOS ANGELES, CA 90024

FOR: CONDUCTING EMPLOYEE INCENTIVE AWARD PROGRAMS TO PROMOTE ON THE JOB SAFETY, PRODUCTIVITY, AND RECOGNITION; CUSTOMER LOYALTY SERVICES FOR COMMERCIAL, PROMOTIONAL AND/OR ADVERTISING PURPOSES; INCENTIVE AWARD PROGRAMS TO PROMOTE THE SALE OF PRODUCTS AND SERVICES OF OTHERS; PROVIDING INCENTIVE AWARD PROGRAMS FOR CUSTOMERS FOR THE

PURPOSE OF REWARDING AND PROMOTING LOYALTY, IN CLASS 35 (U.S. CLS. 100, 101 AND 102).

FIRST USE 9-6-2007; IN COMMERCE 9-6-2007.

THE MARK CONSISTS OF STANDARD CHARACTERS WITHOUT CLAIM TO ANY PARTICULAR FONT, STYLE, SIZE, OR COLOR.

SER. NO. 77-319,986, FILED 11-2-2007.

STEVEN JACKSON, EXAMINING ATTORNEY

**Int. Cl.: 41**

**Prior U.S. Cls.: 100, 101 and 107**

**United States Patent and Trademark Office**

**Reg. No. 3,504,126**

**Registered Sep. 23, 2008**

**SERVICE MARK  
PRINCIPAL REGISTER**

**LAFFALOT**

LAFFALOT SUMMER CAMP LLC (OHIO LIMITED LIABILITY COMPANY)  
3247 BRINTON TRAIL  
CINCINNATI, OH 45241

FOR: RECREATIONAL AND SPORTS CAMPS; AND RECREATIONAL AND SPORTS CAMP PROGRAMS FOR CHILDREN FOR LEARNING PHYSICAL EDUCATION AND FOR ACHIEVING EMOTIONAL AND SOCIAL DEVELOPMENT, IN CLASS 41 (U.S. CLS. 100, 101 AND 107).

FIRST USE 1-0-2004; IN COMMERCE 1-0-2004.

THE MARK CONSISTS OF STANDARD CHARACTERS WITHOUT CLAIM TO ANY PARTICULAR FONT, STYLE, SIZE, OR COLOR.

SER. NO. 77-321,300, FILED 11-5-2007.

MICHELE SWAIN, EXAMINING ATTORNEY



Int. Cl.: 41

Prior U.S. Cls.: 100, 101 and 107

United States Patent and Trademark Office

Reg. No. 3,504,127

Registered Sep. 23, 2008

SERVICE MARK  
PRINCIPAL REGISTER

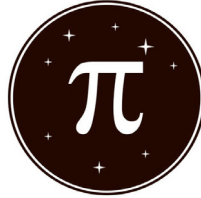

*pi*

CAKE, LLC (CALIFORNIA LIMITED LIABILITY  
COMPANY)  
1545 26TH STREET  
SANTA MONICA, CA 90404

FOR: VISUAL EFFECTS AND COMPUTER GRAPHIC DESIGN SERVICES FOR MOTION PICTURE, TELEVISION, CABLE, COMMERCIAL AND VIDEOS, NAMELY, DESIGN OF COMPUTER GENERATED SPECIAL EFFECTS FOR OTHERS; DESIGN OF ON-SCREEN BROADCAST GRAPHICS AND SPECIAL EFFECTS, IN CLASS 41 (U.S. CLS. 100, 101 AND 107).

FIRST USE 1-2-2007; IN COMMERCE 1-2-2007.

OWNER OF U.S. REG. NO. 3,310,657.

THE MARK CONSISTS OF THE WORD "PI" BELOW A CIRCULAR PIE WHICH HAS THE GREEK LETTER "PI" AND EIGHT FOUR-POINTED STARS INSIDE OF IT.

SER. NO. 77-321,460, FILED 11-5-2007.

MICHAEL ENGEL, EXAMINING ATTORNEY

**Int. Cls.: 38, 41 and 42**

**Prior U.S. Cls.: 100, 101, 104 and 107**

**United States Patent and Trademark Office**

**Reg. No. 3,504,128**

**Registered Sep. 23, 2008**

**SERVICE MARK  
PRINCIPAL REGISTER**

# GEORGIA VIEW

BOARD OF REGENTS OF THE UNIVERSITY  
SYSTEM OF GEORGIA (GEORGIA STATE  
AGENCY)  
270 WASHINGTON STREET, S.W.  
ATLANTA, GA 30334

FOR: COMMUNICATION SERVICES, NAMELY,  
ELECTRONIC TRANSMISSION OF DATA AND  
DOCUMENTS AMONG USERS OF COMPUTERS  
SERVING THE COMMUNICATION NEEDS OF FA-  
CULTY, STUDENTS, AND ADMINISTRATION, IN  
CLASS 38 (U.S. CLS. 100, 101 AND 104).

FIRST USE 4-2-2002; IN COMMERCE 6-17-2002.

FOR: PROVIDING AN INTERACTIVE WEBSITE  
FEATURING EDUCATIONAL INFORMATION  
AND TEST QUESTIONS IN THE FIELD OF UNI-  
VERSITY LEVEL STUDIES ACCESSIBLE BY ON-  
CAMPUS AND OFF-CAMPUS STUDENTS, FACUL-  
TY AND ADMINISTRATION; ONLINE ACADEMIC  
LIBRARY SERVICES, NAMELY, PROVIDING AC-  
CESS TO EDUCATIONAL RESOURCES TO ON-  
CAMPUS AND OFF-CAMPUS STUDENTS, FACUL-  
TY AND ADMINISTRATION; EDUCATIONAL SER-  
VICES, NAMELY, PROVIDING LINKS TO  
EDUCATIONAL RESOURCES, NAMELY, TRAIN-  
ING AND SUPPORT MATERIALS FOR STUDENTS,  
FACULTY, AND ADMINISTRATORS VIA A GLO-  
BAL COMPUTER NETWORK, IN CLASS 41 (U.S.  
CLS. 100, 101 AND 107).

FIRST USE 4-2-2002; IN COMMERCE 6-17-2002.

FOR: PROVIDING TEMPORARY USE OF ON-  
LINE NON-DOWNLOADABLE SOFTWARE, NAME-  
LY, AN INTEGRATED SUITE OF SOFTWARE AP-  
PLICATIONS WHICH SUPPORTS ON-CAMPUS  
AND OFF-CAMPUS LEARNING EXPERIENCES  
THROUGH ASSESSING STUDENT PERFOR-  
MANCE, MANAGING AND REPORTING ON STU-  
DENT ASSIGNMENTS AND STUDENT PROGRESS,  
FACILITATING ACCESS TO EDUCATIONAL RE-  
SOURCE, AND FACILITATING ONLINE COMMU-  
NICATIONS, NAMELY, E-MAIL, ONLINE CHAT  
AND MESSAGING BETWEEN FACULTY, STU-  
DENTS, AND ADMINISTRATION, IN CLASS 42  
(U.S. CLS. 100 AND 101).

FIRST USE 4-2-2002; IN COMMERCE 6-17-2002.

THE MARK CONSISTS OF STANDARD CHAR-  
ACTERS WITHOUT CLAIM TO ANY PARTICULAR  
FONT, STYLE, SIZE, OR COLOR.

OWNER OF U.S. REG. NOS. 1,298,360, 3,025,570  
AND OTHERS.

SEC. 2(F) AS TO "GEORGIA".

SER. NO. 77-322,232, FILED 11-6-2007.

JUSTINE D. PARKER, EXAMINING ATTORNEY

**Int. Cl.: 42**

**Prior U.S. Cls.: 100 and 101**

**United States Patent and Trademark Office**

**Reg. No. 3,504,129**

**Registered Sep. 23, 2008**

**SERVICE MARK  
PRINCIPAL REGISTER**

**FORENSIC PROJECT MANAGEMENT**

IMDISI, INC. (DELAWARE CORPORATION)  
SUITE 115  
300 BERWYN PARK  
BERWYN, PA 19312

FOR: ENGINEERING CONSULTING SERVICES  
IN THE FIELD OF PROBLEMS EXPERIENCED ON  
CONSTRUCTION PROJECTS TO DETERMINE  
CAUSES USING SCIENTIFIC ANALYTICAL METH-  
ODS; INVESTIGATION OF PROBLEMS EXPERI-  
ENCED ON CONSTRUCTION PROJECTS TO  
DETERMINE CAUSES USING SCIENTIFIC ANA-  
LYTICAL METHODS, IN CLASS 42 (U.S. CLS. 100  
AND 101).

FIRST USE 2-28-1997; IN COMMERCE 2-28-1997.

THE MARK CONSISTS OF STANDARD CHAR-  
ACTERS WITHOUT CLAIM TO ANY PARTICULAR  
FONT, STYLE, SIZE, OR COLOR.

OWNER OF U.S. REG. NO. 2,388,826.

NO CLAIM IS MADE TO THE EXCLUSIVE  
RIGHT TO USE "PROJECT MANAGEMENT",  
APART FROM THE MARK AS SHOWN.

SEC. 2(F).

SER. NO. 77-322,287, FILED 11-6-2007.

KATHERINE E. HALMEN, EXAMINING ATTOR-  
NEY

**Int. Cl.: 35**

**Prior U.S. Cls.: 100, 101 and 102**

**United States Patent and Trademark Office**

**Reg. No. 3,504,130**

**Registered Sep. 23, 2008**

**SERVICE MARK  
PRINCIPAL REGISTER**

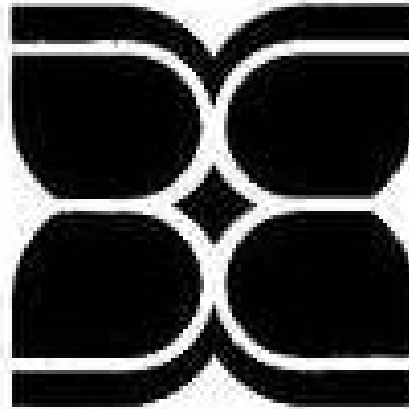

**MLA MULTIBRAND HOLDINGS, INC. (DELA-  
WARE CORPORATION)**

**2761 FRUITLAND AVENUE  
VERNON, CA 90058**

**FOR: RETAIL STORES FEATURING WOMEN'S  
CLOTHING, FOOTWEAR, EYEWEAR, BELTS,  
BAGS, WALLETS, COSTUME JEWELRY, AND AC-  
CESSORIES; ON-LINE RETAIL STORE SERVICES  
FEATURING WOMEN'S CLOTHING, FOOTWEAR,  
EYEWEAR, BELTS, BAGS, WALLETS, COSTUME**

**JEWELRY, AND ACCESSORIES, IN CLASS 35 (U.S.  
CLS. 100, 101 AND 102).**

**FIRST USE 6-13-2007; IN COMMERCE 10-13-2007.**

**THE MARK CONSISTS OF FOUR FLOWER PE-  
TALS OR LEAVES SURROUNDING A DIAMOND  
SHAPE.**

**SER. NO. 77-322,978, FILED 11-6-2007.**

**JENNIFER MARTIN, EXAMINING ATTORNEY**

**Int. Cl.: 41**

**Prior U.S. Cls.: 100, 101 and 107**

**United States Patent and Trademark Office**

**Reg. No. 3,504,131**

**Registered Sep. 23, 2008**

**SERVICE MARK  
PRINCIPAL REGISTER**



RAINBOW PROMOTIONS, LLC (CALIFORNIA  
LIMITED LIABILITY COMPANY)  
SUITE 2G  
3505 LONG BEACH BLVD  
LONG BEACH, CA 908073947

FOR: CONDUCTING ENTERTAINMENT EXHIBITIONS IN THE NATURE OF LIVE MUSIC CONCERTS AND MUSIC FESTIVALS, IN CLASS 41 (U.S. CLS. 100, 101 AND 107).

FIRST USE 1-1-1985; IN COMMERCE 1-1-1985.

NO CLAIM IS MADE TO THE EXCLUSIVE RIGHT TO USE "LONG BEACH JAZZ FESTIVAL", APART FROM THE MARK AS SHOWN.

THE MARK CONSISTS OF THE WORDS "LONG BEACH JAZZ FESTIVAL" SUPERIMPOSED ON A MUSICAL STAFF FLOWING OUT OF A SAXOPHONE.

SER. NO. 77-323,843, FILED 11-7-2007.

BARBARA BROWN, EXAMINING ATTORNEY

**Int. Cl.: 35**

**Prior U.S. Cls.: 100, 101 and 102**

**United States Patent and Trademark Office**

**Reg. No. 3,504,132**

**Registered Sep. 23, 2008**

**SERVICE MARK  
PRINCIPAL REGISTER**



INDIANA SOYBEAN ALLIANCE, INC. (INDIANA NON-PROFIT CORPORATION)  
5757 WEST 74TH STREET  
INDIANAPOLIS, IN 46278

FOR: ASSOCIATION SERVICES, NAMELY, PROMOTING THE INTERESTS OF SOYBEAN GROWERS AND OTHERS INTERESTED IN THE SALE AND UTILIZATION OF SOYBEANS, IN CLASS 35 (U.S. CLS. 100, 101 AND 102).

FIRST USE 10-1-2006; IN COMMERCE 10-1-2006.

NO CLAIM IS MADE TO THE EXCLUSIVE RIGHT TO USE "INDIANA SOYBEAN ALLIANCE"

AND THE OUTLINE OF THE STATE OF INDIANA, APART FROM THE MARK AS SHOWN.

THE MARK CONSISTS OF AN OUTLINE OF THE STATE OF INDIANA, ENCLOSED A SOYBEAN PLANT CONSISTING OF A BEAN ABOVE THREE LONG LINES CURVING TO THE RIGHT AND THREE SHORTER LINES CURVING TO THE LEFT. THE WORDS "INDIANA SOYBEAN ALLIANCE" APPEAR TO THE RIGHT OF THE DESIGN.

SER. NO. 77-323,877, FILED 11-7-2007.

NICHOLAS ALTREE, EXAMINING ATTORNEY

**Int. Cl.: 41**

**Prior U.S. Cls.: 100, 101 and 107**

**United States Patent and Trademark Office**

**Reg. No. 3,504,133**

**Registered Sep. 23, 2008**

**SERVICE MARK  
PRINCIPAL REGISTER**

# Trading Doctor

HIRSCHHORN, DOUGLAS K. (UNITED STATES  
INDIVIDUAL)  
550 BILTMORE WAY, PH 3A  
CORAL GABLES, FL 33134

FOR: TRAINING SERVICES IN THE FIELD OF  
SECURITIES TRADING, IN CLASS 41 (U.S. CLS. 100,  
101 AND 107).

FIRST USE 10-11-2004; IN COMMERCE 3-24-2006.

THE MARK CONSISTS OF STANDARD CHAR-  
ACTERS WITHOUT CLAIM TO ANY PARTICULAR  
FONT, STYLE, SIZE, OR COLOR.

NO CLAIM IS MADE TO THE EXCLUSIVE  
RIGHT TO USE "TRADING", APART FROM THE  
MARK AS SHOWN.

THE NAME "TRADING DOCTOR" IDENTIFIES A  
LIVING INDIVIDUAL WHOSE CONSENT IS OF  
RECORD.

SER. NO. 77-324,092, FILED 11-7-2007.

JAY BESCH, EXAMINING ATTORNEY

**Int. Cl.: 9**

**Prior U.S. Cls.: 21, 23, 26, 36 and 38**

**Reg. No. 3,504,134**

**United States Patent and Trademark Office**

**Registered Sep. 23, 2008**

**TRADEMARK  
PRINCIPAL REGISTER**

**FOR ENLIGHTENED NETWORKS**

NEST TECHNOLOGIES, INC. (DELAWARE CORPORATION)  
SUITE 201  
4511 SINGER COURT  
CHANTILLY, VA 20151

FOR: FIBER OPTIC NETWORKING HARDWARE FOR THE AGGREGATION, ROUTING, SWITCHING, AND TRANSMISSION OF VOICE, DATA AND VIDEO SIGNALS , IN CLASS 9 (U.S. CLS. 21, 23, 26, 36 AND 38).

FIRST USE 6-6-2002; IN COMMERCE 6-6-2002.

THE MARK CONSISTS OF STANDARD CHARACTERS WITHOUT CLAIM TO ANY PARTICULAR FONT, STYLE, SIZE, OR COLOR.

NO CLAIM IS MADE TO THE EXCLUSIVE RIGHT TO USE "NETWORKS", APART FROM THE MARK AS SHOWN.

SER. NO. 77-324,496, FILED 11-8-2007.

KATHLEEN LORENZO, EXAMINING ATTORNEY



**Int. Cl.: 25**

**Prior U.S. Cls.: 22 and 39**

**United States Patent and Trademark Office**

**Reg. No. 3,504,135**

**Registered Sep. 23, 2008**

**TRADEMARK  
PRINCIPAL REGISTER**



RAINBOW PROMOTIONS, LLC (CALIFORNIA  
LIMITED LIABILITY COMPANY)  
SUITE 2G  
3505 LONG BEACH BLVD  
LONG BEACH, CA 908073947

THE MARK CONSISTS OF THE WORDS "LONG  
BEACH JAZZ FESTIVAL" SUPERIMPOSED ON A  
MUSICAL STAFF FLOWING OUT OF A "SAXO-  
PHONE".

FOR: HEADGEAR, NAMELY, BASEBALL CAPS  
AND VISORS; TOPS, IN CLASS 25 (U.S. CLS. 22 AND  
39).

SEC. 2(F).

FIRST USE 1-1-1985; IN COMMERCE 1-1-1985.

SER. NO. 77-325,035, FILED 11-8-2007.

NO CLAIM IS MADE TO THE EXCLUSIVE  
RIGHT TO USE "LONG BEACH JAZZ FESTIVAL",  
APART FROM THE MARK AS SHOWN.

BARBARA BROWN, EXAMINING ATTORNEY

**Int. Cls.: 3 and 5**

**Prior U.S. Cls.: 1, 4, 6, 18, 44, 46, 50, 51 and 52**

**United States Patent and Trademark Office**

**Reg. No. 3,504,136**

**Registered Sep. 23, 2008**

**TRADEMARK  
PRINCIPAL REGISTER**



HUSSAIN, IMRAN (UNITED KINGDOM INDIVIDUAL)  
2A WOODHALL PARK AVENUE  
LEEDS, UNITED KINGDOM LS287HF

FOR: LIP BALM; COSMETICS, NAMELY, LIP REPAIRERS; LIP CREAM; LIP GLOSS; LIP GLOSS PALATTE; LIP LINER; NON-MEDICATED LIP PROTECTOR , IN CLASS 3 (U.S. CLS. 1, 4, 6, 50, 51 AND 52).

FOR: MEDICATED LIP BALM, IN CLASS 5 (U.S. CLS. 6, 18, 44, 46, 51 AND 52).

PRIORITY CLAIMED UNDER SEC. 44(D) ON UNITED KINGDOM APPLICATION NO.

2007512307, FILED 11-9-2007, REG. NO. 2471902, DATED 11-9-2007, EXPIRES 11-9-2017.

THE COLOR(S) BLUE, LIGHT BLUE AND WHITE IS/ARE CLAIMED AS A FEATURE OF THE MARK.

THE MARK CONSISTS OF THE WORD "LIPAID" IN WHITE WITH LIGHT BLUE SHADOWING ON A BLUE BACKGROUND.

SER. NO. 77-325,433, FILED 11-9-2007.

JESSICA A. POWERS, EXAMINING ATTORNEY

**Int. Cl.: 9**

**Prior U.S. Cls.: 21, 23, 26, 36 and 38**

**Reg. No. 3,504,137**

**United States Patent and Trademark Office**

**Registered Sep. 23, 2008**

**TRADEMARK  
PRINCIPAL REGISTER**

**UNIFIED SERIAL**

ADAPTEC, INC. (DELAWARE CORPORATION)  
691 SOUTH MILPITAS BOULEVARD  
MILPITAS, CA 95035

THE MARK CONSISTS OF STANDARD CHARACTERS WITHOUT CLAIM TO ANY PARTICULAR FONT, STYLE, SIZE, OR COLOR.

FOR: COMPUTER HARDWARE, NAMELY, RAID CONTROLLERS AND HOST BUS ADAPTERS; COMPUTER FIRMWARE AND SOFTWARE USED IN CONNECTION WITH RAID CONTROLLERS AND HOST BUS ADAPTERS FOR STORAGE AND SHARING OF DATA AND INFORMATION, IN CLASS 9 (U.S. CLS. 21, 23, 26, 36 AND 38).

NO CLAIM IS MADE TO THE EXCLUSIVE RIGHT TO USE "SERIAL", APART FROM THE MARK AS SHOWN.

SER. NO. 77-325,992, FILED 11-9-2007.

FIRST USE 3-30-2006; IN COMMERCE 3-30-2006.

NATALIE POLZER, EXAMINING ATTORNEY

**Int. Cls.: 35, 41 and 44**

**Prior U.S. Cls.: 100, 101, 102 and 107**

**United States Patent and Trademark Office**

**Reg. No. 3,504,138**

**Registered Sep. 23, 2008**

**SERVICE MARK  
PRINCIPAL REGISTER**

**RED SHOE INITIATIVE**

MEDIMETRIX GROUP, INC. (OHIO CORPORATION)  
2424 NORTH FEDERAL HIGHWAY, SUITE 100  
BOCA RATON, FL 33431

FOR: ARRANGING AND CONDUCTING CHARITY AUCTIONS FOR CHARITABLE FUNDRAISING PURPOSES, IN CLASS 35 (U.S. CLS. 100, 101 AND 102).

FIRST USE 2-0-2006; IN COMMERCE 2-0-2006.

FOR: EDUCATION SERVICES, NAMELY, PROVIDING PROGRAMS IN THE FIELD OF WOMEN'S HEALTH AND WELLNESS, EXERCISE AND DIET; ORGANIZING AND CONDUCTING EVENTS FEATURING DANCING; PROVIDING A WEBSITE FEATURING INFORMATION IN THE FIELD OF WOMEN'S EXERCISE, IN CLASS 41 (U.S. CLS. 100, 101 AND 107).

FIRST USE 2-0-2006; IN COMMERCE 2-0-2006.

FOR: PROVIDING HEALTH INFORMATION; HEALTH CARE SERVICES, NAMELY, PROVIDING WELLNESS PROGRAMS; PROVIDING A WEB SITE FEATURING INFORMATION IN THE FIELD OF WOMEN'S HEALTH AND WELLNESS AND DIET, IN CLASS 44 (U.S. CLS. 100 AND 101).

FIRST USE 2-0-2006; IN COMMERCE 2-0-2006.

THE MARK CONSISTS OF STANDARD CHARACTERS WITHOUT CLAIM TO ANY PARTICULAR FONT, STYLE, SIZE, OR COLOR.

NO CLAIM IS MADE TO THE EXCLUSIVE RIGHT TO USE "INITIATIVE", APART FROM THE MARK AS SHOWN.

SER. NO. 77-326,129, FILED 11-9-2007.

ANGELA GAW, EXAMINING ATTORNEY

**Int. Cls.: 35, 41 and 44**

**Prior U.S. Cls.: 100, 101, 102 and 107**

**United States Patent and Trademark Office**

**Reg. No. 3,504,139**

**Registered Sep. 23, 2008**

**SERVICE MARK  
PRINCIPAL REGISTER**



MEDIMETRIX GROUP, INC. (OHIO CORPORATION)  
2424 NORTH FEDERAL HIGHWAY, SUITE 100  
BOCA RATON, FL 33431

FOR: ARRANGING AND CONDUCTING CHARITY AUCTIONS FOR CHARITABLE FUNDRAISING PURPOSES, IN CLASS 35 (U.S. CLS. 100, 101 AND 102).

FIRST USE 8-0-2007; IN COMMERCE 8-0-2007.

FOR: EDUCATION SERVICES, NAMELY, PROVIDING PROGRAMS IN THE FIELD OF WOMEN'S HEALTH AND WELLNESS, EXERCISE AND DIET; ORGANIZING AND CONDUCTING EVENTS FEATURING DANCING; PROVIDING A WEBSITE FEATURING INFORMATION IN THE FIELD OF WOMEN'S EXERCISE, IN CLASS 41 (U.S. CLS. 100, 101 AND 107).

FIRST USE 8-0-2007; IN COMMERCE 8-0-2007.

FOR: PROVIDING HEALTH INFORMATION; HEALTH CARE SERVICES, NAMELY, PROVIDING WELLNESS PROGRAMS; PROVIDING A WEB SITE FEATURING INFORMATION IN THE FIELD OF WOMEN'S HEALTH AND WELLNESS AND DIET, IN CLASS 44 (U.S. CLS. 100 AND 101).

FIRST USE 8-0-2007; IN COMMERCE 8-0-2007.

THE COLOR(S) RED AND WHITE IS/ARE CLAIMED AS A FEATURE OF THE MARK.

THE MARK CONSISTS OF A WHITE SILHOUETTE OF A DANCING WOMAN WITH A RED HEART BACKGROUND.

SER. NO. 77-326,131, FILED 11-9-2007.

ANGELA GAW, EXAMINING ATTORNEY

**Int. Cl.: 31**

**Prior U.S. Cls.: 1 and 46**

**United States Patent and Trademark Office**

**Reg. No. 3,504,140**

**Registered Sep. 23, 2008**

**TRADEMARK  
PRINCIPAL REGISTER**

**FIBAR**

THE FIBAR GROUP, LLC (NEW YORK LIMITED  
LIABILITY COMPANY)  
80 BUSINESS PARK DRIVE, SUITE 300  
ARMONK, NY 105041705

FOR: SAFETY SURFACING, NAMELY, NATURAL  
WOOD CHIPS FOR USE AS A PLAYGROUND  
COVER AND AS A GROUND COVER FOR OTHER  
INDOOR AND OUTDOOR AREAS , IN CLASS 31  
(U.S. CLS. 1 AND 46).

FIRST USE 11-0-1992; IN COMMERCE 11-0-1992.

THE MARK CONSISTS OF STANDARD CHAR-  
ACTERS WITHOUT CLAIM TO ANY PARTICULAR  
FONT, STYLE, SIZE, OR COLOR.

OWNER OF U.S. REG. NO. 1,464,860.

SER. NO. 77-326,167, FILED 11-9-2007.

SKYE YOUNG, EXAMINING ATTORNEY

**Int. Cl.: 41**

**Prior U.S. Cls.: 100, 101 and 107**

**United States Patent and Trademark Office**

**Reg. No. 3,504,141**

**Registered Sep. 23, 2008**

**SERVICE MARK  
PRINCIPAL REGISTER**

**PATH TO FREEDOM**

DERVAES INSTITUTE (CALIFORNIA CORPORATION)  
631 CYPRESS AVENUE  
PASADENA, CA 91103

FOR: EDUCATIONAL SERVICES, NAMELY, CONDUCTING INFORMAL PROGRAMS IN THE FIELDS OF SUSTAINABLE LIVING, ORGANIC FOODS AND GARDENING, HOMESTEADING, THE ENVIRONMENT, AND CONSERVATION, USING ON-LINE ACTIVITIES AND INTERACTIVE EXHIBITS; ENTERTAINMENT SERVICES, NAMELY, PROVIDING A WEB SITE FEATURING PHOTOGRAPHS, AUDIO, AND VIDEO FEATURING SUSTAINABLE LIVING, ORGANIC FOODS AND GARDENING, HOMESTEADING, THE ENVIRONMENT, AND CONSERVATION; ON-LINE JOUR-

NALS, NAMELY, BLOGS FEATURING SUSTAINABLE LIVING, ORGANIC FOODS AND GARDENING, HOMESTEADING, THE ENVIRONMENT, AND CONSERVATION, IN CLASS 41 (U.S. CLS. 100, 101 AND 107).

FIRST USE 12-16-1999; IN COMMERCE 12-16-1999.

THE MARK CONSISTS OF STANDARD CHARACTERS WITHOUT CLAIM TO ANY PARTICULAR FONT, STYLE, SIZE, OR COLOR.

SER. NO. 77-326,559, FILED 11-10-2007.

JESSICA A. POWERS, EXAMINING ATTORNEY

**Int. Cls.: 35 and 44**

**Prior U.S. Cls.: 100, 101 and 102**

**United States Patent and Trademark Office**

**Reg. No. 3,504,142**

**Registered Sep. 23, 2008**

**SERVICE MARK  
PRINCIPAL REGISTER**

**BROOKSIDE BARKERY & BATH**

BARKERY & BATH, INC. (MISSOURI CORPORATION)  
118 WEST 63RD STREET  
KANSAS CITY, MO 64113

FOR: RETAIL PET STORES; ON-LINE RETAIL STORE SERVICES FEATURING PET PRODUCTS NOT INCLUDING PET TREATS, IN CLASS 35 (U.S. CLS. 100, 101 AND 102).

FIRST USE 7-31-2003; IN COMMERCE 7-31-2003.

FOR: ANIMAL GROOMING, IN CLASS 44 (U.S. CLS. 100 AND 101).

FIRST USE 7-31-2003; IN COMMERCE 7-31-2003.

THE MARK CONSISTS OF STANDARD CHARACTERS WITHOUT CLAIM TO ANY PARTICULAR FONT, STYLE, SIZE, OR COLOR.

NO CLAIM IS MADE TO THE EXCLUSIVE RIGHT TO USE "BROOKSIDE" AND "BATH", APART FROM THE MARK AS SHOWN.

SER. NO. 77-326,696, FILED 11-11-2007.

FRANK LATTUCA, EXAMINING ATTORNEY



**Int. Cl.: 35**

**Prior U.S. Cls.: 100, 101 and 102**

**United States Patent and Trademark Office**

**Reg. No. 3,504,143**

**Registered Sep. 23, 2008**

**SERVICE MARK  
PRINCIPAL REGISTER**

**GO Gloves-Online**

GLOVES-ONLINE, INC. (NORTH CAROLINA CORPORATION)

P.O. BOX 4468

CARY, NC 27519

FOR: DISTRIBUTORSHIPS IN THE FIELD OF GLOVES, IN CLASS 35 (U.S. CLS. 100, 101 AND 102).

FIRST USE 12-0-1996; IN COMMERCE 11-0-1997.

THE MARK CONSISTS OF STANDARD CHARACTERS WITHOUT CLAIM TO ANY PARTICULAR FONT, STYLE, SIZE, OR COLOR.

NO CLAIM IS MADE TO THE EXCLUSIVE RIGHT TO USE "GLOVES-ONLINE", APART FROM THE MARK AS SHOWN.

SER. NO. 77-327,036, FILED 11-12-2007.

G. MAYERSCHOFF, EXAMINING ATTORNEY

**Int. Cl.: 29**

**Prior U.S. Cl.: 46**

**United States Patent and Trademark Office**

**Reg. No. 3,504,144**

**Registered Sep. 23, 2008**

**TRADEMARK  
PRINCIPAL REGISTER**

**Turning Backyard Grills  
into 5-Star Steakhouses**

JAMES RIVER MEAT COMPANY (VIRGINIA  
CORPORATION)  
1250 DOVER CREEK LANE  
MANAKIN SABOT, VA 23103

THE MARK CONSISTS OF STANDARD CHAR-  
ACTERS WITHOUT CLAIM TO ANY PARTICULAR  
FONT, STYLE, SIZE, OR COLOR.

FOR: BEEF; PROCESSED MEAT, NAMELY,  
LAMB, IN CLASS 29 (U.S. CL. 46).

SER. NO. 77-327,866, FILED 11-13-2007.

FIRST USE 7-1-2007; IN COMMERCE 7-1-2007.

DAVID ELTON, EXAMINING ATTORNEY

**Int. Cl.: 28**

**Prior U.S. Cls.: 22, 23, 38 and 50**

**United States Patent and Trademark Office**

**Reg. No. 3,504,145**

**Registered Sep. 23, 2008**

**TRADEMARK  
PRINCIPAL REGISTER**

**BENDEL GIRLS**

HENRI BENDEL, INC. (DELAWARE CORPORATION)  
666 FIFTH AVENUE, 4TH FLOOR  
NEW YORK, NY 10103

FOR: DOLLS, IN CLASS 28 (U.S. CLS. 22, 23, 38 AND 50).

FIRST USE 9-1-2007; IN COMMERCE 9-1-2007.

THE MARK CONSISTS OF STANDARD CHARACTERS WITHOUT CLAIM TO ANY PARTICULAR FONT, STYLE, SIZE, OR COLOR.

OWNER OF U.S. REG. NOS. 409,915, 3,162,070 AND OTHERS.

NO CLAIM IS MADE TO THE EXCLUSIVE RIGHT TO USE "GIRLS", APART FROM THE MARK AS SHOWN.

SEC. 2(F).

SER. NO. 77-328,401, FILED 11-13-2007.

TINA L. SNAPP, EXAMINING ATTORNEY

**Int. Cl.: 25**

**Prior U.S. Cls.: 22 and 39**

**United States Patent and Trademark Office**

**Reg. No. 3,504,146**

**Registered Sep. 23, 2008**

**TRADEMARK  
PRINCIPAL REGISTER**

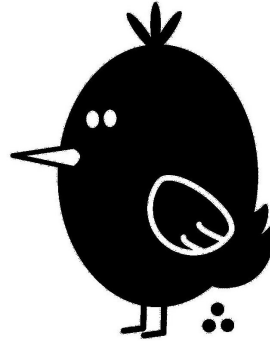

COOPER, JOHN (UNITED STATES INDIVIDUAL), DBA ABE LINCOLN, JR.  
366 UNION ST, APT 2H  
BROOKLYN, NY 11231

FIRST USE 10-5-2007; IN COMMERCE 10-5-2007.

SER. NO. 77-328,477, FILED 11-13-2007.

FOR: SHORT-SLEEVED OR LONG-SLEEVED T-SHIRTS; SHIRTS; SWEAT SHIRTS, IN CLASS 25 (U.S. CLS. 22 AND 39).

KATHERINE CHANG, EXAMINING ATTORNEY

**Int. Cl.: 16**

**Prior U.S. Cls.: 2, 5, 22, 23, 29, 37, 38 and 50**

**United States Patent and Trademark Office**

**Reg. No. 3,504,147**

**Registered Sep. 23, 2008**

**TRADEMARK  
PRINCIPAL REGISTER**

**SPRINGSOURCE**

SPRINGSOURCE INC. (DELAWARE CORPORATION)  
1875 SOUTH GRANT DRIVE, SUITE 650  
SAN MATEO, CA 94402

FOR: PRINTED PUBLICATIONS, NAMELY, TECHNICAL MANUALS AND TRAINING MANUALS RELATED TO THE USE OF COMPUTER SOFTWARE PLATFORMS AND TOOLS FOR DEVELOPMENT OF ENTERPRISE APPLICATIONS, IN CLASS 16 (U.S. CLS. 2, 5, 22, 23, 29, 37, 38 AND 50).

FIRST USE 12-15-2007; IN COMMERCE 12-15-2007.

THE MARK CONSISTS OF STANDARD CHARACTERS WITHOUT CLAIM TO ANY PARTICULAR FONT, STYLE, SIZE, OR COLOR.

SER. NO. 77-328,606, FILED 11-13-2007.

JERI J. FICKES, EXAMINING ATTORNEY

**Int. Cl.: 41**

**Prior U.S. Cls.: 100, 101 and 107**

**United States Patent and Trademark Office**

**Reg. No. 3,504,148**

**Registered Sep. 23, 2008**

**SERVICE MARK  
PRINCIPAL REGISTER**

**SPRINGSOURCE**

SPRINGSOURCE INC. (DELAWARE CORPORATION)  
1875 SOUTH GRANT DRIVE, SUITE 650  
SAN MATEO, CA 94402

FOR: TRAINING SERVICES, NAMELY, PROVIDING SEMINARS, WORKSHOPS, AND CUSTOM TRAINING COURSES IN THE USE OF COMPUTER SOFTWARE PLATFORMS AND TOOLS FOR DEVELOPMENT OF ENTERPRISE APPLICATIONS, IN CLASS 41 (U.S. CLS. 100, 101 AND 107).

FIRST USE 12-15-2007; IN COMMERCE 12-15-2007.

THE MARK CONSISTS OF STANDARD CHARACTERS WITHOUT CLAIM TO ANY PARTICULAR FONT, STYLE, SIZE, OR COLOR.

SER. NO. 77-328,613, FILED 11-13-2007.

JERI J. FICKES, EXAMINING ATTORNEY

**Int. Cl.: 42**

**Prior U.S. Cls.: 100 and 101**

**United States Patent and Trademark Office**

**Reg. No. 3,504,149**

**Registered Sep. 23, 2008**

**SERVICE MARK  
PRINCIPAL REGISTER**

**SPRINGSOURCE**

SPRINGSOURCE INC. (DELAWARE CORPORATION)  
1875 SOUTH GRANT DRIVE, SUITE 650  
SAN MATEO, CA 94402

FOR: COMPUTER SOFTWARE SUPPORT SERVICES FOR OTHERS; NAMELY, DESIGN AND DEVELOPMENT OF COMPUTER SOFTWARE PLATFORMS AND TOOLS FOR DEVELOPMENT OF ENTERPRISE APPLICATIONS, PROVIDING TECHNICAL INFORMATION UPDATES AND UPGRADES RELATED TO COMPUTER SOFTWARE PLATFORMS AND TOOLS FOR DEVELOPMENT OF ENTERPRISE APPLICATIONS, AND PROVIDING CONSULTANCY AND ADVISORY SERVICES

RELATED TO THE USE OF COMPUTER SOFTWARE PLATFORMS AND TOOLS FOR DEVELOPMENT OF ENTERPRISE APPLICATIONS, IN CLASS 42 (U.S. CLS. 100 AND 101).

FIRST USE 12-15-2007; IN COMMERCE 12-15-2007.

THE MARK CONSISTS OF STANDARD CHARACTERS WITHOUT CLAIM TO ANY PARTICULAR FONT, STYLE, SIZE, OR COLOR.

SER. NO. 77-328,624, FILED 11-13-2007.

JERI J. FICKES, EXAMINING ATTORNEY

**Int. Cl.: 21**

**Prior U.S. Cls.: 2, 13, 23, 29, 30, 33, 40 and 50**

**Reg. No. 3,504,150**

**United States Patent and Trademark Office**

**Registered Sep. 23, 2008**

---

**TRADEMARK  
PRINCIPAL REGISTER**

**Bag Ups**

FAST BAGS CORPORATION (DELAWARE CORPORATION)

PO BOX 83

BASKING RIDGE, NJ 07920

FOR: NON ELECTRIC TRASH BAG DISPENSER,  
IN CLASS 21 (U.S. CLS. 2, 13, 23, 29, 30, 33, 40 AND 50).

FIRST USE 1-19-2007; IN COMMERCE 1-19-2007.

THE MARK CONSISTS OF STANDARD CHARACTERS WITHOUT CLAIM TO ANY PARTICULAR FONT, STYLE, SIZE, OR COLOR.

NO CLAIM IS MADE TO THE EXCLUSIVE RIGHT TO USE "BAG", APART FROM THE MARK AS SHOWN.

SER. NO. 77-328,800, FILED 11-13-2007.

FRED MANDIR, EXAMINING ATTORNEY



**Int. Cl.: 41**

**Prior U.S. Cls.: 100, 101 and 107**

**United States Patent and Trademark Office**

**Reg. No. 3,504,151**

**Registered Sep. 23, 2008**

**SERVICE MARK  
PRINCIPAL REGISTER**

# Sand Fest

NW OFFROAD TIMING AUTHORITY LLC (ORE-  
GON LIMITED LIABILITY COMPANY)  
6435 NE COLWOOD WAY  
PORTLAND, OR 97218

FOR: ARRANGING AND CONDUCTING MO-  
TOR SPORT EVENTS, IN CLASS 41 (U.S. CLS. 100, 101  
AND 107).

FIRST USE 8-20-2007; IN COMMERCE 9-20-2007.

THE MARK CONSISTS OF STANDARD CHAR-  
ACTERS WITHOUT CLAIM TO ANY PARTICULAR  
FONT, STYLE, SIZE, OR COLOR.

NO CLAIM IS MADE TO THE EXCLUSIVE  
RIGHT TO USE "FEST", APART FROM THE MARK  
AS SHOWN.

SER. NO. 77-329,173, FILED 11-14-2007.

TOBY BULLOFF, EXAMINING ATTORNEY

**Int. Cl.: 37**

**Prior U.S. Cls.: 100, 103 and 106**

**United States Patent and Trademark Office**

**Reg. No. 3,504,152**

**Registered Sep. 23, 2008**

---

**SERVICE MARK  
PRINCIPAL REGISTER**

**FLAME HEATING COOLING  
ELECTRICAL**

FLAME FURNACE COMPANY (MICHIGAN CORPORATION)

2200 E. ELEVEN MILE ROAD

WARREN, MI 48091

FOR: INSTALLATION AND REPAIR OF HEATING, AIR CONDITIONING AND VENTILATING APPARATUS AND ELECTRICAL CONTRACTOR SERVICES, IN CLASS 37 (U.S. CLS. 100, 103 AND 106).

FIRST USE 11-0-1997; IN COMMERCE 11-0-1997.

THE MARK CONSISTS OF STANDARD CHARACTERS WITHOUT CLAIM TO ANY PARTICULAR FONT, STYLE, SIZE, OR COLOR.

OWNER OF U.S. REG. NO. 3,015,324.

NO CLAIM IS MADE TO THE EXCLUSIVE RIGHT TO USE "HEATING COOLING ELECTRICAL", APART FROM THE MARK AS SHOWN.

SER. NO. 77-329,384, FILED 11-14-2007.

AMY MCMENAMIN, EXAMINING ATTORNEY

**Int. Cl.: 9**

**Prior U.S. Cls.: 21, 23, 26, 36 and 38**

**United States Patent and Trademark Office**

**Reg. No. 3,504,153**

**Registered Sep. 23, 2008**

**TRADEMARK  
PRINCIPAL REGISTER**

# Resource Builder

SITICOV, IGOR (RUSSIAN FED. INDIVIDUAL)  
APT.38  
FESTIVALNAYA STR. 24/2  
MOSCOW, RUSSIAN FED. 125581

FOR: COMPUTER UTILITY SOFTWARE, DOWNLOADABLE COMPUTER SOFTWARE FOR CREATING, ACCESSING, MANAGING AND EDITING APPLICATION DATA, DATA FILES, IMAGE FILES, EXECUTABLE FILES, AND SCRIPTS USED BY COMPUTER PROGRAMMERS TO CREATE COMPUTER APPLICATIONS, COMPUTER SOFTWARE FOR CREATING, ACCESSING, MANAGING AND EDITING APPLICATION DATA, DATA FILES, IMAGE FILES, EXECUTABLE FILES, AND SCRIPTS USED BY COMPUTER PROGRAMMERS TO CRE-

ATE COMPUTER APPLICATIONS, IN CLASS 9 (U.S. CLS. 21, 23, 26, 36 AND 38).

FIRST USE 12-6-1999; IN COMMERCE 12-6-1999.

THE MARK CONSISTS OF STANDARD CHARACTERS WITHOUT CLAIM TO ANY PARTICULAR FONT, STYLE, SIZE, OR COLOR.

NO CLAIM IS MADE TO THE EXCLUSIVE RIGHT TO USE "BUILDER", APART FROM THE MARK AS SHOWN.

SER. NO. 77-329,627, FILED 11-14-2007.

COLLEEN KEARNEY, EXAMINING ATTORNEY

**Int. Cl.: 5**

**Prior U.S. Cls.: 6, 18, 44, 46, 51 and 52**

**Reg. No. 3,504,154**

**United States Patent and Trademark Office**

**Registered Sep. 23, 2008**

**TRADEMARK  
PRINCIPAL REGISTER**

**med-x vapor inhaler**

COSMETIC INDUSTRY & TRADE CORP. (CALI-  
FORNIA CORPORATION)

#A

1501 7TH ST  
RIVERSIDE, CA 92507

FOR: VAPOR INHALER NASAL DECONGE-  
STANT FOR COLDS, HAY FEVER, ALLERGIES  
AND SINUSITIS, IN CLASS 5 (U.S. CLS. 6, 18, 44, 46,  
51 AND 52).

FIRST USE 9-1-2007; IN COMMERCE 9-10-2007.

THE MARK CONSISTS OF STANDARD CHAR-  
ACTERS WITHOUT CLAIM TO ANY PARTICULAR  
FONT, STYLE, SIZE, OR COLOR.

NO CLAIM IS MADE TO THE EXCLUSIVE  
RIGHT TO USE "VAPOR INHALER", APART FROM  
THE MARK AS SHOWN.

SER. NO. 77-329,795, FILED 11-14-2007.

ANNE MADDEN, EXAMINING ATTORNEY

**Int. Cl.: 16**

**Prior U.S. Cls.: 2, 5, 22, 23, 29, 37, 38 and 50**

**United States Patent and Trademark Office**

**Reg. No. 3,504,155**

**Registered Sep. 23, 2008**

**TRADEMARK  
PRINCIPAL REGISTER**

# Big Toy Book

ADVENTURE PUBLISHING GROUP, INC. (NEW  
YORK CORPORATION)  
3RD FLOOR  
286 5TH AVENUE  
NEW YORK, NY 10001

FOR: MAGAZINES FEATURING TOY PRO-  
DUCTS AND SUPPLEMENTAL MAGAZINES IN  
THE FIELD OF TOY PRODUCTS, IN CLASS 16  
(U.S. CLS. 2, 5, 22, 23, 29, 37, 38 AND 50).

FIRST USE 12-21-1999; IN COMMERCE 12-21-1999.

THE MARK CONSISTS OF STANDARD CHAR-  
ACTERS WITHOUT CLAIM TO ANY PARTICULAR  
FONT, STYLE, SIZE, OR COLOR.

OWNER OF U.S. REG. NO. 2,117,723.

NO CLAIM IS MADE TO THE EXCLUSIVE  
RIGHT TO USE "BOOK", APART FROM THE  
MARK AS SHOWN.

SEC. 2(F).

SER. NO. 77-329,862, FILED 11-14-2007.

ALLISON SCHRODY, EXAMINING ATTORNEY

Int. Cl.: 35

Prior U.S. Cls.: 100, 101 and 102

United States Patent and Trademark Office

Reg. No. 3,504,156

Registered Sep. 23, 2008

**SERVICE MARK  
PRINCIPAL REGISTER**



MARIS, DOUGLAS E (UNITED STATES INDIVIDUAL), DBA CROSSTRAINING CONSULTING

2225 W. MARKET STREET SUITE #45  
BLOOMINGTON, IL 617045014

FOR: BUSINESS CONSULTATION; BUSINESS CONSULTATION SERVICES; BUSINESS CONSULTING, MANAGEMENT, PLANNING AND SUPERVISION; BUSINESS MANAGEMENT AND CONSULTATION; BUSINESS MANAGEMENT CONSULTING AND ADVISORY SERVICES; CONSULTING SERVICES IN BUSINESS ORGANIZATION AND MANAGEMENT; CONSULTING SERVICES RELATED TO THE ADMINISTRATIVE COORDINATION OF ORGANIZATIONS PROVIDING HUMANITARIAN ACTIVITIES, IN CLASS 35 (U.S. CLS. 100, 101 AND 102).

FIRST USE 9-1-2007; IN COMMERCE 9-1-2007.

NO CLAIM IS MADE TO THE EXCLUSIVE RIGHT TO USE "CONSULTING", APART FROM THE MARK AS SHOWN.

THE COLOR(S) PANTONE 281 BLUE IS/ARE CLAIMED AS A FEATURE OF THE MARK.

THE MARK CONSISTS OF A STICK FIGURE IN DARK BLUE PROJECTING A SHADOW OF A CROSS IN LIGHT BLUE OVER THE WORDS "CROSSTRAINING CONSULTING" IN DARK BLUE.

SER. NO. 77-329,988, FILED 11-15-2007.

CHERYL CLAYTON, EXAMINING ATTORNEY

**Int. Cl.: 35**

**Prior U.S. Cls.: 100, 101 and 102**

**United States Patent and Trademark Office**

**Reg. No. 3,504,157**

**Registered Sep. 23, 2008**

**SERVICE MARK  
PRINCIPAL REGISTER**

**INSPIRED BY LIFE**

WINE INSTITUTE (CALIFORNIA CORPORATION)  
SUITE 1000  
425 MARKET STREET  
SAN FRANCISCO, CA 94105

FOR: ADVERTISING SERVICES, NAMELY, PROMOTING THE WINE OF OTHERS, NAMELY, CALIFORNIA WINES, IN CLASS 35 (U.S. CLS. 100, 101 AND 102).

FIRST USE 9-1-2005; IN COMMERCE 9-1-2005.

THE MARK CONSISTS OF STANDARD CHARACTERS WITHOUT CLAIM TO ANY PARTICULAR FONT, STYLE, SIZE, OR COLOR.

SER. NO. 77-330,321, FILED 11-15-2007.

INGA ERVIN, EXAMINING ATTORNEY

**Int. Cl.: 25**

**Prior U.S. Cls.: 22 and 39**

**United States Patent and Trademark Office**

**Reg. No. 3,504,158**

**Registered Sep. 23, 2008**

**TRADEMARK  
PRINCIPAL REGISTER**

**LDP DESIGNS**

LINDA DIANE POLICHETTI (UNITED STATES  
INDIVIDUAL)  
35 CARMINE STREET  
NEW YORK, NY 10014

NO CLAIM IS MADE TO THE EXCLUSIVE  
RIGHT TO USE "DESIGNS", APART FROM THE  
MARK AS SHOWN.

FOR: CAPS, IN CLASS 25 (U.S. CLS. 22 AND 39).

FIRST USE 11-1-1998; IN COMMERCE 11-1-1998.

SER. NO. 77-331,352, FILED 11-16-2007.

THE MARK CONSISTS OF STANDARD CHAR-  
ACTERS WITHOUT CLAIM TO ANY PARTICULAR  
FONT, STYLE, SIZE, OR COLOR.

DANNEAN HETZEL, EXAMINING ATTORNEY



**Int. Cl.: 44**

**Prior U.S. Cls.: 100 and 101**

**United States Patent and Trademark Office**

**Reg. No. 3,504,159**

**Registered Sep. 23, 2008**

**SERVICE MARK  
PRINCIPAL REGISTER**

**Liberty Medical Center**

LIBERTY MEDICAL CENTER (MISSOURI LIMITED LIABILITY COMPANY)  
1504 NE 96TH STREET  
LIBERTY, MO 64068

NO CLAIM IS MADE TO THE EXCLUSIVE RIGHT TO USE "MEDICAL CENTER", APART FROM THE MARK AS SHOWN.

FOR: PHYSICIAN SERVICES, IN CLASS 44 (U.S. CLS. 100 AND 101).

SER. NO. 77-333,012, FILED 11-19-2007.

FIRST USE 2-4-2005; IN COMMERCE 7-5-2005.

THE MARK CONSISTS OF STANDARD CHARACTERS WITHOUT CLAIM TO ANY PARTICULAR FONT, STYLE, SIZE, OR COLOR.

JACQUELINE A. LAVINE, EXAMINING ATTORNEY

**Int. Cl.: 25**

**Prior U.S. Cls.: 22 and 39**

**United States Patent and Trademark Office**

**Reg. No. 3,504,160**

**Registered Sep. 23, 2008**

**TRADEMARK  
PRINCIPAL REGISTER**



IRONWEAR INTERNATIONAL, INC. (TEXAS CORPORATION), DBA HOUSE OF PAIN  
P.O. BOX 333  
FATE, TX 75132

FIRST USE 7-1-2002; IN COMMERCE 7-1-2002.

FOR: CLOTHING AND APPAREL, NAMELY, HATS, CAPS, SHIRTS, TEE SHIRTS, LOOSE FITTING TOPS, TANK TOPS, SWEATSHIRTS, FORM FITTING EXERCISE SHIRTS, BAGGIE PANTS, FORM FITTING EXERCISE SUITS, JACKETS, LEOTARDS, LEGGINGS, SPORTS BRAS AND BELTS, IN CLASS 25 (U.S. CLS. 22 AND 39).

THE MARK CONSISTS OF A SYMMETRICAL TRIBAL DESIGN ABOVE THE WORDS "HOUSE OF PAIN".

SER. NO. 77-333,059, FILED 11-19-2007.

DOMINICK J. SALEMI, EXAMINING ATTORNEY

**Int. Cl.: 1**

**Prior U.S. Cls.: 1, 5, 6, 10, 26 and 46**

**United States Patent and Trademark Office**

**Reg. No. 3,504,161**

**Registered Sep. 23, 2008**

**TRADEMARK  
PRINCIPAL REGISTER**

**IBD-CHEK**

TECHLAB, INC. (VIRGINIA CORPORATION)  
2001 KRAFT DRIVE  
BLACKSBURG, VA 24060

FOR: IN VITRO DIAGNOSTIC TEST KIT CONSISTING OF MICROTITER WELLS COATED WITH LACTOFERRIN ANTIBODIES, A CONJUGATE CONSISTING OF ANTIBODIES TO LACTOFERRIN TAGGED WITH PEROXIDASE, LACTOFERRIN POSITIVE CONTROL, DILUENT, SUBSTRATE, INTENSIFIER, AND WASH SOLUTION FOR USE IN THE DETECTION OF ELEVATED LEVELS OF LACTOFERRIN IN HUMANS FOR CLINICAL LABORATORY USE, IN CLASS 1 (U.S. CLS. 1, 5, 6, 10, 26 AND 46).

FIRST USE 7-25-2001; IN COMMERCE 7-31-2001.

THE MARK CONSISTS OF STANDARD CHARACTERS WITHOUT CLAIM TO ANY PARTICULAR FONT, STYLE, SIZE, OR COLOR.

OWNER OF U.S. REG. NOS. 2,664,800 AND 2,952,144.

SEC. 2(F).

SER. NO. 77-333,068, FILED 11-19-2007.

JAMES A. RAUEN, EXAMINING ATTORNEY

**Int. Cl.: 10**

**Prior U.S. Cls.: 26, 39 and 44**

**United States Patent and Trademark Office**

**Reg. No. 3,504,162**

**Registered Sep. 23, 2008**

**TRADEMARK  
PRINCIPAL REGISTER**

**ATLANTIS**

BRAINMASTER TECHNOLOGIES, INC. (OHIO CORPORATION)

#2

24490 BROADWAY AVE.

OAKWOOD VILLAGE, OH 44146

FOR: APPARATUS AND INSTRUMENTATION FOR MEDICAL PURPOSES, NAMELY, MONITORING, RECORDING, DISPLAYING AND ANALYZING OF SLEEP STATE AND BRAIN ACTIVITY OF PATIENTS, NAMELY, ANALYZING AND/OR RECORDING APPARATUS FOR PATIENT PHYSIOLOGICAL VARIABLES, NAMELY, BLOOD PRESSURE, TEMPERATURE, PH, AIR PRESSURE AND AIR

FLOW, ABDOMINAL RESPIRATION, THORACIC RESPIRATION, BODY POSITION, EEG, IN CLASS 10 (U.S. CLS. 26, 39 AND 44).

FIRST USE 5-30-2006; IN COMMERCE 5-30-2006.

THE MARK CONSISTS OF STANDARD CHARACTERS WITHOUT CLAIM TO ANY PARTICULAR FONT, STYLE, SIZE, OR COLOR.

SER. NO. 77-333,845, FILED 11-20-2007.

ROBERT C. CLARK JR., EXAMINING ATTORNEY

Int. Cl.: 7

Prior U.S. Cls.: 13, 19, 21, 23, 31, 34 and 35

Reg. No. 3,504,163

United States Patent and Trademark Office

Registered Sep. 23, 2008

TRADEMARK  
PRINCIPAL REGISTER



B & D ROLLERS OF MINNESOTA, INC. (MINNESOTA CORPORATION)

1430 2ND AVE NE

GLENWOOD, MN 56334

FOR: AGRICULTURAL MACHINES, NAMELY, FIELD CROP CONDITIONING ROLLERS, IN CLASS 7 (U.S. CLS. 13, 19, 21, 23, 31, 34 AND 35).

FIRST USE 7-7-2006; IN COMMERCE 12-18-2006.

NO CLAIM IS MADE TO THE EXCLUSIVE RIGHT TO USE "CRUSHER", APART FROM THE MARK AS SHOWN.

THE MARK CONSISTS OF THE WORDS "THE CRUSHER" IN A STYLIZED DESIGN INCLUDING SMALL INTERMESHING SEGMENTS OF TWO HAY CONDITIONING ROLLERS.

SER. NO. 77-333,849, FILED 11-20-2007.

ROBERT C. CLARK JR., EXAMINING ATTORNEY

**Int. Cl.: 7**

**Prior U.S. Cls.: 13, 19, 21, 23, 31, 34 and 35**

**United States Patent and Trademark Office**

**Reg. No. 3,504,164**

**Registered Sep. 23, 2008**

**TRADEMARK  
PRINCIPAL REGISTER**



BLASTERS, LLC (FLORIDA LIMITED LIABILITY  
COMPANY)  
7815 PROFESSIONAL PLACE  
TAMPA, FL 33637

FOR: APPARATUS FOR CLEANING OUT THE  
INTERIORS OF COMMERCIAL READY-MIXED  
CONCRETE REVOLVING DRUMS USING HIGH  
PRESSURE WATER, IN CLASS 7 (U.S. CLS. 13, 19, 21,  
23, 31, 34 AND 35).

FIRST USE 11-21-2005; IN COMMERCE 11-21-2005.

OWNER OF U.S. REG. NO. 3,192,815.

NO CLAIM IS MADE TO THE EXCLUSIVE  
RIGHT TO USE "JET", APART FROM THE MARK  
AS SHOWN.

THE MARK CONSISTS OF THE WORDS "READY  
JET" AND A SWIRL DESIGN.

SER. NO. 77-334,311, FILED 11-20-2007.

TINA L. SNAPP, EXAMINING ATTORNEY

**Int. Cls.: 16, 35, 41, 42 and 44**

**Prior U.S. Cls.: 2, 5, 22, 23, 29, 37, 38, 50, 100, 101, 102  
and 107**

**Reg. No. 3,504,165**

**United States Patent and Trademark Office**

**Registered Sep. 23, 2008**

**TRADEMARK  
SERVICE MARK  
PRINCIPAL REGISTER**



U.S. SOYBEAN EXPORT COUNCIL, INC. (DELA-  
WARE CORPORATION)  
SUITE 140  
12125 WOODCREST EXECUTIVE DRIVE  
ST. LOUIS, MO 63141

FOR: NEWSLETTERS IN THE FIELD OF THE SOYBEAN INDUSTRY THAT CONTAIN TECHNICAL INFORMATION ABOUT THE USE OF SOY PRODUCTS AND THE EXPORTATION OF SOYBEANS AND SOY PRODUCTS; PRINTED REPORTS FEATURING TECHNICAL INFORMATION AND STUDIES CONCERNING SOYBEANS AND SOY PRODUCTS, IN CLASS 16 (U.S. CLS. 2, 5, 22, 23, 29, 37, 38 AND 50).

FIRST USE 10-31-2005; IN COMMERCE 10-31-2005.

FOR: ASSOCIATION SERVICES, NAMELY, PROMOTING THE INTERESTS OF US SOYBEAN PRODUCERS AND PROCESSORS; PROVIDING FOREIGN TRADE INFORMATION AND CONSULTATION; PROMOTING THE GOODS AND SERVICES OF OTHERS VIA THE INTERNET; PROVIDING ADVISORY AND CONSULTING SERVICES RELATING TO EXPORT, EXPORT SERVICES, EXPORT PROMOTION INFORMATION AND SERVICES; AND GENERAL BUSINESS NETWORKING REFERRAL SERVICES, NAMELY, PROMOTING GOODS AND SERVICES OF OTHERS BY PASSING BUSINESS LEADS AND REFERRALS AMONG ASSOCIATION MEMBERS; ONLINE PRODUCT INFORMATION GUIDE FOR POTENTIAL INTERNATIONAL CUSTOMERS OF US SOYBEANS AND SOY PRODUCTS, IN CLASS 35 (U.S. CLS. 100, 101 AND 102).

FIRST USE 10-31-2005; IN COMMERCE 10-31-2005.

FOR: ONLINE PUBLICATION OF NEWSLETTERS AND INFORMATIONAL AND TECHNICAL BULLETINS AND ARTICLES FOR BUYERS AND SELLERS OF SOYBEANS AND SOYBEAN PRODUCTS, IN CLASS 41 (U.S. CLS. 100, 101 AND 107).

FIRST USE 10-31-2005; IN COMMERCE 10-31-2005.

FOR: PROVIDING ONLINE GUIDES RELATED TO RESEARCH IN THE FIELD OF SOYBEANS AND SOYBEAN PRODUCTS, IN CLASS 42 (U.S. CLS. 100 AND 101).

FIRST USE 10-31-2005; IN COMMERCE 10-31-2005.

FOR: PROVIDING ONLINE GUIDES THAT PROVIDE AGRICULTURAL ADVICE RELATED TO SOYBEANS AND SOYBEAN PRODUCTS, IN CLASS 44 (U.S. CLS. 100 AND 101).

FIRST USE 10-31-2005; IN COMMERCE 10-31-2005.

NO CLAIM IS MADE TO THE EXCLUSIVE RIGHT TO USE "U.S. SOYBEAN EXPORT COUNCIL", APART FROM THE MARK AS SHOWN.

THE COLOR(S) GREEN AND ORANGE IS/ARE CLAIMED AS A FEATURE OF THE MARK.

THE MARK CONSISTS OF THE LETTERS "USSEC" PROMINENTLY FEATURED IN DARK GREEN, ABOVE AN ORANGE HORIZONTAL DIVIDING LINE, AND THE WORDS "U.S. SOYBEAN

EXPORT COUNCIL" IN DARK GREEN BELOW THE ORANGE LINE, AN ORANGE ARC FROM THE UPPER LEFT TO THE LOWER RIGHT OF THE MARK, ENDING AT A FANCIFUL ORANGE SOY-BEAN, WITH A SMALL GREEN MARK ON THE SOYBEAN.

SER. NO. 77-334,611, FILED 11-20-2007.

KAREN BRACEY, EXAMINING ATTORNEY



**Int. Cl.: 39**

**Prior U.S. Cls.: 100 and 105**

**United States Patent and Trademark Office**

**Reg. No. 3,504,166**

**Registered Sep. 23, 2008**

**SERVICE MARK  
PRINCIPAL REGISTER**

**GRIFFIN WASTE SERVICES**

GRIFFIN WASTE SERVICES, LLC (NORTH CAROLINA LIMITED LIABILITY COMPANY)  
402 OLD LEICESTER HIGHWAY  
ASHEVILLE, NC 28806

FOR: SOLID WASTE HAULING SERVICES, IN CLASS 39 (U.S. CLS. 100 AND 105).

FIRST USE 4-0-2002; IN COMMERCE 12-0-2003.

THE MARK CONSISTS OF STANDARD CHARACTERS WITHOUT CLAIM TO ANY PARTICULAR FONT, STYLE, SIZE, OR COLOR.

NO CLAIM IS MADE TO THE EXCLUSIVE RIGHT TO USE "WASTE SERVICES", APART FROM THE MARK AS SHOWN.

SER. NO. 77-335,039, FILED 11-21-2007.

VIVIAN MICZNIK FIRST, EXAMINING ATTORNEY

**Int. Cl.: 41**

**Prior U.S. Cls.: 100, 101 and 107**

**United States Patent and Trademark Office**

**Reg. No. 3,504,167**

**Registered Sep. 23, 2008**

**SERVICE MARK  
PRINCIPAL REGISTER**

**BEAUTIFUL FLOWER**

MAHARRY, AYANNA (UNITED STATES INDIVIDUAL)  
11929 VENICE BLVD., #307  
LOS ANGELES, CA 90066

THE MARK CONSISTS OF STANDARD CHARACTERS WITHOUT CLAIM TO ANY PARTICULAR FONT, STYLE, SIZE, OR COLOR.

FOR: ENTERTAINMENT, NAMELY, PRODUCTION OF MOTION PICTURES, TELEVISION SHOWS, MUSIC; FILM DISTRIBUTION; FILM STUDIOS, IN CLASS 41 (U.S. CLS. 100, 101 AND 107).

SER. NO. 77-335,694, FILED 11-21-2007.

FIRST USE 1-1-1995; IN COMMERCE 10-1-1998.

ESTHER BELENKER, EXAMINING ATTORNEY

**Int. Cl.: 32**

**Prior U.S. Cls.: 45, 46 and 48**

**United States Patent and Trademark Office**

**Reg. No. 3,504,168**

**Registered Sep. 23, 2008**

**TRADEMARK  
PRINCIPAL REGISTER**

**CHE**

SOUTHERN CALIFORNIA BREWING CO., INC  
(CALIFORNIA CORPORATION), DBA ANGEL  
CITY BREWING  
833 W. TORRANCE BLVD. STE #105  
TORRANCE, CA 90502

FOR: BEER, ALE AND LAGER; BEER, ALE AND  
PORTER; BEER, ALE, LAGER, STOUT AND POR-  
TER; BEER, ALE, LAGER, STOUT, PORTER, SHAN-  
DY; BLACK BEER; BREWED MALT-BASED  
ALCOHOLIC BEVERAGE IN THE NATURE OF A  
BEER, IN CLASS 32 (U.S. CLS. 45, 46 AND 48).

FIRST USE 5-1-2007; IN COMMERCE 11-20-2007.

THE MARK CONSISTS OF STANDARD CHAR-  
ACTERS WITHOUT CLAIM TO ANY PARTICULAR  
FONT, STYLE, SIZE, OR COLOR.

THE NAME(S), PORTRAIT(S), AND/OR SIGNA-  
TURE(S) SHOWN IN THE MARK "CHE" DOES NOT  
IDENTIFY A PARTICULAR LIVING INDIVIDUAL.

SER. NO. 77-336,188, FILED 11-24-2007.

KATHERINE CHANG, EXAMINING ATTORNEY

**Int. Cl.: 5**

**Prior U.S. Cls.: 6, 18, 44, 46, 51 and 52**

**Reg. No. 3,504,169**

**United States Patent and Trademark Office**

**Registered Sep. 23, 2008**

**TRADEMARK  
PRINCIPAL REGISTER**

# WEED BLAST

SSI MAXIM COMPANY, INC. (TEXAS CORPORATION)  
P.O. BOX 1954  
KILGORE, TX 75663

FOR: AGRICULTURAL AND INDUSTRIAL CHEMICAL PREPARATION FOR KILLING WEEDS, MAINLY HERBICIDE FOR KILLING WEEDS, IN CLASS 5 (U.S. CLS. 6, 18, 44, 46, 51 AND 52).

FIRST USE 0-0-1983; IN COMMERCE 0-0-1983.

THE MARK CONSISTS OF STANDARD CHARACTERS WITHOUT CLAIM TO ANY PARTICULAR FONT, STYLE, SIZE, OR COLOR.

NO CLAIM IS MADE TO THE EXCLUSIVE RIGHT TO USE "WEED", APART FROM THE MARK AS SHOWN.

SER. NO. 77-336,603, FILED 11-26-2007.

CHRIS WELLS, EXAMINING ATTORNEY

**Int. Cls.: 35, 41 and 42**

**Prior U.S. Cls.: 100, 101, 102 and 107**

**United States Patent and Trademark Office**

**Reg. No. 3,504,170**

**Registered Sep. 23, 2008**

**SERVICE MARK  
PRINCIPAL REGISTER**

**GSTV**

DESTINATION MEDIA, INC. (DELAWARE CORPORATION)  
20TH FLOOR  
45 ROCKEFELLER PLAZA  
NEW YORK, NY 10111

FOR: DISSEMINATION OF ADVERTISING FOR OTHERS VIA AN ONLINE ELECTRONIC COMMUNICATIONS NETWORK; RENTAL OF ADVERTISING SPACE; CREATING, COMPILING AND DISSEMINATING ADVERTISING MATTER FOR OTHERS THROUGH AUDIO-VISUAL DISPLAYS, IN CLASS 35 (U.S. CLS. 100, 101 AND 102).

FIRST USE 12-1-2005; IN COMMERCE 12-1-2005.

FOR: COMPUTER SERVICES, NAMELY, PROVIDING DATABASES FEATURING NEWS IN THE NATURE OF CURRENT EVENT REPORTING; PROVIDING AN ONLINE COMPUTER DATABASE FEATURING INFORMATION IN THE FIELD OF GENERAL AND LOCAL NEWS IN THE NATURE OF CURRENT EVENT REPORTING OF INTEREST TO SPECIFIC GEOGRAPHIC AREAS; AUDIO AND

VISUAL PRODUCTION SERVICES, NAMELY, PREPARING AUDIO-VISUAL DISPLAYS IN THE FIELD OF NEWS, TRAFFIC REPORTS, BUSINESS NEWS, ENTERTAINMENT NEWS AND INFORMATION, AND WEATHER REPORTS ON BEHALF OF OTHERS, IN CLASS 41 (U.S. CLS. 100, 101 AND 107).

FIRST USE 12-1-2005; IN COMMERCE 12-1-2005.

FOR: PROVIDING WEATHER CONDITION INFORMATION, IN CLASS 42 (U.S. CLS. 100 AND 101).

FIRST USE 12-1-2005; IN COMMERCE 12-1-2005.

THE MARK CONSISTS OF STANDARD CHARACTERS WITHOUT CLAIM TO ANY PARTICULAR FONT, STYLE, SIZE, OR COLOR.

OWNER OF U.S. REG. NO. 3,321,141.

SER. NO. 77-337,157, FILED 11-26-2007.

PAUL CROWLEY, EXAMINING ATTORNEY

**Int. Cls.: 30 and 43**

**Prior U.S. Cls.: 46, 100 and 101**

**United States Patent and Trademark Office**

**Reg. No. 3,504,171**

**Registered Sep. 23, 2008**

**TRADEMARK  
SERVICE MARK  
PRINCIPAL REGISTER**

**AUSTIN JAVA**

AUSTIN JAVA HOLDINGS, L.L.C. (TEXAS LIMITED LIABILITY COMPANY)  
1710 EVERGREEN AVENUE  
AUSTIN, TX 78704

FOR: ROASTED COFFEE BEANS, IN CLASS 30 (U.S. CL. 46).

FIRST USE 10-1-2005; IN COMMERCE 10-1-2005.

FOR: RESTAURANT SERVICES; CATERING OF FOOD AND DRINKS; COFFEE SHOPS, IN CLASS 43 (U.S. CLS. 100 AND 101).

FIRST USE 5-5-1995; IN COMMERCE 5-5-1995.

THE MARK CONSISTS OF STANDARD CHARACTERS WITHOUT CLAIM TO ANY PARTICULAR FONT, STYLE, SIZE, OR COLOR.

NO CLAIM IS MADE TO THE EXCLUSIVE RIGHT TO USE "JAVA", APART FROM THE MARK AS SHOWN.

SEC. 2(F) AS TO "AUSTIN".

SER. NO. 77-337,352, FILED 11-27-2007.

LESLEY LAMOTHE, EXAMINING ATTORNEY

**Int. Cls.: 30 and 43**

**Prior U.S. Cls.: 46, 100 and 101**

**United States Patent and Trademark Office**

**Reg. No. 3,504,172**

**Registered Sep. 23, 2008**

**TRADEMARK  
SERVICE MARK  
PRINCIPAL REGISTER**



AUSTIN JAVA HOLDINGS, L.L.C. (TEXAS LIMITED LIABILITY COMPANY)  
1710 EVERGREEN AVENUE  
AUSTIN, TX 78704

THE COLOR(S) BLACK, WHITE AND BROWN IS/ARE CLAIMED AS A FEATURE OF THE MARK.

FOR: ROASTED COFFEE BEANS, IN CLASS 30 (U.S. CL. 46).

THE MARK CONSISTS OF THE WORDS "AUSTIN JAVA" IN BLACK LETTERS OUTLINED IN WHITE SUPERIMPOSED ON A BROWN STAR OUTLINED IN WHITE AND BLACK.

FIRST USE 10-1-2005; IN COMMERCE 10-1-2005.

FOR: RESTAURANT SERVICES; CATERING OF FOOD AND DRINKS; COFFEE SHOPS, IN CLASS 43 (U.S. CLS. 100 AND 101).

SEC. 2(F) AS TO "AUSTIN".

FIRST USE 2-28-2004; IN COMMERCE 2-28-2004.

SER. NO. 77-337,601, FILED 11-27-2007.

NO CLAIM IS MADE TO THE EXCLUSIVE RIGHT TO USE "JAVA", APART FROM THE MARK AS SHOWN.

LESLEY LAMOTHE, EXAMINING ATTORNEY

Int. Cl.: 3

Prior U.S. Cls.: 1, 4, 6, 50, 51 and 52

United States Patent and Trademark Office

Reg. No. 3,504,173

Registered Sep. 23, 2008

TRADEMARK  
PRINCIPAL REGISTER

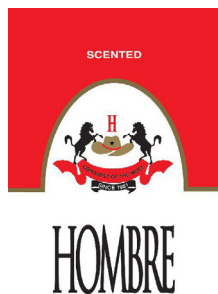

COLLECTION 2000 COSMETICS, INC. (FLORIDA CORPORATION)  
2860 N.W. 72ND AVENUE  
MIAMI, FL 33122

FOR: AFTER-SHAVE; SHAVING CREAM; SHAVING FOAM; ANTIPERSPIRANTS AND DEODORANTS FOR PERSONAL USE; BODY DEODORANTS; BODY SPRAYS; DEODORANTS AND ANTIPERSPIRANTS; PERSONAL DEODORANTS, IN CLASS 3 (U.S. CLS. 1, 4, 6, 50, 51 AND 52).

FIRST USE 3-15-1978; IN COMMERCE 3-15-1978.

OWNER OF U.S. REG. NOS. 1,801,799, 2,020,801 AND OTHERS.

NO CLAIM IS MADE TO THE EXCLUSIVE RIGHT TO USE "SCENTED" AND "SINCE 1981", APART FROM THE MARK AS SHOWN.

THE COLOR(S) RED, WHITE, BLACK AND GOLD IS/ARE CLAIMED AS A FEATURE OF THE MARK.

THE MARK CONSISTS OF AN ARC IN THE COLOR RED WITH A GOLD UNDERLINING STRIPE. IN THE CENTER OF THE RED ARCH

APPEARS THE WORDING "SCENTED" IN WHITE LETTERING. UNDERNEATH THE ARC APPEARS THE DESIGN OF TWO BLACK HORSES FLANKING THE LETTER "H" IN RED OVER THE DESIGN OF A GOLD COWBOY HAT WITH THE DESIGN OF A BLACK STAR AND RED HATBAND APPEARING ON THE HAT. BELOW THESE DESIGNS APPEARS A RED BANNER WITH THE WORDING "CONQUEST OF THE WEST" APPEARING OVER IT IN BLACK LETTERING. UNDERNEATH THE RED BANNER APPEARS A BLACK BANNER WITH THE WORDING "SINCE 1981" APPEARING OVER IT IN WHITE LETTERING. UNDERNEATH ALL OF THESE APPEARS THE WORDING "HOMBRE" IN BLACK LETTERING. THE DESIGNS FOR THE TWO HORSES, LETTER "H", COWBOY HAT, TWO BANNERS AND WORDING "HOMBRE" ALL APPEAR OVER A WHITE BACKGROUND. UNDERNEATH ALL OF THE AFOREMENTIONED APPEARS A GOLD STRIPE OVER A RED STRIPE.

THE FOREIGN WORDING IN THE MARK TRANSLATES INTO ENGLISH AS MAN.

SER. NO. 77-337,786, FILED 11-27-2007.

AMY MCMENAMIN, EXAMINING ATTORNEY



Int. Cl.: 37

Prior U.S. Cls.: 100, 103 and 106

United States Patent and Trademark Office

Reg. No. 3,504,174

Registered Sep. 23, 2008

SERVICE MARK  
PRINCIPAL REGISTER



HONEY DO SERVICE, INC. (VIRGINIA CORPORATION)  
433 SCOTT STREET  
BRISTOL, VA 24201

FOR: HANDYMAN SERVICES IN THE NATURE OF BUILDING REPAIR, BUILDING MAINTENANCE, AND BUILDING IMPROVEMENTS; BUILDING CONSTRUCTION, REPAIR, MAINTENANCE AND DEMOLITION; CONSULTATION IN THE FIELDS OF BUILDING CONSTRUCTION, REPAIR, MAINTENANCE AND DEMOLITION; BUILDING INSPECTION; BUILDING REMODELING AND RENOVATION; CONSTRUCTION, MAINTENANCE, AND RENOVATION OF REAL PROPERTY; HOME BUILDING, CLEANING AND REPAIR; BRICKLAYING; AND PAINTING, IN CLASS 37 (U.S. CLS. 100, 103 AND 106).

FIRST USE 10-1-2003; IN COMMERCE 10-1-2003.

NO CLAIM IS MADE TO THE EXCLUSIVE RIGHT TO USE "SERVICE INC.", APART FROM THE MARK AS SHOWN.

THE COLOR(S) GREEN, YELLOW, PEACH, BROWN, GRAY AND BLACK IS/ARE CLAIMED AS A FEATURE OF THE MARK.

THE MARK CONSISTS OF THE WORDS "THE HONEY DO SERVICE INC." UNDER A WORKING MAN WITH A SWOOSH RUNNING THROUGH AND UNDER THE WORDS OF THE MARK. THE COLOR GREEN APPEARS IN THE LETTERING FOR THE WORDING "THE HONEY DO SERVICE INC." AND IN THE DESIGN OF THE MAN'S VEST. THE COLOR YELLOW APPEARS IN THE DESIGN OF THE MAN'S HAT, SHIRT AND NAME TAG AND IN THE DESIGN OF THE SWOOSH. THE COLOR PEACH APPEARS IN THE DESIGN OF THE MAN. THE COLOR BROWN APPEARS IN THE LETTERING FOR THE TERM "TOM", IN THE DESIGN OF THE HANDLE OF THE HAMMER AND IN THE DESIGN OF THE MAN. THE COLOR GRAY APPEARS IN THE DESIGN OF THE HEAD OF THE HAMMER. THE COLOR BLACK APPEARS IN THE DESIGN OF THE MAN AND IN THE OUTLINE OF THE DESIGN OF THE MAN, THE HAMMER AND THE SWOOSH.

SER. NO. 77-337,792, FILED 11-27-2007.

AMY MCMENAMIN, EXAMINING ATTORNEY

**Int. Cl.: 36**

**Prior U.S. Cls.: 100, 101 and 102**

**United States Patent and Trademark Office**

**Reg. No. 3,504,175**

**Registered Sep. 23, 2008**

**SERVICE MARK  
PRINCIPAL REGISTER**

**CPR by Calgard Comp  
Premium Reduction**

CALGARD ASSOCIATES, INC. (CALIFORNIA CORPORATION)  
303 N. SAN DIMAS AVE.  
SAN DIMAS, CA 91773

FOR: BUNDLED COST SAVING SERVICES FOR WORKERS COMPENSATION INSURANCE POLICY HOLDERS, NAMELY, INSURANCE BROKERAGE, IN CLASS 36 (U.S. CLS. 100, 101 AND 102).

FIRST USE 4-15-2007; IN COMMERCE 4-15-2007.

THE MARK CONSISTS OF STANDARD CHARACTERS WITHOUT CLAIM TO ANY PARTICULAR FONT, STYLE, SIZE, OR COLOR.

NO CLAIM IS MADE TO THE EXCLUSIVE RIGHT TO USE "COMP PREMIUM REDUCTION", APART FROM THE MARK AS SHOWN.

THE WORD "CALGARD" HAS NO MEANING IN A FOREIGN LANGUAGE.

SEC. 2(F).

SER. NO. 77-338,107, FILED 11-27-2007.

SEAN CROWLEY, EXAMINING ATTORNEY

**Int. Cl.: 41**

**Prior U.S. Cls.: 100, 101 and 107**

**United States Patent and Trademark Office**

**Reg. No. 3,504,176**

**Registered Sep. 23, 2008**

**SERVICE MARK  
PRINCIPAL REGISTER**

# TotalFark

FARK, INC. (DELAWARE CORPORATION)  
P.O. BOX 1195  
VERSAILLES, KY 40383

FOR: ENTERTAINMENT SERVICES, NAMELY, PROVIDING A WEBSITE FEATURING PHOTOGRAPHIC, AUDIO, VIDEO AND PROSE PRESENTATIONS FEATURING COMEDIC CAPTIONS ABOUT CURRENT EVENTS; ENTERTAINMENT SERVICES, NAMELY, PROVIDING A WEB SITE FEATURING MUSICAL PERFORMANCES, MUSICAL VIDEOS, RELATED FILM CLIPS, PHOTOGRAPHS, AND OTHER MULTIMEDIA MATERIALS; ENTERTAINMENT SERVICES, NAMELY, PROVIDING ON-LINE REVIEWS OF

NEWS ARTICLES, AND/OR PHOTOGRAPHS; NEWS AGENCIES, NAMELY, GATHERING AND DISSEMINATION OF NEWS, IN CLASS 41 (U.S. CLS. 100, 101 AND 107).

FIRST USE 2-1-2002; IN COMMERCE 2-1-2002.

THE MARK CONSISTS OF STANDARD CHARACTERS WITHOUT CLAIM TO ANY PARTICULAR FONT, STYLE, SIZE, OR COLOR.

SER. NO. 77-338,500, FILED 11-28-2007.

TEJBIR SINGH, EXAMINING ATTORNEY

Int. Cl.: 37

Prior U.S. Cls.: 100, 103 and 106

United States Patent and Trademark Office

Reg. No. 3,504,177

Registered Sep. 23, 2008

**SERVICE MARK  
PRINCIPAL REGISTER**



AMALAK, INC. (NEVADA CORPORATION),  
DBA JET PRO AUTO WASH  
1660 N. WENATCHEE AV.  
WENATCHEE, WA 98801

FOR: AUTOMATED TUNNEL CAR WASHING  
SERVICES, IN CLASS 37 (U.S. CLS. 100, 103 AND 106).

FIRST USE 11-1-2004; IN COMMERCE 2-12-2005.

NO CLAIM IS MADE TO THE EXCLUSIVE  
RIGHT TO USE "PRO AUTO WASH", APART FROM  
THE MARK AS SHOWN.

THE COLOR(S) WHITE, BLACK, BLUE, RED,  
AQUA, GOLDENROD IS/ARE CLAIMED AS A  
FEATURE OF THE MARK.

THE MARK CONSISTS OF WORDS "JET PRO" IN  
RED, OUTLINED IN GOLDENROD; WORDS  
"AUTO WASH" IN WHITE BLUE BACKGROUND;  
CLOUD AND WATER IN AQUA AND BLUE, AIR-  
PLANE OUTLINED IN BLACK WITH RED AND  
BLUE STRIPE.

SER. NO. 77-339,558, FILED 11-29-2007.

ANDREA SAUNDERS, EXAMINING ATTORNEY

**Int. Cl.: 15**

**Prior U.S. Cls.: 2, 21 and 36**

**United States Patent and Trademark Office**

**Reg. No. 3,504,178**

**Registered Sep. 23, 2008**

**TRADEMARK  
PRINCIPAL REGISTER**

# PEG DROPS

ARDSLEY MUSICAL INSTRUMENT SERVICE,  
LTD. (NEW YORK CORPORATION)  
219 SPRAIN RD.  
SCARSDALE, NY 10583

THE MARK CONSISTS OF STANDARD CHAR-  
ACTERS WITHOUT CLAIM TO ANY PARTICULAR  
FONT, STYLE, SIZE, OR COLOR.

FOR: HOMOGENEOUS CHEMICAL PREPARA-  
TION FOR APPLICATION TO THE PEGS OF A  
MUSICAL INSTRUMENT TO PREVENT CREAK-  
ING AND SLIPPING OF THE PEGS OF THE MUSI-  
CAL INSTRUMENT, IN CLASS 15 (U.S. CLS. 2, 21  
AND 36).

SEC. 2(F).

SER. NO. 77-339,884, FILED 11-29-2007.

FIRST USE 7-28-1987; IN COMMERCE 7-28-1987.

GEOFFREY FOSDICK, EXAMINING ATTORNEY

**Int. Cl.: 37**

**Prior U.S. Cls.: 100, 103 and 106**

**United States Patent and Trademark Office**

**Reg. No. 3,504,179**

**Registered Sep. 23, 2008**

**SERVICE MARK  
PRINCIPAL REGISTER**

**revolution cleaners**

GREEN CLEAN, LLC (COLORADO LIMITED  
LIABILITY COMPANY)  
351 W. 45TH AVENUE  
DENVER, CO 80216

FOR: CLEANING OF CLOTHING; DRY CLEAN-  
ING; PROVIDING WASHING AND DRYING LAUN-  
DRY FACILITIES, IN CLASS 37 (U.S. CLS. 100, 103  
AND 106).

FIRST USE 9-1-2004; IN COMMERCE 9-1-2004.

THE MARK CONSISTS OF STANDARD CHAR-  
ACTERS WITHOUT CLAIM TO ANY PARTICULAR  
FONT, STYLE, SIZE, OR COLOR.

NO CLAIM IS MADE TO THE EXCLUSIVE  
RIGHT TO USE "CLEANERS", APART FROM THE  
MARK AS SHOWN.

SER. NO. 77-340,265, FILED 11-29-2007.

INGA ERVIN, EXAMINING ATTORNEY

**Int. Cls.: 16, 36 and 41**

**Prior U.S. Cls.: 2, 5, 22, 23, 29, 37, 38, 50, 100, 101, 102  
and 107**

**Reg. No. 3,504,180**

**United States Patent and Trademark Office**

**Registered Sep. 23, 2008**

**TRADEMARK  
SERVICE MARK  
PRINCIPAL REGISTER**

**ARCUS FOUNDATION**

ARCUS FOUNDATION (MICHIGAN NON-PROFIT CORPORATION)  
402 EAST MICHIGAN AVENUE  
KALAMAZOO, MI 49007

FOR: PUBLICATIONS, NAMELY, JOURNALS AND NEWSLETTERS IN THE FIELDS OF GAY, LESBIAN, BISEXUAL AND TRANSGENDER HUMAN RIGHTS AND SOCIAL JUSTICE, AND THE CONSERVATION OF GREAT APES IN THE WILD AND IN SANCTUARIES FOR CAPTIVE APES, IN CLASS 16 (U.S. CLS. 2, 5, 22, 23, 29, 37, 38 AND 50).

FIRST USE 11-30-2002; IN COMMERCE 11-30-2002.

FOR: CHARITABLE SERVICES, NAMELY, MAKING GRANTS IN THE FIELDS OF GAY, LESBIAN, BISEXUAL AND TRANSGENDER HUMAN RIGHTS AND SOCIAL JUSTICE, AND THE CONSERVATION OF GREAT APES IN THE WILD AND IN SANCTUARIES FOR CAPTIVE APES, IN CLASS 36 (U.S. CLS. 100, 101 AND 102).

FIRST USE 12-31-2000; IN COMMERCE 12-31-2000.

FOR: EDUCATIONAL SERVICES, NAMELY, ARRANGING AND CONDUCTING EDUCATIONAL PROGRAMS AND CONFERENCES IN THE FIELDS OF GAY, LESBIAN, BISEXUAL AND TRANSGEN-

DER HUMAN RIGHTS AND SOCIAL JUSTICE, AND THE CONSERVATION OF GREAT APES IN THE WILD AND IN SANCTUARIES FOR CAPTIVE APES; PROVIDING NON-DOWNLOADABLE ONLINE PUBLICATIONS IN THE NATURE OF ARTICLES IN THE FIELDS OF GAY, LESBIAN, BISEXUAL AND TRANSGENDER HUMAN RIGHTS AND SOCIAL JUSTICE, AND THE CONSERVATION OF GREAT APES IN THE WILD AND IN SANCTUARIES FOR CAPTIVE APES, IN CLASS 41 (U.S. CLS. 100, 101 AND 107).

FIRST USE 12-31-2006; IN COMMERCE 12-31-2006.

THE MARK CONSISTS OF STANDARD CHARACTERS WITHOUT CLAIM TO ANY PARTICULAR FONT, STYLE, SIZE, OR COLOR.

NO CLAIM IS MADE TO THE EXCLUSIVE RIGHT TO USE "FOUNDATION", APART FROM THE MARK AS SHOWN.

THE WORDING "ARCUS" HAS NO MEANING IN A FOREIGN LANGUAGE.

SER. NO. 77-340,323, FILED 11-29-2007.

KATHLEEN LORENZO, EXAMINING ATTORNEY

**Int. Cl.: 35**

**Prior U.S. Cls.: 100, 101 and 102**

**United States Patent and Trademark Office**

**Reg. No. 3,504,181**

**Registered Sep. 23, 2008**

**SERVICE MARK  
PRINCIPAL REGISTER**

**REINDEER GAMES**

ST. NICHOLAS MUSIC INC. (NEW YORK COR-  
PORATION)  
SUITE 601  
1619 BROADWAY  
NEW YORK, NY 10019

FOR: ADVERTISING SERVICES, NAMELY, PRO-  
MOTING THE GIFT CARDS OF OTHERS, IN CLASS  
35 (U.S. CLS. 100, 101 AND 102).

FIRST USE 11-18-2007; IN COMMERCE 11-18-2007.

THE MARK CONSISTS OF STANDARD CHAR-  
ACTERS WITHOUT CLAIM TO ANY PARTICULAR  
FONT, STYLE, SIZE, OR COLOR.

OWNER OF U.S. REG. NOS. 2,501,573, 2,983,404  
AND OTHERS.

SER. NO. 77-341,432, FILED 11-30-2007.

JESSICA A. POWERS, EXAMINING ATTORNEY



**Int. Cl.: 37**

**Prior U.S. Cls.: 100, 103 and 106**

**United States Patent and Trademark Office**

**Reg. No. 3,504,182**

**Registered Sep. 23, 2008**

**SERVICE MARK  
PRINCIPAL REGISTER**

**FENTON**

FENTON RIGGING & CONTRACTING (OHIO CORPORATION)  
2150 LANGDON FARM RD  
CINCINNATI, OH 45237

FOR: GENERAL CONSTRUCTION CONTRACTING, NAMELY, MACHINERY MOVING, RIGGING, SPECIALIZED STEEL ERECTION, BRIDGE REPAIR AND REPLACEMENT, TANK REFURBISHING, CONCRETE RESTORATION, PLANT MAINTENANCE; SPRAYING OF GUNITE; LAYING OF CONCRETE, IN CLASS 37 (U.S. CLS. 100, 103 AND 106).

FIRST USE 3-28-1960; IN COMMERCE 3-28-1960.

THE MARK CONSISTS OF STANDARD CHARACTERS WITHOUT CLAIM TO ANY PARTICULAR FONT, STYLE, SIZE, OR COLOR.

SEC. 2(F).

SER. NO. 77-341,541, FILED 11-30-2007.

ALYSSA PALADINO, EXAMINING ATTORNEY

**Int. Cl.: 35**

**Prior U.S. Cls.: 100, 101 and 102**

**United States Patent and Trademark Office**

**Reg. No. 3,504,183**

**Registered Sep. 23, 2008**

**SERVICE MARK  
PRINCIPAL REGISTER**

**PAW DIGS**

PAW DIGS, LLC (CALIFORNIA LIMITED LIABILITY COMPANY)  
2033 SAN ELIJO AVE. NO. 431  
CARDIFF BY THE SEA, CA 92007

FOR: OPERATING AN ONLINE SHOPPING SITE IN THE FIELD OF PET SUPPLIES, PET ACCESSORIES, PET FURNITURE, PET TOYS AND PET FOOD; COMPUTERIZED ON-LINE RETAIL STORE SERVICES IN THE FIELD OF PET SUPPLIES, PET ACCESSORIES, PET FURNITURE, PET TOYS AND PET FOOD; ON-LINE RETAIL STORE SERVICES FEATURING PET SUPPLIES, PET ACCESSORIES, PET

FURNITURE, PET TOYS AND PET FOOD, IN CLASS 35 (U.S. CLS. 100, 101 AND 102).

FIRST USE 8-11-2005; IN COMMERCE 8-11-2005.

THE MARK CONSISTS OF STANDARD CHARACTERS WITHOUT CLAIM TO ANY PARTICULAR FONT, STYLE, SIZE, OR COLOR.

SER. NO. 77-341,643, FILED 11-30-2007.

ALYSSA PALADINO, EXAMINING ATTORNEY

**Int. Cl.: 35**

**Prior U.S. Cls.: 100, 101 and 102**

**United States Patent and Trademark Office**

**Reg. No. 3,504,184**

**Registered Sep. 23, 2008**

**SERVICE MARK  
PRINCIPAL REGISTER**



The logo features the text "S'COM" in a large, bold, sans-serif font. A superscript dot is positioned between the "S" and "COM". A thick horizontal line is drawn beneath "S'COM". Below this line, the tagline "thinking people" is written in a smaller, lowercase, sans-serif font.

CARLISLE GROUP (UNITED KINGDOM CORPORATION)  
HYDE WAY  
WELWYN GARDEN CITY, UNITED KINGDOM

FOR: TEMPORARY AND PERMANENT STAFFING SERVICES; AND EMPLOYMENT RECRUITING SERVICES, IN CLASS 35 (U.S. CLS. 100, 101 AND 102).

FIRST USE 8-0-1997; IN COMMERCE 8-0-1997.

OWNER OF U.S. REG. NO. 2,527,589.

THE MARK CONSISTS OF THE LETTER "S", A SUPERSCRIPT DOT BETWEEN THE "S" AND THE WORD "COM" WITH A LINE UNDERNEATH AND THE WORDS "THINKING PEOPLE" BELOW THE LINE.

SER. NO. 77-342,200, FILED 12-3-2007.

SALLY SHIH, EXAMINING ATTORNEY

**Int. Cl.: 35**

**Prior U.S. Cls.: 100, 101 and 102**

**United States Patent and Trademark Office**

**Reg. No. 3,504,185**

**Registered Sep. 23, 2008**

**SERVICE MARK  
PRINCIPAL REGISTER**

**enjami**

WOOD, BENJAMIN RANDOLPH (UNITED STATES INDIVIDUAL)

1/2

9027 TOKAY LN., SACRAMENTO, CA 95829

SACRAMENTO, CA 95829

THE MARK CONSISTS OF STANDARD CHARACTERS WITHOUT CLAIM TO ANY PARTICULAR FONT, STYLE, SIZE, OR COLOR.

FOR: RETAIL APPAREL STORES, IN CLASS 35 (U.S. CLS. 100, 101 AND 102).

SER. NO. 77-343,003, FILED 12-3-2007.

FIRST USE 1-10-2007; IN COMMERCE 2-10-2007.

MICHELE SWAIN, EXAMINING ATTORNEY

**Int. Cl.: 5**

**Prior U.S. Cls.: 6, 18, 44, 46, 51 and 52**

**Reg. No. 3,504,186**

**United States Patent and Trademark Office**

**Registered Sep. 23, 2008**

---

**TRADEMARK  
PRINCIPAL REGISTER**

**Rotary 2 SL**

ALLIGARE, LLC (ALABAMA LIMITED LIABILITY COMPANY)

13 NORTH 8TH STREET

OPELIKA, AL 36801

FOR: HERBICIDES, IN CLASS 5 (U.S. CLS. 6, 18, 44, 46, 51 AND 52).

FIRST USE 5-15-2007; IN COMMERCE 5-15-2007.

THE MARK CONSISTS OF STANDARD CHARACTERS WITHOUT CLAIM TO ANY PARTICULAR FONT, STYLE, SIZE, OR COLOR.

NO CLAIM IS MADE TO THE EXCLUSIVE RIGHT TO USE "2 SL", APART FROM THE MARK AS SHOWN.

SER. NO. 77-343,037, FILED 12-3-2007.

HENRY S. ZAK, EXAMINING ATTORNEY

**Int. Cl.: 5**

**Prior U.S. Cls.: 6, 18, 44, 46, 51 and 52**

**United States Patent and Trademark Office**

**Reg. No. 3,504,187**

**Registered Sep. 23, 2008**

**TRADEMARK  
PRINCIPAL REGISTER**

**VELIANA**

ALCON, INC. (SWITZERLAND CORPORATION)  
BOSCH 69  
CH-6331 HUNENBERG, SWITZERLAND

FOR: OPHTHALMIC PREPARATION, IN CLASS 5  
(U.S. CLS. 6, 18, 44, 46, 51 AND 52).

THE MARK CONSISTS OF STANDARD CHAR-  
ACTERS WITHOUT CLAIM TO ANY PARTICULAR  
FONT, STYLE, SIZE, OR COLOR.

PRIORITY CLAIMED UNDER SEC. 44(D) ON  
SWITZERLAND APPLICATION NO. 63079/2007,  
FILED 11-21-2007.

OWNER OF SWITZERLAND REG. NO. 569585,  
DATED 3-26-2008, EXPIRES 11-21-2017.

SER. NO. 77-343,287, FILED 12-4-2007.

SALLY SHIH, EXAMINING ATTORNEY

**Int. Cl.: 35**

**Prior U.S. Cls.: 100, 101 and 102**

**United States Patent and Trademark Office**

**Reg. No. 3,504,188**

**Registered Sep. 23, 2008**

**SERVICE MARK  
PRINCIPAL REGISTER**

**PEDDLER'S WAGON**

DERVAES INSTITUTE (CALIFORNIA CORPORATION)  
631 CYPRESS AVENUE  
PASADENA, CA 91103

FOR: ONLINE RETAIL STORE SERVICES FEATURING SUSTAINABLE AND PRACTICAL WARES, KITCHEN PRODUCTS, HOMESTEAD TOOLS, CLOTHING, BOOKS, GIFTS, GARDEN ITEMS, AND PRODUCTS FOR THE URBAN PIONEER, IN CLASS 35 (U.S. CLS. 100, 101 AND 102).

FIRST USE 9-0-2006; IN COMMERCE 10-0-2006.

THE MARK CONSISTS OF STANDARD CHARACTERS WITHOUT CLAIM TO ANY PARTICULAR FONT, STYLE, SIZE, OR COLOR.

SER. NO. 77-343,450, FILED 12-4-2007.

JESSICA A. POWERS, EXAMINING ATTORNEY

**Int. Cl.: 41**

**Prior U.S. Cls.: 100, 101 and 107**

**United States Patent and Trademark Office**

**Reg. No. 3,504,189**

**Registered Sep. 23, 2008**

**SERVICE MARK  
PRINCIPAL REGISTER**

**San Antonio Performing  
Arts Center**

FOUNDATION FOR CULTURAL ARTS IN SAN ANTONIO (TEXAS NON-PROFIT CORPORATION), DBA LAS CASAS  
SUITE 640  
222 EAST HOUSTON STREET  
SAN ANTONIO, TX 78205

FOR: ENTERTAINMENT IN THE NATURE OF THEATER PRODUCTIONS; ENTERTAINMENT, NAMELY, LIVE MUSIC CONCERTS; EDUCATION SERVICES, NAMELY, PROVIDING LIVE AND ONLINE, WORKSHOPS, AND SEMINARS IN THE FIELD OF THE PERFORMING ARTS; GUIDED TOURS OF THEATERS, IN CLASS 41 (U.S. CLS. 100, 101 AND 107).

FIRST USE 11-0-2001; IN COMMERCE 11-0-2001.

THE MARK CONSISTS OF STANDARD CHARACTERS WITHOUT CLAIM TO ANY PARTICULAR FONT, STYLE, SIZE, OR COLOR.

NO CLAIM IS MADE TO THE EXCLUSIVE RIGHT TO USE "PERFORMING ARTS CENTER", APART FROM THE MARK AS SHOWN.

SEC. 2(F) AS TO "SAN ANTONIO".

SER. NO. 77-343,726, FILED 12-4-2007.

LINDA ORNDORFF, EXAMINING ATTORNEY



**Int. Cl.: 19**

**Prior U.S. Cls.: 1, 12, 33 and 50**

**United States Patent and Trademark Office**

**Reg. No. 3,504,190**

**Registered Sep. 23, 2008**

**TRADEMARK  
PRINCIPAL REGISTER**

**TILE TREASURES**

DAILEY, JUDY (UNITED STATES INDIVIDUAL)  
P.O. BOX 1337  
QUINCY, CA 95971 AND  
DAILEY, HARRY (UNITED STATES INDIVIDUAL)  
P.O. BOX 1337  
QUINCY, CA 95971

FOR: WORKS OF ART OF CERAMIC TILE, IN  
CLASS 19 (U.S. CLS. 1, 12, 33 AND 50).

FIRST USE 10-24-2007; IN COMMERCE 10-24-2007.

THE MARK CONSISTS OF STANDARD CHAR-  
ACTERS WITHOUT CLAIM TO ANY PARTICULAR  
FONT, STYLE, SIZE, OR COLOR.

NO CLAIM IS MADE TO THE EXCLUSIVE  
RIGHT TO USE "TILE", APART FROM THE MARK  
AS SHOWN.

SER. NO. 77-344,114, FILED 12-4-2007.

NAAKWAMA ANKRAH, EXAMINING ATTORNEY

**Int. Cl.: 7**

**Prior U.S. Cls.: 13, 19, 21, 23, 31, 34 and 35**

**United States Patent and Trademark Office**

**Reg. No. 3,504,191**

**Registered Sep. 23, 2008**

**TRADEMARK  
PRINCIPAL REGISTER**

**AQUAJET**

AQUASCAPE DESIGNS, INC. (ILLINOIS CORPORATION)  
901 AQUALAND WAY  
ST. CHARLES, IL 60174

THE MARK CONSISTS OF STANDARD CHARACTERS WITHOUT CLAIM TO ANY PARTICULAR FONT, STYLE, SIZE, OR COLOR.

FOR: ELECTRICAL WATER PUMPS FOR USE IN FOUNTAINS, IN CLASS 7 (U.S. CLS. 13, 19, 21, 23, 31, 34 AND 35).

SER. NO. 77-344,245, FILED 12-5-2007.

FIRST USE 7-1-2006; IN COMMERCE 7-1-2006.

CAROLYN GRAY, EXAMINING ATTORNEY

**Int. Cl.: 5**

**Prior U.S. Cls.: 6, 18, 44, 46, 51 and 52**

**United States Patent and Trademark Office**

**Reg. No. 3,504,192**

**Registered Sep. 23, 2008**

**TRADEMARK  
PRINCIPAL REGISTER**

**NUTRITION WAREHOUSE**

VITAMIN WORLD, INC. (DELAWARE CORPORATION)  
LEGAL DEPT  
90 ORVILLE DRIVE  
BOHEMIA, NY 11716

FOR: VITAMINS, MINERAL SUPPLEMENTS AND NUTRITIONAL SUPPLEMENTS, IN CLASS 5 (U.S. CLS. 6, 18, 44, 46, 51 AND 52).

FIRST USE 7-0-1979; IN COMMERCE 7-0-1979.

THE MARK CONSISTS OF STANDARD CHARACTERS WITHOUT CLAIM TO ANY PARTICULAR FONT, STYLE, SIZE, OR COLOR.

OWNER OF U.S. REG. NOS. 1,844,928 AND 2,508,728.

NO CLAIM IS MADE TO THE EXCLUSIVE RIGHT TO USE "NUTRITION", APART FROM THE MARK AS SHOWN.

SEC. 2(F).

SER. NO. 77-344,427, FILED 12-5-2007.

BERYL GARDNER, EXAMINING ATTORNEY

**Int. Cls.: 9 and 42**

**Prior U.S. Cls.: 21, 23, 26, 36, 38, 100 and 101**

**United States Patent and Trademark Office**

**Reg. No. 3,504,193**

**Registered Sep. 23, 2008**

**TRADEMARK  
SERVICE MARK  
PRINCIPAL REGISTER**



DSCI (NEW JERSEY CORPORATION)  
PO BOX 7259  
FREEHOLD, NJ 077287259

FOR: COMPUTER SOFTWARE FOR USE IN NETWORK COMMUNICATIONS MANAGEMENT, IN THE FIELD OF INSTALLATION, INTEGRATION, ANALYSIS, AND MANAGEMENT OF COMMUNICATION AND DATA NETWORKS, IN CLASS 9 (U.S. CLS. 21, 23, 26, 36 AND 38).

FIRST USE 10-15-2007; IN COMMERCE 10-15-2007.

FOR: ENGINEERING SERVICES, NAMELY, ENGINEERING FOR THE MODELING AND SIMULATION FIELD TO SUPPORT THE ANALYSIS, DESIGN, TESTING, AND EVALUATION OF COMPLEX COMMUNICATIONS SYSTEMS FOR MILITARY AND COMMERCIAL USE, IN CLASS 42 (U.S. CLS. 100 AND 101).

FIRST USE 10-15-2007; IN COMMERCE 10-15-2007.

OWNER OF U.S. REG. NOS. 3,182,858 AND 3,341,592.

NO CLAIM IS MADE TO THE EXCLUSIVE RIGHT TO USE "EXPERT SOLUTIONS, INC." AND "COMPANY", APART FROM THE MARK AS SHOWN.

THE COLOR(S) MAROON AND GRAY IS/ARE CLAIMED AS A FEATURE OF THE MARK.

THE MARK CONSISTS OF A STYLIZED LETTER "X" IN MAROON, A LIGHT-GRAY GRADIENT FADING INTO A THINNER, DARKER GRAY TO THE RIGHT FOLLOWING THE "X, PRT" SOLUTIONS, INC. IN DARKER GRAY LOCATED TO THE RIGHT OF THE "X", AND "A DSCI COMPANY" IN SMALLER BLOCK LETTERS IN MAROON, FOLLOWING THE "X" AT THE BOTTOM.

SER. NO. 77-344,455, FILED 12-5-2007.

BARBARA RUTLAND, EXAMINING ATTORNEY

**Int. Cl.: 7**

**Prior U.S. Cls.: 13, 19, 21, 23, 31, 34 and 35**

**United States Patent and Trademark Office**

**Reg. No. 3,504,194**

**Registered Sep. 23, 2008**

**TRADEMARK  
PRINCIPAL REGISTER**

**RAPID**

ARIENS COMPANY (WISCONSIN CORPORATION)  
655 WEST RYAN STREET  
BRILLION, WI 54110

FOR: MOTOR EQUIPPED POWER HEADS AND ATTACHMENT TOOLS FOR USE THEREWITH, NAMELY, SNOW THROWERS, PLOWS, LAWN MOWERS, BRUSHES, AND PARTS THEREFOR, IN CLASS 7 (U.S. CLS. 13, 19, 21, 23, 31, 34 AND 35).

FIRST USE 9-12-2006; IN COMMERCE 9-12-2006.

THE MARK CONSISTS OF STANDARD CHARACTERS WITHOUT CLAIM TO ANY PARTICULAR FONT, STYLE, SIZE, OR COLOR.

SER. NO. 77-344,684, FILED 12-5-2007.

CIMMERIAN COLEMAN, EXAMINING ATTORNEY

**Int. Cl.: 35**

**Prior U.S. Cls.: 100, 101 and 102**

**United States Patent and Trademark Office**

**Reg. No. 3,504,195**

**Registered Sep. 23, 2008**

**SERVICE MARK  
PRINCIPAL REGISTER**

**TOWN PLANNER**

LARRY G. PAULOZZI (UNITED STATES INDIVIDUAL)

7271 ENGLE RD., SUITE 309

CLEVELAND, OH 44130

FOR: PROMOTING THE GOODS AND SERVICES OF OTHERS THROUGH THE DISTRIBUTION OF ADVERTISING MATERIAL, NAMELY, THROUGH THE DISTRIBUTION OF CALENDARS CONTAINING ADVERTISING MATERIAL FOR THE GOODS AND SERVICES OF OTHERS, IN CLASS 35 (U.S. CLS. 100, 101 AND 102).

FIRST USE 10-1-1986; IN COMMERCE 10-1-1986.

THE MARK CONSISTS OF STANDARD CHARACTERS WITHOUT CLAIM TO ANY PARTICULAR FONT, STYLE, SIZE, OR COLOR.

OWNER OF U.S. REG. NOS. 1,590,137 AND 2,057,595.

NO CLAIM IS MADE TO THE EXCLUSIVE RIGHT TO USE "PLANNER", APART FROM THE MARK AS SHOWN.

SEC. 2(F).

SER. NO. 77-344,887, FILED S.R. 12-5-2007 AM. P.R. 12-21-2007.

EUGENIA MARTIN, EXAMINING ATTORNEY

Int. Cl.: 37

Prior U.S. Cls.: 100, 103 and 106

United States Patent and Trademark Office

Reg. No. 3,504,196

Registered Sep. 23, 2008

SERVICE MARK  
PRINCIPAL REGISTER



AIZEN FIRE PROTECTION, INC. (CALIFORNIA CORPORATION)  
SUITE 463  
4924 BALBOA BLVD.  
ENCINO, CA 91316

FOR: INSTALLATION, MAINTENANCE AND REPAIR OF FIRE PROTECTION SYSTEMS, FIRE ALARMS, FIRE SPRINKLERS, FOAM-WATER FIRE SPRINKLERS, WATER MIST SYSTEMS, AND FIRE DETECTION EQUIPMENT FOR RESIDENTIAL, COMMERCIAL AND INDUSTRIAL CUSTOMERS, IN CLASS 37 (U.S. CLS. 100, 103 AND 106).

FIRST USE 7-24-2006; IN COMMERCE 7-24-2006.

NO CLAIM IS MADE TO THE EXCLUSIVE RIGHT TO USE "FIRE PROTECTION, INC.", APART FROM THE MARK AS SHOWN.

THE COLOR(S) RED, WHITE AND BLUE IS/ARE CLAIMED AS A FEATURE OF THE MARK.

THE MARK CONSISTS OF THE TERM "AIZEN" WRITTEN IN RED LETTERS ABOVE THE TERM "FIRE PROTECTION" WRITTEN IN RED LETTERS.

THE TERM "INC." APPEARS NEXT TO THE WORD "PROTECTION" WRITTEN IN RED LETTERS. THE WORDING "THE EXPERTS IN FIRE PROTECTION" APPEAR IN QUOTES UNDERNEATH THE WORDING "FIRE PROTECTION, INC.", WITH THE LETTERS AND THE QUOTES APPEARING IN BLUE. A DRAWING OF A FIRE EXTINGUISHER WITH TWO AXES CROSSED IN THE BACK OF THE FIRE EXTINGUISHER APPEAR IN THE UPPER RIGHT CORNER OF THE MARK. THE FIRE EXTINGUISHER APPEARS IN THE COLOR BLUE, EXCEPT FOR THE WHITE OUTLINE OF A SQUARE IN THE MIDDLE OF THE FIRE EXTINGUISHER AND SOME WHITE STREAKS AND LINES ON THE TOP ON THE CONTROL LEADING DOWN ALL THE WAY TO THE END OF THE HOSE. THE AX BLADES APPEAR IN BLUE EXCEPT FOR A WHITE LINE ALMOST AT THE TIP OF THE BLADES. THE BACK OF THE AX BLADES APPEAR IN WHITE, AS DO THE AX HANDLES, EXCEPT THAT THE BACK OF THE AX BLADES AND THE AX HANDLE OUTLINES APPEAR IN BLUE.

SER. NO. 77-345,118, FILED 12-5-2007.

MICHAEL WIENER, EXAMINING ATTORNEY

**Int. Cl.: 41**

**Prior U.S. Cls.: 100, 101 and 107**

**United States Patent and Trademark Office**

**Reg. No. 3,504,197**

**Registered Sep. 23, 2008**

**SERVICE MARK  
PRINCIPAL REGISTER**

**Whippersnappers Studio**

FOCUS POCUS, INC. (OREGON CORPORATION)  
SUITE 201  
1458 N.W. COLLEGE WAY  
BEND, OR 97701

FOR: PHOTOGRAPHY; PHOTOGRAPHY SERVICES; PORTRAIT PHOTOGRAPHY; PROVIDING FACILITIES FOR PRODUCING VIDEO, CINEMA AND PHOTOGRAPHY PRODUCTIONS, IN CLASS 41 (U.S. CLS. 100, 101 AND 107).

FIRST USE 11-26-2007; IN COMMERCE 11-26-2007.

THE MARK CONSISTS OF STANDARD CHARACTERS WITHOUT CLAIM TO ANY PARTICULAR FONT, STYLE, SIZE, OR COLOR.

NO CLAIM IS MADE TO THE EXCLUSIVE RIGHT TO USE "STUDIO", APART FROM THE MARK AS SHOWN.

SER. NO. 77-345,359, FILED 12-6-2007.

ELLEN B. AWRICH, EXAMINING ATTORNEY



**Int. Cl.: 36**

**Prior U.S. Cls.: 100, 101 and 102**

**United States Patent and Trademark Office**

**Reg. No. 3,504,198**

**Registered Sep. 23, 2008**

**SERVICE MARK  
PRINCIPAL REGISTER**



MUTUALS ADVISORS, INC. (TEXAS CORPORATION)  
SUITE 900  
PLAZA OF THE AMERICAS, 700 N. PEARL ST.  
DALLAS, TX 75201

FOR: MUTUAL FUND INVESTMENT SERVICES;  
INVESTMENT MANAGEMENT SERVICES; AND  
FINANCIAL SERVICES, NAMELY, MANAGEMENT  
OF PRIVATE EQUITY FUNDS AND MUTUAL  
FUNDS, IN CLASS 36 (U.S. CLS. 100, 101 AND 102).

FIRST USE 8-1-2007; IN COMMERCE 8-1-2007.

NO CLAIM IS MADE TO THE EXCLUSIVE  
RIGHT TO USE "USA MUTUALS", APART FROM  
THE MARK AS SHOWN.

THE COLOR(S) RED AND BLACK IS/ARE  
CLAIMED AS A FEATURE OF THE MARK.

THE MARK CONSISTS OF A STYLIZED HEAD  
AND EXTENDED WING OF AN EAGLE IN RED, IN  
WHICH THE WORDS "USA MUTUALS" APPEARS  
BENEATH THE EXTENDED WING IN BLACK.

SER. NO. 77-345,625, FILED 12-6-2007.

JAMES LOVELACE, EXAMINING ATTORNEY

**Int. Cl.: 41**

**Prior U.S. Cls.: 100, 101 and 107**

**United States Patent and Trademark Office**

**Reg. No. 3,504,199**

**Registered Sep. 23, 2008**

**SERVICE MARK  
PRINCIPAL REGISTER**

**Preserving the Past,  
Creating the Future**

LONE SPRING ARTS, LLC (TEXAS LIMITED  
LIABILITY COMPANY)  
6033 DELOACHE AVENUE  
DALLAS, TX 75225

THE MARK CONSISTS OF STANDARD CHAR-  
ACTERS WITHOUT CLAIM TO ANY PARTICULAR  
FONT, STYLE, SIZE, OR COLOR.

FOR: MUSIC AND VIDEO RECORDING AND  
PRODUCTION SERVICES, IN CLASS 41 (U.S. CLS.  
100, 101 AND 107).

SER. NO. 77-345,965, FILED 12-6-2007.

FIRST USE 12-3-2007; IN COMMERCE 12-3-2007.

ANGELA M. MICHELI, EXAMINING ATTORNEY

**Int. Cl.: 21**

**Prior U.S. Cls.: 2, 13, 23, 29, 30, 33, 40 and 50**

**Reg. No. 3,504,200**

**United States Patent and Trademark Office**

**Registered Sep. 23, 2008**

---

**TRADEMARK  
PRINCIPAL REGISTER**

**LIVING ELEMENT**

AUI (DELAWARE CORPORATION)  
150 STATE HWY, 160, SUITE 8-354  
PAHRUMP, NV 890482133

FOR: CERAMIC SCULPTURES, VASES, VESSELS,  
BOWLS, PLATES AND POTS, IN CLASS 21 (U.S. CLS.  
2, 13, 23, 29, 30, 33, 40 AND 50).

FIRST USE 10-10-1996; IN COMMERCE 10-10-1996.

THE MARK CONSISTS OF STANDARD CHAR-  
ACTERS WITHOUT CLAIM TO ANY PARTICULAR  
FONT, STYLE, SIZE, OR COLOR.

SER. NO. 77-346,088, FILED 12-6-2007.

DOMINIC J. FERRAIUOLO, EXAMINING ATTOR-  
NEY

**Int. Cl.: 3**

**Prior U.S. Cls.: 1, 4, 6, 50, 51 and 52**

**Reg. No. 3,504,201**

**United States Patent and Trademark Office**

**Registered Sep. 23, 2008**

**TRADEMARK  
PRINCIPAL REGISTER**

**NAIL ENVY**

OPI PRODUCTS, INC. (CALIFORNIA CORPORATION)  
13034 SATICOY STREET  
NORTH HOLLYWOOD, CA 91605

FOR: NAIL CARE PREPARATIONS, NAMELY, NAIL STRENGTHENERS, NAIL TREATMENTS AND NAIL HARDENERS, IN CLASS 3 (U.S. CLS. 1, 4, 6, 50, 51 AND 52).

FIRST USE 8-0-1995; IN COMMERCE 8-0-1995.

THE MARK CONSISTS OF STANDARD CHARACTERS WITHOUT CLAIM TO ANY PARTICULAR FONT, STYLE, SIZE, OR COLOR.

NO CLAIM IS MADE TO THE EXCLUSIVE RIGHT TO USE "NAIL", APART FROM THE MARK AS SHOWN.

SER. NO. 77-346,226, FILED 12-6-2007.

ANGELA GAW, EXAMINING ATTORNEY

**Int. Cl.: 7**

**Prior U.S. Cls.: 13, 19, 21, 23, 31, 34 and 35**

**Reg. No. 3,504,202**

**United States Patent and Trademark Office**

**Registered Sep. 23, 2008**

---

**TRADEMARK  
PRINCIPAL REGISTER**

**MPE**

MODERN PROCESS EQUIPMENT, INC. (ILLINOIS CORPORATION)  
3125 S. KOLIN AVE.  
CHICAGO, IL 60623

FOR: GRINDING MACHINES FOR INDUSTRIAL AND COMMERCIAL USE; AND MACHINES AND PARTS THEREFOR FOR USE IN PROCESSING FOODS, CHEMICALS AND MINERALS, NAMELY, LOADING MACHINES, TOTE BINS, PARTICLE SEPARATORS AND DENSIFIERS, IN CLASS 7 (U.S. CLS. 13, 19, 21, 23, 31, 34 AND 35).

FIRST USE 5-5-1995; IN COMMERCE 5-5-1995.

THE MARK CONSISTS OF STANDARD CHARACTERS WITHOUT CLAIM TO ANY PARTICULAR FONT, STYLE, SIZE, OR COLOR.

OWNER OF U.S. REG. NO. 1,995,949.

SER. NO. 77-346,389, FILED 12-7-2007.

INGRID C. EULIN, EXAMINING ATTORNEY

**Int. Cls.: 37, 42 and 45**

**Prior U.S. Cls.: 100, 101, 103 and 106**

**United States Patent and Trademark Office**

**Reg. No. 3,504,203**

**Registered Sep. 23, 2008**

**SERVICE MARK  
PRINCIPAL REGISTER**

# EAGLE FIRE

EAGLE FIRE INC. (VIRGINIA CORPORATION)  
7459 WHITE PINE ROAD  
RICHMOND, VA 23237

FOR: INSTALLATION, MAINTENANCE AND REPAIR OF FIRE PROTECTION SYSTEMS, SECURITY SYSTEMS AND ALARM SYSTEMS, IN CLASS 37 (U.S. CLS. 100, 103 AND 106).

FIRST USE 12-15-1991; IN COMMERCE 12-15-1991.

FOR: INSPECTION OF FIRE PROTECTION SYSTEMS AND ALARM SYSTEMS; DESIGN OF FIRE PROTECTION SYSTEMS, SECURITY SYSTEMS AND ALARM SYSTEMS, IN CLASS 42 (U.S. CLS. 100 AND 101).

FIRST USE 12-15-1991; IN COMMERCE 12-15-1991.

FOR: SECURITY INSPECTION SERVICES FOR OTHERS, IN CLASS 45 (U.S. CLS. 100 AND 101).

FIRST USE 12-15-1991; IN COMMERCE 12-15-1991.

THE MARK CONSISTS OF STANDARD CHARACTERS WITHOUT CLAIM TO ANY PARTICULAR FONT, STYLE, SIZE, OR COLOR.

OWNER OF U.S. REG. NOS. 2,566,489 AND 3,135,820.

NO CLAIM IS MADE TO THE EXCLUSIVE RIGHT TO USE "FIRE", APART FROM THE MARK AS SHOWN.

SER. NO. 77-346,666, FILED 12-7-2007.

DAVID ELTON, EXAMINING ATTORNEY

**Int. Cl.: 1**

**Prior U.S. Cls.: 1, 5, 6, 10, 26 and 46**

**United States Patent and Trademark Office**

**Reg. No. 3,504,204**

**Registered Sep. 23, 2008**

**TRADEMARK  
PRINCIPAL REGISTER**

**POP FOAM**

SUMMIT XTREME DESIGN, LLC (WASHINGTON LIMITED LIABILITY COMPANY)  
141 SUNDOWN DRIVE  
WOODLAND, WA 98674

FOR: POLYMER COMPOSITIONS USED IN THE MANUFACTURE OF COMMERCIAL, INDUSTRIAL AND DOMESTIC GOODS, IN CLASS 1 (U.S. CLS. 1, 5, 6, 10, 26 AND 46).

FIRST USE 4-15-2003; IN COMMERCE 4-15-2003.

THE MARK CONSISTS OF STANDARD CHARACTERS WITHOUT CLAIM TO ANY PARTICULAR FONT, STYLE, SIZE, OR COLOR.

NO CLAIM IS MADE TO THE EXCLUSIVE RIGHT TO USE "FOAM", APART FROM THE MARK AS SHOWN.

THE WORDING "POP FOAM" HAS NO MEANING IN A FOREIGN LANGUAGE.

SER. NO. 77-346,668, FILED 12-7-2007.

DAVID TAYLOR, EXAMINING ATTORNEY

**Int. Cl.: 35**

**Prior U.S. Cls.: 100, 101 and 102**

**United States Patent and Trademark Office**

**Reg. No. 3,504,205**

**Registered Sep. 23, 2008**

**SERVICE MARK  
PRINCIPAL REGISTER**

**CAMO COALITION**

GEORGIA WILDLIFE FEDERATION, INC.  
(GEORGIA CORPORATION)  
11600 HAZELBRAND ROAD  
COVINGTON, GA 30014

FOR: LOBBYING, NAMELY, PROMOTING THE INTERESTS OF HUNTERS AND ANGLERS IN THE FIELDS OF LEGISLATION AND REGULATION; BUSINESS CONSULTATION SERVICES, IN CLASS 35 (U.S. CLS. 100, 101 AND 102).

FIRST USE 1-1-1999; IN COMMERCE 1-1-1999.

THE MARK CONSISTS OF STANDARD CHARACTERS WITHOUT CLAIM TO ANY PARTICULAR FONT, STYLE, SIZE, OR COLOR.

NO CLAIM IS MADE TO THE EXCLUSIVE RIGHT TO USE "COALITION", APART FROM THE MARK AS SHOWN.

SER. NO. 77-346,850, FILED 12-7-2007.

ARETHA SOMERVILLE, EXAMINING ATTORNEY



**Int. Cl.: 16**

**Prior U.S. Cls.: 2, 5, 22, 23, 29, 37, 38 and 50**

**United States Patent and Trademark Office**

**Reg. No. 3,504,206**

**Registered Sep. 23, 2008**

**TRADEMARK  
PRINCIPAL REGISTER**

# OWNING UP

RPW, INC. (D.C. CORPORATION)  
2039 PARK ROAD, N.W.  
WASHINGTON, DC, DC 20010

FOR: PRINTED INSTRUCTIONAL MATERIALS,  
NAMELY, BOOKS, NEWSLETTERS AND MAN-  
UALS FEATURING GENDER BASED VIOLENCE  
PREVENTION, IN CLASS 16 (U.S. CLS. 2, 5, 22, 23, 29,  
37, 38 AND 50).

FIRST USE 6-0-1995; IN COMMERCE 6-0-1995.

THE MARK CONSISTS OF STANDARD CHAR-  
ACTERS WITHOUT CLAIM TO ANY PARTICULAR  
FONT, STYLE, SIZE, OR COLOR.

SER. NO. 77-347,004, FILED 12-7-2007.

MICHELE SWAIN, EXAMINING ATTORNEY

**Int. Cl.: 16**

**Prior U.S. Cls.: 2, 5, 22, 23, 29, 37, 38 and 50**

**United States Patent and Trademark Office**

**Reg. No. 3,504,207**

**Registered Sep. 23, 2008**

**TRADEMARK  
PRINCIPAL REGISTER**

**BIO-PIX PRESENTS POPSTAR!**

LEISURE PUBLISHINGS, LLC (FLORIDA CORPORATION)  
7598 W. SAND LAKE ROAD  
ORLANDO, FL 32819

FOR: MAGAZINES FEATURING CELEBRITIES AND ENTERTAINMENT, IN CLASS 16 (U.S. CLS. 2, 5, 22, 23, 29, 37, 38 AND 50).

FIRST USE 2-1-2002; IN COMMERCE 2-1-2002.

THE MARK CONSISTS OF STANDARD CHARACTERS WITHOUT CLAIM TO ANY PARTICULAR FONT, STYLE, SIZE, OR COLOR.

NO CLAIM IS MADE TO THE EXCLUSIVE RIGHT TO USE "POPSTAR", APART FROM THE MARK AS SHOWN.

SER. NO. 77-348,274, FILED 12-10-2007.

ALLISON HOLTZ, EXAMINING ATTORNEY

**Int. Cls.: 35, 36, 42 and 45**

**Prior U.S. Cls.: 100, 101 and 102**

**United States Patent and Trademark Office**

**Reg. No. 3,504,208**

**Registered Sep. 23, 2008**

**SERVICE MARK  
PRINCIPAL REGISTER**



UTEK CORPORATION (DELAWARE CORPORATION)  
2109 PALM AVENUE  
TAMPA, FL 33605

FOR: BUSINESS INFORMATION SERVICES, NAMELY, PROVIDING INFORMATION REGARDING BUSINESS THROUGH ON-LINE COMPUTER DATABASES IN THE FIELDS OF TECHNOLOGY TRANSFER, NEW BUSINESS DEVELOPMENT, TECHNOLOGY COMMERCIALIZATION, LICENSING, ACQUISITIONS, PARTNERSHIP FUNDING OPPORTUNITIES, ONGOING RESEARCH, EMERGING TECHNOLOGIES, PRODUCT PIPELINES AND BUSINESS DIRECTORIES; PROVIDING AN ON-LINE SEARCHABLE COMPUTER DATABASE FEATURING INFORMATION REGARDING NEW BUSINESS DEVELOPMENT, MARKETING, COMMERCIALIZATION, BUSINESS ACQUISITIONS, PARTNERSHIP FUNDING OPPORTUNITIES FOR BUSINESSES, BUSINESS RESEARCH, PRODUCT PIPELINES, AND BUSINESS DIRECTORIES, IN CLASS 35 (U.S. CLS. 100, 101 AND 102).

FIRST USE 12-31-1994; IN COMMERCE 12-31-1994.

FOR: PROVIDING AN ON-LINE SEARCHABLE COMPUTER DATABASE FEATURING INFORMATION REGARDING MONETARY OR REAL ES-

TATE ACQUISITIONS, VENTURE CAPITAL FUNDING, AND FINANCIAL RESEARCH, IN CLASS 36 (U.S. CLS. 100, 101 AND 102).

FIRST USE 12-31-1994; IN COMMERCE 12-31-1994.

FOR: PROVIDING AN ON-LINE SEARCHABLE COMPUTER DATABASE FEATURING INFORMATION REGARDING TECHNOLOGY TRANSFER, TECHNOLOGICAL RESEARCH AND DEVELOPMENT, AND EMERGING TECHNOLOGIES, IN CLASS 42 (U.S. CLS. 100 AND 101).

FIRST USE 12-31-1994; IN COMMERCE 12-31-1994.

FOR: PROVIDING AN ON-LINE SEARCHABLE COMPUTER DATABASE FEATURING INFORMATION REGARDING LICENSING, IN CLASS 45 (U.S. CLS. 100 AND 101).

FIRST USE 12-31-1994; IN COMMERCE 12-31-1994.

THE MARK CONSISTS OF THE LETTERS "K" AND "E" IN A BOX.

SER. NO. 77-349,260, FILED 12-11-2007.

KAELIE KUNG, EXAMINING ATTORNEY

**Int. Cl.: 5**

**Prior U.S. Cls.: 6, 18, 44, 46, 51 and 52**

**United States Patent and Trademark Office**

**Reg. No. 3,504,209**

**Registered Sep. 23, 2008**

**TRADEMARK  
PRINCIPAL REGISTER**

**AMRUVEN**

DAINIPPON SUMITOMO PHARMA CO., LTD.  
(JAPAN CORPORATION)  
6-8, DOSHO-MACHI 2-CHOME  
CHUO-KU, OSAKA-SHI  
OSAKA, JAPAN 541-8524

FOR: PHARMACEUTICAL PREPARATIONS,  
NAMELY, ANTICANCER PREPARATIONS, ANTIC-  
ANCER ANTIBIOTICS, AND PHARMACEUTICAL  
PREPARATIONS FOR THE TREATMENT OF CAN-  
CER, IN CLASS 5 (U.S. CLS. 6, 18, 44, 46, 51 AND 52).

THE MARK CONSISTS OF STANDARD CHAR-  
ACTERS WITHOUT CLAIM TO ANY PARTICULAR  
FONT, STYLE, SIZE, OR COLOR.

PRIORITY CLAIMED UNDER SEC. 44(D) ON  
JAPAN APPLICATION NO. 2007-113282, FILED 11-7-  
2007, REG. NO. 5128087, DATED 4-11-2008, EXPIRES  
4-11-2018.

SER. NO. 77-349,358, FILED 12-11-2007.

THEODORE MCBRIDE, EXAMINING ATTORNEY

**Int. Cls.: 11, 17 and 21**

**Prior U.S. Cls.: 1, 2, 5, 12, 13, 21, 23, 29, 30, 31, 33, 34,  
35, 40 and 50**

**Reg. No. 3,504,210**

**United States Patent and Trademark Office**

**Registered Sep. 23, 2008**

**TRADEMARK  
PRINCIPAL REGISTER**

**marblo**

MARBLO (HOLDINGS) PTY LIMITED (AUSTRALIA CORPORATION)  
UNIT 5, 13 BOUNDARY ROAD  
NORTHMEAD, AUSTRALIA 2152

FOR: APPARATUS FOR WATER SUPPLY AND SANITARY PURPOSES, NAMELY, KITCHEN SINKS OF STAINLESS STEEL, ENAMEL, PLASTIC MATERIAL, NATURAL STONE, ARTIFICIAL STONE AND CERAMIC, THE AFOREMENTIONED GOODS ALSO USED IN PREPARATION MODULES AND KITCHENETTES; LAVATORY BOWLS; WASHING SINKS, WASHING SINKS IN THE SHAPE OF A TROUGH; BIDETS, SHOWER PLATFORMS, COMPLETE SHOWER CUBICLES, URINALS AS SANITARY FIXTURES, URINALS IN THE NATURE OF GULLEYS, URINALS IN THE NATURE OF STANDS, TOILETS, TOILET BOWLS, TOILET SEATS, ALL BEING PARTS OF SANITARY FACILITIES, IN CLASS 11 (U.S. CLS. 13, 21, 23, 31 AND 34).

FOR: PLASTIC LAMINATED SHEETING USED IN THE MANUFACTURE OF COUNTERTOPS, TA-

BLE TOPS, DESKS, VANITY TOPS, WALL CLADDING, COUNTER FRONTS, JOINERY CLADDING AND OTHER ARCHITECTURAL AND DECORATIVE SURFACES, IN CLASS 17 (U.S. CLS. 1, 5, 12, 13, 35 AND 50).

FOR: WASH BASINS; BOWLS AND RECEPTACLES, NAMELY, BASINS, IN CLASS 21 (U.S. CLS. 2, 13, 23, 29, 30, 33, 40 AND 50).

OWNER OF AUSTRALIA REG. NO. 1082660, DATED 10-26-2005, EXPIRES 10-26-2015.

OWNER OF AUSTRALIA REG. NO. 1082694, DATED 10-26-2005, EXPIRES 10-26-2015.

THE MARK CONSISTS OF (5) WORDS, LETTERS, AND/OR NUMBERS IN STYLIZED FORM.

SER. NO. 77-349,680, FILED 12-12-2007.

ARETHA SOMERVILLE, EXAMINING ATTORNEY

**Int. Cl.: 41**

**Prior U.S. Cls.: 100, 101 and 107**

**United States Patent and Trademark Office**

**Reg. No. 3,504,211**

**Registered Sep. 23, 2008**

**SERVICE MARK  
PRINCIPAL REGISTER**



GRABARITS, MICHAEL J. (UNITED STATES  
INDIVIDUAL)  
3207 BRYNWOOD DRIVE  
WHITEHALL, PA 18052

FOR: EDUCATION SERVICES, NAMELY, PRO-  
VIDING CLASSES AND SEMINARS FEATURING  
BEST PRACTICES IN THE FIELD OF READING,  
LITERACY AND LEARNING, IN CLASS 41 (U.S.  
CLS. 100, 101 AND 107).

FIRST USE 10-26-2006; IN COMMERCE 10-26-2006.

NO CLAIM IS MADE TO THE EXCLUSIVE  
RIGHT TO USE "THE INSTITUTE FOR LITERACY  
AND LEARNING", APART FROM THE MARK AS  
SHOWN.

THE COLOR(S) BLUE, BLACK, GREEN AND  
GREY IS/ARE CLAIMED AS A FEATURE OF THE  
MARK.

THE MARK CONSISTS OF STYLISTIC WORDS-  
BLACK "THE INSTITUTE FOR", BLUE "LITERA-  
CY", GRAY, "AND" GREEN "LEARNING". AN  
ADULT AND CHILD LOOKING FIGURE CONSIST-  
ING OF TWO CRESENTS AND TWO CIRCLES- THE  
ADULT IS BLUE AND CHILD IS GREEN.

SER. NO. 77-350,170, FILED 12-12-2007.

DANIEL CAPSHAW, EXAMINING ATTORNEY

**Int. Cl.: 31**

**Prior U.S. Cls.: 1 and 46**

**United States Patent and Trademark Office**

**Reg. No. 3,504,212**

**Registered Sep. 23, 2008**

**TRADEMARK  
PRINCIPAL REGISTER**



NORTH COUNTY FRUIT SALES, INC. (CALI-  
FORNIA CORPORATION)  
P.O. BOX 1540  
TEMECULA, CA 925931540

OWNER OF U.S. REG. NO. 2,097,043.

FOR: FRESH FRUITS AND VEGETABLES, IN  
CLASS 31 (U.S. CLS. 1 AND 46).

SER. NO. 77-350,669, FILED 12-12-2007.

FIRST USE 1-1-2001; IN COMMERCE 1-1-2001.

SUZANNE BLANE, EXAMINING ATTORNEY

**Int. Cl.: 33**

**Prior U.S. Cls.: 47 and 49**

**United States Patent and Trademark Office**

**Reg. No. 3,504,213**

**Registered Sep. 23, 2008**

**TRADEMARK  
PRINCIPAL REGISTER**

**LES ROSBIFS**

GUY ANDERSON WINES LTD. (GREAT BRIT-  
AIN COMPANY)  
LEFT BANK  
28 JAMES STREET  
SOUTH PETHERTON, ENGLAND TA135BW

FOR: WINES, IN CLASS 33 (U.S. CLS. 47 AND 49).

THE MARK CONSISTS OF STANDARD CHAR-  
ACTERS WITHOUT CLAIM TO ANY PARTICULAR  
FONT, STYLE, SIZE, OR COLOR.

PRIORITY CLAIMED UNDER SEC. 44(D) ON  
UNITED KINGDOM APPLICATION NO. 2474650,  
FILED 12-11-2007, REG. NO. 2474650, DATED 5-9-  
2008, EXPIRES 5-9-2018.

THE MARK "LES ROSBIFS" CAN BE TRANSLA-  
TED FROM THE FRENCH TO "THE ROAST  
BEEFS".

SER. NO. 77-350,813, FILED 12-13-2007.

CYNTHIA SLOAN, EXAMINING ATTORNEY



**Int. Cl.: 18**

**Prior U.S. Cls.: 1, 2, 3, 22 and 41**

**United States Patent and Trademark Office**

**Reg. No. 3,504,214**

**Registered Sep. 23, 2008**

**TRADEMARK  
PRINCIPAL REGISTER**

**Onya**

SIT-N-SLING, LLC (NORTH CAROLINA LIMITED LIABILITY COMPANY)  
1140 STONEDOWN LANE  
MATTHEWS, NC 28104

THE MARK CONSISTS OF STANDARD CHARACTERS WITHOUT CLAIM TO ANY PARTICULAR FONT, STYLE, SIZE, OR COLOR.

FOR: BABY CARRIERS WORN ON THE BODY,  
IN CLASS 18 (U.S. CLS. 1, 2, 3, 22 AND 41).

SER. NO. 77-350,850, FILED 12-13-2007.

FIRST USE 8-1-2007; IN COMMERCE 9-29-2007.

BRIAN PINO, EXAMINING ATTORNEY

**Int. Cl.: 41**

**Prior U.S. Cls.: 100, 101 and 107**

**United States Patent and Trademark Office**

**Reg. No. 3,504,215**

**Registered Sep. 23, 2008**

**SERVICE MARK  
PRINCIPAL REGISTER**

# Face Reading Secrets

ROSETREE, ROSE (UNITED STATES INDIVIDUAL)  
116 HILLSDALE DR  
STERLING, VA 20164

FOR: EDUCATION SERVICES, NAMELY, PROVIDING LIVE AND ON-LINE CLASSES, SEMINARS, WORKSHOPS IN THE FIELD OF FACE READING, IN CLASS 41 (U.S. CLS. 100, 101 AND 107).

FIRST USE 11-1-1998; IN COMMERCE 11-1-1998.

THE MARK CONSISTS OF STANDARD CHARACTERS WITHOUT CLAIM TO ANY PARTICULAR FONT, STYLE, SIZE, OR COLOR.

NO CLAIM IS MADE TO THE EXCLUSIVE RIGHT TO USE "FACE READING", APART FROM THE MARK AS SHOWN.

SER. NO. 77-351,203, FILED 12-13-2007.

MICHAEL GAAFAR, EXAMINING ATTORNEY

**Int. Cl.: 41**

**Prior U.S. Cls.: 100, 101 and 107**

**United States Patent and Trademark Office**

**Reg. No. 3,504,216**

**Registered Sep. 23, 2008**

**SERVICE MARK  
PRINCIPAL REGISTER**

# Ahn Trio

LAMP LLC (NEW YORK LIMITED LIABILITY  
COMPANY)  
188 EAST 64TH STREET, #2401  
NEW YORK, NY 10065

FOR: ENTERTAINMENT, NAMELY, LIVE PER-  
FORMANCES BY A MUSICAL BAND; MULTIME-  
DIA ENTERTAINMENT SERVICES IN THE  
NATURE OF RECORDING, PRODUCTION AND  
POST-PRODUCTION SERVICES IN THE FIELDS OF  
MUSIC, VIDEO, AND FILMS, IN CLASS 41 (U.S. CLS.  
100, 101 AND 107).

FIRST USE 4-1-1994; IN COMMERCE 4-1-1994.

THE MARK CONSISTS OF STANDARD CHAR-  
ACTERS WITHOUT CLAIM TO ANY PARTICULAR  
FONT, STYLE, SIZE, OR COLOR.

NO CLAIM IS MADE TO THE EXCLUSIVE  
RIGHT TO USE "TRIO", APART FROM THE MARK  
AS SHOWN.

SER. NO. 77-351,565, FILED 12-13-2007.

DAWN HAN, EXAMINING ATTORNEY

Int. Cl.: 35

Prior U.S. Cls.: 100, 101 and 102

United States Patent and Trademark Office

Reg. No. 3,504,217

Registered Sep. 23, 2008

SERVICE MARK  
PRINCIPAL REGISTER



THE FRENCH HEN, INC. (CALIFORNIA CORPORATION)  
3200 B FOLSOM BLVD.  
SACRAMENTO, CA 95816

FOR: RETAIL STORE SERVICES FEATURING GLASSWARE, SILVERWARE, PLACE SETTINGS, TABLE LINENS, COOK BOOKS, CENTERPIECES, CANDLES, SPECIALTY FOOD ITEMS, WALL DECORATIONS AND HOLIDAY DECORATIONS, IN CLASS 35 (U.S. CLS. 100, 101 AND 102).

FIRST USE 1-7-2007; IN COMMERCE 1-7-2007.

NO CLAIM IS MADE TO THE EXCLUSIVE RIGHT TO USE "GOURMET" AND "MAISON FONDEE EN 2007", APART FROM THE MARK AS SHOWN.

THE COLOR(S) LIGHT BLUE, DARK BLUE, ORANGE AND WHITE IS/ARE CLAIMED AS A FEATURE OF THE MARK.

THE MARK CONSISTS OF THE WORD "FETE" WITH AN ACCENT OVER THE FIRST "E", ABOVE THE WORDING "GOURMET" AND "CELEBRATE,"

WHICH IS ALSO ABOVE THE WORDING "CELEBRATE MAISON FONDEE EN 2007," WITH AN ACCENT OVER THE FIRST "E" IN "FONDEE." ALL OF THE WORDING IS SURROUNDED BY AN ORNAMENTAL BORDER WITH THE IMAGE OF A FLEUR DE LIS IN THE CENTER SEPARATING THE WORDS "GOURMET" AND "CELEBRATE." THE COLOR LIGHT BLUE APPEARS IN THE INNER BORDER, THE FLEUR DE LIS AND THE SHADING ON THE WORD "FETE". THE COLOR DARK BLUE APPEARS IN THE OUTER BORDER, THE WORDS "FETE," "GOURMET" AND "CELEBRATE." THE COLOR WHITE APPEARS IN THE BACKGROUND AND THE COLOR ORANGE APPEARS IN THE WORDING "MAISON FONDEE EN 2007".

THE ENGLISH TRANSLATION OF THE WORD "FETE" IS FESTIVAL AND THE ENGLISH TRANSLATION OF THE PHRASE "MAISON FONDEE EN 2007" IS HOUSE FOUNDED IN 2007.

SER. NO. 77-351,733, FILED 12-13-2007.

WENDY GOODMAN, EXAMINING ATTORNEY

**Int. Cl.: 41**

**Prior U.S. Cls.: 100, 101 and 107**

**United States Patent and Trademark Office**

**Reg. No. 3,504,218**

**Registered Sep. 23, 2008**

**SERVICE MARK  
PRINCIPAL REGISTER**

# EarthGame

BIG PICTURE, SMALL WORLD, INC. (PENNSYLVANIA CORPORATION)  
281 BISHOP HOLLOW RD  
MEDIA, PA 19063

FOR: EDUCATION SERVICES, NAMELY, LIVE AND ON-LINE PRESENTATIONS, SEMINARS, CLASSES AND MULTI-MEDIA PRESENTATIONS IN THE FIELD OF GLOBAL RESOURCE USE, POLITICAL SCIENCE, SUSTAINABLE DEVELOPMENT, ENVIRONMENTAL SCIENCE, STRATEGIC PLANNING AND POLICY ANALYSIS; PRODUCTION OF EDUCATIONAL VIDEOS IN THE FIELD OF GLOBAL RESOURCE USE, POLITICAL SCIENCE, SUSTAINABLE DEVELOPMENT, ENVIRONMENTAL SCIENCE, STRATEGIC PLANNING AND POLICY ANALYSIS; EDUCATIONAL SERVICES, NAMELY, ONLINE COMPUTER GAMES AND MULTI-PLAYER ONLINE COMPUTER SIMULATION GAMES FEATURING QUALITY OF LIFE AND HUMAN DEVELOPMENT ISSUES, SUSTAIN-

ABLE DEVELOPMENT AND GLOBAL RESOURCE MANAGEMENT; EDUCATIONAL SERVICES, NAMELY, CLASSES AND SEMINARS IN THE FIELD OF STRATEGIC PLANNING AND POLICY ANALYSIS WITH REGARD TO SUSTAINABLE DEVELOPMENT AND ENVIRONMENTAL SCIENCE, GLOBAL RESOURCE USE AND HUMAN RESOURCE DISTRIBUTION AND PROBLEM SOLVING, IN CLASS 41 (U.S. CLS. 100, 101 AND 107).

FIRST USE 12-1-2005; IN COMMERCE 2-1-2007.

THE MARK CONSISTS OF STANDARD CHARACTERS WITHOUT CLAIM TO ANY PARTICULAR FONT, STYLE, SIZE, OR COLOR.

SER. NO. 77-352,113, FILED 12-14-2007.

APRIL ROACH, EXAMINING ATTORNEY

**Int. Cl.: 30**

**Prior U.S. Cl.: 46**

**United States Patent and Trademark Office**

**Reg. No. 3,504,219**

**Registered Sep. 23, 2008**

**TRADEMARK  
PRINCIPAL REGISTER**

**SINFUL SENSATION**

CEREAL CONNECTION INC (FLORIDA CORPORATION)  
5379 LYONS RD. #207  
COCONUT CREEK, FL 33073

THE MARK CONSISTS OF STANDARD CHARACTERS WITHOUT CLAIM TO ANY PARTICULAR FONT, STYLE, SIZE, OR COLOR.

FOR: BREAKFAST CEREALS, NOT MADE OF OR CONTAINING CANDY, AND SOLD ONLY IN RESTAURANTS, IN CLASS 30 (U.S. CL. 46).

SER. NO. 77-352,337, FILED 12-14-2007.

FIRST USE 10-0-2007; IN COMMERCE 11-0-2007.

EDWARD FENNESSY, EXAMINING ATTORNEY

Int. Cl.: 41

Prior U.S. Cls.: 100, 101 and 107

United States Patent and Trademark Office

Reg. No. 3,504,220

Registered Sep. 23, 2008

SERVICE MARK  
PRINCIPAL REGISTER



FATHER FLANAGAN'S BOYS' HOME (NEBRASKA CORPORATION)  
14100 CRAWFORD STREET  
BOYS TOWN, NE 68010

FOR: CONSULTATION IN THE FIELD OF EDUCATIONAL SYSTEMS AND PROGRAMS SERVING HEARING-IMPAIRED CHILDREN, IN CLASS 41 (U.S. CLS. 100, 101 AND 107).

FIRST USE 8-0-2007; IN COMMERCE 8-0-2007.

NO CLAIM IS MADE TO THE EXCLUSIVE RIGHT TO USE "AUDITORY CONSULTANT RESOURCE NETWORK", APART FROM THE MARK AS SHOWN.

THE MARK CONSISTS OF THE WORD "ACORN" IN LOWERCASE LETTERS WITH THE IMAGE OF AN ACORN IN PLACE OF THE LETTER "O".

SER. NO. 77-352,559, FILED 12-14-2007.

KAREN BRACEY, EXAMINING ATTORNEY

**Int. Cls.: 3 and 35**

**Prior U.S. Cls.: 1, 4, 6, 50, 51, 52, 100, 101 and 102**

**United States Patent and Trademark Office**

**Reg. No. 3,504,221**

**Registered Sep. 23, 2008**

**TRADEMARK  
SERVICE MARK  
PRINCIPAL REGISTER**



GLORY FOR ALL, INC. (CALIFORNIA CORPORATION)  
6240 ALVERTON DRIVE  
CARLSBAD, CA 92009

FOR: COSMETICS, NAMELY, FACIAL MAKEUP, CONCEALERS, BLUSHERS, FACIAL POWDERS, FOUNDATION MAKEUP, EYE MAKEUP, EYE PENCILS, EYEBROW PENCILS, MASCARA, COSMETIC PENCILS, LIPSTICKS, LIP GLOSS, LIP PENCILS, MAKEUP REMOVERS, EYE CREAMS, FACIAL CLEANSERS, FACIAL EXFOLIANTS AND SCRUBS, FACIAL MOISTURIZERS, FACIAL LOTIONS, NAIL CARE PREPARATION, NAIL POLISHES, NAIL POLISH REMOVERS, NAIL CREAMS, SKIN MOISTURIZERS AND SKIN CONDITIONERS, HAND CREAMS, MASSAGE OILS, ESSENTIAL OILS FOR PERSONAL USE; BATH GELS, BATH OILS, FACE WASH, SKIN CLEANSERS, BODY SCRUBS AND FRAGRANCES FOR PERSONAL USE, BODY AND HAND LOTIONS, BODY GELS, SHOWER GELS, DEODORANT AND ANTIPERSPIRANT FOR PERSONAL USE, PRE-MOISTENED COSMETIC WIPES, PRE-MOISTENED COSMETIC TISSUES AND TOWELETTES; NON-MEDICATED TOPICAL SKIN CREAMS, OINTMENTS, GELS, TONERS, LOTIONS AND SPRAYS FOR COSMETIC PURPOSES; HAIR CARE PRODUCTS, NAMELY, SHAMPOOS, CONDITIONERS, MOUSSE, GELS, FROSTS, RIN-

SES, SPRAYS, HAIR COLOR, HAIR LIGHTENERS, HAIR DYES, HAIR POMADES, HAIR COLOR REMOVERS, HAIR CARE PREPARATIONS, SUNSCREEN, NON-MEDICATED ACNE TREATMENT PREPARATIONS, IN CLASS 3 (U.S. CLS. 1, 4, 6, 50, 51 AND 52).

FIRST USE 2-1-2007; IN COMMERCE 2-1-2007.

FOR: RETAIL SHOP-AT-HOME PARTY SERVICES IN THE FIELD OF HEALTH, SKIN, HAIR AND BEAUTY CARE PRODUCTS; MAIL ORDER SERVICES FEATURING HEALTH, SKIN, HAIR AND BEAUTY CARE PRODUCTS; ON-LINE ORDERING SERVICES IN THE FIELD OF HEALTH, SKIN, HAIR AND BEAUTY CARE PRODUCTS; DISTRIBUTORSHIP SERVICES IN THE FIELD OF HEALTH, SKIN, HAIR AND BEAUTY CARE PRODUCTS, IN CLASS 35 (U.S. CLS. 100, 101 AND 102).

FIRST USE 2-1-2007; IN COMMERCE 2-1-2007.

THE MARK CONSISTS OF THE WORD "GLORY" INSIDE A STYLIZED IMAGE.

SER. NO. 77-353,158, FILED 12-15-2007.

TIMOTHY FINNEGAN, EXAMINING ATTORNEY



**Int. Cls.: 3 and 35**

**Prior U.S. Cls.: 1, 4, 6, 50, 51, 52, 100, 101 and 102**

**Reg. No. 3,504,222**

**United States Patent and Trademark Office**

**Registered Sep. 23, 2008**

**TRADEMARK  
SERVICE MARK  
PRINCIPAL REGISTER**

# GLORY

GLORY FOR ALL, INC. (CALIFORNIA CORPORATION)  
6240 ALVERTON DRIVE  
CARLSBAD, CA 92009

FOR: COSMETICS, NAMELY, FACIAL MAKEUP, CONCEALERS, BLUSHERS, FACIAL POWDERS, FOUNDATION MAKEUP, EYE MAKEUP, EYE PENCILS, EYEBROW PENCILS, MASCARA, COSMETIC PENCILS, LIPSTICKS, LIP GLOSS, LIP PENCILS, MAKEUP REMOVERS, EYE CREAMS, FACIAL CLEANSERS, FACIAL EXFOLIANTS AND SCRUBS, FACIAL MOISTURIZERS, FACIAL LOTIONS, NAIL CARE PREPARATION, NAIL POLISHES, NAIL POLISH REMOVERS, NAIL CREAMS, SKIN MOISTURIZERS AND SKIN CONDITIONERS, HAND CREAMS, MASSAGE OILS, ESSENTIAL OILS FOR PERSONAL USE; BATH GELS, BATH OILS, FACE WASH, SKIN CLEANSERS, BODY SCRUBS AND FRAGRANCES FOR PERSONAL USE, BODY AND HAND LOTIONS, BODY GELS, SHOWER GELS, DEODORANT AND ANTIPERSPIRANT FOR PERSONAL USE, PRE-MOISTENED COSMETIC WIPES, PRE-MOISTENED COSMETIC TISSUES AND TOWELETTES; NON-MEDICATED TOPICAL SKIN CREAMS, OINTMENTS, GELS, TONERS, LOTIONS AND SPRAYS FOR COSMETIC PURPOSES; HAIR CARE PRODUCTS, NAMELY, SHAMPOOS, CONDITIONERS, MOUSSE, GELS, FROSTS, RINSES, SPRAYS, HAIR COLOR, HAIR LIGHTENERS,

HAIR DYES, HAIR POMADES, HAIR COLOR REMOVERS, HAIR CARE PREPARATIONS, SUNSCREEN, NON-MEDICATED ACNE TREATMENT PREPARATIONS, IN CLASS 3 (U.S. CLS. 1, 4, 6, 50, 51 AND 52).

FIRST USE 2-1-2007; IN COMMERCE 2-1-2007.

FOR: RETAIL SHOP-AT-HOME PARTY SERVICES IN THE FIELD OF HEALTH, SKIN, HAIR AND BEAUTY CARE PRODUCTS; MAIL ORDER SERVICES FEATURING HEALTH, SKIN, HAIR AND BEAUTY CARE PRODUCTS; ON-LINE ORDERING SERVICES IN THE FIELD OF HEALTH, SKIN, HAIR AND BEAUTY CARE PRODUCTS; DISTRIBUTORSHIP SERVICES IN THE FIELD OF HEALTH, SKIN, HAIR AND BEAUTY CARE PRODUCTS, IN CLASS 35 (U.S. CLS. 100, 101 AND 102).

FIRST USE 2-1-2007; IN COMMERCE 2-1-2007.

THE MARK CONSISTS OF STANDARD CHARACTERS WITHOUT CLAIM TO ANY PARTICULAR FONT, STYLE, SIZE, OR COLOR.

SER. NO. 77-353,161, FILED 12-15-2007.

TIMOTHY FINNEGAN, EXAMINING ATTORNEY

**Int. Cl.: 19**

**Prior U.S. Cls.: 1, 12, 33 and 50**

**United States Patent and Trademark Office**

**Reg. No. 3,504,223**

**Registered Sep. 23, 2008**

**TRADEMARK  
PRINCIPAL REGISTER**



BIOLIME, LLC (OREGON LIMITED LIABILITY  
COMPANY)  
16869 SW 65TH AVE.  
LAKE OSWEGO, OR 97035

FOR: PLASTER, IN CLASS 19 (U.S. CLS. 1, 12, 33  
AND 50).

FIRST USE 12-14-2007; IN COMMERCE 12-14-2007.

THE COLOR(S) BROWN AND GREEN IS/ARE  
CLAIMED AS A FEATURE OF THE MARK.

THE MARK CONSISTS OF A TROWEL IN THE  
SHAPE OF A LEAF WITH THE WORDS BIOLIME  
UNDERNEATH. THE COLORS BROWN AND  
GREEN ARE CLAIMED AS A FEATURE OF THE  
MARK. THE COLOR BROWN APPEARS IN THE  
WORDING "BIOLIME" AND IN THE DESIGN ON  
THE HANDLE OF THE TROWEL. THE COLOR  
GREEN APPEARS IN THE DESIGN AS THE COLOR  
OF THE LEAF.

SER. NO. 77-353,650, FILED 12-17-2007.

ARETHA SOMERVILLE, EXAMINING ATTORNEY

**Int. Cl.: 11**

**Prior U.S. Cls.: 13, 21, 23, 31 and 34**

**United States Patent and Trademark Office**

**Reg. No. 3,504,224**

**Registered Sep. 23, 2008**

**TRADEMARK  
PRINCIPAL REGISTER**



ACCOR TECHNOLOGY, INC. (WASHINGTON CORPORATION)  
1400 112TH AVENUE SE  
BELLEVUE, WA 98004

FOR: PLUMBING FITTINGS AND PARTS, NAMELY, VALVES, COUPLERS, AND FLEXIBLE COUPLERS, IN CLASS 11 (U.S. CLS. 13, 21, 23, 31 AND 34).

FIRST USE 6-1-2007; IN COMMERCE 6-1-2007.

OWNER OF U.S. REG. NO. 2,763,285.

NO CLAIM IS MADE TO THE EXCLUSIVE RIGHT TO USE "SINCE 1988", APART FROM THE MARK AS SHOWN.

THE MARK CONSISTS OF A STYLIZED VERSION OF "PUSHON" SUPERIMPOSED ON A FAN-LIKE LOGO OVER THE WORDS "SINCE 1988".

SER. NO. 77-353,813, FILED 12-17-2007.

BERNICE MIDDLETON, EXAMINING ATTORNEY

**Int. Cl.: 42**

**Prior U.S. Cls.: 100 and 101**

**United States Patent and Trademark Office**

**Reg. No. 3,504,225**

**Registered Sep. 23, 2008**

**SERVICE MARK  
PRINCIPAL REGISTER**

**PRECISION VALLEY  
COMMUNICATIONS**

PRECISION VALLEY COMMUNICATIONS OF  
VERMONT, LLC (DELAWARE LIMITED LIA-  
BILITY COMPANY)  
333 RIVER STREET  
SPRINGFIELD, VT 05156

FOR: MAPPING; DRAFTING; DESIGN FOR OTH-  
ERS IN THE FIELD OF COMMUNICATIONS AND  
UTILITY SYSTEMS, IN CLASS 42 (U.S. CLS. 100 AND  
101).

FIRST USE 12-31-1988; IN COMMERCE 12-31-1988.

THE MARK CONSISTS OF STANDARD CHAR-  
ACTERS WITHOUT CLAIM TO ANY PARTICULAR  
FONT, STYLE, SIZE, OR COLOR.

SEC. 2(F).

SER. NO. 77-353,840, FILED 12-17-2007.

BRENDAN MCCAULEY, EXAMINING ATTORNEY

**Int. Cl.: 41**

**Prior U.S. Cls.: 100, 101 and 107**

**United States Patent and Trademark Office**

**Reg. No. 3,504,226**

**Registered Sep. 23, 2008**

**SERVICE MARK  
PRINCIPAL REGISTER**

**MAINE AT ITS BEST**

DOWN EAST ENTERPRISE, INC. (MAINE CORPORATION)

PO 679

CAMDEN, ME 04843

FOR: PUBLICATION OF BOOKS, MAGAZINES,  
IN CLASS 41 (U.S. CLS. 100, 101 AND 107).

FIRST USE 7-18-2007; IN COMMERCE 7-18-2007.

THE MARK CONSISTS OF STANDARD CHARACTERS WITHOUT CLAIM TO ANY PARTICULAR FONT, STYLE, SIZE, OR COLOR.

NO CLAIM IS MADE TO THE EXCLUSIVE RIGHT TO USE "MAINE", APART FROM THE MARK AS SHOWN.

SER. NO. 77-354,047, FILED 12-17-2007.

LAURIE KAUFMAN, EXAMINING ATTORNEY

**Int. Cl.: 42**

**Prior U.S. Cls.: 100 and 101**

**United States Patent and Trademark Office**

**Reg. No. 3,504,227**

**Registered Sep. 23, 2008**

**SERVICE MARK  
PRINCIPAL REGISTER**

# Visualizing Healthcare

CHART ASSIST LLC (ALABAMA LIMITED LIABILITY COMPANY)  
4629 HARVEST WAY  
MONTGOMERY, AL 36106

FOR: PROVIDING TEMPORARY USE OF NON-DOWNLOADABLE SOFTWARE FOR REVIEWING AND MANAGING MEDICAL INFORMATION ABOUT PATIENTS AND PROVIDERS IN MENTAL HEALTH HOSPITALS, NURSING HOMES, HOSPITALS, AND OTHER HEALTHCARE FACILITIES, IN CLASS 42 (U.S. CLS. 100 AND 101).

FIRST USE 11-21-2007; IN COMMERCE 11-23-2007.

THE MARK CONSISTS OF STANDARD CHARACTERS WITHOUT CLAIM TO ANY PARTICULAR FONT, STYLE, SIZE, OR COLOR.

NO CLAIM IS MADE TO THE EXCLUSIVE RIGHT TO USE "HEALTHCARE", APART FROM THE MARK AS SHOWN.

SER. NO. 77-354,203, FILED 12-17-2007.

ESTHER A. BORSUK, EXAMINING ATTORNEY

Int. Cl.: 37

Prior U.S. Cls.: 100, 103 and 106

Reg. No. 3,504,228

United States Patent and Trademark Office

Registered Sep. 23, 2008

SERVICE MARK  
PRINCIPAL REGISTER



WHITE MOUNTAIN CABLE CONSTRUCTION,  
LLC (DELAWARE LIMITED LIABILITY COM-  
PANY)  
P. O. BOX 459  
2113 DOVER ROAD  
EPSOM, NH 03234

FOR: INSTALLATION, MAINTENANCE AND  
REPAIR OF TELECOMMUNICATION INFRA-  
STRUCTURE, NAMELY, FIBER, CABLE AND WIRE  
SYSTEMS, IN CLASS 37 (U.S. CLS. 100, 103 AND 106).

FIRST USE 12-31-1977; IN COMMERCE 12-31-1977.

NO CLAIM IS MADE TO THE EXCLUSIVE  
RIGHT TO USE "FIBER OPTICS CABLE CON-  
STRUCTION, LLC", APART FROM THE MARK AS  
SHOWN.

SEC. 2(F).

SER. NO. 77-354,331, FILED 12-18-2007.

DAVID MILLER, EXAMINING ATTORNEY

**Int. Cl.: 41**

**Prior U.S. Cls.: 100, 101 and 107**

**United States Patent and Trademark Office**

**Reg. No. 3,504,229**

**Registered Sep. 23, 2008**

**SERVICE MARK  
PRINCIPAL REGISTER**

**WHAT'S RIGHT IN HEALTH CARE**

THE STUDER GROUP, L.L.C. (FLORIDA LIMITED LIABILITY COMPANY)  
913 GULF BREEZE PARKWAY, SUITE 6  
GULF BREEZE, FL 32561

FOR: TRAINING SERVICES IN THE FIELD OF HEALTH CARE PROVIDED VIA AN ANNUAL NATIONAL CONFERENCE IN THE FIELDS OF NEW AND ADVANCED TOOLS AND TACTICS USED SUCCESSFULLY BY HIGH-PERFORMING ORGANIZATIONS AND FEATURING PRESENTATIONS, MANUALS, HANDOUTS AND PEER-TO-PEER TRAINING, TO ACHIEVE AND SUSTAIN SERVICE EXCELLENCE AND DRIVE IMPROVED

CLINICAL AND OPERATIONAL OUTCOMES, IN CLASS 41 (U.S. CLS. 100, 101 AND 107).

FIRST USE 4-11-2003; IN COMMERCE 4-11-2003.

THE MARK CONSISTS OF STANDARD CHARACTERS WITHOUT CLAIM TO ANY PARTICULAR FONT, STYLE, SIZE, OR COLOR.

SER. NO. 77-354,335, FILED 12-18-2007.

STEPHEN AQUILA, EXAMINING ATTORNEY



**Int. Cl.: 36**

**Prior U.S. Cls.: 100, 101 and 102**

**United States Patent and Trademark Office**

**Reg. No. 3,504,230**

**Registered Sep. 23, 2008**

**SERVICE MARK  
PRINCIPAL REGISTER**

**AXIOM PROPERTIES**

AXIOM PROPERTIES, INC. (ILLINOIS CORPORATION)  
2201 WAUKEGAN ROAD, SUITE ONE HUNDRED  
BANNOCKBURN, IL 60015

FOR: REAL ESTATE MANAGEMENT, NAMELY,  
MANAGEMENT OF MULTI-TENANT DWELLING  
AND APARTMENT FACILITIES, IN CLASS 36 (U.S.  
CLS. 100, 101 AND 102).

FIRST USE 11-0-2000; IN COMMERCE 11-0-2000.

THE MARK CONSISTS OF STANDARD CHARACTERS WITHOUT CLAIM TO ANY PARTICULAR FONT, STYLE, SIZE, OR COLOR.

NO CLAIM IS MADE TO THE EXCLUSIVE RIGHT TO USE "PROPERTIES", APART FROM THE MARK AS SHOWN.

SER. NO. 77-354,838, FILED 12-18-2007.

KAREN SEVERSON, EXAMINING ATTORNEY

**Int. Cl.: 35**

**Prior U.S. Cls.: 100, 101 and 102**

**United States Patent and Trademark Office**

**Reg. No. 3,504,231**

**Registered Sep. 23, 2008**

**SERVICE MARK  
PRINCIPAL REGISTER**



J.J. BUCKLEY, LLC (CALIFORNIA LIMITED LIABILITY COMPANY)  
SUITE D  
7305 EDGEWATER DRIVE  
OAKLAND, CA 94621

FOR: ON-LINE RETAIL STORE SERVICES FEATURING WINE AND WINE ACCESSORIES; DIRECT MAIL ADVERTISING; PROVIDING A WEBSITE FEATURING PRODUCT RATINGS OF THE CONSUMER GOODS AND SERVICES OF OTHERS IN THE FIELD OF WINE; IMPORT AND EXPORT AGENCIES; WHOLESALE DISTRIBUTORSHIPS FEATURING WINE, IN CLASS 35 (U.S. CLS. 100, 101 AND 102).

FIRST USE 11-30-2006; IN COMMERCE 11-30-2006.

NO CLAIM IS MADE TO THE EXCLUSIVE RIGHT TO USE "FINE WINES", APART FROM THE MARK AS SHOWN.

THE NAME(S), PORTRAIT(S), AND/OR SIGNATURE(S) SHOWN IN THE MARK DOES NOT IDENTIFY A PARTICULAR LIVING INDIVIDUAL.

THE MARK CONSISTS OF AN OVAL-SHAPED BACKGROUND, WITH A SHIELD THAT CONTAINS FOUR CHARGES, WITH THE WORDS "J.J. BUCKLEY FINE WINES" IMPRINTED OVER THE SHIELD.

SER. NO. 77-354,921, FILED 12-18-2007.

AISHA CLARKE, EXAMINING ATTORNEY

**Int. Cl.: 1**

**Prior U.S. Cls.: 1, 5, 6, 10, 26 and 46**

**Reg. No. 3,504,232**

**United States Patent and Trademark Office**

**Registered Sep. 23, 2008**

---

**TRADEMARK  
PRINCIPAL REGISTER**

**SPIDER**

HALLSTAR INNOVATIONS CORP. (DELAWARE  
CORPORATION)  
SUITE 1620  
120 SOUTH RIVERSIDE PLAZA  
CHICAGO, IL 60606

THE MARK CONSISTS OF STANDARD CHAR-  
ACTERS WITHOUT CLAIM TO ANY PARTICULAR  
FONT, STYLE, SIZE, OR COLOR.

FOR: CHEMICALS, NAMELY, SULFUR FOR IN-  
DUSTRIAL APPLICATIONS, IN CLASS 1 (U.S. CLS.  
1, 5, 6, 10, 26 AND 46).

SER. NO. 77-354,926, FILED 12-18-2007.

FIRST USE 0-0-1971; IN COMMERCE 0-0-1971.

KATINA MISTER, EXAMINING ATTORNEY

**Int. Cl.: 20**

**Prior U.S. Cls.: 2, 13, 22, 25, 32 and 50**

**United States Patent and Trademark Office**

**Reg. No. 3,504,233**

**Registered Sep. 23, 2008**

**TRADEMARK  
PRINCIPAL REGISTER**

# Strap Fit Chair Mate

DTB ENTERPRISES LLC (LOUISIANA LIMITED  
LIABILITY COMPANY)  
3733 RIDGEMONT DR  
BATON ROUGE, LA 70814

FOR: CUP HOLDER FOR USE IN ATTACHING  
TO CHAIRS, IN CLASS 20 (U.S. CLS. 2, 13, 22, 25, 32  
AND 50).

FIRST USE 1-2-2008; IN COMMERCE 1-2-2008.

THE MARK CONSISTS OF STANDARD CHAR-  
ACTERS WITHOUT CLAIM TO ANY PARTICULAR  
FONT, STYLE, SIZE, OR COLOR.

NO CLAIM IS MADE TO THE EXCLUSIVE  
RIGHT TO USE "STRAP" AND "CHAIR", APART  
FROM THE MARK AS SHOWN.

SER. NO. 77-355,129, FILED 12-18-2007.

MARY CRAWFORD, EXAMINING ATTORNEY

**Int. Cls.: 3, 35, 41 and 44**

**Prior U.S. Cls.: 1, 4, 6, 50, 51, 52, 100, 101, 102 and 107**

**Reg. No. 3,504,234**

**United States Patent and Trademark Office**

**Registered Sep. 23, 2008**

**TRADEMARK  
SERVICE MARK  
PRINCIPAL REGISTER**

The  
**SwissCellSpa**  
EXPERIENCE

CELLAP LABORATOIRE S.A. (SWITZERLAND CORPORATION)  
EN BUDRON A2  
LE MONT-SUR-LAUSANNE, SWITZERLAND 1052

FOR: COSMETICS, SOAPS, PERFUMES, ESSENTIAL OILS; BODY DEODORANTS; CREAMS, MILKS, LOTIONS, GELS, POWDERS, NON-MEDICATED SERUMS, MASKS AND PEELINGS FOR COSMETIC USE FOR BODY AND FACE CARE; ANTI-AGING AND ANTI-WRINKLE CREAMS, LOTIONS AND NON-MEDICATED SERUMS FOR COSMETIC USE; COSMETIC PREPARATIONS FOR SLIMMING PURPOSES; COSMETIC PREPARATIONS FOR THE SHOWER AND/OR THE BATH; SUN TANNING AND AFTER SUN MILKS, GELS AND OILS; MAKE-UP PRODUCTS; SKIN CLEANSING PRODUCTS, NAMELY, SKIN CREAMS AND SKIN LOTIONS; DEPILATORY PRODUCTS; HAIR CARE AND CLEANSING PRODUCTS, IN PARTICULAR SHAMPOOS, CREAMS, NON-MEDICATED SERUMS, BATH FOAMS; HAIR DYES, IN CLASS 3 (U.S. CLS. 1, 4, 6, 50, 51 AND 52).

FOR: ADVERTISING SERVICES; SERVICES RENDERED BY A FRANCHISOR, NAMELY, COMMERCIAL OPERATING OR MANAGEMENT ASSISTANCE; FRANCHISING, NAMELY, CONSULTATION AND ASSISTANCE IN BUSINESS MANAGEMENT ORGANIZATION AND PROMOTION, THE AFORESAID SERVICES IN THE FIELD OF HYGIENE AND BEAUTY CARE; PROVIDING CONSUMER PRODUCT INFORMATION ON THE INTERNET ABOUT BEAUTY PRODUCTS, IN CLASS 35 (U.S. CLS. 100, 101 AND 102).

FOR: CONDUCTING COURSES AND TRAINING IN THE FIELD OF HYGIENE AND BEAUTY CARE; CONDUCTING COURSES AND TRAINING FOR COSMETIC PRODUCTS USE AND APPLICATION; CONDUCTING COURSES AND TRAINING FOR COSMETIC PRODUCTS SALES STAFF ON THE SUBJECT OF SELLING COSMETIC PRODUCTS, IN CLASS 41 (U.S. CLS. 100, 101 AND 107).

FOR: HYGIENE AND BEAUTY CARE FOR HUMANS; HEALTH SPA SERVICES, SAUNA SERVICES, MASSAGE SERVICES, MANICURE SERVICES, PEDICURE SERVICES, SERVICES OF A MAKE-UP ARTIST; ALTERNATIVE MEDICINE SERVICES IN THE NATURE OF NATURAL MEDICINE OR PHYSIOTHERAPY SERVICES; BEAUTY SALONS; HYGIENE AND BEAUTY CARE CONSULTANCY; PROVIDING INFORMATION ON THE INTERNET ABOUT BEAUTY CARE; DIET CONSULTANCY, IN CLASS 44 (U.S. CLS. 100 AND 101).

PRIORITY CLAIMED UNDER SEC. 44(D) ON SWITZERLAND APPLICATION NO. 57522/2007, FILED 7-12-2007, REG. NO. 565036, DATED 11-26-2007, EXPIRES 7-12-2017.

THE MARK CONSISTS OF THE STYLIZED WORDS "THE SWISSCELLSPA EXPERIENCE".

SER. NO. 77-355,481, FILED 12-19-2007.

DAVID TAYLOR, EXAMINING ATTORNEY

Int. Cl.: 41

Prior U.S. Cls.: 100, 101 and 107

United States Patent and Trademark Office

Reg. No. 3,504,235

Registered Sep. 23, 2008

SERVICE MARK  
PRINCIPAL REGISTER



STEWART, ROGER (UNITED STATES INDIVIDUAL)

#K

3110 VIA ALICANTE DR.  
LA JOLLA, CA 92037

FOR: TRAINING SERVICES IN THE FIELD OF PILATES, YOGA, HOLISTIC FITNESS, IN CLASS 41 (U.S. CLS. 100, 101 AND 107).

FIRST USE 2-1-2001; IN COMMERCE 2-1-2001.

THE MARK CONSISTS OF STYLIZED WORDS "THE ESSENCE OF TRUE STRENGTH" APPEARING IN A CURVED FASHION ABOVE A SINGLE

LINE CIRCLE CONTAINING A JAPANESE CHIKARA SYMBOL, AND THE STYLIZED WORDS "COMES FROM WITHIN" APPEARING IN A CURVED FASHION BELOW THE CIRCLE CONTAINING THE JAPANESE CHIKARA SYMBOL.

THE NON-LATIN CHARACTER(S) IN THE MARK transliterates into CHIKARA, AND THIS MEANS STRENGTH IN ENGLISH.

SER. NO. 77-355,495, FILED 12-19-2007.

DAVID ELTON, EXAMINING ATTORNEY

**Int. Cl.: 9**

**Prior U.S. Cls.: 21, 23, 26, 36 and 38**

**Reg. No. 3,504,236**

**United States Patent and Trademark Office**

**Registered Sep. 23, 2008**

---

**TRADEMARK  
PRINCIPAL REGISTER**

**business simple**

ACCESSTEK,INC. (ILLINOIS CORPORATION)  
SUITE 111  
1700 PARK PLACE  
NAPERVILLE, IL 60563

FOR: COMPUTER SOFTWARE AND HARD-  
WARE FOR ACCOUNTING, IN CLASS 9 (U.S. CLS.  
21, 23, 26, 36 AND 38).

FIRST USE 8-20-2007; IN COMMERCE 8-20-2007.

THE MARK CONSISTS OF STANDARD CHAR-  
ACTERS WITHOUT CLAIM TO ANY PARTICULAR  
FONT, STYLE, SIZE, OR COLOR.

NO CLAIM IS MADE TO THE EXCLUSIVE  
RIGHT TO USE "BUSINESS", APART FROM THE  
MARK AS SHOWN.

SER. NO. 77-355,652, FILED 12-19-2007.

JACLYN KIDWELL, EXAMINING ATTORNEY

**Int. Cl.: 16**

**Prior U.S. Cls.: 2, 5, 22, 23, 29, 37, 38 and 50**

**Reg. No. 3,504,237**

**United States Patent and Trademark Office**

**Registered Sep. 23, 2008**

**TRADEMARK  
PRINCIPAL REGISTER**

**CATH LAB DIGEST**

HMP COMMUNICATIONS, LLC (DELAWARE  
LIMITED LIABILITY COMPANY)  
SUITE 100  
83 GENERAL WARREN BOULEVARD  
MALVERN, PA 19355

FOR: PRINTED PUBLICATIONS, NAMELY, PER-  
IODICALLY PUBLISHED MAGAZINES AND JOUR-  
NALS IN THE FIELDS OF HEALTHCARE AND  
MEDICINE, IN CLASS 16 (U.S. CLS. 2, 5, 22, 23, 29, 37,  
38 AND 50).

FIRST USE 9-1-1993; IN COMMERCE 9-1-1993.

THE MARK CONSISTS OF STANDARD CHAR-  
ACTERS WITHOUT CLAIM TO ANY PARTICULAR  
FONT, STYLE, SIZE, OR COLOR.

NO CLAIM IS MADE TO THE EXCLUSIVE  
RIGHT TO USE "DIGEST", APART FROM THE  
MARK AS SHOWN.

SEC. 2(F).

SER. NO. 77-355,833, FILED 12-19-2007.

ARETHA SOMERVILLE, EXAMINING ATTORNEY



**Int. Cl.: 16**

**Prior U.S. Cls.: 2, 5, 22, 23, 29, 37, 38 and 50**

**United States Patent and Trademark Office**

**Reg. No. 3,504,238**

**Registered Sep. 23, 2008**

**TRADEMARK  
PRINCIPAL REGISTER**

**CLINICAL GERIATRICS**

HMP COMMUNICATIONS, LLC (DELAWARE  
LIMITED LIABILITY COMPANY)  
SUITE 100  
83 GENERAL WARREN BOULEVARD  
MALVERN, PA 19355

FOR: PRINTED PUBLICATIONS, NAMELY, PER-  
IODICALLY PUBLISHED MAGAZINES AND JOUR-  
NALS IN THE FIELDS OF HEALTHCARE AND  
MEDICINE, IN CLASS 16 (U.S. CLS. 2, 5, 22, 23, 29, 37,  
38 AND 50).

FIRST USE 3-1-1993; IN COMMERCE 3-1-1993.

THE MARK CONSISTS OF STANDARD CHAR-  
ACTERS WITHOUT CLAIM TO ANY PARTICULAR  
FONT, STYLE, SIZE, OR COLOR.

SEC. 2(F).

SER. NO. 77-355,848, FILED 12-19-2007.

ARETHA SOMERVILLE, EXAMINING ATTORNEY

**Int. Cl.: 16**

**Prior U.S. Cls.: 2, 5, 22, 23, 29, 37, 38 and 50**

**United States Patent and Trademark Office**

**Reg. No. 3,504,239**

**Registered Sep. 23, 2008**

**TRADEMARK  
PRINCIPAL REGISTER**

**SKIN & AGING**

HMP COMMUNICATIONS, LLC (DELAWARE  
LIMITED LIABILITY COMPANY)  
SUITE 100  
83 GENERAL WARREN BOULEVARD  
MALVERN, PA 19355

FOR: PRINTED PUBLICATIONS, NAMELY, PER-  
IODICALLY PUBLISHED MAGAZINES AND JOUR-  
NALS IN THE FIELDS OF HEALTHCARE AND  
MEDICINE, IN CLASS 16 (U.S. CLS. 2, 5, 22, 23, 29, 37,  
38 AND 50).

FIRST USE 1-1-1998; IN COMMERCE 1-1-1998.

THE MARK CONSISTS OF STANDARD CHAR-  
ACTERS WITHOUT CLAIM TO ANY PARTICULAR  
FONT, STYLE, SIZE, OR COLOR.

SEC. 2(F).

SER. NO. 77-355,875, FILED 12-19-2007.

ARETHA SOMERVILLE, EXAMINING ATTORNEY

**Int. Cl.: 41**

**Prior U.S. Cls.: 100, 101 and 107**

**United States Patent and Trademark Office**

**Reg. No. 3,504,240**

**Registered Sep. 23, 2008**

**SERVICE MARK  
PRINCIPAL REGISTER**

**SYMPOSIUM ON ADVANCED  
WOUND CARE**

HMP COMMUNICATIONS, LLC (DELAWARE  
LIMITED LIABILITY COMPANY)  
SUITE 100  
83 GENERAL WARREN BOULEVARD  
MALVERN, PA 19355

FOR: EDUCATIONAL SERVICES, NAMELY,  
CONDUCTING AND ORGANIZING CLASSES,  
SEMINARS, CONFERENCES AND WORKSHOPS  
IN THE FIELDS OF HEALTHCARE AND MEDI-  
CINE, AS WELL AS THE DISTRIBUTION OF  
COURSE MATERIALS IN CONNECTION THERE-  
WITH, IN CLASS 41 (U.S. CLS. 100, 101 AND 107).

FIRST USE 1-1-1987; IN COMMERCE 1-1-1987.

THE MARK CONSISTS OF STANDARD CHAR-  
ACTERS WITHOUT CLAIM TO ANY PARTICULAR  
FONT, STYLE, SIZE, OR COLOR.

NO CLAIM IS MADE TO THE EXCLUSIVE  
RIGHT TO USE "SYMPOSIUM", APART FROM  
THE MARK AS SHOWN.

SEC. 2(F).

SER. NO. 77-355,884, FILED 12-19-2007.

ARETHA SOMERVILLE, EXAMINING ATTORNEY

**Int. Cl.: 42**

**Prior U.S. Cls.: 100 and 101**

**United States Patent and Trademark Office**

**Reg. No. 3,504,241**

**Registered Sep. 23, 2008**

---

**SERVICE MARK  
PRINCIPAL REGISTER**

**BOSSCO**

BOSSCO INTERNATIONAL CORPORATION (CALIFORNIA CORPORATION)  
11956 BERNARDO PLAZA, SUITE 511  
SAN DEIGO, CA 92128

THE MARK CONSISTS OF STANDARD CHARACTERS WITHOUT CLAIM TO ANY PARTICULAR FONT, STYLE, SIZE, OR COLOR.

FOR: PRODUCT DEVELOPMENT OF RETAIL AND CONSUMER GOODS, IN CLASS 42 (U.S. CLS. 100 AND 101).

SER. NO. 77-356,041, FILED 12-19-2007.

FIRST USE 10-1-2007; IN COMMERCE 10-1-2007.

ALICIA COLLINS, EXAMINING ATTORNEY

**Int. Cls.: 9 and 41**

**Prior U.S. Cls.: 21, 23, 26, 36, 38, 100, 101 and 107**

**Reg. No. 3,504,242**

**United States Patent and Trademark Office**

**Registered Sep. 23, 2008**

**TRADEMARK  
SERVICE MARK  
PRINCIPAL REGISTER**

# RMS Weekly

TECHNOMIC, INC. (DELAWARE CORPORATION)  
SUITE 1940 SOUTH  
300 S. RIVERSIDE PLAZA  
CHICAGO, IL 60606

FOR: DOWNLOADABLE ELECTRONIC PUBLICATION IN THE NATURE OF NEWSLETTERS FOR TRACKING AND REPORTING TRENDS AND DEVELOPMENTS IN THE RETAIL FOOD AND MEAL SOLUTIONS MARKET, IN CLASS 9 (U.S. CLS. 21, 23, 26, 36 AND 38).

FIRST USE 11-1-2007; IN COMMERCE 11-1-2007.

FOR: PROVIDING AN ON-LINE PUBLICATION IN THE NATURE OF NEWSLETTERS FOR TRACKING AND REPORTING TRENDS AND DEVELOP-

MENTS IN THE RETAIL FOOD AND MEAL SOLUTIONS MARKETS, IN CLASS 41 (U.S. CLS. 100, 101 AND 107).

FIRST USE 11-1-2007; IN COMMERCE 11-1-2007.

THE MARK CONSISTS OF STANDARD CHARACTERS WITHOUT CLAIM TO ANY PARTICULAR FONT, STYLE, SIZE, OR COLOR.

NO CLAIM IS MADE TO THE EXCLUSIVE RIGHT TO USE "WEEKLY", APART FROM THE MARK AS SHOWN.

SER. NO. 77-356,167, FILED 12-19-2007.

RAUL CORDOVA, EXAMINING ATTORNEY

Int. Cl.: 42

Prior U.S. Cls.: 100 and 101

United States Patent and Trademark Office

Reg. No. 3,504,243

Registered Sep. 23, 2008

SERVICE MARK  
PRINCIPAL REGISTER

**Brainmerge**  
c r e a t i v e

KRUEGER, AARON (UNITED STATES INDIVIDUAL)

2709 W. SCHUBERT #2

CHICAGO, IL 60647

FOR: COMMERCIAL ART DESIGN; DESIGNING THEME GRAPHICS AND MULTIMEDIA SHOWS FOR CONVENTIONS, PRODUCT LAUNCHES, TRADE SHOWS, KEY NOTE ADDRESSES AND AWARD CEREMONIES FOR OTHERS; GRAPHIC ART DESIGN; GRAPHIC ARTS DESIGNING; GRAPHIC DESIGN; GRAPHIC DESIGN SERVICES, IN CLASS 42 (U.S. CLS. 100 AND 101).

FIRST USE 12-19-2007; IN COMMERCE 12-19-2007.

NO CLAIM IS MADE TO THE EXCLUSIVE RIGHT TO USE "CREATIVE", APART FROM THE MARK AS SHOWN.

THE MARK CONSISTS OF THE WORDS "BRAINMERGE", BEING ONE WORD AND THE WORD CREATIVE SPACED OUT UNDERNEATH WHERE IT IS LINED UP WITH THE CAPITAL "B" AND ENDS JUST UNDER THE "R" IN MERGE. THE "M" IN MERGE CONSISTS OF TWO ARROWS THAT FORM EACH PART OF THE "M" AND POINT IN THE DIRECTION WHERE THE ARROW HEADS MEET IN THE MIDDLE.

SER. NO. 77-356,217, FILED 12-19-2007.

MARLENE BELL, EXAMINING ATTORNEY

**Int. Cls.: 35 and 43**

**Prior U.S. Cls.: 100, 101 and 102**

**United States Patent and Trademark Office**

**Reg. No. 3,504,244**

**Registered Sep. 23, 2008**

**SERVICE MARK  
PRINCIPAL REGISTER**



CARDIFF SEASIDE MARKET, INC. (CALIFORNIA CORPORATION)  
2087 SAN ELIJO AVENUE  
CARDIFF BY THE SEA, CA 92007

FOR: RETAIL DELICATESSEN SERVICES; RETAIL STORE SERVICES FEATURING GROCERY ITEMS, IN CLASS 35 (U.S. CLS. 100, 101 AND 102).

FIRST USE 6-30-1985; IN COMMERCE 6-30-1985.

FOR: RESTAURANT AND CATERING SERVICES, IN CLASS 43 (U.S. CLS. 100 AND 101).

FIRST USE 6-30-1985; IN COMMERCE 6-30-1985.

NO CLAIM IS MADE TO THE EXCLUSIVE RIGHT TO USE "CARDIFF" AND "MARKET", APART FROM THE MARK AS SHOWN.

THE MARK CONSISTS OF THE WORD "CARDIFF" IN FRONT OF A DEPICTION OF A SETTING SUN AND THE WORD "SEASIDE" UNDER THE SETTING SUN AND THE WORD "MARKET" UNDER THE WORD "SEASIDE" WITH BOTH WORDS IN SCRIPT AND AT AN ANGLE RISING FROM LEFT TO RIGHT.

SER. NO. 77-356,310, FILED 12-19-2007.

WILLIAM P. SHANAHAN, EXAMINING ATTORNEY

**Int. Cl.: 42**

**Prior U.S. Cls.: 100 and 101**

**United States Patent and Trademark Office**

**Reg. No. 3,504,245**

**Registered Sep. 23, 2008**

**SERVICE MARK  
PRINCIPAL REGISTER**

# SEOToolSet

BRUCE CLAY, INC. (CALIFORNIA CORPORATION)  
SUITE 277  
207 W. LOS ANGELES AVENUE  
MOORPARK, CA 93021

FOR: PROVIDING ON-LINE NON-DOWNLOADABLE SOFTWARE FOR ANALYSIS OF WEBSITES AND VISITOR BEHAVIOR AS IT RELATES TO MARKETING ON THE INTERNET, IN CLASS 42 (U.S. CLS. 100 AND 101).

FIRST USE 11-1-1999; IN COMMERCE 11-1-1999.

THE MARK CONSISTS OF STANDARD CHARACTERS WITHOUT CLAIM TO ANY PARTICULAR FONT, STYLE, SIZE, OR COLOR.

SEC. 2(F).

SER. NO. 77-356,345, FILED 12-19-2007.

SUNG IN, EXAMINING ATTORNEY



**Int. Cl.: 35**

**Prior U.S. Cls.: 100, 101 and 102**

**United States Patent and Trademark Office**

**Reg. No. 3,504,246**

**Registered Sep. 23, 2008**

**SERVICE MARK  
PRINCIPAL REGISTER**

**EQUATRADE** 

TAYLOR BRANDS INCORPORATED (GEORGIA CORPORATION)  
1025 VETERANS MEMORIAL HWY STE 310-203  
MABLETON, GA 30126

FOR: ADVERTISING AND ADVERTISEMENT SERVICES; ADVERTISING AND MARKETING; ADVERTISING AND PROMOTION SERVICES AND RELATED CONSULTING; ADVERTISING FLYER DISTRIBUTION; ADVERTISING SERVICES, NAMELY PROMOTING PROPERTIES FOR SALE BY OWNER VIA THE INTERNET; ADVERTISING SERVICES, NAMELY, PROMOTING AND MARKETING THE GOODS AND SERVICES OF OTHERS THROUGH ALL PUBLIC COMMUNICATION MEANS; ADVERTISING VIA ELECTRONIC MEDIA AND SPECIFICALLY THE INTERNET; ADVERTISING, INCLUDING PROMOTION RELATING TO THE SALE OF ARTICLES AND SERVICES FOR THIRD PARTIES BY THE TRANSMISSION OF ADVERTISING MATERIAL AND THE DISSEMINATION OF ADVERTISING MESSAGES ON COMPUTER NETWORKS; ADVERTISING, MARKETING AND PROMOTION SERVICES; ADVERTISING, PROMOTION AND MARKETING SERVICES IN THE NATURE OF E-MAIL BLAST CAMPAIGNS FOR OTHERS; COOPERATIVE ADVERTISING AND MARKETING; CREATING AND UPDATING ADVERTISING MATERIAL; CUSTOMER LOYALTY SERVICES AND CUSTOMER CLUB SERVICES, FOR COMMERCIAL, PROMOTIONAL AND/OR ADVERTISING PURPOSES; DESIGN OF ADVERTISING FLYERS FOR OTHERS; DESIGN OF ADVERTISING MATERIALS FOR OTHERS; DISSEMINATION OF ADVERTISEMENTS AND OF ADVERTISING MATERIAL; DISSEMINATION OF ADVERTISING FOR OTHERS VIA AN ON-LINE COMMUNICATIONS NETWORK ON THE INTER-

NET; DISSEMINATION OF ADVERTISING FOR OTHERS VIA THE INTERNET; DISSEMINATION OF ADVERTISING, SCHEDULING AND MANAGING OF TRAINING COURSES AND PROGRAMS FOR OTHERS VIA A GLOBAL COMPUTER NETWORK; INTERNET ADVERTISING SERVICES; LAYOUT SERVICES FOR ADVERTISING PURPOSES; MARKETING, PROMOTIONAL AND ADVERTISING SERVICES PROVIDED BY MOBILE TELEPHONE CONNECTIONS; ON-LINE ADVERTISING ON COMPUTER COMMUNICATION NETWORKS; ORGANISING EXHIBITIONS FOR COMMERCIAL OR ADVERTISING PURPOSES; OUT-OF-HOME ADVERTISING SERVICES, NAMELY, RENTAL OF ADVERTISING SPACE, AND PREPARING AND PLACING ADVERTISEMENTS FOR OTHERS; PLACING ADVERTISEMENTS FOR OTHERS; PLANNING AND CONDUCTING OF TRADE FAIRS, EXHIBITIONS AND PRESENTATIONS FOR ECONOMIC OR ADVERTISING PURPOSES; PREPARATION OF CUSTOM ADVERTISEMENTS FOR OTHERS; PREPARATION OF CUSTOM OR NON-CUSTOM ADVERTISING FOR BUSINESSES FOR DISSEMINATION VIA THE WEB, CD OR DVD FOR OPTIONAL UPLOAD OR DOWNLOAD TO A COMPUTER; PREPARING AND PLACING ADVERTISEMENTS FOR OTHERS; PROMOTING THE GOODS AND SERVICES OF OTHERS BY PREPARING AND PLACING ADVERTISEMENTS IN AN ELECTRONIC MAGAZINE ACCESSED THROUGH A GLOBAL COMPUTER NETWORK; PROMOTING, ADVERTISING AND MARKETING OF THE ON-LINE WEBSITES OF OTHERS; PROVIDING A SEARCHABLE ONLINE ADVERTISING GUIDE FEATURING THE GOODS AND SERVICES OF OTHER ON-LINE VENDORS ON THE INTERNET; PROVIDING A WEB SITE THAT ENABLES USERS TO POST ITEMS FOR SALE

THROUGH ON-LINE CLASSIFIED ADVERTISEMENTS; PROVIDING A WEB SITE WHICH FEATURES ADVERTISEMENTS FOR THE GOODS AND SERVICES OF OTHERS ON A GLOBAL COMPUTER NETWORK; PROVIDING AND RENTAL OF ADVERTISING SPACE ON THE INTERNET; PROVIDING SPACE AT A WEB SITE FOR THE ADVERTISEMENT OF THE GOODS AND SERVICES OF OTHERS; RENTAL OF ADVERTISING SPACE ON WEB SITES; CONDUCTING BUSINESS AND MARKET RESEARCH SURVEYS; CONDUCTING MARKETING STUDIES; DIRECT MARKETING SERVICES; MARKET STUDY AND ANALYSIS OF MARKET STUDIES; MARKETING PLAN DEVELOPMENT; ON-LINE ADVERTISING AND MARKETING SERVICES; PROVIDING A WEBSITE THAT FEATURES AN ONLINE MARKET FOR USERS TO LIST OFFERED OR WANTED PERSONAL AND

BUSINESS ASSETS AND SKILLS FOR HIRE, RENT, SALE OR AUCTION TRANSACTED ON THE BASIS OF PREDEFINED PERFORMANCE AND CLOSING TERMS AND CONDITIONS, IN CLASS 35 (U.S. CLS. 100, 101 AND 102).

FIRST USE 12-19-2007; IN COMMERCE 12-19-2007.

THE MARK CONSISTS OF THE WORD "EQUA-TRADE" IN SMALL CAPS FOLLOWED BY TWO ARROWS TO THE RIGHT OF THE WORD, ONE ARROW POINTING LEFT ABOVE ANOTHER ARROW POINTING RIGHT.

SER. NO. 77-356,402, FILED 12-19-2007.

JENNY PARK, EXAMINING ATTORNEY

**Int. Cl.: 15**

**Prior U.S. Cls.: 2, 21 and 36**

**United States Patent and Trademark Office**

**Reg. No. 3,504,247**

**Registered Sep. 23, 2008**

**TRADEMARK  
PRINCIPAL REGISTER**

**SUPER SLINKY**

ERNIE BALL, INC. (CALIFORNIA CORPORATION)  
P O BOX 877  
COACHELLA, CA 92236

OWNER OF U.S. REG. NOS. 855,117, 873,017, AND 924,269.

FOR: GUITAR STRINGS; STRINGS FOR WESTERN MUSICAL INSTRUMENTS, IN CLASS 15 (U.S. CLS. 2, 21 AND 36).

NO CLAIM IS MADE TO THE EXCLUSIVE RIGHT TO USE "SUPER", APART FROM THE MARK AS SHOWN.

FIRST USE 10-31-1968; IN COMMERCE 10-31-1968.

SER. NO. 77-356,701, FILED 12-20-2007.

THE MARK CONSISTS OF STANDARD CHARACTERS WITHOUT CLAIM TO ANY PARTICULAR FONT, STYLE, SIZE, OR COLOR.

LINDSEY RUBIN, EXAMINING ATTORNEY

**Int. Cls.: 29 and 30**

**Prior U.S. Cl.: 46**

**United States Patent and Trademark Office**

**Reg. No. 3,504,248**

**Registered Sep. 23, 2008**

**TRADEMARK  
PRINCIPAL REGISTER**

# HUEVOLUTION

HICKMAN'S EGG RANCH, INC. (ARIZONA  
CORPORATION)  
6515 S. JACKRABBIT TRAIL  
BUCKEYE, AZ 85326

FOR: EGG PRODUCT; EGG SUBSTITUTE; EGGS;  
FROZEN EGGS; HEN EGGS; PROCESSED EGGS, IN  
CLASS 29 (U.S. CL. 46).

FIRST USE 10-29-2006; IN COMMERCE 10-29-2006.

FOR: SPICES FOR EGGS; SEASONINGS FOR  
EGGS, IN CLASS 30 (U.S. CL. 46).

FIRST USE 10-29-2006; IN COMMERCE 10-29-2006.

THE MARK CONSISTS OF STANDARD CHAR-  
ACTERS WITHOUT CLAIM TO ANY PARTICULAR  
FONT, STYLE, SIZE, OR COLOR.

SER. NO. 77-357,452, FILED 12-20-2007.

JENNIFER MARTIN, EXAMINING ATTORNEY

**Int. Cl.: 15**

**Prior U.S. Cls.: 2, 21 and 36**

**United States Patent and Trademark Office**

**Reg. No. 3,504,249**

**Registered Sep. 23, 2008**

**TRADEMARK  
PRINCIPAL REGISTER**



ERNIE BALL, INC. (CALIFORNIA CORPORATION)  
P O BOX 877  
COACHELLA, CA 92236

NO CLAIM IS MADE TO THE EXCLUSIVE RIGHT TO USE "SUPER", APART FROM THE MARK AS SHOWN.

FOR: GUITAR STRINGS; STRINGS FOR WESTERN MUSICAL INSTRUMENTS, IN CLASS 15 (U.S. CLS. 2, 21 AND 36).

THE MARK CONSISTS OF THE WORDS "SUPER SLINKY" IN FANCIFUL SCRIPT.

FIRST USE 10-31-1968; IN COMMERCE 10-31-1968.

SER. NO. 77-357,520, FILED 12-20-2007.

OWNER OF U.S. REG. NOS. 855,117, 873,017, AND 924,269.

LINDSEY RUBIN, EXAMINING ATTORNEY

**Int. Cl.: 41**

**Prior U.S. Cls.: 100, 101 and 107**

**United States Patent and Trademark Office**

**Reg. No. 3,504,250**

**Registered Sep. 23, 2008**

**SERVICE MARK  
PRINCIPAL REGISTER**

**mathopedia**

RAMAJAYAM, KUMAR (UNITED STATES INDIVIDUAL)  
SUITE 206., 17100 GILLETTE AVE  
IRVINE, CA 92614

FOR: EDUCATIONAL SERVICES, NAMELY, CONDUCTING CLASSES IN THE FIELDS OF MATHEMATICS AND COMPUTATION; AND DISTRIBUTION OF COURSE MATERIAL IN CONNECTION THEREWITH, IN CLASS 41 (U.S. CLS. 100, 101 AND 107).

FIRST USE 5-4-2005; IN COMMERCE 5-4-2005.

THE MARK CONSISTS OF STANDARD CHARACTERS WITHOUT CLAIM TO ANY PARTICULAR FONT, STYLE, SIZE, OR COLOR.

SER. NO. 77-357,702, FILED 12-21-2007.

LEIGH LOWRY, EXAMINING ATTORNEY

**Int. Cl.: 45**

**Prior U.S. Cls.: 100 and 101**

**United States Patent and Trademark Office**

**Reg. No. 3,504,251**

**Registered Sep. 23, 2008**

**SERVICE MARK  
PRINCIPAL REGISTER**

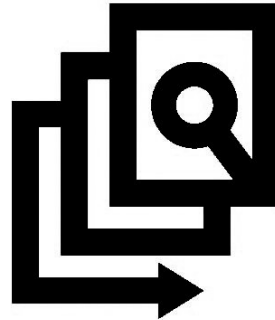

COURTPORT, LLC (NEW YORK LIMITED LIABILITY COMPANY)  
1308 LAKESHORE DRIVE  
MASSAPEQUA PARK, NY 11762

FOR: LEGAL RESEARCH AND LEGAL SERVICES, NAMELY, PROVIDING INFORMATION RELATING TO LEGAL AFFAIRS AND PROVIDING INTERACTIVE DATABASES IN THE FIELD OF LEGAL AFFAIRS, IN CLASS 45 (U.S. CLS. 100 AND 101).

FIRST USE 12-13-2007; IN COMMERCE 12-13-2007.

THE MARK CONSISTS OF THREE RECTANGULAR SHAPES OVERLAPPING ONE ANOTHER WITH AN ARROW AT THE BOTTOM AND THE DESIGN OF A MAGNIFYING GLASS AT THE TOP.

SER. NO. 77-357,726, FILED 12-21-2007.

EVELYN BRADLEY, EXAMINING ATTORNEY

Int. Cls.: 3 and 44

Prior U.S. Cls.: 1, 4, 6, 50, 51, 52, 100 and 101

United States Patent and Trademark Office

Reg. No. 3,504,252

Registered Sep. 23, 2008

TRADEMARK  
SERVICE MARK  
PRINCIPAL REGISTER



MATTSON, JON (UNITED STATES INDIVIDUAL)  
SUITE H  
3429 LAWRENCEVILLE SUWANEE ROAD  
SUWANEE, GA 30024 AND  
MATTSON, LISA (UNITED STATES INDIVIDUAL)  
SUITE H  
3429 LAWRENCEVILLE SUWANEE ROAD  
SUWANEE, GA 30024

FOR: PERSONAL CARE GOODS, NAMELY, BAR SOAP, FACE AND BODY LOTIONS AND CREAMS, BODY POWDERS, AFTERSHAVE, ANTIPERSPIRANTS AND DEODORANTS, AROMATHERAPY BODY CARE PRODUCTS, NAMELY, HAND SOAP, BODY SOAP, FACIAL SOAP, BODY LOTION, SHOWER GEL, CUTICLE CREAM, ASTRINGENTS FOR COSMETIC PURPOSES, BATH AND SHOWER GELS AND SALTS NOT FOR MEDICAL PURPOSES, BEAUTY MASKS, SHAVING PREPARATIONS, NON-MEDICATED SKIN-CARE PREPARATIONS, COSMETIC PREPARATIONS FOR SKIN RENEWAL AND BODY CARE, LOTIONS FOR BEARDS, MUSTACHE WAX, MASSAGE OILS AND CREAMS, AND HAIR CARE PREPARATIONS, NAMELY, SHAMPOO, CONDITIONER, MOUSSE, GEL, POMADE, AND SPRAY, IN CLASS 3 (U.S. CLS. 1, 4, 6, 50, 51 AND 52).

FIRST USE 4-14-2007; IN COMMERCE 5-21-2007.

FOR: SALON SERVICES, NAMELY, FACIALS, MANICURES, WAXING, AND MASSAGES; HEALTH SPA SERVICES, NAMELY, COSMETIC BODY CARE SERVICES; HAIR SALON SERVICES, NAMELY, HAIR CUTTING, STYLING, AND COL-

OR SERVICES; HAIR STYLING SERVICES; FACIAL TREATMENT SERVICES, NAMELY, FACIAL CLEANSING; COSMETOLOGY SERVICES; BARBERING SERVICES; BEAUTY SALON SERVICES; BODY PIERCING SERVICES; BODY WAXING SERVICES; AROMA THERAPY SERVICES; AND MANICURE AND PEDICURE SERVICES, IN CLASS 44 (U.S. CLS. 100 AND 101).

FIRST USE 2-19-2007; IN COMMERCE 5-21-2007.

NO CLAIM IS MADE TO THE EXCLUSIVE RIGHT TO USE "SALON FOR MEN", APART FROM THE MARK AS SHOWN.

THE LINING IN THE MARK INDICATES WOOD GRAIN AND IS A FEATURE OF THE MARK.

THE MARK CONSISTS OF A REPRESENTATION OF A WOODEN BOARD WITH JAGGED SIDE EDGES AND WOOD GRAIN, SERVING AS A BACKGROUND TO THE WORD "LODGE", CENTERED OVER THE WORD "SALON", AND THE WORDS "FOR MEN" POSITIONED BELOW THE LETTERS "LON" OF "SALON", WHEREIN THE LETTER "A" OF THE WORD "SALON" IS FORMED BY AN EVERGREEN TREE, WHEREIN THE REMAINING LETTERS OF THE WORDS "LODGE SALON" ARE FORMED BY BOARDS AND NAILS, AND WHEREIN THE WORDS "FOR MEN" DEPICT A BRANDED/ WOOD-BURNED LOOK.

SER. NO. 77-357,807, FILED 12-21-2007.

MARGARET POWER, EXAMINING ATTORNEY



**Int. Cls.: 35 and 45**

**Prior U.S. Cls.: 100, 101 and 102**

**United States Patent and Trademark Office**

**Reg. No. 3,504,253**

**Registered Sep. 23, 2008**

**SERVICE MARK  
PRINCIPAL REGISTER**



**INSIGHT**

CENTER FOR COMMUNITY  
ECONOMIC DEVELOPMENT

INSIGHT CENTER FOR COMMUNITY ECONOMIC DEVELOPMENT (CALIFORNIA NON-PROFIT ORGANIZATION)

2201 BROADWAY, SUITE 815  
OAKLAND, CA 94612

FOR: RESEARCH AND CONSULTATION SERVICES IN THE FIELD OF PROMOTION OF BUSINESS OPPORTUNITIES FOR PEOPLE AND COMMUNITIES, IN CLASS 35 (U.S. CLS. 100, 101 AND 102).

FIRST USE 10-18-2007; IN COMMERCE 10-18-2007.

FOR: LEGAL SERVICES, IN CLASS 45 (U.S. CLS. 100 AND 101).

FIRST USE 10-18-2007; IN COMMERCE 10-18-2007.

NO CLAIM IS MADE TO THE EXCLUSIVE RIGHT TO USE "CENTER FOR COMMUNITY ECONOMIC DEVELOPMENT", APART FROM THE MARK AS SHOWN.

SER. NO. 77-357,829, FILED 12-21-2007.

STEPHEN AQUILA, EXAMINING ATTORNEY

**Int. Cls.: 43 and 44**

**Prior U.S. Cls.: 100 and 101**

**United States Patent and Trademark Office**

**Reg. No. 3,504,254**

**Registered Sep. 23, 2008**

**SERVICE MARK  
PRINCIPAL REGISTER**

# SuperShmuttle

RUDIN, JUDITH E. (UNITED STATES INDIVIDUAL)  
854 N. FORD ST.  
BURBANK, CA 91505

FOR: PET BOARDING SERVICES; PET DAY CARE SERVICES, IN CLASS 43 (U.S. CLS. 100 AND 101).

FIRST USE 10-29-2007; IN COMMERCE 10-29-2007.

FOR: PET CARE SERVICES, NAMELY, DOG WALKING, DOG BATHING AND NON-MEDICA-

TED PET GROOMING; ANIMAL GROOMING, IN CLASS 44 (U.S. CLS. 100 AND 101).

FIRST USE 10-29-2007; IN COMMERCE 10-29-2007.

THE MARK CONSISTS OF STANDARD CHARACTERS WITHOUT CLAIM TO ANY PARTICULAR FONT, STYLE, SIZE, OR COLOR.

SER. NO. 77-358,165, FILED 12-21-2007.

YONG KIM, EXAMINING ATTORNEY

**Int. Cl.: 35**

**Prior U.S. Cls.: 100, 101 and 102**

**United States Patent and Trademark Office**

**Reg. No. 3,504,255**

**Registered Sep. 23, 2008**

**SERVICE MARK  
PRINCIPAL REGISTER**

**ADVANCED HEALTH EDUCATION CENTER**



ADVANCED HEALTH EDUCATION CENTER,  
LTD. (TEXAS LIMITED PARTNERSHIP)  
8502 TYBOR  
HOUSTON, TX 77074

FOR: PERSONNEL PLACEMENT AND RE-  
CRUITMENT, IN CLASS 35 (U.S. CLS. 100, 101 AND  
102).

FIRST USE 11-0-2007; IN COMMERCE 11-0-2007.

OWNER OF U.S. REG. NO. 2,252,715.

NO CLAIM IS MADE TO THE EXCLUSIVE  
RIGHT TO USE "ADVANCED HEALTH EDUCA-

TION CENTER", APART FROM THE MARK AS  
SHOWN.

THE MARK CONSISTS OF THE STYLIZED  
WORDING "ADVANCED HEALTH EDUCATION  
CENTER" UNDERLINED ALONG WITH A TRIAN-  
GLE EXTENDING UPWARD BETWEEN THE  
TERMS "HEALTH" AND "EDUCATION".

SER. NO. 77-358,411, FILED 12-21-2007.

JAY BESCH, EXAMINING ATTORNEY

**Int. Cl.: 41**

**Prior U.S. Cls.: 100, 101 and 107**

**United States Patent and Trademark Office**

**Reg. No. 3,504,256**

**Registered Sep. 23, 2008**

**SERVICE MARK  
PRINCIPAL REGISTER**

**ADVANCED HEALTH EDUCATION CENTER**



ADVANCED HEALTH EDUCATION CENTER,  
LTD. (TEXAS LIMITED PARTNERSHIP)  
8502 TYBOR  
HOUSTON, TX 77074

FOR: EDUCATIONAL SERVICES, NAMELY,  
CONDUCTING COURSES OF INSTRUCTION,  
SEMINARS AND MINI-CONFERENCES IN THE  
HEALTH CARE FIELD AND DISTRIBUTING  
COURSE MATERIAL IN CONNECTION THERE-  
WITH, IN CLASS 41 (U.S. CLS. 100, 101 AND 107).

FIRST USE 11-0-2007; IN COMMERCE 11-0-2007.

OWNER OF U.S. REG. NO. 2,252,715.

NO CLAIM IS MADE TO THE EXCLUSIVE  
RIGHT TO USE "ADVANCED HEALTH EDUCA-  
TION CENTER", APART FROM THE MARK AS  
SHOWN.

THE MARK CONSISTS OF THE STYLIZED  
WORDING "ADVANCED HEALTH EDUCATION  
CENTER" UNDERLINED ALONG WITH A TRIAN-  
GLE EXTENDING UPWARD BETWEEN THE  
TERMS "HEALTH" AND "EDUCATION".

SER. NO. 77-358,420, FILED 12-21-2007.

JAY BESCH, EXAMINING ATTORNEY

**Int. Cl.: 10**

**Prior U.S. Cls.: 26, 39 and 44**

**Reg. No. 3,504,257**

**United States Patent and Trademark Office**

**Registered Sep. 23, 2008**

**TRADEMARK  
PRINCIPAL REGISTER**

**TORAX**

TORAX MEDICAL, INC. (DELAWARE CORPORATION)  
4188 LEXINGTON AVENUE NORTH  
SHOREVIEW, MN 55126

FOR: MEDICAL DEVICES, NAMELY, AUGMENTATION RINGS PLACED AROUND TISSUE FOR THE TREATMENT OF INCONTINENCE, GASTROESOPHAGEAL REFLUX DISEASE (GERD) AND OBESITY, IN CLASS 10 (U.S. CLS. 26, 39 AND 44).

FIRST USE 2-26-2007; IN COMMERCE 3-6-2007.

THE MARK CONSISTS OF STANDARD CHARACTERS WITHOUT CLAIM TO ANY PARTICULAR FONT, STYLE, SIZE, OR COLOR.

THE WORDING "TORAX" HAS NO MEANING IN A FOREIGN LANGUAGE.

SER. NO. 77-358,445, FILED 12-21-2007.

JAY BESCH, EXAMINING ATTORNEY

**Int. Cl.: 35**

**Prior U.S. Cls.: 100, 101 and 102**

**United States Patent and Trademark Office**

**Reg. No. 3,504,258**

**Registered Sep. 23, 2008**

**SERVICE MARK  
PRINCIPAL REGISTER**



VNY MODEL MANAGEMENT, LLC (NEW YORK  
LIMITED LIABILITY COMPANY)  
SUITE 800  
928 BROADWAY  
NEW YORK, NY 10010

FOR: MODELING AGENCY SERVICES; MAN-  
AGEMENT OF CAREERS OF INDIVIDUAL MOD-  
ELS, IN CLASS 35 (U.S. CLS. 100, 101 AND 102).

FIRST USE 12-27-2007; IN COMMERCE 12-27-2007.

OWNER OF U.S. REG. NO. 3,137,245.

NO CLAIM IS MADE TO THE EXCLUSIVE  
RIGHT TO USE "MODEL MANAGEMENT", APART  
FROM THE MARK AS SHOWN.

THE MARK CONSISTS OF STYLIZED LETTERS  
"VNY MODEL MANAGEMENT".

SER. NO. 77-358,550, FILED 12-21-2007.

LANA PHAM, EXAMINING ATTORNEY

Int. Cl.: 36

Prior U.S. Cls.: 100, 101 and 102

United States Patent and Trademark Office

Reg. No. 3,504,259

Registered Sep. 23, 2008

**SERVICE MARK  
PRINCIPAL REGISTER**



RENTAL PROPERTY RESOURCES, LLC (FLORIDA LIMITED LIABILITY COMPANY)  
1045 RUGGLESTONE WAY  
DULUTH, GA 30097

FOR: REAL ESTATE RENTAL SERVICES, NAME-  
LY, RENTAL OF RESIDENTIAL HOUSING; REAL  
ESTATE SERVICES, NAMELY, RENTAL OF VACA-  
TION HOMES, CONDOMINIUMS, CABINS, AND  
VILLAS USING PAY PER CLICK ADVERTISING ON  
A GLOBAL COMPUTER NETWORK, IN CLASS 36  
(U.S. CLS. 100, 101 AND 102).

FIRST USE 5-13-2007; IN COMMERCE 7-17-2007.

NO CLAIM IS MADE TO THE EXCLUSIVE  
RIGHT TO USE "RENTAL PROPERTY RESOUR-  
CES", APART FROM THE MARK AS SHOWN.

THE COLOR(S) GREEN, PURPLE, AND ORANGE  
IS/ARE CLAIMED AS A FEATURE OF THE MARK.

THE MARK CONSISTS OF THE WORD "REN-  
TAL" FILLED IN GREEN AND OUTLINED IN  
PURPLE, STACKED ABOVE THE WORD "PROPER-  
TY" FILLED IN GREEN AND OUTLINED IN PUR-  
PLE, STACKED ABOVE THE WORD "RESOURCES"  
FILLED IN PURPLE. TO THE LEFT OF THE WORDS  
IS A TWO-TONED ORANGE SUNBURST WITHIN A  
RECTANGLE REPRESENTING THE BOTTOM OF A  
HOUSE. AN ORANGE TRIANGLE WITH LIGHTER  
ORANGE CIRCLE IS ABOVE THE SUNBURST  
REPRESENTING THE ROOF OF THE HOUSE.

SER. NO. 77-358,590, FILED 12-21-2007.

LEIGH CAROLINE CASE, EXAMINING ATTOR-  
NEY

**Int. Cl.: 25**

**Prior U.S. Cls.: 22 and 39**

**United States Patent and Trademark Office**

**Reg. No. 3,504,260**

**Registered Sep. 23, 2008**

**TRADEMARK  
PRINCIPAL REGISTER**

**Luna**

C&F INTERNATIONAL GROUP INC (CALIFORNIA CORPORATION)

10625 E.RUSH ST

S.EL MONTE, CA 91733

FOR: SHOES, IN CLASS 25 (U.S. CLS. 22 AND 39).

FIRST USE 10-1-2004; IN COMMERCE 10-16-2007.

THE MARK CONSISTS OF STANDARD CHARACTERS WITHOUT CLAIM TO ANY PARTICULAR FONT, STYLE, SIZE, OR COLOR.

THE ENGLISH TRANSLATION OF THE WORD "LUNA" IN THE MARK IS MOON.

SER. NO. 77-358,625, FILED 12-21-2007.

JOHN E. MICHOS, EXAMINING ATTORNEY



**Int. Cl.: 25**

**Prior U.S. Cls.: 22 and 39**

**United States Patent and Trademark Office**

**Reg. No. 3,504,261**

**Registered Sep. 23, 2008**

**TRADEMARK  
PRINCIPAL REGISTER**

# Rich Rocker

LEWIS SMITH (UNITED STATES INDIVIDUAL)  
403 SOUTH OAK STREET  
FREEMANSBURG, PA 18017

FOR: CLOTHING, NAMELY, TANK TOPS, LONG SLEEVED T-SHIRTS, SHORT SLEEVED T-SHIRTS, SHOES, HATS, SHORTS, DRESSES, JUMPERS, SHIRTS, BLOUSES, JACKETS, COATS, SWEAT-PANTS, SWEATSHORTS, UNDERWEAR, SLEEPWEAR, LOUNGEWEAR, SWIM WEAR, WET SUITS, OVERALLS, COVERALLS SKI WEAR, VESTS, SWEATERS, JEANS, PANTS, LEGGINGS NECKWEAR, BELTS, SUSPENDERS, CLOTH BIBS,

WRISTBANDS, FOOTWEAR, AND HEADWEAR, IN CLASS 25 (U.S. CLS. 22 AND 39).

FIRST USE 6-12-2007; IN COMMERCE 8-5-2007.

THE MARK CONSISTS OF STANDARD CHARACTERS WITHOUT CLAIM TO ANY PARTICULAR FONT, STYLE, SIZE, OR COLOR.

SER. NO. 77-358,855, FILED 12-22-2007.

VIVIAN MICZNIK FIRST, EXAMINING ATTORNEY

**Int. Cl.: 35**

**Prior U.S. Cls.: 100, 101 and 102**

**Reg. No. 3,504,262**

**United States Patent and Trademark Office**

**Registered Sep. 23, 2008**

**SERVICE MARK  
PRINCIPAL REGISTER**

# LUNA DE MIEL

GAUGHEN HOLDINGS LLC (CALIFORNIA LIMITED LIABILITY COMPANY)  
4954 NAUTILUS ST.  
OXNARD, CA 93035

FOR: INDEPENDENT SALES REPRESENTATIVES IN THE FIELD OF STAPLE FOODS, CANDY, ALCOHOLIC BEVERAGES, PAINTS, PERFUME AND COSMETIC PRODUCTS, SUNSCREEN AND PERSONAL CARE ITEMS, VITAMINS AND HEALTH CARE PRODUCTS, ATHLETIC-ORIENTED EYEWEAR AND SUNGLASSES, SPECTACLES, PAPER PRODUCTS, ELECTRONICS, JEWELRY; WHOLESALE DISTRIBUTORSHIPS AND WHOLESALE STORES FOR GOODS, FEATURING FOOD, FLOWERS AND ARTIFICIAL PLANTS, PAINTINGS, POSTERS, CHARACTER STUFFED ANIMAL COLLECTABLES, CIGARS AND CIGARETTES, CAKES AND PASTRIES, COFFEE, CHOCOLATE AND NON-CHOCOLATE CANDY, WINES, WINE GLASSES, CHAMPAGNE FLUTES, ALCOHOLIC BEVERAGES AND LIQUORS, ELECTRONICS, PERFUME AND COSMETIC PRODUCTS, SUNSCREEN AND PERSONAL CARE ITEMS, VITAMINS AND HEALTH CARE PRODUCTS, ATHLETIC-ORIENTED EYEWEAR AND SUNGLASSES, SPECTACLES, BUILDING MATERIAL PRODUCTS, PAINT AND DECORATING PRODUCTS, SOFT DRINKS AND WATER, ASSORTED NUTS, GIFT SETS, HANDBAGS, JEWELRY, WRITING INSTRUMENTS, TRAVEL-RELATED PRODUCTS, BEDDING AND BATH PRODUCTS; RETAIL STORE SERVICES, NAMELY, GIFT SHOPS, CANDY STORES, JEWELRY STORES, WINERY STORES, LIQUOR STORES, GROCERY STORES, GENERAL MERCHANDISE STORES, CONVENIENCE STORES, PHARMACIES, DRUG STORES, HOME IMPROVEMENT STORES, OUTLET STORES, DUTY FREE STORES, BAKERY SHOPS, MAIL ORDER CATALOGS, TELEPHONE ORDER-TAKING SERVICES FOR OTHERS, AND ON-LINE INTERNET STORES, FOR GOODS, FEATURING FOOD, FLOWERS AND ARTIFICIAL PLANTS,

PAINTINGS, POSTERS, CHARACTER STUFFED ANIMAL COLLECTABLES, CIGARS AND CIGARETTES, CAKES AND PASTRIES, COFFEE, CHOCOLATE AND NON-CHOCOLATE CANDY, WINES, WINE GLASSES, CHAMPAGNE FLUTES, ALCOHOLIC BEVERAGES AND LIQUORS, ELECTRONICS, PERFUME AND COSMETIC PRODUCTS, SUNSCREEN AND PERSONAL CARE ITEMS, VITAMINS AND HEALTH CARE PRODUCTS, ATHLETIC-ORIENTED EYEWEAR AND SUNGLASSES, SPECTACLES, BUILDING MATERIAL PRODUCTS, PAINT AND DECORATING PRODUCTS, SOFT DRINKS AND WATER, ASSORTED NUTS, GIFT SETS, HANDBAGS, JEWELRY, WRITING INSTRUMENTS, TRAVEL-RELATED PRODUCTS, BEDDING AND BATH PRODUCTS, BRACELETS, NECKLACES, WATCHES, SPORT CAPS AND FOOTWEAR AND CLOTHING, ARTICLES MADE OF LEATHER AND IMITATION LEATHER, BACKPACKS, LUGGAGE, SPORTS BAGS, WALLETS, CERAMIC TILES; ADMINISTRATION OF A DISCOUNT PROGRAM FOR ENABLING PARTICIPANTS TO OBTAIN DISCOUNTS ON GOODS AND SERVICES THROUGH USE OF A DISCOUNT MEMBERSHIP CARD; ALCOHOLIC BEVERAGE PROCUREMENT SERVICES FOR OTHERS; ART GALLERIES; BRIDAL REGISTRY SERVICES; BUYING CLUBS; CLUB SERVICES, NAMELY, PROMOTING THE INTERESTS OF SINGLE ADULT MEN, SINGLE ADULT WOMEN, AND MARRIED COUPLES; CONCESSION STANDS FEATURING FOOD, BEER, WINE, CANDY, SOUVENIRS; FASHION SHOW EXHIBITIONS FOR COMMERCIAL PURPOSES; GIFT REGISTRY SERVICES; ISSUING GIFT CERTIFICATES WHICH MAY THAN BE REDEEMED FOR GOODS AND SERVICES; PROVIDING AND RENTAL OF ADVERTISING SPACE ON THE INTERNET; RENTAL OF SIGNS FOR ADVERTISING PURPOSES; SUBSCRIPTION TO A TELEVISION CHANNEL; SUBSCRIPTIONS TO BOOKS, REVIEWS, NEWSPAPERS OR COMIC BOOKS; SUB-

SCRIPTIONS TO ELECTRONIC JOURNALS, IN  
CLASS 35 (U.S. CLS. 100, 101 AND 102).

FIRST USE 8-1-2007; IN COMMERCE 12-22-2007.

THE MARK CONSISTS OF STANDARD CHAR-  
ACTERS WITHOUT CLAIM TO ANY PARTICULAR  
FONT, STYLE, SIZE, OR COLOR.

OWNER OF U.S. REG. NOS. 3,304,601, 3,403,106  
AND OTHERS.

THE FOREIGN WORDING IN THE MARK  
TRANSLATES INTO ENGLISH AS HONEYMOON.

SER. NO. 77-359,202, FILED 12-25-2007.

PATRICIA EVANKO, EXAMINING ATTORNEY

**Int. Cl.: 35**

**Prior U.S. Cls.: 100, 101 and 102**

**United States Patent and Trademark Office**

**Reg. No. 3,504,263**

**Registered Sep. 23, 2008**

**SERVICE MARK  
PRINCIPAL REGISTER**

**Intelligent Organic  
Nutrition**

DEAN, ALEEM (UNITED STATES INDIVIDUAL)  
6320 FREEPORT DRIVE  
SPRING HILL, FL 34608 AND  
DEAN, GLORIA (UNITED STATES INDIVIDUAL)  
6320 FREEPORT DRIVE  
SPRING HILL, FL 34608 AND  
DEAN, SHARARD (UNITED STATES INDIVIDUAL)  
6320 FREEPORT DRIVE  
SPRING HILL, FL 34608

FOR: ON-LINE RETAIL STORE SERVICES FEATURING NUTRITIONAL SUPPLEMENTS; RETAIL STORE SERVICES FEATURING NUTRITIONAL SUPPLEMENTS, IN CLASS 35 (U.S. CLS. 100, 101 AND 102).

FIRST USE 8-0-2007; IN COMMERCE 12-5-2007.

THE MARK CONSISTS OF STANDARD CHARACTERS WITHOUT CLAIM TO ANY PARTICULAR FONT, STYLE, SIZE, OR COLOR.

NO CLAIM IS MADE TO THE EXCLUSIVE RIGHT TO USE "ORGANIC NUTRITION", APART FROM THE MARK AS SHOWN.

SER. NO. 77-359,311, FILED 12-26-2007.

PETER B. BROMAGHIM, EXAMINING ATTORNEY

Int. Cl.: 41

Prior U.S. Cls.: 100, 101 and 107

United States Patent and Trademark Office

Reg. No. 3,504,264

Registered Sep. 23, 2008

SERVICE MARK  
PRINCIPAL REGISTER



CONQUEST SOUND (NEW YORK LIMITED LIABILITY COMPANY)  
3311 NEWKIRK AVENUE  
BROOKLYN, NY 11203

FOR: DISC JOCKEYS FOR PARTIES AND SPECIAL EVENTS, IN CLASS 41 (U.S. CLS. 100, 101 AND 107).

FIRST USE 10-0-2007; IN COMMERCE 11-0-2007.

THE MARK CONSISTS OF A SPEAKER FACE WITH LIGHT SHINING ON THE TOP HALF OF IT.

THERE ARE METALLIC WINGS ATTACHED TO THE LEFT AND RIGHT OF THE SPEAKER FACE. THE STYLIZED WORD "CONQUEST" IS ARCED ABOVE THE SPEAKER FACE AND THE STYLIZED WORD "SOUND" IS ARCED BENEATH THE SPEAKER FACE. UNDER THE SPEAKER WITH WINGS ARE THE STYLIZED WORDS "THE MUSICAL EXPERIENCE!".

SER. NO. 77-359,991, FILED 12-27-2007.

JENNIFER VASQUEZ, EXAMINING ATTORNEY

**Int. Cl.: 16**

**Prior U.S. Cls.: 2, 5, 22, 23, 29, 37, 38 and 50**

**United States Patent and Trademark Office**

**Reg. No. 3,504,265**

**Registered Sep. 23, 2008**

**TRADEMARK  
PRINCIPAL REGISTER**

**OSTOMYWOUND MANAGEMENT**

HMP COMMUNICATIONS, LLC (DELAWARE  
LIMITED LIABILITY COMPANY)  
SUITE 100  
83 GENERAL WARREN BOULEVARD  
MALVERN, PA 19355

FOR: PRINTED PUBLICATIONS, NAMELY, PER-  
IODICALLY PUBLISHED MAGAZINES AND JOUR-  
NALS IN THE FIELDS OF HEALTHCARE AND  
MEDICINE, IN CLASS 16 (U.S. CLS. 2, 5, 22, 23, 29, 37,  
38 AND 50).

FIRST USE 3-1-1980; IN COMMERCE 3-1-1980.

THE MARK CONSISTS OF STANDARD CHAR-  
ACTERS WITHOUT CLAIM TO ANY PARTICULAR  
FONT, STYLE, SIZE, OR COLOR.

SEC. 2(F).

SER. NO. 77-360,019, FILED 12-27-2007.

ARETHA SOMERVILLE, EXAMINING ATTORNEY

Int. Cl.: 29

Prior U.S. Cl.: 46

United States Patent and Trademark Office

Reg. No. 3,504,266

Registered Sep. 23, 2008

TRADEMARK  
PRINCIPAL REGISTER



VERITAS V, LLC (CALIFORNIA LIMITED LIABILITY COMPANY)  
401 MONTEREY STREET, SUITE 201  
SALINAS, CA 93901

FOR: PACKAGED PROCESSED ORGANIC FRESH VEGETABLES, IN CLASS 29 (U.S. CL. 46).

FIRST USE 6-0-2007; IN COMMERCE 6-0-2007.

NO CLAIM IS MADE TO THE EXCLUSIVE RIGHT TO USE "GOOD CLEAN VEGGIES", APART FROM THE MARK AS SHOWN.

THE COLOR(S) RED, ORANGE, GREEN AND BLACK IS/ARE CLAIMED AS A FEATURE OF THE MARK.

THE MARK IS COMPRISED OF THE WORDING "ORGANICGIRL" AND "GOOD CLEAN VEGGIES" AND THE DESIGN OF A TOMATO, CARROT AND LETTUCE LEAF IN A RECTANGULAR BACK-

GROUND CARRIER WITH A SINGLE LINE DISSECTING THE RECTANGLE BELOW THE WORDING. THE COLOR RED APPEARS IN THE TOMATO DESIGN AND IN THE WORDING "GIRL". THE COLOR GREEN APPEARS IN THE LEAF DESIGN AND ON THE LEAVES SHOWN ON THE VEGETABLES. THE COLOR ORANGE APPEARS IN THE CARROT DESIGN. THE COLOR BLACK APPEARS IN THE WORDING "ORGANIC", IN THE WORDING "GOOD CLEAN VEGGIES", IN THE OUTLINE OF THE VEGETABLES, IN THE OUTLINE OF THE RECTANGLE, AND IN THE DESIGN OF THE LINE. THE COLOR WHITE APPEARS ON THE SHADING PART OF THE TOMATO. THE WHITE AREA THAT COMPRISES THE BACKGROUND AREA OF THE MARK WITHIN THE RECTANGLE IS INTENDED AS A TRANSPARENT AREA AND IS NOT PART OF THE MARK.

SER. NO. 77-360,158, FILED 12-27-2007.

SHARON MEIER, EXAMINING ATTORNEY

Int. Cl.: 29

Prior U.S. Cl.: 46

United States Patent and Trademark Office

Reg. No. 3,504,267

Registered Sep. 23, 2008

TRADEMARK  
PRINCIPAL REGISTER



VERITAS V, LLC (CALIFORNIA LIMITED LIABILITY COMPANY)  
401 MONTEREY STREET, SUITE 201  
SALINAS, CA 93901

FOR: PACKAGED PROCESSED ORGANIC FRESH VEGETABLES, IN CLASS 29 (U.S. CL. 46).

FIRST USE 6-0-2007; IN COMMERCE 6-0-2007.

NO CLAIM IS MADE TO THE EXCLUSIVE RIGHT TO USE "GOOD FRESH GREENS", APART FROM THE MARK AS SHOWN.

THE COLOR(S) RED, ORANGE, GREEN AND BLACK IS/ARE CLAIMED AS A FEATURE OF THE MARK.

THE MARK IS COMPRISED OF THE WORDING "ORGANICGIRL" AND "GOOD FRESH GREENS" AND THE DESIGN OF A TOMATO, CARROT AND LETTUCE LEAF IN A RECTANGULAR BACK-

GROUND CARRIER WITH A SINGLE LINE DISSECTING THE RECTANGLE BELOW THE WORDING. THE COLOR RED APPEARS IN THE TOMATO DESIGN AND IN THE WORDING "GIRL". THE COLOR GREEN APPEARS IN THE LEAF DESIGN AND ON THE LEAVES SHOWN ON THE VEGETABLES. THE COLOR ORANGE APPEARS IN THE CARROT DESIGN. THE COLOR BLACK APPEARS IN THE WORDING "ORGANIC", IN THE WORDING "GOOD FRESH GREENS", IN THE OUTLINE OF THE VEGETABLES, IN THE OUTLINE OF THE RECTANGLE, AND IN THE DESIGN OF THE LINE. THE COLOR WHITE APPEARS ON THE SHADING PART OF THE TOMATO. THE WHITE AREA THAT COMPRISES THE BACKGROUND AREA OF THE MARK WITHIN THE RECTANGLE IS INTENDED AS A TRANSPARENT AREA AND IS NOT PART OF THE MARK.

SER. NO. 77-360,207, FILED 12-27-2007.

SHARON MEIER, EXAMINING ATTORNEY



**Int. Cl.: 41**

**Prior U.S. Cls.: 100, 101 and 107**

**United States Patent and Trademark Office**

**Reg. No. 3,504,268**

**Registered Sep. 23, 2008**

**SERVICE MARK  
PRINCIPAL REGISTER**

**THE HANDICAPPER'S EDGE**

CHURCHILL DOWNS INCORPORATED (KEN-  
TUCKY CORPORATION)  
700 CENTRAL AVENUE  
LOUISVILLE, KY 40208

FOR: PROVIDING NEWS AND INFORMATION  
IN THE FIELD OF HORSE RACING AND HORSE  
PEDIGREES VIA A GLOBAL COMPUTER NET-  
WORK, IN CLASS 41 (U.S. CLS. 100, 101 AND 107).

FIRST USE 12-31-1997; IN COMMERCE 12-31-1997.

THE MARK CONSISTS OF STANDARD CHAR-  
ACTERS WITHOUT CLAIM TO ANY PARTICULAR  
FONT, STYLE, SIZE, OR COLOR.

NO CLAIM IS MADE TO THE EXCLUSIVE  
RIGHT TO USE "HANDICAPPER'S", APART FROM  
THE MARK AS SHOWN.

SER. NO. 77-360,242, FILED 12-27-2007.

DARRYL SPRUILL, EXAMINING ATTORNEY

Int. Cl.: 29

Prior U.S. Cl.: 46

United States Patent and Trademark Office

Reg. No. 3,504,269

Registered Sep. 23, 2008

TRADEMARK  
PRINCIPAL REGISTER



VERITAS V, LLC (CALIFORNIA LIMITED LIABILITY COMPANY)  
401 MONTEREY STREET, SUITE 201  
SALINAS, CA 93901

FOR: PACKAGED PROCESSED ORGANIC FRESH VEGETABLES, IN CLASS 29 (U.S. CL. 46).

FIRST USE 6-0-2007; IN COMMERCE 6-0-2007.

NO CLAIM IS MADE TO THE EXCLUSIVE RIGHT TO USE "GOOD FRESH VEGGIES", APART FROM THE MARK AS SHOWN.

THE COLOR(S) RED, ORANGE, GREEN AND BLACK IS/ARE CLAIMED AS A FEATURE OF THE MARK.

THE MARK IS COMPRISED OF THE WORDING "ORGANICGIRL" AND "GOOD FRESH VEGGIES" AND THE DESIGN OF A TOMATO, CARROT AND LETTUCE LEAF IN A RECTANGULAR BACK-

GROUND CARRIER WITH A SINGLE LINE DISSECTING THE RECTANGLE BELOW THE WORDING. THE COLOR RED APPEARS IN THE TOMATO DESIGN AND IN THE WORDING "GIRL". THE COLOR GREEN APPEARS IN THE LEAF DESIGN AND ON THE LEAVES SHOWN ON THE VEGETABLES. THE COLOR ORANGE APPEARS IN THE CARROT DESIGN. THE COLOR BLACK APPEARS IN THE WORDING "ORGANIC", IN THE WORDING "GOOD FRESH VEGGIES", IN THE OUTLINE OF THE VEGETABLES, IN THE OUTLINE OF THE RECTANGLE, AND IN THE DESIGN OF THE LINE. THE COLOR WHITE APPEARS ON THE SHADING PART OF THE TOMATO. THE WHITE AREA THAT COMPRISES THE BACKGROUND AREA OF THE MARK WITHIN THE RECTANGLE IS INTENDED AS A TRANSPARENT AREA AND IS NOT PART OF THE MARK.

SER. NO. 77-360,255, FILED 12-27-2007.

SHARON MEIER, EXAMINING ATTORNEY

Int. Cl.: 29

Prior U.S. Cl.: 46

United States Patent and Trademark Office

Reg. No. 3,504,270

Registered Sep. 23, 2008

TRADEMARK  
PRINCIPAL REGISTER

**washed<sup>2</sup>**  

---

**we washed it 2 times**  
**so you don't have to**

VERITAS V, LLC (CALIFORNIA LIMITED LIABILITY COMPANY)  
401 MONTEREY STREET, SUITE 201  
SALINAS, CA 93901

THE MARK CONSISTS OF THE WORD "WASHED", THE ROMAN NUMERAL "2" AND A LINE ABOVE THE PHRASE "WE WASHED IT 2 TIMES SO YOU DON'T HAVE TO".

FOR: PACKAGED PROCESSED FRESH VEGETABLES, IN CLASS 29 (U.S. CL. 46).

SER. NO. 77-360,313, FILED 12-27-2007.

FIRST USE 6-0-2007; IN COMMERCE 6-0-2007.

SHARON MEIER, EXAMINING ATTORNEY

**Int. Cl.: 35**

**Prior U.S. Cls.: 100, 101 and 102**

**United States Patent and Trademark Office**

**Reg. No. 3,504,271**

**Registered Sep. 23, 2008**

**SERVICE MARK  
PRINCIPAL REGISTER**



**GREENSPOT, INC. (DELAWARE CORPORATION)**

**792 HWY 133**

**CARBONDALE, CO 81623**

**FOR: RETAIL STORE SERVICES FEATURING ENVIRONMENTALLY FRIENDLY BUILDING MATERIALS, HOUSEHOLD GOODS AND APPLIANCES, IN CLASS 35 (U.S. CLS. 100, 101 AND 102).**

**FIRST USE 8-1-2007; IN COMMERCE 8-1-2007.**

**THE STIPLING IS FOR SHADING PURPOSES ONLY.**

**THE MARK CONSISTS OF A LOWER CASE LETTER "G" SURROUNDED BY A TWO POINT STYLIZED BOX WITH BREAKS IN THE UPPER RIGHT HAND CORNER, CREATING A SEPARATE PIECE OF THE EXTERIOR BOX.**

**SER. NO. 77-360,507, FILED 12-27-2007.**

**LESLEY LAMOTHE, EXAMINING ATTORNEY**

Int. Cl.: 28

Prior U.S. Cls.: 22, 23, 38 and 50

United States Patent and Trademark Office

Reg. No. 3,504,272

Registered Sep. 23, 2008

TRADEMARK  
PRINCIPAL REGISTER

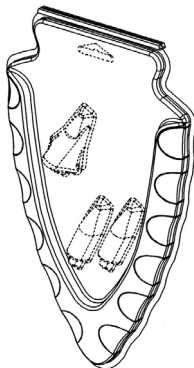

TRU-FIRE CORPORATION (WISCONSIN CORPORATION)  
722 STATE STREET  
N. FOND DU LAC, WI 54937

FOR: ARROWHEADS; ARCHERY ARROW POINTS; HUNTING ARROW POINTS, IN CLASS 28 (U.S. CLS. 22, 23, 38 AND 50).

FIRST USE 2-0-2008; IN COMMERCE 2-0-2008.

THE MARK CONSISTS OF TRADE DRESS CHARACTERIZING THE PACKAGING FOR OWNER'S

GOODS, WITH THE TRADE DRESS COMPRISING A PACKAGE WITH OUTER BOUNDARIES RESEMBLING THE OUTLINE OF A PREHISTORIC SPEARHEAD. THE DASHED LINES REPRESENT A HANGING HOLE AND POCKETS FOR RECEIVING THE GOODS, AND ARE NOT A PORTION OF THE MARK.

SER. NO. 77-360,678, FILED 12-28-2007.

CHARLES L. JENKINS, EXAMINING ATTORNEY

**Int. Cl.: 43**

**Prior U.S. Cls.: 100 and 101**

**United States Patent and Trademark Office**

**Reg. No. 3,504,273**

**Registered Sep. 23, 2008**

**SERVICE MARK  
PRINCIPAL REGISTER**

**WOK HAY FRESH ASIAN DINING**

RTBD, INC. (DELAWARE CORPORATION)  
150 WEST CHURCH AVENUE  
MARYVILLE, TN 37801

FOR: RESTAURANT SERVICES, IN CLASS 43  
(U.S. CLS. 100 AND 101).

FIRST USE 10-9-2007; IN COMMERCE 10-9-2007.

THE MARK CONSISTS OF STANDARD CHAR-  
ACTERS WITHOUT CLAIM TO ANY PARTICULAR  
FONT, STYLE, SIZE, OR COLOR.

OWNER OF U.S. REG. NOS. 3,205,088 AND  
3,248,303.

NO CLAIM IS MADE TO THE EXCLUSIVE  
RIGHT TO USE "FRESH ASIAN DINING", APART  
FROM THE MARK AS SHOWN.

THE FOREIGN WORDING IN THE MARK  
TRANSLATES INTO ENGLISH AS "BREATH OF  
THE WOK".

SER. NO. 77-360,718, FILED 12-28-2007.

CHRISTINE COOPER, EXAMINING ATTORNEY

**Int. Cl.: 29**

**Prior U.S. Cl.: 46**

**United States Patent and Trademark Office**

**Reg. No. 3,504,274**

**Registered Sep. 23, 2008**

**TRADEMARK  
PRINCIPAL REGISTER**



A&P GROWERS COOPERATIVE (CALIFORNIA CORPORATION)  
26487 N. HWY. 99  
TULARE, CA 93274

FOR: DRIED FRUITS; PROCESSED NUTS; ROASTED NUTS, IN CLASS 29 (U.S. CL. 46).

FIRST USE 10-24-1988; IN COMMERCE 10-24-1988.

NO CLAIM IS MADE TO THE EXCLUSIVE RIGHT TO USE "COUNTRY BEST CALIFORNIA

PISTACHIOS", APART FROM THE MARK AS SHOWN.

THE STIPPLING IS FOR SHADING PURPOSES ONLY.

THE MARK CONSISTS OF RECTANGLE ENCLOSING TREE TOPS AND SUN.

SER. NO. 77-360,807, FILED 12-28-2007.

LINDSEY RUBIN, EXAMINING ATTORNEY

**Int. Cl.: 17**

**Prior U.S. Cls.: 1, 5, 12, 13, 35 and 50**

**United States Patent and Trademark Office**

**Reg. No. 3,504,275**

**Registered Sep. 23, 2008**

**TRADEMARK  
PRINCIPAL REGISTER**

**ECO SUPREME**

SIMOUSEK, GEORGE JOSEPH (UNITED STATES INDIVIDUAL)  
5402 FORGE DRIVE  
MADISON, WI 53716

THE MARK CONSISTS OF STANDARD CHARACTERS WITHOUT CLAIM TO ANY PARTICULAR FONT, STYLE, SIZE, OR COLOR.

FOR: RECYCLED ACOUSTIC FLOORING UNDERLAYMENT, IN CLASS 17 (U.S. CLS. 1, 5, 12, 13, 35 AND 50).

SER. NO. 77-360,840, FILED 12-28-2007.

FIRST USE 6-1-2007; IN COMMERCE 6-1-2007.

AISHA CLARKE, EXAMINING ATTORNEY



**Int. Cl.: 36**

**Prior U.S. Cls.: 100, 101 and 102**

**United States Patent and Trademark Office**

**Reg. No. 3,504,276**

**Registered Sep. 23, 2008**

**SERVICE MARK  
PRINCIPAL REGISTER**

**ANYBANK HSA**

FREEDOM SERVICES, INC. (MINNESOTA CORPORATION)  
425 WEST TRAVELERS TRAIL  
BURNSVILLE, MN 55337

FOR: EMPLOYEE BENEFITS ADMINISTRATION SERVICES, NAMELY, THE ADMINISTRATION OF HEALTH SAVINGS ACCOUNTS AND PROCESSING DISBURSEMENTS OF FUNDS TO EMPLOYEE SAVINGS ACCOUNTS, AND RECONCILIATION OF SUCH SAVINGS ACCOUNTS ON BEHALF OF EMPLOYEES AND THEIR EMPLOYERS, IN CLASS 36 (U.S. CLS. 100, 101 AND 102).

FIRST USE 1-1-2007; IN COMMERCE 9-1-2007.

THE MARK CONSISTS OF STANDARD CHARACTERS WITHOUT CLAIM TO ANY PARTICULAR FONT, STYLE, SIZE, OR COLOR.

NO CLAIM IS MADE TO THE EXCLUSIVE RIGHT TO USE "HSA", APART FROM THE MARK AS SHOWN.

SER. NO. 77-360,857, FILED 12-28-2007.

KYLE PEETE, EXAMINING ATTORNEY

**Int. Cl.: 30**

**Prior U.S. Cl.: 46**

**United States Patent and Trademark Office**

**Reg. No. 3,504,277**

**Registered Sep. 23, 2008**

**TRADEMARK  
PRINCIPAL REGISTER**

**FRUIT SUPREMES**

LIBERTY ORCHARDS COMPANY, INC. (WA-  
SHINGTON CORPORATION)  
P.O. BOX C  
CASHMERE, WA 98815

NO CLAIM IS MADE TO THE EXCLUSIVE  
RIGHT TO USE "FRUIT", APART FROM THE  
MARK AS SHOWN.

FOR: CANDY, IN CLASS 30 (U.S. CL. 46).

FIRST USE 11-30-2007; IN COMMERCE 11-30-2007.

SER. NO. 77-361,295, FILED 12-28-2007.

THE MARK CONSISTS OF STANDARD CHAR-  
ACTERS WITHOUT CLAIM TO ANY PARTICULAR  
FONT, STYLE, SIZE, OR COLOR.

SARA THOMAS, EXAMINING ATTORNEY

**Int. Cl.: 42**

**Prior U.S. Cls.: 100 and 101**

**United States Patent and Trademark Office**

**Reg. No. 3,504,278**

**Registered Sep. 23, 2008**

**SERVICE MARK  
PRINCIPAL REGISTER**



MIC ELECTRONICS LIMITED (INDIA CORPORATION)  
A- 4/II, ELECTRONIC COMPLEX, KUSHAIGUDA,  
HYDERABAD, INDIA 500062

FOR: SCIENTIFIC RESEARCH AND DEVELOPMENT; RESEARCH AND DEVELOPMENT AND CONSULTATION RELATED THERETO IN THE FIELD OF LIGHT EMITTING DIODE (LED) VIDEO DISPLAYS AND LIGHT EMITTING DIODE (LED) LIGHTING; RESEARCH AND DEVELOPMENT OF NEW PRODUCTS, IN CLASS 42 (U.S. CLS. 100 AND 101).

FIRST USE 10-30-2006; IN COMMERCE 10-30-2006.

THE COLOR(S) NAVY BLUE, SKY BLUE, RED, GREEN, YELLOW, PURPLE AND WHITE IS/ARE CLAIMED AS A FEATURE OF THE MARK.

THE COLOR NAVY BLUE APPEARS IN THE LETTERING "MIC" AND IN THE DESIGN OF THREE CIRCLES. THE COLOR SKY BLUE APPEARS IN THE WORDING "DRIVING INNOVATION", IN THE ELLIPTICAL CURVED LINE, IN THE LINES THAT HIGHLIGHT THE LETTERING "MIC", AND IN THE DESIGN OF THREE CIRCLES. THE COLORS RED, GREEN, YELLOW, PURPLE AND WHITE APPEAR IN THE DESIGN OF THREE CIRCLES. THE COLOR WHITE APPEARING IN THE CENTER OF THE DESIGN OF THREE CIRCLES CONSTITUTES BACKGROUND, OUTLINING, SHADING OR TRANSPARENT AREAS, AND IS NOT PART OF THE MARK.

SER. NO. 77-361,418, FILED 12-29-2007.

JAMES MACFARLANE, EXAMINING ATTORNEY

Int. Cl.: 16

Prior U.S. Cls.: 2, 5, 22, 23, 29, 37, 38 and 50

United States Patent and Trademark Office

Reg. No. 3,504,279

Registered Sep. 23, 2008

TRADEMARK  
PRINCIPAL REGISTER



ROBYWROTEIT (DELAWARE CORPORATION)  
28 KULLEN DRIVE  
NEWARK, DE 19713

FOR: CARDS, NAMELY, GREETING, HOLIDAY  
AND BUSINESS, IN CLASS 16 (U.S. CLS. 2, 5, 22, 23,  
29, 37, 38 AND 50).

FIRST USE 11-29-2007; IN COMMERCE 12-1-2007.

THE COLOR(S) BLUE, RED, GREEN, BLACK IS/  
ARE CLAIMED AS A FEATURE OF THE MARK.

THE MARK CONSISTS OF BLUE LETTERS UN-  
DERLINED BY THIN BLUE LINE. UNDERNEATH  
BLUE LINE BEGINNING ON THE RIGHT SIDE OF  
THE "W" AND EXTENDING HORIZONTALLY TO  
THE LEFT SIDE OF THE "E" IS BLUE AND GREEN  
GLOBE, SHOWING AFRICA CONTINENT, WITH A  
RED PAW IMPOSED OVER THE GLOBE. THE RED  
PAW HAS BLACK LINES ON IT. A BLUE WING IS  
ATTACHED TO THE RIGHT SIDE OF THE GLOBE  
AND EXTENDS UP ACROSS THE BLUE LINE AND  
ENCLOSES THE BOTTOM PORTION OF THE "E".

SER. NO. 77-363,209, FILED 1-3-2008.

CAROLINE WOOD, EXAMINING ATTORNEY

Int. Cl.: 16

Prior U.S. Cls.: 2, 5, 22, 23, 29, 37, 38 and 50

Reg. No. 3,504,280

United States Patent and Trademark Office

Registered Sep. 23, 2008

TRADEMARK  
PRINCIPAL REGISTER



Hagerty's  
THE VOICE OF THE COLLECTOR CAR COMMUNITY

HAGERTY INSURANCE AGENCY, INC. (MICHIGAN CORPORATION)  
141 RIVER'S EDGE DRIVE, PO BOX 87  
TRAVERSE CITY, MI 49684

FOR: MAGAZINES FEATURING AUTOMOBILE COLLECTING, IN CLASS 16 (U.S. CLS. 2, 5, 22, 23, 29, 37, 38 AND 50).

FIRST USE 11-1-2006; IN COMMERCE 11-1-2006.

OWNER OF U.S. REG. NOS. 2,414,043, 3,103,048 AND OTHERS.

THE MARK CONSISTS OF THE WORD "HAGERTY'S" IN SCRIPT WITH THE WORDS "THE VOICE OF THE COLLECTOR CAR COMMUNITY" CENTERED BELOW IN ALL CAPS. COLOR IS NOT A FEATURE OF THE MARK.

SER. NO. 77-363,295, FILED 1-3-2008.

GEOFFREY FOSDICK, EXAMINING ATTORNEY

**Int. Cl.: 35**

**Prior U.S. Cls.: 100, 101 and 102**

**United States Patent and Trademark Office**

**Reg. No. 3,504,281**

**Registered Sep. 23, 2008**

**SERVICE MARK  
PRINCIPAL REGISTER**

**GRAND SLAM GENETICS**

SHERWOOD PROPERTIES, INC. (TEXAS CORPORATION), DBA 44 FARMS  
SUITE 2222  
1401 MCKINNEY STREET  
HOUSTON, TX 77010

FOR: ARRANGING AND CONDUCTING SALES FOR OTHERS OF LIVESTOCK AND REGISTERED AND COMMERCIAL CATTLE; LIVESTOCK AUCTION SERVICES, IN CLASS 35 (U.S. CLS. 100, 101 AND 102).

FIRST USE 3-15-2007; IN COMMERCE 3-15-2007.

THE MARK CONSISTS OF STANDARD CHARACTERS WITHOUT CLAIM TO ANY PARTICULAR FONT, STYLE, SIZE, OR COLOR.

SER. NO. 77-363,297, FILED 1-3-2008.

MARGERY A. TIERNEY, EXAMINING ATTORNEY

Int. Cl.: 35

Prior U.S. Cls.: 100, 101 and 102

United States Patent and Trademark Office

Reg. No. 3,504,282

Registered Sep. 23, 2008

SERVICE MARK  
PRINCIPAL REGISTER



SHERWOOD PROPERTIES, INC. (TEXAS CORPORATION), DBA 44 FARMS  
SUITE 2222  
1401 MCKINNEY STREET  
HOUSTON, TX 77010

FOR: ARRANGING AND CONDUCTING SALES FOR OTHERS OF LIVESTOCK AND REGISTERED AND COMMERCIAL CATTLE; LIVESTOCK AUCTION SERVICES, IN CLASS 35 (U.S. CLS. 100, 101 AND 102).

FIRST USE 3-15-2007; IN COMMERCE 3-15-2007.

NO CLAIM IS MADE TO THE EXCLUSIVE RIGHT TO USE "ANGUS SALE", APART FROM THE MARK AS SHOWN.

THE MARK CONSISTS OF THE LITERAL ELEMENT AND A "FANCIFUL ANGUS" DESIGN ALL WITHIN A FANCIFUL HOME PLATE DESIGN.

SER. NO. 77-363,329, FILED 1-3-2008.

MARGERY A. TIERNEY, EXAMINING ATTORNEY

**Int. Cls.: 16 and 28**

**Prior U.S. Cls.: 2, 5, 22, 23, 29, 37, 38 and 50**

**United States Patent and Trademark Office**

**Reg. No. 3,504,283**

**Registered Sep. 23, 2008**

**TRADEMARK  
PRINCIPAL REGISTER**

**MILL HILL**

WICHELT IMPORTS, INC. (WISCONSIN CORPORATION)  
N162 HIGHWAY 35  
STODDARD, WI 54658

FOR: PUBLICATIONS, NAMELY, HAND-OUTS FOR KITS AND WORKBOOKS, ON THE SUBJECT OF CRAFTS AND NEEDLEWORK; PERFORATED CRAFT PAPER, IN CLASS 16 (U.S. CLS. 2, 5, 22, 23, 29, 37, 38 AND 50).

FIRST USE 1-1-1999; IN COMMERCE 1-1-1999.

FOR: HOBBY CRAFT KIT COMPRISING OF GLASS BEADS, NEEDLES, INSTRUCTIONS, COLOR COVER SHEET, PERFORATED CRAFT PAPER,

COUNTED THREAD FABRIC, CHARTED DESIGN INSTRUCTIONS, AND THREADS, GLASS BEADS, CERAMIC BUTTONS, GLASS EMBELLISHMENTS, PICTURE FRAMES, IN CLASS 28 (U.S. CLS. 22, 23, 38 AND 50).

FIRST USE 1-1-1999; IN COMMERCE 1-1-1999.

THE MARK CONSISTS OF STANDARD CHARACTERS WITHOUT CLAIM TO ANY PARTICULAR FONT, STYLE, SIZE, OR COLOR.

SER. NO. 77-363,636, FILED 1-3-2008.

NAKWAMA ANKRAH, EXAMINING ATTORNEY



Int. Cl.: 25

Prior U.S. Cls.: 22 and 39

**United States Patent and Trademark Office**

**Reg. No. 3,504,284**

Registered Sep. 23, 2008

**TRADEMARK  
PRINCIPAL REGISTER**



BELLY BROTHERS, LLC (CALIFORNIA LIMITED LIABILITY COMPANY)  
9770 DOUGLAS AVE.  
DELHI, CA 95315

FOR: HATS; JACKETS; SHIRTS, IN CLASS 25 (U.S. CLS. 22 AND 39).

FIRST USE 10-0-2007; IN COMMERCE 12-0-2007.

THE NAME(S), PORTRAIT(S), AND/OR SIGNATURE(S) SHOWN IN THE MARK DOES NOT IDENTIFY A PARTICULAR LIVING INDIVIDUAL.

THE MARK CONSISTS OF A MAN'S FACE. HE ALSO HAS A HAT ON.

SER. NO. 77-363,699, FILED 1-3-2008.

ANDREA HACK, EXAMINING ATTORNEY

**Int. Cl.: 42**

**Prior U.S. Cls.: 100 and 101**

**United States Patent and Trademark Office**

**Reg. No. 3,504,285**

**Registered Sep. 23, 2008**

**SERVICE MARK  
PRINCIPAL REGISTER**

**SSCC**

EARTHWORK SOLUTIONS, INC. (TEXAS CORPORATION)  
11111 KATY FREEWAY, SUITE 910  
HOUSTON, TX 77079

FOR: ENGINEERING SERVICES, NAMELY, ENGINEERING FOR THE COMPACTION OF EARTH, IN CLASS 42 (U.S. CLS. 100 AND 101).

FIRST USE 6-1-2001; IN COMMERCE 5-16-2005.

THE MARK CONSISTS OF STANDARD CHARACTERS WITHOUT CLAIM TO ANY PARTICULAR FONT, STYLE, SIZE, OR COLOR.

SER. NO. 77-363,871, FILED 1-3-2008.

MICHAEL GAAFAR, EXAMINING ATTORNEY

**Int. Cls.: 35 and 42**

**Prior U.S. Cls.: 100, 101 and 102**

**United States Patent and Trademark Office**

**Reg. No. 3,504,286**

**Registered Sep. 23, 2008**

**SERVICE MARK  
PRINCIPAL REGISTER**

**incitrio'**

INCITRIO (CALIFORNIA SOLE PROPRIETORSHIP)  
10951 SORRENTO VALLEY ROAD, SUITE 2C  
SAN DIEGO, CA 92121

FOR: BRANDING SERVICES FOR OTHERS, NAMELY, BRAND IMAGERY CONSULTING, BRAND ANALYSIS, BRAND STRATEGY PLANNING, CREATING BRAND IDENTITY, BRAND ESTABLISHMENT OF TRADEMARKS, TRADE NAMES AND DOMAIN NAMES, AND BRAND DEVELOPMENT IN THE FIELDS OF FINANCE, MEDICINE, CONSUMER GOODS, COMMERCIAL REAL ESTATE DEVELOPMENT, INSURANCE, BIOTECHNOLOGY, CONSUMER ELECTRONICS, NON-PROFIT ORGANIZATIONS, AND ELECTRONIC COMMERCE FOR THE FOREGOING FIELDS, IN CLASS 35 (U.S. CLS. 100, 101 AND 102).

FIRST USE 3-1-2003; IN COMMERCE 3-1-2003.

FOR: GRAPHIC DESIGN; WEBSITE DESIGN; AND COMPUTER PROGRAMMING, IN CLASS 42 (U.S. CLS. 100 AND 101).

FIRST USE 3-1-2003; IN COMMERCE 3-1-2003.

THE MARK CONSISTS OF THE WORD "INCITRIO" WITH A LEAF OVER THE "O".

SER. NO. 77-364,120, FILED 1-4-2008.

BRIAN PINO, EXAMINING ATTORNEY

Int. Cl.: 44

Prior U.S. Cls.: 100 and 101

United States Patent and Trademark Office

Reg. No. 3,504,287

Registered Sep. 23, 2008

**SERVICE MARK  
PRINCIPAL REGISTER**

**ADVANCED HEALTH EDUCATION CENTER**



ADVANCED HEALTH EDUCATION CENTER,  
LTD. (TEXAS LIMITED PARTNERSHIP)  
8502 TYBOR  
HOUSTON, TX 77074

OWNER OF U.S. REG. NO. 2,252,715.

NO CLAIM IS MADE TO THE EXCLUSIVE  
RIGHT TO USE "ADVANCED HEALTH EDUCA-  
TION CENTER", APART FROM THE MARK AS  
SHOWN.

FOR: MEDICAL IMAGING SERVICES, NAMELY,  
CONSULTING SERVICES IN THE FIELD USING  
AND OPERATING MEDICAL IMAGING APPARA-  
TUS, NAMELY, X-RAY, COMPUTED TOMOGRA-  
PHY, CARDIOVASCULAR INTERVENTIONAL  
TECHNOLOGY, MAGNETIC RESONANCE IMA-  
GING, ULTRASOUND, BONE DENSITY, POSI-  
TRON EMISSION TOMOGRAPHY APPARATUS,  
MAMMOGRAPHY AND RADIATION THERAPY  
DIAGNOSTICS APPARATUS, IN CLASS 44 (U.S.  
CLS. 100 AND 101).

THE MARK CONSISTS OF THE STYLIZED  
WORDING "ADVANCED HEALTH EDUCATION  
CENTER" UNDERLINED ALONG WITH A TRIAN-  
GLE EXTENDING UPWARD BETWEEN THE  
TERMS "HEALTH" AND "EDUCATION".

FIRST USE 11-0-2007; IN COMMERCE 11-0-2007.

SER. NO. 77-364,162, FILED 1-4-2008.

JAY BESCH, EXAMINING ATTORNEY

**Int. Cl.: 9**

**Prior U.S. Cls.: 21, 23, 26, 36 and 38**

**Reg. No. 3,504,288**

**United States Patent and Trademark Office**

**Registered Sep. 23, 2008**

---

**TRADEMARK  
PRINCIPAL REGISTER**

# Voice Alert

CROSS POINT INDUSTRIES, INC. (CALIFORNIA  
CORPORATION)  
2240 ENCINITAS BLVD., STE D.  
ENCINITAS, CA 92024

FOR: BURGLAR ALARMS, IN CLASS 9 (U.S. CLS.  
21, 23, 26, 36 AND 38).

FIRST USE 9-0-2000; IN COMMERCE 9-0-2000.

THE MARK CONSISTS OF STANDARD CHAR-  
ACTERS WITHOUT CLAIM TO ANY PARTICULAR  
FONT, STYLE, SIZE, OR COLOR.

SEC. 2(F).

SER. NO. 77-364,315, FILED 1-4-2008.

CURTIS FRENCH, EXAMINING ATTORNEY

**Int. Cl.: 41**

**Prior U.S. Cls.: 100, 101 and 107**

**United States Patent and Trademark Office**

**Reg. No. 3,504,289**

**Registered Sep. 23, 2008**

**SERVICE MARK  
PRINCIPAL REGISTER**

**ePEP**

PEP PRODUCTIVITY SOLUTIONS, INC. (NEVADA CORPORATION)  
1651 SCOOTER LANE  
FALLBROOK, CA 92028

FOR: EDUCATIONAL SERVICES, NAMELY, CONDUCTING ON-LINE CLASSES, SEMINARS, WORKSHOPS, AND PROGRAMS IN THE FIELD OF IMPROVING ORGANIZATIONAL AND PERSONAL WORK HABITS AND EFFECTIVENESS, ORGANIZATIONAL AND FILING SYSTEMS, AND TIME MANAGEMENT SKILLS AND DISTRIBUTION OF COURSE MATERIALS IN CONNECTION

THEREWITH, IN CLASS 41 (U.S. CLS. 100, 101 AND 107).

FIRST USE 4-17-2007; IN COMMERCE 9-12-2007.

THE MARK CONSISTS OF STANDARD CHARACTERS WITHOUT CLAIM TO ANY PARTICULAR FONT, STYLE, SIZE, OR COLOR.

SER. NO. 77-364,435, FILED 1-4-2008.

TRICIA SONNEBORN, EXAMINING ATTORNEY

**Int. Cl.: 35**

**Prior U.S. Cls.: 100, 101 and 102**

**United States Patent and Trademark Office**

**Reg. No. 3,504,290**

**Registered Sep. 23, 2008**

**SERVICE MARK  
PRINCIPAL REGISTER**

**SYNERGY HEALTHCARE  
RESOURCES**

SYNERGY FRANCHISING CORPORATION (IN-  
DIANA CORPORATION)

1150 EASTPORT DRIVE, SUITE C1

VALPARAISO, IN 46383

FOR: MEDICAL BILLING SERVICES, IN CLASS  
35 (U.S. CLS. 100, 101 AND 102).

FIRST USE 2-28-2006; IN COMMERCE 11-30-2006.

THE MARK CONSISTS OF STANDARD CHAR-  
ACTERS WITHOUT CLAIM TO ANY PARTICULAR  
FONT, STYLE, SIZE, OR COLOR.

NO CLAIM IS MADE TO THE EXCLUSIVE  
RIGHT TO USE "HEALTHCARE RESOURCES",  
APART FROM THE MARK AS SHOWN.

SER. NO. 77-365,166, FILED 1-7-2008.

RAMONA ORTIGA, EXAMINING ATTORNEY

**Int. Cl.: 35**

**Prior U.S. Cls.: 100, 101 and 102**

**United States Patent and Trademark Office**

**Reg. No. 3,504,291**

**Registered Sep. 23, 2008**

---

**SERVICE MARK  
PRINCIPAL REGISTER**



SYNERGY FRANCHISING CORPORATION (IN-  
DIANA CORPORATION)  
1150 EASTPORT DRIVE, SUITE C1  
VALPARAISO, IN 46383

NO CLAIM IS MADE TO THE EXCLUSIVE  
RIGHT TO USE "HEALTHCARE RESOURCES",  
APART FROM THE MARK AS SHOWN.

FOR: MEDICAL BILLING SERVICES, IN CLASS  
35 (U.S. CLS. 100, 101 AND 102).

SER. NO. 77-365,167, FILED 1-7-2008.

FIRST USE 2-28-2006; IN COMMERCE 11-30-2006.

RAMONA ORTIGA, EXAMINING ATTORNEY



Int. Cl.: 18

Prior U.S. Cls.: 1, 2, 3, 22 and 41

United States Patent and Trademark Office

Reg. No. 3,504,292

Registered Sep. 23, 2008

TRADEMARK  
PRINCIPAL REGISTER



MAGALI DESIGNS, LLC (CALIFORNIA LIMITED LIABILITY COMPANY)  
5556 S. CENTINELA AVE.  
LOS ANGELES, CA 90066

FOR: HANDBAGS, PURSES AND WALLETS; LEATHER PURSES; SMALL CLUTCH PURSES; SMALL PURSES; MULTI-PURPOSE PURSES, IN CLASS 18 (U.S. CLS. 1, 2, 3, 22 AND 41).

FIRST USE 9-1-2004; IN COMMERCE 9-1-2004.

NO CLAIM IS MADE TO THE EXCLUSIVE RIGHT TO USE "DESIGNS", APART FROM THE MARK AS SHOWN.

THE MARK CONSISTS OF THE WORDS "MAGALI DESIGNS" WHICH APPEAR IN ALL CAPITAL LETTERS. THE WORD "MAGALI" IS CENTERED IN LARGE FONT, AND THE WORD "DESIGNS" APPEARS CENTERED BELOW THE WORD "MA-

GALI" IN A SMALLER FONT. THE WORDS ARE FRAMED ABOVE AND BELOW WITH A GRAPHIC THAT CONSISTS OF THE FOUR SUITS OF A CARD DECK (HEART, DIAMOND, CLUB, SPADE). EACH SUIT APPEARS IN EITHER THE UPPER OR LOWER CORNER OF THE MARK AND APPEAR IN THE FOLLOWING ARRANGEMENT: HEART (UPPER LEFT CORNER); DIAMOND (UPPER RIGHT CORNER); CLUB (LOWER LEFT CORNER); SPADE (LOWER RIGHT CORNER). EACH SUIT IS ATTACHED TO A LARGER GRAPHIC THAT APPEARS ABOVE AND BELOW THE WORDS "MAGALI DESIGNS". THIS GRAPHIC CONSISTS OF AN ABSTRACT SYMMETRICAL SWIRL DESIGN.

SER. NO. 77-366,102, FILED 1-8-2008.

TOBY BULLOFF, EXAMINING ATTORNEY

Int. Cl.: 37

Prior U.S. Cls.: 100, 103 and 106

United States Patent and Trademark Office

Reg. No. 3,504,293

Registered Sep. 23, 2008

SERVICE MARK  
PRINCIPAL REGISTER



GRANGER GROUP OF COMPANIES, L.L.C. (MICHIGAN LIMITED LIABILITY COMPANY)  
SUITE 2200  
2221 HEALTH DRIVE, SW  
WYOMING, MI 49519

FOR: CONSULTATION SERVICES IN THE FIELD OF BUILDING CONSTRUCTION FOR SURGICAL AND OTHER MEDICAL CENTERS CONSISTING OF AN INTEGRATED TURN-KEY DELIVERY SOLUTION BASED ON PROVEN PLANS DESIGNED FROM THE INSIDE OUT, IN CLASS 37 (U.S. CLS. 100, 103 AND 106).

FIRST USE 8-8-2007; IN COMMERCE 9-19-2007.

OWNER OF U.S. REG. NO. 3,258,162.

THE COLOR(S) LIGHT GREEN, DEEP GREEN, PURPLE, LIGHT PURPLE AND WHITE IS/ARE CLAIMED AS A FEATURE OF THE MARK.

THE MARK CONSISTS OF A TRUNCATED OVAL WITH THE UPPER PART OF THE OVAL LIGHT

GREEN AND DEEP GREEN AND THE LOWER PART OF THE OVAL PURPLE AND LIGHT PURPLE. THE MARK FURTHER CONSISTS OF A PURPLE PLANET WITH DEEP GREEN SATELLITES ORBITING THE PLANET, TO THE LEFT OF THE WORDING "INTELLISURG", WHICH IS DEPICTED IN LOWER CASE. THE ORBITS OF THE DEEP GREEN SATELLITES ARE DEPICTED IN WHITE AROUND THE PURPLE PLANET. ONE OF THE DEEP GREEN SATELLITES FORMS THE DOT FOR THE INITIAL PURPLE "I" IN THE WORDING "INTELLISURG". THE LETTERS "INTELLI" ARE PURPLE WITH THE SECOND "I" DOTTED WITH A DEEP GREEN CIRCLE. THE WORDING "SURG" IS IN WHITE COLOR OUTLINED IN PURPLE. FURTHER, THE WORDING "SIMPLIFY THE COMPLEX" IN DEEP GREEN LETTERS APPEARS BELOW THE TERM "INTELLISURG".

SER. NO. 77-366,341, FILED 1-8-2008.

DAWN HAN, EXAMINING ATTORNEY

**Int. Cl.: 25**

**Prior U.S. Cls.: 22 and 39**

**United States Patent and Trademark Office**

**Reg. No. 3,504,294**

**Registered Sep. 23, 2008**

**TRADEMARK  
PRINCIPAL REGISTER**

**BROTALLY**

BROTALLY WORLDWIDE, INC. (ILLINOIS CORPORATION)  
1790 KILLARNEY LANE  
NORTHBROOK, IL 60062

THE MARK CONSISTS OF STANDARD CHARACTERS WITHOUT CLAIM TO ANY PARTICULAR FONT, STYLE, SIZE, OR COLOR.

FOR: SHORT-SLEEVED OR LONG-SLEEVED T-SHIRTS, IN CLASS 25 (U.S. CLS. 22 AND 39).

SER. NO. 77-366,418, FILED 1-8-2008.

FIRST USE 3-16-2005; IN COMMERCE 3-16-2005.

ANGELA GAW, EXAMINING ATTORNEY

**Int. Cl.: 14**

**Prior U.S. Cls.: 2, 27, 28 and 50**

**United States Patent and Trademark Office**

**Reg. No. 3,504,295**

**Registered Sep. 23, 2008**

**TRADEMARK  
PRINCIPAL REGISTER**

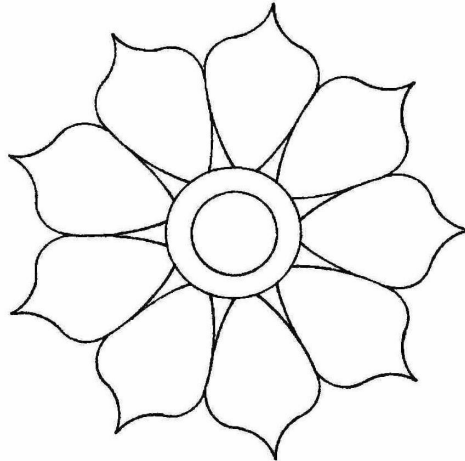

PINK LOTUS LLC (PENNSYLVANIA LIMITED  
LIABILITY COMPANY)  
2-12 ASPEN WAY  
DOYLESTOWN, PA 18901

THE MARK CONSISTS OF 9 PETAL OPEN LOTUS  
FLOWER WITH CIRCULAR CENTER.

FOR: JEWELRY, IN CLASS 14 (U.S. CLS. 2, 27, 28  
AND 50).

SER. NO. 77-366,683, FILED 1-8-2008.

FIRST USE 1-1-2004; IN COMMERCE 1-1-2004.

KIM MONINGHOFF, EXAMINING ATTORNEY

**Int. Cl.: 1**

**Prior U.S. Cls.: 1, 5, 6, 10, 26 and 46**

**United States Patent and Trademark Office**

**Reg. No. 3,504,296**

**Registered Sep. 23, 2008**

**TRADEMARK  
PRINCIPAL REGISTER**



WYK SORBENT, LLC (MISSOURI LIMITED LIABILITY COMPANY)  
10715 KAHLMEYER DR.  
ST. LOUIS, MO 63132

THE MARK CONSISTS OF THE LETTERS "WYK" ENCLOSED BY AN ELONGATED OVAL.

FOR: CHEMICAL COMPOSITION FOR SOLIDIFICATION OF FLUIDS AND FOR ABSORBING SPILLS, IN CLASS 1 (U.S. CLS. 1, 5, 6, 10, 26 AND 46).

SER. NO. 77-366,884, FILED 1-8-2008.

FIRST USE 10-31-1984; IN COMMERCE 10-31-1985.

EMILY CARLSEN, EXAMINING ATTORNEY

Int. Cl.: 29

Prior U.S. Cl.: 46

United States Patent and Trademark Office

Reg. No. 3,504,297

Registered Sep. 23, 2008

TRADEMARK  
PRINCIPAL REGISTER



VERITAS V, LLC (CALIFORNIA LIMITED LIABILITY COMPANY)  
401 MONTEREY STREET, SUITE 201  
SALINAS, CA 93901

FOR: PACKAGED PROCESSED ORGANIC FRESH VEGETABLES, IN CLASS 29 (U.S. CL. 46).

FIRST USE 5-4-2007; IN COMMERCE 5-4-2007.

NO CLAIM IS MADE TO THE EXCLUSIVE RIGHT TO USE "ORGANIC", APART FROM THE MARK AS SHOWN.

THE COLOR(S) GREEN AND BLACK IS/ARE CLAIMED AS A FEATURE OF THE MARK.

THE MARK CONSISTS OF THE LETTER "I", THE WORD "ORGANIC", A HEART SHAPED DESIGN AND AN OUTLINE OF A CIRCLE. THE COLOR BLACK APPEARS IN THE WORDING "I" AND "ORGANIC", IN THE OUTLINE OF THE HEART DESIGN, AND ON THE CIRCLE CARRIER ENCOMPASSING THE WORDING AND THE DESIGN. THE INTERIOR OF THE HEART DESIGN IS IN GREEN. THE WHITE AREA THAT COMPRISES THE BACKGROUND AREA OF THE MARK WITHIN THE CIRCLE IS INTENDED AS A TRANSPARENT AREA AND IS NOT PART OF THE MARK.

SER. NO. 77-366,925, FILED 1-8-2008.

SHARON MEIER, EXAMINING ATTORNEY

**Int. Cl.: 29**

**Prior U.S. Cl.: 46**

**United States Patent and Trademark Office**

**Reg. No. 3,504,298**

**Registered Sep. 23, 2008**

**TRADEMARK  
PRINCIPAL REGISTER**

**washed<sup>3</sup>**  

---

**we washed it 3 times  
so you don't have to**

VERITAS V, LLC (CALIFORNIA LIMITED LIABILITY COMPANY)  
401 MONTEREY STREET, SUITE 201  
SALINAS, CA 93901

FOR: PACKAGED PROCESSED FRESH VEGETABLES, IN CLASS 29 (U.S. CL. 46).

FIRST USE 5-4-2007; IN COMMERCE 5-4-2007.

THE MARK CONSISTS OF THE WORD "WASHED", THE ROMAN NUMERAL "3" AND A LINE ABOVE THE PHRASE "WE WASHED IT 3 TIMES SO YOU DON'T HAVE TO".

SER. NO. 77-366,944, FILED 1-8-2008.

SHARON MEIER, EXAMINING ATTORNEY

Int. Cl.: 25

Prior U.S. Cls.: 22 and 39

United States Patent and Trademark Office

Reg. No. 3,504,299

Registered Sep. 23, 2008

TRADEMARK  
PRINCIPAL REGISTER



SNEAKER HEADZ, LLC (MICHIGAN LIMITED LIABILITY COMPANY), DBA BURN RUBBER  
202 W. FOURTH STREET  
ROYAL OAK, MI 48067

FOR: FOOTWEAR; APPAREL, NAMELY, T-SHIRTS, SHIRTS, SHORTS, PANTS, SWEATSHIRTS, SWEATPANTS, JERSEYS, AND VESTS; AND HEADWEAR, NAMELY, HATS AND CAPS, IN CLASS 25 (U.S. CLS. 22 AND 39).

FIRST USE 3-1-2007; IN COMMERCE 3-1-2007.

THE MARK CONSISTS OF A DESIGN OF A ROBOT WEARING A CHEF HAT SERVING A SHOE ON A PLATTER IN ONE HAND, HOLDING THE LID OF THE PLATTER IN THE OTHER HAND WITH THE LETTERS "BR" ON HIS CHEST.

SER. NO. 77-367,119, FILED 1-9-2008.

GENE MACIOL, EXAMINING ATTORNEY



**Int. Cl.: 35**

**Prior U.S. Cls.: 100, 101 and 102**

**United States Patent and Trademark Office**

**Reg. No. 3,504,300**

**Registered Sep. 23, 2008**

**SERVICE MARK  
PRINCIPAL REGISTER**

**We Build Sound Financial  
Futures**

KISSINGER, WILLIAM I. (UNITED STATES IN-  
DIVIDUAL)  
10155 YORK RD. SUITE 105  
HUNT VALLEY, MD 21030

FOR: CONCEPT AND BRAND DEVELOPMENT  
IN THE FINANCIAL FIELD, IN CLASS 35 (U.S. CLS.  
100, 101 AND 102).

FIRST USE 1-1-2005; IN COMMERCE 1-1-2005.

THE MARK CONSISTS OF STANDARD CHAR-  
ACTERS WITHOUT CLAIM TO ANY PARTICULAR  
FONT, STYLE, SIZE, OR COLOR.

SER. NO. 77-367,275, FILED 1-9-2008.

KARANENDRA S. CHHINA, EXAMINING ATTOR-  
NEY

**Int. Cls.: 38 and 41**

**Prior U.S. Cls.: 100, 101, 104 and 107**

**United States Patent and Trademark Office**

**Reg. No. 3,504,301**

**Registered Sep. 23, 2008**

**SERVICE MARK  
PRINCIPAL REGISTER**

**CONNOISSEUR CLASSICS**

HAMPTON ROADS EDUCATIONAL TELECOM-  
MUNICATIONS ASSOCIATION, INC. (VIRGI-  
NIA CORPORATION), DBA WHRO  
ATTN.: JOHN HEIMERL  
5200 HAMPTON BOULEVARD  
NORFOLK, VA 23508

FOR: STREAMING OF AUDIO AND VIDEO  
MATERIAL BY MUSICAL ARTISTS AND RECORD-  
ING LABELS ON THE INTERNET, IN CLASS 38 (U.S.  
CLS. 100, 101 AND 104).

FIRST USE 12-1-2007; IN COMMERCE 12-1-2007.

FOR: PROVIDING A WEBSITE FEATURING MU-  
SIC, MUSIC VIDEOS, VIDEOS ABOUT MUSIC AND  
MUSICIANS, AND MUSIC INFORMATION BY MU-

SICAL ARTISTS AND RECORDING LABELS, IN  
CLASS 41 (U.S. CLS. 100, 101 AND 107).

FIRST USE 12-1-2007; IN COMMERCE 12-1-2007.

THE MARK CONSISTS OF STANDARD CHAR-  
ACTERS WITHOUT CLAIM TO ANY PARTICULAR  
FONT, STYLE, SIZE, OR COLOR.

NO CLAIM IS MADE TO THE EXCLUSIVE  
RIGHT TO USE "CLASSICS", APART FROM THE  
MARK AS SHOWN.

SER. NO. 77-367,733, FILED 1-9-2008.

PAM WILLIS, EXAMINING ATTORNEY

**Int. Cl.: 41**

**Prior U.S. Cls.: 100, 101 and 107**

**United States Patent and Trademark Office**

**Reg. No. 3,504,302**

**Registered Sep. 23, 2008**

---

**SERVICE MARK  
PRINCIPAL REGISTER**

**HOOPERCISE**

KAREN BELL (UNITED STATES INDIVIDUAL)  
5261 HIGHLAND DRIVE  
TRAVERSE CITY, MI 49684

THE MARK CONSISTS OF STANDARD CHARACTERS WITHOUT CLAIM TO ANY PARTICULAR FONT, STYLE, SIZE, OR COLOR.

FOR: EXERCISE SERVICES, NAMELY, PROVIDING PHYSICAL FITNESS CONDITIONING CLASSES FEATURING EXERCISE HOOPS, IN CLASS 41 (U.S. CLS. 100, 101 AND 107).

SER. NO. 77-368,184, FILED 1-10-2008.

FIRST USE 12-18-2007; IN COMMERCE 12-18-2007.

LINDA LAVACHE, EXAMINING ATTORNEY

**Int. Cl.: 7**

**Prior U.S. Cls.: 13, 19, 21, 23, 31, 34 and 35**

**Reg. No. 3,504,303**

**United States Patent and Trademark Office**

**Registered Sep. 23, 2008**

**TRADEMARK  
PRINCIPAL REGISTER**

AGR STONE & TOOLS USA, INC. (TEXAS CORPORATION)  
11526 FM 2854  
CONROE, TX 77304

FIRST USE 1-1-1992; IN COMMERCE 1-1-1992.

FOR: MACHINES AND MACHINE TOOLS FOR THE CUTTING AND FORMING OF MATERIALS; TOOL BITS FOR MACHINES; GRINDING TOOLS FOR GRINDING MACHINES; BITS FOR POWER DRILLS; CORE DRILLING BITS; POWER DRILL BITS; BLADES FOR POWER SAWS, IN CLASS 7 (U.S. CLS. 13, 19, 21, 23, 31, 34 AND 35).

THE MARK CONSISTS OF STANDARD CHARACTERS WITHOUT CLAIM TO ANY PARTICULAR FONT, STYLE, SIZE, OR COLOR.

SER. NO. 77-368,421, FILED 1-10-2008.

KYLE PEETE, EXAMINING ATTORNEY

**Int. Cl.: 9**

**Prior U.S. Cls.: 21, 23, 26, 36 and 38**

**Reg. No. 3,504,304**

**United States Patent and Trademark Office**

**Registered Sep. 23, 2008**

**TRADEMARK  
PRINCIPAL REGISTER**

**NO GREATER JOY**

NO GREATER JOY MINISTRIES, INC. (TENNESSEE CORPORATION)  
1000 PEARL ROAD  
PLEASANTVILLE, TN 37033

FIRST USE 1-0-2002; IN COMMERCE 1-0-2002.

FOR: DIGITAL MEDIA, NAMELY, PRE-RECORDED AUDIO TAPES AND CASSETTES, CDS, DVDS, AND DOWNLOADABLE AUDIO FILES FEATURING CHILD TRAINING, MARRIAGE AND FAMILY RELATIONSHIPS, RELIGIOUS MISSIONS, BIBLE TEACHING, AND EVANGELICAL PRACTICE, IN CLASS 9 (U.S. CLS. 21, 23, 26, 36 AND 38).

THE MARK CONSISTS OF STANDARD CHARACTERS WITHOUT CLAIM TO ANY PARTICULAR FONT, STYLE, SIZE, OR COLOR.

SER. NO. 77-368,545, FILED 1-10-2008.

EDWARD NELSON, EXAMINING ATTORNEY

Int. Cl.: 33

Prior U.S. Cls.: 47 and 49

United States Patent and Trademark Office

Reg. No. 3,504,305

Registered Sep. 23, 2008

TRADEMARK  
PRINCIPAL REGISTER



MATA CASANOVAS, S.A. (SPAIN SOCIEDAD  
ANONIMA (SA))  
TAMARIT 7  
SANT SADURNI D'ANOIA, SPAIN 08770

THE MARK CONSISTS OF STYLIZED WORD  
"RICAREDO" WITH A CROWN LOCATED ABOVE  
THE WORD.

FOR: WINE, IN CLASS 33 (U.S. CLS. 47 AND 49).

SER. NO. 77-368,573, FILED 1-10-2008.

OWNER OF ERPN CMNTY TM OFC REG. NO.  
000011452, DATED 8-5-1999, EXPIRES 4-1-2016.

JOHN DALIER, EXAMINING ATTORNEY

**Int. Cl.: 14**

**Prior U.S. Cls.: 2, 27, 28 and 50**

**United States Patent and Trademark Office**

**Reg. No. 3,504,306**

**Registered Sep. 23, 2008**

**TRADEMARK  
PRINCIPAL REGISTER**

**Jean Lin**

SPECTRAGEM, INC. (GEORGIA CORPORATION)  
SUITE 340  
1790 CORPORATE DRIVE NW  
NORCROSS, GA 30093

FOR: JEWELRY, NAMELY, PRECIOUS METALS IN THE NATURE OF 14 KARAT GOLD, 10 KARAT GOLD, STERLING SILVER, VERMEIL, CUBIC ZIRCONIA, AND NATURAL GEMSTONES AND CREATED GEMSTONES USED FOR RINGS, BRACELETS, EARRINGS, PENDANTS, NECKLACES, PINS, AND CHARMS, IN CLASS 14 (U.S. CLS. 2, 27, 28 AND 50).

FIRST USE 3-27-2007; IN COMMERCE 3-27-2007.

THE MARK CONSISTS OF STANDARD CHARACTERS WITHOUT CLAIM TO ANY PARTICULAR FONT, STYLE, SIZE, OR COLOR.

THE NAME(S), PORTRAIT(S), AND/OR SIGNATURE(S) SHOWN IN THE MARK IDENTIFIES A LIVING INDIVIDUAL, WHOSE CONSENT(S) TO REGISTER IS SUBMITTED.

SER. NO. 77-368,596, FILED 1-10-2008.

HANNO RITTNER, EXAMINING ATTORNEY

Int. Cl.: 14

Prior U.S. Cls.: 2, 27, 28 and 50

United States Patent and Trademark Office

Reg. No. 3,504,307

Registered Sep. 23, 2008

TRADEMARK  
PRINCIPAL REGISTER



SPECTRAGEM, INC. (GEORGIA CORPORATION)  
SUITE 340  
1790 CORPORATE DRIVE NW  
NORCROSS, GA 30093

FOR: JEWELRY, NAMELY, PRECIOUS METALS IN THE NATURE OF 14 KARAT GOLD, 10 KARAT GOLD, STERLING SILVER, VERMEIL, CUBIC ZIRCONIA, AND NATURAL GEMSTONES AND CREATED GEMSTONES USED FOR RINGS, BRACELETS, EARRINGS, PENDANTS, NECKLACES, PINS, AND CHARMS, IN CLASS 14 (U.S. CLS. 2, 27, 28 AND 50).

FIRST USE 3-27-2007; IN COMMERCE 3-27-2007.

NO CLAIM IS MADE TO THE EXCLUSIVE RIGHT TO USE "COLLECTION", APART FROM THE MARK AS SHOWN.

THE NAME SHOWN IN THE MARK IDENTIFIES A LIVING INDIVIDUAL WHOSE CONSENT IS OF RECORD.

THE MARK CONSISTS OF STYLIZED "JEAN LIN" WITH WORD "COLLECTION" UNDERNEATH IT AND AN IMAGE OF A LOTUS FLOWER ON THE SIDE.

SER. NO. 77-368,649, FILED 1-10-2008.

HANNO RITTNER, EXAMINING ATTORNEY



**Int. Cl.: 36**

**Prior U.S. Cls.: 100, 101 and 102**

**United States Patent and Trademark Office**

**Reg. No. 3,504,308**

**Registered Sep. 23, 2008**

---

**SERVICE MARK  
PRINCIPAL REGISTER**

**BTA 360°**

THE CHUBB CORPORATION (NEW JERSEY  
CORPORATION)  
P.O. BOX 1615  
15 MOUNTAIN VIEW ROAD  
WARREN, NJ 07061

THE MARK CONSISTS OF STANDARD CHAR-  
ACTERS WITHOUT CLAIM TO ANY PARTICULAR  
FONT, STYLE, SIZE, OR COLOR.

FOR: INSURANCE UNDERWRITING SERVICES  
IN THE FIELD OF TRAVEL INSURANCE, IN CLASS  
36 (U.S. CLS. 100, 101 AND 102).

SER. NO. 77-369,332, FILED 1-11-2008.

FIRST USE 9-12-2007; IN COMMERCE 12-20-2007.

DAWN FELDMAN, EXAMINING ATTORNEY

**Int. Cl.: 43**

**Prior U.S. Cls.: 100 and 101**

**United States Patent and Trademark Office**

**Reg. No. 3,504,309**

**Registered Sep. 23, 2008**

**SERVICE MARK  
PRINCIPAL REGISTER**

# Urbanspoon

WANDERSPOT LLC (WASHINGTON LIMITED  
LIABILITY COMPANY)  
117 E LOUISA ST #451  
SEATTLE, WA 98102

FOR: PROVIDING AN ONLINE INTERACTIVE  
WEBSITE OBTAINING USERS COMMENTS CON-  
CERNING RESTAURANTS; PROVIDING INFOR-  
MATION, NAMELY, COMPILATIONS, RANKINGS,  
RATINGS, REVIEWS, REFERRALS, CONTACT IN-  
FORMATION, AND RECOMMENDATIONS RE-  
LATING TO RESTAURANTS USING A GLOBAL

COMPUTER NETWORK, IN CLASS 43 (U.S. CLS. 100  
AND 101).

FIRST USE 11-1-2006; IN COMMERCE 11-1-2006.

THE MARK CONSISTS OF STANDARD CHAR-  
ACTERS WITHOUT CLAIM TO ANY PARTICULAR  
FONT, STYLE, SIZE, OR COLOR.

SER. NO. 77-369,804, FILED 1-11-2008.

YAT SYE, LEE, EXAMINING ATTORNEY

**Int. Cl.: 17**

**Prior U.S. Cls.: 1, 5, 12, 13, 35 and 50**

**United States Patent and Trademark Office**

**Reg. No. 3,504,310**

**Registered Sep. 23, 2008**

**TRADEMARK  
PRINCIPAL REGISTER**

**ACELLA-FLEX**

SLEEP INNOVATIONS INC. (NEW JERSEY CORPORATION)  
187 ROUTE 36 - SUITE 101  
W. LONG BRANCH, NJ 07764

FOR: URETHANE FOAM USED IN THE MANUFACTURE OF MATTRESSES, MATTRESS COVERS AND PILLOWS, IN CLASS 17 (U.S. CLS. 1, 5, 12, 13, 35 AND 50).

FIRST USE 6-13-2005; IN COMMERCE 6-13-2005.

THE MARK CONSISTS OF STANDARD CHARACTERS WITHOUT CLAIM TO ANY PARTICULAR FONT, STYLE, SIZE, OR COLOR.

SER. NO. 77-369,951, FILED 1-11-2008.

CHRIS WELLS, EXAMINING ATTORNEY

Int. Cl.: 30

Prior U.S. Cl.: 46

United States Patent and Trademark Office

Reg. No. 3,504,311

Registered Sep. 23, 2008

TRADEMARK  
PRINCIPAL REGISTER



SHANDONG HUA HONG TRADING CO., LTD.  
(CHINA CORPORATION)  
NO. 30-1, JIEFANG RD.  
ROOM 1113, GUO HUA JING DIAN BLDG. A  
JINAN, SHANDONG, CHINA

FOR: WHEAT-BASED SNACK FOODS IN THE  
NATURE OF CHOW MEIN NOODLES, IN CLASS 30  
(U.S. CL. 46).

FIRST USE 11-27-2007; IN COMMERCE 11-27-2007.

THE COLOR(S) RED, BLUE, AND WHITE IS/ARE  
CLAIMED AS A FEATURE OF THE MARK.

THE MARK CONSISTS OF ONE BIG CIRCLE  
WITH THREE RINGS AND A RED RIBBON. THE  
OUTERMOST CIRCULAR RING IS A VERY THIN  
RING COLORED IN "WHITE". THE MIDDLE CIR-

CULAR RING IS COLORED BLUE WITH 11 WHITE  
STARS IN IT. THE INNER CIRCLE IS WHITE IN  
COLOR WITH A FLAG-SHAPED PICTURE IN IT,  
THIS PICTURE DISPLAYS A LETTER "K" IN  
WHITE, THE LEFT AND UPPER SIDE OF THE  
LETTER "K" IS BORDERED WITH THE BLUE  
REGION OF THE PICTURE, AND THE RIGHT  
LOWER SIDE OF THE LETTER "K" IS BORDERED  
WITH THE RED REGION OF THE PICTURE. THE  
BIG CIRCLE SITS ONTO A RED-COLORED RIB-  
BON, THE RED RIBBON IS BORDERED WITH A  
THIN LAYER OF WHITE RIM. INSIDE THE RIB-  
BON, IT DISPLAYS THE WORDS OF "PACIFIC  
TIME" IN WHITE.

SER. NO. 77-370,197, FILED 1-12-2008.

LESLIE RICHARDS, EXAMINING ATTORNEY

**Int. Cl.: 25**

**Prior U.S. Cls.: 22 and 39**

**United States Patent and Trademark Office**

**Reg. No. 3,504,312**

**Registered Sep. 23, 2008**

**TRADEMARK  
PRINCIPAL REGISTER**

# Skate or Cry

CLAYTOR, DONOVAN D (UNITED STATES INDIVIDUAL), DBA MEYVN CLOTHING CO  
4281 WAHA RD  
KALAHEO, HI 96741

FOR: CHILDREN'S AND INFANTS' CLOTH BIBS; INFANT AND TODDLER ONE PIECE CLOTHING; JERSEYS; LEATHER BELTS; TIES; TOPS; ATHLETIC SHOES; SHOES; ANKLE SOCKS; SOCKS; SHORT-SLEEVED OR LONG-SLEEVED T-SHIRTS; T-SHIRTS; TANK TOPS; TANK-TOPS; CARGO PANTS; DENIMS; STRETCH PANTS; SWEAT PANTS;

TRACK PANTS; HOODED SWEATSHIRTS, IN CLASS 25 (U.S. CLS. 22 AND 39).

FIRST USE 1-2-2003; IN COMMERCE 1-2-2003.

THE MARK CONSISTS OF STANDARD CHARACTERS WITHOUT CLAIM TO ANY PARTICULAR FONT, STYLE, SIZE, OR COLOR.

SER. NO. 77-370,406, FILED 1-13-2008.

MELVIN AXILBUND, EXAMINING ATTORNEY

**Int. Cl.: 7**

**Prior U.S. Cls.: 13, 19, 21, 23, 31, 34 and 35**

**United States Patent and Trademark Office**

**Reg. No. 3,504,313**

**Registered Sep. 23, 2008**

**TRADEMARK  
PRINCIPAL REGISTER**



SUNWAY MARKETING (S) PTE LTD (SINGAPORE LIMITED LIABILITY COMPANY)  
19 SENOKO SOUTH RD  
SINGAPORE, SINGAPORE 758078

FOR: MACHINE PARTS, NAMELY, ADAPTORS FOR PIPES; ADAPTERS FOR MACHINE TOOLS; PARTS OF MACHINES, ENGINES AND MOTORS, NAMELY, HIGH PRESSURE HOSES MADE OF METAL; HOSES MADE OF METAL FOR TRANSFERRING HYDRAULIC POWER IN MACHINES; HOSES MADE OF METAL FOR USE IN HYDRAULIC SYSTEMS IN MACHINES; HOSES NOT MADE OF METAL FOR USE IN HYDRAULIC SYSTEMS IN MACHINES; SWAGING MACHINES FOR USE IN THE ASSEMBLY OF HOSES; COUPLING DEVICES FOR MACHINES; MACHINE PARTS, NAMELY, COUPLINGS FOR HYDRAULIC APPARATUS;

COUPLINGS FOR MACHINES, IN CLASS 7 (U.S. CLS. 13, 19, 21, 23, 31, 34 AND 35).

FIRST USE 7-20-2005; IN COMMERCE 7-20-2005.

THE COLOR(S) RED, WHITE AND BLUE IS/ARE CLAIMED AS A FEATURE OF THE MARK.

THE MARK CONSISTS OF THE WORD "SUN" IN THE COLOR WHITE INSIDE A RED CIRCLE WITH RED BACKGROUND TO THE LEFT OF THE WORD "FLEX" IN THE COLOR BLUE WITH A WHITE BACKGROUND.

SER. NO. 77-370,559, FILED 1-14-2008.

ALLISON SCHRODY, EXAMINING ATTORNEY

Int. Cl.: 31

Prior U.S. Cls.: 1 and 46

United States Patent and Trademark Office

Reg. No. 3,504,314

Registered Sep. 23, 2008

TRADEMARK  
PRINCIPAL REGISTER

**Orbits**  
**Ostrich Dog Treats**

CEBERGS FARMED OSTRICH LLC. (NEBRASKA  
LIMITED LIABILITY COMPANY)

1600 SOUTH 44TH.

LINCOLN, NE 68506

FOR: DOG TREATS, IN CLASS 31 (U.S. CLS. 1  
AND 46).

FIRST USE 11-28-2007; IN COMMERCE 11-28-2007.

THE MARK CONSISTS OF STANDARD CHAR-  
ACTERS WITHOUT CLAIM TO ANY PARTICULAR  
FONT, STYLE, SIZE, OR COLOR.

NO CLAIM IS MADE TO THE EXCLUSIVE  
RIGHT TO USE "OSTRICH DOG TREATS", APART  
FROM THE MARK AS SHOWN.

SER. NO. 77-370,647, FILED 1-14-2008.

LINDA MICKLEBURGH, EXAMINING ATTORNEY

**Int. Cl.: 40**

**Prior U.S. Cls.: 100, 103 and 106**

**United States Patent and Trademark Office**

**Reg. No. 3,504,315**

**Registered Sep. 23, 2008**

**SERVICE MARK  
PRINCIPAL REGISTER**



BELT POWER LLC (DELAWARE LIMITED LIABILITY COMPANY)  
2355 CHURCH RD. SE  
SMYRNA, GA 30080

FOR: FABRICATION OF CONVEYOR BELTING, RUBBER, HOSES AND CONVEYOR COMPONENTS TO THE ORDER AND SPECIFICATION OF OTHERS, IN CLASS 40 (U.S. CLS. 100, 103 AND 106).

FIRST USE 9-1-2007; IN COMMERCE 9-1-2007.

OWNER OF U.S. REG. NO. 2,790,785.

NO CLAIM IS MADE TO THE EXCLUSIVE RIGHT TO USE "BELT", APART FROM THE MARK AS SHOWN.

THE MARK CONSISTS OF THE STYLIZED TEXT "BELT POWER" SPELLED OUT IN BOLD LETTERING WITH SURROUNDING ACCENTS.

SER. NO. 77-370,770, FILED 1-14-2008.

TEJBIR SINGH, EXAMINING ATTORNEY



**Int. Cl.: 9**

**Prior U.S. Cls.: 21, 23, 26, 36 and 38**

**Reg. No. 3,504,316**

**United States Patent and Trademark Office**

**Registered Sep. 23, 2008**

**TRADEMARK  
PRINCIPAL REGISTER**

# TXP Corporation

TXP CORPORATION (NEVADA CORPORATION)  
1299 COMMERCE DRIVE  
RICHARDSON, TX 75081

FOR: TELECOMMUNICATIONS AND DATA NETWORKING HARDWARE, NAMELY, DEVICES FOR TRANSPORTING AND AGGREGATING VOICE, DATA, AND VIDEO COMMUNICATIONS ACROSS MULTIPLE NETWORK INFRASTRUCTURES AND COMMUNICATIONS PROTOCOLS, IN CLASS 9 (U.S. CLS. 21, 23, 26, 36 AND 38).

FIRST USE 12-31-2006; IN COMMERCE 1-1-2007.

THE MARK CONSISTS OF STANDARD CHARACTERS WITHOUT CLAIM TO ANY PARTICULAR FONT, STYLE, SIZE, OR COLOR.

NO CLAIM IS MADE TO THE EXCLUSIVE RIGHT TO USE "CORPORATION", APART FROM THE MARK AS SHOWN.

SER. NO. 77-370,919, FILED 1-14-2008.

DORITT L. CARROLL, EXAMINING ATTORNEY

Int. Cl.: 20

Prior U.S. Cls.: 2, 13, 22, 25, 32 and 50

United States Patent and Trademark Office

Reg. No. 3,504,317

Registered Sep. 23, 2008

TRADEMARK  
PRINCIPAL REGISTER



WOLIN, LORI (UNITED STATES INDIVIDUAL)  
1101 BEL AIR DRIVE, C  
HIGHLAND BEACH, FL 33487

FOR: NON-METAL CLIPS FOR ADJOINING VERTICAL BLINDS, IN CLASS 20 (U.S. CLS. 2, 13, 22, 25, 32 AND 50).

FIRST USE 1-1-2008; IN COMMERCE 1-1-2008.

THE COLOR(S) LIGHT GREEN, MEDIUM GREEN, AND WHITE IS/ARE CLAIMED AS A FEATURE OF THE MARK.

THE MARK CONSISTS OF LARGE LIGHT GREEN "V" ON TOP OF AND TO THE LEFT OF A LARGE WHITE "Q" OUTLINED IN MEDIUM GREEN, WITH A LIGHT GREEN OUTLINE OF A FACE AND FINGERS MAKING A "SHHH" SYMBOL. "VERTIQUIET" IS WRITTEN IN LIGHT GREEN BELOW THE "Q."

SER. NO. 77-371,076, FILED 1-14-2008.

ALICE SUE CARRUTHERS, EXAMINING ATTORNEY

Int. Cl.: 36

Prior U.S. Cls.: 100, 101 and 102

United States Patent and Trademark Office

Reg. No. 3,504,318

Registered Sep. 23, 2008

**SERVICE MARK  
PRINCIPAL REGISTER**



TEXAS SECURITIES, INC. (TEXAS CORPORATION)  
4024 NAZARENE DRIVE  
CARROLLTON, TX 75010

FOR: SECURITIES BROKERAGE, IN CLASS 36  
(U.S. CLS. 100, 101 AND 102).

FIRST USE 11-0-2002; IN COMMERCE 11-0-2002.

NO CLAIM IS MADE TO THE EXCLUSIVE  
RIGHT TO USE "INCORPORATED" AND "SECURITIES",  
APART FROM THE MARK AS SHOWN.

THE MARK CONSISTS OF BLACK CIRCLE SURROUNDING  
FIVE-POINT STAR AND CONTAINING THE WORDS "TEXAS  
SECURITIES INCORPORATED".

SEC. 2(F) AS TO "TEXAS SECURITIES INCORPORATED".

SER. NO. 77-371,384, FILED 1-14-2008.

HENRY S. ZAK, EXAMINING ATTORNEY

**Int. Cl.: 5**

**Prior U.S. Cls.: 6, 18, 44, 46, 51 and 52**

**Reg. No. 3,504,319**

**United States Patent and Trademark Office**

**Registered Sep. 23, 2008**

**TRADEMARK  
PRINCIPAL REGISTER**

# Theraworx

AVADIM, LLC. (NORTH CAROLINA LIMITED  
LIABILITY COMPANY)  
SUITE B  
53 SHILOH ROAD  
ASHEVILLE, NC 28803

FIRST USE 8-10-2007; IN COMMERCE 10-24-2007.

FOR: NO RINSE, ANTIMICROBIAL SKIN  
CLEANSING AND TREATMENT SOLUTION,  
NAMELY, A MEDICATED SKIN CARE PREPARA-  
TION FOR USE IN PRE-MOISTENED WIPES AND  
TOWELS, FOAMING SKIN CLEANSERS, WOUND  
MOISTURIZERS, AND WOUND CONTACT DRES-  
SINGS, IN CLASS 5 (U.S. CLS. 6, 18, 44, 46, 51 AND 52).

THE MARK CONSISTS OF STANDARD CHAR-  
ACTERS WITHOUT CLAIM TO ANY PARTICULAR  
FONT, STYLE, SIZE, OR COLOR.

SER. NO. 77-371,557, FILED 1-14-2008.

JUSTINE D. PARKER, EXAMINING ATTORNEY

**Int. Cl.: 24**

**Prior U.S. Cls.: 42 and 50**

**United States Patent and Trademark Office**

**Reg. No. 3,504,320**

**Registered Sep. 23, 2008**

**TRADEMARK  
PRINCIPAL REGISTER**

**PONKET**

ALEX KAY CREATIONS, LLC (NEW JERSEY  
LIMITED LIABILITY COMPANY)  
117 W. DUDLEY AVENUE  
WESTFIELD, NJ 07090

FOR: BLANKET THROWS AND CHILDREN'S  
BLANKETS, IN CLASS 24 (U.S. CLS. 42 AND 50).

FIRST USE 12-1-2006; IN COMMERCE 12-13-2007.

THE MARK CONSISTS OF STANDARD CHAR-  
ACTERS WITHOUT CLAIM TO ANY PARTICULAR  
FONT, STYLE, SIZE, OR COLOR.

THE WORDING "PONKET" HAS NO MEANING  
IN A FOREIGN LANGUAGE.

SER. NO. 77-371,723, FILED 1-15-2008.

MICHELLE DUBOIS, EXAMINING ATTORNEY

**Int. Cl.: 11**

**Prior U.S. Cls.: 13, 21, 23, 31 and 34**

**Reg. No. 3,504,321**

**United States Patent and Trademark Office**

**Registered Sep. 23, 2008**

---

**TRADEMARK  
PRINCIPAL REGISTER**

**ARCTURUS**

INSIGHT TECHNOLOGY INCORPORATED  
(NEW HAMPSHIRE CORPORATION)  
9 AKIRA WAY  
LONDONDERRY, NH 03053

THE MARK CONSISTS OF STANDARD CHARACTERS WITHOUT CLAIM TO ANY PARTICULAR FONT, STYLE, SIZE, OR COLOR.

FOR: FLASHLIGHTS AND PARTS THEREOF, NAMELY, ELECTRIC BULBS; FLASHLIGHT ACCESSORIES, NAMELY, FLASHLIGHT HOLDERS, IN CLASS 11 (U.S. CLS. 13, 21, 23, 31 AND 34).

SER. NO. 77-372,018, FILED 1-15-2008.

FIRST USE 3-7-2008; IN COMMERCE 3-7-2008.

JANICE KIM, EXAMINING ATTORNEY

**Int. Cl.: 16**

**Prior U.S. Cls.: 2, 5, 22, 23, 29, 37, 38 and 50**

**Reg. No. 3,504,322**

**United States Patent and Trademark Office**

**Registered Sep. 23, 2008**

**TRADEMARK  
PRINCIPAL REGISTER**

# Papersilly

SAENZ, ROWENA E. (UNITED STATES INDIVIDUAL)  
229 W. CARSON ST.  
CARSON, CA 90745

FOR: BLANK PAPER NOTEBOOKS, PAPER ALBUMS, CRAFT PAPER, PAPER GIFT TAG, PAPER NOTEBOOKS, PAPER PARTY FAVORS, PAPER STATIONERY, STATIONERY WRITING PAPER AND ENVELOPES, IN CLASS 16 (U.S. CLS. 2, 5, 22, 23, 29, 37, 38 AND 50).

FIRST USE 9-15-2007; IN COMMERCE 9-15-2007.

THE MARK CONSISTS OF STANDARD CHARACTERS WITHOUT CLAIM TO ANY PARTICULAR FONT, STYLE, SIZE, OR COLOR.

SER. NO. 77-372,690, FILED 1-16-2008.

SAIMA MAKHDOOM, EXAMINING ATTORNEY

Int. Cl.: 25

Prior U.S. Cls.: 22 and 39

United States Patent and Trademark Office

Reg. No. 3,504,323

Registered Sep. 23, 2008

TRADEMARK  
PRINCIPAL REGISTER



ALLURE LINGERIE INC. (CANADA CORPORATION)  
UNIT 6  
94 KENHAR DR.  
NORTH YORK, CANADA M9L1N2

FOR: WOMEN'S UNDERGARMENTS OF AN ADULT NATURE, NAMELY, THONGS, BRASSIERES, BODYSUITS, BUSTIERS, CORSETS, HALTER TOPS, TEDDIES, PANTIES, STOCKINGS, LEGGINGS, GARTER BELTS AND LEG GARTERS, IN CLASS 25 (U.S. CLS. 22 AND 39).

FIRST USE 10-12-2007; IN COMMERCE 10-12-2007.

OWNER OF U.S. REG. NOS. 2,676,641 AND 2,997,270.

NO CLAIM IS MADE TO THE EXCLUSIVE RIGHT TO USE "LINGERIE", APART FROM THE MARK AS SHOWN.

THE MARK CONSISTS OF STYLIZED LETTERS "ALLURE LINGERIE".

SER. NO. 77-372,790, FILED 1-16-2008.

JAY FLOWERS, EXAMINING ATTORNEY



**Int. Cl.: 25**

**Prior U.S. Cls.: 22 and 39**

**United States Patent and Trademark Office**

**Reg. No. 3,504,324**

**Registered Sep. 23, 2008**

**TRADEMARK  
PRINCIPAL REGISTER**

**ARMOUR STRETCH**

UNDER ARMOUR, INC. (MARYLAND CORPORATION)  
1020 HULL STREET  
BALTIMORE, MD 21230

FOR: JACKETS; PULLOVERS; VESTS; GLOVES,  
IN CLASS 25 (U.S. CLS. 22 AND 39).

FIRST USE 6-11-2007; IN COMMERCE 6-11-2007.

THE MARK CONSISTS OF STANDARD CHARACTERS WITHOUT CLAIM TO ANY PARTICULAR FONT, STYLE, SIZE, OR COLOR.

OWNER OF U.S. REG. NO. 3,392,904.

NO CLAIM IS MADE TO THE EXCLUSIVE RIGHT TO USE "STRETCH", APART FROM THE MARK AS SHOWN.

SER. NO. 77-372,820, FILED 1-16-2008.

DAVID C. REIHNER, EXAMINING ATTORNEY

Int. Cl.: 16

Prior U.S. Cls.: 2, 5, 22, 23, 29, 37, 38 and 50

United States Patent and Trademark Office

Reg. No. 3,504,325

Registered Sep. 23, 2008

TRADEMARK  
PRINCIPAL REGISTER



SHEET LABELS, INC. (NEW YORK CORPORATION)  
834 BAY ROAD  
QUEENSBURY, NY 12804

FOR: ADDRESS LABELS; ADHESIVE LABELS; BAR CODE LABELS; BLANK OR PARTIALLY PRINTED PAPER LABELS; FILING FOLDERS, PAPER LABELS AND PRINTED INSTRUCTIONAL MATERIALS FOR ORGANIZING PERSONAL FILES; LABEL PAPER; PAPER LABELS; PRINTED NOVELTY WINE LABELS; PRINTED PAPER LABELS; SHIPPING LABELS; PAPER; OFFICE PAPER STATIONERY; OFFSET PRINTING PAPER FOR PAMPHLETS; LASER PRINTING PAPER; LETTER PAPER; LETTERHEAD PAPER; COMPUTER PAPER; COPIER PAPER; COPY PAPER; PRINTING PAPER, IN CLASS 16 (U.S. CLS. 2, 5, 22, 23, 29, 37, 38 AND 50).

FIRST USE 6-1-2005; IN COMMERCE 6-15-2005.

NO CLAIM IS MADE TO THE EXCLUSIVE RIGHT TO USE "LABELS", APART FROM THE MARK AS SHOWN.

THE COLOR(S) BLUE, RED, YELLOW, WHITE IS/ ARE CLAIMED AS A FEATURE OF THE MARK.

THE MARK CONSISTS OF A BLUE RECTANGLE WITH ROUNDED CORNERS, WITH ITS BOTTOM RIGHT CORNER APPEARING TO BE BENT UPWARD AS IF A LABEL BEING PEELED OFF A SHEET, AND ON THIS RECTANGLE FROM LEFT TO RIGHT ARE THE LETTER "S", THE LETTER "H", THEN TWO CONSECUTIVE STYLIZED LETTER "E'S", THE FIRST PLACED IN A FORWARD POSITION AND THE SECOND PLACED IN A BACKWARDS POSITION TIED TOGETHER WITH A HORIZONTAL YELLOW STRIPE WITH A BLUE BORDER AND A HORIZONTAL RED STRIPE WITH A BLUE BORDER, THEN THE LETTER "T", IN THAT ORDER. ALL OF THE FOREGOING LETTERS APPEAR IN THE COLOR WHITE. THESE LETTERS AND CHARACTERS ARE CENTERED IN POSITION ON THE BLUE RECTANGLE DISPLAYED AS A LABEL. IMMEDIATELY TO THE RIGHT, WITH NO SPACE, IS THE WORD "LABELS" WHICH APPEARS IN THE COLOR BLUE.

SER. NO. 77-372,925, FILED 1-16-2008.

DAVID COLLIER, EXAMINING ATTORNEY

**Int. Cl.: 5**

**Prior U.S. Cls.: 6, 18, 44, 46, 51 and 52**

**United States Patent and Trademark Office**

**Reg. No. 3,504,326**

**Registered Sep. 23, 2008**

**TRADEMARK  
PRINCIPAL REGISTER**

**DAVID KIRSCH WELLNESSCO  
ONE OF A KIND SUPPLEMENTS**

DAVID KIRSCH WELLNESS CO., INC. (NEW  
YORK CORPORATION)  
210 FIFTH AVENUE  
NEW YORK, NY 10010

FOR: DIETARY SUPPLEMENTS; POWDERED  
PROTEIN NUTRITIONAL SUPPLEMENT DRINK  
MIX; APPETITE SUPPRESSANTS; AND VITAMIN  
SUPPLEMENTS, IN CLASS 5 (U.S. CLS. 6, 18, 44, 46, 51  
AND 52).

FIRST USE 2-0-2004; IN COMMERCE 2-0-2004.

THE MARK CONSISTS OF STANDARD CHAR-  
ACTERS WITHOUT CLAIM TO ANY PARTICULAR  
FONT, STYLE, SIZE, OR COLOR.

NO CLAIM IS MADE TO THE EXCLUSIVE  
RIGHT TO USE "SUPPLEMENTS", APART FROM  
THE MARK AS SHOWN.

THE NAME(S), PORTRAIT(S), AND/OR SIGNA-  
TURE(S) SHOWN IN THE MARK IDENTIFIES  
"DAVID KIRSCH", WHOSE CONSENT(S) TO REG-  
ISTER IS SUBMITTED.

SER. NO. 77-373,189, FILED 1-16-2008.

INGA ERVIN, EXAMINING ATTORNEY

**Int. Cl.: 16**

**Prior U.S. Cls.: 2, 5, 22, 23, 29, 37, 38 and 50**

**United States Patent and Trademark Office**

**Reg. No. 3,504,327**

**Registered Sep. 23, 2008**

**TRADEMARK  
PRINCIPAL REGISTER**



SHUTTER PAWS IMAGING (WASHINGTON  
PARTNERSHIP)  
6907 HAVENWOOD DRIVE  
RALEIGH, NC 27616

FOR: PHOTOGRAPHS, IN CLASS 16 (U.S. CLS. 2, 5,  
22, 23, 29, 37, 38 AND 50).

FIRST USE 4-1-2005; IN COMMERCE 4-1-2005.

THE STIPLING IS FOR SHADING PURPOSES  
ONLY.

THE MARK CONSISTS OF A PEMBROKE WELSH  
CORGI, STANDING ON ITS HIND LEGS, FRONT  
PAWS RESTING ON A TRI-POD CAMERA STAND,  
WITH A BELLOWS TYPE CAMERA ON TOP, WITH  
THE PEMBROKE WELSH CORGI LOOKING INTO  
THE VIEW FINDER OF THE CAMERA. THE PEM-  
BROKE WELSH CORGI AND CAMERA ARE FEAT-  
URED AGAINST A TEN POINTED STYLIZED  
STAR.

SER. NO. 77-374,084, FILED 1-17-2008.

TEJBIR SINGH, EXAMINING ATTORNEY

Int. Cl.: 29

Prior U.S. Cl.: 46

United States Patent and Trademark Office

Reg. No. 3,504,328

Registered Sep. 23, 2008

TRADEMARK  
PRINCIPAL REGISTER



FARCHIONI OLII S.P.A. (ITALY CORPORATION)  
FRAZIONE BASTARDO  
VIA B. BUOZZI, 10  
GIANO DELL'UMBRIA (PG), ITALY 06030

FOR: EDIBLE OILS AND FATS, IN CLASS 29 (U.S. CL. 46).

FIRST USE 3-30-2007; IN COMMERCE 4-19-2007.

OWNER OF U.S. REG. NO. 2,096,705.

NO CLAIM IS MADE TO THE EXCLUSIVE RIGHT TO USE "QUALITÀ NELLA TRADIZIONE DAL 1780", APART FROM THE MARK AS SHOWN.

THE MARK CONSISTS OF THE FRAMED WORD "FARCHIONI" AND WITH THE WORDS "QUALITÀ NELLA TRADIZIONE" UNDERNEATH. THE WORDS "DAL 1780" ARE UNDERNEATH THAT AND ALSO FRAMED. ABOVE, THE WORDS ARE A GROUPING OF SIX OLIVES.

THE FOREIGN WORDING IN THE MARK TRANSLATES INTO ENGLISH AS "TRADITION AND QUALITY SINCE 1780".

SER. NO. 77-374,128, FILED 1-17-2008.

DANIEL BRODY, EXAMINING ATTORNEY

**Int. Cl.: 35**

**Prior U.S. Cls.: 100, 101 and 102**

**United States Patent and Trademark Office**

**Reg. No. 3,504,329**

**Registered Sep. 23, 2008**

**SERVICE MARK  
PRINCIPAL REGISTER**

**CALLOWAY'S NURSERY**

CALLOWAY'S NURSERY, INC. (DELAWARE  
CORPORATION)  
SUITE 200  
4200 AIRPORT FREEWAY  
FORT WORTH, TX 76117

FOR: RETAIL LAWN, GARDEN AND NURSERY  
STORES, IN CLASS 35 (U.S. CLS. 100, 101 AND 102).

FIRST USE 3-27-1987; IN COMMERCE 3-27-1987.

THE MARK CONSISTS OF STANDARD CHAR-  
ACTERS WITHOUT CLAIM TO ANY PARTICULAR  
FONT, STYLE, SIZE, OR COLOR.

NO CLAIM IS MADE TO THE EXCLUSIVE  
RIGHT TO USE "NURSERY", APART FROM THE  
MARK AS SHOWN.

THE NAME(S), PORTRAIT(S), AND/OR SIGNA-  
TURE(S) SHOWN IN THE MARK DOES NOT IDENT-  
IFY A PARTICULAR LIVING INDIVIDUAL.

SEC. 2(F).

SER. NO. 77-374,158, FILED 1-17-2008.

JOHN E. MICHOS, EXAMINING ATTORNEY

**Int. Cl.: 41**

**Prior U.S. Cls.: 100, 101 and 107**

**United States Patent and Trademark Office**

**Reg. No. 3,504,330**

**Registered Sep. 23, 2008**

**SERVICE MARK  
PRINCIPAL REGISTER**



AMERICAN HERITAGE GIRLS, INC. (OHIO CORPORATION)  
SUITE 100  
175 TRI COUNTY PKWY  
CINCINNATI, OH 45246

FOR: EDUCATIONAL SERVICES, NAMELY, CONDUCTING PROGRAMS FOR GIRLS AND YOUNG WOMEN IN THE FIELD OF LEADERSHIP, SOCIAL, PHYSICAL AND INTELLECTUAL DEVELOPMENT TO PROMOTE THE TRADITIONAL VALUES OF GOD, FAMILY AND COUNTRY; EDUCATIONAL SERVICES, NAMELY, CONDUCTING SOCIAL SCOUTING AND TROOP CLUB MEETINGS FOR GIRLS AND YOUNG WOMEN IN THE NATURE OF ARRANGING, ORGANIZING, AND HOSTING SOCIAL EVENTS AND GET-TOGETHERS THAT SUPPORT TRADITIONAL VALUES OF GOD, FAMILY AND COUNTRY AS WELL AS PROMOTE LEADERSHIP, SOCIAL, PHYSICAL AND

INTELLECTUAL DEVELOPMENT GIRLS AND YOUNG WOMEN, IN CLASS 41 (U.S. CLS. 100, 101 AND 107).

FIRST USE 9-5-2007; IN COMMERCE 9-5-2007.

THE COLOR(S) RED, WHITE, BLUE IS/ARE CLAIMED AS A FEATURE OF THE MARK.

THE MARK CONSISTS OF GIRL FIGURE IN WHITE, CIRCULAR BLUE BACKGROUND WITH RED CRESCENT ATTACHED AND WHITE STAR WHICH GIRL TOUCHES; WHITE OUTLINES BACKGROUND, CRESCENT AND ENTIRE MARK.

SER. NO. 77-374,346, FILED 1-17-2008.

B. PARADEWELAI, EXAMINING ATTORNEY

**Int. Cl.: 42**

**Prior U.S. Cls.: 100 and 101**

**United States Patent and Trademark Office**

**Reg. No. 3,504,331**

**Registered Sep. 23, 2008**

**SERVICE MARK  
PRINCIPAL REGISTER**

**Simplifying the art &  
science of giving**

JEFF LAWRENCE (CALIFORNIA CORPORATION), DBA OCEANPEAK, INC.  
530 WILSHIRE BLVD., SUITE 207  
SANTA MONICA, CA 90401

FOR: PROVIDING ON-LINE NON-DOWNLOADABLE SOFTWARE FOR MANAGING GRANTMAKING AND GRANTSEEKING; APPLICATION SERVICE PROVIDER (ASP) FEATURING SOFTWARE FOR USE FOR MANAGING GRANTMAKING AND GRANTSEEKING, IN CLASS 42 (U.S. CLS. 100 AND 101).

FIRST USE 5-29-2007; IN COMMERCE 5-29-2007.

THE MARK CONSISTS OF STANDARD CHARACTERS WITHOUT CLAIM TO ANY PARTICULAR FONT, STYLE, SIZE, OR COLOR.

SER. NO. 77-374,375, FILED 1-17-2008.

LYDIA BELZER, EXAMINING ATTORNEY



**Int. Cl.: 25**

**Prior U.S. Cls.: 22 and 39**

**United States Patent and Trademark Office**

**Reg. No. 3,504,332**

**Registered Sep. 23, 2008**

**TRADEMARK  
PRINCIPAL REGISTER**

**G&B**

G&B GLAUBER BROTHERS MENS & BOYS  
CLOTHING INC. (NEW YORK CORPORATION)  
165 DIVISION AVENUE  
BROOKLYN, NY 11211

FOR: CAFTANS; CLOTHING, NAMELY, WRAP-AROUNDS; COATS; COMBINATIONS; COVERALLS; FROCKS; JACKETS; OVERCOATS; PANTS; PANT SUITS; RAIN COATS; RAIN JACKETS; SPORT COATS; SUIT COATS; TOP COATS; TROUSERS; TUXEDOS; VESTED SUITS; VESTS; HASIDIC CLOTHING, NAMELY, ROBES, SHOULDER WRAPS AND SHAWLS; BLACK COATS; BLACK SUIT COATS; BLACK SUIT TROUSERS; BEKISHES IN THE NATURE OF RELIGIOUS COATS; KITTELS IN THE NATURE OF RELIGIOUS SHIRTS, ROBES AND UNDERGARMENTS; SCARVES; SHAWLS; ARBA KANFOS IN THE NATURE OF RELIGIOUS WRAP-AROUND CLOTHING; TZITZIS, NAMELY, STRING FASTENERS FOR JEWISH RELIGIOUS CLOTHING, WAIST AND SHOULDER STRINGS FOR JEWISH RELIGIOUS CLOTHING AND

CLOTHING STRINGS TO BE ATTACHED TO RELIGIOUS CLOTHING; BELTS; GARTELS IN THE NATURE OF WAIST SASHES; HEADGEAR, NAMELY, HATS AND CAPS; HASIDIC HEADGEAR, NAMELY, YARMULKES, KIPAS AND SHTREIMELS IN THE NATURE OF RELIGIOUS HATS AND HEADWEAR; HATS; FEDORAS; YARMULKES; KIPAS IN THE NATURE OF RELIGIOUS HATS AND HEADWEAR; SHTREIMELS IN THE NATURE OF RELIGIOUS HATS; SHOES; BOOTS, IN CLASS 25 (U.S. CLS. 22 AND 39).

THE MARK CONSISTS OF STANDARD CHARACTERS WITHOUT CLAIM TO ANY PARTICULAR FONT, STYLE, SIZE, OR COLOR.

OWNER OF ERPN CMNTY TM OFC REG. NO. 004240214, DATED 4-11-2006, EXPIRES 1-14-2015.

SER. NO. 77-374,383, FILED 1-17-2008.

KHANH LE, EXAMINING ATTORNEY

**Int. Cl.: 39**

**Prior U.S. Cls.: 100 and 105**

**United States Patent and Trademark Office**

**Reg. No. 3,504,333**

**Registered Sep. 23, 2008**

**SERVICE MARK  
PRINCIPAL REGISTER**



K C D THANX INC. (KANSAS CORPORATION)  
645 N BROOKFIELD STREET  
WICHITA, KS 672061519

FOR: EXPRESS DELIVERY OF GOODS BY CAR  
AND/OR TRUCK, IN CLASS 39 (U.S. CLS. 100 AND  
105).

FIRST USE 10-15-2007; IN COMMERCE 10-15-2007.

THE COLOR(S) RED, YELLOW, WHITE, BLACK  
AND LIGHT BROWN IS/ARE CLAIMED AS A  
FEATURE OF THE MARK.

THE MARK CONSISTS OF A MAN IN A UNI-  
FORM HOLDING A LIGHT BROWN DONUT IN HIS  
LEFT HAND. THE MAN'S UNIFORM CONSISTS OF  
RED PANTS, A WHITE SHIRT, A BLACK TIE, A  
YELLOW JACKET WITH A RED COLLAR, A YEL-  
LOW AND RED HAT AND BLACK SHOES. THE  
CHARACTER'S SKIN COLOR IS WHITE. THE  
CHARACTER'S TEETH ARE BRIGHT WHITE. THE  
CHARACTER'S EYES AND HAIR ARE BLACK.

SER. NO. 77-375,249, FILED 1-18-2008.

GIANCARLO CASTRO, EXAMINING ATTORNEY

**Int. Cl.: 9**

**Prior U.S. Cls.: 21, 23, 26, 36 and 38**

**Reg. No. 3,504,334**

**United States Patent and Trademark Office**

**Registered Sep. 23, 2008**

---

**TRADEMARK  
PRINCIPAL REGISTER**

# Parallel Persistence

29WEST INC. (ILLINOIS CORPORATION)  
29W110 BUTTERFIELD RD #306  
WARRENVILLE, IL 60555

FOR: COMPUTER SOFTWARE FOR COMPUTER  
SYSTEM AND APPLICATION DEVELOPMENT, DE-  
PLOYMENT AND MANAGEMENT, IN CLASS 9  
(U.S. CLS. 21, 23, 26, 36 AND 38).

FIRST USE 1-18-2008; IN COMMERCE 1-18-2008.

THE MARK CONSISTS OF STANDARD CHAR-  
ACTERS WITHOUT CLAIM TO ANY PARTICULAR  
FONT, STYLE, SIZE, OR COLOR.

NO CLAIM IS MADE TO THE EXCLUSIVE  
RIGHT TO USE "PARALLEL", APART FROM THE  
MARK AS SHOWN.

SER. NO. 77-375,439, FILED 1-18-2008.

SETH A. RAPPAPORT, EXAMINING ATTORNEY

**Int. Cl.: 28**

**Prior U.S. Cls.: 22, 23, 38 and 50**

**United States Patent and Trademark Office**

**Reg. No. 3,504,335**

**Registered Sep. 23, 2008**

**TRADEMARK  
PRINCIPAL REGISTER**

**LEGACY**

LIONEL L.L.C. (NEW YORK LIMITED LIABILITY COMPANY)  
26750 TWENTY-THREE MILE ROAD  
CHESTERFIELD, MI 48051

FOR: ELECTRIC TOY TRAIN ACCESSORIES AND COMPONENTS, NAMELY, ELECTRIC TOY TRAIN TRANSFORMERS AND REMOTE CONTROL DEVICES FOR OPERATING TOY TRAINS AND MODEL TOY TRAINS, AND PARTS THEREFORE, IN CLASS 28 (U.S. CLS. 22, 23, 38 AND 50).

FIRST USE 7-1-2006; IN COMMERCE 10-1-2007.

THE MARK CONSISTS OF STANDARD CHARACTERS WITHOUT CLAIM TO ANY PARTICULAR FONT, STYLE, SIZE, OR COLOR.

SER. NO. 77-375,449, FILED 1-18-2008.

RUSS HERMAN, EXAMINING ATTORNEY

**Int. Cl.: 10**

**Prior U.S. Cls.: 26, 39 and 44**

**United States Patent and Trademark Office**

**Reg. No. 3,504,336**

**Registered Sep. 23, 2008**

**TRADEMARK  
PRINCIPAL REGISTER**

**4 PAWS**

SANUWAVE, INC. (DELAWARE CORPORATION)  
SUITE 350  
11680 GREAT OAKS WAY  
ALPHARETTA, GA 30022

FOR: MEDICAL DEVICES USING ACOUSTIC ENERGY EMITTING MEDICAL DEVICE TECHNOLOGY FOR VETERINARY TREATMENT, NAMELY, MEDICAL DEVICES FOR THE TREATMENT OF ORTHOPEDIC AND WOUND CONDITIONS, IN CLASS 10 (U.S. CLS. 26, 39 AND 44).

FIRST USE 7-0-2004; IN COMMERCE 11-0-2004.

THE MARK CONSISTS OF STANDARD CHARACTERS WITHOUT CLAIM TO ANY PARTICULAR FONT, STYLE, SIZE, OR COLOR.

SER. NO. 77-375,681, FILED 1-18-2008.

JIM RINGLE, EXAMINING ATTORNEY

**Int. Cl.: 41**

**Prior U.S. Cls.: 100, 101 and 107**

**United States Patent and Trademark Office**

**Reg. No. 3,504,337**

**Registered Sep. 23, 2008**

**SERVICE MARK  
PRINCIPAL REGISTER**

**Dr. Rick's Step-Forum**

LEVENSON, RICK (UNITED STATES INDIVIDUAL)  
15800 TURNBERRY DRIVE  
MIAMI LAKES, FL 33014

FOR: ON-LINE JOURNALS, NAMELY, BLOGS  
FEATURING RELATIONSHIPS, IN CLASS 41 (U.S.  
CLS. 100, 101 AND 107).

FIRST USE 11-7-2007; IN COMMERCE 11-7-2007.

THE MARK CONSISTS OF STANDARD CHARACTERS WITHOUT CLAIM TO ANY PARTICULAR FONT, STYLE, SIZE, OR COLOR.

"DR. RICK" IDENTIFIES A LIVING INDIVIDUAL WHOSE CONSENT IS OF RECORD.

SER. NO. 77-376,017, FILED 1-19-2008.

HELENE LIWINSKI, EXAMINING ATTORNEY

**Int. Cl.: 20**

**Prior U.S. Cls.: 2, 13, 22, 25, 32 and 50**

**United States Patent and Trademark Office**

**Reg. No. 3,504,338**

**Registered Sep. 23, 2008**

**TRADEMARK  
PRINCIPAL REGISTER**

**TAMLYN**

R. H. TAMLYN & SONS, L.P. (TEXAS LIMITED  
PARTNERSHIP)  
13623 PIKE ROAD  
STAFFORD, TX 774775103

FOR: NON-METALLIC BUILDING MATERIALS,  
NAMELY, NON-METALLIC ROOF VENT FOR VEN-  
TILATION IN RESIDENTIAL AND COMMERCIAL  
BUILDINGS, IN CLASS 20 (U.S. CLS. 2, 13, 22, 25, 32  
AND 50).

FIRST USE 10-15-2005; IN COMMERCE 10-15-2005.

THE MARK CONSISTS OF STANDARD CHAR-  
ACTERS WITHOUT CLAIM TO ANY PARTICULAR  
FONT, STYLE, SIZE, OR COLOR.

OWNER OF U.S. REG. NO. 3,126,290.

SEC. 2(F).

SER. NO. 77-376,028, FILED 1-19-2008.

MARY MUNSON, EXAMINING ATTORNEY

**Int. Cl.: 41**

**Prior U.S. Cls.: 100, 101 and 107**

**United States Patent and Trademark Office**

**Reg. No. 3,504,339**

**Registered Sep. 23, 2008**

**SERVICE MARK  
PRINCIPAL REGISTER**

**THEATRE of FOOLS**

BRANT, LLOYD W. (UNITED STATES INDIVIDUAL)  
4244 GARFIELD AVE S.  
MINNEAPOLIS, MN 55409 AND  
COLE, ROSEMARY (UNITED STATES INDIVIDUAL)  
4244 GARFIELD AVE S.  
MINNEAPOLIS, MN 55409

FOR: ENTERTAINMENT AND EDUCATIONAL EXHIBITIONS IN THE NATURE OF VAUDEVILLE, MIME SHOWS, COMEDY AND MAGIC SHOWS, IN CLASS 41 (U.S. CLS. 100, 101 AND 107).

FIRST USE 7-1-1983; IN COMMERCE 7-1-1983.

THE MARK CONSISTS OF STANDARD CHARACTERS WITHOUT CLAIM TO ANY PARTICULAR FONT, STYLE, SIZE, OR COLOR.

NO CLAIM IS MADE TO THE EXCLUSIVE RIGHT TO USE "THEATRE", APART FROM THE MARK AS SHOWN.

SER. NO. 77-376,427, FILED 1-21-2008.

HENRY S. ZAK, EXAMINING ATTORNEY



**Int. Cl.: 21**

**Prior U.S. Cls.: 2, 13, 23, 29, 30, 33, 40 and 50**

**United States Patent and Trademark Office**

**Reg. No. 3,504,340**

**Registered Sep. 23, 2008**

**TRADEMARK  
PRINCIPAL REGISTER**



HARPER BRUSH WORKS, INC. (IOWA CORPORATION)  
400 N. SECOND STREET  
FAIRFIELD, IA 52556

FIRST USE 1-0-2008; IN COMMERCE 1-0-2008.

SER. NO. 77-376,708, FILED 1-21-2008.

FOR: DUSTERS AND CLEANING TOOLS, NAME-  
LY, CLEANING CLOTHS, IN CLASS 21 (U.S. CLS. 2,  
13, 23, 29, 30, 33, 40 AND 50).

ARETHA SOMERVILLE, EXAMINING ATTORNEY

**Int. Cl.: 36**

**Prior U.S. Cls.: 100, 101 and 102**

**United States Patent and Trademark Office**

**Reg. No. 3,504,341**

**Registered Sep. 23, 2008**

**SERVICE MARK  
PRINCIPAL REGISTER**



BRITTON-GALLAGHER & ASSOCIATES, INC.  
(OHIO CORPORATION)  
6240 SOM CENTER ROAD  
CLEVELAND, OH 441392913

THE COLOR(S) BLUE AND BLACK IS/ARE CLAIMED AS A FEATURE OF THE MARK.

FOR: INSURANCE SERVICES IN THE AMUSEMENT INDUSTRY FOR INFLATABLE EQUIPMENT RENTAL COMPANIES, INDOOR INFLATABLE FUN CENTERS AND PARTY RENTAL OPERATIONS, NAMELY, INSURANCE BROKERAGE AND UNDERWRITING SERVICES RELATED TO INFLATABLES, SMALL MECHANICAL AMUSEMENT RIDES, PARTY EQUIPMENT, MECHANICAL BULLS, ROCK WALLS AND MISCELLANEOUS RENTAL GAMES, IN CLASS 36 (U.S. CLS. 100, 101 AND 102).

THE MARK CONSISTS OF THE CAPITAL LETTERS "AIR" IN BLACK IN FRONT OF A BLUE WAVE, THE BLUE WAVE IS DARKER ON THE RIGHT AND FADES TO LIGHT BLUE GOING LEFT. THE COLOR WHITE REPRESENTS BACKGROUND AND/OR TRANSPARENT AREAS AND IS NOT PART OF THE MARK.

SER. NO. 77-376,947, FILED 1-22-2008.

FIRST USE 1-1-2005; IN COMMERCE 1-1-2005.

LINDA LAVACHE, EXAMINING ATTORNEY

**Int. Cl.: 36**

**Prior U.S. Cls.: 100, 101 and 102**

**United States Patent and Trademark Office**

**Reg. No. 3,504,342**

**Registered Sep. 23, 2008**

**SERVICE MARK  
PRINCIPAL REGISTER**

**INSURING INFLATABLE  
FUN...EASILY, SECURELY,  
AFFORDABLY**

BRITTON-GALLAGHER & ASSOCIATES, INC.  
(OHIO CORPORATION)  
6240 SOM CENTER ROAD  
CLEVELAND, OH 441392913

FOR: INSURANCE SERVICES IN THE AMUSE-  
MENT INDUSTRY FOR INFLATABLE EQUIP-  
MENT RENTAL COMPANIES, INDOOR  
INFLATABLE FUN CENTERS AND PARTY REN-  
TAL OPERATIONS, NAMELY, INSURANCE  
BROKERAGE AND UNDERWRITING SERVICES  
RELATED TO INFLATABLES, SMALL MECHAN-  
ICAL AMUSEMENT RIDES, PARTY EQUIPMENT,  
MECHANICAL BULLS, ROCK WALLS AND MIS-

CELLANEOUS RENTAL GAMES, IN CLASS 36 (U.S.  
CLS. 100, 101 AND 102).

FIRST USE 1-1-2005; IN COMMERCE 1-1-2005.

THE MARK CONSISTS OF STANDARD CHAR-  
ACTERS WITHOUT CLAIM TO ANY PARTICULAR  
FONT, STYLE, SIZE, OR COLOR.

SER. NO. 77-376,948, FILED 1-22-2008.

LINDA LAVACHE, EXAMINING ATTORNEY

Int. Cl.: 25

Prior U.S. Cls.: 22 and 39

United States Patent and Trademark Office

Reg. No. 3,504,343

Registered Sep. 23, 2008

TRADEMARK  
PRINCIPAL REGISTER



MORALES, RANDOLPH (UNITED STATES INDIVIDUAL)  
6049 BOND STREET  
RIVERSIDE, CA 92506

FOR: CLOTHING OF ALL TYPES, NAMELY, JERSEYS, SWEATBANDS, JUMPSUITS, UNIFORMS, SPORTS PANTS, KNIT SHIRTS, SHIRTS, T-SHIRTS, POLO SHIRTS, TANK-TOPS, BLOUSES, SLACKS, JEANS, SHORTS, BELTS, UNDERWEAR, STOCKINGS, SOCKS, SWIMWEAR, NIGHTWEAR, LEOTARDS, LEGGINGS, COATS, TUXEDOS, JACKETS, PARKAS, OVERCOATS, PULLOVERS, SWEATSHIRTS AND SWEATERS; HEADWEAR, FOOTWEAR, IN CLASS 25 (U.S. CLS. 22 AND 39).

FIRST USE 1-28-2008; IN COMMERCE 1-28-2008.

THE MARK CONSISTS OF A DRAWING DESIGN THAT SPELLS "LAMA". THE "L" IS DRAWN TO

REPRESENT A LLAMA FOLLOWED BY THE DRAWN LETTERS "A", "M", "A". THE LOGO DRAWING WHICH SPELLS "LAMA", PRONOUNCED LLAMA LIKE THE ANIMAL IS A TEXT STYLE ACRONYM THAT MEANS "LOOK AT MY ASS". "LOOK AT MY ASS" IS PRINTED BELOW THE LOGO DRAWING. THE WORD "PUCHI" IS CENTERED BETWEEN THE "L" AND THE "A" WITHIN THE LOGO DRAWING.

THE FOREIGN WORDING IN THE MARK TRANSLATES INTO ENGLISH AS "STINK" OR "STINKY".

SER. NO. 77-377,186, FILED 1-22-2008.

KAELIE KUNG, EXAMINING ATTORNEY

**Int. Cl.: 12**

**Prior U.S. Cls.: 19, 21, 23, 31, 35 and 44**

**Reg. No. 3,504,344**

**United States Patent and Trademark Office**

**Registered Sep. 23, 2008**

**TRADEMARK  
PRINCIPAL REGISTER**

**MAULE**

MAULE AIR, INC. (GEORGIA CORPORATION)  
2099 S. HIGHWAY 133  
MOULTRIE, GA 31768

THE MARK CONSISTS OF STANDARD CHAR-  
ACTERS WITHOUT CLAIM TO ANY PARTICULAR  
FONT, STYLE, SIZE, OR COLOR.

FOR: AIRCRAFT, IN CLASS 12 (U.S. CLS. 19, 21, 23,  
31, 35 AND 44).

SEC. 2(F).

SER. NO. 77-377,481, FILED 1-22-2008.

FIRST USE 12-31-1941; IN COMMERCE 12-31-1941.

YAT SYE, LEE, EXAMINING ATTORNEY

**Int. Cl.: 42**

**Prior U.S. Cls.: 100 and 101**

**United States Patent and Trademark Office**

**Reg. No. 3,504,345**

**Registered Sep. 23, 2008**

**SERVICE MARK  
PRINCIPAL REGISTER**

# Mytopia Cafe

NEWS-JOURNAL CORPORATION (FLORIDA  
CORPORATION)  
901 SIXTH STREET  
DAYTONA BEACH, FL 32117

FOR: COMPUTER SERVICES, NAMELY, INTER-  
ACTIVE HOSTING SERVICES WHICH ALLOW THE  
USER TO PUBLISH AND SHARE THEIR OWN  
CONTENT AND IMAGES ONLINE, IN CLASS 42  
(U.S. CLS. 100 AND 101).

FIRST USE 9-1-2007; IN COMMERCE 9-12-2007.

THE MARK CONSISTS OF STANDARD CHAR-  
ACTERS WITHOUT CLAIM TO ANY PARTICULAR  
FONT, STYLE, SIZE, OR COLOR.

SER. NO. 77-377,488, FILED 1-22-2008.

KOURTNEE HODGES, EXAMINING ATTORNEY

**Int. Cl.: 20**

**Prior U.S. Cls.: 2, 13, 22, 25, 32 and 50**

**United States Patent and Trademark Office**

**Reg. No. 3,504,346**

**Registered Sep. 23, 2008**

**TRADEMARK  
PRINCIPAL REGISTER**

**MANAGE YOUR MEDICINE.  
MANAGE YOUR HEALTH.**

COOPER & COMPANY, INC. (OHIO CORPORATION)  
10179 COMMERCE PARK DRIVE  
CINCINNATI, OH 45246

FOR: PLASTIC MEDICATION CONTAINERS;  
DISPENSERS FOR MEDICAL PILLS OR CAPSULES  
SOLD EMPTY, IN CLASS 20 (U.S. CLS. 2, 13, 22, 25, 32  
AND 50).

FIRST USE 4-16-2007; IN COMMERCE 4-16-2007.

THE MARK CONSISTS OF STANDARD CHARACTERS WITHOUT CLAIM TO ANY PARTICULAR FONT, STYLE, SIZE, OR COLOR.

SER. NO. 77-377,505, FILED 1-22-2008.

STEVEN PEREZ, EXAMINING ATTORNEY

**Int. Cl.: 44**

**Prior U.S. Cls.: 100 and 101**

**United States Patent and Trademark Office**

**Reg. No. 3,504,347**

**Registered Sep. 23, 2008**

**SERVICE MARK  
PRINCIPAL REGISTER**

**MED INDIA**

DONLEY, HAROLD (UNITED STATES INDIVIDUAL)  
338 PARTRIDGE LANE  
HOUSTON, TX 77060

FOR: SURGICAL SERVICES AND SURGICAL PROCEDURE SERVICES IN INDIA FOR OTHERS; RECUPERATIVE NURSING HOME SERVICES IN INDIA FOR OTHERS, IN CLASS 44 (U.S. CLS. 100 AND 101).

FIRST USE 7-5-2007; IN COMMERCE 7-5-2007.

THE MARK CONSISTS OF STANDARD CHARACTERS WITHOUT CLAIM TO ANY PARTICULAR FONT, STYLE, SIZE, OR COLOR.

NO CLAIM IS MADE TO THE EXCLUSIVE RIGHT TO USE "INDIA", APART FROM THE MARK AS SHOWN.

SER. NO. 77-378,190, FILED 1-23-2008.

RICHARD A. STRASER, EXAMINING ATTORNEY



**Int. Cl.: 25**

**Prior U.S. Cls.: 22 and 39**

**United States Patent and Trademark Office**

**Reg. No. 3,504,348**

**Registered Sep. 23, 2008**

**TRADEMARK  
PRINCIPAL REGISTER**

**BALLINA**

RAPHAEL FASHIONS, INC. (FLORIDA CORPORATION)  
5501 NOB HILL ROAD  
SUNRISE, FL 33351

THE MARK CONSISTS OF STANDARD CHARACTERS WITHOUT CLAIM TO ANY PARTICULAR FONT, STYLE, SIZE, OR COLOR.

FOR: BEACH SHOES; SHOES, IN CLASS 25 (U.S. CLS. 22 AND 39).

SER. NO. 77-378,287, FILED 1-23-2008.

FIRST USE 1-1-2007; IN COMMERCE 1-1-2007.

ALEX KEAM, EXAMINING ATTORNEY

**Int. Cl.: 42**

**Prior U.S. Cls.: 100 and 101**

**United States Patent and Trademark Office**

**Reg. No. 3,504,349**

**Registered Sep. 23, 2008**

**SERVICE MARK  
PRINCIPAL REGISTER**

**MANAGEtO WIN**

MANAGETOWIN, INC. (CALIFORNIA CORPORATION)  
2276 VINEYARD ROAD  
NOVATO, CA 94947

FOR: APPLICATION SERVICE PROVIDER (ASP)  
FEATURING SOFTWARE FOR USE IN DATABASE  
MANAGEMENT IN THE FIELD OF HUMAN RE-  
SOURCE AND EMPLOYEE MANAGEMENT, IN  
CLASS 42 (U.S. CLS. 100 AND 101).

FIRST USE 7-25-2006; IN COMMERCE 7-25-2006.

THE MARK CONSISTS OF STANDARD CHAR-  
ACTERS WITHOUT CLAIM TO ANY PARTICULAR  
FONT, STYLE, SIZE, OR COLOR.

SER. NO. 77-378,559, FILED 1-23-2008.

NICHOLAS COLEMAN, EXAMINING ATTORNEY

**Int. Cl.: 45**

**Prior U.S. Cls.: 100 and 101**

**United States Patent and Trademark Office**

**Reg. No. 3,504,350**

**Registered Sep. 23, 2008**

**SERVICE MARK  
PRINCIPAL REGISTER**



PURE HOME CARE SERVICES, INC. (MICHIGAN CORPORATION)  
31275 FRASER DRIVE  
FRASER, MI 48026

FOR: PERSONAL CARE ASSISTANCE OF ACTIVITIES OF DAILY LIVING, NAMELY, BATHING, GROOMING AND PERSONAL MOBILITY FOR HOME-BOUND INDIVIDUALS; PROVIDING NON-MEDICAL PERSONAL ASSISTANT SERVICES FOR OTHERS, NAMELY, PLANNING, ORGANIZING, COORDINATING, ARRANGING AND ASSISTING INDIVIDUALS TO PERFORM DAILY TASKS; SOCIAL SERVICES, NAMELY, COMPANIONSHIP SERVICES FOR HOME-BOUND INDIVIDUALS, IN CLASS 45 (U.S. CLS. 100 AND 101).

FIRST USE 3-14-2008; IN COMMERCE 3-14-2008.

NO CLAIM IS MADE TO THE EXCLUSIVE RIGHT TO USE "HOME CARE SERVICES", APART FROM THE MARK AS SHOWN.

THE COLOR(S) GREEN, BLUE, AND GOLD IS/ARE CLAIMED AS A FEATURE OF THE MARK.

THE MARK CONSISTS OF THREE OVERLAPPING CRESCENT SHAPES ON THE LEFT SIDE WITH THE TOP CRESCENT SHAPE IN THE COLOR GREEN, THE MIDDLE CRESCENT SHAPE IN THE COLOR BLUE, AND THE BOTTOM CRESCENT SHAPE IN THE COLOR GOLD. THE WORD "PURE" APPEARS IN THE COLOR BLUE TO THE RIGHT OF THE CRESCENT SHAPES WITH THE WORDS "HOME CARE SERVICES" IN THE COLOR GREEN APPEARING BELOW THE WORD "PURE" ALSO TO THE RIGHT OF THE CRESCENT SHAPES.

SER. NO. 77-378,749, FILED 1-23-2008.

LINDA LAVACHE, EXAMINING ATTORNEY

**Int. Cl.: 30**

**Prior U.S. Cl.: 46**

**United States Patent and Trademark Office**

**Reg. No. 3,504,351**

**Registered Sep. 23, 2008**

**TRADEMARK  
PRINCIPAL REGISTER**

**HAPPY MARINATING!**

MLNARIK, LON CHRISTOPHER (UNITED STATES INDIVIDUAL)

POST OFFICE BOX 6281

SCOTTSDALE, AZ 85261

FOR: SAUCES AND MARINADES, IN CLASS 30 (U.S. CL. 46).

FIRST USE 8-0-2000; IN COMMERCE 8-0-2000.

THE MARK CONSISTS OF STANDARD CHARACTERS WITHOUT CLAIM TO ANY PARTICULAR FONT, STYLE, SIZE, OR COLOR.

NO CLAIM IS MADE TO THE EXCLUSIVE RIGHT TO USE "MARINATING", APART FROM THE MARK AS SHOWN.

SER. NO. 77-378,835, FILED 1-23-2008.

JOHN E. MICHOS, EXAMINING ATTORNEY

**Int. Cl.: 9**

**Prior U.S. Cls.: 21, 23, 26, 36 and 38**

**United States Patent and Trademark Office**

**Reg. No. 3,504,352**

**Registered Sep. 23, 2008**

**TRADEMARK  
PRINCIPAL REGISTER**

**ON-AIR PROMOTION  
OPTIMIZATION SYSTEM**

GF MEDIA INC. (NEW YORK CORPORATION),  
DBA EFFECTIVE MEDIA SERVICES  
180 SUMMIT  
MONTVALE, NJ 07645

FOR: COMPUTER SOFTWARE PROGRAM FOR USE BY TELEVISION STATIONS AND NETWORKS TO MAXIMIZE THEIR ON-AIR PROMOTIONAL ANNOUNCEMENTS, NAMELY, SOFTWARE TO PINPOINT THE MOST OPTIMAL TIME TO PROMOTE CAMPAIGNS AND TO ALLOW A NETWORK OR STATION TO TARGET THE DEMOGRAPHIC GROUP THAT IS DESIRED TO BE IMPACTED BY THE PROMOTION BY COMPILING AND ANALYZING DEMOGRAPHIC DATA, AND ALSO FOR RANKING TELEVISION PROGRAMS FOR THE PURPOSE OF OPTIMIZING VIEWER EXPOSURE TO CAMPAIGN PROMOTIONS BY COMPILING DATA REGARDING THE NUMBER OF VIEWERS,

TO TRAFFIC SUCH PROMOTIONAL CAMPAIGNS TO AIR, AND TO PROVIDE REPORTING ON OVERALL RESULTS AGAINST EXPECTATIONS, IN CLASS 9 (U.S. CLS. 21, 23, 26, 36 AND 38).

FIRST USE 4-18-1997; IN COMMERCE 4-18-1997.

THE MARK CONSISTS OF STANDARD CHARACTERS WITHOUT CLAIM TO ANY PARTICULAR FONT, STYLE, SIZE, OR COLOR.

OWNER OF U.S. REG. NO. 2,606,186.

SEC. 2(F).

SER. NO. 77-378,849, FILED 1-23-2008.

ADA HAN, EXAMINING ATTORNEY

Int. Cl.: 28

Prior U.S. Cls.: 22, 23, 38 and 50

United States Patent and Trademark Office

Reg. No. 3,504,353

Registered Sep. 23, 2008

TRADEMARK  
PRINCIPAL REGISTER

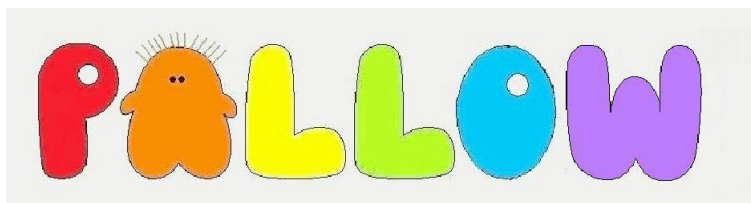

KAREN TANCH (UNITED STATES INDIVIDUAL)  
62 BLUEBERRY LANE  
HAMILTON, MA 01982

FOR: PLUSH TOYS, IN CLASS 28 (U.S. CLS. 22, 23, 38 AND 50).

FIRST USE 11-28-2007; IN COMMERCE 11-28-2007.

THE COLOR(S) RED, ORANGE, YELLOW, GREEN, BLUE, PURPLE AND BLACK IS/ARE CLAIMED AS A FEATURE OF THE MARK.

THE MARK CONSISTS OF THE WORD "PALLOW" WITH THE LETTER "P" IN THE COLOR RED, THE LETTER "A" IN THE COLOR ORANGE, THE FIRST LETTER "L" IN THE COLOR YELLOW, THE SECOND LETTER "L" IN THE COLOR GREEN, THE LETTER "O" IN THE COLOR BLUE AND THE LETTER "W" IN THE COLOR PURPLE. EACH LETTER HAS A BLACK OUTLINE. THE LETTER "A" IS IN THE SHAPE OF THE PRODUCT, DISPLAYING HANDS, FEET, EYES AND HAIR.

SER. NO. 77-379,546, FILED 1-24-2008.

CHRIS WELLS, EXAMINING ATTORNEY

**Int. Cls.: 35 and 45**

**Prior U.S. Cls.: 100, 101 and 102**

**United States Patent and Trademark Office**

**Reg. No. 3,504,354**

**Registered Sep. 23, 2008**

**SERVICE MARK  
PRINCIPAL REGISTER**

**81law**

81LAW.COM (CALIFORNIA CORPORATION)  
2275 E. BAYSHORE RD., #115  
PALO ALTO, CA 94303

FOR: ATTORNEY MATCHING AND REFERAL  
SERVICES, NAMELY, ATTORNEY REFERRAL  
SERVICES, IN CLASS 35 (U.S. CLS. 100, 101 AND 102).

FIRST USE 3-1-2005; IN COMMERCE 3-1-2005.

FOR: PROVIDING ONLINE LEGAL DOCUMENT  
PREPARATION SERVICES, PROVIDING GENERAL

LEGAL INFORMATION, IN CLASS 45 (U.S. CLS. 100  
AND 101).

FIRST USE 3-1-2005; IN COMMERCE 3-1-2005.

THE MARK CONSISTS OF STANDARD CHAR-  
ACTERS WITHOUT CLAIM TO ANY PARTICULAR  
FONT, STYLE, SIZE, OR COLOR.

SER. NO. 77-379,753, FILED 1-24-2008.

SEAN CROWLEY, EXAMINING ATTORNEY

**Int. Cl.: 9**

**Prior U.S. Cls.: 21, 23, 26, 36 and 38**

**Reg. No. 3,504,355**

**United States Patent and Trademark Office**

**Registered Sep. 23, 2008**

---

**TRADEMARK  
PRINCIPAL REGISTER**

**FUTUREFIRST**

COMPUTER SCIENCES CORPORATION (NEVADA CORPORATION)

A209

2100 EAST GRAND AVENUE  
EL SEGUNDO, CA 90245

FOR: COMPUTER SOFTWARE FOR USE FOR ADMINISTRATION OF LONG-TERM CARE INSURANCE, IN CLASS 9 (U.S. CLS. 21, 23, 26, 36 AND 38).

FIRST USE 1-1-2000; IN COMMERCE 1-1-2000.

THE MARK CONSISTS OF STANDARD CHARACTERS WITHOUT CLAIM TO ANY PARTICULAR FONT, STYLE, SIZE, OR COLOR.

SER. NO. 77-380,047, FILED 1-24-2008.

JOHN E. MICHOS, EXAMINING ATTORNEY



**Int. Cls.: 11, 20, 21, 24 and 27**

**Prior U.S. Cls.: 2, 13, 19, 20, 21, 22, 23, 25, 29, 30, 31,  
32, 33, 34, 37, 40, 42 and 50**

**Reg. No. 3,504,356**

**Registered Sep. 23, 2008**

**United States Patent and Trademark Office**

---

**TRADEMARK  
PRINCIPAL REGISTER**

**HAPPY HOME**

ADLER, JONATHAN (UNITED STATES INDIVIDUAL)  
SUITE 702  
333 HUDSON STREET  
NEW YORK, NY 10013

FOR: LAMP BASES, IN CLASS 11 (U.S. CLS. 13, 21, 23, 31 AND 34).

FIRST USE 8-0-2003; IN COMMERCE 8-0-2003.

FOR: FURNITURE, NAMELY, TABLES, CUBES AND OTTOMANS; PILLOWS, IN CLASS 20 (U.S. CLS. 2, 13, 22, 25, 32 AND 50).

FIRST USE 8-0-2005; IN COMMERCE 8-0-2005.

FOR: PORCELAIN AND EARTHWARE, NAMELY, VASES, BOWLS, SERVING TRAYS, DISHES, TOOTHBRUSH HOLDERS, PITCHERS, MUGS, CUPS, TEAPOTS AND PLATES, IN CLASS 21 (U.S. CLS. 2, 13, 23, 29, 30, 33, 40 AND 50).

FIRST USE 8-0-2003; IN COMMERCE 8-0-2003.

FOR: TEXTILES, NAMELY, BED BLANKETS, IN CLASS 24 (U.S. CLS. 42 AND 50).

FIRST USE 6-0-2005; IN COMMERCE 6-0-2005.

FOR: RUGS, IN CLASS 27 (U.S. CLS. 19, 20, 37, 42 AND 50).

FIRST USE 3-0-2004; IN COMMERCE 3-0-2004.

THE MARK CONSISTS OF STANDARD CHARACTERS WITHOUT CLAIM TO ANY PARTICULAR FONT, STYLE, SIZE, OR COLOR.

OWNER OF U.S. REG. NO. 3,136,406.

SER. NO. 77-380,082, FILED 1-24-2008.

SALLY SHIH, EXAMINING ATTORNEY

**Int. Cls.: 35, 41 and 42**

**Prior U.S. Cls.: 100, 101, 102 and 107**

**United States Patent and Trademark Office**

**Reg. No. 3,504,357**

**Registered Sep. 23, 2008**

**SERVICE MARK  
PRINCIPAL REGISTER**

**It's Always Primetime At  
The Pump**

DESTINATION MEDIA, INC. (DELAWARE CORPORATION)  
45 ROCKEFELLER PLAZA, 20TH FLOOR  
NEW YORK, NY 10111

FOR: DISSEMINATION OF ADVERTISING FOR OTHERS VIA AN ONLINE ELECTRONIC COMMUNICATIONS NETWORK; RENTAL OF ADVERTISING SPACE; CREATING, COMPILING AND DISSEMINATING ADVERTISING MATTER FOR OTHERS THROUGH AUDIO-VISUAL DISPLAYS, IN CLASS 35 (U.S. CLS. 100, 101 AND 102).

FIRST USE 8-28-2007; IN COMMERCE 8-28-2007.

FOR: COMPUTER SERVICES, NAMELY, PROVIDING DATABASES FEATURING NEWS IN THE NATURE OF CURRENT EVENT REPORTING; PROVIDING AN ONLINE COMPUTER DATABASE FEATURING INFORMATION IN THE FIELD OF GENERAL AND LOCAL NEWS IN THE NATURE OF CURRENT EVENT REPORTING OF INTEREST TO SPECIFIC GEOGRAPHIC AREAS; AUDIO AND

VISUAL PRODUCTION SERVICES, NAMELY, PREPARING AUDIO-VISUAL DISPLAYS IN THE FIELD OF NEWS, TRAFFIC REPORTS, BUSINESS NEWS, ENTERTAINMENT NEWS AND INFORMATION, AND WEATHER REPORTS ON BEHALF OF OTHERS, IN CLASS 41 (U.S. CLS. 100, 101 AND 107).

FIRST USE 8-28-2007; IN COMMERCE 8-28-2007.

FOR: PROVIDING WEATHER CONDITION INFORMATION, IN CLASS 42 (U.S. CLS. 100 AND 101).

FIRST USE 8-28-2007; IN COMMERCE 8-28-2007.

THE MARK CONSISTS OF STANDARD CHARACTERS WITHOUT CLAIM TO ANY PARTICULAR FONT, STYLE, SIZE, OR COLOR.

SER. NO. 77-380,112, FILED 1-24-2008.

PAUL CROWLEY, EXAMINING ATTORNEY

**Int. Cl.: 9**

**Prior U.S. Cls.: 21, 23, 26, 36 and 38**

**Reg. No. 3,504,358**

**United States Patent and Trademark Office**

**Registered Sep. 23, 2008**

---

**TRADEMARK  
PRINCIPAL REGISTER**

**EXIT LASER SMOKE ALARM**

INTERCONN GROUP INC. (CALIFORNIA CORPORATION), DBA SRS INNOVATIONS  
5540 SIERRA REAL  
EL DORADO, CA 95623

FOR: FIRE AND SMOKE DETECTORS; SAFETY SENSORS, NAMELY, CARBON MONOXIDE DETECTORS AND COMBINATION CARBON MONOXIDE AND SMOKE DETECTORS; SMOKE ALARMS, IN CLASS 9 (U.S. CLS. 21, 23, 26, 36 AND 38).

FIRST USE 12-4-2007; IN COMMERCE 12-4-2007.

THE MARK CONSISTS OF STANDARD CHARACTERS WITHOUT CLAIM TO ANY PARTICULAR FONT, STYLE, SIZE, OR COLOR.

NO CLAIM IS MADE TO THE EXCLUSIVE RIGHT TO USE "LASER SMOKE ALARM", APART FROM THE MARK AS SHOWN.

SER. NO. 77-380,117, FILED 1-24-2008.

ANDREA SAUNDERS, EXAMINING ATTORNEY

**Int. Cl.: 45**

**Prior U.S. Cls.: 100 and 101**

**United States Patent and Trademark Office**

**Reg. No. 3,504,359**

**Registered Sep. 23, 2008**

**SERVICE MARK  
PRINCIPAL REGISTER**

# PlayLounge

GODWIN, GREGORY L (UNITED STATES INDIVIDUAL)  
3912 VIA TRANQUILO  
SAN DIEGO, CA 92122

FOR: ONLINE DATING SERVICE, NAMELY, PROVIDING AN ONLINE WEBSITE FEATURING INFORMATION AND CONTENT IN THE FIELD OF DATING AND SOCIAL INTRODUCTION FOR ADULTS, AND PROVIDING ONLINE DATING SERVICES FOR ADULTS, IN CLASS 45 (U.S. CLS. 100 AND 101).

FIRST USE 1-24-2008; IN COMMERCE 1-24-2008.

THE MARK CONSISTS OF STANDARD CHARACTERS WITHOUT CLAIM TO ANY PARTICULAR FONT, STYLE, SIZE, OR COLOR.

SER. NO. 77-380,197, FILED 1-24-2008.

CARYN GLASSER, EXAMINING ATTORNEY

**Int. Cl.: 41**

**Prior U.S. Cls.: 100, 101 and 107**

**United States Patent and Trademark Office**

**Reg. No. 3,504,360**

**Registered Sep. 23, 2008**

**SERVICE MARK  
PRINCIPAL REGISTER**

**LIGHTSTREAM PICTURES**

LIGHTSTREAM PICTURES, LLC (CALIFORNIA LIMITED LIABILITY COMPANY), FORMERLY LIGHTSTREAM FILMS PTY LTD  
11833 MISSISSIPPI AVE SUITE 100  
LOS ANGELES, CA 90025

FOR: ENTERTAINMENT SERVICES, NAMELY, MOTION PICTURE, FILM, AND VIDEO PRODUCTION SERVICES; DEVELOPMENT OF STORY AND CREATIVE CONTENT, NAMELY, SCRIPT WRITING SERVICES FOR FILM, VIDEO AND MOTION PICTURES, IN CLASS 41 (U.S. CLS. 100, 101 AND 107).

FIRST USE 7-26-2006; IN COMMERCE 8-10-2006.

THE MARK CONSISTS OF STANDARD CHARACTERS WITHOUT CLAIM TO ANY PARTICULAR FONT, STYLE, SIZE, OR COLOR.

NO CLAIM IS MADE TO THE EXCLUSIVE RIGHT TO USE "PICTURES", APART FROM THE MARK AS SHOWN.

SER. NO. 77-380,628, FILED 1-25-2008.

GENE MACIOL, EXAMINING ATTORNEY

**Int. Cl.: 35**

**Prior U.S. Cls.: 100, 101 and 102**

**United States Patent and Trademark Office**

**Reg. No. 3,504,361**

**Registered Sep. 23, 2008**

**SERVICE MARK  
PRINCIPAL REGISTER**



ACTION AGAINST CRIME AND VIOLENCE  
EDUCATION FUND (D.C. NON-PROFIT COR-  
PORATION)

1212 NEW YORK AVENUE, N.W., SUITE 300  
WASHINGTON, DC 20005

FOR: ASSOCIATION SERVICES, NAMELY, PRO-  
MOTING THE INTEREST OF BUSINESS LEADERS,  
PUBLIC OFFICIALS AND THE PUBLIC IN GENER-  
AL IN IMPROVING THE QUALITY OF EDUCA-  
TION FOR ALL AMERICANS TO MEET THE  
DEMANDS OF MODERN SOCIETY AND THE  
COMPETITIVE GLOBAL MARKETPLACE, IN  
CLASS 35 (U.S. CLS. 100, 101 AND 102).

FIRST USE 9-9-2007; IN COMMERCE 9-9-2007.

NO CLAIM IS MADE TO THE EXCLUSIVE  
RIGHT TO USE "AMERICA'S", APART FROM THE  
MARK AS SHOWN.

THE COLOR(S) RED AND BLUE IS/ARE  
CLAIMED AS A FEATURE OF THE MARK.

THE MARK CONSISTS OF THE WORDING "AE  
AMERICA'S EDGE" WITH THE INITIAL LETTER  
"A" AND THE WORD "AMERICA'S" IN BLUE AND  
THE INITIAL LETTER "E" WITH A TRAILING  
BANNER DESIGN AND THE WORD "EDGE" IN  
RED.

SER. NO. 77-380,680, FILED 1-25-2008.

KIMBERLY PERRY, EXAMINING ATTORNEY

**Int. Cl.: 16**

**Prior U.S. Cls.: 2, 5, 22, 23, 29, 37, 38 and 50**

**Reg. No. 3,504,362**

**United States Patent and Trademark Office**

**Registered Sep. 23, 2008**

**TRADEMARK  
PRINCIPAL REGISTER**

**GreyLore**

GREY SANCTUARY, INCORPORATED (PENNSYLVANIA CORPORATION)  
163 VILLAGE WALK DRIVE  
MACUNGIE, PA 180621140

THE MARK CONSISTS OF STANDARD CHARACTERS WITHOUT CLAIM TO ANY PARTICULAR FONT, STYLE, SIZE, OR COLOR.

FOR: SERIES OF FICTION BOOKS, IN CLASS 16 (U.S. CLS. 2, 5, 22, 23, 29, 37, 38 AND 50).

SER. NO. 77-380,983, FILED 1-25-2008.

FIRST USE 8-14-2004; IN COMMERCE 8-14-2004.

FRED MANDIR, EXAMINING ATTORNEY

**Int. Cl.: 40**

**Prior U.S. Cls.: 100, 103 and 106**

**United States Patent and Trademark Office**

**Reg. No. 3,504,363**

**Registered Sep. 23, 2008**

**SERVICE MARK  
PRINCIPAL REGISTER**

# Bella Teres

BELCHER, DEBORAH M. (UNITED STATES INDIVIDUAL)  
SUITE 310-129  
1415 HIGHWAY 85 NORTH  
FAYETTEVILLE, GA 30214 AND  
AIKENS, MAURA L. (UNITED STATES INDIVIDUAL)  
SUITE 310-129  
1415 HIGHWAY 85 NORTH  
FAYETTEVILLE, GA 30214

FOR: CUSTOMIZED PRINTING AND PHOTOGRAPHIC COMPUTER IMAGING OF COMPANY NAMES AND LOGOS FOR PROMOTIONAL AND ADVERTISING PURPOSES ON THE GOODS OF OTHERS, IN CLASS 40 (U.S. CLS. 100, 103 AND 106).

FIRST USE 1-15-2006; IN COMMERCE 1-15-2006.

THE MARK CONSISTS OF STANDARD CHARACTERS WITHOUT CLAIM TO ANY PARTICULAR FONT, STYLE, SIZE, OR COLOR.

THE ENGLISH TRANSLATION OF BELLA TERES IS BEAUTIFUL POLISHED.

SER. NO. 77-381,065, FILED 1-25-2008.

AISHA SALEM, EXAMINING ATTORNEY



**Int. Cl.: 35**

**Prior U.S. Cls.: 100, 101 and 102**

**United States Patent and Trademark Office**

**Reg. No. 3,504,364**

**Registered Sep. 23, 2008**

**SERVICE MARK  
PRINCIPAL REGISTER**



SIX DEGREES, INC. (ILLINOIS CORPORATION)  
SUITE 510  
800 E. NORTHWEST HWY  
PALATINE, IL 60074

FOR: EMPLOYMENT HIRING, RECRUITING,  
PLACEMENT, AND STAFFING SERVICES IN THE  
FIELDS OF ACCOUNTING AND FINANCE-RELA-  
TED EMPLOYMENT, IN CLASS 35 (U.S. CLS. 100, 101  
AND 102).

FIRST USE 10-15-2006; IN COMMERCE 11-15-2006.

NO CLAIM IS MADE TO THE EXCLUSIVE  
RIGHT TO USE "EXECUTIVE RECRUITERS",  
APART FROM THE MARK AS SHOWN.

THE COLOR(S) BLUE, BLACK AND WHITE IS/  
ARE CLAIMED AS A FEATURE OF THE MARK.

THE MARK CONSISTS OF A STYLIZED "6" AND  
DEGREE SYMBOL APPEARING IN BLACK, SU-  
PERIMPOSED OVER A BLUE BACKGROUND,  
AND THE TERMS "EXECUTIVE RECRUITERS"  
DISPOSED BELOW THE "6" AND DEGREE SYM-  
BOL, THE TERMS "EXECUTIVE RECRUITERS"  
BEING IN WHITE AND SUPERIMPOSED OVER A  
BLACK BACKGROUND.

SER. NO. 77-381,145, FILED 1-25-2008.

GENE MACIOL, EXAMINING ATTORNEY

**Int. Cl.: 41**

**Prior U.S. Cls.: 100, 101 and 107**

**United States Patent and Trademark Office**

**Reg. No. 3,504,365**

**Registered Sep. 23, 2008**

**SERVICE MARK  
PRINCIPAL REGISTER**

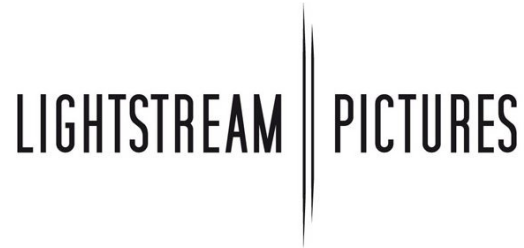

LIGHTSTREAM PICTURES, LLC (CALIFORNIA  
LIMITED LIABILITY COMPANY), FORMER-  
LY LIGHTSTREAM FILMS PTY LTD  
11833 MISSISSIPPI AVE SUITE 100  
LOS ANGELES, CA 90025

FOR: ENTERTAINMENT SERVICES, NAMELY,  
MOTION PICTURE, FILM, AND VIDEO PRODUC-  
TION SERVICES; DEVELOPMENT OF STORY AND  
CREATIVE CONTENT, NAMELY, SCRIPT WRIT-  
ING SERVICES FOR FILM, VIDEO AND MOTION  
PICTURES, IN CLASS 41 (U.S. CLS. 100, 101 AND 107).

FIRST USE 3-29-2007; IN COMMERCE 3-29-2007.

NO CLAIM IS MADE TO THE EXCLUSIVE  
RIGHT TO USE "PICTURES", APART FROM THE  
MARK AS SHOWN.

THE MARK CONSISTS OF THE WORDS "LIGHT-  
STREAM" AND "PICTURES" SEPARATED BY TWO  
THINLY SPACED VERTICAL LINES, THE FIRST  
BEING SLIGHTLY LONGER THAN THE SECOND.

SER. NO. 77-381,201, FILED 1-25-2008.

GENE MACIOL, EXAMINING ATTORNEY

**Int. Cls.: 35, 37 and 42**

**Prior U.S. Cls.: 100, 101, 102, 103 and 106**

**United States Patent and Trademark Office**

**Reg. No. 3,504,366**

**Registered Sep. 23, 2008**

**SERVICE MARK  
PRINCIPAL REGISTER**

**MOBILITYPOINT**

TRAPEZE NETWORKS, INC. (DELAWARE CORPORATION)  
5753 W. LOS POSITAS BLVD  
PLEASANTON, CA 94588

FOR: DISTRIBUTORSHIP SERVICES, WHOLESALE ORDERING SERVICES, AND RETAIL STORE SERVICES IN THE FIELDS OF SYSTEMS AND NETWORKING OF COMPUTER, TELECOMMUNICATIONS, AND SECURITY EQUIPMENT; DISTRIBUTORSHIP SERVICES, WHOLESALE AND RETAIL STORE SERVICES IN THE FIELD OF COMPUTER HARDWARE, SOFTWARE, PERIPHERALS, SYSTEMS, AND NETWORKS; DISTRIBUTORSHIP SERVICES, WHOLESALE ORDERING SERVICES, AND RETAIL STORE SERVICES IN THE FIELD OF TELECOMMUNICATIONS EQUIPMENT, SYSTEMS, AND NETWORKS; DISTRIBUTORSHIP SERVICES, WHOLESALE ORDERING SERVICES, AND RETAIL STORE SERVICES IN THE FIELD OF SECURITY EQUIPMENT, SYSTEMS, AND NETWORKS; ONLINE DISTRIBUTORSHIP SERVICES, WHOLESALE ORDERING SERVICES, AND RETAIL STORE SERVICES IN THE FIELD OF SYSTEMS AND NETWORKING OF COMPUTER, TELECOMMUNICATIONS, AND SECURITY EQUIPMENT, IN THE FIELD OF COMPUTER HARDWARE, SOFTWARE, AND PERIPHERALS, AND IN THE FIELDS OF TELECOMMUNICATIONS AND SECURITY EQUIPMENT; INVENTORY CONTROL AND MANAGEMENT SERVICES IN THE FIELDS OF COMPUTER, TELECOMMUNICATIONS, AND SECURITY EQUIPMENT, FEATURING USE OF RADIO FREQUENCY IDENTIFICATION TAGS AND OTHER IDENTIFICATION DEVICES; COMPUTERIZED TRACKING AND TRACING OF PRODUCTS AND PACKAGES IN TRANSIT FOR OTHERS; PROVIDING INTERACTIVE DATABASES TO RESELLERS OF COMPUTER HARDWARE, SOFTWARE, PERIPHERALS, SYSTEMS, AND NETWORKS, THAT CONTAIN COMMERCIAL INFORMATION, ALLOWING RE-

SELLERS TO MORE EFFECTIVELY SELL NETWORKING, CONVERGENCE, INFORMATION SECURITY AND MOBILITY PRODUCTS AND SOLUTIONS, IN CLASS 35 (U.S. CLS. 100, 101 AND 102).

FIRST USE 3-5-2008; IN COMMERCE 3-5-2008.

FOR: INSTALLATION, MAINTENANCE, AND REPAIR SERVICES FOR COMPUTER HARDWARE, PERIPHERALS, SYSTEMS, AND NETWORKS; INSTALLATION, MAINTENANCE, AND REPAIR SERVICES FOR TELECOMMUNICATIONS EQUIPMENT, SYSTEMS, AND NETWORKS; INSTALLATION, MAINTENANCE, AND REPAIR SERVICES FOR SECURITY EQUIPMENT, SYSTEMS, AND NETWORKS, IN CLASS 37 (U.S. CLS. 100, 103 AND 106).

FIRST USE 3-5-2008; IN COMMERCE 3-5-2008.

FOR: COMPUTER CONSULTATION SERVICES, NAMELY, TECHNICAL SUPPORT, TO RESELLERS OF COMPUTER HARDWARE, SOFTWARE, AND PERIPHERALS, IN THE FIELDS OF COMPUTER SYSTEMS, COMPUTER NETWORKING, AND COMPUTER HARDWARE, SOFTWARE, AND PERIPHERALS, NAMELY, HELP DESK SERVICES AVAILABLE ONLINE AND BY TELEPHONE AND EMAIL FOR PROBLEMS INVOLVING COMPUTER HARDWARE, SOFTWARE, PERIPHERALS, SYSTEMS, AND NETWORKS; INSTALLATION, MAINTENANCE, AND REPAIR SERVICES FOR COMPUTER SOFTWARE; TECHNICAL SUPPORT TO RESELLERS OF TELECOMMUNICATIONS EQUIPMENT, SYSTEMS, AND NETWORKS, NAMELY, PROVIDING GUIDANCE AND SERVICE IN THE NATURE OF THE DESIGN, MONITORING, AND THE TROUBLESHOOTING OF OPERATIONAL PROBLEMS WITHIN, SUCH EQUIPMENT, SYSTEMS, AND NETWORKS; HELP DESK SERVICES AVAILABLE ONLINE AND BY TELEPHONE AND EMAIL FOR PROBLEMS INVOLVING TELECOM-

MUNICATIONS EQUIPMENT, SYSTEMS, AND NETWORKS; COMPUTER SECURITY CONSULTATION SERVICES, NAMELY, TECHNICAL SUPPORT TO RESELLERS OF SECURITY EQUIPMENT, SYSTEMS, AND NETWORKS, NAMELY, PROVIDING GUIDANCE AND SERVICE IN THE NATURE THE DESIGN, MONITORING, AND THE TROUBLESHOOTING OF OPERATIONAL PROBLEMS WITHIN, SUCH EQUIPMENT, SYSTEMS, AND NETWORKS; HELP DESK SERVICES AVAILABLE ONLINE AND BY TELEPHONE AND EMAIL FOR PROBLEMS INVOLVING SECURITY EQUIPMENT, SYSTEMS, AND NETWORKS; PROVIDING INTERACTIVE DATABASES TO RESELLERS OF TELECOMMUNICATIONS EQUIPMENT, SYSTEMS AND

NETWORKS FEATURING TECHNICAL INFORMATION ON AND SPECIFICATIONS FOR TELECOMMUNICATIONS EQUIPMENT, IN CLASS 42 (U.S. CLS. 100 AND 101).

FIRST USE 3-5-2008; IN COMMERCE 3-5-2008.

THE MARK CONSISTS OF STANDARD CHARACTERS WITHOUT CLAIM TO ANY PARTICULAR FONT, STYLE, SIZE, OR COLOR.

SER. NO. 77-381,229, FILED 1-25-2008.

GRETTA YAO, EXAMINING ATTORNEY

**Int. Cl.: 41**

**Prior U.S. Cls.: 100, 101 and 107**

**United States Patent and Trademark Office**

**Reg. No. 3,504,367**

**Registered Sep. 23, 2008**

**SERVICE MARK  
PRINCIPAL REGISTER**

# Simple Evangelism

LIVING THE NEW LIFE MINISTRIES (GEORGIA CORPORATION)

151 RIVERWOOD GLEN

DALLAS, GA 30157

FOR: RELIGIOUS INSTRUCTION SERVICES, IN CLASS 41 (U.S. CLS. 100, 101 AND 107).

FIRST USE 5-15-2007; IN COMMERCE 6-15-2007.

THE MARK CONSISTS OF STANDARD CHARACTERS WITHOUT CLAIM TO ANY PARTICULAR FONT, STYLE, SIZE, OR COLOR.

NO CLAIM IS MADE TO THE EXCLUSIVE RIGHT TO USE "EVANGELISM", APART FROM THE MARK AS SHOWN.

SER. NO. 77-381,490, FILED 1-27-2008.

ANDREA SAUNDERS, EXAMINING ATTORNEY

**Int. Cl.: 30**

**Prior U.S. Cl.: 46**

**United States Patent and Trademark Office**

**Reg. No. 3,504,368**

**Registered Sep. 23, 2008**

**TRADEMARK  
PRINCIPAL REGISTER**

**MAKE OUT MINTS**

HOLLYWOOD FASHION TAPE, INC. (MINNESOTA CORPORATION)  
2112 BROADWAY STREET N.E., SUITE 125  
MINNEAPOLIS, MN 55413

FOR: CANDY MINTS, IN CLASS 30 (U.S. CL. 46).

FIRST USE 7-11-2007; IN COMMERCE 7-11-2007.

THE MARK CONSISTS OF STANDARD CHARACTERS WITHOUT CLAIM TO ANY PARTICULAR FONT, STYLE, SIZE, OR COLOR.

NO CLAIM IS MADE TO THE EXCLUSIVE RIGHT TO USE "MINTS", APART FROM THE MARK AS SHOWN.

SER. NO. 77-381,495, FILED 1-27-2008.

CAROLYN CATALDO, EXAMINING ATTORNEY

**Int. Cl.: 27**

**Prior U.S. Cls.: 19, 20, 37, 42 and 50**

**United States Patent and Trademark Office**

**Reg. No. 3,504,369**

**Registered Sep. 23, 2008**

**TRADEMARK  
PRINCIPAL REGISTER**

**SURROUNDDECOR**

4WALLS.COM, LTD. (OHIO LIMITED LIABILITY  
COMPANY)  
4700 LAKESIDE AVENUE  
CLEVELAND, OH 44114

FOR: PLASTIC WALL COVERINGS; NON-TEX-  
TILE WALL COVERINGS; WALL PAPER, IN CLASS  
27 (U.S. CLS. 19, 20, 37, 42 AND 50).

FIRST USE 10-1-2000; IN COMMERCE 10-1-2000.

THE MARK CONSISTS OF STANDARD CHAR-  
ACTERS WITHOUT CLAIM TO ANY PARTICULAR  
FONT, STYLE, SIZE, OR COLOR.

SER. NO. 77-381,773, FILED 1-28-2008.

DAWN FELDMAN, EXAMINING ATTORNEY

**Int. Cl.: 9**

**Prior U.S. Cls.: 21, 23, 26, 36 and 38**

**Reg. No. 3,504,370**

**United States Patent and Trademark Office**

**Registered Sep. 23, 2008**

---

**TRADEMARK  
PRINCIPAL REGISTER**

**PROVIDER SERIES**

PROVIDER SERIES, LLC (GEORGIA LIMITED  
LIABILITY COMPANY)  
390 WEST PIKE STREET, SUITE 218  
LAWRENCEVILLE, GA 30045

FOR: APPARATUS FOR BROADCAST, REPRODUCTION, PROCESSING AND TRANSMISSION OF SOUND AND VIDEO; MICROPHONES; MICROPHONE ACCESSORIES, NAMELY MICROPHONE POLES, MICROPHONE CABLES, AND MICROPHONE STANDS, IN CLASS 9 (U.S. CLS. 21, 23, 26, 36 AND 38).

FIRST USE 5-1-2007; IN COMMERCE 7-5-2007.

THE MARK CONSISTS OF STANDARD CHARACTERS WITHOUT CLAIM TO ANY PARTICULAR FONT, STYLE, SIZE, OR COLOR.

NO CLAIM IS MADE TO THE EXCLUSIVE RIGHT TO USE "SERIES", APART FROM THE MARK AS SHOWN.

SER. NO. 77-381,872, FILED 1-28-2008.

WARREN L. OLANDRIA, EXAMINING ATTORNEY



**Int. Cl.: 9**

**Prior U.S. Cls.: 21, 23, 26, 36 and 38**

**Reg. No. 3,504,371**

**United States Patent and Trademark Office**

**Registered Sep. 23, 2008**

**TRADEMARK  
PRINCIPAL REGISTER**

# HEAD-CLIP

PROVIDER SERIES, LLC (GEORGIA LIMITED  
LIABILITY COMPANY)  
390 WEST PIKE STREET, SUITE 218  
LAWRENCEVILLE, GA 30045

FOR: APPARATUS FOR BROADCAST, REPRO-  
DUCTION, PROCESSING AND TRANSMISSION OF  
SOUND AND VIDEO; MICROPHONES; MICRO-  
PHONE ACCESSORIES, NAMELY, MICROPHONE  
POLES, MICROPHONE CABLES, AND MICRO-  
PHONE STANDS, IN CLASS 9 (U.S. CLS. 21, 23, 26,  
36 AND 38).

FIRST USE 12-5-2007; IN COMMERCE 12-15-2007.

THE MARK CONSISTS OF STANDARD CHAR-  
ACTERS WITHOUT CLAIM TO ANY PARTICULAR  
FONT, STYLE, SIZE, OR COLOR.

SER. NO. 77-381,881, FILED 1-28-2008.

WARREN L. OLANDRIA, EXAMINING ATTOR-  
NEY

**Int. Cl.: 9**

**Prior U.S. Cls.: 21, 23, 26, 36 and 38**

**United States Patent and Trademark Office**

**Reg. No. 3,504,372**

**Registered Sep. 23, 2008**

**TRADEMARK  
PRINCIPAL REGISTER**

**PAKDROP**

PROVIDER SERIES, LLC (GEORGIA LIMITED  
LIABILITY COMPANY)  
390 WEST PIKE STREET, SUITE 218  
LAWRENCEVILLE, GA 30045

FOR: APPARATUS FOR BROADCAST, REPRO-  
DUCTION, PROCESSING AND TRANSMISSION OF  
SOUND AND VIDEO; MICROPHONES; MICRO-  
PHONE ACCESSORIES, NAMELY, MICROPHONE  
POLES, MICROPHONE CABLES, AND MICRO-  
PHONE STANDS, IN CLASS 9 (U.S. CLS. 21, 23, 26,  
36 AND 38).

FIRST USE 12-10-2007; IN COMMERCE 12-10-2007.

THE MARK CONSISTS OF STANDARD CHAR-  
ACTERS WITHOUT CLAIM TO ANY PARTICULAR  
FONT, STYLE, SIZE, OR COLOR.

SER. NO. 77-381,894, FILED 1-28-2008.

WARREN L. OLANDRIA, EXAMINING ATTOR-  
NEY

**Int. Cl.: 11**

**Prior U.S. Cls.: 13, 21, 23, 31 and 34**

**United States Patent and Trademark Office**

**Reg. No. 3,504,373**

**Registered Sep. 23, 2008**

**TRADEMARK  
PRINCIPAL REGISTER**

**WOWClean**

WOW ENERGY, INC. (TEXAS CORPORATION),  
DBA WOW ENERGIES  
1650 HWY. 6, SUITE 300  
SUGAR LAND, TX 77478

THE MARK CONSISTS OF STANDARD CHAR-  
ACTERS WITHOUT CLAIM TO ANY PARTICULAR  
FONT, STYLE, SIZE, OR COLOR.

FOR: GAS SCRUBBERS, IN CLASS 11 (U.S. CLS.  
13, 21, 23, 31 AND 34).

SER. NO. 77-382,050, FILED 1-28-2008.

FIRST USE 1-1-2007; IN COMMERCE 1-1-2007.

JAMES A. RAUEN, EXAMINING ATTORNEY

**Int. Cl.: 44**

**Prior U.S. Cls.: 100 and 101**

**United States Patent and Trademark Office**

**Reg. No. 3,504,374**

**Registered Sep. 23, 2008**

**SERVICE MARK  
PRINCIPAL REGISTER**

**EMA MD-1**

EMERGENCY MEDICAL ASSOCIATES OF NEW  
JERSEY (NEW JERSEY CORPORATION)  
651 W. MT. PLEASANT AVENUE  
LIVINGSTON, NJ 07039

THE MARK CONSISTS OF STANDARD CHAR-  
ACTERS WITHOUT CLAIM TO ANY PARTICULAR  
FONT, STYLE, SIZE, OR COLOR.

FOR: EMERGENCY MEDICAL SERVICES, IN  
CLASS 44 (U.S. CLS. 100 AND 101).

SER. NO. 77-382,057, FILED 1-28-2008.

FIRST USE 1-17-2008; IN COMMERCE 1-17-2008.

AMY GEARIN, EXAMINING ATTORNEY

**Int. Cls.: 9, 12 and 25**

**Prior U.S. Cls.: 19, 21, 22, 23, 26, 31, 35, 36, 38, 39 and 44**

**Reg. No. 3,504,375**

**United States Patent and Trademark Office**

**Registered Sep. 23, 2008**

**TRADEMARK  
PRINCIPAL REGISTER**

# Roland Sands Design

ROLAND SANDS DESIGN, INC. (CALIFORNIA CORPORATION)  
5700 E. THE TOLEDO  
LONG BEACH, CA 908034050

FOR: MOTORCYCLE HELMETS AND EYEWEAR, IN CLASS 9 (U.S. CLS. 21, 23, 26, 36 AND 38).

FIRST USE 3-0-2006; IN COMMERCE 3-0-2006.

FOR: MOTORCYCLE PARTS AND ACCESSORIES, NAMELY, HANDLEBARS AND HAND GRIPS; SEATS; FENDERS; GASOLINE TANK CAPS; WHEELS; GAS TANKS; SHEET METAL AND FIBERGLASS BODY KITS COMPRISING EXTERNAL STRUCTURES OF MOTORCYCLES; TRANSMISSION COVERS; BRAKES; BRAKE DISCS; BRAKE COMPONENTS, NAMELY, BRAKE PEDALS AND BRAKE CABLES; SWING ARMS; MOTORCYCLE CHASSIS; MOTORCYCLE STRUCTURAL PARTS, NAMELY, TRIPLE CLAMPS FOR HOLDING MOTORCYCLE FORKS, IN CLASS 12 (U.S. CLS. 19, 21, 23, 31, 35 AND 44).

FIRST USE 1-0-2006; IN COMMERCE 1-0-2006.

FOR: CLOTHING, NAMELY, T-SHIRTS, SWEATSHIRTS AND PANTS, JACKETS, GLOVES, CAPS, HATS, BELTS, LEATHER BOOTS AND SHOES, IN CLASS 25 (U.S. CLS. 22 AND 39).

FIRST USE 7-1-2005; IN COMMERCE 7-1-2005.

THE MARK CONSISTS OF STANDARD CHARACTERS WITHOUT CLAIM TO ANY PARTICULAR FONT, STYLE, SIZE, OR COLOR.

NO CLAIM IS MADE TO THE EXCLUSIVE RIGHT TO USE "DESIGN", APART FROM THE MARK AS SHOWN.

THE NAME "ROLAND SANDS" IDENTIFIES A LIVING INDIVIDUAL WHOSE CONSENT IS OF RECORD.

SER. NO. 77-382,209, FILED 1-28-2008.

ALICE SUE CARRUTHERS, EXAMINING ATTORNEY

**Int. Cl.: 16**

**Prior U.S. Cls.: 2, 5, 22, 23, 29, 37, 38 and 50**

**United States Patent and Trademark Office**

**Reg. No. 3,504,376**

**Registered Sep. 23, 2008**

**TRADEMARK  
PRINCIPAL REGISTER**

**HEATSEAL**

GENERAL BINDING CORPORATION (DELA-  
WARE CORPORATION)  
300 TOWER PARKWAY  
LINCOLNSHIRE, IL 60069

FOR: LAMINATING SUPPLIES FOR DOCUMENT  
AND PHOTO LAMINATION COMPRISING PLAS-  
TIC LAMINATING POUCHES, IN CLASS 16 (U.S.  
CLS. 2, 5, 22, 23, 29, 37, 38 AND 50).

FIRST USE 12-31-2002; IN COMMERCE 12-31-2002.

THE MARK CONSISTS OF STANDARD CHAR-  
ACTERS WITHOUT CLAIM TO ANY PARTICULAR  
FONT, STYLE, SIZE, OR COLOR.

OWNER OF U.S. REG. NOS. 2,818,543, 2,974,824,  
AND 3,058,306.

SEC. 2(F).

SER. NO. 77-382,237, FILED 1-28-2008.

RONALD AIKENS, EXAMINING ATTORNEY

Int. Cl.: 25

Prior U.S. Cls.: 22 and 39

United States Patent and Trademark Office

Reg. No. 3,504,377

Registered Sep. 23, 2008

TRADEMARK  
PRINCIPAL REGISTER



KNS INTERNATIONAL, L.L.C. (UTAH LIMITED  
LIABILITY COMPANY)  
12577 S. 265 W. BLD. 1C  
DRAPER, UT 84020

FOR: CLOTHING, NAMELY, SKIRTS, SHIRTS,  
DRESSES, BLOUSES, PANTS, SWEATERS, JACK-  
ETS, SHORTS, T-SHIRTS, SWEATSHIRTS, FOOT-  
WEAR, GLOVES AND BELTS, IN CLASS 25 (U.S.  
CLS. 22 AND 39).

FIRST USE 11-30-2005; IN COMMERCE 11-30-2005.

NO CLAIM IS MADE TO THE EXCLUSIVE  
RIGHT TO USE "COLLECTION", APART FROM  
THE MARK AS SHOWN.

THE ENGLISH TRANSLATION OF THE WORD  
"JOURNEE" IN THE MARK IS DAY.

SER. NO. 77-382,433, FILED 1-28-2008.

KATHERINE M. DUBRAY, EXAMINING ATTOR-  
NEY

**Int. Cl.: 43**

**Prior U.S. Cls.: 100 and 101**

**United States Patent and Trademark Office**

**Reg. No. 3,504,378**

**Registered Sep. 23, 2008**

**SERVICE MARK  
PRINCIPAL REGISTER**

**A FISH CALLED AVALON**

YANKEE DEVELOPMENT CORP. (RHODE IS-  
LAND CORPORATION)  
CHRISTIES LANDING  
NEWPORT, RI 02840

THE MARK CONSISTS OF STANDARD CHAR-  
ACTERS WITHOUT CLAIM TO ANY PARTICULAR  
FONT, STYLE, SIZE, OR COLOR.

FOR: BAR AND RESTAURANT SERVICES, IN  
CLASS 43 (U.S. CLS. 100 AND 101).

SER. NO. 77-382,758, FILED 1-29-2008.

FIRST USE 8-1-1993; IN COMMERCE 8-1-1993.

H. M. FISHER, EXAMINING ATTORNEY



**Int. Cl.: 37**

**Prior U.S. Cls.: 100, 103 and 106**

**United States Patent and Trademark Office**

**Reg. No. 3,504,379**

**Registered Sep. 23, 2008**

**SERVICE MARK  
PRINCIPAL REGISTER**



PW CONSTRUCTION, INC. (CALIFORNIA CORPORATION)  
SUITE 200  
1905 E. ROUTE 66  
GLEN DORA, CA 91740

FOR: GENERAL CONSTRUCTION CONTRACTING, CONSTRUCTION MANAGEMENT, IN CLASS 37 (U.S. CLS. 100, 103 AND 106).

FIRST USE 1-10-2008; IN COMMERCE 1-10-2008.

THE COLOR(S) BLUE, ORANGE AND WHITE IS/ARE CLAIMED AS A FEATURE OF THE MARK.

THE MARK CONSISTS OF THE BLOCK LETTERS "PWCI" IN BLUE WITH THE SLOGAN "SHOOT STRAIGHT. AIM HIGH." IN ORANGE BELOW "PWCI", ALL WITH A WHITE BACKGROUND. TO THE LEFT OF THE WORDING IS A BLUE AND WHITE ARROW FACING UPWARDS TOWARDS AN ORANGE BACKGROUND.

SER. NO. 77-382,975, FILED 1-29-2008.

REBECCA SMITH, EXAMINING ATTORNEY

**Int. Cls.: 29 and 30**

**Prior U.S. Cl.: 46**

**United States Patent and Trademark Office**

**Reg. No. 3,504,380**

**Registered Sep. 23, 2008**

**TRADEMARK  
PRINCIPAL REGISTER**

# Gramp's Gourmet

GRAMP'S GOURMET FOODS, INC. (ILLINOIS CORPORATION)  
801 FRANKLIN STREET  
SCALES MOUND, IL 61075

FOR: PICKLED VEGETABLES, IN CLASS 29 (U.S. CL. 46).

FIRST USE 6-6-2005; IN COMMERCE 6-6-2005.

FOR: PICKLE RELISH, IN CLASS 30 (U.S. CL. 46).

FIRST USE 6-6-2005; IN COMMERCE 6-6-2005.

THE MARK CONSISTS OF STANDARD CHARACTERS WITHOUT CLAIM TO ANY PARTICULAR FONT, STYLE, SIZE, OR COLOR.

NO CLAIM IS MADE TO THE EXCLUSIVE RIGHT TO USE "GOURMET", APART FROM THE MARK AS SHOWN.

SER. NO. 77-382,999, FILED 1-29-2008.

ANDREA HACK, EXAMINING ATTORNEY

**Int. Cl.: 25**

**Prior U.S. Cls.: 22 and 39**

**United States Patent and Trademark Office**

**Reg. No. 3,504,381**

**Registered Sep. 23, 2008**

**TRADEMARK  
PRINCIPAL REGISTER**

**R REAL STREET KLOZE**

AGUIRRE, MICHELLE (UNITED STATES INDIVIDUAL)  
SUITE 332  
10333 NORTHWEST FREEWAY  
HOUSTON, TX 77092

FOR: CLOTHING ITEMS, NAMELY, SHIRTS, T-SHIRTS, BLOUSES, JACKETS, VESTS, JOGGING SUITS, CAPS AND HATS, IN CLASS 25 (U.S. CLS. 22 AND 39).

FIRST USE 10-1-2003; IN COMMERCE 10-1-2003.

THE MARK CONSISTS OF STANDARD CHARACTERS WITHOUT CLAIM TO ANY PARTICULAR FONT, STYLE, SIZE, OR COLOR.

NO CLAIM IS MADE TO THE EXCLUSIVE RIGHT TO USE "STREET CLOTHES", APART FROM THE MARK AS SHOWN.

SER. NO. 77-383,008, FILED 1-29-2008.

MARY CRAWFORD, EXAMINING ATTORNEY

**Int. Cl.: 41**

**Prior U.S. Cls.: 100, 101 and 107**

**United States Patent and Trademark Office**

**Reg. No. 3,504,382**

**Registered Sep. 23, 2008**

**SERVICE MARK  
PRINCIPAL REGISTER**



THE SLATER GROUP, LLC (GEORGIA LIMITED LIABILITY COMPANY)

BUILDING 300, SUITE 150

4595 TOWNE LAKE PARKWAY

WOODSTOCK, GA 30189

FOR: EDUCATION SERVICES, NAMELY, PROVIDING CONSULTING THROUGH CLASSES SEMINARS WORKSHOPS AND ONSITE TRAINING IN THE FIELD OF EDUCATION, IN CLASS 41 (U.S. CLS. 100, 101 AND 107).

FIRST USE 11-1-2007; IN COMMERCE 11-1-2007.

NO CLAIM IS MADE TO THE EXCLUSIVE RIGHT TO USE "GLOBAL LEARNER COLLEGE", APART FROM THE MARK AS SHOWN.

THE COLOR(S) BLUE AND WHITE IS/ARE CLAIMED AS A FEATURE OF THE MARK.

THE MARK CONSISTS OF BLUE GLOBE AS A BACKGROUND WITH THE WORDS "GLOBAL LEARNER COLLEGE" IN WHITE ACROSS THE GLOBE.

SER. NO. 77-383,266, FILED 1-29-2008.

LOURDES AYALA, EXAMINING ATTORNEY

**Int. Cl.: 41**

**Prior U.S. Cls.: 100, 101 and 107**

**United States Patent and Trademark Office**

**Reg. No. 3,504,383**

**Registered Sep. 23, 2008**

**SERVICE MARK  
PRINCIPAL REGISTER**

# Therapeutic Play Interactions

EB PEDIATRIC RESOURCES INC (ILLINOIS  
CORPORATION)  
3712 N BROADWAY#250  
CHICAGO, IL 60613

FOR: INFORMATION IN THE FIELD OF PAR-  
ENTING CONCERNING EDUCATION OF CHIL-  
DREN; EDUCATIONAL SERVICES, NAMELY,  
CONDUCTING PROGRAMS IN THE FIELD OF  
CHILD DEVELOPMENT; EDUCATION SERVICES,  
NAMELY, PROVIDING TUTORING IN THE  
FIELDS OF CHILD DEVELOPMENT IN THE NAT-  
URE OF COGNITIVE, COMMUNICATION AND  
SOCIAL SKILLS; EDUCATION SERVICES, NAME-  
LY, PROVIDING HOME-BASED ONE-ON-ONE DI-  
RECT TUTORING AND WORKSHOPS IN THE  
FIELD OF INFANT AND CHILD DEVELOPMENT  
AND DEVELOPMENTAL SKILLS LEARNED

THROUGH SPECIFIC PLAY ACTIVITIES, IN CLASS  
41 (U.S. CLS. 100, 101 AND 107).

FIRST USE 1-15-2007; IN COMMERCE 7-16-2007.

THE MARK CONSISTS OF STANDARD CHAR-  
ACTERS WITHOUT CLAIM TO ANY PARTICULAR  
FONT, STYLE, SIZE, OR COLOR.

NO CLAIM IS MADE TO THE EXCLUSIVE  
RIGHT TO USE "THERAPEUTIC PLAY", APART  
FROM THE MARK AS SHOWN.

SER. NO. 77-383,516, FILED 1-29-2008.

JESSICA A. POWERS, EXAMINING ATTORNEY

**Int. Cl.: 35**

**Prior U.S. Cls.: 100, 101 and 102**

**United States Patent and Trademark Office**

**Reg. No. 3,504,384**

**Registered Sep. 23, 2008**

**SERVICE MARK  
PRINCIPAL REGISTER**



ONLY NATURAL PET STORE, LLC (COLORADO  
LIMITED LIABILITY COMPANY)  
1840 COMMERCE ST, STE F  
BOULDER, CO 80301

NO CLAIM IS MADE TO THE EXCLUSIVE  
RIGHT TO USE "ONLY NATURAL PET STORE",  
APART FROM THE MARK AS SHOWN.

FOR: RETAIL STORE SERVICES FEATURING  
PET PRODUCTS; ON-LINE RETAIL STORE SERVI-  
CES FEATURING PET PRODUCTS, IN CLASS 35  
(U.S. CLS. 100, 101 AND 102).

SER. NO. 77-383,554, FILED 1-29-2008.

FIRST USE 5-22-2004; IN COMMERCE 5-22-2004.

CHRISTINE COOPER, EXAMINING ATTORNEY

**Int. Cl.: 45**

**Prior U.S. Cls.: 100 and 101**

**United States Patent and Trademark Office**

**Reg. No. 3,504,385**

**Registered Sep. 23, 2008**

**SERVICE MARK  
PRINCIPAL REGISTER**



**Fantasy Fling**  
Share a fantasy - Have a fling

PRINCIPAL VENTURES, LLC (FLORIDA LIMITED LIABILITY COMPANY)  
STE. 22-311  
11924 FOREST HILL BLVD.  
WELLINGTON, FL 33414

THE MARK CONSISTS OF A CIRCLE WITH AN ABSTRACT DESIGN TO THE LEFT OF THE STYLIZED TEXT "FANTASY FLING SHARE A FANTASY - HAVE A FLING".

FOR: INTERNET BASED SOCIAL NETWORKING, INTRODUCTION, AND DATING SERVICES, IN CLASS 45 (U.S. CLS. 100 AND 101).

SER. NO. 77-384,077, FILED 1-30-2008.

FIRST USE 1-1-2004; IN COMMERCE 1-1-2004.

DEZMONA MIZELLE, EXAMINING ATTORNEY

**Int. Cls.: 29 and 30**

**Prior U.S. Cl.: 46**

**United States Patent and Trademark Office**

**Reg. No. 3,504,386**

**Registered Sep. 23, 2008**

**TRADEMARK  
PRINCIPAL REGISTER**

**THE BEST OF WHAT AMERICA  
LOVES MOST**

BUMBLE BEE FOODS, LLC (DELAWARE LIMITED LIABILITY COMPANY)  
9655 GRANITE RIDGE DRIVE, SUITE 100  
SAN DIEGO, CA 92123

FOR: FOOD PRODUCTS, NAMELY, BEEF STEW, CHILI, POTTED MEAT, VIENNA SAUSAGE, BEEF AND BEEF STOCK, BARBECUE BEEF, BARBECUE PORK, BEEF BROTH, CHICKEN BROTH, CHICKEN AND DUMPLINGS, CHICKEN BREAST, CHILI WITH BEANS, CHILI NO BEANS, BRUNSWICK STEW, TURKEY BREAST, CHUNK CHICKEN, CHUNK WHITE CHICKEN MEAT, CHUNK DARK CHICKEN MEAT, CORNED BEEF HASH, CHUNK HAM, WHOLE CHICKEN, BONED CHICKEN, AND PREPARED ENTREES CONSISTING PRIMARILY OF MEAT, IN CLASS 29 (U.S. CL. 46).

FIRST USE 10-22-2007; IN COMMERCE 10-22-2007.

FOR: FOOD PRODUCTS, NAMELY, HOT DOG CHILI SAUCE AND BEEF TAMALES, IN CLASS 30 (U.S. CL. 46).

FIRST USE 10-22-2007; IN COMMERCE 10-22-2007.

THE MARK CONSISTS OF STANDARD CHARACTERS WITHOUT CLAIM TO ANY PARTICULAR FONT, STYLE, SIZE, OR COLOR.

SER. NO. 77-384,687, FILED 1-30-2008.

ANDREA BUTLER, EXAMINING ATTORNEY



**Int. Cl.: 26**

**Prior U.S. Cls.: 37, 39, 40, 42 and 50**

**United States Patent and Trademark Office**

**Reg. No. 3,504,387**

**Registered Sep. 23, 2008**

**TRADEMARK  
PRINCIPAL REGISTER**

**HOLLYWOOD HOOK-UPS**

HOLLYWOOD FASHION TAPE, INC. (MINNESOTA CORPORATION)

2112 BROADWAY STREET N.E., SUITE 125

MINNEAPOLIS, MN 55413

FOR: STRAP BUCKLES, IN CLASS 26 (U.S. CLS. 37, 39, 40, 42 AND 50).

FIRST USE 9-21-2007; IN COMMERCE 9-21-2007.

THE MARK CONSISTS OF STANDARD CHARACTERS WITHOUT CLAIM TO ANY PARTICULAR FONT, STYLE, SIZE, OR COLOR.

NO CLAIM IS MADE TO THE EXCLUSIVE RIGHT TO USE "HOLLYWOOD", APART FROM THE MARK AS SHOWN.

SER. NO. 77-384,867, FILED 1-30-2008.

CAROLYN CATALDO, EXAMINING ATTORNEY

**Int. Cl.: 9**

**Prior U.S. Cls.: 21, 23, 26, 36 and 38**

**Reg. No. 3,504,388**

**United States Patent and Trademark Office**

**Registered Sep. 23, 2008**

**TRADEMARK  
PRINCIPAL REGISTER**

**TRAINING JOY**

TWIN LAKES CONSULTING CORPORATION  
(PENNSYLVANIA CORPORATION)  
527 VINE STREET  
GREENSBURG, PA 15601

FOR: COMPUTER SOFTWARE FOR THE FIELD OF EMPLOYEE TRAINING, TO MANAGE TRAINING DATA, PROVIDE TRAINING PERFORMANCE ANALYSIS, AND PRODUCE TRAINING NOTIFICATIONS AND REPORTS, IN CLASS 9 (U.S. CLS. 21, 23, 26, 36 AND 38).

FIRST USE 11-1-2007; IN COMMERCE 1-9-2008.

THE MARK CONSISTS OF STANDARD CHARACTERS WITHOUT CLAIM TO ANY PARTICULAR FONT, STYLE, SIZE, OR COLOR.

NO CLAIM IS MADE TO THE EXCLUSIVE RIGHT TO USE "TRAINING", APART FROM THE MARK AS SHOWN.

SER. NO. 77-384,924, FILED 1-31-2008.

ARETHA SOMERVILLE, EXAMINING ATTORNEY

Int. Cl.: 35

Prior U.S. Cls.: 100, 101 and 102

United States Patent and Trademark Office

Reg. No. 3,504,389

Registered Sep. 23, 2008

**SERVICE MARK  
PRINCIPAL REGISTER**



INTERNATIONAL  
**T R A D E**  
ADMINISTRATION

INTERNATIONAL TRADE ADMINISTRATION  
(UNITED STATES AGENCY OF THE UNITED STATES GOVERNMENT)

1401 CONSTITUTION AVENUE, N.W.  
WASHINGTON, DC 20230

FOR: BUSINESS CONSULTING SERVICES TO ASSIST THE UNITED STATES BUSINESS COMMUNITY IN THE FIELD OF INTERNATIONAL TRADE, NAMELY, CONSULTATION IN IMPORT AND EXPORT OF GOODS AND SERVICES, INTERNATIONAL MARKETING, CONDUCTING TRADE SHOWS IN THE FIELD OF INTERNATIONAL TRADE, PROMOTING TRADE BETWEEN THE UNITED STATES AND FOREIGN COUNTRIES, BUSINESS

RESEARCH, MARKET RESEARCH, IN CLASS 35 (U.S. CLS. 100, 101 AND 102).

FIRST USE 9-1-2006; IN COMMERCE 9-1-2006.

NO CLAIM IS MADE TO THE EXCLUSIVE RIGHT TO USE "UNITED STATES OF AMERICA", APART FROM THE MARK AS SHOWN.

SEC. 2(F) AS TO "INTERNATIONAL TRADE ADMINISTRATION".

SER. NO. 77-384,982, FILED 1-31-2008.

GIANCARLO CASTRO, EXAMINING ATTORNEY

Int. Cl.: 9

Prior U.S. Cls.: 21, 23, 26, 36 and 38

United States Patent and Trademark Office

Reg. No. 3,504,390

Registered Sep. 23, 2008

TRADEMARK  
PRINCIPAL REGISTER



INTERNATIONAL  
**T R A D E**  
ADMINISTRATION

INTERNATIONAL TRADE ADMINISTRATION  
(UNITED STATES AGENCY OF THE UNITED  
STATES GOVERNMENT)  
1401 CONSTITUTION AVENUE, N.W.  
WASHINGTON, DC 20230

FOR: ELECTRONIC MEDIA INFORMATION  
PRODUCTS AND MAGNETIC DATA CARRIERS,  
NAMELY, COMPACT DISC-READ ONLY MEMORY  
(CD-ROM) PRODUCTS, DIGITAL VIDEO DISCS  
(DVDS), DISKETTES AND MAGNETIC TAPE  
DRIVES IN THE FIELD OF IMPORTS AND INTER-  
NATIONAL TRADE, BUSINESS, EXPORTS AND  
EXPORTING, ECONOMICS, DEMOGRAPHIC AND  
SOCIAL STATISTICS, AGRICULTURE, FINANCE,  
TECHNOLOGY AND MANUFACTURING, IN  
CLASS 9 (U.S. CLS. 21, 23, 26, 36 AND 38).

FIRST USE 4-3-2006; IN COMMERCE 4-3-2006.

NO CLAIM IS MADE TO THE EXCLUSIVE  
RIGHT TO USE "UNITED STATES OF AMERICA",  
APART FROM THE MARK AS SHOWN.

THE MARK CONSISTS OF THE MARK IS A  
CIRCULAR ARRANGEMENT OF THE WORDS  
"DEPARTMENT OF COMMERCE UNITED STATES  
OF AMERICA" , SURROUNDING A RENDERING  
OF A SHIP AND LIGHTHOUSE, WITH THE WORDS  
"INTERNATIONAL TRADE ADMINISTRATION"  
TO THE RIGHT THEREOF.

SEC. 2(F) "INTERNATIONAL TRADE ADMINIS-  
TRATION HAS BECOME DISTINCTIVE OF THE  
GOODS/SERVICES THROUGH THE APPLICANT'S  
SUBSTANTIALLY EXCLUSIVE AND CONTINU-  
OUS USE IN COMMERCE FOR AT LEAST THE  
FIVE YEARS IMMEDIATELY BEFORE THE DATE  
OF THIS STATEMENT."

SER. NO. 77-384,987, FILED 1-31-2008.

GIANCARLO CASTRO, EXAMINING ATTORNEY

**Int. Cl.: 36**

**Prior U.S. Cls.: 100, 101 and 102**

**United States Patent and Trademark Office**

**Reg. No. 3,504,391**

**Registered Sep. 23, 2008**

**SERVICE MARK  
PRINCIPAL REGISTER**

**Life Plus+ Ministry Program**

INSURANCE SOLUTIONS OF AMERICA, LLC  
(PENNSYLVANIA LIMITED LIABILITY COMPANY)  
3023 DAVISON AVENUE  
ERIE, PA 16504

FOR: INSURANCE AND FINANCIAL INFORMATION AND CONSULTANCY SERVICES, IN CLASS 36 (U.S. CLS. 100, 101 AND 102).

FIRST USE 8-1-2007; IN COMMERCE 8-1-2007.

THE MARK CONSISTS OF STANDARD CHARACTERS WITHOUT CLAIM TO ANY PARTICULAR FONT, STYLE, SIZE, OR COLOR.

NO CLAIM IS MADE TO THE EXCLUSIVE RIGHT TO USE "LIFE" AND "PROGRAM", APART FROM THE MARK AS SHOWN.

SER. NO. 77-384,998, FILED 1-31-2008.

NAKIA HENRY, EXAMINING ATTORNEY

**Int. Cl.: 9**

**Prior U.S. Cls.: 21, 23, 26, 36 and 38**

**Reg. No. 3,504,392**

**United States Patent and Trademark Office**

**Registered Sep. 23, 2008**

---

**TRADEMARK  
PRINCIPAL REGISTER**

**SMF**

SIMPLE MACHINES LLC (ARIZONA LIMITED  
LIABILITY COMPANY)  
11230 S BRANDYWINE LN  
TUCSON, AZ 85736

FIRST USE 4-8-2007; IN COMMERCE 4-8-2007.

FOR: DOWNLOADABLE COMPUTER SOFTWARE FOR CREATING AN ONLINE COMMUNITY TO ALLOW USERS TO INTERACTIVELY DISCUSS ITEMS OF GENERAL INTEREST VIA THE INTERNET, IN CLASS 9 (U.S. CLS. 21, 23, 26, 36 AND 38).

THE MARK CONSISTS OF STANDARD CHARACTERS WITHOUT CLAIM TO ANY PARTICULAR FONT, STYLE, SIZE, OR COLOR.

SER. NO. 77-384,999, FILED 1-31-2008.

RON FAIRBANKS, EXAMINING ATTORNEY

**Int. Cl.: 35**

**Prior U.S. Cls.: 100, 101 and 102**

**United States Patent and Trademark Office**

**Reg. No. 3,504,393**

**Registered Sep. 23, 2008**

**SERVICE MARK  
PRINCIPAL REGISTER**



INTERNATIONAL  
**T R A D E**  
ADMINISTRATION

INTERNATIONAL TRADE ADMINISTRATION  
(UNITED STATES AGENCY OF THE UNITED STATES GOVERNMENT)  
1401 CONSTITUTION AVENUE, N.W.  
WASHINGTON, DC 20230

FOR: BUSINESS CONSULTING SERVICES TO ASSIST THE UNITED STATES BUSINESS COMMUNITY IN THE FIELD OF INTERNATIONAL TRADE, NAMELY, CONSULTATION IN IMPORT AND EXPORT OF GOODS AND SERVICES, INTERNATIONAL MARKETING, CONDUCTING TRADE SHOWS IN THE FIELD OF INTERNATIONAL TRADE, PROMOTING TRADE BETWEEN THE UNITED STATES AND FOREIGN COUNTRIES, BUSINESS RESEARCH, MARKET RESEARCH, IN CLASS 35 (U.S. CLS. 100, 101 AND 102).

FIRST USE 10-15-2006; IN COMMERCE 10-15-2006.

NO CLAIM IS MADE TO THE EXCLUSIVE RIGHT TO USE "UNITED STATES OF AMERICA", APART FROM THE MARK AS SHOWN.

THE MARK CONSISTS OF A CIRCULAR ARRANGEMENT OF THE WORDS "DEPARTMENT OF COMMERCE UNITED STATES OF AMERICA", SURROUNDING A RENDERING OF A SHIP AND LIGHTHOUSE, WITH THE WORDS "INTERNATIONAL TRADE ADMINISTRATION" UNDERNEATH.

SEC. 2(F) "INTERNATIONAL TRADE ADMINISTRATION".

SER. NO. 77-385,005, FILED 1-31-2008.

GIANCARLO CASTRO, EXAMINING ATTORNEY

Int. Cl.: 16

Prior U.S. Cls.: 2, 5, 22, 23, 29, 37, 38 and 50

Reg. No. 3,504,394

United States Patent and Trademark Office

Registered Sep. 23, 2008

**TRADEMARK  
PRINCIPAL REGISTER**



INTERNATIONAL  
**T R A D E**  
ADMINISTRATION

INTERNATIONAL TRADE ADMINISTRATION  
(UNITED STATES AGENCY OF THE UNITED STATES GOVERNMENT)  
1401 CONSTITUTION AVE., N.W.  
WASHINGTON, DC 20230

FOR: PUBLICATIONS, NAMELY, PAMPHLETS, BROCHURES, MAGAZINES, JOURNALS, CATALOGS AND BOOKLETS PERTAINING TO INTERNATIONAL TRADE, IN CLASS 16 (U.S. CLS. 2, 5, 22, 23, 29, 37, 38 AND 50).

FIRST USE 4-1-2006; IN COMMERCE 4-1-2006.

NO CLAIM IS MADE TO THE EXCLUSIVE RIGHT TO USE "UNITED STATES OF AMERICA", APART FROM THE MARK AS SHOWN.

THE MARK CONSISTS OF A CIRCULAR ARRANGEMENT OF THE WORDS "DEPARTMENT OF COMMERCE UNITED STATES OF AMERICA", SURROUNDING A RENDERING OF A SHIP AND LIGHTHOUSE, WITH THE WORDS "INTERNATIONAL TRADE ADMINISTRATION" UNDERNEATH.

SEC. 2(F) AS TO "INTERNATIONAL TRADE ADMINISTRATION".

SER. NO. 77-385,034, FILED 1-31-2008.

GIANCARLO CASTRO, EXAMINING ATTORNEY



**Int. Cl.: 44**

**Prior U.S. Cls.: 100 and 101**

**United States Patent and Trademark Office**

**Reg. No. 3,504,395**

**Registered Sep. 23, 2008**

**SERVICE MARK  
PRINCIPAL REGISTER**

**Cape Ann Medical Center**

CAPE ANN MEDICAL CENTER, INC. (MASSACHUSETTS CORPORATION)  
2 BLACKBURN DRIVE  
GLOUCESTER, MA 01915

NO CLAIM IS MADE TO THE EXCLUSIVE RIGHT TO USE "MEDICAL CENTER", APART FROM THE MARK AS SHOWN.

FOR: PHYSICIAN SERVICES, IN CLASS 44 (U.S. CLS. 100 AND 101).

SEC. 2(F).

FIRST USE 1-1-1970; IN COMMERCE 1-1-1970.

SER. NO. 77-385,042, FILED 1-31-2008.

THE MARK CONSISTS OF STANDARD CHARACTERS WITHOUT CLAIM TO ANY PARTICULAR FONT, STYLE, SIZE, OR COLOR.

JOHN DWYER, EXAMINING ATTORNEY

**Int. Cl.: 41**

**Prior U.S. Cls.: 100, 101 and 107**

**United States Patent and Trademark Office**

**Reg. No. 3,504,396**

**Registered Sep. 23, 2008**

**SERVICE MARK  
PRINCIPAL REGISTER**



INTERNATIONAL  
**T R A D E**  
ADMINISTRATION

INTERNATIONAL TRADE ADMINISTRATION  
(UNITED STATES AGENCY OF THE UNITED STATES GOVERNMENT)

1401 CONSTITUTION AVE., N.W.

WASHINGTON, DC 20230

FOR: EDUCATIONAL SERVICES, NAMELY, THE CONDUCT OF SEMINARS, CONFERENCES, WORKSHOPS AND INSTRUCTIONAL PROGRAMS RELATED TO IMPORTS, EXPORTS, INTERNATIONAL TRADE, MARKETING, E-COMMERCE, MANUFACTURING, TECHNOLOGY AND INNOVATION, INCLUDING THE PROVISION OF SAID SERVICES BY MEANS OF THE INTERNET, IN CLASS 41 (U.S. CLS. 100, 101 AND 107).

FIRST USE 12-1-2006; IN COMMERCE 12-1-2006.

NO CLAIM IS MADE TO THE EXCLUSIVE RIGHT TO USE "UNITED STATES OF AMERICA", APART FROM THE MARK AS SHOWN.

THE MARK CONSISTS OF A CIRCULAR ARRANGEMENT OF THE WORDS "DEPARTMENT OF COMMERCE UNITED STATES OF AMERICA", SURROUNDING A RENDERING OF A SHIP AND LIGHTHOUSE, WITH THE WORDS "INTERNATIONAL TRADE ADMINISTRATION" UNDERNEATH.

SEC. 2(F) AS TO "INTERNATIONAL TRADE ADMINISTRATION".

SER. NO. 77-385,055, FILED 1-31-2008.

GIANCARLO CASTRO, EXAMINING ATTORNEY

**Int. Cl.: 9**

**Prior U.S. Cls.: 21, 23, 26, 36 and 38**

**Reg. No. 3,504,397**

**United States Patent and Trademark Office**

**Registered Sep. 23, 2008**

**TRADEMARK  
PRINCIPAL REGISTER**



TELECOMMUNICATIONS TECHNOLOGY IN-  
CORPORATED (NORTH CAROLINA COR-  
PORATION), DBA TTI WIRELESS  
780 PARK AVENUE  
YOUNGSVILLE, NC 27596

FOR: AUTOMATED SELF CONTAINED ELEC-  
TRONIC SURVEILLANCE DEVICES THAT CAN BE  
DEPLOYED TO GATHER EVIDENCE OR INTELLI-  
GENCE IN REMOTE LOCATIONS; ELECTRIC AND  
ELECTRONIC VIDEO SURVEILLANCE INSTALLA-  
TIONS; MOBILE COMPUTING AND OPERATING  
PLATFORMS CONSISTING OF DATA TRANSCEL-  
VERS, WIRELESS NETWORKS AND GATEWAYS  
FOR COLLECTION AND MANAGEMENT OF  
DATA; CENTRAL PROCESSING UNITS FOR PRO-  
CESSING INFORMATION, DATA, SOUND OR IMA-  
GES, IN CLASS 9 (U.S. CLS. 21, 23, 26, 36 AND 38).

FIRST USE 5-10-2007; IN COMMERCE 5-10-2007.

NO CLAIM IS MADE TO THE EXCLUSIVE  
RIGHT TO USE "WIRELESS AIRPORT SURVEIL-  
LANCE PLATFORM", APART FROM THE MARK  
AS SHOWN.

THE MARK CONSISTS OF THE WORDS IN  
LARGE CAPS "WASP"; AND TO THE RIGHT OF  
THE WORDS "WASP" A HALF OF A RAINBOW;  
AND UNDERNEATH THE WORDS "WASP" THE  
WORDS "WIRELESS AIRPORT SURVEILLANCE  
PLATFORM".

SER. NO. 77-385,113, FILED 1-31-2008.

ANN E. SAPPENFIELD, EXAMINING ATTORNEY

**Int. Cl.: 3**

**Prior U.S. Cls.: 1, 4, 6, 50, 51 and 52**

**United States Patent and Trademark Office**

**Reg. No. 3,504,398**

**Registered Sep. 23, 2008**

**TRADEMARK  
PRINCIPAL REGISTER**

**BIO CLAIRE**

Y.Z.Y., INC. (FLORIDA CORPORATION)  
6300 N.W. 72ND AVENUE  
MIAMI, FL 33166

FOR: BODY AND BEAUTY CARE COSMETICS;  
BODY CREAM; BODY LOTIONS; BODY OIL; COS-  
METIC SOAPS, IN CLASS 3 (U.S. CLS. 1, 4, 6, 50, 51  
AND 52).

FIRST USE 12-0-2000; IN COMMERCE 12-0-2000.

THE MARK CONSISTS OF STANDARD CHAR-  
ACTERS WITHOUT CLAIM TO ANY PARTICULAR  
FONT, STYLE, SIZE, OR COLOR.

THE NAME(S), PORTRAIT(S), AND/OR SIGNA-  
TURE(S) SHOWN IN THE MARK DOES NOT IDENTI-  
FY A PARTICULAR LIVING INDIVIDUAL.

SER. NO. 77-385,169, FILED 1-31-2008.

MICHELE SWAIN, EXAMINING ATTORNEY

Int. Cl.: 29

Prior U.S. Cl.: 46

United States Patent and Trademark Office

Reg. No. 3,504,399

Registered Sep. 23, 2008

TRADEMARK  
PRINCIPAL REGISTER



CHAORYANG CITY QIAOFENG GROUP CO., LTD  
(CHINA CORPORATION)  
HARBOUR DOCK GUCHENG JINDU CHAON  
ZONE  
SHANTOU GUANGDONG PROV, CHINA

FOR: SEAFOOD, IN CLASS 29 (U.S. CL. 46).

FIRST USE 10-19-2005; IN COMMERCE 10-19-2005.

OWNER OF U.S. REG. NO. 2,802,131.

THE NAME(S), PORTRAIT(S), AND/OR SIGNA-  
TURE(S) SHOWN IN THE MARK DOES NOT IDENTI-  
FY A PARTICULAR LIVING INDIVIDUAL.

THE MARK CONSISTS OF THE WORDS "CAP-  
TAIN YAO" WITH "CAPTAIN" DISPOSED ABOVE  
AND TO THE LEFT OF "YAO". THE "C" IN  
"CAPTAIN" HAS THE SHAPE OF A PORTION OF  
A SHIP'S STEERING WHEEL AND A TRAILING  
BOTTOM PORTION EXTENDING UNDER A POR-  
TION OF THE WORD "CAPTAIN". THE "O" OF  
"YAO" HAS THE SHAPE OF A FULL SHIP'S STEER-  
ING WHEEL.

SER. NO. 77-385,294, FILED 1-31-2008.

JENNIFER VASQUEZ, EXAMINING ATTORNEY

**Int. Cl.: 36**

**Prior U.S. Cls.: 100, 101 and 102**

**United States Patent and Trademark Office**

**Reg. No. 3,504,400**

**Registered Sep. 23, 2008**

**SERVICE MARK  
PRINCIPAL REGISTER**

**GROWING FINANCIAL  
PARTNERSHIPS**

ARBOR COMMERCIAL MORTGAGE, LLC (NEW  
YORK LIMITED LIABILITY COMPANY)  
333 EARLE LOVINGTON BLVD., SUITE 900  
UNIONDALE, NY 11553

FOR: REAL ESTATE TRUST SERVICES, NAME-  
LY, INVESTMENT AND TRUST COMPANY SERVI-  
CES; FINANCIAL SERVICES, NAMELY,  
FINANCIAL INVESTMENT IN THE FIELD OF  
REAL ESTATE; MORTGAGE BANKING SERVICES,  
IN CLASS 36 (U.S. CLS. 100, 101 AND 102).

FIRST USE 1-8-2008; IN COMMERCE 1-8-2008.

THE MARK CONSISTS OF STANDARD CHAR-  
ACTERS WITHOUT CLAIM TO ANY PARTICULAR  
FONT, STYLE, SIZE, OR COLOR.

SER. NO. 77-385,418, FILED 1-31-2008.

KEVIN CORWIN, EXAMINING ATTORNEY

**Int. Cl.: 14**

**Prior U.S. Cls.: 2, 27, 28 and 50**

**United States Patent and Trademark Office**

**Reg. No. 3,504,401**

**Registered Sep. 23, 2008**

**TRADEMARK  
PRINCIPAL REGISTER**

**BURGERLOVE**

MALLOY, KATHLEEN (UNITED STATES INDIVIDUAL)  
480 ROSECRANS AVE #1  
MANHATTAN BEACH, CA 90066 AND  
REARDON, EILEER (UNITED STATES INDIVIDUAL)  
12746 MATTESON AVE  
LOS ANGELES, CA 90066

FOR: JEWELRY, IN CLASS 14 (U.S. CLS. 2, 27, 28 AND 50).

FIRST USE 2-1-2007; IN COMMERCE 2-1-2007.

THE MARK CONSISTS OF STANDARD CHARACTERS WITHOUT CLAIM TO ANY PARTICULAR FONT, STYLE, SIZE, OR COLOR.

SER. NO. 77-385,440, FILED 1-31-2008.

LINDA MICKLEBURGH, EXAMINING ATTORNEY

**Int. Cl.: 28**

**Prior U.S. Cls.: 22, 23, 38 and 50**

**United States Patent and Trademark Office**

**Reg. No. 3,504,402**

**Registered Sep. 23, 2008**

**TRADEMARK  
PRINCIPAL REGISTER**

**IDRIVE**

TROPHY SPORTS, LLC (CALIFORNIA LIMITED  
LIABILITY COMPANY)  
909 RADECKI COURT  
CITY OF INDUSTRY, CA 91748

THE MARK CONSISTS OF STANDARD CHAR-  
ACTERS WITHOUT CLAIM TO ANY PARTICULAR  
FONT, STYLE, SIZE, OR COLOR.

FOR: GOLF CLUBS; HEAD COVERS FOR GOLF  
CLUBS; GOLF CLUB HEADS; GOLF CLUB SHAFTS,  
IN CLASS 28 (U.S. CLS. 22, 23, 38 AND 50).

SER. NO. 77-385,792, FILED 1-31-2008.

FIRST USE 5-15-2004; IN COMMERCE 5-15-2004.

DANIEL CAPSHAW, EXAMINING ATTORNEY



**Int. Cl.: 28**

**Prior U.S. Cls.: 22, 23, 38 and 50**

**United States Patent and Trademark Office**

**Reg. No. 3,504,403**

**Registered Sep. 23, 2008**

---

**TRADEMARK  
PRINCIPAL REGISTER**

**QUADRATIC**

TROPHY SPORTS, LLC (CALIFORNIA LIMITED  
LIABILITY COMPANY)  
909 RADECKI COURT  
CITY OF INDUSTRY, CA 91748

THE MARK CONSISTS OF STANDARD CHAR-  
ACTERS WITHOUT CLAIM TO ANY PARTICULAR  
FONT, STYLE, SIZE, OR COLOR.

FOR: GOLF CLUB HEADS; GOLF CLUBS; HEAD  
COVERS FOR GOLF CLUBS; GOLF CLUB SHAFTS,  
IN CLASS 28 (U.S. CLS. 22, 23, 38 AND 50).

SER. NO. 77-385,852, FILED 1-31-2008.

FIRST USE 11-15-2006; IN COMMERCE 11-15-2006.

DANIEL CAPSHAW, EXAMINING ATTORNEY

**Int. Cl.: 41**

**Prior U.S. Cls.: 100, 101 and 107**

**United States Patent and Trademark Office**

**Reg. No. 3,504,404**

**Registered Sep. 23, 2008**

**SERVICE MARK  
PRINCIPAL REGISTER**

**CHILDREN'S SCHOOL OF  
EXCELLENCE**

CHILDREN'S SCHOOL OF EXCELLENCE (WA-  
SHINGTON CORPORATION)

13411 CEDAR GROVE LANE SOUTHEAST

RAINIER, WA 98576

FOR: EDUCATIONAL SERVICES, NAMELY,  
PROVIDING COURSES OF INSTRUCTION AT  
THE KINDERGARTEN THROUGH 8TH GRADE  
LEVEL, IN CLASS 41 (U.S. CLS. 100, 101 AND 107).

FIRST USE 2-25-1999; IN COMMERCE 2-25-1999.

THE MARK CONSISTS OF STANDARD CHAR-  
ACTERS WITHOUT CLAIM TO ANY PARTICULAR  
FONT, STYLE, SIZE, OR COLOR.

NO CLAIM IS MADE TO THE EXCLUSIVE  
RIGHT TO USE "SCHOOL", APART FROM THE  
MARK AS SHOWN.

SEC. 2(F).

SER. NO. 77-385,886, FILED 1-31-2008.

JENNY PARK, EXAMINING ATTORNEY

**Int. Cl.: 44**

**Prior U.S. Cls.: 100 and 101**

**United States Patent and Trademark Office**

**Reg. No. 3,504,405**

**Registered Sep. 23, 2008**

**SERVICE MARK  
PRINCIPAL REGISTER**

**CARENA**

CARENA, INC. (WASHINGTON CORPORATION)  
1601 FIFTH AVENUE  
SEATTLE, WA 98101

FOR: HEALTHCARE; MEDICAL SERVICES, IN  
CLASS 44 (U.S. CLS. 100 AND 101).

FIRST USE 11-1-2006; IN COMMERCE 11-1-2006.

THE MARK CONSISTS OF STANDARD CHAR-  
ACTERS WITHOUT CLAIM TO ANY PARTICULAR  
FONT, STYLE, SIZE, OR COLOR.

THE ENGLISH TRANSLATION OF THE ITALIAN  
WORD "CARENA" IN THE MARK IS "KEEL".

SER. NO. 77-386,038, FILED 1-31-2008.

ELLEN BURNS, EXAMINING ATTORNEY

**Int. Cl.: 35**

**Prior U.S. Cls.: 100, 101 and 102**

**United States Patent and Trademark Office**

**Reg. No. 3,504,406**

**Registered Sep. 23, 2008**

**SERVICE MARK  
PRINCIPAL REGISTER**

**THE PEARL LADY**

INTERGLOBAL LIMITED (DELAWARE CORPORATION)  
1957 HARVEST CIRCLE  
STATE COLLEGE, PA 16803

FOR: RETAIL JEWELRY STORE SERVICES; PROVIDING INFORMATION REGARDING RETAIL JEWELRY STORE SERVICES OVER THE GLOBAL COMPUTER NETWORK, IN CLASS 35 (U.S. CLS. 100, 101 AND 102).

FIRST USE 11-20-1997; IN COMMERCE 11-20-1997.

THE MARK CONSISTS OF STANDARD CHARACTERS WITHOUT CLAIM TO ANY PARTICULAR FONT, STYLE, SIZE, OR COLOR.

NO CLAIM IS MADE TO THE EXCLUSIVE RIGHT TO USE "PEARL", APART FROM THE MARK AS SHOWN.

SER. NO. 77-386,070, FILED 1-31-2008.

ELIZABETH KAJUBI, EXAMINING ATTORNEY

**Int. Cl.: 35**

**Prior U.S. Cls.: 100, 101 and 102**

**United States Patent and Trademark Office**

**Reg. No. 3,504,407**

**Registered Sep. 23, 2008**

**SERVICE MARK  
PRINCIPAL REGISTER**

**IMS Wellness Works  
Targeted Population  
Management**

IMS MANAGED CARE, INC. (TEXAS CORPORATION), DBA INSURANCE MANAGEMENT SERVICES  
731 N. TAYLOR  
AMARILLO, TX 79107

FOR: PROVIDING TO OPERATORS OF EMPLOYEE HEALTH BENEFIT PLANS TARGETED POPULATION MANAGEMENT SERVICES FEATURING THE REVIEW OF USERS' SUMMARY MEDICAL CLAIMS AND PHARMACY CLAIMS FOR RISK IDENTIFICATION PURPOSES, IN CLASS 35 (U.S. CLS. 100, 101 AND 102).

FIRST USE 6-5-2006; IN COMMERCE 6-5-2006.

THE MARK CONSISTS OF STANDARD CHARACTERS WITHOUT CLAIM TO ANY PARTICULAR FONT, STYLE, SIZE, OR COLOR.

NO CLAIM IS MADE TO THE EXCLUSIVE RIGHT TO USE "WELLNESS" AND "TARGETED POPULATION MANAGEMENT", APART FROM THE MARK AS SHOWN.

SER. NO. 77-386,215, FILED 2-1-2008.

STEPHEN AQUILA, EXAMINING ATTORNEY

**Int. Cl.: 28**

**Prior U.S. Cls.: 22, 23, 38 and 50**

**United States Patent and Trademark Office**

**Reg. No. 3,504,408**

**Registered Sep. 23, 2008**

**TRADEMARK  
PRINCIPAL REGISTER**

**AMS RETRIEVER**

AMS, LLC (WISCONSIN LIMITED LIABILITY  
COMPANY), DBA AMS BOWFISHING  
EP1064 HEMLOCK LANE  
STRATFORD, WI 54484

FOR: ARCHERY EQUIPMENT, NAMELY, BOW-  
FISHING EQUIPMENT IN THE NATURE OF BOW-  
FISHING REELS, ARROWS, ARROW RESTS AND  
ACCESSORIES THEREFOR, IN CLASS 28 (U.S. CLS.  
22, 23, 38 AND 50).

FIRST USE 2-18-1982; IN COMMERCE 2-18-1982.

THE MARK CONSISTS OF STANDARD CHAR-  
ACTERS WITHOUT CLAIM TO ANY PARTICULAR  
FONT, STYLE, SIZE, OR COLOR.

SER. NO. 77-386,307, FILED 2-1-2008.

JAMES LOVELACE, EXAMINING ATTORNEY

**Int. Cl.: 43**

**Prior U.S. Cls.: 100 and 101**

**United States Patent and Trademark Office**

**Reg. No. 3,504,409**

**Registered Sep. 23, 2008**

---

**SERVICE MARK  
PRINCIPAL REGISTER**

**RōM**

CAFFENOVA, INC. (ILLINOIS CORPORATION)  
1ST FLOOR  
C/O CAFFE BACI, 2 N. LASALLE STREET  
CHICAGO,, IL 60602

FOR: CAFE-RESTAURANTS; CAFETERIA AND  
RESTAURANT SERVICES, IN CLASS 43 (U.S. CLS.  
100 AND 101).

FIRST USE 6-7-2006; IN COMMERCE 6-7-2006.

OWNER OF U.S. REG. NO. 3,260,741.

SER. NO. 77-386,311, FILED 2-1-2008.

CAROLINE WOOD, EXAMINING ATTORNEY

Int. Cl.: 37

Prior U.S. Cls.: 100, 103 and 106

United States Patent and Trademark Office

Reg. No. 3,504,410

Registered Sep. 23, 2008

SERVICE MARK  
PRINCIPAL REGISTER



BLUE CHIP EXTERMINATING (MISSOURI CORPORATION)  
1623 HEADLAND DRIVE  
FENTON, MO 63026

FOR: TERMITE AND PEST CONTROL, IN CLASS 37 (U.S. CLS. 100, 103 AND 106).

FIRST USE 1-1-1972; IN COMMERCE 1-1-1972.

NO CLAIM IS MADE TO THE EXCLUSIVE RIGHT TO USE "PEST SERVICES", APART FROM THE MARK AS SHOWN.

THE STIPPLING IS FOR SHADING PURPOSES ONLY.

THE MARK CONSISTS OF A POKER CHIP, ELONGATED WITH THE WORDS "BLUE CHIP" SET INSIDE AND "PEST SERVICES" UNDERNEATH.

SER. NO. 77-386,347, FILED 2-1-2008.

JAMES LOVELACE, EXAMINING ATTORNEY



**Int. Cl.: 28**

**Prior U.S. Cls.: 22, 23, 38 and 50**

**United States Patent and Trademark Office**

**Reg. No. 3,504,411**

**Registered Sep. 23, 2008**

**TRADEMARK  
PRINCIPAL REGISTER**

**LITTLE PETS LIVING BIG  
LIVES**

NOODLE HEAD, INC. (CALIFORNIA CORPORATION)  
SUITE 7-239  
3905 STATE ST.  
SANTA BARBARA, CA 93105

FOR: CHILDREN'S MULTIPLE ACTIVITY TOYS,  
STUFFED TOY ANIMALS, STUFFED AND PLUSH  
TOYS, IN CLASS 28 (U.S. CLS. 22, 23, 38 AND 50).

FIRST USE 7-15-2005; IN COMMERCE 7-15-2005.

THE MARK CONSISTS OF STANDARD CHARACTERS WITHOUT CLAIM TO ANY PARTICULAR FONT, STYLE, SIZE, OR COLOR.

NO CLAIM IS MADE TO THE EXCLUSIVE RIGHT TO USE "PETS", APART FROM THE MARK AS SHOWN.

SER. NO. 77-386,825, FILED 2-1-2008.

MICHELE SWAIN, EXAMINING ATTORNEY

**Int. Cls.: 25 and 41**

**Prior U.S. Cls.: 22, 39, 100, 101 and 107**

**United States Patent and Trademark Office**

**Reg. No. 3,504,412**

**Registered Sep. 23, 2008**

**TRADEMARK  
SERVICE MARK  
PRINCIPAL REGISTER**

**LDS Business College**

LDS BUSINESS COLLEGE (UTAH CORPORATION)  
305 WEST NORTH TEMPLE  
SALT LAKE CITY, UT 84180

FOR: CLOTHING, NAMELY, T-SHIRTS, SHIRTS, SWEATSHIRTS, AND HATS, IN CLASS 25 (U.S. CLS. 22 AND 39).

FIRST USE 1-1-1931; IN COMMERCE 1-1-1931.

FOR: EDUCATIONAL SERVICES, NAMELY, PROVIDING CAREER ORIENTED COURSES OF INSTRUCTION AT THE POST SECONDARY LEVEL IN THE FIELDS OF BUSINESS, HEALTH CARE, TECHNOLOGY, INTERIOR DESIGN, LEGAL, AND TRAVEL, IN CLASS 41 (U.S. CLS. 100, 101 AND 107).

FIRST USE 1-1-1931; IN COMMERCE 1-1-1931.

THE MARK CONSISTS OF STANDARD CHARACTERS WITHOUT CLAIM TO ANY PARTICULAR FONT, STYLE, SIZE, OR COLOR.

NO CLAIM IS MADE TO THE EXCLUSIVE RIGHT TO USE "BUSINESS COLLEGE", APART FROM THE MARK AS SHOWN.

SEC. 2(F).

SER. NO. 77-386,904, FILED 2-1-2008.

AMY HELLA, EXAMINING ATTORNEY

**Int. Cl.: 25**

**Prior U.S. Cls.: 22 and 39**

**United States Patent and Trademark Office**

**Reg. No. 3,504,413**

**Registered Sep. 23, 2008**

**TRADEMARK  
PRINCIPAL REGISTER**

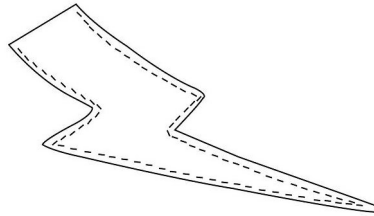

SKECHERS U.S.A., INC. II (DELAWARE CORPORATION)  
228 MANHATTAN BEACH BLVD.  
MANHATTAN BEACH, CA 90266

FIRST USE 8-1-2007; IN COMMERCE 8-1-2007.

SER. NO. 77-386,933, FILED 2-1-2008.

FOR: SHOES AND TSHIRTS AND HATS AND  
CAPS FOR MEN AND WOMEN AND CHILDREN,  
IN CLASS 25 (U.S. CLS. 22 AND 39).

JASON BLAIR, EXAMINING ATTORNEY

**Int. Cl.: 36**

**Prior U.S. Cls.: 100, 101 and 102**

**United States Patent and Trademark Office**

**Reg. No. 3,504,414**

**Registered Sep. 23, 2008**

**SERVICE MARK  
PRINCIPAL REGISTER**

**CLEARSTAR INVESTMENT  
SERVICES**

CLEARSTAR FINANCIAL CREDIT UNION (NE-  
VADA NON-PROFIT ORGANIZATION)  
P.O. BOX 7255  
RENO, NV 89510

OWNER OF U.S. REG. NOS. 3,277,363, 3,277,659  
AND OTHERS.

FOR: FUNDS INVESTMENT; INVESTMENT AD-  
VICE; INVESTMENT MANAGEMENT, IN CLASS 36  
(U.S. CLS. 100, 101 AND 102).

NO CLAIM IS MADE TO THE EXCLUSIVE  
RIGHT TO USE "INVESTMENT SERVICES", APART  
FROM THE MARK AS SHOWN.

FIRST USE 3-10-2007; IN COMMERCE 3-10-2007.

SER. NO. 77-386,958, FILED 2-1-2008.

THE MARK CONSISTS OF STANDARD CHAR-  
ACTERS WITHOUT CLAIM TO ANY PARTICULAR  
FONT, STYLE, SIZE, OR COLOR.

TINA KUAN, EXAMINING ATTORNEY

**Int. Cl.: 40**

**Prior U.S. Cls.: 100, 103 and 106**

**United States Patent and Trademark Office**

**Reg. No. 3,504,415**

**Registered Sep. 23, 2008**

**SERVICE MARK  
PRINCIPAL REGISTER**

# PHOTO CPR

GREEN, ROBERT BARRY (GEORGIA SOLE PROPRIETORSHIP), DBA ATLANTA ART SERVICES

7415 OLD MAINE TRAIL  
SANDY SPRINGS, GA 30328

FOR: DIGITAL RESTORATION AND/OR ENHANCEMENT OF PHOTOGRAPHS, IN CLASS 40 (U.S. CLS. 100, 103 AND 106).

FIRST USE 3-1-2007; IN COMMERCE 3-1-2007.

THE MARK CONSISTS OF STANDARD CHARACTERS WITHOUT CLAIM TO ANY PARTICULAR FONT, STYLE, SIZE, OR COLOR.

NO CLAIM IS MADE TO THE EXCLUSIVE RIGHT TO USE "PHOTO", APART FROM THE MARK AS SHOWN.

SER. NO. 77-387,115, FILED 2-2-2008.

BILL DAWE, EXAMINING ATTORNEY

**Int. Cl.: 9**

**Prior U.S. Cls.: 21, 23, 26, 36 and 38**

**Reg. No. 3,504,416**

**United States Patent and Trademark Office**

**Registered Sep. 23, 2008**

**TRADEMARK  
PRINCIPAL REGISTER**



GOODING, STEVEN (UNITED STATES INDIVIDUAL)  
1738 VALLEY VIEW LANE  
FORT COLLINS, CO 80524

NO CLAIM IS MADE TO THE EXCLUSIVE RIGHT TO USE "RECORDS", APART FROM THE MARK AS SHOWN.

FOR: SOUND RECORDINGS FEATURING MUSIC, IN CLASS 9 (U.S. CLS. 21, 23, 26, 36 AND 38).

SER. NO. 77-387,310, FILED 2-3-2008.

FIRST USE 12-1-1997; IN COMMERCE 12-1-1997.

JENNY PARK, EXAMINING ATTORNEY

**Int. Cl.: 9**

**Prior U.S. Cls.: 21, 23, 26, 36 and 38**

**United States Patent and Trademark Office**

**Reg. No. 3,504,417**

**Registered Sep. 23, 2008**

**TRADEMARK  
PRINCIPAL REGISTER**

**FORTE AUTOMATION DIRECTOR**

FORTE INDUSTRIAL EQUIPMENT SYSTEMS,  
INC. (OHIO CORPORATION)  
6037 COMMERCE COURT  
MASON, OH 45040

FOR: COMPUTER SOFTWARE FOR THE FIELD  
OF WAREHOUSING AND DISTRIBUTION, TO  
MANAGE TRANSACTIONAL DATA, PROVIDE  
STATISTICAL ANALYSIS, AND PRODUCE NOTI-  
FICATIONS AND REPORTS, IN CLASS 9 (U.S. CLS.  
21, 23, 26, 36 AND 38).

FIRST USE 9-23-2003; IN COMMERCE 9-23-2003.

THE MARK CONSISTS OF STANDARD CHAR-  
ACTERS WITHOUT CLAIM TO ANY PARTICULAR  
FONT, STYLE, SIZE, OR COLOR.

NO CLAIM IS MADE TO THE EXCLUSIVE  
RIGHT TO USE "AUTOMATION", APART FROM  
THE MARK AS SHOWN.

SER. NO. 77-387,599, FILED 2-4-2008.

JEFF DEFORD, EXAMINING ATTORNEY

**Int. Cl.: 36**

**Prior U.S. Cls.: 100, 101 and 102**

**United States Patent and Trademark Office**

**Reg. No. 3,504,418**

**Registered Sep. 23, 2008**

**SERVICE MARK  
PRINCIPAL REGISTER**

**J.P. TURNER & COMPANY,  
L.L.C.**

J.P. TURNER & COMPANY, L.L.C. (GEORGIA  
LIMITED LIABILITY COMPANY)  
11TH FLOOR  
3060 PEACHTREE ROAD NW  
ATLANTA, GA 30305

FOR: INVESTMENT BANKING AND INVEST-  
MENT BROKERAGE SERVICES; SECURITIES  
TRADING FOR OTHERS, IN CLASS 36 (U.S. CLS.  
100, 101 AND 102).

FIRST USE 4-11-1997; IN COMMERCE 4-11-1997.

THE MARK CONSISTS OF STANDARD CHAR-  
ACTERS WITHOUT CLAIM TO ANY PARTICULAR  
FONT, STYLE, SIZE, OR COLOR.

NO CLAIM IS MADE TO THE EXCLUSIVE  
RIGHT TO USE "COMPANY, L.L.C.", APART FROM  
THE MARK AS SHOWN.

THE NAME SHOWN IN THE MARK DOES NOT  
IDENTIFY A PARTICULAR LIVING INDIVIDUAL.

SEC. 2(F).

SER. NO. 77-387,832, FILED 2-4-2008.

EDWARD NELSON, EXAMINING ATTORNEY



**Int. Cl.: 14**

**Prior U.S. Cls.: 2, 27, 28 and 50**

**United States Patent and Trademark Office**

**Reg. No. 3,504,419**

**Registered Sep. 23, 2008**

**TRADEMARK  
PRINCIPAL REGISTER**

**MEMORABLE MOMENTS  
COLLECTION**

STUCKEY DIAMONDS, INC. D/B/A THE STUCKEY COMPANY (TEXAS CORPORATION)  
SUITE 370  
952 ECHO LANE  
HOUSTON, TX 77024

FOR: DIAMONDS AND JEWELRY, IN CLASS 14  
(U.S. CLS. 2, 27, 28 AND 50).

FIRST USE 1-31-2007; IN COMMERCE 1-31-2007.

THE MARK CONSISTS OF STANDARD CHARACTERS WITHOUT CLAIM TO ANY PARTICULAR FONT, STYLE, SIZE, OR COLOR.

NO CLAIM IS MADE TO THE EXCLUSIVE RIGHT TO USE "COLLECTION", APART FROM THE MARK AS SHOWN.

SER. NO. 77-387,935, FILED 2-4-2008.

LINDA MICKLEBURGH, EXAMINING ATTORNEY

**Int. Cl.: 25**

**Prior U.S. Cls.: 22 and 39**

**United States Patent and Trademark Office**

**Reg. No. 3,504,420**

**Registered Sep. 23, 2008**

**TRADEMARK  
PRINCIPAL REGISTER**

**GUTHRIE**

GUTHRIE THEATER FOUNDATION (MINNESOTA NON-PROFIT CORPORATION)

818 SOUTH 2ND STREET

MINNEAPOLIS, MN 55415

FOR: CLOTHING, NAMELY, CAPS, HATS, KNIT SHIRTS, SWEAT SHIRTS, T-SHIRTS, PAJAMAS, IN CLASS 25 (U.S. CLS. 22 AND 39).

FIRST USE 7-1-1963; IN COMMERCE 7-1-1963.

THE MARK CONSISTS OF STANDARD CHARACTERS WITHOUT CLAIM TO ANY PARTICULAR FONT, STYLE, SIZE, OR COLOR.

OWNER OF U.S. REG. NOS. 2,433,700, 2,549,151, AND 2,551,868.

SEC. 2(F).

SER. NO. 77-387,989, FILED 2-4-2008.

WENDY GOODMAN, EXAMINING ATTORNEY

**Int. Cl.: 41**

**Prior U.S. Cls.: 100, 101 and 107**

**United States Patent and Trademark Office**

**Reg. No. 3,504,421**

**Registered Sep. 23, 2008**

**SERVICE MARK  
PRINCIPAL REGISTER**

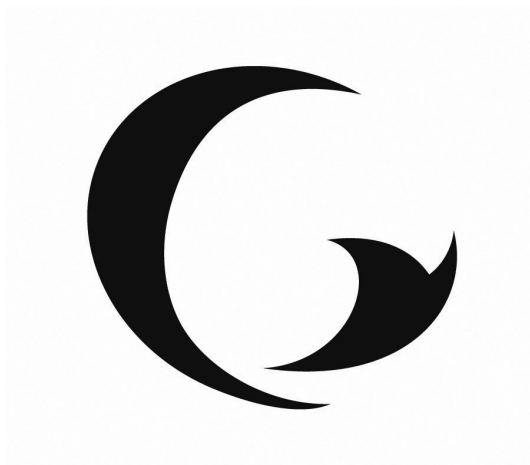

GUTHRIE THEATER FOUNDATION (MINNESOTA NON-PROFIT CORPORATION)  
818 SOUTH 2ND STREET  
MINNEAPOLIS, MN 55415

FOR: ENTERTAINMENT SHOWS, NAMELY, THE PRODUCTION AND PRESENTATION OF LIVE MUSIC CONCERTS AND LIVE MUSICAL, THEATRICAL AND DANCE PERFORMANCES; EDUCATIONAL SERVICES, NAMELY, CONDUCTING WORKSHOPS, CLASSES, CONFERENCES, TOURING LECTURES, AND SEMINARS IN THE FIELDS OF WRITING, THEATRICAL DISPLAYS, STAGE SETTING AND PERFORMING ARTS; SPECIAL

EVENT PLANNING; RENTAL OF STUDIO FACILITIES FOR THEATRICAL PRODUCTIONS; COSTUME RENTAL SERVICES, IN CLASS 41 (U.S. CLS. 100, 101 AND 107).

FIRST USE 5-8-2006; IN COMMERCE 5-8-2006.

THE MARK CONSISTS OF THE LETTER "G" IN A STYLIZED FONT.

SER. NO. 77-388,038, FILED 2-4-2008.

WENDY GOODMAN, EXAMINING ATTORNEY

**Int. Cl.: 35**

**Prior U.S. Cls.: 100, 101 and 102**

**United States Patent and Trademark Office**

**Reg. No. 3,504,422**

**Registered Sep. 23, 2008**

**SERVICE MARK  
PRINCIPAL REGISTER**



GUTHRIE THEATER FOUNDATION (MINNESOTA NON-PROFIT CORPORATION)  
818 SOUTH 2ND STREET  
MINNEAPOLIS, MN 55415

FOR: RETAIL STORE SERVICES, FEATURING CLOTHING, GIFT ITEMS, THEATER BOOKS, AND SOUVENIRS; ASSOCIATION SERVICES, NAMELY, PROMOTING THE INTERESTS OF PATRONS AND MEMBERS OF THE PERFORMING ARTS; RENTAL OF FACILITIES FOR BUSINESS MEETINGS, IN CLASS 35 (U.S. CLS. 100, 101 AND 102).

FIRST USE 5-8-2006; IN COMMERCE 5-8-2006.

THE MARK CONSISTS OF THE LETTER "G" IN A STYLIZED FONT.

SER. NO. 77-388,064, FILED 2-4-2008.

WENDY GOODMAN, EXAMINING ATTORNEY

**Int. Cl.: 43**

**Prior U.S. Cls.: 100 and 101**

**United States Patent and Trademark Office**

**Reg. No. 3,504,423**

**Registered Sep. 23, 2008**

**SERVICE MARK  
PRINCIPAL REGISTER**



GUTHRIE THEATER FOUNDATION (MINNESOTA NON-PROFIT CORPORATION)  
818 SOUTH 2ND STREET  
MINNEAPOLIS, MN 55415

FOR: CATERING, BAR AND RESTAURANT SERVICES; RENTAL OF MEETING FACILITIES FOR PRIVATE EVENTS, IN CLASS 43 (U.S. CLS. 100 AND 101).

FIRST USE 5-8-2006; IN COMMERCE 5-8-2006.

THE MARK CONSISTS OF THE LETTER "G" IN A STYLIZED FONT.

SER. NO. 77-388,072, FILED 2-4-2008.

WENDY GOODMAN, EXAMINING ATTORNEY

**Int. Cl.: 3**

**Prior U.S. Cls.: 1, 4, 6, 50, 51 and 52**

**Reg. No. 3,504,424**

**United States Patent and Trademark Office**

**Registered Sep. 23, 2008**

**TRADEMARK  
PRINCIPAL REGISTER**

**eaü k4**

LADUE, THOMAS (UNITED STATES INDIVIDUAL)  
P.O. BOX 175  
WEST HYANNISPORT, MA 02672

FOR: PERSONAL GROOMING AND HYGIENE PRODUCTS, NAMELY, BODY SPRAYS, DEODORANTS, SKIN LOTIONS, SOAPS, SHAMPOOS, PERFUMES, BODY OILS, AROMA THERAPY OINTMENTS AND OILS, IN CLASS 3 (U.S. CLS. 1, 4, 6, 50, 51 AND 52).

FIRST USE 1-9-2008; IN COMMERCE 1-12-2008.

THE MARK CONSISTS OF STANDARD CHARACTERS WITHOUT CLAIM TO ANY PARTICULAR FONT, STYLE, SIZE, OR COLOR.

THE FOREIGN WORDING IN THE MARK TRANSLATES INTO ENGLISH AS WATER.

SER. NO. 77-388,313, FILED 2-4-2008.

LINDA MICKLEBURGH, EXAMINING ATTORNEY

**Int. Cl.: 45**

**Prior U.S. Cls.: 100 and 101**

**United States Patent and Trademark Office**

**Reg. No. 3,504,425**

**Registered Sep. 23, 2008**

**SERVICE MARK  
PRINCIPAL REGISTER**

# Jafari Law Group

JAFARI LAW GROUP, INC (CALIFORNIA CORPORATION)  
SUITE 220  
801 PARKCENTER DRIVE  
SANTA ANA, CA 92705

FOR: LEGAL SERVICES, NAMELY, PROVIDING CUSTOMIZED INFORMATION, COUNSELING, ADVICE, AND LITIGATION AND PROSECUTION SERVICES IN THE AREAS OF INTELLECTUAL PROPERTY RELATED AND BUSINESS RELATED LAW, IN CLASS 45 (U.S. CLS. 100 AND 101).

FIRST USE 7-1-2005; IN COMMERCE 7-1-2005.

THE MARK CONSISTS OF STANDARD CHARACTERS WITHOUT CLAIM TO ANY PARTICULAR FONT, STYLE, SIZE, OR COLOR.

NO CLAIM IS MADE TO THE EXCLUSIVE RIGHT TO USE "LAW GROUP", APART FROM THE MARK AS SHOWN.

THE ENGLISH TRANSLATION OF THE WORD "JAFARI" IN THE MARK IS "PARSLEY".

SER. NO. 77-388,355, FILED 2-4-2008.

BRIAN PINO, EXAMINING ATTORNEY

**Int. Cl.: 45**

**Prior U.S. Cls.: 100 and 101**

**United States Patent and Trademark Office**

**Reg. No. 3,504,426**

**Registered Sep. 23, 2008**

**SERVICE MARK  
PRINCIPAL REGISTER**

**TRENDINISTA**

TRENDIKI, INC. (CALIFORNIA CORPORATION)  
39899 BALENTINE DRIVE  
NEWARK, CA 94560

FOR: FASHION INFORMATION; PROVIDING A  
WEB SITE FEATURING INFORMATION AND  
CONTENT IN THE FIELDS OF PERSONAL RELA-  
TIONSHIPS, DATING AND FASHION; PROVIDING  
FASHION INFORMATION; PROVIDING INFOR-  
MATION ABOUT FASHION; PROVIDING NEWS  
AND INFORMATION IN THE FIELD OF FASHION;  
PROVISION OF A WEB SITE FEATURING INFOR-

MATION ON FASHION, IN CLASS 45 (U.S. CLS. 100  
AND 101).

FIRST USE 11-0-2007; IN COMMERCE 11-0-2007.

THE MARK CONSISTS OF STANDARD CHAR-  
ACTERS WITHOUT CLAIM TO ANY PARTICULAR  
FONT, STYLE, SIZE, OR COLOR.

SER. NO. 77-388,387, FILED 2-5-2008.

TASHIA BUNCH, EXAMINING ATTORNEY



Int. Cl.: 36

Prior U.S. Cls.: 100, 101 and 102

United States Patent and Trademark Office

Reg. No. 3,504,427

Registered Sep. 23, 2008

SERVICE MARK  
PRINCIPAL REGISTER

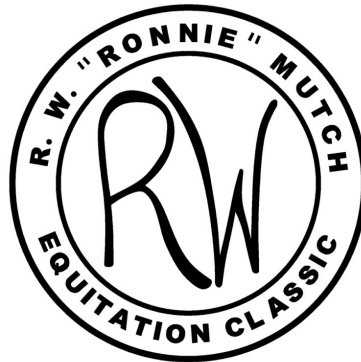

R. W. RONNIE MUTCH FOUNDATION, INC.  
(NEW JERSEY NON-PROFIT CORPORATION)  
14224 STROLLER WAY  
WELLINGTON, FL 33414

FOR: PROVIDING EDUCATIONAL SCHOLARSHIPS, IN CLASS 36 (U.S. CLS. 100, 101 AND 102).

FIRST USE 3-10-2000; IN COMMERCE 3-10-2000.

NO CLAIM IS MADE TO THE EXCLUSIVE RIGHT TO USE "EQUITATION CLASSIC", APART FROM THE MARK AS SHOWN.

THE NAME(S), PORTRAIT(S), AND/OR SIGNATURE(S) SHOWN IN THE MARK DOES NOT IDENTIFY A PARTICULAR LIVING INDIVIDUAL.

THE MARK CONSISTS OF THE WORDS "R.W. RONNIE MUTCH EQUITATION CLASSIC" AND TWO CONCENTRIC CIRCLES.

SER. NO. 77-388,437, FILED 2-5-2008.

JOHN HWANG, EXAMINING ATTORNEY

Int. Cl.: 41

Prior U.S. Cls.: 100, 101 and 107

United States Patent and Trademark Office

Reg. No. 3,504,428

Registered Sep. 23, 2008

SERVICE MARK  
PRINCIPAL REGISTER

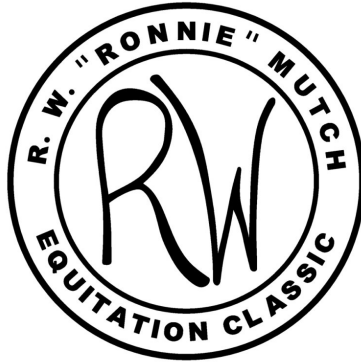

R.W. RONNIE MUTCH FOUNDATION, INC.  
(NEW JERSEY NON-PROFIT CORPORATION)  
14224 STROLLER WAY  
WELLINGTON, FL 33414

FOR: CONDUCTING AND ORGANIZING  
EQUESTRIAN COMPETITIONS, IN CLASS 41 (U.S.  
CLS. 100, 101 AND 107).

FIRST USE 3-10-2000; IN COMMERCE 3-10-2000.

NO CLAIM IS MADE TO THE EXCLUSIVE  
RIGHT TO USE "EQUITATION CLASSIC", APART  
FROM THE MARK AS SHOWN.

THE NAME IN THE MARK DOES NOT IDENTIFY  
A PARTICULAR LIVING INDIVIDUAL.

THE MARK CONSISTS OF THE WORDS "R.W.  
RONNIE MUTCH EQUITATION CLASSIC" AND  
TWO CONCENTRIC CIRCLES.

SER. NO. 77-388,439, FILED 2-5-2008.

JOHN HWANG, EXAMINING ATTORNEY

Int. Cl.: 41

Prior U.S. Cls.: 100, 101 and 107

United States Patent and Trademark Office

Reg. No. 3,504,429

Registered Sep. 23, 2008

SERVICE MARK  
PRINCIPAL REGISTER

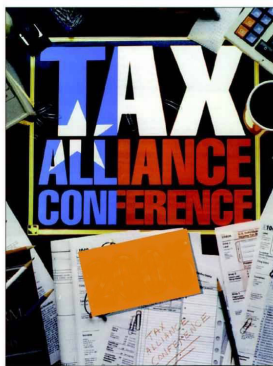

TAX ALLIANCE CONFERENCE (TEXAS CORPORATION), DBA TAX ALLIANCE CONFERENCE

8100 LOMO ALTO, SUITE 238  
DALLAS, TX 75225

FOR: EDUCATION SERVICES, NAMELY, PROVIDING CONFERENCES IN THE FIELD OF TAXATION, IN CLASS 41 (U.S. CLS. 100, 101 AND 107).

FIRST USE 1-1-1993; IN COMMERCE 1-1-1993.

NO CLAIM IS MADE TO THE EXCLUSIVE RIGHT TO USE "TAX" AND "CONFERENCE", APART FROM THE MARK AS SHOWN.

THE COLOR(S) BLACK, WHITE, RED, BLUE, GOLD, BROWN, GREY, ORANGE, SILVER IS/ARE CLAIMED AS A FEATURE OF THE MARK.

THE MARK CONSISTS OF A RECTANGULAR DESKTOP INCLUDING A GREY CALCULATOR WITH BLACK, BLUE, AND ORANGE KEYS IN THE

UPPER RIGHT CORNER; WHITE AND BLACK TAX FORMS ACROSS THE BOTTOM HALF OF THE DESKTOP; BLACK STAPLER IN THE UPPER LEFT, BLACK AND WHITE PENCILS AT THE LOWER LEFT AND RIGHT, SILVER PAPER CLIPS SCATTERED ACROSS THE DESKTOP, A YELLOW, ORANGE AND WHITE COFFEE CUP AT THE CENTER RIGHT, AND AN ORANGE INDEX CARD LAID ATOP THE TAX FORMS, OVER WHICH IS SUPERIMPOSED GOLD-FRAMED SAN-SERIF TEXT IN COLOR BLOCKS SAYING "TAX ALLIANCE CONFERENCE", WHERE THE WORD "TAX" IS BLUE ON THE LEFT HALF AND WHITE ON THE RIGHT HALF, AND THE WORDS "ALLIANCE" AND "CONFERENCE" ARE BLUE ON THE LEFT HALF AND RED ON THE RIGHT HALF.

SEC. 2(F).

SER. NO. 77-388,459, FILED 2-5-2008.

RICHARD WHITE, EXAMINING ATTORNEY

Int. Cl.: 9

Prior U.S. Cls.: 21, 23, 26, 36 and 38

United States Patent and Trademark Office

Reg. No. 3,504,430

Registered Sep. 23, 2008

TRADEMARK  
PRINCIPAL REGISTER



STARR LIFE SCIENCES CORPORATION (PENN-  
SYLVANIA CORPORATION)  
SUITE 300  
333 ALLEGHENY AVENUE  
OAKMONT, PA 15139

FOR: ELECTRIC OR ELECTRONIC SENSORS  
FOR DIAGNOSIS AND MONITORING OF LA-  
BORATORY ANIMALS, IN CLASS 9 (U.S. CLS. 21,  
23, 26, 36 AND 38).

FIRST USE 12-19-2005; IN COMMERCE 12-19-2005.

NO CLAIM IS MADE TO THE EXCLUSIVE  
RIGHT TO USE "LIFE SCIENCES CORP.", APART  
FROM THE MARK AS SHOWN.

THE MARK CONSISTS OF THE WORD "STARR"  
ABOVE THE PHRASE "LIFE SCIENCES CORP"  
WITH THE FINAL "R" IN "STARR" LEADING INTO  
A MODIFIED REPRESENTATION OF AN ELEC-  
TROPHYSIOLOGIC SIGNAL KNOWN AS A "QRS"  
COMPLEX WITH THIS SIGNAL LEADING INTO A  
STAR SHAPED SYMBOL.

SER. NO. 77-388,463, FILED 2-5-2008.

ELISSA GARBER KON, EXAMINING ATTORNEY

**Int. Cl.: 29**

**Prior U.S. Cl.: 46**

**United States Patent and Trademark Office**

**Reg. No. 3,504,431**

**Registered Sep. 23, 2008**

**TRADEMARK  
PRINCIPAL REGISTER**

# Neola Farms

NEOLA FARMS BLACK ANGUS BEEF, LLC  
(TENNESSEE LIMITED LIABILITY COMPA-  
NY)

221 SMITH LANE  
BRIGHTON, TN 38011

FOR: FRESH MEATS, NAMELY, BLACK ANGUS  
BEEF, VARIOUS PROCESSED, CURED OR FRESH  
STAGES, IN CLASS 29 (U.S. CL. 46).

FIRST USE 1-1-1996; IN COMMERCE 1-1-1996.

THE MARK CONSISTS OF STANDARD CHAR-  
ACTERS WITHOUT CLAIM TO ANY PARTICULAR  
FONT, STYLE, SIZE, OR COLOR.

NO CLAIM IS MADE TO THE EXCLUSIVE  
RIGHT TO USE "FARMS", APART FROM THE  
MARK AS SHOWN.

SER. NO. 77-388,519, FILED 2-5-2008.

ZACHARY BELLO, EXAMINING ATTORNEY

**Int. Cl.: 35**

**Prior U.S. Cls.: 100, 101 and 102**

**United States Patent and Trademark Office**

**Reg. No. 3,504,432**

**Registered Sep. 23, 2008**

**SERVICE MARK  
PRINCIPAL REGISTER**

**ACTION FOR RESULTS**

ACTION FOR RESULTS, INC. (MASSACHU-  
SETTS CORPORATION)  
200 ANDOVER STREET  
ANDOVER, MA 01810

FOR: BUSINESS MANAGEMENT CONSULTING  
SERVICES IN REGARDS TO STRATEGY DEVEL-  
OPMENT, CHANGE IMPLEMENTATION METH-  
ODS AND TOOLS, LEADERSHIP DEVELOPMENT  
AND ORGANIZATION DESIGN AND EFFECTIVE-  
NESS, IN CLASS 35 (U.S. CLS. 100, 101 AND 102).

FIRST USE 7-31-1997; IN COMMERCE 7-31-1997.

THE MARK CONSISTS OF STANDARD CHAR-  
ACTERS WITHOUT CLAIM TO ANY PARTICULAR  
FONT, STYLE, SIZE, OR COLOR.

SER. NO. 77-388,583, FILED 2-5-2008.

ANTHONY RINKER, EXAMINING ATTORNEY

**Int. Cl.: 45**

**Prior U.S. Cls.: 100 and 101**

**United States Patent and Trademark Office**

**Reg. No. 3,504,433**

**Registered Sep. 23, 2008**

**SERVICE MARK  
PRINCIPAL REGISTER**

**TRUST INVESTIGATIVE GROUP**

PI FRANCHISE GROUP LLC (MISSISSIPPI LIMITED LIABILITY COMPANY)  
P.O. BOX 1523  
TUPELO, MS 38802

FOR: PRIVATE INVESTIGATION AND SURVEILLANCE SERVICES, IN CLASS 45 (U.S. CLS. 100 AND 101).

FIRST USE 9-30-2006; IN COMMERCE 9-30-2006.

THE MARK CONSISTS OF STANDARD CHARACTERS WITHOUT CLAIM TO ANY PARTICULAR FONT, STYLE, SIZE, OR COLOR.

NO CLAIM IS MADE TO THE EXCLUSIVE RIGHT TO USE "INVESTIGATIVE GROUP", APART FROM THE MARK AS SHOWN.

SER. NO. 77-388,746, FILED 2-5-2008.

DANIEL CAPSHAW, EXAMINING ATTORNEY

**Int. Cl.: 25**

**Prior U.S. Cls.: 22 and 39**

**United States Patent and Trademark Office**

**Reg. No. 3,504,434**

**Registered Sep. 23, 2008**

**TRADEMARK  
PRINCIPAL REGISTER**

**RINGBANG**

GRANT, EDMOND (BARBADOS INDIVIDUAL)  
BAYLEY'S PLANTATION  
ST PHILIP, BARBADOS

FOR: CLOTHING, NAMELY, SHORTS, SHIRTS,  
PANTS, SKIRTS, DRESSES, JACKETS, HATS, BELTS  
AND SOCKS, IN CLASS 25 (U.S. CLS. 22 AND 39).

FIRST USE 12-1-1993; IN COMMERCE 12-1-1993.

THE MARK CONSISTS OF STANDARD CHAR-  
ACTERS WITHOUT CLAIM TO ANY PARTICULAR  
FONT, STYLE, SIZE, OR COLOR.

OWNER OF U.S. REG. NO. 2,578,154.

SER. NO. 77-388,819, FILED 2-5-2008.

SUSAN LESLIE DUBOIS, EXAMINING ATTORNEY



**Int. Cl.: 41**

**Prior U.S. Cls.: 100, 101 and 107**

**United States Patent and Trademark Office**

**Reg. No. 3,504,435**

**Registered Sep. 23, 2008**

**SERVICE MARK  
PRINCIPAL REGISTER**

WORLDPLAY MUSIC PUBLISHING

WORLDPLAY RECORDS, LLC (NEVADA LIMITED LIABILITY COMPANY)  
P.O. BOX 531613  
LAS VEGAS, NV 89053

OWNER OF U.S. REG. NO. 3,278,853.

FOR: ENTERTAINMENT SERVICES, NAMELY, MUSIC PUBLISHING SERVICES, IN CLASS 41 (U.S. CLS. 100, 101 AND 107).

NO CLAIM IS MADE TO THE EXCLUSIVE RIGHT TO USE "MUSIC PUBLISHING", APART FROM THE MARK AS SHOWN.

FIRST USE 10-1-2007; IN COMMERCE 1-5-2008.

SER. NO. 77-388,843, FILED 2-5-2008.

THE MARK CONSISTS OF STANDARD CHARACTERS WITHOUT CLAIM TO ANY PARTICULAR FONT, STYLE, SIZE, OR COLOR.

ESTHER A. BORSUK, EXAMINING ATTORNEY

**Int. Cl.: 41**

**Prior U.S. Cls.: 100, 101 and 107**

**United States Patent and Trademark Office**

**Reg. No. 3,504,436**

**Registered Sep. 23, 2008**

**SERVICE MARK  
PRINCIPAL REGISTER**

BEECHWOOD MUSIC PUBLISHING

WORLDPLAY RECORDS, LLC (NEVADA LIMITED LIABILITY COMPANY)  
P.O. BOX 531613  
LAS VEGAS, NV 89053

FOR: ENTERTAINMENT SERVICES, NAMELY, MUSIC PUBLISHING SERVICES, IN CLASS 41 (U.S. CLS. 100, 101 AND 107).

FIRST USE 10-10-2007; IN COMMERCE 1-15-2008.

THE MARK CONSISTS OF STANDARD CHARACTERS WITHOUT CLAIM TO ANY PARTICULAR FONT, STYLE, SIZE, OR COLOR.

NO CLAIM IS MADE TO THE EXCLUSIVE RIGHT TO USE "MUSIC PUBLISHING", APART FROM THE MARK AS SHOWN.

SER. NO. 77-388,883, FILED 2-5-2008.

ESTHER A. BORSUK, EXAMINING ATTORNEY

**Int. Cl.: 41**

**Prior U.S. Cls.: 100, 101 and 107**

**United States Patent and Trademark Office**

**Reg. No. 3,504,437**

**Registered Sep. 23, 2008**

**SERVICE MARK  
PRINCIPAL REGISTER**

BEECHWOOD RECORDING STUDIOS

WORLDPLAY RECORDS, LLC (NEVADA LIMITED LIABILITY COMPANY)  
P.O. BOX 531613  
LAS VEGAS, NV 89053

FOR: ENTERTAINMENT SERVICES, NAMELY, AUDIO RECORDING SERVICES AND MUSIC PRODUCTION STUDIO SERVICES FOR THE FIXATION OF MUSICAL COMPOSITIONS IN A TANGIBLE MEDIUM, SUCH AS CASSETTE TAPES, CDS, DVDS, DIGITAL MP3S AND OTHER DOWNLOADABLE DIGITAL AUDIO FORMATS, IN CLASS 41 (U.S. CLS. 100, 101 AND 107).

FIRST USE 6-5-2007; IN COMMERCE 9-10-2007.

THE MARK CONSISTS OF STANDARD CHARACTERS WITHOUT CLAIM TO ANY PARTICULAR FONT, STYLE, SIZE, OR COLOR.

NO CLAIM IS MADE TO THE EXCLUSIVE RIGHT TO USE "RECORDING STUDIOS", APART FROM THE MARK AS SHOWN.

SER. NO. 77-388,971, FILED 2-5-2008.

ESTHER A. BORSUK, EXAMINING ATTORNEY

Int. Cl.: 37

Prior U.S. Cls.: 100, 103 and 106

United States Patent and Trademark Office

Reg. No. 3,504,438

Registered Sep. 23, 2008

SERVICE MARK  
PRINCIPAL REGISTER



WHITE RABBIT GARAGE ORGANIZERS, INC  
(ILLINOIS CORPORATION)  
3192 DOOLITTLE DRIVE  
NORTHBROOK, IL 60062

FOR: CUSTOM CONSTRUCTION AND INSTALLATION OF CLOSETS, UTILITY AND PANTRY SHELVING, GARAGE INTERIORS, CABINETS, MEDIA UNITS, AND SHELVING, HOME OFFICES, WALL SYSTEMS, HOBBY CENTER AND STORAGE SPACE SYSTEMS, IN CLASS 37 (U.S. CLS. 100, 103 AND 106).

FIRST USE 1-1-1993; IN COMMERCE 1-1-1993.

NO CLAIM IS MADE TO THE EXCLUSIVE RIGHT TO USE "HOME OFFICES GARAGES BASEMENTS", APART FROM THE MARK AS SHOWN.

THE COLOR(S) GRAY, PINK IS/ARE CLAIMED AS A FEATURE OF THE MARK.

THE MARK CONSISTS OF A TOP HAT SITUATED UPSIDE DOWN, WITH RABBIT EARS EMERGING FROM THE OPENING OF THE HAT. THE HAT AND RABBIT EARS ARE SURROUNDED BY THE WORDS "WHITE" AND "RABBIT". UNDERNEATH THE TOP HAT, ARE THE WORDS, "HOME OFFICES", "GARAGES", AND "BASEMENTS". THE COLOR GRAY APPEARS IN THE WORDING, THE UNDERLINE, THE HAT, AND OUTLINES OF THE RABBIT. THE COLOR PINK APPEARS IN THE RABBIT'S EARS AND IN THE LINES BETWEEN THE WORDS ON THE BOTTOM LINE.

SER. NO. 77-389,026, FILED 2-5-2008.

ANNE MADDEN, EXAMINING ATTORNEY

**Int. Cl.: 41**

**Prior U.S. Cls.: 100, 101 and 107**

**United States Patent and Trademark Office**

**Reg. No. 3,504,439**

**Registered Sep. 23, 2008**

**SERVICE MARK  
PRINCIPAL REGISTER**

**InCycle**

UNDEM, CRAIG (WASHINGTON LIMITED LIABILITY COMPANY), DBA CYCLE U, LLC  
7400 SAND POINT WAY NE #101S  
SEATTLE, WA 98115

FOR: PROVIDING ASSISTANCE, PERSONAL TRAINING AND PHYSICAL FITNESS CONSULTATION TO INDIVIDUALS TO IMPROVE PHYSICAL FITNESS, STRENGTH, AND CONDITIONING IN THE BICYCLING DISCIPLINE AND THEIR DAILY LIVING THROUGH PARTICIPATION IN A SERIES OF COACHED INDOOR CYCLING CLASSES, IN CLASS 41 (U.S. CLS. 100, 101 AND 107).

FIRST USE 10-1-2005; IN COMMERCE 10-1-2005.

THE MARK CONSISTS OF STANDARD CHARACTERS WITHOUT CLAIM TO ANY PARTICULAR FONT, STYLE, SIZE, OR COLOR.

SER. NO. 77-389,082, FILED 2-5-2008.

TEJBIR SINGH, EXAMINING ATTORNEY

**Int. Cl.: 35**

**Prior U.S. Cls.: 100, 101 and 102**

**United States Patent and Trademark Office**

**Reg. No. 3,504,440**

**Registered Sep. 23, 2008**

**SERVICE MARK  
PRINCIPAL REGISTER**



C & L WARD BROS., CO. INC. (MICHIGAN CORPORATION)  
9284 LAPEER ROAD  
DAVISON, MI 48423

FOR: ONLINE RETAIL STORE SERVICES FEATURING WINDOW PARTS AND WINDOW ACCESSORIES, IN CLASS 35 (U.S. CLS. 100, 101 AND 102).

FIRST USE 6-1-2007; IN COMMERCE 6-1-2007.

NO CLAIM IS MADE TO THE EXCLUSIVE RIGHT TO USE "WINDOWPARTS.COM", APART FROM THE MARK AS SHOWN.

THE COLOR(S) BLUE AND BLACK IS/ARE CLAIMED AS A FEATURE OF THE MARK.

THE MARK CONSISTS OF A "BLUE WINDOW" OUTLINE WITH THE WORDING "WINDOW-PARTS.COM" BELOW. "WINDOW" AND ".COM" APPEAR IN BLACK, "PARTS" APPEARS IN BLUE.

SER. NO. 77-389,109, FILED 2-5-2008.

KRISTIN CARLSON, EXAMINING ATTORNEY

**Int. Cl.: 43**

**Prior U.S. Cls.: 100 and 101**

**United States Patent and Trademark Office**

**Reg. No. 3,504,441**

**Registered Sep. 23, 2008**

**SERVICE MARK  
PRINCIPAL REGISTER**

**JIMMY JOHN'S**

JIMMY JOHN'S ENTERPRISES, LLC (DELA-  
WARE LIMITED LIABILITY COMPANY)  
2212 FOX DRIVE  
CHAMPAIGN, IL 61820

FOR: RESTAURANT SERVICES, IN CLASS 43  
(U.S. CLS. 100 AND 101).

FIRST USE 8-0-2003; IN COMMERCE 8-0-2003.

OWNER OF U.S. REG. NOS. 2,555,213, 3,020,392  
AND OTHERS.

THE MARK CONSISTS OF THE WORDS "JIMMY  
JOHN'S" IN CHANNEL LETTERING.

SER. NO. 77-389,149, FILED 2-5-2008.

TEJBIR SINGH, EXAMINING ATTORNEY

**Int. Cl.: 16**

**Prior U.S. Cls.: 2, 5, 22, 23, 29, 37, 38 and 50**

**United States Patent and Trademark Office**

**Reg. No. 3,504,442**

**Registered Sep. 23, 2008**

**TRADEMARK  
PRINCIPAL REGISTER**

**A DEBBIE CAFFREY SERIES  
BECOMING A CONFIDENT  
QUILTER Taking the mystery  
out of great quilts!**

DEBBIE'S CREATIVE MOMENTS, INC. (NEW  
MEXICO CORPORATION)  
P.O. BOX 29418  
SANTA FE, NM 87592

FOR: BOOKS IN THE FIELD OF QUILTING, IN  
CLASS 16 (U.S. CLS. 2, 5, 22, 23, 29, 37, 38 AND 50).

FIRST USE 10-15-2007; IN COMMERCE 10-15-2007.

THE MARK CONSISTS OF STANDARD CHAR-  
ACTERS WITHOUT CLAIM TO ANY PARTICULAR  
FONT, STYLE, SIZE, OR COLOR.

NO CLAIM IS MADE TO THE EXCLUSIVE  
RIGHT TO USE "SERIES", APART FROM THE  
MARK AS SHOWN.

THE NAME(S), PORTRAIT(S), AND/OR SIGNA-  
TURE(S) SHOWN IN THE MARK IDENTIFIES A  
LIVING INDIVIDUAL, WHOSE CONSENT(S) TO  
REGISTER IS SUBMITTED.

SER. NO. 77-389,363, FILED 2-5-2008.

AMY ALFIERI, EXAMINING ATTORNEY



**Int. Cl.: 42**

**Prior U.S. Cls.: 100 and 101**

**United States Patent and Trademark Office**

**Reg. No. 3,504,443**

**Registered Sep. 23, 2008**

**SERVICE MARK  
PRINCIPAL REGISTER**

**EHKCO**

KAPLAN, EVAN HUNT (UNITED STATES INDIVIDUAL)  
5010 E CHEYENNE DR #2019  
PHOENIX, AZ 85044

FOR: COMPUTER SERVICE, NAMELY, ACTING AS AN APPLICATION SERVICE PROVIDER IN THE FIELD OF KNOWLEDGE MANAGEMENT TO HOST COMPUTER APPLICATION SOFTWARE FOR SEARCHING AND RETRIEVING INFORMATION FROM DATABASES AND COMPUTER NETWORKS; COMPUTER SERVICES, NAMELY, COMPUTER SYSTEM ADMINISTRATION FOR OTHERS; COMPUTER SERVICES, NAMELY, CREATING AND MAINTAINING WEB SITES FOR OTHERS; COMPUTER SERVICES, NAMELY, CREATING INDEXES OF INFORMATION, SITES AND OTHER RESOURCES AVAILABLE ON COMPUTER NETWORKS; COMPUTER SERVICES,

NAMELY, DATA RECOVERY SERVICES; COMPUTER SERVICES, NAMELY, DESIGNING AND IMPLEMENTING WEB SITES FOR OTHERS; TECHNICAL SUPPORT SERVICES, NAMELY, TROUBLESHOOTING OF COMPUTER HARDWARE AND SOFTWARE PROBLEMS; CUSTOMIZATION OF COMPUTER HARDWARE AND SOFTWARE, IN CLASS 42 (U.S. CLS. 100 AND 101).

FIRST USE 0-0-1985; IN COMMERCE 10-9-2007.

THE MARK CONSISTS OF STANDARD CHARACTERS WITHOUT CLAIM TO ANY PARTICULAR FONT, STYLE, SIZE, OR COLOR.

SER. NO. 77-389,675, FILED 2-6-2008.

ELLEN BURNS, EXAMINING ATTORNEY

**Int. Cl.: 44**

**Prior U.S. Cls.: 100 and 101**

**United States Patent and Trademark Office**

**Reg. No. 3,504,444**

**Registered Sep. 23, 2008**

**SERVICE MARK  
PRINCIPAL REGISTER**

**ACLAIRO**

ACLAIRO PHARMACEUTICAL DEVELOPMENT  
GROUP, INC. (VIRGINIA CORPORATION)  
SUITE 300  
1950 OLD GALLOWS ROAD  
VIENNA, VA 22182

FOR: BIO-MEDICAL CONSULTATION IN THE  
FIELDS OF PHARMACEUTICALS, BIOLOGICS  
AND MEDICAL DEVICES, IN CLASS 44 (U.S. CLS.  
100 AND 101).

FIRST USE 9-13-2004; IN COMMERCE 9-13-2004.

THE MARK CONSISTS OF STANDARD CHAR-  
ACTERS WITHOUT CLAIM TO ANY PARTICULAR  
FONT, STYLE, SIZE, OR COLOR.

SER. NO. 77-389,743, FILED 2-6-2008.

THOMAS MANOR, EXAMINING ATTORNEY

**Int. Cl.: 3**

**Prior U.S. Cls.: 1, 4, 6, 50, 51 and 52**

**United States Patent and Trademark Office**

**Reg. No. 3,504,445**

**Registered Sep. 23, 2008**

**TRADEMARK  
PRINCIPAL REGISTER**

# Elemental Scents

ANDRADE, ROBERTA (UNITED STATES INDIVIDUAL)  
114 BROOK STREET  
FRAMINGHAM, MA 01701

FOR: PERFUMES ; TOILET WATERS ; EAU DE COLOGNES ; AFTERSHAVES ; FRAGRANCED SOAPS ; FRAGRANCED LOTIONS ; FRAGRANCED INCENSE ; ROOM FRAGRANCES ; BODY SPRAY USED AS A PERSONAL DEODORANT AND AS FRAGRANCE ; FRAGRANCE EMITTING WICKS FOR ROOM FRAGRANCE ; FRAGRANCES FOR AUTOMOBILES ; FRAGRANCES FOR PERSONAL USE ; PET FRAGRANCES ; ROOM FRAGRANCE REFILLS FOR NON-ELECTRIC ROOM FRAGRANCE DISPENSERS ; ESSENTIAL OILS AS PERFUME FOR LAUNDRY PURPOSES ; OILS FOR PERFUMES AND SCENTS ; PERFUME OILS ; PERFUME OILS FOR THE MANUFACTURE OF

COSMETIC PREPARATIONS ; PERFUMED EXTRACTS FOR TISSUES AND PERFUMES, IN CLASS 3 (U.S. CLS. 1, 4, 6, 50, 51 AND 52).

FIRST USE 12-14-2007; IN COMMERCE 12-14-2007.

THE MARK CONSISTS OF STANDARD CHARACTERS WITHOUT CLAIM TO ANY PARTICULAR FONT, STYLE, SIZE, OR COLOR.

NO CLAIM IS MADE TO THE EXCLUSIVE RIGHT TO USE "SCENTS", APART FROM THE MARK AS SHOWN.

SER. NO. 77-389,938, FILED 2-6-2008.

TASHIA BUNCH, EXAMINING ATTORNEY

**Int. Cl.: 20**

**Prior U.S. Cls.: 2, 13, 22, 25, 32 and 50**

**United States Patent and Trademark Office**

**Reg. No. 3,504,446**

**Registered Sep. 23, 2008**

**TRADEMARK  
PRINCIPAL REGISTER**

# Beds By George

BEDS BY GEORGE, INC. (INDIANA CORPORATION)  
51690 CREEKSIDE DRIVE  
GRANGER, IN 46530

FOR: BED FRAMES; BED HEADBOARDS; BED RAILS; BEDS; BUNK BEDS; HOSPITAL BEDS; WOODEN BEDS; BEDROOM FURNITURE, IN CLASS 20 (U.S. CLS. 2, 13, 22, 25, 32 AND 50).

FIRST USE 9-1-2007; IN COMMERCE 10-1-2007.

THE MARK CONSISTS OF STANDARD CHARACTERS WITHOUT CLAIM TO ANY PARTICULAR FONT, STYLE, SIZE, OR COLOR.

NO CLAIM IS MADE TO THE EXCLUSIVE RIGHT TO USE "BEDS", APART FROM THE MARK AS SHOWN.

SER. NO. 77-390,014, FILED 2-6-2008.

TOBY BULLOFF, EXAMINING ATTORNEY

**Int. Cl.: 16**

**Prior U.S. Cls.: 2, 5, 22, 23, 29, 37, 38 and 50**

**Reg. No. 3,504,447**

**United States Patent and Trademark Office**

**Registered Sep. 23, 2008**

**TRADEMARK  
PRINCIPAL REGISTER**

**ZONDERKIDZ**

THE ZONDERVAN CORPORATION LLC (DELA-  
WARE LIMITED LIABILITY COMPANY)  
5300 PATTERSON AVENUE SE  
GRAND RAPIDS, MI 49530

FOR: A SERIES OF PRINTED FICTION AND  
NON-FICTION BOOKS WITH RELIGIOUS AND  
SPIRITUAL THEMES, IN CLASS 16 (U.S. CLS. 2, 5,  
22, 23, 29, 37, 38 AND 50).

FIRST USE 3-0-1998; IN COMMERCE 3-0-1998.

THE MARK CONSISTS OF STANDARD CHAR-  
ACTERS WITHOUT CLAIM TO ANY PARTICULAR  
FONT, STYLE, SIZE, OR COLOR.

OWNER OF U.S. REG. NOS. 2,547,730, 3,148,710,  
AND 3,218,966.

SER. NO. 77-390,022, FILED 2-6-2008.

ANNE FARRELL, EXAMINING ATTORNEY

**Int. Cls.: 30 and 35**

**Prior U.S. Cls.: 46, 100, 101 and 102**

**United States Patent and Trademark Office**

**Reg. No. 3,504,448**

**Registered Sep. 23, 2008**

**TRADEMARK  
SERVICE MARK  
PRINCIPAL REGISTER**

**Joe Brown's Carmel Corn**

JB'S CARMELCORN INC. (OREGON CORPORATION)  
9103 NW BENSON COURT  
PORTLAND, OR 97229

FOR: CORN-BASED SNACK FOODS, IN CLASS 30 (U.S. CL. 46).

FIRST USE 1-1-1960; IN COMMERCE 1-1-1960.

FOR: RETAIL SHOP SERVICES FEATURING SNACKS AND FOOD, CARMEL CORN POPCORN, WHITE CHEESE CORN POPCORN, YELLOW CHEESE CORN POPCORN, A VARIETY OF OTHER FLAVORED POPCORN, CONFECTION PRODUCTS, CARAMEL APPLES, ICE CREAM PRODUCTS, FLAVORED ICES, OTHER BEVERAGE ITEMS, GIFT TINS AND OTHER PROMOTIONAL GIFT ITEMS, IN CLASS 35 (U.S. CLS. 100, 101 AND 102).

FIRST USE 1-1-1960; IN COMMERCE 1-1-1960.

THE MARK CONSISTS OF STANDARD CHARACTERS WITHOUT CLAIM TO ANY PARTICULAR FONT, STYLE, SIZE, OR COLOR.

NO CLAIM IS MADE TO THE EXCLUSIVE RIGHT TO USE "CARMEL CORN", APART FROM THE MARK AS SHOWN.

THE NAME "JOE BROWN" DOES NOT IDENTIFY A LIVING INDIVIDUAL.

SER. NO. 77-390,048, FILED 2-6-2008.

HANNO RITTNER, EXAMINING ATTORNEY

**Int. Cl.: 36**

**Prior U.S. Cls.: 100, 101 and 102**

**United States Patent and Trademark Office**

**Reg. No. 3,504,449**

**Registered Sep. 23, 2008**

**SERVICE MARK  
PRINCIPAL REGISTER**



UTAH LEAGUE OF CREDIT UNIONS (UTAH  
NON-PROFIT CORPORATION)  
1805 SOUTH REDWOOD ROAD  
SALT LAKE CITY, UT 84104

NO CLAIM IS MADE TO THE EXCLUSIVE  
RIGHT TO USE "UTAH'S CREDIT UNIONS",  
APART FROM THE MARK AS SHOWN.

FOR: CREDIT UNIONS, IN CLASS 36 (U.S. CLS.  
100, 101 AND 102).

SER. NO. 77-390,255, FILED 2-6-2008.

FIRST USE 3-29-2005; IN COMMERCE 3-29-2005.

JAMES LOVELACE, EXAMINING ATTORNEY

**Int. Cl.: 4**

**Prior U.S. Cls.: 1, 6 and 15**

**United States Patent and Trademark Office**

**Reg. No. 3,504,450**

**Registered Sep. 23, 2008**

**TRADEMARK  
PRINCIPAL REGISTER**

**SOUKENBERI**

CHAN, SUK (UNITED STATES INDIVIDUAL)  
45 PONDFIELD ROAD WEST, #5G  
BRONXVILLE, NY 10708

FOR: CANDLES; SCENTED CANDLES, IN CLASS  
4 (U.S. CLS. 1, 6 AND 15).

FIRST USE 12-15-2007; IN COMMERCE 12-15-2007.

THE MARK CONSISTS OF STANDARD CHAR-  
ACTERS WITHOUT CLAIM TO ANY PARTICULAR  
FONT, STYLE, SIZE, OR COLOR.

THE WORDING "SOUKENBERI" HAS NO  
MEANING IN A FOREIGN LANGUAGE.

SER. NO. 77-390,400, FILED 2-6-2008.

EDWARD NELSON, EXAMINING ATTORNEY



**Int. Cl.: 41**

**Prior U.S. Cls.: 100, 101 and 107**

**United States Patent and Trademark Office**

**Reg. No. 3,504,451**

**Registered Sep. 23, 2008**

**SERVICE MARK  
PRINCIPAL REGISTER**

# The Balance Workout

MICHELE VAUGHAN ENTERPRISES (CALIFORNIA CORPORATION)

25 TANOAK CT.

CORTE MADERA, CA 94925

FOR: PHYSICAL FITNESS CONDITIONING CLASSES, IN CLASS 41 (U.S. CLS. 100, 101 AND 107).

FIRST USE 4-1-2007; IN COMMERCE 4-1-2007.

THE MARK CONSISTS OF STANDARD CHARACTERS WITHOUT CLAIM TO ANY PARTICULAR FONT, STYLE, SIZE, OR COLOR.

NO CLAIM IS MADE TO THE EXCLUSIVE RIGHT TO USE "WORKOUT", APART FROM THE MARK AS SHOWN.

SER. NO. 77-390,509, FILED 2-6-2008.

KATHLEEN LORENZO, EXAMINING ATTORNEY

**Int. Cl.: 40**

**Prior U.S. Cls.: 100, 103 and 106**

**United States Patent and Trademark Office**

**Reg. No. 3,504,452**

**Registered Sep. 23, 2008**

---

**SERVICE MARK  
PRINCIPAL REGISTER**

**Pro Drag**

REAVIS, RICHARD M. (UNITED STATES INDIVIDUAL)  
2811 W. CLEARVIEW DR.  
TUCSON, AZ 85745

THE MARK CONSISTS OF STANDARD CHARACTERS WITHOUT CLAIM TO ANY PARTICULAR FONT, STYLE, SIZE, OR COLOR.

FOR: IMPRINTING MESSAGES ON WEARING APPAREL, ACCESSORIES AND MUGS, IN CLASS 40 (U.S. CLS. 100, 103 AND 106).

SER. NO. 77-390,570, FILED 2-6-2008.

FIRST USE 3-1-1992; IN COMMERCE 3-1-1992.

ALICIA COLLINS, EXAMINING ATTORNEY

Int. Cl.: 36

Prior U.S. Cls.: 100, 101 and 102

United States Patent and Trademark Office

Reg. No. 3,504,453

Registered Sep. 23, 2008

SERVICE MARK  
PRINCIPAL REGISTER

**EXCEPTIONAL**  
**RISK** ADVISORS *llc*

EXCEPTIONAL RISK ADVISORS, LLC (NEW  
JERSEY LIMITED LIABILITY COMPANY)  
SUITE 625  
1 INTERNATIONAL BLVD.  
MAHWAH, NJ 07495

FOR: INSURANCE BROKERAGE, IN CLASS 36  
(U.S. CLS. 100, 101 AND 102).

FIRST USE 10-1-2006; IN COMMERCE 10-1-2006.

NO CLAIM IS MADE TO THE EXCLUSIVE  
RIGHT TO USE "RISK ADVISORS LLC", APART  
FROM THE MARK AS SHOWN.

THE MARK CONSISTS OF THE TEXT "EXCEP-  
TIONAL RISK ADVISORS, LLC" WITH AN EXTEN-  
DED LETTER "X" AND A HORIZONTAL LINE.

SER. NO. 77-390,642, FILED 2-6-2008.

ELI HELLMAN, EXAMINING ATTORNEY

Int. Cl.: 41

Prior U.S. Cls.: 100, 101 and 107

United States Patent and Trademark Office

Reg. No. 3,504,454

Registered Sep. 23, 2008

SERVICE MARK  
PRINCIPAL REGISTER



AURIT, DANIEL J (UNITED STATES INDIVIDUAL)  
791 BEST STREET  
MARSEILLES, IL 61341 AND  
PAVLICK, KIRK (UNITED STATES INDIVIDUAL)  
WEST GRANT STREET  
STREATOR, IL 61364

FOR: ENTERTAINMENT IN THE NATURE OF VISUAL AND AUDIO PERFORMANCES, NAMELY, MUSICAL BAND, ROCK GROUP, GYMNASTIC, DANCE, AND BALLET PERFORMANCES, IN CLASS 41 (U.S. CLS. 100, 101 AND 107).

FIRST USE 3-29-2006; IN COMMERCE 6-16-2006.

NO CLAIM IS MADE TO THE EXCLUSIVE RIGHT TO USE "PSYCHOBILLY", APART FROM THE MARK AS SHOWN.

THE MARK CONSISTS OF A COWSKULL WITH HORNS DOWNWARD, SURROUNDED BY THE NAME OF THE BAND "PSYCHO BILLY CADILLAC". THE SKULL ALSO HAS A BRANDING, IN THE CENTER OF THE FOREHEAD, OF A HORSESHOE WITH THE LETTERS "P" (ABOVE) & "B" (BELOW) IN THE CENTER OF THE HORSESHOE.

SER. NO. 77-390,753, FILED 2-7-2008.

ERNEST SHOSHO, EXAMINING ATTORNEY

**Int. Cl.: 35**

**Prior U.S. Cls.: 100, 101 and 102**

**United States Patent and Trademark Office**

**Reg. No. 3,504,455**

**Registered Sep. 23, 2008**

**SERVICE MARK  
PRINCIPAL REGISTER**

# Raw Power

BAZLER ENTERPRISES, INC. (IDAHO CORPORATION)  
3911 N. SCHREIBER WAY  
COEUR D'ALENE, ID 83815

FOR: COMPUTERIZED ON-LINE RETAIL STORE SERVICES IN THE FIELD OF RAW FOODS, IN CLASS 35 (U.S. CLS. 100, 101 AND 102).

FIRST USE 4-25-2005; IN COMMERCE 4-25-2005.

THE MARK CONSISTS OF STANDARD CHARACTERS WITHOUT CLAIM TO ANY PARTICULAR FONT, STYLE, SIZE, OR COLOR.

OWNER OF U.S. REG. NO. 3,254,416.

SER. NO. 77-390,785, FILED 2-7-2008.

ERNEST SHOSHO, EXAMINING ATTORNEY

**Int. Cl.: 36**

**Prior U.S. Cls.: 100, 101 and 102**

**United States Patent and Trademark Office**

**Reg. No. 3,504,456**

**Registered Sep. 23, 2008**

**SERVICE MARK  
PRINCIPAL REGISTER**



INVESTORS TITLE INSURANCE COMPANY  
(NORTH CAROLINA CORPORATION)  
121 NORTH COLUMBIA STREET  
CHAPEL HILL, NC 27515

THE MARK CONSISTS OF THE LETTERS "I" "T"  
AND "I" APPEARING INSIDE OF A LARGER  
LETTER "C".

FOR: TITLE INSURANCE UNDERWRITING SER-  
VICES, IN CLASS 36 (U.S. CLS. 100, 101 AND 102).

SER. NO. 77-390,801, FILED 2-7-2008.

FIRST USE 3-30-1973; IN COMMERCE 3-30-1973.

APRIL HESIK, EXAMINING ATTORNEY

**Int. Cl.: 9**

**Prior U.S. Cls.: 21, 23, 26, 36 and 38**

**United States Patent and Trademark Office**

**Reg. No. 3,504,457**

**Registered Sep. 23, 2008**

**TRADEMARK  
PRINCIPAL REGISTER**

**TOTAL CONTROL**

NUMARK INDUSTRIES, LLC (RHODE ISLAND  
LIMITED LIABILITY COMPANY)  
SUITE 201  
200 SCENIC VIEW DRIVE  
CUMBERLAND, RI 02864

FOR: COMPUTER PERIPHERALS, NAMELY,  
MIDI AUDIO INPUT DEVICES, IN CLASS 9 (U.S.  
CLS. 21, 23, 26, 36 AND 38).

FIRST USE 1-0-2007; IN COMMERCE 4-10-2007.

OWNER OF U.S. REG. NO. 3,412,411.

THE MARK CONSISTS OF THE WORD "TOTAL"  
IN A SHADED, STYLIZED RECTANGULAR  
SHAPED BOX WITH THE WORD "CONTROL" BE-  
SIDE IT.

SER. NO. 77-390,966, FILED 2-7-2008.

DAVID C. REIHNER, EXAMINING ATTORNEY

**Int. Cl.: 25**

**Prior U.S. Cls.: 22 and 39**

**United States Patent and Trademark Office**

**Reg. No. 3,504,458**

**Registered Sep. 23, 2008**

**TRADEMARK  
PRINCIPAL REGISTER**

**PLAY HARD, LIVE GREEN.**

KLABIN, JUSTIN M. (UNITED STATES INDIVIDUAL)  
71 VILLAGE PARK ROAD  
CEDAR GROVE, NJ 07009

THE MARK CONSISTS OF STANDARD CHARACTERS WITHOUT CLAIM TO ANY PARTICULAR FONT, STYLE, SIZE, OR COLOR.

FOR: SHORT-SLEEVED OR LONG-SLEEVED T-SHIRTS, IN CLASS 25 (U.S. CLS. 22 AND 39).

SER. NO. 77-391,002, FILED 2-7-2008.

FIRST USE 7-1-2007; IN COMMERCE 7-1-2007.

MIDGE BUTLER, EXAMINING ATTORNEY



**Int. Cl.: 9**

**Prior U.S. Cls.: 21, 23, 26, 36 and 38**

**Reg. No. 3,504,459**

**United States Patent and Trademark Office**

**Registered Sep. 23, 2008**

**TRADEMARK  
PRINCIPAL REGISTER**

**CLEARNAV**

NIELSEN-KELLERMAN COMPANY (PENNSYLVANIA CORPORATION)  
NAAMANS CREEK CENTER  
21 CREEK CIRCLE  
BOOTHWYN, PA 19061

FOR: SOARING DATA INSTRUMENT, NAMELY, A DISPLAY UNIT, REMOTE CONTROL, GPS ANTENNA, WIRING BOARD AND HOOKUP WIRES, PANEL-MOUNTED USB/REMOTE EXTENSION, EXTENSION CORDS, ON-PANEL MOUNTING HARDWARE AND INSTRUCTIONS, ALL SOLD TOGETHER AS A UNIT; ELECTRICAL NAVIGATIONAL INSTRUMENTS; ELECTRONIC DEVICES, NAMELY, COMPUTER HARDWARE FOR LOCATING AND TRACKING PROGRAMMED TO USE GLOBAL POSITIONING SYSTEMS (GPS) AND PER-

SONAL DIGITAL ASSISTANT (PDA) SYSTEMS; PROTECTIVE CARRYING CASES SPECIALLY ADAPTED FOR GLOBAL POSITIONING SYSTEM (GPS) APPARATUS AND PERSONAL DIGITAL ASSISTANTS (PDA), IN CLASS 9 (U.S. CLS. 21, 23, 26, 36 AND 38).

FIRST USE 12-1-2007; IN COMMERCE 2-1-2008.

THE MARK CONSISTS OF STANDARD CHARACTERS WITHOUT CLAIM TO ANY PARTICULAR FONT, STYLE, SIZE, OR COLOR.

SER. NO. 77-391,009, FILED 2-7-2008.

LINDSEY RUBIN, EXAMINING ATTORNEY

**Int. Cl.: 35**

**Prior U.S. Cls.: 100, 101 and 102**

**United States Patent and Trademark Office**

**Reg. No. 3,504,460**

**Registered Sep. 23, 2008**

---

**SERVICE MARK  
PRINCIPAL REGISTER**

**RELIABLE CAPACITY**

MET DEMAND, LLC (ILLINOIS LIMITED LIABILITY COMPANY)  
2761 ARBOR LANE  
CHARLESTON, IL 61920

THE MARK CONSISTS OF STANDARD CHARACTERS WITHOUT CLAIM TO ANY PARTICULAR FONT, STYLE, SIZE, OR COLOR.

FOR: BUSINESS CONSULTING SERVICES IN THE FIELD OF MAINTENANCE AND RELIABILITY, IN CLASS 35 (U.S. CLS. 100, 101 AND 102).

SER. NO. 77-391,054, FILED 2-7-2008.

FIRST USE 9-15-2005; IN COMMERCE 9-15-2005.

DAWN FELDMAN, EXAMINING ATTORNEY

**Int. Cl.: 25**

**Prior U.S. Cls.: 22 and 39**

**United States Patent and Trademark Office**

**Reg. No. 3,504,461**

**Registered Sep. 23, 2008**

**TRADEMARK  
PRINCIPAL REGISTER**

**ACP**

AMERICA'S CHOICE PRODUCTS, LLC (ARKAN-  
SAS LIMITED LIABILITY COMPANY)  
4900 LIGHTHOUSE DR.  
NEWPORT, AR 72112

THE MARK CONSISTS OF STANDARD CHAR-  
ACTERS WITHOUT CLAIM TO ANY PARTICULAR  
FONT, STYLE, SIZE, OR COLOR.

FOR: SHOES; BOOTS, IN CLASS 25 (U.S. CLS. 22  
AND 39).

SER. NO. 77-391,132, FILED 2-7-2008.

FIRST USE 11-1-2007; IN COMMERCE 11-1-2007.

TRACY CROSS, EXAMINING ATTORNEY

**Int. Cl.: 10**

**Prior U.S. Cls.: 26, 39 and 44**

**United States Patent and Trademark Office**

**Reg. No. 3,504,462**

**Registered Sep. 23, 2008**

**TRADEMARK  
PRINCIPAL REGISTER**

**AL5000**

AK SOLUTIONS USA, LLC (NEW JERSEY LIMITED LIABILITY COMPANY), DBA BREATH-ALCOLYZER.COM / PERSONALALCOHOLTESTER.COM  
21 GRAND AVE. SUITE 102  
PALISADES PARK, NJ 07650

THE MARK CONSISTS OF STANDARD CHARACTERS WITHOUT CLAIM TO ANY PARTICULAR FONT, STYLE, SIZE, OR COLOR.

FOR: ALCOHOL BREATH TESTING UNITS, IN CLASS 10 (U.S. CLS. 26, 39 AND 44).

SER. NO. 77-391,319, FILED 2-7-2008.

FIRST USE 10-1-2004; IN COMMERCE 10-1-2004.

DAVID C. REIHNER, EXAMINING ATTORNEY

**Int. Cl.: 10**

**Prior U.S. Cls.: 26, 39 and 44**

**United States Patent and Trademark Office**

**Reg. No. 3,504,463**

**Registered Sep. 23, 2008**

**TRADEMARK  
PRINCIPAL REGISTER**

**AL6000**

AK SOLUTIONS USA, LLC (NEW JERSEY LIMITED LIABILITY COMPANY), DBA BREATH-ALCOLYZER.COM / PERSONALALCOHOLTESTER.COM  
21 GRAND AVE. SUITE 102  
PALISADES PARK, NJ 07650

THE MARK CONSISTS OF STANDARD CHARACTERS WITHOUT CLAIM TO ANY PARTICULAR FONT, STYLE, SIZE, OR COLOR.

FOR: ALCOHOL BREATH TESTING UNITS, IN CLASS 10 (U.S. CLS. 26, 39 AND 44).

SER. NO. 77-391,332, FILED 2-7-2008.

FIRST USE 12-1-2006; IN COMMERCE 12-1-2006.

DAVID C. REIHNER, EXAMINING ATTORNEY

**Int. Cl.: 35**

**Prior U.S. Cls.: 100, 101 and 102**

**United States Patent and Trademark Office**

**Reg. No. 3,504,464**

**Registered Sep. 23, 2008**

**SERVICE MARK  
PRINCIPAL REGISTER**

# Taste Latino

FISPAL MIAMI, INC. (FLORIDA CORPORATION)  
1 ALHAMBRA PLAZA, SUITE 1405  
CORAL GABLES, FL 33134

FOR: ARRANGING AND CONDUCTING TRADE SHOWS IN THE FIELD OF FOOD AND BEVERAGE PRODUCTS, PACKAGING, EQUIPMENT AND SERVICES, IN CLASS 35 (U.S. CLS. 100, 101 AND 102).

FIRST USE 1-1-2004; IN COMMERCE 1-1-2004.

THE MARK CONSISTS OF STANDARD CHARACTERS WITHOUT CLAIM TO ANY PARTICULAR FONT, STYLE, SIZE, OR COLOR.

NO CLAIM IS MADE TO THE EXCLUSIVE RIGHT TO USE "LATINO", APART FROM THE MARK AS SHOWN.

SER. NO. 77-391,335, FILED 2-7-2008.

TARAH HARDY, EXAMINING ATTORNEY

Int. Cl.: 45

Prior U.S. Cls.: 100 and 101

United States Patent and Trademark Office

Reg. No. 3,504,465

Registered Sep. 23, 2008

**SERVICE MARK  
PRINCIPAL REGISTER**

L A W O F F I C E S

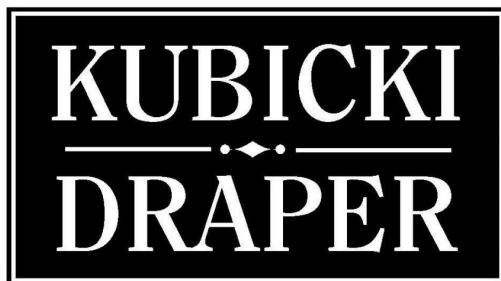

Professional Association

Founded 1963

KUBICKI DRAPER, P.A. (FLORIDA PROFESSIONAL ASSOCIATION)  
PENTHOUSE  
25 WEST FLAGLER STREET  
MIAMI, FL 33131

FOR: LEGAL SERVICES, IN CLASS 45 (U.S. CLS. 100 AND 101).

FIRST USE 10-31-2000; IN COMMERCE 10-31-2000.

NO CLAIM IS MADE TO THE EXCLUSIVE RIGHT TO USE "LAW OFFICES" AND "PROFESSIONAL ASSOCIATION FOUNDED 1963", APART FROM THE MARK AS SHOWN.

THE MARK CONSISTS OF THE WORDS "LAW OFFICES" ABOVE A RECTANGULAR SIGN WITH THE WORD "KUBICKI" SEPARATED FROM THE WORD "DRAPER" BY A STYLIZED LINEAR DESIGN, BELOW WHICH APPEAR THE WORDS "PROFESSIONAL ASSOCIATION", BENEATH WHICH APPEAR THE WORDS "FOUNDED 1963".

SER. NO. 77-391,412, FILED 2-7-2008.

BILL DAWE, EXAMINING ATTORNEY

**Int. Cl.: 3**

**Prior U.S. Cls.: 1, 4, 6, 50, 51 and 52**

**United States Patent and Trademark Office**

**Reg. No. 3,504,466**

**Registered Sep. 23, 2008**

**TRADEMARK  
PRINCIPAL REGISTER**



**S-Scents**

S-SCENTS LLC (KANSAS LIMITED LIABILITY  
COMPANY)  
5037 W. 119TH  
OVERLAND PARK, KS 66209

THE MARK CONSISTS OF A PERFUME BOTTLE  
WITH TWO "S'S", ONE SUPERIMPOSED OVER THE  
OTHER, IN THE MIDDLE OF THE BOTTLE, AND  
THE WORDING "S-SCENTS" BELOW THE BOTTLE.

FOR: PERFUME OILS, BODY LOTIONS, BATH  
GELS, SOAP, BODY MOISTURIZING CREAM, IN  
CLASS 3 (U.S. CLS. 1, 4, 6, 50, 51 AND 52).

SER. NO. 77-391,418, FILED 2-7-2008.

FIRST USE 12-31-2007; IN COMMERCE 12-31-2007.

TEJBIR SINGH, EXAMINING ATTORNEY



**Int. Cl.: 3**

**Prior U.S. Cls.: 1, 4, 6, 50, 51 and 52**

**United States Patent and Trademark Office**

**Reg. No. 3,504,467**

**Registered Sep. 23, 2008**

**TRADEMARK  
PRINCIPAL REGISTER**

**BOAT BRITE**

BRITE GROUP, LLC (NEW YORK LIMITED  
LIABILITY COMPANY)

14 WEST BOULEVARD PARKWAY

ROCHESTER, NY 14612

FOR: MARINE VEHICLE MAINTENANCE PRO-  
DUCTS, NAMELY, CLEANER, POLISH, AND STAIN  
REMOVER, IN CLASS 3 (U.S. CLS. 1, 4, 6, 50, 51 AND  
52).

FIRST USE 7-0-2001; IN COMMERCE 10-24-2002.

THE MARK CONSISTS OF STANDARD CHAR-  
ACTERS WITHOUT CLAIM TO ANY PARTICULAR  
FONT, STYLE, SIZE, OR COLOR.

OWNER OF U.S. REG. NO. 2,790,912.

NO CLAIM IS MADE TO THE EXCLUSIVE  
RIGHT TO USE BOAT, APART FROM THE MARK  
AS SHOWN.

SER. NO. 77-391,483, FILED 2-7-2008.

KHANH LE, EXAMINING ATTORNEY

**Int. Cl.: 35**

**Prior U.S. Cls.: 100, 101 and 102**

**United States Patent and Trademark Office**

**Reg. No. 3,504,468**

**Registered Sep. 23, 2008**

**SERVICE MARK  
PRINCIPAL REGISTER**



SCHOENING GROUP, LLC (WASHINGTON LIMITED LIABILITY COMPANY)  
1905 BARBER PLACE  
RICHLAND, WA 993529271

FOR: DOCUMENT AND RECORD KEEPING CONSULTING SERVICES FOR GROWERS, PACKERS, PROCESSORS, DISTRIBUTORS AND RETAILERS OF THE AGRICULTURAL COMMUNITY; BUSINESS AUDIT PREPARATION AND RECORD KEEPING FOR USE IN REGULATION COMPLIANCE IN THE FIELDS OF THE USDA GOOD AGRICULTURAL PRACTICES (GAP), GOOD HANDLING PRACTICES(GHP) AND OTHER SUSTAINABILITY AUDITS OF BOTH PUBLIC AND

PRIVATE COMPANIES, IN CLASS 35 (U.S. CLS. 100, 101 AND 102).

FIRST USE 10-10-2007; IN COMMERCE 12-10-2007.

THE MARK CONSISTS OF A OUTLINED WATER DROP WITH TWO OVERLAPPING CROP FIELDS BELOW A BRIGHT SUN WITH FIVE SUN RAYS. TO THE RIGHT OF THE DESIGN IS THE STYLIZED WORDS "AGRIGAP".

SER. NO. 77-391,649, FILED 2-7-2008.

CAROLINE WOOD, EXAMINING ATTORNEY

**Int. Cl.: 19**

**Prior U.S. Cls.: 1, 12, 33 and 50**

**United States Patent and Trademark Office**

**Reg. No. 3,504,469**

**Registered Sep. 23, 2008**

**TRADEMARK  
PRINCIPAL REGISTER**

The logo for LATTICESTIX features the word "LATTICE" in a bold, sans-serif font, underlined. To the right of "LATTICE" is a stylized graphic element consisting of a horizontal line that bends 90 degrees downward and then 90 degrees to the right, ending in a vertical line. Below this graphic is the word "STIX" in a lighter, sans-serif font.

LATTICESTIX, INC. (CALIFORNIA CORPORATION)  
1775 EGBERT AVENUE  
SAN FRANCISCO, CA 94124

FOR: NON-METAL AND WOOD LATTICES FOR USE AS DECORATION IN GARDENS AND INTERIORS, IN CLASS 19 (U.S. CLS. 1, 12, 33 AND 50).

FIRST USE 6-16-2006; IN COMMERCE 6-16-2006.

NO CLAIM IS MADE TO THE EXCLUSIVE RIGHT TO USE "LATTICE", APART FROM THE MARK AS SHOWN.

THE MARK CONSISTS OF STYLIZED "E" AT THE END OF THE WORD "LATTICE" WHICH IS UNDERLINED; THE LETTERS "STIX" APPEAR TO RIGHT OF "LATTICE" AND ON A LOWER LEVEL WITH A LINE ABOVE THE LETTERS AND TWO 90 DEGREE BENDS DOWN AND TO THE RIGHT TO END TO THE LEFT OF THE LETTER "S".

SER. NO. 77-391,834, FILED 2-7-2008.

BARBARA A. GOLD, EXAMINING ATTORNEY

**Int. Cl.: 19**

**Prior U.S. Cls.: 1, 12, 33 and 50**

**United States Patent and Trademark Office**

**Reg. No. 3,504,470**

**Registered Sep. 23, 2008**

**TRADEMARK  
PRINCIPAL REGISTER**

**LATTICESTIX**

LATTICESTIX, INC. (CALIFORNIA CORPORATION)  
1775 EGBERT AVENUE  
SAN FRANCISCO, CA 94124

THE MARK CONSISTS OF STANDARD CHARACTERS WITHOUT CLAIM TO ANY PARTICULAR FONT, STYLE, SIZE, OR COLOR.

FOR: NON-METAL AND WOOD LATTICES FOR USE AS DECORATION IN GARDENS AND INTERIORS, IN CLASS 19 (U.S. CLS. 1, 12, 33 AND 50).

SER. NO. 77-391,838, FILED 2-7-2008.

FIRST USE 6-16-2006; IN COMMERCE 6-16-2006.

BARBARA A. GOLD, EXAMINING ATTORNEY

**Int. Cl.: 45**

**Prior U.S. Cls.: 100 and 101**

**United States Patent and Trademark Office**

**Reg. No. 3,504,471**

**Registered Sep. 23, 2008**

**SERVICE MARK  
PRINCIPAL REGISTER**

**EVERYTHING WRITING**

WRITINGROOM.COM, LLC (OHIO LIMITED  
LIABILITY COMPANY)

30799 PINETREE ROAD, NUMBER 415

CHAGRIN FALLS, OH 44022

FOR: ONLINE SOCIAL NETWORKING SERVI-  
CES, IN CLASS 45 (U.S. CLS. 100 AND 101).

FIRST USE 8-14-2007; IN COMMERCE 8-14-2007.

THE MARK CONSISTS OF STANDARD CHAR-  
ACTERS WITHOUT CLAIM TO ANY PARTICULAR  
FONT, STYLE, SIZE, OR COLOR.

NO CLAIM IS MADE TO THE EXCLUSIVE  
RIGHT TO USE "WRITING", APART FROM THE  
MARK AS SHOWN.

SER. NO. 77-391,889, FILED 2-8-2008.

MELVIN AXILBUND, EXAMINING ATTORNEY

**Int. Cl.: 40**

**Prior U.S. Cls.: 100, 103 and 106**

**United States Patent and Trademark Office**

**Reg. No. 3,504,472**

**Registered Sep. 23, 2008**

**SERVICE MARK  
PRINCIPAL REGISTER**



UNIVERSAL FIBERS, INC. (VIRGINIA CORPORATION)  
14401 INDUSTRIAL PARK ROAD  
BRISTOL, VA 24203

FOR: MANUFACTURE OF SYNTHETIC FIBERS AND YARNS TO THE ORDER AND/OR SPECIFICATION OF OTHERS, IN CLASS 40 (U.S. CLS. 100, 103 AND 106).

FIRST USE 6-11-2007; IN COMMERCE 6-11-2007.

OWNER OF U.S. REG. NO. 2,410,389.

NO CLAIM IS MADE TO THE EXCLUSIVE RIGHT TO USE "FIBERS", APART FROM THE MARK AS SHOWN.

THE MARK CONSISTS OF A GLOBE ENCLOSED MULTIPLE TIMES BY A SINGLE STRAND OF FIBER WITH THE WORDS UNIVERSAL FIBERS.

SER. NO. 77-391,987, FILED 2-8-2008.

AMY GEARIN, EXAMINING ATTORNEY

**Int. Cl.: 1**

**Prior U.S. Cls.: 1, 5, 6, 10, 26 and 46**

**United States Patent and Trademark Office**

**Reg. No. 3,504,473**

**Registered Sep. 23, 2008**

**TRADEMARK  
PRINCIPAL REGISTER**

**PERCO**

CHEMICAL PRODUCTS INDUSTRIES, INC. (OKLAHOMA CORPORATION)  
7649 S.W. 34TH ST.  
OKLAHOMA CITY, OK 73179

THE MARK CONSISTS OF STANDARD CHARACTERS WITHOUT CLAIM TO ANY PARTICULAR FONT, STYLE, SIZE, OR COLOR.

FOR: CATALYSTS FOR OXIDATION PROCESSES, IN CLASS 1 (U.S. CLS. 1, 5, 6, 10, 26 AND 46).

SER. NO. 77-392,045, FILED 2-8-2008.

FIRST USE 7-15-2007; IN COMMERCE 1-30-2008.

ANGELA GAW, EXAMINING ATTORNEY

**Int. Cl.: 9**

**Prior U.S. Cls.: 21, 23, 26, 36 and 38**

**Reg. No. 3,504,474**

**United States Patent and Trademark Office**

**Registered Sep. 23, 2008**

---

**TRADEMARK  
PRINCIPAL REGISTER**

# HigherEd Analytics

ISTRATEGY, LLC (MARYLAND LIMITED LIABILITY COMPANY), DBA ISTRATEGY SOLUTIONS

300 REDLAND CT, SUITE 300  
OWINGS MILLS, MD 21117

FOR: COMPUTER SOFTWARE FOR APPLICATION AND DATABASE INTEGRATION, IN CLASS 9 (U.S. CLS. 21, 23, 26, 36 AND 38).

FIRST USE 6-1-2003; IN COMMERCE 6-1-2003.

THE MARK CONSISTS OF STANDARD CHARACTERS WITHOUT CLAIM TO ANY PARTICULAR FONT, STYLE, SIZE, OR COLOR.

NO CLAIM IS MADE TO THE EXCLUSIVE RIGHT TO USE "ANALYTICS", APART FROM THE MARK AS SHOWN.

SER. NO. 77-392,047, FILED 2-8-2008.

DAVID MILLER, EXAMINING ATTORNEY



**Int. Cl.: 41**

**Prior U.S. Cls.: 100, 101 and 107**

**United States Patent and Trademark Office**

**Reg. No. 3,504,475**

**Registered Sep. 23, 2008**

**SERVICE MARK  
PRINCIPAL REGISTER**



GROUP STUDY ASSOCIATES INC. (NEW YORK CORPORATION)  
SUITE 12H  
211 WEST 56TH STREET  
NEW YORK, NY 10019

FIRST USE 7-0-1990; IN COMMERCE 7-0-1990.

THE MARK CONSISTS OF A STAR ABOVE A TREE IN FRONT OF A RISING SUN.

FOR: TRAINING SERVICES IN THE FIELD OF MENTAL HEALTH, IN CLASS 41 (U.S. CLS. 100, 101 AND 107).

SER. NO. 77-392,075, FILED 2-8-2008.

LINDA POWELL, EXAMINING ATTORNEY

**Int. Cls.: 35 and 43**

**Prior U.S. Cls.: 100, 101 and 102**

**United States Patent and Trademark Office**

**Reg. No. 3,504,476**

**Registered Sep. 23, 2008**

**SERVICE MARK  
PRINCIPAL REGISTER**

**La Colombe d'Or**

STEPHEN N. ZIMMERMAN (UNITED STATES  
INDIVIDUAL), DBA LA COLOMBE D'OR  
3410 MONTROSE BLVD.  
HOUSTON, TX 77006

FOR: ART GALLERY RENDERED IN A EUR-  
OPEAN-STYLE CHATEAU, IN CLASS 35 (U.S. CLS.  
100, 101 AND 102).

FIRST USE 11-12-1980; IN COMMERCE 11-12-1980.

FOR: HOTEL AND RESTAURANT SERVICES  
RENDERED IN A EUROPEAN-STYLE CHATEAU,  
IN CLASS 43 (U.S. CLS. 100 AND 101).

FIRST USE 11-12-1980; IN COMMERCE 11-12-1980.

THE MARK CONSISTS OF STANDARD CHAR-  
ACTERS WITHOUT CLAIM TO ANY PARTICULAR  
FONT, STYLE, SIZE, OR COLOR.

THE ENGLISH TRANSLATION OF THE FRENCH  
WORDING "LA COLOMBE D'OR" IS "THE GOLD-  
EN DOVE".

SER. NO. 77-392,082, FILED 2-8-2008.

JUDITH HELFMAN, EXAMINING ATTORNEY

Int. Cl.: 25

Prior U.S. Cls.: 22 and 39

United States Patent and Trademark Office

Reg. No. 3,504,477

Registered Sep. 23, 2008

TRADEMARK  
PRINCIPAL REGISTER



WEAR WISE GUYS, LLC (GEORGIA LIMITED LIABILITY COMPANY)  
1130 CURETON DR.  
AUSTELL, GA 30106

FOR: CLOTHING, NAMELY, T-SHIRTS, SHIRTS, INFANT AND TODDLER ONE PIECE CLOTHING, JACKETS, PANTS, SHORTS, CAPS, JERSEYS, PAJAMAS, UNDERWEAR, TIES, TOPS, SHOES, AND SCARVES, IN CLASS 25 (U.S. CLS. 22 AND 39).

FIRST USE 6-9-2007; IN COMMERCE 6-9-2007.

THE MARK CONSISTS OF AN OWL ENCLOSED WITHIN A BOLD STRIPED CIRCLE. THE OWL IS

WEARING SHADES, A PIN STRIPE SUIT WITH A POCKET PROTECTOR IN THE LEFT POCKET AND A HAT WITH THE STYLIZED WORD "WEAR" ON THE HAT BAND. THE OWL IS HOLDING A CALCULATOR IN THE RIGHT HAND. THE STYLIZED WORDS "WWW.WEARWISEGUYS.COM" IS INSCRIBED ON THE BOLD STRIPED CIRCLE DIRECTLY BENEATH THE OWL. THE STYLIZED WORDS "WISE GUYS" IS LOCATED BENEATH THE BOLD STRIPED CIRCLE IN UNIVERSITY FONT BLOCK LETTERS.

SER. NO. 77-392,091, FILED 2-8-2008.

AISHA CLARKE, EXAMINING ATTORNEY

**Int. Cl.: 5**

**Prior U.S. Cls.: 6, 18, 44, 46, 51 and 52**

**Reg. No. 3,504,478**

**United States Patent and Trademark Office**

**Registered Sep. 23, 2008**

**TRADEMARK  
PRINCIPAL REGISTER**

**CELLUSCIENCE**

SANTICA USA, INC. (FLORIDA CORPORATION)  
SUITE 5  
1141 SOUTH ROGERS CIRCLE  
BOCA RATON, FL 33487

THE MARK CONSISTS OF STANDARD CHAR-  
ACTERS WITHOUT CLAIM TO ANY PARTICULAR  
FONT, STYLE, SIZE, OR COLOR.

FOR: DIETARY SUPPLEMENTS, IN CLASS 5 (U.S.  
CLS. 6, 18, 44, 46, 51 AND 52).

SER. NO. 77-392,167, FILED 2-8-2008.

FIRST USE 8-10-2007; IN COMMERCE 8-10-2007.

NICHOLAS ALTREE, EXAMINING ATTORNEY

**Int. Cl.: 35**

**Prior U.S. Cls.: 100, 101 and 102**

**United States Patent and Trademark Office**

**Reg. No. 3,504,479**

**Registered Sep. 23, 2008**

**SERVICE MARK  
PRINCIPAL REGISTER**



QUALITY FILTERS, INC. (ALABAMA CORPORATION)  
23351 GRISSOM DRIVE  
ROBERTSDALE, AL 36567

FOR: PROVIDING CONSUMER PRODUCT INFORMATION VIA THE INTERNET, IN CLASS 35 (U.S. CLS. 100, 101 AND 102).

FIRST USE 3-1-2003; IN COMMERCE 3-1-2003.

THE COLOR(S) BLUE IS/ARE CLAIMED AS A FEATURE OF THE MARK.

THE MARK CONSISTS OF THE BLUE WORDS "HOMEFILTERS.COM". THE "H" IS CAPPED WITH A TRIANGLE-SHAPED ROOF, MAKING THE "H" LOOK LIKE A HOME. THE WORD "HOME" IS IN DARKER, BOLDER BLUE THAN THE REMAINING LETTERS.

SER. NO. 77-392,180, FILED 2-8-2008.

DAVID I, EXAMINING ATTORNEY

**Int. Cls.: 35 and 44**

**Prior U.S. Cls.: 100, 101 and 102**

**United States Patent and Trademark Office**

**Reg. No. 3,504,480**

**Registered Sep. 23, 2008**

**SERVICE MARK  
PRINCIPAL REGISTER**

# CARESOURCE

CARESOURCE (OHIO CORPORATION)  
ONE S. MAIN STREET, SUITE 440  
ONE DAYTON CENTRE  
DAYTON, OH 45402

FOR: ADMINISTRATIVE SERVICES FOR THE PUBLIC HEALTH SECTOR IN THE NATURE OF GENERAL ADMINISTRATION, NAMELY, MANAGEMENT OF HEALTH CARE CLINICS FOR OTHERS; HEALTH CARE UTILIZATION AND REVIEW SERVICES; CASE AND MEDICAL MANAGEMENT NAMELY, HEALTH CARE COST CONTAINMENT; PROVIDER RELATIONS SERVICES, NAMELY, REQUESTING HEALTH CARE PROVIDER PRIVILEGES FROM HEALTH CARE INSTITUTIONS ON BEHALF OF PHYSICIANS AND HEALTH CARE PROVIDERS; CALL CENTERS SERVICES, NAMELY, OPERATION OF TELEPHONE CALL CENTERS FOR OTHERS; CUSTOMER SERVICE IN THE FIELD OF HEALTH INSURANCE PROVIDED BY MEANS OF A CALL CENTER, THE INTERNET AND THE POSTAL SERVICE, IN CLASS 35 (U.S. CLS. 100, 101 AND 102).

FIRST USE 1-1-2005; IN COMMERCE 1-1-2005.

FOR: TELEPHONE HOTLINE COUNSELING, NAMELY, OFFERING MEDICAL AND HEALTHCARE ADVICE; TELEPHONE INFORMATION SERVICE FEATURING INFORMATION IN THE FIELD OF MEDICAL AND HEALTHCARE ADVICE, IN CLASS 44 (U.S. CLS. 100 AND 101).

FIRST USE 1-1-2003; IN COMMERCE 1-1-2003.

THE MARK CONSISTS OF STANDARD CHARACTERS WITHOUT CLAIM TO ANY PARTICULAR FONT, STYLE, SIZE, OR COLOR.

OWNER OF U.S. REG. NOS. 2,553,920, 2,785,521, AND 2,870,535.

SER. NO. 77-392,274, FILED 2-8-2008.

RONALD DELGIZZI, EXAMINING ATTORNEY

**Int. Cl.: 41**

**Prior U.S. Cls.: 100, 101 and 107**

**United States Patent and Trademark Office**

**Reg. No. 3,504,481**

**Registered Sep. 23, 2008**

**SERVICE MARK  
PRINCIPAL REGISTER**

**Integral Peacemaker  
Training**

PEACEMAKER COMMUNITY USA (COLORADO CORPORATION)  
PO BOX 4632  
BOULDER, CO 803064623

FOR: EDUCATION SERVICES, NAMELY, PROVIDING CONFERENCES, SYMPOSIUMS, WORKSHOPS, SEMINARS, TRAINING, RETREATS, CLASSES, AND PROFESSIONAL COACHING USING INTEGRAL, TRANSFORMATIVE, TRANSPERSONAL, AND CONTEMPLATIVE APPROACHES IN THE FIELDS OF CONFLICT RESOLUTION, MEDIATION, PEACEMAKING, PEACEBUILDING, NONVIOLENCE TRAINING, COMMUNITY BUILDING, CRIMINAL JUSTICE, CORRECTIONS, RESTORATIVE JUSTICE, TRANSFORMATIVE JUSTICE, PRISON MINISTRY, ENVIRONMENTAL ISSUES, INTERNATIONAL RELATIONS, ORGANIZATIONAL DEVELOPMENT, URBAN ISSUES, SOCIAL ACTION AND ACTIVISM, SOCIAL JUSTICE, HUMAN RIGHTS, ECONOMIC DEVELOPMENT AND RELIEF WORK,

END OF LIFE CARE, AND HOSPICE AND PALLIATIVE CARE; CONSULTING SERVICES IN THE FIELD OF NONVIOLENCE TRAINING, IN CLASS 41 (U.S. CLS. 100, 101 AND 107).

FIRST USE 1-1-2002; IN COMMERCE 1-1-2002.

THE MARK CONSISTS OF STANDARD CHARACTERS WITHOUT CLAIM TO ANY PARTICULAR FONT, STYLE, SIZE, OR COLOR.

OWNER OF U.S. REG. NO. 3,198,578.

NO CLAIM IS MADE TO THE EXCLUSIVE RIGHT TO USE "INTEGRAL" OR "TRAINING", APART FROM THE MARK AS SHOWN.

SER. NO. 77-392,388, FILED 2-8-2008.

MARY MUNSON, EXAMINING ATTORNEY

**Int. Cl.: 35**

**Prior U.S. Cls.: 100, 101 and 102**

**United States Patent and Trademark Office**

**Reg. No. 3,504,482**

**Registered Sep. 23, 2008**

**SERVICE MARK  
PRINCIPAL REGISTER**

**Android-Universe.com**

TAPP, ERIC (UNITED STATES INDIVIDUAL)  
1182 COLE RD.  
WINCHESTER, KY 40391

THE MARK CONSISTS OF STANDARD CHAR-  
ACTERS WITHOUT CLAIM TO ANY PARTICULAR  
FONT, STYLE, SIZE, OR COLOR.

FOR: PROMOTING PUBLIC AWARENESS OF  
THE NEED FOR A STANDARDIZED CHASSIS  
FOR USE IN ANDROID AND ROBOT APPLICA-  
TIONS, IN CLASS 35 (U.S. CLS. 100, 101 AND 102).

SER. NO. 77-392,403, FILED 2-8-2008.

FIRST USE 1-10-2006; IN COMMERCE 1-10-2006.

TANYA AMOS, EXAMINING ATTORNEY



Int. Cl.: 45

Prior U.S. Cls.: 100 and 101

United States Patent and Trademark Office

Reg. No. 3,504,483

Registered Sep. 23, 2008

SERVICE MARK  
PRINCIPAL REGISTER



REESE, ROBYN (UNITED STATES INDIVIDUAL)  
2780 FORT MYER AVENUE  
HENDERSON, NV 89052

FOR: DATING SERVICES; MATCHMAKING  
SERVICES, IN CLASS 45 (U.S. CLS. 100 AND 101).

FIRST USE 1-15-2007; IN COMMERCE 3-1-2007.

NO CLAIM IS MADE TO THE EXCLUSIVE  
RIGHT TO USE "SENIOR", APART FROM THE  
MARK AS SHOWN.

THE STIPLING IS FOR SHADING PURPOSES  
ONLY.

THE MARK CONSISTS OF THE STYLIZED  
WORDS "SENIOR MOMENTS DATING WITH LESS  
STRESS MORE CHOICES". TO THE LEFT OF THE  
STYLIZED WORDS IS A PICTURE OF A COFFEE  
CUP WITH A HEART ON THE FRONT.

SER. NO. 77-392,428, FILED 2-8-2008.

SHAUNIA CARLYLE, EXAMINING ATTORNEY

**Int. Cl.: 11**

**Prior U.S. Cls.: 13, 21, 23, 31 and 34**

**Reg. No. 3,504,484**

**United States Patent and Trademark Office**

**Registered Sep. 23, 2008**

**TRADEMARK  
PRINCIPAL REGISTER**

**KC**

K C HILITES, INC. (ARIZONA CORPORATION)  
P.O. BOX 155  
WILLIAMS, AZ 86046

THE MARK CONSISTS OF STANDARD CHARACTERS WITHOUT CLAIM TO ANY PARTICULAR FONT, STYLE, SIZE, OR COLOR.

FOR: AUXILIARY DRIVING LIGHTS, FOG LIGHTS, ROAD RACING LIGHTS, FLOOD LIGHTS, ALL FOR USE ON AUTOMOTIVE VEHICLES; PARTS OF LIGHTS FOR VEHICLES, NAMELY, LIGHT COVERS, STONE GUARDS FOR LIGHTS, IN CLASS 11 (U.S. CLS. 13, 21, 23, 31 AND 34).

OWNER OF U.S. REG. NOS. 1,287,807, 1,479,569, AND 3,122,970.

SER. NO. 77-392,462, FILED 2-8-2008.

FIRST USE 6-29-1971; IN COMMERCE 6-29-1971.

ANDREA HACK, EXAMINING ATTORNEY

**Int. Cl.: 11**

**Prior U.S. Cls.: 13, 21, 23, 31 and 34**

**United States Patent and Trademark Office**

**Reg. No. 3,504,485**

**Registered Sep. 23, 2008**

**TRADEMARK  
PRINCIPAL REGISTER**



K C HILITES, INC. (ARIZONA CORPORATION)  
P.O. BOX 155  
WILLIAMS, AZ 86046

OWNER OF U.S. REG. NOS. 1,287,807, 1,479,569,  
AND 3,122,970.

FOR: PARTS OF LIGHTS FOR VEHICLES, NAME-  
LY, LIGHT COVERS AND STONE GUARDS FOR  
LIGHTS, IN CLASS 11 (U.S. CLS. 13, 21, 23, 31 AND  
34).

THE MARK CONSISTS OF THE LETTERS "K"  
AND "C" WITHIN A CIRCLE.

SER. NO. 77-392,477, FILED 2-8-2008.

FIRST USE 6-29-1971; IN COMMERCE 6-29-1971.

ANDREA HACK, EXAMINING ATTORNEY

**Int. Cl.: 30**

**Prior U.S. Cl.: 46**

**United States Patent and Trademark Office**

**Reg. No. 3,504,486**

**Registered Sep. 23, 2008**

**TRADEMARK  
PRINCIPAL REGISTER**

**UTZ CLUB MIX**

RICE INVESTMENTS, LP (DELAWARE LIMITED  
PARTNERSHIP)  
900 HIGH STREET  
HANOVER, PA 17331

OWNER OF U.S. REG. NOS. 878,317, 3,330,226 AND  
OTHERS.

FOR: SNACK MIX CONSISTING PRIMARILY OF  
WHEAT, RICE AND CORN BASED CRACKERS  
AND PRETZELS, IN CLASS 30 (U.S. CL. 46).

NO CLAIM IS MADE TO THE EXCLUSIVE  
RIGHT TO USE "MIX", APART FROM THE MARK  
AS SHOWN.

FIRST USE 11-5-2007; IN COMMERCE 11-5-2007.

SER. NO. 77-392,609, FILED 2-8-2008.

THE MARK CONSISTS OF STANDARD CHAR-  
ACTERS WITHOUT CLAIM TO ANY PARTICULAR  
FONT, STYLE, SIZE, OR COLOR.

INGRID C. EULIN, EXAMINING ATTORNEY

**Int. Cl.: 35**

**Prior U.S. Cls.: 100, 101 and 102**

**United States Patent and Trademark Office**

**Reg. No. 3,504,487**

**Registered Sep. 23, 2008**

---

**SERVICE MARK  
PRINCIPAL REGISTER**

**PUREADS**

PUREADS, LLC (FLORIDA LIMITED LIABILITY  
COMPANY)  
1730 SOUTH FEDERAL HIGHWAY, SUITE 345  
DELRAY BEACH, FL 33483

THE MARK CONSISTS OF STANDARD CHAR-  
ACTERS WITHOUT CLAIM TO ANY PARTICULAR  
FONT, STYLE, SIZE, OR COLOR.

FOR: ADVERTISING AND MARKETING SERVI-  
CES AND PROMOTION VIA ELECTRONIC MEDIA,  
NAMELY, THE INTERNET, IN CLASS 35 (U.S. CLS.  
100, 101 AND 102).

SER. NO. 77-392,620, FILED 2-8-2008.

FIRST USE 6-15-2007; IN COMMERCE 6-15-2007.

YAT SYE, LEE, EXAMINING ATTORNEY

**Int. Cl.: 41**

**Prior U.S. Cls.: 100, 101 and 107**

**United States Patent and Trademark Office**

**Reg. No. 3,504,488**

**Registered Sep. 23, 2008**

**SERVICE MARK  
PRINCIPAL REGISTER**

# Big League Wrestling

MACHADO, DANIEL M. (UNITED STATES IN-  
DIVIDUAL)  
457 CORONA ROAD  
PETALUMA, CA 94954

FOR: ENTERTAINMENT SERVICES, NAMELY,  
WRESTLING EXHIBITS AND PERFORMANCES BY  
A PROFESSIONAL WRESTLER AND ENTERTAI-  
NER, IN CLASS 41 (U.S. CLS. 100, 101 AND 107).

FIRST USE 1-1-2008; IN COMMERCE 1-1-2008.

THE MARK CONSISTS OF STANDARD CHAR-  
ACTERS WITHOUT CLAIM TO ANY PARTICULAR  
FONT, STYLE, SIZE, OR COLOR.

NO CLAIM IS MADE TO THE EXCLUSIVE  
RIGHT TO USE "WRESTLING", APART FROM  
THE MARK AS SHOWN.

SER. NO. 77-392,834, FILED 2-8-2008.

RONALD DELGIZZI, EXAMINING ATTORNEY

**Int. Cl.: 7**

**Prior U.S. Cls.: 13, 19, 21, 23, 31, 34 and 35**

**United States Patent and Trademark Office**

**Reg. No. 3,504,489**

**Registered Sep. 23, 2008**

**TRADEMARK  
PRINCIPAL REGISTER**

**PROJACK**

PROJACK ENTERPRISES, INC. (FLORIDA CORPORATION)  
2636 WEST 78TH STREET  
HIALEAH, FL 33016

THE MARK CONSISTS OF STANDARD CHARACTERS WITHOUT CLAIM TO ANY PARTICULAR FONT, STYLE, SIZE, OR COLOR.

FOR: HYDRAULIC JACKS FOR SUPPORTING VEHICLES, IN CLASS 7 (U.S. CLS. 13, 19, 21, 23, 31, 34 AND 35).

SER. NO. 77-392,842, FILED 2-8-2008.

FIRST USE 12-31-1994; IN COMMERCE 12-31-1994.

KATHERINE CHANG, EXAMINING ATTORNEY

**Int. Cls.: 14 and 25**

**Prior U.S. Cls.: 2, 22, 27, 28, 39 and 50**

**United States Patent and Trademark Office**

**Reg. No. 3,504,490**

**Registered Sep. 23, 2008**

**TRADEMARK  
PRINCIPAL REGISTER**

**Mission-Driven Merchandise**

ZEPHTEX INDUSTRIES, INC. (CALIFORNIA CORPORATION)  
P.O. BOX 74163  
SAN CLEMENTE, CA 92673

FOR: JEWELRY MADE FROM NON-PRECIOUS METALS AND OTHER NON-PRECIOUS MATERIALS, IN CLASS 14 (U.S. CLS. 2, 27, 28 AND 50).

FIRST USE 8-1-2003; IN COMMERCE 8-1-2003.

FOR: CLOTHING, NAMELY, SHIRTS, PANTS, SHORTS, JACKETS, HATS, SOCKS, SKIRTS, IN CLASS 25 (U.S. CLS. 22 AND 39).

FIRST USE 8-1-2003; IN COMMERCE 8-1-2003.

THE MARK CONSISTS OF STANDARD CHARACTERS WITHOUT CLAIM TO ANY PARTICULAR FONT, STYLE, SIZE, OR COLOR.

NO CLAIM IS MADE TO THE EXCLUSIVE RIGHT TO USE "MERCHANDISE", APART FROM THE MARK AS SHOWN.

SER. NO. 77-392,970, FILED 2-8-2008.

ZACHARY BELLO, EXAMINING ATTORNEY



Int. Cl.: 25

Prior U.S. Cls.: 22 and 39

United States Patent and Trademark Office

Reg. No. 3,504,491

Registered Sep. 23, 2008

TRADEMARK  
PRINCIPAL REGISTER

UNKNOWN NATURE

LABEL NYC, INC. (NEW YORK CORPORATION)  
552 7TH AVENUE, SUITE #403  
NEW YORK, NY 10018

FOR: JEANS; SHORT-SLEEVED OR LONG-SLEEVED T-SHIRTS; T-SHIRTS; BED JACKETS; DENIM JACKETS; DOWN JACKETS; FISHERMEN'S JACKETS; FUR COATS AND JACKETS; FUR JACKETS; HEAVY JACKETS; JACKET LINERS; JACKETS; LEATHER JACKETS; LIGHT-REFLECTING JACKETS; LONG JACKETS; MEN AND WOMEN JACKETS; COATS, TROUSERS, VESTS; RAIN JACKETS; RAINPROOF JACKETS; REVERSIBLE JACKETS; SHELL JACKETS; SKI JACKETS; SLEEVED OR SLEEVELESS JACKETS; SMOKING JACKETS; SPORTS JACKETS; STUFF JACKETS; SUEDE JACKETS; WATERPROOF JACKETS AND PANTS; WIND RESISTANT JACKETS; WIND-JACKETS; BALLOON PANTS; CAPRI PANTS; CARGO PANTS; DENIMS; JOGGING PANTS; LEATHER PANTS; LOUNGE PANTS; NON-DISPOSABLE CLOTH TRAINING PANTS; NURSE PANTS; PANTS; PETTI-PANTS; SKI PANTS; SNOW PANTS; SNOWBOARD PANTS; STRETCH PANTS; SWEAT PANTS; TAP PANTS; TOBOGGAN HATS, PANTS AND CAPS; TRACK PANTS; WIND PANTS; YOGA PANTS; A-SHIRTS; BUTTON-FRONT ALOHA SHIRTS; CAMP SHIRTS; DRESS SHIRTS; GOLF SHIRTS; KNIT SHIRTS; LONG-SLEEVED SHIRTS; NIGHT SHIRTS; OPEN-NECKED SHIRTS; PIQUE SHIRTS; POLO SHIRTS; RUGBY SHIRTS; SHIRT FRONTS; SHIRT YOKES; SHIRTS; SHIRTS FOR SUITS; SHORT-SLEEVED SHIRTS; SLEEP SHIRTS; SPORT SHIRTS; SPORTS SHIRTS; SPORTS SHIRTS WITH SHORT SLEEVES; SWEAT SHIRTS; TEE SHIRTS; TRIATHLON CLOTHING, NAMELY, TRIATHLON TIGHTS, TRIATHLON SHORTS, TRIATHLON SINGLET, TRIATHLON SHIRTS, TRIATHLON SUITS; WIND SHIRTS; YOGA SHIRTS; CHEF'S HATS; FUR HATS; HAT BANDS; HATS; HEADGEAR, NAMELY, HATS WORN ON THE HEAD; PAPER HATS FOR USE AS CLOTHING ITEMS; SEDGE HATS (SUGE-GASA);

SMALL HATS; WOOLLY HATS; BELTS; BIBS NOT OF CLOTH OR PAPER; CAPS; CHILDREN'S AND INFANTS' CLOTH BIBS; CHILDREN'S CLOTH EATING BIBS; CLOTH BIBS; CLOTH BIBS FOR ADULT DINERS; CLOTH BIBS FOR USE BY SENIOR CITIZENS OR PHYSICALLY- OR MENTALLY-CHALLENGED PERSONS; CLOTH DIAPERS; CLOTHING FOR WEAR IN JUDO PRACTICES; CLOTHING FOR WEAR IN WRESTLING GAMES; CLOTHING, NAMELY, ARM WARMERS; CLOTHING, NAMELY, FOLK COSTUMES; CLOTHING, NAMELY, HAND-WARMERS; CLOTHING, NAMELY, KNEE WARMERS; CLOTHING, NAMELY, NECK TUBES; CLOTHING, NAMELY, THOBES; CLOTHING, NAMELY, WRAP-AROUNDS; CORSETS; DUSTERS; FOULARDS; HOODS; INFANT AND TODDLER ONE PIECE CLOTHING; INFANT CLOTH DIAPERS; JERSEYS; LEATHER BELTS; MANTLES; MUFFLERS; PARTS OF CLOTHING, NAMELY, GUSSETS FOR TIGHTS, GUSSETS FOR STOCKINGS, GUSSETS FOR BATHING SUITS, GUSSETS FOR UNDERWEAR, GUSSETS FOR LEOTARDS AND GUSSETS FOR FOOTLETS; PERSPIRATION ABSORBENT UNDERWEAR CLOTHING; SHIFTS; SHORT SETS; SHOULDER WRAPS; SWADDLING CLOTHES; TIES; TOPS; UNDERARM CLOTHING SHIELDS; WRAPS; UPPERS OF WOVEN RATTAN FOR JAPANESE STYLE SANDALS; WOVEN OR KNITTED UNDERWEAR; ANGLERS' SHOES; APRES-SKI SHOES; ATHLETIC SHOES; BALLET SHOES; BALLROOM DANCING SHOES; BASEBALL SHOES; BEACH SHOES; BOWLING SHOES; BOXING SHOES; CANVAS SHOES; CLEATS FOR ATTACHMENT TO SPORTS SHOES; CYCLING SHOES; DANCE SHOES; DECK-SHOES; DRIVERS; FOOTBALL SHOES; GOLF SHOES; GYMNASIUM SHOES; HANDBALL SHOES; HEEL PIECES FOR SHOES; HOCKEY SHOES; INFANTS' SHOES AND BOOTS; INSOLES; LEATHER SHOES; PAPER SHOES USED WHEN GOING THROUGH METAL DETECTORS TO KEEP FEET AND SOCKS CLEAN; PROTECTIVE METAL MEMBERS FOR SHOES AND BOOTS; RUB-

BER SHOES; RUGBY SHOES; RUNNING SHOES; SHOE DOWELS; SHOE INSERTS FOR PRIMARILY NON-ORTHOPEDIC PURPOSES; SHOE PEGS; SHOE SOLES; SHOES; SHOES SOLES FOR REPAIR; SKI AND SNOWBOARD SHOES AND PARTS THEREOF; SKIING SHOES; SOCCER SHOES; TAP SHOES; TENNIS SHOES; TONGUE OR PULLSTRAP FOR SHOES AND BOOTS; TRACK AND FIELD SHOES; TRAINING SHOES; VOLLEYBALL SHOES; WOMEN'S SHOES; WORK SHOES AND BOOTS; ANKLE SOCKS; ANKLETS; ANTI-PERSPIRANT SOCKS; JAPANESE STYLE SOCKS (TABI COVERS); JAPANESE STYLE SOCKS (TABI); MEN'S SOCKS; SOCK SUSPENDERS; SOCKS; SOCKS AND STOCKINGS; THERMAL SOCKS; WATER SOCKS; WOOLLEN SOCKS; BATHING SUITS; BATHING SUITS FOR MEN; BODY SUITS; DRESS SUITS; DRY SUITS; FLIGHT SUITS; GYM SUITS; JOGGING SUITS; JUDO SUITS; KARATE SUITS; LADIES' SUITS; MEN'S SUITS; MEN'S SUITS, WOMEN'S SUITS; ONE-PIECE PLAY SUITS; PLAY SUITS; RAIN SUITS; SKI SUITS; SKI SUITS FOR COMPETITION; SKIRT

SUITS; SNOW BOARDING SUITS; SNOW SUITS; SUIT COATS; SUITS; SUITS OF LEATHER; SWEAT SUITS; TRACK SUITS; TRAINING SUITS; UNION SUITS; VESTED SUITS; WARM UP SUITS; WET SUIT GLOVES; WET SUITS; WET SUITS FOR WATER-SKIING AND SUB-AQUA; ZOOT SUITS; BELTS MADE OF LEATHER; BELTS OF TEXTILE; FABRIC BELTS; GARTER BELTS; MONEY BELTS; SUSPENDER BELTS FOR MEN; SUSPENDER BELTS FOR WOMEN; TUXEDO BELTS; WAIST BELTS; WRAP BELTS FOR KIMONOS (DATEMAKI), IN CLASS 25 (U.S. CLS. 22 AND 39).

FIRST USE 5-19-2007; IN COMMERCE 7-15-2007.

THE MARK CONSISTS OF STANDARD CHARACTERS WITHOUT CLAIM TO ANY PARTICULAR FONT, STYLE, SIZE, OR COLOR.

SER. NO. 77-392,991, FILED 2-8-2008.

DAWN HAN, EXAMINING ATTORNEY

Int. Cl.: 25

Prior U.S. Cls.: 22 and 39

United States Patent and Trademark Office

Reg. No. 3,504,492

Registered Sep. 23, 2008

TRADEMARK  
PRINCIPAL REGISTER

ADDICTED SOUL

GEORGE PARK (UNITED STATES INDIVIDUAL)  
552 7TH AVENUE, SUITE #403  
NEW YORK, NY 10018

FOR: JEANS; SHORT-SLEEVED OR LONG-SLEEVED T-SHIRTS; T-SHIRTS; A-SHIRTS; BUTTON-FRONT ALOHA SHIRTS; CAMP SHIRTS; DRESS SHIRTS; GOLF SHIRTS; KNIT SHIRTS; LONG-SLEEVED SHIRTS; NIGHT SHIRTS; OPEN-NECKED SHIRTS; PIQUE SHIRTS; POLO SHIRTS; RUGBY SHIRTS; SHIRT FRONTS; SHIRT YOKES; SHIRTS; SHIRTS FOR SUITS; SHORT-SLEEVED SHIRTS; SLEEP SHIRTS; SPORT SHIRTS; SPORTS SHIRTS; SPORTS SHIRTS WITH SHORT SLEEVES; SWEAT SHIRTS; TEE SHIRTS; TRIATHLON CLOTHING, NAMELY, TRIATHLON TIGHTS, TRIATHLON SHORTS, TRIATHLON SINGLETS, TRIATHLON SHIRTS, TRIATHLON SUITS; UPPERS OF WOVEN RATTAN FOR JAPANESE STYLE SANDALS; WIND SHIRTS; WOVEN OR KNITTED UNDERWEAR; YOGA SHIRTS; BED JACKETS; DENIM JACKETS; DOWN JACKETS; FISHERMEN'S JACKETS; FUR COATS AND JACKETS; FUR JACKETS; HEAVY JACKETS; JACKET LINERS; JACKETS; LEATHER JACKETS; LIGHT-REFLECTING JACKETS; LONG JACKETS; MEN AND WOMEN JACKETS, COATS, TROUSERS, VESTS; RAIN JACKETS; RAINPROOF JACKETS; REVERSIBLE JACKETS; SHELL JACKETS; SKI JACKETS; SLEEVED OR SLEEVELESS JACKETS; SMOKING JACKETS; SPORTS JACKETS; STUFF JACKETS; SUEDE JACKETS; WATERPROOF JACKETS AND PANTS; WIND RESISTANT JACKETS; WIND-JACKETS; BELTS; BELTS MADE OF LEATHER; BELTS OF TEXTILE; FABRIC BELTS; GARTER BELTS; LEATHER BELTS; MONEY BELTS; SUSPENDER BELTS FOR MEN; SUSPENDER BELTS FOR WOMEN; TUXEDO BELTS; WAIST BELTS; WRAP BELTS FOR KIMONOS (DATEMAKI); BALLOON PANTS; CAPRI PANTS; CARGO PANTS; DENIMS; JOGGING PANTS; LEATHER PANTS; LOUNGE PANTS; NON-DISPOSABLE CLOTH TRAINING PANTS;

NURSE PANTS; PANTS; PETTI-PANTS; SKI PANTS; SNOW PANTS; SNOWBOARD PANTS; STRETCH PANTS; SWEAT PANTS; TAP PANTS; TOBOGGAN HATS, PANTS AND CAPS; TRACK PANTS; WIND PANTS; YOGA PANTS; BATHING SUITS; BATHING SUITS FOR MEN; BODY SUITS; DRESS SUITS; DRY SUITS; FLIGHT SUITS; GYM SUITS; JOGGING SUITS; JUDO SUITS; KARATE SUITS; LADIES' SUITS; MEN'S SUITS; MEN'S SUITS, WOMEN'S SUITS; ONE-PIECE PLAY SUITS; PARTS OF CLOTHING, NAMELY, GUSSETS FOR TIGHTS, GUSSETS FOR STOCKINGS, GUSSETS FOR BATHING SUITS, GUSSETS FOR UNDERWEAR, GUSSETS FOR LEOTARDS AND GUSSETS FOR FOOTLETS; PLAY SUITS; RAIN SUITS; SKI SUITS; SKI SUITS FOR COMPETITION; SKIRT SUITS; SNOW BOARDING SUITS; SNOW SUITS; SUIT COATS; SUITS; SUITS OF LEATHER; SWEAT SUITS; TRACK SUITS; TRAINING SUITS; UNION SUITS; VESTED SUITS; WARM UP SUITS; WET SUIT GLOVES; WET SUITS; WET SUITS FOR WATER-SKIING AND SUB-AQUA; ZOOT SUITS; ANKLE SOCKS; ANKLETS; ANTI-PERSPIRANT SOCKS; JAPANESE STYLE SOCKS (TABI COVERS); JAPANESE STYLE SOCKS (TABI); MEN'S SOCKS; PAPER SHOES USED WHEN GOING THROUGH METAL DETECTORS TO KEEP FEET AND SOCKS CLEAN; SOCK SUSPENDERS; SOCKS; SOCKS AND STOCKINGS; THERMAL SOCKS; WATER SOCKS; WOOLLEN SOCKS; CHEF'S HATS; FUR HATS; HAT BANDS; HATS; HEADGEAR, NAMELY, HATS WORN ON THE HEAD; PAPER HATS FOR USE AS CLOTHING ITEMS; SEDGE HATS (SUGE-GASA); SMALL HATS; WOOLLY HATS; COATS OF DENIM; ANGLERS' SHOES; APRES-SKI SHOES; ATHLETIC SHOES; BALLET SHOES; BALLROOM DANCING SHOES; BASEBALL SHOES; BEACH SHOES; BOWLING SHOES; BOXING SHOES; CANVAS SHOES; CLEATS FOR ATTACHMENT TO SPORTS SHOES; CYCLING SHOES; DANCE SHOES; DECK-SHOES; DRIVERS; FOOTBALL SHOES; GOLF SHOES; GYMNASIIC SHOES; HANDBALL SHOES; HEEL PIECES FOR SHOES;

HOCKEY SHOES; INFANTS' SHOES AND BOOTS; INSOLES; LEATHER SHOES; PROTECTIVE METAL MEMBERS FOR SHOES AND BOOTS; RUBBER SHOES; RUGBY SHOES; RUNNING SHOES; SHOE DOWELS; SHOE INSERTS FOR PRIMARILY NON-ORTHOPEDIC PURPOSES; SHOE PEGS; SHOE SOLES; SHOES; SHOES SOLES FOR REPAIR; SKI AND SNOWBOARD SHOES AND PARTS THEREOF; SKIING SHOES; SOCCER SHOES; TAP SHOES; TENNIS SHOES; TONGUE OR PULLSTRAP FOR SHOES AND BOOTS; TRACK AND FIELD SHOES; TRAINING SHOES; VOLLEYBALL SHOES; WOMEN'S SHOES; WORK SHOES AND BOOTS; BICYCLE GLOVES; BICYCLING GLOVES; CROSS-COUNTRY GLOVES; GLOVES; GLOVES FOR PER-

SONAL HAND CONDITIONING USE; GLOVES INCLUDING THOSE MADE OF SKIN, HIDE OR FUR; MOTORCYCLE GLOVES; OUTDOOR GLOVES; RIDING GLOVES; SKI GLOVES; SNOWBOARD GLOVES, IN CLASS 25 (U.S. CLS. 22 AND 39).

FIRST USE 10-11-2007; IN COMMERCE 12-5-2007.

THE MARK CONSISTS OF STANDARD CHARACTERS WITHOUT CLAIM TO ANY PARTICULAR FONT, STYLE, SIZE, OR COLOR.

SER. NO. 77-392,997, FILED 2-8-2008.

DAWN HAN, EXAMINING ATTORNEY

Int. Cl.: 35

Prior U.S. Cls.: 100, 101 and 102

United States Patent and Trademark Office

Reg. No. 3,504,493

Registered Sep. 23, 2008

SERVICE MARK  
PRINCIPAL REGISTER



JARRIN, JAMIE L. (NEW JERSEY SOLE PROPRIETORSHIP), DBA GIFT CHICK  
22 MEADOW CIRCLE  
MAYS LANDING, NJ 08330

FOR: COMPUTERIZED ON-LINE RETAIL STORE SERVICES IN THE FIELD OF GIFTWARE, IN CLASS 35 (U.S. CLS. 100, 101 AND 102).

FIRST USE 2-1-2008; IN COMMERCE 2-7-2008.

NO CLAIM IS MADE TO THE EXCLUSIVE RIGHT TO USE "GIFT", APART FROM THE MARK AS SHOWN.

THE COLOR(S) PINK, PURPLE, WHITE, AND FLESH TONE IS/ARE CLAIMED AS A FEATURE OF THE MARK.

THE MARK CONSISTS OF A FAIRY WITH PINK WINGS, PURPLE HAIR, A PURPLE SKIRT AND SHIRT, HOLDING A PINK AND PURPLE GIFT BOX, SITTING ON TOP OF THE FIRST LETTER "C". THE WORDS "GIFT CHICK" ARE DEPICTED IN THE COLOR PURPLE AND THE FAIRY'S TEETH AND EARRINGS ARE DEPICTED IN THE COLOR WHITE. THE BODY OF THE FAIRY IS DEPICTED IN A FLESH TONE COLOR.

SER. NO. 77-393,069, FILED 2-9-2008.

BRIDGETT SMITH, EXAMINING ATTORNEY

**Int. Cl.: 41**

**Prior U.S. Cls.: 100, 101 and 107**

**United States Patent and Trademark Office**

**Reg. No. 3,504,494**

**Registered Sep. 23, 2008**

**SERVICE MARK  
PRINCIPAL REGISTER**

**Photography with a Fashion  
Flair**

ADVANTAGE PHOTOGRAPHY, INC. (MICHIGAN CORPORATION)  
4321 BLUEBIRD DR  
COMMERCE, MI 48382

FOR: PHOTOGRAPHY; PHOTOGRAPHY SERVICES; PORTRAIT PHOTOGRAPHY, IN CLASS 41 (U.S. CLS. 100, 101 AND 107).

FIRST USE 10-1-2001; IN COMMERCE 10-1-2001.

THE MARK CONSISTS OF STANDARD CHARACTERS WITHOUT CLAIM TO ANY PARTICULAR FONT, STYLE, SIZE, OR COLOR.

NO CLAIM IS MADE TO THE EXCLUSIVE RIGHT TO USE "PHOTOGRAPHY", APART FROM THE MARK AS SHOWN.

SER. NO. 77-393,075, FILED 2-9-2008.

ELLEN PERKINS, EXAMINING ATTORNEY

Int. Cls.: 21, 25, 41 and 44

Prior U.S. Cls.: 2, 13, 22, 23, 29, 30, 33, 39, 40, 50, 100,  
101 and 107

Reg. No. 3,504,495

United States Patent and Trademark Office

Registered Sep. 23, 2008

TRADEMARK  
SERVICE MARK  
PRINCIPAL REGISTER

*Lean  
on me  
Body Works*

LEAN ON ME BODY WORKS, INC. (NEW YORK CORPORATION)  
85 LIVINGSTON STREET  
BROOKLYN, NY 11201

FOR: BOTTLES, SOLD EMPTY; PLASTIC WATER BOTTLES SOLD EMPTY; SPORTS BOTTLES SOLD EMPTY; SQUEEZE BOTTLE SOLD EMPTY, IN CLASS 21 (U.S. CLS. 2, 13, 23, 29, 30, 33, 40 AND 50).

FIRST USE 1-1-2000; IN COMMERCE 1-1-2000.

FOR: SHORT-SLEEVED OR LONG-SLEEVED T-SHIRTS; T-SHIRTS; CREWNECK SWEATERS; SWEATERS; V-NECK SWEATERS; HATS; HEADGEAR, NAMELY, BASEBALL HATS; JACKETS; SPORTS JACKETS, IN CLASS 25 (U.S. CLS. 22 AND 39).

FIRST USE 1-1-2000; IN COMMERCE 1-1-2000.

FOR: ARRANGING PROFESSIONAL WORKSHOP AND TRAINING COURSES; PERSONAL TRAINING SERVICES, NAMELY, STRENGTH AND CONDITIONING TRAINING; PROVIDING ASSISTANCE, PERSONAL TRAINING AND PHYSICAL FITNESS CONSULTATION TO CORPORATE CLIENTS TO HELP THEIR EMPLOYEES MAKE PHYSICAL FITNESS, STRENGTH, CONDITIONING, AND EXERCISE ALTERATIONS IN THEIR DAILY LIVING; PROVIDING ASSISTANCE, PERSONAL TRAINING AND PHYSICAL FITNESS CONSULTATION TO INDIVIDUALS TO HELP THEM MAKE PHYSICAL FITNESS, STRENGTH, CONDITIONING, AND EXERCISE IMPROVEMENT IN

THEIR DAILY LIVING; PROVIDING INFORMATION IN THE FIELD OF EXERCISE TRAINING; PROVIDING ON-LINE TRAINING PROGRAMS IN THE FIELD OF PERSONAL FITNESS, IN CLASS 41 (U.S. CLS. 100, 101 AND 107).

FIRST USE 1-1-2000; IN COMMERCE 1-1-2000.

FOR: CONSULTING TO INDIVIDUALS AND COMMUNITIES ENGAGED IN GROUP WEIGHT LOSS PROGRAMS; WEIGHT REDUCTION DIET PLANNING AND SUPERVISION; HEALTH SPA SERVICES FOR HEALTH AND WELLNESS OF THE MIND, BODY AND SPIRIT OFFERED IN OR FROM A REMOTE, MOBILE OR TEMPORARY ON-SITE LOCATION; HEALTH SPA SERVICES, NAMELY, COSMETIC BODY CARE SERVICES, IN CLASS 44 (U.S. CLS. 100 AND 101).

FIRST USE 1-1-2000; IN COMMERCE 1-1-2000.

NO CLAIM IS MADE TO THE EXCLUSIVE RIGHT TO USE "BODY", APART FROM THE MARK AS SHOWN.

THE MARK CONSISTS OF THE LITERAL ELEMENT WITH WITH THE LARGER "L" AND THE EMPHASIZED SERIFS ON THE "L," "B," "W," AND "K."

SER. NO. 77-393,100, FILED 2-9-2008.

MARGERY A. TIERNEY, EXAMINING ATTORNEY

Int. Cl.: 41

Prior U.S. Cls.: 100, 101 and 107

United States Patent and Trademark Office

Reg. No. 3,504,496

Registered Sep. 23, 2008

**SERVICE MARK  
PRINCIPAL REGISTER**



EB PEDIATRIC RESOURCES INC (ILLINOIS CORPORATION)

3712 N BROADWAY #250

CHICAGO, IL 60613

FOR: EDUCATION SERVICES, NAMELY, PROVIDING ONE-ON-ONE DIRECT TUTORING AND WORKSHOPS FOR CHILDREN WITH DEVELOPMENTAL DELAYS IN THE FIELDS OF COGNITIVE, COMMUNICATION AND SOCIAL-EMOTIONAL DEVELOPMENT THROUGH THERAPEUTIC PLAY; EDUCATIONAL SERVICES, NAMELY, CONDUCTING PROGRAMS IN THE FIELD OF CHILD DEVELOPMENT; INFORMATION IN THE FIELD OF PARENTING CONCERNING EDUCATION OF CHILDREN, IN CLASS 41 (U.S. CLS. 100, 101 AND 107).

FIRST USE 10-15-2006; IN COMMERCE 12-15-2007.

NO CLAIM IS MADE TO THE EXCLUSIVE RIGHT TO USE "LEARNING THROUGH PLAY", APART FROM THE MARK AS SHOWN.

THE COLOR(S) DARK BLUE, DARK PINK, GREEN, LIGHT BLUE IS/ARE CLAIMED AS A FEATURE OF THE MARK.

THE MARK CONSISTS OF RAINBOW GRAPHIC WITH (IN DESCENDING ORDER) DARK BLUE, DARK PINK, GREEN, LIGHT BLUE COLORS WITH TWO HANDPRINTS BELOW-TWO GREEN PRINTS ON THE LEFT END AND TWO DARK PINK PRINTS ON THE RIGHT END-AND BELOW THAT IS THE WORDING, "LEARNING THROUGH PLAY" IN DARK BLUE.

SER. NO. 77-393,140, FILED 2-9-2008.

JESSICA A. POWERS, EXAMINING ATTORNEY



**Int. Cl.: 25**

**Prior U.S. Cls.: 22 and 39**

**United States Patent and Trademark Office**

**Reg. No. 3,504,497**

**Registered Sep. 23, 2008**

**TRADEMARK  
PRINCIPAL REGISTER**

humanTHREADZ

LAPISH, ROY W (UNITED STATES INDIVIDUAL)  
1429 CAMBRIDGE DR.  
LAPLACE, LA 70068

THE MARK CONSISTS OF STANDARD CHARACTERS WITHOUT CLAIM TO ANY PARTICULAR FONT, STYLE, SIZE, OR COLOR.

FOR: T-SHIRTS, IN CLASS 25 (U.S. CLS. 22 AND 39).

SER. NO. 77-393,146, FILED 2-9-2008.

FIRST USE 1-16-2007; IN COMMERCE 1-16-2007.

THOMAS MANOR, EXAMINING ATTORNEY

**Int. Cl.: 5**

**Prior U.S. Cls.: 6, 18, 44, 46, 51 and 52**

**United States Patent and Trademark Office**

**Reg. No. 3,504,498**

**Registered Sep. 23, 2008**

**TRADEMARK  
PRINCIPAL REGISTER**

**THRUSH OFF**

FERNANDEZ, JORGE, J (PERU INDIVIDUAL)  
135 NAOMI  
PISMO BEACH, CA 93449

FOR: VETERINARY PREPARATIONS FOR  
TREATING THRUSH ON HORSES, IN CLASS 5  
(U.S. CLS. 6, 18, 44, 46, 51 AND 52).

FIRST USE 10-26-2007; IN COMMERCE 10-26-2007.

THE MARK CONSISTS OF STANDARD CHAR-  
ACTERS WITHOUT CLAIM TO ANY PARTICULAR  
FONT, STYLE, SIZE, OR COLOR.

NO CLAIM IS MADE TO THE EXCLUSIVE  
RIGHT TO USE "THRUSH", APART FROM THE  
MARK AS SHOWN.

SER. NO. 77-393,245, FILED 2-10-2008.

INGRID C. EULIN, EXAMINING ATTORNEY

**Int. Cl.: 39**

**Prior U.S. Cls.: 100 and 105**

**United States Patent and Trademark Office**

**Reg. No. 3,504,499**

**Registered Sep. 23, 2008**

**SERVICE MARK  
PRINCIPAL REGISTER**



APPLIED ANSWERS, INC. (GEORGIA CORPORATION)  
3672 MAPLE VALLEY DRIVE  
BUFORD, GA 30519

FOR: ELECTRONIC STORAGE OF FILES AND DOCUMENTS, IN CLASS 39 (U.S. CLS. 100 AND 105).

FIRST USE 2-8-2008; IN COMMERCE 2-8-2008.

THE COLOR(S) BLACK, WHITE, YELLOW AND GRAY IS/ARE CLAIMED AS A FEATURE OF THE MARK.

THE MARK CONSISTS OF A GRAY-OUTLINED HEAD SHAPED AS A LIGHT BULB WITH WHITE EYES, A GRAY MOUTH AT LIGHT BULB BASE, AND A GRAY-SCALE DOCUMENT GOING INTO THE TOP OF THE HEAD. THE COLOR YELLOW APPEARS AS THE FACE AND HEAD. BELOW THE LIGHT BULB IS THE BLACK WORDING "FILE-GENIUS". THE MARK APPEARS AGAINST A TRANSPARENT BACKGROUND.

SER. NO. 77-393,288, FILED 2-10-2008.

KIM MONINGHOFF, EXAMINING ATTORNEY

**Int. Cl.: 25**

**Prior U.S. Cls.: 22 and 39**

**United States Patent and Trademark Office**

**Reg. No. 3,504,500**

**Registered Sep. 23, 2008**

**TRADEMARK  
PRINCIPAL REGISTER**

**PLUMPLIPS**

SPECCHIO CO., LTD. (JAPAN CORPORATION)  
3-3-22, KOMABA MEGURO-KU  
TOKYO, JAPAN 153-0041

FOR: CLOTHING, NAMELY, TOPS, PANTS, SHORTS, T-SHIRTS, BLOUSE, TANK TOPS, VESTS, SWEAT SHIRTS, JERSEYS, PULLOVERS, SWEAT PANTS, SKIRTS, DRESSES, SUITS, RAINWEAR, SWEAT SUITS, WARM UP SUITS, SKI SUITS, JUMP SUITS, AND BELTS, CAPS AND HATS, GLOVES, UNDERWEAR, BRASSIERES, PANTY HOSE, PANTIES, HOSIERY, STOCKINGS, SOCKS, TIGHTS, LEOTARDS, LEG WARMERS, PAJAMAS, ROBES, NIGHTSHIRTS, NIGHT GOWNS, SWIM SUITS, NECKTIE, BELTS, SCARVES, GLOVES, AND WRIST BANDS, JACKETS, COATS, SWEATERS, BOXER

SHORTS, UNDERSHIRTS, SUSPENDERS, GARTER BELTS, HEAD BANDS, WAIST BELTS, FOOTWEAR, MASQUERADE COSTUMES, AND ATHLETIC SHOES, IN CLASS 25 (U.S. CLS. 22 AND 39).

THE MARK CONSISTS OF STANDARD CHARACTERS WITHOUT CLAIM TO ANY PARTICULAR FONT, STYLE, SIZE, OR COLOR.

OWNER OF JAPAN REG. NO. 4809561, DATED 10-8-2004, EXPIRES 10-8-2014.

SER. NO. 77-393,393, FILED 2-11-2008.

KATHERINE STOIDES, EXAMINING ATTORNEY

**Int. Cl.: 36**

**Prior U.S. Cls.: 100, 101 and 102**

**United States Patent and Trademark Office**

**Reg. No. 3,504,501**

**Registered Sep. 23, 2008**

---

**SERVICE MARK  
PRINCIPAL REGISTER**

**InsReserve**

MOREHEAD GROUP, INC., THE (NORTH CAROLINA CORPORATION)  
SUITE 150  
521 E. MOREHEAD STREET  
CHARLOTTE, NC 28202

THE MARK CONSISTS OF STANDARD CHARACTERS WITHOUT CLAIM TO ANY PARTICULAR FONT, STYLE, SIZE, OR COLOR.

FOR: INSURANCE AND FINANCIAL INFORMATION AND CONSULTING SERVICES, IN CLASS 36 (U.S. CLS. 100, 101 AND 102).

SER. NO. 77-393,395, FILED 2-11-2008.

FIRST USE 12-15-2007; IN COMMERCE 12-15-2007.

KATHERINE STOIDES, EXAMINING ATTORNEY

**Int. Cl.: 35**

**Prior U.S. Cls.: 100, 101 and 102**

**United States Patent and Trademark Office**

**Reg. No. 3,504,502**

**Registered Sep. 23, 2008**

**SERVICE MARK  
PRINCIPAL REGISTER**



ROBEPROBE, LLC (NEW JERSEY LIMITED LIABILITY COMPANY)  
259 UNION STREET  
HACKENSACK, NJ 07601

FOR: PROVIDING A WEB SITE WHERE USERS CAN POST RATINGS, REVIEWS AND RECOMMENDATIONS ON PRODUCTS AND SERVICES, IN CLASS 35 (U.S. CLS. 100, 101 AND 102).

FIRST USE 3-1-2006; IN COMMERCE 3-1-2006.

THE MARK CONSISTS OF MAGNIFYING GLASS OVER GAVEL WITH 5 STARS IN A SEMI-CIRCLE BETWEEN THE HANDLES OF THE GAVEL AND MAGNIFYING GLASS.

SER. NO. 77-393,469, FILED 2-11-2008.

TARA PATE, EXAMINING ATTORNEY

**Int. Cl.: 30**

**Prior U.S. Cl.: 46**

**United States Patent and Trademark Office**

**Reg. No. 3,504,503**

**Registered Sep. 23, 2008**

**TRADEMARK  
PRINCIPAL REGISTER**

**UTZ HOOPS MIX**

RICE INVESTMENTS, LP (DELAWARE LIMITED  
PARTNERSHIP)  
900 HIGH STREET  
HANOVER, PA 17331

OWNER OF U.S. REG. NOS. 878,317, 3,330,226 AND  
OTHERS.

FOR: SNACK MIX CONSISTING PRIMARILY OF  
WHEAT, RICE AND CORN BASED CRACKERS  
AND PRETZELS, IN CLASS 30 (U.S. CL. 46).

NO CLAIM IS MADE TO THE EXCLUSIVE  
RIGHT TO USE "MIX", APART FROM THE MARK  
AS SHOWN.

FIRST USE 1-29-2008; IN COMMERCE 1-29-2008.

SER. NO. 77-393,472, FILED 2-11-2008.

THE MARK CONSISTS OF STANDARD CHAR-  
ACTERS WITHOUT CLAIM TO ANY PARTICULAR  
FONT, STYLE, SIZE, OR COLOR.

INGRID C. EULIN, EXAMINING ATTORNEY

**Int. Cls.: 35 and 36**

**Prior U.S. Cls.: 100, 101 and 102**

**United States Patent and Trademark Office**

**Reg. No. 3,504,504**

**Registered Sep. 23, 2008**

**SERVICE MARK  
PRINCIPAL REGISTER**



GOLDEN POND, LLC (SOUTH CAROLINA LIMITED LIABILITY COMPANY)  
1200 WOODRUFF ROAD, SUITE G13  
GREENVILLE, SC 29602

FOR: PROVIDING NON-TRADITIONAL BUSINESS PAYROLL SERVICES FOR OTHERS THROUGH A MOBILE PLATFORM, NAMELY, PAYROLL DELIVERY SERVICES IN THE NATURE OF THE ADMINISTRATION OF BUSINESS PAYROLL FOR OTHERS, AND PAYROLL FULFILLMENT SERVICES IN THE NATURE OF PAYROLL PROCESSING SERVICES, IN CLASS 35 (U.S. CLS. 100, 101 AND 102).

FIRST USE 1-31-2008; IN COMMERCE 1-31-2008.

FOR: PROVIDING NON-TRADITIONAL FINANCIAL SERVICES THROUGH A MOBILE PLATFORM, NAMELY, PROVIDING REMOTE CHECK CASHING, AUTOMATED TELLER MACHINES (ATMS), AND PREPAID DEBIT CARDS, IN CLASS 36 (U.S. CLS. 100, 101 AND 102).

FIRST USE 1-31-2008; IN COMMERCE 1-31-2008.

THE MARK CONSISTS OF THE CHARACTERS "B2E" AND A VEHICLE WITH AN EMBEDDED ARROW.

SER. NO. 77-393,550, FILED 2-11-2008.

KATINA MISTER, EXAMINING ATTORNEY



**Int. Cls.: 35 and 36**

**Prior U.S. Cls.: 100, 101 and 102**

**United States Patent and Trademark Office**

**Reg. No. 3,504,505**

**Registered Sep. 23, 2008**

**SERVICE MARK  
PRINCIPAL REGISTER**

**B2E**

GOLDEN POND, LLC (SOUTH CAROLINA LIMITED LIABILITY COMPANY)  
1200 WOODRUFF ROAD, SUITE G13  
GREENVILLE, SC 29607

FOR: PROVIDING NON-TRADITIONAL BUSINESS PAYROLL SERVICES FOR OTHERS THROUGH A MOBILE PLATFORM, NAMELY, PAYROLL DELIVERY SERVICES IN THE NATURE OF THE ADMINISTRATION OF BUSINESS PAYROLL FOR OTHERS, AND PAYROLL FULFILLMENT SERVICES IN THE NATURE OF PAYROLL PROCESSING SERVICES, IN CLASS 35 (U.S. CLS. 100, 101 AND 102).

FIRST USE 1-31-2008; IN COMMERCE 1-31-2008.

FOR: PROVIDING NON-TRADITIONAL FINANCIAL SERVICES THROUGH A MOBILE PLATFORM, NAMELY, PROVIDING REMOTE CHECK CASHING, AUTOMATED TELLER MACHINES (ATMS), AND PREPAID DEBIT CARDS, IN CLASS 36 (U.S. CLS. 100, 101 AND 102).

FIRST USE 1-31-2008; IN COMMERCE 1-31-2008.

THE MARK CONSISTS OF STANDARD CHARACTERS WITHOUT CLAIM TO ANY PARTICULAR FONT, STYLE, SIZE, OR COLOR.

SER. NO. 77-393,553, FILED 2-11-2008.

KATINA MISTER, EXAMINING ATTORNEY

**Int. Cls.: 7, 35 and 39**

**Prior U.S. Cls.: 13, 19, 21, 23, 31, 34, 35, 100, 101, 102  
and 105**

**Reg. No. 3,504,506**

**United States Patent and Trademark Office**

**Registered Sep. 23, 2008**

**TRADEMARK  
SERVICE MARK  
PRINCIPAL REGISTER**



ISTOBAL, S.A. (SPAIN CORPORATION)  
AV. CONDE DEL SERRALLO 10  
L ALCUDIA, VALENCIA, SPAIN 46259

FOR: MACHINES AND APPARATUS FOR HIGH-PRESSURE LUBRICATION, NAMELY, LUBRICATING PUMPS; MACHINES AND APPARATUS FOR PAINTING THE UNDERSIDES OF MOTOR VEHICLES, NAMELY, PAINTING MACHINES; MOTOR VEHICLE LIFTS HYDRAULIC JACKS; VEHICLE WASHES, NAMELY, VEHICLE WASHING MACHINES, IN CLASS 7 (U.S. CLS. 13, 19, 21, 23, 31, 34 AND 35).

FOR: IMPORT AND EXPORT AGENCIES IN THE FIELD OF VEHICLE WASHING MACHINERY, VEHICLE LUBRICATION MACHINERY AND VEHICLE PAINTING MACHINES VIA A GLOBAL COMPUTER NETWORK; AND DISTRIBUTORSHIPS SERVICES IN THE FIELD OF VEHICLE WASHING MACHINERY, VEHICLE LUBRICATION MACHINERY AND VEHICLE PAINTING MACHINES, IN CLASS 35 (U.S. CLS. 100, 101 AND 102).

FOR: TRANSPORT, STORAGE AND DELIVERY OF VEHICLE WASHING MACHINERY, VEHICLE LUBRICATION MACHINERY AND VEHICLE

PAINTING MACHINES, IN CLASS 39 (U.S. CLS. 100 AND 105).

OWNER OF ERPN CMNTY TM OFC REG. NO. 004769949, DATED 12-14-2006, EXPIRES 11-11-2015.

NO CLAIM IS MADE TO THE EXCLUSIVE RIGHT TO USE "AUTOMOTIVE CLEANING SOLUTIONS", APART FROM THE MARK AS SHOWN.

THE COLOR(S) RED, BLUE, WHITE IS/ARE CLAIMED AS A FEATURE OF THE MARK.

THE MARK CONSISTS OF THE WORDING "ISTOBAL" IN RED LETTERS, ON THE LEFT OF THE WORDING IS A BAND IN RED AND ANOTHER IN BLUE WITH THE WORDING "AUTOMOTIVE CLEANING SOLUTIONS" APPEARING IN BLUE LETTERS BELOW THE WORDING "ISTOBAL", ALL APPEARING WITH A WHITE BACKGROUND.

SER. NO. 77-393,584, FILED 2-11-2008.

SAMUEL E. SHARPER JR., EXAMINING ATTORNEY

**Int. Cl.: 21**

**Prior U.S. Cls.: 2, 13, 23, 29, 30, 33, 40 and 50**

**Reg. No. 3,504,507**

**United States Patent and Trademark Office**

**Registered Sep. 23, 2008**

---

**TRADEMARK  
PRINCIPAL REGISTER**

# Nursing Nanny

NURSING NANNY LLC (LOUISIANA LIMITED  
LIABILITY COMPANY)

1110 AUDUBON AVE. #9,

THIBODAUX, LA 70301

FOR: SMALL ANIMAL FEEDERS, IN CLASS 21  
(U.S. CLS. 2, 13, 23, 29, 30, 33, 40 AND 50).

FIRST USE 6-29-2007; IN COMMERCE 6-29-2007.

THE MARK CONSISTS OF STANDARD CHAR-  
ACTERS WITHOUT CLAIM TO ANY PARTICULAR  
FONT, STYLE, SIZE, OR COLOR.

NO CLAIM IS MADE TO THE EXCLUSIVE  
RIGHT TO USE "NURSING", APART FROM THE  
MARK AS SHOWN.

SER. NO. 77-393,647, FILED 2-11-2008.

LIEF MARTIN, EXAMINING ATTORNEY

**Int. Cl.: 43**

**Prior U.S. Cls.: 100 and 101**

**United States Patent and Trademark Office**

**Reg. No. 3,504,508**

**Registered Sep. 23, 2008**

**SERVICE MARK  
PRINCIPAL REGISTER**



NEW YORK - NEW YORK HOTEL & CASINO,  
LLC (NEVADA LIMITED LIABILITY COMPA-  
NY)  
3950 LAS VEGAS BOULEVARD SOUTH  
LAS VEGAS, NV 89119

THE MARK CONSISTS OF THE WORD "POUR"  
WRITTEN VERTICALLY ON THE LEFT SIDE OF  
THE NUMBERS "24".

FOR: BAR; COCKTAIL LOUNGE SERVICES, IN  
CLASS 43 (U.S. CLS. 100 AND 101).

SER. NO. 77-393,895, FILED 2-11-2008.

FIRST USE 11-20-2007; IN COMMERCE 11-20-2007.

MICHAEL LITZAU, EXAMINING ATTORNEY

**Int. Cl.: 9**

**Prior U.S. Cls.: 21, 23, 26, 36 and 38**

**United States Patent and Trademark Office**

**Reg. No. 3,504,509**

**Registered Sep. 23, 2008**

**TRADEMARK  
PRINCIPAL REGISTER**

**REGIN**

REGIN HVAC PRODUCTS, INC. (CONNECTICUT CORPORATION)  
315 RIGGS STREET, UNIT 1  
OXFORD, CT 06478

FOR: AEROSOL SPRAY FOR TESTING THE FUNCTION AND EFFECTIVENESS OF SMOKE DETECTORS, CARBON MONOXIDE DETECTORS AND HEAT DETECTORS; FLOW METERS; ELECTRIC VALVE ACTUATORS; ELECTRONIC SERVO MOTOR CONTROLLERS; ELECTRONIC-BASED INSTRUMENTS FOR MEASURING ENVIRONMENTAL PARAMETERS INCLUDING HUMIDITY, MOLD, BACTERIA, AIR QUALITY AND WATER QUALITY; WIRELESS REMOTE TEMPERATURE AND HUMIDITY MONITORS FOR BUILDING

MAINTENANCE; MEASURING AND CONTROL DEVICES FOR AIR CONDITIONING TECHNOLOGY, IN CLASS 9 (U.S. CLS. 21, 23, 26, 36 AND 38).

FIRST USE 3-1-1986; IN COMMERCE 3-1-1986.

THE MARK CONSISTS OF STANDARD CHARACTERS WITHOUT CLAIM TO ANY PARTICULAR FONT, STYLE, SIZE, OR COLOR.

SER. NO. 77-393,935, FILED 2-11-2008.

AMOS T. MATTHEWS, JR., EXAMINING ATTORNEY

Int. Cl.: 36

Prior U.S. Cls.: 100, 101 and 102

United States Patent and Trademark Office

Reg. No. 3,504,510

Registered Sep. 23, 2008

**SERVICE MARK  
PRINCIPAL REGISTER**



DR. CREDIT USA, INC. (FLORIDA CORPORATION)  
SUITE 4A  
195 BLANDING BOULEVARD  
ORANGE PARK, FL 32703

FOR: PROVIDING CREDIT REPORT CORRECTION SERVICES TO OTHERS, IN CLASS 36 (U.S. CLS. 100, 101 AND 102).

FIRST USE 7-31-2006; IN COMMERCE 7-31-2006.

OWNER OF U.S. REG. NO. 3,301,307.

NO CLAIM IS MADE TO THE EXCLUSIVE RIGHT TO USE "CREDIT", APART FROM THE MARK AS SHOWN.

THE MARK CONSISTS OF A DOG WEARING COLLAR WITH THE NAME "BETTY" ON IT STANDING NEXT TO A SMILING MAN DRESSED AS A DOCTOR HOLDING A CLIPBOARD WITH A PIECE OF PAPER THAT HAS A CHECK MARK AND THE WORD "CREDIT" ON IT. THE MAN IS HOLDING A BAG WITH A DEPICTION OF PAPER MONEY EXTRUDING FROM THE BAG AND THE PHRASE "DR. CREDIT" APPEARING ON THE BAG ITSELF.

SER. NO. 77-393,953, FILED 2-11-2008.

JACLYN KIDWELL, EXAMINING ATTORNEY

**Int. Cl.: 41**

**Prior U.S. Cls.: 100, 101 and 107**

**United States Patent and Trademark Office**

**Reg. No. 3,504,511**

**Registered Sep. 23, 2008**

**SERVICE MARK  
PRINCIPAL REGISTER**

**FRANK'S-TGIRLWORLD**

SMY WEB IP, INC. (FLORIDA CORPORATION)  
770 KAPIOLANI BLVD.  
#514  
HONOLULU, HI 96813

FOR: ENTERTAINMENT SERVICES, NAMELY,  
PROVIDING A WEB SITE FEATURING PHOTO-  
GRAPHIC, AUDIO, VIDEO AND PROSE PRESEN-  
TATIONS FEATURING ADULT  
ENTERTAINMENT, IN CLASS 41 (U.S. CLS. 100,  
101 AND 107).

FIRST USE 7-18-2002; IN COMMERCE 10-19-2002.

THE MARK CONSISTS OF STANDARD CHAR-  
ACTERS WITHOUT CLAIM TO ANY PARTICULAR  
FONT, STYLE, SIZE, OR COLOR.

SER. NO. 77-393,986, FILED 2-11-2008.

GINA FINK, EXAMINING ATTORNEY

**Int. Cl.: 44**

**Prior U.S. Cls.: 100 and 101**

**United States Patent and Trademark Office**

**Reg. No. 3,504,512**

**Registered Sep. 23, 2008**

**SERVICE MARK  
PRINCIPAL REGISTER**

**ALOHA TATTOO**

ALOHA TATTOO, INC. (HAWAII CORPORATION)

318-B KUULEI ROAD

KAILUA, HI 96734

FOR: TATTOOING, IN CLASS 44 (U.S. CLS. 100 AND 101).

FIRST USE 1-1-1990; IN COMMERCE 1-1-1990.

THE MARK CONSISTS OF STANDARD CHARACTERS WITHOUT CLAIM TO ANY PARTICULAR FONT, STYLE, SIZE, OR COLOR.

NO CLAIM IS MADE TO THE EXCLUSIVE RIGHT TO USE "TATTOO", APART FROM THE MARK AS SHOWN.

SER. NO. 77-394,017, FILED 2-11-2008.

ELIZABETH KAJUBI, EXAMINING ATTORNEY



**Int. Cls.: 9 and 41**

**Prior U.S. Cls.: 21, 23, 26, 36, 38, 100, 101 and 107**

**United States Patent and Trademark Office**

**Reg. No. 3,504,513**

**Registered Sep. 23, 2008**

**TRADEMARK  
SERVICE MARK  
PRINCIPAL REGISTER**

**METHODS IN MOLECULAR  
MEDICINE**

SPRINGER-VERLAG GMBH (FED REP GERMA-  
NY LIMITED LIABILITY COMPANY)  
TIERGARTENSTR. 17  
HEIDELBERG, FED REP GERMANY D-69121

FOR: DOWNLOADABLE ELECTRONIC PUBLI-  
CATIONS IN THE NATURE OF A SERIES OF  
BOOKS IN THE FIELD OF SCIENCE AND MEDI-  
CINE, IN CLASS 9 (U.S. CLS. 21, 23, 26, 36 AND 38).

FIRST USE 6-0-2002; IN COMMERCE 6-0-2002.

FOR: ON-LINE PUBLICATION OF BOOKS IN  
THE FIELD OF SCIENCE AND MEDICINE, IN  
CLASS 41 (U.S. CLS. 100, 101 AND 107).

FIRST USE 6-0-2003; IN COMMERCE 6-0-2003.

THE MARK CONSISTS OF STANDARD CHAR-  
ACTERS WITHOUT CLAIM TO ANY PARTICULAR  
FONT, STYLE, SIZE, OR COLOR.

NO CLAIM IS MADE TO THE EXCLUSIVE  
RIGHT TO USE "MOLECULAR MEDICINE",  
APART FROM THE MARK AS SHOWN.

SEC. 2(F).

SER. NO. 77-394,091, FILED 2-11-2008.

JASON LOTT, EXAMINING ATTORNEY

**Int. Cls.: 9 and 41**

**Prior U.S. Cls.: 21, 23, 26, 36, 38, 100, 101 and 107**

**Reg. No. 3,504,514**

**United States Patent and Trademark Office**

**Registered Sep. 23, 2008**

**TRADEMARK  
SERVICE MARK  
PRINCIPAL REGISTER**

**METHODS IN BIOTECHNOLOGY**

SPRINGER-VERLAG GMBH (FED REP GERMA-  
NY LIMITED LIABILITY COMPANY)  
TIERGARTENSTR. 17  
HEIDELBERG, FED REP GERMANY D-69121

THE MARK CONSISTS OF STANDARD CHAR-  
ACTERS WITHOUT CLAIM TO ANY PARTICULAR  
FONT, STYLE, SIZE, OR COLOR.

FOR: DOWNLOADABLE ELECTRONIC PUBLI-  
CATIONS IN THE NATURE OF A SERIES OF  
BOOKS IN THE FIELD OF SCIENCE , IN CLASS 9  
(U.S. CLS. 21, 23, 26, 36 AND 38).

NO CLAIM IS MADE TO THE EXCLUSIVE  
RIGHT TO USE "BIOTECHNOLOGY", APART  
FROM THE MARK AS SHOWN.

FIRST USE 6-0-2002; IN COMMERCE 6-0-2002.

SEC. 2(F).

FOR: ON-LINE PUBLICATION OF BOOKS IN  
THE FIELD OF SCIENCE, IN CLASS 41 (U.S. CLS.  
100, 101 AND 107).

SER. NO. 77-394,114, FILED 2-11-2008.

FIRST USE 9-0-2006; IN COMMERCE 9-0-2006.

JASON LOTT, EXAMINING ATTORNEY

**Int. Cls.: 9 and 41**

**Prior U.S. Cls.: 21, 23, 26, 36, 38, 100, 101 and 107**

**Reg. No. 3,504,515**

**United States Patent and Trademark Office**

**Registered Sep. 23, 2008**

**TRADEMARK  
SERVICE MARK  
PRINCIPAL REGISTER**

**METHODS IN PHARMACOLOGY  
AND TOXICOLOGY**

SPRINGER-VERLAG GMBH (FED REP GERMA-  
NY LIMITED LIABILITY COMPANY)  
TIERGARTENSTR. 17  
HEIDELBERG, FED REP GERMANY D-69121

THE MARK CONSISTS OF STANDARD CHAR-  
ACTERS WITHOUT CLAIM TO ANY PARTICULAR  
FONT, STYLE, SIZE, OR COLOR.

FOR: DOWNLOADABLE ELECTRONIC PUBLI-  
CATIONS IN THE NATURE OF A SERIES OF  
BOOKS IN THE FIELD OF SCIENCE , IN CLASS 9  
(U.S. CLS. 21, 23, 26, 36 AND 38).

NO CLAIM IS MADE TO THE EXCLUSIVE  
RIGHT TO USE "PHARMACOLOGY AND TOXI-  
COLOGY", APART FROM THE MARK AS SHOWN.

FIRST USE 6-0-2002; IN COMMERCE 6-0-2002.

SEC. 2(F).

FOR: ON-LINE PUBLICATION OF BOOKS IN  
THE FIELD OF SCIENCE, IN CLASS 41 (U.S. CLS.  
100, 101 AND 107).

SER. NO. 77-394,130, FILED 2-11-2008.

FIRST USE 9-0-2006; IN COMMERCE 9-0-2006.

JASON LOTT, EXAMINING ATTORNEY

**Int. Cl.: 44**

**Prior U.S. Cls.: 100 and 101**

**United States Patent and Trademark Office**

**Reg. No. 3,504,516**

**Registered Sep. 23, 2008**

**SERVICE MARK  
PRINCIPAL REGISTER**

**TAN MAKERS**

TAN MAKERS ATASCOCITA INC (TEXAS CORPORATION)

18927 FOREST TRACE DR.

HUMBLE, TX 77346

FOR: TANNING SALONS, IN CLASS 44 (U.S. CLS. 100 AND 101).

FIRST USE 8-1-1992; IN COMMERCE 8-1-1992.

THE MARK CONSISTS OF STANDARD CHARACTERS WITHOUT CLAIM TO ANY PARTICULAR FONT, STYLE, SIZE, OR COLOR.

NO CLAIM IS MADE TO THE EXCLUSIVE RIGHT TO USE "TAN", APART FROM THE MARK AS SHOWN.

SER. NO. 77-394,137, FILED 2-11-2008.

ELLEN PERKINS, EXAMINING ATTORNEY

**Int. Cls.: 9 and 41**

**Prior U.S. Cls.: 21, 23, 26, 36, 38, 100, 101 and 107**

**United States Patent and Trademark Office**

**Reg. No. 3,504,517**

**Registered Sep. 23, 2008**

**TRADEMARK  
SERVICE MARK  
PRINCIPAL REGISTER**

**NEUROMETHODS**

SPRINGER-VERLAG GMBH (FED REP GERMA-  
NY LIMITED LIABILITY COMPANY)  
TIERGARTENSTR. 17  
HEIDELBERG, FED REP GERMANY D-69121

FOR: DOWNLOADABLE ELECTRONIC PUBLI-  
CATIONS IN THE NATURE OF A SERIES OF  
BOOKS IN THE FIELD OF SCIENCE , IN CLASS 9  
(U.S. CLS. 21, 23, 26, 36 AND 38).

FIRST USE 6-0-2002; IN COMMERCE 6-0-2002.

FOR: ON-LINE PUBLICATION OF BOOKS IN  
THE FIELD OF SCIENCE, IN CLASS 41 (U.S. CLS.  
100, 101 AND 107).

FIRST USE 6-0-2003; IN COMMERCE 6-0-2003.

THE MARK CONSISTS OF STANDARD CHAR-  
ACTERS WITHOUT CLAIM TO ANY PARTICULAR  
FONT, STYLE, SIZE, OR COLOR.

SEC. 2(F).

SER. NO. 77-394,150, FILED 2-11-2008.

JASON LOTT, EXAMINING ATTORNEY

**Int. Cl.: 37**

**Prior U.S. Cls.: 100, 103 and 106**

**United States Patent and Trademark Office**

**Reg. No. 3,504,518**

**Registered Sep. 23, 2008**

**SERVICE MARK  
PRINCIPAL REGISTER**

**Home Perfect  
Perfection in Painting**

HOME PERFECT, INC. (NEVADA CORPORATION)  
884 FREEPORT BLVD.  
SPARKS, NV 89431

THE MARK CONSISTS OF STANDARD CHARACTERS WITHOUT CLAIM TO ANY PARTICULAR FONT, STYLE, SIZE, OR COLOR.

FOR: CONSULTATION RELATING TO PAINTING OF BUILDINGS; HOUSE PAINTING; PAINTING; PAINTING AND VARNISHING; PAINTING CONTRACTOR SERVICES; PAINTING IN THE FIELD OF RESIDENTIAL AND COMMERCIAL BUILDINGS, IN CLASS 37 (U.S. CLS. 100, 103 AND 106).

NO CLAIM IS MADE TO THE EXCLUSIVE RIGHT TO USE "HOME", APART FROM THE MARK AS SHOWN.

SER. NO. 77-394,271, FILED 2-11-2008.

FIRST USE 4-20-2005; IN COMMERCE 4-20-2005.

ANDREA BUTLER, EXAMINING ATTORNEY

**Int. Cl.: 35**

**Prior U.S. Cls.: 100, 101 and 102**

**United States Patent and Trademark Office**

**Reg. No. 3,504,519**

**Registered Sep. 23, 2008**

**SERVICE MARK  
PRINCIPAL REGISTER**

**REAL MOTORCARS**

REAL MOTORCARS, INC. (FLORIDA CORPORATION)

3125 CRILL AVENUE

PALATKA, FL 32177

FOR: AUTOMOBILE DEALERSHIPS, IN CLASS 35  
(U.S. CLS. 100, 101 AND 102).

FIRST USE 0-0-2000; IN COMMERCE 0-0-2000.

THE MARK CONSISTS OF STANDARD CHARACTERS WITHOUT CLAIM TO ANY PARTICULAR FONT, STYLE, SIZE, OR COLOR.

NO CLAIM IS MADE TO THE EXCLUSIVE RIGHT TO USE "MOTORCARS", APART FROM THE MARK AS SHOWN.

SER. NO. 77-394,326, FILED 2-11-2008.

HANNO RITTNER, EXAMINING ATTORNEY

**Int. Cl.: 35**

**Prior U.S. Cls.: 100, 101 and 102**

**United States Patent and Trademark Office**

**Reg. No. 3,504,520**

**Registered Sep. 23, 2008**

**SERVICE MARK  
PRINCIPAL REGISTER**



LOYALTY BUILDERS, LLC (NEW HAMPSHIRE  
LIMITED LIABILITY COMPANY)  
ONE HARBOUR PLACE, SUITE 100  
PORTSMOUTH, NH 03801

FIRST USE 9-15-2007; IN COMMERCE 9-15-2007.

OWNER OF U.S. REG. NO. 3,420,588.

FOR: INTERNET-BASED DIRECT MARKETING  
SERVICES; DEVELOPING MARKETING CAM-  
PAIGNS FOR BUSINESS CUSTOMERS, IN CLASS  
35 (U.S. CLS. 100, 101 AND 102).

SER. NO. 77-394,369, FILED 2-12-2008.

KATHERINE CHANG, EXAMINING ATTORNEY



**Int. Cl.: 9**

**Prior U.S. Cls.: 21, 23, 26, 36 and 38**

**Reg. No. 3,504,521**

**United States Patent and Trademark Office**

**Registered Sep. 23, 2008**

**TRADEMARK  
PRINCIPAL REGISTER**

# Elasto Mania

ROZSA, BALAZS (HUNGARY INDIVIDUAL)

CSIKI-HEGYEK U. 16. VII/28.

BUDAPEST, PEST, HUNGARY 1118

FOR: COMPUTER GAME SOFTWARE, IN CLASS  
9 (U.S. CLS. 21, 23, 26, 36 AND 38).

FIRST USE 1-31-2000; IN COMMERCE 1-31-2000.

THE MARK CONSISTS OF STANDARD CHAR-  
ACTERS WITHOUT CLAIM TO ANY PARTICULAR  
FONT, STYLE, SIZE, OR COLOR.

NO CLAIM IS MADE TO THE EXCLUSIVE  
RIGHT TO USE "ELASTO", APART FROM THE  
MARK AS SHOWN.

SER. NO. 77-394,391, FILED 2-12-2008.

TARA PATE, EXAMINING ATTORNEY

**Int. Cl.: 35**

**Prior U.S. Cls.: 100, 101 and 102**

**United States Patent and Trademark Office**

**Reg. No. 3,504,522**

**Registered Sep. 23, 2008**

**SERVICE MARK  
PRINCIPAL REGISTER**

**BEER CASTLE**

LEMBERG ENTERPRISES INC. (NEW YORK  
CORPORATION)  
854 RALPH AVENUE  
BROOKLYN, NY 11236

FOR: DISTRIBUTORSHIP AND RETAIL STORE  
SERVICES IN THE FIELDS OF BEER, SODA, CI-  
GARETTES, CANDY AND PAPER GOODS, IN  
CLASS 35 (U.S. CLS. 100, 101 AND 102).

FIRST USE 3-8-1988; IN COMMERCE 3-8-1988.

THE MARK CONSISTS OF STANDARD CHAR-  
ACTERS WITHOUT CLAIM TO ANY PARTICULAR  
FONT, STYLE, SIZE, OR COLOR.

NO CLAIM IS MADE TO THE EXCLUSIVE  
RIGHT TO USE "BEER", APART FROM THE MARK  
AS SHOWN.

SER. NO. 77-394,427, FILED 2-12-2008.

TRICIA SONNEBORN, EXAMINING ATTORNEY

**Int. Cl.: 44**

**Prior U.S. Cls.: 100 and 101**

**United States Patent and Trademark Office**

**Reg. No. 3,504,523**

**Registered Sep. 23, 2008**

**SERVICE MARK  
PRINCIPAL REGISTER**

**AMERICA TAKES IT OFF**

AOL LLC (DELAWARE LIMITED LIABILITY  
COMPANY)  
22000 AOL WAY  
DULLES, VA 20166

FOR: PROVIDING INFORMATION IN THE  
FIELD OF HEALTH, DIET, NUTRITION, WEIGHT  
MANAGEMENT, AND LIFESTYLE WELLNESS VIA  
THE INTERNET, IN CLASS 44 (U.S. CLS. 100 AND  
101).

FIRST USE 1-1-2006; IN COMMERCE 1-1-2006.

THE MARK CONSISTS OF STANDARD CHAR-  
ACTERS WITHOUT CLAIM TO ANY PARTICULAR  
FONT, STYLE, SIZE, OR COLOR.

SER. NO. 77-394,512, FILED 2-12-2008.

MARK SPARACINO, EXAMINING ATTORNEY

Int. Cl.: 41

Prior U.S. Cls.: 100, 101 and 107

United States Patent and Trademark Office

Reg. No. 3,504,524

Registered Sep. 23, 2008

SERVICE MARK  
PRINCIPAL REGISTER

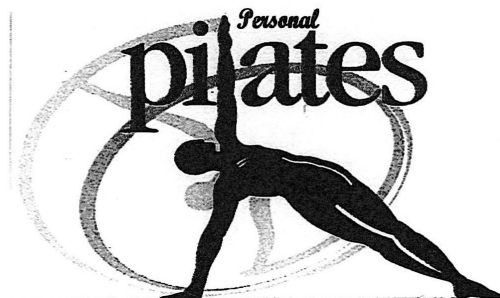

ZEOLI, RENEE (UNITED STATES INDIVIDUAL)  
400 GROVE STREET  
RAMSEY, NJ 07466

FOR: PHYSICAL FITNESS CONDITIONING CLASSES; PHYSICAL FITNESS CONSULTATION; PHYSICAL FITNESS INSTRUCTION; PROVIDING ASSISTANCE, PERSONAL TRAINING AND PHYSICAL FITNESS CONSULTATION TO INDIVIDUALS TO HELP THEM MAKE PHYSICAL FITNESS, STRENGTH, CONDITIONING, AND EXERCISE IMPROVEMENT IN THEIR DAILY LIVING; PROVIDING FITNESS AND EXERCISE FACILITIES, IN CLASS 41 (U.S. CLS. 100, 101 AND 107).

FIRST USE 1-1-2008; IN COMMERCE 1-1-2008.

NO CLAIM IS MADE TO THE EXCLUSIVE RIGHT TO USE "PERSONAL PILATES", APART FROM THE MARK AS SHOWN.

THE MARK CONSISTS OF THE WORD "PERSONAL", IN STYLIZED FONT, POSITIONED OVER THE WORD "PILATES", ABOVE AND OVER THE SILHOUETTE OF A INDIVIDUAL IN A SIDEWAYS POSE, WITH ONE ARM EXTENDED UPWARD AND ONE EXTENDED TO THE GROUND, WITH THE LEGS EXTENDED OUT. BEHIND THE SILHOUETTE IS A ROTATED SHADOW OF THE HEAD AND ARMS WITH CIRCULAR RINGS.

SER. NO. 77-394,552, FILED 2-12-2008.

SAMUEL E. SHARPER JR., EXAMINING ATTORNEY

**Int. Cl.: 41**

**Prior U.S. Cls.: 100, 101 and 107**

**United States Patent and Trademark Office**

**Reg. No. 3,504,525**

**Registered Sep. 23, 2008**

**SERVICE MARK  
PRINCIPAL REGISTER**



AMERICAN ASSOCIATION OF ADAPTED  
SPORTS PROGRAMS, INC. (GEORGIA COR-  
PORATION)

PO BOX 451047  
ATLANTA, GA 31145

FOR: CHARITABLE SERVICES, NAMELY, PRO-  
VIDING TRAINING IN THE FIELD OF INTRA-  
MURAL SPORTS FOR DISABLED STUDENTS;  
DEVELOPMENT AND DISSEMINATION OF EDU-  
CATIONAL MATERIALS OF OTHERS IN THE  
FIELD OF INTRAMURAL SPORTS FOR DISABLED  
STUDENTS; EDUCATIONAL SERVICES, NAMELY,  
CONDUCTING WORKSHOPS, SEMINARS AND  
CONFERENCES IN THE FIELD OF INTRAMURAL  
SPORTS FOR DISABLED STUDENTS AND DISTRI-  
BUTION OF COURSE MATERIAL IN CONNEC-  
TION THEREWITH; ENCOURAGING AMATEUR  
SPORTS AND PHYSICAL EDUCATION BY ORGA-  
NIZING, PROMOTING, SPONSORING, SANCTION-  
ING, CONDUCTING, ADMINISTERING,  
REGULATING AND GOVERNING AMATEUR  
ATHLETIC PROGRAMS AND ACTIVITIES; ORGA-  
NIZING SPORTING EVENTS, NAMELY, INTRA-

MURAL ACTIVITIES FOR DISABLED STUDENTS,  
IN CLASS 41 (U.S. CLS. 100, 101 AND 107).

FIRST USE 1-11-2006; IN COMMERCE 1-11-2006.

NO CLAIM IS MADE TO THE EXCLUSIVE  
RIGHT TO USE "AMERICAN ASSOCIATION OF  
ADAPTED SPORTS PROGRAMS", APART FROM  
THE MARK AS SHOWN.

THE COLOR(S) BLUE, BLACK AND WHITE IS/  
ARE CLAIMED AS A FEATURE OF THE MARK.

THE MARK CONSISTS OF A STYLIZED IMAGE  
OF A STUDENT ATHLETE IN WHITE AGAINST A  
BLACK AND BLUE CIRCULAR IMAGE WITH A  
BLUE RING HIGHLIGHTING THE WHITE LET-  
TERING OF THE LITERAL ELEMENT.

SER. NO. 77-394,562, FILED 2-12-2008.

FLORENTINA BLANDU, EXAMINING ATTORNEY

**Int. Cl.: 3**

**Prior U.S. Cls.: 1, 4, 6, 50, 51 and 52**

**United States Patent and Trademark Office**

**Reg. No. 3,504,526**

**Registered Sep. 23, 2008**

**TRADEMARK  
PRINCIPAL REGISTER**

**INTRA FORCE**

L'OREAL (FRANCE SOCIÉTÉ ANONYME (SA))  
14 RUE ROYALE  
PARIS, FRANCE 75008

FOR: SHAMPOOS; GELS, SPRAYS, MOUSSES  
AND BALMS FOR THE HAIR STYLING AND HAIR  
CARE; HAIR LACQUERS; HAIR COLOURING AND  
HAIR DECOLORANT PREPARATIONS; PERMA-  
NENT WAVING AND CURLING PREPARATIONS;  
ESSENTIAL OILS FOR PERSONAL USE, IN CLASS 3  
(U.S. CLS. 1, 4, 6, 50, 51 AND 52).

THE MARK CONSISTS OF STANDARD CHAR-  
ACTERS WITHOUT CLAIM TO ANY PARTICULAR  
FONT, STYLE, SIZE, OR COLOR.

OWNER OF FRANCE REG. NO. 96609455, DATED  
2-6-1996, EXPIRES 2-6-2016.

SER. NO. 77-394,570, FILED 2-12-2008.

JANET LEE, EXAMINING ATTORNEY

**Int. Cl.: 10**

**Prior U.S. Cls.: 26, 39 and 44**

**United States Patent and Trademark Office**

**Reg. No. 3,504,527**

**Registered Sep. 23, 2008**

**TRADEMARK  
PRINCIPAL REGISTER**

**LYT LASER**

LYTLE, LARRY (UNITED STATES INDIVIDUAL)  
SUITE 100  
520 KANSAS CITY STREET  
RAPID CITY, SD 57701

FOR: LASERS FOR MEDICAL USE, NAMELY,  
LOW LEVEL LASERS DELIVERING ENERGY TO  
THE CELLULAR LEVEL, FOR PAIN MANAGE-  
MENT AND CONTROL OF INFLAMMATION, IN  
CLASS 10 (U.S. CLS. 26, 39 AND 44).

FIRST USE 1-1-2008; IN COMMERCE 1-1-2008.

THE MARK CONSISTS OF STANDARD CHAR-  
ACTERS WITHOUT CLAIM TO ANY PARTICULAR  
FONT, STYLE, SIZE, OR COLOR.

NO CLAIM IS MADE TO THE EXCLUSIVE  
RIGHT TO USE "LASER", APART FROM THE  
MARK AS SHOWN.

SER. NO. 77-394,615, FILED 2-12-2008.

BRIDGETT SMITH, EXAMINING ATTORNEY

Int. Cl.: 37

Prior U.S. Cls.: 100, 103 and 106

United States Patent and Trademark Office

Reg. No. 3,504,528

Registered Sep. 23, 2008

SERVICE MARK  
PRINCIPAL REGISTER



THE HEALEY WERKS (IOWA CORPORATION)  
1821 HIGHWAY 20  
LAWTON, IA 51030

FOR: RESTORATION IN THE FIELD OF AUTO-  
MOBILES, IN CLASS 37 (U.S. CLS. 100, 103 AND 106).

FIRST USE 10-1-2006; IN COMMERCE 10-1-2006.

NO CLAIM IS MADE TO THE EXCLUSIVE  
RIGHT TO USE "PREMIER RESTORATION" AND  
"COLLECTABLES EXOTIC SPORTS CLASSIC LUX-  
URY", APART FROM THE MARK AS SHOWN.

THE STIPPLING IS FOR SHADING PURPOSES  
ONLY.

THE MARK CONSISTS OF AN OVAL SHAPE  
WITH THE STYLIZED TEXT "THE HEALEY  
WERKS PREMIER RESTORATION COLLECT-  
ABLES EXOTIC SPORTS CLASSIC LUXURY", AND  
A CHECKERED FLAG AND STRIPED FLAG BE-  
HIND.

SER. NO. 77-394,634, FILED 2-12-2008.

GIANCARLO CASTRO, EXAMINING ATTORNEY



**Int. Cl.: 26**

**Prior U.S. Cls.: 37, 39, 40, 42 and 50**

**United States Patent and Trademark Office**

**Reg. No. 3,504,529**

**Registered Sep. 23, 2008**

**TRADEMARK  
PRINCIPAL REGISTER**

**BRINGING THE BEAUTY OF  
NATURE INSIDE**

CALIFORNIA SILK PLANT COMPANY, INC.  
(CALIFORNIA CORPORATION)  
SUITE H-6  
24321 AVENIDA DE LA CARLOTA  
LAGUNA HILLS, CA 92653

FOR: ARTIFICIAL FLOWERS, NAMELY, PER-  
MANENT BOTANICALS, NAMELY, ARTIFICIAL  
FLORALS, BOTANICALS, GREENERY, PLANTS,  
TREES, STEMS, SINGLE AND STEM ARTIFICIAL  
FLOWERS, AND FOLIAGE, IN CLASS 26 (U.S. CLS.  
37, 39, 40, 42 AND 50).

FIRST USE 3-4-2008; IN COMMERCE 3-4-2008.

THE MARK CONSISTS OF STANDARD CHAR-  
ACTERS WITHOUT CLAIM TO ANY PARTICULAR  
FONT, STYLE, SIZE, OR COLOR.

SER. NO. 77-394,644, FILED 2-12-2008.

DARRYL SPRUILL, EXAMINING ATTORNEY

**Int. Cl.: 41**

**Prior U.S. Cls.: 100, 101 and 107**

**United States Patent and Trademark Office**

**Reg. No. 3,504,530**

**Registered Sep. 23, 2008**

**SERVICE MARK  
PRINCIPAL REGISTER**

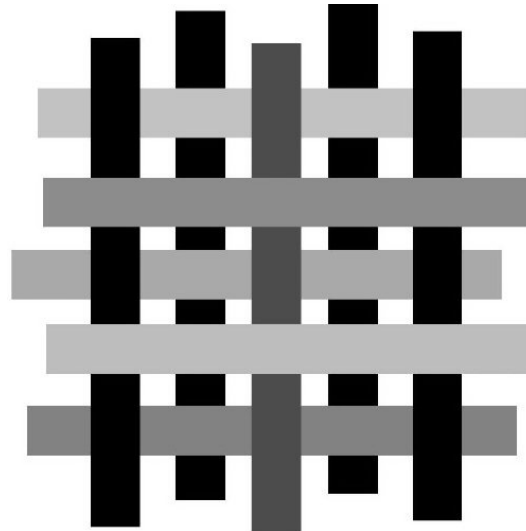

DEPARTMENT OF DEFENSE (UNITED STATES  
AGENCY OF THE UNITED STATES GOVERN-  
MENT)  
THE PENTAGON  
WASHINGTON, DC 20301

THE MARK CONSISTS OF FIVE EACH OF VER-  
TICAL AND HORIZONTAL BARS IN A WEAWE  
DESIGN FORMING AN APPROXIMATELY OVER-  
ALL SQUARE SHAPE.

FOR: LANGUAGE TRANSLATION, IN CLASS 41  
(U.S. CLS. 100, 101 AND 107).

SER. NO. 77-394,702, FILED 2-12-2008.

FIRST USE 1-0-2008; IN COMMERCE 1-0-2008.

ANDREA SAUNDERS, EXAMINING ATTORNEY

**Int. Cl.: 35**

**Prior U.S. Cls.: 100, 101 and 102**

**United States Patent and Trademark Office**

**Reg. No. 3,504,531**

**Registered Sep. 23, 2008**

**SERVICE MARK  
PRINCIPAL REGISTER**

**MAINLINE COMPUTER PRODUCTS**

MAINLINE COMPUTER PRODUCTS, INC. (OHIO CORPORATION)  
470 VILLAGE PARK DRIVE  
POWELL, OH 43065

FOR: DEALERSHIPS IN THE FIELD OF COMMERCIAL COMPUTER COMMAND CONSOLES, COMMERCIAL COMPUTER FURNITURE, OFFICE FURNITURE, COMPUTER SERVER CABINETS, ELECTRONIC VIDEO SURVEILLANCE INSTALLATIONS, VIDEO SCREENS FOR COMMERCIAL USE; DISTRIBUTORSHIPS IN THE FIELD OF COMMERCIAL COMPUTER COMMAND CONSOLES, COMMERCIAL COMPUTER FURNITURE, OFFICE FURNITURE, COMPUTER SERVER CABINETS, ELECTRONIC VIDEO SURVEILLANCE INSTALLATIONS, VIDEO SCREENS FOR COMMERCIAL USE, IN CLASS 35 (U.S. CLS. 100, 101 AND 102).

FIRST USE 11-0-1986; IN COMMERCE 12-0-1987.

THE MARK CONSISTS OF STANDARD CHARACTERS WITHOUT CLAIM TO ANY PARTICULAR FONT, STYLE, SIZE, OR COLOR.

OWNER OF U.S. REG. NO. 2,922,730.

NO CLAIM IS MADE TO THE EXCLUSIVE RIGHT TO USE "COMPUTER PRODUCTS", APART FROM THE MARK AS SHOWN.

SER. NO. 77-394,764, FILED 2-12-2008.

ELLEN BURNS, EXAMINING ATTORNEY

**Int. Cl.: 42**

**Prior U.S. Cls.: 100 and 101**

**United States Patent and Trademark Office**

**Reg. No. 3,504,532**

**Registered Sep. 23, 2008**

---

**SERVICE MARK  
PRINCIPAL REGISTER**

**pcSally**

NEWTON, MICHAEL L. (UNITED STATES INDIVIDUAL)  
4365 RUSHMORE COURT  
CHINO, CA 91710

FOR: TECHNICAL SUPPORT SERVICES, NAME-  
LY, TROUBLESHOOTING OF COMPUTER HARD-  
WARE AND SOFTWARE PROBLEMS, IN CLASS 42  
(U.S. CLS. 100 AND 101).

FIRST USE 2-8-2008; IN COMMERCE 2-8-2008.

THE MARK CONSISTS OF STANDARD CHAR-  
ACTERS WITHOUT CLAIM TO ANY PARTICULAR  
FONT, STYLE, SIZE, OR COLOR.

SER. NO. 77-394,874, FILED 2-12-2008.

KEVIN CORWIN, EXAMINING ATTORNEY

**Int. Cl.: 41**

**Prior U.S. Cls.: 100, 101 and 107**

**United States Patent and Trademark Office**

**Reg. No. 3,504,533**

**Registered Sep. 23, 2008**

**SERVICE MARK  
PRINCIPAL REGISTER**



BARRYCON PRODUCTIONS, LLC (MINNESOTA  
LIMITED LIABILITY COMPANY)  
8615 PARK AVENUE  
ST. BONIFACIUS, MN 55375

FOR: ARRANGING AND CONDUCTING EDUCATIONAL CONFERENCES; ARRANGING OF SEMINARS; ARRANGING PROFESSIONAL WORKSHOP AND TRAINING COURSES; EDUCATIONAL SERVICES, NAMELY, DEVELOPING, ARRANGING, AND CONDUCTING EDUCATIONAL CONFERENCES AND PROGRAMS AND PROVIDING COURSES OF INSTRUCTION IN THE FIELD OF GRAPHIC DESIGN, IN CLASS 41 (U.S. CLS. 100, 101 AND 107).

FIRST USE 9-28-2006; IN COMMERCE 9-28-2006.

OWNER OF U.S. REG. NO. 3,415,430.

THE MARK CONSISTS OF THE LETTERS "M" AND "O" ABOVE THE LETTERS "G" AND "O" AT AN UPWARD TILT WITHIN A CIRCLE.

SER. NO. 77-394,882, FILED 2-12-2008.

LIEF MARTIN, EXAMINING ATTORNEY

**Int. Cl.: 3**

**Prior U.S. Cls.: 1, 4, 6, 50, 51 and 52**

**Reg. No. 3,504,534**

**United States Patent and Trademark Office**

**Registered Sep. 23, 2008**

**TRADEMARK  
PRINCIPAL REGISTER**

**LIFE AROMATHERAPY**

LIFE AROMATHERAPY, L.L.C. (ARIZONA LIMITED LIABILITY COMPANY)  
7305 S. BONARDEN LANE  
TEMPE, AZ 85283

THE MARK CONSISTS OF STANDARD CHARACTERS WITHOUT CLAIM TO ANY PARTICULAR FONT, STYLE, SIZE, OR COLOR.

FOR: AROMATHERAPY ESSENTIAL OIL BLENDS FOR PERSONAL USE; AROMATHERAPY FRAGRANCES AND PERFUMERY; AROMATHERAPY NON-MEDICATED SKIN CARE PREPARATIONS, NAMELY, CREAMS, LOTIONS, GELS, TONERS, AND CLEANERS, IN CLASS 3 (U.S. CLS. 1, 4, 6, 50, 51 AND 52).

NO CLAIM IS MADE TO THE EXCLUSIVE RIGHT TO USE "AROMATHERAPY", APART FROM THE MARK AS SHOWN.

SER. NO. 77-394,912, FILED 2-12-2008.

FIRST USE 12-0-1997; IN COMMERCE 12-0-1997.

KRISTIN DAHLING, EXAMINING ATTORNEY

**Int. Cl.: 37**

**Prior U.S. Cls.: 100, 103 and 106**

**United States Patent and Trademark Office**

**Reg. No. 3,504,535**

**Registered Sep. 23, 2008**

**SERVICE MARK  
PRINCIPAL REGISTER**

**FirstPlus Facilities  
Services, LLC**

FIRSTPLUS FINANCIAL GROUP, INC. (NEVADA CORPORATION)  
SUITE 450  
122 W. JOHN CARPENTER FREEWAY  
IRVING, TX 75039

FOR: JANITORIAL SERVICES; CLEANING OF COMMERCIAL PREMISES; CLEANING OF INDUSTRIAL PREMISES; CLEANING OF CONSTRUCTION PREMISES, IN CLASS 37 (U.S. CLS. 100, 103 AND 106).

FIRST USE 10-1-2007; IN COMMERCE 10-1-2007.

THE MARK CONSISTS OF STANDARD CHARACTERS WITHOUT CLAIM TO ANY PARTICULAR FONT, STYLE, SIZE, OR COLOR.

NO CLAIM IS MADE TO THE EXCLUSIVE RIGHT TO USE "FACILITIES SERVICES, LLC", APART FROM THE MARK AS SHOWN.

SER. NO. 77-395,004, FILED 2-12-2008.

KATHERINE CHANG, EXAMINING ATTORNEY

**Int. Cl.: 44**

**Prior U.S. Cls.: 100 and 101**

**United States Patent and Trademark Office**

**Reg. No. 3,504,536**

**Registered Sep. 23, 2008**

**SERVICE MARK  
PRINCIPAL REGISTER**

**MUSIC TO YOUR HEAD**

FLOYD'S 99 HOLDINGS, LLC (COLORADO LIMITED LIABILITY COMPANY)  
SUITE 205N  
5340 SOUTH QUEBEC  
GREENWOOD VILLAGE, CO 80111

FOR: BARBER SHOP AND BEAUTY AND HAIR-DRESSING SALON SERVICES, IN CLASS 44 (U.S. CLS. 100 AND 101).

FIRST USE 2-1-2008; IN COMMERCE 2-1-2008.

THE MARK CONSISTS OF STANDARD CHARACTERS WITHOUT CLAIM TO ANY PARTICULAR FONT, STYLE, SIZE, OR COLOR.

SER. NO. 77-395,007, FILED 2-12-2008.

FRED CARL, EXAMINING ATTORNEY



**Int. Cls.: 9, 11, 37 and 42**

**Prior U.S. Cls.: 13, 21, 23, 26, 31, 34, 36, 38, 100, 101,  
103 and 106**

**Reg. No. 3,504,537**

**United States Patent and Trademark Office**

**Registered Sep. 23, 2008**

**TRADEMARK  
SERVICE MARK  
PRINCIPAL REGISTER**

**i-Vue**

MCKENNEYS, INC. (GEORGIA CORPORATION)  
1056 MORELAND INDUSTRIAL BOULEVARD  
ATLANTA, GA 30316

FOR: CLIMATE CONTROL SYSTEMS CONSISTING OF DIGITAL THERMOSTATS, AIR CONDITIONING, HEATING, VENTILATION AND DRYING CONTROL DEVICES; COMPUTER HARDWARE AND SOFTWARE SYSTEM FOR REMOTELY MONITORING ENVIRONMENTAL CONDITIONS AND CONTROLLING DEVICES WITHIN A BUILDING, FACILITY, GROUNDS, OR DESIGNATED SPATIAL AREA, IN CLASS 9 (U.S. CLS. 21, 23, 26, 36 AND 38).

FIRST USE 2-28-2007; IN COMMERCE 2-28-2007.

FOR: AIR-CONDITIONING, AIR COOLING AND VENTILATION APPARATUS AND INSTRUMENTS; HEATING INSTALLATIONS, IN CLASS 11 (U.S. CLS. 13, 21, 23, 31 AND 34).

FIRST USE 2-28-2007; IN COMMERCE 2-28-2007.

FOR: HEATING EQUIPMENT INSTALLATION AND REPAIR; INSTALLATION AND REPAIR OF AIR CONDITIONING APPARATUS, IN CLASS 37 (U.S. CLS. 100, 103 AND 106).

FIRST USE 2-28-2007; IN COMMERCE 2-28-2007.

FOR: DESIGN FOR OTHERS IN THE FIELD OF COMPUTER NETWORKS, SOFTWARE, AND ENGINEERING FOR THE REMOTE MONITORING OF ENVIRONMENTAL CONDITIONS AND CONTROLLING DEVICES WITHIN A BUILDING, FACILITY, GROUNDS, OR DESIGNATED SPATIAL AREA, IN CLASS 42 (U.S. CLS. 100 AND 101).

FIRST USE 2-28-2007; IN COMMERCE 2-28-2007.

THE MARK CONSISTS OF STANDARD CHARACTERS WITHOUT CLAIM TO ANY PARTICULAR FONT, STYLE, SIZE, OR COLOR.

SER. NO. 77-395,014, FILED 2-12-2008.

MARK T. MULLEN, EXAMINING ATTORNEY

Int. Cls.: 35 and 42

Prior U.S. Cls.: 100, 101 and 102

United States Patent and Trademark Office

Reg. No. 3,504,538

Registered Sep. 23, 2008

SERVICE MARK  
PRINCIPAL REGISTER



CHR SOLUTIONS, INC. (TEXAS CORPORATION)  
SOUTHWEST CORPORATE CENTER  
9700 BISSONNET, SUITE 2800  
HOUSTON, TX 77036

FOR: DATA PROCESSING SERVICES; BUSINESS MANAGEMENT OF THE NONPROFIT CORPORATIONS AND TRADE ASSOCIATIONS OF OTHERS; DISASTER RECOVERY SERVICES, NAMELY, BUSINESS PLANNING AND BUSINESS CONTINUITY CONSULTING; BUSINESS RISK MANAGEMENT CONSULTATION, IN CLASS 35 (U.S. CLS. 100, 101 AND 102).

FIRST USE 12-6-2006; IN COMMERCE 12-6-2006.

FOR: COMPUTER SOFTWARE DEVELOPMENT; CONSULTATION SERVICES IN THE FIELDS OF SELECTION, IMPLEMENTATION AND USE OF COMPUTER HARDWARE AND SOFTWARE SYSTEMS FOR OTHERS; COMPUTER SERVICES, NAMELY, REMOTE MANAGEMENT OF COMPUTER APPLICATIONS FOR OTHERS; MONITORING THE COMPUTER SYSTEMS OF OTHERS FOR TECHNICAL PURPOSES AND PROVIDING BACK-UP COMPUTER PROGRAMS AND FACILITIES; APPLICATION SERVICE PROVIDER (ASP), NAMELY, HOSTING COMPUTER SOFTWARE APPLICA-

TIONS OF OTHERS; INFORMATION TECHNOLOGY CONSULTATION; COMPUTER DISASTER RECOVERY PLANNING; TECHNICAL SUPPORT, NAMELY, MONITORING OF NETWORK SYSTEMS; TECHNICAL SUPPORT SERVICES, NAMELY, TROUBLESHOOTING OF COMPUTER HARDWARE AND SOFTWARE PROBLEMS; COMPUTER SERVICES, NAMELY, FILTERING OF UNWANTED E-MAILS, IN CLASS 42 (U.S. CLS. 100 AND 101).

FIRST USE 12-6-2006; IN COMMERCE 12-6-2006.

OWNER OF U.S. REG. NOS. 2,530,471, 2,532,736 AND OTHERS.

NO CLAIM IS MADE TO THE EXCLUSIVE RIGHT TO USE "SOLUTIONS", APART FROM THE MARK AS SHOWN.

THE MARK CONSISTS OF THE TERMS "CHR SOLUTIONS" AND "SUCCESS, SIMPLIFIED." AND THREE OVERLAPPING, INCOMPLETE CIRCLES.

SER. NO. 77-395,027, FILED 2-12-2008.

ANDREW RHIM, EXAMINING ATTORNEY

**Int. Cls.: 9, 11, 37 and 42**

**Prior U.S. Cls.: 13, 21, 23, 26, 31, 34, 36, 38, 100, 101,  
103 and 106**

**Reg. No. 3,504,539**

**United States Patent and Trademark Office**

**Registered Sep. 23, 2008**

**TRADEMARK  
SERVICE MARK  
PRINCIPAL REGISTER**

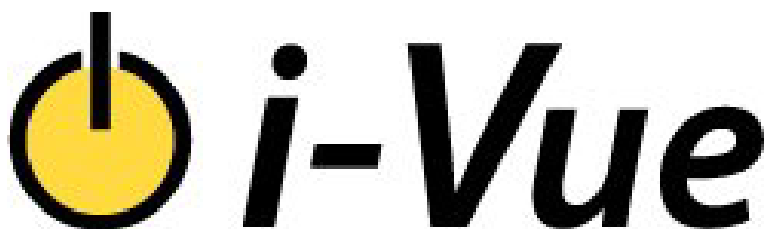

MCKENNEYS, INC. (GEORGIA CORPORATION)  
1056 MORELAND INDUSTRIAL BOULEVARD  
ATLANTA, GA 30316

FOR: CLIMATE CONTROL SYSTEMS CONSISTING OF DIGITAL THERMOSTATS, AIR CONDITIONING, HEATING, VENTILATION AND DRYING CONTROL DEVICES; COMPUTER HARDWARE AND SOFTWARE SYSTEM FOR REMOTELY MONITORING ENVIRONMENTAL CONDITIONS AND CONTROLLING DEVICES WITHIN A BUILDING, FACILITY, GROUNDS, OR DESIGNATED SPATIAL AREA, IN CLASS 9 (U.S. CLS. 21, 23, 26, 36 AND 38).

FIRST USE 2-28-2007; IN COMMERCE 2-28-2007.

FOR: AIR-CONDITIONING, AIR COOLING AND VENTILATION APPARATUS AND INSTRUMENTS; HEATING INSTALLATIONS, IN CLASS 11 (U.S. CLS. 13, 21, 23, 31 AND 34).

FIRST USE 2-28-2007; IN COMMERCE 2-28-2007.

FOR: HEATING EQUIPMENT INSTALLATION AND REPAIR; INSTALLATION AND REPAIR OF AIR CONDITIONING APPARATUS, IN CLASS 37 (U.S. CLS. 100, 103 AND 106).

FIRST USE 2-28-2007; IN COMMERCE 2-28-2007.

FOR: DESIGN FOR OTHERS IN THE FIELD OF COMPUTER NETWORKS, SOFTWARE, AND ENGINEERING FOR THE REMOTE MONITORING OF ENVIRONMENTAL CONDITIONS AND CONTROLLING DEVICES WITHIN A BUILDING, FACILITY, GROUNDS, OR DESIGNATED SPATIAL AREA, IN CLASS 42 (U.S. CLS. 100 AND 101).

FIRST USE 2-28-2007; IN COMMERCE 2-28-2007.

THE COLOR(S) BLACK AND YELLOW IS/ARE CLAIMED AS A FEATURE OF THE MARK.

THE MARK CONSISTS OF A YELLOW CIRCLE WITH A BLACK BORDER AND A VERTICAL BLACK LINE EMERGING FROM THE TOP WITH THE ITALICIZED WORD "I-VUE" IN BLACK LETTERING TO THE RIGHT OF THE CIRCLE.

SER. NO. 77-395,046, FILED 2-12-2008.

MARK T. MULLEN, EXAMINING ATTORNEY

**Int. Cl.: 44**

**Prior U.S. Cls.: 100 and 101**

**United States Patent and Trademark Office**

**Reg. No. 3,504,540**

**Registered Sep. 23, 2008**

**SERVICE MARK  
PRINCIPAL REGISTER**



UNITY HOSPICE MANAGEMENT, INC. (ILLI-  
NOIS CORPORATION)  
7434 SKOKIE BLVD  
SKOKIE, IL 60077

THE MARK CONSISTS OF STYLIZED REPRE-  
SENTATION OF THE LETTERS "U" AND "H".

FOR: HOSPICE SERVICES, IN CLASS 44 (U.S. CLS.  
100 AND 101).

SER. NO. 77-395,078, FILED 2-12-2008.

FIRST USE 1-1-2002; IN COMMERCE 1-1-2002.

JAY FLOWERS, EXAMINING ATTORNEY

**Int. Cl.: 28**

**Prior U.S. Cls.: 22, 23, 38 and 50**

**United States Patent and Trademark Office**

**Reg. No. 3,504,541**

**Registered Sep. 23, 2008**

**TRADEMARK  
PRINCIPAL REGISTER**

**AIR BUILDER**

TINKER MINDS INC. (NEVADA CORPORATION)  
47 NORTH ST.  
LEXINGTON, MA 02420

FOR: CONSTRUCTION TOYS; INFLATABLE TOYS; TOY BUILDING BLOCKS; TOY BUILDING BLOCKS CAPABLE OF INTERCONNECTION; TOY CONSTRUCTION BLOCKS, IN CLASS 28 (U.S. CLS. 22, 23, 38 AND 50).

FIRST USE 12-7-2007; IN COMMERCE 12-7-2007.

THE MARK CONSISTS OF STANDARD CHARACTERS WITHOUT CLAIM TO ANY PARTICULAR FONT, STYLE, SIZE, OR COLOR.

SER. NO. 77-395,090, FILED 2-12-2008.

B. PARADEWELAI, EXAMINING ATTORNEY

Int. Cl.: 9

Prior U.S. Cls.: 21, 23, 26, 36 and 38

Reg. No. 3,504,542

United States Patent and Trademark Office

Registered Sep. 23, 2008

TRADEMARK  
PRINCIPAL REGISTER



**JIMMY CRYSTAL**  
**New York**

JIMMY CRYSTAL (NEW YORK) CO. LTD. (NEW YORK LIMITED LIABILITY COMPANY)  
260 WEST 35TH STREET, 10TH FLOOR  
NEW YORK, NY 10001

FOR: ANTI-GLARE GLASSES; ANTI-GLARE SPECTACLES; CASES FOR CONTACT LENSES; CASES FOR SPECTACLES AND SUNGLASSES; CONTACT LENS CASES; CONTACT LENSES; CORRECTIVE GLASSES; EYE GLASSES; EYEGLASS CASES; EYEGLASS LENSES; OPTICAL GLASSES; OPTICAL LENSES; PROTECTIVE EYEGLASSES; PROTECTIVE GLASSES; PROTECTIVE SPECTACLES; READING EYEGLASSES; READING GLASSES; SKI GLASSES; SPECTACLE CASES; SPECTACLE GLASSES; SPECTACLE LENSES; SPECTACLES; SPORTS GLASSES; SUN GLASSES; SUNGLASSES, IN CLASS 9 (U.S. CLS. 21, 23, 26, 36 AND 38).

FIRST USE 7-24-2006; IN COMMERCE 7-24-2006.

NO CLAIM IS MADE TO THE EXCLUSIVE RIGHT TO USE "CRYSTAL" AND "NEW YORK", APART FROM THE MARK AS SHOWN.

THE NAME "JIMMY CRYSTAL" DOES NOT IDENTIFY A LIVING INDIVIDUAL.

THE MARK CONSISTS OF STYLIZED LETTERS "JC" WITH A STYLIZED DEPICTION OF A DIAMOND ABOVE "JC" AGAINST THE SQUARE BACKGROUND. UNDERNEATH ARE THE WORDS "JIMMY CRYSTAL" AND "NEW YORK" WITH THE FORMER ABOUT TWICE AS LARGE AS THE LATTER IN SIZE.

SER. NO. 77-395,106, FILED 2-12-2008.

ROBIN CHOSID, EXAMINING ATTORNEY

**Int. Cl.: 41**

**Prior U.S. Cls.: 100, 101 and 107**

**United States Patent and Trademark Office**

**Reg. No. 3,504,543**

**Registered Sep. 23, 2008**

**SERVICE MARK  
PRINCIPAL REGISTER**

**FA LA LA LA LIFETIME**

LIFETIME ENTERTAINMENT SERVICES (NEW  
YORK JOINT VENTURE)  
16TH FLOOR  
309 WEST 49TH STREET  
NEW YORK, NY 10019

FOR: ENTERTAINMENT SERVICES IN THE  
NATURE OF TELEVISION SERIES, TELEVISION  
PROGRAMS, MOVIES, INTERSTITIALS AND ON-  
AIR SPOTS FEATURING A HOLIDAY THEME , IN  
CLASS 41 (U.S. CLS. 100, 101 AND 107).

FIRST USE 12-0-2007; IN COMMERCE 12-0-2007.

THE MARK CONSISTS OF STANDARD CHAR-  
ACTERS WITHOUT CLAIM TO ANY PARTICULAR  
FONT, STYLE, SIZE, OR COLOR.

OWNER OF U.S. REG. NOS. 1,450,063, 2,830,659,  
AND 3,180,878.

SER. NO. 77-395,139, FILED 2-12-2008.

DAWN FELDMAN, EXAMINING ATTORNEY

**Int. Cl.: 9**

**Prior U.S. Cls.: 21, 23, 26, 36 and 38**

**United States Patent and Trademark Office**

**Reg. No. 3,504,544**

**Registered Sep. 23, 2008**

**TRADEMARK  
PRINCIPAL REGISTER**

# OneFactor-e

ZENPIRE CORPORATION (CALIFORNIA CORPORATION)  
PO BOX 370  
MOFFETT FIELD, CA 94035

FOR: INDUSTRIAL PROCESS CONTROL SOFTWARE; COMPUTER SOFTWARE FOR THE FIELD OF WAREHOUSING AND DISTRIBUTION, TO MANAGE TRANSACTIONAL DATA, PROVIDE STATISTICAL ANALYSIS, AND PRODUCE NOTIFICATIONS AND REPORTS; COMPUTER SOFTWARE FOR MACHINE CONTROL AND DATA VISUALIZATION AND ANALYSIS THAT MAY BE DOWNLOADED FROM A GLOBAL COMPUTER NETWORK; FACTORY AUTOMATION SOFTWARE, NAMELY, SOFTWARE TO INTEGRATE MANUFACTURING MACHINE OPERATIONS, TRACK PROBLEMS AND GENERATE PRODUC-

TION REPORTS; COMPUTER SOFTWARE AND HARDWARE FOR STORING AND ANALYZING EMPIRICAL, FINANCIAL AND STATISTICAL DATA FROM MATERIALS PROCESSING EQUIPMENT, TRANSMITTING AND DISPLAYING SUCH DATA OVER INTRANETS AND THE INTERNET, IN CLASS 9 (U.S. CLS. 21, 23, 26, 36 AND 38).

FIRST USE 5-1-2006; IN COMMERCE 6-1-2006.

THE MARK CONSISTS OF STANDARD CHARACTERS WITHOUT CLAIM TO ANY PARTICULAR FONT, STYLE, SIZE, OR COLOR.

SER. NO. 77-395,141, FILED 2-12-2008.

JACLYN KIDWELL, EXAMINING ATTORNEY



**Int. Cls.: 41 and 44**

**Prior U.S. Cls.: 100, 101 and 107**

**United States Patent and Trademark Office**

**Reg. No. 3,504,545**

**Registered Sep. 23, 2008**

**SERVICE MARK  
PRINCIPAL REGISTER**

# WORKTEAM

CRITTENDEN HOSPITAL ASSOCIATION (AR-  
KANSAS CORPORATION)

200 TYLER STREET

WEST MEMPHIS, AR 72301

FOR: ACCIDENT AND ILLNESS PREVENTION,  
ON-THE-JOB INJURY, AND HEALTH AND WELL-  
NESS EDUCATIONAL PROGRAMS, IN CLASS 41  
(U.S. CLS. 100, 101 AND 107).

FIRST USE 11-30-2007; IN COMMERCE 11-30-2007.

FOR: HEALTH CARE SERVICES PROVIDED TO  
EMPLOYEES OF SUBSCRIBING EMPLOYERS, IN  
CLASS 44 (U.S. CLS. 100 AND 101).

FIRST USE 11-30-2007; IN COMMERCE 11-30-2007.

THE MARK CONSISTS OF STANDARD CHAR-  
ACTERS WITHOUT CLAIM TO ANY PARTICULAR  
FONT, STYLE, SIZE, OR COLOR.

SER. NO. 77-395,146, FILED 2-12-2008.

BARBARA RUTLAND, EXAMINING ATTORNEY

**Int. Cl.: 43**

**Prior U.S. Cls.: 100 and 101**

**United States Patent and Trademark Office**

**Reg. No. 3,504,546**

**Registered Sep. 23, 2008**

**SERVICE MARK  
PRINCIPAL REGISTER**

**¿POR QUÉ NO?**

CONVIVIUUM, LLC (OREGON LIMITED LIABILITY COMPANY)  
3524 N. MISSISSIPPI AVE.  
PORTLAND, OR 97227

FOR: RESTAURANT SERVICES, IN CLASS 43  
(U.S. CLS. 100 AND 101).

FIRST USE 7-18-2005; IN COMMERCE 7-18-2005.

THE MARK CONSISTS OF STANDARD CHARACTERS WITHOUT CLAIM TO ANY PARTICULAR FONT, STYLE, SIZE, OR COLOR.

THE FOREIGN WORDING IN THE MARK TRANSLATES INTO ENGLISH AS WHY NOT?.

SER. NO. 77-395,147, FILED 2-12-2008.

BARBARA RUTLAND, EXAMINING ATTORNEY

**Int. Cl.: 6**

**Prior U.S. Cls.: 2, 12, 13, 14, 23, 25 and 50**

**Reg. No. 3,504,547**

**United States Patent and Trademark Office**

**Registered Sep. 23, 2008**

---

**TRADEMARK  
PRINCIPAL REGISTER**

**MICROBLEED**

SAFE-T-BLEED (UTAH CORPORATION)  
2170 SOUTH 3140 WEST SUITE B  
WEST VALLEY CITY, UT 84119

THE MARK CONSISTS OF STANDARD CHAR-  
ACTERS WITHOUT CLAIM TO ANY PARTICULAR  
FONT, STYLE, SIZE, OR COLOR.

FOR: HIGH PRESSURE METAL HOSE CONNEC-  
TORS AND FITTINGS, IN CLASS 6 (U.S. CLS. 2, 12,  
13, 14, 23, 25 AND 50).

SER. NO. 77-395,201, FILED 2-12-2008.

FIRST USE 10-30-2000; IN COMMERCE 10-30-2000.

EMILY CARLSEN, EXAMINING ATTORNEY

**Int. Cl.: 43**

**Prior U.S. Cls.: 100 and 101**

**United States Patent and Trademark Office**

**Reg. No. 3,504,548**

**Registered Sep. 23, 2008**

**SERVICE MARK  
PRINCIPAL REGISTER**

**JAVA! JAVA!**

HABENICHT, BRETT A. (UNITED STATES IN-  
DIVIDUAL)  
23130 224TH PLACE SE, SUITE 101  
MAPLE VALLEY, WA 98038

FOR: COFFEE SHOPS; SERVING OF FOOD AND  
DRINK/BEVERAGES, IN CLASS 43 (U.S. CLS. 100  
AND 101).

FIRST USE 10-9-1993; IN COMMERCE 10-9-1993.

THE MARK CONSISTS OF STANDARD CHAR-  
ACTERS WITHOUT CLAIM TO ANY PARTICULAR  
FONT, STYLE, SIZE, OR COLOR.

OWNER OF U.S. REG. NO. 2,077,765.

SER. NO. 77-395,274, FILED 2-12-2008.

KELLY CHOE, EXAMINING ATTORNEY

**Int. Cl.: 41**

**Prior U.S. Cls.: 100, 101 and 107**

**United States Patent and Trademark Office**

**Reg. No. 3,504,549**

**Registered Sep. 23, 2008**

**SERVICE MARK  
PRINCIPAL REGISTER**

**LYNNETTE KHALFANI-COX, THE  
MONEY COACH**

LYNNETTE KHALFANI-COX (UNITED STATES  
INDIVIDUAL)  
1625 NOTTINGHAM WAY  
MOUNTAINSIDE, NJ 07092

FOR: EDUCATIONAL AND ENTERTAINMENT  
SERVICES, NAMELY, CONDUCTING SEMINARS,  
LECTURES, AND WORKSHOPS AND EDUCA-  
TIONAL AND ENTERTAINMENT SERVICES,  
NAMELY, PROVIDING MOTIVATIONAL SPEAK-  
ING SERVICES, ALL IN THE FIELD OF MANAGE-  
MENT AND THE ACQUISITION OF INCOME AND  
CAPITAL, IN CLASS 41 (U.S. CLS. 100, 101 AND 107).

FIRST USE 7-1-2007; IN COMMERCE 7-1-2007.

THE MARK CONSISTS OF STANDARD CHAR-  
ACTERS WITHOUT CLAIM TO ANY PARTICULAR  
FONT, STYLE, SIZE, OR COLOR.

NO CLAIM IS MADE TO THE EXCLUSIVE  
RIGHT TO USE "THE MONEY COACH", APART  
FROM THE MARK AS SHOWN.

SER. NO. 77-395,283, FILED 2-12-2008.

GEOFFREY FOSDICK, EXAMINING ATTORNEY

**Int. Cl.: 10**

**Prior U.S. Cls.: 26, 39 and 44**

**United States Patent and Trademark Office**

**Reg. No. 3,504,550**

**Registered Sep. 23, 2008**

**TRADEMARK  
PRINCIPAL REGISTER**

**CCOMBO**

EDWARDS LIFESCIENCES CORPORATION (DE-  
LAWARE CORPORATION)  
ONE EDWARDS WAY  
IRVINE, CA 92614

FOR: MEDICAL DEVICES, NAMELY, CATHE-  
TERS, IN CLASS 10 (U.S. CLS. 26, 39 AND 44).

FIRST USE 1-1-1994; IN COMMERCE 1-1-1994.

THE MARK CONSISTS OF STANDARD CHAR-  
ACTERS WITHOUT CLAIM TO ANY PARTICULAR  
FONT, STYLE, SIZE, OR COLOR.

OWNER OF U.S. REG. NOS. 2,217,584 AND  
2,627,556.

SER. NO. 77-395,297, FILED 2-12-2008.

JORDAN BAKER, EXAMINING ATTORNEY

**Int. Cl.: 35**

**Prior U.S. Cls.: 100, 101 and 102**

**United States Patent and Trademark Office**

**Reg. No. 3,504,551**

**Registered Sep. 23, 2008**

**SERVICE MARK  
PRINCIPAL REGISTER**

**ValleyPR**

VALLEYPR LLC (CALIFORNIA LIMITED LIABILITY COMPANY)  
773 WIDGEON ST  
FOSTER CITY, CA 94404

FOR: ADVERTISING AND PUBLICITY SERVICES, NAMELY, PROMOTING THE GOODS, SERVICES, BRAND IDENTITY AND COMMERCIAL INFORMATION AND NEWS OF THIRD PARTIES THROUGH PRINT, AUDIO, VIDEO, DIGITAL AND ON-LINE MEDIUM, IN CLASS 35 (U.S. CLS. 100, 101 AND 102).

FIRST USE 8-1-1998; IN COMMERCE 8-1-1998.

THE MARK CONSISTS OF STANDARD CHARACTERS WITHOUT CLAIM TO ANY PARTICULAR FONT, STYLE, SIZE, OR COLOR.

SER. NO. 77-395,317, FILED 2-12-2008.

LINDA E. BLOHM, EXAMINING ATTORNEY

Int. Cl.: 41

Prior U.S. Cls.: 100, 101 and 107

United States Patent and Trademark Office

Reg. No. 3,504,552

Registered Sep. 23, 2008

SERVICE MARK  
PRINCIPAL REGISTER



KNEAD FOR BALANCE, INC. (ARIZONA CORPORATION)  
8702 E. WINDSOR AVE.  
SCOTTSDALE, AZ 85257

FOR: EDUCATIONAL SERVICES, NAMELY, CONDUCTING CLASSES, SEMINARS AND WORKSHOPS IN THE FIELDS OF MASSAGE, BODYWORK, AND MANUAL THERAPIES, AND DISTRIBUTION OF COURSE MATERIAL IN CONNECTION THEREWITH, IN CLASS 41 (U.S. CLS. 100, 101 AND 107).

FIRST USE 1-17-2008; IN COMMERCE 1-17-2008.

NO CLAIM IS MADE TO THE EXCLUSIVE RIGHT TO USE "MASSAGE", APART FROM THE MARK AS SHOWN.

THE STIPLING IS FOR SHADING PURPOSES ONLY.

THE MARK CONSISTS OF THE WORD "KINESSAGE" CENTERED OVER A WAVE WHICH IS INTERSECTED BY A WAVE AT ITS LEFT EDGE. THERE IS A SPACE BETWEEN THE TWO WAVES STARTING UNDER THE "E" IN "KINESSAGE" THROUGH THE END OF THE WAVES. THE WORDS "MASSAGE THROUGH MOVEMENT" START UNDER THE WAVE BENEATH THE "K" IN "KINESSAGE" AND CARRY THROUGH TO THE END OF THE WAVE. FONT IS POPYRUS.

SER. NO. 77-395,333, FILED 2-12-2008.

MICHAEL ENGEL, EXAMINING ATTORNEY



**Int. Cls.: 5, 10 and 44**

**Prior U.S. Cls.: 6, 18, 26, 39, 44, 46, 51, 52, 100 and 101**

**Reg. No. 3,504,553**

**United States Patent and Trademark Office**

**Registered Sep. 23, 2008**

**TRADEMARK  
SERVICE MARK  
PRINCIPAL REGISTER**

# MENTOR

MENTOR CORPORATION (MINNESOTA CORPORATION)  
201 MENTOR DRIVE  
SANTA BARBARA, CA 93111

FOR: DERMAL FILLER KITS COMPRISING A PRE-FILLED SYRINGE; SELF CONTAINED SYRINGES AND AMPULES SOLD FULL FOR DISPENSING PREPACKAGED PHARMACEUTICALS IN THE NATURE OF HYALURONIC ACID AND DERIVATIVES THEREOF ALONE, OR IN COMBINATION WITH OTHER POLYSACCHARIDES, AND WITH OR WITHOUT LIDOCAINE, INJECTED UNDER THE SKIN, USED TO REDUCE OR ELIMINATE FINE LINES AND WRINKLES, FILL SCARS AND CONTOUR THE LIPS AND FACE; PHARMACEUTICAL PREPARATIONS FOR USE IN TREATING DERMATOLOGY, ONCOLOGY, HEMATOLOGY, OPHTHALMOLOGY AND GASTROENTEROLOGICAL DISORDERS, AND FOR USE IN TISSUE AND ORGAN TRANSPLANTATION; PHARMACEUTICAL PREPARATIONS FOR USE IN THE PREVENTION AND TREATMENT OF DISORDERS OF THE NERVOUS SYSTEM, THE IMMUNE SYSTEM, THE CARDIO-VASCULAR SYSTEM, THE METABOLIC SYSTEM, THE RESPIRATORY SYSTEM, THE MUSCULO-SKELETAL SYSTEM, THE GENITOURINARY SYSTEM, AND FOR THE TREATMENT OF INFLAMMATORY DISORDERS, IN CLASS 5 (U.S. CLS. 6, 18, 44, 46, 51 AND 52).

FIRST USE 0-0-1970; IN COMMERCE 0-0-1970.

FOR: SILICONE AND SALINE BREAST IMPLANTS; BREAST IMPLANTS CONSISTING OF ARTIFICIAL MATERIALS AND PARTS AND COMPONENTS THEREFORE; PLASTIC SURGERY DEVICES, NAMELY, MAMMARY PROSTHESES, SURGICAL DEVICES IN THE NATURE OF TISSUE EXPANDERS, FACIAL AND CHIN IMPLANTS

CONSISTING OF ARTIFICIAL MATERIALS, MALAR IMPLANTS CONSISTING OF ARTIFICIAL MATERIALS, RHINOPLASTY PROSTHESES, AND SURGICAL INSTRUMENTS IN THE NATURE OF INJECTION PORT DETECTORS; MEDICAL SURGICAL INSTRUMENTS, NAMELY, REINFORCEMENT PATCH FOR USE AS PORT PROTECTOR FOR ACCESS PORTS OF IMPLANTABLE MEDICAL DEVICES SUCH AS TISSUE EXPANDERS AND BREAST IMPLANTS; ULTRASONIC AND TRADITIONAL LIPOSUCTION SURGICAL INSTRUMENTS, NAMELY, ULTRASONIC CONSOLES, ULTRASONIC GENERATORS, PUMPS, CANNULAE, PATIENT POSITIONERS, PATIENT COMPRESSION BANDAGES, AND ASPIRATION AND IRRIGATION APPARATUS, TUBING, FILTERS, CANISTERS, LINERS, AND PARTS AND FITTINGS THEREFORE, IN CLASS 10 (U.S. CLS. 26, 39 AND 44).

FIRST USE 0-0-1969; IN COMMERCE 0-0-1969.

FOR: PROVIDING MEDICAL INFORMATION TO PHYSICIANS AND PATIENTS REGARDING BREAST IMPLANT SIZING, BREAST IMPLANTS, BREAST RECONSTRUCTION, FACIAL REJUVENATION AND COSMETIC SURGERY; MEDICAL CONSULTATION SERVICES IN THE FIELD OF BREAST IMPLANTS, BREAST RECONSTRUCTION AND COSMETIC SURGERY; MEDICAL SERVICES IN THE NATURE OF PERFORMING ULTRASONIC SURGICAL PROCEDURES, IN CLASS 44 (U.S. CLS. 100 AND 101).

FIRST USE 8-0-2003; IN COMMERCE 8-0-2003.

THE MARK CONSISTS OF STANDARD CHARACTERS WITHOUT CLAIM TO ANY PARTICULAR FONT, STYLE, SIZE, OR COLOR.

OWNER OF U.S. REG. NOS. 1,349,105, 1,941,393 AND OTHERS.

SER. NO. 77-395,414, FILED 2-12-2008.

ZHALEH DELANEY, EXAMINING ATTORNEY

**Int. Cl.: 25**

**Prior U.S. Cls.: 22 and 39**

**United States Patent and Trademark Office**

**Reg. No. 3,504,554**

**Registered Sep. 23, 2008**

**TRADEMARK  
PRINCIPAL REGISTER**

**LUNA DE MIEL**

GAUGHEN HOLDINGS LLC (CALIFORNIA LIMITED LIABILITY COMPANY)  
4954 NAUTILUS ST.  
OXNARD, CA 93035

FOR: COLLARS AND CUFFS USED FOR ADULT FANTASY PURPOSES, EXCLUDING MEN'S CLOTHING AND WOMEN'S CLOTHING AND HEADWEAR; FOOTWEAR, NAMELY, ATHLETIC FOOTWEAR, BOOTS, ESPADRILLES, GALOSHES, HIGH BOOTS, HIGH HEELS, HIKING BOOTS, LOAFERS, MULES, PUMPS, SANDALS, SHOES, SLIPPERS, SNEAKERS, THONGS, IN CLASS 25 (U.S. CLS. 22 AND 39).

FIRST USE 11-25-2006; IN COMMERCE 11-27-2006.

THE MARK CONSISTS OF STANDARD CHARACTERS WITHOUT CLAIM TO ANY PARTICULAR FONT, STYLE, SIZE, OR COLOR.

OWNER OF U.S. REG. NOS. 3,257,007, 3,403,106 AND OTHERS.

THE FOREIGN WORDING IN THE MARK TRANSLATES INTO ENGLISH AS HONEYMOON.

SER. NO. 77-395,426, FILED 2-12-2008.

PATRICIA EVANKO, EXAMINING ATTORNEY

**Int. Cl.: 41**

**Prior U.S. Cls.: 100, 101 and 107**

**United States Patent and Trademark Office**

**Reg. No. 3,504,555**

**Registered Sep. 23, 2008**

**SERVICE MARK  
PRINCIPAL REGISTER**

**COME TO THE TABLE**

CURTIS, MELINDA (UNITED STATES INDIVIDUAL)  
3070 PORTMAN  
KEEGO HARBOR, MI 48320

FOR: ENTERTAINMENT SERVICES, NAMELY, PROVIDING AN ON-GOING RADIO PROGRAM IN THE FIELD OF FOOD; ENTERTAINMENT SERVICES, NAMELY, PROVIDING AN ON-GOING RADIO PROGRAM IN THE FIELD OF DINING; ENTERTAINMENT IN THE NATURE OF SPECIAL EVENTS RELATING TO FOOD AND DINING, IN CLASS 41 (U.S. CLS. 100, 101 AND 107).

FIRST USE 2-10-2008; IN COMMERCE 2-10-2008.

THE MARK CONSISTS OF STANDARD CHARACTERS WITHOUT CLAIM TO ANY PARTICULAR FONT, STYLE, SIZE, OR COLOR.

SER. NO. 77-395,430, FILED 2-12-2008.

STEVEN PEREZ, EXAMINING ATTORNEY

**Int. Cl.: 41**

**Prior U.S. Cls.: 100, 101 and 107**

**United States Patent and Trademark Office**

**Reg. No. 3,504,556**

**Registered Sep. 23, 2008**

---

**SERVICE MARK  
PRINCIPAL REGISTER**

# Memorazzi

FRANCO DEBORAH D (UNITED STATES INDIVIDUAL)  
1361 THORNTON DR.  
SEQUIM, WA 98381

FOR: PHOTOGRAPHY SERVICES; PORTRAIT PHOTOGRAPHY; PROVIDING FACILITIES FOR PRODUCING VIDEO, CINEMA AND PHOTOGRAPHY PRODUCTIONS, IN CLASS 41 (U.S. CLS. 100, 101 AND 107).

FIRST USE 1-1-2008; IN COMMERCE 1-1-2008.

THE MARK CONSISTS OF STANDARD CHARACTERS WITHOUT CLAIM TO ANY PARTICULAR FONT, STYLE, SIZE, OR COLOR.

SER. NO. 77-395,431, FILED 2-12-2008.

STEVEN PEREZ, EXAMINING ATTORNEY

**Int. Cl.: 9**

**Prior U.S. Cls.: 21, 23, 26, 36 and 38**

**United States Patent and Trademark Office**

**Reg. No. 3,504,557**

**Registered Sep. 23, 2008**

**TRADEMARK  
PRINCIPAL REGISTER**

# LionClock

VASSILIEV, EVGENY (CANADA INDIVIDUAL)  
107 FAIRMONT PT S  
LETHBRIDGE, CANADA T1K7W8

THE MARK CONSISTS OF STANDARD CHARACTERS WITHOUT CLAIM TO ANY PARTICULAR FONT, STYLE, SIZE, OR COLOR.

FOR: COMPUTER PROGRAMS USED TO RECORD EMPLOYEE WORK HOURS AND TO CREATE PAYROLL REPORTS, IN CLASS 9 (U.S. CLS. 21, 23, 26, 36 AND 38).

SER. NO. 77-395,458, FILED 2-13-2008.

FIRST USE 2-7-2008; IN COMMERCE 2-7-2008.

REBECCA EISINGER, EXAMINING ATTORNEY

**Int. Cl.: 16**

**Prior U.S. Cls.: 2, 5, 22, 23, 29, 37, 38 and 50**

**Reg. No. 3,504,558**

**United States Patent and Trademark Office**

**Registered Sep. 23, 2008**

---

**TRADEMARK  
PRINCIPAL REGISTER**

**EXTENSIONS**

HMP COMMUNICATIONS, LLC (DELAWARE  
LIMITED LIABILITY COMPANY)  
SUITE 100  
83 GENERAL WARREN BOULEVARD  
MALVERN, PA 19355

FOR: PRINTED PUBLICATIONS, NAMELY, PERIODICALLY PUBLISHED MAGAZINES AND JOURNALS IN THE FIELDS OF HEALTHCARE AND MEDICINE, IN CLASS 16 (U.S. CLS. 2, 5, 22, 23, 29, 37, 38 AND 50).

FIRST USE 4-1-2005; IN COMMERCE 4-1-2005.

THE MARK CONSISTS OF STANDARD CHARACTERS WITHOUT CLAIM TO ANY PARTICULAR FONT, STYLE, SIZE, OR COLOR.

SER. NO. 77-395,607, FILED 2-13-2008.

AHSEN KHAN, EXAMINING ATTORNEY

**Int. Cl.: 42**

**Prior U.S. Cls.: 100 and 101**

**United States Patent and Trademark Office**

**Reg. No. 3,504,559**

**Registered Sep. 23, 2008**

**SERVICE MARK  
PRINCIPAL REGISTER**

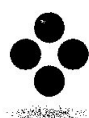

**THOUGHTLOGIKS**  
CONSULTING. TECHNOLOGY. SOLUTIONS.

THOUGHTLOGIKS, LLC (INDIANA LIMITED  
LIABILITY COMPANY)  
SUITE #1600- SOUTH TOWER  
201 N. ILLINOIS STREET  
INDIANAPOLIS, IN 46204

FOR: INFORMATION TECHNOLOGY CONSUL-  
TATION, IN CLASS 42 (U.S. CLS. 100 AND 101).

FIRST USE 1-3-2008; IN COMMERCE 1-3-2008.

NO CLAIM IS MADE TO THE EXCLUSIVE  
RIGHT TO USE "CONSULTING" AND "TECHNOL-  
OGY" AND "SOLUTIONS", APART FROM THE  
MARK AS SHOWN.

THE STIPPLING IS FOR SHADING PURPOSES  
ONLY.

THE MARK CONSISTS OF THE STYLIZED  
WORDS "THOUGHTLOGIKS CONSULTING.  
TECHNOLOGY. SOLUTIONS." TO THE LEFT OF  
THE "THOUGHTLOGIKS" IS A GRAPHIC OF 4  
SPHERES IN A DIAGONAL PATTERN.

SER. NO. 77-395,612, FILED 2-13-2008.

ALICIA COLLINS, EXAMINING ATTORNEY



**Int. Cl.: 16**

**Prior U.S. Cls.: 2, 5, 22, 23, 29, 37, 38 and 50**

**United States Patent and Trademark Office**

**Reg. No. 3,504,560**

**Registered Sep. 23, 2008**

**TRADEMARK  
PRINCIPAL REGISTER**

**PATHWAYS**

HMP COMMUNICATIONS, LLC (DELAWARE  
LIMITED LIABILITY COMPANY)  
SUITE 100  
83 GENERAL WARREN BOULEVARD  
MALVERN, PA 19355

FOR: PRINTED PUBLICATIONS, NAMELY, PER-  
IODICALLY PUBLISHED MAGAZINES AND JOUR-  
NALS IN THE FIELDS OF HEALTHCARE AND  
MEDICINE, IN CLASS 16 (U.S. CLS. 2, 5, 22, 23, 29, 37,  
38 AND 50).

FIRST USE 4-1-2001; IN COMMERCE 4-1-2001.

THE MARK CONSISTS OF STANDARD CHAR-  
ACTERS WITHOUT CLAIM TO ANY PARTICULAR  
FONT, STYLE, SIZE, OR COLOR.

SER. NO. 77-395,613, FILED 2-13-2008.

MELVIN AXILBUND, EXAMINING ATTORNEY

**Int. Cl.: 35**

**Prior U.S. Cls.: 100, 101 and 102**

**United States Patent and Trademark Office**

**Reg. No. 3,504,561**

**Registered Sep. 23, 2008**

**SERVICE MARK  
PRINCIPAL REGISTER**

**American Dream Rooms**

AMERICAN DREAM ROOMS CORPORATION  
(NORTH CAROLINA CORPORATION)  
401 E. RUSSELL STREET  
HIGH POINT, NC 27260

FOR: WHOLESALE ORDERING SERVICES IN  
THE FIELD OF FURNITURE; IMPORT SERVICES  
IN THE FIELD OF FURNITURE, IN CLASS 35 (U.S.  
CLS. 100, 101 AND 102).

FIRST USE 2-1-2008; IN COMMERCE 2-1-2008.

THE MARK CONSISTS OF STANDARD CHAR-  
ACTERS WITHOUT CLAIM TO ANY PARTICULAR  
FONT, STYLE, SIZE, OR COLOR.

NO CLAIM IS MADE TO THE EXCLUSIVE  
RIGHT TO USE "AMERICAN", APART FROM THE  
MARK AS SHOWN.

SER. NO. 77-395,642, FILED 2-13-2008.

MARGERY A. TIERNEY, EXAMINING ATTORNEY

**Int. Cl.: 42**

**Prior U.S. Cls.: 100 and 101**

**United States Patent and Trademark Office**

**Reg. No. 3,504,562**

**Registered Sep. 23, 2008**

**SERVICE MARK  
PRINCIPAL REGISTER**

**Performance Accountability**

PERFORMANCE ACCOUNTABILITY LLC  
(TEXAS LIMITED LIABILITY COMPANY)  
1916-A LARCHMONT DR.  
AUSTIN, TX 78704

FOR: CONSULTING SERVICES IN THE FIELD  
OF DESIGN, SELECTION, IMPLEMENTATION  
AND USE OF COMPUTER SOFTWARE SYSTEMS;  
DESIGN AND DEVELOPMENT OF ON-LINE SOFT-  
WARE SYSTEMS; DATA AUTOMATION AND COL-  
LECTION SERVICE USING PROPRIETARY  
SOFTWARE TO EVALUATE, ANALYZE AND COL-

LECT SERVICE DATA, IN CLASS 42 (U.S. CLS. 100  
AND 101).

FIRST USE 1-1-2008; IN COMMERCE 1-1-2008.

THE MARK CONSISTS OF STANDARD CHAR-  
ACTERS WITHOUT CLAIM TO ANY PARTICULAR  
FONT, STYLE, SIZE, OR COLOR.

SER. NO. 77-395,645, FILED 2-13-2008.

MARGERY A. TIERNEY, EXAMINING ATTORNEY

Int. Cl.: 11

Prior U.S. Cls.: 13, 21, 23, 31 and 34

United States Patent and Trademark Office

Reg. No. 3,504,563

Registered Sep. 23, 2008

TRADEMARK  
PRINCIPAL REGISTER



NEOBULB TECHNOLOGIES, INC. (BRUNEI  
DARUSSALAM CORPORATION)  
RM.51, 5TH FL.  
BRITANNIA HOUSE, JLN.CATOR, BS8811  
BANDAR SERI, BRUNEI DARUSSALAM

FOR: BULBS, NAMELY, LIGHT BULBS, ELECTRIC LIGHT BULBS, HALOGEN LIGHT BULBS; LIGHTING, NAMELY, LIGHT BULBS, INFRARED LIGHTING FIXTURES, AND ELECTRIC NIGHT LIGHTS; FLUORESCENT LAMPS; FLASHLIGHTS; LAMPS FOR INTERNAL ILLUMINATION; LIGHTS FOR VEHICLES, NAMELY, AUTOMOTIVE LIGHT BULBS, MOTORCYCLE LIGHT BULBS, BRAKE LAMPS, VEHICLE HEADLIGHTS, VEHICLE TAILLIGHTS, VEHICLE SIDELIGHTS, AND DIRECTION INDICATOR LIGHTS; BICYCLE LIGHTS, NAMELY,

DYNAMO-POWERED LAMPS FOR BIKE, AND STOP INDICATOR LIGHTS; REFLECTORS FOR VEHICLES; ELECTRICAL LIGHT BULBS; LAMPS; FOG LAMPS, IN CLASS 11 (U.S. CLS. 13, 21, 23, 31 AND 34).

FIRST USE 12-15-2007; IN COMMERCE 12-15-2007.

THE MARK CONSISTS OF THE WORD "NEOBULB" FORMED WITHIN TWO CONCENTRIC OVAL CONTOURS.

SER. NO. 77-395,651, FILED 2-13-2008.

KIMBERLY PERRY, EXAMINING ATTORNEY

**Int. Cl.: 35**

**Prior U.S. Cls.: 100, 101 and 102**

**United States Patent and Trademark Office**

**Reg. No. 3,504,564**

**Registered Sep. 23, 2008**

**SERVICE MARK  
PRINCIPAL REGISTER**

**DR HOME CARE** 

DUANE READE INTERNATIONAL, INC. (DELA-  
WARE CORPORATION)  
440 NINTH AVENUE  
NEW YORK, NY 10001

NO CLAIM IS MADE TO THE EXCLUSIVE  
RIGHT TO USE "HOMECARE", APART FROM  
THE MARK AS SHOWN.

FOR: RETAIL STORE SERVICES AND ONLINE  
RETAIL STORE SERVICES FEATURING HOME  
HEALTH CARE EQUIPMENT AND SUPPLIES, IN  
CLASS 35 (U.S. CLS. 100, 101 AND 102).

THE MARK CONSISTS OF THE LITERAL ELE-  
MENT "DR HOME CARE" POSITIONED TO THE  
LEFT OF A HANDICAP SYMBOL.

FIRST USE 7-11-2007; IN COMMERCE 11-1-2007.

SER. NO. 77-395,660, FILED 2-13-2008.

OWNER OF U.S. REG. NOS. 1,099,871 AND  
3,148,519.

KIMBERLY PERRY, EXAMINING ATTORNEY

**Int. Cl.: 35**

**Prior U.S. Cls.: 100, 101 and 102**

**United States Patent and Trademark Office**

**Reg. No. 3,504,565**

**Registered Sep. 23, 2008**

**SERVICE MARK  
PRINCIPAL REGISTER**

**REAL UNLIMITED. UNREAL  
SAVINGS**

CRICKET COMMUNICATIONS, INC. (DELA-  
WARE CORPORATION)  
10307 PACIFIC CENTER COURT  
SAN DIEGO, CA 92121

FOR: RETAIL STORE SERVICES FEATURING  
WIRELESS COMMUNICATION APPARATUS,  
NAMELY, CELLULAR TELEPHONES, PERSONAL  
COMMUNICATION SERVICES (PCS) HANDSETS  
TELEPHONE ACCESSORIES, NAMELY, FITTED  
CARRYING CASES, BELT CLIPS, BATTERY CHAR-  
GERS; INTEGRATED WIRELESS COMMUNICA-  
TION AND COMPUTING APPARATUS, NAMELY,  
CELLULAR TELEPHONES, AND PERSONAL COM-  
MUNICATION HANDSETS COMBINED WITH A  
COMPUTER OR PERSONAL DIGITAL ASSISTANT

(PDA) DEVICE; TELEPHONE ACCESSORIES,  
NAMELY, FITTED CARRYING CASES, BELT  
CLIPS, BATTERY CHARGERS AND BATTERIES,  
IN CLASS 35 (U.S. CLS. 100, 101 AND 102).

FIRST USE 2-1-2008; IN COMMERCE 2-1-2008.

THE MARK CONSISTS OF STANDARD CHAR-  
ACTERS WITHOUT CLAIM TO ANY PARTICULAR  
FONT, STYLE, SIZE, OR COLOR.

SER. NO. 77-395,678, FILED 2-13-2008.

JENNIFER VASQUEZ, EXAMINING ATTORNEY

Int. Cl.: 41

Prior U.S. Cls.: 100, 101 and 107

United States Patent and Trademark Office

Reg. No. 3,504,566

Registered Sep. 23, 2008

SERVICE MARK  
PRINCIPAL REGISTER



JABBOUR, JOYCE (UNITED STATES INDIVIDUAL)  
19 CROTON AVENUE  
HASTINGS ON HUDSON, NY 10706

FOR: ENTERTAINMENT SERVICES, NAMELY, CONDUCTING PARTIES, IN CLASS 41 (U.S. CLS. 100, 101 AND 107).

FIRST USE 4-12-2007; IN COMMERCE 4-12-2007.

NO CLAIM IS MADE TO THE EXCLUSIVE RIGHT TO USE "KIDS", APART FROM THE MARK AS SHOWN.

THE MARK CONSISTS OF A HEART WITH THE STYLIZED TEXT "GIVING KIDS" TO THE RIGHT. BELOW IS THE STYLIZED TEXT "LEARNING COMPASSION THROUGH FASHION". THE DOT FOR THE LETTERS "I" IN THE TEXT "GIVING KIDS" ARE HEARTS.

SER. NO. 77-395,688, FILED 2-13-2008.

STEVEN R. FINE, EXAMINING ATTORNEY

**Int. Cl.: 42**

**Prior U.S. Cls.: 100 and 101**

**United States Patent and Trademark Office**

**Reg. No. 3,504,567**

**Registered Sep. 23, 2008**

**SERVICE MARK  
PRINCIPAL REGISTER**



CLEAR CHANNEL MANAGEMENT SERVICES,  
L.P. (TEXAS LIMITED PARTNERSHIP)  
200 EAST BASSE ROAD  
SAN ANTONIO, TX 78209

FOR: APPLICATION SERVICE PROVIDER FEATURING SOFTWARE FOR USE IN TRANSACTING, MANAGING, AND REPORTING REVENUE STREAMS FOR BROADCAST ENTERPRISES , IN CLASS 42 (U.S. CLS. 100 AND 101).

FIRST USE 5-0-2001; IN COMMERCE 5-0-2001.

NO CLAIM IS MADE TO THE EXCLUSIVE RIGHT TO USE "INTERNATIONAL", APART FROM THE MARK AS SHOWN.

THE MARK CONSISTS OF THE WORDS "LAN INTERNATIONAL" SURROUNDED BY THREE INCOMPLETE CIRCLES.

SER. NO. 77-395,713, FILED 2-13-2008.

JOHN WILKE, EXAMINING ATTORNEY



Int. Cl.: 37

Prior U.S. Cls.: 100, 103 and 106

**United States Patent and Trademark Office**

**Reg. No. 3,504,568**

Registered Sep. 23, 2008

**SERVICE MARK  
PRINCIPAL REGISTER**



**ELITE MULTIMEDIA**

BYRDCORP INC (TENNESSEE CORPORATION),  
DBA ELITE MULTIMEDIA  
SUITE 104  
2756 APPLING CENTER COVE  
MEMPHIS, TN 38133

FOR: INSTALLATION OF COMMERCIAL  
AUDIO, VIDEO, AND LIGHTING SYSTEMS, IN  
CLASS 37 (U.S. CLS. 100, 103 AND 106).

FIRST USE 1-1-2004; IN COMMERCE 1-1-2004.

NO CLAIM IS MADE TO THE EXCLUSIVE  
RIGHT TO USE "MULTIMEDIA", APART FROM  
THE MARK AS SHOWN.

THE MARK CONSISTS OF AN ABSTRACT DE-  
SIGN ABOVE THE STYLIZED TEXT "ELITE MULTI-  
MEDIA".

SER. NO. 77-395,752, FILED 2-13-2008.

FLORENTINA BLANDU, EXAMINING ATTORNEY

**Int. Cl.: 42**

**Prior U.S. Cls.: 100 and 101**

**United States Patent and Trademark Office**

**Reg. No. 3,504,569**

**Registered Sep. 23, 2008**

**SERVICE MARK  
PRINCIPAL REGISTER**

**V  
E  
R  
T  
I  
C  
A  
L  
K  
I  
T  
C  
H  
E  
N**

HILL, DEAN (UNITED STATES INDIVIDUAL)  
#113  
1330 NEW HAMPSHIRE AVE. NW  
WASHINGTON, DC 20036

THE MARK CONSISTS OF THE STYLIZED TEXT  
"VERTICAL KITCHEN".

FOR: DESIGN FOR OTHERS IN THE FIELD OF  
KITCHEN, IN CLASS 42 (U.S. CLS. 100 AND 101).

SER. NO. 77-395,765, FILED 2-13-2008.

FIRST USE 10-13-2007; IN COMMERCE 10-13-2007.

FLORENTINA BLANDU, EXAMINING ATTORNEY

**Int. Cls.: 41 and 43**

**Prior U.S. Cls.: 100, 101 and 107**

**United States Patent and Trademark Office**

**Reg. No. 3,504,570**

**Registered Sep. 23, 2008**

**SERVICE MARK  
PRINCIPAL REGISTER**



BEARFOOT SCUBA, LLC (TEXAS LIMITED LIABILITY COMPANY)  
4120 FAIRWAY DRIVE  
FLOWER MOUND, TX 75028

FOR: SCUBA TRAINING SERVICES, IN CLASS 41 (U.S. CLS. 100, 101 AND 107).

FIRST USE 7-1-2007; IN COMMERCE 7-1-2007.

FOR: TRAVEL AGENCY SERVICES, NAMELY, MAKING RESERVATIONS AND BOOKING FOR TEMPORARY LODGING, IN CLASS 43 (U.S. CLS. 100 AND 101).

FIRST USE 7-1-2007; IN COMMERCE 7-1-2007.

NO CLAIM IS MADE TO THE EXCLUSIVE RIGHT TO USE "SCUBA", APART FROM THE MARK AS SHOWN.

THE MARK CONSISTS OF A 5-TOED BEAR PAW WITH CLAWS. THE PAW PAD HAS A DIAGONAL STRIPE RUNNING FROM THE UPPER LEFT TO LOWER RIGHT. THIS STRIPE ON THE PAW PAD IS REPRESENTATIVE OF THE RECREATIONAL DIVER FLAG.

SER. NO. 77-395,775, FILED 2-13-2008.

PAUL E. FAHRENKOPF, EXAMINING ATTORNEY

**Int. Cl.: 3**

**Prior U.S. Cls.: 1, 4, 6, 50, 51 and 52**

**Reg. No. 3,504,571**

**United States Patent and Trademark Office**

**Registered Sep. 23, 2008**

---

**TRADEMARK  
PRINCIPAL REGISTER**

**NEUTRA FOAM**

AMPRO INDUSTRIES, INC. (TENNESSEE COR-  
PORATION)  
SUITE 800  
65 UNION AVENUE  
MEMPHIS, TN 38103

FOR: HAIR SHAMPOO AND CONDITIONER,  
LIQUID SOAP FOR HANDS, FACE AND BODY, IN  
CLASS 3 (U.S. CLS. 1, 4, 6, 50, 51 AND 52).

FIRST USE 7-1-1978; IN COMMERCE 7-1-1978.

THE MARK CONSISTS OF STANDARD CHAR-  
ACTERS WITHOUT CLAIM TO ANY PARTICULAR  
FONT, STYLE, SIZE, OR COLOR.

NO CLAIM IS MADE TO THE EXCLUSIVE  
RIGHT TO USE "FOAM", APART FROM THE  
MARK AS SHOWN.

SER. NO. 77-395,790, FILED 2-13-2008.

CAROLINE WOOD, EXAMINING ATTORNEY

**Int. Cl.: 35**

**Prior U.S. Cls.: 100, 101 and 102**

**United States Patent and Trademark Office**

**Reg. No. 3,504,572**

**Registered Sep. 23, 2008**

**SERVICE MARK  
PRINCIPAL REGISTER**



HYDRAULICSTORE (NEBRASKA LIMITED LIABILITY COMPANY)  
3727 WESTGATE ROAD  
GRAND ISLAND, NE 68803

FOR: MAIL ORDER AND RETAIL AND WHOLESALE STORE SERVICES IN THE FIELD OF HYDRAULICS AND PNEUMATICS AND HARDWARE THEREFOR, IN CLASS 35 (U.S. CLS. 100, 101 AND 102).

FIRST USE 1-27-2007; IN COMMERCE 2-16-2007.

NO CLAIM IS MADE TO THE EXCLUSIVE RIGHT TO USE "HYDRAULICSTORE", APART FROM THE MARK AS SHOWN.

THE MARK CONSISTS OF SETS OF PARALLEL ARCS PERPENDICULAR TO EACH OTHER FORMING A THREE-DIMENSIONAL VISUAL GLOBE EFFECT. THE LITERAL ELEMENT "HYDRAULICSTORE" APPEARS BENEATH THE ARC SETS.

SER. NO. 77-395,801, FILED 2-13-2008.

JENNIFER VASQUEZ, EXAMINING ATTORNEY

Int. Cls.: 29 and 43

Prior U.S. Cls.: 46, 100 and 101

United States Patent and Trademark Office

Reg. No. 3,504,573

Registered Sep. 23, 2008

TRADEMARK  
SERVICE MARK  
PRINCIPAL REGISTER

빙 찰수 대

RHEE, ILSONG (REPUBLIC OF KOREA INDIVIDUAL)  
3138 W. 182ND ST.  
TORRANCE, CA 90504

FOR: SAUSAGES, IN CLASS 29 (U.S. CL. 46).

FIRST USE 8-1-2003; IN COMMERCE 8-1-2003.

FOR: RESTAURANT, IN CLASS 43 (U.S. CLS. 100 AND 101).

FIRST USE 8-1-2003; IN COMMERCE 8-1-2003.

NO CLAIM IS MADE TO THE EXCLUSIVE RIGHT TO USE THE LAST TWO NON-LATIN

CHARACTERS IN THE MARK THAT MEAN "SAUSAGE", APART FROM THE MARK AS SHOWN.

THE MARK CONSISTS OF FOUR KOREAN CHARACTERS.

THE KOREAN CHARACTERS IN THE MARK TRANSLITERATE INTO THE WORDS, "BYONG CHON SOONDAE", WHICH TRANSLATES INTO THE ENGLISH WORDING, "BYONG CHON SAUSAGE".

SER. NO. 77-395,875, FILED 2-13-2008.

BARBARA A. GOLD, EXAMINING ATTORNEY

Int. Cl.: 36

Prior U.S. Cls.: 100, 101 and 102

United States Patent and Trademark Office

Reg. No. 3,504,574

Registered Sep. 23, 2008

**SERVICE MARK  
PRINCIPAL REGISTER**

IF YOU'RE BUYING INSURANCE  
FROM ANOTHER BROKER THEN  
WE ARE BOTH LOSING MONEY!

718INSURANCE AGENCY INC. (NEW YORK  
CORPORATION)  
326 KINGSTON AVE  
BROOKLYN, NY 11213

FOR: PERSONAL, BUSINESS, COMMERCIAL,  
INDUSTRIAL, PROPERTY, HEALTH AND LIFE  
INSURANCE AGENCY SERVICES; BUSINESS,  
COMMERCIAL, INDUSTRIAL, PROPERTY,  
HEALTH AND LIFE INSURANCE AND GUARAN-  
TEE ASSURANCE CONSULTANCY SERVICES AND  
PROVIDING INFORMATION RELATED THERETO;  
CONSULTANCY, ADVISORY AND PROVIDING  
INFORMATION RELATING TO THE ADMINIS-  
TRATION OF EMPLOYEE PENSION PLANS, INDI-  
VIDUAL RETIREMENT ACCOUNTS, GROUP AND  
INDIVIDUAL HEALTH POLICIES, MUTUAL  
FUNDS, FINANCIAL PLANNING, AND DISABIL-  
ITY PLANS; ADMINISTRATION OF VARIOUS EM-  
PLOYEES PENSION PLANS; ADMINISTRATION OF  
RETIREMENT PLANS; CAPITAL INVESTMENT  
MANAGEMENT AND CONSULTATION; FINAN-

CING SERVICES; FINANCIAL CONSULTANCY  
SERVICES; FINANCIAL MANAGEMENT SERVI-  
CES; FINANCIAL EVALUATION AND ANALYSIS  
SERVICES FOR INSURANCE PURPOSES; LOAN  
FINANCING SERVICES; HIRE-PURCHASE FINAN-  
CING SERVICES; INSURANCE BROKERAGE SER-  
VICES; SECURITIES BROKERAGE SERVICES;  
STOCKS AND BONDS BROKERAGE SERVICES;  
AND TRUSTEESHIP REPRESENTATIVE SERVICES,  
IN CLASS 36 (U.S. CLS. 100, 101 AND 102).

FIRST USE 2-15-2002; IN COMMERCE 2-15-2002.

THE MARK CONSISTS OF STANDARD CHAR-  
ACTERS WITHOUT CLAIM TO ANY PARTICULAR  
FONT, STYLE, SIZE, OR COLOR.

SER. NO. 77-396,020, FILED 2-13-2008.

DOMINICK J. SALEMI, EXAMINING ATTORNEY

**Int. Cl.: 19**

**Prior U.S. Cls.: 1, 12, 33 and 50**

**United States Patent and Trademark Office**

**Reg. No. 3,504,575**

**Registered Sep. 23, 2008**

**TRADEMARK  
PRINCIPAL REGISTER**

**ceilume**

EMPIRE WEST INC. (CALIFORNIA CORPORATION)  
PO BOX 511  
9270 GRATON ROAD  
GRATON, CA 95444

FOR: NON-METAL CEILING PANELS; PLASTIC  
TILES, IN CLASS 19 (U.S. CLS. 1, 12, 33 AND 50).

FIRST USE 12-31-2007; IN COMMERCE 12-31-2007.

THE MARK CONSISTS OF STANDARD CHARACTERS WITHOUT CLAIM TO ANY PARTICULAR FONT, STYLE, SIZE, OR COLOR.

OWNER OF U.S. REG. NO. 3,215,685.

SER. NO. 77-396,060, FILED 2-13-2008.

VERNA BETH RIRIE, EXAMINING ATTORNEY



**Int. Cl.: 35**

**Prior U.S. Cls.: 100, 101 and 102**

**United States Patent and Trademark Office**

**Reg. No. 3,504,576**

**Registered Sep. 23, 2008**

**SERVICE MARK  
PRINCIPAL REGISTER**

# AREA 41

HULL & KNARR LLP (INDIANA LIMITED  
PARTNERSHIP)  
555 EAST COUNTY LINE ROAD, SUITE 210  
GREENWOOD, IN 46143

FOR: TAX CONSULTING SERVICES, IN CLASS 35  
(U.S. CLS. 100, 101 AND 102).

FIRST USE 2-12-2008; IN COMMERCE 2-12-2008.

THE MARK CONSISTS OF STANDARD CHAR-  
ACTERS WITHOUT CLAIM TO ANY PARTICULAR  
FONT, STYLE, SIZE, OR COLOR.

NO CLAIM IS MADE TO THE EXCLUSIVE  
RIGHT TO USE "41", APART FROM THE MARK  
AS SHOWN.

THE WORDING "41" HAS NO MEANING IN A  
FOREIGN LANGUAGE.

SER. NO. 77-396,067, FILED 2-13-2008.

PRISCILLA MILTON, EXAMINING ATTORNEY

**Int. Cl.: 41**

**Prior U.S. Cls.: 100, 101 and 107**

**United States Patent and Trademark Office**

**Reg. No. 3,504,577**

**Registered Sep. 23, 2008**

**SERVICE MARK  
PRINCIPAL REGISTER**

# HIGHER POWER

DENNIS L. SMITH, LLC (GEORGIA LIMITED LIABILITY COMPANY)  
1670 WELLSHIRE LANE  
DUNWOODY, GA 30338

FOR: ENTERTAINMENT IN THE NATURE OF VISUAL AND AUDIO PERFORMANCES, NAMELY, MUSICAL GROUP PERFORMANCES; ENTERTAINMENT IN THE NATURE OF A MUSICAL GROUP; ENTERTAINMENT, NAMELY, LIVE PERFORMANCES BY A MUSICAL GROUP; ENTERTAINMENT SERVICES, NAMELY, PROVIDING MUSIC PERFORMANCES, MUSICAL VIDEOS, RELATED FILM CLIPS, PHOTOGRAPHS, AND OTHER MULTIMEDIA MATERIALS ON A GLOBAL COMPUTER NETWORK; PRESENTATION OF MUSICAL

PERFORMANCES; ENTERTAINMENT SERVICES IN THE NATURE OF PRODUCTION AND DISTRIBUTION OF VIDEO AND/OR AUDIO PROGRAMS FEATURING MUSICAL PERFORMANCES, IN CLASS 41 (U.S. CLS. 100, 101 AND 107).

FIRST USE 8-30-2007; IN COMMERCE 8-30-2007.

THE MARK CONSISTS OF STANDARD CHARACTERS WITHOUT CLAIM TO ANY PARTICULAR FONT, STYLE, SIZE, OR COLOR.

SER. NO. 77-396,146, FILED 2-13-2008.

COLLEEN DOMBROW, EXAMINING ATTORNEY

**Int. Cl.: 9**

**Prior U.S. Cls.: 21, 23, 26, 36 and 38**

**Reg. No. 3,504,578**

**United States Patent and Trademark Office**

**Registered Sep. 23, 2008**

---

**TRADEMARK  
PRINCIPAL REGISTER**

**CERAMICELL**

COORSTEK, INC. (DELAWARE CORPORATION)  
16000 TABLE MOUNTAIN PARKWAY  
GOLDEN, CO 80403

THE MARK CONSISTS OF STANDARD CHAR-  
ACTERS WITHOUT CLAIM TO ANY PARTICULAR  
FONT, STYLE, SIZE, OR COLOR.

FOR: ELECTROCHEMICAL GENERATORS,  
NAMELY, FUEL CELLS, IN CLASS 9 (U.S. CLS. 21,  
23, 26, 36 AND 38).

SER. NO. 77-396,158, FILED 2-13-2008.

FIRST USE 3-1-2006; IN COMMERCE 3-1-2006.

JERI J. FICKES, EXAMINING ATTORNEY

**Int. Cl.: 5**

**Prior U.S. Cls.: 6, 18, 44, 46, 51 and 52**

**United States Patent and Trademark Office**

**Reg. No. 3,504,579**

**Registered Sep. 23, 2008**

**TRADEMARK  
PRINCIPAL REGISTER**

**FERROFORTE**

BIMEDAMTC ANIMAL HEALTH, INC. (CANADA CORPORATION)  
420 BEAVERDALE ROAD  
CAMBRIDGE, CANADA

FOR: VETERINARY PREPARATION FOR PREVENTION AND TREATMENT OF IRON DEFICIENCY ANEMIA IN BABY PIGS, IN CLASS 5 (U.S. CLS. 6, 18, 44, 46, 51 AND 52).

FIRST USE 5-1-1991; IN COMMERCE 2-11-2008.

THE MARK CONSISTS OF STANDARD CHARACTERS WITHOUT CLAIM TO ANY PARTICULAR FONT, STYLE, SIZE, OR COLOR.

SER. NO. 77-396,190, FILED 2-13-2008.

ELLEN BURNS, EXAMINING ATTORNEY

**Int. Cl.: 41**

**Prior U.S. Cls.: 100, 101 and 107**

**United States Patent and Trademark Office**

**Reg. No. 3,504,580**

**Registered Sep. 23, 2008**

**SERVICE MARK  
PRINCIPAL REGISTER**

**HIGHER  
POWER**

DENNIS L. SMITH, LLC (GEORGIA LIMITED  
LIABILITY COMPANY)  
1670 WELLSHIRE LANE  
DUNWOODY, GA 30338

FOR: ENTERTAINMENT IN THE NATURE OF  
VISUAL AND AUDIO PERFORMANCES, NAMELY,  
MUSICAL GROUP PERFORMANCES; ENTER-  
TAINMENT IN THE NATURE OF A MUSICAL  
GROUP; ENTERTAINMENT, NAMELY, LIVE PER-  
FORMANCES BY A MUSICAL GROUP; ENTER-  
TAINMENT SERVICES, NAMELY, PROVIDING  
MUSIC PERFORMANCES, MUSICAL VIDEOS, RE-  
LATED FILM CLIPS, PHOTOGRAPHS, AND OTHER

MULTIMEDIA MATERIALS ON A GLOBAL COM-  
PUTER NETWORK; PRESENTATION OF MUSICAL  
PERFORMANCES; ENTERTAINMENT SERVICES  
IN THE NATURE OF PRODUCTION AND DISTRI-  
BUTION OF VIDEO AND/OR AUDIO PROGRAMS  
FEATURING MUSICAL PERFORMANCES, IN  
CLASS 41 (U.S. CLS. 100, 101 AND 107).

FIRST USE 8-30-2007; IN COMMERCE 8-30-2007.

SER. NO. 77-396,191, FILED 2-13-2008.

COLLEEN DOMBROW, EXAMINING ATTORNEY

**Int. Cl.: 41**

**Prior U.S. Cls.: 100, 101 and 107**

**United States Patent and Trademark Office**

**Reg. No. 3,504,581**

**Registered Sep. 23, 2008**

**SERVICE MARK  
PRINCIPAL REGISTER**

**THE GHETTO FILM SCHOOL**

THE GHETTO FILM SCHOOL, INC. (NEW YORK  
NON-PROFIT CORPORATION)  
PO BOX 1580 BOULEVARD STATION  
THE BRONX, NY 10459

FOR: FILM SCHOOL; EDUCATION SERVICES,  
NAMELY, PROVIDING CLASSES, SEMINARS,  
WORKSHOPS, TUTORING, AND MENTORING IN  
THE FIELD OF FILM MAKING AND DIGITAL  
MEDIA; FILM AND VIDEO PRODUCTION SERVI-  
CES, IN CLASS 41 (U.S. CLS. 100, 101 AND 107).

FIRST USE 6-15-2000; IN COMMERCE 6-15-2000.

THE MARK CONSISTS OF STANDARD CHAR-  
ACTERS WITHOUT CLAIM TO ANY PARTICULAR  
FONT, STYLE, SIZE, OR COLOR.

NO CLAIM IS MADE TO THE EXCLUSIVE  
RIGHT TO USE "FILM SCHOOL", APART FROM  
THE MARK AS SHOWN.

SER. NO. 77-396,242, FILED 2-13-2008.

CYNTHIA TRIPI, EXAMINING ATTORNEY

**Int. Cl.: 35**

**Prior U.S. Cls.: 100, 101 and 102**

**United States Patent and Trademark Office**

**Reg. No. 3,504,582**

**Registered Sep. 23, 2008**

**SERVICE MARK  
PRINCIPAL REGISTER**



NATIONAL TOUR ASSOCIATION, INC. (KEN-  
TUCKY NON-PROFIT CORPORATION)  
546 E. MAIN ST.  
LEXINGTON, KY 40508

FOR: ASSOCIATION SERVICES, NAMELY, PRO-  
MOTING THE INTERESTS OF THE PACKAGED  
TOUR AND TRAVEL INDUSTRY, IN CLASS 35 (U.S.  
CLS. 100, 101 AND 102).

FIRST USE 2-12-2008; IN COMMERCE 2-12-2008.

OWNER OF U.S. REG. NOS. 1,502,649, 2,664,168,  
AND 2,819,967.

THE MARK CONSISTS OF A STYLIZED GLOBE  
DESIGN WITH THE LETTERS "NTA" POSITIONED  
TO THE RIGHT THEREOF.

SER. NO. 77-396,264, FILED 2-13-2008.

JASON ROTH, EXAMINING ATTORNEY

Int. Cl.: 41

Prior U.S. Cls.: 100, 101 and 107

United States Patent and Trademark Office

Reg. No. 3,504,583

Registered Sep. 23, 2008

SERVICE MARK  
PRINCIPAL REGISTER



ARLINGTON INDEPENDENT SCHOOL DISTRICT (TEXAS INDEPENDENT SCHOOL DISTRICT, A POLITICAL SUBDIVISION OF THE STATE OF TEXAS)

AISSD CENTRAL ADMINISTRATION BUILDING  
1203 W. PIONEER PARKWAY  
ARLINGTON, TX 76013

FOR: EDUCATIONAL SERVICES, NAMELY, PROVIDING COURSES OF INSTRUCTION AT THE ELEMENTARY, MIDDLE SCHOOL, AND HIGH SCHOOL LEVEL AND DISTRIBUTION OF COURSE MATERIAL IN CONNECTION THEREWITH, IN CLASS 41 (U.S. CLS. 100, 101 AND 107).

FIRST USE 6-7-2007; IN COMMERCE 6-7-2007.

NO CLAIM IS MADE TO THE EXCLUSIVE RIGHT TO USE "ARLINGTON INDEPENDENT

SCHOOL DISTRICT", APART FROM THE MARK AS SHOWN.

THE MARK CONSISTS OF STYLIZED STAR DESIGN COMPRISED OF 5 STYLIZED LETTER "A" ARRANGED IN A PATTERN AROUND THE CENTER OF THE STAR. TO THE RIGHT OF THE DESIGN IS THE WORDING "ARLINGTON" IN LARGE LETTERS AND UNDERLINED ABOVE THE WORDING "INDEPENDENT SCHOOL DISTRICT" IN SMALLER LETTERS.

SER. NO. 77-396,267, FILED 2-13-2008.

MATTHEW MCDOWELL, EXAMINING ATTORNEY



**Int. Cl.: 41**

**Prior U.S. Cls.: 100, 101 and 107**

**United States Patent and Trademark Office**

**Reg. No. 3,504,584**

**Registered Sep. 23, 2008**

**SERVICE MARK  
PRINCIPAL REGISTER**

**MORE THAN A REMARKABLE  
EDUCATION**

ARLINGTON INDEPENDENT SCHOOL DISTRICT (TEXAS INDEPENDENT SCHOOL DISTRICT, A POLITICAL SUBDIVISION OF THE STATE OF TEXAS)  
AISD CENTRAL ADMINISTRATION BUILDING  
1203 W. PIONEER PARKWAY  
ARLINGTON, TX 76013

FIRST USE 6-7-2007; IN COMMERCE 6-7-2007.

THE MARK CONSISTS OF STANDARD CHARACTERS WITHOUT CLAIM TO ANY PARTICULAR FONT, STYLE, SIZE, OR COLOR.

FOR: EDUCATIONAL SERVICES, NAMELY, PROVIDING COURSES OF INSTRUCTION AT THE ELEMENTARY, MIDDLE SCHOOL, AND HIGH SCHOOL LEVEL AND DISTRIBUTION OF COURSE MATERIAL IN CONNECTION THEREWITH, IN CLASS 41 (U.S. CLS. 100, 101 AND 107).

SER. NO. 77-396,276, FILED 2-13-2008.

MATTHEW MCDOWELL, EXAMINING ATTORNEY

**Int. Cl.: 41**

**Prior U.S. Cls.: 100, 101 and 107**

**United States Patent and Trademark Office**

**Reg. No. 3,504,585**

**Registered Sep. 23, 2008**

**SERVICE MARK  
PRINCIPAL REGISTER**

**GoodMan Fiske**

GOODMAN FISKE LLC (NEW JERSEY LIMITED  
LIABILITY COMPANY)  
2128 ROSELLA AVENUE  
ATCO, NJ 08004

THE MARK CONSISTS OF STANDARD CHAR-  
ACTERS WITHOUT CLAIM TO ANY PARTICULAR  
FONT, STYLE, SIZE, OR COLOR.

FOR: ENTERTAINMENT, NAMELY, LIVE PER-  
FORMANCES BY A MUSICAL BAND, IN CLASS 41  
(U.S. CLS. 100, 101 AND 107).

SER. NO. 77-396,282, FILED 2-13-2008.

FIRST USE 2-15-2005; IN COMMERCE 9-1-2007.

H. M. FISHER, EXAMINING ATTORNEY

**Int. Cl.: 42**

**Prior U.S. Cls.: 100 and 101**

**United States Patent and Trademark Office**

**Reg. No. 3,504,586**

**Registered Sep. 23, 2008**

**SERVICE MARK  
PRINCIPAL REGISTER**

**242242**

CHACHA SEARCH, INC. (DELAWARE CORPORATION)  
SUITE 130  
14550 CLAY TERRACE BLVD.  
CARMEL, IN 46032

FOR: PROVIDING SEARCH ENGINE SERVICES FOR OBTAINING SPECIFIC USER-REQUESTED INFORMATION VIA TEXT MESSAGING, INSTANT MESSAGING, MOBILE INTERNET, VOICE MESSAGING, AND WIRELESS DEVICES, IN CLASS 42 (U.S. CLS. 100 AND 101).

FIRST USE 1-3-2008; IN COMMERCE 1-3-2008.

THE MARK CONSISTS OF STANDARD CHARACTERS WITHOUT CLAIM TO ANY PARTICULAR FONT, STYLE, SIZE, OR COLOR.

SER. NO. 77-396,309, FILED 2-13-2008.

DAVID ELTON, EXAMINING ATTORNEY

**Int. Cl.: 9**

**Prior U.S. Cls.: 21, 23, 26, 36 and 38**

**United States Patent and Trademark Office**

**Reg. No. 3,504,587**

**Registered Sep. 23, 2008**

**TRADEMARK  
PRINCIPAL REGISTER**

**PROCESSWEAVER**

PROCESSWEAVER, INC. (DELAWARE CORPORATION)  
4496 STICKLEY TERRACE  
FREMONT, CA 94536

FOR: COMPUTER SOFTWARE FOR MANUFACTURING CONTROL, LOGISTICS EXECUTION, ACCOUNTING, BUSINESS MANAGEMENT, AND MANAGEMENT OF MANUFACTURING, WAREHOUSING, INVENTORY, AND DISTRIBUTION , IN CLASS 9 (U.S. CLS. 21, 23, 26, 36 AND 38).

FIRST USE 6-1-2006; IN COMMERCE 6-1-2006.

THE MARK CONSISTS OF STANDARD CHARACTERS WITHOUT CLAIM TO ANY PARTICULAR FONT, STYLE, SIZE, OR COLOR.

SER. NO. 77-396,370, FILED 2-13-2008.

THOMAS MANOR, EXAMINING ATTORNEY

**Int. Cl.: 19**

**Prior U.S. Cls.: 1, 12, 33 and 50**

**United States Patent and Trademark Office**

**Reg. No. 3,504,588**

**Registered Sep. 23, 2008**

**TRADEMARK  
PRINCIPAL REGISTER**

**DYNOTILE**

INNOVATIVE MATERIAL HANDLING, INCOR-  
PORATED (WASHINGTON CORPORATION)  
# 120  
30200 SOUTHEAST 79TH STREET  
ISSAQUAH, WA 98027

THE MARK CONSISTS OF STANDARD CHAR-  
ACTERS WITHOUT CLAIM TO ANY PARTICULAR  
FONT, STYLE, SIZE, OR COLOR.

FOR: NON-METAL FLOOR TILES, IN CLASS 19  
(U.S. CLS. 1, 12, 33 AND 50).

SER. NO. 77-396,402, FILED 2-13-2008.

FIRST USE 4-1-2005; IN COMMERCE 4-11-2005.

RONALD DELGIZZI, EXAMINING ATTORNEY

**Int. Cls.: 5, 35 and 44**

**Prior U.S. Cls.: 6, 18, 44, 46, 51, 52, 100, 101 and 102**

**United States Patent and Trademark Office**

**Reg. No. 3,504,589**

**Registered Sep. 23, 2008**

**TRADEMARK  
SERVICE MARK  
PRINCIPAL REGISTER**

**TAO OF WELLNESS**

TAO OF WELLNESS, A PROFESSIONAL ACUPUNCTURE CORPORATION (CALIFORNIA CORPORATION)

1131 WILSHIRE BLVD, SUITE 300  
SANTA MONICA, CA 90401

FOR: HERBS FOR MEDICINAL PURPOSES; HERBAL SUPPLEMENTS FOR USE IN CONNECTION WITH ACUPUNCTURE, HEALTHCARE SERVICES AND NATURAL HEALING PRACTICES, IN CLASS 5 (U.S. CLS. 6, 18, 44, 46, 51 AND 52).

FIRST USE 7-2-2007; IN COMMERCE 7-2-2007.

FOR: RETAIL STORE SERVICES AND ON-LINE RETAIL STORE SERVICES FEATURING GOODS IN THE FIELD OF ACUPUNCTURE, NATURAL HEALING PRACTICES, NATURAL LIVING, CHINESE MEDICINE AND CHINESE EXERCISES AND SPIRITUALITY, NAMELY, BOOKS, PAMPHLETS, CDS, DVDS, VIDEOTAPES, CLOTHING, HERBS, ETHERAL OILS, MEDICINAL CREAMS, TEAS AND

ACUPUNCTURE EQUIPMENT AND INSTRUMENTS, IN CLASS 35 (U.S. CLS. 100, 101 AND 102).

FIRST USE 8-4-1997; IN COMMERCE 8-4-1997.

FOR: HEALTHCARE SERVICES FEATURING NATURAL HEALING PRACTICES; ACUPUNCTURE, IN CLASS 44 (U.S. CLS. 100 AND 101).

FIRST USE 8-4-1997; IN COMMERCE 8-4-1997.

THE MARK CONSISTS OF STANDARD CHARACTERS WITHOUT CLAIM TO ANY PARTICULAR FONT, STYLE, SIZE, OR COLOR.

OWNER OF U.S. REG. NO. 2,662,659.

SER. NO. 77-396,459, FILED 2-13-2008.

AMY GEARIN, EXAMINING ATTORNEY

**Int. Cl.: 19**

**Prior U.S. Cls.: 1, 12, 33 and 50**

**United States Patent and Trademark Office**

**Reg. No. 3,504,590**

**Registered Sep. 23, 2008**

**TRADEMARK  
PRINCIPAL REGISTER**

**AMBIENTE HOUSING**

ABERSHAM COMMERCIAL SERVICES, LLC  
(DELAWARE LIMITED LIABILITY COMPAN-  
NY)  
P.O. BOX 70005, SUITE 266  
FAJARDO, PUERTO RICO 007387005

FOR: PREFABRICATED BUILDINGS COM-  
PRISED PRIMARILY OF NON-METAL; BUILDING  
MATERIALS, NAMELY, COMPOSITE PANELS  
COMPOSED PRIMARILY OF NON-METAL MATE-  
RIALS, IN CLASS 19 (U.S. CLS. 1, 12, 33 AND 50).

FIRST USE 1-0-1996; IN COMMERCE 1-0-1996.

THE MARK CONSISTS OF STANDARD CHAR-  
ACTERS WITHOUT CLAIM TO ANY PARTICULAR  
FONT, STYLE, SIZE, OR COLOR.

NO CLAIM IS MADE TO THE EXCLUSIVE  
RIGHT TO USE "HOUSING", APART FROM THE  
MARK AS SHOWN.

SER. NO. 77-396,460, FILED 2-13-2008.

AMY GEARIN, EXAMINING ATTORNEY

**Int. Cl.: 36**

**Prior U.S. Cls.: 100, 101 and 102**

**United States Patent and Trademark Office**

**Reg. No. 3,504,591**

**Registered Sep. 23, 2008**

**SERVICE MARK  
PRINCIPAL REGISTER**

**CMVE**

POLESTAR CAPITAL ASSOCIATES, L.L.C. (NEW  
YORK LIMITED LIABILITY COMPANY)  
SUITE 200  
400 MADISON AVENUE  
NEW YORK, NY 10017

FOR: FINANCIAL SERVICES AND PRODUCTS,  
NAMELY, STRUCTURING AND RESTRUCTUR-  
ING COMMERCIAL REAL ESTATE LOANS AND  
LEASE TERMS, IN CLASS 36 (U.S. CLS. 100, 101 AND  
102).

FIRST USE 2-13-2008; IN COMMERCE 2-13-2008.

THE MARK CONSISTS OF STANDARD CHAR-  
ACTERS WITHOUT CLAIM TO ANY PARTICULAR  
FONT, STYLE, SIZE, OR COLOR.

SER. NO. 77-396,491, FILED 2-13-2008.

ALLISON SCHRODY, EXAMINING ATTORNEY



**Int. Cl.: 41**

**Prior U.S. Cls.: 100, 101 and 107**

**United States Patent and Trademark Office**

**Reg. No. 3,504,592**

**Registered Sep. 23, 2008**

**SERVICE MARK  
PRINCIPAL REGISTER**



BLAZENFILMS INC. (ILLINOIS CORPORATION)  
SUITE A  
5141 N. LACROSSE  
CHICAGO, IL 60630

FIRST USE 5-19-2005; IN COMMERCE 5-19-2005.

THE MARK CONSISTS OF AN ABSTRACT DESIGN TO THE LEFT OF THE STYLIZED TEXT "BLAZENFILMS".

FOR: MULTIMEDIA ENTERTAINMENT SERVICES IN THE NATURE OF RECORDING, PRODUCTION AND POST-PRODUCTION SERVICES IN THE FIELDS OF MUSIC, VIDEO, AND FILMS, IN CLASS 41 (U.S. CLS. 100, 101 AND 107).

SER. NO. 77-396,511, FILED 2-13-2008.

TARAH HARDY, EXAMINING ATTORNEY

**Int. Cls.: 19, 37 and 42**

**Prior U.S. Cls.: 1, 12, 33, 50, 100, 101, 103 and 106**

**United States Patent and Trademark Office**

**Reg. No. 3,504,593**

**Registered Sep. 23, 2008**

**TRADEMARK  
SERVICE MARK  
PRINCIPAL REGISTER**



MDU RESOURCES GROUP, INC. (DELAWARE CORPORATION)  
P.O. BOX 5650  
BISMARCK, ND 58506

FOR: CONSTRUCTION MATERIALS, NAMELY, ASPHALT, CONCRETE, READY MIX CONCRETE, CEMENT MIXES, ROCKS AND GRAVEL, LIGNITE AND BITUMINOUS COAL TARS, AND AGGREGATE MATERIAL COMPRISED OF THE FOREGOING FOR CONSTRUCTION OF ROADS, STREETS, INFRASTRUCTURE, COMMERCIAL AND RESIDENTIAL BUILDINGS AND SUBDIVISIONS, IN CLASS 19 (U.S. CLS. 1, 12, 33 AND 50).

FIRST USE 1-9-2007; IN COMMERCE 1-9-2007.

FOR: MINING EXTRACTION; CONSTRUCTION PLANNING, MANAGING AND SUPERVISION; CONSTRUCTION OF ROADS, STREETS, INFRASTRUCTURE, COMMERCIAL AND RESIDENTIAL BUILDINGS AND SUBDIVISIONS, IN CLASS 37 (U.S. CLS. 100, 103 AND 106).

FIRST USE 3-1-2007; IN COMMERCE 3-1-2007.

FOR: MINING AND MINERAL EXPLORATION SERVICES, IN CLASS 42 (U.S. CLS. 100 AND 101).

FIRST USE 1-9-2007; IN COMMERCE 1-9-2007.

OWNER OF U.S. REG. NO. 3,372,379.

THE MARK CONSISTS OF A STYLIZED RIVER SUPERIMPOSED OVER A RECTANGULAR DEVICE, TO THE RIGHT OF WHICH APPEAR THE WORDS "KNIFE RIVER".

SEC. 2(F) AS TO KNIFE RIVER.

SER. NO. 77-396,544, FILED 2-13-2008.

JAY BESCH, EXAMINING ATTORNEY

Int. Cl.: 39

Prior U.S. Cls.: 100 and 105

United States Patent and Trademark Office

Reg. No. 3,504,594

Registered Sep. 23, 2008

SERVICE MARK  
PRINCIPAL REGISTER



NOMAD MOTORSPORTS (ARIZONA LIMITED  
LIABILITY COMPANY)

PO BOX 10732  
SCOTTSDALE, AZ 85271

FOR: TRANSPORT OF GOODS, IN CLASS 39 (U.S.  
CLS. 100 AND 105).

FIRST USE 1-2-2008; IN COMMERCE 1-25-2008.

NO CLAIM IS MADE TO THE EXCLUSIVE  
RIGHT TO USE "MOTORSPORTS", APART FROM  
THE MARK AS SHOWN.

THE COLOR(S) RED, GREY, WHITE, BLACK IS/  
ARE CLAIMED AS A FEATURE OF THE MARK.

THE MARK CONSISTS OF THE WORDING "MO-  
TORSPORTS" IS IN A SOLID GREY COLOR. IN  
THE "O" OF "NOMAD", GREY IS USED IN DASHES  
INSIDE THE "O" FROM THE 6-O-CLOCK TO 4-O-  
CLOCK POSITION. BLACK IS THE BACKGROUND  
WITHIN THE "O" OF "NOMAD". THE NUMBERS  
"6,7,8,9,10,11,12,13,14,15" WITHIN THE "O" OF "NO-  
MAD" ARE WHITE. RED IS USED IN A LINE  
CENTERED WITHIN THE "O" OF "NOMAD"  
POINTING NEXT TO THE "13". A RED BAND  
WITHIN THE "O" OF "NOMAD" IS ALSO USED  
FROM A DASH MARK POSITION BETWEEN "13"  
AND "14" TO A DASH MARK AT "15".

SER. NO. 77-396,577, FILED 2-13-2008.

FLORENTINA BLANDU, EXAMINING ATTORNEY

**Int. Cl.: 41**

**Prior U.S. Cls.: 100, 101 and 107**

**United States Patent and Trademark Office**

**Reg. No. 3,504,595**

**Registered Sep. 23, 2008**

**SERVICE MARK  
PRINCIPAL REGISTER**

**DIGITAL BODEGA**

THE GHETTO FILM SCHOOL, INC. (NEW YORK CORPORATION)

PO BOX 1580 BOULEVARD STATION

BRONX, NY 10459

FOR: FILM PRODUCTION SERVICES, IN CLASS 41 (U.S. CLS. 100, 101 AND 107).

FIRST USE 5-8-2003; IN COMMERCE 5-8-2003.

THE MARK CONSISTS OF STANDARD CHARACTERS WITHOUT CLAIM TO ANY PARTICULAR FONT, STYLE, SIZE, OR COLOR.

NO CLAIM IS MADE TO THE EXCLUSIVE RIGHT TO USE "DIGITAL", APART FROM THE MARK AS SHOWN.

SER. NO. 77-396,585, FILED 2-14-2008.

CYNTHIA TRIPI, EXAMINING ATTORNEY

**Int. Cl.: 5**

**Prior U.S. Cls.: 6, 18, 44, 46, 51 and 52**

**Reg. No. 3,504,596**

**United States Patent and Trademark Office**

**Registered Sep. 23, 2008**

---

**TRADEMARK  
PRINCIPAL REGISTER**

**ENERGO**

EASY-MOTION HORSE PRODUCTS INC. (CANADA CORPORATION)  
489 BOWSLAUGH ROAD  
GRASSIE, ONTARIO, CANADA L0R1M0

THE MARK CONSISTS OF STANDARD CHARACTERS WITHOUT CLAIM TO ANY PARTICULAR FONT, STYLE, SIZE, OR COLOR.

FOR: NUTRITIONAL SUPPLEMENTS TO ENHANCE EQUINE PERFORMANCE IN HORSES, IN CLASS 5 (U.S. CLS. 6, 18, 44, 46, 51 AND 52).

SER. NO. 77-396,680, FILED 2-14-2008.

FIRST USE 10-12-2007; IN COMMERCE 10-31-2007.

ESTHER BELENKER, EXAMINING ATTORNEY

Int. Cl.: 37

Prior U.S. Cls.: 100, 103 and 106

United States Patent and Trademark Office

Reg. No. 3,504,597

Registered Sep. 23, 2008

**SERVICE MARK  
PRINCIPAL REGISTER**



HANDYPRO FRANCHISE, INC. (MICHIGAN CORPORATION)  
995 S. MAIN STREET  
PLYMOUTH, MI 48170

FOR: HOME REPAIR AND REMODELING SERVICES, IN CLASS 37 (U.S. CLS. 100, 103 AND 106).

FIRST USE 12-15-1999; IN COMMERCE 12-15-1999.

NO CLAIM IS MADE TO THE EXCLUSIVE RIGHT TO USE ".COM" OR "HANDYMAN SERVICE, INC.", APART FROM THE MARK AS SHOWN.

THE MARK CONSISTS OF THE WORDS "HANDYPRO .COM HANDYMAN SERVICE, INC.", IN WHICH THE "H" IN "HANDYPRO" IS FORMED WITH AN UPRIGHT HAMMER AND SAW, WITH A HORIZONTAL WRENCH AS THE CROSSBAR, SHOWN BELOW A STYLIZED ROOF OF A HOUSE, ALL SHOWN INSIDE AN UPPER AND A LOWER ARCUATE PAINT STROKE, WITH A STYLIZED PAINTBRUSH AT THE UPPER RIGHT END OF THE LOWER PAINT STROKE.

SER. NO. 77-396,685, FILED 2-14-2008.

ESTHER BELENKER, EXAMINING ATTORNEY

Int. Cl.: 25

Prior U.S. Cls.: 22 and 39

United States Patent and Trademark Office

Reg. No. 3,504,598

Registered Sep. 23, 2008

TRADEMARK  
PRINCIPAL REGISTER



CREATIVE APPAREL CONCEPTS, INC. (MINNE-  
SOTA CORPORATION)  
800 WASHINGTON AVENUE NORTH, SUITE 509  
MINNEAPOLIS, MN 55401

FOR: SLEEPWEAR, IN CLASS 25 (U.S. CLS. 22  
AND 39).

FIRST USE 10-22-2002; IN COMMERCE 10-22-2002.

OWNER OF U.S. REG. NO. 3,063,055.

THE COLOR(S) BROWN AND RED IS/ARE  
CLAIMED AS A FEATURE OF THE MARK.

THE MARK CONSISTS OF THE WORDS "MUNKI  
MUNKI", WITH ONE WORD ABOVE THE OTHER,  
WITH A MONKEY SWINGING FROM THE LET-  
TERS "U" AND "N" IN THE LOWER WORD. THE  
COLOR BROWN APPEARS IN THE MONKEY, AND  
THE COLOR RED APPEARS IN THE WORDS  
"MUNKI MUNKI", IN THE MONKEY'S EYES,  
MOUTH, BELLY BUTTON, KNEES AND FEET.

SER. NO. 77-396,693, FILED 2-14-2008.

ESTHER BELENKER, EXAMINING ATTORNEY

**Int. Cl.: 35**

**Prior U.S. Cls.: 100, 101 and 102**

**United States Patent and Trademark Office**

**Reg. No. 3,504,599**

**Registered Sep. 23, 2008**

**SERVICE MARK  
PRINCIPAL REGISTER**

**THOROUGHBRAND**

THOROUGHBRAND, LLC (OHIO LIMITED LIABILITY COMPANY)  
1550 LEWIS CENTER RD., SUITE E  
LEWIS CENTER, OH 43035

FOR: ADVERTISING AGENCY SERVICES; PUBLIC RELATIONS SERVICES; BUSINESS MARKETING SERVICES; DIRECT MARKETING SERVICES; MARKET RESEARCH AND ANALYSIS SERVICES; PREPARATION AND REALIZATION OF MEDIA AND ADVERTISING PLANS AND CONCEPTS; ADVERTISING AND BUSINESS SERVICES, NAMELY, SECURING AIRTIME ON OR PLACEMENT OF ALL FORMS OF MEDIA COMMUNICATION STATIONS, SYSTEMS, NETWORKS, AND SERVICES FOR THE PURPOSE OF PROMOTING THE GOODS AND SERVICES OF OTHERS; DIRECT MAIL ADVERTISING SERVICES; STRATEGIC PLANNING RELATING TO ADVERTISING, PROMOTION, AND MARKETING; BRAND CONSULTING SERVICES, NAMELY, CREATING BRAND AND CORPORATE

IDENTITIES, AND COMMERCIAL INFORMATION OF OTHERS THROUGH PRINT, AUDIO, VIDEO, DIGITAL, AND ONLINE MEDIA, POINT OF SALE DISPLAYS, SIGNAGE AND PACKAGING; CREATING MARKETING AND ADVERTISING MATERIALS; ADVERTISING AGENCY SERVICES IN THE FIELD OF EMPLOYMENT AND RECRUITMENT, NAMELY, CREATING EMPLOYMENT AND RECRUITMENT COMMUNICATIONS FOR OTHERS, IN CLASS 35 (U.S. CLS. 100, 101 AND 102).

FIRST USE 12-7-2007; IN COMMERCE 12-7-2007.

THE MARK CONSISTS OF STANDARD CHARACTERS WITHOUT CLAIM TO ANY PARTICULAR FONT, STYLE, SIZE, OR COLOR.

SER. NO. 77-396,698, FILED 2-14-2008.

ARETHA SOMERVILLE, EXAMINING ATTORNEY



**Int. Cl.: 37**

**Prior U.S. Cls.: 100, 103 and 106**

**United States Patent and Trademark Office**

**Reg. No. 3,504,600**

**Registered Sep. 23, 2008**

**SERVICE MARK  
PRINCIPAL REGISTER**

**painting. passion.  
professionalism.**

CERTA PROPAINERS, LTD. (MASSACHUSETTS  
CORPORATION)  
150 GREEN TREE ROAD, SUITE 1003  
OAKS, PA 19456

FOR: PAINTING CONTRACTOR SERVICES;  
PAINTING IN THE FIELD OF HOUSES, COMMERCIAL  
BUILDINGS; APPLYING DECORATIVE  
COATINGS TO WOOD, EXTERIOR WALLS , IN  
CLASS 37 (U.S. CLS. 100, 103 AND 106).

FIRST USE 1-9-2008; IN COMMERCE 1-9-2008.

THE MARK CONSISTS OF STANDARD CHARACTERS WITHOUT CLAIM TO ANY PARTICULAR FONT, STYLE, SIZE, OR COLOR.

SER. NO. 77-396,705, FILED 2-14-2008.

ARETHA SOMERVILLE, EXAMINING ATTORNEY

**Int. Cl.: 1**

**Prior U.S. Cls.: 1, 5, 6, 10, 26 and 46**

**United States Patent and Trademark Office**

**Reg. No. 3,504,601**

**Registered Sep. 23, 2008**

**TRADEMARK  
PRINCIPAL REGISTER**

**DYNACAT**

DYNACHEM, INC. (ILLINOIS CORPORATION)  
15662 EAST 980 NORTH  
WESTVILLE, IL 61883

THE MARK CONSISTS OF STANDARD CHAR-  
ACTERS WITHOUT CLAIM TO ANY PARTICULAR  
FONT, STYLE, SIZE, OR COLOR.

FOR: CATALYSTS FOR RESINS FOR USE IN  
COATINGS, LAMINATES AND AGGREGATES, IN  
CLASS 1 (U.S. CLS. 1, 5, 6, 10, 26 AND 46).

SER. NO. 77-396,709, FILED 2-14-2008.

FIRST USE 1-31-2006; IN COMMERCE 1-31-2006.

ARETHA SOMERVILLE, EXAMINING ATTORNEY

**Int. Cls.: 9 and 16**

**Prior U.S. Cls.: 2, 5, 21, 22, 23, 26, 29, 36, 37, 38 and 50**

**Reg. No. 3,504,602**

**United States Patent and Trademark Office**

**Registered Sep. 23, 2008**

---

**TRADEMARK  
PRINCIPAL REGISTER**

**2 MINUTE WISDOM**

WISDOM INTERNATIONAL (TEXAS CORPORATION)  
4051 DENTON HIGHWAY  
FT WORTH, TX 76117

FOR: DOWNLOADABLE E-BOOKS FEATURING FAITH-BASED, MOTIVATIONAL TOPICS, NAME- LY, GUIDANCE AND HOPE, IN CLASS 9 (U.S. CLS. 21, 23, 26, 36 AND 38).

FIRST USE 8-0-2007; IN COMMERCE 8-0-2007.

FOR: BOOKS, ARTICLES, AND MAGAZINES FEATURING FAITH-BASED, MOTIVATIONAL TO-

PICS, NAME- LY, GUIDANCE AND HOPE, IN CLASS 16 (U.S. CLS. 2, 5, 22, 23, 29, 37, 38 AND 50).

FIRST USE 6-0-2007; IN COMMERCE 6-0-2007.

THE MARK CONSISTS OF STANDARD CHAR- ACTERS WITHOUT CLAIM TO ANY PARTICULAR FONT, STYLE, SIZE, OR COLOR.

SER. NO. 77-396,739, FILED 2-14-2008.

JANICE KIM, EXAMINING ATTORNEY

**Int. Cl.: 18**

**Prior U.S. Cls.: 1, 2, 3, 22 and 41**

**United States Patent and Trademark Office**

**Reg. No. 3,504,603**

**Registered Sep. 23, 2008**

**TRADEMARK  
PRINCIPAL REGISTER**

**CRY BABYZ**

STACKS, JANET G. (UNITED STATES INDIVIDUAL)  
5330 SOUTH 7TH ST. EAST  
MUSKOGEE, OK 74403

FOR: DRAWSTRING POUCHES, PURSES, MULTI-PURPOSE PURSES, CARRYING CASES, JEWELRY ORGANIZERS FOR TRAVEL AND DIAPER BAGS ALL MADE OF FABRIC, IN CLASS 18 (U.S. CLS. 1, 2, 3, 22 AND 41).

FIRST USE 2-12-2008; IN COMMERCE 2-12-2008.

THE MARK CONSISTS OF STANDARD CHARACTERS WITHOUT CLAIM TO ANY PARTICULAR FONT, STYLE, SIZE, OR COLOR.

NO CLAIM IS MADE TO THE EXCLUSIVE RIGHT TO USE "BABIES", APART FROM THE MARK AS SHOWN.

SER. NO. 77-396,747, FILED 2-14-2008.

SKYE YOUNG, EXAMINING ATTORNEY

**Int. Cl.: 42**

**Prior U.S. Cls.: 100 and 101**

**United States Patent and Trademark Office**

**Reg. No. 3,504,604**

**Registered Sep. 23, 2008**

**SERVICE MARK  
PRINCIPAL REGISTER**

# Salted Websites

LEPPDESIGN (VIRGINIA LIMITED LIABILITY  
COMPANY)

117 HERON COURT

WILLIAMSBURG, VA 23188

FOR: COMPUTER SERVICES, NAMELY, DE-  
SIGNING AND IMPLEMENTING WEB SITES FOR  
OTHERS, IN CLASS 42 (U.S. CLS. 100 AND 101).

FIRST USE 8-1-2007; IN COMMERCE 10-1-2007.

THE MARK CONSISTS OF STANDARD CHAR-  
ACTERS WITHOUT CLAIM TO ANY PARTICULAR  
FONT, STYLE, SIZE, OR COLOR.

NO CLAIM IS MADE TO THE EXCLUSIVE  
RIGHT TO USE "WEBSITES", APART FROM THE  
MARK AS SHOWN.

SER. NO. 77-396,766, FILED S.R. 2-14-2008 AM. P.R.  
6-5-2008.

SKYE YOUNG, EXAMINING ATTORNEY

**Int. Cl.: 5**

**Prior U.S. Cls.: 6, 18, 44, 46, 51 and 52**

**United States Patent and Trademark Office**

**Reg. No. 3,504,605**

**Registered Sep. 23, 2008**

**TRADEMARK  
PRINCIPAL REGISTER**

**KEYSHURE**

BALCHEM CORPORATION COMPANY (MARY-  
LAND CORPORATION)  
52 SUNRISE PARK ROAD  
NEW HAMPTON, NY 109580600

THE MARK CONSISTS OF STANDARD CHAR-  
ACTERS WITHOUT CLAIM TO ANY PARTICULAR  
FONT, STYLE, SIZE, OR COLOR.

FOR: MINERAL SUPPLEMENTS USED IN ANI-  
MAL FEED, IN CLASS 5 (U.S. CLS. 6, 18, 44, 46, 51  
AND 52).

SER. NO. 77-396,817, FILED 2-14-2008.

FIRST USE 8-0-2007; IN COMMERCE 1-25-2008.

TRICIA SONNEBORN, EXAMINING ATTORNEY

**Int. Cl.: 35**

**Prior U.S. Cls.: 100, 101 and 102**

**United States Patent and Trademark Office**

**Reg. No. 3,504,606**

**Registered Sep. 23, 2008**

---

**SERVICE MARK  
PRINCIPAL REGISTER**

**Making pretty...pretty  
easy!**

LONGFELLOW'S GARDEN CENTER, INC. (MISSOURI CORPORATION)  
12007 HIGHWAY 50  
CENTERTOWN, MO 65023

THE MARK CONSISTS OF STANDARD CHARACTERS WITHOUT CLAIM TO ANY PARTICULAR FONT, STYLE, SIZE, OR COLOR.

FOR: RETAIL LAWN, GARDEN AND NURSERY STORES, IN CLASS 35 (U.S. CLS. 100, 101 AND 102).

SER. NO. 77-396,820, FILED 2-14-2008.

FIRST USE 3-1-2005; IN COMMERCE 3-1-2005.

JASON ROTH, EXAMINING ATTORNEY

**Int. Cl.: 5**

**Prior U.S. Cls.: 6, 18, 44, 46, 51 and 52**

**Reg. No. 3,504,607**

**United States Patent and Trademark Office**

**Registered Sep. 23, 2008**

**TRADEMARK  
PRINCIPAL REGISTER**

**REGLO**

REGLO ENTERPRISES LLC (HAWAII LIMITED  
LIABILITY COMPANY)  
4128 S.W. 195TH TERRACE  
MIRAMAR, FL 33029

THE MARK CONSISTS OF STANDARD CHAR-  
ACTERS WITHOUT CLAIM TO ANY PARTICULAR  
FONT, STYLE, SIZE, OR COLOR.

FOR: DIETARY SUPPLEMENTS, IN CLASS 5 (U.S.  
CLS. 6, 18, 44, 46, 51 AND 52).

SER. NO. 77-396,833, FILED 2-14-2008.

FIRST USE 9-0-2004; IN COMMERCE 9-0-2004.

JEFF DEFORD, EXAMINING ATTORNEY



**Int. Cl.: 28**

**Prior U.S. Cls.: 22, 23, 38 and 50**

**United States Patent and Trademark Office**

**Reg. No. 3,504,608**

**Registered Sep. 23, 2008**

**TRADEMARK  
PRINCIPAL REGISTER**

**729**

CHINA SPORTS EQUIPMENT TRADING (H.K.)  
CO. LTD. (HONG KONG CORPORATION)  
UNIT C, 7/F, FEDERAL CENTER  
77 SHEUNG ON STREET  
CHAI WAN, HONG KONG

FOR: TABLE TENNIS BLADES, TABLE TENNIS  
RACKETS, TABLE TENNIS RUBBERS, TABLE TEN-  
NIS BALLS , IN CLASS 28 (U.S. CLS. 22, 23, 38 AND  
50).

FIRST USE 1-1-1988; IN COMMERCE 1-1-1988.

THE MARK CONSISTS OF STANDARD CHAR-  
ACTERS WITHOUT CLAIM TO ANY PARTICULAR  
FONT, STYLE, SIZE, OR COLOR.

SER. NO. 77-396,847, FILED 2-14-2008.

JEFF DEFORD, EXAMINING ATTORNEY

**Int. Cl.: 5**

**Prior U.S. Cls.: 6, 18, 44, 46, 51 and 52**

**Reg. No. 3,504,609**

**United States Patent and Trademark Office**

**Registered Sep. 23, 2008**

**TRADEMARK  
PRINCIPAL REGISTER**

**NUTRA-FLAX**

REGLO ENTERPRISES LLC (FLORIDA LIMITED  
LIABILITY COMPANY)  
4128 S.W. 195TH TERRACE  
MIRAMAR, FL 33029

THE MARK CONSISTS OF STANDARD CHAR-  
ACTERS WITHOUT CLAIM TO ANY PARTICULAR  
FONT, STYLE, SIZE, OR COLOR.

FOR: DIETARY SUPPLEMENTS, IN CLASS 5 (U.S.  
CLS. 6, 18, 44, 46, 51 AND 52).

SER. NO. 77-396,850, FILED 2-14-2008.

FIRST USE 5-0-2007; IN COMMERCE 5-0-2007.

JEFF DEFORD, EXAMINING ATTORNEY

**Int. Cl.: 28**

**Prior U.S. Cls.: 22, 23, 38 and 50**

**United States Patent and Trademark Office**

**Reg. No. 3,504,610**

**Registered Sep. 23, 2008**

**TRADEMARK  
PRINCIPAL REGISTER**

# Friendship

CHINA SPORTS EQUIPMENT TRADING (H.K.)  
CO. LTD. (HONG KONG CORPORATION)  
UNIT C, 7/F, FEDERAL CENTER  
77 SHEUNG ON STREET  
CHAI WAN, HONG KONG

FOR: TABLE TENNIS BLADES, TABLE TENNIS  
RACKETS, TABLE TENNIS RUBBERS, TABLE TEN-  
NIS BALLS , IN CLASS 28 (U.S. CLS. 22, 23, 38 AND  
50).

FIRST USE 1-1-1988; IN COMMERCE 1-1-1988.

THE MARK CONSISTS OF STANDARD CHAR-  
ACTERS WITHOUT CLAIM TO ANY PARTICULAR  
FONT, STYLE, SIZE, OR COLOR.

SER. NO. 77-396,857, FILED 2-14-2008.

JEFF DEFORD, EXAMINING ATTORNEY

**Int. Cl.: 41**

**Prior U.S. Cls.: 100, 101 and 107**

**United States Patent and Trademark Office**

**Reg. No. 3,504,611**

**Registered Sep. 23, 2008**

**SERVICE MARK  
PRINCIPAL REGISTER**

**YOU CAN'T BEAT THE  
EXPERIENCE**

NEW ENGLAND SCHOOL OF LAW (MASSACHUSETTS CORPORATION)  
154 STUART STREET  
BOSTON, MA 02116

FOR: TEACHING IN THE FIELD OF LAW, IN CLASS 41 (U.S. CLS. 100, 101 AND 107).

FIRST USE 4-17-2007; IN COMMERCE 4-17-2007.

THE MARK CONSISTS OF STANDARD CHARACTERS WITHOUT CLAIM TO ANY PARTICULAR FONT, STYLE, SIZE, OR COLOR.

SER. NO. 77-396,902, FILED 2-14-2008.

DOMINIC J. FERRAIUOLO, EXAMINING ATTORNEY

**Int. Cl.: 41**

**Prior U.S. Cls.: 100, 101 and 107**

**United States Patent and Trademark Office**

**Reg. No. 3,504,612**

**Registered Sep. 23, 2008**

**SERVICE MARK  
PRINCIPAL REGISTER**

**PITAIYO**

PITAIYO, LLC (VIRGINIA LIMITED LIABILITY  
COMPANY)  
205 BROOKSCHASE LANE  
RICHMOND, VA 23229

THE MARK CONSISTS OF STANDARD CHAR-  
ACTERS WITHOUT CLAIM TO ANY PARTICULAR  
FONT, STYLE, SIZE, OR COLOR.

FOR: PHYSICAL FITNESS INSTRUCTION, IN  
CLASS 41 (U.S. CLS. 100, 101 AND 107).

SER. NO. 77-396,924, FILED 2-14-2008.

FIRST USE 2-19-2007; IN COMMERCE 2-19-2007.

JASON ROTH, EXAMINING ATTORNEY

**Int. Cl.: 37**

**Prior U.S. Cls.: 100, 103 and 106**

**United States Patent and Trademark Office**

**Reg. No. 3,504,613**

**Registered Sep. 23, 2008**

**SERVICE MARK  
PRINCIPAL REGISTER**

**Daytner Construction Group**

THE DAYTNER CORPORATION (MARYLAND CORPORATION), DBA DAYTNER CONSTRUCTION GROUP  
1 PARK AVENUE  
MT. AIRY, MD 21771

FOR: CONSTRUCTION MANAGEMENT; CONSTRUCTION OF BUILDINGS, IN CLASS 37 (U.S. CLS. 100, 103 AND 106).

FIRST USE 11-29-2004; IN COMMERCE 11-29-2004.

THE MARK CONSISTS OF STANDARD CHARACTERS WITHOUT CLAIM TO ANY PARTICULAR FONT, STYLE, SIZE, OR COLOR.

NO CLAIM IS MADE TO THE EXCLUSIVE RIGHT TO USE "CONSTRUCTION GROUP", APART FROM THE MARK AS SHOWN.

SER. NO. 77-396,927, FILED 2-14-2008.

KELLEY WELLS, EXAMINING ATTORNEY

**Int. Cl.: 25**

**Prior U.S. Cls.: 22 and 39**

**United States Patent and Trademark Office**

**Reg. No. 3,504,614**

**Registered Sep. 23, 2008**

**TRADEMARK  
PRINCIPAL REGISTER**

**ZAKKA**

ZAKKA CLOTHING INC. (CALIFORNIA CORPORATION)  
424 E. 15TH ST. UNIT#3  
LOS ANGELES, CA 90015

FOR: CLOTHING, NAMELY, SHIRTS, DRESSES, PANTS, JACKETS, SWEATSHIRTS, T-SHIRTS, TANK TOPS, LONG SLEEVED T-SHIRTS; OUTER WEAR, NAMELY, HATS, SHOES, GLOVES, LEG WARMERS, SCARVES, IN CLASS 25 (U.S. CLS. 22 AND 39).

FIRST USE 2-1-2008; IN COMMERCE 2-11-2008.

THE MARK CONSISTS OF STANDARD CHARACTERS WITHOUT CLAIM TO ANY PARTICULAR FONT, STYLE, SIZE, OR COLOR.

SER. NO. 77-396,933, FILED 2-14-2008.

HEATHER SAPP, EXAMINING ATTORNEY

**Int. Cl.: 35**

**Prior U.S. Cls.: 100, 101 and 102**

**United States Patent and Trademark Office**

**Reg. No. 3,504,615**

**Registered Sep. 23, 2008**

**SERVICE MARK  
PRINCIPAL REGISTER**

**DevMar**

DEVMAR PRODUCTS, LLC (TENNESSEE LIMITED LIABILITY COMPANY)  
P.O. BOX 1591  
BRENTWOOD, TN 370241591

FOR: RETAIL STORE SERVICES AND DISTRIBUTORSHIP SERVICES FEATURING CLEANING AND MAINTENANCE SUPPLIES, PRODUCTS AND EQUIPMENT FOR USE IN COMMERCIAL, INDUSTRIAL AND HOUSEHOLD CLEANING AND MAINTENANCE APPLICATIONS, IN CLASS 35 (U.S. CLS. 100, 101 AND 102).

FIRST USE 1-2-2008; IN COMMERCE 1-2-2008.

THE MARK CONSISTS OF STANDARD CHARACTERS WITHOUT CLAIM TO ANY PARTICULAR FONT, STYLE, SIZE, OR COLOR.

SER. NO. 77-396,978, FILED 2-14-2008.

MICHAEL SOUDERS, EXAMINING ATTORNEY



**Int. Cl.: 9**

**Prior U.S. Cls.: 21, 23, 26, 36 and 38**

**Reg. No. 3,504,616**

**United States Patent and Trademark Office**

**Registered Sep. 23, 2008**

**TRADEMARK  
PRINCIPAL REGISTER**

**MIRA**

GERMANN INSTRUMENTS, INC. (ILLINOIS  
CORPORATION)  
8845 FOREST VIEW ROAD  
EVANSTON, IL 60203

FOR: CONCRETE TESTING MACHINES; APPARATUS FOR TESTING GAS, LIQUIDS AND SOLIDS; CEMENT TESTING MACHINES; COMPUTER COMPONENT TESTING AND CALIBRATING EQUIPMENT; METAL HARDNESS TESTING MACHINES; METAL STRENGTH TESTING MACHINES; PLASTIC TESTING MACHINES; METAL COMPRESSION TESTING MACHINES; ULTRASONIC DETECTORS FOR IMPURITIES IN BUILDING MATERIALS, FOR

EXAMPLE, CONCRETE; ULTRASONIC FLAW DETECTORS; ULTRASONIC SENSORS, IN CLASS 9 (U.S. CLS. 21, 23, 26, 36 AND 38).

FIRST USE 2-1-2007; IN COMMERCE 2-1-2007.

THE MARK CONSISTS OF STANDARD CHARACTERS WITHOUT CLAIM TO ANY PARTICULAR FONT, STYLE, SIZE, OR COLOR.

SER. NO. 77-397,003, FILED 2-14-2008.

AHSEN KHAN, EXAMINING ATTORNEY

**Int. Cl.: 5**

**Prior U.S. Cls.: 6, 18, 44, 46, 51 and 52**

**United States Patent and Trademark Office**

**Reg. No. 3,504,617**

**Registered Sep. 23, 2008**

**TRADEMARK  
PRINCIPAL REGISTER**

**NUTRASEC**

NATURAL ORGANICS INC. (NEW YORK CORPORATION)  
548 BROADHOLLOW ROAD  
MELVILLE, NY 117473708

THE MARK CONSISTS OF STANDARD CHARACTERS WITHOUT CLAIM TO ANY PARTICULAR FONT, STYLE, SIZE, OR COLOR.

FOR: DIETARY SUPPLEMENT FOR SYMPTOMS OF OCCASIONAL HEARTBURN AND DIGESTIVE SUPPORT, IN CLASS 5 (U.S. CLS. 6, 18, 44, 46, 51 AND 52).

SER. NO. 77-397,005, FILED 2-14-2008.

FIRST USE 2-4-2007; IN COMMERCE 2-4-2007.

MELVIN AXILBUND, EXAMINING ATTORNEY

**Int. Cl.: 16**

**Prior U.S. Cls.: 2, 5, 22, 23, 29, 37, 38 and 50**

**United States Patent and Trademark Office**

**Reg. No. 3,504,618**

**Registered Sep. 23, 2008**

**TRADEMARK  
PRINCIPAL REGISTER**

The logo for "Cath Lab Digest" features the words "Cath Lab Digest" in a bold, serif font. A horizontal line runs beneath the text, starting from the left edge of the word "Cath" and extending to the right. On the left side of this line, there is a stylized heart rhythm line (ECG) that starts with a vertical line, followed by a small peak, a dip, and another small peak, before merging into the horizontal line.

HMP COMMUNICATIONS, LLC (DELAWARE  
LIMITED LIABILITY COMPANY)  
SUITE 100  
83 GENERAL WARREN BOULEVARD  
MALVERN, PA 19355

FOR: PRINTED PUBLICATIONS, NAMELY, PER-  
IODICALLY PUBLISHED MAGAZINES AND JOUR-  
NALS IN THE FIELDS OF HEALTHCARE AND  
MEDICINE, IN CLASS 16 (U.S. CLS. 2, 5, 22, 23, 29, 37,  
38 AND 50).

FIRST USE 9-1-1993; IN COMMERCE 9-1-1993.

NO CLAIM IS MADE TO THE EXCLUSIVE  
RIGHT TO USE "CATH LAB DIGEST", APART  
FROM THE MARK AS SHOWN.

THE MARK CONSISTS OF THE WORDS "CATH  
LAB DIGEST" ABOVE A HEART RHYTHM LINE.

SEC. 2(F).

SER. NO. 77-397,013, FILED 2-14-2008.

ARETHA SOMERVILLE, EXAMINING ATTORNEY

**Int. Cl.: 29**

**Prior U.S. Cl.: 46**

**United States Patent and Trademark Office**

**Reg. No. 3,504,619**

**Registered Sep. 23, 2008**

**TRADEMARK  
PRINCIPAL REGISTER**

**FALARMA**

GARBANZO MEDITERRANEAN GRILL, LLC  
(COLORADO LIMITED LIABILITY COMPA-  
NY)  
9385 RIVIERA HILLS DRIVE  
GREENWOOD VILLAGE, CO 80111

THE MARK CONSISTS OF STANDARD CHAR-  
ACTERS WITHOUT CLAIM TO ANY PARTICULAR  
FONT, STYLE, SIZE, OR COLOR.

FOR: FALAFEL; MARINATED BEEF AND  
CHICKEN, IN CLASS 29 (U.S. CL. 46).

SER. NO. 77-397,027, FILED 2-14-2008.

FIRST USE 1-1-2008; IN COMMERCE 1-1-2008.

DANNEAN HETZEL, EXAMINING ATTORNEY

Int. Cl.: 35

Prior U.S. Cls.: 100, 101 and 102

United States Patent and Trademark Office

Reg. No. 3,504,620

Registered Sep. 23, 2008

**SERVICE MARK  
PRINCIPAL REGISTER**



WINDY CITY ROLLERS LLC (ILLINOIS LIMITED LIABILITY COMPANY)  
1447 W THOMAS ST #2  
CHICAGO, IL 60622

FOR: ASSOCIATION SERVICES, NAMELY, PROMOTING THE INTERESTS OF INDIVIDUALS, TEAMS, AND LEAGUES THAT PARTICIPATE IN ORGANIZED COMPETITIONS; ADMINISTRATION OF COMMUNITY RECREATIONAL SPORTS LEAGUES; COORDINATION OF RECREATIONAL SPORTING OPPORTUNITIES FOR INDIVIDUALS WHO WISH TO PARTICIPATE IN TEAM LEAGUE SPORTS; PROMOTING SPORTS COMPETITIONS AND/OR EVENTS OF OTHERS; PROMOTING THE GOODS AND SERVICES OF OTHERS BY ARRANGING FOR SPONSORS TO AFFILIATE THEIR GOODS AND SERVICES WITH AN AWARDS PRO-

GRAM, A SPORTS COMPETITION AND SPORTING ACTIVITIES, IN CLASS 35 (U.S. CLS. 100, 101 AND 102).

FIRST USE 9-1-2004; IN COMMERCE 9-1-2004.

NO CLAIM IS MADE TO THE EXCLUSIVE RIGHT TO USE "WINDY CITY", APART FROM THE MARK AS SHOWN.

THE MARK CONSISTS OF A SKULL WITH ROLLER SKATE WHEELS FORMING CROSSED BONES BEHIND THE SKULL.

SER. NO. 77-397,097, FILED 2-14-2008.

THEODORE MCBRIDE, EXAMINING ATTORNEY

Int. Cl.: 43

Prior U.S. Cls.: 100 and 101

United States Patent and Trademark Office

Reg. No. 3,504,621

Registered Sep. 23, 2008

SERVICE MARK  
PRINCIPAL REGISTER



CHOWGIRLS, INC. (MINNESOTA CORPORATION)  
316 5TH AVE NE  
MINNEAPOLIS, MN 55413

FOR: RESTAURANT, BAR AND CATERING SERVICES, IN CLASS 43 (U.S. CLS. 100 AND 101).

FIRST USE 3-15-2004; IN COMMERCE 3-15-2004.

NO CLAIM IS MADE TO THE EXCLUSIVE RIGHT TO USE "CATERING", APART FROM THE MARK AS SHOWN.

THE COLOR(S) BROWN AND RED IS/ARE CLAIMED AS A FEATURE OF THE MARK.

THE COLOR RED APPEARS IN THE LASSO IMAGE, THE RED STAR ABOVE THE "I" IN "CHOWGIRLS" AND IN THE WORDING "KILLER CATERING". THE COLOR BROWN APPEARS IN THE IMAGE OF A COWGIRL RIDING A HORSE AND TWIRLING A LASSO, AND THE WORDING "CHOWGIRLS".

SER. NO. 77-397,120, FILED 2-14-2008.

ALLISON SCHRODY, EXAMINING ATTORNEY

**Int. Cl.: 9**

**Prior U.S. Cls.: 21, 23, 26, 36 and 38**

**Reg. No. 3,504,622**

**United States Patent and Trademark Office**

**Registered Sep. 23, 2008**

**TRADEMARK  
PRINCIPAL REGISTER**

**AIRPORT ACCELERATION**

THINK TANK PHOTO, INC. (CALIFORNIA CORPORATION)  
SUITE 170  
3636 NORTH LAUGHLIN ROAD  
SANTA ROSA, CA 95403

FOR: ROLLING CASES, NAMELY, ROLLING CARRY-ON CASES DESIGNED FOR CARRYING CAMERAS, PHOTOGRAPHIC EQUIPMENT, OPTICAL EQUIPMENT, VIDEO CAMERA EQUIPMENT, AND COMPUTERS AND COMPUTER ACCESSORIES; WAIST HARNESES AND SHOULDER HARNESES DESIGNED FOR USE WITH THE FOREGOING GOODS, IN CLASS 9 (U.S. CLS. 21, 23, 26, 36 AND 38).

FIRST USE 8-31-2006; IN COMMERCE 8-31-2006.

THE MARK CONSISTS OF STANDARD CHARACTERS WITHOUT CLAIM TO ANY PARTICULAR FONT, STYLE, SIZE, OR COLOR.

NO CLAIM IS MADE TO THE EXCLUSIVE RIGHT TO USE "AIRPORT", APART FROM THE MARK AS SHOWN.

SER. NO. 77-397,141, FILED 2-14-2008.

CARRIE GENOVESE, EXAMINING ATTORNEY

**Int. Cls.: 38 and 41**

**Prior U.S. Cls.: 100, 101, 104 and 107**

**United States Patent and Trademark Office**

**Reg. No. 3,504,623**

**Registered Sep. 23, 2008**

**SERVICE MARK  
PRINCIPAL REGISTER**

# Mens Room

ENTERCOM COMMUNICATIONS CORP. (PENNSYLVANIA CORPORATION)  
SUITE 809  
401 CITY AVENUE  
BALA CYNWYD, PA 19004

FOR: RADIO BROADCASTING SERVICES, IN CLASS 38 (U.S. CLS. 100, 101 AND 104).

FIRST USE 2-1-2005; IN COMMERCE 2-1-2005.

FOR: ENTERTAINMENT SERVICES, NAMELY, PRODUCTION OF RADIO PROGRAMS AND RADIO PROGRAMMING; RADIO ENTERTAINMENT SERVICES, NAMELY, ONGOING RADIO

PROGRAMS IN THE FIELDS OF ENTERTAINMENT AND MUSIC, IN CLASS 41 (U.S. CLS. 100, 101 AND 107).

FIRST USE 2-1-2005; IN COMMERCE 2-1-2005.

THE MARK CONSISTS OF STANDARD CHARACTERS WITHOUT CLAIM TO ANY PARTICULAR FONT, STYLE, SIZE, OR COLOR.

SER. NO. 77-397,260, FILED 2-14-2008.

CYNTHIA SLOAN, EXAMINING ATTORNEY



Int. Cl.: 35

Prior U.S. Cls.: 100, 101 and 102

United States Patent and Trademark Office

Reg. No. 3,504,624

Registered Sep. 23, 2008

**SERVICE MARK  
PRINCIPAL REGISTER**



MINNESOTA ROLLERGIRLS LLC (MINNESOTA  
LIMITED LIABILITY COMPANY)

2751 HENNEPIN AVE S #176

MINNEAPOLIS, MN 55408

FOR: COORDINATION OF RECREATIONAL  
SPORTING OPPORTUNITIES FOR INDIVIDUALS  
WHO WISH TO PARTICIPATE IN TEAM LEAGUE  
SPORTS, IN CLASS 35 (U.S. CLS. 100, 101 AND 102).

FIRST USE 5-1-2005; IN COMMERCE 5-1-2005.

NO CLAIM IS MADE TO THE EXCLUSIVE  
RIGHT TO USE "MINNESOTA ROLLERGIRLS",  
APART FROM THE MARK AS SHOWN.

THE MARK CONSISTS OF AN ILLUSTRATED  
WOMAN WITH A HELMET AND THE WORDS  
"MINNESOTA ROLLERGIRLS" IN THE LOWER-  
LEFT-HAND CORNER.

SER. NO. 77-397,266, FILED 2-14-2008.

TEJBIR SINGH, EXAMINING ATTORNEY

**Int. Cl.: 36**

**Prior U.S. Cls.: 100, 101 and 102**

**United States Patent and Trademark Office**

**Reg. No. 3,504,625**

**Registered Sep. 23, 2008**

**SERVICE MARK  
PRINCIPAL REGISTER**

**SAVINGS SPECTRUM**

QUALIFIED BENEFITS CONSULTANTS, INC.  
(MISSOURI CORPORATION), DBA QBC, INC.  
4940 WASHINGTON AVENUE  
ST. LOUIS, MO 63108

FOR: FINANCIAL SERVICES, FINANCIAL RE-  
CORDKEEPING AND FINANCIAL INFORMATION  
PROVIDED BY ELECTRONIC MEANS, ALL RELA-  
TED TO EMPLOYEE BENEFIT PLANS, IN CLASS 36  
(U.S. CLS. 100, 101 AND 102).

FIRST USE 9-30-2005; IN COMMERCE 9-30-2005.

THE MARK CONSISTS OF STANDARD CHAR-  
ACTERS WITHOUT CLAIM TO ANY PARTICULAR  
FONT, STYLE, SIZE, OR COLOR.

NO CLAIM IS MADE TO THE EXCLUSIVE  
RIGHT TO USE "SAVINGS", APART FROM THE  
MARK AS SHOWN.

SER. NO. 77-397,298, FILED 2-14-2008.

DEIRDRE ROBERTSON, EXAMINING ATTORNEY

**Int. Cl.: 9**

**Prior U.S. Cls.: 21, 23, 26, 36 and 38**

**United States Patent and Trademark Office**

**Reg. No. 3,504,626**

**Registered Sep. 23, 2008**

**TRADEMARK  
PRINCIPAL REGISTER**

**AIRPORT ANTIDOTE**

THINK TANK PHOTO, INC. (CALIFORNIA CORPORATION)  
SUITE 170  
3636 NORTH LAUGHLIN ROAD  
SANTA ROSA, CA 95403

FOR: ROLLING CASES, NAMELY, ROLLING CARRY-ON CASES DESIGNED FOR CARRYING CAMERAS, PHOTOGRAPHIC EQUIPMENT, OPTICAL EQUIPMENT, VIDEO CAMERA EQUIPMENT, AND COMPUTERS AND COMPUTER ACCESSORIES; WAIST HARNESES AND SHOULDER HARNESES DESIGNED FOR USE WITH THE FOREGOING GOODS, IN CLASS 9 (U.S. CLS. 21, 23, 26, 36 AND 38).

FIRST USE 8-31-2006; IN COMMERCE 8-31-2006.

THE MARK CONSISTS OF STANDARD CHARACTERS WITHOUT CLAIM TO ANY PARTICULAR FONT, STYLE, SIZE, OR COLOR.

NO CLAIM IS MADE TO THE EXCLUSIVE RIGHT TO USE "AIRPORT", APART FROM THE MARK AS SHOWN.

SER. NO. 77-397,317, FILED 2-14-2008.

CARRIE GENOVESE, EXAMINING ATTORNEY

**Int. Cl.: 36**

**Prior U.S. Cls.: 100, 101 and 102**

**United States Patent and Trademark Office**

**Reg. No. 3,504,627**

**Registered Sep. 23, 2008**

**SERVICE MARK  
PRINCIPAL REGISTER**



SEQUOIA INSURANCE COMPANY (CALIFORNIA CORPORATION)  
SUITE 100 70 GARDEN COURT  
MONTEREY, CA 93940

FOR: UNDERWRITING OF PROPERTY AND CASUALTY INSURANCE AND THE PROCESSING OF INSURANCE CLAIMS, IN CLASS 36 (U.S. CLS. 100, 101 AND 102).

FIRST USE 1-31-2007; IN COMMERCE 1-31-2007.

OWNER OF U.S. REG. NO. 1,531,201.

THE MARK CONSISTS OF TREE DESIGN.

SER. NO. 77-397,377, FILED 2-14-2008.

ESTHER BELENKER, EXAMINING ATTORNEY

**Int. Cl.: 16**

**Prior U.S. Cls.: 2, 5, 22, 23, 29, 37, 38 and 50**

**Reg. No. 3,504,628**

**United States Patent and Trademark Office**

**Registered Sep. 23, 2008**

**TRADEMARK  
PRINCIPAL REGISTER**

VA NATIONAL CENTER FOR PATIENT SAFETY  
(MICHIGAN FEDERAL AGENCY)

LOBBY M

24 FRANK LLOYD WRIGHT DRIVE

ANN ARBOR, MI 481060486

FOR: NEWSLETTERS IN THE FIELD OF PA-  
TIENT SAFETY, IN CLASS 16 (U.S. CLS. 2, 5, 22, 23,  
29, 37, 38 AND 50).

FIRST USE 1-1-2007; IN COMMERCE 1-1-2007.

THE COLOR(S) BLUE, GREEN AND WHITE IS/  
ARE CLAIMED AS A FEATURE OF THE MARK.

THE COLOR BLUE APPEARS IN THE WORD  
"TIPS", EXCEPT FOR THE DOT ABOVE THE "I",  
WHICH IS GREEN, WITH A WHITE CENTER. THE  
MARK APPEARS IN A STYLIZED FONT.

SER. NO. 77-397,388, FILED 2-14-2008.

ESTHER BELENKER, EXAMINING ATTORNEY

Int. Cl.: 35

Prior U.S. Cls.: 100, 101 and 102

United States Patent and Trademark Office

Reg. No. 3,504,629

Registered Sep. 23, 2008

SERVICE MARK  
PRINCIPAL REGISTER

# Mattress Giant

MATTRESS GIANT CORPORATION (TEXAS CORPORATION)  
14665 MIDWAY ROAD, STE. 100  
ADDISON, TX 75001

NO CLAIM IS MADE TO THE EXCLUSIVE RIGHT TO USE "MATTRESS", APART FROM THE MARK AS SHOWN.

FOR: RETAIL STORE SERVICES FEATURING MATTRESSES, BEDS, HEADBOARDS, FOOTBOARDS, MATTRESS PROTECTORS, BEDSPREADS, COMFORTERS, SHEETS AND PILLOWS, IN CLASS 35 (U.S. CLS. 100, 101 AND 102).

THE MARK CONSISTS OF THE WORDS "MATTRESS GIANT" IN ITC BOOKMAN BOLD TYPEFACE.

FIRST USE 4-15-1991; IN COMMERCE 4-15-1991.

SER. NO. 77-397,411, FILED 2-14-2008.

OWNER OF U.S. REG. NOS. 1,738,789 AND 2,354,497.

CAROLINE WOOD, EXAMINING ATTORNEY

**Int. Cl.: 36**

**Prior U.S. Cls.: 100, 101 and 102**

**United States Patent and Trademark Office**

**Reg. No. 3,504,630**

**Registered Sep. 23, 2008**

**SERVICE MARK  
PRINCIPAL REGISTER**

**WESTERN NETWORKED**

WESTERN NETWORKED INSURANCE SERVI-  
CES (CALIFORNIA CORPORATION)  
988 MCCOURTNEY ROAD, UNIT B  
GRASS VALLEY, CA 95949

THE MARK CONSISTS OF STANDARD CHAR-  
ACTERS WITHOUT CLAIM TO ANY PARTICULAR  
FONT, STYLE, SIZE, OR COLOR.

FOR: PROPERTY AND CASUALTY INSURANCE  
UNDERWRITING SERVICES, IN CLASS 36 (U.S.  
CLS. 100, 101 AND 102).

SER. NO. 77-397,429, FILED 2-14-2008.

FIRST USE 10-25-2007; IN COMMERCE 10-25-2007.

SETH A. RAPPAPORT, EXAMINING ATTORNEY

**Int. Cl.: 9**

**Prior U.S. Cls.: 21, 23, 26, 36 and 38**

**United States Patent and Trademark Office**

**Reg. No. 3,504,631**

**Registered Sep. 23, 2008**

**TRADEMARK  
PRINCIPAL REGISTER**

**AIRPORT ADDICTED**

THINK TANK PHOTO, INC. (CALIFORNIA CORPORATION)  
SUITE 170  
3636 NORTH LAUGHLIN ROAD  
SANTA ROSA, CA 95403

FOR: CARRYING CASES, NAMELY, BACKPACKS DESIGNED FOR CARRYING CAMERAS, PHOTOGRAPHIC EQUIPMENT, OPTICAL EQUIPMENT, VIDEO CAMERAS, VIDEOGRAPHIC EQUIPMENT, CINEMA CAMERAS, CINEMATOGRAPHIC EQUIPMENT, AUDIO ELECTRONIC EQUIPMENT, AND COMPUTERS AND COMPUTER ACCESSORIES; WAIST HARNESES AND SHOULDER HARNESES DESIGNED FOR USE WITH THE FOREGOING GOODS, IN CLASS 9 (U.S. CLS. 21, 23, 26, 36 AND 38).

FIRST USE 2-28-2005; IN COMMERCE 2-28-2005.

THE MARK CONSISTS OF STANDARD CHARACTERS WITHOUT CLAIM TO ANY PARTICULAR FONT, STYLE, SIZE, OR COLOR.

NO CLAIM IS MADE TO THE EXCLUSIVE RIGHT TO USE "AIRPORT", APART FROM THE MARK AS SHOWN.

SER. NO. 77-397,452, FILED 2-14-2008.

CARRIE GENOVESE, EXAMINING ATTORNEY



**Int. Cl.: 35**

**Prior U.S. Cls.: 100, 101 and 102**

**United States Patent and Trademark Office**

**Reg. No. 3,504,632**

**Registered Sep. 23, 2008**

**SERVICE MARK  
PRINCIPAL REGISTER**



INSPEC GROUP LLC (OREGON LIMITED LIABILITY COMPANY)

140 SW ARTHUR ST., SUITE 300

PORTLAND, OR 97201

FOR: BUSINESS CONSULTING SERVICES IN THE FIELD OF CONSTRUCTION CONTRACT MANAGEMENT AND BUSINESS STRATEGIC PLANNING FOR INDUSTRIAL AND COMMERCIAL CUSTOMERS , IN CLASS 35 (U.S. CLS. 100, 101 AND 102).

FIRST USE 6-3-2001; IN COMMERCE 6-3-2001.

NO CLAIM IS MADE TO THE EXCLUSIVE RIGHT TO USE "GROUP", APART FROM THE MARK AS SHOWN.

THE MARK CONSISTS OF A STYLIZED ELLIPTICAL OVAL WITH THE LETTERS "INSPEC" IN THE MIDDLE OF THE OVAL, THE WORD "GROUP" LOCATED TO THE LOWER RIGHT CORNER OUTSIDE OF THE OVAL, AND A NAVIGATIONAL STAR IN THE UPPER RIGHT CORNER OUTSIDE OF THE OVAL.

SER. NO. 77-397,457, FILED 2-14-2008.

JOHN E. MICHOS, EXAMINING ATTORNEY

**Int. Cl.: 35**

**Prior U.S. Cls.: 100, 101 and 102**

**United States Patent and Trademark Office**

**Reg. No. 3,504,633**

**Registered Sep. 23, 2008**

**SERVICE MARK  
PRINCIPAL REGISTER**



INSPEC GROUP LLC (OREGON LIMITED LIABILITY COMPANY)  
140 SW ARTHUR ST., SUITE 300  
PORTLAND, OR 97201

FOR: BUSINESS CONSULTING SERVICES IN THE FIELD OF CONSTRUCTION CONTRACT MANAGEMENT AND BUSINESS STRATEGIC PLANNING FOR INDUSTRIAL AND COMMERCIAL CUSTOMERS , IN CLASS 35 (U.S. CLS. 100, 101 AND 102).

FIRST USE 6-3-2001; IN COMMERCE 6-3-2001.

THE MARK CONSISTS OF A STYLIZED ELLIPTICAL OVAL WITH THE LETTERS "INSPEC" IN THE MIDDLE OF THE OVAL AND A NAVIGATIONAL STAR IN THE UPPER RIGHT CORNER OUTSIDE OF THE OVAL.

SER. NO. 77-397,476, FILED 2-14-2008.

JOHN E. MICHOS, EXAMINING ATTORNEY

**Int. Cl.: 6**

**Prior U.S. Cls.: 2, 12, 13, 14, 23, 25 and 50**

**Reg. No. 3,504,634**

**United States Patent and Trademark Office**

**Registered Sep. 23, 2008**

---

**TRADEMARK  
PRINCIPAL REGISTER**

**RIVINOX**

INDUSTRIAL RIVET & FASTENER CO. (NEW  
JERSEY CORPORATION)  
200 PARIS AVENUE  
NORTHVALE, NJ 07647

THE MARK CONSISTS OF STANDARD CHAR-  
ACTERS WITHOUT CLAIM TO ANY PARTICULAR  
FONT, STYLE, SIZE, OR COLOR.

FOR: METAL FASTENERS, NAMELY, RIVETS  
AND COLD-HEADED SPECIALTY FASTENERS, IN  
CLASS 6 (U.S. CLS. 2, 12, 13, 14, 23, 25 AND 50).

SER. NO. 77-397,506, FILED 2-15-2008.

FIRST USE 7-12-2004; IN COMMERCE 7-12-2004.

JOHN DWYER, EXAMINING ATTORNEY

**Int. Cl.: 11**

**Prior U.S. Cls.: 13, 21, 23, 31 and 34**

**United States Patent and Trademark Office**

**Reg. No. 3,504,635**

**Registered Sep. 23, 2008**

**TRADEMARK  
PRINCIPAL REGISTER**

**IMPRESSION PLUS**

WATER-RIGHT, INC. (WISCONSIN CORPORATION)  
1900 PROSPECT COURT  
APPLETON, WI 54914

FOR: WATER TREATMENT EQUIPMENT, NAMELY, WATER CONDITIONING UNITS, WATER SOFTENING UNITS AND WATER FILTRATION UNITS, IN CLASS 11 (U.S. CLS. 13, 21, 23, 31 AND 34).

FIRST USE 3-27-2007; IN COMMERCE 3-27-2007.

THE MARK CONSISTS OF STANDARD CHARACTERS WITHOUT CLAIM TO ANY PARTICULAR FONT, STYLE, SIZE, OR COLOR.

OWNER OF U.S. REG. NO. 2,908,162.

SER. NO. 77-397,509, FILED 2-14-2008.

RONALD AIKENS, EXAMINING ATTORNEY

**Int. Cl.: 11**

**Prior U.S. Cls.: 13, 21, 23, 31 and 34**

**United States Patent and Trademark Office**

**Reg. No. 3,504,636**

**Registered Sep. 23, 2008**

**TRADEMARK  
PRINCIPAL REGISTER**

**IMPRESSION**

WATER-RIGHT, INC. (WISCONSIN CORPORATION)  
1900 PROSPECT COURT  
APPLETON, WI 54914

FOR: WATER TREATMENT EQUIPMENT, NAMELY, WATER CONDITIONING UNITS, WATER SOFTENING UNITS AND WATER FILTRATION UNITS, IN CLASS 11 (U.S. CLS. 13, 21, 23, 31 AND 34).

FIRST USE 6-1-2002; IN COMMERCE 6-1-2002.

THE MARK CONSISTS OF STANDARD CHARACTERS WITHOUT CLAIM TO ANY PARTICULAR FONT, STYLE, SIZE, OR COLOR.

OWNER OF U.S. REG. NO. 2,908,162.

SER. NO. 77-397,516, FILED 2-14-2008.

RONALD AIKENS, EXAMINING ATTORNEY

**Int. Cl.: 36**

**Prior U.S. Cls.: 100, 101 and 102**

**United States Patent and Trademark Office**

**Reg. No. 3,504,637**

**Registered Sep. 23, 2008**

**SERVICE MARK  
PRINCIPAL REGISTER**

**NWA EARTHCARES**

NORTHWEST AIRLINES, INC. (MINNESOTA  
CORPORATION)  
DEPARTMENT 1180  
2700 LONE OAK PARKWAY  
EAGAN, MN 55121

FOR: CHARITABLE FUND RAISING, IN CLASS  
36 (U.S. CLS. 100, 101 AND 102).

FIRST USE 12-12-2007; IN COMMERCE 12-12-2007.

THE MARK CONSISTS OF STANDARD CHAR-  
ACTERS WITHOUT CLAIM TO ANY PARTICULAR  
FONT, STYLE, SIZE, OR COLOR.

OWNER OF U.S. REG. NOS. 2,271,908, 2,850,937  
AND OTHERS.

SER. NO. 77-397,575, FILED 2-14-2008.

MARIA-VICTORIA SUAREZ, EXAMINING ATTOR-  
NEY

**Int. Cl.: 9**

**Prior U.S. Cls.: 21, 23, 26, 36 and 38**

**United States Patent and Trademark Office**

**Reg. No. 3,504,638**

**Registered Sep. 23, 2008**

**TRADEMARK  
PRINCIPAL REGISTER**

# REFLECTION

ATTACHMATE CORPORATION (WASHINGTON CORPORATION)  
1500 DEXTER AVENUE NORTH  
SEATTLE, WA 98109

FOR: COMPUTER PROGRAMS AND INSTRUCTIONAL MATERIALS SOLD AS A UNIT FOR USE BY REMOTE AND WORK STATION COMPUTERS WITH APPLICATIONS FEATURING TERMINAL EMULATION AND HOST ACCESS WITH AUTOMATED AUTHENTICATION AND DATA INTEGRITY; COMPUTER PROGRAMS AND INSTRUCTIONAL MATERIALS SOLD AS A UNIT FOR USE BY REMOTE, MOBILE AND WORK STATION COMPUTERS WITH APPLICATIONS FEATURING SECURITY; COMPUTER PROGRAMS AND INSTRUCTIONAL MATERIALS SOLD AS A UNIT FOR USE BY SERVER-CLASS COMPUTERS

WITH APPLICATIONS FEATURING TERMINAL EMULATION, HOST ACCESS AND SECURITY, IN CLASS 9 (U.S. CLS. 21, 23, 26, 36 AND 38).

FIRST USE 10-1-1985; IN COMMERCE 10-1-1985.

THE MARK CONSISTS OF STANDARD CHARACTERS WITHOUT CLAIM TO ANY PARTICULAR FONT, STYLE, SIZE, OR COLOR.

OWNER OF U.S. REG. NOS. 1,475,672, 1,698,819, AND 2,045,379.

SER. NO. 77-397,605, FILED 2-14-2008.

HENRY S. ZAK, EXAMINING ATTORNEY

**Int. Cl.: 42**

**Prior U.S. Cls.: 100 and 101**

**United States Patent and Trademark Office**

**Reg. No. 3,504,639**

**Registered Sep. 23, 2008**

**SERVICE MARK  
PRINCIPAL REGISTER**

# The Web Corner

THE WEB CORNER INC. (CALIFORNIA CORPORATION)  
19509 VENTURA BLVD.  
TARZANA, CA 91356

FOR: DESIGN, CREATION, HOSTING, MAINTENANCE OF WEB SITES FOR OTHERS, IN CLASS 42 (U.S. CLS. 100 AND 101).

FIRST USE 5-14-2004; IN COMMERCE 5-14-2004.

THE MARK CONSISTS OF STANDARD CHARACTERS WITHOUT CLAIM TO ANY PARTICULAR FONT, STYLE, SIZE, OR COLOR.

NO CLAIM IS MADE TO THE EXCLUSIVE RIGHT TO USE "WEB", APART FROM THE MARK AS SHOWN.

SER. NO. 77-397,629, FILED 2-14-2008.

HENRY S. ZAK, EXAMINING ATTORNEY



**Int. Cl.: 19**

**Prior U.S. Cls.: 1, 12, 33 and 50**

**United States Patent and Trademark Office**

**Reg. No. 3,504,640**

**Registered Sep. 23, 2008**

**TRADEMARK  
PRINCIPAL REGISTER**



CLASSIC AMERICAN HARDWOODS (TENNESSEE CORPORATION)  
1245 N. SEVENTH ST.  
MEMPHIS, TN 381071745

FOR: LUMBER, IN CLASS 19 (U.S. CLS. 1, 12, 33 AND 50).

FIRST USE 12-20-2007; IN COMMERCE 12-20-2007.

THE MARK CONSISTS OF A BROKEN CIRCLE CENTERED UPON A BROKEN RECTANGLE. THE

LETTER "C" IS LOCATED INSIDE THE LEFT PORTION OF THE RECTANGLE. THE LETTER "A" IS LOCATED IN THE CENTER OF THE BROKEN CIRCLE. THE LETTER "H" IS LOCATED INSIDE THE RIGHT PORTION OF THE RECTANGLE.

SER. NO. 77-397,634, FILED 2-14-2008.

MELISSA VALLILLO, EXAMINING ATTORNEY

**Int. Cls.: 35 and 41**

**Prior U.S. Cls.: 100, 101, 102 and 107**

**United States Patent and Trademark Office**

**Reg. No. 3,504,641**

**Registered Sep. 23, 2008**

**SERVICE MARK  
PRINCIPAL REGISTER**

# Momenteam

JULIA DOUGLAS (UNITED STATES INDIVIDUAL)  
51 ORIENT AVENUE  
ARLINGTON, MA 02474

FOR: BUSINESS MANAGEMENT CONSULTING IN THE FIELD OF TEAM DEVELOPMENT, IN CLASS 35 (U.S. CLS. 100, 101 AND 102).

FIRST USE 8-10-2004; IN COMMERCE 8-23-2004.

FOR: TRAINING SERVICES IN THE FIELD OF CORPORATE TEAM BUILDING, IN CLASS 41 (U.S. CLS. 100, 101 AND 107).

FIRST USE 8-10-2004; IN COMMERCE 8-23-2004.

THE MARK CONSISTS OF STANDARD CHARACTERS WITHOUT CLAIM TO ANY PARTICULAR FONT, STYLE, SIZE, OR COLOR.

SER. NO. 77-397,657, FILED 2-14-2008.

SARA THOMAS, EXAMINING ATTORNEY

Int. Cl.: 40

Prior U.S. Cls.: 100, 103 and 106

United States Patent and Trademark Office

Reg. No. 3,504,642

Registered Sep. 23, 2008

SERVICE MARK  
PRINCIPAL REGISTER



ODOR-BEATERS (CALIFORNIA PARTNERSHIP)  
SUITE 104-312  
197 WOODLAND PARKWAY  
SAN MARCOS, CA 92026

FOR: ODOR NEUTRALIZATION SERVICES, IN  
CLASS 40 (U.S. CLS. 100, 103 AND 106).

FIRST USE 10-1-2007; IN COMMERCE 2-1-2008.

THE MARK CONSISTS OF THE WORDS "ODOR-  
BEATERS" STYLIZED IN THE FOLLOWING MAN-

NER: A SKUNK INSIDE THE SECOND "O" IN  
"ODOR". THE HYPHEN AFTER THE WORD  
"ODOR" IS FOLLOWED BY THE WORD "BEA-  
TERS". UNDERNEATH THE WORDS "ODOR-BEA-  
TERS" IS THE TAG LINE, OR PHRASE: "WHAT'S  
YOUR STINKIN' PROBLEM?", WITH A HORIZON-  
TAL LINE ON EACH SIDE.

SER. NO. 77-397,691, FILED 2-14-2008.

MICHELLE DUBOIS, EXAMINING ATTORNEY

Int. Cl.: 41

Prior U.S. Cls.: 100, 101 and 107

United States Patent and Trademark Office

Reg. No. 3,504,643

Registered Sep. 23, 2008

SERVICE MARK  
PRINCIPAL REGISTER



HOLLORAN, SEAN (UNITED STATES INDIVIDUAL)

2405 AUTUMN VIEW WAY

BALTIMORE, MD 21234

FOR: AUDIO RECORDING AND PRODUCTION; MULTIMEDIA ENTERTAINMENT SERVICES IN THE NATURE OF RECORDING, PRODUCTION AND POST-PRODUCTION SERVICES IN THE FIELDS OF MUSIC, VIDEO, AND FILMS, IN CLASS 41 (U.S. CLS. 100, 101 AND 107).

FIRST USE 10-1-2007; IN COMMERCE 1-22-2008.

NO CLAIM IS MADE TO THE EXCLUSIVE RIGHT TO USE "RECORDS", APART FROM THE MARK AS SHOWN.

THE STIPPLING IS FOR SHADING PURPOSES ONLY.

THE MARK CONSISTS OF A SHARK AND THE STYLIZED TEXT "BLUE PHIN RECORDS"; THE SHARK IS FOUND BETWEEN THE WORDS "BLUE" AND "PHIN". THE BORDER IS AN OVAL.

SER. NO. 77-397,698, FILED 2-14-2008.

MICHELLE DUBOIS, EXAMINING ATTORNEY

**Int. Cl.: 7**

**Prior U.S. Cls.: 13, 19, 21, 23, 31, 34 and 35**

**United States Patent and Trademark Office**

**Reg. No. 3,504,644**

**Registered Sep. 23, 2008**

**TRADEMARK  
PRINCIPAL REGISTER**

**APEXDIA**

APEXDIA LTD (REPUBLIC OF KOREA LIMITED  
LIABILITY COMPANY)  
101, SINMOSAN-DONG  
ANSEONG-SI, REPUBLIC OF KOREA 456-390

THE MARK CONSISTS OF STANDARD CHAR-  
ACTERS WITHOUT CLAIM TO ANY PARTICULAR  
FONT, STYLE, SIZE, OR COLOR.

FOR: GRINDING TOOLS FOR GRINDING MA-  
CHINES; BLADES FOR POWER SAWS; POWER SAW  
BLADES, IN CLASS 7 (U.S. CLS. 13, 19, 21, 23, 31, 34  
AND 35).

SER. NO. 77-397,767, FILED 2-15-2008.

FIRST USE 12-14-2000; IN COMMERCE 1-1-2001.

MARY MUNSON, EXAMINING ATTORNEY

Int. Cl.: 12

Prior U.S. Cls.: 19, 21, 23, 31, 35 and 44

United States Patent and Trademark Office

Reg. No. 3,504,645

Registered Sep. 23, 2008

TRADEMARK  
PRINCIPAL REGISTER



EXPRESS WELDING, INC. (MICHIGAN CORPORATION)  
2525 14TH AVENUE NORTH  
ESCANABA, MI 49829

FOR: SEMI-TRACTOR TRAILERS, IN CLASS 12  
(U.S. CLS. 19, 21, 23, 31, 35 AND 44).

FIRST USE 10-6-2006; IN COMMERCE 10-6-2006.

THE MARK CONSISTS OF THE WORD "NITRO" WITH A LIT FIRECRACKER AS THE LETTER "I", A SCORPION UNDER THE WORD "NITRO" AND THE WORK "SPREADER" FOLLOWING THE SCORPION IN SCRIPT FONT.

SER. NO. 77-397,796, FILED 2-15-2008.

LINDA ORNDORFF, EXAMINING ATTORNEY

**Int. Cl.: 9**

**Prior U.S. Cls.: 21, 23, 26, 36 and 38**

**United States Patent and Trademark Office**

**Reg. No. 3,504,646**

**Registered Sep. 23, 2008**

**TRADEMARK  
PRINCIPAL REGISTER**

**DRACOWYRE**

KEVIN MAXFIELD (UNITED STATES INDIVIDUAL)  
429 KINGSRIDGE DRIVE  
HIXSON, TN 37343

THE MARK CONSISTS OF STANDARD CHARACTERS WITHOUT CLAIM TO ANY PARTICULAR FONT, STYLE, SIZE, OR COLOR.

FOR: GUITAR CABLES, IN CLASS 9 (U.S. CLS. 21, 23, 26, 36 AND 38).

SER. NO. 77-397,801, FILED 2-15-2008.

FIRST USE 1-17-2008; IN COMMERCE 1-17-2008.

GEORGE LORENZO, EXAMINING ATTORNEY

**Int. Cl.: 12**

**Prior U.S. Cls.: 19, 21, 23, 31, 35 and 44**

**United States Patent and Trademark Office**

**Reg. No. 3,504,647**

**Registered Sep. 23, 2008**

**TRADEMARK  
PRINCIPAL REGISTER**



EXPRESS WELDING, INC. (MICHIGAN CORPORATION)  
2525 14TH AVENUE NORTH  
ESCANABA, MI 49829

FOR: SEMI-TRACTOR TRAILERS, IN CLASS 12  
(U.S. CLS. 19, 21, 23, 31, 35 AND 44).

FIRST USE 2-1-2008; IN COMMERCE 2-1-2008.

NO CLAIM IS MADE TO THE EXCLUSIVE  
RIGHT TO USE "EQUALIZER BALANCING SYSTEM",  
APART FROM THE MARK AS SHOWN.

THE MARK CONSISTS OF THE WORD "EQUALIZER" WHERE THE MIDDLE BAR OF THE LETTER "E" EXTENDS TO BECOME THE FRAME OF A LOWBOY TRAILER WITH A STINGER AXLE. THE BOTTOM BAR OF THE LETTER "E" EXTENDS TO REPRESENT THE GROUND. IN ADDITION, THE WORDS "BALANCING SYSTEM" ARE PRINTED ON THE BOTTOM BAR OF THE LETTER "E".

SER. NO. 77-397,802, FILED 2-15-2008.

LINDA ORNDORFF, EXAMINING ATTORNEY



**Int. Cl.: 9**

**Prior U.S. Cls.: 21, 23, 26, 36 and 38**

**Reg. No. 3,504,648**

**United States Patent and Trademark Office**

**Registered Sep. 23, 2008**

---

**TRADEMARK  
PRINCIPAL REGISTER**

**KRAYON**

KEVIN MAXFIELD (UNITED STATES INDIVIDUAL)  
429 KINGSRIDGE DRIVE  
HIXSON, TN 37343

THE MARK CONSISTS OF STANDARD CHARACTERS WITHOUT CLAIM TO ANY PARTICULAR FONT, STYLE, SIZE, OR COLOR.

FOR: GUITAR AMPLIFIERS, IN CLASS 9 (U.S. CLS. 21, 23, 26, 36 AND 38).

SER. NO. 77-397,804, FILED 2-15-2008.

FIRST USE 1-17-2008; IN COMMERCE 1-17-2008.

GEORGE LORENZO, EXAMINING ATTORNEY

**Int. Cl.: 3**

**Prior U.S. Cls.: 1, 4, 6, 50, 51 and 52**

**United States Patent and Trademark Office**

**Reg. No. 3,504,649**

**Registered Sep. 23, 2008**

**TRADEMARK  
PRINCIPAL REGISTER**

ARC ABRASIVES, INC. (OHIO CORPORATION)  
85 MARYBILL DR.  
TROY, OH 45373

OWNER OF U.S. REG. NOS. 2,544,269, 2,544,285,  
AND 3,096,753.

FOR: COATED ABRASIVES AND SANDPAPER  
IN THE FORM OF SHEETS, ROLLS AND DISCS, IN  
CLASS 3 (U.S. CLS. 1, 4, 6, 50, 51 AND 52).

SER. NO. 77-397,824, FILED 2-15-2008.

FIRST USE 2-1-2008; IN COMMERCE 2-1-2008.

LINDA ORNDORFF, EXAMINING ATTORNEY

**Int. Cl.: 30**

**Prior U.S. Cl.: 46**

**United States Patent and Trademark Office**

**Reg. No. 3,504,650**

**Registered Sep. 23, 2008**

**TRADEMARK  
PRINCIPAL REGISTER**

**CHOOSE CHANGE**

CHOOSE CHANGE LIMITED CO. (CALIFORNIA  
CORPORATION)  
85 LIBERTY SHIP WAY #201  
SAUSALITO, CA 94965

THE MARK CONSISTS OF STANDARD CHAR-  
ACTERS WITHOUT CLAIM TO ANY PARTICULAR  
FONT, STYLE, SIZE, OR COLOR.

FOR: BAKERY GOODS, IN CLASS 30 (U.S. CL. 46).

SER. NO. 77-397,833, FILED 2-15-2008.

FIRST USE 1-18-2008; IN COMMERCE 1-18-2008.

CARRIE GENOVESE, EXAMINING ATTORNEY

**Int. Cl.: 31**

**Prior U.S. Cls.: 1 and 46**

**United States Patent and Trademark Office**

**Reg. No. 3,504,651**

**Registered Sep. 23, 2008**

**TRADEMARK  
PRINCIPAL REGISTER**

**PIANO**

ROSEN TANTAU MATHIAS TANTAU NACH-  
FOLGER (FED REP GERMANY CORPORA-  
TION)

TORNESCHER WEG 13

UETERSEN, FED REP GERMANY 25436

FOR: LIVING PLANTS AND NATURAL FLOW-  
ERS, IN PARTICULAR ROSES AND ROSE PLANTS,  
IN CLASS 31 (U.S. CLS. 1 AND 46).

THE MARK CONSISTS OF STANDARD CHAR-  
ACTERS WITHOUT CLAIM TO ANY PARTICULAR  
FONT, STYLE, SIZE, OR COLOR.

OWNER OF FED REP GERMANY REG. NO.  
39613514.5, DATED 9-17-1996, EXPIRES 3-31-2016.

SER. NO. 77-397,918, FILED 2-15-2008.

GEORGE LORENZO, EXAMINING ATTORNEY

**Int. Cl.: 41**

**Prior U.S. Cls.: 100, 101 and 107**

**United States Patent and Trademark Office**

**Reg. No. 3,504,652**

**Registered Sep. 23, 2008**

**SERVICE MARK  
PRINCIPAL REGISTER**

**CDELA**

WHITE HAT VENTURES, LLC (OHIO LIMITED  
LIABILITY COMPANY)  
159 S. MAIN ST., SUITE 600  
AKRON, OH 44308

FOR: EDUCATIONAL SERVICES, NAMELY,  
CONDUCTING AND PROVIDING ELEMENTARY,  
JUNIOR HIGH, AND HIGH SCHOOL CLASSES AND  
EDUCATION COURSES THROUGH MEANS OF  
TELECOMMUNICATIONS AND COMPUTER NET-  
WORKS, IN CLASS 41 (U.S. CLS. 100, 101 AND 107).

FIRST USE 4-20-2005; IN COMMERCE 4-20-2005.

THE MARK CONSISTS OF STANDARD CHAR-  
ACTERS WITHOUT CLAIM TO ANY PARTICULAR  
FONT, STYLE, SIZE, OR COLOR.

SER. NO. 77-397,923, FILED 2-15-2008.

BRIAN PINO, EXAMINING ATTORNEY

**Int. Cls.: 35 and 41**

**Prior U.S. Cls.: 100, 101, 102 and 107**

**United States Patent and Trademark Office**

**Reg. No. 3,504,653**

**Registered Sep. 23, 2008**

**SERVICE MARK  
PRINCIPAL REGISTER**

# Tuition Tales

UPROMISE, INC. (DELAWARE CORPORATION)  
95 WELLS AVE.  
NEWTON, MA 02459

FOR: CONTESTS AND INCENTIVE AWARD PROGRAMS TO PROMOTE THE SALE OF PRODUCTS AND SERVICES OF OTHERS, IN CLASS 35 (U.S. CLS. 100, 101 AND 102).

FIRST USE 1-20-2008; IN COMMERCE 1-20-2008.

FOR: PROVIDING RECOGNITION AND INCENTIVES BY THE WAY OF AWARDS AND CONTESTS TO DEMONSTRATE EXCELLENCE IN THE FIELD OF EDUCATION, IN CLASS 41 (U.S. CLS. 100, 101 AND 107).

FIRST USE 1-20-2008; IN COMMERCE 1-20-2008.

THE MARK CONSISTS OF STANDARD CHARACTERS WITHOUT CLAIM TO ANY PARTICULAR FONT, STYLE, SIZE, OR COLOR.

NO CLAIM IS MADE TO THE EXCLUSIVE RIGHT TO USE "TUITION", APART FROM THE MARK AS SHOWN.

SER. NO. 77-397,929, FILED 2-15-2008.

EVELYN BRADLEY, EXAMINING ATTORNEY

Int. Cl.: 35

Prior U.S. Cls.: 100, 101 and 102

United States Patent and Trademark Office

Reg. No. 3,504,654

Registered Sep. 23, 2008

SERVICE MARK  
PRINCIPAL REGISTER



THE PARADIES SHOPS, INC. (GEORGIA CORPORATION)  
5950 FULTON INDUSTRIAL BOULEVARD  
ATLANTA, GA 30336

FOR: RETAIL STORE SERVICES FEATURING BOOKS, NEWSPAPERS AND MAGAZINES THAT ALLOW CUSTOMERS TO RETURN BOOKS IN A SPECIFIED PERIOD OF TIME AND RECEIVE A PARTIAL REFUND, IN CLASS 35 (U.S. CLS. 100, 101 AND 102).

FIRST USE 4-30-2003; IN COMMERCE 4-30-2003.

NO CLAIM IS MADE TO THE EXCLUSIVE RIGHT TO USE "BUY IT, READ IT, RETURN IT!" AND "RECEIVE A 50% REFUND!", APART FROM THE MARK AS SHOWN.

THE MARK CONSISTS, IN PART, OF A SHADED CIRCLE WITH THE WORDS "BUY IT, READ IT, RETURN IT!" CURVED ACROSS THE TOP OF THE

CIRCLE, WITH THE WORDS "RECEIVE A 50% REFUND!" CURVED ACROSS THE BOTTOM OF THE CIRCLE, AND WITH THE WORD "READ" IN LARGE LETTERING IN THE MIDDLE OF THE CIRCLE WITH THE WORD "RETURN" UNDERNEATH. THE "&" SYMBOL APPEARS TO THE RIGHT OF THE WORDS "READ" AND "RETURN" SUPERIMPOSED ON TOP OF A SHADED DIRECTIONAL ARROW MOVING FROM THE WORD "READ" AND POINTING TOWARDS THE TERM "RETURN" TO MEAN "READ AND RETURN". A PAIR OF EYEGGLASS FRAMES ARE LEANING ON THE RIGHT SIDE OF THE LETTER "A" IN THE TERM "READ" AND TOUCHING THE LETTER "D" IN THE TERM "READ".

SEC. 2(F) AS TO "READ" AND "RETURN".

SER. NO. 77-397,939, FILED 2-15-2008.

ZHALEH DELANEY, EXAMINING ATTORNEY

**Int. Cl.: 41**

**Prior U.S. Cls.: 100, 101 and 107**

**United States Patent and Trademark Office**

**Reg. No. 3,504,655**

**Registered Sep. 23, 2008**

**SERVICE MARK  
PRINCIPAL REGISTER**

**DELA**

WHITE HAT VENTURES, LLC (OHIO LIMITED  
LIABILITY COMPANY)  
159 S. MAIN ST., SUITE 600  
AKRON, OH 44308

FOR: EDUCATIONAL SERVICES, NAMELY,  
CONDUCTING AND PROVIDING ELEMENTARY,  
JUNIOR HIGH, AND HIGH SCHOOL CLASSES AND  
EDUCATION COURSES THROUGH MEANS OF  
TELECOMMUNICATIONS AND COMPUTER NET-  
WORKS, IN CLASS 41 (U.S. CLS. 100, 101 AND 107).

FIRST USE 6-1-2005; IN COMMERCE 6-1-2005.

THE MARK CONSISTS OF STANDARD CHAR-  
ACTERS WITHOUT CLAIM TO ANY PARTICULAR  
FONT, STYLE, SIZE, OR COLOR.

SER. NO. 77-397,941, FILED 2-15-2008.

BRIAN PINO, EXAMINING ATTORNEY



**Int. Cl.: 35**

**Prior U.S. Cls.: 100, 101 and 102**

**United States Patent and Trademark Office**

**Reg. No. 3,504,656**

**Registered Sep. 23, 2008**

**SERVICE MARK  
PRINCIPAL REGISTER**

**READ & RETURN**

THE PARADIES SHOPS, INC. (GEORGIA CORPORATION)  
5950 FULTON INDUSTRIAL BOULEVARD  
ATLANTA, GA 30336

FOR: RETAIL STORE SERVICES FEATURING BOOKS, NEWSPAPERS AND MAGAZINES THAT ALLOW CUSTOMERS TO RETURN BOOKS IN A SPECIFIED PERIOD OF TIME AND RECEIVE A PARTIAL REFUND, IN CLASS 35 (U.S. CLS. 100, 101 AND 102).

FIRST USE 4-30-2003; IN COMMERCE 4-30-2003.

THE MARK CONSISTS OF STANDARD CHARACTERS WITHOUT CLAIM TO ANY PARTICULAR FONT, STYLE, SIZE, OR COLOR.

SEC. 2(F).

SER. NO. 77-397,950, FILED 2-15-2008.

ZHALEH DELANEY, EXAMINING ATTORNEY

Int. Cl.: 35

Prior U.S. Cls.: 100, 101 and 102

United States Patent and Trademark Office

Reg. No. 3,504,657

Registered Sep. 23, 2008

SERVICE MARK  
PRINCIPAL REGISTER



THE PARADIES SHOPS, INC. (GEORGIA CORPORATION)  
5950 FULTON INDUSTRIAL BOULEVARD  
ATLANTA, GA 30336

FOR: RETAIL VENDING IN THE FIELD OF NEWSPAPERS, MAGAZINES AND BOOKS, IN CLASS 35 (U.S. CLS. 100, 101 AND 102).

FIRST USE 3-31-1999; IN COMMERCE 3-31-1999.

THE LINING IS A FEATURE OF THE MARK AND DOES NOT INDICATE COLOR.

THE MARK CONSISTS OF THE WORDS "PRESS EXPRESS" SUPERIMPOSED ON A STYLIZED DRAWING OF A NEWSPAPER.

SEC. 2(F) AS TO "PRESS EXPRESS".

SER. NO. 77-397,955, FILED 2-15-2008.

ZHALEH DELANEY, EXAMINING ATTORNEY

**Int. Cl.: 9**

**Prior U.S. Cls.: 21, 23, 26, 36 and 38**

**Reg. No. 3,504,658**

**United States Patent and Trademark Office**

**Registered Sep. 23, 2008**

**TRADEMARK  
PRINCIPAL REGISTER**

**CLIO**

THE PINAX GROUP, INC. (DELAWARE CORPORATION)  
SUITE I-123  
9605 JEFFERSON HIGHWAY  
NEW ORLEANS, LA 70123

FOR: COMPUTER HARDWARE; CENTRAL PROCESSING UNITS (CPU); COMPUTER CHASSIS; COMPUTER HARDWARE AND COMPUTER PERIPHERAL DEVICES; COMPUTER HARDWARE AND COMPUTER PERIPHERALS; COMPUTER HARDWARE AND COMPUTER SOFTWARE FOR RETAIL INVENTORY MANAGEMENT, SOLD AS A UNIT; COMPUTER HARDWARE AND PERIPHERAL DEVICES; COMPUTER HARDWARE AND PERIPHERALS; COMPUTER HARDWARE AND SOFTWARE SYSTEM FOR REMOTELY MONITORING ENVIRONMENTAL CONDITIONS AND CONTROLLING DEVICES WITHIN A BUILDING, FACILITY, GROUNDS, OR DESIGNATED SPATIAL AREA; COMPUTER HARDWARE AND SOFTWARE, FOR USE WITH MEDICAL PATIENT MONITORING EQUIPMENT, FOR RECEIVING, PROCESSING, TRANSMITTING AND DISPLAYING DATA; COMPUTER MOTHERBOARDS AND DAUGHTERBOARDS; COMPUTER STYLUS; COMPUTER TERMINALS; COMPUTER TERMINALS, KEYBOARDS AND PRINTERS; COMPUTER TOUCHSCREENS; COMPUTERS; COMPUTERS

AND COMPUTER HARDWARE; COMPUTERS AND COMPUTER PERIPHERALS; COMPUTERS AND INSTRUCTIONAL MANUALS SOLD AS A UNIT; ELECTRONIC COMPONENTS FOR COMPUTERS; ELECTRONIC COMPUTERS; HANDHELD COMPUTERS; HANDHELD PERSONAL COMPUTERS; LAPTOP COMPUTERS; MICRO-COMPUTER; MICRO-COMPUTERS; MOBILE COMPUTERS; MOBILE COMPUTING AND OPERATING PLATFORMS CONSISTING OF DATA TRANSCEIVERS, WIRELESS NETWORKS AND GATEWAYS FOR COLLECTION AND MANAGEMENT OF DATA; NOTEBOOK AND LAPTOP COMPUTERS; NOTEBOOK COMPUTERS; PERSONAL COMPUTERS; PERSONAL DIGITAL ASSISTANT COMPUTERS; TABLET COMPUTER, IN CLASS 9 (U.S. CLS. 21, 23, 26, 36 AND 38).

FIRST USE 10-1-1997; IN COMMERCE 10-12-1998.

THE MARK CONSISTS OF STANDARD CHARACTERS WITHOUT CLAIM TO ANY PARTICULAR FONT, STYLE, SIZE, OR COLOR.

SER. NO. 77-397,956, FILED 2-15-2008.

ELLEN BURNS, EXAMINING ATTORNEY

**Int. Cl.: 35**

**Prior U.S. Cls.: 100, 101 and 102**

**United States Patent and Trademark Office**

**Reg. No. 3,504,659**

**Registered Sep. 23, 2008**

**SERVICE MARK  
PRINCIPAL REGISTER**

**PRESS EXPRESS**

PARADIES SHOPS, INC., THE (GEORGIA CORPORATION)  
5950 FULTON INDUSTRIAL BOULEVARD  
ATLANTA, GA 30336

FOR: RETAIL VENDING IN THE FIELD OF  
NEWSPAPERS, MAGAZINES AND BOOKS, IN  
CLASS 35 (U.S. CLS. 100, 101 AND 102).

FIRST USE 3-31-1999; IN COMMERCE 3-31-1999.

THE MARK CONSISTS OF STANDARD CHARACTERS WITHOUT CLAIM TO ANY PARTICULAR FONT, STYLE, SIZE, OR COLOR.

SEC. 2(F).

SER. NO. 77-397,972, FILED 2-15-2008.

ZHALEH DELANEY, EXAMINING ATTORNEY

**Int. Cls.: 38 and 42**

**Prior U.S. Cls.: 100, 101 and 104**

**United States Patent and Trademark Office**

**Reg. No. 3,504,660**

**Registered Sep. 23, 2008**

**SERVICE MARK  
PRINCIPAL REGISTER**

**LECNET**

TELEPHONE ELECTRONICS CORPORATION  
(MISSISSIPPI CORPORATION)  
236 E. CAPITOL STREET  
JACKSON, MS 39201

FOR: BROADBAND TELECOMMUNICATIONS  
SERVICES, NAMELY, TRANSMISSION OF VOICE,  
DATA AND VIDEO, IN CLASS 38 (U.S. CLS. 100, 101  
AND 104).

FIRST USE 9-1-1999; IN COMMERCE 9-1-1999.

FOR: TECHNICAL SUPPORT AND MONITOR-  
ING SERVICES, NAMELY, TROUBLESHOOTING

OF BROADBAND SERVICES PROBLEMS VIA TEL-  
EPHONE, E-MAIL, IN-PERSON, IN CLASS 42 (U.S.  
CLS. 100 AND 101).

FIRST USE 9-1-1999; IN COMMERCE 9-1-1999.

THE MARK CONSISTS OF STANDARD CHAR-  
ACTERS WITHOUT CLAIM TO ANY PARTICULAR  
FONT, STYLE, SIZE, OR COLOR.

SER. NO. 77-397,973, FILED 2-15-2008.

ARETHA SOMERVILLE, EXAMINING ATTORNEY

**Int. Cl.: 9**

**Prior U.S. Cls.: 21, 23, 26, 36 and 38**

**United States Patent and Trademark Office**

**Reg. No. 3,504,661**

**Registered Sep. 23, 2008**

**TRADEMARK  
PRINCIPAL REGISTER**

# F-Response

AGILE RISK MANAGEMENT LLC (FLORIDA  
LIMITED LIABILITY COMPANY)  
2202 N WESTSHORE BLVD, SUITE 200  
TAMPA, FL 33607

FIRST USE 1-7-2008; IN COMMERCE 1-7-2008.

FOR: COMPUTER SOFTWARE FOR USE BY  
COMPUTER SECURITY CONSULTANTS AND  
LAW ENFORCEMENT PERSONNEL TO ENABLE  
THE COLLECTION AND ANALYSIS OF COMPU-  
TER EVIDENCE OVER A DATA NETWORK, UTI-  
LIZING COLLECTION AND ANALYSIS TOOLS  
THAT ARE OTHERWISE NOT NETWORK CAP-  
ABLE, IN CLASS 9 (U.S. CLS. 21, 23, 26, 36 AND 38).

THE MARK CONSISTS OF STANDARD CHAR-  
ACTERS WITHOUT CLAIM TO ANY PARTICULAR  
FONT, STYLE, SIZE, OR COLOR.

SER. NO. 77-397,977, FILED 2-15-2008.

MAYUR VAGHANI, EXAMINING ATTORNEY

**Int. Cl.: 41**

**Prior U.S. Cls.: 100, 101 and 107**

**United States Patent and Trademark Office**

**Reg. No. 3,504,662**

**Registered Sep. 23, 2008**

**SERVICE MARK  
PRINCIPAL REGISTER**



WHITE HAT VENTURES, LLC (OHIO LIMITED LIABILITY COMPANY)  
159 S. MAIN ST., SUITE 600  
AKRON, OH 44308

FOR: EDUCATIONAL SERVICES, NAMELY, CONDUCTING AND PROVIDING ELEMENTARY, JUNIOR HIGH, AND HIGH SCHOOL CLASSES AND EDUCATION COURSES THROUGH MEANS OF TELECOMMUNICATIONS AND COMPUTER NETWORKS, IN CLASS 41 (U.S. CLS. 100, 101 AND 107).

FIRST USE 7-1-2005; IN COMMERCE 7-1-2005.

OWNER OF U.S. REG. NOS. 2,765,610 AND 3,100,853.

NO CLAIM IS MADE TO THE EXCLUSIVE RIGHT TO USE "DISTANCE & ELECTRONIC

LEARNING ACADEMY", APART FROM THE MARK AS SHOWN.

THE COLOR(S) LIGHT GREEN, YELLOW, ORANGE, BLUE AND BLACK IS/ARE CLAIMED AS A FEATURE OF THE MARK.

THE MARK CONSISTS OF A LIGHT GREEN BACKGROUND, DEPICTION OF A STUDENT USING COLORS YELLOW, BLACK AND BLUE, THE COLOR ORANGE OUTLINING THE STUDENT AND FORMING THE WORDS "DELA" AND BLACK LETTERING UNDER "DELA".

SER. NO. 77-397,987, FILED 2-15-2008.

BRIAN PINO, EXAMINING ATTORNEY

**Int. Cl.: 35**

**Prior U.S. Cls.: 100, 101 and 102**

**United States Patent and Trademark Office**

**Reg. No. 3,504,663**

**Registered Sep. 23, 2008**

**SERVICE MARK  
PRINCIPAL REGISTER**

**Get Real, Indiana!**

PLANNED PARENTHOOD OF INDIANA, INC.  
(INDIANA CORPORATION)  
SUITE 400  
200 SOUTH MERIDIAN STREET  
INDIANAPOLIS, IN 46225

FOR: PUBLIC ADVOCACY TO PROMOTE  
AWARENESS OF THE NEED FOR COMPREHEN-  
SIVE SEXUALITY EDUCATION, IN CLASS 35 (U.S.  
CLS. 100, 101 AND 102).

FIRST USE 3-1-2006; IN COMMERCE 8-1-2007.

THE MARK CONSISTS OF STANDARD CHAR-  
ACTERS WITHOUT CLAIM TO ANY PARTICULAR  
FONT, STYLE, SIZE, OR COLOR.

NO CLAIM IS MADE TO THE EXCLUSIVE  
RIGHT TO USE "INDIANA", APART FROM THE  
MARK AS SHOWN.

SER. NO. 77-398,002, FILED 2-15-2008.

BRIAN PINO, EXAMINING ATTORNEY



**Int. Cl.: 6**

**Prior U.S. Cls.: 2, 12, 13, 14, 23, 25 and 50**

**Reg. No. 3,504,664**

**United States Patent and Trademark Office**

**Registered Sep. 23, 2008**

---

**TRADEMARK  
PRINCIPAL REGISTER**

**CHECKMATE**

INDUSTRIAL RIVET & FASTENER CO. (NEW  
JERSEY CORPORATION)  
200 PARIS AVENUE  
NORTHVALE, NJ 07647

THE MARK CONSISTS OF STANDARD CHAR-  
ACTERS WITHOUT CLAIM TO ANY PARTICULAR  
FONT, STYLE, SIZE, OR COLOR.

FOR: METAL FASTENERS, NAMELY, RIVETS  
AND COLD-HEADED SPECIALTY FASTENERS, IN  
CLASS 6 (U.S. CLS. 2, 12, 13, 14, 23, 25 AND 50).

SER. NO. 77-398,007, FILED 2-15-2008.

FIRST USE 5-13-2003; IN COMMERCE 5-13-2003.

JOHN DWYER, EXAMINING ATTORNEY

**Int. Cl.: 6**

**Prior U.S. Cls.: 2, 12, 13, 14, 23, 25 and 50**

**Reg. No. 3,504,665**

**United States Patent and Trademark Office**

**Registered Sep. 23, 2008**

---

**TRADEMARK  
PRINCIPAL REGISTER**

**STEMLOCK**

INDUSTRIAL RIVET & FASTENER CO. (NEW  
JERSEY CORPORATION)  
200 PARIS AVENUE  
NORTHVALE, NJ 07647

THE MARK CONSISTS OF STANDARD CHAR-  
ACTERS WITHOUT CLAIM TO ANY PARTICULAR  
FONT, STYLE, SIZE, OR COLOR.

FOR: METAL FASTENERS, NAMELY, RIVETS  
AND COLD-HEADED SPECIALTY FASTENERS, IN  
CLASS 6 (U.S. CLS. 2, 12, 13, 14, 23, 25 AND 50).

SER. NO. 77-398,017, FILED 2-15-2008.

FIRST USE 3-9-2006; IN COMMERCE 3-9-2006.

JOHN DWYER, EXAMINING ATTORNEY

**Int. Cl.: 37**

**Prior U.S. Cls.: 100, 103 and 106**

**United States Patent and Trademark Office**

**Reg. No. 3,504,666**

**Registered Sep. 23, 2008**

**SERVICE MARK  
PRINCIPAL REGISTER**

# EFI Alchemy

WALL, HARRISON D. (UNITED STATES INDIVIDUAL), DBA EFI ALCHEMY  
5630 SILKWOOD LANE  
ORANGE PARK, FL 32003

FOR: AUTOMOTIVE CONVERSION SERVICES, NAMELY, INSTALLING SPECIALTY AUTOMOTIVE EQUIPMENT, IN CLASS 37 (U.S. CLS. 100, 103 AND 106).

FIRST USE 9-14-2007; IN COMMERCE 1-24-2008.

THE MARK CONSISTS OF STANDARD CHARACTERS WITHOUT CLAIM TO ANY PARTICULAR FONT, STYLE, SIZE, OR COLOR.

NO CLAIM IS MADE TO THE EXCLUSIVE RIGHT TO USE "EFI", APART FROM THE MARK AS SHOWN.

SER. NO. 77-398,040, FILED 2-15-2008.

JASON ROTH, EXAMINING ATTORNEY

**Int. Cl.: 36**

**Prior U.S. Cls.: 100, 101 and 102**

**United States Patent and Trademark Office**

**Reg. No. 3,504,667**

**Registered Sep. 23, 2008**

**SERVICE MARK  
PRINCIPAL REGISTER**

**TENNESSEE REAL ESTATE  
CONNECTION**

TENNESSEE REAL ESTATE CONNECTION, INC.  
(FLORIDA CORPORATION)

301 EAST OCEAN AVENUE, SUITE 1

LANTANA, FL 33462

FOR: REAL ESTATE BROKERAGE SERVICES, IN  
CLASS 36 (U.S. CLS. 100, 101 AND 102).

FIRST USE 9-24-2006; IN COMMERCE 9-24-2006.

THE MARK CONSISTS OF STANDARD CHAR-  
ACTERS WITHOUT CLAIM TO ANY PARTICULAR  
FONT, STYLE, SIZE, OR COLOR.

NO CLAIM IS MADE TO THE EXCLUSIVE  
RIGHT TO USE "TENNESSEE REAL ESTATE",  
APART FROM THE MARK AS SHOWN.

SER. NO. 77-398,050, FILED 2-15-2008.

ROBIN MITTLER, EXAMINING ATTORNEY

**Int. Cl.: 36**

**Prior U.S. Cls.: 100, 101 and 102**

**United States Patent and Trademark Office**

**Reg. No. 3,504,668**

**Registered Sep. 23, 2008**

**SERVICE MARK  
PRINCIPAL REGISTER**

# Cosmetic Karma

JAFRI CRANIOFACIAL PLASTIC SURGERY,  
P.C. (NEW YORK CORPORATION)  
APT. #1805  
307 E.44TH STREET  
NEW YORK, NY 10017

FOR: CHARITABLE SERVICES, NAMELY, RAISING FUNDS TO PROVIDE FACIAL RECONSTRUCTIVE SURGERY TO PATIENTS WITH FACIAL TRAUMA RELATED TO DOMESTIC VIOLENCE, WARFARE, TUMORS, TRAUMA AND PHYSICAL ACCIDENTS, IN CLASS 36 (U.S. CLS. 100, 101 AND 102).

FIRST USE 10-1-2007; IN COMMERCE 10-1-2007.

THE MARK CONSISTS OF STANDARD CHARACTERS WITHOUT CLAIM TO ANY PARTICULAR FONT, STYLE, SIZE, OR COLOR.

SER. NO. 77-398,093, FILED 2-15-2008.

JANICE KIM, EXAMINING ATTORNEY

**Int. Cl.: 19**

**Prior U.S. Cls.: 1, 12, 33 and 50**

**United States Patent and Trademark Office**

**Reg. No. 3,504,669**

**Registered Sep. 23, 2008**

**TRADEMARK  
PRINCIPAL REGISTER**

**BRATTLEWORKS**

BRATTLEWORKS (MASSACHUSETTS CORPORATION)  
30 MOONEY STREET  
CAMBRIDGE, MA 02138

FOR: NON-METAL PICKETS; NON-METAL LATTICES; NON-METAL PRIVACY FENCE; NON-METAL GATES AND FENCES; ARBORS AND TRELLISES MADE OF WOOD; PERGOLAS NOT PRIMARILY OF METAL; NON-METAL FENCE PANELS; WOOD POSTS, IN CLASS 19 (U.S. CLS. 1, 12, 33 AND 50).

FIRST USE 4-8-1991; IN COMMERCE 4-8-1991.

THE MARK CONSISTS OF STANDARD CHARACTERS WITHOUT CLAIM TO ANY PARTICULAR FONT, STYLE, SIZE, OR COLOR.

SER. NO. 77-398,099, FILED 2-15-2008.

MAYUR VAGHANI, EXAMINING ATTORNEY

**Int. Cl.: 36**

**Prior U.S. Cls.: 100, 101 and 102**

**United States Patent and Trademark Office**

**Reg. No. 3,504,670**

**Registered Sep. 23, 2008**

**SERVICE MARK  
PRINCIPAL REGISTER**

**MAKINDU CHILDREN'S PROGRAM**

MAKINDU CHILDREN'S PROGRAM (OREGON  
NON-PROFIT CORPORATION)  
P.O. BOX 51556  
EUGENE, OR 97405

FOR: CHARITABLE HUMANITARIAN RELIEF  
SERVICES PROVIDED TO DESTITUTE ORPHANED  
CHILDREN, NAMELY, PROVIDING FINANCIAL  
SUPPORT TO FACILITATE ACCESS TO BASIC  
EDUCATION AND VOCATIONAL TRAINING,  
MEDICAL COUNSELING, SAFE HOUSING, PSY-  
CHOLOGICAL AND MENTAL HEALTH COUNSEL-  
ING, AND NUTRITION COUNSELING AND  
GUIDANCE, IN CLASS 36 (U.S. CLS. 100, 101 AND  
102).

FIRST USE 0-0-1998; IN COMMERCE 0-0-1998.

THE MARK CONSISTS OF STANDARD CHAR-  
ACTERS WITHOUT CLAIM TO ANY PARTICULAR  
FONT, STYLE, SIZE, OR COLOR.

NO CLAIM IS MADE TO THE EXCLUSIVE  
RIGHT TO USE "CHILDREN'S PROGRAM", APART  
FROM THE MARK AS SHOWN.

THE WORD "MAKINDU" DOES NOT HAVE A  
MEANING IN A FOREIGN LANGUAGE.

SEC. 2(F).

SER. NO. 77-398,112, FILED 2-15-2008.

KEVIN DINALLO, EXAMINING ATTORNEY

**Int. Cl.: 35**

**Prior U.S. Cls.: 100, 101 and 102**

**United States Patent and Trademark Office**

**Reg. No. 3,504,671**

**Registered Sep. 23, 2008**

**SERVICE MARK  
PRINCIPAL REGISTER**

**ADAPTIVE RETAINER  
RECRUITING**

SCHWARTZ & CO., LLC (MINNESOTA CORPORATION)  
P.O. BOX 300140  
MINNEAPOLIS, MN 55403

FOR: EMPLOYMENT HIRING, RECRUITING, PLACEMENT, STAFFING AND CAREER NETWORKING SERVICES, IN CLASS 35 (U.S. CLS. 100, 101 AND 102).

FIRST USE 2-12-2008; IN COMMERCE 2-12-2008.

THE MARK CONSISTS OF STANDARD CHARACTERS WITHOUT CLAIM TO ANY PARTICULAR FONT, STYLE, SIZE, OR COLOR.

NO CLAIM IS MADE TO THE EXCLUSIVE RIGHT TO USE "RETAINER RECRUITING", APART FROM THE MARK AS SHOWN.

SER. NO. 77-398,115, FILED 2-15-2008.

EDWARD FENNESSY, EXAMINING ATTORNEY



**Int. Cl.: 6**

**Prior U.S. Cls.: 2, 12, 13, 14, 23, 25 and 50**

**Reg. No. 3,504,672**

**United States Patent and Trademark Office**

**Registered Sep. 23, 2008**

---

**TRADEMARK  
PRINCIPAL REGISTER**

**RIVEX**

INDUSTRIAL RIVET & FASTENER CO. (NEW  
JERSEY CORPORATION)  
200 PARIS AVENUE  
NORTHVALE, NJ 07647

THE MARK CONSISTS OF STANDARD CHAR-  
ACTERS WITHOUT CLAIM TO ANY PARTICULAR  
FONT, STYLE, SIZE, OR COLOR.

FOR: METAL FASTENERS, NAMELY, RIVETS  
AND COLD-HEADED SPECIALTY FASTENERS, IN  
CLASS 6 (U.S. CLS. 2, 12, 13, 14, 23, 25 AND 50).

SER. NO. 77-398,133, FILED 2-15-2008.

FIRST USE 10-31-2007; IN COMMERCE 10-31-2007.

JOHN DWYER, EXAMINING ATTORNEY

**Int. Cl.: 36**

**Prior U.S. Cls.: 100, 101 and 102**

**United States Patent and Trademark Office**

**Reg. No. 3,504,673**

**Registered Sep. 23, 2008**

**SERVICE MARK  
PRINCIPAL REGISTER**

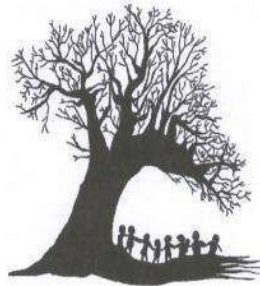

MAKINDU CHILDREN'S PROGRAM (OREGON  
NON-PROFIT CORPORATION)  
P.O. BOX 51556  
EUGENE, OR 97405

FOR: CHARITABLE HUMANITARIAN RELIEF  
SERVICES PROVIDED TO DESTITUTE ORPHANED  
CHILDREN, NAMELY, PROVIDING FINANCIAL  
SUPPORT TO FACILITATE ACCESS TO BASIC  
EDUCATION AND VOCATIONAL TRAINING,  
MEDICAL COUNSELING, SAFE HOUSING, PSY-  
CHOLOGICAL AND MENTAL HEALTH COUNSEL-  
ING, AND NUTRITION COUNSELING AND

GUIDANCE, IN CLASS 36 (U.S. CLS. 100, 101 AND  
102).

FIRST USE 0-0-1999; IN COMMERCE 0-0-1999.

THE MARK CONSISTS OF AN IMAGE OF A  
"BAOBAB TREE" WITH "CHILDREN HOLDING  
HANDS" UNDER THE TREE.

SER. NO. 77-398,144, FILED 2-15-2008.

KEVIN DINALLO, EXAMINING ATTORNEY

**Int. Cl.: 3**

**Prior U.S. Cls.: 1, 4, 6, 50, 51 and 52**

**United States Patent and Trademark Office**

**Reg. No. 3,504,674**

**Registered Sep. 23, 2008**

**TRADEMARK  
PRINCIPAL REGISTER**

**NeutraMaxx**

MASSCO DENTAL (ARKANSAS CORPORATION)  
P.O. BOX 795  
GRAVETTE, AR 72736

THE MARK CONSISTS OF STANDARD CHAR-  
ACTERS WITHOUT CLAIM TO ANY PARTICULAR  
FONT, STYLE, SIZE, OR COLOR.

FOR: PRESCRIPTION TOOTHPASTE, IN CLASS 3  
(U.S. CLS. 1, 4, 6, 50, 51 AND 52).

SER. NO. 77-398,148, FILED 2-15-2008.

FIRST USE 10-3-2007; IN COMMERCE 10-3-2007.

ANDREA BUTLER, EXAMINING ATTORNEY

**Int. Cl.: 36**

**Prior U.S. Cls.: 100, 101 and 102**

**United States Patent and Trademark Office**

**Reg. No. 3,504,675**

**Registered Sep. 23, 2008**

**SERVICE MARK  
PRINCIPAL REGISTER**

**HIGH DESERT STATE BANK**

HIGH DESERT STATE BANK (NEW MEXICO  
CORPORATION)  
8110 VENTURA NE  
ALBUQUERQUE, NM 87122

FOR: FINANCIAL SERVICES IN THE FIELD OF  
MONEY LENDING; BANKING; BANKING AND  
FINANCING SERVICES; INVESTMENT BANKING  
SERVICES; MORTGAGE BANKING; MORTGAGE  
BANKING SERVICES, NAMELY, ORIGINATION,  
ACQUISITION, SERVICING, SECURITIZATION  
AND BROKERAGE OF MORTGAGE LOANS; ON-  
LINE BANKING SERVICES, IN CLASS 36 (U.S. CLS.  
100, 101 AND 102).

FIRST USE 7-23-1999; IN COMMERCE 7-23-1999.

THE MARK CONSISTS OF STANDARD CHAR-  
ACTERS WITHOUT CLAIM TO ANY PARTICULAR  
FONT, STYLE, SIZE, OR COLOR.

NO CLAIM IS MADE TO THE EXCLUSIVE  
RIGHT TO USE "STATE BANK", APART FROM  
THE MARK AS SHOWN.

SER. NO. 77-398,172, FILED 2-15-2008.

TRACY WHITTAKER-BROWN, EXAMINING AT-  
TORNEY

**Int. Cl.: 6**

**Prior U.S. Cls.: 2, 12, 13, 14, 23, 25 and 50**

**Reg. No. 3,504,676**

**United States Patent and Trademark Office**

**Registered Sep. 23, 2008**

---

**TRADEMARK  
PRINCIPAL REGISTER**

**UNOBOLT**

INDUSTRIAL RIVET & FASTENER CO. (NEW  
JERSEY CORPORATION)  
200 PARIS AVENUE  
NORTHVALE, NJ 07647

THE MARK CONSISTS OF STANDARD CHAR-  
ACTERS WITHOUT CLAIM TO ANY PARTICULAR  
FONT, STYLE, SIZE, OR COLOR.

FOR: METAL FASTENERS, NAMELY, RIVETS  
AND COLD-HEADED SPECIALTY FASTENERS, IN  
CLASS 6 (U.S. CLS. 2, 12, 13, 14, 23, 25 AND 50).

SER. NO. 77-398,176, FILED 2-15-2008.

FIRST USE 7-24-2003; IN COMMERCE 7-24-2003.

JOHN DWYER, EXAMINING ATTORNEY

**Int. Cl.: 41**

**Prior U.S. Cls.: 100, 101 and 107**

**United States Patent and Trademark Office**

**Reg. No. 3,504,677**

**Registered Sep. 23, 2008**

---

**SERVICE MARK  
PRINCIPAL REGISTER**

# The Pajama-Man

ROSS, ANDREW (UNITED STATES INDIVIDUAL)  
7520 HEATHER KNOLL CIRCLE  
LAS VEGAS, NV 89129

THE MARK CONSISTS OF STANDARD CHARACTERS WITHOUT CLAIM TO ANY PARTICULAR FONT, STYLE, SIZE, OR COLOR.

FOR: TRAINING SERVICES IN THE FIELD OF HEALTH AND LIFE INSURANCE SALES, IN CLASS 41 (U.S. CLS. 100, 101 AND 107).

SER. NO. 77-398,197, FILED 2-15-2008.

FIRST USE 9-1-2007; IN COMMERCE 9-1-2007.

WENDY GOODMAN, EXAMINING ATTORNEY

**Int. Cls.: 7 and 8**

**Prior U.S. Cls.: 13, 19, 21, 23, 28, 31, 34, 35 and 44**

**United States Patent and Trademark Office**

**Reg. No. 3,504,678**

**Registered Sep. 23, 2008**

**TRADEMARK  
PRINCIPAL REGISTER**



INDUSTRIAL RIVET & FASTENER CO. (NEW  
JERSEY CORPORATION)  
200 PARIS AVENUE  
NORTHVALE, NJ 07647

FOR: POWER-OPERATED FASTENER INSTAL-  
LATION TOOLS, NAMELY, FOR THE INSTALLA-  
TION OF RIVETS, IN CLASS 7 (U.S. CLS. 13, 19, 21, 23,  
31, 34 AND 35).

FIRST USE 1-31-2006; IN COMMERCE 1-31-2006.

FOR: HAND-OPERATED FASTENER INSTALLA-  
TION TOOLS, NAMELY, FOR THE INSTALLATION  
OF RIVETS, IN CLASS 8 (U.S. CLS. 23, 28 AND 44).

FIRST USE 12-31-2007; IN COMMERCE 12-31-2007.

OWNER OF U.S. REG. NOS. 2,189,026, 2,193,307,  
AND 2,369,012.

THE MARK CONSISTS OF A CROWN DESIGN  
WITH A RIVET OR FASTENER THROUGH THE  
CENTER.

SER. NO. 77-398,201, FILED 2-15-2008.

JOHN DWYER, EXAMINING ATTORNEY

**Int. Cl.: 41**

**Prior U.S. Cls.: 100, 101 and 107**

**United States Patent and Trademark Office**

**Reg. No. 3,504,679**

**Registered Sep. 23, 2008**

**SERVICE MARK  
PRINCIPAL REGISTER**

**UBUNTU**

NAPA UBUNTU, LLC (CALIFORNIA LIMITED  
LIABILITY COMPANY)  
1140 MAIN STREET  
NAPA, CA 94581

FOR: EDUCATIONAL SERVICES, NAMELY,  
CONDUCTING CLASSES, SEMINARS, TEACHING,  
TRAINING, AND CONFERENCES IN THE FIELDS  
OF YOGA, MEDITATION AND HEALTH, IN CLASS  
41 (U.S. CLS. 100, 101 AND 107).

FIRST USE 8-20-2007; IN COMMERCE 8-20-2007.

THE MARK CONSISTS OF STANDARD CHAR-  
ACTERS WITHOUT CLAIM TO ANY PARTICULAR  
FONT, STYLE, SIZE, OR COLOR.

OWNER OF U.S. REG. NO. 3,427,688.

THE FOREIGN WORDING IN THE MARK  
TRANSLATES INTO ENGLISH AS "HUMANITY ."

SER. NO. 77-398,225, FILED 2-15-2008.

ALEX KEAM, EXAMINING ATTORNEY



**Int. Cl.: 36**

**Prior U.S. Cls.: 100, 101 and 102**

**United States Patent and Trademark Office**

**Reg. No. 3,504,680**

**Registered Sep. 23, 2008**

**SERVICE MARK  
PRINCIPAL REGISTER**

IT'S BANKING BUILT AROUND  
YOU

FIRST NATIONAL OF NEBRASKA, INC. (NE-  
BRASKA CORPORATION)  
STOP 3290  
1620 DODGE STREET  
OMAHA, NE 681973290

FOR: BANKING SERVICES, IN CLASS 36 (U.S.  
CLS. 100, 101 AND 102).

FIRST USE 1-8-2008; IN COMMERCE 1-8-2008.

THE MARK CONSISTS OF STANDARD CHAR-  
ACTERS WITHOUT CLAIM TO ANY PARTICULAR  
FONT, STYLE, SIZE, OR COLOR.

NO CLAIM IS MADE TO THE EXCLUSIVE  
RIGHT TO USE "BANKING", APART FROM THE  
MARK AS SHOWN.

SER. NO. 77-398,232, FILED 2-15-2008.

IRA J. GOODSaid, EXAMINING ATTORNEY

**Int. Cl.: 41**

**Prior U.S. Cls.: 100, 101 and 107**

**United States Patent and Trademark Office**

**Reg. No. 3,504,681**

**Registered Sep. 23, 2008**

**SERVICE MARK  
PRINCIPAL REGISTER**

# GreenPros

GREENPROS, LLC (NORTH CAROLINA LIMITED LIABILITY COMPANY)  
101 KITTY HAWK DRIVE  
MORRISVILLE, NC 27560

THE MARK CONSISTS OF STANDARD CHARACTERS WITHOUT CLAIM TO ANY PARTICULAR FONT, STYLE, SIZE, OR COLOR.

FOR: TRAINING SERVICES IN THE FIELD OF RENEWABLE ENERGY, SUSTAINABLE DESIGN AND SUSTAINABLE CONSTRUCTION PRACTICES, IN CLASS 41 (U.S. CLS. 100, 101 AND 107).

SER. NO. 77-398,234, FILED 2-15-2008.

FIRST USE 1-1-2007; IN COMMERCE 2-1-2007.

WENDY GOODMAN, EXAMINING ATTORNEY

**Int. Cl.: 36**

**Prior U.S. Cls.: 100, 101 and 102**

**United States Patent and Trademark Office**

**Reg. No. 3,504,682**

**Registered Sep. 23, 2008**

**SERVICE MARK  
PRINCIPAL REGISTER**

**IT'S BANKING BUILT AROUND  
YOUR BUSINESS**

FIRST NATIONAL OF NEBRASKA, INC. (NE-  
BRASKA CORPORATION)  
STOP 3290  
1620 DODGE STREET  
OMAHA, NE 681973290

FOR: BANKING SERVICES, IN CLASS 36 (U.S.  
CLS. 100, 101 AND 102).

FIRST USE 1-8-2008; IN COMMERCE 1-8-2008.

THE MARK CONSISTS OF STANDARD CHAR-  
ACTERS WITHOUT CLAIM TO ANY PARTICULAR  
FONT, STYLE, SIZE, OR COLOR.

NO CLAIM IS MADE TO THE EXCLUSIVE  
RIGHT TO USE "BANKING", APART FROM THE  
MARK AS SHOWN.

SER. NO. 77-398,248, FILED 2-15-2008.

IRA J. GOODSaid, EXAMINING ATTORNEY

**Int. Cl.: 1**

**Prior U.S. Cls.: 1, 5, 6, 10, 26 and 46**

**Reg. No. 3,504,683**

**United States Patent and Trademark Office**

**Registered Sep. 23, 2008**

---

**TRADEMARK  
PRINCIPAL REGISTER**

# Phenolenol

PUREVISION TECHNOLOGY LLC (COLORADO  
LIMITED LIABILITY COMPANY), DBA PURE-  
VISION TECHNOLOGY, INC.  
511 MCKINLEY AVE  
FORT LUPTON, CO 80621

THE MARK CONSISTS OF STANDARD CHAR-  
ACTERS WITHOUT CLAIM TO ANY PARTICULAR  
FONT, STYLE, SIZE, OR COLOR.

FOR: CHEMICALS FOR USE IN THE BIOCHEM-  
ICAL AND CHEMICAL INDUSTRY, IN CLASS 1  
(U.S. CLS. 1, 5, 6, 10, 26 AND 46).

SER. NO. 77-398,261, FILED 2-15-2008.

FIRST USE 1-18-2008; IN COMMERCE 2-4-2008.

ALEX KEAM, EXAMINING ATTORNEY

**Int. Cl.: 12**

**Prior U.S. Cls.: 19, 21, 23, 31, 35 and 44**

**Reg. No. 3,504,684**

**United States Patent and Trademark Office**

**Registered Sep. 23, 2008**

**TRADEMARK  
PRINCIPAL REGISTER**

**SUTC**

DURKEE, BEAU (UNITED STATES INDIVIDUAL)  
968 S. MADISON AVE.  
PASADENA, CA 91106

FIRST USE 8-1-2005; IN COMMERCE 2-25-2006.

FOR: RECREATIONAL VEHICLE, NAMELY, TRUCK CAMPER, SPECIFICALLY, A TRUCK CAMPER WHICH QUICKLY CONVERTS FROM A VEHICLE/CARGO CARRIER INTO A SELF-CONTAINED EXTENDED-STAY CAMPER , IN CLASS 12 (U.S. CLS. 19, 21, 23, 31, 35 AND 44).

THE MARK CONSISTS OF STANDARD CHARACTERS WITHOUT CLAIM TO ANY PARTICULAR FONT, STYLE, SIZE, OR COLOR.

SER. NO. 77-398,262, FILED 2-15-2008.

GEORGIA CARTY, EXAMINING ATTORNEY

**Int. Cls.: 35, 36, 41 and 43**

**Prior U.S. Cls.: 100, 101, 102 and 107**

**United States Patent and Trademark Office**

**Reg. No. 3,504,685**

**Registered Sep. 23, 2008**

**SERVICE MARK  
PRINCIPAL REGISTER**



PHILABUNDANCE (PENNSYLVANIA NON-PROFIT CORPORATION)  
P.O. BOX 37555  
3616 SOUTH GALLOWAY STREET  
PHILADELPHIA, PA 19148

FOR: CHARITABLE SERVICES, NAMELY, COORDINATION OF THE PROCUREMENT AND DISTRIBUTION OF FOOD DONATIONS FROM INDIVIDUALS, MANUFACTURERS, WHOLESALERS, RETAILERS, AND GOVERNMENT AGENCIES TO PROVIDE FREE FOOD TO NEEDY PEOPLE; CHARITABLE SERVICES, NAMELY, PROCURING FOOD, DISTRIBUTING FOOD AND RETAIL STORE FEATURING FOOD AT A DISCOUNT TO NEEDY PEOPLE; ASSOCIATION SERVICES, NAMELY, PROMOTING THE INTERESTS OF THESE RENDERING FINANCIAL, PLANNING AND SUPERVISORY ASSISTANCE TO SOCIAL SERVICE ORGANIZATIONS, IN CLASS 35 (U.S. CLS. 100, 101 AND 102).

FIRST USE 12-0-1984; IN COMMERCE 12-0-1984.

FOR: ACCEPTING AND ADMINISTERING MONETARY CONTRIBUTIONS; CHARITABLE FUND RAISING; ONLINE CHARITABLE FUND RAISING SERVICES; CHARITABLE FUND RAISING SERVICES, NAMELY, ELEEMOSYNARY SERVICES IN THE FIELD OF COLLECTION, MANAGEMENT, AND DISBURSEMENTS OF MON-

EY AND SECURITIES IN CONNECTION WITH PROGRAMS AND FACILITIES FOR THE WELFARE OF NEEDY PERSONS, IN CLASS 36 (U.S. CLS. 100, 101 AND 102).

FIRST USE 12-0-1984; IN COMMERCE 12-0-1984.

FOR: CHARITABLE SERVICES, NAMELY, PROVIDING JOB TRAINING IN THE FIELD OF BUSINESS, COMPUTERS, CULINARY ARTS, EDUCATION, LEGAL, SCIENCE, MEDICAL AND ENTERTAINMENT, IN CLASS 41 (U.S. CLS. 100, 101 AND 107).

FIRST USE 12-0-1984; IN COMMERCE 12-0-1984.

FOR: CHARITABLE SERVICES, NAMELY, PROVIDING FOOD TO THOSE IN NEED; PROVIDING NON-MEDICAL ASSISTED LIVING IN THE NATURE OF MEAL PREPARATION, IN CLASS 43 (U.S. CLS. 100 AND 101).

FIRST USE 12-0-1984; IN COMMERCE 12-0-1984.

THE MARK CONSISTS OF THE WORD "PHILABUNDANCE" WITH A DESIGN "H" AND "A" .

SER. NO. 77-398,288, FILED 2-15-2008.

SALLY SHIH, EXAMINING ATTORNEY

**Int. Cl.: 41**

**Prior U.S. Cls.: 100, 101 and 107**

**United States Patent and Trademark Office**

**Reg. No. 3,504,686**

**Registered Sep. 23, 2008**

**SERVICE MARK  
PRINCIPAL REGISTER**

**The CharacterPlus Way**

COOPERATING SCHOOL DISTRICTS OF  
GREATER ST. LOUIS, INC. (MISSOURI COR-  
PORATION)  
1460 CRAIG ROAD  
CREVE COEUR, MO 63146

FOR: TRAINING IN CHARACTER EDUCATION  
FOR SCHOOL ADMINISTRATORS, FACULTY,  
STUDENTS, AND PARENTS, IN CLASS 41 (U.S.  
CLS. 100, 101 AND 107).

FIRST USE 9-5-2005; IN COMMERCE 9-5-2005.

THE MARK CONSISTS OF STANDARD CHAR-  
ACTERS WITHOUT CLAIM TO ANY PARTICULAR  
FONT, STYLE, SIZE, OR COLOR.

OWNER OF U.S. REG. NOS. 2,582,782, 2,582,788  
AND OTHERS.

SER. NO. 77-398,290, FILED 2-15-2008.

SALLY SHIH, EXAMINING ATTORNEY

Int. Cl.: 38

Prior U.S. Cls.: 100, 101 and 104

United States Patent and Trademark Office

Reg. No. 3,504,687

Registered Sep. 23, 2008

SERVICE MARK  
PRINCIPAL REGISTER



MY CORPORATION BUSINESS SERVICES, INC  
(CALIFORNIA CORPORATION)  
26520 AGOURA ROAD  
CALABASAS, CA 91377

FOR: NOTIFICATION SERVICES FOR BUSINESS ENTITIES, NAMELY, PROVIDING EMAIL NOTIFICATION ALERTS OF CORPORATE COMPLIANCE REQUIREMENTS , IN CLASS 38 (U.S. CLS. 100, 101 AND 104).

FIRST USE 2-1-2008; IN COMMERCE 2-1-2008.

THE COLOR(S) LIGHT GRAY, DARK GRAY, ORANGE, AND BLACK IS/ARE CLAIMED AS A FEATURE OF THE MARK.

THE MARK CONSISTS OF THE FIRST TWO WORDS "MYINC" ARE A LIGHT GRAY WITH THE "M" AND THE "I" CAPITALIZED. THE THIRD WORD "GUARD" IS HAS A LARGER LOWER CASE G WITH AN ORANGE AND BLACK STOP WATCH IN THE UPPER CIRCLE OF THE "G". THE REMAINDER OF THE WORD "GUARD" IS A DARKER GRAY COLOR.

SER. NO. 77-398,298, FILED 2-15-2008.

ALEX KEAM, EXAMINING ATTORNEY



**Int. Cl.: 30**

**Prior U.S. Cl.: 46**

**United States Patent and Trademark Office**

**Reg. No. 3,504,688**

**Registered Sep. 23, 2008**

**TRADEMARK  
PRINCIPAL REGISTER**

**PULAKOS 926**

PULAKOS, INC. (PENNSYLVANIA CORPORATION)  
2530 PARADE STREET  
ERIE, PA 165032097

FOR: FUDGE; CHOCOLATE BARS; CHOCOLATE CANDIES; FILLED CHOCOLATE; GUMMY CANDIES; CANDIES; ICE CREAM, IN CLASS 30 (U.S. CL. 46).

FIRST USE 7-11-1917; IN COMMERCE 7-11-1917.

THE MARK CONSISTS OF STANDARD CHARACTERS WITHOUT CLAIM TO ANY PARTICULAR FONT, STYLE, SIZE, OR COLOR.

OWNER OF U.S. REG. NOS. 665,460 AND 2,245,973.

SER. NO. 77-398,299, FILED 2-15-2008.

ALEX KEAM, EXAMINING ATTORNEY

**Int. Cl.: 6**

**Prior U.S. Cls.: 2, 12, 13, 14, 23, 25 and 50**

**Reg. No. 3,504,689**

**United States Patent and Trademark Office**

**Registered Sep. 23, 2008**

---

**TRADEMARK  
PRINCIPAL REGISTER**

**CMG**

LAMONS GASKET COMPANY (DELAWARE  
CORPORATION)  
7300 AIRPORT BLVD.  
HOUSTON, TX 77061

FOR: METAL GASKETS USED WITH PIPE FLAN-  
GES AND HEAT EXCHANGERS, IN CLASS 6 (U.S.  
CLS. 2, 12, 13, 14, 23, 25 AND 50).

FIRST USE 12-1-1997; IN COMMERCE 12-1-1997.

THE MARK CONSISTS OF STANDARD CHAR-  
ACTERS WITHOUT CLAIM TO ANY PARTICULAR  
FONT, STYLE, SIZE, OR COLOR.

OWNER OF U.S. REG. NO. 2,398,234.

SER. NO. 77-398,324, FILED 2-15-2008.

ALEX KEAM, EXAMINING ATTORNEY

**Int. Cl.: 35**

**Prior U.S. Cls.: 100, 101 and 102**

**United States Patent and Trademark Office**

**Reg. No. 3,504,690**

**Registered Sep. 23, 2008**

---

**SERVICE MARK  
PRINCIPAL REGISTER**

**ZipCast**

GAMMA HOLDINGS, LLC (TEXAS LIMITED  
LIABILITY COMPANY)  
SUITE 242  
510 BERING  
HOUSTON, TX 77057

FOR: ADVERTISING AND ADVERTISEMENT  
SERVICES; DISPLAYING ADVERTISEMENTS FOR  
OTHERS; DISSEMINATION OF ADVERTISE-  
MENTS; ELECTRONIC BILLBOARD ADVERTIS-  
ING; RENTAL OF ADVERTISING SPACE, IN  
CLASS 35 (U.S. CLS. 100, 101 AND 102).

FIRST USE 11-0-2006; IN COMMERCE 11-0-2006.

THE MARK CONSISTS OF STANDARD CHAR-  
ACTERS WITHOUT CLAIM TO ANY PARTICULAR  
FONT, STYLE, SIZE, OR COLOR.

SER. NO. 77-398,326, FILED 2-15-2008.

ALEX KEAM, EXAMINING ATTORNEY

**Int. Cl.: 35**

**Prior U.S. Cls.: 100, 101 and 102**

**United States Patent and Trademark Office**

**Reg. No. 3,504,691**

**Registered Sep. 23, 2008**

**SERVICE MARK  
PRINCIPAL REGISTER**

**BUY BUY BABY**

BUY BUY BABY, INC. (DELAWARE CORPORATION)  
895 EAST GATE BOULEVARD  
GARDEN CITY, NY 11530

OWNER OF U.S. REG. NOS. 2,171,479 AND  
2,517,613.

FOR: ON-LINE RETAIL SERVICES FEATURING  
BABY FURNITURE, BEDDING, CLOTHES, TOYS,  
ACCESSORIES AND SUPPLIES; GIFT REGISTRY  
SERVICES, IN CLASS 35 (U.S. CLS. 100, 101 AND 102).

NO CLAIM IS MADE TO THE EXCLUSIVE  
RIGHT TO USE "BABY", APART FROM THE MARK  
AS SHOWN.

FIRST USE 0-0-1999; IN COMMERCE 0-0-1999.

SER. NO. 77-398,334, FILED 2-15-2008.

THE MARK CONSISTS OF STANDARD CHAR-  
ACTERS WITHOUT CLAIM TO ANY PARTICULAR  
FONT, STYLE, SIZE, OR COLOR.

LESLIE RICHARDS, EXAMINING ATTORNEY

**Int. Cl.: 42**

**Prior U.S. Cls.: 100 and 101**

**United States Patent and Trademark Office**

**Reg. No. 3,504,692**

**Registered Sep. 23, 2008**

**SERVICE MARK  
PRINCIPAL REGISTER**



SACROSANCT SYSTEMS, LLC (NEW MEXICO  
LIMITED LIABILITY COMPANY)  
1300 PRINCETON DRIVE NE  
ALBUQUERQUE, NM 87106

FOR: DESIGN, CREATION, HOSTING, MAINTENANCE OF WEB SITES FOR OTHERS; HOSTING OF WEB SITES; WEB SITE HOSTING SERVICES, IN CLASS 42 (U.S. CLS. 100 AND 101).

FIRST USE 1-15-2007; IN COMMERCE 1-15-2007.

THE STIPPLING IS FOR SHADING PURPOSES ONLY.

THE MARK CONSISTS OF THE IMAGE OF A WHALE SURROUNDED BY THE WORDS "SONIC" AND "WHALE" WITH ITS TAIL HIGHER THAN ITS BODY. THE WHALE IMAGE IS BELOW THE WORD "SONIC" AND TO THE LEFT OF THE WORD "WHALE".

SER. NO. 77-398,336, FILED 2-15-2008.

ALEX KEAM, EXAMINING ATTORNEY

**Int. Cl.: 35**

**Prior U.S. Cls.: 100, 101 and 102**

**United States Patent and Trademark Office**

**Reg. No. 3,504,693**

**Registered Sep. 23, 2008**

**SERVICE MARK  
PRINCIPAL REGISTER**



THE ALEXANDER GROUP, INC. (DELAWARE CORPORATION)  
SUITE 111  
8155 EAST INDIAN BEND ROAD  
SCOTTSDALE, AZ 85250

FOR: ARRANGING AND CONDUCTING BUSINESS CONFERENCES, IN CLASS 35 (U.S. CLS. 100, 101 AND 102).

FIRST USE 9-1-2001; IN COMMERCE 9-1-2001.

OWNER OF U.S. REG. NO. 3,283,112.

NO CLAIM IS MADE TO THE EXCLUSIVE RIGHT TO USE "FORUM", APART FROM THE MARK AS SHOWN.

SEC. 2(F) AS TO "CHIEF SALES EXECUTIVE".

SER. NO. 77-398,337, FILED 2-15-2008.

MICHAEL GAAFAR, EXAMINING ATTORNEY

**Int. Cl.: 14**

**Prior U.S. Cls.: 2, 27, 28 and 50**

**United States Patent and Trademark Office**

**Reg. No. 3,504,694**

**Registered Sep. 23, 2008**

**TRADEMARK  
PRINCIPAL REGISTER**

**Crystale by L & J**

LINDA & JAY KEANE INC (FLORIDA CORPORATION), DBA L & J ACCESSORIES  
140 CANDACE DRIVE  
MAITLAND, FL 32751

THE MARK CONSISTS OF STANDARD CHARACTERS WITHOUT CLAIM TO ANY PARTICULAR FONT, STYLE, SIZE, OR COLOR.

FOR: JEWELRY, IN CLASS 14 (U.S. CLS. 2, 27, 28 AND 50).

SER. NO. 77-398,407, FILED 2-15-2008.

FIRST USE 1-1-2004; IN COMMERCE 1-1-2004.

MICHAEL KEATING, EXAMINING ATTORNEY

**Int. Cl.: 16**

**Prior U.S. Cls.: 2, 5, 22, 23, 29, 37, 38 and 50**

**United States Patent and Trademark Office**

**Reg. No. 3,504,695**

**Registered Sep. 23, 2008**

**TRADEMARK  
PRINCIPAL REGISTER**



MICROCOSM, LTD. (VERMONT CORPORATION)  
823 FERRY ROAD  
P.O. BOX 550  
CHARLOTTE, VT 05445

FOR: BOOKS AND CALENDARS IN THE GENERAL AREAS OF NATURAL HISTORY, SCIENCE, ECOLOGY, GARDENING, AQUARIUM KEEPING, AND PLANT AND ANIMAL HUSBANDRY, IN CLASS 16 (U.S. CLS. 2, 5, 22, 23, 29, 37, 38 AND 50).

FIRST USE 10-28-1996; IN COMMERCE 10-28-1996.

NO CLAIM IS MADE TO THE EXCLUSIVE RIGHT TO USE "MICROCOSM", APART FROM THE MARK AS SHOWN.

THE MARK CONSISTS OF THE WORD "MICROCOSM" WITH A TREE AND FISH DESIGN.

SER. NO. 77-398,449, FILED 2-15-2008.

MAYUR VAGHANI, EXAMINING ATTORNEY



**Int. Cl.: 41**

**Prior U.S. Cls.: 100, 101 and 107**

**United States Patent and Trademark Office**

**Reg. No. 3,504,696**

**Registered Sep. 23, 2008**

**SERVICE MARK  
PRINCIPAL REGISTER**

UNIVERSITY OF BRIDGEPORT

UNIVERSITY OF BRIDGEPORT (CONNECTICUT  
CORPORATION)  
126 PARK AVENUE  
BRIDGEPORT, CT 06604

FOR: EDUCATIONAL SERVICES, NAMELY,  
PROVIDING COURSES OF INSTRUCTION AT  
THE UNIVERSITY LEVEL AND DISTRIBUTION  
OF COURSE MATERIAL IN CONNECTION  
THEREWITH, IN CLASS 41 (U.S. CLS. 100, 101 AND  
107).

FIRST USE 5-8-1947; IN COMMERCE 1-1-1948.

THE MARK CONSISTS OF STANDARD CHAR-  
ACTERS WITHOUT CLAIM TO ANY PARTICULAR  
FONT, STYLE, SIZE, OR COLOR.

SEC. 2(F).

SER. NO. 77-398,458, FILED 2-15-2008.

KAREN K. BUSH, EXAMINING ATTORNEY

**Int. Cl.: 45**

**Prior U.S. Cls.: 100 and 101**

**United States Patent and Trademark Office**

**Reg. No. 3,504,697**

**Registered Sep. 23, 2008**

**SERVICE MARK  
PRINCIPAL REGISTER**

**FOUNTAINS OF FAITH  
MINISTRIES**

JAMES A. PRATHER, IV (UNITED STATES IN-  
DIVIDUAL)

101 S. SUNSET DR.

CASSELBERRY, FL 32707

FOR: MINISTERIAL SERVICES, IN CLASS 45 (U.S.  
CLS. 100 AND 101).

FIRST USE 5-11-1997; IN COMMERCE 5-11-1997.

THE MARK CONSISTS OF STANDARD CHAR-  
ACTERS WITHOUT CLAIM TO ANY PARTICULAR  
FONT, STYLE, SIZE, OR COLOR.

NO CLAIM IS MADE TO THE EXCLUSIVE  
RIGHT TO USE "MINISTRIES", APART FROM  
THE MARK AS SHOWN.

SER. NO. 77-398,484, FILED 2-15-2008.

RENEE SERVANCE, EXAMINING ATTORNEY

**Int. Cl.: 35**

**Prior U.S. Cls.: 100, 101 and 102**

**United States Patent and Trademark Office**

**Reg. No. 3,504,698**

**Registered Sep. 23, 2008**

**SERVICE MARK  
PRINCIPAL REGISTER**

**BuildingInsight**

FENNELL & ASSOCIATES LLC (VIRGINIA LIMITED LIABILITY COMPANY)  
2757 N. QUEBEC STREET  
ARLINGTON, VA 22207

FOR: CONDUCTING BUSINESS AND MARKET RESEARCH SURVEYS; MARKET RESEARCH; MARKET RESEARCH CONSULTATION; MARKET RESEARCH SERVICES; MARKET RESEARCH STUDIES , IN CLASS 35 (U.S. CLS. 100, 101 AND 102).

FIRST USE 1-17-2004; IN COMMERCE 1-17-2004.

THE MARK CONSISTS OF STANDARD CHARACTERS WITHOUT CLAIM TO ANY PARTICULAR FONT, STYLE, SIZE, OR COLOR.

SER. NO. 77-398,508, FILED 2-15-2008.

AMY HELLA, EXAMINING ATTORNEY

**Int. Cl.: 32**

**Prior U.S. Cls.: 45, 46 and 48**

**United States Patent and Trademark Office**

**Reg. No. 3,504,699**

**Registered Sep. 23, 2008**

**TRADEMARK  
PRINCIPAL REGISTER**

**SIPPIN' CITRUS**

PITA PIT, INC. (DELAWARE CORPORATION)  
105 NORTH 4TH STREET, SUITE 208  
COEUR D'ALENE, ID 83814

FOR: SMOOTHIES; BEVERAGES, NAMELY, JUICES BLENDED WITH FRUIT AND YOGURT, IN CLASS 32 (U.S. CLS. 45, 46 AND 48).

FIRST USE 1-2-2006; IN COMMERCE 1-2-2006.

THE MARK CONSISTS OF STANDARD CHARACTERS WITHOUT CLAIM TO ANY PARTICULAR FONT, STYLE, SIZE, OR COLOR.

NO CLAIM IS MADE TO THE EXCLUSIVE RIGHT TO USE "CITRUS", APART FROM THE MARK AS SHOWN.

SER. NO. 77-398,519, FILED 2-15-2008.

JAY FLOWERS, EXAMINING ATTORNEY

**Int. Cl.: 36**

**Prior U.S. Cls.: 100, 101 and 102**

**United States Patent and Trademark Office**

**Reg. No. 3,504,700**

**Registered Sep. 23, 2008**

**SERVICE MARK  
PRINCIPAL REGISTER**

**VIDRIO**

VIDRIO FINANCIAL LTD. (BERMUDA CORPORATION)  
40 CHURCH STREET  
HAMILTON HM12, BERMUDA

FOR: HOUSE MARK FOR FINANCIAL RESEARCH AND INFORMATION SERVICES, IN CLASS 36 (U.S. CLS. 100, 101 AND 102).

FIRST USE 12-1-2007; IN COMMERCE 12-1-2007.

THE MARK CONSISTS OF STANDARD CHARACTERS WITHOUT CLAIM TO ANY PARTICULAR FONT, STYLE, SIZE, OR COLOR.

THE ENGLISH TRANSLATION OF "VIDRIO" IS GLASS.

SER. NO. 77-398,520, FILED 2-15-2008.

CHARLES L. JENKINS, EXAMINING ATTORNEY

**Int. Cl.: 35**

**Prior U.S. Cls.: 100, 101 and 102**

**United States Patent and Trademark Office**

**Reg. No. 3,504,701**

**Registered Sep. 23, 2008**

**SERVICE MARK  
PRINCIPAL REGISTER**

# HobbyTown USA

HOBBY TOWN UNLIMITED, INC. (NEBRASKA CORPORATION)  
6301 SOUTH 58TH STREET  
LINCOLN, NE 68516

FOR: FRANCHISING SERVICES, NAMELY, OFFERING CONSULTING, SUPPORT, AND TECHNICAL ASSISTANCE IN THE ESTABLISHMENT OF RETAIL STORES FEATURING HOBBY MERCHANDISE; RETAIL STORE SERVICES, MAIL ORDER CATALOG SERVICES, AND ONLINE RETAIL STORE SERVICES FEATURING HOBBY MERCHANDISE, NAMELY, RADIO CONTROLLED ITEMS, SLOT CARS, PUZZLES, TOOLS AND PAINTS, MODELS, GAMES, MODEL RAILROADING, MODEL ROCKETS, MODEL TRAINS, MODEL PLANES, MODEL CARS, MODEL HELICOPTERS, BOOKS, VIDEOS, ACTIVITY KITS, KITES, COLLECTIBLES, CHILDREN'S INTERACTIVE PLAY AREAS, PUPPETS, PLUSH AND STUFFED TOYS, CLOTHING AND OTHER RELATED ACCESSORIES FOR PLUSH AND STUFFED TOYS, BASEBALL

CARDS, COMIC BOOKS, STAMPS AND COINS, ART SUPPLIES, TOYS, COMPUTER HARDWARE AND COMPUTER SOFTWARE, IN CLASS 35 (U.S. CLS. 100, 101 AND 102).

FIRST USE 1-1-1948; IN COMMERCE 9-24-1985.

THE MARK CONSISTS OF STANDARD CHARACTERS WITHOUT CLAIM TO ANY PARTICULAR FONT, STYLE, SIZE, OR COLOR.

OWNER OF U.S. REG. NOS. 1,637,763 AND 2,437,003.

NO CLAIM IS MADE TO THE EXCLUSIVE RIGHT TO USE "USA", APART FROM THE MARK AS SHOWN.

SER. NO. 77-398,530, FILED 2-15-2008.

RICHARD WHITE, EXAMINING ATTORNEY

**Int. Cl.: 30**

**Prior U.S. Cl.: 46**

**United States Patent and Trademark Office**

**Reg. No. 3,504,702**

**Registered Sep. 23, 2008**

**TRADEMARK  
PRINCIPAL REGISTER**

**QUESAPITA**

PITA PIT, INC. (DELAWARE CORPORATION)  
105 NORTH 4TH STREET, SUITE 208  
COEUR D'ALENE, ID 83814

THE MARK CONSISTS OF STANDARD CHAR-  
ACTERS WITHOUT CLAIM TO ANY PARTICULAR  
FONT, STYLE, SIZE, OR COLOR.

FOR: SANDWICHES; PITA BREAD WITH  
CHEESE AND OPTIONAL TOPPINGS, IN CLASS 30  
(U.S. CL. 46).

SER. NO. 77-398,591, FILED 2-15-2008.

FIRST USE 1-2-2006; IN COMMERCE 1-2-2006.

JAY FLOWERS, EXAMINING ATTORNEY

**Int. Cl.: 35**

**Prior U.S. Cls.: 100, 101 and 102**

**United States Patent and Trademark Office**

**Reg. No. 3,504,703**

**Registered Sep. 23, 2008**

**SERVICE MARK  
PRINCIPAL REGISTER**

**BCA**

BENDEK CELLULARS AND ACCESSORIES INTERNATIONAL CORPORATION (FLORIDA CORPORATION)  
1890 N.W. 95 AVENUE  
DORAL, FL 33172

FOR: WHOLESALE DISTRIBUTORSHIPS FEATURING CELLULAR TELEPHONE ACCESSORIES, NAMELY, POUCHES, COVERS, CASES, CHARGERS, POWER ADAPTERS, BATTERIES, AND HEADSET KITS COMPRISED OF HANDS FREE EARPIECE WITH MICROPHONE, IN CLASS 35 (U.S. CLS. 100, 101 AND 102).

FIRST USE 1-24-1997; IN COMMERCE 1-24-1997.

THE MARK CONSISTS OF STANDARD CHARACTERS WITHOUT CLAIM TO ANY PARTICULAR FONT, STYLE, SIZE, OR COLOR.

OWNER OF U.S. REG. NO. 3,163,727.

SER. NO. 77-398,595, FILED 2-15-2008.

MICHAEL TANNER, EXAMINING ATTORNEY



**Int. Cl.: 9**

**Prior U.S. Cls.: 21, 23, 26, 36 and 38**

**United States Patent and Trademark Office**

**Reg. No. 3,504,704**

**Registered Sep. 23, 2008**

**TRADEMARK  
PRINCIPAL REGISTER**

**PURITY SOFTWARE**

NUNN, NATHAN (UNITED STATES INDIVIDUAL)  
2403 BURLY OAK DR.  
AUSTIN, TX 78745

FOR: COMPUTER SOFTWARE USED FOR AUTHORIZING SCRIPTS AND APPLICATIONS, USED FOR DEVELOPING WEB AND NETWORK APPLICATIONS, USED FOR WEB PUBLISHING, USED FOR INTERFACING WITH DATABASES, USED FOR INTEGRATING NEW BUSINESS COMPUTER SYSTEMS INTO EXISTING COMPUTER SYSTEMS, AND USED FOR ACCESSING USER PROFILES AND ONLINE SUBSCRIPTIONS FOR WEB SERVICES; AND COMPUTER SOFTWARE USED FOR AUTHORIZING SCRIPTS AND APPLICATIONS, USED FOR DEVELOPING WEB AND NETWORK APPLICATIONS, USED FOR WEB PUBLISHING, USED FOR INTERFACING WITH DATABASES, USED FOR INTEGRATING NEW BUSINESS COMPUTER SYSTEMS INTO EXISTING COMPUTER

SYSTEMS, AND USED FOR ACCESSING USER PROFILES AND ONLINE SUBSCRIPTIONS FOR WEB SERVICES, THAT MAY BE DOWNLOADED FROM A GLOBAL COMPUTER NETWORK, IN CLASS 9, IN CLASS 9 (U.S. CLS. 21, 23, 26, 36 AND 38).

FIRST USE 11-15-1996; IN COMMERCE 11-15-1996.

THE MARK CONSISTS OF STANDARD CHARACTERS WITHOUT CLAIM TO ANY PARTICULAR FONT, STYLE, SIZE, OR COLOR.

NO CLAIM IS MADE TO THE EXCLUSIVE RIGHT TO USE "SOFTWARE", APART FROM THE MARK AS SHOWN.

SER. NO. 77-398,662, FILED 2-15-2008.

ELLEN B. AWRICH, EXAMINING ATTORNEY

**Int. Cl.: 35**

**Prior U.S. Cls.: 100, 101 and 102**

**United States Patent and Trademark Office**

**Reg. No. 3,504,705**

**Registered Sep. 23, 2008**

**SERVICE MARK  
PRINCIPAL REGISTER**

**BLACK FOREST DECOR**

BLACK FOREST DECOR, LLC (OKLAHOMA  
LIMITED LIABILITY COMPANY)  
2717 NORTH VAN BUREN  
ENID, OK 73703

FOR: MAIL ORDER CATALOG SERVICES FEATURING FURNITURE AND ACCESSORIES; ON-LINE RETAIL STORE SERVICES FEATURING FURNITURE AND ACCESSORIES , IN CLASS 35 (U.S. CLS. 100, 101 AND 102).

FIRST USE 7-15-2002; IN COMMERCE 7-15-2002.

THE MARK CONSISTS OF STANDARD CHARACTERS WITHOUT CLAIM TO ANY PARTICULAR FONT, STYLE, SIZE, OR COLOR.

OWNER OF U.S. REG. NO. 3,027,628.

NO CLAIM IS MADE TO THE EXCLUSIVE RIGHT TO USE "DECOR", APART FROM THE MARK AS SHOWN.

SER. NO. 77-398,688, FILED 2-15-2008.

SHANNON TWOHIG, EXAMINING ATTORNEY

**Int. Cls.: 40 and 42**

**Prior U.S. Cls.: 100, 101, 103 and 106**

**United States Patent and Trademark Office**

**Reg. No. 3,504,706**

**Registered Sep. 23, 2008**

**SERVICE MARK  
PRINCIPAL REGISTER**

**StartupMart.com**

PC LEVERAGE, LLC (CALIFORNIA LIMITED  
LIABILITY COMPANY)  
5814 BRITTANY FORREST LANE  
SAN DIEGO, CA 92130

FOR: CUSTOMIZED PRINTING OF COMPANY  
NAMES AND LOGOS FOR PROMOTIONAL AND  
ADVERTISING PURPOSES ON THE GOODS OF  
OTHERS; STATIONERY PRINTING SERVICES;  
SIGN LETTERING, IN CLASS 40 (U.S. CLS. 100, 103  
AND 106).

FIRST USE 11-9-2007; IN COMMERCE 11-9-2007.

FOR: WEB SITE DESIGN; WEB SITE DEVELOP-  
MENT FOR OTHERS; GRAPHIC DESIGN SERVI-  
CES, IN CLASS 42 (U.S. CLS. 100 AND 101).

FIRST USE 11-9-2007; IN COMMERCE 11-9-2007.

THE MARK CONSISTS OF STANDARD CHAR-  
ACTERS WITHOUT CLAIM TO ANY PARTICULAR  
FONT, STYLE, SIZE, OR COLOR.

SER. NO. 77-398,697, FILED 2-15-2008.

NANCY CLARKE, EXAMINING ATTORNEY

**Int. Cl.: 36**

**Prior U.S. Cls.: 100, 101 and 102**

**United States Patent and Trademark Office**

**Reg. No. 3,504,707**

**Registered Sep. 23, 2008**

**SERVICE MARK  
PRINCIPAL REGISTER**

**RUMBLE FOR THE JUNGLE**

CONGO BIOMED (CALIFORNIA CORPORATION)  
2012 STRONGS DRIVE  
VENICE, CA 90291

THE MARK CONSISTS OF STANDARD CHARACTERS WITHOUT CLAIM TO ANY PARTICULAR FONT, STYLE, SIZE, OR COLOR.

FOR: CHARITABLE FUNDRAISING SERVICES,  
IN CLASS 36 (U.S. CLS. 100, 101 AND 102).

SER. NO. 77-398,698, FILED 2-15-2008.

FIRST USE 2-14-2008; IN COMMERCE 2-14-2008.

WON TEAK OH, EXAMINING ATTORNEY

**Int. Cl.: 35**

**Prior U.S. Cls.: 100, 101 and 102**

**United States Patent and Trademark Office**

**Reg. No. 3,504,708**

**Registered Sep. 23, 2008**

**SERVICE MARK  
PRINCIPAL REGISTER**

**The One to Own**

GEMSTV(USA), LTD. (NEVADA CORPORATION)  
1190 TRADEMARK DRIVE  
RENO, NV 89521

THE MARK CONSISTS OF STANDARD CHAR-  
ACTERS WITHOUT CLAIM TO ANY PARTICULAR  
FONT, STYLE, SIZE, OR COLOR.

FOR: PROVIDING HOME SHOPPING SERVICES  
IN THE FIELD OF JEWELRY BY MEANS OF  
TELEVISION, IN CLASS 35 (U.S. CLS. 100, 101 AND  
102).

SER. NO. 77-398,732, FILED 2-15-2008.

FIRST USE 11-1-2007; IN COMMERCE 11-1-2007.

WON TEAK OH, EXAMINING ATTORNEY

**Int. Cl.: 35**

**Prior U.S. Cls.: 100, 101 and 102**

**United States Patent and Trademark Office**

**Reg. No. 3,504,709**

**Registered Sep. 23, 2008**

**SERVICE MARK  
PRINCIPAL REGISTER**

**OPTIMUM WELLNESS**

SKR WELLNESS PARTNERSHIP, LLC (COLOR-  
ADO LIMITED LIABILITY COMPANY)  
P.O. BOX 11, 7601 EAST BURNING TREE DRIV  
FRANKTOWN, CO 80116

FOR: ON-LINE RETAIL STORE SERVICES FEATURING NUTRITIONAL SUPPLEMENTS; RETAIL STORE SERVICES FEATURING NUTRITIONAL SUPPLEMENTS, IN CLASS 35 (U.S. CLS. 100, 101 AND 102).

FIRST USE 1-25-2008; IN COMMERCE 1-25-2008.

THE MARK CONSISTS OF STANDARD CHARACTERS WITHOUT CLAIM TO ANY PARTICULAR FONT, STYLE, SIZE, OR COLOR.

NO CLAIM IS MADE TO THE EXCLUSIVE RIGHT TO USE "WELLNESS", APART FROM THE MARK AS SHOWN.

SER. NO. 77-398,753, FILED 2-15-2008.

PAUL CROWLEY, EXAMINING ATTORNEY

**Int. Cl.: 21**

**Prior U.S. Cls.: 2, 13, 23, 29, 30, 33, 40 and 50**

**United States Patent and Trademark Office**

**Reg. No. 3,504,710**

**Registered Sep. 23, 2008**

**TRADEMARK  
PRINCIPAL REGISTER**



WILSHIRE INDUSTRIES, LLC (CALIFORNIA  
LIMITED LIABILITY COMPANY)  
1001 CALLE RECODO  
SAN CLEMENTE, CA 92673

FOR: CUTTING BOARDS, IN CLASS 21 (U.S. CLS.  
2, 13, 23, 29, 30, 33, 40 AND 50).

FIRST USE 2-15-2008; IN COMMERCE 2-15-2008.

NO CLAIM IS MADE TO THE EXCLUSIVE  
RIGHT TO USE "EARTH FRIENDLY PRODUCTS",  
APART FROM THE MARK AS SHOWN.

THE MARK CONSISTS OF THE WORDS "EARTH  
FRIENDLY PRODUCTS" APPEARING BETWEEN  
TWO CONCENTRIC CIRCLES AND A LEAF DE-  
SIGN APPEARING AT THE CENTER OF THE  
CIRCLES.

SER. NO. 77-398,764, FILED 2-15-2008.

CYNTHIA TRIPI, EXAMINING ATTORNEY

**Int. Cl.: 30**

**Prior U.S. Cl.: 46**

**United States Patent and Trademark Office**

**Reg. No. 3,504,711**

**Registered Sep. 23, 2008**

**TRADEMARK  
PRINCIPAL REGISTER**

**EUROPEAN D'LIGHT**

GREEN FOREST, INC. (NEW YORK CORPORATION)  
4211 NAUTILUS AVENUE  
BROOKLYN, NY 11224

NO CLAIM IS MADE TO THE EXCLUSIVE  
RIGHT TO USE "EUROPEAN", APART FROM THE  
MARK AS SHOWN.

FOR: ICE CREAM, IN CLASS 30 (U.S. CL. 46).

FIRST USE 12-15-2001; IN COMMERCE 12-15-2001.

SER. NO. 77-398,776, FILED 2-15-2008.

THE MARK CONSISTS OF STANDARD CHARACTERS WITHOUT CLAIM TO ANY PARTICULAR FONT, STYLE, SIZE, OR COLOR.

MICHAEL GAAFAR, EXAMINING ATTORNEY



**Int. Cl.: 39**

**Prior U.S. Cls.: 100 and 105**

**United States Patent and Trademark Office**

**Reg. No. 3,504,712**

**Registered Sep. 23, 2008**

**SERVICE MARK  
PRINCIPAL REGISTER**

**CME PARTNERS**

EAST WEST RESORT TRANSPORTATION  
HOLDINGS, LLC (DELAWARE LIMITED LIABILITY COMPANY)  
FIFTH FLOOR DRAWER  
100 EAST THOMAS PLACE  
AVON, CO 81620

FOR: TRANSPORTATION OF PASSENGERS AND/OR GOODS BY VAN AND LIMOUSINE; TRANSPORTATION RESERVATION SERVICES; LIMOUSINE SERVICES , IN CLASS 39 (U.S. CLS. 100 AND 105).

FIRST USE 4-1-2008; IN COMMERCE 4-1-2008.

THE MARK CONSISTS OF STANDARD CHARACTERS WITHOUT CLAIM TO ANY PARTICULAR FONT, STYLE, SIZE, OR COLOR.

OWNER OF U.S. REG. NOS. 2,717,389, 3,075,401, AND 3,150,385.

NO CLAIM IS MADE TO THE EXCLUSIVE RIGHT TO USE "PARTNERS", APART FROM THE MARK AS SHOWN.

SER. NO. 77-398,788, FILED 2-15-2008.

AMY ALFIERI, EXAMINING ATTORNEY

Int. Cl.: 35

Prior U.S. Cls.: 100, 101 and 102

United States Patent and Trademark Office

Reg. No. 3,504,713

Registered Sep. 23, 2008

SERVICE MARK  
PRINCIPAL REGISTER



CHEERS FOR BEERS, LLC (NEVADA LIMITED LIABILITY COMPANY)  
3309 ASHBY FIELD AVENUE  
NORTH LAS VEGAS, NV 89031

FOR: PROVIDING CONSUMER INFORMATION ABOUT BREWERIES AND OF BEER RELATED PRODUCTS, IN CLASS 35 (U.S. CLS. 100, 101 AND 102).

FIRST USE 6-1-2007; IN COMMERCE 6-1-2007.

NO CLAIM IS MADE TO THE EXCLUSIVE RIGHT TO USE ".COM", APART FROM THE MARK AS SHOWN.

THE MARK CONSISTS OF A CUSTOM BEER CAP DESIGN WITH "CHEERS FOR BEERS .COM" SCRIPTED ON THE TOP.

SER. NO. 77-398,825, FILED 2-15-2008.

BRIAN PINO, EXAMINING ATTORNEY

Int. Cl.: 30

Prior U.S. Cl.: 46

United States Patent and Trademark Office

Reg. No. 3,504,714

Registered Sep. 23, 2008

TRADEMARK  
PRINCIPAL REGISTER



GREEN FOREST, INC. (NEW YORK CORPORATION)  
4211 NAUTILUS AVENUE  
BROOKLYN, NY 11224

THE MARK CONSISTS OF FOOTED ICE CREAM PARFAIT DISH WITH THREE SWIRLED ICE CREAM SCOOPS AND THE WORDS "EUROPEAN D'LIGHT" ON THE RIGHT SIDE OF THE DESIGN.

FOR: ICE CREAM, IN CLASS 30 (U.S. CL. 46).

FIRST USE 12-15-2001; IN COMMERCE 12-15-2001.

SER. NO. 77-398,854, FILED 2-15-2008.

NO CLAIM IS MADE TO THE EXCLUSIVE RIGHT TO USE "EUROPEAN", APART FROM THE MARK AS SHOWN.

MICHAEL GAAFAR, EXAMINING ATTORNEY

**Int. Cl.: 9**

**Prior U.S. Cls.: 21, 23, 26, 36 and 38**

**Reg. No. 3,504,715**

**United States Patent and Trademark Office**

**Registered Sep. 23, 2008**

---

**TRADEMARK  
PRINCIPAL REGISTER**

**MICROLADA**

UTAH STATE UNIVERSITY RESEARCH FOUNDATION (UTAH NON-PROFIT CORPORATION)  
1695 NORTH RESEARCH PARKWAY  
NORTH LOGAN, UT 84341

FOR: SCIENTIFIC AND LABORATORY EQUIPMENT IN THE NATURE OF PLANT GROWTH CHAMBERS, NAMELY, CONTROLLED ENVIRONMENT CHAMBERS FOR GROWING PLANTS, IN CLASS 9 (U.S. CLS. 21, 23, 26, 36 AND 38).

FIRST USE 7-20-2005; IN COMMERCE 7-20-2005.

THE MARK CONSISTS OF STANDARD CHARACTERS WITHOUT CLAIM TO ANY PARTICULAR FONT, STYLE, SIZE, OR COLOR.

SER. NO. 77-398,861, FILED 2-15-2008.

MICHAEL TANNER, EXAMINING ATTORNEY

**Int. Cl.: 9**

**Prior U.S. Cls.: 21, 23, 26, 36 and 38**

**Reg. No. 3,504,716**

**United States Patent and Trademark Office**

**Registered Sep. 23, 2008**

---

**TRADEMARK  
PRINCIPAL REGISTER**

**AIMSTOR**

COFIO SOFTWARE, INC. (DELAWARE CORPORATION)  
9893 GRANDVIEW DR  
LA MESA, CA 91941

THE MARK CONSISTS OF STANDARD CHARACTERS WITHOUT CLAIM TO ANY PARTICULAR FONT, STYLE, SIZE, OR COLOR.

FOR: COMPUTER SOFTWARE FOR PROTECTING, MANAGING AND CONTROLLING DATA IN STORAGE ENVIRONMENTS, IN CLASS 9 (U.S. CLS. 21, 23, 26, 36 AND 38).

SER. NO. 77-398,900, FILED 2-16-2008.

FIRST USE 2-5-2008; IN COMMERCE 2-5-2008.

MATTHEW PAPPAS, EXAMINING ATTORNEY

**Int. Cl.: 11**

**Prior U.S. Cls.: 13, 21, 23, 31 and 34**

**United States Patent and Trademark Office**

**Reg. No. 3,504,717**

**Registered Sep. 23, 2008**

**TRADEMARK  
PRINCIPAL REGISTER**

# Techone

SHENZHEN TECHONE TECH CO., LTD (CHINA CORPORATION)  
NO.1302, A BUILDING, NEW TECH PLAZA  
TIAN AN CYBER PARK  
SHENZHEN, CHINA 518000

FOR: LIGHTING FIXTURES; LIGHT REFLECTORS; ARC LAMPS; LAMP CHIMNEYS; SEARCHLIGHTS; FLASHLIGHTS; OUTDOOR LIGHTING, NAMELY, PAVER LIGHTS; LED (LIGHT EMITTING DIODES) LIGHTING FIXTURES FOR USE IN DISPLAY, COMMERCIAL, INDUSTRIAL, RESIDENTIAL, AND ARCHITECTURAL ACCENT LIGHTING APPLICATIONS; DIVING LIGHTS;

LIGHTS FOR VEHICLES; VEHICLE HEADLIGHTS; LED AND HID LIGHT FIXTURES, IN CLASS 11 (U.S. CLS. 13, 21, 23, 31 AND 34).

FIRST USE 4-1-2003; IN COMMERCE 7-1-2004.

THE MARK CONSISTS OF STANDARD CHARACTERS WITHOUT CLAIM TO ANY PARTICULAR FONT, STYLE, SIZE, OR COLOR.

SER. NO. 77-398,920, FILED 2-16-2008.

TARA PATE, EXAMINING ATTORNEY

**Int. Cl.: 41**

**Prior U.S. Cls.: 100, 101 and 107**

**United States Patent and Trademark Office**

**Reg. No. 3,504,718**

**Registered Sep. 23, 2008**

**SERVICE MARK  
PRINCIPAL REGISTER**

# The Waking

KRONENBERGER, JOHN E (UNITED STATES  
INDIVIDUAL)  
9208 S MONITOR AVE  
OAK LAWN, IL 60453

FOR: ENTERTAINMENT IN THE NATURE OF  
VISUAL AND AUDIO PERFORMANCES, NAMELY,  
MUSICAL BAND, ROCK GROUP, GYMNASTIC,  
DANCE, AND BALLET PERFORMANCES, IN  
CLASS 41 (U.S. CLS. 100, 101 AND 107).

FIRST USE 3-5-2005; IN COMMERCE 2-5-2007.

THE MARK CONSISTS OF STANDARD CHAR-  
ACTERS WITHOUT CLAIM TO ANY PARTICULAR  
FONT, STYLE, SIZE, OR COLOR.

SER. NO. 77-398,923, FILED 2-16-2008.

CAROLYN GRAY, EXAMINING ATTORNEY

**Int. Cl.: 14**

**Prior U.S. Cls.: 2, 27, 28 and 50**

**United States Patent and Trademark Office**

**Reg. No. 3,504,719**

**Registered Sep. 23, 2008**

**TRADEMARK  
PRINCIPAL REGISTER**

**Living Art**

GRACE, CHERYL (UNITED STATES INDIVIDUAL)  
5167 CANTABRIA CREST  
SARASOTA, FL 34238

OWNER OF U.S. REG. NO. 3,419,510.

FOR: JEWELRY AND IMITATION JEWELRY, IN CLASS 14 (U.S. CLS. 2, 27, 28 AND 50).

NO CLAIM IS MADE TO THE EXCLUSIVE RIGHT TO USE "ART", APART FROM THE MARK AS SHOWN.

FIRST USE 3-19-2007; IN COMMERCE 12-1-2007.

SER. NO. 77-398,997, FILED 2-16-2008.

THE MARK CONSISTS OF STANDARD CHARACTERS WITHOUT CLAIM TO ANY PARTICULAR FONT, STYLE, SIZE, OR COLOR.

ANDREA SAUNDERS, EXAMINING ATTORNEY



**Int. Cl.: 33**

**Prior U.S. Cls.: 47 and 49**

**United States Patent and Trademark Office**

**Reg. No. 3,504,720**

**Registered Sep. 23, 2008**

**TRADEMARK  
PRINCIPAL REGISTER**

**MAZAMA**

BENDISTILLERY, INC. (OREGON CORPORATION)  
1470 NE 1ST ST #800  
BEND, OR 97701

THE MARK CONSISTS OF STANDARD CHARACTERS WITHOUT CLAIM TO ANY PARTICULAR FONT, STYLE, SIZE, OR COLOR.

FOR: DISTILLED SPIRITS, IN CLASS 33 (U.S. CLS. 47 AND 49).

SER. NO. 77-399,022, FILED 2-16-2008.

FIRST USE 6-23-2003; IN COMMERCE 9-30-2003.

MICHELE SWAIN, EXAMINING ATTORNEY

Int. Cl.: 42

Prior U.S. Cls.: 100 and 101

United States Patent and Trademark Office

Reg. No. 3,504,721

Registered Sep. 23, 2008

SERVICE MARK  
PRINCIPAL REGISTER



BICKELMANN, KEVIN W (UNITED STATES INDIVIDUAL), DBA TOP DRAWER DECOR  
PO BOX 2381  
SANTA CLARA, CA 95055

THE COLOR(S) BROWN, GREEN IS/ARE CLAIMED AS A FEATURE OF THE MARK.

FOR: FURNITURE DESIGN SERVICES; INTERIOR DESIGN SERVICES, IN CLASS 42 (U.S. CLS. 100 AND 101).

THE MARK CONSISTS OF BROWN IN THE TEXT AND DRAWING, GREEN IN THE TOP DRAWER OF IMAGE.

FIRST USE 1-1-2008; IN COMMERCE 1-1-2008.

SER. NO. 77-399,025, FILED 2-16-2008.

NO CLAIM IS MADE TO THE EXCLUSIVE RIGHT TO USE "DECOR", APART FROM THE MARK AS SHOWN.

CAROLYN GRAY, EXAMINING ATTORNEY

Int. Cl.: 35

Prior U.S. Cls.: 100, 101 and 102

United States Patent and Trademark Office

Reg. No. 3,504,722

Registered Sep. 23, 2008

SERVICE MARK  
PRINCIPAL REGISTER



IN-COURAGE GIFTS, L.L.C. (TEXAS LIMITED LIABILITY COMPANY)  
8055 WEST AVE, SUITE 106  
SAN ANTONIO, TX 78213

FOR: RETAIL GIFT SHOPS, IN CLASS 35 (U.S. CLS. 100, 101 AND 102).

FIRST USE 1-1-2004; IN COMMERCE 1-1-2004.

THE COLOR(S) PURPLE, YELLOW AND GREEN AND BLACK IS/ARE CLAIMED AS A FEATURE OF THE MARK.

THE MARK CONSISTS OF THE WORD "IN-COURAGE" IN BLACK AND HIGHLIGHTED IN GREEN. THE DOT IN THE LETTER "I" IS IN THE SHAPE OF A BLACK FLOWER HIGHLIGHTED IN PURPLE WITH A YELLOW CENTER.

SER. NO. 77-399,035, FILED 2-16-2008.

KATHERINE CHANG, EXAMINING ATTORNEY

**Int. Cl.: 35**

**Prior U.S. Cls.: 100, 101 and 102**

**United States Patent and Trademark Office**

**Reg. No. 3,504,723**

**Registered Sep. 23, 2008**

**SERVICE MARK  
PRINCIPAL REGISTER**

**MUSIC SAVES**

MUSIC SAVES LLC (OHIO LIMITED LIABILITY  
COMPANY)  
15801 WATERLOO ROAD  
CLEVELAND, OH 44110

FOR: RETAIL STORE SERVICES FEATURING  
CDS, RECORDS, DVDS, BOOKS, MAGAZINES, POS-  
TERS AND CLOTHING, IN CLASS 35 (U.S. CLS. 100,  
101 AND 102).

FIRST USE 7-17-2004; IN COMMERCE 7-28-2004.

THE MARK CONSISTS OF STANDARD CHAR-  
ACTERS WITHOUT CLAIM TO ANY PARTICULAR  
FONT, STYLE, SIZE, OR COLOR.

SER. NO. 77-399,041, FILED 2-16-2008.

PAUL E. FAHRENKOPF, EXAMINING ATTORNEY

**Int. Cl.: 33**

**Prior U.S. Cls.: 47 and 49**

**United States Patent and Trademark Office**

**Reg. No. 3,504,724**

**Registered Sep. 23, 2008**

**TRADEMARK  
PRINCIPAL REGISTER**

**Vivamus**

DARDEFOX UNLIMITED (CALIFORNIA COR-  
PORATION)  
SUITE 113-607  
7770 REGENTS ROAD  
SAN DIEGO, CA 92122

THE MARK CONSISTS OF STANDARD CHAR-  
ACTERS WITHOUT CLAIM TO ANY PARTICULAR  
FONT, STYLE, SIZE, OR COLOR.

FOR: ALCOHOLIC BEVERAGES, NAMELY,  
WINES, IN CLASS 33 (U.S. CLS. 47 AND 49).

SER. NO. 77-399,044, FILED 2-16-2008.

FIRST USE 2-1-2006; IN COMMERCE 2-1-2006.

PAUL E. FAHRENKOPF, EXAMINING ATTORNEY

**Int. Cl.: 16**

**Prior U.S. Cls.: 2, 5, 22, 23, 29, 37, 38 and 50**

**United States Patent and Trademark Office**

**Reg. No. 3,504,725**

**Registered Sep. 23, 2008**

**TRADEMARK  
PRINCIPAL REGISTER**

**JOYOUS POSSIBILITIES**

HOEY, E MAUREEN (UNITED STATES INDIVIDUAL)  
2315 PIN OAK LANE  
ARLINGTON, TX 76012

THE MARK CONSISTS OF STANDARD CHARACTERS WITHOUT CLAIM TO ANY PARTICULAR FONT, STYLE, SIZE, OR COLOR.

FOR: LAMINATED PAPER; POSTERS MADE OF PAPER, IN CLASS 16 (U.S. CLS. 2, 5, 22, 23, 29, 37, 38 AND 50).

SER. NO. 77-399,068, FILED 2-16-2008.

FIRST USE 12-20-1976; IN COMMERCE 8-15-1977.

TASNEEM HUSSAIN, EXAMINING ATTORNEY

**Int. Cls.: 9 and 35**

**Prior U.S. Cls.: 21, 23, 26, 36, 38, 100, 101 and 102**

**United States Patent and Trademark Office**

**Reg. No. 3,504,726**

**Registered Sep. 23, 2008**

**TRADEMARK  
SERVICE MARK  
PRINCIPAL REGISTER**

**Small Office Advantage**

MLM SOFTWARE SOLUTIONS, INC. (CALIFORNIA CORPORATION), FORMERLY KYNETICS SOFTWARE  
72 WESSEX WAY  
SAN CARLOS, CA 94070

FOR: COMPUTER SOFTWARE FOR USE IN CUSTOMER RELATIONSHIP MANAGEMENT (CRM), IN CLASS 9 (U.S. CLS. 21, 23, 26, 36 AND 38).

FIRST USE 12-15-2007; IN COMMERCE 2-1-2008.

FOR: COMPUTERIZED ACCOUNTING SERVICES; INCOME TAX PREPARATION; TAX PRE-

PARATION, IN CLASS 35 (U.S. CLS. 100, 101 AND 102).

FIRST USE 12-15-2007; IN COMMERCE 2-1-2008.

THE MARK CONSISTS OF STANDARD CHARACTERS WITHOUT CLAIM TO ANY PARTICULAR FONT, STYLE, SIZE, OR COLOR.

SER. NO. 77-399,123, FILED 2-17-2008.

JACQUELINE A. LAVINE, EXAMINING ATTORNEY

**Int. Cl.: 42**

**Prior U.S. Cls.: 100 and 101**

**United States Patent and Trademark Office**

**Reg. No. 3,504,727**

**Registered Sep. 23, 2008**

**SERVICE MARK  
PRINCIPAL REGISTER**

**AXXIEM**

AXXIEM CORP. (DELAWARE CORPORATION)  
578 WARBURTON AVE.  
HASTINGS ON HUDSON, NY 10706

FOR: DESIGN, CREATION, HOSTING, MAINTENANCE OF WEB SITES FOR OTHERS, IN CLASS 42 (U.S. CLS. 100 AND 101).

FIRST USE 9-4-2004; IN COMMERCE 9-4-2004.

THE MARK CONSISTS OF STANDARD CHARACTERS WITHOUT CLAIM TO ANY PARTICULAR FONT, STYLE, SIZE, OR COLOR.

SER. NO. 77-399,125, FILED 2-17-2008.

JACQUELINE A. LAVINE, EXAMINING ATTORNEY



**Int. Cl.: 5**

**Prior U.S. Cls.: 6, 18, 44, 46, 51 and 52**

**Reg. No. 3,504,728**

**United States Patent and Trademark Office**

**Registered Sep. 23, 2008**

**TRADEMARK  
PRINCIPAL REGISTER**

**VIAXTREME**

GLOBAL WELLNESS, LLC (FLORIDA LIMITED  
LIABILITY COMPANY)  
2854 STIRLING RD, SUITE G  
HOLLYWOOD, FL 33020

THE MARK CONSISTS OF STANDARD CHAR-  
ACTERS WITHOUT CLAIM TO ANY PARTICULAR  
FONT, STYLE, SIZE, OR COLOR.

FOR: DIETARY SUPPLEMENTS; DIETARY SUP-  
PLEMENTS FOR IMPROVING SEXUAL PERFOR-  
MANCE; SEXUAL ENHANCEMENT PILLS, IN  
CLASS 5 (U.S. CLS. 6, 18, 44, 46, 51 AND 52).

SER. NO. 77-399,157, FILED 2-17-2008.

FIRST USE 10-0-2007; IN COMMERCE 10-0-2007.

EDWARD NELSON, EXAMINING ATTORNEY

**Int. Cl.: 43**

**Prior U.S. Cls.: 100 and 101**

**United States Patent and Trademark Office**

**Reg. No. 3,504,729**

**Registered Sep. 23, 2008**

**SERVICE MARK  
PRINCIPAL REGISTER**

**SUNDAES AT THE BEACH**

MANGO BANGOS, LLC (MAINE LIMITED LIABILITY COMPANY)  
PO BOX 719  
MOODY, ME 04050

FOR: ICE CREAM SHOP SERVICES IN THE NATURE OF A RESTAURANT; CARRY-OUT RESTAURANTS; RESTAURANT SERVICES; CAFE AND RESTAURANT SERVICES; SNACK BARS, IN CLASS 43 (U.S. CLS. 100 AND 101).

FIRST USE 5-0-2007; IN COMMERCE 5-0-2007.

THE MARK CONSISTS OF STANDARD CHARACTERS WITHOUT CLAIM TO ANY PARTICULAR FONT, STYLE, SIZE, OR COLOR.

SER. NO. 77-399,171, FILED 2-17-2008.

GEOFFREY FOSDICK, EXAMINING ATTORNEY

**Int. Cl.: 39**

**Prior U.S. Cls.: 100 and 105**

**United States Patent and Trademark Office**

**Reg. No. 3,504,730**

**Registered Sep. 23, 2008**

**SERVICE MARK  
PRINCIPAL REGISTER**

**SMOKY MOUNTAIN**

TRIPLE T ENTERPRISES, INC. (IDAHO CORPORATION)  
408 EAST 41ST STREET  
BOISE, ID 83714

FOR: DELIVERY OF FOOD, NAMELY, GRILLED FOOD, PIZZA, PASTA AND SANDWICHES, IN CLASS 39 (U.S. CLS. 100 AND 105).

FIRST USE 2-1-1992; IN COMMERCE 2-1-1992.

THE MARK CONSISTS OF STANDARD CHARACTERS WITHOUT CLAIM TO ANY PARTICULAR FONT, STYLE, SIZE, OR COLOR.

OWNER OF U.S. REG. NOS. 2,879,076, 3,402,972 AND OTHERS.

SER. NO. 77-399,179, FILED 2-17-2008.

MICHAEL GAAFAR, EXAMINING ATTORNEY

**Int. Cl.: 35**

**Prior U.S. Cls.: 100, 101 and 102**

**United States Patent and Trademark Office**

**Reg. No. 3,504,731**

**Registered Sep. 23, 2008**

**SERVICE MARK  
PRINCIPAL REGISTER**

**PLANET RESCUE**

BRASH, TRACE (OREGON SOLE PROPRIETORSHIP), DBA TRACY BRASH CONSTRUCTION  
3326 NE 12TH AVE  
PORTLAND, OR 97212

FOR: BUSINESS VENTURE DEVELOPMENT AND FORMATION CONSULTING SERVICES FOR THE RENEWABLE ENERGY INDUSTRY; CONSULTATION IN THE FIELD OF ENERGY EFFICIENCY; ENERGY AUDITING, IN CLASS 35 (U.S. CLS. 100, 101 AND 102).

FIRST USE 9-15-2007; IN COMMERCE 2-1-2008.

THE MARK CONSISTS OF STANDARD CHARACTERS WITHOUT CLAIM TO ANY PARTICULAR FONT, STYLE, SIZE, OR COLOR.

SER. NO. 77-399,188, FILED 2-17-2008.

NAKIA HENRY, EXAMINING ATTORNEY

**Int. Cl.: 45**

**Prior U.S. Cls.: 100 and 101**

**United States Patent and Trademark Office**

**Reg. No. 3,504,732**

**Registered Sep. 23, 2008**

**SERVICE MARK  
PRINCIPAL REGISTER**

**Give Fraud The Finger**

KIMMEL, SCOTT T. (UNITED STATES INDIVIDUAL)  
3275 WEST HILLSBORO BLVD. SUITE 100  
DEERFIELD BEACH, FL 33442

FOR: FRAUD DETECTION SERVICES IN THE FIELD OF HEALTH CARE INSURANCE, IN CLASS 45 (U.S. CLS. 100 AND 101).

FIRST USE 5-20-2007; IN COMMERCE 5-20-2007.

THE MARK CONSISTS OF STANDARD CHARACTERS WITHOUT CLAIM TO ANY PARTICULAR FONT, STYLE, SIZE, OR COLOR.

SER. NO. 77-399,198, FILED 2-17-2008.

TARAH HARDY, EXAMINING ATTORNEY

**Int. Cl.: 43**

**Prior U.S. Cls.: 100 and 101**

**United States Patent and Trademark Office**

**Reg. No. 3,504,733**

**Registered Sep. 23, 2008**

**SERVICE MARK  
PRINCIPAL REGISTER**



MASAKARI CORPORATION (NEW YORK CORPORATION)  
1631 SHEEPSHEAD BAY ROAD  
BROOKLYN, NY 11235

FOR: RESTAURANT SERVICES, IN CLASS 43  
(U.S. CLS. 100 AND 101).

FIRST USE 6-1-2007; IN COMMERCE 6-1-2007.

NO CLAIM IS MADE TO THE EXCLUSIVE  
RIGHT TO USE "JAPANESE FUSION" , APART  
FROM THE MARK AS SHOWN.

THE COLOR(S) ORANGE, GREEN, AND BLACK  
IS/ARE CLAIMED AS A FEATURE OF THE MARK.

THE MARK CONSISTS OF THE WORDING MASAKARI JAPANESE FUSION IN BLACK. TO THE LEFT OF THE WORDING IS AN ORANGE SEMI-CIRCLE REPRESENTING A TANGERINE WITH A GREEN STEM ABOVE THE WORDING.

THE ENGLISH TRANSLATION OF "MASAKARI" IS "HEIGHT OF FULL BLOOM".

SER. NO. 77-399,213, FILED 2-17-2008.

TARAH HARDY, EXAMINING ATTORNEY

**Int. Cl.: 19**

**Prior U.S. Cls.: 1, 12, 33 and 50**

**United States Patent and Trademark Office**

**Reg. No. 3,504,734**

**Registered Sep. 23, 2008**

**TRADEMARK  
PRINCIPAL REGISTER**

The logo for KANGDA features a stylized lowercase 'k' with horizontal lines through its vertical stem, followed by the word 'KANGDA' in a bold, uppercase, sans-serif font.

GUANGZHOU PANYU KANGDA BOARD CO.,  
LTD. (CHINA CORPORATION)  
NO.24 DONGSHENG ROAD, SHIJI , PANYU  
GUANGZHOU, CHINA 511450

FIRST USE 4-26-1995; IN COMMERCE 12-15-1995.

FOR: FIRED REFRACTORY MATERIALS, NOT  
OF METAL; LUMBER; PLYWOOD; NON-METAL  
FLOORS; WOODEN FLOORING; PAVING BLOCKS;  
VENEER FOR FLOORS; VENEER WOOD; PAR-  
QUET FLOOR BOARDS; NON-METAL CLADDING  
FOR CONSTRUCTION AND BUILDING, IN CLASS  
19 (U.S. CLS. 1, 12, 33 AND 50).

THE WORDING "KANGDA" HAS NO MEANING  
IN A FOREIGN LANGUAGE.

SER. NO. 77-399,225, FILED 2-17-2008.

MATTHEW PAPPAS, EXAMINING ATTORNEY

Int. Cl.: 41

Prior U.S. Cls.: 100, 101 and 107

United States Patent and Trademark Office

Reg. No. 3,504,735

Registered Sep. 23, 2008

SERVICE MARK  
PRINCIPAL REGISTER



CARMONA, MICHAEL E. (UNITED STATES INDIVIDUAL), DBA MASTER DOG TRAINING  
121 N. ARDMORE DRIVE  
SAN GABRIEL, CA 91775

FOR: DOG TRAINING, IN CLASS 41 (U.S. CLS. 100, 101 AND 107).

FIRST USE 1-8-2008; IN COMMERCE 1-8-2008.

NO CLAIM IS MADE TO THE EXCLUSIVE RIGHT TO USE "MASTER DOG TRAINING", APART FROM THE MARK AS SHOWN.

THE MARK CONSISTS OF A STYLIZED LETTER "M" IS FORMED BY TWO VERTICLE PILLARS, ONE ON EACH SIDE, AND A LARGE "V" SHAPE ON TOP IN THE CENTER ALL OF WHICH ARE NOT CONNECTED. INSIDE THE STYLIZED "M" ARE TWO DOG'S TORSOS WITH HEADS DISPLAYED IN SILHOUETTES FACING EACH OTHER. EACH DOG IS ON THE INSIDE OF EACH PILLAR AND THEIR NOSES COME TO MEET AT THE CENTER OF THE STYLIZED "M" .

SER. NO. 77-399,240, FILED 2-18-2008.

DAWN FELDMAN, EXAMINING ATTORNEY



**Int. Cl.: 25**

**Prior U.S. Cls.: 22 and 39**

**United States Patent and Trademark Office**

**Reg. No. 3,504,736**

**Registered Sep. 23, 2008**

**TRADEMARK  
PRINCIPAL REGISTER**

**STUSSY DELUXE**

STUSSY, INC. (CALIFORNIA CORPORATION)  
17426 DAIMLER STREET  
IRVINE, CA 92614

OWNER OF U.S. REG. NOS. 1,395,006, 2,232,002  
AND OTHERS.

FOR: CLOTHING, NAMELY, BELTS, JACKETS,  
PANTS, SHIRTS, SWEATERS, SWEATSHIRTS, T-  
SHIRTS, VESTS AND HEADWEAR, IN CLASS 25  
(U.S. CLS. 22 AND 39).

NO CLAIM IS MADE TO THE EXCLUSIVE  
RIGHT TO USE "DELUXE", APART FROM THE  
MARK AS SHOWN.

FIRST USE 2-15-2008; IN COMMERCE 2-15-2008.

SER. NO. 77-399,244, FILED 2-18-2008.

THE MARK CONSISTS OF STANDARD CHAR-  
ACTERS WITHOUT CLAIM TO ANY PARTICULAR  
FONT, STYLE, SIZE, OR COLOR.

DAWN FELDMAN, EXAMINING ATTORNEY

**Int. Cl.: 41**

**Prior U.S. Cls.: 100, 101 and 107**

**United States Patent and Trademark Office**

**Reg. No. 3,504,737**

**Registered Sep. 23, 2008**

**SERVICE MARK  
PRINCIPAL REGISTER**

**ADA CERP**

AMERICAN DENTAL ASSOCIATION (ILLINOIS  
CORPORATION)  
211 EAST CHICAGO AVENUE  
CHICAGO, IL 60611

FOR: EDUCATIONAL SERVICES, NAMELY,  
CONTINUING EDUCATION SEMINARS AND  
COURSES RELATING TO THE PROFESSION OF  
DENTISTRY FOR DENTAL PROFESSIONALS, IN  
CLASS 41 (U.S. CLS. 100, 101 AND 107).

FIRST USE 7-19-1995; IN COMMERCE 7-19-1995.

THE MARK CONSISTS OF STANDARD CHAR-  
ACTERS WITHOUT CLAIM TO ANY PARTICULAR  
FONT, STYLE, SIZE, OR COLOR.

OWNER OF U.S. REG. NOS. 1,368,287, 3,257,422  
AND OTHERS.

SER. NO. 77-399,265, FILED 2-18-2008.

AMY ALFIERI, EXAMINING ATTORNEY

Int. Cl.: 9

Prior U.S. Cls.: 21, 23, 26, 36 and 38

United States Patent and Trademark Office

Reg. No. 3,504,738

Registered Sep. 23, 2008

TRADEMARK  
PRINCIPAL REGISTER

# RadVantage

DESCRIPTION, INC. (DELAWARE CORPORATION)  
160 GOULD ST.  
NEEDHAM, MA 02494

FOR: COMPUTER PROGRAMS FOR MEDICAL TRANSCRIPTION INCLUDING VOICE CAPTURE AND INTEGRATED SPEECH RECOGNITION AND INTERPRETATION AND FORMATTING AS WELL AS EDITING TOOLS FOR SPEAKERS AND TRANSCRIPTIONISTS AND DOCUMENT MANAGEMENT AND DISTRIBUTION AND ELECTRONIC

SIGNATURE, IN CLASS 9 (U.S. CLS. 21, 23, 26, 36 AND 38).

FIRST USE 2-12-2008; IN COMMERCE 2-12-2008.

THE MARK CONSISTS OF STANDARD CHARACTERS WITHOUT CLAIM TO ANY PARTICULAR FONT, STYLE, SIZE, OR COLOR.

SER. NO. 77-399,271, FILED 2-18-2008.

CHRIS WELLS, EXAMINING ATTORNEY

**Int. Cl.: 39**

**Prior U.S. Cls.: 100 and 105**

**United States Patent and Trademark Office**

**Reg. No. 3,504,739**

**Registered Sep. 23, 2008**

**SERVICE MARK  
PRINCIPAL REGISTER**

# Serentripity

SERENTRIPITY (CALIFORNIA CORPORATION)  
2134 CIPRIANI BLVD  
BELMONT, CA 94002

THE MARK CONSISTS OF STANDARD CHAR-  
ACTERS WITHOUT CLAIM TO ANY PARTICULAR  
FONT, STYLE, SIZE, OR COLOR.

FOR: TOUR OPERATING AND ORGANISING, IN  
CLASS 39 (U.S. CLS. 100 AND 105).

SER. NO. 77-399,274, FILED 2-18-2008.

FIRST USE 2-15-2008; IN COMMERCE 2-15-2008.

CHRIS WELLS, EXAMINING ATTORNEY

Int. Cls.: 36, 43 and 44

Prior U.S. Cls.: 100, 101 and 102

United States Patent and Trademark Office

Reg. No. 3,504,740

Registered Sep. 23, 2008

SERVICE MARK  
PRINCIPAL REGISTER



CHRIS KIDS, INC. (GEORGIA NON-PROFIT CORPORATION)  
3109 CLAIRMONT ROAD, N.E., SUITE B  
ATLANTA, GA 30329

FOR: CHARITABLE FUNDRAISING SERVICES,  
IN CLASS 36 (U.S. CLS. 100, 101 AND 102).

FIRST USE 4-0-2004; IN COMMERCE 4-0-2004.

FOR: CHILD WELFARE SERVICES, NAMELY,  
PROVIDING RESIDENTIAL HOMES AND HOUSING  
FOR AT-RISK CHILDREN AND YOUTH, IN  
CLASS 43 (U.S. CLS. 100 AND 101).

FIRST USE 4-0-2004; IN COMMERCE 4-0-2004.

FOR: PSYCHOLOGICAL COUNSELING, IN  
CLASS 44 (U.S. CLS. 100 AND 101).

FIRST USE 4-0-2004; IN COMMERCE 4-0-2004.

NO CLAIM IS MADE TO THE EXCLUSIVE  
RIGHT TO USE "KIDS", APART FROM THE MARK  
AS SHOWN.

THE MARK CONSISTS OF THE WORDS "CHRIS  
KIDS" WITH AN IMAGE OF A HOUSE AND STICK-  
FIGURE CHILDREN.

SER. NO. 77-399,296, FILED 2-18-2008.

ALICE SUE CARRUTHERS, EXAMINING ATTOR-  
NEY

**Int. Cl.: 36**

**Prior U.S. Cls.: 100, 101 and 102**

**United States Patent and Trademark Office**

**Reg. No. 3,504,741**

**Registered Sep. 23, 2008**

**SERVICE MARK  
PRINCIPAL REGISTER**

**EZLYNX**

WEBCETERA, L.P. (TEXAS LIMITED PARTNER-  
SHIP)  
601 SILVERON BLVD., STE. 170  
FLOWER MOUND, TX 75028

FOR: ONLINE INSURANCE-RELATED SERVI-  
CES, NAMELY, PROVIDING A WEB-BASED POR-  
TAL TO PROVIDE INSURANCE AGENTS AND  
BROKERS QUOTE INFORMATION, IN CLASS 36  
(U.S. CLS. 100, 101 AND 102).

FIRST USE 3-1-2003; IN COMMERCE 6-1-2003.

THE MARK CONSISTS OF STANDARD CHAR-  
ACTERS WITHOUT CLAIM TO ANY PARTICULAR  
FONT, STYLE, SIZE, OR COLOR.

SER. NO. 77-399,328, FILED 2-18-2008.

DAVID ELTON, EXAMINING ATTORNEY

**Int. Cl.: 36**

**Prior U.S. Cls.: 100, 101 and 102**

**United States Patent and Trademark Office**

**Reg. No. 3,504,742**

**Registered Sep. 23, 2008**

**SERVICE MARK  
PRINCIPAL REGISTER**



WEBCETERA, L.P. (TEXAS LIMITED PARTNER-  
SHIP)  
601 SILVERON BLVD., STE. 170  
FLOWER MOUND, TX 75028

FOR: ONLINE INSURANCE-RELATED SERVI-  
CES, NAMELY, PROVIDING A WEB-BASED POR-  
TAL TO PROVIDE INSURANCE AGENTS AND  
BROKERS QUOTE INFORMATION, IN CLASS 36  
(U.S. CLS. 100, 101 AND 102).

FIRST USE 3-1-2003; IN COMMERCE 6-1-2003.

THE MARK CONSISTS OF THE WORDS  
"EZLYNX" ABOVE A SHADOWED SPHERE. INSIDE  
THE SPHERE IS A SPRINTING TIGER.

SER. NO. 77-399,337, FILED 2-18-2008.

DAVID ELTON, EXAMINING ATTORNEY

Int. Cl.: 41

Prior U.S. Cls.: 100, 101 and 107

United States Patent and Trademark Office

Reg. No. 3,504,743

Registered Sep. 23, 2008

SERVICE MARK  
PRINCIPAL REGISTER



UNIVERSITY OF BRIDGEPORT (CONNECTICUT CORPORATION)  
126 PARK AVENUE  
BRIDGEPORT, CT 06604

FOR: EDUCATIONAL SERVICES, NAMELY, PROVIDING COURSES OF INSTRUCTION AT THE UNIVERSITY LEVEL AND DISTRIBUTION OF COURSE MATERIAL IN CONNECTION THEREWITH, IN CLASS 41 (U.S. CLS. 100, 101 AND 107).

FIRST USE 1-1-1983; IN COMMERCE 1-1-1983.

NO CLAIM IS MADE TO THE EXCLUSIVE RIGHT TO USE "MCMXXVII", APART FROM THE MARK AS SHOWN.

THE COLOR(S) VIOLET IS/ARE CLAIMED AS A FEATURE OF THE MARK.

THE MARK CONSISTS OF DEPICTIONS OF A TORCH, A TREE, A BIRD FLYING ABOVE WAVES, AND A BUILDING WITH TWO ARCHES SURROUNDED BY "UNIVERSITY OF BRIDGEPORT" AND THE ROMAN NUMERALS "MCMXXVII" ALL IN THE COLOR VIOLET.

SEC. 2(F) AS TO "UNIVERSITY OF BRIDGEPORT".

SER. NO. 77-399,363, FILED 2-18-2008.

KAREN K. BUSH, EXAMINING ATTORNEY



**Int. Cls.: 3, 11 and 15**

**Prior U.S. Cls.: 1, 2, 4, 6, 13, 21, 23, 31, 34, 36, 50, 51  
and 52**

**Reg. No. 3,504,744**

**United States Patent and Trademark Office**

**Registered Sep. 23, 2008**

**TRADEMARK  
PRINCIPAL REGISTER**



KYSER MUSICAL PRODUCTS, INC. (TEXAS CORPORATION)  
15353 COUNTY ROAD 109  
KAUFMAN, TX 75142

FIRST USE 12-1-2004; IN COMMERCE 12-1-2004.

FOR: TREATMENT LIQUIDS FOR STRINGED INSTRUMENTS, NAMELY, INSTRUMENT POLISH AND STRING CLEANER, IN CLASS 3 (U.S. CLS. 1, 4, 6, 50, 51 AND 52).

OWNER OF U.S. REG. NOS. 1,674,175 AND 1,768,363.

THE COLOR(S) RED, WHITE AND BLACK IS/ARE CLAIMED AS A FEATURE OF THE MARK.

FIRST USE 2-23-2005; IN COMMERCE 2-23-2005.

FOR: HUMIDIFIERS FOR MUSICAL INSTRUMENTS, IN CLASS 11 (U.S. CLS. 13, 21, 23, 31 AND 34).

THE MARK CONSISTS OF A RED OVAL BACKGROUND. THE BACKGROUND DISPLAYS THE WORD "KYSER" IN WHITE LETTERS HAVING A BLACK BORDER. BELOW THE WORD "KYSER" IS A CHRISTIAN CROSS AND THE WORD "KLASSICS" IN A FONT SMALLER THAN "KYSER". THE CROSS AND "KLASSICS" ARE IN WHITE LETTERS HAVING A BLACK BORDER.

FIRST USE 9-14-2005; IN COMMERCE 9-14-2005.

FOR: MUSICAL ACCESSORIES, NAMELY, GUITAR CAPOS, BANJO CAPOS, MANDOLIN CAPOS, AND FINGER PICKS FOR USE WITH STRINGED INSTRUMENTS, IN CLASS 15 (U.S. CLS. 2, 21 AND 36).

SER. NO. 77-399,375, FILED 2-18-2008.

ANDREA BUTLER, EXAMINING ATTORNEY

**Int. Cl.: 41**

**Prior U.S. Cls.: 100, 101 and 107**

**United States Patent and Trademark Office**

**Reg. No. 3,504,745**

**Registered Sep. 23, 2008**

**SERVICE MARK  
PRINCIPAL REGISTER**

# Lightsmith

LAFONTAINE, CHRIS A. (UNITED STATES INDIVIDUAL)  
559 HUMBOLDT AVENUE  
SAINT PAUL, MN 55107 AND  
MAYAMA, MICHELE A. (UNITED STATES INDIVIDUAL)  
559 HUMBOLDT AVENUE  
SAINT PAUL, MN 55107

FOR: EDUCATIONAL SERVICES, NAMELY, CONDUCTING CLASSES, SEMINARS, CONFERENCES AND WORKSHOPS IN THE FIELD OF METAPHYSICS AND DISTRIBUTION OF CREATED MATERIALS VIA VIDEO, AUDIO, DIGITAL, AND/

OR PRINT IN CONNECTION THEREWITH, IN CLASS 41 (U.S. CLS. 100, 101 AND 107).

FIRST USE 3-1-1994; IN COMMERCE 3-1-1994.

THE MARK CONSISTS OF STANDARD CHARACTERS WITHOUT CLAIM TO ANY PARTICULAR FONT, STYLE, SIZE, OR COLOR.

SER. NO. 77-399,377, FILED 2-18-2008.

ANDREA BUTLER, EXAMINING ATTORNEY

**Int. Cl.: 3**

**Prior U.S. Cls.: 1, 4, 6, 50, 51 and 52**

**United States Patent and Trademark Office**

**Reg. No. 3,504,746**

**Registered Sep. 23, 2008**

**TRADEMARK  
PRINCIPAL REGISTER**

**BEACH COTTAGE SOAPS**

PACKARD, GWYNETH (UNITED STATES INDIVIDUAL)  
P.O. BOX 366  
CATAUMET, MA 02534

FOR: BAR SOAP; HAND SOAPS; SOAPS FOR BODY CARE; SOAPS FOR PERSONAL USE, IN CLASS 3 (U.S. CLS. 1, 4, 6, 50, 51 AND 52).

FIRST USE 7-0-2004; IN COMMERCE 7-0-2004.

THE MARK CONSISTS OF STANDARD CHARACTERS WITHOUT CLAIM TO ANY PARTICULAR FONT, STYLE, SIZE, OR COLOR.

NO CLAIM IS MADE TO THE EXCLUSIVE RIGHT TO USE "SOAPS", APART FROM THE MARK AS SHOWN.

SER. NO. 77-399,388, FILED 2-18-2008.

MIDGE BUTLER, EXAMINING ATTORNEY

**Int. Cls.: 25 and 35**

**Prior U.S. Cls.: 22, 39, 100, 101 and 102**

**United States Patent and Trademark Office**

**Reg. No. 3,504,747**

**Registered Sep. 23, 2008**

**TRADEMARK  
SERVICE MARK  
PRINCIPAL REGISTER**



EVLOVE INTIMATES, INC. (ILLINOIS CORPORATION)  
1805 S. FAIRVIEW AVENUE  
PARK RIDGE, IL 60068

FOR: WOMEN'S CLOTHING, NAMELY, LINGERIE, FOUNDATION GARMENTS, UNDERGARMENTS, SLEEPWEAR AND LOUNGEWEAR, IN CLASS 25 (U.S. CLS. 22 AND 39).

FIRST USE 11-25-2006; IN COMMERCE 11-25-2006.

FOR: RETAIL SERVICES FEATURING WOMEN'S CLOTHING, RETAIL SHOP-AT-HOME PARTY SERVICES AND ON-LINE ORDERING SERVICES, ALL FEATURING WOMEN'S CLOTHING AND ALLOWING CUSTOMER CUSTOMIZATION OF THE

CLOTHING, NAMELY, LINGERIE, FOUNDATION GARMENTS, UNDERGARMENTS, SLEEPWEAR AND LOUNGEWEAR, IN CLASS 35 (U.S. CLS. 100, 101 AND 102).

FIRST USE 10-27-2006; IN COMMERCE 11-25-2006.

OWNER OF U.S. REG. NO. 3,406,004.

THE MARK CONSISTS OF A SILHOUETTE OF A WOMAN WITH SHADING WITHIN THE OUTLINE.

SER. NO. 77-399,392, FILED 2-18-2008.

ELLEN BURNS, EXAMINING ATTORNEY

**Int. Cl.: 41**

**Prior U.S. Cls.: 100, 101 and 107**

**United States Patent and Trademark Office**

**Reg. No. 3,504,748**

**Registered Sep. 23, 2008**

**SERVICE MARK  
PRINCIPAL REGISTER**

**ideaHunter**

INNOVA TRAINING & CONSULTING, INC.  
(IOWA CORPORATION)  
2570 106TH ST. SUITE A  
DES MOINES, IA 50322

THE MARK CONSISTS OF STANDARD CHAR-  
ACTERS WITHOUT CLAIM TO ANY PARTICULAR  
FONT, STYLE, SIZE, OR COLOR.

FOR: CONDUCTING WORKSHOPS AND SEMI-  
NARS IN INNOVATIVE THINKING METHODS, IN  
CLASS 41 (U.S. CLS. 100, 101 AND 107).

SER. NO. 77-399,395, FILED 2-18-2008.

FIRST USE 1-1-2008; IN COMMERCE 1-1-2008.

ELLEN BURNS, EXAMINING ATTORNEY

**Int. Cl.: 30**

**Prior U.S. Cl.: 46**

**United States Patent and Trademark Office**

**Reg. No. 3,504,749**

**Registered Sep. 23, 2008**

**TRADEMARK  
PRINCIPAL REGISTER**



HILL, ALISON A. P. (UNITED STATES INDIVIDUAL)  
5671 340TH STREET  
CYLINDER, IA 50528

FOR: BREAD DOUGHS; BISCUITS AND BREAD; BREAD; BREAD AND BUNS; BREAD AND PASTRY; BREAD ROLLS, IN CLASS 30 (U.S. CL. 46).

FIRST USE 11-1-2007; IN COMMERCE 11-1-2007.

NO CLAIM IS MADE TO THE EXCLUSIVE RIGHT TO USE "GOLDEN GROUND INC.", APART FROM THE MARK AS SHOWN.

THE MARK CONSISTS OF STYLIZED WORDS "GOLDEN GROUND", A HEAD OF WHEAT, AND A PAINT BRUSHED CURVE.

SER. NO. 77-399,405, FILED 2-18-2008.

H. M. FISHER, EXAMINING ATTORNEY

**Int. Cl.: 25**

**Prior U.S. Cls.: 22 and 39**

**United States Patent and Trademark Office**

**Reg. No. 3,504,750**

**Registered Sep. 23, 2008**

**TRADEMARK  
PRINCIPAL REGISTER**

**KIMONO KOOL**

WELLNET USA, INC. (OREGON CORPORATION)  
3003 SW 153RD DRIVE, SUITE 209  
BEAVERTON, OR 97006

THE MARK CONSISTS OF STANDARD CHARACTERS WITHOUT CLAIM TO ANY PARTICULAR FONT, STYLE, SIZE, OR COLOR.

FOR: HEADWEAR; BELTS; TIES; STRAPS FOR BRAS, IN CLASS 25 (U.S. CLS. 22 AND 39).

SER. NO. 77-399,418, FILED 2-18-2008.

FIRST USE 10-31-2007; IN COMMERCE 1-31-2008.

LINDA POWELL, EXAMINING ATTORNEY

**Int. Cl.: 43**

**Prior U.S. Cls.: 100 and 101**

**United States Patent and Trademark Office**

**Reg. No. 3,504,751**

**Registered Sep. 23, 2008**

---

**SERVICE MARK  
PRINCIPAL REGISTER**

**NATURES EXPRESS**

MITCH WALLIS (UNITED STATES INDIVIDUAL)

1317 EL ALAMEDA

PALM SPRINGS, CA 92262

FOR: CAFE AND RESTAURANT SERVICES, IN CLASS 43 (U.S. CLS. 100 AND 101).

FIRST USE 8-15-2007; IN COMMERCE 8-15-2007.

THE MARK CONSISTS OF STANDARD CHARACTERS WITHOUT CLAIM TO ANY PARTICULAR FONT, STYLE, SIZE, OR COLOR.

NO CLAIM IS MADE TO THE EXCLUSIVE RIGHT TO USE "EXPRESS", APART FROM THE MARK AS SHOWN.

SER. NO. 77-399,419, FILED 2-18-2008.

LINDA POWELL, EXAMINING ATTORNEY



**Int. Cls.: 36, 43 and 44**

**Prior U.S. Cls.: 100, 101 and 102**

**United States Patent and Trademark Office**

**Reg. No. 3,504,752**

**Registered Sep. 23, 2008**

**SERVICE MARK  
PRINCIPAL REGISTER**

**CHRIS KIDS**

CHRIS KIDS, INC. (GEORGIA NON-PROFIT CORPORATION)  
3109 CLAIRMONT ROAD, N.E., SUITE B  
ATLANTA, GA 30329

FOR: CHARITABLE FUNDRAISING SERVICES,  
IN CLASS 36 (U.S. CLS. 100, 101 AND 102).

FIRST USE 4-0-2004; IN COMMERCE 4-0-2004.

FOR: CHILD WELFARE SERVICES, NAMELY,  
PROVIDING RESIDENTIAL HOMES AND HOUSING FOR AT-RISK CHILDREN AND YOUTH, IN CLASS 43 (U.S. CLS. 100 AND 101).

FIRST USE 4-0-2004; IN COMMERCE 4-0-2004.

FOR: PSYCHOLOGICAL COUNSELING, IN CLASS 44 (U.S. CLS. 100 AND 101).

FIRST USE 4-0-2004; IN COMMERCE 4-0-2004.

THE MARK CONSISTS OF STANDARD CHARACTERS WITHOUT CLAIM TO ANY PARTICULAR FONT, STYLE, SIZE, OR COLOR.

NO CLAIM IS MADE TO THE EXCLUSIVE RIGHT TO USE "KIDS", APART FROM THE MARK AS SHOWN.

SER. NO. 77-399,429, FILED 2-18-2008.

ALICE SUE CARRUTHERS, EXAMINING ATTORNEY

**Int. Cl.: 6**

**Prior U.S. Cls.: 2, 12, 13, 14, 23, 25 and 50**

**Reg. No. 3,504,753**

**United States Patent and Trademark Office**

**Registered Sep. 23, 2008**

---

**TRADEMARK  
PRINCIPAL REGISTER**

**S240**

ATI PROPERTIES, INC. (DELAWARE CORPORATION)  
1600 N.E. OLD SALEM ROAD  
ALBANY, OR 97321

THE MARK CONSISTS OF STANDARD CHARACTERS WITHOUT CLAIM TO ANY PARTICULAR FONT, STYLE, SIZE, OR COLOR.

FOR: STAINLESS STEEL IN MILL PRODUCT FORMS OF BILLET, PLATE, SHEET, STRIP, AND BAR, IN CLASS 6 (U.S. CLS. 2, 12, 13, 14, 23, 25 AND 50).

SER. NO. 77-399,430, FILED 2-18-2008.

FIRST USE 7-6-2006; IN COMMERCE 7-6-2006.

ROBIN CHOSID, EXAMINING ATTORNEY

**Int. Cl.: 5**

**Prior U.S. Cls.: 6, 18, 44, 46, 51 and 52**

**United States Patent and Trademark Office**

**Reg. No. 3,504,754**

**Registered Sep. 23, 2008**

**TRADEMARK  
PRINCIPAL REGISTER**

**ALLERDERM EFAVITE**

VIRBAC CORPORATION (DELAWARE CORPORATION)  
3200 MEACHAM BLVD.  
FORT WORTH, TX 76137

FOR: VETERINARY DIETARY AND MINERAL SUPPLEMENTS FOR DOGS AND CATS, IN CLASS 5 (U.S. CLS. 6, 18, 44, 46, 51 AND 52).

FIRST USE 6-30-1994; IN COMMERCE 6-30-1994.

THE MARK CONSISTS OF STANDARD CHARACTERS WITHOUT CLAIM TO ANY PARTICULAR FONT, STYLE, SIZE, OR COLOR.

OWNER OF U.S. REG. NOS. 1,209,484, 2,485,615 AND OTHERS.

SER. NO. 77-399,448, FILED 2-18-2008.

MICHELE SWAIN, EXAMINING ATTORNEY

**Int. Cl.: 43**

**Prior U.S. Cls.: 100 and 101**

**United States Patent and Trademark Office**

**Reg. No. 3,504,755**

**Registered Sep. 23, 2008**

**SERVICE MARK  
PRINCIPAL REGISTER**

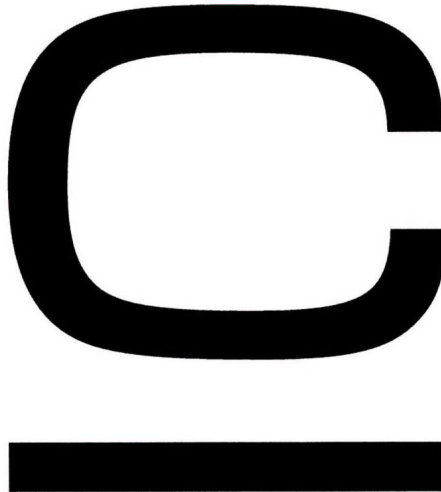

THE CHOCOLATE BAR, LLC (NEVADA LIMITED LIABILITY COMPANY)  
475 S. ARLINGTON AVENUE  
RENO, NV 89501

THE MARK CONSISTS OF THE LETTER "C" WITH A BAR BENEATH IT.

FOR: RESTAURANT AND BAR SERVICES, IN CLASS 43 (U.S. CLS. 100 AND 101).

SER. NO. 77-399,449, FILED 2-18-2008.

FIRST USE 4-1-2006; IN COMMERCE 4-1-2006.

JASON ROTH, EXAMINING ATTORNEY

**Int. Cls.: 9, 35 and 42**

**Prior U.S. Cls.: 21, 23, 26, 36, 38, 100, 101 and 102**

**United States Patent and Trademark Office**

**Reg. No. 3,504,756**

**Registered Sep. 23, 2008**

**TRADEMARK  
SERVICE MARK  
PRINCIPAL REGISTER**



UNIVERSATA, INC. (DELAWARE CORPORATION), DBA UNIVERSATA  
EXECUTIVE OFFICES  
12800 MIDDLEBROOK RD., SUITE 400  
GERMANTOWN, MD 20874

FOR: COMPUTER SOFTWARE FOR CONTROLLING AND MANAGING PATIENT MEDICAL INFORMATION/RECORDS, IN CLASS 9 (U.S. CLS. 21, 23, 26, 36 AND 38).

FIRST USE 9-1-2000; IN COMMERCE 9-1-2003.

FOR: PROVIDING AN INTERNET-BASED DATABASE OF PATIENT MEDICAL INFORMATION DESIGNED TO FACILITATE PATIENT-AUTHORIZED, HIPAA-COMPLIANT SHARING AND MAINTENANCE OF PATIENT MEDICAL INFORMATION AMONGST A PATIENT'S DOCTORS SUCH THAT THIS INFORMATION CAN BE DIRECTLY INSERTED INTO THE DOCTOR'S MEDICAL REPORTS AS A MEANS OF INCREASING MEDICAL RECORD GENERATION EFFICIENCY AND ACCURACY, IN CLASS 35 (U.S. CLS. 100, 101 AND 102).

FIRST USE 9-1-2000; IN COMMERCE 9-1-2003.

FOR: COMPUTER SERVICE, NAMELY, ACTING AS AN APPLICATION SERVICE PROVIDER IN THE FIELD OF KNOWLEDGE MANAGEMENT TO HOST COMPUTER APPLICATION SOFTWARE

FOR SEARCHING AND RETRIEVING INFORMATION FROM DATABASES AND COMPUTER NETWORKS; PROVIDING A WEBSITE FOR USE BY PHYSICIANS TO GENERATE, MANAGE AND EXCHANGE MEDICAL INFORMATION AND DOCUMENTS REGARDLESS OF MEDICAL ORGANIZATION OR GEOGRAPHIC LOCATION, IN CLASS 42 (U.S. CLS. 100 AND 101).

FIRST USE 9-1-2000; IN COMMERCE 9-1-2003.

THE COLOR(S) THE COLOR(S) BLACK, NAVY BLUE AND ORANGE IS/ARE CLAIMED AS A FEATURE OF THE MARK. IS/ARE CLAIMED AS A FEATURE OF THE MARK.

THE MARK CONSISTS OF THE MARK CONSISTS OF "UNIVERSATA" IN BLACK CENTURY GOTHIC FONT. ABOVE THE LETTER "E" THERE ARE TWO INTERSECTING ELLIPTICAL SHAPES; THE LEFT ONE IS NAVY BLUE, AND THE RIGHT ONE IS ORANGE.

THE FOREIGN WORDING IN THE MARK TRANSLATES INTO ENGLISH AS UNIVERSAL.

SER. NO. 77-399,459, FILED 2-18-2008.

ANNE MADDEN, EXAMINING ATTORNEY

**Int. Cl.: 9**

**Prior U.S. Cls.: 21, 23, 26, 36 and 38**

**Reg. No. 3,504,757**

**United States Patent and Trademark Office**

**Registered Sep. 23, 2008**

**TRADEMARK  
PRINCIPAL REGISTER**

**MAGNASTROYER**

APPLIED MAGNETICS LABORATORY, INC.  
(MARYLAND CORPORATION)  
1404 BARE HILLS ROAD  
BALTIMORE, MD 21209

THE MARK CONSISTS OF STANDARD CHAR-  
ACTERS WITHOUT CLAIM TO ANY PARTICULAR  
FONT, STYLE, SIZE, OR COLOR.

FOR: MAGNETIC TAPE ERASERS AND MAG-  
NETIC DATA ERASERS, IN CLASS 9 (U.S. CLS. 21,  
23, 26, 36 AND 38).

SER. NO. 77-399,460, FILED 2-18-2008.

FIRST USE 4-12-2006; IN COMMERCE 4-12-2006.

ANNE MADDEN, EXAMINING ATTORNEY

**Int. Cl.: 9**

**Prior U.S. Cls.: 21, 23, 26, 36 and 38**

**United States Patent and Trademark Office**

**Reg. No. 3,504,758**

**Registered Sep. 23, 2008**

**TRADEMARK  
PRINCIPAL REGISTER**

**BORS**

BARRETT FIREARMS MFG., INC. (TENNESSEE  
CORPORATION)  
PO BOX 1077  
MURFREESBORO, TN 37133

THE MARK CONSISTS OF STANDARD CHAR-  
ACTERS WITHOUT CLAIM TO ANY PARTICULAR  
FONT, STYLE, SIZE, OR COLOR.

FOR: BALLISTIC COMPUTER FOR CONNEC-  
TION TO A RIFLESCOPE, IN CLASS 9 (U.S. CLS.  
21, 23, 26, 36 AND 38).

SER. NO. 77-399,471, FILED 2-18-2008.

FIRST USE 5-0-2007; IN COMMERCE 5-0-2007.

MICHELE SWAIN, EXAMINING ATTORNEY

**Int. Cl.: 3**

**Prior U.S. Cls.: 1, 4, 6, 50, 51 and 52**

**United States Patent and Trademark Office**

**Reg. No. 3,504,759**

**Registered Sep. 23, 2008**

**TRADEMARK  
PRINCIPAL REGISTER**

**GLISTEN**

IRON OUT, INC. (INDIANA CORPORATION)  
1515 DIVIDEND ROAD  
FORT WAYNE, IN 46808

FOR: CLEANING COMPOSITION FOR DISH-  
WASHERS, IN CLASS 3 (U.S. CLS. 1, 4, 6, 50, 51  
AND 52).

FIRST USE 9-0-1987; IN COMMERCE 9-0-1987.

THE MARK CONSISTS OF STANDARD CHAR-  
ACTERS WITHOUT CLAIM TO ANY PARTICULAR  
FONT, STYLE, SIZE, OR COLOR.

OWNER OF U.S. REG. NO. 1,592,671.

SER. NO. 77-399,485, FILED 2-18-2008.

MICHELE SWAIN, EXAMINING ATTORNEY



**Int. Cl.: 9**

**Prior U.S. Cls.: 21, 23, 26, 36 and 38**

**United States Patent and Trademark Office**

**Reg. No. 3,504,760**

**Registered Sep. 23, 2008**

**TRADEMARK  
PRINCIPAL REGISTER**

**HUSHABYE BABY**

CMH RECORDS, INC. (CALIFORNIA CORPORATION)  
P.O. BOX 39439  
LOS ANGELES, CA 90039

THE MARK CONSISTS OF STANDARD CHARACTERS WITHOUT CLAIM TO ANY PARTICULAR FONT, STYLE, SIZE, OR COLOR.

FOR: MUSICAL SOUND RECORDINGS, IN CLASS 9 (U.S. CLS. 21, 23, 26, 36 AND 38).

SER. NO. 77-399,499, FILED 2-18-2008.

FIRST USE 2-14-2008; IN COMMERCE 2-14-2008.

ROBIN CHOSID, EXAMINING ATTORNEY

**Int. Cl.: 41**

**Prior U.S. Cls.: 100, 101 and 107**

**United States Patent and Trademark Office**

**Reg. No. 3,504,761**

**Registered Sep. 23, 2008**

**SERVICE MARK  
PRINCIPAL REGISTER**

**AZVA**

PORTABLE PRACTICAL EDUCATIONAL PREPARATIONS, INC. (ARIZONA CORPORATION)  
802 E. 46TH STREET  
TUCSON, AZ 85713

FOR: EDUCATIONAL SERVICES, NAMELY, PROVIDING INTERNET AND PRINT-BASED COURSES OF INSTRUCTION AT THE K-12 LEVEL; ARRANGING AND CONDUCTING SOCIAL AND EDUCATIONAL FIELD TRIPS, IN CLASS 41 (U.S. CLS. 100, 101 AND 107).

FIRST USE 12-31-2003; IN COMMERCE 12-31-2003.

THE MARK CONSISTS OF STANDARD CHARACTERS WITHOUT CLAIM TO ANY PARTICULAR FONT, STYLE, SIZE, OR COLOR.

SER. NO. 77-399,508, FILED 2-18-2008.

JILL C. ALT, EXAMINING ATTORNEY

**Int. Cl.: 42**

**Prior U.S. Cls.: 100 and 101**

**United States Patent and Trademark Office**

**Reg. No. 3,504,762**

**Registered Sep. 23, 2008**

**SERVICE MARK  
PRINCIPAL REGISTER**

**NATIONAL SURVEY &  
ENGINEERING**

R.A. SMITH NATIONAL, INC. (WISCONSIN CORPORATION)  
16745 WEST BLUEMOUND ROAD  
BROOKFIELD, WI 53005

FOR: LAND SURVEYING; ENGINEERING; CIVIL ENGINEERING; LANDSCAPE ARCHITECTURAL DESIGN; COMPUTER SERVICES, NAMELY, CREATING 3-D VISUALIZATIONS, NAMELY, CREATING 3-D RENDERINGS, ANIMATIONS, AND VIRTUAL TOURS OF ARCHITECTURAL AND LANDSCAPE DESIGNS, IN CLASS 42 (U.S. CLS. 100 AND 101).

FIRST USE 10-31-1976; IN COMMERCE 10-31-1976.

THE MARK CONSISTS OF STANDARD CHARACTERS WITHOUT CLAIM TO ANY PARTICULAR FONT, STYLE, SIZE, OR COLOR.

NO CLAIM IS MADE TO THE EXCLUSIVE RIGHT TO USE "SURVEY & ENGINEERING", APART FROM THE MARK AS SHOWN.

SEC. 2(F) AS TO NATIONAL.

SER. NO. 77-399,509, FILED 2-18-2008.

JILL C. ALT, EXAMINING ATTORNEY

**Int. Cl.: 41**

**Prior U.S. Cls.: 100, 101 and 107**

**United States Patent and Trademark Office**

**Reg. No. 3,504,763**

**Registered Sep. 23, 2008**

**SERVICE MARK  
PRINCIPAL REGISTER**

The logo for "Rock n Tot" is written in a stylized, red, cursive font. The letters are outlined in black. The word "Rock" is on the left, "n" is in the middle, and "Tot" is on the right. Two black stars are positioned between "Rock" and "n", and between "n" and "Tot". The entire logo is arched upwards.

ROCK-N-TOT (OHIO LIMITED LIABILITY COMPANY)  
17767 BRITTANY WOODS DRIVE  
CHAGRIN FALLS, OH 44023

FOR: ENTERTAINMENT SERVICES, NAMELY,  
CONDUCTING PARTIES, IN CLASS 41 (U.S. CLS.  
100, 101 AND 107).

FIRST USE 12-1-2007; IN COMMERCE 12-1-2007.

THE COLOR(S) RED AND BLACK IS/ARE  
CLAIMED AS A FEATURE OF THE MARK.

THE MARK CONSISTS OF RED LETTERS OUT-  
LINED IN BLACK SPELLING "ROCK N TOT",  
BLACK STARS OUTLINED IN RED, IN A CURVED  
OR STRAIGHT LINE.

SER. NO. 77-399,516, FILED 2-18-2008.

ALLISON HOLTZ, EXAMINING ATTORNEY

**Int. Cl.: 3**

**Prior U.S. Cls.: 1, 4, 6, 50, 51 and 52**

**United States Patent and Trademark Office**

**Reg. No. 3,504,764**

**Registered Sep. 23, 2008**

**TRADEMARK  
PRINCIPAL REGISTER**

**Naked by Nature**

MCCAFFERTY, LARA (UNITED STATES INDIVIDUAL)  
505 E. COLUMBIA STREET, SUITE 120  
COLORADO SPRINGS, CO 80907

FOR: AROMATHERAPY BODY CARE PRODUCTS, NAMELY, BODY LOTION, SHOWER GEL, CUTICLE CREAM, SHAMPOO, CONDITIONER, NON-MEDICATED LIP BALM, SOAP, BODY POLISH, BODY AND FOOT SCRUB AND NON-MEDICATED FOOT CREAM, IN CLASS 3 (U.S. CLS. 1, 4, 6, 50, 51 AND 52).

FIRST USE 8-1-2007; IN COMMERCE 8-1-2007.

THE MARK CONSISTS OF STANDARD CHARACTERS WITHOUT CLAIM TO ANY PARTICULAR FONT, STYLE, SIZE, OR COLOR.

SER. NO. 77-399,538, FILED 2-18-2008.

LINDA M. KING, EXAMINING ATTORNEY

**Int. Cl.: 37**

**Prior U.S. Cls.: 100, 103 and 106**

**United States Patent and Trademark Office**

**Reg. No. 3,504,765**

**Registered Sep. 23, 2008**

**SERVICE MARK  
PRINCIPAL REGISTER**

**Help is 6 mouse clicks  
away!**

TECHNOCHILL INC. (NEW YORK CORPORATION)  
43 EAST 18TH STREET  
HUNTINGTON STATION, NY 11746

THE MARK CONSISTS OF STANDARD CHARACTERS WITHOUT CLAIM TO ANY PARTICULAR FONT, STYLE, SIZE, OR COLOR.

FOR: REPAIR OR MAINTENANCE OF COMPUTERS, IN CLASS 37 (U.S. CLS. 100, 103 AND 106).

SER. NO. 77-399,544, FILED 2-18-2008.

FIRST USE 1-30-2008; IN COMMERCE 1-30-2008.

JENNY PARK, EXAMINING ATTORNEY

Int. Cl.: 35

Prior U.S. Cls.: 100, 101 and 102

United States Patent and Trademark Office

Reg. No. 3,504,766

Registered Sep. 23, 2008

SERVICE MARK  
PRINCIPAL REGISTER



NATURAL PROVISIONS, INC. (VERMONT CORPORATION)  
537 RAILROAD STREET  
ST. JOHNSBURY, VT 05819

FOR: MAIL ORDER SERVICES FEATURING PRE-MADE AND CUSTOMIZED GIFT BASKETS; ON-LINE RETAIL STORE SERVICES FEATURING BEER, CLEANING PREPARATIONS, DAIRY PRODUCTS, DRY GOODS, FISH, GIFTS, GROCERIES, HEALTH AND BEAUTY PRODUCTS, KITCHEN WARES, MEATS, NUTRITION, ORGANIC PRODUCTS, PAPER PRODUCTS, PET PRODUCTS, POULTRY, PRODUCE, VITAMINS, AND WINE; RETAIL STORES FEATURING BEER, CLEANING PREPARATIONS, DAIRY PRODUCTS, DRY GOODS, FISH, GIFTS, GROCERIES, HEALTH AND BEAUTY PRODUCTS, KITCHEN WARES, MEATS, NUTRITION, ORGANIC PRODUCTS, PAPER PRODUCTS, PET PRODUCTS, POULTRY, PRODUCE, VITAMINS, AND WINE, IN CLASS 35 (U.S. CLS. 100, 101 AND 102).

FIRST USE 11-1-2006; IN COMMERCE 11-1-2006.

NO CLAIM IS MADE TO THE EXCLUSIVE RIGHT TO USE "MARKET", "ORGANIC FOODS", "FRESH PRODUCE" OR "DELI", APART FROM THE MARK AS SHOWN.

THE MARK CONSISTS OF THE WORD "NATURAL" APPEARING ABOVE THE WORD "PROVISIONS", WITH THE WORDS "ORGANIC FOODS" TO THE LEFT, "DELI" WITH DRAWING OF TOMATOES IN THE CENTER AND "FRESH PRODUCE" BELOW TO THE RIGHT ALL BELOW THE WORD "PROVISIONS", AND THE WORD "MARKET" APPEARING BELOW THE WORD "DELI" WITH DRAWING OF TOMATOES.

SEC. 2(F) AS TO "NATURAL PROVISIONS".

SER. NO. 77-399,554, FILED 2-18-2008.

KYLE PEETE, EXAMINING ATTORNEY

**Int. Cl.: 16**

**Prior U.S. Cls.: 2, 5, 22, 23, 29, 37, 38 and 50**

**United States Patent and Trademark Office**

**Reg. No. 3,504,767**

**Registered Sep. 23, 2008**

**TRADEMARK  
PRINCIPAL REGISTER**

**BELLA WEDDING INVITATIONS**

CARDSDIRECT, LLC (TEXAS LIMITED LIABILITY COMPANY)  
200 CHISOLM PLACE, SUITE 220  
PLANO, TX 75075

FOR: PAPER GOODS, NAMELY, CUSTOM PRINTED PAPER, STATIONERY, ENVELOPES, NOTE CARDS, INVITATIONS, IN CLASS 16 (U.S. CLS. 2, 5, 22, 23, 29, 37, 38 AND 50).

FIRST USE 4-1-2005; IN COMMERCE 5-19-2006.

THE MARK CONSISTS OF STANDARD CHARACTERS WITHOUT CLAIM TO ANY PARTICULAR FONT, STYLE, SIZE, OR COLOR.

NO CLAIM IS MADE TO THE EXCLUSIVE RIGHT TO USE "WEDDING INVITATIONS", APART FROM THE MARK AS SHOWN.

THE ENGLISH TRANSLATION OF THE WORD "BELLA" IN THE MARK IS "BEAUTIFUL".

SER. NO. 77-399,575, FILED 2-18-2008.

RICHARD WHITE, EXAMINING ATTORNEY



Int. Cl.: 35

Prior U.S. Cls.: 100, 101 and 102

United States Patent and Trademark Office

Reg. No. 3,504,768

Registered Sep. 23, 2008

**SERVICE MARK  
PRINCIPAL REGISTER**



TKE AUCTION SOLUTIONS (NEW YORK LIMITED LIABILITY COMPANY)  
APT. 713E  
1 VAN DER DONCK STREET  
YONKERS, NY 10701

FOR: ON-LINE CONSIGNMENT SERVICES WHEREBY GOODS ARE RECEIVED ON CONSIGNMENT FOR AUCTION ON AN ONLINE AUCTION SITE, IN CLASS 35 (U.S. CLS. 100, 101 AND 102).

FIRST USE 4-1-2007; IN COMMERCE 4-1-2007.

THE MARK CONSISTS OF THE "ORBITDROP" WITH NO SPACES. LOGO INCLUDES A TILTED LOOP BETWEEN THE WORDS "ORBIT" & "DROP" AND ALSO A LOOP TILING THE OPPOSITE DIRECTION BETWEEN THE WORDS "ORBIT" & "DROP".

SER. NO. 77-399,598, FILED 2-18-2008.

KEVON CHISOLM, EXAMINING ATTORNEY

**Int. Cl.: 21**

**Prior U.S. Cls.: 2, 13, 23, 29, 30, 33, 40 and 50**

**United States Patent and Trademark Office**

**Reg. No. 3,504,769**

**Registered Sep. 23, 2008**

**TRADEMARK  
PRINCIPAL REGISTER**

**GOLDBOOK PATTERN**

DENG, TIANKE (UNITED STATES INDIVIDUAL)

34 CAMPTOWN ROAD

IRVINGTON, NJ 07111

FOR: PLATES; BOWLS; DINNERWARE, IN CLASS 21 (U.S. CLS. 2, 13, 23, 29, 30, 33, 40 AND 50).

FIRST USE 5-1-2007; IN COMMERCE 7-1-2007.

THE MARK CONSISTS OF STANDARD CHARACTERS WITHOUT CLAIM TO ANY PARTICULAR FONT, STYLE, SIZE, OR COLOR.

NO CLAIM IS MADE TO THE EXCLUSIVE RIGHT TO USE "PATTERN", APART FROM THE MARK AS SHOWN.

SER. NO. 77-399,601, FILED 2-18-2008.

KEVON CHISOLM, EXAMINING ATTORNEY

**Int. Cl.: 43**

**Prior U.S. Cls.: 100 and 101**

**United States Patent and Trademark Office**

**Reg. No. 3,504,770**

**Registered Sep. 23, 2008**

**SERVICE MARK  
PRINCIPAL REGISTER**



BLUE SKY HOLDING'S, INC. (MASSACHUSETTS  
CORPORATION)  
8 ATWATER AVENUE  
MANCHESTER, MA 01944

FOR: CHILD CARE SERVICES, IN CLASS 43 (U.S.  
CLS. 100 AND 101).

FIRST USE 2-15-2005; IN COMMERCE 6-5-2005.

THE MARK CONSISTS OF THE WORD "GYMAZ-  
ING!" WITH A STYLIZED STAR APPEARING TO  
LAUNCH FROM THE TOP MIDDLE OF THE  
WORD.

SER. NO. 77-399,614, FILED 2-18-2008.

PETER B. BROMAGHIM, EXAMINING ATTORNEY

Int. Cl.: 37

Prior U.S. Cls.: 100, 103 and 106

United States Patent and Trademark Office

Reg. No. 3,504,771

Registered Sep. 23, 2008

SERVICE MARK  
PRINCIPAL REGISTER

**DoubleTake**  
*automotive*

PASQUARELLI, OLINDO (UNITED STATES IN-  
DIVIDUAL)

1885 PAINTERS RUN ROAD

PITTSBURGH, PA 15241

FOR: AUTOMOBILE DETAILING; VEHICLE DE-  
TAILING, IN CLASS 37 (U.S. CLS. 100, 103 AND 106).

FIRST USE 12-5-2007; IN COMMERCE 12-5-2007.

NO CLAIM IS MADE TO THE EXCLUSIVE  
RIGHT TO USE "AUTOMOTIVE", APART FROM  
THE MARK AS SHOWN.

THE MARK CONSISTS OF A SWOOSH-LIKE  
IMAGE ABOVE THE LETTERS "OUB" IN THE  
STYLIZED TEXT "DOUBLE TAKE AUTOMOTIVE".

SER. NO. 77-399,619, FILED 2-18-2008.

JAMES LOVELACE, EXAMINING ATTORNEY

**Int. Cl.: 44**

**Prior U.S. Cls.: 100 and 101**

**United States Patent and Trademark Office**

**Reg. No. 3,504,772**

**Registered Sep. 23, 2008**

**SERVICE MARK  
PRINCIPAL REGISTER**

**oliver ifergan atelier**

IFERGAN, OLIVER (MEXICO INDIVIDUAL)  
APT. 304  
1522 AMHERST AVENUE  
LOS ANGELES, CA 90025

FOR: BEAUTY SALONS; HAIR SALON SERVICES; HYGIENIC AND BEAUTY CARE, IN CLASS 44 (U.S. CLS. 100 AND 101).

FIRST USE 1-1-2008; IN COMMERCE 1-1-2008.

THE MARK CONSISTS OF STANDARD CHARACTERS WITHOUT CLAIM TO ANY PARTICULAR FONT, STYLE, SIZE, OR COLOR.

NO CLAIM IS MADE TO THE EXCLUSIVE RIGHT TO USE "ATELIER", APART FROM THE MARK AS SHOWN.

THE NAME "OLIVER IFERGAN" IDENTIFIES A LIVING INDIVIDUAL WHOSE CONSENT IS OF RECORD.

SER. NO. 77-399,636, FILED 2-18-2008.

KATHERINE CHANG, EXAMINING ATTORNEY

Int. Cl.: 37

Prior U.S. Cls.: 100, 103 and 106

United States Patent and Trademark Office

Reg. No. 3,504,773

Registered Sep. 23, 2008

**SERVICE MARK  
PRINCIPAL REGISTER**



OLDROYD, JAMIE (UNITED STATES INDIVIDUAL)  
94 MAIN STREET  
NORTHBOROUGH, MA 01532

FOR: HEATING EQUIPMENT INSTALLATION AND REPAIR; INSTALLATION, REPAIR AND MAINTENANCE OF HEATING EQUIPMENT; MAINTENANCE AND REPAIR OF HEATING INSTALLATIONS; PLUMBING; PLUMBING AND GAS AND WATER INSTALLATION; PLUMBING CONTRACTOR SERVICES; PLUMBING SERVICES, IN CLASS 37 (U.S. CLS. 100, 103 AND 106).

FIRST USE 4-1-2005; IN COMMERCE 4-1-2005.

NO CLAIM IS MADE TO THE EXCLUSIVE RIGHT TO USE "SERVICE" AND "PLUMBING & HEATING", APART FROM THE MARK AS SHOWN.

THE STIPLING IS FOR SHADING PURPOSES ONLY.

THE MARK CONSISTS OF A PIPE WRENCH ON TOP OF A FAUCET WITH A DRIP. THERE IS A LINE THERE AND UNDERNEATH IT SAYS "ASSURED SERVICE". UNDERNEATH THAT SAYS "PLUMBING & HEATING".

SER. NO. 77-399,643, FILED 2-18-2008.

JENNIFER MARTIN, EXAMINING ATTORNEY

**Int. Cl.: 37**

**Prior U.S. Cls.: 100, 103 and 106**

**United States Patent and Trademark Office**

**Reg. No. 3,504,774**

**Registered Sep. 23, 2008**

**SERVICE MARK  
PRINCIPAL REGISTER**

**WE'LL MAKE IT HOME  
TOGETHER.**

MOUNTAIN HOUSING OPPORTUNITIES, INC.  
(NORTH CAROLINA CORPORATION)  
SUITE 101  
64 CLINGMAN AVENUE  
ASHEVILLE, NC 28801

FOR: HOUSING SERVICES, NAMELY, REPAIR,  
IMPROVEMENT, AND CONSTRUCTION OF RESI-  
DENTIAL REAL PROPERTY, IN CLASS 37 (U.S. CLS.  
100, 103 AND 106).

FIRST USE 2-11-2006; IN COMMERCE 2-11-2006.

THE MARK CONSISTS OF STANDARD CHAR-  
ACTERS WITHOUT CLAIM TO ANY PARTICULAR  
FONT, STYLE, SIZE, OR COLOR.

SER. NO. 77-399,677, FILED 2-18-2008.

MELISSA VALLILLO, EXAMINING ATTORNEY

**Int. Cl.: 41**

**Prior U.S. Cls.: 100, 101 and 107**

**United States Patent and Trademark Office**

**Reg. No. 3,504,775**

**Registered Sep. 23, 2008**

**SERVICE MARK  
PRINCIPAL REGISTER**



UNITED INDOOR FOOTBALL ASSOCIATION  
(NEBRASKA NON-PROFIT CORPORATION)  
916 GRANDVIEW BLVD.  
SIOUX CITY, IA 51101

FOR: ENTERTAINMENT SERVICES IN THE  
NATURE OF ORGANIZING AND CONDUCTING  
INDOOR FOOTBALL COMPETITIONS AND EXHI-  
BITIONS, IN CLASS 41 (U.S. CLS. 100, 101 AND 107).

FIRST USE 2-14-2008; IN COMMERCE 2-14-2008.

OWNER OF U.S. REG. NOS. 3,281,732 AND  
3,415,606.

NO CLAIM IS MADE TO THE EXCLUSIVE  
RIGHT TO USE "INDOOR FOOTBALL", APART  
FROM THE MARK AS SHOWN.

THE COLOR(S) RED AND BLUE IS/ARE  
CLAIMED AS A FEATURE OF THE MARK.

THE MARK CONSISTS OF AN IMAGE OF A  
BLUE FOOTBALL BEHIND THE WORD "UIF",  
WHICH IS IN BLUE WITH A RED STAR DOTTING  
THE "I", AND THE WORDING "UNITED INDOOR  
FOOTBALL" IN RED.

SER. NO. 77-399,680, FILED 2-18-2008.

KEVIN DINALLO, EXAMINING ATTORNEY



Int. Cl.: 12

Prior U.S. Cls.: 19, 21, 23, 31, 35 and 44

Reg. No. 3,504,776

United States Patent and Trademark Office

Registered Sep. 23, 2008

TRADEMARK  
PRINCIPAL REGISTER

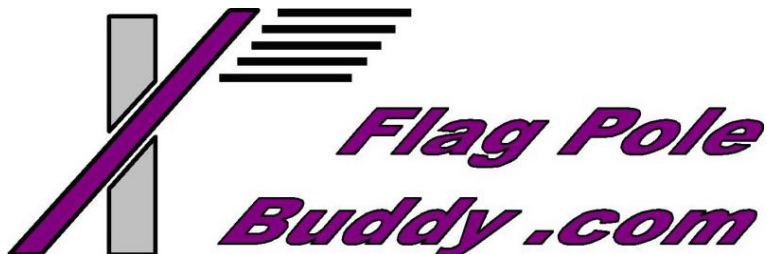

JAHNZ, DAVID B (UNITED STATES INDIVIDUAL)  
7777 FAY AVENUE, SUITE 205  
LA JOLLA, CA 92037

FOR: FLAGPOLE MOUNTS FOR VEHICLES, IN CLASS 12 (U.S. CLS. 19, 21, 23, 31, 35 AND 44).

FIRST USE 3-5-2004; IN COMMERCE 10-30-2005.

NO CLAIM IS MADE TO THE EXCLUSIVE RIGHT TO USE "FLAG POLE", APART FROM THE MARK AS SHOWN.

THE COLOR(S) BLACK, PURPLE AND GREY IS/ARE CLAIMED AS A FEATURE OF THE MARK.

THE MARK CONSISTS OF A STYLIZED IMAGE OF A FLAG AND POLE SECURED WHERE THE FLAGPOLE IS PURPLE BORDERED WITH BLACK; THE FLAG CONSISTS OF BLACK HORIZONTAL BARS; AND WHERE THE FLAGPOLE INTERSECTS A GREY VERTICAL BAR FEATURING A BLACK BORDER. THE WORDING "FLAG POLE BUDDY.COM" IS WRITTEN IN A STYLIZED FONT AND APPEARS IN THE COLOR PURPLE AND BORDERED IN BLACK.

SER. NO. 77-399,693, FILED 2-18-2008.

RICHARD WHITE, EXAMINING ATTORNEY

**Int. Cl.: 41**

**Prior U.S. Cls.: 100, 101 and 107**

**United States Patent and Trademark Office**

**Reg. No. 3,504,777**

**Registered Sep. 23, 2008**

**SERVICE MARK  
PRINCIPAL REGISTER**

**THE DEADBOLT**

BARCLAY STREET PRODUCTIONS, INC. (CANADA CORPORATION)  
309-1414 BARCLAY STREET  
VANCOUVER, CANADA V6G1J4

FOR: PROVIDING ENTERTAINMENT NEWS PROGRAMMING, REVIEWS AND INTERVIEWS FEATURING COVERAGE OF CELEBRITIES AND ENTERTAINMENT EVENTS BY MEANS OF ELECTRONIC COMMUNICATIONS NETWORKS, IN CLASS 41 (U.S. CLS. 100, 101 AND 107).

FIRST USE 12-31-2007; IN COMMERCE 12-31-2007.

THE MARK CONSISTS OF STANDARD CHARACTERS WITHOUT CLAIM TO ANY PARTICULAR FONT, STYLE, SIZE, OR COLOR.

SER. NO. 77-399,719, FILED 2-18-2008.

INGRID C. EULIN, EXAMINING ATTORNEY

**Int. Cl.: 29**

**Prior U.S. Cl.: 46**

**United States Patent and Trademark Office**

**Reg. No. 3,504,778**

**Registered Sep. 23, 2008**

**TRADEMARK  
PRINCIPAL REGISTER**



HAMMONS PRODUCTS COMPANY (MISSOURI CORPORATION)  
ATTN: BRIAN HAMMONS  
PO BOX 140, 105 HAMMONS DR  
STOCKTON, MO 65785

THE MARK CONSISTS OF A WALNUT TREE IN A CIRCLE ABOVE THE WORD "HAMMONS", WITH A HORIZONTAL LINE RUNNING ABOVE THE WORD AND BELOW BEHIND THE TREE.

FOR: NUTMEATS, NAMELY, WALNUTS, IN CLASS 29 (U.S. CL. 46).

SER. NO. 77-399,720, FILED 2-18-2008.

FIRST USE 9-30-1993; IN COMMERCE 9-30-1993.

INGRID C. EULIN, EXAMINING ATTORNEY

**Int. Cl.: 18**

**Prior U.S. Cls.: 1, 2, 3, 22 and 41**

**United States Patent and Trademark Office**

**Reg. No. 3,504,779**

**Registered Sep. 23, 2008**

**TRADEMARK  
PRINCIPAL REGISTER**

**GREEN EYED MONSTER**

GREEN EYED MONSTER (CALIFORNIA PART-  
NERSHIP)  
2352 PIERPONT BLVD.  
VENTURA, CA 93001

THE MARK CONSISTS OF STANDARD CHAR-  
ACTERS WITHOUT CLAIM TO ANY PARTICULAR  
FONT, STYLE, SIZE, OR COLOR.

FOR: TEXTILE SHOPPING BAGS, IN CLASS 18  
(U.S. CLS. 1, 2, 3, 22 AND 41).

SER. NO. 77-399,727, FILED 2-18-2008.

FIRST USE 1-15-2008; IN COMMERCE 1-15-2008.

ALICIA COLLINS, EXAMINING ATTORNEY

**Int. Cls.: 35 and 44**

**Prior U.S. Cls.: 100, 101 and 102**

**United States Patent and Trademark Office**

**Reg. No. 3,504,780**

**Registered Sep. 23, 2008**

**SERVICE MARK  
PRINCIPAL REGISTER**

**ENHANCED HEARING**

ENHANCED HEARING PROFESSIONALS, INC.  
(TEXAS CORPORATION)  
5957 DALLAS PARKWAY, SUITE 100  
PLANO, TX 75093

FOR: RETAIL STORE SERVICES FEATURING  
HEARING AIDS, ASSISTIVE LISTENING DEVICES,  
AND ACCESSORIES AND SUPPLIES THEREFOR,  
IN CLASS 35 (U.S. CLS. 100, 101 AND 102).

FIRST USE 10-21-1999; IN COMMERCE 10-21-1999.

FOR: HEARING AID SERVICES, IN CLASS 44  
(U.S. CLS. 100 AND 101).

FIRST USE 10-21-1999; IN COMMERCE 10-21-1999.

THE MARK CONSISTS OF STANDARD CHAR-  
ACTERS WITHOUT CLAIM TO ANY PARTICULAR  
FONT, STYLE, SIZE, OR COLOR.

OWNER OF U.S. REG. NO. 2,548,599.

SEC. 2(F).

SER. NO. 77-399,734, FILED 2-18-2008.

NANCY CLARKE, EXAMINING ATTORNEY

**Int. Cl.: 35**

**Prior U.S. Cls.: 100, 101 and 102**

**United States Patent and Trademark Office**

**Reg. No. 3,504,781**

**Registered Sep. 23, 2008**

**SERVICE MARK  
PRINCIPAL REGISTER**



CONSUMER BENEFIT SERVICES, INC. (ILLINOIS CORPORATION), DBA CBS DATA SERVICES  
1620 BOND STREET  
NAPERVILLE, IL 60563

FOR: PROVIDING LOYALTY, MARKETING, AND MEMBERSHIP PROGRAMS FOR COMMERCIAL, PROMOTIONAL, AND/OR ADVERTISING PURPOSES, IN CLASS 35 (U.S. CLS. 100, 101 AND 102).

FIRST USE 5-30-2002; IN COMMERCE 5-30-2002.

THE COLOR(S) YELLOW IS/ARE CLAIMED AS A FEATURE OF THE MARK.

THE MARK CONSISTS OF YELLOW APPEARING IN THE LETTERING "CBSI" AND THE LINE OF THE CIRCLE. WHITE IS NOT CLAIMED AS A FEATURE OF THE MARK AND APPEARS ONLY AS BACKGROUND.

SER. NO. 77-399,750, FILED S.R. 2-18-2008 AM. P.R. 2-18-2008.

REBECCA POVARCHUK, EXAMINING ATTORNEY

Int. Cl.: 18

Prior U.S. Cls.: 1, 2, 3, 22 and 41

United States Patent and Trademark Office

Reg. No. 3,504,782

Registered Sep. 23, 2008

TRADEMARK  
PRINCIPAL REGISTER

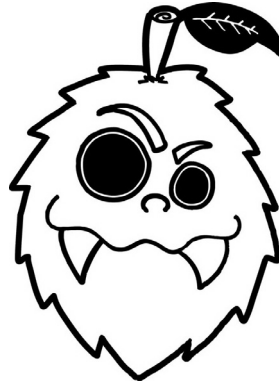

GREEN EYED MONSTER (CALIFORNIA PART-  
NERSHIP)  
2352 PIERPONT BLVD.  
VENTURA, CA 93001

FOR: TEXTILE SHOPPING BAGS, IN CLASS 18  
(U.S. CLS. 1, 2, 3, 22 AND 41).

FIRST USE 1-15-2008; IN COMMERCE 1-15-2008.

THE MARK CONSISTS OF MONSTER HEAD  
WITH ONE EYE BIGGER THAN THE OTHER,  
TWO FANGS AND A STEM AND LEAF ON TOP  
OF THE HEAD.

SER. NO. 77-399,752, FILED 2-18-2008.

ALICIA COLLINS, EXAMINING ATTORNEY

**Int. Cl.: 17**

**Prior U.S. Cls.: 1, 5, 12, 13, 35 and 50**

**United States Patent and Trademark Office**

**Reg. No. 3,504,783**

**Registered Sep. 23, 2008**

**TRADEMARK  
PRINCIPAL REGISTER**

**Boreline**

HOSE SOLUTIONS INC (ARIZONA CORPORATION)  
8260 E RAINTREE DR  
SCOTTSDALE, AZ 85260

THE MARK CONSISTS OF STANDARD CHARACTERS WITHOUT CLAIM TO ANY PARTICULAR FONT, STYLE, SIZE, OR COLOR.

FOR: FLEXIBLE PIPES, NOT OF METAL, IN CLASS 17 (U.S. CLS. 1, 5, 12, 13, 35 AND 50).

SER. NO. 77-399,770, FILED 2-18-2008.

FIRST USE 0-0-1990; IN COMMERCE 0-0-1990.

IRA J. GOODSaid, EXAMINING ATTORNEY



**Int. Cl.: 37**

**Prior U.S. Cls.: 100, 103 and 106**

**United States Patent and Trademark Office**

**Reg. No. 3,504,784**

**Registered Sep. 23, 2008**

**SERVICE MARK  
PRINCIPAL REGISTER**

**888-8-SPARKY**

MISTER SPARKY FRANCHISING, LLC (FLORIDA LIMITED LIABILITY COMPANY)  
SUITE 920  
50 CENTRAL AVE.  
SARASOTA, FL 34236

FOR: REPAIR, MAINTENANCE, AND INSTALLATION OF ELECTRICAL WIRING, LIGHT FIXTURES, SWITCHES, OUTLETS, AND ELECTRICAL PANELS, IN CLASS 37 (U.S. CLS. 100, 103 AND 106).

FIRST USE 7-0-2006; IN COMMERCE 7-0-2006.

THE MARK CONSISTS OF STANDARD CHARACTERS WITHOUT CLAIM TO ANY PARTICULAR FONT, STYLE, SIZE, OR COLOR.

OWNER OF U.S. REG. NOS. 2,331,109 AND 2,334,568.

SER. NO. 77-399,784, FILED 2-18-2008.

BARBARA A. GOLD, EXAMINING ATTORNEY

**Int. Cl.: 42**

**Prior U.S. Cls.: 100 and 101**

**United States Patent and Trademark Office**

**Reg. No. 3,504,785**

**Registered Sep. 23, 2008**

**SERVICE MARK  
PRINCIPAL REGISTER**

GeFRED

FEDERAL RESERVE BANK OF ST. LOUIS (UNITED STATES FEDERALLY CHARTERED CORPORATION)

ONE FEDERAL RESERVE BANK PLAZA  
ST. LOUIS, MO 63166

FOR: APPLICATION SERVICE PROVIDER FEATURING SOFTWARE FOR USE IN THE CREATION OF INTERACTIVE THEMATIC MAPS OF ECONOMIC DATA FOR PARTICULAR GEOGRAPHIC REGIONS, IN CLASS 42 (U.S. CLS. 100 AND 101).

FIRST USE 7-17-2007; IN COMMERCE 7-17-2007.

OWNER OF U.S. REG. NOS. 1,451,349 AND 3,109,822.

THE MARK CONSISTS OF THE WORD "GEOFRED" WITH A STYLIZED EARTH MAKING UP THE LETTER "O".

SER. NO. 77-399,796, FILED 2-18-2008.

MARK SPARACINO, EXAMINING ATTORNEY

**Int. Cl.: 44**

**Prior U.S. Cls.: 100 and 101**

**United States Patent and Trademark Office**

**Reg. No. 3,504,786**

**Registered Sep. 23, 2008**

**SERVICE MARK  
PRINCIPAL REGISTER**

**VAIN**

VAIN INTERNATIONAL, INC. (WASHINGTON CORPORATION)  
2018 1ST AVENUE  
SEATTLE, WA 98121

FOR: BEAUTY SALONS; HAIR SALON SERVICES, IN CLASS 44 (U.S. CLS. 100 AND 101).

FIRST USE 11-30-1996; IN COMMERCE 1-16-1997.

THE MARK CONSISTS OF STANDARD CHARACTERS WITHOUT CLAIM TO ANY PARTICULAR FONT, STYLE, SIZE, OR COLOR.

OWNER OF U.S. REG. NO. 2,137,892.

SER. NO. 77-399,832, FILED 2-18-2008.

MELVIN AXILBUND, EXAMINING ATTORNEY

**Int. Cl.: 25**

**Prior U.S. Cls.: 22 and 39**

**United States Patent and Trademark Office**

**Reg. No. 3,504,787**

**Registered Sep. 23, 2008**

**TRADEMARK  
PRINCIPAL REGISTER**



GEORGE VERANO USA LLC (NEW YORK LIMITED LIABILITY COMPANY)  
96-10 41 AVE  
CORONA, NY 11368

FOR: CLOTHING, NAMELY, KNEE WARMERS; COATS; DENIM JACKETS; DENIMS; DRESS SHIRTS; DRESS SUITS; DRESSES; EVENING DRESSES; FOOTWEAR; JEANS; SHIRTS; SKIRTS; SWEAT PANTS; SWEAT SHIRTS; T-SHIRTS; UNDERWEAR; VESTS; PANTS; HEADGEAR, NAMELY, HATS,

CAPS; JACKETS; WOMEN'S UNDERWEAR; LEATHER COATS; LEATHER JACKETS; SKIRT SUITS; SLIPPERS; BELTS, IN CLASS 25 (U.S. CLS. 22 AND 39).

FIRST USE 8-21-2007; IN COMMERCE 8-21-2007.

SER. NO. 77-399,846, FILED 2-18-2008.

HEATHER SAPP, EXAMINING ATTORNEY

**Int. Cl.: 18**

**Prior U.S. Cls.: 1, 2, 3, 22 and 41**

**Reg. No. 3,504,788**

**United States Patent and Trademark Office**

**Registered Sep. 23, 2008**

**TRADEMARK  
PRINCIPAL REGISTER**



GEORGE VERANO USA LLC (NEW YORK LIMITED LIABILITY COMPANY)  
96-10 41 AVE  
CORONA, NY 11368

FOR: HANDBAGS; PURSES AND WALLETS; BACKPACKS; CLUTCH PURSES; COIN PURSES; EVENING HANDBAGS; COSMETIC BAGS SOLD EMPTY; LUGGAGE; SHOULDER BAGS; TOTE

BAGS; TRAVELING BAGS , IN CLASS 18 (U.S. CLS. 1, 2, 3, 22 AND 41).

FIRST USE 8-21-2007; IN COMMERCE 8-21-2007.

SER. NO. 77-399,848, FILED 2-18-2008.

HEATHER SAPP, EXAMINING ATTORNEY

**Int. Cl.: 15**

**Prior U.S. Cls.: 2, 21 and 36**

**United States Patent and Trademark Office**

**Reg. No. 3,504,789**

**Registered Sep. 23, 2008**

**TRADEMARK  
PRINCIPAL REGISTER**

**The Next Generation of  
Playing Comfort**

KAREN A RINGERIDE (UNITED STATES INDIVIDUAL)  
11 STONE TOWER LANE  
BARRINGTON, RI 02806

THE MARK CONSISTS OF STANDARD CHARACTERS WITHOUT CLAIM TO ANY PARTICULAR FONT, STYLE, SIZE, OR COLOR.

FOR: SLINGS USED TO SUPPORT VIOLINS AND/OR VIOLAS WHILE PLAYING, IN CLASS 15 (U.S. CLS. 2, 21 AND 36).

SER. NO. 77-399,850, FILED 2-18-2008.

FIRST USE 4-1-2007; IN COMMERCE 7-17-2007.

MICHAEL W. BAIRD, EXAMINING ATTORNEY

**Int. Cl.: 37**

**Prior U.S. Cls.: 100, 103 and 106**

**United States Patent and Trademark Office**

**Reg. No. 3,504,790**

**Registered Sep. 23, 2008**

**SERVICE MARK  
PRINCIPAL REGISTER**

**FLOORCARE FOR LIFE**

GLOBAL FLOORCARE SOLUTIONS, LLC  
(GEORGIA LIMITED LIABILITY COMPANY)  
50 HIGHLAND PARK DRIVE  
SHARPSBURG, GA 30277

FOR: CLEANING OF FLOORS; MAINTENANCE  
AND/OR REPAIR OF FLOORS, IN CLASS 37 (U.S.  
CLS. 100, 103 AND 106).

FIRST USE 5-24-2006; IN COMMERCE 10-1-2006.

THE MARK CONSISTS OF STANDARD CHAR-  
ACTERS WITHOUT CLAIM TO ANY PARTICULAR  
FONT, STYLE, SIZE, OR COLOR.

NO CLAIM IS MADE TO THE EXCLUSIVE  
RIGHT TO USE "FLOORCARE", APART FROM  
THE MARK AS SHOWN.

SER. NO. 77-399,855, FILED 2-18-2008.

ELLEN B. AWRICH, EXAMINING ATTORNEY

**Int. Cls.: 9 and 41**

**Prior U.S. Cls.: 21, 23, 26, 36, 38, 100, 101 and 107**

**United States Patent and Trademark Office**

**Reg. No. 3,504,791**

**Registered Sep. 23, 2008**

**TRADEMARK  
SERVICE MARK  
PRINCIPAL REGISTER**

**Caribbean Rhythm Shake It  
Into Shape**

YOUR GYM ON WHEELS LLC (NEW HAMP-  
SHIRE LIMITED LIABILITY COMPANY)  
UNIT #22  
92 EAST BROADWAY STREET  
DERRY, NH 03038

FOR: DVDS FEATURING A FITNESS CLASS  
THAT INVOLVES CARIBBEAN AND SPANISH  
STYLES OF DANCE AS WELL AS RESISTANCE  
TRAINING AND/OR WEIGHT TRAINING, IN  
CLASS 9 (U.S. CLS. 21, 23, 26, 36 AND 38).

FIRST USE 5-1-2006; IN COMMERCE 5-1-2006.

FOR: DANCE INSTRUCTION; PHYSICAL FIT-  
NESS INSTRUCTION, IN CLASS 41 (U.S. CLS. 100,  
101 AND 107).

FIRST USE 5-1-2006; IN COMMERCE 5-1-2006.

THE MARK CONSISTS OF STANDARD CHAR-  
ACTERS WITHOUT CLAIM TO ANY PARTICULAR  
FONT, STYLE, SIZE, OR COLOR.

NO CLAIM IS MADE TO THE EXCLUSIVE  
RIGHT TO USE "CARIBBEAN RHYTHM", APART  
FROM THE MARK AS SHOWN.

SER. NO. 77-399,856, FILED 2-18-2008.

MAYUR VAGHANI, EXAMINING ATTORNEY



**Int. Cl.: 10**

**Prior U.S. Cls.: 26, 39 and 44**

**United States Patent and Trademark Office**

**Reg. No. 3,504,792**

**Registered Sep. 23, 2008**

**TRADEMARK  
PRINCIPAL REGISTER**

**Bungee Backer**

NADA-CONCEPTS, INC. (MINNESOTA CORPORATION), DBA NADA-CHAIR  
2448 LARPEN TEUR AVE WEST  
ST PAUL, MN 55113

FOR: ORTHOPEDIC BELTS; ORTHOPEDIC BRACES; ORTHOPEDIC SUPPORTS, IN CLASS 10 (U.S. CLS. 26, 39 AND 44).

FIRST USE 2-18-2008; IN COMMERCE 2-18-2008.

THE MARK CONSISTS OF STANDARD CHARACTERS WITHOUT CLAIM TO ANY PARTICULAR FONT, STYLE, SIZE, OR COLOR.

NO CLAIM IS MADE TO THE EXCLUSIVE RIGHT TO USE "BUNGEE", APART FROM THE MARK AS SHOWN.

SER. NO. 77-399,860, FILED 2-18-2008.

WILLIAM VERHOSEK, EXAMINING ATTORNEY

Int. Cl.: 16

Prior U.S. Cls.: 2, 5, 22, 23, 29, 37, 38 and 50

United States Patent and Trademark Office

Reg. No. 3,504,793

Registered Sep. 23, 2008

TRADEMARK  
PRINCIPAL REGISTER



PHILIP MADISON JONES (UNITED STATES INDIVIDUAL)  
SUITE 701P  
201 OCEAN AVE  
SANTA MONICA, CA 90402

FOR: A SERIES OF BOOKS AND WRITTEN ARTICLES IN THE FIELD OF SCIENCE FICTION; ANIMATION CELS; ART PRINTS; BOOKS IN THE FIELD OF SCIENCE FICTION; CALENDARS; CHILDREN'S BOOKS; COLORING BOOKS; COMIC BOOKS; COMIC STRIPS; COMIC STRIPS APPEARING IN BOOKS, MAGAZINES, COMIC BOOKS, SERIALS, NEWSPAPER; COMIC STRIPS' COMIC FEATURES; COMPUTER GAME INSTRUCTION MANUALS; DRAWINGS; GRAPHIC ART REPRODUCTIONS; GRAPHIC NOVELS; GRAPHIC PRINTS AND REPRESENTATIONS; ILLUSTRATIONS; LITHOGRAPHIC PRINTS; LITHOGRAPHIC WORKS OF ART; LITHOGRAPHS; MAGAZINES FEATURING SCIENCE FICTION, ANIMATION, SCIENCE FICTION CHARACTERS; NEWSPAPER CARTOONS; NEWSPAPER COMIC STRIPS; PAINTINGS; PAINTINGS AND THEIR REPRODUCTIONS; PICTORIAL PRINTS; PICTURE BOOKS; PICTURES; PRINTED ART REPRODUCTIONS; PRINTED PERIODICALS IN THE FIELD OF FIGURATIVE ARTS; PRINTED PERIODICALS IN THE FIELD OF ANIMATED SCIENCE FICTION; PRINTS; PRINTS IN THE NATURE OF SCIENCE FICTION CHARAC-

TERS IN ANIMATION CELLS, LITHGRAPHICS, COMPUTER GENERATED ANIMATIONS DRAWINGS; PUBLICATIONS, NAMELY, FOLIO BOOKS, COMIC BOOKS, PRINT MEDIA, ELECTRONIC MEDIA IN THE FIELDS OF SCIENCE FICTION CHARACTERS; SERIES OF FICTION BOOKS; STORIES IN ILLUSTRATED FORM; STORY BOOKS, IN CLASS 16 (U.S. CLS. 2, 5, 22, 23, 29, 37, 38 AND 50).

FIRST USE 6-1-2007; IN COMMERCE 12-1-2007.

THE COLOR(S) WHITE AND LIGHT BLUE IS/ARE CLAIMED AS A FEATURE OF THE MARK.

THE COLOR WHITE APPEARS IN THE WORDING "THE MAJESTIC FORCE" AND IN THE LIGHTNING BOLT DESIGN ELEMENT. THE COLOR LIGHT BLUE APPEARS AS SHADOW SURROUNDING THE WORDING "THE MAJESTIC FORCE" AND IN THE LIGHTNING BOLT DESIGN ELEMENT. THE COLOR BLACK REPRESENTS BACKGROUND AND IS NOT CLAIMED AS A FEATURE OF THE MARK.

SER. NO. 77-399,889, FILED 2-19-2008.

JENNIFER HETU, EXAMINING ATTORNEY

**Int. Cl.: 5**

**Prior U.S. Cls.: 6, 18, 44, 46, 51 and 52**

**Reg. No. 3,504,794**

**United States Patent and Trademark Office**

**Registered Sep. 23, 2008**

**TRADEMARK  
PRINCIPAL REGISTER**



CNS INC. (DELAWARE CORPORATION)  
2711 CENTERVILLE ROAD, SUITE 400  
WILMINGTON, DE 19808

FOR: DIETARY SUPPLEMENTS, IN CLASS 5 (U.S.  
CLS. 6, 18, 44, 46, 51 AND 52).

FIRST USE 3-1-2005; IN COMMERCE 3-1-2005.

OWNER OF U.S. REG. NOS. 2,441,387 AND  
3,394,591.

NO CLAIM IS MADE TO THE EXCLUSIVE  
RIGHT TO USE "FIBER", APART FROM THE  
MARK AS SHOWN.

THE MARK CONSISTS OF THE STYLIZED  
WORDS "FIBER CHOICE" WITHIN AN OVAL.

SER. NO. 77-399,926, FILED 2-19-2008.

COLLEEN KEARNEY, EXAMINING ATTORNEY

**Int. Cl.: 2**

**Prior U.S. Cls.: 6, 11 and 16**

**United States Patent and Trademark Office**

**Reg. No. 3,504,795**

**Registered Sep. 23, 2008**

**TRADEMARK  
PRINCIPAL REGISTER**

**DIP-IN**

JOHN WRIGHT COMPANY, INC. (PENNSYLVANIA CORPORATION)  
P.O. BOX 269  
WRIGHTSVILLE, PA 17368

THE MARK CONSISTS OF STANDARD CHARACTERS WITHOUT CLAIM TO ANY PARTICULAR FONT, STYLE, SIZE, OR COLOR.

FOR: FOOD DYES, IN CLASS 2 (U.S. CLS. 6, 11 AND 16).

SER. NO. 77-399,927, FILED 2-19-2008.

FIRST USE 1-7-2008; IN COMMERCE 1-28-2008.

COLLEEN KEARNEY, EXAMINING ATTORNEY

**Int. Cl.: 39**

**Prior U.S. Cls.: 100 and 105**

**United States Patent and Trademark Office**

**Reg. No. 3,504,796**

**Registered Sep. 23, 2008**

**SERVICE MARK  
PRINCIPAL REGISTER**

**EGO**

WEST, KEITH (UNITED STATES INDIVIDUAL)  
2714 E. FRANKLIN ST.  
RICHMOND, VA 23223

FOR: PROVIDING AN ON-LINE COMPUTER  
DATABASE IN THE FIELD OF TRAVEL INFORMA-  
TION SERVICES; PROVIDING INFORMATION,  
NEWS AND COMMENTARY IN THE FIELD OF  
TRAVEL, IN CLASS 39 (U.S. CLS. 100 AND 105).

FIRST USE 2-23-1996; IN COMMERCE 5-7-1996.

THE MARK CONSISTS OF STANDARD CHAR-  
ACTERS WITHOUT CLAIM TO ANY PARTICULAR  
FONT, STYLE, SIZE, OR COLOR.

SER. NO. 77-399,942, FILED 2-19-2008.

JOHN DALIER, EXAMINING ATTORNEY

**Int. Cl.: 36**

**Prior U.S. Cls.: 100, 101 and 102**

**United States Patent and Trademark Office**

**Reg. No. 3,504,797**

**Registered Sep. 23, 2008**

**SERVICE MARK  
PRINCIPAL REGISTER**

**INVEST WELL. MANAGE WELL.  
LIVE WELL.**

CONVERGENT WEALTH ADVISORS, LLC (DE-  
LAWARE LIMITED LIABILITY COMPANY)  
SUITE 300  
2600 TOWER OAKS BOULEVARD  
ROCKVILLE, MD 208524246

FOR: FINANCIAL SERVICES, NAMELY, PORT-  
FOLIO ANALYSIS, FINANCIAL ADVISORY AND  
CONSULTANCY SERVICES, FINANCIAL PLAN-  
NING SERVICES, AND THE INVESTMENT OF  
FUNDS OF OTHERS, IN CLASS 36 (U.S. CLS. 100,  
101 AND 102).

FIRST USE 5-1-2007; IN COMMERCE 5-1-2007.

THE MARK CONSISTS OF STANDARD CHAR-  
ACTERS WITHOUT CLAIM TO ANY PARTICULAR  
FONT, STYLE, SIZE, OR COLOR.

SER. NO. 77-399,945, FILED 2-19-2008.

JOHN DALIER, EXAMINING ATTORNEY

**Int. Cl.: 42**

**Prior U.S. Cls.: 100 and 101**

**United States Patent and Trademark Office**

**Reg. No. 3,504,798**

**Registered Sep. 23, 2008**

**SERVICE MARK  
PRINCIPAL REGISTER**

**CLAUSMASTER**

MECS, INC. (DELAWARE CORPORATION)  
SUITE 100  
14522 SOUTH OUTER FORTY ROAD  
ST. LOUIS, MO 63017

THE MARK CONSISTS OF STANDARD CHAR-  
ACTERS WITHOUT CLAIM TO ANY PARTICULAR  
FONT, STYLE, SIZE, OR COLOR.

FOR: DESIGN AND ENGINEERING OF GAS  
TREATMENT SYSTEMS, IN CLASS 42 (U.S. CLS.  
100 AND 101).

SER. NO. 77-399,956, FILED 2-19-2008.

FIRST USE 1-0-2001; IN COMMERCE 1-0-2001.

SEAN CROWLEY, EXAMINING ATTORNEY

**Int. Cl.: 37**

**Prior U.S. Cls.: 100, 103 and 106**

**United States Patent and Trademark Office**

**Reg. No. 3,504,799**

**Registered Sep. 23, 2008**

**SERVICE MARK  
PRINCIPAL REGISTER**

**DECKSOUTH**

DECKSOUTH, INC. (GEORGIA CORPORATION)  
1101 VIA BAYLESS  
MARIETTA, GA 30066

THE MARK CONSISTS OF STANDARD CHAR-  
ACTERS WITHOUT CLAIM TO ANY PARTICULAR  
FONT, STYLE, SIZE, OR COLOR.

FOR: CONSTRUCTION OF DECKS, PATIOS, GA-  
ZEBOS, AND SCREEN PORCHES, IN CLASS 37 (U.S.  
CLS. 100, 103 AND 106).

SER. NO. 77-399,988, FILED 2-19-2008.

FIRST USE 8-1-2000; IN COMMERCE 11-1-2001.

NICHOLAS ALTREE, EXAMINING ATTORNEY



**Int. Cl.: 36**

**Prior U.S. Cls.: 100, 101 and 102**

**United States Patent and Trademark Office**

**Reg. No. 3,504,800**

**Registered Sep. 23, 2008**

**SERVICE MARK  
PRINCIPAL REGISTER**

**AaSys**

AASYS GROUP, INC. (FLORIDA CORPORATION)  
11301 N.U.S. HIGHWAY 301, SUITE 106  
THONOTOSASSA, FL 33592

THE MARK CONSISTS OF STANDARD CHARACTERS WITHOUT CLAIM TO ANY PARTICULAR FONT, STYLE, SIZE, OR COLOR.

FOR: BANKING CONSULTATION, IN CLASS 36  
(U.S. CLS. 100, 101 AND 102).

SER. NO. 77-400,001, FILED 2-19-2008.

FIRST USE 6-29-1994; IN COMMERCE 6-29-1994.

PAM WILLIS, EXAMINING ATTORNEY

**Int. Cl.: 25**

**Prior U.S. Cls.: 22 and 39**

**United States Patent and Trademark Office**

**Reg. No. 3,504,801**

**Registered Sep. 23, 2008**

**TRADEMARK  
PRINCIPAL REGISTER**

**WINNING THE HUMAN RACE**

TWO TURTLES, LTD. (MARYLAND CORPORATION)  
P.M. BOX 58  
5901 COASTAL HIGHWAY  
OCEAN CITY, MD 21842

THE MARK CONSISTS OF STANDARD CHARACTERS WITHOUT CLAIM TO ANY PARTICULAR FONT, STYLE, SIZE, OR COLOR.

FOR: CLOTHING, NAMELY, T-SHIRTS, HEADWEAR, SHIRTS, BEACHWEAR, IN CLASS 25 (U.S. CLS. 22 AND 39).

SER. NO. 77-400,003, FILED 2-19-2008.

FIRST USE 7-31-2006; IN COMMERCE 7-31-2006.

PAM WILLIS, EXAMINING ATTORNEY

**Int. Cl.: 37**

**Prior U.S. Cls.: 100, 103 and 106**

**United States Patent and Trademark Office**

**Reg. No. 3,504,802**

**Registered Sep. 23, 2008**

**SERVICE MARK  
PRINCIPAL REGISTER**

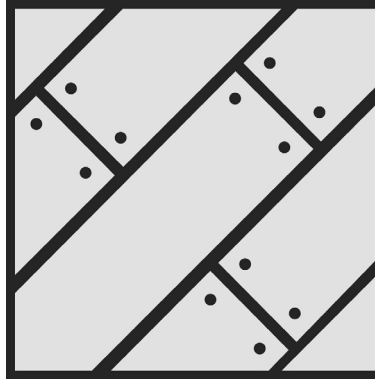

DECKSOUTH, INC. (GEORGIA CORPORATION)  
1101 VIA BAYLESS  
MARIETTA, GA 30066

THE MARK CONSISTS OF A STYLIZED SQUARE  
BOX APPEARING AS A SMALL PORTION OF A  
DECK COMPRISED OF WOODEN BOARDS.

FOR: CONSTRUCTION OF DECKS, PATIOS, GA-  
ZEBOS, AND SCREEN PORCHES, IN CLASS 37 (U.S.  
CLS. 100, 103 AND 106).

SER. NO. 77-400,045, FILED 2-19-2008.

FIRST USE 8-1-2000; IN COMMERCE 11-1-2001.

NICHOLAS ALTREE, EXAMINING ATTORNEY

**Int. Cl.: 35**

**Prior U.S. Cls.: 100, 101 and 102**

**United States Patent and Trademark Office**

**Reg. No. 3,504,803**

**Registered Sep. 23, 2008**

---

**SERVICE MARK  
PRINCIPAL REGISTER**



MUELLER SUPPLY COMPANY, INC. (TEXAS CORPORATION), DBA MUELLER, INC.  
1915 HUTCHINS AVE.  
BALLINGER, TX 76281

FOR: DISTRIBUTORSHIPS IN THE FIELD OF METAL ROOFING COMPONENTS AND PREFABRICATED METAL BUILDING COMPONENTS, IN CLASS 35 (U.S. CLS. 100, 101 AND 102).

FIRST USE 4-0-2007; IN COMMERCE 4-0-2007.

OWNER OF U.S. REG. NO. 2,584,768.

NO CLAIM IS MADE TO THE EXCLUSIVE RIGHT TO USE "INC" AND "METAL BUILDINGS, ROOFING AND COMPONENTS", APART FROM THE MARK AS SHOWN.

THE MARK CONSISTS OF TWO INCOMPLETE TRIANGLES OVERLAPPING ABOVE THE WORDS MUELLER, INC.

SER. NO. 77-400,063, FILED 2-19-2008.

JOHN WILKE, EXAMINING ATTORNEY

**Int. Cl.: 41**

**Prior U.S. Cls.: 100, 101 and 107**

**United States Patent and Trademark Office**

**Reg. No. 3,504,804**

**Registered Sep. 23, 2008**

---

**SERVICE MARK  
PRINCIPAL REGISTER**

**GIGZOOM**

GRABOW, CAROL J. (UNITED STATES INDIVIDUAL)  
4219 CREEKMEADOW DRIVE  
DALLAS, TX 75287

THE MARK CONSISTS OF STANDARD CHARACTERS WITHOUT CLAIM TO ANY PARTICULAR FONT, STYLE, SIZE, OR COLOR.

FOR: EVENT PLANNING AND TALENT BOOKING VIA A GLOBAL COMPUTER NETWORK, IN CLASS 41 (U.S. CLS. 100, 101 AND 107).

SER. NO. 77-400,065, FILED 2-19-2008.

FIRST USE 2-12-2008; IN COMMERCE 2-12-2008.

JOHN WILKE, EXAMINING ATTORNEY

**Int. Cl.: 8**

**Prior U.S. Cls.: 23, 28 and 44**

**United States Patent and Trademark Office**

**Reg. No. 3,504,805**

**Registered Sep. 23, 2008**

**TRADEMARK  
PRINCIPAL REGISTER**

**FALCON**

SUNG, SAM (UNITED STATES INDIVIDUAL)  
14225 TELEPHONE AVE., UNIT D  
CHINO, CA 91710

FOR: FOLDING KNIVES; HUNTING KNIVES;  
JAPANESE SWORDS; KNIVES FOR HOBBY USE;  
SABRES; SABRES; SPORT KNIVES; SWORDS;  
THROWING KNIVES, IN CLASS 8 (U.S. CLS. 23, 28  
AND 44).

FIRST USE 12-3-2007; IN COMMERCE 12-3-2007.

THE MARK CONSISTS OF STANDARD CHAR-  
ACTERS WITHOUT CLAIM TO ANY PARTICULAR  
FONT, STYLE, SIZE, OR COLOR.

SER. NO. 77-400,087, FILED 2-19-2008.

JULIE GUTTADAURO, EXAMINING ATTORNEY

**Int. Cl.: 41**

**Prior U.S. Cls.: 100, 101 and 107**

**United States Patent and Trademark Office**

**Reg. No. 3,504,806**

**Registered Sep. 23, 2008**

**SERVICE MARK  
PRINCIPAL REGISTER**

**SHOWBOX**

1426 FIRST AVENUE, LLC (NEVADA LIMITED  
LIABILITY COMPANY)  
P.O. BOX 2602  
SEATTLE, WA 98111

THE MARK CONSISTS OF STANDARD CHAR-  
ACTERS WITHOUT CLAIM TO ANY PARTICULAR  
FONT, STYLE, SIZE, OR COLOR.

FOR: ENTERTAINMENT SERVICES, NAMELY,  
THE PRESENTATION OF LIVE MUSIC CONCERTS  
AND PERFORMANCES, IN CLASS 41 (U.S. CLS. 100,  
101 AND 107).

SER. NO. 77-400,093, FILED 2-19-2008.

FIRST USE 1-1-1940; IN COMMERCE 1-1-1940.

ARETHA SOMERVILLE, EXAMINING ATTORNEY

**Int. Cl.: 5**

**Prior U.S. Cls.: 6, 18, 44, 46, 51 and 52**

**United States Patent and Trademark Office**

**Reg. No. 3,504,807**

**Registered Sep. 23, 2008**

**TRADEMARK  
PRINCIPAL REGISTER**

**HEPA-DESICOL**

GERMA PRODUCTS, INC. (FLORIDA CORPORATION)  
APT. B-101.  
14301 N. KENDALL DRIVE  
MIAMI, FL 33186

THE MARK CONSISTS OF STANDARD CHARACTERS WITHOUT CLAIM TO ANY PARTICULAR FONT, STYLE, SIZE, OR COLOR.

FOR: DIETARY SUPPLEMENTS, IN CLASS 5 (U.S. CLS. 6, 18, 44, 46, 51 AND 52).

SER. NO. 77-400,115, FILED 2-19-2008.

FIRST USE 1-21-1987; IN COMMERCE 6-1-2000.

JOHN DWYER, EXAMINING ATTORNEY



**Int. Cl.: 35**

**Prior U.S. Cls.: 100, 101 and 102**

**United States Patent and Trademark Office**

**Reg. No. 3,504,808**

**Registered Sep. 23, 2008**

**SERVICE MARK  
PRINCIPAL REGISTER**

**NEW BROAD STREET**

NEW BROAD STREET MANAGEMENT, LLC  
(FLORIDA LIMITED LIABILITY COMPANY)  
SUITE 110  
4776 NEW BROAD STREET  
ORLANDO, FL 32814

FOR: REAL ESTATE MARKETING SERVICES IN  
THE FIELD OF HOMES, BUILDINGS; REAL ES-  
TATE SERVICES, NAMELY, ONLINE SERVICES  
FEATURING THE PROMOTION OF RESIDENTIAL  
NEW CONSTRUCTION, IN CLASS 35 (U.S. CLS. 100,  
101 AND 102).

FIRST USE 1-15-2008; IN COMMERCE 1-15-2008.

THE MARK CONSISTS OF STANDARD CHAR-  
ACTERS WITHOUT CLAIM TO ANY PARTICULAR  
FONT, STYLE, SIZE, OR COLOR.

SER. NO. 77-400,131, FILED 2-19-2008.

FLORENTINA BLANDU, EXAMINING ATTORNEY

**Int. Cl.: 42**

**Prior U.S. Cls.: 100 and 101**

**United States Patent and Trademark Office**

**Reg. No. 3,504,809**

**Registered Sep. 23, 2008**

**SERVICE MARK  
PRINCIPAL REGISTER**

**Amaji**

SOBLE, JEFFREY S. (UNITED STATES INDIVIDUAL)  
215 LAKESIDE PLACE  
HIGHLAND PARK, IL 60035

FOR: APPLICATION SERVICE PROVIDER, NAMELY, PROVIDING, HOSTING, MANAGING, DEVELOPING, RESEARCHING, ANALYZING, REPORTING, AND MAINTAINING APPLICATIONS, SOFTWARE, WEB SITES, AND DATABASES OF OTHERS IN THE FIELDS OF HEALTHCARE, BENEFITS PROGRAMS, EMPLOYEE PRODUCTIVITY,

RISK MANAGEMENT, IN CLASS 42 (U.S. CLS. 100 AND 101).

FIRST USE 2-1-2008; IN COMMERCE 2-1-2008.

THE MARK CONSISTS OF STANDARD CHARACTERS WITHOUT CLAIM TO ANY PARTICULAR FONT, STYLE, SIZE, OR COLOR.

SER. NO. 77-400,136, FILED 2-19-2008.

FLORENTINA BLANDU, EXAMINING ATTORNEY

**Int. Cl.: 37**

**Prior U.S. Cls.: 100, 103 and 106**

**United States Patent and Trademark Office**

**Reg. No. 3,504,810**

**Registered Sep. 23, 2008**

**SERVICE MARK  
PRINCIPAL REGISTER**

**NEW BROAD STREET**

NEW BROAD STREET MANAGEMENT, LLC  
(FLORIDA LIMITED LIABILITY COMPANY)  
SUITE 110  
4776 NEW BROAD STREET  
ORLANDO, FL 32814

FOR: REAL ESTATE DEVELOPMENT, PLAN-  
NING AND LAYING OUT OF RESIDENTIAL AND  
COMMERCIAL PROPERTIES; BUILDING CON-  
STRUCTION AND REPAIR; CONSTRUCTION CON-  
SULTATION; CONSTRUCTION MANAGEMENT,  
IN CLASS 37 (U.S. CLS. 100, 103 AND 106).

FIRST USE 4-30-2007; IN COMMERCE 4-30-2007.

THE MARK CONSISTS OF STANDARD CHAR-  
ACTERS WITHOUT CLAIM TO ANY PARTICULAR  
FONT, STYLE, SIZE, OR COLOR.

SER. NO. 77-400,138, FILED 2-19-2008.

FLORENTINA BLANDU, EXAMINING ATTORNEY

**Int. Cl.: 41**

**Prior U.S. Cls.: 100, 101 and 107**

**United States Patent and Trademark Office**

**Reg. No. 3,504,811**

**Registered Sep. 23, 2008**

**SERVICE MARK  
PRINCIPAL REGISTER**

**EAT THE TRUTH**

EAT THE TRUTH, LLC (TEXAS LIMITED LIABILITY COMPANY)  
1215 N. BEACON STREET  
DALLAS, TX 75206

THE MARK CONSISTS OF STANDARD CHARACTERS WITHOUT CLAIM TO ANY PARTICULAR FONT, STYLE, SIZE, OR COLOR.

FOR: EDUCATION SERVICES, NAMELY, MENTORING IN THE FIELD OF NUTRITION, IN CLASS 41 (U.S. CLS. 100, 101 AND 107).

SER. NO. 77-400,159, FILED 2-19-2008.

FIRST USE 9-5-2004; IN COMMERCE 9-5-2004.

ODESSA BIBBINS, EXAMINING ATTORNEY

**Int. Cl.: 43**

**Prior U.S. Cls.: 100 and 101**

**United States Patent and Trademark Office**

**Reg. No. 3,504,812**

**Registered Sep. 23, 2008**

**SERVICE MARK  
PRINCIPAL REGISTER**

**Stay. Play. Relax.**

HARRAH'S LICENSE COMPANY, LLC (NEVADA  
LIMITED LIABILITY COMPANY)  
ONE HARRAH'S COURT  
LAS VEGAS, NV 89119

THE MARK CONSISTS OF STANDARD CHAR-  
ACTERS WITHOUT CLAIM TO ANY PARTICULAR  
FONT, STYLE, SIZE, OR COLOR.

FOR: HOTEL, RESTAURANT AND BAR SERVI-  
CES, IN CLASS 43 (U.S. CLS. 100 AND 101).

SER. NO. 77-400,162, FILED 2-19-2008.

FIRST USE 9-19-2007; IN COMMERCE 9-19-2007.

JANICE KIM, EXAMINING ATTORNEY

**Int. Cl.: 37**

**Prior U.S. Cls.: 100, 103 and 106**

**United States Patent and Trademark Office**

**Reg. No. 3,504,813**

**Registered Sep. 23, 2008**

**SERVICE MARK  
PRINCIPAL REGISTER**

**HOT WATER IS ON THE WAY!**

PETER WATER HEATER HOLDINGS, LLC (COL-  
ORADO LIMITED LIABILITY COMPANY)  
15636 E. BATAVIA DRIVE  
AURORA, CO 80011

FOR: INSTALLATION, SERVICING, REPAIRING,  
AND REPLACEMENT OF WATER HEATERS AND  
PLUMBING RELATING THERETO; PLUMBING  
SERVICES, IN CLASS 37 (U.S. CLS. 100, 103 AND 106).

FIRST USE 10-1-2007; IN COMMERCE 10-1-2007.

THE MARK CONSISTS OF STANDARD CHAR-  
ACTERS WITHOUT CLAIM TO ANY PARTICULAR  
FONT, STYLE, SIZE, OR COLOR.

SER. NO. 77-400,168, FILED 2-19-2008.

TRACY WHITTAKER-BROWN, EXAMINING AT-  
TORNEY

**Int. Cl.: 5**

**Prior U.S. Cls.: 6, 18, 44, 46, 51 and 52**

**Reg. No. 3,504,814**

**United States Patent and Trademark Office**

**Registered Sep. 23, 2008**

---

**TRADEMARK  
PRINCIPAL REGISTER**

**MaxShot**

9129-5428 QUEBEC INC. (CANADA CORPORATION)  
SUITE 1001  
505 MAISONNEUVE WEST  
MONTREAL, CANADA H3A3C2

THE MARK CONSISTS OF STANDARD CHARACTERS WITHOUT CLAIM TO ANY PARTICULAR FONT, STYLE, SIZE, OR COLOR.

FOR: DIETARY AND NUTRITIONAL SUPPLEMENTS, IN CLASS 5 (U.S. CLS. 6, 18, 44, 46, 51 AND 52).

SER. NO. 77-400,169, FILED 2-19-2008.

FIRST USE 2-13-2008; IN COMMERCE 2-13-2008.

JOHN KELLY, EXAMINING ATTORNEY

**Int. Cls.: 35 and 42**

**Prior U.S. Cls.: 100, 101 and 102**

**United States Patent and Trademark Office**

**Reg. No. 3,504,815**

**Registered Sep. 23, 2008**

**SERVICE MARK  
PRINCIPAL REGISTER**

**newsforce**

NEWSFORCE, INC. (CALIFORNIA CORPORATION)  
2223 AVENIDA DE LA PLAYA, SUITE 208  
LA JOLLA, CA 92037

FOR: DISSEMINATION OF ADVERTISING FOR OTHERS VIA THE INTERNET; ADVERTISING BY TRANSMISSION OF ON-LINE PUBLICITY FOR THIRD PARTIES VIA THE INTERNET; DISSEMINATION OF PREVIEWS OF PRESS RELEASES FOR OTHERS VIA AN INTERNET-BASED ADVERTISING NETWORK, IN CLASS 35 (U.S. CLS. 100, 101 AND 102).

FIRST USE 2-13-2008; IN COMMERCE 2-13-2008.

FOR: PROVIDING TEMPORARY USE OF ON-LINE NON-DOWNLOADABLE SOFTWARE FOR EDITING ONLINE MEDIA; PROVIDING TEMPORARY USE OF ONLINE NON-DOWNLOADABLE

SOFTWARE FOR OPTIMIZING MEDIA FOR ON-LINE DISTRIBUTION; PROVIDING TEMPORARY USE OF ONLINE NON-DOWNLOADABLE SOFTWARE FOR SEARCH ENGINE OPTIMIZATION OF ONLINE MEDIA; PROVIDING TEMPORARY USE OF ONLINE NON-DOWNLOADABLE SOFTWARE FOR MANAGING THE ONLINE DISTRIBUTION OF ONLINE MEDIA, IN CLASS 42 (U.S. CLS. 100 AND 101).

FIRST USE 8-21-2006; IN COMMERCE 8-21-2006.

THE MARK CONSISTS OF A STYLIZED VERSION OF NEWSFORCE.

SER. NO. 77-400,171, FILED 2-19-2008.

KEVON CHISOLM, EXAMINING ATTORNEY



**Int. Cl.: 44**

**Prior U.S. Cls.: 100 and 101**

**United States Patent and Trademark Office**

**Reg. No. 3,504,816**

**Registered Sep. 23, 2008**

**SERVICE MARK  
PRINCIPAL REGISTER**

**CROWNS FOR QUEENS**

BROWN, JACQUELYNE (UNITED STATES INDIVIDUAL)  
UNIT #27  
1670 CLAYTON ROAD  
CONCORD, CA 94520

THE MARK CONSISTS OF STANDARD CHARACTERS WITHOUT CLAIM TO ANY PARTICULAR FONT, STYLE, SIZE, OR COLOR.

FOR: HAIR CARE AND STYLING SERVICES FEATURING MULTICULTURAL FISHTAIL BRAIDING, IN CLASS 44 (U.S. CLS. 100 AND 101).

SER. NO. 77-400,178, FILED 2-19-2008.

FIRST USE 1-1-2000; IN COMMERCE 10-1-2004.

RON FAIRBANKS, EXAMINING ATTORNEY

**Int. Cls.: 25 and 41**

**Prior U.S. Cls.: 22, 39, 100, 101 and 107**

**United States Patent and Trademark Office**

**Reg. No. 3,504,817**

**Registered Sep. 23, 2008**

**TRADEMARK  
SERVICE MARK  
PRINCIPAL REGISTER**



HAWAII WINTER BASEBALL, INC. (HAWAII CORPORATION)  
SUITE 904  
1000 BISHOP STREET  
HONOLULU, HI 96813

FOR: CLOTHING, NAMELY, HATS, T-SHIRTS AND POLO SHIRTS, IN CLASS 25 (U.S. CLS. 22 AND 39).

FIRST USE 10-0-1993; IN COMMERCE 10-0-1993.

FOR: ENTERTAINMENT, IN THE NATURE OF BASEBALL GAMES, IN CLASS 41 (U.S. CLS. 100, 101 AND 107).

FIRST USE 10-0-1993; IN COMMERCE 10-0-1993.

THE MARK CONSISTS OF A SHARK PROFILE IN FRONT OF A BASEBALL DIAMOND HOLDING A BASEBALL AND WEARING A HAT.

SER. NO. 77-400,190, FILED 2-19-2008.

CURTIS FRENCH, EXAMINING ATTORNEY

**Int. Cl.: 16**

**Prior U.S. Cls.: 2, 5, 22, 23, 29, 37, 38 and 50**

**United States Patent and Trademark Office**

**Reg. No. 3,504,818**

**Registered Sep. 23, 2008**

**TRADEMARK  
PRINCIPAL REGISTER**

# Realia A La Carte

LEE, SHERYL F. (UNITED STATES INDIVIDUAL)  
71 OXBOW CREEK LANE  
LAGUNA HILLS, CA 92653

FOR: EDUCATIONAL PUBLICATIONS, NAME-  
LY, EDUCATIONAL LEARNING CARDS, FLASH  
CARDS, ACTIVITY CARDS, WORKBOOKS, TEXT-  
BOOKS, ACTIVITY BOOKS, STORY BOOKS, PUZ-  
ZLE BOOKS, PRINTED PUZZLES, TEACHER GU  
IDES, MA NUALS, POSTERS, EDUCATIONAL  
CARD GAMES AND EDUCATIONAL BOOKLETS  
IN THE FIELD OF LIFE SKILLS; PAPER TEACHING  
MATERIALS IN THE FIELD OF LIFE SKILLS;  
THREE DIMENSIONAL MODELS FOR EDUCA-  
TIONAL PURPOSES, IN CLASS 16 (U.S. CLS. 2, 5,  
22, 23, 29, 37, 38 AND 50).

FIRST USE 1-1-1995; IN COMMERCE 1-1-1995.

THE MARK CONSISTS OF STANDARD CHAR-  
ACTERS WITHOUT CLAIM TO ANY PARTICULAR  
FONT, STYLE, SIZE, OR COLOR.

NO CLAIM IS MADE TO THE EXCLUSIVE  
RIGHT TO USE "REALIA" , APART FROM THE  
MARK AS SHOWN.

SEC. 2(F).

SER. NO. 77-400,204, FILED 2-19-2008.

DAVID MURRAY, EXAMINING ATTORNEY

**Int. Cl.: 38**

**Prior U.S. Cls.: 100, 101 and 104**

**United States Patent and Trademark Office**

**Reg. No. 3,504,819**

**Registered Sep. 23, 2008**

**SERVICE MARK  
PRINCIPAL REGISTER**

ONE GIANT LEAP FOR FANKIND

CSTV ONLINE INC. (DELAWARE CORPORATION)  
85 TENTH AVENUE, THIRD FLOOR  
NEW YORK, NY 10011

FOR: BROADCASTING SERVICES, NAMELY TRANSMITTING, DOWNLOADING AND STREAMING DIGITAL AUDIO, VIDEO, GRAPHICS, TEXT AND DATA IN THE FIELD OF SPORTS AND ATHLETICS, RENDERED VIA THE INTERNET, AND PORTABLE WIRELESS COMMUNICATION DEVICES, IN CLASS 38 (U.S. CLS. 100, 101 AND 104).

FIRST USE 1-24-2008; IN COMMERCE 1-24-2008.

THE MARK CONSISTS OF STANDARD CHARACTERS WITHOUT CLAIM TO ANY PARTICULAR FONT, STYLE, SIZE, OR COLOR.

SER. NO. 77-400,207, FILED 2-19-2008.

CAROLYN GRAY, EXAMINING ATTORNEY

**Int. Cls.: 25 and 41**

**Prior U.S. Cls.: 22, 39, 100, 101 and 107**

**United States Patent and Trademark Office**

**Reg. No. 3,504,820**

**Registered Sep. 23, 2008**

**TRADEMARK  
SERVICE MARK  
PRINCIPAL REGISTER**



HAWAII WINTER BASEBALL, INC. (HAWAII CORPORATION)  
SUITE 904  
1000 BISHOP STREET  
HONOLULU, HI 96813

FOR: CLOTHING, NAMELY, HATS AND T-SHIRTS, IN CLASS 25 (U.S. CLS. 22 AND 39).

FIRST USE 10-0-1993; IN COMMERCE 10-0-1993.

FOR: ENTERTAINMENT, IN THE NATURE OF BASEBALL GAMES, IN CLASS 41 (U.S. CLS. 100, 101 AND 107).

FIRST USE 10-0-1993; IN COMMERCE 10-0-1993.

OWNER OF U.S. REG. NO. 3,334,741.

NO CLAIM IS MADE TO THE EXCLUSIVE RIGHT TO USE "WINTER BASEBALL", APART FROM THE MARK AS SHOWN.

THE MARK CONSISTS OF THE LETTERS HWB IN FRONT OF A BASEBALL ENCIRCLE WITH THE WORDS HAWAII WINTER BASEBALL WITH A STARBURST BEHIND IT ALL.

SEC. 2(F) AS TO "HAWAII WINTER BASEBALL".

SER. NO. 77-400,210, FILED 2-19-2008.

CURTIS FRENCH, EXAMINING ATTORNEY

**Int. Cl.: 37**

**Prior U.S. Cls.: 100, 103 and 106**

**United States Patent and Trademark Office**

**Reg. No. 3,504,821**

**Registered Sep. 23, 2008**

**SERVICE MARK  
PRINCIPAL REGISTER**

**iRepair**

IREPAIR.US, INC. (TENNESSEE CORPORATION)  
7020 CHURCH ST E  
SUITE 5  
BRENTWOOD, TN 37027

FOR: INSTALLATION, MAINTENANCE AND  
REPAIR OF COMPUTER HARDWARE; INSTALLA-  
TION, MAINTENANCE AND REPAIR OF MP3  
PLAYERS, IN CLASS 37 (U.S. CLS. 100, 103 AND 106).

FIRST USE 4-0-2004; IN COMMERCE 4-0-2007.

THE MARK CONSISTS OF STANDARD CHAR-  
ACTERS WITHOUT CLAIM TO ANY PARTICULAR  
FONT, STYLE, SIZE, OR COLOR.

SER. NO. 77-400,229, FILED 2-19-2008.

KYLE PEETE, EXAMINING ATTORNEY

**Int. Cl.: 41**

**Prior U.S. Cls.: 100, 101 and 107**

**United States Patent and Trademark Office**

**Reg. No. 3,504,822**

**Registered Sep. 23, 2008**

**SERVICE MARK  
PRINCIPAL REGISTER**

**BORROWED BLUE PHOTOGRAPHY**

**BORROWED BLUE PHOTOGRAPHY, LLC  
(MARYLAND LIMITED LIABILITY COMPAN-  
NY)**

**209 E. MELROSE AVENUE  
BALTIMORE, MD 21212**

**FOR: PHOTOGRAPHY; PHOTOGRAPHY SERVI-  
CES, IN CLASS 41 (U.S. CLS. 100, 101 AND 107).**

**FIRST USE 2-4-2002; IN COMMERCE 2-4-2002.**

**THE MARK CONSISTS OF STANDARD CHAR-  
ACTERS WITHOUT CLAIM TO ANY PARTICULAR  
FONT, STYLE, SIZE, OR COLOR.**

**NO CLAIM IS MADE TO THE EXCLUSIVE  
RIGHT TO USE "PHOTOGRAPHY", APART FROM  
THE MARK AS SHOWN.**

**SER. NO. 77-400,239, FILED 2-19-2008.**

**CHARISMA HAMPTON, EXAMINING ATTORNEY**

**Int. Cls.: 9 and 42**

**Prior U.S. Cls.: 21, 23, 26, 36, 38, 100 and 101**

**United States Patent and Trademark Office**

**Reg. No. 3,504,823**

**Registered Sep. 23, 2008**

**TRADEMARK  
SERVICE MARK  
PRINCIPAL REGISTER**

**ATTERO TECH**

ATTERO TECH. LLC (INDIANA LIMITED LIABILITY COMPANY)  
1315 DIRECTORS ROW, SUITE 107  
FORT WAYNE, IN 46808

FOR: NETWORKING HARDWARE FOR DATA, AUDIO AND VISUAL COMMUNICATIONS, IN CLASS 9 (U.S. CLS. 21, 23, 26, 36 AND 38).

FIRST USE 7-0-2005; IN COMMERCE 7-0-2005.

FOR: DESIGN AND ENGINEERING FOR OTHERS IN THE FIELDS OF ELECTRONICS, SOFTWARE, AND FIRMWARE, IN CLASS 42 (U.S. CLS. 100 AND 101).

FIRST USE 3-29-2005; IN COMMERCE 3-29-2005.

THE MARK CONSISTS OF STANDARD CHARACTERS WITHOUT CLAIM TO ANY PARTICULAR FONT, STYLE, SIZE, OR COLOR.

NO CLAIM IS MADE TO THE EXCLUSIVE RIGHT TO USE "TECH", APART FROM THE MARK AS SHOWN.

SER. NO. 77-400,242, FILED 2-19-2008.

KRISTIN DAHLING, EXAMINING ATTORNEY



**Int. Cls.: 25 and 41**

**Prior U.S. Cls.: 22, 39, 100, 101 and 107**

**United States Patent and Trademark Office**

**Reg. No. 3,504,824**

**Registered Sep. 23, 2008**

**TRADEMARK  
SERVICE MARK  
PRINCIPAL REGISTER**



HAWAII WINTER BASEBALL, INC. (HAWAII CORPORATION)  
SUITE 904  
1000 BISHOP STREET  
HONOLULU, HI 96813

FOR: CLOTHING, NAMELY, HATS, T-SHIRTS AND POLO SHIRTS, IN CLASS 25 (U.S. CLS. 22 AND 39).

FIRST USE 10-0-2006; IN COMMERCE 10-0-2006.

FOR: ENTERTAINMENT, IN THE NATURE OF BASEBALL GAMES, IN CLASS 41 (U.S. CLS. 100, 101 AND 107).

FIRST USE 10-0-2006; IN COMMERCE 10-0-2006.

THE MARK CONSISTS OF A PERSON IN FRONT OF A SURF BOARD, BOTH IN FRONT OF A BASEBALL, AND BOTH ENCIRCLED WITH VARIOUS RINGS.

SER. NO. 77-400,246, FILED 2-19-2008.

CURTIS FRENCH, EXAMINING ATTORNEY

Int. Cls.: 25 and 41

Prior U.S. Cls.: 22, 39, 100, 101 and 107

United States Patent and Trademark Office

Reg. No. 3,504,825

Registered Sep. 23, 2008

**TRADEMARK  
SERVICE MARK  
PRINCIPAL REGISTER**



HAWAII WINTER BASEBALL, INC. (HAWAII CORPORATION)

SUITE 904

1000 BISHOP STREET

HONOLULU, HI 96813

FOR: CLOTHING, NAMELY, HATS, T-SHIRTS AND POLO SHIRTS, IN CLASS 25 (U.S. CLS. 22 AND 39).

FIRST USE 10-0-1995; IN COMMERCE 10-0-1995.

FOR: ENTERTAINMENT, IN THE NATURE OF BASEBALL GAMES, IN CLASS 41 (U.S. CLS. 100, 101 AND 107).

FIRST USE 10-0-1995; IN COMMERCE 10-0-1995.

THE MARK CONSISTS OF A PERSON WITH A FLAME HEAD HOLDING A BAT IN FRONT OF A CIRCLE DESIGN.

SER. NO. 77-400,252, FILED 2-19-2008.

CURTIS FRENCH, EXAMINING ATTORNEY

**Int. Cl.: 10**

**Prior U.S. Cls.: 26, 39 and 44**

**United States Patent and Trademark Office**

**Reg. No. 3,504,826**

**Registered Sep. 23, 2008**

**TRADEMARK  
PRINCIPAL REGISTER**



WEBER ORTHOPEDIC INC. (CALIFORNIA CORPORATION)  
1185 E. MAIN STREET  
SANTA PAULA, CA 93060

FOR: MEDICAL BRACES FOR WRISTS, IN CLASS 10 (U.S. CLS. 26, 39 AND 44).

FIRST USE 1-31-2005; IN COMMERCE 1-31-2005.

NO CLAIM IS MADE TO THE EXCLUSIVE RIGHT TO USE "WRIST" , APART FROM THE MARK AS SHOWN.

THE MARK CONSISTS OF THE WORDS "TITAN WRIST", WITH THE WORD "WRIST" APPEARING IN A RECTANGLE BENEATH THE "A" AND "N" IN THE WORD "TITAN", AND AN ABSTRACT DEPICTION OF A WRIST BRACE CONSISTING OF FOUR BRACE LACES, FOUR EYELETS, AND A STRAP CURVING AROUND FROM THE BOTTOM TO THE TOP OF THE MARK.

SER. NO. 77-400,256, FILED 2-19-2008.

CYNTHIA TRIPI, EXAMINING ATTORNEY

**Int. Cl.: 25**

**Prior U.S. Cls.: 22 and 39**

**United States Patent and Trademark Office**

**Reg. No. 3,504,827**

**Registered Sep. 23, 2008**

**TRADEMARK  
PRINCIPAL REGISTER**

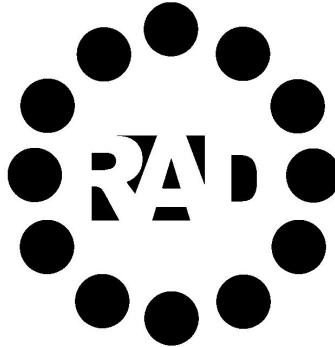

DE JESUS, RANDOLPH (UNITED STATES INDIVIDUAL)  
21824 SANTAQUIN DRIVE  
DIAMOND BAR, CA 91765

FOR: BELTS; HATS; JACKETS; JEANS; SHIRTS; SHORTS; SWEATERS, IN CLASS 25 (U.S. CLS. 22 AND 39).

FIRST USE 10-18-2007; IN COMMERCE 10-18-2007.

THE MARK CONSISTS OF 12 CIRCLES THAT ARE EVENLY SPACED OUT AND LAID OUT IN A CIRCLE. THE CENTER OF THE CIRCLE HAS AN INVERTED REPRESENTATION OF THE WORD "RAD" IN IT.

SER. NO. 77-400,265, FILED 2-19-2008.

PETER B. BROMAGHIM, EXAMINING ATTORNEY

**Int. Cl.: 35**

**Prior U.S. Cls.: 100, 101 and 102**

**United States Patent and Trademark Office**

**Reg. No. 3,504,828**

**Registered Sep. 23, 2008**

**SERVICE MARK  
PRINCIPAL REGISTER**

**COEXIST**

COEXIST, LLC (OHIO LIMITED LIABILITY  
COMPANY)  
SUITE 200  
772 NORTH HIGH STREET  
COLUMBUS, OH 43215

THE MARK CONSISTS OF STANDARD CHAR-  
ACTERS WITHOUT CLAIM TO ANY PARTICULAR  
FONT, STYLE, SIZE, OR COLOR.

FOR: ADVERTISING AND MARKETING, IN  
CLASS 35 (U.S. CLS. 100, 101 AND 102).

SER. NO. 77-400,287, FILED 2-19-2008.

FIRST USE 12-9-2005; IN COMMERCE 12-9-2005.

MARY CRAWFORD, EXAMINING ATTORNEY

**Int. Cl.: 10**

**Prior U.S. Cls.: 26, 39 and 44**

**United States Patent and Trademark Office**

**Reg. No. 3,504,829**

**Registered Sep. 23, 2008**

**TRADEMARK  
PRINCIPAL REGISTER**



WEBER ORTHOPEDIC INC. (CALIFORNIA CORPORATION)  
1185 E. MAIN STREET  
SANTA PAULA, CA 93060

FOR: MEDICAL BRACES FOR THUMBS, IN CLASS 10 (U.S. CLS. 26, 39 AND 44).

FIRST USE 1-31-2005; IN COMMERCE 1-31-2005.

NO CLAIM IS MADE TO THE EXCLUSIVE RIGHT TO USE "THUMB" , APART FROM THE MARK AS SHOWN.

THE MARK CONSISTS OF THE WORDS "TITAN THUMB", WITH THE WORD "THUMB" APPEARING IN A RECTANGLE BENEATH THE "A" AND "N" IN THE WORD "TITAN", AND AN ABSTRACT DEPICTION OF A THUMB BRACE CONSISTING OF FOUR BRACE LACES, FOUR EYELETS, AND A STRAP CURVING AROUND FROM THE BOTTOM TO THE TOP OF THE MARK.

SER. NO. 77-400,304, FILED 2-19-2008.

CYNTHIA TRIPI, EXAMINING ATTORNEY

**Int. Cl.: 25**

**Prior U.S. Cls.: 22 and 39**

**United States Patent and Trademark Office**

**Reg. No. 3,504,830**

**Registered Sep. 23, 2008**

**TRADEMARK  
PRINCIPAL REGISTER**

**REAL BOXER**

CATALYST APPLIED TECHNOLOGIES INC.  
(NEW YORK CORPORATION)

ATTN: BARBARA CARVER

146 WEST 57TH STREET - SUITE 33D

NEW YORK, NY 10019

FOR: CLOTHING, NAMELY, UNDERWEAR,  
SHIRTS, TROUSERS, SKIRTS AND BLOUSES, IN  
CLASS 25 (U.S. CLS. 22 AND 39).

FIRST USE 2-24-1997; IN COMMERCE 2-24-1997.

THE MARK CONSISTS OF STANDARD CHAR-  
ACTERS WITHOUT CLAIM TO ANY PARTICULAR  
FONT, STYLE, SIZE, OR COLOR.

OWNER OF U.S. REG. NO. 3,377,709.

NO CLAIM IS MADE TO THE EXCLUSIVE  
RIGHT TO USE "BOXER", APART FROM THE  
MARK AS SHOWN.

SER. NO. 77-400,315, FILED 2-19-2008.

CHARISMA HAMPTON, EXAMINING ATTORNEY

**Int. Cl.: 5**

**Prior U.S. Cls.: 6, 18, 44, 46, 51 and 52**

**Reg. No. 3,504,831**

**United States Patent and Trademark Office**

**Registered Sep. 23, 2008**

**TRADEMARK  
PRINCIPAL REGISTER**

**UROBIOL**

GERMA PRODUCTS, INC. (FLORIDA CORPORATION)  
APT. B-101.  
14301 N. KENDALL DRIVE  
MIAMI, FL 33186

THE MARK CONSISTS OF STANDARD CHARACTERS WITHOUT CLAIM TO ANY PARTICULAR FONT, STYLE, SIZE, OR COLOR.

FOR: DIETARY SUPPLEMENTS, IN CLASS 5 (U.S. CLS. 6, 18, 44, 46, 51 AND 52).

SER. NO. 77-400,332, FILED 2-19-2008.

FIRST USE 10-2-2001; IN COMMERCE 10-2-2001.

JOHN DWYER, EXAMINING ATTORNEY



**Int. Cl.: 36**

**Prior U.S. Cls.: 100, 101 and 102**

**United States Patent and Trademark Office**

**Reg. No. 3,504,832**

**Registered Sep. 23, 2008**

**SERVICE MARK  
PRINCIPAL REGISTER**

**YOUR FRIENDS IN AUTO  
FINANCE**

DEALERS' FINANCE CO. L.L.C. (OKLAHOMA  
LIMITED LIABILITY COMPANY)  
1125 SOUTHEAST GRAND BLVD., SUITE 102  
OKLAHOMA CITY, OK 73129

FOR: AUTOMOBILE FINANCING SERVICES; FI-  
NANCING RELATING TO AUTOMOBILES; FINAN-  
CING SERVICES, IN CLASS 36 (U.S. CLS. 100, 101  
AND 102).

FIRST USE 11-30-2007; IN COMMERCE 11-30-2007.

THE MARK CONSISTS OF STANDARD CHAR-  
ACTERS WITHOUT CLAIM TO ANY PARTICULAR  
FONT, STYLE, SIZE, OR COLOR.

NO CLAIM IS MADE TO THE EXCLUSIVE  
RIGHT TO USE "AUTO FINANCE", APART FROM  
THE MARK AS SHOWN.

SER. NO. 77-400,346, FILED 2-19-2008.

JOHN HWANG, EXAMINING ATTORNEY

**Int. Cl.: 42**

**Prior U.S. Cls.: 100 and 101**

**United States Patent and Trademark Office**

**Reg. No. 3,504,833**

**Registered Sep. 23, 2008**

**SERVICE MARK  
PRINCIPAL REGISTER**

**SELECTPATH**

MICHAEL C. FINA COMPANY (NEW YORK  
CORPORATION)  
545 FIFTH AVENUE  
NEW YORK, NY 10017

FOR: PROVIDING TEMPORARY USE OF ON-  
LINE NON-DOWNLOADABLE SOFTWARE FOR  
THE MANAGEMENT AND ADMINISTRATION OF  
EMPLOYEE RECOGNITION AWARD PROGRAMS  
DESIGNED TO PROMOTE JOB SATISFACTION  
AND EMPLOYEE PRODUCTIVITY, IN CLASS 42  
(U.S. CLS. 100 AND 101).

FIRST USE 1-2-2000; IN COMMERCE 1-2-2000.

THE MARK CONSISTS OF STANDARD CHAR-  
ACTERS WITHOUT CLAIM TO ANY PARTICULAR  
FONT, STYLE, SIZE, OR COLOR.

OWNER OF U.S. REG. NO. 2,562,211.

SER. NO. 77-400,354, FILED 2-19-2008.

WARREN L. OLANDRIA, EXAMINING ATTOR-  
NEY

Int. Cl.: 45

Prior U.S. Cls.: 100 and 101

United States Patent and Trademark Office

Reg. No. 3,504,834

Registered Sep. 23, 2008

SERVICE MARK  
PRINCIPAL REGISTER



HIRE IMAGE LLC (FLORIDA LIMITED LIABILITY COMPANY)  
6 ALCAZAR AVENUE  
JOHNSTON, RI 02919

FOR: PRE-EMPLOYMENT BACKGROUND SCREENING, IN CLASS 45 (U.S. CLS. 100 AND 101).

FIRST USE 9-16-2006; IN COMMERCE 9-16-2006.

NO CLAIM IS MADE TO THE EXCLUSIVE RIGHT TO USE "PRE-EMPLOYMENT SCREENING SPECIALISTS", APART FROM THE MARK AS SHOWN.

THE COLOR(S) RED AND GREY IS/ARE CLAIMED AS A FEATURE OF THE MARK.

THE MARK CONSISTS OF STYLIZED "HIRE IMAGE" GRAPHIC IN GREY, RED UPPERCASE "I" WITH RED TARGET GRAPHIC OVER THE "I".

SER. NO. 77-400,359, FILED 2-19-2008.

SHAUNIA CARLYLE, EXAMINING ATTORNEY

**Int. Cl.: 42**

**Prior U.S. Cls.: 100 and 101**

**United States Patent and Trademark Office**

**Reg. No. 3,504,835**

**Registered Sep. 23, 2008**

**SERVICE MARK  
PRINCIPAL REGISTER**

# MeshVista

MESH SYSTEMS LLC (WISCONSIN LIMITED  
LIABILITY COMPANY)  
2222 E. PENSAR DRIVE  
APPLETON, WI 54911

FOR: APPLICATION SERVICE PROVIDER,  
NAMELY, PROVIDING, HOSTING, MANAGING,  
DEVELOPING, AND MAINTAINING APPLICA-  
TIONS, SOFTWARE, WEB SITES, AND DATABASES  
IN THE FIELDS OF PERSONAL PRODUCTIVITY,  
WIRELESS COMMUNICATION, MOBILE INFOR-  
MATION ACCESS, AND REMOTE DATA MANAGE-  
MENT FOR WIRELESS DELIVERY OF CONTENT  
TO HANDHELD COMPUTERS, LAPTOPS AND MO-

BILE ELECTRONIC DEVICES, IN CLASS 42 (U.S.  
CLS. 100 AND 101).

FIRST USE 7-1-2005; IN COMMERCE 7-1-2005.

THE MARK CONSISTS OF STANDARD CHAR-  
ACTERS WITHOUT CLAIM TO ANY PARTICULAR  
FONT, STYLE, SIZE, OR COLOR.

SER. NO. 77-400,392, FILED 2-19-2008.

GILBERT SWIFT, EXAMINING ATTORNEY

**Int. Cl.: 36**

**Prior U.S. Cls.: 100, 101 and 102**

**United States Patent and Trademark Office**

**Reg. No. 3,504,836**

**Registered Sep. 23, 2008**

**SERVICE MARK  
PRINCIPAL REGISTER**



DEALERS' FINANCE CO. L.L.C. (OKLAHOMA  
LIMITED LIABILITY COMPANY)  
1125 SOUTHEAST GRAND BLVD., SUITE 102  
OKLAHOMA CITY, OK 73129

FOR: AUTOMOBILE FINANCING SERVICES; FI-  
NANCING RELATING TO AUTOMOBILES; FINAN-  
CING SERVICES, IN CLASS 36 (U.S. CLS. 100, 101  
AND 102).

FIRST USE 5-31-2007; IN COMMERCE 5-31-2007.

OWNER OF U.S. REG. NO. 3,231,833.

NO CLAIM IS MADE TO THE EXCLUSIVE  
RIGHT TO USE "DEALERS FINANCE COMPANY",  
APART FROM THE MARK AS SHOWN.

THE MARK CONSISTS OF CURVED LINES  
ABOVE THE WORD MARK.

SER. NO. 77-400,399, FILED 2-19-2008.

JOHN HWANG, EXAMINING ATTORNEY

**Int. Cl.: 37**

**Prior U.S. Cls.: 100, 103 and 106**

**Reg. No. 3,504,837**

**United States Patent and Trademark Office**

**Registered Sep. 23, 2008**

---

**SERVICE MARK  
PRINCIPAL REGISTER**

**Wellspring Development  
Company**

WELLSPRING DEVELOPMENT COMPANY (ILLINOIS CORPORATION), DBA ROCK HILL TRAILS  
1806 LYNDHURST  
SAVOY, IL 61874

FOR: LAND DEVELOPMENT SERVICES, NAME-  
LY, PLANNING AND LAYING OUT OF RESIDEN-  
TIAL AND/OR COMMERCIAL COMMUNITIES, IN  
CLASS 37 (U.S. CLS. 100, 103 AND 106).

FIRST USE 10-31-2005; IN COMMERCE 10-31-2005.

THE MARK CONSISTS OF STANDARD CHAR-  
ACTERS WITHOUT CLAIM TO ANY PARTICULAR  
FONT, STYLE, SIZE, OR COLOR.

NO CLAIM IS MADE TO THE EXCLUSIVE  
RIGHT TO USE "DEVELOPMENT COMPANY",  
APART FROM THE MARK AS SHOWN.

SER. NO. 77-400,411, FILED 2-19-2008.

MICHAEL SOUDERS, EXAMINING ATTORNEY

**Int. Cl.: 30**

**Prior U.S. Cl.: 46**

**United States Patent and Trademark Office**

**Reg. No. 3,504,838**

**Registered Sep. 23, 2008**

**TRADEMARK  
PRINCIPAL REGISTER**

**NIBBY**

ARTISAN CONFECTIONS COMPANY (CALI-  
FORNIA CORPORATION)  
LAW DEPT.  
100 CRYSTAL A DRIVE  
HERSHEY, PA 17033

FOR: CANDY, IN CLASS 30 (U.S. CL. 46).

FIRST USE 7-31-1999; IN COMMERCE 7-31-1999.

THE MARK CONSISTS OF STANDARD CHAR-  
ACTERS WITHOUT CLAIM TO ANY PARTICULAR  
FONT, STYLE, SIZE, OR COLOR.

OWNER OF U.S. REG. NOS. 3,095,737 AND  
3,359,340.

SER. NO. 77-400,433, FILED 2-19-2008.

GENE MACIOL, EXAMINING ATTORNEY

**Int. Cl.: 41**

**Prior U.S. Cls.: 100, 101 and 107**

**United States Patent and Trademark Office**

**Reg. No. 3,504,839**

**Registered Sep. 23, 2008**

---

**SERVICE MARK  
PRINCIPAL REGISTER**

**VOYAGERS**

GREAT FALLS BASEBALL CLUB, INC. (MONTANA CORPORATION)  
1015 25TH STREET NORTH  
GREAT FALLS, MT 59401

THE MARK CONSISTS OF STANDARD CHARACTERS WITHOUT CLAIM TO ANY PARTICULAR FONT, STYLE, SIZE, OR COLOR.

FOR: ENTERTAINMENT SERVICES, NAMELY, BASEBALL GAMES AND EXHIBITIONS, AND BASEBALL TEAM MASCOT APPEARANCES, IN CLASS 41 (U.S. CLS. 100, 101 AND 107).

SER. NO. 77-400,468, FILED 2-19-2008.

FIRST USE 1-15-2008; IN COMMERCE 1-15-2008.

ROBIN CHOSID, EXAMINING ATTORNEY



**Int. Cl.: 41**

**Prior U.S. Cls.: 100, 101 and 107**

**United States Patent and Trademark Office**

**Reg. No. 3,504,840**

**Registered Sep. 23, 2008**

**SERVICE MARK  
PRINCIPAL REGISTER**

**MATSON 300**

ABUNDANCE TECHNOLOGIES, INC. (OHIO  
CORPORATION)  
SUITE 570  
4555 LAKE FOREST DRIVE  
CINCINNATI, OH 45242

FOR: ARRANGING PROFESSIONAL WORK-  
SHOP AND TRAINING COURSES; BUSINESS  
TRAINING, IN CLASS 41 (U.S. CLS. 100, 101 AND  
107).

FIRST USE 10-25-2007; IN COMMERCE 10-25-2007.

THE MARK CONSISTS OF STANDARD CHAR-  
ACTERS WITHOUT CLAIM TO ANY PARTICULAR  
FONT, STYLE, SIZE, OR COLOR.

SER. NO. 77-400,478, FILED 2-19-2008.

VERNA BETH RIRIE, EXAMINING ATTORNEY

**Int. Cl.: 21**

**Prior U.S. Cls.: 2, 13, 23, 29, 30, 33, 40 and 50**

**United States Patent and Trademark Office**

**Reg. No. 3,504,841**

**Registered Sep. 23, 2008**

**TRADEMARK  
PRINCIPAL REGISTER**

**ALL-CLAD METALCRAFTERS LLC  
GOURMET OVENWARE**

CLAD HOLDINGS INC (DELAWARE CORPORATION)  
424 MORGANZA ROAD  
CANONSBURG, PA 15317

OWNER OF U.S. REG. NO. 2,585,922.

FOR: BAKING PANS, NAMELY, CAKE PANS, PIE PANS, COOKIE SHEETS, ROASTING PANS, LOAF PANS AND MUFFIN PANS, IN CLASS 21 (U.S. CLS. 2, 13, 23, 29, 30, 33, 40 AND 50).

NO CLAIM IS MADE TO THE EXCLUSIVE RIGHT TO USE "METALCRAFTERS LLC GOURMET OVENWARE", APART FROM THE MARK AS SHOWN.

FIRST USE 9-0-2007; IN COMMERCE 9-0-2007.

SER. NO. 77-400,486, FILED 2-19-2008.

THE MARK CONSISTS OF STANDARD CHARACTERS WITHOUT CLAIM TO ANY PARTICULAR FONT, STYLE, SIZE, OR COLOR.

MAYUR VAGHANI, EXAMINING ATTORNEY

**Int. Cl.: 18**

**Prior U.S. Cls.: 1, 2, 3, 22 and 41**

**United States Patent and Trademark Office**

**Reg. No. 3,504,842**

**Registered Sep. 23, 2008**

**TRADEMARK  
PRINCIPAL REGISTER**

**MUNCHKIN**

MUNCHKIN, INC. (DELAWARE CORPORATION)  
16689 SCHOENBORN STREET  
NORTH HILLS, CA 91343

FOR: INFANT CARRIERS WORN ON THE BODY,  
IN CLASS 18 (U.S. CLS. 1, 2, 3, 22 AND 41).

FIRST USE 2-7-2008; IN COMMERCE 2-7-2008.

THE MARK CONSISTS OF STANDARD CHARACTERS WITHOUT CLAIM TO ANY PARTICULAR FONT, STYLE, SIZE, OR COLOR.

OWNER OF U.S. REG. NOS. 2,101,757 AND 2,253,848.

SER. NO. 77-400,491, FILED 2-19-2008.

CHRISIE B. KING, EXAMINING ATTORNEY

**Int. Cl.: 36**

**Prior U.S. Cls.: 100, 101 and 102**

**United States Patent and Trademark Office**

**Reg. No. 3,504,843**

**Registered Sep. 23, 2008**

**SERVICE MARK  
PRINCIPAL REGISTER**



ITUS GROUP INC. (GEORGIA CORPORATION)  
414 OLD HARD ROAD, SUITE 402  
ORANGE PARK, GA 32003

FOR: INSURANCE SERVICES, NAMELY, INSURANCE AGENCY AND BROKERAGE, INSURANCE UNDERWRITING FOR ALL TYPES OF INSURANCE, INSURANCE ADMINISTRATION, INSURANCE CLAIMS ADMINISTRATION, IN CLASS 36 (U.S. CLS. 100, 101 AND 102).

FIRST USE 10-5-2007; IN COMMERCE 10-5-2007.

NO CLAIM IS MADE TO THE EXCLUSIVE RIGHT TO USE "INSURANCE", APART FROM THE MARK AS SHOWN.

THE MARK CONSISTS OF THE DESIGN OF A CURVED ROAD BISECTING A LANDSCAPE WITH THE ROAD DISAPPEARING INTO THE UPPER HALF OF A SUN IN THE SKY THAT APPEARS IN THE HORIZON, THE ENTIRE DESIGN IS CONTAINED IN A RECTANGLE, TO THE RIGHT OF THE DESIGN APPEARS "DAMASCA INSURANCE PROTECTING YOUR CALLING", THERE IS A SOLID VERTICAL LINE BETWEEN "INSURANCE" AND "PROTECTING YOUR CALLING".

SER. NO. 77-400,497, FILED 2-19-2008.

MARY BOAGNI, EXAMINING ATTORNEY

**Int. Cl.: 42**

**Prior U.S. Cls.: 100 and 101**

**United States Patent and Trademark Office**

**Reg. No. 3,504,844**

**Registered Sep. 23, 2008**

**SERVICE MARK  
PRINCIPAL REGISTER**

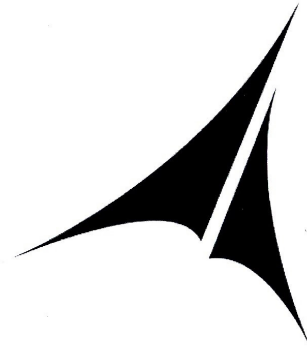

AUBICE LLC (DELAWARE LIMITED LIABILITY  
COMPANY)  
SUITE 250  
5347 SOUTH VALENTIA WAY  
GREENWOOD VILLAGE, CO 80111

FOR: COMPUTER SERVICES, NAMELY, ACTING  
AS AN APPLICATION SERVICE PROVIDER IN THE  
FIELD OF INFORMATION SEARCH AND MAN-  
AGEMENT TO HOST COMPUTER APPLICATION  
SOFTWARE FOR SEARCHING, RETRIEVING AND  
ORGANIZING INFORMATION FROM DATABA-

SES AND COMPUTER NETWORKS, IN CLASS 42  
(U.S. CLS. 100 AND 101).

FIRST USE 10-1-2007; IN COMMERCE 10-1-2007.

THE MARK CONSISTS OF A TWO-TRIANGLE  
DESIGN.

SER. NO. 77-400,501, FILED 2-19-2008.

NAKIA HENRY, EXAMINING ATTORNEY

**Int. Cl.: 41**

**Prior U.S. Cls.: 100, 101 and 107**

**United States Patent and Trademark Office**

**Reg. No. 3,504,845**

**Registered Sep. 23, 2008**

---

**SERVICE MARK  
PRINCIPAL REGISTER**

**DASL**

THE INTEGRATED STRATEGIES GROUP (CALIFORNIA SOLE PROPRIETORSHIP)  
5931 KIRKWOOD AVE  
ALTA LOMA, CA 91737

THE MARK CONSISTS OF STANDARD CHARACTERS WITHOUT CLAIM TO ANY PARTICULAR FONT, STYLE, SIZE, OR COLOR.

FOR: CONDUCTING WORKSHOPS AND SEMINARS IN SELF AWARENESS, IN CLASS 41 (U.S. CLS. 100, 101 AND 107).

SER. NO. 77-400,505, FILED 2-19-2008.

FIRST USE 0-0-1991; IN COMMERCE 0-0-1991.

ROBIN CHOSID, EXAMINING ATTORNEY

**Int. Cl.: 9**

**Prior U.S. Cls.: 21, 23, 26, 36 and 38**

**United States Patent and Trademark Office**

**Reg. No. 3,504,846**

**Registered Sep. 23, 2008**

**TRADEMARK  
PRINCIPAL REGISTER**

**SUNSTAT**

WATTS RADIANT, INC. (DELAWARE COR-  
PORATION)  
3131 WEST CHESTNUT EXPRESSWAY  
SPRINGFIELD, MO 65802

THE MARK CONSISTS OF STANDARD CHAR-  
ACTERS WITHOUT CLAIM TO ANY PARTICULAR  
FONT, STYLE, SIZE, OR COLOR.

FOR: THERMOSTATS, IN CLASS 9 (U.S. CLS. 21,  
23, 26, 36 AND 38).

SER. NO. 77-400,510, FILED 2-19-2008.

FIRST USE 4-0-2003; IN COMMERCE 4-0-2003.

ROBERT LAVACHE, EXAMINING ATTORNEY

**Int. Cl.: 15**

**Prior U.S. Cls.: 2, 21 and 36**

**United States Patent and Trademark Office**

**Reg. No. 3,504,847**

**Registered Sep. 23, 2008**

**TRADEMARK  
PRINCIPAL REGISTER**

**CENTERFOLD**

DEVILLAIN GUITAR CO AB (SWEDEN COR-  
PORATION)  
GYMNASIEVAGEN 16  
SKELLEFTEA, SWEDEN 93157

THE MARK CONSISTS OF STANDARD CHAR-  
ACTERS WITHOUT CLAIM TO ANY PARTICULAR  
FONT, STYLE, SIZE, OR COLOR.

FOR: GUITARS, IN CLASS 15 (U.S. CLS. 2, 21 AND  
36).

SER. NO. 77-400,515, FILED 2-19-2008.

FIRST USE 3-28-2007; IN COMMERCE 6-2-2007.

MARK PILARO, EXAMINING ATTORNEY



Int. Cl.: 35

Prior U.S. Cls.: 100, 101 and 102

United States Patent and Trademark Office

Reg. No. 3,504,848

Registered Sep. 23, 2008

SERVICE MARK  
PRINCIPAL REGISTER



MICHIGAN COMMUNITY COLLEGE ASSOCIATION (MICHIGAN CORPORATION)  
222 N. CHESTNUT STREET  
LANSING, MI 48933

FOR: PUBLIC ADVOCACY TO PROMOTE AWARENESS OF THE INTERESTS OF COMMUNITY COLLEGES, IN CLASS 35 (U.S. CLS. 100, 101 AND 102).

FIRST USE 4-1-2007; IN COMMERCE 4-1-2007.

NO CLAIM IS MADE TO THE EXCLUSIVE RIGHT TO USE "MICHIGAN COMMUNITY COLLEGE ASSOCIATION" AND THE MAP OF THE STATE OF MICHIGAN, APART FROM THE MARK AS SHOWN.

THE COLOR(S) BLUE AND WHITE IS/ARE CLAIMED AS A FEATURE OF THE MARK.

THE MARK CONSISTS OF AN OUTLINE OF THE STATE OF MICHIGAN, IN THE COLOR BLUE, WITH THE LETTERS MCCA PLACED ALONG THE LOWER HALF, THE SECOND LETTER C IN "MCCA" IS INSIDE THE IMAGE AND CONSISTS OF A WHITE COLOR, THE WORD "ASSOCIATION" PLACED BELOW MCCA AND THE WORDS "MICHIGAN COMMUNITY COLLEGE" SPACED IN A HALF MOON ABOVE THE TOP OF THE STATE OUTLINE. THE COLOR WHITE APPEARS IN THE LETTER "C" THAT IS WITHIN THE MAP OF MICHIGAN. THE OTHER ELEMENTS OF THE MARK ARE BLUE. OTHER THAN AS SPECIFICALLY CLAIMED, THE COLOR WHITE REPRESENTS BACKGROUND AND IS NOT PART OF THE MARK.

SER. NO. 77-400,531, FILED 2-19-2008.

MELVIN AXILBUND, EXAMINING ATTORNEY

**Int. Cl.: 35**

**Prior U.S. Cls.: 100, 101 and 102**

**United States Patent and Trademark Office**

**Reg. No. 3,504,849**

**Registered Sep. 23, 2008**

**SERVICE MARK  
PRINCIPAL REGISTER**

**MYCLASSI**

ALONZO, RAY (UNITED STATES INDIVIDUAL)  
3468 W. OLIVE AVENUE  
FRESNO, CA 93722

THE MARK CONSISTS OF STANDARD CHAR-  
ACTERS WITHOUT CLAIM TO ANY PARTICULAR  
FONT, STYLE, SIZE, OR COLOR.

FOR: PROVIDING AN ON-LINE SEARCHABLE  
DATABASE FEATURING CLASSIFIED AD LIST-  
INGS AND EMPLOYMENT OPPORTUNITIES, IN  
CLASS 35 (U.S. CLS. 100, 101 AND 102).

SER. NO. 77-400,552, FILED 2-19-2008.

FIRST USE 8-2-2007; IN COMMERCE 8-2-2007.

MARIA-VICTORIA SUAREZ, EXAMINING ATTOR-  
NEY

**Int. Cl.: 36**

**Prior U.S. Cls.: 100, 101 and 102**

**United States Patent and Trademark Office**

**Reg. No. 3,504,850**

**Registered Sep. 23, 2008**

**SERVICE MARK  
PRINCIPAL REGISTER**



CARMAX BUSINESS SERVICES, LLC (DELAWARE LIMITED LIABILITY COMPANY)  
12800 TUCKAHOE CREEK PARKWAY  
RICHMOND, VA 23238

FOR: AUTOMOBILE APPRAISAL, IN CLASS 36 (U.S. CLS. 100, 101 AND 102).

FIRST USE 5-12-2006; IN COMMERCE 5-12-2006.

OWNER OF U.S. REG. NOS. 1,941,353, 3,394,117 AND OTHERS.

NO CLAIM IS MADE TO THE EXCLUSIVE RIGHT TO USE "CAR BUYING CENTER", APART FROM THE MARK AS SHOWN.

THE COLOR(S) BLUE, WHITE, AND YELLOW IS/ ARE CLAIMED AS A FEATURE OF THE MARK.

THE MARK CONSISTS OF A SMALLER OVAL WITH THE WORD "CAR" IN YELLOW AND THE WORD "MAX" IN WHITE SUPERIMPOSED ON A BLUE BACKGROUND ABOVE A LARGER OVAL WITH THE WORDS "CAR BUYING CENTER" IN WHITE SUPERIMPOSED ON A BLUE BACKGROUND.

SER. NO. 77-400,559, FILED 2-19-2008.

TRICIA SONNEBORN, EXAMINING ATTORNEY

**Int. Cls.: 16 and 41**

**Prior U.S. Cls.: 2, 5, 22, 23, 29, 37, 38, 50, 100, 101 and 107**

**Reg. No. 3,504,851**

**United States Patent and Trademark Office**

**Registered Sep. 23, 2008**

**TRADEMARK  
SERVICE MARK  
PRINCIPAL REGISTER**

**ADMITVIP**

PREPAID VENTURES, INC. (WASHINGTON CORPORATION)  
1325 FOURTH AVENUE, SUITE 940  
SEATTLE, WA 98101

FOR: NON-MAGNETICALLY ENCODED PREPAID PURCHASE CARDS FOR AN ADULT PROVIDES INFORMATION NECESSARY FOR THE ADULT TO ACCESS ADULT ENTERTAINMENT OF A SEXUAL NATURE ON A WEBSITE, IN CLASS 16 (U.S. CLS. 2, 5, 22, 23, 29, 37, 38 AND 50).

FIRST USE 1-15-2008; IN COMMERCE 1-15-2008.

FOR: PROVIDING ENTERTAINMENT OF A SEXUAL NATURE ON A WEBSITE INTENDED TO BE

ACCESSIBLE ONLY BY ADULTS, IN CLASS 41 (U.S. CLS. 100, 101 AND 107).

FIRST USE 1-15-2008; IN COMMERCE 1-15-2008.

THE MARK CONSISTS OF STANDARD CHARACTERS WITHOUT CLAIM TO ANY PARTICULAR FONT, STYLE, SIZE, OR COLOR.

SER. NO. 77-400,597, FILED 2-19-2008.

VIVIAN MICZNIK FIRST, EXAMINING ATTORNEY

**Int. Cl.: 4**

**Prior U.S. Cls.: 1, 6 and 15**

**United States Patent and Trademark Office**

**Reg. No. 3,504,852**

**Registered Sep. 23, 2008**

**TRADEMARK  
PRINCIPAL REGISTER**

**PETAX**

INTERNATIONAL GROUP, INC. (DELAWARE  
CORPORATION)  
85 OLD EAGLE SCHOOL RD  
WAYNE, PA 19087

THE MARK CONSISTS OF STANDARD CHAR-  
ACTERS WITHOUT CLAIM TO ANY PARTICULAR  
FONT, STYLE, SIZE, OR COLOR.

FOR: WAX APPLIED AS A COATING TO PAPER  
PRODUCTS, IN CLASS 4 (U.S. CLS. 1, 6 AND 15).

SER. NO. 77-400,617, FILED 2-19-2008.

FIRST USE 1-1-1995; IN COMMERCE 1-1-1996.

LAURIE KAUFMAN, EXAMINING ATTORNEY

**Int. Cl.: 44**

**Prior U.S. Cls.: 100 and 101**

**United States Patent and Trademark Office**

**Reg. No. 3,504,853**

**Registered Sep. 23, 2008**

**SERVICE MARK  
PRINCIPAL REGISTER**



ADVANCED OPTOMETRY, P.A. (MINNESOTA CORPORATION)  
SUITE 205  
17685 JUNIPER PATH  
LAKEVILLE, MN 55044

FOR: OPTOMETRY SERVICES, IN CLASS 44 (U.S. CLS. 100 AND 101).

FIRST USE 11-30-2006; IN COMMERCE 11-30-2006.

NO CLAIM IS MADE TO THE EXCLUSIVE RIGHT TO USE "EYE CARE PROFESSIONALS", APART FROM THE MARK AS SHOWN.

THE MARK CONSISTS OF A STYLIZED EYE WITH THE WORDS "ADVANCED EYE CARE" STACKED TO THE LEFT OF THE EYE AND THE WORD "PROFESSIONALS" TO THE LEFT OF THE EYE AND CONTINUING UNDERNEATH THE EYE.

SER. NO. 77-400,646, FILED 2-19-2008.

SUSAN STIGLITZ, EXAMINING ATTORNEY

**Int. Cl.: 41**

**Prior U.S. Cls.: 100, 101 and 107**

**United States Patent and Trademark Office**

**Reg. No. 3,504,854**

**Registered Sep. 23, 2008**

**SERVICE MARK  
PRINCIPAL REGISTER**

**RUN N' GUN**

RUN & GUN, LLC (MARYLAND LIMITED LIABILITY COMPANY)  
SUITE 2601  
201 NORTH CHARLES STREET  
BALTIMORE, MD 21201

THE MARK CONSISTS OF STANDARD CHARACTERS WITHOUT CLAIM TO ANY PARTICULAR FONT, STYLE, SIZE, OR COLOR.

FOR: OPERATION OF SPORTS CAMPS, IN CLASS 41 (U.S. CLS. 100, 101 AND 107).

SER. NO. 77-400,647, FILED 2-19-2008.

FIRST USE 11-20-2006; IN COMMERCE 11-20-2006.

DAVID MILLER, EXAMINING ATTORNEY

**Int. Cl.: 30**

**Prior U.S. Cl.: 46**

**United States Patent and Trademark Office**

**Reg. No. 3,504,855**

**Registered Sep. 23, 2008**

**TRADEMARK  
PRINCIPAL REGISTER**



APB INVESTMENTS LIMITED COMPANY  
(UTAH LIMITED LIABILITY COMPANY)  
1980 NORTH STATE STREET  
OREM, UT 84057

OWNER OF U.S. REG. NOS. 2,381,637, 2,661,359  
AND OTHERS.

FOR: BREADS, PASTRIES AND BAKERY PRO-  
DUCTS, IN CLASS 30 (U.S. CL. 46).

SER. NO. 77-400,657, FILED 2-19-2008.

FIRST USE 1-31-2000; IN COMMERCE 1-31-2000.

WILLIAM ROSSMAN, EXAMINING ATTORNEY



**Int. Cl.: 18**

**Prior U.S. Cls.: 1, 2, 3, 22 and 41**

**United States Patent and Trademark Office**

**Reg. No. 3,504,856**

**Registered Sep. 23, 2008**

**TRADEMARK  
PRINCIPAL REGISTER**

**INTELLIGENT DOG**

SHEEPDOG INC. (FLORIDA CORPORATION)  
1007 N. FEDERAL HYWY #D  
FT. LAUDERDALE, FL 33304

FOR: DOG APPAREL, IN CLASS 18 (U.S. CLS. 1, 2,  
3, 22 AND 41).

FIRST USE 4-1-1999; IN COMMERCE 4-20-1999.

THE MARK CONSISTS OF STANDARD CHAR-  
ACTERS WITHOUT CLAIM TO ANY PARTICULAR  
FONT, STYLE, SIZE, OR COLOR.

NO CLAIM IS MADE TO THE EXCLUSIVE  
RIGHT TO USE "DOG", APART FROM THE MARK  
AS SHOWN.

SEC. 2(F).

SER. NO. 77-400,658, FILED 2-19-2008.

CAROLYN GRAY, EXAMINING ATTORNEY

**Int. Cl.: 9**

**Prior U.S. Cls.: 21, 23, 26, 36 and 38**

**Reg. No. 3,504,857**

**United States Patent and Trademark Office**

**Registered Sep. 23, 2008**

**TRADEMARK  
PRINCIPAL REGISTER**

**STRINGDOG**

NAYLOR, JOSEPH F. (UNITED STATES INDIVIDUAL)  
4072 GREENSBORO DR.  
TROY, MI 48085

THE MARK CONSISTS OF STANDARD CHARACTERS WITHOUT CLAIM TO ANY PARTICULAR FONT, STYLE, SIZE, OR COLOR.

FOR: GUITAR CABLES, IN CLASS 9 (U.S. CLS. 21, 23, 26, 36 AND 38).

SER. NO. 77-400,665, FILED 2-19-2008.

FIRST USE 2-19-2008; IN COMMERCE 2-19-2008.

CAROLYN GRAY, EXAMINING ATTORNEY

**Int. Cls.: 35 and 41**

**Prior U.S. Cls.: 100, 101, 102 and 107**

**United States Patent and Trademark Office**

**Reg. No. 3,504,858**

**Registered Sep. 23, 2008**

**SERVICE MARK  
PRINCIPAL REGISTER**

# WEEPING PAIL

BOMBADIL LLC (NEW JERSEY LIMITED LIABILITY COMPANY)

P.O. BOX 637

MARTINSVILLE, NJ 08836

FOR: MARKETING CONSULTATION IN THE FIELDS OF CUSTOMER NEEDS AND SALES STRATEGY; DEVELOPMENT OF MARKETING STRATEGIES AND CONCEPTS; MARKET ANALYSIS; AND MARKET RESEARCH, IN CLASS 35 (U.S. CLS. 100, 101 AND 102).

FIRST USE 10-0-2007; IN COMMERCE 10-0-2007.

FOR: TRAINING COURSES IN STRATEGIC PLANNING RELATING TO ADVERTISING, PROMOTION, MARKETING, AND BUSINESS, IN CLASS 41 (U.S. CLS. 100, 101 AND 107).

FIRST USE 10-0-2007; IN COMMERCE 10-0-2007.

THE MARK CONSISTS OF STANDARD CHARACTERS WITHOUT CLAIM TO ANY PARTICULAR FONT, STYLE, SIZE, OR COLOR.

SER. NO. 77-400,667, FILED 2-19-2008.

CAROLYN GRAY, EXAMINING ATTORNEY

**Int. Cl.: 35**

**Prior U.S. Cls.: 100, 101 and 102**

**United States Patent and Trademark Office**

**Reg. No. 3,504,859**

**Registered Sep. 23, 2008**

**SERVICE MARK  
PRINCIPAL REGISTER**



UPLINK GAMING, LLC (NEW JERSEY LIMITED  
LIABILITY COMPANY)

206 N. HIGH STREET  
MILLVILLE, NJ 08332

FOR: ON-LINE RETAIL STORE SERVICES FEATURING COMPUTERS, IN CLASS 35 (U.S. CLS. 100, 101 AND 102).

FIRST USE 2-8-2008; IN COMMERCE 2-19-2008.

THE COLOR(S) BLUE, BLACK IS/ARE CLAIMED AS A FEATURE OF THE MARK.

THE MARK CONSISTS OF A BLACK CROSSHAIR OVER THE LETTER "A" IN THE BLUE WORD "FRAGTECH".

SER. NO. 77-400,676, FILED 2-19-2008.

CAROLYN GRAY, EXAMINING ATTORNEY

**Int. Cl.: 30**

**Prior U.S. Cl.: 46**

**United States Patent and Trademark Office**

**Reg. No. 3,504,860**

**Registered Sep. 23, 2008**

**TRADEMARK  
PRINCIPAL REGISTER**



THE QUAKER OATS COMPANY (NEW JERSEY CORPORATION)  
555 WEST MONROE STREET  
CHICAGO, IL 60661

FOR: BREAKFAST CEREALS AND CEREAL-BASED PREPARATIONS, NAMELY, READY-TO-EAT CEREAL FOOD BARS, CEREAL BASED SNACK FOODS, IN CLASS 30 (U.S. CL. 46).

FIRST USE 12-10-2007; IN COMMERCE 12-10-2007.

OWNER OF U.S. REG. NOS. 526,830, 3,270,184 AND OTHERS.

THE NAME(S), PORTRAIT(S), AND/OR SIGNATURE(S) SHOWN IN THE MARK DOES NOT IDENTIFY A PARTICULAR LIVING INDIVIDUAL.

THE MARK CONSISTS OF A PORTRAIT OF A MAN WEARING A HAT WITHIN A CIRCLE, APPEARING OVER THE WORD "QUAKER".

SER. NO. 77-400,684, FILED 2-19-2008.

BRIAN CALLAGHAN, EXAMINING ATTORNEY

**Int. Cl.: 45**

**Prior U.S. Cls.: 100 and 101**

**United States Patent and Trademark Office**

**Reg. No. 3,504,861**

**Registered Sep. 23, 2008**

**SERVICE MARK  
PRINCIPAL REGISTER**

**EUROCHEK**

INVESTIGATIVE CONSULTANTS, INC. (ILLINOIS CORPORATION)  
SUITE 813  
2020 PENNSYLVANIA AVENUE NW  
WASHINGTON, DC 20006

FOR: ONLINE SCREENING AND INVESTIGATIVE SERVICES USING AGGREGATED DATA FROM DISPARATE DATABASE CENTERS FOR PERSONAL IDENTIFICATION AND PERSONAL BACKGROUND REVIEWS, IN CLASS 45 (U.S. CLS. 100 AND 101).

FIRST USE 11-11-2004; IN COMMERCE 11-11-2004.

THE MARK CONSISTS OF STANDARD CHARACTERS WITHOUT CLAIM TO ANY PARTICULAR FONT, STYLE, SIZE, OR COLOR.

SER. NO. 77-400,689, FILED 2-19-2008.

PETER B. BROMAGHIM, EXAMINING ATTORNEY

**Int. Cl.: 7**

**Prior U.S. Cls.: 13, 19, 21, 23, 31, 34 and 35**

**United States Patent and Trademark Office**

**Reg. No. 3,504,862**

**Registered Sep. 23, 2008**

**TRADEMARK  
PRINCIPAL REGISTER**

**OUR MOTORS MINE COAL**

GOULD'S ELECTRIC MOTOR REPAIR, INC.  
(WEST VIRGINIA CORPORATION)  
PO BOX 100  
INDORE, WV 25111

THE MARK CONSISTS OF STANDARD CHAR-  
ACTERS WITHOUT CLAIM TO ANY PARTICULAR  
FONT, STYLE, SIZE, OR COLOR.

FOR: ELECTRIC MOTORS FOR MACHINES, IN  
CLASS 7 (U.S. CLS. 13, 19, 21, 23, 31, 34 AND 35).

SER. NO. 77-400,711, FILED 2-19-2008.

FIRST USE 1-1-1986; IN COMMERCE 1-1-1988.

CHARLOTTE CORWIN, EXAMINING ATTORNEY

**Int. Cl.: 29**

**Prior U.S. Cl.: 46**

**United States Patent and Trademark Office**

**Reg. No. 3,504,863**

**Registered Sep. 23, 2008**

**TRADEMARK  
PRINCIPAL REGISTER**

# Coral Bay

OFI INTERNATIONAL, INC. (CALIFORNIA  
CORPORATION), FORMERLY ORIENTAL  
FOODS, INC.  
SUITE 102  
767 N. HILLS STREET  
LOS ANGELES, CA 90012

FOR: FISH, NAMELY, FROZEN AND FRESH  
SHRIMP AND SEAFOOD, IN CLASS 29 (U.S. CL. 46).

FIRST USE 1-1-2008; IN COMMERCE 1-1-2008.

THE MARK CONSISTS OF STANDARD CHAR-  
ACTERS WITHOUT CLAIM TO ANY PARTICULAR  
FONT, STYLE, SIZE, OR COLOR.

SER. NO. 77-400,751, FILED 2-19-2008.

JULIE WATSON, EXAMINING ATTORNEY



**Int. Cl.: 39**

**Prior U.S. Cls.: 100 and 105**

**United States Patent and Trademark Office**

**Reg. No. 3,504,864**

**Registered Sep. 23, 2008**

**SERVICE MARK  
PRINCIPAL REGISTER**

**JET EDGE**

WESTERN AIR CHARTER, INC. (CALIFORNIA  
CORPORATION)  
16135 COHASSET  
VAN NUYS, CA 91406

NO CLAIM IS MADE TO THE EXCLUSIVE  
RIGHT TO USE "JET", APART FROM THE MARK  
AS SHOWN.

FOR: AIR CHARTER TRANSPORTATION SER-  
VICES, IN CLASS 39 (U.S. CLS. 100 AND 105).

SER. NO. 77-400,761, FILED 2-19-2008.

FIRST USE 8-0-2007; IN COMMERCE 8-0-2007.

THE MARK CONSISTS OF STANDARD CHAR-  
ACTERS WITHOUT CLAIM TO ANY PARTICULAR  
FONT, STYLE, SIZE, OR COLOR.

KATHLEEN M. VANSTON, EXAMINING ATTOR-  
NEY

**Int. Cl.: 36**

**Prior U.S. Cls.: 100, 101 and 102**

**United States Patent and Trademark Office**

**Reg. No. 3,504,865**

**Registered Sep. 23, 2008**

**SERVICE MARK  
PRINCIPAL REGISTER**

**COMPWEB**

COMPWEST INSURANCE COMPANY (CALI-  
FORNIA CORPORATION)  
SUITE 1700  
301 HOWARD ST.  
SAN FRANCISCO, CA 94105

FOR: INSURANCE SERVICES, NAMELY, INSUR-  
ANCE UNDERWRITING SERVICES AND CLAIMS  
ADMINISTRATION SERVICES IN THE FIELD OF  
WORKER'S COMPENSATION INSURANCE , IN  
CLASS 36 (U.S. CLS. 100, 101 AND 102).

FIRST USE 9-22-2004; IN COMMERCE 9-22-2004.

THE MARK CONSISTS OF STANDARD CHAR-  
ACTERS WITHOUT CLAIM TO ANY PARTICULAR  
FONT, STYLE, SIZE, OR COLOR.

SER. NO. 77-400,789, FILED 2-19-2008.

APRIL HESIK, EXAMINING ATTORNEY

**Int. Cl.: 42**

**Prior U.S. Cls.: 100 and 101**

**United States Patent and Trademark Office**

**Reg. No. 3,504,866**

**Registered Sep. 23, 2008**

**SERVICE MARK  
PRINCIPAL REGISTER**

**FLEKTOR**

FLEKTOR, INC. (DELAWARE CORPORATION)  
407 N. MAPLE DRIVE  
BEVERLY HILLS, CA 90210

FIRST USE 5-10-2007; IN COMMERCE 5-10-2007.

FOR: PROVIDING TEMPORARY USE OF NON-DOWNLOADABLE SOFTWARE FOR THE INTEGRATION OF LIVE AND PRE-RECORDED MULTIMEDIA CONTENT IN THE FORM OF TEXT, AUDIO, GRAPHICS, STILL IMAGE AND MOVING PICTURES INTO AN INTERACTIVE DELIVERY FOR MULTIMEDIA APPLICATIONS, IN CLASS 42 (U.S. CLS. 100 AND 101).

THE MARK CONSISTS OF STANDARD CHARACTERS WITHOUT CLAIM TO ANY PARTICULAR FONT, STYLE, SIZE, OR COLOR.

SER. NO. 77-400,797, FILED 2-19-2008.

JILL PRATER, EXAMINING ATTORNEY

**Int. Cl.: 37**

**Prior U.S. Cls.: 100, 103 and 106**

**United States Patent and Trademark Office**

**Reg. No. 3,504,867**

**Registered Sep. 23, 2008**

**SERVICE MARK  
PRINCIPAL REGISTER**

# Rock Hill Trails

WELLSPRING DEVELOPMENT COMPANY (ILLINOIS CORPORATION), DBA ROCK HILL TRAILS  
1806 LYNDHURST  
SAVOY, IL 61874

FOR: LAND DEVELOPMENT SERVICES, NAME-  
LY, PLANNING AND LAYING OUT OF RESIDEN-  
TIAL AND/OR COMMERCIAL COMMUNITIES, IN  
CLASS 37 (U.S. CLS. 100, 103 AND 106).

FIRST USE 2-28-2007; IN COMMERCE 4-30-2007.

THE MARK CONSISTS OF STANDARD CHAR-  
ACTERS WITHOUT CLAIM TO ANY PARTICULAR  
FONT, STYLE, SIZE, OR COLOR.

SER. NO. 77-400,804, FILED 2-19-2008.

MICHAEL SOUDERS, EXAMINING ATTORNEY

**Int. Cl.: 9**

**Prior U.S. Cls.: 21, 23, 26, 36 and 38**

**Reg. No. 3,504,868**

**United States Patent and Trademark Office**

**Registered Sep. 23, 2008**

---

**TRADEMARK  
PRINCIPAL REGISTER**

**TriGeo**

TRIGEO NETWORK SECURITY, INC. (IDAHO  
CORPORATION)  
510 CLEARWATER LOOP  
POST FALLS, ID 83854

THE MARK CONSISTS OF STANDARD CHAR-  
ACTERS WITHOUT CLAIM TO ANY PARTICULAR  
FONT, STYLE, SIZE, OR COLOR.

FOR: COMPUTER SOFTWARE AND HARD-  
WARE FOR SECURING ENTERPRISE COMPUTER  
NETWORKS, IN CLASS 9 (U.S. CLS. 21, 23, 26, 36  
AND 38).

SER. NO. 77-400,809, FILED 2-19-2008.

FIRST USE 7-20-2001; IN COMMERCE 7-20-2001.

CHARLES L. JENKINS, EXAMINING ATTORNEY

**Int. Cl.: 9**

**Prior U.S. Cls.: 21, 23, 26, 36 and 38**

**United States Patent and Trademark Office**

**Reg. No. 3,504,869**

**Registered Sep. 23, 2008**

**TRADEMARK  
PRINCIPAL REGISTER**



SPEED TO MARKET, INC. (NEVADA CORPORATION)  
2355 E. FLAMINGO ROAD, SUITE 201G  
LAS VEGAS, NV 89119

FOR: SOFTWARE AND ELECTRONIC DATABASE RECORDED ON COMPUTER MEDIA IN THE FIELD OF QUALITY ASSURANCE AND REGULATORY COMPLIANCE AND DOCUMENT MANAGEMENT FOR THE MEDICAL DEVICE INDUSTRY, IN CLASS 9 (U.S. CLS. 21, 23, 26, 36 AND 38).

FIRST USE 3-15-2006; IN COMMERCE 3-15-2006.

THE MARK CONSISTS OF THE INITIALS "STM" AND THE DESIGN OF A SWOOP WITH A BULLET.

SER. NO. 77-400,849, FILED 2-19-2008.

CURTIS FRENCH, EXAMINING ATTORNEY

Int. Cl.: 35

Prior U.S. Cls.: 100, 101 and 102

United States Patent and Trademark Office

Reg. No. 3,504,870

Registered Sep. 23, 2008

**SERVICE MARK  
PRINCIPAL REGISTER**



SPEED TO MARKET, INC. (NEVADA CORPORATION)  
2355 E. FLAMINGO ROAD, SUITE 201G  
LAS VEGAS, NV 89119

FOR: REGULATORY SUBMISSION MANAGEMENT, NAMELY, ASSISTING OTHERS IN PREPARING AND FILING DOCUMENTS FOR APPROVAL OF MEDICAL DEVICES WITH GOVERNMENTAL REGULATORY BODIES, IN CLASS 35 (U.S. CLS. 100, 101 AND 102).

FIRST USE 3-15-2006; IN COMMERCE 3-15-2006.

THE MARK CONSISTS OF THE INITIALS "STM" AND THE DESIGN OF A SWOOP WITH A BULLET.

SER. NO. 77-400,852, FILED 2-19-2008.

CURTIS FRENCH, EXAMINING ATTORNEY

**Int. Cl.: 42**

**Prior U.S. Cls.: 100 and 101**

**United States Patent and Trademark Office**

**Reg. No. 3,504,871**

**Registered Sep. 23, 2008**

**SERVICE MARK  
PRINCIPAL REGISTER**



SPEED TO MARKET, INC. (NEVADA CORPORATION)  
2355 E. FLAMINGO ROAD, SUITE 201G  
LAS VEGAS, NV 89119

FOR: PRODUCT DEVELOPMENT CONSULTATION; ADVISORY SERVICES IN THE FIELD OF PRODUCT DEVELOPMENT, PRODUCTION, AND QUALITY ASSURANCE IN THE MEDICAL DEVICE INDUSTRY; PROFESSIONAL ADVISORY AND CONSULTING SERVICES IN THE FIELD OF PRODUCT DEVELOPMENT, PRODUCTION, AND QUALITY IMPROVEMENT OF MEDICAL DEVICES; PROVIDING QUALITY ASSURANCE SERVICES IN THE FIELD OF REGULATORY AFFAIRS IN THE MEDICAL DEVICE INDUSTRY; CONSULT-

ING SERVICES IN THE FIELD OF REGULATORY AND QUALITY ASSURANCE PLANNING ASSESSMENT, COMPLIANCE, OPTIMIZATION AND SUPPORT, ALL FOR THE MEDICAL DEVICE INDUSTRY, IN CLASS 42 (U.S. CLS. 100 AND 101).

FIRST USE 3-15-2006; IN COMMERCE 3-15-2006.

THE MARK CONSISTS OF THE INITIALS "STM" AND THE DESIGN OF A SWOOSH WITH A BULLET.

SER. NO. 77-400,853, FILED 2-19-2008.

CURTIS FRENCH, EXAMINING ATTORNEY



**Int. Cl.: 9**

**Prior U.S. Cls.: 21, 23, 26, 36 and 38**

**Reg. No. 3,504,872**

**United States Patent and Trademark Office**

**Registered Sep. 23, 2008**

**TRADEMARK  
PRINCIPAL REGISTER**

**SPEED TO MARKET, INC.**

SPEED TO MARKET, INC. (NEVADA CORPORATION)  
2355 E. FLAMINGO ROAD, SUITE 201G  
LAS VEGAS, NV 89119

FOR: SOFTWARE AND ELECTRONIC DATABASE RECORDED ON COMPUTER MEDIA IN THE FIELD OF QUALITY ASSURANCE AND REGULATORY COMPLIANCE AND DOCUMENT MANAGEMENT FOR THE MEDICAL DEVICE INDUSTRY, IN CLASS 9 (U.S. CLS. 21, 23, 26, 36 AND 38).

FIRST USE 2-16-2001; IN COMMERCE 3-28-2001.

THE MARK CONSISTS OF STANDARD CHARACTERS WITHOUT CLAIM TO ANY PARTICULAR FONT, STYLE, SIZE, OR COLOR.

NO CLAIM IS MADE TO THE EXCLUSIVE RIGHT TO USE "INC.", APART FROM THE MARK AS SHOWN.

SER. NO. 77-400,856, FILED 2-19-2008.

CURTIS FRENCH, EXAMINING ATTORNEY

**Int. Cl.: 35**

**Prior U.S. Cls.: 100, 101 and 102**

**United States Patent and Trademark Office**

**Reg. No. 3,504,873**

**Registered Sep. 23, 2008**

**SERVICE MARK  
PRINCIPAL REGISTER**

**SPEED TO MARKET, INC.**

SPEED TO MARKET, INC. (NEVADA CORPORATION)  
2355 E. FLAMINGO ROAD, SUITE 201G  
LAS VEGAS, NV 89119

FOR: REGULATORY SUBMISSION MANAGEMENT, NAMELY, ASSISTING OTHERS IN PREPARING AND FILING DOCUMENTS FOR APPROVAL OF MEDICAL DEVICES WITH GOVERNMENTAL REGULATORY BODIES, IN CLASS 35 (U.S. CLS. 100, 101 AND 102).

FIRST USE 2-16-2001; IN COMMERCE 3-28-2001.

THE MARK CONSISTS OF STANDARD CHARACTERS WITHOUT CLAIM TO ANY PARTICULAR FONT, STYLE, SIZE, OR COLOR.

NO CLAIM IS MADE TO THE EXCLUSIVE RIGHT TO USE "INC.", APART FROM THE MARK AS SHOWN.

SER. NO. 77-400,862, FILED 2-19-2008.

CURTIS FRENCH, EXAMINING ATTORNEY

**Int. Cl.: 42**

**Prior U.S. Cls.: 100 and 101**

**United States Patent and Trademark Office**

**Reg. No. 3,504,874**

**Registered Sep. 23, 2008**

**SERVICE MARK  
PRINCIPAL REGISTER**

**SPEED TO MARKET, INC.**

SPEED TO MARKET, INC. (NEVADA CORPORATION)  
2355 E. FLAMINGO ROAD, SUITE 201G  
LAS VEGAS, NV 89119

FOR: PRODUCT DEVELOPMENT CONSULTATION; ADVISORY SERVICES IN THE FIELD OF PRODUCT DEVELOPMENT, PRODUCTION, AND QUALITY ASSURANCE IN THE MEDICAL DEVICE INDUSTRY; PROFESSIONAL ADVISORY AND CONSULTING SERVICES IN THE FIELD OF PRODUCT DEVELOPMENT, PRODUCTION, AND QUALITY IMPROVEMENT OF MEDICAL DEVICES; PROVIDING QUALITY ASSURANCE SERVICES IN THE FIELD OF REGULATORY AFFAIRS IN THE MEDICAL DEVICE INDUSTRY; CONSULTING SERVICES IN THE FIELD OF REGULATORY AND QUALITY ASSURANCE PLANNING ASSES-

MENT, COMPLIANCE, OPTIMIZATION AND SUPPORT, ALL FOR THE MEDICAL DEVICE INDUSTRY, IN CLASS 42 (U.S. CLS. 100 AND 101).

FIRST USE 2-16-2001; IN COMMERCE 3-28-2001.

THE MARK CONSISTS OF STANDARD CHARACTERS WITHOUT CLAIM TO ANY PARTICULAR FONT, STYLE, SIZE, OR COLOR.

NO CLAIM IS MADE TO THE EXCLUSIVE RIGHT TO USE "INC.", APART FROM THE MARK AS SHOWN.

SER. NO. 77-400,863, FILED 2-19-2008.

CURTIS FRENCH, EXAMINING ATTORNEY

**Int. Cl.: 30**

**Prior U.S. Cl.: 46**

**United States Patent and Trademark Office**

**Reg. No. 3,504,875**

**Registered Sep. 23, 2008**

**TRADEMARK  
PRINCIPAL REGISTER**

**GLITTERATI**

CHIPURNOI INCORPORATED (NEW YORK  
CORPORATION)  
3 CEMETERY HILL ROAD  
SHARON, CT 06069

FOR: HARD CANDY, IN CLASS 30 (U.S. CL. 46).

FIRST USE 12-31-1998; IN COMMERCE 12-31-1998.

THE MARK CONSISTS OF STANDARD CHAR-  
ACTERS WITHOUT CLAIM TO ANY PARTICULAR  
FONT, STYLE, SIZE, OR COLOR.

OWNER OF U.S. REG. NO. 3,350,476.

SER. NO. 77-400,867, FILED 2-19-2008.

CURTIS FRENCH, EXAMINING ATTORNEY

**Int. Cl.: 42**

**Prior U.S. Cls.: 100 and 101**

**United States Patent and Trademark Office**

**Reg. No. 3,504,876**

**Registered Sep. 23, 2008**

**SERVICE MARK  
PRINCIPAL REGISTER**

**ACTIVE PRODUCT TOUR**

SELLPOINT, INC. (DELAWARE CORPORATION)  
5700 STONERIDGE MALL ROAD, SUITE 320  
PLEASANTON, CA 94588

FOR: PROVIDING TEMPORARY USE OF ON-  
LINE NON-DOWNLOADABLE SOFTWARE FOR  
USE IN PROMOTING SALES ON AN ELECTRONIC  
COMMUNICATION NETWORK, NAMELY, HOST-  
ING AND SYNDICATING DYNAMIC VIDEO WITH  
SALES AND SUPPORT MATERIALS, IN CLASS 42  
(U.S. CLS. 100 AND 101).

FIRST USE 3-20-2006; IN COMMERCE 3-20-2006.

THE MARK CONSISTS OF STANDARD CHAR-  
ACTERS WITHOUT CLAIM TO ANY PARTICULAR  
FONT, STYLE, SIZE, OR COLOR.

NO CLAIM IS MADE TO THE EXCLUSIVE  
RIGHT TO USE "PRODUCT", APART FROM THE  
MARK AS SHOWN.

SER. NO. 77-400,870, FILED 2-19-2008.

JOHN WILKE, EXAMINING ATTORNEY

**Int. Cl.: 5**

**Prior U.S. Cls.: 6, 18, 44, 46, 51 and 52**

**Reg. No. 3,504,877**

**United States Patent and Trademark Office**

**Registered Sep. 23, 2008**

---

**TRADEMARK  
PRINCIPAL REGISTER**

**KIDETOX**

LEONARD HARDY (CANADA INDIVIDUAL)  
P.O. BOX 9  
GHARB GRB100, MALTA

THE MARK CONSISTS OF STANDARD CHAR-  
ACTERS WITHOUT CLAIM TO ANY PARTICULAR  
FONT, STYLE, SIZE, OR COLOR.

FOR: HERBAL SUPPLEMENTS; NUTRITIONAL  
SUPPLEMENTS, IN CLASS 5 (U.S. CLS. 6, 18, 44, 46, 51  
AND 52).

SER. NO. 77-400,872, FILED 2-19-2008.

FIRST USE 1-24-2008; IN COMMERCE 2-14-2008.

JOHN WILKE, EXAMINING ATTORNEY

**Int. Cl.: 45**

**Prior U.S. Cls.: 100 and 101**

**United States Patent and Trademark Office**

**Reg. No. 3,504,878**

**Registered Sep. 23, 2008**

**SERVICE MARK  
PRINCIPAL REGISTER**

**LIKENESS**

ROCKYOU, INC. (DELAWARE CORPORATION)  
585 BROADWAY STREET  
REDWOOD CITY, CA 94063

FOR: ONLINE SOCIAL NETWORKING SERVICES, IN CLASS 45 (U.S. CLS. 100 AND 101).

FIRST USE 7-0-2007; IN COMMERCE 7-0-2007.

THE MARK CONSISTS OF STANDARD CHARACTERS WITHOUT CLAIM TO ANY PARTICULAR FONT, STYLE, SIZE, OR COLOR.

SER. NO. 77-400,885, FILED 2-19-2008.

WILLIAM BRECKENFELD, EXAMINING ATTORNEY

**Int. Cl.: 35**

**Prior U.S. Cls.: 100, 101 and 102**

**United States Patent and Trademark Office**

**Reg. No. 3,504,879**

**Registered Sep. 23, 2008**

**SERVICE MARK  
PRINCIPAL REGISTER**

**Selliva.com**

SELLIVA, LLC (CALIFORNIA LIMITED LIABILITY COMPANY)  
16161 VENTURA BLVD #530  
ENCINO, CA 91436

FOR: ON-LINE TRADING SERVICES IN WHICH SELLER POSTS PRODUCTS TO BE AUCTIONED AND BIDDING IS DONE VIA THE INTERNET; ONLINE AUCTION SERVICES, IN CLASS 35 (U.S. CLS. 100, 101 AND 102).

FIRST USE 2-1-2008; IN COMMERCE 2-1-2008.

THE MARK CONSISTS OF STANDARD CHARACTERS WITHOUT CLAIM TO ANY PARTICULAR FONT, STYLE, SIZE, OR COLOR.

SER. NO. 77-400,916, FILED 2-19-2008.

ANDREA HACK, EXAMINING ATTORNEY



**Int. Cl.: 9**

**Prior U.S. Cls.: 21, 23, 26, 36 and 38**

**Reg. No. 3,504,880**

**United States Patent and Trademark Office**

**Registered Sep. 23, 2008**

**TRADEMARK  
PRINCIPAL REGISTER**

**WEBGUIDER**

SOFTCAFE (MARYLAND LIMITED LIABILITY  
COMPANY)  
P.O. BOX 91  
CABIN JOHN, MD 20818

THE MARK CONSISTS OF STANDARD CHAR-  
ACTERS WITHOUT CLAIM TO ANY PARTICULAR  
FONT, STYLE, SIZE, OR COLOR.

FOR: COMPUTER SOFTWARE FOR DESIGNING  
NETWORK WEB PAGES FOR RESTAURANTS, IN  
CLASS 9 (U.S. CLS. 21, 23, 26, 36 AND 38).

SER. NO. 77-400,918, FILED 2-19-2008.

FIRST USE 9-24-1999; IN COMMERCE 9-24-1999.

KOURTNEE HODGES, EXAMINING ATTORNEY

**Int. Cls.: 35 and 36**

**Prior U.S. Cls.: 100, 101 and 102**

**United States Patent and Trademark Office**

**Reg. No. 3,504,881**

**Registered Sep. 23, 2008**

**SERVICE MARK  
PRINCIPAL REGISTER**

**YOUR ONE STOP MONEY SHOP!**

CHECK INTO CASH, INC. (DELAWARE CORPORATION)  
201 KEITH ST. SW, SUITE 80  
CLEVELAND, TN 37311

FOR: TAX PREPARATION SERVICES, IN CLASS 35 (U.S. CLS. 100, 101 AND 102).

FIRST USE 1-14-2008; IN COMMERCE 1-14-2008.

FOR: FINANCIAL SERVICES, NAMELY, CHECK CASHING SERVICES IN THE NATURE OF CASH ADVANCE, DEFERRED PRESENTMENT AND DELAYED DEPOSIT SERVICES; PROVIDING TEM-

PORARY LOANS; STORED VALUE CARD SERVICES, IN CLASS 36 (U.S. CLS. 100, 101 AND 102).

FIRST USE 1-14-2008; IN COMMERCE 1-14-2008.

THE MARK CONSISTS OF STANDARD CHARACTERS WITHOUT CLAIM TO ANY PARTICULAR FONT, STYLE, SIZE, OR COLOR.

SER. NO. 77-400,965, FILED 2-19-2008.

SOPHIA S. KIM, EXAMINING ATTORNEY

**Int. Cl.: 35**

**Prior U.S. Cls.: 100, 101 and 102**

**United States Patent and Trademark Office**

**Reg. No. 3,504,882**

**Registered Sep. 23, 2008**

**SERVICE MARK  
PRINCIPAL REGISTER**

The logo features the word "OSAM" in a large, bold, italicized sans-serif font. To the right of "OSAM" is the word "INC" in a smaller, regular sans-serif font. Below "OSAM" and "INC" is the phrase "DOCUMENT SOLUTIONS" in a smaller, regular sans-serif font.

OSAM DOCUMENT SOLUTIONS, INC. (ARIZONA CORPORATION)  
3520 NORTH 16TH STREET  
PHOENIX, AZ 85016

FOR: BUSINESS CONSULTING IN THE FIELD OF MARKETING OF HARDWARE, NAMELY, DIGITAL SCANNERS, MICROFILM AND MICROFICHE READERS AND PRINTERS, AND MULTIFUNCTION NETWORK PRINTERS, SCANNERS AND COPIERS; BUSINESS CONSULTING IN THE FIELD OF MARKETING OF SOFTWARE, NAMELY, ELECTRONIC DATA AND DOCUMENT MANAGEMENT SOFTWARE, IN CLASS 35 (U.S. CLS. 100, 101 AND 102).

FIRST USE 4-13-2005; IN COMMERCE 4-13-2005.

OWNER OF U.S. REG. NO. 3,381,854.

NO CLAIM IS MADE TO THE EXCLUSIVE RIGHT TO USE "DOCUMENTS SOLUTIONS INC.", APART FROM THE MARK AS SHOWN.

THE MARK CONSISTS OF THE WORD, "OSAM" IN LARGE CAPITAL LETTERS, THE WORD, "INC" IN SMALLER CAPITAL LETTERS TO THE RIGHT OF THOSE WORD ABOVE THE WORDS "DOCUMENT SOLUTIONS" IN EVEN SMALLER SOLID CAPS.

THE WORDING "OSAM" HAS NO MEANING OTHER THAN TRADEMARK SIGNIFICANCE AND NO MEANING IN A FOREIGN LANGUAGE.

SER. NO. 77-400,993, FILED 2-19-2008.

TASNEEM HUSSAIN, EXAMINING ATTORNEY

Int. Cl.: 17

Prior U.S. Cls.: 1, 5, 12, 13, 35 and 50

United States Patent and Trademark Office

Reg. No. 3,504,883

Registered Sep. 23, 2008

TRADEMARK  
PRINCIPAL REGISTER



COUREY INTERNATIONAL (U.S.A.) INC.  
(FLORIDA CORPORATION)  
UNIT 13  
7500 N.W. 25TH STREET  
MIAMI, FL 33122

FOR: SOUND CONTROL FLOORING UNDER-  
LAYMENT, IN CLASS 17 (U.S. CLS. 1, 5, 12, 13, 35  
AND 50).

FIRST USE 2-1-2008; IN COMMERCE 2-1-2008.

THE MARK CONSISTS OF A STYLIZED SHIELD  
WITH THE WORDS "SILENT SHIELD" IN THE TOP  
ONE-THIRD ABOVE A CURVED LINE WITH A  
GLEAMING STAR ON EACH SIDE OF THE  
SHIELD.

SER. NO. 77-401,056, FILED 2-20-2008.

MARGERY A. TIERNEY, EXAMINING ATTORNEY

**Int. Cl.: 36**

**Prior U.S. Cls.: 100, 101 and 102**

**United States Patent and Trademark Office**

**Reg. No. 3,504,884**

**Registered Sep. 23, 2008**

**SERVICE MARK  
PRINCIPAL REGISTER**

**BUENAVISTA FLATS**

JORDAN, ANDREW C. (UNITED STATES INDIVIDUAL)  
3 ISLAND AVENUE, #3F  
MIAMI BEACH, FL 33139

FOR: RENTAL OF APARTMENTS, IN CLASS 36  
(U.S. CLS. 100, 101 AND 102).

FIRST USE 5-10-2007; IN COMMERCE 12-6-2007.

THE MARK CONSISTS OF STANDARD CHARACTERS WITHOUT CLAIM TO ANY PARTICULAR FONT, STYLE, SIZE, OR COLOR.

NO CLAIM IS MADE TO THE EXCLUSIVE RIGHT TO USE "FLATS", APART FROM THE MARK AS SHOWN.

THE ENGLISH TRANSLATION OF THE WORD "BUENAVISTA" IN THE MARK IS "GOOD VIEW".

SER. NO. 77-401,058, FILED 2-20-2008.

SANDRA MANIOS, EXAMINING ATTORNEY

**Int. Cl.: 45**

**Prior U.S. Cls.: 100 and 101**

**United States Patent and Trademark Office**

**Reg. No. 3,504,885**

**Registered Sep. 23, 2008**

**SERVICE MARK  
PRINCIPAL REGISTER**

# The Psychic Highway

DAVIDSON, HELEN (UNITED KINGDOM INDIVIDUAL)  
NO 7 BELLISTER PARK, PETERLEE,  
COUNTY DURHAM, UNITED KINGDOM SR81PH

FOR: HOROSCOPE CASTING AND FORTUNE TELLING; PROVISION OF HOROSCOPES VIA INTERACTIVE MEDIA, INTERACTIVE TELEVISIONS, MOBILE PHONES OR ONLINE VIA THE INTERNET; PROVISION OF HOROSCOPES VIA TEXT MESSAGING, IN CLASS 45 (U.S. CLS. 100 AND 101).

THE MARK CONSISTS OF STANDARD CHARACTERS WITHOUT CLAIM TO ANY PARTICULAR FONT, STYLE, SIZE, OR COLOR.

OWNER OF UNITED KINGDOM REG. NO. 2420950, DATED 11-10-2006, EXPIRES 11-10-2016.

SER. NO. 77-401,068, FILED 2-20-2008.

JILL C. ALT, EXAMINING ATTORNEY

**Int. Cl.: 11**

**Prior U.S. Cls.: 13, 21, 23, 31 and 34**

**United States Patent and Trademark Office**

**Reg. No. 3,504,886**

**Registered Sep. 23, 2008**

**TRADEMARK  
PRINCIPAL REGISTER**

**HYDRO-PAK**

213 NORTH CORP. (OHIO CORPORATION), DBA  
DELTA TEMP  
12110 NANTUCKET DRIVE  
CHARDON, OH 44024

THE MARK CONSISTS OF STANDARD CHAR-  
ACTERS WITHOUT CLAIM TO ANY PARTICULAR  
FONT, STYLE, SIZE, OR COLOR.

FOR: WATER HEATERS FOR DOMESTIC, COM-  
MERCIAL AND INDUSTRIAL USE, IN CLASS 11  
(U.S. CLS. 13, 21, 23, 31 AND 34).

SER. NO. 77-401,069, FILED 2-20-2008.

FIRST USE 3-10-2007; IN COMMERCE 3-10-2007.

JILL C. ALT, EXAMINING ATTORNEY

**Int. Cl.: 9**

**Prior U.S. Cls.: 21, 23, 26, 36 and 38**

**Reg. No. 3,504,887**

**United States Patent and Trademark Office**

**Registered Sep. 23, 2008**

---

**TRADEMARK  
PRINCIPAL REGISTER**

**DE555**

MCDOWELL SIGNAL PROCESSING (CALIFORNIA LIMITED LIABILITY COMPANY)  
1300 CRITTENDEN LANE, SUITE 401  
MOUNTAIN VIEW, CA 94043

THE MARK CONSISTS OF STANDARD CHARACTERS WITHOUT CLAIM TO ANY PARTICULAR FONT, STYLE, SIZE, OR COLOR.

FOR: COMPUTER SOFTWARE FOR MANIPULATING DIGITAL AUDIO INFORMATION FOR USE IN AUDIO MEDIA APPLICATIONS, IN CLASS 9 (U.S. CLS. 21, 23, 26, 36 AND 38).

SER. NO. 77-401,136, FILED 2-20-2008.

FIRST USE 1-8-2008; IN COMMERCE 1-8-2008.

THOMAS MANOR, EXAMINING ATTORNEY



**Int. Cl.: 9**

**Prior U.S. Cls.: 21, 23, 26, 36 and 38**

**United States Patent and Trademark Office**

**Reg. No. 3,504,888**

**Registered Sep. 23, 2008**

**TRADEMARK  
PRINCIPAL REGISTER**

**Logic Supply**

LOGIC SUPPLY, INC. (VERMONT CORPORATION)  
35 THOMPSON STREET  
SOUTH BURLINGTON, VT 05403

THE MARK CONSISTS OF STANDARD CHARACTERS WITHOUT CLAIM TO ANY PARTICULAR FONT, STYLE, SIZE, OR COLOR.

FOR: DIGITAL COMPUTERS, IN CLASS 9 (U.S. CLS. 21, 23, 26, 36 AND 38).

SER. NO. 77-401,148, FILED 2-20-2008.

FIRST USE 5-15-2003; IN COMMERCE 5-15-2003.

BRIAN NEVILLE, EXAMINING ATTORNEY

**Int. Cl.: 16**

**Prior U.S. Cls.: 2, 5, 22, 23, 29, 37, 38 and 50**

**Reg. No. 3,504,889**

**United States Patent and Trademark Office**

**Registered Sep. 23, 2008**

**TRADEMARK  
PRINCIPAL REGISTER**

**DIGGETY**

NATIONAL ASSOCIATION OF PROFESSIONAL  
BASEBALL LEAGUES, INC. (FLORIDA COR-  
PORATION)  
201 BAYSHORE DRIVE SE  
ST. PETERSBURG, FL 33701

BOOKS OF INTEREST TO BASEBALL FANS, STA-  
TIONERY, STICKERS, STICKER ALBUMS AND  
TRADING CARDS, IN CLASS 16 (U.S. CLS. 2, 5, 22,  
23, 29, 37, 38 AND 50).

FOR: PAPER GOODS AND PRINTED MATTER,  
NAMELY, AUTOGRAPH BOOKS, BINDERS, BOOK-  
MARKS, BUMPER STICKERS, CALENDARS, CAT-  
ALOGS OF INTEREST TO BASEBALL FANS,  
DECALS, MERCHANDISE BAGS, NEWSLETTERS  
OF INTEREST TO BASEBALL FANS, NOTE PADS,  
PAPER CONTAINERS, PAPER PENNANTS, PAPER  
SCHEDULES, PENS, PENCILS, POSTCARDS, POS-  
TERS, PRINTED AWARDS, PRINTED GUIDES OF  
INTEREST TO BASEBALL FANS, REFERENCE

FIRST USE 12-4-2006; IN COMMERCE 12-4-2006.

THE MARK CONSISTS OF STANDARD CHAR-  
ACTERS WITHOUT CLAIM TO ANY PARTICULAR  
FONT, STYLE, SIZE, OR COLOR.

SER. NO. 77-401,159, FILED 2-20-2008.

KEVON CHISOLM, EXAMINING ATTORNEY

**Int. Cl.: 9**

**Prior U.S. Cls.: 21, 23, 26, 36 and 38**

**Reg. No. 3,504,890**

**United States Patent and Trademark Office**

**Registered Sep. 23, 2008**

---

**TRADEMARK  
PRINCIPAL REGISTER**

**FutzBox**

MCDOWELL SIGNAL PROCESSING (CALIFORNIA LIMITED LIABILITY COMPANY)  
SUITE 401  
1300 CRITTENDEN LANE  
MOUNTAIN VIEW, CA 94043

FOR: COMPUTER SOFTWARE FOR MANIPULATING DIGITAL AUDIO INFORMATION FOR USE IN AUDIO MEDIA APPLICATIONS, IN CLASS 9 (U.S. CLS. 21, 23, 26, 36 AND 38).

FIRST USE 1-8-2008; IN COMMERCE 1-8-2008.

THE MARK CONSISTS OF STANDARD CHARACTERS WITHOUT CLAIM TO ANY PARTICULAR FONT, STYLE, SIZE, OR COLOR.

SER. NO. 77-401,163, FILED 2-20-2008.

THOMAS MANOR, EXAMINING ATTORNEY

**Int. Cl.: 43**

**Prior U.S. Cls.: 100 and 101**

**United States Patent and Trademark Office**

**Reg. No. 3,504,891**

**Registered Sep. 23, 2008**

**SERVICE MARK  
PRINCIPAL REGISTER**

**ROBANO'S**

MARC NGUYEN (UNITED STATES INDIVIDUAL)  
14300 CLINTON STREET #75  
GARDEN GROVE, CA 92843

THE MARK CONSISTS OF STANDARD CHARACTERS WITHOUT CLAIM TO ANY PARTICULAR FONT, STYLE, SIZE, OR COLOR.

FOR: CARRY-OUT RESTAURANTS; RESTAURANT, BAR AND CATERING SERVICES, IN CLASS 43 (U.S. CLS. 100 AND 101).

SER. NO. 77-401,172, FILED 2-20-2008.

FIRST USE 2-1-2008; IN COMMERCE 2-14-2008.

THOMAS MANOR, EXAMINING ATTORNEY

**Int. Cl.: 16**

**Prior U.S. Cls.: 2, 5, 22, 23, 29, 37, 38 and 50**

**United States Patent and Trademark Office**

**Reg. No. 3,504,892**

**Registered Sep. 23, 2008**

**TRADEMARK  
PRINCIPAL REGISTER**

**BIRD AND BANNER**

MICHELS, NICOLE (UNITED STATES INDIVIDUAL)  
147 EAST CLAY STREET  
LANCASTER, PA 17602 AND  
MULCAHY, ERIN (UNITED STATES INDIVIDUAL)  
147 EAST CLAY STREET  
LANCASTER, PA 17602

FOR: ANNOUNCEMENT CARDS; PRINTED INVITATIONS, IN CLASS 16 (U.S. CLS. 2, 5, 22, 23, 29, 37, 38 AND 50).

FIRST USE 8-29-2006; IN COMMERCE 1-1-2007.

THE MARK CONSISTS OF STANDARD CHARACTERS WITHOUT CLAIM TO ANY PARTICULAR FONT, STYLE, SIZE, OR COLOR.

SER. NO. 77-401,185, FILED 2-20-2008.

CYNTHIA SLOAN, EXAMINING ATTORNEY

**Int. Cl.: 17**

**Prior U.S. Cls.: 1, 5, 12, 13, 35 and 50**

**United States Patent and Trademark Office**

**Reg. No. 3,504,893**

**Registered Sep. 23, 2008**

**TRADEMARK  
PRINCIPAL REGISTER**



W.J. DENNIS & COMPANY (ILLINOIS CORPORATION)  
1111 DAVIS ROAD  
ELGIN, IL 60123

THE MARK CONSISTS OF THE LETTER "D" IN RED, THE LETTERING "RCR" AND THE WORD "DENNIS" IN WHITE AND A BLACK RECTANGULAR BACKGROUND.

FOR: WEATHERSTRIPPING FOR USE IN HOMES, IN CLASS 17 (U.S. CLS. 1, 5, 12, 13, 35 AND 50).

SER. NO. 77-401,188, FILED 2-20-2008.

FIRST USE 1-1-2004; IN COMMERCE 1-1-2004.

THE COLOR(S) RED, WHITE AND BLACK IS/ARE CLAIMED AS A FEATURE OF THE MARK.

CYNTHIA SLOAN, EXAMINING ATTORNEY

**Int. Cl.: 35**

**Prior U.S. Cls.: 100, 101 and 102**

**United States Patent and Trademark Office**

**Reg. No. 3,504,894**

**Registered Sep. 23, 2008**

**SERVICE MARK  
PRINCIPAL REGISTER**



ADWISE GROUP, INC. (TEXAS CORPORATION)  
3001 KELLER SPRINGS RD #110  
CARROLLTON, TX 75006

FOR: PRODUCING PROMOTIONAL VIDEO-  
TAPES, VIDEO DISCS, AND AUDIO VISUAL RE-  
CORDINGS, IN CLASS 35 (U.S. CLS. 100, 101 AND  
102).

FIRST USE 10-15-2006; IN COMMERCE 10-15-2006.

NO CLAIM IS MADE TO THE EXCLUSIVE  
RIGHT TO USE "GROUP.COM", APART FROM  
THE MARK AS SHOWN.

THE MARK CONSISTS OF "VIDEOWISE" PRIN-  
TED ABOVE A RECTANGULAR BOX. THE REC-  
TANGULAR BOX IS SOLID EXCEPT THAT IT  
CONTAINS THE REVERSED TYPE "GROUP.COM".  
THE TOP OF THE "W" IN "VIDEOWISE" EXTENDS  
ABOVE THE MARK AND THE BOTTOM OF THE  
"W" EXTENDS BELOW THE RECTANGULAR BOX.

SER. NO. 77-401,198, FILED 2-20-2008.

ALLISON SCHRODY, EXAMINING ATTORNEY

**Int. Cl.: 35**

**Prior U.S. Cls.: 100, 101 and 102**

**United States Patent and Trademark Office**

**Reg. No. 3,504,895**

**Registered Sep. 23, 2008**

**SERVICE MARK  
PRINCIPAL REGISTER**

**NBB**

NATIONWIDE BEAUTY & BARBER, LLC (NEW YORK LIMITED LIABILITY COMPANY), DBA NATIONWIDE BEAUTY & BARBER SUPPLY  
2600 ERIE BOULEVARD EAST  
SYRACUSE, NY 13224

FOR: MAIL ORDER CATALOG SERVICES, ON-LINE RETAIL STORE SERVICES, AND RETAIL STORE SERVICES IN THE FIELD OF BEAUTY AND BARBER SALONS, NAIL SALONS AND SPAS, FEATURING, BEAUTY AND BARBER SALON FURNITURE, EQUIPMENT, TOOLS AND SUPPLIES; NAIL SALON FURNITURE, EQUIPMENT, TOOLS AND SUPPLIES; SPA FURNITURE, EQUIPMENT, TOOLS AND SUPPLIES; SHAVING EQUIPMENT, TOOLS AND SUPPLIES; BEAUTY AND BARBER SALON WEAR AND SPA WEAR; BEAUTY AND BARBER SALON SIGNS AND BARBER

POLES; AND BEAUTY AND BARBER PUBLICATIONS AND VIDEOS, IN CLASS 35 (U.S. CLS. 100, 101 AND 102).

FIRST USE 10-10-2007; IN COMMERCE 10-10-2007.

THE MARK CONSISTS OF STANDARD CHARACTERS WITHOUT CLAIM TO ANY PARTICULAR FONT, STYLE, SIZE, OR COLOR.

OWNER OF U.S. REG. NOS. 1,164,129, 2,942,037, AND 2,943,921.

SER. NO. 77-401,206, FILED 2-20-2008.

CAROLYN GRAY, EXAMINING ATTORNEY



**Int. Cl.: 28**

**Prior U.S. Cls.: 22, 23, 38 and 50**

**Reg. No. 3,504,896**

**United States Patent and Trademark Office**

**Registered Sep. 23, 2008**

**TRADEMARK  
PRINCIPAL REGISTER**

**DIGGETY**

NATIONAL ASSOCIATION OF PROFESSIONAL  
BASEBALL LEAGUES, INC. (FLORIDA COR-  
PORATION)  
201 BAYSHORE DRIVE SE  
ST. PETERSBURG, FL 33701

FOR: TOYS AND SPORTING GOODS, NAMELY,  
BALLOONS, BASEBALLS, BASEBALL GLOVES,  
BASEBALL MITTS, BATTING GLOVES, CHRIST-  
MAS TREE ORNAMENTS, DOLLS, FLYING DISCS,  
GOLF BALLS, INFLATABLE TOY BASEBALL BATS,  
KITES, MINIATURE BASEBALL BATS, STUFFED  
TOY ANIMALS, TOY BASEBALL BATTING HEL-  
METS, TOY NOISEMAKERS AND YO-YOS, TOY

BASEBALLS, STUFFED TOYS, IN CLASS 28 (U.S.  
CLS. 22, 23, 38 AND 50).

FIRST USE 12-4-2006; IN COMMERCE 12-4-2006.

THE MARK CONSISTS OF STANDARD CHAR-  
ACTERS WITHOUT CLAIM TO ANY PARTICULAR  
FONT, STYLE, SIZE, OR COLOR.

SER. NO. 77-401,227, FILED 2-20-2008.

KEVON CHISOLM, EXAMINING ATTORNEY

**Int. Cl.: 35**

**Prior U.S. Cls.: 100, 101 and 102**

**United States Patent and Trademark Office**

**Reg. No. 3,504,897**

**Registered Sep. 23, 2008**

**SERVICE MARK  
PRINCIPAL REGISTER**



ADWISE GROUP, INC. (TEXAS CORPORATION)  
3001 KELLER SPRINGS RD #110  
CARROLLTON, TX 75006

FOR: ADVERTISING AGENCIES PROVIDING THE STRATEGY, DESIGN AND EXECUTION OF PROGRAMS TO PROMOTE BUSINESSES IN THE FOOD AND FOODSERVICE INDUSTRIES, IN CLASS 35 (U.S. CLS. 100, 101 AND 102).

FIRST USE 8-5-2005; IN COMMERCE 8-5-2005.

NO CLAIM IS MADE TO THE EXCLUSIVE RIGHT TO USE "GROUP.COM", APART FROM THE MARK AS SHOWN.

THE MARK CONSISTS OF "FOODWISE" PRINTED ABOVE A RECTANGULAR BOX. THE REC-

TANGULAR BOX IS SOLID EXCEPT THAT IT CONTAINS THE REVERSED TYPE "GROUP.COM". THE "W" IN "FOODWISE" EXTENDS ABOVE "FOODWISE" AND BELOW THE RECTANGULAR BOX AND APPROXIMATES THE SHAPE OF A FORK. A SINGLE HORIZONTAL LINE EXTENDS FROM THE OUTSIDE NEAR THE TOP LEFT EDGE OF "W" AND SPLITS INTO THREE HORIZONTAL LINES AS IT ENTERS THE LEFT SIDE OF THE "W". THE THREE HORIZONTAL LINES CONTINUE THROUGH THE TOP OF THE "W" AND EXTEND TO OUTSIDE THE TOP RIGHT EDGE OF THE "W".

SER. NO. 77-401,239, FILED 2-20-2008.

ALLISON SCHRODY, EXAMINING ATTORNEY

Int. Cl.: 33

Prior U.S. Cls.: 47 and 49

United States Patent and Trademark Office

Reg. No. 3,504,898

Registered Sep. 23, 2008

TRADEMARK  
PRINCIPAL REGISTER

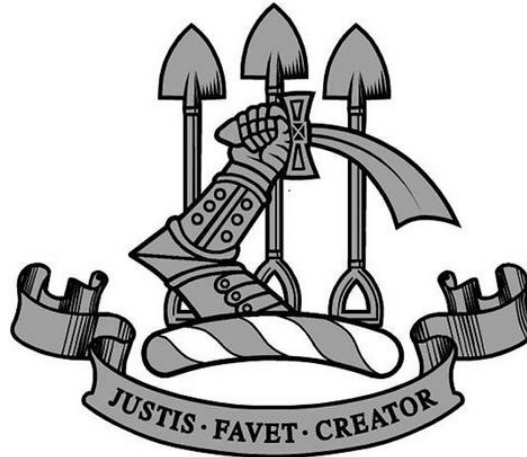

DE GREDEL WINES (PTY) LTD. (SOUTH AFRICA CORPORATION)  
DE GREDEL ESTATE  
PLATTEKLOOF ROAD  
PANORAMA, WESTERN CAPE, SOUTH AFRICA

FOR: ALCOHOLIC BEVERAGES, NAMELY, WINES, IN CLASS 33 (U.S. CLS. 47 AND 49).

FIRST USE 0-0-1912; IN COMMERCE 5-31-2007.

THE MARK CONSISTS OF A BANNER WITH "JUSTIS, FAVET, CREATOR" ON IT, AN ARMOR-

COVERED ARM HOLDING A SCIMITAR AND 3 SPADES, WORKING ENDS UP.

THE FOREIGN WORDING IN THE MARK TRANSLATES INTO ENGLISH AS THE CREATOR FAVORS JUSTICE.

SER. NO. 77-401,248, FILED 2-20-2008.

SALLY SHIH, EXAMINING ATTORNEY

**Int. Cl.: 9**

**Prior U.S. Cls.: 21, 23, 26, 36 and 38**

**Reg. No. 3,504,899**

**United States Patent and Trademark Office**

**Registered Sep. 23, 2008**

---

**TRADEMARK  
PRINCIPAL REGISTER**

**AIR ESCAPE**

ASTRAL BUOYANCY COMPANY, LLC (NORTH  
CAROLINA LIMITED LIABILITY COMPANY)  
2002 RIVERSIDE DRIVE  
ASHEVILLE, NC 28804

THE MARK CONSISTS OF STANDARD CHAR-  
ACTERS WITHOUT CLAIM TO ANY PARTICULAR  
FONT, STYLE, SIZE, OR COLOR.

FOR: FLOTATION VESTS; LIFE JACKETS; AND  
LIFE PRESERVERS, IN CLASS 9 (U.S. CLS. 21, 23, 26,  
36 AND 38).

SER. NO. 77-401,255, FILED 2-20-2008.

FIRST USE 8-10-2007; IN COMMERCE 8-10-2007.

SALLY SHIH, EXAMINING ATTORNEY

**Int. Cl.: 35**

**Prior U.S. Cls.: 100, 101 and 102**

**United States Patent and Trademark Office**

**Reg. No. 3,504,900**

**Registered Sep. 23, 2008**

**SERVICE MARK  
PRINCIPAL REGISTER**



ADWISE GROUP, INC. (TEXAS CORPORATION)  
3001 KELLER SPRINGS RD #110  
CARROLLTON, TX 75006

FOR: ADVERTISING SERVICES, NAMELY, PROMOTING AND MARKETING THE GOODS AND SERVICES OF OTHERS THROUGH ALL PUBLIC COMMUNICATION MEANS, IN CLASS 35 (U.S. CLS. 100, 101 AND 102).

FIRST USE 2-5-2006; IN COMMERCE 2-5-2006.

NO CLAIM IS MADE TO THE EXCLUSIVE RIGHT TO USE "GROUP.COM", APART FROM THE MARK AS SHOWN.

THE MARK CONSISTS OF "PRWISE" PRINTED ABOVE A RECTANGULAR BOX. THE RECTANGULAR BOX IS SOLID EXCEPT THAT IT CONTAINS THE REVERSED TYPE "GROUP.COM". THE "W" IN "PRWISE" IS REVERSED TYPE AND IS CONTAINED IN AN ELEMENT THAT EXTENDS ABOVE THE "W" AND BELOW THE RECTANGULAR BOX AND APPROXIMATES THE SHAPE OF AN APOSTROPHE.

SER. NO. 77-401,264, FILED 2-20-2008.

ALLISON SCHRODY, EXAMINING ATTORNEY

**Int. Cl.: 37**

**Prior U.S. Cls.: 100, 103 and 106**

**United States Patent and Trademark Office**

**Reg. No. 3,504,901**

**Registered Sep. 23, 2008**

**SERVICE MARK  
PRINCIPAL REGISTER**

**Common Sense Quality**

WELLSPRING DEVELOPMENT COMPANY (ILLINOIS CORPORATION), DBA ROCK HILL TRAILS  
1806 LYNTHURST  
SAVOY, IL 61874

FOR: LAND DEVELOPMENT SERVICES, NAME-  
LY, PLANNING AND LAYING OUT OF RESIDEN-  
TIAL AND/OR COMMERCIAL COMMUNITIES, IN  
CLASS 37 (U.S. CLS. 100, 103 AND 106).

FIRST USE 10-31-2005; IN COMMERCE 10-31-2005.

THE MARK CONSISTS OF STANDARD CHAR-  
ACTERS WITHOUT CLAIM TO ANY PARTICULAR  
FONT, STYLE, SIZE, OR COLOR.

NO CLAIM IS MADE TO THE EXCLUSIVE  
RIGHT TO USE "QUALITY", APART FROM THE  
MARK AS SHOWN.

SER. NO. 77-401,285, FILED 2-20-2008.

MICHAEL SOUDERS, EXAMINING ATTORNEY

**Int. Cl.: 37**

**Prior U.S. Cls.: 100, 103 and 106**

**United States Patent and Trademark Office**

**Reg. No. 3,504,902**

**Registered Sep. 23, 2008**

**SERVICE MARK  
PRINCIPAL REGISTER**

**Sudsational**  
"The SPA for your Car"

OCP ACQUISITIONS, LLC (ILLINOIS LIMITED  
LIABILITY COMPANY)  
1590 SOUTH MILWAUKEE AVE. STE 224  
LIBERTYVILLE, IL 60048

FOR: VEHICLE WASHING; AUTOMOBILE  
CLEANING AND CAR WASHING; AUTOMOBILE  
WASHING; CAR CLEANING; CAR WASHING; AU-  
TOMOBILE DETAILING; VEHICLE DETAILING;  
CARPET CLEANING; CLEANING OF VEHICLES  
AND WAXING OF VEHICLES, IN CLASS 37 (U.S.  
CLS. 100, 103 AND 106).

FIRST USE 11-1-2001; IN COMMERCE 11-1-2001.

THE MARK CONSISTS OF THE WORD "SUDSA-  
TIONAL" ABOVE THE WORDS "THE SPA FOR  
YOUR CAR". THREE BUBBLES ARE AROUND THE  
WORD "SUDSATIONAL".

SER. NO. 77-401,301, FILED 2-20-2008.

TRACY CROSS, EXAMINING ATTORNEY

**Int. Cl.: 41**

**Prior U.S. Cls.: 100, 101 and 107**

**United States Patent and Trademark Office**

**Reg. No. 3,504,903**

**Registered Sep. 23, 2008**

---

**SERVICE MARK  
PRINCIPAL REGISTER**

**SHERIFF**

NEW JERSEY THUNDER MOTORSPORTS, INC.  
(NEW JERSEY CORPORATION)  
P.O. BOX 1256  
4101 BOARDWALK  
WILDWOOD, NJ 08260

THE MARK CONSISTS OF STANDARD CHARACTERS WITHOUT CLAIM TO ANY PARTICULAR FONT, STYLE, SIZE, OR COLOR.

FOR: ENTERTAINMENT IN THE NATURE OF MONSTER TRUCK RIDES, IN CLASS 41 (U.S. CLS. 100, 101 AND 107).

SER. NO. 77-401,318, FILED 2-20-2008.

FIRST USE 6-1-2007; IN COMMERCE 6-1-2007.

WILLIAM ROSSMAN, EXAMINING ATTORNEY



**Int. Cl.: 42**

**Prior U.S. Cls.: 100 and 101**

**United States Patent and Trademark Office**

**Reg. No. 3,504,904**

**Registered Sep. 23, 2008**

**SERVICE MARK  
PRINCIPAL REGISTER**

**LIKENESS**

ROCKYOU, INC. (DELAWARE CORPORATION)  
585 BROADWAY STREET  
REDWOOD CITY, CA 94063

FOR: PROVIDING ON-LINE NON-DOWNLOAD-  
ABLE SOFTWARE FOR USERS TO TAKE QUIZZES  
AND TO COMPARE INTERESTS, PREFERENCES  
AND QUIZ RESPONSES WITH THEIR FRIENDS  
AND OTHERS, IN CLASS 42 (U.S. CLS. 100 AND 101).

FIRST USE 7-0-2007; IN COMMERCE 7-0-2007.

THE MARK CONSISTS OF STANDARD CHAR-  
ACTERS WITHOUT CLAIM TO ANY PARTICULAR  
FONT, STYLE, SIZE, OR COLOR.

SER. NO. 77-401,330, FILED 2-20-2008.

WILLIAM BRECKENFELD, EXAMINING ATTOR-  
NEY

**Int. Cl.: 44**

**Prior U.S. Cls.: 100 and 101**

**United States Patent and Trademark Office**

**Reg. No. 3,504,905**

**Registered Sep. 23, 2008**

**SERVICE MARK  
PRINCIPAL REGISTER**

# Cancer Navigation Consultant

GURLAND, KATHRYN (UNITED STATES INDIVIDUAL)  
260 WATER STREET, APT. 5C  
BROOKLYN, NY 11201

FOR: PROVIDING MEDICAL INFORMATION, CONSULTANCY AND ADVISORY SERVICES, IN CLASS 44 (U.S. CLS. 100 AND 101).

FIRST USE 2-8-2008; IN COMMERCE 2-8-2008.

THE MARK CONSISTS OF STANDARD CHARACTERS WITHOUT CLAIM TO ANY PARTICULAR FONT, STYLE, SIZE, OR COLOR.

NO CLAIM IS MADE TO THE EXCLUSIVE RIGHT TO USE "CONSULTANT", APART FROM THE MARK AS SHOWN.

SER. NO. 77-401,344, FILED 2-20-2008.

GEOFFREY FOSDICK, EXAMINING ATTORNEY

**Int. Cl.: 35**

**Prior U.S. Cls.: 100, 101 and 102**

**United States Patent and Trademark Office**

**Reg. No. 3,504,906**

**Registered Sep. 23, 2008**

---

**SERVICE MARK  
PRINCIPAL REGISTER**

**SNEAKERAMA**

SNEAKERAMA, INC. (MASSACHUSETTS CORPORATION)  
12 LAKE AVENUE  
WORCESTER, MA 01604

THE MARK CONSISTS OF STANDARD CHARACTERS WITHOUT CLAIM TO ANY PARTICULAR FONT, STYLE, SIZE, OR COLOR.

FOR: RETAIL STORE SERVICES FEATURING SPORTS, CASUAL, AND ATHLETIC FOOTWEAR AND APPAREL, IN CLASS 35 (U.S. CLS. 100, 101 AND 102).

SER. NO. 77-401,354, FILED 2-20-2008.

FIRST USE 4-20-1978; IN COMMERCE 4-20-1978.

JASON ROTH, EXAMINING ATTORNEY

**Int. Cl.: 37**

**Prior U.S. Cls.: 100, 103 and 106**

**United States Patent and Trademark Office**

**Reg. No. 3,504,907**

**Registered Sep. 23, 2008**

**SERVICE MARK  
PRINCIPAL REGISTER**



BOO BOO BUSTERS, INC. (CALIFORNIA CORPORATION)  
4 OATFIELD FARM  
LADERA RANCH, CA 92694

FOR: INSTALLATION OF CHILD SAFETY DEVICES, IN CLASS 37 (U.S. CLS. 100, 103 AND 106).

FIRST USE 5-1-2001; IN COMMERCE 11-2-2002.

THE MARK CONSISTS OF THE LITERAL ELEMENTS "BOO BOO BUSTERS", WITH THE INTEGRATED DESIGN OF ADHESIVE BANDAGES COVERING THE FOUR LETTER "O"'S IN "BOO BOO", AND THE ASSOCIATED DESIGN OF A LITTLE GIRL HOLDING A TEDDY BEAR.

SER. NO. 77-401,365, FILED 2-20-2008.

JUDITH HELFMAN, EXAMINING ATTORNEY

**Int. Cl.: 30**

**Prior U.S. Cl.: 46**

**United States Patent and Trademark Office**

**Reg. No. 3,504,908**

**Registered Sep. 23, 2008**

**TRADEMARK  
PRINCIPAL REGISTER**

**CAFFE IBIS**

CAFFE IBIS, INC. (UTAH CORPORATION)  
52 FEDERAL AVENUE  
LOGAN, UT 84321

FOR: CAFFEINE-FREE COFFEE; COFFEE  
BEANS; GROUND COFFEE BEANS; ROASTED  
COFFEE BEANS, IN CLASS 30 (U.S. CL. 46).

FIRST USE 1-1-1990; IN COMMERCE 1-1-1990.

THE MARK CONSISTS OF STANDARD CHAR-  
ACTERS WITHOUT CLAIM TO ANY PARTICULAR  
FONT, STYLE, SIZE, OR COLOR.

NO CLAIM IS MADE TO THE EXCLUSIVE  
RIGHT TO USE "CAFFE", APART FROM THE  
MARK AS SHOWN.

THE ENGLISH TRANSLATION OF "CAFFE" IN  
THE MARK IS COFFEE.

SER. NO. 77-401,370, FILED 2-20-2008.

WILLIAM VERHOSEK, EXAMINING ATTORNEY

**Int. Cl.: 35**

**Prior U.S. Cls.: 100, 101 and 102**

**United States Patent and Trademark Office**

**Reg. No. 3,504,909**

**Registered Sep. 23, 2008**

**SERVICE MARK  
PRINCIPAL REGISTER**

DIVERSITY AT THE BLACKBOARD

ASSOCIATED COLLEGES OF ILLINOIS (ILLI-  
NOIS CORPORATION)  
20 N WACKER DR #1456  
CHICAGO, IL 60606

FOR: EMPLOYMENT COUNSELING AND RE-  
CRUITING, IN CLASS 35 (U.S. CLS. 100, 101 AND  
102).

FIRST USE 1-31-2006; IN COMMERCE 1-31-2006.

THE MARK CONSISTS OF STANDARD CHAR-  
ACTERS WITHOUT CLAIM TO ANY PARTICULAR  
FONT, STYLE, SIZE, OR COLOR.

SER. NO. 77-401,392, FILED 2-20-2008.

CHRISTOPHER BUONGIORNO, EXAMINING AT-  
TORNEY

**Int. Cl.: 35**

**Prior U.S. Cls.: 100, 101 and 102**

**United States Patent and Trademark Office**

**Reg. No. 3,504,910**

**Registered Sep. 23, 2008**

**SERVICE MARK  
PRINCIPAL REGISTER**

**LEGALGARD**

MYND PARTNERS (PENNSYLVANIA LIMITED  
PARTNERSHIP), DBA LEGALGARD PART-  
NERS  
10301 WILSON BLVD.  
BLYTHEWOOD, SC 29601

FOR: LEGAL COST MANAGEMENT, LEGAL  
COST CONTAINMENT, AND LEGAL BILL REVIEW  
AND AUDITING SERVICES, IN CLASS 35 (U.S. CLS.  
100, 101 AND 102).

FIRST USE 6-30-1987; IN COMMERCE 6-30-1987.

THE MARK CONSISTS OF STANDARD CHAR-  
ACTERS WITHOUT CLAIM TO ANY PARTICULAR  
FONT, STYLE, SIZE, OR COLOR.

SER. NO. 77-401,403, FILED 2-20-2008.

DAVID HOFFMAN, EXAMINING ATTORNEY

**Int. Cl.: 45**

**Prior U.S. Cls.: 100 and 101**

**United States Patent and Trademark Office**

**Reg. No. 3,504,911**

**Registered Sep. 23, 2008**

**SERVICE MARK  
PRINCIPAL REGISTER**

**NEW BROAD STREET**

NEW BROAD STREET MANAGEMENT, LLC  
(FLORIDA LIMITED LIABILITY COMPANY)  
SUITE 110  
4776 NEW BROAD STREET  
ORLANDO, FL 32814

FOR: PERMITTING, NAMELY, OBTAINING ENVIRONMENTAL, DESIGN, ZONING AND OTHER GOVERNMENTAL PERMITS FOR DEVELOPMENT PROJECTS; REVIEWING STANDARDS AND PRACTICES TO ASSURE COMPLIANCE WITH ZONING LAWS AND REGULATIONS, IN CLASS 45 (U.S. CLS. 100 AND 101).

FIRST USE 4-30-2007; IN COMMERCE 4-30-2007.

THE MARK CONSISTS OF STANDARD CHARACTERS WITHOUT CLAIM TO ANY PARTICULAR FONT, STYLE, SIZE, OR COLOR.

SER. NO. 77-401,419, FILED 2-20-2008.

FLORENTINA BLANDU, EXAMINING ATTORNEY



**Int. Cl.: 25**

**Prior U.S. Cls.: 22 and 39**

**United States Patent and Trademark Office**

**Reg. No. 3,504,912**

**Registered Sep. 23, 2008**

**TRADEMARK  
PRINCIPAL REGISTER**

**BALLROOM BABBLE**

BALLROOM BABBLE, INC. (SOUTH CAROLINA  
CORPORATION)  
39 STEADMAN WAY  
GREER, SC 29650

THE MARK CONSISTS OF STANDARD CHAR-  
ACTERS WITHOUT CLAIM TO ANY PARTICULAR  
FONT, STYLE, SIZE, OR COLOR.

FOR: SHIRTS, IN CLASS 25 (U.S. CLS. 22 AND 39).

SER. NO. 77-401,428, FILED 2-20-2008.

FIRST USE 2-9-2008; IN COMMERCE 2-9-2008.

RONALD DELGIZZI, EXAMINING ATTORNEY

**Int. Cl.: 36**

**Prior U.S. Cls.: 100, 101 and 102**

**United States Patent and Trademark Office**

**Reg. No. 3,504,913**

**Registered Sep. 23, 2008**

**SERVICE MARK  
PRINCIPAL REGISTER**

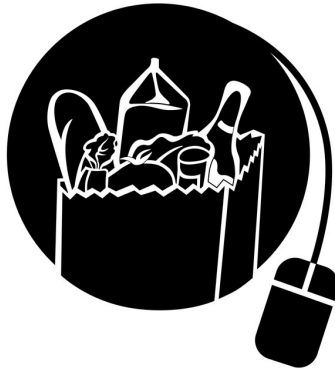

AMERICA'S SECOND HARVEST OF WISCONSIN, INC. (WISCONSIN CORPORATION)  
1700 W. FOND DU LAC AVE.  
MILWAUKEE, WI 53205

THE MARK CONSISTS OF A PAPER BAG FILLED WITH GROCERIES WITHIN A CIRCLE.

FOR: CHARITABLE FUND RAISING, IN CLASS 36 (U.S. CLS. 100, 101 AND 102).

SER. NO. 77-401,429, FILED 2-20-2008.

FIRST USE 11-1-2007; IN COMMERCE 11-1-2007.

NELSON SNYDER, EXAMINING ATTORNEY

**Int. Cl.: 36**

**Prior U.S. Cls.: 100, 101 and 102**

**United States Patent and Trademark Office**

**Reg. No. 3,504,914**

**Registered Sep. 23, 2008**

**SERVICE MARK  
PRINCIPAL REGISTER**

**BEAT CANCER FOR KIDS**

SIMMONDS RESTAURANT MANAGEMENT,  
INC. (NEBRASKA CORPORATION)  
SUITE 650  
11404 WEST DODGE ROAD  
OMAHA, NE 68154

THE MARK CONSISTS OF STANDARD CHAR-  
ACTERS WITHOUT CLAIM TO ANY PARTICULAR  
FONT, STYLE, SIZE, OR COLOR.

FOR: CHARITABLE FUNDRAISING SERVICES,  
IN CLASS 36 (U.S. CLS. 100, 101 AND 102).

SER. NO. 77-401,433, FILED 2-20-2008.

FIRST USE 7-1-2004; IN COMMERCE 7-1-2004.

NELSON SNYDER, EXAMINING ATTORNEY

**Int. Cl.: 36**

**Prior U.S. Cls.: 100, 101 and 102**

**United States Patent and Trademark Office**

**Reg. No. 3,504,915**

**Registered Sep. 23, 2008**

**SERVICE MARK  
PRINCIPAL REGISTER**

**ONLINEHARVEST.ORG**

AMERICA'S SECOND HARVEST OF WISCONSIN, INC. (WISCONSIN CORPORATION)  
1700 W. FOND DU LAC AVE.  
MILWAUKEE, WI 53205

THE MARK CONSISTS OF STANDARD CHARACTERS WITHOUT CLAIM TO ANY PARTICULAR FONT, STYLE, SIZE, OR COLOR.

FOR: CHARITABLE FUND RAISING, IN CLASS 36 (U.S. CLS. 100, 101 AND 102).

SER. NO. 77-401,434, FILED 2-20-2008.

FIRST USE 11-1-2007; IN COMMERCE 11-1-2007.

NELSON SNYDER, EXAMINING ATTORNEY

**Int. Cl.: 14**

**Prior U.S. Cls.: 2, 27, 28 and 50**

**United States Patent and Trademark Office**

**Reg. No. 3,504,916**

**Registered Sep. 23, 2008**

**TRADEMARK  
PRINCIPAL REGISTER**

**10-10**

**RICHLINE GROUP, INC. (DELAWARE COR-  
PORATION)  
516 FIFTH AVENUE  
NEW YORK, NY 10036**

**THE MARK CONSISTS OF STANDARD CHAR-  
ACTERS WITHOUT CLAIM TO ANY PARTICULAR  
FONT, STYLE, SIZE, OR COLOR.**

**FOR: JEWELRY, IN CLASS 14 (U.S. CLS. 2, 27, 28  
AND 50).**

**SER. NO. 77-401,442, FILED 2-20-2008.**

**FIRST USE 2-20-2008; IN COMMERCE 2-20-2008.**

**KEVIN DINALLO, EXAMINING ATTORNEY**

**Int. Cl.: 44**

**Prior U.S. Cls.: 100 and 101**

**United States Patent and Trademark Office**

**Reg. No. 3,504,917**

**Registered Sep. 23, 2008**

**SERVICE MARK  
PRINCIPAL REGISTER**

wax diva

LUCY'S WAX, LLC (WASHINGTON LIMITED  
LIABILITY COMPANY)

268 DAYTON AVE SE

RENTON, WA 98056

FOR: HEALTH SPA SERVICES, NAMELY, COS-  
METIC BODY CARE SERVICES, IN CLASS 44 (U.S.  
CLS. 100 AND 101).

FIRST USE 3-1-2007; IN COMMERCE 3-1-2007.

THE MARK CONSISTS OF STANDARD CHAR-  
ACTERS WITHOUT CLAIM TO ANY PARTICULAR  
FONT, STYLE, SIZE, OR COLOR.

NO CLAIM IS MADE TO THE EXCLUSIVE  
RIGHT TO USE "WAX", APART FROM THE MARK  
AS SHOWN.

SER. NO. 77-401,478, FILED 2-20-2008.

KATHLEEN M. VANSTON, EXAMINING ATTOR-  
NEY

Int. Cl.: 36

Prior U.S. Cls.: 100, 101 and 102

United States Patent and Trademark Office

Reg. No. 3,504,918

Registered Sep. 23, 2008

SERVICE MARK  
PRINCIPAL REGISTER



LEASING GROUP, INC. (TEXAS CORPORATION)  
SUITE #150  
1501 SOUTH MOPAC EXPRESSWAY  
AUSTIN, TX 78746

FOR: FINANCIAL SERVICES, NAMELY, SHORT-TERM AND LONG-TERM FINANCING IN THE NATURE OF ORIGINATING, PROCESSING, REPORTING AND ELECTRONICALLY MANAGING COMMERCIAL LOANS, CAPITAL AND OPERATING LEASES, BOTH SECURED AND UNSECURED, AND PAYMENT PLANS THAT ALLOW FOR THE ACQUISITION OF GOODS AND SERVICES FROM INDIVIDUAL VENDORS AND SUPPLIERS, IN CLASS 36 (U.S. CLS. 100, 101 AND 102).

FIRST USE 10-18-2006; IN COMMERCE 10-18-2006.

NO CLAIM IS MADE TO THE EXCLUSIVE RIGHT TO USE "LEASE", APART FROM THE MARK AS SHOWN.

THE MARK CONSISTS OF ON ONE LINE, THE WORD "LEASE" IN A BOLD ITALIC SANS SERIF FONT. ON THE SECOND LINE, A SYMBOL MADE UP OF A BROKEN, ITALICIZED PLUS SIGN SUPERIMPOSED ON AN OVAL; AND THE WORD "PLUS" IN A BOLD ITALIC SANS SERIF FONT. THE WORD "PLUS" IS UNDERLINED.

SER. NO. 77-401,519, FILED 2-20-2008.

ROBIN CHOSID, EXAMINING ATTORNEY

**Int. Cl.: 9**

**Prior U.S. Cls.: 21, 23, 26, 36 and 38**

**Reg. No. 3,504,919**

**United States Patent and Trademark Office**

**Registered Sep. 23, 2008**

---

**TRADEMARK  
PRINCIPAL REGISTER**

**emphase**

LOGIC SUPPLY, INC. (VERMONT CORPORATION)  
35 THOMPSON STREET  
SOUTH BURLINGTON, VT 05403

THE MARK CONSISTS OF STANDARD CHARACTERS WITHOUT CLAIM TO ANY PARTICULAR FONT, STYLE, SIZE, OR COLOR.

FOR: DIGITAL COMPUTERS, IN CLASS 9 (U.S. CLS. 21, 23, 26, 36 AND 38).

SER. NO. 77-401,525, FILED 2-20-2008.

FIRST USE 8-15-2006; IN COMMERCE 8-15-2006.

BRIAN NEVILLE, EXAMINING ATTORNEY



**Int. Cl.: 40**

**Prior U.S. Cls.: 100, 103 and 106**

**United States Patent and Trademark Office**

**Reg. No. 3,504,920**

**Registered Sep. 23, 2008**

**SERVICE MARK  
PRINCIPAL REGISTER**



EVERGREEN, LLC (NEVADA LIMITED LIABILITY COMPANY)  
5491 ACCURATE DRIVE  
LAS VEGAS, NV 89156

FOR: RECYCLING; RECYCLING OF WASTE; RECYCLING OF WASTE AND TRASH; SORTING OF WASTE AND RECYCLABLE MATERIAL, IN CLASS 40 (U.S. CLS. 100, 103 AND 106).

FIRST USE 1-1-1997; IN COMMERCE 1-1-1997.

NO CLAIM IS MADE TO THE EXCLUSIVE RIGHT TO USE "RECYCLING", APART FROM THE MARK AS SHOWN.

THE COLOR(S) MODERN GREEN IS/ARE CLAIMED AS A FEATURE OF THE MARK.

THE MARK CONSISTS OF THE WORDS "EVERGREEN RECYCLING" IN STYLIZED BLOCK LETTERS, WITH "EVERGREEN" STACKED ON TOP OF THE WORD "RECYCLING" AND A LOGO TO THE LEFT OF THE WORDS CONSISTING OF GRAPHIC IN THE SHAPE OF A PINE TREE ENCASED IN A BOX. THE ENTIRE MARK IS A MODERN GREEN COLOR.

SER. NO. 77-401,527, FILED 2-20-2008.

BERNICE MIDDLETON, EXAMINING ATTORNEY

**Int. Cl.: 41**

**Prior U.S. Cls.: 100, 101 and 107**

**United States Patent and Trademark Office**

**Reg. No. 3,504,921**

**Registered Sep. 23, 2008**

**SERVICE MARK  
PRINCIPAL REGISTER**

**CTP CERTIFIED TOUR  
PROFESSIONAL**

NATIONAL TOUR ASSOCIATION, INC. (KEN-  
TUCKY NON-PROFIT CORPORATION)  
546 E. MAIN ST.  
LEXINGTON, KY 40508

FOR: EDUCATIONAL SERVICES, NAMELY,  
PROVIDING CLASSES, SEMINARS, AND WORK-  
SHOPS IN THE FIELDS OF PACKAGED TRAVEL,  
TRAVEL, AND GROUP TOURS TO PERSONNEL IN  
THE PACKAGED TOUR AND TRAVEL INDUSTRY,  
IN CLASS 41 (U.S. CLS. 100, 101 AND 107).

FIRST USE 10-0-1985; IN COMMERCE 10-0-1985.

THE MARK CONSISTS OF STANDARD CHAR-  
ACTERS WITHOUT CLAIM TO ANY PARTICULAR  
FONT, STYLE, SIZE, OR COLOR.

OWNER OF U.S. REG. NO. 1,478,040.

NO CLAIM IS MADE TO THE EXCLUSIVE  
RIGHT TO USE "CERTIFIED TOUR PROFESSION-  
AL", APART FROM THE MARK AS SHOWN.

SER. NO. 77-401,548, FILED 2-20-2008.

JASON ROTH, EXAMINING ATTORNEY

**Int. Cl.: 36**

**Prior U.S. Cls.: 100, 101 and 102**

**United States Patent and Trademark Office**

**Reg. No. 3,504,922**

**Registered Sep. 23, 2008**

**SERVICE MARK  
PRINCIPAL REGISTER**



LEASING GROUP, INC. (TEXAS CORPORATION)  
SUITE #150  
1501 SOUTH MOPAC EXPRESSWAY  
AUSTIN, TX 78746

FOR: FINANCIAL SERVICES, NAMELY SHORT-TERM FINANCING IN THE NATURE OF CONSUMER AND COMMERCIAL LOANS, FIXED-TERM PAYABLE AND REVOLVING LINES OF CREDIT, BOTH SECURED AND UNSECURED, LEASES, AND PRIVATE LABEL CREDIT CARD PROGRAMS, THAT ALLOW THE ACQUISITION OF GOODS AND SERVICES FROM INDIVIDUAL VENDORS AND SUPPLIERS, IN CLASS 36 (U.S. CLS. 100, 101 AND 102).

FIRST USE 2-7-2008; IN COMMERCE 2-7-2008.

NO CLAIM IS MADE TO THE EXCLUSIVE RIGHT TO USE "XPRESS", APART FROM THE MARK AS SHOWN.

THE MARK CONSISTS OF TWO LINES, WITH THE WORD "XPRESS" IN A BOLD ITALIC SANS SERIF FONT. THE LEFT HAND SIDE OF THE LETTER "X" IS ACCENTED BY A THIN WHITE STRIPE EXTENDING THE ENTIRE LENGTH OF THE "X" AND THE "X" SPANS THE HEIGHT OF BOTH LINES. ON THE SECOND LINE, A SYMBOL MADE UP OF A BROKEN, ITALICIZED PLUS SIGN SUPERIMPOSED ON AN OVAL; AND THE WORD "PLUS" IN A BOLD ITALIC SANS SERIF FONT. THE WORD "PLUS" IS UNDERLINED.

SER. NO. 77-401,566, FILED 2-20-2008.

ROBIN CHOSID, EXAMINING ATTORNEY

**Int. Cl.: 9**

**Prior U.S. Cls.: 21, 23, 26, 36 and 38**

**Reg. No. 3,504,923**

**United States Patent and Trademark Office**

**Registered Sep. 23, 2008**

---

**TRADEMARK  
PRINCIPAL REGISTER**

**CONNECT WITH A LEADER**

DOUGLAS BATTERY MANUFACTURING COMPANY (NORTH CAROLINA CORPORATION)  
500 BATTERY DRIVE  
WINSTON-SALEM, NC 27107

FOR: BATTERIES, IN CLASS 9 (U.S. CLS. 21, 23, 26, 36 AND 38).

FIRST USE 11-0-1996; IN COMMERCE 11-0-1996.

THE MARK CONSISTS OF STANDARD CHARACTERS WITHOUT CLAIM TO ANY PARTICULAR FONT, STYLE, SIZE, OR COLOR.

OWNER OF U.S. REG. NO. 2,139,011.

SER. NO. 77-401,583, FILED 2-20-2008.

JAMES LOVELACE, EXAMINING ATTORNEY

**Int. Cl.: 41**

**Prior U.S. Cls.: 100, 101 and 107**

**Reg. No. 3,504,924**

**United States Patent and Trademark Office**

**Registered Sep. 23, 2008**

**SERVICE MARK  
PRINCIPAL REGISTER**



GET YOUR SKINNY LLC (MICHIGAN LIMITED  
LIABILITY COMPANY)  
1555 WESTGATE DR.  
HOWELL, MI 48843

FIRST USE 10-7-2007; IN COMMERCE 10-7-2007.

FOR: PROVIDING ASSISTANCE, PERSONAL  
TRAINING AND PHYSICAL FITNESS CONSULTA-  
TION TO INDIVIDUALS TO HELP THEM MAKE  
PHYSICAL FITNESS, STRENGTH, CONDITION-  
ING, AND EXERCISE IMPROVEMENT IN THEIR  
DAILY LIVING, IN CLASS 41 (U.S. CLS. 100, 101 AND  
107).

THE MARK CONSISTS OF THREE WAVY "S"  
SHAPED LINES IN FRONT OF THE WORDS "GET  
YOUR SKINNY".

SER. NO. 77-401,596, FILED 2-20-2008.

KRISTIN DAHLING, EXAMINING ATTORNEY

**Int. Cl.: 9**

**Prior U.S. Cls.: 21, 23, 26, 36 and 38**

**United States Patent and Trademark Office**

**Reg. No. 3,504,925**

**Registered Sep. 23, 2008**

**TRADEMARK  
PRINCIPAL REGISTER**

**emphase**

LOGIC SUPPLY, INC. (VERMONT CORPORATION)  
35 THOMPSON STREET  
SOUTH BURLINGTON, VT 05403

FOR: DIGITAL COMPUTERS, IN CLASS 9 (U.S. CLS. 21, 23, 26, 36 AND 38).

FIRST USE 4-15-2007; IN COMMERCE 4-15-2007.

THE COLOR(S) RED AND BLACK IS/ARE CLAIMED AS A FEATURE OF THE MARK.

THE MARK CONSISTS OF THE WORD "EMPHASE" IN LOWER CASE LETTERS, WITH THE LETTERS "EM" IN RED AND THE LETTERS "PHASE" IN BLACK.

SER. NO. 77-401,597, FILED 2-20-2008.

BRIAN NEVILLE, EXAMINING ATTORNEY

**Int. Cl.: 36**

**Prior U.S. Cls.: 100, 101 and 102**

**United States Patent and Trademark Office**

**Reg. No. 3,504,926**

**Registered Sep. 23, 2008**

**SERVICE MARK  
PRINCIPAL REGISTER**

# Comfortease

EQUIGUARD, INC. (ILLINOIS CORPORATION)  
800 JORIE BLVD.  
OAK BROOK, IL 60523

FOR: PROVIDING AND ADMINISTRATING EXTENDED WARRANTY SERVICE AGREEMENTS IN THE HEATING, VENTILATING AIR CONDITIONING AND REFRIGERATION INDUSTRY, IN CLASS 36 (U.S. CLS. 100, 101 AND 102).

FIRST USE 7-1-2007; IN COMMERCE 7-1-2007.

THE MARK CONSISTS OF STANDARD CHARACTERS WITHOUT CLAIM TO ANY PARTICULAR FONT, STYLE, SIZE, OR COLOR.

SER. NO. 77-401,621, FILED 2-20-2008.

MIDGE BUTLER, EXAMINING ATTORNEY

**Int. Cl.: 41**

**Prior U.S. Cls.: 100, 101 and 107**

**United States Patent and Trademark Office**

**Reg. No. 3,504,927**

**Registered Sep. 23, 2008**

**SERVICE MARK  
PRINCIPAL REGISTER**

**HARPERS BAZAAR**

HEARST COMMUNICATIONS, INC. (DELA-  
WARE CORPORATION)  
959 EIGHTH AVENUE  
NEW YORK, NY 10019

FOR: ENTERTAINMENT SERVICES, NAMELY  
PROVIDING A WEB SITE FEATURING PHOTO-  
GRAPHIC, AUDIO, VIDEO AND PROSE PRESEN-  
TATIONS FEATURING FASHION, BEAUTY,  
TRAVEL, HOME DECORATING, RELATIONSHIPS,  
LUXURY GOODS, HEALTH AND FITNESS, TECH-  
NOLOGY, CAREERS, AND CELEBRITY NEWS;  
PROVIDING ON-LINE PUBLICATIONS IN THE  
NATURE OF ARTICLES AND INFORMATION IN  
THE FIELD OF FASHION, BEAUTY, TRAVEL,  
HOME DECORATING, RELATIONSHIPS, LUXURY  
GOODS, HEALTH AND FITNESS, TECHNOLOGY,

CAREERS, AND CELEBRITY NEWS, IN CLASS 41  
(U.S. CLS. 100, 101 AND 107).

FIRST USE 12-7-1998; IN COMMERCE 12-7-1998.

THE MARK CONSISTS OF STANDARD CHAR-  
ACTERS WITHOUT CLAIM TO ANY PARTICULAR  
FONT, STYLE, SIZE, OR COLOR.

OWNER OF U.S. REG. NOS. 274,802, 1,275,129,  
AND 2,503,663.

SER. NO. 77-401,623, FILED 2-20-2008.

JAY FLOWERS, EXAMINING ATTORNEY



Int. Cl.: 36

Prior U.S. Cls.: 100, 101 and 102

United States Patent and Trademark Office

Reg. No. 3,504,928

Registered Sep. 23, 2008

**SERVICE MARK  
PRINCIPAL REGISTER**



LEASING GROUP, INC. (TEXAS CORPORATION)  
SUITE #150  
1501 SOUTH MOPAC EXPRESSWAY  
AUSTIN, TX 78746

FOR: FINANCIAL SERVICES, NAMELY, SHORT-TERM FINANCING IN THE NATURE OF CONSUMER AND COMMERCIAL LOANS, FIXED-TERM PAYABLE AND REVOLVING LINES OF CREDIT BOTH SECURED AND UNSECURED, LEASES, AND PRIVATE LABEL CREDIT CARD PROGRAMS, THAT ALLOW THE ACQUISITION OF GOODS AND SERVICES FROM INDIVIDUAL VENDORS AND SUPPLIERS, IN CLASS 36 (U.S. CLS. 100, 101 AND 102).

FIRST USE 6-19-2006; IN COMMERCE 6-19-2006.

NO CLAIM IS MADE TO THE EXCLUSIVE RIGHT TO USE "MATRIX", APART FROM THE MARK AS SHOWN.

THE MARK CONSISTS OF ON ONE LINE, THE WORD "MATRIX" IN A BOLD ITALIC SAN SERIF FONT. ON THE SECOND LINE, A SYMBOL MADE UP OF A BROKEN, ITALICIZED PLUS SIGN SUPERIMPOSED ON AN OVAL; AND THE WORD "PLUS" IN A BOLD ITALIC SANS SERIF FONT. THE WORD "PLUS" IS UNDERLINED.

SER. NO. 77-401,631, FILED 2-20-2008.

ROBIN CHOSID, EXAMINING ATTORNEY

**Int. Cl.: 36**

**Prior U.S. Cls.: 100, 101 and 102**

**United States Patent and Trademark Office**

**Reg. No. 3,504,929**

**Registered Sep. 23, 2008**

**SERVICE MARK  
PRINCIPAL REGISTER**

**AquaCare Plus**

EQUIGUARD, INC. (ILLINOIS CORPORATION)  
800 JORIE BLVD  
OAK BROOK, IL 60523

FOR: PROVIDING AND ADMINISTRATING EXTENDED WARRANTY SERVICE AGREEMENTS IN THE HEATING, VENTILATING, AIR CONDITIONING AND REFRIGERATION INDUSTRY, IN CLASS 36 (U.S. CLS. 100, 101 AND 102).

FIRST USE 12-3-2007; IN COMMERCE 12-3-2007.

THE MARK CONSISTS OF STANDARD CHARACTERS WITHOUT CLAIM TO ANY PARTICULAR FONT, STYLE, SIZE, OR COLOR.

SER. NO. 77-401,655, FILED 2-20-2008.

MIDGE BUTLER, EXAMINING ATTORNEY

**Int. Cl.: 9**

**Prior U.S. Cls.: 21, 23, 26, 36 and 38**

**Reg. No. 3,504,930**

**United States Patent and Trademark Office**

**Registered Sep. 23, 2008**

**TRADEMARK  
PRINCIPAL REGISTER**

**ZIDGET**

GROUP LOGIC, INC. (VIRGINIA CORPORATION)  
1110 NORTH GLEBE ROAD, SUITE 450  
ARLINGTON, VA 22201

SOFTWARE FOR LOCATING, DISPLAYING AND CONNECTING TO FILE SERVERS AND PRINTERS, IN CLASS 9 (U.S. CLS. 21, 23, 26, 36 AND 38).

FOR: A COMPONENT PART OF COMPUTER SOFTWARE PROVIDED AS A FEATURE OF THE FINISHED SOFTWARE, SUCH SOFTWARE IN THE NATURE OF PRINT MEDIA- AND PRINT PUBLISHING-RELATED SOFTWARE FOR IMPROVING AUTOMATED PRINT PRODUCTION, AND MANUALS PROVIDED THEREWITH; A COMPONENT PART OF DOWNLOADABLE SOFTWARE OF THE SAME NATURE AS STATED ABOVE, AND MANUALS PROVIDED THEREWITH; COMPUTER

FIRST USE 10-17-2007; IN COMMERCE 10-17-2007.

THE MARK CONSISTS OF STANDARD CHARACTERS WITHOUT CLAIM TO ANY PARTICULAR FONT, STYLE, SIZE, OR COLOR.

SER. NO. 77-401,670, FILED 2-20-2008.

DOMINIC FATHY, EXAMINING ATTORNEY

**Int. Cl.: 41**

**Prior U.S. Cls.: 100, 101 and 107**

**Reg. No. 3,504,931**

**United States Patent and Trademark Office**

**Registered Sep. 23, 2008**

**SERVICE MARK  
PRINCIPAL REGISTER**

# Engrade

HOLT, BRIAN D. (UNITED STATES INDIVIDUAL)  
330 J ST. #607  
SAN DIEGO, CA 92101

FOR: ANALYZING EDUCATIONAL TESTS SCORES AND DATA FOR OTHERS; ARRANGING AND CONDUCTING EDUCATIONAL CONFERENCES; CONSULTATION IN THE FIELD OF K-12 EDUCATIONAL SYSTEMS; EDUCATION INFORMATION; CHARITABLE SERVICES, NAMELY, PROVIDING ARTS AND CRAFTS AND EDUCATIONAL MATERIALS IN THE NATURE OF RECYCLED MANUFACTURING BY-PRODUCTS TO NEEDY AND UNDERPRIVILEGED CHILDREN; COMPUTER EDUCATION TRAINING; COMPUTER EDUCATION TRAINING SERVICES; EDUCATING AT SENIOR HIGH SCHOOLS; EDUCATING AT UNIVERSITY OR COLLEGES; EDUCATION COURSES RELATING TO THE TRAVEL INDUSTRY; EDUCATION SERVICES IN THE NATURE OF COURSES AT THE UNIVERSITY LEVEL; EDUCATION SERVICES, NAMELY, A PROGRAM TO PROMOTE THE USE OF PROPER PUNCTUATION TO SCHOOL AGE CHILDREN; EDUCATION SERVICES, NAMELY, PROVIDING CLASSES, SEMINARS, WORKSHOPS, TUTORING, AND MENTORING IN THE FIELD OF MIDDLE AND HIGH SCHOOL REFORM; EDUCATIONAL ASSESSMENT; EDUCATIONAL COURSE MONITORING, NAMELY, TRACKING STUDENT PERFORMANCE; EDUCATIONAL DEMONSTRATIONS; EDUCATIONAL EXAMINATION; EDUCATIONAL EXAMINATION SERVICES; EDUCATIONAL PROGRAMS, NAMELY, PRE-SCHOOLS; EDUCATIONAL RESEARCH; EDUCATIONAL SERVICES IN THE NATURE OF BEAUTY SCHOOLS; EDUCATIONAL SERVICES IN THE NATURE OF CORRESPONDENCE SCHOOLS; EDUCATIONAL SERVICES, NAMELY, CONDUCTING DISTANCE LEARNING INSTRUCTION AT

THE SECONDARY, COLLEGE AND GRADUATE LEVELS; EDUCATIONAL SERVICES, NAMELY, OFFERING OF ASSESSMENTS AND SURVEYS IN THE FIELD OF EDUCATOR TRAINING AND PERFORMANCE FOR THE PURPOSE OF IMPROVING TEACHING PROCEDURES; EDUCATIONAL SERVICES, NAMELY, THE OFFERING OF WEB BASED AND CLASSROOM TRAINING FOR CERTIFICATION OF TEACHERS AND CONTINUING EDUCATION FOR TEACHERS AND PRINCIPALS; EDUCATIONAL TESTING; INFORMATION ABOUT EDUCATION; INFORMATION IN THE FIELD OF PARENTING CONCERNING EDUCATION OF CHILDREN; INFORMATION ON EDUCATION; ON-LINE EDUCATION CREDIT AND DEGREE EVALUATION AND COMPARISON SERVICES; PHYSICAL EDUCATION; PROVIDING A WEB SITE WHERE USERS CAN POST RATINGS, REVIEWS AND RECOMMENDATIONS ON EVENTS AND ACTIVITIES IN THE FIELD OF ENTERTAINMENT AND EDUCATION; PROVIDING ADVICE AND INFORMATION IN THE FIELD OF EDUCATIONAL AND ENTERTAINMENT ACTIVITIES AND EVENTS FOR CHILDREN; PROVIDING AN INTERACTIVE WEB SITE FEATURING EDUCATIONAL INFORMATION AND TEST QUESTIONS IN THE FIELD OF MATHEMATICS, IN CLASS 41 (U.S. CLS. 100, 101 AND 107).

FIRST USE 1-17-2004; IN COMMERCE 1-17-2004.

THE MARK CONSISTS OF STANDARD CHARACTERS WITHOUT CLAIM TO ANY PARTICULAR FONT, STYLE, SIZE, OR COLOR.

SER. NO. 77-401,683, FILED 2-20-2008.

JANICE KIM, EXAMINING ATTORNEY

**Int. Cl.: 42**

**Prior U.S. Cls.: 100 and 101**

**United States Patent and Trademark Office**

**Reg. No. 3,504,932**

**Registered Sep. 23, 2008**

---

**SERVICE MARK  
PRINCIPAL REGISTER**

**in.o.v8**

E-ME VENTURES, LLC (DELAWARE LIMITED  
LIABILITY COMPANY)  
SUITE 500  
137 N. OAK PARK AVE.  
OAK PARK, IL 60301

FOR: APPLICATION SERVICE PROVIDER (ASP)  
FEATURING SOFTWARE FOR USE IN INNOVA-  
TION, APPLICATION, AND COLLABORATION  
SERVICES, IN CLASS 42 (U.S. CLS. 100 AND 101).

FIRST USE 6-15-2007; IN COMMERCE 6-15-2007.

THE MARK CONSISTS OF STANDARD CHAR-  
ACTERS WITHOUT CLAIM TO ANY PARTICULAR  
FONT, STYLE, SIZE, OR COLOR.

SER. NO. 77-401,703, FILED 2-20-2008.

INGA ERVIN, EXAMINING ATTORNEY

**Int. Cl.: 9**

**Prior U.S. Cls.: 21, 23, 26, 36 and 38**

**Reg. No. 3,504,933**

**United States Patent and Trademark Office**

**Registered Sep. 23, 2008**

**TRADEMARK  
PRINCIPAL REGISTER**

# Cyclops Technologies

CYCLOPS TECHNOLOGIES, INC. (FLORIDA CORPORATION)  
2890 SEAPINES CIRCLE W.  
CLEARWATER, FL 33761

FOR: COMPUTER SOFTWARE FOR VEHICLE LICENSE PLATE CAPTURE AND RECOGNITION USING OPTICAL CHARACTER RECOGNITION TECHNOLOGY, IN CLASS 9 (U.S. CLS. 21, 23, 26, 36 AND 38).

FIRST USE 9-15-2004; IN COMMERCE 9-21-2004.

THE MARK CONSISTS OF STANDARD CHARACTERS WITHOUT CLAIM TO ANY PARTICULAR FONT, STYLE, SIZE, OR COLOR.

NO CLAIM IS MADE TO THE EXCLUSIVE RIGHT TO USE "TECHNOLOGIES", APART FROM THE MARK AS SHOWN.

SER. NO. 77-401,738, FILED 2-20-2008.

PAUL E. FAHRENKOPF, EXAMINING ATTORNEY

**Int. Cl.: 25**

**Prior U.S. Cls.: 22 and 39**

**United States Patent and Trademark Office**

**Reg. No. 3,504,934**

**Registered Sep. 23, 2008**

**TRADEMARK  
PRINCIPAL REGISTER**

**DIGGETY**

NATIONAL ASSOCIATION OF PROFESSIONAL  
BASEBALL LEAGUES, INC. (FLORIDA COR-  
PORATION)  
201 BAYSHORE DRIVE SE  
ST. PETERSBURG, FL 33701

FOR: CLOTHING, NAMELY, ATHLETIC UNI-  
FORMS, BANDANAS, BOXER SHORTS, CAPS,  
CLOTH BABY BIBS, COATS, GOLF SHIRTS, GYM  
SHORTS, GYM SUITS, HATS, JACKETS, JERSEYS,  
KNIT SHIRTS, PAJAMAS, POLO SHIRTS,  
PONCHOS, PULLOVERS, RAIN COATS, RAIN-  
WEAR, SWEAT PANTS, SWEAT SHIRTS, SWEAT  
SUITS, SOCKS, SPORT SHIRTS, T-SHIRTS, TANK

TOPS, TIES, VISORS, WIND RESISTANT JACKETS  
AND WRISTBANDS, IN CLASS 25 (U.S. CLS. 22 AND  
39).

FIRST USE 12-4-2006; IN COMMERCE 12-4-2006.

THE MARK CONSISTS OF STANDARD CHAR-  
ACTERS WITHOUT CLAIM TO ANY PARTICULAR  
FONT, STYLE, SIZE, OR COLOR.

SER. NO. 77-401,758, FILED 2-20-2008.

KEVON CHISOLM, EXAMINING ATTORNEY

**Int. Cls.: 43 and 44**

**Prior U.S. Cls.: 100 and 101**

**United States Patent and Trademark Office**

**Reg. No. 3,504,935**

**Registered Sep. 23, 2008**

**SERVICE MARK  
PRINCIPAL REGISTER**



MENORAH MANOR, INC. (FLORIDA CORPORATION)  
255 59TH STREET NORTH  
ST. PETERSBURG, FL 33710

FOR: PROVIDING ASSISTED LIVING FACILITIES; PROVIDING ELDER CARE, IN CLASS 43 (U.S. CLS. 100 AND 101).

FIRST USE 1-31-2008; IN COMMERCE 1-31-2008.

FOR: PHYSICAL REHABILITATION; MEDICAL EVALUATION SERVICES, NAMELY, FUNCTIONAL ASSESSMENT PROGRAM FOR PATIENTS RECEIVING MEDICAL REHABILITATION SERVICES FOR PURPOSES OF GUIDING TREATMENT AND ASSESSING PROGRAM EFFECTIVENESS, IN CLASS 44 (U.S. CLS. 100 AND 101).

FIRST USE 1-31-2008; IN COMMERCE 1-31-2008.

THE COLOR(S) ORANGE, GREEN AND WHITE IS/ARE CLAIMED AS A FEATURE OF THE MARK.

THE MARK CONSISTS OF THE WORDS "MENORAH" IN GREEN AND "MANOR" IN ORANGE, BOTH BENEATH A STYLIZED "MENORAH" (CANDELABRA) IN WHITE ON AN ORANGE CIRCLE.

SER. NO. 77-401,761, FILED 2-20-2008.

DAVID ELTON, EXAMINING ATTORNEY



**Int. Cl.: 35**

**Prior U.S. Cls.: 100, 101 and 102**

**United States Patent and Trademark Office**

**Reg. No. 3,504,936**

**Registered Sep. 23, 2008**

**SERVICE MARK  
PRINCIPAL REGISTER**

**gThankYou**

GTHANKYOU, LLC (WISCONSIN LIMITED LIABILITY COMPANY)  
921 WABAN HILL  
MADISON, WI 53711

THE MARK CONSISTS OF STANDARD CHARACTERS WITHOUT CLAIM TO ANY PARTICULAR FONT, STYLE, SIZE, OR COLOR.

FOR: ISSUING GIFT CERTIFICATES WHICH MAY THEN BE REDEEMED FOR GOODS OR SERVICES, IN CLASS 35 (U.S. CLS. 100, 101 AND 102).

SER. NO. 77-401,789, FILED 2-20-2008.

FIRST USE 11-8-2007; IN COMMERCE 11-8-2007.

ANNE MADDEN, EXAMINING ATTORNEY

Int. Cls.: 9, 16, 35, 36 and 45

Prior U.S. Cls.: 2, 5, 21, 22, 23, 26, 29, 36, 37, 38, 50,  
100, 101 and 102

Reg. No. 3,504,937

United States Patent and Trademark Office

Registered Sep. 23, 2008

TRADEMARK  
SERVICE MARK  
PRINCIPAL REGISTER



BIA FINANCIAL NETWORK, INC (VIRGINIA CORPORATION)  
15120 ENTERPRISE COURT, SUITE 100  
CHANTILLY, VA 20151

FOR: COMPUTER SOFTWARE, NAMELY, A COMPUTER READABLE DATABASE FOR STORING AND RETRIEVING COMPANY INFORMATION ABOUT COMMUNICATIONS BUSINESSES, IN CLASS 9 (U.S. CLS. 21, 23, 26, 36 AND 38).

FIRST USE 6-0-2000; IN COMMERCE 6-0-2000.

FOR: PRINTED ANNUAL REFERENCE GUIDES AND INDIVIDUAL MARKET REPORTS REGARDING THE OWNERSHIP AND OPERATIONS OF MEDIA AND TELECOMMUNICATIONS BUSINESSES; PRINTED ANNUAL REFERENCE GUIDES AND INDIVIDUAL MARKET REPORTS REGARDING THE BUSINESS AND FINANCIAL ASPECTS OF MEDIA AND TELECOMMUNICATIONS BUSINESSES, IN CLASS 16 (U.S. CLS. 2, 5, 22, 23, 29, 37, 38 AND 50).

FIRST USE 6-0-2000; IN COMMERCE 6-0-2000.

FOR: BUSINESS CONSULTING; BUSINESS ACQUISITIONS AND MERGER CONSULTING; BUSINESS RESEARCH AND SURVEYS; BUSINESS PLANNING; BUSINESS APPRAISALS AND VALUA-

TIONS; ALL OF THE FOREGOING IN THE MEDIA AND TELECOMMUNICATIONS INDUSTRY, IN CLASS 35 (U.S. CLS. 100, 101 AND 102).

FIRST USE 2-0-2000; IN COMMERCE 2-0-2000.

FOR: FINANCIAL CONSULTATION AND ANALYSIS IN THE MEDIA AND TELECOMMUNICATIONS INDUSTRY, IN CLASS 36 (U.S. CLS. 100, 101 AND 102).

FIRST USE 2-0-2000; IN COMMERCE 2-0-2000.

FOR: LITIGATION SUPPORT SERVICES; EXPERT WITNESS SERVICES IN LEGAL MATTERS IN THE MEDIA AND TELECOMMUNICATIONS INDUSTRY, IN CLASS 45 (U.S. CLS. 100 AND 101).

FIRST USE 2-0-2000; IN COMMERCE 2-0-2000.

OWNER OF U.S. REG. NO. 2,652,253.

NO CLAIM IS MADE TO THE EXCLUSIVE RIGHT TO USE "FN", APART FROM THE MARK AS SHOWN.

THE MARK CONSISTS OF THE LETTERING "BIA FN" IN A SQUARE WITH A HORIZONTAL LINE SEPARATING THE UPPERCASE LETTERS "BIA" WHICH APPEAR IN THE TOP HALF OF THE

SQUARE AND THE LOWERCASE LETTERS "FN"  
WHICH APPEAR IN THE BOTTOM RIGHT OF THE  
SQUARE.

SER. NO. 77-401,813, FILED 2-20-2008.

IRA J. GOODSaid, EXAMINING ATTORNEY

Int. Cl.: 25

Prior U.S. Cls.: 22 and 39

United States Patent and Trademark Office

Reg. No. 3,504,938

Registered Sep. 23, 2008

TRADEMARK  
PRINCIPAL REGISTER



C.I. EL GLOBO S.A. (COLOMBIA CORPORATION)  
CARRERA 57 #25-33, BARRIO TRINIDAD  
MEDELLIN, COLOMBIA

FOR: JEANS; BELTS; BELTS MADE OF LEATHER; BERMUDA SHORTS; BOXER SHORTS; BRAS; BRIEFS; CAPS; DENIM JACKETS; DENIMS; HEADWEAR; HATS; LONG-SLEEVED SHIRTS; PANTS; SHORT-SLEEVED OR LONG-SLEEVED T-SHIRTS; SWEATERS; SHORTS; SKIRTS AND DRESSES; TOPS; UNDERWEAR; SHIRTS; JACKETS; PANTIES, IN CLASS 25 (U.S. CLS. 22 AND 39).

FIRST USE 12-1-2007; IN COMMERCE 12-1-2007.

NO CLAIM IS MADE TO THE EXCLUSIVE RIGHT TO USE "JEANS", APART FROM THE MARK AS SHOWN.

THE MARK CONSISTS OF THE WORDINGS "CRISTO GRACEFUL JEANS". THE WORD "CRISTO" IS IN SMALL CAPS. THE WORD "CRISTO" IS IN SPANISH AND MEANS "CHRIST". THE WORD "CRISTO" UTILIZES A FONT REMINISCENT OF HEBREW SCRIPT. THE WORDS "GRACEFUL JEANS" ARE LOCATED UNDERNEATH THE WORD "CRISTO". THE WORDS "GRACEFUL JEANS" ARE IN CURSIVE FONT.

THE FOREIGN WORDING IN THE MARK TRANSLATES INTO ENGLISH AS CHRIST.

SER. NO. 77-401,847, FILED 2-20-2008.

ANNE E. GUSTASON, EXAMINING ATTORNEY

**Int. Cl.: 35**

**Prior U.S. Cls.: 100, 101 and 102**

**United States Patent and Trademark Office**

**Reg. No. 3,504,939**

**Registered Sep. 23, 2008**

**SERVICE MARK  
PRINCIPAL REGISTER**

**DATA ALLIANCE INFORMATION  
TECHNOLOGY**

JOLIN, MICHAEL ROBERT (UNITED STATES  
INDIVIDUAL)  
SUITE 381  
371 LAKEPORT BLVD.  
LAKEPORT, CA 95453

FOR: ON-LINE RETAIL STORE SERVICES FEATURING REFURBISHED COMPUTER HARDWARE; RETAIL REFURBISHED COMPUTER HARDWARE STORES, IN CLASS 35 (U.S. CLS. 100, 101 AND 102).

FIRST USE 12-28-2006; IN COMMERCE 12-28-2006.

THE MARK CONSISTS OF STANDARD CHARACTERS WITHOUT CLAIM TO ANY PARTICULAR FONT, STYLE, SIZE, OR COLOR.

NO CLAIM IS MADE TO THE EXCLUSIVE RIGHT TO USE "INFORMATION TECHNOLOGY", APART FROM THE MARK AS SHOWN.

SER. NO. 77-401,853, FILED 2-20-2008.

KATHRYN COWARD, EXAMINING ATTORNEY

**Int. Cl.: 10**

**Prior U.S. Cls.: 26, 39 and 44**

**United States Patent and Trademark Office**

**Reg. No. 3,504,940**

**Registered Sep. 23, 2008**

**TRADEMARK  
PRINCIPAL REGISTER**

**PAG**

X RAY CASSETTE REPAIR CO., INC. (ILLINOIS CORPORATION), DBA REINA IMAGING  
6107 WEST LOU AVENUE  
CRYSTAL LAKE, IL 60014

THE MARK CONSISTS OF STANDARD CHARACTERS WITHOUT CLAIM TO ANY PARTICULAR FONT, STYLE, SIZE, OR COLOR.

FOR: ANTI SCATTER GRIDS FOR USE WITH X-RAY MACHINES, IN CLASS 10 (U.S. CLS. 26, 39 AND 44).

SER. NO. 77-401,952, FILED 2-20-2008.

FIRST USE 8-1-2007; IN COMMERCE 8-1-2007.

KAREN K. BUSH, EXAMINING ATTORNEY

Int. Cl.: 10

Prior U.S. Cls.: 26, 39 and 44

United States Patent and Trademark Office

Reg. No. 3,504,941

Registered Sep. 23, 2008

TRADEMARK  
PRINCIPAL REGISTER

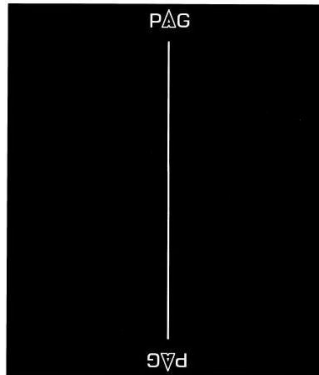

X RAY CASSETTE REPAIR CO., INC. (ILLINOIS CORPORATION), DBA REINA IMAGING  
6107 WEST LOU AVENUE  
CRYSTAL LAKE, IL 60014

FOR: ANTI SCATTER GRIDS FOR USE WITH X-RAY MACHINES, IN CLASS 10 (U.S. CLS. 26, 39 AND 44).

FIRST USE 8-1-2007; IN COMMERCE 8-1-2007.

THE COLOR(S) BLACK, WHITE IS/ARE CLAIMED AS A FEATURE OF THE MARK.

THE MARK CONSISTS OF A BLACK BOX CONTAINING STYLIZED LETTERS "P", "A" AND "G" WITH THE LETTER "A" IN FANCIFUL SCRIPT; THE STYLIZED LETTERS "PAG" APPEARING UPSIDE DOWN AT THE BOTTOM OF THE MARK AND CONNECT TO THE UPPER SCRIPT BY A SOLID WHITE LINE.

SER. NO. 77-401,979, FILED 2-20-2008.

KAREN K. BUSH, EXAMINING ATTORNEY

**Int. Cl.: 35**

**Prior U.S. Cls.: 100, 101 and 102**

**United States Patent and Trademark Office**

**Reg. No. 3,504,942**

**Registered Sep. 23, 2008**

**SERVICE MARK  
PRINCIPAL REGISTER**

**RadGrapes**

RAD GRAPES LLC (NEW JERSEY LIMITED  
LIABILITY COMPANY)

#F

393 CRESCENT AVENUE  
WYCKOFF, NJ 07481

FOR: DISTRIBUTORSHIPS IN THE FIELD OF  
WINE AND IMPORT OF WINE, IN CLASS 35 (U.S.  
CLS. 100, 101 AND 102).

FIRST USE 2-12-2005; IN COMMERCE 3-23-2005.

THE MARK CONSISTS OF THE STYLIZED  
WORDS "RAD GRAPES".

SER. NO. 77-401,982, FILED 2-20-2008.

HOWARD SMIGA, EXAMINING ATTORNEY



**Int. Cls.: 38 and 45**

**Prior U.S. Cls.: 100, 101 and 104**

**United States Patent and Trademark Office**

**Reg. No. 3,504,943**

**Registered Sep. 23, 2008**

**SERVICE MARK  
PRINCIPAL REGISTER**



POSITIVE NETWORKS, INC. (DELAWARE CORPORATION)  
SUITE 400  
8500 W 110TH ST.  
OVERLAND PARK, KS 66210

FOR: PROVIDING PRIVATE AND SECURE REAL TIME ELECTRONIC COMMUNICATION OVER A COMPUTER NETWORK; SECURE E-MAIL SERVICES, IN CLASS 38 (U.S. CLS. 100, 101 AND 104).

FIRST USE 12-1-2006; IN COMMERCE 12-1-2006.

FOR: AUTHENTICATION, ISSUANCE AND VALIDATION OF DIGITAL CERTIFICATES; COMPUTER SECURITY SERVICES IN THE NATURE OF PROVIDING AN INTERNET TRUST CENTER, NAMELY, COMPUTER SECURITY ASSURANCE AND ADMINISTRATION OF DIGITAL KEYS AND DIGITAL CERTIFICATES; IDENTIFICATION VERIFICATION SERVICES, NAMELY, PROVIDING AUTHENTICATION OF PERSONAL IDENTIFICATION

INFORMATION; IDENTIFICATION VERIFICATION SERVICES, NAMELY, PROVIDING AUTHENTICATION OF PERSONAL IDENTIFICATION INFORMATION VIA SECURE STORAGE AND TRANSMITTING SUCH INFORMATION VIA THE INTERNET; PROVIDING USER AUTHENTICATION SERVICES IN E-COMMERCE TRANSACTIONS, IN CLASS 45 (U.S. CLS. 100 AND 101).

FIRST USE 12-1-2006; IN COMMERCE 12-1-2006.

OWNER OF U.S. REG. NO. 3,427,690.

THE MARK CONSISTS OF A STYLIZED LOCK WITH A RIGHT POINTING ARROW TO THE LEFT OF THE WORDS "PHONEFACTOR".

SER. NO. 77-401,991, FILED 2-20-2008.

MICHAEL LITZAU, EXAMINING ATTORNEY

**Int. Cl.: 37**

**Prior U.S. Cls.: 100, 103 and 106**

**United States Patent and Trademark Office**

**Reg. No. 3,504,944**

**Registered Sep. 23, 2008**

**SERVICE MARK  
PRINCIPAL REGISTER**

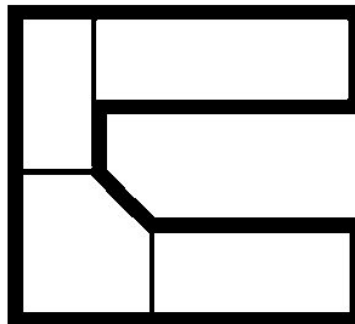

**CORPORATE OFFICE SPECIALISTS, INC (CALI-  
FORNIA CORPORATION)**

**#B**

**190 EAST CROWTHER AVENUE  
PLACENTIA, CA 92870**

**FOR: INSTALLATION OF OFFICE SYSTEMS  
AND WORK STATIONS, IN CLASS 37 (U.S. CLS.  
100, 103 AND 106).**

**FIRST USE 1-1-2008; IN COMMERCE 1-1-2008.**

**THE MARK CONSISTS OF AN ABSTRACT DE-  
SIGN.**

**SER. NO. 77-401,997, FILED 2-20-2008.**

**NANCY CLARKE, EXAMINING ATTORNEY**

**Int. Cl.: 41**

**Prior U.S. Cls.: 100, 101 and 107**

**United States Patent and Trademark Office**

**Reg. No. 3,504,945**

**Registered Sep. 23, 2008**

**SERVICE MARK  
PRINCIPAL REGISTER**

# Men of the Wild

MEN OF THE WILD (ARIZONA SOLE PROPRIETORSHIP)  
8438 W. CHARTER OAK RD.  
PEORIA, AZ 85381

THE MARK CONSISTS OF STANDARD CHARACTERS WITHOUT CLAIM TO ANY PARTICULAR FONT, STYLE, SIZE, OR COLOR.

FOR: ENTERTAINMENT IN THE NATURE OF MALE REVUE SHOWS, IN CLASS 41 (U.S. CLS. 100, 101 AND 107).

SER. NO. 77-401,998, FILED 2-20-2008.

FIRST USE 12-31-2007; IN COMMERCE 12-31-2007.

REBECCA GILBERT, EXAMINING ATTORNEY

**Int. Cl.: 43**

**Prior U.S. Cls.: 100 and 101**

**United States Patent and Trademark Office**

**Reg. No. 3,504,946**

**Registered Sep. 23, 2008**

**SERVICE MARK  
PRINCIPAL REGISTER**

**I WANT MY PT'S**

GOLDEN GAMING, INC. (NEVADA CORPORATION)  
6595 S. JONES BLVD.  
LAS VEGAS, NV 89118

THE MARK CONSISTS OF STANDARD CHARACTERS WITHOUT CLAIM TO ANY PARTICULAR FONT, STYLE, SIZE, OR COLOR.

FOR: RESTAURANT AND BAR SERVICES;  
COCKTAIL LOUNGES, IN CLASS 43 (U.S. CLS. 100  
AND 101).

SER. NO. 77-402,000, FILED 2-20-2008.

FIRST USE 1-28-2008; IN COMMERCE 1-28-2008.

TARAH HARDY, EXAMINING ATTORNEY

**Int. Cl.: 41**

**Prior U.S. Cls.: 100, 101 and 107**

**United States Patent and Trademark Office**

**Reg. No. 3,504,947**

**Registered Sep. 23, 2008**

**SERVICE MARK  
PRINCIPAL REGISTER**

**I WANT MY PT'S**

GOLDEN GAMING, INC. (NEVADA CORPORATION)  
6595 S. JONES BLVD.  
LAS VEGAS, NV 89118

THE MARK CONSISTS OF STANDARD CHARACTERS WITHOUT CLAIM TO ANY PARTICULAR FONT, STYLE, SIZE, OR COLOR.

FOR: CASINOS, IN CLASS 41 (U.S. CLS. 100, 101 AND 107).

SER. NO. 77-402,002, FILED 2-20-2008.

FIRST USE 1-28-2008; IN COMMERCE 1-28-2008.

TARAH HARDY, EXAMINING ATTORNEY

**Int. Cl.: 10**

**Prior U.S. Cls.: 26, 39 and 44**

**United States Patent and Trademark Office**

**Reg. No. 3,504,948**

**Registered Sep. 23, 2008**

**TRADEMARK  
PRINCIPAL REGISTER**

**TRANS-FORMER**

X RAY CASSETTE REPAIR CO., INC. (ILLINOIS  
CORPORATION), DBA REINA IMAGING  
6107 WEST LOU AVENUE  
CRYSTAL LAKE, IL 60014

THE MARK CONSISTS OF STANDARD CHAR-  
ACTERS WITHOUT CLAIM TO ANY PARTICULAR  
FONT, STYLE, SIZE, OR COLOR.

FOR: MOBILE X-RAY GRID CABINET, IN CLASS  
10 (U.S. CLS. 26, 39 AND 44).

SER. NO. 77-402,024, FILED 2-20-2008.

FIRST USE 9-1-2007; IN COMMERCE 9-1-2007.

KAREN K. BUSH, EXAMINING ATTORNEY

**Int. Cl.: 36**

**Prior U.S. Cls.: 100, 101 and 102**

**United States Patent and Trademark Office**

**Reg. No. 3,504,949**

**Registered Sep. 23, 2008**

**SERVICE MARK  
PRINCIPAL REGISTER**

**TENTEN**

TENTEN WILSHIRE, LLC (CALIFORNIA LIMITED LIABILITY COMPANY)  
370 CONVENTION WAY  
REDWOOD CITY, CA 94063

FOR: LEASING OF APARTMENTS; LEASING OF OFFICE SPACE; LEASING OF REAL ESTATE; LEASING OF REAL PROPERTY; RENTAL OF APARTMENTS; RENTAL OF OFFICE SPACE; REAL ESTATE RENTAL SERVICES, NAMELY, RENTAL OF RESIDENTIAL HOUSING; REAL ESTATE SERVICES, NAMELY, RENTAL OF SHORT-TERM FURNISHED APARTMENTS; RENTING OF

APARTMENTS, IN CLASS 36 (U.S. CLS. 100, 101 AND 102).

FIRST USE 10-1-2007; IN COMMERCE 10-1-2007.

THE MARK CONSISTS OF STANDARD CHARACTERS WITHOUT CLAIM TO ANY PARTICULAR FONT, STYLE, SIZE, OR COLOR.

SER. NO. 77-402,025, FILED 2-20-2008.

KAREN K. BUSH, EXAMINING ATTORNEY

**Int. Cl.: 44**

**Prior U.S. Cls.: 100 and 101**

**United States Patent and Trademark Office**

**Reg. No. 3,504,950**

**Registered Sep. 23, 2008**

**SERVICE MARK  
PRINCIPAL REGISTER**

**THE WAX BAR**

THE WAX BAR LLC (WASHINGTON LIMITED  
LIABILITY COMPANY), DBA THE WAX BAR  
5915 15TH AVE NW  
SEATTLE, WA 98107

FOR: BODY WAXING SERVICES, IN CLASS 44  
(U.S. CLS. 100 AND 101).

FIRST USE 1-15-2007; IN COMMERCE 3-15-2007.

THE MARK CONSISTS OF STANDARD CHAR-  
ACTERS WITHOUT CLAIM TO ANY PARTICULAR  
FONT, STYLE, SIZE, OR COLOR.

NO CLAIM IS MADE TO THE EXCLUSIVE  
RIGHT TO USE "WAX", APART FROM THE MARK  
AS SHOWN.

SER. NO. 77-402,071, FILED 2-20-2008.

JOHN E. MICHOS, EXAMINING ATTORNEY



**Int. Cl.: 9**

**Prior U.S. Cls.: 21, 23, 26, 36 and 38**

**Reg. No. 3,504,951**

**United States Patent and Trademark Office**

**Registered Sep. 23, 2008**

---

**TRADEMARK  
PRINCIPAL REGISTER**

**ensemble**

APOGEE ELECTRONICS CORPORATION (CALIFORNIA CORPORATION)  
TRADEMARK DEPARTMENT  
1715 BERKELEY STREET  
SANTA MONICA, CA 90404

FOR: AUDIO APPARATUS AND ELECTRONIC EQUIPMENT FOR CONVERTING SIGNALS AND FORMATS, NAMELY ANALOG/DIGITAL AND DIGITAL/ANALOG CONVERTERS, DIGITAL FORMAT CONVERTERS, DIGITAL I/O DEVICES, DIGITAL SIGNAL PROCESSORS (DSP) MICROPHONE PREAMPLIFIERS, AUDIO FILTERS, ANALOG AND DIGITAL PROCESSING EQUIPMENT

FOR AUDIO, IN CLASS 9 (U.S. CLS. 21, 23, 26, 36 AND 38).

FIRST USE 1-18-2006; IN COMMERCE 1-18-2006.

THE MARK CONSISTS OF STANDARD CHARACTERS WITHOUT CLAIM TO ANY PARTICULAR FONT, STYLE, SIZE, OR COLOR.

SER. NO. 77-402,075, FILED 2-20-2008.

JOHN E. MICHOS, EXAMINING ATTORNEY

Int. Cl.: 25

Prior U.S. Cls.: 22 and 39

United States Patent and Trademark Office

Reg. No. 3,504,952

Registered Sep. 23, 2008

TRADEMARK  
PRINCIPAL REGISTER



The logo features the text "POUND 'EM" on the top line and "FIGHT GEAR" on the bottom line. The letters are rendered in a bold, black, distressed font that appears to be cracked or weathered. The apostrophe in "'EM" is stylized and integrated into the letter 'E'.

MMACHAOS (OHIO PARTNERSHIP)  
1701 FARRINGTON DRIVE  
KETTERING, OH 45420

FOR: BELTS; CAPS; GLOVES; HATS; JACKETS;  
JEANS; LONG-SLEEVED SHIRTS; PANTS; PULL-  
OVERS; RASH GUARDS; SANDALS; SHIRTS;  
SHORTS; SKIRTS; SOCKS; SWEAT PANTS; SWEAT  
SHIRTS; SWEATERS; T-SHIRTS; TANK TOPS; UN-  
DERWEAR, IN CLASS 25 (U.S. CLS. 22 AND 39).

FIRST USE 10-27-2007; IN COMMERCE 11-10-2007.

NO CLAIM IS MADE TO THE EXCLUSIVE  
RIGHT TO USE "FIGHT GEAR", APART FROM  
THE MARK AS SHOWN.

THE MARK CONSISTS OF THE TEXT "POUND  
'EM FIGHT GEAR" MADE IN A CRACKED FONT.

SER. NO. 77-402,086, FILED 2-20-2008.

ESTHER A. BORSUK, EXAMINING ATTORNEY

**Int. Cl.: 35**

**Prior U.S. Cls.: 100, 101 and 102**

**United States Patent and Trademark Office**

**Reg. No. 3,504,953**

**Registered Sep. 23, 2008**

**SERVICE MARK  
PRINCIPAL REGISTER**

**luggagepoint.com**

LUGGAGEPOINT.COM (NEW JERSEY CORPORATION)  
SUITE 6D  
69 VERONICA AVENUE  
SOMERSET, NJ 08873

FOR: ON-LINE RETAIL STORE SERVICES FEATURING LUGGAGE, HANDBAGS, BACKPACKS, BUSINESS CASES, MESSENGER BAGS, TRAVEL ACCESSORIES, WALLETS, PURSES, GARMENT BAGS, WHEELED LUGGAGE, CARRY ON BAGS, TOTE BAGS, LUGGAGE TOTE BAGS, LAPTOP CASES, LUGGAGE LOCKS, UMBRELLAS, TRAVEL PILLOWS, LUGGAGE TAGS, CD CASES, MP3 CASES, AND BUSINESS ACCESSORIES, NAMELY,

CARRYING BAGS AND CASES, FOLDERS, PERSONAL AGENDAS, JOURNALS, WALLETS, MONEY CLIPS AND PLANNERS, IN CLASS 35 (U.S. CLS. 100, 101 AND 102).

FIRST USE 10-15-1998; IN COMMERCE 10-15-1998.

THE MARK CONSISTS OF STANDARD CHARACTERS WITHOUT CLAIM TO ANY PARTICULAR FONT, STYLE, SIZE, OR COLOR.

SER. NO. 77-402,097, FILED 2-20-2008.

JEAN IM, EXAMINING ATTORNEY

**Int. Cl.: 3**

**Prior U.S. Cls.: 1, 4, 6, 50, 51 and 52**

**United States Patent and Trademark Office**

**Reg. No. 3,504,954**

**Registered Sep. 23, 2008**

**TRADEMARK  
PRINCIPAL REGISTER**

**The Science of Safety**

BELLI MATERNA, LLC (DELAWARE LIMITED LIABILITY COMPANY), DBA BELLI COSMETICS  
581 TIMBER CREEK DR. NW  
ISSAQUAH, WA 98027

FOR: BODY CARE PRODUCTS FOR PREGNANT WOMEN, NEW MOTHERS AND INFANTS, NAMELY, NON-MEDICATED SKIN CREAMS AND LOTIONS, BODY WASHES, EXFOLIATING SCRUBS AND OILS, IN CLASS 3 (U.S. CLS. 1, 4, 6, 50, 51 AND 52).

FIRST USE 2-18-2008; IN COMMERCE 2-18-2008.

THE MARK CONSISTS OF STANDARD CHARACTERS WITHOUT CLAIM TO ANY PARTICULAR FONT, STYLE, SIZE, OR COLOR.

SER. NO. 77-402,103, FILED 2-20-2008.

SUSAN STIGLITZ, EXAMINING ATTORNEY

**Int. Cl.: 42**

**Prior U.S. Cls.: 100 and 101**

**United States Patent and Trademark Office**

**Reg. No. 3,504,955**

**Registered Sep. 23, 2008**

**SERVICE MARK  
PRINCIPAL REGISTER**

**MODERNATION**

MODERNATION (VIRGINIA LIMITED LIABILITY COMPANY)  
4134 ULINE AVENUE  
ALEXANDRIA, VA 22304

THE MARK CONSISTS OF STANDARD CHARACTERS WITHOUT CLAIM TO ANY PARTICULAR FONT, STYLE, SIZE, OR COLOR.

FOR: DESIGN FOR OTHERS IN THE FIELD OF GRAPHICS, WEBSITES, AND COMPUTER APPLICATIONS, IN CLASS 42 (U.S. CLS. 100 AND 101).

SER. NO. 77-402,105, FILED 2-20-2008.

FIRST USE 6-1-1996; IN COMMERCE 12-1-1996.

SUSAN STIGLITZ, EXAMINING ATTORNEY

**Int. Cl.: 12**

**Prior U.S. Cls.: 19, 21, 23, 31, 35 and 44**

**United States Patent and Trademark Office**

**Reg. No. 3,504,956**

**Registered Sep. 23, 2008**

**TRADEMARK  
PRINCIPAL REGISTER**



ADALICIA INC. (CALIFORNIA CORPORATION),  
DBA TOUGH GUY CHOPPERS  
7049 RIATA DRIVE  
REDDING, CA 96002

FOR: MOTORCYCLES AND STRUCTURAL  
PARTS THEREFOR, IN CLASS 12 (U.S. CLS. 19, 21,  
23, 31, 35 AND 44).

FIRST USE 4-14-2007; IN COMMERCE 4-14-2007.

OWNER OF U.S. REG. NO. 3,413,709.

NO CLAIM IS MADE TO THE EXCLUSIVE  
RIGHT TO USE "CHOPPERS", APART FROM THE  
MARK AS SHOWN.

THE MARK CONSISTS OF THREE CONCENTRIC  
CIRCLES INSIDE ONE ANOTHER WITH THE  
WORDING "TOUGH GUY" APPEARING INSIDE  
THE OUTERMOST CIRCLES AT THE TOP AND  
THE WORDING "CHOPPERS", ALSO INSIDE THE  
TWO CIRCLES, AT THE BOTTOM OF THE DESIGN.  
IN THE VERY CENTER OF THE DRAWING IS A  
SKULL DESIGN INSIDE THE CENTER CIRCLE.  
INSIDE THE SECOND AND THIRD CIRCLES, ARE  
6 QUADRILATERALS, SIMILAR IN APPEARANCE  
TO THE RADIATION WARNING SYMBOL, SUR-  
ROUNDING THE SKULL DESIGN.

SER. NO. 77-402,123, FILED 2-20-2008.

WENDY GOODMAN, EXAMINING ATTORNEY

**Int. Cl.: 45**

**Prior U.S. Cls.: 100 and 101**

**United States Patent and Trademark Office**

**Reg. No. 3,504,957**

**Registered Sep. 23, 2008**

**SERVICE MARK  
PRINCIPAL REGISTER**

**Model Quality Introductions**

MODEL QUALITY INTRODUCTIONS, INC. (CALIFORNIA CORPORATION)  
9595 WILSHIRE #309  
BEVERLY HILLS, CA 90212

FOR: MARRIAGE PARTNER INTRODUCTION OR DATING SERVICES, IN CLASS 45 (U.S. CLS. 100 AND 101).

FIRST USE 2-1-2001; IN COMMERCE 2-1-2001.

THE MARK CONSISTS OF STANDARD CHARACTERS WITHOUT CLAIM TO ANY PARTICULAR FONT, STYLE, SIZE, OR COLOR.

NO CLAIM IS MADE TO THE EXCLUSIVE RIGHT TO USE "INTRODUCTIONS", APART FROM THE MARK AS SHOWN.

SER. NO. 77-402,150, FILED 2-20-2008.

DAVID YONTEF, EXAMINING ATTORNEY

**Int. Cl.: 6**

**Prior U.S. Cls.: 2, 12, 13, 14, 23, 25 and 50**

**United States Patent and Trademark Office**

**Reg. No. 3,504,958**

**Registered Sep. 23, 2008**

**TRADEMARK  
PRINCIPAL REGISTER**



CHILCOTE, STEFAN (UNITED STATES INDIVIDUAL)  
1425 UNIVERSITY AVE., SUITE #E  
SAN DIEGO, CA 92013

FOR: METAL DOG TAGS; METAL IDENTIFICATION BRACELETS; BUCKLES OF COMMON METAL; KEYRINGS OF COMMON METAL; METAL CHAINS; METAL KEY CHAINS; METAL KEY RINGS; METAL NAME BADGES; METAL NAME PLATES; METAL NAMEPLATES AND DOOR NAMEPLATES; METAL TIME CAPSULES, IN CLASS 6 (U.S. CLS. 2, 12, 13, 14, 23, 25 AND 50).

FIRST USE 2-1-2008; IN COMMERCE 2-1-2008.

THE MARK CONSISTS OF THE WORD "ROOSTERCAT" ABOVE AND PART OF A STYLIZED BARCODE, WITH THE PHRASE "WHAT'S YOUR BARCODE" BELOW THE STYLIZED BARCODE..

SER. NO. 77-402,230, FILED 2-21-2008.

SAIMA MAKHDOOM, EXAMINING ATTORNEY



Int. Cl.: 14

Prior U.S. Cls.: 2, 27, 28 and 50

United States Patent and Trademark Office

Reg. No. 3,504,959

Registered Sep. 23, 2008

TRADEMARK  
PRINCIPAL REGISTER



CHILCOTE, STEFAN (UNITED STATES INDIVIDUAL)  
1425 UNIVERSITY AVE., SUITE #E  
SAN DIEGO, CA 92013

FOR: BEADS FOR USE IN THE MANUFACTURE OF JEWELRY; BRACELETS; BRONZE JEWELRY; COSTUME JEWELRY; DIAMOND JEWELRY; GEMSTONE JEWELRY; IDENTIFICATION BRACELETS; JEWELRY; JEWELRY AND IMITATION JEWELRY; JEWELRY BOXES; JEWELRY BOXES NOT OF METAL; JEWELRY BOXES OF METAL; JEWELRY BOXES OF PRECIOUS METAL; JEWELRY CASES; JEWELRY CASES NOT OF PRECIOUS METAL; JEWELRY CASES OF PRECIOUS METAL; JEWELRY CHAINS; JEWELRY FOR ATTACHMENT TO CLOTHING; JEWELRY FOR THE HEAD; JEWELRY ORGANIZERS; JEWELRY PINS FOR USE ON HATS; JEWELRY RING HOLDERS; JEWELRY WATCHES; JEWELRY, NAMELY, AMULETS; JEWELRY,

NAMELY, CROSSES; JEWELRY, NAMELY, PRECIOUS METAL PLATED REAL LEAVES AND FLOWERS; LAPEL PINS; LEATHER JEWELRY AND ACCESSORY BOXES; PET JEWELRY; PINS BEING JEWELRY; RINGS; RINGS BEING JEWELRY; WATCHES AND JEWELRY; WATCHES, CLOCKS, JEWELRY AND IMITATION JEWELRY, IN CLASS 14 (U.S. CLS. 2, 27, 28 AND 50).

FIRST USE 2-1-2008; IN COMMERCE 2-1-2008.

THE MARK CONSISTS OF THE WORD "ROOSTERCAT" ABOVE AND PART OF A STYLIZED BARCODE, WITH THE PHRASE "WHAT'S YOUR BARCODE" BELOW THE STYLIZED BARCODE.

SER. NO. 77-402,231, FILED 2-21-2008.

SAIMA MAKHDOOM, EXAMINING ATTORNEY

**Int. Cl.: 16**

**Prior U.S. Cls.: 2, 5, 22, 23, 29, 37, 38 and 50**

**United States Patent and Trademark Office**

**Reg. No. 3,504,960**

**Registered Sep. 23, 2008**

**TRADEMARK  
PRINCIPAL REGISTER**



CHILCOTE, STEFAN (UNITED STATES INDIVIDUAL)

1425 UNIVERSITY AVE., SUITE #E  
SAN DIEGO, CA 92013

FOR: ALBUMS FOR STICKERS; BUMPER STICKERS; DECORATIVE STICKERS FOR HELMETS; STICKER ALBUMS; STICKERS; STICKERS; STICKERS AND DECALCOMANIAS; STICKERS AND STICKER ALBUMS; STICKERS AND TRANSFERS, IN CLASS 16 (U.S. CLS. 2, 5, 22, 23, 29, 37, 38 AND 50).

FIRST USE 2-1-2008; IN COMMERCE 2-1-2008.

THE MARK CONSISTS OF THE WORD "ROOSTERCAT" ABOVE AND PART OF A STYLIZED BARCODE, WITH THE PHRASE "WHAT'S YOUR BARCODE" BELOW THE STYLIZED BARCODE.

SER. NO. 77-402,232, FILED 2-21-2008.

SAIMA MAKHDOOM, EXAMINING ATTORNEY

Int. Cl.: 25

Prior U.S. Cls.: 22 and 39

United States Patent and Trademark Office

Reg. No. 3,504,961

Registered Sep. 23, 2008

TRADEMARK  
PRINCIPAL REGISTER



CHILCOTE, STEFAN (UNITED STATES INDIVIDUAL)  
1425 UNIVERSITY AVE., SUITE #E  
SAN DIEGO, CA 92013

FOR: CLOTHING, NAMELY, WRAP-AROUNDS; JERSEYS; LEATHER BELTS; MUFFLERS; PAPER HATS FOR USE AS CLOTHING ITEMS; SHIRTS; SHORT SETS; TIES; TOPS; TRIATHLON CLOTHING, NAMELY, TRIATHLON TIGHTS, TRIATHLON SHORTS, TRIATHLON SINGLETS, TRIATHLON SHIRTS, TRIATHLON SUITS; WRAPS; CHEF'S HATS; HAT BANDS; HATS; SMALL HATS; WOOLLY HATS; BALLOON PANTS; CAPRI PANTS; CARGO PANTS; DENIMS; JOGGING PANTS; LEATHER PANTS; LOUNGE PANTS; PANTS; TRACK PANTS; WIND PANTS; A-SHIRTS; BUTTON-FRONT ALOHA SHIRTS; CAMP SHIRTS; DRESS SHIRTS; GOLF SHIRTS; KNIT SHIRTS; LONG-SLEEVED SHIRTS; NIGHT SHIRTS; OPEN-NECKED SHIRTS; POLO SHIRTS; RUGBY SHIRTS; SHIRTS; SHIRTS FOR SUITS; SHORT-SLEEVED OR LONG-SLEEVED T-SHIRTS; SHORT-SLEEVED SHIRTS; SPORT

SHIRTS; SPORTS SHIRTS; SPORTS SHIRTS WITH SHORT SLEEVES; SWEAT SHIRTS; T-SHIRTS; TEE SHIRTS; WIND SHIRTS; DENIM JACKETS; DOWN JACKETS; HEAVY JACKETS; JACKET LINERS; JACKETS; LEATHER JACKETS; LONG JACKETS; MEN AND WOMEN JACKETS, COATS, TROUSERS, VESTS; RAIN JACKETS; RAINPROOF JACKETS; SHELL JACKETS; ATHLETIC SHOES; CANVAS SHOES; DECK-SHOES; LEATHER SHOES; RUNNING SHOES; SHOES; TENNIS SHOES, IN CLASS 25 (U.S. CLS. 22 AND 39).

FIRST USE 2-1-2008; IN COMMERCE 2-1-2008.

THE MARK CONSISTS OF THE WORD "ROOSTERCAT" ABOVE AND PART OF A STYLIZED BARCODE, WITH THE PHRASE "WHAT'S YOUR BARCODE" BELOW THE STYLIZED BARCODE.

SER. NO. 77-402,233, FILED 2-21-2008.

SAIMA MAKHDOOM, EXAMINING ATTORNEY

**Int. Cl.: 26**

**Prior U.S. Cls.: 37, 39, 40, 42 and 50**

**Reg. No. 3,504,962**

**United States Patent and Trademark Office**

**Registered Sep. 23, 2008**

**TRADEMARK  
PRINCIPAL REGISTER**



CHILCOTE, STEFAN (UNITED STATES INDIVIDUAL)  
1425 UNIVERSITY AVE., SUITE #E  
SAN DIEGO, CA 92013

FOR: CLOTH PATCHES FOR CLOTHING; EMBROIDERED PATCHES FOR CLOTHING; ORNAMENTAL CLOTH PATCHES; PATCHES FOR CLOTHING MADE OF RUBBER, PLASTIC AND VINYL; PATCHES FOR REPAIRING TEXTILE ARTICLES; BELT BUCKLES; BELT BUCKLES NOT OF PRECIOUS METAL; BELT BUCKLES OF PRECIOUS METAL; BUCKLES FOR CLOTHING; CLOTHING

BUCKLES; SHOE BUCKLES; STRAP BUCKLES, IN CLASS 26 (U.S. CLS. 37, 39, 40, 42 AND 50).

FIRST USE 2-1-2008; IN COMMERCE 2-1-2008.

THE MARK CONSISTS OF THE WORD "ROOSTERCAT" ABOVE AND PART OF A STYLIZED BARCODE, WITH THE PHRASE "WHAT'S YOUR BARCODE" BELOW THE STYLIZED BARCODE.

SER. NO. 77-402,234, FILED 2-21-2008.

SAIMA MAKHDOOM, EXAMINING ATTORNEY

Int. Cl.: 35

Prior U.S. Cls.: 100, 101 and 102

United States Patent and Trademark Office

Reg. No. 3,504,963

Registered Sep. 23, 2008

SERVICE MARK  
PRINCIPAL REGISTER



FAMO'S FRANCHISE SYSTEMS, INC. (ILLINOIS CORPORATION)  
3375 MILWAUKEE AVE  
NORTHBROOK, IL 60062

FOR: FRANCHISING, NAMELY, CONSULTATION AND ASSISTANCE IN BUSINESS MANAGEMENT, ORGANIZATION AND PROMOTION; FRANCHISING, NAMELY, OFFERING TECHNICAL ASSISTANCE IN THE ESTABLISHMENT AND/OR OPERATION OF DELICATESSENS, RESTAURANTS, CARRY-OUT RESTAURANTS, CATERING SERVICES; OFFERING TECHNICAL ASSISTANCE IN THE ESTABLISHMENT AND/OR OPERATION OF RESTAURANTS; ON-LINE ORDERING SERVICES IN THE FIELD OF RESTAURANT TAKE-OUT AND DELIVERY; RESTAURANT FRANCHISING; PROMOTION OF BUSINESS OPPORTUNITIES, IN CLASS 35 (U.S. CLS. 100, 101 AND 102).

FIRST USE 2-1-2008; IN COMMERCE 2-1-2008.

OWNER OF U.S. REG. NO. 3,411,458.

NO CLAIM IS MADE TO THE EXCLUSIVE RIGHT TO USE "SUBS & SALADS" AND "SIMPLY THE BEST", APART FROM THE MARK AS SHOWN.

THE NAME(S), PORTRAIT(S), AND/OR SIGNATURE(S) SHOWN IN THE MARK DOES NOT IDENTIFY A PARTICULAR LIVING INDIVIDUAL.

THE COLOR(S) RED, WHITE, BLACK AND GREEN IS/ARE CLAIMED AS A FEATURE OF THE MARK.

THE MARK CONSISTS OF THE STYLIZED WORD "FAMO'S" IN GREEN WITH BLACK SHADOWING IN A LARGE FONT ABOVE A GREEN UNDERLINE WITH BLACK SHADOWING APPEARING ACROSS THE CENTER OF A WIDE RED RING WITH A WHITE CENTER AND A GREEN CERATED BORDER (LIKE A CORPORATE SEAL). INSIDE THE RED OF THE RING APPEAR THE ARCHED WORDS "SUBS & SALADS" IN WHITE IN A STYLIZED FONT ABOVE THE WORD "FAMO'S". ALSO IN THE RED CIRCLE BELOW THE WORD "FAMO'S", APPEAR THE INVERTED ARCHED WORDS "SIMPLY THE BEST!" ALSO IN A WHITE STYLIZED FONT.

SER. NO. 77-402,283, FILED 2-21-2008.

KEVIN DINALLO, EXAMINING ATTORNEY

**Int. Cl.: 35**

**Prior U.S. Cls.: 100, 101 and 102**

**United States Patent and Trademark Office**

**Reg. No. 3,504,964**

**Registered Sep. 23, 2008**

**SERVICE MARK  
PRINCIPAL REGISTER**

**HYPNOTICON**

FONTENOT, DAVID M. (UNITED STATES INDIVIDUAL)  
3829 NEW YORK AVE  
DOUGLASVILLE, GA 30135

FOR: PROVIDING A LIVE FORUM FOR COMPANIES TO SHOWCASE, DISPLAY, DEMONSTRATE AND PROMOTE NEW AND INNOVATIVE IDEAS, PRODUCTS AND SERVICES IN THE CONVENTION/MEETING MANAGEMENT ARENA, IN CLASS 35 (U.S. CLS. 100, 101 AND 102).

FIRST USE 12-31-2006; IN COMMERCE 12-31-2006.

THE MARK CONSISTS OF STANDARD CHARACTERS WITHOUT CLAIM TO ANY PARTICULAR FONT, STYLE, SIZE, OR COLOR.

SER. NO. 77-402,385, FILED 2-21-2008.

AISHA CLARKE, EXAMINING ATTORNEY

**Int. Cl.: 44**

**Prior U.S. Cls.: 100 and 101**

**United States Patent and Trademark Office**

**Reg. No. 3,504,965**

**Registered Sep. 23, 2008**

**SERVICE MARK  
PRINCIPAL REGISTER**

**HT TANNING**

HOLLYWOOD TANS, LLC (DELAWARE LIMITED LIABILITY COMPANY)  
11 ENTERPRISE COURT  
SEWELL, NJ 08080

OWNER OF U.S. REG. NOS. 2,492,716, 2,725,161,  
AND 3,074,282.

FOR: TANNING SALONS, IN CLASS 44 (U.S. CLS. 100 AND 101).

NO CLAIM IS MADE TO THE EXCLUSIVE RIGHT TO USE "TANNING", APART FROM THE MARK AS SHOWN.

FIRST USE 2-27-2008; IN COMMERCE 2-27-2008.

SER. NO. 77-402,389, FILED 2-21-2008.

THE MARK CONSISTS OF STANDARD CHARACTERS WITHOUT CLAIM TO ANY PARTICULAR FONT, STYLE, SIZE, OR COLOR.

LAURIE KAUFMAN, EXAMINING ATTORNEY

**Int. Cl.: 7**

**Prior U.S. Cls.: 13, 19, 21, 23, 31, 34 and 35**

**United States Patent and Trademark Office**

**Reg. No. 3,504,966**

**Registered Sep. 23, 2008**

**TRADEMARK  
PRINCIPAL REGISTER**

**MILLTRONICS**

DIVERSI-PLAST PRODUCTS, INC. (MINNESOTA  
CORPORATION)  
5600 NORTH HIGHWAY 169  
MINNEAPOLIS, MN 554283096

FOR: COMPUTER NUMERICAL CONTROL  
(CNC) MACHINES COMPRISED OF MACHINE  
TOOLS FOR SHAPING METAL PARTS TO A RE-  
QUIRED DIMENSION AND COMPUTER AIDED  
DESIGN/COMPUTER AIDED MANUFACTURING  
(CAD/CAM) SOFTWARE SOLD AS A UNIT, IN  
CLASS 7 (U.S. CLS. 13, 19, 21, 23, 31, 34 AND 35).

FIRST USE 12-31-1984; IN COMMERCE 12-31-1984.

THE MARK CONSISTS OF STANDARD CHAR-  
ACTERS WITHOUT CLAIM TO ANY PARTICULAR  
FONT, STYLE, SIZE, OR COLOR.

SER. NO. 77-402,399, FILED 2-21-2008.

CHARLOTTE CORWIN, EXAMINING ATTORNEY



**Int. Cl.: 35**

**Prior U.S. Cls.: 100, 101 and 102**

**United States Patent and Trademark Office**

**Reg. No. 3,504,967**

**Registered Sep. 23, 2008**

**SERVICE MARK  
PRINCIPAL REGISTER**

**SELLMYBUSINESS.COM**

SELLMYBUSINESSNOW.COM, INC. (MICHIGAN CORPORATION), DBA SELLMYBUSINESS.-COM  
SUITE 2175  
30600 TELEGRAPH ROAD  
BINGHAM FARMS, MI 48025

FOR: ON-LINE BUSINESS LISTING SERVICE FEATURING A SERVICE FOR BUYERS, SELLERS, AND LESSORS IN THE AREA OF BUYING AND SELLING BUSINESSES, REAL ESTATE AND EQUIPMENT, AND AN ON-LINE NETWORKING REFERRAL SERVICES, NAMELY, PROMOTING THE GOODS AND SERVICES OF OTHERS BY PASSING EXCLUSIVE BUSINESS LEADS TO RE-

GISTERED MEMBERS WITH NO COST TO THE REQUESTING PARTY, IN CLASS 35 (U.S. CLS. 100, 101 AND 102).

FIRST USE 1-28-2008; IN COMMERCE 1-28-2008.

THE MARK CONSISTS OF STANDARD CHARACTERS WITHOUT CLAIM TO ANY PARTICULAR FONT, STYLE, SIZE, OR COLOR.

SER. NO. 77-402,405, FILED 2-21-2008.

KEVON CHISOLM, EXAMINING ATTORNEY

**Int. Cl.: 30**

**Prior U.S. Cl.: 46**

**United States Patent and Trademark Office**

**Reg. No. 3,504,968**

**Registered Sep. 23, 2008**

**TRADEMARK  
PRINCIPAL REGISTER**

**Anthony & Sons**

ANTHONY & SONS ITALIAN BAKERY, INC.  
(NEW JERSEY CORPORATION)  
20 LUGAR ROAD  
DENVER, NJ 07834

THE MARK CONSISTS OF STANDARD CHAR-  
ACTERS WITHOUT CLAIM TO ANY PARTICULAR  
FONT, STYLE, SIZE, OR COLOR.

FOR: BREAD; BAKERY GOODS, IN CLASS 30  
(U.S. CL. 46).

SER. NO. 77-402,408, FILED 2-21-2008.

FIRST USE 12-1-1984; IN COMMERCE 12-1-1984.

TOBY BULLOFF, EXAMINING ATTORNEY

**Int. Cl.: 36**

**Prior U.S. Cls.: 100, 101 and 102**

**United States Patent and Trademark Office**

**Reg. No. 3,504,969**

**Registered Sep. 23, 2008**

**SERVICE MARK  
PRINCIPAL REGISTER**

**LEGACY LINK**

LIBERTY MUTUAL INSURANCE COMPANY  
(MASSACHUSETTS CORPORATION)  
175 BERKELEY STREET  
BOSTON, MA 02117

THE MARK CONSISTS OF STANDARD CHAR-  
ACTERS WITHOUT CLAIM TO ANY PARTICULAR  
FONT, STYLE, SIZE, OR COLOR.

FOR: UNDERWRITING AND ADMINISTRA-  
TION OF INSURANCE IN THE AREA OF LIFE  
INSURANCE AND ANNUITY POLICIES, IN CLASS  
36 (U.S. CLS. 100, 101 AND 102).

SER. NO. 77-402,424, FILED 2-21-2008.

FIRST USE 5-21-1999; IN COMMERCE 5-21-1999.

TIMOTHY FINNEGAN, EXAMINING ATTORNEY

**Int. Cl.: 30**

**Prior U.S. Cl.: 46**

**United States Patent and Trademark Office**

**Reg. No. 3,504,970**

**Registered Sep. 23, 2008**

**TRADEMARK  
PRINCIPAL REGISTER**

**Anthony & Sons Bakery**

ANTHONY & SONS ITALIAN BAKERY, INC.  
(NEW JERSEY CORPORATION)

20 LUGAR ROAD

DENVILLE, NJ 07834

FOR: BREAD; BAKERY GOODS, IN CLASS 30  
(U.S. CL. 46).

FIRST USE 1-15-2007; IN COMMERCE 1-15-2007.

THE MARK CONSISTS OF STANDARD CHAR-  
ACTERS WITHOUT CLAIM TO ANY PARTICULAR  
FONT, STYLE, SIZE, OR COLOR.

NO CLAIM IS MADE TO THE EXCLUSIVE  
RIGHT TO USE "BAKERY", APART FROM THE  
MARK AS SHOWN.

SER. NO. 77-402,426, FILED 2-21-2008.

TOBY BULLOFF, EXAMINING ATTORNEY

**Int. Cl.: 5**

**Prior U.S. Cls.: 6, 18, 44, 46, 51 and 52**

**Reg. No. 3,504,971**

**United States Patent and Trademark Office**

**Registered Sep. 23, 2008**

---

**TRADEMARK  
PRINCIPAL REGISTER**

**Enerfood**

ENERHEALTH BOTANICALS, LLC (DELAWARE  
LIMITED LIABILITY COMPANY)  
28454 MEADOW DR  
EVERGREEN, CO 80439

THE MARK CONSISTS OF STANDARD CHAR-  
ACTERS WITHOUT CLAIM TO ANY PARTICULAR  
FONT, STYLE, SIZE, OR COLOR.

FOR: POWDERED NUTRITIONAL SUPPLE-  
MENT DRINK MIX, IN CLASS 5 (U.S. CLS. 6, 18, 44,  
46, 51 AND 52).

SER. NO. 77-402,432, FILED 2-21-2008.

FIRST USE 1-5-2005; IN COMMERCE 1-5-2005.

KATHERINE E. HALMEN, EXAMINING ATTOR-  
NEY

**Int. Cl.: 34**

**Prior U.S. Cls.: 2, 8, 9 and 17**

**United States Patent and Trademark Office**

**Reg. No. 3,504,972**

**Registered Sep. 23, 2008**

**TRADEMARK  
PRINCIPAL REGISTER**

# Angelina

PREMIUM CIGAR IMPORTS, LLC (DELAWARE  
LIMITED LIABILITY COMPANY)  
3511 SILVERSIDE ROAD, SUITE 105  
WILMINGTON, DE 19810

FOR: TOBACCO PRODUCTS, NAMELY, CIGARS  
AND CIGARILLOS, IN CLASS 34 (U.S. CLS. 2, 8, 9  
AND 17).

FIRST USE 2-18-2008; IN COMMERCE 2-18-2008.

THE MARK CONSISTS OF STANDARD CHAR-  
ACTERS WITHOUT CLAIM TO ANY PARTICULAR  
FONT, STYLE, SIZE, OR COLOR.

THE NAME(S), PORTRAIT(S), AND/OR SIGNA-  
TURE(S) SHOWN IN THE MARK DOES NOT IDENTI-  
FY A PARTICULAR LIVING INDIVIDUAL.

SER. NO. 77-402,440, FILED 2-21-2008.

MICHAEL ENGEL, EXAMINING ATTORNEY

**Int. Cl.: 5**

**Prior U.S. Cls.: 6, 18, 44, 46, 51 and 52**

**United States Patent and Trademark Office**

**Reg. No. 3,504,973**

**Registered Sep. 23, 2008**

**TRADEMARK  
PRINCIPAL REGISTER**



GERMA PRODUCTS, INC. (FLORIDA CORPORATION)  
APT. B-101.  
14301 N. KENDALL DRIVE  
MIAMI, FL 33186

THE MARK CONSISTS OF THE WORD "AFTASEPTIC" WITH A DEPICTION OF A DOT IN THE BACKGROUND.

FOR: ANTISEPTICS, IN CLASS 5 (U.S. CLS. 6, 18, 44, 46, 51 AND 52).

SER. NO. 77-402,442, FILED 2-21-2008.

FIRST USE 4-5-2004; IN COMMERCE 4-5-2004.

JOHN DWYER, EXAMINING ATTORNEY

**Int. Cl.: 8**

**Prior U.S. Cls.: 23, 28 and 44**

**United States Patent and Trademark Office**

**Reg. No. 3,504,974**

**Registered Sep. 23, 2008**

**TRADEMARK  
PRINCIPAL REGISTER**

**EZ-MITER**

DON & BOB ENTERPRISES, LLC (NEW JERSEY  
LIMITED LIABILITY COMPANY)  
363 COOLIDGE DRIVE  
KENILWORTH, NJ 07033

THE MARK CONSISTS OF STANDARD CHAR-  
ACTERS WITHOUT CLAIM TO ANY PARTICULAR  
FONT, STYLE, SIZE, OR COLOR.

FOR: FLOORING MATERIAL CUTTING GUIDE,  
IN CLASS 8 (U.S. CLS. 23, 28 AND 44).

SER. NO. 77-402,505, FILED 2-21-2008.

FIRST USE 10-15-2007; IN COMMERCE 10-15-2007.

MICHELE SWAIN, EXAMINING ATTORNEY



**Int. Cl.: 35**

**Prior U.S. Cls.: 100, 101 and 102**

**United States Patent and Trademark Office**

**Reg. No. 3,504,975**

**Registered Sep. 23, 2008**

---

**SERVICE MARK  
PRINCIPAL REGISTER**

# Yogurtiers

CAFE CLK, LLC. (CALIFORNIA LIMITED LIABILITY COMPANY)  
130 NORTH SANFERNANDO BLVD.  
BURBANK, CA 91502

THE MARK CONSISTS OF STANDARD CHARACTERS WITHOUT CLAIM TO ANY PARTICULAR FONT, STYLE, SIZE, OR COLOR.

FOR: RETAIL STORE SERVICES FEATURING FROZEN YOGURT, DRY YOGURT, ICE CREAMS, BAKED GOODS, BEVERAGES, DESSERTS, IN CLASS 35 (U.S. CLS. 100, 101 AND 102).

SER. NO. 77-402,511, FILED 2-21-2008.

FIRST USE 1-1-2007; IN COMMERCE 1-1-2007.

DAVID COLLIER, EXAMINING ATTORNEY

**Int. Cl.: 41**

**Prior U.S. Cls.: 100, 101 and 107**

**United States Patent and Trademark Office**

**Reg. No. 3,504,976**

**Registered Sep. 23, 2008**

**SERVICE MARK  
PRINCIPAL REGISTER**

**LOU E. LOON**

MICHIGAN BASEBALL FOUNDATION, INC.  
(MICHIGAN CORPORATION)  
825 E. MAIN ST.  
MIDLAND, MI 48640

THE MARK CONSISTS OF STANDARD CHAR-  
ACTERS WITHOUT CLAIM TO ANY PARTICULAR  
FONT, STYLE, SIZE, OR COLOR.

FOR: ENTERTAINMENT SERVICES, NAMELY,  
LIVE APPEARANCES BY A BASEBALL MASCOT,  
IN CLASS 41 (U.S. CLS. 100, 101 AND 107).

SER. NO. 77-402,520, FILED 2-21-2008.

FIRST USE 8-26-2006; IN COMMERCE 8-26-2006.

DAVID COLLIER, EXAMINING ATTORNEY

**Int. Cl.: 42**

**Prior U.S. Cls.: 100 and 101**

**United States Patent and Trademark Office**

**Reg. No. 3,504,977**

**Registered Sep. 23, 2008**

**SERVICE MARK  
PRINCIPAL REGISTER**



RED PENCIL LTD. (ILLINOIS CORPORATION)  
531 CHIPPEWA TRAIL  
CAROL STREAM, IL 60188

FOR: ENGINEERING, IN CLASS 42 (U.S. CLS. 100  
AND 101).

FIRST USE 4-10-2005; IN COMMERCE 4-10-2005.

THE STIPPLING IS FOR SHADING PURPOSES  
ONLY.

THE MARK CONSISTS OF A PENCIL, SLANTED  
FROM UPPER RIGHT TO LOWER LEFT, WITH A  
LINE DRAWN FROM UPPER LEFT TO THE PEN-  
CIL POINT.

SER. NO. 77-402,533, FILED 2-21-2008.

TASNEEM HUSSAIN, EXAMINING ATTORNEY

**Int. Cl.: 39**

**Prior U.S. Cls.: 100 and 105**

**United States Patent and Trademark Office**

**Reg. No. 3,504,978**

**Registered Sep. 23, 2008**

**SERVICE MARK  
PRINCIPAL REGISTER**

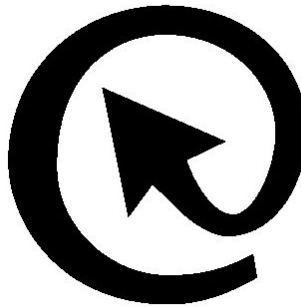

MAHNKEN ENTERPRISES, INC (WASHINGTON CORPORATION)  
35115 SE RIDGE STREET  
SNOQUALMIE, WA 98065

FOR: ARRANGING TRAVEL TOURS; TRAVEL AGENCY SERVICES, NAMELY, MAKING RESERVATIONS AND BOOKINGS FOR TRANSPORTATION; TRAVEL AND TOUR INFORMATION SERVICE; TRAVEL GUIDE SERVICES; TRAVEL,

EXCURSION AND CRUISE ARRANGEMENT, IN CLASS 39 (U.S. CLS. 100 AND 105).

FIRST USE 3-3-2005; IN COMMERCE 3-3-2005.

SER. NO. 77-402,534, FILED 2-21-2008.

HEATHER BIDDULPH, EXAMINING ATTORNEY

**Int. Cl.: 9**

**Prior U.S. Cls.: 21, 23, 26, 36 and 38**

**Reg. No. 3,504,979**

**United States Patent and Trademark Office**

**Registered Sep. 23, 2008**

**TRADEMARK  
PRINCIPAL REGISTER**

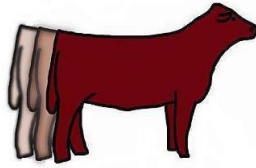

CATTLE IN MOTION, LLC (TEXAS LIMITED LIABILITY COMPANY)  
907 CRESTED POINT DRIVE  
COLLEGE STATION, TX 77845

FOR: AUDIO AND VIDEO RECORDINGS FEATURING CATTLE AND LIVESTOCK; DOWNLOADABLE VIDEO RECORDINGS FEATURING CATTLE AND LIVESTOCK; DIGITAL MEDIA, NAMELY, PRE-RECORDED VIDEO CASSETTES, DIGITAL VIDEO DISCS, DIGITAL VERSATILE DISCS, DOWNLOADABLE AUDIO AND VIDEO RECORDINGS, DVDS, AND HIGH DEFINITION DIGITAL DISKS FEATURING CATTLE AND LIVESTOCK; DOWNLOADABLE FILMS AND TV PROGRAMS FEATURING CATTLE AND LIVESTOCK PROVIDED VIA A VIDEO-ON-DEMAND SERVICE, IN CLASS 9 (U.S. CLS. 21, 23, 26, 36 AND 38).

FIRST USE 3-26-2007; IN COMMERCE 3-26-2007.

THE COLOR(S) BEIGE, LIGHT BROWN, BROWN, AND BLACK IS/ARE CLAIMED AS A FEATURE OF THE MARK.

THE MARK CONSISTS OF A PROFILE VIEW OF THREE CATTLE STANDING NEXT TO EACH OTHER. THE ANIMAL IN THE FRONT IS BROWN AND OUTLINED IN BLACK, THE NEXT IS LIGHT BROWN AND OUTLINED IN BLACK AND THE LAST IS BEIGE AND OUTLINED IN BLACK.

SER. NO. 77-402,535, FILED 2-21-2008.

ANNE E. GUSTASON, EXAMINING ATTORNEY

**Int. Cl.: 9**

**Prior U.S. Cls.: 21, 23, 26, 36 and 38**

**United States Patent and Trademark Office**

**Reg. No. 3,504,980**

**Registered Sep. 23, 2008**

**TRADEMARK  
PRINCIPAL REGISTER**

**EXHAUSTIVE EXTRACTION**

ATTENSITY CORPORATION (DELAWARE CORPORATION)  
SUITE 200  
3600 WEST BAYSHORE ROAD  
PALO ALTO, CA 94303

FOR: COMPUTER SOFTWARE FOR ANALYZING AND ORGANIZING TEXTUAL DATA AND INFORMATION, IN CLASS 9 (U.S. CLS. 21, 23, 26, 36 AND 38).

FIRST USE 8-31-2005; IN COMMERCE 8-31-2005.

THE MARK CONSISTS OF STANDARD CHARACTERS WITHOUT CLAIM TO ANY PARTICULAR FONT, STYLE, SIZE, OR COLOR.

SER. NO. 77-402,555, FILED 2-21-2008.

CIMMERIAN COLEMAN, EXAMINING ATTORNEY

**Int. Cl.: 1**

**Prior U.S. Cls.: 1, 5, 6, 10, 26 and 46**

**United States Patent and Trademark Office**

**Reg. No. 3,504,981**

**Registered Sep. 23, 2008**

**TRADEMARK  
PRINCIPAL REGISTER**

**DIVERSET**

CHEMBRIDGE CORPORATION (CALIFORNIA  
CORPORATION)  
16931 VIA TAZON, SUITE G  
SAN DIEGO, CA 92127

FOR: DIAGNOSTIC CHEMICAL COMPOUNDS  
FOR SCIENTIFIC OR RESEARCH USE SELECTED  
BASED ON DIVERSITY CRITERIA FOR USE IN  
THE PHARMACEUTICAL, LIFE SCIENCES, AGRICULTURAL AND CHEMICAL INDUSTRIES, IN  
CLASS 1 (U.S. CLS. 1, 5, 6, 10, 26 AND 46).

FIRST USE 12-31-1995; IN COMMERCE 12-31-1995.

THE MARK CONSISTS OF STANDARD CHARACTERS WITHOUT CLAIM TO ANY PARTICULAR FONT, STYLE, SIZE, OR COLOR.

SER. NO. 77-402,580, FILED 2-21-2008.

HANNO RITTNER, EXAMINING ATTORNEY

**Int. Cl.: 1**

**Prior U.S. Cls.: 1, 5, 6, 10, 26 and 46**

**Reg. No. 3,504,982**

**United States Patent and Trademark Office**

**Registered Sep. 23, 2008**

**TRADEMARK  
PRINCIPAL REGISTER**

**NOVACORE**

CHEMBRIDGE CORPORATION (CALIFORNIA  
CORPORATION)  
16931 VIA TAZON, SUITE G  
SAN DIEGO, CA 92127

FOR: DIAGNOSTIC CHEMICAL COMPOUNDS  
IN COMBINATORIAL CHEMISTRY LIBRARIES  
FOR SCIENTIFIC OR RESEARCH USE IN THE  
PHARMACEUTICAL, LIFE SCIENCES, AGRICUL-  
TURAL AND CHEMICAL INDUSTRIES, IN CLASS 1  
(U.S. CLS. 1, 5, 6, 10, 26 AND 46).

FIRST USE 8-31-2004; IN COMMERCE 8-31-2004.

THE MARK CONSISTS OF STANDARD CHAR-  
ACTERS WITHOUT CLAIM TO ANY PARTICULAR  
FONT, STYLE, SIZE, OR COLOR.

SER. NO. 77-402,583, FILED 2-21-2008.

HANNO RITTNER, EXAMINING ATTORNEY



**Int. Cl.: 41**

**Prior U.S. Cls.: 100, 101 and 107**

**United States Patent and Trademark Office**

**Reg. No. 3,504,983**

**Registered Sep. 23, 2008**

**SERVICE MARK  
PRINCIPAL REGISTER**

**GIRLONGIRLDODGEBALL**

KRISTEN N. MORELY (UNITED STATES INDIVIDUAL), DBA GIRLONGIRLDODGEBALL  
405 14TH ST STE 1607  
OAKLAND, CA 946122777

THE MARK CONSISTS OF STANDARD CHARACTERS WITHOUT CLAIM TO ANY PARTICULAR FONT, STYLE, SIZE, OR COLOR.

FOR: ORGANIZING SPORTING EVENTS, NAME-  
LY, DODGEBALL COMPETITION, IN CLASS 41  
(U.S. CLS. 100, 101 AND 107).

SER. NO. 77-402,584, FILED 2-21-2008.

FIRST USE 8-20-2005; IN COMMERCE 11-10-2007.

HANNO RITTNER, EXAMINING ATTORNEY

Int. Cl.: 36

Prior U.S. Cls.: 100, 101 and 102

United States Patent and Trademark Office

Reg. No. 3,504,984

Registered Sep. 23, 2008

SERVICE MARK  
PRINCIPAL REGISTER



TRUSTEES OF THE ESTATE OF BERNICE  
PAUahi BISHOP (HAWAII TRUST), DBA KA-  
MEHAMEHA SCHOOLS

SUITE 310  
567 SOUTH KING STREET  
HONOLULU, HI 96813

FOR: SHOPPING CENTER SERVICES, NAMELY,  
RENTAL OF SHOPPING CENTER SPACE; LEASING  
OF SHOPPING MALL SPACE; REAL ESTATE MAN-  
AGEMENT, IN CLASS 36 (U.S. CLS. 100, 101 AND  
102).

FIRST USE 2-1-2008; IN COMMERCE 2-1-2008.

NO CLAIM IS MADE TO THE EXCLUSIVE  
RIGHT TO USE "HAWAIIAN CENTER", APART  
FROM THE MARK AS SHOWN.

THE MARK CONSISTS OF THE STYLIZED  
WORDS "ROYAL HAWAIIAN" CENTERED AND  
IN SMALL CAP LETTERS; BELOW IS THE STY-  
LIZED WORD "CENTER" IN SMALLER TYPE, ALL  
CAPS; ABOVE IS A DESIGN OF AN ARCED  
MOUND WITH TEN PALM TREES OF VARIOUS  
SIZE.

SER. NO. 77-402,641, FILED 2-21-2008.

KEVIN DINALLO, EXAMINING ATTORNEY

**Int. Cl.: 9**

**Prior U.S. Cls.: 21, 23, 26, 36 and 38**

**Reg. No. 3,504,985**

**United States Patent and Trademark Office**

**Registered Sep. 23, 2008**

---

**TRADEMARK  
PRINCIPAL REGISTER**

**SOLIA**

EXCEON AMERICAN BEAUTY SUPPLY (DELA-  
WARE CORPORATION)  
10 SCHALKS CROSSING ROAD #501-332  
PLAINSBORO, NJ 08536

THE MARK CONSISTS OF STANDARD CHAR-  
ACTERS WITHOUT CLAIM TO ANY PARTICULAR  
FONT, STYLE, SIZE, OR COLOR.

FOR: ELECTRIC HAND-HELD HAIR STYLING  
IRONS, IN CLASS 9 (U.S. CLS. 21, 23, 26, 36 AND 38).

SER. NO. 77-402,661, FILED 2-21-2008.

FIRST USE 4-20-2004; IN COMMERCE 10-7-2004.

JENNIFER MARTIN, EXAMINING ATTORNEY

Int. Cl.: 9

Prior U.S. Cls.: 21, 23, 26, 36 and 38

Reg. No. 3,504,986

United States Patent and Trademark Office

Registered Sep. 23, 2008

TRADEMARK  
PRINCIPAL REGISTER

*Sportage  
Plus*

PHOENIX PERFORMANCE PRODUCTS INC.  
(CANADA CORPORATION)  
6955 COLUMBUS ROAD  
MISSISSAUGA, ONTARIO, CANADA L5T1K1

FOR: PROTECTIVE HELMETS; SAFETY EQUIP-  
MENT, NAMELY, SAFETY HELMETS FOR EQUES-  
TRIAN SPORTS, IN CLASS 9 (U.S. CLS. 21, 23, 26, 36  
AND 38).

FIRST USE 1-2-2008; IN COMMERCE 1-2-2008.

THE MARK CONSISTS OF THE STYLIZED  
WORDING "SPORTAGE PLUS".

SER. NO. 77-402,671, FILED 2-21-2008.

LINDA M. KING, EXAMINING ATTORNEY

**Int. Cl.: 29**

**Prior U.S. Cl.: 46**

**United States Patent and Trademark Office**

**Reg. No. 3,504,987**

**Registered Sep. 23, 2008**

**TRADEMARK  
PRINCIPAL REGISTER**

**JACK DANIEL'S**

JACK DANIEL'S PROPERTIES, INC. (DELA-  
WARE CORPORATION)  
SUITE 528  
4040 CIVIC CENTER DRIVE  
SAN RAFAEL, CA 94903

FOR: CANDIED NUTS, IN CLASS 29 (U.S. CL. 46).

FIRST USE 11-1-2004; IN COMMERCE 11-1-2004.

THE MARK CONSISTS OF STANDARD CHAR-  
ACTERS WITHOUT CLAIM TO ANY PARTICULAR  
FONT, STYLE, SIZE, OR COLOR.

OWNER OF U.S. REG. NOS. 1,290,702, 2,592,540  
AND OTHERS.

THE NAME(S), PORTRAIT(S), AND/OR SIGNA-  
TURE(S) SHOWN IN THE MARK DOES NOT IDEN-  
TIFY A PARTICULAR LIVING INDIVIDUAL.

SER. NO. 77-402,682, FILED 2-21-2008.

RUSS HERMAN, EXAMINING ATTORNEY

**Int. Cl.: 43**

**Prior U.S. Cls.: 100 and 101**

**United States Patent and Trademark Office**

**Reg. No. 3,504,988**

**Registered Sep. 23, 2008**

**SERVICE MARK  
PRINCIPAL REGISTER**

# Top Spice

SILVER MAPLE, INC. (GEORGIA CORPORATION), DBA TOP SPICE  
3007 NORTH DRUID HILLS RD  
ATLANTA, GA 30329

FOR: RESTAURANTS FEATURING HOME DELIVERY; RESTAURANT, BAR AND CATERING SERVICES, IN CLASS 43 (U.S. CLS. 100 AND 101).

FIRST USE 1-5-2002; IN COMMERCE 1-5-2002.

THE MARK CONSISTS OF STANDARD CHARACTERS WITHOUT CLAIM TO ANY PARTICULAR FONT, STYLE, SIZE, OR COLOR.

SER. NO. 77-402,730, FILED 2-21-2008.

CORY BOONE, EXAMINING ATTORNEY

**Int. Cl.: 38**

**Prior U.S. Cls.: 100, 101 and 104**

**United States Patent and Trademark Office**

**Reg. No. 3,504,989**

**Registered Sep. 23, 2008**

**SERVICE MARK  
PRINCIPAL REGISTER**

**DIVERSITYINC RECRUITMENT  
NETWORK**

DIVERSITYINC MEDIA, L.L.C. (NEW JERSEY  
LIMITED LIABILITY COMPANY)  
15TH FLOOR  
570 BROAD STREET  
NEWARK, NJ 07102

FOR: PROVIDING ON-LINE ELECTRONIC BUL-  
LETIN BOARDS FOR TRANSMISSION OF MESSA-  
GES AMONG COMPUTER USERS CONCERNING  
JOB SEEKING AND HUMAN RESOURCES , IN  
CLASS 38 (U.S. CLS. 100, 101 AND 104).

FIRST USE 11-0-2007; IN COMMERCE 11-0-2007.

THE MARK CONSISTS OF STANDARD CHAR-  
ACTERS WITHOUT CLAIM TO ANY PARTICULAR  
FONT, STYLE, SIZE, OR COLOR.

OWNER OF U.S. REG. NOS. 2,760,805, 3,052,627  
AND OTHERS.

NO CLAIM IS MADE TO THE EXCLUSIVE  
RIGHT TO USE "RECRUITMENT NETWORK",  
APART FROM THE MARK AS SHOWN.

SER. NO. 77-402,736, FILED 2-21-2008.

CORY BOONE, EXAMINING ATTORNEY

**Int. Cl.: 35**

**Prior U.S. Cls.: 100, 101 and 102**

**United States Patent and Trademark Office**

**Reg. No. 3,504,990**

**Registered Sep. 23, 2008**

**SERVICE MARK  
PRINCIPAL REGISTER**



INTERLINE BRANDS, INC. (NEW JERSEY CORPORATION)  
801 W. BAY STREET  
JACKSONVILLE, FL 32204

FOR: CATALOG ORDERING SERVICES VIA MAIL, TELEPHONE AND FACSIMILE FEATURING HARDWARE, PLUMBING, HVAC, ELECTRICAL AND GENERAL HARDWARE ITEMS AND SUPPLIES, IN CLASS 35 (U.S. CLS. 100, 101 AND 102).

FIRST USE 7-31-2005; IN COMMERCE 7-31-2005.

THE MARK CONSISTS OF THE WORD "BARNETT" WITH FOUR RECTANGULAR SHAPES FORMING A SQUARE APPEARING AT THE UPPER LEFT OF THE WORD.

SER. NO. 77-402,746, FILED 2-21-2008.

CHRISTOPHER BUONGIORNO, EXAMINING ATTORNEY



**Int. Cl.: 41**

**Prior U.S. Cls.: 100, 101 and 107**

**United States Patent and Trademark Office**

**Reg. No. 3,504,991**

**Registered Sep. 23, 2008**

**SERVICE MARK  
PRINCIPAL REGISTER**

**MortgageMpowered**

VERMILLION CONSULTING, INC. (ILLINOIS CORPORATION)  
SUITE 202  
480 W. CENTER STREET  
GRAYSLAKE, IL 60030

FOR: EDUCATION SERVICES, NAMELY, PROVIDING LIVE AND ON-LINE CLASSES, SEMINARS, WORKSHOPS, TRAINING AND CONFERENCES IN THE FIELD OF CONSUMER FINANCE, WEALTH MANAGEMENT AND FINANCIAL INDEPENDENCE, IN CLASS 41 (U.S. CLS. 100, 101 AND 107).

FIRST USE 11-1-2007; IN COMMERCE 11-1-2007.

THE MARK CONSISTS OF STANDARD CHARACTERS WITHOUT CLAIM TO ANY PARTICULAR FONT, STYLE, SIZE, OR COLOR.

SER. NO. 77-402,775, FILED 2-21-2008.

CAROLYN GRAY, EXAMINING ATTORNEY

Int. Cl.: 25

Prior U.S. Cls.: 22 and 39

United States Patent and Trademark Office

Reg. No. 3,504,992

Registered Sep. 23, 2008

TRADEMARK  
PRINCIPAL REGISTER



C.I. EL GLOBO S.A. (COLOMBIA CORPORATION)  
CARRERA 57 #25-33, BARRIO TRINIDAD  
MEDELLIN, COLOMBIA

FOR: JEANS; BELTS; BELTS MADE OF LEATHER; BERMUDA SHORTS; BOXER SHORTS; BRAS; BRIEFS; CAPS; DENIM JACKETS; DENIMS; HEAD WEAR; HATS; LONG-SLEEVED SHIRTS; PANTS; SHORT-SLEEVED OR LONG-SLEEVED T-SHIRTS; SWEATERS; SHORTS; SKIRTS AND DRESSES; TOPS; UNDERWEAR; SHIRTS; PANTIES; JACKETS, IN CLASS 25 (U.S. CLS. 22 AND 39).

FIRST USE 12-1-2007; IN COMMERCE 12-1-2007.

NO CLAIM IS MADE TO THE EXCLUSIVE RIGHT TO USE "JEANS", APART FROM THE MARK AS SHOWN.

THE MARK CONSISTS OF THE WORDINGS "CRISTO GRACEFUL JEANS" AND A DESIGN OF A STAR SUPERIMPOSED ON A CROSS BEHIND THE LETTER "S" OF THE WORD "CRISTO". THE WORD "CRISTO" IS IN SMALL CAPS. THE WORD "CRISTO" IS IN SPANISH AND MEANS "CHRIST". THE WORD "CRISTO" UTILIZES A FONT REMINISCENT OF HEBREW SCRIPT. THE WORDS "GRACEFUL JEANS" ARE LOCATED UNDERNEATH THE WORD "CRISTO". THE WORDS "GRACEFUL JEANS" ARE IN CURSIVE FONT.

THE FOREIGN WORDING IN THE MARK TRANSLATES INTO ENGLISH AS "CHRIST".

SER. NO. 77-402,782, FILED 2-21-2008.

ANNE E. GUSTASON, EXAMINING ATTORNEY

Int. Cl.: 25

Prior U.S. Cls.: 22 and 39

United States Patent and Trademark Office

Reg. No. 3,504,993

Registered Sep. 23, 2008

TRADEMARK  
PRINCIPAL REGISTER



THANE INTERNATIONAL, INC. (DELAWARE CORPORATION)  
78-140 CALLE TAMPICO  
LA QUINTA, CA 92253

FOR: GIRDLES, IN CLASS 25 (U.S. CLS. 22 AND 39).

FIRST USE 8-0-2004; IN COMMERCE 8-0-2004.

OWNER OF U.S. REG. NO. 3,339,260.

NO CLAIM IS MADE TO THE EXCLUSIVE RIGHT TO USE "SILHOUETTE", APART FROM THE MARK AS SHOWN.

THE MARK CONSISTS OF HAND-DRAWN RENDERING OF 3/4 FEMALE FORM-IN 3/4 POSED

"SILHOUETTE", FACING VIEWER'S LEFT, LEFT LEG FORWARD AND BENT AT KNEE, WEARING BIKE SHORTS EXTENDING FROM TOP OF RIBCAGE TO JUST ABOVE KNEES-CENTERED BETWEEN THE WORDS "SLIM" AND "LIFT" WITH "N" CENTERED ON FEMALE FIGURE'S HIP, AND THE WORD "SILHOUETTE" SUPERIMPOSED ACROSS FEMALE FIGURE'S CHEST, ALL OF WHICH ARE CENTERED WITHIN AN OPAQUE HORIZONTAL OVAL.

SEC. 2(F) AS TO "SLIM 'N LIFT".

SER. NO. 77-402,789, FILED 2-21-2008.

MATTHEW EINSTEIN, EXAMINING ATTORNEY

**Int. Cls.: 36 and 42**

**Prior U.S. Cls.: 100, 101 and 102**

**United States Patent and Trademark Office**

**Reg. No. 3,504,994**

**Registered Sep. 23, 2008**

**SERVICE MARK  
PRINCIPAL REGISTER**

**PERACON - GET CONNECTED**

PERACON, INC. (DELAWARE CORPORATION)  
SUITE 950  
1650 TYSONS BOULEVARD  
MCLEAN, VA 22102

FOR: ADMINISTRATION OF A REAL ESTATE INVESTMENT PROGRAM; COORDINATION OF REAL ESTATE INVESTORS, MEMBERS AND PARTICIPANTS, NAMELY, REAL ESTATE EQUITY SHARING, IN CLASS 36 (U.S. CLS. 100, 101 AND 102).

FIRST USE 1-30-2008; IN COMMERCE 1-30-2008.

FOR: APPLICATION SERVICE PROVIDER FEATURING SOFTWARE FOR USE IN SEARCHING AND RETRIEVING INFORMATION FROM DATABASES AND COMPUTER NETWORKS; FOR THE COLLECTION, EDITING, ORGANIZING, MODIFY-

ING, BOOK MARKING, TRANSMISSION, STORAGE AND SHARING OF DATA AND INFORMATION, IN CLASS 42 (U.S. CLS. 100 AND 101).

FIRST USE 1-30-2008; IN COMMERCE 1-30-2008.

THE MARK CONSISTS OF STANDARD CHARACTERS WITHOUT CLAIM TO ANY PARTICULAR FONT, STYLE, SIZE, OR COLOR.

OWNER OF U.S. REG. NOS. 3,271,214 AND 3,271,216.

SER. NO. 77-402,794, FILED 2-21-2008.

MIDGE BUTLER, EXAMINING ATTORNEY

**Int. Cl.: 31**

**Prior U.S. Cls.: 1 and 46**

**United States Patent and Trademark Office**

**Reg. No. 3,504,995**

**Registered Sep. 23, 2008**

**TRADEMARK  
PRINCIPAL REGISTER**

*We take care of calves, naturally !*

NRV INC (WISCONSIN CORPORATION)  
N8155 AMERICAN STREET  
IXONIA, WI 53036

FIRST USE 2-20-2008; IN COMMERCE 2-21-2008.

SER. NO. 77-402,805, FILED 2-21-2008.

FOR: LIVESTOCK FEED, IN CLASS 31 (U.S. CLS. 1  
AND 46).

KIM MONINGHOFF, EXAMINING ATTORNEY

**Int. Cls.: 36 and 42**

**Prior U.S. Cls.: 100, 101 and 102**

**United States Patent and Trademark Office**

**Reg. No. 3,504,996**

**Registered Sep. 23, 2008**

**SERVICE MARK  
PRINCIPAL REGISTER**

**ZERO TIME TO MARKET**

PERACON, INC. (DELAWARE CORPORATION)  
SUITE 950  
1650 TYSONS BOULEVARD  
MCLEAN, VA 22102

FOR: ADMINISTRATION OF A REAL ESTATE INVESTMENT PROGRAM; COORDINATION OF REAL ESTATE INVESTORS, MEMBERS AND PARTICIPANTS, NAMELY, REAL ESTATE EQUITY SHARING, IN CLASS 36 (U.S. CLS. 100, 101 AND 102).

FIRST USE 1-30-2008; IN COMMERCE 1-30-2008.

FOR: APPLICATION SERVICE PROVIDER FEATURING SOFTWARE FOR USE IN SEARCHING AND RETRIEVING INFORMATION FROM DATA-

BASES AND COMPUTER NETWORKS FOR THE COLLECTION, EDITING, ORGANIZING, MODIFYING, BOOK MARKING, TRANSMISSION, STORAGE AND SHARING OF DATA AND INFORMATION, IN CLASS 42 (U.S. CLS. 100 AND 101).

FIRST USE 1-30-2008; IN COMMERCE 1-30-2008.

THE MARK CONSISTS OF STANDARD CHARACTERS WITHOUT CLAIM TO ANY PARTICULAR FONT, STYLE, SIZE, OR COLOR.

SER. NO. 77-402,807, FILED 2-21-2008.

MIDGE BUTLER, EXAMINING ATTORNEY

**Int. Cl.: 12**

**Prior U.S. Cls.: 19, 21, 23, 31, 35 and 44**

**United States Patent and Trademark Office**

**Reg. No. 3,504,997**

**Registered Sep. 23, 2008**

**TRADEMARK  
PRINCIPAL REGISTER**

**AZPHATS**

STUMPWERX, INC. (KENTUCKY CORPORATION)  
374 LILY ROAD  
LONDON, KY 40744

FOR: MOTORCYCLE PARTS AND ACCESSORIES, NAMELY, SWINGARMS, WHEEL HUBS, SUSPENSION SYSTEMS FOR MOTORCYCLES, SHOCK MOUNTS, WHEELS, HANDLEBARS, FENDERS, RADIATORS, BODY PANELS, AIR INTAKES, BRAKE CALIPERS AND BRAKE CALIPER BRACKETS, IN CLASS 12 (U.S. CLS. 19, 21, 23, 31, 35 AND 44).

FIRST USE 8-1-2005; IN COMMERCE 8-1-2005.

THE MARK CONSISTS OF STANDARD CHARACTERS WITHOUT CLAIM TO ANY PARTICULAR FONT, STYLE, SIZE, OR COLOR.

SER. NO. 77-402,828, FILED 2-21-2008.

KEVON CHISOLM, EXAMINING ATTORNEY

**Int. Cl.: 44**

**Prior U.S. Cls.: 100 and 101**

**United States Patent and Trademark Office**

**Reg. No. 3,504,998**

**Registered Sep. 23, 2008**

**SERVICE MARK  
PRINCIPAL REGISTER**

RETURNING PATIENTS TO THE  
SPEED OF LIFE

LAMPE & ASSOCIATES, INC. (KANSAS COR-  
PORATION)  
317 S. LAKEVIEW FORREST HEIGHTS  
FLORISSANT, CO 80816

THE MARK CONSISTS OF STANDARD CHAR-  
ACTERS WITHOUT CLAIM TO ANY PARTICULAR  
FONT, STYLE, SIZE, OR COLOR.

FOR: PHYSICAL REHABILITATION SERVICES  
FOR THE SPINE AND EXTREMITIES OF THE  
HUMAN BODY, IN CLASS 44 (U.S. CLS. 100 AND  
101).

SER. NO. 77-402,831, FILED 2-21-2008.

FIRST USE 12-31-1997; IN COMMERCE 12-31-1997.

PRISCILLA MILTON, EXAMINING ATTORNEY



**Int. Cl.: 5**

**Prior U.S. Cls.: 6, 18, 44, 46, 51 and 52**

**United States Patent and Trademark Office**

**Reg. No. 3,504,999**

**Registered Sep. 23, 2008**

**TRADEMARK  
PRINCIPAL REGISTER**

**HEALTH FROM THE SEA**

NUTRAMARKS, INC. (DELAWARE CORPORATION)  
1500 KEARNS BOULEVARD, SUITE B-200  
PARK CITY, UT 84060

THE MARK CONSISTS OF STANDARD CHARACTERS WITHOUT CLAIM TO ANY PARTICULAR FONT, STYLE, SIZE, OR COLOR.

FOR: FOOD SUPPLEMENTS, IN CLASS 5 (U.S. CLS. 6, 18, 44, 46, 51 AND 52).

SER. NO. 77-402,841, FILED 2-21-2008.

FIRST USE 4-30-1995; IN COMMERCE 4-30-1995.

BARNEY CHARLON, EXAMINING ATTORNEY

**Int. Cl.: 44**

**Prior U.S. Cls.: 100 and 101**

**United States Patent and Trademark Office**

**Reg. No. 3,505,000**

**Registered Sep. 23, 2008**

**SERVICE MARK  
PRINCIPAL REGISTER**

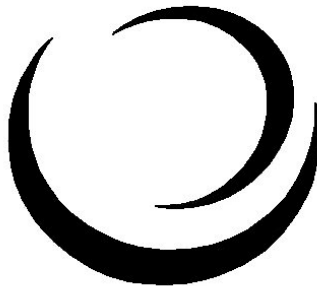

MULLEN, LAURIE (UNITED STATES INDIVIDUAL)  
630 FORT WASHINGTON AVE., SUITE IJ  
NEW YORK, NY 10040

FOR: CHIROPRACTIC SERVICES, IN CLASS 44  
(U.S. CLS. 100 AND 101).

FIRST USE 12-12-2006; IN COMMERCE 12-12-2006.

THE MARK CONSISTS OF TWO HALF CIRCLES.

SER. NO. 77-402,842, FILED 2-21-2008.

GEORGE LORENZO, EXAMINING ATTORNEY

Int. Cl.: 30

Prior U.S. Cl.: 46

United States Patent and Trademark Office

Reg. No. 3,505,001

Registered Sep. 23, 2008

TRADEMARK  
PRINCIPAL REGISTER

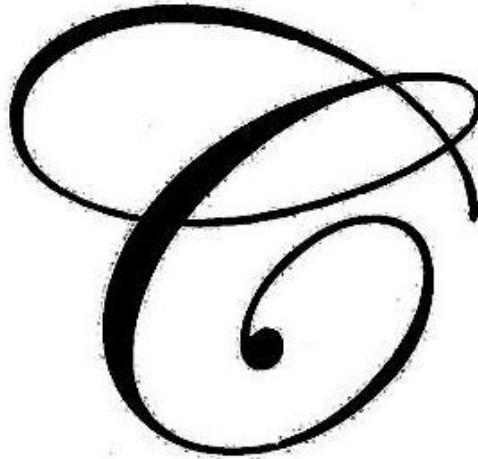

KEARNEY, DENNIS (UNITED STATES INDIVIDUAL), DBA COCO DÉLICE FINE CHOCOLATES

3932 FOREST HILL AVENUE  
OAKLAND, CA 94602

FOR: CHOCOLATES, CANDY, CHOCOLATE CANDIES, CHOCOLATE CONFECTIONS, FILLED CHOCOLATE, CHOCOLATE TRUFFLES, CHOCOLATE COVERED NUTS, IN CLASS 30 (U.S. CL. 46).

FIRST USE 11-0-2005; IN COMMERCE 11-0-2005.

THE MARK CONSISTS OF THE CAPITALIZED LETTER "C" IN SCRIPT.

SER. NO. 77-402,859, FILED 2-21-2008.

JULIE WATSON, EXAMINING ATTORNEY

**Int. Cls.: 9 and 41**

**Prior U.S. Cls.: 21, 23, 26, 36, 38, 100, 101 and 107**

**United States Patent and Trademark Office**

**Reg. No. 3,505,002**

**Registered Sep. 23, 2008**

**TRADEMARK  
SERVICE MARK  
PRINCIPAL REGISTER**

**THINNING THE HERD**

SPIELMAN, GAVIN (UNITED STATES INDIVIDUAL)

#2A

129 FIRST AVENUE  
NEW YORK, NY 10003

FOR: MUSICAL SOUND RECORDINGS, IN CLASS 9 (U.S. CLS. 21, 23, 26, 36 AND 38).

FIRST USE 12-19-2006; IN COMMERCE 12-19-2006.

FOR: ENTERTAINMENT SERVICES IN THE NATURE OF LIVE MUSICAL PERFORMANCES, IN CLASS 41 (U.S. CLS. 100, 101 AND 107).

FIRST USE 4-4-2008; IN COMMERCE 4-4-2008.

THE MARK CONSISTS OF STANDARD CHARACTERS WITHOUT CLAIM TO ANY PARTICULAR FONT, STYLE, SIZE, OR COLOR.

SER. NO. 77-402,872, FILED 2-21-2008.

KEVON CHISOLM, EXAMINING ATTORNEY

**Int. Cl.: 37**

**Prior U.S. Cls.: 100, 103 and 106**

**United States Patent and Trademark Office**

**Reg. No. 3,505,003**

**Registered Sep. 23, 2008**

**SERVICE MARK  
PRINCIPAL REGISTER**

**A Common Sense Quality  
Community**

WELLSPRING DEVELOPMENT COMPANY (IL-  
LINOIS CORPORATION), DBA ROCK HILL  
TRAILS  
1806 LYNDHURST  
EDWARDSVILLE, IL 61874

FOR: LAND DEVELOPMENT SERVICES, NAME-  
LY, PLANNING AND LAYING OUT OF RESIDEN-  
TIAL AND/OR COMMERCIAL COMMUNITIES, IN  
CLASS 37 (U.S. CLS. 100, 103 AND 106).

FIRST USE 11-30-2007; IN COMMERCE 1-31-2008.

THE MARK CONSISTS OF STANDARD CHAR-  
ACTERS WITHOUT CLAIM TO ANY PARTICULAR  
FONT, STYLE, SIZE, OR COLOR.

NO CLAIM IS MADE TO THE EXCLUSIVE  
RIGHT TO USE "QUALITY COMMUNITY", APART  
FROM THE MARK AS SHOWN.

SER. NO. 77-402,876, FILED 2-21-2008.

MICHAEL SOUDERS, EXAMINING ATTORNEY

Int. Cl.: 35

Prior U.S. Cls.: 100, 101 and 102

United States Patent and Trademark Office

Reg. No. 3,505,004

Registered Sep. 23, 2008

SERVICE MARK  
PRINCIPAL REGISTER

The logo for Barnett features a stylized icon on the left consisting of four small squares arranged in a larger square pattern. To the right of this icon, the word "Barnett" is written in a bold, italicized, sans-serif font.

INTERLINE BRANDS, INC. (NEW JERSEY CORPORATION)  
801 W. BAY STREET  
JACKSONVILLE, FL 32204

FOR: ONLINE ORDERING SERVICES FEATURING HARDWARE, PLUMBING, HVAC, ELECTRICAL AND GENERAL HARDWARE ITEMS AND SUPPLIES, IN CLASS 35 (U.S. CLS. 100, 101 AND 102).

FIRST USE 7-31-2005; IN COMMERCE 7-31-2005.

THE MARK CONSISTS OF THE WORD "BARNETT" WITH FOUR RECTANGULAR SHAPES FORMING A SQUARE APPEARING AT THE UPPER LEFT OF THE WORD.

SER. NO. 77-402,900, FILED 2-21-2008.

CHRISTOPHER BUONGIORNO, EXAMINING ATTORNEY

**Int. Cl.: 4**

**Prior U.S. Cls.: 1, 6 and 15**

**United States Patent and Trademark Office**

**Reg. No. 3,505,005**

**Registered Sep. 23, 2008**

**TRADEMARK  
PRINCIPAL REGISTER**



JOY SOY CANDLES LLC (FLORIDA LIMITED LIABILITY COMPANY), DBA BESOY  
1525 PENNSYLVANIA AVE. # 3  
MIAMI, FL 33139

THE COLOR(S) BLACK, LIME GREEN, LIGHT OLIVE GREEN, OLIVE GREEN, SOY GREEN IS/ ARE CLAIMED AS A FEATURE OF THE MARK.

FOR: CANDLE CONTAINED IN A CLAMSHELL; CANDLE-MAKING KITS; CANDLES; CANDLES FOR LIGHTING; SCENTED CANDLES; PERFUMED CANDLES, IN CLASS 4 (U.S. CLS. 1, 6 AND 15).

THE MARK CONSISTS OF THE WORDING "BE SOY SOUTH BEACH" APPEARING IN BLACK. A DEPICTION OF A GREEN SOY BEAN POD APPEARS IN FOUR SHADES OF GREEN AND IS SLIGHTLY OPENED CONTAINING THREE SOY BEANS AND IS IN THE RIGHT UPPER CORNER VERTICALLY PLACED ON TOP OF THE "SOUTH BEACH" WORDING AND BESIDE THE BIG LETTER "E".

FIRST USE 1-1-2008; IN COMMERCE 1-15-2008.

SER. NO. 77-402,960, FILED 2-21-2008.

NO CLAIM IS MADE TO THE EXCLUSIVE RIGHT TO USE "SOY" AND "SOUTH BEACH", APART FROM THE MARK AS SHOWN.

MICHAEL SOUDERS, EXAMINING ATTORNEY

**Int. Cl.: 16**

**Prior U.S. Cls.: 2, 5, 22, 23, 29, 37, 38 and 50**

**Reg. No. 3,505,006**

**United States Patent and Trademark Office**

**Registered Sep. 23, 2008**

**TRADEMARK  
PRINCIPAL REGISTER**

**PACIFIC WESTERN CONTAINER**

BLOWER-DEMPSAY CORPORATION (CALIFORNIA CORPORATION)  
4042 WEST GARRY AVENUE  
SANTA ANA, CA 92704

FOR: CORRUGATED SHIPPING CONTAINERS AND DISPLAYS, IN CLASS 16 (U.S. CLS. 2, 5, 22, 23, 29, 37, 38 AND 50).

FIRST USE 9-24-1973; IN COMMERCE 9-24-1973.

THE MARK CONSISTS OF STANDARD CHARACTERS WITHOUT CLAIM TO ANY PARTICULAR FONT, STYLE, SIZE, OR COLOR.

NO CLAIM IS MADE TO THE EXCLUSIVE RIGHT TO USE "CONTAINER", APART FROM THE MARK AS SHOWN.

SER. NO. 77-402,997, FILED 2-21-2008.

JOHN WILKE, EXAMINING ATTORNEY



**Int. Cl.: 5**

**Prior U.S. Cls.: 6, 18, 44, 46, 51 and 52**

**Reg. No. 3,505,007**

**United States Patent and Trademark Office**

**Registered Sep. 23, 2008**

---

**TRADEMARK  
PRINCIPAL REGISTER**

**CATTLEFLEX**

KENT FEEDS, INC. (IOWA CORPORATION)  
1600 OREGON STREET  
MUSCATINE, IA 52761

THE MARK CONSISTS OF STANDARD CHAR-  
ACTERS WITHOUT CLAIM TO ANY PARTICULAR  
FONT, STYLE, SIZE, OR COLOR.

FOR: MEDICATED ANIMAL FEED SUPPLE-  
MENTS, IN CLASS 5 (U.S. CLS. 6, 18, 44, 46, 51 AND  
52).

SER. NO. 77-403,002, FILED 2-21-2008.

FIRST USE 10-27-2004; IN COMMERCE 10-27-2004.

MARY BOAGNI, EXAMINING ATTORNEY

**Int. Cl.: 41**

**Prior U.S. Cls.: 100, 101 and 107**

**United States Patent and Trademark Office**

**Reg. No. 3,505,008**

**Registered Sep. 23, 2008**

**SERVICE MARK  
PRINCIPAL REGISTER**

**Think Outside the Bone**

PIKOS IMPLANT INSTITUTE, INC. (FLORIDA  
CORPORATION)  
2711 TAMPA ROAD  
PALM HARBOR, FL 34684

FOR: EDUCATIONAL SERVICES, NAMELY,  
CONDUCTING CLASSES, SEMINARS, CONFEREN-  
CES, AND WORKSHOPS IN THE FIELD OF SOFT  
AND HARD TISSUE GRAFTING FOR DENTAL  
IMPLANT RECONSTRUCTION, AND DISTRIBUT-  
ING COURSE MATERIALS IN CONNECTION  
THEREWITH, IN CLASS 41 (U.S. CLS. 100, 101 AND  
107).

FIRST USE 2-7-2008; IN COMMERCE 2-7-2008.

THE MARK CONSISTS OF STANDARD CHAR-  
ACTERS WITHOUT CLAIM TO ANY PARTICULAR  
FONT, STYLE, SIZE, OR COLOR.

SER. NO. 77-403,024, FILED 2-21-2008.

TAMARA FRAZIER, EXAMINING ATTORNEY

Int. Cl.: 25

Prior U.S. Cls.: 22 and 39

United States Patent and Trademark Office

Reg. No. 3,505,009

Registered Sep. 23, 2008

TRADEMARK  
PRINCIPAL REGISTER



C.I. EL GLOBO S.A. (COLOMBIA CORPORATION)  
CARRERA 57 #25-33, BARIO TRINIDAD  
MEDELLIN, COLOMBIA

FOR: JEANS; BELTS; BELTS MADE OF LEATHER; BERMUDA SHORTS; BOXER SHORTS; BRAS; BRIEFS; CAPS; DENIM JACKETS; DENIMS; HEADWEAR; HATS; LONG-SLEEVED SHIRTS; PANTS; SHORT-SLEEVED OR LONG-SLEEVED T-SHIRTS; SWEATERS; SHORTS; SKIRTS AND DRESSES; TOPS; UNDERWEAR; SHIRTS; PANTIES; JACKETS, IN CLASS 25 (U.S. CLS. 22 AND 39).

FIRST USE 12-1-2007; IN COMMERCE 12-1-2007.

NO CLAIM IS MADE TO THE EXCLUSIVE RIGHT TO USE "JEANS", APART FROM THE MARK AS SHOWN.

THE MARK CONSISTS OF THE WORDINGS "CRISTO GRACEFUL JEANS" AND A DESIGN OF WINGS OUTSPREAD BEHIND THE WORD "CRISTO". THE WORD "CRISTO" IS IN SMALL CAPS. THE WORD "CRISTO" IS IN SPANISH AND MEANS "CHRIST". THE WORD "CRISTO" UTILIZES A FONT REMINISCENT OF HEBREW SCRIPT. THE WORDS "GRACEFUL JEANS" ARE LOCATED UNDERNEATH THE WORD "CRISTO". THE WORDS "GRACEFUL JEANS" ARE IN CURSIVE FONT.

THE FOREIGN WORDING IN THE MARK TRANSLATES INTO ENGLISH AS "CHRIST".

SER. NO. 77-403,040, FILED 2-21-2008.

ANNE E. GUSTASON, EXAMINING ATTORNEY

Int. Cl.: 36

Prior U.S. Cls.: 100, 101 and 102

United States Patent and Trademark Office

Reg. No. 3,505,010

Registered Sep. 23, 2008

**SERVICE MARK  
PRINCIPAL REGISTER**



CONSOLIDATED CREDIT COUNSELING SERVICES, INC. (FLORIDA CORPORATION)  
5701 W. SUNRISE BOULEVARD  
FORT LAUDERDALE, FL 33313

FOR: DEBT COUNSELING SERVICES; DEBT MANAGEMENT CONSULTATION; FINANCIAL CONSULTATION IN THE FIELD OF DEBT MANAGEMENT, IN CLASS 36 (U.S. CLS. 100, 101 AND 102).

FIRST USE 1-2-2006; IN COMMERCE 1-2-2006.

OWNER OF U.S. REG. NOS. 2,589,033 AND 3,111,610.

NO CLAIM IS MADE TO THE EXCLUSIVE RIGHT TO USE "CONSOLIDATED CREDIT COUNSELING SERVICES, INC.", APART FROM THE MARK AS SHOWN.

THE COLOR(S) BLUE AND WHITE IS/ARE CLAIMED AS A FEATURE OF THE MARK.

THE MARK CONSISTS OF BLUE RECTANGLE BOX WITH A WHITE AND BLUE STRIPPED LIFE PRESERVE ON THE LEFT HAND SIDE OF THE RECTANGLE ALONG WITH A LIGHTER SHADE OF BLUE DESIGN ON THE LEFT HAND SIDE OF THE LIFE PRESERVE WITH LINES AND TRIANGLES AND CURLS THAT EXTEND TO THE TOP AND BOTTOM OF THE LIFE PRESERVE. THEN IN THE REMAINING PORTION OF THE RECTANGLE ON THE TOP THE WORD "CONSOLIDATED" IN WHITE, WITH THE WORDS "CREDIT COUNSELING SERVICES, INC."; UNDER THAT IN WHITE, WITH A WHITE LINE UNDERLINING THOSE WORDS AND THEN CENTERED BELOW THE WHITE LINE ARE THE FOLLOWING WORDS, ALSO IN WHITE, WHEN DEBT IS THE PROBLEM, WE ARE THE SOLUTION.

SER. NO. 77-403,092, FILED 2-21-2008.

TARAH HARDY, EXAMINING ATTORNEY

**Int. Cl.: 33**

**Prior U.S. Cls.: 47 and 49**

**United States Patent and Trademark Office**

**Reg. No. 3,505,011**

**Registered Sep. 23, 2008**

**TRADEMARK  
PRINCIPAL REGISTER**

**BASKET CASE**

CARLTON, JOHN (UNITED STATES INDIVIDUAL)  
PO BOX 236  
PACIFIC CITY, OR 97135 AND  
CARLTON, CHENIN (UNITED STATES INDIVIDUAL)  
PO BOX 236  
PACIFIC CITY, OR 97135

FIRST USE 1-11-2007; IN COMMERCE 1-11-2007.

THE MARK CONSISTS OF STANDARD CHARACTERS WITHOUT CLAIM TO ANY PARTICULAR FONT, STYLE, SIZE, OR COLOR.

SER. NO. 77-403,123, FILED 2-21-2008.

FOR: WINES, IN CLASS 33 (U.S. CLS. 47 AND 49).

EDWARD NELSON, EXAMINING ATTORNEY

**Int. Cls.: 20 and 21**

**Prior U.S. Cls.: 2, 13, 22, 23, 25, 29, 30, 32, 33, 40 and 50**

**United States Patent and Trademark Office**

**Reg. No. 3,505,012**

**Registered Sep. 23, 2008**

**TRADEMARK  
PRINCIPAL REGISTER**

**GOLLUM**

THE SAUL ZAENTZ COMPANY (DELAWARE CORPORATION)  
2600 TENTH STREET  
BERKELEY, CA 94710

FOR: NON-METAL AND NON-LEATHER KEY CHAINS, IN CLASS 20 (U.S. CLS. 2, 13, 22, 25, 32 AND 50).

FIRST USE 10-2-2003; IN COMMERCE 2-13-2008.

FOR: COOKIE JARS, IN CLASS 21 (U.S. CLS. 2, 13, 23, 29, 30, 33, 40 AND 50).

FIRST USE 1-28-2008; IN COMMERCE 1-28-2008.

THE MARK CONSISTS OF STANDARD CHARACTERS WITHOUT CLAIM TO ANY PARTICULAR FONT, STYLE, SIZE, OR COLOR.

OWNER OF U.S. REG. NOS. 2,679,479, 2,987,672 AND OTHERS.

SER. NO. 77-403,125, FILED 2-21-2008.

BRENDAN REGAN, EXAMINING ATTORNEY

**Int. Cl.: 9**

**Prior U.S. Cls.: 21, 23, 26, 36 and 38**

**United States Patent and Trademark Office**

**Reg. No. 3,505,013**

**Registered Sep. 23, 2008**

**TRADEMARK  
PRINCIPAL REGISTER**

**ThinSAT**

THINKOM SOLUTIONS, INC. (CALIFORNIA  
CORPORATION)  
3825 DEL AMO BLVD., SUITE 200  
TORRANCE, CA 90503

THE MARK CONSISTS OF STANDARD CHAR-  
ACTERS WITHOUT CLAIM TO ANY PARTICULAR  
FONT, STYLE, SIZE, OR COLOR.

FOR: ANTENNAE; ANTENNAS FOR WIRELESS  
COMMUNICATIONS APPARATUS; MICROWAVE  
ANTENNAE, IN CLASS 9 (U.S. CLS. 21, 23, 26, 36 AND  
38).

SER. NO. 77-403,133, FILED 2-21-2008.

FIRST USE 0-0-2008; IN COMMERCE 0-0-2008.

IRA J. GOODSaid, EXAMINING ATTORNEY

**Int. Cl.: 33**

**Prior U.S. Cls.: 47 and 49**

**United States Patent and Trademark Office**

**Reg. No. 3,505,014**

**Registered Sep. 23, 2008**

**TRADEMARK  
PRINCIPAL REGISTER**

**SHY CHENIN**

CARLTON, JOHN (UNITED STATES INDIVIDUAL)  
PO BOX 236  
PACIFIC CITY, OR 97135 AND  
CARLTON, CHENIN (UNITED STATES INDIVIDUAL)  
PO BOX 236  
PACIFIC CITY, OR 97135

THE MARK CONSISTS OF STANDARD CHARACTERS WITHOUT CLAIM TO ANY PARTICULAR FONT, STYLE, SIZE, OR COLOR.

THE NAME SHOWN IN THE MARK IDENTIFIES "CHENIN CARLTON", WHOSE CONSENT TO REGISTER IS MADE OF RECORD.

FOR: WINES, IN CLASS 33 (U.S. CLS. 47 AND 49).

SER. NO. 77-403,135, FILED 2-21-2008.

FIRST USE 10-29-2007; IN COMMERCE 10-29-2007.

EDWARD NELSON, EXAMINING ATTORNEY



**Int. Cl.: 38**

**Prior U.S. Cls.: 100, 101 and 104**

**United States Patent and Trademark Office**

**Reg. No. 3,505,015**

**Registered Sep. 23, 2008**

**SERVICE MARK  
PRINCIPAL REGISTER**

**DRIVESAFE**

SKYWAY SYSTEMS, INC. (DELAWARE CORPORATION)  
1551 U.S. HIGHWAY 287  
BROOMFIELD, CO 80038

FOR: TELECOMMUNICATIONS SERVICES, NAMELY, ELECTRONIC TRANSMISSION OF VOICE MESSAGES AND DATA BETWEEN VEHICLES OWNERS, A 24-HOUR CALL CENTER, AND EMERGENCY RESPONDERS, IN CLASS 38 (U.S. CLS. 100, 101 AND 104).

FIRST USE 1-0-2007; IN COMMERCE 5-0-2007.

THE MARK CONSISTS OF STANDARD CHARACTERS WITHOUT CLAIM TO ANY PARTICULAR FONT, STYLE, SIZE, OR COLOR.

SER. NO. 77-403,142, FILED 2-21-2008.

DEIRDRE ROBERTSON, EXAMINING ATTORNEY

**Int. Cl.: 9**

**Prior U.S. Cls.: 21, 23, 26, 36 and 38**

**United States Patent and Trademark Office**

**Reg. No. 3,505,016**

**Registered Sep. 23, 2008**

**TRADEMARK  
PRINCIPAL REGISTER**

**ThinAIR**

THINKOM SOLUTIONS, INC. (CALIFORNIA  
CORPORATION)  
3825 DEL AMO BLVD., SUITE 200  
TORRANCE, CA 90503

THE MARK CONSISTS OF STANDARD CHAR-  
ACTERS WITHOUT CLAIM TO ANY PARTICULAR  
FONT, STYLE, SIZE, OR COLOR.

FOR: ANTENNAS; ANTENNAS FOR WIRELESS  
COMMUNICATIONS APPARATUS; MICROWAVE  
ANTENNAE, IN CLASS 9 (U.S. CLS. 21, 23, 26, 36 AND  
38).

SER. NO. 77-403,151, FILED 2-21-2008.

FIRST USE 0-0-2008; IN COMMERCE 0-0-2008.

IRA J. GOODSaid, EXAMINING ATTORNEY

**Int. Cl.: 9**

**Prior U.S. Cls.: 21, 23, 26, 36 and 38**

**Reg. No. 3,505,017**

**United States Patent and Trademark Office**

**Registered Sep. 23, 2008**

---

**TRADEMARK  
PRINCIPAL REGISTER**

**ThinLine**

THINKOM SOLUTIONS, INC. (CALIFORNIA  
CORPORATION)  
3825 DEL AMO BLVD., SUITE 200  
TORRANCE, CA 90503

THE MARK CONSISTS OF STANDARD CHAR-  
ACTERS WITHOUT CLAIM TO ANY PARTICULAR  
FONT, STYLE, SIZE, OR COLOR.

FOR: ANTENNAS; ANTENNAS FOR WIRELESS  
COMMUNICATIONS APPARATUS; MICROWAVE  
ANTENNAE, IN CLASS 9 (U.S. CLS. 21, 23, 26, 36 AND  
38).

SER. NO. 77-403,160, FILED 2-21-2008.

FIRST USE 0-0-2008; IN COMMERCE 0-0-2008.

IRA J. GOODSaid, EXAMINING ATTORNEY

**Int. Cl.: 41**

**Prior U.S. Cls.: 100, 101 and 107**

**United States Patent and Trademark Office**

**Reg. No. 3,505,018**

**Registered Sep. 23, 2008**

**SERVICE MARK  
PRINCIPAL REGISTER**

**ISCOWP**

INTERNATIONAL SOCIETY FOR COW PROTECTION (WEST VIRGINIA NON-PROFIT CORPORATION)

RD. 1 BOX 322 A  
MOUNDSVILLE, WV 26041

FOR: EDUCATION SERVICES, NAMELY, ONE-ON-ONE MENTORING IN THE FIELD OF COW PROTECTION; EDUCATIONAL SERVICES, NAMELY, CONDUCTING CLASSES, SEMINARS, CONFERENCES, WORKSHOPS IN THE FIELD OF COW PROTECTION AND DISTRIBUTION OF COURSE

MATERIAL IN CONNECTION THEREWITH, IN CLASS 41 (U.S. CLS. 100, 101 AND 107).

FIRST USE 1-1-1990; IN COMMERCE 4-1-1990.

THE MARK CONSISTS OF STANDARD CHARACTERS WITHOUT CLAIM TO ANY PARTICULAR FONT, STYLE, SIZE, OR COLOR.

SER. NO. 77-403,161, FILED 2-21-2008.

MARTHA FROMM, EXAMINING ATTORNEY

**Int. Cl.: 20**

**Prior U.S. Cls.: 2, 13, 22, 25, 32 and 50**

**United States Patent and Trademark Office**

**Reg. No. 3,505,019**

**Registered Sep. 23, 2008**

**TRADEMARK  
PRINCIPAL REGISTER**

**BILBO**

THE SAUL ZAENTZ COMPANY (DELAWARE  
CORPORATION)  
2600 TENTH STREET  
BERKELEY, CA 94710

FOR: PLASTIC KEY CHAINS, IN CLASS 20 (U.S.  
CLS. 2, 13, 22, 25, 32 AND 50).

FIRST USE 4-20-2002; IN COMMERCE 2-13-2008.

THE MARK CONSISTS OF STANDARD CHAR-  
ACTERS WITHOUT CLAIM TO ANY PARTICULAR  
FONT, STYLE, SIZE, OR COLOR.

OWNER OF U.S. REG. NOS. 2,772,530, 3,377,919  
AND OTHERS.

SER. NO. 77-403,172, FILED 2-21-2008.

BRENDAN REGAN, EXAMINING ATTORNEY

**Int. Cl.: 16**

**Prior U.S. Cls.: 2, 5, 22, 23, 29, 37, 38 and 50**

**Reg. No. 3,505,020**

**United States Patent and Trademark Office**

**Registered Sep. 23, 2008**

---

**TRADEMARK  
PRINCIPAL REGISTER**

**Simply Said, LLC**

SIMPLY SAID, LLC (IOWA LIMITED LIABILITY  
COMPANY)  
3010 140TH STREET  
ROCK RAPIDS, IA 51246

FOR: ADHESIVE-BACKED LETTERS AND NUM-  
BERS FOR USE IN MAKING PRE-PRINTED  
WORDS, PHRASES, AND SYMBOLS THAT ARE  
APPLIED TO HARD SURFACES , IN CLASS 16 (U.S.  
CLS. 2, 5, 22, 23, 29, 37, 38 AND 50).

FIRST USE 2-1-2007; IN COMMERCE 2-1-2007.

THE MARK CONSISTS OF STANDARD CHAR-  
ACTERS WITHOUT CLAIM TO ANY PARTICULAR  
FONT, STYLE, SIZE, OR COLOR.

NO CLAIM IS MADE TO THE EXCLUSIVE  
RIGHT TO USE "LLC", APART FROM THE MARK  
AS SHOWN.

SER. NO. 77-403,183, FILED 2-21-2008.

REBECCA EISINGER, EXAMINING ATTORNEY

**Int. Cl.: 35**

**Prior U.S. Cls.: 100, 101 and 102**

**United States Patent and Trademark Office**

**Reg. No. 3,505,021**

**Registered Sep. 23, 2008**

**SERVICE MARK  
PRINCIPAL REGISTER**

# CourseFlight

RECREATION MARKETING, INC. (ARIZONA CORPORATION), DBA BEST APPROACH  
2627 W. BIRCHWOOD CIRCLE, #2  
MESA, AZ 85202

THE MARK CONSISTS OF STANDARD CHARACTERS WITHOUT CLAIM TO ANY PARTICULAR FONT, STYLE, SIZE, OR COLOR.

FOR: PROVIDING ADVERTISING SERVICES USING 3D AND ANIMATION DESIGNS, IN CLASS 35 (U.S. CLS. 100, 101 AND 102).

SER. NO. 77-403,214, FILED 2-21-2008.

FIRST USE 10-15-2006; IN COMMERCE 10-15-2006.

TINA L. SNAPP, EXAMINING ATTORNEY

**Int. Cl.: 32**

**Prior U.S. Cls.: 45, 46 and 48**

**Reg. No. 3,505,022**

**United States Patent and Trademark Office**

**Registered Sep. 23, 2008**

---

**TRADEMARK  
PRINCIPAL REGISTER**

**ARE YOU THIRSTY?**

LANGENBURG, MAX (FED REP GERMANY  
INDIVIDUAL)  
3590 W. 3RD AVE  
EUGENE, OR 97402

THE MARK CONSISTS OF STANDARD CHAR-  
ACTERS WITHOUT CLAIM TO ANY PARTICULAR  
FONT, STYLE, SIZE, OR COLOR.

FOR: DRINKING WATER, IN CLASS 32 (U.S. CLS.  
45, 46 AND 48).

SER. NO. 77-403,229, FILED 2-21-2008.

FIRST USE 2-2-2002; IN COMMERCE 2-2-2002.

EDWARD NELSON, EXAMINING ATTORNEY



**Int. Cl.: 35**

**Prior U.S. Cls.: 100, 101 and 102**

**United States Patent and Trademark Office**

**Reg. No. 3,505,023**

**Registered Sep. 23, 2008**

**SERVICE MARK  
PRINCIPAL REGISTER**

**PATRICK DEMPSEY**

TDS 66 PRODUCTIONS, INC. (CALIFORNIA CORPORATION)  
C/O GRANT, TANI, BARASH & ALTMAN LLC  
9100 WILSHIRE BOULEVARD, SUITE 1000W  
BEVERLY HILLS, CA 90212

FOR: PROMOTING THE GOODS AND SERVICES OF OTHERS THROUGH PRODUCT ENDORSEMENTS AND CORPORATE SPOKESPERSON SERVICES, IN CLASS 35 (U.S. CLS. 100, 101 AND 102).

FIRST USE 0-0-2005; IN COMMERCE 0-0-2005.

THE MARK CONSISTS OF STANDARD CHARACTERS WITHOUT CLAIM TO ANY PARTICULAR FONT, STYLE, SIZE, OR COLOR.

THE NAME "PATRICK DEMPSEY" IDENTIFIES A LIVING INDIVIDUAL WHOSE CONSENT IS OF RECORD.

SER. NO. 77-403,236, FILED 2-21-2008.

NANCY CLARKE, EXAMINING ATTORNEY

**Int. Cl.: 21**

**Prior U.S. Cls.: 2, 13, 23, 29, 30, 33, 40 and 50**

**United States Patent and Trademark Office**

**Reg. No. 3,505,024**

**Registered Sep. 23, 2008**

**TRADEMARK  
PRINCIPAL REGISTER**

**ORC**

THE SAUL ZAENTZ COMPANY (DELAWARE  
CORPORATION)  
2600 TENTH STREET  
BERKELEY, CA 94710

THE MARK CONSISTS OF STANDARD CHAR-  
ACTERS WITHOUT CLAIM TO ANY PARTICULAR  
FONT, STYLE, SIZE, OR COLOR.

FOR: PEWTER GOBLETS, PEWTER SHOT GLAS-  
SES, PEWTER WINE GLASSES, IN CLASS 21 (U.S.  
CLS. 2, 13, 23, 29, 30, 33, 40 AND 50).

SER. NO. 77-403,240, FILED 2-21-2008.

FIRST USE 4-9-2002; IN COMMERCE 2-13-2008.

BRENDAN REGAN, EXAMINING ATTORNEY

**Int. Cl.: 35**

**Prior U.S. Cls.: 100, 101 and 102**

**United States Patent and Trademark Office**

**Reg. No. 3,505,025**

**Registered Sep. 23, 2008**

**SERVICE MARK  
PRINCIPAL REGISTER**

**ESTATELY**

ESTATELY, INC. (WASHINGTON CORPORATION)  
1809 7TH AVENUE, #1550  
SEATTLE, WA 98101

FOR: REFERRALS IN THE FIELD OF RESIDENTIAL REAL ESTATE, NAMELY, REFERRING PROSPECTIVE HOME BUYERS TO REAL ESTATE AGENTS; MATCHING CONSUMERS WITH REAL ESTATE PROFESSIONALS IN THE FIELD OF REAL ESTATE SERVICES VIA COMPUTER NETWORK; REAL ESTATE MARKETING SERVICES IN THE FIELD OF RESIDENTIAL HOMES AND CONDOMINIUMS FEATURING VIRTUAL TOURS OF SUCH PROPERTIES VIA COMPUTER NETWORK, IN CLASS 35 (U.S. CLS. 100, 101 AND 102).

FIRST USE 6-28-2007; IN COMMERCE 6-28-2007.

THE MARK CONSISTS OF STANDARD CHARACTERS WITHOUT CLAIM TO ANY PARTICULAR FONT, STYLE, SIZE, OR COLOR.

THE WORDING "ESTATELY" HAS NO MEANING IN A FOREIGN LANGUAGE.

SER. NO. 77-403,246, FILED 2-21-2008.

DEIRDRE ROBERTSON, EXAMINING ATTORNEY

**Int. Cl.: 11**

**Prior U.S. Cls.: 13, 21, 23, 31 and 34**

**United States Patent and Trademark Office**

**Reg. No. 3,505,026**

**Registered Sep. 23, 2008**

**TRADEMARK  
PRINCIPAL REGISTER**

**GRATITUDE**

DIAMOND TREE, LLC (DELAWARE LIMITED  
LIABILITY COMPANY)  
12110 SOUTH RIVERA  
TUSTIN, CA 92782

FOR: WATER CONDITIONING UNIT FOR HOME  
AND PERSONAL USE, NAMELY, WATER BOTTLE  
AND CARTRIDGE SYSTEM THAT REDUCES OXI-  
DATION IN WATER, CONVERTS FILTERED WA-  
TER TO AN IONIZED, ALKALINE STATE, AND  
ADDS BENEFICIAL MINERALS TO DRINKING  
WATER, IN CLASS 11 (U.S. CLS. 13, 21, 23, 31 AND  
34).

FIRST USE 3-15-2007; IN COMMERCE 3-15-2007.

THE MARK CONSISTS OF STANDARD CHAR-  
ACTERS WITHOUT CLAIM TO ANY PARTICULAR  
FONT, STYLE, SIZE, OR COLOR.

SER. NO. 77-403,252, FILED 2-21-2008.

TEJBIR SINGH, EXAMINING ATTORNEY

**Int. Cl.: 11**

**Prior U.S. Cls.: 13, 21, 23, 31 and 34**

**United States Patent and Trademark Office**

**Reg. No. 3,505,027**

**Registered Sep. 23, 2008**

**TRADEMARK  
PRINCIPAL REGISTER**

**AQUAPOOCH**

SPRITE INDUSTRIES, INC. (CALIFORNIA CORPORATION)  
1791 RAILROAD ST.  
CORONA, CA 92880

FOR: SHOWER HEADS; WATER FILTERING UNITS FOR DOMESTIC AND COMMERCIAL USE; WATER FILTERS; WATER PURIFICATION UNITS; WATER TREATMENT EQUIPMENT, NAMELY, CARTRIDGE FILTRATION UNITS, IN CLASS 11 (U.S. CLS. 13, 21, 23, 31 AND 34).

FIRST USE 3-15-2007; IN COMMERCE 4-5-2007.

THE MARK CONSISTS OF STANDARD CHARACTERS WITHOUT CLAIM TO ANY PARTICULAR FONT, STYLE, SIZE, OR COLOR.

SER. NO. 77-403,300, FILED 2-21-2008.

TANYA AMOS, EXAMINING ATTORNEY

**Int. Cl.: 1**

**Prior U.S. Cls.: 1, 5, 6, 10, 26 and 46**

**United States Patent and Trademark Office**

**Reg. No. 3,505,028**

**Registered Sep. 23, 2008**

**TRADEMARK  
PRINCIPAL REGISTER**

**MOLECULAR SILICA**

HYBRID PLASTICS, INCORPORATED (MISSISSIPPI CORPORATION)  
55 W.L. RUNNELS INDUSTRIAL DRIVE  
HATTIESBURG, MS 39401

FOR: CHEMICALS FOR USE IN THE MANUFACTURE OF PLASTICS, IN CLASS 1 (U.S. CLS. 1, 5, 6, 10, 26 AND 46).

FIRST USE 3-16-2000; IN COMMERCE 3-16-2000.

THE MARK CONSISTS OF STANDARD CHARACTERS WITHOUT CLAIM TO ANY PARTICULAR FONT, STYLE, SIZE, OR COLOR.

OWNER OF U.S. REG. NO. 2,657,322.

SEC. 2(F).

SER. NO. 77-403,324, FILED 2-21-2008.

HENRY S. ZAK, EXAMINING ATTORNEY

**Int. Cl.: 41**

**Prior U.S. Cls.: 100, 101 and 107**

**United States Patent and Trademark Office**

**Reg. No. 3,505,029**

**Registered Sep. 23, 2008**

**SERVICE MARK  
PRINCIPAL REGISTER**

**SUSHI-ME**

PLEXIPIXEL, INC. (WASHINGTON CORPORATION)  
174 ROY STREET, SUITE C  
SEATTLE, WA 98109

THE MARK CONSISTS OF STANDARD CHARACTERS WITHOUT CLAIM TO ANY PARTICULAR FONT, STYLE, SIZE, OR COLOR.

FOR: ENTERTAINMENT SERVICES, NAMELY, PROVIDING ON-LINE COMPUTER GAMES, IN CLASS 41 (U.S. CLS. 100, 101 AND 107).

SER. NO. 77-403,325, FILED 2-21-2008.

FIRST USE 11-0-2007; IN COMMERCE 11-0-2007.

JOHN GARTNER, EXAMINING ATTORNEY

**Int. Cl.: 1**

**Prior U.S. Cls.: 1, 5, 6, 10, 26 and 46**

**Reg. No. 3,505,030**

**United States Patent and Trademark Office**

**Registered Sep. 23, 2008**

---

**TRADEMARK  
PRINCIPAL REGISTER**

**PROFESSOR GREEN**

WESTERN NUTRIENTS CORPORATION (CALI-  
FORNIA CORPORATION)  
245 INDUSTRIAL STREET  
245 INDUSTRIAL STREET  
BAKERSFIELD, CA 93307

THE MARK CONSISTS OF STANDARD CHAR-  
ACTERS WITHOUT CLAIM TO ANY PARTICULAR  
FONT, STYLE, SIZE, OR COLOR.

FOR: FERTILIZERS FOR AGRICULTURAL USE;  
FERTILIZERS FOR DOMESTIC USE, IN CLASS 1  
(U.S. CLS. 1, 5, 6, 10, 26 AND 46).

SER. NO. 77-403,342, FILED 2-21-2008.

FIRST USE 1-1-2007; IN COMMERCE 1-1-2007.

FLORENTINA BLANDU, EXAMINING ATTORNEY



**Int. Cl.: 44**

**Prior U.S. Cls.: 100 and 101**

**United States Patent and Trademark Office**

**Reg. No. 3,505,031**

**Registered Sep. 23, 2008**

**SERVICE MARK  
PRINCIPAL REGISTER**

# Pleio

PLEIO HEALTH SUPPORT SYSTEMS (CANADA  
CORPORATION)  
8590 MONKLAND STE 11  
MONTREAL, CANADA

FOR: INTERACTIVE MEDICAL MONITORING  
AND ALERT SERVICE FOR REMINDING CLIENTS  
OF MEDICAL INFORMATION, NAMELY, MEDIC-  
INAL DOSAGE, ALLERGIC SENSITIVITY, AND  
PRESCRIPTION REFILLS , IN CLASS 44 (U.S. CLS.  
100 AND 101).

FIRST USE 10-1-2004; IN COMMERCE 6-1-2005.

THE MARK CONSISTS OF STANDARD CHAR-  
ACTERS WITHOUT CLAIM TO ANY PARTICULAR  
FONT, STYLE, SIZE, OR COLOR.

SER. NO. 77-403,343, FILED 2-21-2008.

AMY HELLA, EXAMINING ATTORNEY

**Int. Cl.: 44**

**Prior U.S. Cls.: 100 and 101**

**United States Patent and Trademark Office**

**Reg. No. 3,505,032**

**Registered Sep. 23, 2008**

**SERVICE MARK  
PRINCIPAL REGISTER**

**Pleio GoodStart**

PLEIO HEALTH SUPPORT SYSTEMS (CANADA  
CORPORATION)  
8590 MONKLAND STE 11  
MONTREAL, CANADA

FOR: INTERACTIVE MEDICAL MONITORING  
AND ALERT SERVICE FOR REMINDING CLIENTS  
OF MEDICAL INFORMATION, NAMELY, MEDIC-  
INAL DOSAGE, ALLERGIC SENSITIVITY, AND  
PRESCRIPTION REFILLS , IN CLASS 44 (U.S. CLS.  
100 AND 101).

FIRST USE 5-1-2007; IN COMMERCE 5-1-2007.

THE MARK CONSISTS OF STANDARD CHAR-  
ACTERS WITHOUT CLAIM TO ANY PARTICULAR  
FONT, STYLE, SIZE, OR COLOR.

SER. NO. 77-403,348, FILED 2-21-2008.

AMY HELLA, EXAMINING ATTORNEY

**Int. Cl.: 16**

**Prior U.S. Cls.: 2, 5, 22, 23, 29, 37, 38 and 50**

**Reg. No. 3,505,033**

**United States Patent and Trademark Office**

**Registered Sep. 23, 2008**

**TRADEMARK  
PRINCIPAL REGISTER**

**TREASURED TABS**

TIME INDEX, INC. (ARIZONA CORPORATION)  
4441-A WEST POLK STREET  
PHOENIX, AZ 85043

THE MARK CONSISTS OF STANDARD CHARACTERS WITHOUT CLAIM TO ANY PARTICULAR FONT, STYLE, SIZE, OR COLOR.

FOR: MARKING AND STATIONERY TABS, TABBED DIVIDER PAGES MADE OF PAPER, DIVIDER PAGES MADE OF PAPER, FILE FOLDERS, STORAGE ENVELOPES, STORAGE BOXES MADE OF PAPER, IN CLASS 16 (U.S. CLS. 2, 5, 22, 23, 29, 37, 38 AND 50).

NO CLAIM IS MADE TO THE EXCLUSIVE RIGHT TO USE "TABS", APART FROM THE MARK AS SHOWN.

SER. NO. 77-403,361, FILED 2-21-2008.

FIRST USE 2-0-2008; IN COMMERCE 2-0-2008.

JEAN IM, EXAMINING ATTORNEY

Int. Cl.: 16

Prior U.S. Cls.: 2, 5, 22, 23, 29, 37, 38 and 50

United States Patent and Trademark Office

Reg. No. 3,505,034

Registered Sep. 23, 2008

TRADEMARK  
PRINCIPAL REGISTER



TIME INDEX, INC. (ARIZONA CORPORATION)  
4441-A WEST POLK STREET  
PHOENIX, AZ 85043

FOR: MARKING AND STATIONERY TABS, TAB-  
BED DIVIDER PAGES MADE OF PAPER, DIVIDER  
PAGES MADE OF PAPER, FILE FOLDERS, STO-  
RAGE ENVELOPES, STORAGE BOXES MADE OF  
PAPER, IN CLASS 16 (U.S. CLS. 2, 5, 22, 23, 29, 37, 38  
AND 50).

FIRST USE 2-18-2008; IN COMMERCE 2-18-2008.

NO CLAIM IS MADE TO THE EXCLUSIVE  
RIGHT TO USE "TABS" AND "SCRAPBOOK",  
APART FROM THE MARK AS SHOWN.

SER. NO. 77-403,367, FILED 2-21-2008.

JEAN IM, EXAMINING ATTORNEY

**Int. Cl.: 9**

**Prior U.S. Cls.: 21, 23, 26, 36 and 38**

**United States Patent and Trademark Office**

**Reg. No. 3,505,035**

**Registered Sep. 23, 2008**

**TRADEMARK  
PRINCIPAL REGISTER**

**TYREX**

TYREX GROUP, LTD. (TEXAS PARTNERSHIP)  
2433 RUTLAND DRIVE  
AUSTIN, TX 78758

FOR: ELECTRONIC CABLE ASSEMBLIES FOR  
USE IN TELECOMMUNICATION AND ELECTRO-  
NICS, IN CLASS 9 (U.S. CLS. 21, 23, 26, 36 AND 38).

FIRST USE 1-1-2000; IN COMMERCE 1-1-2000.

THE MARK CONSISTS OF STANDARD CHAR-  
ACTERS WITHOUT CLAIM TO ANY PARTICULAR  
FONT, STYLE, SIZE, OR COLOR.

OWNER OF U.S. REG. NO. 2,163,460.

SER. NO. 77-403,397, FILED 2-22-2008.

ELIZABETH HUGHITT, EXAMINING ATTORNEY

**Int. Cl.: 35**

**Prior U.S. Cls.: 100, 101 and 102**

**United States Patent and Trademark Office**

**Reg. No. 3,505,036**

**Registered Sep. 23, 2008**

**SERVICE MARK  
PRINCIPAL REGISTER**

**BRANDTASTIC**

BRANDTASTIC LLC (FLORIDA LIMITED LIABILITY COMPANY)  
117 E. AMELIA STREET  
ORLANDO, FL 32801

THE MARK CONSISTS OF STANDARD CHARACTERS WITHOUT CLAIM TO ANY PARTICULAR FONT, STYLE, SIZE, OR COLOR.

FOR: ADVERTISING AND MARKETING, IN CLASS 35 (U.S. CLS. 100, 101 AND 102).

SER. NO. 77-403,424, FILED 2-22-2008.

FIRST USE 2-11-2008; IN COMMERCE 2-11-2008.

CAROLINE WOOD, EXAMINING ATTORNEY

**Int. Cl.: 6**

**Prior U.S. Cls.: 2, 12, 13, 14, 23, 25 and 50**

**Reg. No. 3,505,037**

**United States Patent and Trademark Office**

**Registered Sep. 23, 2008**

---

**TRADEMARK  
PRINCIPAL REGISTER**

**CAPILATOR**

WOLVERINE TUBE, INC. (DELAWARE COR-  
PORATION)  
SUITE 1000  
200 CLINTON AVENUE WEST  
HUNTSVILLE, AL 35801

THE MARK CONSISTS OF STANDARD CHAR-  
ACTERS WITHOUT CLAIM TO ANY PARTICULAR  
FONT, STYLE, SIZE, OR COLOR.

FOR: METAL TUBING, IN CLASS 6 (U.S. CLS. 2,  
12, 13, 14, 23, 25 AND 50).

SER. NO. 77-403,491, FILED 2-22-2008.

FIRST USE 1-10-1949; IN COMMERCE 1-10-1949.

DORITT L. CARROLL, EXAMINING ATTORNEY

**Int. Cl.: 9**

**Prior U.S. Cls.: 21, 23, 26, 36 and 38**

**Reg. No. 3,505,038**

**United States Patent and Trademark Office**

**Registered Sep. 23, 2008**

---

**TRADEMARK  
PRINCIPAL REGISTER**

*Sportage*

PHOENIX PERFORMANCE PRODUCTS INC.  
(CANADA CORPORATION)  
6955 COLUMBUS ROAD  
MISSISSAUGA, ONTARIO, CANADA L5T1K1

FIRST USE 3-31-2002; IN COMMERCE 3-31-2002.

THE MARK CONSISTS OF THE STYLIZED  
WORDING "SPORTAGE".

FOR: PROTECTIVE HELMETS; SAFETY EQUIP-  
MENT, NAMELY, SAFETY HELMETS FOR EQUES-  
TRIAN SPORTS, IN CLASS 9 (U.S. CLS. 21, 23, 26, 36  
AND 38).

SER. NO. 77-403,537, FILED 2-22-2008.

LINDA M. KING, EXAMINING ATTORNEY



**Int. Cl.: 45**

**Prior U.S. Cls.: 100 and 101**

**United States Patent and Trademark Office**

**Reg. No. 3,505,039**

**Registered Sep. 23, 2008**

**SERVICE MARK  
PRINCIPAL REGISTER**

**FLH**

FROMMER LAWRENCE & HAUG LLP (NEW  
YORK LIMITED LIABILITY PARTNERSHIP)  
745 FIFTH AVENUE  
NEW YORK, NY 10151

THE MARK CONSISTS OF STANDARD CHAR-  
ACTERS WITHOUT CLAIM TO ANY PARTICULAR  
FONT, STYLE, SIZE, OR COLOR.

FOR: LEGAL SERVICES, IN CLASS 45 (U.S. CLS.  
100 AND 101).

SER. NO. 77-403,555, FILED 2-22-2008.

FIRST USE 6-1-2006; IN COMMERCE 6-1-2006.

JAY FLOWERS, EXAMINING ATTORNEY

**Int. Cl.: 37**

**Prior U.S. Cls.: 100, 103 and 106**

**United States Patent and Trademark Office**

**Reg. No. 3,505,040**

**Registered Sep. 23, 2008**

**SERVICE MARK  
PRINCIPAL REGISTER**

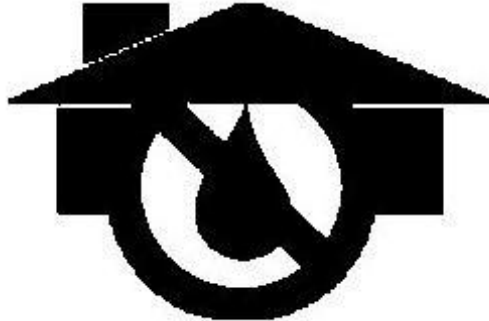

JORDAN ROOF COMPANY (CALIFORNIA CORPORATION)  
915 W. COLLINS AVE.  
ORANGE, CA 92867

THE MARK CONSISTS OF A HOUSE WITH A PROHIBITORY SIGN OVER A WATER/RAIN DROP.

FOR: ROOFING CONTRACTOR SERVICES ; INSTALLATION OF ROOFS, IN CLASS 37 (U.S. CLS. 100, 103 AND 106).

SER. NO. 77-403,585, FILED 2-22-2008.

FIRST USE 5-1-1987; IN COMMERCE 5-1-1987.

JACLYN KIDWELL, EXAMINING ATTORNEY

**Int. Cl.: 2**

**Prior U.S. Cls.: 6, 11 and 16**

**United States Patent and Trademark Office**

**Reg. No. 3,505,041**

**Registered Sep. 23, 2008**

**TRADEMARK  
PRINCIPAL REGISTER**



THE VALSPAR CORPORATION (DELAWARE CORPORATION)  
1101 SOUTH THIRD STREET  
MINNEAPOLIS, MN 55415

FOR: PAINTS AND STAINS FOR EXTERIOR AND INTERIOR USE ON A VARIETY OF SUBSTATES, IN CLASS 2 (U.S. CLS. 6, 11 AND 16).

FIRST USE 5-0-2007; IN COMMERCE 5-0-2007.

NO CLAIM IS MADE TO THE EXCLUSIVE RIGHT TO USE "COLORFAST" AND "FADE RESISTANT FORMULA", APART FROM THE MARK AS SHOWN.

SER. NO. 77-403,613, FILED 2-22-2008.

ANNE E. GUSTASON, EXAMINING ATTORNEY

**Int. Cl.: 5**

**Prior U.S. Cls.: 6, 18, 44, 46, 51 and 52**

**United States Patent and Trademark Office**

**Reg. No. 3,505,042**

**Registered Sep. 23, 2008**

**TRADEMARK  
PRINCIPAL REGISTER**

**HEMRIL-30**

UPSHER-SMITH LABORATORIES, INC. (MINNE-  
SOTA CORPORATION)  
6701 EVENSTAD DRIVE  
MAPLE GROVE, MN 55369

FOR: PHARMACEUTICAL PREPARATIONS,  
NAMELY, RECTAL SUPPOSITORIES, IN CLASS 5  
(U.S. CLS. 6, 18, 44, 46, 51 AND 52).

FIRST USE 8-2-2000; IN COMMERCE 8-2-2000.

THE MARK CONSISTS OF STANDARD CHAR-  
ACTERS WITHOUT CLAIM TO ANY PARTICULAR  
FONT, STYLE, SIZE, OR COLOR.

SER. NO. 77-403,622, FILED 2-22-2008.

SAMUEL E. SHARPER JR., EXAMINING ATTOR-  
NEY

**Int. Cl.: 9**

**Prior U.S. Cls.: 21, 23, 26, 36 and 38**

**Reg. No. 3,505,043**

**United States Patent and Trademark Office**

**Registered Sep. 23, 2008**

**TRADEMARK  
PRINCIPAL REGISTER**

**HOME DIRECTOR**

HOME DIRECTOR, INC. (DELAWARE CORPORATION)  
900 E. HAMILTON AVENUE, SUITE 550  
CAMPBELL, CA 95008

FOR: COMPUTER HARDWARE AND SOFTWARE FOR USE IN CONTROLLING ELECTRICAL FUNCTIONS WITHIN RESIDENCES AND COMMERCIAL BUILDINGS, AND INSTRUCTION MANUALS SOLD AS A UNIT THEREWITH, IN CLASS 9 (U.S. CLS. 21, 23, 26, 36 AND 38).

FIRST USE 8-0-1996; IN COMMERCE 8-0-1996.

THE MARK CONSISTS OF STANDARD CHARACTERS WITHOUT CLAIM TO ANY PARTICULAR FONT, STYLE, SIZE, OR COLOR.

OWNER OF U.S. REG. NO. 2,555,172.

NO CLAIM IS MADE TO THE EXCLUSIVE RIGHT TO USE "HOME", APART FROM THE MARK AS SHOWN.

SER. NO. 77-403,639, FILED 2-22-2008.

ALYSSA PALADINO, EXAMINING ATTORNEY

**Int. Cl.: 25**

**Prior U.S. Cls.: 22 and 39**

**United States Patent and Trademark Office**

**Reg. No. 3,505,044**

**Registered Sep. 23, 2008**

**TRADEMARK  
PRINCIPAL REGISTER**

**ENVOSY**

ENVOSY MASON LLC (COLORADO LIMITED  
LIABILITY COMPANY)  
700 COLORADO BOULEVARD  
DENVER, CO 80206

FOR: DRESS SHIRTS; LONG-SLEEVED SHIRTS;  
OPEN-NECKED SHIRTS; SHIRTS; SHIRTS FOR  
SUITS; SHORT-SLEEVED OR LONG-SLEEVED T-  
SHIRTS; SHORT-SLEEVED SHIRTS; SPORT SHIRTS;  
T-SHIRTS; TEE SHIRTS; TIES, IN CLASS 25 (U.S.  
CLS. 22 AND 39).

FIRST USE 1-28-2007; IN COMMERCE 1-28-2007.

THE MARK CONSISTS OF STANDARD CHAR-  
ACTERS WITHOUT CLAIM TO ANY PARTICULAR  
FONT, STYLE, SIZE, OR COLOR.

SER. NO. 77-403,669, FILED 2-22-2008.

JASON TURNER, EXAMINING ATTORNEY

Int. Cl.: 25

Prior U.S. Cls.: 22 and 39

United States Patent and Trademark Office

Reg. No. 3,505,045

Registered Sep. 23, 2008

TRADEMARK  
PRINCIPAL REGISTER



GRASS COLLECTION, LLC (ARIZONA LIMITED LIABILITY COMPANY), DBA NESTING BABY  
4815 E. CAREFREE HWY #108-167  
CAVE CREEK, AZ 85331

FOR: CHILDREN'S CLOTHING, APPAREL AND ACCESSORIES, NAMELY, DRESSES, SKIRTS, SHORT SLEEVED AND LONG SLEEVED SHIRTS, BLOUSES, TOPS, T-SHIRTS, SWEATERS, VESTS, SHORTS, PANTS, JEANS, JACKETS, COATS, OVERALLS, TIGHTS, SOCKS, SWEATSHIRTS, SWEATPANTS, FOOTWEAR, HEADWEAR, SLEEPWEAR, SWIM WEAR, ROBES, SCARVES, HEADBANDS, CAPS AND BELTS, IN CLASS 25 (U.S. CLS. 22 AND 39).

FIRST USE 4-6-2006; IN COMMERCE 8-1-2006.

THE MARK CONSISTS OF A FLOWERY VINE BORDER WITH THE FANCIFUL TEXT "NESTING BABY" AND TWO BUTTERFLIES WITHIN THE BORDER, THE TEXT "NESTING BABY" HAVING POLKA DOTS, BOWS ON THE "N", "T" AND "Y", A BIRD ON THE "B", A NEST WITH A BIRD IN THE NEST RESTING ON A BEND OF THE "N", AND A FLOWER FOR THE DOTS OF THE "I".

SER. NO. 77-403,690, FILED 2-22-2008.

SAIMA MAKHDOOM, EXAMINING ATTORNEY

**Int. Cl.: 12**

**Prior U.S. Cls.: 19, 21, 23, 31, 35 and 44**

**Reg. No. 3,505,046**

**United States Patent and Trademark Office**

**Registered Sep. 23, 2008**

**TRADEMARK  
PRINCIPAL REGISTER**

**UPLAND**

AMERICA - GW, LLC (TEXAS LIMITED LIABILITY COMPANY), DBA GOLDEN WHEEL AMERICA  
SUITE 200  
4925 GREENVILLE AVE  
DALLAS, TX 75206

THE MARK CONSISTS OF STANDARD CHARACTERS WITHOUT CLAIM TO ANY PARTICULAR FONT, STYLE, SIZE, OR COLOR.

FOR: BICYCLES, IN CLASS 12 (U.S. CLS. 19, 21, 23, 31, 35 AND 44).

SER. NO. 77-403,698, FILED 2-22-2008.

FIRST USE 11-1-2006; IN COMMERCE 11-1-2006.

RONALD DELGIZZI, EXAMINING ATTORNEY



**Int. Cl.: 1**

**Prior U.S. Cls.: 1, 5, 6, 10, 26 and 46**

**Reg. No. 3,505,047**

**United States Patent and Trademark Office**

**Registered Sep. 23, 2008**

**TRADEMARK  
PRINCIPAL REGISTER**



PLANT PRODUCTS CO. LTD. (CANADA CORPORATION)  
314 ORENIDA ROAD  
BRAMPTON, CANADA L6T1G1

THE MARK CONSISTS OF A DESIGN OF A PLANT WITH ROOTS.

FOR: FERTILIZERS, IN CLASS 1 (U.S. CLS. 1, 5, 6, 10, 26 AND 46).

SER. NO. 77-403,711, FILED 2-22-2008.

FIRST USE 12-31-1995; IN COMMERCE 12-31-1995.

JASON LOTT, EXAMINING ATTORNEY

**Int. Cl.: 30**

**Prior U.S. Cl.: 46**

**United States Patent and Trademark Office**

**Reg. No. 3,505,048**

**Registered Sep. 23, 2008**

**TRADEMARK  
PRINCIPAL REGISTER**

**KEITH HARING**

THE CO-EXECUTRIXES OF THE ESTATE OF  
KEITH HARING (NEW YORK ESTATE)  
676 BROADWAY  
NEW YORK, NY 10012

FOR: CHOCOLATES AND COOKIES, IN CLASS 30  
(U.S. CL. 46).

FIRST USE 8-0-2007; IN COMMERCE 8-0-2007.

THE MARK CONSISTS OF STANDARD CHAR-  
ACTERS WITHOUT CLAIM TO ANY PARTICULAR  
FONT, STYLE, SIZE, OR COLOR.

OWNER OF U.S. REG. NOS. 2,413,748 AND  
2,413,749.

THE NAME "KEITH HARING" SHOWN IN THE  
MARK DOES NOT IDENTIFY A PARTICULAR  
LIVING INDIVIDUAL.

SER. NO. 77-403,725, FILED 2-22-2008.

EDWARD NELSON, EXAMINING ATTORNEY

**Int. Cl.: 16**

**Prior U.S. Cls.: 2, 5, 22, 23, 29, 37, 38 and 50**

**United States Patent and Trademark Office**

**Reg. No. 3,505,049**

**Registered Sep. 23, 2008**

**TRADEMARK  
PRINCIPAL REGISTER**

**WRITING GREEN**

ECCOLO LTD. (NEW YORK CORPORATION)  
1425 37TH STREET  
BROOKLYN, NY 11218

FOR: BLANK JOURNAL BOOKS; BLANK JOURNALS; BLANK WRITING JOURNALS; WRITING JOURNAL SHEETS; ADDRESS BOOKS AND DIARIES; CALENDARS AND DIARIES; CALENDAR DESK PADS; CALENDAR REFILLS; DESK CALENDARS; POCKET CALENDARS; PRINTED CALENDARS; WALL CALENDARS; BLANK PAPER NOTEBOOKS; NOTEBOOK DIVIDERS; NOTEBOOK PAPER; WIRE-BOUND NOTEBOOKS; DESK PADS; DRAWING PADS; EASEL PADS; LOOSE-LEAF PADS; MEMO PADS; NOTE PAD HOLDERS; NOTE PADS; SCRATCH PADS; SCRIBBLE PADS; SKETCH PADS; WRITING PADS; MEMO BLOCKS; MEMO SORTERS; ART AND PHOTOGRAPH PORTFOLIO CASES; DOCUMENT PORTFOLIOS; STATIONERY-TYPE PORTFOLIOS; FOLDERS; PRESENTATION FOLDERS; STATIONERY FOLDERS; ENVELOPES FOR STATIONERY USE; OFFICE PAPER STATION-

ERY; OFFICE STATIONERY; ORGANIZERS FOR STATIONERY USE; PAPER STATIONERY; STATIONERY; STATIONERY BOXES; STATIONERY CASES; STATIONERY WRITING PAPER AND ENVELOPES; BRAG BOOKS; MEMORY BOOKS; MINI PHOTO ALBUMS; PHOTO STORAGE BOXES; PHOTOGRAPH ALBUM PAGES; PHOTOGRAPH ALBUMS; SCRAPBOOK ALBUMS; STAMP ALBUMS; STICKER ALBUMS; WEDDING ALBUMS; PICTURE FRAMING MAT BOARDS; NOTE PAPER; LETTER-HEAD PAPER; LOOSE LEAF PAPER, IN CLASS 16 (U.S. CLS. 2, 5, 22, 23, 29, 37, 38 AND 50).

FIRST USE 1-1-2008; IN COMMERCE 2-15-2008.

THE MARK CONSISTS OF STANDARD CHARACTERS WITHOUT CLAIM TO ANY PARTICULAR FONT, STYLE, SIZE, OR COLOR.

SER. NO. 77-403,787, FILED 2-22-2008.

MICHAEL SOUDERS, EXAMINING ATTORNEY

**Int. Cl.: 35**

**Prior U.S. Cls.: 100, 101 and 102**

**United States Patent and Trademark Office**

**Reg. No. 3,505,050**

**Registered Sep. 23, 2008**

**SERVICE MARK  
PRINCIPAL REGISTER**

**SENDOUTS**

SENDOUTS, LLC (MISSOURI LIMITED LIABILITY COMPANY)  
200 SOUTH HANLEY  
ST. LOUIS, MO 63105

FOR: COMPUTERIZED DATABASE MANAGEMENT; AND STAFFING SERVICES, NAMELY, EMPLOYEE COUNSELING AND RECRUITMENT AND PERSONAL MANAGEMENT FOR PROFESSIONALS IN THE STAFFING, RECRUITING AND JOB PLACEMENT INDUSTRY VIA A GLOBAL COMPUTER NETWORK, IN CLASS 35 (U.S. CLS. 100, 101 AND 102).

FIRST USE 5-0-2000; IN COMMERCE 5-0-2000.

THE MARK CONSISTS OF STANDARD CHARACTERS WITHOUT CLAIM TO ANY PARTICULAR FONT, STYLE, SIZE, OR COLOR.

OWNER OF U.S. REG. NOS. 2,530,681 AND 2,551,999.

SER. NO. 77-403,818, FILED 2-22-2008.

SETH A. RAPPAPORT, EXAMINING ATTORNEY

**Int. Cl.: 18**

**Prior U.S. Cls.: 1, 2, 3, 22 and 41**

**United States Patent and Trademark Office**

**Reg. No. 3,505,051**

**Registered Sep. 23, 2008**

**TRADEMARK  
PRINCIPAL REGISTER**

**MODERN IMAGES**

NAVY EXCHANGE SERVICE COMMAND  
("NEXCOM"), A NONAPPROPRIATED FUND  
INSTRUMENTALITY UNDER THE DEPT. OF  
NAVY, AN AGENCY OF THE UNITED  
STATES OF AMERICA (UNITED STATES  
FEDERAL AGENCY)

3280 VIRGINIA BEACH BLVD.  
VIRGINIA BEACH, VA 23452

FOR: GOODS MADE OF LEATHER, IMITATION  
LEATHER, AND SYNTHETIC MATERIALS, NAME-  
LY, PURSES, CLUTCHES, TRAVEL BAGS, ALL  
PURPOSE ATHLETIC BAGS, SHOPPING BAGS,  
TOTE BAGS, KEY CASES, KEY FOBS, AND BELTS,  
IN CLASS 18 (U.S. CLS. 1, 2, 3, 22 AND 41).

FIRST USE 12-1-2000; IN COMMERCE 12-1-2000.

THE MARK CONSISTS OF STANDARD CHAR-  
ACTERS WITHOUT CLAIM TO ANY PARTICULAR  
FONT, STYLE, SIZE, OR COLOR.

OWNER OF U.S. REG. NO. 3,041,432.

SER. NO. 77-403,885, FILED 2-22-2008.

SHAUNIA CARLYLE, EXAMINING ATTORNEY

**Int. Cl.: 16**

**Prior U.S. Cls.: 2, 5, 22, 23, 29, 37, 38 and 50**

**United States Patent and Trademark Office**

**Reg. No. 3,505,052**

**Registered Sep. 23, 2008**

**TRADEMARK  
PRINCIPAL REGISTER**

**RESTAURANT CONFIDENTIAL**

INTRANET-ZONES, INC. (MASSACHUSETTS  
CORPORATION)  
90 YORK STREET  
MANSFIELD, MA 02048

FOR: PUBLICATIONS, NAMELY, MAGAZINES  
IN THE FIELDS OF RESTAURANTS, IN CLASS 16  
(U.S. CLS. 2, 5, 22, 23, 29, 37, 38 AND 50).

FIRST USE 1-15-2007; IN COMMERCE 1-15-2007.

THE MARK CONSISTS OF STANDARD CHAR-  
ACTERS WITHOUT CLAIM TO ANY PARTICULAR  
FONT, STYLE, SIZE, OR COLOR.

NO CLAIM IS MADE TO THE EXCLUSIVE  
RIGHT TO USE "RESTAURANT", APART FROM  
THE MARK AS SHOWN.

SER. NO. 77-403,952, FILED 2-22-2008.

GEOFFREY FOSDICK, EXAMINING ATTORNEY

**Int. Cl.: 9**

**Prior U.S. Cls.: 21, 23, 26, 36 and 38**

**United States Patent and Trademark Office**

**Reg. No. 3,505,053**

**Registered Sep. 23, 2008**

**TRADEMARK  
PRINCIPAL REGISTER**

**THE MOMENT BOX**

NICHOLAS JAMES SAZDANOFF (UNITED STATES INDIVIDUAL)  
SUITE 329  
2727 29TH ST NW  
WASHINGTON, DC 20008

THE MARK CONSISTS OF STANDARD CHARACTERS WITHOUT CLAIM TO ANY PARTICULAR FONT, STYLE, SIZE, OR COLOR.

FOR: BOX CAMERA, IN CLASS 9 (U.S. CLS. 21, 23, 26, 36 AND 38).

SER. NO. 77-403,975, FILED 2-22-2008.

FIRST USE 2-19-2008; IN COMMERCE 2-19-2008.

LESLIE RICHARDS, EXAMINING ATTORNEY

**Int. Cl.: 3**

**Prior U.S. Cls.: 1, 4, 6, 50, 51 and 52**

**Reg. No. 3,505,054**

**United States Patent and Trademark Office**

**Registered Sep. 23, 2008**

**TRADEMARK  
PRINCIPAL REGISTER**

**NIGENOL**

BIOPHARM R&D CORPORATION LIMITED  
(UNITED KINGDOM CORPORATION)  
1162 MILLWOOD POND DRIVE  
HERNDON, VA 20170

FOR: BODY AND BEAUTY CARE COSMETICS,  
CLEANSING CREAMS, COSMETIC CREAMS, COS-  
METIC CREAMS FOR SKIN CARE, COSMETIC  
PREPARATIONS AGAINST SUNBURN, COSMETIC  
PREPARATIONS FOR SKIN RENEWAL, NUTRI-  
TIONAL OILS FOR COSMETIC PURPOSES, SHAM-  
POOS, TOPICAL SKIN SPRAYS FOR COSMETIC  
PURPOSES, HAIR AND SKIN CONDITIONERS,  
BODY, HAND AND FACE LOTIONS, BODY, HAND

AND FACE CLEANSERS, BODY, HAND AND FACE  
MASKS, IN CLASS 3 (U.S. CLS. 1, 4, 6, 50, 51 AND 52).

FIRST USE 6-0-2007; IN COMMERCE 6-0-2007.

THE MARK CONSISTS OF STANDARD CHAR-  
ACTERS WITHOUT CLAIM TO ANY PARTICULAR  
FONT, STYLE, SIZE, OR COLOR.

SER. NO. 77-404,000, FILED 2-22-2008.

JULIE WATSON, EXAMINING ATTORNEY



**Int. Cl.: 35**

**Prior U.S. Cls.: 100, 101 and 102**

**United States Patent and Trademark Office**

**Reg. No. 3,505,055**

**Registered Sep. 23, 2008**

**SERVICE MARK  
PRINCIPAL REGISTER**



BRADLEY INDUSTRIAL TECHNOLOGY CORP.  
(MISSOURI CORPORATION), DBA BRITECH  
2035 DELMAR BOULEVARD  
SAINT LOUIS, MO 631031620

FOR: ART GALLERIES, IN CLASS 35 (U.S. CLS.  
100, 101 AND 102).

FIRST USE 3-31-2007; IN COMMERCE 3-31-2007.

OWNER OF U.S. REG. NO. 2,646,172.

THE COLOR(S) RED, GREEN, AND BLUE IS/ARE  
CLAIMED AS A FEATURE OF THE MARK.

THE MARK CONSISTS OF A RED ARTISTS' PALETTE WHICH FORMS A STYLIZED REPRESENTATION OF THE LETTER "A", A STYLIZED RED PAINTBRUSH WITH A GREEN TIP WHICH VERTICALLY BISECTS THE ARTISTS' PALLET, A GREEN NUMERAL "2" IN STYLIZED TYPE, AND A BLUE MICROMETER WHICH FORMS A STYLIZED REPRESENTATION OF THE LETTER "P". THE LITERAL ELEMENT OF THE MARK IS OVERLAPPING, OFFSET, AND CASCADING DOWNWARDS, INTENDING TO EVOKE THE FIRST CHARACTERS OF THE SYLLABLES OF THE NAME "ART2PART".

SER. NO. 77-404,036, FILED 2-22-2008.

LINDA E. BLOHM, EXAMINING ATTORNEY

Int. Cl.: 21

Prior U.S. Cls.: 2, 13, 23, 29, 30, 33, 40 and 50

Reg. No. 3,505,056

United States Patent and Trademark Office

Registered Sep. 23, 2008

TRADEMARK  
PRINCIPAL REGISTER

The logo for 'Margaux' is written in a highly decorative, cursive script. The letter 'M' is particularly large and ornate, with a large loop at the top. The rest of the word 'argaux' follows in a similar, elegant cursive style.

MONROE HAIR CARE LLC (FLORIDA LIMITED  
LIABILITY COMPANY)  
1325 DIPLOMAT PARKWAY  
HOLLYWOOD, FL 33019

THE MARK CONSISTS OF STYLIZED WORDS.

FOR: HAIR BRUSHES; HAIR COMBS, IN CLASS  
21 (U.S. CLS. 2, 13, 23, 29, 30, 33, 40 AND 50).

SER. NO. 77-404,054, FILED 2-22-2008.

FIRST USE 9-21-2007; IN COMMERCE 10-25-2007.

REBECCA SMITH, EXAMINING ATTORNEY

**Int. Cl.: 28**

**Prior U.S. Cls.: 22, 23, 38 and 50**

**Reg. No. 3,505,057**

**United States Patent and Trademark Office**

**Registered Sep. 23, 2008**

---

**TRADEMARK  
PRINCIPAL REGISTER**

**mr2**

ASIA ACCESS, INC. (MINNESOTA CORPORATION)  
1123 RIVERWOOD DRIVE  
BURNSVILLE, MN 55337

THE MARK CONSISTS OF STANDARD CHARACTERS WITHOUT CLAIM TO ANY PARTICULAR FONT, STYLE, SIZE, OR COLOR.

FOR: BALL BEARINGS FOR IN-LINE SKATES; BALL BEARINGS FOR ROLLER SKATES; BALL BEARINGS FOR SKATEBOARDS, IN CLASS 28 (U.S. CLS. 22, 23, 38 AND 50).

SER. NO. 77-404,069, FILED 2-22-2008.

FIRST USE 10-1-2006; IN COMMERCE 10-1-2006.

KATINA MISTER, EXAMINING ATTORNEY

**Int. Cl.: 21**

**Prior U.S. Cls.: 2, 13, 23, 29, 30, 33, 40 and 50**

**United States Patent and Trademark Office**

**Reg. No. 3,505,058**

**Registered Sep. 23, 2008**

---

**TRADEMARK  
PRINCIPAL REGISTER**

**RELIADENT**

TELLA-TECH, INCORPORATED (FLORIDA  
CORPORATION)  
SUITE 303  
3325 HOLLYWOOD BOULEVARD  
HOLLYWOOD, FL 33021

THE MARK CONSISTS OF STANDARD CHAR-  
ACTERS WITHOUT CLAIM TO ANY PARTICULAR  
FONT, STYLE, SIZE, OR COLOR.

FOR: TOOTHBRUSHES; DENTAL FLOSS; ELEC-  
TRIC TOOTHBRUSHES; TOOTHBRUSH HOLDERS,  
IN CLASS 21 (U.S. CLS. 2, 13, 23, 29, 30, 33, 40 AND 50).

SER. NO. 77-404,105, FILED 2-22-2008.

FIRST USE 8-31-1993; IN COMMERCE 8-31-1993.

GEORGE LORENZO, EXAMINING ATTORNEY

**Int. Cl.: 35**

**Prior U.S. Cls.: 100, 101 and 102**

**United States Patent and Trademark Office**

**Reg. No. 3,505,059**

**Registered Sep. 23, 2008**

**SERVICE MARK  
PRINCIPAL REGISTER**

**ART2PART**

BRADLEY INDUSTRIAL TECHNOLOGY CORP.  
(MISSOURI CORPORATION), DBA BRITECH  
2035 DELMAR BOULEVARD  
SAINT LOUIS, MO 631031620

FOR: ART GALLERIES, IN CLASS 35 (U.S. CLS.  
100, 101 AND 102).

FIRST USE 3-31-2007; IN COMMERCE 3-31-2007.

THE MARK CONSISTS OF STANDARD CHAR-  
ACTERS WITHOUT CLAIM TO ANY PARTICULAR  
FONT, STYLE, SIZE, OR COLOR.

OWNER OF U.S. REG. NO. 2,646,172.

SER. NO. 77-404,108, FILED 2-22-2008.

LINDA E. BLOHM, EXAMINING ATTORNEY

**Int. Cl.: 36**

**Prior U.S. Cls.: 100, 101 and 102**

**United States Patent and Trademark Office**

**Reg. No. 3,505,060**

**Registered Sep. 23, 2008**

**SERVICE MARK  
PRINCIPAL REGISTER**

# XBanker

TXB, LLC (WYOMING LIMITED LIABILITY  
COMPANY)  
348 MILL ST  
RENO, NV 89501

FOR: FINANCIAL ADVICE; FINANCIAL ADVICE AND CONSULTANCY SERVICES; FINANCIAL ADVISORY AND CONSULTANCY SERVICES; FINANCIAL ANALYSES; FINANCIAL ANALYSIS AND CONSULTATION; FINANCIAL CONSULTANCY; FINANCIAL CONSULTATION; FINANCIAL CONSULTING; FINANCIAL DUE DILIGENCE; FINANCIAL FORECASTING; FINANCIAL INFORMATION AND ADVISORY SERVICES; FINANCIAL INFORMATION AND EVALUATIONS; FINANCIAL INFORMATION IN THE NATURE OF RATES OF EXCHANGE; FINANCIAL INFORMATION PROVIDED BY ELECTRONIC MEANS; FINANCIAL LOAN CONSULTATION; FINANCIAL PLANNING; FINANCIAL PLANNING CONSULTATION; FINANCIAL PLANNING, NAMELY, THE CREATION OF

PERSONALIZED STRATEGIES TO ACHIEVE FINANCIAL INDEPENDENCE; PROVIDING FINANCIAL INFORMATION; PROVIDING ON-LINE FINANCIAL CALCULATORS; PROVISION OF FINANCIAL INFORMATION; CREDIT AND FINANCIAL CONSULTATION; CREDIT CONSULTATION; DEBT COUNSELING SERVICES; DEBT MANAGEMENT CONSULTATION; PROVIDING ON-LINE NEWS IN THE FIELD OF FINANCE, IN CLASS 36 (U.S. CLS. 100, 101 AND 102).

FIRST USE 1-14-2008; IN COMMERCE 1-28-2008.

THE MARK CONSISTS OF STANDARD CHARACTERS WITHOUT CLAIM TO ANY PARTICULAR FONT, STYLE, SIZE, OR COLOR.

SER. NO. 77-404,139, FILED 2-22-2008.

FLORENTINA BLANDU, EXAMINING ATTORNEY

**Int. Cl.: 41**

**Prior U.S. Cls.: 100, 101 and 107**

**United States Patent and Trademark Office**

**Reg. No. 3,505,061**

**Registered Sep. 23, 2008**

**SERVICE MARK  
PRINCIPAL REGISTER**

**INSTUDIO**

JODY H. NYENHUIS (UNITED STATES INDIVIDUAL)  
212 N. MAIN ST.  
STILLWATER, MN 55082

THE MARK CONSISTS OF STANDARD CHARACTERS WITHOUT CLAIM TO ANY PARTICULAR FONT, STYLE, SIZE, OR COLOR.

FOR: PHOTOGRAPHY SERVICES, IN CLASS 41 (U.S. CLS. 100, 101 AND 107).

SER. NO. 77-404,199, FILED 2-22-2008.

FIRST USE 12-16-2004; IN COMMERCE 12-16-2004.

ALYSSA PALADINO, EXAMINING ATTORNEY

Int. Cl.: 36

Prior U.S. Cls.: 100, 101 and 102

**United States Patent and Trademark Office**

**Reg. No. 3,505,062**

Registered Sep. 23, 2008

**SERVICE MARK  
PRINCIPAL REGISTER**

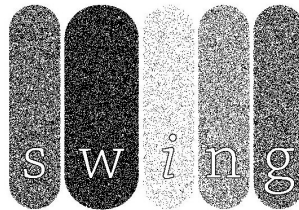

SWING REAL ESTATE & DEVELOPMENT  
GROUP INC. (ARIZONA CORPORATION)

#109

8585 E. HARTFORD DRIVE  
SCOTTSDALE, AZ 85255

FOR: REAL ESTATE BROKERAGE, IN CLASS 36  
(U.S. CLS. 100, 101 AND 102).

FIRST USE 8-1-2007; IN COMMERCE 8-1-2007.

THE STIPLING IS FOR SHADING PURPOSES  
ONLY.

THE MARK CONSISTS OF FIVE VERTICAL  
ROUNDED BARS WITH THE STYLIZED LETTERS  
OF THE WORD "SWING" IN EACH BAR.

SER. NO. 77-404,266, FILED 2-22-2008.

DORITT L. CARROLL, EXAMINING ATTORNEY



**Int. Cls.: 35 and 36**

**Prior U.S. Cls.: 100, 101 and 102**

**United States Patent and Trademark Office**

**Reg. No. 3,505,063**

**Registered Sep. 23, 2008**

**SERVICE MARK  
PRINCIPAL REGISTER**

**KAIZEN**

KAIZEN REALTY PARTNERS, LLC (FLORIDA  
LIMITED LIABILITY COMPANY)  
8800 NW 23RD STREET  
DORAL, FL 33172

FOR: PROVIDING REAL ESTATE LEADS FOR PROSPECTIVE PURCHASERS; REAL ESTATE ADVERTISING SERVICES; REAL ESTATE AUCTIONS; REAL ESTATE MARKETING SERVICES, NAMELY, ON-LINE SERVICES FEATURING TOURS OF RESIDENTIAL AND COMMERCIAL REAL ESTATE; REAL ESTATE MARKETING SERVICES, NAMELY, ONLINE SERVICES FEATURING THE PROMOTION OF RESIDENTIAL NEW CONSTRUCTION, WHICH ALSO CONTAINS BACK OFFICE SOLUTIONS FOR BUILDERS; REAL ESTATE SALES MANAGEMENT, IN CLASS 35 (U.S. CLS. 100, 101 AND 102).

FIRST USE 1-7-2008; IN COMMERCE 1-7-2008.

FOR: FINANCIAL INVESTMENT IN THE FIELD OF REAL ESTATE; FINANCIAL VALUATION OF PERSONAL PROPERTY AND REAL ESTATE; LAND ACQUISITION, NAMELY, REAL ESTATE BROKERAGE; LEASING OF REAL ESTATE; PROVIDING INFORMATION IN THE FIELD OF REAL ESTATE BY MEANS OF LINKING THE WEB SITE TO OTHER WEB SITES FEATURING REAL ESTATE INFORMATION; PROVIDING INFORMATION IN

THE FIELD OF REAL ESTATE VIA THE INTERNET; PROVIDING REAL ESTATE LISTINGS AND REAL ESTATE INFORMATION VIA THE INTERNET; REAL ESTATE ACQUISITION SERVICES; REAL ESTATE BROKERAGE; REAL ESTATE CONSULTANCY; REAL ESTATE CONSULTATION; REAL ESTATE EQUITY SHARING, NAMELY, MANAGING AND ARRANGING FOR CO-OWNERSHIP OF REAL ESTATE; REAL ESTATE INVESTMENT; REAL ESTATE INVESTMENT SERVICES IN THE NATURE OF PURCHASING AND SELLING OF REAL ESTATE FOR OTHERS; REAL ESTATE LISTING; REAL ESTATE MANAGEMENT CONSULTATION; REAL ESTATE MULTIPLE LISTING SERVICES, IN CLASS 36 (U.S. CLS. 100, 101 AND 102).

FIRST USE 1-7-2008; IN COMMERCE 1-7-2008.

THE MARK CONSISTS OF STANDARD CHARACTERS WITHOUT CLAIM TO ANY PARTICULAR FONT, STYLE, SIZE, OR COLOR.

THE ENGLISH TRANSLATION OF THE WORD "KAIZEN" IN THE MARK IS "CONTINUOUS IMPROVEMENT".

SER. NO. 77-404,268, FILED 2-22-2008.

DAVID MURRAY, EXAMINING ATTORNEY

**Int. Cl.: 28**

**Prior U.S. Cls.: 22, 23, 38 and 50**

**United States Patent and Trademark Office**

**Reg. No. 3,505,064**

**Registered Sep. 23, 2008**

**TRADEMARK  
PRINCIPAL REGISTER**

**POWER PAWS**

SCHMIDT, MONICA (UNITED STATES INDIVIDUAL)  
PO BOX 5695  
LIGHTHOUSE POINT, FL 33064

THE MARK CONSISTS OF STANDARD CHARACTERS WITHOUT CLAIM TO ANY PARTICULAR FONT, STYLE, SIZE, OR COLOR.

FOR: ATHLETIC SPORTING GOODS, NAMELY, ATHLETIC WRIST AND JOINT SUPPORTS, IN CLASS 28 (U.S. CLS. 22, 23, 38 AND 50).

SER. NO. 77-404,273, FILED 2-22-2008.

FIRST USE 5-1-2006; IN COMMERCE 5-1-2006.

DORITT L. CARROLL, EXAMINING ATTORNEY

**Int. Cl.: 41**

**Prior U.S. Cls.: 100, 101 and 107**

**United States Patent and Trademark Office**

**Reg. No. 3,505,065**

**Registered Sep. 23, 2008**

**SERVICE MARK  
PRINCIPAL REGISTER**

**BVT PUBLISHING**

BEST VALUE TEXTBOOKS, LLC (CALIFORNIA  
LIMITED LIABILITY COMPANY)  
SUITE 200  
410 HEMSTED DRIVE  
REDDING, CA 96002

FOR: PUBLISHING OF COLLEGE TEXTBOOKS,  
IN CLASS 41 (U.S. CLS. 100, 101 AND 107).

FIRST USE 1-29-2008; IN COMMERCE 1-29-2008.

THE MARK CONSISTS OF STANDARD CHAR-  
ACTERS WITHOUT CLAIM TO ANY PARTICULAR  
FONT, STYLE, SIZE, OR COLOR.

NO CLAIM IS MADE TO THE EXCLUSIVE  
RIGHT TO USE "PUBLISHING", APART FROM  
THE MARK AS SHOWN.

SER. NO. 77-404,307, FILED 2-22-2008.

KAREN K. BUSH, EXAMINING ATTORNEY

**Int. Cl.: 44**

**Prior U.S. Cls.: 100 and 101**

**United States Patent and Trademark Office**

**Reg. No. 3,505,066**

**Registered Sep. 23, 2008**

**SERVICE MARK  
PRINCIPAL REGISTER**

**Test with Confidence**

WESTERN PSYCHOLOGICAL SERVICES (CALI-  
FORNIA CORPORATION)  
12031 WILSHIRE BOULEVARD  
LOS ANGELES, CA 90025

THE MARK CONSISTS OF STANDARD CHAR-  
ACTERS WITHOUT CLAIM TO ANY PARTICULAR  
FONT, STYLE, SIZE, OR COLOR.

FOR: PSYCHOLOGICAL TESTING, IN CLASS 44  
(U.S. CLS. 100 AND 101).

SER. NO. 77-404,314, FILED 2-22-2008.

FIRST USE 10-15-2007; IN COMMERCE 1-1-2008.

DORITT L. CARROLL, EXAMINING ATTORNEY

**Int. Cl.: 35**

**Prior U.S. Cls.: 100, 101 and 102**

**United States Patent and Trademark Office**

**Reg. No. 3,505,067**

**Registered Sep. 23, 2008**

**SERVICE MARK  
PRINCIPAL REGISTER**

# Stoplight

FOCUS ON THE FAMILY ACTION, INC. (COL-  
ORADO CORPORATION)  
LEGAL DEPARTMENT  
8655 EXPLORER DRIVE  
COLORADO SPRINGS, CO 80920

FOR: PROVIDING ON-LINE INFORMATION,  
NAMELY, COMMENTARY IN THE FIELD OF  
PUBLIC POLICY, IN CLASS 35 (U.S. CLS. 100, 101  
AND 102).

FIRST USE 5-23-2007; IN COMMERCE 5-23-2007.

THE MARK CONSISTS OF STANDARD CHAR-  
ACTERS WITHOUT CLAIM TO ANY PARTICULAR  
FONT, STYLE, SIZE, OR COLOR.

SER. NO. 77-404,337, FILED 2-22-2008.

DORITT L. CARROLL, EXAMINING ATTORNEY

**Int. Cl.: 41**

**Prior U.S. Cls.: 100, 101 and 107**

**United States Patent and Trademark Office**

**Reg. No. 3,505,068**

**Registered Sep. 23, 2008**

**SERVICE MARK  
PRINCIPAL REGISTER**

**J2**

J2, INC. (CALIFORNIA CORPORATION)  
11684 VENTURA BLVD., SUITE 968  
STUDIO CITY, CA 91604

THE MARK CONSISTS OF STANDARD CHAR-  
ACTERS WITHOUT CLAIM TO ANY PARTICULAR  
FONT, STYLE, SIZE, OR COLOR.

FOR: ENTERTAINMENT SERVICES, NAMELY,  
PRODUCTION OF MOTION PICTURE AND TELE-  
VISION PROGRAMS, SHOWS, FILMS AND VIDEOS,  
IN CLASS 41 (U.S. CLS. 100, 101 AND 107).

SER. NO. 77-404,372, FILED 2-22-2008.

FIRST USE 1-30-2003; IN COMMERCE 1-30-2003.

ANDREA SAUNDERS, EXAMINING ATTORNEY

**Int. Cl.: 36**

**Prior U.S. Cls.: 100, 101 and 102**

**United States Patent and Trademark Office**

**Reg. No. 3,505,069**

**Registered Sep. 23, 2008**

**SERVICE MARK  
PRINCIPAL REGISTER**

**"Wealth Has Meaning"**

WHM CAPITAL ADVISORS, LLC (SOUTH CAROLINA LIMITED LIABILITY COMPANY)  
1310 LADY ST, STE 800  
COLUMBIA, SC 29201

FOR: FINANCIAL SERVICES IN THE FIELD OF MONEY LENDING; FINANCIAL SERVICES IN THE NATURE OF AN INVESTMENT SECURITY; FINANCIAL SERVICES, NAMELY, A TOTAL PORTFOLIO OFFERING FOR HIGH NET WORTH CLIENTS CONSISTING OF BOTH SEPARATE ACCOUNTS AND MUTUAL FUNDS FOR EQUITY AND FIXED INCOME INVESTMENTS; FINANCIAL SERVICES, NAMELY, ASSISTING OTHERS WITH THE COMPLETION OF FINANCIAL TRANSACTIONS FOR STOCKS, BONDS, SECURITIES AND EQUITIES; FINANCIAL SERVICES, NAMELY, ESTATE SETTLEMENT SERVICES; FINANCIAL SERVICES, NAMELY, INVESTMENT FUND TRANSFER AND TRANSACTION SERVICES; FINANCIAL SERVICES, NAMELY, PROVIDING FOR THE EXCHANGE OF FOREIGN CURRENCY, COMMODITIES, FINANCIAL DERIVATIVES, INTEREST RATE PRODUCTS, AND EQUITIES VIA THE INTERNET AND INTRANET SYSTEMS; INVESTMENT MANAGEMENT; INVESTMENT MAN-

AGEMENT OF AND DISTRIBUTION OF ANNUITIES; INVESTMENT MANAGEMENT OF AND DISTRIBUTION OF VARIABLE ANNUITIES; INVESTMENT MANAGEMENT SERVICES IN THE FIELD OF ACQUIRING JOINT VENTURES; PUBLIC EQUITY INVESTMENT MANAGEMENT; FINANCIAL PLANNING; FINANCIAL PLANNING AND INVESTMENT ADVISORY SERVICES; FINANCIAL PLANNING CONSULTATION; FINANCIAL PLANNING FOR RETIREMENT; FINANCIAL PLANNING, NAMELY, THE CREATION OF PERSONALIZED STRATEGIES TO ACHIEVE FINANCIAL INDEPENDENCE; ONLINE FINANCIAL PLANNING SERVICES, IN CLASS 36 (U.S. CLS. 100, 101 AND 102).

FIRST USE 1-1-2008; IN COMMERCE 1-1-2008.

THE MARK CONSISTS OF STANDARD CHARACTERS WITHOUT CLAIM TO ANY PARTICULAR FONT, STYLE, SIZE, OR COLOR.

SER. NO. 77-404,377, FILED 2-22-2008.

JOHN DALIER, EXAMINING ATTORNEY

**Int. Cl.: 25**

**Prior U.S. Cls.: 22 and 39**

**United States Patent and Trademark Office**

**Reg. No. 3,505,070**

**Registered Sep. 23, 2008**

**TRADEMARK  
PRINCIPAL REGISTER**

# Moxsters

MOXY SPORTSWEAR LLC (INDIANA LIMITED  
LIABILITY COMPANY)  
6011 EAST HANNA AVE., SUITE "P"  
INDIANAPOLIS, IN 46203

FOR: SPORTSWEAR, NAMELY, SHIRTS, JERSEYS, T-SHIRTS, SWEATSHIRTS, HOODED SWEATSHIRTS, HATS, PANTS, SHORTS, JACKETS, COATS, AND JOGGING OUTFITS; FOOTWEAR, IN CLASS 25 (U.S. CLS. 22 AND 39).

FIRST USE 7-31-2007; IN COMMERCE 7-31-2007.

THE MARK CONSISTS OF STANDARD CHARACTERS WITHOUT CLAIM TO ANY PARTICULAR FONT, STYLE, SIZE, OR COLOR.

SER. NO. 77-404,382, FILED 2-22-2008.

JOHN DALIER, EXAMINING ATTORNEY



**Int. Cl.: 25**

**Prior U.S. Cls.: 22 and 39**

**United States Patent and Trademark Office**

**Reg. No. 3,505,071**

**Registered Sep. 23, 2008**

**TRADEMARK  
PRINCIPAL REGISTER**

**Show your Moxsters**

MOXY SPORTSWEAR LLC (INDIANA LIMITED  
LIABILITY COMPANY)  
6011 EAST HANNA AVE., SUITE "P"  
INDIANAPOLIS, IN 46203

FOR: SPORTSWEAR, NAMELY, SHIRTS, JERSEYS, T-SHIRTS, SWEATSHIRTS, HOODED SWEATSHIRTS, HATS, PANTS, SHORTS, JACKETS, COATS, AND JOGGING OUTFITS; FOOTWEAR, IN CLASS 25 (U.S. CLS. 22 AND 39).

FIRST USE 7-31-2007; IN COMMERCE 7-31-2007.

THE MARK CONSISTS OF STANDARD CHARACTERS WITHOUT CLAIM TO ANY PARTICULAR FONT, STYLE, SIZE, OR COLOR.

SER. NO. 77-404,390, FILED 2-22-2008.

JOHN DALIER, EXAMINING ATTORNEY

**Int. Cl.: 8**

**Prior U.S. Cls.: 23, 28 and 44**

**United States Patent and Trademark Office**

**Reg. No. 3,505,072**

**Registered Sep. 23, 2008**

**TRADEMARK  
PRINCIPAL REGISTER**

**PRIVATE SETTING**

SCHMITZ, JULIE (UNITED STATES INDIVIDUAL)  
9655 SHADOWSTONE WAY  
RENO, NV 89521

THE MARK CONSISTS OF STANDARD CHARACTERS WITHOUT CLAIM TO ANY PARTICULAR FONT, STYLE, SIZE, OR COLOR.

FOR: TABLEWARE, NAMELY, KNIVES, FORKS AND SPOONS, IN CLASS 8 (U.S. CLS. 23, 28 AND 44).

SER. NO. 77-404,406, FILED 2-22-2008.

FIRST USE 12-1-2007; IN COMMERCE 2-15-2008.

ALICIA COLLINS, EXAMINING ATTORNEY

**Int. Cl.: 28**

**Prior U.S. Cls.: 22, 23, 38 and 50**

**United States Patent and Trademark Office**

**Reg. No. 3,505,073**

**Registered Sep. 23, 2008**

**TRADEMARK  
PRINCIPAL REGISTER**

# Naughty Charades

PFF ENTERTAINMENT, LLC (NEW YORK LIMITED LIABILITY COMPANY)

201 EAST 87TH STREET, SUITE 3D

NEW YORK, NY 10128

FOR: BOARD GAMES; CARD GAMES; DICE GAMES, IN CLASS 28 (U.S. CLS. 22, 23, 38 AND 50).

FIRST USE 2-12-2008; IN COMMERCE 2-12-2008.

THE MARK CONSISTS OF STANDARD CHARACTERS WITHOUT CLAIM TO ANY PARTICULAR FONT, STYLE, SIZE, OR COLOR.

NO CLAIM IS MADE TO THE EXCLUSIVE RIGHT TO USE "CHARADES", APART FROM THE MARK AS SHOWN.

SER. NO. 77-404,453, FILED 2-22-2008.

DAVID YONTEF, EXAMINING ATTORNEY

**Int. Cl.: 25**

**Prior U.S. Cls.: 22 and 39**

**United States Patent and Trademark Office**

**Reg. No. 3,505,074**

**Registered Sep. 23, 2008**

**TRADEMARK  
PRINCIPAL REGISTER**

**yoli-poli**

YOLI-POLI LLC (CALIFORNIA LIMITED LIABILITY COMPANY)  
6342 VENTURA CANYON AVE.  
VALLEY GLEN, CA 91401

FOR: DRESSES; PANTS; SHORT-SLEEVED OR LONG-SLEEVED T-SHIRTS; SKIRTS AND DRESSES; T-SHIRTS; YOGA PANTS, IN CLASS 25 (U.S. CLS. 22 AND 39).

FIRST USE 1-0-2005; IN COMMERCE 1-0-2005.

THE MARK CONSISTS OF STANDARD CHARACTERS WITHOUT CLAIM TO ANY PARTICULAR FONT, STYLE, SIZE, OR COLOR.

SER. NO. 77-404,488, FILED 2-23-2008.

JUDITH HELFMAN, EXAMINING ATTORNEY

**Int. Cl.: 35**

**Prior U.S. Cls.: 100, 101 and 102**

**United States Patent and Trademark Office**

**Reg. No. 3,505,075**

**Registered Sep. 23, 2008**

**SERVICE MARK  
PRINCIPAL REGISTER**

**resumeNEXT**

BRADLEY, ALISON A. (UNITED STATES INDIVIDUAL)  
186 W. SHOSHONE ST.  
VENTURA, CA 93001

FOR: PROVIDING AN INTERACTIVE WEB SITE THAT FACILITATES THE PREPARATION OF RESUMES; RESUME PREPARATION; ON-LINE ADVERTISING AND MARKETING SERVICES, IN CLASS 35 (U.S. CLS. 100, 101 AND 102).

FIRST USE 8-1-2007; IN COMMERCE 2-1-2008.

THE MARK CONSISTS OF STANDARD CHARACTERS WITHOUT CLAIM TO ANY PARTICULAR FONT, STYLE, SIZE, OR COLOR.

SER. NO. 77-404,537, FILED 2-23-2008.

PETER B. BROMAGHIM, EXAMINING ATTORNEY

**Int. Cl.: 25**

**Prior U.S. Cls.: 22 and 39**

**United States Patent and Trademark Office**

**Reg. No. 3,505,076**

**Registered Sep. 23, 2008**

**TRADEMARK  
PRINCIPAL REGISTER**

**IT'S A SPA THING**

DAIGLE, SHERI C. (UNITED STATES INDIVIDUAL)  
SUITE D  
2946 JAMACHA ROAD  
EL CAJON, CA 92019

FOR: SHORT-SLEEVED OR LONG-SLEEVED T-SHIRTS; DENIM JACKETS; HEAVY JACKETS; JACKETS; APRONS; POLO SHIRTS; SWEAT PANTS; SWEAT SHIRTS; SWEAT SHORTS; BASEBALL CAPS; CAP VISORS; ROBES , IN CLASS 25 (U.S. CLS. 22 AND 39).

FIRST USE 2-15-2008; IN COMMERCE 2-15-2008.

THE MARK CONSISTS OF STANDARD CHARACTERS WITHOUT CLAIM TO ANY PARTICULAR FONT, STYLE, SIZE, OR COLOR.

SER. NO. 77-404,538, FILED 2-23-2008.

PETER B. BROMAGHIM, EXAMINING ATTORNEY

**Int. Cl.: 16**

**Prior U.S. Cls.: 2, 5, 22, 23, 29, 37, 38 and 50**

**United States Patent and Trademark Office**

**Reg. No. 3,505,077**

**Registered Sep. 23, 2008**

**TRADEMARK  
PRINCIPAL REGISTER**

**crosskeywords**

DELELLIS, CHRIS (UNITED STATES INDIVIDUAL)  
11883 MAGNOLIA FALLS DR  
JACKSONVILLE, FL 32258

THE MARK CONSISTS OF STANDARD CHARACTERS WITHOUT CLAIM TO ANY PARTICULAR FONT, STYLE, SIZE, OR COLOR.

FOR: CROSSWORD PUZZLES, IN CLASS 16 (U.S. CLS. 2, 5, 22, 23, 29, 37, 38 AND 50).

SER. NO. 77-404,580, FILED 2-23-2008.

FIRST USE 8-1-2007; IN COMMERCE 10-1-2007.

JAY BESCH, EXAMINING ATTORNEY

**Int. Cl.: 41**

**Prior U.S. Cls.: 100, 101 and 107**

**United States Patent and Trademark Office**

**Reg. No. 3,505,078**

**Registered Sep. 23, 2008**

**SERVICE MARK  
PRINCIPAL REGISTER**

**Eric Lee**

LEE, ERIC (UNITED STATES INDIVIDUAL)  
208-19 32ND AVE  
BAYSIDE, NY 11361

THE MARK CONSISTS OF STANDARD CHAR-  
ACTERS WITHOUT CLAIM TO ANY PARTICULAR  
FONT, STYLE, SIZE, OR COLOR.

FOR: ENTERTAINMENT SERVICES IN THE  
NATURE OF LIVE MUSICAL PERFORMANCES,  
IN CLASS 41 (U.S. CLS. 100, 101 AND 107).

SER. NO. 77-404,581, FILED 2-23-2008.

FIRST USE 11-20-2004; IN COMMERCE 11-20-2004.

JAY BESCH, EXAMINING ATTORNEY



**Int. Cl.: 40**

**Prior U.S. Cls.: 100, 103 and 106**

**United States Patent and Trademark Office**

**Reg. No. 3,505,079**

**Registered Sep. 23, 2008**

**SERVICE MARK  
PRINCIPAL REGISTER**

# Visualize

FRANCHISE CONCEPTS, INC. (DELAWARE  
CORPORATION)  
101 SOUTH HANLEY, SUITE 1280  
ST. LOUIS, MO 63105

THE MARK CONSISTS OF STANDARD CHAR-  
ACTERS WITHOUT CLAIM TO ANY PARTICULAR  
FONT, STYLE, SIZE, OR COLOR.

FOR: FRAMING OF WORKS OF ART, IN CLASS  
40 (U.S. CLS. 100, 103 AND 106).

SER. NO. 77-404,582, FILED 2-23-2008.

FIRST USE 12-1-2007; IN COMMERCE 12-1-2007.

JENNIFER MARTIN, EXAMINING ATTORNEY

**Int. Cl.: 41**

**Prior U.S. Cls.: 100, 101 and 107**

**United States Patent and Trademark Office**

**Reg. No. 3,505,080**

**Registered Sep. 23, 2008**

**SERVICE MARK  
PRINCIPAL REGISTER**

**WikiFur**

PARRY, LAURENCE OM (UNITED KINGDOM  
INDIVIDUAL)  
15090 N BECK ROAD STE. 300  
PLYMOUTH, MI 48170

FOR: PROVIDING AN ONLINE PUBLICATION  
IN THE NATURE OF AN INTERACTIVE ENCY-  
CLOPEDIA IN THE FIELD OF ANTHROPOMORPH-  
IC ANIMALS; ELECTRONIC PUBLISHING  
SERVICES, NAMELY, PUBLICATION OF TEXT  
AND GRAPHIC WORKS OF OTHERS ON THE  
INTERNET FEATURING ANTHROPOMORPHIC  
ANIMALS; PROVIDING INFORMATION, NEWS  
AND COMMENTARY IN THE FIELD OF RECREA-

TION AND LEISURE ACTIVITIES, IN CLASS 41 (U.S.  
CLS. 100, 101 AND 107).

FIRST USE 7-24-2005; IN COMMERCE 8-4-2005.

THE MARK CONSISTS OF STANDARD CHAR-  
ACTERS WITHOUT CLAIM TO ANY PARTICULAR  
FONT, STYLE, SIZE, OR COLOR.

SER. NO. 77-404,609, FILED 2-23-2008.

AMEETA JORDAN, EXAMINING ATTORNEY

**Int. Cl.: 25**

**Prior U.S. Cls.: 22 and 39**

**United States Patent and Trademark Office**

**Reg. No. 3,505,081**

**Registered Sep. 23, 2008**

**TRADEMARK  
PRINCIPAL REGISTER**

**pondür**

PONDUR INC. (GEORGIA CORPORATION)  
572 EDGEWOOD AVENUE #207  
ATLANTA, GA 30312

FOR: CLOTHING, NAMELY, SHIRTS, SHORTS,  
SWEATSHIRTS, SWEATPANTS, SWEAT SUITS,  
GOLF SHIRTS, SHIRTS FOR BABIES, AND HATS,  
IN CLASS 25 (U.S. CLS. 22 AND 39).

FIRST USE 6-1-2006; IN COMMERCE 6-1-2006.

THE MARK CONSISTS OF STANDARD CHAR-  
ACTERS WITHOUT CLAIM TO ANY PARTICULAR  
FONT, STYLE, SIZE, OR COLOR.

OWNER OF U.S. REG. NO. 3,372,971.

SER. NO. 77-404,615, FILED 2-24-2008.

KATHERINE E. HALMEN, EXAMINING ATTOR-  
NEY

**Int. Cl.: 35**

**Prior U.S. Cls.: 100, 101 and 102**

**United States Patent and Trademark Office**

**Reg. No. 3,505,082**

**Registered Sep. 23, 2008**

**SERVICE MARK  
PRINCIPAL REGISTER**

**RIGHT MAKES MIGHT**

HAMMERLE, JUDE K. (UNITED STATES INDIVIDUAL)  
58 SUTTON ROAD  
WARWICK, NY 10990

FOR: BUSINESS CONSULTING SERVICES, NAMELY, PROVIDING ASSISTANCE IN DEVELOPMENT BUSINESS STRATEGIES AND CREATIVE IDEATION, IN CLASS 35 (U.S. CLS. 100, 101 AND 102).

FIRST USE 2-24-2008; IN COMMERCE 2-24-2008.

THE MARK CONSISTS OF STANDARD CHARACTERS WITHOUT CLAIM TO ANY PARTICULAR FONT, STYLE, SIZE, OR COLOR.

SER. NO. 77-404,628, FILED 2-24-2008.

GEOFFREY FOSDICK, EXAMINING ATTORNEY

**Int. Cl.: 20**

**Prior U.S. Cls.: 2, 13, 22, 25, 32 and 50**

**Reg. No. 3,505,083**

**United States Patent and Trademark Office**

**Registered Sep. 23, 2008**

**TRADEMARK  
PRINCIPAL REGISTER**



NUTMEG INDUSTRIES, INC. (CALIFORNIA CORPORATION), DBA ROLL-A-SHADE

#E

29885 2ND STREET  
LAKE ELSINORE, CA 92532

FOR: INTERIOR WINDOW COVERINGS, NAME-  
LY, BLINDS AND SHADES, IN CLASS 20 (U.S. CLS.  
2, 13, 22, 25, 32 AND 50).

FIRST USE 11-30-2007; IN COMMERCE 11-30-2007.

OWNER OF U.S. REG. NO. 2,494,489.

THE MARK CONSISTS OF THREE ARCHES  
ABOVE THE WORD "ROLL" WHICH IS PART OF  
THE WORDS "ROLL-A-SHADE".

SER. NO. 77-404,673, FILED 2-24-2008.

CAROL SPILS, EXAMINING ATTORNEY

**Int. Cl.: 42**

**Prior U.S. Cls.: 100 and 101**

**United States Patent and Trademark Office**

**Reg. No. 3,505,084**

**Registered Sep. 23, 2008**

**SERVICE MARK  
PRINCIPAL REGISTER**

# RocketFuel

ROCKETFUEL, LLC (TENNESSEE LIMITED LIABILITY COMPANY)  
SUITE 625  
80 MONROE AVENUE  
MEMPHIS, TN 38103

FOR: COMPUTER SERVICES, NAMELY, DESIGNING AND IMPLEMENTING WEB SITES FOR OTHERS; HOSTING THE WEB SITES OF OTHERS ON A COMPUTER SERVER FOR A GLOBAL COMPUTER NETWORK , IN CLASS 42 (U.S. CLS. 100 AND 101).

FIRST USE 2-1-2008; IN COMMERCE 2-1-2008.

THE MARK CONSISTS OF STANDARD CHARACTERS WITHOUT CLAIM TO ANY PARTICULAR FONT, STYLE, SIZE, OR COLOR.

SER. NO. 77-404,675, FILED 2-24-2008.

MAYUR VAGHANI, EXAMINING ATTORNEY

**Int. Cl.: 35**

**Prior U.S. Cls.: 100, 101 and 102**

**United States Patent and Trademark Office**

**Reg. No. 3,505,085**

**Registered Sep. 23, 2008**

**SERVICE MARK  
PRINCIPAL REGISTER**

# THE ROSTER

HENDRICK, NILS (UNITED STATES INDIVIDUAL)  
#347  
3000-F DANVILLE BLVD.  
ALAMO, CA 94507

FOR: ELECTRONIC COMMERCE SERVICES, NAMELY, PROVIDING INFORMATION ABOUT PRODUCTS VIA TELECOMMUNICATION NETWORKS FOR ADVERTISING AND SALES PURPOSES; CREATIVE MARKETING DESIGN SERVICES; DESIGN OF ADVERTISING MATERIALS FOR OTHERS; DESIGN OF INTERNET ADVERTISING; BUSINESS CONSULTING SERVICES, NAMELY, PROVIDING ASSISTANCE IN DEVELOPMENT BUSINESS STRATEGIES AND CREATIVE IDEATION; BUSINESS MANAGEMENT CONSULTANCY AS WELL AS DEVELOPMENT OF PROCESSES FOR

THE ANALYSIS AND THE IMPLEMENTATION OF STRATEGY PLANS AND MANAGEMENT PROJECTS; PROMOTING THE GOODS AND SERVICES OF OTHERS THROUGH SEARCH ENGINE REFERRAL TRAFFIC ANALYSIS AND REPORTING, IN CLASS 35 (U.S. CLS. 100, 101 AND 102).

FIRST USE 3-1-2007; IN COMMERCE 3-1-2007.

THE MARK CONSISTS OF STANDARD CHARACTERS WITHOUT CLAIM TO ANY PARTICULAR FONT, STYLE, SIZE, OR COLOR.

SER. NO. 77-404,816, FILED 2-25-2008.

ERNEST SHOSHO, EXAMINING ATTORNEY

**Int. Cls.: 35 and 36**

**Prior U.S. Cls.: 100, 101 and 102**

**United States Patent and Trademark Office**

**Reg. No. 3,505,086**

**Registered Sep. 23, 2008**

**SERVICE MARK  
PRINCIPAL REGISTER**

**ON YOUR CORNER. IN YOUR  
CORNER.**

DIRECT GENERAL CORPORATION (TENNESSEE CORPORATION)  
LEGAL DEPARTMENT  
1281 MURFREESBORO ROAD  
NASHVILLE, TN 37217

FOR: INCOME TAX PREPARATION, IN CLASS 35 (U.S. CLS. 100, 101 AND 102).

FIRST USE 12-7-2007; IN COMMERCE 12-7-2007.

FOR: PROVIDING TEMPORARY LOANS; INSURANCE ADMINISTRATION IN THE FIELD OF AUTOMOBILE LIABILITY, PROPERTY, CASUALTY, PHYSICAL DAMAGE, LIFE INSURANCE; INSUR-

ANCE ADMINISTRATION SERVICES, NAMELY, ASSISTING OTHERS WITH ADJUSTING INSURANCE CLAIMS, IN CLASS 36 (U.S. CLS. 100, 101 AND 102).

FIRST USE 1-7-2008; IN COMMERCE 1-7-2008.

THE MARK CONSISTS OF STANDARD CHARACTERS WITHOUT CLAIM TO ANY PARTICULAR FONT, STYLE, SIZE, OR COLOR.

SER. NO. 77-404,939, FILED 2-25-2008.

AMY ALFIERI, EXAMINING ATTORNEY



**Int. Cl.: 36**

**Prior U.S. Cls.: 100, 101 and 102**

**United States Patent and Trademark Office**

**Reg. No. 3,505,087**

**Registered Sep. 23, 2008**

**SERVICE MARK  
PRINCIPAL REGISTER**



PROPAY USA, INC. (UTAH CORPORATION)  
500 TIMPANOGOS PARKWAY  
OREM, UT 84097

OWNER OF U.S. REG. NOS. 3,061,051, 3,384,847  
AND OTHERS.

FOR: FINANCIAL SERVICES, NAMELY, EN-  
ABLING ONLINE AND HOME BASED BUSINESSES  
TO MAKE AND RECEIVE PAYMENTS VIA TELE-  
PHONE, FACSIMILE, ONLINE AND WIRELESS  
APPLICATIONS, IN CLASS 36 (U.S. CLS. 100, 101  
AND 102).

THE MARK CONSISTS OF THE LETTERS "PRO-  
PAY" FOLLOWED BY DESIGN.

SER. NO. 77-404,955, FILED 2-25-2008.

FIRST USE 5-30-2000; IN COMMERCE 5-30-2000.

MARIAM MAHMOUDI, EXAMINING ATTORNEY

**Int. Cl.: 36**

**Prior U.S. Cls.: 100, 101 and 102**

**United States Patent and Trademark Office**

**Reg. No. 3,505,088**

**Registered Sep. 23, 2008**

**SERVICE MARK  
PRINCIPAL REGISTER**

**The Key to Smarter Buying  
& Selling.**

LUCID REALTY, INC. (ILLINOIS CORPORATION)  
822 W. VILLAGE CT.  
CHICAGO, IL 60608

THE MARK CONSISTS OF STANDARD CHARACTERS WITHOUT CLAIM TO ANY PARTICULAR FONT, STYLE, SIZE, OR COLOR.

FOR: REAL ESTATE BROKERAGE, IN CLASS 36  
(U.S. CLS. 100, 101 AND 102).

SER. NO. 77-404,964, FILED 2-25-2008.

FIRST USE 2-22-2008; IN COMMERCE 2-22-2008.

MARIAM MAHMOUDI, EXAMINING ATTORNEY

**Int. Cl.: 41**

**Prior U.S. Cls.: 100, 101 and 107**

**United States Patent and Trademark Office**

**Reg. No. 3,505,089**

**Registered Sep. 23, 2008**

---

**SERVICE MARK  
PRINCIPAL REGISTER**

**VolleyPop**

VOLLEYPop, LLC (CALIFORNIA LIMITED LIABILITY COMPANY)  
1273 CANYON RIM CIRCLE  
WESTLAKE VILLAGE, CA 91362

THE MARK CONSISTS OF STANDARD CHARACTERS WITHOUT CLAIM TO ANY PARTICULAR FONT, STYLE, SIZE, OR COLOR.

FOR: EDUCATION SERVICES, NAMELY, PROVIDING INSTRUCTIONAL TRAINING IN THE FIELD OF VOLLEYBALL, IN CLASS 41 (U.S. CLS. 100, 101 AND 107).

SER. NO. 77-404,991, FILED 2-25-2008.

FIRST USE 1-2-2008; IN COMMERCE 1-8-2008.

SANJEEV VOHRA, EXAMINING ATTORNEY

**Int. Cl.: 35**

**Prior U.S. Cls.: 100, 101 and 102**

**United States Patent and Trademark Office**

**Reg. No. 3,505,090**

**Registered Sep. 23, 2008**

**SERVICE MARK  
PRINCIPAL REGISTER**

**The Natural Channel**

NATURAL TV CORPORATION (CALIFORNIA CORPORATION)  
5142 HOLLISTER AVE, #74  
SANTA BARBARA, CA 93111

FOR: ADVERTISING SERVICES; ADVERTISING AND MARKETING; ON-LINE ADVERTISING AND MARKETING SERVICES; ADVERTISING VIA ELECTRONIC MEDIA AND SPECIFICALLY THE INTERNET, IN CLASS 35 (U.S. CLS. 100, 101 AND 102).

FIRST USE 2-25-2008; IN COMMERCE 2-25-2008.

THE MARK CONSISTS OF STANDARD CHARACTERS WITHOUT CLAIM TO ANY PARTICULAR FONT, STYLE, SIZE, OR COLOR.

NO CLAIM IS MADE TO THE EXCLUSIVE RIGHT TO USE "CHANNEL", APART FROM THE MARK AS SHOWN.

SER. NO. 77-404,993, FILED 2-25-2008.

DAVID C. REIHNER, EXAMINING ATTORNEY

**Int. Cl.: 30**

**Prior U.S. Cl.: 46**

**United States Patent and Trademark Office**

**Reg. No. 3,505,091**

**Registered Sep. 23, 2008**

**TRADEMARK  
PRINCIPAL REGISTER**

**Casablanca Gardens**

ZINDA PRODUCTS CANADA INC. (CANADA  
CORPORATION)  
104 LIBERTÉ  
CANDIAC, CANADA J5R6X1

THE MARK CONSISTS OF STANDARD CHAR-  
ACTERS WITHOUT CLAIM TO ANY PARTICULAR  
FONT, STYLE, SIZE, OR COLOR.

FOR: PROCESSED SEMOLINA, IN CLASS 30 (U.S.  
CL. 46).

SER. NO. 77-405,025, FILED 2-25-2008.

FIRST USE 1-1-2007; IN COMMERCE 1-1-2007.

KIM MONINGHOFF, EXAMINING ATTORNEY

**Int. Cl.: 35**

**Prior U.S. Cls.: 100, 101 and 102**

**United States Patent and Trademark Office**

**Reg. No. 3,505,092**

**Registered Sep. 23, 2008**

---

**SERVICE MARK  
PRINCIPAL REGISTER**

**ESAGE**

SAGE PARTS PLUS, INC. (DELAWARE CORPORATION)  
25 DUBON COURT  
FARMINGDALE, NY 11735

THE MARK CONSISTS OF STANDARD CHARACTERS WITHOUT CLAIM TO ANY PARTICULAR FONT, STYLE, SIZE, OR COLOR.

FOR: ON-LINE ORDERING SERVICES IN THE FIELD OF REPLACEMENT PARTS FOR AVIATION GROUND SUPPORT EQUIPMENT, IN CLASS 35 (U.S. CLS. 100, 101 AND 102).

SER. NO. 77-405,064, FILED 2-25-2008.

FIRST USE 9-10-2000; IN COMMERCE 9-10-2000.

WENDY JUN, EXAMINING ATTORNEY

**Int. Cls.: 25 and 41**

**Prior U.S. Cls.: 22, 39, 100, 101 and 107**

**Reg. No. 3,505,093**

**United States Patent and Trademark Office**

**Registered Sep. 23, 2008**

**TRADEMARK  
SERVICE MARK  
PRINCIPAL REGISTER**

**SURVIVE N THRIVE**

ARISE MINISTRIES (OKLAHOMA NON-PROFIT ORGANIZATION)

P.O. BOX 2973

EDMOND, OK 73083

FOR: CLOTHING, NAMELY, TOPS, BOTTOMS, DRESSES, SKIRTS, SWEATERS, HEAD WEAR, GLOVES, SOCKS AND OUTERWEAR, NAMELY, JACKETS, COATS, AND RAINWEAR, IN CLASS 25 (U.S. CLS. 22 AND 39).

FIRST USE 6-30-2005; IN COMMERCE 6-30-2005.

FOR: CONDUCTING WORKSHOPS AND SEMINARS IN SELF-AWARENESS AND SPIRITUALITY, IN CLASS 41 (U.S. CLS. 100, 101 AND 107).

FIRST USE 6-30-2005; IN COMMERCE 6-30-2005.

THE MARK CONSISTS OF STANDARD CHARACTERS WITHOUT CLAIM TO ANY PARTICULAR FONT, STYLE, SIZE, OR COLOR.

SER. NO. 77-405,104, FILED 2-25-2008.

GILBERT SWIFT, EXAMINING ATTORNEY

**Int. Cl.: 13**

**Prior U.S. Cls.: 2 and 9**

**United States Patent and Trademark Office**

**Reg. No. 3,505,094**

**Registered Sep. 23, 2008**

**TRADEMARK  
PRINCIPAL REGISTER**

**FREEHAND**

JEFFREY L. SLESAR (UNITED STATES INDIVIDUAL)  
BOX 32  
FORTINE, MT 59918

THE MARK CONSISTS OF STANDARD CHARACTERS WITHOUT CLAIM TO ANY PARTICULAR FONT, STYLE, SIZE, OR COLOR.

FOR: QUICK-RELEASE SUPPORT STRAP DEVICE FOR FIREARMS, IN CLASS 13 (U.S. CLS. 2 AND 9).

SER. NO. 77-405,108, FILED 2-25-2008.

FIRST USE 12-31-2007; IN COMMERCE 12-31-2007.

APRIL HESIK, EXAMINING ATTORNEY



**Int. Cl.: 35**

**Prior U.S. Cls.: 100, 101 and 102**

**United States Patent and Trademark Office**

**Reg. No. 3,505,095**

**Registered Sep. 23, 2008**

**SERVICE MARK  
PRINCIPAL REGISTER**

**GIC**

GLOBAL INDUSTRIAL COMPONENTS, INC.  
(TENNESSEE CORPORATION)  
705 COLLEGE STREET  
WOODBURY, TN 37190

THE MARK CONSISTS OF STANDARD CHAR-  
ACTERS WITHOUT CLAIM TO ANY PARTICULAR  
FONT, STYLE, SIZE, OR COLOR.

FOR: DISTRIBUTORSHIP SERVICES IN THE  
FIELD OF AUTOMOTIVE PARTS, IN CLASS 35  
(U.S. CLS. 100, 101 AND 102).

SER. NO. 77-405,131, FILED 2-25-2008.

FIRST USE 12-0-1998; IN COMMERCE 12-0-1998.

DORITT L. CARROLL, EXAMINING ATTORNEY

**Int. Cl.: 35**

**Prior U.S. Cls.: 100, 101 and 102**

**United States Patent and Trademark Office**

**Reg. No. 3,505,096**

**Registered Sep. 23, 2008**

**SERVICE MARK  
PRINCIPAL REGISTER**

**SAGE PARTS**

SAGE PARTS PLUS, INC. (DELAWARE CORPORATION)  
25 DUBON COURT  
FARMINGDALE, NY 11735

FOR: DISTRIBUTORSHIP SERVICES IN THE FIELD OF REPLACEMENT PARTS FOR AVIATION GROUND SUPPORT EQUIPMENT, IN CLASS 35 (U.S. CLS. 100, 101 AND 102).

FIRST USE 1-28-1998; IN COMMERCE 1-28-1998.

THE MARK CONSISTS OF STANDARD CHARACTERS WITHOUT CLAIM TO ANY PARTICULAR FONT, STYLE, SIZE, OR COLOR.

NO CLAIM IS MADE TO THE EXCLUSIVE RIGHT TO USE "PARTS", APART FROM THE MARK AS SHOWN.

SER. NO. 77-405,135, FILED 2-25-2008.

WENDY JUN, EXAMINING ATTORNEY

**Int. Cl.: 9**

**Prior U.S. Cls.: 21, 23, 26, 36 and 38**

**Reg. No. 3,505,097**

**United States Patent and Trademark Office**

**Registered Sep. 23, 2008**

**TRADEMARK  
PRINCIPAL REGISTER**

LOGIC SUPPLY, INC. (VERMONT CORPORATION)  
35 THOMPSON STREET  
SOUTH BURLINGTON, VT 05403

FOR: DIGITAL COMPUTERS, IN CLASS 9 (U.S. CLS. 21, 23, 26, 36 AND 38).

FIRST USE 5-15-2006; IN COMMERCE 5-15-2006.

THE MARK CONSISTS OF THE WORD "LOGIC" IN ALL UPPER-CASE LETTERS ON A NEUTRAL

BACKGROUND. THE "G" IN "LOGIC" IS UNDERLINED. TO THE RIGHT OF THIS UNDERLINE IS THE WORD "SUPPLY" IN ALL UPPER-CASE LETTERS, SMALLER THAN THOSE USED FOR "LOGIC". THE WORD "SUPPLY" BEGINS DIRECTLY UNDER THE LETTER "I" IN "LOGIC" AND ENDS DIRECTLY UNDER THE LETTER "C" IN "LOGIC".

SER. NO. 77-405,143, FILED 2-25-2008.

BRIAN NEVILLE, EXAMINING ATTORNEY

**Int. Cl.: 21**

**Prior U.S. Cls.: 2, 13, 23, 29, 30, 33, 40 and 50**

**Reg. No. 3,505,098**

**United States Patent and Trademark Office**

**Registered Sep. 23, 2008**

---

**TRADEMARK  
PRINCIPAL REGISTER**

**NORCHILL**

NORCROSS MARINE PRODUCTS, INC (FLORIDA CORPORATION)  
STE 8  
6881 KINGSPONTE PKWY  
ORLANDO, FL 32819

THE MARK CONSISTS OF STANDARD CHARACTERS WITHOUT CLAIM TO ANY PARTICULAR FONT, STYLE, SIZE, OR COLOR.

FOR: PORTABLE ICE CHESTS FOR FOOD AND BEVERAGES, IN CLASS 21 (U.S. CLS. 2, 13, 23, 29, 30, 33, 40 AND 50).

SER. NO. 77-405,222, FILED 2-25-2008.

FIRST USE 1-15-2008; IN COMMERCE 1-15-2008.

ROBERT LAVACHE, EXAMINING ATTORNEY

**Int. Cls.: 35 and 40**

**Prior U.S. Cls.: 100, 101, 102, 103 and 106**

**United States Patent and Trademark Office**

**Reg. No. 3,505,099**

**Registered Sep. 23, 2008**

**SERVICE MARK  
PRINCIPAL REGISTER**

**GABRIEL GROUP**

WORDS, DATA AND IMAGES, LLC (MISSOURI  
LIMITED LIABILITY COMPANY)  
3190 RIDER TRAIL SOUTH  
EARTH CITY, MO 63045

FOR: DIRECT MAIL ADVERTISING AND PRO-  
MOTIONAL SERVICES, ORDER FULFILLMENT  
SERVICES, INVENTORY MANAGEMENT SERVI-  
CES IN THE FIELD OF PRINTING AND PRINTED  
MATERIALS, IN CLASS 35 (U.S. CLS. 100, 101 AND  
102).

FIRST USE 5-1-2003; IN COMMERCE 5-1-2003.

FOR: PRINTING, IN CLASS 40 (U.S. CLS. 100, 103  
AND 106).

FIRST USE 5-1-2003; IN COMMERCE 5-1-2003.

THE MARK CONSISTS OF STANDARD CHAR-  
ACTERS WITHOUT CLAIM TO ANY PARTICULAR  
FONT, STYLE, SIZE, OR COLOR.

OWNER OF U.S. REG. NO. 2,895,542.

NO CLAIM IS MADE TO THE EXCLUSIVE  
RIGHT TO USE "GROUP", APART FROM THE  
MARK AS SHOWN.

SER. NO. 77-405,322, FILED 2-25-2008.

JANICE L. MCMORROW, EXAMINING ATTOR-  
NEY

**Int. Cl.: 40**

**Prior U.S. Cls.: 100, 103 and 106**

**United States Patent and Trademark Office**

**Reg. No. 3,505,100**

**Registered Sep. 23, 2008**

**SERVICE MARK  
PRINCIPAL REGISTER**

**CLAD IT.**

EMS ENGINEERED MATERIALS SOLUTIONS,  
LLC (DELAWARE CORPORATION)  
39 PERRY AVENUE  
ATTLEBORO, GA 02703

FOR: CUSTOM MANUFACTURE OF CLAD METALS AND BIMETAL STRIPS AND SHEETS FOR USE IN MANUFACTURE OF FINISHED PRODUCTS; CUSTOM MANUFACTURE OF ELECTRICAL CONTACTS , IN CLASS 40 (U.S. CLS. 100, 103 AND 106).

FIRST USE 11-30-1978; IN COMMERCE 11-30-1978.

THE MARK CONSISTS OF STANDARD CHARACTERS WITHOUT CLAIM TO ANY PARTICULAR FONT, STYLE, SIZE, OR COLOR.

NO CLAIM IS MADE TO THE EXCLUSIVE RIGHT TO USE "CLAD", APART FROM THE MARK AS SHOWN.

SER. NO. 77-405,331, FILED 2-25-2008.

GEOFFREY FOSDICK, EXAMINING ATTORNEY

**Int. Cls.: 25 and 41**

**Prior U.S. Cls.: 22, 39, 100, 101 and 107**

**United States Patent and Trademark Office**

**Reg. No. 3,505,101**

**Registered Sep. 23, 2008**

**TRADEMARK  
SERVICE MARK  
PRINCIPAL REGISTER**

**SAREET**

ATIAS, SAREET (UNITED STATES INDIVIDUAL)  
6440 MARYLAND DRIVE  
LOS ANGELES, CA 90048

FOR: T-SHIRTS; TANK TOPS, IN CLASS 25 (U.S. CLS. 22 AND 39).

FIRST USE 1-1-1991; IN COMMERCE 3-31-2006.

FOR: ENTERTAINMENT IN THE NATURE OF LIVE PERFORMANCES BY SOLO ARTIST; ENTERTAINMENT SERVICES, NAMELY, PROVIDING A WEB SITE FEATURING MUSICAL PERFORMANCES, MUSICAL VIDEOS, RELATED FILM CLIPS, PHOTOGRAPHS, AND OTHER MULTIMEDIA MA-

TERIALS; ENTERTAINMENT, NAMELY, LIVE MUSIC CONCERTS, IN CLASS 41 (U.S. CLS. 100, 101 AND 107).

FIRST USE 1-1-1991; IN COMMERCE 3-31-2006.

THE MARK CONSISTS OF STANDARD CHARACTERS WITHOUT CLAIM TO ANY PARTICULAR FONT, STYLE, SIZE, OR COLOR.

SER. NO. 77-405,338, FILED 2-25-2008.

JANICE L. MCMORROW, EXAMINING ATTORNEY

**Int. Cl.: 42**

**Prior U.S. Cls.: 100 and 101**

**United States Patent and Trademark Office**

**Reg. No. 3,505,102**

**Registered Sep. 23, 2008**

**SERVICE MARK  
PRINCIPAL REGISTER**



THE NICHOLAS CONOR INSTITUTE (CALIFORNIA CORPORATION)  
3984 VIA HOLGURA  
SAN DIEGO, CA 92130

FOR: MEDICAL AND SCIENTIFIC RESEARCH IN THE FIELD OF PEDIATRIC CANCER; MEDICAL AND SCIENTIFIC RESEARCH INFORMATION IN THE FIELD OF PEDIATRIC CANCER; MEDICAL AND SCIENTIFIC RESEARCH SERVICES IN THE FIELD OF CANCER TREATMENT AND DIAGNOSIS; MEDICAL AND SCIENTIFIC RESEARCH, NAMELY, CONDUCTING CLINICAL TRIALS; MEDICAL RESEARCH; PHARMACEUTICAL RESEARCH AND DEVELOPMENT; PHARMACEUTICAL RESEARCH SERVICES, IN CLASS 42 (U.S. CLS. 100 AND 101).

FIRST USE 3-15-2007; IN COMMERCE 3-15-2007.

THE MARK CONSISTS OF THREE CHILDREN'S BUILDING BLOCKS AFFIXED WITH THE LETTERS "T", "N", "C", AND "I" WHERE THE LETTERS "T" AND "N" ARE AFFIXED IN THAT ORDER ON THE SINGLE TOP BLOCK WHICH SITS UPON TWO ADJACENT BOTTOM BLOCKS EACH AFFIXED WITH THE LETTERS "C" AND "I" IN THAT ORDER.

SER. NO. 77-405,360, FILED 2-25-2008.

EMILY CARLSEN, EXAMINING ATTORNEY



**Int. Cl.: 9**

**Prior U.S. Cls.: 21, 23, 26, 36 and 38**

**United States Patent and Trademark Office**

**Reg. No. 3,505,103**

**Registered Sep. 23, 2008**

**TRADEMARK  
PRINCIPAL REGISTER**

# EnforcementPRO

CORONA SOFTWARE, INC (COLORADO CORPORATION), DBA CORONA SOLUTIONS  
3100 WCR 21  
FORT LUPTON, CO 80621

FOR: COMPUTER SOFTWARE FOR CREATING SEARCHABLE DATABASES OF INFORMATION AND DATA; COMPUTER SOFTWARE FOR REDISTRICTING, NAMELY, AGGREGATING SMALLER GEOGRAPHICAL AREAS INTO MULTIPLE LARGER AREAS, IN CLASS 9 (U.S. CLS. 21, 23, 26, 36 AND 38).

FIRST USE 4-1-2007; IN COMMERCE 4-1-2007.

THE MARK CONSISTS OF STANDARD CHARACTERS WITHOUT CLAIM TO ANY PARTICULAR FONT, STYLE, SIZE, OR COLOR.

SER. NO. 77-405,394, FILED 2-25-2008.

ZACHARY BELLO, EXAMINING ATTORNEY

Int. Cls.: 30 and 32

Prior U.S. Cls.: 45, 46 and 48

United States Patent and Trademark Office

Reg. No. 3,505,104

Registered Sep. 23, 2008

TRADEMARK  
PRINCIPAL REGISTER



AB DISTRIBUTING, LLC (ARKANSAS LIMITED  
LIABILITY COMPANY)  
905 SE 21ST STREET  
BENTONVILLE, AR 72712

FOR: GREEN TEA; TEA, IN CLASS 30 (U.S. CL. 46).

FIRST USE 2-13-2008; IN COMMERCE 2-13-2008.

FOR: FRUIT JUICES, IN CLASS 32 (U.S. CLS. 45, 46  
AND 48).

FIRST USE 2-13-2008; IN COMMERCE 2-13-2008.

THE MARK CONSISTS OF THE WORDS "ARCA-  
DIA FARMS" IN A CIRCLE. THE LETTER "A" IN  
"ARCADIA" HAS LEAVES COMING OFF OF IT.

SER. NO. 77-405,495, FILED 2-25-2008.

CAROLYN GRAY, EXAMINING ATTORNEY

**Int. Cl.: 9**

**Prior U.S. Cls.: 21, 23, 26, 36 and 38**

**United States Patent and Trademark Office**

**Reg. No. 3,505,105**

**Registered Sep. 23, 2008**

**TRADEMARK  
PRINCIPAL REGISTER**

# LimoTouch

RNC SYSTEMS, INC. (NEVADA CORPORATION)  
1636 S. CLEMENTINE STREET  
ANAHEIM, CA 928022901

THE MARK CONSISTS OF STANDARD CHAR-  
ACTERS WITHOUT CLAIM TO ANY PARTICULAR  
FONT, STYLE, SIZE, OR COLOR.

FOR: ELECTRIC AND ELECTRONIC CIRCUITS,  
IN CLASS 9 (U.S. CLS. 21, 23, 26, 36 AND 38).

SER. NO. 77-405,497, FILED 2-25-2008.

FIRST USE 12-1-2004; IN COMMERCE 12-1-2004.

DAVID TAYLOR, EXAMINING ATTORNEY

**Int. Cl.: 16**

**Prior U.S. Cls.: 2, 5, 22, 23, 29, 37, 38 and 50**

**United States Patent and Trademark Office**

**Reg. No. 3,505,106**

**Registered Sep. 23, 2008**

**TRADEMARK  
PRINCIPAL REGISTER**



**AirWine**

WEST COAST PAPER COMPANY (WASHING-  
TON CORPORATION)  
SUITE 120 6703 S 234TH STREET  
KENT, WA 980322903

FOR: PACKAGING MADE OF CORRUGATED  
CARDBOARD FOR TRANSPORTING WINE AND  
LIQUOR BOTTLES IN THE CARGO HOLD OF AN  
AIRPLANE, IN CLASS 16 (U.S. CLS. 2, 5, 22, 23, 29, 37,  
38 AND 50).

FIRST USE 12-0-2007; IN COMMERCE 12-0-2007.

THE MARK CONSISTS OF AN AIRPLANE TAK-  
ING OFF ABOVE THE WORD "AIRWINE" IN  
WHICH THE LETTERS "I" ARE DEPICTED BY  
STYLIZED WINE BOTTLES.

SER. NO. 77-405,519, FILED 2-25-2008.

MICHAEL KEATING, EXAMINING ATTORNEY

**Int. Cl.: 32**

**Prior U.S. Cls.: 45, 46 and 48**

**United States Patent and Trademark Office**

**Reg. No. 3,505,107**

**Registered Sep. 23, 2008**

**TRADEMARK  
PRINCIPAL REGISTER**

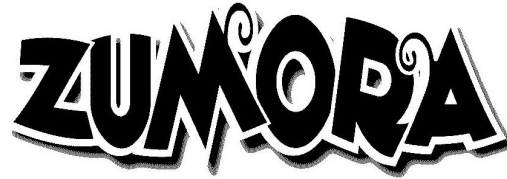

AB DISTRIBUTING, LLC (ARKANSAS LIMITED  
LIABILITY COMPANY)  
905 SE 21ST STREET  
BENTONVILLE, AR 72712

THE MARK CONSISTS OF THE WORD "ZU-  
MORA".

FOR: FRUIT DRINKS; FRUIT FLAVORED  
DRINKS; FRUIT PUNCH, IN CLASS 32 (U.S. CLS.  
45, 46 AND 48).

SER. NO. 77-405,520, FILED 2-25-2008.

FIRST USE 2-13-2008; IN COMMERCE 2-13-2008.

CAROLYN GRAY, EXAMINING ATTORNEY

**Int. Cl.: 25**

**Prior U.S. Cls.: 22 and 39**

**United States Patent and Trademark Office**

**Reg. No. 3,505,108**

**Registered Sep. 23, 2008**

**TRADEMARK  
PRINCIPAL REGISTER**

**MEDSHIELD APPAREL**

OVERSEAS DIRECT IMPORT CO., LTD. (NEW  
YORK CORPORATION)  
SUITE 201  
43 WEST 33RD STREET  
NEW YORK, NY 10001

FOR: BASEBALL CAPS; BATHROBES; BLOUSES;  
BODY SUITS; BOTTOMS; BOXER BRIEFS; BOXER  
SHORTS; BRIEFS; CARDIGANS; CARGO PANTS;  
COATS; DENIM JACKETS; DOWN JACKETS;  
DRESS SHIRTS; DRESSES; EAR MUFFS; FLEECE  
PULLOVERS; FLEECE SHORTS; FLEECE VESTS;  
FLIP FLOPS; FOOTWEAR; GLOVES; GOLF SHIRTS;  
GYM SHORTS; HATS; HEADBANDS; HEADWEAR;  
HOSIERY; JACKET LINERS; JACKETS; JEANS;  
KNIT SHIRTS; LONG UNDERWEAR; MEN'S  
SOCKS; MEN'S SUITS; OVER-TROUSERS; OVER-  
ALLS; PANTS; POLO SHIRTS; PONCHOS; PULL-  
OVERS; RAIN BOOTS; RAIN COATS; RAIN  
JACKETS; RAIN SLICKERS; RAINCOATS; RAIN-  
WEAR; ROBES; ROMPERS; SCARVES; SHIRTS;  
SHOES; SKIRT SUITS; SKIRTS; SNEAKERS; SOCKS;

SPORTS JACKETS; SPORTS SHIRTS; SUITS; SWEAT  
BANDS; SWEATERS; T-SHIRTS; TANK TOPS;  
THERMAL UNDERWEAR; TOPS; WIND-JACKETS;  
WINDJAMMERS; SCRUBS NOT FOR MEDICAL  
PURPOSES; LAB COATS; NURSE'S APPAREL,  
NAMELY, SCRUBS AND LAB COATS, IN CLASS  
25 (U.S. CLS. 22 AND 39).

FIRST USE 2-25-2008; IN COMMERCE 2-25-2008.

THE MARK CONSISTS OF STANDARD CHAR-  
ACTERS WITHOUT CLAIM TO ANY PARTICULAR  
FONT, STYLE, SIZE, OR COLOR.

NO CLAIM IS MADE TO THE EXCLUSIVE  
RIGHT TO USE "APPAREL", APART FROM THE  
MARK AS SHOWN.

SER. NO. 77-405,533, FILED 2-25-2008.

DORITT L. CARROLL, EXAMINING ATTORNEY

**Int. Cl.: 10**

**Prior U.S. Cls.: 26, 39 and 44**

**United States Patent and Trademark Office**

**Reg. No. 3,505,109**

**Registered Sep. 23, 2008**

**TRADEMARK  
PRINCIPAL REGISTER**

**SECURE BALANCE**

INGEN TECHNOLOGIES, INC. (NEVADA CORPORATION)  
C/O 12702 VIA CORTINA, SUITE 100  
DEL MAR, CA 92014

FOR: MEDICAL DIAGNOSTIC EQUIPMENT FOR VESTIBULAR FUNCTION TESTING AND DYNAMIC POSTUROGRAPHY AND RELATED SOFTWARE SOLD AS A UNIT, IN CLASS 10 (U.S. CLS. 26, 39 AND 44).

FIRST USE 7-15-2004; IN COMMERCE 7-15-2004.

THE MARK CONSISTS OF STANDARD CHARACTERS WITHOUT CLAIM TO ANY PARTICULAR FONT, STYLE, SIZE, OR COLOR.

SER. NO. 77-405,551, FILED 2-25-2008.

CAROLYN GRAY, EXAMINING ATTORNEY

**Int. Cls.: 9 and 42**

**Prior U.S. Cls.: 21, 23, 26, 36, 38, 100 and 101**

**United States Patent and Trademark Office**

**Reg. No. 3,505,110**

**Registered Sep. 23, 2008**

**TRADEMARK  
SERVICE MARK  
PRINCIPAL REGISTER**

# CMOSens

SENSIRION AG (SWITZERLAND CORPORATION)  
LAUBISRÜTISTRASSE 50  
8712 STÄFA, SWITZERLAND

FOR: SENSOR CHIPS, SENSOR SYSTEMS, DEVICES, AND TRANSMITTERS, NAMELY, RELATIVE HUMIDITY SENSORS, MASS FLOW SENSORS, AIR FLOW SENSORS, GAS FLOW SENSORS, DIFFERENTIAL PRESSURE SENSORS, TEMPERATURE SENSORS, LIQUID FLOW SENSORS, PRESSURE SENSORS, GAS SENSORS, AND RADIATION SENSORS; INDUSTRIAL PROCESS CONTROL SOFTWARE, IN CLASS 9 (U.S. CLS. 21, 23, 26, 36 AND 38).

FIRST USE 1-0-2001; IN COMMERCE 1-0-2001.

FOR: RESEARCH AND DEVELOPMENT OF SENSOR CHIPS, SENSOR DEVICES, SENSOR SYSTEMS, TRANSMITTERS, AND CONTROL SYSTEMS FOR OTHERS, IN CLASS 42 (U.S. CLS. 100 AND 101).

FIRST USE 1-0-2001; IN COMMERCE 1-0-2001.

THE MARK CONSISTS OF STANDARD CHARACTERS WITHOUT CLAIM TO ANY PARTICULAR FONT, STYLE, SIZE, OR COLOR.

SER. NO. 77-405,589, FILED 2-25-2008.

KEVON CHISOLM, EXAMINING ATTORNEY



**Int. Cl.: 44**

**Prior U.S. Cls.: 100 and 101**

**United States Patent and Trademark Office**

**Reg. No. 3,505,111**

**Registered Sep. 23, 2008**

**SERVICE MARK  
PRINCIPAL REGISTER**

**The Go Green Groomer**

INMAN, STEPHANIE L (UNITED STATES INDIVIDUAL), DBA THE GO GREEN GROOMER

#132

23110 SR 54

LUTZ, FL 33549

FOR: PET CARE SERVICES, NAMELY, DOG WALKING, DOG BATHING AND NON-MEDICATED PET GROOMING, IN CLASS 44 (U.S. CLS. 100 AND 101).

FIRST USE 2-0-2008; IN COMMERCE 2-0-2008.

THE MARK CONSISTS OF STANDARD CHARACTERS WITHOUT CLAIM TO ANY PARTICULAR FONT, STYLE, SIZE, OR COLOR.

SER. NO. 77-405,736, FILED 2-25-2008.

KELLEY WELLS, EXAMINING ATTORNEY

**Int. Cl.: 16**

**Prior U.S. Cls.: 2, 5, 22, 23, 29, 37, 38 and 50**

**United States Patent and Trademark Office**

**Reg. No. 3,505,112**

**Registered Sep. 23, 2008**

**TRADEMARK  
PRINCIPAL REGISTER**

**KRAFT WORKS A FRESH TAKE  
ON BUILDING YOUR BUSINESS**

KRAFT FOODS HOLDINGS, INC. (DELAWARE  
CORPORATION)  
THREE LAKES DRIVE  
NORTHFIELD, IL 60093

THE MARK CONSISTS OF STANDARD CHAR-  
ACTERS WITHOUT CLAIM TO ANY PARTICULAR  
FONT, STYLE, SIZE, OR COLOR.

FOR: MAGAZINES FEATURING GENERAL  
FOOD AND BEVERAGE INFORMATION, IN CLASS  
16 (U.S. CLS. 2, 5, 22, 23, 29, 37, 38 AND 50).

SER. NO. 77-405,946, FILED 2-26-2008.

FIRST USE 6-0-2003; IN COMMERCE 6-0-2003.

RICHARD WHITE, EXAMINING ATTORNEY

**Int. Cl.: 33**

**Prior U.S. Cls.: 47 and 49**

**United States Patent and Trademark Office**

**Reg. No. 3,505,113**

**Registered Sep. 23, 2008**

**TRADEMARK  
PRINCIPAL REGISTER**

**Roseland**

KING FAMILY VINEYARDS LLC (VIRGINIA  
LIMITED LIABILITY COMPANY), DBA KING  
FAMILY VINEYARDS  
6550 ROSELAND FARM  
CROZET, VA 22932

THE MARK CONSISTS OF STANDARD CHAR-  
ACTERS WITHOUT CLAIM TO ANY PARTICULAR  
FONT, STYLE, SIZE, OR COLOR.

FOR: WINE, IN CLASS 33 (U.S. CLS. 47 AND 49).

SER. NO. 77-406,548, FILED 2-26-2008.

FIRST USE 6-1-2002; IN COMMERCE 6-1-2002.

MICHAEL ENGEL, EXAMINING ATTORNEY

**Int. Cl.: 41**

**Prior U.S. Cls.: 100, 101 and 107**

**United States Patent and Trademark Office**

**Reg. No. 3,505,114**

**Registered Sep. 23, 2008**

**SERVICE MARK  
PRINCIPAL REGISTER**

# Roseland Polo

KING FAMILY VINEYARDS LLC (VIRGINIA  
LIMITED LIABILITY COMPANY), DBA KING  
FAMILY VINEYARDS

6550 ROSELAND FARM  
CROZET, VA 22932

FOR: POLO CLUB SERVICES, IN CLASS 41 (U.S.  
CLS. 100, 101 AND 107).

FIRST USE 6-1-2004; IN COMMERCE 6-1-2004.

THE MARK CONSISTS OF STANDARD CHAR-  
ACTERS WITHOUT CLAIM TO ANY PARTICULAR  
FONT, STYLE, SIZE, OR COLOR.

NO CLAIM IS MADE TO THE EXCLUSIVE  
RIGHT TO USE "POLO", APART FROM THE MARK  
AS SHOWN.

SER. NO. 77-406,584, FILED 2-26-2008.

MICHAEL ENGEL, EXAMINING ATTORNEY

**Int. Cls.: 9, 16 and 41**

**Prior U.S. Cls.: 2, 5, 21, 22, 23, 26, 29, 36, 37, 38, 50,  
100, 101 and 107**

**Reg. No. 3,505,115**

**United States Patent and Trademark Office**

**Registered Sep. 23, 2008**

**TRADEMARK  
SERVICE MARK  
PRINCIPAL REGISTER**

# Little D's Nutrition Expedition

NATIONAL DAIRY COUNCIL (ILLINOIS COR-  
PORATION)  
SUITE 900  
10255 WEST HIGGINS ROAD  
ROSEMONT, IL 600185616

FOR: GAMES, NAMELY, INTERACTIVE VIDEO  
GAME PROGRAMS, DIGITAL MEDIA GAMES IN  
THE NATURE OF CD-ROM GAMES, IN CLASS 9  
(U.S. CLS. 21, 23, 26, 36 AND 38).

FIRST USE 3-15-2005; IN COMMERCE 3-15-2005.

FOR: PRINTED TEACHING MATERIALS AND  
TEACHING ACTIVITY GUIDES IN THE FIELD OF  
HEALTH AND NUTRITION DIRECTED PRIMAR-  
ILY AT SCHOOL CHILDREN, IN CLASS 16 (U.S.  
CLS. 2, 5, 22, 23, 29, 37, 38 AND 50).

FIRST USE 3-15-2005; IN COMMERCE 3-15-2005.

FOR: EDUCATION, ENTERTAINMENT, AND  
TRAINING, NAMELY, PROVIDING EDUCATION-

AL INFORMATION, TRAINING AND ENTERTAIN-  
MENT RELATING TO HEALTH AND NUTRITION  
FOR CHILDREN AND ADULTS, VIA CLASSROOM  
INSTRUCTION, ON-LINE INSTRUCTION, INTER-  
ACTIVE ACTIVITIES, DIGITAL MEDIA AND  
GAMES, NAMELY, ON-LINE COMPUTER GAMES  
AND ON-LINE INTERACTIVE COMPUTER  
GAMES, IN CLASS 41 (U.S. CLS. 100, 101 AND 107).

FIRST USE 3-15-2005; IN COMMERCE 3-15-2005.

THE MARK CONSISTS OF STANDARD CHAR-  
ACTERS WITHOUT CLAIM TO ANY PARTICULAR  
FONT, STYLE, SIZE, OR COLOR.

OWNER OF U.S. REG. NO. 3,188,760.

SER. NO. 77-406,673, FILED 2-26-2008.

AMY MCMENAMIN, EXAMINING ATTORNEY

**Int. Cl.: 25**

**Prior U.S. Cls.: 22 and 39**

**United States Patent and Trademark Office**

**Reg. No. 3,505,116**

**Registered Sep. 23, 2008**

**TRADEMARK  
PRINCIPAL REGISTER**

**BOYDGAMING**

BOYD GAMING CORPORATION (NEVADA  
CORPORATION)  
ATTN: MR. LOU NUNZIATA  
6465 SOUTH RAINBOW BOULEVARD  
LAS VEGAS, NV 89118

FOR: BASEBALL CAPS; CAP VISORS; GOLF  
CAPS; GOLF SHIRTS; HATS; JACKETS; LONG-  
SLEEVED SHIRTS; NIGHT SHIRTS; POLO SHIRTS;  
SPORT SHIRTS; SPORTS SHIRTS; SUN VISORS; T-  
SHIRTS; VISORS, IN CLASS 25 (U.S. CLS. 22 AND 39).

FIRST USE 11-1-1993; IN COMMERCE 11-1-1993.

THE MARK CONSISTS OF STANDARD CHAR-  
ACTERS WITHOUT CLAIM TO ANY PARTICULAR  
FONT, STYLE, SIZE, OR COLOR.

OWNER OF U.S. REG. NOS. 2,502,801 AND  
2,502,802.

SEC. 2(F).

SER. NO. 77-406,784, FILED 2-26-2008.

SUNG IN, EXAMINING ATTORNEY

**Int. Cl.: 1**

**Prior U.S. Cls.: 1, 5, 6, 10, 26 and 46**

**Reg. No. 3,505,117**

**United States Patent and Trademark Office**

**Registered Sep. 23, 2008**

---

**TRADEMARK  
PRINCIPAL REGISTER**

**DYNAMIC GARDENER**

WESTERN NUTRIENTS CORPORATION (CALI-  
FORNIA CORPORATION)  
245 INDUSTRIAL STREET  
245 INDUSTRIAL STREET  
BAKERSFIELD, CA 93307

THE MARK CONSISTS OF STANDARD CHAR-  
ACTERS WITHOUT CLAIM TO ANY PARTICULAR  
FONT, STYLE, SIZE, OR COLOR.

FOR: FERTILIZERS FOR AGRICULTURAL USE;  
FERTILIZERS FOR DOMESTIC USE, IN CLASS 1  
(U.S. CLS. 1, 5, 6, 10, 26 AND 46).

SER. NO. 77-407,126, FILED 2-27-2008.

FIRST USE 1-1-2007; IN COMMERCE 1-1-2007.

FLORENTINA BLANDU, EXAMINING ATTORNEY

**Int. Cl.: 41**

**Prior U.S. Cls.: 100, 101 and 107**

**United States Patent and Trademark Office**

**Reg. No. 3,505,118**

**Registered Sep. 23, 2008**

**SERVICE MARK  
PRINCIPAL REGISTER**



CAMP WINNEBAGO (MAINE CORPORATION)  
131 OCEAN STREET  
SOUTH PORTLAND, ME 04106

THE MARK CONSISTS OF THE LETTERS "C"  
AND "W" INTERTWINED INSIDE A CIRCLE.

FOR: SUMMER CAMPS; RECREATIONAL  
CAMPS, IN CLASS 41 (U.S. CLS. 100, 101 AND 107).

SER. NO. 77-407,359, FILED 2-27-2008.

FIRST USE 7-1-1919; IN COMMERCE 7-1-1919.

DORITT L. CARROLL, EXAMINING ATTORNEY



Int. Cls.: 35 and 45

Prior U.S. Cls.: 100, 101 and 102

United States Patent and Trademark Office

Reg. No. 3,505,119

Registered Sep. 23, 2008

SERVICE MARK  
PRINCIPAL REGISTER

法易网

81LAW.COM

81LAW.COM (CALIFORNIA CORPORATION)  
2275 E. BAYSHORE RD., #115  
PALO ALTO, CA 94303

FOR: ATTORNEY MATCHING AND REFERRAL SERVICES, NAMELY, ATTORNEY REFERRAL SERVICES, IN CLASS 35 (U.S. CLS. 100, 101 AND 102).

FIRST USE 3-1-2005; IN COMMERCE 3-1-2005.

FOR: PROVIDING ONLINE LEGAL DOCUMENT PREPARATION SERVICES, PROVIDING GENERAL LEGAL INFORMATION, IN CLASS 45 (U.S. CLS. 100 AND 101).

FIRST USE 3-1-2005; IN COMMERCE 3-1-2005.

NO CLAIM IS MADE TO THE EXCLUSIVE RIGHT TO USE THE NON-LATIN CHARACTERS

THAT MEAN LAW OR WEBSITE, APART FROM THE MARK AS SHOWN.

"THE STIPPLING IS A FEATURE OF THE MARK."

"THE FOREIGN WORDING IN THE MARK TRANSLATES INTO ENGLISH AS LAW EASY WEBSITE."

"THE NON-LATIN CHARACTER(S) IN THE MARK TRANSLITERATES INTO FA YI WANG, AND THIS MEANS LAW EASY WEBSITE IN ENGLISH."

SER. NO. 77-407,600, FILED 2-27-2008.

SEAN CROWLEY, EXAMINING ATTORNEY

**Int. Cl.: 36**

**Prior U.S. Cls.: 100, 101 and 102**

**United States Patent and Trademark Office**

**Reg. No. 3,505,120**

**Registered Sep. 23, 2008**

**SERVICE MARK  
PRINCIPAL REGISTER**

**UBS GLOBAL I/O**

UBS AG (SWITZERLAND CORPORATION)  
BAHNHOFSTRASSE 45  
ZURICH, SWITZERLAND 8001

FOR: FINANCIAL RESEARCH; FINANCIAL  
ANALYSIS AND CONSULTATION, IN CLASS 36  
(U.S. CLS. 100, 101 AND 102).

FIRST USE 10-3-2006; IN COMMERCE 10-3-2006.

THE MARK CONSISTS OF STANDARD CHAR-  
ACTERS WITHOUT CLAIM TO ANY PARTICULAR  
FONT, STYLE, SIZE, OR COLOR.

OWNER OF U.S. REG. NOS. 1,573,828, 3,025,058  
AND OTHERS.

SER. NO. 77-407,718, FILED 2-27-2008.

KELLEY WELLS, EXAMINING ATTORNEY

**Int. Cl.: 42**

**Prior U.S. Cls.: 100 and 101**

**United States Patent and Trademark Office**

**Reg. No. 3,505,121**

**Registered Sep. 23, 2008**

**SERVICE MARK  
PRINCIPAL REGISTER**

**EZPET**

SYSTEMS WEST LLC (CALIFORNIA LIMITED  
LIABILITY COMPANY)  
STE. #0  
12285 WORLD TRADE DR.  
SAN DIEGO, CA 92128

FOR: PROVIDING TEMPORARY USE OF A NON-  
DOWNLOADABLE INTERNET-BASED SOFTWARE  
APPLICATION FOR CREATING, ORGANIZING,  
TRACKING AND STORAGE OF INFORMATION  
ABOUT BUSINESSES' SMALL ANIMAL SALES IN A  
DATABASE, ENABLING USERS TO ACCESS DOC-

UMENTATION EASILY FROM ANYWHERE IN  
THE WORLD, IN CLASS 42 (U.S. CLS. 100 AND 101).

FIRST USE 5-24-2005; IN COMMERCE 5-24-2005.

THE MARK CONSISTS OF STANDARD CHAR-  
ACTERS WITHOUT CLAIM TO ANY PARTICULAR  
FONT, STYLE, SIZE, OR COLOR.

SER. NO. 77-407,754, FILED 2-27-2008.

BRIAN CALLAGHAN, EXAMINING ATTORNEY

**Int. Cl.: 11**

**Prior U.S. Cls.: 13, 21, 23, 31 and 34**

**United States Patent and Trademark Office**

**Reg. No. 3,505,122**

**Registered Sep. 23, 2008**

**TRADEMARK  
PRINCIPAL REGISTER**

**EXTREME CUISINE**

THE MONTAGUE COMPANY (CALIFORNIA  
CORPORATION)  
1830 STEARMAN AVE.  
HAYWARD, CA 94545

THE MARK CONSISTS OF STANDARD CHAR-  
ACTERS WITHOUT CLAIM TO ANY PARTICULAR  
FONT, STYLE, SIZE, OR COLOR.

FOR: COOK TOPS WITH REFRIGERATED  
BASES, IN CLASS 11 (U.S. CLS. 13, 21, 23, 31 AND 34).

SER. NO. 77-408,000, FILED 2-27-2008.

FIRST USE 1-1-2004; IN COMMERCE 1-1-2004.

GINA FINK, EXAMINING ATTORNEY

**Int. Cl.: 36**

**Prior U.S. Cls.: 100, 101 and 102**

**United States Patent and Trademark Office**

**Reg. No. 3,505,123**

**Registered Sep. 23, 2008**

**SERVICE MARK  
PRINCIPAL REGISTER**

**VBID**

GUENTNER, BRYAN L. (UNITED STATES IN-  
DIVIDUAL)  
412 S TAMIAMI TRAIL  
OSPREY, FL 34229

THE MARK CONSISTS OF STANDARD CHAR-  
ACTERS WITHOUT CLAIM TO ANY PARTICULAR  
FONT, STYLE, SIZE, OR COLOR.

FOR: REAL ESTATE BROKERAGE, IN CLASS 36  
(U.S. CLS. 100, 101 AND 102).

SER. NO. 77-408,152, FILED 2-28-2008.

FIRST USE 1-15-2008; IN COMMERCE 1-15-2008.

DANNEAN HETZEL, EXAMINING ATTORNEY

**Int. Cl.: 36**

**Prior U.S. Cls.: 100, 101 and 102**

**United States Patent and Trademark Office**

**Reg. No. 3,505,124**

**Registered Sep. 23, 2008**

**SERVICE MARK  
PRINCIPAL REGISTER**



BLACKSHORE PROPERTIES, INC. (CALIFORNIA CORPORATION)  
2275 HUNTINGTON DRIVE #255  
SAN MARINO, CA 91108

THE MARK CONSISTS OF THE DOLLAR SYMBOL (\$) IN THE MIDDLE OF A FLAG MADE UP OF HORIZONTAL STRIPES OVER THE WORD "BANKAHOLIC".

FOR: PROVIDING FINANCIAL INFORMATION,  
IN CLASS 36 (U.S. CLS. 100, 101 AND 102).

SER. NO. 77-408,531, FILED 2-28-2008.

FIRST USE 2-18-2008; IN COMMERCE 2-18-2008.

OWNER OF U.S. REG. NO. 3,365,466.

BRIAN CALLAGHAN, EXAMINING ATTORNEY

**Int. Cl.: 7**

**Prior U.S. Cls.: 13, 19, 21, 23, 31, 34 and 35**

**United States Patent and Trademark Office**

**Reg. No. 3,505,125**

**Registered Sep. 23, 2008**

**TRADEMARK  
PRINCIPAL REGISTER**



DIVERSI-PLAST PRODUCTS, INC. (MINNESOTA CORPORATION)  
5600 NORTH HIGHWAY 169  
MINNEAPOLIS, MN 554283096

FIRST USE 11-30-2007; IN COMMERCE 11-30-2007.

FOR: COMPUTER NUMERICAL CONTROL (CNC) MACHINES COMPRISED OF MACHINE TOOLS FOR SHAPING METAL PARTS TO A REQUIRED DIMENSION AND COMPUTER AIDED DESIGN/COMPUTER AIDED MANUFACTURING (CAD/CAM) SOFTWARE SOLD AS A UNIT, IN CLASS 7 (U.S. CLS. 13, 19, 21, 23, 31, 34 AND 35).

THE MARK CONSISTS OF THE LETTER "M" IN A LEFT SLANTED OVAL CIRCLE.

SER. NO. 77-408,682, FILED 2-28-2008.

CHARLOTTE CORWIN, EXAMINING ATTORNEY

**Int. Cl.: 41**

**Prior U.S. Cls.: 100, 101 and 107**

**United States Patent and Trademark Office**

**Reg. No. 3,505,126**

**Registered Sep. 23, 2008**

**SERVICE MARK  
PRINCIPAL REGISTER**

**AMRIDGE UNIVERSITY**

AMRIDGE UNIVERSITY, INC. (ALABAMA NON-  
PROFIT CORPORATION)  
1200 TAYLOR ROAD  
MONTGOMERY, AL 361173553

FOR: EDUCATIONAL SERVICES, NAMELY,  
PROVIDING COURSES AND PROGRAMS OF IN-  
STRUCTION AT THE COLLEGE, GRADUATE, AND  
POST-GRADUATE LEVELS, AND GRANTING CER-  
TIFICATES, BACHELOR OF ARTS, BACHELOR OF  
SCIENCE, MASTER OF ARTS, MASTER OF SCI-  
ENCE, MASTER OF DIVINITY, DOCTOR OF MIN-  
ISTRY AND DOCTOR OF PHILOSOPHY DEGREES  
IN CONNECTION THEREWITH, IN CLASS 41 (U.S.  
CLS. 100, 101 AND 107).

FIRST USE 1-31-2008; IN COMMERCE 1-31-2008.

THE MARK CONSISTS OF STANDARD CHAR-  
ACTERS WITHOUT CLAIM TO ANY PARTICULAR  
FONT, STYLE, SIZE, OR COLOR.

NO CLAIM IS MADE TO THE EXCLUSIVE  
RIGHT TO USE "UNIVERSITY", APART FROM  
THE MARK AS SHOWN.

SER. NO. 77-408,689, FILED 2-28-2008.

ALICIA COLLINS, EXAMINING ATTORNEY



**Int. Cls.: 37 and 40**

**Prior U.S. Cls.: 100, 103 and 106**

**United States Patent and Trademark Office**

**Reg. No. 3,505,127**

**Registered Sep. 23, 2008**

**SERVICE MARK  
PRINCIPAL REGISTER**



AMETEK, INC. (DELAWARE CORPORATION)  
P.O. BOX 1764  
37 NORTH VALLEY ROAD, BUILDING 4  
PAOLI, PA 193010801

FOR: REPAIR AND MAINTENANCE OF AIR-  
CRAFT COMPONENTS; REPAIR AND MAINTENANCE  
OF AIRCRAFT, IN CLASS 37 (U.S. CLS.  
100, 103 AND 106).

FIRST USE 5-18-2001; IN COMMERCE 5-18-2001.

FOR: MANUFACTURING SERVICES FOR OTHERS  
IN THE FIELD OF AIRCRAFT COMPONENTS,  
IN CLASS 40 (U.S. CLS. 100, 103 AND 106).

FIRST USE 5-18-2001; IN COMMERCE 5-18-2001.

THE MARK CONSISTS OF THE LETTERS "SAI",  
WITH AN ELLIPTICAL RING REACHING FROM  
THE BOTTOM PORTION OF THE LETTER "S" TO  
THE TOP PORTION OF THE LETTER "I" AND  
FORMING THE CROSS-STROKE CONNECTING  
THE TWO LEGS IN THE LETTER "A".

SER. NO. 77-409,454, FILED 2-29-2008.

APRIL HESIK, EXAMINING ATTORNEY

**Int. Cls.: 35 and 44**

**Prior U.S. Cls.: 100, 101 and 102**

**United States Patent and Trademark Office**

**Reg. No. 3,505,128**

**Registered Sep. 23, 2008**

**SERVICE MARK  
PRINCIPAL REGISTER**

**RXHOPE**

APPLIEDINFO PARTNERS, INC. (NEW JERSEY CORPORATION)  
28 WORLD'S FAIR DRIVE  
SOMERSET, NJ 08873

FOR: SUPPLYING PRESCRIPTION DRUGS TO INDIGENT PATIENTS, WHO DO NOT HAVE ACCESS TO PRESCRIPTION INSURANCE OR GOVERNMENT FUNDED PROGRAMS, AND STARTER KITS AND SAMPLES TO DOCTORS FOR DISTRIBUTION IN CONNECTION THEREWITH, IN CLASS 35 (U.S. CLS. 100, 101 AND 102).

FIRST USE 2-2-2000; IN COMMERCE 2-2-2000.

FOR: PHARMACEUTICAL ADVICE; AND MEDICAL COUNSELING, IN CLASS 44 (U.S. CLS. 100 AND 101).

FIRST USE 2-2-2000; IN COMMERCE 2-2-2000.

THE MARK CONSISTS OF STANDARD CHARACTERS WITHOUT CLAIM TO ANY PARTICULAR FONT, STYLE, SIZE, OR COLOR.

SER. NO. 77-409,605, FILED 2-29-2008.

WENDY GOODMAN, EXAMINING ATTORNEY

**Int. Cl.: 7**

**Prior U.S. Cls.: 13, 19, 21, 23, 31, 34 and 35**

**Reg. No. 3,505,129**

**United States Patent and Trademark Office**

**Registered Sep. 23, 2008**

**TRADEMARK  
PRINCIPAL REGISTER**



DIVERSI-PLAST PRODUCTS, INC. (MINNESOTA CORPORATION)  
5600 NORTH HIGHWAY 169  
MINNEAPOLIS, MN 554283096

FIRST USE 11-30-2007; IN COMMERCE 11-30-2007.

FOR: COMPUTER NUMERICAL CONTROL (CNC) MACHINES COMPRISED OF MACHINE TOOLS FOR SHAPING METAL PARTS TO A REQUIRED DIMENSION AND COMPUTER AIDED DESIGN/COMPUTER AIDED MANUFACTURING (CAD/CAM) SOFTWARE SOLD AS A UNIT, IN CLASS 7 (U.S. CLS. 13, 19, 21, 23, 31, 34 AND 35).

THE MARK CONSISTS OF THE LETTER "M" IN A LEFT SLANTED OVAL CIRCLE AND THE WORD "MILLTRONICS" TO THE RIGHT.

SER. NO. 77-409,815, FILED 2-29-2008.

CHARLOTTE CORWIN, EXAMINING ATTORNEY

**Int. Cl.: 41**

**Prior U.S. Cls.: 100, 101 and 107**

**United States Patent and Trademark Office**

**Reg. No. 3,505,130**

**Registered Sep. 23, 2008**

**SERVICE MARK  
PRINCIPAL REGISTER**

**WHERE TRADITION LIVES**

DEPARTMENT OF THE ARMY (UNITED STATES AGENCY OF THE UNITED STATES GOVERNMENT)

JALS-RL/IP

901 N. STUART ST., STE. 700  
ARLINGTON, VA 22203

FOR: ENTERTAINMENT SERVICES IN THE NATURE OF LIVE MUSICAL PERFORMANCES, IN CLASS 41 (U.S. CLS. 100, 101 AND 107).

FIRST USE 11-8-2006; IN COMMERCE 11-8-2006.

THE MARK CONSISTS OF STANDARD CHARACTERS WITHOUT CLAIM TO ANY PARTICULAR FONT, STYLE, SIZE, OR COLOR.

SER. NO. 77-409,820, FILED 2-29-2008.

ZHALEH DELANEY, EXAMINING ATTORNEY

**Int. Cl.: 35**

**Prior U.S. Cls.: 100, 101 and 102**

**United States Patent and Trademark Office**

**Reg. No. 3,505,131**

**Registered Sep. 23, 2008**

**SERVICE MARK  
PRINCIPAL REGISTER**

**KEEP THE WHEELS TURNING**

ADVANCE AUTO INNOVATIONS, LLC (VIRGINIA LIMITED LIABILITY COMPANY)  
5673 AIRPORT ROAD  
ROANOKE, VA 24012

FOR: RETAIL AUTO PARTS STORE SERVICES; RETAIL AUTO PARTS STORE SERVICES FOR COMMERCIAL CUSTOMERS; ONLINE RETAIL AUTO PARTS STORE SERVICES; ONLINE RETAIL AUTO PARTS STORE SERVICES FOR COMMERCIAL CUSTOMERS, IN CLASS 35 (U.S. CLS. 100, 101 AND 102).

FIRST USE 2-4-2008; IN COMMERCE 2-4-2008.

THE MARK CONSISTS OF STANDARD CHARACTERS WITHOUT CLAIM TO ANY PARTICULAR FONT, STYLE, SIZE, OR COLOR.

SER. NO. 77-410,134, FILED 2-29-2008.

KEVON CHISOLM, EXAMINING ATTORNEY

**Int. Cl.: 35**

**Prior U.S. Cls.: 100, 101 and 102**

**United States Patent and Trademark Office**

**Reg. No. 3,505,132**

**Registered Sep. 23, 2008**

**SERVICE MARK  
PRINCIPAL REGISTER**

**MASTER YOUR MACHINE**

ADVANCE AUTO INNOVATIONS, LLC (VIRGINIA LIMITED LIABILITY COMPANY)  
5673 AIRPORT ROAD  
ROANOKE, VA 24012

FOR: RETAIL AUTO PARTS STORE SERVICES; RETAIL AUTO PARTS STORE SERVICES FOR COMMERCIAL CUSTOMERS; ONLINE RETAIL AUTO PARTS STORE SERVICES; ONLINE RETAIL AUTO PARTS STORE SERVICES FOR COMMERCIAL CUSTOMERS, IN CLASS 35 (U.S. CLS. 100, 101 AND 102).

FIRST USE 2-4-2008; IN COMMERCE 2-4-2008.

THE MARK CONSISTS OF STANDARD CHARACTERS WITHOUT CLAIM TO ANY PARTICULAR FONT, STYLE, SIZE, OR COLOR.

SER. NO. 77-410,152, FILED 2-29-2008.

KEVON CHISOLM, EXAMINING ATTORNEY

**Int. Cl.: 35**

**Prior U.S. Cls.: 100, 101 and 102**

**United States Patent and Trademark Office**

**Reg. No. 3,505,133**

**Registered Sep. 23, 2008**

**SERVICE MARK  
PRINCIPAL REGISTER**

**WRENCH UP**

ADVANCE AUTO INNOVATIONS, LLC (VIRGINIA LIMITED LIABILITY COMPANY)  
5673 AIRPORT ROAD  
ROANOKE, VA 24012

FOR: RETAIL AUTO PARTS STORE SERVICES; RETAIL AUTO PARTS STORE SERVICES FOR COMMERCIAL CUSTOMERS; ONLINE RETAIL AUTO PARTS STORE SERVICES; ONLINE RETAIL AUTO PARTS STORE SERVICES FOR COMMERCIAL CUSTOMERS, IN CLASS 35 (U.S. CLS. 100, 101 AND 102).

FIRST USE 1-31-2008; IN COMMERCE 2-3-2008.

THE MARK CONSISTS OF STANDARD CHARACTERS WITHOUT CLAIM TO ANY PARTICULAR FONT, STYLE, SIZE, OR COLOR.

SER. NO. 77-410,185, FILED 2-29-2008.

KEVON CHISOLM, EXAMINING ATTORNEY

**Int. Cl.: 44**

**Prior U.S. Cls.: 100 and 101**

**United States Patent and Trademark Office**

**Reg. No. 3,505,134**

**Registered Sep. 23, 2008**

**SERVICE MARK  
PRINCIPAL REGISTER**

**KRAUSE**

KRAUSE LANDSCAPE CONTRACTORS, INC.  
(TEXAS CORPORATION)  
P.O. BOX 10241  
AMARILLO, TX 791161024

FOR: LANDSCAPE DESIGN; LANDSCAPE GARDENING; LANDSCAPE GARDENING DESIGN FOR OTHERS, IN CLASS 44 (U.S. CLS. 100 AND 101).

FIRST USE 10-30-1931; IN COMMERCE 2-1-1932.

THE MARK CONSISTS OF STANDARD CHARACTERS WITHOUT CLAIM TO ANY PARTICULAR FONT, STYLE, SIZE, OR COLOR.

SEC. 2(F).

SER. NO. 77-410,203, FILED 2-29-2008.

JOHN GARTNER, EXAMINING ATTORNEY



**Int. Cl.: 9**

**Prior U.S. Cls.: 21, 23, 26, 36 and 38**

**Reg. No. 3,505,135**

**United States Patent and Trademark Office**

**Registered Sep. 23, 2008**

---

**TRADEMARK  
PRINCIPAL REGISTER**

**Symphony**

APOGEE ELECTRONICS CORPORATION (CALI-  
FORNIA CORPORATION)  
TRADEMARK DEPARTMENT  
1715 BERKELEY STREET  
SANTA MONICA, CA 90404

FOR: COMPUTER HARDWARE, NAMELY, DI-  
GITAL AUDIO INTERFACE DEVICES INCLUDING  
PRINTED CIRCUIT BOARDS, IN CLASS 9 (U.S. CLS.  
21, 23, 26, 36 AND 38).

FIRST USE 1-18-2006; IN COMMERCE 1-18-2006.

THE MARK CONSISTS OF STANDARD CHAR-  
ACTERS WITHOUT CLAIM TO ANY PARTICULAR  
FONT, STYLE, SIZE, OR COLOR.

SER. NO. 77-410,423, FILED 2-29-2008.

JOHN E. MICHOS, EXAMINING ATTORNEY

**Int. Cl.: 30**

**Prior U.S. Cl.: 46**

**United States Patent and Trademark Office**

**Reg. No. 3,505,136**

**Registered Sep. 23, 2008**

**TRADEMARK  
PRINCIPAL REGISTER**

**LA PALMA**

GARCIA, FERNANDO (MEXICO INDIVIDUAL)  
740 W. INYO AVE.  
TULARE, CA 93274 AND  
GARCIA, ANDREA (UNITED STATES INDIVI-  
DUAL)  
740 WEST INYO AVE.  
TULARE, CA 93274

THE MARK CONSISTS OF STANDARD CHAR-  
ACTERS WITHOUT CLAIM TO ANY PARTICULAR  
FONT, STYLE, SIZE, OR COLOR.

THE ENGLISH TRANSLATION OF "LA PALMA"  
IS "THE PALM."

FOR: BAKED GOODS; MEXICAN PASTRY, IN  
CLASS 30 (U.S. CL. 46).

SER. NO. 77-411,823, FILED 3-3-2008.

FIRST USE 2-28-2008; IN COMMERCE 2-28-2008.

GEOFFREY FOSDICK, EXAMINING ATTORNEY

**Int. Cl.: 9**

**Prior U.S. Cls.: 21, 23, 26, 36 and 38**

**United States Patent and Trademark Office**

**Reg. No. 3,505,137**

**Registered Sep. 23, 2008**

**TRADEMARK  
PRINCIPAL REGISTER**

**CYBER-SHOT**

SONY CORPORATION (JAPAN CORPORATION)  
1-7-1 KONAN, MINATO-KU  
TOKYO, JAPAN

FOR: CELLULAR TELEPHONES, IN CLASS 9  
(U.S. CLS. 21, 23, 26, 36 AND 38).

FIRST USE 9-30-2006; IN COMMERCE 9-30-2006.

THE MARK CONSISTS OF STANDARD CHAR-  
ACTERS WITHOUT CLAIM TO ANY PARTICULAR  
FONT, STYLE, SIZE, OR COLOR.

OWNER OF U.S. REG. NOS. 2,286,104, 3,002,391,  
AND 3,325,680.

SER. NO. 77-412,292, FILED 3-4-2008.

JEFFERY COWARD, EXAMINING ATTORNEY

**Int. Cl.: 33**

**Prior U.S. Cls.: 47 and 49**

**United States Patent and Trademark Office**

**Reg. No. 3,505,138**

**Registered Sep. 23, 2008**

**TRADEMARK  
PRINCIPAL REGISTER**

**DRINK IT, LOVE IT, KNOW  
WHEN TO STOP.**

BROWN-FORMAN CORPORATION (DELAWARE  
CORPORATION)  
850 DIXIE HIGHWAY  
LOUISVILLE, KY 40210

THE MARK CONSISTS OF STANDARD CHAR-  
ACTERS WITHOUT CLAIM TO ANY PARTICULAR  
FONT, STYLE, SIZE, OR COLOR.

FOR: ALCOHOLIC BEVERAGES, NAMELY,  
WINE, IN CLASS 33 (U.S. CLS. 47 AND 49).

SER. NO. 77-412,387, FILED 3-4-2008.

FIRST USE 9-30-2005; IN COMMERCE 9-30-2005.

JAMES LOVELACE, EXAMINING ATTORNEY

**Int. Cl.: 32**

**Prior U.S. Cls.: 45, 46 and 48**

**United States Patent and Trademark Office**

**Reg. No. 3,505,139**

**Registered Sep. 23, 2008**

**TRADEMARK  
PRINCIPAL REGISTER**



SEA2O, INC. (WASHINGTON CORPORATION)  
SUITE 180  
3060 139TH AVENUE SE  
BELLEVUE, WA 98005

FOR: ORGANIC ENERGY DRINK, IN CLASS 32  
(U.S. CLS. 45, 46 AND 48).

FIRST USE 4-18-2007; IN COMMERCE 4-18-2007.

THE COLOR(S) POWDER BLUE, DARK BLUE  
AND GREEN IS/ARE CLAIMED AS A FEATURE OF  
THE MARK.

THE MARK CONSISTS OF A DESIGN OF A  
WAVE. THE UPPER PORTION OF THE WAVE  
APPEARS IN POWDER BLUE, THE CENTER IN  
DARK BLUE, AND THE BOTTOM IN GREEN.

SER. NO. 77-412,593, FILED 3-4-2008.

JACLYN KIDWELL, EXAMINING ATTORNEY

**Int. Cl.: 9**

**Prior U.S. Cls.: 21, 23, 26, 36 and 38**

**United States Patent and Trademark Office**

**Reg. No. 3,505,140**

**Registered Sep. 23, 2008**

**TRADEMARK  
PRINCIPAL REGISTER**

**IRONKIDS**

WORLD TRIATHLON CORPORATION (FLORIDA CORPORATION)  
PO BOX 1608  
TARPON SPRINGS, FL 346881608

FOR: SUNGLASSES, IN CLASS 9 (U.S. CLS. 21, 23, 26, 36 AND 38).

FIRST USE 1-1-2000; IN COMMERCE 1-1-2001.

THE MARK CONSISTS OF STANDARD CHARACTERS WITHOUT CLAIM TO ANY PARTICULAR FONT, STYLE, SIZE, OR COLOR.

OWNER OF U.S. REG. NOS. 1,718,294 AND 2,525,563.

SER. NO. 77-412,722, FILED 3-4-2008.

MELISSA VALLILLO, EXAMINING ATTORNEY

**Int. Cl.: 5**

**Prior U.S. Cls.: 6, 18, 44, 46, 51 and 52**

**United States Patent and Trademark Office**

**Reg. No. 3,505,141**

**Registered Sep. 23, 2008**

**TRADEMARK  
PRINCIPAL REGISTER**

**ORCHID OASIS**

S. C. JOHNSON & SON, INC. (WISCONSIN CORPORATION)  
1525 HOWE STREET  
RACINE, WI 53403

FOR: AIR FRESHENERS, IN CLASS 5 (U.S. CLS. 6, 18, 44, 46, 51 AND 52).

FIRST USE 11-26-2007; IN COMMERCE 11-26-2007.

THE MARK CONSISTS OF STANDARD CHARACTERS WITHOUT CLAIM TO ANY PARTICULAR FONT, STYLE, SIZE, OR COLOR.

OWNER OF U.S. REG. NO. 3,074,652.

NO CLAIM IS MADE TO THE EXCLUSIVE RIGHT TO USE "ORCHID", APART FROM THE MARK AS SHOWN.

SER. NO. 77-413,330, FILED 3-5-2008.

LOURDES AYALA, EXAMINING ATTORNEY

**Int. Cl.: 5**

**Prior U.S. Cls.: 6, 18, 44, 46, 51 and 52**

**United States Patent and Trademark Office**

**Reg. No. 3,505,142**

**Registered Sep. 23, 2008**

**TRADEMARK  
PRINCIPAL REGISTER**

**OASIS DE ORQUIDEAS**

S. C. JOHNSON & SON, INC. (WISCONSIN CORPORATION)  
1525 HOWE STREET  
RACINE, WI 53403

FOR: AIR FRESHENERS, IN CLASS 5 (U.S. CLS. 6, 18, 44, 46, 51 AND 52).

FIRST USE 11-26-2007; IN COMMERCE 11-26-2007.

THE MARK CONSISTS OF STANDARD CHARACTERS WITHOUT CLAIM TO ANY PARTICULAR FONT, STYLE, SIZE, OR COLOR.

OWNER OF U.S. REG. NO. 3,074,652.

NO CLAIM IS MADE TO THE EXCLUSIVE RIGHT TO USE THE FOREIGN WORDING THAT TRANSLATES TO "ORCHID", APART FROM THE MARK AS SHOWN.

THE FOREIGN WORDING IN THE MARK TRANSLATES INTO ENGLISH AS ORCHID OASIS.

SER. NO. 77-413,351, FILED 3-5-2008.

LOURDES AYALA, EXAMINING ATTORNEY



**Int. Cl.: 28**

**Prior U.S. Cls.: 22, 23, 38 and 50**

**United States Patent and Trademark Office**

**Reg. No. 3,505,143**

**Registered Sep. 23, 2008**

**TRADEMARK  
PRINCIPAL REGISTER**

**CAR-NIVORES**

MATTEL, INC. (DELAWARE CORPORATION)  
M1-1518  
333 CONTINENTAL BLVD.  
EL SEGUNDO, CA 90245

THE MARK CONSISTS OF STANDARD CHAR-  
ACTERS WITHOUT CLAIM TO ANY PARTICULAR  
FONT, STYLE, SIZE, OR COLOR.

FOR: TOYS, GAMES AND PLAYTHINGS, NAME-  
LY, TOY VEHICLES AND ACCESSORIES THERE-  
FOR, IN CLASS 28 (U.S. CLS. 22, 23, 38 AND 50).

SER. NO. 77-414,235, FILED 3-5-2008.

FIRST USE 4-18-2007; IN COMMERCE 4-18-2007.

CHARLES L. JENKINS, EXAMINING ATTORNEY

**Int. Cls.: 12 and 25**

**Prior U.S. Cls.: 19, 21, 22, 23, 31, 35, 39 and 44**

**United States Patent and Trademark Office**

**Reg. No. 3,505,144**

**Registered Sep. 23, 2008**

**TRADEMARK  
PRINCIPAL REGISTER**



ADALICIA INC. (CALIFORNIA CORPORATION),  
DBA TOUGH GIRL CHOPPERS  
7049 RIATA DRIVE  
REDDING, CA 96002

FOR: MOTORCYCLES AND STRUCTURAL  
PARTS THEREFOR, IN CLASS 12 (U.S. CLS. 19, 21,  
23, 31, 35 AND 44).

FIRST USE 4-14-2007; IN COMMERCE 4-14-2007.

FOR: SHORT-SLEEVED OR LONG-SLEEVED T-  
SHIRTS, IN CLASS 25 (U.S. CLS. 22 AND 39).

FIRST USE 4-14-2007; IN COMMERCE 4-14-2007.

NO CLAIM IS MADE TO THE EXCLUSIVE  
RIGHT TO USE "GIRL" AND "CHOPPERS", APART  
FROM THE MARK AS SHOWN.

THE MARK CONSISTS OF THREE CONCENTRIC  
CIRCLES INSIDE ONE ANOTHER WITH THE  
WORDING "TOUGH GIRL" APPEARING INSIDE  
THE OUTERMOST CIRCLES AT THE TOP AND  
THE WORDING "CHOPPERS", ALSO INSIDE THE  
TWO CIRCLES, AT THE BOTTOM OF THE DESIGN.  
IN THE VERY CENTER OF THE DRAWING IS THE  
DESIGN OF A MALTESE CROSS INSIDE THE  
CENTER CIRCLE. INSIDE THE SECOND AND  
THIRD CIRCLES, ARE 6 QUADRILATERALS, SIMI-  
LAR IN APPEARANCE TO THE RADIATION  
WARNING SYMBOL, SURROUNDING THE CROSS  
DESIGN.

SER. NO. 77-414,358, FILED 3-5-2008.

WENDY GOODMAN, EXAMINING ATTORNEY

**Int. Cl.: 29**

**Prior U.S. Cl.: 46**

**United States Patent and Trademark Office**

**Reg. No. 3,505,145**

**Registered Sep. 23, 2008**

**TRADEMARK  
PRINCIPAL REGISTER**

**PRIME FILLET**

BUMBLE BEE FOODS, LLC (DELAWARE LIMITED LIABILITY COMPANY)  
9655 GRANITE RIDGE DRIVE, SUITE 100  
SAN DIEGO, CA 92123

FOR: COOKED MEAT, NAMELY, ALBACORE, IN CLASS 29 (U.S. CL. 46).

FIRST USE 2-0-2003; IN COMMERCE 2-0-2003.

THE MARK CONSISTS OF STANDARD CHARACTERS WITHOUT CLAIM TO ANY PARTICULAR FONT, STYLE, SIZE, OR COLOR.

OWNER OF U.S. REG. NOS. 2,835,584 AND 3,203,187.

NO CLAIM IS MADE TO THE EXCLUSIVE RIGHT TO USE "FILLET", APART FROM THE MARK AS SHOWN.

SEC. 2(F).

SER. NO. 77-414,875, FILED 3-6-2008.

ANDREA BUTLER, EXAMINING ATTORNEY

**Int. Cl.: 5**

**Prior U.S. Cls.: 6, 18, 44, 46, 51 and 52**

**United States Patent and Trademark Office**

**Reg. No. 3,505,146**

**Registered Sep. 23, 2008**

**TRADEMARK  
PRINCIPAL REGISTER**

**X-3 Lean**

THERAPEUTIC BODY CENTER, INC. (FLORIDA  
CORPORATION)  
9657 BAY PINES BLVD.  
ST. PETERSBURG, FL 33708

THE MARK CONSISTS OF STANDARD CHAR-  
ACTERS WITHOUT CLAIM TO ANY PARTICULAR  
FONT, STYLE, SIZE, OR COLOR.

FOR: THERAPEUTIC AGENTS FOR WEIGHT  
CONTROL AND APPETITE SUPPRESSION, IN  
CLASS 5 (U.S. CLS. 6, 18, 44, 46, 51 AND 52).

SER. NO. 77-415,104, FILED 3-6-2008.

FIRST USE 2-22-2008; IN COMMERCE 2-22-2008.

MELISSA VALLILLO, EXAMINING ATTORNEY

**Int. Cl.: 30**

**Prior U.S. Cl.: 46**

**United States Patent and Trademark Office**

**Reg. No. 3,505,147**

**Registered Sep. 23, 2008**

**TRADEMARK  
PRINCIPAL REGISTER**

**PUCKER UPS**

CONCORD BRANDS ULC (CANADA CORPORATION)  
2900-10180 101 STREET  
EDMONTON, CANADA T5J3V5

FOR: CANDY, IN CLASS 30 (U.S. CL. 46).

FIRST USE 11-4-1971; IN COMMERCE 11-4-1971.

THE MARK CONSISTS OF STANDARD CHARACTERS WITHOUT CLAIM TO ANY PARTICULAR FONT, STYLE, SIZE, OR COLOR.

SER. NO. 77-415,239, FILED 3-6-2008.

LEIGH CAROLINE CASE, EXAMINING ATTORNEY

Int. Cl.: 25

Prior U.S. Cls.: 22 and 39

United States Patent and Trademark Office

Reg. No. 3,505,148

Registered Sep. 23, 2008

TRADEMARK  
PRINCIPAL REGISTER



GREAT FALLS BASEBALL CLUB, INC. (MONTANA CORPORATION)  
1015 25TH STREET NORTH  
GREAT FALLS, MT 59401

FOR: CLOTHING, NAMELY, APRONS, ATHLETIC UNIFORMS, BANDANAS, BOXER SHORTS, CAPS, CLOTH BABY BIBS, COATS, GOLF SHIRTS, GYM SHORTS, GYM SUITS, HATS, JACKETS, JERSEYS, JOGGING SUITS, KNIT SHIRTS, PAJAMAS, POLO SHIRTS, PONCHOS, PULLOVERS, RAIN COATS, RAINWEAR, SWEATERS, SWEAT PANTS, SWEAT SHIRTS, SWEAT SUITS, SOCKS, SPORT SHIRTS, T- SHIRTS, TANK TOPS, TIES, VISORS, WIND RESISTANT JACKETS AND WRISTBANDS, IN CLASS 25 (U.S. CLS. 22 AND 39).

FIRST USE 1-15-2008; IN COMMERCE 1-15-2008.

NO CLAIM IS MADE TO THE EXCLUSIVE RIGHT TO USE "GREAT FALLS", APART FROM THE MARK AS SHOWN.

THE MARK CONSISTS OF STYLIZED "GREAT FALLS VOYAGERS" WITH PLANET, STARS AND BASEBALL MOON BEHIND LETTERING.

SER. NO. 77-415,902, FILED 3-7-2008.

ROBIN CHOSID, EXAMINING ATTORNEY

**Int. Cls.: 35 and 37**

**Prior U.S. Cls.: 100, 101, 102, 103 and 106**

**United States Patent and Trademark Office**

**Reg. No. 3,505,149**

**Registered Sep. 23, 2008**

**SERVICE MARK  
PRINCIPAL REGISTER**

# DOOR MAGIC

WINDOWIZARDS, INC. (PENNSYLVANIA CORPORATION), DBA WIDOWIZARDS  
ROUTE 13 & PENNSYLVANIA TURNPIKE  
BRISTOL, PA 19007

FOR: ONLINE RETAIL STORE SERVICES FEATURING DECORATIVE DOOR GLASS FOR INSTALLATION INTO AN EXISTING DOOR, IN CLASS 35 (U.S. CLS. 100, 101 AND 102).

FIRST USE 12-31-2005; IN COMMERCE 12-31-2005.

FOR: INSTALLATION OF DECORATIVE DOOR GLASS INTO AN EXISTING DOOR, IN CLASS 37 (U.S. CLS. 100, 103 AND 106).

FIRST USE 12-31-2005; IN COMMERCE 12-31-2005.

THE MARK CONSISTS OF STANDARD CHARACTERS WITHOUT CLAIM TO ANY PARTICULAR FONT, STYLE, SIZE, OR COLOR.

NO CLAIM IS MADE TO THE EXCLUSIVE RIGHT TO USE DOOR, APART FROM THE MARK AS SHOWN.

SER. NO. 77-416,173, FILED 3-7-2008.

JERI J. FICKES, EXAMINING ATTORNEY

**Int. Cl.: 2**

**Prior U.S. Cls.: 6, 11 and 16**

**United States Patent and Trademark Office**

**Reg. No. 3,505,150**

**Registered Sep. 23, 2008**

**TRADEMARK  
PRINCIPAL REGISTER**

**ULTRA PREMIUM**

THE VALSPAR CORPORATION (DELAWARE  
CORPORATION)  
1101 SOUTH THIRD STREET  
MINNEAPOLIS, MN 55415

FOR: PAINTS, IN CLASS 2 (U.S. CLS. 6, 11 AND 16).

FIRST USE 5-0-2005; IN COMMERCE 5-0-2005.

THE MARK CONSISTS OF STANDARD CHAR-  
ACTERS WITHOUT CLAIM TO ANY PARTICULAR  
FONT, STYLE, SIZE, OR COLOR.

OWNER OF U.S. REG. NO. 3,328,519.

NO CLAIM IS MADE TO THE EXCLUSIVE  
RIGHT TO USE "PREMIUM", APART FROM THE  
MARK AS SHOWN.

SER. NO. 77-416,199, FILED 3-7-2008.

ANNE E. GUSTASON, EXAMINING ATTORNEY



**Int. Cl.: 45**

**Prior U.S. Cls.: 100 and 101**

**United States Patent and Trademark Office**

**Reg. No. 3,505,151**

**Registered Sep. 23, 2008**

**SERVICE MARK  
PRINCIPAL REGISTER**

**IDEFEND**

INVISUS, L.L.C. (UTAH LIMITED LIABILITY  
COMPANY)  
SUITE 400  
732 E. UTAH VALLEY DR.  
AMERICAN FORK, UT 84003

FOR: PERSONAL IDENTITY MONITORING AND  
CONSULTATION SERVICES IN THE FIELD OF  
PERSONAL INFORMATION THEFT AND IDENTITY  
THEFT, NAMELY, MONITORING PERSONAL  
IDENTITY INFORMATION AND PROVIDING PER-  
SONAL ASSISTANCE SERVICES TO VICTIMS OF  
IDENTITY THEFT FOR IDENTITY RESTORATION  
PURPOSES, NAMELY, ASSISTING WITH THE PRO-  
VISION OF INFORMATION AND THE FILING OF

REPORTS OF IDENTITY THEFT TO CREDIT RE-  
PORTING AGENCIES, CREDITORS, AND GOV-  
ERNMENT AND REGULATORY AGENCIES, IN  
CLASS 45 (U.S. CLS. 100 AND 101).

FIRST USE 9-29-2007; IN COMMERCE 10-1-2007.

THE MARK CONSISTS OF STANDARD CHAR-  
ACTERS WITHOUT CLAIM TO ANY PARTICULAR  
FONT, STYLE, SIZE, OR COLOR.

SER. NO. 77-416,266, FILED 3-7-2008.

PAUL CROWLEY, EXAMINING ATTORNEY

**Int. Cl.: 9**

**Prior U.S. Cls.: 21, 23, 26, 36 and 38**

**United States Patent and Trademark Office**

**Reg. No. 3,505,152**

**Registered Sep. 23, 2008**

**TRADEMARK  
PRINCIPAL REGISTER**

**NETWORK CONNECTION  
CENTER**

HOME DIRECTOR, INC. (DELAWARE CORPORATION)  
900 E. HAMILTON AVENUE, SUITE 550  
CAMPBELL, CA 95008

FOR: COMPUTER HARDWARE FOR USE IN MANAGING ELECTRONIC CABLES USED IN CONTROLLING ELECTRICAL FUNCTIONS WITHIN RESIDENTIAL AND COMMERCIAL BUILDINGS, AND PRINTED MANUALS FOR USE THEREWITH, IN CLASS 9 (U.S. CLS. 21, 23, 26, 36 AND 38).

FIRST USE 1-0-2000; IN COMMERCE 1-0-2000.

THE MARK CONSISTS OF STANDARD CHARACTERS WITHOUT CLAIM TO ANY PARTICULAR FONT, STYLE, SIZE, OR COLOR.

OWNER OF U.S. REG. NO. 2,545,417.

SEC. 2(F).

SER. NO. 77-416,739, FILED 3-7-2008.

ALYSSA PALADINO, EXAMINING ATTORNEY

**Int. Cl.: 10**

**Prior U.S. Cls.: 26, 39 and 44**

**United States Patent and Trademark Office**

**Reg. No. 3,505,153**

**Registered Sep. 23, 2008**

**TRADEMARK  
PRINCIPAL REGISTER**

# STATURE

JOERNS HEALTHCARE INC. (DELAWARE COR-  
PORATION)  
5001 JOERNS DRIVE  
STEVENS POINT, WI 54481

THE MARK CONSISTS OF STANDARD CHAR-  
ACTERS WITHOUT CLAIM TO ANY PARTICULAR  
FONT, STYLE, SIZE, OR COLOR.

FOR: INVALID LIFTS, IN CLASS 10 (U.S. CLS. 26,  
39 AND 44).

SER. NO. 77-416,791, FILED 3-8-2008.

FIRST USE 1-30-2007; IN COMMERCE 1-30-2007.

JOHN WILKE, EXAMINING ATTORNEY

**Int. Cls.: 8, 9, 11, 16, 18, 20, 21, 22, 24, 25 and 28**

**Prior U.S. Cls.: 1, 2, 3, 5, 7, 13, 19, 21, 22, 23, 25, 26, 28, 29, 30, 31, 32, 33, 34, 36, 37, 38, 39, 40, 41, 42, 44 and 50**

**Reg. No. 3,505,154**

**United States Patent and Trademark Office**

**Registered Sep. 23, 2008**

**TRADEMARK  
PRINCIPAL REGISTER**

**HITACHI**

KABUSHIKI KAISHA HITACHI SEISAKUSHO  
(JAPAN CORPORATION), DBA HITACHI,  
LTD.

6-6, MARUNOUCHI 1-CHOME, CHIYODA-KU  
TOKYO, JAPAN

FOR: HAND HELD MULTIPURPOSE TOOL COM-  
PRISED OF PLIERS, LED FLASHLIGHT, SCREW-  
DRIVER, AND UTILITY KNIFE, IN CLASS 8 (U.S.  
CLS. 23, 28 AND 44).

FIRST USE 3-7-2008; IN COMMERCE 3-7-2008.

FOR: FLASH MEMORY DRIVES; COMPUTER  
CORD CONNECTORS; MOBILE PHONE HEAD-  
SETS; NETWORK AND MODEM CORD ORGANI-  
ZERS; USB PORT HUBS; BACKPACKS ESPECIALLY  
ADAPTED FOR HOLDING LAPTOPS AND NOTE-  
BOOK COMPUTERS; ROLLING ATTACHÉ CASES  
ESPECIALLY ADAPTED FOR HOLDING LAPTOPS  
AND NOTEBOOK COMPUTERS; LASER POINTERS  
, IN CLASS 9 (U.S. CLS. 21, 23, 26, 36 AND 38).

FIRST USE 3-7-2008; IN COMMERCE 3-7-2008.

FOR: FLASHLIGHTS, IN CLASS 11 (U.S. CLS. 13,  
21, 23, 31 AND 34).

FIRST USE 3-7-2008; IN COMMERCE 3-7-2008.

FOR: PENS; JOURNALS; NOTEBOOKS; PENCILS;  
HIGHLIGHTING PENS; LEATHER BOUND PAD-  
FOLIOS; LEATHER BOUND NOTEBOOKS; GENER-  
AL PURPOSE PLASTIC BAGS, IN CLASS 16 (U.S.  
CLS. 2, 5, 22, 23, 29, 37, 38 AND 50).

FIRST USE 3-7-2008; IN COMMERCE 3-7-2008.

FOR: UMBRELLAS; BUSINESS CARD CASES;  
TOTE BAGS; DUFFEL BAGS; BRIEFCASES; MES-

SENGER BAGS; BACKPACKS; TRAVEL CASES, IN  
CLASS 18 (U.S. CLS. 1, 2, 3, 22 AND 41).

FIRST USE 3-7-2008; IN COMMERCE 3-7-2008.

FOR: FOLDING SEAT CUSHIONS, IN CLASS 20  
(U.S. CLS. 2, 13, 22, 25, 32 AND 50).

FIRST USE 3-7-2008; IN COMMERCE 3-7-2008.

FOR: MUGS; SPORTS BOTTLES SOLD EMPTY;  
THERMAL INSULATED CONTAINERS FOR FOOD  
OR BEVERAGES, IN CLASS 21 (U.S. CLS. 2, 13, 23, 29,  
30, 33, 40 AND 50).

FIRST USE 3-7-2008; IN COMMERCE 3-7-2008.

FOR: LANYARDS FOR HOLDING PENS, BAD-  
GES, KEYS OR EYEGASSES, IN CLASS 22 (U.S.  
CLS. 1, 2, 7, 19, 22, 42 AND 50).

FIRST USE 3-7-2008; IN COMMERCE 3-7-2008.

FOR: GOLF TOWELS, IN CLASS 24 (U.S. CLS. 42  
AND 50).

FIRST USE 3-7-2008; IN COMMERCE 3-7-2008.

FOR: GOLF SHIRTS; POLO SHIRTS; SHIRTS;  
JACKETS; FLEECE PULLOVERS; BASEBALL CAPS;  
VISORS, IN CLASS 25 (U.S. CLS. 22 AND 39).

FIRST USE 3-7-2008; IN COMMERCE 3-7-2008.

FOR: GOLF BALLS; GOLF TEES; STRESS RELIEF  
BALLS FOR HAND EXERCISE; STRESS RELIEF  
DOLLS FOR HAND EXERCISE; WOODEN MANIP-  
ULATIVE PUZZLES, IN CLASS 28 (U.S. CLS. 22, 23, 38  
AND 50).

FIRST USE 3-7-2008; IN COMMERCE 3-7-2008.

THE MARK CONSISTS OF STANDARD CHARACTERS WITHOUT CLAIM TO ANY PARTICULAR FONT, STYLE, SIZE, OR COLOR.

OWNER OF U.S. REG. NOS. 701,266, 3,328,528 AND OTHERS.

SER. NO. 77-417,144, FILED 3-9-2008.

RONALD DELGIZZI, EXAMINING ATTORNEY

**Int. Cl.: 44**

**Prior U.S. Cls.: 100 and 101**

**United States Patent and Trademark Office**

**Reg. No. 3,505,155**

**Registered Sep. 23, 2008**

**SERVICE MARK  
PRINCIPAL REGISTER**

# Commit for Life

GULF COAST REGIONAL BLOOD CENTER  
(TEXAS CORPORATION)  
1400 LA CONCHA  
HOUSTON, TX 77058 AND  
HOUSTON ACADEMY OF MEDICINE (TEXAS  
CORPORATION)  
1515 HERMANN DR.  
HOUSTON, TX 77004

FOR: BLOOD BANK SERVICES, NAMELY, COL-  
LECTING BLOOD AND BLOOD COMPONENTS , IN  
CLASS 44 (U.S. CLS. 100 AND 101).

FIRST USE 11-5-2003; IN COMMERCE 11-5-2003.

THE MARK CONSISTS OF STANDARD CHAR-  
ACTERS WITHOUT CLAIM TO ANY PARTICULAR  
FONT, STYLE, SIZE, OR COLOR.

SER. NO. 77-417,386, FILED 3-10-2008.

ELIZABETH KAJUBI, EXAMINING ATTORNEY

**Int. Cls.: 35 and 44**

**Prior U.S. Cls.: 100, 101 and 102**

**United States Patent and Trademark Office**

**Reg. No. 3,505,156**

**Registered Sep. 23, 2008**

**SERVICE MARK  
PRINCIPAL REGISTER**



APPLIEDINFO PARTNERS, INC. (NEW JERSEY CORPORATION)  
28 WORLD'S FAIR DRIVE  
SOMERSET, NJ 08873

FOR: SUPPLYING PRESCRIPTION DRUGS TO INDIGENT PATIENTS, WHO DO NOT HAVE ACCESS TO PRESCRIPTION INSURANCE OR GOVERNMENT FUNDED PROGRAMS, AND STARTER KITS AND SAMPLES TO DOCTORS FOR DISTRIBUTION IN CONNECTION THEREWITH, IN CLASS 35 (U.S. CLS. 100, 101 AND 102).

FIRST USE 2-2-2000; IN COMMERCE 2-2-2000.

FOR: PHARMACEUTICAL ADVICE; AND MEDICAL COUNSELING, IN CLASS 44 (U.S. CLS. 100 AND 101).

FIRST USE 2-2-2000; IN COMMERCE 2-2-2000.

THE MARK CONSISTS OF THE WORD "RXHOPE" STYLIZED.

SER. NO. 77-417,660, FILED 3-10-2008.

WENDY GOODMAN, EXAMINING ATTORNEY

**Int. Cl.: 41**

**Prior U.S. Cls.: 100, 101 and 107**

**United States Patent and Trademark Office**

**Reg. No. 3,505,157**

**Registered Sep. 23, 2008**

**SERVICE MARK  
PRINCIPAL REGISTER**

**VIDEOTIC**

AIRBORNE MOBILE INC. (CANADA CORPORATION)  
3575 ST. LAURENT BLVD., SUITE 750  
MONTREAL, CANADA H2X2T7

THE MARK CONSISTS OF STANDARD CHARACTERS WITHOUT CLAIM TO ANY PARTICULAR FONT, STYLE, SIZE, OR COLOR.

FOR: ENTERTAINMENT SERVICES, NAMELY, PROVIDING COMEDY VIDEOS TO MOBILE TELEPHONES, IN CLASS 41 (U.S. CLS. 100, 101 AND 107).

SER. NO. 77-417,695, FILED 3-10-2008.

FIRST USE 5-1-2007; IN COMMERCE 5-1-2007.

MIDGE BUTLER, EXAMINING ATTORNEY



**Int. Cl.: 28**

**Prior U.S. Cls.: 22, 23, 38 and 50**

**Reg. No. 3,505,158**

**United States Patent and Trademark Office**

**Registered Sep. 23, 2008**

---

**TRADEMARK  
PRINCIPAL REGISTER**

**LUCKY PUTTER**

PARADISE GOLF EQUIPMENT, INC. (GEORGIA  
CORPORATION)

1331 LYNNAH AVENUE

GARDEN CITY, GA 31408

FOR: GOLF CLUBS, IN CLASS 28 (U.S. CLS. 22, 23,  
38 AND 50).

FIRST USE 9-11-1995; IN COMMERCE 9-11-1995.

THE MARK CONSISTS OF STANDARD CHAR-  
ACTERS WITHOUT CLAIM TO ANY PARTICULAR  
FONT, STYLE, SIZE, OR COLOR.

NO CLAIM IS MADE TO THE EXCLUSIVE  
RIGHT TO USE "PUTTER", APART FROM THE  
MARK AS SHOWN.

SER. NO. 77-418,796, FILED 3-11-2008.

KRISTIN DAHLING, EXAMINING ATTORNEY

**Int. Cl.: 9**

**Prior U.S. Cls.: 21, 23, 26, 36 and 38**

**United States Patent and Trademark Office**

**Reg. No. 3,505,159**

**Registered Sep. 23, 2008**

**TRADEMARK  
PRINCIPAL REGISTER**

**GAMECAM**

EBSCO INDUSTRIES, INC. (DELAWARE COR-  
PORATION)  
FINANCE DEPT  
5724 HWY 280 EAST  
BIRMINGHAM, AL 35242

FOR: PHOTOGRAPHIC CAMERAS, IN CLASS 9  
(U.S. CLS. 21, 23, 26, 36 AND 38).

FIRST USE 4-1-2000; IN COMMERCE 7-1-2000.

THE MARK CONSISTS OF STANDARD CHAR-  
ACTERS WITHOUT CLAIM TO ANY PARTICULAR  
FONT, STYLE, SIZE, OR COLOR.

OWNER OF U.S. REG. NO. 2,606,127.

SEC. 2(F).

SER. NO. 77-418,878, FILED 3-11-2008.

ERNEST SHOSHO, EXAMINING ATTORNEY

**Int. Cl.: 25**

**Prior U.S. Cls.: 22 and 39**

**United States Patent and Trademark Office**

**Reg. No. 3,505,160**

**Registered Sep. 23, 2008**

**TRADEMARK  
PRINCIPAL REGISTER**

**VLTOR**

ABRAMS AIRBORNE MANUFACTURING, INC.  
(ARIZONA CORPORATION), DBA VLTOR  
WEAPON SYSTEMS  
3735 NORTH ROMERO ROAD  
TUCSON, AZ 85705

THE MARK CONSISTS OF STANDARD CHAR-  
ACTERS WITHOUT CLAIM TO ANY PARTICULAR  
FONT, STYLE, SIZE, OR COLOR.

FOR: CLOTHING, NAMELY, HATS AND SHIRTS,  
IN CLASS 25 (U.S. CLS. 22 AND 39).

SER. NO. 77-418,965, FILED 3-11-2008.

FIRST USE 11-15-2003; IN COMMERCE 11-15-2003.

MARGERY A. TIERNEY, EXAMINING ATTORNEY

**Int. Cl.: 42**

**Prior U.S. Cls.: 100 and 101**

**United States Patent and Trademark Office**

**Reg. No. 3,505,161**

**Registered Sep. 23, 2008**

**SERVICE MARK  
PRINCIPAL REGISTER**

**GoToYourSite.com**

ADCUENT, INC. (FLORIDA CORPORATION)  
16328 MIRA VISTA LN  
DELRAY BEACH, FL 33446

FOR: PROVIDING TEMPORARY USE OF ON-  
LINE NON-DOWNLOADABLE SOFTWARE FOR  
THE DEVELOPMENT AND HOSTING OF WEBSITE  
APPLICATIONS, IN CLASS 42 (U.S. CLS. 100 AND  
101).

FIRST USE 4-15-2007; IN COMMERCE 4-15-2007.

THE MARK CONSISTS OF STANDARD CHAR-  
ACTERS WITHOUT CLAIM TO ANY PARTICULAR  
FONT, STYLE, SIZE, OR COLOR.

SER. NO. 77-419,471, FILED 3-12-2008.

RON FAIRBANKS, EXAMINING ATTORNEY

**Int. Cl.: 30**

**Prior U.S. Cl.: 46**

**United States Patent and Trademark Office**

**Reg. No. 3,505,162**

**Registered Sep. 23, 2008**

**TRADEMARK  
PRINCIPAL REGISTER**

**HUNKA CHUNKA PB FUDGE**

FRIENDLY ICE CREAM CORPORATION (MAS-  
SACHUSETTS CORPORATION)  
1855 BOSTON ROAD  
WILBRAHAM, MA 01095

NO CLAIM IS MADE TO THE EXCLUSIVE  
RIGHT TO USE "PB FUDGE", APART FROM THE  
MARK AS SHOWN.

FOR: ICE CREAM, IN CLASS 30 (U.S. CL. 46).

FIRST USE 6-21-2004; IN COMMERCE 6-21-2004.

SER. NO. 77-419,481, FILED 3-12-2008.

THE MARK CONSISTS OF STANDARD CHAR-  
ACTERS WITHOUT CLAIM TO ANY PARTICULAR  
FONT, STYLE, SIZE, OR COLOR.

GRETTA YAO, EXAMINING ATTORNEY

**Int. Cl.: 28**

**Prior U.S. Cls.: 22, 23, 38 and 50**

**United States Patent and Trademark Office**

**Reg. No. 3,505,163**

**Registered Sep. 23, 2008**

**TRADEMARK  
PRINCIPAL REGISTER**

**ZING**

KARSTEN MANUFACTURING CORPORATION  
(ARIZONA CORPORATION)  
2201 WEST DESERT COVE  
PHOENIX, AZ 85029

THE MARK CONSISTS OF STANDARD CHAR-  
ACTERS WITHOUT CLAIM TO ANY PARTICULAR  
FONT, STYLE, SIZE, OR COLOR.

FOR: GOLF CLUBS, IN CLASS 28 (U.S. CLS. 22, 23,  
38 AND 50).

SER. NO. 77-419,784, FILED 3-12-2008.

FIRST USE 12-21-1972; IN COMMERCE 12-22-1972.

ROBIN CHOSID, EXAMINING ATTORNEY

**Int. Cl.: 44**

**Prior U.S. Cls.: 100 and 101**

**United States Patent and Trademark Office**

**Reg. No. 3,505,164**

**Registered Sep. 23, 2008**

**SERVICE MARK  
PRINCIPAL REGISTER**

**TANETICS**

HOLLYWOOD TANS, LLC (DELAWARE LIMITED LIABILITY COMPANY)  
11 ENTERPRISE COURT  
SEWELL, NJ 08080

THE MARK CONSISTS OF STANDARD CHARACTERS WITHOUT CLAIM TO ANY PARTICULAR FONT, STYLE, SIZE, OR COLOR.

FOR: TANNING SALONS, IN CLASS 44 (U.S. CLS. 100 AND 101).

SER. NO. 77-420,574, FILED 3-12-2008.

FIRST USE 3-2-2008; IN COMMERCE 3-2-2008.

LAURIE KAUFMAN, EXAMINING ATTORNEY

**Int. Cl.: 12**

**Prior U.S. Cls.: 19, 21, 23, 31, 35 and 44**

**United States Patent and Trademark Office**

**Reg. No. 3,505,165**

**Registered Sep. 23, 2008**

**TRADEMARK  
PRINCIPAL REGISTER**

**RIDE ON OUR STRENGTH**

THE HERCULES TIRE & RUBBER COMPANY  
(CONNECTICUT CORPORATION)  
16380 U.S. ROUTE 224 EAST, SUITE 200  
FINDLAY, OH 45840

THE MARK CONSISTS OF STANDARD CHAR-  
ACTERS WITHOUT CLAIM TO ANY PARTICULAR  
FONT, STYLE, SIZE, OR COLOR.

FOR: TIRES, IN CLASS 12 (U.S. CLS. 19, 21, 23, 31,  
35 AND 44).

SER. NO. 77-422,475, FILED 3-14-2008.

FIRST USE 6-15-2006; IN COMMERCE 6-15-2006.

CAROL SPILS, EXAMINING ATTORNEY



**Int. Cl.: 5**

**Prior U.S. Cls.: 6, 18, 44, 46, 51 and 52**

**United States Patent and Trademark Office**

**Reg. No. 3,505,166**

**Registered Sep. 23, 2008**

**TRADEMARK  
PRINCIPAL REGISTER**

# Connection

NUTRICOLOGY, INC. (CALIFORNIA CORPORATION)  
2300 NORTH LOOP ROAD  
ALAMEDA, CA 94502

THE MARK CONSISTS OF STANDARD CHARACTERS WITHOUT CLAIM TO ANY PARTICULAR FONT, STYLE, SIZE, OR COLOR.

FOR: DIETARY SUPPLEMENTS, IN CLASS 5 (U.S. CLS. 6, 18, 44, 46, 51 AND 52).

SER. NO. 77-422,577, FILED 3-14-2008.

FIRST USE 3-1-1996; IN COMMERCE 3-1-1996.

JORDAN BAKER, EXAMINING ATTORNEY

**Int. Cl.: 5**

**Prior U.S. Cls.: 6, 18, 44, 46, 51 and 52**

**Reg. No. 3,505,167**

**United States Patent and Trademark Office**

**Registered Sep. 23, 2008**

---

**TRADEMARK  
PRINCIPAL REGISTER**

**Mastica**

NUTRICOLOGY, INC. (CALIFORNIA CORPORATION)  
2300 NORTH LOOP ROAD  
ALAMEDA, CA 94502

THE MARK CONSISTS OF STANDARD CHARACTERS WITHOUT CLAIM TO ANY PARTICULAR FONT, STYLE, SIZE, OR COLOR.

FOR: DIETARY SUPPLEMENTS, IN CLASS 5 (U.S. CLS. 6, 18, 44, 46, 51 AND 52).

SER. NO. 77-422,620, FILED 3-14-2008.

FIRST USE 10-5-1999; IN COMMERCE 10-5-1999.

JORDAN BAKER, EXAMINING ATTORNEY

**Int. Cl.: 41**

**Prior U.S. Cls.: 100, 101 and 107**

**United States Patent and Trademark Office**

**Reg. No. 3,505,168**

**Registered Sep. 23, 2008**

**SERVICE MARK  
PRINCIPAL REGISTER**

**NACCME**

HMP COMMUNICATIONS, LLC (DELAWARE  
LIMITED LIABILITY COMPANY)  
SUITE 100  
83 GENERAL WARREN BOULEVARD  
MALVERN, PA 19355

FOR: EDUCATIONAL SERVICES, NAMELY,  
CONDUCTING AND ORGANIZING CLASSES,  
SEMINARS, CONFERENCES AND WORKSHOPS  
IN THE FIELDS OF HEALTHCARE AND MEDI-  
CINE, AS WELL AS THE DISTRIBUTION OF  
COURSE MATERIALS IN CONNECTION THERE-  
WITH, IN CLASS 41 (U.S. CLS. 100, 101 AND 107).

FIRST USE 3-31-2004; IN COMMERCE 3-31-2004.

THE MARK CONSISTS OF STANDARD CHAR-  
ACTERS WITHOUT CLAIM TO ANY PARTICULAR  
FONT, STYLE, SIZE, OR COLOR.

SER. NO. 77-422,794, FILED 3-14-2008.

AHSEN KHAN, EXAMINING ATTORNEY

**Int. Cl.: 41**

**Prior U.S. Cls.: 100, 101 and 107**

**United States Patent and Trademark Office**

**Reg. No. 3,505,169**

**Registered Sep. 23, 2008**

**SERVICE MARK  
PRINCIPAL REGISTER**



HMP COMMUNICATIONS, LLC (DELAWARE  
LIMITED LIABILITY COMPANY)  
SUITE 100  
83 GENERAL WARREN BOULEVARD  
MALVERN, PA 19355

FOR: EDUCATIONAL SERVICES, NAMELY,  
CONDUCTING AND ORGANIZING CLASSES,  
SEMINARS, CONFERENCES AND WORKSHOPS  
IN THE FIELDS OF HEALTHCARE AND MEDI-  
CINE, AS WELL AS THE DISTRIBUTION OF

COURSE MATERIALS IN CONNECTION THERE-  
WITH, IN CLASS 41 (U.S. CLS. 100, 101 AND 107).

FIRST USE 3-31-2005; IN COMMERCE 3-31-2005.

THE MARK CONSISTS OF THE WORD  
"NACCME" WITH A STYLIZED FIRST "C".

SER. NO. 77-422,819, FILED 3-14-2008.

MELVIN AXILBUND, EXAMINING ATTORNEY

**Int. Cl.: 5**

**Prior U.S. Cls.: 6, 18, 44, 46, 51 and 52**

**United States Patent and Trademark Office**

**Reg. No. 3,505,170**

**Registered Sep. 23, 2008**

**TRADEMARK  
PRINCIPAL REGISTER**

**SOUND SLEEP**

GAIA HERBS, INC. (MASSACHUSETTS CORPORATION)  
101 GAIA HERBS DRIVE  
BREVARD, NC 28712

THE MARK CONSISTS OF STANDARD CHARACTERS WITHOUT CLAIM TO ANY PARTICULAR FONT, STYLE, SIZE, OR COLOR.

FOR: HERBAL, NUTRITIONAL AND DIETARY SUPPLEMENT, IN CLASS 5 (U.S. CLS. 6, 18, 44, 46, 51 AND 52).

SER. NO. 77-423,430, FILED 3-17-2008.

FIRST USE 3-1-2001; IN COMMERCE 3-1-2001.

KELLY CHOE, EXAMINING ATTORNEY

**Int. Cl.: 9**

**Prior U.S. Cls.: 21, 23, 26, 36 and 38**

**Reg. No. 3,505,171**

**United States Patent and Trademark Office**

**Registered Sep. 23, 2008**

---

**TRADEMARK  
PRINCIPAL REGISTER**

**chameleon**

EXCEON AMERICAN BEAUTY SUPPLY (NEW  
JERSEY CORPORATION), DBA AMERICAN  
BEAUTY SUPPLY

#501-332

10 SCHALKS CROSSING ROAD  
PLAINSBORO, NJ 08536

FOR: ELECTRIC HAIR STRAIGHTENER, IN  
CLASS 9 (U.S. CLS. 21, 23, 26, 36 AND 38).

FIRST USE 3-20-2008; IN COMMERCE 4-2-2008.

THE MARK CONSISTS OF STANDARD CHAR-  
ACTERS WITHOUT CLAIM TO ANY PARTICULAR  
FONT, STYLE, SIZE, OR COLOR.

SER. NO. 77-425,379, FILED 3-18-2008.

JENNIFER MARTIN, EXAMINING ATTORNEY

Int. Cl.: 9

Prior U.S. Cls.: 21, 23, 26, 36 and 38

United States Patent and Trademark Office

Reg. No. 3,505,172

Registered Sep. 23, 2008

TRADEMARK  
PRINCIPAL REGISTER



ESRMCO INC. (DELAWARE CORPORATION)  
2366 BERNVILLE ROAD  
READING, PA 19605

FOR: ELECTRIC STORAGE BATTERIES, IN  
CLASS 9 (U.S. CLS. 21, 23, 26, 36 AND 38).

FIRST USE 6-30-2006; IN COMMERCE 6-30-2006.

OWNER OF U.S. REG. NOS. 1,725,132, 3,119,679  
AND OTHERS.

NO CLAIM IS MADE TO THE EXCLUSIVE  
RIGHT TO USE "TUBULAR" OR "1910", APART  
FROM THE MARK AS SHOWN.

THE COLOR(S) GRAY, WHITE, BLACK, BLUE IS/  
ARE CLAIMED AS A FEATURE OF THE MARK.

THE MARK CONSISTS OF A SHIELD SHAPE  
OUTLINED IN BLUE AND WITH A DARK GRAY  
CENTER, GRAY RIVETS AROUND THE PERIPH-  
ERY AND A BLUE BASE, CONTAINING A STY-  
LIZED BLACK HOG WITH A WHITE OUTLINE  
AND WHITE FEATURES WITH THE STYLIZED  
WORDING "LOADHOG" IN BLUE WITH WHITE  
OUTLINING ABOVE IT AND THE WORDS "EN-  
ERSYS" AND A TRIANGLE IN WHITE AND "IR-  
ONCLAD" IN BLACK ON A RECTANGULAR  
GRAY BACKGROUND WITH A BLACK BORDER  
ABOVE THE HOG AND "TUBULAR SINCE 1910" IN  
WHITE WITH A RECTANGULAR WHITE BORDER  
UNDERNEATH THE HOG.

SER. NO. 77-425,823, FILED 3-19-2008.

KYLE PEETE, EXAMINING ATTORNEY

Int. Cl.: 9

Prior U.S. Cls.: 21, 23, 26, 36 and 38

United States Patent and Trademark Office

Reg. No. 3,505,173

Registered Sep. 23, 2008

TRADEMARK  
PRINCIPAL REGISTER



ESRMCO INC (DELAWARE CORPORATION)  
2366 BERNVILLE ROAD  
READING, PA 19605

FOR: ELECTRIC STORAGE BATTERIES, IN  
CLASS 9 (U.S. CLS. 21, 23, 26, 36 AND 38).

FIRST USE 6-30-2006; IN COMMERCE 6-30-2006.

OWNER OF U.S. REG. NOS. 2,229,379, 2,865,140  
AND OTHERS.

NO CLAIM IS MADE TO THE EXCLUSIVE  
RIGHT TO USE "TUBULAR" OR "1910", APART  
FROM THE MARK AS SHOWN.

THE COLOR(S) GRAY, WHITE, BLACK, GREEN  
IS/ARE CLAIMED AS A FEATURE OF THE MARK.

THE MARK CONSISTS OF A SHIELD SHAPE  
OUTLINED IN GREEN AND WITH A DARK GRAY  
CENTER, GRAY RIVETS AROUND THE PERIPH-  
ERY AND A GREEN BASE, CONTAINING A STY-  
LIZED BLACK HOG WITH A WHITE OUTLINE  
AND WHITE FEATURES WITH THE STYLIZED  
WORDING "SMARTHOG" IN GREEN WITH WHITE  
OUTLINING ABOVE IT AND THE WORDS "EN-  
ERSYS" AND A TRIANGLE IN WHITE AND "IR-  
ONCLAD" IN BLACK ON A RECTANGULAR  
GRAY BACKGROUND WITH A BLACK BORDER  
ABOVE THE HOG AND "TUBULAR SINCE 1910" IN  
WHITE WITH A RECTANGULAR WHITE BORDER  
UNDERNEATH THE HOG.

SER. NO. 77-426,002, FILED 3-19-2008.

KYLE PEETE, EXAMINING ATTORNEY



Int. Cl.: 9

Prior U.S. Cls.: 21, 23, 26, 36 and 38

United States Patent and Trademark Office

Reg. No. 3,505,174

Registered Sep. 23, 2008

TRADEMARK  
PRINCIPAL REGISTER



ESRMCO INC. (DELAWARE CORPORATION)  
2366 BERNVILLE ROAD  
READING, PA 19605

FOR: ELECTRIC STORAGE BATTERIES, IN  
CLASS 9 (U.S. CLS. 21, 23, 26, 36 AND 38).

FIRST USE 6-30-2006; IN COMMERCE 6-30-2006.

OWNER OF U.S. REG. NOS. 1,732,555, 3,372,261  
AND OTHERS.

NO CLAIM IS MADE TO THE EXCLUSIVE  
RIGHT TO USE "TUBULAR" OR "1910", APART  
FROM THE MARK AS SHOWN.

THE COLOR(S) GRAY, WHITE, BLACK AND  
RED IS/ARE CLAIMED AS A FEATURE OF THE  
MARK.

THE MARK CONSISTS OF A SHIELD SHAPE  
OUTLINED IN RED AND WITH A DARK GRAY  
CENTER, GRAY RIVETS AROUND THE PERIPH-  
ERY AND A RED BASE, CONTAINING A STY-  
LIZED BLACK HOG WITH A WHITE OUTLINE  
AND WHITE FEATURES WITH THE STYLIZED  
WORDING "SUPERHOG" IN RED WITH WHITE  
OUTLINING ABOVE IT AND THE WORDS "EN-  
ERSYS" AND A TRIANGLE IN WHITE AND "IR-  
ONCLAD" IN BLACK ON A RECTANGULAR  
GRAY BACKGROUND WITH A BLACK BORDER  
ABOVE THE HOG AND "TUBULAR SINCE 1910" IN  
WHITE WITH A RECTANGULAR WHITE BORDER  
UNDERNEATH THE HOG.

SER. NO. 77-426,042, FILED 3-19-2008.

KYLE PEETE, EXAMINING ATTORNEY

Int. Cl.: 9

Prior U.S. Cls.: 21, 23, 26, 36 and 38

United States Patent and Trademark Office

Reg. No. 3,505,175

Registered Sep. 23, 2008

TRADEMARK  
PRINCIPAL REGISTER



ESRMCO INC. (DELAWARE CORPORATION)  
2366 BERNVILLE ROAD  
READING, PA 19605

FOR: ELECTRIC STORAGE BATTERIES, IN  
CLASS 9 (U.S. CLS. 21, 23, 26, 36 AND 38).

FIRST USE 6-30-2006; IN COMMERCE 6-30-2006.

OWNER OF U.S. REG. NOS. 2,709,460, 2,865,140  
AND OTHERS.

NO CLAIM IS MADE TO THE EXCLUSIVE  
RIGHT TO USE "TUBULAR" OR "1910", APART  
FROM THE MARK AS SHOWN.

THE COLOR(S) GRAY, WHITE, BLACK AND  
BROWN IS/ARE CLAIMED AS A FEATURE OF  
THE MARK.

THE MARK CONSISTS OF A SHIELD SHAPE  
OUTLINED IN LIGHT BROWN AND WITH A  
DARK GRAY CENTER, GRAY RIVETS AROUND  
THE PERIPHERY AND A LIGHT BROWN BASE,  
CONTAINING A STYLIZED BLACK HOG WITH A  
WHITE OUTLINE AND WHITE FEATURES WITH  
THE STYLIZED WORDING "DESERTHOG" IN  
LIGHT BROWN WITH WHITE OUTLINING ABOVE  
IT AND THE WORDS "ENERSYS" AND A TRIAN-  
GLE IN WHITE AND "IRONCLAD" IN BLACK ON A  
RECTANGULAR GRAY BACKGROUND WITH A  
BLACK BORDER ABOVE THE HOG AND "TUBU-  
LAR SINCE 1910" IN BLACK WITH A RECTANGU-  
LAR BLACK BORDER UNDERNEATH THE HOG.

SER. NO. 77-426,073, FILED 3-19-2008.

KYLE PEETE, EXAMINING ATTORNEY

Int. Cl.: 9

Prior U.S. Cls.: 21, 23, 26, 36 and 38

United States Patent and Trademark Office

Reg. No. 3,505,176

Registered Sep. 23, 2008

TRADEMARK  
PRINCIPAL REGISTER



ESRMCO INC. (DELAWARE CORPORATION)  
2366 BERNVILLE ROAD  
READING, PA 19605

FOR: ELECTRIC STORAGE BATTERIES, IN  
CLASS 9 (U.S. CLS. 21, 23, 26, 36 AND 38).

FIRST USE 6-30-2006; IN COMMERCE 6-30-2006.

OWNER OF U.S. REG. NOS. 2,357,889, 2,865,140  
AND OTHERS.

NO CLAIM IS MADE TO THE EXCLUSIVE  
RIGHT TO USE "TUBULAR" OR "1910", APART  
FROM THE MARK AS SHOWN.

THE COLOR(S) GRAY, WHITE AND BLACK IS/  
ARE CLAIMED AS A FEATURE OF THE MARK.

THE MARK CONSISTS OF A SHIELD SHAPE  
OUTLINED IN LIGHT GRAY AND WITH A DARK  
GRAY CENTER, GRAY RIVETS AROUND THE  
PERIPHERY AND A LIGHT GRAY BASE, CON-  
TAINING A STYLIZED BLACK HOG WITH A  
WHITE OUTLINE AND WHITE FEATURES WITH  
THE STYLIZED WORDING "WORKHOG" IN  
LIGHT GRAY WITH WHITE OUTLINING ABOVE  
IT AND THE WORDS "ENERSYS" AND A TRIAN-  
GLE IN WHITE AND "IRONCLAD" IN BLACK ON A  
RECTANGULAR GRAY BACKGROUND WITH A  
BLACK BORDER ABOVE THE HOG AND "TUBU-  
LAR SINCE 1910" IN BLACK WITH A RECTANGU-  
LAR BLACK BORDER UNDERNEATH THE HOG.

SER. NO. 77-426,146, FILED 3-19-2008.

KYLE PEETE, EXAMINING ATTORNEY

**Int. Cl.: 36**

**Prior U.S. Cls.: 100, 101 and 102**

**United States Patent and Trademark Office**

**Reg. No. 3,505,177**

**Registered Sep. 23, 2008**

**SERVICE MARK  
PRINCIPAL REGISTER**



ACS MARKETING, L.P. (DELAWARE LIMITED  
PARTNERSHIP)  
2828 N. HASKELL  
DALLAS, TX 75204

FOR: COLLECTING TOLLS AND FEES FOR USE  
OF ROADWAYS, IN CLASS 36 (U.S. CLS. 100, 101  
AND 102).

FIRST USE 11-0-2003; IN COMMERCE 11-0-2003.

OWNER OF U.S. REG. NOS. 2,150,183, 3,329,922  
AND OTHERS.

THE MARK CONSISTS OF THE STYLIZED LET-  
TER "A" WITH THE LETTERS "ACS" BELOW IT.

SER. NO. 77-426,187, FILED 3-19-2008.

BERNICE MIDDLETON, EXAMINING ATTORNEY

**Int. Cl.: 16**

**Prior U.S. Cls.: 2, 5, 22, 23, 29, 37, 38 and 50**

**United States Patent and Trademark Office**

**Reg. No. 3,505,178**

**Registered Sep. 23, 2008**

**TRADEMARK  
PRINCIPAL REGISTER**

# THE MASK

DARK HORSE COMICS, INC. (OREGON CORPORATION)  
10956 SE MAIN STREET  
MILWAUKIE, OR 97222

FOR: PRINTED MATTER, NAMELY, COMIC BOOKS; BOOKS AND MAGAZINES FEATURING COMIC BOOK CHARACTERS AND STORIES IN ILLUSTRATED FORM; ILLUSTRATED GRAPHIC NOVELS FEATURING COMIC BOOK CHARACTERS AND STORIES, IN CLASS 16 (U.S. CLS. 2, 5, 22, 23, 29, 37, 38 AND 50).

FIRST USE 5-1-1989; IN COMMERCE 5-1-1989.

THE MARK CONSISTS OF STANDARD CHARACTERS WITHOUT CLAIM TO ANY PARTICULAR FONT, STYLE, SIZE, OR COLOR.

SER. NO. 77-426,514, FILED 3-19-2008.

LANA PHAM, EXAMINING ATTORNEY

**Int. Cl.: 33**

**Prior U.S. Cls.: 47 and 49**

**United States Patent and Trademark Office**

**Reg. No. 3,505,179**

**Registered Sep. 23, 2008**

**TRADEMARK  
PRINCIPAL REGISTER**

**OLD NO. 7**

JACK DANIEL'S PROPERTIES, INC. (DELA-  
WARE CORPORATION)  
SUITE 528  
4040 CIVIC CENTER DRIVE  
SAN RAFAEL, CA 94903

FOR: ALCOHOLIC BEVERAGES, NAMELY, DIS-  
TILLED SPIRITS, IN CLASS 33 (U.S. CLS. 47 AND 49).

FIRST USE 6-1-1875; IN COMMERCE 6-1-1875.

THE MARK CONSISTS OF STANDARD CHAR-  
ACTERS WITHOUT CLAIM TO ANY PARTICULAR  
FONT, STYLE, SIZE, OR COLOR.

OWNER OF U.S. REG. NOS. 42,663 AND 2,418,109.

SER. NO. 77-427,325, FILED 3-20-2008.

RUSS HERMAN, EXAMINING ATTORNEY

**Int. Cl.: 25**

**Prior U.S. Cls.: 22 and 39**

**United States Patent and Trademark Office**

**Reg. No. 3,505,180**

**Registered Sep. 23, 2008**

**TRADEMARK  
PRINCIPAL REGISTER**

**OLD NO. 7**

JACK DANIEL'S PROPERTIES, INC. (DELA-  
WARE CORPORATION)  
SUITE 528  
4040 CIVIC CENTER DRIVE  
SAN RAFAEL, CA 94903

FOR: FOOTWEAR; HEADGEAR; NAMELY,  
CAPS, HATS, HEADBANDS, STRAW HATS, VISORS,  
BANDANNAS; CLOTHING; NAMELY, APRONS,  
SLEEVE GARTERS, T-SHIRTS, GOLF SHIRTS,  
BASEBALL SHIRTS, SHIRTS, TOPS, TANK TOPS,  
SWEATSHIRTS, SWEATPANTS, JOGGING SUITS,  
PANTS, JACKETS, COATS, BELTS, NECKTIES,  
NECKWEAR, SCARVES, SUSPENDERS, BRACES,

LEATHER JACKETS, RAINSUITS, VESTS, PARKAS,  
GLOVES, TIES, IN CLASS 25 (U.S. CLS. 22 AND 39).

FIRST USE 11-1-1999; IN COMMERCE 11-1-1999.

THE MARK CONSISTS OF STANDARD CHAR-  
ACTERS WITHOUT CLAIM TO ANY PARTICULAR  
FONT, STYLE, SIZE, OR COLOR.

SER. NO. 77-427,387, FILED 3-20-2008.

RUSS HERMAN, EXAMINING ATTORNEY

**Int. Cl.: 30**

**Prior U.S. Cl.: 46**

**United States Patent and Trademark Office**

**Reg. No. 3,505,181**

**Registered Sep. 23, 2008**

**TRADEMARK  
PRINCIPAL REGISTER**

**OLD NO. 7**

JACK DANIEL'S PROPERTIES, INC. (DELA-  
WARE CORPORATION)  
SUITE 528  
4040 CIVIC CENTER DRIVE  
SAN RAFAEL, CA 94903

THE MARK CONSISTS OF STANDARD CHAR-  
ACTERS WITHOUT CLAIM TO ANY PARTICULAR  
FONT, STYLE, SIZE, OR COLOR.

FOR: MUSTARD, IN CLASS 30 (U.S. CL. 46).

SER. NO. 77-427,454, FILED 3-20-2008.

FIRST USE 10-1-1990; IN COMMERCE 10-1-1990.

RUSS HERMAN, EXAMINING ATTORNEY



**Int. Cls.: 35, 36, 44 and 45**

**Prior U.S. Cls.: 100, 101 and 102**

**United States Patent and Trademark Office**

**Reg. No. 3,505,182**

**Registered Sep. 23, 2008**

**SERVICE MARK  
PRINCIPAL REGISTER**

**Premier Staffing We Bring  
People And Companies  
Together**

PREMIER STAFFING SERVICES, LLC (OKLAHOMA LIMITED LIABILITY COMPANY)  
2705 E. 21ST STREET  
TULSA, OK 74114

FOR: EMPLOYMENT AGENCIES; EMPLOYMENT COUNSELING AND RECRUITING; EMPLOYMENT HIRING, RECRUITING, PLACEMENT, STAFFING AND CAREER NETWORKING SERVICES; PROVIDING AN ON-LINE SEARCHABLE DATABASE FEATURING CLASSIFIED AD LISTINGS AND EMPLOYMENT OPPORTUNITIES; TEMPORARY EMPLOYMENT AGENCIES; TESTING TO DETERMINE EMPLOYMENT SKILLS; ADMINISTRATION OF BUSINESS PAYROLL FOR OTHERS; PAYROLL PREPARATION; PAYROLL PROCESSING SERVICES; WAGE PAYROLL PREPARATION; HUMAN RESOURCES CONSULTATION; HUMAN RESOURCES MANAGEMENT; HUMAN RESOURCES SERVICES, NAMELY, PERSONNEL SELECTION FOR OTHERS; SERVING AS A HUMAN RESOURCES DEPARTMENT FOR OTHERS; BUSINESS RISK MANAGEMENT CONSULTATION, IN CLASS 35 (U.S. CLS. 100, 101 AND 102).

FIRST USE 1-1-2000; IN COMMERCE 1-1-2000.

FOR: PAYROLL TAX DEBITING SERVICES; CLAIMS ADMINISTRATION IN THE FIELD OF WORKERS' COMPENSATION; PROVIDING INFORMATION REGARDING WORKERS' COMPENSATION INSURANCE POLICY RATES, IN CLASS 36 (U.S. CLS. 100, 101 AND 102).

FIRST USE 1-1-2000; IN COMMERCE 1-1-2000.

FOR: MEDICAL SERVICES, NAMELY, PRE-EMPLOYMENT DRUG SCREENING, IN CLASS 44 (U.S. CLS. 100 AND 101).

FIRST USE 1-1-2000; IN COMMERCE 1-1-2000.

FOR: ANALYSIS AND CONSULTATION PERTAINING TO JOB SITE SAFETY; CONSULTING IN THE FIELD OF WORKPLACE SAFETY; BACKGROUND INVESTIGATION AND RESEARCH SERVICES; INVESTIGATION OR SURVEILLANCE ON BACKGROUND PROFILES; PERSONAL BACKGROUND INVESTIGATIONS; PRE-EMPLOYMENT BACKGROUND INVESTIGATION SERVICES; PRE-EMPLOYMENT BACKGROUND SCREENING, IN CLASS 45 (U.S. CLS. 100 AND 101).

FIRST USE 1-1-2000; IN COMMERCE 1-1-2000.

THE MARK CONSISTS OF STANDARD CHARACTERS WITHOUT CLAIM TO ANY PARTICULAR FONT, STYLE, SIZE, OR COLOR.

NO CLAIM IS MADE TO THE EXCLUSIVE RIGHT TO USE "STAFFING", APART FROM THE MARK AS SHOWN.

SER. NO. 77-427,497, FILED 3-20-2008.

SAIMA MAKHDOOM, EXAMINING ATTORNEY

**Int. Cl.: 6**

**Prior U.S. Cls.: 2, 12, 13, 14, 23, 25 and 50**

**United States Patent and Trademark Office**

**Reg. No. 3,505,183**

**Registered Sep. 23, 2008**

**TRADEMARK  
PRINCIPAL REGISTER**

**COMPASSO**

USG INTERIORS, INC. (DELAWARE CORPORATION)  
550 WEST ADAMS STREET #189  
CHICAGO, IL 60661

FOR: METAL CEILING TRIM, IN CLASS 6 (U.S. CLS. 2, 12, 13, 14, 23, 25 AND 50).

FIRST USE 12-31-1992; IN COMMERCE 12-31-1992.

THE MARK CONSISTS OF STANDARD CHARACTERS WITHOUT CLAIM TO ANY PARTICULAR FONT, STYLE, SIZE, OR COLOR.

THE MARK IS TRANSLATED INTO ENGLISH AS "COMPASS".

SER. NO. 77-427,640, FILED 3-20-2008.

DAVID C. REIHNER, EXAMINING ATTORNEY

**Int. Cl.: 12**

**Prior U.S. Cls.: 19, 21, 23, 31, 35 and 44**

**Reg. No. 3,505,184**

**United States Patent and Trademark Office**

**Registered Sep. 23, 2008**

---

**TRADEMARK  
PRINCIPAL REGISTER**

**ADVAN SPORT**

YOKOHAMA TIRE CORPORATION (CALIFORNIA CORPORATION)  
601 SOUTH ACACIA AVENUE  
FULLERTON, CA 92831

NO CLAIM IS MADE TO THE EXCLUSIVE RIGHT TO USE "SPORT", APART FROM THE MARK AS SHOWN.

FOR: TIRES AND WHEELS, IN CLASS 12 (U.S. CLS. 19, 21, 23, 31, 35 AND 44).

SER. NO. 77-427,788, FILED 3-20-2008.

FIRST USE 10-0-2004; IN COMMERCE 10-0-2004.

THE MARK CONSISTS OF STANDARD CHARACTERS WITHOUT CLAIM TO ANY PARTICULAR FONT, STYLE, SIZE, OR COLOR.

JANICE L. MCMORROW, EXAMINING ATTORNEY

**Int. Cl.: 12**

**Prior U.S. Cls.: 19, 21, 23, 31, 35 and 44**

**Reg. No. 3,505,185**

**United States Patent and Trademark Office**

**Registered Sep. 23, 2008**

---

**TRADEMARK  
PRINCIPAL REGISTER**

**ADVAN A048**

YOKOHAMA TIRE CORPORATION (CALIFORNIA CORPORATION)  
601 SOUTH ACACIA AVENUE  
FULLERTON, CA 92831

FOR: TIRES AND WHEELS, IN CLASS 12 (U.S. CLS. 19, 21, 23, 31, 35 AND 44).

FIRST USE 10-0-2004; IN COMMERCE 10-0-2004.

THE MARK CONSISTS OF STANDARD CHARACTERS WITHOUT CLAIM TO ANY PARTICULAR FONT, STYLE, SIZE, OR COLOR.

SER. NO. 77-427,846, FILED 3-20-2008.

JANICE L. MCMORROW, EXAMINING ATTORNEY

**Int. Cl.: 13**

**Prior U.S. Cls.: 2 and 9**

**United States Patent and Trademark Office**

**Reg. No. 3,505,186**

**Registered Sep. 23, 2008**

**TRADEMARK  
PRINCIPAL REGISTER**

**M32**

MILKOR USA, INC. (DELAWARE CORPORATION)  
3735 N. ROMERO ROAD  
TUCSON, AZ 85705

THE MARK CONSISTS OF STANDARD CHARACTERS WITHOUT CLAIM TO ANY PARTICULAR FONT, STYLE, SIZE, OR COLOR.

FOR: GRENADE LAUNCHERS, IN CLASS 13 (U.S. CLS. 2 AND 9).

SER. NO. 77-428,363, FILED 3-21-2008.

FIRST USE 11-30-2005; IN COMMERCE 11-30-2005.

COLLEEN DOMBROW, EXAMINING ATTORNEY

**Int. Cl.: 3**

**Prior U.S. Cls.: 1, 4, 6, 50, 51 and 52**

**Reg. No. 3,505,187**

**United States Patent and Trademark Office**

**Registered Sep. 23, 2008**

**TRADEMARK  
PRINCIPAL REGISTER**

**CHERRY POWER**

ADVANCE AUTO INNOVATIONS, LLC (VIRGINIA LIMITED LIABILITY COMPANY)  
5673 AIRPORT ROAD  
ROANOKE, VA 24012

FOR: AUTOMOTIVE CLEANING PREPARATIONS; PREPARATIONS FOR CLEANING, PROTECTING AND PRESERVING VEHICLE SURFACES, IN CLASS 3 (U.S. CLS. 1, 4, 6, 50, 51 AND 52).

FIRST USE 1-31-2003; IN COMMERCE 1-31-2003.

THE MARK CONSISTS OF STANDARD CHARACTERS WITHOUT CLAIM TO ANY PARTICULAR FONT, STYLE, SIZE, OR COLOR.

NO CLAIM IS MADE TO THE EXCLUSIVE RIGHT TO USE "CHERRY", APART FROM THE MARK AS SHOWN.

SER. NO. 77-428,417, FILED 3-21-2008.

KEVON CHISOLM, EXAMINING ATTORNEY

**Int. Cl.: 9**

**Prior U.S. Cls.: 21, 23, 26, 36 and 38**

**United States Patent and Trademark Office**

**Reg. No. 3,505,188**

**Registered Sep. 23, 2008**

**TRADEMARK  
PRINCIPAL REGISTER**

**A WEB OF MUSIC RIGHT AT  
YOUR FINGERTIPS**

YAHOO! INC. (DELAWARE CORPORATION)  
MAIL STOP D202  
701 FIRST AVENUE  
SUNNYVALE, CA 94089

FOR: DOWNLOADABLE COMPUTER SOFTWARE FOR ACCESSING AND POSTING ON-LINE MUSIC, VIDEOS AND WEB ADDRESSES, IN CLASS 9 (U.S. CLS. 21, 23, 26, 36 AND 38).

FIRST USE 5-25-2006; IN COMMERCE 5-25-2006.

THE MARK CONSISTS OF STANDARD CHARACTERS WITHOUT CLAIM TO ANY PARTICULAR FONT, STYLE, SIZE, OR COLOR.

SER. NO. 77-428,669, FILED 3-21-2008.

IRA J. GOODSaid, EXAMINING ATTORNEY

**Int. Cl.: 30**

**Prior U.S. Cl.: 46**

**United States Patent and Trademark Office**

**Reg. No. 3,505,189**

**Registered Sep. 23, 2008**

**TRADEMARK  
PRINCIPAL REGISTER**

**BAGEL BITES**

PROMARK BRANDS INC. (IDAHO CORPORATION)  
2541 NORTH STOKESBERRY PLACE, SUITE 100  
MERIDIAN, ID 83646

OWNER OF U.S. REG. NOS. 1,399,736, 2,926,905,  
AND 3,295,423.

FOR: DOUGH-BASED POCKETS WITH FILLING  
CONSISTING PRIMARILY OF MEATS AND  
CHEESE, IN CLASS 30 (U.S. CL. 46).

NO CLAIM IS MADE TO THE EXCLUSIVE  
RIGHT TO USE "BAGEL", APART FROM THE  
MARK AS SHOWN.

FIRST USE 7-31-2003; IN COMMERCE 7-31-2003.

SER. NO. 77-429,352, FILED 3-24-2008.

THE MARK CONSISTS OF STANDARD CHAR-  
ACTERS WITHOUT CLAIM TO ANY PARTICULAR  
FONT, STYLE, SIZE, OR COLOR.

CHRIS WELLS, EXAMINING ATTORNEY



**Int. Cl.: 30**

**Prior U.S. Cl.: 46**

**United States Patent and Trademark Office**

**Reg. No. 3,505,190**

**Registered Sep. 23, 2008**

**TRADEMARK  
PRINCIPAL REGISTER**

**PAINTERZ**

CONCORD BRANDS ULC (CANADA CORPORATION)  
2900-10180 101 STREET  
EDMONTON, CANADA T5J3V5

FOR: CHEWING GUM, IN CLASS 30 (U.S. CL. 46).

FIRST USE 1-2-2008; IN COMMERCE 1-2-2008.

THE MARK CONSISTS OF STANDARD CHARACTERS WITHOUT CLAIM TO ANY PARTICULAR FONT, STYLE, SIZE, OR COLOR.

SER. NO. 77-430,768, FILED 3-25-2008.

LEIGH CAROLINE CASE, EXAMINING ATTORNEY

**Int. Cl.: 25**

**Prior U.S. Cls.: 22 and 39**

**United States Patent and Trademark Office**

**Reg. No. 3,505,191**

**Registered Sep. 23, 2008**

**TRADEMARK  
PRINCIPAL REGISTER**

**TransWorld Snowboarding**

TRANSWORLD MAGAZINE CORPORATION  
(NEW YORK CORPORATION)  
BONNIER CORP., 460 N. ORLANDO AVE  
SUITE 200, ATTN: MIA SYKES  
WINTER PARK, FL 32789

FOR: CLOTHING, NAMELY, T-SHIRTS, HATS  
AND BANDANNAS FEATURING THE REFER-  
ENCED TRADEMARK, IN CLASS 25 (U.S. CLS. 22  
AND 39).

FIRST USE 2-1-1991; IN COMMERCE 2-1-1991.

THE MARK CONSISTS OF STANDARD CHAR-  
ACTERS WITHOUT CLAIM TO ANY PARTICULAR  
FONT, STYLE, SIZE, OR COLOR.

OWNER OF U.S. REG. NOS. 1,544,399, 2,195,263,  
AND 3,426,699.

NO CLAIM IS MADE TO THE EXCLUSIVE  
RIGHT TO USE "SNOWBOARDING", APART  
FROM THE MARK AS SHOWN.

SER. NO. 77-432,975, FILED 3-27-2008.

CHRISTINE BLOMQUIST, EXAMINING ATTOR-  
NEY

**Int. Cl.: 9**

**Prior U.S. Cls.: 21, 23, 26, 36 and 38**

**Reg. No. 3,505,192**

**United States Patent and Trademark Office**

**Registered Sep. 23, 2008**

**TRADEMARK  
PRINCIPAL REGISTER**

**Ride BMX**

TRANSWORLD MAGAZINE CORPORATION  
(NEW YORK CORPORATION)

460 N. ORLANDO AVENUE, SUITE 200

WINTER PARK, FL 32789

FOR: DIGITAL MEDIA, NAMELY, PRE-RECORDED VIDEO CASSETTES, DIGITAL VIDEO DISCS, DIGITAL VERSATILE DISCS, DVDS, AND HIGH DEFINITION DIGITAL DISKS FEATURING BICYCLE RIDING AND SIMILAR ACTIVITIES, IN CLASS 9 (U.S. CLS. 21, 23, 26, 36 AND 38).

FIRST USE 2-1-1991; IN COMMERCE 2-1-1991.

THE MARK CONSISTS OF STANDARD CHARACTERS WITHOUT CLAIM TO ANY PARTICULAR FONT, STYLE, SIZE, OR COLOR.

OWNER OF U.S. REG. NOS. 2,351,370, 3,005,831 AND OTHERS.

NO CLAIM IS MADE TO THE EXCLUSIVE RIGHT TO USE "BMX", APART FROM THE MARK AS SHOWN.

SER. NO. 77-433,055, FILED 3-27-2008.

CHRISTINE BLOMQUIST, EXAMINING ATTORNEY

**Int. Cls.: 38 and 42**

**Prior U.S. Cls.: 100, 101 and 104**

**United States Patent and Trademark Office**

**Reg. No. 3,505,193**

**Registered Sep. 23, 2008**

**SERVICE MARK  
PRINCIPAL REGISTER**

**MESSAGEMIRROR**

INTERMEDIA, INC. (MINNESOTA CORPORATION)  
SUITE 1601  
156 WEST 56TH STREET  
NEW YORK, NY 10019

FOR: PROVIDING ACCESS TO SOFTWARE APPLICATIONS, COMPUTER SERVER APPLICATIONS, AND WEB SITES FOR OTHERS HOSTED ON COMPUTER SERVERS ACCESSIBLE VIA A GLOBAL COMPUTER NETWORK, IN CLASS 38 (U.S. CLS. 100, 101 AND 104).

FIRST USE 2-21-2007; IN COMMERCE 2-21-2007.

FOR: HOSTING WEB SITES FOR OTHERS ON A COMPUTER SERVER FOR A GLOBAL COMPUTER NETWORK; HOSTING SOFTWARE APPLICATIONS

FOR OTHERS ON A COMPUTER SERVER FOR A GLOBAL COMPUTER NETWORK; EDITING, MODIFICATION AND CUSTOMIZATION OF SOFTWARE APPLICATIONS AND COMPUTER SERVER APPLICATIONS HOSTED ON COMPUTER SERVERS ACCESSIBLE VIA A GLOBAL COMPUTER NETWORK, IN CLASS 42 (U.S. CLS. 100 AND 101).

FIRST USE 2-21-2007; IN COMMERCE 2-21-2007.

THE MARK CONSISTS OF STANDARD CHARACTERS WITHOUT CLAIM TO ANY PARTICULAR FONT, STYLE, SIZE, OR COLOR.

SER. NO. 77-433,162, FILED 3-27-2008.

JOHN WILKE, EXAMINING ATTORNEY

**Int. Cl.: 35**

**Prior U.S. Cls.: 100, 101 and 102**

**United States Patent and Trademark Office**

**Reg. No. 3,505,194**

**Registered Sep. 23, 2008**

**SERVICE MARK  
PRINCIPAL REGISTER**

**FinaDIRECT**

MICHAEL C. FINA COMPANY (NEW YORK CORPORATION)  
545 FIFTH AVENUE  
NEW YORK, NY 10017

FOR: PROVIDING AN ONLINE SEARCHABLE DATABASE FEATURING EMPLOYEE-RELATED INFORMATION FOR PURPOSES OF ADMINISTERING EMPLOYEE RECOGNITION AWARD PROGRAMS, IN CLASS 35 (U.S. CLS. 100, 101 AND 102).

FIRST USE 12-0-2001; IN COMMERCE 12-0-2001.

THE MARK CONSISTS OF STANDARD CHARACTERS WITHOUT CLAIM TO ANY PARTICULAR FONT, STYLE, SIZE, OR COLOR.

OWNER OF U.S. REG. NO. 2,253,512.

SER. NO. 77-433,531, FILED 3-27-2008.

WARREN L. OLANDRIA, EXAMINING ATTORNEY

**Int. Cls.: 16, 20 and 28**

**Prior U.S. Cls.: 2, 5, 13, 22, 23, 25, 29, 32, 37, 38 and 50**

**United States Patent and Trademark Office**

**Reg. No. 3,505,195**

**Registered Sep. 23, 2008**

**TRADEMARK  
PRINCIPAL REGISTER**

**GOLLUM**

THE SAUL ZAENTZ COMPANY (DELAWARE  
CORPORATION)  
2600 TENTH STREET  
BERKELEY, CA 94710

FOR: FIGURES OF CARDBOARD; FIGURES OF  
CARDBOARD WITH TALKING FEATURE, IN  
CLASS 16 (U.S. CLS. 2, 5, 22, 23, 29, 37, 38 AND 50).

FIRST USE 3-26-2008; IN COMMERCE 3-26-2008.

FOR: BUST MADE OF LATEX, IN CLASS 20 (U.S.  
CLS. 2, 13, 22, 25, 32 AND 50).

FIRST USE 3-26-2008; IN COMMERCE 3-26-2008.

FOR: COSTUME MASKS, IN CLASS 28 (U.S. CLS.  
22, 23, 38 AND 50).

FIRST USE 3-26-2008; IN COMMERCE 3-26-2008.

THE MARK CONSISTS OF STANDARD CHAR-  
ACTERS WITHOUT CLAIM TO ANY PARTICULAR  
FONT, STYLE, SIZE, OR COLOR.

OWNER OF U.S. REG. NOS. 2,679,479, 2,987,672  
AND OTHERS.

SER. NO. 77-434,369, FILED 3-28-2008.

BRENDAN REGAN, EXAMINING ATTORNEY

**Int. Cl.: 21**

**Prior U.S. Cls.: 2, 13, 23, 29, 30, 33, 40 and 50**

**United States Patent and Trademark Office**

**Reg. No. 3,505,196**

**Registered Sep. 23, 2008**

**TRADEMARK  
PRINCIPAL REGISTER**

**CLEANnSAFE**

TRONEX INTERNATIONAL, INC (NEW JERSEY CORPORATION)  
ONE TRONEX CENTRE, 2 CRANBERRY ROAD  
PARSIPPANY, NJ 07054

FOR: DISPOSABLE GLOVES FOR HOME USE; DISPOSABLE LATEX AND NITRILE GLOVES FOR GENERAL USE; DISPOSABLE LATEX GLOVES FOR GENERAL USE; DISPOSABLE PLASTIC GLOVES FOR GENERAL USE; DISPOSABLE PLASTIC GLOVES FOR USE IN THE FOOD SERVICE INDUSTRY; GLOVES FOR HOUSEHOLD PURPOSES; HOUSEHOLD GLOVES FOR GENERAL USE; HOUSEHOLD PLASTIC GLOVES; PLASTIC HOUSE-

HOLD GLOVES; RUBBER HOUSEHOLD GLOVES, IN CLASS 21 (U.S. CLS. 2, 13, 23, 29, 30, 33, 40 AND 50).

FIRST USE 2-0-2008; IN COMMERCE 2-0-2008.

THE MARK CONSISTS OF STANDARD CHARACTERS WITHOUT CLAIM TO ANY PARTICULAR FONT, STYLE, SIZE, OR COLOR.

SER. NO. 77-434,544, FILED 3-28-2008.

ELI HELLMAN, EXAMINING ATTORNEY

**Int. Cl.: 7**

**Prior U.S. Cls.: 13, 19, 21, 23, 31, 34 and 35**

**Reg. No. 3,505,197**

**United States Patent and Trademark Office**

**Registered Sep. 23, 2008**

**TRADEMARK  
PRINCIPAL REGISTER**

**CEL**  
***C Enterprise Ltd***

C ENTERPRISE LIMITED (BR. VIRGIN ISLANDS  
LIMITED LIABILITY COMPANY)  
ROOM 912, NAN FUNG COMMERCIAL CENTRE 19  
KOWLOON BAY, HONG KONG

FOR: POWER TOOLS, NAMELY, DRILLS, HAM-  
MER DRILLS, SCREW DRIVERS, GRINDERS, CIR-  
CULAR SAWS, TABLE SAWS, JIGSAWS, SCROLL  
SAWS, DRILL PRESSES, STAPLERS, SANDERS,  
RECIPROCATING SAWS, PLANERS, VACUUM  
CLEANERS, SHOP VACUUM CLEANERS, ORBI-  
TAL SANDERS, IMPACT WRENCHES AND CUT-  
OUT SAWS; POWER LAWN AND GARDEN TOOLS,  
NAMELY, BRANCH TRIMMERS, HEDGE TRIM-  
MERS, GRASS TRIMMERS, LAWN MOWERS AND

EDGERS, IN CLASS 7 (U.S. CLS. 13, 19, 21, 23, 31, 34  
AND 35).

FIRST USE 10-0-2007; IN COMMERCE 10-0-2007.

NO CLAIM IS MADE TO THE EXCLUSIVE  
RIGHT TO USE "ENTERPRISE LTD", APART FROM  
THE MARK AS SHOWN.

THE MARK CONSISTS OF THE STYLIZED  
TERMS "CEL C ENTERPRISE LTD".

SER. NO. 77-435,299, FILED 3-31-2008.

KATHERINE STOIDES, EXAMINING ATTORNEY



**Int. Cl.: 11**

**Prior U.S. Cls.: 13, 21, 23, 31 and 34**

**Reg. No. 3,505,198**

**United States Patent and Trademark Office**

**Registered Sep. 23, 2008**

**TRADEMARK  
PRINCIPAL REGISTER**

**CEL**  
***C Enterprise Ltd***

C ENTERPRISE LIMITED (BR. VIRGIN ISLANDS  
LIMITED LIABILITY COMPANY)  
ROOM 912, NAN FUNG COMMERCIAL CENTRE 19  
KOWLOON BAY, HONG KONG

FOR: ELECTRIC FANS, IN CLASS 11 (U.S. CLS. 13,  
21, 23, 31 AND 34).

FIRST USE 10-0-2007; IN COMMERCE 10-0-2007.

NO CLAIM IS MADE TO THE EXCLUSIVE  
RIGHT TO USE "ENTERPRISE LTD", APART FROM  
THE MARK AS SHOWN.

THE MARK CONSISTS OF THE STYLIZED  
TERMS "CEL C ENTERPRISE LTD".

SER. NO. 77-435,301, FILED 3-31-2008.

KATHERINE STOIDES, EXAMINING ATTORNEY

**Int. Cl.: 17**

**Prior U.S. Cls.: 1, 5, 12, 13, 35 and 50**

**Reg. No. 3,505,199**

**United States Patent and Trademark Office**

**Registered Sep. 23, 2008**

---

**TRADEMARK  
PRINCIPAL REGISTER**

**T-TAK**

COVALENCE SPECIALTY ADHESIVES LLC (DE-  
LAWARE LIMITED LIABILITY COMPANY)  
25 FORGE PARKWAY  
FRANKLIN, MA 02038

THE MARK CONSISTS OF STANDARD CHAR-  
ACTERS WITHOUT CLAIM TO ANY PARTICULAR  
FONT, STYLE, SIZE, OR COLOR.

FOR: ADHESIVE TAPE FOR INDUSTRIAL AND  
COMMERCIAL USE, IN CLASS 17 (U.S. CLS. 1, 5, 12,  
13, 35 AND 50).

SER. NO. 77-436,123, FILED 3-31-2008.

FIRST USE 1-1-1978; IN COMMERCE 1-1-1978.

MARK SPARACINO, EXAMINING ATTORNEY

**Int. Cl.: 37**

**Prior U.S. Cls.: 100, 103 and 106**

**United States Patent and Trademark Office**

**Reg. No. 3,505,200**

**Registered Sep. 23, 2008**

**SERVICE MARK  
PRINCIPAL REGISTER**

**14PLUS**

ALCOA INC. (PENNSYLVANIA CORPORATION)  
ALCOA CORPORATE CENTER  
201 ISABELLA STREET  
PITTSBURGH, PA 152125858

FOR: CONVERSION OF PASSENGER AIRCRAFT  
TO CARGO AIRCRAFT AND TECHNICAL CON-  
SULTATION SERVICES RELATING TO THE CON-  
VERSION OF PASSENGER AIRCRAFT TO CARGO  
AIRCRAFT, IN CLASS 37 (U.S. CLS. 100, 103 AND  
106).

FIRST USE 10-0-2004; IN COMMERCE 10-0-2004.

THE MARK CONSISTS OF STANDARD CHAR-  
ACTERS WITHOUT CLAIM TO ANY PARTICULAR  
FONT, STYLE, SIZE, OR COLOR.

SER. NO. 77-436,707, FILED 4-1-2008.

BARBARA A. GOLD, EXAMINING ATTORNEY

**Int. Cl.: 37**

**Prior U.S. Cls.: 100, 103 and 106**

**United States Patent and Trademark Office**

**Reg. No. 3,505,201**

**Registered Sep. 23, 2008**

**SERVICE MARK  
PRINCIPAL REGISTER**

**14+**

ALCOA INC. (PENNSYLVANIA CORPORATION)  
ALCOA CORPORATE CENTER  
201 ISABELLA STREET  
PITTSBURGH, PA 152125858

FOR: CONVERSION OF PASSENGER AIRCRAFT  
TO CARGO AIRCRAFT AND TECHNICAL CON-  
SULTATION SERVICES RELATING TO THE CON-  
VERSION OF PASSENGER AIRCRAFT TO CARGO  
AIRCRAFT, IN CLASS 37 (U.S. CLS. 100, 103 AND  
106).

FIRST USE 10-0-2004; IN COMMERCE 10-0-2004.

THE MARK CONSISTS OF STANDARD CHAR-  
ACTERS WITHOUT CLAIM TO ANY PARTICULAR  
FONT, STYLE, SIZE, OR COLOR.

SER. NO. 77-436,711, FILED 4-1-2008.

BARBARA A. GOLD, EXAMINING ATTORNEY

**Int. Cl.: 35**

**Prior U.S. Cls.: 100, 101 and 102**

**United States Patent and Trademark Office**

**Reg. No. 3,505,202**

**Registered Sep. 23, 2008**

**SERVICE MARK  
PRINCIPAL REGISTER**

**JCP**

J. C. PENNEY CORPORATION, INC. (DELA-  
WARE CORPORATION)  
6501 LEGACY DRIVE  
PLANO, TX 750243698

FOR: RETAIL DEPARTMENT STORE SERVICES,  
RETAIL MAIL ORDER CATALOG SERVICES, AND  
COMPUTERIZED ONLINE RETAIL DEPARTMENT  
STORE SERVICES IN THE FIELDS OF COSMETICS,  
JEWELRY, LUGGAGE, HANDBAGS, FURNITURE,  
PICTURE FRAMES, LAMPS, DINNERWARE,  
GLASSWARE, WEARING APPAREL AND FOOT-  
WEAR FOR MEN, WOMEN, AND CHILDREN,  
BEDDING, WINDOW COVERINGS AND WINDOW  
HARDWARE, TOWELS, TABLE LINENS, RUGS,  
EXERCISE EQUIPMENT, PET ACCESSORIES, DEC-  
ORATIVE HOME FURNISHINGS ITEMS, SMALL

ELECTRIC APPLIANCES, IN CLASS 35 (U.S. CLS.  
100, 101 AND 102).

FIRST USE 1-5-2007; IN COMMERCE 1-5-2007.

THE MARK CONSISTS OF STANDARD CHAR-  
ACTERS WITHOUT CLAIM TO ANY PARTICULAR  
FONT, STYLE, SIZE, OR COLOR.

OWNER OF U.S. REG. NOS. 949,595, 2,266,337,  
AND 2,437,229.

SER. NO. 77-436,915, FILED 4-1-2008.

HEATHER SAPP, EXAMINING ATTORNEY

**Int. Cl.: 42**

**Prior U.S. Cls.: 100 and 101**

**United States Patent and Trademark Office**

**Reg. No. 3,505,203**

**Registered Sep. 23, 2008**

---

**SERVICE MARK  
PRINCIPAL REGISTER**

**RULE YOUR MEDIA**

FLEKTOR, INC. (DELAWARE CORPORATION)  
407 N. MAPLE DRIVE  
BEVERLY HILLS, CA 90210

FIRST USE 4-22-2007; IN COMMERCE 4-22-2007.

FOR: PROVIDING TEMPORARY USE OF NON-DOWNLOADABLE SOFTWARE FOR THE INTEGRATION OF LIVE AND PRE-RECORDED MULTIMEDIA CONTENT IN THE FORM OF TEXT, AUDIO, GRAPHICS, STILL IMAGE AND MOVING PICTURES INTO AN INTERACTIVE DELIVERY FOR MULTIMEDIA APPLICATIONS, IN CLASS 42 (U.S. CLS. 100 AND 101).

THE MARK CONSISTS OF STANDARD CHARACTERS WITHOUT CLAIM TO ANY PARTICULAR FONT, STYLE, SIZE, OR COLOR.

SER. NO. 77-437,135, FILED 4-1-2008.

JILL PRATER, EXAMINING ATTORNEY

**Int. Cl.: 41**

**Prior U.S. Cls.: 100, 101 and 107**

**United States Patent and Trademark Office**

**Reg. No. 3,505,204**

**Registered Sep. 23, 2008**

**SERVICE MARK  
PRINCIPAL REGISTER**

**INSIGHTOUT**

BUCK CONSULTANTS, LLC (DELAWARE LIMITED LIABILITY COMPANY)  
ONE PENNSYLVANIA PLAZA  
NEW YORK, NY 10119

FOR: DISSEMINATION OF INFORMATION IN THE FIELD OF HUMAN RESOURCES, IN CLASS 41 (U.S. CLS. 100, 101 AND 107).

FIRST USE 3-25-2008; IN COMMERCE 3-25-2008.

THE MARK CONSISTS OF STANDARD CHARACTERS WITHOUT CLAIM TO ANY PARTICULAR FONT, STYLE, SIZE, OR COLOR.

OWNER OF U.S. REG. NO. 3,363,375.

SER. NO. 77-437,205, FILED 4-1-2008.

TRACY WHITTAKER-BROWN, EXAMINING ATTORNEY

**Int. Cl.: 41**

**Prior U.S. Cls.: 100, 101 and 107**

**United States Patent and Trademark Office**

**Reg. No. 3,505,205**

**Registered Sep. 23, 2008**

**SERVICE MARK  
PRINCIPAL REGISTER**



STUDIO ONE NETWORKS, INC. (DELAWARE CORPORATION)  
SUITE 408  
588 BROADWAY  
NEW YORK, NY 10012

FOR: PROVIDING SYNDICATED ONLINE MAGAZINE FOR PET OWNERS FEATURING INFORMATION ON HOW TO CARE FOR AND PAMPER PET CATS, IN CLASS 41 (U.S. CLS. 100, 101 AND 107).

FIRST USE 1-8-2007; IN COMMERCE 1-8-2007.

NO CLAIM IS MADE TO THE EXCLUSIVE RIGHT TO USE "CAT", APART FROM THE MARK AS SHOWN.

THE COLOR(S) RED, GOLD, BLACK AND WHITE IS/ARE CLAIMED AS A FEATURE OF THE MARK.

THE MARK CONSISTS OF THE WORDS "THE DIVINE CAT" IN STYLIZED FONT BELOW AN IMAGE OF A CROWN. THE COLORS RED AND WHITE APPEAR IN THE WORDS "THE DIVINE CAT", THE COLOR WHITE ALSO APPEARS IN FIVE SMALL CIRCLES AT THE BOTTOM OF THE CROWN. THE COLOR GOLD APPEARS IN THE CROWN, AND THE COLOR BLACK APPEARS IN TWO BANDS ABOVE AND BELOW THE FIVE WHITE CIRCLES IN THE CROWN.

SER. NO. 77-437,555, FILED 4-2-2008.

MONIQUE MILLER, EXAMINING ATTORNEY



Int. Cl.: 43

Prior U.S. Cls.: 100 and 101

United States Patent and Trademark Office

Reg. No. 3,505,206

Registered Sep. 23, 2008

SERVICE MARK  
PRINCIPAL REGISTER



PHILABUNDANCE (PENNSYLVANIA NON-PROFIT CORPORATION)

P.O. BOX 37555

3616 SOUTH GALLOWAY STREET  
PHILADELPHIA, PA 19148

FOR: CHARITABLE SERVICES, NAMELY, PROVIDING FOOD TO NEEDY PERSONS; CHARITABLE SERVICES, NAMELY, PROVIDING FOOD FOR NEEDY PERSONS IN A MOBILE RETAIL STAND, IN CLASS 43 (U.S. CLS. 100 AND 101).

FIRST USE 2-18-2008; IN COMMERCE 2-18-2008.

THE MARK CONSISTS OF "PHILABUNDANCE FRESH FOR ALL" WITH "FRUIT" UNDERNEATH.

SER. NO. 77-437,871, FILED 4-2-2008.

SALLY SHIH, EXAMINING ATTORNEY

**Int. Cl.: 30**

**Prior U.S. Cl.: 46**

**United States Patent and Trademark Office**

**Reg. No. 3,505,207**

**Registered Sep. 23, 2008**

**TRADEMARK  
PRINCIPAL REGISTER**

ALLAN WATERMELON SLICES

THE ALLAN CANDY COMPANY LIMITED (CANADA CORPORATION)  
356 EMERALD STREET NORTH  
HAMILTON, CANADA L8L8K6

FOR: CONFECTIONERY, NAMELY, CANDY, IN CLASS 30 (U.S. CL. 46).

THE MARK CONSISTS OF STANDARD CHARACTERS WITHOUT CLAIM TO ANY PARTICULAR FONT, STYLE, SIZE, OR COLOR.

OWNER OF CANADA REG. NO. TMA673298, DATED 9-26-2006, EXPIRES 9-25-2021.

OWNER OF U.S. REG. NOS. 1,708,471 AND 1,718,452.

NO CLAIM IS MADE TO THE EXCLUSIVE RIGHT TO USE "WATERMELON SLICES", APART FROM THE MARK AS SHOWN.

SER. NO. 77-439,016, FILED 4-3-2008.

MICHAEL TANNER, EXAMINING ATTORNEY

**Int. Cl.: 30**

**Prior U.S. Cl.: 46**

**United States Patent and Trademark Office**

**Reg. No. 3,505,208**

**Registered Sep. 23, 2008**

**TRADEMARK  
PRINCIPAL REGISTER**

**CARIBBEAN FISH**

THE ALLAN CANDY COMPANY LIMITED (CANADA CORPORATION)  
356 EMERALD STREET NORTH  
HAMILTON, CANADA L8L8K6

FOR: CONFECTIONERY, NAMELY, CANDY, IN CLASS 30 (U.S. CL. 46).

THE MARK CONSISTS OF STANDARD CHARACTERS WITHOUT CLAIM TO ANY PARTICULAR FONT, STYLE, SIZE, OR COLOR.

OWNER OF CANADA REG. NO. TMA706033, DATED 1-30-2008, EXPIRES 1-30-2023.

NO CLAIM IS MADE TO THE EXCLUSIVE RIGHT TO USE "FISH", APART FROM THE MARK AS SHOWN.

SER. NO. 77-439,026, FILED 4-3-2008.

MICHAEL TANNER, EXAMINING ATTORNEY

**Int. Cl.: 38**

**Prior U.S. Cls.: 100, 101 and 104**

**United States Patent and Trademark Office**

**Reg. No. 3,505,209**

**Registered Sep. 23, 2008**

**SERVICE MARK  
PRINCIPAL REGISTER**

**DRN**

DIVERSITYINC MEDIA, L.L.C. (NEW JERSEY  
LIMITED LIABILITY COMPANY)  
15TH FLOOR  
570 BROAD STREET  
NEWARK, NJ 07102

FOR: PROVIDING ON-LINE ELECTRONIC BUL-  
LETIN BOARDS FOR TRANSMISSION OF MESSA-  
GES AMONG COMPUTER USERS CONCERNING  
JOB SEEKING AND HUMAN RESOURCES , IN  
CLASS 38 (U.S. CLS. 100, 101 AND 104).

FIRST USE 11-0-2007; IN COMMERCE 11-0-2007.

THE MARK CONSISTS OF STANDARD CHAR-  
ACTERS WITHOUT CLAIM TO ANY PARTICULAR  
FONT, STYLE, SIZE, OR COLOR.

SER. NO. 77-439,294, FILED 4-3-2008.

CORY BOONE, EXAMINING ATTORNEY

**Int. Cl.: 29**

**Prior U.S. Cl.: 46**

**United States Patent and Trademark Office**

**Reg. No. 3,505,210**

**Registered Sep. 23, 2008**

**TRADEMARK  
PRINCIPAL REGISTER**

**LEMONHEAD & FRIENDS**

FERRARA PAN CANDY CO., INC. (ILLINOIS  
CORPORATION)  
7301 WEST HARRISON STREET  
FOREST PARK, IL 60130

FOR: CANDIED FRUIT SNACKS, IN CLASS 29  
(U.S. CL. 46).

FIRST USE 10-31-2005; IN COMMERCE 10-31-2005.

THE MARK CONSISTS OF STANDARD CHAR-  
ACTERS WITHOUT CLAIM TO ANY PARTICULAR  
FONT, STYLE, SIZE, OR COLOR.

OWNER OF U.S. REG. NOS. 781,824 AND 1,763,119.

SER. NO. 77-440,557, FILED 4-4-2008.

MICHAEL TANNER, EXAMINING ATTORNEY

**Int. Cl.: 30**

**Prior U.S. Cl.: 46**

**United States Patent and Trademark Office**

**Reg. No. 3,505,211**

**Registered Sep. 23, 2008**

**TRADEMARK  
PRINCIPAL REGISTER**

**LEMONHEAD & FRIENDS**

FERRARA PAN CANDY CO., INC. (ILLINOIS  
CORPORATION)  
7301 WEST HARRISON STREET  
FOREST PARK, IL 60130

FOR: CANDY, IN CLASS 30 (U.S. CL. 46).

FIRST USE 10-31-2007; IN COMMERCE 10-31-2007.

THE MARK CONSISTS OF STANDARD CHAR-  
ACTERS WITHOUT CLAIM TO ANY PARTICULAR  
FONT, STYLE, SIZE, OR COLOR.

OWNER OF U.S. REG. NOS. 781,824 AND 1,763,119.

SER. NO. 77-440,590, FILED 4-4-2008.

MICHAEL TANNER, EXAMINING ATTORNEY

**Int. Cl.: 16**

**Prior U.S. Cls.: 2, 5, 22, 23, 29, 37, 38 and 50**

**United States Patent and Trademark Office**

**Reg. No. 3,505,212**

**Registered Sep. 23, 2008**

**TRADEMARK  
PRINCIPAL REGISTER**

**PLAN IT, BABY!**

CHURCH & DWIGHT CO., INC. (DELAWARE  
CORPORATION)  
469 NORTH HARRISON STREET  
PRINCETON, NJ 08543

FOR: EDUCATIONAL PUBLICATIONS, NAME-  
LY, BROCHURES, HANDOUTS IN THE FIELDS OF  
PREGNANCY FOR THE EXPECTANT MOTHER, IN  
CLASS 16 (U.S. CLS. 2, 5, 22, 23, 29, 37, 38 AND 50).

FIRST USE 9-30-2006; IN COMMERCE 9-30-2006.

THE MARK CONSISTS OF STANDARD CHAR-  
ACTERS WITHOUT CLAIM TO ANY PARTICULAR  
FONT, STYLE, SIZE, OR COLOR.

SER. NO. 77-441,386, FILED 4-7-2008.

MICHAEL WIENER, EXAMINING ATTORNEY

**Int. Cl.: 35**

**Prior U.S. Cls.: 100, 101 and 102**

**United States Patent and Trademark Office**

**Reg. No. 3,505,213**

**Registered Sep. 23, 2008**

**SERVICE MARK  
PRINCIPAL REGISTER**

# CBSi Rewards

CONSUMER BENEFIT SERVICES, INC. (ILLINOIS CORPORATION), DBA CBS DATA SERVICES  
1620 BOND STREET  
NAPERVILLE, IL 60563

FOR: MERCHANDISING SERVICES FOR INDUCING THE PURCHASING PUBLIC TO BUY THE GOODS OF OTHERS THROUGH A PROMOTIONAL GIFT REDEMPTION PROGRAM, IN CLASS 35 (U.S. CLS. 100, 101 AND 102).

FIRST USE 12-1-2001; IN COMMERCE 12-1-2001.

THE MARK CONSISTS OF STANDARD CHARACTERS WITHOUT CLAIM TO ANY PARTICULAR FONT, STYLE, SIZE, OR COLOR.

NO CLAIM IS MADE TO THE EXCLUSIVE RIGHT TO USE "REWARDS", APART FROM THE MARK AS SHOWN.

SER. NO. 77-444,184, FILED S.R. 4-9-2008 AM. P.R. 4-9-2008.

REBECCA POVARCHUK, EXAMINING ATTORNEY



**Int. Cl.: 5**

**Prior U.S. Cls.: 6, 18, 44, 46, 51 and 52**

**United States Patent and Trademark Office**

**Reg. No. 3,505,214**

**Registered Sep. 23, 2008**

**TRADEMARK  
PRINCIPAL REGISTER**

**CHEMINOVA**

CHEMINOVA, INC. (NEW JERSEY CORPORATION)  
1700 ROUTE 23, SUITE 300  
WAYNE, NJ 07470

THE MARK CONSISTS OF STANDARD CHARACTERS WITHOUT CLAIM TO ANY PARTICULAR FONT, STYLE, SIZE, OR COLOR.

FOR: HERBICIDES, INSECTICIDES, FUNGICIDES, IN CLASS 5 (U.S. CLS. 6, 18, 44, 46, 51 AND 52).

SER. NO. 77-444,842, FILED 4-10-2008.

FIRST USE 10-31-1991; IN COMMERCE 10-31-1991.

CAROLINE WOOD, EXAMINING ATTORNEY

**Int. Cl.: 35**

**Prior U.S. Cls.: 100, 101 and 102**

**United States Patent and Trademark Office**

**Reg. No. 3,505,215**

**Registered Sep. 23, 2008**

**SERVICE MARK  
PRINCIPAL REGISTER**

# CADALOG

IVOCAR VIVADENT, INC. (DELAWARE CORPORATION)  
175 PINEVIEW DRIVE  
AMHERST, NY 14228

THE MARK CONSISTS OF STANDARD CHARACTERS WITHOUT CLAIM TO ANY PARTICULAR FONT, STYLE, SIZE, OR COLOR.

FOR: CATALOG ORDERING SERVICE FEATURING DENTAL SUPPLIES, IN CLASS 35 (U.S. CLS. 100, 101 AND 102).

SER. NO. 77-445,008, FILED 4-10-2008.

FIRST USE 1-25-2007; IN COMMERCE 1-25-2007.

KATHERINE STOIDES, EXAMINING ATTORNEY

**Int. Cl.: 9**

**Prior U.S. Cls.: 21, 23, 26, 36 and 38**

**Reg. No. 3,505,216**

**United States Patent and Trademark Office**

**Registered Sep. 23, 2008**

---

**TRADEMARK  
PRINCIPAL REGISTER**

**eScribing**

MDI ACHIEVE (MINNESOTA), INC. (DELA-  
WARE CORPORATION)  
SUITE 100  
940 W. PORT PLAZA DRIVE  
ST. LOUIS, MO 63146

FOR: SOFTWARE THAT ALLOWS THE AUTO-  
MATION OF THE PRESCRIPTION DRUG PROCESS  
BY PROVIDING ELECTRONIC COMMUNICATION  
BETWEEN PAYERS, FACILITIES, PHYSICIANS,  
AND PHARMACIES, IN CLASS 9 (U.S. CLS. 21, 23,  
26, 36 AND 38).

FIRST USE 1-1-2006; IN COMMERCE 1-1-2006.

THE MARK CONSISTS OF STANDARD CHAR-  
ACTERS WITHOUT CLAIM TO ANY PARTICULAR  
FONT, STYLE, SIZE, OR COLOR.

SER. NO. 77-445,442, FILED 4-10-2008.

MIDGE BUTLER, EXAMINING ATTORNEY

**Int. Cl.: 36**

**Prior U.S. Cls.: 100, 101 and 102**

**United States Patent and Trademark Office**

**Reg. No. 3,505,217**

**Registered Sep. 23, 2008**

**SERVICE MARK  
PRINCIPAL REGISTER**

# Upromise Loan Link

UPROMISE, INC. (DELAWARE CORPORATION)  
95 WELLS AVENUE  
NEWTON, MA 02459

FOR: BILL PAYMENT SERVICES, NAMELY, PROVIDING BORROWERS AN OPTION TO LINK THEIR LOANS TO THEIR SAVINGS ACCOUNT AND TO ELECT TO DISTRIBUTE ALL OR A PORTION OF THEIR SAVINGS TO PAY DOWN THEIR COLLEGE LOANS, IN CLASS 36 (U.S. CLS. 100, 101 AND 102).

FIRST USE 1-1-2007; IN COMMERCE 1-8-2007.

THE MARK CONSISTS OF STANDARD CHARACTERS WITHOUT CLAIM TO ANY PARTICULAR FONT, STYLE, SIZE, OR COLOR.

OWNER OF U.S. REG. NOS. 2,618,696 AND 2,669,900.

NO CLAIM IS MADE TO THE EXCLUSIVE RIGHT TO USE "LOAN LINK", APART FROM THE MARK AS SHOWN.

SER. NO. 77-446,206, FILED 4-11-2008.

EVELYN BRADLEY, EXAMINING ATTORNEY

**Int. Cl.: 41**

**Prior U.S. Cls.: 100, 101 and 107**

**United States Patent and Trademark Office**

**Reg. No. 3,505,218**

**Registered Sep. 23, 2008**

**SERVICE MARK  
PRINCIPAL REGISTER**

**VAE**

DEPARTMENT OF THE ARMY (UNITED STATES AGENCY OF THE UNITED STATES GOVERNMENT)

JALS-RL/IP

901 N. STUART STREET, STE. 700  
ARLINGTON, VA 22203

FOR: SPECIAL EVENT PLANNING RELATING TO COMPUTER GAMES AND COMPETITIVE GAME EVENTS; ENTERTAINMENT IN THE NATURE OF COMPUTER GAMING CONTESTS; EDUCATIONAL SERVICES, NAMELY, CONDUCTING ON-LINE EXHIBITIONS AND DISPLAYS AND INTERACTIVE EXHIBITS IN THE FIELDS OF GOVERNMENT SERVICE AND THE MILITARY; CONDUCTING EDUCATIONAL EXHIBITIONS IN THE FIELDS OF GOVERNMENT SERVICE AND THE MILITARY; EDUCATIONAL SERVICES, NAMELY, CONDUCTING INFORMAL PROGRAMS IN THE FIELDS OF GOVERNMENT SERVICE AND THE MILITARY, USING ON-LINE ACTIVITIES AND INTERACTIVE EXHIBITS, AND PRINTABLE

MATERIALS DISTRIBUTED THEREWITH; PROVIDING FACILITIES FOR COMPUTER GAME TOURNAMENTS; CONDUCTING INTERACTIVE COMPUTER GAME EXHIBITIONS FOR ENTERTAINMENT AND EDUCATIONAL PURPOSES IN THE FIELDS OF GOVERNMENT SERVICE AND MILITARY STRATEGY WHERE PARTICIPANTS CAN PARTICIPATE IN VIRTUAL BATTLES ON A VIRTUAL BATTLEFIELD, IN CLASS 41 (U.S. CLS. 100, 101 AND 107).

FIRST USE 2-0-2007; IN COMMERCE 2-0-2007.

THE MARK CONSISTS OF STANDARD CHARACTERS WITHOUT CLAIM TO ANY PARTICULAR FONT, STYLE, SIZE, OR COLOR.

SER. NO. 77-447,685, FILED 4-14-2008.

ZHALEH DELANEY, EXAMINING ATTORNEY

**Int. Cl.: 35**

**Prior U.S. Cls.: 100, 101 and 102**

**United States Patent and Trademark Office**

**Reg. No. 3,505,219**

**Registered Sep. 23, 2008**

**SERVICE MARK  
PRINCIPAL REGISTER**



MCCORMICK & COMPANY, INCORPORATED  
(MARYLAND CORPORATION)  
18 LOVETON CIRCLE  
SPARKS, MD 211526000

FOR: PROVIDING CONSUMER INFORMATION  
IN THE FIELD OF SPICES, IN CLASS 35 (U.S. CLS.  
100, 101 AND 102).

FIRST USE 3-27-2008; IN COMMERCE 3-27-2008.

NO CLAIM IS MADE TO THE EXCLUSIVE  
RIGHT TO USE "SPICES FOR HEALTH", APART  
FROM THE MARK AS SHOWN.

THE COLOR(S) BROWN, GOLD, GRAY, GREEN,  
RED AND YELLOW IS/ARE CLAIMED AS A FEAT-  
TURE OF THE MARK.

THE MARK CONSISTS OF FROM THE TOP, SIX  
CIRCLES FILLED WITH THE COLORS GREEN  
(THREE CIRCLES), RED (TWO CIRCLES), AND  
YELLOW (ONE CIRCLE), ABOVE THE BOWL OF A  
SPOON COLORED GOLD WITH BROWN SHAD-  
ING, BELOW WHICH IS A SHADOW OF THE  
SPOON COLORED GRAY, BENEATH WHICH IS  
THE WORD "SPICES" IN LETTERS SHADED FROM  
RED AT THE TOP TO DARK RED-BROWN AT THE  
BOTTOM, BENEATH WHICH ARE THE WORDS  
"FOR HEALTH" IN LETTERS COLORED DARK  
RED-BROWN.

SER. NO. 77-448,232, FILED 4-15-2008.

ALLISON SCHRODY, EXAMINING ATTORNEY

**Int. Cls.: 35 and 36**

**Prior U.S. Cls.: 100, 101 and 102**

**United States Patent and Trademark Office**

**Reg. No. 3,505,220**

**Registered Sep. 23, 2008**

**SERVICE MARK  
PRINCIPAL REGISTER**

**CITIBUSINESS PREMIERPASS**

CITIGROUP INC. (DELAWARE CORPORATION)  
399 PARK AVENUE  
NEW YORK, NY 10043

FOR: PROMOTING THE GOODS AND SERVICES  
OF OTHERS THROUGH CREDIT CARD CUSTOMER  
INCENTIVE, LOYALTY AND REWARD PROGRAMS,  
IN CLASS 35 (U.S. CLS. 100, 101 AND 102).

FIRST USE 9-0-2004; IN COMMERCE 9-0-2004.

FOR: CREDIT CARD SERVICES, IN CLASS 36  
(U.S. CLS. 100, 101 AND 102).

FIRST USE 9-0-2004; IN COMMERCE 9-0-2004.

THE MARK CONSISTS OF STANDARD CHARACTERS  
WITHOUT CLAIM TO ANY PARTICULAR FONT,  
STYLE, SIZE, OR COLOR.

OWNER OF U.S. REG. NOS. 1,181,467, 2,961,545  
AND OTHERS.

SER. NO. 77-448,846, FILED 4-15-2008.

SHANNON TWOHIG, EXAMINING ATTORNEY

**Int. Cl.: 12**

**Prior U.S. Cls.: 19, 21, 23, 31, 35 and 44**

**United States Patent and Trademark Office**

**Reg. No. 3,505,221**

**Registered Sep. 23, 2008**

---

**TRADEMARK  
PRINCIPAL REGISTER**

**DRAGTEC**

PIRELLI TYRE S.P.A. (ITALY SOCIETÀ PER  
AZIONI (SPA))  
VIALE SARCA 222  
MILANO, ITALY I-20126

FOR: TYRES; PNEUMATIC, SEMI-PNEUMATIC  
AND SOLID TYRES FOR VEHICLE WHEELS;  
WHEELS FOR VEHICLES; WHEEL RIMS; MOTOR-  
CYCLE TYRES, IN CLASS 12 (U.S. CLS. 19, 21, 23, 31,  
35 AND 44).

FIRST USE 3-0-2007; IN COMMERCE 3-0-2007.

THE MARK CONSISTS OF STANDARD CHAR-  
ACTERS WITHOUT CLAIM TO ANY PARTICULAR  
FONT, STYLE, SIZE, OR COLOR.

SER. NO. 77-450,780, FILED 4-17-2008.

ASMAT KHAN, EXAMINING ATTORNEY



**Int. Cls.: 16 and 44**

**Prior U.S. Cls.: 2, 5, 22, 23, 29, 37, 38, 50, 100 and 101**

**Reg. No. 3,505,222**

**United States Patent and Trademark Office**

**Registered Sep. 23, 2008**

**TRADEMARK  
SERVICE MARK  
PRINCIPAL REGISTER**

**Secure | Start**

HOLLISTER INCORPORATED (ILLINOIS CORPORATION)  
2000 HOLLISTER DRIVE  
LIBERTYVILLE, IL 60048

FOR: NEWSLETTERS AND EDUCATIONAL BOOKLETS IN THE FIELD OF OSTOMY AND CONTINENCE INFORMATION AND CARE, IN CLASS 16 (U.S. CLS. 2, 5, 22, 23, 29, 37, 38 AND 50).

FIRST USE 3-31-2005; IN COMMERCE 3-31-2005.

FOR: PROVIDING INFORMATION REGARDING OSTOMY AND CONTINENCE ISSUES, IN CLASS 44 (U.S. CLS. 100 AND 101).

FIRST USE 1-31-2005; IN COMMERCE 1-31-2005.

SER. NO. 77-450,972, FILED 4-17-2008.

DANNEAN HETZEL, EXAMINING ATTORNEY

**Int. Cl.: 9**

**Prior U.S. Cls.: 21, 23, 26, 36 and 38**

**United States Patent and Trademark Office**

**Reg. No. 3,505,223**

**Registered Sep. 23, 2008**

**TRADEMARK  
PRINCIPAL REGISTER**

**CELLULARRAM**

MICRON TECHNOLOGY, INC. (DELAWARE  
CORPORATION)  
8000 SOUTH FEDERAL WAY  
BOISE, ID 83707

OWNER OF U.S. REG. NOS. 3,266,728 AND  
3,266,741.

FOR: SEMICONDUCTOR DEVICES, IN CLASS 9  
(U.S. CLS. 21, 23, 26, 36 AND 38).

SEC. 2(F).

FIRST USE 3-4-2003; IN COMMERCE 3-4-2003.

SER. NO. 77-453,237, FILED 4-21-2008.

THE MARK CONSISTS OF STANDARD CHAR-  
ACTERS WITHOUT CLAIM TO ANY PARTICULAR  
FONT, STYLE, SIZE, OR COLOR.

KEVIN DINALLO, EXAMINING ATTORNEY

**Int. Cl.: 35**

**Prior U.S. Cls.: 100, 101 and 102**

**United States Patent and Trademark Office**

**Reg. No. 3,505,224**

**Registered Sep. 23, 2008**

**SERVICE MARK  
PRINCIPAL REGISTER**

**CHEERS FOR BEERS**

CHEERS FOR BEERS LLC (NEVADA LIMITED  
LIABILITY COMPANY)  
3309 ASHBY FIELD AVENUE  
NORTH LAS VEGAS, NV 89031

THE MARK CONSISTS OF STANDARD CHAR-  
ACTERS WITHOUT CLAIM TO ANY PARTICULAR  
FONT, STYLE, SIZE, OR COLOR.

FOR: PROVIDING CONSUMER INFORMATION  
IN THE FIELD OF BEER, BREWERIES AND BEER-  
RELATED PRODUCTS AND SERVICES, IN CLASS  
35 (U.S. CLS. 100, 101 AND 102).

SER. NO. 77-455,139, FILED 4-22-2008.

FIRST USE 6-1-2007; IN COMMERCE 6-1-2007.

BRIAN PINO, EXAMINING ATTORNEY

**Int. Cl.: 9**

**Prior U.S. Cls.: 21, 23, 26, 36 and 38**

**United States Patent and Trademark Office**

**Reg. No. 3,505,225**

**Registered Sep. 23, 2008**

**TRADEMARK  
PRINCIPAL REGISTER**

**WASP Wireless Access  
Surveillance Platform**

TELECOMMUNICATIONS TECHNOLOGY IN-  
CORPORATED (NORTH CAROLINA COR-  
PORATION), DBA TTI WIRELESS  
780 PARK AVENUE  
YOUNGSVILLE, NC 27596

FOR: AUTOMATED SELF CONTAINED ELEC-  
TRONIC SURVEILLANCE DEVICES THAT CAN BE  
DEPLOYED TO GATHER EVIDENCE OR INTELLI-  
GENCE IN REMOTE LOCATIONS; ELECTRIC AND  
ELECTRONIC VIDEO SURVEILLANCE INSTALLA-  
TIONS, IN CLASS 9 (U.S. CLS. 21, 23, 26, 36 AND 38).

FIRST USE 6-22-2005; IN COMMERCE 6-22-2005.

THE MARK CONSISTS OF STANDARD CHAR-  
ACTERS WITHOUT CLAIM TO ANY PARTICULAR  
FONT, STYLE, SIZE, OR COLOR.

NO CLAIM IS MADE TO THE EXCLUSIVE  
RIGHT TO USE "WIRELESS ACCESS SURVEIL-  
LANCE PLATFORM", APART FROM THE MARK  
AS SHOWN.

SER. NO. 77-455,386, FILED 4-23-2008.

ANN E. SAPPENFIELD, EXAMINING ATTORNEY

**Int. Cls.: 42 and 45**

**Prior U.S. Cls.: 100 and 101**

**United States Patent and Trademark Office**

**Reg. No. 3,505,226**

**Registered Sep. 23, 2008**

**SERVICE MARK  
PRINCIPAL REGISTER**



INVISUS, L.L.C. (UTAH LIMITED LIABILITY COMPANY)  
SUITE 400  
732 E. UTAH VALLEY DR.  
AMERICAN FORK, UT 84003

FOR: TECHNICAL SUPPORT SERVICES, NAME-  
LY, TROUBLESHOOTING OF COMPUTER SOFT-  
WARE PROBLEMS AND UP-DATING OF  
COMPUTER SECURITY SOFTWARE , IN CLASS 42  
(U.S. CLS. 100 AND 101).

FIRST USE 10-1-2007; IN COMMERCE 10-1-2007.

FOR: PERSONAL IDENTITY MONITORING AND  
CONSULTATION SERVICES IN THE FIELD OF  
PERSONAL INFORMATION THEFT AND IDENTI-  
TY THEFT, NAMELY, MONITORING PERSONAL  
IDENTITY INFORMATION AND PROVIDING PER-  
SONAL ASSISTANCE SERVICES TO VICTIMS OF  
IDENTITY THEFT FOR IDENTITY RESTORATION  
PURPOSES, NAMELY, ASSISTING WITH THE PRO-

VISION OF INFORMATION AND THE FILING OF  
REPORTS OF IDENTITY THEFT TO CREDIT RE-  
PORTING AGENCIES, CREDITORS, AND GOV-  
ERNMENT AND REGULATORY AGENCIES, IN  
CLASS 45 (U.S. CLS. 100 AND 101).

FIRST USE 10-1-2007; IN COMMERCE 10-1-2007.

THE COLOR(S) YELLOW AND WHITE IS/ARE  
CLAIMED AS A FEATURE OF THE MARK.

THE MARK CONSISTS OF TWO YELLOW CIR-  
CLES, ONE LARGE AND ONE SMALL, WITH THE  
SMALL CIRCLE LOCATED ABOVE THE LARGE  
CIRCLE AND A WHITE LETTER "I" WITHIN THE  
LARGER CIRCLE.

SER. NO. 77-455,872, FILED 4-23-2008.

PAUL CROWLEY, EXAMINING ATTORNEY

**Int. Cl.: 3**

**Prior U.S. Cls.: 1, 4, 6, 50, 51 and 52**

**United States Patent and Trademark Office**

**Reg. No. 3,505,227**

**Registered Sep. 23, 2008**

**TRADEMARK  
PRINCIPAL REGISTER**



CHURCH & DWIGHT CO., INC. (DELAWARE  
CORPORATION)  
469 NORTH HARRISON STREET  
PRINCETON, NJ 08543

FOR: LAUNDRY DETERGENTS, IN CLASS 3 (U.S.  
CLS. 1, 4, 6, 50, 51 AND 52).

FIRST USE 9-30-2006; IN COMMERCE 9-30-2006.

OWNER OF U.S. REG. NOS. 3,327,996, 3,337,311,  
AND 3,356,988.

THE MARK CONSISTS OF "ESSENTIALS HAR-  
NESSING THE POWER OF NATURE" WITH LEAF  
DESIGN.

SER. NO. 77-456,982, FILED 4-24-2008.

MICHAEL WIENER, EXAMINING ATTORNEY

**Int. Cl.: 9**

**Prior U.S. Cls.: 21, 23, 26, 36 and 38**

**Reg. No. 3,505,228**

**United States Patent and Trademark Office**

**Registered Sep. 23, 2008**

**TRADEMARK  
PRINCIPAL REGISTER**

# ModelMosaic

KNOWLEDGE BASED SYSTEMS, INC. (TEXAS CORPORATION)  
ONE KBSI PLACE  
1408 UNIVERSITY DR EAST  
COLLEGE STATION, TX 77840

FOR: COMPUTER SOFTWARE AND INSTRUCTION MANUAL SOLD AS A UNIT, WHICH PROVIDES A KNOWLEDGE-BASED FRAMEWORK FOR KNOWLEDGE CAPTURE, MODELING, AND ANALYSIS, AND WHICH IS DESIGNED FOR USE WITH MULTIPLE, COMPATIBLE KNOWLEDGE AND ENTERPRISE MODELING AND REPRESENTATION LANGUAGES AND METHODS, FOR THE PURPOSE OF PROCESS KNOWLEDGE REPRESENTATION, ONTOLOGY REPRESENTATION, FUNCTION MODEL REPRESENTATION, AND SYSTEM ANALYSIS, ENGINEERING AND DESIGN, IN CLASS 9 (U.S. CLS. 21, 23, 26, 36 AND 38).

FIRST USE 7-1-1995; IN COMMERCE 7-1-1995.

THE MARK CONSISTS OF STANDARD CHARACTERS WITHOUT CLAIM TO ANY PARTICULAR FONT, STYLE, SIZE, OR COLOR.

SER. NO. 77-457,420, FILED 4-24-2008.

JILL PRATER, EXAMINING ATTORNEY

**Int. Cl.: 35**

**Prior U.S. Cls.: 100, 101 and 102**

**United States Patent and Trademark Office**

**Reg. No. 3,505,229**

**Registered Sep. 23, 2008**

**SERVICE MARK  
PRINCIPAL REGISTER**

**1-888-SPARKY 8**

MISTER SPARKY FRANCHISING, LLC (FLORIDA LIMITED LIABILITY COMPANY)  
50 CENTRAL AVE.  
SUITE 920  
SARASOTA, FL 34236

FOR: FRANCHISE SERVICES, NAMELY, OFFERING BUSINESS MANAGEMENT AND MARKETING ASSISTANCE IN THE ESTABLISHMENT AND OPERATION OF ELECTRICAL BUSINESSES , IN CLASS 35 (U.S. CLS. 100, 101 AND 102).

FIRST USE 3-0-2008; IN COMMERCE 3-0-2008.

THE MARK CONSISTS OF STANDARD CHARACTERS WITHOUT CLAIM TO ANY PARTICULAR FONT, STYLE, SIZE, OR COLOR.

OWNER OF U.S. REG. NOS. 2,331,109 AND 2,334,568.

SER. NO. 77-459,317, FILED 4-28-2008.

BARBARA A. GOLD, EXAMINING ATTORNEY



**Int. Cls.: 3 and 5**

**Prior U.S. Cls.: 1, 4, 6, 18, 44, 46, 50, 51 and 52**

**United States Patent and Trademark Office**

**Reg. No. 3,505,230**

**Registered Sep. 23, 2008**

**TRADEMARK  
PRINCIPAL REGISTER**



PROFESSIONAL DISPOSABLES INTERNATIONAL, INC. (DELAWARE CORPORATION)  
TWO NICE-PAK PARK  
ORANGEBURG, NY 10962

FOR: PRE-MOISTENED COSMETIC TOWELLETTES FOR PERSONAL CLEANSING AND SKIN CLEANSERS, IN CLASS 3 (U.S. CLS. 1, 4, 6, 50, 51 AND 52).

FIRST USE 12-1-1998; IN COMMERCE 12-1-1998.

FOR: PRE-MOISTENED MEDICATED TOWELLETTES AND PADS IMPREGNATED WITH ANTI-SEPTIC, IODINE OR ALCOHOL; PRE-MOISTENED MEDICATED COTTON SWABS; PRE-MOISTENED MEDICATED WIPES FOR PERINEAL USE IMPREGNATED WITH DISINFECTANTS, NAMELY, ANTI-MICROBIALS, IN CLASS 5 (U.S. CLS. 6, 18, 44, 46, 51 AND 52).

FIRST USE 12-1-1998; IN COMMERCE 12-1-1998.

OWNER OF U.S. REG. NO. 2,367,823.

THE COLOR(S) GREEN, RED, AND BLUE IS/ARE CLAIMED AS A FEATURE OF THE MARK.

THE MARK CONSISTS OF A RECTANGLE MADE UP OF THREE HORIZONTAL BARS. THE TOP HORIZONTAL BAR IS GREEN, THE MIDDLE HORIZONTAL BAR IS RED, AND THE BOTTOM HORIZONTAL BAR IS BLUE. THE LETTERS "PDI" ARE FEATURED IN WHITE CAPITAL LETTERS AND ARE DISPLAYED IN THE CENTER OF THE RECTANGLE.

SER. NO. 77-459,389, FILED 4-28-2008.

ESTHER A. BORSUK, EXAMINING ATTORNEY

**Int. Cl.: 25**

**Prior U.S. Cls.: 22 and 39**

**United States Patent and Trademark Office**

**Reg. No. 3,505,231**

**Registered Sep. 23, 2008**

**TRADEMARK  
PRINCIPAL REGISTER**

**THE LETHAL EDGE**

EMERSON, ERNEST (UNITED STATES INDIVIDUAL)  
2730 MONTEREY ST., NO. 101  
TORRANCE, CA 90503 AND  
EMERSON, MARY (UNITED STATES INDIVIDUAL)  
2730 MONTEREY ST., NO. 101  
TORRANCE, CA 90503

FOR: HEADGEAR, NAMELY, CAPS, HATS, SWEATBANDS, VISORS; HOODED SWEAT SHIRTS; JACKETS; PANTS; POLO SHIRTS; SHORT-SLEEVED OR LONG-SLEEVED T-SHIRTS; SHORTS; SOCKS; SWEAT JACKETS; SWEAT PANTS; SWEAT SHIRTS;

SWEAT SHORTS; SWEAT SUITS, IN CLASS 25 (U.S. CLS. 22 AND 39).

FIRST USE 7-0-1996; IN COMMERCE 7-0-1996.

THE MARK CONSISTS OF STANDARD CHARACTERS WITHOUT CLAIM TO ANY PARTICULAR FONT, STYLE, SIZE, OR COLOR.

SER. NO. 77-462,337, FILED 4-30-2008.

KEVON CHISOLM, EXAMINING ATTORNEY

**Int. Cls.: 35 and 41**

**Prior U.S. Cls.: 100, 101, 102 and 107**

**United States Patent and Trademark Office**

**Reg. No. 3,505,232**

**Registered Sep. 23, 2008**

**SERVICE MARK  
PRINCIPAL REGISTER**

**NEW YORK COUNTY DENTAL  
SOCIETY**

THE DISTRICT DENTAL SOCIETY OF THE  
FIRST JUDICIAL DISTRICT (NEW YORK  
NOT FOR PROFIT CORPORATION), DBA  
NEW YORK COUNTY DENTAL SOCIETY  
6 EAST 43RD STREET  
NEW YORK, NY 10017

FOR: ASSOCIATION SERVICES, NAMELY, PRO-  
MOTING THE INTERESTS OF THE DENTAL PRO-  
FESSION AND DENTAL PROFESSIONALS, IN  
CLASS 35 (U.S. CLS. 100, 101 AND 102).

FIRST USE 6-30-1998; IN COMMERCE 6-30-1998.

FOR: EDUCATIONAL SERVICES, NAMELY,  
CONDUCTING COURSES AND SEMINARS RELA-  
TED TO THE PRACTICE OF DENTISTRY, IN CLASS  
41 (U.S. CLS. 100, 101 AND 107).

FIRST USE 6-30-1998; IN COMMERCE 6-30-1998.

THE MARK CONSISTS OF STANDARD CHAR-  
ACTERS WITHOUT CLAIM TO ANY PARTICULAR  
FONT, STYLE, SIZE, OR COLOR.

NO CLAIM IS MADE TO THE EXCLUSIVE  
RIGHT TO USE "DENTAL SOCIETY" , APART  
FROM THE MARK AS SHOWN.

SEC. 2(F).

SER. NO. 77-470,332, FILED 5-9-2008.

BERNICE MIDDLETON, EXAMINING ATTORNEY

**Int. Cl.: 45**

**Prior U.S. Cls.: 100 and 101**

**United States Patent and Trademark Office**

**Reg. No. 3,505,233**

**Registered Sep. 23, 2008**

**SERVICE MARK  
PRINCIPAL REGISTER**

**KALFUS & NACHMAN**

KALFUS & NACHMAN, P.C. (VIRGINIA CORPORATION)  
SUITE 300  
870 NORTH MILITARY HIGHWAY  
NORFOLK, VA 23502

THE MARK CONSISTS OF STANDARD CHARACTERS WITHOUT CLAIM TO ANY PARTICULAR FONT, STYLE, SIZE, OR COLOR.

FOR: LEGAL SERVICES, IN CLASS 45 (U.S. CLS. 100 AND 101).

SER. NO. 77-470,668, FILED 5-9-2008.

FIRST USE 3-19-1992; IN COMMERCE 3-19-1992.

STEVEN JACKSON, EXAMINING ATTORNEY

**Int. Cl.: 35**

**Prior U.S. Cls.: 100, 101 and 102**

**United States Patent and Trademark Office**

**Reg. No. 3,505,234**

**Registered Sep. 23, 2008**

**SERVICE MARK  
PRINCIPAL REGISTER**



CONSUMER BENEFIT SERVICES, INC. (ILLINOIS CORPORATION), DBA CBS DATA SERVICES

1620 BOND STREET  
NAPERVILLE, IL 60563

FOR: PROVIDING LOYALTY, MARKETING, AND MEMBERSHIP PROGRAMS FOR COMMERCIAL, PROMOTIONAL, AND/OR ADVERTISING PURPOSES, NAMELY, A REWARDS PROGRAM ON A SHOPPING SITE FOR CUSTOMERS' GENERAL MERCHANDISE, IN CLASS 35 (U.S. CLS. 100, 101 AND 102).

FIRST USE 1-2-2008; IN COMMERCE 1-2-2008.

THE COLOR(S) PALE GREEN, RED, AND GRAY IS/ARE CLAIMED AS A FEATURE OF THE MARK.

THE MARK CONSISTS OF A GRAY RECTANGLE CONTAINING THREE RED DOTS AND THE WORDING "MORE POINTS" IN PALE GREEN.

SER. NO. 77-477,981, FILED S.R. 5-19-2008 AM. P.R. 5-19-2008.

REBECCA POVARCHUK, EXAMINING ATTORNEY

**Int. Cl.: 39**

**Prior U.S. Cls.: 100 and 105**

**United States Patent and Trademark Office**

**Reg. No. 3,505,235**

**Registered Sep. 23, 2008**

**SERVICE MARK  
PRINCIPAL REGISTER**

**RURAL REACH**

UNITED STATES POSTAL SERVICE (UNITED STATES INDEPENDENT ESTABLISHMENT OF THE EXECUTIVE BRANCH OF THE UNITED STATES GOVERNMENT)  
475 L'ENFANT PLAZA, SW  
WASHINGTON, DC 202601136

FOR: PICKUP, TRANSPORTATION, AND DELIVERY OF POSTCARDS, LETTERS, PACKAGES, ADVERTISEMENTS, CATALOGS, PUBLICATIONS, INVOICES, AND OTHER ITEMS OF MAIL BY VARIOUS MODES OF TRANSPORTATION; RENTAL OF MAIL BOXES; AND CONSULTING SERVICES FOR BUSINESSES RELATING TO THE SHIPMENT AND DELIVERY OF PRODUCTS AND PACKAGES, IN CLASS 39 (U.S. CLS. 100 AND 105).

FIRST USE 4-28-2008; IN COMMERCE 4-28-2008.

THE MARK CONSISTS OF STANDARD CHARACTERS WITHOUT CLAIM TO ANY PARTICULAR FONT, STYLE, SIZE, OR COLOR.

NO CLAIM IS MADE TO THE EXCLUSIVE RIGHT TO USE "RURAL", APART FROM THE MARK AS SHOWN.

SER. NO. 77-478,777, FILED 5-20-2008.

JEFFERY COWARD, EXAMINING ATTORNEY

**Int. Cl.: 35**

**Prior U.S. Cls.: 100, 101 and 102**

**United States Patent and Trademark Office**

**Reg. No. 3,505,236**

**Registered Sep. 23, 2008**

**SERVICE MARK  
PRINCIPAL REGISTER**

**POWER OF THE LETTER**

UNITED STATES POSTAL SERVICE (UNITED STATES INDEPENDENT ESTABLISHMENT OF THE EXECUTIVE BRANCH OF THE UNITED STATES GOVERNMENT)  
475 L'ENFANT PLAZA, SW  
WASHINGTON, DC 202601136

FOR: PROMOTING PUBLIC AWARENESS OF THE IMPORTANCE OF AND NEED FOR HAND-WRITTEN CORRESPONDENCE, IN CLASS 35 (U.S. CLS. 100, 101 AND 102).

FIRST USE 2-4-2008; IN COMMERCE 2-4-2008.

THE MARK CONSISTS OF STANDARD CHARACTERS WITHOUT CLAIM TO ANY PARTICULAR FONT, STYLE, SIZE, OR COLOR.

SER. NO. 77-479,064, FILED 5-20-2008.

JEFFERY COWARD, EXAMINING ATTORNEY

**Int. Cl.: 9**

**Prior U.S. Cls.: 21, 23, 26, 36 and 38**

**Reg. No. 3,505,237**

**United States Patent and Trademark Office**

**Registered Sep. 23, 2008**

**TRADEMARK  
PRINCIPAL REGISTER**



CBOCS PROPERTIES, INC. (MICHIGAN CORPORATION)  
45525 N. I-94 SERVICE ROAD  
BELLEVILLE, MI 48111

FOR: MUSICAL SOUND RECORDINGS; DIGITAL MATERIALS, NAMELY, CDS FEATURING MUSICAL SOUND RECORDINGS, IN CLASS 9 (U.S. CLS. 21, 23, 26, 36 AND 38).

FIRST USE 12-13-2002; IN COMMERCE 12-13-2002.

OWNER OF U.S. REG. NOS. 1,142,958, 3,305,557 AND OTHERS.

NO CLAIM IS MADE TO THE EXCLUSIVE RIGHT TO USE "OLD COUNTRY STORE", APART FROM THE MARK AS SHOWN.

THE MARK CONSISTS OF A MAN SITTING IN A CHAIR WITH ONE ARM RESTING ON A BARREL. TO THE RIGHT OF THE SITTING MAN IS THE STYLIZED WORDING "CRACKER BARREL OLD COUNTRY STORE".

SER. NO. 77-480,058, FILED 5-21-2008.

WENDY GOODMAN, EXAMINING ATTORNEY



**Int. Cl.: 42**

**Prior U.S. Cls.: 100 and 101**

**United States Patent and Trademark Office**

**Reg. No. 3,505,238**

**Registered Sep. 23, 2008**

**SERVICE MARK  
PRINCIPAL REGISTER**

**PING**

KARSTEN MANUFACTURING CORPORATION  
(ARIZONA CORPORATION)  
ATTN: LEGAL DEPARTMENT  
2201 W. DESERT COVE  
PHOENIX, AZ 85029

FOR: APPLICATION SERVICE PROVIDER FEATURING NON-DOWNLOADABLE SOFTWARE FOR PROVIDING AN ON-LINE DATABASE TO ENABLE FILE SHARING AND EXTRACTION AND RETRIEVAL OF DOCUMENTARY INFORMATION, IN CLASS 42 (U.S. CLS. 100 AND 101).

FIRST USE 3-31-2008; IN COMMERCE 3-31-2008.

THE MARK CONSISTS OF STANDARD CHARACTERS WITHOUT CLAIM TO ANY PARTICULAR FONT, STYLE, SIZE, OR COLOR.

OWNER OF U.S. REG. NOS. 704,552, 1,647,448 AND OTHERS.

SER. NO. 77-480,547, FILED 5-21-2008.

ROBIN CHOSID, EXAMINING ATTORNEY

Int. Cls.: 35, 36 and 37

Prior U.S. Cls.: 100, 101, 102, 103 and 106

United States Patent and Trademark Office

Reg. No. 3,505,239

Registered Sep. 23, 2008

SERVICE MARK  
PRINCIPAL REGISTER



INGRAM ENTITIES, INC. (GEORGIA CORPORATION)  
5400 BOWMAN RD.  
MACON, GA 31210

FOR: EVALUATION OF STANDING TIMBER; REAL ESTATE ADVERTISING SERVICES, IN CLASS 35 (U.S. CLS. 100, 101 AND 102).

FIRST USE 2-4-2007; IN COMMERCE 2-4-2007.

FOR: ASSESSMENT AND MANAGEMENT OF REAL ESTATE; EVALUATION OF REAL PROPERTY; FINANCIAL VALUATION OF PERSONAL PROPERTY AND REAL ESTATE; LEASING OF REAL ESTATE; REAL ESTATE ACQUISITION SERVICES; REAL ESTATE CONSULTATION; REAL ESTATE INVESTMENT; REAL ESTATE MANAGEMENT; REAL ESTATE MANAGEMENT CONSULTATION; REAL ESTATE PROCUREMENT FOR OTHERS; REAL ESTATE VALUATION SERVICES; REAL ESTATE VALUATIONS, IN CLASS 36 (U.S. CLS. 100, 101 AND 102).

FIRST USE 2-4-2007; IN COMMERCE 2-4-2007.

FOR: REAL ESTATE DEVELOPMENT; REAL ESTATE SITE SELECTION, IN CLASS 37 (U.S. CLS. 100, 103 AND 106).

FIRST USE 2-4-2007; IN COMMERCE 2-4-2007.

THE STIPPLING ON THE DRAWING IS FOR SHADING PURPOSES ONLY, AND IS NOT INTENDED TO INDICATE COLOR.

THE MARK CONSISTS OF THE DESIGN OF A TREE WITHIN A SINGLE LINE RECTANGLE, ABOVE TWO HORIZONTAL, WAVY LINES, ALL TO THE LEFT OF THE DESIGN OF A HOUSE WITH A DOOR AND TWO WINDOWS.

SER. NO. 77-975,224, FILED 3-14-2007.

BARBARA A. GOLD, EXAMINING ATTORNEY

**Int. Cl.: 36**

**Prior U.S. Cls.: 100, 101 and 102**

**United States Patent and Trademark Office**

**Reg. No. 3,505,240**

**Registered Sep. 23, 2008**

**SERVICE MARK  
PRINCIPAL REGISTER**



INGRAM ENTITIES, INC. (GEORGIA CORPORATION)  
5400 BOWMAN RD.  
MACON, GA 31210

FOR: ASSESSMENT AND MANAGEMENT OF REAL ESTATE; EVALUATION OF REAL PROPERTY; FINANCIAL VALUATION OF PERSONAL PROPERTY AND REAL ESTATE; LEASING OF REAL ESTATE; REAL ESTATE ACQUISITION SERVICES; REAL ESTATE CONSULTATION; REAL ESTATE INVESTMENT; REAL ESTATE MANAGEMENT; REAL ESTATE MANAGEMENT CONSULTATION; REAL ESTATE PROCUREMENT FOR OTHERS; REAL ESTATE VALUATION SERVICES; REAL ESTATE VALUATIONS, IN CLASS 36 (U.S. CLS. 100, 101 AND 102).

FIRST USE 2-4-2007; IN COMMERCE 2-4-2007.

THE STIPPLING ON THE DRAWING IS FOR SHADING PURPOSES ONLY, AND IS NOT INTENDED TO INDICATE COLOR.

THE MARK CONSISTS OF THE LETTERS, "ITE" TO THE RIGHT OF THE DESIGN OF A TREE, ALL WITHIN A SINGLE LINE RECTANGLE DESIGN.

SER. NO. 77-975,247, FILED 3-13-2007.

BARBARA A. GOLD, EXAMINING ATTORNEY

**Int. Cl.: 9**

**Prior U.S. Cls.: 21, 23, 26, 36 and 38**

**Reg. No. 3,505,241**

**United States Patent and Trademark Office**

**Registered Sep. 23, 2008**

**TRADEMARK  
PRINCIPAL REGISTER**

**LAUNCH & LEARN**

CHANNING BETE COMPANY, INC. (MASSACHUSETTS CORPORATION)  
ONE COMMUNITY PLACE  
SOUTH DEERFIELD, MA 01373

FOR: EDUCATIONAL AND INFORMATIONAL COMPUTER SOFTWARE FEATURING INFORMATION AND INSTRUCTION IN THE FIELDS OF EMERGENCY PLANNING, HEALTH, AND ACADEMIC AND SCHOOL ISSUES, NAMELY, ACADEMIC SKILLS, TEST TAKING, TEST ANXIETY, PARENT INVOLVEMENT IN CHILDREN'S EDUCA-

TION AND EDUCATION-RELATED LEGISLATION, IN CLASS 9 (U.S. CLS. 21, 23, 26, 36 AND 38).

FIRST USE 11-5-2007; IN COMMERCE 1-25-2008.

THE MARK CONSISTS OF STANDARD CHARACTERS WITHOUT CLAIM TO ANY PARTICULAR FONT, STYLE, SIZE, OR COLOR.

SER. NO. 77-975,349, FILED 5-15-2007.

MARY BOAGNI, EXAMINING ATTORNEY

**Int. Cl.: 25**

**Prior U.S. Cls.: 22 and 39**

**United States Patent and Trademark Office**

**Reg. No. 3,505,242**

**Registered Sep. 23, 2008**

**TRADEMARK  
PRINCIPAL REGISTER**



J.J. BUCKLEY, LLC (CALIFORNIA LIMITED LIABILITY COMPANY)  
7305 EDGEWATER DRIVE  
SUITE D  
OAKLAND, CA 94621

THE MARK CONSISTS OF AN OVAL-SHAPED BACKGROUND, WITH A SHIELD THAT CONTAINS FOUR CHARGES, WITH THE WORDS "J.J. BUCKLEY FINE WINES" IMPRINTED OVER THE SHIELD.

FOR: CLOTHING, NAMELY, PULLOVERS AND SWEATERS, IN CLASS 25 (U.S. CLS. 22 AND 39).

FIRST USE 12-18-2007; IN COMMERCE 12-18-2007.

SER. NO. 77-975,486, FILED 12-14-2007.

THE NAME(S), PORTRAIT(S), AND/OR SIGNATURE(S) SHOWN IN THE MARK DOES NOT IDENTIFY A PARTICULAR LIVING INDIVIDUAL.

AISHA CLARKE, EXAMINING ATTORNEY

**Int. Cls.: 16 and 35**

**Prior U.S. Cls.: 2, 5, 22, 23, 29, 37, 38, 50, 100, 101 and 102**

**United States Patent and Trademark Office**

**Reg. No. 3,505,243**

**Registered Sep. 23, 2008**

**TRADEMARK  
SERVICE MARK  
PRINCIPAL REGISTER**

**ORTHODONTIC PRODUCTS**

CURANT COMMUNICATIONS, INC (CALIFORNIA CORPORATION)  
6701 CENTER DRIVE WEST #450  
LOS ANGELES, CA 90045

FOR: PRINTED PUBLICATIONS, NAMELY, MAGAZINES AND JOURNALS THAT PROVIDES CURRENT NEWS ON PRODUCTS, SERVICES, AND DEVELOPMENTS IN THE FIELD OF ORTHODONTICS, IN CLASS 16 (U.S. CLS. 2, 5, 22, 23, 29, 37, 38 AND 50).

FIRST USE 10-1-1985; IN COMMERCE 10-1-1985.

FOR: ADVERTISING SERVICES, NAMELY, PROMOTING THE GOODS AND SERVICES OF OTHERS

IN MAGAZINES IN THE FIELD OF ORTHODONTICS, IN CLASS 35 (U.S. CLS. 100, 101 AND 102).

FIRST USE 10-1-1985; IN COMMERCE 10-1-1985.

THE MARK CONSISTS OF STANDARD CHARACTERS WITHOUT CLAIM TO ANY PARTICULAR FONT, STYLE, SIZE, OR COLOR.

OWNER OF U.S. REG. NO. 2,428,987.

SEC. 2(F).

SER. NO. 77-975,489, FILED 1-27-2007.

JENNIFER VASQUEZ, EXAMINING ATTORNEY

**Int. Cl.: 9**

**Prior U.S. Cls.: 21, 23, 26, 36 and 38**

**Reg. No. 3,505,244**

**United States Patent and Trademark Office**

**Registered Sep. 23, 2008**

**TRADEMARK  
PRINCIPAL REGISTER**

**CEELOX ID ONLINE**

CEELOX, INC. (FLORIDA CORPORATION)  
13976 LYNMAR BOULEVARD  
TAMPA, FL 33626

FOR: ELECTRONIC DEVICES, NAMELY, COMPUTER HARDWARE AND SOFTWARE CONTAINING DATA AND PROGRAMMING, AND ELECTRONIC READERS, ALL USED FOR BIOMETRIC RECOGNITION AND FOR STORING, CAPTURING, VERIFYING AND AUTHENTICATING BIOMETRIC DATA TO SECURE ELECTRONIC COMMUNICATIONS AND CONTROL COMPUTER ACCESS; BIOMETRIC READERS; SECURITY DEVICES, NAMELY, SMART CARDS CONTAINING DATA AND PROGRAMMING AND BIOMETRIC READERS, ALL USED FOR BIOMETRIC RECOGNITION AND FOR STORING, CAPTURING, VERIFYING AND AUTHENTICATING BIOMETRIC DATA TO SECURE ELECTRONIC COMMUNICATIONS AND CONTROL COMPUTER ACCESS; ENCODED ELECTRONIC CHIP CARDS CONTAINING

PROGRAMMING USED TO SECURE COMMUNICATIONS AND CONTROL ACCESS TO PHYSICAL AREAS, COMPUTERS, COMPUTER NETWORKS, AND ELECTRONIC DEVICES AND SYSTEMS; COMPUTER SOFTWARE FOR ENCRYPTION AND DECRYPTION OF DATA VIA THE INTERNET, IN CLASS 9 (U.S. CLS. 21, 23, 26, 36 AND 38).

FIRST USE 11-1-2005; IN COMMERCE 3-15-2006.

THE MARK CONSISTS OF STANDARD CHARACTERS WITHOUT CLAIM TO ANY PARTICULAR FONT, STYLE, SIZE, OR COLOR.

NO CLAIM IS MADE TO THE EXCLUSIVE RIGHT TO USE "ID ONLINE", APART FROM THE MARK AS SHOWN.

SER. NO. 77-975,541, FILED 9-20-2006.

JEAN IM, EXAMINING ATTORNEY

**Int. Cls.: 36 and 44**

**Prior U.S. Cls.: 100, 101 and 102**

**United States Patent and Trademark Office**

**Reg. No. 3,505,245**

**Registered Sep. 23, 2008**

**SERVICE MARK  
PRINCIPAL REGISTER**

**TRIESSENT**

PRIME THERAPEUTICS LLC (DELAWARE LIMITED LIABILITY COMPANY)  
1305 CORPORATE CENTER DRIVE  
EAGAN, MN 55121

FOR: PHARMACY BENEFIT MANAGEMENT SERVICES, IN CLASS 36 (U.S. CLS. 100, 101 AND 102).

FIRST USE 11-29-2007; IN COMMERCE 11-29-2007.

FOR: MEDICAL SERVICES, NAMELY, DISEASE MANAGEMENT SERVICES; INFORMATION SERVICES IN THE FIELD OF HEALTHCARE AND PHARMACEUTICALS AS PROVIDED TO PHARMACEUTICAL BENEFIT MANAGEMENT SERVICES CLIENTS, MEMBERS OF CLIENTS,

HEALTHCARE PROFESSIONALS, AND PHARMACEUTICAL BENEFIT MANAGEMENT SERVICES CONSULTANTS, IN CLASS 44 (U.S. CLS. 100 AND 101).

FIRST USE 11-29-2007; IN COMMERCE 11-29-2007.

THE MARK CONSISTS OF STANDARD CHARACTERS WITHOUT CLAIM TO ANY PARTICULAR FONT, STYLE, SIZE, OR COLOR.

SER. NO. 77-975,627, FILED 12-19-2007.

KIMBERLY FRYE, EXAMINING ATTORNEY



**Int. Cls.: 36 and 44**

**Prior U.S. Cls.: 100, 101 and 102**

**United States Patent and Trademark Office**

**Reg. No. 3,505,246**

**Registered Sep. 23, 2008**

**SERVICE MARK  
PRINCIPAL REGISTER**



**trinessent**

PRIME THERAPEUTICS LLC (DELAWARE LIMITED LIABILITY COMPANY)  
1305 CORPORATE CENTER DRIVE  
EAGAN, MN 55121

FOR: PHARMACY BENEFIT MANAGEMENT SERVICES, IN CLASS 36 (U.S. CLS. 100, 101 AND 102).

FIRST USE 11-29-2007; IN COMMERCE 11-29-2007.

FOR: MEDICAL SERVICES, NAMELY, DISEASE MANAGEMENT SERVICES; INFORMATION SERVICES IN THE FIELD OF HEALTHCARE AND PHARMACEUTICALS AS PROVIDED TO PHARMACEUTICAL BENEFIT MANAGEMENT SERVICES CLIENTS, MEMBERS OF CLIENTS, HEALTHCARE PROFESSIONALS, AND PHARMA-

CEUTICAL BENEFIT MANAGEMENT SERVICES CONSULTANTS, IN CLASS 44 (U.S. CLS. 100 AND 101).

FIRST USE 11-29-2007; IN COMMERCE 11-29-2007.

THE MARK CONSISTS OF THE WORD TRIESSENT WITH THE LETTERS "TRI" BOLDER THAN THE LETTERS "ESSENT" AND THREE CIRCLES IN THE SHAPE OF AN INVERTED TRIANGLE ABOVE THE LETTER "I".

SER. NO. 77-975,629, FILED 12-19-2007.

KIMBERLY FRYE, EXAMINING ATTORNEY

**Int. Cls.: 35, 39 and 42**

**Prior U.S. Cls.: 100, 101, 102 and 105**

**United States Patent and Trademark Office**

**Reg. No. 3,505,247**

**Registered Sep. 23, 2008**

**SERVICE MARK  
PRINCIPAL REGISTER**

The logo for MENUgistics features the word "MENUgistics" in a serif font. Above the "g" and "i" in "gistics", there is a semi-circular arrangement of various food-related icons, including a fork, a knife, a spoon, a glass, a plate, and a bowl.

HAWKEYE FOODSERVICE DISTRIBUTION,  
INC. (IOWA CORPORATION)  
3550 2ND STREET  
CORALVILLE, IA 52241

FOR: COMPUTERIZED ON-LINE ORDERING SERVICES IN THE FIELD OF FOOD IN THE INSTITUTIONAL FOOD INDUSTRY AND RESTAURANT INDUSTRY; INVENTORY MANAGEMENT IN THE FIELD OF FOOD IN THE INSTITUTIONAL FOOD INDUSTRY AND RESTAURANT INDUSTRY, IN CLASS 35 (U.S. CLS. 100, 101 AND 102).

FIRST USE 1-31-1995; IN COMMERCE 1-31-1995.

FOR: FOOD DELIVERY SERVICES, IN CLASS 39 (U.S. CLS. 100 AND 105).

FIRST USE 1-31-1995; IN COMMERCE 1-31-1995.

FOR: PROVIDING TEMPORARY USE OF ON-LINE NON-DOWNLOADABLE SOFTWARE FOR

GENERATING CUSTOMIZED IN-HOUSE MENUS FOR USE IN THE INSTITUTIONAL FOOD INDUSTRY AND RESTAURANT INDUSTRY; PROVIDING TEMPORARY USE OF THE ON-LINE NON-DOWNLOADABLE COMPUTER SOFTWARE FOR ACCUMULATING AND ANALYZING DATA AND GENERATING REPORTS FOR A DIETARY MANAGEMENT PROGRAM IN THE INSTITUTIONAL FOOD INDUSTRY AND RESTAURANT INDUSTRY, IN CLASS 42 (U.S. CLS. 100 AND 101).

FIRST USE 1-31-1995; IN COMMERCE 1-31-1995.

THE MARK CONSISTS OF THE WORD "MENU-GISTICS" WITH VARIOUS FOOD ITEMS IN A SEMI-CIRCLE STARTING ABOVE THE FIRST "I" AND ENDING AT THE LAST "I".

SER. NO. 77-975,870, FILED 10-13-2006.

PAUL CROWLEY, EXAMINING ATTORNEY

**Int. Cls.: 16, 41 and 42**

**Prior U.S. Cls.: 2, 5, 22, 23, 29, 37, 38, 50, 100, 101 and 107**

**Reg. No. 3,505,248**

**United States Patent and Trademark Office**

**Registered Sep. 23, 2008**

**TRADEMARK  
SERVICE MARK  
PRINCIPAL REGISTER**

**FASKEN  
MARTINEAU** 

FASKEN MARTINEAU DUMOULIN LLP (CANADA LIMITED LIABILITY PARTNERSHIP)  
TORONTO DOMINION BANK TOWER, SUITE 5200  
TORONTO-DOMINION CENTRE P.O. BOX 20  
TORONTO ONTARIO, CANADA M5K 1N6

FOR: PRINTED PUBLICATIONS, NAMELY, NEWSLETTERS, BOOKS, BROCHURES, PAMPHLETS, TRAINING MANUALS AND STATIONERY, ALL IN THE FIELD OF LEGAL ADVICE AND INFORMATION, IN CLASS 16 (U.S. CLS. 2, 5, 22, 23, 29, 37, 38 AND 50).

FIRST USE 11-15-2001; IN COMMERCE 11-15-2001.

FOR: TRAINING, EDUCATIONAL AND INFORMATIONAL SERVICES IN ASSOCIATION WITH LEGAL EDUCATION, IN CLASS 41 (U.S. CLS. 100, 101 AND 107).

FIRST USE 11-15-2001; IN COMMERCE 11-15-2001.

FOR: LEGAL SERVICES, NAMELY, PROVIDING LEGAL INFORMATION SERVICES RELATING TO BUSINESS, FINANCIAL, MANAGEMENT AND TAX MATTERS; TRADEMARK REPRESENTATION AND CONSULTATION; PATENT REPRESENTATION AND CONSULTATION; AND PROVIDING LEGAL SERVICES BY MEANS OF THE INTERNET, IN-HOUSE INTRANET AND FIRM-CLIENT EXTRANET CONNECTIONS, IN CLASS 42 (U.S. CLS. 100 AND 101).

FIRST USE 11-15-2001; IN COMMERCE 11-15-2001.

PRIORITY CLAIMED UNDER SEC. 44(D) ON CANADA APPLICATION NO. 1120026, FILED 10-31-2001, REG. NO. TMA704,553, DATED 1-11-2008, EXPIRES 1-11-2023.

SER. NO. 78-124,906, FILED 4-29-2002.

CHRIS WELLS, EXAMINING ATTORNEY

**Int. Cls.: 7, 9 and 12**

**Prior U.S. Cls.: 13, 19, 21, 23, 26, 31, 34, 35, 36, 38 and 44**

**Reg. No. 3,505,249**

**United States Patent and Trademark Office**

**Registered Sep. 23, 2008**

**TRADEMARK  
PRINCIPAL REGISTER**



SWITCHED RELUCTANCE DRIVES LIMITED  
(UNITED KINGDOM CORPORATION)  
EAST PARK HOUSE  
OTLEY ROAD  
HARROGATE, UNITED KINGDOM HG3 1PR

FOR: ELECTRIC GENERATORS FOR BICYCLES, TRICYCLES, QUAD BIKES, MOTORCYCLES, INVALID CARRIAGES/CARTS, WHEELCHAIRS, GOLF CARTS, CARS, BUSES, TRUCKS, TRAINS, TRAINS, AMBULANCES, BABY CARRIAGES, FIRE ENGINES, CAMPING CARS, VANS, CARAVANS, RAILWAY VEHICLES, FUNICULARS, LORRIES, MOPEDS, SCOOTERS, MOTOR COACHES, MOTOR HOMES, SNOWMOBILES, LAWN MOWERS, TRACTORS, BULLDOZERS, EARTH MOVING VEHICLES, DUMPER TRUCKS, LOADER VEHICLES FOR CONSTRUCTION PURPOSES, VEHICULAR CRANES, CONCRETE MIXING VEHICLES, AND CONSTRUCTION VEHICLES; ELECTRIC MOTORS FOR LAWN MOWERS, BULLDOZERS, EARTH-MOVING VEHICLES, LOADER VEHICLES FOR CONSTRUCTION, VEHICULAR CRANES, AND CONCRETE MIXING VEHICLES, IN CLASS 7 (U.S. CLS. 13, 19, 21, 23, 31, 34 AND 35).

FOR: ELECTRIC VALVE ACTUATORS, IN CLASS 9 (U.S. CLS. 21, 23, 26, 36 AND 38).

FOR: ELECTRIC MOTORS FOR TRUCKS; ELECTRIC MOTORS FOR LAND VEHICLES; ELECTRIC MOTORS FOR BICYCLES, TRICYCLES, QUAD BIKES, MOTORCYCLES, INVALID CARRIAGES/CARTS, WHEELCHAIRS, GOLF CARTS, CARS, BUSES, TRUCKS, TRAINS, TRAINS, AMBULANCES, BABY CARRIAGES, FIRE ENGINES, CAMPING CARS, VANS, CARAVANS, RAILWAY VEHICLES, FUNICULARS, LORRIES, MOPEDS, SCOOTERS, MOTOR COACHES, MOTOR HOMES, SNOWMOBILES, AND DUMPER TRUCKS, IN CLASS 12 (U.S. CLS. 19, 21, 23, 31, 35 AND 44).

PRIORITY CLAIMED UNDER SEC. 44(D) ON UNITED KINGDOM APPLICATION NO. 2824092, FILED 8-2-2002, REG. NO. 2824092, DATED 12-17-2003, EXPIRES 8-2-2012.

NO CLAIM IS MADE TO THE EXCLUSIVE RIGHT TO USE "DRIVES", APART FROM THE MARK AS SHOWN.

SER. NO. 78-167,677, FILED 9-25-2002.

WILLIAM BRECKENFELD, EXAMINING ATTORNEY

**Int. Cl.: 9**

**Prior U.S. Cls.: 21, 23, 26, 36 and 38**

**United States Patent and Trademark Office**

**Reg. No. 3,505,250**

**Registered Sep. 23, 2008**

**TRADEMARK  
PRINCIPAL REGISTER**

**MAINTAINIT!**

K & G ASSOCIATES, INC., (MICHIGAN CORPORATION), DBA TRADEMASTER, INC.  
1150 STEPHENSON HIGHWAY  
TROY, MI 48084

FOR: COMPUTER SOFTWARE, NAMELY, SOFTWARE DESIGNED TO OPERATE, DIAGNOSE, REPAIR, MAINTAIN, PURCHASE, ASSEMBLE AND TRAIN ONLINE WITH RESPECT TO REPLACEMENT PARTS, IN THE FIELD OF MACHINES AND MACHINE SYSTEMS FOR USE IN MANUFACTURING, ASSEMBLY AND THE REPAIR PROCESS, AND MANUALS PROVIDED THEREWITH., IN CLASS 9 (U.S. CLS. 21, 23, 26, 36 AND 38).

FIRST USE 5-0-2000; IN COMMERCE 5-0-2000.

THE MARK CONSISTS OF STANDARD CHARACTERS WITHOUT CLAIM TO ANY PARTICULAR FONT, STYLE, SIZE, OR COLOR.

OWNER OF U.S. REG. NO. 2,645,293.

SER. NO. 78-237,591, FILED 4-14-2003.

THEODORE MCBRIDE, EXAMINING ATTORNEY

**Int. Cl.: 35**

**Prior U.S. Cls.: 100, 101 and 102**

**United States Patent and Trademark Office**

**Reg. No. 3,505,251**

**Registered Sep. 23, 2008**

**SERVICE MARK  
PRINCIPAL REGISTER**

**WHEN RESULTS MATTER**

RESULTANT CONSULTING GROUP, LLC (WA-  
SHINGTON LIMITED LIABILITY COMPANY)  
733 7TH AVENUE, SUITE 201  
KIRKLAND, WA 98033

FIRST USE 2-25-2003; IN COMMERCE 3-25-2003.

SER. NO. 78-238,148, FILED 4-15-2003.

FOR: BUSINESS CONSULTING SERVICES, IN  
CLASS 35 (U.S. CLS. 100, 101 AND 102).

GIANCARLO CASTRO, EXAMINING ATTORNEY

**Int. Cls.: 7 and 12**

**Prior U.S. Cls.: 13, 19, 21, 23, 31, 34, 35 and 44**

**United States Patent and Trademark Office**

**Reg. No. 3,505,252**

**Registered Sep. 23, 2008**

**TRADEMARK  
PRINCIPAL REGISTER**



K-Z ENTERPRISES LTD. (CANADA LIMITED  
COMPANY (LTD.))  
4468 IMPERIAL STREET  
BURNABY, CANADA V5J 1 B3

FOR: ENGINE MUFFLERS, IN CLASS 7 (U.S. CLS.  
13, 19, 21, 23, 31, 34 AND 35).

FIRST USE 10-24-2003; IN COMMERCE 4-19-2004.

FOR: AUTOMOTIVE ACCESSORIES, NAMELY,  
ROOF RACKS, PUSH GUARDS AND SIDE BARS, IN  
CLASS 12 (U.S. CLS. 19, 21, 23, 31, 35 AND 44).

FIRST USE 10-24-2003; IN COMMERCE 4-19-2004.

PRIORITY CLAIMED UNDER SEC. 44(D) ON  
CANADA APPLICATION NO. 1175376, FILED 4-22-  
2003, REG. NO. TMA667,152, DATED 11-16-2006,  
EXPIRES 11-16-2021.

SER. NO. 78-245,651, FILED 5-5-2003.

ANNE MADDEN, EXAMINING ATTORNEY

**Int. Cl.: 9**

**Prior U.S. Cls.: 21, 23, 26, 36 and 38**

**United States Patent and Trademark Office**

**Reg. No. 3,505,253**

**Registered Sep. 23, 2008**

**TRADEMARK  
PRINCIPAL REGISTER**

**CYBER BUSINESS IN A BOX**

BC MARKETING SOLUTIONS (NEW YORK  
PARTNERSHIP)  
511 AVENUE OF THE AMERICAS #396  
NEW YORK, NY 10011

FOR: INFORMATIONAL CD ROM, DVD, MAG-  
NETIC TAPE, MP3, THAT GUIDES A PERSON  
THROUGH THE IN AND OUTS OF STARTING  
AND RUNNING A BUSINESS , IN CLASS 9 (U.S.  
CLS. 21, 23, 26, 36 AND 38).

FIRST USE 1-3-2000; IN COMMERCE 1-3-2000.

NO CLAIM IS MADE TO THE EXCLUSIVE  
RIGHT TO USE "CYBER", APART FROM THE  
MARK AS SHOWN.

SER. NO. 78-314,725, FILED 10-16-2003.

TRACY CROSS, EXAMINING ATTORNEY



**Int. Cl.: 36**

**Prior U.S. Cls.: 100, 101 and 102**

**United States Patent and Trademark Office**

**Reg. No. 3,505,254**

**Registered Sep. 23, 2008**

**SERVICE MARK  
PRINCIPAL REGISTER**

**MARQUIS CONSERVATIVE PORTFOLIO**

DUNDEE CORPORATION (CANADA CORPORATION)  
1 ADELAIDE STREET EAST, 28TH FLOOR  
TORONTO, ONTARIO, CANADA M5C 2V9

FOR: MUTUAL FUND SERVICES, NAMELY, MUTUAL FUND BROKERAGE, MUTUAL FUND DISTRIBUTION AND THE ADMINISTRATION AND MANAGEMENT OF MUTUAL FUNDS; MUTUAL FUND SERVICES, NAMELY, MUTUAL FUND BROKERAGE, MUTUAL FUND DISTRIBUTION AND THE ADMINISTRATION AND MANAGEMENT OF MUTUAL FUNDS, IN CLASS 36 (U.S. CLS. 100, 101 AND 102).

PRIORITY CLAIMED UNDER SEC. 44(D) ON CANADA APPLICATION NO. 1191546, FILED 10-6-2003, REG. NO. TMA7I2,112, DATED 4-16-2008, EXPIRES 4-16-2023.

NO CLAIM IS MADE TO THE EXCLUSIVE RIGHT TO USE "CONSERVATIVE PORTFOLIO", APART FROM THE MARK AS SHOWN.

SER. NO. 78-316,931, FILED 10-22-2003.

LOURDES AYALA, EXAMINING ATTORNEY

**Int. Cl.: 36**

**Prior U.S. Cls.: 100, 101 and 102**

**United States Patent and Trademark Office**

**Reg. No. 3,505,255**

**Registered Sep. 23, 2008**

**SERVICE MARK  
PRINCIPAL REGISTER**

**DYNAMIC PROTECTED  
INTERNATIONAL  
VALUE FUND**

DUNDEE CORPORATION (CANADA CORPORATION)  
28TH FLOOR  
1 ADELAIDE STREET EAST  
TORONTO, ONTARIO, CANADA M5C 2V9

FOR: MUTUAL FUND SERVICES, NAMELY, FUND BROKERAGE, MUTUAL FUND DISTRIBUTION AND THE ADMINISTRATION AND MANAGEMENT OF MUTUAL FUNDS, IN CLASS 36 (U.S. CLS. 100, 101 AND 102).

THE MARK CONSISTS OF STANDARD CHARACTERS WITHOUT CLAIM TO ANY PARTICULAR FONT, STYLE, SIZE, OR COLOR.

PRIORITY CLAIMED UNDER SEC. 44(D) ON CANADA APPLICATION NO. 1201385, FILED 12-11-2003, REG. NO. TMA657,021, DATED 1-20-2006, EXPIRES 11-20-2021.

NO CLAIM IS MADE TO THE EXCLUSIVE RIGHT TO USE "PROTECTED INTERNATIONAL VALUE FUND", APART FROM THE MARK AS SHOWN.

SER. NO. 78-343,371, FILED 12-19-2003.

CHRIS WELLS, EXAMINING ATTORNEY

Int. Cl.: 32

Prior U.S. Cls.: 45, 46 and 48

United States Patent and Trademark Office

Reg. No. 3,505,256

Registered Sep. 23, 2008

TRADEMARK  
PRINCIPAL REGISTER



TWO BROTHERS BREWING COMPANY (ILLINOIS CORPORATION)  
30W114 BUTTERFIELD ROAD  
WARRENVILLE, IL 60555

FOR: BEER, NAMELY, LAGER, IN CLASS 32 (U.S. CLS. 45, 46 AND 48).

FIRST USE 2-12-2001; IN COMMERCE 7-31-2001.

NO CLAIM IS MADE TO THE EXCLUSIVE RIGHT TO USE "DORTMUNDER STYLE" AND "LAGER BEER", APART FROM THE MARK AS SHOWN.

SER. NO. 78-345,417, FILED 12-24-2003.

CHRISTINE COOPER, EXAMINING ATTORNEY

**Int. Cl.: 30**

**Prior U.S. Cl.: 46**

**United States Patent and Trademark Office**

**Reg. No. 3,505,257**

**Registered Sep. 23, 2008**

**TRADEMARK  
PRINCIPAL REGISTER**

**Dark Velvet**

KOBRICKS COFFEE COMPANY (NEW JERSEY  
CORPORATION)  
693 LUIS MARIN BLVD.  
JERSEY CITY, NJ 07310

NO CLAIM IS MADE TO THE EXCLUSIVE  
RIGHT TO USE "DARK", APART FROM THE  
MARK AS SHOWN.

FOR: COFFEE, IN CLASS 30 (U.S. CL. 46).

FIRST USE 12-13-1996; IN COMMERCE 12-13-1996.

SER. NO. 78-351,863, FILED 1-14-2004.

THE MARK CONSISTS OF STANDARD CHAR-  
ACTERS WITHOUT CLAIM TO ANY PARTICULAR  
FONT, STYLE, SIZE, OR COLOR.

ANDREA SAUNDERS, EXAMINING ATTORNEY

**Int. Cls.: 25, 28 and 32**

**Prior U.S. Cls.: 22, 23, 38, 39, 45, 46, 48 and 50**

**United States Patent and Trademark Office**

**Reg. No. 3,505,258**

**Registered Sep. 23, 2008**

**TRADEMARK  
PRINCIPAL REGISTER**

**IGNITE YOUR GAME**

1590520 ONTARIO LIMITED (CANADA LIMITED  
COMPANY)  
24 CIMARRON CRESCENT  
OTTAWA, ONTARIO, CANADA K2G 6E1

FOR: WEARING APPAREL FOR MEN AND  
WOMEN, NAMELY, T-SHIRTS; HEADWEAR,  
NAMELY, HATS, IN CLASS 25 (U.S. CLS. 22 AND 39).

FOR: SOCCER BALLS, HOCKEY STICKS, IN  
CLASS 28 (U.S. CLS. 22, 23, 38 AND 50).

FOR: NON-ALCOHOLIC BEVERAGES, NAMELY,  
NON-CARBONATED BEVERAGES, NAMELY,  
SPORTS DRINKS, IN CLASS 32 (U.S. CLS. 45, 46  
AND 48).

THE MARK CONSISTS OF STANDARD CHAR-  
ACTERS WITHOUT CLAIM TO ANY PARTICULAR  
FONT, STYLE, SIZE, OR COLOR.

PRIORITY CLAIMED UNDER SEC. 44(D) ON  
CANADA APPLICATION NO. 1205709, FILED 2-9-  
2004, REG. NO. TMA708765, DATED 3-4-2008, EX-  
PIRES 3-4-2023.

SER. NO. 78-368,709, FILED 2-16-2004.

YONG KIM, EXAMINING ATTORNEY

**Int. Cl.: 35**

**Prior U.S. Cls.: 100, 101 and 102**

**United States Patent and Trademark Office**

**Reg. No. 3,505,259**

**Registered Sep. 23, 2008**

**SERVICE MARK  
PRINCIPAL REGISTER**

**SHOEMART SINCE  
1956**

SHOE MART FACTORY OUTLET, INC. (CON-  
NECTICUT CORPORATION)  
3 BERKELEY STREET  
NORWALK, CT 06606

FOR: RETAIL STORE AND ONLINE RETAIL  
STORE SERVICES FEATURING FOOTWEAR,  
FOOTWEAR CARE PRODUCTS, NAMELY, SHOE  
POLISH, SHOE BRUSHES, SHOEHORNS AND SHOE  
TRENDS, CLOTHING, NAMELY, JACKETS, GLOVES  
AND BELTS, AND LEATHER GOODS, NAMELY,  
LEATHER CASES FOR PENS, KEYS, BUSINESS  
CARDS, CREDIT CARDS AND KNIVES, IN CLASS  
35 (U.S. CLS. 100, 101 AND 102).

FIRST USE 0-0-1956; IN COMMERCE 0-0-1956.

THE MARK CONSISTS OF STANDARD CHAR-  
ACTERS WITHOUT CLAIM TO ANY PARTICULAR  
FONT, STYLE, SIZE, OR COLOR.

SEC. 2(F).

SER. NO. 78-374,534, FILED 2-26-2004.

BRIDGETT SMITH, EXAMINING ATTORNEY

**Int. Cl.: 10**

**Prior U.S. Cls.: 26, 39 and 44**

**United States Patent and Trademark Office**

**Reg. No. 3,505,260**

**Registered Sep. 23, 2008**

**TRADEMARK  
PRINCIPAL REGISTER**

**NEURO-COOL**

TRAUMATEC, INC. (DELAWARE CORPORATION)  
12718 CIMARRON PATH  
SAN ANTONIO, TX 78249

FOR: MEDICAL DEVICES, NAMELY, TRAUMA HELMETS FOR STABILIZING A PATIENT'S HEAD, NECK AND SPINE DURING TRANSPORT, WEARABLE BLOOD COOLING EQUIPMENT AND HEAD AND SPINE COOLING AND STABILIZING GEAR IN NATURE OF MEDICAL ICE PACKS, MEDICAL COOLING SPLINTS, MEDICAL COOLING HELMETS AND MEDICAL COOLING CERVICAL COLLARS, IN CLASS 10 (U.S. CLS. 26, 39 AND 44).

FIRST USE 4-1-2003; IN COMMERCE 4-1-2003.

THE MARK CONSISTS OF STANDARD CHARACTERS WITHOUT CLAIM TO ANY PARTICULAR FONT, STYLE, SIZE, OR COLOR.

SER. NO. 78-376,496, FILED 3-1-2004.

WILLIAM BRECKENFELD, EXAMINING ATTORNEY

**Int. Cls.: 32 and 33**

**Prior U.S. Cls.: 45, 46, 47, 48 and 49**

**United States Patent and Trademark Office**

**Reg. No. 3,505,261**

**Registered Sep. 23, 2008**

**TRADEMARK  
PRINCIPAL REGISTER**

**MOJITO LIBRE**

BARSOUMIAN, HAGOP (UNITED STATES INDIVIDUAL)  
10021 1/2 CANOGA AVENUE  
CHATSWORTH, CA 91311 AND  
BARSOUMIAN, MARAL (UNITED STATES INDIVIDUAL)  
10021 1/2 CANOGA AVENUE  
CHATSWORTH, CA 91311

FOR: NON-ALCOHOLIC FLAVOR CONCENTRATES USED IN THE PREPARATION OF ALCOHOLIC AND NON-ALCOHOLIC BEVERAGES; FLAVORED NON-ALCOHOLIC BEVERAGES CONTAINING FRUIT JUICE, IN CLASS 32 (U.S. CLS. 45, 46 AND 48).

FIRST USE 7-8-2004; IN COMMERCE 7-8-2004.

FOR: ALCOHOLIC FLAVOR CONCENTRATES USED IN THE PREPARATION OF ALCOHOLIC

BEVERAGES; PREPARED ALCOHOLIC COCKTAILS, IN CLASS 33 (U.S. CLS. 47 AND 49).

FIRST USE 7-8-2004; IN COMMERCE 7-8-2004.

THE MARK CONSISTS OF STANDARD CHARACTERS WITHOUT CLAIM TO ANY PARTICULAR FONT, STYLE, SIZE, OR COLOR.

NO CLAIM IS MADE TO THE EXCLUSIVE RIGHT TO USE "MOJITO", APART FROM THE MARK AS SHOWN.

THE ENGLISH TRANSLATION OF THE WORD LIBRE IN THE MARK IS FREE.

SER. NO. 78-450,759, FILED 7-14-2004.

MICHAEL KAZAZIAN, EXAMINING ATTORNEY



**Int. Cl.: 41**

**Prior U.S. Cls.: 100, 101 and 107**

**United States Patent and Trademark Office**

**Reg. No. 3,505,262**

**Registered Sep. 23, 2008**

**SERVICE MARK  
PRINCIPAL REGISTER**

**BEAST OF THE EAST**

ODYSSEY ADVENTURE RACING, INC. (VIRGINIA CORPORATION)  
103 MARINA POINT  
WILLIAMSBURG, VA 23188

FOR: ENTERTAINMENT AND SPORTING EVENT SERVICES, NAMELY, CONDUCTING ADVENTURE RACING COMPETITIONS IN WHICH OTHERS PARTICIPATE AND COMPETE, IN CLASS 41 (U.S. CLS. 100, 101 AND 107).

FIRST USE 5-0-1998; IN COMMERCE 5-0-1998.

THE MARK CONSISTS OF STANDARD CHARACTERS WITHOUT CLAIM TO ANY PARTICULAR FONT, STYLE, SIZE, OR COLOR.

SER. NO. 78-467,763, FILED 8-16-2004.

WILLIAM BRECKENFELD, EXAMINING ATTORNEY

**Int. Cl.: 41**

**Prior U.S. Cls.: 100, 101 and 107**

**United States Patent and Trademark Office**

**Reg. No. 3,505,263**

**Registered Sep. 23, 2008**

**SERVICE MARK  
PRINCIPAL REGISTER**

**Mad Mexicans**

MOA (JR.), JUAN C. (UNITED STATES INDIVIDUAL)  
1614 NOLTE DR.  
DALLAS, TX 75208

THE MARK CONSISTS OF STANDARD CHARACTERS WITHOUT CLAIM TO ANY PARTICULAR FONT, STYLE, SIZE, OR COLOR.

FOR: ENTERTAINMENT, NAMELY, LIVE PERFORMANCES BY A MUSICAL BAND, IN CLASS 41 (U.S. CLS. 100, 101 AND 107).

SER. NO. 78-474,008, FILED 8-26-2004.

FIRST USE 6-22-2002; IN COMMERCE 6-22-2002.

WANDA KAY PRICE, EXAMINING ATTORNEY

**Int. Cl.: 35**

**Prior U.S. Cls.: 100, 101 and 102**

**United States Patent and Trademark Office**

**Reg. No. 3,505,264**

**Registered Sep. 23, 2008**

**SERVICE MARK  
PRINCIPAL REGISTER**

**FAMILY FARE**

FAMILY FARE, LLC (MICHIGAN LIMITED LIABILITY COMPANY)  
850 - 76TH STREET  
GRAND RAPIDS, MI 49518

FOR: RETAIL STORE SERVICES FEATURING CONVENIENCE STORE ITEMS AND GASOLINE, IN CLASS 35 (U.S. CLS. 100, 101 AND 102).

FIRST USE 12-13-2004; IN COMMERCE 12-13-2004.

THE MARK CONSISTS OF STANDARD CHARACTERS WITHOUT CLAIM TO ANY PARTICULAR FONT, STYLE, SIZE, OR COLOR.

REGISTRATION LIMITED TO THE AREA COMPRISING THE ENTIRE UNITED STATES EXCEPT THE STATES OF NORTH CAROLINA, SOUTH CAROLINA, VIRGINIA, GEORGIA, FLORIDA AND TENNESSEE. CONCURRENT USE PROCEEDING NO. 94002246 WITH SERIAL NO. 76677651.

OWNER OF U.S. REG. NOS. 785,308 AND 2,445,517.

SER. NO. 78-501,152, FILED 10-18-2004.

MARTHA FROMM, EXAMINING ATTORNEY

**Int. Cls.: 3, 9, 20 and 21**

**Prior U.S. Cls.: 1, 2, 4, 6, 13, 21, 22, 23, 25, 26, 29, 30, 32, 33, 36, 38, 40, 50, 51 and 52**

**Reg. No. 3,505,265**

**United States Patent and Trademark Office**

**Registered Sep. 23, 2008**

**TRADEMARK  
PRINCIPAL REGISTER**



MADDOCKS ENGINEERING LTD. (CANADA CORPORATION)  
84 ROYAL ROAD  
GUELPH, CANADA N1H 1G3

PRIORITY CLAIMED UNDER SEC. 44(D) ON CANADA APPLICATION NO. 1216195, FILED 5-3-2004, REG. NO. TMA687317, DATED 5-9-2007, EXPIRES 5-9-2022.

FOR: PRODUCTS FOR RESIDENTIAL, COMMERCIAL AND INDUSTRIAL USE THAT REDUCE STATIC BUILDUP, NAMELY, ANTI-STATIC CLOTHES DRYER SHEETS, IN CLASS 3 (U.S. CLS. 1, 4, 6, 50, 51 AND 52).

NO CLAIM IS MADE TO THE EXCLUSIVE RIGHT TO USE "STATIC ELIMINATOR", APART FROM THE MARK AS SHOWN.

FOR: KEYBOARD UNDERPADS, NAMELY, PADS FOR PLACEMENT UNDER COMPUTER KEYBOARDS TO REDUCE SLIDING, SCRATCHING AND STATIC BUILDUP, IN CLASS 9 (U.S. CLS. 21, 23, 26, 36 AND 38).

THE STIPPLING IS FOR SHADING PURPOSES ONLY.

FOR: PRODUCTS FOR RESIDENTIAL, COMMERCIAL AND INDUSTRIAL USE THAT REDUCE STATIC BUILDUP, NAMELY, ANTI-STATIC SEAT CUSHIONS, IN CLASS 20 (U.S. CLS. 2, 13, 22, 25, 32 AND 50).

THE MARK CONSISTS OF THE STYLIZED WORDS "STATIC ELIMINATOR" IN STACKED FORM AND THE DEPICTION OF A HELMETED WARRIOR CARRYING A SWORD AND A SHIELD, FROM WHICH FOUR STYLIZED LIGHTNING BOLTS EMANATE, AND THE TOP OF THE FIRST "T" IN "STATIC" IS ALSO FORMED BY A STYLIZED LIGHTNING BOLT.

FOR: PRODUCTS FOR RESIDENTIAL, COMMERCIAL AND INDUSTRIAL USE THAT REDUCE STATIC BUILDUP, NAMELY, ANTI-STATIC DUSTING MITTS OF FABRIC, IN CLASS 21 (U.S. CLS. 2, 13, 23, 29, 30, 33, 40 AND 50).

SER. NO. 78-510,801, FILED 11-3-2004.

ZACHARY BELLO, EXAMINING ATTORNEY

**Int. Cls.: 22 and 23**

**Prior U.S. Cls.: 1, 2, 7, 19, 22, 42, 43 and 50**

**United States Patent and Trademark Office**

**Reg. No. 3,505,266**

**Registered Sep. 23, 2008**

**TRADEMARK  
PRINCIPAL REGISTER**

**CERVELT**

DOUGLAS CREEK LIMITED (NEW ZEALAND CORPORATION)  
C/O COOPERS LIMITED LEVEL 6  
HARRINGTON HOUSE, HARRINGTON STREET  
TAURANGA, NEW ZEALAND

FOR: (BASED NEW ZEALAND REGISTRATION 684379) ROPES, STRING, COMMERCIAL NETS, TENTS, AWNINGS, TARPAULINS NOT FOR SHIPS, SAILS, SACKS OR BAGS FOR THE TRANSPORTATION OR STORAGE OF MATERIALS IN BULK; PADDING AND STUFFING MATERIALS (EXCEPT OF RUBBER OR PLASTIC); RAW FIBROUS TEXTILE MATERIALS; RAW FIBROUS TEXTILE MATERIALS INCLUDING FIBER MADE FROM DEER, IN CLASS 22 (U.S. CLS. 1, 2, 7, 19, 22, 42 AND 50).

FOR: (BASED NEW ZEALAND REGISTRATION 684380) YARNS AND THREADS FOR USE IN THE

MANUFACTURE OF TEXTILES; YARNS AND THREADS INCLUDING YARNS AND THREADS MADE FROM DEER FOR USE IN THE MANUFACTURE OF TEXTILES, IN CLASS 23 (U.S. CL. 43).

THE MARK CONSISTS OF STANDARD CHARACTERS WITHOUT CLAIM TO ANY PARTICULAR FONT, STYLE, SIZE, OR COLOR.

OWNER OF NEW ZEALAND REG. NO. 684380, DATED 2-9-2004, EXPIRES 8-8-2010.

OWNER OF NEW ZEALAND REG. NO. 684379, DATED 2-9-2004, EXPIRES 8-8-2010.

SER. NO. 78-533,289, FILED 12-15-2004.

CHRIS WELLS, EXAMINING ATTORNEY

**Int. Cl.: 34**

**Prior U.S. Cls.: 2, 8, 9 and 17**

**United States Patent and Trademark Office**

**Reg. No. 3,505,267**

**Registered Sep. 23, 2008**

**TRADEMARK  
PRINCIPAL REGISTER**

**TITAN**

TABACALERA BRANDS, INC. (DELAWARE  
CORPORATION)  
300 DELAWARE AVENUE, SUITE 1267  
WILMINGTON, DE 19801

FOR: CIGARS, IN CLASS 34 (U.S. CLS. 2, 8, 9 AND  
17).

FIRST USE 0-0-1976; IN COMMERCE 0-0-1976.

THE MARK CONSISTS OF STANDARD CHAR-  
ACTERS WITHOUT CLAIM TO ANY PARTICULAR  
FONT, STYLE, SIZE, OR COLOR.

SER. NO. 78-553,665, FILED 1-25-2005.

STEVEN PEREZ, EXAMINING ATTORNEY

**Int. Cl.: 41**

**Prior U.S. Cls.: 100, 101 and 107**

**United States Patent and Trademark Office**

**Reg. No. 3,505,268**

**Registered Sep. 23, 2008**

**SERVICE MARK  
PRINCIPAL REGISTER**

**DocuDisk**

EDCO GROUP, INC. (MISSOURI CORPORATION)  
P.O. BOX 7010  
SPRINGFIELD, MO 65801

FOR: DIGITAL IMAGING SERVICES, NAMELY,  
PROVIDING SCANNED IMAGES OF PAPER RE-  
CORDS ON CD-ROM FOR STORAGE, SEARCHING,  
AND RETRIEVAL, IN CLASS 41 (U.S. CLS. 100, 101  
AND 107).

FIRST USE 1-2-2004; IN COMMERCE 1-2-2004.

THE MARK CONSISTS OF STANDARD CHAR-  
ACTERS WITHOUT CLAIM TO ANY PARTICULAR  
FONT, STYLE, SIZE, OR COLOR.

SER. NO. 78-566,781, FILED 2-14-2005.

DORITT L. CARROLL, EXAMINING ATTORNEY

**Int. Cl.: 9**

**Prior U.S. Cls.: 21, 23, 26, 36 and 38**

**Reg. No. 3,505,269**

**United States Patent and Trademark Office**

**Registered Sep. 23, 2008**

**TRADEMARK  
PRINCIPAL REGISTER**



MARKETING SOFTWARE COMPANY, INC. (CALIFORNIA CORPORATION)  
6200 CANOGA AVENUE, SUITE 102  
WOODLAND HILLS, CA 91367

FOR: SOFTWARE PROGRAMS FOR DATABASE MANAGEMENT AND MAINTENANCE IN THE FIELD OF ADVERTISING AND DIRECT MARKETING; CUSTOMIZED SOFTWARE PROGRAMS FOR DATABASE MANAGEMENT AND MAINTENANCE IN THE FIELD OF ADVERTISING AND DIRECT RESPONSE MARKETING; SOFTWARE PROGRAMS FOR DATABASE MANAGEMENT AND MAINTENANCE IN THE FIELD OF ADVERTISING AND DIRECT RESPONSE MARKETING; COMPU-

TER SOFTWARE FOR PROVIDING AN ONLINE DATABASE CONTAINING CUSTOMER LISTS AND CUSTOMER DEMOGRAPHICS DATABASES IN THE FIELD OF ADVERTISING AND DIRECT RESPONSE MARKETING WHICH ARE USED FOR GENERATING SALES LEADS, IN CLASS 9 (U.S. CLS. 21, 23, 26, 36 AND 38).

FIRST USE 1-5-1989; IN COMMERCE 1-5-1989.

SER. NO. 78-568,048, FILED 2-15-2005.

COLLEEN KEARNEY, EXAMINING ATTORNEY



**Int. Cl.: 28**

**Prior U.S. Cls.: 22, 23, 38 and 50**

**Reg. No. 3,505,270**

**United States Patent and Trademark Office**

**Registered Sep. 23, 2008**

---

**TRADEMARK  
PRINCIPAL REGISTER**

**SETRIGHT**

SCORE BETTER INC. (CANADA COMPANY)  
R.R. #4 KOMOKA  
ONTARIO, CANADA N0L 1R0

FOR: GOLF CLUB SWING AID, NAMELY A  
DEVICE TO WHICH ONE OR MORE GOLF CLUBS  
CAN BE DETACHEDLY CONNECTED SO AS TO  
ENABLE A GOLFER TO PRACTICE ALIGNMENT  
OF A CLUB HEAD IN RELATION TO HIS/HER  
FEET, IN CLASS 28 (U.S. CLS. 22, 23, 38 AND 50).

THE MARK CONSISTS OF STANDARD CHAR-  
ACTERS WITHOUT CLAIM TO ANY PARTICULAR  
FONT, STYLE, SIZE, OR COLOR.

OWNER OF CANADA REG. NO. TMA690347,  
DATED 6-20-2007, EXPIRES 6-20-2023.

SER. NO. 78-573,941, FILED 2-24-2005.

GENE MACIOL, EXAMINING ATTORNEY

**Int. Cl.: 5**

**Prior U.S. Cls.: 6, 18, 44, 46, 51 and 52**

**United States Patent and Trademark Office**

**Reg. No. 3,505,271**

**Registered Sep. 23, 2008**

**TRADEMARK  
PRINCIPAL REGISTER**

**CORTICEL**

UNITED HEALTH RESEARCH (NEVADA LIMITED LIABILITY COMPANY)  
P.O. BOX 287  
SHAWANESE, PA 18654

THE MARK CONSISTS OF STANDARD CHARACTERS WITHOUT CLAIM TO ANY PARTICULAR FONT, STYLE, SIZE, OR COLOR.

FOR: DIETARY SUPPLEMENTS, IN CLASS 5 (U.S. CLS. 6, 18, 44, 46, 51 AND 52).

SER. NO. 78-582,188, FILED 3-7-2005.

FIRST USE 1-3-2005; IN COMMERCE 1-3-2005.

STEVEN PEREZ, EXAMINING ATTORNEY

**Int. Cl.: 42**

**Prior U.S. Cls.: 100 and 101**

**United States Patent and Trademark Office**

**Reg. No. 3,505,272**

**Registered Sep. 23, 2008**

**SERVICE MARK  
PRINCIPAL REGISTER**

**WHERE IT ALL COMES  
TOGETHER**

CONFLUENCE CORP. (VIRGINIA CORPORATION)  
2164 WESTGLEN CT.  
VIENNA, VA 22182

FOR: COMPUTER SERVICES, NAMELY, CREATING AND MAINTAINING WEB SITES FOR OTHERS; COMPUTER SERVICES, NAMELY, MANAGING WEB SITES FOR OTHERS; COMPUTER SOFTWARE CONSULTATION; CONSULTING SERVICES IN THE FIELD OF DESIGN, SELECTION, IMPLEMENTATION AND USE OF COMPUTER HARDWARE AND SOFTWARE SYSTEMS FOR OTHERS; TECHNICAL SUPPORT, NAMELY, MONITORING OF NETWORK SYSTEMS; TECHNICAL

SUPPORT SERVICES, NAMELY, TROUBLESHOOTING OF COMPUTER HARDWARE AND SOFTWARE PROBLEMS, IN CLASS 42 (U.S. CLS. 100 AND 101).

FIRST USE 8-20-2001; IN COMMERCE 8-20-2001.

THE MARK CONSISTS OF STANDARD CHARACTERS WITHOUT CLAIM TO ANY PARTICULAR FONT, STYLE, SIZE, OR COLOR.

SER. NO. 78-589,396, FILED 3-17-2005.

WILLIAM VERHOSEK, EXAMINING ATTORNEY

**Int. Cls.: 9, 16, 25, 35, 38 and 41**

**Prior U.S. Cls.: 2, 5, 21, 22, 23, 26, 29, 36, 37, 38, 39,  
50, 100, 101, 102, 104 and 107**

**Reg. No. 3,505,273**

**United States Patent and Trademark Office**

**Registered Sep. 23, 2008**

**TRADEMARK  
SERVICE MARK  
PRINCIPAL REGISTER**



ADMINISTRADORA DE MARCAS RD. S. DE  
R.L. DE C.V. (MEXICO CORPORATION)  
INDUSTRIESTRASSE 7, CH-6301  
ZUG, SWITZERLAND

FOR: TELECOMMUNICATION PRODUCTS, NAMELY, TELEPHONES, CELLULAR TELEPHONES AND TELEPHONE ANSWERING MACHINES; APPARATUS FOR RECORDING, TRANSMISSION, REPRODUCTION OF SOUND OR IMAGES, NAMELY, PHONOGRAPH RECORDS, CD AND DVD PLAYERS, AUDIO AND VIDEO TAPE RECORDERS; BLANK AUDIO AND VIDEO TAPES AND CDS; STEREO RECEIVERS, AMPLIFIERS, AND TUNERS; BLANK MAGNETIC DATA CARRIERS, DATA PROCESSORS AND COMPUTERS; COMPUTER HARDWARE, NAMELY, MEMORY CARDS, MODEMS, COMPUTER INTERFACE BOARDS, BLANK MAGNETIC COMPUTER TAPES, FAX MACHINES, FIBER OPTIC CABLES, COMPUTER AND ELECTRIC CABLES, OPTICAL CHARACTER RECOGNITION APPARATUS, BLANK OPTICAL DISCS, OPTICAL SCANNERS AND MAGNETIC CODED CARDS FOR PREPAID TELECOMMUNICATIONS SERVICES; SATELLITES, BLANK DIGITAL OPTICAL DISKS, COMPUTER KEYBOARDS, PROCESS COMPUTERS, COMPUTERS FOR DATA AND WORD PROCESSING, COMPUTER TERMINALS, COMPUTER PRINTERS, COMPUTER MONITORS, INTEGRATED CIRCUITS AND COMPONENTS, NAMELY, COMPUTER CHIPS; ELECTRONIC CIRCUIT BOARDS, ELECTRONIC NOTICE BOARDS, INTEGRATED CIRCUIT CARDS; DOWNLOADABLE RING TONES AND MASTER TONES, NAMELY, A CLIP OF A SONG IN ITS ORIGINAL FORMAT; DOWNLOADABLE TEXT FILES FEATURING NEWS IN THE FIELD OF ENTERTAINMENT; DOWNLOADABLE WALLPAPER GRAPHICS, IMAGES AND PHOTOGRAPHS, ALL OF THE FOREGOING DOWNLOADABLE VIA

THE INTERNET AND WIRELESS DEVICE, IN CLASS 9 (U.S. CLS. 21, 23, 26, 36 AND 38).

FOR: ADVERTISEMENT BOARDS OF PAPER OR CARDBOARD; BINDERS; BOOK BINDINGS; BOOKLETS IN THE FIELD OF TELECOMMUNICATIONS SERVICES; BOOKMARKERS; BOOKS IN THE FIELD OF TELECOMMUNICATIONS SERVICES; BOXES OF CARDBOARD OR PAPER; CALENDARS; CATALOGUES IN THE FIELD OF TELECOMMUNICATIONS PRODUCTS AND SERVICES; COASTERS OF PAPER; DECALCOMANIA; ENVELOPES; FOUNTAIN PENS; GREETING CARDS; HANDBOOKS IN THE FIELD OF TELECOMMUNICATIONS PRODUCTS AND SERVICES; MANUALS IN THE FIELD OF TELECOMMUNICATIONS PRODUCTS; NEWSPAPERS FOR GENERAL CIRCULATION; OFFICE SUPPLIES, NAMELY, ENVELOPES AND FOLDERS, PACKING PAPER, BOND PAPER, PAPER SHEETS, PEN CASES, PENS, PENCILS, POSTCARDS, POSTERS, PRINTING BLOCKS; PRINTED PUBLICATIONS, NAMELY, BOOKS, MAGAZINES, PAMPHLETS AND INSTRUCTIONAL MANUALS IN THE FIELD OF TELECOMMUNICATIONS; FLYERS, POSTERS, AND PRINTED MENU BOARDS OF PAPER OR CARDBOARD IN THE FIELD OF TELECOMMUNICATIONS PRODUCTS AND SERVICES; STATIONERY, STICKERS, WRITING PADS, WRITING PAPER, IN CLASS 16 (U.S. CLS. 2, 5, 22, 23, 29, 37, 38 AND 50).

FOR: CLOTHING, NAMELY, SHIRTS, TROUSERS, BLOUSES, SKIRTS, PANTS, COATS AND JACKETS; FOOTWEAR; HEADGEAR, NAMELY, HATS, CAPS AND VISORS, IN CLASS 25 (U.S. CLS. 22 AND 39).

FOR: ADVERTISING SERVICES; ADVERTISING BY MAIL ORDER; DISSEMINATION OF ADVER-

TISING MATTER; BUSINESS MANAGEMENT PLANNING, SUPERVISION AND IMPLEMENTATION; DEMONSTRATION OF PRODUCTS; ORGANIZING EXHIBITIONS FOR BUSINESS AND ADVERTISING PURPOSES, NAMELY, IN THE FIELD OF TELECOMMUNICATIONS PRODUCTS AND SERVICES, IN CLASS 35 (U.S. CLS. 100, 101 AND 102).

FOR: TELECOMMUNICATION SERVICES, NAMELY, PERSONAL COMMUNICATION SERVICES; TELEMATIC SERVICES, NAMELY, TELECOMMUNICATION SERVICES, NAMELY, PROVISION OF MOBILE TELECOMMUNICATIONS SERVICES, NAMELY, VOICE AND DATA TRANSMISSIONS, ACCESSIBLE BY ACCESS CODE OR TERMINALS, TELEPHONE, TELEVISION, RADIO AND DATA TRANSMISSIONS ACCESSIBLE BY ACCESS CODE OR TERMINALS, TELEPHONE, TELEVISION, RADIO AND TELEPRINTER; ELECTRONIC TRANSMISSION OF MESSAGES AND CODED IMAGES; ELECTRONIC TRANSMISSION OF MESSAGES AND DATA; WIRELESS DIGITAL MESSAGING SERVICES, ELECTRONIC STORE-AND-FORWARD MESSAGING, ELECTRONIC TRANSMISSION OF DATA AND DOCUMENTS VIA COMPUTER TERMINALS, COMPUTER TELECOMMUNICATIONS, NAMELY, PROVIDING MULTIPLE USER ACCESS TO THE INTERNET; FACSIMILE TRANSMISSION, ELECTRONIC MAIL SERVICES, TELEPHONE COMMUNICATION SERVICES, IN CLASS 38 (U.S. CLS. 100, 101 AND 104).

FOR: EDUCATIONAL SERVICES, NAMELY, CONDUCTING SEMINARS, CONFERENCES, AND WORKSHOPS IN THE FIELD OF TELECOMMUNICATIONS SERVICES; ENTERTAINMENT, NAMELY, CONDUCTING CONTEST RAFFLES AND COMPETITIONS IN THE FIELD OF CULTURE, SPORTS AND SOCIAL FUNCTIONS; ENTERTAINMENT SERVICES, NAMELY, NON-DOWNLOADABLE RING TONES, WALLPAPER GRAPHICS, IMAGES AND PHOTOGRAPHS PRESENTED TO MOBILE COMMUNICATIONS DEVICES VIA A GLOBAL COMPUTER NETWORK AND WIRELESS NETWORKS; PROVIDING NEWS IN THE FIELD OF ENTERTAINMENT, IN CLASS 41 (U.S. CLS. 100, 101 AND 107).

PRIORITY CLAIMED UNDER SEC. 44(D) ON MEXICO APPLICATION NO. 703165, FILED 2-21-2005, REG. NO. 883150, DATED 2-21-2005, EXPIRES 2-21-2015.

PRIORITY CLAIMED UNDER SEC. 44(D) ON MEXICO APPLICATION NO. 703166, FILED 2-21-2005, REG. NO. 878430, DATED 2-21-2005, EXPIRES 2-21-2015.

PRIORITY CLAIMED UNDER SEC. 44(D) ON MEXICO APPLICATION NO. 703167, FILED 2-21-2005, REG. NO. 884840, DATED 2-21-2005, EXPIRES 2-21-2015.

PRIORITY CLAIMED UNDER SEC. 44(D) ON MEXICO APPLICATION NO. 703168, FILED 2-21-2005, REG. NO. 878431, DATED 2-21-2005, EXPIRES 2-21-2015.

PRIORITY CLAIMED UNDER SEC. 44(D) ON MEXICO APPLICATION NO. 703170, FILED 2-21-2005, REG. NO. 879651, DATED 2-21-2005, EXPIRES 2-21-2015.

PRIORITY CLAIMED UNDER SEC. 44(D) ON MEXICO APPLICATION NO. 703169, FILED 2-21-2005, REG. NO. 879650, DATED 2-21-2005, EXPIRES 2-21-2015.

NO CLAIM IS MADE TO THE EXCLUSIVE RIGHT TO USE "DIRECTO", APART FROM THE MARK AS SHOWN.

THE COLOR(S) BLUE IS/ARE CLAIMED AS A FEATURE OF THE MARK.

THE MARK CONSISTS, IN PART, OF A STYLIZED DEPICTION OF A CELLULAR TELEPHONE.

THE ENGLISH TRANSLATION OF THE WORD DIRECTO IN THE MARK IS DIRECT.

SER. NO. 78-589,891, FILED 3-17-2005.

JOHN GARTNER, EXAMINING ATTORNEY

**Int. Cl.: 25**

**Prior U.S. Cls.: 22 and 39**

**United States Patent and Trademark Office**

**Reg. No. 3,505,274**

**Registered Sep. 23, 2008**

**TRADEMARK  
PRINCIPAL REGISTER**



FORUS S.A. (CHILE SOCIEDAD ANONIMA)  
AVDA. DEPARTAMENTAL 01053, LA FLORIDA  
SANTIAGO, CHILE

FOR: CLOTHING, NAMELY, CAPS, HATS, VISORS, KNITTED HEADWEAR, HEADBANDS, BANDANNAS, SHIRTS, T-SHIRTS, TANK TOPS, BLOUSES, SWEATERS, TURTLENECKS, PULL-OVERS, VESTS, SHORTS, PANTS, TROUSERS, SLACKS, DRESSES, SKIRTS, OVERALLS, BODY-SUITS, BASEBALL UNIFORMS, JERSEYS, WARM-UP SUITS, JOGGING SUITS, SWEATSHIRTS, SWEATPANTS, UNDERWEAR, BOXER SHORTS, ROBES, SLEEPWEAR, THERMAL LOUNGEWEAR, NIGHTSHIRTS, NIGHTGOWNS, SWIMWEAR, CLOTHING WRAPS, COATS, JACKETS, PONCHOS, RAINCOATS, CLOTH BIBS, INFANT WEAR, INFANT DIAPER COVERS, CLOTH DIAPER SETS

WITH UNDERSHIRT AND DIAPER COVER, JUMPERS, ROMPERS, COVERALLS, CREEPERS, BABY BOOTIES, TODDLER ANKLETS, TIES, SUSPENDERS, BELTS, MONEY BELT, MITTENS, GLOVES, WRISTBANDS, EARMUFFS, SCARVES, FOOTWEAR, SOCKS, HOSIERY, SLIPPERS, APRONS, SLIDING GIRDLES AND COSTUMES, IN CLASS 25 (U.S. CLS. 22 AND 39).

OWNER OF CHILE REG. NO. 00108945, DATED 9-15-2005, EXPIRES 9-15-2015.

THE MARK CONSISTS OF THE SIDE VIEW OF A DUCK.

SER. NO. 78-590,407, FILED 3-18-2005.

ESTHER A. BORSUK, EXAMINING ATTORNEY

Int. Cl.: 41

Prior U.S. Cls.: 100, 101 and 107

United States Patent and Trademark Office

Reg. No. 3,505,275

Registered Sep. 23, 2008

**SERVICE MARK  
PRINCIPAL REGISTER**



OAKLAND VALLEY, INC. (NEW YORK CORPORATION)  
305 OAKLAND VALLEY ROAD  
CUDDEBACKVILLE, NY 12729

FOR: PROVIDING FACILITIES FOR GO KART RACING, IN CLASS 41 (U.S. CLS. 100, 101 AND 107).

FIRST USE 4-30-2001; IN COMMERCE 4-30-2001.

NO CLAIM IS MADE TO THE EXCLUSIVE RIGHT TO USE "OAKLAND VALLEY RACE PARK" AND "CUDDEBACKVILLE, NY", APART FROM THE MARK AS SHOWN.

SER. NO. 78-591,007, FILED 3-19-2005.

DOUGLAS LEE, EXAMINING ATTORNEY

**Int. Cls.: 9 and 42**

**Prior U.S. Cls.: 21, 23, 26, 36, 38, 100 and 101**

**United States Patent and Trademark Office**

**Reg. No. 3,505,276**

**Registered Sep. 23, 2008**

**TRADEMARK  
SERVICE MARK  
PRINCIPAL REGISTER**

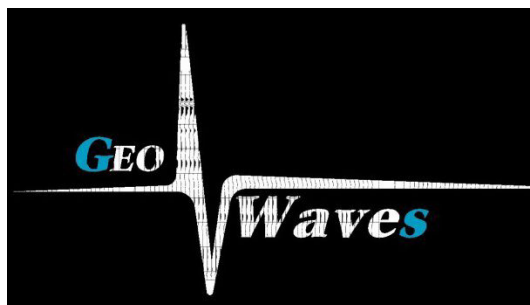

SERCEL (FRANCE SOCIETE ANONYME)  
16, RUE DE BEL AIR  
CARQUEFOU, FRANCE 44470

FOR: APPARATUS AND INSTRUMENTS, NAME-  
LY, MULTILEVEL BOREHOLE SEISMIC INSTRU-  
MENTS AND ASSOCIATED SURFACE  
EQUIPMENT, NAMELY, COMPUTERS, SOFT-  
WARE, AND ELECTRONIC INPUT/OUTPUT HU-  
MAN INTERFACE DEVICES FOR PROCESSING,  
ACQUISITION, INTERPRETATION OF GEOPHYSI-  
CAL DATA FOR THE PURPOSES OF UNDER-  
GROUND EXPLORATION OR EXTRACTION AND  
FOR THE PROCESSING, INTERPRETATION OF  
SEISMIC DATA FOR PROSPECTING AND EX-  
TRACTING HYDROCARBON DEPOSITS; VIBRA-  
TION GENERATORS, VIBRATION SENSORS,  
ELECTRICAL CABLES, FIBRE-OPTIC CABLES, IN  
CLASS 9 (U.S. CLS. 21, 23, 26, 36 AND 38).

FOR: SCIENTIFIC SERVICES FOR THE OIL AND  
GAS INDUSTRIES, NAMELY, PROCESSING, AC-  
QUIRING, AND INTERPRETING GEOPHYSICAL  
DATA FOR UNDERGROUND EXPLORATION OR

EXTRACTION OF HYDROCARBONS; HYDRO-  
CARBON PROSPECTING, IN CLASS 42 (U.S. CLS.  
100 AND 101).

PRIORITY CLAIMED UNDER SEC. 44(D) ON  
ERPN CMNTY TM OFC APPLICATION NO.  
004101234, FILED 10-27-2004, REG. NO. 004101234,  
DATED 12-21-2005, EXPIRES 10-27-2014.

THE COLOR(S) BLUE, WHITE, BLACK IS/ARE  
CLAIMED AS A FEATURE OF THE MARK.

THE MARK CONSISTS OF THE LETTER "G" IN  
"GEO" AND THE LETTER "S" IN "WAVES" ARE  
BLUE. THE REMAINING LETTERS IN "GEO" AND  
"WAVES" AND THE WAVE DESIGN ARE BLACK  
AND WHITE. THE BACKGROUND RECTANGLE IS  
BLACK.

SER. NO. 78-596,425, FILED 3-28-2005.

BARBARA GAYNOR, EXAMINING ATTORNEY



**Int. Cl.: 16**

**Prior U.S. Cls.: 2, 5, 22, 23, 29, 37, 38 and 50**

**Reg. No. 3,505,277**

**United States Patent and Trademark Office**

**Registered Sep. 23, 2008**

**TRADEMARK  
PRINCIPAL REGISTER**

**AXIOM**

PILLAR DATA SYSTEMS, INC. (CALIFORNIA CORPORATION)  
2840 JUNCTION AVENUE  
SAN JOSE, CA 95134

THE MARK CONSISTS OF STANDARD CHARACTERS WITHOUT CLAIM TO ANY PARTICULAR FONT, STYLE, SIZE, OR COLOR.

FOR: PRINTED PUBLICATION, NAMELY, MAGAZINE FEATURING INFORMATION ON NETWORK STORAGE, IN CLASS 16 (U.S. CLS. 2, 5, 22, 23, 29, 37, 38 AND 50).

SER. NO. 78-598,863, FILED 3-31-2005.

FIRST USE 7-1-2005; IN COMMERCE 7-1-2005.

DAVID HOFFMAN, EXAMINING ATTORNEY

**Int. Cl.: 35**

**Prior U.S. Cls.: 100, 101 and 102**

**United States Patent and Trademark Office**

**Reg. No. 3,505,278**

**Registered Sep. 23, 2008**

**SERVICE MARK  
PRINCIPAL REGISTER**

# E-DRAULICS

MANULI RUBBER INDUSTRIES S.P.A. (ITALY  
JOINT STOCK COMPANY)  
ZONA INDUSTRIALE CAMPOLUNGO  
ASCOLI PICENO, ITALY 63100

FOR: ONLINE RETAIL STORE AND ONLINE  
ELECTRONIC CATALOGUE SERVICES FEATUR-  
ING FLEXIBLE PIPES NOT OF METAL; HYDRAU-  
LIC HOSES; RUBBER TUBES AND HOSES AS WELL  
AS RELATED GOODS AND ACCESSORIES, IN  
CLASS 35 (U.S. CLS. 100, 101 AND 102).

THE MARK CONSISTS OF STANDARD CHAR-  
ACTERS WITHOUT CLAIM TO ANY PARTICULAR  
FONT, STYLE, SIZE, OR COLOR.

OWNER OF ERPN CMNTY TM OFC REG. NO.  
004414207, DATED 3-21-2006, EXPIRES 4-29-2015.

SER. NO. 78-609,733, FILED 4-15-2005.

KATHLEEN M. VANSTON, EXAMINING ATTOR-  
NEY

**Int. Cl.: 44**

**Prior U.S. Cls.: 100 and 101**

**United States Patent and Trademark Office**

**Reg. No. 3,505,279**

**Registered Sep. 23, 2008**

**SERVICE MARK  
PRINCIPAL REGISTER**

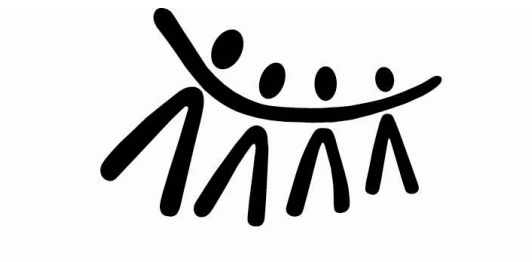

**FAMILY HOME HEALTH CARE  
"COME HOME TO FAMILY"**

FAMILY HOME HEALTH CARE, INC. (KENTUCKY CORPORATION)  
4600 TURPEN COURT, SUITES A & B  
SOMERSET, KY 42501

FOR: HOME HEALTH CARE SERVICES; HEALTH CARE SERVICES, NAMELY, SKILLED NURSING, PRIVATE DUTY NURSING; REHABILITATIVE CARE SERVICES, NAMELY, PHYSICAL THERAPY, SPEECH LANGUAGE PATHOLOGY, AND OCCUPATIONAL THERAPY; VENTILATOR CARE SERVICES, NAMELY, EVALUATION OF PATIENT VITAL SIGNS, AND VENTILATOR MONITORING AND OPERATION; PROVIDING CARE OF THE TERMINALLY ILL, NAMELY, PERSONAL MEDICAL CARE; MEDICAL CASE MANAGEMENT, NAMELY, PSYCHOLOGICAL AND EMOTIONAL EVALUATIONS AND ASSESSMENTS; ADULT DAY HEALTH CARE SERVICES, NAMELY, ASSESSMENT AND TREATMENT OF MEDICAL NEEDS; EARLY PERIODIC MEDICAL SCREENING AND DEVELOPMENT TESTING (EPSDT); APNEA

MONITORING; PHOTO THERAPY; NUTRITIONAL COUNSELING; SPECIALIZED DISEASE MANAGEMENT PROGRAMS, IN CLASS 44 (U.S. CLS. 100 AND 101).

FIRST USE 3-13-2002; IN COMMERCE 3-13-2002.

OWNER OF U.S. REG. NO. 2,692,329.

NO CLAIM IS MADE TO THE EXCLUSIVE RIGHT TO USE "FAMILY HOME HEALTH CARE", APART FROM THE MARK AS SHOWN.

THE MARK CONSISTS OF THE TERM "FAMILY HOME HEALTH CARE "COME HOME TO FAMILY"" BELOW A STYLIZED DEPICTION OF FOUR STICK FIGURES.

SER. NO. 78-612,056, FILED 4-19-2005.

SARA THOMAS, EXAMINING ATTORNEY

**Int. Cl.: 9**

**Prior U.S. Cls.: 21, 23, 26, 36 and 38**

**United States Patent and Trademark Office**

**Reg. No. 3,505,280**

**Registered Sep. 23, 2008**

**TRADEMARK  
PRINCIPAL REGISTER**

**ARGUS MEDIA**

ARGUS MEDIA LIMITED (UNITED KINGDOM CORPORATION)  
93 SHEPPERTON ROAD  
LONDON, UNITED KINGDOM N1 3DF

FOR: ELECTRONIC PUBLICATIONS, NAMELY, JOURNALS, NEWSLETTERS, REPORTS, NEWSPAPERS, PAMPHLETS, PERIODICALS, MAGAZINES AND MANUALS REPORTING OIL PRICING WORLDWIDE, DEVELOPMENTS IN THE OIL INDUSTRY, AND RELATED TOPICS SUCH AS OIL DRILLING, TECHNOLOGY AND INFRASTRUCTURE AND NOT INCLUDING INFORMATION CONCERNING ASSET MANAGEMENT AND INVESTMENT ADVICE RELATING TO STOCKS AND BONDS IN ELECTRONIC FORMAT DOWNLOADABLE FORM AND MADE AVAILABLE VIA A GLOBAL COMPUTER NETWORK ON A SUBSCRIPTION BASIS, IN CLASS 9 (U.S. CLS. 21, 23, 26, 36 AND 38).

FIRST USE 0-0-2002; IN COMMERCE 0-0-2002.

THE MARK CONSISTS OF STANDARD CHARACTERS WITHOUT CLAIM TO ANY PARTICULAR FONT, STYLE, SIZE, OR COLOR.

OWNER OF U.S. REG. NOS. 2,387,568, 2,450,022, AND 2,562,712.

NO CLAIM IS MADE TO THE EXCLUSIVE RIGHT TO USE "MEDIA", APART FROM THE MARK AS SHOWN.

SER. NO. 78-621,675, FILED 5-3-2005.

LINDA MICKLEBURGH, EXAMINING ATTORNEY

**Int. Cl.: 9**

**Prior U.S. Cls.: 21, 23, 26, 36 and 38**

**Reg. No. 3,505,281**

**United States Patent and Trademark Office**

**Registered Sep. 23, 2008**

**TRADEMARK  
PRINCIPAL REGISTER**

**FLEXSELECT**

CIENA CORPORATION (DELAWARE CORPORATION)  
1201 WINTERSON ROAD  
LINTHICUM, MD 21090

FOR: TELECOMMUNICATION AND DATA NETWORKING EQUIPMENT, NAMELY, OPTICAL NETWORK HARDWARE AND COMPUTER SOFTWARE FOR INTERCONNECTING, MANAGING, CONTROLLING AND OPERATING ENTERPRISE, METROPOLITAN, LOCAL AND WIDE AREA NETWORKS; OPTICAL TRANSPORT HARDWARE AND COMPUTER SOFTWARE PLATFORMS FOR USE IN THE TRANSMISSION AND ROUTING OF INTERNET, VOICE, VIDEO AND DATA COMMUNICATIONS; OPTICAL NETWORK COMPUTER OPERATING SYSTEMS; OPTICAL LINK MANAGE-

MENT SOFTWARE APPLICATION SUITES FOR USE IN THE TRANSMISSION AND ROUTING OF INTERNET, VOICE, VIDEO AND DATA COMMUNICATIONS; AND INSTRUCTIONAL MANUALS SOLD THEREWITH, IN CLASS 9 (U.S. CLS. 21, 23, 26, 36 AND 38).

FIRST USE 6-8-2006; IN COMMERCE 6-8-2006.

THE MARK CONSISTS OF STANDARD CHARACTERS WITHOUT CLAIM TO ANY PARTICULAR FONT, STYLE, SIZE, OR COLOR.

SER. NO. 78-628,837, FILED 5-12-2005.

MARCIE MILONE, EXAMINING ATTORNEY

**Int. Cl.: 16**

**Prior U.S. Cls.: 2, 5, 22, 23, 29, 37, 38 and 50**

**United States Patent and Trademark Office**

**Reg. No. 3,505,282**

**Registered Sep. 23, 2008**

**TRADEMARK  
PRINCIPAL REGISTER**



ARGUS MEDIA LIMITED (UNITED KINGDOM CORPORATION)  
93 SHEPPERTON ROAD  
LONDON, UNITED KINGDOM N1 3DF

FOR: PRINTED PUBLICATIONS, NAMELY, JOURNALS NEWSLETTERS, REPORTS, NEWSPAPERS, PAMPHLETS, PERIODICALS, MAGAZINES AND MANUALS REPORTING OIL PRICING WORLDWIDE, DEVELOPMENTS IN THE OIL INDUSTRY, AND RELATED TOPICS SUCH AS OIL DRILLING, TECHNOLOGY AND INFRASTRUCTURE AND NOT INCLUDING INFORMATION CONCERNING ASSET MANAGEMENT AND INVESTMENT ADVICE RELATING TO STOCKS AND BONDS, IN CLASS 16 (U.S. CLS. 2, 5, 22, 23, 29, 37, 38 AND 50).

FIRST USE 5-0-2002; IN COMMERCE 5-0-2002.

OWNER OF U.S. REG. NOS. 2,387,568, 2,450,022, AND 2,562,712.

THE COLOR(S) BLUE AND WHITE IS/ARE CLAIMED AS A FEATURE OF THE MARK.

THE MARK CONSISTS OF A RECTANGULAR SHAPE WITH TWO SHADES OF BLUE SEPARATED BY A CURVED WHITE LINE IN THE UPPER LEFT CORNER. THE WORD "ARGUS" APPEARS IN WHITE, WITHIN THE DARKER BLUE PORTION OF THE RECTANGLE.

SER. NO. 78-649,426, FILED 6-13-2005.

LINDA MICKLEBURGH, EXAMINING ATTORNEY

**Int. Cl.: 16**

**Prior U.S. Cls.: 2, 5, 22, 23, 29, 37, 38 and 50**

**United States Patent and Trademark Office**

**Reg. No. 3,505,283**

**Registered Sep. 23, 2008**

**TRADEMARK  
PRINCIPAL REGISTER**



ARGUS MEDIA LIMITED (UNITED KINGDOM CORPORATION)  
93 SHEPPERTON ROAD  
LONDON, UNITED KINGDOM N1 3DF

FOR: PRINTED PUBLICATIONS, NAMELY, JOURNALS NEWSLETTERS, REPORTS, NEWSPAPERS, PAMPHLETS, PERIODICALS, MAGAZINES AND MANUALS REPORTING OIL PRICING WORLDWIDE, DEVELOPMENTS IN THE OIL INDUSTRY, AND RELATED TOPICS SUCH AS OIL DRILLING, TECHNOLOGY AND INFRASTRUCTURE AND NOT INCLUDING INFORMATION CONCERNING ASSET MANAGEMENT AND INVESTMENT ADVICE RELATING TO STOCKS AND BONDS, IN CLASS 16 (U.S. CLS. 2, 5, 22, 23, 29, 37, 38 AND 50).

FIRST USE 5-0-2002; IN COMMERCE 5-0-2002.

OWNER OF U.S. REG. NOS. 2,387,568, 2,450,022, AND 2,562,712.

NO CLAIM IS MADE TO THE EXCLUSIVE RIGHT TO USE "MEDIA", APART FROM THE MARK AS SHOWN.

THE COLOR(S) BLUE & WHITE IS/ARE CLAIMED AS A FEATURE OF THE MARK.

THE MARK CONSISTS OF A RECTANGULAR SHAPE WITH TWO SHADES OF BLUE SEPARATED BY A CURVED WHITE LINE IN THE UPPER LEFT CORNER. THE WORDS "ARGUS" AND "MEDIA" APPEAR IN WHITE WITHIN THE DARKER BLUE PORTION OF THE RECTANGLE.

SER. NO. 78-649,436, FILED 6-13-2005.

LINDA MICKLEBURGH, EXAMINING ATTORNEY

Int. Cls.: 9 and 36

Prior U.S. Cls.: 21, 23, 26, 36, 38, 100, 101 and 102

United States Patent and Trademark Office

Reg. No. 3,505,284

Registered Sep. 23, 2008

**TRADEMARK  
SERVICE MARK  
PRINCIPAL REGISTER**



ARGUS MEDIA LIMITED (UNITED KINGDOM CORPORATION)  
93 SHEPPERTON ROAD  
LONDON, UNITED KINGDOM N1 3DF

FOR: ELECTRONIC PUBLICATIONS, NAMELY, JOURNALS, NEWSLETTERS, REPORTS, NEWSPAPERS, PAMPHLETS, PERIODICALS, MAGAZINES AND MANUALS REPORTING OIL PRICING WORLDWIDE, DEVELOPMENTS IN THE OIL INDUSTRY, AND RELATED TOPICS SUCH AS OIL DRILLING, TECHNOLOGY AND INFRASTRUCTURE AND NOT INCLUDING INFORMATION CONCERNING ASSET MANAGEMENT AND INVESTMENT ADVICE RELATING TO STOCKS AND BONDS IN ELECTRONIC FORMAT DOWNLOADABLE FORM AND MADE AVAILABLE VIA A GLOBAL COMPUTER NETWORK ON A SUBSCRIPTION BASIS, IN CLASS 9 (U.S. CLS. 21, 23, 26, 36 AND 38).

FIRST USE 5-0-2002; IN COMMERCE 5-0-2005.

FOR: FINANCIAL INFORMATION SERVICES REGARDING THE ENERGY INDUSTRY IN THE NATURE OF CONVEYING PRICING INFORMATION AND PRICING NEWS ABOUT FUEL AND ENERGY PRODUCTS VIA A GLOBAL COMPUTER NETWORK AND NOT INCLUDING INFORMATION CONCERNING ASSET MANAGEMENT AND INVESTMENT ADVICE RELATING TO STOCKS

AND BONDS, IN CLASS 36 (U.S. CLS. 100, 101 AND 102).

FIRST USE 5-0-2005; IN COMMERCE 5-0-2005.

OWNER OF U.S. REG. NOS. 2,387,568, 2,450,022, AND 2,562,712.

NO CLAIM IS MADE TO THE EXCLUSIVE RIGHT TO USE "ONLINE" , APART FROM THE MARK AS SHOWN.

THE COLOR(S) BLUE, WHITE AND ORANGE IS/ ARE CLAIMED AS A FEATURE OF THE MARK.

THE MARK CONSISTS OF A RECTANGULAR SHAPE WITH TWO SHADES OF BLUE ON THE LEFT SIDE AND ORANGE ON THE RIGHT SIDE. THE TWO SHADES OF BLUE THAT APPEAR IN THE RIGHT SIDE OF THE MARK ARE SEPARATED BY A CURVED WHITE LINE. THE WORD "ARGUS" APPEARS IN WHITE, WITHIN THE DARKER BLUE PORTION OF THE RECTANGLE. THE WORD "ONLINE" IN BLUE APPEARS ON THE RIGHT SIDE WITHIN THE ORANGE PART OF THE RECTANGLE.

SER. NO. 78-649,447, FILED 6-13-2005.

LINDA MICKLEBURGH, EXAMINING ATTORNEY



**Int. Cl.: 11**

**Prior U.S. Cls.: 13, 21, 23, 31 and 34**

**United States Patent and Trademark Office**

**Reg. No. 3,505,285**

**Registered Sep. 23, 2008**

**TRADEMARK  
PRINCIPAL REGISTER**

**AUREOLA**

YAMAGIWA CORPORATION (JAPAN CORPORATION)  
1-1, SOTOKANDA 4-CHOME CHIYODA-KU  
TOKYO, JAPAN

OWNER OF JAPAN REG. NO. 4917294, DATED 12-22-2005, EXPIRES 12-22-2015.

FOR: DESK LAMPS; LIGHTING FIXTURES, IN CLASS 11 (U.S. CLS. 13, 21, 23, 31 AND 34).

SER. NO. 78-650,236, FILED 6-14-2005.

THE MARK CONSISTS OF STANDARD CHARACTERS WITHOUT CLAIM TO ANY PARTICULAR FONT, STYLE, SIZE, OR COLOR.

DAVID YONTEF, EXAMINING ATTORNEY

**Int. Cl.: 20**

**Prior U.S. Cls.: 2, 13, 22, 25, 32 and 50**

**United States Patent and Trademark Office**

**Reg. No. 3,505,286**

**Registered Sep. 23, 2008**

**TRADEMARK  
PRINCIPAL REGISTER**

# Easy Riser Bed

LION SPORTS, INC. (NEW YORK CORPORATION)  
SUITE 2  
701 KOEHLER AVENUE  
RONKONKOMA, NY 11779

FOR: INFLATABLE BED FOR USE WHEN CAMPING, IN CLASS 20 (U.S. CLS. 2, 13, 22, 25, 32 AND 50).

FIRST USE 1-1-2001; IN COMMERCE 1-1-2001.

THE MARK CONSISTS OF STANDARD CHARACTERS WITHOUT CLAIM TO ANY PARTICULAR FONT, STYLE, SIZE, OR COLOR.

NO CLAIM IS MADE TO THE EXCLUSIVE RIGHT TO USE "BED", APART FROM THE MARK AS SHOWN.

SER. NO. 78-654,573, FILED 6-20-2005.

EDWARD FENNESSY, EXAMINING ATTORNEY

**Int. Cl.: 20**

**Prior U.S. Cls.: 2, 13, 22, 25, 32 and 50**

**United States Patent and Trademark Office**

**Reg. No. 3,505,287**

**Registered Sep. 23, 2008**

**TRADEMARK  
PRINCIPAL REGISTER**

# E-Z Riser Bed

LION SPORTS, INC. (NEW YORK CORPORATION)  
SUITE 2  
701 KOEHLER AVENUE  
RONKONKOMA, NY 11779

FOR: INFLATABLE BED, IN CLASS 20 (U.S. CLS. 2, 13, 22, 25, 32 AND 50).

FIRST USE 1-1-2001; IN COMMERCE 1-1-2001.

THE MARK CONSISTS OF STANDARD CHARACTERS WITHOUT CLAIM TO ANY PARTICULAR FONT, STYLE, SIZE, OR COLOR.

NO CLAIM IS MADE TO THE EXCLUSIVE RIGHT TO USE "BED", APART FROM THE MARK AS SHOWN.

SER. NO. 78-654,586, FILED 6-20-2005.

EDWARD FENNESSY, EXAMINING ATTORNEY

**Int. Cl.: 5**

**Prior U.S. Cls.: 6, 18, 44, 46, 51 and 52**

**Reg. No. 3,505,288**

**United States Patent and Trademark Office**

**Registered Sep. 23, 2008**

**TRADEMARK  
PRINCIPAL REGISTER**

**ZOTT**

J.B. CHEMICALS AND PHARMACEUTICALS  
(INDIA CORPORATION)  
NEELAM CENTRE "B" WING, 4TH FLOOR  
HIND CYCLE ROAD  
WORLI, MUMBAI, INDIA

FOR: SOFT AND HARD CAPSULES AND TABLETS CONTAINING A FULL LINE OF PHARMACEUTICAL PREPARATIONS FOR HUMAN AND VETERINARY USE; VITAMINS; NUTRITIONAL SUPPLEMENTS; HERBAL SUPPLEMENTS; DRUG DELIVERY SYSTEMS, NAMELY, SLOW AND CONTROLLED RELEASE, ORALLY ADMINISTERED DOSAGE FORMS CONTAINING A FULL LINE OF PHARMACEUTICAL PREPARATIONS, VITAMINS, NUTRITIONAL; SUPPLEMENTS AND HERBAL

SUPPLEMENTS, IN CLASS 5 (U.S. CLS. 6, 18, 44, 46, 51 AND 52).

THE MARK CONSISTS OF STANDARD CHARACTERS WITHOUT CLAIM TO ANY PARTICULAR FONT, STYLE, SIZE, OR COLOR.

PRIORITY CLAIMED UNDER SEC. 44(D) ON INDIA APPLICATION NO. 1367169, FILED 6-28-2005, REG. NO. 1367169, DATED 6-28-2005, EXPIRES 6-28-2015.

SER. NO. 78-669,265, FILED 7-13-2005.

JILL PRATER, EXAMINING ATTORNEY

**Int. Cl.: 9**

**Prior U.S. Cls.: 21, 23, 26, 36 and 38**

**Reg. No. 3,505,289**

**United States Patent and Trademark Office**

**Registered Sep. 23, 2008**

**TRADEMARK  
PRINCIPAL REGISTER**

The logo for 'BARE BONES' features the word 'BARE' in a tall, thin, sans-serif font. Below it, the word 'BONES' is written in a bold, black, sans-serif font. The letter 'O' in 'BONES' is replaced by a grey gear icon.

BARE BONES SOFTWARE, INC. (MASSACHU-  
SETTS CORPORATION)  
P.O. BOX 1048  
213 BURLINGTON ROAD  
BEDFORD, MA 017301048

AND INFORMATION ORGANIZATION SOFT-  
WARE, IN CLASS 9 (U.S. CLS. 21, 23, 26, 36 AND 38).

FIRST USE 8-30-2004; IN COMMERCE 8-30-2004.

FOR: HOUSE MARK FOR TEXT EDITOR SOFT-  
WARE WITH HYPERTEXT MARKUP LANGUAGE  
(HTML) CREATION TOOLS; E-MAIL SOFTWARE;

SER. NO. 78-681,649, FILED 7-29-2005.

DARRYL SPRUILL, EXAMINING ATTORNEY

**Int. Cls.: 21, 25 and 41**

**Prior U.S. Cls.: 2, 13, 22, 23, 29, 30, 33, 39, 40, 50, 100,  
101 and 107**

**Reg. No. 3,505,290**

**United States Patent and Trademark Office**

**Registered Sep. 23, 2008**

**TRADEMARK  
SERVICE MARK  
PRINCIPAL REGISTER**

**I  LAS VEGAS**

BUSINESS SERVICES CORPORATION (NEVADA CORPORATION)  
6442 ARVILLE ST.  
LAS VEGAS, NV 89118

FOR: DRINKING TUMBLERS, DRINKING GLASSES, DRINKING PUB GLASSES; TABLE COASTERS NOT OF PAPER OR CLOTH; THERMAL INSULATED BAGS FOR FOOD AND BEVERAGE; COFFEE MUGS, COFFEE CUPS, SHOT GLASSES, BRANDY AND LIQUOR GLASSES, BEER MUGS, PILSNER GLASSES, BEVERAGE GLASSWARE; BOTTLES SOLD EMPTY; BOWLS; CERAMIC FIGURINES OTHER THAN TERRA COTTA; CHAMPAGNE BUCKETS; COOKIE JARS; COOLING BUCKETS FOR WINE; DECORATIVE CRYSTAL PRISMS; DECORATIVE PLATES; FIGURINES OF CHINA, CRYSTAL, EARTHENWARE, GLASS, AND PORCELAIN; FLOWER VASES AND BOWLS; INSULATING SLEEVE HOLDERS FOR BEVERAGE CANS; ORNAMENTAL GLASS SPHERES AND ORNAMENTS OF CHINA, CRYSTAL, GLASS, PORCELAIN, AND TERRA COTTA; PAPER AND PLASTIC CUPS, BOWLS AND PLATES; SOUVENIR PLATES, MUGS, VASES; THERMAL INSULATED CONTAINERS FOR FOOD AND BEVERAGES; VASES, IN CLASS 21 (U.S. CLS. 2, 13, 23, 29, 30, 33, 40 AND 50).

FIRST USE 2-13-2005; IN COMMERCE 4-21-2005.

FOR: MEN'S, WOMEN'S AND CHILDREN'S APPAREL, NAMELY, T-SHIRTS, COLLARED SHIRTS, ATHLETIC SHIRTS, JEANS, SWEAT PANTS, SWEAT JACKETS, LEATHER JACKETS, ATHLETIC JACK-

ETS, SHORTS, UNDERGARMENTS, TENNIS SHIRTS, POLO SHIRTS, SWEAT SHIRTS, SKIRTS, DRESSES, WRIST BANDS, BELTS, AND NECKTIES; FOOTWEAR, NAMELY, ATHLETIC SHOES, SNEAKERS, SANDALS AND FLIP FLOP SHOES, BOOTS, AND SOCKS; HEADWEAR, NAMELY, HATS, CAPS, VISORS, BASEBALL HATS, AND HEAD BANDS, IN CLASS 25 (U.S. CLS. 22 AND 39).

FIRST USE 2-13-2005; IN COMMERCE 4-21-2005.

FOR: ENTERTAINMENT, SPORTING AND CULTURAL ACTIVITIES, NAMELY, ARRANGING FOR TICKET RESERVATIONS FOR SHOWS AND OTHER ENTERTAINMENT EVENTS; BOOKING OF SEATS FOR SHOWS AND BOOKING OF THEATRE TICKETS; CONDUCTING AND PROVIDING FACILITIES FOR SPECIAL EVENTS FEATURING CASINO AND GAMING CONTESTS AND TOURNAMENTS; ENTERTAINMENT SERVICES, NAMELY, LIVE PERFORMANCES BY MUSICAL BANDS; CONDUCTING LIVE PERFORMANCES BY A MUSICAL BAND; ENTERTAINMENT SERVICES, NAMELY, PERSONAL APPEARANCES BY CELEBRITIES, SPORTS STARS AND FAMOUS PERSONS; CONDUCTING PARTIES, CONDUCTING PARTIES FOR THE PURPOSE OF DATING AND SOCIAL INTRODUCTION FOR ADULTS; PARTY PLANNING AND CONSULTATION, IN CLASS 41 (U.S. CLS. 100, 101 AND 107).

FIRST USE 2-13-2005; IN COMMERCE 4-21-2005.

NO CLAIM IS MADE TO THE EXCLUSIVE  
RIGHT TO USE "LAS VEGAS", APART FROM THE  
MARK AS SHOWN.

SER. NO. 78-686,070, FILED 8-4-2005.

THE MARK CONSISTS OF THE DESIGN OF A  
HEART WITH HORNS AND A DEVIL'S TAIL AND  
WORDS "I" AND "LAS VEGAS".

DAVID C. REIHNER, EXAMINING ATTORNEY

**Int. Cls.: 9, 14, 18, 24, 25, 28 and 35**

**Prior U.S. Cls.: 1, 2, 3, 21, 22, 23, 26, 27, 28, 36, 38, 39,  
41, 42, 50, 100, 101 and 102**

**Reg. No. 3,505,291**

**United States Patent and Trademark Office**

**Registered Sep. 23, 2008**

**TRADEMARK  
SERVICE MARK  
PRINCIPAL REGISTER**

# HEADWORX

HEADWORX LIMITED (UNITED KINGDOM CORPORATION)

FAR GOLDEN WONG

CRIFTIN ENTERPRISE CENTRE, OXTON ROAD  
EPPERSTONE, NOTTINGHAM, UNITED KINGDOM NG14 6AT

FOR: PRE-RECORDED CDS AND VIDEO TAPES RELATED TO SPORTS AND LEISURE PURSUITS; PHOTOGRAPHIC AND CINEMATOGRAPHIC APPARATUS AND INSTRUMENTS, NAMELY, CAMERAS AND SOUND AND VIDEO RECORDINGS AND PLAYBACK MACHINES; DVDS FEATURING MOVIES AND INFORMATION RELATING TO SPORTS AND LEISURE PURSUITS; SOUND RECORDINGS AND VIDEO RECORDINGS BOTH FEATURING INFORMATION RELATING TO SPORTS AND LEISURE PURSUITS, IN CLASS 9 (U.S. CLS. 21, 23, 26, 36 AND 38).

FOR: GOODS MADE OF OR COATED WITH PRECIOUS METALS, NAMELY, WATCHES, CLOCKS, IN CLASS 14 (U.S. CLS. 2, 27, 28 AND 50).

FOR: LEATHER AND IMITATIONS OF LEATHER GOODS, NAMELY, ANIMAL SKINS AND HIDES, LUGGAGE, TRUNKS, TRAVELING BAGS TRAVELING BAGS FOR SPORTS EQUIPMENT, CARRY-ON LUGGAGE, OVERNIGHT CASES, OVERNIGHT BAGS, COSMETIC BAGS SOLD EMPTY, SHOES BAGS AND GARMENT BAGS FOR TRAVEL, RUCKSACKS, HANDBAGS, SHOULDER BAGS, CLUTCH BAGS, TOTE BAGS, ATHLETIC BAGS, BEACH BAGS; WALLETS, PURSES AND KEY CASES; UMBRELLAS, PARASOLS, CANES AND WALKING STICKS; WHIPS, HARNESSES AND SADDLERY, NONE OF THE ABOVE GOODS BEING SPECIFICALLY DESIGNED FOR USE IN CONNECTION WITH RACQUET SPORTS, SKIING

AND/OR GOLF, IN CLASS 18 (U.S. CLS. 1, 2, 3, 22 AND 41).

FOR: TEXTILE FABRICS FOR THE MANUFACTURING OF CLOTHING; BED LINENS AND TABLE LINENS; BED SHEETS, DUVETS, QUILTS, TEXTILE NAPKINS, CLOTH COASTERS, CURTAINS, TEXTILE CURTAIN PELMETS, CUSHION COVERS, PILLOW COVERS, TOWELS, TEA TOWELS, SHOWER CURTAINS; HANDKERCHIEFS; BED BLANKETS; WALL HANGINGS OF TEXTILE; EIDERDOWN COVERS; UPHOLSTERY FABRICS, IN CLASS 24 (U.S. CLS. 42 AND 50).

FOR: MEN'S, WOMEN'S AND CHILDREN'S CLOTHING, NAMELY, T-SHIRTS, SINGLETTS, WAISTCOATS, POLO SHIRTS, SWEATSHIRTS, KNITTED TOPS, TANK TOPS, DICKIES, JUMPERS, JERSEYS, PULLOVERS, SWEATERS, TURTLE-NECK SWEATERS, V-NECK SWEATERS, CARDIGANS, BLOUSES, SHIRTS, TRACKSUITS, SHORTS, WALK SHORTS, BOARD SHORTS, DRESS SHORTS, BERMUDA SHORTS, DRESSES, SKIRTS, TROUSERS, PANTS, JEANS, SWIMWEAR, BATHING TRUNKS, COATS, OVERCOATS, TOPCOATS, SPORTS COATS, JACKETS, RAIN COATS, WIND RESISTANT JACKETS, PARKAS, QUILTED VESTS, LONG SLEEVED NIGHT SHIRTS, SHORT-SLEEVED NIGHT SHIRTS, NONE BEING SPECIFICALLY DESIGNED FOR USE IN CONNECTION WITH RACQUET SPORTS, SKIING AND/OR GOLF; FOOTWEAR INCLUDING SHOES, SANDALS, SNEAKERS, TRAINING SHOES, BOOTS, SLIPPERS AND THONGS, NONE BEING SPECIFICALLY DESIGNED FOR USE IN CONNECTION WITH RACQUET SPORTS, SKIING, GOLF AND/OR SNOWBOARDING; HEADWEAR INCLUDING HATS, HOODS, PEAKS, CAPS, SUN HATS, VISORS AND BEANIES, NONE BEING SPECIFICALLY DE-



SIGNED FOR USE IN CONNECTION WITH RACQUET SPORTS, SKIING AND/OR GOLF, IN CLASS 25 (U.S. CLS. 22 AND 39).

FOR: TOYS, GAMES AND PLAYTHINGS, NAME-  
LY, BOARD GAMES, PLAYING CARDS, TOY AC-  
TION FIGURES, CRAFT TOYS AND MODELS ALL  
SOLD IN COMPLETE OR KIT FORM, SOFT TOYS,  
BATH TUB TOYS, FLYING DISCS; SPORTING AND  
GYMNASTICS ARTICLES, NAMELY, SURF-  
BOARDS, WINDSURFING BOARDS, SKATE-  
BOARDS, ROLLER SKATES, IN-LINE SKATES  
WATER SKIS, KNEE BOARDS, WAKE BOARDS;  
SWIMMING FINS, SWIMMING FLIPPERS, PERSO-  
NAL EXERCISE MATS; RECREATIONAL FLOTA-  
TION PADS; KNEE AND ELBOW PADS FOR  
SPORTS AND ATHLETIC USE, SAIL BOARD FOOT  
STRAPS; PROTECTORS FOR SPORTS AND ATH-  
LETIC USE, NAMELY, CHEST, LIMB AND THROAT  
PROTECTORS, BAGS SPECIALLY ADAPTED FOR  
SPORTS EQUIPMENT, EXCLUDING SPORTS BAGS  
ADAPTED TO CARRY TENNIS RACQUETS, SKIS  
AND OR GOLF EQUIPMENT, IN CLASS 28 (U.S.  
CLS. 22, 23, 38 AND 50).

FOR: ADMINISTRATION OF BUSINESS PAY-  
ROLL FOR OTHERS; DISSEMINATION OF ADVER-  
TISING MATERIAL, MARKET RESEARCH;  
RETAIL STORE SERVICES AND WHOLESALE DIS-

TRIBUTORSHIPS IN THE FIELDS OF CLOTHING,  
CLOTHING ACCESSORIES, LUGGAGE, JEWELRY,  
SUNGLASSES, TOYS, PERSONAL HYGIENE PRO-  
DUCTS, SPORTS, HOUSEHOLD PRODUCTS FOR  
DINING, BED AND BATH, HOUSEWARES AND  
GLASS BEVERAGE WARES, PAPER GOODS, LEA-  
THER CLOTHING AND LEATHER ACCESSORIES,  
SPORTS BAGS AND HANDBAGS, BY MEANS OF A  
CATALOGUE, DIRECT MAIL AND ELECTRONIC  
RETAILING SERVICES VIA AN ONLINE GLOBAL  
COMPUTER NETWORK, IN CLASS 35 (U.S. CLS. 100,  
101 AND 102).

THE MARK CONSISTS OF STANDARD CHAR-  
ACTERS WITHOUT CLAIM TO ANY PARTICULAR  
FONT, STYLE, SIZE, OR COLOR.

OWNER OF ERPN CMNTY TM OFC REG. NO.  
2749251, DATED 2-13-2004, EXPIRES 6-25-2012.

OWNER OF ERPN CMNTY TM OFC REG. NO.  
2749521, DATED 2-13-2004, EXPIRES 6-25-2012.

OWNER OF U.S. REG. NO. 2,927,087.

SER. NO. 78-688,873, FILED 8-9-2005.

SEAN CROWLEY, EXAMINING ATTORNEY

**Int. Cls.: 19 and 35**

**Prior U.S. Cls.: 1, 12, 33, 50, 100, 101 and 102**

**United States Patent and Trademark Office**

**Reg. No. 3,505,292**

**Registered Sep. 23, 2008**

**TRADEMARK  
SERVICE MARK  
PRINCIPAL REGISTER**



WINDOW DEPOT, INC. (ARKANSAS CORPORATION)  
5604 COMMERCE COURT  
SHERWOOD, AR 72120

FOR: VINYL REPLACEMENT WINDOWS, DOORS, AND SIDING, IN CLASS 19 (U.S. CLS. 1, 12, 33 AND 50).

FIRST USE 3-15-2005; IN COMMERCE 3-15-2005.

FOR: RETAIL STORE SERVICES FEATURING VINYL REPLACEMENT WINDOWS, DOORS, AND SIDING, IN CLASS 35 (U.S. CLS. 100, 101 AND 102).

FIRST USE 3-15-2005; IN COMMERCE 3-15-2005.

NO CLAIM IS MADE TO THE EXCLUSIVE RIGHT TO USE "WINDOW" AND "USA", APART FROM THE MARK AS SHOWN.

SER. NO. 78-692,525, FILED 8-15-2005.

GRETTA YAO, EXAMINING ATTORNEY

**Int. Cls.: 21, 25 and 41**

**Prior U.S. Cls.: 2, 13, 22, 23, 29, 30, 33, 39, 40, 50, 100,  
101 and 107**

**Reg. No. 3,505,293**

**United States Patent and Trademark Office**

**Registered Sep. 23, 2008**

**TRADEMARK  
SERVICE MARK  
PRINCIPAL REGISTER**



BUSINESS SERVICES CORPORATION (NEVADA CORPORATION)  
6442 ARVILLE ST.  
LAS VEGAS, NV 89118

FOR: DRINKING TUMBLERS, DRINKING GLASSES, DRINKING PUB GLASSES; TABLE COASTERS NOT OF PAPER OR CLOTH; THERMAL INSULATED BAGS FOR FOOD AND BEVERAGE; COFFEE MUGS, COFFEE CUPS, SHOT GLASSES, BRANDY AND LIQUOR GLASSES, BEER MUGS, PILSNER GLASSES, BEVERAGE GLASSWARE; BOTTLES SOLD EMPTY; BOWLS; CERAMIC FIGURINES OTHER THAN TERRA COTTA; CHAMPAGNE BUCKETS; COOKIE JARS; COOLING BUCKETS FOR WINE; DECORATIVE CRYSTAL PRISMS; DECORATIVE PLATES; FIGURINES OF CHINA, CRYSTAL, EARTHENWARE, GLASS, AND PORCELAIN; FLOWER VASES AND BOWLS; INSULATING SLEEVE HOLDERS FOR BEVERAGE CANS; ORNAMENTAL GLASS SPHERES AND ORNAMENTS OF CHINA, CRYSTAL, GLASS, PORCELAIN, AND TERRA COTTA; PAPER AND PLASTIC CUPS, BOWLS AND PLATES; SOUVENIR PLATES, MUGS, VASES; THERMAL INSULATED CONTAINERS FOR FOOD AND BEVERAGES; VASES, IN CLASS 21 (U.S. CLS. 2, 13, 23, 29, 30, 33, 40 AND 50).

FIRST USE 2-13-2005; IN COMMERCE 4-21-2005.

FOR: MEN'S, WOMEN'S AND CHILDREN'S APPAREL, NAMELY, T-SHIRTS, COLLARED SHIRTS, ATHLETIC SHIRTS, JEANS, SWEAT PANTS, SWEAT JACKETS, LEATHER JACKETS, ATHLETIC JACK-

ETS, SHORTS, UNDERGARMENTS, TENNIS SHIRTS, POLO SHIRTS, SWEAT SHIRTS, SKIRTS, DRESSES, WRIST BANDS, BELTS, AND NECKTIES; FOOTWEAR, NAMELY, ATHLETIC SHOES, SNEAKERS, SANDALS AND FLIP FLOP SHOES, BOOTS, AND SOCKS; HEADWEAR, NAMELY, HATS, CAPS, VISORS, BASEBALL HATS, AND HEAD BANDS, IN CLASS 25 (U.S. CLS. 22 AND 39).

FIRST USE 2-13-2005; IN COMMERCE 4-21-2005.

FOR: ENTERTAINMENT, SPORTING AND CULTURAL ACTIVITIES, NAMELY, ARRANGING FOR TICKET RESERVATIONS FOR SHOWS AND OTHER ENTERTAINMENT EVENTS; BOOKING OF SEATS FOR SHOWS AND BOOKING OF THEATRE TICKETS; CONDUCTING AND PROVIDING FACILITIES FOR SPECIAL EVENTS FEATURING CASINO AND GAMING CONTESTS AND TOURNAMENTS; ENTERTAINMENT SERVICES, NAMELY, LIVE PERFORMANCES BY MUSICAL BANDS; CONDUCTING LIVE PERFORMANCES BY A MUSICAL BAND; ENTERTAINMENT SERVICES, NAMELY, PERSONAL APPEARANCES BY CELEBRITIES, SPORTS STARS AND FAMOUS PERSONS; CONDUCTING PARTIES, CONDUCTING PARTIES FOR THE PURPOSE OF DATING AND SOCIAL INTRODUCTION FOR ADULTS; PARTY PLANNING AND CONSULTATION, IN CLASS 41 (U.S. CLS. 100, 101 AND 107).

FIRST USE 2-13-2005; IN COMMERCE 4-21-2005.

NO CLAIM IS MADE TO THE EXCLUSIVE  
RIGHT TO USE "LAS VEGAS", APART FROM THE  
MARK AS SHOWN.

SER. NO. 78-698,067, FILED 8-23-2005.

THE MARK CONSISTS OF THE DESIGN OF A  
HEART WITH HORNS AND A DEVIL'S TAIL AND  
THE WORDS "LAS VEGAS".

DAVID C. REIHNER, EXAMINING ATTORNEY

**Int. Cls.: 16 and 41**

**Prior U.S. Cls.: 2, 5, 22, 23, 29, 37, 38, 50, 100, 101 and 107**

**United States Patent and Trademark Office**

**Reg. No. 3,505,294**

**Registered Sep. 23, 2008**

**TRADEMARK  
SERVICE MARK  
PRINCIPAL REGISTER**

# Minding Our Elders

CAROL BRADLEY BURSACK (NORTH DAKOTA  
SOLE PROPRIETORSHIP)  
1514 5TH STREET NORTH  
FARGO, ND 58102

FOR: EDUCATIONAL BOOKS FEATURING EL-  
DER CAREGIVING, IN CLASS 16 (U.S. CLS. 2, 5, 22,  
23, 29, 37, 38 AND 50).

FIRST USE 8-20-2005; IN COMMERCE 8-26-2005.

FOR: EDUCATIONAL SERVICES, NAMELY,  
CONDUCTING SEMINARS IN THE FIELD OF

ELDER CAREGIVING, IN CLASS 41 (U.S. CLS. 100,  
101 AND 107).

FIRST USE 8-20-2005; IN COMMERCE 8-26-2005.

THE MARK CONSISTS OF STANDARD CHAR-  
ACTERS WITHOUT CLAIM TO ANY PARTICULAR  
FONT, STYLE, SIZE, OR COLOR.

SER. NO. 78-701,889, FILED 8-27-2005.

JAMES A. RAUEN, EXAMINING ATTORNEY

**Int. Cl.: 41**

**Prior U.S. Cls.: 100, 101 and 107**

**United States Patent and Trademark Office**

**Reg. No. 3,505,295**

**Registered Sep. 23, 2008**

**SERVICE MARK  
PRINCIPAL REGISTER**



CHURCH OF DIVINE MAN (WASHINGTON CORPORATION)  
2402 SUMMIT AVENUE  
EVERETT, WA 98201

FOR: CONDUCTING WORKSHOPS AND SEMINARS IN THE FIELD OF SPIRITUALITY; RELIGIOUS INSTRUCTION SERVICES, IN CLASS 41 (U.S. CLS. 100, 101 AND 107).

FIRST USE 3-26-1990; IN COMMERCE 3-26-1990.

OWNER OF U.S. REG. NO. 1,980,606.

THE MARK CONSISTS OF A VERTICALLY PLACED ROSE ABOVE THE "M" IN THE MIDDLE OF THE "M" ON "CDM" AND AN UNCLOSED CIRCLE BEGINNING AT THE "C" AND ENDING AT THE "M" SURROUNDING THE ROSE.

SEC. 2(F).

SER. NO. 78-702,060, FILED 8-28-2005.

RENEE SERVANCE, EXAMINING ATTORNEY

**Int. Cl.: 16**

**Prior U.S. Cls.: 2, 5, 22, 23, 29, 37, 38 and 50**

**United States Patent and Trademark Office**

**Reg. No. 3,505,296**

**Registered Sep. 23, 2008**

**TRADEMARK  
PRINCIPAL REGISTER**

**NOVASET**

STORA ENSO OYJ (FINLAND CORPORATION)

KANAVARANTA 1

HELSINKI, FINLAND FI-00101

FOR: LABEL PAPER, IN CLASS 16 (U.S. CLS. 2, 5,  
22, 23, 29, 37, 38 AND 50).

FIRST USE 2-0-2003; IN COMMERCE 12-0-2006.

THE MARK CONSISTS OF STANDARD CHAR-  
ACTERS WITHOUT CLAIM TO ANY PARTICULAR  
FONT, STYLE, SIZE, OR COLOR.

PRIORITY CLAIMED UNDER SEC. 44(D) ON  
ERPNTY TM OFC APPLICATION NO.  
004345492, FILED 3-17-2005.

SER. NO. 78-703,473, FILED 8-30-2005.

SUE LAWRENCE, EXAMINING ATTORNEY

Int. Cl.: 36

Prior U.S. Cls.: 100, 101 and 102

United States Patent and Trademark Office

Reg. No. 3,505,297

Registered Sep. 23, 2008

SERVICE MARK  
PRINCIPAL REGISTER



PREMIER MORTGAGE FUNDING, INC. (FLORIDA CORPORATION)  
SUITE 330  
3001 EXECUTIVE DRIVE  
CLEARWATER, FL 33762

FOR: BROKERING MORTGAGE LOANS FOR RESIDENTIAL AND COMMERCIAL BORROWERS, IN CLASS 36 (U.S. CLS. 100, 101 AND 102).

FIRST USE 1-31-2002; IN COMMERCE 1-31-2002.

NO CLAIM IS MADE TO THE EXCLUSIVE RIGHT TO USE "MORTGAGE FUNDING, INC", APART FROM THE MARK AS SHOWN.

THE COLOR(S) GREEN AND BLUE IS/ARE CLAIMED AS A FEATURE OF THE MARK.

THE SLIGHTLY ARCHED LINE UNDERNEATH THE MARK IS COLORED A SOLID SHADE OF BLUE. THE THREE WORDS "MORTGAGE FUNDING, INC." ARE COLORED A SOLID SHADE OF

BLUE. THE TWO SOLID PORTIONS OF THE TWO BUILDINGS TO THE LEFT SIDE OF THE MARK ARE BLUE. THERE ARE TWO OTHER STRIPED PORTIONS OF THE BUILDINGS AND THE LOWER STRIPED PORTION, LOCATED TO THE FAR LEFT OF THE MARK, IS GREEN. THE HIGHER STRIPED PORTION DITHERS FROM A DARKER GREEN TO A LIGHTER GREEN. WITHIN THE WORD "PREMIER" THE COLORATION DITHERS GRADUALLY FROM GREEN TO BLUE TOWARDS THE TOP OF THE WORD. THE TOP PORTION OF THE WORD "PREMIER" IS THEREBY BLUE AND THE BOTTOM PORTION IS THEREBY GREEN WHEREAS THE HORIZONTAL CENTER OF THE WORD "PREMIER" DITHERS GRADUALLY FROM GREEN TO BLUE TOWARDS THE TOP PORTION OF THE WORD "PREMIER".

SER. NO. 78-704,597, FILED 8-31-2005.

MICHAEL WEBSTER, EXAMINING ATTORNEY



**Int. Cl.: 7**

**Prior U.S. Cls.: 13, 19, 21, 23, 31, 34 and 35**

**United States Patent and Trademark Office**

**Reg. No. 3,505,298**

**Registered Sep. 23, 2008**

**TRADEMARK  
PRINCIPAL REGISTER**

**STABECO PERFORMANCE<sup>2</sup>**

NQL ENERGY SERVICES CANADA LTD. (CANADA CORPORATION)  
1507 4TH STREET  
NISKU, ALBERTA, CANADA T9E 7M9

FOR: MOTORS FOR USE IN OIL AND GAS WELL DRILLING, IN CLASS 7 (U.S. CLS. 13, 19, 21, 23, 31, 34 AND 35).

PRIORITY CLAIMED UNDER SEC. 44(D) ON CANADA APPLICATION NO. 1250024, FILED 3-3-

2005, REG. NO. TMA694639, DATED 8-23-2007, EXPIRES 8-23-2022.

OWNER OF U.S. REG. NO. 3,409,023.

THE MARK CONSISTS OF "STABECO PERFORMANCE 2" WHERE THE "2" IS SUPERSCRIPIT.

SER. NO. 78-705,386, FILED 9-1-2005.

PAUL E. FAHRENKOPF, EXAMINING ATTORNEY

**Int. Cl.: 30**

**Prior U.S. Cl.: 46**

**United States Patent and Trademark Office**

**Reg. No. 3,505,299**

**Registered Sep. 23, 2008**

**TRADEMARK  
PRINCIPAL REGISTER**

**RAIN-BLO POPS**

FARLEY'S & SATHERS CANDY COMPANY,  
INC. (DELAWARE CORPORATION)  
ONE SATHER PLAZA  
ROUND LAKE, MN 56167

OWNER OF U.S. REG. NO. 968,775.

FOR: CANDY, BUBBLE GUM, IN CLASS 30 (U.S.  
CL. 46).

NO CLAIM IS MADE TO THE EXCLUSIVE  
RIGHT TO USE POPS, APART FROM THE MARK  
AS SHOWN.

FIRST USE 6-1-2005; IN COMMERCE 6-1-2005.

SER. NO. 78-710,548, FILED 9-10-2005.

THE MARK CONSISTS OF STANDARD CHAR-  
ACTERS WITHOUT CLAIM TO ANY PARTICULAR  
FONT, STYLE, SIZE, OR COLOR.

DORITT L. CARROLL, EXAMINING ATTORNEY

**Int. Cl.: 8**

**Prior U.S. Cls.: 23, 28 and 44**

**Reg. No. 3,505,300**

**United States Patent and Trademark Office**

**Registered Sep. 23, 2008**

**TRADEMARK  
PRINCIPAL REGISTER**

**Witte**

KIRCHHOFF WITTE GMBH & COMPANY (FED  
REP GERMANY CORPORATION)  
FELDMUHENSTRASSE 51  
58093 HAGEN, FED REP GERMANY

THE MARK CONSISTS OF STANDARD CHAR-  
ACTERS WITHOUT CLAIM TO ANY PARTICULAR  
FONT, STYLE, SIZE, OR COLOR.

FOR: NON-POWERED HAND TOOLS, NAMELY,  
SCREWDRIVERS, BITS FOR HAND DRILLS, HEX  
KEY WRENCHES AND KEY WRENCHES, IN  
CLASS 8 (U.S. CLS. 23, 28 AND 44).

SER. NO. 78-711,453, FILED 9-12-2005.

FIRST USE 1-0-1950; IN COMMERCE 1-0-1950.

DAYNA BROWNE, EXAMINING ATTORNEY

**Int. Cl.: 33**

**Prior U.S. Cls.: 47 and 49**

**United States Patent and Trademark Office**

**Reg. No. 3,505,301**

**Registered Sep. 23, 2008**

**TRADEMARK  
PRINCIPAL REGISTER**

**ECLIPSE**

NOON WINERY PTY. LTD. (AUSTRALIA CORPORATION)  
P.O. BOX 88, RIFLE RANGE ROAD  
MCLAREN VALE, AUSTRALIA 5171

OWNER OF AUSTRALIA REG. NO. 766780, DATED 2-19-1999, RENEWED AS REG. NO. 766780, DATED 6-19-2008, EXPIRES 7-8-2018.

FOR: WINE, IN CLASS 33 (U.S. CLS. 47 AND 49).

FIRST USE 12-1-1998; IN COMMERCE 12-1-1998.

SER. NO. 78-713,580, FILED 9-15-2005.

THE MARK CONSISTS OF STANDARD CHARACTERS WITHOUT CLAIM TO ANY PARTICULAR FONT, STYLE, SIZE, OR COLOR.

JULIE GUTTADAURO, EXAMINING ATTORNEY

**Int. Cl.: 5**

**Prior U.S. Cls.: 6, 18, 44, 46, 51 and 52**

**United States Patent and Trademark Office**

**Reg. No. 3,505,302**

**Registered Sep. 23, 2008**

**TRADEMARK  
PRINCIPAL REGISTER**

**ON THE GO PLUS**

206 MACOPIN CORP (NEW JERSEY CORPORATION)  
206 MACOPIN RD  
BLOOMINGDALE, NJ 07403

FOR: DIETARY NUTRITIONAL SUPPLEMENT,  
IN CLASS 5 (U.S. CLS. 6, 18, 44, 46, 51 AND 52).

FIRST USE 8-3-2000; IN COMMERCE 8-3-2000.

THE MARK CONSISTS OF STANDARD CHARACTERS WITHOUT CLAIM TO ANY PARTICULAR FONT, STYLE, SIZE, OR COLOR.

OWNER OF U.S. REG. NO. 1,785,170.

SER. NO. 78-715,725, FILED 9-19-2005.

KATHRYN COWARD, EXAMINING ATTORNEY

**Int. Cls.: 6, 9, 11, 17, 20 and 21**

**Prior U.S. Cls.: 1, 2, 5, 12, 13, 14, 21, 22, 23, 25, 26, 29, 30, 31, 32, 33, 34, 35, 36, 38, 40 and 50**

**Reg. No. 3,505,303**

**United States Patent and Trademark Office**

**Registered Sep. 23, 2008**

**TRADEMARK  
PRINCIPAL REGISTER**

**CHROMDURATEC**

HANSA METALLWERKE AG (FED REP GERMANY AKTIENGESELLSCHAFT (AG))  
SIGMARINGER STR. 107  
STUTT GART, FED REP GERMANY D-70567

FOR: HOSE COUPLINGS FOR SHOWERS MADE OF METAL, IN CLASS 6 (U.S. CLS. 2, 12, 13, 14, 23, 25 AND 50).

FOR: CONTACTLESSLY CONTROLLED SANITARY THERMOSTATICALLY CONTROLLED VALVES AND AUTOMATICALLY CONTROLLED VALVES FOR WATER PIPE AND WATER SUPPLY SYSTEMS, FOR BATH, SHOWER AND WASHING INSTALLATIONS; CONSUMER ELECTRONICS AND INFORMATION TECHNOLOGY COMPONENTS, NAMELY RADIOS, TELEVISION SETS, PERSONAL COMPUTERS, PCS, CD OR DVD PLAYERS FOR USE OR INSTALLATION IN SHOWERS, SHOWER FACILITIES OR SANITARY FACILITIES; AND, ELECTRONICALLY CONTROLLED VALVES FOR CONTROLLING FLUIDS AS PARTS OF SANITARY FACILITIES, IN CLASS 9 (U.S. CLS. 21, 23, 26, 36 AND 38).

FOR: FITTINGS FOR PLUMBING, WATER HEATING, BATHING, SHOWERING, FLUSHING, BIDET AND WASHING FACILITIES, NAMELY MANUALLY OR THERMOSTATICALLY CONTROLLED VALVES AS PARTS OF SANITARY FACILITIES; SHOWERS, SHOWER HEADS, SHOWER HEAD FIXTURES, SHOWER TUBES, SPRAY NOZZLES MADE OF PLASTIC AS PARTS OF SANITARY FACILITIES; SHOWER FAUCET EXTENSIONS, WATER SUPPLY APPARATUS, NAMELY, WATER INLETS AND WATER OUTLETS AS PARTS OF SANITARY FACILITIES; WATER TREATMENT EQUIPMENT, NAMELY CARTRIDGE FILTRATION UNITS; MECHANICAL SAFETY VALVES MADE OF METAL, THE PREVIOUSLY DESCRIBED GOODS AS CONNECTION, CONTROL-, AND SAFE-

TY FITTINGS FOR SANITARY INSTALLATIONS; WATER CONDITIONING UNITS, LIGHTING FIXTURES; PARTS OF THE PREVIOUSLY DESCRIBED GOODS, ULTRAVIOLET LAMPS NOT FOR MEDICAL PURPOSES, IN CLASS 11 (U.S. CLS. 13, 21, 23, 31 AND 34).

FOR: HOSE COUPLINGS FOR SHOWERS MADE OF NON-METAL, IN CLASS 17 (U.S. CLS. 1, 5, 12, 13, 35 AND 50).

FOR: MIRRORS, NON-METAL BATHROBE HOOKS, CRYSTALWARE TRAY AND SHELF BRACKETS MADE OF GLASS OR PLASTIC; PARTS OF THE PREVIOUSLY DESCRIBED GOODS NOT MADE OF METAL OR PRECIOUS METAL, IN CLASS 20 (U.S. CLS. 2, 13, 22, 25, 32 AND 50).

FOR: BATH AND SHOWER ACCESSORIES, NAMELY, TOWEL HOLDERS, CUP HOLDERS, SOAP HOLDERS, HAND TOWEL HOLDERS, BATH TOWEL HOLDERS, TOILET ROLL HOLDERS, SPARE TOILET ROLL HOLDERS, SPONGE HOLDERS, AND TOILET BRUSH HOLDERS; HAND TOWEL RINGS; SOAP DISPENSERS; SOAP DISHES; TOILET BRUSHES, ALL PREVIOUSLY DESCRIBED GOODS BEING MADE OF METAL, GLASS, OR PLASTIC, BUT NOT MADE OF PRECIOUS METAL, IN CLASS 21 (U.S. CLS. 2, 13, 23, 29, 30, 33, 40 AND 50).

THE MARK CONSISTS OF STANDARD CHARACTERS WITHOUT CLAIM TO ANY PARTICULAR FONT, STYLE, SIZE, OR COLOR.

PRIORITY CLAIMED UNDER SEC. 44(D) ON ERPN CMNTY TM OFC APPLICATION NO. 004345344, FILED 3-18-2005, REG. NO. 004345344, DATED 2-20-2006, EXPIRES 3-18-2015.

SER. NO. 78-716,010, FILED 9-19-2005.

JIM RINGLE, EXAMINING ATTORNEY

**Int. Cl.: 9**

**Prior U.S. Cls.: 21, 23, 26, 36 and 38**

**Reg. No. 3,505,304**

**United States Patent and Trademark Office**

**Registered Sep. 23, 2008**

**TRADEMARK  
PRINCIPAL REGISTER**

**MTx**

XSENS TECHNOLOGIES B.V. (NETHERLANDS  
LIMITED LIABILITY COMPANY)  
CAPITool 50,  
7521 PL ENSCHEDE, NETHERLANDS

FOR: MEASURING DEVICES, NAMELY, INERTIAL MEASUREMENT UNITS FOR MEASUREMENT OF 3D MOTION, ORIENTATION, POSITION AND KINEMATIC DATA, COMPRISED OF GYROSCOPES, ACCELEROMETERS OR MAGNETOMETERS; ORIENTATION TRACKERS FOR MEASUREMENT OF 3D MOTION, ORIENTATION, POSITION AND KINEMATIC DATA, COMPRISED OF GYROSCOPES, ACCELEROMETERS OR MAGNETOMETERS, FOR USE IN ANIMATION, TRAINING AND SIMULATION, OR HEALTH, IN CLASS 9 (U.S. CLS. 21, 23, 26, 36 AND 38).

FIRST USE 3-29-2005; IN COMMERCE 8-1-2005.

THE MARK CONSISTS OF STANDARD CHARACTERS WITHOUT CLAIM TO ANY PARTICULAR FONT, STYLE, SIZE, OR COLOR.

PRIORITY CLAIMED UNDER SEC. 44(D) ON ERPN CMNTY TM OFC APPLICATION NO. 004364733, FILED 3-31-2005, REG. NO. 004364733, DATED 7-20-2007, EXPIRES 3-31-2015.

SER. NO. 78-718,403, FILED 9-22-2005.

FLORENTINA BLANDU, EXAMINING ATTORNEY



**Int. Cls.: 39 and 42**

**Prior U.S. Cls.: 100, 101 and 105**

**United States Patent and Trademark Office**

**Reg. No. 3,505,305**

**Registered Sep. 23, 2008**

**SERVICE MARK  
PRINCIPAL REGISTER**

**MOBILE, INFORMED &  
CONNECTED**

EHEALTH SOLUTIONS, INC. (DELAWARE CORPORATION)  
SUITE 202  
360 WEST 31ST STREET  
NEW YORK, NY 10001

FOR: ELECTRONIC STORAGE OF CLINICAL, ADMINISTRATIVE AND FINANCIAL FILES AND DOCUMENTS FOR REMOTE CONSULTATION BY HEALTHCARE PROFESSIONALS IN THE OUTPATIENT, INPATIENT, LONG TERM CARE, HOME HEALTH CARE AND ASSISTED LIVING ENVIRONMENTS USING HANDHELD DEVICES, MOBILE PERSONAL COMPUTERS, OR STATIONARY PERSONAL COMPUTERS, IN CLASS 39 (U.S. CLS. 100 AND 105).

FIRST USE 11-2-2004; IN COMMERCE 11-2-2004.

FOR: PROVIDING ONLINE NON-DOWNLOADABLE SOFTWARE FOR USE BY HEALTHCARE

PROFESSIONALS IN THE OUTPATIENT, INPATIENT, LONG TERM CARE, HOME HEALTH CARE AND ASSISTED LIVING ENVIRONMENTS USING HANDHELD DEVICES, MOBILE PERSONAL COMPUTERS, OR STATIONARY PERSONAL COMPUTERS FOR USE IN ACCESSING MEDICAL REFERENCE MATERIALS, INTEGRATION OF DATA IN MEDICAL RECORDS, ELECTRONIC CHARTING, ORDERING AND PRESCRIBING, IN CLASS 42 (U.S. CLS. 100 AND 101).

FIRST USE 11-2-2004; IN COMMERCE 11-2-2004.

THE MARK CONSISTS OF STANDARD CHARACTERS WITHOUT CLAIM TO ANY PARTICULAR FONT, STYLE, SIZE, OR COLOR.

SER. NO. 78-719,743, FILED 9-23-2005.

SARA THOMAS, EXAMINING ATTORNEY

**Int. Cls.: 9 and 41**

**Prior U.S. Cls.: 21, 23, 26, 36, 38, 100, 101 and 107**

**United States Patent and Trademark Office**

**Reg. No. 3,505,306**

**Registered Sep. 23, 2008**

**TRADEMARK  
SERVICE MARK  
PRINCIPAL REGISTER**

**THE POWER OF TRUTH**

KING, GARY DOUGLAS (UNITED STATES INDIVIDUAL)  
10221 PARADISE BLVD.  
TREASURE ISLAND, FL 33706

FOR: PRERECORDED CD'S FEATURING EDUCATIONAL LECTURES IN THE FIELD OF MORAL ISSUES, IN CLASS 9 (U.S. CLS. 21, 23, 26, 36 AND 38).

FIRST USE 3-7-2002; IN COMMERCE 5-27-2003.

FOR: EDUCATIONAL SERVICES, NAMELY, PROVIDING LECTURE SEMINARS IN THE FIELD

OF MORAL ISSUES, IN CLASS 41 (U.S. CLS. 100, 101 AND 107).

FIRST USE 3-7-2002; IN COMMERCE 5-27-2003.

THE MARK CONSISTS OF STANDARD CHARACTERS WITHOUT CLAIM TO ANY PARTICULAR FONT, STYLE, SIZE, OR COLOR.

SER. NO. 78-721,898, FILED 9-27-2005.

JASON BLAIR, EXAMINING ATTORNEY

**Int. Cl.: 42**

**Prior U.S. Cls.: 100 and 101**

**United States Patent and Trademark Office**

**Reg. No. 3,505,307**

**Registered Sep. 23, 2008**

**SERVICE MARK  
PRINCIPAL REGISTER**

# PHASEDATA

PHASEDATA CORP (NEVADA CORPORATION)  
SUITE 4A  
711 SOUTH CARSON STREET  
CARSON CITY, NV 89701

FOR: COMPUTER SERVICE, NAMELY, ACTING AS AN APPLICATION SERVICE PROVIDER IN THE FIELD OF KNOWLEDGE MANAGEMENT TO HOST COMPUTER APPLICATION SOFTWARE FOR THE COLLECTION, EDITING, ORGANIZING, MODIFYING, BOOK MARKING, TRANSMISSION,

STORAGE AND SHARING OF DATA AND INFORMATION, IN CLASS 42 (U.S. CLS. 100 AND 101).

FIRST USE 2-3-2003; IN COMMERCE 2-3-2003.

THE MARK CONSISTS OF STANDARD CHARACTERS WITHOUT CLAIM TO ANY PARTICULAR FONT, STYLE, SIZE, OR COLOR.

SER. NO. 78-730,350, FILED 10-11-2005.

INGRID C. EULIN, EXAMINING ATTORNEY

**Int. Cl.: 7**

**Prior U.S. Cls.: 13, 19, 21, 23, 31, 34 and 35**

**United States Patent and Trademark Office**

**Reg. No. 3,505,308**

**Registered Sep. 23, 2008**

**TRADEMARK  
PRINCIPAL REGISTER**

**SUREFIRE**

PRECISION PLANTING, INC. (ILLINOIS CORPORATION)  
23207 TOWNLINE ROAD  
TREMONT, IL 61568

THE MARK CONSISTS OF STANDARD CHARACTERS WITHOUT CLAIM TO ANY PARTICULAR FONT, STYLE, SIZE, OR COLOR.

FOR: PARTS AND ACCESSORIES FOR AGRICULTURAL SEED PLANTING MACHINES, NAMELY, SEED BELTS, IN CLASS 7 (U.S. CLS. 13, 19, 21, 23, 31, 34 AND 35).

SER. NO. 78-742,550, FILED 10-28-2005.

FIRST USE 9-13-2005; IN COMMERCE 9-13-2005.

MIDGE BUTLER, EXAMINING ATTORNEY

**Int. Cl.: 41**

**Prior U.S. Cls.: 100, 101 and 107**

**United States Patent and Trademark Office**

**Reg. No. 3,505,309**

**Registered Sep. 23, 2008**

**SERVICE MARK  
PRINCIPAL REGISTER**

**POKER FACE**

GAME SHOW NETWORK, LLC (DELAWARE  
LIMITED LIABILITY COMPANY)  
2150 COLORADO AVENUE  
SANTA MONICA, CA 90404

THE MARK CONSISTS OF STANDARD CHAR-  
ACTERS WITHOUT CLAIM TO ANY PARTICULAR  
FONT, STYLE, SIZE, OR COLOR.

FOR: ENTERTAINMENT SERVICES, NAMELY,  
PROVIDING ON-LINE COMPUTER GAMES, IN  
CLASS 41 (U.S. CLS. 100, 101 AND 107).

SER. NO. 78-752,262, FILED 11-11-2005.

FIRST USE 2-27-2002; IN COMMERCE 2-27-2002.

STEVEN PEREZ, EXAMINING ATTORNEY

**Int. Cl.: 35**

**Prior U.S. Cls.: 100, 101 and 102**

**United States Patent and Trademark Office**

**Reg. No. 3,505,310**

**Registered Sep. 23, 2008**

**SERVICE MARK  
PRINCIPAL REGISTER**

**Student Achievement Review  
(StAR)**

HIGH PERFORMANCE EDUCATION GROUP  
(CONNECTICUT SOLE PROPRIETORSHIP)  
72 SHEFFIELD AVENUE  
NEW HAVEN, CT 06511

FOR: BUSINESS MANAGEMENT CONSULTANCY AS WELL AS DEVELOPMENT OF PROCESSES FOR THE ANALYSIS AND THE IMPLEMENTATION OF STRATEGY PLANS AND MANAGEMENT PROJECTS; EDUCATION LEADERSHIP DEVELOPMENT; PROFESSIONAL BUSINESS CONSULTATION, IN CLASS 35 (U.S. CLS. 100, 101 AND 102).

FIRST USE 2-3-2004; IN COMMERCE 2-3-2004.

THE MARK CONSISTS OF STANDARD CHARACTERS WITHOUT CLAIM TO ANY PARTICULAR FONT, STYLE, SIZE, OR COLOR.

NO CLAIM IS MADE TO THE EXCLUSIVE RIGHT TO USE "STUDENT ACHIEVEMENT REVIEW", APART FROM THE MARK AS SHOWN.

SER. NO. 78-760,910, FILED 11-25-2005.

DAVID COLLIER, EXAMINING ATTORNEY

**Int. Cl.: 33**

**Prior U.S. Cls.: 47 and 49**

**United States Patent and Trademark Office**

**Reg. No. 3,505,311**

**Registered Sep. 23, 2008**

**TRADEMARK  
PRINCIPAL REGISTER**

**FINSTA**

HOOVER DAM TECHNOLOGY GMBH (FED REP  
GERMANY GMBH)  
IN DEN ENGEMATTEN 16  
D- 79286 GLOTTERTAL, FED REP GERMANY

PRIORITY CLAIMED UNDER SEC. 44(D) ON  
ERPN CMNTY TM OFC APPLICATION NO.  
004605903, FILED 8-26-2005, REG. NO. 004605903,  
DATED 7-26-2006, EXPIRES 8-26-2015.

FOR: ALCOHOLIC BEVERAGES, NAMELY, DIS-  
TILLED SPIRITS, IN CLASS 33 (U.S. CLS. 47 AND 49).

SER. NO. 78-763,213, FILED 11-30-2005.

THE MARK CONSISTS OF STANDARD CHAR-  
ACTERS WITHOUT CLAIM TO ANY PARTICULAR  
FONT, STYLE, SIZE, OR COLOR.

SEAN CROWLEY, EXAMINING ATTORNEY

**Int. Cls.: 35 and 42**

**Prior U.S. Cls.: 100, 101 and 102**

**United States Patent and Trademark Office**

**Reg. No. 3,505,312**

**Registered Sep. 23, 2008**

**SERVICE MARK  
PRINCIPAL REGISTER**



KANTER INTERNATIONAL, LLC (DELAWARE  
LIMITED LIABILITY COMPANY)  
SUITE 1313  
325 CHESTNUT STREET  
PHILADELPHIA, PA 19106

FOR: ADVERTISING SERVICES, NAMELY, RESEARCHING, ANALYZING, AND CREATING CORPORATE AND BRAND IDENTITY FOR OTHERS; ADVERTISING SERVICES, NAMELY, CREATING CORPORATE COMMUNICATIONS, ADVERTISING, AND LOGOS FOR OTHERS; BUSINESS MANAGEMENT CONSULTING WITH RELATION TO STRATEGY, ORGANIZATIONAL DEVELOPMENT, LEADERSHIP DEVELOPMENT, MARKETING, PRODUCTION, PERSONNEL AND SALES AND DISTRIBUTION MATTERS; BUSINESS MARKETING CONSULTING SERVICES; BUSINESS CONSULTING, MANAGEMENT, PLANNING AND SUPERVISION; MARKET RESEARCH SERVICES, NAMELY, CONDUCTING BUSINESS AND MARKET RESEARCH SURVEYS; MARKET ANALYSIS; DEVELOPMENT OF MARKETING STRATEGIES AND CONCEPTS; BUSINESS MANAGEMENT CONSULTING DESIGNED TO INCREASE A CLIENT COMPANY'S KNOWLEDGE OF CUSTOMER NEEDS, AND OF ITS COMPETITORS' PRODUCTS AND SERVICES, PRICING, ADVERTISING STRATEGY AND SALES STRATEGY; PUBLIC RELATIONS, IN CLASS 35 (U.S. CLS. 100, 101 AND 102).

FIRST USE 10-0-2003; IN COMMERCE 10-0-2003.

FOR: DESIGN AND DEVELOPMENT OF MULTIMEDIA PRODUCTS FOR OTHERS IN THE FIELD

OF MARKETING; PRODUCT DEVELOPMENT CONSULTATION; COMPUTER SERVICES RELATING TO THE DESIGN OF WEB SITES, RENDERED TO ADVERTISING AND MARKETING CLIENTS; EXCLUDING ALL OF THE FORGOING SERVICES RENDERED TO COMPANIES IN THE FINANCIAL FIELD, IN CLASS 42 (U.S. CLS. 100 AND 101).

FIRST USE 10-0-2003; IN COMMERCE 10-0-2003.

NO CLAIM IS MADE TO THE EXCLUSIVE RIGHT TO USE "INTERNATIONAL", APART FROM THE MARK AS SHOWN.

THE COLORS BLACK, GRAY, CREAM AND GOLD IS/ARE CLAIMED AS A FEATURE OF THE MARK.

THE MARK CONSISTS OF A TRIANGLE CONTAINING GEOMETRIC PATTERNS IN THE COLORS, BLACK, GRAY, CREAM, AND GOLD. THE WORDING IS ENTIRELY IN BLACK.

THE MARK CONSISTS OF THE WORDS KANTER INTERNATIONAL ACCOMPANIED BY A TRIANGLE DESIGN WITH THE LETTER "K" INSIDE THE DESIGN.

SER. NO. 78-764,719, FILED 12-1-2005.

TARAH HARDY, EXAMINING ATTORNEY



**Int. Cl.: 37**

**Prior U.S. Cls.: 100, 103 and 106**

**United States Patent and Trademark Office**

**Reg. No. 3,505,313**

**Registered Sep. 23, 2008**

**SERVICE MARK  
PRINCIPAL REGISTER**

**ROSEN INTEGRITY COCKPIT**

ROSEN SWISS AG (SWITZERLAND CORPORATION)  
OBERE SPICHERMATT 14  
6370 STANS, SWITZERLAND

FOR: REPAIR SERVICES, NAMELY, REPAIR AND SERVICING OF PIPELINES AND PIPELINE CONDUITS AND TANKS, IN CLASS 37 (U.S. CLS. 100, 103 AND 106).

THE MARK CONSISTS OF STANDARD CHARACTERS WITHOUT CLAIM TO ANY PARTICULAR FONT, STYLE, SIZE, OR COLOR.

PRIORITY CLAIMED UNDER SEC. 44(D) ON SWITZERLAND APPLICATION NO. 54936/2005, FILED 6-15-2005, REG. NO. 535451, DATED 7-7-2005, EXPIRES 6-15-2015.

SER. NO. 78-772,986, FILED 12-14-2005.

TEJBIR SINGH, EXAMINING ATTORNEY

**Int. Cls.: 7 and 11**

**Prior U.S. Cls.: 13, 19, 21, 23, 31, 34 and 35**

**United States Patent and Trademark Office**

**Reg. No. 3,505,314**

**Registered Sep. 23, 2008**

**TRADEMARK  
PRINCIPAL REGISTER**

# Medic Care Rinse

LG ELECTRONICS INC. (REPUBLIC OF KOREA CORPORATION)  
20 YOIDO-DONG, YOUNGDUNGPO-KU  
SEOUL, REPUBLIC OF KOREA

FOR: ELECTRICALLY OPERATED BRUSHES BEING PARTS OF MACHINES; AUTOMATIC DISHWASHERS; ELECTRIC WASHING MACHINES FOR HOUSEHOLD USE; ELECTRIC VACUUM CLEANERS; ELECTRIC MULTI-PURPOSE STEAM CLEANERS; HANDHELD POWER DRIVEN GRINDERS; ROTARY COMPRESSORS FOR MACHINES, IN CLASS 7 (U.S. CLS. 13, 19, 21, 23, 31, 34 AND 35).

FOR: HUMIDIFIERS; ELECTRIC REFRIGERATORS; ELECTRIC REFRIGERATING SHOWCASES; AUTOCLAVES; ELECTRIC PRESSURE COOKERS; MICROWAVE OVENS FOR COOKING; ELECTRIC TOASTERS; WATER PURIFIERS FOR HOUSE-

HOLD PURPOSES; AIR CONDITIONERS; OVEN RANGES FOR KITCHEN USE, IN CLASS 11 (U.S. CLS. 13, 21, 23, 31 AND 34).

THE MARK CONSISTS OF STANDARD CHARACTERS WITHOUT CLAIM TO ANY PARTICULAR FONT, STYLE, SIZE, OR COLOR.

OWNER OF REPUBLIC OF KOREA REG. NO. 0733534, DATED 1-8-2008, EXPIRES 1-8-2018.

NO CLAIM IS MADE TO THE EXCLUSIVE RIGHT TO USE "RINSE", APART FROM THE MARK AS SHOWN.

SER. NO. 78-783,044, FILED 12-30-2005.

JOHN WILKE, EXAMINING ATTORNEY

**Int. Cl.: 9**

**Prior U.S. Cls.: 21, 23, 26, 36 and 38**

**Reg. No. 3,505,315**

**United States Patent and Trademark Office**

**Registered Sep. 23, 2008**

**TRADEMARK  
PRINCIPAL REGISTER**

**BEO**

BANG & OLUFSEN A/S (DENMARK PUBLIC LIMITED COMPANY (PLC))  
PETER BANGS VEJ 15 POSTBOKS 40  
7600 STRUER, DENMARK

FOR: REMOTE CONTROL UNITS FOR ELECTRIC AND ELECTRONIC APPARATUS AND APPLIANCES FOR ANALOGUE, DIGITAL OR OPTICAL RECEPTION, PROCESSING, REPRODUCTION, REGULATION OR DISTRIBUTION OF LIGHT, SOUND OR PICTURE SIGNALS; REMOTE CONTROL UNITS FOR TELEVISION SETS, RADIO RECEIVING SETS INCLUDING RADIOS FOR AUTOMOBILES; REMOTE CONTROL UNITS FOR AMPLIFIERS, LOUDSPEAKERS, LOUDSPEAKERS WITH BUILT IN AMPLIFIERS; REMOTE CONTROL UNITS FOR HOME-ENTERTAINMENT SYSTEMS; ELECTRONIC CONTROL UNITS FOR REGULATION OF SOUND, LIGHTS AND PICTURE SIGNALS; REMOTE CONTROL UNITS FOR TAPE-, RECORD- OR DISC- RECORDERS OR PLAYERS AND CARRIERS OF STORED SIGNALS; REMOTE CONTROL UNITS FOR TELEPHONES; REMOTE CONTROL UNITS FOR ANSWERING MACHINES; REMOTE CONTROL UNITS FOR TELECOMMUNI-

CATION EQUIPMENT; REMOTE CONTROL UNITS FOR ELECTRIC AND ELECTRONIC APPARATUS AND APPLIANCES FOR DATA PROCESSING AND FOR INPUT, OUTPUT AND STORAGE OF DATA; REMOTE CONTROL UNITS FOR COMPUTERS, MAGNETIC AND OPTICAL DATA CARRIERS, REMOTE CONTROL UNITS FOR WORD PROCESSING EQUIPMENT; SOFTWARE FOR OPERATING REMOTE CONTROL UNITS; PARTS FOR ALL THE AFOREMENTIONED GOODS INCLUDED IN THIS CLASS; SPARE PARTS FOR ALL THE AFOREMENTIONED GOODS INCLUDED IN THIS CLASS, IN CLASS 9 (U.S. CLS. 21, 23, 26, 36 AND 38).

THE MARK CONSISTS OF STANDARD CHARACTERS WITHOUT CLAIM TO ANY PARTICULAR FONT, STYLE, SIZE, OR COLOR.

OWNER OF ERPN CMNTY TM OFC REG. NO. 003458908, DATED 5-2-2008, EXPIRES 10-28-2013.

SER. NO. 78-785,672, FILED 1-5-2006.

HENRY S. ZAK, EXAMINING ATTORNEY

**Int. Cl.: 40**

**Prior U.S. Cls.: 100, 103 and 106**

**United States Patent and Trademark Office**

**Reg. No. 3,505,316**

**Registered Sep. 23, 2008**

**SERVICE MARK  
PRINCIPAL REGISTER**

**F@ntastic**

PRINCETON LABORATORY SERVICES, LLC  
(NEW JERSEY LIMITED LIABILITY COMPAN-  
NY)  
340 MAC LANE  
KEASBEY, NJ 08832

FOR: CUSTOM MANUFACTURE OF DENTAL  
PROSTHETICS, IN CLASS 40 (U.S. CLS. 100, 103 AND  
106).

FIRST USE 6-1-2005; IN COMMERCE 6-1-2005.

THE MARK CONSISTS OF STANDARD CHAR-  
ACTERS WITHOUT CLAIM TO ANY PARTICULAR  
FONT, STYLE, SIZE, OR COLOR.

SER. NO. 78-790,582, FILED 1-12-2006.

DOMINIC J. FERRAIUOLO, EXAMINING ATTOR-  
NEY

**Int. Cls.: 9 and 42**

**Prior U.S. Cls.: 21, 23, 26, 36, 38, 100 and 101**

**United States Patent and Trademark Office**

**Reg. No. 3,505,317**

**Registered Sep. 23, 2008**

**TRADEMARK  
SERVICE MARK  
PRINCIPAL REGISTER**

THE TOUGHER THE  
ENVIRONMENT, THE BETTER WE  
PERFORM

PSION TEKLOGIX INC. (CANADA CORPORATION)  
2100 MEADOWVALE BOULEVARD  
MISSISSAUGA, CANADA L5N 7J9

FOR: MOBILE COMPUTER HARDWARE AND ASSOCIATED SOFTWARE USED FOR RADIO FREQUENCY SUPPLY CHAIN, LOGISTICS, WAREHOUSING AND INVENTORY CONTROL, IN CLASS 9 (U.S. CLS. 21, 23, 26, 36 AND 38).

FOR: MOBILE COMPUTING AND WIRELESS DATA COLLECTION SERVICES USING PROPRIETARY HARDWARE AND SOFTWARE IN THE FIELDS OF RADIO FREQUENCY SUPPLY CHAIN,

LOGISTICS, WAREHOUSING AND INVENTORY CONTROL, IN CLASS 42 (U.S. CLS. 100 AND 101).

THE MARK CONSISTS OF STANDARD CHARACTERS WITHOUT CLAIM TO ANY PARTICULAR FONT, STYLE, SIZE, OR COLOR.

PRIORITY CLAIMED UNDER SEC. 44(D) ON CANADA APPLICATION NO. 1265574, FILED 7-20-2005, REG. NO. TMA706538, DATED 2-5-2008, EXPIRES 2-5-2023.

SER. NO. 78-792,341, FILED 1-16-2006.

ELLEN BURNS, EXAMINING ATTORNEY

**Int. Cls.: 9 and 28**

**Prior U.S. Cls.: 21, 22, 23, 26, 36, 38 and 50**

**United States Patent and Trademark Office**

**Reg. No. 3,505,318**

**Registered Sep. 23, 2008**

**TRADEMARK  
PRINCIPAL REGISTER**

# JoyGear

SUNPLUS TECHNOLOGY CO., LTD. (TAIWAN CORPORATION)  
SCIENCE-BASED INDUSTRIAL PARK  
19, INNOVATION ROAD 1  
HSIN-CHU, TAIWAN

FOR: COMPUTER CHIPS, SILICON CHIPS AND SEMI-CONDUCTOR CHIPS; COMPUTER AND VIDEO GAME SOFTWARE; VIDEO OUTPUT GAME MACHINES FOR USE WITH TELEVISIONS; VIDEO GAME MACHINES FOR USE WITH TELEVISIONS, IN CLASS 9 (U.S. CLS. 21, 23, 26, 36 AND 38).

FOR: STAND ALONE VIDEO GAME MACHINES, STAND ALONE VIDEO OUTPUT GAME MACHINES, IN CLASS 28 (U.S. CLS. 22, 23, 38 AND 50).

OWNER OF CHINA REG. NO. 01224852, DATED 8-16-2006, EXPIRES 8-15-2016.

SER. NO. 78-794,035, FILED 1-18-2006.

SETH A. RAPPAPORT, EXAMINING ATTORNEY

Int. Cl.: 30

Prior U.S. Cl.: 46

United States Patent and Trademark Office

Reg. No. 3,505,319

Registered Sep. 23, 2008

TRADEMARK  
PRINCIPAL REGISTER



TAMMIE COE CAKES, LLC (ARIZONA LIMITED LIABILITY COMPANY)  
4410 NORTH 40TH STREET  
PHOENIX, AZ 85018

FOR: CAKES; MUFFINS; PASTRIES; PIES, IN CLASS 30 (U.S. CL. 46).

FIRST USE 5-2-2002; IN COMMERCE 5-2-2002.

NO CLAIM IS MADE TO THE EXCLUSIVE RIGHT TO USE "CAKES FINE PASTRIES", APART FROM THE MARK AS SHOWN.

THE NAME "TAMMIE COE" IDENTIFIES A LIVING INDIVIDUAL WHOSE CONSENT IS OF RECORD.

THE COLOR(S) BLACK, BLUE, GREEN AND GOLD IS/ARE CLAIMED AS A FEATURE OF THE MARK.

THE MARK CONSISTS OF ABSTRACT ARTISTIC RENDERING OF A THREE TIER CAKE; TOP TIER IS GREEN; MIDDLE TIER IS BLUE; BOTTOM TIER IS GOLD. EACH TIER IS OUTLINED IN BLACK. UNDERNEATH ARE THE WORDS "TAMMIE COE CAKES". UNDER THOSE WORDS, A GOLD COLOR LINE AND UNDERNEATH THE LINE THE WORDS "FINE PASTRIES" IN BLACK.

SER. NO. 78-804,589, FILED 2-1-2006.

ANGELA M. MICHELI, EXAMINING ATTORNEY

**Int. Cls.: 6, 7, 8, 9, 12, 16, 20, 21, 22 and 25**

**Prior U.S. Cls.: 1, 2, 5, 7, 12, 13, 14, 19, 21, 22, 23, 25, 26, 28, 29, 30, 31, 32, 33, 34, 35, 36, 37, 38, 39, 40, 42, 44 and 50**

**Reg. No. 3,505,320**

**United States Patent and Trademark Office**

**Registered Sep. 23, 2008**

**TRADEMARK  
PRINCIPAL REGISTER**

**VERDI**

VERMOP SALMON GMBH (FED REP GERMANY CORPORATION)  
ZEPPELINSTRASSE 24  
GILCHING, FED REP GERMANY 82205

FOR: METAL FASTENING CLIPS FOR HAND-ACTUATED/HAND-OPERATED WIPING AND CLEANING APPARATUS, ALSO FOR BRUSHES AND SPONGES; METAL ARTICULATED JOINTS FOR TELESCOPIC POLES; METAL NON-ELECTRIC CONNECTION PLUG ADAPTERS FOR HANDLE EXTENSIONS; METAL HANDLES FOR TELESCOPIC POLES; STAINLESS STEEL TELESCOPIC TUBES, IN CLASS 6 (U.S. CLS. 2, 12, 13, 14, 23, 25 AND 50).

FOR: VACUUM CLEANERS AND PARTS THEREOF; VACUUM CLEANER ACCESSORIES, IN PARTICULAR, SUCTION NOZZLES AND SUCTION NOZZLE HOLDERS; VACUUM CLEANERS AND PARTS THEREOF AND VACUUM CLEANER ACCESSORIES, IN PARTICULAR, SUCTION NOZZLES AND SUCTION NOZZLE HOLDERS, ELECTRICAL CABLES, ELECTRICAL PLUGS, ELECTRIC SWITCHES, ALL SOLD AS A UNIT THEREWITH; VACUUM CLEANER DUSTBAGS, DUST FILTERS FOR MOTOR PROTECTION, AIR FILTERS FOR MOTOR PROTECTION, AND OIL FILTERS FOR MOTOR PROTECTION; FINE PARTICLE FILTERS, IN PARTICULAR FOR USE IN HOSPITALS, FLOOR NOZZLES WITH ROLLERS, FURNITURE BRUSHES, CREVICE NOZZLE TOOLS; VACUUM CLEANERS ACCESSORIES, NAMELY, ALUMINUM SHAFTS AS HANDLE EXTENSIONS AND NON-ELECTRIC CONNECTION PLUG ADAPTERS FOR HANDLE EXTENSIONS FOR HAND-OPERATED CLEANING APPARATUS, ALL FOR USE WITH ELECTRICALLY OPERATED CLEANING APPARATUS; METAL POLES, NAMELY, TELESCOPIC POLES AS HANDLE EXTENSIONS FOR ELECTRIC

WINDOW, WALL, CEILING AND FLOOR WIPERS, IN CLASS 7 (U.S. CLS. 13, 19, 21, 23, 31, 34 AND 35).

FOR: HAND TOOLS, NAMELY, STEEL SCRAPER BLADES FOR CLEANING SMOOTH SURFACES; HAND TOOLS, NAMELY, TRASH GRABBER DEVICE FOR PICKING UP PAPER; PERSONAL HAND RETRIEVAL DEVICE THAT ALLOWS AN INDIVIDUAL TO GRAB OR RETRIEVE ITEMS OUT OF NORMAL REACH; METAL POLES, IN PARTICULAR, TELESCOPIC POLES AND ALUMINUM SHAFTS AS HANDLE EXTENSIONS FOR HAND-OPERATED WINDOW, WALL, CEILING AND FLOOR WIPERS, IN CLASS 8 (U.S. CLS. 23, 28 AND 44).

FOR: ELECTRIC CABLES; ELECTRIC PLUGS; ELECTRIC SWITCHES; ELECTRONIC PUBLICATIONS, NAMELY, INSTRUCTIONAL, EDUCATIONAL AND TEACHING MATERIAL FEATURING EQUIPMENT AND PRODUCTS IN THE FIELD OF CLEANING SYSTEMS RECORDED ON CDROMS, CDS, DVDS, VIDEO FILMS AND OTHER ELECTRONIC OR OPTICAL CARRIERS, IN CLASS 9 (U.S. CLS. 21, 23, 26, 36 AND 38).

FOR: TRANSPORT, WORK, CLEANING, DISINFECTION, PAPER AND WASTE DISPOSAL TROLLEYS FOR CLEANING BUILDINGS AND WINDOWS, HOSPITALS, HOTELS AND OTHER PRIVATE OR INDUSTRIAL FACILITIES, AS WELL AS ESSENTIAL STRUCTURAL PARTS OF THE AFOREMENTIONED GOODS, IN CLASS 12 (U.S. CLS. 19, 21, 23, 31, 35 AND 44).

FOR: PRINTED MATTER, NAMELY, INSTRUCTIONAL AND TEACHING MATERIAL, BOOKS, BOOKLETS, PAMPHLETS, AND PRODUCT GUIDES IN THE FIELD OF CLEANING, INCLUD-



ING DIRECTIONS FOR USE OF CLEANING SYSTEMS; PRINTED INSTRUCTIONAL, EDUCATIONAL, AND TEACHING MATERIALS IN THE FIELD OF CLEANING SYSTEMS; WASTE SACKS OF PAPER; WASTE SACKS OF PLASTIC, IN CLASS 16 (U.S. CLS. 2, 5, 22, 23, 29, 37, 38 AND 50).

FOR: NON-METAL POLES, NAMELY, TELESCOPIC POLES AS HANDLE EXTENSIONS FOR ELECTRIC WINDOW, WALL, CEILING AND FLOOR WIPERS; NON-METAL FASTENING CLIPS FOR HAND-ACTUATED/HAND-OPERATED WIPING AND CLEANING APPARATUS/IMPLEMENTS, ALSO FOR BRUSHES AND SPONGES; NON-METAL POLES, IN PARTICULAR, TELESCOPIC POLES AS HANDLE EXTENSIONS FOR HAND-OPERATED WINDOW, WALL, CEILING AND FLOOR WIPERS; NON-METAL ARTICULATED JOINTS FOR TELESCOPIC POLES; NON-METAL NON-ELECTRIC CONNECTION PLUG ADAPTERS FOR HANDLE EXTENSIONS; NON-METAL HANDLES FOR TELESCOPIC POLES; BOAT HOOKS OF FIBERGLASS-REINFORCED PLASTIC MATERIAL, SOME WITH BRASS THREADS, IN CLASS 20 (U.S. CLS. 2, 13, 22, 25, 32 AND 50).

FOR: SMALL HAND-OPERATED HOUSEHOLD OR KITCHEN APPARATUS AND INSTRUMENTS, NAMELY, DUSTPANS, FEATHER AND FURNITURE DUSTERS; HOUSEHOLD OR KITCHEN CONTAINERS NOT OF PRECIOUS METAL OR COATED THEREWITH, IN PARTICULAR BUCKETS; EMPTY SPRAY BOTTLES OF PLASTIC OR METAL FOR CLEANING BUILDINGS AND WINDOWS; DISPENSERS FOR CLEANING, DETERGENT AND DISINFECTANT SOLUTIONS COMPRISED OF METAL AND/OR PLASTIC FOR USE WITH VACUUM CLEANING EQUIPMENT, NAMELY, AEROSOL DISPENSERS NOT FOR MEDICAL USE; PROPORTIONING CONTAINERS FOR MOISTENING MANUALLY OPERATED FLOOR CLEANING APPARATUS, NAMELY, DISPENSERS FOR WATER, CLEANING, POLISHING AND WAXING LIQUIDS OR DISINFECTANTS; FLOOR CLEANING APPARATUS ACCESSORIES, NAMELY, PROPORTIONING CONTAINERS FOR MOISTENING MANUALLY OPERATED FLOOR CLEANING APPARATUS, NAMELY, DISPENSERS FOR WATER, CLEANING, POLISHING AND WAXING LIQUIDS OR DISINFECTANTS; BROOMS, SCRUBBING BRUSHES, HAND BRUSHES, DISH-WASHING BRUSHES, FLOOR BRUSHES; TOILET BRUSH SETS CONSISTING OF BRUSHES AND STANDS; SHIP CLEANING BRUSHES AND MOPS; DUSTERS; RADIATOR CLEANING APPARATUS, NAMELY, FEATHER DUSTERS, BRUSHES, HAND-OPERATED MOPS WITH HANDLES FOR RADIATORS AND HEATING DEVICES; CLEANING CLOTHS; HAND-OPERATED WIPING AND CLEANING APPARATUS FOR WINDOWS, WALLS, CEILINGS AND FLOORS, IN PARTICULAR WINDOW, WALL, CEILING AND FLOOR CLEANERS IN THE NATURE OF A SQUEEGEE, MOP OR BRUSH, A COMBINATION SQUEEGEE AND SCRUBBER, A COMBINATION OF A SQUEEGEE AND MOP, A COMBINATION OF A SQUEEGEE AND SCRAPER, AND HOLDERS FOR WINDOW, WALL, CEILING

AND FLOOR CLEANER COVERS; WATER SQUEEGEES; WINDOW AND FLOOR SCRAPERS; WAXING APPARATUS, NAMELY, FLOOR, WALL, CEILING AND FURNITURE WAXING APPLICATORS WITH HANDLES OR MOUNTABLE ON A MOP HANDLE. WINDOW CLEANERS IN THE NATURE OF A COMBINATION SQUEEGEE AND SCRUBBER PARTS, NAMELY, REPLACEMENT RUNNERS AND SQUEEGEE BLADE RUBBERS; WINDOW, CEILING, WALL AND FLOOR CLEANERS IN THE NATURE OF A COMBINATION SQUEEGEE; WINDOW, CEILING, WALL AND FLOOR CLEANERS IN THE NATURE OF A SQUEEGEE OR MOP, AND CLEANER ACCESSORIES, NAMELY, CLEANER COVERS, ALL SOLD AS A UNIT; FLOOR, WALL, AND CEILING MOP PARTS, NAMELY, REPLACEMENT RUNNERS AND BLADE RUBBERS; WATER SQUEEGEES AND WINDOW FLOOR SCRAPERS; MICROFIBER CLEANING CLOTHS; MICROFIBER POLISHING CLOTHS; MOPS; FLOOR, WALL, CEILING AND WINDOW CLEANING BRUSHES; FLOOR, WALL, CEILING AND WINDOW CLEANING SPONGES; FLOOR, WALL, CEILING AND WINDOW CLEANERS IN THE NATURE OF A COMBINATION SQUEEGEE OR MOP, AND CLEANER ACCESSORIES, NAMELY, CASES WITH STRAPS FOR CLEANER PARTS AND ACCESSORIES, ALL SOLD AS A UNIT; HOLSTERS FOR HOLDING FLOOR, CEILING, WALL AND WINDOW CLEANING APPARATUS; WINDOW CLEANER ACCESSORIES, NAMELY, MOUNTS FOR CLEANING BRUSHES; MOP ACCESSORIES, NAMELY, MOUNTS FOR MOPS; BLADE HOLDERS PRIMARILY COMPRISED OF CORROSION-RESISTANT PLASTIC FOR STEEL BLADES FOR CLEANING GLASS AND SURFACES; ALL OF THE AFOREMENTIONED GOODS EXCLUDING DINNERWARE AND TABLEWARE; WIPING CLOTHS, NAMELY, CHAMOIS AND CHAMOIS FOR CLEANING PURPOSES; BELTS FOR HOLDING CLEANING EQUIPMENT; WATER FLOW-THROUGH POLES CONSISTING OF ALUMINUM POLES WITH BRASS OR PLASTIC CONNECTORS AS PARTS OF MOPS AND WINDOW, CEILING, WALL AND FLOOR CLEANERS IN THE NATURE OF A SQUEEGEE, MOP, WINDOW SCRAPER OR FLOOR SCRAPER, IN CLASS 21 (U.S. CLS. 2, 13, 23, 29, 30, 33, 40 AND 50).

FOR: LAUNDRY AND GARBAGE BAGS OF TEXTILE MATERIAL WITH AND WITHOUT CLOSING TAPES OR BANDS OF TEXTILE, RUBBER OR SYNTHETIC MATERIAL; ROPES, STRING, LAUNDRY NETS, TENTS, AWNINGS, TARPAULINS, SAILS, WASTE SACKS OF TEXTILE MATERIAL; PADDING AND STUFFING MATERIALS NOT OF RUBBER OR PLASTICS; RAW FIBROUS TEXTILE MATERIALS, IN CLASS 22 (U.S. CLS. 1, 2, 7, 19, 22, 42 AND 50).

FOR: WORK CLOTHES FOR CLEANING PERSONNEL, IN PARTICULAR WITH STRAPS, POCKETS, EYELETS OR OTHER FIXTURES FOR HOLDING CLEANING APPARATUS/IMPLEMENTS, NAMELY, WORKING OVERALLS, COVERALLS, JUMPSUITS, PANTS, JACKETS,

CLEANING JACKETS, GLOVES, HATS, AND APRONS, IN CLASS 25 (U.S. CLS. 22 AND 39).

THE MARK CONSISTS OF STANDARD CHARACTERS WITHOUT CLAIM TO ANY PARTICULAR FONT, STYLE, SIZE, OR COLOR.

PRIORITY CLAIMED UNDER SEC. 44(D) ON FED REP GERMANY APPLICATION NO. 30546452.3/2, FILED 8-3-2005, REG. NO. 30546452, DATED 1-30-2006, EXPIRES 8-31-2015.

SER. NO. 78-806,846, FILED 2-3-2006.

AMY MCMENAMIN, EXAMINING ATTORNEY

**Int. Cl.: 35**

**Prior U.S. Cls.: 100, 101 and 102**

**United States Patent and Trademark Office**

**Reg. No. 3,505,321**

**Registered Sep. 23, 2008**

**SERVICE MARK  
PRINCIPAL REGISTER**

# C3Research

C3RESEARCH LLC (FLORIDA CORPORATION)  
SUITE 270  
3452 LAKE LYNDA DR  
ORLANDO, FL 32817

FOR: MARKET RESEARCH; MARKET RESEARCH CONSULTATION; MARKET RESEARCH SERVICES; MARKET RESEARCH STUDIES; MARKET RESEARCH SURVEYS; NONE OF THE ABOVE INCLUDING CLINICAL DRUG TRIALS AND STUDIES; AND EXCLUDING BUSINESS PLANNING SERVICES, AND PROMOTING THE SALE OF THE GOODS AND SERVICES OF OTHERS THROUGH

THE DISTRIBUTION OF PRINTED MATERIAL AND/OR PROMOTIONAL CONTESTS, IN CLASS 35 (U.S. CLS. 100, 101 AND 102).

FIRST USE 3-17-2003; IN COMMERCE 5-14-2003.

THE MARK CONSISTS OF STANDARD CHARACTERS WITHOUT CLAIM TO ANY PARTICULAR FONT, STYLE, SIZE, OR COLOR.

SER. NO. 78-811,914, FILED 2-10-2006.

KRISTIN DAHLING, EXAMINING ATTORNEY

**Int. Cls.: 43 and 44**

**Prior U.S. Cls.: 100 and 101**

**United States Patent and Trademark Office**

**Reg. No. 3,505,322**

**Registered Sep. 23, 2008**

**SERVICE MARK  
PRINCIPAL REGISTER**

**RIVERSIDE TRANSITIONAL CARE**

CHRISTIANA CARE HEALTH SYSTEM, INC.  
(DELAWARE CORPORATION)  
501 WEST 14TH STREET  
WILMINGTON, DE 19801

FOR: ADULT DAYCARE SERVICES, IN CLASS 43  
(U.S. CLS. 100 AND 101).

FIRST USE 2-15-2006; IN COMMERCE 2-15-2006.

FOR: MEDICAL SERVICES, NAMELY, INFUSION SERVICES, NAMELY, THE DELIVERY OF INTRAVENOUS (IV) MEDICATIONS AND FLUIDS, BLOOD AND BLOOD PRODUCTS; MEDICAL IMAGING SERVICES; OCCUPATIONAL THERAPY SERVICES; THERAPY SERVICES, NAMELY, PHYSICAL THERAPY AND VITAMIN THERAPY; REHABILITATION SERVICES, NAMELY, PHYSICAL REHABILITATION AND REHABILITATION OF ALCOHOL, DRUG, AND NARCOTIC ADDICTED PATIENTS; AQUAKINETIC PHYSICAL REHABILITATION SERVICES; HEALTH CARE SERVICES, NAMELY, WELLNESS PROGRAMS; NURSING CARE SERVICES; PHYSICIAN CARE SERVICES; PODIATRIC SERVICES; WOMEN'S HEALTH SERVICES, NAMELY, OBSTETRIC AND GYNECOLOGY SERVICES; MEDICAL SERVICES, NAMELY, HEART CARE SERVICES; MEDICAL SERVICES,

NAMELY, CANCER CARE SERVICES IN THE FORM OF PREVENTION, SCREENING, DETECTION, AND SURVEILLANCE OF CANCER PATIENTS; PREVENTIVE MEDICAL SERVICES; COUNSELING SERVICES, NAMELY, MEDICAL COUNSELING, NUTRITION COUNSELING, AND PSYCHOLOGICAL COUNSELING; MANAGED HEALTH CARE SERVICES; HEALTH INFORMATION SERVICES; EXTENDED MEDICAL CARE SERVICES; MEDICAL AID SERVICES; RADIOLOGY SERVICES; SPEECH AND HEARING THERAPY SERVICES; AND WOUND CARE SERVICES, IN CLASS 44 (U.S. CLS. 100 AND 101).

FIRST USE 7-1-2005; IN COMMERCE 7-1-2005.

THE MARK CONSISTS OF STANDARD CHARACTERS WITHOUT CLAIM TO ANY PARTICULAR FONT, STYLE, SIZE, OR COLOR.

NO CLAIM IS MADE TO THE EXCLUSIVE RIGHT TO USE "TRANSITIONAL CARE", APART FROM THE MARK AS SHOWN.

SER. NO. 78-815,662, FILED 2-15-2006.

MICHELE SWAIN, EXAMINING ATTORNEY

Int. Cl.: 25

Prior U.S. Cls.: 22 and 39

United States Patent and Trademark Office

Reg. No. 3,505,323

Registered Sep. 23, 2008

TRADEMARK  
PRINCIPAL REGISTER

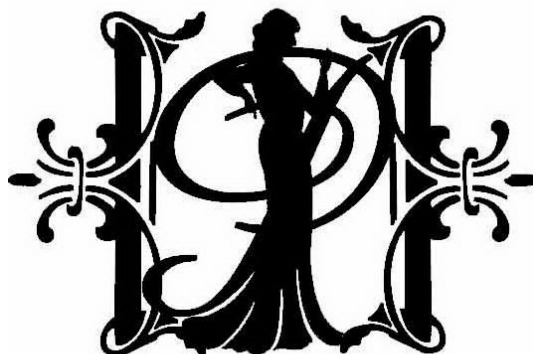

MARTIN, VANESSA D. (UNITED STATES INDIVIDUAL)

456 W. 148TH ST.

# 2A

NEW YORK, NY 10031 AND

PAMPOUR (UNITED STATES A DIVISION OF VM DESIGNS, LLC)

456 W. 148TH ST.

# 2A

NEW YORK, NY 10031 AND

VM DESIGNS, LLC (LOUISIANA LIMITED LIABILITY COMPANY)

456 W. 148TH ST.

# 2A

NEW YORK, NY 10031

FOR: BLAZERS; BLOUSES; BRAS; COATS FOR MEN AND WOMEN; DRESSING GOWNS; EVE-

NING GOWNS; GOWNS; LADIES' UNDERWEAR; LOUNGEWEAR; MEN AND WOMEN JACKETS, COATS, TROUSERS, VESTS; MEN'S SUITS, WOMEN'S SUITS; NIGHT GOWNS; NIGHT SHIRTS; PAJAMAS; ROBES; SCARVES; SHAWLS; SHAWLS AND STOLE; SILK SCARVES; SLEEPWEAR; THONGS; WEDDING GOWNS; WOMEN'S UNDERWEAR, IN CLASS 25 (U.S. CLS. 22 AND 39).

FIRST USE 2-15-2005; IN COMMERCE 3-28-2005.

THE MARK CONSISTS OF 2 SCROLLY BRACKETS WITH THE LETTER "P" IN THE MIDDLE AND A LADY'S SILHOUETTE BEHIND THE "P".

SER. NO. 78-823,452, FILED 2-25-2006.

NAKWAMA ANKRAH, EXAMINING ATTORNEY

**Int. Cl.: 41**

**Prior U.S. Cls.: 100, 101 and 107**

**Reg. No. 3,505,324**

**United States Patent and Trademark Office**

**Registered Sep. 23, 2008**

**SERVICE MARK  
PRINCIPAL REGISTER**

**NPG**

HM PUBLISHERS HOLDINGS LIMITED (UNITED KINGDOM LIMITED LIABILITY COMPANY)  
HOUNDMILLS  
BASINGSTOKE, ENGLAND RG21 6XS

FOR: EDUCATION SERVICES, NAMELY, PROVIDING SEMINARS AND WORKSHOPS IN THE FIELDS OF SCIENCE AND MEDICINE; PUBLISHING OF BOOKS, JOURNALS AND MAGAZINES IN THE FIELDS OF SCIENCE AND MEDICINE; ELECTRONIC PUBLISHING SERVICES, NAMELY, PUBLICATION OF TEXT AND GRAPHIC WORKS OF OTHERS ON CD, DVD AND ONLINE FEATURING INFORMATION IN THE FIELDS OF SCIENCE AND MEDICINE; ORGANIZING AND ARRANGING OF EDUCATIONAL CONFERENCES FOR A SCIENTI-

FIC AND ACADEMIC AUDIENCE, IN CLASS 41 (U.S. CLS. 100, 101 AND 107).

FIRST USE 1-0-2002; IN COMMERCE 1-0-2002.

THE MARK CONSISTS OF STANDARD CHARACTERS WITHOUT CLAIM TO ANY PARTICULAR FONT, STYLE, SIZE, OR COLOR.

PRIORITY CLAIMED UNDER SEC. 44(D) ON ERPNTY TM OFC APPLICATION NO. 004570214, FILED 9-2-2005.

SER. NO. 78-826,436, FILED 3-1-2006.

FLORENTINA BLANDU, EXAMINING ATTORNEY

**Int. Cl.: 41**

**Prior U.S. Cls.: 100, 101 and 107**

**United States Patent and Trademark Office**

**Reg. No. 3,505,325**

**Registered Sep. 23, 2008**

**SERVICE MARK  
PRINCIPAL REGISTER**

**SDSU**

SOUTH DAKOTA STATE UNIVERSITY (SOUTH  
DAKOTA EDUCATIONAL INSTITUTION)  
CMC 105, ROTUNDA LANE, BOX 2230  
BROOKINGS, SD 57007

FOR: EDUCATIONAL SERVICES IN A VARIETY  
OF FIELDS, NAMELY, PROVIDING CLASSES AND  
COURSES AT THE UNDERGRADUATE, GRADU-  
ATE, AND DOCTORAL LEVELS; PROVIDING A  
WEB SITE FEATURING INFORMATION ABOUT  
EDUCATION AT THE UNIVERSITY LEVEL AND  
ABOUT ENTERTAINMENT IN THE NATURE OF  
CULTURAL AND SOCIAL EVENTS WITHIN THE  
UNIVERSITY; AND ENTERTAINMENT SERVICES,  
NAMELY, ARRANGING AND CONDUCTING

ATHLETIC EVENTS AND COMPETITIONS, AS  
WELL AS LIVE PERFORMANCES BY A MARCH-  
ING BAND, IN CLASS 41 (U.S. CLS. 100, 101 AND  
107).

FIRST USE 0-0-1964; IN COMMERCE 0-0-1964.

THE MARK CONSISTS OF STANDARD CHAR-  
ACTERS WITHOUT CLAIM TO ANY PARTICULAR  
FONT, STYLE, SIZE, OR COLOR.

SER. NO. 78-829,937, FILED 3-6-2006.

PAUL F. GAST, EXAMINING ATTORNEY

**Int. Cl.: 3**

**Prior U.S. Cls.: 1, 4, 6, 50, 51 and 52**

**Reg. No. 3,505,326**

**United States Patent and Trademark Office**

**Registered Sep. 23, 2008**

**TRADEMARK  
PRINCIPAL REGISTER**



VELTEK ASSOCIATES, INC. (PENNSYLVANIA CORPORATION)  
15 LEE BOULEVARD  
MALVERN, PA 19355

FOR: A CRITICAL PROCESS CLEANER DESIGNED FOR CLEANING OF MEDICINAL PRODUCT CONTACT SURFACES, EQUIPMENT SURFACES, GLASSWARE, TANKS, FILL LINES, AND PHARMACEUTICAL AND BIOTECH MANUFACTURING OPERATIONS, IN CLASS 3 (U.S. CLS. 1, 4, 6, 50, 51 AND 52).

FIRST USE 1-0-2006; IN COMMERCE 1-0-2006.

NO CLAIM IS MADE TO THE EXCLUSIVE RIGHT TO USE "FOR CRITICAL CLEAN IN PLACE APPLICATIONS", APART FROM THE MARK AS SHOWN.

SER. NO. 78-834,027, FILED 3-10-2006.

KEVIN CORWIN, EXAMINING ATTORNEY



Int. Cl.: 35

Prior U.S. Cls.: 100, 101 and 102

United States Patent and Trademark Office

Reg. No. 3,505,327

Registered Sep. 23, 2008

SERVICE MARK  
PRINCIPAL REGISTER



TRISPORTS, INC. (ARIZONA CORPORATION)  
2555 N COYOTE DR, SUITE 111/112  
TUCSON, AZ 85745

FOR: ON-LINE RETAIL STORE SERVICES FEATURING ATHLETIC CLOTHING AND APPAREL, TRIATHLON MERCHANDISE IN THE NATURE OF SWIMMING, RUNNING, AND CYCLING EQUIPMENT, NUTRITIONAL SUPPLEMENTS, SPORTS FOOD AND BEVERAGES, POSTERS, BOOKS, AND VIDEO, IN CLASS 35 (U.S. CLS. 100, 101 AND 102).

FIRST USE 12-9-1999; IN COMMERCE 12-9-1999.

NO CLAIM IS MADE TO THE EXCLUSIVE RIGHT TO USE "SPORTS", APART FROM THE MARK AS SHOWN.

THE COLOR(S) RED, WHITE, AND BLUE IS/ARE CLAIMED AS A FEATURE OF THE MARK.

THE MARK CONSISTS OF THE WORD "TRISPORTS.COM" SURROUNDED BY AN OVAL BORDER. THREE CURVED LINES UNDERNEATH THE CHARACTERS "TRI". THE OVAL BORDER IS BLUE. THE CHARACTERS "TRI" AND ".COM" ARE BLUE. THE CHARACTERS "SPORTS" ARE RED. THE THREE CURVED LINES ARE RED.

SER. NO. 78-840,844, FILED 3-20-2006.

MICHAEL KEATING, EXAMINING ATTORNEY

Int. Cls.: 18 and 25

Prior U.S. Cls.: 1, 2, 3, 22, 39 and 41

United States Patent and Trademark Office

Reg. No. 3,505,328

Registered Sep. 23, 2008

TRADEMARK  
PRINCIPAL REGISTER



MODES CORWIK INC. (CANADA CORPORATION)  
SUITE 200  
225 CHABANEL STREET WEST  
MONTREAL, QUEBEC, CANADA H2N 2C9

FOR: HANDBAGS, IN CLASS 18 (U.S. CLS. 1, 2, 3, 22 AND 41).

FIRST USE 2-28-2002; IN COMMERCE 2-28-2002.

FOR: LADIES' APPAREL AND ACCESSORIES, NAMELY, SWEATERS, BLOUSES, JACKETS, PANTS, BLAZERS, SKIRTS, SHIRTS AND TURTLE-NECKS, IN CLASS 25 (U.S. CLS. 22 AND 39).

FIRST USE 2-28-2002; IN COMMERCE 2-28-2002.

PRIORITY CLAIMED UNDER SEC. 44(D) ON CANADA APPLICATION NO. 1290974, FILED 2-22-2006.

THE NAME "KATHERINE BARCLAY" DOES NOT IDENTIFY A PARTICULAR LIVING INDIVIDUAL.

SER. NO. 78-843,084, FILED 3-22-2006.

ARETHA SOMERVILLE, EXAMINING ATTORNEY

**Int. Cls.: 9 and 41**

**Prior U.S. Cls.: 21, 23, 26, 36, 38, 100, 101 and 107**

**Reg. No. 3,505,329**

**United States Patent and Trademark Office**

**Registered Sep. 23, 2008**

**TRADEMARK  
SERVICE MARK  
PRINCIPAL REGISTER**

# The Angels

DAVISON, PEGGY, SANTIGLIA (UNITED STATES INDIVIDUAL)  
3230 LITTLESTOWN PIKE  
WESTMINSTER, MD 21158 AND  
SIRICO, PHYLLIS (UNITED STATES INDIVIDUAL)  
347 KENILWORTH AVE  
SAN LEANDRO, CA 94577

FOR: A SERIES OF SOUND RECORDINGS FEATURING ROCK 'N' ROLL MUSICAL PERFORMANCES OF AN AMERICAN BASED GIRL GROUP, IN CLASS 9 (U.S. CLS. 21, 23, 26, 36 AND 38).

FIRST USE 1-1-1961; IN COMMERCE 1-1-1961.

FOR: ENTERTAINMENT IN THE NATURE OF LIVE ROCK 'N' ROLL MUSICAL PERFORMANCES BY AN AMERICAN BASED GIRL GROUP, IN CLASS 41 (U.S. CLS. 100, 101 AND 107).

FIRST USE 1-1-1961; IN COMMERCE 1-1-1961.

THE MARK CONSISTS OF STANDARD CHARACTERS WITHOUT CLAIM TO ANY PARTICULAR FONT, STYLE, SIZE, OR COLOR.

SER. NO. 78-844,072, FILED 3-23-2006.

JUSTINE D. PARKER, EXAMINING ATTORNEY

**Int. Cl.: 10**

**Prior U.S. Cls.: 26, 39 and 44**

**Reg. No. 3,505,330**

**United States Patent and Trademark Office**

**Registered Sep. 23, 2008**

---

**TRADEMARK  
PRINCIPAL REGISTER**

**Fassier-Duval Telescopic  
Intra-Medullary System**

DUJOVNE, ARIEL R. (CANADA INDIVIDUAL)  
1105 HWY CHOMEDEY  
LAVAL, CANADA H7W5J8

THE MARK CONSISTS OF STANDARD CHARACTERS WITHOUT CLAIM TO ANY PARTICULAR FONT, STYLE, SIZE, OR COLOR.

FOR: MEDICAL AND SURGICAL APPARATUS AND INSTRUMENTS, NAMELY, ORTHOPEDIC FIXATION DEVICES, IN THE FORM OF METAL RODS, USED IN ORTHOPEDIC TRANSPLANT AND ORTHOPEDIC IMPLANT SURGERY , IN CLASS 10 (U.S. CLS. 26, 39 AND 44).

NO CLAIM IS MADE TO THE EXCLUSIVE RIGHT TO USE "TELESCOPIC INTRA MEDULLARY SYSTEM", APART FROM THE MARK AS SHOWN.

FIRST USE 3-1-1999; IN COMMERCE 3-6-2000.

SER. NO. 78-848,696, FILED 3-29-2006.

ROBIN CHOSID, EXAMINING ATTORNEY

**Int. Cl.: 9**

**Prior U.S. Cls.: 21, 23, 26, 36 and 38**

**Reg. No. 3,505,331**

**United States Patent and Trademark Office**

**Registered Sep. 23, 2008**

**TRADEMARK  
PRINCIPAL REGISTER**

**ORA**

MOBILE AND WIRELESS GROUP LIMITED  
(UNITED KINGDOM LIMITED COMPANY)  
RUTHERFORD HOUSE  
MANCHESTER SCIENCE PARK  
MANCHESTER, UNITED KINGDOM M15 6GG

FOR: COMPUTER HARDWARE, PHOTO PRINTERS, LASER PRINTERS, INKJET PRINTERS, FAX MACHINES; DVD AND CD PLAYERS, DVD AND CD RECORDING APPARATUS; MOBILE TELEPHONES, SMART PHONES, CAMERA PHONES, TELEPHONES; PERSONAL ELECTRONIC ORGANIZERS; CAMERAS, DIGITAL CAMERAS; BLANK SECURE DIGITAL CARDS, FLASH MEMORY CARDS, USB FLASH DISKS, COMPUTER MEMORIES, MULTI MEDIA CARDS, ELECTRONIC NOTEBOOKS, LAPTOP AND HANDHELD COMPUTERS; ELECTRONIC PUBLICATIONS, NAMELY, DOWNLOADABLE INSTRUCTION MANUALS AND DOWNLOADABLE NEWSLETTERS IN THE FIELD OF MOBILE AND WIRELESS PRODUCTS AND ACCESSORIES; MP3 PLAYERS AND DIGITAL MUSIC PLAYERS; POCKET PCS; PALMTOP COMPUTERS; GPS APPARATUS, NAMELY, GPS SYSTEMS CONSISTING OF COMPUTERS, GPS SOFTWARE AND RELATED ELECTRONIC MAPS, TRANSMITTERS, RECEIVERS, NETWORK INTERFACE DEVICES, AND VEHICLE-MOUNTED GPS APPARATUS FOR DETERMINING THE RATE OF MOTION OF A VEHICLE; GPRS MODEMS, GPRS PROTOCOL RECEIVERS AND TRANSMITTERS, GPRS DATA CARDS, GPRS EXTERNAL ANTENNAE; KEYBOARDS FOR USE WITH COMPUTERS; MONITORS FOR USE WITH COMPUTERS; PROJECTORS FOR USE WITH COMPUTERS, NAMELY, MULTI-MEDIA PROJECTORS, PORTABLE PROJECTORS, WIRELESS PROJECTORS AND PDA/PROJECTOR INTERFACE CONNECTORS, AND THEIR ACCESSORIES; MICE, MODEMS, BATTERIES, POWER ADAPTORS, POWER SUPPLIES FOR USE WITH COMPUTERS AND TELECOMMUNICATIONS EQUIPMENT; ELECTRICAL CABLES

AND CONNECTORS, ANTENNAE, BARCODE READERS, IMAGE SCANNERS, DIGITAL PENS AND STYLI FOR USE WITH COMPUTERS AND COMMUNICATION DEVICES; GAME PADS; PRINT SERVERS, ROUTERS AND SWITCHES FOR USE IN COMPUTER NETWORKS; ETHERNET CARDS, FIBER OPTIC CARDS, PCMCIA CARDS, ETHERNET HUBS; WIRELESS NETWORK FINDERS, NAMELY, PORTABLE APPARATUS WHICH DETECTS WIFI NETWORKS; COMPUTER NETWORK CARDS FOR CONNECTING COMPUTER USERS TO WIFI NETWORKS; WIRELESS ACCESS POINTS, WIRELESS ANTENNAE, WIRELESS BRIDGES, WIRELESS PC CARDS, PERIPHERAL COMPONENT INTERFACE HARDWARE, NAMELY, WIRELESS PCI ADAPTORS; AMPLIFIERS, HEADPHONES; HANDS-FREE SETS, NAMELY, DEVICES FOR HANDS-FREE USE OF MOBILE PHONES; MICROPROCESSORS; VIDEO GAME CARTRIDGES; PHOTOCOPIERS; DISK DRIVES FOR USE WITH COMPUTERS, WRIST RESTS FOR USE WITH COMPUTERS; UNRECORDED FLOPPY DISCS, CDS AND DVDS; CALCULATORS; POCKET ELECTRONIC TRANSLATORS; COMPUTER GAMES APPARATUS, NAMELY, GAMING CONSOLES, PORTABLE GAMING DEVICES, NAMELY, HANDHELD GAMING CONSOLES AND COMPUTERS, GAMING ACCESSORIES SUCH AS JOYSTICKS, CARRYING CASES AND SCREEN PROTECTORS FOR PORTABLE GAMING DEVICES, EXTERNAL BATTERY PACKS, MEMORY MODULES, LED (LIGHT EMITTING DIODES) LIGHTS IN THE NATURE OF COMPUTER ACCESSORY TRAVEL LIGHTS FOR USE ONLY WITH COMPUTERS THROUGH A USB PORT, AND PORTABLE POWER SOLUTIONS, NAMELY, BATTERY PACKS, EXTERNAL BATTERY PACKS, ELECTRICAL POWER CONNECTORS, ELECTRICAL POWER DISTRIBUTION UNITS, AND BATTERY CHARGERS FOR CONSUMER ELECTRONIC GOODS FOR USE IN AUTOMOBILES; BAGS AND CASES ADAPTED FOR CARRYING ALL THE AFORESAID GOODS, IN CLASS 9 (U.S. CLS. 21, 23, 26, 36 AND 38).

THE MARK CONSISTS OF STANDARD CHARACTERS WITHOUT CLAIM TO ANY PARTICULAR FONT, STYLE, SIZE, OR COLOR.

PRIORITY CLAIMED UNDER SEC. 44(D) ON UNITED KINGDOM APPLICATION NO. 2408653, FILED 12-9-2005, REG. NO. 2408653, DATED 12-9-2005, EXPIRES 12-9-2015.

"ORA" APPEARING IN THE MARK HAS NO MEANING IN A FOREIGN LANGUAGE.

SER. NO. 78-849,244, FILED 3-29-2006.

ALLISON SCHRODY, EXAMINING ATTORNEY

**Int. Cls.: 3 and 16**

**Prior U.S. Cls.: 1, 2, 4, 5, 6, 22, 23, 29, 37, 38, 50, 51  
and 52**

**Reg. No. 3,505,332**

**United States Patent and Trademark Office**

**Registered Sep. 23, 2008**

**TRADEMARK  
PRINCIPAL REGISTER**

**TORKY**

SCA HYGIENE PRODUCTS AB (SWEDEN COR-  
PORATION)  
SE-405 03  
GOTEBORG, SWEDEN

FOR: ALL PURPOSE CLEANING, POLISHING,  
AND ABRASIVE COMPOUNDS; STAIN REMOV-  
ERS; BODY, SKIN, FACIAL AND HAND SOAP;  
CLEANING AND POLISHING PAPER , IN CLASS 3  
(U.S. CLS. 1, 4, 6, 50, 51 AND 52).

FOR: PAPER WASHCLOTHS IN ROLLS AND  
PREFORMED, IN CLASS 16 (U.S. CLS. 2, 5, 22, 23,  
29, 37, 38 AND 50).

THE MARK CONSISTS OF STANDARD CHAR-  
ACTERS WITHOUT CLAIM TO ANY PARTICULAR  
FONT, STYLE, SIZE, OR COLOR.

OWNER OF SWEDEN REG. NO. 159537, DATED 5-  
27-1977, EXPIRES 5-17-2017.

OWNER OF U.S. REG. NO. 2,320,389.

SER. NO. 78-851,242, FILED 3-31-2006.

HEATHER SAPP, EXAMINING ATTORNEY

**Int. Cl.: 25**

**Prior U.S. Cls.: 22 and 39**

**United States Patent and Trademark Office**

**Reg. No. 3,505,333**

**Registered Sep. 23, 2008**

**TRADEMARK  
PRINCIPAL REGISTER**



**UNIVERSITY OF  
NEW HAVEN**

UNIVERSITY OF NEW HAVEN (CONNECTICUT  
NON-PROFIT CORPORATION)  
300 BOSTON POST ROAD  
WEST HAVEN, CT 06516

FOR: CLOTHING, NAMELY, SWEATSHIRTS,  
SWEATPANTS, SHORTS, TANK TOPS, T-SHIRTS,  
POLO SHIRTS AND HEADWEAR, IN CLASS 25 (U.S.  
CLS. 22 AND 39).

FIRST USE 11-0-2002; IN COMMERCE 11-0-2002.

THE MARK CONSISTS OF THE STYLIZED LET-  
TERS "UNH" WITH AN ARC RUNNING THROUGH

THE LETTERS FROM THE BOTTOM LEFT TO THE  
CENTER RIGHT, POSITIONED ABOVE THE  
WORDS "UNIVERSITY OF", WHICH IN TURN  
ARE POSITIONED ABOVE THE WORDS "NEW  
HAVEN", ALL IN UPPERCASE LETTERS.

SEC. 2(F) AS TO "UNIVERSITY OF NEW HAVEN".

SER. NO. 78-852,701, FILED 4-3-2006.

KELLY BOULTON, EXAMINING ATTORNEY



**Int. Cl.: 41**

**Prior U.S. Cls.: 100, 101 and 107**

**United States Patent and Trademark Office**

**Reg. No. 3,505,334**

**Registered Sep. 23, 2008**

**SERVICE MARK  
PRINCIPAL REGISTER**



**UNIVERSITY OF  
NEW HAVEN**

UNIVERSITY OF NEW HAVEN (CONNECTICUT  
NON-PROFIT CORPORATION)  
300 BOSTON POST ROAD  
WEST HAVEN, CT 06516

FOR: EDUCATION SERVICES IN THE NATURE  
OF COURSES AT THE UNIVERSITY LEVEL, IN  
CLASS 41 (U.S. CLS. 100, 101 AND 107).

FIRST USE 11-0-2002; IN COMMERCE 11-0-2002.

THE MARK CONSISTS OF THE STYLIZED LET-  
TERS "UNH" WITH AN ARC RUNNING THROUGH

THE LETTERS FROM THE BOTTOM LEFT TO THE  
CENTER RIGHT, POSITIONED ABOVE THE  
WORDS "UNIVERSITY OF", WHICH IN TURN  
ARE POSITIONED ABOVE THE WORDS "NEW  
HAVEN", ALL IN UPPERCASE LETTERS.

SEC. 2(F).

SER. NO. 78-852,714, FILED 4-3-2006.

KELLY BOULTON, EXAMINING ATTORNEY

**Int. Cl.: 20**

**Prior U.S. Cls.: 2, 13, 22, 25, 32 and 50**

**United States Patent and Trademark Office**

**Reg. No. 3,505,335**

**Registered Sep. 23, 2008**

**TRADEMARK  
PRINCIPAL REGISTER**

**TUSCANA**

NIEN MADE ENTERPRISE CO., LTD. (TAIWAN  
CORPORATION)  
WUCHIUAN WEST ROAD  
19/F-1, NO. 236, SEC. 2  
TAICHUNG, TAIWAN 408, CHINA

FOR: WINDOW COVERINGS, NAMELY, ROMAN  
SHADES, ROLL-UP SHADES AND VENETIAN  
BLINDS HAVING FABRIC SLATS, IN CLASS 20  
(U.S. CLS. 2, 13, 22, 25, 32 AND 50).

FIRST USE 3-29-2006; IN COMMERCE 3-29-2006.

THE MARK CONSISTS OF STANDARD CHAR-  
ACTERS WITHOUT CLAIM TO ANY PARTICULAR  
FONT, STYLE, SIZE, OR COLOR.

SER. NO. 78-853,114, FILED 4-4-2006.

LYDIA BELZER, EXAMINING ATTORNEY

**Int. Cl.: 25**

**Prior U.S. Cls.: 22 and 39**

**United States Patent and Trademark Office**

**Reg. No. 3,505,336**

**Registered Sep. 23, 2008**

**TRADEMARK  
PRINCIPAL REGISTER**

**DISCIPL**

FI-FABRY INDUSTRIES, INC. (WISCONSIN  
CORPORATION)  
999 LOMBARDI AVENUE  
GREEN BAY, WI 54304

THE MARK CONSISTS OF STANDARD CHAR-  
ACTERS WITHOUT CLAIM TO ANY PARTICULAR  
FONT, STYLE, SIZE, OR COLOR.

FOR: CLOTHING, NAMELY, GLOVES, IN CLASS  
25 (U.S. CLS. 22 AND 39).

SER. NO. 78-856,359, FILED 4-7-2006.

FIRST USE 8-31-2004; IN COMMERCE 8-31-2004.

STEVEN PEREZ, EXAMINING ATTORNEY

**Int. Cls.: 25, 28 and 35**

**Prior U.S. Cls.: 22, 23, 38, 39, 50, 100, 101 and 102**

**Reg. No. 3,505,337**

**United States Patent and Trademark Office**

**Registered Sep. 23, 2008**

**TRADEMARK  
SERVICE MARK  
PRINCIPAL REGISTER**

**LAZY DOG**

LAZY DOG ISLAND OUTFITTERS AND OUT-  
DOOR ADVENTURE COMPANY, LLC (FLOR-  
IDA LIMITED LIABILITY COMPANY)  
BOX #7  
5114 OVERSEAS HIGHWAY  
KEY WEST, FL 33040

FOR: CLOTHING, NAMELY, SHIRTS, PANTS,  
SWEATERS, JACKETS, SWEATSHIRTS, SCARVES,  
BANDANAS, SOCKS, FOOTWEAR, UNDERGAR-  
MENTS, SWIMWEAR, BELTS, SHORTS, HEAD-  
WEAR-INCLUDING HATS, BERETS, CAPS AND  
VISORS, RAINWEAR, DRESSES, SLIPPERS, IN  
CLASS 25 (U.S. CLS. 22 AND 39).

FIRST USE 5-20-2003; IN COMMERCE 5-20-2003.

FOR: TOYS AND SPORTING GOODS, NAMELY,  
PLASTIC AND WOOLEN ITEMS FOR CHILDREN  
AND PETS, NAMELY, STUFFED ANIMALS AND  
CHARACTERS, FLYING DISCS; SURFBOARDS;  
SKATEBOARDS; WAKEBOARDS KITES; SNOW-

BOARDS; OARS; KAYAKS; AND PADDLES; PLAS-  
TIC WATERPROOF SPORTING GOODS CASES FOR  
STORAGE OF SMALL ITEMS SUITABLE FOR USE  
BY CHILDREN OR ATTACHED TO A DOG COL-  
LAR, IN CLASS 28 (U.S. CLS. 22, 23, 38 AND 50).

FIRST USE 5-9-2005; IN COMMERCE 5-9-2005.

FOR: RETAIL STORE FEATURING CLOTHING,  
LUGGAGE, TOYS, SPORTING GOODS, IN CLASS 35  
(U.S. CLS. 100, 101 AND 102).

FIRST USE 5-9-2005; IN COMMERCE 5-9-2005.

THE MARK CONSISTS OF STANDARD CHAR-  
ACTERS WITHOUT CLAIM TO ANY PARTICULAR  
FONT, STYLE, SIZE, OR COLOR.

SER. NO. 78-857,524, FILED 4-10-2006.

BRIAN NEVILLE, EXAMINING ATTORNEY

Int. Cl.: 10

Prior U.S. Cls.: 26, 39 and 44

United States Patent and Trademark Office

Reg. No. 3,505,338

Registered Sep. 23, 2008

TRADEMARK  
PRINCIPAL REGISTER

*Tsunami Wave*

ELECTRO-TECH PRODUCTS, INC. (CALIFORNIA CORPORATION)  
2001 E. GLADSTONE STREET #A  
GLENDDORA, CA 917405381

FOR: MEDICAL EQUIPMENT FOR USE IN CHIRO-  
PRACTIC, ACUPUNCTURE AND PHYSICAL  
THERAPY, NAMELY, AN APPARATUS THAT PRO-  
VIDES AN ELECTRIC STIMULUS AND USE ELEC-  
TRICAL SIGNALS FOR PAIN MANAGEMENT AND

NEUROMUSCULAR TREATMENT, IN CLASS 10  
(U.S. CLS. 26, 39 AND 44).

FIRST USE 11-1-2005; IN COMMERCE 11-1-2005.

SER. NO. 78-858,886, FILED 4-11-2006.

WILLIAM P. SHANAHAN, EXAMINING ATTOR-  
NEY

**Int. Cl.: 25**

**Prior U.S. Cls.: 22 and 39**

**United States Patent and Trademark Office**

**Reg. No. 3,505,339**

**Registered Sep. 23, 2008**

**TRADEMARK  
PRINCIPAL REGISTER**

**life unleashed**

GALLAGHER, KATHLEEN M. (UNITED STATES  
INDIVIDUAL)  
456 MARINERS DRIVE  
KEMAH, TX 77565

THE MARK CONSISTS OF STANDARD CHAR-  
ACTERS WITHOUT CLAIM TO ANY PARTICULAR  
FONT, STYLE, SIZE, OR COLOR.

FOR: CLOTHING, NAMELY, SKIRTS, SHIRTS,  
PANTS, SHORTS, FOOTWEAR, TIES, BELTS, HEAD-  
WEAR, SWEATERS, JACKETS, SWEATSHIRTS,  
SOCKS, IN CLASS 25 (U.S. CLS. 22 AND 39).

SER. NO. 78-859,059, FILED 4-11-2006.

FIRST USE 4-1-2006; IN COMMERCE 4-7-2006.

PRISCILLA MILTON, EXAMINING ATTORNEY

**Int. Cls.: 35 and 42**

**Prior U.S. Cls.: 100, 101 and 102**

**United States Patent and Trademark Office**

**Reg. No. 3,505,340**

**Registered Sep. 23, 2008**

**SERVICE MARK  
PRINCIPAL REGISTER**



AFS SOFTWARE, INC. (COLORADO CORPORATION)  
PO BOX 6185  
CAREFREE, AZ 85377

FOR: BUSINESS CONSULTING IN THE FIELD OF CUSTOMER SERVICE AND CUSTOMER RELATIONSHIP MANAGEMENT SERVICES FOR AUTOMOBILE DEALERSHIPS; BUSINESS MARKETING CONSULTING SERVICES FOR AUTOMOBILE DEALERSHIPS; COMPUTERIZED DATABASE MANAGEMENT, NAMELY ANALYSIS AND RETRIEVAL OF CLIENT DATABASES IN THE FIELD OF MODELING, SCORING AND ANALYTICS, AND CREATING REPORTS FROM SUCH DATABASES FOR AUTOMOBILE DEALERSHIPS; BUSINESS MARKETING SERVICES FOR AUTOMOBILE DEALERSHIPS, NAMELY, PRODUCING MARKETING AND SOLICITATION PROGRAMS AND MATERIALS, NAMELY, DIRECT MAIL SOLICITATIONS AND ELECTRONIC MAIL SOLICITATIONS AND TELEPHONE SOLICITATIONS, IN CLASS 35 (U.S. CLS. 100, 101 AND 102).

FIRST USE 2-10-2006; IN COMMERCE 2-10-2006.

FOR: PROVIDING AUTOMOBILE DEALERSHIPS WITH TEMPORARY USE OF ON-LINE NON-DOWNLOADABLE CUSTOMER RELATIONSHIP MANAGEMENT SOFTWARE (CRM) FOR COLLECTING AND ANALYZING SALES DATA AND CUSTOMER DEMOGRAPHICS AND CHARACTERISTICS, AND FOR PRODUCING MARKETING AND SOLICITATION PROGRAMS AND MATERIALS, NAMELY, DIRECT MAIL SOLICITATIONS AND ELECTRONIC MAIL SOLICITATIONS AND TELEPHONE SOLICITATIONS, IN CLASS 42 (U.S. CLS. 100 AND 101).

FIRST USE 2-10-2006; IN COMMERCE 2-10-2006.

NO CLAIM IS MADE TO THE EXCLUSIVE RIGHT TO USE "AUTOMOTIVE SALES TECHNOLOGY INTEGRATION", APART FROM THE MARK AS SHOWN.

SER. NO. 78-862,649, FILED 4-17-2006.

KELLY MCCOY, EXAMINING ATTORNEY

**Int. Cls.: 1 and 5**

**Prior U.S. Cls.: 1, 5, 6, 10, 18, 26, 44, 46, 51 and 52**

**Reg. No. 3,505,341**

**United States Patent and Trademark Office**

**Registered Sep. 23, 2008**

**TRADEMARK  
PRINCIPAL REGISTER**

**ACTIM**

OY MEDIX BIOCHEMICA AB (FINLAND JOINT STOCK COMPANY)  
ASEMATIE 13  
KAUNIAINEN, FINLAND 02700

FOR: REAGENT MEDIA FOR MEDICAL RESEARCH PURPOSES UTILIZING IMMUNOLOGICAL METHODS, NOT INCLUDING FOR USE IN HEMOSTASIS, IN CLASS 1 (U.S. CLS. 1, 5, 6, 10, 26 AND 46).

FOR: DIAGNOSTIC PREPARATIONS FOR MEDICAL USE UTILIZING IMMUNOLOGICAL METHODS AND REAGENT MEDIA FOR MEDICAL DIAGNOSTIC PURPOSES UTILIZING IMMUNOLOGICAL METHODS, NOT INCLUDING FOR USE IN HEMOSTASIS; MEDICAL DIAGNOSTIC TEST KITS UTILIZING IMMUNOLOGICAL METHODS FOR USE IN THE FIELD OF IMMUNOLOGY, ANESTHESIA, DERMATOLOGY, NEUROLOGY, OBSTETRICS, GYNECOLOGY, REPRODUCTIVE BIOLOGY, OPHTHALMOLOGY, ORTHOPEDIC SURGERY, OTOLOGY, LARYNGOLOGY, PATHOLOGY, PEDIATRICS, RADIOLOGY, RADIATION, ONCOLOGY AND SURGERY FOR PROFESSIONAL OR HOME USE COMPRISED OF TEST STRIPS CAPABLE OF VISUAL OR INSTRU-

MENT READ OUT OF TEST RESULTS, OPTIONALLY WITH COLLECTION PADS OR SWABS, COLLECTION LOOPS OR VIALS, OR OTHER SAMPLE COLLECTION TOOLS AND/OR VIALS OF DEVELOPER SOLUTION OR REAGENTS, WHICH USE ORAL FLUID, FINGER STICK OR VENIPUNCTURE WHOLE BLOOD, PLASMA, SERUM, AND OTHER BODILY FLUIDS AND SPECIMENS FOR USE IN DETECTING ANTIBODIES, ANTIGEN, VIRUSES, DISEASES, NUCLEIC ACIDS, PATHOGENS, PROTEINS, TOXINS AND CHEMICALS; THE AFOREMENTIONED NOT FOR USE IN HEMOSTASIS, IN CLASS 5 (U.S. CLS. 6, 18, 44, 46, 51 AND 52).

THE MARK CONSISTS OF STANDARD CHARACTERS WITHOUT CLAIM TO ANY PARTICULAR FONT, STYLE, SIZE, OR COLOR.

OWNER OF ERPN CMNTY TM OFC REG. NO. 000342568, DATED 12-24-2004, RENEWED AS REG. NO. 000342568, DATED 8-22-2006, EXPIRES 8-22-2016.

SER. NO. 78-862,836, FILED 4-17-2006.

EVELYN BRADLEY, EXAMINING ATTORNEY



**Int. Cl.: 16**

**Prior U.S. Cls.: 2, 5, 22, 23, 29, 37, 38 and 50**

**Reg. No. 3,505,342**

**United States Patent and Trademark Office**

**Registered Sep. 23, 2008**

**TRADEMARK  
PRINCIPAL REGISTER**

**SG**

COMMERCIAL OFFICE MACHINERY AND  
EQUIPMENT CORP. (NEVADA CORPORATION)  
SUITE 490-239  
1785 EAST SAHARA AVENUE  
LAS VEGAS, NV 89104

THE MARK CONSISTS OF STANDARD CHARACTERS WITHOUT CLAIM TO ANY PARTICULAR FONT, STYLE, SIZE, OR COLOR.

FOR: PAPER CUTTERS, IN CLASS 16 (U.S. CLS. 2, 5, 22, 23, 29, 37, 38 AND 50).

SER. NO. 78-866,334, FILED 4-20-2006.

FIRST USE 9-20-2004; IN COMMERCE 9-20-2004.

EDWARD FENNESSY, EXAMINING ATTORNEY

**Int. Cls.: 1, 2, 9, 10, 11, 17 and 24**

**Prior U.S. Cls.: 1, 5, 6, 10, 11, 12, 13, 16, 21, 23, 26, 31, 34, 35, 36, 38, 39, 42, 44, 46 and 50**

**Reg. No. 3,505,343**

**United States Patent and Trademark Office**

**Registered Sep. 23, 2008**

**TRADEMARK  
PRINCIPAL REGISTER**

**GENTEX**

GENTEX CORPORATION (DELAWARE CORPORATION)  
324 MAIN STREET  
CARBONDALE, PA 18407

FOR: SYNTHETIC RESINS FOR LASER AND RADIATION ABSORPTION, IN CLASS 1 (U.S. CLS. 1, 5, 6, 10, 26 AND 46).

FIRST USE 8-6-1997; IN COMMERCE 8-6-1997.

FOR: SYNTHETIC DYES, NAMELY, LASER AND RADIATION ABSORPTIVE DYES; LASER AND RADIATION ABSORPTIVE INKS, IN CLASS 2 (U.S. CLS. 6, 11 AND 16).

FIRST USE 8-6-1997; IN COMMERCE 8-6-1997.

FOR: PROTECTIVE HELMETS, NAMELY, BALLISTIC HELMETS AND AIRCREW HELMETS; ELECTROACOUSTIC AND ELECTROMECHANICAL CONNECTORS FOR AIRCREW HELMETS, TEST KITS FOR PERFORMING TESTS OF ELECTROACOUSTIC AND ELECTROMECHANICAL COMPONENTS OF AIRCREW HELMETS; CUSHION LINERS FOR PROTECTIVE HELMETS; PROTECTIVE VISORS FOR BALLISTIC PROTECTIVE HELMETS; TEXTILE BALLISTIC ARMOR, NAMELY, ARMORED VESTS, COVERALLS AND INDUSTRIAL SAFETY SUITS; SAFETY GOGGLES; LENS INSERTS FOR SAFETY GOGGLES; SOUND ATTENUATING EARPLUGS NOT FOR MEDICAL PURPOSES; CHEMICAL AND BIOLOGICALLY PROTECTIVE GARMENTS, IN CLASS 9 (U.S. CLS. 21, 23, 26, 36 AND 38).

FIRST USE 4-7-1953; IN COMMERCE 4-7-1953.

FOR: CHEMICAL AND BIOLOGICALLY PROTECTIVE CASUALTY ENCLOSURE SYSTEMS,

NAMELY, MEDICAL EVACUATION STRETCHERS, IN CLASS 10 (U.S. CLS. 26, 39 AND 44).

FIRST USE 1-15-1974; IN COMMERCE 1-15-1974.

FOR: FILTERS, NAMELY, CHEMICAL AND BIOLOGICALLY PROTECTIVE FILTERS FOR AIR FILTRATION, IN CLASS 11 (U.S. CLS. 13, 21, 23, 31 AND 34).

FIRST USE 10-31-1984; IN COMMERCE 10-31-1984.

FOR: PLASTIC SHEETS FOR GENERAL USE, IN CLASS 17 (U.S. CLS. 1, 5, 12, 13, 35 AND 50).

FIRST USE 3-28-2006; IN COMMERCE 3-28-2006.

FOR: CHEMICAL AND BIOLOGICALLY PROTECTIVE FABRICS FOR THE MANUFACTURE OF CHEMICAL AND BIOLOGICALLY PROTECTIVE GARMENTS; ALUMINIZED AND HEAT PROTECTIVE FABRICS FOR THE MANUFACTURE OF HEAT PROTECTIVE GARMENTS, IN CLASS 24 (U.S. CLS. 42 AND 50).

FIRST USE 1-15-1974; IN COMMERCE 1-15-1974.

THE MARK CONSISTS OF STANDARD CHARACTERS WITHOUT CLAIM TO ANY PARTICULAR FONT, STYLE, SIZE, OR COLOR.

OWNER OF U.S. REG. NOS. 606,758, 1,839,287 AND OTHERS.

SER. NO. 78-867,054, FILED 4-21-2006.

YONG KIM, EXAMINING ATTORNEY

**Int. Cl.: 41**

**Prior U.S. Cls.: 100, 101 and 107**

**United States Patent and Trademark Office**

**Reg. No. 3,505,344**

**Registered Sep. 23, 2008**

**SERVICE MARK  
PRINCIPAL REGISTER**

# NOCTURNAL

ROTELLA, PASQUALE (UNITED STATES INDIVIDUAL)  
SUITE 813  
11684 VENTURA BLVD.  
STUDIO CITY, CA 91604

FOR: ORGANIZING AND PROVIDING ENTERTAINMENT IN THE NATURE OF LIVE CONCERTS, DISC JOCKEY CONCERTS, MUSICAL AND ARTISTIC PERFORMANCES, CARNIVALS, CIRCUSES, NIGHTCLUBS, MUSICAL TOURS AND DANCE PARTIES, IN CLASS 41 (U.S. CLS. 100, 101 AND 107).

FIRST USE 9-6-1999; IN COMMERCE 9-6-1999.

THE MARK CONSISTS OF STANDARD CHARACTERS WITHOUT CLAIM TO ANY PARTICULAR FONT, STYLE, SIZE, OR COLOR.

SER. NO. 78-868,102, FILED 4-24-2006.

BRIAN NEVILLE, EXAMINING ATTORNEY

**Int. Cls.: 35 and 37**

**Prior U.S. Cls.: 100, 101, 102, 103 and 106**

**United States Patent and Trademark Office**

**Reg. No. 3,505,345**

**Registered Sep. 23, 2008**

---

**SERVICE MARK  
PRINCIPAL REGISTER**



COMPUTEK LLC (KANSAS LIMITED LIABILITY  
COMPANY)  
1701 N. 14TH AVE.  
DODGE CITY, KS 67801

FOR: RETAIL STORES FEATURING PERSONAL  
COMPUTERS AND PRINTERS, IN CLASS 35 (U.S.  
CLS. 100, 101 AND 102).

FIRST USE 2-1-2000; IN COMMERCE 6-1-2003.

FOR: INSTALLATION, MAINTENANCE AND  
REPAIR OF PERSONAL COMPUTERS AND PRIN-  
TERS, IN CLASS 37 (U.S. CLS. 100, 103 AND 106).

FIRST USE 2-1-2000; IN COMMERCE 6-1-2003.

SER. NO. 78-868,904, FILED 4-25-2006.

KATHERINE CONNOLLY, EXAMINING ATTOR-  
NEY

**Int. Cls.: 35 and 36**

**Prior U.S. Cls.: 100, 101 and 102**

**United States Patent and Trademark Office**

**Reg. No. 3,505,346**

**Registered Sep. 23, 2008**

**SERVICE MARK  
PRINCIPAL REGISTER**

**ROTH**

ROTH CAPITAL PARTNERS, LLC (CALIFORNIA  
LIMITED LIABILITY COMPANY)  
24 CORPORATE PLAZA  
NEWPORT BEACH, CA 92660

FOR: MERGERS AND ACQUISITIONS ADVISORY SERVICES, NAMELY, ACQUISITION AND MERGER CONSULTATION; MARKETING SERVICES, NAMELY, BUSINESS MARKETING SERVICES; CONFERENCES IN THE FIELD OF FINANCE, INVESTMENTS, BROKERAGE, BANKING, AND INSURANCE, NAMELY, ARRANGING AND CONDUCTING BUSINESS CONFERENCES, IN CLASS 35 (U.S. CLS. 100, 101 AND 102).

FIRST USE 1-15-1984; IN COMMERCE 1-15-1984.

FOR: FINANCIAL SERVICES, NAMELY, HELPING PUBLIC COMPANIES RAISE CAPITAL AND CREATE LIQUIDITY, SPECIFICALLY, CAPITAL INVESTMENT SERVICES; INVESTMENT BANKING SERVICES; TRADING SERVICES IN THE FIELD OF SECURITIES, FINANCE, AND INVEST-

MENTS, NAMELY, BROKERAGE OF SHARES AND OTHER SECURITIES; FINANCIAL ADVISORY SERVICES; FINANCIAL CONSULTING SERVICES; BANKING SERVICES; FINANCIAL AND INVESTMENT RESEARCH AND ANALYSIS SERVICES; MONEY MANAGEMENT SERVICES, NAMELY, INVESTMENT MANAGEMENT AND FINANCIAL MANAGEMENT; BROKERAGE SERVICES IN THE FIELD OF STOCKS, COMMODITIES, AND INSURANCE, IN CLASS 36 (U.S. CLS. 100, 101 AND 102).

FIRST USE 1-15-1984; IN COMMERCE 1-15-1984.

THE MARK CONSISTS OF STANDARD CHARACTERS WITHOUT CLAIM TO ANY PARTICULAR FONT, STYLE, SIZE, OR COLOR.

SEC. 2(F).

SER. NO. 78-870,635, FILED 4-26-2006.

JOHN DWYER, EXAMINING ATTORNEY

**Int. Cl.: 33**

**Prior U.S. Cls.: 47 and 49**

**United States Patent and Trademark Office**

**Reg. No. 3,505,347**

**Registered Sep. 23, 2008**

**TRADEMARK  
PRINCIPAL REGISTER**

**Pink Flamenco**

VINLOZANO IMPORTS INC. (MASSACHUSETTS  
CORPORATION)  
110 FRONT STREET  
WINCHENDON, MA 01475

THE MARK CONSISTS OF STANDARD CHAR-  
ACTERS WITHOUT CLAIM TO ANY PARTICULAR  
FONT, STYLE, SIZE, OR COLOR.

FOR: ALCOHOLIC BEVERAGES OF FRUIT, IN  
CLASS 33 (U.S. CLS. 47 AND 49).

SER. NO. 78-875,529, FILED 5-3-2006.

FIRST USE 10-15-2005; IN COMMERCE 4-14-2006.

ELLEN PERKINS, EXAMINING ATTORNEY

**Int. Cls.: 35, 36 and 38**

**Prior U.S. Cls.: 100, 101, 102 and 104**

**United States Patent and Trademark Office**

**Reg. No. 3,505,348**

**Registered Sep. 23, 2008**

**SERVICE MARK  
PRINCIPAL REGISTER**

# BID BUY & GO

CORPORATE ASSETS INC. (CANADA CORPORATION)  
2 ST. CLAIR AVENUE WEST, SUITE 1002  
TORONTO, ONTARIO, CANADA M4V 1L5

FOR: AUCTIONEERING SERVICES; AUCTIONEERING SERVICES VIA A GLOBAL COMPUTER NETWORK; PROVIDING A WEBSITE FEATURING AUCTIONS AND AUCTIONEERING SERVICES; INDUSTRIAL ASSET MANAGEMENT SERVICES, NAMELY, AUCTIONING, LIQUIDATING AND RE-MARKETING INDUSTRIAL ASSETS OF OTHERS, IN CLASS 35 (U.S. CLS. 100, 101 AND 102).

FOR: CORPORATE ASSET VALUATION SERVICES; BUSINESS ASSET LIQUIDATION SERVICES, IN CLASS 36 (U.S. CLS. 100, 101 AND 102).

FOR: AUCTION COMMUNICATIONS SERVICES, NAMELY, TRANSMITTING STREAMED SOUND AND AUDIO-VISUAL RECORDINGS VIA THE INTERNET, STREAMING OF AUCTION AUDIO MA-

TERIAL ON THE INTERNET, STREAMING OF AUCTION VIDEO MATERIAL ON THE INTERNET, IN CLASS 38 (U.S. CLS. 100, 101 AND 104).

THE MARK CONSISTS OF STANDARD CHARACTERS WITHOUT CLAIM TO ANY PARTICULAR FONT, STYLE, SIZE, OR COLOR.

PRIORITY CLAIMED UNDER SEC. 44(D) ON CANADA APPLICATION NO. 1299734, FILED 4-28-2006, REG. NO. TMA694700, DATED 8-24-2007, EXPIRES 8-24-2022.

NO CLAIM IS MADE TO THE EXCLUSIVE RIGHT TO USE "BID BUY", APART FROM THE MARK AS SHOWN.

SER. NO. 78-875,766, FILED 5-3-2006.

LOURDES AYALA, EXAMINING ATTORNEY

**Int. Cl.: 16**

**Prior U.S. Cls.: 2, 5, 22, 23, 29, 37, 38 and 50**

**Reg. No. 3,505,349**

**United States Patent and Trademark Office**

**Registered Sep. 23, 2008**

**TRADEMARK  
PRINCIPAL REGISTER**



HIGHLIGHTS FOR CHILDREN, INC. (DELA-  
WARE CORPORATION)  
1800 WATERMARK DRIVE  
COLUMBUS, OH 43215

THE MARK CONSISTS OF THE STYLIZED  
WORD "HIGHLIGHTS" IN A RHOMBOID.

FOR: CHILDREN'S MAGAZINES AND BOOKS,  
IN CLASS 16 (U.S. CLS. 2, 5, 22, 23, 29, 37, 38 AND 50).

SER. NO. 78-881,593, FILED 5-11-2006.

FIRST USE 5-1-2006; IN COMMERCE 5-1-2006.

NAAKWAMA ANKRAH, EXAMINING ATTORNEY



**Int. Cl.: 33**

**Prior U.S. Cls.: 47 and 49**

**United States Patent and Trademark Office**

**Reg. No. 3,505,350**

**Registered Sep. 23, 2008**

**TRADEMARK  
PRINCIPAL REGISTER**

**THE ROO BROTHERS**

VINOCEROS LIMITED (UNITED KINGDOM  
CORPORATION)  
1ST FLOOR, STANLEY WAY, CARDREW, RE-  
DRUTH  
CORNWALL, UNITED KINGDOM TR15 1SP

FOR: WINES, IN CLASS 33 (U.S. CLS. 47 AND 49).

THE MARK CONSISTS OF STANDARD CHAR-  
ACTERS WITHOUT CLAIM TO ANY PARTICULAR  
FONT, STYLE, SIZE, OR COLOR.

PRIORITY CLAIMED UNDER SEC. 44(D) ON  
ERPN CMNTY TM OFC APPLICATION NO.  
4968228, FILED 3-20-2006, REG. NO. 4968228, DATED  
2-22-2008, EXPIRES 3-20-2016.

SER. NO. 78-883,478, FILED 5-15-2006.

BRENDAN MCCAULEY, EXAMINING ATTORNEY

**Int. Cl.: 45**

**Prior U.S. Cls.: 100 and 101**

**United States Patent and Trademark Office**

**Reg. No. 3,505,351**

**Registered Sep. 23, 2008**

**SERVICE MARK  
PRINCIPAL REGISTER**

**CREDITCARDALARM**

ID ALARM, INC. (CANADA CORPORATION)  
ONE YONGE STREET, 18TH FLOOR  
TORONTO, CANADA M5E 1W7

FOR: IDENTITY THEFT PROTECTION SERVICES, NAMELY, CREDIT CARD THEFT AND CREDIT CARD FRAUD PREVENTION SERVICES IN THE NATURE OF PROVIDING NOTIFICATION OF POTENTIAL AND ACTUAL CREDIT CARD THEFT AND CREDIT CARD FRAUD AND PROVIDING NOTIFICATION OF THE BREACH OF CREDIT CARD HOLDERS' AND MERCHANTS' DATABASES, IN CLASS 45 (U.S. CLS. 100 AND 101).

FIRST USE 2-21-2006; IN COMMERCE 2-21-2006.

THE MARK CONSISTS OF STANDARD CHARACTERS WITHOUT CLAIM TO ANY PARTICULAR FONT, STYLE, SIZE, OR COLOR.

PRIORITY CLAIMED UNDER SEC. 44(D) ON CANADA APPLICATION NO. 1280598, FILED 11-23-2005, REG. NO. TMA693922, DATED 8-10-2007, EXPIRES 8-10-2022.

SER. NO. 78-888,042, FILED 5-19-2006.

KEVIN CORWIN, EXAMINING ATTORNEY

**Int. Cl.: 35**

**Prior U.S. Cls.: 100, 101 and 102**

**United States Patent and Trademark Office**

**Reg. No. 3,505,352**

**Registered Sep. 23, 2008**

**SERVICE MARK  
PRINCIPAL REGISTER**

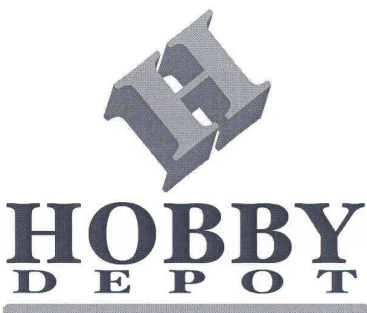

GENERAL SILICONES GROUP, INC. (CALIFORNIA CORPORATION)  
14140 LIVE OAK AVE., UNIT D  
BALDWIN PARK, CA 91706

FOR: IMPORT-EXPORT AGENCIES IN THE FIELD OF TOYS, PRODUCTS REGARDING HOBBIES, RADIO CONTROL CARS, RADIO CONTROL BOATS, RADIO CONTROL AIRPLANES AND PARTS AND ACCESSORIES THEREOF; COMMERCIAL INFORMATION AND DIRECTORY AGENCY IN THE FIELD OF TOYS, PRODUCTS REGARDING HOBBIES, RADIO CONTROL CARS, RADIO CONTROL BOATS, RADIO CONTROL AIRPLANES AND PARTS ACCESSORIES THEREOF; BUSINESS RESEARCH AND SURVEYS IN THE FIELD OF TOYS, PRODUCTS REGARDING HOBBIES, RADIO CONTROL CARS, RADIO CONTROL BOATS, RADIO CONTROL AIRPLANES AND PARTS ACCESSORIES THEREOF; BUSINESS INVESTIGATIONS IN THE FIELD OF TOYS, PRODUCTS REGARDING HOBBIES, RADIO CONTROL CARS, RADIO CONTROL BOATS, RADIO CONTROL AIRPLANES AND PARTS ACCESSORIES THEREOF; COST/PRICE ANALYSIS IN THE IN THE FIELD OF TOYS,

PRODUCTS REGARDING HOBBIES, RADIO CONTROL CARS, RADIO CONTROL BOATS, RADIO CONTROL AIRPLANES AND PARTS ACCESSORIES THEREOF; BUSINESS MANAGEMENT CONSULTATION IN THE FIELD OF TOYS, PRODUCTS REGARDING HOBBIES, RADIO CONTROL CARS, RADIO CONTROL BOATS, RADIO CONTROL AIRPLANES AND PARTS ACCESSORIES THEREOF; PRODUCT DEMONSTRATIONS IN THE FIELD OF TOYS, PRODUCTS REGARDING HOBBIES, RADIO CONTROL CARS, RADIO CONTROL BOATS, RADIO CONTROL AIRPLANES AND PARTS ACCESSORIES THEREOF, IN CLASS 35 (U.S. CLS. 100, 101 AND 102).

FIRST USE 5-6-2006; IN COMMERCE 5-6-2006.

NO CLAIM IS MADE TO THE EXCLUSIVE RIGHT TO USE "HOBBY", APART FROM THE MARK AS SHOWN.

SER. NO. 78-893,058, FILED 5-25-2006.

HEATHER SAPP, EXAMINING ATTORNEY

**Int. Cl.: 36**

**Prior U.S. Cls.: 100, 101 and 102**

**United States Patent and Trademark Office**

**Reg. No. 3,505,353**

**Registered Sep. 23, 2008**

**SERVICE MARK  
PRINCIPAL REGISTER**

**PMA PUBLIC FINANCE  
SPECIALISTS**

PRUDENT MAN ANALYSIS, INC. (ILLINOIS  
CORPORATION)  
27545 DIEHL ROAD, SUITE 100  
WARRENVILLE, IL 60555

FOR: INVESTMENT BROKERAGE, FINANCIAL  
AND INVESTMENT BANKING SERVICES, FINAN-  
CIAL AND INVESTMENT COUNSELING SERVI-  
CES, ALL OF THE FOREGOING FOR PUBLIC  
FINANCE, INSURANCE COOPERATIVE AND PEN-  
SION FUND CUSTOMERS AND SPECIFICALLY  
EXCLUDING SMALL BUSINESS CUSTOMERS  
AND RETAIL OR INDIVIDUAL CONSUMER CUS-  
TOMERS, IN CLASS 36 (U.S. CLS. 100, 101 AND 102).

FIRST USE 10-31-2002; IN COMMERCE 10-31-2002.

THE MARK CONSISTS OF STANDARD CHAR-  
ACTERS WITHOUT CLAIM TO ANY PARTICULAR  
FONT, STYLE, SIZE, OR COLOR.

NO CLAIM IS MADE TO THE EXCLUSIVE  
RIGHT TO USE "PUBLIC FINANCE SPECIALISTS",  
APART FROM THE MARK AS SHOWN.

SER. NO. 78-897,994, FILED 6-1-2006.

KEVON CHISOLM, EXAMINING ATTORNEY

**Int. Cls.: 6, 7 and 9**

**Prior U.S. Cls.: 2, 12, 13, 14, 19, 21, 23, 25, 26, 31, 34,  
35, 36, 38 and 50**

**Reg. No. 3,505,354**

**United States Patent and Trademark Office**

**Registered Sep. 23, 2008**

**TRADEMARK  
PRINCIPAL REGISTER**

**BIANCHI**

BIANCHI USA, INC. (OHIO CORPORATION)  
31336 INDUSTRIAL PARKWAY  
SUITES 3 & 4  
NORTH OLMS TED, OH 44070

FOR: KEY BLANKS MADE OF METAL OR METAL AND PLASTIC; AUTOMOTIVE KEY BLANKS MADE OF METAL OR METAL AND PLASTIC; METAL KEY FOBS; METAL KEY HOOKS, IN CLASS 6 (U.S. CLS. 2, 12, 13, 14, 23, 25 AND 50).

FIRST USE 2-1-2005; IN COMMERCE 2-1-2005.

FOR: KEY DUPLICATING MACHINES, KEY CUTTING MACHINES, CODE CUTTING KEY MACHINES, IN CLASS 7 (U.S. CLS. 13, 19, 21, 23, 31, 34 AND 35).

FIRST USE 2-24-2003; IN COMMERCE 2-24-2003.

FOR: AUTOMOTIVE TRANSPONDER KEY BLANKS, TRANSPONDER DETECTORS, TRANSPONDER CLONING MACHINES, COMPUTER SOFTWARE FOR DIAGNOSTIC AND CLONING TOOLS FOR KEY DUPLICATION, IN CLASS 9 (U.S. CLS. 21, 23, 26, 36 AND 38).

FIRST USE 9-9-2003; IN COMMERCE 9-9-2003.

THE MARK CONSISTS OF STANDARD CHARACTERS WITHOUT CLAIM TO ANY PARTICULAR FONT, STYLE, SIZE, OR COLOR.

THE ENGLISH TRANSLATION OF THE WORD "BIANCHI" IN THE MARK IS WHITES.

SER. NO. 78-898,463, FILED 6-1-2006.

KAELIE KUNG, EXAMINING ATTORNEY

**Int. Cls.: 6, 7 and 9**

**Prior U.S. Cls.: 2, 12, 13, 14, 19, 21, 23, 25, 26, 31, 34,  
35, 36, 38 and 50**

**Reg. No. 3,505,355**

**United States Patent and Trademark Office**

**Registered Sep. 23, 2008**

**TRADEMARK  
PRINCIPAL REGISTER**



BIANCHI USA, INC. (OHIO CORPORATION)  
31336 INDUSTRIAL PARKWAY  
SUITES 3 & 4  
NORTH OLMSTED, OH 44070

FOR: KEY BLANKS MADE OF METAL OR METAL AND PLASTIC; AUTOMOTIVE KEY BLANKS MADE OF METAL OR METAL AND PLASTIC; METAL KEY FOBS; METAL KEY HOOKS, IN CLASS 6 (U.S. CLS. 2, 12, 13, 14, 23, 25 AND 50).

FIRST USE 2-1-2005; IN COMMERCE 2-1-2005.

FOR: KEY DUPLICATING MACHINES, KEY CUTTING MACHINES, CODE CUTTING KEY MACHINES, IN CLASS 7 (U.S. CLS. 13, 19, 21, 23, 31, 34 AND 35).

FIRST USE 2-24-2003; IN COMMERCE 2-24-2003.

FOR: AUTOMOTIVE TRANSPONDER KEY BLANKS, TRANSPONDER DETECTORS, TRANSPONDER CLONING MACHINES, COMPUTER SOFTWARE FOR DIAGNOSTIC AND CLONING TOOLS FOR KEY DUPLICATION, IN CLASS 9 (U.S. CLS. 21, 23, 26, 36 AND 38).

FIRST USE 9-9-2003; IN COMMERCE 9-9-2003.

NO CLAIM IS MADE TO THE EXCLUSIVE RIGHT TO USE "SINCE 1770", APART FROM THE MARK AS SHOWN.

THE ENGLISH TRANSLATION OF THE WORD "BIANCHI" IN THE MARK IS WHITES.

SER. NO. 78-900,884, FILED 6-5-2006.

KAELIE KUNG, EXAMINING ATTORNEY

**Int. Cl.: 1**

**Prior U.S. Cls.: 1, 5, 6, 10, 26 and 46**

**United States Patent and Trademark Office**

**Reg. No. 3,505,356**

**Registered Sep. 23, 2008**

**TRADEMARK  
PRINCIPAL REGISTER**

**R-EARTH**

INTERNATIONAL COMPOSTING CORPORATION (CANADA CORPORATION)  
21-21 DALLAS ROAD  
VICTORIA, CANADA V8V 4Z9

FOR: COMPOST, FERTILIZER, PLANT FOOD, AND SOIL CONDITIONERS FOR DOMESTIC AND HORTICULTURAL USE, IN CLASS 1 (U.S. CLS. 1, 5, 6, 10, 26 AND 46).

THE MARK CONSISTS OF STANDARD CHARACTERS WITHOUT CLAIM TO ANY PARTICULAR FONT, STYLE, SIZE, OR COLOR.

PRIORITY CLAIMED UNDER SEC. 44(D) ON CANADA APPLICATION NO. 1282229, FILED 12-7-2005, REG. NO. TMA702301, DATED 12-4-2007, EXPIRES 12-4-2022.

SER. NO. 78-902,682, FILED 6-7-2006.

MICHELE SWAIN, EXAMINING ATTORNEY

**Int. Cl.: 35**

**Prior U.S. Cls.: 100, 101 and 102**

**United States Patent and Trademark Office**

**Reg. No. 3,505,357**

**Registered Sep. 23, 2008**

**SERVICE MARK  
PRINCIPAL REGISTER**

**GVLN PEACE LAND**

GVLN PEACE LAND INC. (NEW YORK CORPORATION)  
7TH FLOOR  
1230 AVENUE OF THE AMERICAS  
NEW YORK, NY 10020

THE MARK CONSISTS OF STANDARD CHARACTERS WITHOUT CLAIM TO ANY PARTICULAR FONT, STYLE, SIZE, OR COLOR.

FOR: BUSINESS SERVICES, NAMELY, BUSINESS CONSULTING AND ADVISORY SERVICES, IN CLASS 35 (U.S. CLS. 100, 101 AND 102).

SER. NO. 78-902,986, FILED 6-7-2006.

FIRST USE 9-1-2005; IN COMMERCE 9-1-2005.

LYDIA BELZER, EXAMINING ATTORNEY



**Int. Cl.: 35**

**Prior U.S. Cls.: 100, 101 and 102**

**United States Patent and Trademark Office**

**Reg. No. 3,505,358**

**Registered Sep. 23, 2008**

**SERVICE MARK  
PRINCIPAL REGISTER**

**BUILDING AND SECURING  
HUMAN CAPITAL**

GVLN PEACE LAND INC. (NEW YORK COR-  
PORATION)  
7TH FLOOR  
1230 AVENUE OF THE AMERICAS  
NEW YORK, NY 10020

THE MARK CONSISTS OF STANDARD CHAR-  
ACTERS WITHOUT CLAIM TO ANY PARTICULAR  
FONT, STYLE, SIZE, OR COLOR.

FOR: BUSINESS SERVICES, NAMELY, BUSINESS  
CONSULTING AND ADVISORY SERVICES, IN  
CLASS 35 (U.S. CLS. 100, 101 AND 102).

SER. NO. 78-902,991, FILED 6-7-2006.

FIRST USE 9-26-2005; IN COMMERCE 9-26-2005.

LYDIA BELZER, EXAMINING ATTORNEY

Int. Cl.: 35

Prior U.S. Cls.: 100, 101 and 102

United States Patent and Trademark Office

Reg. No. 3,505,359

Registered Sep. 23, 2008

**SERVICE MARK  
PRINCIPAL REGISTER**



PENG, ALEXANDER (UNITED STATES INDIVIDUAL)  
39120 ARGONAUT WAY, #577  
FREMONT, CA 94538

FOR: ADVERTISING AGENCIES; ADVERTISING AND ADVERTISEMENT SERVICES; ADVERTISING AND COMMERCIAL INFORMATION SERVICES, VIA THE INTERNET; ADVERTISING AND MARKETING; ADVERTISING AND PUBLICITY SERVICES, NAMELY, PROMOTING THE GOODS, SERVICES, BRAND IDENTITY AND COMMERCIAL INFORMATION AND NEWS OF THIRD PARTIES THROUGH PRINT, AUDIO, VIDEO, DIGITAL AND ON-LINE MEDIUM; ADVERTISING FLYER DISTRIBUTION; ADVERTISING VIA ELECTRONIC MEDIA AND SPECIFICALLY THE INTERNET; ON-LINE ADVERTISING ON COMPUTER COMMUNICATION NETWORKS; PROMOTING THE GOODS AND SERVICES OF OTHERS BY PREPARING AND PLACING ADVERTISEMENTS IN AN ELECTRONIC MAGAZINE ACCESSED THROUGH A GLOBAL COMPUTER NETWORK; PROVIDING A SEARCHABLE ONLINE ADVERTISING GUIDE

FEATURING THE GOODS AND SERVICES OF OTHER ONLINE VENDORS ON THE INTERNET; PROVIDING A WEB SITE WHICH FEATURES ADVERTISEMENTS FOR THE GOODS AND SERVICES OF OTHERS ON A GLOBAL COMPUTER NETWORK, IN CLASS 35 (U.S. CLS. 100, 101 AND 102).

FIRST USE 1-1-2004; IN COMMERCE 2-11-2006.

THE COLOR(S) YELLOW AND BLACK IS/ARE CLAIMED AS A FEATURE OF THE MARK.

THE COLOR BLACK APPEARS IN THE WORDING "YES", THE MAN AND THE WORDING "POI.COM". THE COLOR YELLOW APPEARS IN THE BUBBLE.

SER. NO. 78-905,865, FILED 6-12-2006.

LEIGH LOWRY, EXAMINING ATTORNEY

**Int. Cl.: 9**

**Prior U.S. Cls.: 21, 23, 26, 36 and 38**

**Reg. No. 3,505,360**

**United States Patent and Trademark Office**

**Registered Sep. 23, 2008**

**TRADEMARK  
PRINCIPAL REGISTER**

**ZSCANNER**

Z CORPORATION (MASSACHUSETTS CORPORATION)  
32 SECOND AVENUE  
BURLINGTON, MA 01803

THE MARK CONSISTS OF STANDARD CHARACTERS WITHOUT CLAIM TO ANY PARTICULAR FONT, STYLE, SIZE, OR COLOR.

FOR: HANDHELD SCANNERS USED TO SCAN 3D OBJECTS AND TO TRANSMIT THAT DATA TO RAPID PROTOTYPING SYSTEMS, COMPRISING A COMPUTER CONTROLLED APPARATUS, BASED ON INK-JET TECHNOLOGY, FOR THE PRODUCTION OF THREE-DIMENSIONAL MODELS, IN CLASS 9 (U.S. CLS. 21, 23, 26, 36 AND 38).

OWNER OF U.S. REG. NOS. 2,577,673, 2,813,900 AND OTHERS.

SER. NO. 78-907,778, FILED 6-14-2006.

FIRST USE 9-19-2006; IN COMMERCE 9-19-2006.

JOHN GARTNER, EXAMINING ATTORNEY

**Int. Cl.: 35**

**Prior U.S. Cls.: 100, 101 and 102**

**United States Patent and Trademark Office**

**Reg. No. 3,505,361**

**Registered Sep. 23, 2008**

**SERVICE MARK  
PRINCIPAL REGISTER**

**THE HOLMES PARTNERSHIP**

THE HOLMES PARTNERSHIP (DELAWARE  
CORPORATION)  
P.O. BOX 11697  
MILWAUKEE, WI 532110697

FOR: MANAGEMENT OF A CONSORTIUM OF  
INSTITUTIONS INTERESTED IN THE REFORM OF  
TEACHING AND LEARNING IN PUBLIC SCHOOLS  
AND HIGHER EDUCATION, IN CLASS 35 (U.S. CLS.  
100, 101 AND 102).

FIRST USE 7-2-1997; IN COMMERCE 7-2-1997.

THE MARK CONSISTS OF STANDARD CHAR-  
ACTERS WITHOUT CLAIM TO ANY PARTICULAR  
FONT, STYLE, SIZE, OR COLOR.

NO CLAIM IS MADE TO THE EXCLUSIVE  
RIGHT TO USE "PARTNERSHIP", APART FROM  
THE MARK AS SHOWN.

SEC. 2(F).

SER. NO. 78-912,085, FILED 6-20-2006.

WILLIAM ROSSMAN, EXAMINING ATTORNEY

**Int. Cl.: 35**

**Prior U.S. Cls.: 100, 101 and 102**

**United States Patent and Trademark Office**

**Reg. No. 3,505,362**

**Registered Sep. 23, 2008**

**SERVICE MARK  
PRINCIPAL REGISTER**



TELMETRICS INC. (CANADA CORPORATION)  
SUITE 900  
2680 SKYMARK AVENUE  
MISSISSAUGA, ONTARIO, CANADA L4W 5L6

FOR: MEASURING THE EFFECTIVENESS AND VALUE OF ADVERTISING MEDIA BY COUNTING THE NUMBER OF TELEPHONE CALLS PLACED BY THE PUBLIC IN RESPONSE TO A PARTICULAR ADVERTISEMENT, IN CLASS 35 (U.S. CLS. 100, 101 AND 102).

FIRST USE 6-30-2005; IN COMMERCE 6-30-2005.

PRIORITY CLAIMED UNDER SEC. 44(D) ON CANADA APPLICATION NO. 1284473, FILED 12-23-

2005, REG. NO. TMA696178, DATED 9-11-2007, EXPIRES 9-11-2022.

OWNER OF U.S. REG. NO. 2,974,762.

NO CLAIM IS MADE TO THE EXCLUSIVE RIGHT TO USE "TELEMETRICS", APART FROM THE MARK AS SHOWN.

THE MARK CONSISTS OF A SQUARE DESIGN WITH AN INSCRIPTION OF THE LETTERS "T", "E", AND "L". THE WORDING "METRICS" FOLLOWS ON THE RIGHT SIDE OF THE SQUARE.

SER. NO. 78-912,463, FILED 6-20-2006.

MARLENE BELL, EXAMINING ATTORNEY

**Int. Cl.: 30**

**Prior U.S. Cl.: 46**

**United States Patent and Trademark Office**

**Reg. No. 3,505,363**

**Registered Sep. 23, 2008**

**TRADEMARK  
PRINCIPAL REGISTER**

**PHÚ HƯƠNG**

ACECOOK VIETNAM COMPANY LIMITED  
(VIETNAM COMPANY)  
BLOCK II-3, RD. #11 TAN BINH INDUS. PARK  
TAY THANH WARD, TAN PHU DISTRICT  
HO CHI MINH CITY, VIETNAM

FOR: INSTANT NOODLES, INSTANT VERMI-  
CELLI, AND INSTANT RICE NOODLES, IN CLASS  
30 (U.S. CL. 46).

OWNER OF VIETNAM REG. NO. RN86829, DA-  
TED 8-21-2007, EXPIRES 3-2-2015.

THE MARK DOES NOT HAVE AN ENGLISH  
TRANSLATION.

SER. NO. 78-915,700, FILED 6-23-2006.

DAWN FELDMAN, EXAMINING ATTORNEY

**Int. Cls.: 1, 2, 3, 7 and 9**

**Prior U.S. Cls.: 1, 4, 5, 6, 10, 11, 13, 16, 19, 21, 23, 26, 31, 34, 35, 36, 38, 46, 50, 51 and 52**

**Reg. No. 3,505,364**

**United States Patent and Trademark Office**

**Registered Sep. 23, 2008**

**TRADEMARK  
PRINCIPAL REGISTER**

# FOILSTAR

HEIDELBERGER DRUCKMASCHINEN AG (FED  
REP GERMANY CORPORATION)  
KURFÜRSTEN-ANLAGE 52-60  
HEIDELBERG, FED REP GERMANY 69115

FOR: GLUE FOR USE IN THE GRAPHICS INDUSTRY; AND CONSUMABLES FOR THE GRAPHICS INDUSTRY, NAMELY, ADHESIVES, IN CLASS 1 (U.S. CLS. 1, 5, 6, 10, 26 AND 46).

FOR: CONSUMABLES FOR THE GRAPHICS INDUSTRY, NAMELY, PRINTING INKS, COATINGS AND PIGMENTS, AND POWDERS IN THE NATURE OF MINERAL-OIL OR ORGANIC SPRAY POWDERS APPLIED TO PRINTING MATERIALS FOR ASSISTING IN PREVENTION OF SMEARING, STICKING AND OFFSETTING OF INK TO ADJOINING PRINTING MATERIALS; AND FOILS, NAMELY, METALS IN FOIL FORM FOR PRINTERS, AND METALS ON BACKING SUBSTRATES IN FOIL FORM FOR PRINTERS, IN CLASS 2 (U.S. CLS. 6, 11 AND 16).

FOR: CLEANING DETERGENTS FOR USE IN THE GRAPHIC ARTS INDUSTRY IN THE NATURE OF MINERAL-OIL BASED CLEANING DETERGENTS, VEGETABLE-OIL BASED CLEANING DETERGENTS, AQUAOUS-SOLUTION-BASED CLEANING DETERGENTS AND DETERGENT SOAPS, IN CLASS 3 (U.S. CLS. 1, 4, 6, 50, 51 AND 52).

FOR: PRINTING MACHINES; AUXILIARY DEVICES FOR PRINTING MACHINES, NAMELY, SPOOLING DEVICES FOR FOIL WEBS, GUIDING DEVICES FOR FOIL WEBS, AND AUXILIARY

POWER UNITS FOR SUPPLYING ELECTRICAL POWER TO PRINTING MACHINES; MACHINES FOR FINISHING OF PRINTED PRODUCTS; PRINTING UNITS, NAMELY, OFFSET PRINTING MACHINES, AND PRINTING PRESSES; FOIL EMBOSSING MACHINES; FOIL STAMPING DEVICES, NAMELY, HOT FOIL STAMPING MACHINES, AND COLD FOIL STAMPING MACHINES; AND SPARE STRUCTURAL PARTS FOR SAID MACHINES AND DEVICES, IN CLASS 7 (U.S. CLS. 13, 19, 21, 23, 31, 34 AND 35).

FOR: ELECTRONIC CONTROL DEVICES FOR PRINTING MACHINES; ELECTRONIC CONTROL DEVICES FOR AUXILIARY DEVICES FOR PRINTING MACHINES; ELECTRONIC CONTROL DEVICES FOR MACHINES FOR FINISHING OF PRINTED PRODUCTS; ELECTRONIC CONTROL DEVICES FOR PRINTING UNITS; ELECTRONIC CONTROL DEVICES FOR FOIL EMBOSSING MACHINES; AND ELECTRONIC CONTROL DEVICES FOR FOIL STAMPING DEVICES, IN CLASS 9 (U.S. CLS. 21, 23, 26, 36 AND 38).

THE MARK CONSISTS OF STANDARD CHARACTERS WITHOUT CLAIM TO ANY PARTICULAR FONT, STYLE, SIZE, OR COLOR.

OWNER OF ERPN CMNTY TM OFC REG. NO. 005129391, DATED 1-4-2008, EXPIRES 6-12-2016.

SER. NO. 78-915,826, FILED 6-23-2006.

SARA THOMAS, EXAMINING ATTORNEY

**Int. Cl.: 9**

**Prior U.S. Cls.: 21, 23, 26, 36 and 38**

**Reg. No. 3,505,365**

**United States Patent and Trademark Office**

**Registered Sep. 23, 2008**

**TRADEMARK  
PRINCIPAL REGISTER**

**Miss Spider's Sunny Patch  
Friends**

CALLAWAY & KIRK COMPANY LLC (DELA-  
WARE LIMITED LIABILITY COMPANY)  
61 BOUNTY LANE  
JERICHO, NY 11753

FOR: DVDS FEATURING EDUCATIONAL AC-  
TIVITIES BASED ON CHILDREN'S STORIES; IN-  
TERACTIVE VIDEO GAME PROGRAMS; PRE-  
RECORDED CD'S, VIDEO TAPES, LASER DISKS  
AND DVD'S FEATURING CHILDREN'S STORIES  
AS AN INTEGRAL ELEMENT, IN CLASS 9 (U.S.  
CLS. 21, 23, 26, 36 AND 38).

FIRST USE 6-17-2006; IN COMMERCE 6-17-2006.

THE MARK CONSISTS OF STANDARD CHAR-  
ACTERS WITHOUT CLAIM TO ANY PARTICULAR  
FONT, STYLE, SIZE, OR COLOR.

OWNER OF U.S. REG. NOS. 2,041,646, 3,190,488  
AND OTHERS.

SER. NO. 78-916,304, FILED 6-25-2006.

ESTHER BELENKER, EXAMINING ATTORNEY



**Int. Cl.: 36**

**Prior U.S. Cls.: 100, 101 and 102**

**United States Patent and Trademark Office**

**Reg. No. 3,505,366**

**Registered Sep. 23, 2008**

**SERVICE MARK  
PRINCIPAL REGISTER**

**UMTB**

MIZRAHI TEFAHOT BANK LTD. (ISRAEL LIMITED COMPANY)  
7 JABOTINSKY STREET  
RAMAT-GAN, ISRAEL

FOR: BANKING, PRIVATE BANKING, INVESTMENT BANKING, MORTGAGE BANKING, FINANCIAL CONSULTANCY SERVICES; FINANCING SERVICES AND OTHER FINANCIAL AND MONETARY SERVICES AND AFFAIRS, NAMELY, FINANCIAL UNDERWRITING SERVICES IN THE FIELDS OF SECURITIES, GUARANTEE ASSURANCE, AND FINANCIAL ANNUITY UNDERWRITING, INSURANCE UNDERWRITING IN THE FIELD OF REINSURANCE UNDERWRITING, CREDIT CARD SERVICES, FINANCIAL CONSULTANCY AND BROKERAGE SERVICES IN THE FIELDS OF INSURANCE, REAL ESTATE, LOANS, MORTGAGES, MUTUAL FUNDS, CURRENCIES, INVESTMENTS, SHARES, COMMODITIES, STOCKS, BONDS, OPTIONS, FUTURES AND OTHER SECURITIES, PROVISION, ARRANGEMENT AND FINANCING OF LOANS, PROVISION,

PLANNING AND LENDING OF MORTGAGES, PROVISION AND ARRANGEMENT OF FINANCIAL GUARANTEES, INSURANCE SERVICES, NAMELY, INSURANCE AGENCY SERVICES, MANAGEMENT, ADMINISTRATION AND INFORMATION RELATING TO INSURANCE, INSURANCE SERVICES RELATING TO CREDIT AND CREDIT CARDS, IN CLASS 36 (U.S. CLS. 100, 101 AND 102).

THE MARK CONSISTS OF STANDARD CHARACTERS WITHOUT CLAIM TO ANY PARTICULAR FONT, STYLE, SIZE, OR COLOR.

PRIORITY CLAIMED UNDER SEC. 44(D) ON ISRAEL APPLICATION NO. 189659, FILED 4-25-2006, REG. NO. 189659, DATED 10-14-2007, EXPIRES 4-25-2016.

SER. NO. 78-920,961, FILED 6-30-2006.

TARAH HARDY, EXAMINING ATTORNEY

**Int. Cl.: 36**

**Prior U.S. Cls.: 100, 101 and 102**

**United States Patent and Trademark Office**

**Reg. No. 3,505,367**

**Registered Sep. 23, 2008**

**SERVICE MARK  
PRINCIPAL REGISTER**

**MIZRAHI TEFAHOT**

MIZRAHI TEFAHOT BANK LTD. (ISRAEL LIMITED COMPANY)  
7 JABOTINSKY STREET  
RAMAT-GAN, ISRAEL

FOR: BANKING, PRIVATE BANKING, INVESTMENT BANKING, MORTGAGE BANKING, FINANCIAL CONSULTANCY SERVICES; FINANCING SERVICES AND OTHER FINANCIAL AND MONETARY SERVICES AND AFFAIRS, NAMELY, FINANCIAL UNDERWRITING SERVICES IN THE FIELDS OF SECURITIES, GUARANTEE ASSURANCE, AND FINANCIAL ANNUITY UNDERWRITING, INSURANCE UNDERWRITING IN THE FIELD OF REINSURANCE UNDERWRITING, CREDIT CARD SERVICES, FINANCIAL CONSULTANCY AND BROKERAGE SERVICES IN THE FIELDS OF INSURANCE, REAL ESTATE, LOANS, MORTGAGES, MUTUAL FUNDS, CURRENCIES, INVESTMENTS, SHARES, COMMODITIES, STOCKS, BONDS, OPTIONS, FUTURES AND OTHER SECURITIES, PROVISION, ARRANGEMENT AND FINANCING OF LOANS, PROVISION, PLANNING AND LENDING OF MORTGAGES, PROVISION AND ARRANGEMENT OF FINANCIAL GUARANTEES, INSURANCE SERVICES,

NAMELY, INSURANCE AGENCY SERVICES, MANAGEMENT, ADMINISTRATION AND INFORMATION RELATING TO INSURANCE, INSURANCE SERVICES RELATING TO CREDIT AND CREDIT CARDS, IN CLASS 36 (U.S. CLS. 100, 101 AND 102).

THE MARK CONSISTS OF STANDARD CHARACTERS WITHOUT CLAIM TO ANY PARTICULAR FONT, STYLE, SIZE, OR COLOR.

OWNER OF ISRAEL REG. NO. 189657, DATED 10-14-2007, EXPIRES 4-25-2016.

THE NAME(S), PORTRAIT(S), AND/OR SIGNATURE(S) SHOWN IN THE MARK DOES NOT IDENTIFY A PARTICULAR LIVING INDIVIDUAL.

THE FOREIGN WORDING IN THE MARK TRANSLATES INTO ENGLISH AS "EASTERN RAFTER".

SER. NO. 78-921,011, FILED 6-30-2006.

TARAH HARDY, EXAMINING ATTORNEY

**Int. Cl.: 9**

**Prior U.S. Cls.: 21, 23, 26, 36 and 38**

**United States Patent and Trademark Office**

**Reg. No. 3,505,368**

**Registered Sep. 23, 2008**

**TRADEMARK  
PRINCIPAL REGISTER**

**FRIENDLYWARE**

COMBOTS AG (FED REP GERMANY AG)  
AMALIENBADSTR. 41  
D-76227 KARLSRUHE, FED REP GERMANY

MESSAGING OR TELECOMMUNICATIONS SERVICE, IN CLASS 9 (U.S. CLS. 21, 23, 26, 36 AND 38).

FOR: SOFTWARE FOR USE IN INTERNET SERVICE ACCESS OR TELECOMMUNICATIONS SERVICE ACCESS IN THE FIELD OF INTERNET COMMUNICATION OR MESSAGING OR TELECOMMUNICATIONS SERVICE RECORDED ON STORAGE MEDIA; DOWNLOADABLE COMPUTER SOFTWARE USING TELECOMMUNICATION DEVICES FOR USE IN INTERNET SERVICE ACCESS OR TELECOMMUNICATIONS SERVICE ACCESS IN THE FIELD OF INTERNET COMMUNICATION OR

THE MARK CONSISTS OF STANDARD CHARACTERS WITHOUT CLAIM TO ANY PARTICULAR FONT, STYLE, SIZE, OR COLOR.

OWNER OF ERPN CMNTY TM OFC REG. NO. 005150172, DATED 7-7-2007, EXPIRES 6-21-2016.

SER. NO. 78-923,947, FILED 7-6-2006.

TARAH HARDY, EXAMINING ATTORNEY

**Int. Cl.: 42**

**Prior U.S. Cls.: 100 and 101**

**United States Patent and Trademark Office**

**Reg. No. 3,505,369**

**Registered Sep. 23, 2008**

**SERVICE MARK  
PRINCIPAL REGISTER**

GUARDIAN MORTGAGE DOCUMENTS, INC.  
(COLORADO CORPORATION)  
SUITE 200  
225 UNION BLVD.  
LAKEWOOD, CO 80228

FOR: TECHNOLOGY CONSULTING SERVICES  
IN THE FIELD OF COMPUTER TECHNOLOGY  
AND PREPARATION OF REAL ESTATE DOCU-  
MENTS, ALL FOR THE LENDING INDUSTRY , IN  
CLASS 42 (U.S. CLS. 100 AND 101).

FIRST USE 12-31-1997; IN COMMERCE 12-31-1997.

THE MARK CONSISTS OF STANDARD CHAR-  
ACTERS WITHOUT CLAIM TO ANY PARTICULAR  
FONT, STYLE, SIZE, OR COLOR.

SER. NO. 78-934,146, FILED 7-20-2006.

FRANK LATTUCA, EXAMINING ATTORNEY

**Int. Cl.: 41**

**Prior U.S. Cls.: 100, 101 and 107**

**United States Patent and Trademark Office**

**Reg. No. 3,505,370**

**Registered Sep. 23, 2008**

**SERVICE MARK  
PRINCIPAL REGISTER**

**ESSENCE OF CALIFORNIA**

GREENWOOD DAYLILY GARDENS, INC. (CALIFORNIA CORPORATION)  
8000 BALCOM CANYON ROAD  
SOMIS, CA 93066

FOR: ENTERTAINMENT SERVICES, NAMELY, CONDUCTING PARTIES, RECEPTIONS, AND SOCIAL EVENTS, IN CLASS 41 (U.S. CLS. 100, 101 AND 107).

FIRST USE 4-15-2006; IN COMMERCE 4-15-2006.

THE MARK CONSISTS OF STANDARD CHARACTERS WITHOUT CLAIM TO ANY PARTICULAR FONT, STYLE, SIZE, OR COLOR.

NO CLAIM IS MADE TO THE EXCLUSIVE RIGHT TO USE "CALIFORNIA", APART FROM THE MARK AS SHOWN.

SER. NO. 78-934,286, FILED 7-20-2006.

JENNIFER VASQUEZ, EXAMINING ATTORNEY

**Int. Cl.: 16**

**Prior U.S. Cls.: 2, 5, 22, 23, 29, 37, 38 and 50**

**Reg. No. 3,505,371**

**United States Patent and Trademark Office**

**Registered Sep. 23, 2008**

**TRADEMARK  
PRINCIPAL REGISTER**



SPOTLIGHT PTY. LTD. (AUSTRALIA LIMITED LIABILITY COMPANY)  
100 MARKET STREET  
SOUTH MELBOURNE, AUSTRALIA VIC 3205

FOR: PAPER, CARDBOARD AND GOODS MADE FROM THESE MATERIALS, NAMELY, CRAFT PAPER AND CARDBOARD, BOXES OF PAPER OR CARDBOARD, BADGES MADE OF PAPER OR CARDBOARD, CREPE PAPER, PARTY DECORATIONS OF PAPER, NAPKINS OF PAPER, GIFT WRAPPING PAPER, STICKERS, PAPER FOR USE IN SCRAP-BOOKING; PRINTED MATTER, NAMELY, CARTOON STRIPS, EMBROIDERY DESIGN PAPER PATTERNS, IRON-ON TRANSFERS AND RECIPE BOOKS; NEWSLETTERS, WORKBOOKS AND PRINTED INSTRUCTIONS IN THE FIELD OF CRAFT ACTIVITIES AND CRAFT PRODUCTS; BOOKS IN THE FIELD OF ART AND CRAFT ACTIVITIES FOR CHILDREN; MAGAZINES FEATURING ART AND CRAFT ACTIVITIES FOR CHILDREN AND CRAFT PRODUCTS; CATALOGS IN THE FIELD OF ORDERING ART AND CRAFT PRODUCTS; PHOTOGRAPHS; PRINTED INSTRUC-

TIONAL AND TEACHING MATERIAL, NAMELY, INSTRUCTION SHEETS AND MANUALS FOR ART AND CRAFT ACTIVITIES FOR CHILDREN; POSTERS; STATIONERY; ARTISTS' MATERIALS, NAMELY, PENS, PENCILS, PASTELS, ARTISTS' BRUSHES, ARTISTS' CANVAS, MODELING CLAY, GLUE PENS AND GLUE STICKS, STENCIL DRAWING AIDS; PAINT BRUSHES; AND ARTS AND CRAFT PAINT AND CLAY KITS, IN CLASS 16 (U.S. CLS. 2, 5, 22, 23, 29, 37, 38 AND 50).

PRIORITY CLAIMED UNDER SEC. 44(D) ON AUSTRALIA APPLICATION NO. 1115982, FILED 5-26-2006, REG. NO. 1115982, DATED 5-26-2006, EXPIRES 5-26-2016.

OWNER OF U.S. REG. NOS. 3,164,574, 3,352,338 AND OTHERS.

SER. NO. 78-944,759, FILED 8-3-2006.

BENJAMIN OKEKE, EXAMINING ATTORNEY

**Int. Cl.: 9**

**Prior U.S. Cls.: 21, 23, 26, 36 and 38**

**United States Patent and Trademark Office**

**Reg. No. 3,505,372**

**Registered Sep. 23, 2008**

**TRADEMARK  
PRINCIPAL REGISTER**

**Tipic**

TIPIC, INC. (NEW YORK CORPORATION)  
26TH FLOOR  
600 MADISON AVENUE  
NEW YORK, NY 10022

FOR: DOWNLOADABLE COMMUNICATIONS  
SOFTWARE FOR CONNECTING DIGITAL DEVI-  
CES THAT ALLOWS THE EXCHANGE OF TEXT,  
AUDIO, VIDEO AND FILES ACROSS WIRED AND  
WIRELESS NETWORKS, IN CLASS 9 (U.S. CLS. 21,  
23, 26, 36 AND 38).

FIRST USE 3-8-2001; IN COMMERCE 3-8-2001.

THE MARK CONSISTS OF STANDARD CHAR-  
ACTERS WITHOUT CLAIM TO ANY PARTICULAR  
FONT, STYLE, SIZE, OR COLOR.

SER. NO. 78-945,915, FILED 8-6-2006.

LINDA E. BLOHM, EXAMINING ATTORNEY

**Int. Cl.: 37**

**Prior U.S. Cls.: 100, 103 and 106**

**United States Patent and Trademark Office**

**Reg. No. 3,505,373**

**Registered Sep. 23, 2008**

**SERVICE MARK  
PRINCIPAL REGISTER**

**LEHIGH CONSTRUCTION SALES  
CO. INC.**

LEHIGH CONSTRUCTION SALES CO. INC.  
(PENNSYLVANIA CORPORATION)  
295 SCHOOLEY AVENUE  
EXETER, PA 18643

FOR: LEASING AND MAINTENANCE OF CON-  
STRUCTION EQUIPMENT, WASTE AND WASTE  
WATER TREATMENT EQUIPMENT AND ELEC-  
TRICAL POWER GENERATION AND DISTRIBU-  
TION EQUIPMENT , IN CLASS 37 (U.S. CLS. 100, 103  
AND 106).

FIRST USE 4-1-2000; IN COMMERCE 4-1-2000.

THE MARK CONSISTS OF STANDARD CHAR-  
ACTERS WITHOUT CLAIM TO ANY PARTICULAR  
FONT, STYLE, SIZE, OR COLOR.

NO CLAIM IS MADE TO THE EXCLUSIVE  
RIGHT TO USE "CONSTRUCTION SALES CO.  
INC.", APART FROM THE MARK AS SHOWN.

SEC. 2(F).

SER. NO. 78-946,513, FILED 8-7-2006.

JESSICA FATHY, EXAMINING ATTORNEY



Int. Cl.: 33

Prior U.S. Cls.: 47 and 49

United States Patent and Trademark Office

Reg. No. 3,505,374

Registered Sep. 23, 2008

TRADEMARK  
PRINCIPAL REGISTER

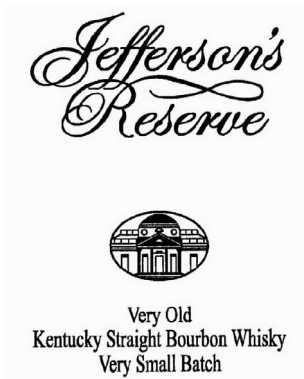

MCLAIN & KYNE DISTILLERY (KENTUCKY CORPORATION)  
227 S. 5TH ST.  
LOUISVILLE, KY 40202

FOR: VERY SMALL BATCH BOURBON WHISKY, IN CLASS 33 (U.S. CLS. 47 AND 49).

FIRST USE 4-30-1998; IN COMMERCE 4-30-1998.

OWNER OF U.S. REG. NO. 3,155,418.

NO CLAIM IS MADE TO THE EXCLUSIVE RIGHT TO USE "RESERVE" AND "VERY OLD KENTUCKY STRAIGHT BOURBON WHISKY

VERY SMALL BATCH", APART FROM THE MARK AS SHOWN.

THE MARK CONSISTS OF THE WORDS "JEFFERSON'S RESERVE" IN CURSIVE LETTERING. THESE WORDS SIT ABOVE AN OVAL THAT CONTAINS A DESIGN OF A BUILDING WITHIN. BELOW THE OVAL ARE THE WORDS "VERY OLD KENTUCKY STRAIGHT BOURBON WHISKY VERY SMALL BATCH.

SER. NO. 78-948,066, FILED 8-9-2006.

SETH A. RAPPAPORT, EXAMINING ATTORNEY

**Int. Cls.: 36 and 37**

**Prior U.S. Cls.: 100, 101, 102, 103 and 106**

**United States Patent and Trademark Office**

**Reg. No. 3,505,375**

**Registered Sep. 23, 2008**

**SERVICE MARK  
PRINCIPAL REGISTER**

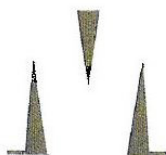

THE M3 COMPANIES, LLC (ARIZONA LIMITED  
LIABILITY COMPANY)  
110 E. GURLEY ST., STE. 200  
PRESCOTT, AZ 86301

FOR: REAL ESTATE BROKERAGE SERVICES  
FOR CUSTOM HOMES, PRODUCTION HOME  
AND CUSTOM HOME SITES, IN CLASS 36 (U.S.  
CLS. 100, 101 AND 102).

FIRST USE 6-0-2002; IN COMMERCE 6-0-2002.

FOR: REAL ESTATE DEVELOPMENT SERVICES,  
NAMELY, THE DEVELOPMENT OF MASTER  
PLANNED COMMUNITIES, PLANNING AND DE-

VELOPMENT OF RESIDENTIAL COMMUNITIES,  
INCLUDING HOUSES AND APARTMENTS; COM-  
MERCIAL PROPERTIES, INDUSTRIAL BUILD-  
INGS, OFFICE AND RETAIL SPACE, IN CLASS 37  
(U.S. CLS. 100, 103 AND 106).

FIRST USE 6-0-2002; IN COMMERCE 6-0-2002.

THE MARK CONSISTS OF GEOMETRIC FIG-  
URES FORMING THE LETTER M.

SER. NO. 78-949,258, FILED 8-10-2006.

JAY FLOWERS, EXAMINING ATTORNEY

**Int. Cl.: 9**

**Prior U.S. Cls.: 21, 23, 26, 36 and 38**

**United States Patent and Trademark Office**

**Reg. No. 3,505,376**

**Registered Sep. 23, 2008**

**TRADEMARK  
PRINCIPAL REGISTER**

**EAQUATIX**

MARINETIX, INC. (DELAWARE CORPORATION)  
1005 PEVETO ST.  
HOUSTON, TX 77019

FOR: AQUARIUM AUTOMATION AND ELECTRONIC MONITORING AND CONTROL EQUIPMENT FOR AUTOMATING, MONITORING, AND CONTROLLING THE ENVIRONMENT, INCLUDING THE TEMPERATURE, PH LEVELS, SALINITY LEVELS AND OTHER CLIMATIC ELEMENTS, IN CLASS 9 (U.S. CLS. 21, 23, 26, 36 AND 38).

FIRST USE 4-7-2006; IN COMMERCE 4-7-2006.

THE MARK CONSISTS OF STANDARD CHARACTERS WITHOUT CLAIM TO ANY PARTICULAR FONT, STYLE, SIZE, OR COLOR.

SER. NO. 78-949,294, FILED 8-10-2006.

JEAN IM, EXAMINING ATTORNEY

**Int. Cl.: 9**

**Prior U.S. Cls.: 21, 23, 26, 36 and 38**

**Reg. No. 3,505,377**

**United States Patent and Trademark Office**

**Registered Sep. 23, 2008**

---

**TRADEMARK  
PRINCIPAL REGISTER**

**WATER MARGIN**

ARISTOCRAT TECHNOLOGIES AUSTRALIA  
PTY LTD (AUSTRALIA CORPORATION)  
71 LONGUEVILLE ROAD  
LANE COVE, NSW, AUSTRALIA 2066

THE MARK CONSISTS OF STANDARD CHAR-  
ACTERS WITHOUT CLAIM TO ANY PARTICULAR  
FONT, STYLE, SIZE, OR COLOR.

FOR: GAMING MACHINES; COMPUTER HARD-  
WARE; ELECTRONIC GAME SOFTWARE; COMPU-  
TER SOFTWARE, NAMELY SOFTWARE FOR  
GAMING PURPOSES AND ONLINE GAMING;  
PARTS AND ACCESSORIES FOR GAMING MA-  
CHINES IN THIS CLASS, NAMELY ERASABLE  
PROGRAMMABLE READ-ONLY MEMORY  
(EPROM) CHIPS, IN CLASS 9 (U.S. CLS. 21, 23, 26,  
36 AND 38).

OWNER OF AUSTRALIA REG. NO. 1098356,  
DATED 2-10-2006, EXPIRES 2-10-2016.

SER. NO. 78-950,205, FILED 8-11-2006.

FRED MANDIR, EXAMINING ATTORNEY

**Int. Cl.: 41**

**Prior U.S. Cls.: 100, 101 and 107**

**United States Patent and Trademark Office**

**Reg. No. 3,505,378**

**Registered Sep. 23, 2008**

**SERVICE MARK  
PRINCIPAL REGISTER**

**COMEDY UNDERGROUND**

FOX, JON O. (UNITED STATES INDIVIDUAL)  
SUITE E  
28 CIRCLE DR.  
TIBURON, CA 94920

NO CLAIM IS MADE TO THE EXCLUSIVE  
RIGHT TO USE "COMEDY", APART FROM THE  
MARK AS SHOWN.

FOR: NIGHTCLUBS FEATURING COMEDIANS,  
IN CLASS 41 (U.S. CLS. 100, 101 AND 107).

SEC. 2(F).

FIRST USE 12-0-1981; IN COMMERCE 9-0-1982.

SER. NO. 78-951,453, FILED 8-14-2006.

THE MARK CONSISTS OF STANDARD CHAR-  
ACTERS WITHOUT CLAIM TO ANY PARTICULAR  
FONT, STYLE, SIZE, OR COLOR.

JOHN E. MICHOS, EXAMINING ATTORNEY

**Int. Cls.: 35 and 36**

**Prior U.S. Cls.: 100, 101 and 102**

**United States Patent and Trademark Office**

**Reg. No. 3,505,379**

**Registered Sep. 23, 2008**

**SERVICE MARK  
PRINCIPAL REGISTER**

[ LIVE in ART ]

HOWARD, GARY (UNITED STATES INDIVIDUAL)  
C/O BRENT T. WINDER (JONES WALDO)  
170 SOUTH MAIN STREET, SUITE 1500  
SALT LAKE CITY, UT 84101

FOR: REAL ESTATE MARKETING SERVICES ON BEHALF OF PROPERTY SELLERS OF COMMERCIAL AND RESIDENTIAL PROPERTIES, IN CLASS 35 (U.S. CLS. 100, 101 AND 102).

FIRST USE 6-1-2006; IN COMMERCE 6-1-2006.

FOR: REAL ESTATE AGENCY SERVICES FOR BUYERS AND SELLERS OF COMMERCIAL AND RESIDENTIAL PROPERTIES INCLUDING ACTING

AS AN AGENT FOR SELLERS AND BUYERS THROUGHOUT THE SELLING PROCESS, NEGOTIATING PRICE AND TERMS OF SALE, INFORMING POTENTIAL PURCHASERS REGARDING PROPERTIES AVAILABLE FOR SALE AND PROVIDING POTENTIAL PURCHASERS ACCESS TO PROPERTIES OF INTEREST, IN CLASS 36 (U.S. CLS. 100, 101 AND 102).

FIRST USE 6-1-2006; IN COMMERCE 6-1-2006.

SER. NO. 78-951,769, FILED 8-14-2006.

PAUL CROWLEY, EXAMINING ATTORNEY

**Int. Cl.: 36**

**Prior U.S. Cls.: 100, 101 and 102**

**United States Patent and Trademark Office**

**Reg. No. 3,505,380**

**Registered Sep. 23, 2008**

**SERVICE MARK  
PRINCIPAL REGISTER**

**A-Spire**

A-SPIRE FINANCIAL CORPORATION (OREGON CORPORATION)  
10200 SW GREENBURG RD., 7TH FLOOR  
PORTLAND, OR 97223

FOR: LEASING OF REAL ESTATE; REAL ESTATE ACQUISITION SERVICES; REAL ESTATE BROKERAGE; REAL ESTATE EQUITY SHARING, NAMELY, MANAGING AND ARRANGING FOR CO-OWNERSHIP OF REAL ESTATE; REAL ESTATE INVESTMENT; REAL ESTATE MANAGEMENT; REAL ESTATE PROCUREMENT FOR OTHERS, IN CLASS 36 (U.S. CLS. 100, 101 AND 102).

FIRST USE 1-17-2006; IN COMMERCE 1-17-2006.

THE MARK CONSISTS OF STANDARD CHARACTERS WITHOUT CLAIM TO ANY PARTICULAR FONT, STYLE, SIZE, OR COLOR.

SER. NO. 78-951,816, FILED 8-14-2006.

TANYA AMOS, EXAMINING ATTORNEY

Int. Cls.: 35 and 41

Prior U.S. Cls.: 100, 101, 102 and 107

United States Patent and Trademark Office

Reg. No. 3,505,381

Registered Sep. 23, 2008

SERVICE MARK  
PRINCIPAL REGISTER



ONECOACH, INC. (DELAWARE CORPORATION)  
512 VIA DE LA VALLE, SUITE 201  
SAN DIEGO, CA 92075

FOR: BUSINESS CLASSIFIED SERVICES, NAME-  
LY, PROVIDING AN ON-LINE SEARCHABLE DA-  
TABASE FEATURING CLASSIFIED AD LISTINGS  
AND EMPLOYMENT OPPORTUNITIES; MEMBER-  
SHIP CLUB SERVICES PROVIDING DISCOUNTS  
AND REBATES FOR THE GOODS AND SERVICES  
OF OTHERS; BUSINESS NETWORKING; NET-  
WORKING GROUPS IN THE NATURE OF GENERAL  
BUSINESS NETWORKING REFERRAL  
SERVICES, NAMELY, PROMOTING THE GOODS  
AND SERVICES OF OTHERS BY PASSING BUSI-  
NESS LEADS AND REFERRALS AMONG GROUP  
MEMBERS; BUSINESS HUMAN RESOURCE MAN-  
AGEMENT; APPOINTMENT SCHEDULING SERVI-  
CES; PROVIDING BUSINESS INFORMATION IN  
CONNECTION WITH CONSULTING AND ADVI-  
SORY SERVICES IN THE FIELD OF BUSINESS  
SCHEDULING AND PLANNING , IN CLASS 35  
(U.S. CLS. 100, 101 AND 102).

FIRST USE 7-17-2005; IN COMMERCE 7-17-2005.

FOR: EDUCATIONAL SERVICES, NAMELY,  
WORKSHOPS, LECTURES, DEMONSTRATIONS,  
COACHING, MENTORING, SEMINARS, CLASSES,  
COURSES, CONFERENCES, SPEECHES ALL IN  
THE FIELDS OF BUSINESS AND BUSINESS MAN-  
AGEMENT TECHNIQUES, ADVISORY TECHNI-  
QUES TO INCREASE REVENUES AND PROFITS  
FOR ENTREPRENEURS, FRANCHISEES, BUSINES-  
SES, SELF-EMPLOYED INDIVIDUALS AND PRO-  
FESSIONALS; PROVIDING NEWS AND  
INFORMATION IN THE NATURE OF CURRENT  
EVENTS AND SPORTS REPORTING, AND IN THE  
FIELD OF COMICS, IN CLASS 41 (U.S. CLS. 100, 101  
AND 107).

FIRST USE 7-17-2005; IN COMMERCE 7-17-2005.

THE MARK CONSISTS OF THE WORD "ONE" IN  
A CIRCLE ADJACENT TO THE WORD "COACH".

SER. NO. 78-953,397, FILED 8-16-2006.

WILLIAM P. SHANAHAN, EXAMINING ATTOR-  
NEY



**Int. Cl.: 16**

**Prior U.S. Cls.: 2, 5, 22, 23, 29, 37, 38 and 50**

**United States Patent and Trademark Office**

**Reg. No. 3,505,382**

**Registered Sep. 23, 2008**

**TRADEMARK  
PRINCIPAL REGISTER**

**BABYSEC**

CMPC TISSUE S.A. (CHILE CORPORATION)  
AGUSTINAS N 1343, PISO 6  
SANTIAGO, CHILE

OWNER OF CHILE REG. NO. 569007, DATED 5-30-  
2000, EXPIRES 5-30-2010.

FOR: PAPER DIAPERS FOR CHILDREN, IN  
CLASS 16 (U.S. CLS. 2, 5, 22, 23, 29, 37, 38 AND 50).

SER. NO. 78-954,259, FILED 8-17-2006.

THE MARK CONSISTS OF STANDARD CHAR-  
ACTERS WITHOUT CLAIM TO ANY PARTICULAR  
FONT, STYLE, SIZE, OR COLOR.

KATHERINE CHANG, EXAMINING ATTORNEY

**Int. Cl.: 9**

**Prior U.S. Cls.: 21, 23, 26, 36 and 38**

**Reg. No. 3,505,383**

**United States Patent and Trademark Office**

**Registered Sep. 23, 2008**

---

**TRADEMARK  
PRINCIPAL REGISTER**

# Bristol Home Central

BRISTOL TECHNOLOGIES, INC. (MONTANA CORPORATION)  
134 MORGAN CREEK LANE  
BOZEMAN, MT 59718

FOR: COMPUTER CABLES; COMPUTER HARDWARE; COMPUTER OPERATING SYSTEM SOFTWARE FOR HOME USE, IN CLASS 9 (U.S. CLS. 21, 23, 26, 36 AND 38).

FIRST USE 7-25-2006; IN COMMERCE 7-25-2006.

THE MARK CONSISTS OF STANDARD CHARACTERS WITHOUT CLAIM TO ANY PARTICULAR FONT, STYLE, SIZE, OR COLOR.

NO CLAIM IS MADE TO THE EXCLUSIVE RIGHT TO USE "HOME", APART FROM THE MARK AS SHOWN.

SER. NO. 78-954,553, FILED 8-17-2006.

SARA THOMAS, EXAMINING ATTORNEY

Int. Cl.: 28

Prior U.S. Cls.: 22, 23, 38 and 50

United States Patent and Trademark Office

Reg. No. 3,505,384

Registered Sep. 23, 2008

TRADEMARK  
PRINCIPAL REGISTER

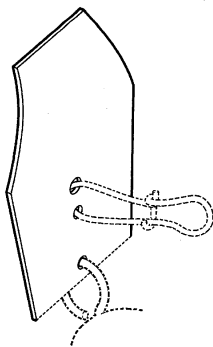

HOLDING ONE, INC. (SOUTH CAROLINA CORPORATION)  
4838 JENKINS AVENUE  
NORTH CHARLESTON, SC 29405

FOR: FISHING LURES, IN CLASS 28 (U.S. CLS. 22, 23, 38 AND 50).

FIRST USE 3-26-2004; IN COMMERCE 3-26-2004.

THE MARK CONSISTS OF A CONFIGURATION CONSISTING OF THE FIVE UNATTACHED SIDES OF A HEXAGONAL BLADE PORTION OF A FISHING LURE, WHEREIN THE SIXTH UNCLAIMED

SIDE OF THE HEXAGONAL BLADE IS CLOSEST TO THE CONNECTION POINT BETWEEN THE BLADE AND A JIG PORTION OF SAID FISHING LURE. THE ATTACHED HARDWARE AND THE LOWER EDGE OF THE HEXAGONAL BLADE, ALL SHOWN IN BROKEN LINES, ARE NOT CLAIMED AS PART OF THE MARK.

SEC. 2(F).

SER. NO. 78-955,597, FILED 8-18-2006.

DAVID ELTON, EXAMINING ATTORNEY

**Int. Cl.: 1**

**Prior U.S. Cls.: 1, 5, 6, 10, 26 and 46**

**United States Patent and Trademark Office**

**Reg. No. 3,505,385**

**Registered Sep. 23, 2008**

**TRADEMARK  
PRINCIPAL REGISTER**

**ENZO LIFE SCIENCES**

ENZO BIOCHEM, INC. (NEW YORK CORPORATION)  
9TH FLOOR  
527 MADISON AVENUE  
NEW YORK, NY 10022

FOR: HOUSE MARK FOR A FULL LINE OF BIOCHEMICAL REAGENTS, PARTICULARLY, ANTIBODIES, PLASMIDS, ENZYMES, ENZYME STABILIZERS, INTERFERON, NUCLEOTIDES, SOLD INDIVIDUALLY OR IN KIT FORM, FILTER MEMBRANES, FOR SCIENTIFIC AND MEDICAL RESEARCH USE, IN CLASS 1 (U.S. CLS. 1, 5, 6, 10, 26 AND 46).

FIRST USE 12-24-2001; IN COMMERCE 12-24-2001.

THE MARK CONSISTS OF STANDARD CHARACTERS WITHOUT CLAIM TO ANY PARTICULAR FONT, STYLE, SIZE, OR COLOR.

OWNER OF U.S. REG. NOS. 2,073,330 AND 2,073,331.

NO CLAIM IS MADE TO THE EXCLUSIVE RIGHT TO USE "LIFE SCIENCES", APART FROM THE MARK AS SHOWN.

SER. NO. 78-956,019, FILED 8-20-2006.

MARK SPARACINO, EXAMINING ATTORNEY

**Int. Cls.: 9, 16 and 35**

**Prior U.S. Cls.: 2, 5, 21, 22, 23, 26, 29, 36, 37, 38, 50,  
100, 101 and 102**

**Reg. No. 3,505,386**

**United States Patent and Trademark Office**

**Registered Sep. 23, 2008**

**TRADEMARK  
SERVICE MARK  
PRINCIPAL REGISTER**

# COMPMETRICA

COMPMETRICA INC. (CANADA CORPORATION)  
6 SAINTE-MARIE STREET  
GATINEAU, QUEBEC, CANADA J8Y 2A3

FOR: COMPUTER SOFTWARE FOR USE IN ASSESSING COMPETENCY, SKILLS, TRAITS OF CHARACTER, KNOWLEDGE AND INTERESTS OF PROSPECTIVE EMPLOYEES, NAMELY, SOFTWARE THAT FEATURES INTERVIEW SCRIPTS, WORKBOOKS, CASE STUDIES, GROUP SIMULATION SCRIPTS, REFERENCING BOOKS, CENTRAL AND 360 DEGREE ASSESSMENT MANUALS, PSYCHOMETRIC TESTS, PARTICIPANT MANUALS, INTERPRETATION GUIDES, MARKETING GRIDS, RESULT REPORTS AND SUMMARIES; COMPUTER SOFTWARE FOR COMPILING, INTERPRETING AND SAVING PROSPECTIVE EMPLOYEE ASSESSMENT RESULTS AND FOR ANALYZING, SENDING AND MANAGING THE ASSESSMENT MATERIALS VIA INTERNET OR EXTRANET, IN CLASS 9 (U.S. CLS. 21, 23, 26, 36 AND 38).

FOR: PRINTED INSTRUCTIONAL MATERIALS FOR PROVIDING TRAINING IN THE FIELD OF EMPLOYEE ASSESSMENTS, NAMELY, INTERVIEW SCRIPTS, WORKBOOKS, CASE STUDIES, GROUP SIMULATION SCRIPTS, REFERENCING BOOKS, CENTRAL AND 360 DEGREE ASSESSMENT MANUALS, PSYCHOMETRIC TESTS, PARTICIPANT MANUALS, PRINTED INTERPRETATION GUIDES, MARKING GRIDS, RESULT REPORTS AND PRINTED SUMMARIES, IN CLASS 16 (U.S. CLS. 2, 5, 22, 23, 29, 37, 38 AND 50).

FOR: PROVIDING EMPLOYMENT ASSESSMENT SERVICES IN THE NATURE OF ASSESSING THE COMPETENCY, SKILLS, TRAITS OF CHARACTER, KNOWLEDGE AND INTERESTS OF PROSPECTIVE EMPLOYEES, NAMELY, THROUGH INTERVIEWING, INDIVIDUAL AND GROUP SIMULATION, CASE STUDY, ASSESSMENT CENTRE AND 360 DEGREE ASSESSMENT; CONSULTING SERVICES IN THE FIELD OF HUMAN RESOURCES, NAMELY, DEVELOPMENT OF CONCEPTUAL MODELS AND PSYCHOMETRIC TESTS FOR MEASURING AND ASSESSING TRAITS OF CHARACTER, SKILLS, COMPETENCIES, KNOWLEDGE AND INTERESTS OF PROSPECTIVE EMPLOYEES FOR PURPOSES OF EMPLOYMENT; ADVISORY SERVICES IN THE FIELD OF INDUSTRIAL RELATIONS, NAMELY, ASSESSMENT AND SELECTION OF PERSONNEL, IN CLASS 35 (U.S. CLS. 100, 101 AND 102).

THE MARK CONSISTS OF STANDARD CHARACTERS WITHOUT CLAIM TO ANY PARTICULAR FONT, STYLE, SIZE, OR COLOR.

PRIORITY CLAIMED UNDER SEC. 44(D) ON CANADA APPLICATION NO. 1313777, FILED 8-21-2006, REG. NO. TMA709088, DATED 3-6-2008, EXPIRES 3-6-2023.

SER. NO. 78-957,267, FILED 8-22-2006.

PAUL CROWLEY, EXAMINING ATTORNEY

Int. Cl.: 36

Prior U.S. Cls.: 100, 101 and 102

United States Patent and Trademark Office

Reg. No. 3,505,387

Registered Sep. 23, 2008

SERVICE MARK  
PRINCIPAL REGISTER

A · S P I R E

A-SPIRE FINANCIAL CORPORATION (OREGON CORPORATION)  
10200 SW GREENBURG RD., 7TH FLOOR  
PORTLAND, OR 97223

FOR: LEASING OF REAL ESTATE; REAL ESTATE ACQUISITION SERVICES; REAL ESTATE BROKERAGE; REAL ESTATE EQUITY SHARING, NAMELY, MANAGING AND ARRANGING FOR CO-OWNERSHIP OF REAL ESTATE; REAL ESTATE INVESTMENT; REAL ESTATE MANAGEMENT; REAL ESTATE PROCUREMENT FOR OTHERS, IN CLASS 36 (U.S. CLS. 100, 101 AND 102).

FIRST USE 5-13-2006; IN COMMERCE 5-13-2006.

THE COLOR(S) TEAL AND PURPLE IS/ARE CLAIMED AS A FEATURE OF THE MARK.

THE MARK CONSISTS OF THE WORD "A-SPIRE" IN A STYLIZED FONT; THE "." BEING STYLIZED AS A CIRCLE IN PURPLE, THE "I" BEING STYLIZED AS A SPIRE IN PURPLE, AND THE REMAINING LETTERS IN TEAL.

SER. NO. 78-957,759, FILED 8-22-2006.

TANYA AMOS, EXAMINING ATTORNEY

**Int. Cl.: 35**

**Prior U.S. Cls.: 100, 101 and 102**

**United States Patent and Trademark Office**

**Reg. No. 3,505,388**

**Registered Sep. 23, 2008**

**SERVICE MARK  
PRINCIPAL REGISTER**

**EXPERT KNOWLEDGE SYSTEMS**

EXPERT KNOWLEDGE SYSTEMS, LLC (NEW  
HAMPSHIRE LIMITED LIABILITY COMPA-  
NY)  
21 BLOOMINGDALE ROAD  
WHITE PLAINS, NY 10605

FOR: BUSINESS MANAGEMENT CONSULTING;  
COST MANAGEMENT FOR THE HEALTH BENE-  
FIT PLANS OF OTHERS; PHARMACEUTICAL  
COST MANAGEMENT SERVICES AND DRUG UTI-  
LIZATION REVIEW SERVICES, IN CLASS 35 (U.S.  
CLS. 100, 101 AND 102).

FIRST USE 7-0-1996; IN COMMERCE 7-0-1996.

THE MARK CONSISTS OF STANDARD CHAR-  
ACTERS WITHOUT CLAIM TO ANY PARTICULAR  
FONT, STYLE, SIZE, OR COLOR.

SEC. 2(F).

SER. NO. 78-959,037, FILED 8-23-2006.

BONNIE LUKEN, EXAMINING ATTORNEY

Int. Cl.: 17

Prior U.S. Cls.: 1, 5, 12, 13, 35 and 50

United States Patent and Trademark Office

Reg. No. 3,505,389

Registered Sep. 23, 2008

TRADEMARK  
PRINCIPAL REGISTER



ARCHITECTURAL FOAMSTONE, INC. (CALIFORNIA CORPORATION)  
9792 GLENOAKS BLVD.  
SUN VALLEY, CA 91352

FIRST USE 2-0-2004; IN COMMERCE 2-0-2004.

FOR: ORNAMENTAL ARCHITECTURAL FOAM PRODUCTS, NAMELY, TRIMS, CROWNS, WALL CAPS, PILASTER CAPS, KEYSTONES, EXTERIOR ROSETTES, COLUMNS, BALUSTRADES, ARCHES, FIREPLACE MANTELS, WINDOW SILLS, BANDS AND QUOINS, IN CLASS 17 (U.S. CLS. 1, 5, 12, 13, 35 AND 50).

NO CLAIM IS MADE TO THE EXCLUSIVE RIGHT TO USE "ARCHITECTURAL", APART FROM THE MARK AS SHOWN.

SER. NO. 78-961,016, FILED 8-25-2006.

KELLY MCCOY, EXAMINING ATTORNEY



Int. Cl.: 25

Prior U.S. Cls.: 22 and 39

United States Patent and Trademark Office

Reg. No. 3,505,390

Registered Sep. 23, 2008

TRADEMARK  
PRINCIPAL REGISTER



blood+roses

LAZCORP PTY LIMITED (AUSTRALIA CORPORATION)  
45-51 HUNTLEY STREET  
UNIT 56  
ALEXANDRIA, NSW 2015, AUSTRALIA

FOR: CLOTHES, NAMELY, COATS, JACKETS, TROUSERS, PANTS, SHIRTS, T-SHIRTS, JEANS, SHORTS, POLO SHIRTS, SWEATERS, SWEATSHIRTS, BELTS AND KNITWEAR, NAMELY, KNITTED SWEATSHIRTS, KNITTED JUMPERS,

KNITTED SHIRTS, KNITTED POLO AND T-SHIRTS; FOOTWEAR; AND HEADWEAR, IN CLASS 25 (U.S. CLS. 22 AND 39).

OWNER OF AUSTRALIA REG. NO. 1117999, DATED 6-9-2006, EXPIRES 6-9-2016.

SER. NO. 78-963,586, FILED 8-30-2006.

LINDA E. BLOHM, EXAMINING ATTORNEY

**Int. Cl.: 9**

**Prior U.S. Cls.: 21, 23, 26, 36 and 38**

**United States Patent and Trademark Office**

**Reg. No. 3,505,391**

**Registered Sep. 23, 2008**

**TRADEMARK  
PRINCIPAL REGISTER**

# Latitude

CONTEX A/S (DENMARK CORPORATION)  
SVANEVANG 2  
ALLEROED, DENMARK 3450

FOR: APPARATUS FOR RECORDING, TRANSMISSION, PROCESSING OR REPRODUCTION OF DATA, NAMELY, 2D-SCANNERS, 2D-PRINTERS OR 3D-PRINTERS; OPERATING SOFTWARE FOR USE INSIDE 2D-SCANNERS; 2D-PRINTERS OR 3D-PRINTERS; COMPUTER SOFTWARE FOR TRANSMISSION, PROCESSING, REPRODUCTION, ENHANCEMENT AND REFINEMENT OF IMAGES, FOR USE IN CONNECTION WITH SCANNERS, 2D-

PRINTERS OR 3D-PRINTERS, IN CLASS 9 (U.S. CLS. 21, 23, 26, 36 AND 38).

FIRST USE 6-1-2003; IN COMMERCE 6-1-2003.

THE MARK CONSISTS OF STANDARD CHARACTERS WITHOUT CLAIM TO ANY PARTICULAR FONT, STYLE, SIZE, OR COLOR.

SER. NO. 78-964,590, FILED 8-31-2006.

PAUL E. FAHRENKOPF, EXAMINING ATTORNEY

**Int. Cl.: 9**

**Prior U.S. Cls.: 21, 23, 26, 36 and 38**

**United States Patent and Trademark Office**

**Reg. No. 3,505,392**

**Registered Sep. 23, 2008**

**TRADEMARK  
PRINCIPAL REGISTER**

# Flash

CONTEX A/S (DENMARK CORPORATION)  
SVANEVANG 2  
ALLEROED, DENMARK 3450

FOR: APPARATUS FOR RECORDING, TRANSMISSION, PROCESSING OR REPRODUCTION OF DATA, NAMELY, 2D-SCANNERS, 3D-SCANNERS, 2D-PRINTERS OR 3D-PRINTERS; COMPUTER SOFTWARE FOR CONTROLLING 2D-SCANNERS, 3D-SCANNERS, 2D-PRINTERS OR 3D-PRINTERS; COMPUTER SOFTWARE FOR THE PURPOSE OF RECORDING, TRANSMISSION, PROCESSING OR REPRODUCTION OF DATA AND PICTURES IN CONNECTION WITH 2D-SCANNERS, 3D-SCANNERS, 2D-PRINTERS OR 3D-PRINTERS, INCLUD-

ING IMPORTING DATA FROM AND EXPORTING DATA TO 2D-SCANNERS, 3D-SCANNERS, 2D-PRINTERS OR 3D-PRINTERS, IN CLASS 9 (U.S. CLS. 21, 23, 26, 36 AND 38).

FIRST USE 3-1-2003; IN COMMERCE 3-1-2003.

THE MARK CONSISTS OF STANDARD CHARACTERS WITHOUT CLAIM TO ANY PARTICULAR FONT, STYLE, SIZE, OR COLOR.

SER. NO. 78-964,598, FILED 8-31-2006.

JASON BLAIR, EXAMINING ATTORNEY

**Int. Cl.: 9**

**Prior U.S. Cls.: 21, 23, 26, 36 and 38**

**Reg. No. 3,505,393**

**United States Patent and Trademark Office**

**Registered Sep. 23, 2008**

**TRADEMARK  
PRINCIPAL REGISTER**

# Atlas

CONTEX A/S (DENMARK CORPORATION)  
SVANEVANG 2  
ALLEROED, DENMARK 3450

FOR: APPARATUS FOR RECORDING, TRANSMISSION, PROCESSING OR REPRODUCTION OF DATA, NAMELY, 2D-SCANNERS, 3D-SCANNERS, 2D-PRINTERS OR 3D-PRINTERS; COMPUTER SOFTWARE FOR CONTROLLING 2D-SCANNERS, 3D-SCANNERS, 2D-PRINTERS OR 3D-PRINTERS; COMPUTER SOFTWARE FOR THE PURPOSE OF RECORDING, TRANSMISSION, PROCESSING OR REPRODUCTION OF DATA AND PICTURES IN CONNECTION WITH 2D-SCANNERS, 3D-SCANNERS, 2D-PRINTERS OR 3D-PRINTERS, INCLUD-

ING IMPORTING DATA FROM AND EXPORTING DATA TO 2D-SCANNERS, 3D-SCANNERS, 2D-PRINTERS OR 3D-PRINTERS, IN CLASS 9 (U.S. CLS. 21, 23, 26, 36 AND 38).

FIRST USE 3-3-2003; IN COMMERCE 3-3-2003.

THE MARK CONSISTS OF STANDARD CHARACTERS WITHOUT CLAIM TO ANY PARTICULAR FONT, STYLE, SIZE, OR COLOR.

SER. NO. 78-964,602, FILED 8-31-2006.

JASON BLAIR, EXAMINING ATTORNEY

**Int. Cl.: 9**

**Prior U.S. Cls.: 21, 23, 26, 36 and 38**

**United States Patent and Trademark Office**

**Reg. No. 3,505,394**

**Registered Sep. 23, 2008**

**TRADEMARK  
PRINCIPAL REGISTER**

# Select

CONTEX A/S (DENMARK CORPORATION)  
SVANEVANG 2  
ALLEROED, DENMARK 3450

FOR: APPARATUS FOR RECORDING, TRANSMISSION, PROCESSING OR REPRODUCTION OF DATA, NAMELY, 2D-SCANNERS, 3D-SCANNERS, 2D-PRINTERS OR 3D-PRINTERS; COMPUTER SOFTWARE FOR CONTROLLING 2D-SCANNERS, 3D-SCANNERS, 2D-PRINTERS OR 3D-PRINTERS; COMPUTER SOFTWARE FOR THE PURPOSE OF RECORDING, TRANSMISSION, PROCESSING OR REPRODUCTION OF DATA AND PICTURES IN CONNECTION WITH 2D-SCANNERS, 3D-SCANNERS, 2D-PRINTERS OR 3D-PRINTERS, INCLUD-

ING IMPORTING DATA FROM AND EXPORTING DATA TO 2D-SCANNERS, 3D-SCANNERS, 2D-PRINTERS OR 3D-PRINTERS, IN CLASS 9 (U.S. CLS. 21, 23, 26, 36 AND 38).

FIRST USE 5-1-2004; IN COMMERCE 5-1-2004.

THE MARK CONSISTS OF STANDARD CHARACTERS WITHOUT CLAIM TO ANY PARTICULAR FONT, STYLE, SIZE, OR COLOR.

SER. NO. 78-964,611, FILED 8-31-2006.

JASON BLAIR, EXAMINING ATTORNEY

**Int. Cl.: 25**

**Prior U.S. Cls.: 22 and 39**

**United States Patent and Trademark Office**

**Reg. No. 3,505,395**

**Registered Sep. 23, 2008**

**TRADEMARK  
PRINCIPAL REGISTER**

**ATTITUDE**

SANSEGAL SPORTSWEAR, INC. (UTAH CORPORATION)  
611 WEST 9560 SOUTH  
SANDY, UT 84070

FOR: CLOTHING AND SPORTSWEAR, NAMELY, JACKETS, SWEATSUITS, SHORTS, SWIMWEAR, SHIRTS, T-SHIRTS, SWEATSHIRTS, HATS, AND TANKTOPS, IN CLASS 25 (U.S. CLS. 22 AND 39).

FIRST USE 10-1-1985; IN COMMERCE 10-1-1985.

THE MARK CONSISTS OF STANDARD CHARACTERS WITHOUT CLAIM TO ANY PARTICULAR FONT, STYLE, SIZE, OR COLOR.

SER. NO. 78-966,418, FILED 9-1-2006.

INGA ERVIN, EXAMINING ATTORNEY

**Int. Cl.: 14**

**Prior U.S. Cls.: 2, 27, 28 and 50**

**United States Patent and Trademark Office**

**Reg. No. 3,505,396**

**Registered Sep. 23, 2008**

**TRADEMARK  
PRINCIPAL REGISTER**

**BEDROOM ATHLETICS**

AMBER DUDES LIMITED (UNITED KINGDOM  
LIMITED LIABILITY COMPANY)  
CELTIC SPRINGS BUSINESS PARK  
CLAMPETT HOUSE, HAZELL DRIVE  
NEWPORT, UNITED KINGDOM NP108FY

FOR: CANDLESTICKS OF PRECIOUS METAL;  
CIGAR AND CIGARETTE BOXES OF PRECIOUS  
METAL; CIGARETTE CASES MADE OF PRECIOUS  
METAL; CLOCKS; JEWELRY; JEWELRY BOXES OF  
PRECIOUS METAL; KEY RINGS OF PRECIOUS  
METAL; ORNAMENTS OF PRECIOUS METAL;  
PRECIOUS GEMSTONES; PRECIOUS METALS;  
PURSES AND WALLETS OF PRECIOUS METAL;  
SCULPTURES MADE OF PRECIOUS METAL;  
WATCHES, IN CLASS 14 (U.S. CLS. 2, 27, 28 AND 50).

THE MARK CONSISTS OF STANDARD CHAR-  
ACTERS WITHOUT CLAIM TO ANY PARTICULAR  
FONT, STYLE, SIZE, OR COLOR.

PRIORITY CLAIMED UNDER SEC. 44(D) ON  
ERPN CMNTY TM OFC APPLICATION NO.  
5296843, FILED 9-6-2006, REG. NO. 005296843, DATED  
8-16-2007, EXPIRES 9-6-2016.

SER. NO. 78-969,983, FILED 9-8-2006.

HOWARD SMIGA, EXAMINING ATTORNEY

**Int. Cl.: 18**

**Prior U.S. Cls.: 1, 2, 3, 22 and 41**

**United States Patent and Trademark Office**

**Reg. No. 3,505,397**

**Registered Sep. 23, 2008**

**TRADEMARK  
PRINCIPAL REGISTER**

**BEDROOM ATHLETICS**

AMBER DUDES LIMITED (UNITED KINGDOM  
LIMITED LIABILITY COMPANY)  
CELTIC SPRINGS BUSINESS PARK  
CLAMPETT HOUSE, HAZELL DRIVE  
NEWPORT, UNITED KINGDOM NP108FY

FOR: ATHLETIC BAGS; BEACH BAGS; BRIEF-CASES; CALLING CARD CASES; CANES; COLLARS FOR PETS; COSMETIC BAGS SOLD EMPTY; CREDIT CARD CASES; GARMENT BAGS FOR TRAVEL; HANDBAGS; KEY CASES; LUGGAGE; MAKE-UP BAGS SOLD EMPTY; OVERNIGHT BAGS; PARASOLS; PET CLOTHING; PURSES; SHOULDER BAGS; SUITCASES; UMBRELLAS; VANITY CASES SOLD EMPTY; WALLETS, IN CLASS 18 (U.S. CLS. 1, 2, 3, 22 AND 41).

THE MARK CONSISTS OF STANDARD CHARACTERS WITHOUT CLAIM TO ANY PARTICULAR FONT, STYLE, SIZE, OR COLOR.

PRIORITY CLAIMED UNDER SEC. 44(D) ON ERPN CMNTY TM OFC APPLICATION NO. 5296843, FILED 9-6-2006, REG. NO. 005296843, DATED 8-16-2007, EXPIRES 9-6-2016.

NO CLAIM IS MADE TO THE EXCLUSIVE RIGHT TO USE "ATHLETICS", APART FROM THE MARK AS SHOWN.

SER. NO. 78-969,987, FILED 9-8-2006.

HOWARD SMIGA, EXAMINING ATTORNEY



**Int. Cl.: 20**

**Prior U.S. Cls.: 2, 13, 22, 25, 32 and 50**

**United States Patent and Trademark Office**

**Reg. No. 3,505,398**

**Registered Sep. 23, 2008**

**TRADEMARK  
PRINCIPAL REGISTER**

**BEDROOM ATHLETICS**

AMBER DUDES LIMITED (UNITED KINGDOM  
LIMITED LIABILITY COMPANY)  
CELTIC SPRINGS BUSINESS PARK  
CLAMPETT HOUSE, HAZELL DRIVE  
NEWPORT, UNITED KINGDOM NP108FY

FOR: BATHROOM AND SHAVING MIRRORS;  
BATHROOM VANITIES; BEDROOM FURNITURE;  
CLOTHES HANGERS; COAT STANDS; CURTAIN  
RAILS; CURTAIN RINGS; CURTAIN RODS; CUSH-  
IONS; DECORATIVE MOBILES; DIVANS; FIGUR-  
INES OF WOOD, PLASTIC OR BONE; FUTONS;  
HAND FANS; HAND-HELD MIRRORS; MIR-  
RORED CABINETS; MIRRORS; NON-METAL  
DOOR TRIMS; NON-METAL DRAWER TRIMS;  
NON-METAL HANDLES FOR DOORS; ORNA-  
MENTS OF WOOD, PLASTIC OR BONE ; OTTO-  
MANS; PERSONAL COMPACT MIRRORS;  
PICTURE FRAMES ; PILLOWS; PLANT STANDS;  
SCREENS ; SCULPTURES OF WOOD, PLASTIC OR

BONE; SOFA BEDS, IN CLASS 20 (U.S. CLS. 2, 13, 22,  
25, 32 AND 50).

THE MARK CONSISTS OF STANDARD CHAR-  
ACTERS WITHOUT CLAIM TO ANY PARTICULAR  
FONT, STYLE, SIZE, OR COLOR.

PRIORITY CLAIMED UNDER SEC. 44(D) ON  
ERPNTY TM OFC APPLICATION NO.  
5296843, FILED 9-6-2006, REG. NO. 005296843, DATED  
8-16-2007, EXPIRES 9-6-2016.

NO CLAIM IS MADE TO THE EXCLUSIVE  
RIGHT TO USE "BEDROOM", APART FROM THE  
MARK AS SHOWN.

SER. NO. 78-970,005, FILED 9-8-2006.

HOWARD SMIGA, EXAMINING ATTORNEY

**Int. Cls.: 9 and 41**

**Prior U.S. Cls.: 21, 23, 26, 36, 38, 100, 101 and 107**

**Reg. No. 3,505,399**

**United States Patent and Trademark Office**

**Registered Sep. 23, 2008**

**TRADEMARK  
SERVICE MARK  
PRINCIPAL REGISTER**

**BERMUDA TRIANGLE**

STAINLESS GAMES LIMITED (UNITED KING-  
DOM CORPORATION)  
NEWPORT, ISLE OF WIGHT  
120A HIGH STREET,  
NEWPORT, UNITED KINGDOM PO30 1TP

FOR: ENTERTAINMENT COMPUTER SOFTWARE IN THE NATURE OF A COMPUTER GAME; COMPUTERS; COMPUTER HARDWARE; COMPUTER GAMES SOFTWARE; COMPUTER GAME DISCS; COMPUTER SOFTWARE FOR A COMPUTER GAME; VIDEO GAMES DISCS; VIDEO GAMES SOFTWARE; ELECTRONIC GAMES PROGRAMS; COMPUTER GAME, INTERACTIVE, AND ENTERTAINMENT SOFTWARE FOR USE ON MOBILE OR CELLULAR TELEPHONES AND OTHER WIRELESS DEVICES; COMPUTER PROGRAM FOR COMPUTER GAMES; DOWNLOADABLE COMPUTER SOFTWARE FOR PLAYING GAMES; INTERACTIVE ENTERTAINMENT SOFTWARE FOR PLAYING GAMES; PRE-RECORDED VIDEO DISCS, DISCS, TAPES, CASSETTES, COMPACT DISCS FEATURING ELECTRONIC AND COMPUTER GAMES; CD-ROMS FEATURING COMPUTER GAMES; MUSICAL SOUND RECORDINGS; PRE-RECORDED DIGITAL VIDEO DISCS FEATURING COMPUTER GAMES; DOWNLOADABLE ELECTRONIC PUBLICATIONS IN THE NATURE OF MAGAZINES AND NEWSLETTERS FEATURING COMPUTER GAMES; PARTS AND FITTINGS FOR THE COMPUTER HARDWARE, IN CLASS 9 (U.S. CLS. 21, 23, 26, 36 AND 38).

FOR: ENTERTAINMENT SERVICES IN THE NATURE OF AN ONLINE COMPUTER GAME; ON-LINE GAMING SERVICES; EDUCATION AND ENTERTAINMENT SERVICES IN THE FORM OF ONGOING TELEVISION AND RADIO PROGRAMS FEATURING COMPUTER GAMES; EDITING AND PRODUCTION OF CINEMATOGRAPHIC, TELEVISUAL, DIGITAL AND MOTION PICTURE FILMS, PRODUCTION OF RADIO AND TELEVISION PROGRAMS; PROVIDING NON-DOWNLOADABLE ELECTRONIC PUBLICATIONS IN THE NATURE OF MAGAZINES AND NEWSLETTERS FEATURING COMPUTER GAMES; PROVIDING INFORMATION IN THE FIELD OF COMPUTER GAMING AND INTERACTIVE ENTERTAINMENT VIA MOBILE OR CELLULAR TELEPHONES AND/OR OTHER WIRELESS DEVICES, IN CLASS 41 (U.S. CLS. 100, 101 AND 107).

THE MARK CONSISTS OF STANDARD CHARACTERS WITHOUT CLAIM TO ANY PARTICULAR FONT, STYLE, SIZE, OR COLOR.

PRIORITY CLAIMED UNDER SEC. 44(D) ON ERPN CMNTY TM OFC APPLICATION NO. 005306741, FILED 9-9-2006, REG. NO. 005306741, DATED 8-1-2007, EXPIRES 9-11-2016.

SER. NO. 78-973,587, FILED 9-13-2006.

DAWN FELDMAN, EXAMINING ATTORNEY

**Int. Cl.: 38**

**Prior U.S. Cls.: 100, 101 and 104**

**United States Patent and Trademark Office**

**Reg. No. 3,505,400**

**Registered Sep. 23, 2008**

**SERVICE MARK  
PRINCIPAL REGISTER**

**CONFERENCECALL.COM**

WEST CORPORATION (DELAWARE CORPORATION)  
11808 MIRACLE HILLS DRIVE  
OMAHA, NE 68154

FOR: VOICEMAIL SERVICES AND FACSIMILE  
TRANSMISSION AND RETRIEVAL SERVICES, IN  
CLASS 38 (U.S. CLS. 100, 101 AND 104).

FIRST USE 7-7-2000; IN COMMERCE 7-7-2000.

THE MARK CONSISTS OF STANDARD CHARACTERS WITHOUT CLAIM TO ANY PARTICULAR FONT, STYLE, SIZE, OR COLOR.

OWNER OF U.S. REG. NO. 2,711,781.

SER. NO. 78-978,853, FILED 10-25-2005.

ALLISON HOLTZ, EXAMINING ATTORNEY

**Int. Cls.: 9, 14 and 33**

**Prior U.S. Cls.: 2, 21, 23, 26, 27, 28, 36, 38, 47, 49 and 50**

**Reg. No. 3,505,401**

**United States Patent and Trademark Office**

**Registered Sep. 23, 2008**

**TRADEMARK  
PRINCIPAL REGISTER**

# INSTANT KARMA

LODESTAR ANSTALT (LIECHTENSTEIN CORPORATION)  
LOVA-CENTER  
P.O. BOX 1150  
FL-9490 VADUZ, LIECHTENSTEIN

FOR: OPTICAL APPARATUS AND INSTRUMENTS, NAMELY, SPECTACLES, GLASSES, SUNGLASSES, ANTI-DAZZLE SPECTACLES, ANTI-GLARE GLASSES AND VISORS, BINOCULARS, CONTACT LENSES, OPTICAL LENSES, OPTICAL FIBRES SOLD AS A COMPONENT OF FIBRE OPTIC CABLES, AND TELESCOPES, IN CLASS 9 (U.S. CLS. 21, 23, 26, 36 AND 38).

FOR: JEWELRY, PRECIOUS STONES; HOROLOGICAL AND CHRONOMETRIC INSTRUMENTS, IN CLASS 14 (U.S. CLS. 2, 27, 28 AND 50).

FOR: ALCOHOLIC BEVERAGES, NAMELY, WINES, SPIRITS AND LIQUEURS, IN CLASS 33 (U.S. CLS. 47 AND 49).

THE MARK CONSISTS OF STANDARD CHARACTERS WITHOUT CLAIM TO ANY PARTICULAR FONT, STYLE, SIZE, OR COLOR.

PRIORITY DATE OF 9-22-2003 IS CLAIMED.

OWNER OF INTERNATIONAL REGISTRATION 0820007 DATED 2-18-2004, EXPIRES 2-18-2014.

SER. NO. 79-001,229, FILED 2-18-2004.

AMY HELLA, EXAMINING ATTORNEY

**Int. Cls.: 1, 3, 5, 10, 29, 30 and 42**

**Prior U.S. Cls.: 1, 4, 5, 6, 10, 18, 26, 39, 44, 46, 50, 51, 52, 100 and 101**

**Reg. No. 3,505,402**

**United States Patent and Trademark Office**

**Registered Sep. 23, 2008**

**TRADEMARK  
SERVICE MARK  
PRINCIPAL REGISTER**

# **INNOGEL**

INNOGEL AG (SWITZERLAND COMPANY)  
BAHNHOFSTRASSE 11  
CH-6301 ZUG, SWITZERLAND

FOR: CHEMICALS USED IN INDUSTRY, SCIENCE, PHOTOGRAPHY, AGRICULTURE, HORTICULTURE AND FORESTRY, NAMELY, ENCAPSULATED CHEMICALS AND/OR AGENTS, NAMELY, SOIL CONDITIONERS, SURFACTANTS FOR USE IN SPRAYS; UNPROCESSED ARTIFICIAL RESINS USED FOR GRANULES, FILMS, SHEETS, CASTING, EXTRUSION; UNPROCESSED PLASTICS USED FOR GRANULES, FILMS, SHEETS, CASTING, EXTRUSION; FERTILIZERS USED FOR DOMESTIC OR AGRICULTURAL USE; FIRE EXTINGUISHING COMPOSITIONS; TEMPERING CHEMICALS FOR USE IN METALWORKING OR SOLDERING; PRODUCE STABILIZER FOR PRESERVING FOODS; TANNING SUBSTANCES FOR USE IN THE MANUFACTURE OF LEATHER, ADHESIVES FOR GENERAL USE, IN CLASS 1 (U.S. CLS. 1, 5, 6, 10, 26 AND 46).

FOR: ALL PURPOSE CLEANING, POLISHING, SCOURING AND ABRASIVE PREPARATIONS; DETERGENT, HAND AND DEODORANT SOAPS; PERFUMERY; ESSENTIAL OILS FOR USE IN THE MANUFACTURE OF SCENTED PRODUCTS; COSMETICS; HAIR LOTIONS, DENTIFRICES, IN CLASS 3 (U.S. CLS. 1, 4, 6, 50, 51 AND 52).

FOR: PHARMACEUTICAL AND VETERINARY PRODUCTS, NAMELY, TABLETS, CAPSULES, MODIFIED RELEASE SYSTEMS AND FLUIDS USED TO TREAT SKIN DEFICIENCIES OR SKIN AGING; DIETARY SUPPLEMENTS; BABY FOOD, MEDICAL PLASTERS; DRESSINGS FOR WOUNDS, BURNS AND SURGERY; MATERIAL FOR STOPPING TEETH; DENTAL WAX; ALL-PURPOSE DISINFECTANTS; FUNGICIDES AND HERBICIDES FOR AGRICULTURAL AND DOMESTIC USE; PHARMACEUTICAL SOFT AND HARD CAPSULES FOR ORAL AND RECTAL ABSORPTION FOR THE

TREATMENT OF INTESTINAL BACTERIAS; DISINFECTANTS FOR HYGIENIC PURPOSES, IN CLASS 5 (U.S. CLS. 6, 18, 44, 46, 51 AND 52).

FOR: SURGICAL, MEDICAL, DENTAL AND VETERINARY APPARATUS AND INSTRUMENTS, NAMELY, GEL COATED AND GEL MODIFIED INSTRUMENTS FOR THE TREATMENT OF TEETH, HUMAN AND ANIMAL BODIES; ARTIFICIAL LIMBS, EYES AND TEETH; ORTHOPEDIC ARTICLES, NAMELY, IN SITU GELS; SUTURES, IN CLASS 10 (U.S. CLS. 26, 39 AND 44).

FOR: MEAT, FISH, POULTRY AND GAME; MEAT EXTRACTS, PRESERVED, DRIED AND COOKED FRUIT AND VEGETABLES; JELLIES, JAMS, COMPOTES; EGGS, MILK AND DAIRY PRODUCTS, NAMELY, YOGURTS; EDIBLE OILS AND FATS; JAMS, IN CLASS 29 (U.S. CL. 46).

FOR: COFFEE, TEA, COCOA, SUGAR, RICE, TAPIOCA, SAGO, ARTIFICIAL COFFEE; FLOURS AND CEREAL PREPARATIONS, NAMELY, FLAKED AND/OR PUFFED CEREALS, MUSH/MUSH, SNACKS FOR REGULAR OR DIETARY USE, NAMELY, CEREAL-BASED OR GRAIN-BASED READY TO EAT ENERGY BARS, GRANO-LA-BASED, CEREAL-BASED, AND WHEAT-BASED SNACKS, OR SNACK MIX CONSISTING PRIMARILY OF CRACKERS, PRETZELS, CANDIED NUTS AND/OR POPPED POPCORN; BREAD, PASTRY AND CONFECTIONERY CHIPS FOR BAKING, FLAVOURED ICES; HONEY, TREACLE; YEAST, BAKING POWDER; SALT; MUSTARD; VINEGAR, SAUCES, SPICES; BREAKFAST CEREALS; PASTA AND RICE-BASED SNACK FOODS; ICE CREAM, IN CLASS 30 (U.S. CL. 46).

FOR: SCIENTIFIC AND TECHNOLOGICAL SERVICES AND RELATED RESEARCH AND DESIGN SERVICES, NAMELY, RESEARCH AND DEVELOPMENT OF MEDICINES, RESINS AND PLACEBOS; INDUSTRIAL ANALYSIS AND RESEARCH SERVI-

CES, NAMELY, RESEARCH AND DEVELOPMENT OF MEDICINES, RESINS, PLACEBOS; COMPUTER SOFTWARE AND HARDWARE DESIGN AND DEVELOPMENT FOR OTHERS; LEGAL SERVICES, IN CLASS 42 (U.S. CLS. 100 AND 101).

PRIORITY DATE OF 6-18-2003 IS CLAIMED.

OWNER OF INTERNATIONAL REGISTRATION 0823026 DATED 12-5-2003, EXPIRES 12-5-2013.

SER. NO. 79-002,054, FILED 12-5-2003.

INGA ERVIN, EXAMINING ATTORNEY

**Int. Cls.: 1 and 3**

**Prior U.S. Cls.: 1, 4, 5, 6, 10, 26, 46, 50, 51 and 52**

**United States Patent and Trademark Office**

**Reg. No. 3,505,403**

**Registered Sep. 23, 2008**

**TRADEMARK  
PRINCIPAL REGISTER**

パ ク ナ

P A K U N A

YUKEN INDUSTRY CO., LTD. (JAPAN JOINT STOCK COMPANY)  
50, BAWARI  
NODA-CHO.; KARIYA-SHI; AICHI 448-8511  
JAPAN

FOR: DETERGENTS FOR CLEANING SOLUTIONS FOR INDUSTRIAL USE, NAMELY, CLEANING METAL ARTICLES PRIOR TO ELECTROPLATING; CLEANING SOLUTIONS CONTAINING DETERGENTS FOR INDUSTRIAL USE, NAMELY, CLEANING METAL ARTICLES PRIOR TO ELECTROPLATING; DETERGENTS FOR CLEANING SOLUTIONS FOR USE IN ELECTRONIC INDUSTRIES, NAMELY, CLEANING ELECTRONIC COMPONENTS; CLEANING SOLUTIONS CONTAINING DETERGENTS FOR USE IN ELECTRONIC INDUSTRIES, NAMELY, CLEANING ELECTRONIC COMPONENTS; DETERGENTS FOR CLEANING SOLUTIONS FOR GENERAL INDUSTRIAL USE, NAMELY, CLEANING DIRT AND FOREIGN MATERIAL FROM SURFACES; CLEANING SOLUTIONS CONTAINING DETERGENTS FOR GENERAL INDUSTRIAL USE, NAMELY, CLEANING DIRT AND FOREIGN MATERIAL FROM SURFACES; WASTE WATER TREATMENT CHEMICALS FOR INDUSTRIAL USE, NAMELY, CHEMICAL AGENTS FOR THE PURPOSE OF COR-

ROSION CONTROL OF INDUSTRIAL WATER, AND CHEMICAL AGENTS FOR THE PURPOSE OF DISPOSING INDUSTRIAL WATER; SURFACTANTS FOR INDUSTRIAL PURPOSES, NAMELY, FOR USE IN THE MANUFACTURE OF DETERGENTS AND CLEANING SOLUTIONS; CHEMICALS FOR SURFACE TREATMENT FOR PAINT, NAMELY, CHEMICAL COMPOSITIONS FOR ADDING CORROSION-RESISTANCE, POLISH, TORQUE STABILITY OR ELECTRIC CONDUCTIVITY, IN CLASS 1 (U.S. CLS. 1, 5, 6, 10, 26 AND 46).

FOR: INDUSTRIAL SOAPS, IN CLASS 3 (U.S. CLS. 1, 4, 6, 50, 51 AND 52).

OWNER OF INTERNATIONAL REGISTRATION 0840594 DATED 5-7-2004, EXPIRES 5-7-2014.

THE TRANSLITERATION OF THE NON-LATIN CHARACTERS IN THE MARK IS "PAKUNA", WHICH HAS NO MEANING IN ENGLISH.

SER. NO. 79-007,983, FILED 5-7-2004.

GINA HAYES, EXAMINING ATTORNEY

Int. Cls.: 9, 10, 35, 36, 37, 41, 42 and 44

Prior U.S. Cls.: 21, 23, 26, 36, 38, 39, 44, 100, 101, 102, 103, 106 and 107

Reg. No. 3,505,404

United States Patent and Trademark Office

Registered Sep. 23, 2008

TRADEMARK  
SERVICE MARK  
PRINCIPAL REGISTER



DORNIER MEDTECH GMBH (FED REP GER-  
MANY GMBH)  
ARGELSRIEDER FELD 7  
82234 WEBLING  
FED REP GERMANY

FOR: ELECTRICAL AND ELECTRONIC APPARATUS AND INSTRUMENTS, NAMELY, COMPUTERS, WORKSTATIONS AND COMPUTER NETWORKS, COMPRISING COMPUTERS, CABLES, CONNECTORS FOR DATA EXCHANGE OR DATA CONTROL AND COMPUTER HARDWARE FOR CONTROLLING NETWORK ACCESS; IMPEDANCE CONTROL APPARATUS, NAMELY, ELECTRIC COILS; FIBER OPTIC APPLICATORS, NAMELY, FIBER OPTIC LIGHT AND IMAGE CONDUITS; INTERSTITIAL AND INTRALUMINAL ANTENNAS; APPARATUS FOR DATA PROCESSING, DATA INPUT, DATA OUTPUT, NAMELY, DATA PROCESSORS; APPARATUS FOR CONTROLLING, MONITORING AND PERFORMING INDUSTRIAL PROCESSES OR SCIENTIFIC RESEARCH IN LABORATORIES, NAMELY, ELECTRICAL CONTROLLERS, ELECTRONIC SCALES; REPLACEMENT PARTS OF ALL THE AFOREMENTIONED GOODS; BLANK DATA STORAGE MEDIA, NAMELY, AUDIOTAPES, COMPUTER CHIPS, COMPACT DISKS AND CD ROMS; SOFTWARE FOR USE IN THE MEDICAL FIELD FOR COLLECTING AND PROCESSING PATIENT DATA, NAMELY, SOFTWARE FOR COMPILING AND MANAGING PATIENT MEDICAL HISTORIES; ALL OF THE AFOREMENTIONED GOODS BEING PROVIDED IN THE FIELD OF MEDICINE OR HAVING MEDICAL APPLICATION AND NONE OF THE AFOREMENTIONED GOODS RELATING IN ANY WAY TO PERSONNEL, RECRUITMENT, TRAINING OR

EVALUATING STAFF, IN CLASS 9 (U.S. CLS. 21, 23, 26, 36 AND 38).

FOR: CATHETERS USED FOR DIAGNOSTIC AND THERAPEUTIC PURPOSES; ENDOSCOPES FOR MEDICAL USE; APPARATUS FOR RECEIVING, RECORDING, TRANSMITTING AND REPRODUCING SIGNALS, IMAGES AND/OR SOUND FOR MEDICAL USE, NAMELY, X-RAY APPARATUS AND ULTRASOUND DIAGNOSTIC APPARATUS; OPTICAL RECORDING APPARATUS, MONITORS, AND VIDEO DISPLAYS FOR MEDICAL USE, NAMELY, HEART MONITORS WITH VIDEO DISPLAYS; CONTROLLING, MEASURING, MONITORING AND RECORDING APPARATUS AND INSTRUMENTS FOR MEDICAL USE, NAMELY, PATIENT MONITORING APPARATUS FOR DIAGNOSTIC DATA ANALYSIS, CONTROL, MEASUREMENT, MONITORING, SUPERVISION AND RECORDING OF MEDICAL ULTRASOUND IMAGES, X-RAY IMAGES, COMPUTED TOMOGRAPHY (CT) SCAN IMAGES, MAGNETIC RESONANCE IMAGING (MRI) IMAGES, POSITRON EMISSION TECHNOLOGY (PET) AND ENDOSCOPIC IMAGES; APPARATUS FOR PROCESSING OF MEDICAL IMAGES, NAMELY, DIAGNOSTIC IMAGE PROCESSORS IN THE NATURE OF X-RAY DIAGNOSTIC APPARATUS; APPARATUS FOR DIGITAL DATA RECORDING AND TRANSMISSION APPARATUS FOR MEDICAL USE, NAMELY, WIRELESS BLOOD PRESSURE AND HEART MONITORS; PATIENT HANDLING APPARATUS, NAMELY, SURGICAL, ORTHOPAEDIC AND UROLOGICAL TABLES; MEDICAL DIAGNOSTIC AND INTERVENTIONAL WORKSTATIONS COMPRISING COMPUTER HARDWARE AND COMPUTER SOFTWARE FOR USE IN IMAGING AND ANALYZING



ULTRASONIC IMAGES, X-RAY, COMPUTED TOMOGRAPHY (CT) SCAN IMAGES, MAGNETIC RESONANCE IMAGING (MRI) IMAGES, POSITRON EMISSION TOMOGRAPHY (PET) IMAGES; LASERS FOR MEDICAL USE; SENSORS FOR MEDICAL USE, NAMELY, PATIENT MOTION SENSORS FOR PROVIDING BIOFEEDBACK IN PATIENT PHYSICAL THERAPY; DIAGNOSTIC IMAGE PROCESSING APPARATUS FOR MEDICAL USE, NAMELY, SIGNAL PROCESSORS FOR TRANSFORMING VISUAL INFORMATION INTO ELECTRONIC SIGNALS AND VICE VERSA FOR, NAMELY, USE IN PERFORMING ENDOSCOPIC PROCEDURES; MEDICAL SHOCK WAVE GENERATORS FOR THE TREATMENT OF HUMAN AND ANIMAL CELLS; MEDICAL SHOCKWAVE AND ACOUSTIC WAVE GENERATORS AND MICROWAVE GENERATORS FOR MEDICAL PURPOSES; UROLOGICAL WORK STATIONS, NAMELY INTEGRATED UNITS FOR UROLOGICAL DIAGNOSIS AND TREATMENT CONSISTING OF X-RAY APPARATUS, PATIENT TABLE, ENDOSCOPIC, SURGICAL AND MICRO INVASIVE INSTRUMENTS, NAMELY UROLOGY PATIENT TABLES, LITHOTRIPTERS, MEDICAL SHOCKWAVE AND LASER DEVICES; EXTRA-CORPOREAL SHOCK WAVE LITHOTRIPTERS FOR USE IN MEDICAL TREATMENT; UROLOGICAL PATIENT EXAMINATION TABLES; MEDICAL DEVICES, NAMELY, MEDICAL LASERS AND ACCESSORIES, NAMELY, FOCUSING LENSES FOR USE IN MEDICAL PROCEDURES; MICRO INVASIVE INSTRUMENTS FOR MEDICAL USE, NAMELY, ENDOSCOPIC EQUIPMENT AND LASER LIGHT GUIDES; MEDICAL APPARATUS USED FOR PAIN THERAPY, ORTHOPEDIC THERAPY AND EXTRA-CORPOREAL SHOCKWAVE THERAPY, NAMELY MEDICAL SHOCKWAVE DEVICES AND LASERS; ELECTROMEDICAL APPARATUS USED FOR DIAGNOSIS AND THERAPY, NAMELY, LITHOTRIPTERS, ULTRASONIC APPARATUS, SHOCKWAVE DEVICES AND LASERS, UROLOGY TABLES, SURGICAL OPERATING TABLES, AND ORTHOPAEDIC TABLES; APPARATUS FOR GENERATING LASER BEAMS, NAMELY, LASERS FOR MEDICAL USE; ACUPUNCTURE EQUIPMENT, NAMELY, ACUPUNCTURE LASERS, SURGICAL LASERS, ELECTRIC AND ELECTRONIC ALARM SYSTEMS FOR PATIENT TREATMENT AND DIAGNOSIS CONSISTING IN PARTICULAR OF SENSORS AND SIGNALING AND MONITORING APPARATUS FOR PROVIDING BIOFEEDBACK IN PATIENT PHYSICAL THERAPY; PRE-RECORDED COMPUTER TAPES, COMPUTER CHIPS, COMPACT DISKS AND CD ROMS FEATURING COMPUTER PROGRAMS FOR OPERATING MEDICAL DEVICES AND INSTRUMENTS FOR THE DIAGNOSIS AND THERAPY OF PATIENTS, NAMELY, HEART MONITORS; DATA PROCESSING AND COMPUTER PROGRAMS USED FOR CONTROLLING MEDICAL TECHNICAL APPARATUS, NAMELY HEART MONITORS; SOFTWARE FOR MEDICAL USE, NAMELY, FOR USE IN CONTROLLING DIAGNOSTIC AND THERAPEUTIC PROCESSES IN MEDICAL-TECHNICAL APPARATUS, NAMELY, CARDIAC MONITORS, IN CLASS 10 (U.S. CLS. 26, 39 AND 44).

FOR: DATA PROCESSING SERVICES; EMPLOYMENT OUTPLACEMENT SERVICES, NAMELY, PERSONNEL PLACEMENT SERVICES IN MEDICAL AND TECHNICAL FIELDS, IN CLASS 35 (U.S. CLS. 100, 101 AND 102).

FOR: LOAN FINANCING AND INSURANCE ADMINISTRATION RELATING TO ELECTRICAL, ELECTRONIC, MEDICAL AND MEDICAL TECHNICAL APPARATUS AND INSTRUMENTS AND DATA PROCESSING AND COMPUTER PROGRAMS; LEASING OF MEDICAL AND MEDICAL TECHNICAL APPARATUS, NAMELY, ELECTRICAL AND ELECTRONIC MEDICAL APPARATUS; LEASING OF MEDICAL AND MEDICAL TECHNICAL INSTRUMENTS AND COMPUTER PROGRAMS; ALL OF THE AFOREMENTIONED SERVICES BEING PROVIDED IN THE FIELD OF MEDICINE OR HAVING MEDICAL APPLICATION AND NONE OF THE AFOREMENTIONED SERVICES RELATING IN ANY WAY TO PERSONNEL, RECRUITMENT, TRAINING OR EVALUATING STAFF, IN CLASS 36 (U.S. CLS. 100, 101 AND 102).

FOR: BUILDING CONSTRUCTION; REPAIR OF MEDICAL AND MEDICAL TECHNICAL APPARATUS AND INSTRUMENTS; INSTALLATION SERVICES IN THE FIELD OF MEDICAL AND MEDICAL TECHNICAL APPARATUS AND INSTRUMENTS AND MEDICAL SYSTEMS, NAMELY, COMPUTER NETWORKS; INSTALLATION, MAINTENANCE AND REPAIR OF ELECTRICAL, ELECTRONIC, MEDICAL AND MEDICAL-TECHNICAL APPARATUS AND INSTRUMENTS, NAMELY COMPUTERS, HEART MONITORS AND PATIENT MONITORING APPARATUS, NAMELY, APPARATUS FOR DATA ANALYSIS, CONTROLLING, MEASURING, MONITORING, SUPERVISION AND RECORDING OF ULTRASOUND IMAGES, X-RAY IMAGES, COMPUTED TOMOGRAPHY (CT) SCAN IMAGES, MAGNETIC RESONANCE IMAGING (MRI) IMAGES, POSITRON EMISSION TOMOGRAPHY (PET) IMAGES AND ENDOSCOPIC IMAGES, AND APPARATUS FOR PROCESSING OF MEDICAL IMAGES, APPARATUS FOR DIGITAL DATA RECORDING AND TRANSMISSION APPARATUS FOR MEDICAL USE; ALL OF THE AFOREMENTIONED SERVICES BEING PROVIDED IN THE FIELD OF MEDICINE OR HAVING MEDICAL APPLICATION AND NONE OF THE AFOREMENTIONED SERVICES RELATING IN ANY WAY TO PERSONNEL, RECRUITMENT, TRAINING OR EVALUATING STAFF, IN CLASS 37 (U.S. CLS. 100, 103 AND 106).

FOR: CLINICAL TRAINING ON THE OPERATION OF MEDICAL DEVICES AND APPARATUS AS APPLIED TO THE TREATMENT OF PATIENTS, NAMELY OPERATION OF MEDICAL DIAGNOSTIC AND TREATMENT EQUIPMENT; TECHNICAL TRAINING ON THE MAINTENANCE AND REPAIR OF MEDICAL DEVICES AND APPARATUS, AND MEDICAL DIAGNOSTIC AND TREATMENT EQUIPMENT, IN CLASS 41 (U.S. CLS. 100, 101 AND 107).

FOR: DEVELOPMENT AND MAINTENANCE OF COMPUTER SOFTWARE; TECHNOLOGY CON-

SULTATION IN THE FIELD OF ELECTRONIC MEDICAL DIAGNOSTIC AND TREATMENT EQUIPMENT; PRODUCT DEVELOPMENT FOR OTHERS, ENGINEERING SERVICES, NAMELY, THE LAYOUT OF MEDICAL DEVICES AND APPARATUS; TECHNICAL PLANNING SERVICES IN THE FIELD OF COMPUTER NETWORK AND MEDICAL INFORMATION SYSTEMS DESIGN; TECHNICAL SYSTEMS ANALYSIS OF SCIENTIFIC, PHYSICAL AND TECHNICAL PROCESSES, NAMELY, HOSPITAL AND TREATMENT WORKFLOWS; INSTALLATION AND MAINTENANCE OF DATA PROCESSING PROGRAMS AND COMPUTER SOFTWARE; TECHNICAL SUPPORT SERVICES, NAMELY, INSTALLATION, MONITORING FOR TECHNICAL PURPOSES AND PROVIDING INFORMATION ON COMPUTERIZED MEDICAL DEVICES AND THEIR INTERFACING DEVICES; ALL OF THE AFOREMENTIONED SERVICES BEING PROVIDED IN THE FIELD OF MEDICINE OR HAVING MEDICAL APPLICATION AND NONE OF THE AFOREMENTIONED SERVICES RELATING IN ANY WAY TO PERSONNEL, RECRUITMENT OR EVALUATING OF STAFF, IN CLASS 42 (U.S. CLS. 100 AND 101).

FOR: MEDICAL SERVICES; MEDICAL-TECHNICAL SERVICES, NAMELY, RENTING AND LEASING OF EQUIPMENT TO END USERS FOR THE TREATMENT OF PATIENTS; SURGICAL SERVICES, NAMELY, SHOCK WAVE TREATMENT OF CELLS TO ENABLE MOLECULAR TRANSFER OF PHARMACEUTICALS, IN CLASS 44 (U.S. CLS. 100 AND 101).

PRIORITY DATE OF 12-19-2003 IS CLAIMED.

OWNER OF INTERNATIONAL REGISTRATION 0842976 DATED 6-1-2004, EXPIRES 6-1-2014.

NO CLAIM IS MADE TO THE EXCLUSIVE RIGHT TO USE "MEDTECH", APART FROM THE MARK AS SHOWN.

SER. NO. 79-008,780, FILED 6-1-2004.

STEVEN PEREZ, EXAMINING ATTORNEY

**Int. Cl.: 36**

**Prior U.S. Cls.: 100, 101 and 102**

**United States Patent and Trademark Office**

**Reg. No. 3,505,405**

**Registered Sep. 23, 2008**

**SERVICE MARK  
PRINCIPAL REGISTER**

**KUHN FINANCE**

KUHN S.A. (FRANCE SOCIÉTÉ ANONYME)  
4, IMPASSE DES FABRIQUES  
F-67700 SAVERNE  
FRANCE

PRIORITY DATE OF 8-25-2004 IS CLAIMED.

OWNER OF INTERNATIONAL REGISTRATION  
0846583 DATED 2-18-2005, EXPIRES 2-18-2015.

FOR: INSURANCE BROKERAGE IN CONNECTION WITH AGRICULTURAL EQUIPMENT; FINANCING SERVICES FOR THE SALE AND LEASING OF AGRICULTURAL EQUIPMENT; ASSET-BASED LENDING IN THE FIELD OF AGRICULTURAL EQUIPMENT; AND LINE OF CREDIT SERVICES IN THE FIELD OF AGRICULTURAL EQUIPMENT, IN CLASS 36 (U.S. CLS. 100, 101 AND 102).

NO CLAIM IS MADE TO THE EXCLUSIVE RIGHT TO USE "FINANCE", APART FROM THE MARK AS SHOWN.

SEC. 2(F) AS TO THE WORDS "KUHN FINANCE".

THE MARK CONSISTS OF STANDARD CHARACTERS WITHOUT CLAIM TO ANY PARTICULAR FONT, STYLE, SIZE, OR COLOR.

SER. NO. 79-009,964, FILED 2-18-2005.

JERI J. FICKES, EXAMINING ATTORNEY

**Int. Cl.: 11**

**Prior U.S. Cls.: 13, 21, 23, 31 and 34**

**United States Patent and Trademark Office**

**Reg. No. 3,505,406**

**Registered Sep. 23, 2008**

**TRADEMARK  
PRINCIPAL REGISTER**

# Bellevue

VILLEROY & BOCH AG (FED REP GERMANY  
JOINT STOCK COMPANY)  
P.O. BOX 1120  
66688 METTLACH  
FED REP GERMANY

FOR: KITCHEN SINKS, SINK UNITS COMPRISING SINKS AND PLUMBING FITTINGS AND FIXTURES, NAMELY, SINK SPRAYERS, SINK STRAINERS AND SINK TRAPS; LAMPS; WALL LIGHTS; SANITARY EQUIPMENT, NAMELY, BATH TUBS, WASHBASINS, SHOWER TUBS, TOILET BOWLS, TOILETS, TOILET TANKS, TRAP COVERS, BIDETS, URINALS; FITTED COVERS FOR URINALS; TOILET SEATS; PLUMBING FITTINGS, NAMELY, DRAINS, VALVES, COCKS AND SPOUTS; PLUMBING FITTINGS, NAMELY, SIPHONS TRAPS; PIPES BEING PARTS OF SANITARY FACILITIES; SHOWERS, PLUMBING FITTINGS, NAMELY, SHOWER CONTROL VALVES AND SHOWER SPRAYERS; SHOWER EQUIPMENT, NAMELY, SHOWER HEADS AND SHOWER DOORS; AND PLUMBING FIXTURES, NAMELY, SHOWER AND BATHTUB SPRAYERS; PLUMBING FITTINGS FOR SINKS, BATH TUBS AND SHOW-

ERS, NAMELY, BIBS, COCKS, TRAPS, VALVES; MANUALLY OPERATED PLUMBING VALVES AND MIXING VALVES FOR SANITARY WATER SUPPLY; REPLACEMENT PARTS FOR THE AFOREMENTIONED GOODS; SHOWER CUBICLES, IN CLASS 11 (U.S. CLS. 13, 21, 23, 31 AND 34).

THE MARK CONSISTS OF STANDARD CHARACTERS WITHOUT CLAIM TO ANY PARTICULAR FONT, STYLE, SIZE, OR COLOR.

PRIORITY DATE OF 3-9-2005 IS CLAIMED.

OWNER OF INTERNATIONAL REGISTRATION  
0868040 DATED 8-12-2005, EXPIRES 8-12-2015.

THE FOREIGN WORDING IN THE MARK  
TRANSLATES INTO ENGLISH AS PRETTY VIEW.

SER. NO. 79-017,581, FILED 8-12-2005.

CHRISIE B. KING, EXAMINING ATTORNEY

**Int. Cls.: 9 and 10**

**Prior U.S. Cls.: 21, 23, 26, 36, 38, 39 and 44**

**Reg. No. 3,505,407**

**United States Patent and Trademark Office**

**Registered Sep. 23, 2008**

**TRADEMARK  
PRINCIPAL REGISTER**

**FARSIGHT**

DORNIER MEDTECH GMBH (FED REP GER-  
MANY LIMITED LIABILITY COMPANY)  
ARGELSRIEDER FELD 7  
82234 WEßLING  
FED REP GERMANY

FOR: ELECTRONIC APPARATUS FOR RECORD-  
ING, TRANSMISSION, OR REPRODUCTION OF  
SOUND OR IMAGES, IN PARTICULAR IN DIGITAL  
FORMAT; DATA PROCESSING EQUIPMENT AND  
COMPUTERS, NAMELY, COMPUTERS, COMPU-  
TER WORKSTATIONS COMPRISING COMPU-  
TERS, CABLES, CONNECTORS FOR DATA  
EXCHANGE OR DATA CONTROL, AND NET-  
WORK ACCESS APPARATUS, COMPUTER PER-  
IPHERALS, DATA PROCESSORS, COMPUTER  
NETWORKS COMPRISING COMPUTERS, CABLES,  
CONNECTORS FOR DATA EXCHANGE OR DATA  
CONTROL AND NETWORK ACCESS APPARATUS,  
COMPUTER PERIPHERALS, DATA PROCESSORS;  
APPARATUS FOR CONTROLLING OR MONITOR-  
ING INDUSTRIAL PROCESSES OR SCIENTIFIC  
RESEARCH IN LABORATORIES, NAMELY, MONI-  
TORS, VIDEO DISPLAYS, NAMELY, STATIONARY  
DISPLAYS FIXED TO COMPUTER WORKSTA-  
TIONS, AND COMPUTERS FOR DATA ANALYSIS  
OF ULTRASOUND IMAGES AND FOR PROCES-  
SING OF MEDICAL IMAGES; APPARATUS FOR  
EXECUTING INDUSTRIAL PROCESSES OR SCIENTI-  
FIC RESEARCH IN LABORATORIES, NAMELY,  
MONITORS, COMPUTERS, AND DATA PROCES-  
SORS FOR CONTROLLING, MONITORING, OR  
PERFORMING OF X-RAY IMAGES, CT IMAGES,  
MRI IMAGES, ULTRASOUND IMAGES, ENDO-  
SCOPIC IMAGES; APPARATUS FOR RECEIVING,  
RECORDING, TRANSMITTING, AND REPRODU-  
CING SIGNALS, IMAGES, OR SOUND FOR MEDI-  
CAL USE, OR COMBINATIONS THEREOF, IN  
PARTICULAR ULTRASONIC APPARATUS; OPTI-

CAL AND DIGITAL RECORDING APPARATUS,  
NAMELY, MONITORS AND DISPLAYS FOR MED-  
ICAL USE; ALL OF THE AFOREMENTIONED AP-  
PARATUS AND INSTRUMENTS FOR USE IN THE  
MEDICAL FIELD FOR LOCALIZING THE PATH  
AND TARGETS OF SHOCK WAVES, IN CLASS 9  
(U.S. CLS. 21, 23, 26, 36 AND 38).

FOR: MEDICAL AND MEDICAL-TECHNICAL  
APPARATUS AND INSTRUMENTS FOR GENERAL  
SURGERY AND TREATMENT OF PATIENTS,  
NAMELY, LITHOTRIPTERS AND ULTRASOUND  
APPARATUS; ELECTRO-MEDICAL AND DIGITAL  
DIAGNOSIS AND THERAPY APPARATUS FOR  
GENERAL SURGERY AND TREATMENT OF PA-  
TIENTS, NAMELY, EXTRACORPORAL SHOCK  
WAVE LITHOTRIPTERS, ULTRASOUND APPARA-  
TUS; ALL OF THE AFOREMENTIONED APPARA-  
TUS AND INSTRUMENTS FOR USE IN THE  
MEDICAL FIELD FOR LOCALIZING THE PATH  
AND TARGETS OF SHOCK WAVES, IN CLASS 10  
(U.S. CLS. 26, 39 AND 44).

THE MARK CONSISTS OF STANDARD CHAR-  
ACTERS WITHOUT CLAIM TO ANY PARTICULAR  
FONT, STYLE, SIZE, OR COLOR.

PRIORITY DATE OF 10-28-2004 IS CLAIMED.

OWNER OF INTERNATIONAL REGISTRATION  
0869170 DATED 1-31-2005, EXPIRES 1-31-2015.

SER. NO. 79-018,027, FILED 1-31-2005.

LYDIA BELZER, EXAMINING ATTORNEY

**Int. Cls.: 3, 18 and 25**

**Prior U.S. Cls.: 1, 2, 3, 4, 6, 22, 39, 41, 50, 51 and 52**

**United States Patent and Trademark Office**

**Reg. No. 3,505,408**

**Registered Sep. 23, 2008**

**TRADEMARK  
PRINCIPAL REGISTER**

# RUE BLANCHE

RUE BLANCHE S.A., SOCIÉTÉ ANONYME (BELGIUM JOINT STOCK COMPANY)  
AVENUE D'OPPEM 10  
B-1150 WOLUWÉ-ST-PIERRE  
BELGIUM

FOR: BLEACHING PREPARATIONS FOR LAUNDRY USE, COSMETICS, SUNTAN LOTION, AFTER-SHAVE, ANTI-PERSPIRANTS, SHAMPOO, CONDITIONER, BODY WASH, BATH BEADS, BATH SALTS, BLUSH, BEAUTY MASKS, BUBBLE BATH, PERFUME, COLOGNE, DEODORANTS FOR PERSONAL USE, DENTRIFICES, LAUNDRY DETERGENT, DISINFECTANT SOAPS, EAU DE TOILETTE, HAIR CARE PREPARATIONS, HAIR COLOR, HAIR FROSTS, HAIR MOUSSE, HAIR SPRAY, HAIR TONIC, LIPSTICK, MAKE-UP, MAKE-UP REMOVER, NAIL ENAMEL, MOUTHWASH, NON-MEDICATED LIP PROTECTOR, NON-MEDICATED TOILETRIES, SHAVING PREPARATIONS, PERFUMERY, ESSENTIAL OILS, AND HAIR LOTION, IN CLASS 3 (U.S. CLS. 1, 4, 6, 50, 51 AND 52).

FOR: LEATHER AND IMITATIONS OF LEATHER GOODS, NAMELY, BACKPACKS; UMBRELLAS; PURSES; WALLETS; TOTE BAGS; CARRY-ON BAGS; BOOK BAGS; BABY CARRYING BAGS; CARRYING CASES; POUCHES, NAMELY, DRAWSTRING POUCHES, FELT POUCHES, POUCHES OF LEATHER; HAND BAGS; FUR, IMITATION OF LEATHER; ANIMAL SKINS AND HIDES; TRUNKS AND SUITCASES; PARASOLS AND WALKING STICKS; WHIPS AND SADDLERY, IN CLASS 18 (U.S. CLS. 1, 2, 3, 22 AND 41).

FOR: CLOTHING, NAMELY, T-SHIRTS, SHIRTS, DRESS SHIRTS, BLOUSES, POLO AND SPORT SHIRTS, SWEATERS, PULLOVERS, THIN POLO-

NECK TOPS, CARDIGANS, DRESSES, PULLOVER DRESSES, TUNICS, POLAR FLEECE TOPS, BOLEROS, POLO-NECK PULLOVERS, JUMPERS, SKIRTS, TROUSERS, SHORTS, JOGGING SUITS, DUNGAREES, SLIPS, BERMUDA SHORTS, JEANS, CULOTTES, VESTS, BLAZERS, JACKETS, COATS, PARKAS, RAINCOATS, ANORAKS, FUR COATS, SUITS, UNDERPANTS, PANTIES AND KNICKERS, TOPS, BODY SUITS, PAJAMAS, DRESSING GOWNS, TIGHTS, PANTYHOSE, SOCKS, LINGERIE, UNDERSHIRTS, SCARVES, GLOVES, BELTS, TIES, CAPES, PAREOS, PONCHOS, SUSPENDERS, MULES, STOLES, FOOTWEAR, SWIMSUITS, BIKINIS, HEADGEAR, NAMELY, CAPS, HATS, AND HOODS, IN CLASS 25 (U.S. CLS. 22 AND 39).

THE MARK CONSISTS OF STANDARD CHARACTERS WITHOUT CLAIM TO ANY PARTICULAR FONT, STYLE, SIZE, OR COLOR.

PRIORITY DATE OF 9-1-2005 IS CLAIMED.

OWNER OF INTERNATIONAL REGISTRATION 0874604 DATED 12-14-2005, EXPIRES 12-14-2015.

OWNER OF U.S. REG. NO. 1,869,728.

THE FOREIGN WORDING IN THE MARK TRANSLATES INTO ENGLISH AS WHITE, PALE, OR CLEAN STREET.

SER. NO. 79-020,075, FILED 12-14-2005.

NAKIA HENRY, EXAMINING ATTORNEY

**Int. Cls.: 9, 38, 41 and 42**

**Prior U.S. Cls.: 21, 23, 26, 36, 38, 100, 101, 104 and 107**

**United States Patent and Trademark Office**

**Reg. No. 3,505,409**

**Registered Sep. 23, 2008**

**TRADEMARK  
SERVICE MARK  
PRINCIPAL REGISTER**

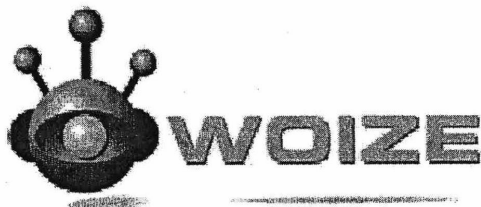

WOIZE LTD (UNITED KINGDOM CORPORATION)  
7 SAVOY COURT  
STRAND; LONDON WC2R 0ER  
UNITED KINGDOM

FOR: COMPUTER GAME PROGRAMS, IN CLASS 9 (U.S. CLS. 21, 23, 26, 36 AND 38).

FOR: DATA COMMUNICATION BY ELECTRONIC MAIL, INTERNET TELEPHONY AND VIDEO-CONFERENCE SERVICES, TELEPHONE CONFERENCE SERVICES, INCLUDING CONFERENCES ACROSS A COMPUTER NETWORK, INSTANT MESSAGING SERVICES, STREAMING OF AUDIO-VISUAL MATERIAL ON THE INTERNET, VOICE OVER INTERNET PROTOCOL (VOIP) SERVICES, PROVIDING HIGH SPEED ACCESS TO AREA NETWORKS AND A GLOBAL COMPUTER INFORMATION NETWORK, COMPUTER AIDED TRANSMISSION OF MESSAGES AND IMAGES, INFORMATION REGARDING TELECOMMUNICATION, RADIO BROADCASTING, TELEPHONE COMMUNICATION SERVICES, TELEVISION BROADCASTING, SATELLITE TRANSMISSION, PROVIDING OF TELECOMMUNICATION CONNECTIONS TO A GLOBAL COMPUTER NETWORK, GRANTING OF ACCESS TO COMPUTER NETWORKS, IN CLASS 38 (U.S. CLS. 100, 101 AND 104).

FOR: PRODUCTION OF VIDEO FILMS, IN CLASS 41 (U.S. CLS. 100, 101 AND 107).

FOR: SERVICES IN THE FIELD OF COMPUTER PROGRAMMING, DESIGN FOR OTHERS AND DEVELOPMENT OF COMPUTER HARDWARE, DESIGN AND DEVELOPMENT OF COMPUTER SOFTWARE, INSTALLATION OF COMPUTER SOFTWARE, CONSULTANCY IN THE FIELD OF COMPUTER HARDWARE, RENTAL OF COMPUTER SOFTWARE, IN CLASS 42 (U.S. CLS. 100 AND 101).

OWNER OF INTERNATIONAL REGISTRATION 0842156 DATED 10-22-2004, EXPIRES 10-22-2014.

"WOIZE" HAS NO SIGNIFICANCE IN OWNER'S TRADE OR INDUSTRY, NO SIGNIFICANCE IN RELATION TO OWNER'S GOODS, AND NO GEOGRAPHICAL SIGNIFICANCE, OR ANY MEANING IN A FOREIGN LANGUAGE.

SER. NO. 79-021,069, FILED 1-4-2006.

BARNEY CHARLON, EXAMINING ATTORNEY

Int. Cl.: 33

Prior U.S. Cls.: 47 and 49

United States Patent and Trademark Office

Reg. No. 3,505,410

Registered Sep. 23, 2008

TRADEMARK  
PRINCIPAL REGISTER

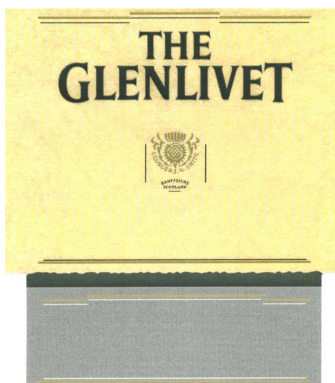

THE GLENLIVET DISTILLERS LIMITED (UNITED KINGDOM COMPANY)

CHIVAS HOUSE

72 CHANCELLORS ROAD LONDON W6 9RS

UNITED KINGDOM

FOR: ALCOHOLIC BEVERAGES, NAMELY, WHISKIES, MALT WHISKIES, BEVERAGES MADE FROM OR CONTAINING WHISKY, BEVERAGES MADE FROM OR CONTAINING MALTS, APERITIFS CONTAINING WHISKY, LIQUEURS MADE FROM OR CONTAINING WHISKY, LIQUEURS MADE FROM OR CONTAINING MALTS, READY-TO-DRINK ALCOHOLIC DRINKS CONTAINING ANY OF THE AFOREMENTIONED, COCKTAILS CONTAINING ANY OF THE AFOREMENTIONED; DISTILLED SPIRITS, WINES, LIQUEURS; DISTILLED BEVERAGES, NAMELY, DISTILLED SPIRITS; WHISKY; MALT WHISKY; WHISKY LIQUEURS; BEVERAGES MADE FROM OR CONTAINING WHISKY; APERITIFS; ALCOHOLIC COCKTAILS; BUT INsofar AS WHISKY AND WHISKY BASED LIQUEURS ARE CONCERNED, ONLY SCOTCH WHISKY AND SCOTCH WHISKY BASED LIQUEURS PRODUCED IN SCOTLAND, IN CLASS 33 (U.S. CLS. 47 AND 49).

PRIORITY DATE OF 9-15-2005 IS CLAIMED.

OWNER OF INTERNATIONAL REGISTRATION 0880103 DATED 1-27-2006, EXPIRES 1-27-2016.

OWNER OF U.S. REG. NOS. 53,002, 3,079,924 AND OTHERS.

NO CLAIM IS MADE TO THE EXCLUSIVE RIGHT TO USE "BANFFSHIRE, SCOTLAND", APART FROM THE MARK AS SHOWN.

THE INDIVIDUALS "GEORGE & J G SMITH" DO NOT IDENTIFY LIVING INDIVIDUALS.

THE COLOR(S) YELLOW, GOLD AND SILVER IS/ ARE CLAIMED AS A FEATURE OF THE MARK.

THE COLORS YELLOW APPEARS IN THE BACKGROUND, GOLD IN THE LETTERING AND DESIGN AND THE BAND ON THE BOTTOM IS SILVER.

SEC. 2(F).

SER. NO. 79-021,938, FILED 1-27-2006.

BENJAMIN OKEKE, EXAMINING ATTORNEY



**Int. Cl.: 38**

**Prior U.S. Cls.: 100, 101 and 104**

**United States Patent and Trademark Office**

**Reg. No. 3,505,411**

**Registered Sep. 23, 2008**

**SERVICE MARK  
PRINCIPAL REGISTER**



NAPFOLT KFT. (HUNGARY LIMITED LIABILITY COMPANY)

MARGIT KRT. 26.

H-1027 BUDAPEST, HUNGARY

FOR: TELECOMMUNICATION SERVICES, NAMELY, INTERNET SERVICE PROVIDER, ELECTRONIC MAIL SERVICES, ELECTRONIC TRANSMISSION OF MESSAGES AND IMAGES AND ELECTRONIC MESSAGE SENDING AND RECEIVING VIA COMPUTER, GLOBAL COMPUTER NETWORK, WIRE TELEPHONE, WIRELESS TELEPHONE, TELEPHONE NETWORK, MOBILE PHONE, OR MOBILE PHONE NETWORK, IN CLASS 38 (U.S. CLS. 100, 101 AND 104).

PRIORITY DATE OF 2-14-2006 IS CLAIMED.

OWNER OF INTERNATIONAL REGISTRATION 0884244 DATED 3-20-2006, EXPIRES 3-20-2016.

THE COLOR(S) TAN, LIGHT OLIVE BROWN, YELLOW AND LIGHT BROWN IS/ARE CLAIMED AS A FEATURE OF THE MARK.

THE COLORS TAN AND LIGHT OLIVE BROWN APPEAR IN GEOMETRICAL SHAPES THAT ARE PART OF THE BACKGROUND, THE COLOR YELLOW APPEARS IN THE WORDING AS FONT COLORS, AND THE COLOR LIGHT BROWN APPEARS IN THE ANIMAL REPRESENTATION.

SER. NO. 79-023,638, FILED 3-20-2006.

ESTHER A. BORSUK, EXAMINING ATTORNEY

**Int. Cls.: 14 and 21**

**Prior U.S. Cls.: 2, 13, 23, 27, 28, 29, 30, 33, 40 and 50**

**Reg. No. 3,505,412**

**United States Patent and Trademark Office**

**Registered Sep. 23, 2008**

**TRADEMARK  
PRINCIPAL REGISTER**

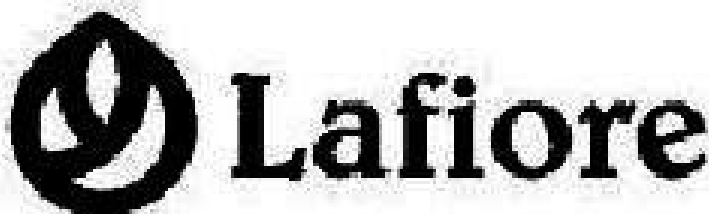

LAFIORE, S.A. (SPAIN SOCIEDAD ANONIMA)  
CARRETERA VALDEMOSA, KM. 11  
E-07193 S'ESGLEIETA (PALMA DE MALLORCA),  
SPAIN

FOR: FASHION JEWELRY AND JEWELRY ARTICLES, NAMELY, BEADS FOR USE IN THE MANUFACTURE OF JEWELRY, BRACELETS, BRONZE JEWELRY, BROOCHES, CHARMS, COSTUME JEWELRY, JADE, JEWELRY CASKETS, CHAINS, JEWELRY FINDINGS, JEWELRY FOR THE HEAD, JEWELRY PINS FOR USE ON HATS, JEWELRY RING HOLDERS, JEWELRY TO BE AFFIXED TO BIKINIS, AMULETS, CROSSES, WATCHES MADE OF PRECIOUS METALS, PRECIOUS METAL PLATED LEAVES AND FLOWERS, LAPEL PINS, LEATHER JEWELRY AND ACCESSORY BOXES, PET JEWELRY, PINS, RINGS, IN CLASS 14 (U.S. CLS. 2, 27, 28 AND 50).

FOR: BEVERAGE GLASSWARE; CERAMIC AND ARTISTIC EARTHENWARE MUGS, BOWLS AND DRINKING JUGS WITH A SPOUT AND HANDLE; GLASS HOUSEHOLD UTENSILS, NAMELY, DEC-

ORATIVE FIGURINES, DECORATIVE PLATES AND CUPS, CUPS AND PLATES, DRINKING GLASSWARE, PITCHERS, SERVING TRAYS, DECANTERS, DECORATIVE VASES, JARS WITH A LONG SPOUT, CANDLESTICKS, SALT CELLARS, BOTTLES, JUGS; CONTAINERS FOR HOUSEHOLD AND KITCHEN USE; DECORATIVE GLASS; CRYSTAL BEVERAGE WARE; ENAMELED GLASS; PAINTED BEVERAGE WARE, IN CLASS 21 (U.S. CLS. 2, 13, 23, 29, 30, 33, 40 AND 50).

PRIORITY DATE OF 4-11-2006 IS CLAIMED.

OWNER OF INTERNATIONAL REGISTRATION  
0885884 DATED 4-27-2006, EXPIRES 4-27-2016.

THE ENGLISH TRANSLATION OF "LAFIORE" IS  
THE FLOWER.

SER. NO. 79-024,217, FILED 4-27-2006.

DAVID HOFFMAN, EXAMINING ATTORNEY

**Int. Cls.: 6 and 20**

**Prior U.S. Cls.: 2, 12, 13, 14, 22, 23, 25, 32 and 50**

**United States Patent and Trademark Office**

**Reg. No. 3,505,413**

**Registered Sep. 23, 2008**

**TRADEMARK  
PRINCIPAL REGISTER**

**Silentia**

ARTURO SALICE S.P.A. (ITALY CORPORATION)  
VIA PROVINCIALE NOVEDRATESE 10  
I-22060 NOVEDRATE (CO), ITALY

OWNER OF INTERNATIONAL REGISTRATION  
0885948 DATED 1-30-2006, EXPIRES 1-30-2016.

FOR: GOODS EXCLUSIVELY FOR USE IN FURNITURE, NAMELY, METAL HINGES, METAL FASTENERS, NAMELY, BOLTS, NAILS, RIVETS, SCREWS, AND SMALL METAL FITTINGS, NAMELY, DRAWER SLIDES AND DOOR HANDLES, IN CLASS 6 (U.S. CLS. 2, 12, 13, 14, 23, 25 AND 50).

THE COLOR(S) ORANGE IS/ARE CLAIMED AS A FEATURE OF THE MARK.

THE ENTIRE MARK IS ORANGE.

FOR: GOODS EXCLUSIVELY FOR USE IN FURNITURE, NAMELY, NON-METAL HINGES, NON-METAL FASTENERS, NAMELY, BOLTS, NAILS, RIVETS, SCREWS AND SMALL NON METAL HARDWARE AND NON METAL FITTINGS, NAMELY, DRAWER SLIDES AND DOOR HANDLES, IN CLASS 20 (U.S. CLS. 2, 13, 22, 25, 32 AND 50).

THE TERM "SILENTIA" IS TRANSLATED FROM LATIN AS SILENT THINGS.

SER. NO. 79-024,247, FILED 1-30-2006.

PRIORITY DATE OF 11-18-2005 IS CLAIMED.

ELLEN B. AWRICH, EXAMINING ATTORNEY

**Int. Cls.: 37 and 42**

**Prior U.S. Cls.: 100, 101, 103 and 106**

**United States Patent and Trademark Office**

**Reg. No. 3,505,414**

**Registered Sep. 23, 2008**

**SERVICE MARK  
PRINCIPAL REGISTER**

**ELCO**

MERLONI BRANDS KFT. (HUNGARY LIMITED  
LIABILITY COMPANY)  
HUN UTCA 2  
H-1135 BUDAPEST  
HUNGARY

FOR: INSTALLATION, MAINTENANCE AND  
REPAIR OF HEATING, VENTILATION, WATER  
SUPPLY AND AIR-CONDITIONING INSTAL-  
LATIONS, IN CLASS 37 (U.S. CLS. 100, 103 AND 106).

FOR: TECHNICAL ADVICE AND CONSTRU-  
TION AND DESIGN PLANNING IN THE AREA OF  
HEATING VENTILATION AND AIR-CONDITION-  
ING ENGINEERING, IN PARTICULAR OF HEAT  
ENGINEERING INSTALLATIONS, OF SOLAR AC-  
CUMULATORS AND HEAT PUMPS AND THE  
INSTALLATION, ASSEMBLY, MAINTENANCE  
AND REPAIR THEREOF, ENGINEERING IN THE  
NATURE OF DESIGN PLANNING, TECHNICAL  
PROJECT PLANNING FOR HEATING, VENTILA-  
TION AND AIR CONDITIONING INSTALLATIONS,  
RESEARCH AND DEVELOPMENT IN THE AREA

OF HEATING, VENTILATION AND AIR-CONDI-  
TIONING ENGINEERING, ENGINEERING; DRAW-  
ING-UP OF TECHNICAL EXPERT REPORTS FOR  
HEATING, VENTILATION AND AIR-CONDITION-  
ING INSTALLATION, RENTAL, MAINTENANCE  
AND UPDATING OF COMPUTER APPLICATION  
SOFTWARE, AND DEVELOPMENT OF COMPU-  
TER DATA PROCESSING PROGRAMS, IN CLASS 42  
(U.S. CLS. 100 AND 101).

THE MARK CONSISTS OF STANDARD CHAR-  
ACTERS WITHOUT CLAIM TO ANY PARTICULAR  
FONT, STYLE, SIZE, OR COLOR.

OWNER OF INTERNATIONAL REGISTRATION  
0774908 DATED 8-22-2001, EXPIRES 8-22-2011.

SER. NO. 79-024,377, FILED 11-10-2005.

TRICIA SONNEBORN, EXAMINING ATTORNEY

Int. Cl.: 29

Prior U.S. Cl.: 46

United States Patent and Trademark Office

Reg. No. 3,505,415

Registered Sep. 23, 2008

TRADEMARK  
PRINCIPAL REGISTER



UNION LAITIÈRE VITTELLOISE; FROMAGERIE  
DE L'ERMITAGE (FRANCE SOCIÉTÉ COOP-  
ÉRATIVE AGRICOLE)  
718, RUE DIVISION LECLERC  
F-88140 BULGNEVILLE  
FRANCE

PRIORITY DATE OF 9-14-2005 IS CLAIMED.

OWNER OF INTERNATIONAL REGISTRATION  
0888563 DATED 3-1-2006, EXPIRES 3-1-2016.

FOR: CHEESES; MILK AND DAIRY PRODUCTS  
EXCLUDING ICE CREAM, ICE MILK, AND FRO-  
ZEN YOGURT; YOGURTS; CREAM; MILK BEV-  
ERAGES, NAMELY, MILK BASED BEVERAGES  
CONTAINING FRUIT JUICE, MILK BEVERAGES  
CONTAINING FRUITS, MILK BEVERAGES WITH  
HIGH MILK CONTENT, MILK-BASED BEVERAGE  
CONTAINING COFFEE, SOY-BASED FOOD BEV-  
ERAGE USED AS MILK SUBSTITUTE; BUTTER;  
MARGARINE; BUTTERCREAM; EGGS; MEAT;  
FISH; POULTRY AND GAME; MEAT EXTRACTS;  
PRESERVED, DRIED AND COOKED FRUITS AND  
VEGETABLES; FRUIT JELLIES; JAMS; CRYSTAL-  
LIZED FRUITS; COMPOTES; PRESERVED FRUITS;  
EDIBLE OILS AND FATS; CANNED MEAT, FISH,  
FRUITS AND VEGETABLES; PICKLES; PRE-  
COOKED DISHES CONSISTING PRIMARILY OF  
CHEESE, VEGETABLE, FISH OR MEAT, IN CLASS  
29 (U.S. CL. 46).

THE COLOR(S) YELLOW, BLACK AND RED IS/  
ARE CLAIMED AS A FEATURE OF THE MARK.

THE COLOR YELLOW APPEARS AS THE BACK-  
GROUND INSIDE THE BANNER DESIGN; THE  
COLOR BLACK APPEARS AS THE OUTLINE OF  
THE BANNER DESIGN; THE COLOR RED AP-  
PEARS AS THE WORD "ERMITAGE".

THE FOREIGN WORDING IN THE MARK  
TRANSLATES INTO ENGLISH AS HERMITAGE.

SER. NO. 79-025,233, FILED 3-1-2006.

KATHERINE E. HALMEN, EXAMINING ATTOR-  
NEY

**Int. Cls.: 7, 9, 37 and 42**

**Prior U.S. Cls.: 13, 19, 21, 23, 26, 31, 34, 35, 36, 38,  
100, 101, 103 and 106**

**Reg. No. 3,505,416**

**United States Patent and Trademark Office**

**Registered Sep. 23, 2008**

**TRADEMARK  
SERVICE MARK  
PRINCIPAL REGISTER**

# TruShear

TRUMPF GMBH + CO. KG (FED REP GERMA-  
NY GMBH + CO. KG)  
JOHANN-MAUS-STRABE 2  
71254 DITZINGEN, FED REP GERMANY

FOR: MACHINE TOOLS, NAMELY, COMPUTER CONTROLLED SHEARING AND CUTTING MACHINES; POWER DRIVEN HAND-HELD TOOLS, NAMELY, SHEARING AND CUTTING MACHINES; WORKPIECE MOVEMENT INSTALLATIONS FOR LOADING AND ORIENTING WORKPIECES IN MACHINES AND FOR REMOVING AND SORTING PROCESSED WORKPIECES, NAMELY, CONVEYORS AND WORKPIECE PROCESSING MACHINES TO SORT PARTS OF DIFFERENT SHAPES OR DIMENSIONS, IN CLASS 7 (U.S. CLS. 13, 19, 21, 23, 31, 34 AND 35).

FOR: COMPUTER NUMERIC CONTROLS FOR INPUTTING CONTROL INFORMATION AND DISPLAY TERMINALS TO MONITOR OPERATION OF MACHINE TOOLS; SOFTWARE FOR CONTROLLING THE MACHINE TOOLS AND FOR MONITORING OPERATION OF THE MACHINE TOOLS, IN CLASS 9 (U.S. CLS. 21, 23, 26, 36 AND 38).

FOR: MAINTENANCE, SERVICING AND REPAIR OF SHEARING AND CUTTING MACHINE

TOOLS, INCLUDING SUCH SERVICES PROVIDED REMOTELY BY MEANS OF ELECTRONIC DATA LINES, IN CLASS 37 (U.S. CLS. 100, 103 AND 106).

FOR: INDIVIDUAL CONSULTATION AND ASSISTANCE IN PROGRAMMING FOR SHEARING AND CUTTING MACHINE TOOLS; AND MATERIAL HANDLING AND TRANSPORTING SYSTEMS; DESIGNING TOOLING, IN CLASS 42 (U.S. CLS. 100 AND 101).

THE MARK CONSISTS OF STANDARD CHARACTERS WITHOUT CLAIM TO ANY PARTICULAR FONT, STYLE, SIZE, OR COLOR.

PRIORITY DATE OF 4-28-2005 IS CLAIMED.

OWNER OF INTERNATIONAL REGISTRATION  
0890074 DATED 10-25-2005, EXPIRES 10-25-2015.

SER. NO. 79-025,777, FILED 10-25-2005.

SUNG IN, EXAMINING ATTORNEY

**Int. Cls.: 7, 9, 37 and 42**

**Prior U.S. Cls.: 13, 19, 21, 23, 26, 31, 34, 35, 36, 38,  
100, 101, 103 and 106**

**Reg. No. 3,505,417**

**United States Patent and Trademark Office**

**Registered Sep. 23, 2008**

**TRADEMARK  
SERVICE MARK  
PRINCIPAL REGISTER**

# TruBend

TRUMPF GMBH + CO. KG (FED REP GERMA-  
NY GMBH + CO. KG)

JOHANN-MAUS-STRABE 2

71254 DITZINGEN, FED REP GERMANY

FOR: MACHINE TOOLS, NAMELY, COMPUTER CONTROLLED BENDING, FOLDING AND FLANGE FORMING MACHINES; POWER DRIVEN HAND-HELD TOOLS, NAMELY, BENDING, FOLDING AND FLANGE FORMING MACHINES; WORKPIECE MOVEMENT INSTALLATIONS FOR LOADING AND ORIENTING WORKPIECES IN MACHINES AND FOR REMOVING AND SORTING PROCESSED WORKPIECES, NAMELY, CONVEYORS AND WORKPIECE PROCESSING MACHINES TO SORT PARTS OF DIFFERENT SHAPES OR DIMENSIONS, IN CLASS 7 (U.S. CLS. 13, 19, 21, 23, 31, 34 AND 35).

FOR: COMPUTER CONTROLS FOR IMPUTTING CONTROL INFORMATION AND DISPLAY TERMINALS TO MONITOR OPERATION OF MACHINE TOOLS; BENDING, FOLDING AND FLANGE FORMING SOFTWARE FOR CONTROLLING THE MACHINE TOOLS AND FOR MONITORING OPERATION OF THE MACHINE TOOLS, IN CLASS 9 (U.S. CLS. 21, 23, 26, 36 AND 38).

FOR: MAINTENANCE, SERVICING AND REPAIR OF BENDING, FOLDING AND FLANGE FORMING MACHINE TOOLS, INCLUDING SUCH SERVICES PROVIDED REMOTELY BY MEANS OF ELECTRONIC DATA LINES, IN CLASS 37 (U.S. CLS. 100, 103 AND 106).

FOR: INDIVIDUAL CONSULTATION AND ASSISTANCE IN PROGRAMMING OF BENDING, FOLDING AND FLANGE FORMING MACHINE TOOLS AND MATERIAL HANDLING AND TRANSPORTING SYSTEMS; DESIGNING TOOLING, IN CLASS 42 (U.S. CLS. 100 AND 101).

THE MARK CONSISTS OF STANDARD CHARACTERS WITHOUT CLAIM TO ANY PARTICULAR FONT, STYLE, SIZE, OR COLOR.

PRIORITY DATE OF 4-28-2005 IS CLAIMED.

OWNER OF INTERNATIONAL REGISTRATION 0890638 DATED 10-25-2005, EXPIRES 10-25-2015.

SER. NO. 79-025,980, FILED 10-25-2005.

SUNG IN, EXAMINING ATTORNEY

**Int. Cl.: 16**

**Prior U.S. Cls.: 2, 5, 22, 23, 29, 37, 38 and 50**

**United States Patent and Trademark Office**

**Reg. No. 3,505,418**

**Registered Sep. 23, 2008**

**TRADEMARK  
PRINCIPAL REGISTER**

**DOTCH**

KING JIM CO., LTD. (JAPAN CORPORATION)  
10-18, HIGASHI-KANDA 2-CHOME  
CHIYODA-KU; TOKYO 101-0031  
JAPAN

OWNER OF INTERNATIONAL REGISTRATION  
0894160 DATED 5-2-2006, EXPIRES 5-2-2016.

FOR: OFFICE REQUISITES, NAMELY, DOCUMENT FILES AND CARD FILES; LOOSE-LEAF BINDERS, ALBUMS FOR COINS, PHOTOGRAPHS, STAMPS; FILE BINDERS, IN CLASS 16 (U.S. CLS. 2, 5, 22, 23, 29, 37, 38 AND 50).

SEC. 2(F).

SER. NO. 79-027,205, FILED 5-2-2006.

NELSON SNYDER, EXAMINING ATTORNEY



**Int. Cls.: 35 and 41**

**Prior U.S. Cls.: 100, 101, 102 and 107**

**United States Patent and Trademark Office**

**Reg. No. 3,505,419**

**Registered Sep. 23, 2008**

**SERVICE MARK  
PRINCIPAL REGISTER**



FONDATION DE LA HAUTE HORLOGERIE  
(SWITZERLAND PRIVATE FOUNDATION)  
BOULEVARD JAMES-FAZY 8  
GENÈVE CH-1201, SWITZERLAND

FOR: BUSINESS INFORMATION SERVICES, NAMELY, PROVIDING BUSINESS INFORMATION IN THE FIELD OF WATCH MAKING AND WATCH DESIGN; DISTRIBUTION OF ADVERTISING MATERIAL; ORGANIZATION OF EXHIBITIONS, TRADE FAIRS AND CONVENTIONS FOR COMMERCIAL AND ADVERTISING PURPOSES, NAMELY, ARRANGING, PLANNING, AND CONDUCTING TRADE FAIRS; THE DISSEMINATION AND UPDATING OF ADVERTISING MATERIAL FOR OTHERS; PUBLISHING OF ADVERTISING TEXTS; PUBLIC RELATIONS; AND CONDUCTING OPINION POLLING, IN CLASS 35 (U.S. CLS. 100, 101 AND 102).

FOR: ORGANIZATION OF COMPETITIONS IN THE FIELD OF WATCH MAKING AND WATCH DESIGN; ARRANGING AND HOLDING EXHIBITIONS IN THE FIELD OF WATCH MAKING, WATCH HISTORY, AND WATCH DESIGN; EDUCATIONAL SERVICES, NAMELY, ARRANGING CONFERENCES AND CONVENTIONS FOR CULTURAL AND EDUCATIONAL PURPOSES IN THE FIELD OF WATCH MAKING, WATCH HISTORY

AND WATCH DESIGN; PUBLICATION OF BOOKS; PARTY PLANNING; AND THE PUBLICATION OF TEXTS, OTHER THAN ADVERTISING AND PUBLICITY TEXTS, IN CLASS 41 (U.S. CLS. 100, 101 AND 107).

PRIORITY DATE OF 3-3-2006 IS CLAIMED.

OWNER OF INTERNATIONAL REGISTRATION 0897390 DATED 8-28-2006, EXPIRES 8-28-2016.

OWNER OF U.S. REG. NO. 2,521,973.

NO CLAIM IS MADE TO THE EXCLUSIVE RIGHT TO USE "FONDATION DE LA HAUTE HORLOGERIE", APART FROM THE MARK AS SHOWN.

THE FOREIGN WORDING IN THE MARK TRANSLATES INTO ENGLISH AS THE FOUNDATION FOR FINE WATCH MAKING.

SER. NO. 79-028,458, FILED 8-28-2006.

MICHAEL TANNER, EXAMINING ATTORNEY

**Int. Cls.: 35 and 42**

**Prior U.S. Cls.: 100, 101 and 102**

**United States Patent and Trademark Office**

**Reg. No. 3,505,420**

**Registered Sep. 23, 2008**

**SERVICE MARK  
PRINCIPAL REGISTER**

**VERICERT**

BUREAU VERITAS, REGISTRE; INTERNATIONAL DE CLASSIFICATION; DE NAVIRES ET D'AERONEFS (FRANCE SOCIÉTÉ ANONYME)

17 BIS, PLACE DES REFLETS  
LA DÉFENSE 2; F-92400 COURBEVOIE  
FRANCE

FOR: ASSISTANCE WITH BUSINESS MANAGEMENT AND WITH MANAGEMENT OF COMMERCIAL OR INDUSTRIAL COMPANIES; BUSINESS APPRAISALS; BUSINESS ORGANIZATION AND MANAGEMENT CONSULTING; PROFESSIONAL BUSINESS CONSULTING; EFFICIENCY EXPERTS; BUSINESS MANAGEMENT; ACCOUNTING; CHECKING ACCOUNTS; PERSONNEL MANAGEMENT CONSULTANCY; DOCUMENT REPRODUCTION; MARKET STUDY; COMPUTER FILE MANAGEMENT; DATA COMPILATION AND SYSTEMATIZATION IN A DATABASE; ECONOMIC FORECASTS, IN CLASS 35 (U.S. CLS. 100, 101 AND 102).

FOR: CHEMICAL ANALYSIS SERVICES, QUALITY CONTROL, TESTING, ANALYSIS AND EVALUATION OF THE GOODS AND SERVICES OF

OTHERS FOR THE PURPOSE OF CERTIFICATION BASED ON A METHOD CENTERED ON THE IMPROVEMENT OF A COMPANY'S BUSINESS-CRITICAL PERFORMANCES, ENGINEERING SERVICES, EXCLUDING AGRICULTURAL PRODUCT TESTING AND ANALYSIS FOR PH, SHELF LIFE, FOODS QUALITY/FRESHNESS, BACTERIA, ANTI-BIOTIC RESIDUE AND HORMONES, IN CLASS 42 (U.S. CLS. 100 AND 101).

THE MARK CONSISTS OF STANDARD CHARACTERS WITHOUT CLAIM TO ANY PARTICULAR FONT, STYLE, SIZE, OR COLOR.

PRIORITY DATE OF 3-20-2006 IS CLAIMED.

OWNER OF INTERNATIONAL REGISTRATION 0899058 DATED 8-30-2006, EXPIRES 8-30-2016.

SER. NO. 79-029,116, FILED 8-30-2006.

DANIEL CAPSHAW, EXAMINING ATTORNEY

Int. Cls.: 2, 17, 19, 24 and 27

Prior U.S. Cls.: 1, 5, 6, 11, 12, 13, 16, 19, 20, 33, 35, 37,  
42 and 50

Reg. No. 3,505,421

United States Patent and Trademark Office

Registered Sep. 23, 2008

TRADEMARK  
PRINCIPAL REGISTER



VITRULAN TEXTILGLAS GMBH (FED REP  
GERMANY COMPANY WITH LIMITED LIA-  
BILITY)  
BERNECKER STRASSE 8  
95509 MARKTSCHORGAST  
FED REP GERMANY

FOR: PAINTS, VARNISHES, LACQUERS; COAT-  
ING IN THE NATURE OF PRESERVATIVES  
AGAINST RUST; PRESERVATIVES AGAINST DE-  
TERIORATION OF WOOD; RAW NATURAL RE-  
SINS FOR USE IN THE MANUFACTURE OF  
RESINS AND FOR GENERAL INDUSTRIAL USE;  
METALS IN FOIL AND POWDER FORM FOR  
PAINTERS, DECORATORS, PRINTERS AND AR-  
TISTS; WALLPAPER REMOVING PREPARATIONS,  
IN CLASS 2 (U.S. CLS. 6, 11 AND 16).

FOR: SEMI-FINISHED PLASTIC GOODS, NAME-  
LY, PLASTIC IN THE FORM OF BARS, BLOCKS,  
PALLETES, RODS, SHEETS AND TUBES FOR USE IN  
MANUFACTURING; SEALING, PACKING AND  
INSULATING MATERIALS, NAMELY, FIBER-  
GLASS INSULATION FOR BUILDINGS; FIBER-  
GLASS FOR USE IN SEALING AND PACKING,  
NAMELY, FIBERGLASS PACKING MATERIAL  
FOR FORMING SEALS; INSULATING PLASTER;  
SEALANT COMPOUNDS FOR JOINTS, NAMELY,  
INDOOR AND OUTDOOR WALL AND FLOOR  
JOINT COMPOUNDS; FIBERGLASS FABRIC AND  
FIBERGLASS FOR BUILDING INSULATION; AD-  
HESIVE TAPE FOR INDUSTRIAL AND COMMER-

CIAL USE; THERMAL INSULATION FOR USE IN  
BUILDINGS; FIBERGLASS MATERIALS FOR  
SOUND ABSORPTION, NAMELY, FLOOR AND  
WALL COVERINGS, SOUND ABSORBING WALL  
FABRICS AND NON-WOVEN PANELS OF FIBER-  
GLASS; PLASTIC SHEETS FOR CONSTRUCTION  
AND GENERAL USE, NAMELY, PLASTIC SHEETS  
FOR PROTECTION SHEETS AND COVERING PUR-  
POSES, IN CLASS 17 (U.S. CLS. 1, 5, 12, 13, 35 AND 50).

FOR: NON-METAL BUILDING MATERIALS,  
NAMELY, WOODEN WALL LININGS, NAMELY,  
WOODEN PANELS, BOARDS AND COMPLETE  
WALLS; CONCRETE BUILDING MATERIALS,  
NAMELY, UNPROCESSED WALL FACES SUCH  
AS BLOCKS, BRICKS, POSTS, POLES, SLABS, PA-  
NELS, ORNAMENTAL STONES; COATINGS FOR  
BUILDING, NAMELY, BITUMINOUS ROOF COAT-  
INGS AND BITUMINOUS CEMENT COATINGS;  
MORTAR; LIME STUCCOS AND MINERAL STUC-  
COS MIXES FOR USE IN CONSTRUCTION; SEA-  
LER COATINGS SOLD AS AN INTEGRAL  
COMPONENT OF NON-METALLIC TILES, NATUR-  
AL STONE AND MOLDED RESIN FOR CON-  
STRUCTION PURPOSES, FINISH PLASTERS  
MADE OF COLORED ARTIFICIAL RESIN; LOW-  
FIRED STRENGTH-FUSED SILICA STUCCO RE-  
FRACTORY CASTING MIX; ASPHALT ROOF  
COATINGS, ASPHALT-BASED COATINGS AND  
SEALANTS FOR USE ON ROOFS, WALLS AND  
PAVEMENTS AND BITUMINOUS ROOF COAT-  
INGS; WALL MASTICS MADE OF CEMENT;

BUILDING MATERIALS, NAMELY, NON-METAL FACADE PROFILES; WASH PRIMER MADE OF CEMENT; NON-METAL REINFORCING MATERIALS FOR BUILDING PURPOSES, NAMELY, REINFORCING FABRIC FOR STRENGTHENING PLASTERS IN THE CONSTRUCTION OF HEAT INSULATION COMPOSITE SYSTEMS; NON-METAL REINFORCING FABRIC TO STRENGTHEN PLASTERS USED IN CONSTRUCTION; NON-METAL REINFORCING FABRIC FOR UNIVERSAL STRENGTHENING APPLICATIONS IN THE FIELD OF PLASTERS AND STUCCO USED IN CONSTRUCTION; NON-METAL REINFORCING FABRIC FOR EXTERIOR STUCCOS USED IN CONSTRUCTION; NON-METAL REINFORCING FABRIC FOR STRENGTHENING OF COATINGS AND FINISHES USED IN CONSTRUCTION; NON-METAL REINFORCING FABRICS FOR REINFORCING PLASTERS IN AREAS SUBJECT TO STRONG MECHANICAL LOAD USED IN CONSTRUCTION; NON-METAL REINFORCING FABRICS FOR REINFORCING CORNER PIECES TO PROTECT WALL CORNERS AGAINST MECHANICAL LOAD USED IN CONSTRUCTION; NON-METAL REINFORCING FABRIC FOR STRENGTHENING OF WOOD USED IN CONSTRUCTION; NON-METAL REINFORCING FABRIC FOR STRENGTHENING BOARDS AND PLATES MADE FROM PLASTIC, GYPSUM, WOOD, CONCRETE AND THE LIKE USED IN CONSTRUCTION; NON-METAL REINFORCING FABRIC FOR REPAIR OF BITUMINOUS ROOFING; NON-METAL REINFORCING FABRIC FOR USE IN CONSTRUCTION FOR PROTECTION AGAINST CRUMBLING AT HIGH WINDOWS; NON-METAL REINFORCING

FABRIC FOR USE IN CONSTRUCTION FOR STRENGTHENING OF RUBBER PARTS ON BUILDING STRUCTURES AND PYRAMID ROOFS; BUILDING MATERIALS, NAMELY, NON-METAL PANELS FOR CONSTRUCTION; NON-METAL PARTITION WALLS FOR CONSTRUCTION, NAMELY, NON-METAL REINFORCING FABRICS, LATTICES AND NON-WOVEN MATERIAL FOR EROSION AND FISSURING CONTROL; BUILDING MATERIALS, NAMELY, NON-METAL DECORATION PROFILES FOR WALLS AND EXTERIOR FACADES, IN CLASS 19 (U.S. CLS. 1, 12, 33 AND 50).

FOR: TEXTILE WALL COVERINGS; TEXTILE WALLPAPER, IN CLASS 24 (U.S. CLS. 42 AND 50).

FOR: NON-TEXTILE WALLPAPER, IN CLASS 27 (U.S. CLS. 19, 20, 37, 42 AND 50).

OWNER OF INTERNATIONAL REGISTRATION 0899197 DATED 12-30-2005, EXPIRES 12-30-2015.

OWNER OF U.S. REG. NOS. 1,958,968 AND 2,574,940.

NO CLAIM IS MADE TO THE EXCLUSIVE RIGHT TO USE "TEXTILE GLASS", APART FROM THE MARK AS SHOWN.

SER. NO. 79-029,213, FILED 12-30-2005.

DAYNA BROWNE, EXAMINING ATTORNEY

**Int. Cls.: 6, 7, 8, 9, 11, 20 and 21**

**Prior U.S. Cls.: 2, 12, 13, 14, 19, 21, 22, 23, 25, 26, 28, 29, 30, 31, 32, 33, 34, 35, 36, 38, 40, 44 and 50**

**Reg. No. 3,505,422**

**United States Patent and Trademark Office**

**Registered Sep. 23, 2008**

**TRADEMARK  
PRINCIPAL REGISTER**



TESCOMA S.R.O. (CZECH REPUBLIC CORPORATION)  
DLOUHÁ 4311  
CZ-760 01 ZLÍN  
CZECH REPUBLIC

FOR: METAL SUSPENSION SYSTEMS AND SETS FOR SUSPENDING METAL RAIL WALL-MOUNTED INSTALLATION SET FOR SUSPENSION OF KITCHEN UTENSILS IN A KITCHEN UNIT WITH METAL RAIL HOOKS, IN CLASS 6 (U.S. CLS. 2, 12, 13, 14, 23, 25 AND 50).

FOR: KITCHEN ELECTRICAL APPLIANCES, NAMELY, HAND-HELD ELECTRIC MIXERS, ELECTRIC UNIVERSAL OPENERS FOR CANS AND BOTTLES, ELECTRIC CAN OPENERS, ELECTRIC GRINDERS FOR HOUSEHOLD PURPOSES, AND ELECTRICAL SPICE GRINDERS, IN CLASS 7 (U.S. CLS. 13, 19, 21, 23, 31, 34 AND 35).

FOR: DINNER CUTLERY; SERVING CUTLERY; FORKS; KNIVES, INCLUDING POCKET KNIVES; LITTLE KNIVES WITH FORK; SPOONS; TEASPOONS; BUTCHER'S KNIVES; KITCHEN KNIVES; SHARPENING STEELS; MINCING KNIVES; HAIRDRESSING SCISSORS; TAILOR SCISSORS; SCISSORS FOR PAPER; SCISSORS FOR FOOD; KNIFE SHARPENERS; TRACERS AND CUTTING WHEELS INCLUDED IN THIS CLASS, NAMELY, HAND-OPERATED TOOLS IN THE NATURE OF FOOD TRIMMERS AND PIZZA CUTTERS; NONELECTRIC UNIVERSAL CAN OPENERS; HAND-OPERATED TOOLS, NAMELY, OPENERS FOR BOTTLE STOPPERS; HAND TOOLS, NAMELY, MULTIFUNCTIONAL OPENERS COMPRISED OF SCREWDRIVERS, KNIVES, CAN OPENERS, CAN OPENERS WITH KNIFE, CORKSCREW OPENERS WITH KNIFE, AND BOTTLE OPENERS WITH KNIFE; EGG SLICERS; NON-ELECTRIC POTATO SLICERS; HAND TOOLS, NAMELY, SCRAPERS; NON-ELECTRICAL STONES, NAMELY, SHARPENING STONES; HAND TOOLS, NAMELY, TONGS FOR

ICE, SUGAR, CAKES, SALAD AND SPAGHETTI; NUTCRACKERS; DECORATING DOUGH CARVERS AND CUTTERS, NAMELY, CARVING KNIVES; HAND TOOLS, NAMELY, FOIL CUTTERS FOR WINE BOTTLE, IN CLASS 8 (U.S. CLS. 23, 28 AND 44).

FOR: KITCHEN SCALES; NON-MEDICAL THERMOMETERS; KITCHEN TIMERS; MEASURING APPARATUS, NAMELY, JUGS SOLD WITH SCALES AND COFFEE MEASURING JUGS; AND BAR MEASURING DISPENSERS FOR BEVERAGES, IN CLASS 9 (U.S. CLS. 21, 23, 26, 36 AND 38).

FOR: WATER ECONOMIZERS FOR WATER SUPPLY SYSTEMS IN THE NATURE OF WATER FLOW LIMITERS FOR SHOWER HEADS AND BUBBLE MAKERS; WATER CLOSET WATER ECONOMIZERS IN THE NATURE OF WATER FLOW LIMITERS AND WATER SAVING AERATORS; ELECTRICAL AND PIEZOELECTRIC GAS LIGHTERS, NAMELY, LIGHTERS PRIMARILY FOR LIGHTING COOKING STOVES, GRILLS, FIREPLACES AND CANDLES; ELECTRICAL GRILLS; ELECTRICAL TOASTERS; AND ELECTRICAL COFFEE MAKERS, IN CLASS 11 (U.S. CLS. 13, 21, 23, 31 AND 34).

FOR: DRINKING STRAWS, IN CLASS 20 (U.S. CLS. 2, 13, 22, 25, 32 AND 50).

FOR: STAINLESS STEEL KITCHEN UTENSILS AND COOKWARE, NAMELY, GRILLS, DISHES, POTS, PANS, PAN LIDS, NONELECTRIC KETTLES, SAUCEPANS, CAKE PANS, BAKING SHEETS, NONELECTRIC GRILLS, GRILL UTENSILS, NAMELY, FORKS, SPOONS, SPATULAS, TONGS AND TURNERS; VACUUM FLASKS; VACUUM FLASKS FOR MEALS; STAINLESS STEEL, NON-ELECTRIC KETTLES; NON-ELECTRIC PRESSURE COOKERS; NON-ELECTRIC COFFEE MAKERS; TEA KETTLES; KITCHEN ACCESSORIES, NAMELY, GLASS LIDS FOR POTS AND PANS; COVERS FOR BOWLS AND DISHES; JUGS; FRYING PANS; FRYING PANS

WITH SPECIAL SURFACES; BAKEWARE; ROASTING PANS; DINNER SERVICES, NAMELY, ALL BEING CHINAWARE, GLASSWARE, PORCELAIN AND EARTHENWARE, CONSISTING OF PLATES, DISHES, CUPS, BOWLS, SAUCERS AND SERVING DISHES; SERVING, DINNER AND CRUMB TRAYS AND SMALL BOWLS, DISHES FOR MICROWAVE OVENS, AND DISHES FOR FREEZING AND COOLING BOXES; SERVINGWARE SETS FOR SERVING FOOD; PLATES; STAINLESS STEEL TRAYS AND BOWLS; FOOD TRAYS FOR MEALS; COASTERS AND COASTER SETS NOT OF PAPER AND NOT BEING TABLE LINEN; MICROWAVE COOKWARE, NAMELY, PANS AND CONTAINERS; COOKWARE FOR FREEZING AND COOLING BOXES, NAMELY, PLASTIC CONTAINERS WITH COVERS FOR FREEZING, ICE CUBE TRAYS, AND WINE AND CHAMPAGNE COOLERS; KITCHEN UTENSILS AND OTHER KITCHEN ACCESSORIES, NAMELY, KITCHEN PASTRY BOARDS MADE OF SILICONE AND BOTTLE OPENERS; TART MOLDS; COOKING SKEWERS FOR GRILLS; GLAZING BRUSHES; WHISKS; KITCHEN LADLES; MOUSSE MAKERS, NAMELY, MILK FROTHERS; HOUSEHOLD UTENSILS, NAMELY, STRAINERS, GRATERS, SIEVES AND FUNNELS; KITCHEN FUNNELS; COOKWARE, NAMELY, STEAMERS; ROLLING PINS; DUMPLING MAKERS INCLUDED IN THIS CLASS, NAMELY, DOUGH, PASTA AND COOKIE FORMERS AND MOLDS; COOKIE CUTTERS; HANDHELD CAKE DECORATING AND DOUGH PRESSES FOR HOUSEHOLD USE; PASTRY BRUSHES; PIE AND CAKE SERVERS; SUGAR BOWLS; CREAM DISHES WITH LID; JARS SOLD EMPTY, NAMELY, GLASS STORAGE JARS; KITCHEN FOIL HOLDERS; SALT, PEPPER AND SUGAR SHAKERS; SPICE JARS AND SETS OF SPICE JARS MADE OF GLASS, PLASTIC, WOOD, AND THEIR COMBINATIONS, ALL SOLD EMPTY; MANUAL FOOD GRINDERS; MANUAL SPICE GRINDERS, TOOTHPICKS, NAPKIN HOLDERS, KNIFE BLOCKS, HOUSEHOLD UTENSILS, NAMELY, TURNERS, POTATO

MASHERS AND GARLIC PRESSES; PLASTIC STORAGE CONTAINERS FOR DOMESTIC USE; RAILS FOR KITCHEN UTENSILS MADE OF PLASTIC COMPONENTS, NAMELY, WALL-MOUNTED STICKS WITH HOOKS FOR KITCHEN UTENSIL SUSPENSION; PLASTIC, WOODEN AND GLASS CUTTING BOARDS; JUGS SOLD EMPTY WITH AND WITHOUT PISTON MADE OF GLASS AND PLASTICS AND COMBINATIONS THEREOF; MUGS; MESH TEA INFUSERS NOT OF PRECIOUS METAL; WINE AND CHAMPAGNE BOTTLE STOPPERS, NAMELY, GLASS STOPPERS; COOLING VESSELS, NAMELY, COOLING BUCKETS FOR WINE; BOTTLE NECK RINGS FOR PREVENTING BEVERAGES FROM SPILLING; VACUUM CLOSURES, NAMELY, WINE BOTTLE VACUUM CLOSURES; VACUUM PUMP BOTTLES SOLD EMPTY; COCKTAIL SHAKERS; BEVERAGE STIRRING STICKS; HOUSEHOLD UTENSILS, NAMELY, SIEVES WITH A SPIRAL SIFTER; TRIVETS AND HEAT-RESISTANT PLASTIC TRAYS FOR USE UNDER HOT COOKWARE; DUSTERS; CLEANING KITCHEN TOWELS, NAMELY, CLEANING CLOTHS FOR USE IN THE KITCHEN; PLACE MATS, OTHER THAN PAPER ONES, FOR USE UNDER COOKWARE; CLEANING INSTRUMENTS, NAMELY, POT CLEANING BRUSHES, CLOTHS, AND DUST-RAGS; HOUSEHOLD GLOVES FOR GENERAL USE; KITCHEN CUTTING BOARDS; METAL SOAP HOLDERS, IN CLASS 21 (U.S. CLS. 2, 13, 23, 29, 30, 33, 40 AND 50).

OWNER OF INTERNATIONAL REGISTRATION  
0830535 DATED 2-24-2004, EXPIRES 2-24-2014.

OWNER OF U.S. REG. NO. 2,710,525.

SER. NO. 79-029,504, FILED 4-20-2006.

DAYNA BROWNE, EXAMINING ATTORNEY

**Int. Cl.: 7**

**Prior U.S. Cls.: 13, 19, 21, 23, 31, 34 and 35**

**United States Patent and Trademark Office**

**Reg. No. 3,505,423**

**Registered Sep. 23, 2008**

**TRADEMARK  
PRINCIPAL REGISTER**

**HYTRON**

**BÖHLER HOCHDRUCKTECHNIK GMBH (AUS-  
TRIA LIMITED LIABILITY COMPANY)  
WERK DEUCHENDORF  
A-8605 KAPFENBERG  
AUSTRIA**

**FOR: HIGH PRESSURE PUMPS FOR WATER-JET  
CUTTING MACHINES, IN CLASS 7 (U.S. CLS. 13, 19,  
21, 23, 31, 34 AND 35).**

**THE MARK CONSISTS OF STANDARD CHAR-  
ACTERS WITHOUT CLAIM TO ANY PARTICULAR  
FONT, STYLE, SIZE, OR COLOR.**

**PRIORITY DATE OF 3-23-2006 IS CLAIMED.**

**OWNER OF INTERNATIONAL REGISTRATION  
0901555 DATED 9-5-2006, EXPIRES 9-5-2016.**

**SER. NO. 79-030,112, FILED 9-5-2006.**

**KEVIN CORWIN, EXAMINING ATTORNEY**

**Int. Cls.: 9, 35 and 42**

**Prior U.S. Cls.: 21, 23, 26, 36, 38, 100, 101 and 102**

**Reg. No. 3,505,424**

**United States Patent and Trademark Office**

**Registered Sep. 23, 2008**

**TRADEMARK  
SERVICE MARK  
PRINCIPAL REGISTER**



INTELLIGENCE FOCUS S.R.L. (ITALY SOCIETÀ  
A RESPONSABILITÀ LIMITATA (SRL))  
VIA CARDINAL FOSSATI, 4  
I-10141 TORINO (TO), ITALY

OWNER OF INTERNATIONAL REGISTRATION  
0901912 DATED 5-22-2006, EXPIRES 5-22-2016.

FOR: COMPUTERS; COMPUTER HARDWARE,  
IN CLASS 9 (U.S. CLS. 21, 23, 26, 36 AND 38).

FOR: BUSINESS MANAGEMENT, PROVIDING  
OFFICE FUNCTIONS, IN CLASS 35 (U.S. CLS. 100,  
101 AND 102).

FOR: DESIGN AND DEVELOPMENT OF COM-  
PUTER HARDWARE AND SOFTWARE, IN CLASS  
42 (U.S. CLS. 100 AND 101).

THE MARK CONSISTS OF A SQUARE WITH  
ROUNDED ANGLES; THE BOTTOM LEFT ANGLE  
IS NOT DRAWN; A HALF MOON SHAPE ENTERS  
INTO THE SQUARE FROM THE BOTTOM LEFT  
ANGLE, AND REACHES TOWARD THE UPPER  
SIDE OF THE SQUARE; THREE SMALLER HALF  
MOON SHAPES ENTER INTO THE SQUARE FROM  
THE SAME BOTTOM LEFT ANGLE.

SER. NO. 79-030,244, FILED 5-22-2006.

PRIORITY DATE OF 3-28-2006 IS CLAIMED.

CHARISMA HAMPTON, EXAMINING ATTORNEY



Int. Cls.: 35, 38 and 45

Prior U.S. Cls.: 100, 101, 102 and 104

United States Patent and Trademark Office

Reg. No. 3,505,425

Registered Sep. 23, 2008

SERVICE MARK  
PRINCIPAL REGISTER



EASYPOLÉ INTERACTIVE (FRANCE CORPORATION)  
3, RUE DU PRÉ FÉLIN  
F-74940 ANNECY LE VIEUX  
FRANCE

FOR: ADVERTISING SERVICES; BUSINESS MANAGEMENT; BUSINESS ADMINISTRATION; DISSEMINATION OF ADVERTISING MATERIAL, NAMELY, LEAFLETS, PROSPECTUSES, PRINTED MATTER, SAMPLES; COMPUTER FILE MANAGEMENT; ORGANIZATION OF EXHIBITIONS FOR COMMERCIAL OR ADVERTISING PURPOSES; ON-LINE ADVERTISING ON A COMPUTER NETWORK; ADVERTISING SERVICES IN THE NATURE OF RENTAL OF ACCESS TIME TO COMMUNICATION MEANS FOR ADVERTISING, NAMELY, ADVERTISING SPACE ON WEBSITES AND BILLBOARDS AND ADVERTISING TIME ON RADIO AND TELEVISION; PUBLISHING OF ADVERTISING TEXTS; RENTAL OF ADVERTISING SPACE; DISSEMINATION OF ADVERTISEMENTS; PUBLIC RELATIONS, IN CLASS 35 (U.S. CLS. 100, 101 AND 102).

FOR: TELECOMMUNICATIONS, NAMELY, TRANSMISSION, EMISSION, AND REMOTE RECEPTION OF SIGNS, SIGNALS, WRITINGS, IMAGES, SOUNDS OR INFORMATION OF ALL NATURES BY WIRE, ELECTROMAGNETIC RADIO-ELECTRICITY, OPTICS OR OTHER SYS-

TEMS; PROVIDING INFORMATION IN THE FIELD OF TELECOMMUNICATIONS; COMMUNICATIONS VIA COMPUTER TERMINALS OR VIA FIBRE-OPTIC NETWORKS; RADIO AND TELEPHONE COMMUNICATION; MOBILE RADIO-TELEPHONY SERVICES; PROVIDING TELECOMMUNICATIONS CONNECTIONS TO A GLOBAL COMPUTER NETWORK; TELECOMMUNICATION ELECTRONIC DISPLAY SERVICES, NAMELY, ELECTRONIC DATA TRANSMISSION AND TRANSMISSION OF DATA, GRAPHICS AND VIDEO BY BULLETIN BOARD SYSTEM AND BILLBOARD OR A COMBINATION THEREOF; AUDIO AND VIDEO TELECONFERENCING; ELECTRONIC MAIL SERVICES, IN CLASS 38 (U.S. CLS. 100, 101 AND 104).

FOR: MARRIAGE BUREAUS; MARRIAGE AGENCIES, IN CLASS 45 (U.S. CLS. 100 AND 101).

PRIORITY DATE OF 4-18-2006 IS CLAIMED.

OWNER OF INTERNATIONAL REGISTRATION 0902016 DATED 10-11-2006, EXPIRES 10-11-2016.

SER. NO. 79-030,331, FILED 10-11-2006.

DOMINIC FATHY, EXAMINING ATTORNEY

**Int. Cl.: 9**

**Prior U.S. Cls.: 21, 23, 26, 36 and 38**

**United States Patent and Trademark Office**

**Reg. No. 3,505,426**

**Registered Sep. 23, 2008**

**TRADEMARK  
PRINCIPAL REGISTER**

# OXYPURE

BANDRIDGE EUROPE N.V. (NETHERLANDS  
LIMITED LIABILITY COMPANY)  
LAMMENSCHANSWEG 130 C  
NL-2321 JX LEIDEN, NETHERLANDS

FOR: OPTICAL, ELECTRONIC AND ELECTRIC CABLES; CORDS, SWITCHING BOXES AND POWER SUPPLIES; ELECTRICAL PLUGS; ELECTRICAL SOCKETS; IN-EARPHONES; HEADPHONES; MICROPHONES; LOUDSPEAKERS; SOUND IMPROVEMENT EQUIPMENT, NAMELY, AMPLIFIERS AND SOUND MIXERS; ELECTRICAL POWER EXTENSION CORDS; PARTS FOR AUDIO EQUIPMENT, VISUAL EQUIPMENT, AUDIO VISUAL EQUIPMENT, DIGITAL EQUIPMENT, TELEVISION, SATELLITE, AERIAL, CAMCORDER, COMPUTER, MULTIMEDIA, TELEPHONE, MOBILE TELEPHONE, REMOTE CONTROL AND RF CORDLESS EQUIPMENT, NAMELY, AUDIO SPEAKERS, PCI CARDS, NETWORK SWITCHES, CORDLESS ROUTERS, USB HUBS, MEMORY CARDS AND AERIALS; ACCESSORIES FOR AUDIO EQUIPMENT, VISUAL EQUIPMENT, AUDIO VI-

SUAL EQUIPMENT, DIGITAL EQUIPMENT, TELEVISION, SATELLITE, AERIAL, CAMCORDER, COMPUTER, MULTIMEDIA, TELEPHONE, MOBILE TELEPHONE, REMOTE CONTROL, AND RF CORDLESS EQUIPMENT, NAMELY, COMPUTER PERIPHERALS, AND REMOTE CONTROLS FOR AUDIO, VISUAL, AUDIO VISUAL AND COMPUTER EQUIPMENT, IN CLASS 9 (U.S. CLS. 21, 23, 26, 36 AND 38).

THE MARK CONSISTS OF STANDARD CHARACTERS WITHOUT CLAIM TO ANY PARTICULAR FONT, STYLE, SIZE, OR COLOR.

OWNER OF INTERNATIONAL REGISTRATION  
0888543 DATED 3-1-2006, EXPIRES 3-1-2016.

SER. NO. 79-031,083, FILED 10-11-2006.

ELI HELLMAN, EXAMINING ATTORNEY

**Int. Cls.: 6, 9, 17 and 40**

**Prior U.S. Cls.: 1, 2, 5, 12, 13, 14, 21, 23, 25, 26, 35, 36,  
38, 50, 100, 103 and 106**

**Reg. No. 3,505,427**

**United States Patent and Trademark Office**

**Registered Sep. 23, 2008**

**TRADEMARK  
SERVICE MARK  
PRINCIPAL REGISTER**

**BOPLA**

BOPLA GEHÄUSE SYSTEME GMBH (FED REP  
GERMANY LIMITED LIABILITY CORPOR-  
ATION)

17-25, BORSIGSTRASSE  
32257 BÜNDE  
FED REP GERMANY

FOR: TRANSPORTABLE BUILDINGS OF METAL; NON-ELECTRIC CABLES AND WIRES OF COMMON METAL; SCREWS, FLANGES, THREADED INSERTS AND QUICK RELEASE FASTENINGS; PIPES AND TUBES OF METAL; METAL SAFES; SCREWED METAL CABLE GLANDS AND HOSE FITTINGS MADE OF METAL; CONNECTORS MADE OF METAL, NAMELY, SCREWS, THREADED BUSHINGS, BAYONET FIXING, METAL CLIPS FOR FIXING CASINGS AT WALLS, MACHINES, LABORATORY EQUIPMENT OR OTHER CASINGS; CLIPS FOR MOUNTING ELECTRIC AND NON-ELECTRIC COMPONENTS, METAL CABLE CLIPS; TURNING LOCKS, HINGES; BOLTS, SUBPLATES, METAL HANDLES FOR CASINGS AND ENCLOSURES, DOORS AND CONTROL CABINETS, AND POSITIONING FEET FOR FRAME STRUCTURE AND CASINGS, ALL AFOREMENTIONED GOODS MADE OF METAL; ALUMINUM CAST PARTS AND EXTRUSION PARTS, NAMELY, PARTS OF CASINGS, PARTS FOR USE IN THE CASING PRODUCTION AND ACCESSORIES FOR CASINGS, NAMELY, CABLE GLANDS, HANDLES, HOSE FITTINGS, FIXING AND MOUNTING CLIPS; METAL SUBPLATES, IN CLASS 6 (U.S. CLS. 2, 12, 13, 14, 23, 25 AND 50).

FOR: SCIENTIFIC, NAUTICAL, SURVEYING, ELECTRIC, PHOTOGRAPHIC, CINEMATOGRAPHIC, OPTICAL, WEIGHING, MEASURING, SIGNALING CONTROL, LIFESAIVING AND TEACHING APPARATUS AND INSTRUMENTS, NAMELY, IN-

STRUMENTS AND APPARATUS FOR THE EXCHANGE OF SUBSTANCES AND HEAT; ELECTRIC CABLES AND WIRES; PROGRAMMABLE LOGIC CONTROLLERS; ELECTRIC CONTROL PANELS, LIGHTING CONTROL PANELS, PHOTOMETERS, AMMETERS, DC POTENTIOMETERS, INCLINOMETERS, TEMPERATURE METERS, WATT METERS, CURRENT METERS, RESISTANCE MEASURING INSTRUMENTS, CONDUCTIVITY METERS, BRACKETS FOR ELECTRONIC AND ELECTRIC EQUIPMENT, ELECTROPLATING APPARATUS FOR ELECTROPLATING PURPOSES; APPARATUS FOR RECORDING TRANSMISSION OR REPRODUCTION OF SOUND OR IMAGES, BLANK MAGNETIC DATA CARRIERS; AUTOMATIC VENDING MACHINES; CALCULATING MACHINES; DATA PROCESSORS AND COMPUTERS; CASES OF METAL AND/OR PLASTIC FOR ELECTRO TECHNICAL AND ELECTRONIC APPARATUS, NAMELY, CASES FOR THE RECEPTACLE OF ELECTRONIC AND ELECTRONIC JUNCTIONS, CASES FOR APPARATUS AND EQUIPMENT FOR DATA INPUT, DATA TRANSFER, DATA STORAGE, DATA PROCESSING, DATA OUTPUT, DISPLAY DEVICES, AND DUS PCB APPLICATION; CONTROL PANEL CASES, PLUG CASES, COMPUTER TOUCH CONTROL INPUT UNITS, NAMELY, COMPUTER TOUCHSCREENS, COMPUTER MONITORS, FLAT PANEL DISPLAY SCREENS, LIQUID CRYSTAL DISPLAY SCREENS, COMPUTER KEYBOARDS, COMPUTER MOUSE, COMPUTER KEYPADS, SIGNAL RECEIVERS AND TRANSMITTERS, SILICONE WAFERS; SEMICONDUCTORS, INTEGRATED CIRCUITS; COMPUTER KEYPADS; PUSHBUTTONS, ELECTRO TECHNICAL COMPONENTS, NAMELY, MEMBRANE KEYPADS, DISPLAY SCREENS, TOUCH SCREENS, ACCUMULATORS, BATTERIES, SWITCHES, PUSHBUTTONS, LED DISPLAY SCREENS, LED PANELS;

ELECTRICAL INSTALLATION, NAMELY, SCREWED CABLE GLANDS AND HOSE FITTINGS MADE OF PLASTICS AND/OR METAL, ELECTROMAGNETIC SHIELDING FOR ELECTRONIC DEVICES AND INSTALLATIONS, IN CLASS 9 (U.S. CLS. 21, 23, 26, 36 AND 38).

FOR: POLYURETHANE FILM FOR USE IN SEALING AND INSULATING; ADHESIVE TAPE FOR SEALING CASES; NON-METAL JUNCTIONS, NAMELY, SCREWED CABLE GLANDS OF PLASTIC, HOSE FITTINGS OF PLASTIC; PLASTIC PARTS, MOLDING AND PRESSING PARTS, NAMELY, PARTS OF CASINGS, PARTS FOR USE IN THE CASING PRODUCTION, AND ACCESSORIES FOR CASING, NAMELY, CABLE GLANDS, MOUNTING PLATES, CONTROL PANELS, FRONT PANELS, SUBPLATES, FOILS OF PLASTIC AS FRONT FOILS, AND OPERATING UNITS NOT FOR PACKAGING PURPOSES, NAMELY, FOILS OF POLYESTER, FOILS OF POLYCARBONATE, LAMINATE FOIL CONSISTING PRIMARILY OF PLASTIC WITH OR WITHOUT METAL LAYER FOR APPLICATION TO A SUBSTRATE; SYNTHETIC PLASTIC AS SEMI-FINISHED PRODUCTS IN FORMS OF FOILS , IN CLASS 17 (U.S. CLS. 1, 5, 12, 13, 35 AND 50).

FOR: TREATMENT OF MATERIALS, NAMELY, TREATMENT OF PLASTIC AND METAL FOR THE CASING PRODUCING AND DISTRIBUTING INDUSTRY; CUSTOM PRINTING OF PLASTIC OR METAL; COATING OF MATERIALS, NAMELY, APPLICATION OF PROTECTIVE COATINGS, APPLICATION OF ELECTROMAGNETIC SHIELDING COATINGS; METALLIZING SERVICES, NAMELY, METALLIZATION OF METALLIC AND PLASTIC SURFACES; TREATMENT OF MATERIAL, NAMELY, SURFACE REFINEMENT BY VACUUM COATING OF METAL AND NON-METAL MATERIAL, IN CLASS 40 (U.S. CLS. 100, 103 AND 106).

THE MARK CONSISTS OF STANDARD CHARACTERS WITHOUT CLAIM TO ANY PARTICULAR FONT, STYLE, SIZE, OR COLOR.

OWNER OF INTERNATIONAL REGISTRATION 0906552 DATED 12-8-2005, EXPIRES 12-8-2015.

OWNER OF U.S. REG. NO. 1,051,737.

SER. NO. 79-032,125, FILED 12-8-2005.

SHARON MEIER, EXAMINING ATTORNEY

**Int. Cls.: 9 and 42**

**Prior U.S. Cls.: 21, 23, 26, 36, 38, 100 and 101**

**United States Patent and Trademark Office**

**Reg. No. 3,505,428**

**Registered Sep. 23, 2008**

**TRADEMARK  
SERVICE MARK  
PRINCIPAL REGISTER**

software ag 

SOFTWARE AG (FED REP GERMANY CORPORATION)  
UHLANDSTR. 12  
64297 DARMSTADT  
FED REP GERMANY

FOR: COMPUTER PROGRAMS FOR USE IN PERFORMANCE MONITORING, SESSION MANAGEMENT, AUTOMATED PRODUCTION AND SCHEDULING CONTROL, RESOURCE MAXIMIZATION AND HIGH VOLUME TRANSACTION PROCESSING, AND TO CONTROL AND ENSURE INTEGRITY OF OTHER COMPUTER PROGRAMS; COMPUTER PROGRAMS FOR USE IN WORD PROCESSING, DOCUMENT MANAGEMENT, DATA RETRIEVAL, ARCHIVAL STORAGE, CALENDARING, COMPUTER BASED TRAINING, CALCULATIONS AND THE MANIPULATION OF SPREADSHEET DATA AND SPREADSHEETING, AND STATISTICAL ANALYSIS; COMPUTER PROGRAMS FOR USE IN GRAPHICS APPLICATIONS FOR THE CREATION OF GRAPHICS; COMPUTER PROGRAMS FOR USE IN SYSTEM ANALYSIS AND ENGINEERING; COMPUTER PROGRAMS FOR USE IN DATA PROCESSING, COMMUNICATION BETWEEN DIFFERENT SOFTWARE FILES, COMMUNICATION WITHIN BUSINESS ENTITIES, COMMUNICATIONS BETWEEN VARIOUS HARDWARE AND SOFTWARE ENVIRONMENTS, NETWORKING BETWEEN DIFFERENT HARDWARE SYSTEMS, INTERFACING OR INTEGRATING BETWEEN NETWORKS OF HARDWARE, OPERATING SYSTEMS AND/OR SOFTWARE, INTERFACING BETWEEN COMPUTER DATABASES, AND TO COMMUNICATE AND INTERFACE BETWEEN DIFFERENT COMPUTER PLATFORMS AND IN LOCAL AREA NETWORKS; COMPUTER PROGRAMS FOR ELECTRONIC MAIL DISTRIBUTION; COMPUTER PROGRAMS FOR USE IN INFORMATION PROCESSING SYSTEMS, NAMELY, ROUTING OR MOVEMENT OF INFORMATION FROM ONE APPLICATION TO ANOTHER; AND

COMPUTER UTILITY PROGRAMS FOR USE WITH THE FOREGOING; COMPUTER PROGRAMS FOR USE IN INCIDENT TRACKING AND REPORTING AND PROBLEMS RESOLUTION, PROJECT MANAGEMENT; COMPUTER PROGRAMS FOR USE IN CATALOGING, INVENTORY, TO CONTROL CIRCULATION, AND TO OTHERWISE CONTROL OPERATION OF A LIBRARY; COMPUTER PROGRAMS WHICH PROVIDE INFORMATION ON PRODUCT FIXES, PRODUCT MAINTENANCE AND PRODUCT INFORMATION; COMPUTER PROGRAMS ACTING AS AN APPLICATIONS PROGRAMMING INTERFACE AND PROVIDING CONNECTIONS BETWEEN VARIOUS SOFTWARE APPLICATIONS RUNNING ON DIFFERENT HARDWARE AND SOFTWARE PLATFORMS; AND COMPUTER UTILITY PROGRAMS THEREFOR; COMPUTER SOFTWARE FOR USE IN ENTERPRISE SYSTEM MANAGEMENT AND ENTERPRISE INTEGRATION THAT PERMITS THE TRANSFER, TRANSMISSION AND INTEGRATION OF DATA, TEXT, GRAPHICS AND CODE BETWEEN DIFFERENT APPLICATION PROGRAMS, OPERATING SYSTEMS, AND COMPUTER PLATFORMS, PROVIDES AN INTERFACE BETWEEN COMPUTER NETWORKS FOR THE TRANSFER, TRANSMISSION AND INTEGRATION OF DATA, TEXT, GRAPHICS, AND CODE, AND ENABLES THE EXPANDED USE BY TRANSMITTING APPLICATION PROGRAMS VIA INTERCONNECTED COMPUTER NETWORKS AND LOCAL NETWORKS LINKED BY COMMON PROTOCOLS; ENTERPRISE SYSTEM PRODUCTS, NAMELY, DATABASES RECORDED ON CD-ROM AND PROPRIETARY PROTOCOLS THAT ENABLES THE DEVELOPMENT OF COMPUTER APPLICATION PROGRAMS AND SOLVES DATE-RELATED PROBLEMS; DOWNLOADABLE SOFTWARE FOR USE IN DATABASE MANAGEMENT DATA RETRIEVAL, WORD PROCESSING, AND FOR USE AS A SPREADSHEET; COMPUTER PROGRAMS FOR DATA PROCESSING; DATA CARRIERS, NAMELY,

BLANK CD-ROMS AND TAPES, FOR RECORDING AND STORING CLIENT DATA, IN CLASS 9 (U.S. CLS. 21, 23, 26, 36 AND 38).

FOR: DESIGN OF COMPUTER PROGRAMS FOR OTHERS; COMPUTER PROGRAM DEVELOPMENT; RENTING OF COMPUTER PROGRAMS; MAINTENANCE AND INSTALLATION OF COMPUTER PROGRAMS, IN CLASS 42 (U.S. CLS. 100 AND 101).

PRIORITY DATE OF 7-25-2006 IS CLAIMED.

OWNER OF INTERNATIONAL REGISTRATION 0907009 DATED 10-17-2006, EXPIRES 10-17-2016.

OWNER OF U.S. REG. NOS. 1,461,705 AND 1,900,390.

NO CLAIM IS MADE TO THE EXCLUSIVE RIGHT TO USE "SOFTWARE", APART FROM THE MARK AS SHOWN.

SER. NO. 79-032,317, FILED 10-17-2006.

TOBY BULLOFF, EXAMINING ATTORNEY

**Int. Cls.: 9, 35, 38, 41 and 42**

**Prior U.S. Cls.: 21, 23, 26, 36, 38, 100, 101, 102, 104  
and 107**

**Reg. No. 3,505,429**

**United States Patent and Trademark Office**

**Registered Sep. 23, 2008**

**TRADEMARK  
SERVICE MARK  
PRINCIPAL REGISTER**

# WIKIPEDIA

WIKIMEDIA FOUNDATION, INC. (FLORIDA CORPORATION)

200 SECOND AVENUE SOUTH, #358  
ST. PETERSBURG, FL, UNITED STATES 33701

FOR: SOFTWARE FOR DOWNLOADING, TRANSMITTING, RECEIVING, PROVIDING, PUBLISHING, EXTRACTING, ENCODING, DECODING, READING, STORING, AND ORGANIZING AUDIOVISUAL, VIDEOGRAPHIC, AND WRITTEN DATA, ALL IN CONJUNCTION WITH A GLOBAL COMPUTER NETWORK; BLANK MULTIMEDIA PRODUCTS FOR CONTAINING OR TRANSMITTING AUDIOVISUAL, VIDEOGRAPHIC, AND WRITTEN DATA AND CONTENT, NAMELY, DVDS, CDS, AND OPTICAL OR ELECTROMAGNETIC STORAGE DEVICES, NAMELY, HARD DRIVES; PRE-RECORDED MULTIMEDIA PRODUCTS, NAMELY, DVDS, CDS, AND OPTICAL OR ELECTROMAGNETIC STORAGE DEVICES, NAMELY, HARD DRIVES, CONTAINING AUDIOVISUAL, VIDEOGRAPHIC, AND WRITTEN DATA AND CONTENT IN THE NATURE OF A GENERAL ENCYCLOPEDIA AND RELATED INFORMATION, IN CLASS 9 (U.S. CLS. 21, 23, 26, 36 AND 38).

FOR: ADVERTISING; BUSINESS MANAGEMENT; BUSINESS ADMINISTRATION; SUBSCRIPTION SERVICES IN THE NATURE OF PROVIDING INFORMATION THROUGH ONLINE WEBSITES IN THE FIELD OF GENERAL ENCYCLOPEDIA KNOWLEDGE TO THIRD PARTIES FOR A SUBSCRIPTION FEE; DISSEMINATION OF ADVERTISING MATERIAL, NAMELY, TRACTS, PROSPECTUSES, PRINTED MATTER, AND SAMPLES; DOCUMENT REPRODUCTION; COMPUTER FILE MANAGEMENT; PUBLIC RELATIONS, IN CLASS 35 (U.S. CLS. 100, 101 AND 102).

FOR: ELECTRONIC TRANSMISSION OF DATA AND DOCUMENTS VIA THE INTERNET AND OTHER DATABASES; ELECTRONIC TRANSMIS-

SION OF AUDIOVISUAL, VIDEOGRAPHIC OR WRITTEN FILES DISSEMINATED AND DOWNLOADABLE VIA ELECTRONIC COMMUNICATION NETWORKS; PROVIDING INFORMATION ON TELECOMMUNICATIONS; MOBILE RADIOTELEPHONY SERVICES; PROVIDING MULTIPLE-USER ACCESS TO A GLOBAL COMPUTER NETWORK; TELECOMMUNICATION SERVICES, NAMELY, PROVIDING ONLINE ELECTRONIC BULLETIN BOARDS AND MESSAGING SERVICES FOR TRANSMISSION OF MESSAGES AMONG COMPUTER USERS CONCERNING ENCYCLOPEDIA ARTICLE ENTRIES AND THE ADMINISTRATION OF AN ENCYCLOPEDIA PROJECT; AUDIO AND VIDEO TELECONFERENCING SERVICES; ELECTRONIC MAIL; PROVIDING ACCESS TO ENCYCLOPEDIA DATABASES, IN CLASS 38 (U.S. CLS. 100, 101 AND 104).

FOR: PROVIDING ONLINE PUBLICATIONS IN THE FORM OF ENCYCLOPEDIAS AND ENCYCLOPEDIA ARTICLES; PROVIDING OF TRAINING, NAMELY, COURSES AND SEMINARS IN THE USE OF SOFTWARE AND MULTIMEDIA PRODUCTS, AND IN THE EDITING OF AND COLLABORATION ON ARTICLES; EDUCATIONAL SERVICES, NAMELY, CONFERENCES, WORKSHOPS, AND SEMINARS CONCERNING THE ADMINISTRATION OF AN ENCYCLOPEDIA PROJECT AND THE USE AND ADMINISTRATION OF ENCYCLOPEDIA ARTICLE ENTRIES; PROVIDING INFORMATION ON EDUCATIONAL OR ENTERTAINMENT EVENTS; PUBLICATION OF BOOKS; PRODUCTION OF MOTION PICTURES; ARRANGING AND CONDUCTING OF COLLOQUIA, CONFERENCES, AND CONVENTIONS IN THE FIELDS OF SOFTWARE AND MULTIMEDIA PRODUCT USE AND IN THE EDITING OF AND COLLABORATION ON ARTICLES; ELECTRONIC PUBLISHING OF ON-LINE BOOKS AND PERIODICALS; DESKTOP PUBLISHING FOR OTHERS, IN CLASS 41 (U.S. CLS. 100, 101 AND 107).

FOR: SOFTWARE DESIGN AND DEVELOPMENT; DEVELOPMENT AND UPDATING OF SOFTWARE; COMPUTER PROGRAMMING; CONVERSION OF COMPUTER DATA AND PROGRAMS; CONVERSION OF DOCUMENTS FROM A PHYSICAL TO AN ELECTRONIC MEDIUM, IN CLASS 42 (U.S. CLS. 100 AND 101).

THE MARK CONSISTS OF STANDARD CHARACTERS WITHOUT CLAIM TO ANY PARTICULAR FONT, STYLE, SIZE, OR COLOR.

PRIORITY DATE OF 3-20-2006 IS CLAIMED.

OWNER OF INTERNATIONAL REGISTRATION 0907474 DATED 9-20-2006, EXPIRES 9-20-2016.

OWNER OF U.S. REG. NO. 3,040,722.

SER. NO. 79-032,490, FILED 9-20-2006.

CORY BOONE, EXAMINING ATTORNEY



**Int. Cls.: 3, 5 and 35**

**Prior U.S. Cls.: 1, 4, 6, 18, 44, 46, 50, 51, 52, 100, 101  
and 102**

**Reg. No. 3,505,430**

**United States Patent and Trademark Office**

**Registered Sep. 23, 2008**

**TRADEMARK  
SERVICE MARK  
PRINCIPAL REGISTER**



LABORATOIRE GIBRO SA (SWITZERLAND  
JOINT STOCK COMPANY)  
ENTRE-DEUX-RIVIÈRES  
CH-2114 FLEURIER  
SWITZERLAND

FOR: NON-MEDICAL BIOLOGICAL PREPARATIONS MADE FROM PLANTS FOR SKIN CARE, NAMELY, BEAUTY CREAMS, SOAPS, HAIR LOTIONS, MOUSSES AND SPRAYS, DEODORIZERS, DEODORANTS, BATH OILS AND GELS, BODY AND HAND CARE LOTIONS, PERFUME, TOILET WATER, EAU-DE-COLOGNE, BODY SPRAYS, ESSENTIAL OILS, SCENTED BODY SPRAYS, SHAMPOOS, TALCUM POWDER FOR TOILETRY USE, BEAUTY MASKS FOR USE ON THE FACE, MOISTURIZING CREAMS FOR THE FACE, BODY AND HAIR, MAKE-UP REMOVING PREPARATIONS FOR FACIAL CARE, CLEANSING PREPARATIONS FOR FACIAL CARE, ASTRINGENT LOTIONS FOR FACIAL CARE, EYE CREAMS, LIP BALMS, MAKE-UP PREPARATIONS, MAKE-UP FOUNDATION, LIPSTICK, MAKE-UP POWDER, FACIAL FOUNDATION, MASCARA, EYE-LINERS, FACIAL MASKS, MASSAGE OILS AND CREAMS, AROMATHERAPY OILS AND CREAMS, DEPILATORY CREAMS AND LOTIONS FOR THE SKIN, IN CLASS 3 (U.S. CLS. 1, 4, 6, 50, 51 AND 52).

FOR: PHARMACEUTICAL PRODUCTS, NAMELY, PHARMACEUTICAL PREPARATIONS FOR THE TREATMENT OF DANDRUFF, FOR WEIGHT CONTROLLING, FOR SLIMMING TREATMENT

AND IMPROVEMENT OF THE BODY FIGURE; MEDICATED SKIN CARE PREPARATIONS AND CREAMS, EMULSIONS FOR SKIN CARE FOR MEDICAL USE; CREAMS FOR SPORTS AND MASSAGES FOR MEDICAL USE; BODY CARE CREAM FOR MEDICAL USE FOR SKIN WITH IMPURITIES AND IRRITATED SKIN SUCH AS PREPARATIONS AGAINST REDNESS AND INFLAMMATIONS AND SKIN ALLERGIES, IN CLASS 5 (U.S. CLS. 6, 18, 44, 46, 51 AND 52).

FOR: ADVERTISING, SALES PROMOTION, PUBLISHING OF ADVERTISING MATERIALS AND PROMOTING THE GOODS AND SERVICES OF OTHERS BY DISTRIBUTING ADVERTISING MATERIALS THROUGH A VARIETY OF METHODS, NAMELY, CATALOGUES, PROSPECTUSES, AND PRINTED MATTER; BUSINESS MANAGEMENT ASSISTANCE, CONSISTING OF CONSULTING, BUSINESS INFORMATION AND INQUIRIES IN THE FIELD OF COSMETICS; RETAIL SERVICES BY DIRECT SOLICITATION BY SALES AGENTS FEATURING COSMETIC PREPARATIONS AND COSMETIC, SANITARY AND MEDICAL PREPARATIONS MADE FROM PLANTS; MAIL ORDER SERVICES FEATURING COSMETIC PREPARATIONS AND COSMETIC, SANITARY AND MEDICAL PREPARATIONS MADE FROM PLANTS; RETAIL STORE SERVICES AT BEAUTY INSTITUTES FEATURING COSMETIC PREPARATIONS; COMMERCIAL INFORMATION AGENCY FOR COSMETIC PRODUCTS, IN CLASS 35 (U.S. CLS. 100, 101 AND 102).

PRIORITY DATE OF 5-18-2006 IS CLAIMED.

OWNER OF INTERNATIONAL REGISTRATION  
0908816 DATED 11-8-2006, EXPIRES 11-8-2016.

OWNER OF U.S. REG. NOS. 1,274,052, 1,947,968,  
AND 3,004,553.

THE COLOR(S) MAUVE, GREEN, BLACK AND  
WHITE IS/ARE CLAIMED AS A FEATURE OF THE  
MARK.

THE WORDING "PHYTO 5" APPEARS IN THE  
COLOR BLACK AND THE LEFT SIDE OF THE  
CIRCLE DESIGN APPEARS IN MAUVE, THE  
RIGHT SIDE APPEARS IN GREEN, AND THE  
DRAGON IN THE MIDDLE OF THE CIRCLE AP-  
PEARS IN WHITE.

SER. NO. 79-033,014, FILED 11-8-2006.

DANIEL BRODY, EXAMINING ATTORNEY

**Int. Cls.: 1, 3, 5, 29, 30, 32, 35, 40 and 42**

**Prior U.S. Cls.: 1, 4, 5, 6, 10, 18, 26, 44, 45, 46, 48, 50, 51, 52, 100, 101, 102, 103 and 106**

**Reg. No. 3,505,431**

**United States Patent and Trademark Office**

**Registered Sep. 23, 2008**

**TRADEMARK  
SERVICE MARK  
PRINCIPAL REGISTER**

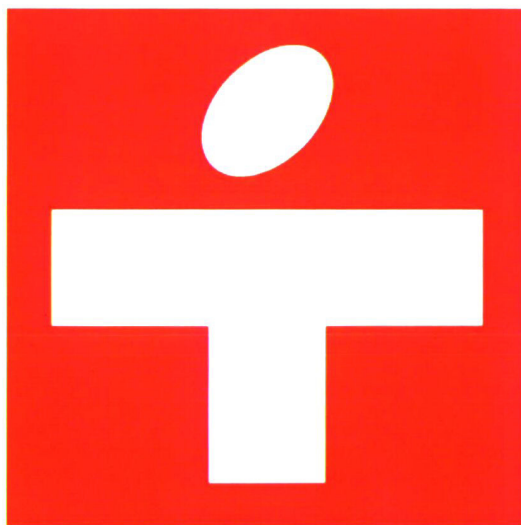

TOYO SHINYAKU CO., LTD. (JAPAN JOINT STOCK COMPANY)  
19-27, HAKATAEKIMAE 2-CHOME  
HAKATA-KU.; FUKUOKA-SHI; FUKUOKA-KEN  
812-0011  
JAPAN

FOR: CHEMICALS FOR USE IN INDUSTRY; CHEMICALS FOR USE IN INDUSTRY, NAMELY, FRAGRANCES FOR USE IN MANUFACTURING COSMETICS; ANTI-CREASING AGENTS, NAMELY, CHEMICAL AGENTS FOR PREVENTING TEXTILES FROM WRINKLING; HEAT RETAINING PREPARATIONS, NAMELY, POLYMER GEL USED IN HEATING PADS AND HEAT TRANSFER FLUIDS FOR INDUSTRIAL USE; ANTI-AGING AGENTS, NAMELY, CHEMICAL REAGENTS FOR NON-MEDICAL PURPOSES; CHEMICALS AS RAW MATERIALS FOR COSMETICS MAINLY CONTAINING PROTEINS, NAMELY, CHEMICAL ADDITIVES FOR USE IN THE MANUFACTURE OF COSMETICS; CHEMICALS AS RAW MATERIALS FOR COSMETICS MAINLY CONTAINING ENZYMES, NAMELY, CHEMICAL ADDITIVES FOR USE IN THE MANUFACTURE OF COSMETICS; CHEMICALS AS RAW MATERIALS FOR COSMETICS MAINLY CONTAINING COLLAGEN, NAMELY, CHEMICAL ADDITIVES FOR USE IN THE MANUFACTURE OF COSMETICS; CHEMICALS AS RAW MATERIALS FOR COSMETICS MAINLY

CONTAINING OLIGOMERIC PROANTHOCYANIDINS EXTRACTED FROM PINE BARK, NAMELY, BOTANICAL EXTRACTS FOR USE IN MAKING COSMETICS; CHEMICALS AS RAW MATERIALS FOR COSMETICS MAINLY CONTAINING SWEET POTATO FIBER, NAMELY, CHEMICAL ADDITIVES FOR USE IN THE MANUFACTURE OF COSMETICS; CHEMICALS AS RAW MATERIALS FOR COSMETICS MAINLY CONTAINING TUBER VEGETABLE FIBER, NAMELY, CHEMICAL ADDITIVES FOR USE IN THE MANUFACTURE OF COSMETICS; CHEMICALS AS RAW MATERIALS FOR COSMETICS MAINLY CONTAINING YOUNG BARLEY LEAF FIBER, NAMELY, CHEMICAL ADDITIVES FOR USE IN THE MANUFACTURE OF COSMETICS; CHEMICALS AS RAW MATERIALS FOR COSMETICS MAINLY CONTAINING YOUNG SWEET-POTATO LEAF FIBER, NAMELY, CHEMICAL ADDITIVES FOR USE IN THE MANUFACTURE OF COSMETICS; CHEMICALS AS RAW MATERIALS FOR COSMETICS MAINLY CONTAINING KALE FIBER, NAMELY, CHEMICAL ADDITIVES FOR USE IN THE MANUFACTURE OF COSMETICS; CHEMICALS AS RAW MATERIALS FOR COSMETICS MAINLY CONTAINING TERMINALIA BELLIRICA EXTRACT, NAMELY, CHEMICAL ADDITIVES FOR USE IN THE MANUFACTURE OF COSMETICS; CHEMICALS AS RAW MATERIALS FOR COSMETICS MAINLY CONTAINING KUDZU VINE FLOWER EXTRACT,

NAMELY, CHEMICAL ADDITIVES FOR USE IN THE MANUFACTURE OF COSMETICS; CHEMICALS AS RAW MATERIALS FOR COSMETICS MAINLY CONTAINING LOQUAT LEAF EXTRACT, NAMELY, CHEMICAL ADDITIVES FOR USE IN THE MANUFACTURE OF COSMETICS; CHEMICALS AS RAW MATERIALS FOR COSMETICS MAINLY CONTAINING GANODERMA LUCIDUM EXTRACT, NAMELY, CHEMICAL ADDITIVES FOR USE IN THE MANUFACTURE OF COSMETICS; CHEMICALS AS RAW MATERIALS FOR COSMETICS MAINLY CONTAINING BLACK VINEGAR, NAMELY, CHEMICAL ADDITIVES FOR USE IN THE MANUFACTURE OF COSMETICS; CHEMICALS AS RAW MATERIALS FOR COSMETICS MAINLY CONTAINING MACA EXTRACT, NAMELY, CHEMICAL ADDITIVES FOR USE IN THE MANUFACTURE OF COSMETICS; CHEMICALS AS RAW MATERIALS FOR COSMETICS MAINLY CONTAINING CABBAGE, ORANGE, ONION, CARROT AND GREEN CHILI EXTRACT, NAMELY, CHEMICAL ADDITIVES FOR USE IN THE MANUFACTURE OF COSMETICS; CHEMICALS AS RAW MATERIALS FOR COSMETICS MAINLY CONTAINING S-ADENOSYLMETHIONINE, NAMELY, CHEMICAL ADDITIVES FOR USE IN THE MANUFACTURE OF COSMETICS; CHEMICALS AS RAW MATERIALS FOR COSMETICS MAINLY CONTAINING NATA DE COCO FIBER, NAMELY, CHEMICAL ADDITIVES FOR USE IN THE MANUFACTURE OF COSMETICS, IN CLASS 1 (U.S. CLS. 1, 5, 6, 10, 26 AND 46).

FOR: FACE CREAM, BODY CREAM, EYE CREAM, HAIR CREAM, FACE LOTION, MILKY LOTION FOR SKIN, ANTI-AGING BEAUTY SERA FOR SKIN, WHITENING BEAUTY SERA FOR SKIN, OIL-CONTROLLING BEAUTY SERA FOR SKIN, MOISTURIZING BEAUTY SERA FOR SKIN, LIFTING BEAUTY SERA FOR SKIN, ANTI-WRINKLE BEAUTY SERA FOR SKIN, FACIAL CLEANSING FOAM, MAKEUP REMOVING CREAM AND OTHER COSMETICS MAINLY CONTAINING OLIGOMERIC PROANTHOCYANIDINS EXTRACTED FROM PINE BARK; SOAPS AND SHAMPOOS MAINLY CONTAINING OLIGOMERIC PROANTHOCYANIDINS EXTRACTED FROM PINE BARK; TOOTHPASTE MAINLY CONTAINING OLIGOMERIC PROANTHOCYANIDINS EXTRACTED FROM PINE BARK; MOUTHWASH MAINLY CONTAINING OLIGOMERIC PROANTHOCYANIDINS EXTRACTED FROM PINE BARK; PERFUMERY MAINLY CONTAINING OLIGOMERIC PROANTHOCYANIDINS EXTRACTED FROM PINE BARK; BATH SALTS MAINLY CONTAINING OLIGOMERIC PROANTHOCYANIDINS EXTRACTED FROM PINE BARK; FACE CREAM, BODY CREAM, EYE CREAM, HAIR CREAM, FACE LOTION, MILKY LOTION FOR SKIN, ANTI-AGING BEAUTY SERA FOR SKIN, WHITENING BEAUTY SERA FOR SKIN, OIL-CONTROLLING BEAUTY SERA FOR SKIN, MOISTURIZING BEAUTY SERA FOR SKIN, LIFTING BEAUTY SERA FOR SKIN, ANTI-WRINKLE BEAUTY SERA FOR SKIN, FACIAL CLEANSING FOAM, MAKEUP REMOVING CREAM AND OTHER COSMETICS MAINLY CONTAINING SWEET POTATO FIBER; TOOTHPASTE MAINLY

CONTAINING SWEET POTATO FIBER; MOUTHWASH MAINLY CONTAINING SWEET POTATO FIBER; PERFUMERY MAINLY CONTAINING SWEET POTATO FIBER; BATH SALTS MAINLY CONTAINING SWEET POTATO FIBER; FACE CREAM, BODY CREAM, EYE CREAM, HAIR CREAM, FACE LOTION, MILKY LOTION FOR SKIN, ANTI-AGING BEAUTY SERA FOR SKIN, WHITENING BEAUTY SERA FOR SKIN, OIL-CONTROLLING BEAUTY SERA FOR SKIN, MOISTURIZING BEAUTY SERA FOR SKIN, LIFTING BEAUTY SERA FOR SKIN, ANTI-WRINKLE BEAUTY SERA FOR SKIN, FACIAL CLEANSING FOAM, MAKEUP REMOVING CREAM AND OTHER COSMETICS MAINLY CONTAINING TUBER VEGETABLE FIBER; SOAPS AND SHAMPOOS MAINLY CONTAINING TUBER VEGETABLE FIBER; TOOTHPASTE MAINLY CONTAINING TUBER VEGETABLE FIBER; MOUTHWASH MAINLY CONTAINING TUBER VEGETABLE FIBER; PERFUMERY MAINLY CONTAINING TUBER VEGETABLE FIBER; BATH SALTS MAINLY CONTAINING TUBER VEGETABLE FIBER; FACE CREAM, BODY CREAM, EYE CREAM, HAIR CREAM, FACE LOTION, MILKY LOTION FOR SKIN, ANTI-AGING BEAUTY SERA FOR SKIN, WHITENING BEAUTY SERA FOR SKIN, OIL-CONTROLLING BEAUTY SERA FOR SKIN, MOISTURIZING BEAUTY SERA FOR SKIN, LIFTING BEAUTY SERA FOR SKIN, ANTI-WRINKLE BEAUTY SERA FOR SKIN, FACIAL CLEANSING FOAM, MAKEUP REMOVING CREAM AND OTHER COSMETICS MAINLY CONTAINING YOUNG BARLEY LEAF FIBER; SOAPS AND SHAMPOOS MAINLY CONTAINING YOUNG BARLEY LEAF FIBER; TOOTHPASTE MAINLY CONTAINING YOUNG BARLEY LEAF FIBER; MOUTHWASH MAINLY CONTAINING YOUNG BARLEY LEAF FIBER; PERFUMERY MAINLY CONTAINING YOUNG BARLEY LEAF FIBER; BATH SALTS MAINLY CONTAINING YOUNG BARLEY LEAF FIBER; FACE CREAM, BODY CREAM, EYE CREAM, HAIR CREAM, FACE LOTION, MILKY LOTION FOR SKIN, ANTI-AGING BEAUTY SERA FOR SKIN, WHITENING BEAUTY SERA FOR SKIN, OIL-CONTROLLING BEAUTY SERA FOR SKIN, MOISTURIZING BEAUTY SERA FOR SKIN, LIFTING BEAUTY SERA FOR SKIN, ANTI-WRINKLE BEAUTY SERA FOR SKIN, FACIAL CLEANSING FOAM, MAKEUP REMOVING CREAM AND OTHER COSMETICS MAINLY CONTAINING YOUNG SWEET-POTATO LEAF FIBER; SOAPS AND SHAMPOOS MAINLY CONTAINING YOUNG SWEET-POTATO LEAF FIBER; TOOTHPASTE MAINLY CONTAINING YOUNG SWEET-POTATO LEAF FIBER; MOUTHWASH MAINLY CONTAINING YOUNG SWEET-POTATO LEAF FIBER; PERFUMERY MAINLY CONTAINING YOUNG SWEET-POTATO LEAF FIBER; BATH SALTS MAINLY CONTAINING YOUNG SWEET-POTATO LEAF FIBER; FACE CREAM, BODY CREAM, EYE CREAM, HAIR CREAM, FACE LOTION, MILKY LOTION FOR SKIN, ANTI-AGING BEAUTY SERA FOR SKIN, WHITENING BEAUTY SERA FOR SKIN, OIL-CONTROLLING BEAUTY SERA FOR SKIN, MOISTURIZING BEAUTY SERA FOR SKIN, LIFTING BEAUTY SERA FOR SKIN, ANTI-WRINKLE BEAU-

TY SERA FOR SKIN, FACIAL CLEANSING FOAM, MAKEUP REMOVING CREAM AND OTHER COSMETICS MAINLY CONTAINING TERMINALIA BELLIRICA EXTRACT; SOAPS AND SHAMPOOS MAINLY CONTAINING TERMINALIA BELLIRICA EXTRACT; TOOTHPASTE MAINLY CONTAINING TERMINALIA BELLIRICA EXTRACT; MOUTHWASH MAINLY CONTAINING TERMINALIA BELLIRICA EXTRACT; PERFUMERY MAINLY CONTAINING TERMINALIA BELLIRICA EXTRACT; BATH SALTS MAINLY CONTAINING TERMINALIA BELLIRICA EXTRACT; FACE CREAM, BODY CREAM, EYE CREAM, HAIR CREAM, FACE LOTION, MILKY LOTION FOR SKIN, ANTI-AGING BEAUTY SERA FOR SKIN, WHITENING BEAUTY SERA FOR SKIN, OIL-CONTROLLING BEAUTY SERA FOR SKIN, MOISTURIZING BEAUTY SERA FOR SKIN, LIFTING BEAUTY SERA FOR SKIN, ANTI-WRINKLE BEAUTY SERA FOR SKIN, FACIAL CLEANSING FOAM, MAKEUP REMOVING CREAM AND OTHER COSMETICS MAINLY CONTAINING KUDZU VINE FLOWER EXTRACT; SOAPS AND SHAMPOOS MAINLY CONTAINING KUDZU VINE FLOWER EXTRACT; TOOTHPASTE MAINLY CONTAINING KUDZU VINE FLOWER EXTRACT; MOUTHWASH MAINLY CONTAINING KUDZU VINE FLOWER EXTRACT; PERFUMERY MAINLY CONTAINING KUDZU VINE FLOWER EXTRACT; BATH SALTS MAINLY CONTAINING KUDZU VINE FLOWER EXTRACT; FACE CREAM, BODY CREAM, EYE CREAM, HAIR CREAM, FACE LOTION, MILKY LOTION FOR SKIN, ANTI-AGING BEAUTY SERA FOR SKIN, WHITENING BEAUTY SERA FOR SKIN, OIL-CONTROLLING BEAUTY SERA FOR SKIN, MOISTURIZING BEAUTY SERA FOR SKIN, LIFTING BEAUTY SERA FOR SKIN, ANTI-WRINKLE BEAUTY SERA FOR SKIN, FACIAL CLEANSING FOAM, MAKEUP REMOVING CREAM AND OTHER COSMETICS MAINLY CONTAINING LOQUAT LEAF EXTRACT; SOAPS AND SHAMPOOS MAINLY CONTAINING LOQUAT LEAF EXTRACT; TOOTHPASTE MAINLY CONTAINING LOQUAT LEAF EXTRACT; MOUTHWASH MAINLY CONTAINING LOQUAT LEAF EXTRACT; PERFUMERY MAINLY CONTAINING LOQUAT LEAF EXTRACT; BATH SALTS MAINLY CONTAINING LOQUAT LEAF EXTRACT; FACE CREAM, BODY CREAM, EYE CREAM, HAIR CREAM, FACE LOTION, MILKY LOTION FOR SKIN, ANTI-AGING BEAUTY SERA FOR SKIN, WHITENING BEAUTY SERA FOR SKIN, OIL-CONTROLLING BEAUTY SERA FOR SKIN, MOISTURIZING BEAUTY SERA FOR SKIN, LIFTING BEAUTY SERA FOR SKIN, ANTI-WRINKLE BEAUTY SERA FOR SKIN, FACIAL CLEANSING FOAM, MAKEUP REMOVING CREAM AND OTHER COSMETICS MAINLY CONTAINING KALE FIBER; SOAPS AND SHAMPOOS MAINLY CONTAINING KALE FIBER; TOOTHPASTE MAINLY CONTAINING KALE FIBER; MOUTHWASH MAINLY CONTAINING KALE FIBER; PERFUMERY MAINLY CONTAINING KALE FIBER; BATH SALTS MAINLY CONTAINING KALE FIBER; FACE CREAM, BODY CREAM, EYE CREAM, HAIR CREAM, FACE LOTION, MILKY LOTION FOR SKIN, ANTI-AGING BEAUTY SERA FOR SKIN, WHITENING BEAUTY SERA FOR SKIN, OIL-CONTROLLING BEAUTY

SERA FOR SKIN, MOISTURIZING BEAUTY SERA FOR SKIN, LIFTING BEAUTY SERA FOR SKIN, ANTI-WRINKLE BEAUTY SERA FOR SKIN, FACIAL CLEANSING FOAM, MAKEUP REMOVING CREAM AND OTHER COSMETICS MAINLY CONTAINING GANODERMA LUCIDUM EXTRACT; SOAPS AND SHAMPOOS MAINLY CONTAINING GANODERMA LUCIDUM EXTRACT; TOOTHPASTE MAINLY CONTAINING GANODERMA LUCIDUM EXTRACT; MOUTHWASH MAINLY CONTAINING GANODERMA LUCIDUM EXTRACT; PERFUMERY MAINLY CONTAINING GANODERMA LUCIDUM EXTRACT; BATH SALTS MAINLY CONTAINING GANODERMA LUCIDUM EXTRACT; FACE CREAM, BODY CREAM, EYE CREAM, HAIR CREAM, FACE LOTION, MILKY LOTION FOR SKIN, ANTI-AGING BEAUTY SERA FOR SKIN, WHITENING BEAUTY SERA FOR SKIN, OIL-CONTROLLING BEAUTY SERA FOR SKIN, MOISTURIZING BEAUTY SERA FOR SKIN, LIFTING BEAUTY SERA FOR SKIN, ANTI-WRINKLE BEAUTY SERA FOR SKIN, FACIAL CLEANSING FOAM, MAKEUP REMOVING CREAM AND OTHER COSMETICS MAINLY CONTAINING BLACK VINEGAR; TOOTHPASTE MAINLY CONTAINING BLACK VINEGAR; MOUTHWASH MAINLY CONTAINING BLACK VINEGAR; PERFUMERY MAINLY CONTAINING BLACK VINEGAR; BATH SALTS MAINLY CONTAINING BLACK VINEGAR; FACE CREAM, BODY CREAM, EYE CREAM, HAIR CREAM, FACE LOTION, MILKY LOTION FOR SKIN, ANTI-AGING BEAUTY SERA FOR SKIN, WHITENING BEAUTY SERA FOR SKIN, OIL-CONTROLLING BEAUTY SERA FOR SKIN, MOISTURIZING BEAUTY SERA FOR SKIN, LIFTING BEAUTY SERA FOR SKIN, ANTI-WRINKLE BEAUTY SERA FOR SKIN, FACIAL CLEANSING FOAM, MAKEUP REMOVING CREAM AND OTHER COSMETICS MAINLY CONTAINING MACA EXTRACT; MOUTHWASH MAINLY CONTAINING MACA EXTRACT; PERFUMERY MAINLY CONTAINING MACA EXTRACT; BATH SALTS MAINLY CONTAINING MACA EXTRACT; FACE CREAM, BODY CREAM, EYE CREAM, HAIR CREAM, FACE LOTION, MILKY LOTION FOR SKIN, ANTI-AGING BEAUTY SERA FOR SKIN, WHITENING BEAUTY SERA FOR SKIN, OIL-CONTROLLING BEAUTY SERA FOR SKIN, MOISTURIZING BEAUTY SERA FOR SKIN, LIFTING BEAUTY SERA FOR SKIN, ANTI-WRINKLE BEAUTY SERA FOR SKIN, FACIAL CLEANSING FOAM, MAKEUP REMOVING CREAM AND OTHER COSMETICS MAINLY CONTAINING EXTRACTS OF CABBAGE, ORANGE, ONION, CARROT AND GREEN CHILI; SOAPS AND SHAMPOOS MAINLY CONTAINING EXTRACTS OF CABBAGE, ORANGE, ONION, CARROT AND GREEN CHILI; TOOTHPASTE MAINLY CONTAINING EXTRACTS OF CABBAGE, ORANGE, ONION, CARROT AND GREEN CHILI; MOUTHWASH MAINLY CONTAINING EXTRACTS OF CABBAGE, ORANGE, ONION, CARROT AND GREEN CHILI; PERFUMERY MAINLY CONTAINING EXTRACTS OF CABBAGE, ORANGE, ONION, CARROT AND GREEN CHILI; BATH SALTS MAINLY CONTAINING EXTRACTS OF CABBAGE, ORANGE, ONION, CARROT AND GREEN CHILI; FACE CREAM, BODY CREAM, EYE CREAM, HAIR

CREAM, FACE LOTION, MILKY LOTION FOR SKIN, ANTI-AGING BEAUTY SERA FOR SKIN, WHITENING BEAUTY SERA FOR SKIN, OIL-CONTROLLING BEAUTY SERA FOR SKIN, MOISTURIZING BEAUTY SERA FOR SKIN, LIFTING BEAUTY SERA FOR SKIN, ANTI-WRINKLE BEAUTY SERA FOR SKIN, FACIAL CLEANSING FOAM, MAKEUP REMOVING CREAM AND OTHER COSMETICS MAINLY CONTAINING S-ADENOSYLMETHIONINE; SOAPS AND SHAMPOOS MAINLY CONTAINING S-ADENOSYLMETHIONINE; TOOTHPASTE MAINLY CONTAINING S-ADENOSYLMETHIONINE; MOUTHWASH MAINLY CONTAINING S-ADENOSYLMETHIONINE; PERFUMERY MAINLY CONTAINING S-ADENOSYLMETHIONINE; BATH SALTS MAINLY CONTAINING S-ADENOSYLMETHIONINE; COSMETIC FACIAL MASKS MAINLY CONTAINING NATA DE COCO FIBER; SHEET-SHAPED SOAP MAINLY CONTAINING NATA DE COCO FIBER; FACE CREAM, BODY CREAM, EYE CREAM, HAIR CREAM, FACE LOTION, MILKY LOTION FOR SKIN, ANTI-AGING BEAUTY SERA FOR SKIN, WHITENING BEAUTY SERA FOR SKIN, OIL-CONTROLLING BEAUTY SERA FOR SKIN, MOISTURIZING BEAUTY SERA FOR SKIN, LIFTING BEAUTY SERA FOR SKIN, ANTI-WRINKLE BEAUTY SERA FOR SKIN, FACIAL CLEANSING FOAM, MAKEUP REMOVING CREAM AND OTHER COSMETICS MAINLY CONTAINING NATA DE COCO FIBER; SOAPS AND SHAMPOOS MAINLY CONTAINING NATA DE COCO FIBER; TOOTHPASTE MAINLY CONTAINING NATA DE COCO FIBER; MOUTHWASH MAINLY CONTAINING NATA DE COCO FIBER; PERFUMERY MAINLY CONTAINING NATA DE COCO FIBER; BATH SALTS MAINLY CONTAINING NATA DE COCO FIBER; SOAPS AND DETERGENTS; DENTIFRICES; COSMETICS AND NON-MEDICATED TOILETRIES; SHEET COSMETICS AND NON-MEDICATED TOILETRIES; PERFUMERY, ROOM FRAGRANCES, FRAGRANCES FOR COSMETICS, NAMELY, FRAGRANCES FOR PERSONAL USE; AND INCENSES, IN CLASS 3 (U.S. CLS. 1, 4, 6, 50, 51 AND 52).

FOR: SHEET-SHAPED PHARMACEUTICALS MAINLY CONTAINING NATA DE COCO FIBER FOR THE TREATMENT OF DERMATOLOGICAL DISORDERS, CARDIAC DISORDERS, MENOPAUSAL SYMPTOMS AND ASTHMA, AND USED AS NICOTINE PATCHES FOR SMOKING CESSATION; SHEET-SHAPED ANTIPHLOGISTIC REFRIGERANTS MAINLY CONTAINING NATA DE COCO FIBER, NAMELY, ANTI-INFLAMMATORIES; SHEET-SHAPED THERAPEUTIC REFRIGERANTS MAINLY CONTAINING NATA DE COCO FIBER NAMELY, ANTI-INFLAMMATORIES; SHEET-SHAPED PATCHES MAINLY CONTAINING NATA DE COCO FIBER, NAMELY, TRANSDERMAL PATCHES, NAMELY, CATAPLASM AND POULTICE, FOR USE IN THE TREATMENT OF CONTUSIONS AND WOUNDS; PHARMACEUTICALS MAINLY CONTAINING OLIGOMERIC PROANTHOCYANIDINS EXTRACTED FROM PINE BARK FOR THE TREATMENT OF DISORDERS IN THE CENTRAL NERVOUS SYSTEM, THE PERIPHERAL NERVOUS SYSTEM, THE RESPIRATORY ORGANS, THE DI-

GESTIVE ORGANS, THE URO-GENITAL AND ANAL ORGANS, AND THE EPIDERMIS, AND FOR THE TREATMENT OF RHINITIC DISEASES, OTITIC DISEASES, HEPATIC DISEASES, DIABETES, GOUT, ALLERGIC DISEASES, ADDICTIONS, GYNECOLOGICAL DISEASES AND CARDIOVASCULAR DISEASES; PHARMACEUTICALS MAINLY CONTAINING OLIGOMERIC PROANTHOCYANIDINS EXTRACTED FROM PINE BARK, NAMELY, CONTRACEPTIVES, EYE DROPS, SOLUTIONS FOR CONTACT LENSES, PHARMACEUTICALS FOR DENTAL TREATMENTS, HEMOSTATS, ALEXIPHARMICS; PHARMACEUTICALS MAINLY CONTAINING OLIGOMERIC PROANTHOCYANIDINS EXTRACTED FROM PINE BARK, NAMELY, PHARMACEUTICALS FOR TREATING SUBSTANCE ABUSES AND ADDICTIONS; NUTRITIONAL ADDITIVES FOR MEDICAL USE FOR USE IN FOODS AND DIETARY SUPPLEMENTS FOR HUMAN CONSUMPTION MAINLY CONTAINING OLIGOMERIC PROANTHOCYANIDINS EXTRACTED FROM PINE BARK FOR MEDICAL SUPPLEMENTS; DIETARY CURE FOODS MAINLY CONTAINING OLIGOMERIC PROANTHOCYANIDINS EXTRACTED FROM PINE BARK, NAMELY, DIETARY SUPPLEMENTS; PHARMACEUTICALS MAINLY CONTAINING SWEET POTATO FIBER FOR THE TREATMENT OF DISORDERS IN THE CENTRAL NERVOUS SYSTEM, THE PERIPHERAL NERVOUS SYSTEM, THE RESPIRATORY ORGANS, THE DIGESTIVE ORGANS, THE URO-GENITAL AND ANAL ORGANS, AND THE EPIDERMIS, AND FOR THE TREATMENT OF RHINITIC DISEASES, OTITIC DISEASES, HEPATIC DISEASES, DIABETES, GOUT, ALLERGIC DISEASES, ADDICTIONS, GYNECOLOGICAL DISEASES AND CARDIOVASCULAR DISEASES; PHARMACEUTICALS MAINLY CONTAINING SWEET POTATO FIBER, NAMELY, CONTRACEPTIVES, EYE DROPS, SOLUTIONS FOR CONTACT LENSES, PHARMACEUTICALS FOR DENTAL TREATMENTS, HEMOSTATS, ALEXIPHARMICS; PHARMACEUTICALS MAINLY CONTAINING SWEET POTATO FIBER, NAMELY, PHARMACEUTICALS FOR TREATING SUBSTANCE ABUSES AND ADDICTIONS; NUTRITIONAL ADDITIVES FOR MEDICAL USE FOR USE IN FOODS AND DIETARY SUPPLEMENTS FOR HUMAN CONSUMPTION MAINLY CONTAINING SWEET POTATO FIBER FOR MEDICAL SUPPLEMENTS; DIETARY CURE FOODS MAINLY CONTAINING SWEET POTATO FIBER, NAMELY, DIETARY SUPPLEMENTS; PHARMACEUTICALS MAINLY CONTAINING TUBER VEGETABLE FIBER FOR THE TREATMENT OF DISORDERS IN THE CENTRAL NERVOUS SYSTEM, THE PERIPHERAL NERVOUS SYSTEM, THE RESPIRATORY ORGANS, THE DIGESTIVE ORGANS, THE URO-GENITAL AND ANAL ORGANS, AND THE EPIDERMIS, AND FOR THE TREATMENT OF RHINITIC DISEASES, OTITIC DISEASES, HEPATIC DISEASES, DIABETES, GOUT, ALLERGIC DISEASES, ADDICTIONS, GYNECOLOGICAL DISEASES AND CARDIOVASCULAR DISEASES; PHARMACEUTICALS MAINLY CONTAINING TUBER VEGETABLE FIBER, NAMELY, CONTRACEPTIVES, EYE DROPS, SOLUTIONS FOR CONTACT LENSES, PHARMACEUTICALS FOR DENTAL TREAT-

MENTS, HEMOSTATS, ALEXIPHARMICS; PHARMACEUTICALS MAINLY CONTAINING TUBER VEGETABLE FIBER, NAMELY, PHARMACEUTICALS FOR TREATING SUBSTANCE ABUSES AND ADDICTIONS; NUTRITIONAL ADDITIVES FOR MEDICAL USE FOR USE IN FOODS AND DIETARY SUPPLEMENTS FOR HUMAN CONSUMPTION MAINLY CONTAINING TUBER VEGETABLE FIBER FOR MEDICAL SUPPLEMENTS; DIETARY CURE FOODS MAINLY CONTAINING TUBER VEGETABLE FIBER, NAMELY, DIETARY SUPPLEMENTS; PHARMACEUTICALS MAINLY CONTAINING YOUNG BARLEY LEAF FIBER FOR THE TREATMENT OF DISORDERS IN THE CENTRAL NERVOUS SYSTEM, THE PERIPHERAL NERVOUS SYSTEM, THE RESPIRATORY ORGANS, THE DIGESTIVE ORGANS, THE URO-GENITAL AND ANAL ORGANS, AND THE EPIDERMIS, AND FOR THE TREATMENT OF RHINITIC DISEASES, OTITIC DISEASES, HEPATIC DISEASES, DIABETES, GOUT, ALLERGIC DISEASES, ADDICTIONS, GYNECOLOGICAL DISEASES AND CARDIOVASCULAR DISEASES; PHARMACEUTICALS MAINLY CONTAINING YOUNG BARLEY LEAF FIBER, NAMELY, CONTRACEPTIVES, EYE DROPS, SOLUTIONS FOR CONTACT LENSES, PHARMACEUTICALS FOR DENTAL TREATMENTS, HEMOSTATS, ALEXIPHARMICS; PHARMACEUTICALS MAINLY CONTAINING YOUNG BARLEY LEAF FIBER, NAMELY, PHARMACEUTICALS FOR TREATING SUBSTANCE ABUSES AND ADDICTIONS; NUTRITIONAL ADDITIVES FOR MEDICAL USE FOR USE IN FOODS AND DIETARY SUPPLEMENTS FOR HUMAN CONSUMPTION MAINLY CONTAINING YOUNG BARLEY LEAVES FOR MEDICAL SUPPLEMENTS; DIETARY CURE FOODS MAINLY CONTAINING YOUNG BARLEY LEAVES, NAMELY, DIETARY SUPPLEMENTS; PHARMACEUTICALS MAINLY CONTAINING YOUNG SWEET POTATO LEAF FIBER FOR THE TREATMENT OF DISORDERS IN THE CENTRAL NERVOUS SYSTEM, THE PERIPHERAL NERVOUS SYSTEM, THE RESPIRATORY ORGANS, THE DIGESTIVE ORGANS, THE URO-GENITAL AND ANAL ORGANS, AND THE EPIDERMIS, AND FOR THE TREATMENT OF RHINITIC DISEASES, OTITIC DISEASES, HEPATIC DISEASES, DIABETES, GOUT, ALLERGIC DISEASES, ADDICTIONS, GYNECOLOGICAL DISEASES AND CARDIOVASCULAR DISEASES; PHARMACEUTICALS MAINLY CONTAINING YOUNG SWEET POTATO LEAF FIBER, NAMELY, CONTRACEPTIVES, EYE DROPS, SOLUTIONS FOR CONTACT LENSES, PHARMACEUTICALS FOR DENTAL TREATMENTS, HEMOSTATS, ALEXIPHARMICS; PHARMACEUTICALS MAINLY CONTAINING YOUNG SWEET POTATO LEAF FIBER, NAMELY, PHARMACEUTICALS FOR TREATING SUBSTANCE ABUSES AND ADDICTIONS; NUTRITIONAL ADDITIVES FOR MEDICAL USE FOR USE IN FOODS AND DIETARY SUPPLEMENTS FOR HUMAN CONSUMPTION MAINLY CONTAINING YOUNG SWEET POTATO LEAF FIBER FOR MEDICAL SUPPLEMENTS; DIETARY CURE FOODS MAINLY CONTAINING YOUNG SWEET POTATO LEAF FIBER, NAMELY, DIETARY SUPPLEMENTS; PHARMACEUTICALS MAINLY CONTAINING TERMINALIA BELLIRICA EX-

TRACT FOR THE TREATMENT OF DISORDERS IN THE CENTRAL NERVOUS SYSTEM, THE PERIPHERAL NERVOUS SYSTEM, THE RESPIRATORY ORGANS, THE DIGESTIVE ORGANS, THE URO-GENITAL AND ANAL ORGANS, AND THE EPIDERMIS, AND FOR THE TREATMENT OF RHINITIC DISEASES, OTITIC DISEASES, HEPATIC DISEASES, DIABETES, GOUT, ALLERGIC DISEASES, ADDICTIONS, GYNECOLOGICAL DISEASES AND CARDIOVASCULAR DISEASES; PHARMACEUTICALS MAINLY CONTAINING TERMINALIA BELLIRICA EXTRACT, NAMELY, CONTRACEPTIVES, EYE DROPS, SOLUTIONS FOR CONTACT LENSES, PHARMACEUTICALS FOR DENTAL TREATMENTS, HEMOSTATS, ALEXIPHARMICS; PHARMACEUTICALS MAINLY CONTAINING TERMINALIA BELLIRICA EXTRACT, NAMELY, PHARMACEUTICALS FOR TREATING SUBSTANCE ABUSES AND ADDICTIONS; NUTRITIONAL ADDITIVES FOR MEDICAL USE FOR USE IN FOODS AND DIETARY SUPPLEMENTS FOR HUMAN CONSUMPTION MAINLY CONTAINING TERMINALIA BELLIRICA EXTRACT FOR MEDICAL SUPPLEMENTS; DIETARY CURE FOODS MAINLY CONTAINING TERMINALIA BELLIRICA EXTRACT, NAMELY, DIETARY SUPPLEMENTS; PHARMACEUTICALS MAINLY CONTAINING KUDZU VINE FLOWER EXTRACT FOR THE TREATMENT OF DISORDERS IN THE CENTRAL NERVOUS SYSTEM, THE PERIPHERAL NERVOUS SYSTEM, THE RESPIRATORY ORGANS, THE DIGESTIVE ORGANS, THE URO-GENITAL AND ANAL ORGANS, AND THE EPIDERMIS, AND FOR THE TREATMENT OF RHINITIC DISEASES, OTITIC DISEASES, HEPATIC DISEASES, DIABETES, GOUT, ALLERGIC DISEASES, ADDICTIONS, GYNECOLOGICAL DISEASES AND CARDIOVASCULAR DISEASES; PHARMACEUTICALS MAINLY CONTAINING KUDZU VINE FLOWER EXTRACT, NAMELY, CONTRACEPTIVES, EYE DROPS, SOLUTIONS FOR CONTACT LENSES, PHARMACEUTICALS FOR DENTAL TREATMENTS, HEMOSTATS, ALEXIPHARMICS; PHARMACEUTICALS MAINLY CONTAINING KUDZU VINE FLOWER EXTRACT, NAMELY, PHARMACEUTICALS FOR TREATING SUBSTANCE ABUSES AND ADDICTIONS; NUTRITIONAL ADDITIVES FOR MEDICAL USE FOR USE IN FOODS AND DIETARY SUPPLEMENTS FOR HUMAN CONSUMPTION MAINLY CONTAINING KUDZU VINE FLOWER EXTRACT FOR MEDICAL SUPPLEMENTS; DIETARY CURE FOODS MAINLY CONTAINING KUDZU VINE FLOWER EXTRACT, NAMELY, DIETARY SUPPLEMENTS; PHARMACEUTICALS MAINLY CONTAINING LOQUAT LEAF EXTRACT FOR THE TREATMENT OF DISORDERS IN THE CENTRAL NERVOUS SYSTEM, THE PERIPHERAL NERVOUS SYSTEM, THE RESPIRATORY ORGANS, THE DIGESTIVE ORGANS, THE URO-GENITAL AND ANAL ORGANS, AND THE EPIDERMIS, AND FOR THE TREATMENT OF RHINITIC DISEASES, OTITIC DISEASES, HEPATIC DISEASES, DIABETES, GOUT, ALLERGIC DISEASES, ADDICTIONS, GYNECOLOGICAL DISEASES AND CARDIOVASCULAR DISEASES; PHARMACEUTICALS MAINLY CONTAINING LOQUAT LEAF EXTRACT, NAMELY, CONTRACEPTIVES, EYE DROPS, SOLUTIONS FOR CONTACT LENSES,

PHARMACEUTICALS FOR DENTAL TREATMENTS, HEMOSTATS, ALEXIPHARMICS; PHARMACEUTICALS MAINLY CONTAINING LOQUAT LEAF EXTRACT, NAMELY, PHARMACEUTICALS FOR TREATING SUBSTANCE ABUSES AND ADDICTIONS; NUTRITIONAL ADDITIVES FOR MEDICAL USE FOR USE IN FOODS AND DIETARY SUPPLEMENTS FOR HUMAN CONSUMPTION MAINLY CONTAINING LOQUAT LEAF EXTRACT FOR MEDICAL SUPPLEMENTS; DIETARY CURE FOODS MAINLY CONTAINING LOQUAT LEAF EXTRACT, NAMELY, DIETARY SUPPLEMENTS; PHARMACEUTICALS MAINLY CONTAINING KALE FIBER FOR THE TREATMENT OF DISORDERS IN THE CENTRAL NERVOUS SYSTEM, THE PERIPHERAL NERVOUS SYSTEM, THE RESPIRATORY ORGANS, THE DIGESTIVE ORGANS, THE URO-GENITAL AND ANAL ORGANS, AND THE EPIDERMIS, AND FOR THE TREATMENT OF RHINITIC DISEASES, OTITIC DISEASES, HEPATIC DISEASES, DIABETES, GOUT, ALLERGIC DISEASES, ADDICTIONS, GYNECOLOGICAL DISEASES AND CARDIOVASCULAR DISEASES; PHARMACEUTICALS MAINLY CONTAINING KALE FIBER, NAMELY, CONTRACEPTIVES, EYE DROPS, SOLUTIONS FOR CONTACT LENSES, PHARMACEUTICALS FOR DENTAL TREATMENTS, HEMOSTATS, ALEXIPHARMICS; PHARMACEUTICALS MAINLY CONTAINING KALE FIBER, NAMELY, PHARMACEUTICALS FOR TREATING SUBSTANCE ABUSES AND ADDICTIONS; NUTRITIONAL ADDITIVES FOR MEDICAL USE FOR USE IN FOODS AND DIETARY SUPPLEMENTS FOR HUMAN CONSUMPTION MAINLY CONTAINING KALE FIBER FOR MEDICAL SUPPLEMENTS; DIETARY CURE FOODS MAINLY CONTAINING KALE FIBER, NAMELY, DIETARY SUPPLEMENTS; PHARMACEUTICALS MAINLY CONTAINING GANODERMA LUCIDUM EXTRACT FOR THE TREATMENT OF DISORDERS IN THE CENTRAL NERVOUS SYSTEM, THE PERIPHERAL NERVOUS SYSTEM, THE RESPIRATORY ORGANS, THE DIGESTIVE ORGANS, THE URO-GENITAL AND ANAL ORGANS, AND THE EPIDERMIS, AND FOR THE TREATMENT OF RHINITIC DISEASES, OTITIC DISEASES, HEPATIC DISEASES, DIABETES, GOUT, ALLERGIC DISEASES, ADDICTIONS, GYNECOLOGICAL DISEASES AND CARDIOVASCULAR DISEASES; PHARMACEUTICALS MAINLY CONTAINING GANODERMA LUCIDUM EXTRACT, NAMELY, CONTRACEPTIVES, EYE DROPS, SOLUTIONS FOR CONTACT LENSES, PHARMACEUTICALS FOR DENTAL TREATMENTS, HEMOSTATS, ALEXIPHARMICS; PHARMACEUTICALS MAINLY CONTAINING GANODERMA LUCIDUM EXTRACT, NAMELY, PHARMACEUTICALS FOR TREATING SUBSTANCE ABUSES AND ADDICTIONS; NUTRITIONAL ADDITIVES FOR MEDICAL USE FOR USE IN FOODS AND DIETARY SUPPLEMENTS FOR HUMAN CONSUMPTION MAINLY CONTAINING GANODERMA LUCIDUM EXTRACT FOR MEDICAL SUPPLEMENTS; DIETARY CURE FOODS MAINLY CONTAINING GANODERMA LUCIDUM EXTRACT, NAMELY, DIETARY SUPPLEMENTS; PHARMACEUTICALS MAINLY CONTAINING BLACK VINEGAR FOR THE TREATMENT OF

DISORDERS IN THE CENTRAL NERVOUS SYSTEM, THE PERIPHERAL NERVOUS SYSTEM, THE RESPIRATORY ORGANS, THE DIGESTIVE ORGANS, THE URO-GENITAL AND ANAL ORGANS, AND THE EPIDERMIS, AND FOR THE TREATMENT OF RHINITIC DISEASES, OTITIC DISEASES, HEPATIC DISEASES, DIABETES, GOUT, ALLERGIC DISEASES, ADDICTIONS, GYNECOLOGICAL DISEASES AND CARDIOVASCULAR DISEASES; PHARMACEUTICALS MAINLY CONTAINING BLACK VINEGAR, NAMELY, CONTRACEPTIVES, EYE DROPS, SOLUTIONS FOR CONTACT LENSES, PHARMACEUTICALS FOR DENTAL TREATMENTS, HEMOSTATS, ALEXIPHARMICS; PHARMACEUTICALS MAINLY CONTAINING BLACK VINEGAR, NAMELY, PHARMACEUTICALS FOR TREATING SUBSTANCE ABUSES AND ADDICTIONS; NUTRITIONAL ADDITIVES FOR MEDICAL USE FOR USE IN FOODS AND DIETARY SUPPLEMENTS FOR HUMAN CONSUMPTION MAINLY CONTAINING BLACK VINEGAR FOR MEDICAL SUPPLEMENTS; DIETARY CURE FOODS MAINLY CONTAINING BLACK VINEGAR, NAMELY, DIETARY SUPPLEMENTS; PHARMACEUTICALS MAINLY CONTAINING MACA EXTRACT FOR THE TREATMENT OF DISORDERS IN THE CENTRAL NERVOUS SYSTEM, THE PERIPHERAL NERVOUS SYSTEM, THE RESPIRATORY ORGANS, THE DIGESTIVE ORGANS, THE URO-GENITAL AND ANAL ORGANS, AND THE EPIDERMIS, AND FOR THE TREATMENT OF RHINITIC DISEASES, OTITIC DISEASES, HEPATIC DISEASES, DIABETES, GOUT, ALLERGIC DISEASES, ADDICTIONS, GYNECOLOGICAL DISEASES AND CARDIOVASCULAR DISEASES; PHARMACEUTICALS MAINLY CONTAINING MACA EXTRACT, NAMELY, CONTRACEPTIVES, EYE DROPS, SOLUTIONS FOR CONTACT LENSES, PHARMACEUTICALS FOR DENTAL TREATMENTS, HEMOSTATS, ALEXIPHARMICS; PHARMACEUTICALS MAINLY CONTAINING MACA EXTRACT, NAMELY, PHARMACEUTICALS FOR TREATING SUBSTANCE ABUSES AND ADDICTIONS; NUTRITIONAL ADDITIVES FOR MEDICAL USE FOR USE IN FOODS AND DIETARY SUPPLEMENTS FOR HUMAN CONSUMPTION MAINLY CONTAINING MACA EXTRACT FOR MEDICAL SUPPLEMENTS; DIETARY CURE FOODS MAINLY CONTAINING MACA EXTRACT, NAMELY, DIETARY SUPPLEMENTS; PHARMACEUTICALS MAINLY CONTAINING EXTRACTS OF CABBAGE, ORANGE, ONION, CARROT AND GREEN CHILI FOR THE TREATMENT OF DISORDERS IN THE CENTRAL NERVOUS SYSTEM, THE PERIPHERAL NERVOUS SYSTEM, THE RESPIRATORY ORGANS, THE DIGESTIVE ORGANS, THE URO-GENITAL AND ANAL ORGANS, AND THE EPIDERMIS, AND FOR THE TREATMENT OF RHINITIC DISEASES, OTITIC DISEASES, HEPATIC DISEASES, DIABETES, GOUT, ALLERGIC DISEASES, ADDICTIONS, GYNECOLOGICAL DISEASES AND CARDIOVASCULAR DISEASES; PHARMACEUTICALS MAINLY CONTAINING EXTRACTS OF CABBAGE, ORANGE, ONION, CARROT AND GREEN CHILI, NAMELY, CONTRACEPTIVES, EYE DROPS, SOLUTIONS FOR CONTACT LENSES, PHARMACEUTICALS FOR DENTAL TREATMENTS, HEMOSTATS,



ALEXIPHARMICS; PHARMACEUTICALS MAINLY CONTAINING EXTRACTS OF CABBAGE, ORANGE, ONION, CARROT AND GREEN CHILI, NAMELY, PHARMACEUTICALS FOR TREATING SUBSTANCE ABUSES AND ADDICTIONS; NUTRITIONAL ADDITIVES FOR MEDICAL USE FOR USE IN FOODS AND DIETARY SUPPLEMENTS FOR HUMAN CONSUMPTION MAINLY CONTAINING EXTRACTS OF CABBAGE, ORANGE, ONION, CARROT AND GREEN CHILI FOR MEDICAL SUPPLEMENTS; DIETARY CURE FOODS MAINLY CONTAINING EXTRACTS OF CABBAGE, ORANGE, ONION, CARROT AND GREEN CHILI, NAMELY, DIETARY SUPPLEMENTS; PHARMACEUTICALS MAINLY CONTAINING S-ADENOSYLMETHIONINE FOR THE TREATMENT OF DISORDERS IN THE CENTRAL NERVOUS SYSTEM, THE PERIPHERAL NERVOUS SYSTEM, THE RESPIRATORY ORGANS, THE DIGESTIVE ORGANS, THE URO-GENITAL AND ANAL ORGANS, AND THE EPIDERMIS, AND FOR THE TREATMENT OF RHINITIC DISEASES, OTITIC DISEASES, HEPATIC DISEASES, DIABETES, GOUT, ALLERGIC DISEASES, ADDICTIONS, GYNECOLOGICAL DISEASES AND CARDIOVASCULAR DISEASES; PHARMACEUTICALS MAINLY CONTAINING S-ADENOSYLMETHIONINE FOR THE TREATMENT OF DISORDERS IN THE CENTRAL NERVOUS SYSTEM, NAMELY, CONTRACEPTIVES, EYE DROPS, SOLUTIONS FOR CONTACT LENSES, PHARMACEUTICALS FOR DENTAL TREATMENTS, HEMOSTATS, ALEXIPHARMICS; PHARMACEUTICALS MAINLY CONTAINING S-ADENOSYLMETHIONINE FOR THE TREATMENT OF DISORDERS IN THE CENTRAL NERVOUS SYSTEM, NAMELY, PHARMACEUTICALS FOR TREATING SUBSTANCE ABUSES AND ADDICTIONS; NUTRITIONAL ADDITIVES FOR MEDICAL USE FOR USE IN FOODS AND DIETARY SUPPLEMENTS FOR HUMAN CONSUMPTION MAINLY CONTAINING S-ADENOSYLMETHIONINE FOR MEDICAL SUPPLEMENTS; DIETARY CURE FOODS MAINLY CONTAINING S-ADENOSYLMETHIONINE, NAMELY, DIETARY SUPPLEMENTS; PHARMACEUTICALS MAINLY CONTAINING METHYLSULFONYLMETHANE COMPOSED OF SULFUR AND METHYL GROUPS FOR THE TREATMENT OF DISORDERS IN THE CENTRAL NERVOUS SYSTEM, THE PERIPHERAL NERVOUS SYSTEM, THE RESPIRATORY ORGANS, THE DIGESTIVE ORGANS, THE URO-GENITAL AND ANAL ORGANS, AND THE EPIDERMIS, AND FOR THE TREATMENT OF RHINITIC DISEASES, OTITIC DISEASES, HEPATIC DISEASES, DIABETES, GOUT, ALLERGIC DISEASES, ADDICTIONS, GYNECOLOGICAL DISEASES AND CARDIOVASCULAR DISEASES; PHARMACEUTICALS MAINLY CONTAINING METHYLSULFONYLMETHANE COMPOSED OF SULFUR AND METHYL GROUPS, NAMELY, CONTRACEPTIVES, EYE DROPS, SOLUTIONS FOR CONTACT LENSES, PHARMACEUTICALS FOR DENTAL TREATMENTS, HEMOSTATS, ALEXIPHARMICS; PHARMACEUTICALS MAINLY CONTAINING METHYLSULFONYLMETHANE COMPOSED OF SULFUR AND METHYL GROUPS, NAMELY, PHARMACEUTICALS FOR TREATING SUBSTANCE ABUSES AND ADDICTIONS; NUTRI-

TIONAL ADDITIVES FOR MEDICAL USE FOR USE IN FOODS AND DIETARY SUPPLEMENTS FOR HUMAN CONSUMPTION MAINLY CONTAINING METHYLSULFONYLMETHANE COMPOSED OF SULFUR AND METHYL GROUPS FOR MEDICAL SUPPLEMENTS; DIETARY CURE FOODS MAINLY CONTAINING METHYLSULFONYLMETHANE COMPOSED OF SULFUR AND METHYL GROUPS, NAMELY, DIETARY SUPPLEMENTS; PHARMACEUTICALS MAINLY CONTAINING BEAR'S GARLIC FOR THE TREATMENT OF DISORDERS IN THE CENTRAL NERVOUS SYSTEM, THE PERIPHERAL NERVOUS SYSTEM, THE RESPIRATORY ORGANS, THE DIGESTIVE ORGANS, THE URO-GENITAL AND ANAL ORGANS, AND THE EPIDERMIS, AND FOR THE TREATMENT OF RHINITIC DISEASES, OTITIC DISEASES, HEPATIC DISEASES, DIABETES, GOUT, ALLERGIC DISEASES, ADDICTIONS, GYNECOLOGICAL DISEASES AND CARDIOVASCULAR DISEASES; PHARMACEUTICALS MAINLY CONTAINING BEAR'S GARLIC, NAMELY, CONTRACEPTIVES, EYE DROPS, SOLUTIONS FOR CONTACT LENSES, PHARMACEUTICALS FOR DENTAL TREATMENTS, HEMOSTATS, ALEXIPHARMICS; PHARMACEUTICALS MAINLY CONTAINING BEAR'S GARLIC, NAMELY, PHARMACEUTICALS FOR TREATING SUBSTANCE ABUSES AND ADDICTIONS; NUTRITIONAL ADDITIVES FOR MEDICAL USE FOR USE IN FOODS AND DIETARY SUPPLEMENTS FOR HUMAN CONSUMPTION MAINLY CONTAINING BEAR'S GARLIC FOR MEDICAL SUPPLEMENTS; DIETARY CURE FOODS MAINLY CONTAINING BEAR'S GARLIC, NAMELY, DIETARY SUPPLEMENTS; PHARMACEUTICALS MAINLY CONTAINING SOYBEANS FOR THE TREATMENT OF DISORDERS IN THE CENTRAL NERVOUS SYSTEM, THE PERIPHERAL NERVOUS SYSTEM, THE RESPIRATORY ORGANS, THE DIGESTIVE ORGANS, THE URO-GENITAL AND ANAL ORGANS, AND THE EPIDERMIS, AND FOR THE TREATMENT OF RHINITIC DISEASES, OTITIC DISEASES, HEPATIC DISEASES, DIABETES, GOUT, ALLERGIC DISEASES, ADDICTIONS, GYNECOLOGICAL DISEASES AND CARDIOVASCULAR DISEASES; PHARMACEUTICALS MAINLY CONTAINING SOYBEANS, NAMELY, CONTRACEPTIVES, EYE DROPS, SOLUTIONS FOR CONTACT LENSES, PHARMACEUTICALS FOR DENTAL TREATMENTS, HEMOSTATS, ALEXIPHARMICS; PHARMACEUTICALS MAINLY CONTAINING SOYBEANS, NAMELY, PHARMACEUTICALS FOR TREATING SUBSTANCE ABUSES AND ADDICTIONS; NUTRITIONAL ADDITIVES FOR MEDICAL USE FOR USE IN FOODS AND DIETARY SUPPLEMENTS FOR HUMAN CONSUMPTION MAINLY CONTAINING SOYBEANS FOR MEDICAL SUPPLEMENTS; DIETARY CURE FOODS MAINLY CONTAINING SOYBEANS, NAMELY, DIETARY SUPPLEMENTS; PHARMACEUTICALS MAINLY CONTAINING DRAGON'S BLOOD FOR THE TREATMENT OF DISORDERS IN THE CENTRAL NERVOUS SYSTEM, THE PERIPHERAL NERVOUS SYSTEM, THE RESPIRATORY ORGANS, THE DIGESTIVE ORGANS, THE URO-GENITAL AND ANAL ORGANS, AND THE EPIDERMIS, AND FOR THE TREAT-

MENT OF RHINITIC DISEASES, OTITIC DISEASES, HEPATIC DISEASES, DIABETES, GOUT, ALLERGIC DISEASES, ADDICTIONS, GYNECOLOGICAL DISEASES AND CARDIOVASCULAR DISEASES; PHARMACEUTICALS MAINLY CONTAINING DRAGON'S BLOOD, NAMELY, CONTRACEPTIVES, EYE DROPS, SOLUTIONS FOR CONTACT LENSES, PHARMACEUTICALS FOR DENTAL TREATMENTS, HEMOSTATS, ALEXIPHARMICS; PHARMACEUTICALS MAINLY CONTAINING DRAGON'S BLOOD, NAMELY, PHARMACEUTICALS FOR TREATING SUBSTANCE ABUSES AND ADDICTIONS; NUTRITIONAL ADDITIVES FOR MEDICAL USE FOR USE IN FOODS AND DIETARY SUPPLEMENTS FOR HUMAN CONSUMPTION MAINLY CONTAINING DRAGON'S BLOOD FOR MEDICAL SUPPLEMENTS; DIETARY CURE FOODS MAINLY CONTAINING DRAGON'S BLOOD, NAMELY, DIETARY SUPPLEMENTS; AGENTS AFFECTING CENTRAL NERVOUS SYSTEM, NAMELY, CENTRAL NERVOUS SYSTEM STIMULANTS; AGENTS AFFECTING PERIPHERAL NERVOUS SYSTEM, NAMELY, DIAGNOSTIC AGENTS FOR MEDICAL PURPOSES; AGENTS AFFECTING SENSORY ORGANS, NAMELY, VISCOELASTIC AGENTS FOR EYE USE; ANTI-ALLERGIC AGENTS, NAMELY, PHARMACEUTICAL ANTI-ALLERGIC PREPARATIONS AND SUBSTANCES; CARDIOVASCULAR AGENTS, CARDIOVASCULAR PHARMACEUTICALS; AGENTS AFFECTING RESPIRATORY ORGANS, NAMELY, RESPIRATORY STIMULANTS; AGENTS AFFECTING DIGESTIVE ORGANS, NAMELY, ANTACIDS; HORMONES FOR MEDICAL PURPOSES; AGENTS FOR URO-GENITAL AND ANAL ORGANS, NAMELY, PHARMACEUTICAL PREPARATIONS FOR USE IN UROLOGY; AGENTS FOR EPIDERMIS, NAMELY, PHARMACEUTICAL PREPARATIONS FOR TREATING SKIN DISORDERS; VITAMIN PREPARATIONS; AMINO ACID PREPARATIONS FOR NUTRITIONAL PURPOSES; NUTRIENTS, TONICS AND ALTERNATIVES, NAMELY, NUTRITIONAL SUPPLEMENTS; ANTICOAGULANTS; AGENTS AFFECTING METABOLISM, NAMELY, APPETITE SUPPRESSANTS; CELLULAR FUNCTION ACTIVATING AGENTS, NAMELY, SYNTHETIC CHOLESTEROL MAINLY FOR USE IN GROWING CELL CULTURES; TUMOR SUPPRESSING AGENTS; AGENTS FOR TREATING PHYSICALLY CAUSED LESIONS, NAMELY, PREPARATIONS FOR CLEANSING THE SKIN FOR MEDICAL USE; AGENTS FOR TREATING CHEMICALLY CAUSED DISORDERS, NAMELY, CHEMOTHERAPEUTICS; ANTIBIOTIC PREPARATIONS; CHEMOTHERAPEUTICS; BIOLOGICAL PREPARATIONS FOR MEDICAL PURPOSES; AGENTS AGAINST PARASITES, NAMELY, PREPARATIONS FOR DESTROYING PARASITES; AGENTS FOR DISPENSING PURPOSES, NAMELY, HOUSEHOLD DEODORANTS, ROOM DEODORIZING COMPOSITIONS AND DEODORANTS FOR CLOTHING AND TEXTILES; DIAGNOSTIC PREPARATIONS FOR MEDICAL OR VETERINARY PURPOSES; RADIO-ISOTOPE MARKERS FOR THERAPEUTIC OR DIAGNOSTIC USE; SYNTHETIC NARCOTICS; CRUDE DRUGS, CHARRED DRUGS AND MOXA, NAMELY, MEDICINAL

HERB EXTRACTS; VETERINARY PREPARATIONS FOR THE TREATMENT OF INFECTIOUS DISEASES, NAMELY, SWINE DYSENTERY, BACTERIAL ENTERITIS AND PNEUMONIA, FOR DECREASING FAT IN ONE'S BODY, PROTECTING ONE'S LIVER, KIDNEY AND STOMACH, LOWERING BLOOD SUGAR LEVEL, LOWERING CHOLESTEROL LEVEL, FOR THE TREATMENT OF RHINITIC DISEASES, OTITIC DISEASES, HEPATIC DISEASES, DIABETES, GOUT, ALLERGIC DISEASES AND CARDIOVASCULAR DISEASES, ALEXIPHARMICS AND ANTICOAGULANTS; MOSQUITO-REPELLENT INCENSES; GERMICIDES AND FUNGICIDES; RODENTICIDES; INSECTICIDES; FUMIGANTS; HERBICIDES IN THE NATURE OF WEEDKILLERS; DEODORANTS OTHER THAN FOR PERSONAL USE, NAMELY, ROOM DEODORANTS; INSECT REPELLENTS; ANTISEPTICS, IN CLASS 5 (U.S. CLS. 6, 18, 44, 46, 51 AND 52).

FOR: POWDER, GRANULAR, HARD CAPSULAR, SOFT CAPSULAR, PASTED, LIQUID, COOKIE AND TABLET-SHAPED PROCESSED FOODS MAINLY CONTAINING OLIGOMERIC PROANTHOCYANIDINS EXTRACTED FROM PINE BARK, NAMELY, EDIBLE, PROCESSED BARLEY LEAVES; POWDER, GRANULAR, HARD CAPSULAR, SOFT CAPSULAR, PASTED, LIQUID, COOKIE AND TABLET-SHAPED PROCESSED FOODS MAINLY CONTAINING SWEET POTATO FIBER, NAMELY, EDIBLE, PROCESSED BARLEY LEAVES; POWDER, GRANULAR, HARD CAPSULAR, SOFT CAPSULAR, PASTED, LIQUID, COOKIE AND TABLET-SHAPED PROCESSED FOODS MAINLY CONTAINING TUBER VEGETABLE FIBER, NAMELY, EDIBLE, PROCESSED BARLEY LEAVES; POWDER, GRANULAR, HARD CAPSULAR, SOFT CAPSULAR, PASTED, LIQUID, COOKIE AND TABLET-SHAPED PROCESSED FOODS MAINLY CONTAINING YOUNG BARLEY LEAF EXTRACT, NAMELY, EDIBLE, PROCESSED BARLEY LEAVES; POWDER, GRANULAR, HARD CAPSULAR, SOFT CAPSULAR, PASTED, LIQUID, COOKIE AND TABLET-SHAPED PROCESSED FOODS MAINLY CONTAINING KALE FIBER, NAMELY, EDIBLE, PROCESSED BARLEY LEAVES; POWDER, GRANULAR, HARD CAPSULAR, SOFT CAPSULAR, PASTED, LIQUID, COOKIE AND TABLET-SHAPED PROCESSED FOODS MAINLY CONTAINING YOUNG SWEET POTATO LEAF FIBER, NAMELY, EDIBLE, PROCESSED BARLEY LEAVES; POWDER, GRANULAR, HARD CAPSULAR, SOFT CAPSULAR, PASTED, LIQUID, COOKIE AND TABLET-SHAPED PROCESSED FOODS MAINLY CONTAINING TERMINALIA BELLIRICA EXTRACT, NAMELY, EDIBLE, PROCESSED BARLEY LEAVES; POWDER, GRANULAR, HARD CAPSULAR, SOFT CAPSULAR, PASTED, LIQUID, COOKIE AND TABLET-SHAPED PROCESSED FOODS MAINLY CONTAINING LOQUAT LEAF EXTRACT, NAMELY, EDIBLE, PROCESSED BARLEY LEAVES; POWDER, GRANULAR, HARD CAPSULAR, SOFT CAPSULAR, PASTED, LIQUID, COOKIE AND TABLET-SHAPED PROCESSED FOODS MAINLY CONTAINING GANODERMA LUCIDUM EXTRACT, NAMELY, EDIBLE, PROCESSED BARLEY LEAVES; POWDER, GRANULAR, HARD CAPSULAR, SOFT CAPSULAR, PASTED,

LIQUID, COOKIE AND TABLET-SHAPED PROCESSED FOODS MAINLY CONTAINING BLACK VINEGAR, NAMELY, EDIBLE, PROCESSED BARLEY LEAVES; POWDER, GRANULAR, HARD CAPSULAR, SOFT CAPSULAR, PASTED, LIQUID, COOKIE AND TABLET-SHAPED PROCESSED FOODS MAINLY CONTAINING MACA EXTRACT, NAMELY, EDIBLE, PROCESSED BARLEY LEAVES; POWDER, GRANULAR, HARD CAPSULAR, SOFT CAPSULAR, PASTED, LIQUID, COOKIE AND TABLET-SHAPED PROCESSED FOODS MAINLY CONTAINING EXTRACTS OF CABBAGE, ORANGE, ONION, CARROT AND GREEN CHILI, NAMELY, EDIBLE, PROCESSED BARLEY LEAVES; POWDER, GRANULAR, HARD CAPSULAR, SOFT CAPSULAR, PASTED, LIQUID, COOKIE AND TABLET-SHAPED PROCESSED FOODS MAINLY CONTAINING METHYLSULFONYLMETHANE COMPOSED OF SULFUR AND METHYL GROUPS, NAMELY, EDIBLE, PROCESSED BARLEY LEAVES; POWDER, GRANULAR, HARD CAPSULAR, SOFT CAPSULAR, PASTED, LIQUID, COOKIE AND TABLET-SHAPED PROCESSED FOODS MAINLY CONTAINING BEAR'S GARLIC EXTRACT, NAMELY, EDIBLE, PROCESSED BARLEY LEAVES; POWDER, GRANULAR, HARD CAPSULAR, SOFT CAPSULAR, PASTED, LIQUID, COOKIE AND TABLET-SHAPED PROCESSED FOODS MAINLY CONTAINING SOYBEAN EXTRACT, NAMELY, EDIBLE, PROCESSED BARLEY LEAVES; POWDER, GRANULAR, HARD CAPSULAR, SOFT CAPSULAR, PASTED, LIQUID, COOKIE AND TABLET-SHAPED PROCESSED FOODS MAINLY CONTAINING DRAGON'S BLOOD EXTRACT, NAMELY, EDIBLE, PROCESSED BARLEY LEAVES; VEGETABLE OILS AND FATS FOR FOOD; ANIMAL OILS AND FATS FOR FOOD; PROCESSED OILS AND FATS FOR FOOD; MILK PRODUCTS EXCLUDING ICE CREAM, ICE MILK AND FROZEN YOGURT; FRESH, CHILLED OR FROZEN MEAT FOR HUMAN CONSUMPTION; EGGS; FRESH, CHILLED OR FROZEN EDIBLE AQUATIC ANIMALS, NAMELY, FISH AND SHELLFISH; FROZEN VEGETABLES; FROZEN FRUITS; PROCESSED MEAT; PROCESSED FISHERIES PRODUCTS, NAMELY, PROCESSED FISH ROE; PROCESSED VEGETABLES AND FRUITS; FRIED TOFU PIECES (ABURA-AGE); FREEZE-DRIED TOFU PIECES (KOHRI-DOFU); JELLY MAINLY CONTAINING DEVIL'S TONGUE ROOT (KONNYAKU); SOYBEAN MILK; TOFU; FERMENTED SOYBEANS (NATTO); PROCESSED EGGS; STEW AND SOUP MIXES; DRIED FLAKES OF LAVER FOR SPRINKLING ON RICE IN HOT WATER (OCHAZUKE-NORI); FERMENTED SOYBEANS AS ACCOMPANIMENT; PROTEIN FOR HUMAN CONSUMPTION FOR USE AS A FOOD ADDITIVE, IN CLASS 29 (U.S. CL. 46).

FOR: TEA MAINLY CONTAINING YOUNG BARLEY LEAVES; TEA MAINLY CONTAINING KALE FIBER; TEA MAINLY CONTAINING YOUNG SWEET-POTATO LEAF FIBER; COOKIES; PAS-

TRIES; CONFECTIONERY, NAMELY, RICE CRACKERS, RICE DUMPLINGS WITH SWEET RED BEAN PASTE, RICE CAKES, ICE CREAMS, CANDIES, COOKIES, CRACKERS, SORBETS, CREAM PUFFS, CAKES, CHEWING GUMS, CHOCOLATES, DOUGHNUTS, BISCUITS, FROZEN YOGURTS, POPCORN, WAFFLES, BREAD AND BUNS; AROMATIC PREPARATIONS FOR FOOD NOT FROM ESSENTIAL OILS, NAMELY, HERBAL INFUSIONS; SEASONINGS; SPICES; CEREAL PREPARATIONS, NAMELY, PROCESSED CEREALS; INSTANT CONFECTIONERY MIXES, NAMELY, SHERBET MIXES; BISCUITS; TEA MAINLY CONTAINING PINE BARK EXTRACTED FROM OLIGOMERIC PROANTHOCYANIDINS; TEA MAINLY CONTAINING SWEET POTATO FIBER; TEA MAINLY CONTAINING TUBER VEGETABLE FIBER; TEA MAINLY CONTAINING TERMINALIA BELLIRICA EXTRACT; TEA MAINLY CONTAINING KUDZU VINE FLOWER EXTRACT; TEA MAINLY CONTAINING LOQUAT LEAF EXTRACT; TEA MAINLY CONTAINING GANODERMA LUCIDUM EXTRACT; TEA MAINLY CONTAINING BLACK VINEGAR; TEA MAINLY CONTAINING MACA EXTRACT; TEA MAINLY CONTAINING EXTRACTS OF CABBAGE, ORANGE, ONION, CARROT AND GREEN CHILI; TEA MAINLY CONTAINING S-ADENOSYLMETHIONINE; TEA MAINLY CONTAINING METHYLSULFONYLMETHANE COMPOSED OF SULFUR AND METHYL GROUPS; TEA MAINLY CONTAINING BEAR'S GARLIC EXTRACT; TEA MAINLY CONTAINING SOYBEAN EXTRACT; TEA MAINLY CONTAINING DRAGON'S BLOOD, IN CLASS 30 (U.S. CL. 46).

FOR: SOFT DRINKS MAINLY CONTAINING OLIGOMERIC PROANTHOCYANIDINS EXTRACTED FROM PINE BARK; POWDER FOR MAKING SOFT DRINKS MAINLY CONTAINING OLIGOMERIC PROANTHOCYANIDINS EXTRACTED FROM PINE BARK; FRUIT BEVERAGES MAINLY CONTAINING OLIGOMERIC PROANTHOCYANIDINS EXTRACTED FROM PINE BARK; VEGETABLE JUICES MAINLY CONTAINING OLIGOMERIC PROANTHOCYANIDINS EXTRACTED FROM PINE BARK; WHEY-BASED BEVERAGES MAINLY CONTAINING OLIGOMERIC PROANTHOCYANIDINS EXTRACTED FROM PINE BARK; SOFT DRINKS MAINLY CONTAINING KALE FIBER; POWDER FOR MAKING SOFT DRINKS MAINLY CONTAINING KALE FIBER; FRUIT BEVERAGES MAINLY CONTAINING KALE FIBER; VEGETABLE JUICES MAINLY CONTAINING KALE FIBER; WHEY-BASED BEVERAGES MAINLY CONTAINING KALE FIBER; SOFT DRINKS MAINLY CONTAINING YOUNG BARLEY LEAF FIBER; POWDER FOR MAKING SOFT DRINKS MAINLY CONTAINING YOUNG BARLEY LEAF FIBER; FRUIT BEVERAGES MAINLY CONTAINING YOUNG BARLEY LEAF FIBER; VEGETABLE JUICES MAINLY CONTAINING YOUNG BARLEY LEAF FIBER; WHEY-BASED BEVERAGES MAINLY CONTAINING YOUNG BARLEY LEAF FIBER; SOFT DRINKS MAINLY CONTAINING YOUNG SWEET-POTATO LEAF FIBER; POWDER FOR MAKING SOFT DRINKS MAINLY CONTAINING YOUNG SWEET-POTATO LEAF FIBER; FRUIT BEVERAGES MAIN-

LY CONTAINING YOUNG SWEET-POTATO LEAF FIBER; VEGETABLE JUICES MAINLY CONTAINING YOUNG SWEET-POTATO LEAF FIBER; WHEY-BASED BEVERAGES MAINLY CONTAINING YOUNG SWEET-POTATO LEAF FIBER; SOFT DRINKS MAINLY CONTAINING SWEET POTATO FIBER; POWDER FOR MAKING SOFT DRINKS MAINLY CONTAINING SWEET POTATO FIBER; FRUIT BEVERAGES MAINLY CONTAINING SWEET POTATO FIBER; VEGETABLE JUICES MAINLY CONTAINING SWEET POTATO FIBER; WHEY-BASED BEVERAGES MAINLY CONTAINING SWEET POTATO FIBER; SOFT DRINKS MAINLY CONTAINING TUBER VEGETABLE FIBER; POWDER FOR MAKING SOFT DRINKS MAINLY CONTAINING TUBER VEGETABLE FIBER; FRUIT BEVERAGES MAINLY CONTAINING TUBER VEGETABLE FIBER; VEGETABLE JUICES MAINLY CONTAINING TUBER VEGETABLE FIBER; WHEY-BASED BEVERAGES MAINLY CONTAINING TUBER VEGETABLE FIBER; SOFT DRINKS MAINLY CONTAINING TERMINALIA BELLIRICA EXTRACT; POWDER FOR MAKING SOFT DRINKS MAINLY CONTAINING TERMINALIA BELLIRICA EXTRACT; FRUIT BEVERAGES MAINLY CONTAINING TERMINALIA BELLIRICA EXTRACT; VEGETABLE JUICES MAINLY CONTAINING TERMINALIA BELLIRICA EXTRACT; WHEY-BASED BEVERAGES MAINLY CONTAINING TERMINALIA BELLIRICA EXTRACT; SOFT DRINKS MAINLY CONTAINING KUDZU VINE FLOWER EXTRACT; POWDER FOR MAKING SOFT DRINKS MAINLY CONTAINING KUDZU VINE FLOWER EXTRACT; FRUIT BEVERAGES MAINLY CONTAINING KUDZU VINE FLOWER EXTRACT; VEGETABLE JUICES MAINLY CONTAINING KUDZU VINE FLOWER EXTRACT; WHEY-BASED BEVERAGES MAINLY CONTAINING KUDZU VINE FLOWER EXTRACT; SOFT DRINKS MAINLY CONTAINING LOQUAT LEAF EXTRACT; POWDER FOR MAKING SOFT DRINKS MAINLY CONTAINING LOQUAT LEAF EXTRACT; FRUIT BEVERAGES MAINLY CONTAINING LOQUAT LEAF EXTRACT; VEGETABLE JUICES MAINLY CONTAINING LOQUAT LEAF EXTRACT; WHEY-BASED BEVERAGES MAINLY CONTAINING LOQUAT LEAF EXTRACT; SOFT DRINKS MAINLY CONTAINING GANODERMA LUCIDUM EXTRACT; POWDER FOR MAKING SOFT DRINKS MAINLY CONTAINING GANODERMA LUCIDUM EXTRACT; FRUIT BEVERAGES MAINLY CONTAINING GANODERMA LUCIDUM EXTRACT; VEGETABLE JUICES MAINLY CONTAINING GANODERMA LUCIDUM EXTRACT; WHEY-BASED BEVERAGES MAINLY CONTAINING GANODERMA LUCIDUM EXTRACT; SOFT DRINKS MAINLY CONTAINING BLACK VINEGAR; POWDER FOR MAKING SOFT DRINKS MAINLY CONTAINING BLACK VINEGAR; FRUIT BEVERAGES MAINLY CONTAINING BLACK VINEGAR; VEGETABLE JUICES MAINLY CONTAINING BLACK VINEGAR; WHEY-BASED BEVERAGES MAINLY CONTAINING BLACK VINEGAR; SOFT DRINKS MAINLY CONTAINING MACA EXTRACT; POWDER FOR MAKING SOFT DRINKS MAINLY CONTAINING MACA EXTRACT; FRUIT BEVERAGES MAINLY CONTAINING MACA EXTRACT; VEGETABLE JUI-

CES MAINLY CONTAINING MACA EXTRACT; WHEY-BASED BEVERAGES MAINLY CONTAINING MACA EXTRACT; SOFT DRINKS MAINLY CONTAINING EXTRACTS OF CABBAGE, ORANGE, ONION, CARROT AND GREEN CHILI; POWDER FOR MAKING SOFT DRINKS MAINLY CONTAINING EXTRACTS OF CABBAGE, ORANGE, ONION, CARROT AND GREEN CHILI; FRUIT BEVERAGES MAINLY CONTAINING EXTRACTS OF CABBAGE, ORANGE, ONION, CARROT AND GREEN CHILI; VEGETABLE JUICES MAINLY CONTAINING EXTRACTS OF CABBAGE, ORANGE, ONION, CARROT AND GREEN CHILI; WHEY-BASED BEVERAGES MAINLY CONTAINING EXTRACTS OF CABBAGE, ORANGE, ONION, CARROT AND GREEN CHILI; SOFT DRINKS MAINLY CONTAINING S-ADENOSYLMETHIONINE; POWDER FOR MAKING SOFT DRINKS MAINLY CONTAINING S-ADENOSYLMETHIONINE; FRUIT BEVERAGES MAINLY CONTAINING S-ADENOSYLMETHIONINE; VEGETABLE JUICES MAINLY CONTAINING S-ADENOSYLMETHIONINE; WHEY-BASED BEVERAGES MAINLY CONTAINING S-ADENOSYLMETHIONINE; SOFT DRINKS MAINLY CONTAINING METHYLSULFONYLMETHANE COMPOSED OF SULFUR AND METHYL GROUPS; POWDER FOR MAKING SOFT DRINKS MAINLY CONTAINING METHYLSULFONYLMETHANE COMPOSED OF SULFUR AND METHYL GROUPS; FRUIT BEVERAGES MAINLY CONTAINING METHYLSULFONYLMETHANE COMPOSED OF SULFUR AND METHYL GROUPS; VEGETABLE JUICES MAINLY CONTAINING METHYLSULFONYLMETHANE COMPOSED OF SULFUR AND METHYL GROUPS; WHEY-BASED BEVERAGES MAINLY CONTAINING METHYLSULFONYLMETHANE COMPOSED OF SULFUR AND METHYL GROUPS; SOFT DRINKS MAINLY CONTAINING BEAR'S GARLIC EXTRACT; POWDER FOR MAKING SOFT DRINKS MAINLY CONTAINING BEAR'S GARLIC EXTRACT; FRUIT BEVERAGES MAINLY CONTAINING BEAR'S GARLIC EXTRACT; VEGETABLE JUICES MAINLY CONTAINING BEAR'S GARLIC EXTRACT; WHEY-BASED BEVERAGES MAINLY CONTAINING BEAR'S GARLIC EXTRACT; SOFT DRINKS MAINLY CONTAINING SOYBEAN EXTRACT; POWDER FOR MAKING SOFT DRINKS MAINLY CONTAINING SOYBEAN EXTRACT; FRUIT BEVERAGES MAINLY CONTAINING SOYBEAN EXTRACT; VEGETABLE JUICES MAINLY CONTAINING SOYBEAN EXTRACT; WHEY-BASED BEVERAGES MAINLY CONTAINING SOYBEAN EXTRACT; SOFT DRINKS MAINLY CONTAINING DRAGON'S BLOOD EXTRACT; POWDER FOR MAKING SOFT DRINKS MAINLY CONTAINING DRAGON'S BLOOD EXTRACT; FRUIT BEVERAGES MAINLY CONTAINING DRAGON'S BLOOD EXTRACT; VEGETABLE JUICES MAINLY CONTAINING DRAGON'S BLOOD EXTRACT; AND WHEY-BASED BEVERAGES MAINLY CONTAINING DRAGON'S BLOOD EXTRACT; BEER; CARBONATED SOFT DRINKS; NON-ALCOHOLIC FRUIT JUICE BEVERAGES; EXTRACTS OF HOPS FOR MAKING BEER; WHEY BEVERAGES; VEGETABLE JUICES, IN CLASS 32 (U.S. CLS. 45, 46 AND 48).

FOR: MARKETING RESEARCH; PROVIDING INFORMATION ON COMMODITY SALES, NAME- LY, PROVIDING INFORMATION ABOUT COM- MODITIES VIA TELECOMMUNICATION NETWORKS FOR ADVERTISING AND SALES PUR- POSSES; PUBLICITY MATERIAL RENTAL; BUSI- NESS APPRAISALS; BUSINESS ORGANIZATION CONSULTANCY; BUSINESS RESEARCH; COM- Mercial INFORMATION AGENCIES; DEMON- STRATION OF GOODS; DIRECT MAIL ADVERTISING; DISSEMINATION OF ADVERTIS- ING MATTER; DISTRIBUTION OF SAMPLES; OR- GANIZATION OF EXHIBITIONS FOR COMMERCIAL OR ADVERTISING PURPOSES IN THE FIELDS OF MANUFACTURING AND SALES AND ADVERTISING OF HEALTH FOODS AND COSMETICS; SALES PROMOTION FOR OTHERS; BUSINESS PLANNING FOR ORGANIZING OVER- SEA BASES FOR PRODUCTION, RESEARCH AND PHYSICAL DISTRIBUTION; BROKERAGE FOR COMMODITY SALES CONTRACTS; FUNDAMEN- TAL DATA COLLECTION FOR NEW PRODUCT DEVELOPMENT, SALES PROMOTION PLANNING, NAMELY, MARKET RESEARCH; INFORMATION RELATING TO MARKETING, NAMELY, PROVID- ING INFORMATION ABOUT BUSINESS MARKET- ING, IN CLASS 35 (U.S. CLS. 100, 101 AND 102).

FOR: PREPARING AND MIXING TO ORDER OF CHEMICALS, MEDICINES, COSMETICS AND PRO- CESSSED FOODS, NAMELY, DIETARY SUPPLE- MENTS; PREPARATION TO ORDER OF FRUIT JUICE, SOFT DRINKS, WHEY BEVERAGES AND LIQUEURS; FOOD PROCESSING; FOOD AND DRINK PRESERVATION; FRUIT CRUSHING; EX- TRACTING, REFINING AND COMPOSING OF CHEMICALS AND MEDICINES, NAMELY, ASSEM- BLY OF PRODUCTS FOR OTHERS; PIECE WRAP- PING, BOTTLING AND FINAL ENCASING OF CHEMICALS, MEDICINES, COSMETICS OR PRO- CESSSED FOODS, NAMELY, DIETARY SUPPLE- MENTS; CONSULTANCY RELATING TO PROCESSING TECHNOLOGY OF CHEMICALS, MEDICINES, COSMETICS OR PROCESSED FOODS, NAMELY, DIETARY SUPPLE- MENTS; INFORMATION ON PROCESSING TECHNOLOGY OF CHE- MICALS, MEDICINES, COSMETICS OR PROCESSED FOODS, NAMELY, DIETARY SUPPLE- MENTS; RENTAL OF MANUFACTURING MA- CHINES FOR CHEMICALS, MEDICINES, COSMETICS OR PROCESSED FOODS, NAMELY, DIETARY SUPPLEMENTS; PHOTOGRAPHIC EN- LARGING; PHOTOGRAPHIC PRINTING; PHOTO- GRAPHIC FILM DEVELOPMENT; BOOKBINDING; RENTAL OF MACHINES AND APPARATUS FOR PROCESSING FOODS OR BEVERAGES, IN CLASS 40 (U.S. CLS. 100, 103 AND 106).

FOR: BACTERIOLOGICAL RESEARCH; BIOLO- GICAL RESEARCH; CHEMICAL RESEARCH; PHARMACEUTICAL RESEARCH; COSMETIC RE- SEARCH; PRODUCT RESEARCH ON PROCESSED FOODS, NAMELY, DIETARY SUPPLEMENTS; MA- TERIAL TESTING; QUALITY CONTROL FOR OTH- ERS; PRODUCT RESEARCH AND DEVELOPMENT FOR OTHERS; TECHNICAL PROJECT STUDIES, NAMELY, TECHNICAL SURVEYING; SCIENTIFIC RESEARCH RELATING TO MEDICAL TREAT- MENT, HEALTH PRESERVATION AND SANITA- TION; DEVELOPMENT AND RESEARCH TO ORDER OF NEW PRODUCTS, NAMELY, CHEMI- CALS, MEDICINES, COSMETICS AND PROCESSED FOOD, NAMELY, DIETARY SUPPLEMENTS; TECHNICAL CONSULTANCY FOR THE MANU- FACTURE OF MEDICINES, CHEMICALS, COSMET- ICS OR PROCESSED FOODS, NAMELY, DIETARY SUPPLEMENTS; PROVIDING INFORMATION ON SCIENTIFIC RESEARCH RELATING TO INGREDI- ENTS, EFFECTS, USAGE AND PHARMACOLOGY OF CHEMICALS, MEDICINES, COSMETICS OR PROCESSED FOODS, NAMELY, DIETARY SUPPLE- MENTS; PROVIDING SCIENTIFIC RESEARCH AND INFORMATION OF MOLECULAR BIOLOGY, CELL CULTURE AND IMMUNOLOGY; TESTING OF RAW MATERIALS, COMMODITIES AND PRO- DUCTS; INDUSTRIAL DESIGN CONSULTATION RELATING TO ENVIRONMENTAL ARRANGE- MENT FOR FOOD MANUFACTURING FACTOR- IES; TESTING, INSPECTION AND RESEARCH OF PHARMACEUTICALS, COSMETICS OR FOOD- STUFF; AGENCIES OR BROKERAGE FOR COPY- RIGHT LICENSING, IN CLASS 42 (U.S. CLS. 100 AND 101).

PRIORITY DATE OF 10-26-2005 IS CLAIMED.

OWNER OF INTERNATIONAL REGISTRATION 0910392 DATED 11-7-2005, EXPIRES 11-7-2015.

THE COLOR(S) RED AND WHITE IS/ARE CLAIMED AS A FEATURE OF THE MARK.

THE MARK CONSISTS OF A BOLD CAPITAL LETTER "T" IN WHITE WITH A WHITE OVAL ABOVE AND PLACED IN THE CENTER OF RED SQUARE.

SER. NO. 79-033,585, FILED 11-7-2005.

ROBERT STRUCK, EXAMINING ATTORNEY

**Int. Cl.: 25**

**Prior U.S. Cls.: 22 and 39**

**United States Patent and Trademark Office**

**Reg. No. 3,505,432**

**Registered Sep. 23, 2008**

**TRADEMARK  
PRINCIPAL REGISTER**



**PALMERS TEXTIL AKTIENGESELLSCHAFT  
(AUSTRIA PUBLIC LIMITED COMPANY)  
PALMERSSTRASSE 6-8  
A-2351 WIENER NEUDORF  
AUSTRIA**

**FOR: CLOTHING, NAMELY, LINGERIE, PANTY-  
HOSE, STOCKINGS, HOSIERY; UNDERWEAR,  
SWIMWEAR, BEACHWEAR, TIGHTS, SOCKS,  
HATS, CAPS, SKIRTS, DRESSES, PANTS, T-SHIRTS,  
IN CLASS 25 (U.S. CLS. 22 AND 39).**

**OWNER OF INTERNATIONAL REGISTRATION  
0882870 DATED 3-6-2006, EXPIRES 3-6-2016.**

**"THE COLOR(S) DARK GREEN AND WHITE IS/  
ARE CLAIMED AS A FEATURE OF THE MARK."**

**THE MARK CONSISTS OF THE COLORS DARK  
GREEN APPEARING ON THE WORDING "PAL-  
MERS"; THE COLORS DARK GREEN AND WHITE  
APPEAR ON THE DESIGN OF THE STYLIZED  
CROWN.**

**SER. NO. 79-033,600, FILED 12-11-2006.**

**COLLEEN DOMBROW, EXAMINING ATTORNEY**

**Int. Cls.: 7, 9, 17, 35, 37 and 42**

**Prior U.S. Cls.: 1, 5, 12, 13, 19, 21, 23, 26, 31, 34, 35,  
36, 38, 50, 100, 101, 102, 103 and 106**

**Reg. No. 3,505,433**

**United States Patent and Trademark Office**

**Registered Sep. 23, 2008**

**TRADEMARK  
SERVICE MARK  
PRINCIPAL REGISTER**



BADGER EXPLORER ASA (NORWAY ALLMEN-  
NAKSJESELSKAP (ASA, WHICH IS A COM-  
MON STOCK COMPANY))

P.O. BOX 360 FORUS  
N-4067 STAVANGER  
NORWAY

FOR: MACHINES, NAMELY, DRILLING MACHINES AND THEIR STRUCTURAL PARTS, AND MACHINE TOOLS, NAMELY, METALWORKING MACHINE TOOLS AND THEIR STRUCTURAL PARTS; MOTORS NOT FOR LAND VEHICLES, NAMELY, ELECTRIC MOTORS AND THEIR STRUCTURAL PARTS, FOR DRILLING MACHINES; AND ENGINES, AND THEIR STRUCTURAL PARTS, NOT FOR LAND VEHICLES; MACHINE COUPLINGS AND TRANSMISSION COMPONENTS, NAMELY, TRANSMISSION BELTS; BITS FOR POWER DRILLS; DRILLING HEADS, NAMELY, DRILLING HEADS AND THEIR STRUCTURAL PARTS FOR UNDERGROUND DRILLING; POWER TRANSMISSIONS AND THEIR STRUCTURAL PARTS, NOT FOR LAND VEHICLES; COMPRESSORS, NAMELY, COMPRESSORS AND THEIR STRUCTURAL PARTS, FOR MACHINES; ROBOTS, NAMELY, INDUSTRIAL ROBOTS AND THEIR STRUCTURAL PARTS; CONTROL MECHANISMS, NAMELY, SPEED AND DIRECTION CONTROLS AND THEIR STRUCTURAL PARTS FOR MACHINES, FOR ENGINES AND FOR MOTORS; EXTRACTORS, NAMELY, HYDROCARBON EXTRACTORS AND THEIR STRUCTURAL PARTS, IN CLASS 7 (U.S. CLS. 13, 19, 21, 23, 31, 34 AND 35).

FOR: SCIENTIFIC APPARATUS AND INSTRUMENTS, NAMELY, SENSING AND SIGNALING DEVICES FOR MEASUREMENT OF MINERALS,

FLUIDS AND HYDROCARBONS; NAUTICAL APPARATUS AND INSTRUMENTS, NAMELY, COMPASSES, MARINE DEPTH FINDERS, WAVEMETERS, SONARS; WEIGHING APPARATUS AND INSTRUMENTS, NAMELY, SCALES; MEASURING APPARATUS AND INSTRUMENTS, NAMELY, LASER MEASURING SYSTEMS, PRESSURE GAUGES, THERMOMETERS, DENSIMETERS, DENSITOMETERS, HYDROMETERS, HYDROCARBON METERS, SLOPE INDICATORS; CHECKING AND SUPERVISING APPARATUS AND INSTRUMENTS, NAMELY, ALARM MONITORING SYSTEMS, VIDEO AND AUDIO MONITORS; SENSORS, NAMELY, ACCELERATION SENSORS, OIL LEVEL SENSORS; APPARATUS AND INSTRUMENTS FOR CONDUCTING ELECTRICITY, NAMELY, CONDUCTIVE FIBERS, NAMELY, FIBERS FOR CONDUCTING ELECTRICAL CHARGES AND STATIC ELECTRICAL CHARGES; APPARATUS AND INSTRUMENTS FOR SWITCHING ELECTRICITY, NAMELY, ELECTRIC SWITCHES; APPARATUS AND INSTRUMENTS FOR TRANSFORMING ELECTRICITY, NAMELY, ELECTRIC TRANSFORMERS; APPARATUS AND INSTRUMENTS FOR ACCUMULATING ELECTRICITY, NAMELY, ELECTRIC ACCUMULATORS; APPARATUS AND INSTRUMENTS FOR REGULATING ELECTRICITY, NAMELY, VOLTAGE REGULATORS FOR ELECTRIC POWER; APPARATUS AND INSTRUMENTS FOR CONTROLLING ELECTRICITY, NAMELY, ELECTRICAL CONTROLLERS; ELECTRIC CABLES AND CONDUCTORS; TESTING APPARATUS, NAMELY, CIRCUIT TESTERS, CARBON TESTERS; COMPUTER PROGRAMMES FOR THE MANAGEMENT OF UNDERGROUND DRILLING ACTIVITIES; DATA PROCESSING EQUIPMENT, NAMELY, DATA PRO-

CESSORS; ELECTRONIC SIGNAL TRANSMITTERS, NAMELY, CABLES FOR ELECTRICAL OR OPTICAL SIGNAL TRANSMISSION, IN CLASS 9 (U.S. CLS. 21, 23, 26, 36 AND 38).

FOR: RUBBER, GUTTA-PERCHA, MICA AND GOODS MADE FROM THESE MATERIALS, NAMELY, CLUTCH LININGS, RUBBER SLEEVES, PIPE JACKETS; PACKING MATERIALS, NAMELY, JOINT PACKINGS FOR USE WITH PIPES FOR UNDERWATER EXPLORATION; CYLINDER JOINTINGS FOR USE WITH PIPES FOR UNDERWATER EXPLORATION; STOPPING MATERIALS, NAMELY, WASHERS OF RUBBER OR VULCANIZED FIBER, STUFFING RINGS OF PLASTIC OR RUBBER; INSULATION FOR ELECTRIC CABLES AND ELECTRICITY CONDUITS; WATERPROOF PACKINGS FOR SUBSEA DRILLING; VALVES OF INDIA-RUBBER OR VULCANIZED FIBER; FLEXIBLE PIPES, NOT OF METAL, IN CLASS 17 (U.S. CLS. 1, 5, 12, 13, 35 AND 50).

FOR: SYSTEMATIZING AND COMPILATION OF INFORMATION INTO COMPUTER DATABASES; MANAGEMENT OF COMPUTERIZED FILES; PROVIDING STATISTICAL INFORMATION, SALES PROMOTION SERVICES AND RETAIL STORE SERVICES FEATURING MACHINES AND MACHINE TOOLS, MOTORS, MACHINE COUPLING AND TRANSMISSION COMPONENTS, DRILLING MACHINES, DRILLING BITS AND DRILLING HEADS, TRANSMISSIONS, OTHER THAN FOR LAND VEHICLES, COMPRESSORS, ROBOTS, CONTROL MECHANISMS FOR MACHINES, ENGINES OR MOTORS, EXTRACTORS, SCIENTIFIC, NAUTICAL, WEIGHING, MEASURING, CHECKING, SUPERVISION AND REGULATING APPARATUS AND INSTRUMENTS, SENSORS, APPARATUS AND INSTRUMENTS FOR CONDUCTING, SWITCHING, TRANSFORMING, ACCUMULATING, REGULATING OR CONTROLLING ELECTRICITY, ELECTRIC CABLES AND CONDUCTORS, TESTING APPARATUS, COMPUTER PROGRAMMES, DATA PROCESSING EQUIPMENT, ELECTRONIC SIGNAL TRANSMITTERS, RUBBER, GUTTA-PERCHA, GUM, ASBESTOS, MICA AND GOODS MADE FROM THESE MATERIALS, PACKING, STOPPING AND INSULATING MATERIALS, INSULATION FOR ELECTRIC CABLES AND ELECTRICITY CONDUITS, WATERPROOF PACKINGS, VALVES OF INDIA-RUBBER OR VULCANIZED FIBER, FLEXIBLE PIPES, NOT OF METAL, PARTS AND FITTINGS FOR ALL THE AFOREMENTIONED GOODS, IN CLASS 35 (U.S. CLS. 100, 101 AND 102).

FOR: INSTALLATION, MAINTENANCE AND REPAIR OF MACHINES AND MACHINE TOOLS, MOTORS, MACHINE COUPLING AND TRANSMISSION COMPONENTS, DRILLING MACHINES, DRILLING BITS AND DRILLING HEADS, TRANSMISSIONS, OTHER THAN FOR LAND VEHICLES, COMPRESSORS, ROBOTS, CONTROL MECHANISMS FOR MACHINES, ENGINES OR MOTORS, EXTRACTORS, SCIENTIFIC, NAUTICAL, WEIGHING, MEASURING, CHECKING, AND SUPERVISION APPARATUS AND INSTRUMENTS, SENSORS, APPARATUS AND INSTRUMENTS FOR

CONDUCTING, SWITCHING, TRANSFORMING, ACCUMULATING, REGULATING OR CONTROLLING ELECTRICITY, ELECTRIC CABLES AND CONDUCTORS, TESTING APPARATUS, PARTS AND FITTINGS FOR ALL THE AFOREMENTIONED GOODS; RENTAL OF DRILLING MACHINES AND MACHINE TOOLS, NAMELY, METALWORKING MACHINE TOOLS, MOTORS AND ENGINES EXCEPT FOR LAND VEHICLES, MACHINE COUPLING AND TRANSMISSION COMPONENTS, DRILLING BITS, DRILLING HEADS, TRANSMISSIONS, OTHER THAN FOR LAND VEHICLES, COMPRESSORS, ROBOTS, CONTROL MECHANISMS FOR MACHINES, ENGINES OR MOTORS, EXTRACTORS, PARTS AND FITTINGS FOR ALL THE AFOREMENTIONED GOODS; DRILLING OF WELLS, IN CLASS 37 (U.S. CLS. 100, 103 AND 106).

FOR: SCIENTIFIC AND TECHNOLOGICAL SERVICES, NAMELY, GEOLOGICAL PROSPECTING, GEOLOGICAL SURVEYS, OIL-FIELD AND GAS-FIELD ENGINEERING SURVEYS, UNDERWATER EXPLORATION; SCIENTIFIC, TECHNOLOGICAL AND INDUSTRIAL RESEARCH, NAMELY, GEOLOGICAL RESEARCH, TECHNICAL RESEARCH, NAMELY, TECHNICAL RESEARCH REGARDING UNDERWATER EXPLORATION, CHEMICAL RESEARCH, MECHANICAL RESEARCH, AND SCIENTIFIC AND TECHNOLOGICAL DESIGN RELATING TO THE AFOREMENTIONED SERVICES, NAMELY, DESIGN OF DRILLING MACHINERY; INDUSTRIAL ANALYSIS SERVICES, NAMELY, CHEMICAL ANALYSIS, ANALYSIS FOR OIL-FIELD AND GAS-FIELD EXPLORATION AND EXPLOITATION, TECHNICAL ANALYSIS OF DRILLING SAMPLES FROM UNDERGROUND DRILLING FOR EXPLOITATION OF NATURAL RESOURCES, TECHNICAL CONSULTANCY SERVICES CONCERNING GEOLOGICAL PROSPECTING, EXPLORATION AND SURVEYS; ENGINEERING; DESIGN AND DEVELOPMENT OF COMPUTER HARDWARE AND SOFTWARE; DESIGN, UPDATING AND MAINTENANCE OF COMPUTER SOFTWARE; RENTAL OF SCIENTIFIC, NAUTICAL, WEIGHING, MEASURING, CHECKING SUPERVISION APPARATUS AND INSTRUMENTS, NAMELY, COMPUTERS, COMPUTER SYSTEMS, COMPUTER PROGRAMMES, DATA PROCESSORS, SENSING AND SIGNALING DEVICES FOR MEASUREMENT OF MINERALS, FLUIDS AND HYDROCARBONS, COMPASSES, MARINE DEPTH FINDERS, WAVEMETERS, SONARS, SOUNDING LINES, SCALES, LASER MEASURING SYSTEMS, PRESSURE GAUGES, THERMOMETERS, DENSIMETERS, DENSITOMETERS, HYDROMETERS, HYDROCARBON METERS, SLOPE INDICATORS, ALARM MONITORING SYSTEMS, VIDEO AND AUDIO MONITORS, SENSORS, NAMELY, ACCELERATION SENSORS, OIL LEVEL SENSORS, TESTING APPARATUS, NAMELY, CARBON TESTERS, COMPUTERS AND COMPUTER PROGRAMMES; QUALITY CONTROL FOR OTHERS, IN CLASS 42 (U.S. CLS. 100 AND 101).

PRIORITY DATE OF 2-7-2006 IS CLAIMED.



OWNER OF INTERNATIONAL REGISTRATION  
0910875 DATED 7-21-2006, EXPIRES 7-21-2016.

SER. NO. 79-033,607, FILED 7-21-2006.  
KATHERINE CHANG, EXAMINING ATTORNEY

**Int. Cls.: 14 and 18**

**Prior U.S. Cls.: 1, 2, 3, 22, 27, 28, 41 and 50**

**United States Patent and Trademark Office**

**Reg. No. 3,505,434**

**Registered Sep. 23, 2008**

**TRADEMARK  
PRINCIPAL REGISTER**

**T e N o**

HEINZ SCHWARZ GMBH (FED REP GERMANY  
GMBH)  
ALEMANNENSTR. 16  
75177 PFORZHEIM, FED REP GERMANY

FOR: JEWELRY; BIJOUTERIE; RINGS, EARRINGS, EARCLIPS, BROOCHES, NECKLACES, COLLIERIES, PENDANTS, JEWELRY AND BIJOUTERIE CHAINS, BRACELETS; PENDANTS FOR KEYS, KEY RINGS MADE OF PRECIOUS METAL; PRECIOUS STONES, PEARLS; HOROLOGICAL AND CHRONOMETRIC INSTRUMENTS, NAMELY, SMALL CLOCKS AND WATCHES, WRIST WATCHES, CLOCK AND WATCH FACES, CLOCK AND WATCH CASES, MOVEMENTS FOR CLOCKS AND WATCHES, PARTS OF MOVEMENTS FOR CLOCKS AND WATCHES, IN CLASS 14 (U.S. CLS. 2, 27, 28 AND 50).

FOR: LEATHER AND IMITATIONS OF LEATHER; GOODS MADE OF LEATHER AND IMITA-

TIONS OF LEATHER, NAMELY, BAGS, SCHOOL BAGS, HAND BAGS, BRIEF CASES, SUITCASES, PURSES, WALLETS; ANIMAL SKINS, HIDES; TRUNKS AND TRAVELLING BAGS; UMBRELLAS, PARASOLS AND WALKING STICKS; WHIPS, HARNESS AND SADDLERY, IN CLASS 18 (U.S. CLS. 1, 2, 3, 22 AND 41).

PRIORITY DATE OF 1-10-2006 IS CLAIMED.

OWNER OF INTERNATIONAL REGISTRATION  
0910553 DATED 7-10-2006, EXPIRES 7-10-2016.

OWNER OF U.S. REG. NO. 2,623,221.

SER. NO. 79-033,636, FILED 7-10-2006.

AMEETA JORDAN, EXAMINING ATTORNEY

**Int. Cl.: 18**

**Prior U.S. Cls.: 1, 2, 3, 22 and 41**

**United States Patent and Trademark Office**

**Reg. No. 3,505,435**

**Registered Sep. 23, 2008**

**TRADEMARK  
PRINCIPAL REGISTER**

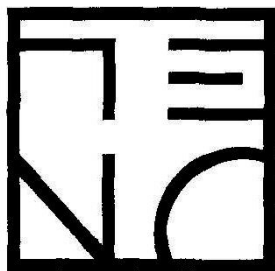

**T e N o**

HEINZ SCHWARZ GMBH (FED REP GERMANY  
LIMITED LIABILITY COMPANY)  
ALEMANNENSTR. 16  
PFORZHEIM; 75177, FED REP GERMANY

FOR: LEATHER AND IMITATIONS OF LEATHER; LEATHER AND IMITATION LEATHER BAGS, SCHOOL BAGS, HAND BAGS, BRIEF CASES, SUITCASES, PURSES, WALLETS, SHOULDER BELTS, SADDLE BELTS; ANIMAL SKINS, HIDES; TRUNKS AND TRAVELLING BAGS; UMBRELLAS, PARASOLS AND WALKING STICKS; WHIPS, HARNESS AND SADDLERY, IN CLASS 18 (U.S. CLS. 1, 2, 3, 22 AND 41).

PRIORITY DATE OF 1-10-2006 IS CLAIMED.

OWNER OF INTERNATIONAL REGISTRATION  
0911002 DATED 7-10-2006, EXPIRES 7-10-2016.

OWNER OF U.S. REG. NO. 2,623,221.

SER. NO. 79-033,699, FILED 7-10-2006.

AMEETA JORDAN, EXAMINING ATTORNEY

Int. Cl.: 16

Prior U.S. Cls.: 2, 5, 22, 23, 29, 37, 38 and 50

Reg. No. 3,505,436

United States Patent and Trademark Office

Registered Sep. 23, 2008

TRADEMARK  
PRINCIPAL REGISTER

# TWIST RING

LIHIT LAB., INC. (JAPAN CORPORATION)  
1-22, NONINBASHI 1-CHOME  
CHUO-KU, OSAKA-SHI; OSAKA 540-8526  
JAPAN

FOR: PEN CASES MADE OF PAPER WITH CLOTH SURFACE; PEN CASES MADE OF PLASTIC; BOXES OF PAPER FOR PACKAGING; BOXES OF PAPER WITH CLOTH SURFACE FOR PACKAGING; LETTER FILE BOXES FOR STORAGE MADE OF PAPER WITH CLOTH SURFACE; LETTER FILE BOXES FOR STORAGE MADE OF PLASTIC; MEMO PADS WITH UNDERLAY; BINDERS; BINDER POCKETS FOR LOOSE-LEAF BINDERS; PAPER RING FASTENERS MADE OF METAL FOR FILES; PAPER FASTENERS MADE OF METAL, FOR USE IN BINDERS, FOLDERS, NOTEBOOKS, AND FILES, SOLD SEPARATELY, WHICH HOLD PAPER IN PLACE BY MEANS OF TWO METAL RINGS THAT RUN THROUGH HOLES PUNCHED IN THE PAPER; FILES, NAMELY, FOLDERS AND BINDERS; FILES, NAMELY, FOLDERS AND BINDERS, WITH FASTENERS; LETTER HOLDERS FOR DOCUMENT FILES; PAPER FASTENERS MADE OF METAL AND PLASTIC FOR FILES; PAPER FASTENERS MADE OF METAL AND PLASTIC, FOR USE IN BINDERS, FOLDERS, NOTEBOOKS, AND FILES, SOLD SEPARATELY, WHICH HOLD PAPER IN PLACE BY MEANS OF METAL RINGS OR WIRE, OR THIN METAL BARS, THAT RUN THROUGH HOLES PUNCHED IN THE PAPER, OR BY CLAMPING; CLEAR DOCUMENT FILE FOLDERS; PORTFOLIO CASES FOR DOCUMENTS AND PLANS; POSTCARD AND TELEPHONE CARD HOLDERS, NAMELY, BINDERS WITH SHEETS HAVING POCKETS FOR HOLDING POSTCARDS AND TELEPHONE CARDS; BUSINESS CARD HOLDERS, NAMELY, BINDERS WITH SHEETS HAVING POCKETS FOR HOLDING BUSINESS CARDS; TICKET BINDERS, WITH OR WITHOUT POCKETS, FOR HOLDING AIRLINE TICKETS AND CONCERT TICKETS; LETTER TRAYS FOR STORAGE MADE OF PAPER WITH CLOTH SURFACE; ADDRESS BOOKS; POCKET NOTEBOOKS; LOOSE-LEAF PADS; GARBAGE BAGS OF PLASTIC WITH FASTENERS; STAPLERS WITHOUT METAL FIT-

TINGS; PAPER CLIPS; DESKTOP TRAYS FOR OFFICE SUPPLIES; PEN TRAYS; CLIPBOARDS; PAPER OTHER THAN "JAPANESE PAPER;" PAPERBOARD; JAPANESE PAPER; PROCESSED PAPER; PAPERBOARD BOXES FOR INDUSTRIAL PACKAGING; PAPER BAGS AND SACKS; CORRUGATED CARDBOARD BOXES; FIBERBOARD BOXES; FOOD WRAPPING PLASTIC FILM FOR HOUSEHOLD USE; GARBAGE BAGS OF PLASTIC FOR HOUSEHOLD USE; HYGIENIC PAPER; TOWELS OF PAPER; TABLE NAPKINS OF PAPER; HAND TOWELS OF PAPER; HANDKERCHIEFS OF PAPER; TAILORS' CHALKS; TABLE CLOTHS OF PAPER; BANNERS OF PAPER; FLAGS OF PAPER; BAGGAGE TAGS; PICTURE POSTCARDS; SHEET MUSIC; SONG BOOKS; PRODUCT CATALOGUES FOR OFFICE SUPPLIES; CALENDARS; NEWSPAPERS; GEOGRAPHICAL MAPS; DIARIES; NEWSLETTERS IN THE FIELD OF OFFICE SUPPLIES; PAMPHLETS AND BROCHURES IN THE FIELD OF OFFICE SUPPLIES; PAINTINGS AND THEIR REPRODUCTIONS; HANGING PAPER SCROLLS FOR MOUNTING A PICTURE, CALLIGRAPHIC WORK OR THE LIKE (JIKU); CALLIGRAPHIC WORKS AND THEIR REPRODUCTIONS; ENGRAVINGS AND THEIR REPRODUCTIONS; PHOTOGRAPHS; PHOTOGRAPH STANDS; CASES FOR RUBBER STAMPS; INDEX CARDS; INDEX DIVIDERS, NOTEBOOK DIVIDERS, DIVIDERS FOR BINDERS; TABS FOR INDEX DIVIDERS, NOTEBOOK DIVIDERS, DIVIDERS FOR BINDERS; ALBUMS, NAMELY, PHOTOGRAPH, STICKER, COIN, EVENT, AND SCRAPBOOK ALBUMS; CARDS, NAMELY, GREETING CARDS AND NOTE CARDS; CARBON PAPER; RULED PAPER; SCRAPBOOKS; SKETCH BOOKS; SCORE-CARDS; SCORE-BOOKS; ACCOUNT BOOKS; POCKET MEMORANDUM BOOKS; ACCOUNT SLIP PADS; STENCIL PAPER; TRACING CLOTH; TRACING PAPER; WRITING PADS; ENVELOPES; GRAPH PLOTTING PAPERS; BUSINESS CARD PAPER; LETTER PAPER; PENCILS; PENCIL POINT PROTECTORS; FELT WRITING PENS; MECHANICAL PENCILS; SLATE PENCILS; STEEL PENS; CHALKS; FELT MARKING PENS; PEN NIBS; PENHOLDERS; BALLPOINT PENS; FOUNTAIN PENS; WRITING BRUSHES; PAINTERS' EASELS;

SILK CANVAS FOR PAINTING; DRAWING BOARDS; CANVAS FOR PAINTING; CRAYONS; PAINTBRUSHES; PASTELS; PALETTES FOR PAINTING; CHARCOAL PENCILS; WRITING INK; INK ERASERS; INKWELLS; SEALING STAMPS; STAMP CASES; STAMP STANDS; SEAL INK PADS; NON-ELECTRIC PENCIL SHARPENERS; THUMB-TACKS; RUBBER ERASERS; BLACKBOARDS; BLACKBOARD ERASERS; PRICE TAGS AND PAPER GIFT TAGS; SEALS; BOOKMARKS; DRAFTING, DRAWING, AND UNGRADUATED RULERS; LETTER RACKS; PAPER FOLDERS; INK STONES; STAMP INKING PADS; STICKERS; SUMI (INK STICKS); WRITING SLATES; ADHESIVE TAPES FOR STATIONERY OR HOUSEHOLD PURPOSES; ADHESIVE TAPE DISPENSERS; TANZAKU (STRIPS OF FANCY PAPER); TERRESTRIAL GLOBES; NUMBERING STAMPS; DATE STAMPS; STANDS FOR PEN AND PENCIL; PEN AND PENCIL CASES AND BOXES; PAPERWEIGHTS; PROTRACTORS; PAPER KNIVES; INDIA INKS; STAPLING PRESSES; MIZUHIKI (JAPANESE CEREMONIAL ENVELOPES); FINGER-STALLS; PAPER LABELS FOR OFFICE USE; PAPER HOLE PUNCHES FOR OFFICE USE; BLANK PAPER TAPES AND CARDS FOR THE RECORDING OF COMPUTER PROGRAMS; ADDRESSING MACHINES; INKING RIBBONS; HEC-

TOGRAPH DUPLICATING MACHINES; AUTOMATIC STAMP PUTTING-ON MACHINES FOR OFFICES; ELECTRIC STAPLERS FOR OFFICES; ENVELOPE SEALING MACHINES FOR OFFICES; STAMP OBLITERATING MACHINES FOR OFFICES; DRAWING INSTRUMENTS; TYPEWRITERS; CHECK WRITING MACHINES FOR OFFICES; MIMEOGRAPHS; RELIEF DUPLICATING MACHINE; PAPER SHREDDERS; FRANKING MACHINES; ROTARY DUPLICATORS; PRINTERS' REGLETS; PRINTING TYPES; MARKING TEMPLATES; PASTES AND OTHER ADHESIVES FOR STATIONERY OR HOUSEHOLD PURPOSES; SEALING WAX, IN CLASS 16 (U.S. CLS. 2, 5, 22, 23, 29, 37, 38 AND 50).

OWNER OF INTERNATIONAL REGISTRATION  
0911407 DATED 7-31-2006, EXPIRES 7-31-2016.

NO CLAIM IS MADE TO THE EXCLUSIVE RIGHT TO USE "RING", APART FROM THE MARK AS SHOWN.

SER. NO. 79-033,908, FILED 7-31-2006.

LEIGH LOWRY, EXAMINING ATTORNEY

**Int. Cls.: 3, 9, 14, 18, 24 and 35**

**Prior U.S. Cls.: 1, 2, 3, 4, 6, 21, 22, 23, 26, 27, 28, 36, 38, 41, 42, 50, 51, 52, 100, 101 and 102**

**Reg. No. 3,505,437**

**United States Patent and Trademark Office**

**Registered Sep. 23, 2008**

**TRADEMARK  
SERVICE MARK  
PRINCIPAL REGISTER**

AZZEDINE ALAÏA (FRANCE INDIVIDUAL)  
18, RUE DE LA VERRERIE  
F-75004 PARIS  
FRANCE

FOR: PERFUMES, TOILET WATER EAU-DE-COLOGNE, SCENTED WATER; SHOWER AND BATH GELS AND SALTS, NOT FOR MEDICAL USE, BUBBLE BATHS; TOILET SOAPS; PERSONAL DEODORANTS; COSMETICS, FACE, BODY AND HAND CREAMS, MILKS, LOTIONS, GELS AND POWDERS, ALL FOR COSMETIC USE; BEAUTY MASKS; LIQUID BODY CREAMS; GELS, NAMELY, BATH, BEAUTY AND EYE GELS AND ESSENTIAL OILS, OILS FOR PERFUMES AND SCENTS; MAKE-UP PREPARATIONS, NAMELY, LIPSTICKS, FOUNDATIONS, PENCILS FOR THE EYES, EYEBROWS AND LIPS, EYE SHADOW, MASCARA, EYELINER, AND NAIL POLISH; SHAMPOO AND CONDITIONERS; HAIR STYLING AND HAIR CARE PREPARATIONS; MAKE-UP REMOVING PREPARATIONS, IN CLASS 3 (U.S. CLS. 1, 4, 6, 50, 51 AND 52).

FOR: OPTICAL GOODS, NAMELY, EYE GLASS FRAMES AND CASES, IN CLASS 9 (U.S. CLS. 21, 23, 26, 36 AND 38).

FOR: JEWELRY, PRECIOUS STONES AND HOROLOGICAL AND CHRONOMETRIC INSTRUMENTS, IN CLASS 14 (U.S. CLS. 2, 27, 28 AND 50).

FOR: LEATHER AND IMITATION LEATHER; ANIMAL SKINS AND HIDES; LUGGAGE; TRUNKS AND SUITCASES; TRAVELING TRUNKS; UMBRELLAS, PARASOLS AND WALKING STICKS; WHIPS, HARNESS AND SADDLERY; RUCKSACKS; WAIST BAGS; HANDBAGS; BEACH BAGS; TRAVELING BAGS; ROLLER BAGS; BAGS FOR CLIM-

BERS AND CAMPERS; SCHOOL BAGS; VALISES; TRAVELING SETS OF LEATHER, NAMELY, MATCHED SETS OF LUGGAGE; BRIEFCASES MADE OF LEATHER; BRIEFCASE-LIKE PORTFOLIOS; GARMENT TRAVEL BAGS; COLLARS AND CLOTHING FOR ANIMALS, LEATHER LEASHES; SUITCASES, ATTACHE CASES; LEATHER SATCHELS; WALLETS; KEY OASES; VANITY CASES SOLD EMPTY; PURSES NOT OF PRECIOUS METAL; STRING BAGS FOR SHOPPING; LEATHER SHOPPING BAGS; LEATHER BAGS AND SMALL LEATHER BAGS IN THE NATURE OF ENVELOPES AND POUCHES FOR PACKAGING, IN CLASS 18 (U.S. CLS. 1, 2, 3, 22 AND 41).

FOR: TEXTILES AND TEXTILE GOODS, NOT INCLUDED IN OTHER CLASSES, NAMELY, BED AND TABLE COVERS, IN CLASS 24 (U.S. CLS. 42 AND 50).

FOR: RETAIL STORE SERVICES FEATURING, COSMETICS, PERFUMES, SOAPS, ESSENTIAL OILS, LEATHER GOODS, JEWELRY, EYEWEAR, BEDDING, TOILETRIES, TABLE ARTS, FURNITURE, CLOTHING, FOOTWEAR, IN CLASS 35 (U.S. CLS. 100, 101 AND 102).

THE MARK CONSISTS OF STANDARD CHARACTERS WITHOUT CLAIM TO ANY PARTICULAR FONT, STYLE, SIZE, OR COLOR.

PRIORITY DATE OF 6-14-2006 IS CLAIMED.

OWNER OF INTERNATIONAL REGISTRATION 0912399 DATED 11-17-2006, EXPIRES 11-17-2016.

SEC. 2(F).

SER. NO. 79-034,227, FILED 11-17-2006.

ALLISON HOLTZ, EXAMINING ATTORNEY

**Int. Cl.: 5**

**Prior U.S. Cls.: 6, 18, 44, 46, 51 and 52**

**Reg. No. 3,505,438**

**United States Patent and Trademark Office**

**Registered Sep. 23, 2008**

**TRADEMARK  
PRINCIPAL REGISTER**

**BARRIERE**

MOCHIGASE CO., LTD. (JAPAN CORPORATION)  
7-2 MOCHIGASE  
MOCHIGASE-CHO  
TOTTORI-SHI, JAPAN 6891201

PURPOSES, NAMELY, FOR USE IN FIXING BANDAGES OR COVERING AN AFFECTED WOUND; BREAST-NURSING PADS, IN CLASS 5 (U.S. CLS. 6, 18, 44, 46, 51 AND 52).

FOR: SANITARY PREPARATIONS FOR MEDICAL USE, NAMELY, SANITARY SKIN MASKS; EDIBLE WAFERS FOR THE TREATMENT OF PAIN RELIEF; GAUZE FOR DRESSINGS; EYE PATCHES FOR MEDICAL PURPOSES; ADHESIVE AND SURGICAL EAR BANDAGES; MENSTRUATION BANDAGES; MENSTRUATION TAMPONS; SANITARY NAPKINS; SANITARY PANTIES; ABSORPTION COTTON FOR MEDICAL USE; ADHESIVE PLASTERS FOR MEDICAL USE; BANDAGE FOR DRESSING; COLLODION FOR PHARMACEUTICAL

OWNER OF INTERNATIONAL REGISTRATION 0912763 DATED 1-11-2007, EXPIRES 1-11-2017.

THE ENGLISH TRANSLATION OF THE "BARRIERE" IS "BARRIER".

SER. NO. 79-034,342, FILED 1-11-2007.

JENNIFER VASQUEZ, EXAMINING ATTORNEY



Int. Cl.: 33

Prior U.S. Cls.: 47 and 49

United States Patent and Trademark Office

Reg. No. 3,505,439

Registered Sep. 23, 2008

TRADEMARK  
PRINCIPAL REGISTER

VALE D' ALGARES

QUATRO ÂNCORAS -; INVESTIMENTOS IMOBILIÁRIOS.; TURÍSTICOS E AGRÍCOLAS, LDA  
(PORTUGAL EMPRESA LIMITADA)

RUA PASSEIO DAS ÂNCORAS

LOTE 4.22.01 - MORADIA R; P-1990-083 LISBOA  
PORTUGAL

FOR: WINE, IN CLASS 33 (U.S. CLS. 47 AND 49).

PRIORITY DATE OF 5-30-2006 IS CLAIMED.

OWNER OF INTERNATIONAL REGISTRATION  
0912920 DATED 11-9-2006, EXPIRES 11-9-2016.

THE ENGLISH TRANSLATION OF THE WORD  
"VALE D' ALGARES" IN THE MARK IS "VALLEY  
OF ALGARES".

SER. NO. 79-034,396, FILED 11-9-2006.

TASNEEM HUSSAIN, EXAMINING ATTORNEY

**Int. Cls.: 16, 17 and 26**

**Prior U.S. Cls.: 1, 2, 5, 12, 13, 22, 23, 29, 35, 37, 38, 39,  
40, 42 and 50**

**United States Patent and Trademark Office**

**Reg. No. 3,505,440**

**Registered Sep. 23, 2008**

**TRADEMARK  
PRINCIPAL REGISTER**

**BIOPRYL**

S2F FLEXICO (FRANCE SOCIÉTÉ À RESPONSABILITÉ LIMITÉE)  
1, ROUTE DE MÉRU  
F-60119 HENONVILLE  
FRANCE

FOR: PLASTIC BAGS FOR PACKAGING PURPOSES, IN CLASS 16 (U.S. CLS. 2, 5, 22, 23, 29, 37, 38 AND 50).

FOR: SEMI-PROCESSED PLASTIC INSULATING MATERIALS, NAMELY, FILMS, SHEETS, TUBES, BARS, OR RODS FOR THE PRODUCTION OF BAGS, SACHETS AND OTHER PACKAGING, IN CLASS 17 (U.S. CLS. 1, 5, 12, 13, 35 AND 50).

FOR: SLIDE FASTENERS MADE OF PLASTIC MATERIALS FOR BAGS, SACHETS AND OTHER PACKAGINGS MADE OF PLASTIC MATERIALS, IN CLASS 26 (U.S. CLS. 37, 39, 40, 42 AND 50).

PRIORITY DATE OF 6-14-2006 IS CLAIMED.

OWNER OF INTERNATIONAL REGISTRATION 0913096 DATED 12-5-2006, EXPIRES 12-5-2016.

SER. NO. 79-034,469, FILED 12-5-2006.

GILBERT SWIFT, EXAMINING ATTORNEY

**Int. Cls.: 9, 36 and 45**

**Prior U.S. Cls.: 21, 23, 26, 36, 38, 100, 101 and 102**

**Reg. No. 3,505,441**

**United States Patent and Trademark Office**

**Registered Sep. 23, 2008**

**TRADEMARK  
SERVICE MARK  
PRINCIPAL REGISTER**

# **RBSWORLDPAY**

THE ROYAL BANK OF SCOTLAND GROUP PLC  
(UNITED KINGDOM PUBLIC LIMITED COMPANY)

36 ST ANDREW SQUARE

EDINBURGH EH2 2YB, UNITED KINGDOM

FOR: COMPUTER PROGRAMS FOR THE PROCESSING OF FINANCIAL TRANSACTIONS AND PAYMENTS; MAGNETIC ENCODED CARD READERS; MAGNETIC ENCODED MEMORY CARD READERS; APPARATUS FOR RECEIVING CASH PAYMENTS, NAMELY, CASH PROCESSING MACHINES; AUTOMATIC PAYMENT MACHINES, NAMELY, MAGNETIC ENCODED CARD READERS AND MAGNETIC ENCODED MEMORY CARD READERS; DEVICES INCORPORATING MICRO-PROCESSORS FOR USE IN FARE PAYMENTS ON PUBLIC TRANSPORT; MACHINE READABLE DEVICES, NAMELY, MAGNETIC TAPES AND BAR CODED CARRIERS FOR CASHLESS PAYMENT SYSTEMS; MAGNETIC PAYMENT CARDS; PAYMENT CARDS BEING MAGNETICALLY ENCODED; READ OUT APPARATUS FOR USE IN THE AUTHENTICATION OF CASHLESS PAYMENT MEANS; READ OUT APPARATUS, NAMELY, MAGNETIC ENCODED CARD READERS FOR USE IN THE IDENTIFICATION OF CASHLESS PAYMENT MEANS; TERMINALS FOR ELECTRONICALLY PROCESSING CREDIT CARD PAYMENTS; TERMINALS FOR ELECTRONIC PAYMENT OF CHARGES WITH CREDIT CARDS; BLANK MAGNETIC DATA CARRIERS; BLANK ACOUSTIC DISKS; CASH REGISTERS, CALCULATING MACHINES, DATA PROCESSORS AND COMPUTERS; COMPUTER SERVERS AND SOFTWARE FOR TELECOMMUNICATIONS, NAMELY, COMPUTER SERVERS AND SOFTWARE FOR TELECOMMUNICATIONS FOR PROCESSING FINANCIAL TRANSACTIONS AND PAYMENTS; ELECTRONIC SEMI-CONDUCTORS, MICROPROCESSORS, ELECTRONIC INTEGRATED CIRCUITS; COMPUTERS FOR MICROPROGRAMMING, SOFTWARE FOR PROCESSING FINANCIAL TRANSACTIONS AND PAYMENTS, COMPUTER MEMORIES, COMPUTER PERIPHERALS, CPU BASED DATA PROCESSING UNITS AND

THEIR PARTS; BLANK ELECTRONIC DATA CARRIER CARDS; MAGNETICALLY ENCODED CREDIT CARDS, MAGNETICALLY ENCODED DEBIT BANK CARDS; MAGNETIC STORED VALUE CARDS, ENCODED MAGNETIC CARD READERS, ELECTRONIC DATA CARRIER CARD READERS, ELECTRONIC ENCRYPTION UNITS; COMPUTER HARDWARE, COMPUTER TERMINALS, COMPUTER PERIPHERALS; COMPUTER SOFTWARE RELATING TO THE HANDLING OF FINANCIAL TRANSACTIONS SUCH AS PAYMENTS BY CHARGE CARDS, BANK CARDS, CREDIT CARDS, DEBIT CARDS, STORED VALUE CARDS AND PAYMENT CARDS; ELECTRONIC VERIFICATION APPARATUS, NAMELY, ENCODED CARD READERS AND MAGNETIC MEMORY CARD READERS FOR VERIFYING THE AUTHENTICITY OF BANK CARDS, CREDIT CARDS, DEBIT CARDS, CHARGE CARDS, STORED VALUE AND PAYMENT CARDS; DOWNLOADABLE ELECTRONIC PUBLICATIONS RELATING TO THE PROCESSING OF FINANCIAL TRANSACTIONS AND PAYMENTS; PARTS AND FITTINGS FOR THE AFORESAID GOODS, IN CLASS 9 (U.S. CLS. 21, 23, 26, 36 AND 38).

FOR: ONLINE BANKING SERVICES, BUT NOT INCLUDING SUCH SERVICES RELATING TO ACCOUNT REPORTING SYSTEMS AND CASH MANAGEMENT SYSTEMS; CREDIT CARD AUTHORIZATION SERVICES; ELECTRONIC FUNDS TRANSFER AND PAYMENT SERVICES, NAMELY, COLLECTION, ADMINISTRATION, CLEARING AND PAYMENT OF FUNDS BY ELECTRONIC MEANS; CURRENCY EXCHANGE SERVICES; FINANCIAL RISK MANAGEMENT; INSURANCE CONSULTATION, IN CLASS 36 (U.S. CLS. 100, 101 AND 102).

FOR: IDENTITY THEFT AND FRAUD PREVENTION SERVICES, NAMELY, PROVISION OF INFORMATION, ADVISORY AND CONSULTANCY SERVICES RELATING TO IDENTITY THEFT AND FRAUD PREVENTION SERVICES, IN CLASS 45 (U.S. CLS. 100 AND 101).

THE MARK CONSISTS OF STANDARD CHAR-  
ACTERS WITHOUT CLAIM TO ANY PARTICULAR  
FONT, STYLE, SIZE, OR COLOR.

OWNER OF INTERNATIONAL REGISTRATION  
0914090 DATED 11-20-2006, EXPIRES 11-20-2016.

SER. NO. 79-034,707, FILED 11-20-2006.

PRIORITY DATE OF 8-10-2006 IS CLAIMED.

SHAUNIA CARLYLE, EXAMINING ATTORNEY

**Int. Cls.: 7, 9, 11, 35 and 42**

**Prior U.S. Cls.: 13, 19, 21, 23, 26, 31, 34, 35, 36, 38,  
100, 101 and 102**

**Reg. No. 3,505,442**

**United States Patent and Trademark Office**

**Registered Sep. 23, 2008**

**TRADEMARK  
SERVICE MARK  
PRINCIPAL REGISTER**



**The Innovation Company**

**LTG Aktiengesellschaft**

LTG AKTIENGESELLSCHAFT (FED REP GER-  
MANY JOINT STOCK COMPANY)  
GRENZSTRASSE 7  
70435 STUTTGART  
FED REP GERMANY

FOR: AIR FILTERS FOR MECHANICAL PURPOSES; FANS FOR MECHANICAL AND INDUSTRIAL PURPOSES, NAMELY, FANS FOR MACHINE ENGINES; PURIFICATION FILTERS, NAMELY, AIR PURIFICATION FILTERS FOR MECHANICAL PURPOSES; DE-DUSTING APPARATUSES, NAMELY, DUST SEPARATORS; AERATION APPARATUSES AND MACHINES, NAMELY, AERATORS; COMPACTERS, NAMELY, AIR COMPACTORS, NAMELY, AIR COMPRESSORS; PRESSING MACHINES, NAMELY, AIR PRESSING MACHINES, NAMELY, COMPRESSED AIR PUMPS; COMPRESSORS, NAMELY, AIR COMPRESSORS, COMPRESSORS FOR AIR CONDITIONING AND COMPRESSORS FOR HUMIDIFYING MACHINES; AIR INLETS AND OUTLETS, NAMELY, BLOWERS FOR MACHINES, AIR FILTERS FOR MECHANICAL PURPOSES, AIR COMPRESSORS, IN CLASS 7 (U.S. CLS. 13, 19, 21, 23, 31, 34 AND 35).

FOR: MEASURING AND CONTROL DEVICES FOR AIR CONDITIONING AND VENTILATOR TECHNOLOGY; VOLUME FLOW REGULATOR FOR DOMESTIC, COMMERCIAL AND INDUSTRIAL USE, IN CLASS 9 (U.S. CLS. 21, 23, 26, 36 AND 38).

FOR: VENTILATORS FOR AIR CONDITIONING, AIR-CONDITIONING, HEATING, COOLING, VENTILATION AND EXHAUST, HUMIDIFYING AND DEHUMIDIFYING SYSTEMS AND DEVICES, AS WELL AS PARTS THEREOF, FOR USE IN ROOMS, BUILDINGS, TRAINS, SHIPS AND VEHICLES; VENTILATORS FOR DOMESTIC, COMMERCIAL AND INDUSTRIAL USE; AIR HEATERS, NAMELY ELECTRIC HEATERS FOR DOMESTIC, COMMER-

CIAL AND INDUSTRIAL USE; EVAPORATIVE AIR COOLERS; AIR FILTERS FOR AIR CONDITIONING UNITS; NOZZLES AS PARTS OF VENTILATORS AND HUMIDIFIERS; SPRAYER NOZZLES, AIR-VOLUME CONTROL VALVES AND STOP VALVES AS PARTS OF AIR-CONDITIONING SYSTEMS; REGENERATIVE HEAT EXCHANGERS NOT BEING PARTS OF A MACHINE; HUMIDITY EXCHANGERS, NAMELY, HIGH PRESSURE HUMIDIFIER NOT BEING PARTS OF MACHINES; AIR OUTLETS AND INLETS AS PARTS OF VENTILATORS, HUMIDIFIERS AND VENTILATION FUME HOODS; INDUCTION DEVICES, NAMELY INDUCTION OVENS FOR ROOM HEATING; VENTILATOR CONVECTOR OVENS FOR ROOM HEATING AND COOLING; ROOM COOLING DEVICES WITH FAN, NAMELY, VENTILATING FANS FOR DOMESTIC, COMMERCIAL AND INDUSTRIAL USE; FAÇADE AIR-CONDITIONING MODULES FOR DECENTRALIZED HEATING, COOLING, FRESH-AIR SUPPLY, AIR CIRCULATION AND AIR EVACUATION OF ROOMS AND BUILDINGS, NAMELY, CENTRAL AIR-CONDITIONING INSTALLATIONS; AIR FILTERING UNITS FOR PROCESS VENTILATION ENGINEERING AND FOR FILTERING DUST, FIBRES, CHIPS, GRANULES AND PAPER, IN CLASS 11 (U.S. CLS. 13, 21, 23, 31 AND 34).

FOR: PROVIDING EXPERT OPINIONS AND ECONOMIC FORECASTS RELATING TO COMPANIES AND BUSINESS IN THE FIELD OF ENERGY MANAGEMENT AND AIR CIRCULATION OF BUILDINGS, PLANTS, APPARATUS, DEVICES AND MACHINES; BUSINESS EFFICIENCY EXPERTS IN THE FIELD OF VENTILATION AND ROOM VENTILATION SYSTEMS, APPARATUS, DEVICES AND MACHINES; BUSINESS MANAGEMENT ANALYSES, NAMELY, ANALYSES OF ENTERPRISES FOR BUSINESSES IN THE FIELD OF VENTILATION AND ROOM VENTILATION SYSTEMS, APPARA-

TUS, DEVICES AND MACHINES, IN CLASS 35 (U.S. CLS. 100, 101 AND 102).

FOR: TECHNICAL PLANNING, TECHNICAL DEVELOPMENT, DESIGN PLANNING, AND MEASUREMENT EVALUATIONS IN THE FIELD OF VENTILATION AND ROOM VENTILATION SYSTEMS, APPARATUS, DEVICES AND MACHINES AS WELL AS THEIR COMPONENTS, FOR USE IN NEW BUILDINGS, REFURBISHMENT OF BUILDINGS, INDUSTRIAL BUILDINGS, LABORATORIES, VEHICLES, TRAINS, SHIPS AND DRYING AND DISPOSAL INSTALLATIONS FOR AIR FLOWS; TECHNICAL SIMULATION, NAMELY, DESIGN AND TESTING FOR NEW PRODUCT DEVELOPMENT AND DEVELOPING PROGRAMS FOR SIMULATING EXPERIMENTS IN THE FIELD OF VENTILATION AND ROOM VENTILATION SYSTEMS, APPARATUS, DEVICES AND MACHINES AS WELL AS THEIR COMPONENTS, FOR USE IN NEW

BUILDINGS, REFURBISHMENT OF BUILDINGS, INDUSTRIAL BUILDINGS, LABORATORIES, VEHICLES, TRAINS, SHIPS AND DRYING AND DISPOSAL INSTALLATIONS FOR AIR FLOWS, IN CLASS 42 (U.S. CLS. 100 AND 101).

PRIORITY DATE OF 1-28-2006 IS CLAIMED.

OWNER OF INTERNATIONAL REGISTRATION 0915082 DATED 6-1-2006, EXPIRES 6-1-2016.

NO CLAIM IS MADE TO THE EXCLUSIVE RIGHT TO USE COMPANY AND AKTIENGESELLSCHAFT, APART FROM THE MARK AS SHOWN.

SER. NO. 79-035,083, FILED 6-1-2006.

BERNICE MIDDLETON, EXAMINING ATTORNEY

**Int. Cls.: 25, 35 and 43**

**Prior U.S. Cls.: 22, 39, 100, 101 and 102**

**United States Patent and Trademark Office**

**Reg. No. 3,505,443**

**Registered Sep. 23, 2008**

**TRADEMARK  
SERVICE MARK  
PRINCIPAL REGISTER**



GREENHOUSE V.O.F. (NETHERLANDS VEN-  
NOOTSCHAP ONDER FIRMA)

TOLSTRAAT 91

NL-1074 VG AMSTERDAM

NETHERLANDS

FOR: CLOTHING, NAMELY, SHIRTS, SHORTS,  
TROUSERS, DRESSES AND SKIRTS; FOOTWEAR,  
HEADWEAR, IN CLASS 25 (U.S. CLS. 22 AND 39).

FOR: ADVERTISING; BUSINESS MANAGE-  
MENT; BUSINESS ADMINISTRATION; OFFICE  
FUNCTIONS, RETAIL STORE SERVICES FEATUR-  
ING CLOTHING, SMOKERS ARTICLES, JEWELRY,  
GARDENING SUPPLIERS, FURNITURE, KITCH-  
ENWARE, PICTURE POSTCARDS AND POSTERS,  
IN CLASS 35 (U.S. CLS. 100, 101 AND 102).

FOR: RESTAURANT SERVICES FOR PROVID-  
ING FOOD AND DRINK, IN CLASS 43 (U.S. CLS. 100  
AND 101).

PRIORITY DATE OF 9-11-2006 IS CLAIMED.

OWNER OF INTERNATIONAL REGISTRATION  
0916687 DATED 12-14-2006, EXPIRES 12-14-2016.

NO CLAIM IS MADE TO THE EXCLUSIVE  
RIGHT TO USE "CANNABIS", APART FROM THE  
MARK AS SHOWN.

SER. NO. 79-035,654, FILED 12-14-2006.

DANIEL BRODY, EXAMINING ATTORNEY

**Int. Cls.: 7, 40 and 42**

**Prior U.S. Cls.: 13, 19, 21, 23, 31, 34, 35, 100, 101, 103  
and 106**

**Reg. No. 3,505,444**

**United States Patent and Trademark Office**

**Registered Sep. 23, 2008**

**TRADEMARK  
SERVICE MARK  
PRINCIPAL REGISTER**

# QUICKSTEP

QUICKSTEP TECHNOLOGIES PTY LTD (AUSTRALIA COMPANY)  
152 VULCAN ROAD  
CANNING VALE WA 6155  
AUSTRALIA

FOR: PRODUCTION MACHINES FOR THE MANUFACTURE OF STRUCTURAL PARTS MADE OF ADVANCED COMPOSITE MATERIALS FOR USE IN MANUFACTURING AIRCRAFT, NAMELY, WINGS, ENGINE PYLONS, ENGINE NARCELLES, FUSELAGES, TAILS, FLAPS, AILERONS, RUDDERS, AND ELEVATORS, AND PRODUCTION MACHINES FOR THE MANUFACTURE OF STRUCTURAL PARTS MADE OF ADVANCED COMPOSITE MATERIALS FOR USE IN MANUFACTURE OF STRUCTURAL PARTS MADE OF ADVANCED COMPOSITE MATERIALS FOR USE IN MANUFACTURING LAND VEHICLES, NAMELY, FLOOR PANS, ENGINE AND TRANSMISSION MOUNTS, FIREWALLS, VEHICLE PANELS, ENGINE HOODS AND DOOR FRAMES, IN CLASS 7 (U.S. CLS. 13, 19, 21, 23, 31, 34 AND 35).

FOR: CUSTOM MANUFACTURE OF STRUCTURAL PARTS MADE OF ADVANCED COMPOSITE MATERIALS FOR USE IN MANUFACTURING AIRCRAFT, NAMELY, WINGS, ENGINE PYLONS, ENGINE NACELLES, FUSELAGES, TAILS, FLAPS, AILERONS, RUDDERS, AND ELEVATORS; CUSTOM MANUFACTURE OF STRUCTURAL PARTS MADE OF ADVANCED COMPOSITE MATERIAL FOR USE IN MANUFACTURING LAND VEHICLES, NAMELY, FLOOR PANS, ENGINES AND TRANSMISSION MOUNTS, FIREWALLS, VEHICLE PA-

NELS, ENGINE HOODS AND DOOR FRAMES, IN CLASS 40 (U.S. CLS. 100, 103 AND 106).

FOR: RESEARCH AND DEVELOPMENT SERVICES IN THE FIELD OF MANUFACTURING STRUCTURAL PARTS MADE OF ADVANCED COMPOSITE MATERIALS FOR USE IN MANUFACTURING AIRCRAFT, NAMELY, RINGS, ENGINE PYLONS, ENGINE NACELLES, FUSELAGES, TAILS, FLAPS, AILERONS, RUDDERS, AND ELEVATORS; RESEARCH AND DEVELOPMENT SERVICES IN THE FIELD OF MANUFACTURING STRUCTURAL PARTS MADE OF ADVANCED COMPOSITE MATERIALS FOR USE IN MANUFACTURING LAND VEHICLES, NAMELY, FLOOR PANS, ENGINE AND TRANSMISSION MOUNTS, FIREWALLS, VEHICLE PANELS, ENGINE HOODS AND DOOR FRAMES, IN CLASS 42 (U.S. CLS. 100 AND 101).

THE MARK CONSISTS OF STANDARD CHARACTERS WITHOUT CLAIM TO ANY PARTICULAR FONT, STYLE, SIZE, OR COLOR.

PRIORITY DATE OF 3-16-2006 IS CLAIMED.

OWNER OF INTERNATIONAL REGISTRATION 0917030 DATED 8-7-2006, EXPIRES 8-7-2016.

SER. NO. 79-035,797, FILED 8-7-2006.

CHRISTINA SOBRAL, EXAMINING ATTORNEY



**Int. Cls.: 16, 24 and 27**

**Prior U.S. Cls.: 2, 5, 19, 20, 22, 23, 29, 37, 38, 42 and 50**

**United States Patent and Trademark Office**

**Reg. No. 3,505,445**

**Registered Sep. 23, 2008**

**TRADEMARK  
PRINCIPAL REGISTER**

**DECORISSIMO**

ZAKRYTOE AKTSIONERNOE OBSHESTVO;  
"ASKOT RUS" (RUSSIAN FED. JOINT STOCK  
COMPANY)

32, STR. 15, ST. NIZHEGORODSKAYA  
RU-109029 MOSCOW  
RUSSIAN FED.

FOR: PAPER RIBBONS; ADHESIVE BANDS FOR  
STATIONERY OR HOUSEHOLD PURPOSES;  
STICKERS ; AND PRINTED MATTER, NAMELY,  
POSTERS, PORTRAITS, PAPER LABELS, PIC-  
TURES, GRAPHIC PRINTS AND GRAPHIC ART  
REPRODUCTIONS, IN CLASS 16 (U.S. CLS. 2, 5, 22,  
23, 29, 37, 38 AND 50).

FOR: ADHESIVE FABRIC FOR APPLICATION BY  
HEAT; TEXTILE LABELS, IN CLASS 24 (U.S. CLS. 42  
AND 50).

FOR: WALLPAPER, IN CLASS 27 (U.S. CLS. 19, 20,  
37, 42 AND 50).

THE MARK CONSISTS OF STANDARD CHAR-  
ACTERS WITHOUT CLAIM TO ANY PARTICULAR  
FONT, STYLE, SIZE, OR COLOR.

OWNER OF INTERNATIONAL REGISTRATION  
0917557 DATED 10-27-2006, EXPIRES 10-27-2016.

SER. NO. 79-036,039, FILED 10-27-2006.

MARLENE BELL, EXAMINING ATTORNEY

**Int. Cls.: 3, 9, 14, 16, 18, 25, 28, 35, 36 and 41**

**Prior U.S. Cls.: 1, 2, 3, 4, 5, 6, 21, 22, 23, 26, 27, 28, 29, 36, 37, 38, 39, 41, 50, 51, 52, 100, 101, 102 and 107**

**Reg. No. 3,505,446**

**United States Patent and Trademark Office**

**Registered Sep. 23, 2008**

**TRADEMARK  
SERVICE MARK  
PRINCIPAL REGISTER**

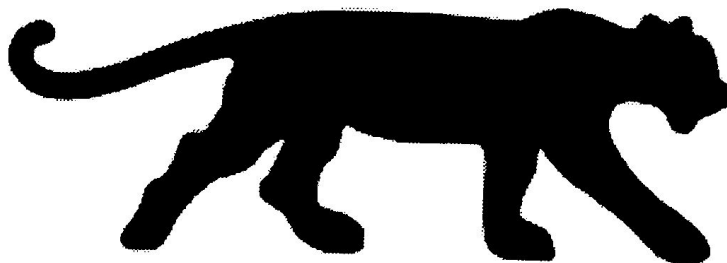

KONÉ MALAMINE (FRANCE INDIVIDUAL)  
8, ALLÉE AUGUSTE RENOIR  
F-92300 LEVALLOIS-PERRET  
FRANCE

FOR: PERFUMES, DEODORANTS FOR PERSONAL USE, COSMETIC CREAMS FOR THE BODY AND FACE, IN CLASS 3 (U.S. CLS. 1, 4, 6, 50, 51 AND 52).

FOR: SPECTACLES, SUNGLASSES AND PROTECTIVE EYEWEAR FOR SPORTSPERSONS; EYEWEAR CASES, NAMELY, CASES FOR SPECTACLES AND SUNGLASSES; TELEPHONE APPARATUS; MOBILE TELEPHONES; GAME SOFTWARE, IN CLASS 9 (U.S. CLS. 21, 23, 26, 36 AND 38).

FOR: FASHION JEWELRY; CHRONOMETRIC INSTRUMENTS; WATCHES; MEDALS, IN CLASS 14 (U.S. CLS. 2, 27, 28 AND 50).

FOR: PHOTOGRAPHS, STATIONERY; PENCILS, PENS; NEWSPAPERS AND MAGAZINES IN THE FIELD OF SPORTS, PRESENTATION CATALOGS IN THE FIELD OF SPORTS CLOTHES AND SPORTS ARTICLES; SALES CATALOGS IN THE FIELD OF SPORTS CLOTHES AND SPORTS ARTICLES, IN CLASS 16 (U.S. CLS. 2, 5, 22, 23, 29, 37, 38 AND 50).

FOR: SUITCASES; UMBRELLAS; SPORTS BAGS, RUCKSACKS AND TRAVEL BAGS; HANDBAGS, COLLEGE SACHELS, IN CLASS 18 (U.S. CLS. 1, 2, 3, 22 AND 41).

FOR: CLOTHING, NAMELY, T-SHIRTS, TRACKSUITS, SOCKS, PULLOVERS, SHIRTS, TROUSERS,

LEOTARDS, FITNESS TOPS, HEADBANDS, JACKETS, SHORTS, BATHING SUITS, UNDERWEAR, FOOTWEAR, SPORTS FOOTWEAR, CAPS, SUNHATS, IN CLASS 25 (U.S. CLS. 22 AND 39).

FOR: GYMNASTIC AND SPORTING ARTICLES, NAMELY, BALLS FOR THE SPORTS GAMES OF FOOTBALL, BASEBALL, BASKETBALL, GOLF, RUGBY AND TENNIS; BASKETBALL AND BOXING GLOVES; BASEBALL BATS; BAGS SPECIALLY ADAPTED FOR SPORTS EQUIPMENT, NAMELY, FOOTBALL BAGS, GOLF BAGS, HANDBALL BAGS, BASKETBALL BAGS AND TENNIS BAGS; SPORTS BALLS; RACKETS FOR TENNIS AND SQUASH, IN CLASS 28 (U.S. CLS. 22, 23, 38 AND 50).

FOR: ADVERTISING SERVICES, NAMELY, ADVERTISING FOR SPORTSWEAR, SPORTS ARTICLES, SPORTS CLOTHES, BAGS, FOOTWEAR, SPECTACLES AND TELEPHONES; RETAIL STORES FEATURING SPORTSWEAR, SPORTS ARTICLES, SPORTS CLOTHES, BAGS, FOOTWEAR, SPECTACLES AND TELEPHONES, IN CLASS 35 (U.S. CLS. 100, 101 AND 102).

FOR: FINANCIAL SPONSORSHIP OF SPORTS EVENTS AND HIGH-LEVEL SPORTSPERSONS, IN CLASS 36 (U.S. CLS. 100, 101 AND 102).

FOR: ORGANIZING SPORTING EVENTS, NAMELY, BASKETBALL, FOOTBALL, BASEBALL, TENNIS, RUGBY AND GOLF COMPETITIONS AND EVENTS; ENTERTAINMENT, NAMELY, PROVIDING ON-LINE COMPUTER GAMES NAMELY, PROVIDING ONLINE BASKETBALL, FOOTBALL, BASEBALL, TENNIS, RUGBY AND GOLF COMPU-

TER GAMES; ENTERTAINMENT SERVICES,  
NAMELY, ARRANGING AND CONDUCTING OF  
SPORTS COMPETITIONS FOR BASKETBALL,  
FOOTBALL, BASEBALL, TENNIS, RUGBY AND  
GOLF, IN CLASS 41 (U.S. CLS. 100, 101 AND 107).

PRIORITY DATE OF 2-14-2006 IS CLAIMED.

OWNER OF INTERNATIONAL REGISTRATION  
0917690 DATED 8-11-2006, EXPIRES 8-11-2016.

SER. NO. 79-036,097, FILED 8-11-2006.

KATHERINE E. HALMEN, EXAMINING ATTOR-  
NEY

**Int. Cls.: 3, 9, 14, 16, 21, 25, 26, 28, 35, 41 and 42**

**Prior U.S. Cls.: 1, 2, 4, 5, 6, 13, 21, 22, 23, 26, 27, 28, 29, 30, 33, 36, 37, 38, 39, 40, 42, 50, 51, 52, 100, 101, 102 and 107**

**Reg. No. 3,505,447**

**United States Patent and Trademark Office**

**Registered Sep. 23, 2008**

**TRADEMARK  
SERVICE MARK  
PRINCIPAL REGISTER**



POTATO ACADEMY LIMITED (UNITED KINGDOM PRIVATE COMPANY LIMITED BY SHARES)  
5 CHERRY WAY  
HAZLEMERE, BUCKS HP15 7HD  
UNITED KINGDOM

FOR: SOAPS; PERFUMERY; ESSENTIAL OILS; COSMETICS; NON-MEDICATED TOILETRIES, HAIR LOTIONS, DENTIFRICES, IN CLASS 3 (U.S. CLS. 1, 4, 6, 50, 51 AND 52).

FOR: AUDIO AND VIDEO RECORDINGS FEATURING MUSIC, CARTOONS, JOKES AND COMEDY; CARRIERS OF AUDIO SIGNALS AND VIDEO SIGNALS, NAMELY, PRERECORDED MAGNETIC DATA CARRIERS FEATURING MUSIC, CARTOONS, JOKES AND COMEDY; MOTION PICTURE FILMS ABOUT MUSIC, CARTOONS, JOKES AND COMEDY; SOUND RECORDINGS FEATURING MUSIC, JOKES AND COMEDY; AUDIO CASSETTES FEATURING MUSIC, JOKES AND COMEDY; BLANK VIDEO CASSETTES; PRE-RECORDED VIDEO CASSETTES FEATURING MUSIC, CARTOONS, JOKES AND COMEDY; COMPACT DISCS FEATURING MUSIC, CARTOONS, JOKES AND COMEDY; DVDS FEATURING MUSIC, CARTOONS, JOKES AND COMEDY; PHONOGRAPH RECORDS FEATURING MUSIC, JOKES AND COMEDY; MULTIMEDIA SOFTWARE RECORDED ON CD-ROM FEATURING MUSIC, CARTOONS, JOKES AND COMEDY; COMPUTER SOFTWARE

RELATING TO BIRTHDAYS AND ANNIVERSARIES FOR MANAGING AND CELEBRATING SPECIAL OCCASIONS, NAMELY, SPECIAL EVENT PLANNING AND THE ISSUE OF REMINDERS AND COMMUNICATIONS RELATED TO SUCH SPECIAL OCCASIONS; COMPUTER GAMES SOFTWARE; COMPUTER GAME PROGRAMS; DOWNLOADABLE MUSIC VIA THE INTERNET; DOWNLOADABLE VIDEO RECORDINGS FEATURING MUSIC, CARTOONS, JOKES AND COMEDY; DOWNLOADABLE ELECTRONIC PUBLICATIONS IN THE NATURE OF CARDS, GREETINGS, MAGAZINES AND COMICS IN THE FIELD OF ENTERTAINMENT, MUSIC, CARTOONS, JOKES AND COMEDY PROVIDED ONLINE FROM DATABASES OR THE INTERNET; ELECTRONIC PUBLICATIONS, NAMELY, CARDS, GREETINGS, MAGAZINES AND COMICS FEATURING ENTERTAINMENT, MUSIC, CARTOONS, JOKES AND COMEDY RECORDED ON COMPUTER MEDIA; COMPUTER SCREENSAVER SOFTWARE; MAGNETS; SUNGLASSES; SUNGLASSES CASES, IN CLASS 9 (U.S. CLS. 21, 23, 26, 36 AND 38).

FOR: JEWELRY; PRECIOUS STONES; HOROLOGICAL AND CHRONOMETRIC INSTRUMENTS, PARTS AND FITTINGS THEREFOR, IN CLASS 14 (U.S. CLS. 2, 27, 28 AND 50).

FOR: GREETING CARDS, TRIVIA CARDS, SOCIAL NOTE CARDS, ANNOUNCEMENT CARDS,

CHRISTMAS CARDS; PAPER, CARDBOARD AND GOODS MADE FROM THESE MATERIALS, NOT INCLUDED IN OTHER CLASSES, NAMELY, NAPKINS, PAPER BOXES, CARDBOARD BOXES, GIFT WRAPPING PAPER, CAKE DECORATIONS, FLAGS, PARTY DECORATIONS, PARTY HATS; DIARIES; DECALCOMANIA; CALENDARS; STATIONERY; PAPER GIFT TAGS; PHOTOGRAPHS; PRINTS; POSTERS; ETCHINGS; ARTISTS' MATERIALS, NAMELY, PAINT BRUSHES, PASTELS, PENCILS, PENS AND CRAYONS; INSTRUCTIONAL AND TEACHING MATERIAL, NAMELY, MAGAZINES, MANUALS AND LEAFLETS IN THE FIELD OF MAGIC, TRICKS, PUBLIC PERFORMING AND ENTERTAINMENT; PAPER BANNERS; PAPER PARTY DECORATIONS; GIFT VOUCHERS, IN CLASS 16 (U.S. CLS. 2, 5, 22, 23, 29, 37, 38 AND 50).

FOR: CONTAINERS FOR HOUSEHOLD OR KITCHEN USE NOT OF PRECIOUS METAL; GLASSWARE, NAMELY, BEVERAGE GLASSWARE; PORCELAIN, NAMELY, PORCELAIN PLATES, CUPS AND MUGS; EARTHENWARE, NAMELY, PLATES, CUPS AND MUGS; MUGS, IN CLASS 21 (U.S. CLS. 2, 13, 23, 29, 30, 33, 40 AND 50).

FOR: CLOTHING, NAMELY, SHORTS, PANTS, SHIRTS, T-SHIRTS, JERSEYS, BELTS; FOOTWEAR; HEADGEAR, NAMELY, HATS, CAPS, NOVELTY HEADWEAR AND NOVELTY HEADWEAR WITH ATTACHED WIGS, IN CLASS 25 (U.S. CLS. 22 AND 39).

FOR: LACE AND EMBROIDERY; RIBBONS AND BRAIDS; SHOE LACES, IN CLASS 26 (U.S. CLS. 37, 39, 40, 42 AND 50).

FOR: TOYS, GAMES AND PLAYTHINGS, NAMELY, ACTION SKILL GAMES, ACTION TARGET GAMES, BALLS FOR GAMES, BOARD GAMES, CARD GAMES, BINGO GAME PLAYING EQUIPMENT, DISPOSABLE TICKET SETS FOR PLAYING GAMES OF CHANCE, HAND-HELD UNIT FOR PLAYING ELECTRONIC OR VIDEO GAMES, PARLOR GAMES, PARTY GAMES, BENDABLE TOYS, ELECTRONIC ACTION TOYS, MECHANICAL TOYS, PARTY FAVORS IN THE NATURE OF SMALL TOYS, STUFFED TOY ANIMALS, TOY FIGURES, WATER SQUIRTING TOYS AND TOY MASKS; BALLOONS; GOLF BALLS; GOLF BAGS; GOLF CLUBS; DECORATIONS FOR PARTIES, NAMELY, CHRISTMAS TREE DECORATIONS; TEDDY BEARS; SOFT SCULPTURE TOYS; PUZZLES; PLAYING CARDS, IN CLASS 28 (U.S. CLS. 22, 23, 38 AND 50).

FOR: THE BRINGING TOGETHER FOR THE BENEFIT OF OTHERS OF A VARIETY OF GOODS AND SERVICES ENABLING CUSTOMERS TO CONVENIENTLY VIEW AND TO PURCHASE THESE GOODS AND SERVICES FROM A GENERAL MERCHANDISE INTERNET WEBSITE, BY MEANS OF TELECOMMUNICATIONS OR BY MAIL ORDER, IN CLASS 35 (U.S. CLS. 100, 101 AND 102).

FOR: ENTERTAINMENT SERVICES IN THE NATURE OF PRERECORDED SEX-ORIENTED, JOKE-ORIENTED AND INSULT-ORIENTED MESSAGES BY TELEPHONE; PROVIDING INFORMATION, NEWS AND COMMENTARY IN THE FIELD OF ENTERTAINMENT; THE PROVISION OF ON-LINE NON-DOWNLOADABLE ELECTRONIC PUBLICATIONS IN THE NATURE OF COMICS, CARTOONS AND FUN ARTICLES AND MAGAZINES IN THE FIELD OF ENTERTAINMENT; ARRANGING AND CONDUCTING OF COMPETITIONS FOR FOOTBALL, MAGIC, COMEDY AND SINGING; PROVIDING ENTERTAINMENT INFORMATION; INFORMATION RELATING TO ENTERTAINMENT PROVIDED ON-LINE FROM A COMPUTER DATABASE OR THE INTERNET; PARTY PLANNING SERVICES; PRODUCTION OF SOUND AND MUSIC VIDEO RECORDINGS; PUBLICATION OF BOOKS, MAGAZINES, GREETINGS CARDS AND TEXTS, IN CLASS 41 (U.S. CLS. 100, 101 AND 107).

FOR: LICENSING OF INTELLECTUAL PROPERTY, IN CLASS 42 (U.S. CLS. 100 AND 101).

OWNER OF INTERNATIONAL REGISTRATION 0917948 DATED 9-7-2006, EXPIRES 9-7-2016.

THE COLOR(S) LIGHT BLUE, DARK BLUE, WHITE AND ORANGE IS/ARE CLAIMED AS A FEATURE OF THE MARK.

THE MARK CONSISTS OF THE FOLLOWING: LIGHT BLUE: BACKGROUND, DARK BLUE: WORD CONTENT OF MARK - "POTATO ACADEMY", WHITE: EDGING TO NUMERALS IN MARK, ORANGE: NUMERALS IN MARK - 21.

SER. NO. 79-036,174, FILED 9-7-2006.

KATHERINE E. HALMEN, EXAMINING ATTORNEY

**Int. Cls.: 10, 20 and 35**

**Prior U.S. Cls.: 2, 13, 22, 25, 26, 32, 39, 44, 50, 100, 101  
and 102**

**Reg. No. 3,505,448**

**United States Patent and Trademark Office**

**Registered Sep. 23, 2008**

**TRADEMARK  
SERVICE MARK  
PRINCIPAL REGISTER**

**M2M**

HTL INTERNATIONAL HOLDINGS LIMITED  
(SINGAPORE LIMITED COMPANY)  
11 GUL CIRCLE  
SINGAPORE 629567  
SINGAPORE

FOR: MASSAGE CHAIRS; KNEADING AND MASSAGING APPARATUS FOR MEDICAL USE; REFLEXOLOGY APPARATUS FOR MEDICAL USE; EXERCISE MACHINES FOR THERAPEUTIC AND MEDICAL PURPOSES; FURNITURE ESPECIALLY ADAPTED FOR THERAPEUTIC PURPOSES, NAMELY, MASSAGE APPARATUS FOR THERAPEUTIC PURPOSES; STRUCTURAL AND REPLACEMENT PARTS THEREFORE, IN CLASS 10 (U.S. CLS. 26, 39 AND 44).

FOR: SOFAS, ARMCHAIRS, CUSHIONS, DIVANS, EASY CHAIRS, FOOTSTOOLS, SETTEES, LIVING ROOM FURNITURE, IN CLASS 20 (U.S. CLS. 2, 13, 22, 25, 32 AND 50).

FOR: BRINGING TOGETHER, FOR THE BENEFIT OF OTHERS, OF A VARIETY OF SOFAS, ARM CHAIRS, CUSHIONS, DIVANS, EASY CHAIRS,

FOOTSTOOLS, SETTEES AND OTHER LIVING ROOM FURNITURE EXCLUDING THE TRANSPORT THEREOF, ENABLING CUSTOMERS TO CONVENIENTLY VIEW AND PURCHASE THOSE GOODS; DEMONSTRATION OF PRODUCTS; DISTRIBUTION OF SAMPLES; ORGANIZATION OF EXHIBITIONS OR TRADE FAIRS FOR COMMERCIAL OR ADVERTISING PURPOSES; SALES PROMOTION, IN CLASS 35 (U.S. CLS. 100, 101 AND 102).

THE MARK CONSISTS OF STANDARD CHARACTERS WITHOUT CLAIM TO ANY PARTICULAR FONT, STYLE, SIZE, OR COLOR.

PRIORITY DATE OF 9-18-2006 IS CLAIMED.

OWNER OF INTERNATIONAL REGISTRATION  
0917993 DATED 12-22-2006, EXPIRES 12-22-2016.

SER. NO. 79-036,190, FILED 12-22-2006.

ROBERT STRUCK, EXAMINING ATTORNEY

Int. Cls.: 16, 24 and 25

Prior U.S. Cls.: 2, 5, 22, 23, 29, 37, 38, 39, 42 and 50

United States Patent and Trademark Office

Reg. No. 3,505,449

Registered Sep. 23, 2008

TRADEMARK  
PRINCIPAL REGISTER



COUTURE TECH LIMITED (BR. VIRGIN ISLANDS COMPANY WITH LIMITED LIABILITY)

TRIDENT CHAMBERS, P.O. BOX 146  
ROAD TOWN, TORTOLA; VIRGIN ISLANDS OF GREAT BRITAIN  
UNITED KINGDOM

FOR: PAPER AND CARDBOARD; PRINTED MATTER NAMELY, BOOKS FEATURING MEN'S AND LADIES FASHIONS; MAGAZINES FEATURING MEN'S AND LADIES FASHIONS; NEWSPAPERS AND NEWSLETTERS FEATURING MEN'S AND LADIES FASHIONS; BROCHURES FEATURING MEN'S AND LADIES FASHIONS; PRINTED INVITATIONS; PHOTOGRAPHS; STATIONERY; ADHESIVES FOR STATIONERY OR HOUSEHOLD PURPOSES; PAINT BRUSHES; TYPEWRITERS; PLASTIC MATERIALS FOR PACKAGING, NAMELY, PRINTED PLASTIC BAGS AND CARRIERS FOR PACKAGING; PRINTERS' TYPE; PRINTING BLOCKS, IN CLASS 16 (U.S. CLS. 2, 5, 22, 23, 29, 37, 38 AND 50).

FOR: TEXTILES AND TEXTILE GOODS, NAMELY, FABRIC FOR THE MANUFACTURE OF UPHOLSTERY, CLOTHES MAKING AND CURTAINS; BED COVERS, NAMELY, BED SPREADS, BED SHEETS, COMFORTERS, DUVETS, DUVET COVERS, BLANKETS; TABLE COVERS, NAMELY, TABLE CLOTHS, TABLE RUNNERS MADE OF CLOTH, TOWELS, DISH CLOTHS, CLOTH NAP-

KINS AND PLACEMATS, IN CLASS 24 (U.S. CLS. 42 AND 50).

FOR: CLOTHING, NAMELY, PULLOVERS, CARDIGANS, SWEATERS, TROUSERS, SKIRTS, JACKETS, BLOUSES, SHIRTS, JEANS, SWEATPANTS, SHORTS, SWEATSHIRTS, SUITS, DRESSES, OVERCOATS, COATS, RAINCOATS, BELTS, JERSEYS, NECKWEAR, SOCKS AND STOCKINGS, TIGHTS, VESTS, WAISTCOATS, JUMPERS, TRACKSUITS, BLOUSONS, GYM SUITS, KNICKERS, T-SHIRTS, ANORAKS, LOUNGEWEAR, OVERALLS, UNDERWEAR, BEACHWEAR, SLEEPWEAR, HEADWEAR, HATS AND CAPS, SCARVES, GLOVES, SHOES, SANDALS, BOOTS AND SLIPPERS, IN CLASS 25 (U.S. CLS. 22 AND 39).

OWNER OF INTERNATIONAL REGISTRATION  
0918451 DATED 8-7-2006, EXPIRES 8-7-2016.

THE COLOR(S) RED, BLUE, BLACK, BEIGE, YELLOW, YELLOW OCHRE AND ORANGE IS/ARE CLAIMED AS A FEATURE OF THE MARK.

THE MARK CONSISTS OF A BLUE GLOBE WITH THE COLOR ORANGE APPEARING AS CONTINENTS AND THE COLOR BLACK AS LATITUDE DIVISION LINES. THE COLOR BEIGE APPEARS OUTLINED IN BLACK AS THE SICKLE AND HAMMER OVER THE GLOBE. THE GLOBE IS

SHOWN ABOVE A DEPICTION OF THE SUN IN YELLOW AND BELOW A FIVE POINT RED AND YELLOW STAR EDGED IN BLACK. ON EITHER SIDE OF THE GLOBE IS WHEAT IN THE COLOR BEIGE WITH BLACK SHADING AND OUTLINED IN BLACK WRAPPED IN A RED RIBBON OUTLINED IN BLACK WITH THE WORDING WRITTEN IN BEIGE THE WORDING ON THE RIBBON APPEARS IN YELLOW.

THE FOREIGN WORDING IN THE MARK TRANSLATES INTO ENGLISH AS PROLETARIATS

OF ALL COUNTRIES, UNITE! IN THE FOLLOWING LANGUAGES, NAMELY, UKRAINIAN, BELARUSIAN, TURKMEN, AZERBAIJANI, ARMENIAN, GEORGIAN, RUSSIAN, UZBEK, TAJIK, KAZAKH, KYRGYZ, MOLDAVIAN, ESTONIAN, LATVIAN, LITHUANIAN,

SER. NO. 79-036,377, FILED 8-7-2006.

WILLIAM ROSSMAN, EXAMINING ATTORNEY



**Int. Cls.: 18 and 25**

**Prior U.S. Cls.: 1, 2, 3, 22, 39 and 41**

**United States Patent and Trademark Office**

**Reg. No. 3,505,450**

**Registered Sep. 23, 2008**

**TRADEMARK  
PRINCIPAL REGISTER**

# **BETTY JACKSON**

BETTY JACKSON LIMITED (UNITED KING-  
DOM LIMITED COMPANY)  
1 NETHERWOOD PLACE  
NETHERWOOD ROAD; LONDON W14 OBW  
UNITED KINGDOM

FOR: GOODS MADE OF LEATHER AND IMITA-  
TIONS OF LEATHER IN THIS CLASS, NAMELY,  
SHOULDER BAGS, HANDBAGS, TUCK BAGS,  
MESSY BAGS, CLUTCH BAGS, SHOPPING BAGS,  
SMALL ZIP SHOPPER BAGS, SNAP BAGS, PURSES,  
WALLETS; LEATHER SHOULDER BELTS;  
TRUNKS, SUITCASES, TRAVELLING CASES OF  
LEATHER, BRIEFCASES; DOCUMENT CASES;  
HOLDALLS; RUCKSACKS; ALL PURPOSE SPORT  
BAGS; GARMENT BAGS FOR TRAVELLING; KEY  
CASES; UMBRELLAS; PARASOLS; SADDLERY,  
HARNESSES, WHIPS; WALKING STICKS; KEY  
CASES MADE OF LEATHER OR IMITATION LEA-  
THER, IN CLASS 18 (U.S. CLS. 1, 2, 3, 22 AND 41).

FOR: CLOTHING, NAMELY, PANTS, TROUSERS,  
SHORTS, SKIRTS, UNDERWEAR, LINGERIE,  
SOCKS, SHIRTS, BLOUSES, BLAZERS, JACKETS,  
DRESSES, COATS, SCARVES, T-SHIRTS, TIES,

PULLOVERS, SWEATERS, JERSEYS, VESTS, TOPS,  
JEANS, CARDIGANS, SUITS, CRAVATS, DRESSING  
GOWNS, HOUSECOATS, NIGHTGOWNS, PAJA-  
MAS, SWIM SHORTS, SWIM TRUNKS, SWIMMING  
COSTUMES, BIKINIS; FOOTWEAR; HEADGEAR,  
NAMELY, HATS, CAPS AND HEAD SCARVES;  
BELTS, IN CLASS 25 (U.S. CLS. 22 AND 39).

PRIORITY DATE OF 11-7-2006 IS CLAIMED.

OWNER OF INTERNATIONAL REGISTRATION  
0918928 DATED 11-9-2006, EXPIRES 11-9-2016.

THE NAME(S), PORTRAIT(S), AND/OR SIGNA-  
TURE(S) SHOWN IN THE MARK IDENTIFIES  
"BETTY JACKSON", WHOSE CONSENT(S) TO REG-  
ISTER IS SUBMITTED.

SER. NO. 79-036,529, FILED 11-9-2006.

MICHAEL GAAFAR, EXAMINING ATTORNEY

**Int. Cls.: 8, 20, 21, 25 and 31**

**Prior U.S. Cls.: 1, 2, 13, 22, 23, 25, 28, 29, 30, 32, 33,  
39, 40, 44, 46 and 50**

**Reg. No. 3,505,451**

**United States Patent and Trademark Office**

**Registered Sep. 23, 2008**

**TRADEMARK  
PRINCIPAL REGISTER**



**DUCHY**

DUCHY ORIGINALS LIMITED (UNITED KING-  
DOM LIMITED COMPANY)  
THE OLD RYDE HOUSE  
393 RICHMOND ROAD  
TW1 2EF EAST TWICKENHAM, MIDDLESEX, UNI-  
TED KINGDOM

FOR: NON ELECTRIC GARDEN TOOLS, NAME-  
LY, SPADES, GARDEN FORKS, WEEDING FORKS,  
HAND FORKS, SHOVELS, TROWELS, EDGING  
TOOLS, HOES, RAKES, LAWN RAKES, SHEARS,  
BORDER SHEARS, LOPPING SHEARS, PRUNING  
SHEARS, HAND OPERATED HEDGE CUTTERS,  
HAND OPERATED HEDGE TRIMMERS, AND  
HAND OPERATED GRASS CUTTING APPARATUS,  
TOOL BELTS, HOLDERS FOR HAND TOOLS, IN  
CLASS 8 (U.S. CLS. 23, 28 AND 44).

FOR: CUSHIONS, IN CLASS 20 (U.S. CLS. 2, 13, 22,  
25, 32 AND 50).

FOR: WATERING CANS, GARDENING GLOVES,  
IN CLASS 21 (U.S. CLS. 2, 13, 23, 29, 30, 33, 40 AND 50).

FOR: APRONS, IN CLASS 25 (U.S. CLS. 22 AND 39).

FOR: SEEDS FOR HORTICULTURAL PURPOSES,  
BULBS FOR HORTICULTURAL PURPOSES, SEED-  
LINGS, LIVE PLANTS AND LIVE FLOWERS, IN  
CLASS 31 (U.S. CLS. 1 AND 46).

PRIORITY DATE OF 6-10-2006 IS CLAIMED.

OWNER OF INTERNATIONAL REGISTRATION  
0919173 DATED 12-7-2006, EXPIRES 12-7-2016.

OWNER OF U.S. REG. NOS. 2,116,530, 3,099,187,  
AND 3,226,898.

SER. NO. 79-036,612, FILED 12-7-2006.

DOMINIC FATHY, EXAMINING ATTORNEY

**Int. Cl.: 25**

**Prior U.S. Cls.: 22 and 39**

**United States Patent and Trademark Office**

**Reg. No. 3,505,452**

**Registered Sep. 23, 2008**

**TRADEMARK  
PRINCIPAL REGISTER**

# RedYacht

MUSTO LIMITED (UNITED KINGDOM LIMITED LIABILITY INCORPORATED COMPANY)

CHRISTY WAY  
LAINDON, ESSEX SS15 6TR  
UNITED KINGDOM

FOR: ARTICLES OF CLOTHING, NAMELY, T-SHIRTS, POLO SHIRTS, TURTLE NECKS, SWEATSHIRTS, GILETS, SHORTS, SKIRTS, PANTS, TROUSERS, COATS, JACKETS, JERSEYS, CARDIGANS, VESTS, BLOUSONS, UNDERGARMENTS, SOCKS, KNIT SHIRTS, KNITTED UNDERWEAR, KNITTED CAPS, KNITTED HATS, KNITTED JUMPERS, KNITTED SWEATERS, KNITTED HATS, KNITTED GLOVES, KNITTED SOCKS, WOVEN SHIRTS; WATERPROOF CLOTHING, NAMELY, WATERPROOF JACKETS, WATERPROOF SMOCKS, WATERPROOF SALOPETTES, WATERPROOF TROUSERS; SAILING CLOTHING, NAMELY, JACKETS, SALOPETTES, SMOCKS, TROUSERS, DRY SUITS, ONE-

PIECE SUITS, THERMAL UNDERWEAR, THERMAL CAPS, THERMAL HATS, THERMAL UNDERSHIRTS, THERMAL GLOVES; HEADGEAR, NAMELY, HATS, VISORS, CAPS; FOOTWEAR, IN CLASS 25 (U.S. CLS. 22 AND 39).

THE MARK CONSISTS OF STANDARD CHARACTERS WITHOUT CLAIM TO ANY PARTICULAR FONT, STYLE, SIZE, OR COLOR.

PRIORITY DATE OF 9-18-2006 IS CLAIMED.

OWNER OF INTERNATIONAL REGISTRATION 0919333 DATED 3-15-2007, EXPIRES 3-15-2017.

SER. NO. 79-036,669, FILED 3-15-2007.

KAREN SEVERSON, EXAMINING ATTORNEY

**Int. Cls.: 9, 14, 16, 18, 24, 25, 26, 28 and 41**

**Prior U.S. Cls.: 1, 2, 3, 5, 21, 22, 23, 26, 27, 28, 29, 36, 37, 38, 39, 40, 41, 42, 50, 100, 101 and 107**

**Reg. No. 3,505,453**

**United States Patent and Trademark Office**

**Registered Sep. 23, 2008**

**TRADEMARK  
SERVICE MARK  
PRINCIPAL REGISTER**

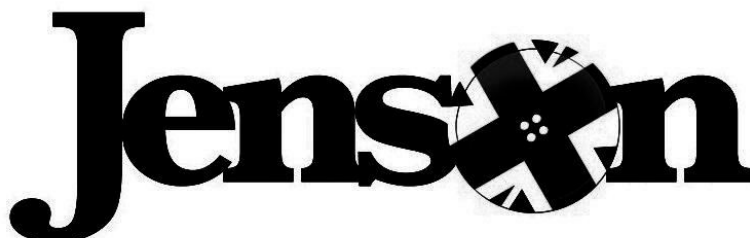

JENSON HOLDING NV (NETHERLD ANTILLES COMPANY)  
VAN ENGELENWEG 21A  
CURACAO, NETHERLD ANTILLES

FOR: CLOTHING, FOOTWEAR, HEADGEAR, HELMETS, GLOVES, BELTS, GOGGLES, ALL OF A PROTECTIVE NATURE; LUMINOUS AND MECHANICAL SIGNS; SUN GLASSES, SPECTACLES AND CASES THEREOF; PRERECORDED AUDIO BOOKS ON DISCS AND AUDIO TAPES FEATURING RACE SOUND FOOTAGE IN THE FIELD OF AUTO RACING; CINEMATOGRAPHIC FILMS IN THE FIELD OF AUTO RACING; PRERECORDED COMPUTER GAME DISCS; DOWNLOADABLE ON-LINE ELECTRONIC PUBLICATIONS, NAMELY, NEWSLETTERS PROVIDED FROM THE INTERNET IN THE FIELD OF AUTO RACING; SAFETY HELMETS, IN CLASS 9 (U.S. CLS. 21, 23, 26, 36 AND 38).

FOR: TIME PIECES AND TIMERS; WATCH BANDS; JEWELRY AND IMITATION JEWELRY; COLLECTIBLE COINS; MEDALS; CUFFLINKS; TIE CLIPS AND PINS; MEDALLIONS; AND BADGES OF PRECIOUS METAL, SHIRT STUDS, FIGURINES OF PRECIOUS METAL, BUSTS OF PRECIOUS METAL, CAMEOS, ASHTRAYS, SMOKERS' ARTICLES, KEY-RINGS OF PRECIOUS METAL, KEY FOBS, PAPER KNIVES, PAPER WEIGHTS, TROPHIES, ALL OF EITHER PRECIOUS OR SEMI-PRECIOUS METALS OR COATED WITH SAME, IN CLASS 14 (U.S. CLS. 2, 27, 28 AND 50).

FOR: PICTURES; PHOTOGRAPHS; NEWSPAPERS; MAGAZINES IN THE FIELD OF AUTO RACING; BOOKS IN THE FIELD OF AUTO RA-

CING; COMICS; ROUTE MAPS; PAPERMACHE FIGURINES, IN CLASS 16 (U.S. CLS. 2, 5, 22, 23, 29, 37, 38 AND 50).

FOR: BACK PACKS; HANDBAGS; PURSES; UMBRELLAS; WALLETS; ALL OF THE AFOREMENTIONED GOODS MADE OF LEATHER OR IMITATION LEATHER, IN CLASS 18 (U.S. CLS. 1, 2, 3, 22 AND 41).

FOR: CLOTH BANNERS; CLOTH FLAGS; TOWELS; CLOTH FACE FLANNELS FOR WASHING FACES; BED LINEN; DUVET COVERS; SLEEPING BAGS, CURTAINS; BEAN BAG COVERS; LINEN TABLE WARE, NAMELY, TABLECLOTHS; NAPKINS; FABRIC, NAMELY, COTTON, LINEN AND SILK; FABRIC BADGES AND LABELS; CURTAINS, NAMELY, TEXTILE BLINDS AND TEXTILE SUN SCREENS AND SHADES OF FABRIC FOR OUTDOOR USE; KITCHEN LINEN; HANDKERCHIEFS; FRIEZES; PLASTIC TABLE MATS, IN CLASS 24 (U.S. CLS. 42 AND 50).

FOR: CLOTHING, NAMELY, UNDERWEAR; TRACKSUITS; SHELL SUITS; OVERALLS; COATS; MANTLES; SUITS; JACKETS; WAIST COATS; BATH ROBES; CLOTHING BELTS; GLOVES; JUMPERS; TROUSERS; SKIRTS; SHORTS; SHIRTS; POLO SHIRTS; T-SHIRTS; SWEAT SHIRTS; SWEAT BANDS; SCARVES; GLOVES; NECKWEAR; FOOTWEAR; HEADGEAR, NAMELY, HATS; CAPS; CAP PEAKS; VISORS; BASEBALL CAPS; HEADBANDS, IN CLASS 25 (U.S. CLS. 22 AND 39).

FOR: TEXTILE BADGES OR PATCHES FOR CLOTHING; EMBROIDERED BADGES, NAMELY, EMBLEMS AND PATCHES FOR CLOTHING; EM-

BROIDERY; EMBROIDERED MONOGRAM TABS; EMBROIDERED LABELS; EMBROIDERED LETTERING; EMBROIDERED ROSETTES; RIBBONS; HAT ORNAMENTS NOT OF PRECIOUS METALS, NAMELY, HAT AND HEAD BANDS; HAIR GRIPS, IN CLASS 26 (U.S. CLS. 37, 39, 40, 42 AND 50).

FOR: TOYS, NAMELY, PLUSH TOYS, STUFFED TOYS, SPINNING TOPS, BUILDING BLOCKS, DOLLS; PLAYTHINGS, NAMELY, BOARD GAMES, PLAYING CARDS, BALLS FOR GAMES; GAMES, NAMELY, DICE GAMES, HAND HELD UNIT FOR PLAYING ELECTRONIC GAMES, BOARD GAMES; SPORTING ARTICLES, NAMELY, ELBOW GUARDS, EXPANDERS FOR EXERCISING, GLOVES FOR GAMES, KNEE GUARDS, INLINE ROLLER SKATES; BAGS FOR SPORT ITEMS; PLAY BALLOONS; BATH TOYS; BOARD GAMES; CARD GAMES; CHRISTMAS NOVELTIES, NAMELY, ORNAMENTS AND DECORATIONS FOR CHRISTMAS TREES; TOY CONSTRUCTION SETS; ELECTRONIC DART GAMES AND DART APPARATUS, NAMELY, DARTS, DART BOARDS, DART POINTS; DICE GAMES; EDUCATIONAL PLAYTHINGS, NAMELY, MANIPULATIVE GAMES, JIGSAW PUZZLES; PUZZLES; ELECTRONIC TOYS AND GAMES, NAMELY, AMUSEMENT MACHINES; TOY FIGURINES; FOOTBALLS AND FOOTBALL APPARATUS, NAMELY, FOOTBALL ELBOW PADS, FOOTBALL KNEE PADS, NETS FOR SPORTS; SPORT GLOVES, NAMELY, BASEBALL GLOVES, BATTING GLOVES, BOXING GLOVES, GOLF GLOVES, FENCING GLOVES; FITNESS APPARATUS, NAMELY, EXERCISERS, WEIGHT LIFTING BELTS, CHEST EXPANDERS, DUMB BELLS; INFLATABLE TOYS, JIGSAW PUZZLES; KITES; TOY MODEL VEHICLES AND RELATED ACCESSORIES SOLD AS UNITS; TOY GARAGES; PAPER TOYS, NAMELY, PAPER AIRPLANES, PAPER DOLLS, PAPER MOBILES; PAPER STREAMERS; PLASTIC MODELS, NAMELY, TOY MODEL KIT CARS; PLAY TENTS; PLUSH AND SOFT TOYS; PUZZLES; RIDE-ON OR IN TOYS, NAMELY, TOY BICYCLES AND TOY VEHICLES; ROLLER SKATES AND IN-LINE SKATES; SKATE BOARDS; SAIL AND SURFBOARDS; BOB-SLEIGHS; TOY VEHICLE TRACKS AND RACING SETS; TOY MONEY BOXES; PARTY NOVELTIES, NAMELY, PARTY FAVORS IN THE NATURE OF SMALL

TOYS; SCALE MOTOR VEHICLES, IN CLASS 28 (U.S. CLS. 22, 23, 38 AND 50).

FOR: INFORMATION RELATING TO ENTERTAINMENT OR EDUCATION, PROVIDED ON-LINE FROM A COMPUTER DATABASE OR THE INTERNET; PROVIDING ON-LINE CARD ELECTRONIC GAMES BY MEANS OF THE INTERNET; PROVIDING ON-LINE NON-DOWNLOADABLE ELECTRONIC PUBLICATIONS IN THE FORM OF JOURNALS, AND MAGAZINES IN THE FIELD OF AUTO RACING; PUBLICATION OF ELECTRONIC BOOKS AND JOURNALS ON-LINE; ORGANIZING SPORTING AND CULTURAL ACTIVITIES; ENTERTAINMENT SERVICES IN THE NATURE OF LIVE ACTION, COMEDY, DRAMA, ANIMATED TELEVISION PROGRAMS AND ANIMATED MOTION PICTURE FILMS; PRODUCTION OF LIVE ACTION, COMEDY, DRAMA, ANIMATED TELEVISION PROGRAMS AND ANIMATED MOTION PICTURE FILMS; ENTERTAINMENT SERVICES IN THE NATURE OF PARTICIPATING IN AUTOMOBILE RACES AND RELATED EXHIBITIONS; PROVIDING TRAINING AND ENTERTAINMENT FACILITIES FOR GO-KART, OFF ROAD VEHICLES AND QUAD BIKES; CONSULTANCY IN THE FIELD OF MOTOR SPORTS, IN CLASS 41 (U.S. CLS. 100, 101 AND 107).

PRIORITY DATE OF 12-13-2005 IS CLAIMED.

OWNER OF INTERNATIONAL REGISTRATION 0919753 DATED 6-9-2006, EXPIRES 6-9-2016.

OWNER OF U.S. REG. NOS. 2,705,881 AND 2,705,882.

THE NAME "JENSON" IDENTIFIES A LIVING INDIVIDUAL WHOSE CONSENT IS OF RECORD.

THE MARK CONSISTS OF THE WORD "JENSON" WITH A BUTTON REPLACING THE LETTER "O" AND THE BUTTON EVOKING THE BRITISH FLAG.

SER. NO. 79-036,785, FILED 6-9-2006.

WILLIAM ROSSMAN, EXAMINING ATTORNEY

**Int. Cls.: 9 and 37**

**Prior U.S. Cls.: 21, 23, 26, 36, 38, 100, 103 and 106**

**United States Patent and Trademark Office**

**Reg. No. 3,505,454**

**Registered Sep. 23, 2008**

**TRADEMARK  
SERVICE MARK  
PRINCIPAL REGISTER**



BAC ELECTRONIC GMBH (FED REP GERMANY  
LIMITED LIABILITY COMPANY)  
HEILBRONNER STRASSE 15/1  
73037 GÖPPINGEN  
FED REP GERMANY

OWNER OF INTERNATIONAL REGISTRATION  
0919870 DATED 2-1-2007, EXPIRES 2-1-2017.

FOR: ELECTRONIC TEMPERATURE CONTROL  
CIRCUITS FOR REGULATING THE TEMPERA-  
TURE OF LOW-PRESSURE CASTING MACHINES  
USED TO MAKE PARTS FOR THE AUTOMOTIVE,  
AVIATION AND MACHINE TOOL MANUFACTUR-  
ING INDUSTRIES; SOFTWARE IN THE FOUNDRY  
SECTOR, NAMELY, SOFTWARE FOR CONTROL  
SYSTEMS FOR PRESSURE CASTING MACHINES,  
IN CLASS 9 (U.S. CLS. 21, 23, 26, 36 AND 38).

NO CLAIM IS MADE TO THE EXCLUSIVE  
RIGHT TO USE "ELECTRONIC", APART FROM  
THE MARK AS SHOWN.

THE COLOR(S) RED IS/ARE CLAIMED AS A  
FEATURE OF THE MARK.

FOR: INSTALLATION, MAINTENANCE AND  
REPAIR OF ELECTRONIC TEMPERATURE CON-  
TROL CIRCUITS FOR REGULATING THE TEM-  
PERATURE OF LOW-PRESSURE CASTING  
MACHINES USED TO MAKE PARTS FOR THE  
AUTOMOTIVE, AVIATION AND MACHINE TOOL  
MANUFACTURING INDUSTRIES, IN CLASS 37  
(U.S. CLS. 100, 103 AND 106).

THE COLOR WHITE APPEARS IN THE WORD  
"BAC" IN THE RIGHT RECTANGLE; THE COLOR  
RED APPEARS IN THE WORD "ELECTRONIC"  
AND THE LEFT RECTANGLE AND AS BORDER  
AROUND THE WORDS "BAC ELECTRONIC".

SER. NO. 79-036,843, FILED 2-1-2007.

PRIORITY DATE OF 11-27-2006 IS CLAIMED.

B. PARADEWELAI, EXAMINING ATTORNEY

**Int. Cls.: 3, 9, 18, 25 and 35**

**Prior U.S. Cls.: 1, 2, 3, 4, 6, 21, 22, 23, 26, 36, 38, 39, 41, 50, 51, 52, 100, 101 and 102**

**Reg. No. 3,505,455**

**United States Patent and Trademark Office**

**Registered Sep. 23, 2008**

**TRADEMARK  
SERVICE MARK  
PRINCIPAL REGISTER**

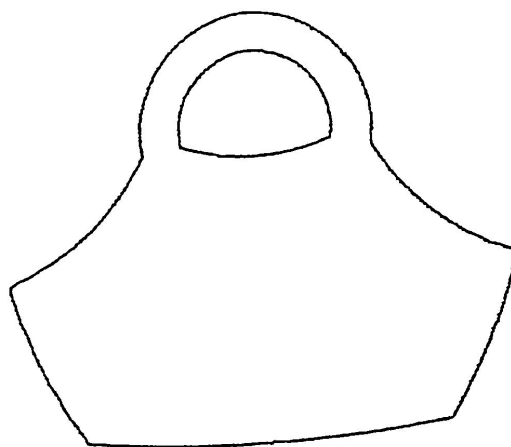

ROSATO GIOIELLI S.R.L. (ITALY SOCIÉTÉ À  
RESPONSABILITÉ LIMITÉE)

VIA ROMA, 26  
I-52100 AREZZO (AR)  
ITALY

FOR: NON-MEDICATED TOILETRIES, EAU DE PARFUM, ESSENTIAL OILS, BATH OILS AND FOAMS; COSMETIC PRODUCTS, NAMELY, BEAUTY CREAMS, FACE AND BODY CREAMS, HAIR LOTIONS, BODY LOTIONS, FACE LOTIONS AND BEAUTY MASKS, MAKE-UP PREPARATIONS, NAMELY, EYE SHADOWS, EYE PENCILS, LIP GLOSS, MASCARA, TALCUM POWDER, MAKE-UP POWDER, FACE POWDER, BLUSH, FOUNDATION, NAIL VARNISH FOR COSMETIC PURPOSES, HAIR CARE PRODUCTS, NAMELY, SHAMPOOS, HAIR CONDITIONERS, HAIR GELS AND HAIR MOUSSES; SKIN CONDITIONERS, IN CLASS 3 (U.S. CLS. 1, 4, 6, 50, 51 AND 52).

FOR: SUNGLASSES, GLASSES, NAMELY, CORRECTIVE GLASSES, SKI GLASSES; EYE GLASSES, NAMELY, AESTHETIC GLASSES, PROTECTIVE GLASSES, GLASSES FOR SPORTS, NAMELY, MOTORCYCLISTS, MOTOR SCOOTERISTS, CYCLISTS, AND SKIERS; SPECTACLES FRAMES, CASES AND PROTECTIVE COVERS FOR SPECTACLES, PROTECTIVE HELMETS, IN CLASS 9 (U.S. CLS. 21, 23, 26, 36 AND 38).

FOR: HANDBAGS, TRAVELING LEATHER BAGS, KNITTED HANDBAGS NOT IN PRECIOUS METALS, SHOULDER BAGS, BACKPACKS, TRAVELING BAGS, LEATHER SHOPPING BAGS, MESH SHOPPING BAGS, TEXTILE SHOPPING BAGS, WALLETS, PURSES, DOCUMENT CASES, LUGGAGE, SUITCASES, GARMENT BAGS FOR TRAVEL, BRIEFCASES, TRUNKS, VANITY CASES NOT FITTED SOLD EMPTY, LEATHER CASES FOR KEYS, KEY WALLETS, KEY BAGS, UMBRELLAS, PARASOLS AND WALKING STICKS, SADDLERY, IN CLASS 18 (U.S. CLS. 1, 2, 3, 22 AND 41).

FOR: ARTICLES OF CLOTHING, NAMELY, JERSEYS AND SWEATERS, SHIRTS, JACKETS, BLOUSONS, RAINCOATS, OVERCOATS, TROUSERS, SKIRTS, BATHING SUITS, UNDERWEAR, STOCKINGS, SCARVES, FOULARDS, SILK POCKET SQUARES, GLOVES, CLOTHING BELTS, SHOES, BOOTS, SLIPPERS, SPORTING FOOTWEAR, HATS AND CAPS, IN CLASS 25 (U.S. CLS. 22 AND 39).

FOR: ORGANIZING EXHIBITIONS FOR COMMERCIAL AND ADVERTISING PURPOSES; RETAIL STORE SERVICES, NAMELY, BRINGING TOGETHER A VARIETY OF FASHION GOODS IN STORES; RETAIL DEPARTMENT STORES; ONLINE RETAIL STORES FEATURING FASHION GOODS, IN CLASS 35 (U.S. CLS. 100, 101 AND 102).

PRIORITY DATE OF 11-22-2006 IS CLAIMED.

OWNER OF INTERNATIONAL REGISTRATION  
0919956 DATED 1-19-2007, EXPIRES 1-19-2017.

SER. NO. 79-036,878, FILED 1-19-2007.

THE TRADEMARK CONSISTS OF THE STY-  
LIZED DEPICTION OF A HANDBAG.

CHRISTINA SOBRAL, EXAMINING ATTORNEY



Int. Cls.: 6, 9, 35, 36, 37, 38, 39, 41, 42 and 45

Prior U.S. Cls.: 2, 12, 13, 14, 21, 23, 25, 26, 36, 38, 50,  
100, 101, 102, 103, 104, 105, 106 and 107

Reg. No. 3,505,456

United States Patent and Trademark Office

Registered Sep. 23, 2008

**TRADEMARK  
SERVICE MARK  
PRINCIPAL REGISTER**

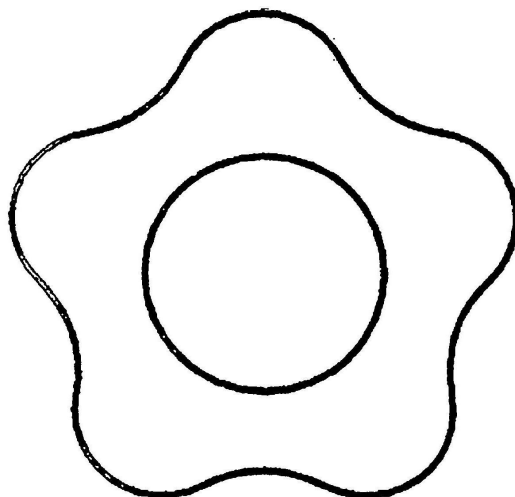

SECURITAS DIRECT AB (SWEDEN JOINT  
STOCK COMPANY)  
BOX 2511  
LINKÖPING, SWEDEN SE580 02

FOR: GATES OF METAL AND DOORS OF METAL; METAL SAFES; METAL GRILLES, NAMELY, METAL GRATES; NON-ELECTRICAL LOCKS OF METAL; METAL KEY TUBES, IN CLASS 6 (U.S. CLS. 2, 12, 13, 14, 23, 25 AND 50).

FOR: SECURITY SYSTEMS CONSISTING OF ALARMS, NAMELY, BURGLAR ALARMS, FIRE ALARMS, ANTI-INTRUSION ALARMS, WATER LEAKAGE ALARMS, ENGINE BREAK DOWN ALARMS; CONTROL UNITS, NAMELY, REMOTE CONTROLS FOR BURGLAR ALARMS, FIRE ALARMS, ANTI-INTRUSION ALARMS, WATER LEAKAGE ALARMS, ENGINE BREAK DOWN ALARMS; TELEVISIONS, VIDEO UNITS, NAMELY, VIDEO MONITORS, DIGITAL VIDEO RECORDERS; TELEPHONES; PASS CONTROL EQUIPMENT, NAMELY ACCESS CONTROL UNITS, NAMELY, ACCESS CONTROL AND ALARM MONITORING SYSTEMS; AUTOMATED SECURITY GATES, ELECTRIC GATE AND DOOR OPERATORS; IDENTITY CHECKING UNITS, NAMELY, RADIO FREQUENCY IDENTIFICATION READERS, INFRARED IDENTIFICATION READERS AND ULTRASOUND IDENTIFICATION READERS; CON-

TROL UNITS FOR AUTOMATIC DOORS AND ELECTRIC LOCKING PLATES, SMOKE, HEAT, TEMPERATURE, SOUND, OPTICAL, VIBRATION, ANTI-THEFT, EMERGENCY, SECURITY AND MOVEMENT DETECTORS; CONTROL PANELS FOR ALARM AND PROTECTION SYSTEMS; CONTROL DESKS FOR ALARM AND PROTECTION SYSTEMS; ELECTRIC CONTACTS, ELECTROMAGNETIC LOCKS; SOUND RECORDING DEVICES, NAMELY, TAPE RECORDERS; TELECOMMUNICATIONS INSTRUMENTS, NAMELY, TELEPHONES AND BURGLAR ALARMS, FIRE ALARMS, ANTI-INTRUSION ALARMS, WATER LEAKAGE ALARMS, ENGINE BREAK DOWN ALARMS TRANSMITTING INFORMATION THROUGH TELECOMMUNICATION TO CONTROL UNIT OR TELEPHONES; RADIO ENGINEERING INSTRUMENTS, NAMELY, RADIO FREQUENCY IDENTIFICATION TAGS, PHOTOGRAPHIC INSTRUMENTS AND APPARATUS, NAMELY, VIDEO CAMERAS AND VIDEO SURVEILLANCE CAMERAS, VIDEO TECHNOLOGY INSTRUMENTS AND APPARATUS, NAMELY, VIDEO CAMERAS AND VIDEO SURVEILLANCE CAMERAS; ACOUSTIC APPARATUS AND INSTRUMENTS, NAMELY, ULTRASOUND IDENTIFICATION UNITS, SIRENS AND HORNS, IN THE NATURE OF ELECTRONIC WARNING HORNS; OPTICAL APPARATUS AND INSTRUMENT, NAMELY, OPTICAL SCANNERS AND SENDERS,

IN THE NATURE OF COMPUTER HARDWARE FOR MONITORING REMOTE CONTROLS, REMOTE OPERATING, REMOTE METERING, INFORMATION TRANSMISSION, INFORMATION GATHERING, MESSAGE SENDING, WIRE-TAPPING, POSITION FINDING, RELAYING AND ALARM PURPOSES; SUPERVISION AND TELECOMMUNICATIONS TRANSMISSION APPARATUS AND INSTRUMENTS, NAMELY, SECURITY CAMERAS AND TELECOMMUNICATIONS EXCHANGERS; LIFE-SAVING AND TEACHING APPARATUS AND INSTRUMENTS, NAMELY, FIRE ESCAPE LADDERS, FIRE BLANKETS, LIFE JACKETS AND CPR-EQUIPMENT, NAMELY, CPR MASKS; FIRE-EXTINGUISHER APPARATUS; FIRE-PROTECTION INSTALLATIONS, NAMELY, FIRE HYDRANTS, FIRE ALARMS AND FIRE DETECTORS; BAR CODE READERS; ACTIVE AND PASSIVE IDENTITY AND INFORMATION CARRIERS, NAMELY, BLANK SMART CARDS AND ENCODED ELECTRONIC SMART CARDS CONTAINING PROGRAMMING USED FOR IDENTIFICATION AND CONTROLLING OF ALARM AND PROTECTION SYSTEMS; INDUCTIVE READERS, NAMELY, ELECTRONIC CARD AND TAG READERS AND CARRIERS, NAMELY, BLANK SMART CARDS AND ENCODED ELECTRONIC SMART CARDS CONTAINING PROGRAMMING USED FOR IDENTIFICATION AND CONTROLLING OF ALARM AND PROTECTION SYSTEMS; INTER-COMMUNICATION APPARATUS, NAMELY, TWO-WAY RADIOS; ACOUSTIC AND OPTICAL ALARM DEVICES, NAMELY, BURGLAR ALARMS, FIRE ALARM, ANTI-INTRUSION ALARMS, WATER LEAKAGE ALARMS, ENGINE BREAK DOWN ALARMS; COMPUTER SOFTWARE FOR USE IN DATABASE ARRANGEMENT AND USE IN CONTROLLING ALARM AND PROTECTION SYSTEMS; REPLACEMENT PARTS FOR THE AFORESAID GOODS, IN CLASS 9 (U.S. CLS. 21, 23, 26, 36 AND 38).

FOR: ADVERTISING VIA MAIL ORDER, NAMELY, DISTRIBUTION OF ADVERTISING MAIL AND OF ADVERTISING SUPPLEMENTS ATTACHED TO REGULAR EDITIONS; DIRECT MAIL ADVERTISING; DATA PROCESSING SERVICES, NAMELY, COMPILATION OF INFORMATION INTO DATABASES AND HOME PAGES; COMPUTERIZED FILE MANAGEMENT; PROVIDING CONSUMER INFORMATION ABOUT PRODUCTS AND SERVICES RELATING TO PERSONAL PROTECTION AND SECURITY; TELEPHONE ANSWERING SERVICES; CUSTOMER SUPPORT SERVICES VIA TELEPHONE OR COMPUTER RELATING TO GPS POSITIONING OF MOTOR VEHICLES, BOATS, PERSONS, ANIMALS OR OTHER MOVABLE ARTICLES, IN CLASS 35 (U.S. CLS. 100, 101 AND 102).

FOR: MONETARY AFFAIRS, NAMELY, DEBIT AND CREDIT CARD SERVICES; FINANCING SERVICES; PROVIDING INFORMATION IN THE FIELD OF INSURANCE AND INSURANCE CONSULTANCY; SAFE DEPOSIT SERVICES AND SAFETY DEPOSIT BOX SERVICES, NAMELY, PROVIDING FOR THE DEPOSIT OF VALUABLES AND CONFIDENTIAL INFORMATION; LEASING OF ALARM AND

SECURITY DEVICES; LEASING OF ALARM EQUIPMENT, IN CLASS 36 (U.S. CLS. 100, 101 AND 102).

FOR: INSTALLATION, REPAIR AND MAINTENANCE OF BURGLAR, FIRE, SECURITY, ANTI-THEFT, ASSAULT, FREEZE, TEMPERATURE AND MONITORING ALARMS; INSTALLATION, REPAIR AND MAINTENANCE OF ELECTRIC EQUIPMENT AND MACHINES, NAMELY, HOME OFFICE AND OFFICE MACHINERY AND EQUIPMENT, SAFES AND TELECOMMUNICATIONS EQUIPMENT; REPAIR OF ALARM AND PROTECTION SYSTEMS FOR HOMES, BUILDINGS AND OFFICES; EXTERMINATION OF VERMIN OTHER THAN FOR AGRICULTURE; WINDOW CLEANING; CLEANING SERVICES, NAMELY, CLEANING OF HOMES, OFFICES, VEHICLES, BUILDINGS, DOORS, WALLS, FLOORS AND CEILINGS; WASTE DISPOSAL FOR OTHERS; REPAIR AND MAINTENANCE OF ELECTRICAL DOMESTIC APPLIANCES, ELECTRICAL APPARATUS OR OTHER OPERATING SYSTEMS IN PRIVATE LODGING OR ENTERPRISES, NAMELY, AIR-CONDITIONERS, HEATERS, REFRIGERATORS, DISHWASHERS, CLOTHES WASHERS AND DRYERS, IN CLASS 37 (U.S. CLS. 100, 103 AND 106).

FOR: COMPUTER-AIDED TRANSMISSION OF MESSAGES AND IMAGES; ELECTRONIC MAIL SERVICES; MESSAGE SENDING; COMMUNICATIONS BY MOBILE TELEPHONE, COMPUTER TERMINAL OR TELEPHONE; PAGING SERVICES CONDUCTED VIA RADIO, TELEPHONE, SATELLITE OR OTHER ELECTRONIC EQUIPMENT; SATELLITE TRANSMISSION SERVICES; RENTAL OF ELECTRONIC AND TELECOMMUNICATIONS MESSAGE SENDING APPARATUS; RENTAL OF MODEMS AND OTHER TELECOMMUNICATION EQUIPMENT; RENTAL OF TELECOMMUNICATION EQUIPMENT; PROVIDING INFORMATION RELATED TO THE STATUS OF COMMUNICATION SYSTEMS, IN CLASS 38 (U.S. CLS. 100, 101 AND 104).

FOR: STORAGE SERVICES; STORAGE OF KEYS, IN CLASS 39 (U.S. CLS. 100 AND 105).

FOR: PROVIDING INFORMATION IN THE FIELD OF EDUCATION; RENTAL OF VIDEO CASSETTE RECORDERS AND VIDEO CAMERAS; PHOTOGRAPHY SERVICES, IN CLASS 41 (U.S. CLS. 100, 101 AND 107).

FOR: ENGINEERING AND LEGAL CONSULTANCY, DESIGN, UPDATING AND MAINTENANCE OF COMPUTER SOFTWARE; DESIGN OF SECURITY SYSTEMS, IN CLASS 42 (U.S. CLS. 100 AND 101).

FOR: ALL TYPES OF PROTECTION AND SECURITY SERVICES, NAMELY, SECURITY GUARD AND PROTECTION GUARD SERVICES, MONITORING OF SECURITY AND PROTECTION SYSTEMS, CIVIL PROTECTION, AND PROTECTION AND SECURITY SERVICES, NAMELY, MONITORING SECURITY ALARMS TO PROTECT AGAINST BURGLARY, FIRE, FLOOD AND WATER LEAKAGE; LOCKSMITHING, NAMELY, OPENING OF LOCKS; CENTRAL ALARM SERVICES, NAMELY, MONI-

TORING ALARMS; ALARM RESPONSE AND VERIFICATION SERVICES, NAMELY, INFORMING OF ALARMS TO INDIVIDUALS AND COMPANIES AND INFORMING WATCH MEN OF ALARMS; ALARM MONITORING SERVICES; SECURITY GUARD SERVICES, NAMELY, MOBILE AND STATIONARY GUARD SERVICES RESCUE ALARM SERVICES IN THE NATURE OF VERIFICATION SERVICES, NAMELY, INFORMING OF ALARMS TO INDIVIDUALS AND COMPANIES AND INFORMING WATCHMEN OF ALARMS; PROVIDING ASSISTANCE IN CASE OF BURGLARY, FIRE, FLOOD AND WATER LEAKAGE, NAMELY, MONITORING SECURITY ALARMS; RENTAL OF SAFES AND OTHER SECURITY EQUIPMENT, NAMELY, BURGLAR ALARMS, FIRE ALARMS, ANTI-INTRUSION ALARMS, WATER LEAKAGE ALARMS, ENGINE BREAK DOWN ALARMS; SECURITY CONSULTANCY, NAMELY, PERSONAL, DOMESTIC, BUSINESS AND OFFICE SECURITY CONSULTATION; PERSONAL BODYGUARD SERVICES; CONCIERGE SERVICES FOR OTHERS COMPRISING MAKING REQUESTED PERSONAL ARRANGEMENTS AND RESERVATIONS AND PROVIDING CUSTOMER-SPECIFIC INFORMA-

TION TO MEET INDIVIDUAL NEEDS RENDERED TOGETHER IN A APARTMENT COMPLEX, BUSINESS CONFERENCE, SHOPPING CENTER AND INDUSTRIAL ESTATES, NAMELY, OFFICE BUILDINGS; SECURITY SERVICES, NAMELY, GEOGRAPHIC POSITIONING SERVICES FOR THE PURPOSE OF FINDING THE LOCATION OF LIVING BEINGS AND OBJECTS BY RADIO, TELEPHONE, SATELLITE OR OTHER ELECTRONIC EQUIPMENT; REMOTE ALARM MONITORING SERVICES TO INDIVIDUALS AND COMPANIES IN CASE OF BURGLARY, FIRE, FLOOD, WATER LEAKAGE, VIA TELEPHONE OR COMPUTER, RELATED TO DIFFERENT SECURITY, PLANT SUPERVISION AND SAFETY SYSTEMS, IN CLASS 45 (U.S. CLS. 100 AND 101).

OWNER OF INTERNATIONAL REGISTRATION 0921024 DATED 12-21-2006, EXPIRES 12-21-2016.

SER. NO. 79-037,294, FILED 12-21-2006.

ROBERT STRUCK, EXAMINING ATTORNEY

**Int. Cl.: 7**

**Prior U.S. Cls.: 13, 19, 21, 23, 31, 34 and 35**

**United States Patent and Trademark Office**

**Reg. No. 3,505,457**

**Registered Sep. 23, 2008**

**TRADEMARK  
PRINCIPAL REGISTER**

**PERFECTA** 

TEEPACK SPEZIALMASCHINEN; GMBH & CO.  
KG (FED REP GERMANY COMPANY UNDER  
GERMAN LAW)  
DÜSSELDORFER STRASSE 73  
40667 MEERBUSCH  
FED REP GERMANY

PRIORITY DATE OF 9-13-2006 IS CLAIMED.

OWNER OF INTERNATIONAL REGISTRATION  
0921063 DATED 3-12-2007, EXPIRES 3-12-2017.

FOR: FILLING AND PACKAGING MACHINES,  
AND PARTS THEREOF, FOR FILLING PACKAGES,  
BOXES, BAGS, ENVELOPES, WRAPPINGS, POU-  
CHES, AND CARTONS WITH TEAS, IN CLASS 7  
(U.S. CLS. 13, 19, 21, 23, 31, 34 AND 35).

SER. NO. 79-037,310, FILED 3-12-2007.

ESTHER BELENKER, EXAMINING ATTORNEY

**Int. Cls.: 7 and 42**

**Prior U.S. Cls.: 13, 19, 21, 23, 31, 34, 35, 100 and 101**

**United States Patent and Trademark Office**

**Reg. No. 3,505,458**

**Registered Sep. 23, 2008**

**TRADEMARK  
SERVICE MARK  
PRINCIPAL REGISTER**

# MULTISTEP

MIKRON HOLDING AG (SWITZERLAND JOINT  
STOCK COMPANY)  
MÜHLEBRÜCKE 2  
CH-2502 BIEL/BIENNE, SWITZERLAND

FOR: TRANSFER MACHINES FOR THE PROCES-  
SING OF PRODUCTION PARTS; AUTOMATIC AS-  
SEMBLY MACHINES; INDUSTRIAL ROBOTS,  
TRANSPORT CONVEYORS AND FEEDING CON-  
VEYORS, IN CLASS 7 (U.S. CLS. 13, 19, 21, 23, 31, 34  
AND 35).

FOR: TECHNICAL PROJECT PLANNING FOR  
ASSEMBLING AND PROCESSING PLANTS; TECH-  
NICAL PROJECT STUDIES IN THE FIELD OF  
MECHANICAL CONSTRUCTION AND OF AUTO-

MATIC MACHINE CONSTRUCTION; DEVELOP-  
MENT OF ELECTRIC, ELECTRONIC AND  
PNEUMATIC CONTROLLING DEVICES, IN CLASS  
42 (U.S. CLS. 100 AND 101).

OWNER OF INTERNATIONAL REGISTRATION  
0639237 DATED 7-19-1995, EXPIRES 7-19-2015.

OWNER OF U.S. REG. NO. 2,036,672.

SER. NO. 79-037,319, FILED 11-22-2006.

CHRISTINE COOPER, EXAMINING ATTORNEY

**Int. Cls.: 6, 9, 14, 16, 18, 20, 21, 25, 28, 41 and 42**

**Prior U.S. Cls.: 1, 2, 3, 5, 12, 13, 14, 21, 22, 23, 25, 26, 27, 28, 29, 30, 32, 33, 36, 37, 38, 39, 40, 41, 50, 100, 101 and 107**

**Reg. No. 3,505,459**

**United States Patent and Trademark Office**

**Registered Sep. 23, 2008**

**TRADEMARK  
SERVICE MARK  
PRINCIPAL REGISTER**



UNION DES ASSOCIATIONS EUROPÉENNES;  
DE FOOTBALL (UEFA) (SWITZERLAND AS-  
SOCIATION)  
ROUTE DE GENÈVE 46  
CH-1260 NYON 2  
SWITZERLAND

FOR: METAL RINGS AND METALLIC CHAINS FOR KEYS; METAL CASTINGS, NAMELY, METAL EMBLEMS FOR VEHICLES; FIGURINES, STATUETTES, AND ORNAMENTS OF COMMON METALS AND THEIR ALLOYS INCLUDED IN THIS CLASS, IN CLASS 6 (U.S. CLS. 2, 12, 13, 14, 23, 25 AND 50).

FOR: PARTS FOR COMPUTERS, NAMELY, COMPUTER CHIPS; OPTICAL DISCS, NAMELY, BLANK OPTICAL DISCS; OPTICAL DISCS FEATURING FOOTBALL; RECORDED COMPUTER OPERATING PROGRAMS; ENTERTAINMENT APPARATUS, NAMELY, SMALL ELECTRONIC VIDEO GAME MACHINES INTENDED FOR USE WITH A TELEVISION SET; MECHANISMS VIDEO GAMES, NAMELY, VIDEO GAME MACHINES FOR USE WITH EXTERNAL TELEVISIONS, VIDEO GAME SOFTWARE; COMPUTER GAMES, NAMELY, COMPUTER GAME PROGRAMS, COMPUTER GAME TAPES, COMPUTER GAME SOFTWARE; SOUND RECORDING MEDIA, NAMELY, BLANK MAGNETIC TAPES FOR TAPE RECORDERS; MAGNETIC WIRES AND FILAMENTS, NAMELY, MAGNETIC TELEPHONE WIRES AND LIGHT CONDUCTING FILAMENTS; COMPACT DISCS

FEATURING FOOTBALL; INTERACTIVE COMPACT DISCS FEATURING FOOTBALL; SUNGLASSES, SPECTACLES, CASES AND CHAINS FOR SUNGLASSES AND SPECTACLE GLASSES; APPARATUS FOR RECORDING, TRANSMITTING AND REPRODUCING SOUNDS AND IMAGES; COMPUTERS; DATA PROCESSORS; MODEMS; ACOUSTIC COUPLERS; FLOPPY DISC DRIVES; PRINTERS FOR USE WITH COMPUTERS AND PLOTTERS; BAR CODE READERS; ELECTRIC DISTRIBUTION CONSOLES, NAMELY, VIDEO DISPLAY CONSOLES; DATA ENTRY KEYBOARDS; COMPUTER MEMORY APPARATUS, NAMELY, MEMORY CARDS, COMPUTER MEMORY HARDWARE; COMPUTER INTERFACE APPARATUS, NAMELY, COMPUTER INTERFACE BOARDS; COMPUTER DATA ENTRY AND TRANSFER APPARATUS, FOR COIN-OPERATED APPARATUS, NAMELY, AUTOMATIC COIN-OPERATED AMUSEMENT MACHINES; ADDING MACHINES; LOUDSPEAKERS, VIDEO CAMERAS, CAMERAS, VIDEOCASSETTE RECORDERS FOR CAMERAS; VIDEOTAPES RECORDED WITH ANIMATION; SOUND RECORDING MEDIA, NAMELY, BLANK MAGNETIC TAPES FOR TAPE RECORDERS, BLANK CD-ROMS; FACSIMILE TRANSMITTING APPARATUS; PHOTOCOPYING APPARATUS AND EQUIPMENT, NAMELY, PHOTOCOPYING MACHINES, UNFILLED INK CARTRIDGES FOR PHOTOCOPY MACHINES; PHOTOGRAPHIC EQUIPMENT, NAMELY, PHOTOGRAPH PROJECTION APPARATUS, PROJECTION SCREENS, EX-

POSED CAMERA FILMS, FLASH-BULBS, BATTERIES, MAGNETS, CINEMATOGRAPHIC FILM; MOBILE PHONES, PAGERS, INTEGRATED CIRCUITS, BLANK SMARTCARDS, LAPTOP COMPUTERS; STRUCTURAL AND COMPONENT PARTS THEREOF FOR ALL THE ABOVE GOODS INCLUDED IN THIS CLASS, IN CLASS 9 (U.S. CLS. 21, 23, 26, 36 AND 38).

FOR: CHRONOMETRIC APPARATUS AND INSTRUMENTS, NAMELY, TIMEPIECES, ALARM CLOCKS, STOPWATCHES; CHRONOMETRIC INSTRUMENTS, NAMELY, STOPWATCHES USED AS TIMERS; WATCH STRAPS, WATCH GLASSES, WATCH SPRINGS, WATCH CHAINS; JEWELRY, NECKLACES, BRACELETS, EARRINGS, RINGS, JEWELRY CHAINS, PINS BEING JEWELRY, BROOCHES, JEWELRY, NAMELY, NEEDLES OF PRECIOUS METAL; INSIGNIAS OF PRECIOUS METAL; COSTUME JEWELRY, CUFFLINKS, JEWELRY CASES, CIGARETTE BOXES AND CASES OF PRECIOUS METAL, SMALL DRINKING FLASKS OF PRECIOUS METAL, SMALL ENGRAVED DRINKING FLASKS OF PRECIOUS METAL, POWDER COMPACTS OF PRECIOUS METAL SOLD EMPTY; CROCKERY, NAMELY, CRUETS OF PRECIOUS METAL; STATUES MADE OF PRECIOUS METAL, VASES OF PRECIOUS METAL, ORNAMENTS MADE OF PRECIOUS METAL, RINGS FOR KEYS, KEY HOLDERS, ALL OF THE AFOREMENTIONED GOODS MADE OF PRECIOUS METALS AND THEIR ALLOYS AND PLATED THEREWITH; JEWELRY; PRECIOUS STONES; PENDANTS, MEDALS, MEDALLIONS; JEWELRY, NAMELY, PINS FOR TEAMS AND PLAYERS MADE OF PRECIOUS METAL; TIE CLIPS, TIEPINS; ASHTRAYS MADE OF PRECIOUS METALS; COSTUME JEWELRY, NAMELY, PINS IN COMMON METALS OR THEIR ALLOYS AND PLASTIC; COSTUME JEWELRY, NAMELY, PLASTIC INSIGNIAS, IN CLASS 14 (U.S. CLS. 2, 27, 28 AND 50).

FOR: PRINTED MATTER, NAMELY, PAPER, CARDBOARD AND STATIONERY; BOOKS AND MAGAZINES FEATURING REVIEWS ON COMPUTERS; NEWSLETTERS IN THE FIELD OF VIDEO GAMES; CALENDARS; WRITING IMPLEMENTS; GIFT WRAPPING PAPER, GREETING CARDS, INVITATION CARDS, ILLUSTRATED GREETING CARDS; POSTCARDS; TRANSFERS; STICKERS; PHOTOGRAPHS, PHOTOGRAPH ALBUMS, STAMP ALBUMS; POSTERS; INK PENS, BALLPOINT PENS, FELT-TIP PENS, PENCILS, PEN NIBS, COLORED PENCILS, MARKERS; PEN AND PENCIL CASES AND HOLDERS; PAPERWEIGHTS; ADHESIVES FOR STATIONERY OR HOUSEHOLD PURPOSES; PRINTED INSTRUCTIONAL AND TEACHING MATERIAL, NAMELY, MANUALS AND BOOKS IN THE FIELD OF FOOTBALL; PAPER PLAYING CARDS; PRINTING BLOCKS; PLASTIC OR PAPER BAGS FOR HOUSEHOLD USE, NAMELY, PLASTIC SACKS AND SMALL PLASTIC OR PAPER BAGS; CONICAL PAPER BAGS; TYPEWRITERS; OFFICE SUPPLIES EXCEPT FURNITURE, NAMELY, STAPLERS, PAPERCLIPS, BUSINESS CARDS, FILE FOLDERS; ELECTRIC AND NON-ELECTRIC OFFICE APPARATUS INCLUDED IN THIS CLASS,

NAMELY, STAPLERS, PENCIL SHARPENERS, TYPEWRITERS; PRINTED MATTER, NAMELY, PROSPECTUSES IN THE FIELD OF FOOTBALL TEAMS; PRINTERS' TYPE, BROCHURES ABOUT FOOTBALL; ENTRY TICKETS; PAPER FLAGS; STRUCTURAL AND COMPONENT PARTS THEREOF FOR ALL THE ABOVE GOODS INCLUDED IN THIS CLASS, IN CLASS 16 (U.S. CLS. 2, 5, 22, 23, 29, 37, 38 AND 50).

FOR: LUGGAGE; GOODS MADE OF LEATHER AND IMITATION LEATHER INCLUDED IN THIS CLASS, NAMELY, SHOULDER BELTS, LEATHER CASES, LEATHER FOR FURNITURE, LEATHER STRAPS; PURSES; BAGS INCLUDED IN THIS CLASS, NAMELY, CLUTCH BAGS; SADDLEBAGS; RUCKSACKS AND TRAVEL BAGS; WALLETS; BRIEFCASES, DOCUMENT WALLETS, NAMELY, WALLETS WITH CARD COMPARTMENTS; UMBRELLAS; ALL-PURPOSE SPORTS BAGS; CARRYALLS; PARASOLS, IN CLASS 18 (U.S. CLS. 1, 2, 3, 22 AND 41).

FOR: PLASTIC GOODS INCLUDED IN THIS CLASS, NAMELY, BUSTS OF PLASTIC, DOOR STOPS OF PLASTIC; STATUES, ORNAMENTS, RINGS FOR KEYS, KEY CHAINS, FIGURINES, STATUETTES, ALL OF THE ABOVE GOODS MADE OF PLASTIC; CUSHIONS; CUSHIONS AS CAR ACCESSORIES; CUSHIONS FOR USE OUTSIDE; SLEEPING BAGS FOR CAMPING; MIRRORS, IN CLASS 20 (U.S. CLS. 2, 13, 22, 25, 32 AND 50).

FOR: VASES, DRINKING VESSELS; GLASSES, NAMELY, DRINKING GLASSES, TUMBLERS; DISHES, PLATES, SAUCERS, COFFEE AND TEAPOTS NOT OF PRECIOUS METAL; TRAYS NOT OF PRECIOUS METAL; PLASTIC COASTERS; BOTTLE OPENERS; PLASTIC WATER BOTTLES, SOLD EMPTY; COMBS, HAIRBRUSHES, TOOTHBRUSHES; SPONGES FOR HOUSEHOLD PURPOSES; SMALL BEVERAGE CUPS NOT MADE OF METAL OR PRECIOUS METALS; PAPER OR PLASTIC BEVERAGE CUPS; PLASTIC MESS TINS; GLASS STATUETTES, IN CLASS 21 (U.S. CLS. 2, 13, 23, 29, 30, 33, 40 AND 50).

FOR: SPORTSWEAR, NAMELY, SWEAT SOCKS, JERSEYS, SHORTS; LEISUREWEAR, NAMELY, SWEATPANTS, LEGGINGS; T-SHIRTS, PULL-OVERS, SWEATSHIRTS, SHORTS, TRACKSUITS, UNDERSHIRTS, TOPS, TROUSERS, SKIRTS, DRESSES, SHIRTS, BLOUSES, POLO SHIRTS, JACKETS, COATS, SUITS, BLAZERS, UNDERGARMENTS; SHOES, FOOTWEAR; SOCKS, HOSIERY; HEADWEAR, NAMELY, HATS, CAPS, ABSORBENT HEADBANDS, HEADBANDS; SWIMMING COSTUMES; TIES, BRACES, CLOTHING, NAMELY, WRIST BAND BRACELETS; SCARVES, SHAWLS, GLOVES, MITTENS; PAJAMAS, ROMPER SUITS AND PLAY SUITS FOR SMALL CHILDREN, IN CLASS 25 (U.S. CLS. 22 AND 39).

FOR: BOARD GAMES AND BATH TOYS; GYMNASTICS AND SPORTS ARTICLES INCLUDED IN THIS CLASS, NAMELY, GYMNASTIC APPARATUS, PARALLEL BARS, TRAINING STOOLS, AND

VAULTING HORSES; HANDLE GRIPS FOR SPORTING EQUIPMENT; SPORT BALLS; SMALL ELECTRONIC GAMES OTHER THAN FOR USE WITH A TELEVISION SET; STRUCTURAL AND COMPONENT PARTS THEREOF FOR ALL THE ABOVE GOODS INCLUDED IN THIS CLASS, IN CLASS 28 (U.S. CLS. 22, 23, 38 AND 50).

FOR: ORGANIZATION AND CONDUCTING OF SPORTS' EVENTS AND COMPETITIONS IN THE FIELD OF FOOTBALL; ENTERTAINMENT IN THE NATURE OF FOOTBALL GAMES; PERSONAL TRAINING SERVICES IN THE FIELD OF STRENGTH CONDITIONING; PRODUCTION OF FILMS ON VIDEOTAPES, VIDEOCASSETTES AND VIDEO GRAMS; RENTAL OF AUDIO AND VIDEO EQUIPMENT, IN CLASS 41 (U.S. CLS. 100, 101 AND 107).

FOR: RENTAL OF ACCESS TIME TO A COMPUTER DATA BASE OR INTERNET SITE; BAR SERVICES; BEAUTY SALONS; HEALTH CARE; MAKING HOTEL RESERVATIONS FOR OTHERS; PROVIDING TEMPORARY ACCOMMODATION AND PROVIDING OF FOOD AND DRINK IN

RESTAURANTS; RESTAURANT SERVICES, FAST FOOD OUTLETS AND SELF-SERVICE RESTAURANTS; INTELLECTUAL PROPERTY LICENSING; SERVICES OF JOURNALISTS, NAMELY, COURT REPORTING; TRANSLATION SERVICES; PHOTOGRAPHY AND VIDEOTAPING AS WELL AS PHOTOGRAPHIC PRINTING SERVICES; COMPUTER CONSULTANCY; COMPUTER PROGRAMMING, NAMELY, DATA PROCESSING; VIDEO SURVEILLANCE AND SECURITY GUARD SERVICES; DRUG DISCOVERY SERVICES; SERVICES OF A GRAPHIC DESIGNER, IN CLASS 42 (U.S. CLS. 100 AND 101).

OWNER OF INTERNATIONAL REGISTRATION 0718095 DATED 4-16-1999, EXPIRES 4-16-2009.

THE MARK CONSISTS OF A TWO-DIMENSIONAL DEPICTION OF A TROPHY OR PRIZE CUP.

SER. NO. 79-037,323, FILED 9-13-2006.

DAVID MURRAY, EXAMINING ATTORNEY



**Int. Cls.: 3, 9, 14, 16, 18 and 25**

**Prior U.S. Cls.: 1, 2, 3, 4, 5, 6, 21, 22, 23, 26, 27, 28, 29, 36, 37, 38, 39, 41, 50, 51 and 52**

**Reg. No. 3,505,460**

**United States Patent and Trademark Office**

**Registered Sep. 23, 2008**

**TRADEMARK  
PRINCIPAL REGISTER**

**KURT MULLER**

KURT MULLER INTERNATIONAL; TRADE MARK LIMITED (UNITED KINGDOM LIMITED COMPANY)  
21 CLAYTON STREET,  
NEWCASTLE UPON TYNE; TYNE & WEAR NE1 5NP  
UNITED KINGDOM

FOR: LIQUID AND BAR SOAPS; PERFUMES; TOILETRIES, NAMELY, AFTERSHAVE AND SCENTED FACE AND BODY CREAMS; COSMETICS; SHAVING PREPARATIONS; AFTER SHAVE LOTIONS; ANTIPERSPIRANTS; DEODORANTS FOR PERSONAL USE; SHAMPOOS; HAIR LOTIONS; COSMETIC CREAMS, IN CLASS 3 (U.S. CLS. 1, 4, 6, 50, 51 AND 52).

FOR: SPECTACLES; SPECTACLE FRAMES; SPECTACLE CASES; SUNGLASSES; SUNGLASS CASES, IN CLASS 9 (U.S. CLS. 21, 23, 26, 36 AND 38).

FOR: JEWELLERY; HOROLOGICAL AND CHRONOMETRIC INSTRUMENTS; WATCHES INCORPORATING CHRONOMETERS; WATCH STRAPS; WATCH CHAINS; CUFF LINKS; TIE PINS; TIE CLIPS; ORNAMENTAL PINS; RINGS; NECKLACES; NECK CHAINS; BRACELETS; BROOCHES; EARRINGS; COSTUME JEWELLERY; KEY RINGS OF PRECIOUS METAL; CLOCKS; ALARM CLOCKS, IN CLASS 14 (U.S. CLS. 2, 27, 28 AND 50).

FOR: PENS; FOUNTAIN PENS; BALLPOINT PENS; PEN CASES; PRINTED MATTER, NAMELY, BOOKS IN THE FIELD OF FASHION, CALENDARS, IN CLASS 16 (U.S. CLS. 2, 5, 22, 23, 29, 37, 38 AND 50).

FOR: LEATHER AND IMITATIONS OF LEATHER, AND GOODS MADE OF THESE MATERIALS AND NOT INCLUDED IN OTHER CLASSES, NAMELY, TRAVEL BAGS; GARMENT BAGS FOR TRAVEL; SUIT CARRIERS; BACKPACKS; RUCKSACKS; BRIEFCASES; HANDBAGS; WALLETS; PURSES; KEY CASES; UMBRELLAS, IN CLASS 18 (U.S. CLS. 1, 2, 3, 22 AND 41).

FOR: CLOTHING, NAMELY, UNDERWEAR, SOCKS, TROUSERS, JACKETS, JEANS, TOPS, SHIRTS, BLOUSES, SWEATSHIRTS, JUMPERS, TIES, SCARVES, SKIRTS, SHORTS, SWIMWEAR; FOOTWEAR; HEADGEAR, NAMELY, HATS; BELTS, IN CLASS 25 (U.S. CLS. 22 AND 39).

THE MARK CONSISTS OF STANDARD CHARACTERS WITHOUT CLAIM TO ANY PARTICULAR FONT, STYLE, SIZE, OR COLOR.

PRIORITY DATE OF 5-16-2006 IS CLAIMED.

OWNER OF INTERNATIONAL REGISTRATION 0921241 DATED 11-16-2006, EXPIRES 11-16-2016.

THE NAME(S), PORTRAIT(S), AND/OR SIGNATURE(S) SHOWN IN THE MARK DOES NOT IDENTIFY A PARTICULAR LIVING INDIVIDUAL.

SER. NO. 79-037,412, FILED 11-16-2006.

PETER B. BROMAGHIM, EXAMINING ATTORNEY

**Int. Cl.: 10**

**Prior U.S. Cls.: 26, 39 and 44**

**United States Patent and Trademark Office**

**Reg. No. 3,505,461**

**Registered Sep. 23, 2008**

**TRADEMARK  
PRINCIPAL REGISTER**



MEDACTA INTERNATIONAL S.A. (SWITZER-  
LAND SOCIETE ANONYME)  
STRADA REGINA  
CH-6874 CASTEL SAN PIETRO, SWITZERLAND

FOR: ORTHOPEDIC PROSTHESES, NAMELY,  
KNEE-, FEMORAL-, ACETABULAR- PROSTHESES,  
AND JOINTS IMPLANTS, IN CLASS 10 (U.S. CLS. 26,  
39 AND 44).

PRIORITY DATE OF 10-30-2006 IS CLAIMED.

OWNER OF INTERNATIONAL REGISTRATION  
0921382 DATED 3-9-2007, EXPIRES 3-9-2017.

THE MARK CONSISTS OF THE WORD "MINI-  
MAX" WHEREIN BOTH THE LETTERS "M" ARE  
EACH FORMED OF TWO TRIANGULAR SAILS.

SER. NO. 79-037,456, FILED 3-9-2007.

BONNIE LUKEN, EXAMINING ATTORNEY

**Int. Cls.: 9, 37 and 42**

**Prior U.S. Cls.: 21, 23, 26, 36, 38, 100, 101, 103 and 106**

**Reg. No. 3,505,462**

**United States Patent and Trademark Office**

**Registered Sep. 23, 2008**

**TRADEMARK  
SERVICE MARK  
PRINCIPAL REGISTER**

**Businesses Living IN Change BLINC**

UNIT 4 AGRESSO BUSINESS SOFTWARE HOLD-  
ING B.V. (NETHERLANDS LIMITED LIABILITY  
COMPANY)  
STATIONSPARK 200  
NL-3364 DA SLIEDRECHT  
NETHERLANDS

FOR: BLANK MAGNETIC DATA CARRIERS;  
PRERECORDED DATA CARRIERS FEATURING  
BUSINESS SOFTWARE FOR ENTERPRISE RE-  
SOURCE PLANNING, NAMELY, PROCURING  
AND MANAGING OF BUSINESS DATA, FINAN-  
CIAL DATA, HUMAN RESOURCES DATA, PRO-  
JECT DATA, WORK FLOW DATA, PROCUREMENT  
DATA, PAYROLL DATA AND INCLUDING FIELD  
SERVICE AND ASSET MANAGEMENT AND RE-  
PORTING AND ANALYTICAL CAPABILITIES;  
COMPUTERS; COMPUTER NETWORK ADAPTERS;  
DATA PROCESSING APPARATUS AND INSTRU-  
MENTS, NAMELY, DATA PROCESSORS; COMPU-  
TER HARDWARE; COMPUTER SOFTWARE FOR  
USE IN ADMINISTRATION OF BUSINESSES AND  
FINANCIAL SOFTWARE, NAMELY, ENTERPRISE  
RESOURCE PLANNING THAT ALLOWS THE USER  
TO PROCURE AND MANAGE BUSINESS DATA,  
FINANCIAL DATA, HUMAN RESOURCES DATA,  
PROJECT DATA, WORK FLOW DATA, PROCURE-  
MENT DATA, PAYROLL DATA AND INCLUDING  
FIELD SERVICE AND ASSET MANAGEMENT AND  
REPORTING AND ANALYTICAL CAPABILITIES;  
SECURITY SOFTWARE, NAMELY, SOFTWARE  
FOR PROTECTION AND SECURITY OF COMPU-  
TER FILES, DATA AND APPLICATIONS; APPARA-  
TUS AND INSTRUMENTS, ALL FOR USE WITH  
COMPUTERS, NAMELY, PERSONAL DIGITAL AS-  
SISTANTS AND OTHER MOBILE DEVICES, NAME-  
LY, MOBILE PHONES, SMART PHONES, ULTRA-

MOBILE PERSONAL COMPUTERS, DIGITAL  
PLAYERS AND DIGITAL RECORDERS, IN CLASS  
9 (U.S. CLS. 21, 23, 26, 36 AND 38).

FOR: INSTALLATION AND MAINTENANCE OF  
COMPUTER HARDWARE AND NETWORKS, IN  
CLASS 37 (U.S. CLS. 100, 103 AND 106).

FOR: COMPUTER SERVICES, NAMELY, COM-  
PUTER PROGRAMMING; DESIGN AND DEVEL-  
OPMENT OF COMPUTER PROGRAMS AND  
COMPUTER SOFTWARE FOR OTHERS; CONSUL-  
TATION IN THE FIELD OF COMPUTER PRO-  
G R A M M I N G ; I N S T A L L A T I O N ,  
IMPLEMENTATION AND MAINTENANCE OF  
COMPUTER SOFTWARE; INSTALLATION, IMPE-  
LEMENTATION AND MAINTENANCE OF SECURITY  
SOFTWARE; COMPUTER CONSULTATION IN THE  
FIELD OF SETTING UP INFORMATION TECH-  
NOLOGY INFRASTRUCTURES; TECHNICAL  
COMPUTER CONSULTATION IN THE FIELD OF  
SECURITY OF COMPUTER HARDWARE AND  
NETWORKS, IN CLASS 42 (U.S. CLS. 100 AND 101).

PRIORITY DATE OF 2-28-2007 IS CLAIMED.

OWNER OF INTERNATIONAL REGISTRATION  
0921638 DATED 3-14-2007, EXPIRES 3-14-2017.

SER. NO. 79-037,567, FILED 3-14-2007.

REBECCA POVARCHUK, EXAMINING ATTOR-  
NEY

Int. Cls.: 30 and 32

Prior U.S. Cls.: 45, 46 and 48

United States Patent and Trademark Office

Reg. No. 3,505,463

Registered Sep. 23, 2008

TRADEMARK  
PRINCIPAL REGISTER

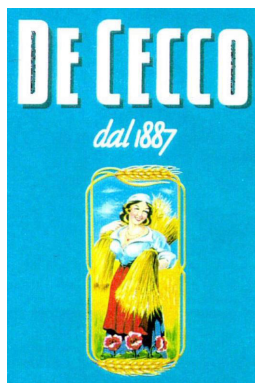

F.LLI DE CECCO DI FILIPPO FARA; S. MARTINO S.P.A. (ITALY S.P.A. SOCIÉTÉ PAR ACTION)  
VIA FILIPPO DE CECCO  
I-66015 FARA S. MARTINO (CHIETI)  
ITALY

FOR: ALIMENTARY PASTA, FLOUR, AND SAUCES, IN CLASS 30 (U.S. CL. 46).

FOR: BEERS; MINERAL AND AERATED WATERS, IN CLASS 32 (U.S. CLS. 45, 46 AND 48).

OWNER OF INTERNATIONAL REGISTRATION 0679633 DATED 8-19-1997, EXPIRES 8-19-2017.

OWNER OF U.S. REG. NOS. 584,824, 2,594,891 AND OTHERS.

NO CLAIM IS MADE TO THE EXCLUSIVE RIGHT TO USE "DAL 1887", APART FROM THE MARK AS SHOWN.

THE COLOR(S) AZURE, WHITE, RED, GREEN, BLUE, YELLOW IS/ARE CLAIMED AS A FEATURE OF THE MARK.

THE MARK CONSISTS OF A RECTANGULAR LABEL ON AN AZURE BACKGROUND WITH, IN THE CENTRE, THE REPRODUCTION OF AN IMAGE OF A PEASANT WOMAN, CARRYING TWO YELLOW WHEAT SHEAFs, WITH A WHITE SHIRT, AZURE SKIRT AND RED APRON, AT HER FEET THERE ARE THREE POPPIES ON A GREEN BACKGROUND; THE PEASANT IS IN A FIELD OF RIPE WHEAT WITH A BLUE SKY IN THE BACKGROUND; ALL THE ABOVE IN A FRAME SHAPED BY THE STALKS OF TWO YELLOW HEADS OF WHEAT ABOVE THE PEASANT THERE ARE THE FOLLOWING WORDS, ON TWO LINES: "DE CECCO DAL 1887" IN FANCY WHITE FONT.

THE ENGLISH TRANSLATION OF "DE CECCO DAL 1887" IS DE CECCO SINCE 1887.

SER. NO. 79-037,715, FILED 7-21-2006.

KELLY BOULTON, EXAMINING ATTORNEY

**Int. Cls.: 11, 20 and 21**

**Prior U.S. Cls.: 2, 13, 21, 22, 23, 25, 29, 30, 31, 32, 33,  
34, 40 and 50**

**Reg. No. 3,505,464**

**United States Patent and Trademark Office**

**Registered Sep. 23, 2008**

**TRADEMARK  
PRINCIPAL REGISTER**

# Elemental Spa

ALOYS F. DORNBRACHT; GMBH & CO. KG  
(FED REP GERMANY GMBH & CO. KG)  
KÖBBINGSER MÜHLE 6  
58640 ISERLOHN  
FED REP GERMANY

FOR: ELECTRIC AND ELECTRONIC SANITARY FITTINGS FOR SUPPLYING, DISTRIBUTING, CONTROLLING AND REGULATING WATER, NAMELY, CONTROL VALVES, COUPLERS, ELECTRIC THERMOSTATS, BIBS, USED TO DISTRIBUTE, CONTROL AND REGULATE WATER SUPPLY, RADIANT HEATERS, BATH-WATER PURIFYING APPARATUS FOR HOUSEHOLD PURPOSES, FLOW RESTRICTORS FOR REVERSE OSMOSIS WATER PURIFICATION UNITS AND HOT WATER TANKS; SUPPLEMENTARY PARTS OF METAL FOR SANITARY FITTINGS, NAMELY BATH TUB CONTROL VALVES; SANITARY FITTINGS OF METAL AND PLASTIC FOR TOILETS, BATHROOMS AND KITCHENS, NAMELY, FITTINGS FOR SUPPLYING, DISTRIBUTING, CONTROLLING AND REGULATING WATER, IN PARTICULAR REGULATING WATER TEMPERATURE, NAMELY, DRAINS, FAUCET FILTERS, SPOUTS, SINK STRAINERS, TRAPS, COUPLERS USED FOR THE SUPPLY, DISTRIBUTION, CONTROL AND REGULATION OF WATER, IN CLASS 11 (U.S. CLS. 13, 21, 23, 31 AND 34).

FOR: SANITARY FITTINGS OF PLASTIC OR GLASS, IN THE NATURE OF FURNITURE AND

ACCESSORIES TO BE USED IN A BATHROOM, NAMELY, STORAGE VANITIES, NON-METAL HANDLES FOR CABINETS, NON-METAL SHELF BRACKETS, NON-METAL TOWEL HOOKS, NON-METAL BATHTUB HANDLES; STORAGE UNITS IN THE NATURE OF TOWEL CLOSETS, TOWEL STANDS, BATHROOM VANITIES AND SHELVING FITTED WITH MIRRORS, MIRRORS, MIRRORING CABINETS AND RACKS, SUSPENDED CABINETS FITTED WITH MIRRORS, IN CLASS 20 (U.S. CLS. 2, 13, 22, 25, 32 AND 50).

FOR: SANITARY FITTINGS OF PLASTIC, METAL OR GLASS, NAMELY SOAP DISHES, TOWEL HOLDERS, TOILET PAPER HOLDERS, IN CLASS 21 (U.S. CLS. 2, 13, 23, 29, 30, 33, 40 AND 50).

PRIORITY DATE OF 1-12-2007 IS CLAIMED.

OWNER OF INTERNATIONAL REGISTRATION  
0922258 DATED 2-12-2007, EXPIRES 2-12-2017.

NO CLAIM IS MADE TO THE EXCLUSIVE RIGHT TO USE "SPA", APART FROM THE MARK AS SHOWN.

SER. NO. 79-037,798, FILED 2-12-2007.

ADA HAN, EXAMINING ATTORNEY

**Int. Cls.: 3, 5, 10 and 28**

**Prior U.S. Cls.: 1, 4, 6, 18, 22, 23, 26, 38, 39, 44, 46, 50, 51 and 52**

**Reg. No. 3,505,465**

**United States Patent and Trademark Office**

**Registered Sep. 23, 2008**

**TRADEMARK  
PRINCIPAL REGISTER**



PINO PHARMAZEUTISCHE PRÄPARATE GMBH  
(FED REP GERMANY CORPORATION)  
PAUL-DESSAU-STRABE 5  
22761 HAMBURG  
FED REP GERMANY

FOR: COSMETICS; PERSONAL CLEANING PRODUCTS, NAMELY, BATH SOAPS, SKIN CLEANSERS, SHAMPOOS, CONDITIONERS, ESSENTIAL OILS AND BATH OILS, BATH GELS, BODY CREAMS, BODY RUBS, NAMELY, BODY SCRUBS, SKIN EXFOLIATES, NAMELY, MECHANICAL PEELS AND FRUIT ACID PEELS, IN CLASS 3 (U.S. CLS. 1, 4, 6, 50, 51 AND 52).

FOR: MEDICAL PREPARATIONS, NAMELY, MEDICATED BATH PREPARATIONS, NAMELY, MEDICINAL BATH OILS, BATH SALTS, AND HERBAL BATH SALTS, MEDICINAL VEGETABLE AND ESSENTIAL OIL FOR PHARMACEUTICAL PURPOSES; MEDICAL PREPARATIONS FOR SKIN CLEANSING AND TREATMENT, NAMELY, MEDICATED SKIN CARE PREPARATIONS, NAMELY, CREAMS, LOTIONS, GELS, TONERS, CLEANERS AND PEELS; WARM AND COLD SKIN CARE CREAM FOR MEDICINAL PURPOSES; LINIMENTS; MEDICINAL PREPARATIONS FOR USE IN THERMAL THERAPY, NAMELY, MUD PACKS, MOOR PACKS AND WAXES; ADHESIVE TAPES FOR THERAPEUTIC AND MEDICINAL PURPOSES; MEDICAL PREPARATIONS FOR THERAPEUTIC MASSAGE, NAMELY, MASSAGE OILS, MASSAGE LOTIONS, AND MASSAGE CREAMS ALL FOR

MEDICINAL USE; COMPRESSES FOR MEDICAL THERAPY, NAMELY, MEDICATED COMPRESSES; DIETARY SUPPLEMENTS BASED ON VITAMINS AND/OR MINERALS, IN CLASS 5 (U.S. CLS. 6, 18, 44, 46, 51 AND 52).

FOR: MASSAGE TABLES; ELECTRICAL MEDICAL APPARATUS FOR PREPARING AND HEATING MINERAL MUDS FOR CURATIVE TREATMENT, NAMELY, HEATED MIXERS AND OVENS, IN CLASS 10 (U.S. CLS. 26, 39 AND 44).

FOR: SPORTS APPARATUS, ESPECIALLY APPLIANCES FOR GYMNASTICS, NAMELY, GYMNASTIC TAPES, ATHLETIC ADHESIVE TAPES, AND ELASTIC EXERCISE BANDS, IN CLASS 28 (U.S. CLS. 22, 23, 38 AND 50).

OWNER OF INTERNATIONAL REGISTRATION 0657524 DATED 11-9-1995, EXPIRES 11-9-2015.

NO CLAIM IS MADE TO THE EXCLUSIVE RIGHT TO USE "PINO" FOR CLASSES 03 AND 05, APART FROM THE MARK AS SHOWN.

THE ENGLISH TRANSLATION OF THE WORD PINO IN THE MARK IS PINE.

SER. NO. 79-037,964, FILED 11-13-2006.

MYRIAH HABEEB, EXAMINING ATTORNEY

**Int. Cls.: 9, 16 and 41**

**Prior U.S. Cls.: 2, 5, 21, 22, 23, 26, 29, 36, 37, 38, 50,  
100, 101 and 107**

**Reg. No. 3,505,466**

**United States Patent and Trademark Office**

**Registered Sep. 23, 2008**

**TRADEMARK  
SERVICE MARK  
PRINCIPAL REGISTER**

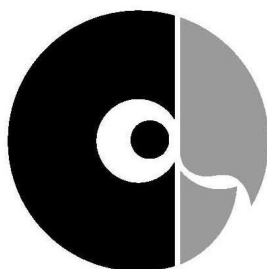

**Corella**

CORELLA PUBLISHING GMBH (FED REP GER-  
MANY CORPORATION)  
NIETZSCHESTR. 37  
28201 BREMEN  
FED REP GERMANY

FOR: EXPOSED AND PRE-RECORDED FILMS  
AND VIDEO FILMS FEATURING ARCHITEC-  
TURE, INDUSTRY, GEOGRAPHY, PEOPLE, NAT-  
URE, TRAVEL, SOCIAL AND CULTURAL  
SURROUNDINGS, IN CLASS 9 (U.S. CLS. 21, 23, 26,  
36 AND 38).

FOR: PRINTED MATTER, NAMELY, BOOKS  
FEATURING DECORATIVE COVERS AND CON-  
TAINING PHOTOGRAPHS, ILLUSTRATIONS AND  
INSTRUCTIVE OR ENTERTAINING TEXTS ON  
SOCIETY, WORLD AFFAIRS AND ARTS, IN CLASS  
16 (U.S. CLS. 2, 5, 22, 23, 29, 37, 38 AND 50).

FOR: PUBLISHING AND ISSUING OF BOOKS,  
NEWSPAPERS, MAGAZINES; PRODUCTION OF  
FILMS AND VIDEOS, IN CLASS 41 (U.S. CLS. 100,  
101 AND 107).

OWNER OF INTERNATIONAL REGISTRATION  
0923196 DATED 11-30-2006, EXPIRES 11-30-2016.

THE MARK CONSISTS OF A CIRCULAR IMAGE  
RESEMBLING A PARROT HEAD WITH THE WORD  
"CORELLA" UNDERNEATH.

THE WORDING "CORELLA" HAS NO MEANING  
IN A FOREIGN LANGUAGE.

SER. NO. 79-038,155, FILED 11-30-2006.

REGINA DRUMMOND, EXAMINING ATTORNEY

**Int. Cls.: 9, 16, 35, 38, 41 and 42**

**Prior U.S. Cls.: 2, 5, 21, 22, 23, 26, 29, 36, 37, 38, 50,  
100, 101, 102, 104 and 107**

**Reg. No. 3,505,467**

**United States Patent and Trademark Office**

**Registered Sep. 23, 2008**

**TRADEMARK  
SERVICE MARK  
PRINCIPAL REGISTER**

# VIVENDI TELECOM

VIVENDI (FRANCE SOCIÉTÉ ANONYME)  
42, AVENUE DE FRIEDLAND  
F-75008 PARIS  
FRANCE

FOR: APPARATUS FOR RECORDING, INPUTTING, STORING, TRANSMITTING, DISTRIBUTING, READING, REPRODUCING, PROCESSING SOUND, IMAGES AND INFORMATION, NAMELY, FLASH MEMORY CARDS, HARD DRIVES, ELECTRONIC AUDIO AND VIDEO RECORDERS, FLOPPY DISKS, COMPUTERS, TELEVISIONS, RADIO TRANSCEIVERS; DATA PROCESSING APPARATUS AND EQUIPMENT, NAMELY, DATA PROCESSORS; COMPUTERS; SOFTWARE AND RECORDED COMPUTER PROGRAMS FOR USE AS A SPREADSHEET, WORD PROCESSING, AND FOR USE IN DATABASE MANAGEMENT; SOFTWARE FOR DOWNLOADING MUSIC, SOUND, IMAGES AND TEXT; INTERACTIVE MULTIMEDIA SOFTWARE FEATURING GAMES, EDUCATIONAL MATTERS, MUSIC, MOVIES, CULTURAL PRESENTATIONS AND PRIVATE INFORMATION; BLANK SOUND AND IMAGE MEDIA, NAMELY, CDS AND DVDS; PRE-RECORDED SOUND AND IMAGE MEDIA, NAMELY, MAGNETIC AND DIGITAL RECORDING MEDIA, NAMELY, OPTICAL DISKS, CD-ROMS, VIDEO AND AUDIO TAPES, SOUND RECORDING DISKS, DIGITAL COMPACT CASSETTES, MINIDISKS, AUDIO, VIDEO AND MULTIMEDIA COMPACT DISKS, DIGITAL VERSATILE DISKS (DVDS) ALL FEATURING GAMES, EDUCATIONAL MATTERS, MUSIC, MOVIES, CULTURAL PRESENTATIONS AND PRIVATE INFORMATION; TELECOMMUNICATION APPARATUS AND INSTRUMENTS, NAMELY, TELEPHONES, TELEVISIONS, CAMERAS, COMPUTERS, COMPUTER PROGRAMS; TELEPHONE APPARATUS AND RECEIVERS; TELEPHONE SETS; RADIO TELEPHONES; PORTABLE, MOBILE AND HANDS-FREE TELEPHONES; RADIOTELEPHONY SETS; TELEPHONE TRANSMITTERS; PROJECTION SCREENS; COMMUNICATIONS COMPUTERS; COMPUTER

PROGRAMS FOR TRANSMISSION AND RECEPTION OF DATA, SOUNDS AND IMAGES AVAILABLE ON A GLOBAL TELECOMMUNICATION NETWORK FOR TELEPHONES AND TELEVISION RECEIVERS; MODEMS; ELECTRIC CABLES FOR TELECOMMUNICATION APPARATUS AND INSTRUMENTS, IN CLASS 9 (U.S. CLS. 21, 23, 26, 36 AND 38).

FOR: PRINTED MATTER, NAMELY, GUIDES, BOOKS, BROCHURES, NEWSPAPERS, MAGAZINES AND INSTRUCTION MANUALS IN THE FIELDS OF TELECOMMUNICATION, MUSIC, ENTERTAINMENT AND EDUCATION; PRINTED INSTRUCTIONAL, EDUCATIONAL, AND TEACHING MATERIALS IN THE FIELD OF TELECOMMUNICATIONS, IN CLASS 16 (U.S. CLS. 2, 5, 22, 23, 29, 37, 38 AND 50).

FOR: DOCUMENT REPRODUCTION; DATABASE MANAGEMENT; NEWSPAPER SUBSCRIPTION SERVICES FOR THIRD PARTIES; ADMINISTRATIVE AND COMMERCIAL MANAGEMENT OF COMPUTER SERVERS, OF DATA, SOUND AND IMAGE TRANSMISSION NETWORKS, OF TELECOMMUNICATION NETWORKS; TELEPHONE ANSWERING FOR UNAVAILABLE SUBSCRIBERS; TRANSCRIPTION OF MESSAGE COMMUNICATIONS, IN CLASS 35 (U.S. CLS. 100, 101 AND 102).

FOR: TELECOMMUNICATIONS, NAMELY, TRANSMISSION OF VOICE AND DATA BY TELEPHONE, BY FIBER-OPTIC NETWORK, BY TELE-MATIC MEANS, BY SATELLITES AND BY COMPUTER NETWORKS, AND BY A GLOBAL TELECOMMUNICATION NETWORK; COMMUNICATIONS BY COMPUTER TERMINALS; DISSEMINATION OF DATA, OF SOUNDS AND IMAGES, OF RADIO AND TELEVISION PROGRAMS, ON TELECOMMUNICATION APPARATUS AND ON COMPUTERS VIA A GLOBAL TELECOMMUNICATION NETWORK; CABLE TELEVISION BROADCAST-



ING; NEWS AND INFORMATION AGENCIES, NAMELY, TRANSMISSION OF NEWS ITEMS TO NEWS REPORTING ORGANIZATIONS; TRANSMISSION OF MESSAGES, DATA, SOUNDS AND IMAGES BY TELEPHONE, COMPUTER, CABLE, SATELLITE AND BY RADIO RELAY CHANNELS; CONSULTING AND PROVISION OF INFORMATION IN THE FIELD OF TELECOMMUNICATION NETWORKS BY MEANS OF COMPUTERS; RENTAL OF TELECOMMUNICATION APPARATUS; MOBILE TELEPHONY; CALL TRANSFER, CALL FORWARDING, TELEPHONE DIRECTORY AND INFORMATION AND VOICE MAIL SERVICES; PROVISION OF ACCESS TO SOFTWARE FOR INTERACTIVE GAMES BY MEANS OF TELEVISION, SATELLITE OR ELECTRONIC NETWORK; PROVISION OF ACCESS TO A TELEPHONE OR RADIO-TELEPHONE NETWORK; RENTAL OF ACCESS TIME TO A DATABASE SERVER CENTER VIA A GLOBAL COMPUTER NETWORK; PROVISION OF ACCESS TO A TELECOMMUNICATION NETWORK BY MEANS OF A COMPUTER, TELEPHONE AND TELEVISION; PROVISION OF ACCESS TO A TELECOMMUNICATION NETWORK PORTAL, IN PARTICULAR BY MEANS OF A COMPUTER, TELEPHONE OR TELEVISION; PROVISION OF ACCESS TO A TELECOMMUNICATION NETWORK SEARCH ENGINE; TRANSFER OF VIDEO GAMES AND SOFTWARE BY MEANS OF TELECOMMUNICATION, IN CLASS 38 (U.S. CLS. 100, 101 AND 104).

FOR: TRAINING COURSES AND SEMINARS IN THE FIELDS OF MUSIC, SPORTS AND CULTURE; EDUCATIONAL SERVICES, NAMELY, PRODUCTION OF INFORMATIONAL CD-ROMS AND DIDACTIC GAMES IN THE FIELDS OF MUSIC, MOVIES, SPORTS AND CULTURE; PUBLISHING OF BOOKS, OF JOURNALS, OF MAGAZINES, OF MAGNETIC AND DIGITAL DATA FEATURING MUSIC, MOVIES, SPORTS AND CULTURE, AND OF SOUND AND IMAGE MEDIA FEATURING MUSIC, MOVIES, SPORTS AND CULTURE; ORGANIZATION OF CULTURAL AND EDUCATIONAL EXHIBITIONS, IN CLASS 41 (U.S. CLS. 100, 101 AND 107).

FOR: DESIGN AND UPDATING OF COMPUTER PROGRAMS AND SOFTWARE; COMPUTER PROGRAMMING; DESIGN, UPDATING AND DEVELOPMENT OF MULTIMEDIA PRODUCTS, NAMELY, COMPACT DISKS, INTERACTIVE CD-ROMS, DIGITAL VIDEODISKS, CD-ROMS USED IN CONNECTION WITH THE INTERNET AND OF OTHER RECORDING MEDIA; DEVELOPMENT MAINTENANCE AND UPDATING OF INTERNET SITES FOR OTHERS; DESIGN AND DEVELOPMENT OF WEB PAGES DISSEMINATED BY COMPUTER NETWORKS; CONSULTING, ENGINEERING AND ENGINEERING SERVICES IN THE FIELD OF COMPUTING AND TELECOMMUNICATION NETWORKS; DEVELOPMENT, MAINTENANCE AND UPDATING OF A TELECOMMUNICATION NETWORK SEARCH ENGINE; PROVIDING INFORMATION ON COMPUTER TECHNOLOGY AND PROGRAMMING; DESIGN OF TELECOMMUNICATION NETWORKS AND DESIGN AND UPDATING OF TELECOMMUNICATION SITES FOR ELECTRONIC COMMERCE, INCLUDING BY MEANS OF COMPUTER, IN CLASS 42 (U.S. CLS. 100 AND 101).

THE MARK CONSISTS OF STANDARD CHARACTERS WITHOUT CLAIM TO ANY PARTICULAR FONT, STYLE, SIZE, OR COLOR.

PRIORITY DATE OF 2-10-2006 IS CLAIMED.

OWNER OF INTERNATIONAL REGISTRATION 0924751 DATED 7-28-2006, EXPIRES 7-28-2016.

OWNER OF U.S. REG. NOS. 2,516,132, 2,766,054, AND 2,814,429.

NO CLAIM IS MADE TO THE EXCLUSIVE RIGHT TO USE "TELECOM", APART FROM THE MARK AS SHOWN.

SER. NO. 79-038,692, FILED 7-28-2006.

PETER B. BROMAGHIM, EXAMINING ATTORNEY

**Int. Cls.: 9, 16, 28, 38, 41 and 42**

**Prior U.S. Cls.: 2, 5, 21, 22, 23, 26, 29, 36, 37, 38, 50,  
100, 101, 104 and 107**

**Reg. No. 3,505,468**

**United States Patent and Trademark Office**

**Registered Sep. 23, 2008**

**TRADEMARK  
SERVICE MARK  
PRINCIPAL REGISTER**

# VIVENDI GAMES

VIVENDI (FRANCE SOCIÉTÉ ANONYME)  
42, AVENUE DE FRIEDLAND  
F-75008 PARIS  
FRANCE

FOR: APPARATUS FOR RECORDING, INPUTTING, STORING, TRANSMITTING, DISTRIBUTING, READING, REPRODUCING, PROCESSING SOUND, IMAGES AND INFORMATION, NAMELY, MEMORY STICKS, HARD DRIVES, ELECTRONIC AUDIO AND VIDEO RECORDERS, FLOPPY DISKS, COMPUTERS, TELEVISIONS, RADIO TRANSCIEVERS; DATA PROCESSING APPARATUS AND EQUIPMENT, NAMELY, DATA PROCESSORS; COMPUTERS; SOFTWARE AND RECORDED COMPUTER PROGRAMS FOR USE AS A SPREADSHEET, WORD PROCESSING, AND FOR USE IN DATABASE MANAGEMENT; SOFTWARE FOR DOWNLOADING MUSIC, SOUND, IMAGES AND TEXT; INTERACTIVE MULTIMEDIA SOFTWARE FEATURING GAMES, EDUCATIONAL MATTERS, MUSIC, MOVIES, CULTURAL PRESENTATIONS AND PRIVATE INFORMATION; BLANK SOUND AND IMAGE MEDIA, NAMELY, CDS AND DVDS; PRE-RECORDED SOUND AND IMAGE MEDIA, NAMELY, MAGNETIC AND DIGITAL RECORDING MEDIA, NAMELY, OPTICAL DISKS, CD-ROMS, VIDEO AND AUDIO TAPES, SOUND RECORDING DISKS, DIGITAL COMPACT CASSETTES, MINIDISKS, AUDIO, VIDEO AND MULTIMEDIA COMPACT DISKS, DIGITAL VERSATILE DISKS (DVDS) ALL FEATURING GAMES, EDUCATIONAL MATTERS, MUSIC, MOVIES, CULTURAL PRESENTATIONS AND PRIVATE INFORMATION; TELECOMMUNICATION APPARATUS AND INSTRUMENTS, NAMELY, TELEPHONES, TELEVISIONS, CAMERAS, COMPUTERS, COMPUTER PROGRAMS; TELEPHONE APPARATUS AND RECEIVERS; TELEPHONE SETS; RADIO TELEPHONES; PORTABLE, MOBILE AND HANDS-FREE TELEPHONES; RADIOTELEPHONY SETS; TELEPHONE TRANSMITTERS; PROJECTION SCREENS; COMMUNICATIONS COMPUTERS; COMPUTER

PROGRAMS FOR TRANSMISSION AND RECEPTION OF DATA, SOUNDS AND IMAGES AVAILABLE ON A GLOBAL TELECOMMUNICATION NETWORK FOR TELEPHONES AND TELEVISION RECEIVERS; MODEMS; ELECTRIC CABLES FOR TELECOMMUNICATION APPARATUS AND INSTRUMENTS, IN CLASS 9 (U.S. CLS. 21, 23, 26, 36 AND 38).

FOR: PRINTED MATTER, NAMELY, GUIDES, BOOKS, BROCHURES, NEWSPAPERS, MAGAZINES AND INSTRUCTION MANUALS IN THE FIELDS OF TELECOMMUNICATION, MUSIC, ENTERTAINMENT AND EDUCATION; MANUALS FOR SOFTWARE FOR INTERACTIVE AND VIDEO GAMES, IN CLASS 16 (U.S. CLS. 2, 5, 22, 23, 29, 37, 38 AND 50).

FOR: GAMES, NAMELY, BOARD GAMES, ACTION SKILL GAMES, ARCADE GAMES AND DICE GAMES; TOYS, NAMELY, BATH TOYS, MECHANICAL TOYS, PLASTIC CHARACTER TOYS; SPORTING AND GYMNAS TIC ARTICLES, NAMELY, BASEBALL GLOVES, BASEBALLS, BASKETBALLS, FOOTBALLS AND CRICKET BATS; APPARATUS FOR ELECTRONIC GAMES OTHER THAN THOSE ADAPTED FOR USE WITH AN EXTERNAL DISPLAY SCREEN OR MONITOR, IN CLASS 28 (U.S. CLS. 22, 23, 38 AND 50).

FOR: TRANSFER OF VIDEO GAMES AND SOFTWARE BY MEANS OF TELECOMMUNICATION, IN CLASS 38 (U.S. CLS. 100, 101 AND 104).

FOR: ENTERTAINMENT IN THE NATURE OF PRODUCTION OF MUSIC SHOWS, MOVIE PREMIERES AND LIVE PERFORMANCES OF MUSICAL GROUPS FOR OTHERS; EDUCATIONAL SERVICES, NAMELY, PRODUCTION OF INFORMATIONAL CD-ROMS AND DIDACTIC GAMES IN THE FIELDS OF MUSIC, MOVIES, SPORTS AND CULTURE; ORGANIZING CULTURAL EXHIBITIONS; RADIO AND TELEVISION PRODUCTION;

ENTERTAINMENT PROVIDED ON LINE VIA LOCAL AND GLOBAL NETWORKS, NAMELY, PROVIDING ON-LINE COMPUTER GAMES; PROVIDING INFORMATION ON ENTERTAINMENT AND CULTURAL ACTIVITIES; PUBLISHING OF BOOKS, OF JOURNALS, OF MAGAZINES, OF DIGITAL VIDEO, AUDIO, AND MULTIMEDIA, AND OF SOUND AND IMAGE MEDIA FEATURING MUSIC, MOVIES, SPORTS AND CULTURE; BOOKING OF SEATS FOR SHOWS; ORGANIZATION OF CULTURAL AND EDUCATIONAL EXHIBITIONS; AMUSEMENT PARKS; VIDEOTAPE EDITING; EDITING OF INTERACTIVE GAMES FOR COMPUTERS, FOR CONSOLES, FOR PORTABLE TERMINALS AND FOR GLOBAL COMPUTER NETWORKS; PROVIDING ENTERTAINMENT INFORMATION ON THE LATEST NEWS REGARDING INTERACTIVE GAMES FOR COMPUTERS, CONSOLES, PORTABLE TERMINALS AND GLOBAL COMPUTER NETWORKS , IN CLASS 41 (U.S. CLS. 100, 101 AND 107).

FOR: DESIGN AND UPDATING OF COMPUTER PROGRAMS AND SOFTWARE; COMPUTER PROGRAMMING; DESIGN, UPDATING AND DEVELOPMENT OF MULTIMEDIA PRODUCTS,

NAMELY, OF COMPACT DISKS, OF INTERACTIVE CD-ROMS, OF CD-ROMS USED IN CONNECTION WITH THE INTERNET AND OF OTHER RECORDING MEDIA, IN CLASS 42 (U.S. CLS. 100 AND 101).

THE MARK CONSISTS OF STANDARD CHARACTERS WITHOUT CLAIM TO ANY PARTICULAR FONT, STYLE, SIZE, OR COLOR.

PRIORITY DATE OF 2-10-2006 IS CLAIMED.

OWNER OF INTERNATIONAL REGISTRATION 0924752 DATED 7-28-2006, EXPIRES 7-28-2016.

OWNER OF U.S. REG. NOS. 2,516,132, 2,766,054, AND 2,814,429.

NO CLAIM IS MADE TO THE EXCLUSIVE RIGHT TO USE "GAMES", APART FROM THE MARK AS SHOWN.

SER. NO. 79-038,693, FILED 7-28-2006.

PETER B. BROMAGHIM, EXAMINING ATTORNEY

**Int. Cl.: 25**

**Prior U.S. Cls.: 22 and 39**

**United States Patent and Trademark Office**

**Reg. No. 3,505,469**

**Registered Sep. 23, 2008**

**TRADEMARK  
PRINCIPAL REGISTER**

**BUGWEB**

VANBESTCO SCANDINAVIA AB (SWEDEN A  
LIMITED LIABILITY COMPANY)  
SVARTSKÄRSVÄGEN 9  
SE-439 93 ONSALA  
SWEDEN

FOR: FOOTWEAR, IN CLASS 25 (U.S. CLS. 22 AND  
39).

THE MARK CONSISTS OF STANDARD CHAR-  
ACTERS WITHOUT CLAIM TO ANY PARTICULAR  
FONT, STYLE, SIZE, OR COLOR.

PRIORITY DATE OF 11-8-2006 IS CLAIMED.

OWNER OF INTERNATIONAL REGISTRATION  
0924940 DATED 4-17-2007, EXPIRES 4-17-2017.

SER. NO. 79-038,767, FILED 4-17-2007.

PRISCILLA MILTON, EXAMINING ATTORNEY

**Int. Cls.: 9 and 25**

**Prior U.S. Cls.: 21, 22, 23, 26, 36, 38 and 39**

**United States Patent and Trademark Office**

**Reg. No. 3,505,470**

**Registered Sep. 23, 2008**

**TRADEMARK  
PRINCIPAL REGISTER**

**TUZO**

M & P DIRECT LIMITED (UNITED KINGDOM  
PRIVATE LIMITED COMPANY)  
PHOENIX WAY,  
GARNGOCH, GORSEINON; SWANSEA SA4 9HN,  
WALES  
UNITED KINGDOM

FOR: PROTECTIVE HELMETS; SPORTS HELMETS; MOTORCYCLE HELMETS; PROTECTIVE WEAR, NAMELY, PROTECTIVE CLOTHING AND FOOTWEAR, PROTECTIVE CLOTHING AND FOOTWEAR FOR PROTECTION AGAINST MOTORCYCLE ACCIDENTS, PROTECTIVE MOTORCYCLE SUITS FOR PROTECTION AGAINST ACCIDENTS, PROTECTIVE GLOVES FOR PROTECTION AGAINST MOTORCYCLE ACCIDENTS, PROTECTIVE BOOTS FOR PROTECTION AGAINST MOTORCYCLE ACCIDENTS, PROTECTIVE BODY ARMOR FOR SPORTS AND FOR MOTORCYCLISTS, NAMELY, HARD PLATE PERSONAL BODY ARMOR; GOGGLES FOR SPORTS; SPECTACLES; SUNGLASSES; AUTOMOTIVE MEASURING INSTRUMENTS, NAMELY, VACUUM GAUGES, SPEEDOMETERS, TACHOMETERS, BATTERY CHARGERS, ALL FOR USE WITH MOTORCYCLES AND BICYCLES; REPLACEMENT PARTS AND FITTINGS FOR ALL THE AFOREMENTIONED GOODS, IN CLASS 9 (U.S. CLS. 21, 23, 26, 36 AND 38).

FOR: CLOTHING, NAMELY, JACKETS, TROUSERS, BOOTS, LEATHER SUITS, LEATHER JACKETS, LEATHER TROUSERS, GLOVES, MOTORCYCLE CLOTHING, NAMELY, MOTORCYCLE RIDING SUITS, MOTORCYCLE JACKETS, MOTORCYCLE TROUSERS, MOTORCYCLE GLOVES, WATERPROOF CLOTHING, NAMELY, JACKETS, COATS, RIDING SUITS; FOOTWEAR; BOOTS; MOTORCYCLE BOOTS; HEADWEAR; HATS; CAPS; BALACLAVAS, IN CLASS 25 (U.S. CLS. 22 AND 39).

THE MARK CONSISTS OF STANDARD CHARACTERS WITHOUT CLAIM TO ANY PARTICULAR FONT, STYLE, SIZE, OR COLOR.

PRIORITY DATE OF 7-6-2006 IS CLAIMED.

OWNER OF INTERNATIONAL REGISTRATION  
0925079 DATED 1-4-2007, EXPIRES 1-4-2017.

SER. NO. 79-038,834, FILED 1-4-2007.

WANDA KAY PRICE, EXAMINING ATTORNEY

Int. Cl.: 30

Prior U.S. Cl.: 46

United States Patent and Trademark Office

Reg. No. 3,505,471

Registered Sep. 23, 2008

TRADEMARK  
PRINCIPAL REGISTER



LOC MARIA (FRANCE SOCIÉTÉ PAR ACTIONS  
SIMPLIFIÉE)  
13 RUE DE LA LONGERAIE  
F-35760 SAINT-GREGOIRE  
FRANCE

FOR: COFFEE, TEA, COCOA, SUGAR, RICE,  
TAPIOCA, SAGO, ARTIFICIAL COFFEE, BREAD,  
COOKIES AND BISCUITS, CAKES, MADELEINE  
CAKES, PASTRY, FRUIT CAKES, CREPES DEN-  
TELLE, PANCAKES, EDIBLE FRUIT ICES, SHER-  
BETS, HONEY, TRACLE SYRUP, YEAST, BAKING-  
POWDER, SALT, MUSTARD VINEGAR, SAUCES,  
SPICES, ICE FOR REFRESHMENT, COOKIE AND  
BISCUITS PRODUCTS, NAMELY, CRISPY CREPES,  
RUSKS, CHOCOLATE, BEVERAGES MADE WITH  
COCOA, COFFEE, CHOCOLATE OR TEA, CHOCO-  
LATE SWEETS, IN CLASS 30 (U.S. CL. 46).

PRIORITY DATE OF 10-24-2006 IS CLAIMED.

OWNER OF INTERNATIONAL REGISTRATION  
0925323 DATED 3-30-2007, EXPIRES 3-30-2017.

OWNER OF U.S. REG. NO. 1,908,686.

THE ENGLISH TRANSLATION OF THE WORD  
"GAVOTTES" IS DANCES.

SER. NO. 79-038,943, FILED 3-30-2007.

WENDY JUN, EXAMINING ATTORNEY

Int. Cls.: 35 and 41

Prior U.S. Cls.: 100, 101, 102 and 107

United States Patent and Trademark Office

Reg. No. 3,505,472

Registered Sep. 23, 2008

**SERVICE MARK  
PRINCIPAL REGISTER**

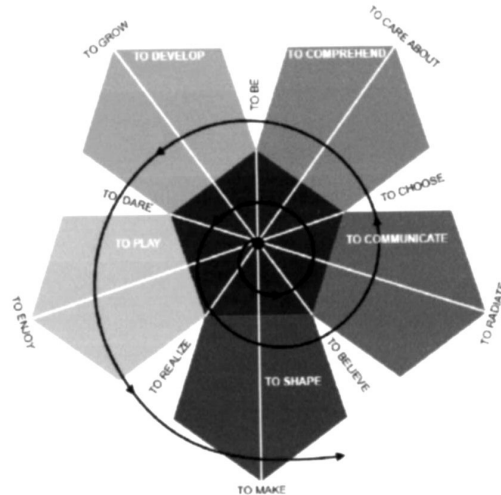

CHOCO, COÖPERATIEVE; VENNOOTSCHAP  
MET BEPERKTE; AANSPRAKELIJKHEID  
(BELGIUM LIMITED LIABILITY COMPANY)  
FLORENT VAN CAUWENBERGHSTRAAT 5  
B-2500 LIER, BELGIUM

FOR: ADVERTISING SERVICES; BUSINESS MANAGEMENT AND BUSINESS ADMINISTRATION; PROVIDING OFFICE FUNCTIONS; CONSULTING IN INDUSTRIAL MANAGEMENT; MANAGEMENT OF COMPUTER FILES; SYSTEMIZATION OF INFORMATION INTO COMPUTER DATABASES; ASSISTANCE WITH MANAGEMENT OF INDUSTRIAL AND COMMERCIAL COMPANIES; PERSONNEL CONSULTANCY; BUSINESS MANAGEMENT AND CONSULTATION, NAMELY, PROVIDING ADVICE TO COMPANIES REGARDING COMMUNICATION BETWEEN THEIR MANAGEMENT, EMPLOYEES AND END CONSUMERS; PSYCHOLOGICAL TESTING FOR THE SELECTION OF PERSONNEL; BUSINESS ORGANIZATIONAL CONSULTATION SERVICES, NAMELY, ASSISTING COMPANIES IN DEVELOPING BUSINESS MODELS FOR THE ORGANIZATION OF COMPANIES, IN CLASS 35 (U.S. CLS. 100, 101 AND 102).

FOR: EDUCATION SERVICES, NAMELY, THE ORGANIZATION OF SEMINARS AND WORKSHOPS IN THE FIELDS OF ACCOUNTING, BUSINESS MANAGEMENT AND MARKETING, COMMERCIAL MANAGEMENT AND HUMAN RESOURCES; PROVIDING TRAINING SERVICES IN THE FIELD OF ACCOUNTING, ADVERTISING,

BUSINESS MANAGEMENT AND MARKETING, COMMERCIAL MANAGEMENT AND HUMAN RESOURCES; ENTERTAINMENT SERVICES, NAMELY, MOVIES AND THEATER; ORGANIZATION OF EDUCATIONAL CONFERENCES AND CONVENTIONS IN THE FIELD OF ACCOUNTING, ADVERTISING, BUSINESS MANAGEMENT AND MARKETING, COMMERCIAL MANAGEMENT AND HUMAN RESOURCES; TEACHING IN THE FIELD OF ACCOUNTING, ADVERTISING, BUSINESS MANAGEMENT AND MARKETING, COMMERCIAL MANAGEMENT AND HUMAN RESOURCES; PROVIDING COLLECTIVE TRAINING IN THE FIELD OF ACCOUNTING, ADVERTISING, BUSINESS MANAGEMENT AND MARKETING, COMMERCIAL MANAGEMENT AND HUMAN RESOURCES; AND PERSONAL COACHING IN THE FIELD OF ACCOUNTING, ADVERTISING, BUSINESS MANAGEMENT AND MARKETING, COMMERCIAL MANAGEMENT AND HUMAN RESOURCES, IN CLASS 41 (U.S. CLS. 100, 101 AND 107).

PRIORITY DATE OF 11-13-2006 IS CLAIMED.

OWNER OF INTERNATIONAL REGISTRATION  
0925586 DATED 4-17-2007, EXPIRES 4-17-2017.

SER. NO. 79-039,050, FILED 4-17-2007.

NAAKWAMA ANKRAH, EXAMINING ATTORNEY

**Int. Cl.: 14**

**Prior U.S. Cls.: 2, 27, 28 and 50**

**United States Patent and Trademark Office**

**Reg. No. 3,505,473**

**Registered Sep. 23, 2008**

**TRADEMARK  
PRINCIPAL REGISTER**

**SWISS KubiK**

PHILIPPE SUBILIA  
CASE POSTALE 186  
CH-1000 LAUSANNE 6  
SWITZERLAND

OWNER OF INTERNATIONAL REGISTRATION  
0926035 DATED 4-24-2007, EXPIRES 4-24-2017.

FOR: PRECIOUS METALS AND THEIR ALLOYS;  
GOODS MADE OF PRECIOUS METALS AND  
THEIR ALLOYS, NAMELY, JEWELLERY, RINGS,  
BRACELETS, WATCHES; JEWELLERY; PRECIOUS  
STONES; TIMEPIECES AND CHRONOMETRIC IN-  
STRUMENTS; WATCH WINDING BUTTONS;  
WATCH WINDERS FOR AUTOMATIC WATCHES,  
IN CLASS 14 (U.S. CLS. 2, 27, 28 AND 50).

NO CLAIM IS MADE TO THE EXCLUSIVE  
RIGHT TO USE "SWISS", APART FROM THE MARK  
AS SHOWN.

SER. NO. 79-039,255, FILED 4-24-2007.

PRIORITY DATE OF 1-18-2007 IS CLAIMED.

BARBARA A. GOLD, EXAMINING ATTORNEY



**Int. Cls.: 32, 33 and 43**

**Prior U.S. Cls.: 45, 46, 47, 48, 49, 100 and 101**

**United States Patent and Trademark Office**

**Reg. No. 3,505,474**

**Registered Sep. 23, 2008**

**TRADEMARK  
SERVICE MARK  
PRINCIPAL REGISTER**

**SHATLER'S**

SHATLER'S GETRÄNKE GMBH (FED REP GER-  
MANY GMBH (LIMITED PARTNERSHIP UN-  
DER THE GERMAN LAW))

ARNDTSTRASSE 4  
50676 KÖLN  
FED REP GERMANY

FOR: NON-ALCOHOLIC BEVERAGES, NAMELY,  
FRUIT DRINKS, FRUIT JUICES AND FRUIT JUICE  
BEVERAGES; SYRUPS FOR MAKING BEVERAGES;  
NON-ALCOHOLIC COCKTAILS, IN CLASS 32 (U.S.  
CLS. 45, 46 AND 48).

FOR: ALCOHOLIC BEVERAGES, EXCEPT  
BEERS, NAMELY, WINES, SPARKLING WINES,  
DISTILLED AND POTABLE SPIRITS AND LI-  
QUORS, ALCOHOLIC COCKTAILS, IN CLASS 33  
(U.S. CLS. 47 AND 49).

FOR: SERVICES FOR PROVIDING FOOD AND  
DRINK, IN CLASS 43 (U.S. CLS. 100 AND 101).

THE MARK CONSISTS OF STANDARD CHAR-  
ACTERS WITHOUT CLAIM TO ANY PARTICULAR  
FONT, STYLE, SIZE, OR COLOR.

PRIORITY DATE OF 10-26-2006 IS CLAIMED.

OWNER OF INTERNATIONAL REGISTRATION  
0926477 DATED 4-23-2007, EXPIRES 4-23-2017.

SER. NO. 79-039,409, FILED 4-23-2007.

JEAN IM, EXAMINING ATTORNEY

**Int. Cls.: 9, 35 and 38**

**Prior U.S. Cls.: 21, 23, 26, 36, 38, 100, 101, 102 and 104**

**United States Patent and Trademark Office**

**Reg. No. 3,505,475**

**Registered Sep. 23, 2008**

**TRADEMARK  
SERVICE MARK  
PRINCIPAL REGISTER**

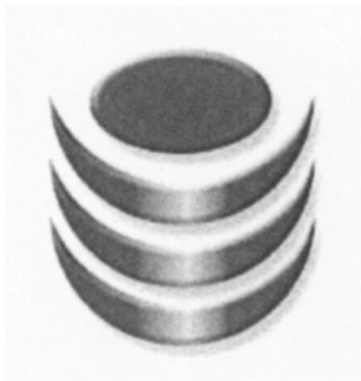

PIRELLI & C. S.P.A. (ITALY SPA)  
VIA GAETANO NEGRI, 10  
I-20123 MILANO (MI)  
ITALY

FOR: ACCESS AND HOME NETWORKS AND SYSTEMS COMPRISED OF COMPUTERS, COMMUNICATION SERVERS, ASYMMETRIC DIGITAL SUBSCRIBER LINE, ROUTERS, MODULAR AND INTEGRATED ACCESS GATEWAYS, SET TOP BOXES, DATA SMART CARDS, MODEMS, MULTIPLEXERS, TERMINALS, RECEIVERS, TRANSMITTERS, DECODERS, AND TRANSCEIVERS CAPABLE OF PROCESSING BROADCAST, SATELLITE, FACSIMILE, TELEVISION, TELECOMMUNICATION, NETWORK, INFRARED, AND COMPUTER DATA SIGNALS AND FOR TRANSMISSION, REPRODUCING OR RECEIVING OF SOUND, IMAGES, VIDEO, MULTIMEDIA OR DATA AND FIBER ETHERNET ACCESSES, NAMELY, SWITCHES, WIRELESS LOCAL AREA NETWORKS (LAN) PRODUCTS, NAMELY, MOBILE COMPUTER, SERVERS, ROUTERS, MODULAR AND INTEGRATED ACCESS GATEWAYS, SET TOP BOXES, DATA SMART CARDS, MODEMS, MULTIPLEXERS, TERMINALS, RECEIVERS, TRANSMITTERS, DECODERS, AND TRANSCEIVERS, WIRELESS ETHERNET DUAL ACCESS POINTS, WIRELESS ETHERNET ACCESS POINTS AND STARTER KITS COMPRISING INSTALLATION CD ROM; EQUIPMENT AND DEVICES FOR USE IN HOME COMMUNICATIONS AND ENTERTAINMENT SYSTEMS, NAMELY, MODULAR AND INTEGRATED ACCESS GATEWAYS FOR HOME NETWORKING, SET TOP BOXES FOR HOME EN-

TERTAINMENT AND MANAGEMENT SYSTEM COMPRISED OF RADIO TRANSMITTERS AND RECEIVERS FOR REMOTE CONTROL; OPTICAL COMMUNICATIONS APPARATUS, NAMELY, SIGNAL DISTRIBUTION NETWORKS AND SYSTEMS COMPRISED OF COMPUTER HARDWARE AND SOFTWARE, TRANSMITTERS AND RECEIVERS FEATURING SDH (SYNCHRONOUS DIGITAL HIERARCHY), PDH (PLESIOCHRONOUS DIGITAL HIERARCHY), PON (PASSIVE OPTICAL NETWORK), AND WDM (WAVELENGTH DIVISION MULTIPLEXING); OPTICAL MODEMS, NAMELY, OPTICAL TRANSCEIVER; DATA PROCESSING APPARATUS, NAMELY, ROUTERS, SWITCHES, AND INTEGRATED ACCESS PLATFORMS IN THE NATURE OF COMPUTER SOFTWARE FOR USE IN ACCESSING COMPUTER NETWORKS; EQUIPMENT AND DEVICES FOR USE IN ACCESS AND HOME NETWORKS AND SYSTEMS, NAMELY, MOBILE COMPUTER SERVERS, ROUTERS, MODULAR AND INTEGRATED ACCESS GATEWAYS, SET TOP BOXES, DATA SMART CARDS, MODEMS, MULTIPLEXERS, TERMINALS, RECEIVERS, TRANSMITTERS, DECODERS, AND TRANSCEIVERS, WIRELESS ETHERNET DUAL ACCESS POINTS FOR CONNECTING NETWORKS COMPUTER USERS, WIRELESS ETHERNET ACCESS POINTS FOR CONNECTING NETWORKS COMPUTER USERS AND STARTER KITS COMPRISING INSTALLATION CD ROM AND INSTRUCTIONAL MANUALS SOLD AS A UNIT THEREWITH, WIRELESS GATEWAY ROUTERS IN THE NATURE OF COMPUTER CONTROL HARDWARE FOR HOME AND BUSINESS APPLICATIONS, WIRELESS MODULES IN THE NATURE OF TRANSMITTERS AND

RECEIVERS FOR HANDHELDS, NAMELY, COMPUTERS, WIRELESS LAN ANTENNAS, WIRELESS LAN POWER INJECTORS, DOMESTIC APPLIANCES, NAMELY, SET TOP BOXES, VIDEO STATIONS COMPRISED OF MONITORS AND CAMERAS, REMOTELY CONTROLLED HOME APPLIANCES REGULATORS IN THE NATURE OF THERMOSTATS, ELECTRIC LIGHT DIMMER AND SWITCHES, SET TOP BOXES FOR USE IN VIDEO-CONFERENCING, DATA PROCESSING APPARATUS, NAMELY, ROUTERS SWITCHES AND INTEGRATED ACCESS PLATFORMS IN THE NATURE OF COMPUTER SOFTWARE FOR USE IN COMPUTER NETWORK ACCESS; CUSTOMER PREMISE EQUIPMENT (CPE) IN THE NATURE OF SET TOP BOXES, INTEGRATED ACCESS DEVICES (IAD) IN THE NATURE OF MODEMS, CAMERAS FOR USE IN TRANSMITTING IMAGES VIA A COMPUTER NETWORK, DIGITAL SUBSCRIBER LINE (DSL) ENABLED CUSTOMER ELECTRONIC GOODS, NAMELY, MODEMS, ALARM SYSTEMS, NAMELY, ACCESS CONTROL AND ALARM MONITORING SYSTEMS; HOME NETWORKING APPLIANCES, NAMELY, VIDEO PHONES, SET-TOP-BOXES (STB), INTERNET PROTOCOL TELEVISION (IPTV) SET TOP-BOXES, INTEGRATED ACCESS DEVICES (IAD), WEBCAMS, XDSL ENABLED CONSUMER ELECTRONICS GOODS, NAMELY, MODEMS AND ALARM SYSTEMS; DIGITAL SUBSCRIBER LINE (DSL) TERMINATIONS AND DISTRIBUTION, NAMELY, TERMINALS AND EQUIPMENT AND DEVICES FOR USE IN THE ABOVE BROADBAND ACCESS SYSTEMS, NAMELY, MODEMS, SWITCHES, ROUTERS, HUBS, VOIP (VOICE OVER IP), WIRELESS LOCAL AREA NETWORK ACCESS POINTS FOR CONNECTING NETWORK COMPUTER USERS, REPEATERS AND ADAPTERS; PASSIVE OPTICAL NETWORK (PON) COMPRISED OF COMPUTER HARDWARE FOR USE IN LOCAL AREA NETWORK (LAN), COMPUTER NETWORK SWITCHES AND ROUTERS, NAMELY, OPTICAL NETWORK UNIT (ONU) AND OPTICAL LINE TERMINATION (OLT) SWITCHES/ ROUTERS FOR METRO AREA NETWORKS, PDH (PLESIOCHRONOUS DIGITAL HIERARCHY) ACCESS MULTIPLEXERS, DSL MULTIPLEXERS; LAST MILE TELECOMMUNICATION EQUIPMENT, NAMELY, MEDIA CONVERTERS, MODEMS, GATEWAY HARDWARE AND SOFTWARE, SWITCHES, ROUTERS, MULTIPLEXERS, TELECOMMUNICATIONS EXCHANGERS; MEDIA CONVERTERS, MODEMS, GATEWAYS FOR RESIDENTIAL AND VIRTUAL PRIVATE NETWORK USE, NAMELY, COMPUTER HARDWARE AND SOFTWARE FOR TRANSMITTING INFORMATION BETWEEN COMPUTERS AND NETWORKS, VPN ROUTERS (VIRTUAL PRIVATE NETWORK ROUTERS), COMPUTER SOFTWARE FOR THE CREATION OF FIREWALLS FOR PERSONAL COMPUTER, GATEWAYS ROUTERS IN THE NATURE OF COMPUTER CONTROL HARDWARE; TELECOMMUNICATIONS AND ELECTRIC SWITCHES, ROUTERS, NAMELY, VPN ROUTERS (VIRTUAL PRIVATE NETWORK ROUTERS), WIRELESS GAMING ROUTERS, DSL ROUTERS (DIGITAL SUBSCRIBER LINE ROUTERS), WIRELESS DSL ROUTERS (WIRELESS DIGITAL SUBSCRIBER

LINE ROUTERS), ADSL ROUTERS (ASYMMETRIC DIGITAL SUBSCRIBER LINE ROUTERS), ISDN ROUTERS (INTEGRATED SERVICE DIGITAL NETWORK ROUTERS), ISDN TERMINAL ROUTERS (INTEGRATED SERVICE DIGITAL NETWORK TERMINAL ADAPTERS); MULTIPLEXERS; HOME NETWORKING APPLIANCES, NAMELY, VIDEO CASSETTE RECORDERS, CABLE BOXES IN THE NATURE OF CABLE TELEVISION CONVERTERS, SET TOP BOXES (STB), VIDEO STATIONS FEATURING CAMERAS AND MONITORS AND LIQUID CRYSTAL DISPLAYS; MODEMS, AMPLIFIERS FOR WIRELESS COMMUNICATIONS; SET-TOP BOXES; DIGITAL SUBSCRIBER LINE (XDSL) EQUIPMENT, NAMELY, COMPUTER HARDWARE THAT ENABLES VIDEO COMMUNICATIONS, VOICE COMMUNICATIONS, VOICE-OVER INTERNET PROTOCOL COMMUNICATIONS, VIDEO-OVER INTERNET PROTOCOL COMMUNICATIONS, ONLINE COMMUNICATIONS, VOICE-OVER-DIGITAL-SUBSCRIBER LINE COMMUNICATIONS, VIDEO-OVER-DIGITAL-SUBSCRIBER LINE COMMUNICATIONS, VOICE MAIL, VIDEO MAIL, CALL FORWARDING, CALLER ID, CONFERENCING, CUSTOMIZED PHONE NUMBER DIRECTORIES, CALL ROUTING SERVICES AND VOICE-OVER DIGITAL LINE COMMUNICATIONS; COMPUTER SOFTWARE THAT ENABLES VIDEO COMMUNICATIONS, VOICE COMMUNICATIONS, VOICE-OVER INTERNET PROTOCOL COMMUNICATIONS, VIDEO-OVER INTERNET PROTOCOL COMMUNICATIONS, ONLINE COMMUNICATIONS, VOICE-OVER-DIGITAL-SUBSCRIBER LINE COMMUNICATIONS, VIDEO-OVER-DIGITAL-SUBSCRIBER LINE COMMUNICATIONS, VOICE MAIL, VIDEO MAIL, CALL FORWARDING, CALLER ID, CONFERENCING, CUSTOMIZED PHONE NUMBER DIRECTORIES, CALL ROUTING SERVICES AND VOICE-OVER DIGITAL LINE COMMUNICATIONS; COMPONENTS FOR USE IN THE ABOVE DEVICES, NAMELY, DSL MODEMS, CABLE MODEMS AND SATELLITE MODEMS THAT INTERFACE DIRECTLY WITH DIGITAL SUBSCRIBER LINE OTHERWISE KNOWN AS DSL, SATELLITE DATA OR CABLE BROADBAND DATA SERVICES AND RELATED SOFTWARE AS A UNIT THEREWITH; COMPONENTS FOR USE IN THE ABOVE DEVICES, NAMELY, OPTICAL TELEPHONE AND ELECTRICAL CONNECTORS, POWER SUPPLIERS, FAN-OUT FOR SEPARATING INDIVIDUAL FIBERS OR BUFFER TUBES OF A FIBER-OPTIC CABLE FOR THE PURPOSE OF SPLICING OR INSTALLING OPTICAL CONNECTORS, SPLICES FOR ELECTRICAL TRANSMISSION LINES, OPTICAL NETWORKING SPLITTERS; END-TO-END VIDEO SOLUTION, NAMELY, VIDEO ENCODERS, VIDEO SERVERS, SET TOP BOXES, VIDEO CAMERAS, VIDEO ENCODERS AND SOFTWARE, NAMELY, FOR COMPLETE IP VIDEO BROADCASTING, OPTICAL CABLES, ELECTRICAL CABLES, COAXIAL CABLES, TELECOMMUNICATION NETWORK CABLES; VIDEO ENCODERS AND RELATED SOFTWARE SOLD AS A UNIT; TELECOMMUNICATIONS SYSTEMS AND LINES, NAMELY, TERMINALS FOR TRANSMITTING DATA, AUDIO, VOICE, VIDEO AND TELEPHONE SIGNALS AND TRANSMISSION WIRES, TELE-

COMMUNICATIONS CABLES; OPTICAL TELECOMMUNICATIONS SYSTEMS COMPRISED PRIMARILY OF SWITCHES AND TRANSMITTERS AND TELECOMMUNICATION CABLES; APPARATUS FOR GENERATING OR CONVERTING AN OPTICAL SIGNAL FOR USE IN OPTICAL TELECOMMUNICATIONS, OPTICAL CABLES, APPARATUS FOR RECEIVING AN OPTICAL TELECOMMUNICATION SIGNAL AND TRANSMITTING SAID SIGNAL IN OPTICAL OR ELECTRICAL FORM, OPTICAL AMPLIFIERS, OPTICAL REPEATERS, OPTICAL FILTERS, SIGNAL PROCESSING APPARATUS BOTH ELECTRONIC AND OPTICAL, ELECTRONIC APPARATUS FOR GENERATING, RECEIVING, PROCESSING, CONTROLLING, SWITCHING AND FORWARDING SIGNAL PROCESSING OPERATIONS FOR USE IN OPTICAL TELECOMMUNICATION AND TRANSMISSION LINES, TELECOMMUNICATION SWITCHES AND FIBER OPTIC CABLES AND SOFTWARE, NAMELY, COMPUTER PROGRAMS FOR USE IN OPERATING OPTICAL TELECOMMUNICATION AND TRANSMISSION LINES, TELECOMMUNICATION SWITCHES AND FIBER OPTIC CABLES AND COMPUTER MANUALS, DIAGRAMS AND OPERATING INSTRUCTIONS SOLD AS A UNIT THEREWITH, OPTICAL TELECOMMUNICATIONS SYSTEMS AND LINES WITH WAVELENGTH MULTIPLEXING, NAMELY, TRANSMITTING APPARATUS, CABLES, RECEIVING APPARATUS, AMPLIFIERS, REPEATERS, FILTERS, SIGNAL PROCESSING APPARATUS, TELECOMMUNICATIONS SWITCHES; VIDEO, VOICE AND DATA TRANSMISSION SYSTEMS AND LINES, NAMELY, THE COMBINATION OF ONE OR MORE TRANSMITTERS AND A TRANSMISSION CABLE, OPERATIVE TO TRANSMIT VIDEO, VOICE AND/OR DATA OF OTHER KIND FROM A TRANSMITTER TO ONE OR MORE RECEIVERS, NAMELY, RADIO TRANSMISSION SYSTEMS, TELEPHONE NETWORK OR SYSTEMS FOR THE TRANSMISSION OF DATA, TELECOMMUNICATIONS TRANSMITTERS, FIBER OPTIC CABLES; DISTRIBUTION SYSTEMS AND LINES FOR INTERACTIVE SYSTEMS, NAMELY, OPTOELECTRONIC SYSTEMS, NAMELY, TRANSMISSION/RECEPTION APPARATUS AND TRANSMISSION DISTRIBUTION APPARATUS FOR CONVERSION BETWEEN ELECTRICAL AND OPTICAL SIGNALS AND VICE VERSA; APPARATUS FOR THE TRANSMISSION OF OPTICAL SIGNALS WITHOUT AMPLIFICATION, NAMELY, FIBER OPTICS, FIBER OPTIC PASSIVE NETWORKS PRINCIPALLY COMPRISING TRANSMITTERS, CABLES, RECEIVERS, AMPLIFIERS, REPEATERS, FILTERS, SIGNAL PROCESSOR AND SWITCHES, AND PASSIVE OPTICAL CABLES; OPTICAL GENERATORS, NAMELY, RECEIVERS, AMPLIFIERS, REPEATERS, FILTERS, SIGNAL PROCESSOR AND SWITCHES, OPTICAL RECEIVERS, OPTICAL TRANSMITTERS, OPTICAL REGENERATORS, NAMELY, RECEIVERS, AMPLIFIERS, REPEATERS, FILTERS, SIGNAL PROCESSOR AND SWITCHES; OPTICAL AMPLIFIERS, OPTICAL COUPLERS AND OPTICAL SWITCHES; DEVICES FOR THE TRANSMISSION OF OPTICAL SIGNALS WITHOUT AMPLIFICATION, NAMELY, OPTICAL FIBERS AND

OPTICAL FIBER PASSIVE NETWORKS DEVICES FOR THE TRANSMISSION OF OPTICAL SIGNALS WITHOUT AMPLIFICATION, NAMELY, FIBER OPTIC AND FIBER OPTIC PASSIVE NETWORKS PRINCIPALLY COMPRISING TRANSMITTERS, CABLES, RECEIVERS, AMPLIFIERS, REPEATERS, FILTERS, SIGNAL PROCESSOR AND SWITCHES, AND PASSIVE OPTICAL LINES; DEVICES FOR GENERATING, SWITCHING, COMBINING, AMPLIFYING, REGENERATING, TRANSMITTING AND RECEIVING OPTICAL SIGNALS, NAMELY, OPTICAL FIBERS, OPTICAL FIBER PASSIVE NETWORKS PRINCIPALLY COMPRISING TRANSMITTERS, CABLES, RECEIVERS, AMPLIFIERS, REPEATERS, FILTERS, SIGNAL PROCESSOR AND SWITCHES; DEVICES FOR CABLE TELEVISION, NAMELY, CABLE TV TRANSMITTERS, CABLE TV DISTRIBUTION NETWORKS COMPRISED OF COMPUTER HARDWARE AND SOFTWARE, CABLE TV MODULATORS, CABLE TV AMPLIFIERS AND CABLE TV RECEIVERS; OPTICAL DEVICES, NAMELY, OPTICAL SPLITTERS, OPTICAL MODULATORS, OPTICAL FILTERS, SWITCHES; LASERS NOT FOR MEDICAL USE, IN CLASS 9 (U.S. CLS. 21, 23, 26, 36 AND 38).

FOR: ADVERTISING AND BUSINESS ADMINISTRATION SERVICES, NAMELY, TELEPHONE ANSWERING FOR UNAVAILABLE SUBSCRIBERS, BUSINESS ADMINISTRATION SERVICES, NAMELY PROVIDING START-UP SUPPORT FOR BUSINESSES OF OTHERS, OPERATION OF BUSINESS FOR OTHERS; BUSINESS MANAGEMENT AND FUNCTIONAL ADMINISTRATION OF A TRADING OR COMMERCIAL COMPANY, BUSINESS MARKETING SERVICES, ADVERTISEMENT SERVICES; PROVIDING ADVERTISING AND PROMOTIONAL INFORMATION ACCESSED THROUGH A GLOBAL COMPUTER NETWORK; PROVISION OF COMPUTER DATABASES RELATING TO BUSINESS; PREPARING AUDIO-VISUAL PRESENTATIONS FOR USE IN ADVERTISING; ORGANISATION OF EXHIBITIONS, FAIRS, CONGRESSES, SYMPOSIUMS AND MEETINGS FOR COMMERCIAL AND ADVERTISING PURPOSES; AUCTIONEERING PROVIDED ON THE INTERNET; BUSINESS ADMINISTRATION SERVICES FOR THE PROCESSING OF SALES MADE ON THE INTERNET; ADVERTISING SERVICES FOR THE PROMOTION OF E-COMMERCE; PROVISION OF INFORMATION AND ADVICE ON SUPPLY CHAINS AND PROMOTING OF COMMODITIES AND SELECTION AND DISPLAY OF GOODS; PROVISION OF CONSUMER PRODUCT INFORMATION AND ADVICE TO THE PROSPECTIVE PURCHASERS FOR COMMODITIES AND GOODS; THE BRINGING TOGETHER, FOR THE BENEFIT OF OTHERS, OF A VARIETY OF GOODS, EXCLUDING THE TRANSPORT THEREOF, ENABLING CUSTOMERS TO CONVENIENTLY VIEW AND PURCHASE THOSE GOODS; ALL OF THE AFORESAID PROVIDED ON-LINE FROM A COMPUTER DATABASE OR VIA THE INTERNET OR PROVIDED BY OTHER MEANS; BUSINESS INFORMATION SERVICES; DISSEMINATION OF ADVERTISING MATERIALS, UPDATING OF ADVERTISING MATERIALS, COMPILATION OF ADVERTISEMENTS FOR USE AS WEB PAGES ON THE

INTERNET AND BY TELEPHONE, COMPUTER DATA PROCESSING; PROMOTIONAL AND BUSINESS INFORMATION SERVICES, NAMELY, CONCEPTION AND DEVELOPMENT OF ADVERTISEMENT FOR THIRD PARTIES; COMPI- LATION OF COMMERCIAL DIRECTORIES CON- TAINING COMMUNITY INFORMATION, NAMELY, INFORMATION ABOUT TRANSPORTA- TION, TOURIST ATTRACTIONS, SHOPPING FA- CILITIES, MAPS, RECREATIONAL AND LEISURE ACTIVITIES, ENTERTAINMENT, CULTURAL AND SPORTS EVENTS AND FACILITIES FOR PUBLISH- ING ON THE INTERNET; PROVISION OF SPACE ON WEBSITES FOR ADVERTISING GOODS AND SERVICES; DATA PROCESSING SERVICES; BUSI- NESS INFORMATION AND DATA PROCESSING, IN CLASS 35 (U.S. CLS. 100, 101 AND 102).

FOR: TELECOMMUNICATION SERVICES, NAMELY, NETWORK SERVICES, NAMELY, NET- WORK CALL WAITING SERVICES, THREE-PARTY CONFERENCING SERVICES; INTERNET PROVIDER SERVICES, MOBILE TELEPHONE SERVICES, PAGING SERVICES, MOBILE DATA ELECTRONIC TRANSMISSION SERVICES, NAMELY, WIRELESS TEXT MESSAGING, GLOBAL POSITIONING, NAMELY, ELECTRONIC TRANSMISSION OF DATA OBTAINED WITH THE AID OF A GLOBAL

POSITIONING SYSTEM (GPS) TO ENABLE THIRD PARTIES TO COME TO AN ACCURATE LOCATION OR ORIENTATION, PROVIDING E-MAIL SERVI- CES, CELLULAR TELEPHONE SERVICES, BROAD- BAND CABLE NETWORK SERVICES, NAMELY, BROADCASTING OF ANALOG TELEVISION AND RADIO PROGRAMS, TOLL FREE NUMBER SER- VICES; RENTAL OF TELECOMMUNICATION EQUIPMENT, NAMELY, FOR BROADCASTING AND TELEVISION, IN CLASS 38 (U.S. CLS. 100, 101 AND 104).

PRIORITY DATE OF 10-10-2006 IS CLAIMED.

OWNER OF INTERNATIONAL REGISTRATION 0926653 DATED 2-23-2007, EXPIRES 2-23-2017.

THE MARK CONSISTS OF THREE SEPARATED SHADED SEMICIRCLES PLACED ONE ON TOP OF ANOTHER, AND A SHADED OVAL ON THE TOP.

SER. NO. 79-039,475, FILED 2-23-2007.

REBECCA POVARCHUK, EXAMINING ATTOR- NEY

Int. Cls.: 35 and 41

Prior U.S. Cls.: 100, 101, 102 and 107

United States Patent and Trademark Office

Reg. No. 3,505,476

Registered Sep. 23, 2008

**SERVICE MARK  
PRINCIPAL REGISTER**

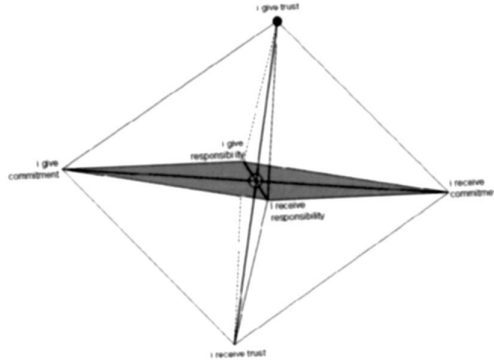

CHOCO, COÖPERATIEVE; VENNOOTSCHAP  
MET BEPERKTE; AANSPRAKELIJKHEID  
(BELGIUM LIMITED LIABILITY COMPANY)  
FLORENT VAN CAUWENBERGHSTRAAT 5  
B-2500 LIER, BELGIUM

FOR: ADVERTISING SERVICES; BUSINESS  
MANAGEMENT AND BUSINESS ADMINISTRA-  
TION; PROVIDING OFFICE FUNCTIONS; CON-  
SULTING IN INDUSTRIAL MANAGEMENT;  
MANAGEMENT OF COMPUTER FILES; SYSTEM-  
ISATION OF INFORMATION INTO COMPUTER  
DATABASES; ASSISTANCE WITH MANAGEMENT  
OF INDUSTRIAL AND COMMERCIAL COMPA-  
NIES; PERSONNEL CONSULTANCY; BUSINESS  
MANAGEMENT AND CONSULTATION, NAMELY,  
PROVIDING ADVICE TO COMPANIES REGARD-  
ING COMMUNICATION BETWEEN THEIR MAN-  
AGEMENT, EMPLOYEES AND END CONSUMERS;  
PSYCHOLOGICAL TESTING FOR THE SELECTION  
OF PERSONNEL; BUSINESS ORGANIZATIONAL  
CONSULTATION SERVICES, NAMELY, ASSISTING  
COMPANIES IN DEVELOPING BUSINESS MODELS  
FOR THE ORGANISATION OF COMPANIES, IN  
CLASS 35 (U.S. CLS. 100, 101 AND 102).

FOR: EDUCATION SERVICES, NAMELY, THE  
ORGANIZATION OF SEMINARS AND WORK-  
SHOPS IN THE FIELDS OF ACCOUNTING, BUSI-  
NESS MANAGEMENT AND MARKETING,  
COMMERCIAL MANAGEMENT AND HUMAN RE-  
SOURCEES; PROVIDING TRAINING SERVICES IN  
THE FIELD OF ACCOUNTING, ADVERTISING,  
BUSINESS MANAGEMENT AND MARKETING,

COMMERCIAL MANAGEMENT AND HUMAN RE-  
SOURCEES; ENTERTAINMENT SERVICES, NAME-  
LY, MOVIES AND THEATER; ORGANIZATION OF  
EDUCATIONAL CONFERENCES AND CONVEN-  
TIONS IN THE FIELD OF ACCOUNTING, ADVER-  
TISING, BUSINESS MANAGEMENT AND  
MARKETING, COMMERCIAL MANAGEMENT  
AND HUMAN RESOURCES; TEACHING IN THE  
FIELD OF ACCOUNTING, ADVERTISING, BUSI-  
NESS MANAGEMENT AND MARKETING, COM-  
MERCIAL MANAGEMENT AND HUMAN RE-  
SOURCEES; PROVIDING COLLECTIVE TRAIN-  
ING IN THE FIELD OF ACCOUNTING, ADVERTIS-  
ING, BUSINESS MANAGEMENT AND  
MARKETING, COMMERCIAL MANAGEMENT  
AND HUMAN RESOURCES; AND PERSONAL  
COACHING IN THE FIELD OF ACCOUNTING,  
ADVERTISING, BUSINESS MANAGEMENT AND  
MARKETING, COMMERCIAL MANAGEMENT  
AND HUMAN RESOURCES, IN CLASS 41 (U.S.  
CLS. 100, 101 AND 107).

PRIORITY DATE OF 11-13-2006 IS CLAIMED.

OWNER OF INTERNATIONAL REGISTRATION  
0926947 DATED 4-17-2007, EXPIRES 4-17-2017.

SER. NO. 79-039,613, FILED 4-17-2007.

NAAKWAMA ANKRAH, EXAMINING ATTORNEY

Int. Cl.: 3

Prior U.S. Cls.: 1, 4, 6, 50, 51 and 52

Reg. No. 3,505,477

United States Patent and Trademark Office

Registered Sep. 23, 2008

TRADEMARK  
PRINCIPAL REGISTER

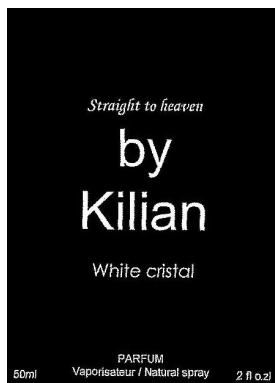

BY KILIAN (FRANCE SARL À ASSOCIÉ UN-  
IQUE)  
44 RUE DE LA TOUR  
F-75016 PARIS  
FRANCE

FOR: PERFUMES, EAU DE PARFUM, TOILET WATER, EAU-DE-COLOGNE, ESSENTIAL OILS, COSMETIC CREAMS, NON MEDICATED COSMETIC PREPARATIONS FOR USE IN THE BATH OR SHOWER, NAMELY, BATH AND SHOWER MILK, BATH AND SHOWER GEL, BATH OIL, BATH SALTS, SKIN MOISTURIZING CREAMS, ANTI-WRINKLE CREAMS, SKIN CLEANSING GELS, NON MEDICATED EXFOLIATING CREAMS AND GELS FOR THE SKIN, BEAUTY MASKS, COSMETIC PREPARATIONS FOR SKIN RENEWAL, COSMETIC SUN TANNING PREPARATIONS, NAMELY, MILKS, GELS, LOTIONS AND OILS, HAIR LOTIONS, HAIR SPRAYS, COSMETIC PREPARATIONS, NAMELY, MASCARA, LIPSTICK, MAKE-UP, FACIAL FOUNDATION, EYE-LINER, MAKE-UP POWDER, NAIL VARNISH FOR COSMETIC PURPOSES, COSMETIC PREPARATIONS FOR SLIMMING PURPOSES, NAMELY, SCULPTING GELS, CREAMS AND LOTIONS FOR CELLULITE REDUCTION, MAKE-UP REMOVING PREPARATIONS, NAMELY, MILKS, GELS, LOTIONS AND CREAMS, DEODORANTS FOR PER-

SONAL USE, ANTI-PERSPIRANTS, SOAPS, OILS FOR COSMETIC PURPOSES, COSMETIC MILK, BODY CREAM, MOISTURIZING LOTION FOR THE BODY, TALCUM POWDER FOR TOILETRY USE, AFTER-SHAVE LOTION, AFTER-SHAVE BALM, ALUM STONE FOR PERSONAL USE, SHAVING FOAM, SHAVING PREPARATIONS, POTPOURRI, TISSUES IMPREGNATED WITH COSMETIC LOTIONS, COSMETIC PREPARATIONS FOR MOUTH CARE, DENTIFRICES, IN CLASS 3 (U.S. CLS. 1, 4, 6, 50, 51 AND 52).

PRIORITY DATE OF 9-6-2006 IS CLAIMED.

OWNER OF INTERNATIONAL REGISTRATION  
0927009 DATED 3-6-2007, EXPIRES 3-6-2017.

NO CLAIM IS MADE TO THE EXCLUSIVE RIGHT TO USE "PARFUM" "50ML" "VAPORISATEUR" "NATURAL SPRAY" AND "2 FL O.Z!", APART FROM THE MARK AS SHOWN.

SER. NO. 79-039,640, FILED 3-6-2007.

DAVID I, EXAMINING ATTORNEY

**Int. Cls.: 3, 14 and 25**

**Prior U.S. Cls.: 1, 2, 4, 6, 22, 27, 28, 39, 50, 51 and 52**

**United States Patent and Trademark Office**

**Reg. No. 3,505,478**

**Registered Sep. 23, 2008**

**TRADEMARK  
PRINCIPAL REGISTER**

# ILLAMASQUA

ILLAMASQUA LIMITED (UNITED KINGDOM LIMITED COMPANY)  
EQUILIBRIUM, APARTMENT 47, PLOVER ROAD  
HUDDERSFIELD, WEST YORKSHIRE HD3 3HL  
UNITED KINGDOM

FOR: COSMETIC PREPARATIONS FOR BODY CARE, AND SKIN RENEWAL; COSMETICS, NAMELY, PRIMER LIQUIDS AND FOUNDATION LIQUIDS AND CREAMS FOR USE ON THE SKIN; FOUNDATION POWDER FOR USE ON THE SKIN; TOILETRIES, NAMELY, SHOWER GEL, SHOWER GEL INCORPORATING EXFOLIATORS, SHOWER GEL INCORPORATING MOISTURIZERS, SHOWER GEL INCORPORATING CLEANSERS, BUBBLE BATH, BATH OILS; COSMETIC PREPARATIONS FOR BATHS, BATH SALTS; COSMETIC PREPARATIONS FOR THE CARE OF THE HAIR, SKIN AND OF THE NAILS; PERFUMES, ESSENTIAL OILS AND SUNTAN LOTIONS; NON-MEDICATED TOILET PREPARATIONS, NAMELY, LOTIONS, SHAMPOOS AND CONDITIONERS, ALL FOR USE ON THE HAIR; TOILET WATERS; SUN TANNING PREPARATIONS; SUN TAN LOTIONS; SUN TAN OILS; AFTER SUN CREAMS; SKIN MOISTURIZING CREAMS; DEODORANTS FOR PERSONAL USE; NON-MEDICATED SKIN CARE PREPARATIONS; SOAP; DENTIFRICES; COSMETICS; AFTER SHAVE LOTIONS; EAU DE COLOGNE; BLUSHER; MAS-CARA; EYELINERS; EYE SHADOW POWDER; EYE SHADOW CREAM; EYEBROW AND LASH GEL; LIPSTICK; LIP GLOSS; EYELINER PENCILS; NAIL POLISH; ANTI-AGING CREAMS, IN CLASS 3 (U.S. CLS. 1, 4, 6, 50, 51 AND 52).

FOR: JEWELRY; COSTUME JEWELRY; PRECIOUS STONES; WATCHES AND CLOCKS; IMITATION JEWELRY; ARTICLES OF PRECIOUS METAL OR OF SEMI-PRECIOUS METALS COATED THEREWITH, NAMELY, JEWELRY, COSTUME JEWELRY, PRECIOUS STONES, WATCHES AND CLOCKS AND IMITATION JEWELRY; REPLACEMENT PARTS AND FITTINGS FOR ALL THE AFORESAID GOODS, IN CLASS 14 (U.S. CLS. 2, 27, 28 AND 50).

FOR: ARTICLES OF CLOTHING, NAMELY, SKIRTS, DRESSES, JUMPERS, T-SHIRTS, JEANS, TROUSERS, VESTS, JACKETS, COATS, TRACK-SUITS, BLOUSES, SCARVES, GLOVES; HATS; SHOES; SHRUGS; PASHMINAS; ARTICLES OF UNDERCLOTHING, NAMELY, LINGERIE AND HOSIERY; HATS AND CAPS; BEACHWEAR; SWIMWEAR; FOOTWEAR, NAMELY, TRAINERS, IN CLASS 25 (U.S. CLS. 22 AND 39).

OWNER OF INTERNATIONAL REGISTRATION  
0927145 DATED 5-29-2007, EXPIRES 5-29-2017.

THE MARK HAS NO MEANING IN A FOREIGN LANGUAGE

SER. NO. 79-039,681, FILED 5-29-2007.

WILLIAM ROSSMAN, EXAMINING ATTORNEY



Int. Cls.: 9 and 42

Prior U.S. Cls.: 21, 23, 26, 36, 38, 100 and 101

United States Patent and Trademark Office

Reg. No. 3,505,479

Registered Sep. 23, 2008

TRADEMARK  
SERVICE MARK  
PRINCIPAL REGISTER

al toolbar

알툴바

ESTSOFT CORP.; ESTSOFT R&D CENTER (RE-  
PUBLIC OF KOREA LIMITED COMPANY)  
867-12 BONGCHEON 4 (SA)-DONG  
GWANAK-GU; SEOUL,151-836,  
REPUBLIC OF KOREA

FOR: COMPUTER PROGRAMS DESIGNED FOR USE IN FILE COMPRESSION, ARCHIVING, VIRUS SCANNING AND COMPUTER FILE MANAGEMENT FOR PERSONAL USE BY END USERS; COMPUTER PROGRAMS DESIGNED FOR VIEWING, PRINTING, ANNOTATING AND MANAGING IMAGE FILES FOR PERSONAL USE BY END USERS; COMPUTER PROGRAMS DESIGNED FOR GRAPHICAL APPLICATIONS, NAMELY, FOR THE CREATION, DELIVERY, EDITING AND VIEWING OF DIGITAL MEDIA, SPECIFICALLY VIDEO, SOUND, ANIMATION, GRAPHICS, TEXT, MUSIC AND VIRTUAL REALITY FOR PERSONAL USE BY END USERS; COMPUTER PROGRAMS DESIGNED FOR TRANSFERRING FILES BETWEEN COMPUTER SYSTEMS FOR PERSONAL USE BY END USERS; COMPUTER PROGRAMS DESIGNED FOR USE IN OPERATING VEHICLE NAVIGATION COMPUTERS, NAMELY, FOR NAVIGATION, ROUTE SEARCHING AND DRAWING MAPS; COMPUTER PROGRAMS DESIGNED FOR DIGITAL RIGHT MANAGEMENT, NAMELY, TO PREVENT USERS FROM PIRATING DIGITAL CONTENTS, TO PROTECT DIGITAL CONTENTS FROM BEING MODIFIED OR AFFECTED, AND TO PROTECT INTELLECTUAL PROPERTY RIGHTS DERIVED FROM DIGITAL CONTENTS; COMPUTER PROGRAMS DESIGNED FOR USE IN DATABASE MANAGEMENT AND ACCESSING COMPUTER

COMMUNICATIONS NETWORKS, COMPUTER PROGRAMS DESIGNED FOR COMPUTER GAMES PROVIDED ON INTERNET OR OTHER NETWORK, IN CLASS 9 (U.S. CLS. 21, 23, 26, 36 AND 38).

FOR: COMPUTER SERVICES, NAMELY, PROVIDING SEARCH ENGINES FOR OBTAINING DATA OVER THE INTERNET; COMPUTER VIRUS PROTECTION SERVICES; CONVERSION OF DATA OR DOCUMENTS FROM PHYSICAL TO ELECTRONIC MEDIA; DATA CONVERSION OF COMPUTER PROGRAMS AND DATA, NOT PHYSICAL CONVERSION, IN CLASS 42 (U.S. CLS. 100 AND 101).

PRIORITY DATE OF 5-14-2007 IS CLAIMED.

OWNER OF INTERNATIONAL REGISTRATION 0927653 DATED 5-29-2007, EXPIRES 5-29-2017.

NO CLAIM IS MADE TO THE EXCLUSIVE RIGHT TO USE THE NON-LATIN CHARACTERS THAT MEAN "TOOLBAR", APART FROM THE MARK AS SHOWN.

THE NON-LATIN CHARACTER(S) IN THE MARK transliterates into "ALTOOLBAR", AND THIS MEANS "TOOLBAR" IN ENGLISH.

SER. NO. 79-039,850, FILED 5-29-2007.

WILLIAM ROSSMAN, EXAMINING ATTORNEY

**Int. Cls.: 16 and 17**

**Prior U.S. Cls.: 1, 2, 5, 12, 13, 22, 23, 29, 35, 37, 38 and 50**

**United States Patent and Trademark Office**

**Reg. No. 3,505,480**

**Registered Sep. 23, 2008**

**TRADEMARK  
PRINCIPAL REGISTER**

**BALETITE**

BRITISH POLYTHENE LIMITED (UNITED  
KINGDOM PRIVATE LIMITED COMPANY)  
10 FOSTER LANE  
LONDON EC2V 6HR  
UNITED KINGDOM

FOR: PLASTIC FILM AND WRAP FOR WRAP-  
PING AND PACKAGING OF GOODS; FILMS,  
SHEETS, BAGS AND TUBES OF PLASTIC FOR  
WRAPPING AND PACKAGING, NOT FOR COM-  
MERCIAL OR INDUSTRIAL PURPOSES, IN CLASS  
16 (U.S. CLS. 2, 5, 22, 23, 29, 37, 38 AND 50).

FOR: SEALING, PACKING AND INSULATING  
MATERIALS, NAMELY, ADHESIVE PACKING  
TAPE FOR INDUSTRIAL OR COMMERCIAL USE;  
PLASTIC FILM USED AS INDUSTRIAL OR COM-

MERCIAL PACKING MATERIAL; PLASTIC FILM  
FOR AGRICULTURAL PURPOSES; SEALING AND  
STUFFING MATERIALS OF PLASTIC AND PLAS-  
TIC FILM NOT FOR PACKAGING, IN CLASS 17  
(U.S. CLS. 1, 5, 12, 13, 35 AND 50).

OWNER OF INTERNATIONAL REGISTRATION  
0928306 DATED 5-24-2007, EXPIRES 5-24-2017.

THE WORD "BALETITE" HAS NO MEANING IN  
A FOREIGN LANGUAGE.

SER. NO. 79-040,044, FILED 5-24-2007.

KELLY MCCOY, EXAMINING ATTORNEY

Int. Cl.: 35

Prior U.S. Cls.: 100, 101 and 102

United States Patent and Trademark Office

Reg. No. 3,505,481

Registered Sep. 23, 2008

SERVICE MARK  
PRINCIPAL REGISTER



PROTECTIVE COMFORT GROUP, S.L. (SPAIN  
SOCIEDAD DE RESPONSABILIDAD LIMITADA (SL))

PARTIDA CANASTELL, I-98/100  
E-03690 SAN VICENTE DEL RASPEIG (ALICANTE)  
SPAIN

FOR: BUSINESS OPERATION FOR WHOLESALE FLORIST, GYMNASICS SCHOOL FOR OTHERS; BUSINESS MANAGEMENT ASSISTANCE TO COMMERCIAL OR INDUSTRIAL COMPANIES; IMPORT-EXPORT AGENCIES; EXCLUSIVE INDEPENDENT SALES REPRESENTATIVES IN THE FIELD OF CARPETS, RUGS, MATS, MATTING, LINOLEUM AND OTHER FLOOR COVERINGS; RETAILING SERVICES IN STORES AND VIA GLOBAL COMPUTER NETWORKS FEATURING CARPETS, RUGS, MATS AND MATTING, LINOLEUM AND OTHER MATERIALS FOR COVERING EXISTING FLOORS, NON-TEXTILE WALL HANGINGS, MOVABLE ANTISLIP RUBBER LAYERS FOR GYMNASIUM FLOORS, GYMNASIUM MATS, GAMES, TOYS, SPORTING AND GYMNASIUM GOODS, EXERCISE MATS AND OTHER APPLIANCES FOR GYMNASIUM; FRANCHISING, NAMELY, CONSULTATION AND ASSISTANCE IN BUSINESS MANAGEMENT, ORGANIZATION AND PROMOTION, IN CLASS 35 (U.S. CLS. 100, 101 AND 102).

PRIORITY DATE OF 1-31-2007 IS CLAIMED.

OWNER OF INTERNATIONAL REGISTRATION  
0928564 DATED 5-10-2007, EXPIRES 5-10-2017.

NO CLAIM IS MADE TO THE EXCLUSIVE RIGHT TO USE "GROUP", APART FROM THE MARK AS SHOWN.

"THE COLOR(S) BLACK AND ORANGE IS/ARE CLAIMED AS A FEATURE OF THE MARK."

THE MARK CONSISTS OF THE WORDING "PROTECTIVE COMFORT GROUP" AND A DESIGN TO THE LEFT OF THE WORDING OF AN ASYMMETRICAL, CURVED BAND OVER A SINGLE, HORIZONTAL BAR. THE COLOR BLACK APPEARS IN THE WORDING "PROTECTIVE COMFORT"; THE COLOR ORANGE APPEARS IN THE WORDING, "GROUP," AND IN THE DESIGN TO THE LEFT OF THE MARK COMPRISED OF AN ASYMMETRICAL, CURVED BAND OVER A SINGLE, HORIZONTAL BAR.

SER. NO. 79-040,150, FILED 5-10-2007.

GILBERT SWIFT, EXAMINING ATTORNEY

**Int. Cls.: 36, 37 and 42**

**Prior U.S. Cls.: 100, 101, 102, 103 and 106**

**Reg. No. 3,505,482**

**United States Patent and Trademark Office**

**Registered Sep. 23, 2008**

**SERVICE MARK  
PRINCIPAL REGISTER**

# FORTIS

FORTIS N.V. (NETHERLANDS NAAMLOZE  
VENNOOTSCHAP)  
ARCHIMEDES LAAN 6  
NL-3584 BA UTRECHT  
NETHERLANDS AND  
FORTIS SA/NV (BELGIUM NAAMLOZE VENNOOT-  
SCHAP)  
KONINGSSTRAAT 20  
B-1000 BRUSSEL  
BELGIUM

FOR: INSURANCE SERVICES, NAMELY, PROVIDING INSURANCE UNDERWRITING, ADMINISTRATION AND INSURANCE CONSULTATION SERVICES IN THE FIELDS OF LIFE, PROPERTY AND CASUALTY, ACCIDENT, HEALTH AND CREDIT INSURANCE SERVICES; FINANCIAL SERVICES, NAMELY, FINANCIAL CONSULTATION SERVICES, FINANCIAL CLEARING HOUSE SERVICES, FINANCIAL MANAGEMENT AND FINANCIAL PORTFOLIO MANAGEMENT, FINANCIAL PLANNING, FINANCIAL RESEARCH, FINANCIAL SERVICES IN THE NATURE OF AN INVESTMENT SECURITY, ASSISTING OTHERS WITH THE COMPLETION OF FINANCIAL TRANSACTIONS FOR STOCKS, BONDS, SECURITIES AND EQUITIES, FUND INVESTMENTS CONSULTATION, FUNDS INVESTMENT, MANAGEMENT OF A CAPITAL INVESTMENT FUND, INVESTMENT SERVICES, NAMELY INVESTMENT CONSULTATION AND INVESTMENT BROKERAGE; MONETARY AFFAIRS, NAMELY, ACQUISITION AND TRANSFER OF MONETARY CLAIMS, MONETARY EXCHANGE; REAL ESTATE AFFAIRS, NAMELY, REAL ESTATE MANAGEMENT AND APPRAISAL; REAL ESTATE BROKERAGE SERVICES, NAMELY, RENTAL AND INTERMEDIARY SERVICES RELATED TO THE ACQUISITION, TRANSFER, ENCUMBRANCE OF REAL ESTATE; PROVIDING AGENCIES FOR THE COLLECTION OF RENTS; FINANCIAL CONSULTING AND PLANNING IN

THE FIELD OF REAL ESTATE PROJECT DEVELOPMENT, IN CLASS 36 (U.S. CLS. 100, 101 AND 102).

FOR: BUILDING CONSTRUCTION, REPAIR AND INSTALLATION SERVICES, NAMELY, CONSTRUCTION, RENOVATION, RESTORATION AND MAINTENANCE OF BUILDINGS; CLEANING SERVICES, NAMELY, CLEANING OF BUILDINGS; CONSULTING SERVICES IN CONNECTION WITH CONSTRUCTION, RENOVATION, RESTORATION AND MAINTENANCE OF BUILDINGS, IN CLASS 37 (U.S. CLS. 100, 103 AND 106).

FOR: DESIGN SERVICES, NAMELY, ARCHITECTURAL DESIGN; TECHNICAL SURVEYING AND BUILDING INSPECTION SERVICES; TECHNICAL RESEARCH IN THE FIELD OF BUILDINGS; MATERIALS TESTING, NAMELY, RESEARCH INTO THE CONDITION OF BUILDING MATERIALS AND TESTING OF BUILDING MATERIALS; PROVIDING CONSULTING SERVICES IN THE FIELDS OF ENGINEERING AND ARCHITECTURAL DESIGN, IN CLASS 42 (U.S. CLS. 100 AND 101).

THE MARK CONSISTS OF STANDARD CHARACTERS WITHOUT CLAIM TO ANY PARTICULAR FONT, STYLE, SIZE, OR COLOR.

PRIORITY DATE OF 11-23-2006 IS CLAIMED.

OWNER OF INTERNATIONAL REGISTRATION 0928619 DATED 4-10-2007, EXPIRES 4-10-2017.

OWNER OF U.S. REG. NOS. 1,902,973, 2,878,221 AND OTHERS.

SER. NO. 79-040,184, FILED 4-10-2007.

CHARISMA HAMPTON, EXAMINING ATTORNEY

**Int. Cls.: 17, 19 and 20**

**Prior U.S. Cls.: 1, 2, 5, 12, 13, 22, 25, 32, 33, 35 and 50**

**United States Patent and Trademark Office**

**Reg. No. 3,505,483**

**Registered Sep. 23, 2008**

**TRADEMARK  
PRINCIPAL REGISTER**

# RAUCORD

REHAU AG + CO. (FED REP GERMANY AG + CO)  
RHENIUMHAUS  
95111 REHAU, FED REP GERMANY

FOR: RUBBER, ASBESTOS, MICA; SEALING AND INSULATING MATERIALS; ACRYLIC RESINS; ASBESTOS FIBRES; ASBESTOS FELT; ASBESTOS MESH; ASBESTOS FABRICS; ASBESTOS PAPER; ASBESTOS CARDBOARD; ASBESTOS SLATE; ASBESTOS SOLES; ASBESTOS CLOTHS; ASBESTOS CLADDING; WOOD BARK FOR ACOUSTIC INSULATION; PROTECTIVE PLASTIC FRAME FILMS FOR WINDOWS; FLOWER ARRANGING FOAM; ELASTIC YARNS AND THREADS, NOT FOR TEXTILE PURPOSES; MOISTURE INSULATING MATERIALS FOR BUILDINGS; FIRE HOSES; GARDEN HOSES; FIBREGLASS FABRIC FOR INSULATION PURPOSES; FIBREGLASS WOOL FOR INSULATION; MICA, RAW OR PARTIALLY PROCESSED; RUBBER MATERIAL FOR RECAPPING TIRES; RUBBER, RAW OR PARTIALLY PROCESSED; RUBBER SEALS FOR GLASS VESSELS; RUBBER THREADS, NOT FOR TEXTILE PURPOSES; RUBBER SLEEVES TO PROTECT MECHANICAL PARTS; RUBBER BUFFERS; RUBBER ROPES AND CORDS; RUBBER STOPPERS; HARD RUBBER; INSULATORS FOR ELECTRICAL CABLES; INSULATORS FOR RAIL WAY TRACKS; INSULATORS AND INSULATING MATERIALS; INSULATING PAINTS; INSULATING TAPE; INSULATING FELT; INSULATING VARNISHES; INSULATING FILMS MADE OF METAL; INSULATING FABRICS; INSULATED GLOVES; INSULATING MATERIALS; INSULATING MATERIALS FOR CABLES; INSULATING OIL FOR TRANSFORMERS; INSULATING OILS; INSULATING PAPER; INSULATING MORTAR; ADHESIVE TAPES AND STRIPS, APART FROM FOR MEDICAL PURPOSES, FOR PAPER AND STATIONERY OR FOR HOUSEHOLD PURPOSES; CARBON FIBRES, NOT FOR TEXTILE PURPOSES; SYNTHETIC RESINS; PLASTICS, PARTIALLY PROCESSED; CLUTCH LININGS; SOLDERING WIRE MADE OF PLASTIC; PAPER FOR ELECTRICAL CAPACITORS; PIPE SOCKETS, NOT MADE OF METAL; PIPE JOINTS, NOT MADE OF

METAL; ACOUSTIC INSULATION MATERIALS; HOSES MADE OF TEXTILE MATERIALS; HOSES, NOT MADE OF METAL; PLASTIC SUBSTANCES USED AS WELDING WIRE; FLOATING BARRIERS TO CONTAIN ENVIRONMENTAL CONTAMINANTS; SELF-ADHESIVE TAPES, APART FROM FOR MEDICAL PURPOSES, FOR PAPER AND STATIONERY OR FOR THE HOUSEHOLD; SAFETY CURTAINS MADE OF ASBESTOS; SYNTHETIC RUBBER; WASHERS MADE OF RUBBER OR VULCANIZED FIBRE; VALVES MADE OF RUBBER OR VULCANIZED FIBRE; CONNECTING HOSES FOR VEHICLE RADIATORS; PACKAGING BAGS MADE OF RUBBER; VULCANIZED FIBRE; THERMAL INSULATING MATERIALS; CYLINDER SEALS, IN CLASS 17 (U.S. CLS. 1, 5, 12, 13, 35 AND 50).

FOR: ASPHALT, PITCH AND BITUMEN; DRAINAGE PIPES, NOT MADE OF METAL; PIPE BRANCHES, NOT MADE OF METAL; ALABASTER; ALABASTER GLASS; BOLLARDS, NOT MADE OF METAL; AQUARIUM GRAVEL; AQUARIUM SAND; REINFORCING MATERIALS FOR BUILDING PURPOSES, NOT MADE OF METAL; ASBESTOS MORTAR; ASBESTOS CEMENT; ASPHALT PAVING BLOCKS; BEACONS, NOT ILLUMINATED AND NOT MADE OF METAL; BEAMS, NOT MADE OF METAL; BALUSTRADES; TRANSPORTABLE BUILDINGS NOT OF METAL "BARRACKS"; BUILDING WOOD AND TIMBER; BUILDING FELT; BUILDING GLASS; BRICKS; QUARTZ; CONCRETE; BITUMEN; BITUMINOUS COVERING COMPOUNDS FOR ROOFS; BRICKWORK LETTER BOXES; NATURAL STONE; BUSTS MADE OF STONE, CONCRETE OR MARBLE; ROOF COVERINGS, NOT MADE OF METAL; ROOFS, NOT MADE OF METAL; ROOFS, NOT MADE OF METAL, WITH INTEGRATED SOLAR CELLS; ROOFING FELT; ROOF TILES, NOT MADE OF METAL; GUTTERS, NOT MADE OF METAL; ROOF CLADDING BOARDS; ROOF SLATES; BOLLARD TIMBER; MONUMENTS, NOT MADE OF METAL; WIRE-REINFORCED GLASS; DRAINAGE PIPES, NOT MADE OF METAL; RAILWAY SLEEPERS, NOT MADE OF METAL; PAINT SPRAYING BOOTHS,

NOT OF METAL; WINDOWS, NOT MADE OF METAL; WINDOW GLASS; WINDOW SHUTTERS, NOT MADE OF METAL; WINDOW FRAMES, NOT MADE OF METAL; WINDOW GLASS; FIGURES MADE OF STONE, CONCRETE OR MARBLE; GRATINGS, NOT MADE OF METAL; TILE COVERINGS, NOT MADE OF METAL; FLOORS, NOT MADE OF METAL; SCAFFOLDING, NOT MADE OF METAL; CORNICES, NOT MADE OF METAL; GREENHOUSES, NOT MADE OF METAL; GREENHOUSE FRAMES, NOT MADE OF METAL; PLASTER; GLASS GRANULES FOR ROAD MARKINGS; GLASS PANES FOR BUILDING PURPOSES; HEADSTONES, NOT MADE OF METAL; GRAVE BORDERS, NOT MADE OF METAL; GRAVESTONES, NOT MADE OF METAL; TOMBS, NOT MADE OF METAL; GRAVE COLUMNS, NOT MADE OF METAL; GRANITE; BLAST FURNACE CEMENT; WOOD FIBRE CONCRETE; WOODEN BARS FOR PANELLING; HARDBOARD FOR BUILDING PURPOSES; WOOD PAVING BLOCKS; WOODEN PANELLING; CHICKEN COOPS, NOT MADE OF METAL; INSULATING GLASS FOR BUILDING PURPOSES; ROLLER SHUTTERS, NOT MADE OF METAL; TILES FOR BUILDING PURPOSES, NOT MADE OF METAL; PREFABRICATED CEMENT POSTS, GUSSET TROUGHS, NOT MADE OF METAL, FOR ROOFS, FOR BUILDING PURPOSES; GRAVEL; STAINED-GLASS WINDOWS FOR CHURCH; GATE VALVES FOR DRAINAGE PIPES, NOT MADE OF METAL OR MADE OF PLASTIC; GATE VALVES, NOT MADE OF METAL OR PLASTIC, FOR WATER PIPING; CORK ICE RINKS, NOT MADE OF METAL; OBJECTS OF ART MADE OF STONE, CONCRETE OR MARBLE; SYNTHETIC STONES; PRE-FABRICATED SUMMER HOUSES; ROADSIDE BARRIERS, NOT MADE OF METAL, FOR ROADS; DUCTS FOR VENTILATION AND AIR CONDITIONING, NOT MADE OF METAL; ILLUMINATED PAVING BLOCKS; AWNING STRUCTURES, NOT MADE OF METAL; MARBLE; MORTAR; TIMBER; SKYLIGHTS, NOT MADE OF METAL; FRAMEWORK FOR SUMMER HOUSES, NOT MADE OF METAL; FURNACE CEMENT; PITCH; POSTS, NOT MADE OF METAL; POST FENCES, NOT MADE OF METAL; PAVING BLOCKS, NOT MADE OF METAL; POSTS MADE OF CEMENT; FLAGSTONES; BLOCKS MADE OF CEMENT; ROCKET LAUNCHING PLATFORMS, NOT OF METAL; EDGING STRIPS, NOT MADE OF METAL, FOR CORNICES; RAW CHALK FOR BUILDING PURPOSES; PIPES MADE OF SANDSTONE; PIPES FOR BUILDING PURPOSES, NOT MADE OF METAL; SAND; SILVER SAND; SANDSTONE FOR BUILDING PURPOSES; SLATE; SLATE POWDER FOR BUILDING PURPOSES; SLAG BRICKS; DRESSED TIMBER; CHIMNEY TOPS, NOT MADE OF METAL; CHIMNEY HOODS, NOT MADE OF METAL; CHIMNEY PIPES, NOT MADE OF METAL; SHARP GRAVEL; FLOATING DOCKS, NOT MADE OF METAL, TO HOLD SHIPS; CAISSONS FOR CONSTRUCTION WORK UNDER WATER; SIGNAL SIGNS, NOT ILLUMINATED, NOT MECHANICAL AND NOT MADE OF METAL; SILOS, NOT MADE OF METAL; PLYWOOD; DIVING BOARDS, NOT MADE OF METAL; HOARDING POSTS, NOT MADE OF METAL; STATUES MADE OF STONE, CONCRETE OR MARBLE; STATU-

ETTES MADE OF STONE, CONCRETE OR MARBLE; BRICKS; ROADSIDE POSTS, NOT ILLUMINATED, NOT MECHANICAL AND NOT MADE OF METAL; ROADSIDE BARRIERS, NOT MADE OF METAL; ROAD MARKING SHEETS AND BLOCKS MADE OF PLASTIC; PANELLING, NOT MADE OF METAL; TARRED TAPE AND MEMBRANES FOR BUILDING PURPOSES; TAR BOARD FOR BUILDING PURPOSES; TELEPHONE BOXES, NOT MADE OF METAL; POTTERY CLAY; GATES, NOT MADE OF METAL; JOISTS, NOT MADE OF METAL; DOORS, NOT MADE OF METAL; DOOR LEAFS, NOT MADE OF METAL; DOOR FRAMES, BARS, NOT MADE OF METAL; CLADDING PARTS FOR BUILDINGS, NOT MADE OF METAL; EXTENSIONS FOR CHIMNEYS, NOT MADE OF METAL; RIGID PIPE ELEMENTS, NOT MADE OF METAL; VINYL RAILS; BIRD BATHS, NOT MADE OF METAL; AVIARIES, NOT MADE OF METAL; WALL CLADDING PARTS, NOT MADE OF METAL; WATER PIPING, NOT MADE OF METAL; FENCES, NOT MADE OF METAL; CEMENT MORTAR; BRICK CLAY; BRICKS; ROOM CEILINGS, NOT MADE OF METAL; GANGWAYS, NOT MADE OF METAL, IN CLASS 19 (U.S. CLS. 1, 12, 33 AND 50).

FOR: FURNITURE, MIRRORS, WORK TOPS; FILING CABINETS; AMBROID BOARDS; AMBROID RODS; ANCHOR BUOYS, NOT MADE OF METAL; CUPBOARDS; MEDICINE CABINETS; INFLATABLE FURNITURE; INFLATABLE ADVERTISING ARTICLES; STUFFED ANIMALS; STUFFED BIRDS; OYSTER SHELLS; BAMBOO CURTAINS; BENCHES; CLIPS MADE OF PLASTIC FOR CABLES AND PIPES; TANK STOPPERS, NOT MADE OF METAL; BRUSH HANDLES, NOT MADE OF METAL; CREMATION URNS; BED FITTINGS, NOT MADE OF METAL; BEDS; BEDS FOR PETS; BED FRAMES MADE OF WOOD; BED CASTORS, NOT MADE OF METAL; BEEHIVES; PICTURE FRAMES; PLANT STANDS; PLANT TABLES; PORTABLE TUBS, NOT MADE OF METAL; LETTER BOXES NOT MADE OF METAL OR BRICKWORK; BOOKCASES; BUFFETS; TEA TROLLEYS; OFFICE FURNITURE; BUSTS MADE OF WOOD, WAX, PLASTER OR PLASTIC; COMPUTER DESKS; COMPUTER TROLLEYS; DECORATION ARTICLES MADE OF PLASTIC FOR FOOD; DIVANS; CASES, BOXES AND CRATES MADE OF WOOD OR PLASTIC; DOWELS, NOT MADE OF METAL; IVORY, RAW OR PARTIALLY PROCESSED; SHELVES FOR FURNITURE; FANS FOR PERSONAL USE; FLAG POLES; VEHICLE LOCKS, NOT MADE OF METAL; BARRELS, NOT MADE OF METAL; BARREL TAPS, NOT MADE OF METAL; BARREL HOOPS, NOT MADE OF METAL; WINDOW FITTINGS, NOT MADE OF METAL; FISH BONE, RAW OR PARTIALLY PROCESSED; BOTTLE CAPS, NOT MADE OF METAL; BOTTLE CORKS; BOTTLE STOPPERS, NOT MADE OF METAL; BUTCHERS' BLOCKS; TRANSPORT PALLETS, NOT MADE OF METAL; HAIRDRESSING SEATS; FODDER TROUGHS; WARDROBE HOOKS, NOT MADE OF METAL; WARDROBE STANDS; CURTAIN HOOKS; CURTAIN HOLDERS, NOT MADE OF TEXTILE MATERIALS; CURTAIN RINGS; CURTAIN ROLLS; CURTAIN RODS; GUN STANDS; HAND MIRRORS; TOWEL CABINETS;

HOUSE NUMBERS, NOT ILLUMINATED AND NOT MADE OF METAL; ANTLERS; WORKBENCHES; HONEYCOMBS; HAT STANDS; IDENTITY BADGES, NOT MADE OF METAL; VENETIAN BLINDS; CABLE CLIPS, NOT MADE OF METAL; FIRE SCREENS FOR THE HOUSEHOLD; CANOPIES FOR BEDS; EDGINGS OF PLASTIC FOR FURNITURE; BOXES, CRATES, NOT MADE OF METAL; TRIANGULAR CUSHIONS; SIGNBOARDS OF WOOD OR PLASTICS, FOR VEHICLES; HIGH CHAIRS; CUSHIONS; CUSHIONS FOR PETS; GATE VALVES MADE OF PLASTIC FOR WATER PIPING; GATE VALVES MADE OF PLASTIC FOR DRAINAGE PIPES; CLOTHES HANGERS; CLOTHES HOOKS, NOT MADE OF METAL; MANNEQUINS; CLOTHES STANDS; COMMODES; PILLOWS; CORAL; BASKETS, NOT MADE OF METAL; CORKS; COSMETIC MIRRORS; HOSPITAL BEDS; PLAYING POSTS FOR CATS; OBJECTS OF ART MADE OF WOOD, WAX, PLASTER OR PLASTIC; PLASTIC KEY CARDS; FURNITURE FOR SHOP COUNTERS; LOADING GAUGE RODS NOT OF METAL FOR RAILWAY WAGGONS; STORAGE RACKS, NOT OF METAL, FOR DRUMS; BEDSTEADS, NOT MADE OF METAL; PLAYPENS FOR INFANTS; LECTERNS; BEDS FOR PETS; SUN LOUNGERS; INFLATABLE PILLOWS, NOT FOR MEDICAL PURPOSES; AIR PILLOWS, NOT FOR MEDICAL PURPOSES; AIR-BEDS, NOT FOR MEDICAL PURPOSES; MASSAGE SEATS; MASSAGE BENCHES; MATTRESSES; MEERSCHAUM; KNIFE HANDLES, NOT MADE OF METAL; FURNITURE MADE OF METAL; FURNITURE FITTINGS, NOT MADE OF METAL; WOODEN SHELVES; CASTORS, NOT MADE OF METAL; FURNITURE DOORS; MORTAR TROUGHS, NOT MADE OF METAL; NAME BRACELETS, NOT MADE OF METAL, FOR USE IN HOSPITALS; NESTING BOXES FOR HOUSEHOLD PETS; RIVETS, NOT MADE OF METAL; REGISTRATION PLATES, NOT MADE OF METAL, FOR VEHICLES; PAPER BASKETS; FURNITURE PARTITIONS OF WOOD; PARK BENCHES; BEAD CURTAINS FOR DECORATIVE PURPOSES; MOTHER OF PEARL, RAW OR PARTIALLY PROCESSED; SIDEBOARDS MADE OF WOOD OR PLASTIC; UPHOLSTERED FURNITURE; ARMCHAIRS; DESKS; ROSETTES FOR CURTAINS; EMBROIDERY FRAMES; FRAMES FOR BEEHIVES; PICTURE FRAMES; RATTAN; ROOM DIVIDERS; SHELVES; SHELVES FOR FILE FOLDERS; COFFIN FITTINGS, NOT MADE OF METAL; COFFINS; HINGES, NOT MADE OF METAL; SHOWCASES; SHIP SUN LOUNGERS; TORTOISESHELLS; IMITATION TORTOISESHELLS; UMBRELLA STANDS; SLEEPING BAGS FOR CAMPING; REELS, NOT OF METAL, NON-MECHANICAL, FOR FLEXIBLE HOSES; WINDING SPOOLS, NOT OF METAL,

NON-MECHANICAL, FOR FLEXIBLE HOSES; LOCKS, NOT MADE OF METAL; JEWELLERY CASES, NOT MADE OF NOBLE METALS; SCREWS, NOT MADE OF METAL; NUTS, NOT MADE OF METAL; VICE BENCHES, NOT MADE OF METAL; TYPEWRITER DESKS; STATIONERY CABINETS; DRAWERS; SCHOOL FURNITURE; SCYTHE HANDLES, NOT MADE OF METAL; SEATS MADE OF METAL; SOFAS; FOOD CUPBOARDS, NOT MADE OF METAL; MIRROR TILES; MIRROR GLASS; TOY BOXES; LADDERS, MADE OF WOOD OR PLASTIC; SPRING MATTRESSES; SINK MATS; STANDS FOR FLOWER POTS; STATUES MADE OF WOOD, WAX, PLASTER OR PLASTIC; STATUETTES MADE OF WOOD, WAX, PLASTER OR PLASTIC; STEP LADDERS, NOT MADE OF METAL; STRAW MATTRESSES; CHAIRS; TANKS, NOT MADE OF METAL, FOR LIQUID FUELS; BAKERS' BREAD BASKETS; ANIMAL HORNS; ANIMAL CLAWS; TABLES; TABLES MADE OF METAL; TABLE TOPS; VANITY DRAWERS; TRANSPORT PALLETS, NOT MADE OF METAL; DRINKING STRAWS MADE OF STRAW AND PLASTIC; DOOR FITTINGS, NOT MADE OF METAL; DOOR HANDLES, NOT MADE OF METAL; DOOR BOLTS, NOT MADE OF METAL; PACKAGING CONTAINERS MADE OF PLASTIC; SEALING CAPS, NOT MADE OF METAL; SILVERED GLASS; SHOW CABINETS; CURTAIN ROLLERS MADE OF PLASTIC; CURTAIN RAILS; HONEYCOMB BASES FOR BEE HIVES; WAX FIGURES; VANITY CABINETS; WATER BEDS, NOT FOR MEDICAL PURPOSES; WINE CLARIFYING TUBS MADE OF WOOD; TOOL HANDLES, NOT MADE OF METAL; COTS; WIND CHIMES; DRAWING DESKS; NEWSPAPER RACKS; NEWSPAPER STANDS; TENT PEGS, NOT MADE OF METAL, IN CLASS 20 (U.S. CLS. 2, 13, 22, 25, 32 AND 50).

THE MARK CONSISTS OF STANDARD CHARACTERS WITHOUT CLAIM TO ANY PARTICULAR FONT, STYLE, SIZE, OR COLOR.

PRIORITY DATE OF 2-28-2006 IS CLAIMED.

OWNER OF INTERNATIONAL REGISTRATION 0928709 DATED 8-23-2006, EXPIRES 8-23-2016.

THE WORDING "RAUCORD" HAS NO MEANING IN A FOREIGN LANGUAGE.

SER. NO. 79-040,209, FILED 8-23-2006.

WILLIAM P. SHANAHAN, EXAMINING ATTORNEY

Int. Cl.: 43

Prior U.S. Cls.: 100 and 101

United States Patent and Trademark Office

Reg. No. 3,505,484

Registered Sep. 23, 2008

SERVICE MARK  
PRINCIPAL REGISTER



RENATA MICONI (ITALY INDIVIDUAL)  
VIA DE NARDIS, 1  
I-65100 PESCARA  
ITALY

FOR: SERVICES FOR PROVIDING FOOD AND  
DRINK; TEMPORARY ACCOMMODATION, IN  
CLASS 43 (U.S. CLS. 100 AND 101).

PRIORITY DATE OF 12-13-2006 IS CLAIMED.

OWNER OF INTERNATIONAL REGISTRATION  
0928781 DATED 5-15-2007, EXPIRES 5-15-2017.

NO CLAIM IS MADE TO THE EXCLUSIVE  
RIGHT TO USE "GRANCHIO ROYAL", APART  
FROM THE MARK AS SHOWN.

THE COLOR(S) RED, ORANGE, YELLOW,  
BLACK AND WHITE IS/ARE CLAIMED AS A  
FEATURE OF THE MARK.

THE MARK CONSISTS OF A DRAWING OF A  
CRAB WITH DECORATIVE ABSTRACT CYLIND-  
RICAL POST-SHAPED DESIGNS AS THE BACK-  
GROUND, WITH THE WORDS "GRANCHIO  
ROYAL" UNDERNEATH. THE COLORS RED AND  
YELLOW APPEAR IN THE SHELL AND CLAWS IN  
THE REPRESENTATION OF A CRAB; THE COLOR  
ORANGE APPEARS IN THE BODY OF THE CRAB  
AND AT THE FOOT OF THE CYLINDER SHAPED  
BACKGROUND; THE COLORS BROWN AND  
WHITE APPEAR IN THE CYLINDER SHAPED  
BACKGROUND; THE COLOR WHITE APPEARS  
IN THE EYES OF THE CRAB AND IN THE WORD-  
ING "GRANCHIO ROYAL", AND THE COLOR  
BLACK APPEARS IN THE EYEBALLS OF THE  
CRAB, IN THE OUTLINE OF THE BODY OF THE  
CRAB, AND IN THE OUTLINE OF THE WORDS  
"GRANCHIO ROYAL".

THE ENGLISH TRANSLATION OF THE WORD  
"GRANCHIO" IN THE MARK IS CRAB.

SER. NO. 79-040,231, FILED 5-15-2007.

CARYN GLASSER, EXAMINING ATTORNEY



**Int. Cl.: 6**

**Prior U.S. Cls.: 2, 12, 13, 14, 23, 25 and 50**

**United States Patent and Trademark Office**

**Reg. No. 3,505,485**

**Registered Sep. 23, 2008**

**TRADEMARK  
PRINCIPAL REGISTER**

**DYLAN**

DYLANSTAAL BV (NETHERLANDS BESLOTEN  
VENNOOTSCHAP)  
JAN VAN DER HEYDENSTRAAT 13  
NL-3262 LE OUD BEIJERLAND  
NETHERLANDS

FOR: METAL PIPES AND FLANGES, IN CLASS 6  
(U.S. CLS. 2, 12, 13, 14, 23, 25 AND 50).

THE MARK CONSISTS OF STANDARD CHAR-  
ACTERS WITHOUT CLAIM TO ANY PARTICULAR  
FONT, STYLE, SIZE, OR COLOR.

PRIORITY DATE OF 12-14-2006 IS CLAIMED.

OWNER OF INTERNATIONAL REGISTRATION  
0929126 DATED 6-14-2007, EXPIRES 6-14-2017.

SER. NO. 79-040,386, FILED 6-14-2007.

MARTHA SANTOMARTINO, EXAMINING ATTOR-  
NEY

**Int. Cls.: 16 and 17**

**Prior U.S. Cls.: 1, 2, 5, 12, 13, 22, 23, 29, 35, 37, 38 and 50**

**Reg. No. 3,505,486**

**United States Patent and Trademark Office**

**Registered Sep. 23, 2008**

**TRADEMARK  
PRINCIPAL REGISTER**

# **AGRIBALE**

BRITISH POLYTHENE LIMITED (UNITED  
KINGDOM PRIVATE LIMITED COMPANY)  
10 FOSTER LANE  
LONDON EC2V 6HR  
UNITED KINGDOM

FOR: PLASTIC FILM AND WRAP FOR WRAP-  
PING AND PACKAGING OF GOODS; FILMS,  
SHEETS, BAGS AND TUBES OF PLASTIC FOR  
WRAPPING AND PACKAGING, NOT FOR COM-  
MERCIAL OR INDUSTRIAL PURPOSES, IN CLASS  
16 (U.S. CLS. 2, 5, 22, 23, 29, 37, 38 AND 50).

FOR: SEALING, PACKING AND INSULATING  
MATERIALS, NAMELY, ADHESIVE PACKING  
TAPE FOR INDUSTRIAL OR COMMERCIAL USE;  
PLASTIC FILM USED AS INDUSTRIAL OR COM-

MERCIAL PACKING MATERIAL; PLASTIC FILM  
FOR AGRICULTURAL PURPOSES; SEALING AND  
STUFFING MATERIALS OF PLASTIC AND PLAS-  
TIC FILM NOT FOR PACKAGING, IN CLASS 17  
(U.S. CLS. 1, 5, 12, 13, 35 AND 50).

OWNER OF INTERNATIONAL REGISTRATION  
0929285 DATED 5-24-2007, EXPIRES 5-24-2017.

THE WORD "AGRIBALE" HAS NO MEANING IN  
A FOREIGN LANGUAGE.

SER. NO. 79-040,453, FILED 5-24-2007.

KELLY MCCOY, EXAMINING ATTORNEY

Int. Cls.: 32 and 43

Prior U.S. Cls.: 45, 46, 48, 100 and 101

United States Patent and Trademark Office

Reg. No. 3,505,487

Registered Sep. 23, 2008

TRADEMARK  
SERVICE MARK  
PRINCIPAL REGISTER



VITA JUICE KFT. (HUNGARY KORLÁTOLT  
FELELŐSÉGŰ TÁRSASÁG (KFT))  
TAMÁSI ÁRON U. 38  
H-1124 BUDAPEST  
HUNGARY

FOR: BEERS; MINERAL AND AERATED WATERS AND OTHER NON-ALCOHOLIC DRINKS, NAMELY, ENERGY DRINKS, FROZEN FRUIT BEVERAGES, FROZEN FRUIT-BASED BEVERAGES, FRUIT BEVERAGES, NON-ALCOHOLIC BEVERAGES CONTAINING FRUIT JUICES, SHERBETS, SMOOTHIES, SORBETS IN THE FORM OF BEVERAGES, SPORTS DRINKS, AND VEGETABLE JUICES; FRUIT DRINKS AND FRUIT JUICES; SYRUPS AND OTHER PREPARATIONS FOR MAKING BEVERAGES IN THE NATURE OF ENERGY DRINKS, FROZEN FRUIT BEVERAGES, FROZEN FRUIT-BASED BEVERAGES, FRUIT BEVERAGES, NON-ALCOHOLIC BEVERAGES CONTAINING FRUIT JUICES, SHERBETS, SMOOTHIES, SORBETS IN THE FORM OF BEVERAGES, AND SPORTS DRINKS, IN CLASS 32 (U.S. CLS. 45, 46 AND 48).

FOR: SERVICES FOR PROVIDING FOOD AND DRINK; PROVIDING TEMPORARY ACCOMMODATION, IN CLASS 43 (U.S. CLS. 100 AND 101).

PRIORITY DATE OF 5-8-2007 IS CLAIMED.

OWNER OF INTERNATIONAL REGISTRATION  
0929512 DATED 5-16-2007, EXPIRES 5-16-2017.

NO CLAIM IS MADE TO THE EXCLUSIVE RIGHT TO USE "JUICE BAR", APART FROM THE MARK AS SHOWN.

THE COLOR(S) LIGHT GREEN AND ORANGE IS/ ARE CLAIMED AS A FEATURE OF THE MARK.

THE COLOR LIGHT GREEN APPEARS IN THE WORDING "VITA" AND "BAR", IN THE LEAF AND STEM OF THE ORANGE, IN THE CROSS AND THE CIRCLE CARRIER OF THE CROSS, AND IN THE SMILEY FACE. THE COLOR ORANGE APPEARS IN THE WORDING "JUICE", THE BORDER OF THE ORANGE, AND THE LOWER LEFT HAND CORNER OF THE ORANGE.

THE FOREIGN WORDING IN THE MARK TRANSLATES INTO ENGLISH AS "LIFE".

SER. NO. 79-040,540, FILED 5-16-2007.

TASHIA BUNCH, EXAMINING ATTORNEY

**Int. Cl.: 28**

**Prior U.S. Cls.: 22, 23, 38 and 50**

**Reg. No. 3,505,488**

**United States Patent and Trademark Office**

**Registered Sep. 23, 2008**

**TRADEMARK  
PRINCIPAL REGISTER**



ESCA GLOBAL AS (NORWAY AKSJESELSKAP)  
SKUTEVIKSODER 22  
N-5035 BERGEN  
NORWAY

FOR: GAMES AND PLAYTHINGS, NAMELY,  
TOY VEHICLES, TOY MUSICAL INSTRUMENTS,  
BALLS FOR GAMES, SPORT BALLS, FLYING  
DISCS, AND KITES; FISHING EQUIPMENT, NAME-  
LY, FISHING LURES, FISHING HOOKS, FISHING  
TACKLE, CRAB, FISH AND LOBSTER POTS,  
HAND-HELD FISHING NETS, FISH CAGES, FISH-  
ING RODS, AND FISHING REELS, IN CLASS 28  
(U.S. CLS. 22, 23, 38 AND 50).

PRIORITY DATE OF 5-25-2007 IS CLAIMED.

OWNER OF INTERNATIONAL REGISTRATION  
0931168 DATED 6-26-2007, EXPIRES 6-26-2017.

NO CLAIM IS MADE TO THE EXCLUSIVE  
RIGHT TO USE "TECHNOLOGY", APART FROM  
THE MARK AS SHOWN.

SER. NO. 79-041,202, FILED 6-26-2007.

JEFFERY COWARD, EXAMINING ATTORNEY

**Int. Cls.: 32 and 33**

**Prior U.S. Cls.: 45, 46, 47, 48 and 49**

**United States Patent and Trademark Office**

**Reg. No. 3,505,489**

**Registered Sep. 23, 2008**

**TRADEMARK  
PRINCIPAL REGISTER**

# QUASH

A-TRADE, BESLOTEN VENNOOTSCHAP MET;  
BEPERKTE AANSPRAKELIJKHEID (BEL-  
GIUM A BELGIAN LIMITED LIABILITY  
COMPANY)

JOZEF VERBOVENLEI 136  
B-2100 DEURNE  
BELGIUM

FOR: NON ALCOHOLIC ENERGY DRINKS, IN  
CLASS 32 (U.S. CLS. 45, 46 AND 48).

FOR: ALCOHOLIC BEVERAGES EXCEPT BEER,  
IN CLASS 33 (U.S. CLS. 47 AND 49).

THE MARK CONSISTS OF STANDARD CHAR-  
ACTERS WITHOUT CLAIM TO ANY PARTICULAR  
FONT, STYLE, SIZE, OR COLOR.

PRIORITY DATE OF 2-2-2007 IS CLAIMED.

OWNER OF INTERNATIONAL REGISTRATION  
0931560 DATED 7-4-2007, EXPIRES 7-4-2017.

"QUASH" HAS NO MEANING IN A FOREIGN  
LANGUAGE.

SER. NO. 79-041,361, FILED 7-4-2007.

CARYN GLASSER, EXAMINING ATTORNEY

**Int. Cls.: 37, 40 and 42**

**Prior U.S. Cls.: 100, 101, 103 and 106**

**United States Patent and Trademark Office**

**Reg. No. 3,505,490**

**Registered Sep. 23, 2008**

**SERVICE MARK  
PRINCIPAL REGISTER**



VALTRONIC SA (SWITZERLAND SOCIÉTÉ PAR  
ACTIONS)  
CH-1343 LES CHARBONNIÈRES  
SWITZERLAND

FOR: CUSTOM, MADE TO ORDER CONSTRUCTION AND DEVELOPMENT OF A WIDE VARIETY OF MEDICAL, DENTAL AND VETERINARY DEVICES FOR THIRD PARTIES IN THE MEDICAL, DENTAL AND VETERINARY INDUSTRIES AND FOR USE IN AN UNLIMITED VARIETY OF MEDICAL, DENTAL AND VETERINARY APPLICATIONS, IN CLASS 37 (U.S. CLS. 100, 103 AND 106).

FOR: TREATMENT OF ARTIFICIAL IMPLANTS FOR THIRD PARTIES, IN CLASS 40 (U.S. CLS. 100, 103 AND 106).

FOR: TECHNICAL PROJECT STUDY IN THE FIELD OF ELECTRONICS; DESIGN AND DEVELOPMENT OF ELECTRONIC COMPONENTS; DE-

SIGN AND DEVELOPMENT OF ELECTRONIC APPARATUS AND DEVICES; ALL THESE SERVICES DIRECTED TOWARDS APPLICATIONS PARTICULARLY IN THE MEDICAL FIELD, IN CLASS 42 (U.S. CLS. 100 AND 101).

PRIORITY DATE OF 3-5-2007 IS CLAIMED.

OWNER OF INTERNATIONAL REGISTRATION  
0931590 DATED 6-4-2007, EXPIRES 6-4-2017.

NO CLAIM IS MADE TO THE EXCLUSIVE RIGHT TO USE "TECHNOLOGIES", APART FROM THE MARK AS SHOWN.

SER. NO. 79-041,376, FILED 6-4-2007.

PAUL E. FAHRENKOPF, EXAMINING ATTORNEY

**Int. Cls.: 11, 19 and 37**

**Prior U.S. Cls.: 1, 12, 13, 21, 23, 31, 33, 34, 50, 100, 103  
and 106**

**Reg. No. 3,505,491**

**United States Patent and Trademark Office**

**Registered Sep. 23, 2008**

**TRADEMARK  
SERVICE MARK  
PRINCIPAL REGISTER**

The logo for AquaBio features the word "Aqua" in a bold, black, sans-serif font, followed by "Bio" in a blue, sans-serif font with a white outline. The letters are slightly slanted to the right.

WASHTEC HOLDING GMBH (FED REP GER-  
MANY GESELLSCHAFT MIT BESCHRÄNK-  
TER HAFTUNG)

ARGONSTRASSE 7  
86153 AUGSBURG  
FED REP GERMANY

FOR: SEWAGE CLARIFICATION SYSTEMS AND DEVICES, NAMELY, SEWAGE TREATMENT PLANTS; SYSTEMS AND DEVICES FOR WATER SUPPLY, WATER DISTRIBUTION AND WATER CONDUIT, NAMELY, METERED VALVES; WATER FILTERING DEVICES, NAMELY, WATER FILTERING UNITS FOR INDUSTRIAL USE IN PARTICULAR FOR THE USE IN VEHICLE WASHING APPARATUS AND WATER FILTERS; PARTS FOR THE AFOREMENTIONED SYSTEMS ALL SOLD AS A UNIT, NAMELY, METERED VALVES, PUMPS FOR WATER SUPPLY SYSTEMS, WATER CONDUITS, NAMELY, TUBES AND PIPES, ACCOUTERMENTS, NAMELY, COCKS AND VALVES, MIXING BATTERIES FOR WATER CONDUITS, WATER CONTAINERS AND SERVICE WATER CONTAINERS NOT MADE OF METAL AND NOT MADE OF BRICK WORK, NAMELY, TANKS FOR WATER PURIFICATION INSTALLATIONS; FILTER CONTAINERS, NAMELY, WATER COOLERS, WATER FILTERS CONTAINING SAND, MULTILAYER WATER FILTERS, ACCOUTERMENTS FOR INLET AND OUTLET, IN THE NATURE OF ACCESSORIES FOR CONTROLLING THE INFLOW AND OUTFLOW OF LIQUIDS, NAMELY, VALVES, WATER METERS, WATER TUBES, WATER COCKS, WATER FAUCETS; WATER FAUCET AERATORS, DISINFECTION AND STERILIZATION APPARATUS FOR SEWAGE SYSTEMS, NAMELY, SEWAGE TREAT-

MENT PLANTS, IN CLASS 11 (U.S. CLS. 13, 21, 23, 31 AND 34).

FOR: GRAVEL, SILICA STONE, GRAVEL FOR USE IN A FILTER, IN CLASS 19 (U.S. CLS. 1, 12, 33 AND 50).

FOR: CONSULTING SERVICES FOR THE INSTALLATION, ASSEMBLY, REPAIR AND MAINTENANCE OF WATER TREATMENT AND PURIFICATION PLANTS, SOLID WASTE TREATMENT PLANTS AND OTHER MUNICIPAL INFRASTRUCTURE FACILITIES USED FOR CLEANING, DISINFECTING, STERILIZING, CONVEYING AND TREATING WASTE WATER AND FOR STORING WATER, IN CLASS 37 (U.S. CLS. 100, 103 AND 106).

PRIORITY DATE OF 12-13-2006 IS CLAIMED.

OWNER OF INTERNATIONAL REGISTRATION 0931774 DATED 6-12-2007, EXPIRES 6-12-2017.

THE COLOR(S) GREY, BLUE, BLACK IS/ARE CLAIMED AS A FEATURE OF THE MARK.

THE MARK CONSISTS OF THE WORD "AQUA" IN BLACK WITH GRAY SHADING NEXT TO THE WORD "BIO" IN BLUE WITH GRAY SHADING.

SER. NO. 79-041,461, FILED 6-12-2007.

JESSICA A. POWERS, EXAMINING ATTORNEY

**Int. Cls.: 14 and 35**

**Prior U.S. Cls.: 2, 27, 28, 50, 100, 101 and 102**

**United States Patent and Trademark Office**

**Reg. No. 3,505,492**

**Registered Sep. 23, 2008**

**TRADEMARK  
SERVICE MARK  
PRINCIPAL REGISTER**

**AZENDI**

AZENDI LIMITED (UNITED KINGDOM LIMITED COMPANY)  
PARK ROW HOUSE  
19-20 PARK ROW; LEEDS LS1 5JF  
UNITED KINGDOM

FOR: JEWELLERY; PENDANTS, NECKLACES, RINGS, BRACELETS, ANKLETS, EARRINGS, BROOCHES; WATCHES; PRECIOUS METALS AND THEIR ALLOYS AND GOODS MADE OF PRECIOUS METALS OR COATED THEREWITH, NAMELY, CUFF LINKS; TIE PINS; CLOCKS; ALARM CLOCKS; PARTS AND FITTINGS FOR ALL THE AFORESAID GOODS, IN CLASS 14 (U.S. CLS. 2, 27, 28 AND 50).

FOR: THE BRINGING TOGETHER, FOR THE BENEFIT OF OTHERS, OF A VARIETY OF JEWELLERY GOODS AND TIMEPIECES, ENABLING CUSTOMERS TO CONVENIENTLY VIEW AND PURCHASE THOSE GOODS IN A RETAIL JEWELLERY STORE; THE BRINGING TOGETHER, FOR THE BENEFIT OF OTHERS, OF A VARIETY OF JEWELLERY AND JEWELLERY ACCESSORIES, ENABLING CUSTOMERS TO CONVENIENTLY

VIEW AND PURCHASE THOSE GOODS FROM AN INTERNET WEB SITE SPECIALIZING IN THE MARKETING OF JEWELLERY AND ACCESSORIES; AND PROVIDING INFORMATION AND INFORMATION PROVIDED OVER THE INTERNET, BOTH RELATING TO THE SALE OF JEWELLERY, JEWELLERY ACCESSORIES, AND TIMEPIECES, IN CLASS 35 (U.S. CLS. 100, 101 AND 102).

THE MARK CONSISTS OF STANDARD CHARACTERS WITHOUT CLAIM TO ANY PARTICULAR FONT, STYLE, SIZE, OR COLOR.

OWNER OF INTERNATIONAL REGISTRATION 0931900 DATED 7-7-2007, EXPIRES 7-7-2017.

THE WORDING "AZENDI" HAS NO MEANING IN A FOREIGN LANGUAGE.

SER. NO. 79-041,512, FILED 7-7-2007.

JOHN E. MICHOS, EXAMINING ATTORNEY



**Int. Cl.: 9**

**Prior U.S. Cls.: 21, 23, 26, 36 and 38**

**Reg. No. 3,505,493**

**United States Patent and Trademark Office**

**Registered Sep. 23, 2008**

**TRADEMARK  
PRINCIPAL REGISTER**

# MetroCirc

MURATA MANUFACTURING CO., LTD. (JAPAN CORPORATION)  
10-1 HIGASHIKOTARI 1 CHROME  
NAGAOKAKYO-SHI  
KYOTO, JAPAN 6178555

FOR: SUBSTRATES WITH EMBEDDED ACTIVE AND PASSIVE COMPONENTS, NAMELY, SUBSTRATES INCORPORATING ELECTRONIC COMPONENTS, NAMELY, SEMICONDUCTORS, LSI, IC, TRANSISTORS, DIODES, CAPACITORS, RESISTORS, INDUCTORS, RESONATORS, FILTERS, CONNECTORS, ANTENNAS, THERMISTORS, TEMPERATURE SENSORS, HUMIDITY SENSORS, DENSITY SENSORS, MICROPHONE SENSORS, WEIGHT SENSORS, PHOTO SENSORS, INFRARED SENSORS, ULTRAVIOLET SENSORS, IMAGE SENSORS, COLOR SENSORS, FLOW SENSORS, DISTANCE SENSORS, ULTRASONIC SENSORS, MAGNETIC SENSORS, PRESSURE SENSORS, POWER SENSORS, MECHANICAL SENSORS, ACCELERATION SENSORS, ANGULAR VELOCITY SENSORS, ANGLE SENSORS, ROTATION SENSORS, POSITION SENSORS, DIRECTION SENSORS, SHOCK SENSORS,

GRADIENT SENSORS, STRAIN SENSORS, ELECTRIC POTENTIAL SENSORS, VIBRATION SENSORS, GAS SENSORS, TASTE SENSORS, ODOR SENSORS, TOUCH SENSORS, FINGERPRINT SENSORS, BIO SENSORS, ION SENSORS, SOUNDERS, TRANSFORMERS, CIRCUIT MODULES, BATTERY AND MEMS, IN CLASS 9 (U.S. CLS. 21, 23, 26, 36 AND 38).

THE MARK CONSISTS OF STANDARD CHARACTERS WITHOUT CLAIM TO ANY PARTICULAR FONT, STYLE, SIZE, OR COLOR.

PRIORITY DATE OF 4-6-2007 IS CLAIMED.

OWNER OF INTERNATIONAL REGISTRATION 0931908 DATED 4-16-2007, EXPIRES 4-16-2017.

SER. NO. 79-041,515, FILED 4-16-2007.

Laurie Kaufman, Examining Attorney

**Int. Cl.: 42**

**Prior U.S. Cls.: 100 and 101**

**United States Patent and Trademark Office**

**Reg. No. 3,505,494**

**Registered Sep. 23, 2008**

**SERVICE MARK  
PRINCIPAL REGISTER**



UCB PHARMA, S.A. (BELGIUM SOCIÉTÉ ANON-  
YME)

60, ALLÉE DE LA RECHERCHE

B-1070 BRUXELLES

BELGIUM

FOR: MEDICAL AND SCIENTIFIC RESEARCH,  
IN PARTICULAR CLINICAL STUDIES, IN CLASS 42  
(U.S. CLS. 100 AND 101).

OWNER OF INTERNATIONAL REGISTRATION  
0932706 DATED 5-8-2007, EXPIRES 5-8-2017.

THE COLOR(S) LIGHT GREEN AND DARK  
GREEN IS/ARE CLAIMED AS A FEATURE OF  
THE MARK.

THE MARK CONSISTS OF THE WORDING LO-  
TUS IN DARK GREEN ABOVE WHICH IS A DE-  
SIGN FEATURING A CRESCENT SHAPE IN LIGHT  
GREEN, AND A FANCIFUL CURVED INTERSECT-  
ING LINE IN DARK GREEN.

SER. NO. 79-041,882, FILED 5-8-2007.

REBECCA POVARCHUK, EXAMINING ATTOR-  
NEY

Int. Cl.: 7

Prior U.S. Cls.: 13, 19, 21, 23, 31, 34 and 35

United States Patent and Trademark Office

Reg. No. 3,505,495

Registered Sep. 23, 2008

TRADEMARK  
PRINCIPAL REGISTER



SANTONI S.P.A. (ITALY JOINT STOCK COMPANY)  
VIA CARLO FENZI, 14  
I-25135 BRESCIA  
ITALY

FOR: DYEING MACHINES; HOT AIR DRYING MACHINES FOR TEXTILES; KNITTING MACHINES; PORTABLE ROTARY STEAM PRESSES FOR FABRICS; SPINNING MACHINES FOR THREAD AND TEXTILES; YARN WARPING MACHINES; PRINTING MACHINES FOR TEXTILES; EMBROIDERY MACHINES; HOSIERY LOOMS; LACE MAKING MACHINES; HOSIERY KNITTING MACHINES AND PARTS THEREOF; SPINNING WHEELS AND FRAMES FOR TEXTILE WEAVING MACHINES; POWER WEAVING LOOMS; SIZING MACHINES FOR TEXTILES; PRESSING MACHINES TO MAKE SATIN-LIKE FINISH ON TEXTILES; CARDING MACHINES; WIRE DRAWING MACHINES; REELS FOR WEAVING LOOMS; BOBINS FOR WEAVING LOOMS; SLIDES FOR KNITTING MACHINES; CARRIAGES FOR KNITTING MACHINES; THREAD TWISTING MACHINES; THREADING MACHINES; LOOM SHAFTS; LOOMS BEING MACHINES; TAMBOURS FOR EMBROIDERY MACHINES; INDUSTRIAL SEWING MACHINES, IN CLASS 7 (U.S. CLS. 13, 19, 21, 23, 31, 34 AND 35).

OWNER OF INTERNATIONAL REGISTRATION  
0933153 DATED 5-22-2007, EXPIRES 5-22-2017.

OWNER OF U.S. REG. NOS. 2,549,016 AND  
2,549,017.

NO CLAIM IS MADE TO THE EXCLUSIVE RIGHT TO USE "WEAR", APART FROM THE MARK AS SHOWN.

THE COLOR(S) WHITE, GREEN SHADED FROM LIGHT TO DARK, BLACK IS/ARE CLAIMED AS A FEATURE OF THE MARK.

THE COLOUR WHITE APPEARS IN THE CIRCULAR SHAPE; THE COLOUR DARK GREEN APPEARS IN THE STYLIZED LETTER "S" AND THE OUTLINE OF THE CIRCULAR SHAPE; THE COLOUR GREEN SHADED FROM LIGHT TO DARK APPEARS IN THE CIRCULAR LETTER; THE COLOUR BLACK APPEARS IN THE WORDINGS "3D WEAR" AND "SANTONI", THE OUTLINE OF THE CIRCULAR SHAPE AND OF THE STYLIZED LETTER "S".

THE MARK CONSISTS OF A SIGN DEPICTING A WHITE, GREEN, SHADED FROM LIGHT TO DARK, CIRCULAR SHAPE, OUTLINED IN GREEN, PROFILED IN BLACK, CONTAINING TWO SPECULAR IDENTICAL BANDS FORMED BY SEVERAL GREEN PARALLEL LINES, PROFILED IN BLACK, OF CURVILINEAR EXTENSION, EACH TERMINATING IN THE INNER CURVED PORTION OF THE OTHER, ALL EVOCATIVE OF A STYLIZED LETTER "S", SAID SHAPE BEING PLACED BETWEEN THE WORDING "3D WEAR" AND THE WORDING "SANTONI" BOTH IN FANCY CHARACTERS.

SER. NO. 79-042,042, FILED 5-22-2007.

WILLIAM ROSSMAN, EXAMINING ATTORNEY

Int. Cl.: 3

Prior U.S. Cls.: 1, 4, 6, 50, 51 and 52

United States Patent and Trademark Office

Reg. No. 3,505,496

Registered Sep. 23, 2008

TRADEMARK  
PRINCIPAL REGISTER



EUGENE PERMA FRANCE (FRANCE SOCIÉTÉ ANONYME)  
6 RUE D'ATHÈNES  
F-75009 PARIS  
FRANCE

FOR: HAIR LOTIONS; HAIR CREAMS; HAIR GELS; HAIR SPRAYS; HAIR MOUSSES; HAIR-STYLING PRODUCTS, NAMELY, STYLING WAX, STYLING GELS, STYLING LOTIONS, STYLING HAIR CREAMS, STYLING HAIR FOAM, STYLING MOUSSE, STYLING CLAY, STYLING HAIR MASK, STYLING PASTE, STYLING BALSAM, EMOLLIENTS, LACQUERS, HAIR POMADES, SCULPTING GEL, COSMETIC HAIR BALMS; HAIR CURLING PRODUCTS, NAMELY, HAIR LOTIONS, HAIR SPRAYS, HAIR MOUSSES, STYLING HAIR FOAMS; SHAMPOOS; BRILLIANTINES; HAIR FIXERS; HAIR COLORANTS; PERMING PRODUCTS AND THEIR NEUTRALIZERS, NAMELY PERMANENT WAVE PREPARATIONS AND THEIR NEUTRALIZERS; HAIR STRAIGHTENING PREPARATIONS AND THEIR NEUTRALIZERS; PRODUCTS FOR HAIR AND SCALP HYGIENE NOT FOR MEDICAL USE, NAMELY, SHAMPOOS, CONDITIONERS, HAIR STYLING MASKS; HAIR BLEACHING AND HAIR LIGHTENING PREPARATIONS; HAIR COLORING PREPARATIONS, IN CLASS 3 (U.S. CLS. 1, 4, 6, 50, 51 AND 52).

PRIORITY DATE OF 11-23-2006 IS CLAIMED.

OWNER OF INTERNATIONAL REGISTRATION 0933269 DATED 5-18-2007, EXPIRES 5-18-2017.

OWNER OF U.S. REG. NOS. 3,071,210, 3,071,211, AND 3,233,575.

NO CLAIM IS MADE TO THE EXCLUSIVE RIGHT TO USE "COLOR SYSTEM", APART FROM THE MARK AS SHOWN.

THE COLOR(S) PINK, RED AND DARK RED IS/ ARE CLAIMED AS A FEATURE OF THE MARK.

THE MARK CONSISTS OF THREE CONCENTRIC CIRCLES, THE OUTER CIRCLE IS IN PINK, THE MIDDLE CIRCLE IS ALSO PINK AND FILLED IN TO THE NEXT RED FILL-IN CIRCLE, WHICH INCLUDES THE WORDING "BLUSH CARE." A RED FILLED-IN CIRCLE RESTS ON THE OUTERMOST CIRCLES AND INCLUDES THE WORDING "INTUITIVE COLOR SYSTEM." ABOVE THE ENTIRE DESIGN IS THE WORDING "EUGENE PERMA" IN PINK AND A VERTICAL RECTANGLE IN THE MIDDLE OF THE WORDING THAT ENCOMPASSES THE "E" AND "P." THERE IS NO BACKGROUND COLOR.

SER. NO. 79-042,089, FILED 5-18-2007.

NAKIA HENRY, EXAMINING ATTORNEY

**Int. Cls.: 18, 23 and 25**

**Prior U.S. Cls.: 1, 2, 3, 22, 39, 41 and 43**

**Reg. No. 3,505,497**

**United States Patent and Trademark Office**

**Registered Sep. 23, 2008**

**TRADEMARK  
PRINCIPAL REGISTER**

# VERYTA

VERYTA FOUNDATION (SWITZERLAND  
FOUNDATION)  
VIA MAGGIO, 1  
CH-6900 LUGANO  
SWITZERLAND

FOR: LEATHER AND IMITATION LEATHER;  
LEATHER AND IMITATION LEATHER GOODS,  
NAMELY, KEY CHAINS, HANDBAGS, LUGGAGE,  
SHOULDER BAGS, BEACH BAGS, CLUTCH BAGS,  
ALL PURPOSE SPORT BAGS, ATTACHE CASES,  
SCHOOL BAGS, TOTE BAGS, TRAVELLING BAGS,  
CREDIT CARD CASES, DOCUMENT CASES, PASS-  
PORT CASES, COSMETIC CASES SOLD EMPTY,  
KEY CASES, KNAPSACKS, RUCKSACKS, BRIEF-  
CASES, PURSES, WALLETS, LUGGAGE TRUNKS,  
SUITCASES; ANIMAL SKINS, HIDES; TRUNKS  
AND SUITCASES; UMBRELLAS, PARASOLS AND  
WALKING STICKS; WHIPS, HARNESS AND SADD-  
LERY, IN CLASS 18 (U.S. CLS. 1, 2, 3, 22 AND 41).

FOR: YARNS AND THREADS FOR TEXTILE  
PURPOSES, IN CLASS 23 (U.S. CL. 43).

FOR: CLOTHING, NAMELY, DRESSES, SWEA-  
TERS, PANTS, PULLOVERS, GLOVES, CARDI-  
GANS, TROUSERS, SKIRTS, JACKETS, BLOUSES,

SHIRTS, JEANS, SWEAT PANTS, SHORTS, SWEAT-  
SHIRTS, SUITS AND DRESSES, OVERCOATS,  
COATS, RAINCOATS, BELTS, JERSEYS, NECK-  
WEAR, SOCKS AND STOCKINGS, TIGHTS, VESTS,  
WAISTCOATS, JUMPERS, TRACK SUITS, BLOU-  
SONS, GYM SUITS, KNICKERS, T-SHIRTS, ANOR-  
AKS, SUSPENDERS, LOUNGEWEAR,  
UNDERWEAR, BEACHWEAR, SLEEPWEAR,  
OVERALLS; FOOTWEAR; HEADGEAR, NAMELY  
HATS, CAPS AND BERETS, IN CLASS 25 (U.S. CLS.  
22 AND 39).

THE MARK CONSISTS OF STANDARD CHAR-  
ACTERS WITHOUT CLAIM TO ANY PARTICULAR  
FONT, STYLE, SIZE, OR COLOR.

PRIORITY DATE OF 5-15-2007 IS CLAIMED.

OWNER OF INTERNATIONAL REGISTRATION  
0933617 DATED 7-31-2007, EXPIRES 7-31-2017.

SER. NO. 79-042,253, FILED 7-31-2007.

SUZANNE BLANE, EXAMINING ATTORNEY

**Int. Cls.: 1, 5 and 42**

**Prior U.S. Cls.: 1, 5, 6, 10, 18, 26, 44, 46, 51, 52, 100  
and 101**

**Reg. No. 3,505,498**

**United States Patent and Trademark Office**

**Registered Sep. 23, 2008**

**TRADEMARK  
SERVICE MARK  
PRINCIPAL REGISTER**

# StarGate

IBA GMBH (FED REP GERMANY LIMITED  
LIABILITY CORPORATION)  
RUDOLF-WISSELL-STRABE 28  
37079 GÖTTINGEN, FED REP GERMANY

FOR: CHEMICALS USED IN INDUSTRY AND SCIENCE, IN PARTICULAR REAGENTS FOR THE CLONING OF NUCLEIC ACIDS, REAGENTS FOR THE AMPLIFICATION OF NUCLEIC ACIDS, REAGENTS FOR THE MUTAGENESIS OF NUCLEIC ACIDS, REAGENT KITS CONTAINING OLIGONUCLEOTIDES, ENZYMES AND BUFFERS FOR THE AMPLIFICATION OF NUCLEIC ACIDS, REAGENT KITS CONTAINING OLIGONUCLEOTIDES, ENZYMES AND BUFFERS FOR MUTAGENESIS OF NUCLEIC ACIDS, SINGLE AND DOUBLE STRANDED DNA, PLASMID DNA, OLIGONUCLEOTIDES, ENZYMES FOR THE CLONING OF NUCLEIC ACIDS, BUFFERS FOR THE CLONING OF NUCLEIC ACIDS, ENZYMES FOR THE AMPLIFICATION OF NUCLEIC ACIDS, BUFFERS FOR THE AMPLIFICATION OF NUCLEIC ACIDS, ENZYMES FOR THE MUTAGENESIS OF NUCLEIC ACIDS, BUFFERS FOR THE MUTAGENESIS OF NUCLEIC ACIDS, REAGENTS FOR PURIFICATION AND/OR TAGGING AND/OR DETECTION AND/OR IMMOBILIZATION AND/OR FUNCTIONALIZATION OF PEPTIDES AND PROTEINS INCLUDING FUSIONS PROTEINS, REAGENT KITS CONTAINING AFFINITY MATERIALS AND BUFFERS FOR THE PURIFICATION AND/OR TAGGING AND/OR DETECTION AND/OR IMMOBILIZATION AND/OR FUNCTIONALIZATION OF PEPTIDES AND PROTEINS INCLUDING FUSION PROTEINS, ANALYTIC KITS AND TEST REAGENTS USED IN

INDUSTRY AND SCIENCE, DIAGNOSTIC REAGENTS OTHER THAN FOR MEDICAL OR VETERINARY USE, IN CLASS 1 (U.S. CLS. 1, 5, 6, 10, 26 AND 46).

FOR: DIAGNOSTIC REAGENTS FOR MEDICAL USE, IN CLASS 5 (U.S. CLS. 6, 18, 44, 46, 51 AND 52).

FOR: RESEARCH IN SCIENCE AND INDUSTRY IN THE AREAS OF BIOCHEMISTRY, DIAGNOSTICS AND PHARMACEUTICALS; SERVICES OF A BIOCHEMICAL OR PHARMACEUTICAL LABORATORY, IN PARTICULAR CLONING, AMPLIFICATION AND MUTAGENESIS OF NUCLEIC ACIDS, PURIFICATION AND/OR TAGGING AND/OR DETECTION AND/OR IMMOBILIZATION AND/OR FUNCTIONALIZATION OF PEPTIDES AND PROTEINS INCLUDING FUSIONS PEPTIDES, IN CLASS 42 (U.S. CLS. 100 AND 101).

THE MARK CONSISTS OF STANDARD CHARACTERS WITHOUT CLAIM TO ANY PARTICULAR FONT, STYLE, SIZE, OR COLOR.

PRIORITY DATE OF 12-18-2006 IS CLAIMED.

OWNER OF INTERNATIONAL REGISTRATION  
0933686 DATED 6-8-2007, EXPIRES 6-8-2017.

SER. NO. 79-042,288, FILED 6-8-2007.

JILL PRATER, EXAMINING ATTORNEY

**Int. Cls.: 7 and 8**

**Prior U.S. Cls.: 13, 19, 21, 23, 28, 31, 34, 35 and 44**

**United States Patent and Trademark Office**

**Reg. No. 3,505,499**

**Registered Sep. 23, 2008**

**TRADEMARK  
PRINCIPAL REGISTER**

**(infinity)**

HARDER & STEENBECK METALLWARENFABRIK E.K. (FED REP GERMANY SOLE PROPRIETORSHIP)

IM HEGEN 3  
22113 OSTSTEINBEK  
FED REP GERMANY

FOR: AIR BRUSHES FOR APPLYING COLOUR FOR GRAPHIC ART, PHOTO TECHNICAL ART AND APPLIED ART, IN CLASS 7 (U.S. CLS. 13, 19, 21, 23, 31, 34 AND 35).

FOR: HAND-OPERATED TOOLS FOR ARTISTS, NAMELY, CHISELS, SPATULAS AND BLADES, FOR RETOUCHING GRAPHIC ART, PHOTO TECH-

NICAL ART AND APPLIED ART, IN CLASS 8 (U.S. CLS. 23, 28 AND 44).

PRIORITY DATE OF 11-9-2006 IS CLAIMED.

OWNER OF INTERNATIONAL REGISTRATION 0934151 DATED 3-3-2007, EXPIRES 3-3-2017.

SER. NO. 79-042,468, FILED 3-3-2007.

REBECCA POVARCHUK, EXAMINING ATTORNEY



**Int. Cl.: 9**

**Prior U.S. Cls.: 21, 23, 26, 36 and 38**

**Reg. No. 3,505,500**

**United States Patent and Trademark Office**

**Registered Sep. 23, 2008**

**TRADEMARK  
PRINCIPAL REGISTER**

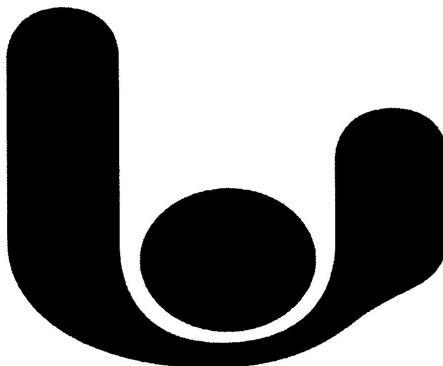

AUDIO TECHNOLOGY S.N.C.; DI TAMANTI  
MARIO & C. (ITALY PARTNERSHIP)  
VIA ROMA, 68/A  
I-62100 MACERATA, ITALY

FOR: SOUND SIGNAL CABLES, POWER CABLES FOR LOUDSPEAKERS, 110-220V SUPPLY CABLES IN THE NATURE OF POWER SUPPLY CABLES; VEHICLE LOUDSPEAKERS; ANTENNAS; CAR RADIOS; REMOTES FOR AMPLIFIERS; LOUDSPEAKERS FOR PLAYING STEREO AND MONO SOUND; PLAYERS AND RECORDERS FOR COMPACT DISCS; DIGITAL AUDIO PLAYERS; AUDIO CASSETTE PLAYERS; MP3 PLAYERS; VIDEO CAMERAS AND TELECAMERAS; TIMERS; LOUDSPEAKERS SYSTEMS; SUB-WOOFER SYSTEM COMPRISED OF HARDWARE AND SOFTWARE FOR OPERATING SUBWOOFERS; HARDWARE AND PERIPHERAL UNITS, NAMELY, RECORD PLAYERS, FLASH MEMORY CARDS, MEMORY CHIPS AND CARDS, MEMORY CARD PLAYERS; COMPACT DISC/AUDIOCASSETTE/AM/FM PLAY-

ERS FOR VEHICLES; COAXIAL STEREO AND LOUDSPEAKER CABINETS FOR VEHICLES, AUDIO AMPLIFIERS FOR VEHICLES, IN CLASS 9 (U.S. CLS. 21, 23, 26, 36 AND 38).

PRIORITY DATE OF 2-28-2007 IS CLAIMED.

OWNER OF INTERNATIONAL REGISTRATION  
0934164 DATED 4-5-2007, EXPIRES 4-5-2017.

THE MARK CONSISTS OF A STYLIZED "U", WHEREIN A VERTICAL LINE OF THE "U" IS LOWER THAN THE OTHER ONE, AND INSIDE THE "U" IS A CIRCLE.

SER. NO. 79-042,476, FILED 4-5-2007.

REBECCA POVARCHUK, EXAMINING ATTORNEY

Int. Cl.: 32

Prior U.S. Cls.: 45, 46 and 48

United States Patent and Trademark Office

Reg. No. 3,505,501

Registered Sep. 23, 2008

TRADEMARK  
PRINCIPAL REGISTER

# Adelholzener

ADELHOLZENER ALPENQUELLEN GMBH  
(FED REP GERMANY GESELLSCHAFT MIT  
BESCHRÄNKTER HAFTUNG)

ST.-PRIMUS-STR. 1-5

83313 SIEGSDORF, FED REP GERMANY

FOR: NATURAL MINERAL WATER FROM BAD  
ADELHOLZEN; NON-ALCOHOLIC BEVERAGES  
MADE EXCLUSIVELY WITH BAD ADELHOLZEN  
MINERAL WATER, NAMELY, CARBONATED BEV-  
ERAGES, NON-ALCOHOLIC FRUIT JUICE BEV-  
ERAGES, NON-ALCOHOLIC FRUIT FLAVORED  
BEVERAGES, NON-ALCOHOLIC DRINKS BEING  
MIXTURES OF FRUIT JUICE AND SPARKLING  
WATER; NON-ALCOHOLIC DRINKS CONSISTING

PRIMARILY OF MINERAL WATER, IN CLASS 32  
(U.S. CLS. 45, 46 AND 48).

OWNER OF INTERNATIONAL REGISTRATION  
0648244 DATED 12-1-1995, EXPIRES 12-1-2015.

THE WORD "ADELHOLZENER" HAS NO MEAN-  
ING IN ANOTHER LANGUAGE.

SER. NO. 79-042,505, FILED 7-20-2007.

TANYA AMOS, EXAMINING ATTORNEY

**Int. Cls.: 7 and 11**

**Prior U.S. Cls.: 13, 19, 21, 23, 31, 34 and 35**

**United States Patent and Trademark Office**

**Reg. No. 3,505,502**

**Registered Sep. 23, 2008**

**TRADEMARK  
PRINCIPAL REGISTER**

# VKR MIST ELIMINATOR

SULZER CHEMTECH AG (SWITZERLAND SOCIÉTÉ ANONYME (SWISS CORPORATION))  
SULZER-ALLEE 48  
CH-8404 WINTERTHUR  
SWITZERLAND

FOR: MACHINES FOR THE SEPARATION OF MULTIPHASE MIXTURES FOR USE IN THE OIL AND GAS INDUSTRIES AND IN THE CHEMICAL INDUSTRY; MACHINES, NAMELY, SEPARATORS, COALESCENCE SEPARATORS AND CENTRIFUGES FOR USE IN THE SEPARATION OF MULTIPHASE STREAMS AND COMPONENT PARTS THEREOF; PARTS OF MACHINES FOR USE IN THE OIL AND GAS INDUSTRIES AND IN THE CHEMICAL INDUSTRY, NAMELY, PARTS FOR THE SEPARATION OF DROPS OF LIQUID OUT OF A GAS OR VAPOR STREAM OR FOR THE SEPARATION OF A NON-SOLUBLE LIQUID OUT OF ANOTHER LIQUID; AND COMPONENT PARTS OF MACHINES FOR ALL THE AFOREMENTIONED MACHINES AND DEVICES, IN CLASS 7 (U.S. CLS. 13, 19, 21, 23, 31, 34 AND 35).

FOR: INSTALLATIONS FOR THE SEPARATION OF LIQUID/GAS OR LIQUID/LIQUID PHASE MIX-

TURES, NAMELY, SEPARATORS FOR THE CLEANING AND PURIFICATION OF LIQUIDS AND GASES AND COMPONENT PARTS THEREOF, IN CLASS 11 (U.S. CLS. 13, 21, 23, 31 AND 34).

THE MARK CONSISTS OF STANDARD CHARACTERS WITHOUT CLAIM TO ANY PARTICULAR FONT, STYLE, SIZE, OR COLOR.

PRIORITY DATE OF 2-27-2007 IS CLAIMED.

OWNER OF INTERNATIONAL REGISTRATION 0934472 DATED 5-29-2007, EXPIRES 5-29-2017.

NO CLAIM IS MADE TO THE EXCLUSIVE RIGHT TO USE "MIST ELIMINATOR", APART FROM THE MARK AS SHOWN.

SER. NO. 79-042,609, FILED 5-29-2007.

DAYNA BROWNE, EXAMINING ATTORNEY

**Int. Cl.: 25**

**Prior U.S. Cls.: 22 and 39**

**United States Patent and Trademark Office**

**Reg. No. 3,505,503**

**Registered Sep. 23, 2008**

**TRADEMARK  
PRINCIPAL REGISTER**

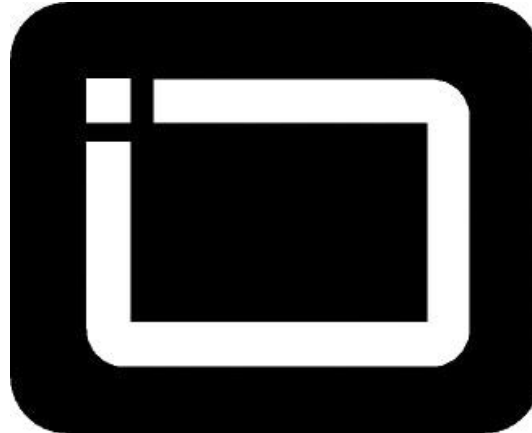

PROJECT 9 PTY LTD (AUSTRALIA COMPANY)  
1506 MAIN NORTH ROAD  
SALISBURY SOUTH SA 5106, AUSTRALIA

OWNER OF INTERNATIONAL REGISTRATION  
0934493 DATED 8-17-2007, EXPIRES 8-17-2017.

FOR: CLOTHING AND APPAREL, NAMELY,  
JERSEYS, SHORT-SLEEVED AND LONG-SLEEVED  
T-SHIRTS, HOODS, PANTS; HEAD WEAR, NAME-  
LY, HATS AND CAPS; SHORTS, TOPS, SHIRTS AND  
JACKETS; SURF WEAR , IN CLASS 25 (U.S. CLS. 22  
AND 39).

SER. NO. 79-042,617, FILED 8-17-2007.

AISHA SALEM, EXAMINING ATTORNEY

**Int. Cl.: 11**

**Prior U.S. Cls.: 13, 21, 23, 31 and 34**

**United States Patent and Trademark Office**

**Reg. No. 3,505,504**

**Registered Sep. 23, 2008**

**TRADEMARK  
PRINCIPAL REGISTER**



NINGBO YUSING ELECTRONICS CO., LTD.;  
(NINGBO YUXING DIANZI YOUXIAN  
GONGSI) (CHINA CORPORATION)  
MINYING GONGYEQU  
EAST OF PUGEN VILLAGE,; QIU AI TOWN,  
YINGZHOU; NINGBO; 315101 ZHEJIANG  
CHINA

FOR: LIGHTERS, NAMELY, LIGHTERS PRI-  
MARILY FOR LIGHTING GRILLS, FIREPLACES  
AND CANDLES; ELECTRIC LIGHT BULBS; LAMPS;  
ELECTRIC POCKET TORCHES, NAMELY, FLASH-  
LIGHTS; SOCKETS FOR ELECTRIC LIGHTS; PRO-  
JECTOR LAMPS; ELECTRIC CEILING LIGHTS;

ELECTRIC LIGHTS FOR CHRISTMAS TREES;  
STREET LAMPS, IN CLASS 11 (U.S. CLS. 13, 21, 23,  
31 AND 34).

OWNER OF INTERNATIONAL REGISTRATION  
0935076 DATED 5-30-2007, EXPIRES 5-30-2017.

"YU YUSING" DOES NOT IDENTIFY A LIVING  
INDIVIDUAL.

SER. NO. 79-042,779, FILED 5-30-2007.

DAYNA BROWNE, EXAMINING ATTORNEY

**Int. Cl.: 18**

**Prior U.S. Cls.: 1, 2, 3, 22 and 41**

**United States Patent and Trademark Office**

**Reg. No. 3,505,505**

**Registered Sep. 23, 2008**

**TRADEMARK  
PRINCIPAL REGISTER**



**DESIGNERS REMIX COLLECTION**

IC COMPANYS A/S (DENMARK PUBLIC LIMITED COMPANY)  
RAFFINADERIVEJ 10  
DK-2300 COPENHAGEN S  
DENMARK

FOR: RUCKSACKS, VALISES, WALLETS, HAND BAGS, SUITCASES, TRAVELLING BAGS, IN CLASS 18 (U.S. CLS. 1, 2, 3, 22 AND 41).

OWNER OF INTERNATIONAL REGISTRATION 0935154 DATED 8-9-2007, EXPIRES 8-9-2017.

OWNER OF U.S. REG. NOS. 2,967,230 AND 3,159,117.

NO CLAIM IS MADE TO THE EXCLUSIVE RIGHT TO USE "DESIGNERS" AND "COLLECTION", APART FROM THE MARK AS SHOWN.

SER. NO. 79-042,800, FILED 8-9-2007.

GIANCARLO CASTRO, EXAMINING ATTORNEY

Int. Cl.: 32

Prior U.S. Cls.: 45, 46 and 48

United States Patent and Trademark Office

Reg. No. 3,505,506

Registered Sep. 23, 2008

TRADEMARK  
PRINCIPAL REGISTER



ADELHOLZENER ALPENQUELLEN GMBH  
(FED REP GERMANY GESELLSCHAFT MIT  
BESCHRÄNKTER HAFTUNG)

ST.-PRIMUS-STR. 1-5  
83313 SIEGSDORF, FED REP GERMANY

OWNER OF INTERNATIONAL REGISTRATION  
0935258 DATED 7-27-2007, EXPIRES 7-27-2017.

FOR: MINERAL AND AERATED WATERS; SOFT  
DRINKS; FRUIT-FLAVORED BEVERAGES; FRUIT  
DRINKS; FRUIT JUICES; NON-ALCOHOLIC  
DRINKS BEING MIXTURES OF FRUIT JUICE  
AND SPARKLING WATER; NON-ALCOHOLIC  
DRINKS CONSISTING PRIMARILY OF MINERAL  
WATER, IN CLASS 32 (U.S. CLS. 45, 46 AND 48).

THE WORD "ADELHOLZENER" HAS NO MEAN-  
ING IN ANOTHER LANGUAGE.

SER. NO. 79-042,922, FILED 7-27-2007.

PRIORITY DATE OF 1-29-2007 IS CLAIMED.

TANYA AMOS, EXAMINING ATTORNEY

**Int. Cls.: 7, 8 and 9**

**Prior U.S. Cls.: 13, 19, 21, 23, 26, 28, 31, 34, 35, 36, 38  
and 44**

**Reg. No. 3,505,507**

**United States Patent and Trademark Office**

**Registered Sep. 23, 2008**

**TRADEMARK  
PRINCIPAL REGISTER**

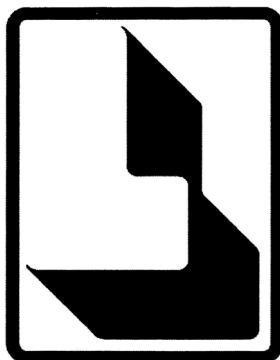

LUMBERG CONNECT GMBH (FED REP GER-  
MANY LIMITED LIABILITY COMPANY)  
IM GEWERBEPARK 2  
58579 SCHALKSMÜHLE, FED REP GERMANY

FOR: MACHINES AND MECHANICAL APPARA-  
TUS, NAMELY, ELECTROPNEUMATIC PROCES-  
SING MACHINES FOR TERMINATION OF  
CONNECTORS IN INSULATION DISPLACEMENT  
TECHNIQUES, SEMIAUTOMATIC PROCESSING  
MACHINE FOR TERMINATION OF CONNECTORS  
IN INSULATION DISPLACEMENT TECHNIQUES,  
PROCESSING MACHINE FOR TERMINATION OF  
CRIMP CONTACT SPRINGS CONSISTING OF  
DRIVING MOTOR AND CRIMP TOOL PNEUMAT-  
IC NOTCH PRESSES, ALL FOR MANUFACTURING  
CONNECTORS AND CABLE SETS, ALL THE  
ABOVE MENTIONED GOODS NOT FOR OPTICAL  
FIBER CONTACTS, OPTICAL FIBER CABLE SETS  
AND OPTICAL FIBER CONNECTORS, IN CLASS 7  
(U.S. CLS. 13, 19, 21, 23, 31, 34 AND 35).

FOR: HAND OPERATED TOOLS, NAMELY,  
MANUAL TONGS WITH RATCHETS, CUTTERS  
AND STRIPPERS, PULL-OFF TONGS KNUCKLE  
JOINT PRESSES, CUTTERS, CUTTERS BASED ON A  
KNUCKLE JOINT PRESS, NOTCH PRESSES,  
NOTCH PRESSES BASED ON A KNUCKLE JOINT  
PRESS ALL FOR MANUFACTURING CONNEC-  
TORS AND CABLE SETS, ALL THE ABOVE MEN-  
TIONED GOODS NOT FOR OPTICAL FIBER  
CONTACTS, OPTICAL FIBER CABLE SETS AND  
OPTICAL FIBER CONNECTORS, IN CLASS 8 (U.S.  
CLS. 23, 28 AND 44).

FOR: ELECTRIC, ELECTRONIC AND ELECTRO-  
MECHANICAL APPARATUS, EQUIPMENT, IN-  
STRUMENTS AND COMPONENTS, NAMELY,  
ANTENNAS, ELECTRIC CABLES AND CONDUITS,  
SETS OF ELECTRIC CABLES AND CONDUITS,  
CONNECTORS, CONNECTING AND CONTACT-  
ING DEVICES, NAMELY, CONNECTIONS BE-  
TWEEN PRINTED CIRCUIT BOARDS (PCB'S),  
CONNECTIONS BETWEEN CHIP CARDS AND  
CHIP CARD READERS CONNECTORS WITH IN-  
TEGRATED ELECTRONICS OR SWITCHES, ME-  
CHATRONIC ASSEMBLIES WITH INTEGRATED  
CONTACT ELEMENTS, JACKS, TERMINALS, IN  
PARTICULAR SPRING TERMINAL BLOCKS,  
SCREW TERMINAL BLOCKS, PLUGGABLE  
SCREW TERMINAL BLOCKS ON SOCKET  
BOARDS, PLUGGABLE TERMINAL BLOCKS ON  
PIN HEADERS, IN PARTICULAR FOR CONNEC-  
TING CABLES ON PRINTED CIRCUIT BOARDS;  
SWITCHES; ACTUATORS, ALL THE ABOVE MEN-  
TIONED GOODS NOT FOR OPTICAL FIBER CON-  
TACTS, OPTICAL FIBER CABLE SETS AND  
OPTICAL FIBER CONNECTORS, IN CLASS 9 (U.S.  
CLS. 21, 23, 26, 36 AND 38).

PRIORITY DATE OF 2-20-2007 IS CLAIMED.

OWNER OF INTERNATIONAL REGISTRATION  
0935486 DATED 6-29-2007, EXPIRES 6-29-2017.

SER. NO. 79-043,013, FILED 6-29-2007.

FLORENTINA BLANDU, EXAMINING ATTORNEY



Int. Cl.: 9

Prior U.S. Cls.: 21, 23, 26, 36 and 38

Reg. No. 3,505,508

United States Patent and Trademark Office

Registered Sep. 23, 2008

TRADEMARK  
PRINCIPAL REGISTER

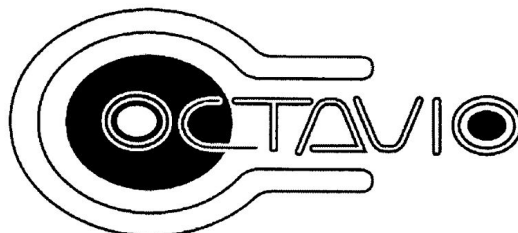

IPPV PTY LTD (AUSTRALIA COMPANY)  
25 FIRST AVENUE  
ST PETERS SA 5069  
AUSTRALIA

FOR: ALL OF THE FOLLOWING GOODS BEING HOME AND COMMERCIAL ENTERTAINMENT CONSUMER ELECTRONICS; DIGITAL AUDIO AND VISUAL REPRODUCTION APPARATUS, NAMELY AUDIO AMPLIFIERS, AUDIO SPEAKERS, AND ELECTRIC CONTROL AND SWITCHING APPARATUS FOR USE WITH THE AMPLIFIERS AND SPEAKERS, SOLD SEPARATELY AND COMBINED WITH THE AFOREMENTIONED GOODS; LOUDSPEAKERS, NAMELY, TWEETERS, MID-RANGE, BASS, WOOFERS, AND SUB-WOOFERS SPEAKERS; LOUDSPEAKER ENCLOSURES AND STRUCTURAL PARTS FOR LOUDSPEAKERS NAMELY FRAMES, SIDES AND GRILLES; LOUDSPEAKER COMPONENTS NAMELY CROSS-OVERS, AMPLIFIERS, DRIVERS FOR AMPLIFIERS AND PRE-AMPLIFIERS; ELECTRIC POWER SUPPLIES; AUDIO AND VISUAL SIGNAL CONNECTORS; AUDIO AND VISUAL SIGNAL PROCESSING EQUIPMENT NAMELY RECEIVERS, TUNERS, AND AMPLIFIERS; AUDIO AND VISUAL MEDIA PLAYERS; GRAPHIC EQUALIZERS; DOWN AND

UP CONVERTERS; REMOTE CONTROL UNITS FOR AUDIO, VISUAL AND COMPUTER APPARATUS; DIGITAL WIRELESS APPARATUS FOR COMMUNICATING DIGITAL AUDIO AND VISUAL SIGNALS BETWEEN AUDIO VISUAL EQUIPMENT, COMPUTER NETWORKS, INDUSTRIAL, COMMERCIAL AND HOME ENTERTAINMENT EQUIPMENT AND SYSTEMS, IN CLASS 9 (U.S. CLS. 21, 23, 26, 36 AND 38).

PRIORITY DATE OF 10-6-2006 IS CLAIMED.

OWNER OF INTERNATIONAL REGISTRATION  
0936161 DATED 4-5-2007, EXPIRES 4-5-2017.

"THE MARK CONSISTS OF THE WORDING OCTAVIO WITH THE DESIGN OF OVALS AND CIRCLES SURROUNDING THE INITIAL LETTERS OF THE MARK AND INSIDE EACH OF THE LETTERS "O" IN THE WORDING."

SER. NO. 79-043,299, FILED 4-5-2007.

REBECCA POVARCHUK, EXAMINING ATTORNEY

**Int. Cls.: 9 and 10**

**Prior U.S. Cls.: 21, 23, 26, 36, 38, 39 and 44**

**Reg. No. 3,505,509**

**United States Patent and Trademark Office**

**Registered Sep. 23, 2008**

**TRADEMARK  
PRINCIPAL REGISTER**

# PhysioMem

GETEMED MEDIZIN- UND; INFORMATION-  
STECHNIK AG (FED REP GERMANY PUBLIC  
LIMITED COMPANY)  
ODERSTRASSE 77  
14513 TELTOW, FED REP GERMANY

FOR: DATA PROCESSING EQUIPMENT AND COMPUTERS, FOR MEDICAL-TECHNICAL PURPOSES, NAMELY, PHYSIOLOGICAL DATA EVALUATION AND MANAGEMENT PERSONAL COMPUTERS, MEMORY CARDS FOR STORING ELECTROCARDIOGRAM AND OTHER PHYSIOLOGICAL DATA, AND CARD READERS FOR READING AND TRANSFERRING THE AFOREMENTIONED DATA TO EVALUATION AND MANAGEMENT PERSONAL COMPUTERS; COMPUTER SOFTWARE FOR THE EVALUATION AND MANAGEMENT OF ELECTROCARDIOGRAM AND OTHER PHYSIOLOGICAL DATA, IN CLASS 9 (U.S. CLS. 21, 23, 26, 36 AND 38).

FOR: MEDICO-TECHNICAL DEVICES, NAMELY, CARDIOLOGICAL WORKSTATIONS COMPRISING ELECTROCARDIOGRAM MEASUREMENT, ANALYSIS AND EVALUATION DEVICES, NAMELY, DIAGNOSTIC SENSORS, DIGITAL RECORDERS, MONITORS, TRANSMITTERS AND ANALYZERS; REST AND STRESS ELECTROCARDIOGRAM EVALUATION DEVICES, NAMELY, DIAGNOSTIC SEN-

SORS, DIGITAL RECORDERS, MONITORS, TRANSMITTERS AND ANALYZERS; DIGITAL RECORDERS AND MEMORIES FOR RECORDING, STORING AND TRANSFERRING ELECTROCARDIOGRAM AND OTHER PHYSIOLOGICAL DATA, MONITORS FOR MONITORING OF HEART RATE, RESPIRATION, PULSE RATE, ARTERIAL OXYGEN SATURATION, BLOOD PRESSURE, BODY TEMPERATURE, CARBON MONOXIDE AND CARBON DIOXIDE AND OTHER PHYSIOLOGICAL PARAMETERS OF INFLUENCE FOR DIAGNOSTIC AND MEDICAL PURPOSES, IN CLASS 10 (U.S. CLS. 26, 39 AND 44).

THE MARK CONSISTS OF STANDARD CHARACTERS WITHOUT CLAIM TO ANY PARTICULAR FONT, STYLE, SIZE, OR COLOR.

PRIORITY DATE OF 2-14-2007 IS CLAIMED.

OWNER OF INTERNATIONAL REGISTRATION  
0936233 DATED 8-10-2007, EXPIRES 8-10-2017.

SER. NO. 79-043,324, FILED 8-10-2007.

JAMES STEIN, EXAMINING ATTORNEY

**Int. Cl.: 41**

**Prior U.S. Cls.: 100, 101 and 107**

**United States Patent and Trademark Office**

**Reg. No. 3,505,510**

**Registered Sep. 23, 2008**

**SERVICE MARK  
PRINCIPAL REGISTER**



FÉDÉRATION INTERNATIONALE; DU SPORT  
UNIVERSITAIRE.; EN ABRÉGÉ FISU AISBL  
(BELGIUM AISBL)  
CHÂTEAU DE LA SOLITUDE,  
AVENUE SCHALLER 54; B-1160 BRUXELLES  
BELGIUM

FOR: EDUCATION IN THE FIELD OF SPORTS  
RENDERED THROUGH PROVISION OF TRAIN-  
ING CLASSES; ENTERTAINMENT IN THE NAT-  
URE OF SPORTS GAMES; ORGANIZATION OF  
EVENTS AND DEMONSTRATIONS FOR EDUCA-  
TIONAL AND SPORTING PURPOSES, NAMELY,  
SEMINARS, RESEARCH GROUPS AND CONVEN-  
TIONS IN THE FIELD OF UNIVERSITY SPORTS;  
ARRANGING AND CONDUCTING OF SPORTS  
COMPETITIONS; ORGANIZATION OF GAMES  
AND CONTESTS FOR LEISURE, EDUCATIONAL  
AND ENTERTAINMENT PURPOSES; ARRANGING  
AND CONDUCTING OF COLLOQUIUMS, CON-  
FERENCES, CONGRESSES, SEMINARS, SYMPO-  
SIUMS RELATING TO UNIVERSITY SPORTS;  
PUBLISHING, EDITING AND ON-LINE DISTRIBU-  
TION OF NEWSPAPERS, BROCHURES, PERIOD-  
ICALS AND OTHER PRINTED MATTER; MOTION  
PICTURE FILM PRODUCTION, IN CLASS 41 (U.S.  
CLS. 100, 101 AND 107).

PRIORITY DATE OF 12-21-2006 IS CLAIMED.

OWNER OF INTERNATIONAL REGISTRATION  
0936256 DATED 5-25-2007, EXPIRES 5-25-2017.

NO CLAIM IS MADE TO THE EXCLUSIVE  
RIGHT TO USE "U", APART FROM THE MARK  
AS SHOWN.

THE COLOR(S) BLUE; BLACK; RED; YELLOW;  
GREEN; WHITE IS/ARE CLAIMED AS A FEATURE  
OF THE MARK.

THE COLOR BLACK APPEARS IN THE WORD-  
ING "FISU," THE OUTLINE OF THE LARGE LET-  
TER 'U' AND IN ONE OF THE STARS; THE COLOR  
WHITE APPEARS IN THE LARGE LETTER 'U'; THE  
COLOR BLUE APPEARS IN ONE OF THE STARS,  
THE COLOR RED APPEARS IN ONE OF THE  
STARS; THE COLOR YELLOW APPEARS IN ONE  
OF THE STARS; THE COLOR GREEN APPEARS IN  
ONE OF THE STARS.

SER. NO. 79-043,333, FILED 5-25-2007.

SUZANNE BLANE, EXAMINING ATTORNEY

**Int. Cl.: 19**

**Prior U.S. Cls.: 1, 12, 33 and 50**

**United States Patent and Trademark Office**

**Reg. No. 3,505,511**

**Registered Sep. 23, 2008**

**TRADEMARK  
PRINCIPAL REGISTER**

**CHRONOLIA**

LAFARGE (FRANCE SOCIÉTÉ ANONYME)  
61, RUE DES BELLES FEUILLES  
F-75116 PARIS  
FRANCE

OWNER OF INTERNATIONAL REGISTRATION  
0936292 DATED 7-18-2007, EXPIRES 7-18-2017.

FOR: NON METALLIC BUILDING MATERIALS,  
NAMELY, CONCRETE, READY-MIX CONCRETES,  
REFRACTORY CONCRETE, IN CLASS 19 (U.S. CLS.  
1, 12, 33 AND 50).

THE WORDING "CHRONOLIA" HAS NO MEAN-  
ING IN A FOREIGN LANGUAGE.

SER. NO. 79-043,352, FILED 7-18-2007.

PRIORITY DATE OF 1-26-2007 IS CLAIMED.

BERNICE MIDDLETON, EXAMINING ATTORNEY

**Int. Cl.: 19**

**Prior U.S. Cls.: 1, 12, 33 and 50**

**United States Patent and Trademark Office**

**Reg. No. 3,505,512**

**Registered Sep. 23, 2008**

**TRADEMARK  
PRINCIPAL REGISTER**

**EXTENSIA**

LAFARGE (FRANCE SOCIÉTÉ ANONYME)  
61, RUE DES BELLES FEUILLES  
F-75116 PARIS  
FRANCE

OWNER OF INTERNATIONAL REGISTRATION  
0936293 DATED 7-18-2007, EXPIRES 7-18-2017.

FOR: NON METALLIC BUILDING MATERIALS,  
NAMELY, CONCRETE, READY-MIX CONCRETES,  
REFRACTORY CONCRETE, IN CLASS 19 (U.S. CLS.  
1, 12, 33 AND 50).

THE WORDING "EXTENSIA" HAS NO MEAN-  
ING IN A FOREIGN LANGUAGE.

SER. NO. 79-043,353, FILED 7-18-2007.

PRIORITY DATE OF 1-26-2007 IS CLAIMED.

BERNICE MIDDLETON, EXAMINING ATTORNEY

**Int. Cls.: 3, 9, 14, 18 and 25**

**Prior U.S. Cls.: 1, 2, 3, 4, 6, 21, 22, 23, 26, 27, 28, 36,  
38, 39, 41, 50, 51 and 52**

**Reg. No. 3,505,513**

**United States Patent and Trademark Office**

**Registered Sep. 23, 2008**

**TRADEMARK  
PRINCIPAL REGISTER**

**SOLEA**

KURT GEIGER LIMITED (UNITED KINGDOM  
LIMITED COMPANY)  
75 BERMONDSEY STREET  
LONDON SE1 3XF  
UNITED KINGDOM

FOR: SOAPS, PERFUMERY, ESSENTIAL OILS,  
COSMETICS, NON- MEDICATED TOILETRIES,  
HAIR CARE AND HAIR COLORING PREPARA-  
TIONS, BODY LOTIONS, HAND LOTIONS, FOOT  
LOTIONS, NAMELY, SKIN LOTIONS; DENTIFRI-  
CES; SHOE CREAM, SHOE POLISH, SHOE WAX,  
NAMELY, COBBLERS' WAX, IN CLASS 3 (U.S. CLS.  
1, 4, 6, 50, 51 AND 52).

FOR: MAGNETICALLY ENCODED CREDIT  
CARDS; MAGNETICALLY ENCODED DEBIT  
CARDS; REWARD CARDS, NAMELY, BLANK  
SMART CARDS; PAYMENT CARDS, NAMELY,  
ELECTRONIC AND MAGNETIC ID CARDS FOR  
USE IN CONNECTION WITH PAYMENT FOR SER-  
VICES; UNENCODED MAGNETIC CARDS; BLANK  
SMART CARDS; ENCODED BANK CARDS, NAME-  
LY, MAGNETICALLY ENCODED DEBIT CARDS;  
APPARATUS FOR RECORDING, TRANSMISSION  
OR REPRODUCTION OF SOUND AND IMAGES;  
BLANK MAGNETIC DATA CARRIERS; BLANK  
RECORD DISCS; PRE-RECORDED CD'S, CD-  
ROM'S, TAPES AND AUDIO DISCS FEATURING  
MUSIC; SUNGLASSES; SPECTACLES; SUNGLAS-  
SES AND SPECTACLES CASES AND FRAMES;  
CONTACT LENSES AND CONTACT LENS CON-  
TAINERS; PROTECTIVE FOOTWEAR, NAMELY,  
PROTECTIVE INDUSTRIAL BOOTS, IN CLASS 9,  
IN CLASS 9 (U.S. CLS. 21, 23, 26, 36 AND 38).

FOR: JEWELRY, CLOCKS AND WATCHES;  
CUFF-LINKS; PRECIOUS STONES; PRECIOUS ME-  
TALS AND THEIR ALLOYS; JEWEL CHAINS AND  
JEWEL PENDANTS IN PRECIOUS METALS OR  
COATED THEREWITH, NAMELY, GOLD, SILVER,

AND PLATINUM AND RHENIUM; HOROLOGI-  
CAL AND CHRONOMETRIC INSTRUMENTS, IN  
CLASS 14 (U.S. CLS. 2, 27, 28 AND 50).

FOR: LEATHER, IMITATIONS OF LEATHER  
AND GOODS MADE OF THESE MATERIALS,  
NAMELY, ATTACHE CASES, LEATHER TRUNKS,  
SUITCASES, BRIEFCASES, PORTFOLIOS, KEY  
CASES, CREDIT CARD HOLDERS, SHOULDER  
BAGS, RUCKSACKS, BACKPACKS, GARMENT  
BAGS FOR TRAVEL, VANITY CASES SOLD EMP-  
TY; COSMETIC CASES SOLD EMPTY; CARRY ON  
BAGS; UMBRELLAS; HANDBAGS, PURSES AND  
WALLETS; LEATHER JEWELRY ROLLS AND POU-  
CHES; AND BAGS MADE OF FABRIC, NAMELY,  
SHOULDER BAGS, RUCKSACKS, BACK PACKS,  
GARMENT BAGS FOR TRAVEL, CARRY ON BAGS  
AND HANDBAGS; PARASOLS AND WALKING  
STICKS, IN CLASS 18 (U.S. CLS. 1, 2, 3, 22 AND 41).

FOR: CLOTHING, NAMELY, DRESSES, SUITS,  
COATS, JACKETS, PANTS, SKIRTS, SHIRTS, BLOU-  
SES, SWEATERS, BELTS, HOSIERY, NIGHTWEAR,  
BATHROBES, DRESSING GOWNS, SHORTS,  
SCARVES, GLOVES, T-SHIRTS, RUGBY SHIRTS,  
CARDIGANS, CLOTHING FOR SPORT AND GYM-  
NASTICS, NAMELY, LEOTARDS, UNITARDS,  
SWEAT SUITS, JOGGING SUITS, TRACK SUITS,  
HEADBANDS, SPORTS BRAS AND TOPS; SHAWLS  
AND PASHMINAS; HEADWEAR, NAMELY, HATS  
AND CAPS; FOOTWEAR; SHOES, BOOTS, SLIPPERS  
AND SANDALS, IN CLASS 25 (U.S. CLS. 22 AND 39).

OWNER OF INTERNATIONAL REGISTRATION  
0936399 DATED 5-25-2007, EXPIRES 5-25-2017.

SER. NO. 79-043,388, FILED 5-25-2007.

ROBERT STRUCK, EXAMINING ATTORNEY

**Int. Cls.: 9, 14, 18 and 28**

**Prior U.S. Cls.: 1, 2, 3, 21, 22, 23, 26, 27, 28, 36, 38, 41  
and 50**

**Reg. No. 3,505,514**

**United States Patent and Trademark Office**

**Registered Sep. 23, 2008**

**TRADEMARK  
PRINCIPAL REGISTER**



ACHILLES SPORTS PTE. LTD. (SINGAPORE  
PRIVATE LIMITED COMPANY)  
152 BEACH ROAD  
#37-06 GATEWAY EAST  
SINGAPORE 189721, SINGAPORE

FOR: OPTICAL APPLIANCES AND INSTRUMENTS, NAMELY, SPECTACLES AND SUNGLASSES, OPTICAL FRAMES; OPTICAL LENSES, PROTECTIVE EYEGASSES, NAMELY, SKI EYEWEAR, PROTECTIVE EYEWEAR FOR DUST, DIVING GOGGLES, SAFETY GOGGLES FOR AVIATORS, VISORS; SPECTACLE CASES, IN CLASS 9 (U.S. CLS. 21, 23, 26, 36 AND 38).

FOR: TIMEPIECES AND PARTS THEREOF; HOROLOGICAL INSTRUMENTS; CHRONOMETERS, CLOCKS AND WATCHES; WATCHSTRAPS; JEWELRY; PRECIOUS STONES; PRECIOUS METALS AND THEIR ALLOYS; GOODS MADE OF PRECIOUS METALS AND THEIR ALLOYS OR COATED THEREWITH, NAMELY, KEY RINGS OF PRECIOUS METAL, IN CLASS 14 (U.S. CLS. 2, 27, 28 AND 50).

FOR: TRUNKS AND SUITCASES, SPORTS BAGS NOT ADAPTED TO THE PRODUCTS THEY ARE INTENDED TO CONTAIN, HANDBAGS, RUCK-

SACKS AND KITBAGS; PURSES, UMBRELLAS, PARASOLS, IN CLASS 18 (U.S. CLS. 1, 2, 3, 22 AND 41).

FOR: GYMNASTICS AND SPORTS ARTICLES, NAMELY, FOOTBALLS, IN CLASS 28 (U.S. CLS. 22, 23, 38 AND 50).

PRIORITY DATE OF 5-2-2007 IS CLAIMED.

OWNER OF INTERNATIONAL REGISTRATION  
0936517 DATED 5-21-2007, EXPIRES 5-21-2017.

THE ENGLISH TRANSLATION OF "VENI", "VIDI", "VICI" APPEARING IN THE MARK IS "I CAME, I SAW, I CONQUERED".

THE NON-LATIN CHARACTERS IN THE MARK TRANSLITERATE TO "DONG" AND THIS MEANS "MOVE" IN ENGLISH.

SER. NO. 79-043,446, FILED 5-21-2007.

ROBERT STRUCK, EXAMINING ATTORNEY

**Int. Cls.: 29, 30, 31, 32 and 33**

**Prior U.S. Cls.: 1, 45, 46, 47, 48 and 49**

**United States Patent and Trademark Office**

**Reg. No. 3,505,515**

**Registered Sep. 23, 2008**

**CERTIFICATION MARK  
PRINCIPAL REGISTER**



AUTONOME PROVINZ BOZEN - SÜDTIROL;  
PROVINCIA AUTONOMA DI BOLZANO -  
ALTO ADIGE.; RESSORT FÜR HANDWERK,  
INDUSTRIE, HANDEL.; FINANZEN UND  
HAUSHALT (ITALY PUBLIC (GOVERNMENT)  
CORPORATION)

LANDHAUS V  
RAIFFEISENSTR. 5;  
I-39100 BOZEN, ITALY

FOR: MEAT, FISH, POULTRY AND GAME;  
MEAT EXTRACTS; PRESERVED, DRIED AND  
COOKED FRUITS AND VEGETABLES; JELLIES,  
JAMS, COMPOTES; EGGS, MILK AND MILK PRO-  
DUCTS EXCLUDING ICE CREAM, ICE MILK, AND  
FROZEN YOGURT; EDIBLE OILS AND FATS, IN  
CLASS 29 (U.S. CL. 46).

FOR: COFFEE, TEA, COCOA, SUGAR, RICE,  
TAPIOCA, SAGO, ARTIFICIAL COFFEE; FLOUR  
AND PREPARATIONS MADE FROM CEREALS,  
NAMELY PROCESSED CEREALS, PORRIDGE,  
BREAKFAST CEREAL, CEREAL BASED SNACK  
FOOD, PUDDINGS, ALIMENTARY PASTA, GNOC-  
CHI AND RAVIOLI; BREAD, PASTRY AND CON-  
FECTIONERY, NAMELY, CRYSTAL SUGAR,  
FROZEN YOGURT, FRUIT JELLIES; EDIBLE ICES;  
HONEY, TREACLE; YEAST, BAKING-POWDER;  
SALT; MUSTARD; VINEGAR, SAUCES; SPICES;  
ICE, IN CLASS 30 (U.S. CL. 46).

FOR: AGRICULTURAL PRODUCTS, NAMELY,  
SEEDS AND BULBS FOR AGRICULTURAL PUR-  
POSES, AGRICULTURAL SEEDS, AGRICULTURAL  
GRAINS FOR PLANTING; HORTICULTURAL PRO-  
DUCTS, NAMELY, SEEDS AND BULBS FOR HOR-  
TICULTURAL PURPOSES, NATURAL PLANTS  
AND FLOWERS; SEEDS FOR FLOWERS; GRASS  
SEEDS; LIVE ANIMALS; FRESH FRUITS AND

VEGETABLES; SEEDS FOR AGRICULTURAL  
AND HORTICULTURAL PURPOSES; NATURAL  
PLANTS AND FLOWERS; FOODSTUFFS FOR ANI-  
MALS; MALT FOR BREWING AND DISTILLING;  
FORESTRY PRODUCTS, NAMELY, LIVE TREES, IN  
CLASS 31 (U.S. CLS. 1 AND 46).

FOR: BEERS; MINERAL AND AERATED WA-  
TERS AND OTHER NON-ALCOHOLIC DRINKS,  
NAMELY, NON-ALCOHOLIC FRUIT BEVERAGES,  
NON-ALCOHOLIC MALT BEVERAGE, NON-ALCO-  
HOLIC BEVERAGES WITH TEA FLAVOR, NON-  
ALCOHOLIC CARBONATED BEVERAGES; FRUIT  
DRINKS AND FRUIT JUICES; APPLE JUICE; SYR-  
UPS AND OTHER PREPARATIONS FOR MAKING  
BEVERAGES, NAMELY, FRUIT DRINKS, IN CLASS  
32 (U.S. CLS. 45, 46 AND 48).

FOR: ALCOHOLIC BEVERAGES, EXCEPT  
BEERS, IN CLASS 33 (U.S. CLS. 47 AND 49).

PRIORITY DATE OF 4-17-2007 IS CLAIMED.

OWNER OF INTERNATIONAL REGISTRATION  
0936520 DATED 5-15-2007, EXPIRES 5-15-2017.

THE ENGLISH TRANSLATION OF THE WORD  
"SÜDTIROL" IN THE MARK IS "SOUTH TYROL".

THE CERTIFICATION MARK, AS USED BY  
PERSONS AUTHORIZED BY THE CERTIFIER,  
CERTIFIES THAT THE GOODS AND/OR SERVICES  
PROVIDED FULFILL SPECIFIC CRITERIA WITH  
REGARD TO THEIR PROVENANCE IN THE AU-  
TONOMOUS PROVINCE OF BOLZANO, SOUTH  
TYROL, ITALY.



SER. NO. 79-043,448, FILED 5-15-2007.

SUSAN HAYASH, EXAMINING ATTORNEY

**Int. Cls.: 35 and 41**

**Prior U.S. Cls.: 100, 101, 102 and 107**

**United States Patent and Trademark Office**

**Reg. No. 3,505,516**

**Registered Sep. 23, 2008**

**SERVICE MARK  
PRINCIPAL REGISTER**

**SALES ARE IN OUR GENES**

SALESGEN AB (SWEDEN LIMITED COMPANY)  
KISTA SCIENCE TOWER  
KISTA, SWEDEN SE164 51

FOR: BUSINESS MANAGEMENT; ASSISTANCE IN THE MANAGEMENT OF BUSINESS COMMERCIAL UNDERTAKINGS; ASSISTANCE IN THE MANAGEMENT OF BUSINESS AFFAIRS, ASSISTANCE IN THE MANAGEMENT OF BUSINESS COMMERCIAL FUNCTIONS OF AN INDUSTRIAL OR COMMERCIAL ENTERPRISE; EMPLOYMENT STAFFING IN THE FORM OF AGENCY SERVICES AND THE HIRE OF LABOR, IN CLASS 35 (U.S. CLS. 100, 101 AND 102).

FOR: TEACHING AND EDUCATION, NAMELY, TEACHING IN THE FIELD OF BUSINESS MANAGEMENT, TEACHING IN THE FIELD OF MANAGEMENT OF BUSINESS AFFAIRS; TEACHING IN THE FIELD OF BUSINESS MANAGEMENT FOR

INDUSTRIAL OR COMMERCIAL ENTERPRISES; EDUCATION SEMINARS AND WORKSHOPS IN THE FIELD OF BUSINESS MANAGEMENT , IN CLASS 41 (U.S. CLS. 100, 101 AND 107).

THE MARK CONSISTS OF STANDARD CHARACTERS WITHOUT CLAIM TO ANY PARTICULAR FONT, STYLE, SIZE, OR COLOR.

PRIORITY DATE OF 2-15-2007 IS CLAIMED.

OWNER OF INTERNATIONAL REGISTRATION 0936574 DATED 8-7-2007, EXPIRES 8-7-2017.

SER. NO. 79-043,467, FILED 8-7-2007.

CARYN GLASSER, EXAMINING ATTORNEY

**Int. Cls.: 9, 14, 18 and 28**

**Prior U.S. Cls.: 1, 2, 3, 21, 22, 23, 26, 27, 28, 36, 38, 41  
and 50**

**Reg. No. 3,505,517**

**United States Patent and Trademark Office**

**Registered Sep. 23, 2008**

**TRADEMARK  
PRINCIPAL REGISTER**



ACHILLES SPORTS PTE. LTD. (SINGAPORE A  
PRIVATE LIMITED COMPANY)  
152 BEACH ROAD,  
#37-06 GATEWAY EAST; SINGAPORE 189721  
SINGAPORE

FOR: OPTICAL APPLIANCES AND INSTRUMENTS, NAMELY, SPECTACLES AND SUNGLASSES, OPTICAL FRAMES; OPTICAL LENSES, PROTECTIVE EYEGLASSES, NAMELY, SKI EYEWEAR, PROTECTIVE EYEWEAR FOR DUST, DIVING GOGGLES, SAFETY GOGGLES FOR AVIATORS, VISORS; SPECTACLE CASES, IN CLASS 9 (U.S. CLS. 21, 23, 26, 36 AND 38).

FOR: TIMEPIECES AND PARTS THEREOF; HOROLOGICAL INSTRUMENTS; CHRONOMETERS, CLOCKS AND WATCHES; WATCH STRAPS; JEWELRY; PRECIOUS STONES; PRECIOUS METALS AND THEIR ALLOYS; GOODS MADE OF PRECIOUS METALS AND THEIR ALLOYS OR COATED THEREWITH, NAMELY, KEY RINGS OF PRECIOUS METAL, IN CLASS 14 (U.S. CLS. 2, 27, 28 AND 50).

FOR: TRUNKS AND SUITCASES, SPORTS BAGS NOT ADAPTED TO THE PRODUCTS THEY ARE INTENDED TO CONTAIN, HANDBAGS, RUCK-

SACKS AND KITBAGS; PURSES, UMBRELLAS, PARASOLS, IN CLASS 18 (U.S. CLS. 1, 2, 3, 22 AND 41).

FOR: GYMNASTICS AND SPORTS ARTICLES, NAMELY, FOOTBALLS, IN CLASS 28 (U.S. CLS. 22, 23, 38 AND 50).

PRIORITY DATE OF 5-2-2007 IS CLAIMED.

OWNER OF INTERNATIONAL REGISTRATION 0936685 DATED 5-21-2007, EXPIRES 5-21-2017.

THE ENGLISH TRANSLATION OF THE FOREIGN WORD(S) "VENI, VIDI, VICI" MEANS "I CAME, I SAW, I CONQUERED."

THE NON-LATIN CHARACTERS IN THE MARK TRANSLITERATE TO "DONG" AND THIS MEANS "MOVE" IN ENGLISH.

SER. NO. 79-043,532, FILED 5-21-2007.

ROBERT STRUCK, EXAMINING ATTORNEY

**Int. Cls.: 1, 3, 5 and 29**

**Prior U.S. Cls.: 1, 4, 5, 6, 10, 18, 26, 44, 46, 50, 51 and 52**

**Reg. No. 3,505,518**

**United States Patent and Trademark Office**

**Registered Sep. 23, 2008**

**TRADEMARK  
PRINCIPAL REGISTER**

# **NANOCUBE**

NANOEGG; RESEARCH LABORATORIES, INC.  
(JAPAN CORPORATION)  
2-16-1, SUGAO, MIYAMAE-KU  
KAWASAKI-SHI; KANAGAWA 216-8512  
JAPAN

FOR: CHEMICALS FOR USE IN INDUSTRY AND SCIENCE; HIGHER FATTY ACIDS FOR USE IN INDUSTRY AND SCIENCE, IN CLASS 1 (U.S. CLS. 1, 5, 6, 10, 26 AND 46).

FOR: SOAPS AND DETERGENTS; COSMETICS; PERFUMERY, IN CLASS 3 (U.S. CLS. 1, 4, 6, 50, 51 AND 52).

FOR: PHARMACEUTICAL ANTI-ALLERGIC PREPARATIONS AND SUBSTANCES; PHARMACEUTICAL PREPARATIONS FOR USE IN CHEMOTHERAPY; PHARMACEUTICAL PREPARATIONS FOR THE TREATMENT OF INFECTIOUS DISEASES; PHARMACEUTICAL PREPARATIONS FOR THE TREATMENT OF HORMONAL DISORDERS AND THE PREVENTION OF OSTEOPOROSIS; PHARMACEUTICAL PREPARATIONS FOR WOUNDS; PHARMACEUTICAL PREPARATIONS FOR THE PREVENTION AND TREATMENT OF DISORDERS OF THE NERVOUS SYSTEM, THE IMMUNE SYSTEM, THE CARDIO-VASCULAR SYSTEM, THE METABOLIC SYSTEM, THE RESPIRATORY SYSTEM, THE MUSCULO-SKELETAL SYSTEM, THE GENITOURINARY SYSTEM; FOR THE TREATMENT OF INFLAMMATORY DISORDERS; FOR USE IN DERMATOLOGY, ONCOLOGY, HEMATOLOGY AND IN TISSUE AND ORGAN TRANSPLANTATION, IN OPHTHALMOLOGY AND FOR GASTROENTEROLOGICAL DISOR-

DERS; PHARMACEUTICAL PREPARATIONS, NAMELY, A TRANSDERMAL DRUG DELIVERY SYSTEM COMPRISING POLYMER-BASED SKIN CREAMS OR GEL FOR THE CONTINUOUS RELEASE OF A WIDE VARIETY OF THERAPEUTIC AGENTS, IN CLASS 5 (U.S. CLS. 6, 18, 44, 46, 51 AND 52).

FOR: DIETETIC FOOD STUFFS, NOT FOR MEDICAL PURPOSES, PRIMARILY BASED ON VITAMIN AND INORGANIC SALT IN THE FORM OF POWDER, CAPSULE, GEL, JELLY, AND TABLET, NAMELY, EDIBLE OILS, JELLIES FOR FOOD, ANIMAL OILS AND FATS FOR FOOD, BLENDED OIL FOR FOOD, COCOA BUTTER FOR FOOD PURPOSES, COCONUT OIL, COLZA OIL FOR FOOD, CORN OIL FOR FOOD, OLIVE OIL FOR FOOD, PALM OIL FOR FOOD, PROCESSED OILS AND FATS FOR FOOD, SESAME OIL, SUNFLOWER OIL FOR FOOD, JELLIES BREAD SPREADS, JELLIES, JAMS, JELLIES AND JAMS, JELLIES FOR FOOD, IN CLASS 29 (U.S. CL. 46).

THE MARK CONSISTS OF STANDARD CHARACTERS WITHOUT CLAIM TO ANY PARTICULAR FONT, STYLE, SIZE, OR COLOR.

OWNER OF INTERNATIONAL REGISTRATION 0936993 DATED 3-30-2007, EXPIRES 3-30-2017.

SER. NO. 79-043,662, FILED 3-30-2007.

REBECCA POVARCHUK, EXAMINING ATTORNEY

**Int. Cls.: 3, 9, 16, 18, 20, 21 and 25**

**Prior U.S. Cls.: 1, 2, 3, 4, 5, 6, 13, 21, 22, 23, 25, 26, 29, 30, 32, 33, 36, 37, 38, 39, 40, 41, 50, 51 and 52**

**Reg. No. 3,505,519**

**United States Patent and Trademark Office**

**Registered Sep. 23, 2008**

**TRADEMARK  
PRINCIPAL REGISTER**

**MILUS**

MILUS INTERNATIONAL S.A. (SWITZERLAND  
SOCIÉTÉ ANONYME (SA))  
REUCHENETTESTRASSE 19  
CH-2502 BIEL/BIENNE, SWITZERLAND

FOR: SOAPS; PERFUMERY, ESSENTIAL OILS,  
COSMETICS, HAIR LOTIONS; DENTIFRICES, IN  
CLASS 3 (U.S. CLS. 1, 4, 6, 50, 51 AND 52).

FOR: SCIENTIFIC, NAUTICAL, PHOTOGRAPHIC,  
CINEMATOGRAPHIC, OPTICAL, WEIGHING,  
MEASURING, SIGNALING, CHECKING, SUPERVI-  
SION, RESCUE, LIFE-SAVING, AND TEACHING  
APPARATUS AND INSTRUMENTS, NAMELY, AL-  
TIMETERS, ASTRONOMETRIC MEASURING MA-  
CHINES AND INSTRUMENTS, BAROMETERS,  
DIRECTIONAL COMPASSES, SPEED INDICATORS,  
MARINE COMPASSES, TIME RECORDING APPA-  
RATUS, DISTANCE MEASURING APPARATUS,  
SPECTACLE CASES, HYDROMETERS, HYGROME-  
TERS, BINOCULARS, LASERS NOT FOR MEDICAL  
USE, TELESCOPES, MAGNIFYING GLASSES, ME-  
TRONOMES, HOURGLASSES, OPTICAL GOODS,  
NAMELY, SUNGLASSES, GOGGLES FOR SPORTS,  
SPECTACLES, OPTICAL LENSES AND HEAD-  
PHONES; APPARATUS FOR RECORDING, TRANS-  
MITTING OR REPRODUCING SOUND OR  
IMAGES; MAGNETIC RECORDING MEDIA,  
NAMELY, PERSONAL STEREOS AND MAGNETIC  
TAPE RECORDERS; CALCULATING MACHINES,  
NAMELY, CALCULATING MACHINES, CALCULA-  
TORS; UNRECORDED MAGNETIC DATA MEDIA,  
NAMELY OPTICAL DISKS, COMPACT DISCS, CD-  
ROMS, VIDEO DISCS, MEMORY CARDS, USB  
KEYS, ENCODED MAGNETIC CARDS, MAGNETI-  
CALLY ENCODED IDENTIFICATION BRACELETS,  
IN CLASS 9 (U.S. CLS. 21, 23, 26, 36 AND 38).

FOR: PAPER, CARDBOARD AND GOODS MADE  
OF THESE MATERIALS, NOT INCLUDED IN

OTHER CLASSES, NAMELY, WRITING PAPER,  
WRAPPING PAPER, CARDBOARD BOXES, CARD-  
BOARD PACKAGING, ART PAPER, BOND PAPER,  
COASTERS MADE OF PAPER; PRINTED MATTER,  
NAMELY, MAGAZINES, NEWSPAPERS, NEWS-  
LETTERS AND BROCHURES IN THE FIELD OF  
PRECIOUS METALS, GEMSTONES, JEWELRY,  
ART, CHRONOMETRIC INSTRUMENTS AND  
SMOKER'S ARTICLES, PRINTED INVITATIONS,  
PRINTED FORMS, PRINTED INSTRUCTIONAL  
AND TEACHING MATERIAL IN THE FIELD OF  
PRECIOUS METALS, GEMSTONES, JEWELRY,  
ART, CHRONOMETRIC INSTRUMENTS AND  
SMOKER'S ARTICLES; PHOTOGRAPHS; STATION-  
ERY; MATERIALS FOR ARTISTS, NAMELY, BOOK-  
BINDINGS, BOOKBINDING WIRE, BOOKBINDING  
TAPE, CLOTH FOR BOOKBINDING, BRUSHES,  
PASTELS, PENCILS, PENS; PAINTBRUSHES; TYPE-  
WRITERS; PLASTIC MATERIALS FOR PACKA-  
GING NOT INCLUDED IN OTHER CLASSES,  
NAMELY, PLASTIC BAGS; INSTRUMENTS FOR  
WRITING, IN CLASS 16 (U.S. CLS. 2, 5, 22, 23, 29, 37,  
38 AND 50).

FOR: LEATHER AND IMITATION LEATHER;  
GOODS MADE OF LEATHER AND IMITATION  
LEATHER NOT INCLUDED IN OTHER CLASSES,  
NAMELY, TRUNKS, VALISES, TRAVELLING  
BAGS, LUGGAGE FOR TRAVEL, GARMENT BAGS  
FOR TRAVEL, VANITY CASES SOLD EMPTY,  
RUCKSACKS, HAND BAGS, BEACH BAGS, SHOP-  
PING BAGS, SHOULDER BAGS, ATTACHE CASES,  
BRIEFCASES, POCKET WALLETS, PURSES, LEA-  
THER KEY HOLDERS, BUSINESS CARD CASES,  
CALLING CARD CASES, AND CREDIT CARD  
CASES; UMBRELLAS, PARASOLS AND WALKING  
STICKS, IN CLASS 18 (U.S. CLS. 1, 2, 3, 22 AND 41).

FOR: FURNITURE, MIRRORS, PICTURE  
FRAMES; PRODUCTS, NOT INCLUDED IN OTHER

CLASSES, OF WOOD, CORK, REED, CANE, WICKER, HORN, BONE, IVORY, WHALEBONE, SHELL, AMBER, MOTHER-OF-PEARL, MEERSCHAUM AND SUBSTITUTES FOR ALL THESE MATERIALS, OR OF PLASTICS, NAMELY, STATUTES, WALL PLAQUES, PLACARDS, PLAQUES, FURNITURE, IN CLASS 20 (U.S. CLS. 2, 13, 22, 25, 32 AND 50).

FOR: HOUSEHOLD OR KITCHEN UTENSILS AND CONTAINERS, NAMELY, TABLE PLATES; COOKING POT SETS; KITCHEN UTENSILS, NAMELY, COOKING FORKS, SERVING FORKS, BASTING SPOONS, MIXING SPOONS AND SERVING SPOONS; BOTTLE OPENERS; CORKSCREWS; SERVING DISHES; TOWEL RAILS AND RINGS; CANDLESTICKS; PERFUME BURNERS; UNWORKED OR SEMI-WORKED GLASS EXCEPT GLASS USED IN BUILDING; GLASSWARE, PORCELAIN AND EARTHENWARE NOT INCLUDED IN OTHER CLASSES, NAMELY, BEVERAGE GLASSWARE, PORCELAIN MUGS, PORCELAIN DOOR-KNOBS, FIGURES OF EARTHENWARE, EARTHENWARE MUGS, IN CLASS 21 (U.S. CLS. 2, 13, 23, 29, 30, 33, 40 AND 50).

FOR: CLOTHING, NAMELY, SHIRTS, SOCKS, PANTS, SUITS; FOOTWEAR; HEADGEAR, NAMELY, HATS, CAPS, IN CLASS 25 (U.S. CLS. 22 AND 39).

THE MARK CONSISTS OF STANDARD CHARACTERS WITHOUT CLAIM TO ANY PARTICULAR FONT, STYLE, SIZE, OR COLOR.

PRIORITY DATE OF 12-21-2006 IS CLAIMED.

OWNER OF INTERNATIONAL REGISTRATION 0937039 DATED 6-21-2007, EXPIRES 6-21-2017.

OWNER OF U.S. REG. NOS. 2,873,584 AND 3,142,300.

SER. NO. 79-043,687, FILED 6-21-2007.

AMY MCMENAMIN, EXAMINING ATTORNEY

**Int. Cl.: 9**

**Prior U.S. Cls.: 21, 23, 26, 36 and 38**

**United States Patent and Trademark Office**

**Reg. No. 3,505,520**

**Registered Sep. 23, 2008**

**TRADEMARK  
PRINCIPAL REGISTER**

**COMPUTOX**

COMPUR MONITORS GMBH & CO. KG (FED  
REP GERMANY CORPORATION)  
WEISSENSEESTRASSE 101  
81539 MÜNCHEN  
FED REP GERMANY

FOR: GAS-ANALYTIC MEASURING, TESTING  
AND WARNING APPARATUS, NAMELY, PERSONAL  
DETECTORS FOR WARNING THE USER  
ABOUT POSSIBLE EXPOSURE TO DANGEROUS  
GASES, ANALYZERS FOR MEASURING AND  
TESTING GASES AND SIGNALING WHEN PRESET  
CONCENTRATIONS ARE EXCEEDED AND ELEC-

TRONIC GAS MONITORING INSTRUMENTS FOR  
EMPLOYMENT AND ENVIRONMENTAL PROTECTION,  
IN CLASS 9 (U.S. CLS. 21, 23, 26, 36 AND 38).

OWNER OF INTERNATIONAL REGISTRATION  
0555601 DATED 5-30-1990, EXPIRES 5-30-2010.

SER. NO. 79-043,783, FILED 7-31-2007.

KELLY MCCOY, EXAMINING ATTORNEY

Int. Cl.: 33

Prior U.S. Cls.: 47 and 49

United States Patent and Trademark Office

Reg. No. 3,505,521

Registered Sep. 23, 2008

TRADEMARK  
PRINCIPAL REGISTER

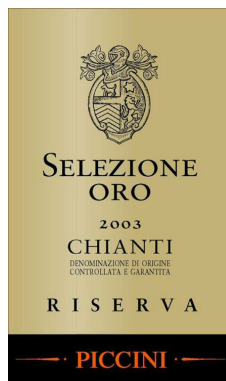

GESTIONI PICCINI, S.R.L. (ITALY SOCIÉTÉ À  
RESPONSABILITÉ LIMITÉE (SARL))  
LOCALITA' PIAZZOLE  
I-53011 CASTELLINA IN CHIANTI (SI)  
ITALY

FOR: WINES AND GRAPPA, IN CLASS 33 (U.S.  
CLS. 47 AND 49).

PRIORITY DATE OF 2-16-2007 IS CLAIMED.

OWNER OF INTERNATIONAL REGISTRATION  
0937395 DATED 8-8-2007, EXPIRES 8-8-2017.

OWNER OF U.S. REG. NO. 1,816,085.

NO CLAIM IS MADE TO THE EXCLUSIVE  
RIGHT TO USE "2003 CHIANTI DENOMINAZIONE  
DI ORIGINE CONTROLLATA E GARANTITA RI-  
SERVA", APART FROM THE MARK AS SHOWN.

THE COLOR(S) ORANGE, BLACK AND GOLD IS/  
ARE CLAIMED AS A FEATURE OF THE MARK.

THE MARK COMPRISES A RECTANGULAR  
LABEL WITH THE LONGER PORTION VERTICAL-  
LY PRESENTED, THE UPPER 7/8 PORTION IN THE  
COLOR GOLD AND THE LOWER 1/8 PORTION IN  
THE COLOR BLACK, A HERALDIC COAT OF  
ARMS IN THE UPPER PORTION WITH THE IN-  
SCRIPTION "SELEZIONE ORO 2003 CHIANTI 2003  
CHIANTI DENOMINAZIONE DI ORIGINE CON-  
TROLLATA E GARANTITA RISERVA" BELOW ALL  
IN THE COLOR BLACK, AND THE WORDING  
"PICCINI" WITH LINES ON EACH SIDE IN THE  
LOWER PORTION IN THE COLOR ORANGE.

THE FOREIGN WORDING IN THE MARK  
TRANSLATES INTO ENGLISH AS GOLD SELEC-  
TION RESERVE DENOMINATION OF ORIGIN  
CHECKED AND GUARANTEED (D.O.C.G.) PICCI-  
NI.

SER. NO. 79-043,828, FILED 8-8-2007.

BILL DAWE, EXAMINING ATTORNEY



**Int. Cls.: 7 and 11**

**Prior U.S. Cls.: 13, 19, 21, 23, 31, 34 and 35**

**Reg. No. 3,505,522**

**United States Patent and Trademark Office**

**Registered Sep. 23, 2008**

**TRADEMARK  
PRINCIPAL REGISTER**



GLEM GAS SPA (ITALY JOINT STOCK COMPANY)  
VIA MODENESE, 4266  
I-41018 SAN CESARIO SUL PANARO (MO), ITALY

FOR: ELECTRIC KITCHEN MACHINES, NAME-  
LY, STANDING MIXERS; DISHWASHERS;  
CLOTHES WASHING MACHINES; ELECTROME-  
CHANICAL BEVERAGE PREPARATION MA-  
CHINES, NAMELY, AERATED BEVERAGE  
MAKING MACHINE; ELECTRIC FOOD BLENDERS  
FOR HOUSEHOLD PURPOSES; CENTRIFUGES,  
BEING MACHINES; ELECTRIC MACHINES AND  
APPARATUS FOR CLEANING, NAMELY, CARPET  
CLEANING MACHINES; ELECTRIC MINCING MA-  
CHINES FOR HOUSEHOLD PURPOSES; PLYWOOD  
DRYING MACHINES; KNEADING MACHINES  
FOR PREPARING BREAD; ELECTROMECHANICAL  
FOOD PREPARATION MACHINES, NAMELY,  
FOOD PROCESSORS; GRATING MACHINES FOR  
VEGETABLES; ELECTRIC KNIVES; MEAT MINCER  
MACHINES, IN CLASS 7 (U.S. CLS. 13, 19, 21, 23, 31, 34  
AND 35).

FOR: GAS COOKERS; ELECTRIC COOKERS;  
ELECTROMAGNETIC INDUCTION COOKERS  
FOR HOUSEHOLD PURPOSES; CERAMIC AND  
GAS STOVES; ELECTRIC PRESSURE COOKERS;  
ELECTRIC SLOW COOKERS; COOKING RINGS,  
NAMELY, COOKTOPS; DOMESTIC COOKING  
OVENS, OTHER THAN FOR EXPERIMENTAL PUR-  
POSES; CONVECTION OVENS; FURNACES, OTHER  
THAN FOR EXPERIMENTAL PURPOSES; HOT AIR  
OVENS; ROASTING APPARATUS, NAMELY, COFFEE  
ROASTING OVENS; BARBECUES; EXTRAC-  
TOR HOODS FOR KITCHENS; ELECTRIC HOT  
PLATES; ELECTRIC DEEP FRYERS; ELECTRIC  
BOILERS; ELECTRIC EGG BOILERS; REFRIGER-  
ATING MACHINES; REFRIGERATING APPARA-  
TUS, NAMELY, ELECTRIC REFRIGERATORS FOR  
HOUSEHOLD PURPOSES; REFRIGERATING DIS-  
PLAY CABINETS; REFRIGERATORS; ELECTRIC  
BREAD TOASTERS; REGULATING AND SAFETY  
ACCESSORIES FOR GAS APPARATUS, NAMELY,

GAS REGULATORS; AIR FILTERING INSTALA-  
TIONS, NAMELY, AIR FILTER FOR DOMESTIC  
USE; BEVERAGE COOLING APPARATUS, NAME-  
LY, THERMOELECTRIC COOLER FOR BEVERA-  
GES; ELECTRIC COFFEE MAKERS;  
REFRIGERATED SHIPPING CONTAINERS; FREE-  
ZERS; SHAPED FITTINGS FOR FURNACES,  
NAMELY, HEAD DIFFUSION COLLARS AND  
DISCS FOR USE IN FURNACES; GAS BURNERS  
FOR DOMESTIC USE; BRACKETS SOLD AS A  
COMPONENT PART OF GAS BURNERS FOR DO-  
MESTIC USE; KILN FURNITURE; MICROWAVE  
OVENS, BEING COOKING APPARATUS; PASTEUR-  
IZERS FOR USE IN THE FOOD INDUSTRY; RE-  
FRIGERATING APPLIANCES AND  
INSTALLATIONS, NAMELY, REFRIGERATING  
CABINETS CONTAINING RACKS FOR WINE BOT-  
TLES; REFRIGERATING CHAMBERS, NAMELY,  
PORTABLE REFRIGERATED ROOMS; REGULAT-  
ING ACCESSORIES FOR WATER SUPPLY, NAME-  
LY, METERED VALVES; POWERED COFFEE  
ROASTERS; ELECTRIC FOOD STEAMER; ICE MA-  
CHINES; SINKS; FAUCETS; ELECTRIC COOKING  
HOBS, IN CLASS 11 (U.S. CLS. 13, 21, 23, 31 AND 34).

OWNER OF INTERNATIONAL REGISTRATION  
0937542 DATED 9-7-2006, EXPIRES 9-7-2016.

OWNER OF U.S. REG. NO. 3,247,686.

THE MARK CONSISTS OF A PRINT REPRESENT-  
ING THE WORD "GLEM" IN FANTASY CHARAC-  
TERS PRECEDED BY A STYLIZED FIGURE OF A  
CROWN WITH FIVE TIPS ON WHOSE EXTREMI-  
TIES ARE PLACED FIVE SMALL CIRCULAR FIG-  
URES.

THE WORDING "GLEM" HAS NO MEANING IN  
A FOREIGN LANGUAGE.

SER. NO. 79-043,866, FILED 9-7-2006.

MARY BOAGNI, EXAMINING ATTORNEY

**Int. Cl.: 10**

**Prior U.S. Cls.: 26, 39 and 44**

**United States Patent and Trademark Office**

**Reg. No. 3,505,523**

**Registered Sep. 23, 2008**

**TRADEMARK  
PRINCIPAL REGISTER**

# SpotPlus

SIEMENS AKTIENGESELLSCHAFT (FED REP  
GERMANY AKTIENGESELLSCHAFT)  
WITTELSBACHERPLATZ 2  
80333 MÜNCHEN  
FED REP GERMANY

FOR: MEDICAL EQUIPMENT AND APPARATUS,  
NAMELY, MEDICAL X-RAY DIAGNOSIS APPARA-  
TUS; X-RAY THERAPY APPARATUS FOR MEDI-  
CAL USE; X-RAY DIAGNOSIS APPARATUS FOR  
MAMMOGRAPHY; ACCESSORIES FOR THE  
AFORESAID APPARATUS, NAMELY, MAMMO-  
GRAPHY COMPRESSION PADDLES USED IN CON-

JUNCTION WITH MAMMOGRAPHY X-RAY  
APPARATUS, IN CLASS 10 (U.S. CLS. 26, 39 AND 44).

PRIORITY DATE OF 4-26-2007 IS CLAIMED.

OWNER OF INTERNATIONAL REGISTRATION  
0937555 DATED 6-6-2007, EXPIRES 6-6-2017.

SER. NO. 79-043,873, FILED 6-6-2007.

MARY BOAGNI, EXAMINING ATTORNEY

**Int. Cl.: 9**

**Prior U.S. Cls.: 21, 23, 26, 36 and 38**

**United States Patent and Trademark Office**

**Reg. No. 3,505,524**

**Registered Sep. 23, 2008**

**TRADEMARK  
PRINCIPAL REGISTER**



D1 CORPORATION CO., LTD. (JAPAN CORPORATION)  
19 HARAMACHI 3-CHOME  
SHINJUKU-KU; TOKYO 162-0053  
JAPAN

FOR: ARCADE VIDEO GAME STAND ALONE MACHINES; DOWNLOADABLE ELECTRONIC PUBLICATIONS IN THE NATURE OF MAGAZINES IN THE FIELD OF VIDEO GAMES; CONSUMER VIDEO GAMES IN THE NATURE OF SOFTWARE; VIDEO GAME SOFTWARE; ELECTRONIC CIRCUITS AND CD-ROMS FEATURING RECORDED COMPUTER SOFTWARE PROGRAMS FOR OPERATING CONSUMER VIDEO GAMES IN THE FIELD OF VIDEO GAMES; RECORDED VIDEO DISCS FEATURING AUTOMOBILE RACING; RECORDED VIDEO TAPES FEATURING AUTOMOBILE RACING; RECORDED DVDS FEATURING AUTOMO-

BILE RACING, IN CLASS 9 (U.S. CLS. 21, 23, 26, 36 AND 38).

OWNER OF INTERNATIONAL REGISTRATION 0937587 DATED 8-10-2007, EXPIRES 8-10-2017.

OWNER OF U.S. REG. NOS. 3,159,369, 3,303,076 AND OTHERS.

NO CLAIM IS MADE TO THE EXCLUSIVE RIGHT TO USE "PROFESSIONAL DRIFT GAME ARCADE", APART FROM THE MARK AS SHOWN.

SER. NO. 79-043,877, FILED 8-10-2007.

JAMES STEIN, EXAMINING ATTORNEY

**Int. Cls.: 7, 12 and 25**

**Prior U.S. Cls.: 13, 19, 21, 22, 23, 31, 34, 35, 39 and 44**

**Reg. No. 3,505,525**

**United States Patent and Trademark Office**

**Registered Sep. 23, 2008**

**TRADEMARK  
PRINCIPAL REGISTER**



M.I.V.V. METAL INDUSTRIA; VAL VIBRATA  
S.P.A. (ITALY JOINT STOCK COMPANY)  
ZONA INDUSTRIALE  
I-64027 SANT'OMERO (TERAMO)  
ITALY

FOR: EXHAUST MUFFLERS FOR ENGINES, IN  
CLASS 7 (U.S. CLS. 13, 19, 21, 23, 31, 34 AND 35).

FOR: MOTOR VEHICLES, NAMELY, AUTOMO-  
BILES, MOTORBIKES, TRACTORS, FORK LIFT  
TRUCKS, THEIR PARTS AND ACCESSORIES IN-  
CLUDED IN THIS CLASS, NAMELY, BRAKE PED-  
ALS, GEAR SHIFTS, TRANSMISSIONS, PETROL  
TANK CAPS, IN CLASS 12 (U.S. CLS. 19, 21, 23, 31,  
35 AND 44).

FOR: CLOTHING, NAMELY, SHIRTS, POLO  
SHIRTS, SWEATERS, SWEATSHIRTS, T-SHIRTS,  
TROUSERS, SHORTS; FOOTWEAR; HEADGEAR,  
NAMELY, HATS, IN CLASS 25 (U.S. CLS. 22 AND 39).

PRIORITY DATE OF 7-30-2007 IS CLAIMED.

OWNER OF INTERNATIONAL REGISTRATION  
0937624 DATED 8-10-2007, EXPIRES 8-10-2017.

SER. NO. 79-043,888, FILED 8-10-2007.

JAMES STEIN, EXAMINING ATTORNEY

**Int. Cl.: 7**

**Prior U.S. Cls.: 13, 19, 21, 23, 31, 34 and 35**

**Reg. No. 3,505,526**

**United States Patent and Trademark Office**

**Registered Sep. 23, 2008**

**TRADEMARK  
PRINCIPAL REGISTER**



RÖSLER OBERFLÄCHENTECHNIK GMBH (FED  
REP GERMANY LIMITED LIABILITY COM-  
PANY)  
VORSTADT 1  
96190 UNTERMERZBACH  
FED REP GERMANY

GOODS FOR USE IN SURFACE TREATMENT IN  
THE NATURE OF GRINDING AND POLISHING  
METAL, WOOD, CERAMIC AND PLASTICS, IN  
CLASS 7 (U.S. CLS. 13, 19, 21, 23, 31, 34 AND 35).

PRIORITY DATE OF 2-28-2007 IS CLAIMED.

OWNER OF INTERNATIONAL REGISTRATION  
0937681 DATED 8-17-2007, EXPIRES 8-17-2017.

SER. NO. 79-043,895, FILED 8-17-2007.

FOR: POWER OPERATED MACHINES FOR THE  
WORKING OF METAL, WOOD, CERAMIC AND  
PLASTICS, NAMELY, VIBRATORY GRINDING  
MACHINES; ROUND VIBRATORS; CENTRIFUGAL  
VIBRATORY GRINDING MACHINES; THROUGH  
VIBRATORS; WASHING MACHINES FOR PROCES-  
SED PARTS; MAGNETIC SEPARATION MA-  
CHINES; ACOUSTICALLY INSULATED CABINS  
AND ACOUSTICALLY INSULATED COVERS;  
SHOT BLASTING MACHINES, ALL OF THE ABOVE

PRISCILLA MILTON, EXAMINING ATTORNEY

Int. Cl.: 29

Prior U.S. Cl.: 46

United States Patent and Trademark Office

Reg. No. 3,505,527

Registered Sep. 23, 2008

TRADEMARK  
PRINCIPAL REGISTER



RODRIGUEZ PASCUAL Y COMPAÑÍA, S.L.  
(SPAIN SOCIEDAD LIMITADA)  
AVENIDA DE MENDIÑO, S/N  
E-36800 REDONDELA (PONTEVEDRA)  
SPAIN

FOR: MEAT AND FISH; MEAT EXTRACTS; PRESERVED, DRIED AND COOKED FRUITS AND VEGETABLES; JELLIES, JAMS, COMPOTES; EGGS; MILK AND DAIRY PRODUCTS EXCLUDING ICE CREAM, ICE MILK AND FROZEN YOGURT; EDIBLE OILS AND FATS, IN CLASS 29 (U.S. CL. 46).

PRIORITY DATE OF 6-28-2007 IS CLAIMED.

OWNER OF INTERNATIONAL REGISTRATION  
0937692 DATED 7-5-2007, EXPIRES 7-5-2017.

NO CLAIM IS MADE TO THE EXCLUSIVE RIGHT TO USE "CONSERVAS", APART FROM THE MARK AS SHOWN.

THE COLOR(S) YELLOW, RED, GREEN, WHITE, AND BLACK IS/ARE CLAIMED AS A FEATURE OF THE MARK.

THE MARK CONSISTS OF A MYTHICAL WINGED DRAGON WITH A SHIELD SURROUNDED BY A CIRCLE. THE COLOR RED APPEARS IN THE WORDING "LA COCA CONSERVAS" AS WELL AS ON THE DEPICTION OF THE SHIELD; THE COLOR YELLOW APPEARS IN THE DEPICTION OF THE CIRCLE; THE COLOR GREEN APPEARS IN THE DEPICTION OF THE MYTHICAL WINGED DRAGON; THE COLOR WHITE APPEARS IN THE WORDING "RPC" AS WELL AS ON THE DEPICTION OF THE THREE CIRCLES ON THE SHIELD, THE BORDER SURROUNDING THE COLOR RED ON THE SHIELD, THE RECTANGLE SURROUNDING THE WORD "CONSERVAS", AND AS SHADING ON THE MYTHICAL WINGED DRAGON; THE COLOR BLACK APPEARS IN THE OUTER BORDER OF THE CIRCLE AND THE SHIELD, AS WELL AS IN THE DEPICTION OF THE MYTHICAL WINGED DRAGON.

THE ENGLISH TRANSLATION OF THE WORD "LA" IS THE; THE ENGLISH TRANSLATION OF THE WORD "CONSERVAS" IN THE MARK IS CANNING; THE WORDING "COCA" HAS NO MEANING IN ENGLISH.

SER. NO. 79-043,898, FILED 7-5-2007.

MICHAEL TANNER, EXAMINING ATTORNEY

**Int. Cls.: 9, 35, 37 and 38**

**Prior U.S. Cls.: 21, 23, 26, 36, 38, 100, 101, 102, 103,  
104 and 106**

**Reg. No. 3,505,528**

**United States Patent and Trademark Office**

**Registered Sep. 23, 2008**

**TRADEMARK  
SERVICE MARK  
PRINCIPAL REGISTER**

# FIFTHPLAY

FIFTHPLAY N.V. (BELGIUM SOCIÉTÉ ANON-  
YME)

INDUSTRIEPARK WEST 40

B-9100 SINT-NIKLAAS

BELGIUM

FOR: OPTICAL, MONITORING AND SIGNALING APPARATUS, NAMELY, CAMERAS, RADIO FREQUENCY IDENTIFICATION TAGS, MOTION DETECTORS, GAS DETECTORS, SMOKE DETECTORS, DOOR AND WINDOW CONTACT DETECTORS, SOUND DETECTORS, LIGHTING CONTROL SENSORS, TEMPERATURE SENSORS AND BAR CODE SCANNERS; ENERGY MONITORS, NAMELY, DEVICES FOR MONITORING, MEASURING AND REGULATING ELECTRICITY AND GAS USAGE; APPARATUS FOR MEASURING WEIGHT, NAMELY, SCALES; MEASURING APPARATUS, NAMELY, ELECTRICITY METERS; HOME AND OFFICE AUTOMATION SYSTEMS COMPRISING WIRELESS AND WIRED CONTROLLERS, CONTROLLED DEVICES, AND SOFTWARE FOR LIGHTING, HVAC, SECURITY, SAFETY AND OTHER HOME AND OFFICE MONITORING AND CONTROL APPLICATIONS; APPARATUS FOR SWITCHING, TRANSFORMING AND ACCUMULATING ELECTRICITY, NAMELY, SWITCHING DEVICES, ADAPTERS, TRANSFORMERS AND ACTUATORS; APPARATUS FOR RECORDING, TRANSMITTING AND REPRODUCING SOUNDS AND IMAGES, NAMELY, LCD TOUCH SCREENS, LCD TOUCH SCREENS INCORPORATING THIN FILM TECHNOLOGY AND PDAS; PRERECORDED MAGNETIC AND OPTICAL DATA CARRIERS, NAMELY, USB STICKS FEATURING COMPUTER SOFTWARE FOR INTERCONNECTING MULTIPLE WIRELESS DEVICES; DATA-PROCESSING APPARATUS, NAMELY, GATEWAYS, ROUTERS AND MODEMS; AND COMPUTER SOFTWARE EMBEDDED IN EACH OF THE FOREMENTIONED GOODS FOR PURPOSES OF CONTROL THEREOF, IN CLASS 9 (U.S. CLS. 21, 23, 26, 36 AND 38).

FOR: COMPILATION AND MANAGEMENT OF DATABASES, IN CLASS 35 (U.S. CLS. 100, 101 AND 102).

FOR: PROVIDING INFORMATION VIA TELECOMMUNICATIONS MEANS, NAMELY, PROVIDING INFORMATION REGARDING THE INSTALLATION, MAINTENANCE AND REPAIR OF CAMERAS, RADIO FREQUENCY IDENTIFICATION TAGS, MOTION DETECTORS, GAS DETECTORS, SMOKE DETECTORS, DOOR AND WINDOW CONTACT DETECTORS, SOUND DETECTORS, LIGHTING CONTROL SENSORS, TEMPERATURE SENSORS, DEVICES FOR MONITORING, MEASURING AND REGULATING ELECTRICITY AND GAS USAGE, BAR CODE SCANNERS, SCALES, ELECTRICITY METERS, HOME AND OFFICE AUTOMATION SYSTEMS, APPARATUS FOR SWITCHING, TRANSFORMING AND ACCUMULATING ELECTRICITY, LCD TOUCH SCREENS, LCD TOUCH SCREENS INCORPORATING THIN FILM TECHNOLOGY, PDAS, AND DATA-PROCESSING APPARATUS IN THE NATURE OF GATEWAYS, ROUTERS AND MODEMS, IN CLASS 37 (U.S. CLS. 100, 103 AND 106).

FOR: ELECTRONIC TRANSMISSION OF IMAGES, SOUND AND DATA VIA TELECOMMUNICATION MEANS IN THE FIELD OF HOME AND BUILDING AUTOMATION, IN CLASS 38 (U.S. CLS. 100, 101 AND 104).

THE MARK CONSISTS OF STANDARD CHARACTERS WITHOUT CLAIM TO ANY PARTICULAR FONT, STYLE, SIZE, OR COLOR.

PRIORITY DATE OF 1-30-2007 IS CLAIMED.

OWNER OF INTERNATIONAL REGISTRATION  
0937857 DATED 7-30-2007, EXPIRES 7-30-2017.

SER. NO. 79-043,947, FILED 7-30-2007.

LINDA LAVACHE, EXAMINING ATTORNEY



**Int. Cls.: 25 and 32**

**Prior U.S. Cls.: 22, 39, 45, 46 and 48**

**United States Patent and Trademark Office**

**Reg. No. 3,505,529**

**Registered Sep. 23, 2008**

**TRADEMARK  
PRINCIPAL REGISTER**



SPUMADOR S.P.A. (ITALY JOINT STOCK COMPANY)  
VIA ALLA FONTE, 13  
FRAZ. CASLINO AL PIANO; I-22071 CADORAGO(-  
COMO)  
ITALY

FOR: CLOTHING, NAMELY, SHIRTS, PANTS, SHORTS, DRESSES AND JACKETS, JEANS AND T-SHIRTS; SHOES, SLIPPERS, BOOTS; HEADGEAR, NAMELY, HATS, CAPS AND VISORS, IN CLASS 25 (U.S. CLS. 22 AND 39).

FOR: BEERS; MINERAL AND AERATED WATERS; NON-ALCOHOLIC DRINKS, NAMELY, SODA POPS; FRUIT DRINKS AND FRUIT JUICES; SYRUPS FOR MAKING BEVERAGES, EXCLUDING MILK, COCOA, COFFEE AND CHOCOLATE BEVERAGES, IN CLASS 32 (U.S. CLS. 45, 46 AND 48).

PRIORITY DATE OF 3-23-2007 IS CLAIMED.

OWNER OF INTERNATIONAL REGISTRATION  
0937917 DATED 8-22-2007, EXPIRES 8-22-2017.

THE MARK CONSISTS OF A SHIELD FEATURING AN EAGLE WITH OUTSTRETCHED WINGS, AND WAVY HORIZONTAL LINES IN THE BACKGROUND.

SER. NO. 79-043,968, FILED 8-22-2007.

COLLEEN KEARNEY, EXAMINING ATTORNEY

**Int. Cl.: 5**

**Prior U.S. Cls.: 6, 18, 44, 46, 51 and 52**

**United States Patent and Trademark Office**

**Reg. No. 3,505,530**

**Registered Sep. 23, 2008**

**TRADEMARK  
PRINCIPAL REGISTER**

The logo for Dulcolax features the word "Dulcolax" in a bold, sans-serif font. The letters "D", "L", "C", and "L" are dark green, while the "O" is a light green circle with a yellow-to-green gradient and a dark green shadow on its left side, giving it a 3D effect. The letters "A", "X", and "A" are a lighter shade of green.

BOEHRINGER INGELHEIM INTERNATIONAL  
GMBH (FED REP GERMANY CORPORA-  
TION)

55218 INGELHEIM  
FED REP GERMANY

FOR: PHARMACEUTICAL PREPARATIONS FOR  
THE TREATMENT OF ALIMENTARY TRACT AND  
METABOLISM DISORDERS, IN CLASS 5 (U.S. CLS.  
6, 18, 44, 46, 51 AND 52).

PRIORITY DATE OF 5-3-2007 IS CLAIMED.

OWNER OF INTERNATIONAL REGISTRATION  
0937960 DATED 8-16-2007, EXPIRES 8-16-2017.

OWNER OF U.S. REG. NOS. 671,422, 2,861,373,  
AND 2,953,044.

THE COLOR(S) DARK GREEN, LIGHT GREEN  
AND YELLOW IS/ARE CLAIMED AS A FEATURE  
OF THE MARK.

THE MARK CONSISTS OF THE COLOR DARK  
GREEN APPEARS IN THE LETTERS "DULC", AND  
IN THE LEFT PORTION AND BORDER OF THE "O"  
SHAPED DESIGN; THE COLOR LIGHT GREEN  
APPEARS AS THE LETTERING "LAX" AND IN  
THE RIGHT PORTION OF THE "O" SHAPED DE-  
SIGN; THE COLOR YELLOW APPEARS AS SHAD-  
ING IN THE "O" SHAPED DESIGN.

THE WORD "DULCOLAX" HAS NO MEANING  
IN A FOREIGN LANGUAGE.

SER. NO. 79-043,985, FILED 8-16-2007.

KATHERINE E. HALMEN, EXAMINING ATTOR-  
NEY

**Int. Cl.: 25**

**Prior U.S. Cls.: 22 and 39**

**United States Patent and Trademark Office**

**Reg. No. 3,505,531**

**Registered Sep. 23, 2008**

**TRADEMARK  
PRINCIPAL REGISTER**



VENTURELLI S.R.L. (ITALY LIMITED LIABILITY COMPANY)  
VIA DEL SIGNURI, 51/C  
I-25085 GAVARDO (BRESCIA)  
ITALY

PATRONYMIC "VENTURELLI" IN COMBINATION WITH A REPRESENTATION OF A DANCER.

FOR: FOOTWEAR FOR DANCE AND GYMNASTICS, IN CLASS 25 (U.S. CLS. 22 AND 39).

SER. NO. 79-044,101, FILED 8-27-2007.

OWNER OF INTERNATIONAL REGISTRATION 0741191 DATED 7-26-2000, EXPIRES 7-26-2010.

KATINA MISTER, EXAMINING ATTORNEY

Int. Cl.: 3

Prior U.S. Cls.: 1, 4, 6, 50, 51 and 52

United States Patent and Trademark Office

Reg. No. 3,505,532

Registered Sep. 23, 2008

TRADEMARK  
PRINCIPAL REGISTER

floritene

LABORATOIRES MAGISTRA S.A. (SWITZER-  
LAND CORPORATION)  
CHEMIN DU GRAND-PUITS 28  
CH-1217 MEYRIN  
SWITZERLAND

FOR: SKIN CARE PRODUCTS, NAMELY, LO-  
TION, MAKEUP REMOVER, MOISTURIZING  
CREAM, ANTI-WRINKLE CREAM, SKIN GEL,  
SUN LOTION, MAKEUP EMULSION, MAKEUP  
GEL, TONIC LOTION, EYE MAKEUP REMOVAL  
LOTION, HAIR LOTION AND ESSENTIAL OILS, IN  
CLASS 3 (U.S. CLS. 1, 4, 6, 50, 51 AND 52).

OWNER OF INTERNATIONAL REGISTRATION  
0642585 DATED 8-15-1995, EXPIRES 8-15-2015.

THE WORDING "FLORITENE" HAS NO MEAN-  
ING IN A FOREIGN LANGUAGE.

SER. NO. 79-044,408, FILED 9-21-2007.

JENNIFER DIXON, EXAMINING ATTORNEY

Int. Cl.: 7

Prior U.S. Cls.: 13, 19, 21, 23, 31, 34 and 35

United States Patent and Trademark Office

Reg. No. 3,505,533

Registered Sep. 23, 2008

TRADEMARK  
PRINCIPAL REGISTER



SURFLEX S.R.L. (ITALY LIMITED LIABILITY  
COMPANY)  
VIA MONTESANTO 46  
I-21049 TRADATE (VARESE), ITALY

FOR: PARTLY PROCESSED FRICTION MATERIALS, MADE WITH FIBRES IMPREGNATED WITH SYNTHETIC RESINS, COMMONLY USED FOR CLUTCH FACINGS AND BRAKE LININGS AND FRICTION PARTS OF INDUSTRIAL MACHINES, PARTS AND MECHANISMS OF ALL KINDS WHERE A BRAKE OR CLUTCH SYSTEM IS REQUIRED, IN CLASS 7 (U.S. CLS. 13, 19, 21, 23, 31, 34 AND 35).

OWNER OF INTERNATIONAL REGISTRATION  
0786591 DATED 5-20-2002, EXPIRES 5-20-2012.

OWNER OF U.S. REG. NO. 1,548,192.

NO CLAIM IS MADE TO THE EXCLUSIVE RIGHT TO USE "PER FRENI PER FRIZIONI", APART FROM THE MARK AS SHOWN.

THE FOREIGN WORDING IN THE MARK TRANSLATES INTO ENGLISH AS FOR BRAKES FOR CLUTCHES. THE WORDING "SURFLEX" HAS NO MEANING IN A FOREIGN LANGUAGE.

SER. NO. 79-044,423, FILED 2-20-2007.

BARBARA RUTLAND, EXAMINING ATTORNEY

**Int. Cls.: 3 and 10**

**Prior U.S. Cls.: 1, 4, 6, 26, 39, 44, 50, 51 and 52**

**United States Patent and Trademark Office**

**Reg. No. 3,505,534**

**Registered Sep. 23, 2008**

**TRADEMARK  
PRINCIPAL REGISTER**

# **RESONANCES**

RESONANCES (FRANCE SOCIETE ANONYME)  
1, AVENUE DE L'EUROPE  
F-78117 TOUSSUS LE NOBLE  
FRANCE

FOR: COSMETICS, MASSAGE COSMETICS,  
SLIMMING COSMETICS, COSMETICS BASED ON  
PRODUCTS OF MARINE ORIGIN, ESSENTIAL  
OILS, INCENSE, MASSAGE OILS, PERFUMERY,  
EAUX DE TOILETTE, HAIR LOTIONS, DENTIFRI-  
CES, PARQUET FLOOR WAXES, POLISH FOR  
FURNITURE AND FLOORING, STAIN REMOV-  
ERS, IN CLASS 3 (U.S. CLS. 1, 4, 6, 50, 51 AND 52).

FOR: GLOVES FOR MASSAGE, IN CLASS 10 (U.S.  
CLS. 26, 39 AND 44).

THE MARK CONSISTS OF STANDARD CHAR-  
ACTERS WITHOUT CLAIM TO ANY PARTICULAR  
FONT, STYLE, SIZE, OR COLOR.

OWNER OF INTERNATIONAL REGISTRATION  
0836884 DATED 10-8-2004, EXPIRES 10-8-2014.

SER. NO. 79-044,429, FILED 1-11-2007.

BARBARA RUTLAND, EXAMINING ATTORNEY

Int. Cl.: 37

Prior U.S. Cls.: 100, 103 and 106

United States Patent and Trademark Office

Reg. No. 3,505,535

Registered Sep. 23, 2008

SERVICE MARK  
PRINCIPAL REGISTER

**TATNEFT**

OTKRYTOE AKTSIONERNOE OBCHTCHESTVO;  
"TATNEFT" IMENI V.D. CHACHINA (RUS-  
SIAN FED. SOCIÉTÉ À RESPONSABILITÉ  
LIMITÉE)

75, OUL. LENINA

RU-423450 ALMETYEVSK

RÉPUBLIQUE TATARSTAN, RUSSIAN FED.

FOR: CONSTRUCTION, NAMELY, LAYING AND CONSTRUCTION OF OIL PIPELINES; REPAIR, NAMELY, OIL PIPELINES REPAIR; INSTALLATION SERVICES, NAMELY, INSTALLATION OF MINING EXTRACTION EQUIPMENT, MINING EXTRACTION; EXTRACTION OF PETROLEUM AND GAS; DRILLING OF WELLS; INSTALLATION, REPAIR AND MAINTENANCE OF PETROLEUM AND GAS EQUIPMENT FOR THE EXTRACTION AND PROCESSING OF PETROLEUM AND GAS; CONSTRUCTION MANAGEMENT AND SUPERVISION OF INSTALLATION, REPAIR AND MAINTENANCE WORK ON PETROLEUM AND GAS EQUIPMENT; CONSTRUCTION MANAGEMENT AND SUPERVISION OF MINING EXTRACTION WORKS; INFORMATION ON MINING EXTRACTION; RENTAL OF CONSTRUCTION MACHINERY, PETROLEUM AND GAS EQUIPMENT FOR THE EXTRACTION AND PROCESSING OF PETROLEUM AND GAS; PREVENTIVE ANTI-RUST TREATMENT FOR VEHICLES; WASHING, CLEANING, REPAIR AND MAINTENANCE OF VEHICLES, OF MACHINERY AND EQUIPMENT FOR CONSTRUCTION, LIFTING EQUIPMENT AND APPARATUS; REPAIR OF RESIDENTIAL AND INDUSTRIAL PREMISES; CONSTRUCTION SERVICES, NAMELY, LAYING OUT, REPAIRING AND CHANGING URBAN UNDERGROUND UTILITY INSTALLATIONS NAMELY, WATER AND GAS DISTRIBUTION NETWORKS; FITTING OUT STORAGE SHEDS, NAMELY, REPAIR OR MAINTENANCE OF STORAGE TANKS; CLEANING OF EDIFICES; PARTIAL VITRIFICATION, NAMELY MACHINERY RETROFIT AND CONVERSION SERVICES; BUILDING CONSTRUCTION SUPERVISION; INSTALLATION OF COVERINGS FOR

EDIFICES; ASSEMBLY, INSTALLATION AND REPAIR OF UTILITIES, NAMELY, CABLING, WATER AND GAS DISTRIBUTION NETWORKS, HEATING SYSTEMS, SANITARY SYSTEMS, AIR-CONDITIONERS, LIFTS, ANTI-THEFT ALARM SYSTEMS AND FIRE ALARM SYSTEMS, TELEPHONE APPARATUS, KITCHEN APPLIANCES; INSTALLATION OF PLANT EQUIPMENT, NAMELY POWER EQUIPMENT, MANUFACTURING EQUIPMENT, INDUSTRIAL EQUIPMENT; INTERFERENCE SUPPRESSION IN ELECTRICAL APPARATUS; ELECTRIC APPLIANCE INSTALLATION AND REPAIR; MENDING CLOTHING; ASPHALTING; DAMP-PROOFING FOR BUILDINGS; FINISHING WORK FOR THE CONSTRUCTION AND REPAIR OF BUILDING EDIFICES; DISINFECTING; RAT EXTERMINATING OTHER THAN FOR AGRICULTURE, FORESTRY OR HORTICULTURE PURPOSES; RIVETING; VARNISHING; RE-TINNING; SCAFFOLDING CONSTRUCTION, REPAIR AND ERECTION; ROAD PAVING; DEMOLITION OF BUILDINGS; STREET CLEANING; BOILER CLEANING AND REPAIR; CHIMNEY SWEEPING; INFORMATION ON CONSTRUCTION AND REPAIR SERVICES RELATED TO THE FOREGOING SERVICES; SERVICES OF A LAUNDRY, IN CLASS 37 (U.S. CLS. 100, 103 AND 106).

OWNER OF INTERNATIONAL REGISTRATION  
0919194 DATED 8-3-2006, EXPIRES 8-3-2016.

THE VERBAL MARK COMPRISES THE WORD  
"TATNEFT".

THE NON-LATIN CHARACTER(S) IN THE  
MARK TRANSLITERATES INTO TATNEFT, AND  
THIS MEANS NO MEANING IN ENGLISH.

SER. NO. 79-044,435, FILED 4-25-2007.

BARBARA RUTLAND, EXAMINING ATTORNEY

**Int. Cls.: 7, 8 and 16**

**Prior U.S. Cls.: 2, 5, 13, 19, 21, 22, 23, 28, 29, 31, 34, 35, 37, 38, 44 and 50**

**Reg. No. 3,505,536**

**United States Patent and Trademark Office**

**Registered Sep. 23, 2008**

**TRADEMARK  
PRINCIPAL REGISTER**

# Securio

HSM GMBH + CO.KG  
BAHNHOFSTRABE 115  
88682 SALEM  
FED REP GERMANY

FOR: MACHINES, APPARATUS AND TOOLS (FOR INDUSTRIAL PURPOSES), WHICH ARE MOTOR-DRIVEN (ELECTRICALLY, MECHANICALLY, PNEUMATICALLY, HYDRAULICALLY OR BY A COMBINED DRIVE SYSTEM) AS WELL AS PARTS, SUBASSEMBLIES AND ACCESSORIES THEREOF, NAMELY, CUTTING MACHINES FOR PAPER, CARDBOARD AND CARTON BOARD, LEVER CUTTING MACHINES, ROLLER CUTTING MACHINES, BINDING APPARATUS AND BINDING MACHINES FOR BINDING WITH WIRE BINDING SPINES OR PLASTIC BINDING SPINES OR WITH USE OF ADHESIVE TAPE, THERMAL BINDING APPARATUS AND THERMAL BINDING MACHINES, TAPE BINDING APPARATUS AND TAPE BINDING MACHINES, DOCUMENT SHREDDING MACHINES, DOCUMENT SHREDDERS, INCLUDING DOCUMENT SHREDDERS WITH COMPACT DISC AND CREDIT CARD DESTRUCTORS, COMPACT DISC DESTRUCTORS PER SE, CUTTING MECHANISMS AND STANDS FOR DOCUMENT SHREDDING MACHINES, PARTS AND ACCESSORIES OF DOCUMENT SHREDDERS AND DOCUMENT SHREDDING MACHINES, NAMELY, COLLECTING CONTAINERS, COLLECTING POUCHES AND COLLECTING BAGS AS MACHINE PARTS AND APPARATUS PARTS, COMBINATIONS CONTAINING DOCUMENT SHREDDERS AND DOCUMENT SHREDDING MACHINES, DATA CARRIER SHREDDING MACHINES, NAMELY, SHREDDERS, FOR PAPER, CARDBOARD AND MATERIALS PARTLY CONTAINING PAPER AND/OR CARDBOARD, FOR FILM MATERIALS AS WELL AS FOR DATA CARRIERS IN THE FORM OF MICROFILMS, TAPES, FILM MATERIALS, COMPACT DISCS AND DISKETTES, ALL THE

AFORESAID GOODS INCLUDED IN THIS CLASS, IN CLASS 7 (U.S. CLS. 13, 19, 21, 23, 31, 34 AND 35).

FOR: HAND-OPERATED APPARATUS AND TOOLS (FOR INDUSTRIAL PURPOSES), AS WELL AS PARTS, SUBASSEMBLIES AND ACCESSORIES THEREOF, NAMELY CUTTING APPARATUS FOR PAPER, CARDBOARD AND CARTON BOARD, LEVER CUTTING APPARATUS, ROLLER CUTTING APPARATUS; HOBBY CUTTERS AND PROFESSIONAL CUTTERS, ALL THE AFORESAID GOODS INCLUDED IN THIS CLASS, IN CLASS 8 (U.S. CLS. 23, 28 AND 44).

FOR: PRINTED MATTER NAMELY BOOKBINDING MATERIAL, PHOTOGRAPHS, INSTRUCTIONAL AND TEACHING MATERIAL IN THE FIELD OF PHOTOGRAPHS, PAPER BOARDS, BROCHURES IN THE FIELD OF PHOTOGRAPHS; GOODS MADE FROM PLASTIC MATERIALS FOR STORAGE AND/OR PACKAGING OF ARTICLES NAMELY BAGS, ENVELOPES, POUCHES, PLASTIC FILMS; ADHESIVES FOR STATIONERY; WRITING MATERIALS NAMELY PENCILS, STANDS FOR PENS AND PENCILS, NOTE BOOKS, COPYING PAPER, CUTTING MATS, CUTTING RULES; TYPEWRITERS, OFFICE SUPPLIES NAMELY LAMINATING APPARATUS FOR HOT AND/OR COLD LAMINATING, SPIRAL BINDING MACHINES, THERMAL BINDING MACHINES, ACCESSORIES FOR THE AFORESAID BINDING MACHINES AS BOOKBINDING MATERIAL, NAMELY PLASTIC BINDING SPINES, WIRE BINDING SPINES, ADHESIVE TAPE, FABRIC TAPE AND THERMAL BINDING FOLDERS; DOCUMENT SHREDDING MACHINES, DOCUMENT SHREDDERS, INCLUDING DOCUMENT SHREDDERS WITH COMPACT-DISC AND CREDIT-CARD DESTRUCTORS, COMPACT-DISC DESTRUCTORS PER SE, CUTTING MECHANISMS AND STANDS FOR DOCUMENT SHREDDERS, PARTS AND ACCESSORIES OF DOCUMENT SHREDDERS AND



DOCUMENT SHREDDING MACHINES, NAMELY COLLECTING CONTAINERS, COLLECTING POUCHES AND COLLECTING BAGS, ALL AS OFFICE SUPPLIES, IN CLASS 16 (U.S. CLS. 2, 5, 22, 23, 29, 37, 38 AND 50).

THE MARK CONSISTS OF STANDARD CHARACTERS WITHOUT CLAIM TO ANY PARTICULAR FONT, STYLE, SIZE, OR COLOR.

PRIORITY DATE OF 5-23-2006 IS CLAIMED.

OWNER OF INTERNATIONAL REGISTRATION 0939191 DATED 11-8-2006, EXPIRES 11-8-2016.

SER. NO. 79-044,512, FILED 11-8-2006.

JOHN HWANG, EXAMINING ATTORNEY

**Int. Cl.: 5**

**Prior U.S. Cls.: 6, 18, 44, 46, 51 and 52**

**United States Patent and Trademark Office**

**Reg. No. 3,505,537**

**Registered Sep. 23, 2008**

**TRADEMARK  
PRINCIPAL REGISTER**

**VITROSHIELD**

VITROLIFE SWEDEN AB (SWEDEN CORPORATION)

FAKTORVÄGEN 13

SE-434 37 KUNGSBACKA

SWEDEN

FOR: PHARMACEUTICAL PREPARATIONS AND MEDICINES FOR USE IN THE TREATMENT OF INFERTILITY, IN STEM CELL CULTIVATION, AND IN TISSUE TRANSPLANTATION, NAMELY, IN THE PREPARATION, STORAGE, CULTIVATION, PRESERVATION AND TREATMENT OF CELLS, EMBRYOS, ORGANS AND CELLULAR ORGANISMS, IN CLASS 5 (U.S. CLS. 6, 18, 44, 46, 51 AND 52).

THE MARK CONSISTS OF STANDARD CHARACTERS WITHOUT CLAIM TO ANY PARTICULAR FONT, STYLE, SIZE, OR COLOR.

PRIORITY DATE OF 6-28-2007 IS CLAIMED.

OWNER OF INTERNATIONAL REGISTRATION 0939214 DATED 8-22-2007, EXPIRES 8-22-2017.

THE WORDING "VITROSHIELD" HAS NO MEANING IN A FOREIGN LANGUAGE.

SER. NO. 79-044,519, FILED 8-22-2007.

KEVIN CORWIN, EXAMINING ATTORNEY

**Int. Cls.: 9, 14 and 42**

**Prior U.S. Cls.: 2, 21, 23, 26, 27, 28, 36, 38, 50, 100 and 101**

**Reg. No. 3,505,538**

**United States Patent and Trademark Office**

**Registered Sep. 23, 2008**

**TRADEMARK  
SERVICE MARK  
PRINCIPAL REGISTER**

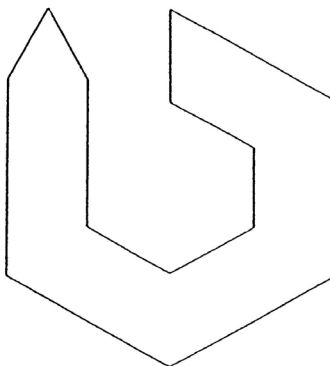

COMOTEC S.A.; (INCORPORATED COMPANY)  
(FRANCE SOCIETE ANONYME)  
LA DOYE  
MOREZ, FRANCE F39400

FOR: OPTICAL GOODS, NAMELY, SPECTACLES, SPECTACLE FRAMES AND THEIR COMPONENT AND REPLACEMENT PARTS, NAMELY, SPECTACLE TEMPLES, TEMPLES, SPECTACLE TEMPLE CASES, END PIECES, GROOVED EYEWIRES, METAL AND NON-METAL HINGES, BRIDGES, NOSE SUPPORT PADS, TEMPLE SUPPORT PADS; OPTICAL LENSES, LENSES FOR SUNGLASSES AND EYEGGLASS LENSES FOR PROTECTIVE EYEGGLASSES, IN CLASS 9 (U.S. CLS. 21, 23, 26, 36 AND 38).

FOR: PRECIOUS METALS AND THEIR ALLOYS, JEWELRY, TIMEPIECES, NAMELY, WATCHES, CHRONOMETERS, BRACELETS, BRACELET LINKS, WATCH-CLASPS, WATCH CASES, WATCH FACES, WATCH PARTS, ROUGH WATCH CASES, IN CLASS 14 (U.S. CLS. 2, 27, 28 AND 50).

FOR: PRODUCT RESEARCH IN THE NATURE OF STUDY PROJECTS IN THE FIELDS OF HOROLOGICAL GOODS, JEWELRY, AND EYEWEAR, IN CLASS 42 (U.S. CLS. 100 AND 101).

PRIORITY DATE OF 2-6-2007 IS CLAIMED.

OWNER OF INTERNATIONAL REGISTRATION 0939257 DATED 8-2-2007, EXPIRES 8-2-2017.

THE MARK IS A BAND HAVING FIVE CONSECUTIVE SEGMENTS FORMING A PARTIAL OUTLINE OF AN HEXAGON STARTING FROM A TIP THEREOF IN A CLOCKWISE DIRECTION, THE FIFTH SEGMENT EXTENDING IN A VERTICAL DIRECTION AND HAVING A POINTED TIP.

SER. NO. 79-044,525, FILED 8-2-2007.

Laura Hammel, Examining Attorney

**Int. Cls.: 9, 14 and 42**

**Prior U.S. Cls.: 2, 21, 23, 26, 27, 28, 36, 38, 50, 100 and 101**

**Reg. No. 3,505,539**

**United States Patent and Trademark Office**

**Registered Sep. 23, 2008**

**TRADEMARK  
SERVICE MARK  
PRINCIPAL REGISTER**

**COMOTEC**

COMOTEC S.A.; (INCORPORATED COMPANY)  
(FRANCE SOCIÉTÉ ANONYME)  
LA DOYE  
F-39400 MOREZ, FRANCE

FOR: OPTICAL GOODS, NAMELY, SPECTACLES, SPECTACLE FRAMES AND THEIR COMPONENT AND REPLACEMENT PARTS, NAMELY, SPECTACLE TEMPLES, TEMPLES, SPECTACLE TEMPLE CASES, END PIECES, GROOVED EYEWIRES, METAL AND NON-METAL HINGES, BRIDGES, NOSE SUPPORT PADS, TEMPLE SUPPORT PADS; OPTICAL LENSES, LENSES FOR SUNGLASSES AND EYEGGLASS LENSES FOR PROTECTIVE EYEGASSES, IN CLASS 9 (U.S. CLS. 21, 23, 26, 36 AND 38).

FOR: PRECIOUS METALS AND THEIR ALLOYS, JEWELRY, TIMEPIECES, NAMELY WATCHES, CHRONOMETERS, BRACELETS, BRACELET LINKS, WATCH-CLASPS, WATCH CASES, WATCH FACES, WATCH PARTS, ROUGH WATCH CASES, IN CLASS 14 (U.S. CLS. 2, 27, 28 AND 50).

FOR: PRODUCT RESEARCH IN THE NATURE OF STUDY PROJECTS IN THE FIELDS OF HORO-

LOGICAL GOODS, JEWELRY, AND EYEWEAR, IN CLASS 42 (U.S. CLS. 100 AND 101).

THE MARK CONSISTS OF STANDARD CHARACTERS WITHOUT CLAIM TO ANY PARTICULAR FONT, STYLE, SIZE, OR COLOR.

PRIORITY DATE OF 2-6-2007 IS CLAIMED.

OWNER OF INTERNATIONAL REGISTRATION 0939258 DATED 8-2-2007, EXPIRES 8-2-2017.

OWNER OF U.S. REG. NO. 1,525,347.

THE WORD "COMOTEC" HAS NO MEANING IN A FOREIGN LANGUAGE.

SER. NO. 79-044,526, FILED 8-2-2007.

LAURA HAMMEL, EXAMINING ATTORNEY

**Int. Cls.: 9, 35, 38 and 41**

**Prior U.S. Cls.: 21, 23, 26, 36, 38, 100, 101, 102, 104  
and 107**

**Reg. No. 3,505,540**

**United States Patent and Trademark Office**

**Registered Sep. 23, 2008**

**TRADEMARK  
SERVICE MARK  
PRINCIPAL REGISTER**

**LAST.TV**

AUDIOSCROBBLER LIMITED (UNITED KING-  
DOM LIMITED LIABILITY COMPANY)  
86C GREENFIELD ROAD  
LONDON E1 1EJ  
UNITED KINGDOM

FOR: DIGITAL MUSIC, DOWNLOADABLE FROM THE INTERNET AND VIA OTHER COMMUNICATIONS NETWORKS; DOWNLOADABLE TELEPHONE RING TONES VIA THE INTERNET AND WIRELESS DEVICE; MUSICAL SOUND RECORDINGS; ELECTRONIC PUBLICATIONS IN THE NATURE OF MAGAZINES, MANUALS AND BOOKS IN THE FIELD OF MUSIC AND ART, DOWNLOADABLE FROM THE INTERNET, IN CLASS 9 (U.S. CLS. 21, 23, 26, 36 AND 38).

FOR: PROVISION OF ADVERTISING SPACE ON INTERNET WEBSITES; RADIO ADVERTISING; THE BRINGING TOGETHER, FOR THE BENEFIT OF OTHERS, OF A VARIETY OF MUSIC RELATED GOODS, INCLUDING MUSICAL RECORDINGS, ENABLING CUSTOMERS TO CONVENIENTLY VIEW AND PURCHASE THOSE GOODS FROM A GENERAL MERCHANDISE CATALOGUE BY MAIL ORDER, BY MEANS OF TELECOMMUNICATIONS SYSTEMS, FROM AN INTERNET WEB SITE, FROM A GENERAL MERCHANDISE RETAIL STORE, FROM A RETAIL OUTLET SPECIALIZING IN MUSIC, IN CLASS 35 (U.S. CLS. 100, 101 AND 102).

FOR: PROVIDING ACCESS TO ELECTRONIC SITES FEATURING DIGITAL MUSIC, AND ELECTRONIC DELIVERY OF DIGITAL MUSIC VIA THE INTERNET; ELECTRONIC DELIVERY OF DIGITAL MUSIC BY TELECOMMUNICATION NETWORKS

AND WIRELESS RADIO COMMUNICATIONS SYSTEMS; AUDIO BROADCASTING FEATURING MUSIC; DIGITAL RADIO BROADCASTING, IN CLASS 38 (U.S. CLS. 100, 101 AND 104).

FOR: PROVISION OF NON DOWNLOADABLE DIGITAL MUSIC VIA THE INTERNET AND OTHER COMMUNICATIONS NETWORKS; PRODUCTION AND DISTRIBUTION OF RADIO PROGRAMS; ENTERTAINMENT BY MEANS OF RADIO, NAMELY RADIO ENTERTAINMENT PRODUCTION, RADIO PROGRAM SYNDICATION, RADIO PROGRAMMING; PROVISION OF MUSICAL ENTERTAINMENT, NAMELY, PROVIDING PRERECORDED MUSIC, INFORMATION IN THE FIELD OF MUSIC, AND COMMENTARY AND ARTICLES ABOUT MUSIC AND LIVE MUSICAL PERFORMANCES BY MUSICAL BANDS, DISC JOCKEYS AND INDIVIDUALS, ALL ON-LINE VIA A GLOBAL COMPUTER NETWORK; PROVISION OF MUSICAL ENTERTAINMENT, NAMELY, LIVE MUSICAL PERFORMANCES BY MUSICAL BANDS, DISC JOCKEYS AND INDIVIDUALS; MUSIC LIBRARY SERVICES, IN CLASS 41 (U.S. CLS. 100, 101 AND 107).

PRIORITY DATE OF 2-23-2007 IS CLAIMED.

OWNER OF INTERNATIONAL REGISTRATION 0939324 DATED 8-22-2007, EXPIRES 8-22-2017.

SER. NO. 79-044,544, FILED 8-22-2007.

KEVIN CORWIN, EXAMINING ATTORNEY

**Int. Cl.: 25**

**Prior U.S. Cls.: 22 and 39**

**United States Patent and Trademark Office**

**Reg. No. 3,505,541**

**Registered Sep. 23, 2008**

**TRADEMARK  
PRINCIPAL REGISTER**

**a F**

**ALBERTO FERMANI**

AEFFE S.R.L. (ITALY LIMITED LIABILITY  
COMPANY)  
VIA FIASTRA, 89  
I-62010 PETRIOLO  
ITALY

FOR: CLOTHING ITEMS, NAMELY, SWEATERS,  
CARDIGANS, SUITS, TROUSERS, SHORTS, JUM-  
PERS, RAINCOATS, SUITS AND DRESSES MADE  
OF LEATHER, STOCKINGS AND SOCKS, GARTER  
BELTS, WIND RESISTANT JACKETS, SKI-TROU-  
SERS, FUR COATS, OVERCOATS, JACKETS,  
SKIRTS, DRESSES, UNDERSHIRTS, T-SHIRTS,  
SPORT T-SHIRTS, BLOUSES, SHIRT COLLARS,  
SHIRTS, FOULARDS, BEACHWEAR, SWIMSUITS,  
BIKINIS, TRACKSUITS, UNDERWEAR, BRAS,  
BRASSIERES, CORSETS, FOUNDATION SLIPS,  
BRIEFS AND BIKINI BRIEFS, VESTS, NIGHT-  
GOWNS, NEGLIGEEES, PAJAMAS, GLOVES,  
SHAWLS, SCARVES, NECKTIES, BOWTIES, BELTS  
CLOTHING, SUSPENDERS, HATS AND CAPS,

SHOES, BOOTS, LACED BOOTS, LEATHER SHOES,  
RUBBER SHOES, RAIN SHOES, SPORT SHOES,  
SANDALS, SLIPPERS, SHOE SOLES, SHOES HEELS,  
MOULDED SOLES FOR SHOES, NAMELY, RUB-  
BER, IN CLASS 25 (U.S. CLS. 22 AND 39).

PRIORITY DATE OF 5-24-2007 IS CLAIMED.

OWNER OF INTERNATIONAL REGISTRATION  
0939459 DATED 8-27-2007, EXPIRES 8-27-2017.

THE NAME IN THE MARK IDENTIFIES A LIV-  
ING INDIVIDUAL WHOSE CONSENT IS OF RE-  
CORD.

SER. NO. 79-044,577, FILED 8-27-2007.

DAYNA BROWNE, EXAMINING ATTORNEY

**Int. Cl.: 3**

**Prior U.S. Cls.: 1, 4, 6, 50, 51 and 52**

**United States Patent and Trademark Office**

**Reg. No. 3,505,542**

**Registered Sep. 23, 2008**

**TRADEMARK  
PRINCIPAL REGISTER**

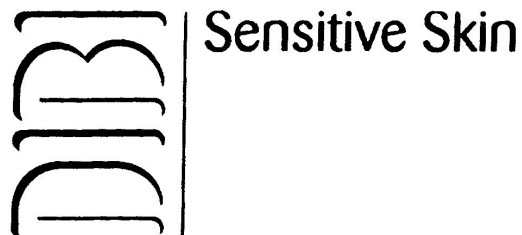

GTS GROUP S.P.A. (ITALY JOINT STOCK COMPANY)  
VIALE LOMBARDIA, 67  
TORRE BOLDONE (BERGAMO), ITALY I24020

FOR: COSMETIC PRODUCTS, NAMELY, SKIN CREAMS, EMULSION CREAMS AND LOTIONS FOR THE HANDS, FEET AND FACE, BEAUTY MASKS FOR SENSITIVE SKINS, IN CLASS 3 (U.S. CLS. 1, 4, 6, 50, 51 AND 52).

PRIORITY DATE OF 6-14-2007 IS CLAIMED.

OWNER OF INTERNATIONAL REGISTRATION 0939627 DATED 7-5-2007, EXPIRES 7-5-2017.

OWNER OF U.S. REG. NOS. 1,372,057, 3,181,158 AND OTHERS.

NO CLAIM IS MADE TO THE EXCLUSIVE RIGHT TO USE "SENSITIVE SKIN", APART FROM THE MARK AS SHOWN.

THE MARK CONSISTS IN THE WORDING "DIBI SENSITIVE SKIN" WHEREIN THE WORDING "DIBI" UNDERLINED BY A STRAIGHT LINE, WRITTEN IN FANCY BLOCK CAPITAL LETTERS, IS PLACED VERTICALLY, WHILE "SENSITIVE SKIN", WRITTEN IN FANCY LOWER-CASE LETTERS WITH CAPITAL INITIALS IS PLACED HORIZONTALLY AT RIGHT ANGLES.

THE WORDING "DIBI" HAS NO MEANING OTHER THAN TRADEMARK SIGNIFICANCE.

SER. NO. 79-044,620, FILED 7-5-2007.

RONALD DELGIZZI, EXAMINING ATTORNEY

**Int. Cl.: 9**

**Prior U.S. Cls.: 21, 23, 26, 36 and 38**

**Reg. No. 3,505,543**

**United States Patent and Trademark Office**

**Registered Sep. 23, 2008**

**TRADEMARK  
PRINCIPAL REGISTER**

**MULTIDAPT**

KRUSSEL UNITED AB (SWEDEN LIMITED LIABILITY COMPANY)  
KRYPTONGATAN 5B  
SE-431 53 MÖLNDAL  
SWEDEN

THE MARK CONSISTS OF STANDARD CHARACTERS WITHOUT CLAIM TO ANY PARTICULAR FONT, STYLE, SIZE, OR COLOR.

FOR: PLASTIC HOLDERS AND CASES SPECIALLY ADAPTED FOR HOLDING OR CARRYING APPARATUS FOR RECORDING, TRANSMISSION OR REPRODUCTION OF SOUND OR IMAGES, TELEPHONES, COMPUTERS, COMMUNICATION APPARATUS, TAPE RECORDERS, COMPACT DISC PLAYERS AND CAMERAS, IN CLASS 9 (U.S. CLS. 21, 23, 26, 36 AND 38).

OWNER OF INTERNATIONAL REGISTRATION  
0939721 DATED 8-31-2007, EXPIRES 8-31-2017.

SER. NO. 79-044,643, FILED 8-31-2007.

ELI HELLMAN, EXAMINING ATTORNEY



**Int. Cl.: 18**

**Prior U.S. Cls.: 1, 2, 3, 22 and 41**

**Reg. No. 3,505,544**

**United States Patent and Trademark Office**

**Registered Sep. 23, 2008**

**TRADEMARK  
PRINCIPAL REGISTER**

**QUINEL**

WINTER; MARKENHANDELS- UND ENTWICK-  
LUNGS AG (SWITZERLAND JOINT STOCK  
COMPANY)  
HINTERDORF 1  
CH-6390 ENGELBERG  
SWITZERLAND

LEATHER ARTICLES AND FOR DECORATION,  
IN CLASS 18 (U.S. CLS. 1, 2, 3, 22 AND 41).

OWNER OF INTERNATIONAL REGISTRATION  
0499028 DATED 11-27-1985, EXPIRES 11-27-2015.

FOR: IMITATION LEATHER SOLD IN BULK  
INTENDED FOR USE AS COVERING MATERIAL  
USED IN THE PACKAGING AND CARDBOARD  
PACKING INDUSTRY, BOOKBINDING, SMALL

SER. NO. 79-044,652, FILED 8-20-2007.

DAVID TAYLOR, EXAMINING ATTORNEY

**Int. Cls.: 35 and 42**

**Prior U.S. Cls.: 100, 101 and 102**

**United States Patent and Trademark Office**

**Reg. No. 3,505,545**

**Registered Sep. 23, 2008**

**SERVICE MARK  
PRINCIPAL REGISTER**



MOTEL ONE MANAGEMENT GMBH (FED REP  
GERMANY GESELLSCHAFT MIT BES-  
CHRÄNKTER HAFTUNG (GMBH))  
THEATINERSTRASSE 16  
80333 MÜNCHEN, FED REP GERMANY

FOR: PROFESSIONAL BUSINESS CONSULTING  
SERVICES FOR CATERING AND ACCOMMODA-  
TION ENTERPRISES, INCLUDING TECHNICAL  
ASSISTANCE IN THE ESTABLISHMENT AND OP-  
ERATION OF CATERING AND ACCOMMODA-  
TION BUSINESSES; CONSULTING SERVICES FOR  
BUSINESS MANAGEMENT, PLANNING AND SU-  
PERVISION OF CATERING AND ACCOMMODA-  
TION ENTERPRISES; FRANCHISING OF  
CATERING ENTERPRISES, NAMELY, OFFERING  
BUSINESS KNOW-HOW CONCERNING THE ES-  
TABLISHMENT AND/OR OPERATION OF CATER-  
ING AND ACCOMMODATION ENTERPRISES, IN  
CLASS 35 (U.S. CLS. 100, 101 AND 102).

FOR: PROVIDING TEMPORARY ACCOMMODA-  
TION; CATERING SERVICES; MAKING RESERVA-  
TIONS OF TEMPORARY LODGING FOR OTHERS;  
TECHNICAL CONSULTING, NAMELY, COMPU-  
TER CONSULTATION IN CONNECTION WITH  
CATERING AND TEMPORARY ACCOMMODA-  
TION ENTERPRISES, IN CLASS 42 (U.S. CLS. 100  
AND 101).

OWNER OF INTERNATIONAL REGISTRATION  
0739344 DATED 2-18-2000, EXPIRES 2-18-2010.

NO CLAIM IS MADE TO THE EXCLUSIVE  
RIGHT TO USE "MOTEL", APART FROM THE  
MARK AS SHOWN.

SER. NO. 79-044,672, FILED 7-10-2007.

STEVEN PEREZ, EXAMINING ATTORNEY

**Int. Cls.: 39 and 40**

**Prior U.S. Cls.: 100, 103, 105 and 106**

**United States Patent and Trademark Office**

**Reg. No. 3,505,546**

**Registered Sep. 23, 2008**

**SERVICE MARK  
PRINCIPAL REGISTER**

**B V L G A R I**

BULGARI S.P.A. (ITALY JOINT STOCK COMPANY)

VIA LUNGOTEVERE MARZIO, 11  
I-00186 ROMA  
ITALY

FOR: TRANSPORT BY MOTOR VEHICLE, BOAT, RAIL AND AIR; PACKAGING AND STORAGE OF LUGGAGE, CLOTHING, FURNITURE, CARPETS, GYMNAS TIC AND SPORTING ARTICLES FOR TRANSPORTATION; TRAVEL SERVICES, NAME- LY, ARRANGING AND COORDINATING TRAVEL PLANS, TRAVEL BOOKINGS, TRAVEL TOURS, TRAVEL EXCURSIONS AND CRUISES FOR INDI- VIDUALS AND FOR GROUPS; TRAVEL SERVICES, NAMELY, ARRANGING FOR TRAVEL VISA, PASS- PORTS AND TRAVEL DOCUMENTS FOR DOMES- TIC AND INTERNATIONAL TRAVELERS, IN CLASS 39 (U.S. CLS. 100 AND 105).

FOR: TREATMENT OF MATERIALS, NAMELY, METALS, PRECIOUS METALS, SILVER, PRECIOUS STONES, GLASS, FABRICS, TEXTILES, LEATHER AND ESSENTIAL OILS , IN CLASS 40 (U.S. CLS. 100, 103 AND 106).

THE MARK CONSISTS OF STANDARD CHAR- ACTERS WITHOUT CLAIM TO ANY PARTICULAR FONT, STYLE, SIZE, OR COLOR.

OWNER OF INTERNATIONAL REGISTRATION 0761853 DATED 7-18-2001, EXPIRES 7-18-2011.

OWNER OF U.S. REG. NOS. 2,102,804, 2,954,459 AND OTHERS.

SER. NO. 79-044,677, FILED 7-30-2007.

SOPHIA S. KIM, EXAMINING ATTORNEY

**Int. Cls.: 6, 22 and 43**

**Prior U.S. Cls.: 1, 2, 7, 12, 13, 14, 19, 22, 23, 25, 42, 50,  
100 and 101**

**Reg. No. 3,505,547**

**United States Patent and Trademark Office**

**Registered Sep. 23, 2008**

**TRADEMARK  
SERVICE MARK  
PRINCIPAL REGISTER**

**RDS**

LOSBERGER INTERTENT GMBH (FED REP  
GERMANY PUBLIC LIMITED COMPANY)  
GOTTLIEB-DAIMLER-RING 14  
74906 BAD RAPPENAU  
FED REP GERMANY

FOR: TRANSPORTABLE BUILDINGS, LIGHT-WEIGHT CONSTRUCTION HALLS IN THE NATURE OF METAL SHELTER STRUCTURES, AFORESAID OF METAL AND LIGHT METAL, ROOFING AND ROOF COVERINGS OF METAL AND LIGHT METAL, NAMELY, METAL ROOFING PANELS AND TILES; ACCESSORIES AND INTERIOR FITTING ACCESSORIES ALL OF METAL AND LIGHT METAL FOR METAL FLOORS, NAMELY, FLOOR PANELS OF METAL, METAL FLOOR TILES, AND METAL EXPANSION JOINTS FOR FLOORS; ACCESSORIES AND INTERIOR FITTING ACCESSORIES ALL OF METAL AND LIGHT METAL FOR GALLERIES, NAMELY, BAR HANGERS AND PARTS AND FITTINGS THEREOF MADE OF METAL FOR LIGHTING FIXTURES; ACCESSORIES AND INTERIOR FITTING ACCESSORIES ALL OF METAL AND LIGHT METAL FOR PODIUM PLATFORMS OF METAL AND LIGHT METAL, NAMELY, PREFABRICATED METAL PLATFORMS AND METAL BRACKETS USED IN THE CONSTRUCTION OF SAID PODIUM PLATFORMS; TRANSPORTABLE FLOORS OF METAL, SEPARATING WALLS OF METAL, NAMELY, METAL CURTAIN WALLS, WALL PANELS OF METAL, PARTS OF FRAMES OF METAL TO COVER WITH A LINING, NAMELY, METAL FRAMEWORKS; SUPPORT STANDS OF METAL, NAMELY, METAL BEARINGS; ALL THE GOODS OF THIS CLASS NOT FOR MILITARY PURPOSES, IN CLASS 6 (U.S. CLS. 2, 12, 13, 14, 23, 25 AND 50).

FOR: TENTS FOR EXHIBITIONS AND EVENTS, SUN SHADING AND RAIN SHELTER AWNINGS, ALL OF TEXTILE, TENTS FOR USE AS EXHIBITION HALLS, TENTS FOR USE AS EXHIBITION HALL IN A MULTI-LEVEL TYPE; ALL THE GOODS OF THIS CLASS NOT FOR MILITARY PURPOSES, IN CLASS 22 (U.S. CLS. 1, 2, 7, 19, 22, 42 AND 50).

FOR: RENTAL OF TRANSPORTABLE BUILDINGS, NAMELY, OF TENTS, IN PARTICULAR LARGE TENTS; RENTAL OF PORTABLE BUILDINGS AND MODULAR ROOM COMPONENTS, NAMELY, AWNINGS AND TENTS TO PROVIDE SHADE FROM SUN AND SHELTER FROM RAIN, LIGHTWEIGHT CONSTRUCTION HALLS, MODULAR SEPARATING WALLS, AND STEEL FRAMED PORTABLE BUILDINGS AND TENTS COVERED WITH LINING; ALL THE SERVICES OF THE CLASS NOT FOR MILITARY PURPOSES, IN CLASS 43 (U.S. CLS. 100 AND 101).

THE MARK CONSISTS OF STANDARD CHARACTERS WITHOUT CLAIM TO ANY PARTICULAR FONT, STYLE, SIZE, OR COLOR.

PRIORITY DATE OF 1-31-2007 IS CLAIMED.

OWNER OF INTERNATIONAL REGISTRATION  
0939940 DATED 7-25-2007, EXPIRES 7-25-2017.

SER. NO. 79-044,759, FILED 7-25-2007.

ADA HAN, EXAMINING ATTORNEY

Int. Cl.: 25

Prior U.S. Cls.: 22 and 39

United States Patent and Trademark Office

Reg. No. 3,505,548

Registered Sep. 23, 2008

TRADEMARK  
PRINCIPAL REGISTER



ARTHUR DE SOULTRAIT (FRANCE INDIVIDUAL)  
125 RUE PIERRE BROSOLETT  
PRESLES, FRANCE F95590 AND  
SEGUR SARL (FRANCE SARL)  
PARC DES BEAUX SOLEILS -  
9 CHAUSSÉE JULES CÉSAR; BP 80227 OSNY  
CERGY CEDEX, FRANCE F95523

FOR: CLOTHING, NAMELY, JACKETS, SPORTS JACKETS, SINGLE OR DOUBLE BREASTED JACKETS, POLO SHIRTS, T-SHIRTS, SWEATSHIRTS, PANTS, PULLOVERS, WAISTCOATS, SHORT JACKETS, DRESSES, SHORTS, BERMUDA SHORTS, COATS, SWIMSUITS, BLOUSES, SKIRTS, DRESSES, FOOTWEAR; HEAD WEAR, NAMELY, CAPS, HATS, RAIN HATS, SUN HATS; SHIRTS; LEATHER OR IMITATION LEATHER CLOTHING, NAMELY, JACKETS, SHORT JACKETS, COATS, VESTS, PANTS; BELTS; COATS AND JACKETS IN FUR, SCARVES TIES, HOSIERY, SOCKS, SLIPPERS; BEACH, SKI OR SPORTS FOOTWEAR, NAPPIES OF TEXTILE, UNDERWEAR, IN CLASS 25 (U.S. CLS. 22 AND 39).

PRIORITY DATE OF 3-1-2007 IS CLAIMED.

OWNER OF INTERNATIONAL REGISTRATION  
0939978 DATED 8-10-2007, EXPIRES 8-10-2017.

NO CLAIM IS MADE TO THE EXCLUSIVE RIGHT TO USE "PARIS PALM BEACH", APART FROM THE MARK AS SHOWN.

THE NAME "VICOMTE ARTHUR" DOES NOT IDENTIFY A LIVING INDIVIDUAL.

THE COLOR(S) FUCHSIA AND WHITE IS/ARE CLAIMED AS A FEATURE OF THE MARK.

THE INTERLACED LETTERS, THE CROWN AND THE INSCRIPTION OF THE MARK NAME ARE IN WHITE; ALL THE ABOVE ON A FUCHSIA BACKGROUND.

THE MARK CONSISTS OF A FUSCIA COLORED RECTANGULAR BACKGROUND WITH THE STYLIZED WORDING "VA VICOMTE ARTHUR PARIS - PALM BEACH" IN WHITE AS WELL AS A CROWN ABOVE THE INITIALS.

SER. NO. 79-044,775, FILED 8-10-2007.

TARAH HARDY, EXAMINING ATTORNEY

**Int. Cls.: 24 and 25**

**Prior U.S. Cls.: 22, 39, 42 and 50**

**United States Patent and Trademark Office**

**Reg. No. 3,505,549**

**Registered Sep. 23, 2008**

**TRADEMARK  
PRINCIPAL REGISTER**

# **C24 CARACTERE**

MIROGLIO SPA (ITALY SOCIETÀ PER AZIONI  
(SPA))  
VIA S. MARGHERITA, 23  
I-12051 ALBA  
ITALY

FOR: TEXTILES AND TEXTILE GOODS, NOT INCLUDED IN OTHER CLASSES, NAMELY, TEXTILE LABELS, TEXTILE TABLE CLOTHS, TEXTILE WALL HANGINGS, TEXTILE FABRICS FOR THE MANUFACTURE OF CLOTHING; BED AND TABLE COVERS, NAMELY, DUVET COVERS, COMFORTERS, BED AND TABLE LINEN, TABLE CLOTHS NOT OF PAPER, IN CLASS 24 (U.S. CLS. 42 AND 50).

FOR: CLOTHING, NAMELY, PANTS, SHIRTS, SHORTS, TOPS, DRESSES; FOOTWEAR; HEADGEAR, NAMELY, HATS AND CAPS, IN CLASS 25 (U.S. CLS. 22 AND 39).

THE MARK CONSISTS OF STANDARD CHARACTERS WITHOUT CLAIM TO ANY PARTICULAR FONT, STYLE, SIZE, OR COLOR.

PRIORITY DATE OF 3-7-2007 IS CLAIMED.

OWNER OF INTERNATIONAL REGISTRATION 0940062 DATED 8-27-2007, EXPIRES 8-27-2017.

OWNER OF U.S. REG. NOS. 2,760,591 AND 3,158,849.

THE ENGLISH TRANSLATION OF THE WORD "CARACTERE" IN THE MARK IS "CHARACTER".

SER. NO. 79-044,798, FILED 8-27-2007.

ROBERT STRUCK, EXAMINING ATTORNEY

**Int. Cl.: 25**

**Prior U.S. Cls.: 22 and 39**

**United States Patent and Trademark Office**

**Reg. No. 3,505,550**

**Registered Sep. 23, 2008**

**TRADEMARK  
PRINCIPAL REGISTER**

**CORE-POINT**  
BODYWEAR

REWOLF SARL (FRANCE INDIVIDUAL)  
57 RUE D'AMSTERDAM  
PARIS, FRANCE F75008

FOR: CLOTHING, NAMELY, T-SHIRTS, UNDERWEAR, CAPS AND BELTS, IN CLASS 25 (U.S. CLS. 22 AND 39).

PRIORITY DATE OF 3-5-2007 IS CLAIMED.

OWNER OF INTERNATIONAL REGISTRATION  
0940160 DATED 8-21-2007, EXPIRES 8-21-2017.

NO CLAIM IS MADE TO THE EXCLUSIVE RIGHT TO USE "BODYWEAR", APART FROM THE MARK AS SHOWN.

THE ENGLISH TRANSLATION OF THE FOREIGN WORD(S) IN THE MARK IS "CORE-POINT BODYWEAR".

SER. NO. 79-044,827, FILED 8-21-2007.

FLORENTINA BLANDU, EXAMINING ATTORNEY

**Int. Cls.: 17 and 19**

**Prior U.S. Cls.: 1, 5, 12, 13, 33, 35 and 50**

**Reg. No. 3,505,551**

**United States Patent and Trademark Office**

**Registered Sep. 23, 2008**

**TRADEMARK  
PRINCIPAL REGISTER**

**TONGA**

SAINT-GOBAIN EUROCOUSTIC (FRANCE SOCI-  
ETE ANONYME)  
ZONE INDUSTRIELLE BELLEVUE  
F-23350 GENOUILLAC  
FRANCE

FOR: GUTTA-PERCHA, ELASTIC GUM, NAME-  
LY, ELASTIC RUBBER-LIKE MATERIAL FOR USE  
AS A SEALANT FOR CAULKING AND ADHESIVE  
PURPOSES, BALATA, RUBBER AND SUBSTI-  
TUTES, NAMELY, SYNTHETIC RUBBER; SEMI-  
WORKED SYNTHETIC PLASTIC AND SYNTHETIC  
RESIN AS SEMI-FINISHED PRODUCTS IN THE  
FORM OF SHEETS, PLATES AND RODS ALL MADE  
OF PLASTICS; BUILDING INSULATION, NAMELY,  
FIREPROOF AND DAMP PROOF BOARDS, DEC-  
ORATIVE OR OTHERWISE, FOR THERMAL AND  
ACOUSTIC INSULATION, AND GENERALLY  
PACKING, STOPPING AND INSULATING MATE-  
RIALS OF ALL KINDS; ASBESTOS, MICA AND  
GOODS MADE FROM THESE MATERIALS, NAME-  
LY, ASBESTOS BOARDS, MICA FOR USE AS A  
FILLER IN PLASTICS; FLEXIBLE PIPES, NOT OF  
METAL, IN CLASS 17 (U.S. CLS. 1, 5, 12, 13, 35 AND  
50).

FOR: NON-METALLIC BUILDING MATERIALS,  
NAMELY, FLASHING, FASCIA, SHUTTERS, SHIN-

GLS; PANELS, NOT OF METAL, NAMELY, NON-  
METAL ROOFING PANELS, PLATES, NOT OF  
METAL AND ROLLS, NOT OF METAL, FOR USE  
AS NON-METALLIC REINFORCEMENTS FOR  
CONCRETE AND WOOD BUILDING CONSTRU-  
CTION WITH OR WITHOUT SURFACE COATINGS,  
USED AS THERMAL AND ACOUSTIC INSULA-  
TION AND FOR PROTECTION AGAINST DAMP IN  
THE CONSTRUCTION OF WALLS, PARTITIONS,  
CEILINGS, FALSE CEILINGS, FLOORS, ROOFS,  
ROOF LININGS, WEATHERBOARDING, IN CLASS  
19 (U.S. CLS. 1, 12, 33 AND 50).

PRIORITY DATE OF 3-21-2007 IS CLAIMED.

OWNER OF INTERNATIONAL REGISTRATION  
0940172 DATED 9-19-2007, EXPIRES 9-19-2017.

THE WORDING "TONGA" HAS NO MEANING  
IN A FOREIGN LANGUAGE.

SER. NO. 79-044,831, FILED 9-19-2007.

MARLENE BELL, EXAMINING ATTORNEY



**Int. Cls.: 7, 37 and 42**

**Prior U.S. Cls.: 13, 19, 21, 23, 31, 34, 35, 100, 101, 103  
and 106**

**Reg. No. 3,505,552**

**United States Patent and Trademark Office**

**Registered Sep. 23, 2008**

**TRADEMARK  
SERVICE MARK  
PRINCIPAL REGISTER**

**ARABELLE**

ALSTOM POWER TURBOMACHINES (FRANCE  
SOCIÉTÉ ANONYME (SA))  
3 AVENUE DES TROIS CHÊNES  
F-90018 BELFORT  
FRANCE

FOR: NUCLEAR TURBINES; TURBINE ELEC-  
TRICITY GENERATORS; DRIER-SUPERHEATERS  
AS COMPONENT PARTS OF THE FOREGOING, IN  
CLASS 7 (U.S. CLS. 13, 19, 21, 23, 31, 34 AND 35).

FOR: INSTALLATION OF INDUSTRIAL MA-  
CHINES, NAMELY, NUCLEAR TURBINES, TUR-  
BINE GENERATORS AND DRIER-  
SUPERHEATERS AND MAINTENANCE AND RE-  
PAIR OF NUCLEAR TURBINES, TURBINE GEN-  
ERATORS AND DRIER-SUPERHEATERS, IN  
CLASS 37 (U.S. CLS. 100, 103 AND 106).

FOR: DESIGN OF INDUSTRIAL MACHINES,  
NAMELY, NUCLEAR TURBINES, TURBINE GEN-  
ERATORS AND DRIER-SUPERHEATERS, IN  
CLASS 42 (U.S. CLS. 100 AND 101).

THE MARK CONSISTS OF STANDARD CHAR-  
ACTERS WITHOUT CLAIM TO ANY PARTICULAR  
FONT, STYLE, SIZE, OR COLOR.

PRIORITY DATE OF 3-21-2007 IS CLAIMED.

OWNER OF INTERNATIONAL REGISTRATION  
0940197 DATED 8-31-2007, EXPIRES 8-31-2017.

SER. NO. 79-044,843, FILED 8-31-2007.

ELI HELLMAN, EXAMINING ATTORNEY

**Int. Cl.: 32**

**Prior U.S. Cls.: 45, 46 and 48**

**United States Patent and Trademark Office**

**Reg. No. 3,505,553**

**Registered Sep. 23, 2008**

**TRADEMARK  
PRINCIPAL REGISTER**

**XENIA**

DIWISA DISTILLERIE WILLISAU SA (SWITZER-  
LAND SOCIÉTÉ ANONYME)  
MENZNAUERSTRASSE 23  
CH-6130 WILLISAU  
SWITZERLAND

FOR: MINERAL AND AERATED WATERS; NON-  
ALCOHOLIC BEVERAGES, NAMELY, CARBONA-  
TED BEVERAGES; FRUIT BEVERAGES AND  
FRUIT JUICES; SYRUPS FOR MAKING BEVERA-  
GES; OTHER PREPARATIONS FOR MAKING BEVE-  
RAGES, NAMELY, NON-ALCOHOLIC FRUIT  
EXTRACTS USED IN THE PREPARATION OF  
BEVERAGES, CONCENTRATES, SYRUPS OR POW-  
DERS USED IN THE PREPARATION OF SOFT  
DRINKS, IN CLASS 32 (U.S. CLS. 45, 46 AND 48).

THE MARK CONSISTS OF STANDARD CHAR-  
ACTERS WITHOUT CLAIM TO ANY PARTICULAR  
FONT, STYLE, SIZE, OR COLOR.

OWNER OF INTERNATIONAL REGISTRATION  
0795413 DATED 12-2-2002, EXPIRES 12-2-2012.

OWNER OF U.S. REG. NO. 2,927,765.

THE TERM "XENIA" IS THE TRANSLITERA-  
TION OF AN ANCIENT GREEK TERM MEANING  
"HOSPITALITY".

SER. NO. 79-044,896, FILED 6-11-2007.

MICHAEL TANNER, EXAMINING ATTORNEY

**Int. Cls.: 1, 3 and 5**

**Prior U.S. Cls.: 1, 4, 5, 6, 10, 18, 26, 44, 46, 50, 51 and 52**

**Reg. No. 3,505,554**

**United States Patent and Trademark Office**

**Registered Sep. 23, 2008**

**TRADEMARK  
PRINCIPAL REGISTER**

# LYOPAN

PANTEC AG (SWITZERLAND SOCIÉTÉ ANONYME)  
BREMENSTALLSTRASSE 1  
CH-4313 MÖHLIN  
SWITZERLAND

FOR: CHEMICAL PREPARATIONS FOR SCIENTIFIC PURPOSES, CHEMICALS FOR USE IN INDUSTRY, CHEMICALS USED IN INDUSTRY, CHEMICALS USED IN THE MANUFACTURE OF FABRIC OR TEXTILES, CLEANING AGENTS AND CLEANING AGENTS IN TABLET FORM FOR INDUSTRIAL USE; UNPROCESSED ARTIFICIAL RESINS, UNPROCESSED PLASTICS; SOIL FERTILIZERS; FIRE EXTINGUISHING COMPOSITIONS; TEMPERING AND SOLDERING PREPARATIONS; CHEMICAL PREPARATIONS FOR PRESERVING FOODSTUFFS; ADHESIVES USED IN INDUSTRY; DESCALING AGENTS AND DESCALING AGENTS IN TABLET FORM, OTHER THAN FOR HOUSEHOLD USE, IN CLASS 1 (U.S. CLS. 1, 5, 6, 10, 26 AND 46).

FOR: DENTAL BLEACHING GEL, TOOTH BLEACHING PREPARATIONS, LAUNDRY BLEACH, LAUNDRY BLUEING, LAUNDRY DETERGENT, LAUNDRY DETERGENTS, LAUNDRY PRE-SOAK, LAUNDRY SIZING, LAUNDRY SOAP, LAUNDRY STARCH; CLEANING, POLISHING, SCOURING AND ABRASIVE PREPARATIONS; SOAPS; PERFUMERY, ESSENTIAL OILS, COSMETICS, HAIR LOTIONS; DENTIFRICES; DESCALING AGENTS AND DESCALING AGENTS IN TABLET FORM FOR HOUSEHOLD USE; CLEANING AGENTS AND CLEANING AGENTS IN TABLET FORM, IN CLASS 3 (U.S. CLS. 1, 4, 6, 50, 51 AND 52).

FOR: ALMOND OIL FOR PHARMACEUTICAL PURPOSES, ALMOND OILS FOR PHARMACEUTICAL PURPOSES, ANTIBACTERIAL PHARMACEUTICALS, ANTI-DIABETIC PHARMACEUTICALS, CARDIOVASCULAR PHARMACEUTICALS, DERMATOLOGICAL PHARMACEUTICAL PRODUCTS,

DRUG DELIVERY AGENTS CONSISTING OF COMPOUNDS THAT FACILITATE DELIVERY OF A WIDE RANGE OF PHARMACEUTICALS, HOMEOPATHIC PHARMACEUTICALS FOR USE IN THE TREATMENT OF VARIOUS DISEASES AND CONDITIONS, PHARMACEUTICAL ANTITUSSIVE-COLD PREPARATIONS, PHARMACEUTICAL ANTI-ALLERGIC PREPARATIONS AND SUBSTANCES, PHARMACEUTICAL FOR THE TREATMENT OF ERECTILE DYSFUNCTION, PHARMACEUTICAL PREPARATIONS, NAMELY, ANTICOAGULANTS, PHARMACEUTICAL PREPARATIONS, NAMELY, ANTIDEPRESSANTS, PHARMACEUTICAL PREPARATIONS, NAMELY, APPETITE SUPPRESSANTS, PHARMACEUTICAL PREPARATIONS FOR USE IN CHEMOTHERAPY, PHARMACEUTICAL PREPARATION FOR THE TREATMENT OF GOUT, PHARMACEUTICAL PREPARATIONS FOR THE TREATMENT OF HEART RHYTHM DISORDERS, PHARMACEUTICAL PREPARATIONS FOR THE TREATMENT OF VARIOUS DISEASES, PHARMACEUTICAL PREPARATIONS FOR THE TREATMENT OF INFECTIOUS DISEASES, PHARMACEUTICAL PREPARATIONS ACTING ON THE CENTRAL NERVOUS SYSTEM, PHARMACEUTICAL PREPARATIONS AND SUBSTANCES FOR THE TREATMENT OF GASTROINTESTINAL DISEASES, PHARMACEUTICAL PREPARATIONS FOR ANIMAL SKINCARE, PHARMACEUTICAL PREPARATIONS FOR INHALATION FOR THE TREATMENT OF PULMONARY HYPERTENSION, PHARMACEUTICAL PREPARATIONS FOR OCULAR OR INTRAOCULAR SURGERY, PHARMACEUTICAL PREPARATIONS FOR THE TREATMENT OF HORMONAL DISORDERS AND THE PREVENTION OF OSTEOPOROSIS, PHARMACEUTICAL PREPARATIONS FOR TREATING ALLERGIC RHINITIS AND ASTHMA, PHARMACEUTICAL PREPARATIONS FOR TREATING DIABETES, PHARMACEUTICAL PREPARATIONS FOR TREATING SKIN DISORDERS, PHARMACEUTICAL PREPARATIONS FOR USE IN DERMATOLOGY, PHARMACEUTICAL PREPARA-

TIONS FOR USE IN UROLOGY, PHARMACEUTICAL PREPARATIONS FOR THE TREATMENT OF EYE DISEASES AND CONDITIONS, PHARMACEUTICAL PREPARATIONS FOR THE PREVENTION AND TREATMENT OF DISORDERS OF THE NERVOUS SYSTEM, THE IMMUNE SYSTEM, THE CARDIO-VASCULAR SYSTEM, THE METABOLIC SYSTEM, THE RESPIRATORY SYSTEM, THE MUSCULO-SKELETAL SYSTEM, THE GENITOURINARY SYSTEM; FOR THE TREATMENT OF INFLAMMATORY DISORDERS; FOR USE IN DERMATOLOGY, ONCOLOGY, HEMATOLOGY AND IN TISSUE AND ORGAN TRANSPLANTATION, IN OPHTHALMOLOGY AND FOR GASTROENTEROLOGICAL DISORDERS, PHARMACEUTICAL PREPARATIONS FOR SKIN CARE, PHARMACEUTICAL PRODUCTS AND PREPARATIONS TO PREVENT SWELLING IN THE LEGS, PHARMACEUTICAL PRODUCTS FOR OPHTHALMOLOGICAL USE, PHARMACEUTICAL PRODUCTS FOR SKIN CARE FOR ANIMALS, PHARMACEUTICAL PRODUCTS FOR THE TREATMENT OF BONE DISEASES, PHARMACEUTICAL PRODUCTS FOR THE TREATMENT OF VIRAL AND INFECTIOUS DISEASES, FOR THE TREATMENT OF CANCER, PHARMACEUTICAL PRODUCTS FOR TREATING RESPIRATORY DISEASES AND ASTHMA, PHARMACEUTICAL PRODUCTS FOR THE TREATMENT OF JOINT DISEASE, PHARMACEUTICALS FOR THE TREATMENT OF ERECTILE DYSFUNCTION, PHARMACEUTICALS, NAMELY, INDUCERS OF ERECTIONS, PHARMACEUTICALS, NAMELY, LIPID LOWERING AGENTS, PHARMACEUTICALS, NAMELY, PSYCHOTROPICS, PHARMACEUTICALS, NAMELY, ANTI-INFECTIVES, AMINO ACIDS FOR MEDICAL OR VETERINARY PURPOSES, ANTI-INFECTIVE PRODUCTS FOR VETERINARY USE, BACTERIAL AND BACTERIOLOGICAL PREPARATIONS FOR MEDICAL OR VETERINARY PURPOSES, BACTERIOSTATS FOR MEDICINAL, DENTAL AND VETERINARY USE, BIOCHEMICAL

PREPARATIONS FOR MEDICAL OR VETERINARY PURPOSES, PLANT EXTRACTS FOR MEDICAL, VETERINARY AND PHARMACEUTICAL PURPOSES, VETERINARY PREPARATIONS, NAMELY, PAIN RELIEF MEDICATION, VETERINARY PREPARATIONS FOR TREATMENT OF INTESTINAL BACTERIA, VETERINARY PREPARATIONS FOR VARIOUS ANIMAL CONDITIONS, VETERINARY PREPARATIONS, NAMELY, ANTIOXIDANTS, DIETIC FOODS ADAPTED FOR MEDICAL USE; DIET CAPSULES, DIET PILLS, FOOD FOR MEDICALLY RESTRICTED DIETS; MEDICAL PLASTERS; ALL PURPOSE DISINFECTANTS; GASTROINTESTINAL CLEANING AGENTS; SANITARY PREPARATIONS FOR MEDICAL PURPOSES; DIETETIC SUBSTANCES ADAPTED FOR MEDICAL USE, NAMELY, DIETETIC FOODS; FOOD FOR BABIES; MEDICAL PLASTERS; MATERIAL FOR STOPPING TEETH AND DENTAL WAX; PREPARATIONS FOR DESTROYING VERMIN; FUNGICIDES; HERBICIDES; NUTRITIONAL SUPPLEMENTS AND EFFERVESCENT TABLETS FOR PHARMACEUTICAL USE, IN CLASS 5 (U.S. CLS. 6, 18, 44, 46, 51 AND 52).

THE MARK CONSISTS OF STANDARD CHARACTERS WITHOUT CLAIM TO ANY PARTICULAR FONT, STYLE, SIZE, OR COLOR.

PRIORITY DATE OF 3-23-2007 IS CLAIMED.

OWNER OF INTERNATIONAL REGISTRATION 0940258 DATED 8-14-2007, EXPIRES 8-14-2017.

"LYOPAN" APPEARING IN THE MARK HAS NO MEANING IN A FOREIGN LANGUAGE.

SER. NO. 79-044,961, FILED 8-14-2007.

SHANNON TWOHIG, EXAMINING ATTORNEY

**Int. Cl.: 24**

**Prior U.S. Cls.: 42 and 50**

**United States Patent and Trademark Office**

**Reg. No. 3,505,555**

**Registered Sep. 23, 2008**

**TRADEMARK  
PRINCIPAL REGISTER**



AZNAR TEXTIL, S.L. (SPAIN SOCIEDAD LIMIT-  
ADA (CORPORATION))  
VILLA DE BILBAO, 2,  
POL. IND. FUENTE DE JARRO; E-46988 PATERNA  
(VALENCIA)  
SPAIN

FOR: FABRICS AND TEXTILE GOODS, NAME-  
LY, BED SHEET SETS, MATTRESS AND PILLOW  
COVERS, BEDSPREADS, EIDERDOWNS, BED  
BLANKETS, TABLE LINEN AND NAPKINS NOT  
MADE OF PAPER, SCRUBBERS IN THE NATURE  
OF DISH CLOTHS, FACE CLOTHS, TOWELS, CUR-  
TAINS AND TEXTILES FOR UPHOLSTERIES AND  
HOME AND COMMERCIAL INTERIORS, IN CLASS  
24 (U.S. CLS. 42 AND 50).

OWNER OF INTERNATIONAL REGISTRATION  
0940285 DATED 6-18-2007, EXPIRES 6-18-2017.

OWNER OF U.S. REG. NO. 2,468,693.

NO CLAIM IS MADE TO THE EXCLUSIVE  
RIGHT TO USE "BON DRAP", APART FROM THE  
MARK AS SHOWN.

THE ENGLISH TRANSLATION OF THE FOR-  
EIGN WORD(S) IN THE MARK IS: "GOOD CLOTH".

SER. NO. 79-044,973, FILED 6-18-2007.

KRISTINA MORRIS, EXAMINING ATTORNEY

**Int. Cls.: 24 and 25**

**Prior U.S. Cls.: 22, 39, 42 and 50**

**United States Patent and Trademark Office**

**Reg. No. 3,505,556**

**Registered Sep. 23, 2008**

**TRADEMARK  
PRINCIPAL REGISTER**

( i21 )

CORTEFIEL, S.A. (SPAIN S.A.)  
AVDA. DEL LLANO CASTELLANO, 51  
E-28034 MADRID  
SPAIN

TUMES; NON ORTHOPAEDIC FOOTWEAR AND  
HEADWEAR, NAMELY, HATS AND CAPS, IN  
CLASS 25 (U.S. CLS. 22 AND 39).

FOR: LINGERIE FABRIC, IN CLASS 24 (U.S. CLS.  
42 AND 50).

OWNER OF INTERNATIONAL REGISTRATION  
0940288 DATED 8-23-2007, EXPIRES 8-23-2017.

FOR: MEN'S, WOMEN'S AND CHILDREN'S  
READY-TO-WEAR CLOTHING, NAMELY, PANTS,  
SHIRTS, JACKETS, SWEATERS, SUITS, SHORTS,  
DRESSES, SKIRTS, UNDERWEAR, BATHING COS-

SER. NO. 79-044,974, FILED 8-23-2007.

ANGELA M. MICHELI, EXAMINING ATTORNEY

**Int. Cls.: 3, 8, 9, 11, 12, 14, 16, 18, 25, 28, 37 and 41**

**Prior U.S. Cls.: 1, 2, 3, 4, 5, 6, 13, 19, 21, 22, 23, 26, 27, 28, 29, 31, 34, 35, 36, 37, 38, 39, 41, 44, 50, 51, 52, 100, 101, 103, 106 and 107**

**Reg. No. 3,505,557**

**United States Patent and Trademark Office**

**Registered Sep. 23, 2008**

**TRADEMARK  
SERVICE MARK  
PRINCIPAL REGISTER**

# Transsyberia

DR. ING. H.C. F. PORSCHE AKTIENGESELLSCHAFT (FED REP GERMANY STOCK COMPANY)

PORSCHEPLATZ, 1

STUTTGART, FED REP GERMANY 70435

FOR: BLEACHING PREPARATIONS AND OTHER SUBSTANCES FOR LAUNDRY USE; CLEANING, POLISHING, SCOURING AND ABRASIVE PREPARATIONS, NAMELY, AUTOMOBILE AND AUTOMOBILE PARTS CLEANSERS, POLISH AND SCOURING POWDERS AND LIQUIDS; SOAPS; PERFUMERY, ESSENTIAL OILS, COSMETICS, HAIR LOTIONS, IN CLASS 3 (U.S. CLS. 1, 4, 6, 50, 51 AND 52).

FOR: KNIVES; RAZORS, IN CLASS 8 (U.S. CLS. 23, 28 AND 44).

FOR: SCIENTIFIC, NAUTICAL, SURVEYING, ELECTRONIC APPARATUS AND INSTRUMENTS, NAMELY, INTEGRATED NAVIGATION COMPUTER SYSTEMS FOR AUTOMOBILES CONSISTING OF A DISPLAY, TERMINAL, OPERATING SYSTEM SOFTWARE, CD-ROM DRIVE, TELEPHONE, CASSETTE PLAYER, RADIO AND SATELLITE-CONTROLLED GLOBAL POSITIONING SYSTEM WITH INTEGRATED ANTENNA, SATELLITE RECEIVER AND ELECTRICAL CABLE; PHOTOGRAPHIC, CINEMATOGRAPHIC, OPTICAL DEVICES AND APPARATUS FOR RECORDING, TRANSMISSION OR REPRODUCTION OF SOUND OR IMAGES, NAMELY, BLANK AND PRERECORDED MAGNETIC DATA CARRIERS AND DISCS CONTAINING INFORMATION RELATING TO AUTOMOBILES AND AUTOMOTIVE PARTS AND BLANK AND PRERECORDED COMPACT DISCS AND DIGITAL VIDEO DISCS CONTAINING INFORMATION RELATING TO AUTOMOBILES AND AUTOMOTIVE PARTS FOR COMPUTERS AND COMPACT DISC PLAYERS, CAMERAS, RADIOS, TELEVISIONS, AUDIO

TAPE CASSETTE RECORDERS, VIDEOTAPE CASSETTE RECORDERS; CASH REGISTERS; CALCULATING MACHINES AND DATA PROCESSING EQUIPMENT, NAMELY, COMPUTERS; DATA CARRIERS EQUIPPED WITH PROGRAMS, NAMELY, INTERACTIVE VIDEO GAMES OF VIRTUAL REALITY COMPRISED OF COMPUTER HARDWARE AND SOFTWARE; INTERACTIVE MULTIMEDIA COMPUTER GAME PROGRAMS FOR USE ON PERSONAL COMPUTERS AND TELEVISIONS; FIRE-EXTINGUISHING APPARATUS, SPECTACLES, IN CLASS 9 (U.S. CLS. 21, 23, 26, 36 AND 38).

FOR: ELECTRIC TORCHES FOR LIGHTING; AIR-CONDITIONERS FOR AUTOMOBILES, IN CLASS 11 (U.S. CLS. 13, 21, 23, 31 AND 34).

FOR: VEHICLES, NAMELY, MOTORCYCLES AND BICYCLES, APPARATUS FOR LOCOMOTION BY LAND, AIR OR WATER, NAMELY, LIGHT TRUCKS, MOTORCYCLES, BICYCLES, AIRPLANES AND BOATS; AND STRUCTURAL PARTS THEREFORE, IN CLASS 12 (U.S. CLS. 19, 21, 23, 31, 35 AND 44).

FOR: PRECIOUS METALS AND THEIR ALLOYS AND GOODS IN PRECIOUS METALS OR COATED THEREWITH, NAMELY, MODEL CARS AS JEWELRY AND PERFUME ATOMIZERS, CIGARETTE LIGHTERS AS JEWELRY; JEWELRY; PRECIOUS STONES; HOROLOGICAL AND CHRONOMETRIC INSTRUMENTS; KEY CHAINS MADE OF PRECIOUS METAL AS JEWELRY, PINS, TIE PINS, CUFF LINKS, IN CLASS 14 (U.S. CLS. 2, 27, 28 AND 50).

FOR: PAPER, CARDBOARD AND GOODS MADE FROM THESE MATERIALS, NAMELY, STICKERS; PRINTED MATTER, NAMELY, BOOKS, MAGAZINES, MANUALS AND TECHNICAL DRAWINGS, BROCHURES AND PAMPHLETS CONTAINING INFORMATION RELATING TO AUTOMOBILES

AND AUTOMOTIVE PARTS; BOOKBINDING MATERIAL; PHOTOGRAPHS; STATIONERY; ADHESIVES FOR STATIONERY OR HOUSEHOLD PURPOSES; ARTISTS' MATERIALS, NAMELY, PENS, PENCILS, INK PENS, BALLPOINT PENS, FOUNTAIN PENS, PAINT BRUSHES; TYPEWRITERS AND OFFICE REQUISITES, NAMELY, DESK SETS COMPRISED OF BLOTTER, PEN AND PENCIL HOLDER, BUSINESS CARD HOLDER, CALENDAR HOLDER AND LETTER OPENER; PRINTED INSTRUCTIONAL AND TEACHING MATERIAL RELATING TO AUTOMOBILES FOR DRIVERS AND TECHNICIANS; PLASTIC BAGS FOR PACKAGING; PRINTERS TYPE; PRINTING BLOCKS; CALENDARS, IN CLASS 16 (U.S. CLS. 2, 5, 22, 23, 29, 37, 38 AND 50).

FOR: LEATHER AND IMITATIONS OF LEATHER, AND GOODS MADE OF THESE MATERIALS; TRUNKS, BAGS, SMALL ARTICLES OF LEATHERWARE, NAMELY, KEY POUCHES, PURSES, CREDIT CARD CASES, BUSINESS CARD CASES AND WALLETS; UMBRELLAS, PARASOLS, IN CLASS 18 (U.S. CLS. 1, 2, 3, 22 AND 41).

FOR: CLOTHING, NAMELY, ANORAKS, BEACHWEAR, BLAZERS, BLOUSES, BLOUSONS, BODY SUITS, CARDIGANS, COATS, DRESSES, FOUL WEATHER GEAR, INFANT WEAR, JACKETS, JEANS, JOGGING SUITS, LEATHER COATS, LEATHER JACKETS, OVERALLS, PANTS, PARKAS, POLO SHIRTS, SCARVES, SHIRTS, SHORTS, SKI WEAR, SKIRTS, SLACKS, SLEEPWEAR, SNOW SUITS, SOCKS, SUITS, SWEATSHIRTS, SWEATERS, T-SHIRTS, TENNIS WEAR, NECKTIES, TIGHTS, TOPS, TRACKSUITS, TROUSERS, UNDERWEAR, VESTS, WRIST BANDS, FOOTWEAR, HEADGEAR, NAMELY, HATS, CAPS, SUN VISORS AND SWEAT BANDS; GLOVES AS CLOTHING AND BELTS AS CLOTHING, IN CLASS 25 (U.S. CLS. 22 AND 39).

FOR: GAMES AND PLAYTHINGS, NAMELY, PARLOR-TYPE GAMES, CHESS SETS, TOY MODEL RACING CAR SETS COMPRISED OF TOY MODEL CARS, RACE TRACK, SPEED CONTROLLERS AND CRASH BARRIERS, TOY MODEL HOBBY CRAFT KITS FOR MAKING TOY CARS; PLAYING CARDS, TOY CARS, MODEL CARS, GYMNASTIC, GAME AND SPORTING ARTICLES, NAMELY, TENNIS RACKETS, GOLF BAGS, SKIS, SNOW BOARDS, SKATE BOARDS, INLINE SKATES, JUMP ROPES,

TOY NON-MOTORIZED PUSH SCOOTERS, GOLF CLUBS, GOLF BALLS, IN CLASS 28 (U.S. CLS. 22, 23, 38 AND 50).

FOR: BUILDING CONSTRUCTION AND REPAIR; REPAIR AND MAINTENANCE OF AUTOMOBILES, NAMELY, FITTING OUT AND TUNING OF STANDARD CARS TO SPORT AND RACING CARS, IN CLASS 37 (U.S. CLS. 100, 103 AND 106).

FOR: ENTERTAINMENT SERVICES, NAMELY, PERSONAL APPEARANCES BY SPORTS CELEBRITIES PERFORMING AND COMPETING IN MOTOR SPORT EVENTS, AUTOMOBILE RACES AND AUTOMOBILE RALLIES; TEACHING AND PROVIDING TRAINING IN THE FIELD OF DRIVING, NAMELY, DRIVING SCHOOLS, SPORTS DRIVING SCHOOLS, DRIVER SAFETY TRAINING, TRAINING IN THE FIELD OF AUTOMOTIVE REPAIR; SPORTING ACTIVITIES, NAMELY, ORGANIZING FESTIVALS, TOURNAMENTS, EXHIBITIONS AND COMPETITIONS THAT CELEBRATE AND FEATURE AUTOMOBILE RACES AND AUTOMOBILE RALLIES AND/OR CELEBRITY DRIVERS; EVENTS ORGANIZED BY SPORTS DRIVING SCHOOLS AND EVENTS IN THE FIELD OF MOTOR SPORTS, NAMELY, AUTOMOBILE RACES, RALLIES, TOURNAMENTS, EXHIBITIONS, COMPETITIONS, AND CLUB SERVICES, NAMELY, PROMOTING THE INTERESTS OF ENTHUSIASTS OF AUTOMOBILES, IN CLASS 41 (U.S. CLS. 100, 101 AND 107).

THE MARK CONSISTS OF STANDARD CHARACTERS WITHOUT CLAIM TO ANY PARTICULAR FONT, STYLE, SIZE, OR COLOR.

PRIORITY DATE OF 11-9-2006 IS CLAIMED.

OWNER OF INTERNATIONAL REGISTRATION 0940402 DATED 5-9-2007, EXPIRES 5-9-2017.

"TRANSYBERIA" APPEARING IN THE MARK HAS NO SIGNIFICANCE NOR ANY MEANING IN A FOREIGN LANGUAGE

SER. NO. 79-044,991, FILED 5-9-2007.

KRISTIN DAHLING, EXAMINING ATTORNEY



**Int. Cl.: 10**

**Prior U.S. Cls.: 26, 39 and 44**

**United States Patent and Trademark Office**

**Reg. No. 3,505,558**

**Registered Sep. 23, 2008**

**TRADEMARK  
PRINCIPAL REGISTER**



smilite

GENERAL PROJECT S.R.L. (ITALY LIMITED  
LIABILITY COMPANY)  
VIA DELLA GORA, 13/1  
FRAZIONE BACCAIANO; MONTESPERTOLI; I-  
50025 FIRENZE  
ITALY

PRIORITY DATE OF 5-18-2007 IS CLAIMED.

OWNER OF INTERNATIONAL REGISTRATION  
0940468 DATED 8-28-2007, EXPIRES 8-28-2017.

FOR: INTRA-ORAL DENTAL LIGHT SYSTEM,  
INTRA-ORAL DENTAL DIODE LIGHT SYSTEM  
FOR TOOTH WHITENING, STRUCTURAL PARTS  
AND ACCESSORIES, NAMELY, DENTAL BITE  
TRAYS, IN CLASS 10 (U.S. CLS. 26, 39 AND 44).

SER. NO. 79-045,019, FILED 8-28-2007.

DOMINIC FATHY, EXAMINING ATTORNEY

**Int. Cls.: 9, 25, 28 and 41**

**Prior U.S. Cls.: 21, 22, 23, 26, 36, 38, 39, 50, 100, 101  
and 107**

**Reg. No. 3,505,559**

**United States Patent and Trademark Office**

**Registered Sep. 23, 2008**

**TRADEMARK  
SERVICE MARK  
PRINCIPAL REGISTER**



WORLD SUPERLEAGUE FORMULA, S.L. (SPAIN  
SOCIEDAD LIMITADA)

VÍA AUGUSTA, 29-31, 3º 2ª

E-08021 BARCELONA

SPAIN

FOR: SCIENTIFIC, NAUTICAL, SURVEYING, PHOTOGRAPHIC, CINEMATOGRAPHIC, OPTICAL, WEIGHING, MEASURING, SIGNALING, MONITORING SUPERVISION, EMERGENCY LIFE-SAVING AND TEACHING APPARATUS AND INSTRUMENTS, NAMELY, CAMERAS; APPARATUS FOR CONDUCTING, SWITCHING, TRANSFORMING, ACCUMULATING, REGULATING AND CONTROLLING ELECTRICITY, NAMELY, ELECTRICITY CONDUITS; APPARATUS FOR RECORDING, TRANSMITTING, REPRODUCING SOUNDS OR IMAGES; MAGNETIC DATA MEDIA AND SOUND RECORDING DISKS, NAMELY, BLANK CDS, PRERECORDED CDS FEATURING MUSIC; AUTOMATIC VENDING MACHINES AND MECHANISMS FOR COIN OPERATED APPARATUS; CASH REGISTERS, CALCULATING MACHINES, DATA PROCESSING EQUIPMENT AND COMPUTERS; FIRE EXTINGUISHERS; BLANK MAGNETIC DISKS, BLANK OPTICAL DISKS AND BLANK SMART CARDS FOR STORAGE OF COMPUTER PROGRAMS; COMPUTER PROGRAMS FOR USE AS A SPREADSHEET; APPARATUS FOR GAMES ADAPTED FOR USE WITH TELEVISION RECEIVERS ONLY AND ACCESSORIES FOR GAME MACHINES, NAMELY, COMPUTER GAME JOYSTICKS; CONSUMER VIDEO GAMES, NAMELY, VIDEO GAME CARTRIDGES; PROGRAMS FOR CONSUMER VIDEO GAMES; ELECTRONIC CIRCUITS; BLANK OPTICAL DISKS AND BLANK CD-ROM CARTRIDGES FOR KEEPING COMPUTER GAME MACHINE PROGRAMS; RECORDED VIDEO DISKS AND VIDEO TAPES FEATURING

MUSIC; TELEPHONES, MOBILE TELEPHONES, IN CLASS 9 (U.S. CLS. 21, 23, 26, 36 AND 38).

FOR: CLOTHING, NAMELY, JUMPERS, TROUSERS; SOCKS, STOCKINGS, GLOVES, SHIRTS, T-SHIRTS, SWEAT-SHIRTS, SWEAT-PANTS, SHORTS, BLOUSES, JERKINS, JACKETS, SOCK SUSPENDERS, UNDERWEAR, PAJAMAS, NIGHT GOWNS, WAISTCOATS, CAPES, SCARVES, COATS, SHAWLS, PULLOVERS, SKIRTS, DRESSES, TIES, BELTS OF TEXTILE, TROUSER SUSPENDERS, BATHING SUITS, BASKETBALL JERSEYS, FOOTBALL AND SOCCER SHORTS AND JERSEYS, CLOTH NAPPIES, BOAS FOR WEARING AROUND THE NECK; NON-ELECTRIC FOOT MUFFS AND BIRETTA; CLOTH BIBS; HALF BELTS, GLOVES, SKI GLOVES, SKATEBOARD GLOVES, AND RIDING GLOVES, FOOTWEAR, HEADWEAR, IN CLASS 25 (U.S. CLS. 22 AND 39).

FOR: GAMES, NAMELY, DART GAMES; TOYS, NAMELY, TOY ACTION FIGURES; MINIATURE OR SCALE REPRODUCTIONS OF ALL TYPES OF VEHICLES, NAMELY, SCALE MODEL VEHICLES, IN CLASS 28 (U.S. CLS. 22, 23, 38 AND 50).

FOR: ORGANIZATION OF ALL TYPES OF SPORTS COMPETITIONS; ORGANIZATION OF CLASSES AND SEMINARS IN THE FIELD OF AUTOMOBILES, IN CLASS 41 (U.S. CLS. 100, 101 AND 107).

OWNER OF INTERNATIONAL REGISTRATION  
0940523 DATED 5-3-2007, EXPIRES 5-3-2017.

THE COLOR(S) BLACK, GREY AND WHITE IS/  
ARE CLAIMED AS A FEATURE OF THE MARK.

THE MARK CONSISTS OF THE MARK CONSISTS OF THE STYLIZED WHITE LETTERING "WSF:" WITH THE TOP OUTLINE IN GREY AND THE BOTTOM OUTLINE IN BLACK, ABOVE THE WORDING "WORLD SUPERLEAGUE FORMULA" IN BLACK.

SER. NO. 79-045,045, FILED 5-3-2007.

KRISTIN DAHLING, EXAMINING ATTORNEY

**Int. Cls.: 9, 25, 28 and 41**

**Prior U.S. Cls.: 21, 22, 23, 26, 36, 38, 39, 50, 100, 101  
and 107**

**Reg. No. 3,505,560**

**United States Patent and Trademark Office**

**Registered Sep. 23, 2008**

**TRADEMARK  
SERVICE MARK  
PRINCIPAL REGISTER**



WORLD SUPERLEAGUE FORMULA, S.L. (SPAIN  
SOCIEDAD LIMITADA)  
VÍA AUGUSTA, 29-31, 3º 2ª  
E-08021 BARCELONA  
SPAIN

FOR: SCIENTIFIC, NAUTICAL, SURVEYING, PHOTOGRAPHIC, CINEMATOGRAPHIC, OPTICAL, WEIGHING, MEASURING, SIGNALING, MONITORING SUPERVISION, EMERGENCY LIFE-SAVING AND TEACHING APPARATUS AND INSTRUMENTS, NAMELY, CAMERAS; APPARATUS FOR CONDUCTING, SWITCHING, TRANSFORMING, ACCUMULATING, REGULATING AND CONTROLLING ELECTRICITY, NAMELY, ELECTRICITY CONDUITS; APPARATUS FOR RECORDING, TRANSMITTING, REPRODUCING SOUNDS OR IMAGES; MAGNETIC DATA MEDIA AND SOUND RECORDING DISKS, NAMELY, BLANK CDS, PRERECORDED CDS FEATURING MUSIC; AUTOMATIC VENDING MACHINES AND MECHANISMS FOR COIN OPERATED APPARATUS; CASH REGISTERS, CALCULATING MACHINES, DATA PROCESSING EQUIPMENT AND COMPUTERS; FIRE EXTINGUISHERS; BLANK MAGNETIC DISKS, BLANK OPTICAL DISKS AND BLANK SMART CARDS FOR STORAGE OF COMPUTER PROGRAMS; COMPUTER PROGRAMS FOR USE AS A SPREADSHEET; APPARATUS FOR GAMES ADAPTED FOR USE WITH TELEVISION RECEIVERS ONLY AND ACCESSORIES FOR GAME MACHINES, NAMELY, COMPUTER GAME JOYSTICKS; CONSUMER VIDEO GAMES, NAMELY, VIDEO GAME CARTRIDGES; PROGRAMS FOR CONSUMER VIDEO GAMES; ELECTRONIC CIRCUITS; BLANK OPTICAL DISKS AND BLANK CD-ROM CARTRIDGES FOR KEEPING COMPUTER

GAME MACHINE PROGRAMS; RECORDED VIDEO DISKS AND VIDEO TAPES FEATURING MUSIC; TELEPHONES, MOBILE TELEPHONES, IN CLASS 9 (U.S. CLS. 21, 23, 26, 36 AND 38).

FOR: CLOTHING, NAMELY, JUMPERS, TROUSERS; SOCKS, STOCKINGS, GLOVES, SHIRTS, T-SHIRTS, SWEAT-SHIRTS, SWEAT-PANTS, SHORTS, BLOUSES, JERKINS, JACKETS, SOCK SUSPENDERS, UNDERWEAR, PAJAMAS, NIGHT GOWNS, WAISTCOATS, CAPES, SCARVES, COATS, SHAWLS, PULLOVERS, SKIRTS, DRESSES, TIES, BELTS OF TEXTILE, TROUSER SUSPENDERS, BATHING SUITS, BASKETBALL JERSEYS, FOOTBALL AND SOCCER SHORTS AND JERSEYS, CLOTH NAPPIES, BOAS FOR WEARING AROUND THE NECK; NON-ELECTRIC FOOT MUFFS AND BIRETTA; CLOTH BIBS; HALF BELTS, GLOVES, SKI GLOVES, SKATEBOARD GLOVES, AND RIDING GLOVES, FOOTWEAR, HEADWEAR, IN CLASS 25 (U.S. CLS. 22 AND 39).

FOR: GAMES, NAMELY, DART GAMES; TOYS, NAMELY, TOY ACTION FIGURES; MINIATURE OR SCALE REPRODUCTIONS OF ALL TYPES OF VEHICLES, NAMELY, SCALE MODEL VEHICLES, IN CLASS 28 (U.S. CLS. 22, 23, 38 AND 50).

FOR: ORGANIZATION OF ALL TYPES OF SPORTS COMPETITIONS; ORGANIZATION OF CLASSES AND SEMINARS IN THE FIELD OF AUTOMOBILES, IN CLASS 41 (U.S. CLS. 100, 101 AND 107).

OWNER OF INTERNATIONAL REGISTRATION  
0940524 DATED 5-3-2007, EXPIRES 5-3-2017.

THE COLOR(S) BLACK, GREY AND WHITE IS/  
ARE CLAIMED AS A FEATURE OF THE MARK.

THE MARK CONSISTS OF THE STYLIZED  
WHITE LETTERING "SF:" WITH THE TOP OUT-  
LINE IN GREY AND THE BOTTOM OUTLINE IN

BLACK, ABOVE THE WORDING "SUPERLEAGUE  
FORMULA" IN BLACK.

SER. NO. 79-045,046, FILED 5-3-2007.

KRISTIN DAHLING, EXAMINING ATTORNEY

**Int. Cl.: 5**

**Prior U.S. Cls.: 6, 18, 44, 46, 51 and 52**

**United States Patent and Trademark Office**

**Reg. No. 3,505,561**

**Registered Sep. 23, 2008**

**TRADEMARK  
PRINCIPAL REGISTER**

**GISATEK**

NEUROPHARMA, S.A. (SPAIN SOCIEDAD ANONIMA)  
JOSE ABASCAL, 2-1 PLANTA  
E-28003 MADRID  
SPAIN

FOR: PHARMACEUTICAL AND VETERINARY PREPARATIONS, NAMELY, PREPARATIONS FOR COMBATING NEURON DISEASES; NATURAL AND SYNTHETIC BIOACTIVE PREPARATIONS FOR APPLICATION IN THE FIELDS OF HUMAN OR ANIMAL MEDICINE, NAMELY, PHARMACEUTICAL AND VETERINARY PREPARATIONS ACTING ON THE CENTRAL NERVOUS SYSTEM AND FOR COMBATING NEURON DISEASES; INTERMEDIATE PHARMACEUTICAL AND VETERIN-

ARY PREPARATIONS SOLD AS COMPONENTS OF PHARMACEUTICAL AND VETERINARY PREPARATIONS ACTING ON THE CENTRAL NERVOUS SYSTEM AND FOR COMBATING NEURON DISEASES, IN CLASS 5 (U.S. CLS. 6, 18, 44, 46, 51 AND 52).

OWNER OF INTERNATIONAL REGISTRATION  
0940743 DATED 8-20-2007, EXPIRES 8-20-2017.

SER. NO. 79-045,144, FILED 8-20-2007.

CAROLYN GRAY, EXAMINING ATTORNEY

**Int. Cl.: 9**

**Prior U.S. Cls.: 21, 23, 26, 36 and 38**

**United States Patent and Trademark Office**

**Reg. No. 3,505,562**

**Registered Sep. 23, 2008**

**TRADEMARK  
PRINCIPAL REGISTER**

**CODIXX**

CODIXX AG (FED REP GERMANY AG)  
STEINFELDSTR. 3  
39179 BARLEBEN  
FED REP GERMANY

FOR: SCREENS IN THE NATURE OF FLAT  
PANEL DISPLAY SCREENS, FLUORESCENT  
SCREENS, PROJECTION SCREENS; COMPUTER  
HARDWARE FOR INFORMATION SYSTEMS; LI-  
QUID CRYSTAL DISPLAYS (LCD); HIGH-TEM-  
PERATURE DISPLAYS IN THE NATURE OF  
ELECTRIC LUMINESCENT DISPLAY PANELS; LI-  
QUID CRYSTAL DISPLAY COMPONENTS IN THE  
NATURE OF DICHROITIC SHEET POLARIZERS,

COLOR POLARIZERS, GLASS POLARIZERS, AND  
COLOR FILTERS; 3-D VIDEO PROJECTORS;  
LARGE LED (LIGHT EMITTING DIODE) DIS-  
PLAYS, LED (LIGHT EMITTING DIODE) DIS-  
PLAYS, IN CLASS 9 (U.S. CLS. 21, 23, 26, 36 AND 38).

OWNER OF INTERNATIONAL REGISTRATION  
0940907 DATED 8-22-2007, EXPIRES 8-22-2017.

SER. NO. 79-045,223, FILED 8-22-2007.

KEVIN CORWIN, EXAMINING ATTORNEY

**Int. Cl.: 14**

**Prior U.S. Cls.: 2, 27, 28 and 50**

**United States Patent and Trademark Office**

**Reg. No. 3,505,563**

**Registered Sep. 23, 2008**

**TRADEMARK  
PRINCIPAL REGISTER**



**IKE S.R.L. (ITALY SOCIETÀ A RESPONSABILITÀ LIMITATA (SRL))  
VIA E. CALDARA, 24  
I-20122 MILANO  
ITALY**

**FOR: WATCHES, CHRONOMETERS, CLOCKS AND STRUCTURAL PARTS THEREFOR; WATCH STRAPS, WATCH BRACELETS, WATCHBANDS, BOXES OF PRECIOUS METALS FOR WATCHES , IN CLASS 14 (U.S. CLS. 2, 27, 28 AND 50).**

**PRIORITY DATE OF 3-23-2007 IS CLAIMED.**

**OWNER OF INTERNATIONAL REGISTRATION  
0940942 DATED 8-27-2007, EXPIRES 8-27-2017.**

**THE TRADEMARK CONSISTS OF THE WORDING "IKE" UNDER THE REPRESENTATION OF A FANTASY GRAPHIC ELEMENT.**

**SER. NO. 79-045,236, FILED 8-27-2007.**

**KATHERINE E. HALMEN, EXAMINING ATTORNEY**



**Int. Cls.: 1 and 5**

**Prior U.S. Cls.: 1, 5, 6, 10, 18, 26, 44, 46, 51 and 52**

**United States Patent and Trademark Office**

**Reg. No. 3,505,564**

**Registered Sep. 23, 2008**

**TRADEMARK  
PRINCIPAL REGISTER**

# ALLPROTECTOR

QIAGEN GMBH (FED REP GERMANY GMBH  
UNDER GERMAN LAW)  
QIAGEN STR. 1  
40724 HILDEN, FED REP GERMANY

FOR: CHEMICAL, BIOCHEMICAL AND BIOTECHNOLOGICAL PRODUCTS FOR INDUSTRIAL AND SCIENTIFIC PURPOSES, NAMELY, NUCLEIC ACIDS AND ENZYMES; KITS COMPRISING CHEMICAL, BIOCHEMICAL AND BIOTECHNOLOGICAL PRODUCTS, NAMELY, NUCLEIC ACIDS AND ENZYMES, IN CLASS 1 (U.S. CLS. 1, 5, 6, 10, 26 AND 46).

FOR: PRODUCTS FOR MEDICAL AND VETERINARY MEDICAL PURPOSES, NAMELY, NUCLEIC ACIDS AND ENZYMES; DIAGNOSTIC PREPARATIONS, NAMELY, NUCLEIC ACIDS AND ENZYMES; KITS COMPRISING PRODUCTS FOR

MEDICAL AND VETERINARY MEDICAL PURPOSES, NAMELY, NUCLEIC ACIDS AND ENZYMES, IN CLASS 5 (U.S. CLS. 6, 18, 44, 46, 51 AND 52).

THE MARK CONSISTS OF STANDARD CHARACTERS WITHOUT CLAIM TO ANY PARTICULAR FONT, STYLE, SIZE, OR COLOR.

PRIORITY DATE OF 2-26-2007 IS CLAIMED.

OWNER OF INTERNATIONAL REGISTRATION  
0940959 DATED 8-21-2007, EXPIRES 8-21-2017.

SER. NO. 79-045,245, FILED 8-21-2007.

FLORENTINA BLANDU, EXAMINING ATTORNEY

**Int. Cls.: 9 and 38**

**Prior U.S. Cls.: 21, 23, 26, 36, 38, 100, 101 and 104**

**United States Patent and Trademark Office**

**Reg. No. 3,505,565**

**Registered Sep. 23, 2008**

**TRADEMARK  
SERVICE MARK  
PRINCIPAL REGISTER**

**MYIREX**

IREX TECHNOLOGIES B.V. (NETHERLANDS  
LIMITED LIABILITY COMPANY)  
HIGH TECH CAMPUS 46  
NL-5656 AE EINDHOVEN  
NETHERLANDS

FOR: ELECTRONIC DOCUMENT READERS FOR  
RECEIVING, PROCESSING, TRANSMITTING AND  
REPRODUCING ELECTRONIC MESSAGES, PUBLI-  
CATIONS, NEWSPAPERS, AND PERIODICALS,  
ALL DISTRIBUTED THROUGH ELECTRONIC  
MEANS OR VIA THE INTERNET, IN CLASS 9 (U.S.  
CLS. 21, 23, 26, 36 AND 38).

FOR: TELECOMMUNICATION SERVICES,  
NAMELY, LOCAL AND LONG DISTANCE TRANS-  
MISSION OF DATA, ELECTRONIC MESSAGES,  
NEWSPAPERS AND PERIODICALS THROUGH SA-  
TELLITE TRANSMISSIONS AND VIA THE INTER-  
NET, IN CLASS 38 (U.S. CLS. 100, 101 AND 104).

THE MARK CONSISTS OF STANDARD CHAR-  
ACTERS WITHOUT CLAIM TO ANY PARTICULAR  
FONT, STYLE, SIZE, OR COLOR.

PRIORITY DATE OF 4-6-2007 IS CLAIMED.

OWNER OF INTERNATIONAL REGISTRATION  
0941011 DATED 9-10-2007, EXPIRES 9-10-2017.

OWNER OF U.S. REG. NO. 3,211,567.

SER. NO. 79-045,260, FILED 9-10-2007.

SHANNON TWOHIG, EXAMINING ATTORNEY

**Int. Cls.: 41 and 44**

**Prior U.S. Cls.: 100, 101 and 107**

**United States Patent and Trademark Office**

**Reg. No. 3,505,566**

**Registered Sep. 23, 2008**

**SERVICE MARK  
PRINCIPAL REGISTER**

**K I N E S I O T A P I N G**

KINESIO IP LLC (UNITED STATES CORPORATION)  
3901 GEORGIA STREET NE, STE. F2  
ALBUQUERQUE, NM 87110  
UNITED STATES

FOR: EDUCATIONAL AND INSTRUCTION SERVICES, NAMELY, CONDUCTING CLASSES, SEMINARS, CONFERENCES AND WORKSHOPS IN THE FIELD OF APPLYING ADHESIVE TAPE TO THE BODY; EDUCATIONAL AND INSTRUCTION SERVICE, NAMELY, CONDUCTING CLASSES, SEMINARS, CONFERENCES AND WORKSHOPS IN THE FIELD OF APPLYING ADHESIVE TAPE AND RELATING TO BEAUTY; BOOK RENTAL; RENTAL OF IMAGE-RECORDED MAGNETIC TAPES AND DISKS; EDUCATIONAL AND INSTRUCTION SERVICES, NAMELY, CONDUCTING CLASSES, SEMINARS, CONFERENCES, AND WORKSHOPS IN THE FIELD OF CHIROPRACTICS; ORGANIZATION AND ARRANGEMENT OF SEMINARS IN THE FIELD OF APPLYING ADHESIVE TAPE TO THE BODY; PROVIDING ELECTRONIC PUBLICATIONS, NAMELY, PUBLISHING OF ELECTRONIC PUBLICATIONS; PUBLICATION OF BOOKS; PRODUCTION OF VIDEO TAPE FILM IN THE FIELDS OF EDUCATION, CULTURE, ENTERTAINMENT OR SPORTS AND NOT FOR MOVIES, RADIO OR TELEVISION PROGRAMS AND NOT FOR ADVERTISING AND PUBLICITY; ORGANIZATION OR ARRANGEMENT OF SPORTS COMPETITIONS; RENTAL OF SPORTS EQUIPMENT; PROVIDING SPORTS FACILITIES; PROVIDING FACILITIES FOR EDUCATIONAL TRAINING, IN CLASS 41 (U.S. CLS. 100, 101 AND 107).

FOR: BEAUTY SALONS; HAIRDRESSING SALONS; MASSAGE AND THERAPEUTIC SHIATSU MASSAGE; CHIROPRACTICS; MOXIBUSTION; TREATMENT TO JOINT-DISLOCATION, SPRAIN, BONE-FRACTURE OR THE LIKE (JUDO-SEIFUKU); ACUPUNCTURE; MEDICAL SERVICES; PROVIDING MEDICAL INFORMATION; DIETARY

AND NUTRITIONAL GUIDANCE; RENTAL OF MACHINES AND APPARATUS FOR USE IN BEAUTY SALONS; TAPING TREATMENT FOR MUSCLE AND JOINT PAIN, INCREASED FLOW OF BLOOD AND LYMPHATIC FLUID, PREVENTING INJURY, REPAIRING DAMAGED JOINTS AND LIGAMENTS, ENHANCING ATHLETIC PERFORMANCE, AND RE-EDUCATING THE NEUROMUSCULAR SYSTEM BY PUTTING ON ADHESIVE TAPE TO BODY; HYGIENIC AND BEAUTY CARE SERVICES IN THE NATURE OF PUTTING ON ADHESIVE TAPE TO THE BODY; CHIROPRACTICS BY PUTTING ON ADHESIVE TAPE TO BODY; TREATMENT FOR MUSCLE AND JOINT PAIN, INCREASED FLOW OF BLOOD AND LYMPHATIC FLUID, PREVENTING INJURY, REPAIRING DAMAGED JOINTS AND LIGAMENTS, ENHANCING ATHLETIC PERFORMANCE, AND RE-EDUCATING THE NEUROMUSCULAR SYSTEM BY MEANS OF PUTTING ON ADHESIVE TAPE TO BODY, IN CLASS 44 (U.S. CLS. 100 AND 101).

THE MARK CONSISTS OF STANDARD CHARACTERS WITHOUT CLAIM TO ANY PARTICULAR FONT, STYLE, SIZE, OR COLOR.

OWNER OF INTERNATIONAL REGISTRATION 0911274 DATED 11-9-2006, EXPIRES 11-9-2016.

OWNER OF U.S. REG. NOS. 1,613,689 AND 2,277,481.

NO CLAIM IS MADE TO THE EXCLUSIVE RIGHT TO USE "TAPING", APART FROM THE MARK AS SHOWN.

SER. NO. 79-045,351, FILED 9-10-2007.

JAMES STEIN, EXAMINING ATTORNEY

**Int. Cl.: 14**

**Prior U.S. Cls.: 2, 27, 28 and 50**

**United States Patent and Trademark Office**

**Reg. No. 3,505,567**

**Registered Sep. 23, 2008**

**TRADEMARK  
PRINCIPAL REGISTER**

# Symphony of Pearls

TAMARA COMOLLI FINE JEWELRY COLLEC-  
TION GMBH & CO. KG (FED REP GERMANY  
LIMITED PARTNERSHIP WITH A LIMITED  
LIABILITY COMPANY AS GENERAL PART-  
NER.)

TEGERNSEESTR. 23

83703 GMUND

FED REP GERMANY

FOR: PRECIOUS METALS AND THEIR ALLOYS;  
AND GOODS MADE OF PRECIOUS METALS OR  
COATED THEREWITH, NAMELY, STATUES, FIG-  
URINES AND JEWELRY BOXES, JEWELRY, PRE-  
CIOUS STONES, AND HOROLOGICAL AND  
CHRONOMETRIC INSTRUMENTS, ALL FEATUR-  
ING PEARLS, IN CLASS 14 (U.S. CLS. 2, 27, 28 AND  
50).

THE MARK CONSISTS OF STANDARD CHAR-  
ACTERS WITHOUT CLAIM TO ANY PARTICULAR  
FONT, STYLE, SIZE, OR COLOR.

PRIORITY DATE OF 3-23-2007 IS CLAIMED.

OWNER OF INTERNATIONAL REGISTRATION  
0941425 DATED 9-21-2007, EXPIRES 9-21-2017.

NO CLAIM IS MADE TO THE EXCLUSIVE  
RIGHT TO USE "PEARLS" , APART FROM THE  
MARK AS SHOWN.

SER. NO. 79-045,379, FILED 9-21-2007.

PATRICIA EVANKO, EXAMINING ATTORNEY

**Int. Cl.: 9**

**Prior U.S. Cls.: 21, 23, 26, 36 and 38**

**United States Patent and Trademark Office**

**Reg. No. 3,505,568**

**Registered Sep. 23, 2008**

**TRADEMARK  
PRINCIPAL REGISTER**



**Loving music**

CLEARAUDIO ELECTRONIC GMBH (FED REP GERMANY GMBH)  
SPARDORFER STR. 150  
91054 ERLANGEN, FED REP GERMANY

FOR: APPARATUS FOR RECORDING, REPRODUCTION, TRANSMISSION OR AMPLIFICATION OF SOUND AND/OR IMAGE SIGNALS; ANALOG RECORDING DISC DRIVES, MOTORS FOR RECORDING DISC DRIVES; SCANNING EQUIPMENT FOR ANALOGUE RECORDING DISCS, NAMELY, TONE ARMS, IN PARTICULAR TANGENTIAL TONE ARMS; PICK-UPS, NAMELY, MOVING MAGNET AND MOVING COIL PICK-UPS; STORAGE RACKS FOR ANALOGUE RECORDING DISC PLAYERS; ALIGNMENT AIDS FOR ANALOGUE RECORDING DISC PLAYERS; TONE ARM CABLES; AMPLIFIERS, NAMELY, MOVING MAGNET AND MOVING COIL PHONO PRE-AMPLIFIERS; SINGLE-CHANNEL AND MULTIPLE-CHANNEL AMPLIFIER INPUT AND OUTPUT TRANSFORMERS; CONNECTOR CABLES FOR USE IN AMPLIFIER

INSTALLATIONS; WASHING DEVICES FOR ANALOGUE RECORDING DISCS; LOUDSPEAKERS, HEADPHONES, MAGNETIC BEARINGS FOR RECORD PLAYERS; REPLACEMENT PARTS FOR THE AFORESAID APPARATUS AND INSTRUMENTS, IN CLASS 9 (U.S. CLS. 21, 23, 26, 36 AND 38).

OWNER OF INTERNATIONAL REGISTRATION  
0941487 DATED 8-16-2007, EXPIRES 8-16-2017.

OWNER OF U.S. REG. NO. 3,335,388.

NO CLAIM IS MADE TO THE EXCLUSIVE RIGHT TO USE "MUSIC", APART FROM THE MARK AS SHOWN.

SER. NO. 79-045,395, FILED 8-16-2007.

CURTIS FRENCH, EXAMINING ATTORNEY

Int. Cls.: 12 and 25

Prior U.S. Cls.: 19, 21, 22, 23, 31, 35, 39 and 44

United States Patent and Trademark Office

Reg. No. 3,505,569

Registered Sep. 23, 2008

TRADEMARK  
PRINCIPAL REGISTER

AGUTI

AGUTI PRODUKTENTWICKLUNG & DESIGN  
GMBH (FED REP GERMANY LIMITED LIABILITY COMPANY)

BILDSTOCK 18/3  
88085 LANGENARGEN  
FED REP GERMANY

FOR: BOATS; YACHTS; SHIPS, IN CLASS 12 (U.S. CLS. 19, 21, 23, 31, 35 AND 44).

FOR: CLOTHING, NAMELY, SHIRTS, SHORTS, TOPS, PANTS, DRESSES, JACKETS, T-SHIRTS, SWEATSHIRTS, RAINWEAR; FOOTWEAR; HEADGEAR FOR WEAR, NAMELY, HATS AND CAPS, IN CLASS 25 (U.S. CLS. 22 AND 39).

THE MARK CONSISTS OF STANDARD CHARACTERS WITHOUT CLAIM TO ANY PARTICULAR FONT, STYLE, SIZE, OR COLOR.

PRIORITY DATE OF 2-27-2007 IS CLAIMED.

OWNER OF INTERNATIONAL REGISTRATION 0941515 DATED 8-27-2007, EXPIRES 8-27-2017.

THE MARK HAS NO MEANING IN A FOREIGN LANGUAGE.

SER. NO. 79-045,404, FILED 8-27-2007.

ROBERT STRUCK, EXAMINING ATTORNEY

**Int. Cl.: 5**

**Prior U.S. Cls.: 6, 18, 44, 46, 51 and 52**

**United States Patent and Trademark Office**

**Reg. No. 3,505,570**

**Registered Sep. 23, 2008**

**TRADEMARK  
PRINCIPAL REGISTER**

The logo consists of a square icon on the left containing a stylized 'D' and 'M' formed by intersecting lines. To the right of the icon, the letters 'DMG' are written in a large, bold, sans-serif font, followed by the word 'Ident' in a smaller, regular sans-serif font.

ERNST MÜHLBAUER GMBH & CO. KG (FED  
REP GERMANY GMBH & CO. KG)  
KOOGSTRAAT 4  
25870 NORDERFRIEDRICHSKOOG, FED REP GER-  
MANY

FOR: MATERIALS FOR DENTAL FILLINGS  
AND FOR SEALING PURPOSES; FIXING MATERI-  
ALS FOR DENTAL PURPOSES; AND MATERIALS  
FOR MAKING DENTAL IMPRESSIONS, IN CLASS 5  
(U.S. CLS. 6, 18, 44, 46, 51 AND 52).

PRIORITY DATE OF 4-27-2007 IS CLAIMED.

OWNER OF INTERNATIONAL REGISTRATION  
0941523 DATED 9-5-2007, EXPIRES 9-5-2017.

SER. NO. 79-045,407, FILED 9-5-2007.

ANGELA M. MICHELI, EXAMINING ATTORNEY

**Int. Cl.: 33**

**Prior U.S. Cls.: 47 and 49**

**United States Patent and Trademark Office**

**Reg. No. 3,505,571**

**Registered Sep. 23, 2008**

**TRADEMARK  
PRINCIPAL REGISTER**

**BELLAVISTA**

TERRA MORETTI S.P.A. (ITALY JOINT-STOCK  
COMPANY)  
VIA BELLAVISTA, 5  
ERBUSCO (BS), ITALY I25030

THE ENGLISH TRANSLATION OF THE WORD  
"BELLA VISTA" IN THE MARK IS BEAUTIFUL  
VIEW.

FOR: WINES, SPIRITS AND LIQUEURS, IN  
CLASS 33 (U.S. CLS. 47 AND 49).

SER. NO. 79-045,413, FILED 8-30-2007.

OWNER OF INTERNATIONAL REGISTRATION  
0941537 DATED 8-30-2007, EXPIRES 8-30-2017.

LAURIE KAUFMAN, EXAMINING ATTORNEY



**Int. Cl.: 10**

**Prior U.S. Cls.: 26, 39 and 44**

**United States Patent and Trademark Office**

**Reg. No. 3,505,572**

**Registered Sep. 23, 2008**

**TRADEMARK  
PRINCIPAL REGISTER**

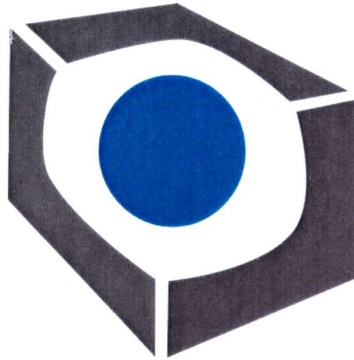

PNN MEDICAL A/S (DENMARK AKTIESELS-  
KAP (A/S))  
OLDENVEJ 13  
KVISTGAARD, DENMARK DK3490

FOR: SURGICAL APPARATUS AND INSTRUMENTS, MEDICAL APPARATUS AND INSTRUMENTS FOR USE IN MINIMALLY INVASIVE TREATMENT IN UROLOGY, GYNAECOLOGY, PULMONOLOGY AND OTHER SOLID AND SOFT TISSUE DISORDERS; ARTIFICIAL LIMBS, EYES AND TEETH; SUTURE MATERIALS, IN CLASS 10 (U.S. CLS. 26, 39 AND 44).

PRIORITY DATE OF 3-23-2007 IS CLAIMED.

OWNER OF INTERNATIONAL REGISTRATION  
0941662 DATED 9-21-2007, EXPIRES 9-21-2017.

THE COLOR(S) GREY AND BLUE IS/ARE  
CLAIMED AS A FEATURE OF THE MARK.

INDICATION OF BOX IN GREY WITH A BLUE  
CIRCLE IN THE MIDDLE.

SER. NO. 79-045,456, FILED 9-21-2007.

PATRICIA EVANKO, EXAMINING ATTORNEY

**Int. Cls.: 9, 16, 38, 39, 41, 42 and 45**

**Prior U.S. Cls.: 2, 5, 21, 22, 23, 26, 29, 36, 37, 38, 50,  
100, 101, 104, 105 and 107**

**Reg. No. 3,505,573**

**United States Patent and Trademark Office**

**Registered Sep. 23, 2008**

**TRADEMARK  
SERVICE MARK  
PRINCIPAL REGISTER**

# PEOPLE PLANNER

MACONOMY A/S (DENMARK AKTIESELSKAP  
(A/S))  
VORDINGBORGGADE 18-22  
DK-2100 KØBENHAVN Ø  
DENMARK

FOR: COMPUTER HARDWARE AND SOFTWARE FOR COMMUNICATION VIA COMPUTER NETWORKS AND VIA MOBILE TELEPHONES; SOFTWARE, NAMELY, SOFTWARE FOR USE IN COLLECTING AND COLLATION OF DATA ON A COMMON DATABASE ACCESSIBLE VIA LOCAL OR GLOBAL COMPUTER NETWORKS OR VIA MOBILE TELEPHONES, SOFTWARE FOR USE IN DATABASE MANAGEMENT, USE AS A SPREADSHEET, WORD PROCESSING FOR OPTIMIZATION OF BUSINESS PROCESSES; SOFTWARE FOR EDUCATIONAL PURPOSES, NAMELY, SOFTWARE FOR USE IN DATABASE MANAGEMENT, USE AS A SPREADSHEET, WORD PROCESSING; COMPUTER SOFTWARE FOR USE IN DATABASE MANAGEMENT, USE AS A SPREADSHEET, WORD PROCESSING FOR USE IN SALES ANALYSIS AND SALES TRAINING; SOFTWARE FOR USE IN DATABASE MANAGEMENT, USE AS A SPREADSHEET, WORD PROCESSING FOR USE IN FINANCIAL MANAGEMENT, PROJECT MANAGEMENT AND GENERAL CONTROL OF MANAGEMENT INFORMATION, SOFTWARE FOR USE IN DATABASE MANAGEMENT, USE AS A SPREADSHEET, AND FOR WORD PROCESSING FOR USE IN CONNECTION WITH INTEGRATED BUSINESS SOLUTIONS, IN CLASS 9 (U.S. CLS. 21, 23, 26, 36 AND 38).

FOR: PAPER, CARDBOARD, GOODS MADE FROM PAPER AND CARDBOARD, NAMELY, ART PAPER, BLOTTING PAPER, CARBON PAPER, CARDBOARD CONTAINERS, CARDBOARD TUBES, CORRUGATED CARDBOARD; PRINTED INSTRUCTIONAL AND TEACHING MATERIALS IN THE FIELDS OF DATABASE MANAGEMENT, SPREADSHEET, WORD PROCESSING FOR USE IN PREPARATION OF DATA PROGRAMS AND FOR USE WITH DATA MACHINES; EVENTS PRO-

GRAMS, PRINTED INSTRUCTIONAL AND TEACHING MATERIAL FOR USE IN CONNECTION WITH SALES TRAINING, SALES ASSISTANCE AND SALES ANALYSIS; BOOKS, NAMELY, ADDRESS BOOKS, EXERCISE BOOKS, BOOKS IN THE FIELD DATABASE MANAGEMENT, SPREADSHEET, WORD PROCESSING; PRINTED PERIODICALS IN THE FIELD OF DATABASE MANAGEMENT, SPREADSHEET, WORD PROCESSING; AND PRINTED MATTERS, NAMELY, PRINTED REPORTS FEATURING DATABASE MANAGEMENT, SPREADSHEET, WORD PROCESSING; PRINTED LESSONS ON DATABASE MANAGEMENT, SPREADSHEET, WORD PROCESSING, IN CLASS 16 (U.S. CLS. 2, 5, 22, 23, 29, 37, 38 AND 50).

FOR: TELECOMMUNICATION SERVICES, NAMELY, TRANSMISSION OF WEB CASTS, TRANSMISSION OF PODCASTS AND PERSONAL COMMUNICATION SERVICES; TRANSMISSION OF INFORMATION AND MESSAGES VIA COMPUTER NETWORKS AND VIA MOBILE TELEPHONES, ELECTRONIC MAIL SERVICES; VOICE MAIL SERVICES, IN CLASS 38 (U.S. CLS. 100, 101 AND 104).

FOR: ELECTRONIC STORAGE OF DIGITAL STORED DATA; ELECTRONIC STORAGE OF DIGITAL STORED DATA IN THE NATURE OF COMPUTER FILES CONTAINING BUSINESS INFORMATION; PHYSICAL STORAGE OF ELECTRONICALLY STORED DOCUMENTS, PHYSICAL STORAGE OF ELECTRONICALLY STORED DATA CONTAINING BUSINESS INFORMATION , IN CLASS 39 (U.S. CLS. 100 AND 105).

FOR: EDUCATION SERVICES, NAMELY, PROVIDING CLASSES, SEMINARS, AND WORKSHOPS IN THE FIELD OF DATABASE MANAGEMENT, USE OF SPREADSHEETS, AND WORD PROCESSING; EDUCATION, NAMELY, COMPUTER EDUCATION TRAINING; EDUCATION PROVIDED THROUGH GLOBAL OR LOCAL COMPUTER NETWORKS, NAMELY, PROVIDING CLASSES, SEMINARS, WORKSHOPS IN THE FIELD OF DATABASE MANAGEMENT, USE OF SPREADSHEET, WORD

PROCESSING; CONSULTANCY REGARDING SALES TRAINING, IN CLASS 41 (U.S. CLS. 100, 101 AND 107).

FOR: COMPUTER PROGRAMMING; DESIGN, DEVELOPMENT AND IMPLEMENTATION OF SOFTWARE, SOFTWARE FOR OPTIMIZATION OF BUSINESS PROCESSES IN BUSINESSES, SOFTWARE FOR OPTIMIZATION OF BUSINESSES BASED ON A COMMON DATABASE AND USE OF COMPUTER NETWORKS OR MOBILE TELEPHONES; RENTAL OF COMPUTER EQUIPMENT, NAMELY, COMPUTERS AND COMPUTER SOFTWARE; PROFESSIONAL COMPUTER CONSULTANCY AND COMPUTER SOFTWARE CONSULTATION FOR OPTIMIZATION OF BUSINESS PROCESSES AND IMPLEMENTING METHODS IN THE NATURE OF DESIGN, SELECTION, IMPLEMENTATION AND USE OF COMPUTER

HARDWARE AND SOFTWARE SYSTEMS FOR OTHERS, IN CLASS 42 (U.S. CLS. 100 AND 101).

FOR: LEGAL ADVICE; LICENSING OF SOFTWARE, IN CLASS 45 (U.S. CLS. 100 AND 101).

THE MARK CONSISTS OF STANDARD CHARACTERS WITHOUT CLAIM TO ANY PARTICULAR FONT, STYLE, SIZE, OR COLOR.

PRIORITY DATE OF 3-9-2007 IS CLAIMED.

OWNER OF INTERNATIONAL REGISTRATION 0941803 DATED 5-30-2007, EXPIRES 5-30-2017.

SER. NO. 79-045,501, FILED 5-30-2007.

BRENDAN MCCAULEY, EXAMINING ATTORNEY

**Int. Cls.: 1 and 18**

**Prior U.S. Cls.: 1, 2, 3, 5, 6, 10, 22, 26, 41 and 46**

**United States Patent and Trademark Office**

**Reg. No. 3,505,574**

**Registered Sep. 23, 2008**

**TRADEMARK  
PRINCIPAL REGISTER**

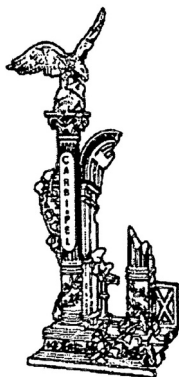

CARBI.PEL S.R.L. (ITALY LIMITED LIABILITY COMPANY)  
VIA ROVERI, 2  
I-36050 ZERMEGHEDO (VI)  
ITALY

FOR: MATERIALS FOR TANNING LEATHER, NAMELY, CHEMICALS FOR INDUSTRIAL USE; CHEMICALS FOR SCIENTIFIC USE; PHOTOGRAPHIC CHEMICALS; ARTIFICIAL AND SYNTHETIC RESINS; DISPERSIONS OF PLASTICS, NAMELY, UNPROCESSED PLASTICS; UNPROCESSED PLASTIC MATERIALS IN POWDER, LIQUID OR PASTE FORM; FIRE EXTINGUISHING COMPOSITIONS; TEMPERING SUBSTANCES; GASES FOR WELDING; CHEMICAL SUBSTANCES FOR PRESERVING FOODSTUFFS; ADHESIVES FOR INDUSTRIAL USE; ANTIFREEZES; SCALE-PREVENTING AGENTS, NAMELY, CHEMICAL PRODUCTS FOR PREVENTING SCALE, IN CLASS 1 (U.S. CLS. 1, 5, 6, 10, 26 AND 46).

FOR: ALL-PURPOSE CARRYING BAGS; HANDBAGS; SUITCASES; RUCKSACKS; WALLETS; CHANGE PURSES; SCHOOL BAGS; DOCUMENT SATCHELS IN LEATHER AND SIMULATED LEATHER; CLUTCH BAGS; TRUNKS; LEATHER AND LEATHER GOODS, NAMELY, PURSES, WALLETS; IMITATIONS OF LEATHER AND ARTICLES MADE

WITH THESE MATERIALS, NAMELY, PURSES, WALLETS; PARASOLS; SUNSHADES, NAMELY, SUN UMBRELLAS; UMBRELLAS; WALKING STICKS; WHIPS AND SADDLERY, IN CLASS 18 (U.S. CLS. 1, 2, 3, 22 AND 41).

PRIORITY DATE OF 5-17-2007 IS CLAIMED.

OWNER OF INTERNATIONAL REGISTRATION 0941898 DATED 8-27-2007, EXPIRES 8-27-2017.

THE MARK COMPRISES A FIGURATIVE PART AND A NAME; IN PARTICULAR IT IS COMPOSED OF A REPRESENTATION OF SOME RUINS AMONG WHICH APPEAR A COLUMN AND AN EAGLE; THE SCRIPT "CARBI.PEL" IS WRITTEN VERTICALLY WITH SPECIAL TYPE ON THE COLUMN.

THE WORDING "CARBI.PEL" HAS NO MEANING IN A FOREIGN LANGUAGE.

SER. NO. 79-045,524, FILED 8-27-2007.

ROBERT STRUCK, EXAMINING ATTORNEY

**Int. Cls.: 16, 20, 35 and 42**

**Prior U.S. Cls.: 2, 5, 13, 22, 23, 25, 29, 32, 37, 38, 50,  
100, 101 and 102**

**Reg. No. 3,505,575**

**United States Patent and Trademark Office**

**Registered Sep. 23, 2008**

**TRADEMARK  
SERVICE MARK  
PRINCIPAL REGISTER**

# Medical Stick

MATTHIAS BECKER (FED REP GERMANY IN-  
DIVIDUAL)  
AUSSERHALB 5  
55270 OBER-OLM  
FED REP GERMANY

FOR: PACKAGING MATERIALS OF CARDBOARD AND/OR PAPER, NAMELY, CARDBOARD PACKAGING, CARDBOARD CONTAINERS, PAPER FOR PACKAGING AND PACKAGING CONTAINERS MADE OF PAPER; WRAPPING PAPER; PACKAGING BAGS, ENVELOPES, POUCHES MADE OF PAPER AND MADE OF PLASTIC; PLASTIC FILM FOR WRAPPING NOT FOR COMMERCIAL OR INDUSTRIAL PURPOSES, NOTE PADS, DESK PADS, BALLPOINT PENS, IN CLASS 16 (U.S. CLS. 2, 5, 22, 23, 29, 37, 38 AND 50).

FOR: POINT OF PURCHASE DISPLAYS, PLASTIC DISPLAY RACKS, STANDS, TABLES, CASES AND BOARDS, IN CLASS 20 (U.S. CLS. 2, 13, 22, 25, 32 AND 50).

FOR: ADVERTISING AGENCIES; DISTRIBUTION OF ADVERTISING MATERIAL, IN CLASS 35 (U.S. CLS. 100, 101 AND 102).

FOR: COMPUTER SOFTWARE DESIGN AND DEVELOPMENT FOR OTHERS IN THE FIELDS OF PROGRAMMING OF USER INTERFACES, DEVELOPMENT AND PRODUCTION OF A SOFTWARE LOGIC AND STRUCTURE, SOFTWARE

PRODUCTION, SOFTWARE DESIGN AND PRODUCTION OF SOURCE CODES; COMPUTER SOFTWARE DESIGN FOR OTHERS, NAMELY, PRODUCTION OF PROGRAMMING CONTENT IN THE NATURE OF SOURCE CODES AND DEVELOPMENTS OF SYSTEMS LOGICS FOR DATA MANAGEMENT; DATABASE DEVELOPMENT SERVICES, NAMELY, CONSTRUCTION OF A UNIVERSAL DATABASE; SOFTWARE MAINTENANCE AND INSTALLATION; DESIGN AND CREATION OF WEBSITES; HOMEPAGE AND WEBSITE DESIGN, GRAPHIC DESIGN, INDUSTRIAL DESIGN, CONFIGURATION OF COMPUTER NETWORKS USING SOFTWARE; COMMERCIAL ART DESIGN OF TRADEMARKS AND LOGOS, IN CLASS 42 (U.S. CLS. 100 AND 101).

PRIORITY DATE OF 11-28-2006 IS CLAIMED.

OWNER OF INTERNATIONAL REGISTRATION  
0941927 DATED 5-18-2007, EXPIRES 5-18-2017.

NO CLAIM IS MADE TO THE EXCLUSIVE RIGHT TO USE "MEDICAL", APART FROM THE MARK AS SHOWN.

SER. NO. 79-045,534, FILED 5-18-2007.

ERNEST SHOSHO, EXAMINING ATTORNEY

**Int. Cls.: 9, 14 and 18**

**Prior U.S. Cls.: 1, 2, 3, 21, 22, 23, 26, 27, 28, 36, 38, 41 and 50**

**Reg. No. 3,505,576**

**United States Patent and Trademark Office**

**Registered Sep. 23, 2008**

**TRADEMARK  
PRINCIPAL REGISTER**



DIATTO INTERNATIONAL; TRADEMARKS  
MARKETING LDA (ITALY SOCIÉTÉ À RE-  
SPONSABILITÉ LIMITÉE)

RUA DOS MURCAS, 88  
FUNCHAL, MADEIRA  
PORTUGAL

FOR: SPECTACLES, SUNGLASSES, SPORTS  
GLASSES, ANTI-GLARE GLASSES, THEATRE  
GLASSES, PROTECTIVE GLASSES FOR SPORTS,  
SKI GLASSES, GOGGLES FOR SPORTS; PINCE-  
NEZ, SPECTACLES CASES; SPECTACLE CHAINS,  
SPECTACLE FRAMES, FRAMES FOR SUNGLAS-  
SES AND PINCE-NEZ, SPECTACLE LENSES, CON-  
TACT LENSES, OPTICAL LENSES; CASES FOR  
PINCE-NEZ AND FOR CONTACT LENSES; PRO-  
TECTIVE HELMETS, IN CLASS 9 (U.S. CLS. 21, 23, 26,  
36 AND 38).

FOR: EARRINGS, CLIP EARRINGS, BRACELETS,  
ANKLE BRACELETS, NECKLACES, RINGS, PEN-  
DANTS, BROOCHES, CHAINS, PINS, ORNAMEN-  
TAL PINS, DIADEMS, MEDALLIONS, MEDALS,  
CUFFLINKS, TIE CLIPS, NECKTIE FASTENERS;  
JEWELRY, IMITATION JEWELRY; DIVING  
WATCHES, WRISTWATCHES, POCKET WATCHES,  
WATCH BRACELETS, CHRONOMETERS, CHRON-  
OGRAPHS FOR USE AS WATCHES, SUN DIALS,  
WATCH STRAPS, WATCH BANDS, WATCH  
CHAINS, WATCH GLASSES, WATCH MOVE-  
MENTS; ALARM CLOCKS, PENDULUM CLOCKS,  
TABLE CLOCKS, WALL CLOCKS; JEWELRY CASES  
AND BOXES; JEWELRY CASKETS; CASES AND  
BOXES FOR WATCHES AND CLOCKS; KEYRINGS  
OF PRECIOUS METALS; FIGURINES OF PRE-  
CIOUS METAL, STATUETTES OF PRECIOUS ME-  
TAL, WORKS OF ART OF PRECIOUS METAL;  
ORNAMENTS OF PRECIOUS METAL; PRECIOUS  
STONES, SEMI-PRECIOUS STONES, PROCESSED  
OR SEMI-PROCESSED PRECIOUS METALS;

PEARLS; SHOE ORNAMENTS OF PRECIOUS ME-  
TAL, IN CLASS 14 (U.S. CLS. 2, 27, 28 AND 50).

FOR: HANDBAGS, HANDBAGS FOR MEN,  
SHOULDER BAGS, BEACH BAGS, CLUTCH BAGS,  
ALL PURPOSE SPORTS BAGS, ATHLETIC BAGS,  
ATTACHE CASES, SCHOOL BAGS, TOTE BAGS,  
TRAVELLING BAGS, BOSTON BAGS, CARRY-ON  
BAGS, DIAPER BAGS, DUFFEL BAGS, FLEXIBLE  
BAGS FOR GARMENTS, SHOE BAGS FOR TRAV-  
EL, GLADSTONE BAGS, SATCHELS, HANDBAG  
FRAMES; HIKING BAGS, HIKING RUCKSACKS;  
LUGGAGE, LUGGAGE TAGS, TOOL BAGS SOLD  
EMPTY, WAIST BAGS; CARD CASES, BEING NO-  
TECASES, CASES OF LEATHER OR LEATHER-  
BOARD, COSMETIC CASES SOLD EMPTY,  
KEYCASES, KNAPSACKS, RUCKSACKS, BACK-  
PACKS, BRIEFCASES, COIN PURSES, LEATHER  
PURSES, POCKET WALLETS, TRAVELLING  
TRUNKS, SUITCASES, UMBRELLAS, BEACH UM-  
BRELLAS, UMBRELLA COVERS, UMBRELLA  
FRAMES, UMBRELLA HANDLES, UMBRELLA  
RINGS; PARASOLS, WALKING STICKS, ALPEN-  
STOCKS; DOG CLOTHING, DOG COLLARS; UN-  
WORKED OR SEMI-WORKED LEATHER,  
SADDLERY, IN CLASS 18 (U.S. CLS. 1, 2, 3, 22 AND  
41).

OWNER OF INTERNATIONAL REGISTRATION  
0784369 DATED 6-13-2002, EXPIRES 6-13-2012.

OWNER OF U.S. REG. NOS. 2,824,294, 2,873,206,  
AND 3,011,563.

THE MARK COMPRISES AN IMPRINT REPRESENTING THE WORD "DIATTO" IN FANCY TYPE, INSERTED IN AN OVAL FRAME WHOSE EXTERIOR BORDER IS DEMARCATED BY A SERIES OF

STYLIZED POLKA DOTS, ALL CONTAINED WITH-  
IN AN OVAL LABEL.

SER. NO. 79-045,595, FILED 8-13-2007.

THE MARK "DIATTO" HAS NO MEANING IN A  
FOREIGN LANGUAGE.

CURTIS FRENCH, EXAMINING ATTORNEY

**Int. Cls.: 1 and 20**

**Prior U.S. Cls.: 1, 2, 5, 6, 10, 13, 22, 25, 26, 32, 46 and 50**

**United States Patent and Trademark Office**

**Reg. No. 3,505,577**

**Registered Sep. 23, 2008**

**TRADEMARK  
PRINCIPAL REGISTER**

**ADP**

SÜD-CHEMIE AG (FED REP GERMANY CORPORATION)  
LENBACHPLATZ 6  
80333 MÜNCHEN  
FED REP GERMANY

FOR: CHEMICAL PRODUCTS FOR COMMERCIAL USE, NAMELY, DESICCANTS, IN PARTICULAR DESICCANTS INTEGRATED IN PLASTICS OR POLYMERS, IN CLASS 1 (U.S. CLS. 1, 5, 6, 10, 26 AND 46).

FOR: CONTAINERS MADE OF PLASTIC WITH INTEGRATED DESICCANTS, IN PARTICULAR FOR STORING OR PACKAGING PHARMACEUTICALS, NUTRACEUTICALS, DIAGNOSTICS AND MEDICAL DEVICES, IN CLASS 20 (U.S. CLS. 2, 13, 22, 25, 32 AND 50).

THE MARK CONSISTS OF STANDARD CHARACTERS WITHOUT CLAIM TO ANY PARTICULAR FONT, STYLE, SIZE, OR COLOR.

PRIORITY DATE OF 7-13-2007 IS CLAIMED.

OWNER OF INTERNATIONAL REGISTRATION 0942597 DATED 10-15-2007, EXPIRES 10-15-2017.

SER. NO. 79-045,836, FILED 10-15-2007.

DOMINIC FATHY, EXAMINING ATTORNEY



**Int. Cls.: 9, 35 and 38**

**Prior U.S. Cls.: 21, 23, 26, 36, 38, 100, 101, 102 and 104**

**United States Patent and Trademark Office**

**Reg. No. 3,505,578**

**Registered Sep. 23, 2008**

**TRADEMARK  
SERVICE MARK  
PRINCIPAL REGISTER**

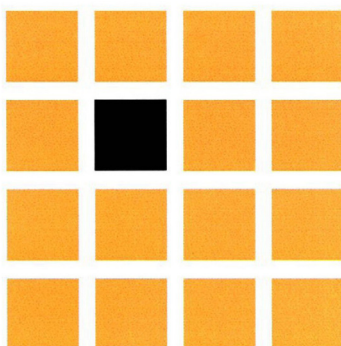

NORTH COUNTRY HOLDING AB (SWEDEN  
JOINT STOCK COMPANY)  
BOX 7555  
SE-103 93 STOCKHOLM  
SWEDEN

FOR: INTERFACES FOR COMPUTERS, MOBILE TELEPHONES, TELEVISION RECEIVERS AND HAND-HELD TERMINALS; COMPUTER SOFTWARE FOR COMPUTERS, MOBILE TELEPHONES, TELEVISION RECEIVERS AND HAND-HELD TERMINALS, NAMELY, WEB BROWSERS AND COMPUTER SOFTWARE FOR MAKING THE INFORMATION OF A DATABASE ACCESSIBLE VIA AN INTERFACE, IN CLASS 9 (U.S. CLS. 21, 23, 26, 36 AND 38).

FOR: ADVERTISING, IN CLASS 35 (U.S. CLS. 100, 101 AND 102).

FOR: PROVIDING ACCESS TO COMPUTER DATABASES; PROVIDING ACCESS TO A GLOBAL COMPUTER INFORMATION NETWORK FEATURING WEBSITES CONTAINING CUSTOMIZED INTERFACES FOR COMPUTERS, MOBILE TELEPHONES, TELEVISION RECEIVERS AND HAND-HELD TERMINALS, IN CLASS 38 (U.S. CLS. 100, 101 AND 104).

PRIORITY DATE OF 1-15-2007 IS CLAIMED.

OWNER OF INTERNATIONAL REGISTRATION  
0942721 DATED 6-29-2007, EXPIRES 6-29-2017.

THE COLOR(S) BLACK, ORANGE AND WHITE  
IS/ARE CLAIMED AS A FEATURE OF THE MARK.

THE MARK CONSISTS OF 16 SQUARES, POSITIONED IN ROWS 4 ACROSS AND 4 DOWN, FORMING ONE LARGE SQUARE. THE COLOR ORANGE APPEARS IN ALL OF THE SQUARES ON THE FIRST, THIRD AND FOURTH ROWS AND IN THE FIRST, THIRD AND FOURTH SQUARES ON THE SECOND ROW. THE COLOR BLACK APPEARS IN THE SECOND SQUARE ON THE SECOND ROW. THE COLOR WHITE APPEARS IN THE BACKGROUND OF THE MARK.

SER. NO. 79-045,869, FILED 6-29-2007.

TINA BROWN, EXAMINING ATTORNEY

**Int. Cl.: 14**

**Prior U.S. Cls.: 2, 27, 28 and 50**

**United States Patent and Trademark Office**

**Reg. No. 3,505,579**

**Registered Sep. 23, 2008**

**TRADEMARK  
PRINCIPAL REGISTER**

**ETERNA SOLEURE**

ETERNA AG UHRENFABRIK; (ETERNA SA  
FABRIQUE D'HORLOGERIE); (ETERNA LTD  
WATCH FACTORY) (SWITZERLAND LIM-  
ITED COMPANY)  
SCHÜTZENGASSE 46  
CH-2540 GRENCHEN, SWITZERLAND

FOR: HOROLOGICAL AND CHRONOMETRIC  
INSTRUMENTS, NAMELY, WATCHES, ALL OF  
SWISS ORIGIN, IN CLASS 14 (U.S. CLS. 2, 27, 28  
AND 50).

THE MARK CONSISTS OF STANDARD CHAR-  
ACTERS WITHOUT CLAIM TO ANY PARTICULAR  
FONT, STYLE, SIZE, OR COLOR.

PRIORITY DATE OF 3-29-2007 IS CLAIMED.

OWNER OF INTERNATIONAL REGISTRATION  
0942808 DATED 9-26-2007, EXPIRES 9-26-2017.

OWNER OF U.S. REG. NOS. 136,798, 1,233,490 AND  
OTHERS.

THE ENGLISH TRANSLATION OF THE TERM  
"ETERNA" IN THE MARK IS ETERNAL. THERE IS  
NO ENGLISH TRANSLATION OF THE TERM "SO-  
LEURE".

SER. NO. 79-045,960, FILED 9-26-2007.

MICHAEL WEBSTER, EXAMINING ATTORNEY

**Int. Cl.: 14**

**Prior U.S. Cls.: 2, 27, 28 and 50**

**Reg. No. 3,505,580**

**United States Patent and Trademark Office**

**Registered Sep. 23, 2008**

**TRADEMARK  
PRINCIPAL REGISTER**

# ETERNA CONTESSA

ETERNA AG UHRENFABRIK; (ETERNA SA  
FABRIQUE D'HORLOGERIE); (ETERNA LTD  
WATCH FACTORY) (SWITZERLAND LIM-  
ITED COMPANY)  
SCHÜTZENGASSE 46  
CH-2540 GRENCHEN, SWITZERLAND

FOR: HOROLOGICAL AND CHRONOMETRIC  
INSTRUMENTS, NAMELY, WATCHES; JEWELRY,  
NAMELY, JEWELRY WATCHES; ALL OF SWISS  
ORIGIN, IN CLASS 14 (U.S. CLS. 2, 27, 28 AND 50).

THE MARK CONSISTS OF STANDARD CHAR-  
ACTERS WITHOUT CLAIM TO ANY PARTICULAR  
FONT, STYLE, SIZE, OR COLOR.

PRIORITY DATE OF 3-29-2007 IS CLAIMED.

OWNER OF INTERNATIONAL REGISTRATION  
0942809 DATED 9-26-2007, EXPIRES 9-26-2017.

OWNER OF U.S. REG. NOS. 136,798, 1,233,490 AND  
OTHERS.

THE ENGLISH TRANSLATION OF THE TERM  
"ETERNA CONTESSA" IS ETERNAL COUNTRIES.

SER. NO. 79-045,961, FILED 9-26-2007.

MICHAEL WEBSTER, EXAMINING ATTORNEY

**Int. Cl.: 9**

**Prior U.S. Cls.: 21, 23, 26, 36 and 38**

**Reg. No. 3,505,581**

**United States Patent and Trademark Office**

**Registered Sep. 23, 2008**

**TRADEMARK  
PRINCIPAL REGISTER**

# Han-Radial Clamp

HARTING ELECTRIC GMBH & CO. KG (FED  
REP GERMANY LIMITED LIABILITY COM-  
PANY)  
WILHELM-HARTING-STRASSE 1  
32339 ESPELKAMP  
FED REP GERMANY

FOR: ELECTRICAL DEVICES AS FAR AS INCLU-  
DED IN THIS CLASS, NAMELY, ELECTRICALLY  
CONDUCTIVE CONNECTORS AND ELECTRICAL  
CONNECTOR TERMINALS WITH SPRING CON-  
NECTIONS FOR CONNECTING ELECTRICAL  
CONDUCTORS WITHIN INDUSTRIAL ENVIRON-  
MENT FOR USE IN TELECOMMUNICATION,  
ELECTRIC AND ELECTRONIC AREAS, IN CLASS  
9 (U.S. CLS. 21, 23, 26, 36 AND 38).

THE MARK CONSISTS OF STANDARD CHAR-  
ACTERS WITHOUT CLAIM TO ANY PARTICULAR  
FONT, STYLE, SIZE, OR COLOR.

PRIORITY DATE OF 12-21-2006 IS CLAIMED.

OWNER OF INTERNATIONAL REGISTRATION  
0942901 DATED 5-22-2007, EXPIRES 5-22-2017.

OWNER OF U.S. REG. NOS. 2,791,127, 3,018,081  
AND OTHERS.

NO CLAIM IS MADE TO THE EXCLUSIVE  
RIGHT TO USE "CLAMP", APART FROM THE  
MARK AS SHOWN.

SER. NO. 79-045,994, FILED 5-22-2007.

DOMINIC FATHY, EXAMINING ATTORNEY

**Int. Cls.: 14 and 28**

**Prior U.S. Cls.: 2, 22, 23, 27, 28, 38 and 50**

**United States Patent and Trademark Office**

**Reg. No. 3,505,582**

**Registered Sep. 23, 2008**

**TRADEMARK  
PRINCIPAL REGISTER**

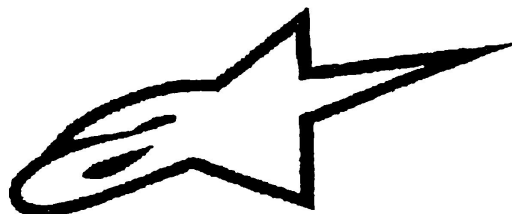

ALPINESTARS RESEARCH SRL (ITALY LIMITED LIABILITY COMPANY)  
VIA DE GASPERI 54  
I-31010 COSTE DI MASER (TREVISO)  
ITALY

FOR: JEWELLERY, NAMELY, RINGS, BRACELETS, BROOCHES, ORNAMENTAL PINS, CHARMS; HOROLOGICAL AND CHRONOMETRIC INSTRUMENTS, NAMELY, WATCHES, SPORTING WATCHES, WRISTWATCHES, WATERPROOF WATCHES, WATCH CASES, IN CLASS 14 (U.S. CLS. 2, 27, 28 AND 50).

FOR: ATHLETIC PROTECTIVE PADS AND PROTECTIVE GEAR, NAMELY, BACK PROTECTORS, KNEE PROTECTORS, SHOULDER PROTECTORS AND ELBOW PROTECTORS USED IN CONNECTION WITH SPORTING ACTIVITIES, NAMELY, IN CYCLING, MOUNTAIN BIKING, MOTORCYCLING

AND AUTO RACING SPORTS, IN CLASS 28 (U.S. CLS. 22, 23, 38 AND 50).

PRIORITY DATE OF 7-26-2007 IS CLAIMED.

OWNER OF INTERNATIONAL REGISTRATION 0943419 DATED 9-4-2007, EXPIRES 9-4-2017.

OWNER OF U.S. REG. NO. 2,778,539.

THE MARK CONSISTS OF A GRAPHIC AND FANCY ELEMENT CONSTITUTED BY THE COMBINATION OF A LETTER "A" IN SMALL CHARACTERS AND A STYLIZED STAR.

SER. NO. 79-046,224, FILED 9-4-2007.

Laurie Kaufman, Examining Attorney

Int. Cls.: 3, 25 and 41

Prior U.S. Cls.: 1, 4, 6, 22, 39, 50, 51, 52, 100, 101 and 107

United States Patent and Trademark Office

Reg. No. 3,505,583

Registered Sep. 23, 2008

TRADEMARK  
SERVICE MARK  
PRINCIPAL REGISTER

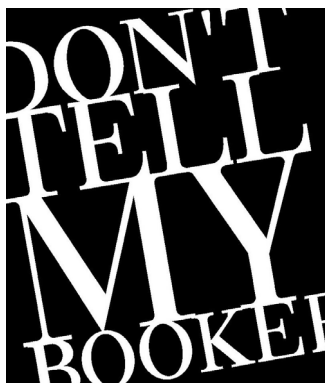

PERET, CYRIL (FRANCE INDIVIDUAL)  
4 RUE DE L'AMIRAL CLOUE  
F-75016 PARIS  
FRANCE

FOR: COSMETICS, LIPSTICKS, IN CLASS 3 (U.S. CLS. 1, 4, 6, 50, 51 AND 52).

FOR: CLOTHING, NAMELY, SWIMMING SUITS, BATH ROBES, JACKETS, BELTS, GLOVES; HEADGEAR, NAMELY, CAPS, HATS, IN CLASS 25 (U.S. CLS. 22 AND 39).

FOR: ENTERTAINMENT SERVICES, NAMELY, ORGANIZING OF NIGHT CLUB PARTIES, FASH-

ION SHOWS, PHOTOGRAPHIC EXHIBITIONS; PROVIDING INFORMATION ON ENTERTAINMENT EVENTS; PHOTOGRAPHIC SERVICES, NAMELY, PHOTOGRAPHY SERVICES, IN CLASS 41 (U.S. CLS. 100, 101 AND 107).

OWNER OF INTERNATIONAL REGISTRATION 0943442 DATED 9-13-2007, EXPIRES 9-13-2017.

OWNER OF U.S. REG. NO. 3,348,079.

SER. NO. 79-046,231, FILED 9-13-2007.

ANDREW RHIM, EXAMINING ATTORNEY

**Int. Cl.: 21**

**Prior U.S. Cls.: 2, 13, 23, 29, 30, 33, 40 and 50**

**United States Patent and Trademark Office**

**Reg. No. 3,505,584**

**Registered Sep. 23, 2008**

**TRADEMARK  
PRINCIPAL REGISTER**

# Quick One Plate

SHIN TOKYO INTERNATIONAL INC. (JAPAN CORPORATION)  
1-8-18, CHUO-CHO, MEGURO-KU  
TOKYO 152-0001, JAPAN

OWNER OF INTERNATIONAL REGISTRATION  
0943582 DATED 7-13-2007, EXPIRES 7-13-2017.

FOR: FOOD PREPARATION BOARDS FOR FROZEN SUSHI THAWING FOR USE IN MICROWAVE OVENS; FOOD PREPARATION BOARDS FOR FROZEN FOOD THAWING FOR USE IN MICRO WAVE OVENS, IN CLASS 21 (U.S. CLS. 2, 13, 23, 29, 30, 33, 40 AND 50).

NO CLAIM IS MADE TO THE EXCLUSIVE RIGHT TO USE "PLATE", APART FROM THE MARK AS SHOWN.

SER. NO. 79-046,278, FILED 7-13-2007.

THE MARK CONSISTS OF STANDARD CHARACTERS WITHOUT CLAIM TO ANY PARTICULAR FONT, STYLE, SIZE, OR COLOR.

KAELIE KUNG, EXAMINING ATTORNEY

**Int. Cl.: 32**

**Prior U.S. Cls.: 45, 46 and 48**

**United States Patent and Trademark Office**

**Reg. No. 3,505,585**

**Registered Sep. 23, 2008**

**TRADEMARK  
PRINCIPAL REGISTER**

# **Maisel's Weisse**

BRAUEREI GEBR. MAISEL KG (FED REP GER-  
MANY LIMITED PARTNERSHIP)  
HINDENBURGSTRASSE 9  
95445 BAYREUTH  
FED REP GERMANY

FOR: BEER, NAMELY, WHEAT BEER (WHITE  
BEER), IN CLASS 32 (U.S. CLS. 45, 46 AND 48).

THE MARK CONSISTS OF STANDARD CHAR-  
ACTERS WITHOUT CLAIM TO ANY PARTICULAR  
FONT, STYLE, SIZE, OR COLOR.

OWNER OF INTERNATIONAL REGISTRATION  
0944215 DATED 10-10-2007, EXPIRES 10-10-2017.

OWNER OF U.S. REG. NOS. 2,085,089 AND  
2,545,761.

NO CLAIM IS MADE TO THE EXCLUSIVE  
RIGHT TO USE "WEISSE", APART FROM THE  
MARK AS SHOWN.

THE ENGLISH TRANSLATION OF THE WORD  
"WEISSE" IN THE MARK IS "WHEAT."

SEC. 2(F) AS TO "MAISEL'S".

SER. NO. 79-046,520, FILED 10-10-2007.

Laurie Kaufman, Examining Attorney



**Int. Cls.: 14, 18 and 25**

**Prior U.S. Cls.: 1, 2, 3, 22, 27, 28, 39, 41 and 50**

**Reg. No. 3,505,586**

**United States Patent and Trademark Office**

**Registered Sep. 23, 2008**

**TRADEMARK  
PRINCIPAL REGISTER**

**GP**  
**GIRARD-PERREGAUX**

GIRARD-PERREGAUX S.A. (SWITZERLAND SOCIÉTÉ ANONYME)  
1, PLACE GIRARDET  
CH-2300 LA CHAUX-DE-FONDS  
SWITZERLAND

FOR: CASES FOR CLOCKS AND WATCHES; CUFF LINKS; DIAMONDS; WATCH HANDS, WATCHCASES, WATCH STRAPS, WATCH DIALS, WATCH CHAINS, WATCHES USED AS CHRONOGRAPHS, CHRONOSCOPES, CHRONOMETERS, CLOCKS, WATCHES, WRISTWATCHES, JEWELRY WATCHES, DIVING WATCHES, MOVEMENTS FOR CLOCKS AND WATCHES, MOVEMENTS FOR WATCHES, WALL CLOCKS, CARRIAGE CLOCKS, ALARM CLOCKS, WATCH GLASSES, IN CLASS 14 (U.S. CLS. 2, 27, 28 AND 50).

FOR: LEATHER OR IMITATION LEATHER PRODUCTS, NAMELY, WALLETTS, PURSES, KEY CASES, HANDBAGS, BRIEFCASES, ATTACHÉ CASES, ALL-PURPOSE POUCHES, IN CLASS 18 (U.S. CLS. 1, 2, 3, 22 AND 41).

FOR: CLOTHING, NAMELY, SHIRTS, TEE-SHIRTS, JERSEYS, TROUSERS, SUITS, BLAZERS, SWEATERS, JACKETS, COATS, ANORAKS, SWEAT-SHIRTS, TRACK PANTS, SHORTS, SKIRTS, DRESSES, LOUNGING WEAR, SHOES, SOCKS, HOSIERY, HEADWEAR PRODUCTS, NAMELY, CAPS, HATS; BANDANAS, BELTS, GLOVES AND SCARVES, IN CLASS 25 (U.S. CLS. 22 AND 39).

PRIORITY DATE OF 9-21-2006 IS CLAIMED.

OWNER OF INTERNATIONAL REGISTRATION 0944733 DATED 3-19-2007, EXPIRES 3-19-2017.

OWNER OF U.S. REG. NOS. 522,620, 3,013,542 AND OTHERS.

SER. NO. 79-046,726, FILED 3-19-2007.

Laurie Kaufman, Examining Attorney

**Int. Cls.: 1, 2, 16 and 17**

**Prior U.S. Cls.: 1, 2, 5, 6, 10, 11, 12, 13, 16, 22, 23, 26,  
29, 35, 37, 38, 46 and 50**

**Reg. No. 3,505,587**

**United States Patent and Trademark Office**

**Registered Sep. 23, 2008**

**TRADEMARK  
PRINCIPAL REGISTER**



SELENA CO. S.A. (POLAND CORPORATION)  
UL. STRZEGOMSKA 2-4  
PL-53-611 WROCLAW, POLAND

FOR: ADHESIVES AND OTHER ADHESIVE MATERIALS, NAMELY, PLASTIC ADHESIVES NOT FOR STATIONERY OR HOUSEHOLD PURPOSES AND POLYURETHANE ADHESIVES FOR USE IN INDUSTRY AND BUILDING, PRIMING AGENTS, NAMELY, ADHESIVE PRIMERS, GLUES FOR USE ON MASTICS FOR USE IN THE BUILDING INDUSTRY AND PASTES FOR SMOOTHING, NAMELY, FILLERS AND ADHESIVE PREPARATIONS USED BY DECORATORS, IN CLASS 1 (U.S. CLS. 1, 5, 6, 10, 26 AND 46).

FOR: PAINTS, VARNISHES AND LACQUERS FOR USE ON PARQUET FLOORING, IN CLASS 2 (U.S. CLS. 6, 11 AND 16).

FOR: GLUE FOR STATIONERY OR HOUSEHOLD PURPOSES, IN CLASS 16 (U.S. CLS. 2, 5, 22, 23, 29, 37, 38 AND 50).

FOR: JOINT SEALING PUTTIES FOR BUILDING, PASTES FOR SMOOTHING, NAMELY, CAULKING COMPOUNDS AND EXPANSION JOINT FILLERS, IN CLASS 17 (U.S. CLS. 1, 5, 12, 13, 35 AND 50).

OWNER OF INTERNATIONAL REGISTRATION  
0944927 DATED 8-10-2007, EXPIRES 8-10-2017.

THE MARK "ARTELIT" HAS NO MEANING IN A FOREIGN LANGUAGE.

SER. NO. 79-046,794, FILED 8-10-2007.

DOMINIC FATHY, EXAMINING ATTORNEY

**Int. Cls.: 35, 36, 37, 38, 41 and 42**

**Prior U.S. Cls.: 100, 101, 102, 103, 104, 106 and 107**

**United States Patent and Trademark Office**

**Reg. No. 3,505,588**

**Registered Sep. 23, 2008**

**SERVICE MARK  
PRINCIPAL REGISTER**

# ENGADA

ENGADA SWISS AG; C/O DR. HANS DURRER  
(SWITZERLAND CORPORATION)  
GOTTHARDSTRASSE 20  
6304 ZUG  
SWITZERLAND

FOR: BUSINESS MANAGEMENT; BUSINESS ADMINISTRATION AND OFFICE WORK, IN CLASS 35 (U.S. CLS. 100, 101 AND 102).

FOR: FINANCIAL SERVICES, NAMELY, FINANCIAL ADVICE AND CONSULTANCY SERVICES; MONETARY SERVICES, NAMELY, MONETARY EXCHANGE; REAL ESTATE SERVICES, NAMELY, FINANCIAL INVESTMENT IN REAL ESTATE, LEASING OF REAL ESTATE AND REAL ESTATE PROPERTY MANAGEMENT, IN CLASS 36 (U.S. CLS. 100, 101 AND 102).

FOR: BUILDING, NAMELY CONSTRUCTION OF BUILDINGS, IN CLASS 37 (U.S. CLS. 100, 103 AND 106).

FOR: TELECOMMUNICATIONS ROUTING AND JUNCTION SERVICES (GATEWAY SERVICES), VOICE MAIL SERVICES, (ELECTRONIC) MESSAGE SENDING, PROVIDING ACCESS TO DATABASES, COMPUTER AIDED TRANSMISSION OF MESSAGES AND IMAGES PROVIDING TELECOMMUNICATIONS CONNECTIONS TO A GLOBAL COMPUTER NETWORK, SATELLITE TRANSMIS-

SION, COMMUNICATIONS BY FIBRE-OPTIC NETWORKS, IN CLASS 38 (U.S. CLS. 100, 101 AND 104).

FOR: TRAINING IN THE FIELD OF REAL ESTATE LEASING, BUILDING CONSTRUCTION, FINANCIAL SERVICES AND DEVELOPMENT, IN CLASS 41 (U.S. CLS. 100, 101 AND 107).

FOR: SCIENTIFIC AND TECHNOLOGICAL SERVICES AND RELATED RESEARCH AND DESIGN SERVICES IN THE FIELDS OF THE BUILDING CONSTRUCTION INDUSTRY AND ASSOCIATED INDUSTRIAL ANALYSIS AND RESEARCH SERVICES; DESIGN AND DEVELOPMENT OF COMPUTER HARDWARE AND SOFTWARE, IN CLASS 42 (U.S. CLS. 100 AND 101).

THE MARK CONSISTS OF STANDARD CHARACTERS WITHOUT CLAIM TO ANY PARTICULAR FONT, STYLE, SIZE, OR COLOR.

PRIORITY DATE OF 10-10-2007 IS CLAIMED.

OWNER OF INTERNATIONAL REGISTRATION 0944981 DATED 11-8-2007, EXPIRES 11-8-2017.

SER. NO. 79-046,815, FILED 11-8-2007.

ODESSA BIBBINS, EXAMINING ATTORNEY

**Int. Cl.: 5**

**Prior U.S. Cls.: 6, 18, 44, 46, 51 and 52**

**United States Patent and Trademark Office**

**Reg. No. 3,505,589**

**Registered Sep. 23, 2008**

**TRADEMARK  
PRINCIPAL REGISTER**

**TPS**

IDL BIOTECH AB (SWEDEN LIMITED LIABILITY COMPANY)

BOX 111 51

SE-168 11 BROMMA

SWEDEN

FOR: DIAGNOSTIC PRODUCTS, NAMELY, TUMOR CELL ACTIVITY MARKER FOR PROGNOSIS, MONITORING AND FOLLOW-UP OF CANCER PATIENTS, IN CLASS 5 (U.S. CLS. 6, 18, 44, 46, 51 AND 52).

THE MARK CONSISTS OF STANDARD CHARACTERS WITHOUT CLAIM TO ANY PARTICULAR FONT, STYLE, SIZE, OR COLOR.

OWNER OF INTERNATIONAL REGISTRATION 0944982 DATED 10-29-2007, EXPIRES 10-29-2017.

OWNER OF U.S. REG. NO. 1,909,690.

SER. NO. 79-046,816, FILED 10-29-2007.

PRISCILLA MILTON, EXAMINING ATTORNEY

Int. Cls.: 25 and 28

Prior U.S. Cls.: 22, 23, 38, 39 and 50

Reg. No. 3,505,590

United States Patent and Trademark Office

Registered Sep. 23, 2008

**TRADEMARK  
PRINCIPAL REGISTER**



CHAPMAN ENTERTAINMENT LIMITED (UNITED KINGDOM PRIVATE LIMITED COMPANY)  
THE PAVILION,  
90 POINT PLEASANT,; WANDSWORTH; LONDON  
SW18 1NN  
UNITED KINGDOM

FOR: CLOTHING, NAMELY, APRONS, BANDANAS, BATH ROBES, BATHING SUITS, BATHING TRUNKS, BELTS, BIBS, NAMELY, CLOTH BIBS, CHILDREN'S AND INFANT'S CLOTH EATING BIBS, COATS, FANCY DRESS COSTUMES, DRESSING GOWNS, DRESSES, GLOVES, JACKETS, JERSEYS, JUMPERS, LEGGINGS, MONEY BELTS, NECKTIES, PANTS, PAJAMAS, OVERCOATS, SCARVES, SHAWLS, SHIRTS, SOCKS, TEE SHIRTS, SHORTS, SWEATERS, SKIRTS, TIGHTS, TROUSERS, UNDERWEAR; FOOTWEAR; HEADWEAR, IN CLASS 25 (U.S. CLS. 22 AND 39).

FOR: TOY GARDENING SETS; TOY BUCKETS AND SPADES; ACTION FIGURES; ACTION FIGURE ACCESSORIES AND PLAYSETS THEREFOR, INCLUDING ENVIRONMENTS, NAMELY, SCALED MODELS OF SCENERY FROM AN ANIMATED CARTOON SERIES, INCLUDING TOY RACE TRACKS; BUBBLE MAKING WAND AND SOLUTION SETS; BALLOONS; BALLS, NAMELY, PLAYGROUND BALLS AND RUBBER BALLS, SOCCER BALLS, RUGBY BALLS, BALLS FOR RACKET GAMES, AND JUGGLING BALLS; BATTERY OPERATED ACTION TOYS; BOARD GAMES; TOY BUILDING BLOCKS; BUILDING GAMES; CARD GAMES; CHRISTMAS TREE ORNAMENTS AND DECORATION; CLOTHES FOR DOLLS OR SOFT TOYS; DOLL ACCESSORIES; DOLLS; DOLL'S

PRAMS; GAMES, NAMELY, ACTION SKILL GAMES, ARCADE GAMES, ELECTRONIC EDUCATIONAL GAME MACHINES FOR CHILDREN, LCD GAME MACHINES; GYMNAS TIC ARTICLES AND SPORTING ARTICLES, NAMELY, BEAMS, BENCHES, BALLS AND RINGS FOR GYMNAS TIC, RACKETS FOR RACKET GAMES, NAMELY, TENNIS, BADMINTON, SQUASH AND RACKETBALL; HAND PUPPETS; INFANT RATTLES; INFANT ACTION CRIB TOYS; JIGSAW PUZZLES; KITES; MANIPULATIVE PUZZLES; TOY MASKS; TOY MOBILES; TOY MODEL VEHICLES; TOY APPARATUS FOR USE WITH MODELLING COMPOUND, NAMELY, TOY MOULDS AND TOY CUTTERS FOR MODELLING COMPOUND; HOBBY CRAFT SETS FOR PAINTING AND DECORATING BALLOONS, CLOTHING AND TABLEWARE; NOVELTIES FOR PARTIES, NAMELY, PARTY FAVORS IN THE NATURE OF SMALL TOYS; PLAYING CARDS; PLUSH TOYS; PUPPETS; PUZZLES; RIDE ON TOYS; SANDBOXES; PLAYGROUND EQUIPMENT, NAMELY, SLIDES, SWIMMING AIDS, NAMELY, POOL RINGS AND WATER WINGS; INFLATABLE SWIMMING POOLS; BATH TOYS; POOL TOYS, NAMELY, FLOATING ACTION FIGURES; WATER SQUIRTING TOYS; SKATEBOARDS, ICE SKATES, SKIS, FLYING DISCS, HOCKEY STICKS, SNOW SLEDS; BUBBLE MAKING SOAP BUBBLE SOLUTION; SOFT SCULPTED TOY FIGURES; TOY BAKE WARE; TOY BANKS; TOY COOKWARE; TOY FIGURES; TOY TOOLS, TOY TOOL BELTS, TOY HARD HATS; TOY VEHICLES; TOY TRICYCLES; PAPER PARTY HATS, IN CLASS 28 (U.S. CLS. 22, 23, 38 AND 50).

PRIORITY DATE OF 5-9-2007 IS CLAIMED.

OWNER OF INTERNATIONAL REGISTRATION  
0945125 DATED 7-18-2007, EXPIRES 7-18-2017.

SER. NO. 79-046,861, FILED 7-18-2007.  
KEVIN CORWIN, EXAMINING ATTORNEY

**Int. Cl.: 7**

**Prior U.S. Cls.: 13, 19, 21, 23, 31, 34 and 35**

**United States Patent and Trademark Office**

**Reg. No. 3,505,591**

**Registered Sep. 23, 2008**

**TRADEMARK  
PRINCIPAL REGISTER**

**Monte-Bianco**

MONTE-BIANCO DIAMOND APPLICATIONS  
CO., LTD. (CHINA CORPORATION)  
NO. 7, XINGYE BA ROAD, GUANGLONG  
INDUSTRIAL PARK, CHENCUN TOWN,; SHUNDE  
DISTRICT, FOSHAN CITY; GUANGDONG PRO-  
VINCE  
CHINA

FOR: MILLSTONES; GRINDSTONES; ELECTRIC  
POLISHING MACHINES FOR USE IN GRINDING  
AND POLISHING METAL, WOOD, CERAMICS  
AND PLASTICS; MINING DRILL SHARPENERS;  
CUTTING MACHINES; ELECTRIC KNIVES; MA-  
CHINE PARTS, NAMELY, BLADES; POWER OPER-  
ATED SHARPENERS; STROPPING MACHINES,  
NAMELY, POWER OPERATED KNIFE SHARPEN-  
ERS; TOOLS, NAMELY, DIAMOND-POINTED MET-  
AL CUTTING TOOLS; APPARATUS FOR  
DRESSING, NAMELY, MACHINES UTILIZING RO-

TATIONAL MOTION FOR HIGH ENERGY SUR-  
FACE FINISHING AND MATERIAL TREATMENT;  
GLAZIERS' DIAMONDS, NAMELY, POWER OPER-  
ATED DIAMOND-POINTED GLASS CUTTING  
TOOLS, IN CLASS 7 (U.S. CLS. 13, 19, 21, 23, 31, 34  
AND 35).

OWNER OF INTERNATIONAL REGISTRATION  
0945126 DATED 8-6-2007, EXPIRES 8-6-2017.

THE FOREIGN WORDING IN THE MARK  
TRANSLATES INTO ENGLISH AS "WHITE MOUN-  
TAIN".

SER. NO. 79-046,862, FILED 8-6-2007.

DOMINIC FATHY, EXAMINING ATTORNEY

**Int. Cl.: 32**

**Prior U.S. Cls.: 45, 46 and 48**

**Reg. No. 3,505,592**

**United States Patent and Trademark Office**

**Registered Sep. 23, 2008**

**TRADEMARK  
PRINCIPAL REGISTER**



IRIS SCHACHINGER (AUSTRIA INDIVIDUAL)  
PIELGASSE 62  
A-7023 PÖTTELSDORF  
AUSTRIA

OWNER OF INTERNATIONAL REGISTRATION  
0945163 DATED 10-3-2007, EXPIRES 10-3-2017.

FOR: NON-ALCOHOLIC BEVERAGES, NAMELY,  
CARBONATED BEVERAGES, IN CLASS 32 (U.S.  
CLS. 45, 46 AND 48).

SER. NO. 79-046,876, FILED 10-3-2007.

PRIORITY DATE OF 4-4-2007 IS CLAIMED.

ANDREW RHIM, EXAMINING ATTORNEY



**Int. Cls.: 29 and 31**

**Prior U.S. Cls.: 1 and 46**

**United States Patent and Trademark Office**

**Reg. No. 3,505,593**

**Registered Sep. 23, 2008**

**TRADEMARK  
PRINCIPAL REGISTER**

**MOZZARELLA & FRIENDS**

MACCAFERRI PAOLO (ITALY INDIVIDUAL)  
VIA GUIDO ROSSA, 3/A  
I-43030 SAN MARTINO SINZANO (PR)  
ITALY AND  
ROZZI ROBERTO (ITALY INDIVIDUAL)  
STRADA BERGONZI, 42  
I-43040 VICOFERTILE (PR)  
ITALY

FOR: MEAT; FISH PRODUCTS, NAMELY, FISH;  
NOT LIVE MOLLUSCS AND CRUSTACEANS;  
POULTRY AND GAME; MEAT EXTRACTS; TIN-  
NED MEAT; PRESERVED, DRIED AND COOKED  
FRUITS AND VEGETABLES; JELLIES; JAMS; EGGS;  
MILK; DAIRY PRODUCTS EXCLUDING ICE  
CREAM, ICE MIL AND FROZEN YOGURT; MILK-  
BASED PRODUCTS, NAMELY, MILK BASED BEV-  
ERAGES CONTAINING COFFEE; CHEESES; BUT-  
TER; YOGURTS; BEVERAGES MADE WITH MILK;  
EDIBLE OILS AND FATS; VEGETABLES WITH  
VINEGAR; TINNED FRUITS; TINNED VEGETA-  
BLES; TINNED MEAT; CANNED FISH, IN CLASS 29  
(U.S. CL. 46).

FOR: AGRICULTURAL, HORTICULTURAL  
AND FORESTRY PRODUCTS, NAMELY, SEEDS;

UNPROCESSED GRAINS; UNSAWN TIMBER; LIVE  
ANIMALS; FRESH FRUITS AND VEGETABLES;  
SEEDS FOR FRUIT AND VEGETABLES; NATURAL  
PLANTS AND FLOWERS; ANIMAL FEED; MALT  
FOR BREWING AND DISTILLING, IN CLASS 31  
(U.S. CLS. 1 AND 46).

PRIORITY DATE OF 9-18-2007 IS CLAIMED.

OWNER OF INTERNATIONAL REGISTRATION  
0945331 DATED 11-7-2007, EXPIRES 11-7-2017.

NO CLAIM IS MADE TO THE EXCLUSIVE  
RIGHT TO USE "MOZZARELLA", APART FROM  
THE MARK AS SHOWN.

THE MARK CONSISTS OF THE INSCRIPTION  
"MOZZARELLA & FRIENDS" IN SPECIAL CHAR-  
ACTERS.

SER. NO. 79-046,933, FILED 11-7-2007.

DANIEL BRODY, EXAMINING ATTORNEY

Int. Cl.: 20

Prior U.S. Cls.: 2, 13, 22, 25, 32 and 50

Reg. No. 3,505,594

United States Patent and Trademark Office

Registered Sep. 23, 2008

TRADEMARK  
PRINCIPAL REGISTER



HANGZHOU SHENGSHENG; BAMBOO & WOOD  
CRAFT CO., LTD. (CHINA CORPORATION)  
BAIZHANG TOWN  
YUHANG DISTRICT, HANGZHOU; 311118 ZHE-  
JIANG  
CHINA

FOR: BAMBOO BLINDS; FURNITURE; REEDS  
BEING RAW OR PARTLY WORKED MATERIAL;  
WINDOW SHADES, IN CLASS 20 (U.S. CLS. 2, 13, 22,  
25, 32 AND 50).

OWNER OF INTERNATIONAL REGISTRATION  
0945659 DATED 11-15-2007, EXPIRES 11-15-2017.

THE WORDING "SHENG SHENG" HAS NO  
MEANING IN A FOREIGN LANGUAGE.

THE NON-LATIN CHARACTERS IN THE MARK  
TRANSLITERATE TO "SHENG SHENG" AND THIS  
HAS NO MEANING IN ENGLISH.

SER. NO. 79-047,059, FILED 11-15-2007.

ROBERT STRUCK, EXAMINING ATTORNEY

Int. Cl.: 28

Prior U.S. Cls.: 22, 23, 38 and 50

United States Patent and Trademark Office

Reg. No. 3,505,595

Registered Sep. 23, 2008

TRADEMARK  
PRINCIPAL REGISTER



CAI SHAOYANG (CHINA INDIVIDUAL)  
DONGYUAN ROAD, DONGHU  
FENGXIANG STREET,; CHENGAI DISTRICT,;  
SHANTOU CITY; GUANGDONG PROVINCE  
CHINA

FOR: TOYS, NAMELY, BOARD GAMES, WATER  
SQUIRTING TOYS, DRAWING TOYS; TOY VEHI-  
CLES; TOY BUILDING BLOCKS; TOY MINI-CARS;  
PLAYTHINGS, NAMELY, RATTLES; TOY PISTOLS;  
TOY FLYING DISCS; INTELLIGENT TOYS, NAME-

LY, ELECTRONIC EDUCATIONAL GAME MA-  
CHINES FOR CHILDREN; TOY MOBILES, IN  
CLASS 28 (U.S. CLS. 22, 23, 38 AND 50).

OWNER OF INTERNATIONAL REGISTRATION  
0945660 DATED 11-15-2007, EXPIRES 11-15-2017.

SER. NO. 79-047,060, FILED 11-15-2007.

DAYNA BROWNE, EXAMINING ATTORNEY

**Int. Cl.: 19**

**Prior U.S. Cls.: 1, 12, 33 and 50**

**United States Patent and Trademark Office**

**Reg. No. 3,505,596**

**Registered Sep. 23, 2008**

**TRADEMARK  
PRINCIPAL REGISTER**

**BLUTILE**

BLU CERAMIC S.P.A. (ITALY JOINT STOCK  
COMPANY)  
VIA SAN NICOLA, 16  
I-85025 MELFI (PZ), ITALY

FOR: CERAMIC TILES FOR FLOORING AND  
COVERINGS, IN CLASS 19 (U.S. CLS. 1, 12, 33 AND  
50).

THE MARK CONSISTS OF STANDARD CHAR-  
ACTERS WITHOUT CLAIM TO ANY PARTICULAR  
FONT, STYLE, SIZE, OR COLOR.

PRIORITY DATE OF 10-16-2007 IS CLAIMED.

OWNER OF INTERNATIONAL REGISTRATION  
0945730 DATED 10-16-2007, EXPIRES 10-16-2017.

SER. NO. 79-047,091, FILED 10-16-2007.

JAMES STEIN, EXAMINING ATTORNEY

**Int. Cl.: 29**

**Prior U.S. Cl.: 46**

**Reg. No. 3,505,597**

**United States Patent and Trademark Office**

**Registered Sep. 23, 2008**

**TRADEMARK  
PRINCIPAL REGISTER**

**DARLING SPUDS**

**POTATO CHIPS**

SALTY DOG BRANDS LIMITED (UNITED  
KINGDOM COMPANY)  
THE ALMHOUSE, ELLESBOROUGH ROAD  
BUTLERS CROSS, BUCKINGHAMSHIRE HP17 0XG  
UNITED KINGDOM

FOR: POTATO CRISPS, MIXED VEGETABLE  
CRISPS, SWEET POTATO CRISPS, PARSNIP CRISPS,  
BEETROOT CRISPS, IN CLASS 29 (U.S. CL. 46).

OWNER OF INTERNATIONAL REGISTRATION  
0946226 DATED 11-20-2007, EXPIRES 11-20-2017.

NO CLAIM IS MADE TO THE EXCLUSIVE  
RIGHT TO USE "SPUDS" AND "POTATO CHIPS",  
APART FROM THE MARK AS SHOWN.

SER. NO. 79-047,269, FILED 11-20-2007.

JAY FLOWERS, EXAMINING ATTORNEY

**Int. Cl.: 6**

**Prior U.S. Cls.: 2, 12, 13, 14, 23, 25 and 50**

**Reg. No. 3,505,598**

**United States Patent and Trademark Office**

**Registered Sep. 23, 2008**

**TRADEMARK  
PRINCIPAL REGISTER**

# AVINS

AVINS INTERNATIONAL AG (SWITZERLAND CORPORATION)  
WEIDENSTRASSE 50  
CH-4143 DORNACH, SWITZERLAND

FOR: COMMON METALS AND THEIR ALLOYS, NAMELY, BRASS, COPPER, BRONZE, NICKEL-COPPER, NICKEL-SILVER, ALFENIDE, TIN-BRASS, COPPER-TELLURIUM, BRONZE-PHOSPHORUS, BRONZE-TIN, BRONZE-ALUMINIUM, BRONZE-NICKEL-ALUMINIUM, COPPER-NICKEL-SILICON, FERROCOPPER, COPPER-BERYLIUM, COPPER-NICKEL-PHOSPHORUS, COPPER-CHROME, COPPER-ZIRCONIUM, COPPER-NICKEL-TIN, BRONZE-SILICON, COPPER-SILICON, SILVER COPPER, BRONZE-MANGANESE, STEEL, STAINLESS STEEL, CARBON STEEL, ALUMINIUM, TITANIUM, NICKEL; SEMI-MANUFACTURED PRODUCTS OF COMMON METAL AND THEIR ALLOYS, NAMELY, SHEET METAL; METAL BUILDING MATERIALS, NAMELY, SOFFITS, FASCIA, REINFORCING MATERIALS; MATERIALS OF METAL FOR RAILWAY TRACKS; NON-ELECTRIC CABLES AND WIRES OF METAL; PIPES OF METAL; METAL TUBES; METAL BARS FOR LATCHES

AND RAILINGS; METALLIC POLES AND MASTS; METAL RINGS, NAMELY, KEY RINGS, SCREW RINGS; SEMI-MANUFACTURED PRODUCTS OF METAL, NAMELY, METAL STRIPS, METAL SECTIONS, SHEETING OF METAL; METALLIC FORGED OBJECTS, NAMELY, SCREWS, EXPANDING SLEEVES FOR AFFIXING SCREWS; ORES, NAMELY, IRON ORE, IN CLASS 6 (U.S. CLS. 2, 12, 13, 14, 23, 25 AND 50).

THE MARK CONSISTS OF STANDARD CHARACTERS WITHOUT CLAIM TO ANY PARTICULAR FONT, STYLE, SIZE, OR COLOR.

PRIORITY DATE OF 3-14-2007 IS CLAIMED.

OWNER OF INTERNATIONAL REGISTRATION 0946304 DATED 9-13-2007, EXPIRES 9-13-2017.

SER. NO. 79-047,301, FILED 9-13-2007.

ANDREA HACK, EXAMINING ATTORNEY

Int. Cls.: 20 and 24

Prior U.S. Cls.: 2, 13, 22, 25, 32, 42 and 50

United States Patent and Trademark Office

Reg. No. 3,505,599

Registered Sep. 23, 2008

TRADEMARK  
PRINCIPAL REGISTER



SILIK SPA (ITALY CORPORATION)  
VIA ANGLIERI, 10  
I-22060 VIGHIZZOLO DI CANTU'  
ITALY

FOR: FURNITURE, INCLUDING FURNITURE MADE OF POLYURETHANE, SOFAS, ARM-CHAIRS, BENCHES, CHAIRS, EASY CHAIRS, CUPBOARDS, SMALL FURNITURE, CHESTS OF DRAWERS, KITCHEN CABINETS, DRESSERS, NIGHT TABLES, LIBRARY SHELVES, TABLES AND SMALL TABLES; BEDS; MIRRORS AND PICTURE FRAMES, IN CLASS 20 (U.S. CLS. 2, 13, 22, 25, 32 AND 50).

FOR: TEXTILES, NAMELY, PAINTED AND UNPAINTED TEXTILE FABRICS FOR HOME AND

COMMERCIAL INTERIORS; BED COVERS; BED AND TABLE LINEN, IN CLASS 24 (U.S. CLS. 42 AND 50).

OWNER OF INTERNATIONAL REGISTRATION 0927346 DATED 2-23-2007, EXPIRES 2-23-2017.

THE FOREIGN WORDING IN THE MARK TRANSLATES INTO ENGLISH AS "CREATIONS – THE FANTASY IS FURNITURE."

SER. NO. 79-047,385, FILED 11-20-2007.

DAYNA BROWNE, EXAMINING ATTORNEY

**Int. Cl.: 14**

**Prior U.S. Cls.: 2, 27, 28 and 50**

**United States Patent and Trademark Office**

**Reg. No. 3,505,600**

**Registered Sep. 23, 2008**

**TRADEMARK  
PRINCIPAL REGISTER**

# ETERNA MADISON

ETERNA AG UHRENFABRIK; (ETERNA SA  
FABRIQUE D'HORLOGERIE); (ETERNA LTD  
WATCH FACTORY) (SWITZERLAND COR-  
PORATION)

SCHÜTZENGASSE 46  
CH-2540 GRENCHEN  
SWITZERLAND

FOR: HOROLOGICAL AND CHRONOMETRIC  
INSTRUMENTS, IN CLASS 14 (U.S. CLS. 2, 27, 28  
AND 50).

THE MARK CONSISTS OF STANDARD CHAR-  
ACTERS WITHOUT CLAIM TO ANY PARTICULAR  
FONT, STYLE, SIZE, OR COLOR.

OWNER OF INTERNATIONAL REGISTRATION  
0946628 DATED 11-2-2007, EXPIRES 11-2-2017.

OWNER OF U.S. REG. NOS. 136,798, 554,609 AND  
OTHERS.

THE ENGLISH TRANSLATION OF "ETERNA" IN  
THE MARK IS ETERNAL. THE WORD "MADISON"  
HAS NO MEANING IN A FOREIGN LANGUAGE.

SER. NO. 79-047,419, FILED 11-2-2007.

CIMMERIAN COLEMAN, EXAMINING ATTOR-  
NEY



**Int. Cl.: 14**

**Prior U.S. Cls.: 2, 27, 28 and 50**

**United States Patent and Trademark Office**

**Reg. No. 3,505,601**

**Registered Sep. 23, 2008**

**TRADEMARK  
PRINCIPAL REGISTER**

**ETERNA VAUGHAN**

ETERNA AG UHRENFABRIK; (ETERNA SA  
FABRIQUE D'HORLOGERIE); (ETERNA LTD  
WATCH FACTORY) (SWITZERLAND COR-  
PORATION)

SCHÜTZENGASSE 46  
CH-2540 GRENCHE  
SWITZERLAND

FOR: HOROLOGICAL AND CHRONOMETRIC  
INSTRUMENTS, IN CLASS 14 (U.S. CLS. 2, 27, 28  
AND 50).

THE MARK CONSISTS OF STANDARD CHAR-  
ACTERS WITHOUT CLAIM TO ANY PARTICULAR  
FONT, STYLE, SIZE, OR COLOR.

OWNER OF INTERNATIONAL REGISTRATION  
0946629 DATED 11-2-2007, EXPIRES 11-2-2017.

OWNER OF U.S. REG. NOS. 136,798, 554,609 AND  
OTHERS.

THE ENGLISH TRANSLATION OF "ETERNA" IN  
THE MARK IS ETERNAL. THE WORD "VAUGH-  
AN" HAS NO MEANING IN THE FOREIGN LAN-  
GUAGE.

SER. NO. 79-047,420, FILED 11-2-2007.

CIMMERIAN COLEMAN, EXAMINING ATTOR-  
NEY

**Int. Cls.: 1 and 17**

**Prior U.S. Cls.: 1, 5, 6, 10, 12, 13, 26, 35, 46 and 50**

**United States Patent and Trademark Office**

**Reg. No. 3,505,602**

**Registered Sep. 23, 2008**

**TRADEMARK  
PRINCIPAL REGISTER**

**Xmod**

BOREALIS AG (AUSTRIA CORPORATION)  
IZD TOWER, WAGRAMERSTR. 17-19  
VIENNA, AUSTRIA A1220

FOR: UNPROCESSED ARTIFICIAL OR SYNTHETIC RESINS; UNPROCESSED PLASTICS; UNPROCESSED PLASTICS IN PELLET FORM; POLYETHYLENE RESINS; POLYPROPYLENE RESINS; POLYOLEFIN RESINS, IN CLASS 1 (U.S. CLS. 1, 5, 6, 10, 26 AND 46).

FOR: SEMI-PROCESSED PLASTIC IN THE FORM OF FILMS, SHEETS, TUBES, BARS, RODS OR FIBERS; PLASTICS IN EXTRUDED FORM USED IN PRODUCTION OF PLASTIC PRODUCTS; SYNTHETIC RESINS IN EXTRUDED FORM, OR IN BARS, BLOCKS, PELLETS, RODS, SHEETS AND

TUBES, AS SEMI-FINISHED PRODUCTS ALL FOR GENERAL INDUSTRIAL USE; SEMI-FINISHED PRODUCTS, NAMELY, SEMI-FINISHED ACRYLIC MOLDED PLASTIC SUBSTANCES, FOR USE IN MAKING PLASTIC PRODUCTS, IN CLASS 17 (U.S. CLS. 1, 5, 12, 13, 35 AND 50).

PRIORITY DATE OF 11-20-2007 IS CLAIMED.

OWNER OF INTERNATIONAL REGISTRATION 0946777 DATED 11-22-2007, EXPIRES 11-22-2017.

SER. NO. 79-047,481, FILED 11-22-2007.

ALYSSA PALADINO, EXAMINING ATTORNEY

**Int. Cls.: 1 and 17**

**Prior U.S. Cls.: 1, 5, 6, 10, 12, 13, 26, 35, 46 and 50**

**United States Patent and Trademark Office**

**Reg. No. 3,505,603**

**Registered Sep. 23, 2008**

**TRADEMARK  
PRINCIPAL REGISTER**

**BORSEAL**

BOREALIS AG (AUSTRIA AKTIENGESELL-  
SCHAFT)  
IZD TOWER, WAGRAMERSTR. 17-19  
VIENNA, AUSTRIA A1220

FOR: UNPROCESSED ARTIFICIAL OR SYN-  
THETIC RESINS; UNPROCESSED PLASTICS IN  
PELLET FORM; POLYETHYLENE RESINS; POLY-  
PROPYLENE RESINS; POLYOLEFIN RESINS, IN  
CLASS 1 (U.S. CLS. 1, 5, 6, 10, 26 AND 46).

FOR: SEMI-PROCESSED PLASTIC IN THE FORM  
OF FILMS, SHEETS, TUBES, BARS, RODS OR  
FIBRES; PLASTICS IN EXTRUDED FORM USED  
IN PRODUCTION OF PLASTIC PRODUCTS; SYN-  
THETIC RESINS IN EXTRUDED FORM, OR IN

BARS, BLOCKS, PELLETS, RODS, SHEETS AND  
TUBES, AS SEMI-FINISHED PRODUCTS ALL FOR  
GENERAL INDUSTRIAL USE; SEMI-FINISHED  
PRODUCTS, NAMELY, SEMI-FINISHED ACRYLIC  
MOLDED PLASTIC SUBSTANCE, FOR MAKING  
PLASTIC PRODUCTS, IN CLASS 17 (U.S. CLS. 1, 5,  
12, 13, 35 AND 50).

OWNER OF INTERNATIONAL REGISTRATION  
0946778 DATED 11-22-2007, EXPIRES 11-22-2017.

SER. NO. 79-047,482, FILED 11-22-2007.

ALYSSA PALADINO, EXAMINING ATTORNEY

Int. Cls.: 9, 16 and 42

Prior U.S. Cls.: 2, 5, 21, 22, 23, 26, 29, 36, 37, 38, 50,  
100 and 101

Reg. No. 3,505,604

United States Patent and Trademark Office

Registered Sep. 23, 2008

TRADEMARK  
SERVICE MARK  
PRINCIPAL REGISTER



F.M. SYSTEMS LTD (IRELAND A LIMITED  
COMPANY)  
2 LEOPARDSTOWN OFFICE PARK  
FOXROCK; DUBLIN 18  
IRELAND

FOR: FINANCIAL AND INSURANCE RELATED COMPUTER SOFTWARE AND PROGRAMS, NAMELY, SOFTWARE FOR SHARING, ACCESSING AND COMMUNICATING INFORMATION OVER COMPUTER NETWORKS; COMPUTER SOFTWARE PROGRAMS FOR THE CREATION, AUTOMATION, ELECTRONIC DISSEMINATION OF FINANCIAL AND INSURANCE RELATED SERVICE PRODUCTS, AND INSTRUCTION MANUALS SOLD AS A UNIT THEREWITH; SOFTWARE FOR INTERNET ENABLED ELECTRONIC COMMERCE, NAMELY, COMPUTER NETWORK CONNECTION SOFTWARE PROGRAMS FOR INSURANCE AND FINANCIAL SERVICE COMPANIES AND RELATED ENTITIES TO ENABLE ELECTRONIC COMMERCE VIA A GLOBAL COMPUTER NETWORK, AND INSTRUCTION MANUALS SOLD AS A UNIT THEREWITH; COMPACT DISCS FEATURING DATA AND INFORMATION IN THE FIELD OF INSURANCE AND FINANCIAL SERVICE PRODUCTS, AND INSTRUCTION MANUALS SOLD AS A UNIT THEREWITH; PRERECORDED MAGNETIC DATA CARRIERS FEATURING INSURANCE AND FINANCIAL INFORMATION, AND INSTRUCTION MANUALS SOLD AS A UNIT THEREWITH; DOWNLOADABLE PUBLICATIONS, NAMELY, NEWSLETTERS, MAGAZINES, INFORMATIONAL BROCHURES, MANUALS, AND BOOKS IN ELECTRONIC FORM OVER A COMPUTER WEB SITE, ALL IN THE FIELD OF INSURANCE AND FINANCIAL SERVICE PRODUCTS; ELECTRONIC PUBLICATIONS, NAMELY, ELECTRONIC USER MANUALS FEATURING INFORMATION ON INSURANCE AND FINANCIAL SERVICE PRODUCTS

RECORDED ON COMPUTER MEDIA; COMPUTER SOFTWARE AND APPARATUS, NAMELY, COMPUTER HARDWARE, TO ENABLE CONNECTION TO DATABASES AND THE INTERNET FOR ACCESSING AND DISSEMINATING INSURANCE AND FINANCIAL AND RELATED SERVICE PRODUCTS, AND INSTRUCTION MANUALS SOLD AS A UNIT THEREWITH, IN CLASS 9 (U.S. CLS. 21, 23, 26, 36 AND 38).

FOR: PRINTED INSTRUCTIONAL AND TEACHING MATERIAL EXCEPT APPARATUS IN THE FIELD OF INSURANCE AND FINANCIAL SERVICE INFORMATION AND PRODUCTS; PRINTED EDUCATIONAL PUBLICATIONS, NAMELY, USER GUIDES, REFERENCE GUIDES, AND INSTRUCTION MANUALS IN THE FIELD OF INSURANCE AND FINANCIAL SERVICES, IN CLASS 16 (U.S. CLS. 2, 5, 22, 23, 29, 37, 38 AND 50).

FOR: COMPUTER CONSULTING SERVICES; DESIGN OF COMPUTER SOFTWARE; COMPUTER PROGRAMMING; MAINTENANCE AND UPDATING OF COMPUTER SOFTWARE; DESIGN, CREATION AND MAINTENANCE OF WEB PAGES ON THE INTERNET; PROFESSIONAL CONSULTANCY IN THE FIELD OF COMPUTER BASED INFORMATION SYSTEMS RELATING TO INSURANCE AND FINANCIAL SERVICES, IN CLASS 42 (U.S. CLS. 100 AND 101).

PRIORITY DATE OF 3-29-2007 IS CLAIMED.

OWNER OF INTERNATIONAL REGISTRATION  
0946911 DATED 7-25-2007, EXPIRES 7-25-2017.

OWNER OF U.S. REG. NO. 2,673,551.

SER. NO. 79-047,541, FILED 7-25-2007.

WILLIAM ROSSMAN, EXAMINING ATTORNEY

Int. Cl.: 33

Prior U.S. Cls.: 47 and 49

United States Patent and Trademark Office

Reg. No. 3,505,605

Registered Sep. 23, 2008

TRADEMARK  
PRINCIPAL REGISTER

白  
岳

TAKAHASHI SHUZO CO., LTD. (JAPAN CORPORATION)  
498, GOUNOHARU-MACHI  
HITAYOSHI-SHI; KUMAMOTO-KEN 868-0026  
JAPAN

FOR: DISTILLED SPIRIT, IN CLASS 33 (U.S. CLS. 47 AND 49).

OWNER OF INTERNATIONAL REGISTRATION  
0947414 DATED 10-16-2007, EXPIRES 10-16-2017.

THE ENGLISH TRANSLATION OF THE FOREIGN WORD(S) IN THE MARK IS WHITE MOUN-

TAIN. THE FIRST CHARACTER MEANS WHITE AND THE SECOND CHARACTER MEANS MOUNTAIN.

THE TRANSLITERATION OF THE NON-LATIN CHARACTERS IN THE MARK IS HAKUTAKE AND THIS MEANS WHITE MOUNTAIN.

SER. NO. 79-047,708, FILED 10-16-2007.

JAMES STEIN, EXAMINING ATTORNEY

**Int. Cl.: 25**

**Prior U.S. Cls.: 22 and 39**

**United States Patent and Trademark Office**

**Reg. No. 3,505,606**

**Registered Sep. 23, 2008**

**TRADEMARK  
PRINCIPAL REGISTER**

**TRACTECH RUBBER**

ECCO SKO A/S (DENMARK CORPORATION  
WITH LIMITED LIABILITY)  
INDUSTRIVEJ 5  
DK-6261 BREDEBRO  
DENMARK

OWNER OF INTERNATIONAL REGISTRATION  
0947466 DATED 11-26-2007, EXPIRES 11-26-2017.

FOR: SOLES FOR FOOTWEAR, IN CLASS 25 (U.S.  
CLS. 22 AND 39).

NO CLAIM IS MADE TO THE EXCLUSIVE  
RIGHT TO USE "RUBBER", APART FROM THE  
MARK AS SHOWN.

THE MARK CONSISTS OF STANDARD CHAR-  
ACTERS WITHOUT CLAIM TO ANY PARTICULAR  
FONT, STYLE, SIZE, OR COLOR.

SER. NO. 79-047,724, FILED 11-26-2007.

PRIORITY DATE OF 10-18-2007 IS CLAIMED.

KEVIN CORWIN, EXAMINING ATTORNEY

**Int. Cls.: 3, 9 and 14**

**Prior U.S. Cls.: 1, 2, 4, 6, 21, 23, 26, 27, 28, 36, 38, 50,  
51 and 52**

**Reg. No. 3,505,607**

**United States Patent and Trademark Office**

**Registered Sep. 23, 2008**

**TRADEMARK  
PRINCIPAL REGISTER**

**UMBRO**

UMBRO INTERNATIONAL LIMITED (UNITED  
KINGDOM COMPANY)  
UMBRO HOUSE, LAKESIDE  
CHEADLE, CHESHIRE SK8 3GQ  
UNITED KINGDOM

FOR: NON-MEDICATED TOILET PREPARA-  
TIONS, NAMELY, SOAPS, WATERS, PERFUMES;  
COSMETIC PREPARATIONS; SOAPS; ESSENTIAL  
OILS; PERFUME; COSMETIC PREPARATIONS FOR  
THE CARE OF TEETH; HAIR CARE PREPARA-  
TIONS; DEODORANTS FOR PERSONAL USE; AN-  
TIPERSPIRANTS; NON-MEDICATED  
PREPARATIONS ALL FOR THE CARE OF THE  
SKIN, HAIR AND SCALP; NON-MEDICATED SUN  
CARE PREPARATIONS; GELS FOR THE SHOWER;  
HAIR SHAMPOOS AND HAIR LOTIONS, IN CLASS  
3 (U.S. CLS. 1, 4, 6, 50, 51 AND 52).

FOR: MOTION PICTURE FILMS ABOUT SOCCER  
FOOTBALL; AUDIO AND VIDEO RECORDINGS  
FEATURING SOCCER FOOTBALL; COMPUTER

PROGRAMMES FOR USE IN THE PRESENTATION  
OF FILMS ABOUT SOCCER FOOTBALL; RADIOS,  
SUNGLASSES, SPECTACLE GLASSES, SPECTACLE  
FRAMES AND SPECTACLE CASES, IN CLASS 9  
(U.S. CLS. 21, 23, 26, 36 AND 38).

FOR: HOROLOGICAL AND CHRONOMETRIC  
INSTRUMENTS; WATCHES AND CLOCKS;  
WATCH BANDS AND WATCH STRAPS; JEWELRY,  
IN CLASS 14 (U.S. CLS. 2, 27, 28 AND 50).

OWNER OF INTERNATIONAL REGISTRATION  
0947709 DATED 11-5-2007, EXPIRES 11-5-2017.

OWNER OF U.S. REG. NOS. 1,359,276, 2,319,330  
AND OTHERS.

SER. NO. 79-047,817, FILED 11-5-2007.

GEOFFREY FOSDICK, EXAMINING ATTORNEY



**Int. Cls.: 1 and 17**

**Prior U.S. Cls.: 1, 5, 6, 10, 12, 13, 26, 35, 46 and 50**

**United States Patent and Trademark Office**

**Reg. No. 3,505,608**

**Registered Sep. 23, 2008**

**TRADEMARK  
PRINCIPAL REGISTER**

# AERONITE

DSM IP ASSETS B.V. (NETHERLANDS BESLO-  
TEN VENNOOTSCHAP)  
HET OVERLOON 1  
NL-6411 TE HEERLEN  
NETHERLANDS

FOR: UNPROCESSED SYNTHETIC RESINS; UN-  
PROCESSED THERMOSETTING RESINS; ALL  
AFOREMENTIONED GOODS EXCLUSIVELY IN-  
TENDED FOR THE AVIATION INDUSTRY, IN  
CLASS 1 (U.S. CLS. 1, 5, 6, 10, 26 AND 46).

FOR: SEMI-PROCESSED SYNTHETIC RESINS;  
SEMI-PROCESSED THERMOSETTING RESINS;  
SEMI-PROCESSED SYNTHETIC RESINS IN THE  
FORM OF FOILS, SHEETS, PROFILES AND LAMI-  
NATES; SEMI-PROCESSED THERMOSETTING RE-  
SINS IN THE FORM OF FOILS, SHEETS, PROFILES  
AND LAMINATES; SEMI-PROCESSED COMPO-  
SITES BASED ON FIBRE-REINFORCED SYNTHET-  
IC MATERIALS; SEMI-PROCESSED COMPOSITES  
BASED ON FIBRE-REINFORCED THERMOSET-

TING RESINS; RODS AND FLEXIBLE TUBES  
MADE OF THERMOSETTING RESINS AND SYN-  
THETIC RESINS, ALL AFOREMENTIONED GOODS  
EXCLUSIVELY INTENDED FOR THE AVIATION  
INDUSTRY, IN CLASS 17 (U.S. CLS. 1, 5, 12, 13, 35  
AND 50).

THE MARK CONSISTS OF STANDARD CHAR-  
ACTERS WITHOUT CLAIM TO ANY PARTICULAR  
FONT, STYLE, SIZE, OR COLOR.

PRIORITY DATE OF 6-7-2007 IS CLAIMED.

OWNER OF INTERNATIONAL REGISTRATION  
0948044 DATED 11-15-2007, EXPIRES 11-15-2017.

SER. NO. 79-047,960, FILED 11-15-2007.

CURTIS FRENCH, EXAMINING ATTORNEY

**Int. Cl.: 11**

**Prior U.S. Cls.: 13, 21, 23, 31 and 34**

**United States Patent and Trademark Office**

**Reg. No. 3,505,609**

**Registered Sep. 23, 2008**

**TRADEMARK  
PRINCIPAL REGISTER**

**AIRVAX**

IDEAVAX CO., LTD. (REPUBLIC OF KOREA  
INCORPORATED COMPANY)  
2 FL., SUHYEON BUILDING,  
517-34, SINSA-DONG., GANGNAM-GU; SEOUL 135-  
888  
REPUBLIC OF KOREA

FOR: AIR PURIFIERS; AIR STERILIZERS; AIR  
PURIFYING APPARATUS AND MACHINES; AIR  
DEODORIZING APPARATUS, NAMELY, ELEC-  
TRIC AIR DEODORIZERS; IONIZATION APPARA-  
TUS FOR TREATMENT OF AIR, NAMELY, AIR  
FILTERS FOR DOMESTIC USE; AIR FILTERING

INSTALLATIONS, IN CLASS 11 (U.S. CLS. 13, 21, 23,  
31 AND 34).

PRIORITY DATE OF 8-9-2007 IS CLAIMED.

OWNER OF INTERNATIONAL REGISTRATION  
0948346 DATED 9-5-2007, EXPIRES 9-5-2017.

SER. NO. 79-048,098, FILED 9-5-2007.

ROBERT STRUCK, EXAMINING ATTORNEY

**Int. Cls.: 7, 12 and 37**

**Prior U.S. Cls.: 13, 19, 21, 23, 31, 34, 35, 44, 100, 103  
and 106**

**Reg. No. 3,505,610**

**United States Patent and Trademark Office**

**Registered Sep. 23, 2008**

**TRADEMARK  
SERVICE MARK  
PRINCIPAL REGISTER**



TATRA, A.S. (CZECH REPUBLIC CORPORATION)  
CZ-742 21 KOPRIVNICE  
CZECH REPUBLIC

FOR: MOTORS AND ENGINES EXCEPT FOR LAND VEHICLES AND STRUCTURAL PARTS THEREFOR, IN CLASS 7 (U.S. CLS. 13, 19, 21, 23, 31, 34 AND 35).

FOR: VEHICLES FOR LOCOMOTION BY LAND, AIR OR WATER AND THEIR PARTS, NAMELY, MOTOR VEHICLES IN THE NATURE OF LAND VEHICLES AND THEIR PARTS, NAMELY, MOTORS AND ENGINES FOR LAND VEHICLES, AUTOMOBILE CHASSIS, AUTOMOBILE BODIES, GEARS FOR VEHICLES, GEARBOXES FOR MOTOR CARS, TRANSMISSIONS FOR LAND VEHICLES, TRANSMISSION CHAINS FOR LAND VEHICLES, TRANSMISSION SHAFTS FOR LAND VEHICLES, CLUTCHES FOR LAND VEHICLES, BRAKES FOR LAND VEHICLES, WHEEL HUBS, WHEEL RIMS, AXLES FOR LAND VEHICLES, AXLE BOOT KITS FOR USE WITH LAND VEHICLES, AXLE BEARINGS FOR LAND VEHICLES,

SUSPENSION SPRINGS FOR MOTOR CARS, TORSION BARS FOR MOTOR CARS, MUDGUARDS, RUNNING BOARDS, AUTOMOBILE BUMPERS, IN CLASS 12 (U.S. CLS. 19, 21, 23, 31, 35 AND 44).

FOR: REPAIR, MAINTENANCE, SERVICING OF MOTOR VEHICLES AND THEIR PARTS, ENGINES AND ACCESSORIES, NAMELY, AUTOMOBILE REPAIR AND MAINTENANCE, IN CLASS 37 (U.S. CLS. 100, 103 AND 106).

PRIORITY DATE OF 4-27-2007 IS CLAIMED.

OWNER OF INTERNATIONAL REGISTRATION 0949175 DATED 9-12-2007, EXPIRES 9-12-2017.

OWNER OF U.S. REG. NOS. 1,771,117 AND 1,940,509.

SER. NO. 79-048,370, FILED 9-12-2007.

ROBERT STRUCK, EXAMINING ATTORNEY

**Int. Cls.: 35 and 38**

**Prior U.S. Cls.: 100, 101, 102 and 104**

**United States Patent and Trademark Office**

**Reg. No. 3,505,611**

**Registered Sep. 23, 2008**

**SERVICE MARK  
PRINCIPAL REGISTER**

**PRIX FUTES**

REDCATS (SOCIÉTÉ ANONYME) (FRANCE SO-  
CIÉTÉ ANONYME)  
110 RUE DE BLANCHEMAILLE  
F-59100 ROUBAIX  
FRANCE

FOR: ADVERTISING, NAMELY, ADVERTISING  
AGENCY SERVICES; BUSINESS MANAGEMENT  
AND BUSINESS ADMINISTRATION FOR THIRD  
PARTIES, IN CLASS 35 (U.S. CLS. 100, 101 AND 102).

FOR: COMMUNICATION VIA COMPUTER  
TERMINALS; COMPUTER-ASSISTED TRANSMIS-  
SION OF MESSAGES AND IMAGES, IN CLASS 38  
(U.S. CLS. 100, 101 AND 104).

THE MARK CONSISTS OF STANDARD CHAR-  
ACTERS WITHOUT CLAIM TO ANY PARTICULAR  
FONT, STYLE, SIZE, OR COLOR.

OWNER OF INTERNATIONAL REGISTRATION  
0949249 DATED 10-30-2007, EXPIRES 10-30-2017.

THE FOREIGN WORDING IN THE MARK  
TRANSLATES INTO ENGLISH AS "SMART PRI-  
CES".

SER. NO. 79-048,402, FILED 10-30-2007.

KATHERINE CHANG, EXAMINING ATTORNEY

**Int. Cls.: 9 and 28**

**Prior U.S. Cls.: 21, 22, 23, 26, 36, 38 and 50**

**United States Patent and Trademark Office**

**Reg. No. 3,505,612**

**Registered Sep. 23, 2008**

**TRADEMARK  
PRINCIPAL REGISTER**

# Dino Meal

ADAR GOLAD (NETHERLANDS INDIVIDUAL)  
SCHERENENKWEG 16  
NL-8051 KH HATTEM  
NETHERLANDS

FOR: APPARATUS FOR RECORDING, TRANSMISSION OR REPRODUCTION OF SOUND OR IMAGES, IN CLASS 9 (U.S. CLS. 21, 23, 26, 36 AND 38).

FOR: GAMES, NAMELY, ACTION GAMES; PLAYTHINGS, NAMELY, EQUIPMENT SOLD AS A UNIT FOR PLAYING ACTION GAMES, IN CLASS 28 (U.S. CLS. 22, 23, 38 AND 50).

THE MARK CONSISTS OF STANDARD CHARACTERS WITHOUT CLAIM TO ANY PARTICULAR FONT, STYLE, SIZE, OR COLOR.

PRIORITY DATE OF 8-20-2007 IS CLAIMED.

OWNER OF INTERNATIONAL REGISTRATION 0949296 DATED 12-6-2007, EXPIRES 12-6-2017.

SER. NO. 79-048,413, FILED 12-6-2007.

MONIQUE MILLER, EXAMINING ATTORNEY

**Int. Cls.: 3, 9, 14 and 25**

**Prior U.S. Cls.: 1, 2, 4, 6, 21, 22, 23, 26, 27, 28, 36, 38, 39, 50, 51 and 52**

**Reg. No. 3,505,613**

**United States Patent and Trademark Office**

**Registered Sep. 23, 2008**

**TRADEMARK  
PRINCIPAL REGISTER**

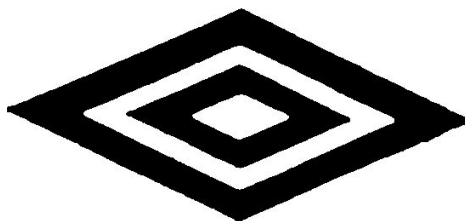

UMBRO INTERNATIONAL LIMITED (UNITED KINGDOM COMPANY)  
UMBRO HOUSE, LAKESIDE  
CHEADLE, CHESHIRE SK8 3GQ  
UNITED KINGDOM

FOR: NON-MEDICATED TOILET PREPARATIONS, NAMELY, SOAPS, WATERS, PERFUMES; COSMETIC PREPARATIONS; SOAPS; ESSENTIAL OILS; PERFUME; COSMETIC PREPARATIONS FOR THE CARE OF TEETH; HAIR CARE PREPARATIONS; DEODORANTS FOR PERSONAL USE; ANTIPERSPIRANTS; NON-MEDICATED PREPARATIONS ALL FOR THE CARE OF THE SKIN, HAIR AND SCALP; NON-MEDICATED SUN CARE PREPARATIONS; GELS FOR THE SHOWER; HAIR SHAMPOOS AND HAIR LOTIONS, IN CLASS 3 (U.S. CLS. 1, 4, 6, 50, 51 AND 52).

FOR: MOTION PICTURE FILMS ABOUT SOCCER FOOTBALL; AUDIO AND VIDEO RECORDINGS FEATURING SOCCER FOOTBALL; COMPUTER PROGRAMMES FOR USE IN THE PRESENTATION OF FILMS ABOUT SOCCER FOOTBALL; RADIOS, SUNGLASSES, SPECTACLE GLASSES, SPECTACLE FRAMES AND SPECTACLE CASES, IN CLASS 9 (U.S. CLS. 21, 23, 26, 36 AND 38).

FOR: HOROLOGICAL AND CHRONOMETRIC INSTRUMENTS; WATCHES AND CLOCKS;

WATCH BANDS AND WATCH STRAPS; JEWELRY, IN CLASS 14 (U.S. CLS. 2, 27, 28 AND 50).

FOR: ARTICLES OF CLOTHING, NAMELY, SHIRTS, SHORTS, PANTS, SWEAT SUITS, JACKETS, RAIN SUITS, SOCKS, T-SHIRTS, RUGBY SHIRTS, RUGBY SHORTS, FOOTBALL SHORTS, TRACK UNIFORMS, BOXING TRUNKS, UMPIRE COATS, WATER POLO CAPS, VESTS, SWIMMING TRUNKS, JERSEYS, PULLOVERS, TROUSERS, GOLF JACKETS, SPORTS STOCKINGS, BELTS, HATS, CAPS, RUGBY AND SOCCER JERSEYS, GOAL KEEPERS SWEATERS, SHORTS AND PANTS, SWEAT TOPS, POLO SHIRTS, GLOVES, FLEECE TOPS, TRACK SINGLET AND TRACK SHORTS, SHOWER JACKETS, TRAINING POLYESTER AND COTTON MIX BIBS, NAMELY, A GARMENT WORN OVER A TRAINING JERSEY; FOOTWEAR, IN CLASS 25 (U.S. CLS. 22 AND 39).

OWNER OF INTERNATIONAL REGISTRATION  
0949325 DATED 11-5-2007, EXPIRES 11-5-2017.

SER. NO. 79-048,423, FILED 11-5-2007.

GEOFFREY FOSDICK, EXAMINING ATTORNEY

**Int. Cls.: 14, 35 and 41**

**Prior U.S. Cls.: 2, 27, 28, 50, 100, 101, 102 and 107**

**United States Patent and Trademark Office**

**Reg. No. 3,505,614**

**Registered Sep. 23, 2008**

**TRADEMARK  
SERVICE MARK  
PRINCIPAL REGISTER**



ROBERTO COIN S.P.A. (ITALY JOINT-STOCK CORPORATION)  
VIALE TRIESTE, 13  
I-36100 VICENZA  
ITALY

FOR: PRECIOUS METALS, NAMELY, GOLD, WHITE GOLD, SILVER, PLATINUM AND THEIR ALLOYS SOLD IN BULK; GOODS IN PRECIOUS METALS OR COATED THEREWITH, NAMELY, DECORATIVE BOXES, NAMELY, JEWEL BOXES, JEWELRY, NAMELY, RINGS, WEDDING RINGS, DIAMOND RINGS, EARRINGS, BRACELETS, ARMLETS, NECKLACES, PENDANTS, BROOCHES, TIEPINS, CUFFLINKS; PRECIOUS GEMSTONES; HOROLOGICAL AND CHRONOMETRIC INSTRUMENTS, NAMELY, WATCHES, WATCH CASES, WRIST-WATCHES, POCKET WATCHES, CLOCKS, TABLE CLOCKS, ALARM CLOCKS, ELECTRIC WATCHES, DIGITAL WATCHES, QUARTZ WATCHES AND CLOCKS, WATER-PROOF WATCHES, PENDULUM-CLOCKS, SELF-WINDING WATCHES, STOP-WATCHES AND CHRONOMETERS, IN CLASS 14 (U.S. CLS. 2, 27, 28 AND 50).

FOR: ADVERTISING AND MARKETING; BUSINESS MANAGEMENT; ADVERTISING SERVICES INCLUDING PROMOTION OF THE SALE OF ARTICLES FOR THIRD PARTIES MANUFACTURED IN A GOLDSMITH'S WORKSHOP, NAMELY JEWELRY AND HOROLOGY; ORGANIZATION EXHIBITIONS FOR ADVERTISING AND COMMERCIAL PURPOSES IN THE FIELD OF GOLDSMITH'S WORKSHOP SERVICES, NAMELY, MANUFACTURING OF JEWELRY AND HOROLOGY; FRANCHISING, NAMELY, CONSULTATION AND ASSISTANCE IN BUSINESS MANAGEMENT, ORGANIZATION AND PROMOTION, FRANCHISING, NAMELY, OFFERING TECHNICAL ASSISTANCE IN THE ESTABLISHMENT AND/OR OPERATION OF JEWELRY SHOPS, IN CLASS 35 (U.S. CLS. 100, 101 AND 102).

FOR: ORGANIZATION OF FASHION SHOWS, ENTERTAINMENT IN THE NATURE OF FASHION SHOWS, CONDUCTING CONTESTS IN THE FIELD OF GOLDSMITH'S WORKSHOP SERVICES, NAMELY, MANUFACTURING OF JEWELRY AND HOROLOGY; EDUCATIONAL SERVICES, NAMELY, CONDUCTING CONFERENCES AND CONGRESSES IN THE FIELD OF GOLDSMITH'S WORKSHOP SERVICES IN RELATION TO THE MANUFACTURING OF JEWELRY AND HOROLOGY, IN CLASS 41 (U.S. CLS. 100, 101 AND 107).

PRIORITY DATE OF 8-10-2007 IS CLAIMED.

OWNER OF INTERNATIONAL REGISTRATION 0949748 DATED 11-20-2007, EXPIRES 11-20-2017.

OWNER OF U.S. REG. NO. 2,670,934.

THE NAME "ROBERTO COIN" IDENTIFIES A LIVING INDIVIDUAL WHOSE CONSENT IS OF RECORD.

THE COLOR(S) WHITE, SEA GREEN, RED, BLUE, GOLD AND YELLOW IS/ARE CLAIMED AS A FEATURE OF THE MARK.

THE COLOR WHITE APPEARS IN THE WORDING "ROBERTO COIN" THAT IS SET ON A SEA BLUE-GREEN BACKGROUND, WITH A SMALL OVAL DESIGN OUTLINED IN WHITE WITH SOME LIGHT GOLD SHADING. THE OVAL DESIGN CONTAINS SWIRLS OR BITS OF RED, BLUE, GOLD, YELLOW, AND SEA GREEN.

SER. NO. 79-048,580, FILED 11-20-2007.

WILLIAM ROSSMAN, EXAMINING ATTORNEY

**Int. Cl.: 20**

**Prior U.S. Cls.: 2, 13, 22, 25, 32 and 50**

**United States Patent and Trademark Office**

**Reg. No. 3,505,615**

**Registered Sep. 23, 2008**

**TRADEMARK  
PRINCIPAL REGISTER**

**brand stands**

ERIK AHLBERG (SWEDEN INDIVIDUAL)  
ST ERIKSGATAN 109  
SE-113 31 STOCKHOLM  
SWEDEN AND  
MAXIBIT WORLDWIDE AB (SWEDEN JOINT  
STOCK COMPANY)  
BOX 33  
SE-171 11 SOLNA  
SWEDEN

FOR: FURNITURE COUNTERS, NAMELY, DISPLAY COUNTERS; PLACARDS OF WOOD OR PLASTICS; DISPLAY STANDS; NEWSPAPER DISPLAY STANDS; LECTERNS; MOLDINGS FOR PICTURE FRAMES; DISPLAY CASES, NAMELY, SHOWCASES; INDOOR WINDOW BLINDS, IN CLASS 20 (U.S. CLS. 2, 13, 22, 25, 32 AND 50).

THE MARK CONSISTS OF STANDARD CHARACTERS WITHOUT CLAIM TO ANY PARTICULAR FONT, STYLE, SIZE, OR COLOR.

PRIORITY DATE OF 6-4-2007 IS CLAIMED.

OWNER OF INTERNATIONAL REGISTRATION  
0949813 DATED 12-4-2007, EXPIRES 12-4-2017.

NO CLAIM IS MADE TO THE EXCLUSIVE RIGHT TO USE "STANDS" , APART FROM THE MARK AS SHOWN.

SER. NO. 79-048,610, FILED 12-4-2007.

SAIMA MAKHDOOM, EXAMINING ATTORNEY



**Int. Cl.: 5**

**Prior U.S. Cls.: 6, 18, 44, 46, 51 and 52**

**United States Patent and Trademark Office**

**Reg. No. 3,505,616**

**Registered Sep. 23, 2008**

**TRADEMARK  
PRINCIPAL REGISTER**

**HEALTHIA**

POLA PHARMA INC. (JAPAN CORPORATION)  
8-9-5 NISHIGOTANDA  
SHINAGAWA-KU; TOKYO 141-0031  
JAPAN

PRIORITY DATE OF 11-7-2007 IS CLAIMED.

FOR: DRUGS FOR MEDICAL PURPOSES, NAME-  
LY, MEDICATED PREPARATIONS FOR TREAT-  
ING ACNE AND INFLAMMATION; AND  
PHARMACEUTICAL PREPARATIONS, NAMELY,  
ANTIFUNGALS, ANALGESICS, ANTIVIRALS,  
AND ANTIBIOTICS, IN CLASS 5 (U.S. CLS. 6, 18, 44,  
46, 51 AND 52).

OWNER OF INTERNATIONAL REGISTRATION  
0949824 DATED 12-21-2007, EXPIRES 12-21-2017.

SER. NO. 79-048,616, FILED 12-21-2007.

JACLYN KIDWELL, EXAMINING ATTORNEY

**Int. Cl.: 5**

**Prior U.S. Cls.: 6, 18, 44, 46, 51 and 52**

**United States Patent and Trademark Office**

**Reg. No. 3,505,617**

**Registered Sep. 23, 2008**

**TRADEMARK  
PRINCIPAL REGISTER**

**A n i p o**

POLA PHARMA INC. (JAPAN CORPORATION)  
8-9-5 NISHIGOTANDA  
SHINAGAWA-KU; TOKYO 141-0031  
JAPAN

FOR: DRUGS FOR MEDICAL PURPOSES, NAME-  
LY, MEDICATED PREPARATIONS FOR TREAT-  
ING ACNE AND INFLAMMATION; AND  
PHARMACEUTICAL PREPARATIONS, NAMELY,  
ANTIFUNGALS, ANALGESICS, ANTIVIRALS,  
AND ANTIBIOTICS, IN CLASS 5 (U.S. CLS. 6, 18, 44,  
46, 51 AND 52).

PRIORITY DATE OF 11-7-2007 IS CLAIMED.

OWNER OF INTERNATIONAL REGISTRATION  
0949825 DATED 12-21-2007, EXPIRES 12-21-2017.

SER. NO. 79-048,617, FILED 12-21-2007.

JACLYN KIDWELL, EXAMINING ATTORNEY

**Int. Cls.: 9 and 38**

**Prior U.S. Cls.: 21, 23, 26, 36, 38, 100, 101 and 104**

**Reg. No. 3,505,618**

**United States Patent and Trademark Office**

**Registered Sep. 23, 2008**

**TRADEMARK  
SERVICE MARK  
PRINCIPAL REGISTER**

# **NATAJAK**

NICE- 1 MOBILE LTD (UNITED KINGDOM LIMITED COMPANY)  
SPECTRUM HOUSE,  
DUNSTABLE ROAD, REDBOURN; ST ALBANS,  
HERTFORDSHIRE AL3 7PR  
UNITED KINGDOM

FOR: COMPUTER APPLICATION SOFTWARE FOR MOBILE PHONES; COMMUNICATIONS SOFTWARE FOR CONNECTING MOBILE PHONE USERS; COMPUTER TELEPHONY SOFTWARE ENABLING TELEPHONE AND COMMUNICATION ACTIVITIES TO BE PERFORMED THROUGH A COMPUTER, IN CLASS 9 (U.S. CLS. 21, 23, 26, 36 AND 38).

FOR: TELECOMMUNICATIONS SERVICES, NAMELY, ELECTRONIC TRANSMISSION OF DATA, AUDIO AND VISUAL IMAGES AMONG USERS OF COMPUTERS AND MOBILE TELEPHONES BY MEANS OF TELECOMMUNICATIONS NETWORKS, WIRELESS COMMUNICATION NET-

WORKS, THE INTERNET, INFORMATION SERVICES NETWORKS AND DATA NETWORKS; ELECTRONIC COMMUNICATION SERVICES, NAMELY, ELECTRONIC MAIL SERVICES, ELECTRONIC MESSAGING SERVICES TRANSMITTED BY MEANS OF TELECOMMUNICATIONS NETWORKS, WIRELESS COMMUNICATION NETWORKS, THE INTERNET, INFORMATION SERVICES NETWORKS AND DATA NETWORKS; TELECOMMUNICATIONS MEANS TO PROVIDE AND DISPLAY INFORMATION ON A DATABASE, IN CLASS 38 (U.S. CLS. 100, 101 AND 104).

OWNER OF INTERNATIONAL REGISTRATION 0950008 DATED 12-3-2007, EXPIRES 12-3-2017.

SER. NO. 79-048,695, FILED 12-3-2007.

MICHAEL WIENER, EXAMINING ATTORNEY

**Int. Cls.: 19 and 27**

**Prior U.S. Cls.: 1, 12, 19, 20, 33, 37, 42 and 50**

**United States Patent and Trademark Office**

**Reg. No. 3,505,619**

**Registered Sep. 23, 2008**

**TRADEMARK  
PRINCIPAL REGISTER**

**BELETAGE BY KAINDL**

KAINDL FLOORING GMBH (AUSTRIA GMBH)  
KAINDLSTR. 2  
A-5071 WALS/SALZBURG  
AUSTRIA

FOR: NON-METAL BUILDING MATERIALS, NAMELY, PANELS, STRIPS, RODS AND SLABS MADE OF WOOD AND WOOD PRODUCTS FOR BUILDING; WOOD PRODUCTS AND DERIVED WOOD PRODUCTS, NAMELY, WOOD FLOORING, WOOD PLANKS, WOOD BEAMS, AND WOOD VENEERS; GLUED HARDBOARDS, CHIPBOARDS, FIBER BOARDS, PARQUET FLOORING AND PARQUET SLABS MADE WHOLLY OR MAINLY OF WOOD; AND HIGH PRESSURE LAMINATED FLOOR PANELS, IN CLASS 19 (U.S. CLS. 1, 12, 33 AND 50).

FOR: CARPETS, RUGS AND FLOOR COVERINGS, IN CLASS 27 (U.S. CLS. 19, 20, 37, 42 AND 50).

PRIORITY DATE OF 7-26-2007 IS CLAIMED.

OWNER OF INTERNATIONAL REGISTRATION 0950010 DATED 12-11-2007, EXPIRES 12-11-2017.

THE TERM "BELETAGE" IS AN OBSCURE FRENCH TERM FOR THE MOST LUXURIOUS FLOORS OF LARGE HOUSES IN THE 19TH CENTURY.

SER. NO. 79-048,697, FILED 12-11-2007.

SKYE YOUNG, EXAMINING ATTORNEY

**Int. Cl.: 5**

**Prior U.S. Cls.: 6, 18, 44, 46, 51 and 52**

**United States Patent and Trademark Office**

**Reg. No. 3,505,620**

**Registered Sep. 23, 2008**

**TRADEMARK  
PRINCIPAL REGISTER**

**F i l f o r t**

POLA PHARMA INC. (JAPAN CORPORATION)  
8-9-5 NISHIGOTANDA  
SHINAGAWA-KU; TOKYO 141-0031  
JAPAN

PRIORITY DATE OF 11-7-2007 IS CLAIMED.

FOR: DRUGS FOR MEDICAL PURPOSES, NAME-  
LY, MEDICATED PREPARATIONS FOR TREAT-  
ING ACNE AND INFLAMMATION; AND  
PHARMACEUTICAL PREPARATIONS, NAMELY,  
ANTIFUNGALS, ANALGESICS, ANTIVIRALS,  
AND ANTIBIOTICS, IN CLASS 5 (U.S. CLS. 6, 18, 44,  
46, 51 AND 52).

OWNER OF INTERNATIONAL REGISTRATION  
0950518 DATED 12-21-2007, EXPIRES 12-21-2017.

SER. NO. 79-048,877, FILED 12-21-2007.

JACLYN KIDWELL, EXAMINING ATTORNEY

**Int. Cl.: 24**

**Prior U.S. Cls.: 42 and 50**

**United States Patent and Trademark Office**

**Reg. No. 3,505,621**

**Registered Sep. 23, 2008**

**TRADEMARK  
PRINCIPAL REGISTER**



NORAFIN INDUSTRIES (GERMANY) GMBH  
(FED REP GERMANY GESELLSCHAFT MIT  
BESCHRÄNKTER HAFTUNG (GMBH))

GEWERBEGEBIET NORD 3

09456 MILDENAU

FED REP GERMANY

OWNER OF U.S. REG. NO. 3,127,145.

THE COLOR(S) GREY, RED AND WHITE IS/ARE  
CLAIMED AS A FEATURE OF THE MARK.

FOR: TEXTILE-LIKE NON-WOVEN MATERIALS  
PRODUCED WITH STAPLE FIBERS, NAMELY,  
TEXTILE SUBSTITUTE MATERIALS MADE FROM  
SYNTHETIC MATERIALS FOR THE FABRICATION  
OF TEXTILE SURFACES, IN CLASS 24 (U.S. CLS. 42  
AND 50).

THE MARK CONSISTS OF THE GREY WORD-  
ING "NORAFIN" TO THE LEFT OF A DESIGN  
ELEMENT COMPOSED OF INCOMPLETE POLY-  
GONS AND THE TERM "3D PERFORMANCE"  
BENEATH IN RED ALL ON A WHITE BACK-  
GROUND.

PRIORITY DATE OF 6-5-2007 IS CLAIMED.

SER. NO. 79-049,239, FILED 11-29-2007.

OWNER OF INTERNATIONAL REGISTRATION  
0951602 DATED 11-29-2007, EXPIRES 11-29-2017.

ELLEN PERKINS, EXAMINING ATTORNEY

**Int. Cls.: 4 and 35**

**Prior U.S. Cls.: 1, 6, 15, 100, 101 and 102**

**United States Patent and Trademark Office**

**Reg. No. 3,505,622**

**Registered Sep. 23, 2008**

**TRADEMARK  
SERVICE MARK  
PRINCIPAL REGISTER**

**HE**

SHE BLENDS HOLDING B.V. (BENELUX BESLO-  
TEN VENNOOTSCHAP)  
CATHARINASTRAAT 21 F  
NL-4811 XD BREDA  
NETHERLANDS

FOR: INDUSTRIAL OILS AND GREASES; IN-  
DUSTRIAL LUBRICANTS; DUST ABSORBING,  
DUST WETTING AND DUST BINDING COMPOSI-  
TIONS FOR USE IN ROAD BUILDING, SWEEPING,  
AND DUST LAYING; FUELS; MOTOR FUELS; AND  
ILLUMINANTS, NAMELY, CANDLES AND WICKS  
FOR LIGHTING, IN CLASS 4 (U.S. CLS. 1, 6 AND 15).

FOR: ADVERTISING, BUSINESS MANAGE-  
MENT, BUSINESS ADMINISTRATION, OFFICE  
WORK, WHOLESALE AND RETAIL STORE SERVI-

CES FEATURING FUELS, IN CLASS 35 (U.S. CLS.  
100, 101 AND 102).

THE MARK CONSISTS OF STANDARD CHAR-  
ACTERS WITHOUT CLAIM TO ANY PARTICULAR  
FONT, STYLE, SIZE, OR COLOR.

PRIORITY DATE OF 6-14-2007 IS CLAIMED.

OWNER OF INTERNATIONAL REGISTRATION  
0951810 DATED 12-7-2007, EXPIRES 12-7-2017.

SER. NO. 79-049,316, FILED 12-7-2007.

ERNEST SHOSHO, EXAMINING ATTORNEY

**Int. Cls.: 11, 20, 21, 37 and 42**

**Prior U.S. Cls.: 2, 13, 21, 22, 23, 25, 29, 30, 31, 32, 33,  
34, 40, 50, 100, 101, 103 and 106**

**Reg. No. 3,505,623**

**United States Patent and Trademark Office**

**Registered Sep. 23, 2008**

**TRADEMARK  
SERVICE MARK  
PRINCIPAL REGISTER**



LASVIT

LASVIT S.R.O. (CZECH REPUBLIC CORPORATION)  
ZA ZAHRADAMI 421  
DOLNÍ MECHOLUPY  
CZ-109 00 PRAHA 10, CZECH REPUBLIC

FOR: APPARATUS FOR LIGHTING, HEATING, STEAM GENERATING, COOKING, REFRIGERATING, DRYING, VENTILATING, WATER SUPPLY AND SANITARY PURPOSES, NAMELY, LIGHTING FIXTURES, ELECTRIC SPACE HEATERS, STEAM GENERATORS, DOMESTIC COOKING OVENS AND COOKING RANGES, REFRIGERATORS, HAIR DRYERS AND CLOTHES DRYERS, VENTILATING EXHAUST FANS, HOT WATER TANKS, OZONE SANITIZERS FOR AIR AND WATER, IN CLASS 11 (U.S. CLS. 13, 21, 23, 31 AND 34).

FOR: FURNITURE, MIRRORS, PICTURE FRAMES, AND GOODS OF WOOD, CORK, REED, CANE, WICKER, HORN, BONE, IVORY, WHALE-BONE, SHELL, AMBER, MOTHER-OF-PEARL, MEERSCHAUM AND SUBSTITUTES FOR ALL THESE MATERIALS, OR OF PLASTICS, NAMELY, DRAWER PULLS, REEDS, FIGURINES, IN CLASS 20 (U.S. CLS. 2, 13, 22, 25, 32 AND 50).

FOR: HOUSEHOLD OR KITCHEN CONTAINERS AND UTENSILS IN THE NATURE OF SPATULAS, SIEVES, STRAINERS, COMBS AND SPONGES BEING BATH SPONGES, TOILET SPONGES, BRUSHES, NAMELY, BATH BRUSHES, HAIR BRUSHES, SHAVING BRUSHES, TOILET BRUSHES, BRUSH-MAKING MATERIALS, ARTICLES FOR CLEANING PURPOSES, NAMELY, CLEANING CLOTHS, CLEANING RAGS, CLEANING SPONGES, STEEL

WOOL, UNWORKED OR SEMI-WORKED GLASS, GLASSWARE, NAMELY, BEVERAGE GLASSWARE, PORCELAIN AND EARTHENWARE ARTICLES, NAMELY, FIGURINES, DOORKNOBS, STATUES, IN CLASS 21 (U.S. CLS. 2, 13, 23, 29, 30, 33, 40 AND 50).

FOR: BUILDING CONSTRUCTION AND REPAIR, AND BUILDING INSTALLATION SERVICES, NAMELY, INSTALLATION OF DOORS AND WINDOWS, BLINDS, KITCHEN CABINETS, IN CLASS 37 (U.S. CLS. 100, 103 AND 106).

FOR: SCIENTIFIC AND TECHNOLOGICAL SERVICES AND RESEARCH AND DESIGN RELATING THERETO, NAMELY, INDUSTRIAL ANALYSIS AND RESEARCH SERVICES RELATING TO ANALYSIS OF OIL FIELDS, COMPUTER SYSTEMS ANALYSIS, BIOLOGICAL RESEARCH, MEDICAL RESEARCH AND PRODUCT RESEARCH, DESIGN AND DEVELOPMENT OF COMPUTER HARDWARE AND SOFTWARE, IN CLASS 42 (U.S. CLS. 100 AND 101).

PRIORITY DATE OF 7-24-2007 IS CLAIMED.

OWNER OF INTERNATIONAL REGISTRATION  
0951884 DATED 12-19-2007, EXPIRES 12-19-2017.

SER. NO. 79-049,353, FILED 12-19-2007.

MICHAEL KAZAZIAN, EXAMINING ATTORNEY



**Int. Cls.: 1 and 19**

**Prior U.S. Cls.: 1, 5, 6, 10, 12, 26, 33, 46 and 50**

**United States Patent and Trademark Office**

**Reg. No. 3,505,624**

**Registered Sep. 23, 2008**

**TRADEMARK  
PRINCIPAL REGISTER**



MAPEI S.P.A. (ITALY SOCIÉTÉ PAR ACTION)  
VIA CAFIERO, 22  
I-20158 MILANO  
ITALY

FOR: CHEMICALS FOR INDUSTRIAL PURPOSES; INDUSTRIAL CHEMICALS FOR USE IN THE BUILDING INDUSTRY; DUAL COMPONENT CHEMICAL ADDITIVES FOR USE AS BINDING AGENTS IN CEMENT MORTARS; CHEMICALS USED IN SCIENCE; ARTIFICIAL AND SYNTHETIC RESINS; DISPERSIONS OF UNPROCESSED PLASTICS; UNPROCESSED PLASTICS IN POWDER, LIQUID OR PASTE FORM; FIRE EXTINGUISHING COMPOSITIONS; CHEMICALS FOR WELDING AND SOLDERING PURPOSES; ADHESIVE USED IN INDUSTRY; ANTIFREEZE; CHEMICAL PRODUCTS FOR PREVENTING SCALE; INDUSTRIAL ADHESIVES FOR STONE SLABS AND STRIPS, IN CLASS 1 (U.S. CLS. 1, 5, 6, 10, 26 AND 46).

FOR: BUILDING SUPPLIES, NAMELY, PLASTIC PIPE SUPPORTS, ADHESIVE MORTAR FOR BUILDING PURPOSES; BRICKS; SLABS OF CEMENT, CONCRETE, CLAY, SLATE, NON METAL TILES; CEMENT MIXES; NON AGRICULTURAL LIME FOR USE IN CONSTRUCTION, MORTARS; DUAL COMPONENT CEMENT MORTARS, ELASTIC CEMENT MORTARS; DAMP-PROOFING CEMENT MORTARS FOR PROTECTING CONCRETES, SWIMMING POOLS AND BALCONIES; PLASTER AND GRAVEL; TUBING MADE OF SANDSTONE AND CEMENT; ROAD BUILDING

MATERIALS, NAMELY, CEMENT MIXES; ASPHALT; PITCH AND BITUMEN; SEMI-WORKED WOOD; BUILDING TIMBER; NON-METAL BEAMS; PLANKS; WOOD PANELING; WOOD VENEERS; COMPOUND WOOD BOARDS; BUILDING GLASS; GLASS PANELS FOR BUILDING CONSTRUCTION PURPOSES; AND GLASS TILES, IN CLASS 19 (U.S. CLS. 1, 12, 33 AND 50).

PRIORITY DATE OF 9-25-2007 IS CLAIMED.

OWNER OF INTERNATIONAL REGISTRATION  
0952252 DATED 11-6-2007, EXPIRES 11-6-2017.

THE MARK CONSISTS OF A CIRCULAR IMPRINT WITHIN WHICH THE WORDS "DUST FREE" ARE WRITTEN IN SPECIAL CHARACTERS; BETWEEN THESE TWO WORDS TWO ARROWS ARE DRAWN THAT ARE DESCENDING, CURVED AND DIVERGENT; A DESIGN OF CIRCLES OF DIFFERENT SIZES DEPARTS FROM THE SPACE BETWEEN THE TWO ARROW TIPS AND THE CIRCLES ARE ARRANGED SO AS TO REPRESENT A TRIANGLE WHOSE BASE COINCIDES WITH THE RELEVANT PORTION OF THE CIRCUMFERENCE.

SER. NO. 79-049,457, FILED 11-6-2007.

PRISCILLA MILTON, EXAMINING ATTORNEY

**Int. Cl.: 5**

**Prior U.S. Cls.: 6, 18, 44, 46, 51 and 52**

**United States Patent and Trademark Office**

**Reg. No. 3,505,625**

**Registered Sep. 23, 2008**

**TRADEMARK  
PRINCIPAL REGISTER**

**FESTINAVIR**

ONCOLYS BIOPHARMA INC. (JAPAN JOINT  
STOCK COMPANY)  
3-16-33, ROPPONGI  
MINATO-KU; TOKYO 106-0032  
JAPAN

FOR: PHARMACEUTICAL PREPARATIONS FOR  
THE TREATMENT OF INFECTIOUS DISEASES  
AND CANCER, IN CLASS 5 (U.S. CLS. 6, 18, 44, 46,  
51 AND 52).

THE MARK CONSISTS OF STANDARD CHAR-  
ACTERS WITHOUT CLAIM TO ANY PARTICULAR  
FONT, STYLE, SIZE, OR COLOR.

PRIORITY DATE OF 8-7-2007 IS CLAIMED.

OWNER OF INTERNATIONAL REGISTRATION  
0952932 DATED 2-5-2008, EXPIRES 2-5-2018.

SER. NO. 79-049,722, FILED 2-5-2008.

KAREN SEVERSON, EXAMINING ATTORNEY

**Int. Cl.: 9**

**Prior U.S. Cls.: 21, 23, 26, 36 and 38**

**United States Patent and Trademark Office**

**Reg. No. 3,505,626**

**Registered Sep. 23, 2008**

**TRADEMARK  
PRINCIPAL REGISTER**

**WESTOMAT**

STRIKOWESTOFEN GMBH (FED REP GERMA-  
NY GMBH)  
LORENZ-SCHOTT-STRASSE 5  
55252 MAINZ-KASTEL, FED REP GERMANY

OWNER OF INTERNATIONAL REGISTRATION  
0435109 DATED 12-12-1977, EXPIRES 12-12-2017.

FOR: AUTOMATIC DOSING APPARATUS,  
NAMELY, FURNACES FOR SUPPLYING MEA-  
SURED AMOUNTS OF LIQUID METALS INTO  
FOUNDRY MACHINES, IN CLASS 9 (U.S. CLS. 21,  
23, 26, 36 AND 38).

SER. NO. 79-049,728, FILED 12-21-2007.

MARIAM MAHMOUDI, EXAMINING ATTORNEY

**Int. Cl.: 4**

**Prior U.S. Cls.: 1, 6 and 15**

**United States Patent and Trademark Office**

**Reg. No. 3,505,627**

**Registered Sep. 23, 2008**

**TRADEMARK  
PRINCIPAL REGISTER**



SHANXI COKING; GROUP LIMITED COMPANY  
(CHINA CORPORATION)  
GUANGSHENGSI TOWN  
HONGDONG COUNTY; SHANXI PROVINCE  
CHINA

FOR: COAL TAR OIL; COKE, IN CLASS 4 (U.S.  
CLS. 1, 6 AND 15).

OWNER OF INTERNATIONAL REGISTRATION  
0952974 DATED 2-12-2008, EXPIRES 2-12-2018.

THE ENGLISH TRANSLATION OF THE FOR-  
EIGN WORD(S) IN THE MARK IS: "FEI" MEANS

"FLY", "HONG" MEANS "RAINBOW"; THE TWO  
CHARACTERS "FEI HONG" COMBINED TOGE-  
THER HAVE NO MEANING IN ENGLISH.

THE TRANSLITERATION OF THE NON-LATIN  
CHARACTERS IN THE MARK IS "FEI HONG" AND  
THIS MEANS, SEPARATELY, "FLY" AND "RAIN-  
BOW."

SER. NO. 79-049,788, FILED 2-12-2008.

JAMES STEIN, EXAMINING ATTORNEY

**Int. Cl.: 2**

**Prior U.S. Cls.: 6, 11 and 16**

**United States Patent and Trademark Office**

**Reg. No. 3,505,628**

**Registered Sep. 23, 2008**

**TRADEMARK  
PRINCIPAL REGISTER**



ECKART GMBH (FED REP GERMANY LIMITED  
LIABILITY COMPANY)  
KAISERSTRASSE 30  
90763 FÜRTH  
FED REP GERMANY

OWNER OF INTERNATIONAL REGISTRATION  
0953031 DATED 12-5-2007, EXPIRES 12-5-2017.

FOR: PRINTING INKS, PARTICULARLY INKJET  
PRINTING INKS, NAMELY, METAL EFFECT AND  
PEARLESCENT EFFECT INKJET PRINTING INKS;  
PRINTER'S INKS, PARTICULARLY INKJET PRIN-  
TER'S INKS, NAMELY, METAL EFFECT AND  
PEARLESCENT EFFECT INKJET PRINTER'S INKS;  
PRINTER'S PASTES, PARTICULARLY INKJET  
PRINTER'S PASTES, NAMELY, METAL EFFECT  
AND PEARLESCENT INKJET PRINTER'S PASTES,  
IN CLASS 2 (U.S. CLS. 6, 11 AND 16).

THE MARK CONSISTS OF A SOLID CIRCLE-  
SHAPED DESIGN THAT IS COMPRISED OF A  
STRAIGHT LINE AT THE TOP AND A POINTED  
EDGE IN THE TOP RIGHT OF THE DESIGN; A  
HALF STAR IS SITUATED WITHIN THE CIRCLE-  
LIKE DESIGN ON THE RIGHT SIDE. THE ENTIRE  
DESIGN SITS NEXT TO THE WORDING "JET-  
FLUID".

SER. NO. 79-049,809, FILED 12-5-2007.

PRIORITY DATE OF 6-28-2007 IS CLAIMED.

NAKIA HENRY, EXAMINING ATTORNEY

Int. Cl.: 32

Prior U.S. Cls.: 45, 46 and 48

United States Patent and Trademark Office

Reg. No. 3,505,629

Registered Sep. 23, 2008

TRADEMARK  
PRINCIPAL REGISTER



BRAUEREI BECK GMBH & CO. KG (FED REP  
GERMANY GMBH & CO. KG)  
AM DEICH 18/19  
28199 BREMEN  
FED REP GERMANY

FOR: BEERS, IN CLASS 32 (U.S. CLS. 45, 46 AND  
48).

PRIORITY DATE OF 12-18-2007 IS CLAIMED.

OWNER OF INTERNATIONAL REGISTRATION  
0953204 DATED 12-20-2007, EXPIRES 12-20-2017.

OWNER OF U.S. REG. NOS. 600,471, 2,773,953 AND  
OTHERS.

NO CLAIM IS MADE TO THE EXCLUSIVE  
RIGHT TO USE "BRAUEREI", "& CO", "GOLD"  
AND "BREMEN GERMANY", APART FROM THE  
MARK AS SHOWN.

THE COLOR(S) GOLD, YELLOW, RED, WHITE,  
BLUE, BLACK IS/ARE CLAIMED AS A FEATURE  
OF THE MARK.

THE COLOR GOLD APPEARS IN THE TWO  
OVAL BORDERS THAT ENCLOSE THE MARK, IN  
THE TERM "GOLD" AND IN TWO LINES THAT  
APPEAR IN THE RECTANGLE DESIGN, THE COL-  
OR RED APPEARS IN THE BACKGROUND OF THE  
SHIELD DESIGN CONTAINING THE KEY AND IN  
A SHADED OVAL CONTAINING THE WORDS  
"BRAUEREI BECK & CO BREMEN . GERMANY",  
THE COLOR BLACK APPEARS IN THE RECTAN-  
GLE DESIGN, AS AN OUTLINE OF THE SHIELD  
DESIGN CONTAINING THE KEY AND AS HIGH-  
LIGHTS IN THE KEY DESIGN AND TERM  
"BECK'S" WHICH APPEARS INSIDE THE RECTAN-  
GLE DESIGN AND THE COLOR WHITE APPEARS  
IN THE WORDING "BRAUEREI BECK & CO BRE-  
MEN . GERMANY", THE WORDING "BECK'S" IN  
THE RECTANGLE DESIGN, THE BACKGROUND  
OF THE INTERIOR OVAL AND AS AN OVAL  
SEPARATING THE TWO OUTER GOLD OVALS.

THE FOREIGN WORDING IN THE MARK  
TRANSLATES INTO ENGLISH AS "BRAUEREI"  
MEANS BREWERY.

SER. NO. 79-049,864, FILED 12-20-2007.

GENE MACIOL, EXAMINING ATTORNEY

**Int. Cls.: 38, 41 and 42**

**Prior U.S. Cls.: 100, 101, 104 and 107**

**United States Patent and Trademark Office**

**Reg. No. 3,505,630**

**Registered Sep. 23, 2008**

**SERVICE MARK  
PRINCIPAL REGISTER**

# RE-VOLVE

BOEHRINGER INGELHEIM INTERNATIONAL  
GMBH (FED REP GERMANY CORPORATION)

55218 INGELHEIM  
FED REP GERMANY

FOR: PROVISION OF ACCESS TO ELECTRONIC  
SITES VIA THE INTERNET FEATURING MEDICAL  
AND PHARMACEUTICAL INFORMATION OF  
PHARMACEUTICAL PREPARATIONS , IN CLASS  
38 (U.S. CLS. 100, 101 AND 104).

FOR: PUBLICATION OF BOOKS, MAGAZINES,  
JOURNALS, PRESS RELEASES, AND MEDIA RE-  
PORTS FEATURING THE RESULTS OF CLINICAL  
TRIALS FOR PHARMACEUTICAL PREPARA-  
TIONS, IN CLASS 41 (U.S. CLS. 100, 101 AND 107).

FOR: CONDUCTING CLINICAL TRIALS FOR  
PHARMACEUTICAL PRODUCTS, IN CLASS 42  
(U.S. CLS. 100 AND 101).

THE MARK CONSISTS OF STANDARD CHAR-  
ACTERS WITHOUT CLAIM TO ANY PARTICULAR  
FONT, STYLE, SIZE, OR COLOR.

PRIORITY DATE OF 11-23-2007 IS CLAIMED.

OWNER OF INTERNATIONAL REGISTRATION  
0953220 DATED 1-15-2008, EXPIRES 1-15-2018.

SER. NO. 79-049,870, FILED 1-15-2008.

JAMES STEIN, EXAMINING ATTORNEY

**Int. Cls.: 4, 35 and 42**

**Prior U.S. Cls.: 1, 6, 15, 100, 101 and 102**

**United States Patent and Trademark Office**

**Reg. No. 3,505,631**

**Registered Sep. 23, 2008**

**TRADEMARK  
SERVICE MARK  
PRINCIPAL REGISTER**

**SHE**

SHE BLENDS HOLDING B.V. (BENELUX LIMITED LIABILITY COMPANY)  
CATHARINASTRAAT 21 F  
NL-4811 XD BREDA  
NETHERLANDS

FOR: INDUSTRIAL OILS AND GREASES; INDUSTRIAL LUBRICANTS; DUST ABSORBING, DUST WETTING AND DUST BINDING COMPOSITIONS FOR USE IN ROAD BUILDING, SWEEPING AND DUST LAYING; FUELS; MOTOR FUELS; ILLUMINANTS, NAMELY, CANDLES AND WICKS FOR LIGHTING, IN CLASS 4 (U.S. CLS. 1, 6 AND 15).

FOR: ADVERTISING; BUSINESS MANAGEMENT; BUSINESS ADMINISTRATION AND OFFICE WORK; WHOLESALE AND RETAIL STORE SERVICES FEATURING FUELS, IN CLASS 35 (U.S. CLS. 100, 101 AND 102).

FOR: SCIENTIFIC AND TECHNOLOGICAL SERVICES, NAMELY, SCIENTIFIC RESEARCH AND DESIGN FOR OTHERS IN THE FIELD OF FUELS; INDUSTRIAL ANALYSIS AND RESEARCH SERVICES IN THE FIELD OF OIL FIELDS; DESIGN AND DEVELOPMENT OF COMPUTER HARDWARE AND SOFTWARE, IN CLASS 42 (U.S. CLS. 100 AND 101).

PRIORITY DATE OF 6-14-2007 IS CLAIMED.

OWNER OF INTERNATIONAL REGISTRATION 0953287 DATED 12-4-2007, EXPIRES 12-4-2017.

SER. NO. 79-049,891, FILED 12-4-2007.

ERNEST SHOSHO, EXAMINING ATTORNEY



**Int. Cls.: 1 and 3**

**Prior U.S. Cls.: 1, 4, 5, 6, 10, 26, 46, 50, 51 and 52**

**United States Patent and Trademark Office**

**Reg. No. 3,505,632**

**Registered Sep. 23, 2008**

**TRADEMARK  
PRINCIPAL REGISTER**

# AQU'ACTIV

COGNIS IP MANAGEMENT GMBH (FED REP  
GERMANY LIMITED LIABILITY COMPANY)  
HENKELSTRASSE 67  
40589 DÜSSELDORF  
FED REP GERMANY

FOR: CHEMICALS USED IN INDUSTRY, NAME-  
LY, BASIC, RAW AND INTERMEDIATE PRO-  
DUCTS AS WELL AS THOSE OBTAINED FROM  
EXTRACTS OF NATURAL, VEGETAL, MARINE,  
SYNTHETIC, OR BIOTECHNOLOGICAL ORIGIN  
AND INTENDED FOR BEING INCORPORATED  
IN THE COMPOSITION OF COSMETIC PRODUCTS  
AND SANITARY PREPARATIONS FOR BODY,  
HAIR AND FACE CARE, AND COLOR COSMETICS,  
IN CLASS 1 (U.S. CLS. 1, 5, 6, 10, 26 AND 46).

FOR: COSMETIC PREPARATIONS FOR BODY,  
HAIR AND FACE CARE; COSMETIC PREPARA-  
TIONS FOR THE CARE AND MAINTENANCE OF  
SKIN; COSMETIC EMULSIONS, GELS AND LO-  
TIONS FOR SKIN CARE; DEPILATORY PREPARA-  
TIONS; COSMETIC HAIR CARE PRODUCTS,  
NAMELY, SHAMPOOS, COSMETIC EMULSIONS  
AND COSMETIC HAIR LOTIONS, PRODUCTS  
FOR BINDING OF HAIRDRESSING IN THE NAT-  
URE OF HAIR STYLING PREPARATIONS; MAKE  
UP PREPARATIONS, NAMELY, POWDERS, FOUN-

DATIONS, ROUGE, RED FOR CHEEKS, LIPSTICKS,  
MASCARAS, SHADES AND EYE PENCILS AND  
COLOR COSMETICS; COSMETIC CREAMS AND  
COSMETIC LOTIONS AND OTHER SUN CARE  
PREPARATIONS, NAMELY, COSMETIC PREPARA-  
TIONS FOR TANNING OF SKIN; NAIL CARE  
PREPARATIONS; MAKE UP REMOVAL PREPARA-  
TIONS, SOAP; PERFUMES AND OTHER PERFUM-  
ERY; ESSENTIAL OILS, OILS FOR COSMETIC  
PURPOSES, IN CLASS 3 (U.S. CLS. 1, 4, 6, 50, 51  
AND 52).

THE MARK CONSISTS OF STANDARD CHAR-  
ACTERS WITHOUT CLAIM TO ANY PARTICULAR  
FONT, STYLE, SIZE, OR COLOR.

PRIORITY DATE OF 6-21-2007 IS CLAIMED.

OWNER OF INTERNATIONAL REGISTRATION  
0953570 DATED 11-29-2007, EXPIRES 11-29-2017.

SER. NO. 79-049,998, FILED 11-29-2007.

ERNEST SHOSHO, EXAMINING ATTORNEY

Int. Cl.: 9

Prior U.S. Cls.: 21, 23, 26, 36 and 38

United States Patent and Trademark Office

Reg. No. 3,505,633

Registered Sep. 23, 2008

TRADEMARK  
PRINCIPAL REGISTER



IGAP SPA (ITALY SOCIÉTÉ PAR ACTIONS)  
VIA ALDO MORO, 1/D  
I-46016 COGOZZO - VIADANA (MANTOVA)  
ITALY

FOR: PHOTOVOLTAIC CELLS FOR GENERATING ELECTRICITY ALSO INCLUDING A SOLAR THERMAL COLLECTOR SOLD AS A UNIT; TRANSFORMERS, INVERTERS FOR CONVERTING ELECTRICITY GENERATED BY THE AC-DC PANELS, IN CLASS 9 (U.S. CLS. 21, 23, 26, 36 AND 38).

OWNER OF INTERNATIONAL REGISTRATION  
0954301 DATED 12-11-2007, EXPIRES 12-11-2017.

THE BRAND CONSISTS OF THE WORD "GRANDSOLEIL", WHICH IS A NOVELTY NAME; THIS WORD IS UNDERLINED AND ABOVE IT IS A GRAPHIC REPRESENTATION CONSISTING OF A FANCY IMAGE SHOWING HALF A SUN SURROUNDED BY A STYLIZED HALO.

THE ENGLISH TRANSLATION OF THE FOREIGN WORD(S) IN THE MARK IS: BIG SUN.

SER. NO. 79-050,274, FILED 12-11-2007.

ELI HELLMAN, EXAMINING ATTORNEY

**Int. Cls.: 14 and 40**

**Prior U.S. Cls.: 2, 27, 28, 50, 100, 103 and 106**

**United States Patent and Trademark Office**

**Reg. No. 3,505,634**

**Registered Sep. 23, 2008**

**TRADEMARK  
SERVICE MARK  
PRINCIPAL REGISTER**



METALOR TECHNOLOGIES INTERNATIONAL  
SA; (METALOR TECHNOLOGIES INTERNA-  
TIONAL AG); (METALOR TECHNOLOGIES  
INTERNATIONAL LTD) (SWITZERLAND SO-  
CIÉTÉ ANONYME)  
AVENUE DU VIGNOBLE 2  
CH-2009 NEUCHÂTEL, SWITZERLAND

PRIORITY DATE OF 8-9-2007 IS CLAIMED.

OWNER OF INTERNATIONAL REGISTRATION  
0954310 DATED 1-7-2008, EXPIRES 1-7-2018.

FOR: PRECIOUS METALS AND THEIR ALLOYS,  
JEWELLERY IN PRECIOUS METALS, HOROLOGI-  
CAL AND CHRONOMETRIC INSTRUMENTS IN  
PRECIOUS METALS, IN CLASS 14 (U.S. CLS. 2, 27, 28  
AND 50).

NO CLAIM IS MADE TO THE EXCLUSIVE  
RIGHT TO USE "PRECIOUS METALS RECYCLED",  
APART FROM THE MARK AS SHOWN.

FOR: RECYCLING OF PRECIOUS METALS, PRO-  
CESSING OF PRECIOUS METALS, IN CLASS 40  
(U.S. CLS. 100, 103 AND 106).

SER. NO. 79-050,278, FILED 1-7-2008.

MELISSA VALLILLO, EXAMINING ATTORNEY

**Int. Cl.: 1**

**Prior U.S. Cls.: 1, 5, 6, 10, 26 and 46**

**Reg. No. 3,505,635**

**United States Patent and Trademark Office**

**Registered Sep. 23, 2008**

**TRADEMARK  
PRINCIPAL REGISTER**

**EMFLO**

EMSLAND-STÄRKE GMBH (FED REP GERMA-  
NY GMBH)  
EMSLANDSTR. 58  
49824 EMLICHHEIM  
FED REP GERMANY

OWNER OF INTERNATIONAL REGISTRATION  
0954469 DATED 12-17-2007, EXPIRES 12-17-2017.

FOR: CHEMICALLY MODIFIED STARCH USED  
IN INDUSTRY, IN PARTICULAR FOR THE FOOD  
AND LUXURY FOOD INDUSTRY; ADHESIVES  
USED IN INDUSTRY, IN PARTICULAR DEX-  
TRINE; GLUE USED IN INDUSTRY, IN CLASS 1  
(U.S. CLS. 1, 5, 6, 10, 26 AND 46).

OWNER OF U.S. REG. NOS. 3,389,274, 3,398,814  
AND OTHERS.

SER. NO. 79-050,330, FILED 12-17-2007.

THE MARK CONSISTS OF STANDARD CHAR-  
ACTERS WITHOUT CLAIM TO ANY PARTICULAR  
FONT, STYLE, SIZE, OR COLOR.

REBECCA POVARCHUK, EXAMINING ATTOR-  
NEY

**Int. Cls.: 19 and 27**

**Prior U.S. Cls.: 1, 12, 19, 20, 33, 37, 42 and 50**

**United States Patent and Trademark Office**

**Reg. No. 3,505,636**

**Registered Sep. 23, 2008**

**TRADEMARK  
PRINCIPAL REGISTER**



KAINDL FLOORING GMBH (AUSTRIA GMBH)  
KAINDLSTR. 2  
A-5071 WALS/SALZBURG, AUSTRIA

OWNER OF INTERNATIONAL REGISTRATION  
0954655 DATED 12-28-2007, EXPIRES 12-28-2017.

FOR: NON-METAL BUILDING MATERIALS, NAMELY, PANELS, STRIPS, RODS AND SLABS MADE OF WOOD AND WOOD PRODUCTS FOR BUILDING; WOOD PRODUCTS AND DERIVED WOOD PRODUCTS, NAMELY, WOOD FLOORING, WOOD PLANKS, WOOD BEAMS, AND WOOD VENEERS; GLUED HARDBOARDS, CHIPBOARDS, FIBER BOARDS, PARQUET FLOORING AND PARQUET SLABS MADE WHOLLY OR MAINLY OF WOOD; AND HIGH PRESSURE LAMINATED FLOOR PANELS, IN CLASS 19 (U.S. CLS. 1, 12, 33 AND 50).

THE COLOR(S) RED, BROWN, TAN, GRAY, BLACK AND WHITE IS/ARE CLAIMED AS A FEATURE OF THE MARK.

THE MARK CONSISTS OF THE COLORS BROWN AND TAN IN THE TWO HANDS, THE HANDS ARE OUTLINED IN WHITE, THE BACKGROUND OF THE TOP RECTANGLE IS RED AND THE BACKGROUND OF THE BOTTOM RECTANGLE IS GRAY. THE LITERAL ELEMENTS APPEAR IN BLACK.

FOR: CARPETS, RUGS AND FLOOR COVERINGS, IN CLASS 27 (U.S. CLS. 19, 20, 37, 42 AND 50).

SER. NO. 79-050,381, FILED 12-28-2007.

PRIORITY DATE OF 6-29-2007 IS CLAIMED.

CHRISIE B. KING, EXAMINING ATTORNEY

Int. Cl.: 33

Prior U.S. Cls.: 47 and 49

United States Patent and Trademark Office

Reg. No. 3,505,637

Registered Sep. 23, 2008

TRADEMARK  
PRINCIPAL REGISTER



NOLAN  
WINE COMPANY

NOLAN WINES AUSTRALIA PTY LTD (AUSTRALIA COMPANY)

PO BOX 932  
NARACOORTE SA 5271  
AUSTRALIA

FOR: WINE, IN CLASS 33 (U.S. CLS. 47 AND 49).

OWNER OF INTERNATIONAL REGISTRATION  
0954766 DATED 1-22-2008, EXPIRES 1-22-2018.

NO CLAIM IS MADE TO THE EXCLUSIVE RIGHT TO USE "WINE COMPANY", APART FROM THE MARK AS SHOWN.

THE ENGLISH TRANSLATION OF THE FOREIGN WORD(S) IN THE MARK IS: "ONE HEART", "ONE WAY".

SER. NO. 79-050,403, FILED 1-22-2008.

CARRIE GENOVESE, EXAMINING ATTORNEY

**Int. Cls.: 6 and 17**

**Prior U.S. Cls.: 1, 2, 5, 12, 13, 14, 23, 25, 35 and 50**

**United States Patent and Trademark Office**

**Reg. No. 3,505,638**

**Registered Sep. 23, 2008**

**TRADEMARK  
PRINCIPAL REGISTER**

**T L C**

CHOI, YUK NAM (REPUBLIC OF KOREA INDIVIDUAL)  
#2235-202, JINDALREAMEAUL, WONMIGU  
BUCHEONSI GYOUNGGIDO  
REPUBLIC OF KOREA

FOR: METAL PIPES; METAL TUBES; METAL PIPE COUPLINGS; METAL PIPE GASKETS; METAL HOSE PIPES AND METAL TUBE FITTINGS AND COMPONENTS THEREOF; METAL FASTENER JOINTS FOR PIPING; METAL REDUCING PIECES AND TUBE ADAPTORS FOR PIPES, NAMELY, ELBOWS, STRAIGHTS, TEES AND CROSSES; METAL PLUGS; AND PARTS AND FITTINGS FOR ALL OF THE AFORESAID GOODS, INCLUDED IN THIS CLASS, IN CLASS 6 (U.S. CLS. 2, 12, 13, 14, 23, 25 AND 50).

FOR: PLASTIC PIPES; PLASTIC TUBES; PLASTIC PIPE COUPLINGS; PLASTIC PIPE GASKETS; PLASTIC HOSE PIPES AND PLASTIC TUBE FITTINGS

AND COMPONENTS THEREOF; PLASTIC FASTENER JOINTS FOR PIPING; PLASTIC REDUCING PIECES AND TUBE ADAPTORS FOR PIPES, NAMELY, ELBOWS, STRAIGHTS, TEES AND CROSSES; PLASTIC PLUGS; AND PARTS AND FITTINGS FOR ALL OF THE AFORESAID GOODS, INCLUDED IN THIS CLAS, IN CLASS 17 (U.S. CLS. 1, 5, 12, 13, 35 AND 50).

PRIORITY DATE OF 9-7-2007 IS CLAIMED.

OWNER OF INTERNATIONAL REGISTRATION  
0954774 DATED 1-18-2008, EXPIRES 1-18-2018.

SER. NO. 79-050,406, FILED 1-18-2008.

PATRICIA EVANKO, EXAMINING ATTORNEY

Int. Cl.: 3

Prior U.S. Cls.: 1, 4, 6, 50, 51 and 52

United States Patent and Trademark Office

Reg. No. 3,505,639

Registered Sep. 23, 2008

TRADEMARK  
PRINCIPAL REGISTER

# SAMOURAI

PARFUMS ALAIN DELON SA (SWITZERLAND  
JOINT STOCK COMPANY)  
BÜHLSTRASSE 1  
CH-8125 ZOLLIKERBERG  
SWITZERLAND

FOR: SOAPS AND CLEANING PREPARATIONS,  
NAMELY, CAKES OF SOAP, ANTIPERSPIRANT  
SOAPS, DEODORANT SOAP, LIQUID SOAPS; PER-  
FUMERY, NAMELY, PERFUMES, EAU DE TOIL-  
ETTE, EAU DE COLOGNE, ESSENTIAL OILS,  
SHAVING PRODUCTS, NAMELY, SHAVING  
CREAM, SHAVING LOTION AND AFTERSHAVE;  
COSMETICS, NAMELY, COSMETIC CREAMS, TON-  
ING LOTIONS FOR THE BODY, FACE AND  
HANDS, MAKE-UP, BLUSH, EYESHADOW; NON-  
MEDICATED TOILETRIES, NAIL CARE PREPARA-

TIONS, NAIL VARNISHES, DEPILATORY PRE-  
PARATIONS, DEODORANTS FOR PERSONAL  
USE, SELF-TANNING PREPARATIONS; SHAM-  
POOS, HAIR CARE LOTIONS, IN CLASS 3 (U.S.  
CLS. 1, 4, 6, 50, 51 AND 52).

OWNER OF INTERNATIONAL REGISTRATION  
0630637 DATED 1-6-1995, EXPIRES 1-6-2015.

OWNER OF U.S. REG. NO. 1,962,835.

SER. NO. 79-050,425, FILED 11-29-2007.

ROBERT STRUCK, EXAMINING ATTORNEY



**Int. Cl.: 6**

**Prior U.S. Cls.: 2, 12, 13, 14, 23, 25 and 50**

**United States Patent and Trademark Office**

**Reg. No. 3,505,640**

**Registered Sep. 23, 2008**

**TRADEMARK  
PRINCIPAL REGISTER**

**WATER WAY**

WATER WAY ENGINEERING GMBH (FED REP  
GERMANY GMBH)

BAERLER STR. 100

47441 MOERS

FED REP GERMANY

THE MARK CONSISTS OF STANDARD CHAR-  
ACTERS WITHOUT CLAIM TO ANY PARTICULAR  
FONT, STYLE, SIZE, OR COLOR.

OWNER OF INTERNATIONAL REGISTRATION  
0954926 DATED 8-23-2007, EXPIRES 8-23-2017.

FOR: FLEXIBLE STAINLESS STEEL TUBES FOR  
PASSING GLYCOL AS PART OF SOLAR THERMAL  
ENERGY SYSTEMS, IN CLASS 6 (U.S. CLS. 2, 12, 13,  
14, 23, 25 AND 50).

SER. NO. 79-050,473, FILED 8-23-2007.

COLLEEN KEARNEY, EXAMINING ATTORNEY

**Int. Cl.: 12**

**Prior U.S. Cls.: 19, 21, 23, 31, 35 and 44**

**Reg. No. 3,505,641**

**United States Patent and Trademark Office**

**Registered Sep. 23, 2008**

**TRADEMARK  
PRINCIPAL REGISTER**



MAKMARINE LIMITED (UNITED KINGDOM  
LIMITED LIABILITY COMPANY)  
3 BERKELEY CLOSE ROSS ON WYE  
HEREFORDSHIRE HR9 7XL  
UNITED KINGDOM

OWNER OF INTERNATIONAL REGISTRATION  
0955037 DATED 2-20-2008, EXPIRES 2-20-2018.

FOR: SPEEDBOATS, IN CLASS 12 (U.S. CLS. 19, 21,  
23, 31, 35 AND 44).

SER. NO. 79-050,514, FILED 2-20-2008.

PRIORITY DATE OF 9-24-2007 IS CLAIMED.

JACQUELINE A. LAVINE, EXAMINING ATTOR-  
NEY

**Int. Cl.: 12**

**Prior U.S. Cls.: 19, 21, 23, 31, 35 and 44**

**Reg. No. 3,505,642**

**United States Patent and Trademark Office**

**Registered Sep. 23, 2008**

**TRADEMARK  
PRINCIPAL REGISTER**

VOLKSWAGEN AG (FED REP GERMANY JOINT  
STOCK COMPANY)  
38440 WOLFSBURG  
FED REP GERMANY

FOR: MOTORIZED LAND VEHICLES AND  
STRUCTURAL PARTS THEREFOR; ENGINES FOR  
LAND VEHICLES; TIRES FOR VEHICLE WHEELS,  
RIMS FOR VEHICLE WHEELS, COMPLETE VEHI-  
CLE WHEELS AND STRUCTURAL PARTS THERE-  
FOR; ANTI-THEFT DEVICES FOR MOTORIZED  
LAND VEHICLES, IN CLASS 12 (U.S. CLS. 19, 21,  
23, 31, 35 AND 44).

THE MARK CONSISTS OF STANDARD CHAR-  
ACTERS WITHOUT CLAIM TO ANY PARTICULAR  
FONT, STYLE, SIZE, OR COLOR.

PRIORITY DATE OF 8-22-2007 IS CLAIMED.

OWNER OF INTERNATIONAL REGISTRATION  
0955050 DATED 1-23-2008, EXPIRES 1-23-2018.

SER. NO. 79-050,517, FILED 1-23-2008.

KRISTINA MORRIS, EXAMINING ATTORNEY

**Int. Cls.: 12, 28, 35 and 37**

**Prior U.S. Cls.: 19, 21, 22, 23, 31, 35, 38, 44, 50, 100,  
101, 102, 103 and 106**

**Reg. No. 3,505,643**

**United States Patent and Trademark Office**

**Registered Sep. 23, 2008**

**TRADEMARK  
SERVICE MARK  
PRINCIPAL REGISTER**

**PASSAT C**

VOLKSWAGEN AKTIENGESELLSCHAFT (FED  
REP GERMANY JOINT STOCK COMPANY)  
38436 WOLFSBURG  
FED REP GERMANY

FOR: MOTORIZED LAND VEHICLES AND  
STRUCTURAL PARTS THEREFOR; TRAILERS  
FOR VEHICLES AND STRUCTURAL PARTS  
THEREFOR; ENGINES FOR LAND VEHICLES;  
TIRES FOR VEHICLE WHEELS, RIMS FOR VEHI-  
CLE WHEELS, COMPLETE VEHICLE WHEELS  
AND STRUCTURAL PARTS THEREFOR FOR  
LAND VEHICLES; MOTORIZED SCOOTERS AND  
MOTORIZED AUTOMOBILES FOR CHILDREN, IN  
CLASS 12 (U.S. CLS. 19, 21, 23, 31, 35 AND 44).

FOR: SCALE MODEL VEHICLES, SCALE MODEL  
AUTOMOBILES AND TOY AUTOMOBILES; NON-  
MOTORIZED TOY VEHICLES FOR CHILDREN,  
NON-MOTORIZED TOY SCOOTERS; PLAYING  
CARDS; STUFFED TOY ANIMALS AND STUFFED  
TOYS; APPARATUS FOR ELECTRONIC GAMES  
OTHER THAN THOSE ADAPTED FOR USE WITH  
EXTERNAL DISPLAY SCREENS OR MONITORS,  
IN CLASS 28 (U.S. CLS. 22, 23, 38 AND 50).

FOR: RETAIL AND WHOLESALE STORE SERVI-  
CES FEATURING MOTOR VEHICLES AND THEIR  
PARTS AND FITTINGS; RETAIL AND WHOLE-  
SALE MAIL-ORDER SERVICES FEATURING MO-  
TOR VEHICLES AND THEIR PARTS AND  
FITTINGS; ONLINE RETAIL AND WHOLESALE  
STORE SERVICES FEATURING MOTOR VEHICLES  
AND THEIR PARTS AND FITTINGS; RETAIL AND  
WHOLESALE STORE SERVICES VIA TELESHP-  
PING, NAMELY, CATALOG ORDERING SERVICE  
FEATURING MOTOR VEHICLES AND THEIR  
PARTS AND FITTINGS; BRINGING TOGETHER,  
BUT NOT TRANSPORTING, A VARIETY OF MO-  
TOR VEHICLES AND PARTS AND FITTINGS  
THEREFOR FOR THE BENEFIT OF OTHERS,  
THEREBY ENABLING CUSTOMERS TO VIEW

AND PURCHASE THE GOODS IN A RETAIL OUT-  
LET; NEGOTIATION OF CONTRACTS FOR THE  
BENEFIT OF OTHERS ABOUT SALE AND PUR-  
CHASE OF MOTOR VEHICLES AND THEIR PARTS  
AND FITTINGS, NAMELY, NEGOTIATION AND  
SETTLEMENT OF COMMERCIAL TRANSACTIONS  
FOR THIRD PARTIES; CONSULTANCY AND AS-  
SISTANCE IN ORGANIZATION AND MANAGE-  
MENT OF RETAIL AND BUSINESS COMPANIES,  
IN CLASS 35 (U.S. CLS. 100, 101 AND 102).

FOR: RECONSTRUCTION, REPAIR, SERVICING,  
DISMANTLING, CLEANING, MAINTENANCE  
AND VARNISHING OF VEHICLES AND THEIR  
PARTS AND MOTORS AND THEIR PARTS, NAME-  
LY, REPAIR AND MAINTENANCE OF VEHICLES;  
VEHICLE REPAIR IN THE COURSE OF VEHICLE  
BREAKDOWN SERVICE; REFINEMENT AND TUN-  
ING OF AUTOMOBILES, NAMELY, REPAIR AND  
MAINTENANCE OF AUTOMOBILES, IN CLASS 37  
(U.S. CLS. 100, 103 AND 106).

THE MARK CONSISTS OF STANDARD CHAR-  
ACTERS WITHOUT CLAIM TO ANY PARTICULAR  
FONT, STYLE, SIZE, OR COLOR.

PRIORITY DATE OF 6-11-2007 IS CLAIMED.

OWNER OF INTERNATIONAL REGISTRATION  
0955114 DATED 12-4-2007, EXPIRES 12-4-2017.

OWNER OF U.S. REG. NO. 1,468,206.

THE ENGLISH TRANSLATION OF "PASSAT" IN  
THE MARK IS TRADE WIND.

SER. NO. 79-050,534, FILED 12-4-2007.

COLLEEN KEARNEY, EXAMINING ATTORNEY

Int. Cl.: 10

Prior U.S. Cls.: 26, 39 and 44

United States Patent and Trademark Office

Reg. No. 3,505,644

Registered Sep. 23, 2008

TRADEMARK  
PRINCIPAL REGISTER

IV Sty

CORNWALL AND ISLES OF SCILLY; PRIMARY  
CARE TRUST (UNITED KINGDOM PUBLIC  
SECTOR CORPORATION)  
SEDGEMOOR CENTRE,  
PRIORY ROAD; ST. AUSTELL, CORNWALL  
PL255AS  
UNITED KINGDOM

FOR: DEVICES FOR MEDICAL USE IN PRO-  
TECTING INJECTION SITES ON AN INTRAVE-  
NOUS GIVING SET LINE , IN CLASS 10 (U.S. CLS.  
26, 39 AND 44).

PRIORITY DATE OF 8-9-2007 IS CLAIMED.

OWNER OF INTERNATIONAL REGISTRATION  
0955263 DATED 11-30-2007, EXPIRES 11-30-2017.

NO CLAIM IS MADE TO THE EXCLUSIVE  
RIGHT TO USE "IV", APART FROM THE MARK  
AS SHOWN.

SER. NO. 79-050,585, FILED 11-30-2007.

JACLYN KIDWELL, EXAMINING ATTORNEY

**Int. Cls.: 3, 5 and 21**

**Prior U.S. Cls.: 1, 2, 4, 6, 13, 18, 23, 29, 30, 33, 40, 44,  
46, 50, 51 and 52**

**Reg. No. 3,505,645**

**United States Patent and Trademark Office**

**Registered Sep. 23, 2008**

**TRADEMARK  
PRINCIPAL REGISTER**

**PARO**

ESRO AG (SWITZERLAND SOCIÉTÉ ANON-  
YME)  
DORFSTRASSE 143  
CH-8802 KILCHBERG  
SWITZERLAND

FOR: PREPARATIONS FOR THE CARE OF THE MOUTH AND TEETH, NAMELY, COSMETIC PREPARATIONS FOR THE CARE OF THE MOUTH AND TEETH; DENTAL PLAQUE INDICATOR TABLETS, NOT FOR MEDICAL USE; NON-MEDICATED MOUTH RINSES; TOOTH-CLEANING PREPARATIONS, TOOTH PASTE, TOOTH GEL, NON-MEDICATED DENTAL RINSES, IN CLASS 3 (U.S. CLS. 1, 4, 6, 50, 51 AND 52).

FOR: MEDICATED MOUTH AND TEETH CARE PREPARATIONS, DENTAL PLAQUE INDICATOR TABLETS, FOR MEDICAL USE; MOUTH RINSES FOR MEDICAL USE, IN CLASS 5 (U.S. CLS. 6, 18, 44, 46, 51 AND 52).

FOR: TOOTH BRUSHES, DENTURE BRUSHES, INTERDENTAL CLEANERS FOR ORAL HYGIENE,

ELECTRIC TOOTH BRUSHES, TOOTHPICKS MADE OF PLASTIC; TOOTHPICKS MADE OF WOOD; DENTAL FLOSS, APPARATUS FOR CLEANING TEETH AND GUMS USING HIGH PRESSURE WATER, IN CLASS 21 (U.S. CLS. 2, 13, 23, 29, 30, 33, 40 AND 50).

THE MARK CONSISTS OF STANDARD CHARACTERS WITHOUT CLAIM TO ANY PARTICULAR FONT, STYLE, SIZE, OR COLOR.

PRIORITY DATE OF 7-20-2007 IS CLAIMED.

OWNER OF INTERNATIONAL REGISTRATION 0955334 DATED 12-31-2007, EXPIRES 12-31-2017.

OWNER OF U.S. REG. NO. 2,299,603.

SER. NO. 79-050,601, FILED 12-31-2007.

TASHIA BUNCH, EXAMINING ATTORNEY

**Int. Cl.: 5**

**Prior U.S. Cls.: 6, 18, 44, 46, 51 and 52**

**United States Patent and Trademark Office**

**Reg. No. 3,505,646**

**Registered Sep. 23, 2008**

**TRADEMARK  
PRINCIPAL REGISTER**

**PHARYDAX**

NOVARTIS AG (SWITZERLAND CORPORATION)  
CH-4002 BASEL  
SWITZERLAND

FOR: PHARMACEUTICAL PREPARATIONS FOR  
USE IN ONCOLOGY, IN CLASS 5 (U.S. CLS. 6, 18, 44,  
46, 51 AND 52).

THE MARK CONSISTS OF STANDARD CHAR-  
ACTERS WITHOUT CLAIM TO ANY PARTICULAR  
FONT, STYLE, SIZE, OR COLOR.

PRIORITY DATE OF 9-27-2007 IS CLAIMED.

OWNER OF INTERNATIONAL REGISTRATION  
0955560 DATED 2-1-2008, EXPIRES 2-1-2018.

OWNER OF U.S. REG. NOS. 3,073,839 AND  
3,194,646.

THE WORD "PHARYDAX" HAS NO MEANING  
IN ENGLISH OR ANY FOREIGN LANGUAGE.

SER. NO. 79-050,669, FILED 2-1-2008.

MICHAEL ENGEL, EXAMINING ATTORNEY

**Int. Cl.: 5**

**Prior U.S. Cls.: 6, 18, 44, 46, 51 and 52**

**United States Patent and Trademark Office**

**Reg. No. 3,505,647**

**Registered Sep. 23, 2008**

**TRADEMARK  
PRINCIPAL REGISTER**

**FANODAK**

NOVARTIS AG (SWITZERLAND CORPORATION)  
CH-4002 BASEL  
SWITZERLAND

OWNER OF INTERNATIONAL REGISTRATION  
0955561 DATED 2-1-2008, EXPIRES 2-1-2018.

FOR: PHARMACEUTICAL PREPARATIONS FOR  
USE IN ONCOLOGY, IN CLASS 5 (U.S. CLS. 6, 18, 44,  
46, 51 AND 52).

THE WORD "FANODAK" HAS NO MEANING IN  
ENGLISH OR ANY FOREIGN LANGUAGE.

THE MARK CONSISTS OF STANDARD CHAR-  
ACTERS WITHOUT CLAIM TO ANY PARTICULAR  
FONT, STYLE, SIZE, OR COLOR.

SER. NO. 79-050,670, FILED 2-1-2008.

PRIORITY DATE OF 9-27-2007 IS CLAIMED.

MICHAEL ENGEL, EXAMINING ATTORNEY



**Int. Cls.: 29 and 31**

**Prior U.S. Cls.: 1 and 46**

**United States Patent and Trademark Office**

**Reg. No. 3,505,648**

**Registered Sep. 23, 2008**

**TRADEMARK  
PRINCIPAL REGISTER**

**FRULANA**

FRULANA SRL (ITALY S.R.L.)  
VIA J. KRAVOGI 8/1 STRASSE  
I-39011 LANA (BZ)  
ITALY

FOR: MEAT, FISH, POULTRY AND GAME;  
MEAT EXTRACTS; PRESERVED, DRIED AND  
COOKED FRUITS AND VEGETABLES; JELLIES,  
JAMS, FRUIT SAUCES, NAMELY, CRANBERRY  
SAUCE AND APPLE SAUCE; EGGS, MILK AND  
MILK PRODUCTS, EXCLUDING ICE CREAM, ICE  
MILK, AND FROZEN YOGURT; EDIBLE OILS AND  
FATS, IN CLASS 29 (U.S. CL. 46).

FOR: AGRICULTURAL, HORTICULTURAL  
AND FORESTRY PRODUCTS AND GRAINS NOT  
INCLUDED IN OTHER CLASSES, NAMELY, BULBS  
FOR AGRICULTURAL PURPOSES, BULBS FOR  
HORTICULTURAL PURPOSES, AGRICULTURAL

GRAINS FOR PLANTING, UNPROCESSED GRAIN,  
LIVE PLANTS, LIVE TREES, LIVE SHRUBS, AND  
LIVE BRUSHES; LIVE ANIMALS; FRESH FRUITS  
AND VEGETABLES; AGRICULTURAL SEEDS,  
NATURAL PLANTS AND FLOWERS; FOOD-  
STUFFS FOR ANIMALS, MALT FOR BREWING  
AND DISTILLING, IN CLASS 31 (U.S. CLS. 1 AND  
46).

OWNER OF INTERNATIONAL REGISTRATION  
0955666 DATED 1-12-2008, EXPIRES 1-12-2018.

THE WORDING "FRULANA" HAS NO MEAN-  
ING IN A FOREIGN LANGUAGE.

SER. NO. 79-050,739, FILED 1-12-2008.

BRIAN CALLAGHAN, EXAMINING ATTORNEY

**Int. Cl.: 9**

**Prior U.S. Cls.: 21, 23, 26, 36 and 38**

**Reg. No. 3,505,649**

**United States Patent and Trademark Office**

**Registered Sep. 23, 2008**

---

**TRADEMARK  
PRINCIPAL REGISTER**

**SOLZEUS**

SENJU METAL INDUSTRY CO., LTD. (JAPAN  
CORPORATION)  
23 SENJU-HASHIDO-CHO  
ADACHI-KU  
TOKYO, JAPAN 1208555

OWNER OF INTERNATIONAL REGISTRATION  
0956004 DATED 2-19-2008, EXPIRES 2-19-2018.

FOR: ELECTRIC SOLDERING APPARATUS, IN  
CLASS 9 (U.S. CLS. 21, 23, 26, 36 AND 38).

SER. NO. 79-050,839, FILED 2-19-2008.

PRIORITY DATE OF 11-21-2007 IS CLAIMED.

ALLISON HOLTZ, EXAMINING ATTORNEY

**Int. Cl.: 9**

**Prior U.S. Cls.: 21, 23, 26, 36 and 38**

**Reg. No. 3,505,650**

**United States Patent and Trademark Office**

**Registered Sep. 23, 2008**

**TRADEMARK  
PRINCIPAL REGISTER**

**ECOPASCAL**

SENJU METAL INDUSTRY CO., LTD. (JAPAN  
CORPORATION)  
23 SENJU-HASHIDO-CHO  
ADACHI-KU  
TOKYO, JAPAN 1208555

OWNER OF INTERNATIONAL REGISTRATION  
0956005 DATED 2-19-2008, EXPIRES 2-19-2018.

SER. NO. 79-050,840, FILED 2-19-2008.

FOR: ELECTRIC SOLDERING APPARATUS, IN  
CLASS 9 (U.S. CLS. 21, 23, 26, 36 AND 38).

ALLISON HOLTZ, EXAMINING ATTORNEY

**Int. Cl.: 25**

**Prior U.S. Cls.: 22 and 39**

**United States Patent and Trademark Office**

**Reg. No. 3,505,651**

**Registered Sep. 23, 2008**

**TRADEMARK  
PRINCIPAL REGISTER**

The logo consists of the letters 'M', 'A', and 'D' in a very bold, black, sans-serif font. The 'M' and 'A' are connected at the top, and the 'A' has a unique shape with a pointed top and a wide base. The 'D' is also very bold and blocky.

ITOCHU CORPORATION (JAPAN CORPORATION)  
1-3, KYUTARO-MACHI 4-CHOME  
CHUO-KU, OSAKA-SHI; OSAKA 541-8577  
JAPAN AND  
TSURUYA SHOE STORE CO., LTD. (JAPAN CORPORATION)  
3-4-10 IMAIKE, CHIKUSA-KU  
NAGOYA-CITY, AICHI 464-0850  
JAPAN

FOR: CLOTHING, NAMELY, SHIRTS, T-SHIRTS, PANTS, JEANS, JACKETS, COATS, DRESSES, SKIRTS, SOCKS, TIGHTS, GLOVES, VESTS, UNDERWEAR, ANORAKS, RAINWEAR, WIND RESISTANT JACKETS, SWEATSHIRTS, TANK TOPS,

PULLOVERS, SWEATERS, KNIT SHIRTS, CARDIGANS, BELTS, PARKAS, MUFFLERS, FLEECE PULLOVERS, CAPS, HATS, VISORS; FOOTWEAR, IN CLASS 25 (U.S. CLS. 22 AND 39).

PRIORITY DATE OF 9-5-2007 IS CLAIMED.

OWNER OF INTERNATIONAL REGISTRATION  
0956041 DATED 2-18-2008, EXPIRES 2-18-2018.

SER. NO. 79-050,851, FILED 2-18-2008.

TASNEEM HUSSAIN, EXAMINING ATTORNEY

**Int. Cl.: 14**

**Prior U.S. Cls.: 2, 27, 28 and 50**

**United States Patent and Trademark Office**

**Reg. No. 3,505,652**

**Registered Sep. 23, 2008**

**TRADEMARK  
PRINCIPAL REGISTER**

**SILICHRON**

NIVAROX-FAR S.A. (SWITZERLAND SOCIÉTÉ  
ANONYME (JOINT STOCK COMPANY, SOCI-  
EDAD ANONIMA))  
AVENUE DU COLLÈGE 10  
CH-2400 LE LOCLE  
SWITZERLAND

FOR: TIMEPIECE COMPONENTS, NAMELY  
HAIRSPRINGS FOR WATCHES, IN CLASS 14 (U.S.  
CLS. 2, 27, 28 AND 50).

THE MARK CONSISTS OF STANDARD CHAR-  
ACTERS WITHOUT CLAIM TO ANY PARTICULAR  
FONT, STYLE, SIZE, OR COLOR.

PRIORITY DATE OF 11-19-2007 IS CLAIMED.

OWNER OF INTERNATIONAL REGISTRATION  
0956155 DATED 2-15-2008, EXPIRES 2-15-2018.

SER. NO. 79-050,899, FILED 2-15-2008.

SANI KHOURI, EXAMINING ATTORNEY

Int. Cl.: 30

Prior U.S. Cl.: 46

United States Patent and Trademark Office

Reg. No. 3,505,653

Registered Sep. 23, 2008

TRADEMARK  
PRINCIPAL REGISTER



DORIA S.P.A. (ITALY JOINT STOCK COMPANY)  
VIA PONTEBBANA, 32  
I-31010 ORSAGO (TV)  
ITALY

FOR: COFFEE, TEA, COCOA, SUGAR, RICE, TAPIOCA, SAGO, SUBSTITUTES FOR COFFEE; FLOURS AND PREPARATIONS MADE OF CEREALS, NAMELY, EDIBLE FLOUR, BUCKWHEAT FLOUR FOR FOOD, BARLEY FLOUR FOR FOOD; CORN FLOUR FOR FOOD, CORN STARCH FLOUR, RICE FLOUR FOR FOOD, TOASTED CEREALS, CEREAL FLAKES, BREAKFAST CEREALS, CEREAL BASED ENERGY BAR NOT FOR USE AS A MEAL REPLACEMENT, CEREAL BASED SNACK FOOD, PROCESSED CEREALS, PROCESSED CEREAL-BASED FOOD TO BE USED AS BREAKFAST FOOD, READY TO EAT CEREAL DERIVED FOOD BARS; BREAD, PASTRY AND FROZEN CONFECTIONERY, ICE CREAMS; HONEY, TREACLE; YEAST, FOOD LEAVENING POWDER; SALT, VINEGAR, SPICES; ICE; BISCUITS; CRACKERS; SALTED BISCUITS AND SWEETS, IN CLASS 30 (U.S. CL. 46).

PRIORITY DATE OF 10-11-2007 IS CLAIMED.

OWNER OF INTERNATIONAL REGISTRATION  
0956304 DATED 1-7-2008, EXPIRES 1-7-2018.

OWNER OF U.S. REG. NO. 3,117,404.

THE COLOR(S) WHITE, RED AND GREY IS/ARE  
CLAIMED AS A FEATURE OF THE MARK.

THE MARK CONSISTS OF THE WORD "DORIA"  
IN WHITE COLOR WITH SHADINGS AND LOWER-  
CASE FANCIFUL LETTERS WITH CAPITAL INITIAL  
LETTER "D"; THE WHOLE BEING POSITIONED  
INSIDE AN OVAL RED FIGURE WITH SHADES  
SHOWING A GREY SHADING AND A WHITE  
FANCIFUL DECORATION.

SER. NO. 79-050,947, FILED 1-7-2008.

TARAH HARDY, EXAMINING ATTORNEY

**Int. Cl.: 3**

**Prior U.S. Cls.: 1, 4, 6, 50, 51 and 52**

**United States Patent and Trademark Office**

**Reg. No. 3,505,654**

**Registered Sep. 23, 2008**

**TRADEMARK  
PRINCIPAL REGISTER**

**GET**  
the  
**color**

PIDIELLE SRL (ITALY LIMITED LIABILITY  
COMPANY)  
VIA BERGAMINA, 7  
I-20014 NERVIANO (MILANO)  
ITALY

OWNER OF INTERNATIONAL REGISTRATION  
0956443 DATED 2-18-2008, EXPIRES 2-18-2018.

FOR: PERFUMERY, ESSENTIAL OILS, COSMET-  
ICS, HAIR LOTIONS, IN CLASS 3 (U.S. CLS. 1, 4, 6, 50,  
51 AND 52).

SER. NO. 79-051,032, FILED 2-18-2008.

PRIORITY DATE OF 11-12-2007 IS CLAIMED.

TASNEEM HUSSAIN, EXAMINING ATTORNEY

Int. Cl.: 33

Prior U.S. Cls.: 47 and 49

United States Patent and Trademark Office

Reg. No. 3,505,655

Registered Sep. 23, 2008

TRADEMARK  
PRINCIPAL REGISTER



Hahn Barossa Vineyards (SA) Pty Ltd  
(Australia a company of Australia)  
PO Box 64  
Stockwell SA 5355  
Australia

OWNER OF INTERNATIONAL REGISTRATION  
0956456 DATED 2-22-2008, EXPIRES 2-22-2018.

FOR: WINE, IN CLASS 33 (U.S. CLS. 47 AND 49).

SER. NO. 79-051,041, FILED 2-22-2008.

PRIORITY DATE OF 8-31-2007 IS CLAIMED.

RICHARD WHITE, EXAMINING ATTORNEY



**Int. Cl.: 33**

**Prior U.S. Cls.: 47 and 49**

**United States Patent and Trademark Office**

**Reg. No. 3,505,656**

**Registered Sep. 23, 2008**

**TRADEMARK  
PRINCIPAL REGISTER**

**FLÄMINGER JAGD**

DRINKS & FOOD VERTRIEBS-GMBH (FED REP  
GERMANY GMBH)  
KÖPNICKER STRAÙE 1  
06895 ZAHNA  
FED REP GERMANY

FOR: SPIRITS, IN CLASS 33 (U.S. CLS. 47 AND 49).

THE MARK CONSISTS OF STANDARD CHAR-  
ACTERS WITHOUT CLAIM TO ANY PARTICULAR  
FONT, STYLE, SIZE, OR COLOR.

OWNER OF INTERNATIONAL REGISTRATION  
0956887 DATED 10-30-2007, EXPIRES 10-30-2017.

THE ENGLISH TRANSLATION OF "JAGD" IN  
THE MARK IS HUNT. "FLÄMINGER" HAS NO  
MEANING IN A FOREIGN LANGUAGE.

SER. NO. 79-051,189, FILED 10-30-2007.

REBECCA POVARCHUK, EXAMINING ATTOR-  
NEY

**Int. Cl.: 9**

**Prior U.S. Cls.: 21, 23, 26, 36 and 38**

**United States Patent and Trademark Office**

**Reg. No. 3,505,657**

**Registered Sep. 23, 2008**

**TRADEMARK  
PRINCIPAL REGISTER**

**LOCALIS**

SOMFY SAS (FRANCE SOCIÉTÉ PAR ACTIONS  
SIMPLIFIÉE)  
50 AVENUE DU NOUVEAU MONDE  
F-74300 CLUSES  
FRANCE

FOR: ELECTRIC OR ELECTRONIC APPARATUS  
AND INSTRUMENTS FOR THE CONTROL AND  
REMOTE CONTROL OF OPERATING MOTORS  
FOR BLINDS, SCREENS, CURTAINS, SHUTTERS,  
WINDOWS, VENTILATION HATCHES, LOCKS,  
DOORS, GARAGE DOORS, GATES, BARRIERS  
AND GRILLS; ELECTRIC OR ELECTRONIC MON-  
ITORING AND ALARM APPARATUS AND IN-  
STRUMENTS AND THEIR CONTROL DEVICES

FOR PROTECTION OF PEOPLE, GOODS AND  
BUILDINGS, IN CLASS 9 (U.S. CLS. 21, 23, 26, 36  
AND 38).

PRIORITY DATE OF 8-30-2007 IS CLAIMED.

OWNER OF INTERNATIONAL REGISTRATION  
0957042 DATED 2-19-2008, EXPIRES 2-19-2018.

SER. NO. 79-051,260, FILED 2-19-2008.

ALLISON HOLTZ, EXAMINING ATTORNEY

**Int. Cl.: 21**

**Prior U.S. Cls.: 2, 13, 23, 29, 30, 33, 40 and 50**

**Reg. No. 3,505,658**

**United States Patent and Trademark Office**

**Registered Sep. 23, 2008**

---

**TRADEMARK  
PRINCIPAL REGISTER**

**TRIPLE RIPPLE**

DETMOLD PACKAGING PTY LTD (AUSTRALIA  
PROPRIETARY LIMITED COMPANY (PTY  
LTD))

45 CHIEF STREET  
BROMPTON SA 5007  
AUSTRALIA

PRIORITY DATE OF 8-24-2007 IS CLAIMED.

OWNER OF INTERNATIONAL REGISTRATION  
0957047 DATED 2-20-2008, EXPIRES 2-20-2018.

FOR: CUPS OF PAPER OR PLASTIC; DISPOSABLE CUPS, IN CLASS 21 (U.S. CLS. 2, 13, 23, 29, 30, 33, 40 AND 50).

SER. NO. 79-051,264, FILED 2-20-2008.

THE MARK CONSISTS OF STANDARD CHARACTERS WITHOUT CLAIM TO ANY PARTICULAR FONT, STYLE, SIZE, OR COLOR.

ESTHER BELENKER, EXAMINING ATTORNEY

**Int. Cl.: 5**

**Prior U.S. Cls.: 6, 18, 44, 46, 51 and 52**

**United States Patent and Trademark Office**

**Reg. No. 3,505,659**

**Registered Sep. 23, 2008**

**TRADEMARK  
PRINCIPAL REGISTER**

**KAYORVEK**

SANOFI-AVENTIS (FRANCE SOCIÉTÉ ANON-  
YME)  
174 AVENUE DE FRANCE  
F-75013 PARIS  
FRANCE

FOR: PHARMACEUTICAL PREPARATIONS,  
NAMELY, PREPARATIONS FOR THE PREVEN-  
TION AND TREATMENT OF CARDIOVASCULAR  
DISEASES; PHARMACEUTICAL PREPARATIONS,  
NAMELY, PREPARATIONS FOR THE PREVEN-  
TION AND TREATMENT OF CANCER; PHARMA-  
CEUTICAL PREPARATIONS, NAMELY,  
PREPARATIONS FOR THE PREVENTION AND  
TREATMENT OF THROMBOSIS; PHARMACEUTI-  
CAL PREPARATIONS, NAMELY, PREPARATIONS  
FOR THE PREVENTION AND TREATMENT OF  
DISEASES IN THE FIELD OF INTERNAL MEDI-  
CINE; PHARMACEUTICAL PREPARATIONS,  
NAMELY, PREPARATIONS FOR THE PREVEN-  
TION AND TREATMENT OF DISEASES OF THE

CENTRAL NERVOUS SYSTEM; PHARMACEUTI-  
CAL PREPARATIONS, NAMELY, PREPARATIONS  
FOR THE PREVENTION AND TREATMENT OF  
RESPIRATORY DISEASES , IN CLASS 5 (U.S. CLS. 6,  
18, 44, 46, 51 AND 52).

THE MARK CONSISTS OF STANDARD CHAR-  
ACTERS WITHOUT CLAIM TO ANY PARTICULAR  
FONT, STYLE, SIZE, OR COLOR.

PRIORITY DATE OF 9-12-2007 IS CLAIMED.

OWNER OF INTERNATIONAL REGISTRATION  
0957185 DATED 2-15-2008, EXPIRES 2-15-2018.

SER. NO. 79-051,322, FILED 2-15-2008.

PATRICIA EVANKO, EXAMINING ATTORNEY

**Int. Cl.: 19**

**Prior U.S. Cls.: 1, 12, 33 and 50**

**United States Patent and Trademark Office**

**Reg. No. 3,505,660**

**Registered Sep. 23, 2008**

**TRADEMARK  
PRINCIPAL REGISTER**

**FORMAG**

REFRATECHNIK HOLDING GMBH (FED REP  
GERMANY CORPORATION (LIMITED LIABILITY COMPANY))

ADALPEROSTRASSE 82

85737 ISMANING

FED REP GERMANY

FOR: STONES AND BRICKS FOR LINING INDUSTRIAL FURNACES, ESPECIALLY FIREPROOF AND HEAT RESISTANT STONES AND BRICKS; FIREPROOF MASSES NOT MADE OF METAL FOR THE MANUFACTURING OF FIREPROOF LININGS, FIREPROOF MORTARS, FIREPROOF CEMENT AND FIREPROOF CONCRETE, IN CLASS 19 (U.S. CLS. 1, 12, 33 AND 50).

THE MARK CONSISTS OF STANDARD CHARACTERS WITHOUT CLAIM TO ANY PARTICULAR FONT, STYLE, SIZE, OR COLOR.

PRIORITY DATE OF 10-11-2007 IS CLAIMED.

OWNER OF INTERNATIONAL REGISTRATION  
0957403 DATED 1-31-2008, EXPIRES 1-31-2018.

OWNER OF U.S. REG. NO. 2,850,888.

SER. NO. 79-051,394, FILED 1-31-2008.

RON FAIRBANKS, EXAMINING ATTORNEY

**Int. Cls.: 36, 39, 42 and 45**

**Prior U.S. Cls.: 100, 101, 102 and 105**

**United States Patent and Trademark Office**

**Reg. No. 3,505,661**

**Registered Sep. 23, 2008**

**SERVICE MARK  
PRINCIPAL REGISTER**

# SAROPA

CLICKSAFE AUSTRALIA PTY LIMITED (AUSTRALIA COMPANY)

LEVEL 14

309 KENT STREET; SYDNEY NSW 2000

AUSTRALIA

FOR: FINANCIAL INFORMATION SERVICES, NAMELY, PROVIDING FINANCIAL INFORMATION RELATING TO THE OWNERSHIP, PROTECTION AND MANAGEMENT OF GOODS, THE COMPILATION AND SYSTEMISATION OF FINANCIAL INFORMATION INTO COMPUTER DATABASES AND MAINTAINING A COMPUTER DATABASE ABOUT OWNERSHIP, PROTECTION AND MANAGEMENT OF GOODS; ANALYSIS OF FINANCIAL INFORMATION; FINANCIAL RECORDS MANAGEMENT; FINANCIAL RISK MANAGEMENT; FINANCIAL VALUATION OF PERSONAL PROPERTY AND REAL ESTATE; PROVIDING ON-LINE FINANCIAL CALCULATORS; INSURANCE INFORMATION SERVICES, NAMELY, THE SUPPLY OF INFORMATION ABOUT INSURANCE POLICIES, APPLICATIONS FOR INSURANCE, INSURANCE CLAIM LODGEMENT AND THE OWNERSHIP OF GOODS AND FINANCIAL INTERESTS IN GOODS, THE COMPILATION AND SYSTEMISATION OF INSURANCE INFORMATION INTO COMPUTER DATABASES, AND MAINTAINING A COMPUTER DATABASE ABOUT OWNERSHIP OF GOODS AND FINANCIAL INTERESTS IN GOODS; ANALYSIS OF INSURANCE INFORMATION, NAMELY, INSURANCE ADMINISTRATION; INSURANCE RECORDS MANAGEMENT, NAMELY, INSURANCE CLAIMS PROCESSING; INSURANCE RISK MANAGEMENT; INSURANCE BROKERAGE SERVICES; PROVIDING ON-LINE INSURANCE PREMIUM CALCULATORS, NAMELY, INSURANCE PREMIUM RATE COMPUTING; ADMINISTRATION AND PROCESSING OF INSURANCE CLAIMS, IN CLASS 36 (U.S. CLS. 100, 101 AND 102).

FOR: STORAGE OF ELECTRONIC MEDIA, NAMELY, DATABASES, IMAGES, TEXT, AUDIO

AND OTHER ELECTRONIC DATA, IN CLASS 39 (U.S. CLS. 100 AND 105).

FOR: HOSTING COMPUTER WEBSITES; RECORDING DATA FOR OTHERS ON OPTICAL, DIGITAL AND MAGNETIC MEDIA FOR ELECTRONIC STORAGE; ON-LINE SECURITY SERVICES, NAMELY, PROVIDING SECURITY AND ANONYMITY FOR ONLINE TRANSACTIONS; COMPUTER VIRUS PROTECTION SERVICES, IN CLASS 42 (U.S. CLS. 100 AND 101).

FOR: SECURITY SERVICES, NAMELY, PROVIDING A LIST AND PHOTOGRAPHS OF ALL FURNITURE AND BELONGINGS IN A RESIDENCE AND BUSINESS, AS A RECORD TO THE OWNER OF THE CONTENTS IN THE EVENT OF A DISASTER; ADVISORY AND CONSULTANCY SERVICES RELATING TO THE SECURITY OF BUSINESS PREMISES, HOUSEHOLDS AND VEHICLES; COMPUTERIZED SECURITY SERVICES FOR BUSINESS PREMISES, HOUSEHOLDS AND VEHICLES, NAMELY, MONITORING BURGLAR AND SECURITY ALARMS; MONITORING OF SECURITY SYSTEMS; PROVIDING SECURITY ASSESSMENTS OF BUSINESS PREMISES, HOUSEHOLDS, VEHICLES AND COMPUTER SYSTEMS, NAMELY, SECURITY CONSULTANCY; SECURITY SERVICES RELATING TO COMPUTERIZED DATA, NAMELY, MONITORING OF COMPUTER SYSTEMS FOR SECURITY PURPOSES, IN CLASS 45 (U.S. CLS. 100 AND 101).

THE MARK CONSISTS OF STANDARD CHARACTERS WITHOUT CLAIM TO ANY PARTICULAR FONT, STYLE, SIZE, OR COLOR.

PRIORITY DATE OF 10-17-2007 IS CLAIMED.

OWNER OF INTERNATIONAL REGISTRATION 0957719 DATED 11-20-2007, EXPIRES 11-20-2017.

THE MARK HAS NO MEANING IN A FOREIGN  
LANGUAGE.

SER. NO. 79-051,522, FILED 11-20-2007.

ROBERT STRUCK, EXAMINING ATTORNEY

**Int. Cl.: 1**

**Prior U.S. Cls.: 1, 5, 6, 10, 26 and 46**

**United States Patent and Trademark Office**

**Reg. No. 3,505,662**

**Registered Sep. 23, 2008**

**TRADEMARK  
PRINCIPAL REGISTER**

**AQUATIX**

BYK-CERA B.V. (NETHERLANDS B.V.)  
23, DANZIGWEG  
NL-7418 EN DEVENTER  
NETHERLANDS

FOR: CHEMICAL ADDITIVES FOR IMPROVING  
THE SURFACE AND APPLICATION PROPERTIES  
OF DYE, LACQUER, PRINTING INK AND RELAT-  
ED PRODUCTS, IN PARTICULAR, AQUEOUS  
WAX EMULSIONS, IN CLASS 1 (U.S. CLS. 1, 5, 6,  
10, 26 AND 46).

THE MARK CONSISTS OF STANDARD CHAR-  
ACTERS WITHOUT CLAIM TO ANY PARTICULAR  
FONT, STYLE, SIZE, OR COLOR.

PRIORITY DATE OF 11-2-2007 IS CLAIMED.

OWNER OF INTERNATIONAL REGISTRATION  
0957732 DATED 2-19-2008, EXPIRES 2-19-2018.

SER. NO. 79-051,527, FILED 2-19-2008.

TINA BROWN, EXAMINING ATTORNEY



**Int. Cl.: 1**

**Prior U.S. Cls.: 1, 5, 6, 10, 26 and 46**

**United States Patent and Trademark Office**

**Reg. No. 3,505,663**

**Registered Sep. 23, 2008**

**TRADEMARK  
PRINCIPAL REGISTER**

**AQUAMAT**

BYK-CERA B.V. (NETHERLANDS B.V.)  
23, DANZIGWEG  
NL-7418 EN DEVENTER  
NETHERLANDS

FOR: CHEMICAL ADDITIVES FOR IMPROVING  
THE SURFACE AND APPLICATION PROPERTIES  
OF DYE, LACQUER, PRINTING INK AND RELAT-  
ED PRODUCTS, IN PARTICULAR, AQUEOUS  
WAX DISPERSIONS , IN CLASS 1 (U.S. CLS. 1, 5, 6,  
10, 26 AND 46).

THE MARK CONSISTS OF STANDARD CHAR-  
ACTERS WITHOUT CLAIM TO ANY PARTICULAR  
FONT, STYLE, SIZE, OR COLOR.

PRIORITY DATE OF 11-2-2007 IS CLAIMED.

OWNER OF INTERNATIONAL REGISTRATION  
0957733 DATED 2-19-2008, EXPIRES 2-19-2018.

SER. NO. 79-051,528, FILED 2-19-2008.

TINA BROWN, EXAMINING ATTORNEY

**Int. Cl.: 1**

**Prior U.S. Cls.: 1, 5, 6, 10, 26 and 46**

**United States Patent and Trademark Office**

**Reg. No. 3,505,664**

**Registered Sep. 23, 2008**

**TRADEMARK  
PRINCIPAL REGISTER**

**CERACOL**

BYK-CERA B.V. (NETHERLANDS B.V.)  
23, DANZIGWEG  
NL-7418 EN DEVENTER, NETHERLANDS

PRIORITY DATE OF 11-2-2007 IS CLAIMED.

FOR: CHEMICAL ADDITIVES FOR IMPROVING  
THE SURFACE AND APPLICATION PROPERTIES  
OF DYE, LACQUER, PRINTING INK AND RELAT-  
ED PRODUCTS, IN PARTICULAR, SOLVENT  
BASED WAX DISPERSIONS , IN CLASS 1 (U.S.  
CLS. 1, 5, 6, 10, 26 AND 46).

OWNER OF INTERNATIONAL REGISTRATION  
0957824 DATED 2-19-2008, EXPIRES 2-19-2018.

THE WORDING "CERACOL" HAS NO MEANING  
IN A FOREIGN LANGUAGE.

THE MARK CONSISTS OF STANDARD CHAR-  
ACTERS WITHOUT CLAIM TO ANY PARTICULAR  
FONT, STYLE, SIZE, OR COLOR.

SER. NO. 79-051,552, FILED 2-19-2008.

TINA BROWN, EXAMINING ATTORNEY

**Int. Cl.: 1**

**Prior U.S. Cls.: 1, 5, 6, 10, 26 and 46**

**United States Patent and Trademark Office**

**Reg. No. 3,505,665**

**Registered Sep. 23, 2008**

**TRADEMARK  
PRINCIPAL REGISTER**

**CERAFAK**

BYK-CERA B.V. (NETHERLANDS B.V.)  
23, DANZIGWEG  
NL-7418 EN DEVENTER  
NETHERLANDS

FOR: CHEMICAL ADDITIVES FOR IMPROVING  
THE SURFACE AND APPLICATION PROPERTIES  
OF DYE, LACQUER, PRINTING INK AND RELAT-  
ED PRODUCTS, IN PARTICULAR, SOLVENT  
BASED WAX DISPERSIONS , IN CLASS 1 (U.S.  
CLS. 1, 5, 6, 10, 26 AND 46).

THE MARK CONSISTS OF STANDARD CHAR-  
ACTERS WITHOUT CLAIM TO ANY PARTICULAR  
FONT, STYLE, SIZE, OR COLOR.

PRIORITY DATE OF 11-2-2007 IS CLAIMED.

OWNER OF INTERNATIONAL REGISTRATION  
0957825 DATED 2-19-2008, EXPIRES 2-19-2018.

SER. NO. 79-051,553, FILED 2-19-2008.

TINA BROWN, EXAMINING ATTORNEY

**Int. Cl.: 1**

**Prior U.S. Cls.: 1, 5, 6, 10, 26 and 46**

**United States Patent and Trademark Office**

**Reg. No. 3,505,666**

**Registered Sep. 23, 2008**

**TRADEMARK  
PRINCIPAL REGISTER**

**CERATIX**

BYK-CERA B.V. (NETHERLANDS B.V.)  
23, DANZIGWEG  
NL-7418 EN DEVENTER  
NETHERLANDS

FOR: CHEMICAL ADDITIVES FOR IMPROVING  
THE SURFACE AND APPLICATION PROPERTIES  
OF DYE, LACQUER, PRINTING INK AND RELAT-  
ED PRODUCTS, IN PARTICULAR, SOLVENT  
BASED WAX DISPERSIONS , IN CLASS 1 (U.S.  
CLS. 1, 5, 6, 10, 26 AND 46).

THE MARK CONSISTS OF STANDARD CHAR-  
ACTERS WITHOUT CLAIM TO ANY PARTICULAR  
FONT, STYLE, SIZE, OR COLOR.

PRIORITY DATE OF 11-2-2007 IS CLAIMED.

OWNER OF INTERNATIONAL REGISTRATION  
0957826 DATED 2-19-2008, EXPIRES 2-19-2018.

SER. NO. 79-051,554, FILED 2-19-2008.

TINA BROWN, EXAMINING ATTORNEY

**Int. Cl.: 1**

**Prior U.S. Cls.: 1, 5, 6, 10, 26 and 46**

**United States Patent and Trademark Office**

**Reg. No. 3,505,667**

**Registered Sep. 23, 2008**

**TRADEMARK  
PRINCIPAL REGISTER**

**CERAFLOUR**

BYK-CERA B.V. (NETHERLANDS B.V.)  
23, DANZIGWEG  
NL-7418 EN DEVENTER  
NETHERLANDS

PRIORITY DATE OF 11-2-2007 IS CLAIMED.

FOR: CHEMICAL ADDITIVES FOR IMPROVING  
THE SURFACE AND APPLICATION PROPERTIES  
OF DYE, LACQUER, PRINTING INK AND RE-  
LATED PRODUCTS, IN PARTICULAR, SOLID WAXES,  
IN CLASS 1 (U.S. CLS. 1, 5, 6, 10, 26 AND 46).

OWNER OF INTERNATIONAL REGISTRATION  
0957853 DATED 2-19-2008, EXPIRES 2-19-2018.

SER. NO. 79-051,562, FILED 2-19-2008.

THE MARK CONSISTS OF STANDARD CHAR-  
ACTERS WITHOUT CLAIM TO ANY PARTICULAR  
FONT, STYLE, SIZE, OR COLOR.

TINA BROWN, EXAMINING ATTORNEY

**Int. Cl.: 1**

**Prior U.S. Cls.: 1, 5, 6, 10, 26 and 46**

**United States Patent and Trademark Office**

**Reg. No. 3,505,668**

**Registered Sep. 23, 2008**

**TRADEMARK  
PRINCIPAL REGISTER**

**CERAMAT**

BYK-CERA B.V. (NETHERLANDS B.V.)  
23, DANZIGWEG  
NL-7418 EN DEVENTER  
NETHERLANDS

FOR: CHEMICAL ADDITIVES FOR IMPROVING  
THE SURFACE AND APPLICATION PROPERTIES  
OF DYE, LACQUER, PRINTING INK AND RELAT-  
ED PRODUCTS, IN PARTICULAR, SOLVENT  
BASED WAX DISPERSIONS , IN CLASS 1 (U.S.  
CLS. 1, 5, 6, 10, 26 AND 46).

THE MARK CONSISTS OF STANDARD CHAR-  
ACTERS WITHOUT CLAIM TO ANY PARTICULAR  
FONT, STYLE, SIZE, OR COLOR.

PRIORITY DATE OF 11-2-2007 IS CLAIMED.

OWNER OF INTERNATIONAL REGISTRATION  
0957855 DATED 2-19-2008, EXPIRES 2-19-2018.

SER. NO. 79-051,564, FILED 2-19-2008.

TINA BROWN, EXAMINING ATTORNEY

**Int. Cl.: 1**

**Prior U.S. Cls.: 1, 5, 6, 10, 26 and 46**

**United States Patent and Trademark Office**

**Reg. No. 3,505,669**

**Registered Sep. 23, 2008**

**TRADEMARK  
PRINCIPAL REGISTER**

**MINERPOL**

BYK-CERA B.V. (NETHERLANDS B.V.)  
23, DANZIGWEG  
NL-7418 EN DEVENTER  
NETHERLANDS

FOR: CHEMICAL ADDITIVES FOR IMPROVING  
THE SURFACE AND APPLICATION PROPERTIES  
OF DYE, LACQUER, PRINTING INK AND RELAT-  
ED PRODUCTS, IN PARTICULAR, OIL BASED  
WAX PASTES, IN CLASS 1 (U.S. CLS. 1, 5, 6, 10, 26  
AND 46).

THE MARK CONSISTS OF STANDARD CHAR-  
ACTERS WITHOUT CLAIM TO ANY PARTICULAR  
FONT, STYLE, SIZE, OR COLOR.

PRIORITY DATE OF 11-2-2007 IS CLAIMED.

OWNER OF INTERNATIONAL REGISTRATION  
0957856 DATED 2-19-2008, EXPIRES 2-19-2018.

SER. NO. 79-051,565, FILED 2-19-2008.

TINA BROWN, EXAMINING ATTORNEY

**Int. Cl.: 1**

**Prior U.S. Cls.: 1, 5, 6, 10, 26 and 46**

**United States Patent and Trademark Office**

**Reg. No. 3,505,670**

**Registered Sep. 23, 2008**

**TRADEMARK  
PRINCIPAL REGISTER**

**NOVACER**

BYK-CERA B.V. (NETHERLANDS B.V.)  
23, DANZIGWEG  
NL-7418 EN DEVENTER  
NETHERLANDS

THE MARK CONSISTS OF STANDARD CHARACTERS WITHOUT CLAIM TO ANY PARTICULAR FONT, STYLE, SIZE, OR COLOR.

PRIORITY DATE OF 11-14-2007 IS CLAIMED.

FOR: CHEMICAL ADDITIVES FOR IMPROVING THE SURFACE AND APPLICATION PROPERTIES OF DIVERSE PRODUCTS, LIKE LEATHER, GLASS FIBERS, TEXTILE, WOOD, METAL AND RUBBER, IN PARTICULAR, AQUEOUS AND SOLVENT-BASED WAX DISPERSIONS, IN CLASS 1 (U.S. CLS. 1, 5, 6, 10, 26 AND 46).

OWNER OF INTERNATIONAL REGISTRATION 0957857 DATED 2-19-2008, EXPIRES 2-19-2018.

SER. NO. 79-051,566, FILED 2-19-2008.

TINA BROWN, EXAMINING ATTORNEY



**Int. Cl.: 1**

**Prior U.S. Cls.: 1, 5, 6, 10, 26 and 46**

**United States Patent and Trademark Office**

**Reg. No. 3,505,671**

**Registered Sep. 23, 2008**

**TRADEMARK  
PRINCIPAL REGISTER**

**NANOCER**

BYK-CERA B.V. (NETHERLANDS B.V.)  
23, DANZIGWEG  
NL-7418 EN DEVENTER  
NETHERLANDS

FOR: CHEMICAL ADDITIVES FOR IMPROVING  
THE SURFACE AND APPLICATION PROPERTIES  
OF DYE, LACQUER, PRINTING INK AND RELAT-  
ED PRODUCTS, IN PARTICULAR, ACQUEOUS  
WAX EMULSIONS USING NANO PARTICLES, IN  
CLASS 1 (U.S. CLS. 1, 5, 6, 10, 26 AND 46).

THE MARK CONSISTS OF STANDARD CHAR-  
ACTERS WITHOUT CLAIM TO ANY PARTICULAR  
FONT, STYLE, SIZE, OR COLOR.

PRIORITY DATE OF 11-14-2007 IS CLAIMED.

OWNER OF INTERNATIONAL REGISTRATION  
0957858 DATED 2-19-2008, EXPIRES 2-19-2018.

SER. NO. 79-051,567, FILED 2-19-2008.

TINA BROWN, EXAMINING ATTORNEY

**Int. Cl.: 1**

**Prior U.S. Cls.: 1, 5, 6, 10, 26 and 46**

**United States Patent and Trademark Office**

**Reg. No. 3,505,672**

**Registered Sep. 23, 2008**

**TRADEMARK  
PRINCIPAL REGISTER**

**AQUACER**

BYK-CERA B.V. (NETHERLANDS B.V.)  
23, DANZIGWEG  
NL-7418 EN DEVENTER  
NETHERLANDS

FOR: CHEMICAL ADDITIVES FOR IMPROVING  
THE SURFACE AND APPLICATION PROPERTIES  
OF DYE, LACQUER, PRINTING INK AND RELAT-  
ED PRODUCTS, IN PARTICULAR, AQUEOUS  
WAX EMULSIONS, IN CLASS 1 (U.S. CLS. 1, 5, 6,  
10, 26 AND 46).

THE MARK CONSISTS OF STANDARD CHAR-  
ACTERS WITHOUT CLAIM TO ANY PARTICULAR  
FONT, STYLE, SIZE, OR COLOR.

PRIORITY DATE OF 11-2-2007 IS CLAIMED.

OWNER OF INTERNATIONAL REGISTRATION  
0957859 DATED 2-19-2008, EXPIRES 2-19-2018.

SER. NO. 79-051,568, FILED 2-19-2008.

TINA BROWN, EXAMINING ATTORNEY

**Int. Cls.: 9, 35 and 42**

**Prior U.S. Cls.: 21, 23, 26, 36, 38, 100, 101 and 102**

**Reg. No. 3,505,673**

**United States Patent and Trademark Office**

**Registered Sep. 23, 2008**

**TRADEMARK  
SERVICE MARK  
PRINCIPAL REGISTER**

# Intohits

POLYPHONIC HUMAN MEDIA INTERFACE,  
S.L. (SPAIN PARTNERSHIP)  
CALLE ARTESANS  
10 - PARC TECNOLOGIC DEL VALLÉS  
E-08290 CERDANYOLA (BARCELONA), SPAIN

FOR: COMPUTER PROGRAMS FOR ANALYZING CHARACTERISTICS IN MUSICAL COMPOSITIONS, IN CLASS 9 (U.S. CLS. 21, 23, 26, 36 AND 38).

FOR: SERVICES CONSISTING OF THE COMPI-  
LATION OF DATA IN COMPUTER DATA BANKS  
OR DATABASES, IN CLASS 35 (U.S. CLS. 100, 101  
AND 102).

FOR: COMPUTER PROGRAMMING, CONSULT-  
ING SERVICES IN THE FIELD OF DESIGN, SELEC-  
TION, IMPLEMENTATION AND USE OF

COMPUTER HARDWARE AND SOFTWARE SYS-  
TEMS FOR OTHERS; RENTAL OF SOFTWARE FOR  
COMPUTERS; DESIGN AND DEVELOPMENT OF  
ON-LINE COMPUTER SOFTWARE SYSTEMS;  
COMPUTER SYSTEM DESIGN, INSTALLATION  
OF COMPUTER SOFTWARE; DESIGN OF WEB  
SITES FOR OTHERS, IN CLASS 42 (U.S. CLS. 100  
AND 101).

OWNER OF INTERNATIONAL REGISTRATION  
0958041 DATED 2-26-2008, EXPIRES 2-26-2018.

SER. NO. 79-051,621, FILED 2-26-2008.

DOMINICK J. SALEMI, EXAMINING ATTORNEY

**Int. Cls.: 9, 35 and 42**

**Prior U.S. Cls.: 21, 23, 26, 36, 38, 100, 101 and 102**

**United States Patent and Trademark Office**

**Reg. No. 3,505,674**

**Registered Sep. 23, 2008**

**TRADEMARK  
SERVICE MARK  
PRINCIPAL REGISTER**

# In2hits

POLYPHONIC HUMAN MEDIA INTERFACE,  
S.L. (SPAIN PARTNERSHIP)  
CALLE ARTESANS  
10 PARC TECNOLOGIC DEL VALLÉS  
E-08290 CERDANYOLA (BARCELONA), SPAIN

FOR: COMPUTER PROGRAMS FOR ANALYZING CHARACTERISTICS IN MUSICAL COMPOSITIONS, IN CLASS 9 (U.S. CLS. 21, 23, 26, 36 AND 38).

FOR: SERVICES CONSISTING OF THE COMPI-  
LATION OF DATA IN COMPUTER DATA BANKS  
OR DATABASES, IN CLASS 35 (U.S. CLS. 100, 101  
AND 102).

FOR: COMPUTER PROGRAMMING; CONSULT-  
ING SERVICES IN THE FIELD OF DESIGN, SELEC-  
TION, IMPLEMENTATION AND USE OF

COMPUTER HARDWARE AND SOFTWARE SYS-  
TEMS FOR OTHERS; RENTAL OF SOFTWARE FOR  
COMPUTERS; DESIGN AND DEVELOPMENT OF  
ON-LINE COMPUTER SOFTWARE SYSTEMS;  
COMPUTER SYSTEM DESIGN, INSTALLATION  
OF COMPUTER SOFTWARE; DESIGN OF WEB  
SITES FOR OTHERS, IN CLASS 42 (U.S. CLS. 100  
AND 101).

OWNER OF INTERNATIONAL REGISTRATION  
0958043 DATED 2-26-2008, EXPIRES 2-26-2018.

SER. NO. 79-051,623, FILED 2-26-2008.

DOMINICK J. SALEMI, EXAMINING ATTORNEY

**Int. Cl.: 29**

**Prior U.S. Cl.: 46**

**United States Patent and Trademark Office**

**Reg. No. 3,505,675**

**Registered Sep. 23, 2008**

**TRADEMARK  
PRINCIPAL REGISTER**

**OPTIWELL**

CAMPINA NEDERLAND HOLDING BV (NETHERLANDS BESLOTEN VENNOOTSCHAP)  
HOGEWEG 9  
NL-5301 LB ZALTBOMMEL  
NETHERLANDS

FOR: MILK AND DAIRY PRODUCTS EXCLUDING ICE CREAM, ICE MILK AND FROZEN YOGURT, NON FLAVOURED OR FLAVOURED WITH COCOA, CHOCOLATE, COFFEE, VANILLA, FRUIT JUICES, FRUIT FLAVORINGS, FRUIT FLAVORS, MOCHA, CARAMEL, GREEN TEA, MINT OR HONEY, NAMELY, MILK, BUTTERMILK, DAIRY-BASED FOOD BEVERAGES, YOGURT, NATURAL YOGURT, DRINKABLE YOGURT, DIETETIC YOGURT FOR NON-MEDICAL PURPOSES, NAMELY, LOW-FAT YOGURT, NON-FAT YOGURT, LOW-SUGAR YOGURT, SUGAR-FREE YOGURT AND

YOGURT AND YOGURT DRINKS WITH SLOW DIGESTING INGREDIENTS DECREASING APPE-TITE, IN CLASS 29 (U.S. CL. 46).

THE MARK CONSISTS OF STANDARD CHARACTERS WITHOUT CLAIM TO ANY PARTICULAR FONT, STYLE, SIZE, OR COLOR.

OWNER OF INTERNATIONAL REGISTRATION  
0809901 DATED 8-7-2003, EXPIRES 8-7-2013.

SER. NO. 79-051,707, FILED 9-17-2007.

KATHERINE E. HALMEN, EXAMINING ATTOR-  
NEY

**Int. Cl.: 25**

**Prior U.S. Cls.: 22 and 39**

**United States Patent and Trademark Office**

**Reg. No. 3,505,676**

**Registered Sep. 23, 2008**

**TRADEMARK  
PRINCIPAL REGISTER**



KUBOTA SANGYO CO., LTD. (JAPAN CORPORATION)  
73, TAMACHI 4-CHOME  
AOI-KU.; SHIZUOKA-SHI; SHIZUOKA 420-0068  
JAPAN

OWNER OF INTERNATIONAL REGISTRATION  
0958434 DATED 2-22-2008, EXPIRES 2-22-2018.

SER. NO. 79-051,791, FILED 2-22-2008.

FOR: FOOTWEAR, NAMELY, SANDALS, SHOES,  
BOOTS, CANVAS SHOES; INSOLES FOR FOOT-  
WEAR, IN CLASS 25 (U.S. CLS. 22 AND 39).

BERYL GARDNER, EXAMINING ATTORNEY

**Int. Cl.: 25**

**Prior U.S. Cls.: 22 and 39**

**United States Patent and Trademark Office**

**Reg. No. 3,505,677**

**Registered Sep. 23, 2008**

**TRADEMARK  
PRINCIPAL REGISTER**

# **PersoFit**

**KUBOTA SANGYO CO., LTD. (JAPAN CORPORATION)  
73, TAMACHI 4-CHOME  
AOI-KU,; SHIZUOKA-SHI; SHIZUOKA 420-0068  
JAPAN**

**OWNER OF INTERNATIONAL REGISTRATION  
0958435 DATED 2-22-2008, EXPIRES 2-22-2018.**

**SER. NO. 79-051,792, FILED 2-22-2008.**

**FOR: FOOTWEAR, NAMELY, SANDALS, SHOES,  
BOOTS, CANVAS SHOES; INSOLES FOR FOOT-  
WEAR, IN CLASS 25 (U.S. CLS. 22 AND 39).**

**BERYL GARDNER, EXAMINING ATTORNEY**

**Int. Cl.: 14**

**Prior U.S. Cls.: 2, 27, 28 and 50**

**United States Patent and Trademark Office**

**Reg. No. 3,505,678**

**Registered Sep. 23, 2008**

**TRADEMARK  
PRINCIPAL REGISTER**

**NIVACRISTAL**

NIVAROX-FAR S.A. (SWITZERLAND SOCIÉTÉ  
ANONYME (JOINT STOCK COMPANY, SOCI-  
EDAD ANONIMA))  
AVENUE DU COLLÈGE 10  
CH-2400 LE LOCLE  
SWITZERLAND

FOR: HOROLOGICAL COMPONENTS, NAMELY,  
WATCH PALLETS, IN CLASS 14 (U.S. CLS. 2, 27, 28  
AND 50).

THE MARK CONSISTS OF STANDARD CHAR-  
ACTERS WITHOUT CLAIM TO ANY PARTICULAR  
FONT, STYLE, SIZE, OR COLOR.

PRIORITY DATE OF 11-19-2007 IS CLAIMED.

OWNER OF INTERNATIONAL REGISTRATION  
0958515 DATED 3-17-2008, EXPIRES 3-17-2018.

SER. NO. 79-051,821, FILED 3-17-2008.

SANI KHOURI, EXAMINING ATTORNEY



Int. Cl.: 13

Prior U.S. Cls.: 2 and 9

United States Patent and Trademark Office

Reg. No. 3,505,679

Registered Sep. 23, 2008

TRADEMARK  
PRINCIPAL REGISTER



PRIMA ARMI S.R.L. (ITALY LIMITED LIABILITY COMPANY)  
VIALE KENNEDY, 8  
I-10064 PINEROLO (TORINO), ITALY

FOR: FIREARMS; AMMUNITION AND PROJECTILES; EXPLOSIVES; FIREWORKS, IN CLASS 13 (U.S. CLS. 2 AND 9).

PRIORITY DATE OF 11-30-2007 IS CLAIMED.

OWNER OF INTERNATIONAL REGISTRATION 0959115 DATED 2-6-2008, EXPIRES 2-6-2018.

THE MARK CONSISTS OF THE FANTASY WORD "STAR" REPRODUCED TWICE, THE FIRST ONE IN CAPITAL LETTERS AND WITH A SEMICIRCULAR TREND PLACED ABOVE AND THE SECOND ONE IN CAPITAL BOLD LETTERS PLACED BELOW AN EIGHT-POINTED STAR WITH DOUBLE PERIMETRICAL SILHOUETTE SURROUNDED BY A THICK SHORT-RAYED RADIAL PATTERN ALONG WITH TWELVE LONGER RAYS.

SER. NO. 79-052,044, FILED 2-6-2008.

BERNICE MIDDLETON, EXAMINING ATTORNEY

**Int. Cl.: 1**

**Prior U.S. Cls.: 1, 5, 6, 10, 26 and 46**

**United States Patent and Trademark Office**

**Reg. No. 3,505,680**

**Registered Sep. 23, 2008**

**TRADEMARK  
PRINCIPAL REGISTER**

**EXCELLASE**

DANISCO A/S (DENMARK A PUBLIC LIMITED  
COMPANY)  
LANGEBROGADE 1,  
P.O. BOX 17; DK-1001 COPENHAGEN K  
DENMARK

FOR: CHEMICALS FOR USE IN INDUSTRY,  
NAMELY, ENZYMES FOR USE IN THE MANU-  
FACTURE OF DETERGENTS AND CLEANING  
PRODUCTS, IN CLASS 1 (U.S. CLS. 1, 5, 6, 10, 26  
AND 46).

THE MARK CONSISTS OF STANDARD CHAR-  
ACTERS WITHOUT CLAIM TO ANY PARTICULAR  
FONT, STYLE, SIZE, OR COLOR.

PRIORITY DATE OF 9-14-2007 IS CLAIMED.

OWNER OF INTERNATIONAL REGISTRATION  
0959127 DATED 3-11-2008, EXPIRES 3-11-2018.

SER. NO. 79-052,050, FILED 3-11-2008.

BERYL GARDNER, EXAMINING ATTORNEY

**Int. Cl.: 10**

**Prior U.S. Cls.: 26, 39 and 44**

**United States Patent and Trademark Office**

**Reg. No. 3,505,681**

**Registered Sep. 23, 2008**

**TRADEMARK  
PRINCIPAL REGISTER**

**Q-PIDT**

DRS. JAN BEUTE (NETHERLANDS INDIVIDUAL)  
HOFMARK 137  
NL-1355 HK ALMERE  
NETHERLANDS

FOR: SURGICAL AND MEDICAL INSTRUMENTS FOR CHECKING BLOOD FLOW IN THE GASTROINTESTINAL TRACT, AS WELL AS FOR REGISTERING INTESTINAL PERISTALSIS, IN CLASS 10 (U.S. CLS. 26, 39 AND 44).

THE MARK CONSISTS OF STANDARD CHARACTERS WITHOUT CLAIM TO ANY PARTICULAR FONT, STYLE, SIZE, OR COLOR.

PRIORITY DATE OF 5-31-2007 IS CLAIMED.

OWNER OF INTERNATIONAL REGISTRATION 0959530 DATED 11-28-2007, EXPIRES 11-28-2017.

SER. NO. 79-052,182, FILED 11-28-2007.

ERNEST SHOSHO, EXAMINING ATTORNEY

**Int. Cl.: 5**

**Prior U.S. Cls.: 6, 18, 44, 46, 51 and 52**

**United States Patent and Trademark Office**

**Reg. No. 3,505,682**

**Registered Sep. 23, 2008**

**TRADEMARK  
PRINCIPAL REGISTER**

**LIQUI-PEARLS**

BOEHRINGER INGELHEIM INTERNATIONAL  
GMBH (FED REP GERMANY CORPORA-  
TION)  
55218 INGELHEIM  
FED REP GERMANY

FOR: PHARMACEUTICAL PREPARATIONS FOR  
THE TREATMENT OF ABDOMINAL PAIN AND  
CRAMPS FOR HUMAN USE, IN CLASS 5 (U.S. CLS.  
6, 18, 44, 46, 51 AND 52).

THE MARK CONSISTS OF STANDARD CHAR-  
ACTERS WITHOUT CLAIM TO ANY PARTICULAR  
FONT, STYLE, SIZE, OR COLOR.

PRIORITY DATE OF 11-23-2007 IS CLAIMED.

OWNER OF INTERNATIONAL REGISTRATION  
0960193 DATED 2-20-2008, EXPIRES 2-20-2018.

SER. NO. 79-052,393, FILED 2-20-2008.

TINA BROWN, EXAMINING ATTORNEY

Int. Cl.: 25

Prior U.S. Cls.: 22 and 39

United States Patent and Trademark Office

Reg. No. 3,505,683

Registered Sep. 23, 2008

TRADEMARK  
PRINCIPAL REGISTER



DREAMLAND S.R.L. (ITALY LIMITED PART-  
NERSHIP)

P.GGIO CANONICI LATERANENSI 12

I-24100 BERGAMO

ITALY

FOR: CLOTHING ARTICLES FOR MEN, WOMEN AND CHILDREN, NAMELY, SHIRTS, T-SHIRTS, BLOUSES, SKIRTS, COATS, PULLOVERS, CARDIGANS, SWEATERS, TROUSERS, PANTS, VESTS, JERSEYS, PAJAMAS, PAJAMAS, SOCKS AND STOCKINGS, LEGGINGS, SINGLETs, CORSETS, GARTERS, UNDERPANTS, PETTICOATS, HATS, HEADSCARVES, NECKTIES, RAINCOATS, OVERCOATS, GREATCOATS, BATHING SUITS, SPORT OVERALLS, WIND-RESISTANT JACKETS, SKI PANTS, BELTS, FUR COATS, SCARVES, GLOVES, DRESSING GOWNS; FOOTWEAR, NAMELY, SHOES, SPORTS SHOES, SLIPPERS AND BOOTS; CAPS, IN CLASS 25 (U.S. CLS. 22 AND 39).

PRIORITY DATE OF 10-17-2007 IS CLAIMED.

OWNER OF INTERNATIONAL REGISTRATION  
0960298 DATED 1-25-2008, EXPIRES 1-25-2018.

THE TRADEMARK CONSISTS IN A SIGN REPRESENTING THE NUMBER "12", BELOW WHICH THERE APPEARS THE WORDING "ENVIRONMENT INSPIRED", SURROUNDED BY TWO SUBSTANTIALLY CIRCULAR BANDS; IN THE INNER BAND THERE APPEARS IN A CLOCKWISE DIRECTION, THE SERIES OF NUMBERS FROM 1 TO 11 AND A GRAPHIC SYMBOL PLACED BETWEEN THE NUMBER "1" AND THE NUMBER "11"; IN THE OUTER BAND THERE APPEARS THE WORDING "TWELVE W.E.A.T.H.E.R." REPEATED TWICE.

SER. NO. 79-052,420, FILED 1-25-2008.

BERNICE MIDDLETON, EXAMINING ATTORNEY

**Int. Cl.: 13**

**Prior U.S. Cls.: 2 and 9**

**United States Patent and Trademark Office**

**Reg. No. 3,505,684**

**Registered Sep. 23, 2008**

**TRADEMARK  
PRINCIPAL REGISTER**



PRIMA ARMI S.R.L. (ITALY LIMITED LIABILITY COMPANY)

VIALE KENNEDY, 8

I-10064 PINEROLO (TORINO), ITALY

FOR: FIREARMS; AMMUNITION AND PROJECTILES; EXPLOSIVES; FIREWORKS, IN CLASS 13 (U.S. CLS. 2 AND 9).

PRIORITY DATE OF 11-30-2007 IS CLAIMED.

OWNER OF INTERNATIONAL REGISTRATION 0960447 DATED 1-31-2008, EXPIRES 1-31-2018.

NO CLAIM IS MADE TO THE EXCLUSIVE RIGHT TO USE "FIREARMS", APART FROM THE MARK AS SHOWN.

THE MARK CONSISTS OF A CIRCULAR FIELD DELIMITED BY TWO CONCENTRIC CIRCUMFERENCES IN WHOSE SUPERIOR HALF IS REPRODUCED, IN NEGATIVE AND WITH A SEMICIRCULAR TREND, THE FANTASY WORDING "STAR FIREARMS" AND INSIDE WHICH IS INSCRIBED AN EIGHT-POINTED STAR WITH DOUBLE PERIMETRICAL SILHOUETTE WITH THE FANTASY WORDING "STAR".

SER. NO. 79-052,468, FILED 1-31-2008.

BERNICE MIDDLETON, EXAMINING ATTORNEY

**Int. Cl.: 33**

**Prior U.S. Cls.: 47 and 49**

**United States Patent and Trademark Office**

**Reg. No. 3,505,685**

**Registered Sep. 23, 2008**

**TRADEMARK  
PRINCIPAL REGISTER**

**ESCONDIDO**

BODEGA LA MILAGROSA; SOCIEDAD COOP-  
ERATIVA (SPAIN SOCIEDAD COOPERATIVA)  
CARRETERA DE MADRID, KM. 147  
E-09460 MILAGROS (BURGOS)  
SPAIN

OWNER OF INTERNATIONAL REGISTRATION  
0960617 DATED 2-1-2008, EXPIRES 2-1-2018.

FOR: WINES, IN CLASS 33 (U.S. CLS. 47 AND 49).

THE ENGLISH TRANSLATION OF THE FOR-  
EIGN WORD(S) IN THE MARK IS: HIDDEN.

THE MARK CONSISTS OF STANDARD CHAR-  
ACTERS WITHOUT CLAIM TO ANY PARTICULAR  
FONT, STYLE, SIZE, OR COLOR.

SER. NO. 79-052,539, FILED 2-1-2008.

PRIORITY DATE OF 10-5-2007 IS CLAIMED.

JAMES MACFARLANE, EXAMINING ATTORNEY

**Int. Cls.: 1 and 42**

**Prior U.S. Cls.: 1, 5, 6, 10, 26, 46, 100 and 101**

**United States Patent and Trademark Office**

**Reg. No. 3,505,686**

**Registered Sep. 23, 2008**

**TRADEMARK  
SERVICE MARK  
PRINCIPAL REGISTER**

**KEMFORM**

KEMIRA OYJ (FINLAND JOINT STOCK COMPANY)  
PORKKALANKATU 3  
FI-00180 HELSINKI, FINLAND

FOR: CHEMICALS FOR USE IN THE MANUFACTURE OF PAPER, IN PARTICULAR RETENTION AND DRAINAGE CHEMICALS, IN CLASS 1 (U.S. CLS. 1, 5, 6, 10, 26 AND 46).

FOR: SCIENTIFIC AND TECHNOLOGICAL ADVICE RELATING TO THE DEVELOPMENT OF PAPER MAKING PROCESSES, IN CLASS 42 (U.S. CLS. 100 AND 101).

THE MARK CONSISTS OF STANDARD CHARACTERS WITHOUT CLAIM TO ANY PARTICULAR FONT, STYLE, SIZE, OR COLOR.

PRIORITY DATE OF 10-25-2007 IS CLAIMED.

OWNER OF INTERNATIONAL REGISTRATION 0960966 DATED 12-12-2007, EXPIRES 12-12-2017.

SER. NO. 79-052,629, FILED 12-12-2007.

LIEF MARTIN, EXAMINING ATTORNEY



**Int. Cl.: 3**

**Prior U.S. Cls.: 1, 4, 6, 50, 51 and 52**

**United States Patent and Trademark Office**

**Reg. No. 3,505,687**

**Registered Sep. 23, 2008**

**TRADEMARK  
PRINCIPAL REGISTER**

**STAY MAXX**

COTY DEUTSCHLAND GMBH (FED REP GER-  
MANY GMBH)  
FORT MALAKOFF PARK,  
RHEINSTRASSE 4E; 55116 MAINZ  
FED REP GERMANY

FOR: SOAPS, PERFUMERY; ESSENTIAL OILS;  
COSMETICS; COSMETIC HAIR LOTIONS, IN CLASS  
3 (U.S. CLS. 1, 4, 6, 50, 51 AND 52).

THE MARK CONSISTS OF STANDARD CHAR-  
ACTERS WITHOUT CLAIM TO ANY PARTICULAR  
FONT, STYLE, SIZE, OR COLOR.

PRIORITY DATE OF 9-12-2007 IS CLAIMED.

OWNER OF INTERNATIONAL REGISTRATION  
0961022 DATED 3-7-2008, EXPIRES 3-7-2018.

SER. NO. 79-052,657, FILED 3-7-2008.

LYDIA BELZER, EXAMINING ATTORNEY

**Int. Cl.: 33**

**Prior U.S. Cls.: 47 and 49**

**United States Patent and Trademark Office**

**Reg. No. 3,505,688**

**Registered Sep. 23, 2008**

**TRADEMARK  
PRINCIPAL REGISTER**

**CA' RUGATE**

SOCIETA' AGRICOLA CA'; RUGATE DI TES-  
SARI MICHELE,; AMEDEO E GIOVANNI -;  
SOCIETA' SEMPLICE (ITALY SIMPLE PART-  
NERSHIP)

VIA PERGOLA, 36  
I-37030 MONTECCHIA DI CROSARA (VR)  
ITALY

FOR: WINES AND GRAPPA, IN CLASS 33 (U.S.  
CLS. 47 AND 49).

THE MARK CONSISTS OF STANDARD CHAR-  
ACTERS WITHOUT CLAIM TO ANY PARTICULAR  
FONT, STYLE, SIZE, OR COLOR.

OWNER OF INTERNATIONAL REGISTRATION  
0961024 DATED 1-31-2008, EXPIRES 1-31-2018.

THE WORDING "CA'RUGATE" HAS NO MEAN-  
ING IN ENGLISH.

SER. NO. 79-052,659, FILED 1-31-2008.

JAMES MACFARLANE, EXAMINING ATTORNEY

**Int. Cl.: 16**

**Prior U.S. Cls.: 2, 5, 22, 23, 29, 37, 38 and 50**

**United States Patent and Trademark Office**

**Reg. No. 3,505,689**

**Registered Sep. 23, 2008**

**TRADEMARK  
PRINCIPAL REGISTER**

**Cube<sup>3</sup>**

ARJOWIGGINS (FRANCE SOCIÉTÉ PAR AC-  
TIONS SIMPLIFIÉE)  
117, QUAI DU PRÉSIDENT ROOSEVELT  
F-92130 ISSY LES MOULINEAUX, FRANCE

OWNER OF INTERNATIONAL REGISTRATION  
0961316 DATED 1-23-2008, EXPIRES 1-23-2018.

FOR: PAPER AND CARDBOARD, UNPROCES-  
SED, SEMI-PROCESSED OR FOR STATIONERY OR  
PRINTING PURPOSES, LAMINATED HIGH GRAM-  
MAGE PAPER, IN CLASS 16 (U.S. CLS. 2, 5, 22, 23, 29,  
37, 38 AND 50).

SER. NO. 79-052,760, FILED 1-23-2008.

PRIORITY DATE OF 8-2-2007 IS CLAIMED.

MARK PILARO, EXAMINING ATTORNEY

**Int. Cl.: 43**

**Prior U.S. Cls.: 100 and 101**

**United States Patent and Trademark Office**

**Reg. No. 3,505,690**

**Registered Sep. 23, 2008**

**SERVICE MARK  
PRINCIPAL REGISTER**

**DEPÓSITO DO PÃO**

SEQUOIA - SGPS, LDA. (PORTUGAL PRIVATE  
LIMITED COMPANY)  
PRAÇA MARQUÊS DE POMBAL 1, 8.º ANDAR  
P-1250-160 LISBOA  
PORTUGAL

OWNER OF INTERNATIONAL REGISTRATION  
0961323 DATED 2-12-2008, EXPIRES 2-12-2018.

FOR: CATERING SERVICES, NAMELY, PROVID-  
ING FOOD AND DRINK, IN HOTELS, CANTEENS,  
CAFÉ, RESTAURANTS AND SNACK-BARS, IN  
CLASS 43 (U.S. CLS. 100 AND 101).

THE ENGLISH TRANSLATION OF THE WORD  
"DEPÓSITO DO PÃO" IN THE MARK IS "BREAD  
STORAGE".

THE MARK CONSISTS OF STANDARD CHAR-  
ACTERS WITHOUT CLAIM TO ANY PARTICULAR  
FONT, STYLE, SIZE, OR COLOR.

SER. NO. 79-052,763, FILED 2-12-2008.

PRIORITY DATE OF 11-7-2007 IS CLAIMED.

LAURIE KAUFMAN, EXAMINING ATTORNEY

Int. Cl.: 33

Prior U.S. Cls.: 47 and 49

United States Patent and Trademark Office

Reg. No. 3,505,691

Registered Sep. 23, 2008

TRADEMARK  
PRINCIPAL REGISTER

O B R A

BODEGAS Y VIÑEDOS NEO, S.L. (SPAIN SOCIE-  
DAD LIMITADA)  
CARRETERA NACIONAL 122, KM. 274  
E-09391 CASTRILL VEG (BURGOS), SPAIN

FOR: WINES, IN CLASS 33 (U.S. CLS. 47 AND 49).

THE MARK CONSISTS OF STANDARD CHAR-  
ACTERS WITHOUT CLAIM TO ANY PARTICULAR  
FONT, STYLE, SIZE, OR COLOR.

OWNER OF INTERNATIONAL REGISTRATION  
0961660 DATED 2-22-2008, EXPIRES 2-22-2018.

THE ENGLISH TRANSLATION OF THE FOR-  
EIGN WORD(S) IN THE MARK IS: "WORK".

SER. NO. 79-052,891, FILED 2-22-2008.

RICHARD WHITE, EXAMINING ATTORNEY

**Int. Cl.: 35**

**Prior U.S. Cls.: 100, 101, and 102**

**United States Patent and Trademark Office**

**Reg. No. 3,505,692**

**Registered Sep. 23, 2008**

**SERVICE MARK  
PRINCIPAL REGISTER**

**#SEX**

PILGRIM TELEPHONE, INC. (DELAWARE CORPORATION)  
181 SPRING STREET  
LEXINGTON, MA 22201

GIOUS, POLITICAL, HOROSCOPE AND SEXUALITY SERVICES AND FORUMS, IN CLASS 35 (U.S. CLS. 100, 101 AND 102).

FOR: TELEPHONE DIRECTORY INFORMATION SERVICES, NAMELY, GENERAL TELEPHONE LISTING DIRECTORIES; AND TELEPHONE, WIRELESS AND ONLINE DIRECTORY INFORMATION SERVICES, NAMELY, DIRECTORIES OF COMMUNITY ACTIVITY, PERSONAL, DATING, RELI-

FIRST USE 7-15-2008; IN COMMERCE 7-15-2008.

SN 75-753,938, FILED 7-15-1999.

SUSAN STIGLITZ, EXAMINING ATTORNEY

**Int. Cl.: 9**

**Prior U.S. Cls.: 21, 23, 26, 36, and 38**

**Reg. No. 3,505,693**

**United States Patent and Trademark Office**

**Registered Sep. 23, 2008**

**TRADEMARK  
PRINCIPAL REGISTER**

**ASIMO**

HONDA GIKEN KOGYO KABUSHIKI KAISHA  
(JAPAN CORPORATION), TA HONDA MO-  
TOR CO., LTD.,  
NO. 1-1, 2-CHOME  
MINAMI-AOYAMA, MINATO-KU  
TOKYO, JAPAN

FOR: LABORATORY ROBOTS HAVING HUMAN  
LIKE MOTION AND MOBILITY AND STRUCTUR-  
AL PARTS THEREFOR NOT FOR USE IN CONNEC-  
TION WITH PROVIDING MEDICAL CARE OR  
PATIENT MONITORING IN HOSPITALS OR

OTHER PATIENT CARE FACILITIES; ROBOTS  
HAVING HUMAN LIKE MOTION AND MOBILITY  
FOR PERSONAL OR HOBBY USES AND STRUC-  
TURAL PARTS THEREFOR, IN CLASS 9 (U.S. CLS.  
21, 23, 26, 36 AND 38).

FIRST USE 11-0-2000; IN COMMERCE 2-0-2003.

SN 76-138,012, FILED 9-28-2000.

SIMON TENG, EXAMINING ATTORNEY

**Int. Cls.: 25, 35, 38, and 42**

**Prior U.S. Cls.: 22, 39, 100, 101, 102, and 104**

**United States Patent and Trademark Office**

**Reg. No. 3,505,694**

**Registered Sep. 23, 2008**

**TRADEMARK  
SERVICE MARK  
PRINCIPAL REGISTER**

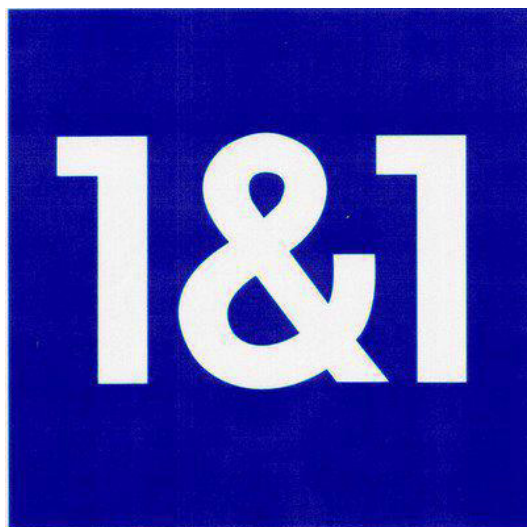

1&1 INTERNET AG (FED REP GERMANY CORPORATION)

ELGENDORFER STRABE 57

56410 MONTABAUER, FED REP GERMANY

FOR: CLOTHING, NAMELY, SHIRTS, DRESSES, PANTS, JACKETS, COATS, T-SHIRTS, SHORTS, SWEATERS, PULLOVERS, JERSEYS, TRACK SUITS, PAJAMAS, SWIMSUITS, SKIING SUITS, UNDERWEAR, TIGHTS, SOCKS; SHOES; HEADWEAR, CAPS AND HATS, IN CLASS 25 (U.S. CLS. 22 AND 39).

FIRST USE 11-1-2007; IN COMMERCE 11-1-2007.

FOR: ADVERTISING AGENCY SERVICES IN PREPARING AND PLACING ADVERTISEMENTS AND DESIGNING PROMOTIONAL CAMPAIGNS FOR OTHERS FOR DISTRIBUTION IN PRINT, RADIO, TELEVISION MEDIA AND OVER GLOBAL COMPUTER NETWORKS; RENTING AND PROVIDING TIME AND SPACE IN PRINT, RADIO, TELEVISION MEDIA AND OVER GLOBAL COMPUTER NETWORKS, ELECTRONIC BILL BOARD ADVERTISING, CREATING AND UPDATING OF ADVERTISING MATERIAL AND THE DISTRIBUTION OF THE SAME, DISTRIBUTION OF PRINTED ADVERTISING MATERIALS FOR OTHERS, PROMOTING THE WEB SITES OF OTHERS, PROVIDING ADVERTISING FOR OTHERS TRIGGERED BY KEYWORD SEARCHING ON AN ON-LINE ELEC-

TRONIC COMMUNICATIONS NETWORK, PROVIDING TELECOMMUNICATION AND RADIO ADVERTISING FOR OTHERS, PROVIDING MARKET RESEARCH, PREPARING BUSINESS PLANS, NEW MEDIA MARKETING; BUSINESS CONSULTATION SERVICES; BUSINESS ADMINISTRATION AND MANAGEMENT OF COMPANIES FOR OTHERS; DATA PROCESSING FOR OTHERS; BOOKKEEPING AND BOOKKEEPING SERVICES UTILIZING THE INTERNET; BUSINESS CONSULTATION SERVICES IN THE FIELD OF ADVERTISING AND FOR INTRODUCTION OF COMPANIES TO THE INTERNET AND GLOBAL COMPUTER NETWORKS; BUSINESS CONSULTING SERVICES IN THE FIELD OF E-COMMERCE ACTIVITIES OVER A GLOBAL COMPUTER NETWORK; COMPILING AND ASSEMBLING STATISTICAL DATA AND PROVIDING STATISTICAL EVALUATION FOR OTHERS; PROMOTING THE GOODS AND SERVICES OF OTHERS THROUGH ON-LINE ORDERING AND CATALOGING OF THOSE GOODS AND SERVICES; ON-LINE COMPUTER ORDERING SERVICES, NAMELY, OFFERING THE GOODS AND SERVICES OF OTHERS THROUGH A GLOBAL COMPUTER NETWORK; FACILITATING E-COMMERCE BUSINESS TRANSACTIONS BY PROCESSING AND FULFILLING ELECTRONIC ORDERS FOR PURCHASES OF GOODS AND SERVICES VIA A GLOBAL COMPUTER NETWORK; BOOKKEEPING FOR ON-LINE PURCHASES AND ELECTRONIC FUNDS TRANSFERS. DEVELOP-



MENT AND OPERATION OF ON-LINE CLEARING HOUSES OPERATIONS FOR OTHERS IN THE FIELD OF RADIO, TELEVISION AND THE INTERNET; PROVIDING HOME SHOPPING SERVICES FEATURING GENERAL MERCHANDISE BY TELEVISION AND ON THE INTERNET; ON-LINE RETAIL STORE SERVICES FEATURING GENERAL MERCHANDISE; PROCESSING ORDERS FOR THE PROVISION OF SERVICES AND THE ACQUISITION AND PURCHASE OF GOODS; THE PRESENTATION OF GOODS AND SERVICES BY MEANS OF A TELEVISION SHOPPING NETWORK; ON-LINE TRADING SERVICES IN WHICH SERVICES OR PRODUCTS ARE TO BE AUCTIONED AND NEGOTIATION AND BIDDING IS DONE VIA A GLOBAL COMPUTER NETWORK; OPERATING ON-LINE MARKETPLACES FOR SELLERS OF GOODS AND/OR SERVICES; TELEPHONE ANSWERING SERVICES FOR OTHERS; ARRANGING AND CONDUCTING OF FAIRS AND EXHIBITIONS FOR BUSINESS AND ADVERTISING PURPOSES; SERVICES OF A CALL-CENTER, NAMELY, THE FACILITATING AND PROCESSING OF PRODUCT AND SERVICE PURCHASE ORDERS; OPERATION OF A TELEVISION SHOPPING CHANNEL; LICENSING OF COMPUTER SOFTWARE TO OTHERS, IN CLASS 35 (U.S. CLS. 100, 101 AND 102).

FIRST USE 11-1-2003; IN COMMERCE 11-1-2003.

FOR: INTERNET SERVICE PROVIDER (ISP) SERVICE; ELECTRONIC MAIL SERVICES; INSTANT MESSAGING SERVICES, ELECTRONIC TRANSMISSION OF FACSIMILE COMMUNICATIONS; TELECOMMUNICATION SERVICES, NAMELY, BROADCASTING AND DELIVERY OF VOICE, DATA, IMAGES, DOCUMENTS, AUDIO, VIDEO AND MULTIMEDIA CONTENT BY MEANS OF CELLULAR AND WIRELESS COMMUNICATIONS, ELECTRONIC COMMUNICATIONS NETWORKS, OPTICAL AND FIBER NETWORKS, AND COMPUTER NETWORKS; LEASING OF COMMUNICATION LINES, NAMELY, DIAL-UP LINES, FIXED LINES, BROADBAND, OPTICAL LINES, FIBER LINES AND WIRELESS, FOR OTHERS; LEASING OF WIRELESS, TELECOMMUNICATION, ELECTRONIC COMMUNICATION, COMPUTER, OPTICAL AND FIBER NETWORKS FOR OTHERS; WEBCASTING AUDIO/VISUAL PROGRAMMING VIA A GLOBAL COMPUTER NETWORK; PROVIDING ON-LINE CHAT ROOMS FOR TRANSMISSION OF MESSAGES AND INTERACTION AMONG COMPUTER USERS CONCERNING TOPICS OF GENERAL INTEREST, TELEVISION PROGRAMMING AND RELATED TOPICS, ENTERTAINMENT, SPORTS AND NEWS; ELECTRONIC TRANSMISSION OF TEXTS, DRAWINGS AND IMAGES ABOUT GOODS AND SERVICES; PROVIDING AN ELECTRONIC BULLETIN BOARD IN THE FIELDS OF NEWS, POLITICS, POLICY, SPORTS, BUSINESS, FINANCE, TECHNOLOGY, ENTERTAINMENT, ARTS, LEISURE, AND TRAVEL; PERSONAL COMMUNICATION SERVICES; LEASING OF TELECOMMUNICATION EQUIPMENT IN GENERAL; OPERATION AND ADMINISTRATION OF TELECOMMUNICATION SYSTEMS AND NETWORKS FOR OTHERS; OPERATION AND ADMIN-

ISTRATION OF VIRTUAL PRIVATE NETWORKS FOR OTHERS; WEB-MESSAGING, NAMELY, THE FORWARDING OF INFORMATION OF ALL KINDS TO INTERNET ADDRESSES; TELECOMMUNICATIONS GATEWAY, ROUTING AND JUNCTION SERVICES; SERVICES OF AN INTERNET PROVIDER, NAMELY, PROVIDING MULTIPLE USER ACCESS TO A GLOBAL COMPUTER NETWORK AND THE WEBCASTING OF NEWS AND ENTERTAINMENT VIA GLOBAL COMPUTER NETWORKS; PROVIDING AND OPERATING INTERNET DIAL-IN NODES, WEB SERVERS, E-MAIL SERVERS, COMPUTER NETWORK SERVERS AND COMMUNICATION NETWORK SERVERS FOR OTHERS; PROVIDING MULTIPLE USER ACCESS TO THE INTERNET, IN CLASS 38 (U.S. CLS. 100, 101 AND 104).

FIRST USE 11-1-2003; IN COMMERCE 11-1-2003.

FOR: DEVELOPMENT, DESIGN AND MAINTENANCE OF COMPUTER SOFTWARE FOR OTHERS; DATA AUTOMATION, BACKUP, RECOVERY AND COLLECTION SERVICES FOR OTHERS; LEASING OF ACCESS TIME TO COMPUTER DATABASES IN THE FIELD OF KNOWLEDGE MANAGEMENT; COMPUTER SYSTEM ANALYSES FOR OTHERS; COMPUTER SERVICES, NAMELY, MANAGING, DESIGNING, IMPLEMENTING AND MAINTAINING WEB SITES FOR OTHERS; DISPLAYING THE WEB SITES AND IMAGES OF OTHERS ON A COMPUTER SERVER; HOSTING THE WEB SITES OF OTHERS ON A COMPUTER SERVER FOR A GLOBAL COMPUTER NETWORK; DESIGNING AND CREATING CUSTOMIZED ON-LINE WEB PAGES FEATURING USER-DEFINED INFORMATION, WHICH INCLUDES SEARCH ENGINES AND ON-LINE WEB LINKS TO OTHER WEB SITES; THE REGISTRATION AND MAINTENANCE OF DOMAIN NAMES FOR OTHERS FOR IDENTIFICATION OF USERS ON A GLOBAL COMPUTER NETWORK; CONSULTING SERVICES IN THE FIELD OF DOMAIN NAME CREATION AND SELECTION; DATA ENCRYPTION SERVICES; CONSULTING SERVICES IN THE FIELD OF ENCRYPTION; COMPUTER SERVICES, NAMELY, COMPUTER SECURITY, AND NETWORK MONITORING, ANALYSIS, FIREWALL MANAGEMENT, AND VIRUS PROTECTION AND PROVIDING SEARCH ENGINES FOR OBTAINING DATA ON A GLOBAL COMPUTER NETWORK; CONSULTING IN THE FIELD OF COMPUTER SECURITY, AND NETWORK MONITORING, ANALYSIS, FIREWALL MANAGEMENT, AND VIRUS PROTECTION; HOSTING OF A DIGITAL VIDEO-LIBRARY ON THE INTERNET; CONSULTING SERVICES IN THE FIELD OF TECHNICAL PLANNING AND CONCEPTION OF INTERNAL AND EXTERNAL COMPUTER NETWORKS; DESIGN OF COMPUTER AND TELECOMMUNICATION DATA AND NETWORK CONNECTIONS SYSTEMS FOR OTHERS; DESIGN OF INTERNAL AND EXTERNAL COMPUTER AND TELECOMMUNICATION DATA AND NETWORKS FOR OTHERS; SERVICES OF AN APPLICATION SERVICE PROVIDER (ASP), NAMELY, HOSTING OF COMPUTER SOFTWARE APPLICATIONS FOR OTHERS; INTERNET CONSULTING SERVICES;

NETWORK MANAGEMENT AND CONFIGURATION SERVICES FOR OTHERS, NAMELY, SERVICE SUPERVISION AND ANALYSIS OF NETWORK OPERATION AND PROVIDING PROTECTION FROM ILLEGAL NETWORK ATTACKS AND DATA SECURITY; CONFIGURATION OF HARDWARE AND SOFTWARE FOR OTHERS; OPERATING, MAINTAINING AND PROVIDING ACCESS TO COMPUTER SERVERS TO FUNCTION AS DOMAIN NAME SERVERS FOR OTHERS FOR USE IN CONNECTION WITH A GLOBAL COMPUTER NETWORK; LEASING OF WEB-SERVERS; DESIGN FOR OTHERS OF COMPUTER SOFTWARE DATA PROCESSING PROGRAMS FOR USE WITH NETWORK STRUCTURES; RESERVING AND PROVIDING E-MAIL ADDRESSES TO OTHERS; CONSULTING SERVICES IN THE FIELD OF DESIGN, SELECTION, IMPLEMENTATION AND USE OF COMPUTER HARDWARE AND SOFTWARE SYSTEMS; COMPUTER SYSTEM ANALYSES FOR OTHERS; CREATING AND MAINTAINING WEB SITES FOR OTHERS; MONITORING COMPUTER SYSTEMS AND ENCRYPTING DATA TO PROVIDE SECURITY FOR DATA IN COMPUTER DATA BANKS; INSTALLATION, MAINTENANCE, AND REPAIR OF COMPUTER SOFTWARE FOR OTHERS; PROVIDING ACCESS TO COMPUTER HARDWARE AND SOFTWARE FOR OTHERS WITHIN LOCAL AREA AND VIRTUAL PRIVATE NETWORKS; COMPUTER CONSULTATION SERVICES

IN THE NATURE OF PROVIDING A TELEPHONE HOTLINE FOR INFORMATION ABOUT AND ASSISTANCE IN THE USE OF THE INTERNET, COMPUTERS AND COMPUTER SOFTWARE; INSTALLATION OF INFRASTRUCTURE IN THE NATURE OF APPLICATIONS SOFTWARE IN COMPUTER CENTERS; UPGRADING COMPUTER SOFTWARE FOR OTHERS; LEASING COMPUTER NETWORKS AND COMPUTER DATABASES FOR OTHERS; AND TECHNICAL SUPPORT SERVICES IN THE NATURE OF TROUBLESHOOTING OF COMPUTER HARDWARE PROBLEMS, IN CLASS 42 (U.S. CLS. 100 AND 101).

FIRST USE 11-1-2003; IN COMMERCE 11-1-2003.

OWNER OF FED REP GERMANY REG. NO. 300600402, DATED 1-9-2001, EXPIRES 7-31-2010.

THE COLOR(S) BLUE AND WHITE IS/ARE CLAIMED AS A FEATURE OF THE MARK.

THE COLOR BLUE APPEARS AS THE BACKGROUND SQUARE DESIGN AND THE WORDING 1&1 APPEARS IN THE COLOR WHITE.

SN 76-195,807, FILED 1-18-2001.

VERNA BETH RIRIE, EXAMINING ATTORNEY

**Int. Cl.: 25**

**Prior U.S. Cls.: 22 and 39**

**United States Patent and Trademark Office**

**Reg. No. 3,505,695**

**Registered Sep. 23, 2008**

**TRADEMARK  
PRINCIPAL REGISTER**

**G L O R Y**

GEORGE SHOE CORP (TAIWAN CORPORATION)  
NO.19-3, SHANG SHAN VILLAGE  
CHIUNG LIN HSIANG  
HSINCHU HSIEN, TAIWAN

FOR: SHOES; SANDALS; SLIPPERS; RAIN SHOES;  
CANVAS SHOES; GYM SHOES; LEATHER SHOES;  
RUBBER SHOES; JOGGING SHOES; BOOTS; DAN-  
CING SHOES; STRAW SANDALS; CLOGS; HIGH-  
HEELED SHOES; SPORTS SHOES, MOUNTAINEER-  
ING BOOTS; SKI BOOTS; TRACK-AND-FIELD

SHOES; LOAFER SHOES; WALKING SHOES; SNEA-  
KERS; BEACH SHOES; SOLES OF SHOES; VAMPS  
OF SHOES; HEELS OF SHOES; UPPERS OF SHOES;  
SHOE TOES; SHOE TONGUES; SPIKED SHOES, IN  
CLASS 25 (U.S. CLS. 22 AND 39).

FIRST USE 5-17-2002; IN COMMERCE 6-30-2008.

SN 76-353,425, FILED 12-31-2001.

JORDAN BAKER, EXAMINING ATTORNEY

**Int. Cl.: 35**

**Prior U.S. Cls.: 100, 101, and 102**

**United States Patent and Trademark Office**

**Reg. No. 3,505,696**

**Registered Sep. 23, 2008**

---

**SERVICE MARK  
PRINCIPAL REGISTER**

**PRICE LOCK**

SAFEWAY INC. (DELAWARE CORPORATION)  
5918 STONERIDGE MALL ROAD  
PLEASANTON, CA 945882322

FIRST USE 6-21-2002; IN COMMERCE 6-21-2002.

SN 76-422,867, FILED 6-12-2002.

FOR: RETAIL GROCERY STORE SERVICES, IN  
CLASS 35 (U.S. CLS. 100, 101 AND 102).

PAM WILLIS, EXAMINING ATTORNEY

Int. Cls.: 29, 33, and 43

Prior U.S. Cls.: 46, 47, 49, 100, and 101

United States Patent and Trademark Office

Reg. No. 3,505,697

Registered Sep. 23, 2008

TRADEMARK  
SERVICE MARK  
PRINCIPAL REGISTER



LA TOGA S.R.L. (ITALY LIMITED LIABILITY COMPANY)  
VIA SCUDO DI FRANCIA, 3  
VERONA, ITALY

FOR: EDIBLE OILS, IN CLASS 29 (U.S. CL. 46).

FIRST USE 7-0-2002; IN COMMERCE 9-0-2002.

FOR: WINES, IN CLASS 33 (U.S. CLS. 47 AND 49).

FIRST USE 7-0-2002; IN COMMERCE 9-0-2002.

FOR: (BASED ON 44(E)) RESTAURANT AND WINE BAR SERVICES; CATERING, IN CLASS 43 (U.S. CLS. 100 AND 101).

PRIORITY CLAIMED UNDER SEC. 44(D) ON ITALY APPLICATION NO. RM2002C00259, FILED 5-9-2002, REG. NO. 990539, DATED 1-18-2006, EXPIRES 5-9-2012.

NO CLAIM IS MADE TO THE EXCLUSIVE RIGHT TO USE "BOTTEGA DEL VINO", APART FROM THE MARK AS SHOWN.

THE LINING IS A FEATURE OF THE MARK AND DOES NOT INDICATE COLOR.

THE MARK CONSISTS OF THE WORDS "ANTICA BOTTEGA DEL VINO" WITH A REPRESENTATION OF A WOMAN WITHIN AN OVAL AND AN ARBITRARY DESIGN.

THE ENGLISH TRANSLATION OF "ANTICA BOTTEGA DEL VINO" IS "OLD WINE SHOP".

SN 76-449,378, FILED 9-9-2002.

ESTHER A. BORSUK, EXAMINING ATTORNEY

**Int. Cl.: 29**

**Prior U.S. Cl.: 46**

**United States Patent and Trademark Office**

**Reg. No. 3,505,698**

**Registered Sep. 23, 2008**

**TRADEMARK  
PRINCIPAL REGISTER**

**TAYO**

FOOD STEPS INTERNATIONAL INC. (CANADA  
FEDERAL CORPORATION)  
UNIT 203 - 873 BEATTY STREET  
VANCOUVER, BRITISH COLUMBIA V6B 2M6

FOR: SOY BASED BEVERAGES USED AS A MILK  
SUBSTITUTE; VEGETABLE-BASED FOOD BEV-  
ERAGES, IN CLASS 29 (U.S. CL. 46).

FIRST USE 7-31-2003; IN COMMERCE 4-5-2007.

PRIORITY CLAIMED UNDER SEC. 44(D) ON  
CANADA APPLICATION NO. 1,144,881, FILED 6-25-  
2002, REG. NO. TMA614751, DATED 7-13-2004, EX-  
PIRES 7-13-2019.

SN 76-478,460, FILED 12-20-2002.

GEORGIA CARTY, EXAMINING ATTORNEY

**Int. Cl.: 3**

**Prior U.S. Cls.: 1, 4, 6, 50, 51, and 52**

**United States Patent and Trademark Office**

**Reg. No. 3,505,699**

**Registered Sep. 23, 2008**

**TRADEMARK  
PRINCIPAL REGISTER**

**MAGMA**

WELLA AKTIENGESELLSCHAFT (FED REP  
GERMANY CORPORATION)  
BERLINER ALLEE 65  
64274 DARMSTADT, FED REP GERMANY

FOR: HAIR CARE PREPARATIONS, NAMELY,  
HAIR COLORS AND DYES, COLOR REMOVAL  
AND LIGHTENING PREPARATIONS AND HAIR

BLEACHES, IN CLASS 3 (U.S. CLS. 1, 4, 6, 50, 51 AND  
52).

FIRST USE 8-0-2004; IN COMMERCE 8-0-2004.

SN 76-493,357, FILED 2-27-2003.

ANGELA M. MICHELI, EXAMINING ATTORNEY

**Int. Cls.: 16 and 41**

**Prior U.S. Cls.: 2, 5, 22, 23, 29, 37, 38, 50, 100, 101, and 107**

**Reg. No. 3,505,700**

**United States Patent and Trademark Office**

**Registered Sep. 23, 2008**

---

**TRADEMARK  
SERVICE MARK  
PRINCIPAL REGISTER**

**T.I.P.S. - TEACHER INSPIRED PRACTICAL STUFF**

TEACHER INSPIRED PRACTICAL STUFF, INC.  
(FLORIDA CORPORATION)  
2689 MEADOWOOD COURT  
WESTON, FL 33332

FOR: PRINTED COURSE MATERIALS, BOOKS, LESSON PLANS, THEME UNITS AND CURRICULUM SUPPORT MATERIALS, ALL FEATURING ACADEMIC SUBJECTS, FOR THE EDUCATION OF ELEMENTARY SCHOOL STUDENTS, IN CLASS 16 (U.S. CLS. 2, 5, 22, 23, 29, 37, 38 AND 50).

FIRST USE 12-1-2004; IN COMMERCE 12-1-2004.

FOR: EDUCATIONAL SERVICES, NAMELY, PROVIDING LEARNING CENTERS FEATURING INSTRUCTION IN ACADEMIC COURSES FOR ELEMENTARY SCHOOL STUDENTS, IN CLASS 41 (U.S. CLS. 100, 101 AND 107).

FIRST USE 12-1-2004; IN COMMERCE 12-1-2004.

SN 76-541,630, FILED 8-21-2003.

ODESSA BIBBINS, EXAMINING ATTORNEY



Int. Cl.: 10

Prior U.S. Cls.: 26, 39, and 44

United States Patent and Trademark Office

Reg. No. 3,505,701

Registered Sep. 23, 2008

TRADEMARK  
PRINCIPAL REGISTER



JET MEDICAL, SA (SWITZERLAND CORPORATION)  
RUE FRITZ-COURVOISIER 40  
2300 LA CHAUX-DE-FONDS, SWITZERLAND

FOR: HEMODIALYSIS CATHETERS AND HEMODIALYSIS CATHETER KITS; MEDICAL GUIDE WIRE BULB INTRODUCERS AND MEDICAL GUIDE WIRES; HEMODIALYSIS CATHETER INTRODUCERS; HEMODIALYSIS CATHETER INSERTION TRAYS; INTRODUCER SHEATHS AND

DILATORS USED TO INSERT HEMODIALYSIS CATHETERS; HYPODERMIC NEEDLES; AND CAPS FOR MEDICAL OR SURGICAL PURPOSES, IN CLASS 10 (U.S. CLS. 26, 39 AND 44).

FIRST USE 1-1-2008; IN COMMERCE 1-1-2008.

SN 76-581,677, FILED 3-17-2004.

ANGELA M. MICHELI, EXAMINING ATTORNEY

**Int. Cl.: 33**

**Prior U.S. Cls.: 47 and 49**

**United States Patent and Trademark Office**

**Reg. No. 3,505,702**

**Registered Sep. 23, 2008**

**TRADEMARK  
PRINCIPAL REGISTER**

**SUPER PASO**

NINER WINE ESTATES, LLC (CALIFORNIA  
LIMITED LIABILITY COMPANY)  
5921 BIRKDALE LANE  
SAN LUIS OBISPO, CA 93401

NO CLAIM IS MADE TO THE EXCLUSIVE  
RIGHT TO USE "SUPER", APART FROM THE  
MARK AS SHOWN.

FOR: WINE, IN CLASS 33 (U.S. CLS. 47 AND 49).

FIRST USE 7-7-2008; IN COMMERCE 7-7-2008.

SN 76-590,203, FILED 5-3-2004.

THE MARK CONSISTS OF STANDARD CHAR-  
ACTERS WITHOUT CLAIM TO ANY PARTICULAR  
FONT, STYLE, SIZE, OR COLOR.

BRIAN NEVILLE, EXAMINING ATTORNEY

**Int. Cl.: 28**

**Prior U.S. Cls.: 22, 23, 38, and 50**

**United States Patent and Trademark Office**

**Reg. No. 3,505,703**

**Registered Sep. 23, 2008**

**TRADEMARK  
PRINCIPAL REGISTER**

**GOOBOO**

STELOR PRODUCTIONS, LLC (DELAWARE  
LIMITED LIABILITY COMPANY)  
14701 MOCKINGBIRD DRIVE  
DARNESTOWN, MD 20874

THE MARK CONSISTS OF STANDARD CHAR-  
ACTERS WITHOUT CLAIM TO ANY PARTICULAR  
FONT, STYLE, SIZE, OR COLOR.

FOR: TOYS, NAMELY, STUFFED AND PLUSH  
TOYS, IN CLASS 28 (U.S. CLS. 22, 23, 38 AND 50).

SN 76-591,378, FILED 5-7-2004.

FIRST USE 5-22-2008; IN COMMERCE 5-22-2008.

ERNEST SHOSHO, EXAMINING ATTORNEY

**Int. Cl.: 9**

**Prior U.S. Cls.: 21, 23, 26, 36, and 38**

**United States Patent and Trademark Office**

**Reg. No. 3,505,704**

**Registered Sep. 23, 2008**

**TRADEMARK  
PRINCIPAL REGISTER**

**CHARMMY KITTY**

SANRIO COMPANY, LTD. (JAPAN CORPORATION)  
1-6-1 OSAKI, SHINAGAWA-KU  
TOKYO 141, JAPAN

FOR: ELECTRONIC CALCULATORS; CONTACT LENS CASES; SUNGLASSES AND BEEPER CARRYING CASES; BAGS, CARRYING CASES AND HOLDERS FOR WIRELESS TELEPHONE AND RADIO PAGERS, IN CLASS 9 (U.S. CLS. 21, 23, 26, 36 AND 38).

FIRST USE 6-1-2005; IN COMMERCE 6-1-2005.

THE MARK CONSISTS OF STANDARD CHARACTERS WITHOUT CLAIM TO ANY PARTICULAR FONT, STYLE, SIZE, OR COLOR.

SN 76-593,954, FILED 5-21-2004.

JASON LOTT, EXAMINING ATTORNEY

**Int. Cl.: 21**

**Prior U.S. Cls.: 2, 13, 23, 29, 30, 33, 40, and 50**

**United States Patent and Trademark Office**

**Reg. No. 3,505,705**

**Registered Sep. 23, 2008**

**TRADEMARK  
PRINCIPAL REGISTER**

**CHARMMY KITTY**

SANRIO COMPANY, LTD. (JAPAN CORPORATION)  
1-6-1 OSAKI, SHINAGAWA-KU  
TOKYO 141, JAPAN

FOR: SPORT BEVERAGE BOTTLES SOLD EMPTY; NON-METAL COIN BANKS; SOAP CONTAINERS; TRASH CANS; NON-METAL LUNCH BOXES; NON-METAL LUNCH PAILS; CHOPSTICKS; PLASTIC FACIAL TISSUE HOLDERS; HAIRBRUSHES; HAIR COMBS; ELECTRIC TOOTHBRUSHES; THERMAL INSULATED LUNCH CONTAINERS; THERMAL INSULATED BEVERAGE BOTTLES; PLASTIC ALL-PURPOSE PORTABLE HOUSEHOLD CONTAINERS; KITS COMPRISES PRIMARILY OF CHOPSTICKS AND SPOONS; KITS COMPRISED

PRIMARILY OF CHOPSTICKS, FORKS, AND SPOONS; EATING UTENSIL KITS COMPRISED OF CHOPSTICKS IN A CASE, IN CLASS 21 (U.S. CLS. 2, 13, 23, 29, 30, 33, 40 AND 50).

FIRST USE 6-1-2004; IN COMMERCE 6-1-2004.

THE MARK CONSISTS OF STANDARD CHARACTERS WITHOUT CLAIM TO ANY PARTICULAR FONT, STYLE, SIZE, OR COLOR.

SN 76-593,960, FILED 5-21-2004.

JASON LOTT, EXAMINING ATTORNEY

**Int. Cl.: 25**

**Prior U.S. Cls.: 22 and 39**

**United States Patent and Trademark Office**

**Reg. No. 3,505,706**

**Registered Sep. 23, 2008**

**TRADEMARK  
PRINCIPAL REGISTER**

**CHARMMY KITTY**

SANRIO COMPANY, LTD. (JAPAN CORPORATION)  
1-6-1 OSAKI, SHINAGAWA-KU  
TOKYO 141, JAPAN

FOR: CHILDREN'S, WOMEN'S AND MEN'S CLOTHING, NAMELY, T-SHIRTS, KNIT SHIRTS, TANK TOPS, SLEEPWEAR, APRONS, SHOWER CAPS, SOCKS, SANDALS, SLIPPERS, IN CLASS 25 (U.S. CLS. 22 AND 39).

FIRST USE 2-1-2005; IN COMMERCE 2-1-2005.

THE MARK CONSISTS OF STANDARD CHARACTERS WITHOUT CLAIM TO ANY PARTICULAR FONT, STYLE, SIZE, OR COLOR.

SN 76-593,963, FILED 5-21-2004.

JASON LOTT, EXAMINING ATTORNEY

**Int. Cl.: 26**

**Prior U.S. Cls.: 37, 39, 40, 42, and 50**

**Reg. No. 3,505,707**

**United States Patent and Trademark Office**

**Registered Sep. 23, 2008**

---

**TRADEMARK  
PRINCIPAL REGISTER**

**CHARMMY KITTY**

SANRIO COMPANY, LTD. (JAPAN CORPORATION)  
1-6-1 OSAKI, SHINAGAWA-KU  
TOKYO 141, JAPAN

THE MARK CONSISTS OF STANDARD CHARACTERS WITHOUT CLAIM TO ANY PARTICULAR FONT, STYLE, SIZE, OR COLOR.

FOR: HAIR BANDS; HAIR CLIPS; PONYTAIL HOLDERS; CLOTHING BUCKLES NOT OF PRECIOUS METAL, IN CLASS 26 (U.S. CLS. 37, 39, 40, 42 AND 50).

SN 76-593,964, FILED 5-21-2004.

FIRST USE 10-1-2004; IN COMMERCE 10-1-2004.

JASON LOTT, EXAMINING ATTORNEY

**Int. Cl.: 28**

**Prior U.S. Cls.: 22, 23, 38, and 50**

**United States Patent and Trademark Office**

**Reg. No. 3,505,708**

**Registered Sep. 23, 2008**

**TRADEMARK  
PRINCIPAL REGISTER**

**CHARMMY KITTY**

SANRIO COMPANY, LTD. (JAPAN CORPORATION)  
1-6-1 OSAKI, SHINAGAWA-KU  
TOKYO 141, JAPAN

FOR: PLUSH ANIMALS; SOFT SCULPTURE  
TOYS; TOY FIGURES; CASES FOR TOY ACCESSORIES;  
SNOW GLOBES; PLAYING CARDS; CHRISTMAS TREE  
ORNAMENTS, IN CLASS 28 (U.S. CLS. 22, 23, 38 AND 50).

FIRST USE 10-1-2004; IN COMMERCE 10-1-2004.

THE MARK CONSISTS OF STANDARD CHARACTERS  
WITHOUT CLAIM TO ANY PARTICULAR FONT, STYLE,  
SIZE, OR COLOR.

SN 76-593,966, FILED 5-21-2004.

JASON LOTT, EXAMINING ATTORNEY



**Int. Cl.: 20**

**Prior U.S. Cls.: 2, 13, 22, 25, 32, and 50**

**United States Patent and Trademark Office**

**Reg. No. 3,505,709**

**Registered Sep. 23, 2008**

**TRADEMARK  
PRINCIPAL REGISTER**

**THOMAS O'BRIEN**

TOB INTERNATIONAL MARKETING CORP.  
(NEW YORK CORPORATION)  
419 BROOME STREET  
NEW YORK, NY 10013

FOR: (BASED ON USE IN COMMERCE) FURNITURE, NAMELY, CHAIRS, SOFAS, TABLES, CABINETS, DESKS, BEDS, STOOLS, CHESTS, BENCHES, MIRRORS, PICTURE FRAMES, DECORATIVE PILLOWS, AND MATTRESS CUSHIONS, DECORATIVE CUSHIONS AND MATTRESSES (BASED ON INTENT TO USE) MATTRESS TOPPERS, CURTAIN RODS, POLES, HOOKS AND FINIALS, NON-METAL CURTAIN RINGS, WINDOW BLINDS, WINDOW SHADES, IN CLASS 20 (U.S. CLS. 2, 13, 22, 25, 32 AND 50).

FIRST USE 10-0-1999; IN COMMERCE 10-0-1999.

THE MARK CONSISTS OF STANDARD CHARACTERS WITHOUT CLAIM TO ANY PARTICULAR FONT, STYLE, SIZE, OR COLOR.

OWNER OF U.S. REG. NO. 2,648,415.

"THOMAS O'BRIEN" IS THE NAME OF A LIVING INDIVIDUAL, WHOSE CONSENT IS IMPLIED BY EXECUTION OF THIS APPLICATION AS PRESIDENT OF APPLICANT.

SN 76-595,718, FILED 6-4-2004.

BRIAN NEVILLE, EXAMINING ATTORNEY

**Int. Cl.: 5**

**Prior U.S. Cls.: 6, 18, 44, 46, 51, and 52**

**Reg. No. 3,505,710**

**United States Patent and Trademark Office**

**Registered Sep. 23, 2008**

**TRADEMARK  
PRINCIPAL REGISTER**

**HEALTHY SKIN FOR LIFE**

LEDERMA, INC. (CALIFORNIA CORPORATION)  
602 NORTH ROXBURY DRIVE  
BEVERLY HILLS, CA 90210

FIRST USE 2-14-2007; IN COMMERCE 2-14-2007.

THE MARK CONSISTS OF STANDARD CHARACTERS WITHOUT CLAIM TO ANY PARTICULAR FONT, STYLE, SIZE, OR COLOR.

FOR: MEDICATED TRANSDERMAL AND EPIDERMAL ANTIOXIDANTS, LOTIONS, CREAMS, GELS, CONTAINING MEDICATIONS TO REDUCE SKIN ERYTHEMA AND DERMATITIS AND FOR MOISTURIZING, ANTI-AGING, SKIN DAMAGE REPAIR, SUN BLOCKING AND WRINKLE REDUCING; TOPICAL ACNE, ECZEMA AND PSORIASIS TREATMENT PREPARATIONS, IN CLASS 5 (U.S. CLS. 6, 18, 44, 46, 51 AND 52).

NO CLAIM IS MADE TO THE EXCLUSIVE RIGHT TO USE "HEALTHY SKIN", APART FROM THE MARK AS SHOWN.

SN 76-596,197, FILED 6-7-2004.

NAAKWAMA ANKRAH, EXAMINING ATTORNEY

**Int. Cl.: 42**

**Prior U.S. Cls.: 100 and 101**

**United States Patent and Trademark Office**

**Reg. No. 3,505,711**

**Registered Sep. 23, 2008**

**SERVICE MARK  
PRINCIPAL REGISTER**

**QUANTUM**

CYBERGENETICS CORPORATION (PENNSYLVANIA CORPORATION)  
OMEGA BUILDING, SUITE 210  
160 NORTH CRAIG STREET  
PITTSBURGH, PA 15213

FOR: ANALYSIS OF BIOLOGICAL DATA AND BIOMEDICAL RESEARCH, FORENSIC TESTING FOR IDENTIFICATION PURPOSES, AND GENETIC TESTING FOR FORENSICS PURPOSES, IN CLASS 42 (U.S. CLS. 100 AND 101).

FIRST USE 2-21-2006; IN COMMERCE 2-21-2006.

THE MARK CONSISTS OF STANDARD CHARACTERS WITHOUT CLAIM TO ANY PARTICULAR FONT, STYLE, SIZE, OR COLOR.

SN 76-599,031, FILED 6-24-2004.

DANIEL CAPSHAW, EXAMINING ATTORNEY

**Int. Cl.: 42**

**Prior U.S. Cls.: 100 and 101**

**United States Patent and Trademark Office**

**Reg. No. 3,505,712**

**Registered Sep. 23, 2008**

**SERVICE MARK  
PRINCIPAL REGISTER**

**freshwave** **studio**

FRESHWAVE STUDIO, LLC (NEW JERSEY LIMITED LIABILITY COMPANY)  
800 DENOW ROAD, SUITE C #378  
PENNINGTON, NJ 08534

NO CLAIM IS MADE TO THE EXCLUSIVE RIGHT TO USE "STUDIO", APART FROM THE MARK AS SHOWN.

FOR: DESIGN AND PRODUCT DEVELOPMENT IN THE FIELDS OF FASHION AND CONSUMER PRODUCTS, IN CLASS 42 (U.S. CLS. 100 AND 101).

SN 76-603,895, FILED 7-23-2004.

FIRST USE 6-3-2006; IN COMMERCE 7-10-2008.

CHERYL CLAYTON, EXAMINING ATTORNEY

**Int. Cl.: 25**

**Prior U.S. Cls.: 22 and 39**

**United States Patent and Trademark Office**

**Reg. No. 3,505,713**

**Registered Sep. 23, 2008**

**TRADEMARK  
PRINCIPAL REGISTER**

**X FACTOR SPORTSWEAR**

X-FACTOR SPORTSWEAR LLC (UTAH LIMITED  
LIABILITY COMPANY)  
824 APPLE GROVE LANE  
PLEASANT GROVE, UT 84062

THE MARK CONSISTS OF STANDARD CHAR-  
ACTERS WITHOUT CLAIM TO ANY PARTICULAR  
FONT, STYLE, SIZE, OR COLOR.

FOR: CLOTHING, NAMELY, MEN'S, WOMEN'S,  
AND CHILDREN'S PANTS, SHORTS, SHIRTS, T-  
SHIRTS, VESTS, SKIRTS, JACKETS, COATS, SPORT  
COATS, SWEATERS, SWEATSHIRTS, SWEAT-  
PANTS, HATS, HEADBANDS, TIES, SOCKS AND  
SHOES, IN CLASS 25 (U.S. CLS. 22 AND 39).

NO CLAIM IS MADE TO THE EXCLUSIVE  
RIGHT TO USE "SPORTSWEAR", APART FROM  
THE MARK AS SHOWN.

SN 76-618,526, FILED 10-25-2004.

FIRST USE 6-25-2004; IN COMMERCE 6-25-2004.

STEVEN R. FINE, EXAMINING ATTORNEY

**Int. Cls.: 9, 16, 41, and 44**

**Prior U.S. Cls.: 2, 5, 21, 22, 23, 26, 29, 36, 37, 38, 50,  
100, 101, and 107**

**Reg. No. 3,505,714**

**United States Patent and Trademark Office**

**Registered Sep. 23, 2008**

**TRADEMARK  
SERVICE MARK  
PRINCIPAL REGISTER**

**FOOD OPTIMISING**

MILES-BRAMWELL EXECUTIVE SERVICES  
LIMITED (UNITED KINGDOM CORPORA-  
TION)  
CLOVER NOOK ROAD  
SOMERCOTES, ALFRETON  
DERBYSHIRE DE55 4RF, ENGLAND

FOR: ELECTRONIC PUBLICATIONS IN THE  
NATURE OF NEWSLETTERS IN THE FIELD OF  
HEALTH NEWS AND HEALTH INFORMATION  
RECORDED ON COMPUTER MEDIA, IN CLASS 9  
(U.S. CLS. 21, 23, 26, 36 AND 38).

FIRST USE 11-0-2005; IN COMMERCE 11-0-2005.

FOR: (BASED ON 44(E)) PRINTED MATTER,  
NAMELY, PRINTED GUIDES, DIARIES, LEAF-  
LETS, PAMPHLETS, BOOKS, BOOKLETS, PRINTED  
TABLES, PRINTED SCHEDULES, PRINTED CARDS  
ALL FOR THE USE IN THE AREAS OF, OR  
RELATING TO, SLIMMING, WEIGHT CONTROL,  
DIET, DIETING, EXERCISE AND HEALTH; DIREC-  
TORIES, PAMPHLETS AND CHARTS, ALL FOR  
USE IN THE AREAS OF, OR RELATING TO, SLIM-  
MING, WEIGHT CONTROL, DIET, DIETING, EX-  
ERCISE AND HEALTH; RECIPE BOOKS, RECIPE  
CARDS, RECIPE LEAFLETS, RECIPE BOOKLETS;  
PUBLICATIONS IN THE NATURE OF BOOKS,  
MAGAZINES, DIARIES, BROCHURES, LEAFLETS,  
PAMPHLETS, DIRECTORIES, GUIDES AND BOOK-  
LETS IN THE AREAS OF, OR RELATING TO,  
SLIMMING, WEIGHT CONTROL, DIET, DIETING,  
EXERCISE AND HEALTH, IN CLASS 16 (U.S. CLS. 2,  
5, 22, 23, 29, 37, 38 AND 50).

FOR: (BASED ON 44(E)) PROVIDING TRAINING  
IN THE FIELDS OF SLIMMING, WEIGHT CON-

TROL, DIET, DIETING, EXERCISE AND HEALTH;  
ARRANGING EDUCATIONAL SEMINARS RELAT-  
ING TO SLIMMING, DIET, DIETING, WEIGHT  
CONTROL, EXERCISE AND HEALTH; PROVIDING  
EDUCATION AND TRAINING SERVICES, NAME-  
LY, CONDUCTING EDUCATIONAL SEMINARS  
AND CLASSES RELATING TO SLIMMING,  
WEIGHT CONTROL, DIET, DIETING, EXERCISE  
AND HEALTH AND THE DISSEMINATION OF  
EDUCATIONAL PUBLICATIONS, VIDEOS, DVDS,  
AND TUTORIALS FOR USE IN CONNECTION  
THEREWITH; PHYSICAL FITNESS CONSULTA-  
TION, IN CLASS 41 (U.S. CLS. 100, 101 AND 107).

FOR: (BASED ON 44(E)) HEALTHCARE ADVI-  
SORY AND COUNSELING SERVICES RELATING  
TO SLIMMING, DIET, DIETING, WEIGHT CON-  
TROL AND HEALTHCARE; ADVISORY AND  
COUNSELING SERVICES RELATING TO DIET,  
DIETING, WEIGHT CONTROL, IN CLASS 44 (U.S.  
CLS. 100 AND 101).

THE MARK CONSISTS OF STANDARD CHAR-  
ACTERS WITHOUT CLAIM TO ANY PARTICULAR  
FONT, STYLE, SIZE, OR COLOR.

OWNER OF ERPN CMNTY TM OFC REG. NO.  
1453513, DATED 3-15-2001, EXPIRES 3-15-2011.

NO CLAIM IS MADE TO THE EXCLUSIVE  
RIGHT TO USE "FOOD", APART FROM THE  
MARK AS SHOWN.

SN 76-623,329, FILED 12-6-2004.

MARLENE BELL, EXAMINING ATTORNEY

**Int. Cls.: 12 and 25**

**Prior U.S. Cls.: 19, 21, 22, 23, 31, 35, 39, and 44**

**United States Patent and Trademark Office**

**Reg. No. 3,505,715**

**Registered Sep. 23, 2008**

**TRADEMARK  
PRINCIPAL REGISTER**

**TOP FISH**

CIGARETTE RACING TEAM, LLC. (ILLINOIS  
LIMITED LIABILITY COMPANY)  
4355 N.W. 128 STREET  
MIAMI, FL 33054

FOR: POWERBOATS, IN CLASS 12 (U.S. CLS. 19,  
21, 23, 31, 35 AND 44).

FIRST USE 11-0-2006; IN COMMERCE 11-0-2006.

FOR: CLOTHING, NAMELY, T-SHIRTS AND  
CAPS, IN CLASS 25 (U.S. CLS. 22 AND 39).

FIRST USE 11-0-2006; IN COMMERCE 11-0-2006.

THE MARK CONSISTS OF STANDARD CHAR-  
ACTERS WITHOUT CLAIM TO ANY PARTICULAR  
FONT, STYLE, SIZE, OR COLOR.

SN 76-635,608, FILED 4-11-2005.

CURTIS FRENCH, EXAMINING ATTORNEY

**Int. Cls.: 37, 41, 43, and 44**

**Prior U.S. Cls.: 100, 101, 103, 106, and 107**

**United States Patent and Trademark Office**

**Reg. No. 3,505,716**

**Registered Sep. 23, 2008**

**SERVICE MARK  
PRINCIPAL REGISTER**

**TAVISTOCK**

BARA ISHIDU INTERNATIONAL CORPORA-  
TION (BAHAMAS CORPORATION)  
P.O. BOX N7776  
CAY HOUSE LYFORD CAY  
NEW PROVIDENCE, BAHAMAS

FOR: PLANNING AND LAYING OUT OF RESI-  
DENTIAL COMMUNITIES, IN CLASS 37 (U.S. CLS.  
100, 103 AND 106).

FIRST USE 3-1-2006; IN COMMERCE 3-1-2006.

FOR: HEALTH CLUB SERVICES, NAMELY, PRO-  
VIDING INSTRUCTION AND EQUIPMENT IN THE  
FIELD OF PHYSICAL EXERCISE; PROVIDING  
GOLF COURSE FACILITIES, AND PROVIDING  
EDUCATIONAL SERVICES, NAMELY, CONDUCT-  
ING SEMINARS, WORKSHOPS AND CLASSES IN  
THE FIELD OF GOLF; PROVIDING FITNESS IN-  
FORMATION AND CONSULTATION, IN CLASS 41  
(U.S. CLS. 100, 101 AND 107).

FIRST USE 5-1-2008; IN COMMERCE 5-1-2008.

FOR: LODGE, HOTEL, RESTAURANT AND BAR  
SERVICES, IN CLASS 43 (U.S. CLS. 100 AND 101).

FIRST USE 5-1-2008; IN COMMERCE 5-1-2008.

FOR: HEALTH SPA SERVICES FEATURING  
SKIN CARE AND HAIR CARE SERVICES, FACIAL  
TREATMENTS, AROMA THERAPY, BODY AND  
FACIAL WAXING, BODY TREATMENTS, MAS-  
SAGE THERAPY, MANICURE AND PEDICURE  
SERVICES, BEAUTY SALON SERVICES, AND RE-  
LATED RETAIL SALES; PROVIDING HEALTH IN-  
FORMATION AND CONSULTATION,  
NUTRITIONAL CONSULTATION AND COUNSEL-  
ING, IN CLASS 44 (U.S. CLS. 100 AND 101).

FIRST USE 5-1-2008; IN COMMERCE 5-1-2008.

THE MARK CONSISTS OF STANDARD CHAR-  
ACTERS WITHOUT CLAIM TO ANY PARTICULAR  
FONT, STYLE, SIZE, OR COLOR.

SN 76-643,269, FILED 7-20-2005.

MARGERY A. TIERNEY, EXAMINING ATTORNEY



**Int. Cl.: 32**

**Prior U.S. Cls.: 45, 46, and 48**

**United States Patent and Trademark Office**

**Reg. No. 3,505,717**

**Registered Sep. 23, 2008**

**TRADEMARK  
PRINCIPAL REGISTER**

**SALUTE OUR HEROES**

D-GENERATION, INC. (FLORIDA CORPORATION)  
BOX 30  
DAYTONA BEACH, FL 321150030

FOR: BEER; IMITATION BEER; NON-ALCOHOLIC BEER; BEER-BASED COOLERS; BLACK BEER; PALE BEER; SOFT DRINKS, NAMELY, COLAS; FRUIT FLAVORED SOFT DRINKS; SOFT DRINKS, NAMELY, POP; CARBONATED SOFT DRINKS; LOW CALORIE SOFT DRINKS; NONCARBONATED SOFT DRINKS, IN CLASS 32 (U.S. CLS. 45, 46 AND 48).

FIRST USE 4-1-2004; IN COMMERCE 4-1-2004.

THE MARK CONSISTS OF STANDARD CHARACTERS WITHOUT CLAIM TO ANY PARTICULAR FONT, STYLE, SIZE, OR COLOR.

SN 76-643,970, FILED 8-1-2005.

GRETTA YAO, EXAMINING ATTORNEY

**Int. Cl.: 41**

**Prior U.S. Cls.: 100, 101, and 107**

**United States Patent and Trademark Office**

**Reg. No. 3,505,718**

**Registered Sep. 23, 2008**

**SERVICE MARK  
PRINCIPAL REGISTER**

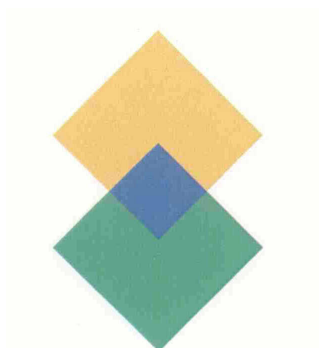

GILEAD SCIENCES, INC. (DELAWARE CORPORATION)  
333 LAKESIDE DRIVE  
FOSTER CITY, CA 94404

FOR: EDUCATIONAL SERVICES, NAMELY, CONDUCTING OFFLINE AND ONLINE CLASSES, COURSES, WORKSHOPS, HEALTH FAIRS, TUTORIALS AND SEMINARS RELATED TO HIV INFECTION AND DEVELOPMENT AND DISSEMINATION OF BROCHURES, PAMPHLETS, BOOKLETS, DVD'S AND VIDEOS IN CONNECTION THEREWITH, IN CLASS 41 (U.S. CLS. 100, 101 AND 107).

FIRST USE 8-8-2006; IN COMMERCE 8-8-2006.

THE COLOR(S) GREEN, GOLD AND BLUE IS/ARE CLAIMED AS A FEATURE OF THE MARK.

THE MARK CONSISTS OF OVERLAPPING GREEN AND GOLD DIAMOND SHAPES FORMING A SMALLER BLUE DIAMOND SHAPE IN THE CENTER.

SN 76-650,191, FILED 11-14-2005.

PRISCILLA MILTON, EXAMINING ATTORNEY

**Int. Cls.: 9 and 25**

**Prior U.S. Cls.: 21, 22, 23, 26, 36, 38, and 39**

**United States Patent and Trademark Office**

**Reg. No. 3,505,719**

**Registered Sep. 23, 2008**

**TRADEMARK  
PRINCIPAL REGISTER**

**PRAYING FOR OUR CHILDREN ... ARE YOU?**

HARRIS, DEBORAH M. (UNITED STATES INDIVIDUAL)  
133 BROWN STREET  
PROVIDENCE, RI 02906

FOR: MAGNETS, NAMELY, DECORATIVE MAGNETS AND REFRIGERATOR MAGNETS, IN CLASS 9 (U.S. CLS. 21, 23, 26, 36 AND 38).

FIRST USE 7-31-2006; IN COMMERCE 11-30-2007.

FOR: CLOTHING AND HEADGEAR, NAMELY, T-SHIRTS, GOLF SHIRTS, COATS, JACKETS, PULL-

OVERS, HATS AND VISORS, IN CLASS 25 (U.S. CLS. 22 AND 39).

FIRST USE 7-31-2006; IN COMMERCE 11-30-2007.

THE MARK CONSISTS OF STANDARD CHARACTERS WITHOUT CLAIM TO ANY PARTICULAR FONT, STYLE, SIZE, OR COLOR.

SN 76-653,785, FILED 1-23-2006.

BRIAN PINO, EXAMINING ATTORNEY

**Int. Cl.: 16**

**Prior U.S. Cls.: 2, 5, 22, 23, 29, 37, 38, and 50**

**United States Patent and Trademark Office**

**Reg. No. 3,505,720**

**Registered Sep. 23, 2008**

**TRADEMARK  
PRINCIPAL REGISTER**

**LACE CURTAIN LIZA**

MORADO, ELIZABETH (UNITED STATES INDIVIDUAL)  
1211 NORTH "J" STREET  
TACOMA, WA 98403

THE MARK CONSISTS OF STANDARD CHARACTERS WITHOUT CLAIM TO ANY PARTICULAR FONT, STYLE, SIZE, OR COLOR.

FOR: ART PRINTS; AND STATIONERY, IN CLASS 16 (U.S. CLS. 2, 5, 22, 23, 29, 37, 38 AND 50).

SN 76-654,751, FILED 2-8-2006.

FIRST USE 12-7-2005; IN COMMERCE 12-7-2005.

ANDREW RHIM, EXAMINING ATTORNEY

**Int. Cl.: 6**

**Prior U.S. Cls.: 2, 12, 13, 14, 23, 25, and 50**

**Reg. No. 3,505,721**

**United States Patent and Trademark Office**

**Registered Sep. 23, 2008**

**TRADEMARK  
PRINCIPAL REGISTER**

**MAX-LIFE**

YOUNG INDUSTRIES, INC., THE (PENNSYLVANIA CORPORATION)  
16 PAINTER STREET  
MUNCY, PA 177560030

THE MARK CONSISTS OF STANDARD CHARACTERS WITHOUT CLAIM TO ANY PARTICULAR FONT, STYLE, SIZE, OR COLOR.

FOR: WIRE ROPE ASSEMBLIES FOR MECHANICAL CONVEYORS USED TO CONVEY BULK MATERIALS, IN CLASS 6 (U.S. CLS. 2, 12, 13, 14, 23, 25 AND 50).

SN 76-655,661, FILED 2-24-2006.

FIRST USE 1-13-2006; IN COMMERCE 1-13-2006.

ANTHONY RINKER, EXAMINING ATTORNEY

**Int. Cl.: 9**

**Prior U.S. Cls.: 21, 23, 26, 36, and 38**

**Reg. No. 3,505,722**

**United States Patent and Trademark Office**

**Registered Sep. 23, 2008**

**TRADEMARK  
PRINCIPAL REGISTER**

**SKOOT**

TOPIA TECHNOLOGY, INC. (WASHINGTON CORPORATION)  
1119 PACIFIC AVENUE, STE 200  
TACOMA, WA 98402

FOR: COMPUTER PROGRAM EMPLOYING MOBILE OBJECT TECHNOLOGY TO TRANSFER DIGITAL FILES OF UNLIMITED SIZE BETWEEN COMPUTERS THROUGH THE INTERNET OR PRIVATE NETWORKS , IN CLASS 9 (U.S. CLS. 21, 23, 26, 36 AND 38).

FIRST USE 2-28-2006; IN COMMERCE 10-16-2007.

THE MARK CONSISTS OF STANDARD CHARACTERS WITHOUT CLAIM TO ANY PARTICULAR FONT, STYLE, SIZE, OR COLOR.

SN 76-655,803, FILED 2-28-2006.

ANNE MADDEN, EXAMINING ATTORNEY

**Int. Cl.: 16**

**Prior U.S. Cls.: 2, 5, 22, 23, 29, 37, 38, and 50**

**Reg. No. 3,505,723**

**United States Patent and Trademark Office**

**Registered Sep. 23, 2008**

**TRADEMARK  
PRINCIPAL REGISTER**

**PATHWAY TO PEACE  
PRESCHOOL**

LAWTON, ELIZABETH (UNITED STATES INDIVIDUAL)  
213 SLAB BRIDGE ROAD  
ASSONET, MA 02702

FIRST USE 12-15-2007; IN COMMERCE 12-15-2007.

FOR: EDUCATIONAL MATERIALS, NAMELY, PRINTED MULTI-CULTURAL EDUCATIONAL, INSTRUCTIONAL AND TEACHING MATERIALS, TEXTBOOKS, WORKBOOKS, AND STUDY GUIDES ALL ON THE SUBJECTS OF MATH, SCIENCE, GEOGRAPHY, HISTORY AND LANGUAGE, IN CLASS 16 (U.S. CLS. 2, 5, 22, 23, 29, 37, 38 AND 50).

NO CLAIM IS MADE TO THE EXCLUSIVE RIGHT TO USE "PRESCHOOL", APART FROM THE MARK AS SHOWN.

SN 76-657,513, FILED 3-30-2006.

JEFFERY COWARD, EXAMINING ATTORNEY

**Int. Cl.: 24**

**Prior U.S. Cls.: 42 and 50**

**United States Patent and Trademark Office**

**Reg. No. 3,505,724**

**Registered Sep. 23, 2008**

**TRADEMARK  
PRINCIPAL REGISTER**

# MAGIC COMFORT

LNT MERCHANDISING COMPANY, LLC (DE-  
LAWARE LIMITED LIABILITY COMPANY)  
6 BRIGHTON ROAD  
CLIFTON, NJ 07012

FOR: BEDDING AND ACCESSORIES, NAMELY,  
COMFORTERS, DUVETS, DUVET COVERS,  
QUILTS, BED LINENS, BED SHEETS, BED  
SPREADS, BED SKIRTS, BED DUST RUFFLES,  
BLANKETS, BED PADS, THROWS, PILLOW CASES,  
PILLOW COVERS, PILLOW SHAMS, MATTRESS  
PADS, MATTRESS COVERS, BED CANOPIES; BED-  
DING FOR INFANTS, NAMELY, COMFORTERS,  
CRIB BUMPERS, CRIB SHEETS, CRIB DUST RUF-

FLES, CRIB BLANKETS, RECEIVING BLANKETS,  
AND SHEET SAVERS, IN CLASS 24 (U.S. CLS. 42  
AND 50).

FIRST USE 5-0-2006; IN COMMERCE 6-0-2006.

THE MARK CONSISTS OF STANDARD CHAR-  
ACTERS WITHOUT CLAIM TO ANY PARTICULAR  
FONT, STYLE, SIZE, OR COLOR.

SN 76-659,622, FILED 5-5-2006.

ALICE BENMAMAN, EXAMINING ATTORNEY



**Int. Cl.: 16**

**Prior U.S. Cls.: 2, 5, 22, 23, 29, 37, 38, and 50**

**Reg. No. 3,505,725**

**United States Patent and Trademark Office**

**Registered Sep. 23, 2008**

**TRADEMARK  
PRINCIPAL REGISTER**

**TAKE OUT**

OUR SUNDAY VISITOR, INC. (INDIANA CORPORATION)  
200 NOLL PLAZA  
HUNTINGTON, IN 46750

FIRST USE 9-0-2006; IN COMMERCE 9-0-2006.

THE MARK CONSISTS OF STANDARD CHARACTERS WITHOUT CLAIM TO ANY PARTICULAR FONT, STYLE, SIZE, OR COLOR.

FOR: PRINTED PERIODICALS IN THE FIELD OF CHRISTIAN FAMILY AND PARENTING ISSUES DISTRIBUTED THROUGH CHRISTIAN PARISHES AND BY DIRECT MAIL , IN CLASS 16 (U.S. CLS. 2, 5, 22, 23, 29, 37, 38 AND 50).

SN 76-660,168, FILED 5-17-2006.

WILLIAM ROSSMAN, EXAMINING ATTORNEY

**Int. Cls.: 9 and 45**

**Prior U.S. Cls.: 21, 23, 26, 36, 38, 100, and 101**

**United States Patent and Trademark Office**

**Reg. No. 3,505,726**

**Registered Sep. 23, 2008**

**TRADEMARK  
SERVICE MARK  
PRINCIPAL REGISTER**

**NOTRELIGION.COM**

GOOD NEWS BROADCASTING ASSOCIATION,  
INC. (NEBRASKA CORPORATION)  
6400 CORNHUSKER HWY.  
P.O. BOX 82808  
LINCOLN, NE 685012808

FOR: PRE-RECORDED AUDIO CASSETTES,  
COMPACT DISCS, AND DOWNLOADABLE AUDIO  
RECORDINGS FEATURING MUSIC, EDUCATION-  
AL MESSAGES, BIBLE TEACHINGS, MOTIVATION-  
AL MESSAGES, AND INSPIRATIONAL MESSAGES,  
IN CLASS 9 (U.S. CLS. 21, 23, 26, 36 AND 38).

FIRST USE 10-31-2005; IN COMMERCE 10-31-2005.

FOR: EVANGELISTIC AND MINISTERIAL SER-  
VICES; PROVIDING RELIGIOUS INFORMATION

VIA THE INTERNET, NAMELY, PROVIDING A  
WEBSITE IN THE FIELD OF BIBLE STUDIES AND  
SPIRITUAL GROWTH, INCLUDING COMMENT-  
TARY AND ARTICLES ABOUT THE BIBLE AND  
SPIRITUAL GROWTH, IN CLASS 45 (U.S. CLS. 100  
AND 101).

FIRST USE 9-27-2007; IN COMMERCE 9-27-2007.

THE MARK CONSISTS OF STANDARD CHAR-  
ACTERS WITHOUT CLAIM TO ANY PARTICULAR  
FONT, STYLE, SIZE, OR COLOR.

SN 76-660,454, FILED 5-23-2006.

CAROLYN CATALDO, EXAMINING ATTORNEY

**Int. Cl.: 9**

**Prior U.S. Cls.: 21, 23, 26, 36, and 38**

**United States Patent and Trademark Office**

**Reg. No. 3,505,727**

**Registered Sep. 23, 2008**

**TRADEMARK  
PRINCIPAL REGISTER**

**NOTIFEX**

EHRENBERG, THOMAS (UNITED STATES IN-  
DIVIDUAL)  
61 PUTNEY LANDING  
PUTNEY, VT 05346

FOR: ELECTRONIC ALARM SYSTEM COMPRIS-  
ING MOTION DETECTORS AND A HAND HELD  
PAGER UNIT THAT ALERTS THE WEARER OF  
MOTION, IN CLASS 9 (U.S. CLS. 21, 23, 26, 36 AND  
38).

FIRST USE 11-30-2006; IN COMMERCE 2-10-2007.

THE MARK CONSISTS OF STANDARD CHAR-  
ACTERS WITHOUT CLAIM TO ANY PARTICULAR  
FONT, STYLE, SIZE, OR COLOR.

SN 76-664,346, FILED 8-9-2006.

COLLEEN KEARNEY, EXAMINING ATTORNEY

**Int. Cls.: 9 and 35**

**Prior U.S. Cls.: 21, 23, 26, 36, 38, 100, 101, and 102**

**United States Patent and Trademark Office**

**Reg. No. 3,505,728**

**Registered Sep. 23, 2008**

**TRADEMARK  
SERVICE MARK  
PRINCIPAL REGISTER**

**PROP WIZARD**

TURNING POINT PROPELLERS, INC. (ILLINOIS  
CORPORATION)  
896 CAMBRIDGE DRIVE  
ELK GROVE VILLAGE, IL 60007

FOR: COMPUTER SOFTWARE FOR VIEWING  
AND SELECTING PROPELLERS, IN CLASS 9 (U.S.  
CLS. 21, 23, 26, 36 AND 38).

FIRST USE 9-30-2006; IN COMMERCE 9-30-2006.

FOR: PURCHASING INFORMATION IN THE  
FIELD OF MARINE PROPELLERS, IN CLASS 35  
(U.S. CLS. 100, 101 AND 102).

FIRST USE 9-30-2006; IN COMMERCE 9-30-2006.

NO CLAIM IS MADE TO THE EXCLUSIVE  
RIGHT TO USE "PROP", APART FROM THE MARK  
AS SHOWN.

SN 76-666,365, FILED 9-20-2006.

JOHN HWANG, EXAMINING ATTORNEY

**Int. Cl.: 16**

**Prior U.S. Cls.: 2, 5, 22, 23, 29, 37, 38, and 50**

**United States Patent and Trademark Office**

**Reg. No. 3,505,729**

**Registered Sep. 23, 2008**

**TRADEMARK  
PRINCIPAL REGISTER**

**HOME COMFORT STYLE**

LENNOX INDUSTRIES INC. (IOWA CORPORATION)  
2100 LAKE PARK BLVD.  
RICHARDSON, TX 75080

NO CLAIM IS MADE TO THE EXCLUSIVE  
RIGHT TO USE "HOME" AND "STYLE", APART  
FROM THE MARK AS SHOWN.

FOR: PERIODICAL MAGAZINES DEALING  
WITH TOPICS OF INTEREST TO HOMEOWNERS,  
IN CLASS 16 (U.S. CLS. 2, 5, 22, 23, 29, 37, 38 AND 50).

SN 76-666,518, FILED 9-25-2006.

FIRST USE 3-20-2007; IN COMMERCE 3-20-2007.

KELLY BOULTON, EXAMINING ATTORNEY

**Int. Cls.: 35 and 41**

**Prior U.S. Cls.: 100, 101, 102, and 107**

**United States Patent and Trademark Office**

**Reg. No. 3,505,730**

**Registered Sep. 23, 2008**

**SERVICE MARK  
PRINCIPAL REGISTER**

**THE GENTLEMEN'S FUND**

ADVANCE MAGAZINE PUBLISHERS INC. (NEW YORK CORPORATION)  
FOUR TIMES SQUARE  
NEW YORK, NY 10036

FOR: ORGANIZING AND PROMOTING OPPORTUNITIES IN THE NATURE OF ONLINE AUCTIONS AND CONTESTS, AND AN ONLINE STORE AND A WEBSITE FOR CHARITABLE ORGANIZATIONS, IN CLASS 35 (U.S. CLS. 100, 101 AND 102).

FIRST USE 2-24-2007; IN COMMERCE 2-24-2007.

FOR: ARRANGING AND CONDUCTING EXHIBITIONS AND EVENTS IN THE NATURE OF ONLINE VIDEOS, CONTESTS, AUCTIONS AND PARTIES FOR CHARITABLE ORGANIZATIONS, IN CLASS 41 (U.S. CLS. 100, 101 AND 107).

FIRST USE 2-24-2007; IN COMMERCE 2-24-2007.

THE MARK CONSISTS OF STANDARD CHARACTERS WITHOUT CLAIM TO ANY PARTICULAR FONT, STYLE, SIZE, OR COLOR.

OWNER OF U.S. REG. NOS. 407,439, 2,553,759, AND OTHERS.

NO CLAIM IS MADE TO THE EXCLUSIVE RIGHT TO USE "FUND", APART FROM THE MARK AS SHOWN.

SN 76-667,701, FILED 10-18-2006.

SUSAN RICHARDS, EXAMINING ATTORNEY

**Int. Cl.: 25**

**Prior U.S. Cls.: 22 and 39**

**United States Patent and Trademark Office**

**Reg. No. 3,505,731**

**Registered Sep. 23, 2008**

**TRADEMARK  
PRINCIPAL REGISTER**

**HOMELAND PRESERVATION**

THE U.S. SECRET SERVICE UNIFORMED DIVISION BENEFIT FUND (D.C. NON-PROFIT ORGANIZATION)

C/O MR. TOM MULDOON  
529 14TH STREET, N.W.  
WASHINGTON, DC 20045

FOR: CLOTHING AND HEADWEAR, NAMELY, T-SHIRTS, SWEAT SHIRTS, JERSEYS, SHORTS, SWEAT PANTS, JACKETS, HATS, HOODED SWEATSHIRTS, CAPS, PAJAMAS, ROBES, NIGHT SHIRTS, NIGHT GOWNS, UNDERWEAR, SHIRTS, TANK TOPS, PANTS, COATS, AND SWEATERS, IN CLASS 25 (U.S. CLS. 22 AND 39).

FIRST USE 9-10-2007; IN COMMERCE 9-10-2007.

THE MARK CONSISTS OF STANDARD CHARACTERS WITHOUT CLAIM TO ANY PARTICULAR FONT, STYLE, SIZE, OR COLOR.

SN 76-667,869, FILED 10-23-2006.

TRACY WHITTAKER-BROWN, EXAMINING ATTORNEY

**Int. Cl.: 11**

**Prior U.S. Cls.: 13, 21, 23, 31, and 34**

**United States Patent and Trademark Office**

**Reg. No. 3,505,732**

**Registered Sep. 23, 2008**

**TRADEMARK  
PRINCIPAL REGISTER**

**TRE'O**

INSIGHT LIGHTING, INC. (NEW MEXICO CORPORATION)  
4341 FULCRUM WAY  
RIO RANCHO, NM 87124

THE MARK CONSISTS OF STANDARD CHARACTERS WITHOUT CLAIM TO ANY PARTICULAR FONT, STYLE, SIZE, OR COLOR.

FOR: LED (LIGHT-EMITTING DIODE) LIGHTING SYSTEMS, NAMELY, ELECTRIC LIGHTING FIXTURES AND LED LIGHT BULBS, IN CLASS 11 (U.S. CLS. 13, 21, 23, 31 AND 34).

SN 76-668,048, FILED 10-25-2006.

FIRST USE 10-1-2006; IN COMMERCE 10-1-2006.

CHARLOTTE CORWIN, EXAMINING ATTORNEY



**Int. Cls.: 3 and 42**

**Prior U.S. Cls.: 1, 4, 6, 50, 51, 52, 100, and 101**

**United States Patent and Trademark Office**

**Reg. No. 3,505,733**

**Registered Sep. 23, 2008**

**TRADEMARK  
SERVICE MARK  
PRINCIPAL REGISTER**

**BEAUTY IS OUR SCIENCE**

LIPO CHEMICALS, INC. (NEW JERSEY CORPORATION)  
207 19TH AVENUE  
PATERSON, NJ 07504

FOR: SKIN CARE PRODUCTS, NAMELY, MOISTURIZING SKIN LOTION, ANTI-AGING CREAM, SKIN CREAM, HAND CREAM AND FACIAL CREAM; HAIR CARE PREPARATIONS AND CREAMS, IN CLASS 3 (U.S. CLS. 1, 4, 6, 50, 51 AND 52).

FIRST USE 10-0-2006; IN COMMERCE 10-0-2006.

FOR: TECHNICAL AND SCIENTIFIC RESEARCH AND DEVELOPMENT IN THE FIELD OF COSMET-

ICS AND PERFUMERY, NEW MIXTURES OF CHEMICAL COMPOUNDS, AND PHARMACEUTICAL TECHNOLOGY, IN CLASS 42 (U.S. CLS. 100 AND 101).

FIRST USE 10-0-2006; IN COMMERCE 10-0-2006.

THE MARK CONSISTS OF STANDARD CHARACTERS WITHOUT CLAIM TO ANY PARTICULAR FONT, STYLE, SIZE, OR COLOR.

SN 76-671,068, FILED 1-5-2007.

JENNIFER DIXON, EXAMINING ATTORNEY

**Int. Cl.: 25**

**Prior U.S. Cls.: 22 and 39**

**United States Patent and Trademark Office**

**Reg. No. 3,505,734**

**Registered Sep. 23, 2008**

**TRADEMARK  
PRINCIPAL REGISTER**

**FLY NY**

ROBINSON, RHASIAH J. (UNITED STATES  
INDIVIDUAL)  
103 ALJOY CT. APT#. 5  
CINCINNATI, OH 45215

OWNER OF U.S. REG. NOS. 2,876,188 AND  
2,969,178.

FOR: CLOTHING, NAMELY, T-SHIRTS, SHIRTS  
AND JEANS; HEADGEAR, NAMELY, BASEBALL  
CAPS; AND FOOTWEAR, IN CLASS 25 (U.S. CLS. 22  
AND 39).

NO CLAIM IS MADE TO THE EXCLUSIVE  
RIGHT TO USE "NY", APART FROM THE MARK  
AS SHOWN.

FIRST USE 1-0-2003; IN COMMERCE 1-0-2003.

SN 76-672,193, FILED 2-2-2007.

THE MARK CONSISTS OF STANDARD CHAR-  
ACTERS WITHOUT CLAIM TO ANY PARTICULAR  
FONT, STYLE, SIZE, OR COLOR.

CAROLYN CATALDO, EXAMINING ATTORNEY

Int. Cl.: 41

Prior U.S. Cls.: 100, 101, and 107

United States Patent and Trademark Office

Reg. No. 3,505,735

Registered Sep. 23, 2008

**SERVICE MARK  
PRINCIPAL REGISTER**



OZZIDI, CLIFFORD (NIGERIA INDIVIDUAL)  
P.O.BOX 968  
ELIZABETH, NJ 07207

FOR: ENTERTAINMENT, NAMELY, LIVE PERFORMANCES BY A MUSICAL BAND, IN CLASS 41 (U.S. CLS. 100, 101 AND 107).

FIRST USE 4-17-2007; IN COMMERCE 11-19-2007.

THE COLOR(S) BLACK, RED, GREEN AND BLUE IS/ARE CLAIMED AS A FEATURE OF THE MARK.

THE MARK CONSISTS OF THE WORDING "CLIFFORD & THE OZZIDI" AND THE WORD "HELLFIRE" AND FOUR SQUARES BENEATH ALL THE WORDING. THE COLOR BLACK APPEARS IN ALL THE WORDING. THE COLOR RED APPEARS AS OUTLINING THE WORD "HELLFIRE". THE COLORS RED, GREEN, AND BLUE APPEAR IN THE FOUR SQUARES. THE COLOR WHITE APPEARS AS BACKGROUND AS IS NOT A FEATURE OF THE MARK.

SN 76-673,936, FILED 3-12-2007.

PAUL MORENO, EXAMINING ATTORNEY

**Int. Cl.: 3**

**Prior U.S. Cls.: 1, 4, 6, 50, 51, and 52**

**United States Patent and Trademark Office**

**Reg. No. 3,505,736**

**Registered Sep. 23, 2008**

**TRADEMARK  
PRINCIPAL REGISTER**

**PARADISE SPA**

TRI-COASTAL DESIGN GROUP, INC. (NEW  
JERSEY CORPORATION)  
C/O THE LAW FIRM OF TEDD S. LEVINE, LLC  
1010 FRANKLIN AVENUE - 2ND FLOOR  
GARDEN CITY, NY 11530

FOR: SHOWER GELS, BODY BUTTER LOTIONS,  
BODY SCRUBS, BODY SPRAYS AND BATH GIFT  
SETS COMPRISED OF THE FOREGOING PRO-  
DUCTS, IN CLASS 3 (U.S. CLS. 1, 4, 6, 50, 51 AND 52).

FIRST USE 9-1-2007; IN COMMERCE 9-1-2007.

THE MARK CONSISTS OF STANDARD CHAR-  
ACTERS WITHOUT CLAIM TO ANY PARTICULAR  
FONT, STYLE, SIZE, OR COLOR.

NO CLAIM IS MADE TO THE EXCLUSIVE  
RIGHT TO USE "SPA", APART FROM THE MARK  
AS SHOWN.

SN 76-674,774, FILED 3-29-2007.

DAVID YONTEF, EXAMINING ATTORNEY

**Int. Cl.: 37**

**Prior U.S. Cls.: 100, 103, and 106**

**United States Patent and Trademark Office**

**Reg. No. 3,505,737**

**Registered Sep. 23, 2008**

**SERVICE MARK  
PRINCIPAL REGISTER**

**STREETSCAPES**

OUTDOOR INSTALLATIONS, LLC (NEW YORK  
LIMITED LIABILITY COMPANY), DBA  
SPRING SCAFFOLDING,  
28-20 BORDEN AVENUE  
LONG ISLAND CITY, NY 11101

FOR: CONSTRUCTION SERVICES, NAMELY,  
CONSTRUCTING PROPERTY AND PEDESTRIAN  
PROTECTION FOR BUILDINGS UNDER RENOVATION,  
MAINTENANCE, AND THE LIKE USING  
SCAFFOLDING, SHEDS, NETTING AND BRIDGES  
TO PROTECT PEOPLE AND PROPERTY FROM

FALLING OBJECTS, IN CLASS 37 (U.S. CLS. 100,  
103 AND 106).

FIRST USE 5-0-2008; IN COMMERCE 5-0-2008.

THE MARK CONSISTS OF STANDARD CHARACTERS  
WITHOUT CLAIM TO ANY PARTICULAR  
FONT, STYLE, SIZE, OR COLOR.

SN 76-675,264, FILED 4-9-2007.

DARRYL SPRUILL, EXAMINING ATTORNEY

**Int. Cl.: 20**

**Prior U.S. Cls.: 2, 13, 22, 25, 32, and 50**

**United States Patent and Trademark Office**

**Reg. No. 3,505,738**

**Registered Sep. 23, 2008**

**TRADEMARK  
PRINCIPAL REGISTER**

**ETERNA LOCK**

VERPLANK ENTERPRISES, INC. (TENNESSEE  
CORPORATION)

1 WALNUT STREET

IRON CITY, TN 38463

FOR: CASKETS AND LOCKS FOR CASKETS, IN  
CLASS 20 (U.S. CLS. 2, 13, 22, 25, 32 AND 50).

FIRST USE 1-15-2007; IN COMMERCE 5-12-2007.

THE MARK CONSISTS OF STANDARD CHAR-  
ACTERS WITHOUT CLAIM TO ANY PARTICULAR  
FONT, STYLE, SIZE, OR COLOR.

NO CLAIM IS MADE TO THE EXCLUSIVE  
RIGHT TO USE "LOCK", APART FROM THE MARK  
AS SHOWN.

SN 76-675,988, FILED 4-25-2007.

CHRISIE B. KING, EXAMINING ATTORNEY

**Int. Cl.: 36**

**Prior U.S. Cls.: 100, 101, and 102**

**United States Patent and Trademark Office**

**Reg. No. 3,505,739**

**Registered Sep. 23, 2008**

**SERVICE MARK  
PRINCIPAL REGISTER**

**FOUNDED BY EDUCATORS FOR  
EDUCATORS**

HORACE MANN EDUCATORS CORPORATION  
(DELAWARE CORPORATION)  
THE HORACE MANN COMPANIES  
1 HORACE MANN PLAZA  
SPRINGFIELD, IL 627150001

FOR: INSURANCE UNDERWRITING AND FI-  
NANCIAL PLANNING SERVICES, IN CLASS 36 (U.S.  
CLS. 100, 101 AND 102).

FIRST USE 3-1-2007; IN COMMERCE 3-1-2007.

THE MARK CONSISTS OF STANDARD CHAR-  
ACTERS WITHOUT CLAIM TO ANY PARTICULAR  
FONT, STYLE, SIZE, OR COLOR.

SN 76-676,209, FILED 4-30-2007.

KATHERINE CONNOLLY, EXAMINING ATTOR-  
NEY

**Int. Cls.: 11 and 19**

**Prior U.S. Cls.: 1, 12, 13, 21, 23, 31, 33, 34, and 50**

**United States Patent and Trademark Office**

**Reg. No. 3,505,740**

**Registered Sep. 23, 2008**

**TRADEMARK  
PRINCIPAL REGISTER**

**LIVE BEYOND THE SURFACE**

SYNDECRETE LLC (UTAH CORPORATION)  
10653 SOUTH RIVERFRONT PARKWAY  
SUITE 300  
SOUTH JORDAN, UT 84095

FOR: LIGHTWEIGHT CONCRETE PRODUCTS,  
NAMELY, SINKS, IN CLASS 11 (U.S. CLS. 13, 21, 23,  
31 AND 34).

FIRST USE 4-1-2007; IN COMMERCE 4-1-2007.

FOR: LIGHTWEIGHT CONCRETE PRODUCTS,  
NAMELY, TILES AND COUNTERTOPS WHICH  
ARE NOT FURNITURE PARTS, IN CLASS 19 (U.S.  
CLS. 1, 12, 33 AND 50).

FIRST USE 4-1-2007; IN COMMERCE 4-1-2007.

SN 76-677,385, FILED 5-25-2007.

AMOS T. MATTHEWS, JR., EXAMINING ATTOR-  
NEY



**Int. Cl.: 41**

**Prior U.S. Cls.: 100, 101, and 107**

**United States Patent and Trademark Office**

**Reg. No. 3,505,741**

**Registered Sep. 23, 2008**

**SERVICE MARK  
PRINCIPAL REGISTER**

**NORTHWEST CHRISTIAN UNIVERSITY**

NORTHWEST CHRISTIAN COLLEGE (OREGON  
NON-PROFIT CORPORATION)  
828 EAST ELEVENTH AVENUE  
EUGENE, OR 97401

FOR: EDUCATION SERVICES, NAMELY, PRO-  
VIDING COURSES OF INSTRUCTION AT THE  
COLLEGE LEVEL, IN CLASS 41 (U.S. CLS. 100, 101  
AND 107).

FIRST USE 7-1-2008; IN COMMERCE 7-1-2008.

THE MARK CONSISTS OF STANDARD CHAR-  
ACTERS WITHOUT CLAIM TO ANY PARTICULAR  
FONT, STYLE, SIZE, OR COLOR.

NO CLAIM IS MADE TO THE EXCLUSIVE  
RIGHT TO USE "CHRISTIAN UNIVERSITY",  
APART FROM THE MARK AS SHOWN.

SN 76-677,467, FILED 5-29-2007.

JASON TURNER, EXAMINING ATTORNEY

**Int. Cl.: 25**

**Prior U.S. Cls.: 22 and 39**

**United States Patent and Trademark Office**

**Reg. No. 3,505,742**

**Registered Sep. 23, 2008**

**TRADEMARK  
PRINCIPAL REGISTER**

**DEVINENNERCROSS**

JOSEPH EDWARDS (UNITED STATES INDIVIDUAL)  
2345 SKYLAND PLACE SE APT#825  
WASHINGTON DC 20020, DC 20020

FOR: T-SHIRTS; SWEAT SUITS; SWEAT SHIRTS;  
SWEAT PANTS; HATS; SHOES; SOCKS; UNDERWEAR;  
JEANS; SWEATERS; DRESS SHIRTS; HEAD BANDS;  
WRIST BANDS, IN CLASS 25 (U.S. CLS. 22 AND 39).

FIRST USE 6-5-2008; IN COMMERCE 6-8-2008.

THE MARK CONSISTS OF STANDARD CHARACTERS WITHOUT CLAIM TO ANY PARTICULAR FONT, STYLE, SIZE, OR COLOR.

SN 76-678,100, FILED 6-8-2007.

JULIE GUTTADAURO, EXAMINING ATTORNEY

**Int. Cl.: 16**

**Prior U.S. Cls.: 2, 5, 22, 23, 29, 37, 38, and 50**

**United States Patent and Trademark Office**

**Reg. No. 3,505,743**

**Registered Sep. 23, 2008**

**TRADEMARK  
PRINCIPAL REGISTER**

**GIVE A HOOT**

BATES, PAUL (UNITED STATES INDIVIDUAL)  
3052 OLD NEW CUT ROAD  
SPRINGFIELD, TN 37172

THE MARK CONSISTS OF STANDARD CHAR-  
ACTERS WITHOUT CLAIM TO ANY PARTICULAR  
FONT, STYLE, SIZE, OR COLOR.

FOR: GREETING CARDS, IN CLASS 16 (U.S. CLS.  
2, 5, 22, 23, 29, 37, 38 AND 50).

SN 76-679,588, FILED 7-17-2007.

FIRST USE 4-11-2008; IN COMMERCE 5-14-2008.

ROBERT LAVACHE, EXAMINING ATTORNEY

**Int. Cl.: 41**

**Prior U.S. Cls.: 100, 101, and 107**

**United States Patent and Trademark Office**

**Reg. No. 3,505,744**

**Registered Sep. 23, 2008**

**SERVICE MARK  
PRINCIPAL REGISTER**

**PRACTICE LIKE A PRO**

TOUR PRACTICE, LLC (FLORIDA LIMITED  
LIABILITY COMPANY)  
602 FRONT STREET  
CELEBRATION, FL 34747

THE MARK CONSISTS OF STANDARD CHAR-  
ACTERS WITHOUT CLAIM TO ANY PARTICULAR  
FONT, STYLE, SIZE, OR COLOR.

FOR: GOLF INSTRUCTION, IN CLASS 41 (U.S.  
CLS. 100, 101 AND 107).

SN 76-680,305, FILED 8-6-2007.

FIRST USE 11-5-2007; IN COMMERCE 11-5-2007.

MICHELE SWAIN, EXAMINING ATTORNEY

Int. Cl.: 10

Prior U.S. Cls.: 26, 39, and 44

United States Patent and Trademark Office

Reg. No. 3,505,745

Registered Sep. 23, 2008

TRADEMARK  
PRINCIPAL REGISTER



Mother baby

CAS MEDICAL SYSTEMS, INC. (DELAWARE CORPORATION)  
44 EAST INDUSTRIAL ROAD  
BRANFORD, CT 06405

FOR: MATERNAL AND FETAL MONITORS, NAMELY, FETAL HEART RATE MONITORS, MATERNAL UTERINE ACTIVITY MONITORS, AND MATERNAL BLOOD PRESSURE MONITORS; NEONATAL INFANT HEALTH PRODUCTS FOR MEDICAL USE, NAMELY, INFANT APNEA DETECTION MONITORS, BLOOD PRESSURE CUFFS, ELECTRODES, LIMB BOARDS, ADHESIVE PATCHES USED TO SECURE A TEMPERATURE PROBE TO A

PATIENT, AND TEMPERATURE PROBES, IN CLASS 10 (U.S. CLS. 26, 39 AND 44).

FIRST USE 6-3-2008; IN COMMERCE 6-3-2008.

NO CLAIM IS MADE TO THE EXCLUSIVE RIGHT TO USE "BABY", APART FROM THE MARK AS SHOWN.

SN 76-680,929, FILED 8-20-2007.

BONNIE LUKEN, EXAMINING ATTORNEY

Int. Cl.: 36

Prior U.S. Cls.: 100, 101, and 102

United States Patent and Trademark Office

Reg. No. 3,505,746

Registered Sep. 23, 2008

SERVICE MARK  
PRINCIPAL REGISTER

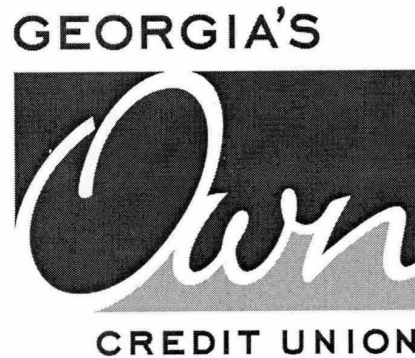

GEORGIA TELCO CREDIT UNION (GEORGIA CORPORATION)  
1155 PEACHTREE STREET  
ATLANTA, GA 30348

NO CLAIM IS MADE TO THE EXCLUSIVE RIGHT TO USE "GEORGIA'S" "CREDIT UNION", APART FROM THE MARK AS SHOWN.

FOR: CREDIT UNION SERVICES, IN CLASS 36 (U.S. CLS. 100, 101 AND 102).

SN 76-683,173, FILED 10-22-2007.

FIRST USE 9-10-2007; IN COMMERCE 9-10-2007.

ANGELA GAW, EXAMINING ATTORNEY

**Int. Cl.: 4**

**Prior U.S. Cls.: 1, 6, and 15**

**United States Patent and Trademark Office**

**Reg. No. 3,505,747**

**Registered Sep. 23, 2008**

**TRADEMARK  
PRINCIPAL REGISTER**

**IT ROCKS TO RECYCLE!**

THE ELIZABETH R. VON SCHLEGELL - ALISON  
SHERWOOD (CALIFORNIA PARTNERSHIP)  
1955 ESCARPA DRIVE  
LOS ANGELES, CA 90041

THE MARK CONSISTS OF STANDARD CHAR-  
ACTERS WITHOUT CLAIM TO ANY PARTICULAR  
FONT, STYLE, SIZE, OR COLOR.

FOR: CANDLES AND SCENTED CANDLES, IN  
CLASS 4 (U.S. CLS. 1, 6 AND 15).

SN 76-978,823, FILED 12-28-2006.

FIRST USE 7-27-2007; IN COMMERCE 7-27-2007.

EMILY CARLSEN, EXAMINING ATTORNEY

**Int. Cls.: 6 and 17**

**Prior U.S. Cls.: 1, 2, 5, 12, 13, 14, 23, 25, 35, and 50**

**United States Patent and Trademark Office**

**Reg. No. 3,505,748**

**Registered Sep. 23, 2008**

**TRADEMARK  
PRINCIPAL REGISTER**

**LANDIS + GYR**

LANDIS+GYR AG (SWITZERLAND CORPORATION)  
FELDSTRASSE 1  
ZUG, SWITZERLAND 6300

FOR: METAL TUBES, IN CLASS 6 (U.S. CLS. 2, 12, 13, 14, 23, 25 AND 50).

FIRST USE 12-1-2002; IN COMMERCE 12-1-2002.

FOR: PLASTIC LAMINATES FOR USE IN MANUFACTURING METER HOUSINGS, IN CLASS 17 (U.S. CLS. 1, 5, 12, 13, 35 AND 50).

FIRST USE 12-1-2002; IN COMMERCE 12-1-2002.

PRIORITY CLAIMED UNDER SEC. 44(D) ON SWITZERLAND APPLICATION NO. 07713/2002, FILED 10-10-2002, REG. NO. 503553, DATED 9-6-2002, EXPIRES 10-10-2012.

OWNER OF U.S. REG. NO. 2,437,910.

SN 76-978,849, FILED 2-4-2003.

SHAILA SETTLES, EXAMINING ATTORNEY



**Int. Cls.: 16, 41, and 44**

**Prior U.S. Cls.: 2, 5, 22, 23, 29, 37, 38, 50, 100, 101, and 107**

**Reg. No. 3,505,749**

**United States Patent and Trademark Office**

**Registered Sep. 23, 2008**

**TRADEMARK  
SERVICE MARK  
PRINCIPAL REGISTER**



CATAPULT LEARNING LLC (DELAWARE LIMITED LIABILITY COMPANY)  
1001 FLEET STREET  
BALTIMORE, MD 212024382

FOR: BOOKS AND PRINTED CURRICULUMS IN THE FIELD OF EDUCATION AND HEALTH, IN CLASS 16 (U.S. CLS. 2, 5, 22, 23, 29, 37, 38 AND 50).

FIRST USE 5-0-2004; IN COMMERCE 5-0-2004.

FOR: EDUCATIONAL SERVICES, NAMELY, PROGRAMS ON THE K-12 LEVEL OFFERED TO SCHOOLS, SCHOOL DISTRICTS, COMMUNITY BASED ORGANIZATIONS; ASSESSMENT, EXAMINATION AND EVALUATION OF STUDENTS, REGARDING THEIR PROFICIENCY AND SKILL LEVEL IN SUBJECTS ON THE K-12 LEVEL, IN CLASS 41 (U.S. CLS. 100, 101 AND 107).

FIRST USE 5-0-2004; IN COMMERCE 5-0-2004.

FOR: SPEECH THERAPY, LANGUAGE THERAPY, OCCUPATIONAL THERAPY AND PHYSICAL THERAPY SERVICES; HEALTH CARE SERVICES, NAMELY, IN-SCHOOL SPEECH THERAPY, LANGUAGE THERAPY, OCCUPATIONAL THERAPY AND PHYSICAL THERAPY SERVICES; CONSULTATION SERVICES IN THE FIELDS OF SPEECH THERAPY, LANGUAGE THERAPY, OCCUPATIONAL THERAPY AND PHYSICAL THERAPY, IN CLASS 44 (U.S. CLS. 100 AND 101).

FIRST USE 5-0-2004; IN COMMERCE 5-0-2004.

SN 76-978,851, FILED 4-2-2004.

LEIGH LOWRY, EXAMINING ATTORNEY

**Int. Cl.: 35**

**Prior U.S. Cls.: 100, 101, and 102**

**United States Patent and Trademark Office**

**Reg. No. 3,505,750**

**Registered Sep. 23, 2008**

**SERVICE MARK  
PRINCIPAL REGISTER**

**INTELLIFARES**

CRYSTAL INTERNATIONAL TRAVEL GROUP,  
INC. (DELAWARE CORPORATION)  
641 SHUNPIKE ROAD, #333  
CHATHAM, NJ 07928

THE MARK CONSISTS OF STANDARD CHAR-  
ACTERS WITHOUT CLAIM TO ANY PARTICULAR  
FONT, STYLE, SIZE, OR COLOR.

FOR: PROVIDING A GUARANTEED PRICING  
PROGRAM SERVICE IN THE FIELD OF AIRFARE  
TICKETS, IN CLASS 35 (U.S. CLS. 100, 101 AND 102).

SN 77-000,857, FILED 9-15-2006.

FIRST USE 8-20-2007; IN COMMERCE 8-20-2007.

MICHAEL TANNER, EXAMINING ATTORNEY

**Int. Cl.: 9**

**Prior U.S. Cls.: 21, 23, 26, 36, and 38**

**Reg. No. 3,505,751**

**United States Patent and Trademark Office**

**Registered Sep. 23, 2008**

**TRADEMARK  
PRINCIPAL REGISTER**

**MUXEO**

BOGHOSSIAN, HRATCH (UNITED STATES IN-  
DIVIDUAL)  
2363 SOUTHEAST 15TH ST.  
POMPANO BEACH, FL 33062

THE MARK CONSISTS OF STANDARD CHAR-  
ACTERS WITHOUT CLAIM TO ANY PARTICULAR  
FONT, STYLE, SIZE, OR COLOR.

FOR: FRAMES FOR EYEGLASSES AND PINCE-  
NEZ, IN CLASS 9 (U.S. CLS. 21, 23, 26, 36 AND 38).

SN 77-001,970, FILED 9-19-2006.

FIRST USE 11-2-2006; IN COMMERCE 2-13-2007.

DANIEL BRODY, EXAMINING ATTORNEY

**Int. Cls.: 41, 42, and 45**

**Prior U.S. Cls.: 100, 101, and 107**

**United States Patent and Trademark Office**

**Reg. No. 3,505,752**

**Registered Sep. 23, 2008**

**SERVICE MARK  
PRINCIPAL REGISTER**



ADVANCED VIDEO COMMUNICATIONS, INC.  
(CALIFORNIA CORPORATION)  
SUITE 6800  
633 W. 5TH STREET  
LOS ANGELES, CA 90071

FOR: ELECTRONIC PUBLISHING SERVICES, NAMELY, PUBLICATION OF TEXT, AUDIO, VIDEO AND GRAPHIC WORKS ONLINE FEATURING DIARIES, COMMENTARY, PHOTOS, VIDEOS, MUSIC, NEWS, PROJECT UPDATES, NON-FICTION AND FICTION, IN CLASS 41 (U.S. CLS. 100, 101 AND 107).

FIRST USE 2-15-2006; IN COMMERCE 2-15-2006.

FOR: COMPUTER SERVICES, NAMELY, HOSTING ONLINE WEB FACILITIES FOR OTHERS FOR ORGANIZING AND CONDUCTING ONLINE MEETINGS, GATHERINGS, AND INTERACTIVE DISCUSSIONS; AND COMPUTER SERVICES IN THE NATURE OF CUSTOMIZED WEB PAGES FEATURING USER-DEFINED INFORMATION,

AND PERSONAL PROFILES, IN CLASS 42 (U.S. CLS. 100 AND 101).

FIRST USE 2-15-2006; IN COMMERCE 2-15-2006.

FOR: ONLINE SOCIAL NETWORKING SERVICES, NAMELY, FACILITATING SOCIAL INTERACTION AMONG INDIVIDUALS FOR THE PURPOSE OF DEVELOPING FRIENDSHIPS, FINDING ACTIVITY PARTNERS, SOCIAL INTRODUCTIONS, AND FOR FINDING PERSONS WITH PARTICULAR HOBBIES, INTERESTS AND BACKGROUNDS, IN CLASS 45 (U.S. CLS. 100 AND 101).

FIRST USE 2-15-2006; IN COMMERCE 2-15-2006.

THE MARK CONSISTS OF A CRESCENT WRAPPED AROUND A CIRCLE WHICH CONTAINS AN OFF-CENTER CONTRASTING SMALLER CIRCLE.

SN 77-002,021, FILED 9-19-2006.

CARYN GLASSER, EXAMINING ATTORNEY

**Int. Cl.: 35**

**Prior U.S. Cls.: 100, 101, and 102**

**United States Patent and Trademark Office**

**Reg. No. 3,505,753**

**Registered Sep. 23, 2008**

**SERVICE MARK  
PRINCIPAL REGISTER**

**THE BIG SIPPER**

COST PLUS MANAGEMENT SERVICES, INC.  
(CALIFORNIA CORPORATION)  
200 4TH STREET  
OAKLAND, CA 94607

THE MARK CONSISTS OF STANDARD CHAR-  
ACTERS WITHOUT CLAIM TO ANY PARTICULAR  
FONT, STYLE, SIZE, OR COLOR.

FOR: RETAIL STORE SERVICES FEATURING  
ALCOHOLIC BEVERAGES, IN CLASS 35 (U.S. CLS.  
100, 101 AND 102).

SN 77-002,081, FILED 9-19-2006.

FIRST USE 9-17-2006; IN COMMERCE 9-17-2006.

JOHN WILKE, EXAMINING ATTORNEY

**Int. Cl.: 28**

**Prior U.S. Cls.: 22, 23, 38, and 50**

**United States Patent and Trademark Office**

**Reg. No. 3,505,754**

**Registered Sep. 23, 2008**

**TRADEMARK  
PRINCIPAL REGISTER**

**MINI TURBO SHOTS**

JAKKS PACIFIC, INC. (DELAWARE CORPORATION)  
22619 PACIFIC COAST HIGHWAY  
MALIBU, CA 90265

OWNER OF U.S. REG. NOS. 2,067,832 AND  
2,678,875.

FOR: TOYS, GAMES, AND PLAYTHINGS, NAME-  
LY, SPINNING TOYS AND ACCESSORIES THERE-  
FOR, IN CLASS 28 (U.S. CLS. 22, 23, 38 AND 50).

NO CLAIM IS MADE TO THE EXCLUSIVE  
RIGHT TO USE "MINI", APART FROM THE MARK  
AS SHOWN.

FIRST USE 11-1-2006; IN COMMERCE 11-1-2006.

SN 77-002,596, FILED 9-19-2006.

THE MARK CONSISTS OF STANDARD CHAR-  
ACTERS WITHOUT CLAIM TO ANY PARTICULAR  
FONT, STYLE, SIZE, OR COLOR.

BILL DAWE, EXAMINING ATTORNEY

**Int. Cl.: 9**

**Prior U.S. Cls.: 21, 23, 26, 36, and 38**

**United States Patent and Trademark Office**

**Reg. No. 3,505,755**

**Registered Sep. 23, 2008**

**TRADEMARK  
PRINCIPAL REGISTER**



HOLOGRAM BI (AUSTRALIA CORPORATION)  
C/O GUY PITMAN  
97 WATSON AVENUE  
TOORAK GARDENS, AUSTRALIA 5065

FOR: COMPUTER SOFTWARE FOR USE IN  
ACCESSING, PLANNING, ANALYZING, REPORT-  
ING AND AUTOMATING BUSINESS INTELLI-  
GENCE, FINANCE, PERFORMANCE DATA, DATA  
RECOVERY AND DISASTER RECOVERY, IN  
CLASS 9 (U.S. CLS. 21, 23, 26, 36 AND 38).

FIRST USE 6-17-2008; IN COMMERCE 6-17-2008.

THE COLOR(S) BLUE, GREEN AND ORANGE IS/  
ARE CLAIMED AS A FEATURE OF THE MARK.

THE MARK CONSISTS OF THE FANCIFUL DE-  
SIGN OF A UPPERCASE LETTER "H", JUXTO-  
POSED INTO A CUBE DESIGN, WITH THE TOP  
"H" IN THE COLOR ORANGE, THE RIGHT SIDE  
"H" IN THE COLOR BLUE AND THE LEFT SIDE  
"H" IN THE COLOR GREEN.

SN 77-002,796, FILED 9-19-2006.

STEVEN R. FINE, EXAMINING ATTORNEY

**Int. Cl.: 13**

**Prior U.S. Cls.: 2 and 9**

**United States Patent and Trademark Office**

**Reg. No. 3,505,756**

**Registered Sep. 23, 2008**

**TRADEMARK  
PRINCIPAL REGISTER**

**B50TWO**

ESCALONA, WAIN H. (UNITED STATES INDIVIDUAL)  
P.O. BOX 290  
SHADY COVE, OR 97539

FOR: RIFLE CARTRIDGES; RIFLES AND PARTS THEREOF, IN CLASS 13 (U.S. CLS. 2 AND 9).

FIRST USE 8-1-2006; IN COMMERCE 7-28-2008.

THE MARK CONSISTS OF STANDARD CHARACTERS WITHOUT CLAIM TO ANY PARTICULAR FONT, STYLE, SIZE, OR COLOR.

SN 77-003,546, FILED 9-20-2006.

KATHERINE CONNOLLY, EXAMINING ATTORNEY



**Int. Cl.: 16**

**Prior U.S. Cls.: 2, 5, 22, 23, 29, 37, 38, and 50**

**Reg. No. 3,505,757**

**United States Patent and Trademark Office**

**Registered Sep. 23, 2008**

**TRADEMARK  
PRINCIPAL REGISTER**

**MOUNTAIN PRIDE CONNECTIONS**

HOFER, SUSAN (UNITED STATES INDIVIDUAL)  
SUITE 400-A  
2299 PEARL STREET  
BOULDER, CO 80302

FOR: DIRECTORY AND GUIDE BOOKS IN THE FIELD OF BUSINESS, PROFESSIONAL SERVICES AND ORGANIZATIONS FOR THE GAY COMMUNITY, IN CLASS 16 (U.S. CLS. 2, 5, 22, 23, 29, 37, 38 AND 50).

FIRST USE 8-30-2006; IN COMMERCE 7-21-2008.

THE MARK CONSISTS OF STANDARD CHARACTERS WITHOUT CLAIM TO ANY PARTICULAR FONT, STYLE, SIZE, OR COLOR.

SN 77-004,019, FILED 9-21-2006.

ANGELA GAW, EXAMINING ATTORNEY

**Int. Cl.: 41**

**Prior U.S. Cls.: 100, 101, and 107**

**United States Patent and Trademark Office**

**Reg. No. 3,505,758**

**Registered Sep. 23, 2008**

**SERVICE MARK  
PRINCIPAL REGISTER**

**POP WORKSHOP**

INFLUENCE AT WORK, L.L.C. (ARIZONA LIMITED LIABILITY COMPANY)  
2248 SOUTH FOREST  
TEMPE, AZ 85282

FOR: TRAINING SERVICES AND TRAINING PROGRAMS IN THE FIELDS OF THE APPLIED SCIENCE AND THE PSYCHOLOGY OF INFLUENCE AND PERSUASION, AND DISTRIBUTING TRAINING MATERIALS IN CONNECTION THEREWITH, IN CLASS 41 (U.S. CLS. 100, 101 AND 107).

FIRST USE 0-0-1999; IN COMMERCE 0-0-1999.

THE MARK CONSISTS OF STANDARD CHARACTERS WITHOUT CLAIM TO ANY PARTICULAR FONT, STYLE, SIZE, OR COLOR.

NO CLAIM IS MADE TO THE EXCLUSIVE RIGHT TO USE "WORKSHOP", APART FROM THE MARK AS SHOWN.

SN 77-004,248, FILED 9-21-2006.

ANNE E. GUSTASON, EXAMINING ATTORNEY

**Int. Cl.: 16**

**Prior U.S. Cls.: 2, 5, 22, 23, 29, 37, 38, and 50**

**United States Patent and Trademark Office**

**Reg. No. 3,505,759**

**Registered Sep. 23, 2008**

**TRADEMARK  
PRINCIPAL REGISTER**

# Sassy Swirl

TOP FLIGHT, INC. (TENNESSEE CORPORATION)  
1300 CENTRAL AVENUE  
CHATTANOOGA, TN 37408

FOR: STATIONERY GOODS, NAMELY, PORTFOLIOS, WIRE-BOUND NOTEBOOKS, COMPOSITION BOOKS, BINDERS, POUCHES FOR WRITING INSTRUMENTS, MEMO PADS, DAY PLANNERS, ILLUSTRATED NOTEPADS AND PERSONAL ORGANIZERS, IN CLASS 16 (U.S. CLS. 2, 5, 22, 23, 29, 37, 38 AND 50).

FIRST USE 6-7-2007; IN COMMERCE 6-7-2007.

THE MARK CONSISTS OF STANDARD CHARACTERS WITHOUT CLAIM TO ANY PARTICULAR FONT, STYLE, SIZE, OR COLOR.

SN 77-004,413, FILED 9-21-2006.

TIMOTHY FINNEGAN, EXAMINING ATTORNEY

**Int. Cl.: 41**

**Prior U.S. Cls.: 100, 101, and 107**

**United States Patent and Trademark Office**

**Reg. No. 3,505,760**

**Registered Sep. 23, 2008**

**SERVICE MARK  
PRINCIPAL REGISTER**

**NURSE MANAGER BOOT CAMP**

CROSS COUNTRY HEALTHCARE, INC. (DELA-  
WARE CORPORATION)  
6551 PARK OF COMMERCE BLVD.  
BOCA RATON, FL 33487

FOR: TRAINING AND EDUCATION SERVICES,  
NAMELY, CONDUCTING COURSES FOR NURSES  
AND NURSE MANAGERS IN THE FIELDS OF  
MANAGERIAL, LEADERSHIP, ORGANIZATION-  
AL, AND FINANCIAL SKILLS, IN CLASS 41 (U.S.  
CLS. 100, 101 AND 107).

FIRST USE 6-0-2002; IN COMMERCE 6-0-2002.

THE MARK CONSISTS OF STANDARD CHAR-  
ACTERS WITHOUT CLAIM TO ANY PARTICULAR  
FONT, STYLE, SIZE, OR COLOR.

NO CLAIM IS MADE TO THE EXCLUSIVE  
RIGHT TO USE "NURSE MANAGER", APART  
FROM THE MARK AS SHOWN.

SN 77-006,421, FILED 9-25-2006.

PRISCILLA MILTON, EXAMINING ATTORNEY

**Int. Cl.: 16**

**Prior U.S. Cls.: 2, 5, 22, 23, 29, 37, 38, and 50**

**Reg. No. 3,505,761**

**United States Patent and Trademark Office**

**Registered Sep. 23, 2008**

**TRADEMARK  
PRINCIPAL REGISTER**

**APRÈS PEAU**

ALSTER, TINA S. (UNITED STATES INDIVIDUAL)  
2311 M STREET, NW, SUITE 200  
WASHINGTON, DC 20037

FOR: PAPER GOODS AND PRINTED MATERIALS, NAMELY, STATIONERY, PAPER BAGS, AND NOTE CARDS, IN CLASS 16 (U.S. CLS. 2, 5, 22, 23, 29, 37, 38 AND 50).

FIRST USE 2-1-2007; IN COMMERCE 2-1-2007.

THE MARK CONSISTS OF STANDARD CHARACTERS WITHOUT CLAIM TO ANY PARTICULAR FONT, STYLE, SIZE, OR COLOR.

THE FOREIGN WORDING IN THE MARK TRANSLATES INTO ENGLISH AS AFTER SKIN.

SN 77-006,767, FILED 9-25-2006.

KIM SAITO, EXAMINING ATTORNEY

**Int. Cl.: 28**

**Prior U.S. Cls.: 22, 23, 38, and 50**

**United States Patent and Trademark Office**

**Reg. No. 3,505,762**

**Registered Sep. 23, 2008**

**TRADEMARK  
PRINCIPAL REGISTER**



**CRAYOLA PROPERTIES, INC. (DELAWARE CORPORATION)  
2035 EDGEWOOD AVENUE  
EASTON, PA 18042**

**FOR: EDUCATIONAL TOYS IN THE NATURE OF MANIPULATIVE GAMES FOR LEARNING COLORS, SHAPES, AND PATTERNS, IN CLASS 28 (U.S. CLS. 22, 23, 38 AND 50).**

**FIRST USE 7-17-2007; IN COMMERCE 7-17-2007.**

**OWNER OF U.S. REG. NOS. 641,294, 1,279,429, AND OTHERS.**

**SN 77-006,900, FILED 9-25-2006.**

**MICHAEL LITZAU, EXAMINING ATTORNEY**

Int. Cl.: 29

Prior U.S. Cl.: 46

United States Patent and Trademark Office

Reg. No. 3,505,763

Registered Sep. 23, 2008

TRADEMARK  
PRINCIPAL REGISTER



LY BROTHERS CORPORATION (CALIFORNIA CORPORATION)

1963 SABRE STREET

HAYWARD, CA 94545

FOR: SOY-BASED SNACK FOODS, IN CLASS 29 (U.S. CL. 46).

FIRST USE 9-1-2006; IN COMMERCE 9-1-2006.

NO CLAIM IS MADE TO THE EXCLUSIVE RIGHT TO USE "ALL NATURAL SOY BEAN MUNCHIES", APART FROM THE MARK AS SHOWN.

THE MARK CONSISTS OF A DEPICTION OF SOY BEANS ABOVE A BANNER CONTAINING STYLIZED WORDS.

SN 77-007,354, FILED 9-26-2006.

JOHN DWYER, EXAMINING ATTORNEY

Int. Cls.: 39 and 45

Prior U.S. Cls.: 100, 101, and 105

United States Patent and Trademark Office

Reg. No. 3,505,764

Registered Sep. 23, 2008

SERVICE MARK  
PRINCIPAL REGISTER



GLOBAL CHARTER SERVICES, LTD. (DELA-  
WARE CORPORATION)  
SUITE 1100  
200 WEST ADAMS  
CHICAGO, IL 60606

FOR: TRANSPORTATION OF PASSENGERS BY  
BUS; TRANSPORTATION RESERVATION SERVI-  
CES; PROVIDING CONSULTATION AND INFOR-  
MATION IN THE FIELD OF EMERGENCY  
EVACUATION TRANSPORTATION OF PASSEN-  
GERS BY BUS; ASSISTING OTHERS IN ARRAN-  
GING AND ORGANIZING TRANSPORTATION OF  
PASSENGERS BY BUS, IN CLASS 39 (U.S. CLS. 100  
AND 105).

FIRST USE 8-31-2006; IN COMMERCE 8-31-2006.

FOR: PROVIDING CONSULTATION AND IN-  
FORMATION IN THE FIELD OF EMERGENCY

RESPONSE FOR COMMUNITIES, IN CLASS 45  
(U.S. CLS. 100 AND 101).

FIRST USE 8-31-2006; IN COMMERCE 8-31-2006.

OWNER OF U.S. REG. NO. 2,524,988.

NO CLAIM IS MADE TO THE EXCLUSIVE  
RIGHT TO USE "RESPONSE TEAM", APART FROM  
THE MARK AS SHOWN.

THE MARK CONSISTS OF THE LETTER "R"  
ENCLOSED IN A CIRCLE ON THE TOP OF WHICH  
THE WORDS "BUS BANK" APPEAR AND ON THE  
BOTTOM OF WHICH APPEAR THE WORDS "RE-  
SPONSE TEAM".

SN 77-007,768, FILED 9-26-2006.

SOPHIA S. KIM, EXAMINING ATTORNEY



**Int. Cl.: 42**

**Prior U.S. Cls.: 100 and 101**

**United States Patent and Trademark Office**

**Reg. No. 3,505,765**

**Registered Sep. 23, 2008**

**SERVICE MARK  
PRINCIPAL REGISTER**

**VIRTUSOFT**

VIRTUSOFT SOLUTIONS LLC (PENNSYLVANIA  
LIMITED LIABILITY COMPANY)  
365 WEST COTTAGE PLACE  
YORK, PA 17405

FOR: PROVIDING ON-LINE NON-DOWNLOAD-  
ABLE SOFTWARE FOR SCHEDULING, CALEN-  
DARING, CONTACT MANAGEMENT, AND  
COLLABORATION BETWEEN MULTIPLE PARTIES  
, IN CLASS 42 (U.S. CLS. 100 AND 101).

FIRST USE 6-1-2008; IN COMMERCE 6-1-2008.

THE MARK CONSISTS OF STANDARD CHAR-  
ACTERS WITHOUT CLAIM TO ANY PARTICULAR  
FONT, STYLE, SIZE, OR COLOR.

SN 77-008,556, FILED 9-27-2006.

ROBERT C. CLARK JR., EXAMINING ATTORNEY

**Int. Cl.: 25**

**Prior U.S. Cls.: 22 and 39**

**United States Patent and Trademark Office**

**Reg. No. 3,505,766**

**Registered Sep. 23, 2008**

**TRADEMARK  
PRINCIPAL REGISTER**

**CUSHION SOLUTIONS**

HBI BRANDED APPAREL ENTERPRISES, LLC  
(DELAWARE LIMITED LIABILITY COMPAN-  
NY)

1000 EAST HANES MILL ROAD  
WINSTON-SALEM, NC 27105

FOR: HOSIERY; KNEE HIGHS; PANTYHOSE;  
SOCKS, IN CLASS 25 (U.S. CLS. 22 AND 39).

FIRST USE 12-11-2006; IN COMMERCE 12-11-2006.

THE MARK CONSISTS OF STANDARD CHAR-  
ACTERS WITHOUT CLAIM TO ANY PARTICULAR  
FONT, STYLE, SIZE, OR COLOR.

NO CLAIM IS MADE TO THE EXCLUSIVE  
RIGHT TO USE "CUSHION", APART FROM THE  
MARK AS SHOWN.

SN 77-009,305, FILED 9-28-2006.

PAUL CROWLEY, EXAMINING ATTORNEY

**Int. Cl.: 16**

**Prior U.S. Cls.: 2, 5, 22, 23, 29, 37, 38, and 50**

**United States Patent and Trademark Office**

**Reg. No. 3,505,767**

**Registered Sep. 23, 2008**

**TRADEMARK  
PRINCIPAL REGISTER**

**MILEPOST 6**

MILEPOST 6, INC. (VIRGINIA CORPORATION)  
UNIT J  
5805 SCHOOL AVENUE  
RICHMOND, VA 23228

THE MARK CONSISTS OF STANDARD CHAR-  
ACTERS WITHOUT CLAIM TO ANY PARTICULAR  
FONT, STYLE, SIZE, OR COLOR.

FOR: POSTERS, IN CLASS 16 (U.S. CLS. 2, 5, 22, 23,  
29, 37, 38 AND 50).

SN 77-009,692, FILED 9-28-2006.

FIRST USE 1-2-2007; IN COMMERCE 1-2-2007.

DEIRDRE ROBERTSON, EXAMINING ATTORNEY

**Int. Cl.: 40**

**Prior U.S. Cls.: 100, 103, and 106**

**United States Patent and Trademark Office**

**Reg. No. 3,505,768**

**Registered Sep. 23, 2008**

**SERVICE MARK  
PRINCIPAL REGISTER**



ADERA, INC. (FLORIDA CORPORATION)  
8805 TAMIAMI TRAIL NORTH, #324  
NAPLES, FL 34108

MENT DISPOSAL SERVICES, IN CLASS 40 (U.S. CLS.  
100, 103 AND 106).

FIRST USE 1-0-2008; IN COMMERCE 1-0-2008.

FOR: SECURE DOCUMENT DESTRUCTION  
SERVICES; SHREDDING SERVICES; ELECTRONIC  
DOCUMENT SCANNING SERVICES; AND DOCU-

SN 77-009,698, FILED 9-28-2006.

ANDREA SAUNDERS, EXAMINING ATTORNEY

**Int. Cl.: 41**

**Prior U.S. Cls.: 100, 101, and 107**

**United States Patent and Trademark Office**

**Reg. No. 3,505,769**

**Registered Sep. 23, 2008**

**SERVICE MARK  
PRINCIPAL REGISTER**

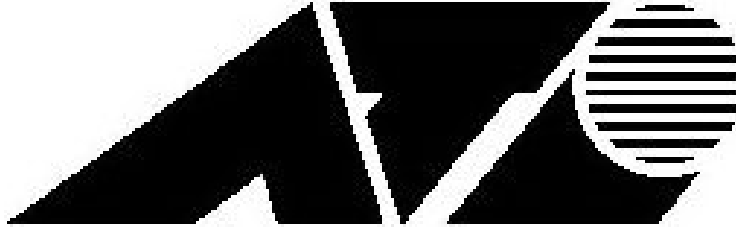

ALLIED TELESIS, INC. (DELAWARE CORPORATION)  
19800 NORTH CREEK PARKWAY  
BOTHELL, WA 98011

FOR: EDUCATIONAL SERVICES, NAMELY,  
CONDUCTING SEMINARS, COURSES, WORK-  
SHOPS AND CERTIFICATION COURSES IN THE  
FIELDS OF NETWORKING EQUIPMENT AND  
COMPUTER SYSTEMS; EDUCATIONAL EXAMI-

NATION SERVICES, IN CLASS 41 (U.S. CLS. 100,  
101 AND 107).

FIRST USE 1-1-2001; IN COMMERCE 1-1-2001.

SN 77-010,174, FILED 9-29-2006.

KIMBERLY FRYE, EXAMINING ATTORNEY

**Int. Cl.: 18**

**Prior U.S. Cls.: 1, 2, 3, 22, and 41**

**United States Patent and Trademark Office**

**Reg. No. 3,505,770**

**Registered Sep. 23, 2008**

**TRADEMARK  
PRINCIPAL REGISTER**

**DANIJELA BELLE**

ZAKIC, DANIJELA (UNITED STATES INDIVIDUAL)  
230 SHELDON ST. 1  
EL SEGUNDO, CA 90245

FOR: EVENING HANDBAGS; HANDBAGS; HANDBAGS FOR MEN; LEATHER AND IMITATION LEATHER BAGS; LEATHER BAGS, SUITCASES AND WALLETS; LEATHER HANDBAGS; WALLETS, IN CLASS 18 (U.S. CLS. 1, 2, 3, 22 AND 41).

FIRST USE 11-30-2006; IN COMMERCE 12-10-2006.

THE MARK CONSISTS OF STANDARD CHARACTERS WITHOUT CLAIM TO ANY PARTICULAR FONT, STYLE, SIZE, OR COLOR.

THE NAME(S), PORTRAIT(S), AND/OR SIGNATURE(S) SHOWN IN THE MARK DOES NOT IDENTIFY A PARTICULAR LIVING INDIVIDUAL.

SN 77-012,830, FILED 10-3-2006.

CAROLYN CATALDO, EXAMINING ATTORNEY

Int. Cl.: 25

Prior U.S. Cls.: 22 and 39

United States Patent and Trademark Office

Reg. No. 3,505,771

Registered Sep. 23, 2008

TRADEMARK  
PRINCIPAL REGISTER

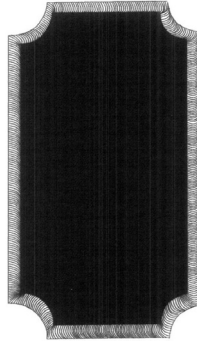

WASHINGTON, ARCKEY (UNITED STATES IN-  
DIVIDUAL)  
4548 S. PRAIRIE  
CHICAGO, IL 60653

FOR: MEN'S, WOMEN'S AND CHILDREN'S  
CLOTHING, NAMELY, T-SHIRTS, PANTS, SWEAT-  
PANTS, SWEATSHIRTS, SHIRTS, BLOUSES,  
SHORTS, SKIRTS, HATS, VISORS, SOCKS, SHOES,  
JEANS, VESTS, JACKETS, DRESSES, UNDERWEAR,  
SWIMWEAR, GLOVES AND BELTS, IN CLASS 25  
(U.S. CLS. 22 AND 39).

THE MARK CONSISTS OF PATCH WITH A  
GENERALLY RECTANGULAR FIGURE WITH  
THE LONGER DIMENSION DISPOSED IN A VER-  
TICAL DIRECTION AND WITH EACH CORNER OF  
THE RECTANGLE BEING NOTCHED, SAID PATCH  
HAVING A BORDER WITH A DISTINCT RAISED  
THREAD DESIGN. THE CENTER OF THE PATCH  
WITHIN THE BORDER IS UNIFORMLY COLORED.

SN 77-013,488, FILED 10-4-2006.

FIRST USE 10-4-2006; IN COMMERCE 1-26-2007.

PETER B. BROMAGHIM, EXAMINING ATTORNEY

**Int. Cl.: 36**

**Prior U.S. Cls.: 100, 101, and 102**

**United States Patent and Trademark Office**

**Reg. No. 3,505,772**

**Registered Sep. 23, 2008**

**SERVICE MARK  
PRINCIPAL REGISTER**

**INCONTROL**

SUN LIFE ASSURANCE COMPANY OF CANADA (CANADA CORPORATION)  
150 KING STREET WEST, SUITE 1400  
TORONTO, ONTARIO, CANADA M5H1J9

FOR: INSURANCE SERVICES, NAMELY, UNDERWRITING, ISSUING AND ADMINISTRATION OF ANNUITIES, CONSULTATION AND BROKERAGE SERVICES, IN CLASS 36 (U.S. CLS. 100, 101 AND 102).

FIRST USE 7-25-2007; IN COMMERCE 7-25-2007.

THE MARK CONSISTS OF STANDARD CHARACTERS WITHOUT CLAIM TO ANY PARTICULAR FONT, STYLE, SIZE, OR COLOR.

SN 77-013,727, FILED 10-4-2006.

ROBIN MITTLER, EXAMINING ATTORNEY



Int. Cl.: 35

Prior U.S. Cls.: 100, 101, and 102

United States Patent and Trademark Office

Reg. No. 3,505,773

Registered Sep. 23, 2008

SERVICE MARK  
PRINCIPAL REGISTER

# Almost Amish

ALMOST AMISH, L.L.C. (PENNSYLVANIA LIMITED LIABILITY COMPANY)  
THE 1740 HOUSE, 1325 VILLAGE ROAD  
STRASBURG, PA 17579

FOR: RETAIL STORE SERVICES FEATURING A WIDE VARIETY OF CONSUMER GOODS, NAMELY, INDOOR AND OUTDOOR FURNISHINGS AND ACCENTS, FOOD PRODUCTS, NAMELY, CANDY, SNACKS, BAKED GOODS AND NOODLES, CANNED ITEMS, NAMELY, RELISHES AND JAMS, BOTTLED BEVERAGES, NAMELY, FRUIT CONCENTRATES, ARTWORK; HANDMADE ITEMS, NAMELY, CHILDREN TOYS AND CRAFTS, BOOKS, FRAGRANCE OILS AND POTPOURRI, QUILTS, GLASSWARE, TABLEWARE, CHILDREN'S TOYS, CANDLES AND CANDLE HOLDERS, FABRIC, NAMELY, QUILTS AND QUILTED

ITEMS, SOAPS, AND UTILITARIAN WAGONS, IN CLASS 35 (U.S. CLS. 100, 101 AND 102).

FIRST USE 10-28-2006; IN COMMERCE 3-26-2007.

THE MARK CONSISTS OF STANDARD CHARACTERS WITHOUT CLAIM TO ANY PARTICULAR FONT, STYLE, SIZE, OR COLOR.

NO CLAIM IS MADE TO THE EXCLUSIVE RIGHT TO USE "AMISH", APART FROM THE MARK AS SHOWN.

SN 77-014,442, FILED 10-5-2006.

ROBIN CHOSID, EXAMINING ATTORNEY

**Int. Cl.: 35**

**Prior U.S. Cls.: 100, 101, and 102**

**United States Patent and Trademark Office**

**Reg. No. 3,505,774**

**Registered Sep. 23, 2008**

**SERVICE MARK  
PRINCIPAL REGISTER**

**NATURAL TERRITORY**

NATURAL TERRITORY, LLC (ARIZONA LIMITED LIABILITY COMPANY)  
10438 N. 57TH STREET  
PARADISE VALLEY, AZ 85253

FOR: RETAIL STORE SERVICES AND ONLINE RETAIL STORE SERVICES FEATURING ORGANIC PRODUCTS, NAMELY, FURNITURE, FURNISHINGS, HOUSEHOLD ACCESSORIES, PAINT, FLOORING AND HOUSEHOLD LINENS, IN CLASS 35 (U.S. CLS. 100, 101 AND 102).

FIRST USE 12-7-2007; IN COMMERCE 12-7-2007.

THE MARK CONSISTS OF STANDARD CHARACTERS WITHOUT CLAIM TO ANY PARTICULAR FONT, STYLE, SIZE, OR COLOR.

NO CLAIM IS MADE TO THE EXCLUSIVE RIGHT TO USE "NATURAL", APART FROM THE MARK AS SHOWN.

SN 77-014,999, FILED 10-5-2006.

MARK PILARO, EXAMINING ATTORNEY

**Int. Cl.: 3**

**Prior U.S. Cls.: 1, 4, 6, 50, 51, and 52**

**Reg. No. 3,505,775**

**United States Patent and Trademark Office**

**Registered Sep. 23, 2008**

**TRADEMARK  
PRINCIPAL REGISTER**

**LITTLE BUNNY**

LITTLE BUNNY SWEET CHEEKS, LLC (CALI-  
FORNIA LIMITED LIABILITY COMPANY)  
3333 FERNSIDE BLVD.  
ALAMEDA, CA 94501

THE MARK CONSISTS OF STANDARD CHAR-  
ACTERS WITHOUT CLAIM TO ANY PARTICULAR  
FONT, STYLE, SIZE, OR COLOR.

FOR: NON-MEDICATED TOILETRIES, IN CLASS  
3 (U.S. CLS. 1, 4, 6, 50, 51 AND 52).

SN 77-015,880, FILED 10-6-2006.

FIRST USE 8-5-2008; IN COMMERCE 8-5-2008.

CORY BOONE, EXAMINING ATTORNEY

**Int. Cl.: 33**

**Prior U.S. Cls.: 47 and 49**

**United States Patent and Trademark Office**

**Reg. No. 3,505,776**

**Registered Sep. 23, 2008**

**TRADEMARK  
PRINCIPAL REGISTER**

**ABRACADABRA**

BRIAN CARTER CELLARS, LLC (WASHINGTON  
LIMITED LIABILITY COMPANY)  
13521 SE 57TH STREET  
BELLEVUE, WA 98006

THE MARK CONSISTS OF STANDARD CHAR-  
ACTERS WITHOUT CLAIM TO ANY PARTICULAR  
FONT, STYLE, SIZE, OR COLOR.

FOR: GRAPE WINE; RED WINE; WHITE WINE;  
WINE, IN CLASS 33 (U.S. CLS. 47 AND 49).

SN 77-016,422, FILED 10-7-2006.

FIRST USE 1-27-2007; IN COMMERCE 3-8-2007.

DAWN FELDMAN, EXAMINING ATTORNEY

**Int. Cls.: 9 and 42**

**Prior U.S. Cls.: 21, 23, 26, 36, 38, 100, and 101**

**Reg. No. 3,505,777**

**United States Patent and Trademark Office**

**Registered Sep. 23, 2008**

**TRADEMARK  
SERVICE MARK  
PRINCIPAL REGISTER**

# StrongEye

STRONGEYE, LLC (WASHINGTON LIMITED LIABILITY COMPANY)  
532 31ST AVENUE  
SEATTLE, WA 98122

FOR: COMPUTER APPLICATION SOFTWARE FOR MOBILE PHONES; COMPUTER SOFTWARE DEVELOPMENT TOOLS; COMPUTER SOFTWARE FOR APPLICATION AND DATABASE INTEGRATION; COMPUTER SOFTWARE FOR THE COLLECTION, EDITING, ORGANIZING, MODIFYING, BOOK MARKING, TRANSMISSION, STORAGE AND SHARING OF DATA AND INFORMATION; COMPUTER SOFTWARE FOR TASK AND PROJECT MANAGEMENT AND COLLABORATION BY MULTIPLE USERS, NAMELY, FOR PROVIDING SHARED ACCESS TO FILES AND DATA WHICH MAY BE VIEWED, EDITED, AND TRANSMITTED BETWEEN USERS; COMPUTER SOFTWARE FOR TASK AND PROJECT MANAGEMENT AND COLLABORATION THAT MAY BE DOWNLOADED FROM A GLOBAL COMPUTER NETWORK BY MULTIPLE USERS, NAMELY, FOR PROVIDING SHARED ACCESS TO FILES AND DATA WHICH MAY BE VIEWED, EDITED, AND TRANSMITTED BETWEEN USERS, IN CLASS 9 (U.S. CLS. 21, 23, 26, 36 AND 38).

FIRST USE 12-1-2006; IN COMMERCE 1-1-2007.

FOR: APPLICATION SERVICE PROVIDER (ASP), NAMELY, HOSTING COMPUTER SOFTWARE APPLICATIONS OF OTHERS; COMPUTER CONSULTATION; COMPUTER PROGRAMMING; COMPUTER PROGRAMMING FOR OTHERS; COMPUTER PROJECT MANAGEMENT SERVICES; COMPUTER SERVICE, NAMELY, ACTING AS AN APPLICATION SERVICE PROVIDER IN THE FIELD OF KNOWLEDGE MANAGEMENT TO HOST COMPUTER APPLICATION SOFTWARE FOR CREATING SEARCHABLE DATABASES OF

INFORMATION AND DATA; COMPUTER SERVICE, NAMELY, ACTING AS AN APPLICATION SERVICE PROVIDER IN THE FIELD OF KNOWLEDGE MANAGEMENT TO HOST COMPUTER APPLICATION SOFTWARE FOR SEARCHING AND RETRIEVING INFORMATION FROM DATABASES AND COMPUTER NETWORKS; COMPUTER SERVICE, NAMELY, ACTING AS AN APPLICATION SERVICE PROVIDER IN THE FIELD OF KNOWLEDGE MANAGEMENT TO HOST COMPUTER APPLICATION SOFTWARE FOR THE COLLECTION, EDITING, ORGANIZING, MODIFYING, BOOK MARKING, TRANSMISSION, STORAGE AND SHARING OF DATA AND INFORMATION; COMPUTER SERVICES IN THE NATURE OF CUSTOMIZED WEB PAGES FEATURING USER-DEFINED INFORMATION, PERSONAL PROFILES AND INFORMATION; COMPUTER SERVICES, NAMELY CREATING INDEXES OF INFORMATION, SITES AND OTHER RESOURCES AVAILABLE ON COMPUTER NETWORKS; COMPUTER SERVICES, NAMELY, CREATING AND MAINTAINING WEB SITES FOR OTHERS; COMPUTER SERVICES, NAMELY, DESIGNING AND IMPLEMENTING NETWORK WEB PAGES FOR OTHERS; COMPUTER SERVICES, NAMELY, DESIGNING AND IMPLEMENTING WEB SITES FOR OTHERS; COMPUTER SERVICES, NAMELY, HOSTING ONLINE WEB FACILITIES FOR OTHERS FOR ORGANIZING AND CONDUCTING ONLINE MEETINGS, GATHERINGS, AND INTERACTIVE DISCUSSIONS; COMPUTER SOFTWARE CONSULTATION; COMPUTER SOFTWARE DESIGN FOR OTHERS; COMPUTER SOFTWARE DESIGN, COMPUTER PROGRAMMING, OR MAINTENANCE OF COMPUTER SOFTWARE; COMPUTER SOFTWARE DEVELOPMENT; COMPUTER SYSTEMS ANALYSIS; CONSULTING SERVICES IN THE FIELD OF DESIGN, SELECTION, IMPLEMENTATION AND USE OF COMPUTER HARDWARE AND SOFTWARE SYSTEMS FOR OTHERS; PROVIDING ON-LINE

NON-DOWNLOADABLE SOFTWARE FOR TASK AND PROJECT MANAGEMENT AND COLLABORATION BY MULTIPLE USERS, NAMELY, FOR PROVIDING SHARED ACCESS TO FILES AND DATA WHICH MAY BE VIEWED, EDITED, AND TRANSMITTED BETWEEN USERS; PROVIDING TEMPORARY USE OF ON-LINE NON-DOWNLOADABLE SOFTWARE FOR TASK AND PROJECT MANAGEMENT AND COLLABORATION BY MULTIPLE USERS, NAMELY, FOR PROVIDING SHARED ACCESS TO FILES AND DATA WHICH MAY BE VIEWED, EDITED, AND TRANSMITTED

BETWEEN USERS, IN CLASS 42 (U.S. CLS. 100 AND 101).

FIRST USE 12-1-2006; IN COMMERCE 1-1-2007.

THE MARK CONSISTS OF STANDARD CHARACTERS WITHOUT CLAIM TO ANY PARTICULAR FONT, STYLE, SIZE, OR COLOR.

SN 77-016,510, FILED 10-8-2006.

STEVEN PEREZ, EXAMINING ATTORNEY

**Int. Cls.: 9, 16, 28, 35, 36, and 41**

**Prior U.S. Cls.: 2, 5, 21, 22, 23, 26, 29, 36, 37, 38, 50,  
100, 101, 102, and 107**

**Reg. No. 3,505,778**

**United States Patent and Trademark Office**

**Registered Sep. 23, 2008**

**TRADEMARK  
SERVICE MARK  
PRINCIPAL REGISTER**

# HIGHER LAWS

SERVE TO BE RICH, INC. (UTAH CORPORATION)  
459 N. 300 W., SUITE 14  
KAYSVILLE, UT 84037

FOR: AUDIO TAPES, VIDEO TAPES, PRE-RECORDED CDS AND DVDS FEATURING FINANCIAL EDUCATIONAL INFORMATION, IN CLASS 9 (U.S. CLS. 21, 23, 26, 36 AND 38).

FIRST USE 7-29-2006; IN COMMERCE 9-27-2006.

FOR: INSTRUCTIONAL AND TEACHING MATERIAL, NAMELY, BOOKS, WORKBOOKS, PAMPHLETS FEATURING FINANCIAL EDUCATIONAL INFORMATION, IN CLASS 16 (U.S. CLS. 2, 5, 22, 23, 29, 37, 38 AND 50).

FIRST USE 7-29-2006; IN COMMERCE 10-5-2006.

FOR: BOARD GAMES, IN CLASS 28 (U.S. CLS. 22, 23, 38 AND 50).

FIRST USE 7-27-2006; IN COMMERCE 2-22-2007.

FOR: PRODUCING ADVERTISING MATERIALS, NAMELY, PRODUCING AUDIO OR VIDEO COMMERCIALS; PROVIDING AN ON-LINE RETAIL STORE FEATURING FINANCIAL EDUCATIONAL PRODUCTS, IN CLASS 35 (U.S. CLS. 100, 101 AND 102).

FIRST USE 7-29-2006; IN COMMERCE 9-29-2006.

FOR: PROVIDING INFORMATION IN THE FIELD OF FINANCIAL AND WEALTH ACCUMULATION AND WEALTH MANAGEMENT PROVIDED VIA ELECTRONIC METHODS INCLUDING VIA INTERNET ACCESS, IN CLASS 36 (U.S. CLS. 100, 101 AND 102).

FIRST USE 7-29-2006; IN COMMERCE 9-25-2006.

FOR: EDUCATIONAL SERVICES, NAMELY, CONDUCTING CLASSES, SEMINARS, CONFERENCES, AND WORKSHOPS IN THE FIELD OF FINANCIAL EDUCATION AND DISTRIBUTION OF RELATED COURSE MATERIAL IN CONNECTION THEREWITH, IN CLASS 41 (U.S. CLS. 100, 101 AND 107).

FIRST USE 7-29-2006; IN COMMERCE 9-27-2006.

THE MARK CONSISTS OF STANDARD CHARACTERS WITHOUT CLAIM TO ANY PARTICULAR FONT, STYLE, SIZE, OR COLOR.

SN 77-016,526, FILED 10-9-2006.

JAMES STEIN, EXAMINING ATTORNEY

**Int. Cls.: 9, 16, 28, 35, 36, and 41**

**Prior U.S. Cls.: 2, 5, 21, 22, 23, 26, 29, 36, 37, 38, 50, 100, 101, 102, and 107**

**Reg. No. 3,505,779**

**United States Patent and Trademark Office**

**Registered Sep. 23, 2008**

**TRADEMARK  
SERVICE MARK  
PRINCIPAL REGISTER**



SERVE TO BE RICH, INC. (UTAH CORPORATION)  
459 N. 300 W., SUITE 14  
KAYSVILLE, UT 84037

FOR: AUDIO TAPES, VIDEO TAPES, PRE-RECORDED CDS AND DVDS FEATURING FINANCIAL EDUCATIONAL INFORMATION, IN CLASS 9 (U.S. CLS. 21, 23, 26, 36 AND 38).

FIRST USE 7-29-2006; IN COMMERCE 9-27-2006.

FOR: INSTRUCTIONAL AND TEACHING MATERIAL, NAMELY, BOOKS, WORKBOOKS, PAMPHLETS FEATURING FINANCIAL EDUCATIONAL INFORMATION, IN CLASS 16 (U.S. CLS. 2, 5, 22, 23, 29, 37, 38 AND 50).

FIRST USE 7-29-2006; IN COMMERCE 10-5-2006.

FOR: BOARD GAMES, IN CLASS 28 (U.S. CLS. 22, 23, 38 AND 50).

FIRST USE 7-27-2006; IN COMMERCE 2-22-2007.

FOR: PRODUCING ADVERTISING MATERIALS INCLUDING AUDIO OR VIDEO INFOMERCIALS, AND PROVIDING AN ON-LINE STORE PROMOTING FINANCIAL EDUCATIONAL PRODUCTS AND SERVICES, IN CLASS 35 (U.S. CLS. 100, 101 AND 102).

FIRST USE 7-29-2006; IN COMMERCE 9-29-2006.

FOR: FINANCIAL AND WEALTH ACCUMULATION AND MANAGEMENT INFORMATION PRO-

VIDED BY ELECTRONIC METHODS INCLUDING VIA INTERNET ACCESS, IN CLASS 36 (U.S. CLS. 100, 101 AND 102).

FIRST USE 7-29-2006; IN COMMERCE 9-25-2006.

FOR: EDUCATIONAL SERVICES, NAMELY, CONDUCTING CLASSES, SEMINARS, CONFERENCES, WEBINARS AND WORKSHOPS IN THE FIELD OF FINANCIAL EDUCATION AND DISTRIBUTION OF RELATED COURSE MATERIAL IN FORMS INCLUDING LITERATURE, AUDIO AND VIDEO RECORDINGS, GAMES AND SOFTWARE DISTRIBUTED PHYSICALLY OR BY ELECTRONIC METHODS INCLUDING INTERNET ACCESS, IN CLASS 41 (U.S. CLS. 100, 101 AND 107).

FIRST USE 7-29-2006; IN COMMERCE 9-27-2006.

THE COLOR(S) WHITE, BLACK, YELLOW AND BLUE IS/ARE CLAIMED AS A FEATURE OF THE MARK.

THE MARK CONSISTS OF A STYLIZED WHITE CANDLE WITH GLOWING FLAME ON A BLUE RECTANGULAR FIELD IMMEDIATELY ADJACENT TO THE LEFT OF A WIDER YELLOW RECTANGULAR FIELD CONTAINING THE BLACK WORDS "HIGHER LAWS".

SN 77-016,527, FILED 10-9-2006.

JAMES STEIN, EXAMINING ATTORNEY



**Int. Cl.: 41**

**Prior U.S. Cls.: 100, 101, and 107**

**United States Patent and Trademark Office**

**Reg. No. 3,505,780**

**Registered Sep. 23, 2008**

**SERVICE MARK  
PRINCIPAL REGISTER**

**HUGG**

TREEHUGGER ACQUISITION CORP. (DELA-  
WARE CORPORATION)  
ONE DISCOVERY PLACE  
SILVER SPRING, MD 20910

FOR: ELECTRONIC PUBLISHING SERVICES,  
NAMELY, PUBLICATION OF AUDIO, TEXT AND  
GRAPHICS OF OTHERS FEATURING ENVIRON-  
MENTAL MATTERS AND SUSTAINABLE AND  
ECO-FRIENDLY RESOURCES, IN CLASS 41 (U.S.  
CLS. 100, 101 AND 107).

FIRST USE 3-27-2006; IN COMMERCE 3-27-2006.

THE MARK CONSISTS OF STANDARD CHAR-  
ACTERS WITHOUT CLAIM TO ANY PARTICULAR  
FONT, STYLE, SIZE, OR COLOR.

SN 77-016,717, FILED 10-9-2006.

LAURIE KAUFMAN, EXAMINING ATTORNEY

Int. Cl.: 30

Prior U.S. Cl.: 46

United States Patent and Trademark Office

Reg. No. 3,505,781

Registered Sep. 23, 2008

TRADEMARK  
PRINCIPAL REGISTER



DISTRIBUTION MARKETING SERVICES, L.P.  
(DELAWARE LIMITED PARTNERSHIP)  
16000 MEMORIAL DRIVE, SUITE 200  
HOUSTON, TX 77079

FOR: COFFEE, TEA, COCOA AND HOT CHOCOLATE BEVERAGES, CAPPUCCINO, IN CLASS 30 (U.S. CL. 46).

FIRST USE 1-31-2007; IN COMMERCE 1-31-2007.

THE MARK CONSISTS OF A STYLIZED COFFEE CUP AND THE WORD "TRES CERRO".

THE ENGLISH TRANSLATION OF THE WORDING "TRES CERRO" IN THE MARK IS THREE HILL.

SN 77-017,175, FILED 10-9-2006.

NATALIE POLZER, EXAMINING ATTORNEY

**Int. Cl.: 40**

**Prior U.S. Cls.: 100, 103, and 106**

**United States Patent and Trademark Office**

**Reg. No. 3,505,782**

**Registered Sep. 23, 2008**

**SERVICE MARK  
PRINCIPAL REGISTER**

**ADERA**

ADERA, INC. (FLORIDA CORPORATION)  
8805 TAMiami TRAIL NORTH, #324  
NAPLES, FL 34108

FOR: SECURE DOCUMENT DESTRUCTION  
SERVICES; SHREDDING SERVICES; ELECTRONIC  
DOCUMENT SCANNING SERVICES; AND DOCU-  
MENT DISPOSAL SERVICES, IN CLASS 40 (U.S. CLS.  
100, 103 AND 106).

FIRST USE 1-0-2007; IN COMMERCE 1-0-2007.

THE MARK CONSISTS OF STANDARD CHAR-  
ACTERS WITHOUT CLAIM TO ANY PARTICULAR  
FONT, STYLE, SIZE, OR COLOR.

SN 77-017,453, FILED 10-10-2006.

ANDREA SAUNDERS, EXAMINING ATTORNEY

**Int. Cl.: 10**

**Prior U.S. Cls.: 26, 39, and 44**

**United States Patent and Trademark Office**

**Reg. No. 3,505,783**

**Registered Sep. 23, 2008**

**TRADEMARK  
PRINCIPAL REGISTER**

**iBRACELET**

WELLGATE PRODUCTS, LLC (NEW YORK LIMITED LIABILITY COMPANY)  
SUITE 308  
118 EAST 28TH STREET  
NEW YORK, NY 10016

FOR: ORTHOPEDIC WRIST BAND, NAMELY, A BRACELET ADAPTED TO PROVIDE SUPPORT FOR THE WRIST OF A PERSON WHILE USING A COMPUTER MOUSE, A COMPUTER KEYBOARD, OR A WRITING IMPLEMENT, IN CLASS 10 (U.S. CLS. 26, 39 AND 44).

FIRST USE 10-15-2007; IN COMMERCE 3-26-2008.

THE MARK CONSISTS OF STANDARD CHARACTERS WITHOUT CLAIM TO ANY PARTICULAR FONT, STYLE, SIZE, OR COLOR.

SN 77-018,859, FILED 10-11-2006.

JANICE KIM, EXAMINING ATTORNEY

**Int. Cl.: 1**

**Prior U.S. Cls.: 1, 5, 6, 10, 26, and 46**

**Reg. No. 3,505,784**

**United States Patent and Trademark Office**

**Registered Sep. 23, 2008**

---

**TRADEMARK  
PRINCIPAL REGISTER**

**DENTASHIELD**

THE HARTZ MOUNTAIN CORPORATION (NEW  
JERSEY CORPORATION)  
400 PLAZA DRIVE  
SECAUCUS, NJ 07094

FOR: CHEMICALS FOR USE IN COATING RAW-  
HIDE USED IN THE MANUFACTURE OF PET  
CHEWS TO REDUCE TARTAR ACCUMULATION  
IN PETS, NAMELY, HEXAMETAPHOSPHATE,  
SOLD AS AN INTEGRAL COMPONENT OF RAW-  
HIDE CHEWS FOR DOGS, IN CLASS 1 (U.S. CLS. 1, 5,  
6, 10, 26 AND 46).

FIRST USE 2-0-2007; IN COMMERCE 2-0-2007.

THE MARK CONSISTS OF STANDARD CHAR-  
ACTERS WITHOUT CLAIM TO ANY PARTICULAR  
FONT, STYLE, SIZE, OR COLOR.

SN 77-019,559, FILED 10-12-2006.

JESSICA FATHY, EXAMINING ATTORNEY

**Int. Cl.: 29**

**Prior U.S. Cl.: 46**

**United States Patent and Trademark Office**

**Reg. No. 3,505,785**

**Registered Sep. 23, 2008**

**TRADEMARK  
PRINCIPAL REGISTER**

**POPPER TOPPERZ**

CVC FINANCIAL, L.P. (TEXAS LIMITED PART-  
NERSHIP)  
10550 BISSONNET  
HOUSTON, TX 77099

THE MARK CONSISTS OF STANDARD CHAR-  
ACTERS WITHOUT CLAIM TO ANY PARTICULAR  
FONT, STYLE, SIZE, OR COLOR.

FOR: CLARIFIED BUTTER, IN CLASS 29 (U.S. CL.  
46).

SN 77-020,380, FILED 10-13-2006.

FIRST USE 12-31-2006; IN COMMERCE 12-31-2006.

MIDGE BUTLER, EXAMINING ATTORNEY

**Int. Cl.: 30**

**Prior U.S. Cl.: 46**

**United States Patent and Trademark Office**

**Reg. No. 3,505,786**

**Registered Sep. 23, 2008**

**TRADEMARK  
PRINCIPAL REGISTER**

**HEALTHY BEGINNINGS**

KELLOGG NORTH AMERICA COMPANY (DE-  
LAWARE CORPORATION)  
ONE KELLOGG SQUARE  
BATTLE CREEK, MI 49016

FOR: PROCESSED CEREALS FOR USE AS A  
BREAKFAST CEREAL, SNACK FOOD OR INGRE-  
DIENT FOR MAKING FOOD, IN CLASS 30 (U.S. CL.  
46).

FIRST USE 0-0-2003; IN COMMERCE 0-0-2003.

THE MARK CONSISTS OF STANDARD CHAR-  
ACTERS WITHOUT CLAIM TO ANY PARTICULAR  
FONT, STYLE, SIZE, OR COLOR.

NO CLAIM IS MADE TO THE EXCLUSIVE  
RIGHT TO USE "HEALTHY", APART FROM THE  
MARK AS SHOWN.

SN 77-021,293, FILED 10-14-2006.

TIMOTHY FINNEGAN, EXAMINING ATTORNEY

**Int. Cl.: 9**

**Prior U.S. Cls.: 21, 23, 26, 36, and 38**

**United States Patent and Trademark Office**

**Reg. No. 3,505,787**

**Registered Sep. 23, 2008**

**TRADEMARK  
PRINCIPAL REGISTER**

**BIGFOOT**

SMARTWARE GROUP, INC. (NEW HAMPSHIRE  
CORPORATION)  
P.O. BOX 188  
CENTER HARBOR, NH 03226

FOR: COMPUTER SOFTWARE FOR THE MAN-  
AGEMENT OF ASSETS AND, IN PARTICULAR,  
MANAGEMENT OF THE MAINTENANCE OF FA-  
CILITIES AND EQUIPMENT, IN CLASS 9 (U.S. CLS.  
21, 23, 26, 36 AND 38).

FIRST USE 2-14-2008; IN COMMERCE 2-14-2008.

THE MARK CONSISTS OF STANDARD CHAR-  
ACTERS WITHOUT CLAIM TO ANY PARTICULAR  
FONT, STYLE, SIZE, OR COLOR.

SN 77-021,618, FILED 10-16-2006.

PAM WILLIS, EXAMINING ATTORNEY



**Int. Cl.: 35**

**Prior U.S. Cls.: 100, 101, and 102**

**United States Patent and Trademark Office**

**Reg. No. 3,505,788**

**Registered Sep. 23, 2008**

**SERVICE MARK  
PRINCIPAL REGISTER**

**REALSTORY**

REALSIGHT RESEARCH LLC (CONNECTICUT  
LIMITED LIABILITY COMPANY)  
16 HILLSIDE PLACE, UNIT I-4  
NORWALK, CT 06854

FOR: CREATION OF MARKETING TOOLS DE-  
SIGNING TO INCREASE A CLIENT COMPANY'S  
KNOWLEDGE OF CUSTOMER NEEDS, AND ITS  
COMPETITORS' PRODUCTS AND SERVICES, PRI-  
CING, ADVERTISING STRATEGY AND SALES  
STRATEGY, IN CLASS 35 (U.S. CLS. 100, 101 AND  
102).

FIRST USE 9-30-2006; IN COMMERCE 5-31-2007.

THE MARK CONSISTS OF STANDARD CHAR-  
ACTERS WITHOUT CLAIM TO ANY PARTICULAR  
FONT, STYLE, SIZE, OR COLOR.

SN 77-021,627, FILED 10-16-2006.

CHRIS WELLS, EXAMINING ATTORNEY

Int. Cls.: 14 and 25

Prior U.S. Cls.: 2, 22, 27, 28, 39, and 50

United States Patent and Trademark Office

Reg. No. 3,505,789

Registered Sep. 23, 2008

TRADEMARK  
PRINCIPAL REGISTER



HER ROYAL HIGHNESS PRINCESS SIRIVAN-  
NAVARI NARIRATANA (THAILAND INDIVI-  
DUAL)

DUSIT PALACE, U THONG NOK RD DUSIT DUSIT  
NO. 904 AMPORNSATAN THRONE HALL  
BANGKOK, THAILAND

FOR: JEWELRY MADE FROM PRECIOUS GEM,  
JEWELRY MADE FROM PRECIOUS METAL , IN  
CLASS 14 (U.S. CLS. 2, 27, 28 AND 50).

FIRST USE 5-22-2008; IN COMMERCE 5-22-2008.

FOR: CLOTHING, NAMELY, SHIRTS, T-SHIRTS,  
SKIRTS, PANTS, TROUSERS, DRESSES, UNDER-  
WEAR, SCARVES, AND HATS; FOOTWEAR; BELTS,  
IN CLASS 25 (U.S. CLS. 22 AND 39).

FIRST USE 5-22-2008; IN COMMERCE 5-22-2008.

THE MARK CONSISTS OF A STYLIZED PEA-  
COCK ALONG WITH THE LETTERS "SM".

SN 77-021,870, FILED 10-16-2006.

ANDREA HACK, EXAMINING ATTORNEY

Int. Cls.: 14 and 25

Prior U.S. Cls.: 2, 22, 27, 28, 39, and 50

United States Patent and Trademark Office

Reg. No. 3,505,790

Registered Sep. 23, 2008

TRADEMARK  
PRINCIPAL REGISTER

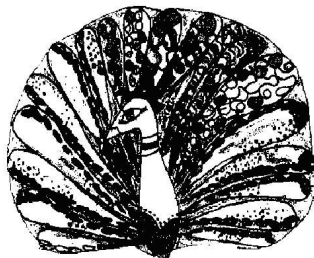

*Sirivannavari*

HER ROYAL HIGHNESS PRINCESS SIRIVAN-  
NAVARI NARIRATANA (THAILAND INDIVI-  
DUAL)

DUSIT PALACE U THONG NOK RD DUSIT DUSIT  
NO.904 AMPORN SATAN THRONE HALL  
BANGKOK, THAILAND

FOR: JEWELRY MADE FROM PRECIOUS GEM,  
JEWELRY MADE FROM PRECIOUS METAL , IN  
CLASS 14 (U.S. CLS. 2, 27, 28 AND 50).

FIRST USE 5-22-2008; IN COMMERCE 5-22-2008.

FOR: CLOTHING, NAMELY, SHIRTS, T-SHIRTS,  
SKIRTS, PANTS, TROUSERS, DRESSES, UNDER-

WEAR, SCARVES, AND HATS; FOOTWEAR; BELTS,  
IN CLASS 25 (U.S. CLS. 22 AND 39).

FIRST USE 5-22-2008; IN COMMERCE 5-22-2008.

THE MARK CONSISTS OF A STYLIZED PEA-  
COCK WITH THE NAME "SIRIVANNAVARI".

THE TERM "SIRIVANNIVARI" IS THE ROYAL  
FAMILY'S NAME IN THAILAND.

SN 77-021,898, FILED 10-16-2006.

ANDREA HACK, EXAMINING ATTORNEY

**Int. Cl.: 9**

**Prior U.S. Cls.: 21, 23, 26, 36, and 38**

**United States Patent and Trademark Office**

**Reg. No. 3,505,791**

**Registered Sep. 23, 2008**

**TRADEMARK  
PRINCIPAL REGISTER**

**LADY OF THE LAKE**

IGT (NEVADA CORPORATION)  
9295 PROTOTYPE DRIVE  
RENO, NV 895218986

FOR: GAMING MACHINES, NAMELY, DEVICES WHICH ACCEPT A WAGER AND COMPONENTS THEREFOR, NAMELY, CONTROLLERS, DISPLAYS, BUTTON PANELS, BOLSTERS, ELECTRICAL WIRING, AND COMPUTER HARDWARE AND SOFTWARE ASSOCIATED THEREWITH, IN CLASS 9 (U.S. CLS. 21, 23, 26, 36 AND 38).

FIRST USE 9-21-2007; IN COMMERCE 9-21-2007.

THE MARK CONSISTS OF STANDARD CHARACTERS WITHOUT CLAIM TO ANY PARTICULAR FONT, STYLE, SIZE, OR COLOR.

SN 77-022,206, FILED 10-16-2006.

ASMAT KHAN, EXAMINING ATTORNEY

**Int. Cl.: 16**

**Prior U.S. Cls.: 2, 5, 22, 23, 29, 37, 38, and 50**

**Reg. No. 3,505,792**

**United States Patent and Trademark Office**

**Registered Sep. 23, 2008**

**TRADEMARK  
PRINCIPAL REGISTER**

**COUNTER INTELLIGENCE**

STRUCTURAL GRAPHICS, LLC (CONNECTICUT  
LIMITED LIABILITY COMPANY)  
38 PLAINS ROAD  
ESSEX, CT 06426

THE MARK CONSISTS OF STANDARD CHAR-  
ACTERS WITHOUT CLAIM TO ANY PARTICULAR  
FONT, STYLE, SIZE, OR COLOR.

FOR: CARDBOARD DISPLAY UNITS FOR MER-  
CHANDISING PRODUCTS, IN CLASS 16 (U.S. CLS.  
2, 5, 22, 23, 29, 37, 38 AND 50).

SN 77-022,494, FILED 10-17-2006.

FIRST USE 2-1-2006; IN COMMERCE 2-1-2006.

JAY FLOWERS, EXAMINING ATTORNEY

Int. Cl.: 35

Prior U.S. Cls.: 100, 101, and 102

Reg. No. 3,505,793

United States Patent and Trademark Office

Registered Sep. 23, 2008

**SERVICE MARK  
PRINCIPAL REGISTER**



SILICON VALLEY ASSOCIATION OF REALTORS  
(CALIFORNIA PUBLIC BENEFIT CORPORATION)  
345 SOUTH ANTONIO ROAD  
LOS ALTOS, CA 94022

FOR: CHARITABLE SERVICES, NAMELY, ORGANIZING AND CONDUCTING VOLUNTEER PROGRAMS AND COMMUNITY SERVICE PROJECTS, IN CLASS 35 (U.S. CLS. 100, 101 AND 102).

FIRST USE 7-1-2008; IN COMMERCE 7-1-2008.

NO CLAIM IS MADE TO THE EXCLUSIVE RIGHT TO USE "WEEK SPONSORED BY SILICON VALLEY ASSOCIATION", APART FROM THE MARK AS SHOWN.

THE MARK CONSISTS OF LETTERS WITHIN BLOCKS COLLECTIVELY RESEMBLING A HOUSE.

SN 77-023,339, FILED 10-17-2006.

RICHARD WHITE, EXAMINING ATTORNEY

Int. Cl.: 35

Prior U.S. Cls.: 100, 101, and 102

United States Patent and Trademark Office

Reg. No. 3,505,794

Registered Sep. 23, 2008

SERVICE MARK  
PRINCIPAL REGISTER



SILICON VALLEY ASSOCIATION OF REALTORS  
(CALIFORNIA PUBLIC BENEFIT CORPORATION)  
345 SOUTH ANTONIO ROAD  
LOS ALTOS, CA 94022

FOR: CHARITABLE SERVICES, NAMELY, ORGANIZING AND CONDUCTING VOLUNTEER PROGRAMS AND COMMUNITY SERVICE PROJECTS, IN CLASS 35 (U.S. CLS. 100, 101 AND 102).

FIRST USE 7-1-2008; IN COMMERCE 7-1-2008.

NO CLAIM IS MADE TO THE EXCLUSIVE RIGHT TO USE "SPONSORED BY SILICON VALLEY ASSOCIATION" AND "SERVICE VOLUNTEER PROGRAM", APART FROM THE MARK AS SHOWN.

THE MARK CONSISTS OF LETTERS WITHIN BLOCKS COLLECTIVELY RESEMBLING A HOUSE.

SN 77-023,344, FILED 10-17-2006.

RICHARD WHITE, EXAMINING ATTORNEY

**Int. Cl.: 1**

**Prior U.S. Cls.: 1, 5, 6, 10, 26, and 46**

**Reg. No. 3,505,795**

**United States Patent and Trademark Office**

**Registered Sep. 23, 2008**

**TRADEMARK  
PRINCIPAL REGISTER**

**Poet**

POET RESEARCH, INC. (SOUTH DAKOTA CORPORATION)  
4615 N. LEWIS AVE.  
SIOUX FALLS, SD 57104

THE MARK CONSISTS OF STANDARD CHARACTERS WITHOUT CLAIM TO ANY PARTICULAR FONT, STYLE, SIZE, OR COLOR.

FOR: ETHANOL AND LIQUEFIED CARBON DIOXIDE (CO<sub>2</sub>), IN CLASS 1 (U.S. CLS. 1, 5, 6, 10, 26 AND 46).

SN 77-023,565, FILED 10-18-2006.

FIRST USE 6-1-2008; IN COMMERCE 6-1-2008.

PAUL E. FAHRENKOPF, EXAMINING ATTORNEY



**Int. Cl.: 16**

**Prior U.S. Cls.: 2, 5, 22, 23, 29, 37, 38, and 50**

**Reg. No. 3,505,796**

**United States Patent and Trademark Office**

**Registered Sep. 23, 2008**

**TRADEMARK  
PRINCIPAL REGISTER**

**THE-W.O.R.D. "TheWay Of  
Receiving Deliverance"**

NOBLE, ROBERT R. (UNITED STATES INDIVIDUAL)  
2020 N. 57TH STREET  
PHILADELPHIA, PA 19131

FOR: BLANK WRITING JOURNALS; BOOKMARKS; BUMPER STICKERS; BUSINESS CARDS; CALENDAR DESK PADS; CALENDAR STANDS; CALENDARS; CARDBOARD FLOOR DISPLAY UNITS FOR MERCHANDISING PRODUCTS; CROSSWORD PUZZLES; ENVELOPES; GREETING CARDS; LETTERHEAD PAPER; PAPER PARTY HATS; PENCILS; PENS; POSTERS; PRINTED INSTRUCTIONAL, EDUCATIONAL, AND TEACHING MATERIALS IN THE FIELD OF OUTREACH MIN-

ISTRY, IN CLASS 16 (U.S. CLS. 2, 5, 22, 23, 29, 37, 38 AND 50).

FIRST USE 10-20-2006; IN COMMERCE 10-20-2006.

THE MARK CONSISTS OF STANDARD CHARACTERS WITHOUT CLAIM TO ANY PARTICULAR FONT, STYLE, SIZE, OR COLOR.

SN 77-023,641, FILED 10-18-2006.

JOHN SCHUYLER YARD, EXAMINING ATTORNEY

**Int. Cl.: 3**

**Prior U.S. Cls.: 1, 4, 6, 50, 51, and 52**

**United States Patent and Trademark Office**

**Reg. No. 3,505,797**

**Registered Sep. 23, 2008**

**TRADEMARK  
PRINCIPAL REGISTER**

**COLLAMETICS**

MEEHAN, KEVIN (UNITED STATES INDIVIDUAL)  
P.O. BOX 4616  
JACKSON, WY 83001

FOR: COSMETICS, NAMELY, COSMETIC PREPARATIONS FOR SKIN ENHANCEMENT; COSMETIC CREAMS FOR SKIN CARE; SKIN CONDITIONERS; SKIN CREAMS; SKIN LOTIONS; SKIN MOISTURIZER; SKIN LIGHTENERS; SKIN LIGHTENING CREAM; ANTI-WRINKLE CREAMS; AND WRINKLE-REMOVING SKIN CARE PRE-

PARATIONS, IN CLASS 3 (U.S. CLS. 1, 4, 6, 50, 51 AND 52).

FIRST USE 7-11-2008; IN COMMERCE 7-11-2008.

THE MARK CONSISTS OF STANDARD CHARACTERS WITHOUT CLAIM TO ANY PARTICULAR FONT, STYLE, SIZE, OR COLOR.

SN 77-026,099, FILED 10-20-2006.

RAUL CORDOVA, EXAMINING ATTORNEY

**Int. Cl.: 21**

**Prior U.S. Cls.: 2, 13, 23, 29, 30, 33, 40, and 50**

**United States Patent and Trademark Office**

**Reg. No. 3,505,798**

**Registered Sep. 23, 2008**

**TRADEMARK  
PRINCIPAL REGISTER**

**ADS**

LUCINI, MARCELO JAIME (ARGENTINA INDIVIDUAL)  
ARENALES 1618  
BUENOS AIRES, ARGENTINA

THE MARK CONSISTS OF STANDARD CHARACTERS WITHOUT CLAIM TO ANY PARTICULAR FONT, STYLE, SIZE, OR COLOR.

FOR: CANDLESTICKS NOT OF PRECIOUS METAL; CONTAINERS FOR HOUSEHOLD OR KITCHEN USE; FLASKS; PITCHERS; TRAYS, IN CLASS 21 (U.S. CLS. 2, 13, 23, 29, 30, 33, 40 AND 50).

SN 77-026,170, FILED 10-20-2006.

FIRST USE 10-25-2007; IN COMMERCE 6-17-2008.

ELLEN PERKINS, EXAMINING ATTORNEY

**Int. Cl.: 25**

**Prior U.S. Cls.: 22 and 39**

**United States Patent and Trademark Office**

**Reg. No. 3,505,799**

**Registered Sep. 23, 2008**

**TRADEMARK  
PRINCIPAL REGISTER**

**SEAT CANDY**

COLWELL, SOPHIE (UNITED STATES INDIVIDUAL)  
1933 EL PASO STREET  
RAMONA, CA 92065

FOR: APPAREL, NAMELY, SHIRTS, PANTS, SHORTS, SWEATSHIRTS, SWEATPANTS, SWIM SUITS, JACKETS, SKIRTS, OVERALLS, SOCKS, JERSEYS, UNDER WEAR, SWEATERS, GLOVES, SHOES, AND HATS, IN CLASS 25 (U.S. CLS. 22 AND 39).

FIRST USE 6-27-2008; IN COMMERCE 6-27-2008.

THE MARK CONSISTS OF STANDARD CHARACTERS WITHOUT CLAIM TO ANY PARTICULAR FONT, STYLE, SIZE, OR COLOR.

SN 77-027,999, FILED 10-24-2006.

DAVID H. STINE, EXAMINING ATTORNEY

**Int. Cls.: 35, 36, and 37**

**Prior U.S. Cls.: 100, 101, 102, 103, and 106**

**United States Patent and Trademark Office**

**Reg. No. 3,505,800**

**Registered Sep. 23, 2008**

**SERVICE MARK  
PRINCIPAL REGISTER**

**THE SHORTEST DISTANCE  
BETWEEN IDEA AND REALITY**

HAMMES COMPANY HEALTHCARE, LLC (WISCONSIN LIMITED LIABILITY COMPANY)  
SUITE 250  
18000 W. SARAH LANE  
BROOKFIELD, WI 53045

FOR: REAL ESTATE MARKETING SERVICES IN THE HEALTHCARE FIELD, NAMELY, MARKET PLANNING, MARKET AND DEMOGRAPHIC ANALYSIS; PHYSICIAN NEED ANALYSIS IN RELATION TO THE MARKET; HEALTHCARE FACILITY PLANNING, NAMELY, IDENTIFICATION OF FUTURE MEDICAL SERVICE NEEDS IN RELATION TO THE MARKET; PUBLIC AND REGULATORY APPROVAL SERVICES IN RELATION TO SECURING REQUIRED APPROVALS FOR CONSTRUCTION OF HEALTH CARE FACILITIES, IN CLASS 35 (U.S. CLS. 100, 101 AND 102).

FIRST USE 2-1-2007; IN COMMERCE 2-1-2007.

FOR: REAL ESTATE ADVISORY SERVICES IN THE HEALTHCARE FIELD, NAMELY, REAL ESTATE MANAGEMENT; REAL ESTATE ACQUISITION SERVICES; REAL ESTATE FINANCING SERVICES, NAMELY, FACILITATING AND ARRANGING FOR THE FINANCING OF REAL ESTATE AND REAL ESTATE DEVELOPMENT; PROPERTY MANAGEMENT IN THE HEALTHCARE FIELD; REAL ESTATE MANAGEMENT;

PROJECT MANAGEMENT SERVICES FOR OTHERS IN THE HEALTHCARE FIELD, NAMELY, REAL ESTATE SITE ANALYSIS AND REAL ESTATE ACQUISITION, IN CLASS 36 (U.S. CLS. 100, 101 AND 102).

FIRST USE 2-1-2007; IN COMMERCE 2-1-2007.

FOR: PROJECT MANAGEMENT SERVICES FOR OTHERS IN THE HEALTHCARE FIELD, NAMELY, REAL ESTATE SITE SELECTION; MASTER PLANNING SERVICES IN RELATION TO REAL ESTATE DEVELOPMENT IN THE HEALTHCARE FIELD; CONSTRUCTION PLANNING; REAL ESTATE DEVELOPMENT IN THE HEALTHCARE FIELD AND REAL ESTATE SITE SELECTION; REAL ESTATE DEVELOPMENT; SITE IDENTIFICATION, NAMELY, REAL ESTATE SITE SELECTION, IN CLASS 37 (U.S. CLS. 100, 103 AND 106).

FIRST USE 2-1-2007; IN COMMERCE 2-1-2007.

THE MARK CONSISTS OF STANDARD CHARACTERS WITHOUT CLAIM TO ANY PARTICULAR FONT, STYLE, SIZE, OR COLOR.

SN 77-028,344, FILED 10-24-2006.

ALYSSA PALADINO, EXAMINING ATTORNEY

**Int. Cls.: 16 and 21**

**Prior U.S. Cls.: 2, 5, 13, 22, 23, 29, 30, 33, 37, 38, 40,  
and 50**

**Reg. No. 3,505,801**

**United States Patent and Trademark Office**

**Registered Sep. 23, 2008**

**TRADEMARK  
PRINCIPAL REGISTER**



HANA COBI CO., LTD. (REPUBLIC OF KOREA CORPORATION)  
1556-1, SEOCHO-DONG, SEOCHO-GU  
SEOUL, REPUBLIC OF KOREA

FOR: PLASTIC BAGS FOR KEEPING FOOD AND WRAPPING FILMS FOR KEEPING FOOD FOR HOUSEHOLD USE , IN CLASS 16 (U.S. CLS. 2, 5, 22, 23, 29, 37, 38 AND 50).

FIRST USE 9-29-2006; IN COMMERCE 1-24-2007.

FOR: PLASTIC CUPS, BOWLS, TRAYS, NOT OF PRECIOUS METAL; CRUETS, NOT OF PRECIOUS METAL; CONTAINERS FOR HOUSEHOLD, NOT OF PRECIOUS METAL; BOTTLES SOLD EMPTY FOR BEVERAGES AND FOOD, IN CLASS 21 (U.S. CLS. 2, 13, 23, 29, 30, 33, 40 AND 50).

FIRST USE 9-29-2006; IN COMMERCE 1-24-2007.

PRIORITY CLAIMED UNDER SEC. 44(D) ON REPUBLIC OF KOREA APPLICATION NO. 40-2006-0050, FILED 9-29-2006.

OWNER OF U.S. REG. NOS. 2,509,283, 2,848,901, AND OTHERS.

NO CLAIM IS MADE TO THE EXCLUSIVE RIGHT TO USE "LOCK" AND "BAG", APART FROM THE MARK AS SHOWN.

SN 77-028,362, FILED 10-24-2006.

JOHN WILKE, EXAMINING ATTORNEY

**Int. Cl.: 21**

**Prior U.S. Cls.: 2, 13, 23, 29, 30, 33, 40, and 50**

**United States Patent and Trademark Office**

**Reg. No. 3,505,802**

**Registered Sep. 23, 2008**

**TRADEMARK  
PRINCIPAL REGISTER**

**ZIPFLIP**

CHEF'N CORPORATION (WASHINGTON COR-  
PORATION)  
3RD FLOOR  
1520 4TH AVENUE  
SEATTLE, WA 98101

FOR: HOUSEHOLD UTENSILS, NAMELY,  
TURNERS AND SPATULAS, IN CLASS 21 (U.S.  
CLS. 2, 13, 23, 29, 30, 33, 40 AND 50).

FIRST USE 1-0-2007; IN COMMERCE 1-0-2007.

THE MARK CONSISTS OF STANDARD CHAR-  
ACTERS WITHOUT CLAIM TO ANY PARTICULAR  
FONT, STYLE, SIZE, OR COLOR.

SN 77-028,525, FILED 10-24-2006.

JACQUELINE A. LAVINE, EXAMINING ATTOR-  
NEY

**Int. Cl.: 21**

**Prior U.S. Cls.: 2, 13, 23, 29, 30, 33, 40, and 50**

**United States Patent and Trademark Office**

**Reg. No. 3,505,803**

**Registered Sep. 23, 2008**

**TRADEMARK  
PRINCIPAL REGISTER**

**OILWAND**

CHEF'N CORPORATION (WASHINGTON COR-  
PORATION)  
3RD FLOOR  
1520 4TH AVENUE  
SEATTLE, WA 98101

FOR: HOUSEHOLD UTENSILS, NAMELY, DIS-  
PENSERS FOR LIQUID CONDIMENTS AND BAST-  
ING BRUSHES, IN CLASS 21 (U.S. CLS. 2, 13, 23, 29,  
30, 33, 40 AND 50).

FIRST USE 3-0-2007; IN COMMERCE 3-0-2007.

THE MARK CONSISTS OF STANDARD CHAR-  
ACTERS WITHOUT CLAIM TO ANY PARTICULAR  
FONT, STYLE, SIZE, OR COLOR.

SN 77-028,527, FILED 10-24-2006.

JACQUELINE A. LAVINE, EXAMINING ATTOR-  
NEY



**Int. Cl.: 35**

**Prior U.S. Cls.: 100, 101, and 102**

**United States Patent and Trademark Office**

**Reg. No. 3,505,804**

**Registered Sep. 23, 2008**

**SERVICE MARK  
PRINCIPAL REGISTER**

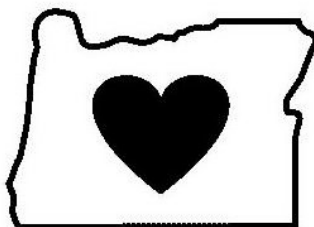

BUCCI, CHRISTOPHER R. (UNITED STATES  
INDIVIDUAL)  
1810 SE 77TH AVE.  
PORTLAND, OR 97215

FOR: ONLINE RETAIL STORE SERVICES FEATURING STICKERS, DECALS, POSTCARDS, CLOTHING, ORNAMENTAL CLOTH PATCHES, BUTTONS, PINS, CUPS, MUGS, IN CLASS 35 (U.S. CLS. 100, 101 AND 102).

FIRST USE 6-1-2008; IN COMMERCE 8-1-2008.

NO CLAIM IS MADE TO THE EXCLUSIVE RIGHT TO USE THE REPRESENTATION OF THE MAP OF THE STATE OF OREGON, APART FROM THE MARK AS SHOWN.

THE MARK CONSISTS OF A REPRESENTATION OF A MAP OF THE STATE OF OREGON WITH AN IMAGE OF A HEART IN THE CENTER.

SN 77-029,439, FILED 10-25-2006.

LAURIE MAYES, EXAMINING ATTORNEY

**Int. Cl.: 41**

**Prior U.S. Cls.: 100, 101, and 107**

**United States Patent and Trademark Office**

**Reg. No. 3,505,805**

**Registered Sep. 23, 2008**

**SERVICE MARK  
PRINCIPAL REGISTER**

**FANTASY EXPERIENCE**

VELOCITY INTERNATIONAL, INC. (PENNSYLVANIA CORPORATION)  
24TH FLOOR DOMINION TOWER  
625 LIBERTY AVENUE  
PITTSBURGH, PA 15222

FOR: ENTERTAINMENT SERVICES, NAMELY, PROVIDING A DIGITAL THEATER ENVIRONMENT IN PRIVATE CLUBS, RESTAURANTS, HOTEL BANQUET FACILITIES AND CONVENTION CENTER BANQUET FACILITIES; AUDIO AND VISUAL SPORTS RELATED PERFORMANCES, E;G., COMMENTARY, ANALYSIS AND REVIEW FROM SPORTS EXPERTS, SPORTS WRITERS AND PERSONALITIES; INTERVIEWS OF ATHLETES AND SPORTS PERSONALITIES; SPORTING EVENTS AND PERFORMANCES; SIMULATED OR RE-ENACTED SPORTING EVENTS AND PERFORMANCES; ENTERTAINMENT, NAMELY, PRODUCTION OF AUDIO AND VISUAL SPORTS RELATED

PERFORMANCES, E;G; COMMENTARY, ANALYSIS AND REVIEW FROM SPORTS EXPERTS, SPORTS WRITERS AND PERSONALITIES; INTERVIEWS OF ATHLETES AND SPORTS PERSONALITIES; SPORTING EVENTS AND PERFORMANCES; SIMULATED OR RE-ENACTED SPORTING EVENTS AND PERFORMANCES, IN CLASS 41 (U.S. CLS. 100, 101 AND 107).

FIRST USE 7-26-2006; IN COMMERCE 7-26-2006.

THE MARK CONSISTS OF STANDARD CHARACTERS WITHOUT CLAIM TO ANY PARTICULAR FONT, STYLE, SIZE, OR COLOR.

SN 77-029,515, FILED 10-25-2006.

JILL C. ALT, EXAMINING ATTORNEY

**Int. Cl.: 43**

**Prior U.S. Cls.: 100 and 101**

**United States Patent and Trademark Office**

**Reg. No. 3,505,806**

**Registered Sep. 23, 2008**

**SERVICE MARK  
PRINCIPAL REGISTER**

**OUR FOODS TASTE FRESH,  
ALIVE AND DO THE HULA ON  
YOUR TONGUE**

MAUI TACOS INTERNATIONAL, INC. (GEOR-  
GIA CORPORATION)  
145 HUGUENOT STREET  
NEW ROCHELLE, NY 10801

FOR: RESTAURANT SERVICES, IN CLASS 43  
(U.S. CLS. 100 AND 101).

FIRST USE 3-4-2008; IN COMMERCE 3-4-2008.

THE MARK CONSISTS OF STANDARD CHAR-  
ACTERS WITHOUT CLAIM TO ANY PARTICULAR  
FONT, STYLE, SIZE, OR COLOR.

SN 77-029,726, FILED 10-26-2006.

ANDREA K. NADELMAN, EXAMINING ATTOR-  
NEY

**Int. Cl.: 21**

**Prior U.S. Cls.: 2, 13, 23, 29, 30, 33, 40, and 50**

**Reg. No. 3,505,807**

**United States Patent and Trademark Office**

**Registered Sep. 23, 2008**

---

**TRADEMARK  
PRINCIPAL REGISTER**

**PAINTSAVER**

WAGNER, PAUL (UNITED STATES INDIVIDUAL)

#2

3711 OCEANFRONT WALK  
MARINA DEL REY, CA 90292

THE MARK CONSISTS OF STANDARD CHARACTERS WITHOUT CLAIM TO ANY PARTICULAR FONT, STYLE, SIZE, OR COLOR.

FOR: CONTAINERS FOR HOUSEHOLD USE, NAMELY, NON-METAL PAINT CONTAINERS, IN CLASS 21 (U.S. CLS. 2, 13, 23, 29, 30, 33, 40 AND 50).

SN 77-031,096, FILED 10-27-2006.

FIRST USE 5-6-2008; IN COMMERCE 5-6-2008.

BRENDAN REGAN, EXAMINING ATTORNEY

**Int. Cl.: 11**

**Prior U.S. Cls.: 13, 21, 23, 31, and 34**

**Reg. No. 3,505,808**

**United States Patent and Trademark Office**

**Registered Sep. 23, 2008**

---

**TRADEMARK  
PRINCIPAL REGISTER**

**ZANAQUA**

ZANAQUA TECHNOLOGIES, INC. (DELAWARE  
CORPORATION)  
12 EXECUTIVE DRIVE  
HUSON, NH 03051

THE MARK CONSISTS OF STANDARD CHAR-  
ACTERS WITHOUT CLAIM TO ANY PARTICULAR  
FONT, STYLE, SIZE, OR COLOR.

FOR: WATER TREATMENT AND HANDLING  
EQUIPMENT, NAMELY UNITS THAT FILTER,  
STERILIZE AND DISTILL WATER, IN CLASS 11  
(U.S. CLS. 13, 21, 23, 31 AND 34).

SN 77-032,137, FILED 10-30-2006.

FIRST USE 2-24-2008; IN COMMERCE 2-24-2008.

JULIE GUTTADAURO, EXAMINING ATTORNEY

**Int. Cl.: 20**

**Prior U.S. Cls.: 2, 13, 22, 25, 32, and 50**

**Reg. No. 3,505,809**

**United States Patent and Trademark Office**

**Registered Sep. 23, 2008**

---

**TRADEMARK  
PRINCIPAL REGISTER**

**SPOTLIGHT SEATING**

ROYAL CAMERON CORPORATION (TEXAS  
CORPORATION)  
1205 INDUSTRIAL BLVD.  
CAMERON, TX 76520

FOR: SEATING MANUFACTURED FOR AUDI-  
TORIUM AND STADIUM USE, IN CLASS 20 (U.S.  
CLS. 2, 13, 22, 25, 32 AND 50).

FIRST USE 1-2-2007; IN COMMERCE 1-2-2007.

THE MARK CONSISTS OF STANDARD CHAR-  
ACTERS WITHOUT CLAIM TO ANY PARTICULAR  
FONT, STYLE, SIZE, OR COLOR.

NO CLAIM IS MADE TO THE EXCLUSIVE  
RIGHT TO USE "SEATING", APART FROM THE  
MARK AS SHOWN.

SN 77-032,990, FILED 10-31-2006.

LINDA MICKLEBURGH, EXAMINING ATTORNEY

**Int. Cl.: 4**

**Prior U.S. Cls.: 1, 6, and 15**

**United States Patent and Trademark Office**

**Reg. No. 3,505,810**

**Registered Sep. 23, 2008**

**TRADEMARK  
PRINCIPAL REGISTER**

**40 Fuel**

TRUSOUTH OIL, LLC (LOUISIANA LIMITED  
LIABILITY COMPANY)

1935 E. 70TH STREET

SHREVEPORT, LA 71105

FOR: FUEL FOR TWO CYCLE ENGINES, IN  
CLASS 4 (U.S. CLS. 1, 6 AND 15).

FIRST USE 7-1-2007; IN COMMERCE 7-1-2007.

THE MARK CONSISTS OF STANDARD CHAR-  
ACTERS WITHOUT CLAIM TO ANY PARTICULAR  
FONT, STYLE, SIZE, OR COLOR.

NO CLAIM IS MADE TO THE EXCLUSIVE  
RIGHT TO USE "FUEL", APART FROM THE MARK  
AS SHOWN.

SN 77-033,260, FILED 10-31-2006.

JAMES A. RAUEN, EXAMINING ATTORNEY

**Int. Cl.: 9**

**Prior U.S. Cls.: 21, 23, 26, 36, and 38**

**United States Patent and Trademark Office**

**Reg. No. 3,505,811**

**Registered Sep. 23, 2008**

**TRADEMARK  
PRINCIPAL REGISTER**



DIMPLEDOUGH, INC. (DELAWARE CORPORATION)  
4807 ROCKSIDE ROAD, SUITE 240  
INDEPENDENCE, OH 44131

FOR: COMPUTER HARDWARE AND COMPUTER SOFTWARE PROGRAMS FOR THE INTEGRATION OF TEXT, AUDIO, GRAPHICS, STILL IMAGE AND MOVING PICTURES INTO AN INTERACTIVE DELIVERY FOR MULTIMEDIA APPLICATIONS; COMPUTER SOFTWARE FOR COMPUTER SYSTEM AND APPLICATION DEVELOPMENT, DEPLOYMENT AND MANAGEMENT; COMPUTER SOFTWARE FOR CONTROLLING SELF-SERVICE TERMINALS; COMPUTER SOFTWARE FOR USE IN RELATION TO DIGITAL ANIMATION AND SPECIAL EFFECTS OF IMAGES, IN CLASS 9 (U.S. CLS. 21, 23, 26, 36 AND 38).

FIRST USE 10-5-2006; IN COMMERCE 11-1-2007.

THE COLOR(S) GREEN, BLACK, GRAY AND WHITE IS/ARE CLAIMED AS A FEATURE OF THE MARK.

THE COLOR GREEN APPEARS IN THE RECTANGLE SURROUNDING THE FACE; THE COLOR BLACK APPEARS IN THE WORD "DOUGH"; THE COLOR GRAY APPEARS IN THE WORD "DIMPLE", IN THE SHADOW BEHIND THE RECTANGLE, AND IN THE WORDS "MAKE IT PERSONAL"; AND THE COLOR WHITE APPEARS IN THE EYES AND MOUTH OF THE FACE.

SN 77-034,230, FILED 11-1-2006.

ESTHER BELENKER, EXAMINING ATTORNEY



**Int. Cl.: 35**

**Prior U.S. Cls.: 100, 101, and 102**

**United States Patent and Trademark Office**

**Reg. No. 3,505,812**

**Registered Sep. 23, 2008**

**SERVICE MARK  
PRINCIPAL REGISTER**

**SHE SAID, SHE SAID**

WICKFORD EQUITIES, LLC (NEVADA LIMITED  
LIABILITY COMPANY)  
2248 MERIDIAN BLVD STE H  
MINDEN, NV 89423

FOR: PROVIDING A WEB SITE WHERE USERS  
CAN POST RATINGS, REVIEWS AND RECOMMEN-  
DATIONS ON PRODUCTS AND SERVICES, IN  
CLASS 35 (U.S. CLS. 100, 101 AND 102).

FIRST USE 7-7-2008; IN COMMERCE 7-7-2008.

THE MARK CONSISTS OF STANDARD CHAR-  
ACTERS WITHOUT CLAIM TO ANY PARTICULAR  
FONT, STYLE, SIZE, OR COLOR.

SN 77-034,529, FILED 11-1-2006.

DORITT L. CARROLL, EXAMINING ATTORNEY

**Int. Cl.: 10**

**Prior U.S. Cls.: 26, 39, and 44**

**United States Patent and Trademark Office**

**Reg. No. 3,505,813**

**Registered Sep. 23, 2008**

**TRADEMARK  
PRINCIPAL REGISTER**

**K9**

JOHN REID & SONS (STRUCSTEEL) LIMITED  
(UNITED KINGDOM CORPORATION)  
STRUCSTEEL HOUSE, 6  
106 REID STREET  
CHRISTCHURCH, UNITED KINGDOM BH232BT

FOR: MEDICAL APPARATUS, NAMELY,  
WHEELED TROLLEYS AND SCOOTERS FOR USE  
AS WALKING AIDS; PARTS AND FITTINGS FOR  
THE AFORESAID GOODS, IN CLASS 10 (U.S. CLS.  
26, 39 AND 44).

FIRST USE 0-0-1986; IN COMMERCE 8-8-2001.

THE MARK CONSISTS OF STANDARD CHAR-  
ACTERS WITHOUT CLAIM TO ANY PARTICULAR  
FONT, STYLE, SIZE, OR COLOR.

PRIORITY CLAIMED UNDER SEC. 44(D) ON  
UNITED KINGDOM APPLICATION NO. 2430761,  
FILED 8-24-2006, REG. NO. 2430761, DATED 8-24-  
2006, EXPIRES 8-24-2016.

SN 77-034,877, FILED 11-2-2006.

KEVIN DINALLO, EXAMINING ATTORNEY

**Int. Cl.: 36**

**Prior U.S. Cls.: 100, 101, and 102**

**United States Patent and Trademark Office**

**Reg. No. 3,505,814**

**Registered Sep. 23, 2008**

**SERVICE MARK  
PRINCIPAL REGISTER**



REGIONS ASSET COMPANY (DELAWARE CORPORATION)  
SUITE 209  
3501 SILVERSIDE ROAD  
WILMINGTON, DE 19810

FOR: BANKING SERVICES, IN CLASS 36 (U.S. CLS. 100, 101 AND 102).

FIRST USE 11-4-2006; IN COMMERCE 11-4-2006.

OWNER OF U.S. REG. NOS. 1,881,600, 3,150,549, AND OTHERS.

THE COLOR(S) GREEN AND WHITE IS/ARE CLAIMED AS A FEATURE OF THE MARK.

THE MARK CONSISTS OF A GREEN PYRAMID-SHAPED DELTA CONTAINING FOUR WHITE SPIKES TO THE LEFT OF THE WORD "REGIONS" WRITTEN IN GREEN.

SN 77-034,923, FILED 11-2-2006.

LINDA E. BLOHM, EXAMINING ATTORNEY

Int. Cl.: 4

Prior U.S. Cls.: 1, 6, and 15

United States Patent and Trademark Office

Reg. No. 3,505,815

Registered Sep. 23, 2008

TRADEMARK  
PRINCIPAL REGISTER

PURISIMA

JOSE PAIEWONSKY E HIJOS C X A (DOMINICAN REP CORPORATION)  
AVE. ESTRELLA SADHALA  
SANTIAGO, DOMINICAN REP

FOR: BEESWAX FOR USE IN THE MANUFACTURE OF CANDLES; CANDLE TORCHES; CANDLE-MAKING KITS; CANDLES; CANDLES FOR LIGHTING; PERFUMED CANDLES; SCENTED CANDLES; TALLOW CANDLES, IN CLASS 4 (U.S. CLS. 1, 6 AND 15).

FIRST USE 10-15-1986; IN COMMERCE 7-13-2007.

THE MARK CONSISTS OF STANDARD CHARACTERS WITHOUT CLAIM TO ANY PARTICULAR FONT, STYLE, SIZE, OR COLOR.

THE ENGLISH TRANSLATION OF "PURISIMA" IN SPANISH IS "VERY PURE, VERY CLEAN, NO BLENDS, USE ONLY OF THE PUREST INGREDIENTS."

SN 77-035,006, FILED 11-2-2006.

JANICE L. MCMORROW, EXAMINING ATTORNEY

Int. Cl.: 25

Prior U.S. Cls.: 22 and 39

United States Patent and Trademark Office

Reg. No. 3,505,816

Registered Sep. 23, 2008

TRADEMARK  
PRINCIPAL REGISTER



DANIELS, TROY M. (UNITED STATES INDIVIDUAL)  
5524 CHANCELLOR WAY  
RIVERBANK, CA 95367

FOR: ANKLE SOCKS; ATHLETIC FOOTWEAR; ATHLETIC SHOES; BANDANAS; BASEBALL CAPS; BATHING SUITS; BEACH COVERUPS; BIKINIS; BOARD SHORTS; BOXER BRIEFS; BOXER SHORTS; BRAS; CAP VISORS; CAPS; CAPS WITH VISORS; COATS FOR MEN AND WOMEN; DO RAGS; FOOTWEAR FOR MEN AND WOMEN; FOUL WEATHER GEAR; G-STRINGS; GAITERS; GLOVES; HALTER TOPS; HEAD SWEATBANDS; HEAD WEAR; HEADGEAR, NAMELY, HATS, CAPS; JEANS; JERSEYS; JOGGING OUTFITS; KNITTED CAPS; LADIES' UNDERWEAR; LEATHER JACKETS; LINGERIE; PANTIES; SKULL CAPS; SPORT SHIRTS; SPORTS BRA; SPORTS JERSEYS; T-SHIRTS; TANK TOPS; TANKTOPS; THONGS; WRIST BANDS, IN CLASS 25 (U.S. CLS. 22 AND 39).

FIRST USE 6-1-2007; IN COMMERCE 9-7-2007.

NO CLAIM IS MADE TO THE EXCLUSIVE RIGHT TO USE "GEAR", APART FROM THE MARK AS SHOWN.

THE COLOR(S) RED, BLACK AND WHITE IS/ARE CLAIMED AS A FEATURE OF THE MARK.

THE MARK CONSISTS OF THE TERM "GEAR" IN A RED COLOR WITH WHITE TRIM CENTERED IN FRONT OF A LARGE BLACK "X" WITH WHITE TRIM. THE MARK IS SHOWN ON A BLACK BACKGROUND.

SN 77-035,156, FILED 11-2-2006.

TRACY WHITTAKER-BROWN, EXAMINING ATTORNEY

**Int. Cls.: 18 and 25**

**Prior U.S. Cls.: 1, 2, 3, 22, 39, and 41**

**Reg. No. 3,505,817**

**United States Patent and Trademark Office**

**Registered Sep. 23, 2008**

**TRADEMARK  
PRINCIPAL REGISTER**



MCINTYRE, MICHAEL (UNITED STATES INDIVIDUAL)  
1543 CLIFFTOP AVENUE  
SAN MARCOS, CA 92078

FOR: ALL PURPOSE SPORT BAGS; ALL-PURPOSE ATHLETIC BAGS; ALL-PURPOSE CARRYING BAGS; ATHLETIC BAGS; BACKPACKS; BAGS AND HOLDALLS FOR SPORTS CLOTHING; DUFFEL BAGS; DUFFLE BAGS; GYM BAGS; SPORTS BAGS; SPORTS PACKS, IN CLASS 18 (U.S. CLS. 1, 2, 3, 22 AND 41).

FIRST USE 9-1-2007; IN COMMERCE 9-1-2007.

FOR: ATHLETIC FOOTWEAR; ATHLETIC SHOES; ATHLETIC UNIFORMS; BEANIES; BELTS; BOARD SHORTS; BOTTOMS; BOXER BRIEFS; BOXER SHORTS; BOXING SHOES; BRIEFS; CAPS; CLOTHING FOR WEAR IN JUDO PRACTICES; CLOTHING FOR WEAR IN WRESTLING GAMES; COATS; DENIMS; FABRIC BELTS; FOOTWEAR; GLOVES; GYM SHORTS; GYM SUITS; HATS; HEAD WEAR; HEADWEAR; HOODS; JACKETS; JEANS; JERSEYS; JOGGING SUITS; JUDO SUITS; KARATE

SUITS; KENDO OUTFITS; MOTORCYCLE GLOVES; MOTORCYCLIST BOOTS; PANTS; PULLOVERS; SANDALS; SHIRTS; SHOES; SHORTS; SKULL CAPS; SPORT SHIRTS; SPORTS JERSEYS AND BREECHES FOR SPORTS; SPORTS OVERUNIFORMS; SWEAT BANDS; SWEAT PANTS; SWEAT SHIRTS; SWEAT SHORTS; SWEAT SUITS; SWEATBANDS; SWEAT-SOCKS; T-SHIRTS; TANK TOPS; TOPS; TRAINING SHOES; TRAINING SUITS; UNDER GARMENTS; UNDERCLOTHES; UNDERGARMENTS; UNDERPANTS; UNDERWEAR; UNIFORMS; VISORS; WALKING SHORTS, IN CLASS 25 (U.S. CLS. 22 AND 39).

FIRST USE 3-1-2003; IN COMMERCE 3-1-2003.

THE MARK CONSISTS OF THE WORD "THROWDOWN" IN BLOCK LETTERS ABOVE A STYLIZED RIVET SUGGESTING THE LETTER "T" AND THE LETTER "I".

SN 77-035,343, FILED 11-2-2006.

GILBERT SWIFT, EXAMINING ATTORNEY

Int. Cl.: 44

Prior U.S. Cls.: 100 and 101

United States Patent and Trademark Office

Reg. No. 3,505,818

Registered Sep. 23, 2008

**SERVICE MARK  
PRINCIPAL REGISTER**



CENTENE CORPORATION (DELAWARE CORPORATION)  
7711 CARONDELET, SUITE 800  
CLAYTON, MO 63105

FOR: MANAGED HEALTH CARE SERVICES, IN CLASS 44 (U.S. CLS. 100 AND 101).

FIRST USE 10-0-2005; IN COMMERCE 10-0-2005.

NO CLAIM IS MADE TO THE EXCLUSIVE RIGHT TO USE "INTEGRATED HEALTHCARE FOR PEOPLE WITH DISABILITIES AND THE ELDERLY", APART FROM THE MARK AS SHOWN.

SN 77-035,374, FILED 11-2-2006.

DAVID YONTEF, EXAMINING ATTORNEY

**Int. Cl.: 43**

**Prior U.S. Cls.: 100 and 101**

**United States Patent and Trademark Office**

**Reg. No. 3,505,819**

**Registered Sep. 23, 2008**

**SERVICE MARK  
PRINCIPAL REGISTER**

**HOLA FRESH MEXICAN GRILL**

GEPPETTO'S PIZZA & RIBS FRANCHISE SYSTEMS, INC. (OHIO CORPORATION)  
3314 WARREN ROAD  
CLEVELAND, OH 44111

FOR: RESTAURANT AND CARRY-OUT RESTAURANT SERVICES, IN CLASS 43 (U.S. CLS. 100 AND 101).

FIRST USE 10-24-2007; IN COMMERCE 10-24-2007.

THE MARK CONSISTS OF STANDARD CHARACTERS WITHOUT CLAIM TO ANY PARTICULAR FONT, STYLE, SIZE, OR COLOR.

NO CLAIM IS MADE TO THE EXCLUSIVE RIGHT TO USE "FRESH MEXICAN GRILL", APART FROM THE MARK AS SHOWN.

THE ENGLISH TRANSLATION OF THE WORD "HOLA" IN THE MARK IS "HELLO".

SN 77-035,499, FILED 11-2-2006.

LINDA E. BLOHM, EXAMINING ATTORNEY



**Int. Cl.: 19**

**Prior U.S. Cls.: 1, 12, 33, and 50**

**United States Patent and Trademark Office**

**Reg. No. 3,505,820**

**Registered Sep. 23, 2008**

**TRADEMARK  
PRINCIPAL REGISTER**

**CAMINO**

THERMA-TRU CORP. (OHIO CORPORATION)  
1750 INDIAN WOOD CIRCLE  
MAUMEE, OH 43537

FOR: DECORATIVE GLASS INSERTS FOR  
DOORS FOR BUILDINGS, IN CLASS 19 (U.S. CLS.  
1, 12, 33 AND 50).

FIRST USE 2-0-2007; IN COMMERCE 2-0-2007.

THE MARK CONSISTS OF STANDARD CHAR-  
ACTERS WITHOUT CLAIM TO ANY PARTICULAR  
FONT, STYLE, SIZE, OR COLOR.

THE ENGLISH TRANSLATION OF THE WORD  
"CAMINO" IN THE MARK IS ROAD OR PATHWAY.

SN 77-036,412, FILED 11-3-2006.

BARBARA RUTLAND, EXAMINING ATTORNEY

**Int. Cl.: 19**

**Prior U.S. Cls.: 1, 12, 33, and 50**

**Reg. No. 3,505,821**

**United States Patent and Trademark Office**

**Registered Sep. 23, 2008**

---

**TRADEMARK  
PRINCIPAL REGISTER**

**AUGUSTINE**

THERMA-TRU CORP. (OHIO CORPORATION)  
1750 INDIAN WOOD CIRCLE  
MAUMEE, OH 43537

THE MARK CONSISTS OF STANDARD CHAR-  
ACTERS WITHOUT CLAIM TO ANY PARTICULAR  
FONT, STYLE, SIZE, OR COLOR.

FOR: DECORATIVE GLASS INSERTS FOR  
DOORS FOR BUILDINGS, IN CLASS 19 (U.S. CLS.  
1, 12, 33 AND 50).

SN 77-036,434, FILED 11-3-2006.

FIRST USE 2-0-2007; IN COMMERCE 2-0-2007.

BARBARA RUTLAND, EXAMINING ATTORNEY

Int. Cl.: 39

Prior U.S. Cls.: 100 and 105

United States Patent and Trademark Office

Reg. No. 3,505,822

Registered Sep. 23, 2008

SERVICE MARK  
PRINCIPAL REGISTER

*BIG FIVE*  
TOURS & EXPEDITIONS

*Enriching Lives Through Distinctive Journeys*

BIG FIVE TOURS & EXPEDITIONS, INC (FLOR-  
IDA CORPORATION)

1551 SE PALM COURT

STUART, FL 34994

FOR: ARRANGING TRAVEL TOURS; TRAVEL  
AND TOUR INFORMATION SERVICE, IN CLASS 39  
(U.S. CLS. 100 AND 105).

FIRST USE 8-1-2004; IN COMMERCE 8-1-2004.

NO CLAIM IS MADE TO THE EXCLUSIVE  
RIGHT TO USE "TOURS & EXPEDITIONS", APART  
FROM THE MARK AS SHOWN.

THE MARK CONSISTS OF STYLIZED TEXT OF  
THE WORDS, "BIG FIVE TOURS & EXPEDITIONS  
ENRICHING LIVES THROUGH DISTINCTIVE  
JOURNEYS".

SN 77-037,438, FILED 11-6-2006.

REGINA DRUMMOND, EXAMINING ATTORNEY

**Int. Cl.: 39**

**Prior U.S. Cls.: 100 and 105**

**United States Patent and Trademark Office**

**Reg. No. 3,505,823**

**Registered Sep. 23, 2008**

**SERVICE MARK  
PRINCIPAL REGISTER**

**LUXURY ADVENTURE**

PEARL SEAS CRUISES LLC (MARSHALL ISLANDS LIMITED LIABILITY COMPANY)  
741 BOSTON POST ROAD, SUITE 200  
GUILFORD, CT 06437

FOR: CRUISE SHIP SERVICES; TRANSPORTATION OF PASSENGERS BY SHIP ARRANGING AND CONDUCTING CRUISES FOR OTHERS, IN CLASS 39 (U.S. CLS. 100 AND 105).

FIRST USE 12-0-2006; IN COMMERCE 12-0-2006.

THE MARK CONSISTS OF STANDARD CHARACTERS WITHOUT CLAIM TO ANY PARTICULAR FONT, STYLE, SIZE, OR COLOR.

NO CLAIM IS MADE TO THE EXCLUSIVE RIGHT TO USE "LUXURY", APART FROM THE MARK AS SHOWN.

SN 77-037,637, FILED 11-6-2006.

JOHN DALIER, EXAMINING ATTORNEY

**Int. Cl.: 16**

**Prior U.S. Cls.: 2, 5, 22, 23, 29, 37, 38, and 50**

**Reg. No. 3,505,824**

**United States Patent and Trademark Office**

**Registered Sep. 23, 2008**

**TRADEMARK  
PRINCIPAL REGISTER**

**ARTE EXPERTO**

ET PUBLISHING INTERNATIONAL, INC. (DE-  
LAWARE CORPORATION)  
6355 NW 36TH STREET  
MIAMI, FL 33166

NO CLAIM IS MADE TO THE EXCLUSIVE  
RIGHT TO USE "ARTE", APART FROM THE MARK  
AS SHOWN.

FOR: SPANISH LANGUAGE MAGAZINE IN THE  
FIELD OF ART, IN CLASS 16 (U.S. CLS. 2, 5, 22, 23, 29,  
37, 38 AND 50).

THE FOREIGN WORDING IN THE MARK  
TRANSLATES INTO ENGLISH AS ART EXPERT.

FIRST USE 1-0-2005; IN COMMERCE 6-0-2008.

SN 77-037,727, FILED 11-6-2006.

THE MARK CONSISTS OF STANDARD CHAR-  
ACTERS WITHOUT CLAIM TO ANY PARTICULAR  
FONT, STYLE, SIZE, OR COLOR.

JAMES LOVELACE, EXAMINING ATTORNEY

**Int. Cl.: 35**

**Prior U.S. Cls.: 100, 101, and 102**

**United States Patent and Trademark Office**

**Reg. No. 3,505,825**

**Registered Sep. 23, 2008**

**SERVICE MARK  
PRINCIPAL REGISTER**

**brix N flix**

BLACKWELL, LORI (UNITED STATES INDIVIDUAL)  
1122 N DEARBORN #12A  
CHICAGO, IL 60610

FOR: ADVERTISING SERVICES, NAMELY, WEB BASED ADVERTISING OF SELECTED RESIDENTIAL AND COMMERCIAL REAL ESTATE THROUGHOUT THE UNITED STATES, IN CLASS 35 (U.S. CLS. 100, 101 AND 102).

FIRST USE 8-15-2006; IN COMMERCE 1-15-2007.

THE MARK CONSISTS OF STANDARD CHARACTERS WITHOUT CLAIM TO ANY PARTICULAR FONT, STYLE, SIZE, OR COLOR.

SN 77-037,736, FILED 11-6-2006.

DAVID TAYLOR, EXAMINING ATTORNEY

**Int. Cls.: 25 and 35**

**Prior U.S. Cls.: 22, 39, 100, 101, and 102**

**United States Patent and Trademark Office**

**Reg. No. 3,505,826**

**Registered Sep. 23, 2008**

**TRADEMARK  
SERVICE MARK  
PRINCIPAL REGISTER**

**THE BANKS @ 9° LATITUDE**

LOVISON, DOUGLAS (UNITED STATES INDIVIDUAL)  
1392 RUBENSTEIN AVE.  
CARDIFF BY THE SEA, CA 92007

FOR: HATS; T-SHIRTS, IN CLASS 25 (U.S. CLS. 22 AND 39).

FIRST USE 8-1-2008; IN COMMERCE 8-7-2008.

FOR: ASSOCIATION SERVICES, NAMELY, PROMOTING THE INTERESTS OF FISHERMEN, IN CLASS 35 (U.S. CLS. 100, 101 AND 102).

FIRST USE 6-24-2006; IN COMMERCE 6-30-2006.

THE MARK CONSISTS OF STANDARD CHARACTERS WITHOUT CLAIM TO ANY PARTICULAR FONT, STYLE, SIZE, OR COLOR.

SN 77-037,891, FILED 11-6-2006.

RICHARD A. STRASER, EXAMINING ATTORNEY

**Int. Cl.: 9**

**Prior U.S. Cls.: 21, 23, 26, 36, and 38**

**Reg. No. 3,505,827**

**United States Patent and Trademark Office**

**Registered Sep. 23, 2008**

**TRADEMARK  
PRINCIPAL REGISTER**

**REALSIGHT**

REALSIGHT RESEARCH LLC (CONNECTICUT  
LIMITED LIABILITY COMPANY)  
UNIT I-4  
16 HILLSIDE PLACE  
NORWALK, CT 06854

FOR: COMPUTER SOFTWARE FOR THE COL-  
LECTION, EDITING, ORGANIZING, MODIFYING,  
BOOK MARKING, TRANSMISSION, STORAGE  
AND SHARING OF DATA AND INFORMATION ,  
IN CLASS 9 (U.S. CLS. 21, 23, 26, 36 AND 38).

FIRST USE 5-31-2007; IN COMMERCE 5-31-2007.

THE MARK CONSISTS OF STANDARD CHAR-  
ACTERS WITHOUT CLAIM TO ANY PARTICULAR  
FONT, STYLE, SIZE, OR COLOR.

SN 77-037,992, FILED 11-6-2006.

CHRIS WELLS, EXAMINING ATTORNEY



**Int. Cl.: 42**

**Prior U.S. Cls.: 100 and 101**

**United States Patent and Trademark Office**

**Reg. No. 3,505,828**

**Registered Sep. 23, 2008**

**SERVICE MARK  
PRINCIPAL REGISTER**

**TANGO**

HRB DIGITAL LLC (DELAWARE LIMITED LIABILITY COMPANY)  
ONE H&R BLOCK WAY  
KANSAS CITY, MO 64105

FOR: PROVIDING TEMPORARY USE OF NON-DOWNLOADABLE SOFTWARE VIA THE INTERNET FOR INCOME TAX PREPARATION; AND APPLICATION SERVICE PROVIDER (ASP) FEATURING SOFTWARE IN THE FIELD OF INCOME TAX PREPARATION, WHICH ALLOWS USERS TO ENGAGE IN THE PREPARATION OF TAX DOCUMENTS, IN CLASS 42 (U.S. CLS. 100 AND 101).

FIRST USE 2-17-2007; IN COMMERCE 2-17-2007.

THE MARK CONSISTS OF STANDARD CHARACTERS WITHOUT CLAIM TO ANY PARTICULAR FONT, STYLE, SIZE, OR COLOR.

SN 77-039,850, FILED 11-8-2006.

DAVID HOFFMAN, EXAMINING ATTORNEY

**Int. Cl.: 25**

**Prior U.S. Cls.: 22 and 39**

**United States Patent and Trademark Office**

**Reg. No. 3,505,829**

**Registered Sep. 23, 2008**

**TRADEMARK  
PRINCIPAL REGISTER**

**MORNING WOOD CAMO**

TEAM HARD, INC. (MINNESOTA CORPORATION)  
3200 FOXPOINT ROAD  
BURNSVILLE, MN 55337

FOR: CAMOUFLAGE CLOTHING, NAMELY, SHIRTS, PANTS, HATS, SHORTS AND SHOES, IN CLASS 25 (U.S. CLS. 22 AND 39).

FIRST USE 2-19-2007; IN COMMERCE 2-19-2007.

THE MARK CONSISTS OF STANDARD CHARACTERS WITHOUT CLAIM TO ANY PARTICULAR FONT, STYLE, SIZE, OR COLOR.

NO CLAIM IS MADE TO THE EXCLUSIVE RIGHT TO USE "CAMO", APART FROM THE MARK AS SHOWN.

SN 77-041,281, FILED 11-10-2006.

WENDY GOODMAN, EXAMINING ATTORNEY

**Int. Cl.: 29**

**Prior U.S. Cl.: 46**

**United States Patent and Trademark Office**

**Reg. No. 3,505,830**

**Registered Sep. 23, 2008**

**TRADEMARK  
PRINCIPAL REGISTER**

**Yo on the Go**

STEUBEN FOODS INCORPORATED (NEW  
YORK CORPORATION)  
155-04 LIBERTY AVENUE  
JAMAICA, NY 11433

FOR: DAIRY-BASED PRODUCTS THAT CON-  
TAIN YOGURT, EXCLUDING ICE CREAM, ICE  
MILK AND FROZEN YOGURT, IN CLASS 29 (U.S.  
CL. 46).

FIRST USE 5-23-2008; IN COMMERCE 5-23-2008.

THE MARK CONSISTS OF STANDARD CHAR-  
ACTERS WITHOUT CLAIM TO ANY PARTICULAR  
FONT, STYLE, SIZE, OR COLOR.

OWNER OF U.S. REG. NOS. 3,122,858 AND  
3,138,034.

SN 77-042,582, FILED 11-13-2006.

SHARON MEIER, EXAMINING ATTORNEY

**Int. Cls.: 35 and 41**

**Prior U.S. Cls.: 100, 101, 102, and 107**

**United States Patent and Trademark Office**

**Reg. No. 3,505,831**

**Registered Sep. 23, 2008**

**SERVICE MARK  
PRINCIPAL REGISTER**

# COOL CENTS

INDIANAPOLIS POWER & LIGHT COMPANY  
(INDIANA CORPORATION)  
ONE MONUMENT CIRCLE  
INDIANAPOLIS, IN 46204

FOR: CONSULTING SERVICES IN THE FIELD OF ENERGY EFFICIENCY; PROVIDING INFORMATION IN THE FIELD OF ENERGY EFFICIENCY; ENERGY AUDITING; CONDUCTING INCENTIVE PROGRAMS TO PROMOTE ENERGY EFFICIENCY, IN CLASS 35 (U.S. CLS. 100, 101 AND 102).

FIRST USE 12-0-2002; IN COMMERCE 12-0-2002.

FOR: EDUCATIONAL SERVICES, NAMELY, CONDUCTING PROGRAMS IN THE FIELD OF ENERGY EFFICIENCY, IN CLASS 41 (U.S. CLS. 100, 101 AND 107).

FIRST USE 12-0-2002; IN COMMERCE 12-0-2002.

THE MARK CONSISTS OF STANDARD CHARACTERS WITHOUT CLAIM TO ANY PARTICULAR FONT, STYLE, SIZE, OR COLOR.

SN 77-042,731, FILED 11-13-2006.

HOWARD SMIGA, EXAMINING ATTORNEY

**Int. Cl.: 25**

**Prior U.S. Cls.: 22 and 39**

**United States Patent and Trademark Office**

**Reg. No. 3,505,832**

**Registered Sep. 23, 2008**

**TRADEMARK  
PRINCIPAL REGISTER**

**ISABELLA RODRIGUEZ**

PHANNY SILK GROUP INC. (NEW YORK COR-  
PORATION)  
ROOM #1005  
530 7TH AVENUE  
NEW YORK, NY 10016

FOR: WOMEN'S CLOTHING, NAMELY, SKIRTS,  
SHIRTS, T-SHIRTS, BLOUSES, PANTS, PANTSUITS,  
SLACKS, SHORTS, DRESSES, TOPS, SWEATERS,  
SWEAT SUITS, SOCKS, JACKETS, COATS, UNDER-  
WEAR, PAJAMAS, SLEEPWEAR, IN CLASS 25 (U.S.  
CLS. 22 AND 39).

FIRST USE 10-15-2006; IN COMMERCE 3-15-2007.

THE MARK CONSISTS OF STANDARD CHAR-  
ACTERS WITHOUT CLAIM TO ANY PARTICULAR  
FONT, STYLE, SIZE, OR COLOR.

THE NAME(S), PORTRAIT(S), AND/OR SIGNA-  
TURE(S) SHOWN IN THE MARK DOES NOT IDENT-  
IFY A PARTICULAR LIVING INDIVIDUAL.

SN 77-042,733, FILED 11-13-2006.

EMILY CARLSEN, EXAMINING ATTORNEY

**Int. Cls.: 35 and 41**

**Prior U.S. Cls.: 100, 101, 102, and 107**

**United States Patent and Trademark Office**

**Reg. No. 3,505,833**

**Registered Sep. 23, 2008**

**SERVICE MARK  
PRINCIPAL REGISTER**

**PERFECT CENTS**

INDIANAPOLIS POWER & LIGHT COMPANY  
(INDIANA CORPORATION)  
ONE MONUMENT CIRCLE  
INDIANAPOLIS, IN 46204

FOR: CONSULTING SERVICES IN THE FIELD OF ENERGY EFFICIENCY; PROVIDING INFORMATION IN THE FIELD OF ENERGY EFFICIENCY; ENERGY AUDITING; CONDUCTING INCENTIVE PROGRAMS TO PROMOTE ENERGY EFFICIENCY, IN CLASS 35 (U.S. CLS. 100, 101 AND 102).

FIRST USE 4-15-2006; IN COMMERCE 4-15-2006.

FOR: EDUCATIONAL SERVICES, NAMELY, CONDUCTING PROGRAMS IN THE FIELD OF ENERGY EFFICIENCY, IN CLASS 41 (U.S. CLS. 100, 101 AND 107).

FIRST USE 4-15-2006; IN COMMERCE 4-15-2006.

THE MARK CONSISTS OF STANDARD CHARACTERS WITHOUT CLAIM TO ANY PARTICULAR FONT, STYLE, SIZE, OR COLOR.

SN 77-042,734, FILED 11-13-2006.

HOWARD SMIGA, EXAMINING ATTORNEY

**Int. Cls.: 6 and 20**

**Prior U.S. Cls.: 2, 12, 13, 14, 22, 23, 25, 32, and 50**

**United States Patent and Trademark Office**

**Reg. No. 3,505,834**

**Registered Sep. 23, 2008**

**TRADEMARK  
PRINCIPAL REGISTER**

**ASWOON**

ASWOON/SUSAN WOODS STUDIO, LLC (NEW YORK LIMITED LIABILITY COMPANY)  
BUILDING 131, ROOMS 204 & 207  
63 FLUSHING AVE. - UNIT 347  
BROOKLYN, NY 11205

FOR: SCULPTURES OF METAL, IN CLASS 6 (U.S. CLS. 2, 12, 13, 14, 23, 25 AND 50).

FIRST USE 11-0-2006; IN COMMERCE 11-0-2006.

FOR: FURNITURE, OUTDOOR FURNITURE; FREE STANDING, HANGING OR WALL MOUNTABLE PANELS AND PARTITIONS; ROOM DIVI-

DERS, SCREENS; SCULPTURES MADE OF WOOD, IN CLASS 20 (U.S. CLS. 2, 13, 22, 25, 32 AND 50).

FIRST USE 11-0-2006; IN COMMERCE 11-0-2006.

THE MARK CONSISTS OF STANDARD CHARACTERS WITHOUT CLAIM TO ANY PARTICULAR FONT, STYLE, SIZE, OR COLOR.

SN 77-043,510, FILED 11-14-2006.

TIMOTHY FINNEGAN, EXAMINING ATTORNEY

**Int. Cl.: 20**

**Prior U.S. Cls.: 2, 13, 22, 25, 32, and 50**

**United States Patent and Trademark Office**

**Reg. No. 3,505,835**

**Registered Sep. 23, 2008**

**TRADEMARK  
PRINCIPAL REGISTER**

**CARAMBA**

JOHN J. MADISON COMPANY INC. (CALIFOR-  
NIA CORPORATION)  
SUITE G  
42319 WINCHESTER ROAD  
TEMECULA, CA 92590

THE MARK CONSISTS OF STANDARD CHAR-  
ACTERS WITHOUT CLAIM TO ANY PARTICULAR  
FONT, STYLE, SIZE, OR COLOR.

FOR: WIND CHIMES, IN CLASS 20 (U.S. CLS. 2, 13,  
22, 25, 32 AND 50).

SN 77-044,030, FILED 11-14-2006.

FIRST USE 1-5-2007; IN COMMERCE 1-5-2007.

MARTHA FROMM, EXAMINING ATTORNEY



**Int. Cl.: 3**

**Prior U.S. Cls.: 1, 4, 6, 50, 51, and 52**

**Reg. No. 3,505,836**

**United States Patent and Trademark Office**

**Registered Sep. 23, 2008**

---

**TRADEMARK  
PRINCIPAL REGISTER**

**STRENGTHENS TEETH FROM THE  
INSIDE OUT**

SMITHKLINE BEECHAM CORPORATION  
(PENNSYLVANIA CORPORATION)  
ONE FRANKLIN PLAZA  
PHILADELPHIA, PA 19102

THE MARK CONSISTS OF STANDARD CHAR-  
ACTERS WITHOUT CLAIM TO ANY PARTICULAR  
FONT, STYLE, SIZE, OR COLOR.

FOR: TOOTHPASTES, IN CLASS 3 (U.S. CLS. 1, 4, 6,  
50, 51 AND 52).

SN 77-045,226, FILED 11-16-2006.

FIRST USE 11-30-2007; IN COMMERCE 11-30-2007.

KEVIN DINALLO, EXAMINING ATTORNEY

**Int. Cl.: 33**

**Prior U.S. Cls.: 47 and 49**

**United States Patent and Trademark Office**

**Reg. No. 3,505,837**

**Registered Sep. 23, 2008**

**TRADEMARK  
PRINCIPAL REGISTER**

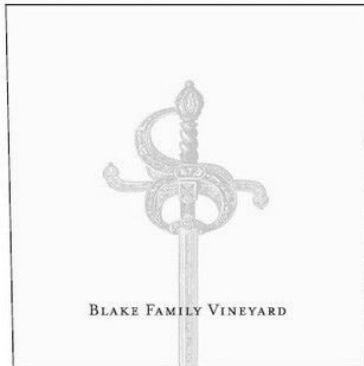

BLAKE FAMILY VINEYARD LIMITED (NEW  
ZEALAND CORPORATION)  
125 GIMBLETT ROAD  
HASTINGS, NEW ZEALAND

FOR: WINE, IN CLASS 33 (U.S. CLS. 47 AND 49).

FIRST USE 9-2-2007; IN COMMERCE 4-11-2008.

PRIORITY CLAIMED UNDER SEC. 44(D) ON  
NEW ZEALAND APPLICATION NO. 755694, FILED  
9-22-2006, REG. NO. 755694, DATED 9-22-2006, EX-  
PIRES 9-22-2016.

NO CLAIM IS MADE TO THE EXCLUSIVE  
RIGHT TO USE "FAMILY VINEYARD", APART  
FROM THE MARK AS SHOWN.

THE MARK CONSISTS OF "BLAKE FAMILY  
VINEYARD" APPEARING IN DISTINCTIVE TYPE-  
FACE, OVERLAPPING THE DEPICTION OF A  
HANDLE-END OF A SWORD.

SN 77-045,536, FILED 11-16-2006.

ANTHONY RINKER, EXAMINING ATTORNEY

**Int. Cls.: 5 and 31**

**Prior U.S. Cls.: 1, 6, 18, 44, 46, 51, and 52**

**United States Patent and Trademark Office**

**Reg. No. 3,505,838**

**Registered Sep. 23, 2008**

**TRADEMARK  
PRINCIPAL REGISTER**

**BLUE ORGANICS**

BLUE BUFFALO COMPANY, LLC (DELAWARE  
LIMITED LIABILITY COMPANY)  
11 RIVER ROAD  
WILTON, CT 06987

FOR: ANIMAL FEED ADDITIVE FOR USE AS A  
NUTRITIONAL SUPPLEMENT FOR MEDICAL  
PURPOSES; ANIMAL FEED SUPPLEMENTS; DIET-  
ARY SUPPLEMENTS FOR ANIMALS; FEED SUP-  
PLEMENTS FOR PETS, IN CLASS 5 (U.S. CLS. 6, 18,  
44, 46, 51 AND 52).

FIRST USE 9-0-2007; IN COMMERCE 9-0-2007.

FOR: ANIMAL FEED; ANIMAL FOODSTUFFS;  
BEVERAGES FOR ANIMALS; CAT FOOD; CAT  
TREATS; DIGESTIBLE CHEWING BONES FOR  
DOGS; DOG BISCUITS; DOG FOOD; DOG TREATS;

FOOD FOR ANIMALS; MIXED ANIMAL FEED; PET  
BEVERAGES; PET FOOD; PET TREATS, IN CLASS  
31 (U.S. CLS. 1 AND 46).

FIRST USE 9-0-2007; IN COMMERCE 9-0-2007.

THE MARK CONSISTS OF STANDARD CHAR-  
ACTERS WITHOUT CLAIM TO ANY PARTICULAR  
FONT, STYLE, SIZE, OR COLOR.

NO CLAIM IS MADE TO THE EXCLUSIVE  
RIGHT TO USE "ORGANICS", APART FROM THE  
MARK AS SHOWN.

SN 77-046,077, FILED 11-16-2006.

MICHAEL KEATING, EXAMINING ATTORNEY

**Int. Cl.: 9**

**Prior U.S. Cls.: 21, 23, 26, 36, and 38**

**Reg. No. 3,505,839**

**United States Patent and Trademark Office**

**Registered Sep. 23, 2008**

**TRADEMARK  
PRINCIPAL REGISTER**

**AUCTIONEXPERT**

ACTIVANT SOLUTIONS INC. (DELAWARE CORPORATION)  
7683 SOUTHFRONT ROAD  
LIVERMORE, CA 94551

FIRST USE 10-31-2006; IN COMMERCE 10-31-2006.

FOR: COMPUTER SOFTWARE FOR AUTOMATING AUCTIONS OF AUTOMOBILE PARTS, NAMELY, SOFTWARE FOR USE IN ORGANIZING, MANAGING AND OPERATING ONLINE AUCTIONS INCLUDING DATABASE MANAGEMENT, INVENTORY MANAGEMENT AND AUCTION BIDDING, IN CLASS 9 (U.S. CLS. 21, 23, 26, 36 AND 38).

THE MARK CONSISTS OF STANDARD CHARACTERS WITHOUT CLAIM TO ANY PARTICULAR FONT, STYLE, SIZE, OR COLOR.

SN 77-046,169, FILED 11-16-2006.

KATHERINE STOIDES, EXAMINING ATTORNEY

**Int. Cl.: 36**

**Prior U.S. Cls.: 100, 101, and 102**

**United States Patent and Trademark Office**

**Reg. No. 3,505,840**

**Registered Sep. 23, 2008**

**SERVICE MARK  
PRINCIPAL REGISTER**

**CORMARK SECURITIES (USA)  
LIMITED**

CORMARK SECURITIES INC. (CANADA COR-  
PORATION)  
SUITE 2800, ROYAL BANK PLAZA  
P.O. BOX 63 SOUTH TOWER  
TORONTO, ONTARIO, CANADA M5J2J2

FOR: SECURITIES BROKERAGE, IN CLASS 36  
(U.S. CLS. 100, 101 AND 102).

FIRST USE 4-0-2007; IN COMMERCE 4-0-2007.

THE MARK CONSISTS OF STANDARD CHAR-  
ACTERS WITHOUT CLAIM TO ANY PARTICULAR  
FONT, STYLE, SIZE, OR COLOR.

NO CLAIM IS MADE TO THE EXCLUSIVE  
RIGHT TO USE "SECURITIES (USA) LIMITED",  
APART FROM THE MARK AS SHOWN.

SN 77-047,213, FILED 11-17-2006.

BILL DAWE, EXAMINING ATTORNEY

**Int. Cl.: 25**

**Prior U.S. Cls.: 22 and 39**

**United States Patent and Trademark Office**

**Reg. No. 3,505,841**

**Registered Sep. 23, 2008**

**TRADEMARK  
PRINCIPAL REGISTER**

# American Chauvinist

AMERICAN CHAUVINIST, INC. (CALIFORNIA CORPORATION)  
7709 FAY AVENUE  
LA JOLLA, CA 92037

FOR: APRONS; BASEBALL CAPS; BEANIES; BOTTOMS; BREECHES; CAP VISORS; CAPS; CAPS WITH VISORS; CHEMISES; GOLF CAPS; GOLF SHIRTS; HATS; HEAD WEAR; HEADGEAR, NAMELY, HATS, CAPS; HEADWEAR; JEANS; JERSEYS; KNIT SHIRTS; KNITTED CAPS; LOUNGEWEAR; MEN AND WOMEN JACKETS, COATS, TROUSERS, VESTS; NIGHTWEAR; OPEN-NECK SHIRTS; POLO SHIRTS; PULLOVERS; SHIRTS; SHORT-SLEEVED OR LONG-SLEEVED T-SHIRTS; SHORT-SLEEVED SHIRT; SKI WEAR; SLEEP SHIRTS; SLEEPING GARMENTS; SLEEPWEAR; SLEEVELESS JERSEYS;

SMALL HATS; SPORT SHIRTS; SPORT JERSEYS AND BREECHES FOR SPORTS; SPORTS SHIRTS; SPORTS SHIRTS WITH SHORT SLEEVES; SUN VISORS; SURF WEAR; SWEAT SHIRTS; SWEATERS; T-SHIRTS; TANK TOPS; TENNIS WEAR; TOPS; VISORS, IN CLASS 25 (U.S. CLS. 22 AND 39).

FIRST USE 10-19-2006; IN COMMERCE 8-18-2007.

THE MARK CONSISTS OF STANDARD CHARACTERS WITHOUT CLAIM TO ANY PARTICULAR FONT, STYLE, SIZE, OR COLOR.

SN 77-048,656, FILED 11-21-2006.

RAUL CORDOVA, EXAMINING ATTORNEY

Int. Cl.: 25

Prior U.S. Cls.: 22 and 39

United States Patent and Trademark Office

Reg. No. 3,505,842

Registered Sep. 23, 2008

TRADEMARK  
PRINCIPAL REGISTER



IMAGEWEAR APPAREL CORP. (DELAWARE CORPORATION)  
3411 SILVERSIDE ROAD  
WILMINGTON, DE 19810

FOR: WORK UNIFORMS FOR CULINARY PROFESSIONALS, NAMELY, SHIRTS, PANTS, BLOUSES, JACKETS, APRONS, HATS, CAPS, SCARVES AND NECKERCHIEFS, IN CLASS 25 (U.S. CLS. 22 AND 39).

FIRST USE 2-2-2004; IN COMMERCE 2-2-2004.

NO CLAIM IS MADE TO THE EXCLUSIVE RIGHT TO USE "MASTER SERIES" AND "CHEF DESIGNS", APART FROM THE MARK AS SHOWN.

THE MARK CONSISTS OF AN OUTLINE OF A POT AND PAN AS USED IN A KITCHEN.

SN 77-049,457, FILED 11-22-2006.

JULIE GUTTADAURO, EXAMINING ATTORNEY

**Int. Cl.: 9**

**Prior U.S. Cls.: 21, 23, 26, 36, and 38**

**United States Patent and Trademark Office**

**Reg. No. 3,505,843**

**Registered Sep. 23, 2008**

**TRADEMARK  
PRINCIPAL REGISTER**

**SOLUTIONS BEGIN WITH U**

UEVEN, LLC (ARIZONA LIMITED LIABILITY  
COMPANY)  
17505 N. 79TH AVENUE, SUITE303  
PHOENIX, AZ 85308

FOR: COMPUTER SOFTWARE FOR TIME MAN-  
AGEMENT AND TIME ATTENDANCE OF CON-  
TRACTORS; COMPUTER SOFTWARE FOR  
PROJECT MANAGEMENT IN THE CONSTRU-  
TION OF BUILDINGS; COMPUTER SOFTWARE  
FOR THE CONSTRUCTION INDUSTRY ASSISTING  
IN OPERATIONS AND PROJECT MANAGEMENT,  
INCLUDING FACILITATING PAYROLL, PUR-

CHASING AND SCHEDULING ACTIVITIES, IN  
CLASS 9 (U.S. CLS. 21, 23, 26, 36 AND 38).

FIRST USE 6-1-2007; IN COMMERCE 6-1-2007.

THE MARK CONSISTS OF STANDARD CHAR-  
ACTERS WITHOUT CLAIM TO ANY PARTICULAR  
FONT, STYLE, SIZE, OR COLOR.

SN 77-049,945, FILED 11-22-2006.

SANDRA MANIOS, EXAMINING ATTORNEY



**Int. Cls.: 35 and 41**

**Prior U.S. Cls.: 100, 101, 102, and 107**

**United States Patent and Trademark Office**

**Reg. No. 3,505,844**

**Registered Sep. 23, 2008**

**SERVICE MARK  
PRINCIPAL REGISTER**

# Aventine Hill

AVENTINE HILL, LLC (CONNECTICUT LIMITED LIABILITY COMPANY)  
ONE MORNINGSIDE DRIVE NORTH, SUITE 200  
WESTPORT, CT 06880

FOR: IMPORTATION OF WINES; DISTRIBUTORSHIP SERVICES IN THE FIELD OF WINE, IN CLASS 35 (U.S. CLS. 100, 101 AND 102).

FIRST USE 1-15-2007; IN COMMERCE 1-15-2007.

FOR: EDUCATION AND ENTERTAINMENT SERVICES, NAMELY, WINE TASTINGS AND LEC-

TURES CONCERNING WINES, IN CLASS 41 (U.S. CLS. 100, 101 AND 107).

FIRST USE 1-15-2007; IN COMMERCE 1-15-2007.

THE MARK CONSISTS OF STANDARD CHARACTERS WITHOUT CLAIM TO ANY PARTICULAR FONT, STYLE, SIZE, OR COLOR.

SN 77-052,890, FILED 11-29-2006.

SUZANNE BLANE, EXAMINING ATTORNEY

**Int. Cl.: 34**

**Prior U.S. Cls.: 2, 8, 9, and 17**

**Reg. No. 3,505,845**

**United States Patent and Trademark Office**

**Registered Sep. 23, 2008**

**TRADEMARK  
PRINCIPAL REGISTER**



INTELLECTUAL SOLUTIONS, INC. (DELA-  
WARE CORPORATION)  
41 JAMES WAY  
EATONTOWN, NJ 07724

NO CLAIM IS MADE TO THE EXCLUSIVE  
RIGHT TO USE "BUTT" , APART FROM THE  
MARK AS SHOWN.

FOR: ASH TRAYS, IN CLASS 34 (U.S. CLS. 2, 8, 9  
AND 17).

SN 77-052,938, FILED 11-29-2006.

FIRST USE 5-2-2008; IN COMMERCE 5-2-2008.

KAELIE KUNG, EXAMINING ATTORNEY

**Int. Cls.: 35 and 42**

**Prior U.S. Cls.: 100, 101, and 102**

**United States Patent and Trademark Office**

**Reg. No. 3,505,846**

**Registered Sep. 23, 2008**

**SERVICE MARK  
PRINCIPAL REGISTER**

# Demandvertise

KULAS, CHARLES J. (UNITED STATES INDIVIDUAL)  
651 ORIZABA AVE.  
SAN FRANCISCO, CA 94132

FOR: ADVERTISING AND ADVERTISEMENT SERVICES; ADVERTISING AND COMMERCIAL INFORMATION SERVICES, VIA THE INTERNET; ADVERTISING AND PUBLICITY SERVICES; ADVERTISING BY TRANSMISSION OF ON-LINE PUBLICITY FOR THIRD PARTIES THROUGH ELECTRONIC COMMUNICATIONS NETWORKS; ADVERTISING SERVICES; ADVERTISING SERVICES, NAMELY, PROMOTING AND MARKETING THE GOODS AND SERVICES OF OTHERS THROUGH ALL PUBLIC COMMUNICATION MEANS; ADVERTISING VIA ELECTRONIC MEDIA AND SPECIFICALLY THE INTERNET; CREATING AND UPDATING ADVERTISING MATERIAL; DISPLAYING ADVERTISEMENTS FOR OTHERS; DISSEMINATION OF ADVERTISING FOR OTHERS VIA AN ON-LINE COMMUNICATIONS NETWORK ON THE INTERNET; DISSEMINATION OF ADVERTISING FOR OTHERS VIA THE INTERNET; DISTRIBUTION OF ADVERTISEMENTS AND COMMERCIAL ANNOUNCEMENTS; ELECTRONIC COMMERCE SERVICES, NAMELY, PROVIDING INFORMATION PRODUCTS VIA TELECOMMUNICATION NETWORKS FOR ADVERTISING AND SALES PURPOSES; ISSUING AND UPDATING OF ADVERTISING TEXTS; MEDIA BUYING ADVICE, NAMELY, ADVISING THE CLIENT HOW MUCH MEDIA TIME, AND AT WHAT TIMES THE CLIENT SHOULD BE PURCHASING ADVERTISING; MEDIA PLANNING, NAMELY, ADVISING THE CLIENT ON THE CORRECT TIMES AND STATIONS TO ADVERTISE BASED ON MEDIA ANALYSIS OF THE MARKET FOR THAT MEDIA; ON-LINE ADVERTISING AND MARKETING SERVICES; ON-LINE ADVERTISING ON COMPUTER COMMUNICATION NETWORKS; PLACING ADVERTISEMENTS FOR OTHERS; PRE-

PARATION AND REALIZATION OF MEDIA AND ADVERTISING PLANS AND CONCEPTS; PREPARATION OF CUSTOM ADVERTISEMENTS FOR OTHERS; PREPARATION OF CUSTOM OR NON-CUSTOM ADVERTISING FOR BUSINESSES FOR DISSEMINATION VIA THE WEB, CD OR DVD FOR OPTIONAL UPLOAD OR DOWNLOAD TO A COMPUTER; PREPARING ADVERTISEMENTS FOR OTHERS; PREPARING AND PLACING ADVERTISEMENTS FOR OTHERS; PREPARING AND PLACING OF ADVERTISEMENTS; PROMOTING, ADVERTISING AND MARKETING OF THE ON-LINE WEBSITES OF OTHERS; PROMOTION, ADVERTISING AND MARKETING OF ON-LINE WEBSITES; PROVIDING A SEARCHABLE ONLINE ADVERTISING GUIDE FEATURING THE GOODS AND SERVICES OF OTHER ON-LINE VENDORS ON THE INTERNET; PROVIDING A WEB SITE WHICH FEATURES ADVERTISEMENTS FOR THE GOODS AND SERVICES OF OTHERS ON A GLOBAL COMPUTER NETWORK; PROVIDING ADVERTISING SERVICES USING 3D AND ANIMATION DESIGNS; PROVIDING TELEVISION ADVERTISING FOR OTHERS; PROVISION OF ADVERTISING SPACE BY ELECTRONIC MEANS AND GLOBAL INFORMATION NETWORKS, IN CLASS 35 (U.S. CLS. 100, 101 AND 102).

FIRST USE 11-1-2007; IN COMMERCE 11-1-2007.

FOR: DESIGNING WEBSITES FOR ADVERTISING PURPOSES, IN CLASS 42 (U.S. CLS. 100 AND 101).

FIRST USE 2-10-2008; IN COMMERCE 2-10-2008.

THE MARK CONSISTS OF STANDARD CHARACTERS WITHOUT CLAIM TO ANY PARTICULAR FONT, STYLE, SIZE, OR COLOR.

SN 77-053,734, FILED 11-30-2006.

SUNG IN, EXAMINING ATTORNEY

Int. Cl.: 25

Prior U.S. Cls.: 22 and 39

United States Patent and Trademark Office

Reg. No. 3,505,847

Registered Sep. 23, 2008

**TRADEMARK  
PRINCIPAL REGISTER**



A & C CAMISEROS, S.L. (SPAIN SOCIEDAD DE  
RESPONSABILIDAD LIMITADA)  
CAMI DE LA VIA, 29. (08840 VILADECANS)  
BARCELONA, SPAIN

FOR: SHIRTS, T-SHIRTS, BLOUSES, SKIRTS,  
JERKINS, CAPS, PARKAS, OVERALLS, COATS,  
ANORAKS, PULL-OVERS, SWEATSHIRT, JACK-  
ETS, TROUSERS, GLOVES, SOCKS, STOCKINGS,  
UNDERWEAR, PANTIES, NYLON STOCKINGS,  
PAJAMAS, NIGHTGOWNS, RAINCOATS, WAIST-  
COAT, CAPES, SHAWLS, SCARVES, JERSEYS,  
DRESSES, TIES, BELTS, SUSPENDERS, BATHING  
SUITS, STOLE, SPORT CLOTHING, NAMELY,  
SPORT SHIRTS, DRESSING GOWNS, SUITS, PETTI-

COATS, GARMENTS FOR LADIES, NAMELY, LA-  
DIES' SHIRTS, GARMENTS FOR GENTLEMEN,  
NAMELY, SHIRTS, SLEEPING GARMENTS, AND  
UNDER GARMENTS, GARMENTS FOR CHIL-  
DREN, NAMELY, SHIRTS, BLOUSES, SLEEPING  
GARMENTS, UNDER GARMENTS, FOOTWEAR,  
HEADWEAR, AND HOSIERY, IN CLASS 25 (U.S.  
CLS. 22 AND 39).

FIRST USE 5-29-2008; IN COMMERCE 5-29-2008.

SN 77-053,995, FILED 11-30-2006.

JAMES STEIN, EXAMINING ATTORNEY

**Int. Cl.: 38**

**Prior U.S. Cls.: 100, 101, and 104**

**United States Patent and Trademark Office**

**Reg. No. 3,505,848**

**Registered Sep. 23, 2008**

**SERVICE MARK  
PRINCIPAL REGISTER**

**MYSAY**

ROCOCO SOFTWARE LTD. (IRELAND CORPORATION)  
3 LINCOLN PLACE  
DUBLIN 2, IRELAND

FOR: TELECOMMUNICATIONS SERVICES, NAMELY, PROVIDING SERVICES FOR THE SIMULTANEOUS TRANSMISSION OF VOICE MESSAGES OVER THE TELEPHONE AND OVER THE INTERNET AND RELATED ONLINE AND TELEPHONE SERVICES, NAMELY, RECORDING USERS' VOICE MESSAGES OVER THE PHONE AND INTERNET, ALLOWING PLAYBACK OF MESSAGES FROM THE USER OR OTHER USERS ON THE PHONE AND INTERNET, ALLOWING USERS TO ADD TEXT (SMS) COMMENTS ON THEIR PHONES OR ADD TEXT COMMENTS OVER THE INTERNET AND DISPLAY OF THESE COMMENTS OVER THE INTERNET ON THE USER'S PHONE, PROVIDING USERS ACCESS VIA A WEB-BASED

SERVICE TO MESSAGES THEY HAVE SENT OR RECEIVED; PROVIDING USERS ACCESS TO AN ONLINE DATABASE FOR STORAGE OF INFORMATION ABOUT THEIR NETWORK OF CONTACTS; TELECOMMUNICATIONS SERVICES, NAMELY, PROVISION OF TELEPHONE CONFERENCE SERVICES OVER THE TELEPHONE AND OVER THE INTERNET, IN CLASS 38 (U.S. CLS. 100, 101 AND 104).

FIRST USE 11-30-2006; IN COMMERCE 11-30-2006.

THE MARK CONSISTS OF STANDARD CHARACTERS WITHOUT CLAIM TO ANY PARTICULAR FONT, STYLE, SIZE, OR COLOR.

SN 77-054,017, FILED 11-30-2006.

KATHY DE JONGE, EXAMINING ATTORNEY

**Int. Cl.: 38**

**Prior U.S. Cls.: 100, 101, and 104**

**United States Patent and Trademark Office**

**Reg. No. 3,505,849**

**Registered Sep. 23, 2008**

**SERVICE MARK  
PRINCIPAL REGISTER**

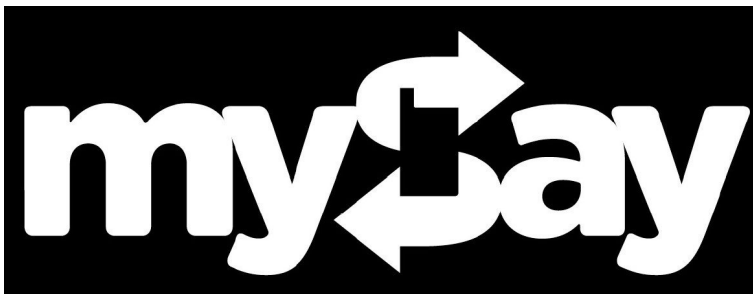

ROCOCO SOFTWARE LTD. (IRELAND CORPORATION)  
3 LINCOLN PLACE  
DUBLIN 2, IRELAND

FOR: TELECOMMUNICATIONS SERVICES, NAMELY, PROVIDING SERVICES FOR THE SIMULTANEOUS TRANSMISSION OF VOICE MESSAGES OVER THE TELEPHONE AND OVER THE INTERNET AND RELATED ONLINE AND TELEPHONE SERVICES, NAMELY, RECORDING USERS' VOICE MESSAGES OVER THE PHONE AND INTERNET, ALLOWING PLAYBACK OF MESSAGES FROM THE USER OR OTHER USERS ON THE PHONE AND INTERNET, ALLOWING USERS TO ADD TEXT (SMS) COMMENTS ON THEIR PHONES OR ADD TEXT COMMENTS OVER THE INTERNET AND DISPLAY OF THESE COMMENTS OVER THE INTERNET ON THE USER'S PHONE, PROVIDING USERS ACCESS VIA A WEB-BASED SERVICE TO MESSAGES THEY HAVE SENT OR RECEIVED; PROVIDING USERS ACCESS TO AN ONLINE DATABASE FOR STORAGE OF INFOR-

MATION ABOUT THEIR NETWORK OF CONTACTS, TELECOMMUNICATIONS SERVICES, NAMELY, PROVISION OF TELEPHONE CONFERENCE SERVICES OVER THE TELEPHONE AND OVER THE INTERNET, IN CLASS 38 (U.S. CLS. 100, 101 AND 104).

FIRST USE 11-30-2006; IN COMMERCE 11-30-2006.

THE MARK CONSISTS OF THE STYLIZED WORD "MYSAY", WITH THE LETTERS "M" AND "Y" IN LOWER CASE, FOLLOWED BY A CAPITAL STYLIZED "S", THEN LOWER-CASE "A" AND "Y". THE TOP AND BOTTOM OF THE STYLIZED CAPITAL "S" INCORPORATE ARROWS, AND A SILHOUETTE OF A PHONE APPEARS OVER THE MIDDLE OF THE "S".

SN 77-054,020, FILED 11-30-2006.

KATHY DE JONGE, EXAMINING ATTORNEY

**Int. Cl.: 21**

**Prior U.S. Cls.: 2, 13, 23, 29, 30, 33, 40, and 50**

**United States Patent and Trademark Office**

**Reg. No. 3,505,850**

**Registered Sep. 23, 2008**

**TRADEMARK  
PRINCIPAL REGISTER**

**SPICESHOT**

CHEF'N CORPORATION (WASHINGTON COR-  
PORATION)  
1520 4TH AVENUE, 3RD FLOOR  
SEATTLE, WA 98101

FOR: DISPENSER IN THE NATURE OF A HAND-  
HELD, MANUALLY-OPERATED CONTAINER FOR  
DISPENSING DRY CONDIMENTS, HERBS AND  
SPICES, IN CLASS 21 (U.S. CLS. 2, 13, 23, 29, 30, 33,  
40 AND 50).

FIRST USE 3-0-2007; IN COMMERCE 3-0-2007.

THE MARK CONSISTS OF STANDARD CHAR-  
ACTERS WITHOUT CLAIM TO ANY PARTICULAR  
FONT, STYLE, SIZE, OR COLOR.

SN 77-054,076, FILED 11-30-2006.

JACQUELINE A. LAVINE, EXAMINING ATTOR-  
NEY



**Int. Cl.: 16**

**Prior U.S. Cls.: 2, 5, 22, 23, 29, 37, 38, and 50**

**Reg. No. 3,505,851**

**United States Patent and Trademark Office**

**Registered Sep. 23, 2008**

**TRADEMARK  
PRINCIPAL REGISTER**

**4 POINTS**

TELMEX USA, L.L.C. (DELAWARE LIMITED  
LIABILITY COMPANY)  
3350 S.W. 148TH AVENUE  
MIRAMAR, FL 33027

THE MARK CONSISTS OF STANDARD CHAR-  
ACTERS WITHOUT CLAIM TO ANY PARTICULAR  
FONT, STYLE, SIZE, OR COLOR.

FOR: PRE-PAID TELEPHONE CALLING CARDS,  
NOT MAGNETICALLY ENCODED, IN CLASS 16  
(U.S. CLS. 2, 5, 22, 23, 29, 37, 38 AND 50).

SN 77-055,800, FILED 12-1-2006.

FIRST USE 8-8-2007; IN COMMERCE 8-8-2007.

ANN E. SAPPENFIELD, EXAMINING ATTORNEY

**Int. Cl.: 41**

**Prior U.S. Cls.: 100, 101, and 107**

**United States Patent and Trademark Office**

**Reg. No. 3,505,852**

**Registered Sep. 23, 2008**

**SERVICE MARK  
PRINCIPAL REGISTER**

**JUMPIN MONKEY**

THE JUMPIN MONKEY, LLC (VIRGINIA LIMITED LIABILITY COMPANY)  
829 LYNNHAVEN PARKWAY, SUITE 116  
VIRGINIA BEACH, VA 23452

FOR: CHILDREN'S ENTERTAINMENT AND AMUSEMENT CENTERS WITH INTERACTIVE AND INFLATABLE DEVICE PLAY AREA AND PARTY FACILITIES, IN CLASS 41 (U.S. CLS. 100, 101 AND 107).

FIRST USE 9-1-2005; IN COMMERCE 9-1-2005.

THE MARK CONSISTS OF STANDARD CHARACTERS WITHOUT CLAIM TO ANY PARTICULAR FONT, STYLE, SIZE, OR COLOR.

SN 77-056,095, FILED 12-4-2006.

JASON BLAIR, EXAMINING ATTORNEY

**Int. Cls.: 35 and 36**

**Prior U.S. Cls.: 100, 101, and 102**

**United States Patent and Trademark Office**

**Reg. No. 3,505,853**

**Registered Sep. 23, 2008**

**SERVICE MARK  
PRINCIPAL REGISTER**

**FIDELITY WEALTH ADVISOR  
SOLUTIONS**

FMR CORP. (DELAWARE LIMITED LIABILITY  
COMPANY)  
F7D  
82 DEVONSHIRE STREET  
BOSTON, MA 02109

FOR: REFERRALS IN THE FIELD OF INVEST-  
MENT ADVICE AND FINANCIAL PLANNING, IN  
CLASS 35 (U.S. CLS. 100, 101 AND 102).

FIRST USE 12-14-2006; IN COMMERCE 12-14-2006.

FOR: INVESTMENT ADVISORY SERVICES, IN  
CLASS 36 (U.S. CLS. 100, 101 AND 102).

FIRST USE 12-14-2006; IN COMMERCE 12-14-2006.

THE MARK CONSISTS OF STANDARD CHAR-  
ACTERS WITHOUT CLAIM TO ANY PARTICULAR  
FONT, STYLE, SIZE, OR COLOR.

OWNER OF U.S. REG. NOS. 1,481,037, 1,543,851,  
AND 3,092,353.

NO CLAIM IS MADE TO THE EXCLUSIVE  
RIGHT TO USE "WEALTH" AND "SOLUTIONS",  
APART FROM THE MARK AS SHOWN.

SEC. 2(F) ADVISOR.

SN 77-056,434, FILED 12-4-2006.

SANJEEV VOHRA, EXAMINING ATTORNEY

**Int. Cl.: 16**

**Prior U.S. Cls.: 2, 5, 22, 23, 29, 37, 38, and 50**

**Reg. No. 3,505,854**

**United States Patent and Trademark Office**

**Registered Sep. 23, 2008**

---

**TRADEMARK  
PRINCIPAL REGISTER**

**DESKTOP POPS**

STRUCTURAL GRAPHICS, LLC (CONNECTICUT  
LIMITED LIABILITY COMPANY)  
38 PLAINS ROAD  
ESSEX, CT 06426

FOR: PRINTED VISUALS IN THE NATURE OF  
PROMOTIONAL MATERIALS, IN CLASS 16 (U.S.  
CLS. 2, 5, 22, 23, 29, 37, 38 AND 50).

FIRST USE 4-1-2006; IN COMMERCE 4-1-2006.

THE MARK CONSISTS OF STANDARD CHAR-  
ACTERS WITHOUT CLAIM TO ANY PARTICULAR  
FONT, STYLE, SIZE, OR COLOR.

NO CLAIM IS MADE TO THE EXCLUSIVE  
RIGHT TO USE "DESKTOP", APART FROM THE  
MARK AS SHOWN.

SN 77-057,253, FILED 12-5-2006.

JAY FLOWERS, EXAMINING ATTORNEY

**Int. Cl.: 28**

**Prior U.S. Cls.: 22, 23, 38, and 50**

**United States Patent and Trademark Office**

**Reg. No. 3,505,855**

**Registered Sep. 23, 2008**

**TRADEMARK  
PRINCIPAL REGISTER**

**SLIDE ACTION**

FRANKLIN SPORTS, INC. (DELAWARE COR-  
PORATION)  
17 CAMPANELLI PARKWAY  
STOUGHTON, MA 02072

FOR: ACTION SKILL GAMES, IN CLASS 28 (U.S.  
CLS. 22, 23, 38 AND 50).

FIRST USE 9-1-2007; IN COMMERCE 9-1-2007.

THE MARK CONSISTS OF STANDARD CHAR-  
ACTERS WITHOUT CLAIM TO ANY PARTICULAR  
FONT, STYLE, SIZE, OR COLOR.

SN 77-057,713, FILED 12-5-2006.

REBECCA POVARCHUK, EXAMINING ATTOR-  
NEY

**Int. Cls.: 9, 16, and 35**

**Prior U.S. Cls.: 2, 5, 21, 22, 23, 26, 29, 36, 37, 38, 50,  
100, 101, and 102**

**Reg. No. 3,505,856**

**United States Patent and Trademark Office**

**Registered Sep. 23, 2008**

**TRADEMARK  
SERVICE MARK  
PRINCIPAL REGISTER**

**NATIONWIDE AT YOUR  
FINGERTIPS**

GLOBAL DIRECTORIES, INC. (FLORIDA CORPORATION)  
2000 CORPORATE SQUARE BLVD, SUITE 101  
JACKSONVILLE, FL 32216

FOR: DIGITAL MATERIALS, NAMELY, CDS FEATURING DIRECTORIES OF NATIONWIDE ADVERTISEMENTS, IN CLASS 9 (U.S. CLS. 21, 23, 26, 36 AND 38).

FIRST USE 7-0-2006; IN COMMERCE 7-0-2006.

FOR: PRINTED DIRECTORIES OF NATIONWIDE ADVERTISEMENTS, IN CLASS 16 (U.S. CLS. 2, 5, 22, 23, 29, 37, 38 AND 50).

FIRST USE 7-0-2006; IN COMMERCE 7-0-2006.

FOR: PROVIDING AN ON-LINE COMMERCIAL ADVERTISEMENT DIRECTORY VIA A GLOBAL COMPUTER COMMUNICATIONS NETWORK, IN CLASS 35 (U.S. CLS. 100, 101 AND 102).

FIRST USE 7-0-2006; IN COMMERCE 7-0-2006.

THE MARK CONSISTS OF STANDARD CHARACTERS WITHOUT CLAIM TO ANY PARTICULAR FONT, STYLE, SIZE, OR COLOR.

NO CLAIM IS MADE TO THE EXCLUSIVE RIGHT TO USE "NATIONWIDE", APART FROM THE MARK AS SHOWN.

SN 77-058,202, FILED 12-6-2006.

TOBY BULLOFF, EXAMINING ATTORNEY

**Int. Cls.: 11, 20, and 21**

**Prior U.S. Cls.: 2, 13, 21, 22, 23, 25, 29, 30, 31, 32, 33,  
34, 40, and 50**

**Reg. No. 3,505,857**

**United States Patent and Trademark Office**

**Registered Sep. 23, 2008**

**TRADEMARK  
PRINCIPAL REGISTER**

**LLADRO**

LLADRO USA, INC. (NEW JERSEY CORPORATION)  
1 LLADRO DRIVE  
MOONACHIE, NJ 07074

FOR: LAMPS AND CEILING LIGHTS; CHANDELIERS, IN CLASS 11 (U.S. CLS. 13, 21, 23, 31 AND 34).

FIRST USE 12-11-2006; IN COMMERCE 12-11-2006.

FOR: NON-METALLIC BOTTLE STOPPERS, WALL HOOKS, ROOM DIVIDERS, IN CLASS 20 (U.S. CLS. 2, 13, 22, 25, 32 AND 50).

FIRST USE 12-21-2006; IN COMMERCE 12-21-2006.

FOR: VASES, BOWLS, SALT AND PEPPER SHAKERS, IN CLASS 21 (U.S. CLS. 2, 13, 23, 29, 30, 33, 40 AND 50).

FIRST USE 12-20-2006; IN COMMERCE 12-20-2006.

THE MARK CONSISTS OF STANDARD CHARACTERS WITHOUT CLAIM TO ANY PARTICULAR FONT, STYLE, SIZE, OR COLOR.

OWNER OF U.S. REG. NOS. 834,717, 1,755,981, AND OTHERS.

SN 77-058,825, FILED 12-7-2006.

COLLEEN KEARNEY, EXAMINING ATTORNEY

**Int. Cls.: 11, 20, and 21**

**Prior U.S. Cls.: 2, 13, 21, 22, 23, 25, 29, 30, 31, 32, 33,  
34, 40, and 50**

**Reg. No. 3,505,858**

**United States Patent and Trademark Office**

**Registered Sep. 23, 2008**

**TRADEMARK  
PRINCIPAL REGISTER**



LLADRO USA, INC. (NEW JERSEY CORPORATION)  
1 LLADRO DRIVE  
MOONACHIE, NJ 07074

FOR: LAMPS AND CEILING LIGHTS; CHANDELIERS, IN CLASS 11 (U.S. CLS. 13, 21, 23, 31 AND 34).

FIRST USE 12-11-2006; IN COMMERCE 12-11-2006.

FOR: NON-METALLIC BOTTLE STOPPERS, WALL HOOKS, ROOM DIVIDERS, IN CLASS 20 (U.S. CLS. 2, 13, 22, 25, 32 AND 50).

FIRST USE 12-21-2006; IN COMMERCE 12-21-2006.

FOR: VASES, BOWLS, SALT AND PEPPER SHAKERS, IN CLASS 21 (U.S. CLS. 2, 13, 23, 29, 30, 33, 40 AND 50).

FIRST USE 12-20-2006; IN COMMERCE 12-20-2006.

OWNER OF U.S. REG. NOS. 1,310,087, 2,885,239, AND OTHERS.

THE MARK CONSISTS OF A FLOWER DESIGN.

SN 77-058,847, FILED 12-7-2006.

STEPHEN AQUILA, EXAMINING ATTORNEY



**Int. Cl.: 20**

**Prior U.S. Cls.: 2, 13, 22, 25, 32, and 50**

**Reg. No. 3,505,859**

**United States Patent and Trademark Office**

**Registered Sep. 23, 2008**

**TRADEMARK  
PRINCIPAL REGISTER**

**SCANRITE**

ST. JOHN COMPANIES, INC. (CALIFORNIA  
CORPORATION)  
25167 ANZA DRIVE  
VALENCIA, CA 91355

THE MARK CONSISTS OF STANDARD CHAR-  
ACTERS WITHOUT CLAIM TO ANY PARTICULAR  
FONT, STYLE, SIZE, OR COLOR.

FOR: NON-METAL THERMAL PRINTABLE PA-  
TIENT IDENTIFICATION WRISTBANDS, IN CLASS  
20 (U.S. CLS. 2, 13, 22, 25, 32 AND 50).

SN 77-059,040, FILED 12-7-2006.

FIRST USE 1-19-2007; IN COMMERCE 1-19-2007.

ROBIN CHOSID, EXAMINING ATTORNEY

**Int. Cl.: 35**

**Prior U.S. Cls.: 100, 101, and 102**

**United States Patent and Trademark Office**

**Reg. No. 3,505,860**

**Registered Sep. 23, 2008**

**SERVICE MARK  
PRINCIPAL REGISTER**



HOSPITALITY MARKETING CONSULTANTS  
LLC (CALIFORNIA LIMITED LIABILITY  
COMPANY)  
4701 VON KARMAN AVENUE  
NEWPORT BEACH, CA 92660

FOR: CUSTOMER LOYALTY SERVICES, NAME-  
LY, PROVIDING A TRAVEL AND HOTEL LOYAL-  
TY PROGRAM FEATURING LOYALTY POINTS,  
DISCOUNT RATES, AND RECOGNITION BENE-  
FITS FOR COMMERCIAL, PROMOTIONAL AND/  
OR ADVERTISING PURPOSES, IN CLASS 35 (U.S.  
CLS. 100, 101 AND 102).

FIRST USE 6-25-2008; IN COMMERCE 6-25-2008.

NO CLAIM IS MADE TO THE EXCLUSIVE  
RIGHT TO USE "HOTEL REWARDS", APART  
FROM THE MARK AS SHOWN.

THE MARK CONSISTS OF THE WORDS "VOILA  
HOTEL REWARDS" IN A STYLIZED FONT.

SN 77-059,208, FILED 12-7-2006.

SONYA STEPHENS, EXAMINING ATTORNEY

**Int. Cl.: 5**

**Prior U.S. Cls.: 6, 18, 44, 46, 51, and 52**

**United States Patent and Trademark Office**

**Reg. No. 3,505,861**

**Registered Sep. 23, 2008**

**TRADEMARK  
PRINCIPAL REGISTER**

**MIGRATOSE**

DESERT LAKE TECHNOLOGIES, LLC (OREGON  
LIMITED LIABILITY COMPANY)  
PO BOX 489  
KLAMATH FALLS, OR 97601

FOR: A NUTRITIONAL EXTRACT FOR NUTRI-  
TIONAL AND DIETARY PURPOSES, NAMELY, AN  
EXTRACT FROM ALGAE USED TO ENHANCE  
STEM CELL PHYSIOLOGY , IN CLASS 5 (U.S. CLS.  
6, 18, 44, 46, 51 AND 52).

FIRST USE 10-31-2005; IN COMMERCE 3-3-2006.

THE MARK CONSISTS OF STANDARD CHAR-  
ACTERS WITHOUT CLAIM TO ANY PARTICULAR  
FONT, STYLE, SIZE, OR COLOR.

SN 77-059,233, FILED 12-7-2006.

DAVID TAYLOR, EXAMINING ATTORNEY

**Int. Cl.: 9**

**Prior U.S. Cls.: 21, 23, 26, 36, and 38**

**United States Patent and Trademark Office**

**Reg. No. 3,505,862**

**Registered Sep. 23, 2008**

**TRADEMARK  
PRINCIPAL REGISTER**

**CALCUDISC**

JAMES MARTIN BEYEA (CANADA INDIVIDUAL)  
BOX 793  
1020 OLD CREAMERY ROAD  
COLDWATER, ONTARIO, CANADA L0K1E0

FOR: GAUGE FOR MEASURING THE LENGTH, WIDTH, DIAMETER AND SIMILAR DIMENSIONS OF VARIOUS OBJECTS, IN CLASS 9 (U.S. CLS. 21, 23, 26, 36 AND 38).

FIRST USE 7-11-2008; IN COMMERCE 7-11-2008.

THE MARK CONSISTS OF STANDARD CHARACTERS WITHOUT CLAIM TO ANY PARTICULAR FONT, STYLE, SIZE, OR COLOR.

SN 77-059,303, FILED 12-7-2006.

RUDY R. SINGLETON, EXAMINING ATTORNEY

Int. Cls.: 25 and 38

Prior U.S. Cls.: 22, 39, 100, 101, and 104

United States Patent and Trademark Office

Reg. No. 3,505,863

Registered Sep. 23, 2008

**TRADEMARK  
SERVICE MARK  
PRINCIPAL REGISTER**

**Lead It. Live It.**

GAMBOA, ALEX (UNITED STATES INDIVIDUAL)  
348 MILL ST  
RENO, NV 89501

FOR: CLOTHING, FORMAL WEAR, CASUAL WEAR, AND SPORTSWEAR FOR MEN, WOMEN, CHILDREN AND INFANTS, NAMELY, SHIRTS, T-SHIRTS, JACKETS, SWEATSHIRTS, JERSEYS, HATS, CAPS, SCARVES, BANDANAS, SHORTS, JEANS, SKIRTS, SLACKS, BLOUSES, DRESSES, VESTS, COATS, SWEATERS, SWIMSUITS, UNDERWEAR, UNDERPANTS, SLIPS, CAMISOLES, BRAS, NIGHTGOWNS, ROBES, SOCKS, HOSIERY, LONG SLEEVED SHIRTS, PANTS, JUMPERS, JUMPSUITS, OVERALLS, ONE-PIECE PLAYSUITS, PAJAMAS, FOOTWEAR, HEADWEAR, BELTS, UNDER SHIRTS, NIGHT SHIRTS, RUGBY SHIRTS, POLO SHIRTS, TOPS, CROP TOPS, TANK TOPS, HALTER TOPS, SWEAT SHIRTS, SWEAT SHORTS, SWEAT PANTS, WARM-UP SUITS, JOGGING SUITS, FLEECE VESTS, PULLOVERS, FLEECE PULLOVERS, PARKAS, ANORAKS, PONCHOS, DINNER JACKETS, SPORTS JACKETS, WRAPS, TOPS, TIES, GOLF AND SKI JACKETS, REVERSIBLE JACKETS,

COATS, BLAZERS, TURTLENECKS, SWIMWEAR, BEACHWEAR, HEADBANDS, WRIST BANDS, BRIEFS, TRUNKS, LOUNGEWEAR, RAINWEAR, UNIFORMS, ATHLETIC UNIFORMS, TROUSERS, DENIM JEANS, COVERALLS, JUMP SUITS, AND BOXER SHORTS, IN CLASS 25 (U.S. CLS. 22 AND 39).

FIRST USE 4-14-2007; IN COMMERCE 4-28-2007.

FOR: STREAMING OF VIDEO MATERIAL ON THE INTERNET; STREAMING OF AUDIO MATERIAL ON THE INTERNET, IN CLASS 38 (U.S. CLS. 100, 101 AND 104).

FIRST USE 11-13-2006; IN COMMERCE 11-13-2006.

THE MARK CONSISTS OF STANDARD CHARACTERS WITHOUT CLAIM TO ANY PARTICULAR FONT, STYLE, SIZE, OR COLOR.

SN 77-059,966, FILED 12-8-2006.

HANNO RITTNER, EXAMINING ATTORNEY

**Int. Cl.: 31**

**Prior U.S. Cls.: 1 and 46**

**United States Patent and Trademark Office**

**Reg. No. 3,505,864**

**Registered Sep. 23, 2008**

**TRADEMARK  
PRINCIPAL REGISTER**

**Evelina**

PFLANZEN HOFMANN GMBH (FED REP GER-  
MANY CORPORATION)

HAUPTSTR. 36

LANGENSEDELBACH, FED REP GERMANY D-  
91094 AND

FENO GMBH (FED REP GERMANY CORPORA-  
TION)

BAHNHOFSTR. 10

NEUMARKT (BZ), FED REP GERMANY I-39044

FOR: LIVE APPLE TREES AND FRESH APPLE  
FRUITS OBTAINED THEREFROM, IN CLASS 31  
(U.S. CLS. 1 AND 46).

FIRST USE 3-31-2007; IN COMMERCE 3-31-2007.

THE MARK CONSISTS OF STANDARD CHAR-  
ACTERS WITHOUT CLAIM TO ANY PARTICULAR  
FONT, STYLE, SIZE, OR COLOR.

OWNER OF FED REP GERMANY REG. NO.  
304344893, DATED 8-31-2004, EXPIRES 6-16-2014.

SN 77-061,175, FILED 12-11-2006.

BRIAN PINO, EXAMINING ATTORNEY

**Int. Cls.: 16, 38, and 42**

**Prior U.S. Cls.: 2, 5, 22, 23, 29, 37, 38, 50, 100, 101, and 104**

**Reg. No. 3,505,865**

**United States Patent and Trademark Office**

**Registered Sep. 23, 2008**

**TRADEMARK  
SERVICE MARK  
PRINCIPAL REGISTER**



CHINA INTERNATIONAL COMMUNICATIONS  
CO., LTD. (CHINA CORPORATION)  
9 YANGFANGDIANLU  
ROOM 712, JINMEN PLAZA  
HAIDIANQU, BEIJING, CHINA 100038

FOR: PRINTED PERIODICALS IN THE FIELD OF TELEVISION PROGRAMS; MAGAZINES FEATURING TELEVISION PROGRAMS; BOOKS IN THE FIELD OF TELEVISION PROGRAMS; NEWSLETTERS IN THE FIELD OF TELEVISION PROGRAMS; PRINTED PUBLICATIONS, NAMELY, BROCHURES, BOOKLETS, POSTERS IN THE FIELD OF TELEVISION PROGRAMS; PRINTED MATTERS NAMELY, BROCHURES, BOOKLETS, POSTERS IN THE FIELD OF TELEVISION PROGRAMS; ALBUMS, NAMELY, EVENT ALBUMS, PHOTOGRAPHIC ALBUMS; PHOTOGRAPHS, IN CLASS 16 (U.S. CLS. 2, 5, 22, 23, 29, 37, 38 AND 50).

FIRST USE 12-4-2006; IN COMMERCE 3-1-2007.

FOR: RADIO BROADCASTING; TELEVISION BROADCASTING; CABLE TELEVISION BROADCASTING; NEWS AGENCIES, NAMELY, THE TRANSMISSION OF NEWS ITEMS TO NEWS REPORTING ORGANIZATIONS; ELECTRONIC MESSAGE SENDING; COMMUNICATIONS BY COMPUTER TERMINALS; ELECTRONIC MAIL SERVICES; PROVIDING ON-LINE CHAT ROOMS AND ELECTRONIC BULLETIN BOARDS FOR TRANSMISSION OF MESSAGES AMONG USERS IN THE FIELD OF GENERAL INTEREST, IN CLASS 38 (U.S. CLS. 100, 101 AND 104).

FIRST USE 10-1-2004; IN COMMERCE 10-1-2004.

FOR: CONVERSION OF DATA OR DOCUMENTS FROM PHYSICAL TO ELECTRONIC MEDIA; HOSTING COMPUTER WEB SITES OF OTHERS ON A COMPUTER SERVER FOR A GLOBAL NETWORK; CREATING AND MAINTAINING WEB SITES FOR OTHERS; ENGINEERING; RESEARCH AND DEVELOPMENT FOR NEW PRODUCTS FOR OTHERS; COMPUTER SYSTEMS ANALYSIS; UPDATING OF COMPUTER SOFTWARE FOR OTHERS, IN CLASS 42 (U.S. CLS. 100 AND 101).

FIRST USE 10-1-2004; IN COMMERCE 10-1-2004.

NO CLAIM IS MADE TO THE EXCLUSIVE RIGHT TO USE "PING TAI", THE CHARACTERS THAT TRANSLATE INTO "PLATFORM", APART FROM THE MARK AS SHOWN.

THE FOREIGN WORDING IN THE MARK TRANSLATES INTO ENGLISH AS GREAT WALL PLATFORM.

THE NON-LATIN CHARACTERS IN THE MARK TRANSLITERATE TO "CHANG CHENG PING TAI" AND THIS MEANS "GREAT WALL PLATFORM" IN ENGLISH.

SN 77-063,676, FILED 12-13-2006.

MATTHEW MCDOWELL, EXAMINING ATTORNEY

**Int. Cl.: 45**

**Prior U.S. Cls.: 100 and 101**

**United States Patent and Trademark Office**

**Reg. No. 3,505,866**

**Registered Sep. 23, 2008**

**SERVICE MARK  
PRINCIPAL REGISTER**



WYETH (DELAWARE CORPORATION)  
FIVE GIRALDA FARMS  
MADISON, NJ 07940

THE GRAY IS FOR SHADING PURPOSES ONLY.

FOR: ORGANIZING AND CONDUCTING SUPPORT GROUPS FOR PATIENTS IN THE FIELD OF MENOPAUSE, IN CLASS 45 (U.S. CLS. 100 AND 101).

THE MARK CONSISTS OF THE WORDS "M POWERED WOMAN" IN WHITE; IN A BLACK AND GRAY RECTANGULAR DESIGN.

FIRST USE 4-15-2007; IN COMMERCE 4-15-2007.

SN 77-064,527, FILED 12-14-2006.

NO CLAIM IS MADE TO THE EXCLUSIVE RIGHT TO USE "WOMAN", APART FROM THE MARK AS SHOWN.

BERYL GARDNER, EXAMINING ATTORNEY



**Int. Cl.: 11**

**Prior U.S. Cls.: 13, 21, 23, 31, and 34**

**United States Patent and Trademark Office**

**Reg. No. 3,505,867**

**Registered Sep. 23, 2008**

**TRADEMARK  
PRINCIPAL REGISTER**

**ECOFRESH**

DESICCANT ROTORS INTERNATIONAL (INDIA  
PRIVATE LIMITED COMPANY)  
20, RAJPUR ROAD  
DELHI, INDIA 110054

FOR: ENERGY RECOVERY VENTILATORS FOR  
RECOVERING AND REFRESHING AIR AND  
PARTS THEREFOR, NAMELY, ENTHALPY RO-  
TORS, SENSIBLE ROTORS, ENERGY RECOVERY  
HEATERS, ALSO KNOWN AS HEAT WHEELS,  
ROTORS, AND CASSETTES; EQUIPMENT FOR  
FRESH AIR TREATMENT, NAMELY, AIR PURIFI-  
ERS, AIR CLEANING UNITS AND INDUSTRIAL  
AND COMMERCIAL AIR FILTER MACHINES,  
WHICH ALSO FUNCTION TO RECOVER ENERGY  
AND MAINTAIN INDOOR AIR QUALITY; AIR  
HANDLING AND TREATED FRESH AIR UNITS,

NAMELY, AIR CLEANING UNITS CONTAINING  
AN AIR FILTER, ULTRAVIOLET LIGHTS AND A  
PHOTOCATALYTIC FILTER, IN CLASS 11 (U.S.  
CLS. 13, 21, 23, 31 AND 34).

FIRST USE 1-31-1995; IN COMMERCE 12-31-1996.

THE MARK CONSISTS OF STANDARD CHAR-  
ACTERS WITHOUT CLAIM TO ANY PARTICULAR  
FONT, STYLE, SIZE, OR COLOR.

OWNER OF U.S. REG. NO. 2,903,098.

SN 77-065,071, FILED 12-15-2006.

BRENDAN MCCAULEY, EXAMINING ATTORNEY

**Int. Cl.: 6**

**Prior U.S. Cls.: 2, 12, 13, 14, 23, 25, and 50**

**Reg. No. 3,505,868**

**United States Patent and Trademark Office**

**Registered Sep. 23, 2008**

**TRADEMARK  
PRINCIPAL REGISTER**

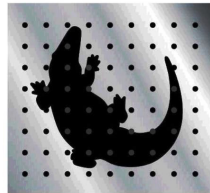

**GatorGrid**  
**PEG PANELS**  
METAL IS STRONGER

SYR-TECH PERFORATING CO. (ILLINOIS CORPORATION)  
325 WINDY POINT DRIVE  
GLENDALE HEIGHTS, IL 60139

FOR: METAL PEG BOARDS, IN CLASS 6 (U.S. CLS. 2, 12, 13, 14, 23, 25 AND 50).

FIRST USE 7-7-2007; IN COMMERCE 7-7-2007.

NO CLAIM IS MADE TO THE EXCLUSIVE RIGHT TO USE "PEG PANELS" AND "METAL IS

STRONGER", APART FROM THE MARK AS SHOWN.

THE MARK CONSISTS OF AN IMAGE OF AN ALLIGATOR SUPERIMPOSED OVER A SQUARE SHAPED PEG PANEL UNDER WHICH THE LITERAL ELEMENTS OF THE MARK ARE SHOWN.

SN 77-065,380, FILED 12-15-2006.

CAROLYN CATALDO, EXAMINING ATTORNEY

**Int. Cls.: 35 and 45**

**Prior U.S. Cls.: 100, 101, and 102**

**United States Patent and Trademark Office**

**Reg. No. 3,505,869**

**Registered Sep. 23, 2008**

**SERVICE MARK  
PRINCIPAL REGISTER**

**"WE'RE GOING TO MAKE YOUR  
BUSINESS DAY BETTER!"**

SMARTTALENT LLC (WASHINGTON LIMITED  
LIABILITY COMPANY)  
1321 FOURTH AVENUE  
SEATTLE, WA 98101

FOR: BUSINESS SERVICES, NAMELY, BUSINESS CONSULTING IN THE FIELDS OF HUMAN RESOURCES, MANAGEMENT CONSULTING, AND SCREENING, EVALUATION AND TRAINING JOB RECRUITS; JOB, PROFESSIONAL EMPLOYMENT, EXECUTIVE, CAREER AND PERSONNEL PLACEMENT SERVICES; EMPLOYMENT HIRING, RECRUITING AND STAFFING SERVICES; EXECUTIVE SEARCH SERVICES; ONLINE BUSINESS DIRECTORIES FEATURING JOB LISTINGS AND EMPLOYMENT CANDIDATE BIOS; EMPLOYMENT COUNSELING; TEMPORARY EMPLOYMENT AGENCIES; PROVIDING OFFICE SUPPORT STAFF SERVICES; EMPLOYMENT OUTPLACEMENT SERVICES; ON-SITE BUSINESS MANAGEMENT; OVERSIGHT IN THE NATURE OF BUSINESS MANAGEMENT AND BUSINESS SUPERVISION SERVICES; ADMINISTRATION OF ACCOUNTING AND BUSINESS PAYROLL SERVICES FOR OTHERS; FULL-TIME JOB PLACEMENT; TEMPORARY JOB PLACEMENT; TEMP-TO-HIRE JOB PLACEMENT; ACCOUNTING SERVICES; OPERATION OF TELEPHONE CALL CENTERS FOR

OTHERS; CUSTOMER SERVICE IN THE FIELD OF HUMAN RESOURCES; WAREHOUSE STAFFING SERVICES; DISTRIBUTION CENTER STAFFING SERVICES; TRANSPORTATION STAFFING SERVICES; MEDICAL OFFICE STAFFING SERVICES; LEGAL OFFICE STAFFING SERVICES; ADMINISTRATIVE STAFFING SERVICES; FINANCIAL STAFFING SERVICES; PROFESSIONAL STAFFING SERVICES; PRE-EMPLOYMENT SKILLS EVALUATION TO DETERMINE EMPLOYMENT SKILLS, IN CLASS 35 (U.S. CLS. 100, 101 AND 102).

FIRST USE 0-0-2001; IN COMMERCE 0-0-2007.

FOR: PRE-EMPLOYMENT BACKGROUND SCREENING, IN CLASS 45 (U.S. CLS. 100 AND 101).

FIRST USE 0-0-2001; IN COMMERCE 0-0-2007.

THE MARK CONSISTS OF STANDARD CHARACTERS WITHOUT CLAIM TO ANY PARTICULAR FONT, STYLE, SIZE, OR COLOR.

SN 77-065,704, FILED 12-15-2006.

ALEX KEAM, EXAMINING ATTORNEY

**Int. Cl.: 32**

**Prior U.S. Cls.: 45, 46, and 48**

**Reg. No. 3,505,870**

**United States Patent and Trademark Office**

**Registered Sep. 23, 2008**

---

**TRADEMARK  
PRINCIPAL REGISTER**

**CRANERGY**

OCEAN SPRAY CRANBERRIES, INC. (DELA-  
WARE CORPORATION)  
ONE OCEAN SPRAY DRIVE  
LAKEVILLE, MA 02349

THE MARK CONSISTS OF STANDARD CHAR-  
ACTERS WITHOUT CLAIM TO ANY PARTICULAR  
FONT, STYLE, SIZE, OR COLOR.

FOR: JUICE BASED ENERGY DRINK, IN CLASS  
32 (U.S. CLS. 45, 46 AND 48).

SN 77-067,338, FILED 12-19-2006.

FIRST USE 2-11-2008; IN COMMERCE 2-11-2008.

NICHOLAS ALTREE, EXAMINING ATTORNEY

Int. Cl.: 25

Prior U.S. Cls.: 22 and 39

United States Patent and Trademark Office

Reg. No. 3,505,871

Registered Sep. 23, 2008

TRADEMARK  
PRINCIPAL REGISTER



MORERA, LAWRENCE (UNITED STATES INDIVIDUAL)

# 736

9903 SANTA MONICA BLVD.  
BEVERLY HILLS, CA 90212

FOR: CLOTHING, NAMELY, SHIRTS, T-SHIRTS, PULLOVERS, SWEATERS, JACKETS, COATS, PANTS, UNDERWEAR, BEACHWEAR, SHORTS, SKIRTS, DRESSES, SOCKS, STOCKINGS, SLEEPWEAR, CAPS AND HATS, AND FOOTWEAR, IN CLASS 25 (U.S. CLS. 22 AND 39).

FIRST USE 2-15-2008; IN COMMERCE 2-15-2008.

NO CLAIM IS MADE TO THE EXCLUSIVE RIGHT TO USE "LOS ANGELES", APART FROM THE MARK AS SHOWN.

THE MARK CONSISTS OF A LION, UNICORN, AND HELMET WITH CROWN SURROUNDING A SHIELD WHICH IN TURN COMPRISES FOUR QUARTERS, INCLUDING AN ANGEL, A CROSS, A FLEUR DE LIE AND AN EAGLE, SUPERIMPOSED UPON A BACKGROUND OF FLOWERS.

SN 77-067,632, FILED 12-19-2006.

DAVID HOFFMAN, EXAMINING ATTORNEY

**Int. Cl.: 28**

**Prior U.S. Cls.: 22, 23, 38, and 50**

**United States Patent and Trademark Office**

**Reg. No. 3,505,872**

**Registered Sep. 23, 2008**

**TRADEMARK  
PRINCIPAL REGISTER**



SLINGO, INC. (NEW JERSEY CORPORATION)  
411 HACKENSACK AVENUE  
HACKENSACK, NJ 07601

FOR: GAME TABLES FOR PLAYING CARDS, IN  
CLASS 28 (U.S. CLS. 22, 23, 38 AND 50).

FIRST USE 8-27-2007; IN COMMERCE 8-27-2007.

OWNER OF U.S. REG. NOS. 2,063,768 AND  
2,651,182.

NO CLAIM IS MADE TO THE EXCLUSIVE  
RIGHT TO USE "BONUS BET 21 BLACKJACK  
ROULETTE", APART FROM THE MARK AS  
SHOWN.

THE MARK CONSISTS OF THE WORDS SLINGO  
BONUS BET 21 BLACKJACK ROULETTE WITH  
DESIGN ELEMENTS INCLUDING STARS AND A  
GAMBLING WHEEL.

SN 77-067,764, FILED 12-19-2006.

JENNIFER VASQUEZ, EXAMINING ATTORNEY

**Int. Cl.: 25**

**Prior U.S. Cls.: 22 and 39**

**United States Patent and Trademark Office**

**Reg. No. 3,505,873**

**Registered Sep. 23, 2008**

**TRADEMARK  
PRINCIPAL REGISTER**

**I Rest My Case**

ROBERTS, VICKI (UNITED STATES INDIVIDUAL), DBA I REST MY CASE,  
3435 OCEAN PARK BOULEVARD, SUITE 107  
SANTA MONICA, CA 90405

FOR: CLOTHING, NAMELY, SHIRTS, PANTS, JACKETS, HATS, SKIRTS AND BLOUSES ALL FOR USE AS DRESSWEAR, SPORTSWEAR AND CASUALWEAR, IN CLASS 25 (U.S. CLS. 22 AND 39).

FIRST USE 2-12-2007; IN COMMERCE 2-12-2007.

THE MARK CONSISTS OF STANDARD CHARACTERS WITHOUT CLAIM TO ANY PARTICULAR FONT, STYLE, SIZE, OR COLOR.

SN 77-068,279, FILED 12-20-2006.

SKYE YOUNG, EXAMINING ATTORNEY

**Int. Cls.: 20 and 24**

**Prior U.S. Cls.: 2, 13, 22, 25, 32, 42, and 50**

**United States Patent and Trademark Office**

**Reg. No. 3,505,874**

**Registered Sep. 23, 2008**

**TRADEMARK  
PRINCIPAL REGISTER**

**EVERYTHING KIDS**

CROWN CRAFTS INFANT PRODUCTS, INC.  
(DELAWARE CORPORATION)  
916 S. BURNSIDE AVENUE  
GONZALES, LA 70737

FOR: NURSING PILLOWS; PILLOWS, IN CLASS  
20 (U.S. CLS. 2, 13, 22, 25, 32 AND 50).

FIRST USE 5-31-2007; IN COMMERCE 5-31-2007.

FOR: BATH TOWELS; BED BLANKETS; BED  
SHEETS; BED SKIRTS; BED SPREADS; BLANKET  
THROWS; BURP CLOTHS; CHILDREN'S BLAN-  
KETS; CHILDREN'S TOWELS; COMFORTERS;  
CRIB BUMPER PADS; CRIB BUMPERS; DIAPER  
CHANGING MATS; DIAPER CHANGING PADS  
NOT OF PAPER; DUST RUFFLES; FABRIC DIAPER  
STACKERS; MATTRESS PADS; PILLOW CASES;

RECEIVING BLANKETS; SHOWER CURTAINS;  
WASHCLOTHS, IN CLASS 24 (U.S. CLS. 42 AND 50).

FIRST USE 5-31-2007; IN COMMERCE 5-31-2007.

THE MARK CONSISTS OF STANDARD CHAR-  
ACTERS WITHOUT CLAIM TO ANY PARTICULAR  
FONT, STYLE, SIZE, OR COLOR.

NO CLAIM IS MADE TO THE EXCLUSIVE  
RIGHT TO USE "KIDS", APART FROM THE MARK  
AS SHOWN.

SN 77-069,426, FILED 12-21-2006.

WILLIAM BRECKENFELD, EXAMINING ATTOR-  
NEY



**Int. Cl.: 38**

**Prior U.S. Cls.: 100, 101, and 104**

**United States Patent and Trademark Office**

**Reg. No. 3,505,875**

**Registered Sep. 23, 2008**

**SERVICE MARK  
PRINCIPAL REGISTER**

**FASTTRAC**

GULF STATES FINANCIAL SERVICES, INC.  
(TEXAS CORPORATION)  
SUITE 801  
13201 NW FREEWAY  
HOUSTON, TX 77040

FOR: COMMUNICATIONS SERVICES, NAMELY,  
PROVIDING ACCESS TO DATABASES IN FIELDS  
OF AUTOMOTIVE EXTENDED WARRANTIES, AU-  
TOMOTIVE INSURANCE, AUTOMOTIVE FINAN-  
CING AND AUTOMOTIVE SALES, IN CLASS 38  
(U.S. CLS. 100, 101 AND 104).

FIRST USE 12-21-2005; IN COMMERCE 12-21-2005.

THE MARK CONSISTS OF STANDARD CHAR-  
ACTERS WITHOUT CLAIM TO ANY PARTICULAR  
FONT, STYLE, SIZE, OR COLOR.

SN 77-069,696, FILED 12-21-2006.

MARILYN IZZI, EXAMINING ATTORNEY

Int. Cl.: 25

Prior U.S. Cls.: 22 and 39

United States Patent and Trademark Office

Reg. No. 3,505,876

Registered Sep. 23, 2008

**TRADEMARK  
PRINCIPAL REGISTER**



FAMIGLIETTI ANTHONY (UNITED STATES INDIVIDUAL)  
3656 TALILUNA AVE  
KNOXVILLE, TN 37919

FOR: GYM SHORTS; JOGGING PANTS; RUNNING SHOES; SPORTS SHIRTS; SWEAT PANTS; TRACK AND FIELD SHOES; TRACK PANTS; TRACK SUITS, IN CLASS 25 (U.S. CLS. 22 AND 39).

FIRST USE 8-16-2006; IN COMMERCE 11-30-2006.

THE MARK CONSISTS OF A WINGED SKELETON FOOT. THE BONEY FOOT HAS FRACTURES AND CRACKS SHOWING WEAR AND TEAR. THE WING ATTACHED TO THE FOOT APPEARS SHREDDED AND MANGLED. THE FEATHERS ARE TATTERED AS WELL EXPOSING THE BONES OF THE WING.

SN 77-070,443, FILED 12-22-2006.

THEODORE MCBRIDE, EXAMINING ATTORNEY

**Int. Cls.: 3 and 5**

**Prior U.S. Cls.: 1, 4, 6, 18, 44, 46, 50, 51, and 52**

**United States Patent and Trademark Office**

**Reg. No. 3,505,877**

**Registered Sep. 23, 2008**

**TRADEMARK  
PRINCIPAL REGISTER**

**GOREADY**

NATURAL TRENDS, LLC (UTAH LIMITED LIABILITY COMPANY)  
63 NORTH 400 WEST  
PROVO, UT 84601

FOR: NON-MEDICATED SKIN CARE PREPARATIONS; SUNSCREEN PREPARATIONS; CLEANING PREPARATIONS FOR HOUSEHOLD PURPOSES; CLEANING PREPARATIONS FOR PERSONAL PURPOSES, NAMELY, SKIN CARE, IN CLASS 3 (U.S. CLS. 1, 4, 6, 50, 51 AND 52).

FIRST USE 10-1-2006; IN COMMERCE 10-1-2006.

FOR: INSECT REPELLENTS FOR TOPICAL APPLICATION; ANTIBACTERIAL PREPARATIONS

FOR TOPICAL APPLICATION IN THE FORM OF LOTIONS, SPRAYS, SOAPS, AND GELS, IN CLASS 5 (U.S. CLS. 6, 18, 44, 46, 51 AND 52).

FIRST USE 10-1-2006; IN COMMERCE 10-1-2006.

THE MARK CONSISTS OF STANDARD CHARACTERS WITHOUT CLAIM TO ANY PARTICULAR FONT, STYLE, SIZE, OR COLOR.

SN 77-070,848, FILED 12-22-2006.

CORY BOONE, EXAMINING ATTORNEY

**Int. Cls.: 39 and 40**

**Prior U.S. Cls.: 100, 103, 105, and 106**

**United States Patent and Trademark Office**

**Reg. No. 3,505,878**

**Registered Sep. 23, 2008**

**SERVICE MARK  
PRINCIPAL REGISTER**



DCP MIDSTREAM, LLC (DELAWARE LIMITED  
LIABILITY COMPANY)  
370 17TH STREET  
SUITE 200  
DENVER, CO 80202

FOR: GATHERING, TRANSPORTING, DISTRI-  
BUTION, STORING AND TERMINALING OF NAT-  
URAL GAS AND NATURAL GAS LIQUIDS, IN  
CLASS 39 (U.S. CLS. 100 AND 105).

FIRST USE 1-1-2007; IN COMMERCE 1-1-2007.

FOR: TREATING, COMPRESSION, AND PRO-  
CESSING, NAMELY, SEPARATING AND FRACTIO-  
NATING OF NATURAL GAS AND NATURAL GAS  
LIQUIDS, IN CLASS 40 (U.S. CLS. 100, 103 AND 106).

FIRST USE 1-1-2007; IN COMMERCE 1-1-2007.

NO CLAIM IS MADE TO THE EXCLUSIVE  
RIGHT TO USE "MIDSTREAM", APART FROM  
THE MARK AS SHOWN.

THE MARK CONSISTS OF THE WORDS "DCP  
MIDSTREAM" WITH STYLIZED WEDGING; THE  
MARK IS NOT IN COLOR, GRAY SHADING IN-  
DICATES CONTRAST ONLY.

SN 77-071,443, FILED 12-26-2006.

ANDREA BUTLER, EXAMINING ATTORNEY

**Int. Cl.: 3**

**Prior U.S. Cls.: 1, 4, 6, 50, 51, and 52**

**United States Patent and Trademark Office**

**Reg. No. 3,505,879**

**Registered Sep. 23, 2008**

**TRADEMARK  
PRINCIPAL REGISTER**

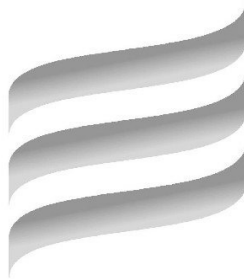

PERIO, INC. (OHIO CORPORATION)  
6156 WILCOX ROAD  
COLUMBUS, OH 43016

FOR: AFTER-SHAVE BALMS; BODY SPRAYS;  
SHAVING CREAM; SHAVING GEL; SHOWER  
AND BATH GEL, IN CLASS 3 (U.S. CLS. 1, 4, 6, 50,  
51 AND 52).

FIRST USE 11-0-2006; IN COMMERCE 11-0-2006.

THE MARK CONSISTS OF THREE HORIZONTAL  
STRIPES DISPLAYED ON AN ANGLE.

SN 77-072,627, FILED 12-28-2006.

ERIN FALK, EXAMINING ATTORNEY

**Int. Cl.: 25**

**Prior U.S. Cls.: 22 and 39**

**United States Patent and Trademark Office**

**Reg. No. 3,505,880**

**Registered Sep. 23, 2008**

**TRADEMARK  
PRINCIPAL REGISTER**

**ZIPZ SYSTEM**

MARSHMALLOW SKINS, INC. (CALIFORNIA  
CORPORATION)  
1315 N. TUSTIN AVENUE, SUITE I-183  
ORANGE, CA 92867

FOR: CLOTHING, NAMELY, HATS, PANTS,  
JACKETS, AND SHIRTS; FOOTWEAR; AND FOOT-  
WEAR COMPONENTS, NAMELY, UPPERS, INNER  
SOLES, AND OUTER SOLES, IN CLASS 25 (U.S. CLS.  
22 AND 39).

FIRST USE 12-0-2006; IN COMMERCE 12-0-2006.

THE MARK CONSISTS OF STANDARD CHAR-  
ACTERS WITHOUT CLAIM TO ANY PARTICULAR  
FONT, STYLE, SIZE, OR COLOR.

SN 77-074,350, FILED 1-2-2007.

TIMOTHY FINNEGAN, EXAMINING ATTORNEY

**Int. Cl.: 29**

**Prior U.S. Cl.: 46**

**United States Patent and Trademark Office**

**Reg. No. 3,505,881**

**Registered Sep. 23, 2008**

**TRADEMARK  
PRINCIPAL REGISTER**

**SYMMETRIX**

CARGILL MEAT SOLUTIONS CORPORATION  
(DELAWARE CORPORATION)  
151 NORTH MAIN  
WICHITA, KS 67202

THE MARK CONSISTS OF STANDARD CHAR-  
ACTERS WITHOUT CLAIM TO ANY PARTICULAR  
FONT, STYLE, SIZE, OR COLOR.

FOR: MEAT, IN CLASS 29 (U.S. CL. 46).

SN 77-074,835, FILED 1-3-2007.

FIRST USE 10-20-2007; IN COMMERCE 10-20-2007.

LOURDES AYALA, EXAMINING ATTORNEY

**Int. Cl.: 3**

**Prior U.S. Cls.: 1, 4, 6, 50, 51, and 52**

**Reg. No. 3,505,882**

**United States Patent and Trademark Office**

**Registered Sep. 23, 2008**

---

**TRADEMARK  
PRINCIPAL REGISTER**

**ALPINE FORCE**

COLGATE-PALMOLIVE COMPANY (DELA-  
WARE CORPORATION)  
300 PARK AVENUE  
NEW YORK, NY 10022

THE MARK CONSISTS OF STANDARD CHAR-  
ACTERS WITHOUT CLAIM TO ANY PARTICULAR  
FONT, STYLE, SIZE, OR COLOR.

FOR: DEODORANTS AND ANTIPERSPIRANTS,  
IN CLASS 3 (U.S. CLS. 1, 4, 6, 50, 51 AND 52).

SN 77-075,086, FILED 1-3-2007.

FIRST USE 8-1-2007; IN COMMERCE 8-1-2007.

KATHERINE CHANG, EXAMINING ATTORNEY



**Int. Cls.: 25 and 26**

**Prior U.S. Cls.: 22, 37, 39, 40, 42, and 50**

**United States Patent and Trademark Office**

**Reg. No. 3,505,883**

**Registered Sep. 23, 2008**

**TRADEMARK  
PRINCIPAL REGISTER**



FOSTER, KAREN D (UNITED STATES INDIVIDUAL)  
919 GEERS AVE  
COLUMBUS, OH 43206

FOR: SWIMMING CAPS, IN CLASS 25 (U.S. CLS. 22 AND 39).

FIRST USE 8-13-2007; IN COMMERCE 8-18-2007.

FOR: HAIR EXTENSIONS, IN CLASS 26 (U.S. CLS. 37, 39, 40, 42 AND 50).

FIRST USE 8-13-2007; IN COMMERCE 8-18-2007.

THE MARK CONSISTS OF A DESIGN TO SYMBOLIZE THE CAPITAL LETTER "S" WITH A LETTER "W" UNDER AND WITHIN THE "S", ALONG WITH A LOWER CASE "I" AND "G". THE MARK SHOULD SPELL "SWIG" (WSIG).

SN 77-077,919, FILED 1-8-2007.

EMILY CARLSEN, EXAMINING ATTORNEY

Int. Cl.: 35

Prior U.S. Cls.: 100, 101, and 102

United States Patent and Trademark Office

Reg. No. 3,505,884

Registered Sep. 23, 2008

SERVICE MARK  
PRINCIPAL REGISTER



BLUE COAST FINANCIAL GROUP (ARIZONA  
LIMITED LIABILITY COMPANY)  
SUITE C100  
2929 N. POWER ROAD  
MESA, AZ 85215

FOR: PROMOTION OF BUSINESS OPPORTUNITIES TO CONSUMERS IN THE FOLLOWING AREAS, NAMELY REVIEWING OF WORKER'S COMPENSATION PREMIUMS; LEASING EQUIPMENT; REVIEWING AND AUDITING OF COSTS OF OTHER SERVICES, IN CLASS 35 (U.S. CLS. 100, 101 AND 102).

FIRST USE 10-0-2006; IN COMMERCE 1-0-2007.

NO CLAIM IS MADE TO THE EXCLUSIVE RIGHT TO USE "FINANCIAL GROUP", APART FROM THE MARK AS SHOWN.

THE COLOR(S) DARK BLUE PMS534C, WHITE, LIGHT BLUE PMS279C IS/ARE CLAIMED AS A FEATURE OF THE MARK.

THE MARK CONSISTS OF THE DESIGN OF THE WAVE IS IN THE FOLLOWING COLORS: THE BOTTOM WAVE IS IN DARK BLUE, THE NEXT WAVE ABOVE IS IN WHITE, WHILE THE BACKGROUND IS LIGHT BLUE; THE ENTIRE RECTANGLE DESIGN OF THE WAVE IS OUTLINED IN A THICK WHITE LINE; THE WORDING "BLUE COAST" IS IN DARK BLUE; THE WORDING "BLUE COAST" IS UNDERLINED IN A LIGHT BLUE LINE; AND THE WORDING "FINANCIAL GROUP" IS IN LIGHT BLUE.

SN 77-079,594, FILED 1-10-2007.

SUE LAWRENCE, EXAMINING ATTORNEY

**Int. Cl.: 1**

**Prior U.S. Cls.: 1, 5, 6, 10, 26, and 46**

**United States Patent and Trademark Office**

**Reg. No. 3,505,885**

**Registered Sep. 23, 2008**

**TRADEMARK  
PRINCIPAL REGISTER**

**CHIRALSCREEN**

DAICEL CHEMICAL INDUSTRIES, LTD. (JAPAN  
CORPORATION)  
1, TEPPU-CHO, SAKAI-KU  
SAKAI-SHI, OSAKA, JAPAN

FOR: ENZYME PREPARATIONS FOR FINE CHEMICALS INDUSTRY; ENZYME PREPARATIONS FOR AGRICULTURAL USE; ENZYME PREPARATIONS FOR RESEARCH PURPOSES; ENZYME PREPARATIONS FOR SYNTHESIS OR PRODUCTION OF FINE CHEMICALS; OTHER ENZYME AND ENZYME PREPARATIONS FOR SYNTHESIS OR PRODUCTION OF RAW MATERIALS FOR PHAR-

MACEUTICALS OR AGROCHEMICALS, IN CLASS 1 (U.S. CLS. 1, 5, 6, 10, 26 AND 46).

FIRST USE 7-1-2007; IN COMMERCE 1-29-2008.

THE MARK CONSISTS OF STANDARD CHARACTERS WITHOUT CLAIM TO ANY PARTICULAR FONT, STYLE, SIZE, OR COLOR.

SN 77-080,708, FILED 1-11-2007.

CAROLYN CATALDO, EXAMINING ATTORNEY

**Int. Cl.: 33**

**Prior U.S. Cls.: 47 and 49**

**United States Patent and Trademark Office**

**Reg. No. 3,505,886**

**Registered Sep. 23, 2008**

**TRADEMARK  
PRINCIPAL REGISTER**

**CINQUAIN CELLARS**

NAGENGAST, DAVID (UNITED STATES INDIVIDUAL)  
6404 INDEPENDENCE RANCH PLACE  
SAN MIGUEL, CA 93451

NO CLAIM IS MADE TO THE EXCLUSIVE RIGHT TO USE "CELLARS", APART FROM THE MARK AS SHOWN.

FOR: WINE, IN CLASS 33 (U.S. CLS. 47 AND 49).

FIRST USE 5-9-2008; IN COMMERCE 5-9-2008.

SN 77-082,232, FILED 1-12-2007.

THE MARK CONSISTS OF STANDARD CHARACTERS WITHOUT CLAIM TO ANY PARTICULAR FONT, STYLE, SIZE, OR COLOR.

DORITT L. CARROLL, EXAMINING ATTORNEY

**Int. Cl.: 28**

**Prior U.S. Cls.: 22, 23, 38, and 50**

**United States Patent and Trademark Office**

**Reg. No. 3,505,887**

**Registered Sep. 23, 2008**

**TRADEMARK  
PRINCIPAL REGISTER**

**OOGWAY**

DREAMWORKS ANIMATION L.L.C. (DELA-  
WARE LIMITED LIABILITY COMPANY)  
1000 FLOWER STREET  
GLENDALE, CA 91201

FOR: ACTION FIGURES AND ACCESSORIES  
THEREFOR, IN CLASS 28 (U.S. CLS. 22, 23, 38 AND  
50).

FIRST USE 5-1-2008; IN COMMERCE 5-1-2008.

THE MARK CONSISTS OF STANDARD CHAR-  
ACTERS WITHOUT CLAIM TO ANY PARTICULAR  
FONT, STYLE, SIZE, OR COLOR.

THE ENGLISH TRANSLATION OF THE CHI-  
NESE WORD "OOGWAY" IS "TURTLE" OR "TOR-  
TOISE".

SN 77-082,370, FILED 1-12-2007.

ANDREW RHIM, EXAMINING ATTORNEY

Int. Cl.: 41

Prior U.S. Cls.: 100, 101, and 107

United States Patent and Trademark Office

Reg. No. 3,505,888

Registered Sep. 23, 2008

**SERVICE MARK  
PRINCIPAL REGISTER**



*The road home is a long journey.*

WILHELM, DONNETTA DBA CBT PUBLICATIONS, LLC. (COLORADO LIMITED LIABILITY COMPANY)  
1642 SOUTH PAGOSA COURT  
AURORA, CO 80017

FOR: BOOK AND REVIEW PUBLISHING; ELECTRONIC PUBLISHING SERVICES, NAMELY, PUBLICATION OF TEXT AND GRAPHIC WORKS OF OTHERS ON WEB AND ON-LINE FEATURING CHRISTIAN, SPIRITUAL AND INSPIRATIONAL TOPICS; PUBLISHING OF BOOKS, MAGAZINES; PUBLISHING OF ELECTRONIC PUBLICATIONS, IN CLASS 41 (U.S. CLS. 100, 101 AND 107).

FIRST USE 3-1-2007; IN COMMERCE 10-1-2007.

THE MARK CONSISTS OF AN IMAGE OF AN OLD WOMAN WALKING DOWN A TREE-LINED, DIRT PATH WITH THE WORDS "THE ROAD HOME IS A LONG JOURNEY." AT THE BOTTOM OF THE IMAGE.

SN 77-082,741, FILED 1-14-2007.

APRIL ROACH, EXAMINING ATTORNEY

Int. Cl.: 25

Prior U.S. Cls.: 22 and 39

United States Patent and Trademark Office

Reg. No. 3,505,889

Registered Sep. 23, 2008

TRADEMARK  
PRINCIPAL REGISTER

*Damita K*

SPOT FOOTWEAR INC (CALIFORNIA COR-  
PORATION)  
17448 RAILROAD ST  
ROWLAND HEIGHTS, CA 91748

FIRST USE 7-1-2007; IN COMMERCE 7-1-2007.

SN 77-083,037, FILED 1-15-2007.

FOR: SHOES, IN CLASS 25 (U.S. CLS. 22 AND 39).

BENJAMIN ALLEN, EXAMINING ATTORNEY

**Int. Cl.: 18**

**Prior U.S. Cls.: 1, 2, 3, 22, and 41**

**United States Patent and Trademark Office**

**Reg. No. 3,505,890**

**Registered Sep. 23, 2008**

**TRADEMARK  
PRINCIPAL REGISTER**

**physhion**

PHYSHION LLC (NEW JERSEY LIMITED LIABILITY COMPANY)  
10 CONOVER LANE  
RUMSON, NJ 07760

FOR: FITNESS BAGS, NAMELY, ALL PURPOSE SPORTS BAGS, ALL-PURPOSE ATHLETIC BAGS, BAGS AND HOLD-ALLS FOR SPORTS CLOTHING, BAGS FOR SPORTS, GYM BAGS, GENERAL PURPOSE BAGS FOR YOGA EQUIPMENT, IN CLASS 18 (U.S. CLS. 1, 2, 3, 22 AND 41).

FIRST USE 5-9-2008; IN COMMERCE 5-9-2008.

THE MARK CONSISTS OF STANDARD CHARACTERS WITHOUT CLAIM TO ANY PARTICULAR FONT, STYLE, SIZE, OR COLOR.

SN 77-084,133, FILED 1-16-2007.

ANGELA GAW, EXAMINING ATTORNEY



Int. Cl.: 9

Prior U.S. Cls.: 21, 23, 26, 36, and 38

United States Patent and Trademark Office

Reg. No. 3,505,891

Registered Sep. 23, 2008

TRADEMARK  
PRINCIPAL REGISTER

*BassBoy*

ARPINO, ROBERT (UNITED STATES INDIVIDUAL)  
2165 EAST CORTEZ DRIVE  
GILBERT, AZ 85234

FOR: ELECTRICAL PICKUPS FOR USE WITH MUSICAL INSTRUMENTS; ELECTRONIC SOUND PICKUP FOR GUITARS AND BASSES, IN CLASS 9 (U.S. CLS. 21, 23, 26, 36 AND 38).

FIRST USE 9-18-2007; IN COMMERCE 9-18-2007.

THE MARK CONSISTS OF THE WORDS "BASS" AND "BOY" IN STYLIZED FONT WITHOUT A SPACE SEPARATING THE WORDS WITH THE UPPER PORTION OF THE CAPITAL "B"'S FORMED BY A BASS CLEF.

SN 77-085,264, FILED 1-18-2007.

ANDREA K. NADELMAN, EXAMINING ATTORNEY

**Int. Cls.: 9 and 41**

**Prior U.S. Cls.: 21, 23, 26, 36, 38, 100, 101, and 107**

**United States Patent and Trademark Office**

**Reg. No. 3,505,892**

**Registered Sep. 23, 2008**

**TRADEMARK  
SERVICE MARK  
PRINCIPAL REGISTER**

**STUNTBLASTERS**

STUNTBLASTERS, INC. (CALIFORNIA CORPORATION)  
11944 OTSEGO STREET  
VALLEY VILLAGE, CA 91607

FOR: PRERECORDED DVDS FEATURING EXERCISE WORKOUTS, IN CLASS 9 (U.S. CLS. 21, 23, 26, 36 AND 38).

FIRST USE 5-0-2007; IN COMMERCE 5-0-2007.

FOR: EXERCISE TRAINING, IN CLASS 41 (U.S. CLS. 100, 101 AND 107).

FIRST USE 5-0-2007; IN COMMERCE 5-0-2007.

THE MARK CONSISTS OF STANDARD CHARACTERS WITHOUT CLAIM TO ANY PARTICULAR FONT, STYLE, SIZE, OR COLOR.

SN 77-085,282, FILED 1-18-2007.

JENNIFER HETU, EXAMINING ATTORNEY

**Int. Cl.: 36**

**Prior U.S. Cls.: 100, 101, and 102**

**United States Patent and Trademark Office**

**Reg. No. 3,505,893**

**Registered Sep. 23, 2008**

**SERVICE MARK  
PRINCIPAL REGISTER**

**POSIT MATCH**

ITG SOFTWARE SOLUTIONS, INC. (DELAWARE  
CORPORATION)  
400 CORPORATE POINTE 6TH FLOOR  
CULVER CITY, CA 90230

FOR: COMPUTERIZED STOCK BROKERAGE  
SERVICES, IN CLASS 36 (U.S. CLS. 100, 101 AND 102).

FIRST USE 10-27-2005; IN COMMERCE 10-27-2005.

THE MARK CONSISTS OF STANDARD CHAR-  
ACTERS WITHOUT CLAIM TO ANY PARTICULAR  
FONT, STYLE, SIZE, OR COLOR.

OWNER OF U.S. REG. NO. 1,530,044.

NO CLAIM IS MADE TO THE EXCLUSIVE  
RIGHT TO USE "MATCH", APART FROM THE  
MARK AS SHOWN.

SN 77-088,110, FILED 1-22-2007.

SCOTT BIBB, EXAMINING ATTORNEY

**Int. Cl.: 29**

**Prior U.S. Cl.: 46**

**United States Patent and Trademark Office**

**Reg. No. 3,505,894**

**Registered Sep. 23, 2008**

**TRADEMARK  
PRINCIPAL REGISTER**

**EXTREME PRODUCE**

AMERICA FREEZE DRY, INC. (CALIFORNIA CORPORATION)  
12396 WORLD TRADE DRIVE, SUITE 210  
SAN DIEGO, CA 92128

NO CLAIM IS MADE TO THE EXCLUSIVE RIGHT TO USE "PRODUCE", APART FROM THE MARK AS SHOWN.

FOR: FREEZE-DRIED FRUIT, FREEZE-DRIED FRUIT ASSORTMENT, IN CLASS 29 (U.S. CL. 46).

SN 77-089,283, FILED 1-23-2007.

FIRST USE 5-4-2007; IN COMMERCE 5-4-2007.

THE MARK CONSISTS OF STANDARD CHARACTERS WITHOUT CLAIM TO ANY PARTICULAR FONT, STYLE, SIZE, OR COLOR.

JANICE L. MCMORROW, EXAMINING ATTORNEY

**Int. Cl.: 28**

**Prior U.S. Cls.: 22, 23, 38, and 50**

**United States Patent and Trademark Office**

**Reg. No. 3,505,895**

**Registered Sep. 23, 2008**

**TRADEMARK  
PRINCIPAL REGISTER**



RIDEMAKERZ LLC (DELAWARE LIMITED LIABILITY COMPANY)  
8191 STRAWBERRY LANE  
FALLS CHURCH, VA 22042

FOR: TOY VEHICLES, PARTS AND ACCESSORIES THEREFOR, IN CLASS 28 (U.S. CLS. 22, 23, 38 AND 50).

FIRST USE 6-1-2007; IN COMMERCE 6-1-2007.

THE COLOR(S) BLACK, WHITE AND RED IS/ARE CLAIMED AS A FEATURE OF THE MARK.

THE MARK CONSISTS OF A SQUARE BLACK FIELD WITH A CIRCULAR SYMBOL INCORPORATING A STYLIZED LETTER "R" IN WHITE AND A "Z" IN RED.

SN 77-089,783, FILED 1-24-2007.

MICHELE SWAIN, EXAMINING ATTORNEY

**Int. Cl.: 3**

**Prior U.S. Cls.: 1, 4, 6, 50, 51, and 52**

**Reg. No. 3,505,896**

**United States Patent and Trademark Office**

**Registered Sep. 23, 2008**

**TRADEMARK  
PRINCIPAL REGISTER**

**SCENT SURROUND**

JO MALONE INC. (DELAWARE CORPORATION)  
767 FIFTH AVENUE  
NEW YORK, NY 10153

FOR: SCENTED LINEN SPRAYS, SCENTED  
LINEN WATER, SCENTED FABRIC REFRESHER  
SPRAYS, SCENTED ROOM SPRAYS, IN CLASS 3  
(U.S. CLS. 1, 4, 6, 50, 51 AND 52).

FIRST USE 3-31-2007; IN COMMERCE 3-31-2007.

THE MARK CONSISTS OF STANDARD CHAR-  
ACTERS WITHOUT CLAIM TO ANY PARTICULAR  
FONT, STYLE, SIZE, OR COLOR.

NO CLAIM IS MADE TO THE EXCLUSIVE  
RIGHT TO USE "SCENT", APART FROM THE  
MARK AS SHOWN.

SN 77-090,978, FILED 1-25-2007.

PRISCILLA MILTON, EXAMINING ATTORNEY

**Int. Cls.: 9, 40, and 41**

**Prior U.S. Cls.: 21, 23, 26, 36, 38, 100, 101, 103, 106,  
and 107**

**Reg. No. 3,505,897**

**United States Patent and Trademark Office**

**Registered Sep. 23, 2008**

**TRADEMARK  
SERVICE MARK  
PRINCIPAL REGISTER**

# Sagas

SAGAS GROUP LLC (CALIFORNIA LIMITED  
LIABILITY COMPANY)  
11530 EMPIRE GRADE  
BONNY DOON, CA 95060

FOR: DIGITAL MATERIALS, IN THE FORM OF  
PRE-RECORDED DVDS, AND DOWNLOADABLE  
AUDIO AND VIDEO FILES CONTAINING PHOTO-  
GRAPHS, GRAPHICS, VIDEO, AUDIO AND TEXT,  
AND ELECTRONIC PUBLICATIONS, NAMELY,  
BOOKS ALL FEATURING PERSONAL HISTORIES  
OF INDIVIDUALS AND ANIMALS, IN CLASS 9 (U.S.  
CLS. 21, 23, 26, 36 AND 38).

FIRST USE 11-6-2007; IN COMMERCE 11-6-2007.

FOR: IMPRINTING OF GRAPHICS OR OTHER  
IMAGES ON CLOTHING, HATS, HOUSE WARES,  
PAPER PRODUCTS AND SOUVENIRS; VIDEO DU-  
PLICATION AND AUDIO DUPLICATION FEATUR-  
ING PERSONAL HISTORIES OF INDIVIDUALS  
AND ANIMALS, IN CLASS 40 (U.S. CLS. 100, 103  
AND 106).

FIRST USE 11-6-2007; IN COMMERCE 11-6-2007.

FOR: VIDEO PRODUCTION AND VIDEO EDIT-  
ING SERVICES FEATURING PHOTOGRAPHS, VI-  
DEO, AUDIO, TEXT AND GRAPHICS, AND  
ELECTRONIC PUBLISHING SERVICES ALL FEAT-  
URING PERSONAL HISTORIES OF INDIVIDUALS  
AND ANIMALS, IN CLASS 41 (U.S. CLS. 100, 101  
AND 107).

FIRST USE 11-6-2007; IN COMMERCE 11-6-2007.

THE MARK CONSISTS OF STANDARD CHAR-  
ACTERS WITHOUT CLAIM TO ANY PARTICULAR  
FONT, STYLE, SIZE, OR COLOR.

SN 77-092,550, FILED 1-26-2007.

PAUL F. GAST, EXAMINING ATTORNEY

**Int. Cl.: 35**

**Prior U.S. Cls.: 100, 101, and 102**

**United States Patent and Trademark Office**

**Reg. No. 3,505,898**

**Registered Sep. 23, 2008**

**SERVICE MARK  
PRINCIPAL REGISTER**

**SPARKLE NETWORK**

MARGARET J. PRUSAN (UNITED STATES IN-  
DIVIDUAL)  
37 OAKLAND ROAD  
MAPLEWOOD, NJ 07040

FOR: INTERNET BASED BUSINESS, MARKET-  
ING AND STRATEGIC CONSULTING FOR START  
UP COMPANIES AND FEMALE BASED COMPA-  
NIES, IN CLASS 35 (U.S. CLS. 100, 101 AND 102).

FIRST USE 1-1-2008; IN COMMERCE 1-1-2008.

THE MARK CONSISTS OF STANDARD CHAR-  
ACTERS WITHOUT CLAIM TO ANY PARTICULAR  
FONT, STYLE, SIZE, OR COLOR.

SN 77-093,767, FILED 1-29-2007.

MARK SPARACINO, EXAMINING ATTORNEY



**Int. Cl.: 9**

**Prior U.S. Cls.: 21, 23, 26, 36, and 38**

**Reg. No. 3,505,899**

**United States Patent and Trademark Office**

**Registered Sep. 23, 2008**

**TRADEMARK  
PRINCIPAL REGISTER**

**Savvant Music**

SAVVANT MUSIC CORPORATION (COLORADO CORPORATION)  
5831 SOUTHRIDGE GREENS BLVD.  
FORT COLLINS, CO 80525

FOR: DOWNLOADABLE MP3 FILES, MP3 RECORDINGS, ONLINE DISCUSSION BOARDS, WEB CASTS, POD CASTS FEATURING MUSIC, AUDIO BOOKS AND NEWS BROADCASTS , IN CLASS 9 (U.S. CLS. 21, 23, 26, 36 AND 38).

FIRST USE 5-25-2006; IN COMMERCE 7-12-2008.

THE MARK CONSISTS OF STANDARD CHARACTERS WITHOUT CLAIM TO ANY PARTICULAR FONT, STYLE, SIZE, OR COLOR.

NO CLAIM IS MADE TO THE EXCLUSIVE RIGHT TO USE "MUSIC", APART FROM THE MARK AS SHOWN.

SN 77-094,026, FILED 1-29-2007.

JORDAN BAKER, EXAMINING ATTORNEY

**Int. Cl.: 33**

**Prior U.S. Cls.: 47 and 49**

**United States Patent and Trademark Office**

**Reg. No. 3,505,900**

**Registered Sep. 23, 2008**

**TRADEMARK  
PRINCIPAL REGISTER**

**BARON LEDAC**

D & M NEW WORLD MANAGEMENT, INC.  
(NEW YORK CORPORATION)  
50 HEMPSTEAD GARDENS DR.  
W. HEMPSTEAD, NY 11552

FOR: ALCOHOLIC BEVERAGES, NAMELY,  
BRANDY AND DISTILLED SPIRITS, IN CLASS 33  
(U.S. CLS. 47 AND 49).

FIRST USE 4-0-2007; IN COMMERCE 11-0-2007.

THE MARK CONSISTS OF STANDARD CHAR-  
ACTERS WITHOUT CLAIM TO ANY PARTICULAR  
FONT, STYLE, SIZE, OR COLOR.

THE NAME "BARON LEDAC" SHOWN IN THE  
MARK DOES NOT IDENTIFY A PARTICULAR  
LIVING INDIVIDUAL.

SN 77-095,372, FILED 1-31-2007.

ALLISON SCHRODY, EXAMINING ATTORNEY

**Int. Cl.: 41**

**Prior U.S. Cls.: 100, 101, and 107**

**United States Patent and Trademark Office**

**Reg. No. 3,505,901**

**Registered Sep. 23, 2008**

**SERVICE MARK  
PRINCIPAL REGISTER**

**SOAPBOX**

DYKEMAN, KIMBERLIE A. (UNITED STATES  
INDIVIDUAL)  
P.O. BOX 42277  
AUSTIN, TX 78704

FOR: EDUCATIONAL AND ENTERTAINMENT  
SERVICES, NAMELY, PROVIDING MOTIVATION-  
AL AND EDUCATIONAL SPEAKERS IN THE  
FIELDS OF PERSONAL GROWTH AND PHYSICAL,  
MENTAL, AND SPIRITUAL WELLNESS , IN CLASS  
41 (U.S. CLS. 100, 101 AND 107).

FIRST USE 12-1-1999; IN COMMERCE 12-1-1999.

THE MARK CONSISTS OF STANDARD CHAR-  
ACTERS WITHOUT CLAIM TO ANY PARTICULAR  
FONT, STYLE, SIZE, OR COLOR.

SN 77-095,642, FILED 1-31-2007.

DEBRA LEE, EXAMINING ATTORNEY

**Int. Cl.: 41**

**Prior U.S. Cls.: 100, 101, and 107**

**United States Patent and Trademark Office**

**Reg. No. 3,505,902**

**Registered Sep. 23, 2008**

**SERVICE MARK  
PRINCIPAL REGISTER**

**ROUNDAABOUT RACING**

KWITEK, BENJAMIN J. (UNITED STATES INDIVIDUAL)  
1061 VALLEY VIEW DRIVE  
CANON CITY, CO 81212

FOR: ENTERTAINMENT IN THE NATURE OF AUTOMOBILE RACES, IN CLASS 41 (U.S. CLS. 100, 101 AND 107).

FIRST USE 7-2-2008; IN COMMERCE 7-2-2008.

THE MARK CONSISTS OF STANDARD CHARACTERS WITHOUT CLAIM TO ANY PARTICULAR FONT, STYLE, SIZE, OR COLOR.

NO CLAIM IS MADE TO THE EXCLUSIVE RIGHT TO USE "RACING", APART FROM THE MARK AS SHOWN.

SN 77-095,852, FILED 1-31-2007.

KRISTINA MORRIS, EXAMINING ATTORNEY

**Int. Cl.: 16**

**Prior U.S. Cls.: 2, 5, 22, 23, 29, 37, 38, and 50**

**Reg. No. 3,505,903**

**United States Patent and Trademark Office**

**Registered Sep. 23, 2008**

**TRADEMARK  
PRINCIPAL REGISTER**

**HEARTLAND MESSAGES**

TAYLOR, TIMOTHY D. (UNITED STATES INDIVIDUAL)  
107 N. ELMHURST AVENUE  
MOUNT PROSPECT, IL 600562420

THE MARK CONSISTS OF STANDARD CHARACTERS WITHOUT CLAIM TO ANY PARTICULAR FONT, STYLE, SIZE, OR COLOR.

FOR: APPLIQUES IN THE FORM OF DECALS; DECALS, IN CLASS 16 (U.S. CLS. 2, 5, 22, 23, 29, 37, 38 AND 50).

SN 77-097,416, FILED 2-1-2007.

FIRST USE 3-4-2007; IN COMMERCE 3-4-2007.

AISHA CLARKE, EXAMINING ATTORNEY

**Int. Cl.: 11**

**Prior U.S. Cls.: 13, 21, 23, 31, and 34**

**United States Patent and Trademark Office**

**Reg. No. 3,505,904**

**Registered Sep. 23, 2008**

**TRADEMARK  
PRINCIPAL REGISTER**

**TRUE-BROIL**

WHIRLPOOL PROPERTIES, INC. (MICHIGAN  
CORPORATION)  
SUITE 101  
500 RENAISSANCE DRIVE  
ST. JOSEPH, MI 49085

THE MARK CONSISTS OF STANDARD CHAR-  
ACTERS WITHOUT CLAIM TO ANY PARTICULAR  
FONT, STYLE, SIZE, OR COLOR.

FOR: INTEGRAL COMPONENT OF DOMESTIC  
COOKING OVENS, NAMELY, A BROILER, IN  
CLASS 11 (U.S. CLS. 13, 21, 23, 31 AND 34).

SN 77-099,876, FILED 2-6-2007.

FIRST USE 3-1-2008; IN COMMERCE 3-1-2008.

TRICIA SONNEBORN, EXAMINING ATTORNEY

**Int. Cl.: 1**

**Prior U.S. Cls.: 1, 5, 6, 10, 26, and 46**

**United States Patent and Trademark Office**

**Reg. No. 3,505,905**

**Registered Sep. 23, 2008**

**TRADEMARK  
PRINCIPAL REGISTER**

**DAVEY ARBOR GREEN PRO**

THE DAVEY TREE EXPERT COMPANY (OHIO  
CORPORATION)  
1500 NORTH MANTUA STREET  
KENT, OH 44240

FOR: TREE FOOD, IN CLASS 1 (U.S. CLS. 1, 5, 6, 10,  
26 AND 46).

FIRST USE 9-30-2007; IN COMMERCE 9-30-2007.

THE MARK CONSISTS OF STANDARD CHAR-  
ACTERS WITHOUT CLAIM TO ANY PARTICULAR  
FONT, STYLE, SIZE, OR COLOR.

OWNER OF U.S. REG. NOS. 766,975 AND 2,598,415.

NO CLAIM IS MADE TO THE EXCLUSIVE  
RIGHT TO USE "PRO", APART FROM THE MARK  
AS SHOWN.

SEC. 2(F) AS TO "ARBOR GREEN".

SN 77-099,917, FILED 2-6-2007.

JAY BESCH, EXAMINING ATTORNEY

**Int. Cl.: 36**

**Prior U.S. Cls.: 100, 101, and 102**

**United States Patent and Trademark Office**

**Reg. No. 3,505,906**

**Registered Sep. 23, 2008**

**SERVICE MARK  
PRINCIPAL REGISTER**



UNUM GROUP (DELAWARE CORPORATION)  
ONE FOUNTAIN SQUARE  
CHATTANOOGA, TN 374021307

FOR: INSURANCE UNDERWRITING SERVICES;  
INSURANCE ADMINISTRATION; INSURANCE  
AGENCIES; INSURANCE BROKERAGE; INSUR-  
ANCE CLAIMS ADMINISTRATION; PROCESSING  
OF INSURANCE CLAIMS AND PAYMENT DATA;  
INSURANCE CONSULTATION; REINSURANCE  
UNDERWRITING SERVICES AND REINSURANCE  
ADMINISTRATIVE SERVICES, IN CLASS 36 (U.S.  
CLS. 100, 101 AND 102).

FIRST USE 4-19-2007; IN COMMERCE 4-19-2007.

OWNER OF U.S. REG. NOS. 1,392,617 AND  
2,077,150.

NO CLAIM IS MADE TO THE EXCLUSIVE  
RIGHT TO USE "GROUP", APART FROM THE  
MARK AS SHOWN.

THE COLOR(S) BLUE AND LIGHT BLUE IS/ARE  
CLAIMED AS A FEATURE OF THE MARK.

THE MARK CONSISTS OF THE WORDS "UNUM  
GROUP" IN BLUE WITH A CIRCLE IN LIGHT BLUE  
ABOVE THE LETTER "N", A CIRCLE IN LIGHT  
BLUE ABOVE THE LETTER "U", AND A CIRCLE IN  
LIGHT BLUE ABOVE THE LETTER "M".

SN 77-102,284, FILED 2-8-2007.

GEOFFREY FOSDICK, EXAMINING ATTORNEY



**Int. Cl.: 32**

**Prior U.S. Cls.: 45, 46, and 48**

**United States Patent and Trademark Office**

**Reg. No. 3,505,907**

**Registered Sep. 23, 2008**

**TRADEMARK  
PRINCIPAL REGISTER**

**BADMONKEY**

CRAIG MCGONIGLE (UNITED STATES INDIVIDUAL)  
2090 DUNWOODY CLUB DRIVE, SUITE 106-07  
ATLANTA, GA 30350

THE MARK CONSISTS OF STANDARD CHARACTERS WITHOUT CLAIM TO ANY PARTICULAR FONT, STYLE, SIZE, OR COLOR.

FOR: BEER, IN CLASS 32 (U.S. CLS. 45, 46 AND 48).

SN 77-103,677, FILED 2-9-2007.

FIRST USE 7-17-2008; IN COMMERCE 7-17-2008.

LINDSEY RUBIN, EXAMINING ATTORNEY

**Int. Cl.: 3**

**Prior U.S. Cls.: 1, 4, 6, 50, 51, and 52**

**United States Patent and Trademark Office**

**Reg. No. 3,505,908**

**Registered Sep. 23, 2008**

**TRADEMARK  
PRINCIPAL REGISTER**

**BRONZING BODY SILK**

DESIGNER SKIN LLC (ARIZONA LIMITED LIABILITY COMPANY)

6270 CORPORATE DRIVE

INDIANAPOLIS, AZ 46278

FOR: COSMETIC - TANNING PREPARATIONS,  
IN CLASS 3 (U.S. CLS. 1, 4, 6, 50, 51 AND 52).

FIRST USE 11-1-2007; IN COMMERCE 11-1-2007.

THE MARK CONSISTS OF STANDARD CHARACTERS WITHOUT CLAIM TO ANY PARTICULAR FONT, STYLE, SIZE, OR COLOR.

NO CLAIM IS MADE TO THE EXCLUSIVE RIGHT TO USE "BRONZING BODY", APART FROM THE MARK AS SHOWN.

SN 77-103,753, FILED 2-9-2007.

MIDGE BUTLER, EXAMINING ATTORNEY

**Int. Cl.: 36**

**Prior U.S. Cls.: 100, 101, and 102**

**United States Patent and Trademark Office**

**Reg. No. 3,505,909**

**Registered Sep. 23, 2008**

---

**SERVICE MARK  
PRINCIPAL REGISTER**

**OUTSIDE**

URANGA & ASSOCIATES (IDAHO SOLE PROPRIETORSHIP)  
480 WASHINGTON ST.  
KETCHUM, ID 83340

THE MARK CONSISTS OF STANDARD CHARACTERS WITHOUT CLAIM TO ANY PARTICULAR FONT, STYLE, SIZE, OR COLOR.

FOR: REAL ESTATE INVESTING SERVICE, NAMELY, A SERVICE FOR INVESTING IRA EQUITY IN REAL ESTATE, IN CLASS 36 (U.S. CLS. 100, 101 AND 102).

SN 77-103,908, FILED 2-9-2007.

FIRST USE 12-31-2006; IN COMMERCE 12-31-2006.

IRA J. GOODSaid, EXAMINING ATTORNEY

**Int. Cl.: 25**

**Prior U.S. Cls.: 22 and 39**

**United States Patent and Trademark Office**

**Reg. No. 3,505,910**

**Registered Sep. 23, 2008**

**TRADEMARK  
PRINCIPAL REGISTER**

**ENJOY THE PROCESS**

ENJOY THE PROCESS, LLC (FLORIDA LIMITED  
LIABILITY COMPANY)  
6034 CHESTER AVENUE, SUITE 209  
JACKSONVILLE, FL 32217

THE MARK CONSISTS OF STANDARD CHAR-  
ACTERS WITHOUT CLAIM TO ANY PARTICULAR  
FONT, STYLE, SIZE, OR COLOR.

FOR: CLOTHING, NAMELY, T-SHIRTS, HATS,  
SWEATSHIRTS, AND GOLF SHIRTS, IN CLASS 25  
(U.S. CLS. 22 AND 39).

SN 77-104,898, FILED 2-12-2007.

FIRST USE 10-22-2007; IN COMMERCE 10-22-2007.

STEVEN PEREZ, EXAMINING ATTORNEY

**Int. Cl.: 1**

**Prior U.S. Cls.: 1, 5, 6, 10, 26, and 46**

**Reg. No. 3,505,911**

**United States Patent and Trademark Office**

**Registered Sep. 23, 2008**

**TRADEMARK  
PRINCIPAL REGISTER**

**DUOLINK**

OLINK AB (SWEDEN COMPANY)  
RUDBECK LABORATORY  
UPPSALA, SWEDEN 75185

THE MARK CONSISTS OF STANDARD CHAR-  
ACTERS WITHOUT CLAIM TO ANY PARTICULAR  
FONT, STYLE, SIZE, OR COLOR.

FOR: CHEMICAL KIT FOR ANALYSIS OF PRO-  
TEIN INTERACTIONS FOR LABORATORY, RE-  
SEARCH OR INDUSTRIAL USE, IN CLASS 1 (U.S.  
CLS. 1, 5, 6, 10, 26 AND 46).

SN 77-105,658, FILED 2-12-2007.

FIRST USE 7-18-2007; IN COMMERCE 7-18-2007.

BARBARA BROWN, EXAMINING ATTORNEY

**Int. Cl.: 11**

**Prior U.S. Cls.: 13, 21, 23, 31, and 34**

**United States Patent and Trademark Office**

**Reg. No. 3,505,912**

**Registered Sep. 23, 2008**

**TRADEMARK  
PRINCIPAL REGISTER**

**POWERLOAD**

INTERNATIONAL GROWER'S SUPPLY INCOR-  
PORATED (CALIFORNIA CORPORATION)  
2643 SOUTH FAIRFAX AVE.  
CULVER CITY, CA 90232

THE MARK CONSISTS OF STANDARD CHAR-  
ACTERS WITHOUT CLAIM TO ANY PARTICULAR  
FONT, STYLE, SIZE, OR COLOR.

FOR: LIGHT BULBS, IN CLASS 11 (U.S. CLS. 13, 21,  
23, 31 AND 34).

SN 77-107,879, FILED 2-14-2007.

FIRST USE 1-19-2007; IN COMMERCE 1-19-2007.

CHARLOTTE CORWIN, EXAMINING ATTORNEY

**Int. Cl.: 5**

**Prior U.S. Cls.: 6, 18, 44, 46, 51, and 52**

**Reg. No. 3,505,913**

**United States Patent and Trademark Office**

**Registered Sep. 23, 2008**

---

**TRADEMARK  
PRINCIPAL REGISTER**

**VITAFUSION**

NORTHWEST NATURAL PRODUCTS, INC. (DE-  
LAWARE CORPORATION)  
6350 NE CAMPUS DRIVE  
VANCOUVER, WA 986616877

THE MARK CONSISTS OF STANDARD CHAR-  
ACTERS WITHOUT CLAIM TO ANY PARTICULAR  
FONT, STYLE, SIZE, OR COLOR.

FOR: DIETARY SUPPLEMENTS; VITAMINS, IN  
CLASS 5 (U.S. CLS. 6, 18, 44, 46, 51 AND 52).

SN 77-107,994, FILED 2-15-2007.

FIRST USE 5-14-2007; IN COMMERCE 8-1-2007.

BONNIE LUKEN, EXAMINING ATTORNEY

Int. Cl.: 6

Prior U.S. Cls.: 2, 12, 13, 14, 23, 25, and 50

United States Patent and Trademark Office

Reg. No. 3,505,914

Registered Sep. 23, 2008

TRADEMARK  
PRINCIPAL REGISTER

smarTainer  
by



VECTOR...A MOVE AHEAD, INC. (CALIFORNIA  
CORPORATION)  
1480 CARROLL AVENUE  
SAN FRANCISCO, CA 94124

FIRST USE 7-20-2006; IN COMMERCE 7-20-2006.

SN 77-109,691, FILED 2-16-2007.

FOR: METAL CONTAINERS FOR THE STORAGE  
AND TRANSPORTATION OF GOODS, IN CLASS 6  
(U.S. CLS. 2, 12, 13, 14, 23, 25 AND 50).

HOWARD FRIEDMAN, EXAMINING ATTORNEY



**Int. Cl.: 10**

**Prior U.S. Cls.: 26, 39, and 44**

**United States Patent and Trademark Office**

**Reg. No. 3,505,915**

**Registered Sep. 23, 2008**

**TRADEMARK  
PRINCIPAL REGISTER**

**MOJO**

SLEEPNET CORPORATION (NEW HAMPSHIRE  
CORPORATION)  
5 MERRILL DRIVE  
HAMPTON, NH 03842

THE MARK CONSISTS OF STANDARD CHAR-  
ACTERS WITHOUT CLAIM TO ANY PARTICULAR  
FONT, STYLE, SIZE, OR COLOR.

FOR: RESPIRATORY MASK FOR MEDICAL  
PURPOSES, NAMELY, NASAL AND FULL FACE  
MASKS, FOR DELIVERING BREATHABLE GAS TO  
A WEARER, IN CLASS 10 (U.S. CLS. 26, 39 AND 44).

SN 77-110,287, FILED 2-18-2007.

FIRST USE 6-2-2006; IN COMMERCE 6-2-2006.

KAREN BRACEY, EXAMINING ATTORNEY

**Int. Cl.: 9**

**Prior U.S. Cls.: 21, 23, 26, 36, and 38**

**United States Patent and Trademark Office**

**Reg. No. 3,505,916**

**Registered Sep. 23, 2008**

**TRADEMARK  
PRINCIPAL REGISTER**

**SupelMIP**

SIGMA-ALDRICH BIOTECHNOLOGY L.P. (MISSOURI LIMITED PARTNERSHIP)  
3050 SPRUCE STREET  
ST. LOUIS, MO 63103

FOR: APPARATUS AND INSTRUMENTS FOR CHROMATOGRAPHY, NAMELY, CHROMATOGRAPHY CARTRIDGES, PLATES, FUNNELS, TIPS, FILTERS, FIBERS AND COLUMNS; APPARATUS FOR AUTOMATIC CHROMATOGRAPHY; AUTOMATIC ION-EXCHANGE CHROMATOGRAPHY APPARATUS FOR LABORATORY USE; GAS CHROMATOGRAPHY APPARATUS; CHROMATOGRAPHY AND PURIFICATION APPARATUS FOR LABORATORY USE, NAMELY, PREPARATIVE CARTRIDGES, MEMBRANES AND FLUSH CAR-

TRIDGES, IN CLASS 9 (U.S. CLS. 21, 23, 26, 36 AND 38).

FIRST USE 12-15-2006; IN COMMERCE 12-15-2006.

THE MARK CONSISTS OF STANDARD CHARACTERS WITHOUT CLAIM TO ANY PARTICULAR FONT, STYLE, SIZE, OR COLOR.

OWNER OF U.S. REG. NO. 2,535,368.

SN 77-111,509, FILED 2-20-2007.

Laurie Kaufman, Examining Attorney

**Int. Cl.: 6**

**Prior U.S. Cls.: 2, 12, 13, 14, 23, 25, and 50**

**United States Patent and Trademark Office**

**Reg. No. 3,505,917**

**Registered Sep. 23, 2008**

**TRADEMARK  
PRINCIPAL REGISTER**

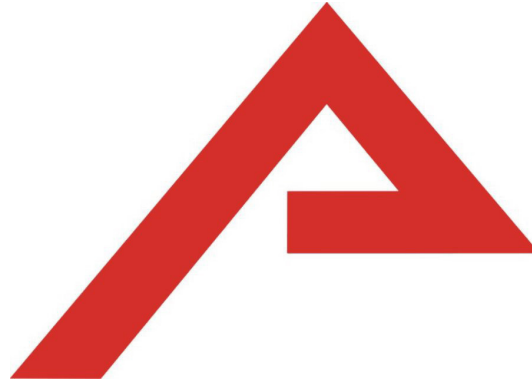

ALLIED TUBE & CONDUIT CORPORATION  
(DELAWARE CORPORATION)  
16100 SOUTH LATHROP AVENUE  
HARVEY, IL 60426

FOR: METAL TRUSSES FOR ROOFS, WALLS  
AND FLOORS; BUILDING WALL AND ROOF  
FRAMING MADE PRIMARILY OF METAL, IN  
CLASS 6 (U.S. CLS. 2, 12, 13, 14, 23, 25 AND 50).

FIRST USE 3-1-2007; IN COMMERCE 3-1-2007.

THE COLOR(S) RED IS/ARE CLAIMED AS A  
FEATURE OF THE MARK.

THE MARK CONSISTS OF A FANCIFUL AN-  
GLED LINE DESIGN APPEARING IN RED.

SN 77-112,619, FILED 2-21-2007.

THEODORE MCBRIDE, EXAMINING ATTORNEY

**Int. Cls.: 32 and 33**

**Prior U.S. Cls.: 45, 46, 47, 48, and 49**

**United States Patent and Trademark Office**

**Reg. No. 3,505,918**

**Registered Sep. 23, 2008**

**TRADEMARK  
PRINCIPAL REGISTER**

**MIKE'S SCREWDRIVER PREMIUM  
MALT COCKTAIL**

MARK ANTHONY INTERNATIONAL SRL (BARBADOS CORPORATION)  
STEVMAR HOUSE, SUITE 302  
ROCKLEY, CHRIST CHURCH, BARBADOS BB15137

FOR: FLAVORED BREWED MALT-BASED ALCOHOLIC BEVERAGES IN THE NATURE OF BEER, IN CLASS 32 (U.S. CLS. 45, 46 AND 48).

FIRST USE 4-27-2007; IN COMMERCE 4-27-2007.

FOR: ALCOHOLIC FLAVORED MALT COOLERS, IN CLASS 33 (U.S. CLS. 47 AND 49).

FIRST USE 4-27-2007; IN COMMERCE 4-27-2007.

THE MARK CONSISTS OF STANDARD CHARACTERS WITHOUT CLAIM TO ANY PARTICULAR FONT, STYLE, SIZE, OR COLOR.

OWNER OF U.S. REG. NOS. 2,501,401, 3,125,866, AND OTHERS.

NO CLAIM IS MADE TO THE EXCLUSIVE RIGHT TO USE "SCREWDRIVER PREMIUM MALT COCKTAIL", APART FROM THE MARK AS SHOWN.

SN 77-114,872, FILED 2-23-2007.

ANTHONY RINKER, EXAMINING ATTORNEY

**Int. Cl.: 9**

**Prior U.S. Cls.: 21, 23, 26, 36, and 38**

**United States Patent and Trademark Office**

**Reg. No. 3,505,919**

**Registered Sep. 23, 2008**

**TRADEMARK  
PRINCIPAL REGISTER**

**SPEEDGUARD**

REDSPEED USA CORPORATION (ILLINOIS  
CORPORATION)  
400 EISENHOWER LANE NORTH  
LOMBARD, IL 60148

THE MARK CONSISTS OF STANDARD CHAR-  
ACTERS WITHOUT CLAIM TO ANY PARTICULAR  
FONT, STYLE, SIZE, OR COLOR.

FOR: CAMERAS, TRIPODS FOR CAMERAS AND  
LASER SPEED DETECTORS, IN CLASS 9 (U.S. CLS.  
21, 23, 26, 36 AND 38).

SN 77-115,010, FILED 2-23-2007.

FIRST USE 2-0-2008; IN COMMERCE 2-0-2008.

DAVID MURRAY, EXAMINING ATTORNEY

**Int. Cl.: 9**

**Prior U.S. Cls.: 21, 23, 26, 36, and 38**

**Reg. No. 3,505,920**

**United States Patent and Trademark Office**

**Registered Sep. 23, 2008**

**TRADEMARK  
PRINCIPAL REGISTER**

**REDFUSION**

REDSPEED USA CORPORATION (ILLINOIS  
CORPORATION)  
400 EISENHOWER LANE NORTH  
LOMBARD, IL 60148

THE MARK CONSISTS OF STANDARD CHAR-  
ACTERS WITHOUT CLAIM TO ANY PARTICULAR  
FONT, STYLE, SIZE, OR COLOR.

FOR: CAMERAS AND LASER SPEED DETEC-  
TORS, IN CLASS 9 (U.S. CLS. 21, 23, 26, 36 AND 38).

SN 77-115,017, FILED 2-23-2007.

FIRST USE 2-0-2008; IN COMMERCE 2-0-2008.

DAVID MURRAY, EXAMINING ATTORNEY

**Int. Cl.: 9**

**Prior U.S. Cls.: 21, 23, 26, 36, and 38**

**Reg. No. 3,505,921**

**United States Patent and Trademark Office**

**Registered Sep. 23, 2008**

---

**TRADEMARK  
PRINCIPAL REGISTER**

**SPEEDHUNTER**

REDSPEED USA CORPORATION (ILLINOIS  
CORPORATION)  
400 EISENHOWER LANE NORTH  
LOMBARD, IL 60148

THE MARK CONSISTS OF STANDARD CHAR-  
ACTERS WITHOUT CLAIM TO ANY PARTICULAR  
FONT, STYLE, SIZE, OR COLOR.

FOR: LASER SPEED DETECTORS, IN CLASS 9  
(U.S. CLS. 21, 23, 26, 36 AND 38).

SN 77-115,064, FILED 2-23-2007.

FIRST USE 2-0-2008; IN COMMERCE 2-0-2008.

DAVID MURRAY, EXAMINING ATTORNEY

Int. Cl.: 3

Prior U.S. Cls.: 1, 4, 6, 50, 51, and 52

United States Patent and Trademark Office

Reg. No. 3,505,922

Registered Sep. 23, 2008

TRADEMARK  
PRINCIPAL REGISTER



THE PROCTER & GAMBLE COMPANY (OHIO CORPORATION)  
ONE PROCTER & GAMBLE PLAZA  
CINCINNATI, OH 45202

FOR: DISH DETERGENT, IN CLASS 3 (U.S. CLS. 1, 4, 6, 50, 51 AND 52).

FIRST USE 1-31-2005; IN COMMERCE 1-31-2005.

OWNER OF U.S. REG. NOS. 562,962, 3,220,733, AND OTHERS.

NO CLAIM IS MADE TO THE EXCLUSIVE RIGHT TO USE "BLEACH ALTERNATIVE", APART FROM THE MARK AS SHOWN.

THE STIPPLING IS A FEATURE OF THE MARK.

THE MARK CONSISTS OF THE WORDS "DAWN WITH BLEACH ALTERNATIVE" SUPERIMPOSED OVER A DESIGN OF RAYS REPRESENTING SHAFTS OF LIGHT WITHIN AN OVAL WITH LINES REPRESENTING WAVES IN A SEMI-CIRCLE AROUND THE OUTSIDE OVAL ON THE RIGHT SIDE.

SN 77-115,872, FILED 2-26-2007.

TINA L. SNAPP, EXAMINING ATTORNEY



**Int. Cl.: 28**

**Prior U.S. Cls.: 22, 23, 38, and 50**

**United States Patent and Trademark Office**

**Reg. No. 3,505,923**

**Registered Sep. 23, 2008**

**TRADEMARK  
PRINCIPAL REGISTER**

**STREETSTRIDER**

STREETSTRIDER INTERNATIONAL, LLC (NE-  
VADA LIMITED LIABILITY COMPANY)  
502 NORTH DIVISION STREET  
CARSON CITY, NV 89703

THE MARK CONSISTS OF STANDARD CHAR-  
ACTERS WITHOUT CLAIM TO ANY PARTICULAR  
FONT, STYLE, SIZE, OR COLOR.

FOR: MOBILE ELLIPTICALLY DRIVEN EXER-  
CISE MACHINES, IN CLASS 28 (U.S. CLS. 22, 23, 38  
AND 50).

SN 77-116,879, FILED 2-27-2007.

FIRST USE 5-14-2008; IN COMMERCE 5-14-2008.

DOMINIC FATHY, EXAMINING ATTORNEY

**Int. Cl.: 2**

**Prior U.S. Cls.: 6, 11, and 16**

**United States Patent and Trademark Office**

**Reg. No. 3,505,924**

**Registered Sep. 23, 2008**

**TRADEMARK  
PRINCIPAL REGISTER**

**ROVALIZE**

ROVAL CORPORATION (JAPAN CORPORATION)  
2-3-13, UCHI-AWAJIMACHI, CHUO-KU  
OSAKA, JAPAN 540-0038

THE MARK CONSISTS OF STANDARD CHARACTERS WITHOUT CLAIM TO ANY PARTICULAR FONT, STYLE, SIZE, OR COLOR.

OWNER OF U.S. REG. NO. 2,826,010.

FOR: PAINTS, IN CLASS 2 (U.S. CLS. 6, 11 AND 16).

SN 77-118,271, FILED 2-28-2007.

FIRST USE 11-11-2007; IN COMMERCE 11-11-2007.

ELIZABETH BEYER, EXAMINING ATTORNEY

Int. Cl.: 35

Prior U.S. Cls.: 100, 101, and 102

United States Patent and Trademark Office

Reg. No. 3,505,925

Registered Sep. 23, 2008

SERVICE MARK  
PRINCIPAL REGISTER

Llame al líder

RADIATOR EXPRESS WAREHOUSE, INC. (CALIFORNIA CORPORATION)  
4401 PARK ROAD  
BENICIA, CA 94510

FOR: RETAIL AND WHOLESALE AUTOMOBILE PARTS AND ACCESSORIES STORES; -RETAIL AND WHOLESALE TELEPHONE ORDERING SERVICES FEATURING VEHICLE PARTS AND ACCESSORIES; -RETAIL AND WHOLESALE COMPUTERIZED ON-LINE ORDERING SERVICES FEATURING VEHICLE PARTS AND ACCESSORIES; AND -FRANCHISE SERVICES, NAMELY, OFFERING TECHNICAL AND BUSINESS MANAGEMENT ASSISTANCE IN THE ESTABLISHMENT AND OPERATION OF RETAIL AND WHOLESALE STORE SERVICES, RETAIL AND WHOLESALE TELEPHONE ORDERING SERVICES AND RETAIL AND WHOLESALE COMPUTERIZED ON-LINE ORDER-

ING SERVICES FEATURING VEHICLE PARTS AND ACCESSORIES, IN CLASS 35 (U.S. CLS. 100, 101 AND 102).

FIRST USE 2-1-2008; IN COMMERCE 2-1-2008.

THE MARK CONSISTS OF STANDARD CHARACTERS WITHOUT CLAIM TO ANY PARTICULAR FONT, STYLE, SIZE, OR COLOR.

THE FOREIGN WORDING IN THE MARK TRANSLATES INTO ENGLISH AS CALL ON THE LEADER.

SN 77-118,532, FILED 2-28-2007.

SUE LAWRENCE, EXAMINING ATTORNEY

**Int. Cl.: 9**

**Prior U.S. Cls.: 21, 23, 26, 36, and 38**

**Reg. No. 3,505,926**

**United States Patent and Trademark Office**

**Registered Sep. 23, 2008**

**TRADEMARK  
PRINCIPAL REGISTER**

**RAILEDGE**

GE TRANSPORTATION SYSTEMS GLOBAL SIGNALING, LLC (DELAWARE LIMITED LIABILITY COMPANY)

2712 SOUTH DILLINGHAM ROAD  
P.O. BOX 600  
GRAIN VALLEY, MO 64029

FOR: AUTOMATED SYSTEMS, NAMELY, SOFTWARE, HARDWARE AND COMMUNICATIONS DEVICES FOR PLANNING, SCHEDULING, CONTROLLING, MONITORING AND PROVIDING INFORMATION ON TRANSPORTATION ASSETS

AND PARTS THEREOF, IN CLASS 9 (U.S. CLS. 21, 23, 26, 36 AND 38).

FIRST USE 5-23-2007; IN COMMERCE 5-23-2007.

THE MARK CONSISTS OF STANDARD CHARACTERS WITHOUT CLAIM TO ANY PARTICULAR FONT, STYLE, SIZE, OR COLOR.

SN 77-119,594, FILED 3-1-2007.

RENEE SERVANCE, EXAMINING ATTORNEY

**Int. Cl.: 42**

**Prior U.S. Cls.: 100 and 101**

**United States Patent and Trademark Office**

**Reg. No. 3,505,927**

**Registered Sep. 23, 2008**

**SERVICE MARK  
PRINCIPAL REGISTER**

**MATCH VIEW**

NATIONAL MARROW DONOR PROGRAM  
(COLORADO NON-PROFIT CORPORATION)  
SUITE 500  
3001 BROADWAY STREET  
MINNEAPOLIS, MN 55413

FOR: COMPUTER SERVICES, NAMELY, PROVIDING SEARCH ENGINES FOR OBTAINING DATA, NAMELY, POTENTIAL ORGAN, TISSUE, BLOOD, AND STEM CELL SOURCES ON A GLOBAL COMPUTER NETWORK, IN CLASS 42 (U.S. CLS. 100 AND 101).

FIRST USE 5-15-2007; IN COMMERCE 5-15-2007.

THE MARK CONSISTS OF STANDARD CHARACTERS WITHOUT CLAIM TO ANY PARTICULAR FONT, STYLE, SIZE, OR COLOR.

SN 77-119,908, FILED 3-1-2007.

SKYE YOUNG, EXAMINING ATTORNEY

**Int. Cl.: 34**

**Prior U.S. Cls.: 2, 8, 9, and 17**

**United States Patent and Trademark Office**

**Reg. No. 3,505,928**

**Registered Sep. 23, 2008**

**TRADEMARK  
PRINCIPAL REGISTER**

**CASA GOMEZ**

GOMEZ, LOREN (UNITED STATES INDIVIDUAL)  
525 WEST 39TH PLACE  
HIALEAH, FL 33012

FOR: CIGAR BANDS; CIGAR BOXES; CIGAR CASES; CIGAR CUTTERS; CIGAR HOLDERS; CIGAR HUMIDIFIERS; CIGAR LIGHTERS; CIGAR TUBES; CIGARS, IN CLASS 34 (U.S. CLS. 2, 8, 9 AND 17).

FIRST USE 8-13-2007; IN COMMERCE 8-13-2007.

THE MARK CONSISTS OF STANDARD CHARACTERS WITHOUT CLAIM TO ANY PARTICULAR FONT, STYLE, SIZE, OR COLOR.

THE FOREIGN WORDING IN THE MARK TRANSLATES INTO ENGLISH AS HOUSE OF GOMEZ.

SN 77-120,889, FILED 3-2-2007.

ELLEN PERKINS, EXAMINING ATTORNEY

Int. Cl.: 41

Prior U.S. Cls.: 100, 101, and 107

United States Patent and Trademark Office

Reg. No. 3,505,929

Registered Sep. 23, 2008

SERVICE MARK  
PRINCIPAL REGISTER



NATIONAL RAILROAD HALL OF FAME, INC.  
(ILLINOIS NON-PROFIT CORPORATION)  
200 EAST MAIN STREET  
GALESBURG, IL 61401

FOR: MUSEUMS, IN CLASS 41 (U.S. CLS. 100, 101 AND 107).

FIRST USE 9-0-2005; IN COMMERCE 3-0-2006.

OWNER OF U.S. REG. NO. 2,044,251.

NO CLAIM IS MADE TO THE EXCLUSIVE RIGHT TO USE "NATIONAL RAILROAD HALL OF FAME", APART FROM THE MARK AS SHOWN.

THE COLOR(S) BLACK, GREEN, GOLD AND WHITE IS/ARE CLAIMED AS A FEATURE OF THE MARK.

THE MARK CONSISTS OF THE WORDS, "NATIONAL RAILROAD HALL OF FAME" AND DE-

SIGN. THE WORDS, "NATIONAL RAILROAD HALL OF FAME" APPEAR IN GOLD WITH THE WORDS, "NATIONAL HALL OF FAME" APPEARING ON A BLACK CIRCLE, DIVIDED INTO TWO SEMI-CIRCLES BY A GOLD CIRCLE IN THE CENTER, THE CENTER CIRCLE HAVING DIAGONAL BANDS OF ALTERNATING GOLD AND BLACK SHADING, THAT FADE INTO EACH OTHER, WITHOUT DISTINCT BORDERS; THE WORD "RAILROAD" IS SHOWN IN GOLD ON A ROUNDED GREEN RECTANGLE THAT BISECTS THE CIRCLE DESIGN AND CONNECTS TO THE GREEN OUTER CIRCULAR BORDER SURROUNDING THE BLACK BROKEN CIRCLE DESIGN; THE COLOR GOLD APPEARS AS OUTLINING FOR THE CIRCLE DESIGNS; THE COLOR WHITE APPEARS AS HIGHLIGHTING FOR ALL ELEMENTS APPEARING IN GOLD.

SN 77-121,398, FILED 3-2-2007.

BARBARA A. GOLD, EXAMINING ATTORNEY

**Int. Cl.: 35**

**Prior U.S. Cls.: 100, 101, and 102**

**United States Patent and Trademark Office**

**Reg. No. 3,505,930**

**Registered Sep. 23, 2008**

**SERVICE MARK  
PRINCIPAL REGISTER**

**HARVESTING WORLD**

CLAAS OMAHA INC. (NEBRASKA CORPORATION)  
8401 SOUTH 132ND STREET  
OMAHA, NE 68138

FOR: RETAIL OUTLETS FEATURING USED AGRICULTURAL EQUIPMENT, NAMELY, COMBINES, FORAGE HARVESTERS, HEADERS, HAY RAKES, CONVEYERS, MOWERS, TEDDERS, SWATHERS; CULTIVATING MACHINES AND DEVICES, NAMELY, HARROWS AND PLOWS; SPREADERS, NAMELY, FERTILIZER, HERBICIDE, AND PESTICIDE SPREADERS; EARTH MOVER LOADERS, FRONT END LOADERS, IN CLASS 35 (U.S. CLS. 100, 101 AND 102).

FIRST USE 3-0-2007; IN COMMERCE 3-0-2007.

THE MARK CONSISTS OF STANDARD CHARACTERS WITHOUT CLAIM TO ANY PARTICULAR FONT, STYLE, SIZE, OR COLOR.

NO CLAIM IS MADE TO THE EXCLUSIVE RIGHT TO USE "HARVESTING", APART FROM THE MARK AS SHOWN.

SN 77-122,188, FILED 3-5-2007.

KAPIL BHANOT, EXAMINING ATTORNEY



**Int. Cl.: 16**

**Prior U.S. Cls.: 2, 5, 22, 23, 29, 37, 38, and 50**

**United States Patent and Trademark Office**

**Reg. No. 3,505,931**

**Registered Sep. 23, 2008**

**TRADEMARK  
PRINCIPAL REGISTER**



HARRIS, LORETTA L. (FLORIDA SOLE PROPRIETORSHIP)  
P. O. BOX 679005  
ORLANDO, FL 32867

FOR: BOOK BINDINGS; BOOK COVERS, BOOK HOLDERS; BOOK-COVER PAPER; BUSINESS RECORD BOOKS; BLANK JOURNAL BOOKS, MANUSCRIPT BOOKS, NON-FICTION BOOKS ON A VARIETY OF TOPICS; NON-FICTION BOOKS ON A VARIETY OF TOPICS; PRAYER BOOKS, RELIGIOUS BOOKS; SCHOLARLY BOOKS ON VARIOUS TOPICS, NAMELY, SOCIAL AWARENESS; SERIES OF FICTION AND NON-FICTION BOOKS ON A VARIETY OF TOPICS; SERIES OF FICTION AND NON-FICTION BOOKS ON A VARIETY OF TOPICS; SERIES OF FICTION BOOKS; SERIES OF NON-FICTION BOOKS IN THE FIELD OF SPIRITUAL AWARENESS, SELF-HELP, AUTOBIOGRAPHY, BIOGRAPHY; STORY BOOK, A SERIES OF BOOKS, WRITTEN ARTICLES, HANDOUTS AND WORK-

SHEETS IN THE FIELD OF SELF-PUBLISHING; EDUCATIONAL BOOKS FEATURING ELEMENTARY, HIGH SCHOOL AND COLLEGE GUIDE TO SUCCESS IN THE FIELD OF SELF-HELP, IN CLASS 16 (U.S. CLS. 2, 5, 22, 23, 29, 37, 38 AND 50).

FIRST USE 7-21-2007; IN COMMERCE 7-21-2007.

THE COLOR(S) RED AND BLACK IS/ARE CLAIMED AS A FEATURE OF THE MARK.

THE MARK CONSISTS OF STYLIZED LETTERS "C" AND "H" JOINED TOGETHER AND FEATURED IN RED AND BLACK.

SN 77-122,634, FILED 3-5-2007.

DEIRDRE ROBERTSON, EXAMINING ATTORNEY

Int. Cl.: 3

Prior U.S. Cls.: 1, 4, 6, 50, 51, and 52

United States Patent and Trademark Office

Reg. No. 3,505,932

Registered Sep. 23, 2008

TRADEMARK  
PRINCIPAL REGISTER



DUNCAN, NANCY (UNITED STATES INDIVIDUAL)  
7279 RAY DR  
SWARTZ CREEK, MI 48473

FOR: HAND CREAM, IN CLASS 3 (U.S. CLS. 1, 4, 6, 50, 51 AND 52).

FIRST USE 8-8-2007; IN COMMERCE 8-8-2007.

NO CLAIM IS MADE TO THE EXCLUSIVE RIGHT TO USE "HAND CREAM" , APART FROM THE MARK AS SHOWN.

THE STIPPLING IS FOR SHADING PURPOSES ONLY.

THE MARK CONSISTS IN PART OF A LIKENESS OF A PERSONS BACK SIDE IN JEANS WITH A BELT AND TEE SHIRT WITH LOW RISE PANTS SO YOU SEE A LITTLE BIT OF BUTT CRACK.

SN 77-122,738, FILED 3-5-2007.

LINDA E. BLOHM, EXAMINING ATTORNEY

**Int. Cls.: 35 and 36**

**Prior U.S. Cls.: 100, 101, and 102**

**United States Patent and Trademark Office**

**Reg. No. 3,505,933**

**Registered Sep. 23, 2008**

**SERVICE MARK  
PRINCIPAL REGISTER**

**EVOFI**

EVOFI (NEVADA CORPORATION)  
1140 TOWN CENTER DRIVE, SUITE 300  
LAS VEGAS, NV 89144

FOR: ASSISTANCE IN BUSINESS MANAGEMENT AND PRODUCT COMMERCIALIZATION, WITHIN THE FRAMEWORK OF A FRANCHISE CONTRACT; FRANCHISE SERVICES, NAMELY, OFFERING TECHNICAL AND BUSINESS MANAGEMENT ASSISTANCE IN THE OPERATION OF REAL ESTATE LENDING AND BROKERAGE BUSINESSES, IN THE FIELD OF MORTGAGE LENDING AND BROKERAGE, AND INSURANCE AGENCY AND BROKERAGE, IN CLASS 35 (U.S. CLS. 100, 101 AND 102).

FIRST USE 9-30-2006; IN COMMERCE 9-30-2006.

FOR: REAL ESTATE LENDING SERVICES; REAL ESTATE BROKERAGE; MORTGAGE LENDING; MORTGAGE BANKING SERVICES, NAMELY, ORIGINATION, ACQUISITION, SERVICING, SECURITIZATION AND BROKERAGE OF MORTGAGE LOANS; INSURANCE AGENCY AND BROKERAGE, IN CLASS 36 (U.S. CLS. 100, 101 AND 102).

FIRST USE 9-30-2006; IN COMMERCE 9-30-2006.

THE MARK CONSISTS OF STANDARD CHARACTERS WITHOUT CLAIM TO ANY PARTICULAR FONT, STYLE, SIZE, OR COLOR.

SN 77-124,485, FILED 3-7-2007.

MARY ROSSMAN, EXAMINING ATTORNEY

**Int. Cls.: 36 and 37**

**Prior U.S. Cls.: 100, 101, 102, 103, and 106**

**United States Patent and Trademark Office**

**Reg. No. 3,505,934**

**Registered Sep. 23, 2008**

**SERVICE MARK  
PRINCIPAL REGISTER**

**INSIDE THE WALLS**

BEAZER HOMES HOLDINGS CORP. (DELA-  
WARE CORPORATION)  
1000 ABERNATHY ROAD, SUITE 1200  
ATLANTA, GA 30328

FOR: REAL ESTATE BROKERAGE SERVICES, IN  
CLASS 36 (U.S. CLS. 100, 101 AND 102).

FIRST USE 5-1-2007; IN COMMERCE 5-1-2007.

FOR: CONSTRUCTION, PLANNING AND LAY-  
ING OUT OF RESIDENTIAL COMMUNITIES AND

RESIDENTIAL CONSTRUCTION SERVICES, IN  
CLASS 37 (U.S. CLS. 100, 103 AND 106).

FIRST USE 5-1-2007; IN COMMERCE 5-1-2007.

THE MARK CONSISTS OF STANDARD CHAR-  
ACTERS WITHOUT CLAIM TO ANY PARTICULAR  
FONT, STYLE, SIZE, OR COLOR.

SN 77-124,790, FILED 3-7-2007.

SKYE YOUNG, EXAMINING ATTORNEY

**Int. Cl.: 10**

**Prior U.S. Cls.: 26, 39, and 44**

**United States Patent and Trademark Office**

**Reg. No. 3,505,935**

**Registered Sep. 23, 2008**

**TRADEMARK  
PRINCIPAL REGISTER**

**GENTEC**

GENSTAR TECHNOLOGIES CO., INC. (CALI-  
FORNIA CORPORATION)  
4525 EDISON AVENUE  
CHINO, CA 91710

FOR: MEDICAL ALARM SYSTEMS, PRIMARILY  
COMPOSED OF PRESSURE TRANSDUCERS AND  
SWITCHES TO MONITOR THE DISTRIBUTION OF  
MEDICAL GASES, IN CLASS 10 (U.S. CLS. 26, 39  
AND 44).

FIRST USE 3-26-2008; IN COMMERCE 3-26-2008.

THE MARK CONSISTS OF STANDARD CHAR-  
ACTERS WITHOUT CLAIM TO ANY PARTICULAR  
FONT, STYLE, SIZE, OR COLOR.

OWNER OF U.S. REG. NOS. 2,693,835 AND  
2,965,868.

SN 77-124,794, FILED 3-7-2007.

BERYL GARDNER, EXAMINING ATTORNEY

**Int. Cl.: 9**

**Prior U.S. Cls.: 21, 23, 26, 36, and 38**

**Reg. No. 3,505,936**

**United States Patent and Trademark Office**

**Registered Sep. 23, 2008**

**TRADEMARK  
PRINCIPAL REGISTER**

**EZ YEGO**

RITEK CORPORATION (TAIWAN CORPORATION)  
NO. 42, KUANGFU N. ROAD  
HSIN CHU INDUSTRIAL PK, TAIWAN

FOR: COMPUTER HARDWARE; COMPUTER PERIPHERALS; USB (UNIVERSAL SERIAL BUS) HARDWARE AND HUBS; COMPUTER STORAGE DEVICES, NAMELY, JUMP DRIVES, FLASH DRIVES, THUMB DRIVES; COMPUTER SOFTWARE FOR PROVIDING SECURITY AND PASSWORD PROTECTION FOR COMPUTER DEVICES, IN CLASS 9 (U.S. CLS. 21, 23, 26, 36 AND 38).

FIRST USE 3-19-2007; IN COMMERCE 3-20-2007.

THE MARK CONSISTS OF STANDARD CHARACTERS WITHOUT CLAIM TO ANY PARTICULAR FONT, STYLE, SIZE, OR COLOR.

SN 77-124,847, FILED 3-7-2007.

TRACY WHITTAKER-BROWN, EXAMINING ATTORNEY

**Int. Cl.: 10**

**Prior U.S. Cls.: 26, 39, and 44**

**United States Patent and Trademark Office**

**Reg. No. 3,505,937**

**Registered Sep. 23, 2008**

**TRADEMARK  
PRINCIPAL REGISTER**

**DSS**

PARADIGM SPINE, LLC (DELAWARE LIMITED  
LIABILITY COMPANY)  
505 PARK AVENUE, 14TH FLOOR  
NEW YORK, NY 10022

FOR: MEDICAL PRODUCTS, NAMELY, SURGI-  
CALLY IMPLANTABLE SPINAL STABILIZATION  
DEVICES FOR TREATING SPINAL DISEASE OR  
INSTABILITY IN THE NATURE OF IMPLANTS  
CONSISTING OF ARTIFICIAL MATERIALS; SUR-  
GICAL INSTRUMENTS TO DIAGNOSE AND  
TREAT SPINAL AND BONE DISORDERS AND  
DISEASE, IN CLASS 10 (U.S. CLS. 26, 39 AND 44).

FIRST USE 5-23-2008; IN COMMERCE 5-23-2008.

THE MARK CONSISTS OF STANDARD CHAR-  
ACTERS WITHOUT CLAIM TO ANY PARTICULAR  
FONT, STYLE, SIZE, OR COLOR.

SN 77-125,066, FILED 3-7-2007.

BENJAMIN ALLEN, EXAMINING ATTORNEY

**Int. Cl.: 9**

**Prior U.S. Cls.: 21, 23, 26, 36, and 38**

**Reg. No. 3,505,938**

**United States Patent and Trademark Office**

**Registered Sep. 23, 2008**

**TRADEMARK  
PRINCIPAL REGISTER**



GIU CO., LTD. (TAIWAN CORPORATION)  
JHONGSHAN DISTRICT  
13F.-5, NO.112, SEC. 2, JHONGSHAN N. RD.  
TAIPEI CITY 104, TAIWAN

PARATUSES, NICKEL-CADMIUM STORAGE  
BATTERIES, IN CLASS 9 (U.S. CLS. 21, 23, 26, 36  
AND 38).

FOR: WIRELESS INTERCOMS, EARPHONES,  
AUDIO SPEAKERS FOR HI-FI EQUIPMENT, MI-  
CROPHONES, AUDIO PROCESSORS FOR TONE  
QUALITY, LITHIUM STORAGE BATTERIES, TELE-  
GRAPHIC TRANSMITTING AND RECEIVING AP-

FIRST USE 10-4-2007; IN COMMERCE 10-4-2007.

SN 77-125,461, FILED 3-8-2007.

DAYNA BROWNE, EXAMINING ATTORNEY



**Int. Cl.: 31**

**Prior U.S. Cls.: 1 and 46**

**United States Patent and Trademark Office**

**Reg. No. 3,505,939**

**Registered Sep. 23, 2008**

**TRADEMARK  
PRINCIPAL REGISTER**

HOMESTYLE FROM THE PRAIRIE

M.I. INDUSTRIES, INCORPORATED (NEBRASKA CORPORATION)  
6200 NORTH 56TH STREET  
LINCOLN, NE 68504

THE MARK CONSISTS OF STANDARD CHARACTERS WITHOUT CLAIM TO ANY PARTICULAR FONT, STYLE, SIZE, OR COLOR.

FOR: PET FOOD; PET TREATS, IN CLASS 31 (U.S. CLS. 1 AND 46).

SN 77-125,766, FILED 3-8-2007.

FIRST USE 8-30-2007; IN COMMERCE 9-14-2007.

BARBARA A. GOLD, EXAMINING ATTORNEY

**Int. Cls.: 20 and 21**

**Prior U.S. Cls.: 2, 13, 22, 23, 25, 29, 30, 32, 33, 40, and 50**

**United States Patent and Trademark Office**

**Reg. No. 3,505,940**

**Registered Sep. 23, 2008**

**TRADEMARK  
PRINCIPAL REGISTER**

**ECONOLIGHT**

PRETIUM PACKAGING, L.L.C. (DELAWARE  
LIMITED LIABILITY COMPANY)  
9112 MARYLAND AVENUE, SUITE 250  
ST. LOUIS, MO 63105

FOR: PLASTIC STORAGE CONTAINERS FOR  
COMMERCIAL OR INDUSTRIAL USE, IN CLASS  
20 (U.S. CLS. 2, 13, 22, 25, 32 AND 50).

FIRST USE 11-0-2005; IN COMMERCE 11-0-2005.

FOR: PLASTIC STORAGE CONTAINERS FOR  
DOMESTIC USE, IN CLASS 21 (U.S. CLS. 2, 13, 23,  
29, 30, 33, 40 AND 50).

FIRST USE 11-0-2005; IN COMMERCE 11-0-2005.

THE MARK CONSISTS OF STANDARD CHAR-  
ACTERS WITHOUT CLAIM TO ANY PARTICULAR  
FONT, STYLE, SIZE, OR COLOR.

SN 77-126,965, FILED 3-9-2007.

MARK SPARACINO, EXAMINING ATTORNEY

Int. Cl.: 36

Prior U.S. Cls.: 100, 101, and 102

United States Patent and Trademark Office

Reg. No. 3,505,941

Registered Sep. 23, 2008

SERVICE MARK  
PRINCIPAL REGISTER

The logo for "MyRewards" is written in a black, cursive script. The word "My" is written in a smaller, more compact script, while "Rewards" is written in a larger, more flowing script. The "Y" in "My" extends significantly below the baseline of the other letters, creating a distinctive visual element.

CONNEXUS CREDIT UNION (WISCONSIN CORPORATION)  
2600 PINE RIDGE BLVD  
WAUSAU, WI 54402

FOR: CREDIT UNIONS, IN CLASS 36 (U.S. CLS. 100, 101 AND 102).

FIRST USE 3-15-2007; IN COMMERCE 3-15-2007.

THE MARK CONSISTS OF THE WORDS "MYREWARDS" IN A STYLIZED SCRIPT WITH NO SPACE BETWEEN. THE "M" IN "MY" AND THE FIRST "R" IN "REWARDS" ARE CAPITALIZED. THE "Y" IN "MY" EXTENDS BELOW THE "M" ALMOST UNDERLINING IT.

SN 77-127,025, FILED 3-9-2007.

TIMOTHY FINNEGAN, EXAMINING ATTORNEY

**Int. Cl.: 28**

**Prior U.S. Cls.: 22, 23, 38, and 50**

**United States Patent and Trademark Office**

**Reg. No. 3,505,942**

**Registered Sep. 23, 2008**

**TRADEMARK  
PRINCIPAL REGISTER**

**BELAHOCKEY**

BELA HOCKEY, LLC (MAINE LIMITED LIABILITY COMPANY)  
30 ADELBERT STREET  
SOUTH PORTLAND, ME 04106

THE MARK CONSISTS OF STANDARD CHARACTERS WITHOUT CLAIM TO ANY PARTICULAR FONT, STYLE, SIZE, OR COLOR.

FOR: SPORTING GOODS, NAMELY, HOCKEY STICKS, IN CLASS 28 (U.S. CLS. 22, 23, 38 AND 50).

SN 77-128,015, FILED 3-12-2007.

FIRST USE 12-12-2007; IN COMMERCE 12-12-2007.

SUZANNE BLANE, EXAMINING ATTORNEY

**Int. Cl.: 11**

**Prior U.S. Cls.: 13, 21, 23, 31, and 34**

**United States Patent and Trademark Office**

**Reg. No. 3,505,943**

**Registered Sep. 23, 2008**

**TRADEMARK  
PRINCIPAL REGISTER**

**WARMSTEP**

THERMOSOFT INTERNATIONAL CORPORA-  
TION (ILLINOIS CORPORATION)  
310 LEXINGTON DRIVE  
BUFFALO GROVE, IL 60089

FOR: ELECTRICAL RADIANT FLOOR HEATING  
SYSTEM COMPRISED OF HEATING MATS AND/  
OR HEATING CABLES FOR USE UNDER TILE,  
MARBLE, PORCELAIN, STONE, FLOATING  
FLOORS CONCRETE PAVEMENT AND OTHER  
FLOOR COVERINGS FOR HOUSEHOLD AND IN-  
DUSTRIAL PURPOSES, IN CLASS 11 (U.S. CLS. 13,  
21, 23, 31 AND 34).

FIRST USE 4-30-2008; IN COMMERCE 4-30-2008.

THE MARK CONSISTS OF STANDARD CHAR-  
ACTERS WITHOUT CLAIM TO ANY PARTICULAR  
FONT, STYLE, SIZE, OR COLOR.

SN 77-129,444, FILED 3-13-2007.

NANCY CLARKE, EXAMINING ATTORNEY

**Int. Cl.: 11**

**Prior U.S. Cls.: 13, 21, 23, 31, and 34**

**Reg. No. 3,505,944**

**United States Patent and Trademark Office**

**Registered Sep. 23, 2008**

**TRADEMARK  
PRINCIPAL REGISTER**

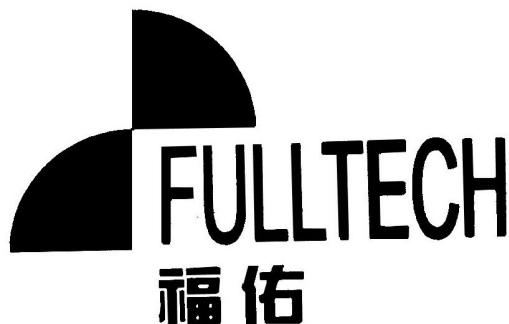

FULLTECH ELECTRIC CO., LTD. (TAIWAN CORPORATION)  
NO. 392, NAN SHANG RD., KUEI SHAN HSIANG  
TAO YUAN HSIEN, TAIWAN

FOR: ELECTRIC HEATING FANS; VENTILATING EXHAUST FANS; VENTILATING FANS FOR COMMERCIAL AND INDUSTRIAL USE, IN CLASS 11 (U.S. CLS. 13, 21, 23, 31 AND 34).

FIRST USE 2-1-2002; IN COMMERCE 4-16-2008.

THE MARK CONSISTS OF A STYLIZED FAN BLADE, THE WORD "FULLTECH", AND THE CHINESE CHARACTERS SYMBOLIZING GOOD FORTUNE, HAPPINESS AND TO HELP, TO PROTECT.

THE FOREIGN WORDING IN THE MARK TRANSLATES INTO ENGLISH AS GOOD FORTUNE/HAPPINESS AND TO HELP; TO PROTECT.

THE NON-LATIN CHARACTER(S) IN THE MARK TRANSLITERATES INTO FU YOU , AND THIS MEANS GOOD FORTUNE/HAPPINESS AND TO HELP/TO PROTECT IN ENGLISH.

SN 77-131,226, FILED 3-14-2007.

SCOTT BIBB, EXAMINING ATTORNEY

**Int. Cl.: 18**

**Prior U.S. Cls.: 1, 2, 3, 22, and 41**

**United States Patent and Trademark Office**

**Reg. No. 3,505,945**

**Registered Sep. 23, 2008**

**TRADEMARK  
PRINCIPAL REGISTER**

**WEST END COLLECTION**

KINGPORT INDUSTRIES, L.L.C. (ILLINOIS LIMITED LIABILITY COMPANY)  
1303 SHERMER RD.  
NORTHBROOK, IL 60062

FOR: LUGGAGE, TRAVEL BAGS, TOTE BAGS, HANDBAGS, BRIEF BAGS AND CASES, WALLETS AND BACKPACKS, IN CLASS 18 (U.S. CLS. 1, 2, 3, 22 AND 41).

FIRST USE 7-13-2007; IN COMMERCE 7-13-2007.

THE MARK CONSISTS OF STANDARD CHARACTERS WITHOUT CLAIM TO ANY PARTICULAR FONT, STYLE, SIZE, OR COLOR.

NO CLAIM IS MADE TO THE EXCLUSIVE RIGHT TO USE "COLLECTION", APART FROM THE MARK AS SHOWN.

SN 77-131,321, FILED 3-14-2007.

BENJAMIN ALLEN, EXAMINING ATTORNEY

**Int. Cls.: 1, 17, and 19**

**Prior U.S. Cls.: 1, 5, 6, 10, 12, 13, 26, 33, 35, 46, and 50**

**United States Patent and Trademark Office**

**Reg. No. 3,505,946**

**Registered Sep. 23, 2008**

**TRADEMARK  
PRINCIPAL REGISTER**

**PRO!**

TILE GRUPO AMERICA, INC. (TEXAS CORPORATION)  
450 S. RONALD REAGAN BLVD.  
LONGWOOD, FL 32750

FOR: FLOORING SUPPLIES AND SUNDRIES, NAMELY, ADHESIVES FOR APPLYING FLOOR TILES, THIN SET MATERIALS, NAMELY, CEMENT AND CEMENTITIOUS ADHESIVE FOR SETTING FLOOR TILE AND ACRYLIC ADMIXTURES FOR THIN SET MORTAR ADHESIVES, IN CLASS 1 (U.S. CLS. 1, 5, 6, 10, 26 AND 46).

FIRST USE 5-18-2008; IN COMMERCE 5-18-2008.

FOR: FLOORING SEAM TAPE, IN CLASS 17 (U.S. CLS. 1, 5, 12, 13, 35 AND 50).

FIRST USE 5-18-2008; IN COMMERCE 5-18-2008.

FOR: FLOORING SUPPLIES AND FLOORING SUNDRIES, NAMELY, GYPSUM AND CONCRETE BACKER BOARDS, FLOOR BOARDS, GROUT, NON-METAL COVE BASES, WOODEN TACK STRIP USED TO HOLD DOWN FLOORING, IN CLASS 19 (U.S. CLS. 1, 12, 33 AND 50).

FIRST USE 5-18-2008; IN COMMERCE 5-18-2008.

THE MARK CONSISTS OF STANDARD CHARACTERS WITHOUT CLAIM TO ANY PARTICULAR FONT, STYLE, SIZE, OR COLOR.

SN 77-132,135, FILED 3-15-2007.

JOHN GARTNER, EXAMINING ATTORNEY



**Int. Cl.: 41**

**Prior U.S. Cls.: 100, 101, and 107**

**United States Patent and Trademark Office**

**Reg. No. 3,505,947**

**Registered Sep. 23, 2008**

**SERVICE MARK  
PRINCIPAL REGISTER**



A MILLION STARS, INC. (MISSOURI NON-PROFIT CORPORATION)  
2901 NORTH GRAND AVENUE  
ST. LOUIS, MO 63107

FOR: COUNSELING SERVICES IN THE FIELD OF COLLEGE PREPARATION, SELECTION, AND ADMISSION, NAMELY, ASSISTING HIGH SCHOOL STUDENTS FROM DISADVANTAGED BACKGROUNDS IN DEVELOPING THE ACADEMIC CAPACITY TO APPLY, MATRICULATE AND PERSIST IN COLLEGES AND OTHER FORMS OF HIGHER EDUCATION, MENTORING SERVICES, NAMELY, ASSISTING HIGH SCHOOL STUDENTS FROM DISADVANTAGED BACKGROUNDS IN DEVELOPING

THE PERSISTENCE, LIFE SKILLS AND SUPPORT TO APPLY, MATRICULATE AND PERSIST IN COLLEGES AND OTHER FORMS OF HIGHER EDUCATION AND ASSISTING THEM IN OBTAINING ADMISSION TO COLLEGES AND OTHER FORMS OF HIGHER EDUCATION, IN CLASS 41 (U.S. CLS. 100, 101 AND 107).

FIRST USE 4-30-2007; IN COMMERCE 4-30-2007.

SN 77-132,672, FILED 3-16-2007.

JASON TURNER, EXAMINING ATTORNEY

**Int. Cls.: 4 and 35**

**Prior U.S. Cls.: 1, 6, 15, 100, 101, and 102**

**United States Patent and Trademark Office**

**Reg. No. 3,505,948**

**Registered Sep. 23, 2008**

**TRADEMARK  
SERVICE MARK  
PRINCIPAL REGISTER**

**DESTINY**

AMERICAN DESTINY HOLDINGS, LTD (TEXAS  
LIMITED PARTNERSHIP)  
2415 W. NORTHWEST HIGHWAY SUITE 105  
DALLAS, TX 75220

FOR: LIQUID PETROLEUM GASES TO BE USED  
IN MOTOR VEHICLES, IN CLASS 4 (U.S. CLS. 1, 6  
AND 15).

FIRST USE 1-2-2008; IN COMMERCE 1-2-2008.

FOR: RETAIL STORE SERVICES FEATURING  
CONVENIENCE STORE ITEMS AND GASOLINE, IN  
CLASS 35 (U.S. CLS. 100, 101 AND 102).

FIRST USE 1-2-2008; IN COMMERCE 1-2-2008.

THE MARK CONSISTS OF STANDARD CHAR-  
ACTERS WITHOUT CLAIM TO ANY PARTICULAR  
FONT, STYLE, SIZE, OR COLOR.

SN 77-133,248, FILED 3-16-2007.

SANJEEV VOHRA, EXAMINING ATTORNEY

**Int. Cl.: 9**

**Prior U.S. Cls.: 21, 23, 26, 36, and 38**

**Reg. No. 3,505,949**

**United States Patent and Trademark Office**

**Registered Sep. 23, 2008**

**TRADEMARK  
PRINCIPAL REGISTER**

# Motion Picture Pro

MATSUSHITA ELECTRIC INDUSTRIAL CO.,  
LTD. (JAPAN CORPORATION)  
1006, OAZA KADOMA, KADOMA-SHI  
OSAKA, JAPAN 571-8501

NO CLAIM IS MADE TO THE EXCLUSIVE  
RIGHT TO USE "MOTION PICTURE", APART  
FROM THE MARK AS SHOWN.

FOR: SLIM TELEVISION SETS, IN CLASS 9 (U.S.  
CLS. 21, 23, 26, 36 AND 38).

SN 77-133,262, FILED 3-16-2007.

FIRST USE 1-8-2007; IN COMMERCE 1-8-2007.

THE MARK CONSISTS OF STANDARD CHAR-  
ACTERS WITHOUT CLAIM TO ANY PARTICULAR  
FONT, STYLE, SIZE, OR COLOR.

ALEXANDER L. POWERS, EXAMINING ATTOR-  
NEY

**Int. Cls.: 35 and 42**

**Prior U.S. Cls.: 100, 101, and 102**

**United States Patent and Trademark Office**

**Reg. No. 3,505,950**

**Registered Sep. 23, 2008**

**SERVICE MARK  
PRINCIPAL REGISTER**

**andCulture**

ANDCULTURE, INC. (PENNSYLVANIA CORPORATION)  
130 LOCUST STREET  
HARRISBURG, PA 17101

FOR: INTEGRATED MARKETING COMMUNICATION SERVICES, NAMELY, ADVERTISING AGENCY SERVICES, DIRECT MARKETING ADVERTISING FOR OTHERS, SALES PROMOTION SERVICES, BUSINESS MARKETING CONSULTATION IN THE FIELD OF BRANDS, BRAND IDENTITY AND BRAND MANAGEMENT, IN CLASS 35 (U.S. CLS. 100, 101 AND 102).

FIRST USE 10-0-2006; IN COMMERCE 10-0-2006.

FOR: DESIGN AND DEVELOPMENT OF WEB SITES AND E-COMMERCE FACILITIES FOR OTHERS, GRAPHIC ARTS DESIGN SERVICES, IN CLASS 42 (U.S. CLS. 100 AND 101).

FIRST USE 10-0-2006; IN COMMERCE 10-0-2006.

THE MARK CONSISTS OF STANDARD CHARACTERS WITHOUT CLAIM TO ANY PARTICULAR FONT, STYLE, SIZE, OR COLOR.

SN 77-133,406, FILED 3-16-2007.

MAUREEN DALL, EXAMINING ATTORNEY

**Int. Cl.: 28**

**Prior U.S. Cls.: 22, 23, 38, and 50**

**Reg. No. 3,505,951**

**United States Patent and Trademark Office**

**Registered Sep. 23, 2008**

---

**TRADEMARK  
PRINCIPAL REGISTER**

**PIRATE'S GOLD**

THINKFUN, INC. (VIRGINIA CORPORATION)  
1321 CAMERON STREET  
ALEXANDRIA, VA 22314

THE MARK CONSISTS OF STANDARD CHAR-  
ACTERS WITHOUT CLAIM TO ANY PARTICULAR  
FONT, STYLE, SIZE, OR COLOR.

FOR: AMUSEMENT DEVICES, NAMELY, MA-  
NIPULABLE PUZZLES, IN CLASS 28 (U.S. CLS. 22,  
23, 38 AND 50).

SN 77-134,010, FILED 3-19-2007.

FIRST USE 4-0-2007; IN COMMERCE 4-0-2007.

AMY MCMENAMIN, EXAMINING ATTORNEY

**Int. Cl.: 25**

**Prior U.S. Cls.: 22 and 39**

**United States Patent and Trademark Office**

**Reg. No. 3,505,952**

**Registered Sep. 23, 2008**

**TRADEMARK  
PRINCIPAL REGISTER**

**RICKNECK**

HUFFMAN, RICKY E. (UNITED STATES INDIVIDUAL)  
560 NEW WAY CIRCLE  
LENIOR, NC 28645

THE MARK CONSISTS OF STANDARD CHARACTERS WITHOUT CLAIM TO ANY PARTICULAR FONT, STYLE, SIZE, OR COLOR.

FOR: CLOTHING, NAMELY, SHIRTS AND CAPS,  
IN CLASS 25 (U.S. CLS. 22 AND 39).

SN 77-135,734, FILED 3-20-2007.

FIRST USE 7-15-2008; IN COMMERCE 7-15-2008.

MARY MUNSON, EXAMINING ATTORNEY

**Int. Cls.: 35 and 37**

**Prior U.S. Cls.: 100, 101, 102, 103, and 106**

**United States Patent and Trademark Office**

**Reg. No. 3,505,953**

**Registered Sep. 23, 2008**

**SERVICE MARK  
PRINCIPAL REGISTER**

# TechTurn

TECHTURN, LTD. (TEXAS LIMITED PARTNER-  
SHIP)  
2214 WEST BRAKER LANE  
AUSTIN, TX 78758

FOR: WHOLESALE DISTRIBUTORSHIP OF RE-  
MANUFACTURED PERSONAL COMPUTERS,  
COMPUTER LAPTOPS, COMPUTER MONITORS,  
CELL PHONES AND VIDEO GAME EQUIPMENT ,  
IN CLASS 35 (U.S. CLS. 100, 101 AND 102).

FIRST USE 4-30-2007; IN COMMERCE 4-30-2007.

FOR: RECYCLING TECHNOLOGY EQUIPMENT,  
NAMELY, REFURBISHING AND REMANUFAC-  
TURING OF PERSONAL COMPUTERS, COMPU-

TER LAPTOPS, COMPUTER MONITORS, CELL  
PHONES AND VIDEO GAME EQUIPMENT TO  
THE ORDER AND SPECIFICATION OF OTHERS,  
IN CLASS 37 (U.S. CLS. 100, 103 AND 106).

FIRST USE 4-30-2007; IN COMMERCE 4-30-2007.

THE MARK CONSISTS OF STANDARD CHAR-  
ACTERS WITHOUT CLAIM TO ANY PARTICULAR  
FONT, STYLE, SIZE, OR COLOR.

SN 77-137,685, FILED 3-22-2007.

BERYL GARDNER, EXAMINING ATTORNEY

**Int. Cl.: 7**

**Prior U.S. Cls.: 13, 19, 21, 23, 31, 34, and 35**

**Reg. No. 3,505,954**

**United States Patent and Trademark Office**

**Registered Sep. 23, 2008**

---

**TRADEMARK  
PRINCIPAL REGISTER**

**GT**

POSITEC GROUP LIMITED (CHINA CORPORATION)  
LEVEL 28, THREE PACIFIC PLACE  
1 QUEEN'S ROAD EAST  
HONG KONG ADM. REGION, CHINA

THE MARK CONSISTS OF STANDARD CHARACTERS WITHOUT CLAIM TO ANY PARTICULAR FONT, STYLE, SIZE, OR COLOR.

FOR: POWER-OPERATED GRASS/WEED TRIMMERS, IN CLASS 7 (U.S. CLS. 13, 19, 21, 23, 31, 34 AND 35).

SN 77-139,129, FILED 3-23-2007.

FIRST USE 5-17-2008; IN COMMERCE 5-17-2008.

SKYE YOUNG, EXAMINING ATTORNEY



**Int. Cls.: 35 and 41**

**Prior U.S. Cls.: 100, 101, 102, and 107**

**United States Patent and Trademark Office**

**Reg. No. 3,505,955**

**Registered Sep. 23, 2008**

**SERVICE MARK  
PRINCIPAL REGISTER**

## Clarity at the Highest Levels

SULGRAVE RESOURCES LLC (WASHINGTON  
LIMITED LIABILITY COMPANY)  
8515 SE 44TH PLACE  
MERCER ISLAND, WA 98040

FOR: CONSULTANCY SERVICES REGARDING BUSINESS STRATEGIES; CONSULTATION IN THE FIELD OF BUSINESS ACQUISITIONS; CONSULTING SERVICES IN BUSINESS ORGANIZATION AND MANAGEMENT; CONSULTING SERVICES IN THE FIELD OF MANAGING INTELLECTUAL PROPERTIES; ON-LINE BUSINESS DIRECTORIES FEATURING BUSINESS COACHES, CONSULTANTS, AND SPECIALIZED EXPERTS; ONLINE BUSINESS NETWORKING SERVICES; REAL ESTATE MARKETING SERVICES IN THE FIELD OF EXECUTIVE HOME SALES AND RENTALS; REAL ESTATE MARKETING SERVICES, NAMELY, ON-LINE SERVICES FEATURING TOURS OF RESIDENTIAL AND COMMERCIAL REAL ESTATE; ASSISTANCE, ADVISORY SERVICES AND CONSULTANCY WITH REGARD TO BUSINESS PLANNING, BUSINESS ANALYSIS, BUSINESS MANAGEMENT, AND BUSINESS ORGANIZATION; BUSINESS ACQUISITION AND MERGER CONSULTATION; BUSINESS CONSULTING SERVICES IN THE FIELD OF BUSINESS KNOWLEDGE TRANSFER THROUGH AUDIO TOOLS, NAMELY, RECORDING INTERVIEWS WITH SUBJECT MATTER EXPERTS FOR AN ORGANIZATION'S CAPTURE AND FUTURE USE; BUSINESS SUCCESSION PLANNING; BUSINESS MANAGEMENT CONSULTANCY AS WELL AS DEVELOPMENT OF PROCESSES FOR THE ANALYSIS AND THE IMPLEMENTATION OF STRATEGY PLANS AND MANAGEMENT PROJECTS; BUSINESS MANAGEMENT CONSULTATION IN THE FIELD OF EXECUTIVE AND LEADERSHIP DEVELOPMENT; BUSINESS DEVELOPMENT SERVICES, NAMELY, PROVIDING START-UP SUPPORT FOR BUSINESSES OF OTHERS; BUSINESS LEADERSHIP DEVELOPMENT; BUSINESS SERVICES, NAMELY,

MATCHING POTENTIAL PRIVATE INVESTORS WITH ENTREPRENEURS NEEDING FUNDING; BUSINESS SERVICES, NAMELY, PROCURING QUALIFIED AND CREDENTIALLED THIRD-PARTY EXPERTS, PROFESSIONALS AND OTHER QUALIFIED PERSONNEL, AND DOCUMENTATION AND INFORMATION ALL ON BEHALF OF OTHERS; EXPERT EVALUATIONS AND REPORTS RELATING TO BUSINESS MATTERS; MANAGEMENT AND BUSINESS CONSULTING SERVICES IN THE FIELD OF PREPARING AND GUIDING OWNERS IN SALES OF BUSINESSES. ADVERTISING AND PUBLICITY SERVICES, NAMELY, PROMOTING THE GOODS, SERVICES, BRAND IDENTITY AND COMMERCIAL INFORMATION AND NEWS OF THIRD PARTIES THROUGH PRINT, AUDIO, VIDEO, DIGITAL AND ON-LINE MEDIUM; PROVIDING ONLINE BUSINESS MANAGEMENT INFORMATION, IN CLASS 35 (U.S. CLS. 100, 101 AND 102).

FIRST USE 8-20-2007; IN COMMERCE 8-20-2007.

FOR: ON-LINE PUBLICATION OF TEXTS, NEWSLETTERS, TEMPLATES, AND BUSINESS MANAGEMENT AND COACHING DIRECTORIES; PERSONAL COACHING SERVICES IN THE FIELD OF BUSINESS LEADERSHIP, PLANNING AND STRATEGY; ELECTRONIC PUBLISHING SERVICES, NAMELY, PUBLICATION OF TEXT AND GRAPHIC WORKS OF OTHERS ON CD, DVD, ON-LINE FEATURING BUSINESS MANAGEMENT, LEADERSHIP, STRATEGY AND DEVELOPMENT ADVICE; PUBLICATION AND EDITING OF PRINTED MATTER; PUBLICATION OF PRINTED MATTER; PUBLICATION OF NEWSLETTERS, PAMPHLETS, AND BOOKS; PUBLISHING OF ELECTRONIC PUBLICATIONS; WRITING OF TEXTS, IN CLASS 41 (U.S. CLS. 100, 101 AND 107).

FIRST USE 8-20-2007; IN COMMERCE 8-20-2007.

THE MARK CONSISTS OF STANDARD CHAR-  
ACTERS WITHOUT CLAIM TO ANY PARTICULAR  
FONT, STYLE, SIZE, OR COLOR.

SN 77-139,525, FILED 3-24-2007.

KIMBERLY FRYE, EXAMINING ATTORNEY

**Int. Cl.: 35**

**Prior U.S. Cls.: 100, 101, and 102**

**United States Patent and Trademark Office**

**Reg. No. 3,505,956**

**Registered Sep. 23, 2008**

**SERVICE MARK  
PRINCIPAL REGISTER**

**Reconnaissance Relativity  
& Revival**

SCHRODER, SIGRID CAROLINE (UNITED STATES INDIVIDUAL)  
8515 SE 44TH PLACE  
MERCER ISLAND, WA 98040

FOR: INFORMATION, ADVISORY AND CONSULTANCY SERVICES RELATING TO BUSINESS AND MANAGEMENT OR BUSINESS ADMINISTRATION, INCLUDING SUCH SERVICES PROVIDED ON LINE OR VIA THE INTERNET; CONSULTANCY SERVICES REGARDING BUSINESS STRATEGIES; CONSULTATION IN THE FIELD OF BUSINESS ACQUISITIONS; CONSULTING SERVICES IN BUSINESS ORGANIZATION AND MANAGEMENT; MANAGEMENT AND BUSINESS CONSULTING SERVICES IN THE FIELD OF PREPARING AND GUIDING OWNERS IN SALES OF BUSINESSES; CONSULTING SERVICES IN THE FIELD OF MANAGING INTELLECTUAL PROPERTIES; BUSINESS MANAGEMENT SUPERVISION; BUSINESS SERVICES, NAMELY, MATCHING POTENTIAL PRIVATE INVESTORS WITH ENTREPRENEURS NEEDING FUNDING; BUSINESS SUCCESSION PLANNING; ASSISTANCE, ADVISORY SERVICES AND CONSULTANCY WITH REGARD TO BUSINESS PLANNING, BUSINESS ANALYSIS, BUSINESS MANAGEMENT, AND BUSINESS ORGANIZATION; ADVICE RELATING TO THE ORGANIZATION AND MANAGEMENT OF BUSINESS; ADVISORY SERVICES RELATING TO

BUSINESS MANAGEMENT AND BUSINESS OPERATIONS; EXPERT EVALUATIONS AND REPORTS RELATING TO BUSINESS MATTERS; BUSINESS DEVELOPMENT SERVICES, NAMELY, PROVIDING START-UP SUPPORT FOR BUSINESSES OF OTHERS; BUSINESS INTERMEDIARY AND ADVISORY SERVICES IN THE FIELD OF SELLING PRODUCTS AND RENDERING SERVICES; BUSINESS MANAGEMENT CONSULTANCY AS WELL AS DEVELOPMENT OF PROCESSES FOR THE ANALYSIS AND THE IMPLEMENTATION OF STRATEGY PLANS AND MANAGEMENT PROJECTS; BUSINESS MANAGEMENT CONSULTATION IN THE FIELD OF EXECUTIVE AND LEADERSHIP DEVELOPMENT. BUSINESS ACQUISITION AND MERGER CONSULTATION; BUSINESS LEADERSHIP DEVELOPMENT; PROVIDING ONLINE BUSINESS MANAGEMENT INFORMATION, IN CLASS 35 (U.S. CLS. 100, 101 AND 102).

FIRST USE 6-21-2007; IN COMMERCE 6-21-2007.

THE MARK CONSISTS OF STANDARD CHARACTERS WITHOUT CLAIM TO ANY PARTICULAR FONT, STYLE, SIZE, OR COLOR.

SN 77-139,526, FILED 3-24-2007.

KIMBERLY FRYE, EXAMINING ATTORNEY

**Int. Cl.: 29**

**Prior U.S. Cl.: 46**

**United States Patent and Trademark Office**

**Reg. No. 3,505,957**

**Registered Sep. 23, 2008**

**TRADEMARK  
PRINCIPAL REGISTER**

# Quick Sides

NONPAREIL CORPORATION (IDAHO CORPORATION)

40 NORTH 400 WEST

BLACKFOOT, ID 83221

FOR: PROCESSED POTATOES, IN CLASS 29 (U.S. CL. 46).

FIRST USE 5-31-2007; IN COMMERCE 5-31-2007.

THE MARK CONSISTS OF STANDARD CHARACTERS WITHOUT CLAIM TO ANY PARTICULAR FONT, STYLE, SIZE, OR COLOR.

NO CLAIM IS MADE TO THE EXCLUSIVE RIGHT TO USE "SIDES", APART FROM THE MARK AS SHOWN.

SN 77-139,586, FILED 3-24-2007.

SCOTT BIBB, EXAMINING ATTORNEY

**Int. Cl.: 41**

**Prior U.S. Cls.: 100, 101, and 107**

**United States Patent and Trademark Office**

**Reg. No. 3,505,958**

**Registered Sep. 23, 2008**

**SERVICE MARK  
PRINCIPAL REGISTER**

**KAMPK9**

KAMPGROUNDS OF AMERICA, INC. (MONTANA CORPORATION)  
P.O. BOX 30558  
BILLINGS, MT 59114

FOR: RECREATIONAL PARK SERVICES, NAME-  
LY, PROVIDING FACILITIES FOR RECREATION  
FOR PETS AND THEIR OWNERS IN THE NATURE  
OF A PARK LIKE SETTING WHERE PETS CAN  
PLAY, IN CLASS 41 (U.S. CLS. 100, 101 AND 107).

FIRST USE 8-1-2007; IN COMMERCE 8-1-2007.

THE MARK CONSISTS OF STANDARD CHAR-  
ACTERS WITHOUT CLAIM TO ANY PARTICULAR  
FONT, STYLE, SIZE, OR COLOR.

SN 77-140,693, FILED 3-26-2007.

BRIAN CALLAGHAN, EXAMINING ATTORNEY

**Int. Cl.: 33**

**Prior U.S. Cls.: 47 and 49**

**United States Patent and Trademark Office**

**Reg. No. 3,505,959**

**Registered Sep. 23, 2008**

**TRADEMARK  
PRINCIPAL REGISTER**

**SHENANIGANS**

GRADY, JAMES J. (UNITED STATES INDIVIDUAL)

1257 RIVERGATE DRIVE  
LODI, CA 95240 AND

GRADY, ELIZABETH M. (UNITED STATES INDIVIDUAL)

1257 RIVERGATE DRIVE  
LODI, CA 95240

FIRST USE 3-12-2008; IN COMMERCE 3-12-2008.

THE MARK CONSISTS OF STANDARD CHARACTERS WITHOUT CLAIM TO ANY PARTICULAR FONT, STYLE, SIZE, OR COLOR.

SN 77-140,813, FILED 3-26-2007.

FOR: WINES, IN CLASS 33 (U.S. CLS. 47 AND 49).

KAELIE KUNG, EXAMINING ATTORNEY

**Int. Cls.: 5 and 30**

**Prior U.S. Cls.: 6, 18, 44, 46, 51, and 52**

**United States Patent and Trademark Office**

**Reg. No. 3,505,960**

**Registered Sep. 23, 2008**

**TRADEMARK  
PRINCIPAL REGISTER**

**WHEN NATURE CALLS**

TRADITIONAL MEDICINALS, INC. (CALIFORNIA CORPORATION)  
4515 ROSS ROAD  
SEBASTOPOL, CA 95472

FOR: DIETARY SUPPLEMENTS; LAXATIVES, IN CLASS 5 (U.S. CLS. 6, 18, 44, 46, 51 AND 52).

FIRST USE 6-13-2008; IN COMMERCE 6-13-2008.

FOR: HERB TEA , IN CLASS 30 (U.S. CL. 46).

FIRST USE 6-13-2008; IN COMMERCE 6-13-2008.

THE MARK CONSISTS OF STANDARD CHARACTERS WITHOUT CLAIM TO ANY PARTICULAR FONT, STYLE, SIZE, OR COLOR.

SN 77-141,399, FILED 3-27-2007.

CURTIS FRENCH, EXAMINING ATTORNEY

**Int. Cl.: 36**

**Prior U.S. Cls.: 100, 101, and 102**

**United States Patent and Trademark Office**

**Reg. No. 3,505,961**

**Registered Sep. 23, 2008**

**SERVICE MARK  
PRINCIPAL REGISTER**

**REAL CHOICES**

ASSURANT, INC. (DELAWARE CORPORATION)  
41ST FLOOR  
ONE CHASE MANHATTAN PLAZA  
NEW YORK, NY 10005

THE MARK CONSISTS OF STANDARD CHAR-  
ACTERS WITHOUT CLAIM TO ANY PARTICULAR  
FONT, STYLE, SIZE, OR COLOR.

FOR: UNDERWRITING AND ADMINISTRA-  
TION OF HEALTH INSURANCE, IN CLASS 36  
(U.S. CLS. 100, 101 AND 102).

SN 77-141,501, FILED 3-27-2007.

FIRST USE 8-1-2007; IN COMMERCE 8-1-2007.

DAVID MILLER, EXAMINING ATTORNEY



**Int. Cl.: 9**

**Prior U.S. Cls.: 21, 23, 26, 36, and 38**

**United States Patent and Trademark Office**

**Reg. No. 3,505,962**

**Registered Sep. 23, 2008**

---

**TRADEMARK  
PRINCIPAL REGISTER**

**PUMP NOW**

BUCK'S INC. (NEBRASKA CORPORATION)  
4973 DODGE STREET  
OMAHA, NE 68131

FOR: MAGNETICALLY ENCODED CARDS  
USED TO ACTIVATE GASOLINE PUMPS, IN CLASS  
9 (U.S. CLS. 21, 23, 26, 36 AND 38).

FIRST USE 6-26-2007; IN COMMERCE 2-10-2008.

THE MARK CONSISTS OF STANDARD CHAR-  
ACTERS WITHOUT CLAIM TO ANY PARTICULAR  
FONT, STYLE, SIZE, OR COLOR.

SN 77-142,893, FILED 3-28-2007.

JACQUELINE A. LAVINE, EXAMINING ATTOR-  
NEY

**Int. Cl.: 29**

**Prior U.S. Cl.: 46**

**United States Patent and Trademark Office**

**Reg. No. 3,505,963**

**Registered Sep. 23, 2008**

---

**TRADEMARK  
PRINCIPAL REGISTER**

**Atlantic Beauty**

TANGMU SEAFOOD PRODUCTS USA INC.  
(MASSACHUSETTS CORPORATION)  
541 COLUMBIAN STREET SUITE 201  
WEYMOUTH, MA 02190

NO CLAIM IS MADE TO THE EXCLUSIVE  
RIGHT TO USE "ATLANTIC", APART FROM THE  
MARK AS SHOWN.

FOR: SEAFOOD, IN CLASS 29 (U.S. CL. 46).

FIRST USE 1-25-2008; IN COMMERCE 1-25-2008.

SN 77-143,494, FILED 3-29-2007.

THE MARK CONSISTS OF STANDARD CHAR-  
ACTERS WITHOUT CLAIM TO ANY PARTICULAR  
FONT, STYLE, SIZE, OR COLOR.

JUSTINE D. PARKER, EXAMINING ATTORNEY

**Int. Cl.: 25**

**Prior U.S. Cls.: 22 and 39**

**United States Patent and Trademark Office**

**Reg. No. 3,505,964**

**Registered Sep. 23, 2008**

**TRADEMARK  
PRINCIPAL REGISTER**

**RJK SURVIVAL SERIES**

KESTER, ROBERT J. (UNITED STATES INDIVIDUAL)  
1817 CEDAR AVENUE  
SCRANTON, PA 18505

FOR: WIND RESISTANT JACKETS; JACKETS; WATERPROOF JACKETS AND PANTS, IN CLASS 25 (U.S. CLS. 22 AND 39).

FIRST USE 6-30-2008; IN COMMERCE 6-30-2008.

THE MARK CONSISTS OF STANDARD CHARACTERS WITHOUT CLAIM TO ANY PARTICULAR FONT, STYLE, SIZE, OR COLOR.

NO CLAIM IS MADE TO THE EXCLUSIVE RIGHT TO USE "SURVIVAL SERIES", APART FROM THE MARK AS SHOWN.

SN 77-143,559, FILED 3-29-2007.

DANIEL CAPSHAW, EXAMINING ATTORNEY

**Int. Cl.: 42**

**Prior U.S. Cls.: 100 and 101**

**United States Patent and Trademark Office**

**Reg. No. 3,505,965**

**Registered Sep. 23, 2008**

**SERVICE MARK  
PRINCIPAL REGISTER**

**IT PLUS NETWORK**

RIDGWAYS, LTD (TEXAS LIMITED PARTNER-  
SHIP)  
6300 GULFTON  
HOUSTON, TX 77081

FOR: COMPUTER NETWORK DESIGN FOR THE  
COPYING AND PRINTING INDUSTRY, IN CLASS  
42 (U.S. CLS. 100 AND 101).

FIRST USE 8-6-2007; IN COMMERCE 8-6-2007.

THE MARK CONSISTS OF STANDARD CHAR-  
ACTERS WITHOUT CLAIM TO ANY PARTICULAR  
FONT, STYLE, SIZE, OR COLOR.

NO CLAIM IS MADE TO THE EXCLUSIVE  
RIGHT TO USE "IT" AND "NETWORK", APART  
FROM THE MARK AS SHOWN.

SN 77-143,783, FILED 3-29-2007.

JUSTINE D. PARKER, EXAMINING ATTORNEY

**Int. Cl.: 42**

**Prior U.S. Cls.: 100 and 101**

**United States Patent and Trademark Office**

**Reg. No. 3,505,966**

**Registered Sep. 23, 2008**

**SERVICE MARK  
PRINCIPAL REGISTER**



RIDGWAYS, LTD (TEXAS LIMITED PARTNER-  
SHIP)

6300 GULFTON  
HOUSTON, TX 77081

FOR: COMPUTER NETWORK DESIGN FOR THE  
COPYING AND PRINTING INDUSTRY, IN CLASS  
42 (U.S. CLS. 100 AND 101).

FIRST USE 8-6-2007; IN COMMERCE 8-6-2007.

NO CLAIM IS MADE TO THE EXCLUSIVE  
RIGHT TO USE "IT" AND "NETWORK", APART  
FROM THE MARK AS SHOWN.

THE COLOR(S) BLACK, ORANGE AND GREEN  
IS/ARE CLAIMED AS A FEATURE OF THE MARK.

THE MARK CONSISTS OF THE WORDING "IT  
PLUS NETWORK" IN BLACK WITH A BOX  
AROUND THE LETTERS "IT" AND TWO WAVY  
LINES AT THE TOP OF THE MARK IN ORANGE; A  
BAR UNDERLINING THE WORD "PLUS" AND  
TWO WAVY LINES AT THE TOP OF THE MARK  
IN GREEN.

SN 77-144,489, FILED 3-30-2007.

JUSTINE D. PARKER, EXAMINING ATTORNEY

**Int. Cl.: 29**

**Prior U.S. Cl.: 46**

**United States Patent and Trademark Office**

**Reg. No. 3,505,967**

**Registered Sep. 23, 2008**

**TRADEMARK  
PRINCIPAL REGISTER**

**Maria's Naturals**

HUI, RAPHAEL Y. (UNITED STATES INDIVIDUAL)  
1503 ELKWOOD DRIVE  
WEST COVINA, CA 91791

FOR: PROCESSED NUTS, IN CLASS 29 (U.S. CL. 46).

FIRST USE 1-15-2008; IN COMMERCE 1-15-2008.

THE MARK CONSISTS OF STANDARD CHARACTERS WITHOUT CLAIM TO ANY PARTICULAR FONT, STYLE, SIZE, OR COLOR.

NO CLAIM IS MADE TO THE EXCLUSIVE RIGHT TO USE "NATURALS", APART FROM THE MARK AS SHOWN.

THE NAME(S), PORTRAIT(S), AND/OR SIGNATURE(S) SHOWN IN THE MARK DOES NOT IDENTIFY A PARTICULAR LIVING INDIVIDUAL.

SN 77-145,682, FILED 4-1-2007.

LAURIE MAYES, EXAMINING ATTORNEY

Int. Cl.: 37

Prior U.S. Cls.: 100, 103, and 106

United States Patent and Trademark Office

Reg. No. 3,505,968

Registered Sep. 23, 2008

**SERVICE MARK  
PRINCIPAL REGISTER**



BLACKDOG BUILDERS, INC. (NEW HAMPSHIRE CORPORATION)  
7 RED ROOF LANE  
SALEM, NH 03079

FOR: CUSTOM CONSTRUCTION AND BUILDING RENOVATION, IN CLASS 37 (U.S. CLS. 100, 103 AND 106).

FIRST USE 12-19-2003; IN COMMERCE 12-19-2003.

NO CLAIM IS MADE TO THE EXCLUSIVE RIGHT TO USE "DESIGN BUILD REMODEL", APART FROM THE MARK AS SHOWN.

THE COLOR(S) RED, WHITE AND BLACK IS/ARE CLAIMED AS A FEATURE OF THE MARK.

THE COLOR RED APPEARS IN THE BACKGROUND OF THE RECTANGLE. THE COLOR WHITE APPEARS IN THE WORDING BLACKDOG DESIGN BUILD REMODEL AND IN THE STYLIZED DESIGN OF THE DOG. THE COLOR BLACK APPEARS IN THE BORDER AROUND THE RECTANGLE AND IN THE STYLIZED DESIGN OF THE DOG.

SN 77-145,907, FILED 4-2-2007.

ROBERT STRUCK, EXAMINING ATTORNEY

**Int. Cl.: 35**

**Prior U.S. Cls.: 100, 101, and 102**

**United States Patent and Trademark Office**

**Reg. No. 3,505,969**

**Registered Sep. 23, 2008**

**SERVICE MARK  
PRINCIPAL REGISTER**

**SAVE MONEY. LIVE BETTER.**

WAL-MART STORES, INC. (DELAWARE CORPORATION)  
702 S.W. 8TH ST.  
BENTONVILLE, AR 727160520

FOR: ONLINE RETAIL DEPARTMENT STORE SERVICES; RETAIL DEPARTMENT STORE SERVICES, IN CLASS 35 (U.S. CLS. 100, 101 AND 102).

FIRST USE 7-16-2007; IN COMMERCE 9-11-2007.

THE MARK CONSISTS OF STANDARD CHARACTERS WITHOUT CLAIM TO ANY PARTICULAR FONT, STYLE, SIZE, OR COLOR.

SN 77-146,160, FILED 4-2-2007.

ALEXANDER L. POWERS, EXAMINING ATTORNEY



**Int. Cls.: 35 and 42**

**Prior U.S. Cls.: 100, 101, and 102**

**United States Patent and Trademark Office**

**Reg. No. 3,505,970**

**Registered Sep. 23, 2008**

**SERVICE MARK  
PRINCIPAL REGISTER**

The logo for jobfox features the word "jobfox" in a lowercase, sans-serif font. The "j" and "o" are in a lighter gray, while "bfox" is in black. The "x" is stylized with a three-pointed starburst shape at its top right corner.

MKT10, INC. (DELAWARE CORPORATION)  
7900 WESTPARK DRIVE  
MCLEAN, VA 22102

FOR: PROVIDING AN INTERACTIVE COMPUTER DATABASE FEATURING RECRUITMENT AND EMPLOYMENT INFORMATION FOR OTHERS; PROVIDING PERSONNEL RECRUITMENT, PERSONNEL MANAGEMENT, AND JOB SEARCHING INFORMATION FOR OTHERS, IN CLASS 35 (U.S. CLS. 100, 101 AND 102).

FIRST USE 4-6-2007; IN COMMERCE 4-6-2007.

FOR: COMPUTER SERVICES, NAMELY, WEBSITE HOSTING FOR OTHERS IN THE FIELD OF PERSONNEL RECRUITMENT, PERSONNEL MANAGEMENT, AND JOB SEARCHING, IN CLASS 42 (U.S. CLS. 100 AND 101).

FIRST USE 4-6-2007; IN COMMERCE 4-6-2007.

OWNER OF U.S. REG. NO. 3,293,459.

THE MARK CONSISTS OF "JOBFOX".

SN 77-146,286, FILED 4-2-2007.

LESLIE RICHARDS, EXAMINING ATTORNEY

**Int. Cl.: 38**

**Prior U.S. Cls.: 100, 101, and 104**

**United States Patent and Trademark Office**

**Reg. No. 3,505,971**

**Registered Sep. 23, 2008**

**SERVICE MARK  
PRINCIPAL REGISTER**

# Totaltoons

AWARD PICTURES, LLC (CONNECTICUT LIMITED LIABILITY COMPANY)  
112 CARMEN 2 HILL  
NEW MILFORD, CT 067764511

THE MARK CONSISTS OF STANDARD CHARACTERS WITHOUT CLAIM TO ANY PARTICULAR FONT, STYLE, SIZE, OR COLOR.

FOR: CABLE TELEVISION BROADCASTING, IN CLASS 38 (U.S. CLS. 100, 101 AND 104).

SN 77-146,427, FILED 4-2-2007.

FIRST USE 6-15-2008; IN COMMERCE 6-15-2008.

NAAKWAMA ANKRAH, EXAMINING ATTORNEY

**Int. Cl.: 20**

**Prior U.S. Cls.: 2, 13, 22, 25, 32, and 50**

**Reg. No. 3,505,972**

**United States Patent and Trademark Office**

**Registered Sep. 23, 2008**

**TRADEMARK  
PRINCIPAL REGISTER**

**DPX**

PROVO STEEL & SUPPLY CO. (UTAH CORPORATION)  
P.O. BOX 944  
1400 SOUTH STATE STREET  
PROVO, UT 84603

FIRST USE 11-30-2007; IN COMMERCE 11-30-2007.

THE MARK CONSISTS OF STANDARD CHARACTERS WITHOUT CLAIM TO ANY PARTICULAR FONT, STYLE, SIZE, OR COLOR.

FOR: STORAGE SYSTEM FOR USE IN METAL SAFES, NAMELY, RACKS AND SHELVES FOR USE IN METAL SAFES, IN CLASS 20 (U.S. CLS. 2, 13, 22, 25, 32 AND 50).

SN 77-146,762, FILED 4-2-2007.

KAPIL BHANOT, EXAMINING ATTORNEY

**Int. Cls.: 41, 42, and 45**

**Prior U.S. Cls.: 100, 101, and 107**

**United States Patent and Trademark Office**

**Reg. No. 3,505,973**

**Registered Sep. 23, 2008**

**SERVICE MARK  
PRINCIPAL REGISTER**



ANIMATEDWORKS PRODUCTIONS, INC. (ILLINOIS CORPORATION)  
#3103  
57 EAST DELAWARE PLACE  
CHICAGO, IL 60611

FOR: ANIMATION PRODUCTION SERVICES, IN CLASS 41 (U.S. CLS. 100, 101 AND 107).

FIRST USE 7-11-2007; IN COMMERCE 7-11-2007.

FOR: DESIGNING ANIMATIONS AND ANIMATED FILMS FOR OTHERS; DESIGN AND DEVELOPMENT OF MULTIMEDIA PRODUCTS, IN CLASS 42 (U.S. CLS. 100 AND 101).

FIRST USE 12-27-2007; IN COMMERCE 12-27-2007.

FOR: LICENSING OF INTELLECTUAL PROPERTY, NAMELY, LICENSING TO OTHERS OF STILL IMAGES, MOVING IMAGES, STOCK FOOTAGE, FILMS AND ANIMATIONS; CARTOON CHARACTER LICENSING, IN CLASS 45 (U.S. CLS. 100 AND 101).

FIRST USE 12-27-2007; IN COMMERCE 12-27-2007.

NO CLAIM IS MADE TO THE EXCLUSIVE RIGHT TO USE "ANIMATED WORKS PRODUCTIONS, INC.", APART FROM THE MARK AS SHOWN.

SN 77-148,127, FILED 4-4-2007.

AISHA SALEM, EXAMINING ATTORNEY

**Int. Cls.: 42 and 45**

**Prior U.S. Cls.: 100 and 101**

**United States Patent and Trademark Office**

**Reg. No. 3,505,974**

**Registered Sep. 23, 2008**

**SERVICE MARK  
PRINCIPAL REGISTER**

# SyncLive

SYNCHRONICITY LIVE, LLC (FLORIDA LIMITED LIABILITY COMPANY)  
SUITE C  
637 1ST AVE NORTH  
JACKSONVILLE BEACH, FL 32250

FOR: PROVIDING AN ON-LINE, NON-DOWNLOADABLE WEB APPLICATION PLATFORM FOR STREAMING LIVE AUDIO AND VIDEO MATERIAL ON THE INTERNET AND FOR ENABLING USERS TO UPLOAD, POST, WATCH, TAG AND ELECTRONICALLY TRANSMIT DIGITAL CONTENT IN THE FIELDS OF MUSICAL PERFORMANCES, CONCERTS AND MUSIC VIDEOS, IN CLASS 42 (U.S. CLS. 100 AND 101).

FIRST USE 12-1-2007; IN COMMERCE 12-1-2007.

FOR: ONLINE SOCIAL NETWORKING SERVICES, IN CLASS 45 (U.S. CLS. 100 AND 101).

FIRST USE 12-1-2007; IN COMMERCE 12-1-2007.

THE MARK CONSISTS OF STANDARD CHARACTERS WITHOUT CLAIM TO ANY PARTICULAR FONT, STYLE, SIZE, OR COLOR.

SN 77-149,128, FILED 4-5-2007.

LEIGH CAROLINE CASE, EXAMINING ATTORNEY

**Int. Cl.: 12**

**Prior U.S. Cls.: 19, 21, 23, 31, 35, and 44**

**United States Patent and Trademark Office**

**Reg. No. 3,505,975**

**Registered Sep. 23, 2008**

**TRADEMARK  
PRINCIPAL REGISTER**

**NISSAN GT-R**

NISSAN JIDOSHA KABUSHIKI KAISHA T/A  
NISSAN MOTOR CO., LTD. (JAPAN COR-  
PORATION)  
NO. 2 TAKARACHO, KANAGAWA-KU  
YOKOHAMA-SHI  
KANAGAWA-KEN, JAPAN

FOR: MOTOR VEHICLES, NAMELY, AUTOMO-  
BILES, TRUCKS, VANS, SPORT UTILITY VEHICLES  
AND STRUCTURAL PARTS THEREFOR EXCEPT  
TIRES, IN CLASS 12 (U.S. CLS. 19, 21, 23, 31, 35 AND  
44).

FIRST USE 7-7-2008; IN COMMERCE 7-7-2008.

THE MARK CONSISTS OF STANDARD CHAR-  
ACTERS WITHOUT CLAIM TO ANY PARTICULAR  
FONT, STYLE, SIZE, OR COLOR.

SN 77-149,686, FILED 4-5-2007.

JANICE L. MCMORROW, EXAMINING ATTOR-  
NEY

**Int. Cl.: 16**

**Prior U.S. Cls.: 2, 5, 22, 23, 29, 37, 38, and 50**

**United States Patent and Trademark Office**

**Reg. No. 3,505,976**

**Registered Sep. 23, 2008**

**TRADEMARK  
PRINCIPAL REGISTER**

**LIGHTEN THE NIGHT**

KIMBERLY-CLARK WORLDWIDE, INC. (DELA-  
WARE CORPORATION)  
401 NORTH LAKE STREET  
NEENAH, WI 54956

THE MARK CONSISTS OF STANDARD CHAR-  
ACTERS WITHOUT CLAIM TO ANY PARTICULAR  
FONT, STYLE, SIZE, OR COLOR.

FOR: DISPOSABLE DIAPERS, DISPOSABLE  
TRAINING PANTS, IN CLASS 16 (U.S. CLS. 2, 5, 22,  
23, 29, 37, 38 AND 50).

SN 77-149,972, FILED 4-5-2007.

FIRST USE 4-20-2008; IN COMMERCE 4-20-2008.

GENE MACIOL, EXAMINING ATTORNEY

**Int. Cl.: 3**

**Prior U.S. Cls.: 1, 4, 6, 50, 51, and 52**

**United States Patent and Trademark Office**

**Reg. No. 3,505,977**

**Registered Sep. 23, 2008**

**TRADEMARK  
PRINCIPAL REGISTER**

**DOLCE ME**

PELLE, LLC (DELAWARE LIMITED LIABILITY  
COMPANY)  
12 SKYCREST  
NEWPORT COAST, CA 926571806

FOR: COSMETICS AND NON-MEDICATED SKIN  
CARE PREPARATIONS, IN CLASS 3 (U.S. CLS. 1, 4, 6,  
50, 51 AND 52).

FIRST USE 11-30-2006; IN COMMERCE 11-30-2006.

THE MARK CONSISTS OF STANDARD CHAR-  
ACTERS WITHOUT CLAIM TO ANY PARTICULAR  
FONT, STYLE, SIZE, OR COLOR.

THE ENGLISH TRANSLATION OF "DOLCE" IS  
SWEET.

SN 77-151,141, FILED 4-6-2007.

ROBIN CHOSID, EXAMINING ATTORNEY



**Int. Cl.: 35**

**Prior U.S. Cls.: 100, 101, and 102**

**United States Patent and Trademark Office**

**Reg. No. 3,505,978**

**Registered Sep. 23, 2008**

**SERVICE MARK  
PRINCIPAL REGISTER**



PERRY, LATISHA MIGNON (NEW JERSEY SOLE  
PROPRIETORSHIP)  
226 SHEPARD AVENUE  
EAST ORANGE, NJ 07018

THE NAME "LATISHA MIGNON" IDENTIFIES A  
LIVING INDIVIDUAL WHOSE CONSENT IS OF  
RECORD.

FOR: RETAIL CLOTHING BOUTIQUES, IN  
CLASS 35 (U.S. CLS. 100, 101 AND 102).

SN 77-151,246, FILED 4-7-2007.

FIRST USE 5-1-2007; IN COMMERCE 5-1-2007.

SONYA STEPHENS, EXAMINING ATTORNEY

**Int. Cl.: 33**

**Prior U.S. Cls.: 47 and 49**

**United States Patent and Trademark Office**

**Reg. No. 3,505,979**

**Registered Sep. 23, 2008**

**TRADEMARK  
PRINCIPAL REGISTER**

**TENBRINK**

TENBRINK WINERY, LLC (CALIFORNIA LIMITED LIABILITY COMPANY)  
4185 CHARBORNE ROAD  
FAIRFIELD, CA 94534

FOR: WINES, IN CLASS 33 (U.S. CLS. 47 AND 49).

FIRST USE 2-20-2008; IN COMMERCE 2-20-2008.

THE MARK CONSISTS OF STANDARD CHARACTERS WITHOUT CLAIM TO ANY PARTICULAR FONT, STYLE, SIZE, OR COLOR.

SN 77-152,311, FILED 4-9-2007.

WILLIAM P. SHANAHAN, EXAMINING ATTORNEY

**Int. Cl.: 36**

**Prior U.S. Cls.: 100, 101, and 102**

**United States Patent and Trademark Office**

**Reg. No. 3,505,980**

**Registered Sep. 23, 2008**

**SERVICE MARK  
PRINCIPAL REGISTER**

**ENDOW CARLSBAD**

THE SAN DIEGO FOUNDATION (CALIFORNIA CORPORATION)  
2508 HISTORIC DECATUR ROAD, SUITE 200  
SAN DIEGO, CA 92106

FOR: CHARITABLE SERVICES, NAMELY, ACCEPTING AND ADMINISTERING MONETARY CHARITABLE CONTRIBUTIONS; PROVIDING INFORMATION ABOUT MONETARY CHARITABLE CONTRIBUTIONS AND COMMUNITY NEEDS RELATED THERETO; PHILANTHROPIC PLANNING SERVICES CONCERNING MONETARY DONATIONS, IN CLASS 36 (U.S. CLS. 100, 101 AND 102).

FIRST USE 2-0-2007; IN COMMERCE 2-0-2007.

THE MARK CONSISTS OF STANDARD CHARACTERS WITHOUT CLAIM TO ANY PARTICULAR FONT, STYLE, SIZE, OR COLOR.

SN 77-152,314, FILED 4-9-2007.

NAAKWAMA ANKRAH, EXAMINING ATTORNEY

**Int. Cl.: 36**

**Prior U.S. Cls.: 100, 101, and 102**

**United States Patent and Trademark Office**

**Reg. No. 3,505,981**

**Registered Sep. 23, 2008**

**SERVICE MARK  
PRINCIPAL REGISTER**

**ENDOW OCEANSIDE**

THE SAN DIEGO FOUNDATION (CALIFORNIA CORPORATION)  
2508 HISTORIC DECATUR ROAD, SUITE 200  
SAN DIEGO, CA 92106

FOR: CHARITABLE SERVICES, NAMELY, ACCEPTING AND ADMINISTERING MONETARY CHARITABLE CONTRIBUTIONS; PROVIDING INFORMATION ABOUT MONETARY CHARITABLE CONTRIBUTIONS AND COMMUNITY NEEDS RELATED THERETO; PHILANTHROPIC PLANNING SERVICES CONCERNING MONETARY DONATIONS, IN CLASS 36 (U.S. CLS. 100, 101 AND 102).

FIRST USE 6-0-2007; IN COMMERCE 6-0-2007.

THE MARK CONSISTS OF STANDARD CHARACTERS WITHOUT CLAIM TO ANY PARTICULAR FONT, STYLE, SIZE, OR COLOR.

SN 77-152,336, FILED 4-9-2007.

NAAKWAMA ANKRAH, EXAMINING ATTORNEY

Int. Cls.: 18 and 25

Prior U.S. Cls.: 1, 2, 3, 22, 39, and 41

United States Patent and Trademark Office

Reg. No. 3,505,982

Registered Sep. 23, 2008

TRADEMARK  
PRINCIPAL REGISTER



KEY WEST  
POLLO

WEAVER, MARCIA G. (UNITED STATES INDIVIDUAL)  
19 FIFE ROAD  
WELLESLEY, MA 02481

FOR: PURSES AND BAGS, NAMELY, TOTE BAGS, HANDBAGS, ATHLETIC BAGS, BEACH BAGS, CARRY-ALL BAGS, AND BOOK BAGS, IN CLASS 18 (U.S. CLS. 1, 2, 3, 22 AND 41).

FIRST USE 2-0-2008; IN COMMERCE 2-0-2008.

FOR: CLOTHING, NAMELY, SHORTS, SHIRTS, DRESSES, HATS, PANTS, BELTS, TIES, SCARVES,

JACKETS, FLEECE SWEATSHIRTS, SWEATSHIRTS, SHOES, BOOTS, SANDALS, IN CLASS 25 (U.S. CLS. 22 AND 39).

FIRST USE 2-0-2008; IN COMMERCE 2-0-2008.

"THE FOREIGN WORDING IN THE MARK TRANSLATES INTO ENGLISH AS CHICKEN."

SN 77-153,272, FILED 4-10-2007.

LINDA E. BLOHM, EXAMINING ATTORNEY

**Int. Cl.: 37**

**Prior U.S. Cls.: 100, 103, and 106**

**United States Patent and Trademark Office**

**Reg. No. 3,505,983**

**Registered Sep. 23, 2008**

**SERVICE MARK  
PRINCIPAL REGISTER**

**CONNECTLIFE**

ELEVATION TECHNOLOGY DESIGN GROUP  
LLC (FLORIDA LIMITED LIABILITY COMPA-  
NY)  
PMB 340  
501 NORTH ORLANDO AVE, SUITE 313  
WINTER PARK, FL 32789

FOR: INSTALLATION AND MAINTENANCE OF  
HOME AUTOMATION SYSTEMS, HOME NET-  
WORKS, PHONE SYSTEMS, THEATERS, PERSONAL  
COMPUTERS, LAPTOPS, WIRELESS  
TECHNOLOGIES, AND COMPUTER HARDWARE,  
IN CLASS 37 (U.S. CLS. 100, 103 AND 106).

FIRST USE 3-7-2007; IN COMMERCE 3-15-2007.

THE MARK CONSISTS OF STANDARD CHAR-  
ACTERS WITHOUT CLAIM TO ANY PARTICULAR  
FONT, STYLE, SIZE, OR COLOR.

SN 77-154,098, FILED 4-11-2007.

SIMON TENG, EXAMINING ATTORNEY

**Int. Cls.: 41 and 42**

**Prior U.S. Cls.: 100, 101, and 107**

**United States Patent and Trademark Office**

**Reg. No. 3,505,984**

**Registered Sep. 23, 2008**

**SERVICE MARK  
PRINCIPAL REGISTER**

# Doheny View

DOHENY EYE INSTITUTE (CALIFORNIA CORPORATION)  
1450 SAN PABLO STREET #3025  
LOS ANGELES, CA 90033

FOR: PUBLICATION OF MAGAZINES IN THE FIELD OF OPHTHALMOLOGY, IN CLASS 41 (U.S. CLS. 100, 101 AND 107).

FIRST USE 9-15-2007; IN COMMERCE 10-15-2007.

FOR: PROVIDING MEDICAL AND SCIENTIFIC RESEARCH INFORMATION IN THE FIELD OF PHARMACEUTICALS AND CLINICAL TRIALS RE-

LATING TO OPHTHALMOLOGY, IN CLASS 42 (U.S. CLS. 100 AND 101).

FIRST USE 9-15-2007; IN COMMERCE 10-15-2007.

THE MARK CONSISTS OF STANDARD CHARACTERS WITHOUT CLAIM TO ANY PARTICULAR FONT, STYLE, SIZE, OR COLOR.

SN 77-154,428, FILED 4-11-2007.

TOBY BULLOFF, EXAMINING ATTORNEY

**Int. Cl.: 1**

**Prior U.S. Cls.: 1, 5, 6, 10, 26, and 46**

**United States Patent and Trademark Office**

**Reg. No. 3,505,985**

**Registered Sep. 23, 2008**

**TRADEMARK  
PRINCIPAL REGISTER**

**EZFILL**

JEA (FLORIDA BODY POLITIC AND CORPORATE)  
21 WEST CHURCH ST.  
JACKSONVILLE, FL 32202

FOR: COMPOSITION CONTAINING FLY ASH USED AS LAYERING MATTER IN LANDFILLS, IN CLASS 1 (U.S. CLS. 1, 5, 6, 10, 26 AND 46).

FIRST USE 1-8-2008; IN COMMERCE 1-8-2008.

THE MARK CONSISTS OF STANDARD CHARACTERS WITHOUT CLAIM TO ANY PARTICULAR FONT, STYLE, SIZE, OR COLOR.

OWNER OF U.S. REG. NO. 3,187,909.

SN 77-154,752, FILED 4-12-2007.

REGINA DRUMMOND, EXAMINING ATTORNEY



**Int. Cls.: 9 and 36**

**Prior U.S. Cls.: 21, 23, 26, 36, 38, 100, 101, and 102**

**United States Patent and Trademark Office**

**Reg. No. 3,505,986**

**Registered Sep. 23, 2008**

**TRADEMARK  
SERVICE MARK  
PRINCIPAL REGISTER**

**FARMERS BUSINESS INSURANCE  
EXPRESS**

FARMERS GROUP, INC. (NEVADA CORPORATION)  
4680 WILSHIRE BOULEVARD  
LOS ANGELES, CA 90010

FOR: COMPUTER SOFTWARE FOR THE MANAGEMENT AND ADMINISTRATION OF INSURANCE UNDERWRITING, CLAIMS ADMINISTRATION AND AGENCY SERVICES FOR USE BY INSURANCE AGENTS, IN CLASS 9 (U.S. CLS. 21, 23, 26, 36 AND 38).

FIRST USE 4-20-2007; IN COMMERCE 5-4-2007.

FOR: INSURANCE BROKERAGE SERVICES; INSURANCE SERVICES, NAMELY, PROVIDING A FULL RANGE OF BUSINESS INSURANCE AND RISK MANAGEMENT SERVICES FOR BUSINESSES, INSURANCE UNDERWRITING, CLAIMS AD-

MINISTRATION AND AGENCY SERVICES, IN CLASS 36 (U.S. CLS. 100, 101 AND 102).

FIRST USE 4-20-2007; IN COMMERCE 5-4-2007.

THE MARK CONSISTS OF STANDARD CHARACTERS WITHOUT CLAIM TO ANY PARTICULAR FONT, STYLE, SIZE, OR COLOR.

OWNER OF U.S. REG. NOS. 1,657,608, 1,821,672, AND OTHERS.

NO CLAIM IS MADE TO THE EXCLUSIVE RIGHT TO USE "BUSINESS INSURANCE EXPRESS", APART FROM THE MARK AS SHOWN.

SN 77-154,755, FILED 4-12-2007.

REGINA DRUMMOND, EXAMINING ATTORNEY

**Int. Cl.: 1**

**Prior U.S. Cls.: 1, 5, 6, 10, 26, and 46**

**United States Patent and Trademark Office**

**Reg. No. 3,505,987**

**Registered Sep. 23, 2008**

**TRADEMARK  
PRINCIPAL REGISTER**

**EZCOVER**

JEA (FLORIDA BODY POLITIC AND CORPORATE)  
21 WEST CHURCH ST.  
JACKSONVILLE, FL 32202

FOR: COMPOSITION CONTAINING FLY ASH  
USED IN LANDFILLS, IN CLASS 1 (U.S. CLS. 1, 5, 6,  
10, 26 AND 46).

FIRST USE 1-8-2008; IN COMMERCE 1-8-2008.

THE MARK CONSISTS OF STANDARD CHARACTERS WITHOUT CLAIM TO ANY PARTICULAR FONT, STYLE, SIZE, OR COLOR.

OWNER OF U.S. REG. NO. 3,187,909.

SN 77-154,756, FILED 4-12-2007.

REGINA DRUMMOND, EXAMINING ATTORNEY

**Int. Cl.: 7**

**Prior U.S. Cls.: 13, 19, 21, 23, 31, 34, and 35**

**Reg. No. 3,505,988**

**United States Patent and Trademark Office**

**Registered Sep. 23, 2008**

---

**TRADEMARK  
PRINCIPAL REGISTER**

**STYLITE**

SEARS BRANDS, LLC (ILLINOIS LIMITED LIABILITY COMPANY)  
3333 BEVERLY ROAD  
HOFFMAN ESTATES, IL 60179

THE MARK CONSISTS OF STANDARD CHARACTERS WITHOUT CLAIM TO ANY PARTICULAR FONT, STYLE, SIZE, OR COLOR.

FOR: VACUUM CLEANERS, IN CLASS 7 (U.S. CLS. 13, 19, 21, 23, 31, 34 AND 35).

SN 77-154,898, FILED 4-12-2007.

FIRST USE 9-0-2007; IN COMMERCE 9-0-2007.

SCOTT BIBB, EXAMINING ATTORNEY

**Int. Cl.: 36**

**Prior U.S. Cls.: 100, 101, and 102**

**United States Patent and Trademark Office**

**Reg. No. 3,505,989**

**Registered Sep. 23, 2008**

**SERVICE MARK  
PRINCIPAL REGISTER**

**WAMU COMMUNITY ACCESS**

WASHINGTON MUTUAL, INC. (WASHINGTON CORPORATION)

WMC 3501

1301 SECOND AVENUE

SEATTLE, WA 98101

FOR: MORTGAGE LENDING SERVICES; LOW INCOME AND AFFORDABLE HOUSING MORTGAGE LENDING SERVICES, IN CLASS 36 (U.S. CLS. 100, 101 AND 102).

FIRST USE 6-18-2007; IN COMMERCE 6-18-2007.

THE MARK CONSISTS OF STANDARD CHARACTERS WITHOUT CLAIM TO ANY PARTICULAR FONT, STYLE, SIZE, OR COLOR.

OWNER OF U.S. REG. NOS. 2,315,782, 2,879,308, AND OTHERS.

NO CLAIM IS MADE TO THE EXCLUSIVE RIGHT TO USE "COMMUNITY", APART FROM THE MARK AS SHOWN.

SN 77-155,453, FILED 4-12-2007.

ERNEST SHOSHO, EXAMINING ATTORNEY

**Int. Cl.: 9**

**Prior U.S. Cls.: 21, 23, 26, 36, and 38**

**Reg. No. 3,505,990**

**United States Patent and Trademark Office**

**Registered Sep. 23, 2008**

**TRADEMARK  
PRINCIPAL REGISTER**

**RAPID RESPONSE VIRTUAL EOC**

CORUS CONSULTING, LLC (GEORGIA LIMITED LIABILITY COMPANY)  
22 TECHNOLOGY PARKWAY  
NORCROSS, GA 30092

FOR: COMPUTER SOFTWARE FOR ACCESSING INFORMATION DIRECTORIES THAT MAY BE DOWNLOADED FROM THE GLOBAL COMPUTER NETWORK, COMPUTER SOFTWARE FOR APPLICATION AND DATABASE INTEGRATION, COMPUTER SOFTWARE FOR CREATING SEARCHABLE DATABASES OF INFORMATION AND DATA, AND COMPUTER SOFTWARE FOR WIRELESS CONTENT DELIVERY, ALL IN SUPPORT OF EMERGENCY SERVICES, IN CLASS 9 (U.S. CLS. 21, 23, 26, 36 AND 38).

FIRST USE 6-5-2007; IN COMMERCE 6-5-2007.

THE MARK CONSISTS OF STANDARD CHARACTERS WITHOUT CLAIM TO ANY PARTICULAR FONT, STYLE, SIZE, OR COLOR.

NO CLAIM IS MADE TO THE EXCLUSIVE RIGHT TO USE "VIRTUAL EOC", APART FROM THE MARK AS SHOWN.

SN 77-155,740, FILED 4-12-2007.

LINDA POWELL, EXAMINING ATTORNEY

**Int. Cl.: 40**

**Prior U.S. Cls.: 100, 103, and 106**

**United States Patent and Trademark Office**

**Reg. No. 3,505,991**

**Registered Sep. 23, 2008**

**SERVICE MARK  
PRINCIPAL REGISTER**

**CAJUNMAX**

MCCULLY, CLYDE (UNITED STATES INDIVIDUAL)  
324 EULA ST. APT D  
PARADIS, LA 70080

THE MARK CONSISTS OF STANDARD CHARACTERS WITHOUT CLAIM TO ANY PARTICULAR FONT, STYLE, SIZE, OR COLOR.

FOR: CUSTOM MANUFACTURE OF FOOD SEASONINGS, COOKING POTS, PANS, BURNERS, AND UTENSILS AND TABLES FOR OTHERS, IN CLASS 40 (U.S. CLS. 100, 103 AND 106).

SN 77-156,050, FILED 4-13-2007.

FIRST USE 3-31-2007; IN COMMERCE 3-31-2007.

ANNE MADDEN, EXAMINING ATTORNEY

**Int. Cl.: 29**

**Prior U.S. Cl.: 46**

**United States Patent and Trademark Office**

**Reg. No. 3,505,992**

**Registered Sep. 23, 2008**

**TRADEMARK  
PRINCIPAL REGISTER**

**DETOUR CORE STRENGTH**

FORWARD FOODS, LLC (DELAWARE LIMITED  
LIABILITY COMPANY)  
2542 BUSINESS PARKWAY, #2  
MINDEN, NV 89423

FOR: PROTEIN BASED, NUTRIENT-DENSE  
SNACK BARS, IN CLASS 29 (U.S. CL. 46).

FIRST USE 6-21-2007; IN COMMERCE 6-21-2007.

THE MARK CONSISTS OF STANDARD CHAR-  
ACTERS WITHOUT CLAIM TO ANY PARTICULAR  
FONT, STYLE, SIZE, OR COLOR.

OWNER OF U.S. REG. NO. 2,807,222.

SN 77-156,427, FILED 4-13-2007.

APRIL ROACH, EXAMINING ATTORNEY

**Int. Cl.: 9**

**Prior U.S. Cls.: 21, 23, 26, 36, and 38**

**Reg. No. 3,505,993**

**United States Patent and Trademark Office**

**Registered Sep. 23, 2008**

**TRADEMARK  
PRINCIPAL REGISTER**

**BILLIONS OF IMAGES.  
THOUSANDS OF PATTERNS.  
ONE SOLUTION.**

MITEK SYSTEMS, INC. (DELAWARE CORPORATION)  
8911 BALBOA AVENUE, SUITE B  
SAN DIEGO, CA 92123

FOR: COMPUTER SOFTWARE FOR USE IN DOCUMENT IMAGING AND INTELLIGENT CHARACTER RECOGNITION; AND INSTRUCTIONAL BOOKS AND MANUALS SOLD THEREWITH, IN CLASS 9 (U.S. CLS. 21, 23, 26, 36 AND 38).

FIRST USE 2-0-2006; IN COMMERCE 2-0-2006.

THE MARK CONSISTS OF STANDARD CHARACTERS WITHOUT CLAIM TO ANY PARTICULAR FONT, STYLE, SIZE, OR COLOR.

SN 77-156,461, FILED 4-13-2007.

CAROLYN CATALDO, EXAMINING ATTORNEY



**Int. Cl.: 35**

**Prior U.S. Cls.: 100, 101, and 102**

**United States Patent and Trademark Office**

**Reg. No. 3,505,994**

**Registered Sep. 23, 2008**

**SERVICE MARK  
PRINCIPAL REGISTER**

KNOW US BEFORE YOU NEED US

PROPAC, INC. (SOUTH CAROLINA CORPORATION)  
2390 AIR PARK ROAD  
N. CHARLESTON, SC 29406

FOR: WHOLESALE DISTRIBUTORSHIP SERVICES AND ONLINE WHOLESALE DISTRIBUTORSHIP SERVICES FEATURING EMERGENCY KITS, FIRST AID KITS, EVACUATION KITS, PREPAREDNESS KITS, COMMUNITY EMERGENCY RESPONSE TEAM PRODUCTS, TENTS, AND SHELTERS, COTS, SELF PROTECTION PRODUCTS,

AND EMERGENCY TRAILERS, IN CLASS 35 (U.S. CLS. 100, 101 AND 102).

FIRST USE 10-1-2006; IN COMMERCE 10-1-2006.

THE MARK CONSISTS OF STANDARD CHARACTERS WITHOUT CLAIM TO ANY PARTICULAR FONT, STYLE, SIZE, OR COLOR.

SN 77-157,240, FILED 4-16-2007.

DAVID H. STINE, EXAMINING ATTORNEY

**Int. Cl.: 9**

**Prior U.S. Cls.: 21, 23, 26, 36, and 38**

**Reg. No. 3,505,995**

**United States Patent and Trademark Office**

**Registered Sep. 23, 2008**

**TRADEMARK  
PRINCIPAL REGISTER**

**REALITY MILLIONAIRE**

REALITY MEDIA, INC. (UTAH CORPORATION)  
SUITE 140  
1780 WEST 9000 SOUTH  
WEST JORDAN, UT 84088

FOR: DIGITAL MATERIALS, NAMELY, CDS AND DVDS IN THE FIELD OF FINANCE AND PERSONAL FINANCE; SOFTWARE USED FOR TRACKING INVESTMENT PORTFOLIOS, IDENTIFYING ALLOCATION MODELS, REBALANCING PORTFOLIOS, IDENTIFYING ESTATE ASSETS, FINANCIAL AND ESTATE PLANNING CALCULATORS, AND BUDGET PREPARATION, REPORTS AND MAINTENANCE, ALL IN THE FIELDS OF FINANCE AND PERSONAL FINANCE; DOWN-

LOADABLE AUDIO FILES TO A COMPUTER OR PORTABLE DEVICE FROM THE INTERNET FEATURING TRAINING MATERIALS IN THE FIELD OF FINANCE AND PERSONAL FINANCE, IN CLASS 9 (U.S. CLS. 21, 23, 26, 36 AND 38).

FIRST USE 6-29-2007; IN COMMERCE 6-29-2007.

THE MARK CONSISTS OF STANDARD CHARACTERS WITHOUT CLAIM TO ANY PARTICULAR FONT, STYLE, SIZE, OR COLOR.

SN 77-157,935, FILED 4-16-2007.

CYNTHIA SLOAN, EXAMINING ATTORNEY

**Int. Cl.: 12**

**Prior U.S. Cls.: 19, 21, 23, 31, 35, and 44**

**United States Patent and Trademark Office**

**Reg. No. 3,505,996**

**Registered Sep. 23, 2008**

**TRADEMARK  
PRINCIPAL REGISTER**

**FEEL THE RIDE. LIVE THE  
LEGEND.**

BERTRAM HOLDING COMPANY, INC. (DELA-  
WARE CORPORATION)  
3663 N.W. 21ST STREET  
MIAMI, FL 33142

THE MARK CONSISTS OF STANDARD CHAR-  
ACTERS WITHOUT CLAIM TO ANY PARTICULAR  
FONT, STYLE, SIZE, OR COLOR.

FOR: YACHTS, IN CLASS 12 (U.S. CLS. 19, 21, 23,  
31, 35 AND 44).

SN 77-158,122, FILED 4-17-2007.

FIRST USE 9-1-2006; IN COMMERCE 9-1-2006.

BARBARA RUTLAND, EXAMINING ATTORNEY

**Int. Cl.: 12**

**Prior U.S. Cls.: 19, 21, 23, 31, 35, and 44**

**Reg. No. 3,505,997**

**United States Patent and Trademark Office**

**Registered Sep. 23, 2008**

**TRADEMARK  
PRINCIPAL REGISTER**



BERTRAM HOLDING COMPANY, INC. (DELA-  
WARE CORPORATION)  
3663 N.W. 21ST STREET  
MIAMI, FL 33142

THE MARK CONSISTS OF AN EAGLE POISED  
ATOP A V-SHAPED SYMBOL WITH THE WORDS  
"BERTRAM FEEL THE RIDE. LIVE THE LEGEND."  
UNDERNEATH.

FOR: YACHTS, IN CLASS 12 (U.S. CLS. 19, 21, 23,  
31, 35 AND 44).

SN 77-158,125, FILED 4-17-2007.

FIRST USE 9-1-2006; IN COMMERCE 9-1-2006.

BARBARA RUTLAND, EXAMINING ATTORNEY

**Int. Cls.: 16 and 41**

**Prior U.S. Cls.: 2, 5, 22, 23, 29, 37, 38, 50, 100, 101, and 107**

**Reg. No. 3,505,998**

**United States Patent and Trademark Office**

**Registered Sep. 23, 2008**

**TRADEMARK  
SERVICE MARK  
PRINCIPAL REGISTER**

# Kids Love to Sign

HODGES, JENNIFER L. (UNITED STATES INDIVIDUAL)  
1812 W. ROSAL DRIVE  
CHANDLER, AZ 85224

FOR: EDUCATIONAL PUBLICATIONS, NAME-  
LY, EDUCATIONAL LEARNING CARDS, FLASH  
CARDS, ACTIVITY CARDS, WORKBOOKS, TEXT-  
BOOKS, ACTIVITY BOOKS, STORY BOOKS, PUZ-  
ZLE BOOKS, PUZZLES, TEACHER GUIDES,  
MANUALS, POSTERS, EDUCATIONAL CARD  
GAMES AND EDUCATIONAL BOOKLETS IN THE  
FIELD OF SIGN LANGUAGE, IN CLASS 16 (U.S.  
CLS. 2, 5, 22, 23, 29, 37, 38 AND 50).

FIRST USE 1-1-2008; IN COMMERCE 1-1-2008.

FOR: EDUCATION SERVICES, NAME-  
LY, PROVIDING CLASSES, SEMINARS, WORKSHOPS IN

THE FIELD OF SIGN LANGUAGE, IN CLASS 41  
(U.S. CLS. 100, 101 AND 107).

FIRST USE 1-1-2008; IN COMMERCE 1-1-2008.

THE MARK CONSISTS OF STANDARD CHAR-  
ACTERS WITHOUT CLAIM TO ANY PARTICULAR  
FONT, STYLE, SIZE, OR COLOR.

NO CLAIM IS MADE TO THE EXCLUSIVE  
RIGHT TO USE "KIDS", APART FROM THE MARK  
AS SHOWN.

SN 77-158,888, FILED 4-17-2007.

ZACHARY BELLO, EXAMINING ATTORNEY

**Int. Cl.: 32**

**Prior U.S. Cls.: 45, 46, and 48**

**United States Patent and Trademark Office**

**Reg. No. 3,505,999**

**Registered Sep. 23, 2008**

**TRADEMARK  
PRINCIPAL REGISTER**

**FIT2O**

MEIJER, INC. (MICHIGAN CORPORATION)  
2929 WALKER AVE., N.W.  
GRAND RAPIDS, MI 49544

THE MARK CONSISTS OF STANDARD CHAR-  
ACTERS WITHOUT CLAIM TO ANY PARTICULAR  
FONT, STYLE, SIZE, OR COLOR.

FOR: NON-ALCOHOLIC AND NON-CARBONA-  
TED FRUIT FLAVORED DRINKS, IN CLASS 32 (U.S.  
CLS. 45, 46 AND 48).

SN 77-159,255, FILED 4-18-2007.

FIRST USE 9-29-2007; IN COMMERCE 9-29-2007.

LINDA ESTRADA, EXAMINING ATTORNEY

**Int. Cl.: 16**

**Prior U.S. Cls.: 2, 5, 22, 23, 29, 37, 38, and 50**

**Reg. No. 3,506,000**

**United States Patent and Trademark Office**

**Registered Sep. 23, 2008**

**TRADEMARK  
PRINCIPAL REGISTER**

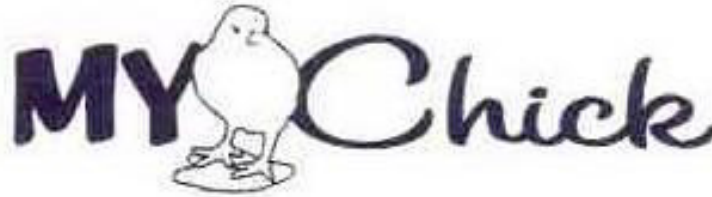

ADVANCED GRAPHICS, INC. (FLORIDA CORPORATION)  
342 WILLIAM POINT BLVD.  
COCOA, FL 32927

THE MARK CONSISTS OF THE WORD "MY" IN CAPS AND THE WORD "CHICK" IN CURSIVE LETTERS WITH AN IMAGE OF A BABY CHICK BETWEEN THE WORDS.

FOR: PAPER GOODS, NAMELY, DECALS, BUMPER STICKERS AND MAGNETIC BOARDS, IN CLASS 16 (U.S. CLS. 2, 5, 22, 23, 29, 37, 38 AND 50).

SN 77-160,465, FILED 4-19-2007.

FIRST USE 6-0-2007; IN COMMERCE 6-0-2007.

CARYN GLASSER, EXAMINING ATTORNEY

**Int. Cl.: 12**

**Prior U.S. Cls.: 19, 21, 23, 31, 35, and 44**

**Reg. No. 3,506,001**

**United States Patent and Trademark Office**

**Registered Sep. 23, 2008**

**TRADEMARK  
PRINCIPAL REGISTER**

**VERSYS**

KAWASAKI JUKOGYO KABUSHIKI KAISHA  
(JAPAN KABUSHIKI KAISHA), DBA KAWA-  
SAKI HEAVY INDUSTRIES, LTD.,  
1-1, HIGASHIKAWASAKI-CHO 3-CHOME  
CHUO-KU, KOBE, JAPAN 650-8670

FOR: MOTORCYCLES, MOPEDS, AND SCOO-  
TERS; PARTS AND ACCESSORIES FOR MOTOR-  
CYCLES, MOPEDS, AND SCOOTERS, NAMELY,  
TANK PADS, IN CLASS 12 (U.S. CLS. 19, 21, 23, 31,  
35 AND 44).

FIRST USE 9-24-2006; IN COMMERCE 6-18-2007.

THE MARK CONSISTS OF STANDARD CHAR-  
ACTERS WITHOUT CLAIM TO ANY PARTICULAR  
FONT, STYLE, SIZE, OR COLOR.

SN 77-160,720, FILED 4-19-2007.

CHARLOTTE CORWIN, EXAMINING ATTORNEY



**Int. Cl.: 12**

**Prior U.S. Cls.: 19, 21, 23, 31, 35, and 44**

**Reg. No. 3,506,002**

**United States Patent and Trademark Office**

**Registered Sep. 23, 2008**

---

**TRADEMARK  
PRINCIPAL REGISTER**

**SS**

BRUNSWICK CORPORATION (DELAWARE  
CORPORATION)  
1 NORTH FIELD COURT  
LAKE FOREST, IL 60045

THE MARK CONSISTS OF STANDARD CHAR-  
ACTERS WITHOUT CLAIM TO ANY PARTICULAR  
FONT, STYLE, SIZE, OR COLOR.

FOR: PONTOON BOATS, IN CLASS 12 (U.S. CLS.  
19, 21, 23, 31, 35 AND 44).

SN 77-161,487, FILED 4-20-2007.

FIRST USE 7-1-2007; IN COMMERCE 7-1-2007.

JENNY PARK, EXAMINING ATTORNEY

**Int. Cl.: 11**

**Prior U.S. Cls.: 13, 21, 23, 31, and 34**

**Reg. No. 3,506,003**

**United States Patent and Trademark Office**

**Registered Sep. 23, 2008**

---

**TRADEMARK  
PRINCIPAL REGISTER**

**FIRE POWER TO TAKE ON THE  
COMPETITION**

PIZZA EQUIPMENT SUPPLY, INC. (NORTH  
CAROLINA CORPORATION)  
SUITE 232  
1437 E. FRANKLIN BOULEVARD  
GASTONIA, NC 28054

THE MARK CONSISTS OF STANDARD CHAR-  
ACTERS WITHOUT CLAIM TO ANY PARTICULAR  
FONT, STYLE, SIZE, OR COLOR.

FOR: COMMERCIAL COOKING OVENS, IN  
CLASS 11 (U.S. CLS. 13, 21, 23, 31 AND 34).

SN 77-161,740, FILED 4-20-2007.

FIRST USE 7-3-2007; IN COMMERCE 7-3-2007.

BENJAMIN ALLEN, EXAMINING ATTORNEY

**Int. Cl.: 16**

**Prior U.S. Cls.: 2, 5, 22, 23, 29, 37, 38, and 50**

**Reg. No. 3,506,004**

**United States Patent and Trademark Office**

**Registered Sep. 23, 2008**

---

**TRADEMARK  
PRINCIPAL REGISTER**

**ECO-TOTE**

ACT GLOBAL TRADING, INC. (CALIFORNIA  
CORPORATION)  
2785 PACIFIC COAST HIGHWAY SUITE #324  
TORRANCE, CA 905057066

THE MARK CONSISTS OF STANDARD CHAR-  
ACTERS WITHOUT CLAIM TO ANY PARTICULAR  
FONT, STYLE, SIZE, OR COLOR.

FOR: PLASTIC PACKAGING BAGS, IN CLASS 16  
(U.S. CLS. 2, 5, 22, 23, 29, 37, 38 AND 50).

SN 77-162,301, FILED 4-20-2007.

FIRST USE 12-0-2006; IN COMMERCE 12-0-2006.

KAPIL BHANOT, EXAMINING ATTORNEY

**Int. Cl.: 33**

**Prior U.S. Cls.: 47 and 49**

**United States Patent and Trademark Office**

**Reg. No. 3,506,005**

**Registered Sep. 23, 2008**

**TRADEMARK  
PRINCIPAL REGISTER**

**SOUTH EXTRÊME**

CAVE EXTRÊME S.A. (ARGENTINA CORPORATION)  
FLORIDA 375 6°  
BUENOS AIRES, ARGENTINA

FOR: SPARKLING WINE; WINES, IN CLASS 33  
(U.S. CLS. 47 AND 49).

FIRST USE 9-30-2007; IN COMMERCE 9-30-2007.

THE MARK CONSISTS OF STANDARD CHARACTERS WITHOUT CLAIM TO ANY PARTICULAR FONT, STYLE, SIZE, OR COLOR.

THE FOREIGN WORDING IN THE MARK TRANSLATES INTO ENGLISH AS "EXTREME".

SN 77-162,455, FILED 4-21-2007.

SKYE YOUNG, EXAMINING ATTORNEY

**Int. Cl.: 33**

**Prior U.S. Cls.: 47 and 49**

**United States Patent and Trademark Office**

**Reg. No. 3,506,006**

**Registered Sep. 23, 2008**

**TRADEMARK  
PRINCIPAL REGISTER**

**CAVE EXTRÊME**

CAVE EXTRÊME S.A. (ARGENTINA CORPORATION)  
FLORIDA 375 6°  
BUENOS AIRES, ARGENTINA

FOR: WINES; SPARKLING WINE, IN CLASS 33  
(U.S. CLS. 47 AND 49).

FIRST USE 9-30-2007; IN COMMERCE 9-30-2007.

THE MARK CONSISTS OF STANDARD CHARACTERS WITHOUT CLAIM TO ANY PARTICULAR FONT, STYLE, SIZE, OR COLOR.

THE FOREIGN WORDING IN THE MARK TRANSLATES INTO ENGLISH AS "EXTREME".

SN 77-162,460, FILED 4-21-2007.

SKYE YOUNG, EXAMINING ATTORNEY

**Int. Cl.: 35**

**Prior U.S. Cls.: 100, 101, and 102**

**United States Patent and Trademark Office**

**Reg. No. 3,506,007**

**Registered Sep. 23, 2008**

**SERVICE MARK  
PRINCIPAL REGISTER**

PERFORMANCE NEVER GOES OUT  
OF STYLE

MARRIOTT INTERNATIONAL, INC. (DELA-  
WARE CORPORATION)  
10400 FERNWOOD ROAD  
BETHESDA, MD 20817

FOR: FRANCHISE SERVICES, NAMELY, OFFER-  
ING TECHNICAL AND BUSINESS MANAGEMENT  
ASSISTANCE IN THE ESTABLISHMENT AND OP-  
ERATION OF HOTELS, RESTAURANTS AND CON-  
DOMINIUMS; BUSINESS MANAGEMENT,  
NAMELY, MANAGEMENT AND OPERATION OF  
HOTELS, RESTAURANTS, CONDOMINIUMS,  
APARTMENT BUILDINGS, CONFERENCE CEN-  
TERS AND TIMESHARE RESORTS FOR OTHERS;

BUSINESS CONSULTATION SERVICES, IN CLASS  
35 (U.S. CLS. 100, 101 AND 102).

FIRST USE 5-15-2007; IN COMMERCE 5-15-2007.

THE MARK CONSISTS OF STANDARD CHAR-  
ACTERS WITHOUT CLAIM TO ANY PARTICULAR  
FONT, STYLE, SIZE, OR COLOR.

SN 77-162,873, FILED 4-23-2007.

CAROLYN CATALDO, EXAMINING ATTORNEY

**Int. Cls.: 35 and 42**

**Prior U.S. Cls.: 100, 101, and 102**

**United States Patent and Trademark Office**

**Reg. No. 3,506,008**

**Registered Sep. 23, 2008**

**SERVICE MARK  
PRINCIPAL REGISTER**

**RED ROCKET STUDIOS**

RED ROCKET INCORPORATED (FLORIDA CORPORATION)  
STUDIO 14  
1600 NORTH ORANGE AVE.  
ORLANDO, FL 32804

FOR: ADVERTISING SERVICES, NAMELY, PLANNING, DEVELOPING, CREATING AND PLACING ADVERTISING FOR CLIENTS VIA PRINT, OUTDOOR, DIRECT MAIL, EMAIL, WEBSITE, DIGITAL, ELECTRONIC, VIDEO, AND AUDIO MEDIA; PLANNING AND DEVELOPING MARKETING AND PROMOTIONAL CAMPAIGNS FOR THE BUSINESSES OF OTHERS; CREATING AND PROMOTING CORPORATE AND BRAND IDENTITY FOR OTHERS; AND PUBLIC RELATIONS SERVICES, IN CLASS 35 (U.S. CLS. 100, 101 AND 102).

FIRST USE 1-1-2008; IN COMMERCE 1-1-2008.

FOR: WEBSITE AND WEBSITE BLOG DEVELOPMENT FOR OTHERS; WEB HOSTING FOR OTHERS, IN CLASS 42 (U.S. CLS. 100 AND 101).

FIRST USE 1-1-2008; IN COMMERCE 1-1-2008.

THE MARK CONSISTS OF STANDARD CHARACTERS WITHOUT CLAIM TO ANY PARTICULAR FONT, STYLE, SIZE, OR COLOR.

OWNER OF U.S. REG. NO. 2,551,642.

NO CLAIM IS MADE TO THE EXCLUSIVE RIGHT TO USE "STUDIOS", APART FROM THE MARK AS SHOWN.

SN 77-163,141, FILED 4-23-2007.

PAUL CROWLEY, EXAMINING ATTORNEY

**Int. Cl.: 36**

**Prior U.S. Cls.: 100, 101, and 102**

**United States Patent and Trademark Office**

**Reg. No. 3,506,009**

**Registered Sep. 23, 2008**

**SERVICE MARK  
PRINCIPAL REGISTER**

**DARE TO CARE**

COMPWEST INSURANCE COMPANY (CALI-  
FORNIA CORPORATION)  
SUITE 2268  
425 MARKET STREET  
SAN FRANCISCO, CA 94105

FOR: INSURANCE SERVICES, NAMELY, INSUR-  
ANCE UNDERWRITING SERVICES, CLAIMS AD-  
MINISTRATION SERVICES AND LOSS CONTROL  
SERVICES IN THE FIELD OF WORKER'S COM-  
PENSATION INSURANCE, IN CLASS 36 (U.S. CLS.  
100, 101 AND 102).

FIRST USE 10-1-2006; IN COMMERCE 10-1-2006.

THE MARK CONSISTS OF STANDARD CHAR-  
ACTERS WITHOUT CLAIM TO ANY PARTICULAR  
FONT, STYLE, SIZE, OR COLOR.

SN 77-163,407, FILED 4-23-2007.

LESLIE RICHARDS, EXAMINING ATTORNEY



**Int. Cl.: 36**

**Prior U.S. Cls.: 100, 101, and 102**

**United States Patent and Trademark Office**

**Reg. No. 3,506,010**

**Registered Sep. 23, 2008**

**SERVICE MARK  
PRINCIPAL REGISTER**

**SCHOOLS FOR HUMANITY**

SCHOOLS FOR HUMANITY (CALIFORNIA CORPORATION)  
2629 SEQUOIA WAY  
BELMONT, CA 94002

FOR: CHARITABLE FUNDRAISING SERVICES, EXCLUDING SERVICES IN CONNECTION WITH RENOVATION AND CONSTRUCTION OF RESIDENTIAL HOUSING, IN CLASS 36 (U.S. CLS. 100, 101 AND 102).

FIRST USE 11-0-2006; IN COMMERCE 11-0-2006.

THE MARK CONSISTS OF STANDARD CHARACTERS WITHOUT CLAIM TO ANY PARTICULAR FONT, STYLE, SIZE, OR COLOR.

SN 77-164,146, FILED 4-24-2007.

C. DIONNE CLYBURN, EXAMINING ATTORNEY

**Int. Cl.: 36**

**Prior U.S. Cls.: 100, 101, and 102**

**United States Patent and Trademark Office**

**Reg. No. 3,506,011**

**Registered Sep. 23, 2008**

**SERVICE MARK  
PRINCIPAL REGISTER**



SCHOOLS FOR HUMANITY (CALIFORNIA CORPORATION)  
2629 SEQUOIA WAY  
BELMONT, CA 94002

FOR: CHARITABLE FUNDRAISING SERVICES, EXCLUDING SERVICES IN CONNECTION WITH THE RENOVATION AND CONSTRUCTION OF RESIDENTIAL HOUSING, IN CLASS 36 (U.S. CLS. 100, 101 AND 102).

FIRST USE 11-0-2006; IN COMMERCE 11-0-2006.

THE MARK CONSISTS OF A PERSON READING A BOOK IN A CIRCLE.

SN 77-164,149, FILED 4-24-2007.

C. DIONNE CLYBURN, EXAMINING ATTORNEY

Int. Cl.: 14

Prior U.S. Cls.: 2, 27, 28, and 50

Reg. No. 3,506,012

United States Patent and Trademark Office

Registered Sep. 23, 2008

TRADEMARK  
PRINCIPAL REGISTER



BELLA SHAYE (CALIFORNIA LIMITED LIABILITY COMPANY)  
13848 CARMEL RIDGE RD.  
SAN DIEGO, CA 92128

FOR: FASHION JEWELRY AND MEN'S JEWELRY MADE OF NON PRECIOUS METALS, PRECIOUS METALS OF STERLING SILVER, WHITE AND YELLOW GOLD, NON PRECIOUS STONES, AND SEMI PRECIOUS STONES; NECKLACES, EARRINGS, BRACELETS, NECKLACE AND EARRING SETS, RINGS, ANKLET AND TOE RINGS, NAVEL JEWELRY, BROOCHES AND JEWELRY PINS, WATCHES; KEY RINGS OF PRECIOUS METALS; KEY RINGS OF NON-PRECIOUS STONES

AND SEMI-PRECIOUS STONES, IN CLASS 14 (U.S. CLS. 2, 27, 28 AND 50).

FIRST USE 4-15-2007; IN COMMERCE 4-15-2007.

THE LIKENESS IN THE MARK DOES NOT IDENTIFY A LIVING INDIVIDUAL.

BELLA FROM THE ITALIAN WORD "BEAUTIFUL". SHAYE FROM THE NAME "SHEA" WITH A UNCOMMON SPELLING.

SN 77-164,210, FILED 4-24-2007.

WILLIAM VERHOSEK, EXAMINING ATTORNEY

**Int. Cls.: 29 and 32**

**Prior U.S. Cls.: 45, 46, and 48**

**United States Patent and Trademark Office**

**Reg. No. 3,506,013**

**Registered Sep. 23, 2008**

**TRADEMARK  
PRINCIPAL REGISTER**

**CODE GREEN**

LASKO, FRED (UNITED STATES INDIVIDUAL)  
111 E. CHESTNUT, APT. 19K  
CHICAGO, IL 60611

FOR: VEGETABLE BASED FOOD BEVERAGES,  
IN CLASS 29 (U.S. CL. 46).

FIRST USE 3-11-2008; IN COMMERCE 7-28-2008.

FOR: FRUIT BEVERAGES, IN CLASS 32 (U.S. CLS.  
45, 46 AND 48).

FIRST USE 3-11-2008; IN COMMERCE 7-28-2008.

THE MARK CONSISTS OF STANDARD CHAR-  
ACTERS WITHOUT CLAIM TO ANY PARTICULAR  
FONT, STYLE, SIZE, OR COLOR.

SN 77-164,212, FILED 4-24-2007.

JULIE WATSON, EXAMINING ATTORNEY

**Int. Cl.: 43**

**Prior U.S. Cls.: 100 and 101**

**United States Patent and Trademark Office**

**Reg. No. 3,506,014**

**Registered Sep. 23, 2008**

**SERVICE MARK  
PRINCIPAL REGISTER**

**CATER THE FLAVOR**

AFC ENTERPRISES, INC. (MINNESOTA CORPORATION)  
SUITE 300  
5555 GLENRIDGE CONNECTOR, N.E.  
ATLANTA, GA 30342

THE MARK CONSISTS OF STANDARD CHARACTERS WITHOUT CLAIM TO ANY PARTICULAR FONT, STYLE, SIZE, OR COLOR.

FOR: RESTAURANT SERVICES, IN CLASS 43 (U.S. CLS. 100 AND 101).

SN 77-164,883, FILED 4-25-2007.

FIRST USE 7-0-2007; IN COMMERCE 7-0-2007.

CHERYL CLAYTON, EXAMINING ATTORNEY

**Int. Cl.: 5**

**Prior U.S. Cls.: 6, 18, 44, 46, 51, and 52**

**Reg. No. 3,506,015**

**United States Patent and Trademark Office**

**Registered Sep. 23, 2008**

---

**TRADEMARK  
PRINCIPAL REGISTER**

**ARSON**

IML US TRADEMARK LTD. (CANADA COR-  
PORATION)  
381 NORTH SERVICE ROAD WEST  
OAKVILLE ONTARIO, CANADA L6M 0H4

THE MARK CONSISTS OF STANDARD CHAR-  
ACTERS WITHOUT CLAIM TO ANY PARTICULAR  
FONT, STYLE, SIZE, OR COLOR.

FOR: DIETARY SUPPLEMENTS, IN CLASS 5 (U.S.  
CLS. 6, 18, 44, 46, 51 AND 52).

SN 77-165,011, FILED 4-25-2007.

FIRST USE 8-0-2007; IN COMMERCE 8-0-2007.

MARK SPARACINO, EXAMINING ATTORNEY

**Int. Cl.: 18**

**Prior U.S. Cls.: 1, 2, 3, 22, and 41**

**United States Patent and Trademark Office**

**Reg. No. 3,506,016**

**Registered Sep. 23, 2008**

**TRADEMARK  
PRINCIPAL REGISTER**

**PURLPOD**

GARSON, ELIZABETH (UNITED STATES INDIVIDUAL)  
4233 AMBER COURT SE  
OLYMPIA, WA 98501

THE MARK CONSISTS OF STANDARD CHARACTERS WITHOUT CLAIM TO ANY PARTICULAR FONT, STYLE, SIZE, OR COLOR.

FOR: BAG FOR CARRYING AND DISPENSING YARN, IN CLASS 18 (U.S. CLS. 1, 2, 3, 22 AND 41).

SN 77-165,717, FILED 4-25-2007.

FIRST USE 6-2-2007; IN COMMERCE 6-2-2007.

BILL DAWE, EXAMINING ATTORNEY

**Int. Cl.: 7**

**Prior U.S. Cls.: 13, 19, 21, 23, 31, 34, and 35**

**Reg. No. 3,506,017**

**United States Patent and Trademark Office**

**Registered Sep. 23, 2008**

**TRADEMARK  
PRINCIPAL REGISTER**

# Absolute Power

RAYBURN, JERRY A. (UNITED STATES INDIVIDUAL)  
209 RADIO ROAD  
ALMO, KY 42020

FOR: PORTABLE ELECTRIC POWER GENERATORS; ELECTRIC GENERATORS AND RELATED EQUIPMENT, NAMELY, AUTOMATIC STANDBY ELECTRIC GENERATOR SETS, IN CLASS 7 (U.S. CLS. 13, 19, 21, 23, 31, 34 AND 35).

FIRST USE 7-28-2008; IN COMMERCE 7-28-2008.

THE MARK CONSISTS OF STANDARD CHARACTERS WITHOUT CLAIM TO ANY PARTICULAR FONT, STYLE, SIZE, OR COLOR.

NO CLAIM IS MADE TO THE EXCLUSIVE RIGHT TO USE "POWER", APART FROM THE MARK AS SHOWN.

SN 77-166,229, FILED 4-26-2007.

BRIAN CALLAGHAN, EXAMINING ATTORNEY



**Int. Cls.: 5, 10, and 42**

**Prior U.S. Cls.: 6, 18, 26, 39, 44, 46, 51, 52, 100, and 101**

**Reg. No. 3,506,018**

**United States Patent and Trademark Office**

**Registered Sep. 23, 2008**

**TRADEMARK  
SERVICE MARK  
PRINCIPAL REGISTER**

**NBS**

NANOBIOSYM, INC. (DELAWARE CORPORATION)  
SUITE 400  
2711 CENTERVILLE ROAD  
WILMINGTON, DE 19808

FOR: MEDICAL TEST KITS COMPRISED OF PROTEINS PRODUCED BY HUMAN GENES, REAGENTS, NUCLEIC ACID, PEPTIDES AND ASSAYS FOR THE PURPOSE OF MEDICAL DIAGNOSIS; BIOCHEMICALS AND BIOCHEMICAL MARKERS, NAMELY, PROTEINS PRODUCED BY HUMAN GENES, REAGENTS, NUCLEIC ACID PEPTIDES AND ASSAYS AND FOR MEDICAL DIAGNOSTIC USE, IN CLASS 5 (U.S. CLS. 6, 18, 44, 46, 51 AND 52).

FIRST USE 3-31-2006; IN COMMERCE 3-31-2006.

FOR: MEDICAL DIAGNOSTIC APPARATUS FOR DETECTION, AMPLIFICATION AND ANALYSIS OF NUCLEIC ACIDS AND PROTEINS, IN CLASS 10 (U.S. CLS. 26, 39 AND 44).

FIRST USE 3-31-2006; IN COMMERCE 3-31-2006.

FOR: SCIENTIFIC RESEARCH; RESEARCH AND DEVELOPMENT SERVICES AND SCIENTIFIC CONSULTING IN THE FIELDS OF NANOTECHNOLOGY, BIOTECHNOLOGY, MEDICINE AND DIAGNOSTIC DEVICES, IN CLASS 42 (U.S. CLS. 100 AND 101).

FIRST USE 3-31-2004; IN COMMERCE 3-31-2004.

THE MARK CONSISTS OF STANDARD CHARACTERS WITHOUT CLAIM TO ANY PARTICULAR FONT, STYLE, SIZE, OR COLOR.

SN 77-166,355, FILED 4-26-2007.

SUSAN STIGLITZ, EXAMINING ATTORNEY

**Int. Cls.: 5, 10, and 42**

**Prior U.S. Cls.: 6, 18, 26, 39, 44, 46, 51, 52, 100, and 101**

**Reg. No. 3,506,019**

**United States Patent and Trademark Office**

**Registered Sep. 23, 2008**

**TRADEMARK  
SERVICE MARK  
PRINCIPAL REGISTER**

**NBSDx**

NANOBIOSYM DIAGNOSTICS, INC. (DELAWARE CORPORATION)  
SUITE 400  
2711 CENTERVILLE ROAD  
WILMINGTON, DE 19808

FOR: MEDICAL TEST KITS COMPRISED OF PROTEINS PRODUCED BY HUMAN GENES, REAGENTS, NUCLEIC ACID, PEPTIDES AND ASSAYS FOR THE PURPOSE OF MEDICAL DIAGNOSIS; BIOCHEMICALS AND BIOCHEMICAL MARKERS, NAMELY, PROTEINS PRODUCED BY HUMAN GENES, REAGENTS, NUCLEIC ACID PEPTIDES AND ASSAYS AND FOR MEDICAL DIAGNOSTIC USE, IN CLASS 5 (U.S. CLS. 6, 18, 44, 46, 51 AND 52).

FIRST USE 3-31-2006; IN COMMERCE 3-31-2006.

FOR: DIAGNOSTIC APPARATUS FOR DETECTION, AMPLIFICATION AND ANALYSIS OF NU-

CLEIC ACIDS AND PROTEINS, IN CLASS 10 (U.S. CLS. 26, 39 AND 44).

FIRST USE 3-31-2006; IN COMMERCE 3-31-2006.

FOR: SCIENTIFIC CONSULTING AND CONTRACT RESEARCH SERVICES IN THE FIELD OF DETECTION, AMPLIFICATION AND ANALYSIS OF NUCLEIC ACIDS AND PROTEINS, IN CLASS 42 (U.S. CLS. 100 AND 101).

FIRST USE 3-31-2006; IN COMMERCE 3-31-2006.

THE MARK CONSISTS OF STANDARD CHARACTERS WITHOUT CLAIM TO ANY PARTICULAR FONT, STYLE, SIZE, OR COLOR.

SN 77-166,384, FILED 4-26-2007.

SUSAN STIGLITZ, EXAMINING ATTORNEY

**Int. Cl.: 30**

**Prior U.S. Cl.: 46**

**United States Patent and Trademark Office**

**Reg. No. 3,506,020**

**Registered Sep. 23, 2008**

**TRADEMARK  
PRINCIPAL REGISTER**

**DIPPIN' DESSERTS**

WILTON INDUSTRIES, INC. (DELAWARE CORPORATION)  
2240 WEST 75TH STREET  
WOODRIDGE, IL 60517

FOR: A DESSERT MAKING KIT COMPRISED OF CONFECTIONERY COATING WAFERS FOR FOOD DECORATING AND A MICROWAVEABLE BAG, IN CLASS 30 (U.S. CL. 46).

FIRST USE 11-30-2007; IN COMMERCE 11-30-2007.

THE MARK CONSISTS OF STANDARD CHARACTERS WITHOUT CLAIM TO ANY PARTICULAR FONT, STYLE, SIZE, OR COLOR.

NO CLAIM IS MADE TO THE EXCLUSIVE RIGHT TO USE "DESSERTS", APART FROM THE MARK AS SHOWN.

SN 77-167,396, FILED 4-27-2007.

CURTIS FRENCH, EXAMINING ATTORNEY

**Int. Cl.: 34**

**Prior U.S. Cls.: 2, 8, 9, and 17**

**United States Patent and Trademark Office**

**Reg. No. 3,506,021**

**Registered Sep. 23, 2008**

**TRADEMARK  
PRINCIPAL REGISTER**



CIBAO ENTERPRISES LLC (NORTH CAROLINA  
LIMITED LIABILITY COMPANY)  
6821 ELMSTONE DRIVE  
CHARLOTTE, NC 28277

FOR: NON-ELECTRIC CIGAR LIGHTERS NOT OF PRECIOUS METAL; CIGAR AND CIGARETTE BOXES; CIGAR AND CIGARETTE BOXES NOT OF PRECIOUS METAL; CIGAR AND CIGARETTE BOXES OF PRECIOUS METAL; CIGAR BANDS; CIGAR BOXES; CIGAR BOXES NOT OF PRECIOUS METAL; CIGAR BOXES OF PRECIOUS METAL; CIGAR CASES; CIGAR CASES OF PRECIOUS METAL; CIGAR CUTTERS; CIGAR HOLDERS; CIGAR HOLDERS OF PRECIOUS METAL; CIGAR HUMIDIFIERS; CIGAR LIGHTERS; CIGAR TUBES; CIGARS; HOLDERS FOR CIGAR AND CIGARETTE OF PRECIOUS METAL; HOLDERS FOR CIGARS AND CIGARETTES; HOLDERS OF CIGARS AND CIGARETTES OF PRECIOUS METAL, IN CLASS 34 (U.S. CLS. 2, 8, 9 AND 17).

FIRST USE 5-6-2008; IN COMMERCE 5-19-2008.

THE MARK CONSISTS OF A HAND, LEANING AGAINST VERTICAL STRIKES PATTERNS, HOLDING A SMOKING CIGAR IS ENCASED IN AN ASYMMETRICAL CONCENTRIC PATTERN BACKGROUND. UNDERNEATH THE HAND, ACROSS THE CONCENTRIC PATTERN APPEARS THE STATEMENT "PURA EXPERIENCIA".

THE FOREIGN WORDING IN THE MARK TRANSLATES INTO ENGLISH AS "PURE EXPERIENCE".

SN 77-168,297, FILED 4-28-2007.

MICHELLE DUBOIS, EXAMINING ATTORNEY

**Int. Cl.: 43**

**Prior U.S. Cls.: 100 and 101**

**United States Patent and Trademark Office**

**Reg. No. 3,506,022**

**Registered Sep. 23, 2008**

**SERVICE MARK  
PRINCIPAL REGISTER**



MARRIOTT INTERNATIONAL, INC. (DELA-  
WARE CORPORATION)  
10400 FERNWOOD ROAD  
BETHESDA, MD 20817

FOR: HOTEL SERVICES; RESTAURANT AND  
BAR SERVICES; RESORT LODGING SERVICES;  
AND RESERVATION SERVICES FOR HOTEL AC-  
COMMODATIONS, IN CLASS 43 (U.S. CLS. 100 AND  
101).

FIRST USE 6-30-2007; IN COMMERCE 6-30-2007.

THE MARK CONSISTS OF SUN DESIGN.

SN 77-169,147, FILED 4-30-2007.

DAVID HOFFMAN, EXAMINING ATTORNEY

**Int. Cls.: 35 and 41**

**Prior U.S. Cls.: 100, 101, 102, and 107**

**United States Patent and Trademark Office**

**Reg. No. 3,506,023**

**Registered Sep. 23, 2008**

**SERVICE MARK  
PRINCIPAL REGISTER**

# David Carradine

CARRADINE, DAVID (UNITED STATES INDIVIDUAL)  
6130 SHIRLEY AVENUE  
TARZANA, CA 91356 AND  
CARRADINE, ANNE (UNITED STATES INDIVIDUAL)  
6130 SHIRLEY AVENUE  
TARZANA, CA 91356

FOR: ON-LINE RETAIL STORE SERVICES FEATURING MOVIE MEMORABILIA, BOOKS, AUDIO DISCS, VISUAL DISCS AND ART, IN CLASS 35 (U.S. CLS. 100, 101 AND 102).

FIRST USE 3-19-2008; IN COMMERCE 3-19-2008.

FOR: ENTERTAINMENT SERVICES, NAMELY, PERSONAL APPEARANCES BY A MOVIE STAR AND SINGER; ENTERTAINMENT SERVICES, NAMELY, PROVIDING A WEB SITE FEATURING MUSICAL PERFORMANCES, MUSICAL VIDEOS, RELATED FILM CLIPS, PHOTOGRAPHS, AND OTHER MULTIMEDIA MATERIALS; ENTERTAINMENT IN THE NATURE OF LIVE PERFORMAN-

CES BY DAVID CARRADINE; ENTERTAINMENT IN THE NATURE OF VISUAL AND AUDIO PERFORMANCES, AND MUSICAL, VARIETY, NEWS AND COMEDY SHOWS; MULTIMEDIA ENTERTAINMENT SERVICES IN THE NATURE OF RECORDING, PRODUCTION AND POST-PRODUCTION SERVICES IN THE FIELDS OF MUSIC, VIDEO, AND FILMS, IN CLASS 41 (U.S. CLS. 100, 101 AND 107).

FIRST USE 3-1-2008; IN COMMERCE 3-1-2008.

THE MARK CONSISTS OF STANDARD CHARACTERS WITHOUT CLAIM TO ANY PARTICULAR FONT, STYLE, SIZE, OR COLOR.

THE NAME "DAVID CARRADINE" IDENTIFIES A LIVING INDIVIDUAL WHOSE CONSENT IS OF RECORD.

SN 77-169,314, FILED 4-30-2007.

BENJAMIN ALLEN, EXAMINING ATTORNEY

**Int. Cl.: 36**

**Prior U.S. Cls.: 100, 101, and 102**

**United States Patent and Trademark Office**

**Reg. No. 3,506,024**

**Registered Sep. 23, 2008**

**SERVICE MARK  
PRINCIPAL REGISTER**

**BLUE HORIZON REALTY, INC.**

BLUE HORIZON REALTY, INC. (NEW YORK CORPORATION)  
1391 STEBBINS AVENUE  
BRONX, NY 10459

FOR: BROKERAGE IN THE FIELD OF REAL ESTATE AND MORTGAGES, IN CLASS 36 (U.S. CLS. 100, 101 AND 102).

FIRST USE 3-22-2007; IN COMMERCE 3-22-2007.

THE MARK CONSISTS OF STANDARD CHARACTERS WITHOUT CLAIM TO ANY PARTICULAR FONT, STYLE, SIZE, OR COLOR.

NO CLAIM IS MADE TO THE EXCLUSIVE RIGHT TO USE "REALTY, INC.", APART FROM THE MARK AS SHOWN.

SN 77-169,502, FILED 4-30-2007.

GISELLE AGOSTO, EXAMINING ATTORNEY

**Int. Cl.: 29**

**Prior U.S. Cl.: 46**

**United States Patent and Trademark Office**

**Reg. No. 3,506,025**

**Registered Sep. 23, 2008**

**TRADEMARK  
PRINCIPAL REGISTER**



CARGILL MEAT SOLUTIONS CORPORATION  
(DELAWARE CORPORATION)  
151 NORTH MAIN  
WICHITA, KS 67202

THE MARK CONSISTS OF A FLAME.

SN 77-169,611, FILED 5-1-2007.

FOR: MEAT, IN CLASS 29 (U.S. CL. 46).

FIRST USE 7-31-2007; IN COMMERCE 7-31-2007.

THEODORE MCBRIDE, EXAMINING ATTORNEY



**Int. Cl.: 28**

**Prior U.S. Cls.: 22, 23, 38, and 50**

**Reg. No. 3,506,026**

**United States Patent and Trademark Office**

**Registered Sep. 23, 2008**

**TRADEMARK  
PRINCIPAL REGISTER**



CLIFF EMMONS (UNITED STATES INDIVIDUAL)  
2601 DUTTON  
WOODWAY, TX 76711

FOR: HUNTING DECOY BAGS; HUNTING GAME CALLS; CAMOUFLAGE NETTING USED IN HUNTING; CAMOUFLAGE SCREENS FOR HUNTING PURPOSES, IN CLASS 28 (U.S. CLS. 22, 23, 38 AND 50).

FIRST USE 7-1-2008; IN COMMERCE 7-1-2008.

NO CLAIM IS MADE TO THE EXCLUSIVE RIGHT TO USE "OUTDOOR GEAR", APART FROM THE MARK AS SHOWN.

THE MARK CONSISTS OF A ROCKY MOUNTAIN WITH A CURVED BANNER ACROSS THE BOTTOM. THE CENTER OF THE BANNER CONTAINS THE WORDS "RED ROCK". BELOW THE BANNER AT THE BOTTOM OF THE MOUNTAIN ARE THE WORDS "OUTDOOR GEAR" IN A SMALLER FONT SIZE THAN "RED ROCK" ON THE BANNER.

SN 77-170,626, FILED 5-2-2007.

CYNTHIA SLOAN, EXAMINING ATTORNEY

**Int. Cl.: 16**

**Prior U.S. Cls.: 2, 5, 22, 23, 29, 37, 38, and 50**

**Reg. No. 3,506,027**

**United States Patent and Trademark Office**

**Registered Sep. 23, 2008**

---

**TRADEMARK  
PRINCIPAL REGISTER**

**FRESH TO GO**

ROBBIE MANUFACTURING, INC. (KANSAS  
CORPORATION)  
10810 MID AMERICA AVENUE  
LENEXA, KS 66219

THE MARK CONSISTS OF STANDARD CHAR-  
ACTERS WITHOUT CLAIM TO ANY PARTICULAR  
FONT, STYLE, SIZE, OR COLOR.

FOR: PLASTIC FOOD STORAGE BAGS FOR  
HOUSEHOLD, INDUSTRIAL, AND COMMERCIAL  
USE, IN CLASS 16 (U.S. CLS. 2, 5, 22, 23, 29, 37, 38 AND  
50).

SN 77-171,783, FILED 5-3-2007.

FIRST USE 10-19-2007; IN COMMERCE 11-16-2007.

SANDRA MANIOS, EXAMINING ATTORNEY

**Int. Cl.: 33**

**Prior U.S. Cls.: 47 and 49**

**United States Patent and Trademark Office**

**Reg. No. 3,506,028**

**Registered Sep. 23, 2008**

**TRADEMARK  
PRINCIPAL REGISTER**

**CHERCHER TROUVER**

TROUVER WINES LLC (CALIFORNIA LIMITED  
LIABILITY COMPANY)  
223 OLD VINE WAY  
NAPA, CA 94558

THE FOREIGN WORDING IN THE MARK  
TRANSLATES INTO ENGLISH AS TO "SEEK TO  
FIND".

FOR: WINES, IN CLASS 33 (U.S. CLS. 47 AND 49).

SN 77-172,514, FILED 5-3-2007.

FIRST USE 6-13-2007; IN COMMERCE 6-1-2008.

THE MARK CONSISTS OF STANDARD CHAR-  
ACTERS WITHOUT CLAIM TO ANY PARTICULAR  
FONT, STYLE, SIZE, OR COLOR.

CHRISTOPHER BUONGIORNO, EXAMINING AT-  
TORNEY

**Int. Cl.: 9**

**Prior U.S. Cls.: 21, 23, 26, 36, and 38**

**Reg. No. 3,506,029**

**United States Patent and Trademark Office**

**Registered Sep. 23, 2008**

**TRADEMARK  
PRINCIPAL REGISTER**

**EDOCWARE**

ECOMPEX, INC. (VIRGINIA CORPORATION)  
7926 JONES BRANCH DRIVE, SUITE 560  
MCLEAN, VA 22102

THE MARK CONSISTS OF STANDARD CHAR-  
ACTERS WITHOUT CLAIM TO ANY PARTICULAR  
FONT, STYLE, SIZE, OR COLOR.

FOR: COMPUTER PROGRAMMES FOR DOCU-  
MENT MANAGEMENT, IN CLASS 9 (U.S. CLS. 21,  
23, 26, 36 AND 38).

SN 77-173,309, FILED 5-4-2007.

FIRST USE 12-31-2007; IN COMMERCE 12-31-2007.

JASON TURNER, EXAMINING ATTORNEY

**Int. Cl.: 16**

**Prior U.S. Cls.: 2, 5, 22, 23, 29, 37, 38, and 50**

**Reg. No. 3,506,030**

**United States Patent and Trademark Office**

**Registered Sep. 23, 2008**

**TRADEMARK  
PRINCIPAL REGISTER**

**Lunch With the Saints**

PETER'S PATH, LLC (WASHINGTON LIMITED  
LIABILITY COMPANY)  
11506 206TH PL SE  
ISSAQUAH, WA 98027

FOR: MOTIVATIONAL CARDS, NOT PROVIDED  
OR USED IN CONNECTION WITH AMERICAN  
FOOTBALL OR AMERICAN FOOTBALL SPORT-  
ING EVENTS, IN CLASS 16 (U.S. CLS. 2, 5, 22, 23, 29,  
37, 38 AND 50).

FIRST USE 8-31-2007; IN COMMERCE 11-7-2007.

THE MARK CONSISTS OF STANDARD CHAR-  
ACTERS WITHOUT CLAIM TO ANY PARTICULAR  
FONT, STYLE, SIZE, OR COLOR.

SN 77-173,682, FILED 5-5-2007.

JOHN KELLY, EXAMINING ATTORNEY

**Int. Cl.: 14**

**Prior U.S. Cls.: 2, 27, 28, and 50**

**United States Patent and Trademark Office**

**Reg. No. 3,506,031**

**Registered Sep. 23, 2008**

**TRADEMARK  
PRINCIPAL REGISTER**

**KONSTANTINA MAHLIA**

MAHLIA COLLECTION INC. (ARIZONA CORPORATION)

410 N. TOOLE AVENUE

TUCSON, AZ 85701

FOR: JEWELRY, IN CLASS 14 (U.S. CLS. 2, 27, 28 AND 50).

FIRST USE 4-22-2008; IN COMMERCE 4-22-2008.

THE MARK CONSISTS OF STANDARD CHARACTERS WITHOUT CLAIM TO ANY PARTICULAR FONT, STYLE, SIZE, OR COLOR.

THE NAME "KONSTANTINA MAHLIA" IDENTIFIES A LIVING INDIVIDUAL WHOSE CONSENT IS OF RECORD.

SN 77-174,295, FILED 5-7-2007.

JULIE WATSON, EXAMINING ATTORNEY

**Int. Cl.: 9**

**Prior U.S. Cls.: 21, 23, 26, 36, and 38**

**United States Patent and Trademark Office**

**Reg. No. 3,506,032**

**Registered Sep. 23, 2008**

**TRADEMARK  
PRINCIPAL REGISTER**

**ROAD TALK**

DREAMGEAR, LLC (CALIFORNIA LIMITED  
LIABILITY COMPANY)  
20001 S. WESTERN AVENUE  
TORRANCE, CA 90501

FOR: WIRELESS TRANSCEIVERS, NAMELY, A  
TRANSCEIVER CONTAINING A MICROPHONE  
THAT CONNECTS TO RECEIVE AN AUDIO SIG-  
NAL FROM A PORTABLE AUDIO PLAYER OR A  
MOBILE TELEPHONE AND WIRELESSLY CON-  
NECTS TO AN FM RADIO, IN CLASS 9 (U.S. CLS.  
21, 23, 26, 36 AND 38).

FIRST USE 9-6-2007; IN COMMERCE 9-6-2007.

THE MARK CONSISTS OF STANDARD CHAR-  
ACTERS WITHOUT CLAIM TO ANY PARTICULAR  
FONT, STYLE, SIZE, OR COLOR.

SN 77-175,291, FILED 5-8-2007.

SANJEEV VOHRA, EXAMINING ATTORNEY

**Int. Cl.: 3**

**Prior U.S. Cls.: 1, 4, 6, 50, 51, and 52**

**Reg. No. 3,506,033**

**United States Patent and Trademark Office**

**Registered Sep. 23, 2008**

---

**TRADEMARK  
PRINCIPAL REGISTER**

**Crave**

SUPRE, INC. (TEXAS CORPORATION)  
SUITE 700 LB 40  
15770 N. DALLAS PARKWAY  
DALLAS, TX 75248

FIRST USE 11-1-2007; IN COMMERCE 11-1-2007.

THE MARK CONSISTS OF STANDARD CHARACTERS WITHOUT CLAIM TO ANY PARTICULAR FONT, STYLE, SIZE, OR COLOR.

FOR: INDOOR AND OUTDOOR TANNING PRODUCTS, NAMELY, NON-MEDICATED TAN DARKENING LOTIONS AND SKIN MOISTURIZERS, IN CLASS 3 (U.S. CLS. 1, 4, 6, 50, 51 AND 52).

SN 77-176,159, FILED 5-9-2007.

NAAKWAMA ANKRAH, EXAMINING ATTORNEY



**Int. Cl.: 3**

**Prior U.S. Cls.: 1, 4, 6, 50, 51, and 52**

**Reg. No. 3,506,034**

**United States Patent and Trademark Office**

**Registered Sep. 23, 2008**

---

**TRADEMARK  
PRINCIPAL REGISTER**

**Mirage**

SUPRE, INC. (TEXAS CORPORATION)  
SUITE 700 LB 40  
15770 N. DALLAS PARKWAY  
DALLAS, TX 75248

FIRST USE 11-1-2007; IN COMMERCE 11-1-2007.

THE MARK CONSISTS OF STANDARD CHARACTERS WITHOUT CLAIM TO ANY PARTICULAR FONT, STYLE, SIZE, OR COLOR.

FOR: INDOOR AND OUTDOOR TANNING PRODUCTS, NAMELY, NON-MEDICATED TAN DARKENING LOTIONS AND SKIN MOISTURIZERS, IN CLASS 3 (U.S. CLS. 1, 4, 6, 50, 51 AND 52).

SN 77-176,194, FILED 5-9-2007.

NAAKWAMA ANKRAH, EXAMINING ATTORNEY

**Int. Cl.: 3**

**Prior U.S. Cls.: 1, 4, 6, 50, 51, and 52**

**Reg. No. 3,506,035**

**United States Patent and Trademark Office**

**Registered Sep. 23, 2008**

---

**TRADEMARK  
PRINCIPAL REGISTER**

**Prism**

SUPRE, INC. (TEXAS CORPORATION)  
SUITE 700 LB 40  
15770 N. DALLAS PARKWAY  
DALLAS, TX 75248

FIRST USE 11-1-2007; IN COMMERCE 11-1-2007.

THE MARK CONSISTS OF STANDARD CHARACTERS WITHOUT CLAIM TO ANY PARTICULAR FONT, STYLE, SIZE, OR COLOR.

FOR: INDOOR AND OUTDOOR TANNING PRODUCTS, NAMELY, NON-MEDICATED TAN DARKENING LOTIONS AND SKIN MOISTURIZERS, IN CLASS 3 (U.S. CLS. 1, 4, 6, 50, 51 AND 52).

SN 77-176,293, FILED 5-9-2007.

NAAKWAMA ANKRAH, EXAMINING ATTORNEY

**Int. Cl.: 9**

**Prior U.S. Cls.: 21, 23, 26, 36, and 38**

**Reg. No. 3,506,036**

**United States Patent and Trademark Office**

**Registered Sep. 23, 2008**

**TRADEMARK  
PRINCIPAL REGISTER**

JACK HANNA'S INTO THE WILD

JUNGLE JACK PRODUCTIONS, LLC (OHIO LIMITED LIABILITY COMPANY)  
P.O. BOX 1450  
POWELL, OH 43065

FOR: PRE-RECORDED VIDEOTAPES AND DVDS IN THE FIELD OF ANIMALS, NATURE AND CONSERVATION, IN CLASS 9 (U.S. CLS. 21, 23, 26, 36 AND 38).

FIRST USE 12-10-2007; IN COMMERCE 12-10-2007.

THE MARK CONSISTS OF STANDARD CHARACTERS WITHOUT CLAIM TO ANY PARTICULAR FONT, STYLE, SIZE, OR COLOR.

THE NAME "JACK HANNA" IDENTIFIES A LIVING INDIVIDUAL WHOSE CONSENT IS OF RECORD.

SN 77-176,522, FILED 5-9-2007.

JORDAN BAKER, EXAMINING ATTORNEY

**Int. Cl.: 36**

**Prior U.S. Cls.: 100, 101, and 102**

**United States Patent and Trademark Office**

**Reg. No. 3,506,037**

**Registered Sep. 23, 2008**

**SERVICE MARK  
PRINCIPAL REGISTER**

**S-GATE**

EVERCOM SYSTEMS, INC. (DELAWARE CORPORATION)  
14651 DALLAS PARKWAY, SUITE 600  
DALLAS, TX 75254

THE MARK CONSISTS OF STANDARD CHARACTERS WITHOUT CLAIM TO ANY PARTICULAR FONT, STYLE, SIZE, OR COLOR.

FOR: FINANCIAL SERVICES, NAMELY, PROVIDING STORED VALUE ACCOUNTS, IN CLASS 36 (U.S. CLS. 100, 101 AND 102).

SN 77-177,242, FILED 5-10-2007.

FIRST USE 6-16-2005; IN COMMERCE 4-13-2006.

JOHN WILKE, EXAMINING ATTORNEY

**Int. Cl.: 35**

**Prior U.S. Cls.: 100, 101, and 102**

**United States Patent and Trademark Office**

**Reg. No. 3,506,038**

**Registered Sep. 23, 2008**

**SERVICE MARK  
PRINCIPAL REGISTER**

**WIDGEADS**

KICKAPPS CORPORATION (DELAWARE CORPORATION)  
29 WEST 38TH STREET, 5TH FLOOR  
NEW YORK, NY 10018

FOR: ADVERTISING SERVICES, NAMELY, DESIGNING AND PLACING INDIVIDUALLY PROGRAMMABLE INTERACTIVE ONLINE ADVERTISEMENTS FOR OTHERS ON INTERNET WEB SITES, IN CLASS 35 (U.S. CLS. 100, 101 AND 102).

FIRST USE 7-11-2008; IN COMMERCE 7-11-2008.

THE MARK CONSISTS OF STANDARD CHARACTERS WITHOUT CLAIM TO ANY PARTICULAR FONT, STYLE, SIZE, OR COLOR.

SN 77-177,571, FILED 5-10-2007.

THEODORE MCBRIDE, EXAMINING ATTORNEY

**Int. Cl.: 35**

**Prior U.S. Cls.: 100, 101, and 102**

**United States Patent and Trademark Office**

**Reg. No. 3,506,039**

**Registered Sep. 23, 2008**

**SERVICE MARK  
PRINCIPAL REGISTER**

**MOMUNITY**

SAYLOR, KERI L. (UNITED STATES INDIVIDUAL)  
7904 OWL CREEK LANE  
MCKINNEY, TX 75070

THE MARK CONSISTS OF STANDARD CHARACTERS WITHOUT CLAIM TO ANY PARTICULAR FONT, STYLE, SIZE, OR COLOR.

FOR: ADVERTISING AND ADVERTISEMENT SERVICES, IN CLASS 35 (U.S. CLS. 100, 101 AND 102).

SN 77-177,677, FILED 5-10-2007.

FIRST USE 11-30-2007; IN COMMERCE 11-30-2007.

JENNIFER DIXON, EXAMINING ATTORNEY

**Int. Cl.: 25**

**Prior U.S. Cls.: 22 and 39**

**United States Patent and Trademark Office**

**Reg. No. 3,506,040**

**Registered Sep. 23, 2008**

**TRADEMARK  
PRINCIPAL REGISTER**

# Trail Bunny

KEMMSIES, SUZANNE (UNITED STATES INDIVIDUAL)  
12484 YERBA VALLEY ROAD  
LAKESIDE, CA 92040

FOR: SHIRTS, IN CLASS 25 (U.S. CLS. 22 AND 39).

FIRST USE 2-1-2008; IN COMMERCE 2-1-2008.

THE MARK CONSISTS OF STANDARD CHARACTERS WITHOUT CLAIM TO ANY PARTICULAR FONT, STYLE, SIZE, OR COLOR.

SN 77-177,908, FILED 5-10-2007.

SAMUEL E. SHARPER JR., EXAMINING ATTORNEY

**Int. Cl.: 16**

**Prior U.S. Cls.: 2, 5, 22, 23, 29, 37, 38, and 50**

**United States Patent and Trademark Office**

**Reg. No. 3,506,041**

**Registered Sep. 23, 2008**

**TRADEMARK  
PRINCIPAL REGISTER**

# Who's Your Bunny?

KEMMSIES, SUZANNE M (UNITED STATES IN-  
DIVIDUAL)  
12484 YERBA VALLEY ROAD  
LAKESIDE, CA 92040

FOR: STICKERS, IN CLASS 16 (U.S. CLS. 2, 5, 22,  
23, 29, 37, 38 AND 50).

FIRST USE 2-1-2008; IN COMMERCE 2-1-2008.

THE MARK CONSISTS OF STANDARD CHAR-  
ACTERS WITHOUT CLAIM TO ANY PARTICULAR  
FONT, STYLE, SIZE, OR COLOR.

SN 77-177,971, FILED 5-10-2007.

SAMUEL E. SHARPER JR., EXAMINING ATTOR-  
NEY



**Int. Cl.: 33**

**Prior U.S. Cls.: 47 and 49**

**United States Patent and Trademark Office**

**Reg. No. 3,506,042**

**Registered Sep. 23, 2008**

**TRADEMARK  
PRINCIPAL REGISTER**

**ZHOO ZHOO**

ROBERTSON, STEPHEN (UNITED STATES IN-  
DIVIDUAL)  
18835 SYMMS ROAD  
CALDWELL, ID 83607 AND  
ROBERTSON, ANNE (UNITED STATES INDIVI-  
DUAL)  
18835 SYMMS ROAD  
CALDWELL, ID 83607

FIRST USE 6-10-2007; IN COMMERCE 6-10-2007.

THE MARK CONSISTS OF STANDARD CHAR-  
ACTERS WITHOUT CLAIM TO ANY PARTICULAR  
FONT, STYLE, SIZE, OR COLOR.

SN 77-178,137, FILED 5-10-2007.

FOR: WINE, IN CLASS 33 (U.S. CLS. 47 AND 49).

RONALD MCMORROW, EXAMINING ATTORNEY

Int. Cl.: 37

Prior U.S. Cls.: 100, 103, and 106

United States Patent and Trademark Office

Reg. No. 3,506,043

Registered Sep. 23, 2008

**SERVICE MARK  
PRINCIPAL REGISTER**

*Metropolitan Renovation Services, Inc.*

METROPOLITAN RENOVATION SERVICES,  
INC. (GEORGIA CORPORATION)  
3120 OLD DOUGLASVILLE RD.  
LITHIA SPRINGS, GA 30122

FOR: CONSTRUCTION AND RENOVATION OF  
THE INTERIOR OF HOUSES; CUSTOM RENOVA-  
TION OF THE INTERIOR OF HOUSES; RENOVA-  
TION IN THE FIELD OF HOUSES; HOUSING  
SERVICES, NAMELY, REPAIR, IMPROVEMENT,  
AND CONSTRUCTION OF THE INTERIOR OF  
RESIDENTIAL REAL PROPERTY; MAINTENANCE  
AND REPAIR OF THE INTERIOR OF HOUSES;  
CONSTRUCTION CONSULTATION; CONSTRU-  
TION CONSULTANCY; CONSTRUCTION PLAN-

NING; CONSTRUCTION, MAINTENANCE AND  
RENOVATION OF PROPERTY; CUSTOM CON-  
STRUCTION OF HOMES, IN CLASS 37 (U.S. CLS.  
100, 103 AND 106).

FIRST USE 4-10-1998; IN COMMERCE 4-10-1998.

NO CLAIM IS MADE TO THE EXCLUSIVE  
RIGHT TO USE "RENOVATION SERVICES, INC.",  
APART FROM THE MARK AS SHOWN.

SN 77-178,733, FILED 5-11-2007.

SHANNON TWOHIG, EXAMINING ATTORNEY

Int. Cl.: 43

Prior U.S. Cls.: 100 and 101

United States Patent and Trademark Office

Reg. No. 3,506,044

Registered Sep. 23, 2008

SERVICE MARK  
PRINCIPAL REGISTER



UMBRIA PIZZERIA, LLC (MINNESOTA LIMITED LIABILITY COMPANY)  
16251 ROYAL ROAD  
RAMSEY, MN 55303

FOR: RESTAURANTS; RESTAURANTS FEATURING HOME DELIVERY; TAKE-OUT RESTAURANT SERVICES, IN CLASS 43 (U.S. CLS. 100 AND 101).

FIRST USE 1-1-2006; IN COMMERCE 1-1-2006.

"THE COLOR(S) GREEN, RED AND WHITE IS/ARE CLAIMED AS A FEATURE OF THE MARK."

THE PICTORIAL PORTION OF THE MARK CONSISTS OF AN ANTIC CROWN WITH A CASTLE

FACADE; THE COLOR GREEN APPEARS IN THE DESIGN, SPECIFICALLY, THE BACKGROUND TO THE PICTORIAL PORTION OF THE MARK; THE COLOR RED APPEARS IN THE DESIGN, SPECIFICALLY, IN A CIRCLE AROUND THE GREEN BACKGROUND; THE COLOR WHITE APPEARS IN THE WORDING "UMBRIA," AND IN THE DESIGN, SPECIFICALLY, IN THE BACKSWOOP AND IN THE ANTIC CROWN WITH A CASTLE FACADE AND IN A CIRCLE BETWEEN THE GREEN BACKGROUND AND RED CIRCLE SURROUNDING IT.

SN 77-178,845, FILED 5-11-2007.

MATTHEW PAPPAS, EXAMINING ATTORNEY

**Int. Cl.: 18**

**Prior U.S. Cls.: 1, 2, 3, 22, and 41**

**United States Patent and Trademark Office**

**Reg. No. 3,506,045**

**Registered Sep. 23, 2008**

**TRADEMARK  
PRINCIPAL REGISTER**

**ECO CHOICE**

THE GEM GROUP, INC. (MASSACHUSETTS CORPORATION), DBA GEMLINE,  
9 INTERNATIONAL WAY  
LAWRENCE, MA 01843

FOR: BRIEF CASES, BUSINESS CASES, HANDBAGS, POUCHES OF LEATHER AND IMITATION LEATHER, TOTE BAGS, DUFFEL BAGS, AND BRIEFCASE-TYPE PORTFOLIOS ALL INCORPORATING ENVIRONMENTALLY FRIENDLY MATERIALS AND MANUFACTURING PROCESSES, IN CLASS 18 (U.S. CLS. 1, 2, 3, 22 AND 41).

FIRST USE 1-1-2008; IN COMMERCE 1-1-2008.

THE MARK CONSISTS OF STANDARD CHARACTERS WITHOUT CLAIM TO ANY PARTICULAR FONT, STYLE, SIZE, OR COLOR.

NO CLAIM IS MADE TO THE EXCLUSIVE RIGHT TO USE "ECO", APART FROM THE MARK AS SHOWN.

SN 77-178,933, FILED 5-11-2007.

HEATHER BIDDULPH, EXAMINING ATTORNEY

**Int. Cl.: 41**

**Prior U.S. Cls.: 100, 101, and 107**

**United States Patent and Trademark Office**

**Reg. No. 3,506,046**

**Registered Sep. 23, 2008**

**SERVICE MARK  
PRINCIPAL REGISTER**

**The Healthy Goddess**

CLOUD NINE WOMEN, INC (WASHINGTON  
CORPORATION)  
3208 33RD AVE SOUTH  
SEATTLE, WA 98144

FOR: PERSONAL TRAINING SERVICES, NAME-  
LY, STRENGTH AND CONDITIONING TRAINING;  
PHYSICAL FITNESS CONDITIONING CLASSES;  
PHYSICAL FITNESS INSTRUCTION, IN CLASS 41  
(U.S. CLS. 100, 101 AND 107).

FIRST USE 6-30-2007; IN COMMERCE 6-30-2007.

THE MARK CONSISTS OF STANDARD CHAR-  
ACTERS WITHOUT CLAIM TO ANY PARTICULAR  
FONT, STYLE, SIZE, OR COLOR.

SN 77-179,013, FILED 5-11-2007.

LINDA MICKLEBURGH, EXAMINING ATTORNEY

**Int. Cl.: 44**

**Prior U.S. Cls.: 100 and 101**

**United States Patent and Trademark Office**

**Reg. No. 3,506,047**

**Registered Sep. 23, 2008**

**SERVICE MARK  
PRINCIPAL REGISTER**

**PULMONARY ADVANTAGE**

SKILLED HEALTHCARE, LLC (DELAWARE  
LIMITED LIABILITY COMPANY)  
SUITE 200  
27442 PORTOLA PARKWAY  
FOOTHILL RANCH, CA 92610

FOR: HEALTH CARE SERVICES, NAMELY, RE-  
SPIRATORY THERAPY SERVICES AND VENTILA-  
TOR MANAGEMENT, IN CLASS 44 (U.S. CLS. 100  
AND 101).

FIRST USE 5-1-2008; IN COMMERCE 5-1-2008.

THE MARK CONSISTS OF STANDARD CHAR-  
ACTERS WITHOUT CLAIM TO ANY PARTICULAR  
FONT, STYLE, SIZE, OR COLOR.

NO CLAIM IS MADE TO THE EXCLUSIVE  
RIGHT TO USE "PULMONARY", APART FROM  
THE MARK AS SHOWN.

SN 77-179,331, FILED 5-11-2007.

CYNTHIA SLOAN, EXAMINING ATTORNEY

**Int. Cl.: 5**

**Prior U.S. Cls.: 6, 18, 44, 46, 51, and 52**

**United States Patent and Trademark Office**

**Reg. No. 3,506,048**

**Registered Sep. 23, 2008**

**TRADEMARK  
PRINCIPAL REGISTER**

# Sinus Genie

SICAP INDUSTRIES, LLC (NEW YORK LIMITED  
LIABILITY COMPANY)  
PO BOX 27  
GUILDERLAND, NY 12084

OWNER OF U.S. REG. NOS. 2,934,888 AND  
3,194,160.

FOR: NASAL SPRAY PREPARATIONS, IN CLASS  
5 (U.S. CLS. 6, 18, 44, 46, 51 AND 52).

NO CLAIM IS MADE TO THE EXCLUSIVE  
RIGHT TO USE "SINUS", APART FROM THE  
MARK AS SHOWN.

FIRST USE 5-11-2007; IN COMMERCE 6-1-2007.

SN 77-179,422, FILED 5-11-2007.

THE MARK CONSISTS OF STANDARD CHAR-  
ACTERS WITHOUT CLAIM TO ANY PARTICULAR  
FONT, STYLE, SIZE, OR COLOR.

DAVID YONTEF, EXAMINING ATTORNEY

**Int. Cl.: 5**

**Prior U.S. Cls.: 6, 18, 44, 46, 51, and 52**

**Reg. No. 3,506,049**

**United States Patent and Trademark Office**

**Registered Sep. 23, 2008**

**TRADEMARK  
PRINCIPAL REGISTER**

**BIOCLEAN**

CITREX, INC. (FLORIDA CORPORATION)  
2766 S.W. 37 AVENUE  
COCONUT GROVE, FL 33133

FOR: DISINFECTANT CROP SPRAY FOR AGRICULTURAL USE; DISINFECTANT SPRAY FOR HARVESTED FRUITS, VEGETABLES, FLOWERS AND EGGS; DISINFECTANT DIP FOR HARVESTED FRUITS, VEGETABLES AND FLOWERS; SURFACE BACTERICIDE AND FUNGICIDE FOR HOSPITAL USE; SURFACE BACTERICIDE AND FUNGICIDE FOR FOOD PREPARATION USE; SURFACE BACTERICIDE AND FUNGICIDE FOR GENERAL PURPOSE USE; BACTERICIDE AND FUNGICIDE FOR USE AS INGREDIENT IN COS-

METICS, IN CLASS 5 (U.S. CLS. 6, 18, 44, 46, 51 AND 52).

FIRST USE 6-0-2007; IN COMMERCE 6-0-2007.

THE MARK CONSISTS OF STANDARD CHARACTERS WITHOUT CLAIM TO ANY PARTICULAR FONT, STYLE, SIZE, OR COLOR.

OWNER OF U.S. REG. NO. 2,631,465.

SN 77-179,796, FILED 5-14-2007.

AISHA SALEM, EXAMINING ATTORNEY



**Int. Cl.: 14**

**Prior U.S. Cls.: 2, 27, 28, and 50**

**United States Patent and Trademark Office**

**Reg. No. 3,506,050**

**Registered Sep. 23, 2008**

**TRADEMARK  
PRINCIPAL REGISTER**

**VERSIL**

QUALITY GOLD, INC. (OHIO CORPORATION)  
P.O. BOX 18490  
500 QUALITY BOULEVARD  
FAIRFIELD, OH 45018

THE MARK CONSISTS OF STANDARD CHAR-  
ACTERS WITHOUT CLAIM TO ANY PARTICULAR  
FONT, STYLE, SIZE, OR COLOR.

FOR: JEWELRY, IN CLASS 14 (U.S. CLS. 2, 27, 28  
AND 50).

SN 77-179,829, FILED 5-14-2007.

FIRST USE 6-1-2007; IN COMMERCE 11-4-2007.

STEVEN R. FINE, EXAMINING ATTORNEY

**Int. Cl.: 14**

**Prior U.S. Cls.: 2, 27, 28, and 50**

**United States Patent and Trademark Office**

**Reg. No. 3,506,051**

**Registered Sep. 23, 2008**

**TRADEMARK  
PRINCIPAL REGISTER**

**ROTATIONS**

QUALITY GOLD, INC. (OHIO CORPORATION)  
P.O. BOX 18490  
500 QUALITY BOULEVARD  
FAIRFIELD, OH 45018

THE MARK CONSISTS OF STANDARD CHAR-  
ACTERS WITHOUT CLAIM TO ANY PARTICULAR  
FONT, STYLE, SIZE, OR COLOR.

FOR: WATCH BOXES AND WATCH CASES, IN  
CLASS 14 (U.S. CLS. 2, 27, 28 AND 50).

SN 77-179,837, FILED 5-14-2007.

FIRST USE 6-1-2007; IN COMMERCE 10-24-2007.

STEVEN R. FINE, EXAMINING ATTORNEY

**Int. Cl.: 16**

**Prior U.S. Cls.: 2, 5, 22, 23, 29, 37, 38, and 50**

**United States Patent and Trademark Office**

**Reg. No. 3,506,052**

**Registered Sep. 23, 2008**

**TRADEMARK  
PRINCIPAL REGISTER**

**ZIPPY**

TELMEX USA, LLC (DELAWARE LIMITED LIABILITY COMPANY)  
3350 S.W. 148TH AVENUE  
MIRAMAR, FL 33027

THE MARK CONSISTS OF STANDARD CHARACTERS WITHOUT CLAIM TO ANY PARTICULAR FONT, STYLE, SIZE, OR COLOR.

FOR: PRE-PAID TELEPHONE CALLING CARDS, NOT MAGNETICALLY ENCODED, IN CLASS 16 (U.S. CLS. 2, 5, 22, 23, 29, 37, 38 AND 50).

SN 77-182,260, FILED 5-16-2007.

FIRST USE 6-20-2007; IN COMMERCE 6-20-2007.

ELLEN PERKINS, EXAMINING ATTORNEY

**Int. Cl.: 10**

**Prior U.S. Cls.: 26, 39, and 44**

**United States Patent and Trademark Office**

**Reg. No. 3,506,053**

**Registered Sep. 23, 2008**

**TRADEMARK  
PRINCIPAL REGISTER**

**DRYSCRUBS**

DRYSCRUBS INC. (TEXAS CORPORATION)  
7 STEEPBANK DRIVE  
THE WOODLANDS, TX 77381

THE MARK CONSISTS OF STANDARD CHAR-  
ACTERS WITHOUT CLAIM TO ANY PARTICULAR  
FONT, STYLE, SIZE, OR COLOR.

FOR: MEDICAL UNIFORMS, NAMELY, MEDI-  
CAL SCRUBS CONSISTING OF PANTS, TOPS,  
SHIRTS, JACKETS, SMOCKS, COATS, HATS, CAPS  
AND TUNICS, IN CLASS 10 (U.S. CLS. 26, 39 AND 44).

SN 77-182,299, FILED 5-16-2007.

FIRST USE 10-0-2007; IN COMMERCE 10-0-2007.

RICHARD WHITE, EXAMINING ATTORNEY

**Int. Cl.: 42**

**Prior U.S. Cls.: 100 and 101**

**United States Patent and Trademark Office**

**Reg. No. 3,506,054**

**Registered Sep. 23, 2008**

**SERVICE MARK  
PRINCIPAL REGISTER**

**THE RIGHT TRAFFIC**

POSITION TECHNOLOGIES, INC. (ILLINOIS CORPORATION)  
2325 DEAN STREET, SUITE 800  
ST. CHARLES, IL 60175

FOR: INTERNET SEARCH ENGINE SERVICES, NAMELY, SEARCH ENGINE OPTIMIZATION FOR OTHERS FOR ENSURING THAT THEIR WEBSITES ARE ACCESSIBLE TO SEARCH ENGINES, ESTABLISHING DIRECT DATA FEEDS FOR OTHERS TO HAVE THEIR WEBSITE CONTENT RAPIDLY REFRESHED IN THE SEARCH ENGINES, IMPROVING THE CHANCES THAT A WEBSITE WILL BE FOUND BY THE SEARCH ENGINES, AND RE-

PORTING THE SITE HITS GENERATED BY THE SEARCH ENGINES, IN CLASS 42 (U.S. CLS. 100 AND 101).

FIRST USE 5-0-2008; IN COMMERCE 5-0-2008.

THE MARK CONSISTS OF STANDARD CHARACTERS WITHOUT CLAIM TO ANY PARTICULAR FONT, STYLE, SIZE, OR COLOR.

SN 77-182,542, FILED 5-16-2007.

JAMES GRIFFIN, EXAMINING ATTORNEY

**Int. Cl.: 25**

**Prior U.S. Cls.: 22 and 39**

**United States Patent and Trademark Office**

**Reg. No. 3,506,055**

**Registered Sep. 23, 2008**

**TRADEMARK  
PRINCIPAL REGISTER**

**SLO MO**

TURNER, SHAWN (UNITED STATES INDIVIDUAL)  
512 E MARKET STREET  
BLAIRSVILLE, PA 15717

THE MARK CONSISTS OF STANDARD CHARACTERS WITHOUT CLAIM TO ANY PARTICULAR FONT, STYLE, SIZE, OR COLOR.

FOR: CLOTHING, NAMELY, SHIRTS, JACKETS, HATS, SWEATSHIRTS, T-SHIRTS, IN CLASS 25 (U.S. CLS. 22 AND 39).

SN 77-182,548, FILED 5-16-2007.

FIRST USE 1-28-1994; IN COMMERCE 1-25-2008.

JAMES GRIFFIN, EXAMINING ATTORNEY

**Int. Cl.: 29**

**Prior U.S. Cl.: 46**

**United States Patent and Trademark Office**

**Reg. No. 3,506,056**

**Registered Sep. 23, 2008**

**TRADEMARK  
PRINCIPAL REGISTER**

**PARK MANOR**

HEB GROCERY COMPANY, LP (TEXAS LIMITED PARTNERSHIP)  
CORPORATE LAW DEPARTMENT  
646 SOUTH MAIN  
SAN ANTONIO, TX 78204

FOR: MILK, IN CLASS 29 (U.S. CL. 46).

FIRST USE 8-0-2007; IN COMMERCE 8-0-2007.

THE MARK CONSISTS OF STANDARD CHARACTERS WITHOUT CLAIM TO ANY PARTICULAR FONT, STYLE, SIZE, OR COLOR.

OWNER OF U.S. REG. NOS. 863,633 AND 867,660.

SN 77-182,579, FILED 5-16-2007.

LINDA POWELL, EXAMINING ATTORNEY

**Int. Cl.: 44**

**Prior U.S. Cls.: 100 and 101**

**United States Patent and Trademark Office**

**Reg. No. 3,506,057**

**Registered Sep. 23, 2008**

**SERVICE MARK  
PRINCIPAL REGISTER**

**The Barbershop is Back**

V'S BARBERSHOP FRANCHISE, LLC (ARIZONA  
LIMITED LIABILITY COMPANY)  
4801 E. INDIAN SCHOOL RD., #3  
PHOENIX, AZ 85018

FOR: HAIR CUTTING, HAIR STYLING AND  
SHAVING SERVICES; BEARD AND MOUSTACHE  
TRIMMING SERVICES; MASSAGE SERVICES; AND  
SPA SERVICES, NAMELY, FACIAL TREATMENTS,  
IN CLASS 44 (U.S. CLS. 100 AND 101).

FIRST USE 9-30-2007; IN COMMERCE 9-30-2007.

THE MARK CONSISTS OF STANDARD CHAR-  
ACTERS WITHOUT CLAIM TO ANY PARTICULAR  
FONT, STYLE, SIZE, OR COLOR.

SN 77-182,760, FILED 5-16-2007.

WILLIAM BRECKENFELD, EXAMINING ATTOR-  
NEY



**Int. Cl.: 20**

**Prior U.S. Cls.: 2, 13, 22, 25, 32, and 50**

**Reg. No. 3,506,058**

**United States Patent and Trademark Office**

**Registered Sep. 23, 2008**

**TRADEMARK  
PRINCIPAL REGISTER**

**COLUMBIA**  

---

**PolyLife**

PARTITION SYSTEMS INCORPORATED OF  
SOUTH CAROLINA (SOUTH CAROLINA  
CORPORATION)  
825 GARLAND STREET  
COLUMBIA, SC 29201

FOR: FURNITURE PARTITIONS, IN CLASS 20  
(U.S. CLS. 2, 13, 22, 25, 32 AND 50).

FIRST USE 3-31-2007; IN COMMERCE 3-31-2007.

NO CLAIM IS MADE TO THE EXCLUSIVE  
RIGHT TO USE "COLUMBIA", APART FROM THE  
MARK AS SHOWN.

THE MARK CONSISTS OF THE WORD "COLUM-  
BIA" IN BOLD OVER THE WORD "POLYLIFE" NOT  
BOLDED AND IN LOWER CASE EXCEPT FOR A  
CAPITAL "P" AND "L" AND WITH A HORIZONTAL  
HOLLOW BAR BETWEEN "COLUMBIA" AND  
"POLYLIFE".

SN 77-183,245, FILED 5-17-2007.

ELLEN PERKINS, EXAMINING ATTORNEY

**Int. Cl.: 21**

**Prior U.S. Cls.: 2, 13, 23, 29, 30, 33, 40, and 50**

**United States Patent and Trademark Office**

**Reg. No. 3,506,059**

**Registered Sep. 23, 2008**

**TRADEMARK  
PRINCIPAL REGISTER**

**HairFree'**

GROOMEZ, INC. (NEW YORK CORPORATION)  
PO BOX 364  
TUCKAHOE, NY 10707

THE MARK CONSISTS OF STANDARD CHAR-  
ACTERS WITHOUT CLAIM TO ANY PARTICULAR  
FONT, STYLE, SIZE, OR COLOR.

FOR: HAIR BRUSHES, IN CLASS 21 (U.S. CLS. 2,  
13, 23, 29, 30, 33, 40 AND 50).

SN 77-183,463, FILED 5-17-2007.

FIRST USE 11-27-2007; IN COMMERCE 2-25-2008.

CHRISTINA SOBRAL, EXAMINING ATTORNEY

Int. Cls.: 16, 35, and 41

Prior U.S. Cls.: 2, 5, 22, 23, 29, 37, 38, 50, 100, 101, 102, and 107

Reg. No. 3,506,060

United States Patent and Trademark Office

Registered Sep. 23, 2008

TRADEMARK  
SERVICE MARK  
PRINCIPAL REGISTER



BREA OLINDA UNIFIED SCHOOL DISTRICT  
(CALIFORNIA PUBLIC SCHOOL DISTRICT)  
1 CIVIC CENTER CIRCLE, LEVEL II  
BREA, CA 928210300

FOR: PRINTED PUBLICATIONS, NAMELY, INSTRUCTIONAL MATERIALS, BOOKS, NEWSLETTERS, MANUALS AND GUIDES FOR HIGH SCHOOL AND UNDERGRADUATE LEVEL STUDENTS RELATED TO BUSINESS, MATHEMATICS, SCIENCE, INFORMATION TECHNOLOGY, GAMING, INTERNATIONAL AND MULTI-CULTURAL STUDIES, FOREIGN LANGUAGES, COMPUTER SCIENCE, COMPUTER SOFTWARE AND PROGRAMMING, COMMUNICATIONS, INDUSTRY, PROBLEM SOLVING, LEADERSHIP AND TECHNOLOGY PARTNERSHIP, IN CLASS 16 (U.S. CLS. 2, 5, 22, 23, 29, 37, 38 AND 50).

FIRST USE 12-2-2005; IN COMMERCE 12-2-2005.

FOR: ADMINISTRATION OF CULTURAL AND EDUCATIONAL EXCHANGE PROGRAMS, IN CLASS 35 (U.S. CLS. 100, 101 AND 102).

FIRST USE 12-2-2005; IN COMMERCE 12-2-2005.

FOR: EDUCATIONAL SERVICES, NAMELY, PROVIDING COURSES OF INSTRUCTION, LECTURES, WORKSHOPS, SEMINARS, SYMPOSIA, AND CONFERENCES AT THE HIGH SCHOOL AND UNDERGRADUATE LEVEL RELATED TO BUSINESS, MATHEMATICS, SCIENCE, INFORMA-

TION TECHNOLOGY, GAMING, INTERNATIONAL AND MULTI-CULTURAL STUDIES, FOREIGN LANGUAGES, COMPUTER SCIENCE, COMPUTER SOFTWARE AND PROGRAMMING, COMMUNICATIONS, INDUSTRY, PROBLEM SOLVING, LEADERSHIP AND TECHNOLOGY PARTNERSHIP, IN CLASS 41 (U.S. CLS. 100, 101 AND 107).

FIRST USE 12-2-2005; IN COMMERCE 12-2-2005.

NO CLAIM IS MADE TO THE EXCLUSIVE RIGHT TO USE "IT ACADEMY", APART FROM THE MARK AS SHOWN.

THE COLOR(S) GREEN AND BLUE IS/ARE CLAIMED AS A FEATURE OF THE MARK.

THE MARK CONSISTS OF THE LETTERS "GITA" IN GREEN OVERWRITTEN WITH THE WORDS "GLOBAL IT ACADEMY" IN BLUE, ABOVE A HORIZONTAL BLUE LINE NEXT TO THE TERMS "@BOHS" IN BLUE ALL ABOVE THE WORDS "CONNECTING THE WORLD" ALSO IN BLUE, WITH A SOLID BLUE SQUARE TO THE LEFT OF THE ENTIRE MARK. THE COLOR WHITE CONSTITUTES THE BACKGROUND FOR THE MARK BUT IS NOT PART OF THE MARK.

SN 77-183,579, FILED 5-17-2007.

JOHN HWANG, EXAMINING ATTORNEY

**Int. Cl.: 25**

**Prior U.S. Cls.: 22 and 39**

**United States Patent and Trademark Office**

**Reg. No. 3,506,061**

**Registered Sep. 23, 2008**

**TRADEMARK  
PRINCIPAL REGISTER**

**SUNTECT**

COOLIBAR, INC. (DELAWARE CORPORATION)  
2401 EDGEWOOD AVENUE SOUTH SUITE 400  
ST. LOUIS PARK, MN 55426

FOR: HATS, CAPS, HEADWEAR, SHIRTS, T-SHIRTS, BLOUSES, TUNICS, PANTS, TROUSERS, SHORTS, SWIM WEAR, SWIMSUITS, COVERUPS, JACKETS, SARONGS, ROMPERS, GLOVES, SKIRTS, DRESSES, SCARVES, BANDANAS, SHAWLS, SUN SLEEVES, WRAPS, IN CLASS 25 (U.S. CLS. 22 AND 39).

FIRST USE 3-5-2006; IN COMMERCE 3-5-2006.

THE MARK CONSISTS OF STANDARD CHARACTERS WITHOUT CLAIM TO ANY PARTICULAR FONT, STYLE, SIZE, OR COLOR.

SN 77-184,026, FILED 5-17-2007.

ANDREA BUTLER, EXAMINING ATTORNEY

**Int. Cl.: 9**

**Prior U.S. Cls.: 21, 23, 26, 36, and 38**

**Reg. No. 3,506,062**

**United States Patent and Trademark Office**

**Registered Sep. 23, 2008**

**TRADEMARK  
PRINCIPAL REGISTER**

**THE NEW VIRTUAL REALITY**

ICUITI CORPORATION (DELAWARE CORPORATION)  
2166 BRIGHTON HENRIETTA TOWNLINE ROAD  
ROCHESTER, NY 14623

FOR: VIRTUAL REALITY HEADSETS, HEAD MOUNTED DISPLAY SYSTEMS COMPRISED OF HEAD MOUNTED VIDEO DISPLAYS, VIDEO DISPLAYS MOUNTED IN EYEWEAR, AND OPERATING SOFTWARE FOR HEAD MOUNTED VIDEO DISPLAY DEVICES; HEAD TRACKING APPARATUS, NAMELY, VIRTUAL REALITY HEADSETS AND HEAD MOUNTED VIDEO DISPLAYS INCLUDING ELECTRONIC SENSORS FOR TRACKING THE MOTION OF A USER'S HEAD, IN CLASS 9 (U.S. CLS. 21, 23, 26, 36 AND 38).

FIRST USE 5-25-2007; IN COMMERCE 5-25-2007.

THE MARK CONSISTS OF STANDARD CHARACTERS WITHOUT CLAIM TO ANY PARTICULAR FONT, STYLE, SIZE, OR COLOR.

NO CLAIM IS MADE TO THE EXCLUSIVE RIGHT TO USE "VIRTUAL REALITY", APART FROM THE MARK AS SHOWN.

SN 77-184,057, FILED 5-17-2007.

KATHY DE JONGE, EXAMINING ATTORNEY

**Int. Cl.: 3**

**Prior U.S. Cls.: 1, 4, 6, 50, 51, and 52**

**United States Patent and Trademark Office**

**Reg. No. 3,506,063**

**Registered Sep. 23, 2008**

**TRADEMARK  
PRINCIPAL REGISTER**

**AS-18**

JAPIN INTERNATIONAL, INC. (TAIWAN CORPORATION)  
57, SEC. 2, JIAO-TAN RD.  
FONG YUAN, TAICHUNG, TAIWAN

FOR: COSMETICS, NAMELY, FACIAL SCRUBS, SKIN CLEANSING PRODUCTS, NAMELY, SKIN CLEANSERS FOR THE BODY AND HANDS, SKIN CREAMS, NIGHT CREAMS, SKIN MOISTURIZER, FACIAL MASKS, SKIN EMOLLIENTS, FACE CREAMS, ANTI-AGING CREAMS, ANTI-WRINKLE CREAMS, AND BODY CREAMS, IN CLASS 3 (U.S. CLS. 1, 4, 6, 50, 51 AND 52).

FIRST USE 8-7-2006; IN COMMERCE 8-7-2006.

THE MARK CONSISTS OF STANDARD CHARACTERS WITHOUT CLAIM TO ANY PARTICULAR FONT, STYLE, SIZE, OR COLOR.

SN 77-184,136, FILED 5-17-2007.

MIDGE BUTLER, EXAMINING ATTORNEY

**Int. Cl.: 32**

**Prior U.S. Cls.: 45, 46, and 48**

**United States Patent and Trademark Office**

**Reg. No. 3,506,064**

**Registered Sep. 23, 2008**

**TRADEMARK  
PRINCIPAL REGISTER**

**Power Mocha**

XUNI BEVERAGE COMPANY, LLC (COLORADO  
LIMITED LIABILITY COMPANY)  
1555 MAIN STREET  
#A3-100  
WINDSOR, CO 80550

FOR: BEVERAGES, NAMELY, ENERGY  
DRINKS, MADE WITH COFFEE, COCOA AND/OR  
ESPRESSO, IN CLASS 32 (U.S. CLS. 45, 46 AND 48).

FIRST USE 6-1-2008; IN COMMERCE 7-15-2008.

THE MARK CONSISTS OF STANDARD CHAR-  
ACTERS WITHOUT CLAIM TO ANY PARTICULAR  
FONT, STYLE, SIZE, OR COLOR.

NO CLAIM IS MADE TO THE EXCLUSIVE  
RIGHT TO USE "MOCHA", APART FROM THE  
MARK AS SHOWN.

SN 77-184,363, FILED 5-18-2007.

KIM SAITO, EXAMINING ATTORNEY

**Int. Cl.: 3**

**Prior U.S. Cls.: 1, 4, 6, 50, 51, and 52**

**United States Patent and Trademark Office**

**Reg. No. 3,506,065**

**Registered Sep. 23, 2008**

**TRADEMARK  
PRINCIPAL REGISTER**



TRANSFORMATIONAL ENTERPRISES, INC.  
(WASHINGTON CORPORATION)  
UNIT 6P  
708 WEST 192ND  
NEW YORK, NY 100402427

THE MARK CONSISTS OF THE WORD "AROMANDALAS" WITH A CAPITAL "M" IN THE MIDDLE.

FOR: ESSENTIAL OIL BLENDS AND LOTIONS,  
IN CLASS 3 (U.S. CLS. 1, 4, 6, 50, 51 AND 52).

SN 77-184,502, FILED 5-18-2007.

FIRST USE 5-29-2007; IN COMMERCE 5-29-2007.

SHAUNIA CARLYLE, EXAMINING ATTORNEY



**Int. Cl.: 45**

**Prior U.S. Cls.: 100 and 101**

**United States Patent and Trademark Office**

**Reg. No. 3,506,066**

**Registered Sep. 23, 2008**

**SERVICE MARK  
PRINCIPAL REGISTER**

**GREAT EX-PET-TATIONS**

WOOD, LEE A. (UNITED STATES INDIVIDUAL),  
DBA GREAT EX-PET-TATIONS PET-SITTING  
SERVICES,  
P. O. BOX 6934  
BRANDON, FL 335086015

THE MARK CONSISTS OF STANDARD CHAR-  
ACTERS WITHOUT CLAIM TO ANY PARTICULAR  
FONT, STYLE, SIZE, OR COLOR.

FOR: PET SITTING, IN CLASS 45 (U.S. CLS. 100  
AND 101).

SN 77-184,654, FILED 5-18-2007.

FIRST USE 7-0-2007; IN COMMERCE 7-0-2007.

DAVID YONTEF, EXAMINING ATTORNEY

**Int. Cl.: 28**

**Prior U.S. Cls.: 22, 23, 38, and 50**

**United States Patent and Trademark Office**

**Reg. No. 3,506,067**

**Registered Sep. 23, 2008**

**TRADEMARK  
PRINCIPAL REGISTER**

**POWER SLEEVE**

ROCKROLLER, LLC (NEVADA LIMITED LIABILITY COMPANY)  
SUITE 4  
711 S. CARSON STREET  
CARSON CITY, NV 89701

FOR: GOLF CLUB SWING AID, NAMELY, A WEIGHT THAT ATTACHES TO A GOLF CLUB SHAFT; BASEBALL BAT SWING AID, NAMELY, A WEIGHT THAT ATTACHES TO A BAT, IN CLASS 28 (U.S. CLS. 22, 23, 38 AND 50).

FIRST USE 10-0-2007; IN COMMERCE 10-0-2007.

THE MARK CONSISTS OF STANDARD CHARACTERS WITHOUT CLAIM TO ANY PARTICULAR FONT, STYLE, SIZE, OR COLOR.

SN 77-184,662, FILED 5-18-2007.

KEVIN DINALLO, EXAMINING ATTORNEY

**Int. Cl.: 25**

**Prior U.S. Cls.: 22 and 39**

**United States Patent and Trademark Office**

**Reg. No. 3,506,068**

**Registered Sep. 23, 2008**

**TRADEMARK  
PRINCIPAL REGISTER**

**LIFE'S SHORT. GET A  
DIVORCE.**

FETMAN, GARLAND & ASSOCIATES, LTD. (IL-  
LINOIS CORPORATION)  
SUITE 200  
33 WEST JACKSON BOULEVARD  
CHICAGO, IL 60604

THE MARK CONSISTS OF STANDARD CHAR-  
ACTERS WITHOUT CLAIM TO ANY PARTICULAR  
FONT, STYLE, SIZE, OR COLOR.

FOR: CLOTHING, NAMELY, SHIRTS, IN CLASS  
25 (U.S. CLS. 22 AND 39).

SN 77-184,742, FILED 5-18-2007.

FIRST USE 5-1-2007; IN COMMERCE 5-1-2007.

EDWARD FENNESSY, EXAMINING ATTORNEY

**Int. Cl.: 32**

**Prior U.S. Cls.: 45, 46, and 48**

**Reg. No. 3,506,069**

**United States Patent and Trademark Office**

**Registered Sep. 23, 2008**

---

**TRADEMARK  
PRINCIPAL REGISTER**

**FILL WITH CARE**

DANONE WATERS OF AMERICA, INC. (NEW  
YORK CORPORATION)  
100 HILLSIDE AVENUE  
WHITE PLAINS, NY 10603

THE MARK CONSISTS OF STANDARD CHAR-  
ACTERS WITHOUT CLAIM TO ANY PARTICULAR  
FONT, STYLE, SIZE, OR COLOR.

FOR: BOTTLED WATER, IN CLASS 32 (U.S. CLS.  
45, 46 AND 48).

SN 77-185,238, FILED 5-18-2007.

FIRST USE 3-0-2007; IN COMMERCE 3-0-2007.

NELSON SNYDER, EXAMINING ATTORNEY

**Int. Cl.: 28**

**Prior U.S. Cls.: 22, 23, 38, and 50**

**United States Patent and Trademark Office**

**Reg. No. 3,506,070**

**Registered Sep. 23, 2008**

**TRADEMARK  
PRINCIPAL REGISTER**



HIGH TECH PROFESSIONAL CORPORATION  
(NEVADA CORPORATION)  
430  
5190 NEIL ROAD  
RENO, NV 895028535

FOR: PET TOYS, IN CLASS 28 (U.S. CLS. 22, 23, 38  
AND 50).

FIRST USE 5-27-2007; IN COMMERCE 5-27-2007.

NO CLAIM IS MADE TO THE EXCLUSIVE  
RIGHT TO USE "PETS", APART FROM THE MARK  
AS SHOWN.

THE COLOR(S) RED, WHITE, DARK BLUE AND  
LIGHT PURPLE IS/ARE CLAIMED AS A FEATURE  
OF THE MARK.

THE MARK CONSISTS OF THE COLOR DARK  
BLUE APPEARS ON THE WORDING "KINGDOM  
PETS". THE COLOR DARK BLUE AND LIGHT  
PURPLE APPEARS ON THE CASTLE DESIGN.  
THE COLOR WHITE APPEARS ON CASTLE DE-  
SIGN AND BEHIND THE WORD KINGDOM PETS.  
THE COLOR RED APPEARS ON THE CROWN  
DESIGN AND THE SILHOUETTE OF THE CAT  
AND DOG DESIGN ON THE CASTLE.

SN 77-185,389, FILED 5-19-2007.

ROBIN CHOSID, EXAMINING ATTORNEY

**Int. Cl.: 12**

**Prior U.S. Cls.: 19, 21, 23, 31, 35, and 44**

**United States Patent and Trademark Office**

**Reg. No. 3,506,071**

**Registered Sep. 23, 2008**

**TRADEMARK  
PRINCIPAL REGISTER**

**BITE MX**

EXCEL TIRE & WHEEL CORP. (CALIFORNIA CORPORATION)

P.O. BOX 1044

WALNUT, CA 91788

FOR: TIRES, IN CLASS 12 (U.S. CLS. 19, 21, 23, 31, 35 AND 44).

FIRST USE 1-2-2008; IN COMMERCE 1-2-2008.

THE MARK CONSISTS OF STANDARD CHARACTERS WITHOUT CLAIM TO ANY PARTICULAR FONT, STYLE, SIZE, OR COLOR.

NO CLAIM IS MADE TO THE EXCLUSIVE RIGHT TO USE "MX", APART FROM THE MARK AS SHOWN.

SN 77-186,032, FILED 5-21-2007.

DAWN HAN, EXAMINING ATTORNEY

**Int. Cl.: 3**

**Prior U.S. Cls.: 1, 4, 6, 50, 51, and 52**

**United States Patent and Trademark Office**

**Reg. No. 3,506,072**

**Registered Sep. 23, 2008**

**TRADEMARK  
PRINCIPAL REGISTER**

**TOTALLYFRESH**

THE PROCTER & GAMBLE COMPANY (OHIO  
CORPORATION)  
ONE PROCTER & GAMBLE PLAZA  
CINCINNATI, OH 45202

THE MARK CONSISTS OF STANDARD CHAR-  
ACTERS WITHOUT CLAIM TO ANY PARTICULAR  
FONT, STYLE, SIZE, OR COLOR.

FOR: ANTIPERSPIRANTS AND DEODORANTS,  
IN CLASS 3 (U.S. CLS. 1, 4, 6, 50, 51 AND 52).

SN 77-186,725, FILED 5-22-2007.

FIRST USE 4-21-2008; IN COMMERCE 4-21-2008.

SHANNON TWOHIG, EXAMINING ATTORNEY

**Int. Cl.: 9**

**Prior U.S. Cls.: 21, 23, 26, 36, and 38**

**Reg. No. 3,506,073**

**United States Patent and Trademark Office**

**Registered Sep. 23, 2008**

---

**TRADEMARK  
PRINCIPAL REGISTER**

**WIZARD**

DICKSON/UNIGAGE, INC. (ILLINOIS CORPORATION)  
930 S. WESTWOOD  
ADDISON, IL 60101

FOR: INSTRUMENTS, NAMELY, PRESSURE, SIGNAL, TEMPERATURE AND HUMIDITY RECORDING DEVICES AND DOWNLOADABLE DATA CONCERNING SAME VIA THE INTERNET, IN CLASS 9 (U.S. CLS. 21, 23, 26, 36 AND 38).

FIRST USE 10-1-2007; IN COMMERCE 10-1-2007.

THE MARK CONSISTS OF STANDARD CHARACTERS WITHOUT CLAIM TO ANY PARTICULAR FONT, STYLE, SIZE, OR COLOR.

SN 77-187,129, FILED 5-22-2007.

AISHA CLARKE, EXAMINING ATTORNEY



**Int. Cl.: 41**

**Prior U.S. Cls.: 100, 101, and 107**

**United States Patent and Trademark Office**

**Reg. No. 3,506,074**

**Registered Sep. 23, 2008**

**SERVICE MARK  
PRINCIPAL REGISTER**

**BEAT THE STREET**

THESTREET.COM, INC. (DELAWARE CORPORATION)  
14 WALL STREET, 14TH FLOOR  
NEW YORK, NY 10005

FOR: ENTERTAINMENT SERVICES, NAMELY, PROVIDING AN INTERACTIVE ONLINE COMPUTER GAME BASED ON THE STOCK MARKET, WHEREIN PARTICIPANTS SUBMIT GUESSES AS TO THE STATISTICAL LEVELS ACHIEVED BY VARIOUS STOCK MARKET INDICES AS OF VARIOUS DATES, IN CLASS 41 (U.S. CLS. 100, 101 AND 107).

FIRST USE 3-30-2007; IN COMMERCE 6-2-2007.

THE MARK CONSISTS OF STANDARD CHARACTERS WITHOUT CLAIM TO ANY PARTICULAR FONT, STYLE, SIZE, OR COLOR.

SN 77-187,619, FILED 5-22-2007.

GEOFFREY FOSDICK, EXAMINING ATTORNEY

**Int. Cl.: 14**

**Prior U.S. Cls.: 2, 27, 28, and 50**

**United States Patent and Trademark Office**

**Reg. No. 3,506,075**

**Registered Sep. 23, 2008**

---

**TRADEMARK  
PRINCIPAL REGISTER**

**OMP3**

BLOCH, ELIZABETH (UNITED STATES INDIVIDUAL)  
20 WEST MARTART AVE  
HAVERTOWN, PA 19083

THE MARK CONSISTS OF STANDARD CHARACTERS WITHOUT CLAIM TO ANY PARTICULAR FONT, STYLE, SIZE, OR COLOR.

FOR: JEWELRY, IN CLASS 14 (U.S. CLS. 2, 27, 28 AND 50).

SN 77-187,775, FILED 5-22-2007.

FIRST USE 7-29-2008; IN COMMERCE 7-29-2008.

TANYA AMOS, EXAMINING ATTORNEY

**Int. Cl.: 10**

**Prior U.S. Cls.: 26, 39, and 44**

**United States Patent and Trademark Office**

**Reg. No. 3,506,076**

**Registered Sep. 23, 2008**

**TRADEMARK  
PRINCIPAL REGISTER**



DRYSCRUBS INC. (TEXAS CORPORATION)  
7 STEEPBANK DRIVE  
THE WOODLANDS, TX 77381

FOR: MEDICAL UNIFORMS, NAMELY, MEDICAL SCRUBS CONSISTING OF PANTS, TOPS, SHIRTS, JACKETS, SMOCKS, COATS, HATS, CAPS AND TUNICS, IN CLASS 10 (U.S. CLS. 26, 39 AND 44).

FIRST USE 10-0-2007; IN COMMERCE 10-0-2007.

THE MARK CONSISTS OF THE WORD "DRY-SCRUBS" WITH A STETHOSCOPE INSIDE A BOX.

SN 77-189,314, FILED 5-24-2007.

RICHARD WHITE, EXAMINING ATTORNEY

**Int. Cl.: 21**

**Prior U.S. Cls.: 2, 13, 23, 29, 30, 33, 40, and 50**

**United States Patent and Trademark Office**

**Reg. No. 3,506,077**

**Registered Sep. 23, 2008**

**TRADEMARK  
PRINCIPAL REGISTER**

**Joy Jar**

CLAYDEN, CARRIE R. (UNITED STATES INDIVIDUAL)  
1608 FOUNTAIN SPRINGS CIRCLE  
DANVILLE, CA 94526

FOR: GLASS STORAGE JARS, IN CLASS 21 (U.S. CLS. 2, 13, 23, 29, 30, 33, 40 AND 50).

FIRST USE 7-1-2006; IN COMMERCE 7-1-2006.

THE MARK CONSISTS OF STANDARD CHARACTERS WITHOUT CLAIM TO ANY PARTICULAR FONT, STYLE, SIZE, OR COLOR.

NO CLAIM IS MADE TO THE EXCLUSIVE RIGHT TO USE "JAR", APART FROM THE MARK AS SHOWN.

SN 77-189,654, FILED 5-24-2007.

JACQUELINE A. LAVINE, EXAMINING ATTORNEY

**Int. Cl.: 45**

**Prior U.S. Cls.: 100 and 101**

**United States Patent and Trademark Office**

**Reg. No. 3,506,078**

**Registered Sep. 23, 2008**

**SERVICE MARK  
PRINCIPAL REGISTER**

**SOUND.PROOF.SECURITY.**

VOICEVERIFIED, INC. (DELAWARE CORPORATION)  
110 UNION SQUARE DRIVE  
NEW HOPE, PA 18938

FOR: IDENTIFICATION VERIFICATION SERVICES, NAMELY, PROVIDING AUTHENTICATION OF PERSONAL IDENTIFICATION INFORMATION, IN CLASS 45 (U.S. CLS. 100 AND 101).

FIRST USE 5-29-2007; IN COMMERCE 6-11-2007.

THE MARK CONSISTS OF STANDARD CHARACTERS WITHOUT CLAIM TO ANY PARTICULAR FONT, STYLE, SIZE, OR COLOR.

SN 77-189,701, FILED 5-24-2007.

TOBY BULLOFF, EXAMINING ATTORNEY

Int. Cl.: 33

Prior U.S. Cls.: 47 and 49

**United States Patent and Trademark Office**

**Reg. No. 3,506,079**

Registered Sep. 23, 2008

**TRADEMARK  
PRINCIPAL REGISTER**

CROWN ROYAL CASK NO. 16

DIAGEO NORTH AMERICA, INC. (CONNECTI-  
CUT CORPORATION)  
801 MAIN AVENUE  
NORWALK, CT 06851

FOR: ALCOHOLIC BEVERAGES, NAMELY,  
WHISKY, IN CLASS 33 (U.S. CLS. 47 AND 49).

FIRST USE 9-30-2007; IN COMMERCE 9-30-2007.

THE MARK CONSISTS OF STANDARD CHAR-  
ACTERS WITHOUT CLAIM TO ANY PARTICULAR  
FONT, STYLE, SIZE, OR COLOR.

OWNER OF U.S. REG. NOS. 635,313 AND 2,851,028.

NO CLAIM IS MADE TO THE EXCLUSIVE  
RIGHT TO USE "CASK", APART FROM THE MARK  
AS SHOWN.

SN 77-189,749, FILED 5-24-2007.

MARK SPARACINO, EXAMINING ATTORNEY

**Int. Cl.: 19**

**Prior U.S. Cls.: 1, 12, 33, and 50**

**United States Patent and Trademark Office**

**Reg. No. 3,506,080**

**Registered Sep. 23, 2008**

**TRADEMARK  
PRINCIPAL REGISTER**

# EMISSARY

JOHNSONITE INC. (OHIO CORPORATION)  
16910 MUNN ROAD  
CHAGRIN FALLS, OH 44023

THE MARK CONSISTS OF STANDARD CHAR-  
ACTERS WITHOUT CLAIM TO ANY PARTICULAR  
FONT, STYLE, SIZE, OR COLOR.

FOR: FLOORING ACCESSORIES, NAMELY,  
NON-METAL COVE BASES AND NON-METAL  
WALL BASES, IN CLASS 19 (U.S. CLS. 1, 12, 33  
AND 50).

SN 77-190,377, FILED 5-25-2007.

FIRST USE 6-7-2007; IN COMMERCE 6-7-2007.

EVELYN BRADLEY, EXAMINING ATTORNEY

Int. Cls.: 35 and 41

Prior U.S. Cls.: 100, 101, 102, and 107

United States Patent and Trademark Office

Reg. No. 3,506,081

Registered Sep. 23, 2008

SERVICE MARK  
PRINCIPAL REGISTER



CHERRY HEART, LLC (TENNESSEE LIMITED LIABILITY COMPANY)

725 COOL SPRINGS BLVD., SUITE 320

FRANKLIN, TN 37067

FOR: ADVERTISING AND ADVERTISEMENT SERVICES; ADVERTISING AND BUSINESS MANAGEMENT CONSULTANCY; ADVERTISING AND MARKETING; ADVERTISING AND PUBLICITY SERVICES; ADVERTISING AND PUBLICITY SERVICES, NAMELY, PROMOTING THE GOODS, SERVICES, BRAND IDENTITY AND COMMERCIAL INFORMATION AND NEWS OF THIRD PARTIES THROUGH PRINT, AUDIO, VIDEO, DIGITAL AND ON-LINE MEDIUM; ADVERTISING SERVICES, NAMELY, PROMOTING AND MARKETING THE GOODS AND SERVICES OF OTHERS THROUGH ALL PUBLIC COMMUNICATION MEANS; ADVERTISING, MARKETING AND PROMOTION SERVICES; CREATING AND UPDATING ADVERTISING MATERIAL; ENTERTAINMENT MARKETING SERVICES, NAMELY, MARKETING, PROMOTION AND ADVERTISING FOR INDEPENDENT RECORDING ARTISTS; MEDIA PLANNING, NAMELY, ADVISING THE CLIENT ON THE CORRECT TIMES AND STATIONS TO ADVERTISE BASED ON MEDIA ANALYSIS OF THE MARKET FOR THAT MEDIA; ON-LINE ADVERTISING AND MARKETING SERVICES; PLACING ADVERTISEMENTS FOR OTHERS; PREPARING AND PLACING ADVERTISEMENTS FOR OTHERS; PREPARING AND PLACING OF ADVERTISEMENTS; PREPARING AUDIO-VISUAL PRESENTATIONS FOR USE IN ADVERTISING, IN CLASS 35 (U.S. CLS. 100, 101 AND 102).

FIRST USE 2-1-2007; IN COMMERCE 2-1-2007.

FOR: BOOKING OF ENTERTAINMENT HALLS; ENTERTAINMENT IN THE NATURE OF AN ONGOING SPECIAL VARIETY, NEWS, MUSIC OR COMEDY SHOW FEATURING RECORDING ARTISTS BROADCAST OVER TELEVISION, SATELLITE, AUDIO, AND VIDEO MEDIA; ENTERTAINMENT IN THE NATURE OF LIVE PERFORMANCES BY RECORDING ARTISTS; ENTERTAINMENT IN THE NATURE OF VISUAL AND AUDIO PERFORMANCES, AND MUSICAL, VARIETY, NEWS AND COMEDY SHOWS; ENTERTAINMENT IN THE NATURE OF VISUAL AND AUDIO PERFORMANCES, NAMELY, MUSICAL BAND, ROCK GROUP, GYMNASTIC, DANCE, AND BALLET PERFORMANCES; ENTERTAINMENT, NAMELY, LIVE PERFORMANCES BY A MUSICAL BAND; ENTERTAINMENT SERVICES, NAMELY, PERSONAL APPEARANCES BY A RECORDING ARTISTS; ENTERTAINMENT SERVICES, NAMELY, PROVIDING A WEB SITE FEATURING MUSICAL PERFORMANCES, MUSICAL VIDEOS, RELATED FILM CLIPS, PHOTOGRAPHS, AND OTHER MULTIMEDIA MATERIALS; ENTERTAINMENT, NAMELY, LIVE MUSIC CONCERTS; ENTERTAINMENT, NAMELY, LIVE PERFORMANCES BY MUSICAL BANDS, IN CLASS 41 (U.S. CLS. 100, 101 AND 107).

FIRST USE 2-1-2007; IN COMMERCE 2-1-2007.

NO CLAIM IS MADE TO THE EXCLUSIVE RIGHT TO USE "MUSIC" AND "ENTERTAINMENT", APART FROM THE MARK AS SHOWN.

THE COLOR(S) BLACK, WHITE, GREEN AND RED IS/ARE CLAIMED AS A FEATURE OF THE MARK.



THE MARK CONSISTS OF THE WORDS CHERRY HEART MUSIC & ENTERTAINMENT IN BLACK IN A SCRIPT FONT IN THE FOREGROUND WITH THE UPPER PARTS OF THE LETTERS "RRY" IN CHERRY AND THE LEFT EDGE OF THE LETTER "H" IN HEART OUTLINED IN WHITE. IN THE BACKGROUND IS A RED, HEART-SHAPED

IMAGE OUTLINED IN BLACK WITH A BLACK CHERRY STEM FROM WHICH A GREEN LEAF DESIGN PROTRUDES.

SN 77-190,868, FILED 5-25-2007.

KEVIN CORWIN, EXAMINING ATTORNEY

Int. Cl.: 18

Prior U.S. Cls.: 1, 2, 3, 22, and 41

United States Patent and Trademark Office

Reg. No. 3,506,082

Registered Sep. 23, 2008

TRADEMARK  
PRINCIPAL REGISTER

mía mariú

PRICE, MARIA EUGENIA (UNITED STATES  
INDIVIDUAL)  
4640 IRVIN SIMMONS  
DALLAS, TX 75229

FOR: HANDBAGS; TOTE BAGS; COSMETIC  
BAGS SOLD EMPTY, IN CLASS 18 (U.S. CLS. 1, 2, 3,  
22 AND 41).

FIRST USE 1-1-2008; IN COMMERCE 1-1-2008.

THE MARK CONSISTS OF STANDARD CHAR-  
ACTERS WITHOUT CLAIM TO ANY PARTICULAR  
FONT, STYLE, SIZE, OR COLOR.

THE ENGLISH TRANSLATION OF THE WORD  
"MIA" IN THE MARK IS MINE.

SN 77-190,922, FILED 5-25-2007.

JOHN DWYER, EXAMINING ATTORNEY

**Int. Cl.: 16**

**Prior U.S. Cls.: 2, 5, 22, 23, 29, 37, 38, and 50**

**Reg. No. 3,506,083**

**United States Patent and Trademark Office**

**Registered Sep. 23, 2008**

**TRADEMARK  
PRINCIPAL REGISTER**

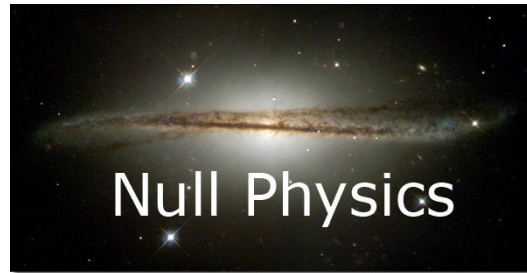

ARIDIAN PUBLISHING CORPORATION (FLORIDA CORPORATION)  
2900 N RIVERSIDE DR.  
INDIALANTIC, FL 32903

FOR: BOOKS IN THE FIELD OF PHYSICS, IN CLASS 16 (U.S. CLS. 2, 5, 22, 23, 29, 37, 38 AND 50).

FIRST USE 8-6-2007; IN COMMERCE 8-6-2007.

NO CLAIM IS MADE TO THE EXCLUSIVE RIGHT TO USE "PHYSICS", APART FROM THE MARK AS SHOWN.

THE COLOR(S) BLACK, BROWN, GRAY, AND WHITE IS/ARE CLAIMED AS A FEATURE OF THE MARK.

THE MARK CONSISTS OF A STYLIZED DRAWING OF A WARPED GALAXY. BLACK COLOR IS USED FOR THE BACKGROUND FOR THE ENTIRE MARK, AND BENEATH THE GALAXY THE TEXT "NULL PHYSICS" APPEARS IN WHITE. VARIOUS SHADES OF BROWN, GRAY, BLACK AND WHITE ARE DISTRIBUTED THROUGHOUT THE GALACTIC IMAGE.

SN 77-190,989, FILED 5-25-2007.

JANICE L. MCMORROW, EXAMINING ATTORNEY

**Int. Cl.: 9**

**Prior U.S. Cls.: 21, 23, 26, 36, and 38**

**Reg. No. 3,506,084**

**United States Patent and Trademark Office**

**Registered Sep. 23, 2008**

---

**TRADEMARK  
PRINCIPAL REGISTER**

**FEEDWATCH**

VALLEY AGRICULTURAL SOFTWARE, INC.  
(CALIFORNIA CORPORATION)  
3950 SOUTH "K" STREET  
TULARE, CA 93274

THE MARK CONSISTS OF STANDARD CHARACTERS WITHOUT CLAIM TO ANY PARTICULAR FONT, STYLE, SIZE, OR COLOR.

FOR: COMPUTER PROGRAMS FOR MANAGING FEED FOR DAIRY HERDS, IN CLASS 9 (U.S. CLS. 21, 23, 26, 36 AND 38).

SN 77-190,997, FILED 5-25-2007.

FIRST USE 1-1-2004; IN COMMERCE 1-1-2004.

NAAKWAMA ANKRAH, EXAMINING ATTORNEY

**Int. Cl.: 25**

**Prior U.S. Cls.: 22 and 39**

**United States Patent and Trademark Office**

**Reg. No. 3,506,085**

**Registered Sep. 23, 2008**

**TRADEMARK  
PRINCIPAL REGISTER**

**FRIENDSHIRTS**

EISENMAN, LAVI (UNITED STATES INDIVIDUAL)  
10771 LA BATISTA AVE.  
FOUNTAIN VALLEY, CA 92708

FOR: PANTS; SHIRTS; SWEATERS; T-SHIRTS, IN CLASS 25 (U.S. CLS. 22 AND 39).

FIRST USE 10-8-2007; IN COMMERCE 10-8-2007.

THE MARK CONSISTS OF STANDARD CHARACTERS WITHOUT CLAIM TO ANY PARTICULAR FONT, STYLE, SIZE, OR COLOR.

SN 77-191,517, FILED 5-28-2007.

ALICE SUE CARRUTHERS, EXAMINING ATTORNEY

**Int. Cl.: 25**

**Prior U.S. Cls.: 22 and 39**

**United States Patent and Trademark Office**

**Reg. No. 3,506,086**

**Registered Sep. 23, 2008**

**TRADEMARK  
PRINCIPAL REGISTER**

**My Cute Little Feet**

MCCRACKEN, SHAWN L. (UNITED STATES  
INDIVIDUAL)  
748 ROWLEY DRIVE  
SALT LAKE CITY, UT 84107 AND  
MCCRACKEN, YUJIE L. (UNITED STATES INDIVI-  
DUAL)  
748 ROWLEY DRIVE  
SALT LAKE CITY, UT 84107

FIRST USE 11-26-2007; IN COMMERCE 11-26-2007.

THE MARK CONSISTS OF STANDARD CHAR-  
ACTERS WITHOUT CLAIM TO ANY PARTICULAR  
FONT, STYLE, SIZE, OR COLOR.

SN 77-191,518, FILED 5-28-2007.

FOR: SHOES, IN CLASS 25 (U.S. CLS. 22 AND 39).

JENNIFER VASQUEZ, EXAMINING ATTORNEY

**Int. Cl.: 41**

**Prior U.S. Cls.: 100, 101, and 107**

**United States Patent and Trademark Office**

**Reg. No. 3,506,087**

**Registered Sep. 23, 2008**

**SERVICE MARK  
PRINCIPAL REGISTER**

**SEATQUEST**

SEATQUEST LLC (ILLINOIS LIMITED LIABILITY COMPANY)  
175 N. HARBOR DR., #3503  
CHICAGO, IL 60601

THE MARK CONSISTS OF STANDARD CHARACTERS WITHOUT CLAIM TO ANY PARTICULAR FONT, STYLE, SIZE, OR COLOR.

FOR: ONLINE DATABASES FEATURING SEATING CHARTS OR PLANS FOR ENTERTAINMENT VENUES, IN CLASS 41 (U.S. CLS. 100, 101 AND 107).

SN 77-191,551, FILED 5-28-2007.

FIRST USE 1-10-2007; IN COMMERCE 1-10-2007.

MELVIN AXILBUND, EXAMINING ATTORNEY

**Int. Cl.: 41**

**Prior U.S. Cls.: 100, 101, and 107**

**United States Patent and Trademark Office**

**Reg. No. 3,506,088**

**Registered Sep. 23, 2008**

**SERVICE MARK  
PRINCIPAL REGISTER**

**KNOW WHERE YOU SIT**

SEATQUEST LLC (ILLINOIS LIMITED LIABILITY COMPANY)  
175 N. HARBOR DR., #3503  
CHICAGO, IL 60601

THE MARK CONSISTS OF STANDARD CHARACTERS WITHOUT CLAIM TO ANY PARTICULAR FONT, STYLE, SIZE, OR COLOR.

FOR: ONLINE DATABASES FEATURING SEATING CHARTS OR PLANS FOR ENTERTAINMENT VENUES, IN CLASS 41 (U.S. CLS. 100, 101 AND 107).

SN 77-191,555, FILED 5-28-2007.

FIRST USE 1-10-2007; IN COMMERCE 1-10-2007.

MELVIN AXILBUND, EXAMINING ATTORNEY



**Int. Cl.: 20**

**Prior U.S. Cls.: 2, 13, 22, 25, 32, and 50**

**Reg. No. 3,506,089**

**United States Patent and Trademark Office**

**Registered Sep. 23, 2008**

**TRADEMARK  
PRINCIPAL REGISTER**

**FUSE**

HNI TECHNOLOGIES INC. (IOWA CORPORATION)  
408 EAST 2ND STREET  
MUSCATINE, IA 52761

THE MARK CONSISTS OF STANDARD CHARACTERS WITHOUT CLAIM TO ANY PARTICULAR FONT, STYLE, SIZE, OR COLOR.

FOR: FURNITURE, DESKS, CREDENZAS, STORAGE CABINETS, TABLES, IN CLASS 20 (U.S. CLS. 2, 13, 22, 25, 32 AND 50).

SN 77-191,788, FILED 5-29-2007.

FIRST USE 1-31-2008; IN COMMERCE 1-31-2008.

SONYA STEPHENS, EXAMINING ATTORNEY

Int. Cl.: 16

Prior U.S. Cls.: 2, 5, 22, 23, 29, 37, 38, and 50

United States Patent and Trademark Office

Reg. No. 3,506,090

Registered Sep. 23, 2008

TRADEMARK  
PRINCIPAL REGISTER

mía mariú

PRICE, MARIA EUGENIA (UNITED STATES  
INDIVIDUAL)  
4640 IRVIN SIMMONS  
DALLAS, TX 75229

FOR: PUBLICATIONS, NAMELY, EDUCATION-  
AL BROCHURES AND BOOKLETS, AND TEACH-  
ING MATERIALS IN THE FIELD OF PROMOTION  
AND SALE OF SKIN CARE PRODUCTS, COSMET-  
ICS, BODY CARE PRODUCTS, FRAGRANCE PRO-  
DUCTS, NUTRITIONAL SUPPLEMENT  
PRODUCTS, JEWELRY, TOTE BAGS, HANDBAGS  
AND COSMETIC BAGS SOLD EMPTY, IN CLASS 16  
(U.S. CLS. 2, 5, 22, 23, 29, 37, 38 AND 50).

FIRST USE 1-1-2008; IN COMMERCE 1-1-2008.

THE MARK CONSISTS OF STANDARD CHAR-  
ACTERS WITHOUT CLAIM TO ANY PARTICULAR  
FONT, STYLE, SIZE, OR COLOR.

THE ENGLISH TRANSLATION OF THE WORD  
"MIA" IN THE MARK IS MINE.

SN 77-191,791, FILED 5-29-2007.

JOHN DWYER, EXAMINING ATTORNEY

**Int. Cl.: 3**

**Prior U.S. Cls.: 1, 4, 6, 50, 51, and 52**

**Reg. No. 3,506,091**

**United States Patent and Trademark Office**

**Registered Sep. 23, 2008**

**TRADEMARK  
PRINCIPAL REGISTER**

**mía mariú**

MARIA EUGENIA PRICE (UNITED STATES INDIVIDUAL)  
4640 IRVIN SIMMONS  
DALLAS, TX 75229

FOR: SKIN CARE PRODUCTS, NAMELY, LIP BALM, NIGHT CREAM, EYE CREAM, ANTI-AGING CREAM, COSMETIC CLEANSING CREAMS, SKIN CLEANSING LOTION, FACIAL SCRUBS AND NON-MEDICATED ACNE TREATMENT PREPARATIONS. BODY CARE PRODUCTS, NAMELY, SHOWER AND BATH GEL, FOAM SKIN CLEANSING PREPARATIONS, BATH SALTS, BODY LOTION, HAND CREAM, SHAVING GEL, EXFOLIANT CREAMS, AND MASSAGE OILS. COSMETICS, NAMELY, MAKE-UP, MAKE-UP PENCILS, LOOSE FACE POWDER, PRESSED FACE POWDER, FOUNDATION MAKE-UP, EYELINER, EYE SHADOW, BLUSH, SKIN BRONZING POWDER, MASCARA,

LIPSTICK, LIP GLOSS, COSMETIC PADS, AND EYE MAKE-UP REMOVER. FRAGRANCES FOR PERSONAL USE, NAMELY, PERFUME, COLOGNE, AND SCENTED BODY SPRAYS, IN CLASS 3 (U.S. CLS. 1, 4, 6, 50, 51 AND 52).

FIRST USE 1-1-2008; IN COMMERCE 1-1-2008.

THE MARK CONSISTS OF STANDARD CHARACTERS WITHOUT CLAIM TO ANY PARTICULAR FONT, STYLE, SIZE, OR COLOR.

THE ENGLISH TRANSLATION OF THE WORD "MIA" IN THE MARK IS MINE.

SN 77-191,909, FILED 5-29-2007.

JOHN DWYER, EXAMINING ATTORNEY

**Int. Cl.: 36**

**Prior U.S. Cls.: 100, 101, and 102**

**United States Patent and Trademark Office**

**Reg. No. 3,506,092**

**Registered Sep. 23, 2008**

**SERVICE MARK  
PRINCIPAL REGISTER**

**TRUEINCOME**

THE PRUDENTIAL INSURANCE COMPANY OF  
AMERICA (NEW JERSEY CORPORATION)  
LAW DEPARTMENT  
751 BROAD STREET, 22ND FLOOR  
NEWARK, NJ 07102

FOR: FINANCIAL SERVICES, NAMELY, THE  
ORIGINATION, UNDERWRITING, DISTRIBUTION,  
INVESTMENT MANAGEMENT, AND ADMINISTRATION  
OF ANNUITIES, MUTUAL FUNDS AND SECURITIES,  
IN CLASS 36 (U.S. CLS. 100, 101 AND 102).

FIRST USE 7-27-2007; IN COMMERCE 7-27-2007.

THE MARK CONSISTS OF STANDARD CHARACTERS  
WITHOUT CLAIM TO ANY PARTICULAR FONT,  
STYLE, SIZE, OR COLOR.

OWNER OF U.S. REG. NO. 2,932,799.

SN 77-192,228, FILED 5-29-2007.

RICHARD A. STRASER, EXAMINING ATTORNEY

**Int. Cls.: 41, 44, and 45**

**Prior U.S. Cls.: 100, 101, and 107**

**United States Patent and Trademark Office**

**Reg. No. 3,506,093**

**Registered Sep. 23, 2008**

**SERVICE MARK  
PRINCIPAL REGISTER**

**JOURNEYLITE**  **FOR LIFE.**

BARIATRIC PARTNERS, INC. (DELAWARE CORPORATION)  
SUITE 200  
7401 CARMEL EXECUTIVE PARK DR.  
CHARLOTTE, NC 28226

FOR: EDUCATIONAL SERVICES, NAMELY, DESIGNING AND CONDUCTING SEMINARS, PROGRAMS, WORKSHOPS AND HEALTH FAIRS RELATING TO PREOPERATIVE PREPARATION FOR SURGICAL WEIGHT LOSS AND THE PSYCHOLOGICAL, NUTRITIONAL, SOCIAL, AND ECONOMIC ASPECTS OF SURGICAL WEIGHT LOSS, AND DISTRIBUTING EDUCATIONAL MATERIALS IN CONNECTION THEREWITH, IN CLASS 41 (U.S. CLS. 100, 101 AND 107).

FIRST USE 7-1-2007; IN COMMERCE 7-1-2007.

FOR: AMBULATORY SURGERY CENTER AND HEALTH CARE SERVICES, NAMELY, DIAGNOSTIC, THERAPEUTIC AND SURGICAL SERVICES; PROVIDING INFORMATION RELATING TO PREOPERATIVE PREPARATION FOR SURGICAL WEIGHT LOSS AND THE PSYCHOLOGICAL, NUTRITIONAL, SOCIAL, AND ECONOMIC ASPECTS OF SURGICAL WEIGHT LOSS; INDIVIDUAL AND GROUP MEDICAL COUNSELING SERVICES FOR PATIENTS RELATING TO PREOPERATIVE PREPARATION FOR SURGICAL WEIGHT LOSS AND

THE PSYCHOLOGICAL AND NUTRITIONAL ASPECTS OF SURGICAL WEIGHT LOSS, IN CLASS 44 (U.S. CLS. 100 AND 101).

FIRST USE 7-1-2007; IN COMMERCE 7-1-2007.

FOR: ORGANIZING AND CONDUCTING INDIVIDUAL AND GROUP SUPPORT SERVICES FOR PATIENTS AND FAMILIES OF PATIENTS RELATING TO PREOPERATIVE PREPARATION FOR SURGICAL WEIGHT LOSS AND THE PSYCHOLOGICAL, NUTRITIONAL, SOCIAL AND ECONOMIC ASPECTS OF SURGICAL WEIGHT LOSS, IN CLASS 45 (U.S. CLS. 100 AND 101).

FIRST USE 7-1-2007; IN COMMERCE 7-1-2007.

THE COLOR(S) GREEN AND BLACK IS/ARE CLAIMED AS A FEATURE OF THE MARK.

THE MARK CONSISTS OF THE COLOR BLACK APPEARS IN THE WORDING "JOURNEYLITE FOR LITE". THE COLOR GREEN APPEARS IN THE CURVED LINE DESIGN.

SN 77-192,297, FILED 5-29-2007.

TIMOTHY FINNEGAN, EXAMINING ATTORNEY

**Int. Cl.: 16**

**Prior U.S. Cls.: 2, 5, 22, 23, 29, 37, 38, and 50**

**United States Patent and Trademark Office**

**Reg. No. 3,506,094**

**Registered Sep. 23, 2008**

**TRADEMARK  
PRINCIPAL REGISTER**

**Compared to ComfortGlide,  
All other Brushes are Just  
Bristles on the End of a  
Stick**

COMFORTGLIDE, INC. (GEORGIA CORPORATION)  
4840 HAMMOND INDUSTRIAL DRIVE  
CUMMING, GA 30040

THE MARK CONSISTS OF STANDARD CHARACTERS WITHOUT CLAIM TO ANY PARTICULAR FONT, STYLE, SIZE, OR COLOR.

FOR: PAINT APPLICATORS AND BRUSHES, IN CLASS 16 (U.S. CLS. 2, 5, 22, 23, 29, 37, 38 AND 50).

SN 77-193,247, FILED 5-30-2007.

FIRST USE 5-9-2007; IN COMMERCE 5-14-2007.

NANCY CLARKE, EXAMINING ATTORNEY

**Int. Cl.: 41**

**Prior U.S. Cls.: 100, 101, and 107**

**United States Patent and Trademark Office**

**Reg. No. 3,506,095**

**Registered Sep. 23, 2008**

**SERVICE MARK  
PRINCIPAL REGISTER**

**HIGHLANDER ROBBIE**

WORLD WRESTLING ENTERTAINMENT, INC.  
(DELAWARE CORPORATION)  
1241 EAST MAIN STREET  
STAMFORD, CT 06902

FOR: ENTERTAINMENT SERVICES, NAMELY,  
WRESTLING EXHIBITIONS AND PERFORMAN-  
CES BY A PROFESSIONAL WRESTLER AND EN-  
TERTAINER; PROVIDING WRESTLING NEWS  
AND INFORMATION VIA A GLOBAL COMPUTER  
NETWORK, IN CLASS 41 (U.S. CLS. 100, 101 AND  
107).

FIRST USE 6-30-2006; IN COMMERCE 6-30-2006.

THE MARK CONSISTS OF STANDARD CHAR-  
ACTERS WITHOUT CLAIM TO ANY PARTICULAR  
FONT, STYLE, SIZE, OR COLOR.

SN 77-193,255, FILED 5-30-2007.

THEODORE MCBRIDE, EXAMINING ATTORNEY

**Int. Cl.: 41**

**Prior U.S. Cls.: 100, 101, and 107**

**United States Patent and Trademark Office**

**Reg. No. 3,506,096**

**Registered Sep. 23, 2008**

**SERVICE MARK  
PRINCIPAL REGISTER**

**HIGHLANDER RORY**

WORLD WRESTLING ENTERTAINMENT, INC.  
(DELAWARE CORPORATION)  
1241 EAST MAIN STREET  
STAMFORD, CT 06902

FOR: ENTERTAINMENT SERVICES, NAMELY,  
WRESTLING EXHIBITIONS AND PERFORMAN-  
CES BY A PROFESSIONAL WRESTLER AND EN-  
TERTAINER; PROVIDING WRESTLING NEWS  
AND INFORMATION VIA A GLOBAL COMPUTER  
NETWORK, IN CLASS 41 (U.S. CLS. 100, 101 AND  
107).

FIRST USE 6-30-2006; IN COMMERCE 6-30-2006.

THE MARK CONSISTS OF STANDARD CHAR-  
ACTERS WITHOUT CLAIM TO ANY PARTICULAR  
FONT, STYLE, SIZE, OR COLOR.

SN 77-193,313, FILED 5-30-2007.

THEODORE MCBRIDE, EXAMINING ATTORNEY



**Int. Cl.: 32**

**Prior U.S. Cls.: 45, 46, and 48**

**United States Patent and Trademark Office**

**Reg. No. 3,506,097**

**Registered Sep. 23, 2008**

**TRADEMARK  
PRINCIPAL REGISTER**

**HERMAN JOSEPH'S**

MILLERCOORS LLC (DELAWARE LIMITED  
LIABILITY COMPANY)  
1209 ORANGE STREET  
WILMINGTON, DE 19801

THE NAME(S), PORTRAIT(S), AND/OR SIGNA-  
TURE(S) SHOWN IN THE MARK DOES NOT IDEN-  
TIFY A PARTICULAR LIVING INDIVIDUAL.

FOR: BEER, IN CLASS 32 (U.S. CLS. 45, 46 AND 48).

FIRST USE 6-17-2008; IN COMMERCE 6-17-2008.

SN 77-193,527, FILED 5-30-2007.

THE MARK CONSISTS OF STANDARD CHAR-  
ACTERS WITHOUT CLAIM TO ANY PARTICULAR  
FONT, STYLE, SIZE, OR COLOR.

MIDGE BUTLER, EXAMINING ATTORNEY

**Int. Cl.: 5**

**Prior U.S. Cls.: 6, 18, 44, 46, 51, and 52**

**Reg. No. 3,506,098**

**United States Patent and Trademark Office**

**Registered Sep. 23, 2008**

---

**TRADEMARK  
PRINCIPAL REGISTER**

**FERTILE LIFE**

WERTHMAN, PHIL (UNITED STATES INDIVIDUAL)  
SUITE 907  
2080 CENTURY PARK EAST  
CENTURY CITY, CA 900672012

FOR: VITAMINS; DIETARY SUPPLEMENTS, IN CLASS 5 (U.S. CLS. 6, 18, 44, 46, 51 AND 52).

FIRST USE 6-1-2008; IN COMMERCE 7-15-2008.

THE MARK CONSISTS OF STANDARD CHARACTERS WITHOUT CLAIM TO ANY PARTICULAR FONT, STYLE, SIZE, OR COLOR.

SN 77-194,387, FILED 5-31-2007.

MARIA-VICTORIA SUAREZ, EXAMINING ATTORNEY

Int. Cls.: 25 and 30

Prior U.S. Cls.: 22, 39, and 46

United States Patent and Trademark Office

Reg. No. 3,506,099

Registered Sep. 23, 2008

TRADEMARK  
PRINCIPAL REGISTER

# Gasseey Jack's

MEINER, SAM C. (UNITED STATES INDIVIDUAL)  
6319 GIBSON DR  
ORLANDO, FL 32809

FOR: A-SHIRTS; BUTTON-FRONT ALOHA SHIRTS; CAMP SHIRTS; DRESS SHIRTS; GOLF SHIRTS; KNIT SHIRTS; NIGHT SHIRTS; OPEN-NECKED SHIRTS; PIQUE SHIRTS; POLO SHIRTS; SHIRT FRONTS; SHIRT YOKES; SHIRTS; SHIRTS FOR SUITS; SHORT-SLEEVED OR LONG-SLEEVED T-SHIRTS; SHORT-SLEEVED SHIRTS; SLEEP SHIRTS; SPORT SHIRTS; SPORTS SHIRTS; SPORTS SHIRTS WITH SHORT SLEEVES; SWEAT SHIRTS; T-SHIRTS; WIND SHIRTS; YOGA SHIRTS, IN CLASS 25 (U.S. CLS. 22 AND 39).

FIRST USE 1-12-2003; IN COMMERCE 1-12-2003.

FOR: ARTICHOKE SAUCE; BARBECUE SAUCE; BARBEQUE SAUCE; CHEESE SAUCE; CHICKEN WING SAUCE; CHILI SAUCE; CONDIMENT, NAMELY, PEPPER SAUCE; DIPPING SAUCES; FISH SAUCE; FRUIT SAUCES EXCLUDING CRANBERRY SAUCE AND APPLESAUCE; HOT SAUCE; MIX FOR MAKING COMBINED NOODLE AND SAUCE DISH; NOODLES AND SAUCE MIXES COMBINED

IN UNITARY PACKAGES; NOODLES, SAUCE, AND PROCESSED VEGETABLES COMBINED IN UNITARY PACKAGES; NOODLES, SAUCE, AND SEASONING TOPPINGS COMBINED IN UNITARY PACKAGES; NOODLES, SAUCE, AND TOPPING COMBINED IN UNITARY PACKAGES; NOODLES, SAUCE, DEHYDRATED VEGETABLES, AND TOPPING COMBINED IN UNITARY PACKAGES; PICANTE SAUCE; PICO DE GALLO SAUCE; PIZZA SAUCE; READY-MADE SAUCES; SALAD SAUCES; SAUCE MIXES; SAUCES; SAUCES FOR BARBECUED MEAT; SLOPPY JOE SAUCE; SOY SAUCE; SOY SAUCE; SPAGHETTI SAUCE; STEAK SAUCE; TARTAR SAUCE; TERIYAKI SAUCE; TOMATO SAUCE; WORCESTERSHIRE SAUCE, IN CLASS 30 (U.S. CL. 46).

FIRST USE 1-12-2003; IN COMMERCE 1-12-2003.

THE MARK CONSISTS OF STANDARD CHARACTERS WITHOUT CLAIM TO ANY PARTICULAR FONT, STYLE, SIZE, OR COLOR.

SN 77-194,984, FILED 5-31-2007.

CHARLOTTE CORWIN, EXAMINING ATTORNEY

**Int. Cl.: 41**

**Prior U.S. Cls.: 100, 101, and 107**

**United States Patent and Trademark Office**

**Reg. No. 3,506,100**

**Registered Sep. 23, 2008**

**SERVICE MARK  
PRINCIPAL REGISTER**

MIL MASCARAS VS THE AZTEC  
MUMMY

OSMIUM ENTERTAINMENT, LLC (MISSOURI  
LIMITED LIABILITY COMPANY)  
404 CARPATHIAN DRIVE  
COLUMBIA, MO 65203

FOR: ENTERTAINMENT SERVICES IN THE NATURE OF AN ACTION, HORROR, COMEDY, DRAMA AND ANIMATED MOTION FILM SERIES; PRODUCTION OF AN ACTION, HORROR, COMEDY, DRAMA AND ANIMATED MOTION FILM SERIES; ACTION, HORROR COMEDY, DRAMA AND ANIMATED MOTION PICTURE THEATRICAL FILM SERIES; PRODUCTION OF ACTION, HORROR COMEDY, DRAMA AND ANIMATED MOTION PICTURE THEATRICAL FILM SERIES; DISTRIBUTION OF AN ACTION, HORROR COMEDY, DRAMA AND ANIMATED MOTION PICTURE THEATRICAL FILM SERIES; THEATRICAL PERFORMANCES BOTH ANIMATED AND LIVE ACTION; INTERNET SERVICES PROVIDING INFORMATION VIA AN ELECTRONIC GLOBAL COMPUTER NETWORK IN THE FIELD OF ENTERTAINMENT RELATING SPECIFICALLY TO MUSIC, MOVIES, AND TELEVISION; PROVIDING

GENERAL INTEREST NEWS, ENTERTAINMENT, AND EDUCATIONAL INFORMATION VIA A GLOBAL COMPUTER NETWORK; AND PROVIDING INFORMATION FOR AND ACTUAL ENTERTAINMENT VIA ELECTRONIC GLOBAL COMMUNICATIONS NETWORK IN THE NATURE OF AN ACTION, HORROR COMEDY, DRAMA AND ANIMATED PROGRAMS AND PRODUCTION OF AN ACTION, HORROR, COMEDY, DRAMA AND ANIMATED MOTION FILMS FOR DISTRIBUTION VIA A GLOBAL COMPUTER NETWORK, IN CLASS 41 (U.S. CLS. 100, 101 AND 107).

FIRST USE 6-1-2007; IN COMMERCE 6-1-2007.

THE MARK CONSISTS OF STANDARD CHARACTERS WITHOUT CLAIM TO ANY PARTICULAR FONT, STYLE, SIZE, OR COLOR.

SN 77-195,078, FILED 6-1-2007.

RICHARD WHITE, EXAMINING ATTORNEY

**Int. Cl.: 10**

**Prior U.S. Cls.: 26, 39, and 44**

**Reg. No. 3,506,101**

**United States Patent and Trademark Office**

**Registered Sep. 23, 2008**

---

**TRADEMARK  
PRINCIPAL REGISTER**

**WARMED ENCOUNTERS**

EAGLE T.W.E., INC. (GEORGIA CORPORATION)  
SUITE A5  
2090 TUCKER INDUSTRIAL ROAD  
TUCKER, GA 300851511

THE MARK CONSISTS OF STANDARD CHAR-  
ACTERS WITHOUT CLAIM TO ANY PARTICULAR  
FONT, STYLE, SIZE, OR COLOR.

FOR: CONDOMS, IN CLASS 10 (U.S. CLS. 26, 39  
AND 44).

SN 77-195,167, FILED 6-1-2007.

FIRST USE 1-23-2008; IN COMMERCE 1-23-2008.

BENJAMIN ALLEN, EXAMINING ATTORNEY

**Int. Cl.: 44**

**Prior U.S. Cls.: 100 and 101**

**United States Patent and Trademark Office**

**Reg. No. 3,506,102**

**Registered Sep. 23, 2008**

**SERVICE MARK  
PRINCIPAL REGISTER**

**LIFE EXTRA CARE**

LIFE EMS, INC. (MICHIGAN CORPORATION)

1275 CEDAR STREET, N.E.

GRAND RAPIDS, MI 49504

FOR: EMERGENCY MEDICAL RESPONSE SERVICES, IN CLASS 44 (U.S. CLS. 100 AND 101).

FIRST USE 4-11-2007; IN COMMERCE 4-11-2007.

THE MARK CONSISTS OF STANDARD CHARACTERS WITHOUT CLAIM TO ANY PARTICULAR FONT, STYLE, SIZE, OR COLOR.

NO CLAIM IS MADE TO THE EXCLUSIVE RIGHT TO USE "CARE", APART FROM THE MARK AS SHOWN.

SN 77-195,170, FILED 6-1-2007.

JANICE KIM, EXAMINING ATTORNEY

**Int. Cls.: 29 and 30**

**Prior U.S. Cl.: 46**

**United States Patent and Trademark Office**

**Reg. No. 3,506,103**

**Registered Sep. 23, 2008**

**TRADEMARK  
PRINCIPAL REGISTER**



JTM PROVISIONS COMPANY, INC. (OHIO CORPORATION)  
200 SALES DRIVE  
HARRISON, OH 45030

FOR: SOUPS, IN CLASS 29 (U.S. CL. 46).

FIRST USE 5-4-2007; IN COMMERCE 5-4-2007.

FOR: SAUCES; MIXES FOR MAKING COMBINED NOODLE AND SAUCE DISHES, IN CLASS 30 (U.S. CL. 46).

FIRST USE 5-4-2007; IN COMMERCE 5-4-2007.

THE MARK CONSISTS OF THE WORDS "CABIN CREEK" APPEARING WITHIN A TWO-DIMENSIONAL CIRCLE.

SN 77-195,487, FILED 6-1-2007.

MICHELE SWAIN, EXAMINING ATTORNEY

**Int. Cl.: 43**

**Prior U.S. Cls.: 100 and 101**

**United States Patent and Trademark Office**

**Reg. No. 3,506,104**

**Registered Sep. 23, 2008**

**SERVICE MARK  
PRINCIPAL REGISTER**

**FULTON'S ON THE RIVER**

LEVY WORLD LIMITED PARTNERSHIP (ILLINOIS LIMITED PARTNERSHIP)

SUITE 400

980 N. MICHIGAN AVENUE

CHICAGO, IL 60611

FOR: RESTAURANT SERVICES; COCKTAIL LOUNGES; WINE BARS; BAR SERVICES; CONTRACT FOOD SERVICES; CATERING, IN CLASS 43 (U.S. CLS. 100 AND 101).

FIRST USE 11-2-2005; IN COMMERCE 11-2-2005.

THE MARK CONSISTS OF STANDARD CHARACTERS WITHOUT CLAIM TO ANY PARTICULAR FONT, STYLE, SIZE, OR COLOR.

OWNER OF U.S. REG. NOS. 2,041,498 AND 2,267,488.

NO CLAIM IS MADE TO THE EXCLUSIVE RIGHT TO USE "ON THE RIVER", APART FROM THE MARK AS SHOWN.

SN 77-196,489, FILED 6-4-2007.

DAVID YONTEF, EXAMINING ATTORNEY



**Int. Cl.: 9**

**Prior U.S. Cls.: 21, 23, 26, 36, and 38**

**United States Patent and Trademark Office**

**Reg. No. 3,506,105**

**Registered Sep. 23, 2008**

**TRADEMARK  
PRINCIPAL REGISTER**

**I'M FEELING THE LOVE**

EVERGREEN MEDIA METHODS, LLC (CALI-  
FORNIA LIMITED LIABILITY COMPANY)  
SUITE 711  
9595 WILSHIRE BOULEVARD  
BEVERLY HILLS, CA 90212

FOR: PRE-RECORDED CDS, VIDEO TAPES, LA-  
SER DISKS AND DVDS FEATURING INSTRU-  
CTIONAL MATERIAL FOR BUSINESSES, IN CLASS 9  
(U.S. CLS. 21, 23, 26, 36 AND 38).

FIRST USE 2-19-2008; IN COMMERCE 2-19-2008.

THE MARK CONSISTS OF STANDARD CHAR-  
ACTERS WITHOUT CLAIM TO ANY PARTICULAR  
FONT, STYLE, SIZE, OR COLOR.

SN 77-196,859, FILED 6-4-2007.

GINA HAYES, EXAMINING ATTORNEY

**Int. Cl.: 8**

**Prior U.S. Cls.: 23, 28, and 44**

**United States Patent and Trademark Office**

**Reg. No. 3,506,106**

**Registered Sep. 23, 2008**

**TRADEMARK  
PRINCIPAL REGISTER**

**THE VETERAN**

RA BRANDS, L.L.C. (DELAWARE LIMITED LIABILITY COMPANY)  
870 REMINGTON DRIVE  
MADISON, NC 27025

THE MARK CONSISTS OF STANDARD CHARACTERS WITHOUT CLAIM TO ANY PARTICULAR FONT, STYLE, SIZE, OR COLOR.

FOR: CUTLERY, NAMELY, POCKET KNIVES, IN CLASS 8 (U.S. CLS. 23, 28 AND 44).

SN 77-197,049, FILED 6-4-2007.

FIRST USE 10-0-2007; IN COMMERCE 10-0-2007.

ANTHONY RINKER, EXAMINING ATTORNEY

**Int. Cl.: 43**

**Prior U.S. Cls.: 100 and 101**

**United States Patent and Trademark Office**

**Reg. No. 3,506,107**

**Registered Sep. 23, 2008**

**SERVICE MARK  
PRINCIPAL REGISTER**

**Little U**

HORNBACK, JEANNINE M. (UNITED STATES  
INDIVIDUAL)  
444 MEADOWBROOK DRIVE  
VALPARAISO, IN 46383 AND  
HORNBACK, ERIC T (UNITED STATES INDIVI-  
DUAL)  
444 MEADOWBROOK DRIVE  
VALPARAISO, IN 46383

FOR: CHILD CARE, IN CLASS 43 (U.S. CLS. 100  
AND 101).

FIRST USE 6-4-2007; IN COMMERCE 6-4-2007.

THE MARK CONSISTS OF STANDARD CHAR-  
ACTERS WITHOUT CLAIM TO ANY PARTICULAR  
FONT, STYLE, SIZE, OR COLOR.

SN 77-197,422, FILED 6-5-2007.

WILLIAM ROSSMAN, EXAMINING ATTORNEY

**Int. Cl.: 11**

**Prior U.S. Cls.: 13, 21, 23, 31, and 34**

**United States Patent and Trademark Office**

**Reg. No. 3,506,108**

**Registered Sep. 23, 2008**

**TRADEMARK  
PRINCIPAL REGISTER**

**KENYON PUPS**

KENYON INTERNATIONAL, INC. (DELAWARE  
CORPORATION)  
P. O. BOX 925  
CLINTON, CT 06413

THE MARK CONSISTS OF STANDARD CHAR-  
ACTERS WITHOUT CLAIM TO ANY PARTICULAR  
FONT, STYLE, SIZE, OR COLOR.

FOR: GAS AND ELECTRIC COOKING APPLIAN-  
CES, NAMELY, STOVES, COOKERS, COOK TOPS,  
RANGES AND GRILLS, IN CLASS 11 (U.S. CLS. 13,  
21, 23, 31 AND 34).

OWNER OF U.S. REG. NO. 2,475,070.

SN 77-197,527, FILED 6-5-2007.

FIRST USE 3-28-2008; IN COMMERCE 3-28-2008.

MICHAEL LITZAU, EXAMINING ATTORNEY

**Int. Cl.: 44**

**Prior U.S. Cls.: 100 and 101**

**United States Patent and Trademark Office**

**Reg. No. 3,506,109**

**Registered Sep. 23, 2008**

**SERVICE MARK  
PRINCIPAL REGISTER**

**IMPROVING THE QUALITY OF  
LIFE FOR PATIENTS AND  
CAREGIVERS**

EDGE MEDICAL, LLC (NEVADA LIMITED LIABILITY COMPANY)  
5875 TYRONE ROAD  
RENO, NV 80502

FOR: PRESCRIPTION REFILL REMINDER SERVICES; PHARMACIST'S SERVICES TO MAKE UP PRESCRIPTIONS, IN CLASS 44 (U.S. CLS. 100 AND 101).

FIRST USE 4-7-2008; IN COMMERCE 4-7-2008.

THE MARK CONSISTS OF STANDARD CHARACTERS WITHOUT CLAIM TO ANY PARTICULAR FONT, STYLE, SIZE, OR COLOR.

SN 77-197,600, FILED 6-5-2007.

JOHN SCHUYLER YARD, EXAMINING ATTORNEY

**Int. Cl.: 6**

**Prior U.S. Cls.: 2, 12, 13, 14, 23, 25, and 50**

**Reg. No. 3,506,110**

**United States Patent and Trademark Office**

**Registered Sep. 23, 2008**

**TRADEMARK  
PRINCIPAL REGISTER**

**YJK**

EOK SEALING TECHNOLOGIES CO., LTD. (TAI-  
WAN CORPORATION)  
10, LANE 152, SEC. 1, FUXING RD.  
TAICHUNG CITY, TAIWAN

FOR: METAL OIL SEALS, PORT OIL SEALS  
MADE OF METAL, PORT OIL SEALS MADE OF  
METAL FOR VEHICLES, AND PORT OIL SEALS  
MADE OF METAL FOR MOTORCYCLES, IN CLASS  
6 (U.S. CLS. 2, 12, 13, 14, 23, 25 AND 50).

FIRST USE 2-18-2008; IN COMMERCE 2-18-2008.

THE MARK CONSISTS OF STANDARD CHAR-  
ACTERS WITHOUT CLAIM TO ANY PARTICULAR  
FONT, STYLE, SIZE, OR COLOR.

SN 77-197,977, FILED 6-5-2007.

CAROLYN GRAY, EXAMINING ATTORNEY

**Int. Cl.: 9**

**Prior U.S. Cls.: 21, 23, 26, 36, and 38**

**Reg. No. 3,506,111**

**United States Patent and Trademark Office**

**Registered Sep. 23, 2008**

**TRADEMARK  
PRINCIPAL REGISTER**



DEXTER & CHANEY, INC. (WASHINGTON CORPORATION)

9700 LAKE CITY WAY NE

SEATTLE, WA 98115

FOR: COMPUTER SOFTWARE FOR CONSTRUCTION MANAGEMENT TOGETHER WITH THE INSTRUCTION MANUALS THEREFOR, SOLD AS A UNIT, IN CLASS 9 (U.S. CLS. 21, 23, 26, 36 AND 38).

FIRST USE 7-9-2007; IN COMMERCE 8-1-2007.

NO CLAIM IS MADE TO THE EXCLUSIVE RIGHT TO USE "CONSTRUCTION SOFTWARE", APART FROM THE MARK AS SHOWN.

THE MARK CONSISTS OF A PLUS-SIGN SYMBOL COMPOSED OF DOTS OF VARIOUS SIZES AND APPEARANCES, WITH THE WORDS "SPECTRUM CONSTRUCTION SOFTWARE" APPEARING UNDERNEATH.

SN 77-198,381, FILED 6-5-2007.

SETH A. RAPPAPORT, EXAMINING ATTORNEY

**Int. Cl.: 36**

**Prior U.S. Cls.: 100, 101, and 102**

**United States Patent and Trademark Office**

**Reg. No. 3,506,112**

**Registered Sep. 23, 2008**

**SERVICE MARK  
PRINCIPAL REGISTER**

**DIRECT ONE**

FARM CREDIT SERVICES OF AMERICA, ACA  
(UNITED STATES FEDERALLY CHARTERED  
CORPORATION)  
5015 SOUTH 118TH STREET  
OMAHA, NE 68137

THE MARK CONSISTS OF STANDARD CHAR-  
ACTERS WITHOUT CLAIM TO ANY PARTICULAR  
FONT, STYLE, SIZE, OR COLOR.

FOR: LEASE-PURCHASE FINANCING, IN CLASS  
36 (U.S. CLS. 100, 101 AND 102).

SN 77-198,700, FILED 6-6-2007.

FIRST USE 10-7-2007; IN COMMERCE 8-1-2008.

JAMES A. RAUEN, EXAMINING ATTORNEY



**Int. Cl.: 41**

**Prior U.S. Cls.: 100, 101, and 107**

**United States Patent and Trademark Office**

**Reg. No. 3,506,113**

**Registered Sep. 23, 2008**

**SERVICE MARK  
PRINCIPAL REGISTER**

**SKILLPRENEUR**

EDWARD ABEL (UNITED STATES INDIVIDUAL)  
1895 WALT WHITMAN RD.  
MELVILLE, NY 11747

FOR: EDUCATION SERVICES, NAMELY, PROVIDING LIVE AND ON-LINE CLASSES, SEMINARS, WORKSHOPS IN THE FIELD OF BUSINESS; PERSONAL COACHING SERVICES IN THE FIELD OF BUSINESS; BUSINESS TRAINING, IN CLASS 41 (U.S. CLS. 100, 101 AND 107).

FIRST USE 7-1-2008; IN COMMERCE 7-1-2008.

THE MARK CONSISTS OF STANDARD CHARACTERS WITHOUT CLAIM TO ANY PARTICULAR FONT, STYLE, SIZE, OR COLOR.

SN 77-199,839, FILED 6-6-2007.

NAAKWAMA ANKRAH, EXAMINING ATTORNEY

**Int. Cls.: 34 and 43**

**Prior U.S. Cls.: 2, 8, 9, 17, 100, and 101**

**United States Patent and Trademark Office**

**Reg. No. 3,506,114**

**Registered Sep. 23, 2008**

**TRADEMARK  
SERVICE MARK  
PRINCIPAL REGISTER**

**AVO LOUNGE**

OETTINGER IMEX AG (SWITZERLAND CORPORATION)  
NAUENSTRASSE 73  
BASEL, SWITZERLAND 4002

FOR: CIGARS, IN CLASS 34 (U.S. CLS. 2, 8, 9 AND 17).

FIRST USE 7-0-2003; IN COMMERCE 3-0-2006.

FOR: RESTAURANT SERVICES FEATURING CIGAR BARS, IN CLASS 43 (U.S. CLS. 100 AND 101).

FIRST USE 1-0-2003; IN COMMERCE 8-0-2005.

THE MARK CONSISTS OF STANDARD CHARACTERS WITHOUT CLAIM TO ANY PARTICULAR FONT, STYLE, SIZE, OR COLOR.

OWNER OF U.S. REG. NOS. 1,857,852, 2,306,490, AND OTHERS.

NO CLAIM IS MADE TO THE EXCLUSIVE RIGHT TO USE "LOUNGE" FOR CLASS 43, APART FROM THE MARK AS SHOWN.

SN 77-201,100, FILED 6-8-2007.

SONYA STEPHENS, EXAMINING ATTORNEY

**Int. Cl.: 35**

**Prior U.S. Cls.: 100, 101, and 102**

**United States Patent and Trademark Office**

**Reg. No. 3,506,115**

**Registered Sep. 23, 2008**

**SERVICE MARK  
PRINCIPAL REGISTER**

# Belief Brief

GERBIG, SNELL/WEISHEIMER ADVERTISING,  
LLC (OHIO LIMITED LIABILITY COMPANY)  
500 OLDE WORTHINGTON ROAD  
WESTERVILLE, OH 43082

FOR: ADVERTISING AGENCY AND MARKET-  
ING SERVICES, NAMELY, BUSINESS MARKETING  
CONSULTING SERVICES, IN CLASS 35 (U.S. CLS.  
100, 101 AND 102).

FIRST USE 1-1-2006; IN COMMERCE 1-1-2006.

THE MARK CONSISTS OF STANDARD CHAR-  
ACTERS WITHOUT CLAIM TO ANY PARTICULAR  
FONT, STYLE, SIZE, OR COLOR.

SN 77-201,515, FILED 6-8-2007.

WILLIAM BRECKENFELD, EXAMINING ATTOR-  
NEY

**Int. Cl.: 28**

**Prior U.S. Cls.: 22, 23, 38, and 50**

**United States Patent and Trademark Office**

**Reg. No. 3,506,116**

**Registered Sep. 23, 2008**

**TRADEMARK  
PRINCIPAL REGISTER**

**CHEVROLETOR**

GENERAL MOTORS CORPORATION (DELA-  
WARE CORPORATION)  
300 RENAISSANCE CENTER, P.O. BOX 300  
DETROIT, MI 482653000

FOR: TOY VEHICLES, IN CLASS 28 (U.S. CLS. 22,  
23, 38 AND 50).

FIRST USE 7-1-2008; IN COMMERCE 7-1-2008.

THE MARK CONSISTS OF STANDARD CHAR-  
ACTERS WITHOUT CLAIM TO ANY PARTICULAR  
FONT, STYLE, SIZE, OR COLOR.

OWNER OF U.S. REG. NOS. 1,471,518, 2,522,861,  
AND OTHERS.

SN 77-202,381, FILED 6-11-2007.

HEATHER THOMPSON, EXAMINING ATTORNEY

**Int. Cl.: 5**

**Prior U.S. Cls.: 6, 18, 44, 46, 51, and 52**

**United States Patent and Trademark Office**

**Reg. No. 3,506,117**

**Registered Sep. 23, 2008**

**TRADEMARK  
PRINCIPAL REGISTER**



SCIELE PHARMA, INC. (GEORGIA CORPORATION)  
SUITE 1800  
FIVE CONCOURSE PARKWAY  
ATLANTA, GA 30328

THE MARK CONSISTS OF A WOMAN HOLDING  
A BABY WEARING A GRADUATE CAP WRAPPED  
IN A BLANKET.

FOR: NUTRITIONAL SUPPLEMENTS, IN CLASS  
5 (U.S. CLS. 6, 18, 44, 46, 51 AND 52).

SN 77-202,470, FILED 6-11-2007.

FIRST USE 8-1-2007; IN COMMERCE 8-1-2007.

KATHERINE CHANG, EXAMINING ATTORNEY

**Int. Cl.: 5**

**Prior U.S. Cls.: 6, 18, 44, 46, 51, and 52**

**Reg. No. 3,506,118**

**United States Patent and Trademark Office**

**Registered Sep. 23, 2008**

**TRADEMARK  
PRINCIPAL REGISTER**

**COMFORT GRIP**

CENTRAL GARDEN & PET COMPANY (DELA-  
WARE CORPORATION)  
1340 TREAT BLVD., SUITE 600  
WALNUT CREEK, CA 94597

FOR: INSECTICIDES; PESTICIDES; INSECTICIDE  
FEATURING A SPRAY APPLICATOR SOLD AS A  
COMPONENT; PESTICIDE FEATURING A SPRAY  
APPLICATOR SOLD AS A COMPONENT, IN CLASS  
5 (U.S. CLS. 6, 18, 44, 46, 51 AND 52).

FIRST USE 1-15-2008; IN COMMERCE 1-15-2008.

THE MARK CONSISTS OF STANDARD CHAR-  
ACTERS WITHOUT CLAIM TO ANY PARTICULAR  
FONT, STYLE, SIZE, OR COLOR.

NO CLAIM IS MADE TO THE EXCLUSIVE  
RIGHT TO USE "GRIP", APART FROM THE MARK  
AS SHOWN.

SN 77-202,679, FILED 6-11-2007.

ANNE E. GUSTASON, EXAMINING ATTORNEY

**Int. Cl.: 25**

**Prior U.S. Cls.: 22 and 39**

**United States Patent and Trademark Office**

**Reg. No. 3,506,119**

**Registered Sep. 23, 2008**

**TRADEMARK  
PRINCIPAL REGISTER**

**MIA GIRL**

MIA SHOES, INC. (DELAWARE CORPORATION)  
9985 NW 19TH STREET  
MIAMI, FL 33172

OWNER OF U.S. REG. NO. 2,259,181.

FOR: FOOTWEAR, IN CLASS 25 (U.S. CLS. 22 AND 39).

NO CLAIM IS MADE TO THE EXCLUSIVE RIGHT TO USE "GIRL", APART FROM THE MARK AS SHOWN.

FIRST USE 12-0-2007; IN COMMERCE 12-0-2007.

SN 77-202,824, FILED 6-11-2007.

THE MARK CONSISTS OF STANDARD CHARACTERS WITHOUT CLAIM TO ANY PARTICULAR FONT, STYLE, SIZE, OR COLOR.

ANDREA SAUNDERS, EXAMINING ATTORNEY

**Int. Cl.: 14**

**Prior U.S. Cls.: 2, 27, 28, and 50**

**United States Patent and Trademark Office**

**Reg. No. 3,506,120**

**Registered Sep. 23, 2008**

**TRADEMARK  
PRINCIPAL REGISTER**



VOCK, DONNA (UNITED STATES INDIVIDUAL)  
608 FIFTH AVENUE, STE. 703  
NEW YORK, NY 10020

FOR: BRACELETS; BROOCHES; CHARMS; JEWELRY; PINS BEING JEWELRY; RINGS BEING JEWELRY; NECKLACES; CLIP EARRINGS; EAR CLIPS; EAR STUDS; EARRINGS, IN CLASS 14 (U.S. CLS. 2, 27, 28 AND 50).

FIRST USE 5-1-2007; IN COMMERCE 6-1-2007.

THE MARK CONSISTS OF THE LETTER "D" AND THE LETTER "V" AND THE NAME "DONNA VOCK".

SN 77-204,742, FILED 6-13-2007.

ADA HAN, EXAMINING ATTORNEY



**Int. Cl.: 45**

**Prior U.S. Cls.: 100 and 101**

**United States Patent and Trademark Office**

**Reg. No. 3,506,121**

**Registered Sep. 23, 2008**

**SERVICE MARK  
PRINCIPAL REGISTER**



GLOBAL COMRADES (UTAH CORPORATION)  
223 RAWLINS LN  
DRAPER, UT 84020

FOR: ONLINE SOCIAL, CULTURAL AND POLITICAL NETWORKING SERVICES, IN CLASS 45 (U.S. CLS. 100 AND 101).

FIRST USE 6-1-2008; IN COMMERCE 6-1-2008.

NO CLAIM IS MADE TO THE EXCLUSIVE RIGHT TO USE "GLOBAL", APART FROM THE MARK AS SHOWN.

THE MARK CONSISTS OF A GLOBE HELD BY TWO HANDS WITH THE WORDS "GLOBAL COMRADES".

SN 77-205,595, FILED 6-13-2007.

REGINA DRUMMOND, EXAMINING ATTORNEY

**Int. Cl.: 9**

**Prior U.S. Cls.: 21, 23, 26, 36, and 38**

**United States Patent and Trademark Office**

**Reg. No. 3,506,122**

**Registered Sep. 23, 2008**

**TRADEMARK  
PRINCIPAL REGISTER**

# MagnaVis

ILLINOIS TOOL WORKS INC. (DELAWARE  
CORPORATION)  
3600 WEST LAKE AVENUE  
GLENVIEW, IL 60026

THE MARK CONSISTS OF STANDARD CHAR-  
ACTERS WITHOUT CLAIM TO ANY PARTICULAR  
FONT, STYLE, SIZE, OR COLOR.

FOR: MAGNETIC PARTICLES FOR MAGNETIC  
PARTICLE INSPECTION TESTING, IN CLASS 9 (U.S.  
CLS. 21, 23, 26, 36 AND 38).

SN 77-206,264, FILED 6-14-2007.

FIRST USE 3-1-2008; IN COMMERCE 3-1-2008.

DAWN HAN, EXAMINING ATTORNEY

**Int. Cl.: 7**

**Prior U.S. Cls.: 13, 19, 21, 23, 31, 34, and 35**

**Reg. No. 3,506,123**

**United States Patent and Trademark Office**

**Registered Sep. 23, 2008**

---

**TRADEMARK  
PRINCIPAL REGISTER**

**NEXITE**

HONDA MOTOR CO., LTD. (JAPAN CORPORATION)  
1-1, MINAMI-AOYAMA 2-CHOME, MINATO-KU  
TOKYO, JAPAN 107-8556

THE MARK CONSISTS OF STANDARD CHARACTERS WITHOUT CLAIM TO ANY PARTICULAR FONT, STYLE, SIZE, OR COLOR.

FOR: MOWING DECKS FOR LAWN MOWERS AND STRUCTURAL PARTS THEREFOR, IN CLASS 7 (U.S. CLS. 13, 19, 21, 23, 31, 34 AND 35).

SN 77-206,517, FILED 6-14-2007.

FIRST USE 7-0-2007; IN COMMERCE 7-0-2007.

DAVID MILLER, EXAMINING ATTORNEY

**Int. Cl.: 16**

**Prior U.S. Cls.: 2, 5, 22, 23, 29, 37, 38, and 50**

**Reg. No. 3,506,124**

**United States Patent and Trademark Office**

**Registered Sep. 23, 2008**

---

**TRADEMARK  
PRINCIPAL REGISTER**

**THE FORCE OF THE HORSE**

FITCH, RONALD (UNITED STATES INDIVIDUAL)

14910 WILDWOOD CIRCLE

MAGNOLIA, TX 77354

FOR: BOOKS IN THE FIELD OF HORSES, IN CLASS 16 (U.S. CLS. 2, 5, 22, 23, 29, 37, 38 AND 50).

FIRST USE 1-15-2007; IN COMMERCE 5-23-2008.

THE MARK CONSISTS OF STANDARD CHARACTERS WITHOUT CLAIM TO ANY PARTICULAR FONT, STYLE, SIZE, OR COLOR.

NO CLAIM IS MADE TO THE EXCLUSIVE RIGHT TO USE "HORSE", APART FROM THE MARK AS SHOWN.

SN 77-207,065, FILED 6-15-2007.

KATHY DE JONGE, EXAMINING ATTORNEY

**Int. Cl.: 16**

**Prior U.S. Cls.: 2, 5, 22, 23, 29, 37, 38, and 50**

**Reg. No. 3,506,125**

**United States Patent and Trademark Office**

**Registered Sep. 23, 2008**

**TRADEMARK  
PRINCIPAL REGISTER**

# Word Stump

MORSEL MUNK, LLC (CONNECTICUT LIMITED LIABILITY COMPANY)  
P.O. BOX 902  
WINSTED, CT 06098

FOR: CROSSWORD PUZZLES; BOOKS IN THE FIELD OF BRAINTEASERS, INSPIRATION AND MOTIVATION; SERIES OF BOOKS OF PUZZLES, GAMES, CHALLENGES, WORD SEARCHES AND CROSSWORDS; PUZZLES, NAMELY, WORD SEARCHES AND CROSSWORDS; EDUCATIONAL PUBLICATIONS, NAMELY, PUZZLE BOOKS, PUZZLES, AND EDUCATIONAL BOOKLETS IN THE FIELDS OF CREATIVITY, LANGUAGE AND GRAMMAR, IN CLASS 16 (U.S. CLS. 2, 5, 22, 23, 29, 37, 38 AND 50).

FIRST USE 10-13-2007; IN COMMERCE 7-12-2008.

THE MARK CONSISTS OF STANDARD CHARACTERS WITHOUT CLAIM TO ANY PARTICULAR FONT, STYLE, SIZE, OR COLOR.

NO CLAIM IS MADE TO THE EXCLUSIVE RIGHT TO USE "WORD", APART FROM THE MARK AS SHOWN.

SN 77-208,125, FILED 6-18-2007.

ANTHONY RINKER, EXAMINING ATTORNEY

**Int. Cl.: 16**

**Prior U.S. Cls.: 2, 5, 22, 23, 29, 37, 38, and 50**

**United States Patent and Trademark Office**

**Reg. No. 3,506,126**

**Registered Sep. 23, 2008**

**TRADEMARK  
PRINCIPAL REGISTER**

# Chik Munks Rule

MORSEL MUNK, LLC (CONNECTICUT LIMITED LIABILITY COMPANY)  
P.O. BOX 902  
WINSTED, CT 06098

THE MARK CONSISTS OF STANDARD CHARACTERS WITHOUT CLAIM TO ANY PARTICULAR FONT, STYLE, SIZE, OR COLOR.

FOR: BUMPER STICKERS; DECALS; DECORATIVE STICKERS FOR HELMETS; STICKERS, IN CLASS 16 (U.S. CLS. 2, 5, 22, 23, 29, 37, 38 AND 50).

SN 77-208,127, FILED 6-18-2007.

FIRST USE 10-13-2007; IN COMMERCE 10-13-2007.

ROBIN CHOSID, EXAMINING ATTORNEY

**Int. Cl.: 25**

**Prior U.S. Cls.: 22 and 39**

**United States Patent and Trademark Office**

**Reg. No. 3,506,127**

**Registered Sep. 23, 2008**

**TRADEMARK  
PRINCIPAL REGISTER**



GANDER MOUNTAIN COMPANY (MINNESOTA CORPORATION)  
SUITE 1300  
180 EAST FIFTH STREET  
ST. PAUL, MN 55101

FOR: HEADWEAR, FOOTWEAR AND SPORTSWEAR, NAMELY, T-SHIRTS, SHIRTS, SWEATERS, TURTLENECKS, SWEATSHIRTS, WINDSHIRTS, COATS, RAINWEAR, JACKETS, VESTS, PANTS, SHORTS, COVERALLS, OVERALLS, PARKAS, CLOTH BIBS, HATS, CAPS, GLOVES, MITTENS, SOCKS, UNDERWEAR, BOOTS, SHOES, AND SANDALS, IN CLASS 25 (U.S. CLS. 22 AND 39).

FIRST USE 2-0-2005; IN COMMERCE 2-0-2005.

OWNER OF U.S. REG. NOS. 2,659,032, 2,925,335, AND OTHERS.

THE MARK CONSISTS OF A FLYING GOOSE AND MOUNTAIN PEAK.

SN 77-208,204, FILED 6-18-2007.

WILLIAM VERHOSEK, EXAMINING ATTORNEY

**Int. Cl.: 28**

**Prior U.S. Cls.: 22, 23, 38, and 50**

**United States Patent and Trademark Office**

**Reg. No. 3,506,128**

**Registered Sep. 23, 2008**

**TRADEMARK  
PRINCIPAL REGISTER**



GANDER MOUNTAIN COMPANY (MINNESOTA CORPORATION)  
180 EAST FIFTH STREET SUITE 1300  
ST. PAUL, MN 55101

FOR: FISHING RODS AND FISHING ROD CASES; FISHING REELS; FISHING RODS AND REEL COMBINATIONS; FISHING TACKLE BOXES; HUNTING EQUIPMENT AND ACCESSORIES, NAMELY, HUNTING BLINDS; HUNTING DECOY BAGS; TREE STANDS FOR HUNTING; ARCHERY EQUIPMENT, NAMELY, ARCHERY BOWS, ARM GUARDS, BOW CASES, QUIVERS AND TARGETS, IN CLASS 28 (U.S. CLS. 22, 23, 38 AND 50).

FIRST USE 5-0-2006; IN COMMERCE 5-0-2006.

OWNER OF U.S. REG. NOS. 2,659,032, 2,925,335, AND OTHERS.

THE MARK CONSISTS OF A FLYING GOOSE AND MOUNTAIN PEAK.

SN 77-208,206, FILED 6-18-2007.

WILLIAM VERHOSEK, EXAMINING ATTORNEY



**Int. Cl.: 36**

**Prior U.S. Cls.: 100, 101, and 102**

**United States Patent and Trademark Office**

**Reg. No. 3,506,129**

**Registered Sep. 23, 2008**

**SERVICE MARK  
PRINCIPAL REGISTER**



GANDER MOUNTAIN COMPANY (MINNESOTA CORPORATION)  
SUITE 1300  
180 EAST FIFTH STREET  
ST. PAUL, MN 55101

FOR: FINANCIAL SPONSORSHIP OF SPORTING EVENTS, TELEVISION AND RADIO PROGRAMS, CONTESTS, PROMOTIONS, CHARITABLE EVENTS, AND EDUCATIONAL SEMINARS IN THE FIELD OF HUNTING AND FISHING; CREDIT CARD SERVICES, IN CLASS 36 (U.S. CLS. 100, 101 AND 102).

FIRST USE 8-1-2008; IN COMMERCE 8-1-2008.

OWNER OF U.S. REG. NOS. 2,659,032, 2,925,335, AND OTHERS.

THE MARK CONSISTS OF A FLYING GOOSE AND MOUNTAIN PEAK.

SN 77-208,208, FILED 6-18-2007.

WILLIAM VERHOSEK, EXAMINING ATTORNEY

**Int. Cl.: 37**

**Prior U.S. Cls.: 100, 103, and 106**

**United States Patent and Trademark Office**

**Reg. No. 3,506,130**

**Registered Sep. 23, 2008**

**SERVICE MARK  
PRINCIPAL REGISTER**



GANDER MOUNTAIN COMPANY (MINNESOTA CORPORATION)  
180 EAST FIFTH STREET SUITE 1300  
ST. PAUL, MN 55101

FOR: GUNSMITHING, NAMELY, REPAIR AND MAINTENANCE OF FIREARMS; ARCHERY EQUIPMENT REPAIR AND MAINTENANCE, IN CLASS 37 (U.S. CLS. 100, 103 AND 106).

FIRST USE 12-0-2005; IN COMMERCE 12-0-2005.

OWNER OF U.S. REG. NOS. 2,659,032, 2,925,335, AND OTHERS.

THE MARK CONSISTS OF A FLYING GOOSE AND MOUNTAIN PEAK.

SN 77-208,210, FILED 6-18-2007.

WILLIAM VERHOSEK, EXAMINING ATTORNEY

**Int. Cl.: 39**

**Prior U.S. Cls.: 100 and 105**

**United States Patent and Trademark Office**

**Reg. No. 3,506,131**

**Registered Sep. 23, 2008**

**SERVICE MARK  
PRINCIPAL REGISTER**



GANDER MOUNTAIN COMPANY (MINNESOTA CORPORATION)  
SUITE 1300  
180 EAST FIFTH STREET  
ST. PAUL, MN 55101

FOR: ARRANGING AND CONDUCTING HUNTING, FISHING AND ADVENTURE EXPEDITIONS; TRAVEL BOOKING AGENCY SERVICES FOR AIR TRAVEL AND HUNTING, FISHING AND ADVENTURE EXPEDITIONS; PROVIDING TRAVEL INFORMATION AND TRAVEL GUIDE SERVICES; CONDUCTING AND ARRANGING SIGHTSEEING

TOURS FOR OTHERS, IN CLASS 39 (U.S. CLS. 100 AND 105).

FIRST USE 4-0-2005; IN COMMERCE 4-0-2005.

OWNER OF U.S. REG. NOS. 2,659,032, 2,925,335, AND OTHERS.

THE MARK CONSISTS OF A FLYING GOOSE AND MOUNTAIN PEAK.

SN 77-208,213, FILED 6-18-2007.

WILLIAM VERHOSEK, EXAMINING ATTORNEY

**Int. Cl.: 41**

**Prior U.S. Cls.: 100, 101, and 107**

**United States Patent and Trademark Office**

**Reg. No. 3,506,132**

**Registered Sep. 23, 2008**

**SERVICE MARK  
PRINCIPAL REGISTER**



GANDER MOUNTAIN COMPANY (MINNESOTA CORPORATION)

180 EAST FIFTH STREET

SUITE 1300

ST. PAUL, MN 55101

FOR: ENTERTAINMENT IN THE NATURE OF ON-GOING TELEVISION PROGRAMS IN THE FIELD OF OUTDOOR ACTIVITIES; EDUCATIONAL SERVICES, NAMELY, PROVIDING SEMINARS IN THE FIELDS OF HUNTING, FISHING, CAMPING AND OUTDOOR RECREATIONAL ACTIVITIES, HUNTER AND FIREARM SAFETY, BOAT

SAFETY, AND ALL-TERRAIN VEHICLES, IN CLASS 41 (U.S. CLS. 100, 101 AND 107).

FIRST USE 1-3-2004; IN COMMERCE 1-3-2004.

OWNER OF U.S. REG. NOS. 2,659,032, 2,925,335, AND OTHERS.

THE MARK CONSISTS OF A FLYING GOOSE AND MOUNTAIN PEAK.

SN 77-208,215, FILED 6-18-2007.

WILLIAM VERHOSEK, EXAMINING ATTORNEY

**Int. Cls.: 39, 41, and 43**

**Prior U.S. Cls.: 100, 101, 105, and 107**

**United States Patent and Trademark Office**

**Reg. No. 3,506,133**

**Registered Sep. 23, 2008**

**SERVICE MARK  
PRINCIPAL REGISTER**

**FABUGO**

THE MARK TRAVEL CORPORATION (NEVADA CORPORATION)  
8907 NORTH PORT WASHINGTON ROAD  
MILWAUKEE, WI 53217

FOR: TRAVEL AGENCY SERVICES, NAMELY, MAKING RESERVATIONS AND BOOKINGS FOR TRANSPORTATION, IN CLASS 39 (U.S. CLS. 100 AND 105).

FIRST USE 6-1-2008; IN COMMERCE 6-1-2008.

FOR: TRAVEL AGENCY SERVICES, NAMELY, ARRANGING FOR TICKET RESERVATIONS AND TICKET BOOKINGS FOR ENTERTAINMENT, IN CLASS 41 (U.S. CLS. 100, 101 AND 107).

FIRST USE 6-1-2008; IN COMMERCE 6-1-2008.

FOR: TRAVEL AGENCY SERVICES, NAMELY, MAKING RESERVATIONS AND BOOKINGS FOR TEMPORARY LODGING, IN CLASS 43 (U.S. CLS. 100 AND 101).

FIRST USE 6-1-2008; IN COMMERCE 6-1-2008.

THE MARK CONSISTS OF STANDARD CHARACTERS WITHOUT CLAIM TO ANY PARTICULAR FONT, STYLE, SIZE, OR COLOR.

"FABUGO" HAS NO MEANING IN A FOREIGN LANGUAGE.

SN 77-208,750, FILED 6-18-2007.

JAMES STEIN, EXAMINING ATTORNEY

**Int. Cl.: 35**

**Prior U.S. Cls.: 100, 101, and 102**

**United States Patent and Trademark Office**

**Reg. No. 3,506,134**

**Registered Sep. 23, 2008**

**SERVICE MARK  
PRINCIPAL REGISTER**

**VIZERGY**

JJJ&H, INC. (FLORIDA CORPORATION)  
4237 SALISBURY ROAD NORTH  
JACKSONVILLE, FL 32216

FOR: ADVERTISING AND MARKETING SERVICES FOR OTHERS, CREATING AND PROMOTING BRAND IDENTITY FOR OTHERS, PUBLIC RELATIONS SERVICES FOR OTHERS, IN CLASS 35 (U.S. CLS. 100, 101 AND 102).

FIRST USE 9-0-2007; IN COMMERCE 9-0-2007.

THE MARK CONSISTS OF STANDARD CHARACTERS WITHOUT CLAIM TO ANY PARTICULAR FONT, STYLE, SIZE, OR COLOR.

SN 77-208,751, FILED 6-18-2007.

DEIRDRE ROBERTSON, EXAMINING ATTORNEY

**Int. Cl.: 10**

**Prior U.S. Cls.: 26, 39, and 44**

**United States Patent and Trademark Office**

**Reg. No. 3,506,135**

**Registered Sep. 23, 2008**

**TRADEMARK  
PRINCIPAL REGISTER**

**Power Pain Away!**

SYRUS ENTERPRISES, INC. (CALIFORNIA CORPORATION)  
8330 LINCOLN BOULEVARD  
LOS ANGELES, CA 90045

FOR: MEDICAL BRACES FOR APPLYING HOT OR COLD THERAPY ALONG WITH ELECTRICAL NERVE OR MUSCLE STIMULATION TO THE NECK, UPPER BACK, SHOULDER, LOWER BACK, THIGH, KNEE, CALF, ANKLE, ELBOW, TENNIS ELBOW (EPICONDYLITIS), OR WRIST, IN CLASS 10 (U.S. CLS. 26, 39 AND 44).

FIRST USE 10-4-2007; IN COMMERCE 10-4-2007.

THE MARK CONSISTS OF STANDARD CHARACTERS WITHOUT CLAIM TO ANY PARTICULAR FONT, STYLE, SIZE, OR COLOR.

SN 77-208,753, FILED 6-18-2007.

WILLIAM BRECKENFELD, EXAMINING ATTORNEY

Int. Cl.: 29

Prior U.S. Cl.: 46

United States Patent and Trademark Office

Reg. No. 3,506,136

Registered Sep. 23, 2008

TRADEMARK  
PRINCIPAL REGISTER



FIORAVANTI'S RISTORANTE ITALIANO, INC.  
(ILLINOIS CORPORATION)  
31 GOLDFINCH LANE  
HILTON HEAD, SC 29928

FOR: CHILI; FRIED POTATOES; INSTANT POTATOES; PROCESSED POTATOES; PRE-PACKAGED DINNERS IN THE NATURE OF CASSEROLES CONSISTING PRIMARILY OF MEAT SERVED WITH POTATOES AND CHOCOLATE, IN CLASS 29 (U.S. CL. 46).

FIRST USE 2-1-2008; IN COMMERCE 2-1-2008.

NO CLAIM IS MADE TO THE EXCLUSIVE RIGHT TO USE "GOURMET ITALIAN CHILI", APART FROM THE MARK AS SHOWN.

THE COLOR(S) BLACK, GOLD, RED, GREEN AND WHITE IS/ARE CLAIMED AS A FEATURE OF THE MARK.

THE MARK CONSISTS OF THE LETTER A ABOVE "ANNETTE'S GOURMET" ABOVE THE

PHRASE "FROM OUR KITCHEN TO YOURS". THE IMAGE OF GARLIC, ONIONS, TOMATOES AND A PITCHER ARE LOCATED ON THE SIDE TO THE WORDS, WHICH ARE INSIDE AN OVAL DESIGN FEATURE. THE LETTER "A," THE WORDING "ANNETTE'S GOURMET" AND THE DESIGN FEATURE IS IN GOLD. THE TERM GOURMET IS IN GREEN. AT THE BOTTOM OF THE MARK, THE PHRASE "FROM OUR KITCHEN TO YOURS" IS IN WHITE. THE CLOVES OF GARLIC ARE WHITE, THE ONIONS ARE GOLD, AND THE TOMATOES ARE RED WITH GREEN STEMS. THE IMAGE OF A PITCHER IS LOCATED ON THE RIGHT SIDE OF THE WORDS AND HAS A GOLD BASE, NECK WITH WHITE HANDLES AND WHITE BAND BELOW THE NECK. THE ENTIRE MARK IS CONTAINED IN A BLACK RECTANGULAR BACKGROUND CARRIER.

SN 77-209,296, FILED 6-19-2007.

SHARON MEIER, EXAMINING ATTORNEY



**Int. Cl.: 21**

**Prior U.S. Cls.: 2, 13, 23, 29, 30, 33, 40, and 50**

**United States Patent and Trademark Office**

**Reg. No. 3,506,137**

**Registered Sep. 23, 2008**

**TRADEMARK  
PRINCIPAL REGISTER**

**TOURQUAM**

COBALT BALLOON LLC (DELAWARE LIMITED  
LIABILITY COMPANY)  
10 EAST 53RD STREET, 34TH FLOOR  
NEW YORK, NY 10022

THE MARK CONSISTS OF STANDARD CHAR-  
ACTERS WITHOUT CLAIM TO ANY PARTICULAR  
FONT, STYLE, SIZE, OR COLOR.

FOR: COSMETIC BRUSHES, IN CLASS 21 (U.S.  
CLS. 2, 13, 23, 29, 30, 33, 40 AND 50).

SN 77-209,438, FILED 6-19-2007.

FIRST USE 4-26-2008; IN COMMERCE 4-26-2008.

PETER B. BROMAGHIM, EXAMINING ATTORNEY

**Int. Cl.: 44**

**Prior U.S. Cls.: 100 and 101**

**United States Patent and Trademark Office**

**Reg. No. 3,506,138**

**Registered Sep. 23, 2008**

**SERVICE MARK  
PRINCIPAL REGISTER**

**BIOSCRIPCARE**

BIOSCRIP, INC. (DELAWARE CORPORATION)  
100 CLEARBROOK ROAD  
ELMSFORD, NY 10523

FOR: PATIENT HEALTH CARE MANAGEMENT PROGRAMS, NAMELY, PROVIDING EVALUATION SERVICES TO FORMULATE DISEASE-SPECIFIC PATIENT TREATMENT PLANS, THERAPY OPTIMIZATION PLANS FOR THE TREATMENT OF CHRONIC DISEASES AND PATIENT CARE PROGRAMS IN THE NATURE OF MONITORING EFFECTIVENESS OF MEDICAL TREATMENTS

AND PLANNING MEDICAL TREATMENT INTERVENTIONS, IN CLASS 44 (U.S. CLS. 100 AND 101).

FIRST USE 8-1-2007; IN COMMERCE 8-1-2007.

THE MARK CONSISTS OF STANDARD CHARACTERS WITHOUT CLAIM TO ANY PARTICULAR FONT, STYLE, SIZE, OR COLOR.

SN 77-209,722, FILED 6-19-2007.

ALLISON HOLTZ, EXAMINING ATTORNEY

**Int. Cl.: 36**

**Prior U.S. Cls.: 100, 101, and 102**

**United States Patent and Trademark Office**

**Reg. No. 3,506,139**

**Registered Sep. 23, 2008**

**SERVICE MARK  
PRINCIPAL REGISTER**

**Alliance Investment  
Management**

ALLIANCE FINANCIAL CORPORATION (NEW  
YORK CORPORATION)  
18TH FLOOR  
120 MADISON STREET  
SYRACUSE, NY 13202

FOR: INVESTMENT MANAGEMENT, IN CLASS  
36 (U.S. CLS. 100, 101 AND 102).

FIRST USE 10-1-2007; IN COMMERCE 10-1-2007.

THE MARK CONSISTS OF STANDARD CHAR-  
ACTERS WITHOUT CLAIM TO ANY PARTICULAR  
FONT, STYLE, SIZE, OR COLOR.

NO CLAIM IS MADE TO THE EXCLUSIVE  
RIGHT TO USE "INVESTMENT MANAGEMENT",  
APART FROM THE MARK AS SHOWN.

SN 77-209,841, FILED 6-19-2007.

SUSAN RICHARDS, EXAMINING ATTORNEY

**Int. Cl.: 28**

**Prior U.S. Cls.: 22, 23, 38, and 50**

**Reg. No. 3,506,140**

**United States Patent and Trademark Office**

**Registered Sep. 23, 2008**

**TRADEMARK  
PRINCIPAL REGISTER**

# BUSTY RACKS

16-BALL, INC. MICHAEL KNUPP, PRESIDENT  
(FLORIDA CORPORATION)  
10182 PENNSYLVANIA AVENUE  
BONITA SPRINGS, FL 341354725

FOR: BILLIARD BALLS; BILLIARD BRIDGES;  
BILLIARD BUMPERS; BILLIARD CHALK; BIL-  
LIARD CUE RACKS; BILLIARD CUES; BILLIARD  
CUSHIONS; BILLIARD GAME PLAYING EQUIP-  
MENT; BILLIARD NETS; BILLIARD TABLES; BIL-  
LIARD TALLY BALLS; BILLIARD TIPS; BILLIARD  
TRIANGLES; CHALK FOR BILLIARD CUES; CUE  
STICKS; POOL BRIDGES; POOL BUMPERS; POOL  
CHALK HOLDERS; POOL CUE CASES; POOL CUE  
CEMENT; POOL CUE CHALK; POOL CUE CLAMPS;  
POOL CUE RACKS; POOL CUE REPAIR KITS; POOL  
CUE TIPS; POOL CUES; POOL CUSHIONS; POOL

TALLY BALLS, IN CLASS 28 (U.S. CLS. 22, 23, 38  
AND 50).

FIRST USE 5-3-2007; IN COMMERCE 6-21-2007.

THE MARK CONSISTS OF STANDARD CHAR-  
ACTERS WITHOUT CLAIM TO ANY PARTICULAR  
FONT, STYLE, SIZE, OR COLOR.

NO CLAIM IS MADE TO THE EXCLUSIVE  
RIGHT TO USE RACKS, APART FROM THE MARK  
AS SHOWN.

SN 77-209,975, FILED 6-19-2007.

KAREN BRACEY, EXAMINING ATTORNEY

**Int. Cls.: 16 and 36**

**Prior U.S. Cls.: 2, 5, 22, 23, 29, 37, 38, 50, 100, 101, and 102**

**United States Patent and Trademark Office**

**Reg. No. 3,506,141**

**Registered Sep. 23, 2008**

**TRADEMARK  
SERVICE MARK  
PRINCIPAL REGISTER**

**ARIEL INVESTMENTS**

ARIEL INVESTMENTS, LLC (DELAWARE LIMITED LIABILITY COMPANY)  
200 E. RANDOLPH DRIVE  
SUITE 2900  
CHICAGO, IL 60601

FOR: PRINTED PUBLICATIONS, NAMELY, REPORTS, EDUCATIONAL MATERIALS, NEWSLETTERS, PAMPHLETS AND PERIODICALS FEATURING INVESTMENT NEWS AND COMMENTARY, IN CLASS 16 (U.S. CLS. 2, 5, 22, 23, 29, 37, 38 AND 50).

FIRST USE 4-30-2008; IN COMMERCE 4-30-2008.

FOR: INVESTMENT ADVISORY SERVICES; INVESTMENT MANAGEMENT; MUTUAL FUND BROKERAGE, DISTRIBUTION AND INVESTMENT; FINANCIAL SPONSORSHIP OF CULTURAL AND PERFORMING ARTS EVENTS; PROVIDING ON-LINE INFORMATION IN THE FIELD OF IN-

VESTMENTS, IN CLASS 36 (U.S. CLS. 100, 101 AND 102).

FIRST USE 4-30-2008; IN COMMERCE 4-30-2008.

THE MARK CONSISTS OF STANDARD CHARACTERS WITHOUT CLAIM TO ANY PARTICULAR FONT, STYLE, SIZE, OR COLOR.

OWNER OF U.S. REG. NOS. 1,286,420, 2,772,980, AND OTHERS.

NO CLAIM IS MADE TO THE EXCLUSIVE RIGHT TO USE "INVESTMENTS", APART FROM THE MARK AS SHOWN.

SN 77-209,986, FILED 6-19-2007.

IRA J. GOODSaid, EXAMINING ATTORNEY

**Int. Cls.: 9 and 41**

**Prior U.S. Cls.: 21, 23, 26, 36, 38, 100, 101, and 107**

**United States Patent and Trademark Office**

**Reg. No. 3,506,142**

**Registered Sep. 23, 2008**

**TRADEMARK  
SERVICE MARK  
PRINCIPAL REGISTER**

# PLAYPOND

PIXELSTORM ENTERTAINMENT STUDIOS INC.  
(CANADA CORPORATION)  
5033 154 STREET  
EDMONTON, ALBERTA, CANADA T6H5P1

FOR: ELECTRONIC GAME PROGRAMS; DOWNLOADABLE ELECTRONIC GAME PROGRAMS; ELECTRONIC GAME SOFTWARE; COMPUTER GAME PROGRAMS; DOWNLOADABLE COMPUTER GAME PROGRAMS; INTERACTIVE GAME PROGRAMS; AND INTERACTIVE GAME SOFTWARE, IN CLASS 9 (U.S. CLS. 21, 23, 26, 36 AND 38).

FIRST USE 2-29-2008; IN COMMERCE 2-29-2008.

FOR: ENTERTAINMENT SERVICES, NAMELY, PROVIDING ON-LINE COMPUTER GAMES AND ENTERTAINMENT CONTENT IN THE FIELD OF GAMES; PROVIDING A WEBSITE FEATURING

ELECTRONIC GAME CONTENT, DOWNLOADABLE ELECTRONIC GAME CONTENT, COMPUTER GAME CONTENT, INTERACTIVE GAME CONTENT, ELECTRONIC GAME ENTERTAINMENT, DOWNLOADABLE ELECTRONIC GAME ENTERTAINMENT, AND COMPUTER GAME ENTERTAINMENT, IN CLASS 41 (U.S. CLS. 100, 101 AND 107).

FIRST USE 2-29-2008; IN COMMERCE 2-29-2008.

THE MARK CONSISTS OF STANDARD CHARACTERS WITHOUT CLAIM TO ANY PARTICULAR FONT, STYLE, SIZE, OR COLOR.

SN 77-210,882, FILED 6-20-2007.

JENNIFER VASQUEZ, EXAMINING ATTORNEY

Int. Cl.: 36

Prior U.S. Cls.: 100, 101, and 102

United States Patent and Trademark Office

Reg. No. 3,506,143

Registered Sep. 23, 2008

**SERVICE MARK  
PRINCIPAL REGISTER**

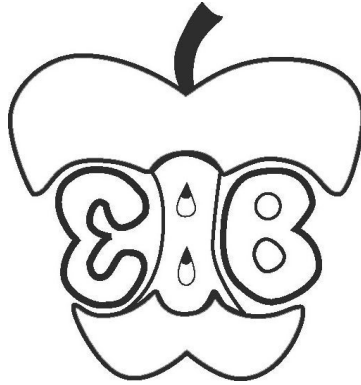

BROWNSTEIN, EVELINE H. (UNITED STATES  
INDIVIDUAL)  
578 WASHINGTON BLVD #449  
MARINA DEL REY, CA 90292

FOR: REAL ESTATE AGENCIES; REAL ESTATE  
BROKERAGE; REAL ESTATE CONSULTANCY;  
REAL ESTATE CONSULTATION; PROVIDING IN-  
FORMATION IN THE FIELD OF REAL ESTATE VIA  
THE INTERNET; PROVIDING REAL ESTATE LIST-  
INGS AND REAL ESTATE INFORMATION VIA

THE INTERNET, IN CLASS 36 (U.S. CLS. 100, 101  
AND 102).

FIRST USE 6-30-2007; IN COMMERCE 6-30-2007.

THE MARK CONSISTS OF AN APPLE CORE  
WITH THE LITERAL ELEMENT "EHB".

SN 77-211,657, FILED 6-21-2007.

JOHN WILKE, EXAMINING ATTORNEY

**Int. Cl.: 12**

**Prior U.S. Cls.: 19, 21, 23, 31, 35, and 44**

**Reg. No. 3,506,144**

**United States Patent and Trademark Office**

**Registered Sep. 23, 2008**

---

**TRADEMARK  
PRINCIPAL REGISTER**

**IMPULSE**

IMPULSE MARINE, LLC (NORTH CAROLINA  
LIMITED LIABILITY COMPANY)  
5185 NC HWY 41 SOUTH  
WALLACE, NC 28466

THE MARK CONSISTS OF STANDARD CHAR-  
ACTERS WITHOUT CLAIM TO ANY PARTICULAR  
FONT, STYLE, SIZE, OR COLOR.

FOR: BOATS, IN CLASS 12 (U.S. CLS. 19, 21, 23, 31,  
35 AND 44).

SN 77-211,920, FILED 6-21-2007.

FIRST USE 10-25-2007; IN COMMERCE 10-25-2007.

ELLEN B. AWRICH, EXAMINING ATTORNEY



**Int. Cl.: 41**

**Prior U.S. Cls.: 100, 101, and 107**

**United States Patent and Trademark Office**

**Reg. No. 3,506,145**

**Registered Sep. 23, 2008**

**SERVICE MARK  
PRINCIPAL REGISTER**

**The Gift Of The Twelfth  
Fairy**

DR. PAPIROVA, INC. (COLORADO CORPORATION)  
950 S. CHERRY ST., SUITE 422  
DENVER, CO 80246

FOR: CONDUCTING WORKSHOPS AND SEMINARS IN SELF AWARENESS, PERSONAL DESTINY, AND FREE WILL; EDUCATIONAL SERVICES, NAMELY, CONDUCTING LECTURES, SEMINARS, AND WORKSHOPS IN THE FIELD OF SELF AWARENESS, PERSONAL DESTINY, AND FREE WILL AND DISTRIBUTION OF COURSE MATERIAL IN CONNECTION THEREWITH; CONDUCTING

WORKSHOPS AND SEMINARS IN SELF AWARENESS, IN CLASS 41 (U.S. CLS. 100, 101 AND 107).

FIRST USE 8-1-2008; IN COMMERCE 8-1-2008.

THE MARK CONSISTS OF STANDARD CHARACTERS WITHOUT CLAIM TO ANY PARTICULAR FONT, STYLE, SIZE, OR COLOR.

SN 77-211,994, FILED 6-21-2007.

MARILYN IZZI, EXAMINING ATTORNEY

**Int. Cl.: 41**

**Prior U.S. Cls.: 100, 101, and 107**

**United States Patent and Trademark Office**

**Reg. No. 3,506,146**

**Registered Sep. 23, 2008**

**SERVICE MARK  
PRINCIPAL REGISTER**

# Allow Unfolding

DR. PAPIROVA, INC. (COLORADO CORPORATION)  
950 S. CHERRY ST., SUITE 422  
DENVER, CO 80246

FOR: CONDUCTING WORKSHOPS AND SEMINARS IN SELF AWARENESS; CONDUCTING WORKSHOPS AND SEMINARS IN SELF AWARENESS, SELF ACCEPTANCE, PERSONAL DESTINY, FREE WILL, AND PARENTING; EDUCATIONAL SERVICES, NAMELY, CONDUCTING LECTURES, SEMINARS, AND WORKSHOPS IN THE FIELD OF SELF AWARENESS, SELF ACCEPTANCE, PERSONAL DESTINY, FREE WILL, AND PARENTING

AND DISTRIBUTION OF COURSE MATERIAL IN CONNECTION THEREWITH, IN CLASS 41 (U.S. CLS. 100, 101 AND 107).

FIRST USE 7-28-2008; IN COMMERCE 7-28-2008.

THE MARK CONSISTS OF STANDARD CHARACTERS WITHOUT CLAIM TO ANY PARTICULAR FONT, STYLE, SIZE, OR COLOR.

SN 77-212,046, FILED 6-21-2007.

MARILYN IZZI, EXAMINING ATTORNEY

**Int. Cl.: 42**

**Prior U.S. Cls.: 100 and 101**

**United States Patent and Trademark Office**

**Reg. No. 3,506,147**

**Registered Sep. 23, 2008**

**SERVICE MARK  
PRINCIPAL REGISTER**

# PROFOLIO

SYSTEM DEVELOPMENT.INTEGRATION, INC.  
(ILLINOIS CORPORATION)  
33 WEST MONROE STREET, SUITE 400  
CHICAGO, IL 60603

FOR: PROVIDING TEMPORARY USE OF AN  
ONLINE, NON-DOWNLOADABLE COMPUTER  
SOFTWARE FACILITIES MANAGEMENT APPLI-  
CATION, NAMELY, AN INTERNET-BASED INFOR-  
MATION TECHNOLOGY TOOL THAT PROVIDES  
PROPERTY MANAGERS, LEASE MANAGERS,  
AND BUILDING ENGINEERS WITH INSTANT AC-

CESS TO THEIR BUILDINGS' FACILITY INFOR-  
MATION, IN CLASS 42 (U.S. CLS. 100 AND 101).

FIRST USE 6-0-2002; IN COMMERCE 6-0-2002.

THE MARK CONSISTS OF STANDARD CHAR-  
ACTERS WITHOUT CLAIM TO ANY PARTICULAR  
FONT, STYLE, SIZE, OR COLOR.

SN 77-212,451, FILED 6-21-2007.

DAVID MILLER, EXAMINING ATTORNEY

**Int. Cl.: 16**

**Prior U.S. Cls.: 2, 5, 22, 23, 29, 37, 38, and 50**

**Reg. No. 3,506,148**

**United States Patent and Trademark Office**

**Registered Sep. 23, 2008**

---

**TRADEMARK  
PRINCIPAL REGISTER**

**PRELUDE**

U.S. VINYL MANUFACTURING CORPORATION  
(TEXAS CORPORATION)  
1766 BROOMTOWN ROAD  
LAFAYETTE, GA 30728

THE MARK CONSISTS OF STANDARD CHAR-  
ACTERS WITHOUT CLAIM TO ANY PARTICULAR  
FONT, STYLE, SIZE, OR COLOR.

FOR: WALL COVERING SAMPLE BOOKS, IN  
CLASS 16 (U.S. CLS. 2, 5, 22, 23, 29, 37, 38 AND 50).

SN 77-213,593, FILED 6-22-2007.

FIRST USE 7-31-2007; IN COMMERCE 7-31-2007.

SKYE YOUNG, EXAMINING ATTORNEY

**Int. Cl.: 41**

**Prior U.S. Cls.: 100, 101, and 107**

**United States Patent and Trademark Office**

**Reg. No. 3,506,149**

**Registered Sep. 23, 2008**

**SERVICE MARK  
PRINCIPAL REGISTER**

**SEX IN STEREO**

NAZARIAN, MIRELLA (UNITED STATES INDIVIDUAL)

#203

27604 NORTH MARTA LANE  
SANTA CLARITA, CA 91387

FOR: ENTERTAINMENT, NAMELY, LIVE PERFORMANCES BY A MUSICAL BAND; ENTERTAINMENT SERVICES, NAMELY, LIVE, TELEVISED AND MOVIE APPEARANCES BY A PROFESSIONAL ENTERTAINER; ENTERTAINMENT SERVICES, NAMELY, PERSONAL APPEARANCES BY A MUSICAL BAND; ENTERTAINMENT, NAMELY, LIVE

MUSIC CONCERTS, IN CLASS 41 (U.S. CLS. 100, 101 AND 107).

FIRST USE 9-1-2007; IN COMMERCE 9-1-2007.

THE MARK CONSISTS OF STANDARD CHARACTERS WITHOUT CLAIM TO ANY PARTICULAR FONT, STYLE, SIZE, OR COLOR.

SN 77-213,740, FILED 6-22-2007.

STEVEN R. FINE, EXAMINING ATTORNEY

Int. Cl.: 34

Prior U.S. Cls.: 2, 8, 9, and 17

Reg. No. 3,506,150

United States Patent and Trademark Office

Registered Sep. 23, 2008

TRADEMARK  
PRINCIPAL REGISTER

CARLOS V

MANGIAMELI, DANIELE (ITALY INDIVIDUAL)  
SUITE T8  
9153 SW 72 AVENUE  
MIAMI, FL 33156

FOR: ASHTRAYS; ASHTRAYS FOR SMOKERS; ASHTRAYS FOR SMOKERS MADE OF NON-PRECIOUS METALS; ASHTRAYS FOR SMOKERS MADE OF PRECIOUS METALS; ASHTRAYS OF PRECIOUS METAL; ASHTRAYS, NOT OF PRECIOUS METAL; CHEWING TOBACCO; CIGAR AND CIGARETTE BOXES; CIGAR AND CIGARETTE BOXES NOT OF PRECIOUS METAL; CIGAR AND CIGARETTE BOXES OF PRECIOUS METAL; CIGAR BANDS; CIGAR BOXES; CIGAR BOXES NOT OF PRECIOUS METAL; CIGAR BOXES OF PRECIOUS METAL; CIGAR CASES; CIGAR CASES OF PRECIOUS METAL; CIGAR CUTTERS; CIGAR HOLDERS; CIGAR HOLDERS OF PRECIOUS METAL; CIGAR HUMIDIFIERS; CIGAR LIGHTERS; CIGAR TUBES; CIGARETTE ASH RECEPTACLES; CIGARETTE CASES; CIGARETTE CASES MADE OF PRECIOUS METAL; CIGARETTE CASES, NOT OF PRECIOUS METAL; CIGARETTE HOLDERS; CIGARETTE HOLDERS OF PRECIOUS METAL; CIGARETTE HOLDERS, NOT OF PRECIOUS METAL; CIGARETTE LIGHTERS NOT FOR LAND VEHICLES; CIGARETTE LIGHTERS NOT OF PRECIOUS METAL; CIGARETTE LIGHTERS OF PRECIOUS METAL; CIGARETTE PAPERS; CIGARETTE ROLLING MACHINES; CIGARETTE ROLLING PAPERS; CIGARETTE TUBES; CIGARETTES; CIGARETTES CONTAINING TOBACCO SUBSTITUTES NOT FOR MEDICAL PURPOSES; CIGARILLOS; CIGARS; FILTER-TIPPED CIGARETTES; FLINTS FOR LIGHTERS; HAND-ROLLING TOBACCO; HERBS FOR SMOKING; HOLDERS FOR CIGAR AND CIGARETTE OF PRECIOUS METAL; HOLDERS FOR CIGARS AND CIGARETTES; HOLDERS OF CIGARS AND CIGARETTES OF PRECIOUS METAL; HUMIDORS; LIGHTER FLINTS; LIGHTERS FOR SMOKERS; LIGHTERS NOT OF PRECIOUS METAL;

LIQUEFIED GAS CYLINDERS FOR CIGARETTE LIGHTERS; MACHINES ALLOWING SMOKERS TO MAKE CIGARETTES BY THEMSELVES; MATCH BOXES; MATCH BOXES NOT OF PRECIOUS METAL; MATCH BOXES OF PRECIOUS METAL; MATCH HOLDERS; MATCH HOLDERS NOT OF PRECIOUS METAL; MATCH HOLDERS OF PRECIOUS METAL; MATCHES; MENTHOLATED PIPES; NON-ELECTRIC CIGAR LIGHTERS NOT OF PRECIOUS METAL; PARAFFIN MATCHES; PIPE POUCHES; PIPE TAMPERS; PIPE TOBACCO; POCKET APPARATUS FOR ROLLING CIGARETTES; POCKET APPARATUS FOR SELF-ROLLING CIGARETTES; POCKET APPLIANCES FOR ROLLING ONE'S OWN CIGARETTES; POCKET DEVICES FOR SELF-ROLLING OF CIGARETTES; POCKET MACHINES FOR ROLLING CIGARETTES; POCKET-SIZE CIGARETTE ROLLING MACHINES; ROLL YOUR OWN TOBACCO; ROLLING TOBACCO; SAFETY MATCHES; SMOKELESS TOBACCO; SMOKING PIPE CLEANERS; SMOKING PIPES; SMOKING TOBACCO; SMOKING URNS; SNUFF; SNUFF BOXES; SNUFF BOXES MADE OF PRECIOUS METAL; SNUFF BOXES, NOT OF PRECIOUS METAL; SNUFF DISPENSERS; SNUFFBOXES NOT MADE OF PRECIOUS METALS; SULFUR MATCHES; TOBACCO; TOBACCO FILTERS; TOBACCO GRINDERS; TOBACCO JARS; TOBACCO JARS OF PRECIOUS METAL; TOBACCO PIPE CLEANERS; TOBACCO PIPES; TOBACCO POUCHES; TOBACCO POWDER, NAMELY, SNU; TOBACCO SPITTOONS; TOBACCO SUBSTITUTE; TOBACCO SUBSTITUTES; TOBACCO TINS; YELLOW PHOSPHORUS MATCHES, IN CLASS 34 (U.S. CLS. 2, 8, 9 AND 17).

FIRST USE 7-10-2008; IN COMMERCE 7-10-2008.

THE MARK CONSISTS OF STANDARD CHARACTERS WITHOUT CLAIM TO ANY PARTICULAR FONT, STYLE, SIZE, OR COLOR.

SN 77-213,939, FILED 6-23-2007.

DAVID TOOLEY, EXAMINING ATTORNEY

**Int. Cl.: 35**

**Prior U.S. Cls.: 100, 101, and 102**

**United States Patent and Trademark Office**

**Reg. No. 3,506,151**

**Registered Sep. 23, 2008**

**SERVICE MARK  
PRINCIPAL REGISTER**

**eyebeyond sports**

T JAY L MARKETING, INC (OKLAHOMA CORPORATION)  
P.O. BOX 32532  
OKLAHOMA CITY, OK 73123

FOR: ONLINE RETAIL CONSIGNMENT STORES FEATURING CLOTHING, IN CLASS 35 (U.S. CLS. 100, 101 AND 102).

FIRST USE 1-1-2008; IN COMMERCE 5-31-2008.

THE MARK CONSISTS OF STANDARD CHARACTERS WITHOUT CLAIM TO ANY PARTICULAR FONT, STYLE, SIZE, OR COLOR.

NO CLAIM IS MADE TO THE EXCLUSIVE RIGHT TO USE "SPORTS", APART FROM THE MARK AS SHOWN.

SN 77-214,082, FILED 6-24-2007.

MATTHEW PAPPAS, EXAMINING ATTORNEY



**Int. Cl.: 29**

**Prior U.S. Cl.: 46**

**United States Patent and Trademark Office**

**Reg. No. 3,506,152**

**Registered Sep. 23, 2008**

**TRADEMARK  
PRINCIPAL REGISTER**



CARGILL MEAT SOLUTIONS CORPORATION  
(DELAWARE CORPORATION)  
151 NORTH MAIN  
WICHITA, KS 67202

THE MARK CONSISTS OF THE WORDS "VAL-  
LEY TRADITION" AND IMAGE OF AN ABSTRACT  
VALLEY INCLUDING LAND, HILLS, SUN AND  
SKY.

FOR: MEAT, IN CLASS 29 (U.S. CL. 46).

SN 77-214,156, FILED 6-25-2007.

FIRST USE 10-31-2007; IN COMMERCE 10-31-2007.

OWNER OF U.S. REG. NO. 2,939,515.

THEODORE MCBRIDE, EXAMINING ATTORNEY

**Int. Cl.: 6**

**Prior U.S. Cls.: 2, 12, 13, 14, 23, 25, and 50**

**United States Patent and Trademark Office**

**Reg. No. 3,506,153**

**Registered Sep. 23, 2008**

**TRADEMARK  
PRINCIPAL REGISTER**



MASTER LOCK COMPANY LLC (DELAWARE  
LIMITED LIABILITY COMPANY)  
P.O. BOX 927  
137 W. FOREST HILL AVENUE  
OAK CREEK, WI 53154

THE MARK CONSISTS OF THE WORD "BUMP"  
IN A STYLIZED FORMAT ON TOP OF A TRAFFIC  
STOP SIGN CONTAINING THE WORD "STOP".

FOR: METAL LOCKS AND KEYS AND PARTS  
THEREFOR, IN CLASS 6 (U.S. CLS. 2, 12, 13, 14, 23, 25  
AND 50).

SN 77-214,467, FILED 6-25-2007.

FIRST USE 7-1-2007; IN COMMERCE 7-1-2007.

CHERYL CLAYTON, EXAMINING ATTORNEY

**Int. Cl.: 12**

**Prior U.S. Cls.: 19, 21, 23, 31, 35, and 44**

**United States Patent and Trademark Office**

**Reg. No. 3,506,154**

**Registered Sep. 23, 2008**

**TRADEMARK  
PRINCIPAL REGISTER**

**VANTAGE**

DOREL JUVENILE GROUP, INC. (MASSACHU-  
SETTS CORPORATION)  
25 FORBES BLVD  
FOXBORO, MA 02035

FOR: JUVENILE CAR SEATS, IN CLASS 12 (U.S.  
CLS. 19, 21, 23, 31, 35 AND 44).

FIRST USE 12-1-2001; IN COMMERCE 12-1-2001.

THE MARK CONSISTS OF STANDARD CHAR-  
ACTERS WITHOUT CLAIM TO ANY PARTICULAR  
FONT, STYLE, SIZE, OR COLOR.

OWNER OF U.S. REG. NO. 2,698,522.

SN 77-214,721, FILED 6-25-2007.

PAUL F. GAST, EXAMINING ATTORNEY

**Int. Cl.: 11**

**Prior U.S. Cls.: 13, 21, 23, 31, and 34**

**United States Patent and Trademark Office**

**Reg. No. 3,506,155**

**Registered Sep. 23, 2008**

**TRADEMARK  
PRINCIPAL REGISTER**

**THE INSIDER**

JW PET COMPANY, INC. (NEW JERSEY CORPORATION)  
ONE UNITED LANE  
TETERBORO, NJ 07608

THE MARK CONSISTS OF STANDARD CHARACTERS WITHOUT CLAIM TO ANY PARTICULAR FONT, STYLE, SIZE, OR COLOR.

FOR: AQUARIUM FILTRATION APPARATUS,  
IN CLASS 11 (U.S. CLS. 13, 21, 23, 31 AND 34).

SN 77-215,437, FILED 6-26-2007.

FIRST USE 6-3-2008; IN COMMERCE 6-3-2008.

JENNIFER HETU, EXAMINING ATTORNEY

**Int. Cls.: 35, 37, 38, 41, and 42**

**Prior U.S. Cls.: 100, 101, 102, 103, 104, 106, and 107**

**United States Patent and Trademark Office**

**Reg. No. 3,506,156**

**Registered Sep. 23, 2008**

**SERVICE MARK  
PRINCIPAL REGISTER**

**TELIRIS**

TELIRIS, INC. (DELAWARE CORPORATION)  
5TH FLOOR  
369 LEXINGTON AVENUE  
NEW YORK, NY 10017

FOR: OPERATION, SCHEDULING AND MANAGEMENT OF VIDEO TELECONFERENCING SYSTEMS FOR OTHERS, IN CLASS 35 (U.S. CLS. 100, 101 AND 102).

FIRST USE 5-31-2003; IN COMMERCE 5-31-2003.

FOR: INSTALLATION AND MAINTENANCE OF VIDEO TELECONFERENCING SYSTEMS, IN CLASS 37 (U.S. CLS. 100, 103 AND 106).

FIRST USE 7-31-1999; IN COMMERCE 7-31-1999.

FOR: CONSULTATION IN THE FIELD OF VIDEO TELECONFERENCING SYSTEMS; TELECOMMUNICATIONS SERVICES, NAMELY, TRANSMISSION OF DATA VIA COMPUTER NETWORKS FOR USE IN VIDEO TELECONFERENCES, IN CLASS 38 (U.S. CLS. 100, 101 AND 104).

FIRST USE 7-31-1999; IN COMMERCE 7-31-1999.

FOR: TRAINING IN THE USE OF VIDEO TELECONFERENCING SYSTEMS, IN CLASS 41 (U.S. CLS. 100, 101 AND 107).

FIRST USE 1-31-2006; IN COMMERCE 1-31-2006.

FOR: DESIGN FOR OTHERS IN THE FIELD OF VIDEO TELECONFERENCING SYSTEMS, IN CLASS 42 (U.S. CLS. 100 AND 101).

FIRST USE 7-31-1999; IN COMMERCE 7-31-1999.

THE MARK CONSISTS OF STANDARD CHARACTERS WITHOUT CLAIM TO ANY PARTICULAR FONT, STYLE, SIZE, OR COLOR.

SN 77-215,514, FILED 6-26-2007.

JEFFERY COWARD, EXAMINING ATTORNEY

**Int. Cl.: 41**

**Prior U.S. Cls.: 100, 101, and 107**

**United States Patent and Trademark Office**

**Reg. No. 3,506,157**

**Registered Sep. 23, 2008**

**SERVICE MARK  
PRINCIPAL REGISTER**

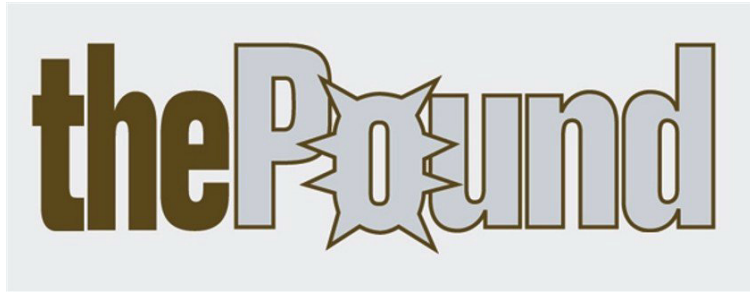

SOUNDHOUND INCORPORATED (NEW YORK CORPORATION)  
4TH FLOOR  
45 WEST 45TH STREET  
NEW YORK, NY 10036

FOR: VIDEO, DIGITAL, FILM, VIDEOTAPE AND GRAPHICS EDITING SERVICES, INCLUDING TELEVISION COMMERCIALS, NETWORK PROMOTIONS, CORPORATE VIDEOS, INDEPENDENT FILMS, AND RELATED PRODUCTIONS, IN CLASS 41 (U.S. CLS. 100, 101 AND 107).

FIRST USE 8-10-2007; IN COMMERCE 8-10-2007.

THE COLOR(S) BROWN AND GRAY IS/ARE CLAIMED AS A FEATURE OF THE MARK.

THE MARK CONSISTS OF THE WORD "THE" IN BROWN, AND THE WORD "POUND" IN GRAY INSIDE AN OUTLINE OF BROWN.

SN 77-215,666, FILED 6-26-2007.

SHARON MEIER, EXAMINING ATTORNEY

**Int. Cl.: 39**

**Prior U.S. Cls.: 100 and 105**

**United States Patent and Trademark Office**

**Reg. No. 3,506,158**

**Registered Sep. 23, 2008**

**SERVICE MARK  
PRINCIPAL REGISTER**

**SILVER SKY**

SILVERSEA CRUISES, LTD. (BAHAMAS CORPORATION)  
110 EAST BROWARD BOULEVARD  
FORT LAUDERDALE, FL 33301

THE MARK CONSISTS OF STANDARD CHARACTERS WITHOUT CLAIM TO ANY PARTICULAR FONT, STYLE, SIZE, OR COLOR.

FOR: TRAVEL ARRANGEMENT SERVICES, NAMELY, MAKING RESERVATIONS AND BOOKINGS FOR TRANSPORTATION APPURTENANT TO CRUISES, IN CLASS 39 (U.S. CLS. 100 AND 105).

SN 77-215,997, FILED 6-26-2007.

FIRST USE 6-0-2007; IN COMMERCE 6-0-2007.

STEVEN R. FOSTER, EXAMINING ATTORNEY

**Int. Cl.: 41**

**Prior U.S. Cls.: 100, 101, and 107**

**United States Patent and Trademark Office**

**Reg. No. 3,506,159**

**Registered Sep. 23, 2008**

**SERVICE MARK  
PRINCIPAL REGISTER**



JACOB BURNS FILM CENTER, INC. (NEW  
YORK NON-PROFIT CORPORATION)  
39 WASHINGTON AVENUE  
PLEASANTVILLE, NY 10570

FOR: MOTION PICTURE FILM PRODUCTION;  
ENTERTAINMENT SERVICES, NAMELY, SCREEN-  
ING FILMS AND MOVIES FOR STUDENTS; EDU-  
CATIONAL SERVICES, NAMELY, WORKSHOPS,  
CLASSES, STUDY GROUPS AND SEMINARS IN  
THE FIELD OF FILM-MAKING AND MOVIE PRO-  
DUCTION, IN CLASS 41 (U.S. CLS. 100, 101 AND 107).

FIRST USE 6-30-2007; IN COMMERCE 6-30-2007.

THE MARK CONSISTS OF THE WORDS  
"WORLD CREW" IN BLACK WITH A SHADED  
THREE-QUARTER CIRCLE.

SN 77-216,145, FILED 6-26-2007.

AISHA SALEM, EXAMINING ATTORNEY



**Int. Cl.: 9**

**Prior U.S. Cls.: 21, 23, 26, 36, and 38**

**United States Patent and Trademark Office**

**Reg. No. 3,506,160**

**Registered Sep. 23, 2008**

**TRADEMARK  
PRINCIPAL REGISTER**

# Sunstick

PLUMSTONE (MICHIGAN LIMITED LIABILITY  
COMPANY)  
2016 WILSHIRE DRIVE, SE  
GRAND RAPIDS, MI 49506

FOR: MEASUREMENT DEVICE FOR GARDEN-  
ING, NAMELY, A TOOL USED TO MEASURE THE  
AMOUNT OF SUNLIGHT A SPECIFIC AREA RE-  
CEIVES IN ONE DAY , IN CLASS 9 (U.S. CLS. 21, 23,  
26, 36 AND 38).

FIRST USE 4-19-2008; IN COMMERCE 4-19-2008.

THE MARK CONSISTS OF STANDARD CHAR-  
ACTERS WITHOUT CLAIM TO ANY PARTICULAR  
FONT, STYLE, SIZE, OR COLOR.

SN 77-216,243, FILED 6-26-2007.

KATHERINE CONNOLLY, EXAMINING ATTOR-  
NEY

**Int. Cl.: 9**

**Prior U.S. Cls.: 21, 23, 26, 36, and 38**

**Reg. No. 3,506,161**

**United States Patent and Trademark Office**

**Registered Sep. 23, 2008**

**TRADEMARK  
PRINCIPAL REGISTER**

**INK'D**

SKULLCANDY, INC. (UTAH CORPORATION)  
1441 UTE BLVD  
SUITE 250  
PARK CITY, UT 840987632

FIRST USE 7-1-2006; IN COMMERCE 7-1-2006.

FOR: HEADPHONE AND EARPHONES, NAME-  
LY, HEADPHONES AND EARPHONES FOR USE  
WITH MOBILE COMMUNICATION DEVICES;  
HEADPHONES AND EARPHONES FOR USE WITH  
MEDIA PLAYBACK DEVICES , IN CLASS 9 (U.S.  
CLS. 21, 23, 26, 36 AND 38).

THE MARK CONSISTS OF STANDARD CHAR-  
ACTERS WITHOUT CLAIM TO ANY PARTICULAR  
FONT, STYLE, SIZE, OR COLOR.

SN 77-217,249, FILED 6-27-2007.

JOHN E. MICHOS, EXAMINING ATTORNEY

Int. Cl.: 5

Prior U.S. Cls.: 6, 18, 44, 46, 51, and 52

United States Patent and Trademark Office

Reg. No. 3,506,162

Registered Sep. 23, 2008

TRADEMARK  
PRINCIPAL REGISTER



TONGJITANG

GUIZHOU TONGJITANG PHARMACEUTICAL  
CO., LTD. (CHINA CORPORATION)  
NO. 296, SOUTH WEST LINK  
XIAOHE DISTRICT, GUIYANG CITY  
GUIZHOU PROVINCE, CHINA

FOR: DIAGNOSTIC AGENTS, PREPARATIONS  
AND SUBSTANCES FOR MEDICAL PURPOSES;  
VITAMIN FORTIFIED BEVERAGES; HERB TEAS  
FOR MEDICINAL PURPOSES; STIMULATORY  
MEDICATIONS FOR USE IN WEIGHT REDUCTION  
PROGRAMS; MEDICINAL HERB EXTRACTS; RUB-  
BING ALCOHOL; SANITARY STERILISING PRE-  
PARATIONS; FOOD FOR INFANTS;  
NUTRITIONALLY FORTIFIED BEVERAGES; NU-  
TRITIONAL ADDITIVES FOR MEDICAL PURPO-  
SES FOR USE IN FOODS AND DIETARY  
SUPPLEMENTS FOR HUMAN CONSUMPTION, IN  
CLASS 5 (U.S. CLS. 6, 18, 44, 46, 51 AND 52).

FIRST USE 6-5-1998; IN COMMERCE 9-10-2007.

THE MARK CONSISTS OF THE WORD "TONG-  
JITANG" AND THREE CHINESE CHARACTERS IN  
STYLIZED FORMS.

THE ENGLISH TRANSLATION OF "TONG"; "JI";  
"TANG" IS EQUAL; HELP; HOUSE.

THE WORD "TONGJITANG" IS THE TRANSLI-  
TERATION OF THE CHINESE CHARACTERS AND  
HAS NO MEANING OR SIGNIFICANCE IN THE  
RELEVANT TRADE OR IN ANY LANGUAGES.  
THE NON-LATIN CHARACTERS IN THE MARK  
TRANSLITERATE TO "TONG"; "JI"; "TANG".

SN 77-217,435, FILED 6-27-2007.

JAMES GRIFFIN, EXAMINING ATTORNEY

**Int. Cl.: 30**

**Prior U.S. Cl.: 46**

**United States Patent and Trademark Office**

**Reg. No. 3,506,163**

**Registered Sep. 23, 2008**

**TRADEMARK  
PRINCIPAL REGISTER**



GUIZHOU TONGJITANG PHARMACEUTICAL  
CO., LTD. (CHINA CORPORATION)  
NO. 296, SOUTH WEST LINK  
XIAOHE DISTRICT, GUIYANG CITY  
GUIZHOU PROVINCE, CHINA

FOR: ROYAL JELLY FOR FOOD PURPOSES;  
BAKING POWDERS; PROCESSED HERBS; NUTRI-  
TIONAL OILS FOR FOOD PURPOSES; TEA; REL-  
ISH; INSTANT NOODLES; PROCESSED CEREALS;  
SEASONINGS, IN CLASS 30 (U.S. CL. 46).

FIRST USE 6-5-1998; IN COMMERCE 9-10-2007.

THE MARK CONSISTS OF THE WORD "TONG-  
JITANG" AND THREE CHINESE CHARACTERS IN  
STYLIZED FORMS.

THE ENGLISH TRANSLATION OF "TONG"; "JI";  
"TANG" IS EQUAL; HELP; HOUSE.

THE WORD "TONGJITANG" IS THE TRANSLI-  
TERATION OF THE CHINESE CHARACTERS AND  
HAS NO MEANING OR SIGNIFICANCE IN THE  
RELEVANT TRADE OR IN ANY LANGUAGES.  
THE NON-LATIN CHARACTERS IN THE MARK  
TRANSLITERATE TO "TONG"; "JI"; "TANG".

SN 77-217,437, FILED 6-27-2007.

JAMES GRIFFIN, EXAMINING ATTORNEY

**Int. Cl.: 5**

**Prior U.S. Cls.: 6, 18, 44, 46, 51, and 52**

**Reg. No. 3,506,164**

**United States Patent and Trademark Office**

**Registered Sep. 23, 2008**

**TRADEMARK  
PRINCIPAL REGISTER**



The trademark logo consists of four large, bold Chinese characters '仙灵骨葆' (Xian Ling Gu Bao) stacked above the English transliteration 'XIANLINGGUBAO' in a smaller, all-caps font. The entire logo is centered within a light gray rectangular background.

GUIZHOU TONGJITANG PHARMACEUTICAL  
CO., LTD. (CHINA CORPORATION)  
NO. 296, SOUTH WEST LINK  
XIAOHE DISTRICT, GUIYANG CITY  
GUIZHOU PROVINCE, CHINA

FOR: DIAGNOSTIC AGENTS, PREPARATIONS  
AND SUBSTANCES FOR MEDICAL PURPOSES;  
VITAMIN FORTIFIED BEVERAGES; HERB TEAS  
FOR MEDICINAL PURPOSES; STIMULATORY  
MEDICATIONS FOR USE IN WEIGHT REDUCTION  
PROGRAMS; MEDICINAL HERB EXTRACTS; RUB-  
BING ALCOHOL; SANITARY STERILISING PRE-  
PARATIONS; FOOD FOR INFANTS; NU-  
TRITIONALLY FORTIFIED BEVERAGES; NU-  
TRITIONAL ADDITIVES FOR MEDICAL PURPO-  
SES FOR USE IN FOODS AND DIETARY  
SUPPLEMENTS FOR HUMAN CONSUMPTION, IN  
CLASS 5 (U.S. CLS. 6, 18, 44, 46, 51 AND 52).

FIRST USE 3-2-1996; IN COMMERCE 9-21-2007.

THE MARK CONSISTS OF THE WORD "XIAN-  
LINGGUBAO" AND FOUR CHINESE CHARAC-  
TERS.

THE ENGLISH TRANSLATION OF "XIAN",  
"LING", "GU", AND "BAO" IS FAIRY, EFFECTIVE,  
BONE, AND KEEP.

THE WORD "XIANLINGGUBAO" IS THE  
TRANSLITERATION OF THE CHINESE CHARAC-  
TERS AND HAS NO MEANING OR SIGNIFICANCE  
IN THE RELEVANT TRADE OR IN ANY LANGUA-  
GES. THE NON-LATIN CHARACTERS IN THE  
MARK TRANSLITERATE TO "XIAN"; "LING";  
"GU"; "BAO".

SN 77-217,448, FILED 6-27-2007.

JAMES GRIFFIN, EXAMINING ATTORNEY

**Int. Cl.: 10**

**Prior U.S. Cls.: 26, 39, and 44**

**United States Patent and Trademark Office**

**Reg. No. 3,506,165**

**Registered Sep. 23, 2008**

**TRADEMARK  
PRINCIPAL REGISTER**

**PARI SMARTMASK**

PARI GMBH SPEZIALISTEN FUER EFFEKTIVE  
INHALATION (FED REP GERMANY COR-  
PORATION)  
MOOSSTRASSE #3  
STARNBERG, FED REP GERMANY D 82319

FOR: MEDICAL AND HEALTHCARE APPARA-  
TUS, EQUIPMENT AND INSTRUMENTS, NAMELY,  
RESPIRATORY MASKS FOR MEDICAL PURPOSES,  
OXYGEN MASKS FOR MEDICAL USE, INHALERS  
FOR MEDICAL PURPOSES, ELECTRIC VAPORI-  
ZERS FOR UPPER RESPIRATORY CONDITIONS,  
NEBULIZERS FOR RESPIRATION THERAPY, AND  
COMPONENT PARTS FOR ALL THE AFORESAID  
GOODS, IN CLASS 10 (U.S. CLS. 26, 39 AND 44).

FIRST USE 6-30-2007; IN COMMERCE 6-30-2007.

THE MARK CONSISTS OF STANDARD CHAR-  
ACTERS WITHOUT CLAIM TO ANY PARTICULAR  
FONT, STYLE, SIZE, OR COLOR.

OWNER OF U.S. REG. NOS. 1,405,662, 1,917,232,  
AND 2,940,783.

SN 77-217,742, FILED 6-28-2007.

KATHERINE CONNOLLY, EXAMINING ATTOR-  
NEY

**Int. Cl.: 30**

**Prior U.S. Cl.: 46**

**United States Patent and Trademark Office**

**Reg. No. 3,506,166**

**Registered Sep. 23, 2008**

**TRADEMARK  
PRINCIPAL REGISTER**

**Sip in Style!**

MATURI, DHEEPA R. (UNITED STATES INDIVIDUAL)  
10548 CHATHAM COURT  
CARMEL, IN 46032

THE MARK CONSISTS OF STANDARD CHARACTERS WITHOUT CLAIM TO ANY PARTICULAR FONT, STYLE, SIZE, OR COLOR.

FOR: TEA, IN CLASS 30 (U.S. CL. 46).

SN 77-217,834, FILED 6-28-2007.

FIRST USE 6-1-2007; IN COMMERCE 12-1-2007.

KAREN BRACEY, EXAMINING ATTORNEY

**Int. Cl.: 44**

**Prior U.S. Cls.: 100 and 101**

**United States Patent and Trademark Office**

**Reg. No. 3,506,167**

**Registered Sep. 23, 2008**

**SERVICE MARK  
PRINCIPAL REGISTER**

**ACCUIMAGING**

ACCUIMAGING PEARLRIDGE LLC (HAWAII  
LIMITED LIABILITY COMPANY)  
TOWER 4, SUITE 510  
500 ALA MOANA BLVD.  
HONOLULU, HI 96813

THE MARK CONSISTS OF STANDARD CHAR-  
ACTERS WITHOUT CLAIM TO ANY PARTICULAR  
FONT, STYLE, SIZE, OR COLOR.

FOR: MEDICAL IMAGING SERVICES; MEDICAL  
CONSULTING SERVICES, IN CLASS 44 (U.S. CLS.  
100 AND 101).

SN 77-219,352, FILED 6-29-2007.

FIRST USE 8-0-2006; IN COMMERCE 8-0-2006.

TANYA AMOS, EXAMINING ATTORNEY



**Int. Cl.: 44**

**Prior U.S. Cls.: 100 and 101**

**United States Patent and Trademark Office**

**Reg. No. 3,506,168**

**Registered Sep. 23, 2008**

**SERVICE MARK  
PRINCIPAL REGISTER**



ACCUIMAGING PEARLRIDGE LLC (HAWAII  
LIMITED LIABILITY COMPANY)  
TOWER 4, SUITE 510  
500 ALA MOANA BLVD.  
HONOLULU, HI 96813

FIRST USE 8-0-2006; IN COMMERCE 8-0-2006.

SN 77-219,369, FILED 6-29-2007.

FOR: MEDICAL IMAGING SERVICES; MEDICAL  
CONSULTING SERVICES, IN CLASS 44 (U.S. CLS.  
100 AND 101).

TANYA AMOS, EXAMINING ATTORNEY

**Int. Cl.: 44**

**Prior U.S. Cls.: 100 and 101**

**United States Patent and Trademark Office**

**Reg. No. 3,506,169**

**Registered Sep. 23, 2008**

**SERVICE MARK  
PRINCIPAL REGISTER**

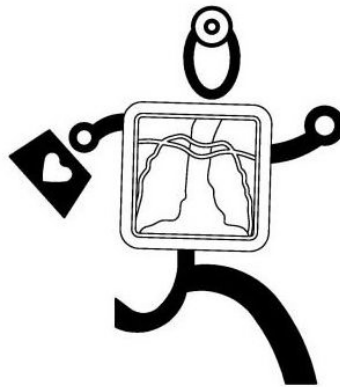

ACCUIMAGING PEARLRIDGE LLC (HAWAII  
LIMITED LIABILITY COMPANY)  
500 ALA MOANA BLVD.  
TOWER 4, SUITE 510  
HONOLULU, HI 96813

FIRST USE 8-0-2006; IN COMMERCE 8-0-2006.

SN 77-219,389, FILED 6-29-2007.

FOR: MEDICAL IMAGING SERVICES; MEDICAL  
CONSULTING SERVICES, IN CLASS 44 (U.S. CLS.  
100 AND 101).

TANYA AMOS, EXAMINING ATTORNEY

**Int. Cl.: 41**

**Prior U.S. Cls.: 100, 101, and 107**

**United States Patent and Trademark Office**

**Reg. No. 3,506,170**

**Registered Sep. 23, 2008**

**SERVICE MARK  
PRINCIPAL REGISTER**

**SOULTOWN**

HARMONIE HOLDINGS, LLC (MICHIGAN LIMITED LIABILITY COMPANY)  
3995 LAKELAND LANE  
BLOOMFIELD HILLS, MI 48302

FOR: PRODUCTION AND DISTRIBUTION OF TELEVISION AND RADIO PROGRAMS; PRODUCTION AND PUBLISHING OF MUSIC; FAN CLUBS; DEVELOPMENT AND DISSEMINATION OF EDUCATIONAL MATERIAL OF OTHERS IN THE FIELD OF MUSIC AND MUSIC ENTERTAINMENT; RADIO ENTERTAINMENT PRODUCTION AND DISTRIBUTION; AUDIO RECORDING PRODUCTION; RECORD PRODUCTION; VIDEOTAPE PRODUCTION; TELEVISION PROGRAM SYNDICATION; ENTERTAINMENT IN THE NATURE OF ONGOING TELEVISION PROGRAMS IN THE FIELD OF MUSIC PERFORMANCES; ENTERTAINMENT, NAMELY, A CONTINUING MUSIC AND ENTERTAINMENT VARIETY SHOW DISTRIBUTED OVER TELEVISION, SATELLITE, AUDIO, AND VIDEO MEDIA; PUBLICATION OF BOOKS AND MAGAZINES; ENTERTAINMENT IN THE NATURE OF ONGOING RADIO PROGRAMS IN THE FIELD OF MUSIC AND LIVE MUSIC PERFORMANCES; ENTERTAINMENT IN THE NATURE OF LIVE CONCERTS AND PERFORMANCES BY MUSICAL ARTISTS AND GROUPS; ENTERTAINMENT SERVICES, NAMELY, PERSONAL APPEARANCES BY MUSICAL GROUPS, MUSICAL ARTISTS AND CELEBRITIES; EDUCATIONAL AND ENTERTAINMENT SERVICES, NAMELY, PRODUCTION AND PRESENTATION OF TELEVISION SHOWS, SPORTS EVENTS, FASHION SHOWS, GAME SHOWS, MUSIC SHOWS, AWARD SHOWS AND COMEDY SHOWS BEFORE LIVE AUDIENCES

WHICH ARE ALL BROADCAST LIVE OR TAPED FOR LATER BROADCAST; ENTERTAINMENT SERVICES, NAMELY, PROVIDING A WEB SITE FEATURING MUSICAL PERFORMANCES, MUSICAL VIDEOS, RELATED FILM CLIPS, PHOTOGRAPHS, AND OTHER MULTIMEDIA MATERIALS; ENTERTAINMENT SERVICES, NAMELY, PROVIDING ON-LINE REVIEWS OF MUSIC, MUSICAL ARTISTS AND MUSIC VIDEOS; ENTERTAINMENT SERVICES, NAMELY, PROVIDING PRERECORDED MUSIC, INFORMATION IN THE FIELD OF MUSIC, AND COMMENTARY AND ARTICLES ABOUT MUSIC, ALL ON-LINE VIA A GLOBAL COMPUTER NETWORK; ENTERTAINMENT SERVICES, NAMELY, LIVE, TELEVISED AND MOVIE APPEARANCES BY A PROFESSIONAL ENTERTAINER; DISCOTHEQUES; OPERATING OF A DISCOTHEQUE; NIGHT CLUBS; ART EXHIBITIONS; CONDUCTING ENTERTAINMENT EXHIBITIONS IN THE NATURE OF MUSIC FESTIVALS. ORGANIZING EXHIBITIONS FOR THE PROMOTION OF MUSIC AND THE ARTS; AND PUBLISHING OF WEB MAGAZINES, IN CLASS 41 (U.S. CLS. 100, 101 AND 107).

FIRST USE 8-3-2007; IN COMMERCE 8-3-2007.

THE MARK CONSISTS OF STANDARD CHARACTERS WITHOUT CLAIM TO ANY PARTICULAR FONT, STYLE, SIZE, OR COLOR.

SN 77-219,999, FILED 7-1-2007.

MARK T. MULLEN, EXAMINING ATTORNEY

**Int. Cl.: 10**

**Prior U.S. Cls.: 26, 39, and 44**

**United States Patent and Trademark Office**

**Reg. No. 3,506,171**

**Registered Sep. 23, 2008**

**TRADEMARK  
PRINCIPAL REGISTER**

**MINDFRAME**

MINDFRAME, INC. (DELAWARE CORPORATION)  
26429 RANCHO PARKWAY SOUTH  
SUITE NO. 140  
LAKE FOREST, CA 92630

FOR: MINIMALLY INVASIVE VASCULAR DEVICES, NAMELY, NEUROVASCULAR DEVICES FOR THE TREATMENT OF NEUROLOGICAL DISEASES, IN CLASS 10 (U.S. CLS. 26, 39 AND 44).

FIRST USE 5-11-2008; IN COMMERCE 5-11-2008.

THE MARK CONSISTS OF STANDARD CHARACTERS WITHOUT CLAIM TO ANY PARTICULAR FONT, STYLE, SIZE, OR COLOR.

SN 77-220,868, FILED 7-2-2007.

ADA HAN, EXAMINING ATTORNEY

**Int. Cls.: 20 and 35**

**Prior U.S. Cls.: 2, 13, 22, 25, 32, 50, 100, 101, and 102**

**United States Patent and Trademark Office**

**Reg. No. 3,506,172**

**Registered Sep. 23, 2008**

**TRADEMARK  
SERVICE MARK  
PRINCIPAL REGISTER**



**AMERICAN SIGNATURE**

AMERICAN SIGNATURE, INC. (OHIO CORPORATION)  
1800 MOLER ROAD  
COLUMBUS, OH 43207

FOR: FURNITURE, IN CLASS 20 (U.S. CLS. 2, 13, 22, 25, 32 AND 50).

FIRST USE 6-0-2007; IN COMMERCE 6-0-2007.

FOR: RETAIL STORE SERVICES FEATURING FURNITURE, HOME FURNISHINGS AND OFFICE FURNISHINGS, IN CLASS 35 (U.S. CLS. 100, 101 AND 102).

FIRST USE 6-0-2007; IN COMMERCE 6-0-2007.

OWNER OF U.S. REG. NOS. 2,386,599, 3,197,140, AND OTHERS.

NO CLAIM IS MADE TO THE EXCLUSIVE RIGHT TO USE "AMERICAN", APART FROM THE MARK AS SHOWN.

THE MARK CONSISTS OF A CHAIR ABOVE THE WORDS "AMERICAN SIGNATURE".

SN 77-221,072, FILED 7-3-2007.

KEVIN DINALLO, EXAMINING ATTORNEY

**Int. Cl.: 25**

**Prior U.S. Cls.: 22 and 39**

**United States Patent and Trademark Office**

**Reg. No. 3,506,173**

**Registered Sep. 23, 2008**

**TRADEMARK  
PRINCIPAL REGISTER**



CALCADOS FERRACINI LTDA. (BRAZIL LIMITED COMPANY)  
RUA OLIVIO FENATTI, 149 DIST. INDUSTRIAL  
FRANCA/SP, BRAZIL

FOR: FOOTWEAR, SHOES, SANDALS, BELTS;  
CLOTHING, NAMELY, SHIRTS, T-SHIRTS, PANTS,  
SOCKS, BERMUDA SHORTS, IN CLASS 25 (U.S.  
CLS. 22 AND 39).

FIRST USE 11-21-2006; IN COMMERCE 10-16-2007.

OWNER OF U.S. REG. NOS. 2,679,263, 3,163,644,  
AND 3,259,160.

THE MARK CONSISTS OF THE WORD "FERRACINI" IN ALL CAPITAL LETTERS TO THE LEFT OF THE NUMBER "24" AND A LOWER CASE "H".

SN 77-221,448, FILED 7-3-2007.

G. MAYERSCHOFF, EXAMINING ATTORNEY

**Int. Cl.: 30**

**Prior U.S. Cl.: 46**

**United States Patent and Trademark Office**

**Reg. No. 3,506,174**

**Registered Sep. 23, 2008**

**TRADEMARK  
PRINCIPAL REGISTER**

The logo features the word "AmazonHoney" in a bold, black, sans-serif font. The letter "A" is stylized as a triangle with a leaf-like shape on top, resembling the Amazon logo. The "H" is also stylized with a leaf-like shape on top.

FARALDO, JOSE HENRIQUE FERNANDES  
(BRAZIL INDIVIDUAL)  
AVENIDA FLORIANO PEIXOTO, NO. 1-CENTRO  
BOTUCATU/SP, BRAZIL

FOR: ROYAL JELLY FOR FOOD PURPOSES;  
HONEY; MOLASSES SYRUP; MOLASSES FOR  
FOOD; PROPOLIS FOR FOOD PURPOSES, IN  
CLASS 30 (U.S. CL. 46).

FIRST USE 10-6-2004; IN COMMERCE 4-3-2007.

NO CLAIM IS MADE TO THE EXCLUSIVE  
RIGHT TO USE "AMAZON HONEY", APART FROM  
THE MARK AS SHOWN.

THE MARK CONSISTS OF THE WORDS "AMA-  
ZON" WITH A CAPITAL "A" AND "HONEY" WITH  
A CAPITAL "H" IN A STYLIZED FONT.

SN 77-221,484, FILED 7-3-2007.

H. M. FISHER, EXAMINING ATTORNEY

**Int. Cl.: 10**

**Prior U.S. Cls.: 26, 39, and 44**

**United States Patent and Trademark Office**

**Reg. No. 3,506,175**

**Registered Sep. 23, 2008**

**TRADEMARK  
PRINCIPAL REGISTER**



LE, VINH CHI (UNITED STATES INDIVIDUAL)  
9004 WESTBAY BLVD.  
TAMPA, FL 33615

OWNER OF U.S. REG. NO. 3,082,685.

FOR: BEAUTY SALON EQUIPMENT, NAMELY,  
MASSAGE CHAIR COMPRISING A MASSAGER  
AND A FOOTBATH SOLD TOGETHER AS A UNIT,  
IN CLASS 10 (U.S. CLS. 26, 39 AND 44).

THE MARK CONSISTS OF THE STYLIZED LET-  
TERS "LC".

SN 77-221,656, FILED 7-3-2007.

FIRST USE 10-16-2007; IN COMMERCE 10-16-2007.

MARIAM MAHMOUDI, EXAMINING ATTORNEY



**Int. Cl.: 3**

**Prior U.S. Cls.: 1, 4, 6, 50, 51, and 52**

**United States Patent and Trademark Office**

**Reg. No. 3,506,176**

**Registered Sep. 23, 2008**

**TRADEMARK  
PRINCIPAL REGISTER**

**CLEAN UP**

MBL/TIGI PRODUCTS, LP (TEXAS LIMITED  
PARTNERSHIP)  
2311 MIDWAY ROAD  
CARROLLTON, TX 75006

THE MARK CONSISTS OF STANDARD CHAR-  
ACTERS WITHOUT CLAIM TO ANY PARTICULAR  
FONT, STYLE, SIZE, OR COLOR.

FOR: HAIR CARE PRODUCTS FOR MEN, NAME-  
LY, HAIR SHAMPOO, HAIR CONDITIONERS, IN  
CLASS 3 (U.S. CLS. 1, 4, 6, 50, 51 AND 52).

SN 77-221,765, FILED 7-3-2007.

FIRST USE 8-1-2007; IN COMMERCE 8-1-2007.

JUDITH HELFMAN, EXAMINING ATTORNEY

**Int. Cl.: 3**

**Prior U.S. Cls.: 1, 4, 6, 50, 51, and 52**

**United States Patent and Trademark Office**

**Reg. No. 3,506,177**

**Registered Sep. 23, 2008**

**TRADEMARK  
PRINCIPAL REGISTER**

**PURE TEXTURE**

MBL/TIGI PRODUCTS, LP (TEXAS LIMITED  
PARTNERSHIP)

2311 MIDWAY ROAD

CARROLLTON, TX 75006

FOR: HAIR CARE PRODUCTS, NAMELY, HAIR  
WAXES, IN CLASS 3 (U.S. CLS. 1, 4, 6, 50, 51 AND 52).

FIRST USE 8-1-2007; IN COMMERCE 8-1-2007.

THE MARK CONSISTS OF STANDARD CHAR-  
ACTERS WITHOUT CLAIM TO ANY PARTICULAR  
FONT, STYLE, SIZE, OR COLOR.

NO CLAIM IS MADE TO THE EXCLUSIVE  
RIGHT TO USE "TEXTURE", APART FROM THE  
MARK AS SHOWN.

SN 77-221,768, FILED 7-3-2007.

JUDITH HELFMAN, EXAMINING ATTORNEY

**Int. Cl.: 1**

**Prior U.S. Cls.: 1, 5, 6, 10, 26, and 46**

**Reg. No. 3,506,178**

**United States Patent and Trademark Office**

**Registered Sep. 23, 2008**

---

**TRADEMARK  
PRINCIPAL REGISTER**

**VADER**

LOVELAND PRODUCTS, INC. (COLORADO  
CORPORATION)  
7251 W. 4TH STREET  
GREELEY, CO 80634

FOR: PENETRATING SURFACTANT ADJUVANT FOR AGRICULTURAL USES, NAMELY, FOR USE WITH PESTICIDES, IN CLASS 1 (U.S. CLS. 1, 5, 6, 10, 26 AND 46).

FIRST USE 5-15-2008; IN COMMERCE 5-15-2008.

THE MARK CONSISTS OF STANDARD CHARACTERS WITHOUT CLAIM TO ANY PARTICULAR FONT, STYLE, SIZE, OR COLOR.

THE FOREIGN WORDING IN THE MARK TRANSLATES INTO ENGLISH AS "FATHER".

SN 77-221,784, FILED 7-3-2007.

JOHN DWYER, EXAMINING ATTORNEY

**Int. Cl.: 41**

**Prior U.S. Cls.: 100, 101, and 107**

**United States Patent and Trademark Office**

**Reg. No. 3,506,179**

**Registered Sep. 23, 2008**

**SERVICE MARK  
PRINCIPAL REGISTER**

**H2OH!**

GJR ENTERTAINMENT, LLC (TEXAS LIMITED  
LIABILITY COMPANY)  
P.O. BOX 2689  
ALVIN, TX 77512

FOR: ENTERTAINMENT IN THE NATURE OF  
ON-GOING TELEVISION PROGRAMS IN THE  
FIELD OF BOATS AND BOATING; ENTERTAIN-  
MENT IN THE NATURE OF ON-GOING TELEVI-  
SION PROGRAMS IN THE FIELD OF BOATS AND  
BOATING VIA A GLOBAL COMPUTER NETWORK;  
AND ENTERTAINMENT IN THE NATURE OF ON-  
GOING TELEVISION PROGRAMS IN THE FIELD  
OF BOATS AND BOATING BROADCAST OVER

TELEVISION, SATELLITE, AUDIO, AND VIDEO  
MEDIA, IN CLASS 41 (U.S. CLS. 100, 101 AND 107).

FIRST USE 6-3-2007; IN COMMERCE 6-3-2007.

THE MARK CONSISTS OF STANDARD CHAR-  
ACTERS WITHOUT CLAIM TO ANY PARTICULAR  
FONT, STYLE, SIZE, OR COLOR.

SN 77-221,861, FILED 7-3-2007.

DANIEL BRODY, EXAMINING ATTORNEY

**Int. Cl.: 41**

**Prior U.S. Cls.: 100, 101, and 107**

**United States Patent and Trademark Office**

**Reg. No. 3,506,180**

**Registered Sep. 23, 2008**

**SERVICE MARK  
PRINCIPAL REGISTER**

**SIBLING DIVORCE**

ACORN CONSULTING, INC. (WASHINGTON  
CORPORATION)  
P.O. BOX 1800  
MARYSVILLE, WA 98270

FOR: EDUCATIONAL SERVICES, NAMELY,  
CONDUCTING WORKSHOPS, SPEECHES, PRESEN-  
TATIONS, AND CLASSES IN THE FIELD OF EL-  
DERCARE ISSUES AND LONG-TERM CARE  
PLANNING, IN CLASS 41 (U.S. CLS. 100, 101 AND  
107).

FIRST USE 6-28-2007; IN COMMERCE 6-28-2007.

THE MARK CONSISTS OF STANDARD CHAR-  
ACTERS WITHOUT CLAIM TO ANY PARTICULAR  
FONT, STYLE, SIZE, OR COLOR.

SN 77-222,279, FILED 7-5-2007.

JUDITH HELFMAN, EXAMINING ATTORNEY

**Int. Cl.: 35**

**Prior U.S. Cls.: 100, 101, and 102**

**United States Patent and Trademark Office**

**Reg. No. 3,506,181**

**Registered Sep. 23, 2008**

**SERVICE MARK  
PRINCIPAL REGISTER**

**Think it: Dream it: Live  
it!**

REICHSTADT, JODETTE L (UNITED STATES  
INDIVIDUAL)  
6655 BUCKLEY CIRCLE 305  
INVER GROVE HEIGHTS, MN 55076

FOR: ADVERTISING SERVICES, NAMELY, PRO-  
MOTING AND MARKETING THE GOODS AND  
SERVICES OF OTHERS THROUGH ALL PUBLIC  
COMMUNICATION MEANS , IN CLASS 35 (U.S.  
CLS. 100, 101 AND 102).

FIRST USE 1-1-2008; IN COMMERCE 1-1-2008.

THE MARK CONSISTS OF STANDARD CHAR-  
ACTERS WITHOUT CLAIM TO ANY PARTICULAR  
FONT, STYLE, SIZE, OR COLOR.

SN 77-225,359, FILED 7-9-2007.

BRENDAN MCCAULEY, EXAMINING ATTORNEY

**Int. Cl.: 31**

**Prior U.S. Cls.: 1 and 46**

**United States Patent and Trademark Office**

**Reg. No. 3,506,182**

**Registered Sep. 23, 2008**

**TRADEMARK  
PRINCIPAL REGISTER**



NOURICHE NUTRITION LTD (MISSOURI CORPORATION)  
21 NORMANDY DRIVE  
LAKE ST. LOUIS, MO 63367

FIRST USE 1-14-2008; IN COMMERCE 4-2-2008.

SN 77-225,367, FILED 7-9-2007.

FOR: LIVESTOCK FEED, IN CLASS 31 (U.S. CLS. 1 AND 46).

ANNE MADDEN, EXAMINING ATTORNEY

**Int. Cl.: 5**

**Prior U.S. Cls.: 6, 18, 44, 46, 51, and 52**

**Reg. No. 3,506,183**

**United States Patent and Trademark Office**

**Registered Sep. 23, 2008**

---

**TRADEMARK  
PRINCIPAL REGISTER**

**PHIX**

PHIX INC. (WASHINGTON CORPORATION)  
SUITE 600  
505 FIFTH AVENUE SOUTH  
SEATTLE, WA 98104

THE MARK CONSISTS OF STANDARD CHAR-  
ACTERS WITHOUT CLAIM TO ANY PARTICULAR  
FONT, STYLE, SIZE, OR COLOR.

FOR: DIETARY AND NUTRITIONAL SUPPLE-  
MENTS, IN CLASS 5 (U.S. CLS. 6, 18, 44, 46, 51 AND  
52).

SN 77-226,254, FILED 7-10-2007.

FIRST USE 2-5-2008; IN COMMERCE 4-5-2008.

THEODORE MCBRIDE, EXAMINING ATTORNEY



**Int. Cl.: 7**

**Prior U.S. Cls.: 13, 19, 21, 23, 31, 34, and 35**

**Reg. No. 3,506,184**

**United States Patent and Trademark Office**

**Registered Sep. 23, 2008**

**TRADEMARK  
PRINCIPAL REGISTER**

**E<sup>2</sup> Energy (r)Evolution**

HELIX WIND, INC. (NEVADA CORPORATION)  
1848 COMMERCIAL ST.  
SAN DIEGO, CA 92113

FOR: WIND TURBINES AND ACCESSORIES FOR  
WIND TURBINES, NAMELY, INVERTERS,  
CABLES, COLUMNS, MOUNTING TURBINES  
AND PLATFORMS FOR MOUNTING TURBINES  
SOLD AS A UNIT, IN CLASS 7 (U.S. CLS. 13, 19, 21, 23,  
31, 34 AND 35).

FIRST USE 6-30-2007; IN COMMERCE 6-30-2007.

NO CLAIM IS MADE TO THE EXCLUSIVE  
RIGHT TO USE "ENERGY", APART FROM THE  
MARK AS SHOWN.

THE MARK CONSISTS OF THE LETTER E WITH  
A SUPERSCRIP NUMERAL 2 AND THE WORD  
ENERGY FOLLOWED BY THE LETTER R IN  
PARENTHESIS FOLLOWED BY THE WORD EVO-  
LUTION.

SN 77-226,913, FILED 7-11-2007.

CHRISTINA SOBRAL, EXAMINING ATTORNEY

**Int. Cl.: 16**

**Prior U.S. Cls.: 2, 5, 22, 23, 29, 37, 38, and 50**

**United States Patent and Trademark Office**

**Reg. No. 3,506,185**

**Registered Sep. 23, 2008**

**TRADEMARK  
PRINCIPAL REGISTER**

**TRILLIUM**

STORK GRAMS, INC. (OHIO CORPORATION)  
SUITE K  
50 WEST TECHNECENTER DRIVE  
MILFORD, OH 45150

THE MARK CONSISTS OF STANDARD CHAR-  
ACTERS WITHOUT CLAIM TO ANY PARTICULAR  
FONT, STYLE, SIZE, OR COLOR.

FOR: STATIONERY; PRINTED INVITATIONS;  
ANNOUNCEMENT CARDS; NOTE CARDS, IN  
CLASS 16 (U.S. CLS. 2, 5, 22, 23, 29, 37, 38 AND 50).

SN 77-227,075, FILED 7-11-2007.

FIRST USE 10-20-2007; IN COMMERCE 10-20-2007.

AISHA CLARKE, EXAMINING ATTORNEY

**Int. Cl.: 35**

**Prior U.S. Cls.: 100, 101, and 102**

**United States Patent and Trademark Office**

**Reg. No. 3,506,186**

**Registered Sep. 23, 2008**

**SERVICE MARK  
PRINCIPAL REGISTER**

# SmartMetric

WATSON, SCOTT C. (UNITED STATES INDIVIDUAL)  
STE.1003  
5850 TOWN AND COUNTRY BLVD  
FRISCO, TX 75034

FOR: PROVIDING STATISTICAL ANALYSIS OF DATA FOR BUSINESSES ON THE IMPACT OF TRAINING IN NEW BUSINESS PROCESSES, METHODS OR TOOLS AND CONSULTATION RELATED THERETO, IN CLASS 35 (U.S. CLS. 100, 101 AND 102).

FIRST USE 6-13-2007; IN COMMERCE 6-13-2007.

THE MARK CONSISTS OF STANDARD CHARACTERS WITHOUT CLAIM TO ANY PARTICULAR FONT, STYLE, SIZE, OR COLOR.

SN 77-227,079, FILED 7-11-2007.

AISHA CLARKE, EXAMINING ATTORNEY

**Int. Cl.: 41**

**Prior U.S. Cls.: 100, 101, and 107**

**United States Patent and Trademark Office**

**Reg. No. 3,506,187**

**Registered Sep. 23, 2008**

**SERVICE MARK  
PRINCIPAL REGISTER**

**GREEN ROOM MUSIC SOURCE**

GROSSMAN, CRAIG P. (UNITED STATES INDIVIDUAL)  
4621 34TH AVENUE SOUTH  
MINNEAPOLIS, MN 55406

FOR: BOOKING AND SCHEDULING OF ENTERTAINMENT SERVICES, NAMELY, BOOKING LIVE PERFORMANCES BY MUSICAL GROUPS AND OTHER ENTERTAINERS, IN CLASS 41 (U.S. CLS. 100, 101 AND 107).

FIRST USE 8-1-2006; IN COMMERCE 10-15-2007.

THE MARK CONSISTS OF STANDARD CHARACTERS WITHOUT CLAIM TO ANY PARTICULAR FONT, STYLE, SIZE, OR COLOR.

NO CLAIM IS MADE TO THE EXCLUSIVE RIGHT TO USE "MUSIC", APART FROM THE MARK AS SHOWN.

SN 77-227,220, FILED 7-11-2007.

BILL DAWE, EXAMINING ATTORNEY

Int. Cl.: 35

Prior U.S. Cls.: 100, 101, and 102

United States Patent and Trademark Office

Reg. No. 3,506,188

Registered Sep. 23, 2008

SERVICE MARK  
PRINCIPAL REGISTER



*Printing...Promotion...Perfection!*

BOWDRING, JAMES (UNITED STATES INDIVIDUAL)  
SUITE 34  
407 R. MYSTIC AVENUE  
MEDFORD, MA 02155

FOR: PROMOTING THE GOODS AND SERVICES OF OTHERS BY DISTRIBUTING ADVERTISING MATERIALS THROUGH A VARIETY OF METHODS, IN CLASS 35 (U.S. CLS. 100, 101 AND 102).

FIRST USE 5-9-2008; IN COMMERCE 5-9-2008.

NO CLAIM IS MADE TO THE EXCLUSIVE RIGHT TO USE "PROMOTIONS", "PROMOTION"

AND "PRINTING", APART FROM THE MARK AS SHOWN.

THE STIPPLING IS A FEATURE OF THE MARK AND DOES NOT INDICATE COLOR.

THE MARK CONSISTS OF A CIRCULAR DESIGN APPEARING TO THE LEFT OF THE WORDS "SUPERIOR PROMOTIONS" AND ABOVE THE WORDS "PRINTING PROMOTION PERFECTION".

SN 77-228,086, FILED 7-12-2007.

JEFF DEFORD, EXAMINING ATTORNEY

**Int. Cl.: 9**

**Prior U.S. Cls.: 21, 23, 26, 36, and 38**

**United States Patent and Trademark Office**

**Reg. No. 3,506,189**

**Registered Sep. 23, 2008**

**TRADEMARK  
PRINCIPAL REGISTER**

# RetroOffice

PLANAMESA INC. (CALIFORNIA CORPORATION)  
P.O. BOX 2427  
SANTA CLARA, CA 95055

FOR: COMPUTER PROGRAMS FOR BUSINESS AND PERSONAL USE, NAMELY, WORD PROCESSING PROGRAMS; GRAPHICS AUTHORING PROGRAMS; ELECTRONIC SPREADSHEET PROGRAMS; DATABASE PROGRAMS; PRESENTATION GRAPHICS PROGRAMS, IN CLASS 9 (U.S. CLS. 21, 23, 26, 36 AND 38).

FIRST USE 7-12-2007; IN COMMERCE 8-25-2007.

THE MARK CONSISTS OF STANDARD CHARACTERS WITHOUT CLAIM TO ANY PARTICULAR FONT, STYLE, SIZE, OR COLOR.

SN 77-228,280, FILED 7-12-2007.

MATTHEW EINSTEIN, EXAMINING ATTORNEY

**Int. Cls.: 9 and 18**

**Prior U.S. Cls.: 1, 2, 3, 21, 22, 23, 26, 36, 38, and 41**

**United States Patent and Trademark Office**

**Reg. No. 3,506,190**

**Registered Sep. 23, 2008**

**TRADEMARK  
PRINCIPAL REGISTER**

**UNITY ICT**

SAMSONITE CORPORATION (DELAWARE CORPORATION)  
575 WEST STREET, SUITE 110  
MANSFIELD, MA 02048

FOR: LAPTOP CARRYING CASES; BACKPACKS ESPECIALLY ADAPTED FOR HOLDING LAPTOPS, IN CLASS 9 (U.S. CLS. 21, 23, 26, 36 AND 38).

FIRST USE 9-1-2007; IN COMMERCE 9-1-2007.

FOR: LUGGAGE; SUITCASES; BRIEFCASES; BACKPACKS; MESSENGER BAGS; SHOULDER BAGS, IN CLASS 18 (U.S. CLS. 1, 2, 3, 22 AND 41).

FIRST USE 9-1-2007; IN COMMERCE 9-1-2007.

THE MARK CONSISTS OF STANDARD CHARACTERS WITHOUT CLAIM TO ANY PARTICULAR FONT, STYLE, SIZE, OR COLOR.

SN 77-228,794, FILED 7-13-2007.

ALEXANDER L. POWERS, EXAMINING ATTORNEY

**Int. Cl.: 41**

**Prior U.S. Cls.: 100, 101, and 107**

**United States Patent and Trademark Office**

**Reg. No. 3,506,191**

**Registered Sep. 23, 2008**

**SERVICE MARK  
PRINCIPAL REGISTER**

**CUMBRE NORTEÑA**

LECHUGA, JOSE A. (UNITED STATES INDIVIDUAL)  
193 E. 48ST.  
LOS ANGELES, CA 90011

THE MARK CONSISTS OF STANDARD CHARACTERS WITHOUT CLAIM TO ANY PARTICULAR FONT, STYLE, SIZE, OR COLOR.

FOR: ENTERTAINMENT SERVICES IN THE FIELD OF LIVE MUSICAL PERFORMANCES BY A MUSICAL BAND, IN CLASS 41 (U.S. CLS. 100, 101 AND 107).

SN 77-229,579, FILED 7-13-2007.

FIRST USE 5-19-2000; IN COMMERCE 10-5-2001.

DOMINICK J. SALEMI, EXAMINING ATTORNEY



**Int. Cl.: 41**

**Prior U.S. Cls.: 100, 101, and 107**

**United States Patent and Trademark Office**

**Reg. No. 3,506,192**

**Registered Sep. 23, 2008**

**SERVICE MARK  
PRINCIPAL REGISTER**

# Bailiff

SIEGEL, JOSHUA D (UNITED STATES INDIVIDUAL)  
1229 MAPLE AVENUE  
WILMETTE, IL 60091

FOR: ENTERTAINMENT IN THE NATURE OF VISUAL AND AUDIO PERFORMANCES, NAMELY, MUSICAL BAND, ROCK GROUP, GYMNASTIC, DANCE, AND BALLET PERFORMANCES; ENTERTAINMENT NAMELY, LIVE PERFORMANCES BY A MUSICAL BAND; ENTERTAINMENT, NAMELY LIVE PERFORMANCES BY MUSICAL BANDS, IN CLASS 41 (U.S. CLS. 100, 101 AND 107).

FIRST USE 3-1-2007; IN COMMERCE 5-1-2007.

THE MARK CONSISTS OF STANDARD CHARACTERS WITHOUT CLAIM TO ANY PARTICULAR FONT, STYLE, SIZE, OR COLOR.

SN 77-230,622, FILED 7-16-2007.

MICHAEL ENGEL, EXAMINING ATTORNEY

**Int. Cl.: 15**

**Prior U.S. Cls.: 2, 21, and 36**

**United States Patent and Trademark Office**

**Reg. No. 3,506,193**

**Registered Sep. 23, 2008**

**TRADEMARK  
PRINCIPAL REGISTER**

**RESONA**

BURKART-PHELAN, INC. (MASSACHUSETTS  
CORPORATION)  
2 SHAKER ROAD, #D107  
SHIRLEY, MA 01464

FOR: WOODWIND MUSICAL INSTRUMENTS IN  
THE NATURE OF BASSOONS, CLARINETS, CON-  
TRABASSOONS, ENGLISH HORNS, FLUTES, PIC-  
COLOS, SAXOPHONES, HEADJOINTS FOR  
FLUTES AND HEADJOINTS FOR PICCOLOS, IN  
CLASS 15 (U.S. CLS. 2, 21 AND 36).

FIRST USE 6-11-2008; IN COMMERCE 6-17-2008.

THE MARK CONSISTS OF STANDARD CHAR-  
ACTERS WITHOUT CLAIM TO ANY PARTICULAR  
FONT, STYLE, SIZE, OR COLOR.

THE TERM "RESONA" HAS NO MEANING IN A  
FOREIGN LANGUAGE.

SN 77-231,980, FILED 7-17-2007.

BENJAMIN OKEKE, EXAMINING ATTORNEY

**Int. Cl.: 21**

**Prior U.S. Cls.: 2, 13, 23, 29, 30, 33, 40, and 50**

**United States Patent and Trademark Office**

**Reg. No. 3,506,194**

**Registered Sep. 23, 2008**

**TRADEMARK  
PRINCIPAL REGISTER**

**POTTEASE**

OPTILIFE PRODUCTS, INC. (DELAWARE COR-  
PORATION)  
488 EAST DUNBARTON ROAD  
GOFFSTOWN, NH 030452817

THE MARK CONSISTS OF STANDARD CHAR-  
ACTERS WITHOUT CLAIM TO ANY PARTICULAR  
FONT, STYLE, SIZE, OR COLOR.

FOR: FITTED DISPOSABLE PLASTIC LINERS  
FOR TODDLER POTTY TRAINER SEATS, IN CLASS  
21 (U.S. CLS. 2, 13, 23, 29, 30, 33, 40 AND 50).

SN 77-232,345, FILED 7-18-2007.

FIRST USE 10-15-2007; IN COMMERCE 11-1-2007.

SCOTT BIBB, EXAMINING ATTORNEY

**Int. Cl.: 11**

**Prior U.S. Cls.: 13, 21, 23, 31, and 34**

**United States Patent and Trademark Office**

**Reg. No. 3,506,195**

**Registered Sep. 23, 2008**

**TRADEMARK  
PRINCIPAL REGISTER**

**ENERGIZER E2 LITHIUM**

EVEREADY BATTERY COMPANY, INC. (DELA-  
WARE CORPORATION)  
533 MARYVILLE UNIVERSITY DRIVE  
ST. LOUIS, MO 63141

FOR: FLASHLIGHTS, IN CLASS 11 (U.S. CLS. 13,  
21, 23, 31 AND 34).

FIRST USE 3-10-2008; IN COMMERCE 3-10-2008.

THE MARK CONSISTS OF STANDARD CHAR-  
ACTERS WITHOUT CLAIM TO ANY PARTICULAR  
FONT, STYLE, SIZE, OR COLOR.

OWNER OF U.S. REG. NOS. 2,612,594, 2,957,320,  
AND OTHERS.

NO CLAIM IS MADE TO THE EXCLUSIVE  
RIGHT TO USE "LITHIUM", APART FROM THE  
MARK AS SHOWN.

SN 77-232,548, FILED 7-18-2007.

SANI KHOURI, EXAMINING ATTORNEY

**Int. Cl.: 3**

**Prior U.S. Cls.: 1, 4, 6, 50, 51, and 52**

**United States Patent and Trademark Office**

**Reg. No. 3,506,196**

**Registered Sep. 23, 2008**

**TRADEMARK  
PRINCIPAL REGISTER**

**Alchemie` Innovative Skin  
Care**

BODY NATURALS LTD. (NEW YORK CORPORATION)  
333 NEW YORK AVENUE  
HUNTINGTON, NY 11743

FOR: COSMETIC CREAMS FOR SKIN CARE; COSMETIC PREPARATIONS FOR BODY CARE; COSMETIC PREPARATIONS FOR SKIN RENEWAL; SKIN ABRASIVE PREPARATIONS; SKIN AND BODY TOPICAL LOTIONS, CREAMS AND OILS FOR COSMETIC USE; SKIN CARE PREPARATIONS, NAMELY, CHEMICAL PEELS FOR SKIN; SKIN CARE PREPARATIONS, NAMELY, FRUIT ACID PEELS FOR SKIN; SKIN CARE PRODUCTS, NAMELY, NON-MEDICATED SKIN SERUM; SKIN CLARIFIERS; SKIN CLEANSERS; SKIN CLEANSING CREAM; SKIN CLEANSING LOTION; SKIN CONDITIONERS; SKIN CREAM; SKIN CREAMS; SKIN CREAMS IN LIQUID AND IN SOLID FORM; SKIN CREAMS IN LIQUID AND SOLID; SKIN

EMOLLIENTS; SKIN LOTION; SKIN LOTIONS; SKIN MASKS; SKIN MOISTURIZER; SKIN MOISTURIZER MASKS; SKIN TEXTURIZERS; SKIN TONERS, IN CLASS 3 (U.S. CLS. 1, 4, 6, 50, 51 AND 52).

FIRST USE 1-0-2008; IN COMMERCE 1-0-2008.

THE MARK CONSISTS OF STANDARD CHARACTERS WITHOUT CLAIM TO ANY PARTICULAR FONT, STYLE, SIZE, OR COLOR.

NO CLAIM IS MADE TO THE EXCLUSIVE RIGHT TO USE "SKIN CARE", APART FROM THE MARK AS SHOWN.

SN 77-232,776, FILED 7-18-2007.

DORITT L. CARROLL, EXAMINING ATTORNEY

**Int. Cl.: 32**

**Prior U.S. Cls.: 45, 46, and 48**

**United States Patent and Trademark Office**

**Reg. No. 3,506,197**

**Registered Sep. 23, 2008**

**TRADEMARK  
PRINCIPAL REGISTER**

**FOR YOUR LIPS ONLY**

EVERFRESH BEVERAGES, INC. (DELAWARE  
CORPORATION)  
6600 EAST 9 MILE ROAD  
WARREN, MI 48091

THE MARK CONSISTS OF STANDARD CHAR-  
ACTERS WITHOUT CLAIM TO ANY PARTICULAR  
FONT, STYLE, SIZE, OR COLOR.

FOR: SOFT DRINKS, ENERGY DRINKS, NON-  
ALCOHOLIC BEVERAGES CONTAINING FRUIT  
JUICES, IN CLASS 32 (U.S. CLS. 45, 46 AND 48).

SN 77-232,946, FILED 7-18-2007.

FIRST USE 4-30-2007; IN COMMERCE 4-30-2007.

DEBRA LEE, EXAMINING ATTORNEY

**Int. Cl.: 35**

**Prior U.S. Cls.: 100, 101, and 102**

**United States Patent and Trademark Office**

**Reg. No. 3,506,198**

**Registered Sep. 23, 2008**

**SERVICE MARK  
PRINCIPAL REGISTER**



BI-LO, LLC (DELAWARE LIMITED LIABILITY  
COMPANY)  
208 BI-LO BOULEVARD  
GREENVILLE, SC 29607

FOR: RETAIL GROCERY STORE SERVICES, IN  
CLASS 35 (U.S. CLS. 100, 101 AND 102).

FIRST USE 6-0-2007; IN COMMERCE 6-0-2007.

OWNER OF U.S. REG. NOS. 1,880,217, 1,929,328,  
AND OTHERS.

THE MARK CONSISTS OF "SUPER BI-LO" WITH  
LEAF AS HYPHEN.

SN 77-234,871, FILED 7-20-2007.

CHERYL CLAYTON, EXAMINING ATTORNEY

**Int. Cl.: 36**

**Prior U.S. Cls.: 100, 101, and 102**

**United States Patent and Trademark Office**

**Reg. No. 3,506,199**

**Registered Sep. 23, 2008**

**SERVICE MARK  
PRINCIPAL REGISTER**

**BOOBIES BASH**

HURST, LEIGH A. (UNITED STATES INDIVIDUAL)  
209 SPRUCE STREET  
MIDDLETOWN, PA 17057

FOR: CHARITABLE FUND RAISING; ACCEPTING AND ADMINISTERING MONETARY CHARITABLE CONTRIBUTIONS, IN CLASS 36 (U.S. CLS. 100, 101 AND 102).

FIRST USE 9-1-2007; IN COMMERCE 9-1-2007.

THE MARK CONSISTS OF STANDARD CHARACTERS WITHOUT CLAIM TO ANY PARTICULAR FONT, STYLE, SIZE, OR COLOR.

NO CLAIM IS MADE TO THE EXCLUSIVE RIGHT TO USE "BASH", APART FROM THE MARK AS SHOWN.

SN 77-235,829, FILED 7-23-2007.

SKYE YOUNG, EXAMINING ATTORNEY



**Int. Cl.: 32**

**Prior U.S. Cls.: 45, 46, and 48**

**United States Patent and Trademark Office**

**Reg. No. 3,506,200**

**Registered Sep. 23, 2008**

**TRADEMARK  
PRINCIPAL REGISTER**

**METROELECTRO**

SOMA BEVERAGE COMPANY, LLC (DELA-  
WARE LIMITED LIABILITY COMPANY)

P.O. BOX 885462

SAN FRANCISCO, CA 94188

FOR: BOTTLED DRINKING WATER, IN CLASS  
32 (U.S. CLS. 45, 46 AND 48).

FIRST USE 1-1-2008; IN COMMERCE 6-16-2008.

THE MARK CONSISTS OF STANDARD CHAR-  
ACTERS WITHOUT CLAIM TO ANY PARTICULAR  
FONT, STYLE, SIZE, OR COLOR.

OWNER OF U.S. REG. NOS. 2,961,414, 2,997,272,  
AND 3,233,056.

SN 77-236,037, FILED 7-23-2007.

NICHOLAS ALTREE, EXAMINING ATTORNEY

**Int. Cl.: 37**

**Prior U.S. Cls.: 100, 103, and 106**

**United States Patent and Trademark Office**

**Reg. No. 3,506,201**

**Registered Sep. 23, 2008**

**SERVICE MARK  
PRINCIPAL REGISTER**

**FLOOD TECH**

FRENZLEY, SAMEER (UNITED STATES INDIVIDUAL)  
SUITE C-329  
70 225 HWY. 111  
RANCHO MIRAGE, CA 92270

FOR: RESTORATION IN THE FIELD OF BUILDINGS AND STRUCTURAL DAMAGE CAUSED BY WATER DISASTERS, IN CLASS 37 (U.S. CLS. 100, 103 AND 106).

FIRST USE 8-1-2007; IN COMMERCE 8-1-2007.

THE MARK CONSISTS OF STANDARD CHARACTERS WITHOUT CLAIM TO ANY PARTICULAR FONT, STYLE, SIZE, OR COLOR.

NO CLAIM IS MADE TO THE EXCLUSIVE RIGHT TO USE "FLOOD", APART FROM THE MARK AS SHOWN.

SN 77-236,410, FILED 7-23-2007.

ADA HAN, EXAMINING ATTORNEY

**Int. Cls.: 41 and 42**

**Prior U.S. Cls.: 100, 101, and 107**

**United States Patent and Trademark Office**

**Reg. No. 3,506,202**

**Registered Sep. 23, 2008**

**SERVICE MARK  
PRINCIPAL REGISTER**

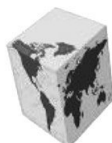

**TEMENOS**

TEMENOS HEADQUARTERS SA (SWITZERLAND CORPORATION)  
PLACE DES PHILOSOPHES 18  
1205 GENEVA, SWITZERLAND

FOR: EDUCATIONAL SERVICES, NAMELY, ORGANIZING CONFERENCES, CONDUCTING PRACTICAL TRAINING AND DEMONSTRATIONS, AND TEACHING WORKSHOPS FOR USE IN ADMINISTRATION OF BANKING SOFTWARE FOR FINANCIAL INSTITUTIONS, IN CLASS 41 (U.S. CLS. 100, 101 AND 107).

FIRST USE 11-1-2007; IN COMMERCE 11-1-2007.

FOR: COMPUTER PROGRAMMING, MAINTENANCE OF COMPUTER SOFTWARE, UPDATING

OF COMPUTER SOFTWARE, COMPUTER SOFTWARE DESIGN AND COMPUTER SOFTWARE ANALYSIS, IN CLASS 42 (U.S. CLS. 100 AND 101).

FIRST USE 11-1-2007; IN COMMERCE 11-1-2007.

OWNER OF U.S. REG. NOS. 2,611,156, 3,151,739, AND OTHERS.

THE ENGLISH TRANSLATION OF THE WORD "TEMENOS" IN THE MARK IS SACRED PLACE.

SN 77-237,458, FILED 7-24-2007.

WILLIAM VERHOSEK, EXAMINING ATTORNEY

**Int. Cls.: 41 and 42**

**Prior U.S. Cls.: 100, 101, and 107**

**United States Patent and Trademark Office**

**Reg. No. 3,506,203**

**Registered Sep. 23, 2008**

**SERVICE MARK  
PRINCIPAL REGISTER**

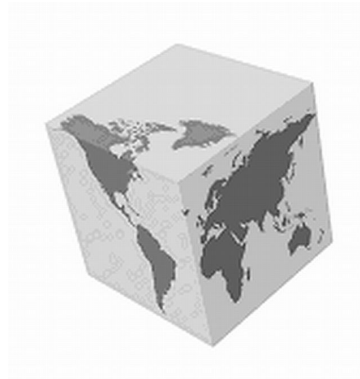

TEMENOS HEADQUARTERS SA (SWITZERLAND CORPORATION)  
PLACE DES PHILOSOPHES 18  
1205 GENEVA, SWITZERLAND

FOR: EDUCATIONAL SERVICES, NAMELY, ORGANIZING CONFERENCES, CONDUCTING PRACTICAL TRAINING AND DEMONSTRATIONS, AND TEACHING WORKSHOPS FOR USE IN ADMINISTRATION OF BANKING SOFTWARE FOR FINANCIAL INSTITUTIONS, IN CLASS 41 (U.S. CLS. 100, 101 AND 107).

FIRST USE 11-1-2007; IN COMMERCE 11-1-2007.

FOR: COMPUTER PROGRAMMING, MAINTENANCE OF COMPUTER SOFTWARE, UPDATING OF COMPUTER SOFTWARE, COMPUTER SOFTWARE DESIGN AND COMPUTER SOFTWARE ANALYSIS, IN CLASS 42 (U.S. CLS. 100 AND 101).

FIRST USE 11-1-2007; IN COMMERCE 11-1-2007.

OWNER OF U.S. REG. NOS. 2,611,156 AND 2,629,668.

SN 77-237,516, FILED 7-24-2007.

WILLIAM VERHOSEK, EXAMINING ATTORNEY

**Int. Cls.: 36 and 41**

**Prior U.S. Cls.: 100, 101, 102, and 107**

**United States Patent and Trademark Office**

**Reg. No. 3,506,204**

**Registered Sep. 23, 2008**

**SERVICE MARK  
PRINCIPAL REGISTER**

# FirstImage

FIRST NATIONAL OF NEBRASKA, INC. (NEBRASKA CORPORATION)  
1620 DODGE STREET  
STOP 3290  
OMAHA, NE 681973290

FOR: BANKING SERVICES, IN CLASS 36 (U.S. CLS. 100, 101 AND 102).

FIRST USE 7-1-2007; IN COMMERCE 7-1-2007.

FOR: CHECK PROCESSING SERVICES, NAME-  
LY, CHECK IMAGING SERVICES, IN CLASS 41 (U.S.  
CLS. 100, 101 AND 107).

FIRST USE 7-1-2007; IN COMMERCE 7-1-2007.

THE MARK CONSISTS OF STANDARD CHARACTERS WITHOUT CLAIM TO ANY PARTICULAR FONT, STYLE, SIZE, OR COLOR.

SN 77-238,323, FILED 7-25-2007.

ALICE BENMAMAN, EXAMINING ATTORNEY

**Int. Cl.: 43**

**Prior U.S. Cls.: 100 and 101**

**United States Patent and Trademark Office**

**Reg. No. 3,506,205**

**Registered Sep. 23, 2008**

**SERVICE MARK  
PRINCIPAL REGISTER**

**LAZY BONZ BOARDING HOUSE**

GRESCH, GORDON (UNITED STATES INDIVIDUAL)

5425 RESSIE DRIVE

JACKSONVILLE, FL 32217

FOR: BOARDING FOR ANIMALS, IN CLASS 43 (U.S. CLS. 100 AND 101).

FIRST USE 7-15-2008; IN COMMERCE 7-15-2008.

THE MARK CONSISTS OF STANDARD CHARACTERS WITHOUT CLAIM TO ANY PARTICULAR FONT, STYLE, SIZE, OR COLOR.

NO CLAIM IS MADE TO THE EXCLUSIVE RIGHT TO USE "BOARDING HOUSE", APART FROM THE MARK AS SHOWN.

SN 77-241,470, FILED 7-29-2007.

CYNTHIA SLOAN, EXAMINING ATTORNEY

**Int. Cl.: 19**

**Prior U.S. Cls.: 1, 12, 33, and 50**

**United States Patent and Trademark Office**

**Reg. No. 3,506,206**

**Registered Sep. 23, 2008**

**TRADEMARK  
PRINCIPAL REGISTER**

**WIRELITE**

J.R. FOUR LTD. (WASHINGTON CORPORATION), DBA TECHNICAL GLASS PRODUCTS,  
606 - 6TH STREET SOUTH  
KIRKLAND, WA 98033

FOR: FIRE-RATED GLASS; GLASS FOR WINDOWS; GLASS FOR DOORS; COMMON SHEET GLASS FOR BUILDING; COLORED SHEET GLASS FOR BUILDING; GLASS PANES , IN CLASS 19 (U.S. CLS. 1, 12, 33 AND 50).

FIRST USE 9-0-2007; IN COMMERCE 9-0-2007.

THE MARK CONSISTS OF STANDARD CHARACTERS WITHOUT CLAIM TO ANY PARTICULAR FONT, STYLE, SIZE, OR COLOR.

SN 77-241,800, FILED 7-30-2007.

ALICE BENMAMAN, EXAMINING ATTORNEY

**Int. Cl.: 41**

**Prior U.S. Cls.: 100, 101, and 107**

**United States Patent and Trademark Office**

**Reg. No. 3,506,207**

**Registered Sep. 23, 2008**

**SERVICE MARK  
PRINCIPAL REGISTER**

**rebel inc.**

ADAM ARMSTRONG (UNITED STATES INDIVIDUAL), DBA REBEL INC.,  
1428 HANOVER ST.  
BALTIMORE, MD 21230 AND  
KEVIN SYCHTA (UNITED STATES INDIVIDUAL),  
DBA REBEL INC.,  
1428 HANOVER ST.  
BALTIMORE, MD 21230

FOR: ENTERTAINMENT IN THE NATURE OF  
LIVE PERFORMANCES BY MUSIC, IN CLASS 41  
(U.S. CLS. 100, 101 AND 107).

FIRST USE 9-1-2001; IN COMMERCE 4-5-2008.

THE MARK CONSISTS OF STANDARD CHARACTERS WITHOUT CLAIM TO ANY PARTICULAR FONT, STYLE, SIZE, OR COLOR.

NO CLAIM IS MADE TO THE EXCLUSIVE RIGHT TO USE "INC.", APART FROM THE MARK AS SHOWN.

SN 77-243,327, FILED 7-31-2007.

BILL DAWE, EXAMINING ATTORNEY



**Int. Cl.: 16**

**Prior U.S. Cls.: 2, 5, 22, 23, 29, 37, 38, and 50**

**Reg. No. 3,506,208**

**United States Patent and Trademark Office**

**Registered Sep. 23, 2008**

---

**TRADEMARK  
PRINCIPAL REGISTER**

**CLEAR IMPRESSIONS**

MEADWESTVACO CORPORATION (DELAWARE  
CORPORATION)  
MEADWESTVACO CORPORATE CENTER  
11013 WEST BROAD STREET  
GLEN ALLEN, VA 23060

FOR: PERSONAL ORGANIZERS; NOTEBOOKS;  
STUDENT PLANNERS; WEEKLY ASSIGNMENT  
BOOKS, IN CLASS 16 (U.S. CLS. 2, 5, 22, 23, 29, 37, 38  
AND 50).

FIRST USE 3-24-2004; IN COMMERCE 3-24-2004.

THE MARK CONSISTS OF STANDARD CHAR-  
ACTERS WITHOUT CLAIM TO ANY PARTICULAR  
FONT, STYLE, SIZE, OR COLOR.

SN 77-245,459, FILED 8-2-2007.

JASON BLAIR, EXAMINING ATTORNEY

**Int. Cl.: 25**

**Prior U.S. Cls.: 22 and 39**

**United States Patent and Trademark Office**

**Reg. No. 3,506,209**

**Registered Sep. 23, 2008**

**TRADEMARK  
PRINCIPAL REGISTER**

# Queensberry Rules

UNDISPUTED INTERNATIONAL LLC (NEVADA  
LIMITED LIABILITY COMPANY)  
4410 MASSACHUSETTS AVE NW # 318  
WASHINGTON, DC 20016

THE MARK CONSISTS OF STANDARD CHAR-  
ACTERS WITHOUT CLAIM TO ANY PARTICULAR  
FONT, STYLE, SIZE, OR COLOR.

FOR: SHORT-SLEEVED T-SHIRTS, IN CLASS 25  
(U.S. CLS. 22 AND 39).

SN 77-246,450, FILED 8-3-2007.

FIRST USE 5-5-2008; IN COMMERCE 5-5-2008.

ANNE E. GUSTASON, EXAMINING ATTORNEY

**Int. Cl.: 5**

**Prior U.S. Cls.: 6, 18, 44, 46, 51, and 52**

**United States Patent and Trademark Office**

**Reg. No. 3,506,210**

**Registered Sep. 23, 2008**

**TRADEMARK  
PRINCIPAL REGISTER**

**SLIMMETRY**

ALTICOR INC. (MICHIGAN CORPORATION)  
7575 FULTON STREET EAST  
78-2G  
ADA, MI 49355

THE MARK CONSISTS OF STANDARD CHAR-  
ACTERS WITHOUT CLAIM TO ANY PARTICULAR  
FONT, STYLE, SIZE, OR COLOR.

FOR: DIETARY AND NUTRITIONAL SUPPLE-  
MENTS, IN CLASS 5 (U.S. CLS. 6, 18, 44, 46, 51 AND  
52).

SN 77-248,913, FILED 8-7-2007.

FIRST USE 2-15-2008; IN COMMERCE 2-15-2008.

MARGERY A. TIERNEY, EXAMINING ATTORNEY

**Int. Cl.: 9**

**Prior U.S. Cls.: 21, 23, 26, 36, and 38**

**United States Patent and Trademark Office**

**Reg. No. 3,506,211**

**Registered Sep. 23, 2008**

**TRADEMARK  
PRINCIPAL REGISTER**

# CoolPA

PARAGON COMMUNICATIONS LTD. (ISRAEL  
CORPORATION)  
6 PAL-YAM AVENUE  
HAIFA, ISRAEL

THE MARK CONSISTS OF STANDARD CHAR-  
ACTERS WITHOUT CLAIM TO ANY PARTICULAR  
FONT, STYLE, SIZE, OR COLOR.

FOR: AMPLIFIER FOR WIRELESS COMMUNI-  
CATIONS; AMPLIFIERS; POWER AMPLIFIERS, IN  
CLASS 9 (U.S. CLS. 21, 23, 26, 36 AND 38).

SN 77-249,670, FILED 8-8-2007.

FIRST USE 10-2-2007; IN COMMERCE 10-2-2007.

MICHAEL LITZAU, EXAMINING ATTORNEY

**Int. Cl.: 36**

**Prior U.S. Cls.: 100, 101, and 102**

**United States Patent and Trademark Office**

**Reg. No. 3,506,212**

**Registered Sep. 23, 2008**

**SERVICE MARK  
PRINCIPAL REGISTER**



HOUSE HANDLER LLC (INDIANA LIMITED  
LIABILITY COMPANY)  
730 N LEBANON ST  
LEBANON, IN 46052

THE MARK CONSISTS OF STANDARD CHAR-  
ACTERS WITHOUT CLAIM TO ANY PARTICULAR  
FONT, STYLE, SIZE, OR COLOR.

FOR: REAL ESTATE MANAGEMENT, IN CLASS  
36 (U.S. CLS. 100, 101 AND 102).

SN 77-249,714, FILED 8-8-2007.

FIRST USE 6-1-2008; IN COMMERCE 6-1-2008.

JULIE GUTTADAURO, EXAMINING ATTORNEY

**Int. Cl.: 16**

**Prior U.S. Cls.: 2, 5, 22, 23, 29, 37, 38, and 50**

**Reg. No. 3,506,213**

**United States Patent and Trademark Office**

**Registered Sep. 23, 2008**

**TRADEMARK  
PRINCIPAL REGISTER**

# Bobble Sign

MOY, AARON (UNITED STATES INDIVIDUAL),  
DBA BOBBLESIGNS.COM,  
18160 SETTLERS WAY  
EDEN PRAIRIE, MN 55347

FOR: MOUNTED POSTERS; POSTERS; POSTERS  
MADE OF PAPER; UNMOUNTED POSTERS; AD-  
VERTISING SIGNS OF PAPER OR CARDBOARD;  
PAPER SIGN HOLDERS; PRINTED PAPER SIGNS,  
IN CLASS 16 (U.S. CLS. 2, 5, 22, 23, 29, 37, 38 AND 50).

FIRST USE 8-9-2007; IN COMMERCE 8-9-2007.

THE MARK CONSISTS OF STANDARD CHAR-  
ACTERS WITHOUT CLAIM TO ANY PARTICULAR  
FONT, STYLE, SIZE, OR COLOR.

NO CLAIM IS MADE TO THE EXCLUSIVE  
RIGHT TO USE "SIGN", APART FROM THE MARK  
AS SHOWN.

SN 77-253,256, FILED 8-13-2007.

CAROLYN CATALDO, EXAMINING ATTORNEY

**Int. Cl.: 32**

**Prior U.S. Cls.: 45, 46, and 48**

**United States Patent and Trademark Office**

**Reg. No. 3,506,214**

**Registered Sep. 23, 2008**

**TRADEMARK  
PRINCIPAL REGISTER**

**LONG STRANGE TRIPEL**

BOULEVARD BREWING ASSOCIATES LIMITED  
PARTNERSHIP (MISSOURI LIMITED PART-  
NERSHIP)  
2501 SOUTHWEST BOULEVARD  
KANSAS CITY, MO 64108

THE MARK CONSISTS OF STANDARD CHAR-  
ACTERS WITHOUT CLAIM TO ANY PARTICULAR  
FONT, STYLE, SIZE, OR COLOR.

FOR: BEER, ALE AND MALT LIQUOR, IN CLASS  
32 (U.S. CLS. 45, 46 AND 48).

SN 77-253,850, FILED 8-13-2007.

FIRST USE 11-11-2007; IN COMMERCE 11-11-2007.

MARK SPARACINO, EXAMINING ATTORNEY

**Int. Cl.: 29**

**Prior U.S. Cl.: 46**

**United States Patent and Trademark Office**

**Reg. No. 3,506,215**

**Registered Sep. 23, 2008**

**TRADEMARK  
PRINCIPAL REGISTER**

**ORYZAPRO**

ACH FOOD COMPANIES, INC. (TENNESSEE  
CORPORATION)  
7171 GOODLETT FARMS PARKWAY  
CORDOVA, TN 38016

THE MARK CONSISTS OF STANDARD CHAR-  
ACTERS WITHOUT CLAIM TO ANY PARTICULAR  
FONT, STYLE, SIZE, OR COLOR.

FOR: TEXTURED RICE PROTEIN FOR USE AS A  
FOOD ADDITIVE; TEXTURED RICE PROTEIN  
BEING FOODSTUFFS FOR HUMAN CONSUMP-  
TION, IN CLASS 29 (U.S. CL. 46).

SN 77-254,192, FILED 8-13-2007.

FIRST USE 7-17-2005; IN COMMERCE 10-16-2007.

CHRISTINA SOBRAL, EXAMINING ATTORNEY



**Int. Cl.: 16**

**Prior U.S. Cls.: 2, 5, 22, 23, 29, 37, 38, and 50**

**Reg. No. 3,506,216**

**United States Patent and Trademark Office**

**Registered Sep. 23, 2008**

**TRADEMARK  
PRINCIPAL REGISTER**

**CHOCOMAIL**

CHOCOLAFABRIKEN LINDT & SPRÜNGLI  
AG (SWITZERLAND CORPORATION)  
SEESTRAßE 204  
8802 KILCHBERG, SWITZERLAND

THE MARK CONSISTS OF STANDARD CHAR-  
ACTERS WITHOUT CLAIM TO ANY PARTICULAR  
FONT, STYLE, SIZE, OR COLOR.

FOR: NEWSLETTER RELATING TO THE CHO-  
COLATE INDUSTRY, IN CLASS 16 (U.S. CLS. 2, 5, 22,  
23, 29, 37, 38 AND 50).

SN 77-255,696, FILED 8-15-2007.

FIRST USE 5-5-2006; IN COMMERCE 5-5-2006.

GRETTA YAO, EXAMINING ATTORNEY

Int. Cl.: 41

Prior U.S. Cls.: 100, 101, and 107

United States Patent and Trademark Office

Reg. No. 3,506,217

Registered Sep. 23, 2008

SERVICE MARK  
PRINCIPAL REGISTER

 **Advancing Senior Health**  
— *Conference* —

PINNACLE HEALTH COMMUNICATIONS LLC  
(NEW JERSEY LIMITED LIABILITY COMPAN-  
NY)  
THIRD FLOOR  
259 VETERANS LANE  
DOYLESTOWN, PA 18901

FOR: EDUCATIONAL AND CONTINUING MEDICAL AND NURSING EDUCATIONAL SERVICES FOR PROFESSIONAL HEALTHCARE PROVIDERS AND ADMINISTRATORS WORKING WITH SENIORS, NAMELY, CONDUCTING ANNUAL EDUCATIONAL CONFERENCES FEATURING ON-LINE ACTIVITIES AND INTERACTIVE EXHIBITS AND ON-SITE WORKSHOPS, SEMINARS, SPEAKER PRESENTATIONS AND EXHIBITIONS ALL IN THE FIELD OF HEALTHCARE FOR SENIOR CITIZENS, IN CLASS 41 (U.S. CLS. 100, 101 AND 107).

FIRST USE 7-7-2008; IN COMMERCE 7-7-2008.

NO CLAIM IS MADE TO THE EXCLUSIVE RIGHT TO USE "SENIOR HEALTH CONFERENCE", APART FROM THE MARK AS SHOWN.

THE MARK CONSISTS OF THE WORDS "ADVANCING SENIOR HEALTH CONFERENCE"; THE FIRST "A" IS STYLIZED AND HAS THREE CURVED BANDS EMANATING FROM ITS LEFT SIDE. BELOW THE WORDS "ADVANCING SENIOR HEALTH", THE WORD "CONFERENCE" APPEARS WITH LINES EMANATING FROM THE LEFT AND RIGHT.

SN 77-256,579, FILED 8-16-2007.

CHRISTINE BLOMQUIST, EXAMINING ATTORNEY

Int. Cl.: 16

Prior U.S. Cls.: 2, 5, 22, 23, 29, 37, 38, and 50

United States Patent and Trademark Office

Reg. No. 3,506,218

Registered Sep. 23, 2008

TRADEMARK  
PRINCIPAL REGISTER



LIBERTY DISTRIBUTORS, INC. (WEST VIRGINIA CORPORATION)  
P.O. BOX 498  
TRIDELPHIA, WV 26059

FOR: SCRAPBOOK ALBUMS; SCRAPBOOK PAGES; SCRAPBOOKS; CRAFT PAPER, IN CLASS 16 (U.S. CLS. 2, 5, 22, 23, 29, 37, 38 AND 50).

FIRST USE 2-14-2008; IN COMMERCE 2-14-2008.

THE COLOR(S) PURPLE, LAVENDER AND YELLOW IS/ARE CLAIMED AS A FEATURE OF THE MARK.

THE MARK CONSISTS OF A BANNER IN PURPLE WITH THE WORD "CORE" IN YELLOW SCRIPT AND THE WORD "DINATIONS" IN LAVENDER. THERE IS ALSO A YELLOW BOX IN THE UPPER RIGHT OF THE BANNER WITH A PURPLE SCRIPT "C".

SN 77-258,060, FILED 8-17-2007.

SKYE YOUNG, EXAMINING ATTORNEY

**Int. Cl.: 12**

**Prior U.S. Cls.: 19, 21, 23, 31, 35, and 44**

**United States Patent and Trademark Office**

**Reg. No. 3,506,219**

**Registered Sep. 23, 2008**

**TRADEMARK  
PRINCIPAL REGISTER**

# Bonzaiboard

BENNETT, MICHAEL J. (UNITED STATES INDIVIDUAL)  
1225 ROBIN DR.  
ROANOKE, TX 76262

THE MARK CONSISTS OF STANDARD CHARACTERS WITHOUT CLAIM TO ANY PARTICULAR FONT, STYLE, SIZE, OR COLOR.

FOR: NON-MOTORIZED SCOOTERS, IN CLASS 12 (U.S. CLS. 19, 21, 23, 31, 35 AND 44).

SN 77-258,700, FILED 8-18-2007.

FIRST USE 6-20-2008; IN COMMERCE 6-20-2008.

CHERYL CLAYTON, EXAMINING ATTORNEY

**Int. Cl.: 41**

**Prior U.S. Cls.: 100, 101, and 107**

**United States Patent and Trademark Office**

**Reg. No. 3,506,220**

**Registered Sep. 23, 2008**

**SERVICE MARK  
PRINCIPAL REGISTER**

bloom pilates

AGRO, CATHERINE E (UNITED STATES INDIVIDUAL)  
6105 N. 8TH STREET  
PHOENIX, AZ 85014

FOR: PROVIDING ASSISTANCE, PERSONAL TRAINING AND PHYSICAL FITNESS CONSULTATION TO INDIVIDUALS TO HELP THEM MAKE PHYSICAL FITNESS, STRENGTH, CONDITIONING, AND EXERCISE IMPROVEMENT IN THEIR DAILY LIVING, IN CLASS 41 (U.S. CLS. 100, 101 AND 107).

FIRST USE 5-1-2008; IN COMMERCE 5-1-2008.

NO CLAIM IS MADE TO THE EXCLUSIVE RIGHT TO USE "PILATES", APART FROM THE MARK AS SHOWN.

THE COLOR(S) TURQUOISE AND GRAY IS/ARE CLAIMED AS A FEATURE OF THE MARK.

THE MARK CONSISTS OF THE WORD "BLOOM" IN THE COLOR TURQUOISE AND THE WORD "PILATES" IN GRAY.

SN 77-258,727, FILED 8-18-2007.

TRICIA SONNEBORN, EXAMINING ATTORNEY

**Int. Cl.: 30**

**Prior U.S. Cl.: 46**

**United States Patent and Trademark Office**

**Reg. No. 3,506,221**

**Registered Sep. 23, 2008**

**TRADEMARK  
PRINCIPAL REGISTER**

The logo consists of the word 'TerDZ' in a stylized, hand-drawn font. The 'T' is a simple block letter. The 'e' is lowercase and has a small loop at the bottom. The 'r' is lowercase and has a small loop at the bottom. The 'D' is uppercase and has a small loop at the bottom. The 'Z' is uppercase and has a long, flowing tail that curves upwards and to the right.

CROSS, PHOENIX P. H. (UNITED STATES INDIVIDUAL)  
5329 LAURIE LANE  
MEMPHIS, TN 38120

FIRST USE 8-18-2007; IN COMMERCE 7-27-2008.

SN 77-258,747, FILED 8-18-2007.

FOR: CANDIES, IN CLASS 30 (U.S. CL. 46).

DANNEAN HETZEL, EXAMINING ATTORNEY

**Int. Cl.: 36**

**Prior U.S. Cls.: 100, 101, and 102**

**United States Patent and Trademark Office**

**Reg. No. 3,506,222**

**Registered Sep. 23, 2008**

**SERVICE MARK  
PRINCIPAL REGISTER**



FARM CREDIT SERVICES OF AMERICA, ACA  
(UNITED STATES FEDERALLY CHARTERED  
CORPORATION)  
5015 SOUTH 118TH STREET  
OMAHA, NE 68137

FOR: LOAN FINANCING OF BUSINESS PUR-  
CHASES, IN CLASS 36 (U.S. CLS. 100, 101 AND 102).

FIRST USE 9-28-2007; IN COMMERCE 8-1-2008.

THE MARK CONSISTS OF A FANCIFUL DESIGN  
OF TWO CURVED BANDS.

SN 77-259,320, FILED 8-20-2007.

ALEXANDER L. POWERS, EXAMINING ATTOR-  
NEY

**Int. Cl.: 9**

**Prior U.S. Cls.: 21, 23, 26, 36, and 38**

**Reg. No. 3,506,223**

**United States Patent and Trademark Office**

**Registered Sep. 23, 2008**

**TRADEMARK  
PRINCIPAL REGISTER**

**Q-GARD QUANTUMWEAR**

QUEST ENVIRONMENTAL & SAFETY PRO-  
DUCTS, INC. (INDIANA CORPORATION)  
9892 EAST 121ST STREET  
FISHERS, IN 46038

FOR: DISPOSABLE PROTECTIVE CLOTHING;  
AND DISPOSABLE PROTECTIVE CLOTHING FOR  
USE IN THE NUCLEAR INDUSTRY, IN CLASS 9  
(U.S. CLS. 21, 23, 26, 36 AND 38).

FIRST USE 10-23-2007; IN COMMERCE 10-23-2007.

THE MARK CONSISTS OF STANDARD CHAR-  
ACTERS WITHOUT CLAIM TO ANY PARTICULAR  
FONT, STYLE, SIZE, OR COLOR.

OWNER OF U.S. REG. NO. 2,906,642.

SN 77-259,417, FILED 8-20-2007.

DANIEL CAPSHAW, EXAMINING ATTORNEY



Int. Cl.: 35

Prior U.S. Cls.: 100, 101, and 102

United States Patent and Trademark Office

Reg. No. 3,506,224

Registered Sep. 23, 2008

SERVICE MARK  
PRINCIPAL REGISTER

# CROBAR

CROBAR, L.L.C. (NORTH CAROLINA LIMITED  
LIABILITY COMPANY)  
1101 NORWALK ST.  
GREENSBORO, NC 27407

FOR: ADVERTISING AGENCIES; ADVERTISING AGENCIES, NAMELY, PROMOTING THE GOODS AND SERVICES OF OTHERS; ADVERTISING AND MARKETING; ADVERTISING AND PROMOTION SERVICES AND RELATED CONSULTING; ADVERTISING AND PUBLICITY SERVICES; ADVERTISING AND PUBLICITY SERVICES, NAMELY, PROMOTING THE GOODS, SERVICES, BRAND IDENTITY AND COMMERCIAL INFORMATION AND NEWS OF THIRD PARTIES THROUGH PRINT, AUDIO, VIDEO, DIGITAL AND ON-LINE MEDIUM; ADVERTISING CONSULTATION; ADVERTISING SERVICES; ADVERTISING SERVICES,

NAMELY, CREATING CORPORATE AND BRAND IDENTITY FOR OTHERS; ADVERTISING SERVICES, NAMELY, PROMOTING AND MARKETING THE GOODS AND SERVICES OF OTHERS THROUGH ALL PUBLIC COMMUNICATION MEANS; PUBLIC RELATIONS, IN CLASS 35 (U.S. CLS. 100, 101 AND 102).

FIRST USE 12-13-2004; IN COMMERCE 12-13-2004.

THE MARK CONSISTS OF STANDARD CHARACTERS WITHOUT CLAIM TO ANY PARTICULAR FONT, STYLE, SIZE, OR COLOR.

SN 77-259,440, FILED 8-20-2007.

ALYSSA PALADINO, EXAMINING ATTORNEY

**Int. Cl.: 36**

**Prior U.S. Cls.: 100, 101, and 102**

**United States Patent and Trademark Office**

**Reg. No. 3,506,225**

**Registered Sep. 23, 2008**

**SERVICE MARK  
PRINCIPAL REGISTER**



FARM CREDIT SERVICES OF AMERICA, ACA  
(UNITED STATES FEDERALLY CHARTERED  
CORPORATION)  
5015 SOUTH 118TH STREET  
OMAHA, NE 68137

THE MARK CONSISTS OF A FANCIFUL DESIGN  
OF TWO CURVED BANDS, ONE OF WHICH IS  
GREEN AND THE OTHER OF WHICH IS BROWN.

FOR: LOAN FINANCING OF BUSINESS PUR-  
CHASES, IN CLASS 36 (U.S. CLS. 100, 101 AND 102).

SN 77-259,813, FILED 8-20-2007.

FIRST USE 8-1-2008; IN COMMERCE 8-1-2008.

THE COLOR(S) BROWN AND GREEN IS/ARE  
CLAIMED AS A FEATURE OF THE MARK.

ALEXANDER L. POWERS, EXAMINING ATTOR-  
NEY

**Int. Cls.: 43 and 44**

**Prior U.S. Cls.: 100 and 101**

**United States Patent and Trademark Office**

**Reg. No. 3,506,226**

**Registered Sep. 23, 2008**

**SERVICE MARK  
PRINCIPAL REGISTER**

**HUG-A-BUBBA'S**

HUG-A-BUBBA'S DOGGIE DAYCARE &  
GROOMING, LLC (OREGON LIMITED LIABILITY COMPANY)

8635 SW CANYON ROAD  
PORTLAND, OR 97225

FOR: PET DAY CARE SERVICES; KENNEL SERVICES; PET BOARDING SERVICES, IN CLASS 43 (U.S. CLS. 100 AND 101).

FIRST USE 12-17-2007; IN COMMERCE 12-17-2007.

FOR: PET CARE SERVICES, NAMELY, DOG WALKING, DOG BATHING AND NON-MEDICA-

TED PET GROOMING, IN CLASS 44 (U.S. CLS. 100 AND 101).

FIRST USE 12-17-2007; IN COMMERCE 12-17-2007.

THE MARK CONSISTS OF STANDARD CHARACTERS WITHOUT CLAIM TO ANY PARTICULAR FONT, STYLE, SIZE, OR COLOR.

SN 77-259,979, FILED 8-20-2007.

MARLENE BELL, EXAMINING ATTORNEY

**Int. Cls.: 21 and 26**

**Prior U.S. Cls.: 2, 13, 23, 29, 30, 33, 37, 39, 40, 42, and 50**

**United States Patent and Trademark Office**

**Reg. No. 3,506,227**

**Registered Sep. 23, 2008**

**TRADEMARK  
PRINCIPAL REGISTER**

**MONROE**

MONROE HAIR CARE LLC (FLORIDA LIMITED  
LIABILITY COMPANY)  
1325 DIPLOMAT PARKWAY  
HOLLYWOOD, FL 33019

FOR: HAIR BRUSHES; HAIR COMBS, IN CLASS  
21 (U.S. CLS. 2, 13, 23, 29, 30, 33, 40 AND 50).

FIRST USE 9-21-2007; IN COMMERCE 10-25-2007.

FOR: HAIR ACCESSORIES, NAMELY, JAW  
CLIPS; HAIR PINS; HAIR PINS AND GRIPS; NON-

ELECTRIC HAIR ROLLERS, IN CLASS 26 (U.S. CLS.  
37, 39, 40, 42 AND 50).

FIRST USE 9-21-2007; IN COMMERCE 10-25-2007.

THE MARK CONSISTS OF STANDARD CHAR-  
ACTERS WITHOUT CLAIM TO ANY PARTICULAR  
FONT, STYLE, SIZE, OR COLOR.

SN 77-260,142, FILED 8-21-2007.

WILLIAM ROSSMAN, EXAMINING ATTORNEY

**Int. Cl.: 41**

**Prior U.S. Cls.: 100, 101, and 107**

**United States Patent and Trademark Office**

**Reg. No. 3,506,228**

**Registered Sep. 23, 2008**

**SERVICE MARK  
PRINCIPAL REGISTER**

**DEPENDENT SOUL**

ILCH, JOSHUA (UNITED STATES INDIVIDUAL)  
33 INDIAN DRIVE  
WOOD RIVER, IL 62095 AND  
ILCH, DAWN (UNITED STATES INDIVIDUAL)  
33 INDIAN DRIVE  
WOOD RIVER, IL 62095 AND  
STUMPF, JEREMY (UNITED STATES INDIVIDUAL)  
33 INDIAN DRIVE  
WOOD RIVER, IL 62095 AND  
TAYLOR, BRIAN (UNITED STATES INDIVIDUAL)  
33 INDIAN DRIVE  
WOOD RIVER, IL 62095

FOR: ENTERTAINMENT IN THE NATURE OF  
LIVE PERFORMANCES BY A CHRISTIAN MUSICAL  
GROUP, IN CLASS 41 (U.S. CLS. 100, 101 AND  
107).

FIRST USE 1-1-2008; IN COMMERCE 1-1-2008.

THE MARK CONSISTS OF STANDARD CHARACTERS  
WITHOUT CLAIM TO ANY PARTICULAR  
FONT, STYLE, SIZE, OR COLOR.

SN 77-260,518, FILED 8-21-2007.

LINDA E. BLOHM, EXAMINING ATTORNEY

**Int. Cl.: 9**

**Prior U.S. Cls.: 21, 23, 26, 36, and 38**

**Reg. No. 3,506,229**

**United States Patent and Trademark Office**

**Registered Sep. 23, 2008**

**TRADEMARK  
PRINCIPAL REGISTER**

# GoalPost

KURT SALMON ASSOCIATES, INC. (DELA-  
WARE CORPORATION)  
SUITE 900, 1355 PEACHTREE ST. NE  
ATLANTA, GA 30309

FOR: COMPUTER SOFTWARE FOR USE IN  
MEASURING AND CALCULATING COSTS AND  
PRODUCTIVITY, IN CLASS 9 (U.S. CLS. 21, 23, 26, 36  
AND 38).

FIRST USE 8-23-2007; IN COMMERCE 9-15-2007.

THE MARK CONSISTS OF STANDARD CHAR-  
ACTERS WITHOUT CLAIM TO ANY PARTICULAR  
FONT, STYLE, SIZE, OR COLOR.

OWNER OF U.S. REG. NOS. 1,018,927 AND  
2,210,709.

SN 77-262,207, FILED 8-22-2007.

DAVID MURRAY, EXAMINING ATTORNEY

**Int. Cls.: 35 and 41**

**Prior U.S. Cls.: 100, 101, 102, and 107**

**United States Patent and Trademark Office**

**Reg. No. 3,506,230**

**Registered Sep. 23, 2008**

**SERVICE MARK  
PRINCIPAL REGISTER**

**GameStop**  
**power to the players**

GAMESTOP, INC. (MINNESOTA CORPORATION)  
625 WESTPORT PARKWAY  
GRAPEVINE, TX 76051

FOR: RETAIL STORE SERVICES AND ONLINE RETAIL STORE SERVICES PROVIDED VIA A GLOBAL COMPUTER NETWORK FEATURING NEW AND USED COMPUTER, VIDEO AND ELECTRONIC GAMES, VIDEO GAME CONSOLES, HAND-HELD VIDEO GAME PLAYERS, DIGITAL MEDIA PLAYERS AND RECORDERS, VIDEOS, DVDS, MOVIES, ROLE-PLAYING CARDS, GAME CARDS, BOOKS, MAGAZINES, STRATEGY GUIDES, COMPUTER HARDWARE, COMPUTER ACCESSORIES, TOYS AND ACTION FIGURES; PROMOTING THE SALE OF GOODS OF OTHERS THROUGH THE ADMINISTRATION OF A CUSTOMER INCENTIVE AWARD AND DISCOUNT PROGRAM FEATURING DISCOUNTS ON NEW AND USED COMPUTER, VIDEO AND ELECTRONIC GAMES, VIDEO GAME CONSOLES, HAND-HELD VIDEO GAME PLAYERS, DIGITAL MEDIA PLAYERS AND RECORDERS, VIDEOS, DVDS, MOVIES, ROLE-PLAYING CARDS, GAME CARDS, BOOKS, MAGAZINES, STRATEGY GUIDES, COMPUTER HARDWARE, COMPUTER

ACCESSORIES, TOYS AND ACTION FIGURES, IN CLASS 35 (U.S. CLS. 100, 101 AND 102).

FIRST USE 5-31-2007; IN COMMERCE 5-31-2007.

FOR: PROVIDING A WEB SITE CONTAINING INFORMATION AND CONTENT ON NEW AND USED COMPUTER, VIDEO AND ELECTRONIC GAMES, VIDEO GAME CONSOLES, HAND-HELD VIDEO GAME PLAYERS, DIGITAL MEDIA PLAYERS AND RECORDERS, VIDEOS, DVDS, MOVIES, ROLE-PLAYING CARDS, GAME CARDS, BOOKS, MAGAZINES, STRATEGY GUIDES, COMPUTER GAME HARDWARE, COMPUTER GAME ACCESSORIES, TOYS AND ACTION FIGURE, IN CLASS 41 (U.S. CLS. 100, 101 AND 107).

FIRST USE 5-31-2007; IN COMMERCE 5-31-2007.

OWNER OF U.S. REG. NOS. 1,707,460, 2,902,027, AND OTHERS.

SN 77-262,385, FILED 8-23-2007.

STEVEN R. FINE, EXAMINING ATTORNEY

**Int. Cl.: 7**

**Prior U.S. Cls.: 13, 19, 21, 23, 31, 34, and 35**

**Reg. No. 3,506,231**

**United States Patent and Trademark Office**

**Registered Sep. 23, 2008**

---

**TRADEMARK  
PRINCIPAL REGISTER**

**ORBITEK**

ORBITEK, INC. (OKLAHOMA CORPORATION)  
7050 SOUTH YALE AVENUE, SUITE 350  
TULSA, OK 74136

FIRST USE 8-1-2007; IN COMMERCE 8-1-2007.

FOR: MACHINES FOR MANUFACTURING BIO-DIESEL FUEL, NAMELY, CONTINUOUS FLUID FLOW SYSTEMS COMPRISED OF BOILERS AND POLISHING UNITS , IN CLASS 7 (U.S. CLS. 13, 19, 21, 23, 31, 34 AND 35).

THE MARK CONSISTS OF STANDARD CHARACTERS WITHOUT CLAIM TO ANY PARTICULAR FONT, STYLE, SIZE, OR COLOR.

SN 77-263,475, FILED 8-24-2007.

AMY GEARIN, EXAMINING ATTORNEY



**Int. Cl.: 15**

**Prior U.S. Cls.: 2, 21, and 36**

**United States Patent and Trademark Office**

**Reg. No. 3,506,232**

**Registered Sep. 23, 2008**

**TRADEMARK  
PRINCIPAL REGISTER**

**ELEGANTE**

PEARL CORPORATION (TENNESSEE COR-  
PORATION)  
549 METROPLEX DRIVE  
NASHVILLE, TN 37211

FOR: MUSICAL INSTRUMENTS, NAMELY,  
FLUTES, IN CLASS 15 (U.S. CLS. 2, 21 AND 36).

FIRST USE 10-0-1986; IN COMMERCE 10-0-1986.

THE MARK CONSISTS OF STANDARD CHAR-  
ACTERS WITHOUT CLAIM TO ANY PARTICULAR  
FONT, STYLE, SIZE, OR COLOR.

THE ENGLISH TRANSLATION OF THE WORD  
"ELEGANTE" IS "ELEGANT".

SN 77-264,055, FILED 8-24-2007.

HANNO RITTNER, EXAMINING ATTORNEY

**Int. Cl.: 15**

**Prior U.S. Cls.: 2, 21, and 36**

**United States Patent and Trademark Office**

**Reg. No. 3,506,233**

**Registered Sep. 23, 2008**

**TRADEMARK  
PRINCIPAL REGISTER**

**DOLCE**

PEARL CORPORATION (TENNESSEE COR-  
PORATION)  
549 METROPLEX DRIVE  
NASHVILLE, TN 37211

THE MARK CONSISTS OF STANDARD CHAR-  
ACTERS WITHOUT CLAIM TO ANY PARTICULAR  
FONT, STYLE, SIZE, OR COLOR.

FOR: MUSICAL INSTRUMENTS, NAMELY,  
FLUTES, IN CLASS 15 (U.S. CLS. 2, 21 AND 36).

SN 77-264,063, FILED 8-24-2007.

FIRST USE 10-0-1986; IN COMMERCE 10-0-1986.

HANNO RITTNER, EXAMINING ATTORNEY

**Int. Cl.: 15**

**Prior U.S. Cls.: 2, 21, and 36**

**United States Patent and Trademark Office**

**Reg. No. 3,506,234**

**Registered Sep. 23, 2008**

**TRADEMARK  
PRINCIPAL REGISTER**

**FORTE**

PEARL CORPORATION (TENNESSEE COR-  
PORATION)  
549 METROPLEX DRIVE  
NASHVILLE, TN 37238

THE MARK CONSISTS OF STANDARD CHAR-  
ACTERS WITHOUT CLAIM TO ANY PARTICULAR  
FONT, STYLE, SIZE, OR COLOR.

FOR: MUSICAL INSTRUMENTS, NAMELY,  
FLUTE HEADJOINTS, IN CLASS 15 (U.S. CLS. 2, 21  
AND 36).

SN 77-264,072, FILED 8-24-2007.

FIRST USE 4-0-2002; IN COMMERCE 4-0-2002.

HANNO RITTNER, EXAMINING ATTORNEY

**Int. Cl.: 10**

**Prior U.S. Cls.: 26, 39, and 44**

**United States Patent and Trademark Office**

**Reg. No. 3,506,235**

**Registered Sep. 23, 2008**

**TRADEMARK  
PRINCIPAL REGISTER**

**FITMORE**

ZIMMER GMBH (SWITZERLAND CORPORATION)  
SULZER ALLEE 8  
WINTERTHUR, SWITZERLAND 8404

FOR: ARTIFICIAL JOINTS AND IMPLANTS, NAMELY, ARTIFICIAL HIP JOINTS, ARTIFICIAL FEMORAL RODS, ARTIFICIAL HIP CUPS, AND ARTIFICIAL HEADS FOR HIP PROSTHESES; INSTRUMENTS AND TOOLS FOR THE IMPLANTATION OF PROSTHESES AND PARTS OF PROSTHESES, IN CLASS 10 (U.S. CLS. 26, 39 AND 44).

FIRST USE 6-0-2008; IN COMMERCE 6-0-2008.

THE MARK CONSISTS OF STANDARD CHARACTERS WITHOUT CLAIM TO ANY PARTICULAR FONT, STYLE, SIZE, OR COLOR.

OWNER OF SWITZERLAND REG. NO. 514589, DATED 9-29-2003, EXPIRES 1-27-2009.

SN 77-265,360, FILED 8-27-2007.

JANICE L. MCMORROW, EXAMINING ATTORNEY

**Int. Cl.: 41**

**Prior U.S. Cls.: 100, 101, and 107**

**United States Patent and Trademark Office**

**Reg. No. 3,506,236**

**Registered Sep. 23, 2008**

**SERVICE MARK  
PRINCIPAL REGISTER**

**WHEN WORLDS OF ILLUSION  
COLLIDE**

VEST, HOLLIE D. (UNITED STATES INDIVIDUAL)  
P. O. BOX 33219  
LAS VEGAS, NV 89133

THE MARK CONSISTS OF STANDARD CHARACTERS WITHOUT CLAIM TO ANY PARTICULAR FONT, STYLE, SIZE, OR COLOR.

FOR: PRODUCING LIVE STAGE SHOWS FEATURING MUSIC, ILLUSIONS, AND COMEDY, IN CLASS 41 (U.S. CLS. 100, 101 AND 107).

SN 77-265,479, FILED 8-27-2007.

FIRST USE 9-0-2007; IN COMMERCE 7-0-2007.

DANIEL CAPSHAW, EXAMINING ATTORNEY

**Int. Cl.: 43**

**Prior U.S. Cls.: 100 and 101**

**United States Patent and Trademark Office**

**Reg. No. 3,506,237**

**Registered Sep. 23, 2008**

**SERVICE MARK  
PRINCIPAL REGISTER**

**FOUR MOONS**

ZEUS INDUSTRIAL PRODUCTS, INC. (NEW  
JERSEY CORPORATION)  
3737 INDUSTRIAL BOULEVARD  
ORANGEBURG, SC 29118

THE MARK CONSISTS OF STANDARD CHAR-  
ACTERS WITHOUT CLAIM TO ANY PARTICULAR  
FONT, STYLE, SIZE, OR COLOR.

FOR: RESTAURANT SERVICES, IN CLASS 43  
(U.S. CLS. 100 AND 101).

SN 77-266,368, FILED 8-28-2007.

FIRST USE 6-25-2008; IN COMMERCE 6-25-2008.

BERYL GARDNER, EXAMINING ATTORNEY

**Int. Cl.: 35**

**Prior U.S. Cls.: 100, 101, and 102**

**United States Patent and Trademark Office**

**Reg. No. 3,506,238**

**Registered Sep. 23, 2008**

**SERVICE MARK  
PRINCIPAL REGISTER**

**IMPROVING THE  
ENVIRONMENTAL CONDITION**

CARGILL, INCORPORATED (DELAWARE CORPORATION)  
15407 MCGINTY ROAD WEST  
WAYZATA, MN 55391

FOR: BUSINESS DEVELOPMENT SERVICES, NAMELY, PROVIDING BUSINESS CONSULTATION FOR BUSINESSES OF OTHERS PARTICIPATING IN CARBON EMISSION CONTROL AND TRADING OF CARBON CREDITS; PROVIDING BUSINESS INFORMATION, NAMELY, THE DISTRIBUTION OF INFORMATION RELATING TO THE MANAGEMENT OF TRADING OF CARBON CREDITS AMONG BUSINESSES OF OTHERS FOR

THE PURPOSE OF REDUCTION OF CARBON EMISSIONS, IN CLASS 35 (U.S. CLS. 100, 101 AND 102).

FIRST USE 8-20-2007; IN COMMERCE 8-20-2007.

THE MARK CONSISTS OF STANDARD CHARACTERS WITHOUT CLAIM TO ANY PARTICULAR FONT, STYLE, SIZE, OR COLOR.

SN 77-266,887, FILED 8-29-2007.

CYNTHIA SLOAN, EXAMINING ATTORNEY

**Int. Cl.: 10**

**Prior U.S. Cls.: 26, 39, and 44**

**United States Patent and Trademark Office**

**Reg. No. 3,506,239**

**Registered Sep. 23, 2008**

**TRADEMARK  
PRINCIPAL REGISTER**

**TAKE IT WITH YOU!**

MAJESTIC DRUG CO., INC. (NEW YORK CORPORATION)  
4996 MAIN STREET (ROUTE 42)  
SOUTH FALLSBURG, NY 12779

THE MARK CONSISTS OF STANDARD CHARACTERS WITHOUT CLAIM TO ANY PARTICULAR FONT, STYLE, SIZE, OR COLOR.

FOR: DENTAL INSTRUMENTS, NAMELY, EXPLORER PIKS AND DENTAL SCALERS, IN CLASS 10 (U.S. CLS. 26, 39 AND 44).

SN 77-269,171, FILED 8-31-2007.

FIRST USE 12-20-2007; IN COMMERCE 12-20-2007.

EDWARD FENNESSY, EXAMINING ATTORNEY



**Int. Cl.: 43**

**Prior U.S. Cls.: 100 and 101**

**United States Patent and Trademark Office**

**Reg. No. 3,506,240**

**Registered Sep. 23, 2008**

**SERVICE MARK  
PRINCIPAL REGISTER**



WHG TM CORP. (DELAWARE CORPORATION)  
10750 WEST CHARLESTON BLVD., SUITE 130  
LAS VEGAS, NV 89135

FOR: MAKING HOTEL RESERVATIONS FOR  
OTHERS, IN CLASS 43 (U.S. CLS. 100 AND 101).

FIRST USE 9-18-2007; IN COMMERCE 9-18-2007.

THE MARK CONSISTS OF A GLOBE SURROUNDED BY FOUR WAVE-LIKE GEOMETRIC SHAPES; THE WORDS "RESCENTRAL" IN BLOCK LETTERS APPEAR TO THE RIGHT OF THE GLOBE.

SN 77-271,047, FILED 9-4-2007.

JAMES LOVELACE, EXAMINING ATTORNEY

**Int. Cl.: 9**

**Prior U.S. Cls.: 21, 23, 26, 36, and 38**

**Reg. No. 3,506,241**

**United States Patent and Trademark Office**

**Registered Sep. 23, 2008**

---

**TRADEMARK  
PRINCIPAL REGISTER**

**SPECTROMANCER**

THREE DONKEYS, LLC (WASHINGTON LIMITED LIABILITY COMPANY)  
C/O BRIAN E. LEWIS  
615 SECOND AVE SUITE 760  
SEATTLE, WA 98104

THE MARK CONSISTS OF STANDARD CHARACTERS WITHOUT CLAIM TO ANY PARTICULAR FONT, STYLE, SIZE, OR COLOR.

FOR: COMPUTER GAME PROGRAMS; COMPUTER GAME SOFTWARE; GAME SOFTWARE, IN CLASS 9 (U.S. CLS. 21, 23, 26, 36 AND 38).

SN 77-271,331, FILED 9-4-2007.

FIRST USE 2-1-2008; IN COMMERCE 2-1-2008.

LINDSEY RUBIN, EXAMINING ATTORNEY

**Int. Cl.: 16**

**Prior U.S. Cls.: 2, 5, 22, 23, 29, 37, 38, and 50**

**Reg. No. 3,506,242**

**United States Patent and Trademark Office**

**Registered Sep. 23, 2008**

**TRADEMARK  
PRINCIPAL REGISTER**

**INLAND LIVING MAGAZINE**

CALIFORNIA NEWSPAPER PARTNERSHIP (DE-  
LAWARE PARTNERSHIP), DBA THE SUN,  
1560 BROADWAY, SUITE 1200  
DENVER, CO 80202

FOR: MAGAZINES FEATURING LIFESTYLE,  
FASHION AND HOME DECORATING ISSUES, IN  
CLASS 16 (U.S. CLS. 2, 5, 22, 23, 29, 37, 38 AND 50).

FIRST USE 11-1-2007; IN COMMERCE 11-1-2007.

THE MARK CONSISTS OF STANDARD CHAR-  
ACTERS WITHOUT CLAIM TO ANY PARTICULAR  
FONT, STYLE, SIZE, OR COLOR.

NO CLAIM IS MADE TO THE EXCLUSIVE  
RIGHT TO USE "MAGAZINE", APART FROM THE  
MARK AS SHOWN.

SN 77-271,823, FILED 9-5-2007.

JASON TURNER, EXAMINING ATTORNEY

**Int. Cl.: 42**

**Prior U.S. Cls.: 100 and 101**

**United States Patent and Trademark Office**

**Reg. No. 3,506,243**

**Registered Sep. 23, 2008**

**SERVICE MARK  
PRINCIPAL REGISTER**

The logo for StreamCARE features the word "StreamCARE" in a bold, sans-serif font. To the left of the text is a graphic element consisting of three curved, overlapping lines that resemble a stylized stream or water ripples.

SIEMENS HEALTHCARE DIAGNOSTICS INC.  
(CALIFORNIA CORPORATION)  
1717 DEERFIELD ROAD  
SANDRA PAULOV, LEGAL GROUP  
DEERFIELD, IL 60015

FIRST USE 12-31-2007; IN COMMERCE 1-31-2008.

OWNER OF U.S. REG. NO. 3,166,701.

FOR: CONSULTING SERVICES IN THE FIELD  
OF MEDICAL AND CLINICAL DIAGNOSTIC LA-  
BORATORIES AND LABORATORY EQUIPMENT,  
IN CLASS 42 (U.S. CLS. 100 AND 101).

SN 77-271,841, FILED 9-5-2007.

MATTHEW PAPPAS, EXAMINING ATTORNEY

**Int. Cl.: 35**

**Prior U.S. Cls.: 100, 101, and 102**

**United States Patent and Trademark Office**

**Reg. No. 3,506,244**

**Registered Sep. 23, 2008**

**SERVICE MARK  
PRINCIPAL REGISTER**

**I VOTE FOR THE CURE**

THE SUSAN G. KOMEN BREAST CANCER  
FOUNDATION, INC. (TEXAS NON-PROFIT  
CORPORATION)  
5005 LBJ FREEWAY, SUITE 250  
DALLAS, TX 75244

FOR: PROMOTING PUBLIC AWARENESS, EDU-  
CATION AND EARLY DETECTION OF BREAST  
CANCER; PROMOTING PUBLIC AWARENESS OF  
THE NEED TO REGISTER TO VOTE, IN CLASS 35  
(U.S. CLS. 100, 101 AND 102).

FIRST USE 8-24-2007; IN COMMERCE 8-24-2007.

THE MARK CONSISTS OF STANDARD CHAR-  
ACTERS WITHOUT CLAIM TO ANY PARTICULAR  
FONT, STYLE, SIZE, OR COLOR.

OWNER OF U.S. REG. NOS. 1,593,469, 2,406,792,  
AND OTHERS.

SN 77-273,304, FILED 9-6-2007.

SUSAN STIGLITZ, EXAMINING ATTORNEY

**Int. Cl.: 25**

**Prior U.S. Cls.: 22 and 39**

**United States Patent and Trademark Office**

**Reg. No. 3,506,245**

**Registered Sep. 23, 2008**

**TRADEMARK  
PRINCIPAL REGISTER**

**PRINCESS DANNIELYNN**

TIMO, TEREZA (UNITED STATES INDIVIDUAL)  
83-33 AUSTIN STREET  
KEW GARDENS, NY 11415

FOR: BABY BIBS NOT OF PAPER; BABY BODY-SUITS; BABY BOTTOMS; BABY TOPS; BELTS; CAPS; CHILDREN'S AND INFANTS' CLOTH BIBS; CLOTH BIBS; INFANT AND TODDLER ONE PIECE CLOTHING; INFANT CLOTH DIAPERS; JERSEYS; CHILDRENS CLOTHING, NAMELY, TROUSERS, DRESSES, SKIRTS, BLOUSES, SWEATERS, WARM-UP- SUITS, CARDIGANS, JACKETS, COATS, SHIRTS, T-SHIRTS, OVERALLS, SMOCKS, DRESS-TROUSERS, TUNICS, SHORTS, SKORTS, SOCKS, TIGHTS, SHAWL, BELTS, HEADBANDS, HEAD-

WEAR, PAJAMAS, SHORTS, JUMPERS, IN CLASS 25 (U.S. CLS. 22 AND 39).

FIRST USE 6-1-2008; IN COMMERCE 6-30-2008.

THE MARK CONSISTS OF STANDARD CHARACTERS WITHOUT CLAIM TO ANY PARTICULAR FONT, STYLE, SIZE, OR COLOR.

"PRINCESS DANNIELYNN" DOES NOT IDENTIFY A LIVING INDIVIDUAL.

SN 77-273,996, FILED 9-7-2007.

STEVEN JACKSON, EXAMINING ATTORNEY

**Int. Cls.: 41 and 43**

**Prior U.S. Cls.: 100, 101, and 107**

**United States Patent and Trademark Office**

**Reg. No. 3,506,246**

**Registered Sep. 23, 2008**

**SERVICE MARK  
PRINCIPAL REGISTER**

**FORK & SCREEN**

AMERICAN MULTI-CINEMA, INC. (MISSOURI CORPORATION)  
920 MAIN STREET  
KANSAS CITY, MO 64105

FOR: MOVIE THEATRE SERVICES; DINNER THEATRE SERVICES, IN CLASS 41 (U.S. CLS. 100, 101 AND 107).

FIRST USE 4-17-2008; IN COMMERCE 4-17-2008.

FOR: RESTAURANT AND BAR SERVICES; RESTAURANT AND BAR SERVICES IN LUXURY AUDITORIUMS, IN CLASS 43 (U.S. CLS. 100 AND 101).

FIRST USE 4-17-2008; IN COMMERCE 4-17-2008.

THE MARK CONSISTS OF STANDARD CHARACTERS WITHOUT CLAIM TO ANY PARTICULAR FONT, STYLE, SIZE, OR COLOR.

SN 77-274,074, FILED 9-7-2007.

MARLENE BELL, EXAMINING ATTORNEY

**Int. Cls.: 41 and 43**

**Prior U.S. Cls.: 100, 101, and 107**

**United States Patent and Trademark Office**

**Reg. No. 3,506,247**

**Registered Sep. 23, 2008**

**SERVICE MARK  
PRINCIPAL REGISTER**

**MOVIES. MENUS. MORE.**

AMERICAN MULTI-CINEMA, INC. (MISSOURI CORPORATION)  
920 MAIN STREET  
KANSAS CITY, MO 64105

FOR: MOVIE THEATRE SERVICES; DINNER THEATRE SERVICES, IN CLASS 41 (U.S. CLS. 100, 101 AND 107).

FIRST USE 4-17-2008; IN COMMERCE 4-17-2008.

FOR: RESTAURANT AND BAR SERVICES; RESTAURANT AND BAR SERVICES IN LUXURY AUDITORIUMS, IN CLASS 43 (U.S. CLS. 100 AND 101).

FIRST USE 4-17-2008; IN COMMERCE 4-17-2008.

THE MARK CONSISTS OF STANDARD CHARACTERS WITHOUT CLAIM TO ANY PARTICULAR FONT, STYLE, SIZE, OR COLOR.

SN 77-274,087, FILED 9-7-2007.

MARLENE BELL, EXAMINING ATTORNEY



**Int. Cls.: 41 and 43**

**Prior U.S. Cls.: 100, 101, and 107**

**United States Patent and Trademark Office**

**Reg. No. 3,506,248**

**Registered Sep. 23, 2008**

**SERVICE MARK  
PRINCIPAL REGISTER**

**FORK & SCREEN. MOVIES.  
MENUS. MORE.**

AMERICAN MULTI-CINEMA, INC. (MISSOURI  
CORPORATION)  
920 MAIN STREET  
KANSAS CITY, MO 64105

FOR: MOVIE THEATRE SERVICES; DINNER  
THEATRE SERVICES, IN CLASS 41 (U.S. CLS. 100,  
101 AND 107).

FIRST USE 4-17-2008; IN COMMERCE 4-17-2008.

FOR: RESTAURANT AND BAR SERVICES; RES-  
TAURANT AND BAR SERVICES IN LUXURY AU-  
DITORIUMS, IN CLASS 43 (U.S. CLS. 100 AND 101).

FIRST USE 4-17-2008; IN COMMERCE 4-17-2008.

THE MARK CONSISTS OF STANDARD CHAR-  
ACTERS WITHOUT CLAIM TO ANY PARTICULAR  
FONT, STYLE, SIZE, OR COLOR.

SN 77-274,097, FILED 9-7-2007.

MARLENE BELL, EXAMINING ATTORNEY

**Int. Cl.: 37**

**Prior U.S. Cls.: 100, 103, and 106**

**United States Patent and Trademark Office**

**Reg. No. 3,506,249**

**Registered Sep. 23, 2008**

**SERVICE MARK  
PRINCIPAL REGISTER**

**GEM**

GEM PLUMBING & HEATING CO., INC.  
(RHODE ISLAND CORPORATION)  
ONE WELLINGTON ROAD  
LINCOLN, RI 02865

FOR: RESIDENTIAL HOME REPAIR AND GENERAL RESIDENTIAL HOME MAINTENANCE SERVICES, IN CLASS 37 (U.S. CLS. 100, 103 AND 106).

FIRST USE 1-0-2005; IN COMMERCE 1-0-2005.

THE MARK CONSISTS OF STANDARD CHARACTERS WITHOUT CLAIM TO ANY PARTICULAR FONT, STYLE, SIZE, OR COLOR.

OWNER OF U.S. REG. NO. 2,962,917.

SN 77-274,162, FILED 9-7-2007.

MARK PILARO, EXAMINING ATTORNEY

**Int. Cl.: 44**

**Prior U.S. Cls.: 100 and 101**

**United States Patent and Trademark Office**

**Reg. No. 3,506,250**

**Registered Sep. 23, 2008**

**SERVICE MARK  
PRINCIPAL REGISTER**

**CHOOSE WELLNESS**

IMADULATION INTERNTIONAL, LP (TEXAS  
LIMITED PARTNERSHIP)  
7201 CUTTER MILL DR.  
DALLAS, TX 75248

FOR: HEALTH CARE SERVICES, NAMELY,  
WELLNESS PROGRAMS; PROVIDING A WEBSITE  
FEATURING INFORMATION IN THE FIELD OF  
MENTAL HEALTH AND WELLNESS, IN CLASS 44  
(U.S. CLS. 100 AND 101).

FIRST USE 12-10-2007; IN COMMERCE 1-3-2008.

THE MARK CONSISTS OF STANDARD CHAR-  
ACTERS WITHOUT CLAIM TO ANY PARTICULAR  
FONT, STYLE, SIZE, OR COLOR.

NO CLAIM IS MADE TO THE EXCLUSIVE  
RIGHT TO USE "WELLNESS", APART FROM THE  
MARK AS SHOWN.

SN 77-274,913, FILED 9-8-2007.

RICHARD A. STRASER, EXAMINING ATTORNEY

**Int. Cl.: 41**

**Prior U.S. Cls.: 100, 101, and 107**

**United States Patent and Trademark Office**

**Reg. No. 3,506,251**

**Registered Sep. 23, 2008**

**SERVICE MARK  
PRINCIPAL REGISTER**

**HOLLYWOOD FAST TRACK**

PARAMOUNT PICTURES CORPORATION (DE-  
LAWARE CORPORATION)  
5555 MELROSE AVENUE  
HOLLYWOOD, CA 90038

FOR: ENTERTAINMENT SERVICES, NAMELY,  
PROVIDING ON-LINE INFORMATION IN THE  
NATURE OF ENTERTAINMENT NEWS BY MEANS  
OF A GLOBAL COMPUTER NETWORK; PROVID-  
ING PODCASTS IN THE FIELD OF ENTERTAIN-  
MENT NEWS, IN CLASS 41 (U.S. CLS. 100, 101 AND  
107).

FIRST USE 11-1-2007; IN COMMERCE 11-1-2007.

THE MARK CONSISTS OF STANDARD CHAR-  
ACTERS WITHOUT CLAIM TO ANY PARTICULAR  
FONT, STYLE, SIZE, OR COLOR.

NO CLAIM IS MADE TO THE EXCLUSIVE  
RIGHT TO USE "HOLLYWOOD", APART FROM  
THE MARK AS SHOWN.

SN 77-275,965, FILED 9-10-2007.

THEODORE MCBRIDE, EXAMINING ATTORNEY

**Int. Cl.: 41**

**Prior U.S. Cls.: 100, 101, and 107**

**United States Patent and Trademark Office**

**Reg. No. 3,506,252**

**Registered Sep. 23, 2008**

**SERVICE MARK  
PRINCIPAL REGISTER**

# PROPELLER

AOL LLC (DELAWARE LIMITED LIABILITY  
COMPANY)  
22000 AOL WAY  
DULLES, VA 20166

FOR: PROVIDING ON-LINE INFORMATION IN  
THE FIELD OF NEWS AND ENTERTAINMENT;  
NEWS AGENCIES, NAMELY, AGGREGATING  
AND DISSEMINATING OF NEWS; PUBLICATION  
OF TEXT AND GRAPHIC WORKS OF OTHERS ON  
THE INTERNET BASED ON VOTING RESULTS OF  
ONLINE USERS FEATURING INFORMATION IN

THE FIELD OF NEWS AND ENTERTAINMENT, IN  
CLASS 41 (U.S. CLS. 100, 101 AND 107).

FIRST USE 9-21-2007; IN COMMERCE 9-21-2007.

THE MARK CONSISTS OF STANDARD CHAR-  
ACTERS WITHOUT CLAIM TO ANY PARTICULAR  
FONT, STYLE, SIZE, OR COLOR.

SN 77-277,666, FILED 9-12-2007.

ANNE MADDEN, EXAMINING ATTORNEY

**Int. Cl.: 3**

**Prior U.S. Cls.: 1, 4, 6, 50, 51, and 52**

**United States Patent and Trademark Office**

**Reg. No. 3,506,253**

**Registered Sep. 23, 2008**

**TRADEMARK  
PRINCIPAL REGISTER**

**VOLUME XL SEDUCTION**

L'OREAL USA CREATIVE, INC. (DELAWARE  
CORPORATION)

575 FIFTH AVENUE

NEW YORK, NY 10017

FOR: LIP COLOR, IN CLASS 3 (U.S. CLS. 1, 4, 6, 50,  
51 AND 52).

FIRST USE 12-1-2007; IN COMMERCE 12-1-2007.

THE MARK CONSISTS OF STANDARD CHAR-  
ACTERS WITHOUT CLAIM TO ANY PARTICULAR  
FONT, STYLE, SIZE, OR COLOR.

NO CLAIM IS MADE TO THE EXCLUSIVE  
RIGHT TO USE "VOLUME", APART FROM THE  
MARK AS SHOWN.

SN 77-277,756, FILED 9-12-2007.

SANI KHOURI, EXAMINING ATTORNEY

**Int. Cl.: 36**

**Prior U.S. Cls.: 100, 101, and 102**

**United States Patent and Trademark Office**

**Reg. No. 3,506,254**

**Registered Sep. 23, 2008**

**SERVICE MARK  
PRINCIPAL REGISTER**

**OPENING THE DOOR TO  
OPPORTUNITY**

BANK OF AMERICA CORPORATION (DELA-  
WARE CORPORATION)  
100 NORTH TRYON STREET  
CHARLOTTE, NC 28255

THE MARK CONSISTS OF STANDARD CHAR-  
ACTERS WITHOUT CLAIM TO ANY PARTICULAR  
FONT, STYLE, SIZE, OR COLOR.

FOR: BANKING AND RELATED FINANCIAL  
SERVICES, IN CLASS 36 (U.S. CLS. 100, 101 AND 102).

SN 77-278,934, FILED 9-13-2007.

FIRST USE 11-0-2007; IN COMMERCE 11-0-2007.

STEVEN R. FINE, EXAMINING ATTORNEY

**Int. Cl.: 30**

**Prior U.S. Cl.: 46**

**United States Patent and Trademark Office**

**Reg. No. 3,506,255**

**Registered Sep. 23, 2008**

**TRADEMARK  
PRINCIPAL REGISTER**

**CREME BETWEENES**

SAVE-A-LOT FOOD STORES, LTD. (BERMUDA  
CORPORATION)  
100 CORPORATE OFFICE DRIVE  
EARTH CITY, MO 63045

NO CLAIM IS MADE TO THE EXCLUSIVE  
RIGHT TO USE "CREME", APART FROM THE  
MARK AS SHOWN.

FOR: COOKIES, IN CLASS 30 (U.S. CL. 46).

FIRST USE 8-11-2007; IN COMMERCE 8-11-2007.

SN 77-279,657, FILED 9-14-2007.

THE MARK CONSISTS OF STANDARD CHAR-  
ACTERS WITHOUT CLAIM TO ANY PARTICULAR  
FONT, STYLE, SIZE, OR COLOR.

BARBARA RUTLAND, EXAMINING ATTORNEY



**Int. Cls.: 18 and 21**

**Prior U.S. Cls.: 1, 2, 3, 13, 22, 23, 29, 30, 33, 40, 41, and 50**

**United States Patent and Trademark Office**

**Reg. No. 3,506,256**

**Registered Sep. 23, 2008**

**TRADEMARK  
PRINCIPAL REGISTER**

**MISTY HARBOR**

ESSEX MANUFACTURING, INC. (GEORGIA CORPORATION)  
350 FIFTH AVENUE SUITE 501  
NEW YORK, NY 10118

FOR: BAGS, NAMELY, DIAPER BAGS, TRAVELING BAGS; LUGGAGE, HAND BAGS, AND SMALL LEATHER ACCESSORIES, NAMELY, BRIEFCASE-TYPE PORTFOLIOS AND WALLETS, IN CLASS 18 (U.S. CLS. 1, 2, 3, 22 AND 41).

FIRST USE 12-31-2001; IN COMMERCE 12-31-2001.

FOR: THERMAL INSULATED BAGS FOR FOOD OR BEVERAGES, IN CLASS 21 (U.S. CLS. 2, 13, 23, 29, 30, 33, 40 AND 50).

FIRST USE 7-1-2008; IN COMMERCE 7-1-2008.

THE MARK CONSISTS OF STANDARD CHARACTERS WITHOUT CLAIM TO ANY PARTICULAR FONT, STYLE, SIZE, OR COLOR.

OWNER OF U.S. REG. NOS. 791,893, 1,816,880, AND 3,217,514.

SN 77-279,718, FILED 9-14-2007.

JAMES GRIFFIN, EXAMINING ATTORNEY

**Int. Cl.: 29**

**Prior U.S. Cl.: 46**

**United States Patent and Trademark Office**

**Reg. No. 3,506,257**

**Registered Sep. 23, 2008**

**TRADEMARK  
PRINCIPAL REGISTER**

**PIACCI**

GRANDE CHEESE COMPANY (ILLINOIS COR-  
PORATION)  
DAIRY ROAD  
P.O. BOX 67  
BROWNSVILLE, WI 53006

THE MARK CONSISTS OF STANDARD CHAR-  
ACTERS WITHOUT CLAIM TO ANY PARTICULAR  
FONT, STYLE, SIZE, OR COLOR.

FOR: CHEESE, IN CLASS 29 (U.S. CL. 46).

SN 77-280,832, FILED 9-17-2007.

FIRST USE 7-27-2008; IN COMMERCE 7-27-2008.

RAMONA ORTIGA, EXAMINING ATTORNEY

**Int. Cl.: 41**

**Prior U.S. Cls.: 100, 101, and 107**

**United States Patent and Trademark Office**

**Reg. No. 3,506,258**

**Registered Sep. 23, 2008**

**SERVICE MARK  
PRINCIPAL REGISTER**

**MULTI U**

DISCOVERLINK, INC. (TENNESSEE CORPORATION)  
102 PEMBROKE DRIVE  
HENDERSONVILLE, TN 37075

FOR: EDUCATIONAL SERVICES, NAMELY, PROVIDING ONLINE COURSES IN THE FIELD OF LEADERSHIP TRAINING FEATURING INTERACTIVE MULTIMEDIA TRAINING, COURSE ENROLLMENT, EDUCATIONAL CONTENT, TESTING, EVALUATION, CREATING AND ADMINISTERING LEARNING CONTENT AND TRACKING LEARNING PROGRESS AND RESULTS AND DISTRIBUTION OF COURSE MATERIAL IN CONNECTION THEREWITH, NAMELY, USER MANUALS, IN CLASS 41 (U.S. CLS. 100, 101 AND 107).

FIRST USE 3-0-2007; IN COMMERCE 3-0-2007.

THE MARK CONSISTS OF STANDARD CHARACTERS WITHOUT CLAIM TO ANY PARTICULAR FONT, STYLE, SIZE, OR COLOR.

NO CLAIM IS MADE TO THE EXCLUSIVE RIGHT TO USE "U", APART FROM THE MARK AS SHOWN.

SN 77-281,862, FILED 9-18-2007.

SKYE YOUNG, EXAMINING ATTORNEY

**Int. Cl.: 5**

**Prior U.S. Cls.: 6, 18, 44, 46, 51, and 52**

**United States Patent and Trademark Office**

**Reg. No. 3,506,259**

**Registered Sep. 23, 2008**

**TRADEMARK  
PRINCIPAL REGISTER**



PHARMAVITE LLC (CALIFORNIA LIMITED  
LIABILITY COMPANY)  
P.O. BOX 9606  
MISSION HILLS, CA 913469606

FOR: DIETARY SUPPLEMENTS, IN CLASS 5 (U.S.  
CLS. 6, 18, 44, 46, 51 AND 52).

FIRST USE 5-1-2008; IN COMMERCE 5-1-2008.

NO CLAIM IS MADE TO THE EXCLUSIVE  
RIGHT TO USE "FORMULATED FOR EASY AB-  
SORPTION", APART FROM THE MARK AS  
SHOWN.

THE COLOR(S) GREEN, BLUE, YELLOW, AND  
WHITE IS/ARE CLAIMED AS A FEATURE OF THE  
MARK.

THE COLOR GREEN APPEARS IN THE SQUARE  
BORDER WITH ROUNDED CORNERS, THE  
WORDING "FORMULATED FOR EASY ABSORP-  
TION", AND THE CENTER OVERLAPPING CIR-  
CLE. THE COLOR BLUE APPEARS IN THE FIRST  
THREE CIRCLES FROM THE LEFT. THE COLOR  
YELLOW APPEARS IN THE FIRST THREE CIR-  
CLES FROM THE RIGHT. THE COLOR WHITE  
APPEARS AS THE BACKGROUND COLOR IN THE  
SQUARE.

SN 77-283,907, FILED 9-19-2007.

DANNEAN HETZEL, EXAMINING ATTORNEY

**Int. Cl.: 24**

**Prior U.S. Cls.: 42 and 50**

**United States Patent and Trademark Office**

**Reg. No. 3,506,260**

**Registered Sep. 23, 2008**

**TRADEMARK  
PRINCIPAL REGISTER**



MEIJER, INC. (MICHIGAN CORPORATION)  
2929 WALKER AVE., N.W.  
GRAND RAPIDS, MI 49544

FOR: BED SHEETS; PILLOWCASES; BATH TOWELS; WASHCLOTHS; HAND TOWELS, IN CLASS 24 (U.S. CLS. 42 AND 50).

FIRST USE 2-9-2008; IN COMMERCE 2-9-2008.

NO CLAIM IS MADE TO THE EXCLUSIVE RIGHT TO USE "ORGANICS", APART FROM THE MARK AS SHOWN.

THE MARK CONSISTS OF THE LETTERS "A" AND "H" EACH ENCOMPASSED IN A CIRCLE, WHERE THE CIRCLES OVERLAP ONE ANOTHER, WITH THE WORD "ORGANICS" BELOW.

SN 77-285,747, FILED 9-21-2007.

ROBIN CHOSID, EXAMINING ATTORNEY

**Int. Cl.: 9**

**Prior U.S. Cls.: 21, 23, 26, 36, and 38**

**United States Patent and Trademark Office**

**Reg. No. 3,506,261**

**Registered Sep. 23, 2008**

**TRADEMARK  
PRINCIPAL REGISTER**

**GOBIT**

GOBIT, INC. (WASHINGTON CORPORATION)  
8414 42ND AVE. S.W.  
SEATTLE, WA 98136

THE MARK CONSISTS OF STANDARD CHAR-  
ACTERS WITHOUT CLAIM TO ANY PARTICULAR  
FONT, STYLE, SIZE, OR COLOR.

FOR: COMPUTER GAME SOFTWARE, IN CLASS  
9 (U.S. CLS. 21, 23, 26, 36 AND 38).

SN 77-287,214, FILED 9-24-2007.

FIRST USE 10-9-2007; IN COMMERCE 10-9-2007.

SANJEEV VOHRA, EXAMINING ATTORNEY

**Int. Cl.: 9**

**Prior U.S. Cls.: 21, 23, 26, 36, and 38**

**United States Patent and Trademark Office**

**Reg. No. 3,506,262**

**Registered Sep. 23, 2008**

**TRADEMARK  
PRINCIPAL REGISTER**

**BURGER SHOP**

GOBIT, INC. (WASHINGTON CORPORATION)  
8414 42ND AVE. S.W.  
SEATTLE, WA 98136

THE MARK CONSISTS OF STANDARD CHAR-  
ACTERS WITHOUT CLAIM TO ANY PARTICULAR  
FONT, STYLE, SIZE, OR COLOR.

FOR: COMPUTER GAME SOFTWARE, IN CLASS  
9 (U.S. CLS. 21, 23, 26, 36 AND 38).

SN 77-287,229, FILED 9-24-2007.

FIRST USE 10-9-2007; IN COMMERCE 10-9-2007.

SANJEEV VOHRA, EXAMINING ATTORNEY

**Int. Cl.: 42**

**Prior U.S. Cls.: 100 and 101**

**United States Patent and Trademark Office**

**Reg. No. 3,506,263**

**Registered Sep. 23, 2008**

**SERVICE MARK  
PRINCIPAL REGISTER**

**CHEAT FREAK**

GAMEFLY, INC. (DELAWARE CORPORATION)  
SUITE J  
5870 WEST JEFFERSON BOULEVARD  
LOS ANGELES, CA 90016

FOR: COMPUTER SERVICES, NAMELY, PROVIDING SEARCH ENGINES FOR OBTAINING DATA ON A GLOBAL COMPUTER NETWORK; DEVELOPMENT, MAINTENANCE AND UPDATING OF A TELECOMMUNICATION NETWORK SEARCH ENGINE, IN CLASS 42 (U.S. CLS. 100 AND 101).

FIRST USE 11-14-2007; IN COMMERCE 11-14-2007.

THE MARK CONSISTS OF STANDARD CHARACTERS WITHOUT CLAIM TO ANY PARTICULAR FONT, STYLE, SIZE, OR COLOR.

NO CLAIM IS MADE TO THE EXCLUSIVE RIGHT TO USE "CHEAT", APART FROM THE MARK AS SHOWN.

SN 77-287,344, FILED 9-24-2007.

SIMON TENG, EXAMINING ATTORNEY



**Int. Cl.: 32**

**Prior U.S. Cls.: 45, 46, and 48**

**United States Patent and Trademark Office**

**Reg. No. 3,506,264**

**Registered Sep. 23, 2008**

**TRADEMARK  
PRINCIPAL REGISTER**

**SERIOUS FOCUS**

ODWALLA, INC. (CALIFORNIA CORPORATION)  
120 STONE PINE ROAD  
HALF MOON BAY, CA 94019

THE MARK CONSISTS OF STANDARD CHARACTERS WITHOUT CLAIM TO ANY PARTICULAR FONT, STYLE, SIZE, OR COLOR.

FOR: FRUIT JUICE WITH GREEN TEA, IN CLASS 32 (U.S. CLS. 45, 46 AND 48).

SN 77-287,359, FILED 9-24-2007.

FIRST USE 1-28-2008; IN COMMERCE 1-28-2008.

COLLEEN KEARNEY, EXAMINING ATTORNEY

**Int. Cl.: 3**

**Prior U.S. Cls.: 1, 4, 6, 50, 51, and 52**

**Reg. No. 3,506,265**

**United States Patent and Trademark Office**

**Registered Sep. 23, 2008**

---

**TRADEMARK  
PRINCIPAL REGISTER**

**BLACK LACE**

FINANZ ST. HONORE, B.V. (NETHERLANDS  
LIMITED LIABILITY COMPANY)  
PRINS BERNHARDPLEIN 200  
1097 JB AMSTERDAM, NETHERLANDS

THE MARK CONSISTS OF STANDARD CHAR-  
ACTERS WITHOUT CLAIM TO ANY PARTICULAR  
FONT, STYLE, SIZE, OR COLOR.

FOR: COSMETICS AND FRAGRANCES FOR  
PERSONAL USE, SKIN MOISTURIZERS, BODY  
LOTION, TALCUM POWDERS, IN CLASS 3 (U.S.  
CLS. 1, 4, 6, 50, 51 AND 52).

SN 77-287,832, FILED 9-25-2007.

FIRST USE 1-1-2008; IN COMMERCE 1-1-2008.

CHARLOTTE CORWIN, EXAMINING ATTORNEY

**Int. Cls.: 9, 38, and 41**

**Prior U.S. Cls.: 21, 23, 26, 36, 38, 100, 101, 104, and 107**

**Reg. No. 3,506,266**

**United States Patent and Trademark Office**

**Registered Sep. 23, 2008**

**TRADEMARK  
SERVICE MARK  
PRINCIPAL REGISTER**

# THE STUDIO

EXERCISE TV LLC (DELAWARE LIMITED LIABILITY COMPANY)  
11611 SAN VICENTE BLVD. #505  
LOS ANGELES, CA 90049

FOR: DVDS, DOWNLOADABLE VIDEO AND AUDIO FILES VIA THE INTERNET, AND DOWNLOADABLE TELEVISION PROGRAMS VIA A VIDEO ON DEMAND SERVICE, ALL IN THE FIELDS OF HEALTH AND FITNESS, IN CLASS 9 (U.S. CLS. 21, 23, 26, 36 AND 38).

FIRST USE 1-1-2008; IN COMMERCE 1-1-2008.

FOR: STREAMING OF AUDIO AND VIDEO MATERIAL ON THE INTERNET; VIDEO-ON-DEMAND TRANSMISSION SERVICES, IN CLASS 38 (U.S. CLS. 100, 101 AND 104).

FIRST USE 6-1-2007; IN COMMERCE 6-1-2007.

FOR: PROVISION OF NON-DOWNLOADABLE TELEVISION PROGRAMS VIA A VIDEO-ON-DEMAND SERVICE; PROVIDING AN ONLINE DATABASE TO ALLOW USERS TO CREATE CUSTOM WORKOUTS, IN CLASS 41 (U.S. CLS. 100, 101 AND 107).

FIRST USE 6-1-2007; IN COMMERCE 6-1-2007.

THE MARK CONSISTS OF STANDARD CHARACTERS WITHOUT CLAIM TO ANY PARTICULAR FONT, STYLE, SIZE, OR COLOR.

SN 77-288,060, FILED 9-25-2007.

AISHA CLARKE, EXAMINING ATTORNEY

**Int. Cl.: 3**

**Prior U.S. Cls.: 1, 4, 6, 50, 51, and 52**

**United States Patent and Trademark Office**

**Reg. No. 3,506,267**

**Registered Sep. 23, 2008**

**TRADEMARK  
PRINCIPAL REGISTER**

**BRITISH STERLING NO LIMIT**

FINANZ ST. HONORE, B.V. (NETHERLANDS  
LIMITED LIABILITY COMPANY)  
PRINS BERNHARDPLEIN 200  
AMSTERDAM, NETHERLANDS

FOR: MEN'S COLOGNE, IN CLASS 3 (U.S. CLS. 1,  
4, 6, 50, 51 AND 52).

FIRST USE 1-1-2008; IN COMMERCE 1-1-2008.

THE MARK CONSISTS OF STANDARD CHAR-  
ACTERS WITHOUT CLAIM TO ANY PARTICULAR  
FONT, STYLE, SIZE, OR COLOR.

OWNER OF U.S. REG. NOS. 804,836, 870,209, AND  
OTHERS.

SN 77-289,071, FILED 9-26-2007.

CHARLOTTE CORWIN, EXAMINING ATTORNEY

**Int. Cls.: 3 and 37**

**Prior U.S. Cls.: 1, 4, 6, 50, 51, 52, 100, 103, and 106**

**United States Patent and Trademark Office**

**Reg. No. 3,506,268**

**Registered Sep. 23, 2008**

**TRADEMARK  
SERVICE MARK  
PRINCIPAL REGISTER**

**GAETANO**

GAETANO HARDWOOD FLOORS, INC. (CALIFORNIA CORPORATION)  
7071 KEARNY DRIVE  
HUNTINGTON BEACH, CA 92648

FOR: CLEANING PREPARATIONS FOR HARDWOOD FLOORING, IN CLASS 3 (U.S. CLS. 1, 4, 6, 50, 51 AND 52).

FIRST USE 2-9-2008; IN COMMERCE 2-9-2008.

FOR: INSTALLATION, MAINTENANCE AND REPAIR OF HARDWOOD FLOORING, IN CLASS 37 (U.S. CLS. 100, 103 AND 106).

FIRST USE 1-0-1994; IN COMMERCE 1-0-1994.

THE MARK CONSISTS OF STANDARD CHARACTERS WITHOUT CLAIM TO ANY PARTICULAR FONT, STYLE, SIZE, OR COLOR.

SN 77-289,462, FILED 9-26-2007.

RUDY R. SINGLETON, EXAMINING ATTORNEY

**Int. Cl.: 35**

**Prior U.S. Cls.: 100, 101, and 102**

**United States Patent and Trademark Office**

**Reg. No. 3,506,269**

**Registered Sep. 23, 2008**

**SERVICE MARK  
PRINCIPAL REGISTER**

**UTILIMETRICS**

THE AUTOMATIC METER READING ASSOCIATION, INC. (NEW JERSEY NON-PROFIT CORPORATION)  
111 DEER LAKE RD., SUITE 100  
DEERFIELD, IL 60015

FOR: ASSOCIATION SERVICES, NAMELY, PROMOTING THE INTERESTS OF THOSE INVOLVED WITH GAS, WATER, ELECTRIC, AND TELECOMMUNICATION UTILITIES, IN CLASS 35 (U.S. CLS. 100, 101 AND 102).

FIRST USE 10-2-2007; IN COMMERCE 10-2-2007.

THE MARK CONSISTS OF STANDARD CHARACTERS WITHOUT CLAIM TO ANY PARTICULAR FONT, STYLE, SIZE, OR COLOR.

SN 77-289,564, FILED 9-26-2007.

MARY ROSSMAN, EXAMINING ATTORNEY

Int. Cls.: 43 and 44

Prior U.S. Cls.: 100 and 101

United States Patent and Trademark Office

Reg. No. 3,506,270

Registered Sep. 23, 2008

SERVICE MARK  
PRINCIPAL REGISTER



ROBINSON, STEVE (UNITED STATES INDIVIDUAL)  
6453 SPEARS POINT LANE  
LEXINGTON, KY 40515

FOR: PET CARE SERVICES, NAMELY, PET BOARDING AND DAY CARE SERVICES, IN CLASS 43 (U.S. CLS. 100 AND 101).

FIRST USE 5-1-2008; IN COMMERCE 5-1-2008.

FOR: PET CARE SERVICES, NAMELY, NON-MEDICATED GROOMING SERVICES, IN CLASS 44 (U.S. CLS. 100 AND 101).

FIRST USE 5-1-2008; IN COMMERCE 5-1-2008.

NO CLAIM IS MADE TO THE EXCLUSIVE RIGHT TO USE "AMERICA'S" AND "HOUNDS" AND "LUXURY RESORTS", APART FROM THE MARK AS SHOWN.

THE MARK CONSISTS OF A CARTOON DOG HOLDING AN AMERICAN FLAG, SITTING ON AN OUTLINE OF A CITY SKYLINE IN BETWEEN THE WORDS "AMERICA'S" AND "UPTOWN HOUNDS LUXURY RESORTS".

SN 77-291,191, FILED 9-28-2007.

NAPOLEON SHARMA, EXAMINING ATTORNEY

**Int. Cl.: 43**

**Prior U.S. Cls.: 100 and 101**

**United States Patent and Trademark Office**

**Reg. No. 3,506,271**

**Registered Sep. 23, 2008**

**SERVICE MARK  
PRINCIPAL REGISTER**

**PHASES MOON BAR**

ZEUS INDUSTRIAL PRODUCTS, INC. (NEW  
JERSEY CORPORATION)

3737 INDUSTRIAL BLVD.

ORANGEBURG, SC 29118

FOR: BAR SERVICES, IN CLASS 43 (U.S. CLS. 100  
AND 101).

FIRST USE 6-25-2008; IN COMMERCE 6-25-2008.

THE MARK CONSISTS OF STANDARD CHAR-  
ACTERS WITHOUT CLAIM TO ANY PARTICULAR  
FONT, STYLE, SIZE, OR COLOR.

NO CLAIM IS MADE TO THE EXCLUSIVE  
RIGHT TO USE "BAR", APART FROM THE MARK  
AS SHOWN.

SN 77-292,979, FILED 10-1-2007.

BERYL GARDNER, EXAMINING ATTORNEY



**Int. Cl.: 28**

**Prior U.S. Cls.: 22, 23, 38, and 50**

**United States Patent and Trademark Office**

**Reg. No. 3,506,272**

**Registered Sep. 23, 2008**

**TRADEMARK  
PRINCIPAL REGISTER**

# SPIKEBALL

KANKAKEE SPIKEBALL, INC. (ILLINOIS CORPORATION)  
3337 NORTH HOYNE  
CHICAGO, IL 60618

FOR: SPORT BALLS; NETS FOR BALL GAMES; GAME TABLES; ACTION SKILL GAMES; ACTION TARGET GAMES; ACTION-TYPE TARGET GAMES; BALLS FOR GAMES; OUTDOOR ACTIVITY GAMES IN THE NATURE OF GAME FEATURING A SURFACE FOR BOUNCING A BALL; TRAMPOLINES; EQUIPMENT SOLD AS A UNIT FOR PLAYING ACTION TYPE TARGET GAMES; PARLOR

GAMES; PARTY GAMES; TARGET GAMES; BEACH BALLS, IN CLASS 28 (U.S. CLS. 22, 23, 38 AND 50).

FIRST USE 4-1-2008; IN COMMERCE 4-1-2008.

THE MARK CONSISTS OF STANDARD CHARACTERS WITHOUT CLAIM TO ANY PARTICULAR FONT, STYLE, SIZE, OR COLOR.

SN 77-296,248, FILED 10-4-2007.

CYNTHIA SLOAN, EXAMINING ATTORNEY

**Int. Cl.: 16**

**Prior U.S. Cls.: 2, 5, 22, 23, 29, 37, 38, and 50**

**United States Patent and Trademark Office**

**Reg. No. 3,506,273**

**Registered Sep. 23, 2008**

**TRADEMARK  
PRINCIPAL REGISTER**



SCHULMAN, CARL H. (UNITED STATES INDIVIDUAL)  
80379 AVENIDA SANTA ALICIA  
INDIO, CA 922037441

FOR: DESKTOP ORGANIZERS, IN CLASS 16 (U.S. CLS. 2, 5, 22, 23, 29, 37, 38 AND 50).

FIRST USE 2-1-2008; IN COMMERCE 5-12-2008.

NO CLAIM IS MADE TO THE EXCLUSIVE RIGHT TO USE "DESK", APART FROM THE MARK AS SHOWN.

THE COLOR(S) WHITE, GRAY AND BLACK IS/ ARE CLAIMED AS A FEATURE OF THE MARK.

THE VERTICAL AND HORIZONTAL LINES ARE IN GRAY, THE WORDING "DESK SAVER" IS IN WHITE AND THE BACKGROUND OF THE RECTANGLE IS IN BLACK.

SN 77-296,635, FILED 10-4-2007.

EDWARD NELSON, EXAMINING ATTORNEY

**Int. Cl.: 25**

**Prior U.S. Cls.: 22 and 39**

**United States Patent and Trademark Office**

**Reg. No. 3,506,274**

**Registered Sep. 23, 2008**

**TRADEMARK  
PRINCIPAL REGISTER**

**POPPY & CLOVER**

SUBLIMATION FACTORY, INC. (CALIFORNIA CORPORATION)  
3400 S. MAIN STREET  
LOS ANGELES, CA 90007

FOR: CLOTHING, NAMELY, MEN'S AND WOMEN'S PANTS, TROUSERS, SLACKS, JEANS, LEGGINGS, CAPRIS, SKIRTS, SKORTS, SHORTS, OVERALLS, DRESSES, BLOUSES, TOPS, SHIRTS, T-SHIRTS, CAMISOLES, TANK TOPS, SWEATERS, CARDIGANS, JACKETS, COATS, VESTS, SCARVES, NECKTIES, HEADWEAR AND FOOTWEAR, BELTS, IN CLASS 25 (U.S. CLS. 22 AND 39).

FIRST USE 3-1-2008; IN COMMERCE 3-1-2008.

THE MARK CONSISTS OF STANDARD CHARACTERS WITHOUT CLAIM TO ANY PARTICULAR FONT, STYLE, SIZE, OR COLOR.

SN 77-297,078, FILED 10-5-2007.

KATHY DE JONGE, EXAMINING ATTORNEY

**Int. Cl.: 36**

**Prior U.S. Cls.: 100, 101, and 102**

**United States Patent and Trademark Office**

**Reg. No. 3,506,275**

**Registered Sep. 23, 2008**

**SERVICE MARK  
PRINCIPAL REGISTER**

**UNITED COUNTRY HOME  
MORTGAGE**

UNITED COUNTRY REAL ESTATE, INC. (MISSOURI CORPORATION)  
2820 NW BARRY ROAD  
KANSAS CITY, MO 641880250

OWNER OF U.S. REG. NOS. 1,109,683, 2,186,596,  
AND 2,188,368.

FOR: HOME EQUITY LOANS AND MORTGAGE LENDING SERVICES, IN CLASS 36 (U.S. CLS. 100, 101 AND 102).

NO CLAIM IS MADE TO THE EXCLUSIVE RIGHT TO USE "HOME MORTGAGE", APART FROM THE MARK AS SHOWN.

FIRST USE 12-7-2007; IN COMMERCE 12-7-2007.

SN 77-297,802, FILED 10-5-2007.

THE MARK CONSISTS OF STANDARD CHARACTERS WITHOUT CLAIM TO ANY PARTICULAR FONT, STYLE, SIZE, OR COLOR.

JOHN KELLY, EXAMINING ATTORNEY

**Int. Cl.: 35**

**Prior U.S. Cls.: 100, 101, and 102**

**United States Patent and Trademark Office**

**Reg. No. 3,506,276**

**Registered Sep. 23, 2008**

**SERVICE MARK  
PRINCIPAL REGISTER**

# Tipsy Gourmet

TIPSY GOURMET, INC. (NORTH CAROLINA CORPORATION)  
11721 RETAIL DRIVE, SUITE 105  
WAKE FOREST, NC 27587

FOR: RETAIL COOKWARE, BAKING ITEMS, COOKING UTENSILS, GOURMET FOODS, WINE, CHEESES, AND ALES STORES, IN CLASS 35 (U.S. CLS. 100, 101 AND 102).

FIRST USE 4-1-2008; IN COMMERCE 7-1-2008.

THE MARK CONSISTS OF STANDARD CHARACTERS WITHOUT CLAIM TO ANY PARTICULAR FONT, STYLE, SIZE, OR COLOR.

NO CLAIM IS MADE TO THE EXCLUSIVE RIGHT TO USE "GOURMET", APART FROM THE MARK AS SHOWN.

SN 77-298,125, FILED 10-7-2007.

DANNEAN HETZEL, EXAMINING ATTORNEY

**Int. Cl.: 45**

**Prior U.S. Cls.: 100 and 101**

**United States Patent and Trademark Office**

**Reg. No. 3,506,277**

**Registered Sep. 23, 2008**

**SERVICE MARK  
PRINCIPAL REGISTER**

# GIFTOLOGY

AZRIA, MARINE (UNITED STATES INDIVIDUAL)  
C/O LEGAL DEPARTMENT  
2761 FUITLAND AVE.  
VERNON, CA 90058

THE MARK CONSISTS OF STANDARD CHARACTERS WITHOUT CLAIM TO ANY PARTICULAR FONT, STYLE, SIZE, OR COLOR.

FOR: PERSONAL SHOPPING FOR OTHERS, IN CLASS 45 (U.S. CLS. 100 AND 101).

SN 77-298,749, FILED 10-8-2007.

FIRST USE 3-31-2008; IN COMMERCE 3-31-2008.

APRIL ROACH, EXAMINING ATTORNEY

**Int. Cl.: 14**

**Prior U.S. Cls.: 2, 27, 28, and 50**

**United States Patent and Trademark Office**

**Reg. No. 3,506,278**

**Registered Sep. 23, 2008**

**TRADEMARK  
PRINCIPAL REGISTER**

**LUCKY BRAND**

LUCKY BRAND DUNGAREES, INC. (DELA-  
WARE CORPORATION)  
5233 ALCOA AVENUE  
VERNON, CA 90058

FOR: WATCHES, IN CLASS 14 (U.S. CLS. 2, 27, 28  
AND 50).

FIRST USE 7-28-2008; IN COMMERCE 7-28-2008.

THE MARK CONSISTS OF STANDARD CHAR-  
ACTERS WITHOUT CLAIM TO ANY PARTICULAR  
FONT, STYLE, SIZE, OR COLOR.

OWNER OF U.S. REG. NOS. 2,883,694 AND  
2,936,774.

NO CLAIM IS MADE TO THE EXCLUSIVE  
RIGHT TO USE "BRAND", APART FROM THE  
MARK AS SHOWN.

SN 77-299,071, FILED 10-9-2007.

ALEXANDER L. POWERS, EXAMINING ATTOR-  
NEY

**Int. Cl.: 21**

**Prior U.S. Cls.: 2, 13, 23, 29, 30, 33, 40, and 50**

**Reg. No. 3,506,279**

**United States Patent and Trademark Office**

**Registered Sep. 23, 2008**

---

**TRADEMARK  
PRINCIPAL REGISTER**

**Earth Pan**

MEYER INTELLECTUAL PROPERTIES LIMITED  
(BR. VIRGIN ISLANDS CORPORATION)

382 KWUN TONG ROAD

KOWLOON, HONGKONG, CHINA

FOR: COOKWARE, NAMELY, POTS AND PANS,  
IN CLASS 21 (U.S. CLS. 2, 13, 23, 29, 30, 33, 40 AND 50).

FIRST USE 3-10-2008; IN COMMERCE 4-1-2008.

THE MARK CONSISTS OF STANDARD CHAR-  
ACTERS WITHOUT CLAIM TO ANY PARTICULAR  
FONT, STYLE, SIZE, OR COLOR.

NO CLAIM IS MADE TO THE EXCLUSIVE  
RIGHT TO USE "PAN", APART FROM THE MARK  
AS SHOWN.

SN 77-299,104, FILED 10-9-2007.

BILL DAWE, EXAMINING ATTORNEY



**Int. Cl.: 3**

**Prior U.S. Cls.: 1, 4, 6, 50, 51, and 52**

**United States Patent and Trademark Office**

**Reg. No. 3,506,280**

**Registered Sep. 23, 2008**

**TRADEMARK  
PRINCIPAL REGISTER**

**BellaBrite**

CONVERTIS, LLC (COLORADO LIMITED LIABILITY COMPANY)  
6260 LOOKOUT ROAD  
BOULDER, CO 80301

THE MARK CONSISTS OF STANDARD CHARACTERS WITHOUT CLAIM TO ANY PARTICULAR FONT, STYLE, SIZE, OR COLOR.

FOR: TOOTH WHITENING GELS; TOOTH WHITENING PREPARATIONS, IN CLASS 3 (U.S. CLS. 1, 4, 6, 50, 51 AND 52).

SN 77-299,337, FILED 10-9-2007.

FIRST USE 1-7-2008; IN COMMERCE 1-8-2008.

MICHAEL SOUDERS, EXAMINING ATTORNEY

Int. Cl.: 10

Prior U.S. Cls.: 26, 39, and 44

United States Patent and Trademark Office

Reg. No. 3,506,281

Registered Sep. 23, 2008

TRADEMARK  
PRINCIPAL REGISTER



IDEAL IMPLANT INCORPORATED (TEXAS CORPORATION)  
SUITE 120  
8345 WALNUT HILL  
DALLAS, TX 75231

FOR: COSMETIC SURGICAL IMPLANTS COMPRISING ARTIFICIAL MATERIAL, IN CLASS 10 (U.S. CLS. 26, 39 AND 44).

FIRST USE 9-26-2006; IN COMMERCE 9-26-2006.

OWNER OF U.S. REG. NO. 3,220,933.

NO CLAIM IS MADE TO THE EXCLUSIVE RIGHT TO USE "IDEAL IMPLANT", APART FROM THE MARK AS SHOWN.

THE MARK CONSISTS OF THE WORDS "IDEAL IMPLANT" WITH A LOWER CASE SCRIPT "I" POSITIONED ABOVE THE WORDS "IDEAL IMPLANT".

SN 77-299,696, FILED 10-9-2007.

STEVEN JACKSON, EXAMINING ATTORNEY

**Int. Cl.: 43**

**Prior U.S. Cls.: 100 and 101**

**United States Patent and Trademark Office**

**Reg. No. 3,506,282**

**Registered Sep. 23, 2008**

**SERVICE MARK  
PRINCIPAL REGISTER**

**WYNDHAM ALLIANCE RESORTS**

WYNDHAM TM CORP. (DELAWARE CORPORATION)  
10750 WEST CHARLESTON BLVD., SUITE 130  
LAS VEGAS, NV 89135

OWNER OF U.S. REG. NOS. 3,043,521, 3,223,148,  
AND OTHERS.

FOR: RESORT HOTEL, HOTEL, MOTEL AND  
RESTAURANT SERVICES; VACATION RENTAL  
SERVICES; MAKING LODGING RESERVATIONS  
FOR OTHERS, IN CLASS 43 (U.S. CLS. 100 AND 101).

NO CLAIM IS MADE TO THE EXCLUSIVE  
RIGHT TO USE "RESORTS", APART FROM THE  
MARK AS SHOWN.

FIRST USE 7-0-2007; IN COMMERCE 7-0-2007.

SN 77-299,706, FILED 10-9-2007.

THE MARK CONSISTS OF STANDARD CHAR-  
ACTERS WITHOUT CLAIM TO ANY PARTICULAR  
FONT, STYLE, SIZE, OR COLOR.

CHERYL CLAYTON, EXAMINING ATTORNEY

**Int. Cl.: 45**

**Prior U.S. Cls.: 100 and 101**

**United States Patent and Trademark Office**

**Reg. No. 3,506,283**

**Registered Sep. 23, 2008**

**SERVICE MARK  
PRINCIPAL REGISTER**

**Ce Ce's Closet**

SHERRY SPALDING-FARDIE (UNITED STATES  
INDIVIDUAL)  
6501 RED HOOK PLAZA, SUITE 201, PMB 60  
ST. THOMAS, US VIRGIN ISLANDS 00802

THE MARK CONSISTS OF STANDARD CHAR-  
ACTERS WITHOUT CLAIM TO ANY PARTICULAR  
FONT, STYLE, SIZE, OR COLOR.

FOR: CHARITABLE SERVICES, NAMELY, PRO-  
VIDING CLOTHING TO THE NEEDY, IN CLASS 45  
(U.S. CLS. 100 AND 101).

SN 77-300,332, FILED 10-10-2007.

FIRST USE 7-30-2008; IN COMMERCE 7-30-2008.

KAELIE KUNG, EXAMINING ATTORNEY

**Int. Cl.: 42**

**Prior U.S. Cls.: 100 and 101**

**United States Patent and Trademark Office**

**Reg. No. 3,506,284**

**Registered Sep. 23, 2008**

**SERVICE MARK  
PRINCIPAL REGISTER**

**MYCASEINFO**

CCH INCORPORATED (DELAWARE CORPORATION)  
2700 LAKE COOK ROAD  
RIVERWOODS, IL 60015

FOR: PROVIDING TEMPORARY USE OF ONLINE NON-DOWNLOADABLE SOFTWARE FOR BANKRUPTCY CASE MANAGEMENT, IN CLASS 42 (U.S. CLS. 100 AND 101).

FIRST USE 11-0-2007; IN COMMERCE 11-0-2007.

THE MARK CONSISTS OF STANDARD CHARACTERS WITHOUT CLAIM TO ANY PARTICULAR FONT, STYLE, SIZE, OR COLOR.

SN 77-301,602, FILED 10-11-2007.

JOHN WILKE, EXAMINING ATTORNEY

**Int. Cl.: 19**

**Prior U.S. Cls.: 1, 12, 33, and 50**

**United States Patent and Trademark Office**

**Reg. No. 3,506,285**

**Registered Sep. 23, 2008**

**TRADEMARK  
PRINCIPAL REGISTER**

**Sustainable. Sound.  
Rustic. Elegant. Classic.**

AMBIENT BAMBOO PRODUCTS INC. (VIRGINIA CORPORATION)  
5108 BUCHANAN ST  
HYATTSVILLE, MD 20781

THE MARK CONSISTS OF STANDARD CHARACTERS WITHOUT CLAIM TO ANY PARTICULAR FONT, STYLE, SIZE, OR COLOR.

FOR: BAMBOO FLOORING, IN CLASS 19 (U.S. CLS. 1, 12, 33 AND 50).

SN 77-303,888, FILED 10-15-2007.

FIRST USE 5-1-2006; IN COMMERCE 6-1-2008.

NAAKWAMA ANKRAH, EXAMINING ATTORNEY

**Int. Cl.: 11**

**Prior U.S. Cls.: 13, 21, 23, 31, and 34**

**United States Patent and Trademark Office**

**Reg. No. 3,506,286**

**Registered Sep. 23, 2008**

**TRADEMARK  
PRINCIPAL REGISTER**

# Thermalflex

IEM SOLUTIONS, INC. (NEVADA CORPORATION)  
SUITE 304  
144 WESTMINSTER STREET  
PROVIDENCE, RI 02903

FOR: ELECTRICAL DEVICES TO BE PLUGGED INTO WALL OUTLETS HAVING A HEATING ELEMENT AND WHICH DISPENSES HEAT; ELECTRICAL HEATING CABLES; ELECTRICALLY HEATED CARPETS; ELECTRICALLY-HEATED MUGS; FLEXIBLE HEATING ELEMENTS FOR AUTOMOBILE SEATS, NAMELY, FLEXIBLE WIRE-KNITTED AND WOVEN HEATING TAPES; FOOD AND BEVERAGE COOLING AND HEATING RECEPTACLES CONTAINING HEAT EXCHANGE FLUID FOR HOUSEHOLD PURPOSES; HEAT PIPES TO COOL HEAT PRODUCING COMPONENTS; HEATING CUSHIONS NOT FOR MEDICAL PURPOSES; HEAT-

ING INSERTS FOR PET BEDS; HEATING PADS NOT FOR MEDICAL PURPOSES; PAVEMENT HEATING APPARATUS; PORTABLE THERMAL SELF-HEATING POUCH FOR THE PURPOSE OF HEATING FOOD, IN CLASS 11 (U.S. CLS. 13, 21, 23, 31 AND 34).

FIRST USE 7-1-2008; IN COMMERCE 7-1-2008.

THE MARK CONSISTS OF STANDARD CHARACTERS WITHOUT CLAIM TO ANY PARTICULAR FONT, STYLE, SIZE, OR COLOR.

SN 77-303,979, FILED 10-15-2007.

JACQUELINE A. LAVINE, EXAMINING ATTORNEY

**Int. Cl.: 41**

**Prior U.S. Cls.: 100, 101, and 107**

**United States Patent and Trademark Office**

**Reg. No. 3,506,287**

**Registered Sep. 23, 2008**

**SERVICE MARK  
PRINCIPAL REGISTER**

**AMANDA JANE**

HARGENS, AMANDA JANE (UNITED STATES  
INDIVIDUAL)  
6013 N. WINWOOD DRIVE  
JOHNSTON, IA 50131

THE MARK CONSISTS OF STANDARD CHAR-  
ACTERS WITHOUT CLAIM TO ANY PARTICULAR  
FONT, STYLE, SIZE, OR COLOR.

FOR: ENTERTAINMENT SERVICES, NAMELY,  
LIVE SINGING PERFORMANCES BY AN INDIVI-  
DUAL, IN CLASS 41 (U.S. CLS. 100, 101 AND 107).

SN 77-304,014, FILED 10-15-2007.

FIRST USE 9-0-2007; IN COMMERCE 11-27-2007.

DAVID MURRAY, EXAMINING ATTORNEY



Int. Cl.: 20

Prior U.S. Cls.: 2, 13, 22, 25, 32, and 50

United States Patent and Trademark Office

Reg. No. 3,506,288

Registered Sep. 23, 2008

TRADEMARK  
PRINCIPAL REGISTER



R. D. GARRETT AND ASSOCIATES (SOUTH  
CAROLINA SOLE PROPRIETORSHIP), DBA  
NOT JUST WICKER,  
3508 HOPEWELL ROAD  
ANDERSON, SC 29621

FOR: CABINETS; CAST STONE HOUSEHOLD  
AND GARDEN FURNITURE; CUSHIONS; FURNI-  
TURE; FURNITURE FOR HOUSE, OFFICE AND  
GARDEN; FURNITURE MADE FROM WOOD OR  
SUBSTITUTES OF WOOD; LAWN FURNITURE;  
OUTDOOR FURNITURE; SEATING FURNITURE;  
SEATS; TABLES, IN CLASS 20 (U.S. CLS. 2, 13, 22, 25,  
32 AND 50).

FIRST USE 2-1-2008; IN COMMERCE 4-1-2008.

THE COLOR(S) WHITE AND GREEN IS/ARE  
CLAIMED AS A FEATURE OF THE MARK.

THE COLOR WHITE APPEARS IN THE WORD-  
ING "NOT JUST WICKER YOUR OUTLET STORE  
FOR CASUAL LIVING". THE COLOR GREEN AP-  
PEARS IN THE PALM TREE AND BACKGROUND  
OVAL DESIGN.

SN 77-304,035, FILED 10-15-2007.

ADA HAN, EXAMINING ATTORNEY

**Int. Cl.: 33**

**Prior U.S. Cls.: 47 and 49**

**United States Patent and Trademark Office**

**Reg. No. 3,506,289**

**Registered Sep. 23, 2008**

**TRADEMARK  
PRINCIPAL REGISTER**

THE SPARKLING ITALIAN FUN

CARRIAGE HOUSE IMPORTS LTD. (DELA-  
WARE CORPORATION)  
99 MORRIS AVENUE  
SPRINGFIELD, NJ 07081

FOR: ALCOHOLIC BEVERAGE PRODUCED  
FROM A BREWED MALT BASE WITH NATURAL  
FLAVORS, IN CLASS 33 (U.S. CLS. 47 AND 49).

FIRST USE 3-0-2007; IN COMMERCE 3-0-2007.

THE MARK CONSISTS OF STANDARD CHAR-  
ACTERS WITHOUT CLAIM TO ANY PARTICULAR  
FONT, STYLE, SIZE, OR COLOR.

NO CLAIM IS MADE TO THE EXCLUSIVE  
RIGHT TO USE "SPARKLING ITALIAN", APART  
FROM THE MARK AS SHOWN.

SN 77-304,224, FILED 10-15-2007.

MELISSA VALLILLO, EXAMINING ATTORNEY

**Int. Cl.: 36**

**Prior U.S. Cls.: 100, 101, and 102**

**United States Patent and Trademark Office**

**Reg. No. 3,506,290**

**Registered Sep. 23, 2008**

**SERVICE MARK  
PRINCIPAL REGISTER**

**Educational Pathways  
International**

LAFRANCE FAMILY FOUNDATION (NEVADA  
NON-PROFIT CORPORATION)  
500 FAIRVIEW DRIVE  
INCLINE VILLAGE, NV 89451

FOR: CHARITABLE FUNDRAISING; PROVIDING EDUCATIONAL SCHOLARSHIPS; PROVIDING COLLEGE SCHOLARSHIPS; FINANCING SERVICES IN THE FIELD OF FINANCIAL ASSISTANCE; FINANCING SERVICES IN THE FIELD OF TUITION ASSISTANCE, IN CLASS 36 (U.S. CLS. 100, 101 AND 102).

FIRST USE 1-1-2008; IN COMMERCE 1-1-2008.

THE MARK CONSISTS OF STANDARD CHARACTERS WITHOUT CLAIM TO ANY PARTICULAR FONT, STYLE, SIZE, OR COLOR.

NO CLAIM IS MADE TO THE EXCLUSIVE RIGHT TO USE "EDUCATIONAL" AND "INTERNATIONAL", APART FROM THE MARK AS SHOWN.

SN 77-304,296, FILED 10-15-2007.

REBECCA GILBERT, EXAMINING ATTORNEY

**Int. Cl.: 36**

**Prior U.S. Cls.: 100, 101, and 102**

**United States Patent and Trademark Office**

**Reg. No. 3,506,291**

**Registered Sep. 23, 2008**

**SERVICE MARK  
PRINCIPAL REGISTER**



LAFRANCE FAMILY FOUNDATION (NEVADA  
NON-PROFIT CORPORATION)  
500 FAIRVIEW DRIVE  
INCLINE VILLAGE, NV 89451

FOR: CHARITABLE FUNDRAISING; PROVIDING EDUCATIONAL SCHOLARSHIPS; PROVIDING COLLEGE SCHOLARSHIPS; FINANCING SERVICES IN THE FIELD OF FINANCIAL ASSISTANCE; FINANCING SERVICES IN THE FIELD OF TUITION ASSISTANCE, IN CLASS 36 (U.S. CLS. 100, 101 AND 102).

FIRST USE 1-1-2008; IN COMMERCE 1-1-2008.

NO CLAIM IS MADE TO THE EXCLUSIVE RIGHT TO USE "EDUCATIONAL" AND "INTERNATIONAL", APART FROM THE MARK AS SHOWN.

THE COLOR(S) GREEN, BLACK AND WHITE IS/ARE CLAIMED AS A FEATURE OF THE MARK.

THE MARK CONSISTS OF A GREEN ARC OVER THE BLACK WORDS "EDUCATIONAL PATHWAYS INTERNATIONAL" WITH A BLACK GRADUATION CAP WITH WHITE ACCENTS AT THE TOP CENTER OF THE ARC. THE WHITE WITHIN THE ARC CONSTITUTES BACKGROUND WHICH IS NOT A PART OF THE MARK.

SN 77-304,312, FILED 10-15-2007.

REBECCA GILBERT, EXAMINING ATTORNEY

**Int. Cl.: 35**

**Prior U.S. Cls.: 100, 101, and 102**

**United States Patent and Trademark Office**

**Reg. No. 3,506,292**

**Registered Sep. 23, 2008**

**SERVICE MARK  
PRINCIPAL REGISTER**

**MY COMMIT REWARDS**

SMITHKLINE BEECHAM CORPORATION  
(PENNSYLVANIA CORPORATION)  
ONE FRANKLIN PLAZA  
PHILADELPHIA, PA 19102

FOR: CONSUMER LOYALTY INCENTIVE PROGRAM FOR COMMERCIAL, PROMOTIONAL AND/OR ADVERTISING PURPOSES WHEREBY PARTICIPANTS ACCUMULATE VALUE FROM PURCHASES WHICH CAN BE REDEEMED FOR MERCHANDISE, DISCOUNTS AND CASH PRIZES, IN CLASS 35 (U.S. CLS. 100, 101 AND 102).

FIRST USE 6-2-2008; IN COMMERCE 6-2-2008.

THE MARK CONSISTS OF STANDARD CHARACTERS WITHOUT CLAIM TO ANY PARTICULAR FONT, STYLE, SIZE, OR COLOR.

OWNER OF U.S. REG. NOS. 2,718,146 AND 3,218,753.

NO CLAIM IS MADE TO THE EXCLUSIVE RIGHT TO USE "REWARDS", APART FROM THE MARK AS SHOWN.

SN 77-304,867, FILED 10-16-2007.

ELLEN PERKINS, EXAMINING ATTORNEY

**Int. Cl.: 35**

**Prior U.S. Cls.: 100, 101, and 102**

**United States Patent and Trademark Office**

**Reg. No. 3,506,293**

**Registered Sep. 23, 2008**

**SERVICE MARK  
PRINCIPAL REGISTER**

**VISUALCV**

VISUALCV, INC. (DELAWARE CORPORATION)  
SUITE 1300  
11951 FREEDOM DRIVE  
RESTON, VA 20190

FOR: HUMAN RESOURCE CONSULTANCY SERVICES, NAMELY, RECRUITING SERVICES, EXECUTIVE SEARCH SERVICES, PLACEMENT SERVICES, STAFFING SERVICES, AND HUMAN RESOURCES CONSULTING, EMPLOYMENT AND CAREER COUNSELING SERVICES, RESUME EDITING SERVICES, HIRING CONSULTATION AND

EMPLOYEE AND JOB PROFILING SERVICES, IN CLASS 35 (U.S. CLS. 100, 101 AND 102).

FIRST USE 2-0-2008; IN COMMERCE 2-0-2008.

THE MARK CONSISTS OF STANDARD CHARACTERS WITHOUT CLAIM TO ANY PARTICULAR FONT, STYLE, SIZE, OR COLOR.

SN 77-304,877, FILED 10-16-2007.

ODESSA BIBBINS, EXAMINING ATTORNEY

**Int. Cl.: 35**

**Prior U.S. Cls.: 100, 101, and 102**

**United States Patent and Trademark Office**

**Reg. No. 3,506,294**

**Registered Sep. 23, 2008**

**SERVICE MARK  
PRINCIPAL REGISTER**



ONYX M.D. (COLORADO CORPORATION)  
1660 PEARL STREET  
DENVER, CO 80203

FOR: BUSINESS MANAGEMENT AND CONSULTATION IN THE FIELD OF HEALTHCARE, IN CLASS 35 (U.S. CLS. 100, 101 AND 102).

FIRST USE 7-4-2007; IN COMMERCE 8-4-2007.

NO CLAIM IS MADE TO THE EXCLUSIVE RIGHT TO USE "HEALTHCARE", APART FROM THE MARK AS SHOWN.

THE MARK CONSISTS OF THE WORD "IVITA" IN STYLIZED FONT WITH THE WORD "HEALTHCARE" IN SMALLER FONT DIRECTLY BELOW "IVITA". THE LETTER V APPEARS AS A DESIGN TO THE LEFT OF "IVITA" AND "HEALTHCARE", WITH A SMALL CIRCLE APPEARING ABOVE THE "V".

SN 77-304,983, FILED 10-16-2007.

JILL C. ALT, EXAMINING ATTORNEY

**Int. Cl.: 36**

**Prior U.S. Cls.: 100, 101, and 102**

**United States Patent and Trademark Office**

**Reg. No. 3,506,295**

**Registered Sep. 23, 2008**

**SERVICE MARK  
PRINCIPAL REGISTER**

# Brancor International

ZWEIG, ROBERT B (VIRGINIA SOLE PROPRIETORSHIP)  
615 PLANTATION CT  
CHARLOTTESVILLE, VA 22903

FOR: FINANCIAL ANALYSIS AND CONSULTATION; FINANCIAL CONSULTATION; FINANCIAL CONSULTATION IN THE FIELD OF EQUITIES; FINANCIAL CONSULTING; FINANCIAL FORECASTING; FINANCIAL PLANNING AND INVESTMENT ADVISORY SERVICES; FINANCIAL PORTFOLIO ANALYSIS SERVICES; FINANCIAL PORTFOLIO MANAGEMENT; FINANCIAL RESEARCH; FINANCIAL RISK MANAGEMENT CONSULTATION; FINANCIAL SERVICES IN THE NATURE OF AN INVESTMENT SECURITY; FINANCIAL SERVICES, NAMELY, ASSISTING OTHERS WITH THE COMPLETION OF FINANCIAL TRANSACTIONS FOR STOCKS, BONDS, SECURITIES AND EQUITIES; FINANCIAL SERVICES, NAMELY, A TOTAL PORTFOLIO OFFERING FOR HIGH NET WORTH CLIENTS CONSISTING OF

BOTH SEPARATE ACCOUNTS AND MUTUAL FUNDS FOR EQUITY AND FIXED INCOME INVESTMENTS; PROVIDING INFORMATION AND ADVICE IN THE FIELD OF FINANCE, FINANCIAL INVESTMENTS, FINANCIAL VALUATIONS, AND THE FINANCIAL ASPECTS OF RETIREMENT, IN CLASS 36 (U.S. CLS. 100, 101 AND 102).

FIRST USE 2-7-2007; IN COMMERCE 2-7-2007.

THE MARK CONSISTS OF STANDARD CHARACTERS WITHOUT CLAIM TO ANY PARTICULAR FONT, STYLE, SIZE, OR COLOR.

NO CLAIM IS MADE TO THE EXCLUSIVE RIGHT TO USE "INTERNATIONAL", APART FROM THE MARK AS SHOWN.

SN 77-305,195, FILED 10-16-2007.

THEODORE MCBRIDE, EXAMINING ATTORNEY



**Int. Cl.: 28**

**Prior U.S. Cls.: 22, 23, 38, and 50**

**United States Patent and Trademark Office**

**Reg. No. 3,506,296**

**Registered Sep. 23, 2008**

**TRADEMARK  
PRINCIPAL REGISTER**

**COYOTE HOOKER**

HUNTER'S SPECIALTIES, INC. (IOWA CORPORATION)

6000 HUNTINGTON CT. NE

CEDAR RAPIDS, IA 52402

FOR: HUNTING GAME CALLS, IN CLASS 28 (U.S. CLS. 22, 23, 38 AND 50).

FIRST USE 5-22-2008; IN COMMERCE 5-22-2008.

THE MARK CONSISTS OF STANDARD CHARACTERS WITHOUT CLAIM TO ANY PARTICULAR FONT, STYLE, SIZE, OR COLOR.

NO CLAIM IS MADE TO THE EXCLUSIVE RIGHT TO USE "COYOTE", APART FROM THE MARK AS SHOWN.

SN 77-305,981, FILED 10-17-2007.

DANIEL CAPSHAW, EXAMINING ATTORNEY

**Int. Cls.: 16 and 41**

**Prior U.S. Cls.: 2, 5, 22, 23, 29, 37, 38, 50, 100, 101, and 107**

**Reg. No. 3,506,297**

**United States Patent and Trademark Office**

**Registered Sep. 23, 2008**

**TRADEMARK  
SERVICE MARK  
PRINCIPAL REGISTER**

**BOOKS YOU CAN READ, BEFORE  
YOU CAN READ.**

AMERICAN READING COMPANY (PENNSYLVANIA CORPORATION)  
201 S. GULPH ROAD  
KING OF PRUSSIA, PA 19406

FOR: EDUCATIONAL BOOKS, NAMELY, BOOKS FOR CHILDREN THAT ASSIST THEM LEARNING HOW TO READ , IN CLASS 16 (U.S. CLS. 2, 5, 22, 23, 29, 37, 38 AND 50).

FIRST USE 11-1-2007; IN COMMERCE 11-1-2007.

FOR: EDUCATIONAL SERVICES, NAMELY, A READING PROGRAM FOR PRE- KINDERGARTEN THROUGH SECONDARY SCHOOL STUDENTS AND DISTRIBUTION OF PRINTED BOOKS IN CONNECTION THEREWITH; A PROGRAM FOR ASSESSING THE LEVEL OF DIFFICULTY OF

BOOKS AS PART OF A READING PROGRAM, IN CLASS 41 (U.S. CLS. 100, 101 AND 107).

FIRST USE 11-1-2007; IN COMMERCE 11-1-2007.

THE MARK CONSISTS OF STANDARD CHARACTERS WITHOUT CLAIM TO ANY PARTICULAR FONT, STYLE, SIZE, OR COLOR.

NO CLAIM IS MADE TO THE EXCLUSIVE RIGHT TO USE "BOOKS", APART FROM THE MARK AS SHOWN.

SN 77-306,174, FILED 10-17-2007.

NAPOLEON SHARMA, EXAMINING ATTORNEY

**Int. Cl.: 36**

**Prior U.S. Cls.: 100, 101, and 102**

**United States Patent and Trademark Office**

**Reg. No. 3,506,298**

**Registered Sep. 23, 2008**

**SERVICE MARK  
PRINCIPAL REGISTER**



WATERTON ASSOCIATES L.L.C. (ILLINOIS LIMITED LIABILITY COMPANY)

SUITE 1150

ONE NORTH FRANKLIN

CHICAGO, IL 60606

FOR: RESIDENTIAL REAL ESTATE SERVICES, NAMELY, REAL ESTATE MANAGEMENT AND LEASING OF REAL ESTATE, IN CLASS 36 (U.S. CLS. 100, 101 AND 102).

FIRST USE 12-0-2007; IN COMMERCE 12-0-2007.

NO CLAIM IS MADE TO THE EXCLUSIVE RIGHT TO USE "RESIDENTIAL", APART FROM THE MARK AS SHOWN.

THE COLOR(S) BLUE, GREEN, ORANGE AND BEIGE IS/ARE CLAIMED AS A FEATURE OF THE MARK.

THE MARK CONSISTS OF A BLUE CIRCLE DESIGN WHICH CONTAINS FOUR, THREE-PRONGED OBJECTS, EACH ONE DISPLAYED IN A DIFFERENT COLOR, ONE ORANGE, ONE BLUE, ONE GREEN AND ONE BEIGE. THE WORD "WATERTON" IS SHOWN IN BLUE LETTERING NEXT TO THE DESIGN AND THE WORD "RESIDENTIAL" IS IN BLUE LETTERING BELOW "WATERTON".

SN 77-306,281, FILED 10-17-2007.

TRICIA SONNEBORN, EXAMINING ATTORNEY

**Int. Cl.: 35**

**Prior U.S. Cls.: 100, 101, and 102**

**United States Patent and Trademark Office**

**Reg. No. 3,506,299**

**Registered Sep. 23, 2008**

**SERVICE MARK  
PRINCIPAL REGISTER**



THE ESOP ASSOCIATION (D.C. NON-PROFIT ASSOCIATION), DBA TEA, 1726 M STREET, NW, SUITE 501 WASHINGTON, DC 20036

FOR: ADVERTISING AND MARKETING, IN CLASS 35 (U.S. CLS. 100, 101 AND 102).

FIRST USE 1-1-2008; IN COMMERCE 1-1-2008.

NO CLAIM IS MADE TO THE EXCLUSIVE RIGHT TO USE "ESOPS," OR THE OUTLINE MAPS OF THE UNITED STATES AND "ALASKA", APART FROM THE MARK AS SHOWN.

THE COLOR(S) BLUE, WHITE AND LIGHT BLUE IS/ARE CLAIMED AS A FEATURE OF THE MARK.

THE MARK CONSISTS OF THE NUMBER "30" IN REFLEX BLUE WITH A BORDER IN WHITE, WITHIN THE ZERO THE "ESOP" LOGO, UNDERNEATH THE "30" THE WORDS "SERVING ESOPS FOR 30 YEARS", BEHIND THE "30" AN IMAGE OF THE U.S. CAPITOL BUILDING'S DOME AND BEHIND THE DOME A MAP OF THE U.S. INCLUDING ALASKA AND HAWAII.

SN 77-307,701, FILED 10-18-2007.

CHRIS WELLS, EXAMINING ATTORNEY

**Int. Cl.: 28**

**Prior U.S. Cls.: 22, 23, 38, and 50**

**Reg. No. 3,506,300**

**United States Patent and Trademark Office**

**Registered Sep. 23, 2008**

---

**TRADEMARK  
PRINCIPAL REGISTER**

**g-glove**

WIDERIGHT LLC (TEXAS LIMITED LIABILITY  
COMPANY)  
PO BOX 340902  
AUSTIN, TX 78734

THE MARK CONSISTS OF STANDARD CHAR-  
ACTERS WITHOUT CLAIM TO ANY PARTICULAR  
FONT, STYLE, SIZE, OR COLOR.

FOR: GOLF CLUB COVERS, IN CLASS 28 (U.S.  
CLS. 22, 23, 38 AND 50).

SN 77-309,263, FILED 10-20-2007.

FIRST USE 3-15-2008; IN COMMERCE 6-10-2008.

KATHERINE CHANG, EXAMINING ATTORNEY

**Int. Cl.: 41**

**Prior U.S. Cls.: 100, 101, and 107**

**United States Patent and Trademark Office**

**Reg. No. 3,506,301**

**Registered Sep. 23, 2008**

---

**SERVICE MARK  
PRINCIPAL REGISTER**

**PASS TIME**

SPEED CHANNEL, INC. (DELAWARE CORPORATION)  
10201 WEST PICO BOULEVARD  
LOS ANGELES, CA 90035

THE MARK CONSISTS OF STANDARD CHARACTERS WITHOUT CLAIM TO ANY PARTICULAR FONT, STYLE, SIZE, OR COLOR.

FOR: ENTERTAINMENT SERVICES IN THE NATURE OF A TELEVISION SERIES FEATURING MOTORSPORT RACING, IN CLASS 41 (U.S. CLS. 100, 101 AND 107).

SN 77-310,425, FILED 10-22-2007.

FIRST USE 2-18-2008; IN COMMERCE 2-18-2008.

LINDA E. BLOHM, EXAMINING ATTORNEY

**Int. Cl.: 32**

**Prior U.S. Cls.: 45, 46, and 48**

**United States Patent and Trademark Office**

**Reg. No. 3,506,302**

**Registered Sep. 23, 2008**

**TRADEMARK  
PRINCIPAL REGISTER**

# Smoothie Rox

SMOOTHIE ROX FRANCHISE, LLC (LOUISIANA  
LIMITED LIABILITY COMPANY)

4102 MAGNOLIA RIDGE

LAKE CHARLES, LA 70605

FOR: SMOOTHIES, IN CLASS 32 (U.S. CLS. 45, 46  
AND 48).

FIRST USE 5-1-2008; IN COMMERCE 5-1-2008.

THE MARK CONSISTS OF STANDARD CHAR-  
ACTERS WITHOUT CLAIM TO ANY PARTICULAR  
FONT, STYLE, SIZE, OR COLOR.

NO CLAIM IS MADE TO THE EXCLUSIVE  
RIGHT TO USE "SMOOTHIE", APART FROM THE  
MARK AS SHOWN.

SN 77-311,975, FILED 10-24-2007.

BRENDAN REGAN, EXAMINING ATTORNEY

**Int. Cl.: 35**

**Prior U.S. Cls.: 100, 101, and 102**

**United States Patent and Trademark Office**

**Reg. No. 3,506,303**

**Registered Sep. 23, 2008**

**SERVICE MARK  
PRINCIPAL REGISTER**



**DataStraits**

**Profit from our insights**

DATASTRAITS INC. (ILLINOIS CORPORATION)  
# 1510  
512 N. MCCLURG CT.  
CHICAGO, IL 60611

FOR: BUSINESS MANAGEMENT CONSULTING;  
CONSULTATION SERVICES IN THE FIELD OF  
DATA ANALYSIS OUTSOURCING, IN CLASS 35  
(U.S. CLS. 100, 101 AND 102).

FIRST USE 5-29-2008; IN COMMERCE 5-29-2008.

THE MARK CONSISTS OF THE STYLIZED  
NAME "DATASTRAITS PROFIT FROM OUR IN-  
SIGHTS". THERE ARE THREE DIAGONAL LINES  
ABOVE THE WRITING.

SN 77-313,136, FILED 10-25-2007.

MATTHEW MCDOWELL, EXAMINING ATTOR-  
NEY



**Int. Cls.: 16 and 41**

**Prior U.S. Cls.: 2, 5, 22, 23, 29, 37, 38, 50, 100, 101, and 107**

**Reg. No. 3,506,304**

**United States Patent and Trademark Office**

**Registered Sep. 23, 2008**

**TRADEMARK  
SERVICE MARK  
PRINCIPAL REGISTER**

**POWERRGIRLS**

JBC GLOBAL DIVERSITY AND INCLUSION INSTITUTE (NORTH CAROLINA NON-PROFIT CORPORATION)

900 EAST WASHINGTON STREET  
GREENSBORO, NC 27401

FOR: MAGAZINE FEATURING CONTENT IN THE FIELD OF LEADERSHIP AND EDUCATION , IN CLASS 16 (U.S. CLS. 2, 5, 22, 23, 29, 37, 38 AND 50).

FIRST USE 11-0-2007; IN COMMERCE 11-0-2007.

FOR: LEADERSHIP TRAINING SERVICES, IN CLASS 41 (U.S. CLS. 100, 101 AND 107).

FIRST USE 1-0-2005; IN COMMERCE 1-0-2005.

THE MARK CONSISTS OF STANDARD CHARACTERS WITHOUT CLAIM TO ANY PARTICULAR FONT, STYLE, SIZE, OR COLOR.

SN 77-314,244, FILED 10-26-2007.

DAVID MILLER, EXAMINING ATTORNEY

**Int. Cl.: 37**

**Prior U.S. Cls.: 100, 103, and 106**

**United States Patent and Trademark Office**

**Reg. No. 3,506,305**

**Registered Sep. 23, 2008**

---

**SERVICE MARK  
PRINCIPAL REGISTER**

**Dr. DecknFence**

DR. DECKNFENCE, INC. (PENNSYLVANIA  
CORPORATION)  
4515 SEIGER ST  
BROOKHAVEN, PA 19015

THE MARK CONSISTS OF STANDARD CHAR-  
ACTERS WITHOUT CLAIM TO ANY PARTICULAR  
FONT, STYLE, SIZE, OR COLOR.

FOR: HOUSING SERVICES, NAMELY, REPAIR,  
IMPROVEMENT, AND CONSTRUCTION OF RESI-  
DENTIAL REAL PROPERTY, IN CLASS 37 (U.S. CLS.  
100, 103 AND 106).

SN 77-314,259, FILED 10-26-2007.

FIRST USE 3-12-2008; IN COMMERCE 3-12-2008.

JANICE KIM, EXAMINING ATTORNEY

**Int. Cl.: 10**

**Prior U.S. Cls.: 26, 39, and 44**

**United States Patent and Trademark Office**

**Reg. No. 3,506,306**

**Registered Sep. 23, 2008**

**TRADEMARK  
PRINCIPAL REGISTER**

# Penetrator

ALAN M. ZAMORE (UNITED STATES INDIVIDUAL)  
600 CHESTNUT RIDGE ROAD  
CHESTNUT RIDGE, NY 10977

THE MARK CONSISTS OF STANDARD CHARACTERS WITHOUT CLAIM TO ANY PARTICULAR FONT, STYLE, SIZE, OR COLOR.

FOR: CATHETERS, IN CLASS 10 (U.S. CLS. 26, 39 AND 44).

SN 77-315,423, FILED 10-28-2007.

FIRST USE 4-1-2008; IN COMMERCE 4-1-2008.

TRICIA SONNEBORN, EXAMINING ATTORNEY

**Int. Cl.: 35**

**Prior U.S. Cls.: 100, 101, and 102**

**United States Patent and Trademark Office**

**Reg. No. 3,506,307**

**Registered Sep. 23, 2008**

**SERVICE MARK  
PRINCIPAL REGISTER**

# Webalytics

WEBALYTICS, INC. (KENTUCKY CORPORATION)  
3777 DICKSONIA DRIVE  
LEXINGTON, KY 40517

THE MARK CONSISTS OF STANDARD CHARACTERS WITHOUT CLAIM TO ANY PARTICULAR FONT, STYLE, SIZE, OR COLOR.

FOR: ADVERTISING AND COMMERCIAL INFORMATION SERVICES, VIA THE INTERNET, IN CLASS 35 (U.S. CLS. 100, 101 AND 102).

SN 77-315,866, FILED 10-29-2007.

FIRST USE 10-3-2007; IN COMMERCE 6-12-2008.

HENRY S. ZAK, EXAMINING ATTORNEY

**Int. Cl.: 44**

**Prior U.S. Cls.: 100 and 101**

**United States Patent and Trademark Office**

**Reg. No. 3,506,308**

**Registered Sep. 23, 2008**

**SERVICE MARK  
PRINCIPAL REGISTER**

The logo for bioscripcare features the word "bioscripcare" in a lowercase, sans-serif font. The letters "bio" are colored in a light green, "scrip" is in a medium blue, and "care" is in a light green. The letters are closely spaced and have a slight shadow effect.

BIOSCRIP, INC. (DELAWARE CORPORATION)  
100 CLEARBROOK ROAD  
ELMSFORD, NY 10523

FOR: PATIENT HEALTH CARE MANAGEMENT PROGRAMS, NAMELY, PROVIDING EVALUATION SERVICES TO FORMULATE DISEASE-SPECIFIC PATIENT TREATMENT PLANS, THERAPY OPTIMIZATION PLANS FOR THE TREATMENT OF CHRONIC DISEASES AND PATIENT CARE PROGRAMS IN THE NATURE OF MONITORING EFFECTIVENESS OF MEDICAL TREATMENTS AND PLANNING MEDICAL TREATMENT INTERVENTIONS, IN CLASS 44 (U.S. CLS. 100 AND 101).

FIRST USE 8-1-2007; IN COMMERCE 8-1-2007.

THE COLOR(S) BLUE AND GREEN IS/ARE CLAIMED AS A FEATURE OF THE MARK.

THE MARK CONSISTS OF WORD "BIOSCRIP-CARE" WITH "BIO" AND "CARE" BEING COLORED GREEN AND "SCRIP" BEING COLORED BLUE.

SN 77-316,764, FILED 10-30-2007.

RONALD MCMORROW, EXAMINING ATTORNEY

**Int. Cl.: 29**

**Prior U.S. Cl.: 46**

**United States Patent and Trademark Office**

**Reg. No. 3,506,309**

**Registered Sep. 23, 2008**

**TRADEMARK  
PRINCIPAL REGISTER**



WAREHOUSE SERVICE GROUP LIMITED LIABILITY COMPANY (OHIO LIMITED LIABILITY COMPANY)  
6145 MERGER DRIVE  
HOLLAND, OH 43528

NO CLAIM IS MADE TO THE EXCLUSIVE RIGHT TO USE "STEAK" , APART FROM THE MARK AS SHOWN.

FOR: BEEF, IN CLASS 29 (U.S. CL. 46).

SN 77-317,010, FILED 10-30-2007.

FIRST USE 11-27-2007; IN COMMERCE 11-27-2007.

ROBERT LAVACHE, EXAMINING ATTORNEY

**Int. Cl.: 1**

**Prior U.S. Cls.: 1, 5, 6, 10, 26, and 46**

**Reg. No. 3,506,310**

**United States Patent and Trademark Office**

**Registered Sep. 23, 2008**

---

**TRADEMARK  
PRINCIPAL REGISTER**

**Legacy**

SEPRO CORPORATION (INDIANA CORPORATION)  
11550 N. MERIDIAN STREET, STE. 600  
CARMEL, IN 46032

THE MARK CONSISTS OF STANDARD CHARACTERS WITHOUT CLAIM TO ANY PARTICULAR FONT, STYLE, SIZE, OR COLOR.

FOR: PLANT GROWTH REGULATORS FOR AGRICULTURAL USE, IN CLASS 1 (U.S. CLS. 1, 5, 6, 10, 26 AND 46).

SN 77-317,411, FILED 10-30-2007.

FIRST USE 7-9-2008; IN COMMERCE 7-9-2008.

DANIEL CAPSHAW, EXAMINING ATTORNEY

**Int. Cl.: 41**

**Prior U.S. Cls.: 100, 101, and 107**

**United States Patent and Trademark Office**

**Reg. No. 3,506,311**

**Registered Sep. 23, 2008**

**SERVICE MARK  
PRINCIPAL REGISTER**

**JOURNEY WEST**

DIXIE STAMPEDE, LLC (TENNESSEE LIMITED  
LIABILITY COMPANY)  
3849 PARKWAY  
PIGEON FORGE, TN 37863

FOR: CONDUCTING ENTERTAINMENT EXHIBITS IN THE NATURE OF PLAYS, SHOWS, AND PAGEANTS, FEATURING LIVESTOCK, AND PERIOD COSTUMES RELATING TO THE PERIOD OF WESTERN EXPANSION IN THE UNITED STATES, IN CLASS 41 (U.S. CLS. 100, 101 AND 107).

FIRST USE 2-1-2008; IN COMMERCE 2-1-2008.

THE MARK CONSISTS OF STANDARD CHARACTERS WITHOUT CLAIM TO ANY PARTICULAR FONT, STYLE, SIZE, OR COLOR.

NO CLAIM IS MADE TO THE EXCLUSIVE RIGHT TO USE "WEST", APART FROM THE MARK AS SHOWN.

SN 77-318,180, FILED 10-31-2007.

JANICE KIM, EXAMINING ATTORNEY



**Int. Cl.: 31**

**Prior U.S. Cls.: 1 and 46**

**United States Patent and Trademark Office**

**Reg. No. 3,506,312**

**Registered Sep. 23, 2008**

**TRADEMARK  
PRINCIPAL REGISTER**

**WAGGALATTE**

JAVA DU MUTT, LLC (WASHINGTON LIMITED  
LIABILITY COMPANY)  
4736 48TH AVE. NE  
SEATTLE, WA 981053826

THE MARK CONSISTS OF STANDARD CHAR-  
ACTERS WITHOUT CLAIM TO ANY PARTICULAR  
FONT, STYLE, SIZE, OR COLOR.

FOR: ANIMAL FOODSTUFFS, IN CLASS 31 (U.S.  
CLS. 1 AND 46).

SN 77-319,486, FILED 11-1-2007.

FIRST USE 2-7-2008; IN COMMERCE 2-7-2008.

LINDSEY RUBIN, EXAMINING ATTORNEY

**Int. Cl.: 31**

**Prior U.S. Cls.: 1 and 46**

**United States Patent and Trademark Office**

**Reg. No. 3,506,313**

**Registered Sep. 23, 2008**

**TRADEMARK  
PRINCIPAL REGISTER**

**CAPOOCHINO**

JAVA DU MUTT, LLC (WASHINGTON LIMITED  
LIABILITY COMPANY)  
4736 48TH AVE. NE  
SEATTLE, WA 981053826

THE MARK CONSISTS OF STANDARD CHAR-  
ACTERS WITHOUT CLAIM TO ANY PARTICULAR  
FONT, STYLE, SIZE, OR COLOR.

FOR: ANIMAL FOODSTUFFS, IN CLASS 31 (U.S.  
CLS. 1 AND 46).

SN 77-319,488, FILED 11-1-2007.

FIRST USE 2-7-2008; IN COMMERCE 2-7-2008.

LINDSEY RUBIN, EXAMINING ATTORNEY

**Int. Cl.: 9**

**Prior U.S. Cls.: 21, 23, 26, 36, and 38**

**United States Patent and Trademark Office**

**Reg. No. 3,506,314**

**Registered Sep. 23, 2008**

**TRADEMARK  
PRINCIPAL REGISTER**

**FORTE**

AUDIO AND VIDEO LABS, INC. (NEW JERSEY CORPORATION)  
7905 NORTH ROUTE 130  
PENNSAUKEN, NJ 08110

FOR: DISC PUBLISHING DEVICE, NAMELY, AUTOMATED CD/DVD DUPLICATOR AND DISC PRINTER, IN CLASS 9 (U.S. CLS. 21, 23, 26, 36 AND 38).

FIRST USE 1-0-2008; IN COMMERCE 1-0-2008.

THE MARK CONSISTS OF STANDARD CHARACTERS WITHOUT CLAIM TO ANY PARTICULAR FONT, STYLE, SIZE, OR COLOR.

SN 77-319,699, FILED 11-2-2007.

AMOS T. MATTHEWS, JR., EXAMINING ATTORNEY

**Int. Cl.: 36**

**Prior U.S. Cls.: 100, 101, and 102**

**United States Patent and Trademark Office**

**Reg. No. 3,506,315**

**Registered Sep. 23, 2008**

---

**SERVICE MARK  
PRINCIPAL REGISTER**

**MLStimate**

NORTHERN NEVADA REGIONAL MULTIPLE  
LISTING SERVICE, INC. (NEVADA COR-  
PORATION)  
SUITE 300  
5650 RIGGINS COURT  
RENO, NV 89502

FOR: REAL ESTATE VALUATIONS, IN CLASS 36  
(U.S. CLS. 100, 101 AND 102).

FIRST USE 1-28-2008; IN COMMERCE 1-28-2008.

THE MARK CONSISTS OF STANDARD CHAR-  
ACTERS WITHOUT CLAIM TO ANY PARTICULAR  
FONT, STYLE, SIZE, OR COLOR.

SN 77-319,904, FILED 11-2-2007.

AHSEN KHAN, EXAMINING ATTORNEY

**Int. Cls.: 35 and 43**

**Prior U.S. Cls.: 100, 101, and 102**

**United States Patent and Trademark Office**

**Reg. No. 3,506,316**

**Registered Sep. 23, 2008**

**SERVICE MARK  
PRINCIPAL REGISTER**



LANTOS, ANDREA (UNITED STATES INDIVIDUAL)  
703 LOCUST STREET SUITE #8  
PASADENA, CA 91101

FOR: RETAIL BAKERY SHOPS, IN CLASS 35 (U.S. CLS. 100, 101 AND 102).

FIRST USE 1-1-2008; IN COMMERCE 1-1-2008.

FOR: RESTAURANT SERVICES FEATURING SANDWICHES, IN CLASS 43 (U.S. CLS. 100 AND 101).

FIRST USE 1-1-2008; IN COMMERCE 1-1-2008.

THE MARK CONSISTS OF THE WORD "AP-PETITE" IN STYLIZED TEXT. INCLUDED ARE 5 CIRCLES TO THE LEFT.

SN 77-320,211, FILED 11-2-2007.

JENNIFER VASQUEZ, EXAMINING ATTORNEY

**Int. Cl.: 36**

**Prior U.S. Cls.: 100, 101, and 102**

**United States Patent and Trademark Office**

**Reg. No. 3,506,317**

**Registered Sep. 23, 2008**

**SERVICE MARK  
PRINCIPAL REGISTER**

**INBANK**

INTERSTATE BANK (ILLINOIS STATE BANK)  
15533 SOUTH CICERO AVENUE  
OAK FOREST, IL 60452

FOR: BANKING; BANKING SERVICES; DEBIT CARD SERVICES; PAYMENT PROCESSING SERVICES, NAMELY, CREDIT CARD AND DEBIT CARD TRANSACTION PROCESSING SERVICES; PROVIDING ELECTRONIC PROCESSING OF ELECTRONIC FUNDS TRANSFER, ACH, CREDIT CARD, DEBIT CARD, ELECTRONIC CHECK AND ELECTRONIC PAYMENTS; CREDIT CARD SERVICES; SAVINGS BANK SERVICES; ELECTRONIC DEBIT TRANSACTIONS; FINANCIAL LOAN CONSULTATION; LOAN FINANCING; MORTGAGE LENDING; IN-

VESTMENT CONSULTATION; MUTUAL FUND INVESTMENT; FINANCIAL PLANNING FOR RETIREMENT; ELECTRONIC TRANSFER OF MONEY; ISSUING OF CHECKS AND LETTERS OF CREDIT, IN CLASS 36 (U.S. CLS. 100, 101 AND 102).

FIRST USE 3-31-2008; IN COMMERCE 3-31-2008.

THE MARK CONSISTS OF STANDARD CHARACTERS WITHOUT CLAIM TO ANY PARTICULAR FONT, STYLE, SIZE, OR COLOR.

SN 77-321,150, FILED 11-5-2007.

BENJAMIN ALLEN, EXAMINING ATTORNEY

**Int. Cl.: 27**

**Prior U.S. Cls.: 19, 20, 37, 42, and 50**

**United States Patent and Trademark Office**

**Reg. No. 3,506,318**

**Registered Sep. 23, 2008**

---

**TRADEMARK  
PRINCIPAL REGISTER**

**CUSHY FLOOR**

UNITED PLASTICS CORPORATION (NORTH  
CAROLINA CORPORATION)

511 HAY STREET

MOUNT AIRY, NC 27030

FOR: ANTI-FATIGUE FLOOR MAT; FLOOR  
MATS, IN CLASS 27 (U.S. CLS. 19, 20, 37, 42 AND 50).

FIRST USE 5-31-2008; IN COMMERCE 5-31-2008.

THE MARK CONSISTS OF STANDARD CHAR-  
ACTERS WITHOUT CLAIM TO ANY PARTICULAR  
FONT, STYLE, SIZE, OR COLOR.

NO CLAIM IS MADE TO THE EXCLUSIVE  
RIGHT TO USE "FLOOR", APART FROM THE  
MARK AS SHOWN.

SN 77-322,261, FILED 11-6-2007.

BRENDAN MCCAULEY, EXAMINING ATTORNEY

**Int. Cl.: 27**

**Prior U.S. Cls.: 19, 20, 37, 42, and 50**

**United States Patent and Trademark Office**

**Reg. No. 3,506,319**

**Registered Sep. 23, 2008**

**TRADEMARK  
PRINCIPAL REGISTER**

**LOOPS & KNOTS**

WARP & WEFT CARPETS, INC. (NEW YORK CORPORATION), DBA WARP & WEFT,  
145 MADISON AVENUE  
NEW YORK, NY 10016

THE MARK CONSISTS OF STANDARD CHARACTERS WITHOUT CLAIM TO ANY PARTICULAR FONT, STYLE, SIZE, OR COLOR.

FOR: CARPETS; RUGS, IN CLASS 27 (U.S. CLS. 19, 20, 37, 42 AND 50).

SN 77-322,488, FILED 11-6-2007.

FIRST USE 4-30-2008; IN COMMERCE 4-30-2008.

MICHAEL GAAFAR, EXAMINING ATTORNEY



**Int. Cl.: 36**

**Prior U.S. Cls.: 100, 101, and 102**

**United States Patent and Trademark Office**

**Reg. No. 3,506,320**

**Registered Sep. 23, 2008**

**SERVICE MARK  
PRINCIPAL REGISTER**

**Rumpelstiltskin**

PERFORMANCE DRIVEN PROPERTIES, INC.  
(DELAWARE CORPORATION)  
11 HANOVER SQUARE, 12TH FLOOR  
NEW YORK, NY 10005

FOR: FINANCIAL AND INVESTMENT SERVICES, NAMELY, MANAGEMENT AND BROKERAGE IN THE FIELDS OF STOCKS, BONDS, OPTIONS, COMMODITIES, FUTURES AND OTHER SECURITIES, AND THE INVESTMENT OF FUNDS OF OTHERS, IN CLASS 36 (U.S. CLS. 100, 101 AND 102).

FIRST USE 6-23-2008; IN COMMERCE 6-23-2008.

THE MARK CONSISTS OF STANDARD CHARACTERS WITHOUT CLAIM TO ANY PARTICULAR FONT, STYLE, SIZE, OR COLOR.

SN 77-322,796, FILED 11-6-2007.

KIM SAITO, EXAMINING ATTORNEY

**Int. Cl.: 9**

**Prior U.S. Cls.: 21, 23, 26, 36, and 38**

**Reg. No. 3,506,321**

**United States Patent and Trademark Office**

**Registered Sep. 23, 2008**

---

**TRADEMARK  
PRINCIPAL REGISTER**

**INSTINCT**

SAMSUNG ELECTRONICS CO., LTD. (REPUBLIC OF KOREA CORPORATION)  
416, MAETAN-DONG  
YEONGTONG-GU  
SUWON-SI, GYEONGGI-DO, REPUBLIC OF KOREA

FOR: MOBILE PHONES; SMARTPHONES, IN CLASS 9 (U.S. CLS. 21, 23, 26, 36 AND 38).

FIRST USE 6-19-2008; IN COMMERCE 6-19-2008.

THE MARK CONSISTS OF STANDARD CHARACTERS WITHOUT CLAIM TO ANY PARTICULAR FONT, STYLE, SIZE, OR COLOR.

SN 77-324,569, FILED 11-8-2007.

NAPOLEON SHARMA, EXAMINING ATTORNEY

**Int. Cl.: 40**

**Prior U.S. Cls.: 100, 103, and 106**

**United States Patent and Trademark Office**

**Reg. No. 3,506,322**

**Registered Sep. 23, 2008**

**SERVICE MARK  
PRINCIPAL REGISTER**



MORGAN, RUTH (UNITED STATES INDIVIDUAL)  
PO BOX 67  
WALNUT GROVE, CA 95690

THE COLOR(S) RED, BLACK AND WHITE IS/ARE CLAIMED AS A FEATURE OF THE MARK.

FOR: CUSTOMIZED PRINTING OF COMPANY NAMES AND LOGOS FOR PROMOTIONAL AND ADVERTISING PURPOSES ON THE GOODS OF OTHERS; PRINTING OF ADVERTISING MATTER, IN CLASS 40 (U.S. CLS. 100, 103 AND 106).

THE MARK CONSISTS OF THE WORDS "EZ PROMOTIONS" IN BLACK IN BROADWAY FONT WITH THE DESIGN OF A RED, WHITE AND BLACK STAR LAYERED ON TOP OF A RED CIRCLE TO THE LEFT OF THE TEXT.

FIRST USE 1-1-1999; IN COMMERCE 1-1-2000.

SN 77-324,987, FILED 11-8-2007.

NO CLAIM IS MADE TO THE EXCLUSIVE RIGHT TO USE "PROMOTIONS", APART FROM THE MARK AS SHOWN.

WILLIAM ROSSMAN, EXAMINING ATTORNEY

Int. Cl.: 16

Prior U.S. Cls.: 2, 5, 22, 23, 29, 37, 38, and 50

United States Patent and Trademark Office

Reg. No. 3,506,323

Registered Sep. 23, 2008

**TRADEMARK  
PRINCIPAL REGISTER**



JESUS LOVES ME CHILDREN'S BOOKS LLC  
(NEW JERSEY LIMITED LIABILITY COMPAN-  
NY)  
14 VILLAGE OF STONEY RUN  
APT.# F  
MAPLE SHADE, NJ 08052

FOR: CHILDREN'S BOOKS; CHILDREN'S STORYBOOKS; EDUCATIONAL BOOKS FEATURING BIBLE PRINCIPLES; EDUCATIONAL PUBLICATIONS, NAMELY, EDUCATIONAL LEARNING CARDS, FLASH CARDS, WORKBOOKS, TEXTBOOKS, STORY BOOKS, TEACHER GUIDES, MANUALS, POSTERS, EDUCATIONAL BOOKLETS IN THE FIELD OF BIBLICAL LESSONS; FLIP BOOKS; FREE-STANDING AND WALL-MOUNTED PAPER AND CARDBOARD BOXES FOR DEPOSITING A WRITTEN MESSAGE OR PRAYER WISHING A LOVED ONE WELL, FOR USE IN HOSPITALS, ELDER CARE RESIDENCES, SCHOOLS, AND INSTITUTIONS FOR CHILDREN WITH SPECIAL NEEDS, IN CLASS 16 (U.S. CLS. 2, 5, 22, 23, 29, 37, 38 AND 50).

FIRST USE 12-31-2007; IN COMMERCE 7-2-2008.

NO CLAIM IS MADE TO THE EXCLUSIVE RIGHT TO USE "CHILDREN'S BOOKS", APART FROM THE MARK AS SHOWN.

THE COLOR(S) RED, BLUE, DARK YELLOW/GOLD, GREEN, BLACK, WHITE AND GRAY IS/ARE CLAIMED AS A FEATURE OF THE MARK.

THE MARK CONSISTS OF THE WORDS "JESUS LOVES ME", WITH THE FOLLOWING LETTER COLORS: RED - "J", BLUE - "E", DARK YELLOW/GOLD - "S", GREEN - "U", RED - "S"; BLUE - "L", DARK YELLOW/GOLD - "O", GREEN - "V", RED - "E", BLUE - "S"; GREEN - "M", RED - "E". THE WORDING "CHILDREN'S BOOKS" APPEARS BENEATH "JESUS LIVES ME", IN BLACK. TO THE RIGHT IS A STYLIZED ANGEL IN BLACK AND GRAY, WITH WHITE ROBE AND WINGS, KNEELING WITH BACK FACING OUT.

SN 77-325,437, FILED 11-9-2007.

ELISSA GARBER KON, EXAMINING ATTORNEY

**Int. Cl.: 42**

**Prior U.S. Cls.: 100 and 101**

**United States Patent and Trademark Office**

**Reg. No. 3,506,324**

**Registered Sep. 23, 2008**

**SERVICE MARK  
PRINCIPAL REGISTER**

**icollaborate**

GHIERE, JESSE M (UNITED STATES INDIVIDUAL)  
5858 WALSH STREET  
SAINT LOUIS, MO 63109

FOR: COMPUTER SERVICES IN THE NATURE OF CUSTOMIZED WEB PAGES FEATURING USER-DEFINED INFORMATION, PERSONAL PROFILES AND INFORMATION, IN CLASS 42 (U.S. CLS. 100 AND 101).

FIRST USE 7-1-2008; IN COMMERCE 7-1-2008.

THE MARK CONSISTS OF STANDARD CHARACTERS WITHOUT CLAIM TO ANY PARTICULAR FONT, STYLE, SIZE, OR COLOR.

SN 77-327,264, FILED 11-12-2007.

STEVEN R. FOSTER, EXAMINING ATTORNEY

**Int. Cl.: 35**

**Prior U.S. Cls.: 100, 101, and 102**

**United States Patent and Trademark Office**

**Reg. No. 3,506,325**

**Registered Sep. 23, 2008**

**SERVICE MARK  
PRINCIPAL REGISTER**

**GARAGE SALE GENIE**

GEMINI INVESTMENTS, LLC (ARKANSAS LIMITED LIABILITY COMPANY)  
195 N SUMMIT AVE  
FAYETTEVILLE, AR 72701

FOR: PROVIDING AN ONLINE DIRECTORY INFORMATION SERVICE FEATURING INFORMATION REGARDING GARAGE SALES, IN CLASS 35 (U.S. CLS. 100, 101 AND 102).

FIRST USE 2-27-2007; IN COMMERCE 3-31-2008.

THE MARK CONSISTS OF STANDARD CHARACTERS WITHOUT CLAIM TO ANY PARTICULAR FONT, STYLE, SIZE, OR COLOR.

NO CLAIM IS MADE TO THE EXCLUSIVE RIGHT TO USE "GARAGE SALE", APART FROM THE MARK AS SHOWN.

SN 77-327,830, FILED 11-13-2007.

ELLEN B. AWRICH, EXAMINING ATTORNEY

**Int. Cl.: 45**

**Prior U.S. Cls.: 100 and 101**

**United States Patent and Trademark Office**

**Reg. No. 3,506,326**

**Registered Sep. 23, 2008**

**SERVICE MARK  
PRINCIPAL REGISTER**

**YUHOTTIE**

BYRNES, GEORGE (CANADA INDIVIDUAL)  
20658 HART ST.  
WINNETKA, CA 91306

THE MARK CONSISTS OF STANDARD CHAR-  
ACTERS WITHOUT CLAIM TO ANY PARTICULAR  
FONT, STYLE, SIZE, OR COLOR.

FOR: COMPUTER DATING SERVICES; WEB SITE  
SERVICES FEATURING ON-LINE DATING CLUB,  
IN CLASS 45 (U.S. CLS. 100 AND 101).

SN 77-328,742, FILED 11-13-2007.

FIRST USE 7-28-2008; IN COMMERCE 7-28-2008.

NAAKWAMA ANKRAH, EXAMINING ATTORNEY

Int. Cl.: 30

Prior U.S. Cl.: 46

United States Patent and Trademark Office

Reg. No. 3,506,327

Registered Sep. 23, 2008

TRADEMARK  
PRINCIPAL REGISTER



HDIP, INC. (DELAWARE CORPORATION)  
NUMBER ONE GENERAL MILLS BOULEVARD  
MINNEAPOLIS, MN 55426

OWNER OF U.S. REG. NOS. 737,244, 1,360,895,  
AND 1,696,350.

FOR: ICE CREAM, SORBET, FROZEN YOGURT,  
ICE CREAM BARS AND SORBET BARS, IN CLASS  
30 (U.S. CL. 46).

SN 77-329,454, FILED 11-14-2007.

FIRST USE 2-5-2008; IN COMMERCE 2-5-2008.

NATALIE POLZER, EXAMINING ATTORNEY



**Int. Cl.: 16**

**Prior U.S. Cls.: 2, 5, 22, 23, 29, 37, 38, and 50**

**Reg. No. 3,506,328**

**United States Patent and Trademark Office**

**Registered Sep. 23, 2008**

**TRADEMARK  
PRINCIPAL REGISTER**



MEADWESTVACO CORPORATION (DELAWARE CORPORATION)  
11013 WEST BROAD ST.  
GLEN ALLEN, VA 23060

OWNER OF U.S. REG. NOS. 2,147,297, 2,911,258, AND OTHERS.

FOR: CALENDARS; DESK PADS; ORGANIZERS FOR STATIONERY USE; PERSONAL ORGANIZERS; APPOINTMENT BOOKS; DAILY PLANNERS; TIME PLANNERS; DIARIES; PADFOLIOS; ADDRESS BOOKS; CALENDAR REFILLS, IN CLASS 16 (U.S. CLS. 2, 5, 22, 23, 29, 37, 38 AND 50).

THE MARK CONSISTS OF THE WORDS "AT-A-GLANCE" POSITIONED TO THE SIDE OF A CHECKMARK IN A CIRCLE LOGO.

SN 77-330,110, FILED 11-15-2007.

FIRST USE 2-14-2008; IN COMMERCE 2-14-2008.

ELISSA GARBER KON, EXAMINING ATTORNEY

Int. Cl.: 36

Prior U.S. Cls.: 100, 101, and 102

United States Patent and Trademark Office

Reg. No. 3,506,329

Registered Sep. 23, 2008

SERVICE MARK  
PRINCIPAL REGISTER

REDI FX

GOLDMAN, SACHS & CO. (NEW YORK LIMITED PARTNERSHIP)  
85 BROAD STREET  
NEW YORK, NY 10004

FOR: FINANCIAL SERVICES, NAMELY, PROVIDING FINANCIAL INFORMATION IN THE NATURE OF MARKET AND QUOTATION INFORMATION FOR FOREIGN CURRENCIES AND FOREIGN CURRENCY EXCHANGE TRANSACTIONS; TRADING SUPPORT SERVICES IN THE FIELDS OF FOREIGN CURRENCIES AND FOREIGN CURRENCY EXCHANGE TRANSACTIONS, NAMELY, TRADE COMPARISON, COLLECTION, PROCESSING, TABULATION, DISTRIBUTION, NEGOTIATION, AND EXECUTION; CLASSIFICATION OF FOREIGN CURRENCIES AND FOREIGN CURRENCY EXCHANGE TRANSACTIONS; CREATION, DISTRIBUTION AND UPDATING FOREIGN CURRENCY VALUES AND PRICES; AUTOMATED FINANCIAL SERVICES, NAMELY, ONLINE BROKERAGE OF FOREIGN CURRENCIES AND CONDUCTING FOREIGN CURRENCY EXCHANGE TRANSACTIONS VIA A GLOBAL COMPUTER NETWORK; PROVIDING ONLINE ELECTRONIC COMPUTER DATABASES FEATURING FOREIGN CURRENCIES AND FOREIGN CURRENCY EXCHANGE TRANSACTIONS

INFORMATION VIA A GLOBAL COMPUTER NETWORK; PROVIDING ONLINE ELECTRONIC COMPUTER DATABASES WHICH PROVIDE SUBSCRIBERS WITH TRADING INFORMATION CONCERNING FOREIGN CURRENCIES AND FOREIGN CURRENCY EXCHANGE TRANSACTIONS AND PROVIDE INSTITUTIONS AND INDIVIDUAL INVESTORS WITH AN AUTOMATIC NETWORK FOR TRADING IN FOREIGN CURRENCIES AND CONDUCTING FOREIGN CURRENCY EXCHANGE TRANSACTIONS, IN CLASS 36 (U.S. CLS. 100, 101 AND 102).

FIRST USE 10-0-2007; IN COMMERCE 10-0-2007.

THE MARK CONSISTS OF STANDARD CHARACTERS WITHOUT CLAIM TO ANY PARTICULAR FONT, STYLE, SIZE, OR COLOR.

NO CLAIM IS MADE TO THE EXCLUSIVE RIGHT TO USE "FX", APART FROM THE MARK AS SHOWN.

SN 77-331,079, FILED 11-15-2007.

ROBIN CHOSID, EXAMINING ATTORNEY

**Int. Cl.: 41**

**Prior U.S. Cls.: 100, 101, and 107**

**United States Patent and Trademark Office**

**Reg. No. 3,506,330**

**Registered Sep. 23, 2008**

**SERVICE MARK  
PRINCIPAL REGISTER**

**Moving Up Unlimited**

WATSON, KATHLEEN A. (UNITED STATES IN-  
DIVIDUAL)  
426 GOLDENROD CIRCLE  
VERONA, WI 53593

FOR: BUSINESS TRAINING AND EDUCATION-  
AL SERVICES, NAMELY, CONDUCTING WORK-  
SHOPS AND SEMINARS IN THE FIELDS OF  
PERSONAL GROOMING, ATTIRE, ETIQUETTE  
AND BUSINESS COMMUNICATION SKILLS, AND  
DISTRIBUTION OF COURSE MATERIALS IN CON-  
NECTION THEREWITH, IN CLASS 41 (U.S. CLS. 100,  
101 AND 107).

FIRST USE 11-20-2007; IN COMMERCE 4-14-2008.

THE MARK CONSISTS OF STANDARD CHAR-  
ACTERS WITHOUT CLAIM TO ANY PARTICULAR  
FONT, STYLE, SIZE, OR COLOR.

SN 77-331,403, FILED 11-16-2007.

TOBY BULLOFF, EXAMINING ATTORNEY

**Int. Cl.: 3**

**Prior U.S. Cls.: 1, 4, 6, 50, 51, and 52**

**United States Patent and Trademark Office**

**Reg. No. 3,506,331**

**Registered Sep. 23, 2008**

**TRADEMARK  
PRINCIPAL REGISTER**

# Wide Eyed

ANAZAOHEALTH CORPORATION (FLORIDA CORPORATION)  
5710 HOOVER BLVD.  
TAMPA, FL 33634

FOR: AGE RETARDANT GEL; AGE RETARDANT LOTION; BEAUTY SERUMS; SKIN CARE PRODUCTS, NAMELY, NON-MEDICATED SKIN SERUM; SKIN TEXTURIZERS; UNDER-EYE ENHANCERS; WRINKLE REMOVING SKIN CARE PREPARATIONS; EYE GELS; NON-MEDICATED SKIN CARE PREPARATIONS; COSMETIC PREPARATIONS; COSMETICS AND COSMETIC PRE-

PARATIONS, IN CLASS 3 (U.S. CLS. 1, 4, 6, 50, 51 AND 52).

FIRST USE 12-13-2007; IN COMMERCE 12-13-2007.

THE MARK CONSISTS OF STANDARD CHARACTERS WITHOUT CLAIM TO ANY PARTICULAR FONT, STYLE, SIZE, OR COLOR.

SN 77-332,609, FILED 11-19-2007.

REBECCA GILBERT, EXAMINING ATTORNEY

**Int. Cl.: 38**

**Prior U.S. Cls.: 100, 101, and 104**

**United States Patent and Trademark Office**

**Reg. No. 3,506,332**

**Registered Sep. 23, 2008**

**SERVICE MARK  
PRINCIPAL REGISTER**

**SHOUTPOINT**

SHOUTPOINT, INC. (CALIFORNIA CORPORATION)  
SUITE 420  
4695 MACARTHUR COURT  
NEWPORT BEACH, CA 92660

FOR: TELECOMMUNICATIONS SERVICES,  
NAMELY, TRANSMISSION OF VOICE AND DATA  
VIA THE INTERNET, IN CLASS 38 (U.S. CLS. 100, 101  
AND 104).

FIRST USE 9-17-2007; IN COMMERCE 9-17-2007.

THE MARK CONSISTS OF STANDARD CHARACTERS WITHOUT CLAIM TO ANY PARTICULAR FONT, STYLE, SIZE, OR COLOR.

SN 77-334,122, FILED 11-20-2007.

ESTHER BELENKER, EXAMINING ATTORNEY

**Int. Cl.: 36**

**Prior U.S. Cls.: 100, 101, and 102**

**United States Patent and Trademark Office**

**Reg. No. 3,506,333**

**Registered Sep. 23, 2008**

**SERVICE MARK  
PRINCIPAL REGISTER**

KEEPING AGENTS INDEPENDENT

FIRST INSURANCE FUNDING CORP. (ILLINOIS  
CORPORATION)  
450 SKOKIE BLVD., SUITE 1000  
NORTHBROOK, IL 60062

THE MARK CONSISTS OF STANDARD CHAR-  
ACTERS WITHOUT CLAIM TO ANY PARTICULAR  
FONT, STYLE, SIZE, OR COLOR.

FOR: COMMERCIAL INSURANCE PREMIUM  
FINANCING, IN CLASS 36 (U.S. CLS. 100, 101 AND  
102).

SN 77-335,394, FILED 11-21-2007.

FIRST USE 12-1-2007; IN COMMERCE 12-1-2007.

BRIAN PINO, EXAMINING ATTORNEY

**Int. Cl.: 9**

**Prior U.S. Cls.: 21, 23, 26, 36, and 38**

**United States Patent and Trademark Office**

**Reg. No. 3,506,334**

**Registered Sep. 23, 2008**

**TRADEMARK  
PRINCIPAL REGISTER**

**CACTUS**

HARVEST ONE LIMITED (HONG KONG LIMITED LIABILITY COMPANY)  
1101 DAVID HOUSE, 8-20 NANKING STREET  
KOWLOON, HONG KONG

FOR: FLASH BULBS; HAND-HELD SECURITY DEVICE THAT DISABLES ASSAILANTS USING FLASHING LIGHT EMITTING DIODES; 35MM CAMERAS; ADAPTER RINGS FOR ATTACHING OBJECTIVES ON CAMERAS; AN OPTICAL METROLOGY INSPECTION SYSTEM COMPRISED OF A LIGHT SOURCE, ONE OR MORE CAMERAS AND SENSORS IN COMMUNICATION WITH COMPUTER SOFTWARE AND HARDWARE; BAGS FOR CAMERAS AND PHOTOGRAPHIC EQUIPMENT; BELLOWS; CAMERA CLOSURES; CAMERA CONTAINING A LINEAR IMAGE SENSOR; CAMERA HANDLES; CAMERA HOODS; CAMERAS FOR SELF-DEVELOPING FILM; CELLULAR PHONE USAGE DETECTION SYSTEM COMPRISING A CAMERA AND A MOBILE PHONE SIGNAL RECEIVING DEVICE; COMPUTER CAMERAS; DIGITAL CAMERA ACCESSORY IN THE NATURE OF A DIGITAL PHOTO VIEWER; DIGITAL CAMERAS; DISPOSABLE CAMERAS; ENVIRONMENTAL ENCLOSURES, NAMELY, STRUCTURES SPECIALLY ADAPTED TO HOLD AND PROTECT CAMERAS FROM OUTDOOR ELEMENTS AND TAMPERING; EXPOSED CAMERA FILM; FILM CAMERAS; FILM PORTRAIT CAMERAS; INFRARED CAMERAS; LIGHTS FOR USE ON VIDEO CAMERAS; MONOPODS FOR CAMERAS; MOUNTING DEVICES FOR

CAMERAS AND MONITORS; MULTIFRAME VIEW CAMERAS; MULTIPLE PURPOSE CAMERAS; PLATE CAMERAS; PORTABLE VIDEO CAMERAS WITH BUILT-IN VIDEOCASSETTE RECORDERS; RANGE FINDERS; SELF-TIMERS; SOLAR RECHARGING BATTERY PACK FOR DIGITAL CAMERAS; TV CAMERAS; TILTING HEADS; VEHICLE SAFETY EQUIPMENT, NAMELY, BACK-UP SENSORS AND CAMERAS; VIDEO CAMERAS(BASED ON 44(E)) CAMERA FLASHES; FLASH GUNS; FLASH LAMPS; PHOTOGRAPHIC FLASH UNITS; CAMERA CASES; CAMERA FILTERS; CAMERA TRIPODS; CAMERAS; CAMERAS SHUTTERS; CINEMATOGRAPHIC CAMERAS; FLASHLAMPS FOR CAMERAS; LENS FILTERS; LENS HOODS; PHOTOGRAPHIC CAMERAS; SHUTTER RELEASES; SHUTTERS; TRIPODS; TRIPODS FOR CAMERAS; VIEWFINDERS, IN CLASS 9 (U.S. CLS. 21, 23, 26, 36 AND 38).

FIRST USE 8-9-2006; IN COMMERCE 9-1-2006.

OWNER OF HONG KONG REG. NO. 300686962,  
DATED 7-25-2006, EXPIRES 7-24-2016.

THE MARK CONSISTS OF STYLIZED LETTERS OF THE WORD "CACTUS" IN CAPITAL LETTERS.

SN 77-335,889, FILED 11-23-2007.

JAMES A. RAUEN, EXAMINING ATTORNEY

**Int. Cl.: 28**

**Prior U.S. Cls.: 22, 23, 38, and 50**

**United States Patent and Trademark Office**

**Reg. No. 3,506,335**

**Registered Sep. 23, 2008**

**TRADEMARK  
PRINCIPAL REGISTER**

**Balls Out Entertainment**

RADFORD, BENJAMIN T (UNITED STATES IN-  
DIVIDUAL)

732 BALTIC AVE SE

RIO RANCHO, NM 87124

FOR: BOARD GAMES, IN CLASS 28 (U.S. CLS. 22,  
23, 38 AND 50).

FIRST USE 7-15-2008; IN COMMERCE 7-15-2008.

THE MARK CONSISTS OF STANDARD CHAR-  
ACTERS WITHOUT CLAIM TO ANY PARTICULAR  
FONT, STYLE, SIZE, OR COLOR.

NO CLAIM IS MADE TO THE EXCLUSIVE  
RIGHT TO USE "ENTERTAINMENT", APART  
FROM THE MARK AS SHOWN.

SN 77-338,365, FILED 11-27-2007.

KAPIL BHANOT, EXAMINING ATTORNEY



**Int. Cl.: 41**

**Prior U.S. Cls.: 100, 101, and 107**

**United States Patent and Trademark Office**

**Reg. No. 3,506,336**

**Registered Sep. 23, 2008**

**SERVICE MARK  
PRINCIPAL REGISTER**

**Payless Traffic School**

JOHNNY WALKER (UNITED STATES INDIVIDUAL)  
9903 SANTA MONICA BLVD. 736  
BEVERLY HILLS, CA 90212

FOR: EDUCATIONAL SERVICES IN THE NATURE OF DRIVING, TRAFFIC, TRAFFIC SAFETY AND DEFENSIVE DRIVING COURSE SCHOOLS, IN CLASS 41 (U.S. CLS. 100, 101 AND 107).

FIRST USE 8-1-2008; IN COMMERCE 8-1-2008.

THE MARK CONSISTS OF STANDARD CHARACTERS WITHOUT CLAIM TO ANY PARTICULAR FONT, STYLE, SIZE, OR COLOR.

NO CLAIM IS MADE TO THE EXCLUSIVE RIGHT TO USE "TRAFFIC SCHOOL", APART FROM THE MARK AS SHOWN.

SN 77-341,916, FILED 12-1-2007.

REBECCA POVARCHUK, EXAMINING ATTORNEY

**Int. Cl.: 28**

**Prior U.S. Cls.: 22, 23, 38, and 50**

**United States Patent and Trademark Office**

**Reg. No. 3,506,337**

**Registered Sep. 23, 2008**

**TRADEMARK  
PRINCIPAL REGISTER**

**Grow'ems**

SAY WHAT ENTERPRISES, INC (NEW JERSEY  
CORPORATION)  
P.O. BOX 79  
MIDDLETOWN, NJ 07748

THE MARK CONSISTS OF STANDARD CHAR-  
ACTERS WITHOUT CLAIM TO ANY PARTICULAR  
FONT, STYLE, SIZE, OR COLOR.

FOR: RUBBER CHARACTER TOYS, IN CLASS 28  
(U.S. CLS. 22, 23, 38 AND 50).

SN 77-343,021, FILED 12-3-2007.

FIRST USE 11-15-2007; IN COMMERCE 11-15-2007.

LINDA E. BLOHM, EXAMINING ATTORNEY

**Int. Cl.: 5**

**Prior U.S. Cls.: 6, 18, 44, 46, 51, and 52**

**Reg. No. 3,506,338**

**United States Patent and Trademark Office**

**Registered Sep. 23, 2008**

**TRADEMARK  
PRINCIPAL REGISTER**

# CITRUS REVIVE

OSMEGEN, INC. (PENNSYLVANIA CORPORATION)  
700 N. FENWICK STREET  
ALLENTOWN, PA 18109

FOR: DEODORIZING PRODUCTS, NAMELY, ALL PURPOSE DEODORIZER PREPARATIONS FOR HOUSEHOLD, COMMERCIAL AND INDUSTRIAL USE, IN CLASS 5 (U.S. CLS. 6, 18, 44, 46, 51 AND 52).

FIRST USE 3-0-2008; IN COMMERCE 3-0-2008.

THE MARK CONSISTS OF STANDARD CHARACTERS WITHOUT CLAIM TO ANY PARTICULAR FONT, STYLE, SIZE, OR COLOR.

NO CLAIM IS MADE TO THE EXCLUSIVE RIGHT TO USE "CITRUS", APART FROM THE MARK AS SHOWN.

SN 77-343,113, FILED 12-4-2007.

DEIRDRE ROBERTSON, EXAMINING ATTORNEY

**Int. Cl.: 36**

**Prior U.S. Cls.: 100, 101, and 102**

**United States Patent and Trademark Office**

**Reg. No. 3,506,339**

**Registered Sep. 23, 2008**

**SERVICE MARK  
PRINCIPAL REGISTER**

PARENTACHIEVER LOAN DIRECT

KEYCORP (OHIO CORPORATION)  
127 PUBLIC SQUARE  
CLEVELAND, OH 44114

OWNER OF U.S. REG. NO. 1,916,786.

FOR: BANKING SERVICES, NAMELY, EDUCATIONAL LENDING SERVICES, IN CLASS 36 (U.S. CLS. 100, 101 AND 102).

NO CLAIM IS MADE TO THE EXCLUSIVE RIGHT TO USE "LOAN", APART FROM THE MARK AS SHOWN.

FIRST USE 1-15-2008; IN COMMERCE 1-15-2008.

SN 77-346,600, FILED 12-7-2007.

THE MARK CONSISTS OF STANDARD CHARACTERS WITHOUT CLAIM TO ANY PARTICULAR FONT, STYLE, SIZE, OR COLOR.

ANTHONY RINKER, EXAMINING ATTORNEY

**Int. Cl.: 9**

**Prior U.S. Cls.: 21, 23, 26, 36, and 38**

**Reg. No. 3,506,340**

**United States Patent and Trademark Office**

**Registered Sep. 23, 2008**

**TRADEMARK  
PRINCIPAL REGISTER**

**L.A. MAFIA**

PACIFIC LINK TRADE USA, INC. (GEORGIA  
CORPORATION)  
SUITE 3  
1223 CORONET DRIVE  
DALTON, GA 30720

THE MARK CONSISTS OF STANDARD CHAR-  
ACTERS WITHOUT CLAIM TO ANY PARTICULAR  
FONT, STYLE, SIZE, OR COLOR.

FOR: SUNGLASSES, IN CLASS 9 (U.S. CLS. 21, 23,  
26, 36 AND 38).

SN 77-347,095, FILED 12-7-2007.

FIRST USE 6-12-2008; IN COMMERCE 6-12-2008.

WENDY GOODMAN, EXAMINING ATTORNEY

**Int. Cl.: 12**

**Prior U.S. Cls.: 19, 21, 23, 31, 35, and 44**

**United States Patent and Trademark Office**

**Reg. No. 3,506,341**

**Registered Sep. 23, 2008**

**TRADEMARK  
PRINCIPAL REGISTER**

**ALUMILENE**

TOWTECTOR, INC. (IOWA CORPORATION)  
907 7TH ST NW  
ORANGE CITY, IA 51041

FOR: VEHICLE-MOUNTED SLIDING CARRIER  
FOR THE TRANSPORTATION OF ANIMALS, CAR-  
GO AND THE LIKE, IN CLASS 12 (U.S. CLS. 19, 21, 23,  
31, 35 AND 44).

FIRST USE 3-3-2008; IN COMMERCE 3-3-2008.

THE MARK CONSISTS OF STANDARD CHAR-  
ACTERS WITHOUT CLAIM TO ANY PARTICULAR  
FONT, STYLE, SIZE, OR COLOR.

SN 77-348,064, FILED 12-10-2007.

MARIA-VICTORIA SUAREZ, EXAMINING ATTOR-  
NEY

**Int. Cl.: 36**

**Prior U.S. Cls.: 100, 101, and 102**

**United States Patent and Trademark Office**

**Reg. No. 3,506,342**

**Registered Sep. 23, 2008**

**SERVICE MARK  
PRINCIPAL REGISTER**

**EDACHIEVER LOAN**

KEYCORP (OHIO CORPORATION)  
127 PUBLIC SQUARE  
CLEVELAND, OH 44114

OWNER OF U.S. REG. NOS. 1,916,786, 2,142,784,  
AND OTHERS.

FOR: BANKING SERVICES, NAMELY, EDUCATIONAL LENDING SERVICES, IN CLASS 36 (U.S. CLS. 100, 101 AND 102).

NO CLAIM IS MADE TO THE EXCLUSIVE RIGHT TO USE "LOAN", APART FROM THE MARK AS SHOWN.

FIRST USE 1-3-2008; IN COMMERCE 1-3-2008.

SN 77-352,534, FILED 12-14-2007.

THE MARK CONSISTS OF STANDARD CHARACTERS WITHOUT CLAIM TO ANY PARTICULAR FONT, STYLE, SIZE, OR COLOR.

ANTHONY RINKER, EXAMINING ATTORNEY

**Int. Cl.: 36**

**Prior U.S. Cls.: 100, 101, and 102**

**United States Patent and Trademark Office**

**Reg. No. 3,506,343**

**Registered Sep. 23, 2008**

**SERVICE MARK  
PRINCIPAL REGISTER**

**PARENTACHIEVER LOAN**

KEYCORP (OHIO CORPORATION)  
127 PUBLIC SQUARE  
CLEVELAND, OH 44114

OWNER OF U.S. REG. NOS. 1,916,786, 2,142,784,  
AND OTHERS.

FOR: BANKING SERVICES, NAMELY, EDUCATIONAL LENDING SERVICES, IN CLASS 36 (U.S. CLS. 100, 101 AND 102).

NO CLAIM IS MADE TO THE EXCLUSIVE RIGHT TO USE "LOAN", APART FROM THE MARK AS SHOWN.

FIRST USE 1-15-2008; IN COMMERCE 1-15-2008.

SN 77-352,553, FILED 12-14-2007.

THE MARK CONSISTS OF STANDARD CHARACTERS WITHOUT CLAIM TO ANY PARTICULAR FONT, STYLE, SIZE, OR COLOR.

ANTHONY RINKER, EXAMINING ATTORNEY



**Int. Cl.: 5**

**Prior U.S. Cls.: 6, 18, 44, 46, 51, and 52**

**Reg. No. 3,506,344**

**United States Patent and Trademark Office**

**Registered Sep. 23, 2008**

**TRADEMARK  
PRINCIPAL REGISTER**



TIMOTHY J. O'BRIEN (UNITED STATES INDIVIDUAL)  
109 COOPERATIVE WAY, #101  
KALISPELL, MT 59901

THE MARK CONSISTS OF THE WORD "AQUILA" UNDERNEATH A STYLIZED DEPICTION OF AN EAGLE.

FOR: NUTRITIONAL SUPPLEMENTS, IN CLASS 5 (U.S. CLS. 6, 18, 44, 46, 51 AND 52).

SN 77-975,590, FILED 4-3-2007.

FIRST USE 8-17-2007; IN COMMERCE 8-17-2007.

EVELYN BRADLEY, EXAMINING ATTORNEY

**Int. Cl.: 35**

**Prior U.S. Cls.: 100, 101, and 102**

**United States Patent and Trademark Office**

**Reg. No. 3,506,345**

**Registered Sep. 23, 2008**

**SERVICE MARK  
PRINCIPAL REGISTER**



HYPERTRONICS CORPORATION (MASSACHU-  
SETTS CORPORATION)  
16 BRENT DRIVE  
HUDSON, MA 017492978

FOR: BUSINESS MARKETING SERVICES FOR  
OTHERS; DISTRIBUTORSHIP SERVICES FEATUR-  
ING ELECTRO-MECHANICAL GOODS, NAMELY,  
CABLES AND CONNECTORS, IN CLASS 35 (U.S.  
CLS. 100, 101 AND 102).

FIRST USE 1-0-2008; IN COMMERCE 1-0-2008.

THE MARK CONSISTS OF "ECONNEK FITS  
YOUR DESIGN. FITS YOUR SCHEDULE." AND  
MISCELLANEOUS DESIGN.

SN 77-975,720, FILED 3-30-2007.

SOPHIA S. KIM, EXAMINING ATTORNEY

**Int. Cl.: 10**

**Prior U.S. Cls.: 26, 39, and 44**

**Reg. No. 3,506,346**

**United States Patent and Trademark Office**

**Registered Sep. 23, 2008**

**TRADEMARK  
PRINCIPAL REGISTER**



SOLARIS MEDICAL TECHNOLOGY, INC. (CALIFORNIA CORPORATION)  
SUITE 534  
400 OYSTER POINT BLVD.  
SOUTH SAN FRANCISCO, CA 94080

FOR: MULTIPARAMETER PATIENT MONITORS AND PULSE OXIMETERS AND ACCESSORIES FOR THE AFOREMENTIONED, NAMELY, OXIMETRY SENSORS OR SPO2 (SPOT OXYGEN SATURATION) SENSORS, IN CLASS 10 (U.S. CLS. 26, 39 AND 44).

FIRST USE 11-18-2003; IN COMMERCE 2-26-2007.

THE MARK CONSISTS OF AN ELECTRONIC WAVEFORM DESIGN DISPLAYING PULSE BLOOD OXYGEN SATURATION LEVEL AND THE WORD "SOLARIS" ABOVE THE FLAT DISPLAY LINE.

SN 77-975,733, FILED 11-6-2006.

CHRIS WELLS, EXAMINING ATTORNEY

**Int. Cl.: 16**

**Prior U.S. Cls.: 2, 5, 22, 23, 29, 37, 38, and 50**

**Reg. No. 3,506,347**

**United States Patent and Trademark Office**

**Registered Sep. 23, 2008**

**TRADEMARK  
PRINCIPAL REGISTER**



Young  
FOUNDATIONS

VOICE OF GOD RECORDINGS, INC. (INDIANA CORPORATION)  
P.O. BOX 950  
JEFFERSONVILLE, IN 47131

THE MARK CONSISTS OF THE WORDS "YOUNG FOUNDATIONS" WITH A STYLIZED WORD "YOUNG" AND STYLIZED LETTER "T" IN THE SECOND WORD.

FOR: BOOKS, NAMELY, RELIGIOUS BOOKS FEATURING RELIGIOUS SERMONS, IN CLASS 16 (U.S. CLS. 2, 5, 22, 23, 29, 37, 38 AND 50).

SN 77-975,786, FILED 4-3-2007.

FIRST USE 4-13-2007; IN COMMERCE 4-13-2007.

MARY MUNSON, EXAMINING ATTORNEY

**Int. Cl.: 21**

**Prior U.S. Cls.: 2, 13, 23, 29, 30, 33, 40, and 50**

**United States Patent and Trademark Office**

**Reg. No. 3,506,348**

**Registered Sep. 23, 2008**

**TRADEMARK  
PRINCIPAL REGISTER**

**FIT & FRESH**

MEDPORT LLC (RHODE ISLAND LIMITED LIABILITY COMPANY)  
23 ACORN STREET  
PROVIDENCE, RI 02903

FOR: CUTTING BOARDS, IN CLASS 21 (U.S. CLS. 2, 13, 23, 29, 30, 33, 40 AND 50).

FIRST USE 12-1-2007; IN COMMERCE 12-1-2007.

THE MARK CONSISTS OF STANDARD CHARACTERS WITHOUT CLAIM TO ANY PARTICULAR FONT, STYLE, SIZE, OR COLOR.

OWNER OF U.S. REG. NO. 3,121,829.

SN 77-975,855, FILED 6-11-2007.

MICHAEL KEATING, EXAMINING ATTORNEY

**Int. Cl.: 29**

**Prior U.S. Cl.: 46**

**United States Patent and Trademark Office**

**Reg. No. 3,506,349**

**Registered Sep. 23, 2008**

**TRADEMARK  
PRINCIPAL REGISTER**

**TOUR EIFFEL**

MCCAIN FOODS USA, INC. (MAINE CORPORATION)  
2275 CABOT DRIVE  
LISLE, IL 605323653

FIRST USE 12-0-1998; IN COMMERCE 12-0-1998.

SN 78-150,144, FILED 8-2-2002.

FOR: TERRINES, PATES; APPETIZERS, SIDE DISHES AND ENTREES CONSISTING PRIMARILY OF MEAT OR POULTRY, IN CLASS 29 (U.S. CL. 46).

ROBIN CHOSID, EXAMINING ATTORNEY

**Int. Cl.: 33**

**Prior U.S. Cls.: 47 and 49**

**United States Patent and Trademark Office**

**Reg. No. 3,506,350**

**Registered Sep. 23, 2008**

**TRADEMARK  
PRINCIPAL REGISTER**

**KISS**

SAZERAC COMPANY, INC. (LOUISIANA COR-  
PORATION)  
803 JEFFERSON HIGHWAY  
P.O. BOX 52821  
NEW ORLEANS, LA 70121

THE MARK CONSISTS OF STANDARD CHAR-  
ACTERS WITHOUT CLAIM TO ANY PARTICULAR  
FONT, STYLE, SIZE, OR COLOR.

FOR: VODKA, IN CLASS 33 (U.S. CLS. 47 AND 49).

SN 78-171,791, FILED 10-7-2002.

FIRST USE 11-0-2006; IN COMMERCE 11-0-2006.

GINA HAYES, EXAMINING ATTORNEY

**Int. Cl.: 21**

**Prior U.S. Cls.: 2, 13, 23, 29, 30, 33, 40, and 50**

**Reg. No. 3,506,351**

**United States Patent and Trademark Office**

**Registered Sep. 23, 2008**

**TRADEMARK  
PRINCIPAL REGISTER**

**SPRAYMO**

DE LA GUARDIA, MARIO FELIX (UNITED STATES INDIVIDUAL)  
5740 SW 4TH COURT  
PLANTATION, FL 33317

LIQUID OUT OF THE BOTTLES , IN CLASS 21 (U.S. CLS. 2, 13, 23, 29, 30, 33, 40 AND 50).

FIRST USE 6-1-2008; IN COMMERCE 6-1-2008.

FOR: SPRAY BOTTLES SOLD EMPTY CONTAINING AN AIR PUMP, MOLDED HANDLE, TRIGGER, AND AN ADJUSTABLE NOZZLE FOR DISPENSING

SN 78-191,965, FILED 12-6-2002.

ANDREA SAUNDERS, EXAMINING ATTORNEY



**Int. Cls.: 35, 39, and 41**

**Prior U.S. Cls.: 100, 101, 102, 105, and 107**

**United States Patent and Trademark Office**

**Reg. No. 3,506,352**

**Registered Sep. 23, 2008**

**SERVICE MARK  
PRINCIPAL REGISTER**

**SHOWTIME.COM**

SHOWTIME TOURS INCORPORATED (CANADA CORPORATION)  
892 ADELAIDE STREET NORTH  
LONDON, ONTARIO N5Y 2M5

FOR: OPERATING AN ONLINE MARKETPLACE FOR SELLERS OF GOODS AND SERVICES FEATURING TICKETS RELATING TO ENTERTAINMENT EVENTS, CONCERTS, SPORTING EVENTS, AND TRAVEL, IN CLASS 35 (U.S. CLS. 100, 101 AND 102).

FIRST USE 12-28-1994; IN COMMERCE 12-28-1994.

FOR: TRAVEL AGENCY SERVICES, NAMELY, MAKING RESERVATIONS AND BOOKINGS FOR TRANSPORTATION AS PART OF A TRAVEL AND

ENTERTAINMENT PACKAGE, IN CLASS 39 (U.S. CLS. 100 AND 105).

FIRST USE 12-0-1994; IN COMMERCE 12-0-1994.

FOR: ARRANGING FOR TICKET RESERVATIONS FOR THEATRES, CONCERTS, SPORTING EVENTS AND OTHER EVENTS, IN CLASS 41 (U.S. CLS. 100, 101 AND 107).

FIRST USE 5-0-1995; IN COMMERCE 5-0-1995.

SN 78-215,623, FILED 2-17-2003.

DORITT L. CARROLL, EXAMINING ATTORNEY

**Int. Cls.: 30 and 43**

**Prior U.S. Cls.: 46, 100, and 101**

**United States Patent and Trademark Office**

**Reg. No. 3,506,353**

**Registered Sep. 23, 2008**

**TRADEMARK  
SERVICE MARK  
PRINCIPAL REGISTER**

**咖 哩 匠**

**Curry Champ  
Passion for curry**

SHIN YEH INDUSTRIAL CO., LTD. (TAIWAN  
CORPORATION)  
2ND FL., NO. 34-1, SHUANG CHENG STREET  
TAIPEI, TAIWAN

FOR: NON-ALCOHOLIC TEA-BASED BEVERAGES, NON-ALCOHOLIC TEA-BASED BEVERAGES WITH FRUIT FLAVORING, COFFEE, COCOA, CHOCOLATE-BASED FOOD BEVERAGES NOT BEING DAIRY OR VEGETABLE BASED, HOT CHOCOLATE, ICE CREAM, SAUCES, PASTRIES, CANDY, CAKES, BREAD, PUDDINGS, SNACKS IN THE NATURE OF STEAMED RICE CAKES AND STEAMED STARCH PIE WITH MEAT STUFFING; ENTREES CONSISTING PRIMARILY OF SOUP NOODLES AND ALSO CONTAINING SPARERIBS; DUMPLINGS, FROZEN DUMPLINGS, COOL NOODLES WITH SAUCE, SAGO, SPICES, AND PREPARED MEALS IN THE NATURE OF BOXED LUNCHEES CONSISTING PRIMARILY OF PASTA OR RICE, IN CLASS 30 (U.S. CL. 46).

FIRST USE 4-15-2002; IN COMMERCE 1-1-2008.

FOR: RESTAURANTS, IN CLASS 43 (U.S. CLS. 100 AND 101).

FIRST USE 4-15-2002; IN COMMERCE 1-1-2008.

NO CLAIM IS MADE TO THE EXCLUSIVE RIGHT TO USE "CURRY" OR THE NON-LATIN CHARACTERS MEANING "CURRY CRAFTSMAN", APART FROM THE MARK AS SHOWN.

THE CHINESE CHARACTERS IN THE MARK TRANSLITERATE TO KA LI JIANG WHICH MEANS "CURRY CRAFTSMAN" IN ENGLISH.

SN 78-230,732, FILED 3-27-2003.

ZHALEH DELANEY, EXAMINING ATTORNEY

**Int. Cl.: 20**

**Prior U.S. Cls.: 2, 13, 22, 25, 32, and 50**

**United States Patent and Trademark Office**

**Reg. No. 3,506,354**

**Registered Sep. 23, 2008**

---

**TRADEMARK  
PRINCIPAL REGISTER**

**ECHO**

THE ECHO DESIGN GROUP, INC. (NEW YORK  
CORPORATION)  
10 EAST 40TH STREET  
NEW YORK, NY 10016

OWNER OF U.S. REG. NOS. 246,934, 2,646,159,  
AND OTHERS.

FOR: FURNITURE, IN CLASS 20 (U.S. CLS. 2, 13,  
22, 25, 32 AND 50).

SN 78-235,410, FILED 4-8-2003.

FIRST USE 7-3-2008; IN COMMERCE 7-3-2008.

ODESSA BIBBINS, EXAMINING ATTORNEY

**Int. Cl.: 33**

**Prior U.S. Cls.: 47 and 49**

**United States Patent and Trademark Office**

**Reg. No. 3,506,355**

**Registered Sep. 23, 2008**

**TRADEMARK  
PRINCIPAL REGISTER**

**PROVIDENCE**

ETABLISSEMENTS JEAN-PIERRE MOUEIX  
(FRANCE CORPORATION)  
54 QUAI DU PRIOURAT  
33500 LIBOURNE, FRANCE

THE MARK CONSISTS OF STANDARD CHAR-  
ACTERS WITHOUT CLAIM TO ANY PARTICULAR  
FONT, STYLE, SIZE, OR COLOR.

FOR: WINES, IN CLASS 33 (U.S. CLS. 47 AND 49).

SN 78-240,668, FILED 4-22-2003.

FIRST USE 9-0-2007; IN COMMERCE 9-0-2007.

NAAKWAMA ANKRAH, EXAMINING ATTORNEY

**Int. Cl.: 41**

**Prior U.S. Cls.: 100, 101, and 107**

**United States Patent and Trademark Office**

**Reg. No. 3,506,356**

**Registered Sep. 23, 2008**

**SERVICE MARK  
PRINCIPAL REGISTER**

**VEGAS SPORTS**

VILLANI, SERGE P (UNITED STATES INDIVIDUAL)  
P.O. BOX 1551  
CASTLE ROCK, CO 80104

FOR: HANDICAPPING FOR SPORTING EVENTS;  
ENTERTAINMENT, NAMELY, PROVIDING INFORMATION AND ANALYSIS IN THE FIELD OF SPORTS VIA GLOBAL COMPUTER NETWORK, IN CLASS 41 (U.S. CLS. 100, 101 AND 107).

FIRST USE 7-11-2007; IN COMMERCE 7-11-2007.

NO CLAIM IS MADE TO THE EXCLUSIVE RIGHT TO USE "SPORTS", APART FROM THE MARK AS SHOWN.

SN 78-258,803, FILED 6-5-2003.

KAREN BRACEY, EXAMINING ATTORNEY

**Int. Cl.: 7**

**Prior U.S. Cls.: 13, 19, 21, 23, 31, 34, and 35**

**Reg. No. 3,506,357**

**United States Patent and Trademark Office**

**Registered Sep. 23, 2008**

**TRADEMARK  
PRINCIPAL REGISTER**

**NEX**

NISSEI PLASTIC INDUSTRIAL CO., LTD. (JAPAN CORPORATION)  
2110, OAZA MINAMIJO, SAKAKI-MACHI  
HANISHINA-GUN  
NAGANO-KEN, JAPAN

FOR: PLASTIC PROCESSING MACHINES AND APPARATUS, NAMELY, INJECTION MOLDING MACHINES, COMPRESSION MOLDING MACHINES, PLASTIC LENS MOLDING MACHINES, AND MACHINE PARTS, NAMELY, PLASTIC MOLDS FOR USE IN MOLDING MACHINES FOR FORMING OR PRODUCING PLASTIC PRODUCTS; RUBBER-GOODS MANUFACTURING MACHINES

AND APPARATUS, NAMELY, INJECTION MOLDING MACHINES AND COMPRESSION MOLDING MACHINES FOR MANUFACTURING RUBBER PRODUCTS; MOLDS FOR FORMING RUBBER PRODUCTS, IN CLASS 7 (U.S. CLS. 13, 19, 21, 23, 31, 34 AND 35).

FIRST USE 5-17-2003; IN COMMERCE 5-17-2003.

SN 78-280,984, FILED 7-30-2003.

EUGENIA MARTIN, EXAMINING ATTORNEY

**Int. Cl.: 9**

**Prior U.S. Cls.: 21, 23, 26, 36, and 38**

**Reg. No. 3,506,358**

**United States Patent and Trademark Office**

**Registered Sep. 23, 2008**

**TRADEMARK  
PRINCIPAL REGISTER**



TNA ENTERTAINMENT, LLC (DELAWARE LIMITED LIABILITY COMPANY)  
SUITE 1001  
4100 SPRING VALLEY ROAD  
DALLAS, TX 75244

FOR: COMPACT DISCS AND PRERECORDED VIDEO TAPES FEATURING SPORTS ENTERTAINMENT, IN CLASS 9 (U.S. CLS. 21, 23, 26, 36 AND 38).

FIRST USE 11-10-2002; IN COMMERCE 8-6-2005.

NO CLAIM IS MADE TO THE EXCLUSIVE RIGHT TO USE WRESTLING, APART FROM THE MARK AS SHOWN.

THE COLOR(S) RED, GOLD AND BLACK IS/ARE CLAIMED AS A FEATURE OF THE MARK.

THE LETTERS "TNA" APPEAR IN THE COLOR RED WITH THE SURROUNDING DESIGN PORTIONS APPEARING IN THE COLORS BLACK AND GOLD, AND THE REMAINING WORDING "TOTAL NONSTOP ACTION WRESTLING" APPEARING IN THE COLOR BLACK.

SN 78-281,869, FILED 8-1-2003.

KAREN BRACEY, EXAMINING ATTORNEY

**Int. Cls.: 14, 16, 35, 36, 38, 41, and 44**

**Prior U.S. Cls.: 2, 5, 22, 23, 27, 28, 29, 37, 38, 50, 100, 101, 102, 104, and 107**

**Reg. No. 3,506,359**

**United States Patent and Trademark Office**

**Registered Sep. 23, 2008**

**TRADEMARK  
SERVICE MARK  
PRINCIPAL REGISTER**

**GO RED FOR WOMEN**

AMERICAN HEART ASSOCIATION, INC. (NEW YORK CORPORATION)  
7272 GREENVILLE AVENUE  
DALLAS, TX 752314596

FOR: JEWELRY, NAMELY, PINS, CHARMS AND PENDANTS, IN CLASS 14 (U.S. CLS. 2, 27, 28 AND 50).

FIRST USE 8-30-2003; IN COMMERCE 8-30-2003.

FOR: PRINTED AND ELECTRONIC MEDIA EDUCATIONAL MATERIALS, NAMELY, BOOKS, PAMPHLETS, BROCHURES, AND BOOKLETS, POSTERS, WALLET CARDS, AND BOOK MARKS RELATING TO PREVENTION OF CARDIOVASCULAR DISEASE IN WOMEN; AND KITS COMPRISING POSTERS, ABRIDGED/DIGEST VERSION OF TREATMENT GUIDELINES, PERSONALIZED APPOINTMENT REMINDER CARDS, PATIENT EDUCATION BOOKLETS, INTERNET ACCESS AND DOWNLOADING INSTRUCTIONS, PINS, BROCHURES, WALLET CARDS AND BOOKMARKS, RELATING TO PREVENTION OF CARDIOVASCULAR DISEASE IN WOMEN, IN CLASS 16 (U.S. CLS. 2, 5, 22, 23, 29, 37, 38 AND 50).

FIRST USE 8-30-2003; IN COMMERCE 8-30-2003.

FOR: PROMOTING PUBLIC AWARENESS TO EDUCATE WOMEN REGARDING THE RISK AND PREVENTION OF CARDIOVASCULAR DISEASE, BY MEANS OF CONDUCTING PUBLIC RELATIONS/MEDIA CAMPAIGNS CONSISTING OF AUDIO AND VIDEO NEWS RELEASES, MORNING TALK SHOWS, CELEBRITY SPOKESPERSON, SATELLITE MEDIA TOURS, DESK SIDE INTERVIEWS, ADVERTISING, CONDUCTING LOBBYING AND ADVOCACY PROGRAMS RELATING TO CARDIOVASCULAR HEALTH AND DISEASE AND ITS RISKS AND PREVENTION;

CONDUCTING SURVEYS OF WOMEN RELATING TO CARDIOVASCULAR HEALTH AND CARDIOVASCULAR DISEASE, IN CLASS 35 (U.S. CLS. 100, 101 AND 102).

FIRST USE 8-30-2003; IN COMMERCE 8-30-2003.

FOR: CHARITABLE FUNDRAISING SERVICES FOR PROMOTING RESEARCH, EDUCATION AND OTHER ACTIVITIES RELATING TO CARDIOVASCULAR HEALTH, FITNESS AND NUTRITION, AND/OR THE PREVENTION OR REDUCTION OF CARDIOVASCULAR DISEASE AND STROKE; CHARITABLE FUNDRAISING IN THE FIELD OF CARDIOVASCULAR HEALTH IN THE NATURE OF MEMORIAL DONATIONS; CHARITABLE FUNDRAISING SERVICES IN CONNECTION WITH CARDIOVASCULAR HEALTH AWARENESS, IN CLASS 36 (U.S. CLS. 100, 101 AND 102).

FIRST USE 8-30-2003; IN COMMERCE 8-30-2003.

FOR: OPERATING AN INTERNET WEB SITE PROVIDING CHAT ROOMS AND BULLETIN BOARDS FOR THE TRANSMISSION OF MESSAGES, AND ONLINE CONFERENCING SERVICES, ALL IN THE FIELD OF CARDIOVASCULAR DISEASE AND HEALTH, IN CLASS 38 (U.S. CLS. 100, 101 AND 104).

FIRST USE 8-30-2003; IN COMMERCE 8-30-2003.

FOR: EDUCATION SERVICES, NAMELY, CONDUCTING SEMINARS IN CONNECTION WITH WOMEN'S RISK OF CARDIOVASCULAR DISEASE AND ITS PREVENTION; CONTINUING EDUCATION FOR HEALTHCARE PROFESSIONALS, PATIENT EDUCATION PROGRAMS; AND CONDUCTING PUBLIC PARTICIPATION EVENTS, ALL TO PROMOTE AWARENESS OF CARDIOVAS-



CULAR HEALTH, FITNESS AND NUTRITION, IN CLASS 41 (U.S. CLS. 100, 101 AND 107).

FIRST USE 8-30-2003; IN COMMERCE 8-30-2003.

FOR: CONDUCTING SCREENINGS FOR CARDIOVASCULAR DISEASE RISK FACTORS; PROVIDING INTERACTIVE ONLINE RESOURCE INFORMATION AND MATERIALS VIA A GLOBAL COMPUTER NETWORK RELATING TO CARDIOVASCULAR HEALTH, FITNESS, AND NUTRITION, AND/OR THE PREVENTION OR REDUCTION OF CARDIOVASCULAR DISEASE AND STROKE; OP-

ERATING AN INTERNET WEBSITE PROVIDING INFORMATION IN THE FIELD OF CARDIOVASCULAR DISEASE AND HEALTH THAT MAY BE DOWNLOADED TO DVD'S, PDA'S, PERSONAL COMPUTERS, AND/OR PRINT, IN CLASS 44 (U.S. CLS. 100 AND 101).

FIRST USE 8-30-2003; IN COMMERCE 8-30-2003.

SN 78-302,957, FILED 9-19-2003.

MARY ROSSMAN, EXAMINING ATTORNEY

**Int. Cl.: 41**

**Prior U.S. Cls.: 100, 101, and 107**

**United States Patent and Trademark Office**

**Reg. No. 3,506,360**

**Registered Sep. 23, 2008**

**SERVICE MARK  
PRINCIPAL REGISTER**

**CO-DEMENTIA**

DAMPEER, JANET K. (UNITED STATES INDIVIDUAL)  
2961 SOUTH FRANKLIN  
ENGLEWOOD, CO 80110

FOR: EDUCATIONAL SERVICES, NAMELY, ARRANGING AND CONDUCTING PROGRAMS, WORKSHOPS AND SEMINARS IN THE FIELD OF MENTAL HEALTH, CONDUCTING WORKSHOPS

AND SEMINARS IN PERSONAL AWARENESS, IN CLASS 41 (U.S. CLS. 100, 101 AND 107).

FIRST USE 5-24-2008; IN COMMERCE 5-24-2008.

SN 78-310,663, FILED 10-7-2003.

CHRIS WELLS, EXAMINING ATTORNEY

**Int. Cl.: 9**

**Prior U.S. Cls.: 21, 23, 26, 36, and 38**

**Reg. No. 3,506,361**

**United States Patent and Trademark Office**

**Registered Sep. 23, 2008**

**TRADEMARK  
PRINCIPAL REGISTER**



CARBON DESIGN SYSTEMS, INC. (DELAWARE CORPORATION)  
375 TOTTEN POND ROAD  
WALTHAM, MA 02451

NO CLAIM IS MADE TO THE EXCLUSIVE RIGHT TO USE "DESIGN SYSTEMS", APART FROM THE MARK AS SHOWN.

FOR: COMPUTER SOFTWARE FOR ELECTRONIC DESIGN AUTOMATION, IN CLASS 9 (U.S. CLS. 21, 23, 26, 36 AND 38).

SN 78-314,555, FILED 10-16-2003.

FIRST USE 9-30-2002; IN COMMERCE 12-31-2002.

SONYA STEPHENS, EXAMINING ATTORNEY

**Int. Cl.: 9**

**Prior U.S. Cls.: 21, 23, 26, 36, and 38**

**United States Patent and Trademark Office**

**Reg. No. 3,506,362**

**Registered Sep. 23, 2008**

**TRADEMARK  
PRINCIPAL REGISTER**

**KP HEALTHCONNECT**

KAISER FOUNDATION HEALTH PLAN, INC.  
(CALIFORNIA CORPORATION)  
ONE KAISER PLAZA  
OAKLAND, CA 94612

FOR: COMPUTER SOFTWARE FOR USE IN  
MAINTAINING MEDICAL AND OTHER RECORDS  
OF PATIENTS AND MEMBERS OF AN INTEGRA-  
TED HEALTH PLAN AND HEALTHCARE PROVI-  
DER ORGANIZATION AND COMMUNICATING  
INFORMATION AMONG HEALTH CARE PROFES-

SIONALS AND OTHERS RELATING TO THE CARE  
OF SUCH PATIENTS AND PLAN MEMBERS, IN  
CLASS 9 (U.S. CLS. 21, 23, 26, 36 AND 38).

FIRST USE 1-15-2005; IN COMMERCE 1-15-2005.

SN 78-319,951, FILED 10-28-2003.

CAROLYN CATALDO, EXAMINING ATTORNEY

**Int. Cl.: 9**

**Prior U.S. Cls.: 21, 23, 26, 36, and 38**

**United States Patent and Trademark Office**

**Reg. No. 3,506,363**

**Registered Sep. 23, 2008**

**TRADEMARK  
PRINCIPAL REGISTER**

**ACTION REPLAY**

DATEL DESIGN & DEVELOPMENT LIMITED  
(UNITED KINGDOM COMPANY)  
STAFFORD ROAD  
STONE, STAFFORDSHIRE, UNITED KINGDOM  
ST15 0DG

FOR: COMPUTER SOFTWARE FOR USE WITH  
GAME SYSTEMS TO ENHANCE A USER'S SKILL  
LEVEL; DVDS AND CDS FOR USE WITH COMPU-  
TER GAME SYSTEMS TO ENHANCE A USER'S  
SKILL LEVEL, IN CLASS 9 (U.S. CLS. 21, 23, 26, 36  
AND 38).

FIRST USE 12-31-1984; IN COMMERCE 12-31-1985.

THE MARK CONSISTS OF STANDARD CHAR-  
ACTERS WITHOUT CLAIM TO ANY PARTICULAR  
FONT, STYLE, SIZE, OR COLOR.

SN 78-325,899, FILED 11-11-2003.

CHRIS WELLS, EXAMINING ATTORNEY

**Int. Cl.: 39**

**Prior U.S. Cls.: 100 and 105**

**United States Patent and Trademark Office**

**Reg. No. 3,506,364**

**Registered Sep. 23, 2008**

**SERVICE MARK  
PRINCIPAL REGISTER**

**EKLINVAULT**

EKLIN MEDICAL SYSTEMS, INC. (CALIFORNIA CORPORATION)  
1605 WYATT DRIVE  
SANTA CLARA, CA 95054

FOR: STORAGE OF ELECTRONIC MEDIA, NAMELY, DIGITAL IMAGES AND RELATED DATA TEXT IN THE MEDICAL AND VETERINARY FIELDS; ALLOWING UPLOADING, SHARING AND RETRIEVING OF SUCH MEDIA VIA A GLOBAL COMPUTER NETWORK, IN CLASS 39 (U.S. CLS. 100 AND 105).

FIRST USE 6-9-2008; IN COMMERCE 6-9-2008.

THE MARK CONSISTS OF STANDARD CHARACTERS WITHOUT CLAIM TO ANY PARTICULAR FONT, STYLE, SIZE, OR COLOR.

SN 78-330,118, FILED 11-19-2003.

NAAKWAMA ANKRAH, EXAMINING ATTORNEY

**Int. Cl.: 39**

**Prior U.S. Cls.: 100 and 105**

**United States Patent and Trademark Office**

**Reg. No. 3,506,365**

**Registered Sep. 23, 2008**

**SERVICE MARK  
PRINCIPAL REGISTER**

**INDEPENDENCE**

AMERICAN CRUISE LINES, INC. (DELAWARE  
CORPORATION)  
741 BOSTON POST ROAD, SUITE 200  
GUILFORD, CT 06437

THE MARK CONSISTS OF STANDARD CHAR-  
ACTERS WITHOUT CLAIM TO ANY PARTICULAR  
FONT, STYLE, SIZE, OR COLOR.

FOR: TRANSPORTATION OF PASSENGERS BY  
SHIP, IN CLASS 39 (U.S. CLS. 100 AND 105).

SN 78-333,629, FILED 11-26-2003.

FIRST USE 6-5-2007; IN COMMERCE 6-5-2007.

MICHAEL WEBSTER, EXAMINING ATTORNEY

**Int. Cl.: 35**

**Prior U.S. Cls.: 100, 101, and 102**

**United States Patent and Trademark Office**

**Reg. No. 3,506,366**

**Registered Sep. 23, 2008**

**SERVICE MARK  
PRINCIPAL REGISTER**

**SERVICEFIRST**

SAKS & COMPANY (NEW YORK CORPORATION)  
12 EAST 49TH STREET  
NEW YORK, NY 10017

THE MARK CONSISTS OF STANDARD CHARACTERS WITHOUT CLAIM TO ANY PARTICULAR FONT, STYLE, SIZE, OR COLOR.

FOR: CUSTOMER SERVICE IN THE FIELD OF APPLICANT'S RETAIL DEPARTMENT STORES, IN CLASS 35 (U.S. CLS. 100, 101 AND 102).

SN 78-334,943, FILED 12-2-2003.

FIRST USE 3-0-2003; IN COMMERCE 3-0-2003.

BARBARA BROWN, EXAMINING ATTORNEY



**Int. Cl.: 16**

**Prior U.S. Cls.: 2, 5, 22, 23, 29, 37, 38, and 50**

**United States Patent and Trademark Office**

**Reg. No. 3,506,367**

**Registered Sep. 23, 2008**

**TRADEMARK  
PRINCIPAL REGISTER**

**MARIAH**

AUTOMATIC PRINCESS HOLDINGS, LLC (DE-  
LAWARE LIMITED LIABILITY COMPANY)  
360 HAMILTON AVENUE  
C/O GELFAND, RENNERT & FELDMAN LLP  
WHITE PLAINS, NY 10601

FOR: POSTERS, IN CLASS 16 (U.S. CLS. 2, 5, 22, 23,  
29, 37, 38 AND 50).

FIRST USE 3-0-2008; IN COMMERCE 3-0-2008.

THE MARK CONSISTS OF STANDARD CHAR-  
ACTERS WITHOUT CLAIM TO ANY PARTICULAR  
FONT, STYLE, SIZE, OR COLOR.

OWNER OF U.S. REG. NO. 2,566,896.

THE NAME "MARIAH" IDENTIFIES A LIVING  
INDIVIDUAL WHOSE CONSENT IS OF RECORD.

SN 78-337,965, FILED 12-8-2003.

SHARON MEIER, EXAMINING ATTORNEY

Int. Cl.: 9

Prior U.S. Cls.: 21, 23, 26, 36, and 38

United States Patent and Trademark Office

Reg. No. 3,506,368

Registered Sep. 23, 2008

TRADEMARK  
PRINCIPAL REGISTER



JAKKS PACIFIC, INC. (DELAWARE CORPORATION)  
22619 PACIFIC COAST HIGHWAY  
MALIBU, CA 90265

FOR: ELECTRONIC GAMES, NAMELY, PORTABLE GAMING SYSTEMS FOR USE WITH TELEVISIONS, IN CLASS 9 (U.S. CLS. 21, 23, 26, 36 AND 38).

FIRST USE 1-1-2004; IN COMMERCE 1-1-2004.

NO CLAIM IS MADE TO THE EXCLUSIVE RIGHT TO USE "PLUG IT IN & PLAY TV GAMES", APART FROM THE MARK AS SHOWN.

THE COLOR(S) PURPLE, BLACK, BLUE, YELLOWISH GREEN, YELLOW AND WHITE IS/ARE CLAIMED AS A FEATURE OF THE MARK.

THE MARK CONSISTS OF THE WORDS "PLUG IT IN & PLAY" AND "GAMES" IN PURPLE LETTERING; THE WORD "TV" IN YELLOWISH GREEN; THE BACKGROUND TELEVISION SCREEN IS BLUE, WITH A BLACK OUTLINE, YELLOW BORDERS THE EXTERIOR OF THE TELEVISION DESIGN, TWO POWER CORDS APPEAR IN BLACK AND ONE CORD HAS A BLUE CAP AND ONE CORD HAS A YELLOW CAP, A WHITE STARBURST APPEARS AT THE BOTTOM OF THE MARK. THE BLACK IN THE BACKGROUND IS USED TO DISPLAY THE WHITE RAY DESIGN AND IS NOT PART OF THE MARK.

SN 78-339,769, FILED 12-11-2003.

JANICE L. MCMORROW, EXAMINING ATTORNEY

**Int. Cls.: 36 and 39**

**Prior U.S. Cls.: 100, 101, 102, and 105**

**United States Patent and Trademark Office**

**Reg. No. 3,506,369**

**Registered Sep. 23, 2008**

**SERVICE MARK  
PRINCIPAL REGISTER**

**ASSET WEB WATCH**

ASSET WEB WATCH, INC. (GEORGIA CORPORATION)  
SUITE 200  
133 CARRIAGE WAY, N.W.  
ATLANTA, GA 30303

FOR: ACTUARIAL SERVICES, NAMELY, SUBSTANTIATION OF INSURANCE ACTUARIAL CALCULATIONS AND CALCULATION OF LOSS PREVENTION PROBABILITIES VIA THE INTERNET OR OTHER GLOBAL COMPUTER NETWORK, IN CLASS 36 (U.S. CLS. 100, 101 AND 102).

FIRST USE 7-28-2008; IN COMMERCE 7-28-2008.

FOR: STORAGE AND RETRIEVAL OF DATABASE INFORMATION, IMAGES AND OTHER ELECTRONIC DATA, NAMELY, STORAGE AND RETRIEVAL OF INFORMATION CONCERNING PERSONAL PROPERTY BELONGING TO INDIVIDUALS AND BUSINESSES, SHARING OF SUCH INFORMATION AMONG INSURERS, INSURANCE

AGENCIES AND OTHERS AND THE LOCATION AND RETRIEVAL OF LOST OR STOLEN ASSETS VIA THE INTERNET OR OTHER GLOBAL COMPUTER NETWORK, IN CLASS 39 (U.S. CLS. 100 AND 105).

FIRST USE 7-28-2008; IN COMMERCE 7-28-2008.

THE MARK CONSISTS OF STANDARD CHARACTERS WITHOUT CLAIM TO ANY PARTICULAR FONT, STYLE, SIZE, OR COLOR.

NO CLAIM IS MADE TO THE EXCLUSIVE RIGHT TO USE "ASSET WEB", APART FROM THE MARK AS SHOWN.

SN 78-356,881, FILED 1-23-2004.

MARIA-VICTORIA SUAREZ, EXAMINING ATTORNEY

**Int. Cl.: 9**

**Prior U.S. Cls.: 21, 23, 26, 36, and 38**

**United States Patent and Trademark Office**

**Reg. No. 3,506,370**

**Registered Sep. 23, 2008**

**TRADEMARK  
PRINCIPAL REGISTER**

**BUCKHORN**

BUSHNELL INC. (DELAWARE CORPORATION)  
9200 CODY  
OVERLAND PARK, KS 66214

OWNER OF U.S. REG. NO. 1,778,320.

FOR: TELESCOPIC RIFLESOPES AND BINOCULARS, IN CLASS 9 (U.S. CLS. 21, 23, 26, 36 AND 38).

SEC. 2(F).

FIRST USE 2-0-1992; IN COMMERCE 2-0-1992.

SN 78-361,815, FILED 2-3-2004.

THE MARK CONSISTS OF STANDARD CHARACTERS WITHOUT CLAIM TO ANY PARTICULAR FONT, STYLE, SIZE, OR COLOR.

KATHERINE CHANG, EXAMINING ATTORNEY

**Int. Cl.: 5**

**Prior U.S. Cls.: 6, 18, 44, 46, 51, and 52**

**United States Patent and Trademark Office**

**Reg. No. 3,506,371**

**Registered Sep. 23, 2008**

**TRADEMARK  
PRINCIPAL REGISTER**

**FIBERSTAR**

FIBERSTAR, INC. (MINNESOTA CORPORATION)  
3023 15TH STREET SW  
WILLMAR, MN 56201

FOR: DIETARY FIBER FOR USE AS AN ADDITIVE IN THE MANUFACTURE OF FOOD FOR HUMAN AND ANIMAL CONSUMPTION, IN CLASS 5 (U.S. CLS. 6, 18, 44, 46, 51 AND 52).

FIRST USE 7-22-2008; IN COMMERCE 7-22-2008.

THE MARK CONSISTS OF STANDARD CHARACTERS WITHOUT CLAIM TO ANY PARTICULAR FONT, STYLE, SIZE, OR COLOR.

SN 78-363,770, FILED 2-6-2004.

MICHAEL SOUDERS, EXAMINING ATTORNEY

**Int. Cl.: 3**

**Prior U.S. Cls.: 1, 4, 6, 50, 51, and 52**

**United States Patent and Trademark Office**

**Reg. No. 3,506,372**

**Registered Sep. 23, 2008**

**TRADEMARK  
PRINCIPAL REGISTER**

**DAILY RICH**

TUPPERWARE PRODUCTS S.A. (SWITZERLAND  
CORPORATION)  
ROUTE DU JURA 37  
FRIBOURG, SWITZERLAND CH-1700

THE MARK CONSISTS OF STANDARD CHAR-  
ACTERS WITHOUT CLAIM TO ANY PARTICULAR  
FONT, STYLE, SIZE, OR COLOR.

FOR: LOTIONS AND CREAMS FOR THE CARE  
OF THE SKIN, NAMELY, SKIN LOTIONS AND  
CREAMS, IN CLASS 3 (U.S. CLS. 1, 4, 6, 50, 51 AND  
52).

SN 78-378,271, FILED 3-4-2004.

FIRST USE 6-14-2008; IN COMMERCE 6-14-2008.

BRENDAN MCCAULEY, EXAMINING ATTORNEY

**Int. Cl.: 3**

**Prior U.S. Cls.: 1, 4, 6, 50, 51, and 52**

**United States Patent and Trademark Office**

**Reg. No. 3,506,373**

**Registered Sep. 23, 2008**

**TRADEMARK  
PRINCIPAL REGISTER**

**PAUL HILL**

TUPPERWARE PRODUCTS S.A. (SWITZERLAND  
CORPORATION)

ROUTE DU JURA 37

FRIBOURG, SWITZERLAND CH-1700

FOR: EAU DE COLOGNE, TALCUM POWDER, IN  
CLASS 3 (U.S. CLS. 1, 4, 6, 50, 51 AND 52).

FIRST USE 6-14-2008; IN COMMERCE 6-14-2008.

THE MARK CONSISTS OF STANDARD CHAR-  
ACTERS WITHOUT CLAIM TO ANY PARTICULAR  
FONT, STYLE, SIZE, OR COLOR.

THE NAME(S), PORTRAIT(S), AND/OR SIGNA-  
TURE(S) SHOWN IN THE MARK DOES NOT IDEN-  
TIFY A PARTICULAR LIVING INDIVIDUAL.

SN 78-378,315, FILED 3-4-2004.

DORITT L. CARROLL, EXAMINING ATTORNEY

**Int. Cl.: 6**

**Prior U.S. Cls.: 2, 12, 13, 14, 23, 25, and 50**

**United States Patent and Trademark Office**

**Reg. No. 3,506,374**

**Registered Sep. 23, 2008**

**TRADEMARK  
PRINCIPAL REGISTER**

**CHILDRESS  
VINEYARDS**

CHILDRESS VINEYARDS, LLC (NORTH CAROLINA LIMITED LIABILITY COMPANY)  
425 INDUSTRIAL DRIVE  
WELCOME, NC 27374

THE MARK CONSISTS OF STANDARD CHARACTERS WITHOUT CLAIM TO ANY PARTICULAR FONT, STYLE, SIZE, OR COLOR.

FOR: METAL KEY RINGS, IN CLASS 6 (U.S. CLS. 2, 12, 13, 14, 23, 25 AND 50).

SN 78-388,509, FILED 3-22-2004.

FIRST USE 1-1-2008; IN COMMERCE 1-1-2008.

SHARON MEIER, EXAMINING ATTORNEY



**Int. Cl.: 8**

**Prior U.S. Cls.: 23, 28, and 44**

**United States Patent and Trademark Office**

**Reg. No. 3,506,375**

**Registered Sep. 23, 2008**

**TRADEMARK  
PRINCIPAL REGISTER**

**CHILDRESS  
VINEYARDS**

CHILDRESS VINEYARDS, LLC (NORTH CAROLINA LIMITED LIABILITY COMPANY)  
425 INDUSTRIAL DRIVE  
WELCOME, NC 27374

THE MARK CONSISTS OF STANDARD CHARACTERS WITHOUT CLAIM TO ANY PARTICULAR FONT, STYLE, SIZE, OR COLOR.

FOR: POCKET KNIVES, IN CLASS 8 (U.S. CLS. 23, 28 AND 44).

SN 78-388,516, FILED 3-22-2004.

FIRST USE 1-1-2008; IN COMMERCE 1-1-2008.

SHARON MEIER, EXAMINING ATTORNEY

**Int. Cl.: 14**

**Prior U.S. Cls.: 2, 27, 28, and 50**

**United States Patent and Trademark Office**

**Reg. No. 3,506,376**

**Registered Sep. 23, 2008**

**TRADEMARK  
PRINCIPAL REGISTER**

**CHILDRESS  
VINEYARDS**

CHILDRESS VINEYARDS, LLC (NORTH CAROLINA LIMITED LIABILITY COMPANY)  
425 INDUSTRIAL DRIVE  
WELCOME, NC 27374

THE MARK CONSISTS OF STANDARD CHARACTERS WITHOUT CLAIM TO ANY PARTICULAR FONT, STYLE, SIZE, OR COLOR.

FOR: WALL CLOCKS; DRESS PINS, IN CLASS 14 (U.S. CLS. 2, 27, 28 AND 50).

SN 78-388,521, FILED 3-22-2004.

FIRST USE 5-18-2006; IN COMMERCE 5-18-2006.

SHARON MEIER, EXAMINING ATTORNEY

**Int. Cl.: 18**

**Prior U.S. Cls.: 1, 2, 3, 22, and 41**

**United States Patent and Trademark Office**

**Reg. No. 3,506,377**

**Registered Sep. 23, 2008**

**TRADEMARK  
PRINCIPAL REGISTER**

**CHILDRESS  
VINEYARDS**

CHILDRESS VINEYARDS, LLC (NORTH CAROLINA LIMITED LIABILITY COMPANY)  
425 INDUSTRIAL DRIVE  
WELCOME, NC 27374

THE MARK CONSISTS OF STANDARD CHARACTERS WITHOUT CLAIM TO ANY PARTICULAR FONT, STYLE, SIZE, OR COLOR.

FOR: LEATHER GOODS, NAMELY, TOTE BAGS, IN CLASS 18 (U.S. CLS. 1, 2, 3, 22 AND 41).

SN 78-388,527, FILED 3-22-2004.

FIRST USE 2-19-2007; IN COMMERCE 2-19-2007.

SHARON MEIER, EXAMINING ATTORNEY

**Int. Cl.: 42**

**Prior U.S. Cls.: 100 and 101**

**United States Patent and Trademark Office**

**Reg. No. 3,506,378**

**Registered Sep. 23, 2008**

**SERVICE MARK  
PRINCIPAL REGISTER**

**Medical Up**

DAVID L. MERIDETH, M.D., J.D., M.B.A., PLLC  
(MISSISSIPPI CORPORATION)  
PO DRAWER 3220  
RIDGELAND, MS 39158

FOR: EXPERT WITNESS SERVICES IN THE  
FIELD OF MEDICAL TREATMENT; REVIEWING  
STANDARDS AND PRACTICES TO ASSURE COM-  
PLIANCE WITH MEDICAL STANDARDS OF CARE  
, IN CLASS 42 (U.S. CLS. 100 AND 101).

FIRST USE 5-16-2008; IN COMMERCE 5-16-2008.

THE MARK CONSISTS OF STANDARD CHAR-  
ACTERS WITHOUT CLAIM TO ANY PARTICULAR  
FONT, STYLE, SIZE, OR COLOR.

SN 78-401,201, FILED 4-13-2004.

MARCIE MILONE, EXAMINING ATTORNEY

**Int. Cl.: 35**

**Prior U.S. Cls.: 100, 101, and 102**

**United States Patent and Trademark Office**

**Reg. No. 3,506,379**

**Registered Sep. 23, 2008**

**SERVICE MARK  
PRINCIPAL REGISTER**



**Galerie de Bijoux**

VALUEVISION MEDIA, INC. (MINNESOTA CORPORATION)  
6740 SHADY OAK ROAD  
EDEN PRAIRIE, MN 55344

FOR: PROVIDING HOME SHOPPING SERVICES FEATURING JEWELRY BY MEANS OF TELEVISION AND VIA A GLOBAL COMPUTER NETWORK, IN CLASS 35 (U.S. CLS. 100, 101 AND 102).

FIRST USE 10-11-2000; IN COMMERCE 10-11-2000.

NO CLAIM IS MADE TO THE EXCLUSIVE RIGHT TO USE "BIJOUX", APART FROM THE MARK AS SHOWN.

THE ENGLISH TRANSLATION OF THE WORDING "GALERIE DE BIJOUX" IS "GALLERY OF JEWELS".

SN 78-403,349, FILED 4-16-2004.

ANNE E. GUSTASON, EXAMINING ATTORNEY

**Int. Cl.: 21**

**Prior U.S. Cls.: 2, 13, 23, 29, 30, 33, 40, and 50**

**United States Patent and Trademark Office**

**Reg. No. 3,506,380**

**Registered Sep. 23, 2008**

**TRADEMARK  
PRINCIPAL REGISTER**



CAROSELLI, KEITH W (UNITED STATES INDIVIDUAL)  
76896 NEW YORK AVENUE  
PALM DESERT, CA 92211 AND  
CAROSELLI, LEE R (UNITED STATES INDIVIDUAL)  
42465 TENNESSEE AVE  
PALM DESERT, CA 92211

FOR: NOVELTY METAL NON-ELECTRIC GRID-DLE DESIGNED TO LEAVE A SEARED IMPRINT OF TIRE TREAD AND THE WORDS ROAD KILL

ON MEAT, IN CLASS 21 (U.S. CLS. 2, 13, 23, 29, 30, 33, 40 AND 50).

FIRST USE 4-20-2004; IN COMMERCE 4-20-2004.

THE MARK CONSISTS OF TIRE TREAD WITH "ROAD KILL" CENTERED.

SN 78-406,680, FILED 4-22-2004.

LINDA ORNDORFF, EXAMINING ATTORNEY

**Int. Cl.: 41**

**Prior U.S. Cls.: 100, 101, and 107**

**United States Patent and Trademark Office**

**Reg. No. 3,506,381**

**Registered Sep. 23, 2008**

**SERVICE MARK  
PRINCIPAL REGISTER**

**IQT**

CALCAR, INC. (CALIFORNIA CORPORATION)  
SUITE C139  
1001 AVENIDA PICO  
SAN CLEMENTE, CA 92673

FOR: EDUCATIONAL SERVICES, NAMELY,  
PROVIDING VEHICLE OPERATING AND DRIVING  
INSTRUCTIONAL INFORMATION VIA THE  
INTERNET; PROVIDING OPERATING AND DRIVING  
INSTRUCTIONAL INFORMATION IN AN INTERACTIVE  
FORMAT VIA THE INTERNET, IN  
CLASS 41 (U.S. CLS. 100, 101 AND 107).

FIRST USE 4-23-2004; IN COMMERCE 4-23-2004.

THE MARK CONSISTS OF STANDARD CHARACTERS  
WITHOUT CLAIM TO ANY PARTICULAR  
FONT, STYLE, SIZE, OR COLOR.

SN 78-407,096, FILED 4-23-2004.

EVELYN BRADLEY, EXAMINING ATTORNEY

**Int. Cl.: 38**

**Prior U.S. Cls.: 100, 101, and 104**

**United States Patent and Trademark Office**

**Reg. No. 3,506,382**

**Registered Sep. 23, 2008**

**SERVICE MARK  
PRINCIPAL REGISTER**

**CLEARWIFI**

CLEARWIRE CORPORATION (DELAWARE CORPORATION)  
4400 CARILLON POINT  
KIRKLAND, WA 98033

FOR: TELECOMMUNICATIONS SERVICES, NAMELY, PROVIDING HIGH-SPEED ACCESS TO COMPUTER AND COMMUNICATION NETWORKS, AND THE ELECTRONIC TRANSMISSION OF VOICE, VIDEO AND DATA VIA COMPUTER AND COMMUNICATION NETWORKS, IN CLASS 38 (U.S. CLS. 100, 101 AND 104).

FIRST USE 5-5-2007; IN COMMERCE 5-5-2007.

THE MARK CONSISTS OF STANDARD CHARACTERS WITHOUT CLAIM TO ANY PARTICULAR FONT, STYLE, SIZE, OR COLOR.

SN 78-410,837, FILED 4-29-2004.

FRED MANDIR, EXAMINING ATTORNEY



**Int. Cl.: 9**

**Prior U.S. Cls.: 21, 23, 26, 36, and 38**

**Reg. No. 3,506,383**

**United States Patent and Trademark Office**

**Registered Sep. 23, 2008**

**TRADEMARK  
PRINCIPAL REGISTER**

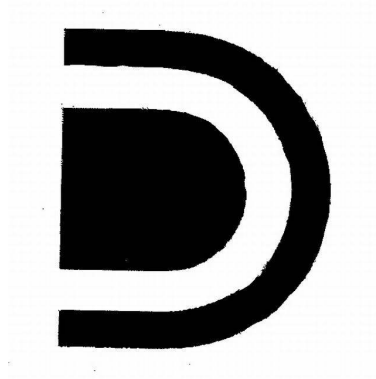

OLYMPUS CORPORATION (JAPAN JOINT  
STOCK COMPANY)  
43-2, HATAGAYA 2-CHOME SHIBUYA-KU  
TOKYO, JAPAN

FOR: STORAGE DEVICES, NAMELY, DIGITAL  
DATA RECORDERS FOR USE WITH IMAGES,  
MOVIES, MUSIC, AUDIO AND VOICE FILES; COM-  
PUTER PERIPHERALS; SOFTWARE USED FOR  
ACQUIRING, EDITING, PROCESSING, MANA-  
GING AND TRANSMITTING IMAGES, SOUNDS

AND DATA, IN CLASS 9 (U.S. CLS. 21, 23, 26, 36 AND  
38).

FIRST USE 10-31-2004; IN COMMERCE 10-31-2004.

THE MARK IS CONSISTS OF A STYLIZED LET-  
TER "D".

SN 78-411,403, FILED 4-30-2004.

JENNIFER VASQUEZ, EXAMINING ATTORNEY

Int. Cls.: 25, 28, and 41

Prior U.S. Cls.: 22, 23, 38, 39, 50, 100, 101, and 107

United States Patent and Trademark Office

Reg. No. 3,506,384

Registered Sep. 23, 2008

TRADEMARK  
SERVICE MARK  
PRINCIPAL REGISTER



CALLAS, MICHAEL C. (UNITED STATES INDIVIDUAL)

P.O. BOX 2237  
BOULDER, CO 80306

FOR: SHIRTS, SOCKS, SWEATSHIRTS, HATS, AND BALL CAPS; PANTS, SWEATERS, JACKETS, UNDERWEAR, BRAS, SOCKS, SHORTS, SKIRTS, DRESSES, BOOTS, SHOES, SKI AND SNOWBOARD BOOTS, CLIMBING SHOES, HIKING BOOTS, SANDALS, VESTS, BATHING SUITS, RASHGUARDS, TOPS MADE OF SPECIAL FABRIC TO KEEP THE WEARER DRY, SNOW PANTS, RAIN PANTS, BICYCLING SHORTS, BICYCLING JERSEYS, BICYCLING GLOVES, AND SHOES, AND ACTIVE MATERNITY WEAR, NAMELY, SHIRTS, SHORTS, SKIRTS, AND BATHING SUITS, IN CLASS 25 (U.S. CLS. 22 AND 39).

FIRST USE 11-22-2002; IN COMMERCE 11-22-2002.

FOR: SPORTING GOODS EQUIPMENT, NAMELY, SKIS, SNOWBOARDS, BINDINGS, YOGA MATS, CLIMBING HARNESSSES, BELTS, IN CLASS 28 (U.S. CLS. 22, 23, 38 AND 50).

FIRST USE 7-3-2008; IN COMMERCE 7-3-2008.

FOR: CLASSES, COURSES, PROGRAMS, AND WORKSHOPS PROVIDING INSTRUCTION AND TRAINING IN THE FIELDS OF CLIMBING, KAYAKING, SNOWSHOEING, HIKING, BICYCLING, MOUNTAINEERING, CAMPING, ORIENTEERING, FISHING, TREKING, NUTRITION, SNOWBOARDING, SKIING, AND RAFTING, IN CLASS 41 (U.S. CLS. 100, 101 AND 107).

FIRST USE 11-22-2002; IN COMMERCE 11-22-2002.

NO CLAIM IS MADE TO THE EXCLUSIVE RIGHT TO USE "OUTDOOR", APART FROM THE MARK AS SHOWN.

THE COLOR(S) ORANGE, GREEN AND DARK GRAY IS/ARE CLAIMED AS A FEATURE OF THE MARK.

THE FLOWER DESIGN IS IN ORANGE, THE WORD "DIVAS" IS IN GREEN AND THE WORD "OUTDOOR" IS IN DARK GRAY.

SN 78-412,547, FILED 5-3-2004.

MONIQUE MILLER, EXAMINING ATTORNEY

**Int. Cl.: 41**

**Prior U.S. Cls.: 100, 101, and 107**

**United States Patent and Trademark Office**

**Reg. No. 3,506,385**

**Registered Sep. 23, 2008**

**SERVICE MARK  
PRINCIPAL REGISTER**

**CLUBACHILLES**

GERACI, CRAIG E. (UNITED STATES INDIVIDUAL)  
79-450 HIGHWAY 111  
LA QUINTA, CA 92253

THE MARK CONSISTS OF STANDARD CHARACTERS WITHOUT CLAIM TO ANY PARTICULAR FONT, STYLE, SIZE, OR COLOR.

FOR: HEALTH AND FITNESS CLUB SERVICES, NAMELY, PROVIDING INSTRUCTION AND EQUIPMENT IN THE FIELD OF PHYSICAL EXERCISE, IN CLASS 41 (U.S. CLS. 100, 101 AND 107).

SN 78-415,255, FILED 5-7-2004.

FIRST USE 8-0-2005; IN COMMERCE 5-0-2006.

EVELYN BRADLEY, EXAMINING ATTORNEY

**Int. Cl.: 3**

**Prior U.S. Cls.: 1, 4, 6, 50, 51, and 52**

**United States Patent and Trademark Office**

**Reg. No. 3,506,386**

**Registered Sep. 23, 2008**

**TRADEMARK  
PRINCIPAL REGISTER**

**LET IT SNOW**

PHILOSOPHY, INC. (ARIZONA CORPORATION)  
3809 EAST WATKINS STREET  
PHOENIX, AZ 85034

FOR: NON-MEDICATED SKIN CARE PRODUCTS, NAMELY, SCRUBS; BATH CARE PRODUCTS, NAMELY, GEL AND BUBBLE BATH, IN CLASS 3 (U.S. CLS. 1, 4, 6, 50, 51 AND 52).

FIRST USE 5-29-2008; IN COMMERCE 5-29-2008.

THE MARK CONSISTS OF STANDARD CHARACTERS WITHOUT CLAIM TO ANY PARTICULAR FONT, STYLE, SIZE, OR COLOR.

SN 78-416,486, FILED 5-11-2004.

KIMBERLY FRYE, EXAMINING ATTORNEY

**Int. Cl.: 10**

**Prior U.S. Cls.: 26, 39, and 44**

**United States Patent and Trademark Office**

**Reg. No. 3,506,387**

**Registered Sep. 23, 2008**

**TRADEMARK  
PRINCIPAL REGISTER**

**ChronoDose**

DIPIERRO VENTURES, INC. (DELAWARE CORPORATION)  
36 SOUTH BROAD STREET  
TRENTON, NJ 08608

FOR: AUTOMATED DEVICE WORN ON THE BODY, WHICH CAN BE PROGRAMMED TO ADMINISTER CERTAIN DOSES OF DRUGS OR COMPOUNDS, IN CLASS 10 (U.S. CLS. 26, 39 AND 44).

FIRST USE 1-15-2005; IN COMMERCE 1-15-2005.

THE MARK CONSISTS OF STANDARD CHARACTERS WITHOUT CLAIM TO ANY PARTICULAR FONT, STYLE, SIZE, OR COLOR.

SN 78-418,559, FILED 5-13-2004.

DAVID TOOLEY, EXAMINING ATTORNEY

Int. Cls.: 29 and 30

Prior U.S. Cl.: 46

United States Patent and Trademark Office

Reg. No. 3,506,388

Registered Sep. 23, 2008

TRADEMARK  
PRINCIPAL REGISTER



R.H. FOSTER ENERGY LLC (MAINE LIMITED  
LIABILITY COMPANY)  
P.O. BOX 161  
10 MECAW ROAD  
HAMPDEN, ME 04444

FOR: PREPARED FOOD, NAMELY, PREPARED  
ENTREES CONSISTING PRIMARILY OF MEAT,  
FISH, OR POULTRY; FRENCH FRIED POTATOES;  
FRIED CHEESE; ONION RINGS; BREADED MUSH-  
ROOMS; AND SALADS EXCEPT MACARONI, RICE,  
AND PASTA SALADS, IN CLASS 29 (U.S. CL. 46).

FIRST USE 4-1-2005; IN COMMERCE 4-1-2005.

FOR: PREPARED FOOD, NAMELY, PREPARED  
ENTREES CONSISTING PRIMARILY OF PASTA OR  
RICE; PIZZAS; PREPARED PASTA; PREPARED  
SANDWICHES, NAMELY, HAMBURGER SANDWI-  
CHES, CHEESEBURGER SANDWICHES, CHICKEN  
SANDWICHES, HAM SANDWICHES, FISH SAND-  
WICHES, ROAST BEEF SANDWICHES, COLD CUT  
SANDWICHES, SANDWICH WRAPS CONSISTING

OF COLD CUTS, CHICKEN, TURKEY, HAM, OR  
VEGETABLES, AND CALZONE SANDWICHES, IN  
CLASS 30 (U.S. CL. 46).

FIRST USE 4-1-2005; IN COMMERCE 4-1-2005.

THE COLOR(S) GREEN, WHITE AND RED IS/  
ARE CLAIMED AS A FEATURE OF THE MARK.

THE MARK CONSISTS OF THE WORD "FRESH-  
IES" IN A FREE FORM SCRIPT, THE LETTERS  
BEING GREEN AND OUTLINED IN WHITE, WITH  
THE LETTER "I" DOTTED WITH A RED TOMATO,  
AND THE TEXT UNDERLINED WITH A RED  
CURVED STRIPE; NO BACKGROUND COLOR IS  
CLAIMED (GRAY BACKGROUND IS MERELY TO  
INDICATE WHITE OUTLINE OF LETTERS).

SN 78-421,694, FILED 5-19-2004.

HELEN BRYAN, EXAMINING ATTORNEY

Int. Cl.: 12

Prior U.S. Cls.: 19, 21, 23, 31, 35, and 44

Reg. No. 3,506,389

United States Patent and Trademark Office

Registered Sep. 23, 2008

TRADEMARK  
PRINCIPAL REGISTER



TEAM DIRTY GIRLS, INC. (CALIFORNIA CORPORATION)  
27856 HOLLY OAK LANE  
MISSION VIEJO, CA 92691

NO CLAIM IS MADE TO THE EXCLUSIVE RIGHT TO USE "GIRLS", APART FROM THE MARK AS SHOWN.

FOR: BICYCLES AND BICYCLE PARTS AND ACCESSORIES THEREFOR, NAMELY, FRAMES, HANDLEBAR GRIPS, RACING NUMBER PLATES, WATER BOTTLES; TRAILER PARTS AND ACCESSORIES THEREFOR; AND TRAILER HITCH PARTS AND ACCESSORIES THEREFOR, IN CLASS 12 (U.S. CLS. 19, 21, 23, 31, 35 AND 44).

THE MARK CONSISTS OF AN OVAL CONTAINING THE WORDS "DIRTY GIRLS" WITH FLOWERS ABOVE EACH WORD AND THE WORDS "FOR THE GIRL WHO'S NOT AFRAID TO GET DIRTY" OUTSIDE OF AND BELOW THE OVAL.

FIRST USE 1-2-2008; IN COMMERCE 1-2-2008.

SN 78-425,112, FILED 5-26-2004.

OWNER OF U.S. REG. NO. 2,875,918.

ROBIN CHOSID, EXAMINING ATTORNEY

Int. Cl.: 30

Prior U.S. Cl.: 46

**United States Patent and Trademark Office**

**Reg. No. 3,506,390**

Registered Sep. 23, 2008

**TRADEMARK  
PRINCIPAL REGISTER**



STARBUCKS U.S. BRANDS, LLC (NEVADA LIMITED LIABILITY COMPANY)  
2525 STARBUCKS WAY  
MINDEN, NV 89423

FOR: COFFEE AND ESPRESSO BEVERAGES, BEVERAGES MADE WITH A BASE OF COFFEE AND/OR ESPRESSO, ICE CREAM, FROZEN CONFECTIONS, AND READY-TO-DRINK COFFEE, IN CLASS 30 (U.S. CL. 46).

FIRST USE 4-30-2004; IN COMMERCE 4-30-2004.

OWNER OF U.S. REG. NOS. 1,745,953, 2,283,531, AND OTHERS.

SN 78-426,177, FILED 5-27-2004.

LINDA ESTRADA, EXAMINING ATTORNEY



**Int. Cls.: 29, 30, and 32**

**Prior U.S. Cls.: 45, 46, and 48**

**United States Patent and Trademark Office**

**Reg. No. 3,506,391**

**Registered Sep. 23, 2008**

**TRADEMARK  
PRINCIPAL REGISTER**

**HEALTHY HABITS FOR  
LIFE**

SESAME WORKSHOP (NEW YORK NON-PROFIT CORPORATION)  
ONE LINCOLN PLAZA  
NEW YORK, NY 10023

FOR: APPLESAUCE, FRUIT-BASED SNACK FOOD, FROZEN MEALS CONSISTING PRIMARILY OF MEAT, FISH, POULTRY OR VEGETABLES, SOUPS AND CHEESE, IN CLASS 29 (U.S. CL. 46).

FIRST USE 8-1-2006; IN COMMERCE 8-1-2006.

FOR: BREAKFAST CEREAL, READY TO EAT CEREAL DERIVED FOOD BARS, GRANOLA-BASED SNACK BARS, MACARONI AND CHEESE, FROZEN MEALS CONSISTING PRIMARILY OF PASTA OR RICE, COOKIES, CRACKERS, IN CLASS 30 (U.S. CL. 46).

FIRST USE 9-1-2007; IN COMMERCE 9-1-2007.

FOR: FRUIT JUICES AND DRINKING WATER, IN CLASS 32 (U.S. CLS. 45, 46 AND 48).

FIRST USE 9-1-2005; IN COMMERCE 9-1-2005.

THE MARK CONSISTS OF STANDARD CHARACTERS WITHOUT CLAIM TO ANY PARTICULAR FONT, STYLE, SIZE, OR COLOR.

SN 78-426,770, FILED 5-28-2004.

ANNE E. GUSTASON, EXAMINING ATTORNEY

**Int. Cl.: 3**

**Prior U.S. Cls.: 1, 4, 6, 50, 51, and 52**

**United States Patent and Trademark Office**

**Reg. No. 3,506,392**

**Registered Sep. 23, 2008**

**TRADEMARK  
PRINCIPAL REGISTER**

**BRIGHT SECRETS**

GUTHY-RENKER CORPORATION (DELAWARE  
CORPORATION)  
SUITE 200  
41-550 ECLECTIC STREET  
PALM DESERT, CA 92260

FOR: SKIN AND BODY CARE PREPARATIONS,  
NAMELY, SKIN MOISTURIZERS, SKIN CREAMS,  
FACE CREAMS, WRINKLE SMOOTHING CREAMS,  
EYE CREAMS, EYE GELS, EYE LOTIONS, SKIN  
LOTIONS, SKIN TONERS AND BODY LOTIONS, IN  
CLASS 3 (U.S. CLS. 1, 4, 6, 50, 51 AND 52).

FIRST USE 7-11-2008; IN COMMERCE 7-11-2008.

THE MARK CONSISTS OF STANDARD CHAR-  
ACTERS WITHOUT CLAIM TO ANY PARTICULAR  
FONT, STYLE, SIZE, OR COLOR.

SN 78-427,288, FILED 5-28-2004.

BRIAN NEVILLE, EXAMINING ATTORNEY

**Int. Cl.: 9**

**Prior U.S. Cls.: 21, 23, 26, 36, and 38**

**Reg. No. 3,506,393**

**United States Patent and Trademark Office**

**Registered Sep. 23, 2008**

**TRADEMARK  
PRINCIPAL REGISTER**



PHILIP MORRIS USA INC. (VIRGINIA CORPORATION)  
6601 WEST BROAD STREET  
RICHMOND, VA 23230

NO CLAIM IS MADE TO THE EXCLUSIVE RIGHT TO USE "LABEL", APART FROM THE MARK AS SHOWN.

FOR: AUDIO AND VISUAL RECORDINGS FEATURING MUSIC VIDEOS AND INTERVIEWS WITH MUSICAL GROUPS AND /OR ARTISTS AND/OR BANDS; AUDIO AND VISUAL RECORDINGS OF MUSIC COMPILATIONS , IN CLASS 9 (U.S. CLS. 21, 23, 26, 36 AND 38).

THE MARK CONSISTS OF "COPPER LABEL" WITH ZIG ZAG OR LIGHTNING BOLT LINES, ALL WITHIN A CIRCLE.

SN 78-429,345, FILED 6-3-2004.

FIRST USE 12-0-2003; IN COMMERCE 12-0-2003.

MICHAEL ENGEL, EXAMINING ATTORNEY

**Int. Cl.: 25**

**Prior U.S. Cls.: 22 and 39**

**United States Patent and Trademark Office**

**Reg. No. 3,506,394**

**Registered Sep. 23, 2008**

**TRADEMARK  
PRINCIPAL REGISTER**

**BOLD RULER**

THOROUGHbred LEGENDS, LLC (GEORGIA  
LIMITED LIABILITY COMPANY)  
600 PEACHTREE STREET, N.E.  
SUITE 5200  
ATLANTA, GA 30308

FOR: CLOTHING, NAMELY, HATS, CAPS, VI-  
SORS, APRONS, SHIRTS, T-SHIRTS, JACKETS,  
VESTS, SWEATSHIRTS, SWEATPANTS, PANTS,  
AND SHORTS , IN CLASS 25 (U.S. CLS. 22 AND 39).

FIRST USE 7-2-2008; IN COMMERCE 7-2-2008.

THE MARK CONSISTS OF STANDARD CHAR-  
ACTERS WITHOUT CLAIM TO ANY PARTICULAR  
FONT, STYLE, SIZE, OR COLOR.

SN 78-430,111, FILED 6-4-2004.

RUDY R. SINGLETON, EXAMINING ATTORNEY

**Int. Cl.: 25**

**Prior U.S. Cls.: 22 and 39**

**United States Patent and Trademark Office**

**Reg. No. 3,506,395**

**Registered Sep. 23, 2008**

**TRADEMARK  
PRINCIPAL REGISTER**

**NATIVE DANCER**

THOROUGHbred LEGENDS, LLC (GEORGIA  
LIMITED LIABILITY COMPANY)  
600 PEACHTREE STREET, NE  
SUITE 5200  
ATLANTA, GA 303082216

FOR: CLOTHING, NAMELY, HATS, CAPS, VI-  
SORS, APRONS, SHIRTS, T-SHIRTS, JACKETS,  
VESTS, SWEATSHIRTS, SWEATPANTS, PANTS,  
AND SHORTS, IN CLASS 25 (U.S. CLS. 22 AND 39).

FIRST USE 7-2-2008; IN COMMERCE 7-2-2008.

THE MARK CONSISTS OF STANDARD CHAR-  
ACTERS WITHOUT CLAIM TO ANY PARTICULAR  
FONT, STYLE, SIZE, OR COLOR.

SN 78-430,221, FILED 6-4-2004.

ANNE MADDEN, EXAMINING ATTORNEY

**Int. Cl.: 25**

**Prior U.S. Cls.: 22 and 39**

**United States Patent and Trademark Office**

**Reg. No. 3,506,396**

**Registered Sep. 23, 2008**

**TRADEMARK  
PRINCIPAL REGISTER**

**NECKBONE CIRCUIT**

VINTAGE SPORTSWEAR, INC. (FLORIDA CORPORATION)  
566 NORTH BISCAYNE RIVER DRIVE  
MIAMI, FL 33169

THE MARK CONSISTS OF STANDARD CHARACTERS WITHOUT CLAIM TO ANY PARTICULAR FONT, STYLE, SIZE, OR COLOR.

FOR: CLOTHING, FOOTWEAR AND HEADGEAR, NAMELY, SHIRTS, SHORTS, PANTS, JACKETS, SWEATERS, SKIRTS, BLOUSES, SHOES, HATS, IN CLASS 25 (U.S. CLS. 22 AND 39).

SN 78-431,890, FILED 6-8-2004.

FIRST USE 7-20-2008; IN COMMERCE 7-20-2008.

DAWN HAN, EXAMINING ATTORNEY

Int. Cl.: 38

Prior U.S. Cls.: 100, 101, and 104

**United States Patent and Trademark Office**

**Reg. No. 3,506,397**

Registered Sep. 23, 2008

**SERVICE MARK  
PRINCIPAL REGISTER**

**SMITHVILLE  
WIRELESS**

EARLES FAMILY L.L.C. (INDIANA LIMITED  
LIABILITY COMPANY)  
1600 W. TEMPERANCE STREET  
ELLETSVILLE, IN 47429

FOR: PROVIDING WIRELESS VOICE DATA  
TRANSMISSION, IN CLASS 38 (U.S. CLS. 100, 101  
AND 104).

FIRST USE 8-15-2007; IN COMMERCE 8-15-2007.

THE MARK CONSISTS OF STANDARD CHAR-  
ACTERS WITHOUT CLAIM TO ANY PARTICULAR  
FONT, STYLE, SIZE, OR COLOR.

NO CLAIM IS MADE TO THE EXCLUSIVE  
RIGHT TO USE "WIRELESS", APART FROM THE  
MARK AS SHOWN.

SN 78-433,268, FILED 6-10-2004.

DAVID H. STINE, EXAMINING ATTORNEY

Int. Cl.: 30

Prior U.S. Cl.: 46

United States Patent and Trademark Office

Reg. No. 3,506,398

Registered Sep. 23, 2008

TRADEMARK  
PRINCIPAL REGISTER

*teanita*

ABRAMS, MICHAEL S. (UNITED STATES INDIVIDUAL)  
15 KUIKELE PLACE  
MAKAWAO, HI 967688880

FIRST USE 7-1-2008; IN COMMERCE 7-17-2008.

SN 78-434,775, FILED 6-14-2004.

FOR: NON-ALCOHOLIC TEA-BASED BEVERAGE, IN CLASS 30 (U.S. CL. 46).

JOHN DWYER, EXAMINING ATTORNEY



**Int. Cls.: 9 and 42**

**Prior U.S. Cls.: 21, 23, 26, 36, 38, 100, and 101**

**Reg. No. 3,506,399**

**United States Patent and Trademark Office**

**Registered Sep. 23, 2008**

**TRADEMARK  
SERVICE MARK  
PRINCIPAL REGISTER**

**DIGITAL NATURAL  
EXPRESSION**

PIXELWORKS, INC. (OREGON CORPORATION)  
8100 SW NYBERG ROAD, SUITE 107  
TUALATIN, OR 97062

FOR: TELEVISIONS; PROJECTORS USED FOR A WIDE VARIETY OF USER-SPECIFIED CONTENT AND FORMATS UTILIZING LCD, NAMELY, LIQUID CRYSTAL DISPLAY, DISPLAY TECHNOLOGY; PROJECTORS USED FOR A WIDE VARIETY OF USER-SPECIFIED CONTENT AND FORMATS UTILIZING LCOS, NAMELY, LIQUID CRYSTAL ON SILICON, DISPLAY TECHNOLOGY; PROJECTORS USED FOR A WIDE VARIETY OF USER-SPECIFIED CONTENT AND FORMATS UTILIZING POLYSILICON DISPLAY TECHNOLOGY; PROJECTORS USED FOR A WIDE VARIETY OF USER-SPECIFIED CONTENT AND FORMATS UTILIZING PLASMA DISPLAY TECHNOLOGY; PROJECTORS USED FOR A WIDE VARIETY OF USER-SPECIFIED CONTENT AND FORMATS UTILIZING CRT, NAMELY, CATHODE RAY TUBE, DISPLAY TECHNOLOGY; PROJECTORS USED FOR A WIDE VARIETY OF USER-SPECIFIED CONTENT AND FORMATS UTILIZING DLP, NAMELY, DIGITAL LIGHT PROCESSING, DISPLAY TECHNOLOGY; LCD, NAMELY, LIQUID CRYSTAL DISPLAY, DISPLAYS; LCOS, NAMELY, LIQUID CRYSTAL ON SILICON, DISPLAYS; POLYSILICON DISPLAYS; PLASMA DISPLAYS; CRT, NAMELY, CATHODE RAY TUBE, DISPLAYS; DLP, NAMELY, DIGITAL LIGHT PROCESSING, DISPLAYS; HDTV, NAMELY, HIGH DEFINITION TELEVISION, DISPLAYS; STANDARD DEFINITION TELEVISION DISPLAYS; DIGITAL RGB, NAMELY, RED-GREEN-BLUE, DISPLAYS; ANALOG RGB, NAMELY, RED-GREEN-BLUE, DISPLAYS; COMPUTER MONITORS; PRINTED CIRCUIT BOARDS; COMPUTER SOFTWARE FOR TESTING DISPLAYS AND ASSOCIATED CONTROLLERS; FIRMWARE FOR TESTING DISPLAYS

AND ASSOCIATED CONTROLLERS; HARDWARE FOR TESTING DISPLAYS AND ASSOCIATED CONTROLLERS; COMPUTER SOFTWARE FOR MANIPULATING, STORING, RECEIVING, TRANSFERRING, PROCESSING, AND DIGITIZING IMAGES; COMPUTER FIRMWARE FOR MANIPULATING, STORING, RECEIVING, TRANSFERRING, PROCESSING, AND DIGITIZING IMAGES; COMPUTER SOFTWARE FOR DRIVING, SUPPORTING, AND ENHANCING DISPLAYS AND PROJECTED IMAGES FOR MULTIMEDIA PROJECTORS; COMPUTER SOFTWARE FOR DRIVING, SUPPORTING, AND ENHANCING DISPLAYS AND PROJECTED IMAGES FOR MULTIMEDIA PROJECTORS; INTEGRATED CIRCUITS; INTEGRATED CIRCUIT MODULES; AND DOWNLOADABLE ELECTRONIC PUBLICATIONS, NAMELY, BOOKS, BROCHURES, WHITE PAPERS, CATALOGS, AND PAMPHLETS IN THE FIELD OF IMAGE PROCESSING TECHNOLOGY, IN CLASS 9 (U.S. CLS. 21, 23, 26, 36 AND 38).

FIRST USE 12-0-2003; IN COMMERCE 12-0-2003.

FOR: TECHNICAL SUPPORT SERVICES, NAMELY, TROUBLESHOOTING OF DISPLAY DESIGN AND DISPLAY APPLICATION PROBLEMS; TECHNICAL SUPPORT SERVICES NAMELY, SUPPORT AND CONSULTING SERVICES FOR DRIVING, SUPPORTING, AND ENHANCING DISPLAYS; PROVIDING INFORMATION IN THE FIELD OF IMAGE PROCESSING TECHNOLOGY VIA THE INTERNET; DESIGN FOR OTHERS IN THE FIELD OF INTEGRATED CIRCUITS FOR DRIVING, SUPPORTING, AND ENHANCING DISPLAYS; DESIGNING AND DEVELOPING EXAMPLE CIRCUIT REFERENCE STANDARDS TO ASSIST OTHERS IN THE IMPLEMENTATION OF INTEGRATED CIRCUITS IN DISPLAY SYSTEMS FOR DRIVING, SUPPORTING,

AND ENHANCING DISPLAYS; DESIGNING AND DEVELOPING EXAMPLE SOFTWARE REFERENCE STANDARDS TO ASSIST OTHERS IN THE IMPLEMENTATION OF INTEGRATED CIRCUITS IN DISPLAY SYSTEMS FOR DRIVING, SUPPORTING, AND ENHANCING DISPLAYS, IN CLASS 42 (U.S. CLS. 100 AND 101).

FIRST USE 12-0-2003; IN COMMERCE 12-0-2003.

THE MARK CONSISTS OF STANDARD CHARACTERS WITHOUT CLAIM TO ANY PARTICULAR FONT, STYLE, SIZE, OR COLOR.

NO CLAIM IS MADE TO THE EXCLUSIVE RIGHT TO USE "DIGITAL", APART FROM THE MARK AS SHOWN.

SN 78-435,342, FILED 6-15-2004.

TIMOTHY FINNEGAN, EXAMINING ATTORNEY

**Int. Cl.: 7**

**Prior U.S. Cls.: 13, 19, 21, 23, 31, 34, and 35**

**Reg. No. 3,506,400**

**United States Patent and Trademark Office**

**Registered Sep. 23, 2008**

---

**TRADEMARK  
PRINCIPAL REGISTER**

**ROTO INTERNATIONAL**

ADP DISTRIBUTORS INC. (CANADA CORPORATION)  
18940 - 94TH AVENUE  
SURREY, BRITISH COLUMBIA, CANADA V4N 4X5

FOR: TURBOCHARGERS AND SUPERCHARGERS FOR LAND VEHICLES, AND PARTS THEREFOR, IN CLASS 7 (U.S. CLS. 13, 19, 21, 23, 31, 34 AND 35).

FIRST USE 9-30-2004; IN COMMERCE 9-30-2004.

THE MARK CONSISTS OF STANDARD CHARACTERS WITHOUT CLAIM TO ANY PARTICULAR FONT, STYLE, SIZE, OR COLOR.

NO CLAIM IS MADE TO THE EXCLUSIVE RIGHT TO USE "INTERNATIONAL", APART FROM THE MARK AS SHOWN.

SN 78-436,438, FILED 6-16-2004.

BARBARA RUTLAND, EXAMINING ATTORNEY

**Int. Cl.: 16**

**Prior U.S. Cls.: 2, 5, 22, 23, 29, 37, 38, and 50**

**Reg. No. 3,506,401**

**United States Patent and Trademark Office**

**Registered Sep. 23, 2008**

**TRADEMARK  
PRINCIPAL REGISTER**

**HOLIDAY LIVING**

LF, LLC (DELAWARE LIMITED LIABILITY  
COMPANY)  
2601 ANNAND DRIVE, SUITE 17  
WILMINGTON, DE 19808

FOR: PLASTIC GIFT BAGS, AND PLASTIC TREE  
STORAGE BAGS, IN CLASS 16 (U.S. CLS. 2, 5, 22, 23,  
29, 37, 38 AND 50).

FIRST USE 11-0-2004; IN COMMERCE 11-0-2004.

THE MARK CONSISTS OF STANDARD CHAR-  
ACTERS WITHOUT CLAIM TO ANY PARTICULAR  
FONT, STYLE, SIZE, OR COLOR.

OWNER OF U.S. REG. NOS. 2,595,259 AND  
2,695,992.

SN 78-441,275, FILED 6-25-2004.

SUE LAWRENCE, EXAMINING ATTORNEY

**Int. Cl.: 11**

**Prior U.S. Cls.: 13, 21, 23, 31, and 34**

**United States Patent and Trademark Office**

**Reg. No. 3,506,402**

**Registered Sep. 23, 2008**

**TRADEMARK  
PRINCIPAL REGISTER**

**NEUTRA AIR**

RECKITT BENCKISER INC. (DELAWARE CORPORATION)  
399 INTERPACE PARKWAY  
PARSIPPANY, NJ 07054

FOR: AIR FILTERS FOR COMMERCIAL AND DOMESTIC USE; AIR SANITIZERS AND AIR PURIFIERS FOR DOMESTIC AND COMMERCIAL USE; ELECTRICAL POWERED AIR PURIFIERS FOR THE NEUTRALIZATION, REDUCTION OR CONTROL OF ALLERGENS, IN CLASS 11 (U.S. CLS. 13, 21, 23, 31 AND 34).

FIRST USE 6-29-2005; IN COMMERCE 6-29-2005.

THE MARK CONSISTS OF STANDARD CHARACTERS WITHOUT CLAIM TO ANY PARTICULAR FONT, STYLE, SIZE, OR COLOR.

OWNER OF U.S. REG. NOS. 1,968,321, 2,095,448, AND 2,821,295.

NO CLAIM IS MADE TO THE EXCLUSIVE RIGHT TO USE "AIR", APART FROM THE MARK AS SHOWN.

SN 78-443,079, FILED 6-29-2004.

THEODORE MCBRIDE, EXAMINING ATTORNEY

**Int. Cl.: 37**

**Prior U.S. Cls.: 100, 103, and 106**

**United States Patent and Trademark Office**

**Reg. No. 3,506,403**

**Registered Sep. 23, 2008**

---

**SERVICE MARK  
PRINCIPAL REGISTER**

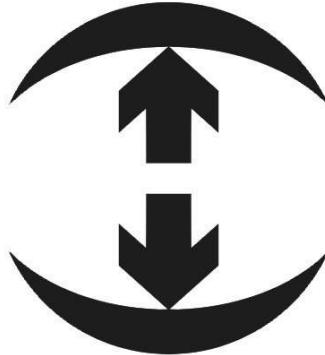

LIFESIZE COMMUNICATIONS, INC. (DELA-  
WARE CORPORATION)  
901 S. MOPAC BUILDING 3, SUITE 300  
AUSTIN, TX 78746

FOR: MAINTENANCE, INSTALLATION AND  
REPAIR OF COMPUTER HARDWARE, COMPU-  
TER PERIPHERALS AND COMMUNICATIONS

SYSTEMS AND COMPONENTS FOR THE FORE-  
GOING , IN CLASS 37 (U.S. CLS. 100, 103 AND 106).

FIRST USE 9-1-2005; IN COMMERCE 9-1-2005.

SN 78-443,980, FILED 6-30-2004.

DARRYL SPRUILL, EXAMINING ATTORNEY

Int. Cl.: 30

Prior U.S. Cl.: 46

United States Patent and Trademark Office

Reg. No. 3,506,404

Registered Sep. 23, 2008

TRADEMARK  
PRINCIPAL REGISTER

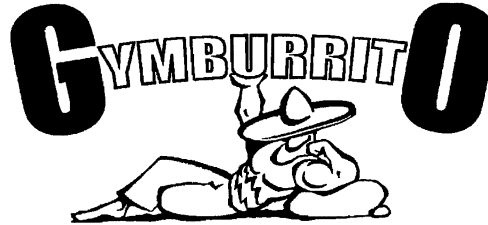

ULTIMATE PERFORMANCE FOODS, L.L.C. (CALIFORNIA LIMITED LIABILITY COMPANY)  
808 WESTMOUNT DRIVE  
SUITE 7  
WEST HOLLYWOOD, CA 90069

THE MARK CONSISTS OF A RENDERING OF A RECLINING ADULT MALE FIGURE WEARING A SOMBRERO, HOLDING ALOFT A BARBELL SHAPED DEPICTION OF THE WORD "GYMBURRITO".

FOR: PREPARED BURRITOS, IN CLASS 30 (U.S. CL. 46).

SN 78-460,749, FILED 8-2-2004.

FIRST USE 11-13-2000; IN COMMERCE 2-1-2001.

CHARLOTTE CORWIN, EXAMINING ATTORNEY

**Int. Cl.: 41**

**Prior U.S. Cls.: 100, 101, and 107**

**United States Patent and Trademark Office**

**Reg. No. 3,506,405**

**Registered Sep. 23, 2008**

**SERVICE MARK  
PRINCIPAL REGISTER**

**NOW THAT'S WHAT I  
CALL MUSIC**

EMI (IP) LIMITED (UNITED KINGDOM COR-  
PORATION)  
27 WRIGHTS LANE  
LONDON, ENGLAND W8 5SW

FOR: PROVIDING INFORMATION IN THE  
FIELD OF ENTERTAINMENT BY MEANS OF A  
GLOBAL COMPUTER NETWORK, IN CLASS 41  
(U.S. CLS. 100, 101 AND 107).

FIRST USE 1-0-1999; IN COMMERCE 1-0-1999.

THE MARK CONSISTS OF STANDARD CHAR-  
ACTERS WITHOUT CLAIM TO ANY PARTICULAR  
FONT, STYLE, SIZE, OR COLOR.

OWNER OF U.S. REG. NOS. 2,089,508 AND  
2,848,543.

SN 78-474,693, FILED 8-27-2004.

LESLIE RICHARDS, EXAMINING ATTORNEY



**Int. Cl.: 16**

**Prior U.S. Cls.: 2, 5, 22, 23, 29, 37, 38, and 50**

**United States Patent and Trademark Office**

**Reg. No. 3,506,406**

**Registered Sep. 23, 2008**

**TRADEMARK  
PRINCIPAL REGISTER**

**COOKIE PAWS**

GILDED DOG ENTERPRISES, LLC (PENNSYLVANIA LIMITED LIABILITY COMPANY)  
106 HIGH POINT DRIVE  
CHURCHVILLE, PA 18966

THE MARK CONSISTS OF STANDARD CHARACTERS WITHOUT CLAIM TO ANY PARTICULAR FONT, STYLE, SIZE, OR COLOR.

FOR: CHILDREN'S BOOKS, IN CLASS 16 (U.S. CLS. 2, 5, 22, 23, 29, 37, 38 AND 50).

SN 78-475,918, FILED 8-30-2004.

FIRST USE 6-1-2007; IN COMMERCE 6-1-2007.

DEBRA LEE, EXAMINING ATTORNEY

**Int. Cl.: 32**

**Prior U.S. Cls.: 45, 46, and 48**

**United States Patent and Trademark Office**

**Reg. No. 3,506,407**

**Registered Sep. 23, 2008**

**TRADEMARK  
PRINCIPAL REGISTER**

**Southern Cross**

GOLDEN WEST BREWING COMPANY (DELA-  
WARE CORPORATION)  
P.O. BOX 114  
THE SEA RANCH, CA 95497

THE MARK CONSISTS OF STANDARD CHAR-  
ACTERS WITHOUT CLAIM TO ANY PARTICULAR  
FONT, STYLE, SIZE, OR COLOR.

FOR: ALES AND LAGERS, IN CLASS 32 (U.S. CLS.  
45, 46 AND 48).

SN 78-479,009, FILED 9-4-2004.

FIRST USE 2-1-2008; IN COMMERCE 2-1-2008.

BARBARA A. GOLD, EXAMINING ATTORNEY

**Int. Cl.: 32**

**Prior U.S. Cls.: 45, 46, and 48**

**United States Patent and Trademark Office**

**Reg. No. 3,506,408**

**Registered Sep. 23, 2008**

**TRADEMARK  
PRINCIPAL REGISTER**

# Catch and Release

GOLDEN WEST BREWING COMPANY (DELA-  
WARE CORPORATION)  
P.O. BOX 114  
THE SEA RANCH, CA 95497

THE MARK CONSISTS OF STANDARD CHAR-  
ACTERS WITHOUT CLAIM TO ANY PARTICULAR  
FONT, STYLE, SIZE, OR COLOR.

FOR: ALES AND LAGERS, IN CLASS 32 (U.S. CLS.  
45, 46 AND 48).

SN 78-479,011, FILED 9-4-2004.

FIRST USE 1-21-2008; IN COMMERCE 1-21-2008.

BARBARA A. GOLD, EXAMINING ATTORNEY

**Int. Cl.: 5**

**Prior U.S. Cls.: 6, 18, 44, 46, 51, and 52**

**United States Patent and Trademark Office**

**Reg. No. 3,506,409**

**Registered Sep. 23, 2008**

**TRADEMARK  
PRINCIPAL REGISTER**

**VERSIVA XC**

E.R. SQUIBB & SONS, L.L.C. (DELAWARE LIMITED LIABILITY COMPANY)  
LAWRENCEVILLE-PRINCETON ROAD  
PRINCETON, NJ 08540

FOR: MEDICAL AND SURGICAL BANDAGES AND WOUND DRESSINGS, IN CLASS 5 (U.S. CLS. 6, 18, 44, 46, 51 AND 52).

FIRST USE 4-30-2007; IN COMMERCE 10-31-2007.

THE MARK CONSISTS OF STANDARD CHARACTERS WITHOUT CLAIM TO ANY PARTICULAR FONT, STYLE, SIZE, OR COLOR.

OWNER OF U.S. REG. NO. 2,632,060.

SN 78-480,760, FILED 9-9-2004.

DORITT L. CARROLL, EXAMINING ATTORNEY

**Int. Cl.: 19**

**Prior U.S. Cls.: 1, 12, 33, and 50**

**United States Patent and Trademark Office**

**Reg. No. 3,506,410**

**Registered Sep. 23, 2008**

**TRADEMARK  
PRINCIPAL REGISTER**

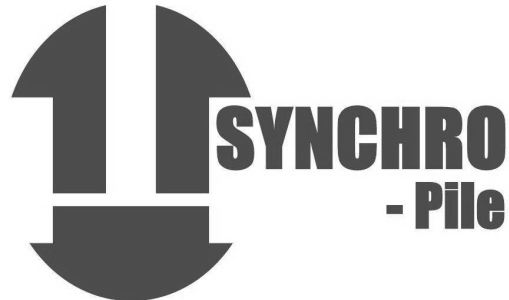

SYNCHRO PATENTS, INC. (TEXAS CORPORATION)  
4643 GREEN WILLOW WOODS  
SAN ANTONIO, TX 78249

FOR: STRUCTURAL FOUNDATION COMPONENTS, NAMELY, CEMENT PIERS, RUBBER BLADDERS, CONDUITS, PILING, ANCHORS, SUPPORTS, AND METAL RODS, PIPES AND PLATES

ALL SOLD TOGETHER AS A UNIT, IN CLASS 19 (U.S. CLS. 1, 12, 33 AND 50).

FIRST USE 9-27-2004; IN COMMERCE 9-27-2004.

SN 78-491,705, FILED 9-29-2004.

SHAUNIA CARLYLE, EXAMINING ATTORNEY

**Int. Cl.: 41**

**Prior U.S. Cls.: 100, 101, and 107**

**United States Patent and Trademark Office**

**Reg. No. 3,506,411**

**Registered Sep. 23, 2008**

**SERVICE MARK  
PRINCIPAL REGISTER**

**NICKELODEON TAK**

VIACOM INTERNATIONAL INC. (DELAWARE CORPORATION)  
1515 BROADWAY  
NEW YORK, NY 10036

FOR: ENTERTAINMENT SERVICES IN THE NATURE OF AN ONGOING TELEVISION SERIES FEATURING ANIMATION, COMEDY AND DRAMA; PROVIDING ONLINE INFORMATION IN THE FIELD OF ENTERTAINMENT CONCERNING TELEVISION PROGRAMS, IN CLASS 41 (U.S. CLS. 100, 101 AND 107).

FIRST USE 8-31-2007; IN COMMERCE 8-31-2007.

THE MARK CONSISTS OF STANDARD CHARACTERS WITHOUT CLAIM TO ANY PARTICULAR FONT, STYLE, SIZE, OR COLOR.

OWNER OF U.S. REG. NO. 1,907,159 AND OTHERS.

SN 78-498,095, FILED 10-12-2004.

BRENDAN REGAN, EXAMINING ATTORNEY

**Int. Cl.: 34**

**Prior U.S. Cls.: 2, 8, 9, and 17**

**United States Patent and Trademark Office**

**Reg. No. 3,506,412**

**Registered Sep. 23, 2008**

**TRADEMARK  
PRINCIPAL REGISTER**

**FONSECA FIERO**

MANUFACTURA DE TABACOS S.A. (PANAMA  
CORPORATION)  
ZONA FRANCA INDUSTRIAL  
APARTADO 708  
SANTIAGO, DOMINICAN REP

OWNER OF U.S. REG. NOS. 1,093,382, 2,500,970,  
AND 2,806,224.

FOR: CIGARS, IN CLASS 34 (U.S. CLS. 2, 8, 9 AND  
17).

THE ENGLISH TRANSLATION OF "FIERO" IS  
WILD, FEROCIOUS.

FIRST USE 7-11-2008; IN COMMERCE 7-11-2008.

SN 78-500,064, FILED 10-14-2004.

THE MARK CONSISTS OF STANDARD CHAR-  
ACTERS WITHOUT CLAIM TO ANY PARTICULAR  
FONT, STYLE, SIZE, OR COLOR.

TANYA AMOS, EXAMINING ATTORNEY

**Int. Cl.: 3**

**Prior U.S. Cls.: 1, 4, 6, 50, 51, and 52**

**United States Patent and Trademark Office**

**Reg. No. 3,506,413**

**Registered Sep. 23, 2008**

**TRADEMARK  
PRINCIPAL REGISTER**

**SHOW OFF TIME**

FNC MEDICAL CORPORATION (CALIFORNIA CORPORATION)  
6000 LELAND STREET  
VENTURA, CA 93003

FOR: NON-MEDICATED SKIN CARE PREPARATIONS FOR HORSES, IN CLASS 3 (U.S. CLS. 1, 4, 6, 50, 51 AND 52).

FIRST USE 4-0-2006; IN COMMERCE 4-0-2006.

THE MARK CONSISTS OF STANDARD CHARACTERS WITHOUT CLAIM TO ANY PARTICULAR FONT, STYLE, SIZE, OR COLOR.

OWNER OF U.S. REG. NO. 2,884,707.

SN 78-502,081, FILED 10-19-2004.

ATTIYA MALIK, EXAMINING ATTORNEY



**Int. Cl.: 9**

**Prior U.S. Cls.: 21, 23, 26, 36, and 38**

**United States Patent and Trademark Office**

**Reg. No. 3,506,414**

**Registered Sep. 23, 2008**

**TRADEMARK  
PRINCIPAL REGISTER**

**HOME GUARD READY  
KID**

READY SOLUTIONS, INC. (NORTH CAROLINA CORPORATION)  
PO BOX 1333  
CORNELIUS, NC 28031

FOR: PERSONAL EMERGENCY KIT CONSISTING OF A RADIO, FIRST AID KIT, THERMAL BLANKET, PONCHO, WATER BAG, GLOVES, SAFETY WHISTLES, FOOD BARS AND/OR RESPIRATORY MASKS, IN CLASS 9 (U.S. CLS. 21, 23, 26, 36 AND 38).

FIRST USE 4-29-2005; IN COMMERCE 4-29-2005.

THE MARK CONSISTS OF STANDARD CHARACTERS WITHOUT CLAIM TO ANY PARTICULAR FONT, STYLE, SIZE, OR COLOR.

OWNER OF U.S. REG. NO. 2,919,609.

NO CLAIM IS MADE TO THE EXCLUSIVE RIGHT TO USE "HOME" AND "KID", APART FROM THE MARK AS SHOWN.

SN 78-519,044, FILED 11-18-2004.

ODESSA BIBBINS, EXAMINING ATTORNEY

**Int. Cl.: 29**

**Prior U.S. Cl.: 46**

**United States Patent and Trademark Office**

**Reg. No. 3,506,415**

**Registered Sep. 23, 2008**

**TRADEMARK  
PRINCIPAL REGISTER**

**AMELIA**

ACEITUNAS SEVILLANAS, S.A. (SPAIN CORPORATION)  
PARROCO VICENTE MOYA, 14-16, PILAS  
SEVILLA, SPAIN 41840

FOR: PRESERVED OLIVES; MEAT PRESERVES;  
FRUIT PRESERVES; FISH PRESERVES; VEGETABLE  
PRESERVES; PRESERVED PULSES; EDIBLE  
FATS AND OILS; EDIBLE CRUSTACEANS AND  
SHELLFISH (NOT LIVE) , IN CLASS 29 (U.S. CL. 46).

FIRST USE 6-19-2008; IN COMMERCE 6-19-2008.

THE MARK CONSISTS OF STANDARD CHARACTERS WITHOUT CLAIM TO ANY PARTICULAR FONT, STYLE, SIZE, OR COLOR.

SN 78-522,824, FILED 11-24-2004.

ERNEST SHOSHO, EXAMINING ATTORNEY

**Int. Cl.: 11**

**Prior U.S. Cls.: 13, 21, 23, 31, and 34**

**United States Patent and Trademark Office**

**Reg. No. 3,506,416**

**Registered Sep. 23, 2008**

**TRADEMARK  
PRINCIPAL REGISTER**



SKELTON, DAVID R (UNITED STATES INDIVIDUAL)  
3868 WINDY TAIL COVE  
BARTLETT, TN 38135

FOR: AIR DISINFECTION UNITS CONTAINING  
ULTRAVIOLET LIGHTS, IN CLASS 11 (U.S. CLS. 13,  
21, 23, 31 AND 34).

FIRST USE 10-15-2004; IN COMMERCE 11-1-2004.

THE COLOR(S) WHITE, RED, BLACK AND BLUE  
IS/ARE CLAIMED AS A FEATURE OF THE MARK.

THE COLOR WHITE APPEARS IN THE CROSS,  
THE COLOR RED APPEARS AS A BORDER OF THE  
CROSS, THE COLOR BLACK APPEARS IN THE  
LETTERING "SAFEAIR SOLUTIONS" AND THE  
COLOR BLUE APPEARS IN THE FLAGS IN THE  
BACKGROUND.

SN 78-525,717, FILED 12-2-2004.

JULIE GUTTADAURO, EXAMINING ATTORNEY

**Int. Cl.: 8**

**Prior U.S. Cls.: 23, 28, and 44**

**United States Patent and Trademark Office**

**Reg. No. 3,506,417**

**Registered Sep. 23, 2008**

**TRADEMARK  
PRINCIPAL REGISTER**

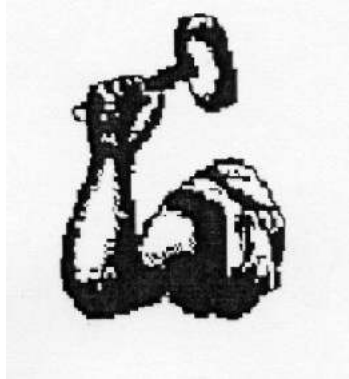

QUEEN CUTLERY COMPANY (PENNSYLVANIA  
CORPORATION)  
507 CHESTNUT STREET  
TITUSVILLE, PA 16354

FOR: KNIVES USED FOR HUNTING, SPORT,  
MILITARY, LAW ENFORCEMENT, EMERGENCY  
SERVICES, FOOD PREPARATION AND HOUSE-  
HOLD USE, IN CLASS 8 (U.S. CLS. 23, 28 AND 44).

FIRST USE 4-17-2008; IN COMMERCE 4-17-2008.

THE MARK CONSISTS OF AN ARM HOLDING A  
HAMMER.

SN 78-529,683, FILED 12-9-2004.

NAAKWAMA ANKRAH, EXAMINING ATTORNEY

**Int. Cl.: 36**

**Prior U.S. Cls.: 100, 101, and 102**

**United States Patent and Trademark Office**

**Reg. No. 3,506,418**

**Registered Sep. 23, 2008**

**SERVICE MARK  
PRINCIPAL REGISTER**

# Payment Station

MONEYGRAM PAYMENT SOLUTIONS, INC.  
(DELAWARE CORPORATION)

1550 UTICA AVENUE SOUTH  
MINNEAPOLIS, MN 55416

FOR: ELECTRONIC FUNDS TRANSFER, IN  
CLASS 36 (U.S. CLS. 100, 101 AND 102).

FIRST USE 8-1-2005; IN COMMERCE 8-1-2005.

THE MARK CONSISTS OF STANDARD CHAR-  
ACTERS WITHOUT CLAIM TO ANY PARTICULAR  
FONT, STYLE, SIZE, OR COLOR.

NO CLAIM IS MADE TO THE EXCLUSIVE  
RIGHT TO USE "PAYMENT", APART FROM THE  
MARK AS SHOWN.

SN 78-533,867, FILED 12-16-2004.

DAVID TAYLOR, EXAMINING ATTORNEY

**Int. Cl.: 5**

**Prior U.S. Cls.: 6, 18, 44, 46, 51, and 52**

**Reg. No. 3,506,419**

**United States Patent and Trademark Office**

**Registered Sep. 23, 2008**

**TRADEMARK  
PRINCIPAL REGISTER**

**SPRING FLOWERS**

PURE & NATURAL COMPANY (ARIZONA COR-  
PORATION)  
15501 NORTH DIAL BOULEVARD  
M.S. 2214  
SCOTTSDALE, AZ 852601619

THE MARK CONSISTS OF STANDARD CHAR-  
ACTERS WITHOUT CLAIM TO ANY PARTICULAR  
FONT, STYLE, SIZE, OR COLOR.

FOR: AIR FRESHENERS, ROOM DEODORIZERS,  
IN CLASS 5 (U.S. CLS. 6, 18, 44, 46, 51 AND 52).

SN 78-537,725, FILED 12-23-2004.

FIRST USE 12-5-2005; IN COMMERCE 12-5-2005.

JOHN DWYER, EXAMINING ATTORNEY

**Int. Cl.: 10**

**Prior U.S. Cls.: 26, 39, and 44**

**United States Patent and Trademark Office**

**Reg. No. 3,506,420**

**Registered Sep. 23, 2008**

**TRADEMARK  
PRINCIPAL REGISTER**

**HEALOZONE**

CUROZONE USA, INC. (DELAWARE CORPORATION)  
C/O LAUB INTERNATIONAL  
1051 CLINTON STREET  
BUFFALO, NY 14206

FOR: MEDICAL DENTAL DEVICE, NAMELY, AN OZONE GENERATOR AND DENTAL HAND PIECE, WITH ATTACHMENTS, FOR INJECTING TEETH WITH OZONE, IN CLASS 10 (U.S. CLS. 26, 39 AND 44).

FIRST USE 4-30-2002; IN COMMERCE 1-15-2007.

THE MARK CONSISTS OF STANDARD CHARACTERS WITHOUT CLAIM TO ANY PARTICULAR FONT, STYLE, SIZE, OR COLOR.

SN 78-548,520, FILED 1-17-2005.

AISHA CLARKE, EXAMINING ATTORNEY

**Int. Cls.: 1, 3, 7, and 16**

**Prior U.S. Cls.: 1, 2, 4, 5, 6, 10, 13, 19, 21, 22, 23, 26, 29, 31, 34, 35, 37, 38, 46, 50, 51, and 52**

**Reg. No. 3,506,421**

**United States Patent and Trademark Office**

**Registered Sep. 23, 2008**

**TRADEMARK  
PRINCIPAL REGISTER**



DAY INTERNATIONAL, INC. (DELAWARE CORPORATION)  
130 WEST SECOND STREET  
DAYTON, OH 45402

FOR: PRINTING ROLLERS, PARTICLE REMOVING ROLLERS FOR PRINTING PRESSES; MACHINE PARTS, NAMELY, DIE CUTTING MATS, BLANKETS, COVERS AND ACCESSORIES, NAMELY, CHANNEL ADAPTORS; BUSINESS MACHINERY PARTS, NAMELY, MICRO CELLULAR PADS AND ROLLERS AND VULCANIZED ROLLS, BEING PARTS OF MACHINES OR FOR USE AS PARTS OF MACHINES, MACHINE PARTS FOR PRINTING MACHINES, NAMELY, PRINTING SLEEVES, METAL BACK BLANKETS, AND IMAGE TRANSFER BELTS, IMAGE TRANSFER DRUMS, IMAGE TRANSFER CYLINDERS, CLEANING APPARATUS FOR PRINTING PRESSES COMPRISED OF INK SOLVENT DISPENSERS AND LIQUID REMOVAL MACHINES, FILTERS FOR SOLUTIONS USED IN PRINTING EQUIPMENT AND MACHINES, AND PARTS FOR THE AFOREMENTIONED GOODS; PARTS FOR PRINTING MACHINES, NAMELY, FLEXOGRAPHIC PRINTING SLEEVES, CARRIERS, AND BRIDGES, IN CLASS 1 (U.S. CLS. 1, 5, 6, 10, 26 AND 46).

FIRST USE 3-0-2005; IN COMMERCE 3-0-2005.

FOR: CLEANING PREPARATIONS, CLEANING SOLVENTS, AND DETERGENTS, ALL FOR USE IN PRINTING PROCESSES, IN CLASS 3 (U.S. CLS. 1, 4, 6, 50, 51 AND 52).

FIRST USE 3-0-2005; IN COMMERCE 3-0-2005.

FOR: PRINTING ROLLERS, PARTICLE REMOVING ROLLERS FOR PRINTING PRESSES; MACHINE PARTS, NAMELY, DIE CUTTING MATS,

BLANKETS, COVERS AND ACCESSORIES, NAMELY, CHANNEL ADAPTORS; BUSINESS MACHINERY PARTS, NAMELY, MICROCELLULAR PADS AND ROLLERS AND VULCANIZED ROLLS, BEING PARTS OF MACHINES OR FOR USE AS PARTS OF MACHINES, MACHINE PARTS FOR PRINTING MACHINES, NAMELY, PRINTING SLEEVES, METAL BACK BLANKETS, AND IMAGE TRANSFER BELTS, IMAGE TRANSFER DRUMS, IMAGE TRANSFER CYLINDERS, CLEANING APPARATUS FOR PRINTING PRESSES COMPRISED OF INK SOLVENT DISPENSERS AND LIQUID REMOVAL MACHINES, FILTERS FOR SOLUTIONS USED IN PRINTING EQUIPMENT AND MACHINES, AND PARTS FOR THE AFOREMENTIONED GOODS; PARTS FOR PRINTING MACHINES, NAMELY, FLEXOGRAPHIC PRINTING SLEEVES, CARRIERS, AND BRIDGES, IN CLASS 7 (U.S. CLS. 13, 19, 21, 23, 31, 34 AND 35).

FIRST USE 3-0-2005; IN COMMERCE 3-0-2005.

FOR: PARTS FOR PRINTING EQUIPMENT AND MACHINES, NAMELY, PRINTING BLANKETS, PRINTING BLANKET ACCESSORIES, NAMELY, BARS SOLD AS A COMPONENTS OF PRINTING BLANKET ASSEMBLIES, INK ROLLERS FOR USE IN MACHINES, AND PARTS FOR THE AFOREMENTIONED GOODS, IN CLASS 16 (U.S. CLS. 2, 5, 22, 23, 29, 37, 38 AND 50).

FIRST USE 3-0-2005; IN COMMERCE 3-0-2005.

OWNER OF U.S. REG. NO. 1,701,423.

SN 78-551,973, FILED 1-21-2005.

Laura Hammel, Examining Attorney



**Int. Cls.: 5, 35, and 44**

**Prior U.S. Cls.: 6, 18, 44, 46, 51, 52, 100, 101, and 102**

**United States Patent and Trademark Office**

**Reg. No. 3,506,422**

**Registered Sep. 23, 2008**

**TRADEMARK  
SERVICE MARK  
PRINCIPAL REGISTER**

**TALECRIS**

TALECRIS BIOTHERAPEUTICS, INC. (DELAWARE CORPORATION)  
79 TW ALEXANDER DRIVE  
4101 RESEARCH COMMONS  
RESEARCH TRIANGLE PARK, NC 27709

FOR: PHARMACEUTICAL PREPARATIONS FOR USE IN TREATING BLOOD DISORDERS; BIOLOGICAL PREPARATIONS FOR MEDICAL PURPOSES; BLOOD PLASMA AND COMPONENTS THEREOF SUCH AS ANTIBODIES, ALBUMIN, AND COAGULATION FACTORS FOR THE TREATMENT OF LUNG DISEASE, HEMOPHILIA AND OTHER COAGULATION DISORDERS, INFECTION, SHOCK, BLOOD LOSS DUE TO TRAUMA, BURNS AND SURGERY, IMMUNE DISORDERS, HEPATITIS, TETANUS AND RABIES EXPOSURE, IN CLASS 5 (U.S. CLS. 6, 18, 44, 46, 51 AND 52).

FIRST USE 6-13-2005; IN COMMERCE 6-13-2005.

FOR: DISTRIBUTORSHIP SERVICES FOR BIOLOGICAL AND PHARMACEUTICAL PRODUCTS, IN CLASS 35 (U.S. CLS. 100, 101 AND 102).

FIRST USE 4-1-2005; IN COMMERCE 4-1-2005.

FOR: PREPARATION AND DISPENSING OF MEDICATIONS, IN CLASS 44 (U.S. CLS. 100 AND 101).

FIRST USE 4-1-2005; IN COMMERCE 4-1-2005.

THE MARK CONSISTS OF STANDARD CHARACTERS WITHOUT CLAIM TO ANY PARTICULAR FONT, STYLE, SIZE, OR COLOR.

SN 78-551,985, FILED 1-21-2005.

ADA HAN, EXAMINING ATTORNEY

**Int. Cls.: 5, 35, and 44**

**Prior U.S. Cls.: 6, 18, 44, 46, 51, 52, 100, 101, and 102**

**United States Patent and Trademark Office**

**Reg. No. 3,506,423**

**Registered Sep. 23, 2008**

**TRADEMARK  
SERVICE MARK  
PRINCIPAL REGISTER**

**TALECRIS  
BIOTHERAPEUTICS**

TALECRIS BIOTHERAPEUTICS, INC. (DELA-  
WARE CORPORATION)  
79 TW ALEXANDER DRIVE  
4101 RESEARCH COMMONS  
RESEARCH TRIANGLE PARK, NC 27709

FOR: PHARMACEUTICAL PREPARATIONS FOR  
USE IN TREATING BLOOD DISORDERS; BIOLO-  
GICAL PREPARATIONS FOR MEDICAL PURPO-  
SES; BLOOD PLASMA AND COMPONENTS  
THEREOF SUCH AS ANTIBODIES, ALBUMIN,  
AND COAGULATION FACTORS FOR THE TREAT-  
MENT OF LUNG DISEASE, HEMOPHILIA AND  
OTHER COAGULATION DISORDERS, INFECTION,  
SHOCK, BLOOD LOSS DUE TO TRAUMA, BURNS  
AND SURGERY, IMMUNE DISORDERS, HEPATI-  
TIS, TETANUS AND RABIES EXPOSURE, IN CLASS  
5 (U.S. CLS. 6, 18, 44, 46, 51 AND 52).

FIRST USE 6-13-2005; IN COMMERCE 6-13-2005.

FOR: DISTRIBUTORSHIP SERVICES FOR BIO-  
LOGICAL AND PHARMACEUTICAL PRODUCTS,  
IN CLASS 35 (U.S. CLS. 100, 101 AND 102).

FIRST USE 4-1-2005; IN COMMERCE 4-1-2005.

FOR: PREPARATION AND DISPENSING OF  
MEDICATIONS, IN CLASS 44 (U.S. CLS. 100 AND  
101).

FIRST USE 4-1-2005; IN COMMERCE 4-1-2005.

THE MARK CONSISTS OF STANDARD CHAR-  
ACTERS WITHOUT CLAIM TO ANY PARTICULAR  
FONT, STYLE, SIZE, OR COLOR.

NO CLAIM IS MADE TO THE EXCLUSIVE  
RIGHT TO USE "BIOTHERAPEUTICS", APART  
FROM THE MARK AS SHOWN.

SN 78-551,989, FILED 1-21-2005.

ADA HAN, EXAMINING ATTORNEY

**Int. Cl.: 10**

**Prior U.S. Cls.: 26, 39, and 44**

**United States Patent and Trademark Office**

**Reg. No. 3,506,424**

**Registered Sep. 23, 2008**

---

**TRADEMARK  
PRINCIPAL REGISTER**

**Handisol NB**

NATIONAL BIOLOGICAL CORPORATION  
(OHIO CORPORATION)  
1532 ENTERPRISE PARKWAY  
TWINSBURG, OH 44087

FOR: PHOTOTHERAPY APPARATUS FOR THE  
HOME TREATMENT OF PSORIASIS AND OTHER  
DISEASES, IN CLASS 10 (U.S. CLS. 26, 39 AND 44).

FIRST USE 2-22-2004; IN COMMERCE 2-22-2004.

THE MARK CONSISTS OF STANDARD CHAR-  
ACTERS WITHOUT CLAIM TO ANY PARTICULAR  
FONT, STYLE, SIZE, OR COLOR.

SN 78-553,674, FILED 1-25-2005.

ANNE MADDEN, EXAMINING ATTORNEY

**Int. Cl.: 10**

**Prior U.S. Cls.: 26, 39, and 44**

**United States Patent and Trademark Office**

**Reg. No. 3,506,425**

**Registered Sep. 23, 2008**

**TRADEMARK  
PRINCIPAL REGISTER**

**O.R. NECESSITIES**

MEDLINE INDUSTRIES, INC. (ILLINOIS CORPORATION)  
ONE MEDLINE PLACE  
MUNDELEIN, IL 60060

FOR: MEDICAL ACCESSORIES FOR THE OPERATING ROOM, NAMELY, LIGHT HANDLE COVERS AND ADAPTERS FOR SURGICAL LIGHTS, NEEDLE COUNTERS, SURGICAL BLADE AND DISPOSABLE SCALPELS, ANTI-FOG SOLUTION FOR SCOPES, INSUFFLATING TUBING AND NEEDLES, DISPOSABLE SCALPEL BLADE REMOVER, MAGNETIC DRAPES FOR USE AS SURGICAL TRAYS, TRANSFER TRAYS, SCALPEL HOLDERS, VESSEL LOOPS, SUTURE BOOTS, SKIN MARKERS, BONE WAX, CAUTERY TIP CLEANER, ALL-PURPOSE TUBE HOLDERS, UMBILICAL CORD CLAMPS, AMNIO HOOKS, STERILE RUBBER

BANDS, STERILE SAFETY PINS, STERILE COTTON BALLS, IN CLASS 10 (U.S. CLS. 26, 39 AND 44).

FIRST USE 8-0-2006; IN COMMERCE 8-0-2006.

THE MARK CONSISTS OF STANDARD CHARACTERS WITHOUT CLAIM TO ANY PARTICULAR FONT, STYLE, SIZE, OR COLOR.

NO CLAIM IS MADE TO THE EXCLUSIVE RIGHT TO USE "O.R.", APART FROM THE MARK AS SHOWN.

SN 78-561,126, FILED 2-4-2005.

KEVIN DINALLO, EXAMINING ATTORNEY

**Int. Cl.: 35**

**Prior U.S. Cls.: 100, 101, and 102**

**United States Patent and Trademark Office**

**Reg. No. 3,506,426**

**Registered Sep. 23, 2008**

**SERVICE MARK  
PRINCIPAL REGISTER**

**PRODUCER PATHWAY  
TO SUCCESS: CONTACT  
TO CONTRACT TO  
IMPACT**

AMERICAN FAMILY LIFE ASSURANCE COM-  
PANY OF COLUMBUS (NEBRASKA COR-  
PORATION)  
1932 WYNNNTON ROAD  
COLUMBUS, GA 31999

FOR: EMPLOYMENT INFORMATION SERVI-  
CES, NAMELY, PROVIDING ONLINE INFORMA-  
TION ABOUT JOB OPPORTUNITIES IN THE FIELD  
OF INSURANCE SALES, VIA A WEBSITE FOR USE  
BY PROSPECTIVE EMPLOYERS AND APPLICANTS  
IN THE INSURANCE FIELD THAT ALSO ALLOWS  
PROSPECTIVE EMPLOYERS TO COMMUNICATE

WITH APPLICANTS, IN CLASS 35 (U.S. CLS. 100, 101  
AND 102).

FIRST USE 4-1-2007; IN COMMERCE 4-1-2007.

THE MARK CONSISTS OF STANDARD CHAR-  
ACTERS WITHOUT CLAIM TO ANY PARTICULAR  
FONT, STYLE, SIZE, OR COLOR.

SN 78-562,414, FILED 2-8-2005.

ELISSA GARBER KON, EXAMINING ATTORNEY

**Int. Cl.: 41**

**Prior U.S. Cls.: 100, 101, and 107**

**United States Patent and Trademark Office**

**Reg. No. 3,506,427**

**Registered Sep. 23, 2008**

**SERVICE MARK  
PRINCIPAL REGISTER**

**THE ULTIMATE ROAD  
TRIP**

MONSTER (CALIFORNIA), INC. (CALIFORNIA CORPORATION)  
11845 W. OLYMPIC BLVD.  
SUITE 500  
LOS ANGELES, CA 90064

FOR: EDUCATIONAL SERVICES, NAMELY, PRESENTATIONS AND WORKSHOPS IN THE FIELD OF PROVIDING GUIDANCE TOWARDS SUCCEEDING IN ACADEMICS, EXTRA CURRICULAR ACTIVITIES, JOBS, AND CAREERS AND DISTRIBUTING COURSE MATERIALS ASSOCIATED THEREWITH; PROVIDING ONLINE INFORMATION IN THE FIELD OF GUIDANCE TOWARD SUCCESS IN COLLEGE AND TRANSITIONING FROM COLLEGE TO A SUCCESSFUL CAREER;

PROVIDING NEWSLETTERS IN THE FIELD OF PROVIDING GUIDANCE TOWARDS SUCCEEDING IN ACADEMICS, EXTRA CURRICULAR ACTIVITIES, JOBS, AND CAREERS VIA E-MAIL, IN CLASS 41 (U.S. CLS. 100, 101 AND 107).

FIRST USE 2-13-2008; IN COMMERCE 2-13-2008.

THE MARK CONSISTS OF STANDARD CHARACTERS WITHOUT CLAIM TO ANY PARTICULAR FONT, STYLE, SIZE, OR COLOR.

SN 78-569,674, FILED 2-17-2005.

DAWN HAN, EXAMINING ATTORNEY

**Int. Cl.: 16**

**Prior U.S. Cls.: 2, 5, 22, 23, 29, 37, 38, and 50**

**United States Patent and Trademark Office**

**Reg. No. 3,506,428**

**Registered Sep. 23, 2008**

**TRADEMARK  
PRINCIPAL REGISTER**

**BECAUSE YOU TREAT  
THE WHOLE PATIENT**

BRISTOL-MYERS SQUIBB COMPANY (DELA-  
WARE CORPORATION)  
345 PARK AVENUE  
NEW YORK, NY 10154

FOR: PRINTED MATERIALS, NAMELY, BRO-  
CHURES AND PAMPHLETS RELATING TO THE  
TREATMENT AND PREVENTION OF HIV AND  
AIDS, IN CLASS 16 (U.S. CLS. 2, 5, 22, 23, 29, 37, 38  
AND 50).

FIRST USE 9-16-2004; IN COMMERCE 9-16-2004.

THE MARK CONSISTS OF STANDARD CHAR-  
ACTERS WITHOUT CLAIM TO ANY PARTICULAR  
FONT, STYLE, SIZE, OR COLOR.

SN 78-573,165, FILED 2-23-2005.

WILLIAM P. SHANAHAN, EXAMINING ATTOR-  
NEY

**Int. Cl.: 41**

**Prior U.S. Cls.: 100, 101, and 107**

**United States Patent and Trademark Office**

**Reg. No. 3,506,429**

**Registered Sep. 23, 2008**

**SERVICE MARK  
PRINCIPAL REGISTER**

**Take Time To Be  
Kind**

GREEN, TERREL A. (UNITED STATES INDIVIDUAL)  
8075 BOULDER RIDGE RD.  
WOODBURY, MN 55125

FOR: KINDNESS EDUCATION PROGRAM, IN  
CLASS 41 (U.S. CLS. 100, 101 AND 107).

FIRST USE 3-2-2005; IN COMMERCE 4-1-2005.

THE MARK CONSISTS OF STANDARD CHARACTERS WITHOUT CLAIM TO ANY PARTICULAR FONT, STYLE, SIZE, OR COLOR.

SN 78-578,891, FILED 3-2-2005.

AISHA CLARKE, EXAMINING ATTORNEY



**Int. Cls.: 36, 43, and 45**

**Prior U.S. Cls.: 100, 101, and 102**

**United States Patent and Trademark Office**

**Reg. No. 3,506,430**

**Registered Sep. 23, 2008**

**SERVICE MARK  
PRINCIPAL REGISTER**

**YOU'LL VACATION  
LIKE YOU OWN THE  
PLACE. BECAUSE  
YOU DO.**

BVG RESORT HOMES, INC. (FLORIDA CORPORATION)  
SUITE 925  
777 SOUTH HARBOR ISLAND BLVD.  
TAMPA, FL 33602

FOR: BROKERAGE AND MANAGEMENT OF VACATION PROPERTIES; FINANCIAL INVESTMENT IN THE FIELD OF REAL ESTATE; REAL ESTATE EQUITY SHARING, NAMELY, MANAGING AND ARRANGING FOR OWNERSHIP AND TRANSIENT USE OF REAL ESTATE BY MULTIPLE INVESTORS; REAL ESTATE MANAGEMENT, INCLUDING RENTAL OF PROPERTIES; REAL ESTATE SERVICES, NAMELY, MEMBERSHIP VACATION CLUB SERVICES IN THE NATURE OF FORMATION AND OPERATION OF EQUITY INTERESTS IN VACATION PROPERTIES, IN CLASS 36 (U.S. CLS. 100, 101 AND 102).

FIRST USE 7-23-2005; IN COMMERCE 7-23-2005.

FOR: RESORT LODGING SERVICES, IN CLASS 43 (U.S. CLS. 100 AND 101).

FIRST USE 7-23-2005; IN COMMERCE 7-23-2005.

FOR: CONCIERGE SERVICES FOR OTHERS COMPRISED OF MAKING REQUESTED PERSONAL ARRANGEMENTS AND RESERVATIONS AND PROVIDING CUSTOMER-SPECIFIC INFORMATION TO MEET INDIVIDUAL NEEDS RENDERED TOGETHER IN A TEMPORARY LIVING RESIDENTIAL ENVIRONMENT, IN CLASS 45 (U.S. CLS. 100 AND 101).

FIRST USE 7-23-2005; IN COMMERCE 7-23-2005.

THE MARK CONSISTS OF STANDARD CHARACTERS WITHOUT CLAIM TO ANY PARTICULAR FONT, STYLE, SIZE, OR COLOR.

SN 78-589,515, FILED 3-17-2005.

ADA HAN, EXAMINING ATTORNEY

Int. Cls.: 18 and 25

Prior U.S. Cls.: 1, 2, 3, 22, 39, and 41

**United States Patent and Trademark Office**

**Reg. No. 3,506,431**

Registered Sep. 23, 2008

**TRADEMARK  
PRINCIPAL REGISTER**



VISGILIO, ROBERT M. (UNITED STATES INDIVIDUAL)  
33 CRANDALL AVE.  
WESTERLY, RI 02891

FOR: TOTE BAGS, IN CLASS 18 (U.S. CLS. 1, 2, 3, 22 AND 41).

FIRST USE 1-1-2007; IN COMMERCE 2-1-2008.

FOR: CLOTHING, NAMELY, T-SHIRTS, SWEAT-PANTS, SHORTS, PANTS, HATS, COATS, AND POLO SHIRTS, IN CLASS 25 (U.S. CLS. 22 AND 39).

FIRST USE 1-1-2007; IN COMMERCE 2-1-2008.

SN 78-600,150, FILED 4-1-2005.

GEORGE LORENZO, EXAMINING ATTORNEY

**Int. Cl.: 42**

**Prior U.S. Cls.: 100 and 101**

**United States Patent and Trademark Office**

**Reg. No. 3,506,432**

**Registered Sep. 23, 2008**

**SERVICE MARK  
PRINCIPAL REGISTER**

**This Firm Means Business**

FLOYD, JOHN B. (UNITED STATES INDIVIDUAL)  
SUITE 2025  
23801 CALABASAS ROAD  
CALABASAS, CA 91302

THE MARK CONSISTS OF STANDARD CHARACTERS WITHOUT CLAIM TO ANY PARTICULAR FONT, STYLE, SIZE, OR COLOR.

FOR: LEGAL SERVICES, IN CLASS 42 (U.S. CLS. 100 AND 101).

SN 78-602,136, FILED 4-5-2005.

FIRST USE 2-28-2007; IN COMMERCE 5-7-2007.

CHARLOTTE CORWIN, EXAMINING ATTORNEY

**Int. Cl.: 41**

**Prior U.S. Cls.: 100, 101, and 107**

**United States Patent and Trademark Office**

**Reg. No. 3,506,433**

**Registered Sep. 23, 2008**

**SERVICE MARK  
PRINCIPAL REGISTER**

**LIFE ENHANCEMENT  
COMPANY**

CR LICENSE, LLC (ARIZONA LIMITED LIABILITY COMPANY)  
8600 EAST ROCKCLIFF ROAD  
TUCSON, AZ 85750

FOR: HEALTH CLUB SERVICES, NAMELY, PROVIDING INSTRUCTION AND EQUIPMENT IN THE FIELD OF PHYSICAL EXERCISE AND EXERCISE CLASSES TO OTHERS AND CONDUCTING CLASSES IN EXERCISE AND PHYSICAL CONDITIONING; EDUCATIONAL SERVICES, NAMELY, CONDUCTING CLASSES, SEMINARS, CONFERENCES, AND WORKSHOPS IN THE FIELDS OF NUTRITION, EXERCISE, PHYSICAL CONDITIONING, CONFLICT MANAGEMENT, FAMILY HEALTH, WELLNESS, PREVENTION OF DISEASE, BEAUTY, SKIN CARE, PHYSICAL FITNESS, PHYSICAL TRAINING, STRESS MANAGEMENT AND BEHAVIOR MODIFICATION; COUNSELING AND CONSULTATION SERVICES IN THE FIELDS OF EXERCISE AND PHYSICAL CONDITIONING, PHYSICAL FITNESS AND PHYSICAL TRAINING, IN CLASS 41 (U.S. CLS. 100, 101 AND 107).

FIRST USE 2-12-2008; IN COMMERCE 2-12-2008.

THE MARK CONSISTS OF STANDARD CHARACTERS WITHOUT CLAIM TO ANY PARTICULAR FONT, STYLE, SIZE, OR COLOR.

OWNER OF U.S. REG. NOS. 2,066,095 AND 2,066,096.

NO CLAIM IS MADE TO THE EXCLUSIVE RIGHT TO USE "COMPANY", APART FROM THE MARK AS SHOWN.

SEC. 2(F) AS TO "LIFE ENHANCEMENT".

SN 78-602,534, FILED 4-5-2005.

TRICIA SONNEBORN, EXAMINING ATTORNEY

**Int. Cl.: 44**

**Prior U.S. Cls.: 100 and 101**

**United States Patent and Trademark Office**

**Reg. No. 3,506,434**

**Registered Sep. 23, 2008**

**SERVICE MARK  
PRINCIPAL REGISTER**

**LIFE ENHANCEMENT  
COMPANY**

CR LICENSE, LLC (ARIZONA LIMITED LIABILITY COMPANY)  
8600 EAST ROCKCLIFF ROAD  
TUCSON, AZ 85750

FOR: MEDICAL AND THERAPEUTIC COUNSELING SERVICES RELATING TO BEHAVIOR MODIFICATION AND STRESS MANAGEMENT; COUNSELING AND CONSULTING SERVICES IN THE FIELDS OF NUTRITION, CONFLICT MANAGEMENT, FAMILY HEALTH, WELLNESS, PREVENTION OF DISEASE, BEAUTY, SKIN CARE, STRESS MANAGEMENT AND BEHAVIOR MODIFICATION; HAIR STYLING AND SKIN CARE SALON SERVICES; MANICURE AND PEDICURE SERVICES; HEALTH SPA SERVICES, NAMELY, COSMETIC BODY CARE SERVICES; MASSAGE; HEALTH SPA SERVICES FOR HEALTH AND WELLNESS OF THE BODY AND SPIRIT OFFERED AT A HEALTH RESORT; MEDICAL SERVICES; MAINTAINING FILES AND RECORDS CONCERNING THE MENTAL AND PHYSICAL HEALTH AND WELLNESS OF INDIVIDUALS; OPERATION OF SAUNA FACILITIES; PROVIDING INFORMATION IN THE FIELDS OF MENTAL AND PHYSICAL HEALTH, NAMELY, NUTRITION, CONFLICT MANAGEMENT, FAMILY HEALTH, WELLNESS, PREVENTION OF DISEASE, BEAUTY, SKIN CARE,

STRESS MANAGEMENT AND BEHAVIOR MODIFICATION; MEDICAL CONSULTATIONS; MEDICAL COUNSELING; MEDICAL ASSISTANCE CONSULTANCY PROVIDED BY DOCTORS AND OTHER SPECIALIZED MEDICAL PERSONNEL; MEDICAL TESTING; PROVIDING MEDICAL INFORMATION, IN CLASS 44 (U.S. CLS. 100 AND 101).

FIRST USE 2-12-2008; IN COMMERCE 2-12-2008.

THE MARK CONSISTS OF STANDARD CHARACTERS WITHOUT CLAIM TO ANY PARTICULAR FONT, STYLE, SIZE, OR COLOR.

OWNER OF U.S. REG. NOS. 2,066,095 AND 2,066,096.

NO CLAIM IS MADE TO THE EXCLUSIVE RIGHT TO USE "COMPANY", APART FROM THE MARK AS SHOWN.

SEC. 2(F) AS TO "LIFE ENHANCEMENT".

SN 78-602,544, FILED 4-5-2005.

TRICIA SONNEBORN, EXAMINING ATTORNEY

**Int. Cl.: 35**

**Prior U.S. Cls.: 100, 101, and 102**

**United States Patent and Trademark Office**

**Reg. No. 3,506,435**

**Registered Sep. 23, 2008**

**SERVICE MARK  
PRINCIPAL REGISTER**

**MISSHA**

MISSHA USA CORP. (NEW YORK CORPORATION)  
1720 BROADWAY, SUITE 1009  
C/O THE CORPORATION  
NEW YORK, NY 10001

FOR: RETAIL STORE SERVICES, ON-LINE RETAIL STORE SERVICES AND CATALOG ORDERING SERVICES, IN THE FIELD OF COSMETICS, TOILETRIES, SKIN CARE, HAIR CARE, FRAGRANCES, INCENSES AND PERSONAL CARE PRODUCTS, IN CLASS 35 (U.S. CLS. 100, 101 AND 102).

FIRST USE 9-0-2005; IN COMMERCE 9-0-2005.

THE MARK CONSISTS OF STANDARD CHARACTERS WITHOUT CLAIM TO ANY PARTICULAR FONT, STYLE, SIZE, OR COLOR.

OWNER OF U.S. REG. NO. 3,023,407.

SN 78-605,868, FILED 4-11-2005.

JEAN IM, EXAMINING ATTORNEY

**Int. Cl.: 1**

**Prior U.S. Cls.: 1, 5, 6, 10, 26, and 46**

**Reg. No. 3,506,436**

**United States Patent and Trademark Office**

**Registered Sep. 23, 2008**

---

**TRADEMARK  
PRINCIPAL REGISTER**

**ATTSITE**

INTREXON CORPORATION (VIRGINIA CORPORATION)  
1872 PRATT DRIVE, SUITE 1400  
BLACKSBURG, VA 24060

THE MARK CONSISTS OF STANDARD CHARACTERS WITHOUT CLAIM TO ANY PARTICULAR FONT, STYLE, SIZE, OR COLOR.

FOR: RESEARCH REAGENTS FOR PHARMACEUTICAL DISCOVERY OR DISEASE RESEARCH, DRUG DISCOVERY OR DRUG DEVELOPMENT, IN CLASS 1 (U.S. CLS. 1, 5, 6, 10, 26 AND 46).

SN 78-608,418, FILED 4-14-2005.

FIRST USE 10-30-2007; IN COMMERCE 10-30-2007.

PRISCILLA MILTON, EXAMINING ATTORNEY

**Int. Cl.: 9**

**Prior U.S. Cls.: 21, 23, 26, 36, and 38**

**United States Patent and Trademark Office**

**Reg. No. 3,506,437**

**Registered Sep. 23, 2008**

**TRADEMARK  
PRINCIPAL REGISTER**



NEW BOUNDARY TECHNOLOGIES, INC (MINNESOTA CORPORATION)  
1300 GODWARD ST. NE SUITE 3100  
MINNEAPOLIS, MN 55413

FOR: CONFIGURATION AND DESKTOP MANAGEMENT SOFTWARE APPLICATION, NAMELY, COMPUTER SOFTWARE FOR NETWORK ADMINISTRATORS, IN CLASS 9 (U.S. CLS. 21, 23, 26, 36 AND 38).

FIRST USE 4-1-2005; IN COMMERCE 8-29-2005.

OWNER OF U.S. REG. NOS. 2,570,275 AND 3,117,905.

NO CLAIM IS MADE TO THE EXCLUSIVE RIGHT TO USE "SUITE", APART FROM THE MARK AS SHOWN.

THE COLOR(S) BLUE AND GRAY IS/ARE CLAIMED AS A FEATURE OF THE MARK.

THE MARK CONSISTS OF THE COLORS BLUE AND GRAY APPEAR IN THE TRIANGULAR DESIGN ELEMENT, THE COLOR BLUE APPEARS IN THE WORDING "PRISM", AND THE COLOR GRAY APPEARS IN THE CIRCLE DESIGN ELEMENTS AND THE WORDING "SUITE".

SN 78-611,862, FILED 4-19-2005.

TEJBIR SINGH, EXAMINING ATTORNEY



**Int. Cl.: 25**

**Prior U.S. Cls.: 22 and 39**

**United States Patent and Trademark Office**

**Reg. No. 3,506,438**

**Registered Sep. 23, 2008**

**TRADEMARK  
PRINCIPAL REGISTER**

**WORLD COMBAT LEAGUE**

NORRIS, CARLOS RAY (UNITED STATES INDIVIDUAL)  
C/O MICHAEL S. FORSHEY, PATTON BOGGS LLP  
2001 ROSS AVE., #3000  
DALLAS, TX 75201

FOR: CLOTHING, NAMELY, SHIRTS, PANTS AND JACKETS FOR MARTIAL ARTS; FOOTWEAR FOR MARTIAL ARTS AND TEAM UNIFORMS FOR MARTIAL ARTS; T-SHIRTS, PANTS, JACKETS, SWEATSHIRTS, TOPS, AND CAPS, IN CLASS 25 (U.S. CLS. 22 AND 39).

FIRST USE 9-30-2005; IN COMMERCE 9-30-2005.

THE MARK CONSISTS OF STANDARD CHARACTERS WITHOUT CLAIM TO ANY PARTICULAR FONT, STYLE, SIZE, OR COLOR.

SN 78-619,911, FILED 4-29-2005.

TAMARA FRAZIER, EXAMINING ATTORNEY

**Int. Cls.: 18 and 25**

**Prior U.S. Cls.: 1, 2, 3, 22, 39, and 41**

**United States Patent and Trademark Office**

**Reg. No. 3,506,439**

**Registered Sep. 23, 2008**

**TRADEMARK  
PRINCIPAL REGISTER**

# Fitness Counts

PARIS ACCESSORIES, INC. (NEW YORK CORPORATION)  
350 FIFTH AVENUE 70TH FLOOR  
NEW YORK, NY 10118

FOR: BAGS, NAMELY, ATHLETIC BAGS, BACKPACKS, PURSES, CLOTH SHOPPING BAGS, FANNY PACKS, WALLETS AND COIN PURSES, TOTE BAGS, IN CLASS 18 (U.S. CLS. 1, 2, 3, 22 AND 41).

FIRST USE 5-2-2008; IN COMMERCE 5-2-2008.

FOR: CLOTHING, NAMELY, BALACLAVAS, BATHROBES, BEACHWEAR, BIKER TOPS, BLANKETS, BLOUSES, BOXER SHORTS, BRIEFS, CLOTH BIBS, CLOTH DIAPERS, CROP TOPS, CYCLE PANTS, DICKIES, FLEECE PULLOVERS, FLEECE VESTS, HALTERS, INFANT UNDERWEAR, JACKETS, JOGGING SUITS, KNIT SHIRTS, LOUNGEWEAR, NIGHT SHIRTS, PAJAMAS, PANTS, PAREOS, POLO SHIRTS, RAINWEAR, ROBES, SHORTS, SINGLETS, SWEAT SHORTS, SWEATERS, SWEATPANTS, SWEATSHIRTS, SWIMWEAR, TANK TOPS, THERMAL TOPS AND BOTTOMS,

TROUSERS, T-SHIRTS, TUBE TOPS, TURTLENECKS, UNDERSHIRTS, UNDERWEAR, VESTS, WARM-UP SUITS, WOVEN SHIRTS; FOOTWEAR, NAMELY, BOOTIES, BOOTS, ESPADRILLES, GALOSHES, HOSIERY, LEG WARMERS, SANDALS, SLIPPERS, SLIPPER SOCKS, STOCKINGS, SNEAKERS, SOCKS, TIGHTS, TOE SOCKS, ZORIS; ACCESSORIES, NAMELY, BALACLAVAS, BANDANNAS, BELTS, BERETS, BONNETS, BOW TIES, CAPS, COLLARS, EARMUFFS, FACE MASKS, GAITERS, GLOVES, HATS, HEADBANDS, MITTENS, MUFFLERS, SCARVES, SHAWLS, SUSPENDERS, VISORS, IN CLASS 25 (U.S. CLS. 22 AND 39).

FIRST USE 5-2-2008; IN COMMERCE 5-2-2008.

THE MARK CONSISTS OF STANDARD CHARACTERS WITHOUT CLAIM TO ANY PARTICULAR FONT, STYLE, SIZE, OR COLOR.

SN 78-622,314, FILED 5-4-2005.

EVELYN BRADLEY, EXAMINING ATTORNEY

**Int. Cl.: 36**

**Prior U.S. Cls.: 100, 101, and 102**

**United States Patent and Trademark Office**

**Reg. No. 3,506,440**

**Registered Sep. 23, 2008**

**SERVICE MARK  
PRINCIPAL REGISTER**

**THE UNDERWEAR AFFAIR**

CAUSEFORCE, INC. (CALIFORNIA CORPORATION)  
8380 SANTA MONICA BOULEVARD  
SUITE 200  
WEST HOLLYWOOD, CA 90069

FOR: CHARITABLE FUNDRAISING, NAMELY,  
ORGANIZING ATHLETIC EVENTS TO GENERATE  
FUNDS FOR RESEARCH ON, AND TREATMENT  
OF, CANCERS BELOW THE WAIST , IN CLASS 36  
(U.S. CLS. 100, 101 AND 102).

FIRST USE 8-6-2008; IN COMMERCE 8-6-2008.

THE MARK CONSISTS OF STANDARD CHARACTERS WITHOUT CLAIM TO ANY PARTICULAR FONT, STYLE, SIZE, OR COLOR.

SN 78-624,761, FILED 5-6-2005.

BRIAN PINO, EXAMINING ATTORNEY

**Int. Cl.: 41**

**Prior U.S. Cls.: 100, 101, and 107**

**United States Patent and Trademark Office**

**Reg. No. 3,506,441**

**Registered Sep. 23, 2008**

**SERVICE MARK  
PRINCIPAL REGISTER**

**QUIKSCIENCE**

QUIKSILVER, INC. (DELAWARE CORPORATION)  
15202 GRAHAM STREET  
HUNTINGTON BEACH, CA 92649

FOR: EDUCATIONAL SERVICES, NAMELY, PROVIDING CLASSES, WORKSHOPS AND SEMINARS AND CONDUCTING EDUCATIONAL PROGRAMS IN THE FIELD OF SCIENCE; PROVIDING INCENTIVES TO STUDENTS TO DEMONSTRATE EXCELLENCE IN THE FIELD OF SCIENCE THROUGH ISSUANCE OF AWARDS AND PARTI-

CIPATION IN FIELD TRIP, IN CLASS 41 (U.S. CLS. 100, 101 AND 107).

FIRST USE 12-26-2007; IN COMMERCE 12-26-2007.

THE MARK CONSISTS OF STANDARD CHARACTERS WITHOUT CLAIM TO ANY PARTICULAR FONT, STYLE, SIZE, OR COLOR.

SN 78-624,826, FILED 5-6-2005.

DAWN HAN, EXAMINING ATTORNEY

**Int. Cls.: 6, 20, and 26**

**Prior U.S. Cls.: 2, 12, 13, 14, 22, 23, 25, 32, 37, 39, 40,  
42, and 50**

**Reg. No. 3,506,442**

**United States Patent and Trademark Office**

**Registered Sep. 23, 2008**

**TRADEMARK  
PRINCIPAL REGISTER**

**BANDIT**

YEAR ONE, INC. (GEORGIA CORPORATION)  
1001 CHERRY DRIVE, SUITE 1  
BRASELTON, GA 30517

FOR: METAL NAMEPLATES; NOVELTY LI-  
CENSE PLATES ALL MADE OF METAL, IN CLASS  
6 (U.S. CLS. 2, 12, 13, 14, 23, 25 AND 50).

FIRST USE 5-18-2007; IN COMMERCE 5-18-2007.

FOR: PLASTIC NAMEPLATES; NOVELTY LI-  
CENSE PLATES ALL MADE OF PLASTIC, IN CLASS  
20 (U.S. CLS. 2, 13, 22, 25, 32 AND 50).

FIRST USE 5-18-2007; IN COMMERCE 5-18-2007.

FOR: EMBROIDERED PATCHES FOR CLOTH-  
ING, IN CLASS 26 (U.S. CLS. 37, 39, 40, 42 AND 50).

FIRST USE 8-1-2007; IN COMMERCE 8-1-2007.

THE MARK CONSISTS OF STANDARD CHAR-  
ACTERS WITHOUT CLAIM TO ANY PARTICULAR  
FONT, STYLE, SIZE, OR COLOR.

SN 78-624,955, FILED 5-6-2005.

KELLEY WELLS, EXAMINING ATTORNEY

**Int. Cl.: 9**

**Prior U.S. Cls.: 21, 23, 26, 36, and 38**

**Reg. No. 3,506,443**

**United States Patent and Trademark Office**

**Registered Sep. 23, 2008**

---

**TRADEMARK  
PRINCIPAL REGISTER**

**EZSPIN**

STIRLING TECHNOLOGIES, LLC (DELAWARE  
LIMITED LIABILITY COMPANY)  
1735 WEST 18TH ST  
INDIANAPOLIS, IN 46202

THE MARK CONSISTS OF STANDARD CHAR-  
ACTERS WITHOUT CLAIM TO ANY PARTICULAR  
FONT, STYLE, SIZE, OR COLOR.

FOR: HEX NUTS SOLD AS AN INTEGRAL COM-  
PONENT OF COAXIAL CABLE CONNECTORS, IN  
CLASS 9 (U.S. CLS. 21, 23, 26, 36 AND 38).

SN 78-625,826, FILED 5-9-2005.

FIRST USE 4-0-2005; IN COMMERCE 4-0-2005.

KHANH LE, EXAMINING ATTORNEY

**Int. Cls.: 16 and 41**

**Prior U.S. Cls.: 2, 5, 22, 23, 29, 37, 38, 50, 100, 101, and 107**

**Reg. No. 3,506,444**

**United States Patent and Trademark Office**

**Registered Sep. 23, 2008**

**TRADEMARK  
SERVICE MARK  
PRINCIPAL REGISTER**

# INTERPRET

BOARD OF REGENTS, THE UNIVERSITY OF  
TEXAS SYSTEM (TEXAS STATE AGENCY)  
201 WEST 7TH STREET  
AUSTIN, TX 78701

FOR: PRINTED EDUCATIONAL, TRAINING,  
AND TEACHING MATERIALS FOR TRAINING  
HEALTH CARE PROFESSIONALS HOW TO INTER-  
ACT WITH PERSONS WHOSE FIRST LANGUAGE  
IS NOT ENGLISH, IN CLASS 16 (U.S. CLS. 2, 5, 22, 23,  
29, 37, 38 AND 50).

FIRST USE 0-0-2002; IN COMMERCE 0-0-2002.

FOR: EDUCATIONAL SERVICES, NAMELY,  
CONDUCTING WORKSHOPS, SEMINARS, AND

TRAINING TO TEACH HEALTH CARE PROFES-  
SIONALS HOW TO INTERACT WITH PERSONS  
WHOSE FIRST LANGUAGE IS NOT ENGLISH, IN  
CLASS 41 (U.S. CLS. 100, 101 AND 107).

FIRST USE 0-0-2002; IN COMMERCE 0-0-2002.

THE MARK CONSISTS OF STANDARD CHAR-  
ACTERS WITHOUT CLAIM TO ANY PARTICULAR  
FONT, STYLE, SIZE, OR COLOR.

SN 78-628,074, FILED 5-11-2005.

ELI HELLMAN, EXAMINING ATTORNEY

**Int. Cl.: 16**

**Prior U.S. Cls.: 2, 5, 22, 23, 29, 37, 38, and 50**

**Reg. No. 3,506,445**

**United States Patent and Trademark Office**

**Registered Sep. 23, 2008**

---

**TRADEMARK  
PRINCIPAL REGISTER**

**DISNEY FAIRIES**

DISNEY ENTERPRISES, INC. (DELAWARE CORPORATION)  
500 SOUTH BUENA VISTA STREET  
BURBANK, CA 91521

THE MARK CONSISTS OF STANDARD CHARACTERS WITHOUT CLAIM TO ANY PARTICULAR FONT, STYLE, SIZE, OR COLOR.

FOR: BOOKENDS; COLORING BOOKS; PAPER PARTY FAVORS; PEN AND PENCIL BOXES; POSTERS; STAPLES, IN CLASS 16 (U.S. CLS. 2, 5, 22, 23, 29, 37, 38 AND 50).

SN 78-638,988, FILED 5-27-2005.

FIRST USE 9-11-2007; IN COMMERCE 9-11-2007.

BARBARA A. GOLD, EXAMINING ATTORNEY



**Int. Cl.: 28**

**Prior U.S. Cls.: 22, 23, 38, and 50**

**Reg. No. 3,506,446**

**United States Patent and Trademark Office**

**Registered Sep. 23, 2008**

**TRADEMARK  
PRINCIPAL REGISTER**

**DISNEY FAIRIES**

DISNEY ENTERPRISES, INC. (DELAWARE CORPORATION)  
500 SOUTH BUENA VISTA STREET  
BURBANK, CA 91521

THE MARK CONSISTS OF STANDARD CHARACTERS WITHOUT CLAIM TO ANY PARTICULAR FONT, STYLE, SIZE, OR COLOR.

FOR: BOARD GAMES; BUBBLE MAKING WANDS AND SOLUTION SETS; CHILDREN'S PLAY COSMETICS; COLLECTABLE TOY FIGURES; DOLL ACCESSORIES; HAND HELD UNIT FOR PLAYING ELECTRONIC GAMES; JUMP ROPES; KITES; PARLOR GAMES; RUBBER BALLS; TOY ACTION FIGURES; TOY VEHICLES; YO-YOS, IN CLASS 28 (U.S. CLS. 22, 23, 38 AND 50).

NO CLAIM IS MADE TO THE EXCLUSIVE RIGHT TO USE "FAIRIES", APART FROM THE MARK AS SHOWN.

SN 78-639,000, FILED 5-27-2005.

FIRST USE 8-28-2007; IN COMMERCE 8-28-2007.

BARBARA A. GOLD, EXAMINING ATTORNEY

**Int. Cl.: 25**

**Prior U.S. Cls.: 22 and 39**

**United States Patent and Trademark Office**

**Reg. No. 3,506,447**

**Registered Sep. 23, 2008**

**TRADEMARK  
PRINCIPAL REGISTER**

**YO BODY**

GLENN, YVETTE (UNITED STATES INDIVIDUAL)  
5165 VENICE BLVD. SUITE A  
LOS ANGELES, CA 90019

FOR: ANKLETS, SOCKS, ATHLETIC SHOES, ATHLETIC UNIFORMS, ATHLETIC FOOTWEAR, BANDANAS, SWEAT BANDS, HEAD BANDS, WRIST BANDS, NECK BANDS, BASEBALL CAPS, BATHING TRUNKS, BATHING SUITS, BATHROBES, BEACHWEAR, BELTS, BERMUDA SHORTS, BIKINIS, BLAZERS, BLOUSES, BODY SUITS, BOXER SHORTS, BRIEFS, UNDERWEAR, COATS, DRESSES, FOOTWEAR, GLOVES, GOWNS, EVENING GOWNS, GYM SUITS, GYM SHORTS, HALTER TOPS, HATS, CAPS, HEAD WEAR, HOODS, INFANTWEAR, JACKETS, LEATHER-JACKETS, JEANS, JERSEYS, JOGGING SUITS, JUMPSUITS, LEG WARMERS, LEGGINGS, LINGERIE, MINISKIRTS, PAJAMAS, PANTIES, SKI

PANTS, PANTS, SWEAT PANTS, PANTSUITS, PLAY SUITS, SHIRTS, SWEAT SHIRTS, SPORT SHIRTS, SHORT SETS, SHORTS, SWEAT SHORTS, SKI WEAR, SNEAKERS, SPORT COATS, WARM-UP SUITS, SUN VISORS, SWEAT SUITS, SWEATSOCKS, SWIM WEAR, SWIMSUITS, T-SHIRTS, TANK TOPS, TEDDIES, THERMAL UNDERWEAR, TOPS, UNDERCLOTHES, UNDERGARMENTS, AND VISORS, IN CLASS 25 (U.S. CLS. 22 AND 39).

FIRST USE 6-11-2007; IN COMMERCE 9-11-2007.

THE MARK CONSISTS OF STANDARD CHARACTERS WITHOUT CLAIM TO ANY PARTICULAR FONT, STYLE, SIZE, OR COLOR.

SN 78-639,542, FILED 5-29-2005.

COLLEEN KEARNEY, EXAMINING ATTORNEY

**Int. Cl.: 3**

**Prior U.S. Cls.: 1, 4, 6, 50, 51, and 52**

**Reg. No. 3,506,448**

**United States Patent and Trademark Office**

**Registered Sep. 23, 2008**

**TRADEMARK  
PRINCIPAL REGISTER**

**HIP STICK**

INTER-MARK USA, INC. (NEW YORK CORPORATION)  
SUITE 307  
200 BUSINESS PARK DRIVE  
ARMONK, NY 10504

FOR: COSMETICS, NAMELY, LIPSTICK, IN CLASS 3 (U.S. CLS. 1, 4, 6, 50, 51 AND 52).

FIRST USE 5-31-2006; IN COMMERCE 5-31-2006.

THE MARK CONSISTS OF STANDARD CHARACTERS WITHOUT CLAIM TO ANY PARTICULAR FONT, STYLE, SIZE, OR COLOR.

NO CLAIM IS MADE TO THE EXCLUSIVE RIGHT TO USE "STICK", APART FROM THE MARK AS SHOWN.

SN 78-641,190, FILED 6-1-2005.

TINA L. SNAPP, EXAMINING ATTORNEY

**Int. Cls.: 30 and 37**

**Prior U.S. Cls.: 46, 100, 103, and 106**

**United States Patent and Trademark Office**

**Reg. No. 3,506,449**

**Registered Sep. 23, 2008**

**TRADEMARK  
SERVICE MARK  
PRINCIPAL REGISTER**

# Dakota Harvest

HOLJE, PAUL D. (UNITED STATES INDIVIDUAL)

921 10TH AVENUE SE

EAST GRAND FORKS, MN 56721 AND

KELLEY, GEORGE E. (UNITED STATES INDIVIDUAL)

921 10TH AVENUE SE

EAST GRAND FORKS, MN 56721

FOR: BREADS; ROLLS; PASTRIES; DOUGHNUTS; MUFFINS; BAGELS; COOKIES; BAKERY DESSERTS; PROCESSED GRAIN PRODUCTS, NAMELY, PROCESSED WHEAT AND OTHER PROCESSED GRAINS; MIXES FOR BAKERY GOODS; PASTA; PIZZA; SANDWICHES; MACARONI, RICE AND PASTA SALADS; COFFEE AND TEA, IN CLASS 30 (U.S. CL. 46).

FIRST USE 9-20-2005; IN COMMERCE 5-6-2006.

FOR: CONSTRUCTION PLANNING; CONSTRUCTION CONSULTATION; BUILDING CONSTRUCTION, REMODELING AND REPAIR; GENERAL CONSTRUCTION CONTRACTING; AND CONSTRUCTION MANAGEMENT, IN CLASS 37 (U.S. CLS. 100, 103 AND 106).

FIRST USE 11-7-2005; IN COMMERCE 11-7-2005.

THE MARK CONSISTS OF STANDARD CHARACTERS WITHOUT CLAIM TO ANY PARTICULAR FONT, STYLE, SIZE, OR COLOR.

NO CLAIM IS MADE TO THE EXCLUSIVE RIGHT TO USE "DAKOTA", APART FROM THE MARK AS SHOWN.

SN 78-643,320, FILED 6-3-2005.

KATHY DE JONGE, EXAMINING ATTORNEY

**Int. Cl.: 41**

**Prior U.S. Cls.: 100, 101, and 107**

**United States Patent and Trademark Office**

**Reg. No. 3,506,450**

**Registered Sep. 23, 2008**

**SERVICE MARK  
PRINCIPAL REGISTER**

**PERSPECTOLOGIST**

BERNS ROSENTHAL INSURANCE & FINANCIAL SERVICES, INC. (CALIFORNIA CORPORATION)  
6338 VARIEL AVE.  
WOODLAND HILLS, CA 91367

FOR: PERSONAL COACHING SERVICES BY A TRAINED PROFESSIONAL IN THE FIELD OF ACCURATELY IDENTIFYING AND REMOVING THE MENTAL, PSYCHOLOGICAL, AND EMOTIONAL BARRIERS TO REACHING BREAKTHROUGH LEVELS OF ACHIEVEMENT TOWARDS ONE'S PROFESSIONAL AND PERSONAL

GOALS, IN CLASS 41 (U.S. CLS. 100, 101 AND 107).

FIRST USE 11-11-2006; IN COMMERCE 11-11-2006.

THE MARK CONSISTS OF STANDARD CHARACTERS WITHOUT CLAIM TO ANY PARTICULAR FONT, STYLE, SIZE, OR COLOR.

SN 78-644,084, FILED 6-6-2005.

TANYA AMOS, EXAMINING ATTORNEY

**Int. Cl.: 9**

**Prior U.S. Cls.: 21, 23, 26, 36, and 38**

**Reg. No. 3,506,451**

**United States Patent and Trademark Office**

**Registered Sep. 23, 2008**

---

**TRADEMARK  
PRINCIPAL REGISTER**

**Outdoor Life's**

BONNIER ACTIVE MEDIA, INC. (NEW YORK CORPORATION)

460 N. ORLANDO AVE., SUITE 200

WINTER PARK, FL 32789

FOR: ELECTRONIC VIDEO GAME PROGRAMS,  
IN CLASS 9 (U.S. CLS. 21, 23, 26, 36 AND 38).

FIRST USE 5-16-2008; IN COMMERCE 5-16-2008.

THE MARK CONSISTS OF STANDARD CHARACTERS WITHOUT CLAIM TO ANY PARTICULAR FONT, STYLE, SIZE, OR COLOR.

NO CLAIM IS MADE TO THE EXCLUSIVE RIGHT TO USE "OUTDOOR", APART FROM THE MARK AS SHOWN.

SN 78-644,592, FILED 6-6-2005.

TIMOTHY FINNEGAN, EXAMINING ATTORNEY

**Int. Cl.: 9**

**Prior U.S. Cls.: 21, 23, 26, 36, and 38**

**Reg. No. 3,506,452**

**United States Patent and Trademark Office**

**Registered Sep. 23, 2008**

**TRADEMARK  
PRINCIPAL REGISTER**



ASTLEY BAKER DAVIES LTD. (UNITED KING-  
DOM CORPORATION)  
120 NEW CAVENDISH STREET  
LONDON, UNITED KINGDOM W1W 6XX AND  
CONTENDER LIMITED (UNITED KINGDOM COR-  
PORATION)  
120 NEW CAVENDISH STREET  
LONDON, UNITED KINGDOM W1W 6XX

FOR: DVDS FEATURING PRE-SCHOOL AGED  
CHILDREN'S EDUCATIONAL AND ENTERTAIN-

MENT MATTER, GAMES, MUSIC, IMAGES, AND  
ANIMATED CARTOONS, IN CLASS 9 (U.S. CLS. 21,  
23, 26, 36 AND 38).

FIRST USE 9-25-2007; IN COMMERCE 9-25-2007.

SN 78-647,159, FILED 6-9-2005.

SHARON MEIER, EXAMINING ATTORNEY

**Int. Cl.: 10**

**Prior U.S. Cls.: 26, 39, and 44**

**United States Patent and Trademark Office**

**Reg. No. 3,506,453**

**Registered Sep. 23, 2008**

**TRADEMARK  
PRINCIPAL REGISTER**



MEDTRONIC, INC. (MINNESOTA CORPORATION)  
710 MEDTRONIC PARKWAY  
MINNEAPOLIS, MN 554325604

FIRST USE 12-4-2007; IN COMMERCE 12-4-2007.

SN 78-657,475, FILED 6-24-2005.

FOR: MRI COMPATIBLE IMPLANTED MEDICAL DEVICES, NAMELY, CARDIAC AND NEURAL LEADS, IN CLASS 10 (U.S. CLS. 26, 39 AND 44).

MATTHEW MCDOWELL, EXAMINING ATTORNEY



**Int. Cls.: 7 and 9**

**Prior U.S. Cls.: 13, 19, 21, 23, 26, 31, 34, 35, 36, and 38**

**Reg. No. 3,506,454**

**United States Patent and Trademark Office**

**Registered Sep. 23, 2008**

**TRADEMARK  
PRINCIPAL REGISTER**

**PURE FORCE**

BALDWIN FILTERS, INC. (DELAWARE CORPORATION)

4400 EAST HIGHWAY 30 P.O. BOX 6010

KEARNEY, NE 68848

FOR: INDUSTRIAL MACHINE AND VEHICLE ENGINE PARTS, NAMELY, HYDRAULIC FILTERS AND HYDRAULIC FILTER BASES, IN CLASS 7 (U.S. CLS. 13, 19, 21, 23, 31, 34 AND 35).

FIRST USE 0-0-2006; IN COMMERCE 0-0-2006.

FOR: PRESSURE GAUGES FOR INDUSTRIAL AND VEHICLE APPLICATIONS, IN CLASS 9 (U.S. CLS. 21, 23, 26, 36 AND 38).

FIRST USE 0-0-2006; IN COMMERCE 0-0-2006.

THE MARK CONSISTS OF STANDARD CHARACTERS WITHOUT CLAIM TO ANY PARTICULAR FONT, STYLE, SIZE, OR COLOR.

SN 78-658,622, FILED 6-27-2005.

ELI HELLMAN, EXAMINING ATTORNEY

**Int. Cl.: 35**

**Prior U.S. Cls.: 100, 101, and 102**

**United States Patent and Trademark Office**

**Reg. No. 3,506,455**

**Registered Sep. 23, 2008**

**SERVICE MARK  
PRINCIPAL REGISTER**

**Decorative Arts District**

EAST MIDTOWN ASSOCIATION (NEW YORK  
NON-PROFIT CORPORATION)  
875 THIRD AVENUE, MEZZANINE  
NEW YORK, NY 10022

FOR: PROMOTING THE GOODS AND SERVICES  
OF OTHERS BY MEANS OF DISSEMINATION OF  
PROMOTIONAL MATERIALS, IN CLASS 35 (U.S.  
CLS. 100, 101 AND 102).

FIRST USE 3-31-2003; IN COMMERCE 2-14-2005.

THE MARK CONSISTS OF STANDARD CHAR-  
ACTERS WITHOUT CLAIM TO ANY PARTICULAR  
FONT, STYLE, SIZE, OR COLOR.

SN 78-662,963, FILED 7-1-2005.

KATHERINE M. DUBRAY, EXAMINING ATTOR-  
NEY

**Int. Cl.: 16**

**Prior U.S. Cls.: 2, 5, 22, 23, 29, 37, 38, and 50**

**United States Patent and Trademark Office**

**Reg. No. 3,506,456**

**Registered Sep. 23, 2008**

**TRADEMARK  
PRINCIPAL REGISTER**



MEADWESTVACO CORPORATION (DELAWARE CORPORATION)  
11013 WEST BROAD STREET  
MEADWESTVACO CORPORATE CENTER  
GLEN ALLEN, VA 23060

FOR: ENVELOPES, IN CLASS 16 (U.S. CLS. 2, 5, 22, 23, 29, 37, 38 AND 50).

FIRST USE 1-30-2008; IN COMMERCE 1-30-2008.

OWNER OF U.S. REG. NOS. 1,454,166, 1,935,113, AND OTHERS.

NO CLAIM IS MADE TO THE EXCLUSIVE RIGHT TO USE "ENVELOPES", APART FROM THE MARK AS SHOWN.

SN 78-667,221, FILED 7-11-2005.

JAMES GRIFFIN, EXAMINING ATTORNEY

Int. Cls.: 41 and 43

Prior U.S. Cls.: 100, 101, and 107

United States Patent and Trademark Office

Reg. No. 3,506,457

Registered Sep. 23, 2008

**SERVICE MARK  
PRINCIPAL REGISTER**



GRAU, JAMES (UNITED STATES INDIVIDUAL)  
1600 PARKER AVENUE  
FORT LEE, NJ 07024 AND  
GRAU, ELVIRA (UNITED STATES INDIVIDUAL)  
1600 PARKER AVENUE  
FORT LEE, NJ 07024

FOR: ENTERTAINMENT SERVICES, NAMELY, PROVISION OF RECREATIONAL AREAS IN THE NATURE OF PLAY AREAS, ARCADE GAME AND ARCADE RIDE SERVICES AND ACTIVITIES, NAMELY, BASKETBALL, BOWLING, LASER TAG, PAINTLESS PAINTBALL, SKEE BALL; ENTERTAINMENT IN THE NATURE OF THEATRICAL PRODUCTIONS FEATURING LIVE AND ELECTRONICALLY ANIMATED CHARACTERS; PROVIDING VIDEO AND COIN OPERATED GAMES, NAMELY, AMUSEMENT ARCADE SERVICES, IN CLASS 41 (U.S. CLS. 100, 101 AND 107).

FIRST USE 10-1-2006; IN COMMERCE 10-1-2006.

FOR: RESTAURANT SERVICES, IN CLASS 43 (U.S. CLS. 100 AND 101).

FIRST USE 10-1-2006; IN COMMERCE 10-1-2006.

NO CLAIM IS MADE TO THE EXCLUSIVE RIGHT TO USE "USA", APART FROM THE MARK AS SHOWN.

THE COLOR(S) BLACK, GREEN, YELLOW, WHITE, ORANGE, PURPLE, BLUE AND PINK IS/ ARE CLAIMED AS A FEATURE OF THE MARK.

THE WORD "SPACE" IS YELLOW WITH BLACK SHADING, THE WORD "ODYSSEY" IS GREEN WITH BLACK SHADING, THE TERM "USA" IS WHITE, THE OUTERMOST RING OF THE ORBIT IS WHITE, THEN INSIDE OF THAT IS A BLUE RING, THEN A PURPLE RING, WITH THE RINGS CONTINUING TO ALTERNATE IN BLUE AND PURPLE TO THE CENTER OF THE CIRCLE, THE STARS ARE YELLOW IN THE CENTER AND OUTLINED IN PURPLE, THE PLANET IS ORANGE WITH THE OUTERMOST RING AROUND THE PLANET BEING BLUE, THEN INSIDE OF THAT, TWO GREEN RINGS, THEN A BLACK RING NEAREST TO THE PLANET, WITH PINK AND WHITE SHADING AROUND THE OUTERMOST RING OF THE PLANET.

THE MARK CONSISTS OF A PLANET WITH RINGS AROUND IT ON A BACKGROUND RESEMBLING THE SOLAR SYSTEM CONSISTING OF RINGS, FOUR-POINTED STARS ON THE RINGS ABOVE AND TO THE SIDES OF THE PLANET, AND THE WORDING "SPACE ODYSSEY USA" BELOW THE PLANET OVER THE BACKGROUND OF RINGS.

SN 78-675,052, FILED 7-21-2005.

SARA THOMAS, EXAMINING ATTORNEY

**Int. Cls.: 6 and 20**

**Prior U.S. Cls.: 2, 12, 13, 14, 22, 23, 25, 32, and 50**

**United States Patent and Trademark Office**

**Reg. No. 3,506,458**

**Registered Sep. 23, 2008**

**TRADEMARK  
PRINCIPAL REGISTER**

**ZEROCASTER**

DIAMETER, INC. (CALIFORNIA CORPORATION)  
131 CREEKSIDE COURT  
EL SOBRANTE, CA 94803

FOR: METAL CASTERS FOR USE ON OFFICE FURNITURE, IN CLASS 6 (U.S. CLS. 2, 12, 13, 14, 23, 25 AND 50).

FIRST USE 6-10-2006; IN COMMERCE 6-10-2006.

FOR: PLASTIC OR NON-METAL CASTERS FOR USE ON OFFICE FURNITURE, IN CLASS 20 (U.S. CLS. 2, 13, 22, 25, 32 AND 50).

FIRST USE 6-10-2006; IN COMMERCE 6-10-2006.

THE MARK CONSISTS OF STANDARD CHARACTERS WITHOUT CLAIM TO ANY PARTICULAR FONT, STYLE, SIZE, OR COLOR.

SN 78-679,213, FILED 7-27-2005.

NAAKWAMA ANKRAH, EXAMINING ATTORNEY

**Int. Cls.: 16, 18, and 25**

**Prior U.S. Cls.: 1, 2, 3, 5, 22, 23, 29, 37, 38, 39, 41, and 50**

**United States Patent and Trademark Office**

**Reg. No. 3,506,459**

**Registered Sep. 23, 2008**

**TRADEMARK  
PRINCIPAL REGISTER**

**NIGHTFIRE**

VIEJAS BAND OF MISSION INDIANS (UNITED STATES FEDERALLY-RECOGNIZED INDIAN TRIBE)  
5000 WILLOWS ROAD  
ALPINE, CA 91901

FOR: POSTCARDS; POSTERS; STICKERS, IN CLASS 16 (U.S. CLS. 2, 5, 22, 23, 29, 37, 38 AND 50).

FIRST USE 8-1-1998; IN COMMERCE 8-1-1998.

FOR: TOTE BAGS, IN CLASS 18 (U.S. CLS. 1, 2, 3, 22 AND 41).

FIRST USE 8-1-1998; IN COMMERCE 8-1-1998.

FOR: CLOTHING, NAMELY, T-SHIRTS, SHIRTS AND SCARVES, IN CLASS 25 (U.S. CLS. 22 AND 39).

FIRST USE 8-1-1998; IN COMMERCE 8-1-1998.

THE MARK CONSISTS OF STANDARD CHARACTERS WITHOUT CLAIM TO ANY PARTICULAR FONT, STYLE, SIZE, OR COLOR.

OWNER OF U.S. REG. NOS. 2,634,121 AND 3,246,284.

SN 78-681,892, FILED 7-29-2005.

MATTHEW PAPPAS, EXAMINING ATTORNEY

**Int. Cl.: 9**

**Prior U.S. Cls.: 21, 23, 26, 36, and 38**

**United States Patent and Trademark Office**

**Reg. No. 3,506,460**

**Registered Sep. 23, 2008**

**TRADEMARK  
PRINCIPAL REGISTER**



TWG SYSTEMS, INC. (COLORADO CORPORATION)  
4775 CENTENNIAL BL SUITE 107  
COLORADO SPRINGS, CO 80919

FOR: COMPUTER SOFTWARE PLATFORMS FOR COMMERCIAL, LIFE, AUTO, AND HOME OWNERS' INSURANCE UNDERWRITING, IN CLASS 9 (U.S. CLS. 21, 23, 26, 36 AND 38).

FIRST USE 1-1-2008; IN COMMERCE 7-1-2008.

THE COLOR(S) BLACK, BLUE AND WHITE IS/ ARE CLAIMED AS A FEATURE OF THE MARK.

THE MARK CONSISTS OF BLACK OUTSIDE BORDER, WHITE INSIDE BORDER, BLACK AND BLUE FILL, LIGHTNING BOLT THROUGH "INDEMEX" NAME.

SN 78-682,588, FILED 8-1-2005.

ALEXANDER L. POWERS, EXAMINING ATTORNEY



**Int. Cl.: 30**

**Prior U.S. Cl.: 46**

**United States Patent and Trademark Office**

**Reg. No. 3,506,461**

**Registered Sep. 23, 2008**

**TRADEMARK  
PRINCIPAL REGISTER**

**SUNDIAL BRIDGE**

TURTLE BAY EXPLORATION PARK (CALIFORNIA CORPORATION)  
1335 ARBORETUM DRIVE, SUITE A  
REDDING, CA 96003

THE MARK CONSISTS OF STANDARD CHARACTERS WITHOUT CLAIM TO ANY PARTICULAR FONT, STYLE, SIZE, OR COLOR.

FOR: CANDY, IN CLASS 30 (U.S. CL. 46).

SN 78-683,552, FILED 8-2-2005.

FIRST USE 6-30-2005; IN COMMERCE 6-30-2005.

GEORGE LORENZO, EXAMINING ATTORNEY

**Int. Cl.: 16**

**Prior U.S. Cls.: 2, 5, 22, 23, 29, 37, 38, and 50**

**United States Patent and Trademark Office**

**Reg. No. 3,506,462**

**Registered Sep. 23, 2008**

**TRADEMARK  
PRINCIPAL REGISTER**

**EXECUTIVE**

MEADWESTVACO CORPORATION (DELAWARE  
CORPORATION)  
11013 WEST BROAD STREET  
MEADWESTVACO CORPORATE CENTER  
GLEN ALLEN, VA 23060

FOR: ENVELOPES, IN CLASS 16 (U.S. CLS. 2, 5, 22,  
23, 29, 37, 38 AND 50).

FIRST USE 1-30-2008; IN COMMERCE 1-30-2008.

THE MARK CONSISTS OF STANDARD CHAR-  
ACTERS WITHOUT CLAIM TO ANY PARTICULAR  
FONT, STYLE, SIZE, OR COLOR.

OWNER OF U.S. REG. NOS. 1,454,166, 1,935,113,  
AND OTHERS.

SN 78-684,292, FILED 8-3-2005.

JAMES GRIFFIN, EXAMINING ATTORNEY

Int. Cls.: 16 and 24

Prior U.S. Cls.: 2, 5, 22, 23, 29, 37, 38, 42, and 50

United States Patent and Trademark Office

Reg. No. 3,506,463

Registered Sep. 23, 2008

TRADEMARK  
PRINCIPAL REGISTER



SMARTY PARENTS INC. (OREGON CORPORATION)  
2845 NE 56TH AVENUE  
PORTLAND, OR 97213

FOR: BOOKS IN THE FIELD OF CHILDREN'S EDUCATION AND ENTERTAINMENT, IN CLASS 16 (U.S. CLS. 2, 5, 22, 23, 29, 37, 38 AND 50).

FIRST USE 9-9-2006; IN COMMERCE 9-9-2006.

FOR: PLACE MATS NOT OF PAPER, IN CLASS 24 (U.S. CLS. 42 AND 50).

FIRST USE 9-11-2005; IN COMMERCE 12-20-2005.

THE COLOR(S) BEIGE, GREEN, BLACK, WHITE, AND RED IS/ARE CLAIMED AS A FEATURE OF THE MARK.

THE MARK CONSISTS OF TWO STYLIZED PIG FACES AND THE WORDS "PERRY & PENNY'S", ALL WITHIN A TRIANGLE. THE COLOR BEIGE APPEARS IN BOTH PIG'S FACES AND ON THE OUTER PORTION OF THE WORDS "PERRY" AND "PENNY'S". THE COLOR GREEN APPEARS WITHIN THE TRIANGLE AND THE WITHIN THE AMPERSAND. THE COLOR BLACK APPEARS WITHIN THE WORDS "PERRY" AND "PENNY'S" AND ON THE OUTER LINING OF BOTH PIGS. THE COLOR WHITE APPEARS IN THE PIG'S BIBS, AND THE COLOR RED APPEARS IN THE PIG'S BOW.

SN 78-685,011, FILED 8-3-2005.

DAVID COLLIER, EXAMINING ATTORNEY

**Int. Cl.: 39**

**Prior U.S. Cls.: 100 and 105**

**United States Patent and Trademark Office**

**Reg. No. 3,506,464**

**Registered Sep. 23, 2008**

**SERVICE MARK  
PRINCIPAL REGISTER**

**ANEW**

ASSET NETWORK FOR EDUCATION WORLD-  
WIDE, INC. (CALIFORNIA CORPORATION)  
115 W. CALIFORNIA BLVD., #552  
PASADENA, CA 91105

FOR: COLLECTION, WAREHOUSING, DELIV-  
ERY AND SETUP OF SURPLUS ASSETS IN THE  
NATURE OF INTERIOR FURNISHING, LIGHT  
FIXTURES, FURNITURE, COMPUTER EQUIP-  
MENT, VOCATIONS AND TRAINING TOOLS  
EQUIPMENT, AND CLASSROOM AND VOCATION-  
AL SUPPLIES THEREFOR, IN CLASS 39 (U.S. CLS.  
100 AND 105).

FIRST USE 12-0-2005; IN COMMERCE 12-0-2005.

THE MARK CONSISTS OF STANDARD CHAR-  
ACTERS WITHOUT CLAIM TO ANY PARTICULAR  
FONT, STYLE, SIZE, OR COLOR.

SN 78-685,134, FILED 8-3-2005.

AISHA CLARKE, EXAMINING ATTORNEY

**Int. Cl.: 28**

**Prior U.S. Cls.: 22, 23, 38, and 50**

**United States Patent and Trademark Office**

**Reg. No. 3,506,465**

**Registered Sep. 23, 2008**

**TRADEMARK  
PRINCIPAL REGISTER**

**DEIDRE**

MATTEL, INC. (DELAWARE CORPORATION)  
M1-1518  
333 CONTINENTAL BLVD.  
EL SEGUNDO, CA 902455012

FOR: TOYS, GAMES AND PLAYTHINGS, NAME-  
LY, DOLLS, DOLL CLOTHING AND DOLL ACCES-  
SORIES, TOY FIGURES AND ACCESSORIES  
THEREFOR, IN CLASS 28 (U.S. CLS. 22, 23, 38 AND  
50).

FIRST USE 6-24-2008; IN COMMERCE 6-24-2008.

THE MARK CONSISTS OF STANDARD CHAR-  
ACTERS WITHOUT CLAIM TO ANY PARTICULAR  
FONT, STYLE, SIZE, OR COLOR.

SN 78-685,135, FILED 8-3-2005.

AISHA CLARKE, EXAMINING ATTORNEY

**Int. Cl.: 3**

**Prior U.S. Cls.: 1, 4, 6, 50, 51, and 52**

**United States Patent and Trademark Office**

**Reg. No. 3,506,466**

**Registered Sep. 23, 2008**

**TRADEMARK  
PRINCIPAL REGISTER**

**FIRST IMPRESSIONS**

ALENA, LLC (DELAWARE LIMITED LIABILITY  
COMPANY)  
21015 CACTUS CLIFF  
SAN ANTONIO, TX 78258

THE MARK CONSISTS OF STANDARD CHAR-  
ACTERS WITHOUT CLAIM TO ANY PARTICULAR  
FONT, STYLE, SIZE, OR COLOR.

FOR: NON-MEDICATED LIP CARE PREPARA-  
TIONS, IN CLASS 3 (U.S. CLS. 1, 4, 6, 50, 51 AND 52).

SN 78-686,902, FILED 8-5-2005.

FIRST USE 8-31-2005; IN COMMERCE 8-31-2005.

JORDAN BAKER, EXAMINING ATTORNEY

**Int. Cls.: 16, 18, 25, and 41**

**Prior U.S. Cls.: 1, 2, 3, 5, 22, 23, 29, 37, 38, 39, 41, 50,  
100, 101, and 107**

**Reg. No. 3,506,467**

**United States Patent and Trademark Office**

**Registered Sep. 23, 2008**

**TRADEMARK  
SERVICE MARK  
PRINCIPAL REGISTER**



VIEJAS BAND OF KUMEYAAY INDIANS (UNITED STATES FEDERALLY-RECOGNIZED INDIAN TRIBE)  
5000 WILLOWS ROAD  
ALPINE, CA 91901

FOR: POSTCARDS; POSTERS; STATIONERY STICKERS, IN CLASS 16 (U.S. CLS. 2, 5, 22, 23, 29, 37, 38 AND 50).

FIRST USE 8-1-1998; IN COMMERCE 8-1-1998.

FOR: LUGGAGE, IN CLASS 18 (U.S. CLS. 1, 2, 3, 22 AND 41).

FIRST USE 8-1-1998; IN COMMERCE 8-1-1998.

FOR: CLOTHING, NAMELY, T-SHIRTS, SHIRTS, AND SCARVES, IN CLASS 25 (U.S. CLS. 22 AND 39).

FIRST USE 8-1-1998; IN COMMERCE 8-1-1998.

FOR: ENTERTAINMENT IN THE NATURE OF LIVE MUSICAL PERFORMANCES, MAGIC SHOWS, LIGHT AND LASER SHOWS, WATER FOUNTAIN PERFORMANCES, DANCE, FIREWORKS DISPLAYS, AND PERSONAL APPEARANCES BY CELEBRITY MOVIE STARS, IN CLASS 41 (U.S. CLS. 100, 101 AND 107).

FIRST USE 8-1-1998; IN COMMERCE 8-1-1998.

OWNER OF U.S. REG. NO. 2,634,121.

THE MARK CONSISTS OF THE WORDS "THE POWER OF NIGHTFIRE" BELOW WHICH IS THREE CRESCENTS AND A SILHOUETTE OF A DANCER SURROUNDED BY FLAMES.

SN 78-691,890, FILED 8-12-2005.

JOHN DALIER, EXAMINING ATTORNEY

**Int. Cl.: 12**

**Prior U.S. Cls.: 19, 21, 23, 31, 35, and 44**

**Reg. No. 3,506,468**

**United States Patent and Trademark Office**

**Registered Sep. 23, 2008**

**TRADEMARK  
PRINCIPAL REGISTER**

**MFX**

INTERTREND LTD. (HONG KONG CORPORATION)  
UNIT 1709 CITICORP CENTRE  
18 WHITEFIELD ROAD  
CAUSEWAY BAY, HONG KONG

FOR: BICYCLE BELLS; BICYCLE FRAMES; BICYCLE HANDLEBAR GRIPS; BICYCLE HORNS; BICYCLE PUMPS; BICYCLE SADDLE COVERS; BICYCLE SADDLES; BICYCLE WATER BOTTLE CAGES; BICYCLE WHEELS; BICYCLES; FRAMES FOR BICYCLES; HANDLEBARS; MOUNTAIN BICYCLES; MUDGUARDS; ROAD RACING BICYCLES; SPOKES FOR BICYCLE WHEELS;

TOURING BICYCLES; WATER BOTTLE HOLDERS FOR BICYCLES; WHEEL RIMS, IN CLASS 12 (U.S. CLS. 19, 21, 23, 31, 35 AND 44).

FIRST USE 6-30-2008; IN COMMERCE 6-30-2008.

THE MARK CONSISTS OF STANDARD CHARACTERS WITHOUT CLAIM TO ANY PARTICULAR FONT, STYLE, SIZE, OR COLOR.

SN 78-693,970, FILED 8-16-2005.

DAVID MILLER, EXAMINING ATTORNEY



**Int. Cl.: 12**

**Prior U.S. Cls.: 19, 21, 23, 31, 35, and 44**

**Reg. No. 3,506,469**

**United States Patent and Trademark Office**

**Registered Sep. 23, 2008**

**TRADEMARK  
PRINCIPAL REGISTER**

**SFX**

INTERTREND LTD. (HONG KONG CORPORATION)  
UNIT 1709 CITICORP CENTRE  
18 WHITEFIELD ROAD  
CAUSEWAY BAY, HONG KONG

FOR: BICYCLE BELLS; BICYCLE FRAMES; BICYCLE HANDLEBAR GRIPS; BICYCLE HORNS; BICYCLE PUMPS; BICYCLE SADDLE COVERS; BICYCLE SADDLES; BICYCLE WATER BOTTLE CAGES; BICYCLE WHEELS; BICYCLES; FRAMES FOR BICYCLES; HANDLEBARS; MOUNTAIN BICYCLES; MUDGUARDS; ROAD RACING BICYCLES; SPOKES FOR BICYCLE WHEELS;

TOURING BICYCLES; WATER BOTTLE HOLDERS FOR BICYCLES; WHEEL RIMS, IN CLASS 12 (U.S. CLS. 19, 21, 23, 31, 35 AND 44).

FIRST USE 6-30-2008; IN COMMERCE 6-30-2008.

THE MARK CONSISTS OF STANDARD CHARACTERS WITHOUT CLAIM TO ANY PARTICULAR FONT, STYLE, SIZE, OR COLOR.

SN 78-693,976, FILED 8-16-2005.

COLLEEN KEARNEY, EXAMINING ATTORNEY

**Int. Cl.: 17**

**Prior U.S. Cls.: 1, 5, 12, 13, 35, and 50**

**Reg. No. 3,506,470**

**United States Patent and Trademark Office**

**Registered Sep. 23, 2008**

---

**TRADEMARK  
PRINCIPAL REGISTER**

**EASY ON YOU AND YOUR  
ENERGY BILLS**

OWENS CORNING INTELLECTUAL CAPITAL,  
LLC (DELAWARE LIMITED LIABILITY COM-  
PANY)  
ONE OWENS CORNING PARKWAY  
TOLEDO, OH 43659

THE MARK CONSISTS OF STANDARD CHAR-  
ACTERS WITHOUT CLAIM TO ANY PARTICULAR  
FONT, STYLE, SIZE, OR COLOR.

FOR: BUILDING INSULATION, IN CLASS 17 (U.S.  
CLS. 1, 5, 12, 13, 35 AND 50).

SN 78-694,229, FILED 8-17-2005.

FIRST USE 5-31-2007; IN COMMERCE 5-31-2007.

LINDA POWELL, EXAMINING ATTORNEY

**Int. Cls.: 16, 35, 36, and 41**

**Prior U.S. Cls.: 2, 5, 22, 23, 29, 37, 38, 50, 100, 101, 102, and 107**

**Reg. No. 3,506,471**

**United States Patent and Trademark Office**

**Registered Sep. 23, 2008**

**TRADEMARK  
SERVICE MARK  
PRINCIPAL REGISTER**

**POWER TO END STROKE**

AMERICAN HEART ASSOCIATION, INC. (NEW YORK CORPORATION)  
7272 GREENVILLE AVENUE  
DALLAS, TX 752314596

FOR: PRINTED EDUCATIONAL MATERIALS, NAMELY, BOOKS, PAMPHLETS, BROCHURES, BOOKLETS, IN THE FIELD OF AWARENESS OF STROKE IN AFRICAN AMERICANS AND THE RISK FACTORS ASSOCIATE THEREWITH, IN CLASS 16 (U.S. CLS. 2, 5, 22, 23, 29, 37, 38 AND 50).

FIRST USE 11-30-2005; IN COMMERCE 11-30-2005.

FOR: PROMOTING PUBLIC AWARENESS OF THE NEED TO EDUCATE AFRICAN-AMERICANS REGARDING THE RISK AND PREVENTION OF STROKE, IN CLASS 35 (U.S. CLS. 100, 101 AND 102).

FIRST USE 11-30-2005; IN COMMERCE 11-30-2005.

FOR: CHARITABLE FUNDRAISING SERVICES FOR PROMOTING RESEARCH, EDUCATION AND OTHER ACTIVITIES RELATING TO THE PREVENTION OR REDUCTION OF CARDIOVASCULAR DISEASE AND STROKE, IN CLASS 36 (U.S. CLS. 100, 101 AND 102).

FIRST USE 11-30-2006; IN COMMERCE 11-30-2006.

FOR: EDUCATION SERVICES, NAMELY, CONDUCTING SEMINARS IN CONNECTION WITH AFRICAN-AMERICAN'S RISK OF STROKE AND ITS PREVENTION; CONTINUING MEDICAL EDUCATION FOR HEALTHCARE PROFESSIONALS, CONDUCTING EDUCATION PROGRAMS FOR PATIENTS IN THE FIELD OF CARDIOVASCULAR DISEASE AND STROKE, IN CLASS 41 (U.S. CLS. 100, 101 AND 107).

FIRST USE 4-30-2006; IN COMMERCE 4-30-2006.

THE MARK CONSISTS OF STANDARD CHARACTERS WITHOUT CLAIM TO ANY PARTICULAR FONT, STYLE, SIZE, OR COLOR.

OWNER OF U.S. REG. NOS. 2,549,640 AND 2,605,613.

SN 78-696,264, FILED 8-19-2005.

TIMOTHY FINNEGAN, EXAMINING ATTORNEY

**Int. Cl.: 25**

**Prior U.S. Cls.: 22 and 39**

**United States Patent and Trademark Office**

**Reg. No. 3,506,472**

**Registered Sep. 23, 2008**

**TRADEMARK  
PRINCIPAL REGISTER**



SHERRARD, TROY, D (UNITED STATES INDIVIDUAL)  
1225 BENNETT AVE., APT. 205  
LONG BEACH, CA 90804 AND  
PAPADOPOULOS, PANAYIOTIS, C (CYPRUS INDIVIDUAL)  
5551 E. 23RD ST. APT. 18  
LONG BEACH, CA 90815

LONG-SLEEVED T-SHIRTS; SHORT-SLEEVED SHIRTS; SLEEP SHIRTS; SPORT SHIRTS; SPORTS SHIRTS; SPORTS SHIRTS WITH SHORT SLEEVES; SWEAT SHIRTS; T-SHIRTS; WIND SHIRTS, IN CLASS 25 (U.S. CLS. 22 AND 39).

FIRST USE 2-8-2007; IN COMMERCE 4-8-2008.

FOR: CAMP SHIRTS; GOLF SHIRTS; KNIT SHIRTS; NIGHT SHIRTS; OPEN-NECKED SHIRTS; PIQUET SHIRTS; POLO SHIRTS; SHIRT FRONTS; SHIRTS; SHIRTS FOR SUITS; SHORT-SLEEVED OR

SN 78-697,945, FILED 8-22-2005.

CHERYL CLAYTON, EXAMINING ATTORNEY

**Int. Cl.: 25**

**Prior U.S. Cls.: 22 and 39**

**United States Patent and Trademark Office**

**Reg. No. 3,506,473**

**Registered Sep. 23, 2008**

**TRADEMARK  
PRINCIPAL REGISTER**

The image shows the trademark '07' in a bold, stylized, black font. The '0' is a simple, rounded shape with a vertical bar through the center. The '7' is more complex, with a curved top and a sharp, pointed bottom right corner.

JACK DANIEL'S PROPERTIES, INC. (DELA-  
WARE CORPORATION)  
SUITE 528  
4040 CIVIC CENTER DRIVE  
SAN RAFAEL, CA 94903

FOR: HEADGEAR, NAMELY, CAPS, HATS, VI-  
SORS, BANDANNAS; CLOTHING, NAMELY, T-  
SHIRTS, BASEBALL SHIRTS, POLO SHIRTS,  
SHIRTS, TOPS, TANK TOPS, SWEATSHIRTS, JACK-  
ETS, LEATHER JACKETS, IN CLASS 25 (U.S. CLS. 22  
AND 39).

FIRST USE 2-1-2005; IN COMMERCE 2-1-2005.

OWNER OF U.S. REG. NOS. 2,418,109 AND  
2,643,214.

THE COLOR(S) BLACK AND WHITE IS/ARE  
CLAIMED AS A FEATURE OF THE MARK.

THE MARK CONSISTS OF THE STYLIZED NUM-  
BERS "0" AND "7" IN BLACK ON A WHITE BACK-  
GROUND.

SN 78-698,641, FILED 8-23-2005.

MICHAEL SOUDERS, EXAMINING ATTORNEY

**Int. Cl.: 7**

**Prior U.S. Cls.: 13, 19, 21, 23, 31, 34, and 35**

**Reg. No. 3,506,474**

**United States Patent and Trademark Office**

**Registered Sep. 23, 2008**

---

**TRADEMARK  
PRINCIPAL REGISTER**

# REGIS

EDWARDS VACUUM, INC. (DELAWARE CORPORATION)  
301 BALLARDVALE STREET  
WILMINGTON, MA 01887

FOR: VACUUM APPARATUS AND VACUUM MACHINES FOR USE IN INDUSTRY AND RESEARCH, NAMELY, VACUUM PUMPS AND PARTS AND FITTINGS THEREFORE, EXCLUDING PETROL, VENDING, SURGICAL, OR VEHICLE PUMPS, IN CLASS 7 (U.S. CLS. 13, 19, 21, 23, 31, 34 AND 35).

FIRST USE 3-26-2008; IN COMMERCE 3-26-2008.

THE MARK CONSISTS OF STANDARD CHARACTERS WITHOUT CLAIM TO ANY PARTICULAR FONT, STYLE, SIZE, OR COLOR.

THE NAME REGIS DOES NOT IDENTIFY A LIVING INDIVIDUAL.

SN 78-705,024, FILED 9-1-2005.

PAULA MAHONEY, EXAMINING ATTORNEY

**Int. Cl.: 28**

**Prior U.S. Cls.: 22, 23, 38, and 50**

**United States Patent and Trademark Office**

**Reg. No. 3,506,475**

**Registered Sep. 23, 2008**

**TRADEMARK  
PRINCIPAL REGISTER**

**C3**

TIPPMANN SPORTS, LLC (DELAWARE LIMITED LIABILITY COMPANY)  
2955 ADAMS CENTER ROAD  
FT. WAYNE, IN 46803

FOR: PAINTBALL MARKERS AND PARTS AND ACCESSORIES, NAMELY, TRIGGER UPGRADES, PAINTBALL MARKER PERFORMANCE UPGRADES, NAMELY, TRIGGERS, GRIPS AND AMMUNITION FEEDERS, EXPANSION CHAMBERS, LOW PRESSURE SYSTEMS COMPRISING PRIMARILY OF VOLUMIZERS, REAR BOLTS AND REDUCED TENSION DRIVE SPRINGS, AND ELECTRONICS; PAINTBALL MARKER COSMETIC UPGRADES, NAMELY, STOCKS, BARRELS, AND SHROUDS; PAINTBALL AMMUNITION, NAMELY,

PAINTBALLS; PAINTBALL MARKER POWER SYSTEMS COMPRISING TANK ADAPTORS, REGULATORS, GAS LINES, TANKS, AND VALVES, IN CLASS 28 (U.S. CLS. 22, 23, 38 AND 50).

FIRST USE 10-17-2007; IN COMMERCE 10-17-2007.

THE MARK CONSISTS OF STANDARD CHARACTERS WITHOUT CLAIM TO ANY PARTICULAR FONT, STYLE, SIZE, OR COLOR.

SN 78-705,084, FILED 9-1-2005.

SARA THOMAS, EXAMINING ATTORNEY

**Int. Cls.: 1 and 5**

**Prior U.S. Cls.: 1, 5, 6, 10, 18, 26, 44, 46, 51, and 52**

**United States Patent and Trademark Office**

**Reg. No. 3,506,476**

**Registered Sep. 23, 2008**

**TRADEMARK  
PRINCIPAL REGISTER**

**SALTIGO**

LANXESS DEUTSCHLAND GMBH (FED REP  
GERMANY LIMITED LIABILITY COMPANY)  
D-51369  
LEVERKUSEN, FED REP GERMANY

FOR: FULL LINE OF CHEMICALS USED IN  
INDUSTRY, AS WELL AS AGRICULTURE, HORTI-  
CULTURE AND FORESTRY, IN CLASS 1 (U.S. CLS.  
1, 5, 6, 10, 26 AND 46).

FIRST USE 2-0-2006; IN COMMERCE 2-0-2006.

FOR: PHARMACEUTICAL AND VETERINARY  
PREPARATIONS, NAMELY, PHARMACEUTICAL

AGENTS FOR THE DEFENSE AGAINST INSECTS;  
INSECT REPELLENTS, IN CLASS 5 (U.S. CLS. 6, 18,  
44, 46, 51 AND 52).

FIRST USE 2-0-2006; IN COMMERCE 2-0-2006.

THE MARK CONSISTS OF STANDARD CHAR-  
ACTERS WITHOUT CLAIM TO ANY PARTICULAR  
FONT, STYLE, SIZE, OR COLOR.

SN 78-707,032, FILED 9-6-2005.

ANDREA SAUNDERS, EXAMINING ATTORNEY



**Int. Cl.: 9**

**Prior U.S. Cls.: 21, 23, 26, 36, and 38**

**United States Patent and Trademark Office**

**Reg. No. 3,506,477**

**Registered Sep. 23, 2008**

**TRADEMARK  
PRINCIPAL REGISTER**

**HOTSTART**

MICROSOFT CORPORATION (WASHINGTON  
CORPORATION)  
ONE MICROSOFT WAY  
REDMOND, WA 980526399

THE MARK CONSISTS OF STANDARD CHAR-  
ACTERS WITHOUT CLAIM TO ANY PARTICULAR  
FONT, STYLE, SIZE, OR COLOR.

FOR: OPERATING SYSTEM SOFTWARE AND  
COMPUTER SOFTWARE FOR INITIALIZING DI-  
GITAL MEDIA DEVICES AND SOFTWARE, IN  
CLASS 9 (U.S. CLS. 21, 23, 26, 36 AND 38).

SN 78-713,209, FILED 9-14-2005.

FIRST USE 5-2-2006; IN COMMERCE 5-2-2006.

DEIRDRE ROBERTSON, EXAMINING ATTORNEY

**Int. Cls.: 11 and 21**

**Prior U.S. Cls.: 2, 13, 21, 23, 29, 30, 31, 33, 34, 40, and 50**

**Reg. No. 3,506,478**

**United States Patent and Trademark Office**

**Registered Sep. 23, 2008**

---

**TRADEMARK  
PRINCIPAL REGISTER**

**SMARTAG**

COOKTEK, LLC (ILLINOIS LIMITED LIABILITY COMPANY)  
810 W. WASHINGTON BLVD.  
CHICAGO, IL 60607

FOR: ELECTROMAGNETIC INDUCTION COOK-TOPS; INDUCTION CHARGERS FOR USE WITH ELECTROMAGNETIC INDUCIBLE PELLETS AND VAPOR VENT BAGS , IN CLASS 11 (U.S. CLS. 13, 21, 23, 31 AND 34).

FIRST USE 1-31-2006; IN COMMERCE 1-31-2006.

FOR: MAGNETICALLY INDUCIBLE COOKWARE, NAMELY, POTS AND PANS, IN CLASS 21 (U.S. CLS. 2, 13, 23, 29, 30, 33, 40 AND 50).

FIRST USE 1-31-2006; IN COMMERCE 1-31-2006.

THE MARK CONSISTS OF STANDARD CHARACTERS WITHOUT CLAIM TO ANY PARTICULAR FONT, STYLE, SIZE, OR COLOR.

SN 78-714,953, FILED 9-16-2005.

JENNIFER DIXON, EXAMINING ATTORNEY

**Int. Cls.: 5 and 22**

**Prior U.S. Cls.: 1, 2, 6, 7, 18, 19, 22, 42, 44, 46, 50, 51,  
and 52**

**Reg. No. 3,506,479**

**United States Patent and Trademark Office**

**Registered Sep. 23, 2008**

**TRADEMARK  
PRINCIPAL REGISTER**

**DESTINATION ADVENTURE**

WISCONSIN PHARMACAL COMPANY, LLC  
(WISCONSIN LIMITED LIABILITY COMPAN-  
NY)  
ONE PHARMACAL WAY  
JACKSON, WI 53037

FOR: INSECT REPELLANT, INSECT BITE RE-  
LIEF MEDICATION, MEDICATED SUNBURN LO-  
TION, AND PERSONAL MEDICAL KITS  
COMPRISED PRIMARILY OF WOUND AND BLIS-  
TER TREATMENT PREPARATIONS, BANDAGES,  
AND PAIN RELIEF MEDICATIONS, IN CLASS 5  
(U.S. CLS. 6, 18, 44, 46, 51 AND 52).

FIRST USE 3-31-2006; IN COMMERCE 3-31-2006.

FOR: CAMPING SUPPLIES, NAMELY, TENTS  
AND PARTS THEREFORE, IN CLASS 22 (U.S. CLS.  
1, 2, 7, 19, 22, 42 AND 50).

FIRST USE 3-31-2006; IN COMMERCE 3-31-2006.

THE MARK CONSISTS OF STANDARD CHAR-  
ACTERS WITHOUT CLAIM TO ANY PARTICULAR  
FONT, STYLE, SIZE, OR COLOR.

SN 78-715,845, FILED 9-19-2005.

LOURDES AYALA, EXAMINING ATTORNEY

**Int. Cl.: 9**

**Prior U.S. Cls.: 21, 23, 26, 36, and 38**

**United States Patent and Trademark Office**

**Reg. No. 3,506,480**

**Registered Sep. 23, 2008**

**TRADEMARK  
PRINCIPAL REGISTER**

**GET SMART! ASK FOR  
INTELLIGENCE**

PIONEER MAGNETICS, INC. (CALIFORNIA CORPORATION)  
1745 BERKELEY STREET  
SANTA MONICA, CA 90404

FOR: POWER DISTRIBUTION SYSTEMS, MOBILE AND PORTABLE POWER SYSTEMS, AND TELECOMMUNICATIONS POWER SYSTEMS COMPRISED OF POWER REGULATORS, TRANSFORMERS, DISTRIBUTORS, RECTIFIERS, COMPUTER COMPONENTS, COMPUTER NETWORKS AND COMPUTER PERIPHERAL EQUIPMENT; POWER RECTIFIERS, REMOTE MONITORING AND SHUT-DOWN SYSTEMS COMPRISED OF POWER REGULATORS, TRANSFORMERS, DISTRIBUTORS, RECTIFIERS, COMPUTER COMPONENTS, COMPUTER NETWORKS AND COMPUTER PERIPHER-

AL EQUIPMENT; ALL FOR USE IN CONJUNCTION WITH OR IN THE FURTHER ASSEMBLY OF ELECTRONIC EQUIPMENT, MODULAR POWER SUPPLIES AND COMPUTERS AND IN CONTRACT MANUFACTURING ACTIVITIES, IN CLASS 9 (U.S. CLS. 21, 23, 26, 36 AND 38).

FIRST USE 1-31-2008; IN COMMERCE 1-31-2008.

THE MARK CONSISTS OF STANDARD CHARACTERS WITHOUT CLAIM TO ANY PARTICULAR FONT, STYLE, SIZE, OR COLOR.

SN 78-716,483, FILED 9-20-2005.

JEFFERY COWARD, EXAMINING ATTORNEY

Int. Cl.: 30

Prior U.S. Cl.: 46

United States Patent and Trademark Office

Reg. No. 3,506,481

Registered Sep. 23, 2008

TRADEMARK  
PRINCIPAL REGISTER

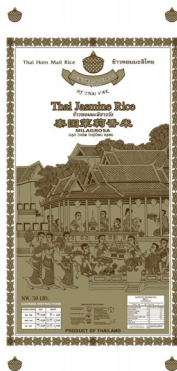

ASIA INTER RICE CO., LTD. (THAILAND CORPORATION)  
59 MOO 12, SOI MITTRAPAP  
BANGNA-TRAD ROAD, BANGKEAW, BANGPLEE  
SAMUTPRAKARN, THAILAND

FOR: RICE, IN CLASS 30 (U.S. CL. 46).

FIRST USE 0-0-1997; IN COMMERCE 0-0-2005.

NO CLAIM IS MADE TO THE EXCLUSIVE RIGHT TO USE THE NON-LATIN CHARACTERS THAT MEAN "THAI HOM MALI RICE", "PREMIUM THAI JASMINE RICE WITH ROYAL PREMIUM QUALITY", AND "THAI JASMINE RICE" APART FROM THE MARK AS SHOWN; AND NO CLAIM IS MADE TO THE EXCLUSIVE RIGHT TO USE "THAI HOM MALI RICE", "BRAND", "SINCE 1955", "BY THAI VAR", "THAI JASMINE RICE WITH ROYAL PREMIUM QUALITY", "MILAGROSA", "NW. 50 LBS.", "PRODUCT OF THAILAND", AND THE COOKING INSTRUCTIONS AND NUTRITION INFORMATION, APART FROM THE MARK AS SHOWN.

THE COLOR(S) BROWN AND WHITE IS/ARE CLAIMED AS A FEATURE OF THE MARK.

THE DESIGNS AND WORDING IN THE MARK ARE VARIOUS SHADES OF THE BROWN. THE SKY AREA AND AREA BEHIND THE COOKING IN-

STRUCTIONS AND NUTRITIONAL INFORMATION ARE WHITE.

THE FOREIGN WORDING IN THE MARK TRANSLATES INTO ENGLISH AS BENCHARONG, WHICH MEANS THE FIVE PRIMARY COLORS, RED, BLUE (OR GREEN), YELLOW, BLACK, AND WHITE.

THE NON-LATIN CHARACTERS IN THE UPPER RIGHT CORNER OF THE DRAWING TRANSLITERATE TO KHAO-HOM-MA-LI-THAI, WHICH MEANS THAI HOM MALI RICE IN ENGLISH. THE NON-LATIN, THAI CHARACTERS BENEATH THE WORDING "THAI JASMINE RICE" TRANSLITERATE TO KHAO-HOME-MA-LI-CHAO-WANG, WHICH MEANS THAI JASMINE RICE WITH ROYAL PREMIUM QUALITY IN ENGLISH. THE NON-LATIN, CHINESE CHARACTERS ABOVE THE WORD "MILAGROSA" TRANSLITERATE TO TAI-GUO-MO-LI-ZIANG-MI, WHICH MEANS THAI JASMINE RICE IN ENGLISH. "BY THAI VAR" REFERS TO THE DISTRIBUTOR OF THE GOODS SOLD UNDER THE MARK.

SN 78-717,097, FILED 9-20-2005.

ALICE SUE CARRUTHERS, EXAMINING ATTORNEY

**Int. Cl.: 20**

**Prior U.S. Cls.: 2, 13, 22, 25, 32, and 50**

**Reg. No. 3,506,482**

**United States Patent and Trademark Office**

**Registered Sep. 23, 2008**

**TRADEMARK  
PRINCIPAL REGISTER**

**NANOPATH**

STATLAB MEDICAL PRODUCTS, INC. (TEXAS  
CORPORATION)  
106 HILLSIDE DRIVE  
LEWISVILLE, TX 75057

FIRST USE 5-0-2008; IN COMMERCE 5-0-2008.

FOR: NON-METAL CONTAINERS FOR USE IN  
THE FIELDS OF BIO-ENGINEERING, PHARMA-  
CEUTICAL TECHNOLOGY, MEDICAL TECHNOL-  
OGY, PATHOLOGY, CYTOLOGY, AND  
HISTOLOGY , IN CLASS 20 (U.S. CLS. 2, 13, 22, 25,  
32 AND 50).

THE MARK CONSISTS OF STANDARD CHAR-  
ACTERS WITHOUT CLAIM TO ANY PARTICULAR  
FONT, STYLE, SIZE, OR COLOR.

SN 78-722,686, FILED 9-28-2005.

JORDAN BAKER, EXAMINING ATTORNEY

**Int. Cl.: 18**

**Prior U.S. Cls.: 1, 2, 3, 22, and 41**

**Reg. No. 3,506,483**

**United States Patent and Trademark Office**

**Registered Sep. 23, 2008**

---

**TRADEMARK  
PRINCIPAL REGISTER**

**VERTEX**

GEM GROUP, INC., THE (MASSACHUSETTS CORPORATION), DBA GEMLINE,  
9 INTERNATIONAL WAY  
LAWRENCE, MA 01843

THE MARK CONSISTS OF STANDARD CHARACTERS WITHOUT CLAIM TO ANY PARTICULAR FONT, STYLE, SIZE, OR COLOR.

FOR: DUFFEL BAGS, TOTE BAGS, SPORTS BAGS, BRIEF CASES, HANDBAGS, PORTFOLIOS, PADFOLIOS AND BACKPACKS, IN CLASS 18 (U.S. CLS. 1, 2, 3, 22 AND 41).

SN 78-723,362, FILED 9-29-2005.

FIRST USE 1-1-2008; IN COMMERCE 1-1-2008.

PAUL F. GAST, EXAMINING ATTORNEY

**Int. Cl.: 5**

**Prior U.S. Cls.: 6, 18, 44, 46, 51, and 52**

**Reg. No. 3,506,484**

**United States Patent and Trademark Office**

**Registered Sep. 23, 2008**

**TRADEMARK  
PRINCIPAL REGISTER**

**JOINT MATRIX**

CYTOSPORT, INC. (CALIFORNIA CORPORATION)  
4795 INDUSTRIAL WAY  
BENICIA, CA 94510

FOR: DIETARY AND NUTRITIONAL SUPPLEMENT; POWDERED NUTRITIONAL SUPPLEMENT FOR ADDING LIQUID BEVERAGE, IN CLASS 5 (U.S. CLS. 6, 18, 44, 46, 51 AND 52).

FIRST USE 7-15-1998; IN COMMERCE 7-15-1998.

THE MARK CONSISTS OF STANDARD CHARACTERS WITHOUT CLAIM TO ANY PARTICULAR FONT, STYLE, SIZE, OR COLOR.

NO CLAIM IS MADE TO THE EXCLUSIVE RIGHT TO USE "JOINT", APART FROM THE MARK AS SHOWN.

SN 78-723,529, FILED 9-29-2005.

CHERYL CLAYTON, EXAMINING ATTORNEY



**Int. Cl.: 10**

**Prior U.S. Cls.: 26, 39, and 44**

**United States Patent and Trademark Office**

**Reg. No. 3,506,485**

**Registered Sep. 23, 2008**

**TRADEMARK  
PRINCIPAL REGISTER**



**SURGE**  
MEDICAL SOLUTIONS, LLC

SURGE MEDICAL SOLUTIONS LLC (MICHIGAN  
LIMITED LIABILITY COMPANY)  
44 EAST 8TH STREET, SUITE 210  
HOLLAND, MI 49423

FOR: MEDICAL DEVICES, NAMELY, PATIENT  
TRANSPORT PADS FOR USE WITH STRETCHERS,  
TUBE SETS CONSISTING OF PLASTIC TUBING  
AND FITTINGS FOR CONNECTING THE TUBING  
FOR BLOOD TRANSFER TO PATIENT, AND  
HEART TISSUE VALVE WASHERS, IN CLASS 10  
(U.S. CLS. 26, 39 AND 44).

FIRST USE 3-3-2006; IN COMMERCE 3-24-2006.

NO CLAIM IS MADE TO THE EXCLUSIVE  
RIGHT TO USE "MEDICAL SOLUTIONS, LLC",  
APART FROM THE MARK AS SHOWN.

THE COLOR(S) BLUE AND GRAY IS/ARE  
CLAIMED AS A FEATURE OF THE MARK.

THE MARK CONSISTS OF A BLUE SQUARE  
WITH GRAY WORDING AND A GRAY "S" WITHIN  
THE BLUE SQUARE.

SN 78-724,290, FILED 9-30-2005.

MICHELLE DUBOIS, EXAMINING ATTORNEY

Int. Cl.: 36

Prior U.S. Cls.: 100, 101, and 102

United States Patent and Trademark Office

Reg. No. 3,506,486

Registered Sep. 23, 2008

**SERVICE MARK  
PRINCIPAL REGISTER**



DELACH, MIKE (UNITED STATES INDIVIDUAL)  
118 BREESE TERRACE  
MADISON, WI 53726

FOR: FINANCIAL ANALYSIS AND CONSULTATION, IN CLASS 36 (U.S. CLS. 100, 101 AND 102).

FIRST USE 1-1-2007; IN COMMERCE 1-1-2007.

NO CLAIM IS MADE TO THE EXCLUSIVE RIGHT TO USE "SECURITY ANALYSIS INCORPORATED", APART FROM THE MARK AS SHOWN.

THE COLOR(S) RED, BLUE, GRAY, BLACK, SILVER, COPPER AND GOLD IS/ARE CLAIMED AS A FEATURE OF THE MARK.

THE MARK CONSISTS OF A GLOBE WITH THE COLORS BLUE AND GRAY, WITH A COMPASS OVERLAID. THE COMPASS CONTAINS BLACK LINING AND LETTERS WITH A SILVER OUTER CORE, AND COPPER INNER CORE, THE COMPASS POINTS HAVE RED TIPS AND RED AND SILVER CENTERS; THE BACKGROUND OF THE DRAWING IS GOLD AND ALL LETTERING APPEARS IN BLACK.

THE FOREIGN WORDING IN THE MARK TRANSLATES INTO ENGLISH AS ALWAYS CAREFUL WITH MONEY AND RESOURCES.

SN 78-724,684, FILED 10-1-2005.

LINDA MICKLEBURGH, EXAMINING ATTORNEY

**Int. Cl.: 42**

**Prior U.S. Cls.: 100 and 101**

**United States Patent and Trademark Office**

**Reg. No. 3,506,487**

**Registered Sep. 23, 2008**

**SERVICE MARK  
PRINCIPAL REGISTER**

**FOLX**

FOLX SYSTEMS, INC. (PENNSYLVANIA CORPORATION)  
103 ROYALWOOD DRIVE  
EBENSBURG, PA 15931

FOR: APPLICATION SERVICE PROVIDER (ASP)  
FEATURING SOFTWARE IN THE FIELD OF HUMAN RESOURCE AND SERVICES MANAGEMENT, APPOINTMENT SCHEDULING, AND PLANNING, IN CLASS 42 (U.S. CLS. 100 AND 101).

FIRST USE 11-12-2007; IN COMMERCE 3-4-2008.

THE MARK CONSISTS OF STANDARD CHARACTERS WITHOUT CLAIM TO ANY PARTICULAR FONT, STYLE, SIZE, OR COLOR.

SN 78-728,921, FILED 10-7-2005.

MICHAEL GAAFAR, EXAMINING ATTORNEY

Int. Cls.: 16 and 25

Prior U.S. Cls.: 2, 5, 22, 23, 29, 37, 38, 39, and 50

United States Patent and Trademark Office

Reg. No. 3,506,488

Registered Sep. 23, 2008

TRADEMARK  
PRINCIPAL REGISTER



VAZQUEZ, ANTHONY (UNITED STATES INDIVIDUAL)

19726 ARMINTA STREET  
WINNETKA, CA 91306 AND

VAZQUEZ, ALBERT (UNITED STATES INDIVIDUAL)

19726 ARMINTA STREET  
WINNETKA, CA 91306 AND

VAZQUEZ, ANGIE (UNITED STATES INDIVIDUAL)

19726 ARMINTA STREET  
WINNETKA, CA 91306

FIRST USE 9-1-2007; IN COMMERCE 9-1-2007.

FOR: CLOTHING, NAMELY, T-SHIRTS, HATS AND WOMEN'S UNDERWEAR, IN CLASS 25 (U.S. CLS. 22 AND 39).

FIRST USE 9-1-2007; IN COMMERCE 9-1-2007.

SN 78-731,106, FILED 10-11-2005.

FOR: STICKERS, IN CLASS 16 (U.S. CLS. 2, 5, 22, 23, 29, 37, 38 AND 50).

AMOS T. MATTHEWS, JR., EXAMINING ATTORNEY

**Int. Cl.: 14**

**Prior U.S. Cls.: 2, 27, 28, and 50**

**United States Patent and Trademark Office**

**Reg. No. 3,506,489**

**Registered Sep. 23, 2008**

**TRADEMARK  
PRINCIPAL REGISTER**

**SEAH**

SEAH, LLC (FLORIDA LIMITED LIABILITY  
COMPANY)

820 E. COCO PLUM CIRCLE

PLANTATION, FL 333243706

FOR: JEWELRY, NAMELY, WATCHES, IN CLASS  
14 (U.S. CLS. 2, 27, 28 AND 50).

FIRST USE 4-1-2008; IN COMMERCE 4-1-2008.

THE MARK CONSISTS OF STANDARD CHAR-  
ACTERS WITHOUT CLAIM TO ANY PARTICULAR  
FONT, STYLE, SIZE, OR COLOR.

THE FOREIGN WORDING IN THE MARK  
TRANSLATES INTO ENGLISH AS O'CLOCK AND/  
OR OF CLOCK AND/OR HOUR.

SN 78-735,419, FILED 10-18-2005.

BARBARA A. GOLD, EXAMINING ATTORNEY

**Int. Cl.: 44**

**Prior U.S. Cls.: 100 and 101**

**United States Patent and Trademark Office**

**Reg. No. 3,506,490**

**Registered Sep. 23, 2008**

**SERVICE MARK  
PRINCIPAL REGISTER**

**24 HOUR AUGMENTATION**

THRESHOLD RESEARCH & DEVELOPMENT,  
INC. (NEVADA CORPORATION)  
SUITE 300  
2801 LEMMON AVENUE  
DALLAS, TX 75204

FOR: MEDICAL SERVICES, IN CLASS 44 (U.S.  
CLS. 100 AND 101).

FIRST USE 4-0-2008; IN COMMERCE 4-0-2008.

THE MARK CONSISTS OF STANDARD CHAR-  
ACTERS WITHOUT CLAIM TO ANY PARTICULAR  
FONT, STYLE, SIZE, OR COLOR.

NO CLAIM IS MADE TO THE EXCLUSIVE  
RIGHT TO USE "AUGMENTATION", APART  
FROM THE MARK AS SHOWN.

SN 78-743,373, FILED 10-31-2005.

REBECCA EISINGER, EXAMINING ATTORNEY

**Int. Cl.: 44**

**Prior U.S. Cls.: 100 and 101**

**United States Patent and Trademark Office**

**Reg. No. 3,506,491**

**Registered Sep. 23, 2008**

**SERVICE MARK  
PRINCIPAL REGISTER**

**OUT TO DINNER BREAST  
AUGMENTATION - 24 HOUR  
RECOVERY**

THRESHOLD RESEARCH & DEVELOPMENT,  
INC. (NEVADA CORPORATION)  
2801 LEMMON AVENUE, SUITE 300  
DALLAS, TX 75204

FOR: MEDICAL SERVICES, IN CLASS 44 (U.S.  
CLS. 100 AND 101).

FIRST USE 4-0-2008; IN COMMERCE 4-0-2008.

THE MARK CONSISTS OF STANDARD CHAR-  
ACTERS WITHOUT CLAIM TO ANY PARTICULAR  
FONT, STYLE, SIZE, OR COLOR.

NO CLAIM IS MADE TO THE EXCLUSIVE  
RIGHT TO USE "BREAST AUGMENTATION" OR  
"24 HOUR RECOVERY", APART FROM THE MARK  
AS SHOWN.

SN 78-743,376, FILED 10-31-2005.

REBECCA EISINGER, EXAMINING ATTORNEY

**Int. Cl.: 20**

**Prior U.S. Cls.: 2, 13, 22, 25, 32, and 50**

**United States Patent and Trademark Office**

**Reg. No. 3,506,492**

**Registered Sep. 23, 2008**

**TRADEMARK  
PRINCIPAL REGISTER**

**DISNEY PRINCESS**

DISNEY ENTERPRISES, INC. (DELAWARE CORPORATION)  
500 SOUTH BUENA VISTA STREET  
BURBANK, CA 91521

FOR: CABINETS; DECORATIVE GLITTER; DESKS; FIGURINES AND STATUETTES MADE OF PLASTIC; GIFT PACKAGE DECORATIONS MADE OF PLASTIC; HAND FANS; HAND-HELD MIRRORS; JEWELRY BOXES NOT OF METAL; KEY FOBS NOT OF METAL; LAWN FURNITURE; PARTY ORNAMENTS OF PLASTIC; PICTURE FRAMES; PLASTIC NOVELTY LICENSE PLATES; PLASTIC CAKE DECORATIONS; TABLES, IN CLASS 20 (U.S. CLS. 2, 13, 22, 25, 32 AND 50).

FIRST USE 5-6-2008; IN COMMERCE 5-6-2008.

THE MARK CONSISTS OF STANDARD CHARACTERS WITHOUT CLAIM TO ANY PARTICULAR FONT, STYLE, SIZE, OR COLOR.

OWNER OF U.S. REG. NOS. 1,037,788, 3,045,495, AND OTHERS.

SN 78-743,848, FILED 10-31-2005.

BRIDGETT SMITH, EXAMINING ATTORNEY



**Int. Cl.: 21**

**Prior U.S. Cls.: 2, 13, 23, 29, 30, 33, 40, and 50**

**Reg. No. 3,506,493**

**United States Patent and Trademark Office**

**Registered Sep. 23, 2008**

**TRADEMARK  
PRINCIPAL REGISTER**

**DISNEY PRINCESS**

DISNEY ENTERPRISES, INC. (DELAWARE CORPORATION)  
500 SOUTH BUENA VISTA STREET  
BURBANK, CA 91521

THE MARK CONSISTS OF STANDARD CHARACTERS WITHOUT CLAIM TO ANY PARTICULAR FONT, STYLE, SIZE, OR COLOR.

FOR: CAKE SERVERS; DECORATIVE GLASS NOT FOR BUILDING; FIGURINES MADE OF CHINA; LUNCH BOXES; PIE SERVERS; TOOTHBRUSHES; TRAYS NOT OF PRECIOUS METAL , IN CLASS 21 (U.S. CLS. 2, 13, 23, 29, 30, 33, 40 AND 50).

OWNER OF U.S. REG. NOS. 1,037,788, 3,057,988, AND OTHERS.

SN 78-743,852, FILED 10-31-2005.

FIRST USE 5-5-2008; IN COMMERCE 5-5-2008.

BRIDGETT SMITH, EXAMINING ATTORNEY

**Int. Cl.: 24**

**Prior U.S. Cls.: 42 and 50**

**United States Patent and Trademark Office**

**Reg. No. 3,506,494**

**Registered Sep. 23, 2008**

**TRADEMARK  
PRINCIPAL REGISTER**

**DISNEY PRINCESS**

DISNEY ENTERPRISES, INC. (DELAWARE CORPORATION)  
500 SOUTH BUENA VISTA STREET  
BURBANK, CA 91521

FOR: BATH LINEN; BATH TOWELS; BED BLANKETS; BED CANOPIES; BED LINEN; BED SHEETS; BED SKIRTS; BED SPREADS; BLANKET THROWS; CHILDREN'S BLANKETS; COMFORTERS; CRIB BUMPERS; CURTAINS; HAND TOWELS; HOODED TOWELS; KITCHEN TOWELS; PILLOW CASES; PILLOW COVERS; QUILTS; THROWS; TOWELS; WASHCLOTHS, IN CLASS 24 (U.S. CLS. 42 AND 50).

FIRST USE 9-25-2007; IN COMMERCE 9-25-2007.

THE MARK CONSISTS OF STANDARD CHARACTERS WITHOUT CLAIM TO ANY PARTICULAR FONT, STYLE, SIZE, OR COLOR.

OWNER OF U.S. REG. NOS. 2,412,749, 3,060,962, AND OTHERS.

SN 78-743,856, FILED 10-31-2005.

BRIDGETT SMITH, EXAMINING ATTORNEY

**Int. Cl.: 25**

**Prior U.S. Cls.: 22 and 39**

**United States Patent and Trademark Office**

**Reg. No. 3,506,495**

**Registered Sep. 23, 2008**

**TRADEMARK  
PRINCIPAL REGISTER**

**DISNEY PRINCESS**

DISNEY ENTERPRISES, INC. (DELAWARE CORPORATION)  
500 SOUTH BUENA VISTA STREET  
BURBANK, CA 91521

FOR: BASEBALL CAPS; BEACH COVER-UPS; BEACHWEAR; BIKINIS; CAPS; HATS; HEAD BANDS; HEADWEAR; MITTENS; PANTS; ROBES; SANDALS; SCARVES; SHORTS; SLACKS, IN CLASS 25 (U.S. CLS. 22 AND 39).

FIRST USE 9-24-2007; IN COMMERCE 9-24-2007.

THE MARK CONSISTS OF STANDARD CHARACTERS WITHOUT CLAIM TO ANY PARTICULAR FONT, STYLE, SIZE, OR COLOR.

OWNER OF U.S. REG. NOS. 2,412,749, 2,870,954, AND OTHERS.

SN 78-743,873, FILED 10-31-2005.

BRIDGETT SMITH, EXAMINING ATTORNEY

**Int. Cl.: 20**

**Prior U.S. Cls.: 2, 13, 22, 25, 32, and 50**

**United States Patent and Trademark Office**

**Reg. No. 3,506,496**

**Registered Sep. 23, 2008**

**TRADEMARK  
PRINCIPAL REGISTER**

**MARK HAMPTON**

MARK HAMPTON, INC. (NEW YORK CORPORATION)  
654 MADISON AVENUE  
NEW YORK, NY 10021

OWNER OF U.S. REG. NO. 2,392,929.

FOR: FURNITURE, CHESTS, MIRRORS, BEDS, SOFAS, TABLES, CABINETS, PILLOWS, CUSHIONS, IN CLASS 20 (U.S. CLS. 2, 13, 22, 25, 32 AND 50).

THE NAME(S), PORTRAIT(S), AND/OR SIGNATURE(S) SHOWN IN THE MARK DOES NOT IDENTIFY A PARTICULAR LIVING INDIVIDUAL.

FIRST USE 1-1-1997; IN COMMERCE 1-1-1997.

SN 78-745,276, FILED 11-2-2005.

THE MARK CONSISTS OF STANDARD CHARACTERS WITHOUT CLAIM TO ANY PARTICULAR FONT, STYLE, SIZE, OR COLOR.

PETER B. BROMAGHIM, EXAMINING ATTORNEY

**Int. Cl.: 14**

**Prior U.S. Cls.: 2, 27, 28, and 50**

**United States Patent and Trademark Office**

**Reg. No. 3,506,497**

**Registered Sep. 23, 2008**

**TRADEMARK  
PRINCIPAL REGISTER**

**GEMESIS THE CULTURED  
DIAMOND**

THE GEMESIS CORPORATION (DELAWARE  
CORPORATION)  
7040 PROFESSIONAL PARKWAY EAST  
SARASOTA, FL 34240

OWNER OF U.S. REG. NOS. 2,516,250 AND  
2,662,799.

FOR: SYNTHETIC DIAMONDS, IN CLASS 14 (U.S.  
CLS. 2, 27, 28 AND 50).

SEC. 2(F) AS TO "CULTURED DIAMOND".

FIRST USE 11-4-2005; IN COMMERCE 11-4-2005.

SN 78-747,194, FILED 11-4-2005.

THE MARK CONSISTS OF STANDARD CHAR-  
ACTERS WITHOUT CLAIM TO ANY PARTICULAR  
FONT, STYLE, SIZE, OR COLOR.

VIVIAN MICZNIK FIRST, EXAMINING ATTOR-  
NEY

**Int. Cls.: 35 and 44**

**Prior U.S. Cls.: 100, 101, and 102**

**United States Patent and Trademark Office**

**Reg. No. 3,506,498**

**Registered Sep. 23, 2008**

**SERVICE MARK  
PRINCIPAL REGISTER**

**BAUMANN SKIN TYPES**

METABEAUTY, INC. (FLORIDA CORPORATION)  
5025 NORTH BAY ROAD  
MIAMI BEACH, FL 33140

FOR: PROMOTING THE GOODS AND SERVICES OF OTHERS VIA A GLOBAL COMPUTER NETWORK; PROMOTING THE GOODS AND SERVICES OF OTHERS BY DISTRIBUTING ADVERTISING MATERIALS THROUGH A VARIETY OF METHODS, IN CLASS 35 (U.S. CLS. 100, 101 AND 102).

FIRST USE 2-1-2005; IN COMMERCE 2-1-2005.

FOR: PROVIDING A WEBSITE FEATURING INFORMATION ABOUT SKIN CARE AND RELATED COSMETIC SKIN CARE AND DERMATOLOGICAL ISSUES; CONSULTING SERVICES IN THE FIELD OF SKIN CARE AND RELATED COSMETIC SKIN

CARE AND DERMATOLOGICAL ISSUES, IN CLASS 44 (U.S. CLS. 100 AND 101).

FIRST USE 2-1-2005; IN COMMERCE 2-1-2005.

THE MARK CONSISTS OF STANDARD CHARACTERS WITHOUT CLAIM TO ANY PARTICULAR FONT, STYLE, SIZE, OR COLOR.

OWNER OF U.S. REG. NOS. 3,045,342, 3,103,211, AND OTHERS.

NO CLAIM IS MADE TO THE EXCLUSIVE RIGHT TO USE "SKIN TYPES", APART FROM THE MARK AS SHOWN.

SN 78-750,657, FILED 11-9-2005.

DAVID YONTEF, EXAMINING ATTORNEY

**Int. Cl.: 10**

**Prior U.S. Cls.: 26, 39, and 44**

**United States Patent and Trademark Office**

**Reg. No. 3,506,499**

**Registered Sep. 23, 2008**

**TRADEMARK  
PRINCIPAL REGISTER**

**SYNPOR**

SYNTHES (U.S.A.) (PENNSYLVANIA PARTNER-  
SHIP)  
1302 WRIGHTS LANE EAST  
WEST CHESTER, PA 19380

FOR: SURGICAL IMPLANTS MADE OF POLY-  
ETHYLENE AND TITANIUM FOR USE IN CRA-  
NIOFACIAL AUGMENTATION AND  
RECONSTRUCTION, IN CLASS 10 (U.S. CLS. 26, 39  
AND 44).

FIRST USE 3-16-2007; IN COMMERCE 3-16-2007.

THE MARK CONSISTS OF STANDARD CHAR-  
ACTERS WITHOUT CLAIM TO ANY PARTICULAR  
FONT, STYLE, SIZE, OR COLOR.

SN 78-751,039, FILED 11-10-2005.

ELIZABETH BEYER, EXAMINING ATTORNEY

**Int. Cl.: 36**

**Prior U.S. Cls.: 100, 101, and 102**

**United States Patent and Trademark Office**

**Reg. No. 3,506,500**

**Registered Sep. 23, 2008**

**SERVICE MARK  
PRINCIPAL REGISTER**



**FUNDAMENTAL  
BROKERS INTER-DEALER**

WUNDERLICH SECURITIES, INC. (TENNESSEE  
CORPORATION)  
SUITE 210  
6305 HUMPHREYS BOULEVARD  
MEMPHIS, TN 38120

FOR: FINANCIAL SERVICES, NAMELY, STOCK  
BROKERAGE, BOND BROKERAGE, SECURITY  
BROKERAGE; UNDERWRITING IN SECURITIES,  
STOCKS AND BONDS; INVESTMENT BANKING  
SERVICES; INVESTMENT CONSULTATION; COR-  
PORATE LOAN FINANCING; CAPITAL INVEST-  
MENT CONSULTATION; FISCAL ASSESSMENT  
AND EVALUATION; FINANCIAL ANALYSIS AND

CONSULTATION; FUNDS INVESTMENT, IN CLASS  
36 (U.S. CLS. 100, 101 AND 102).

FIRST USE 11-0-2005; IN COMMERCE 11-0-2005.

NO CLAIM IS MADE TO THE EXCLUSIVE  
RIGHT TO USE "BROKERS INTER-DEALER",  
APART FROM THE MARK AS SHOWN.

SN 78-754,003, FILED 11-15-2005.

BARBARA A. GOLD, EXAMINING ATTORNEY



**Int. Cl.: 38**

**Prior U.S. Cls.: 100, 101, and 104**

**United States Patent and Trademark Office**

**Reg. No. 3,506,501**

**Registered Sep. 23, 2008**

**SERVICE MARK  
PRINCIPAL REGISTER**

世界之门

THE WORLD'S GATE, INC. (DELAWARE CORPORATION)  
42 READ'S WAY  
NEW CASTLE, DE 19720

FOR: PROVIDING MULTIPLE-USER ACCESS TO A GLOBAL COMPUTER INFORMATION NETWORK, IN CLASS 38 (U.S. CLS. 100, 101 AND 104).

FIRST USE 9-0-2005; IN COMMERCE 9-0-2005.

THE MARK CONSISTS OF FOUR CHINESE CHARACTERS. THE CHARACTERS TRANSLATE INTO ENGLISH AS "WORLD GATE". THE PHONETIC PRONUNCIATION OF THE MARK IS "SHI JIE ZHI MEN".

SN 78-754,496, FILED 11-15-2005.

ANDREA K. NADELMAN, EXAMINING ATTORNEY

**Int. Cl.: 7**

**Prior U.S. Cls.: 13, 19, 21, 23, 31, 34, and 35**

**Reg. No. 3,506,502**

**United States Patent and Trademark Office**

**Registered Sep. 23, 2008**

---

**TRADEMARK  
PRINCIPAL REGISTER**

The logo for FILTROPUR features the word "FILTROPUR" in a bold, serif font. The letters are white and set against a dark, horizontal, oval-shaped background that has a slight gradient and a shadow effect, giving it a three-dimensional appearance.

F.V.S., INC. (IOWA CORPORATION)  
120 WINNEBAGO  
DECORAH, IA 52101

FIRST USE 7-1-2008; IN COMMERCE 7-1-2008.

SN 78-758,193, FILED 11-21-2005.

FOR: VACUUM CLEANERS FOR FLOOR CARE,  
IN CLASS 7 (U.S. CLS. 13, 19, 21, 23, 31, 34 AND 35).

BARBARA BROWN, EXAMINING ATTORNEY

**Int. Cl.: 21**

**Prior U.S. Cls.: 2, 13, 23, 29, 30, 33, 40, and 50**

**Reg. No. 3,506,503**

**United States Patent and Trademark Office**

**Registered Sep. 23, 2008**

**TRADEMARK  
PRINCIPAL REGISTER**

**SOCK VALET**

ROCKY MOUNTAIN MARKETING, L.L.C. (OK-  
LAHOMA LIMITED LIABILITY COMPANY)  
5146 S. 94TH E. AVE.  
TULSA, OK 74145

OWNER OF U.S. REG. NOS. 2,384,842 AND  
3,078,981.

FOR: DEVICES FOR PULLING ON SOCKS,  
NAMELY, THROUGH THE USE OF A PLASTIC  
HANDLE AND CLAMP, IN CLASS 21 (U.S. CLS. 2, 13,  
23, 29, 30, 33, 40 AND 50).

NO CLAIM IS MADE TO THE EXCLUSIVE  
RIGHT TO USE "SOCK", APART FROM THE MARK  
AS SHOWN.

FIRST USE 6-19-2008; IN COMMERCE 6-19-2008.

SN 78-758,314, FILED 11-21-2005.

THE MARK CONSISTS OF STANDARD CHAR-  
ACTERS WITHOUT CLAIM TO ANY PARTICULAR  
FONT, STYLE, SIZE, OR COLOR.

JUSTINE D. PARKER, EXAMINING ATTORNEY

**Int. Cls.: 24 and 25**

**Prior U.S. Cls.: 22, 39, 42, and 50**

**United States Patent and Trademark Office**

**Reg. No. 3,506,504**

**Registered Sep. 23, 2008**

**TRADEMARK  
PRINCIPAL REGISTER**



WAL-MART STORES, INC. (DELAWARE CORPORATION)  
702 S.W. 8TH ST.  
BENTONVILLE, AR 727160520

FOR: BEDDING, NAMELY, COMFORTERS, BED BLANKETS, BED SHEETS, CRIB BUMPERS, CRIB SKIRTS, RECEIVING BLANKETS AND THROWS, IN CLASS 24 (U.S. CLS. 42 AND 50).

FIRST USE 1-31-2006; IN COMMERCE 1-31-2006.

FOR: CLOTHING, NAMELY, SHIRTS, TOPS, SWEATERS, PANTS, JEANS, SKIRTS, SHORTS, JACKETS, VESTS, DRESSES, JUMPERS, ROMPERS, TIGHTS, SOCKS, SLEEPWEAR, IN CLASS 25 (U.S. CLS. 22 AND 39).

FIRST USE 6-30-2002; IN COMMERCE 6-30-2002.

SN 78-760,146, FILED 11-23-2005.

WENDY JUN, EXAMINING ATTORNEY

**Int. Cls.: 16, 39, and 43**

**Prior U.S. Cls.: 2, 5, 22, 23, 29, 37, 38, 50, 100, 101, and 105**

**Reg. No. 3,506,505**

**United States Patent and Trademark Office**

**Registered Sep. 23, 2008**

**TRADEMARK  
SERVICE MARK  
PRINCIPAL REGISTER**

**EVERY JOURNEY TELLS A STORY**

GLOBUS-GATEWAY LTD. (PANAMA CORPORATION)  
EDIFICIO VALLARINO 32 ESTE AVENIDA JUSTO Y CALLE TERCER;  
PANAMA, PANAMA 0

FOR: PRINTED MATTER, NAMELY, MAGAZINES, BROCHURES, TRAVEL BROCHURES, NEWSLETTERS, POSTERS, AND FLYERS, ALL RELATING TO TRAVEL AND TOURISM, IN CLASS 16 (U.S. CLS. 2, 5, 22, 23, 29, 37, 38 AND 50).

FIRST USE 7-0-2006; IN COMMERCE 7-0-2006.

FOR: TRAVEL AGENCY AND TRAVEL RESERVATION SERVICES; ARRANGING OF TOURS; RIVER CRUISES; SEA CRUISES; ESCORTING OF TRAVELLERS OR OF PASSENGERS; VEHICLE RENTAL; TRANSPORTATION OF TRAVELLERS, FREIGHT, AND BAGGAGE BY AIR, BOATS, RIVER BOATS, SHIPS, TRAINS, BUSES, AND VANS; BOOKING OF CABINS ON TRAINS, BOATS, RIVER BOATS AND SHIPS, IN CLASS 39 (U.S. CLS. 100 AND 105).

FIRST USE 7-0-2006; IN COMMERCE 7-0-2006.

FOR: HOTEL AND ACCOMMODATION SERVICES; ACCOMMODATION BUREAUX FOR HOTELS; ARRANGING FOR THE PROVISION OF ACCOMMODATION IN HOTELS, BOARDING HOUSES, CAMPSITES, TOURIST HOTELS AND IN TOURIST HOMES; BOOKING OF CAMPSITES, FACILITIES; CATERING SERVICES; ARRANGING FOR THE PROVISION OF MEALS; BOOKING OF CABINS FOR TEMPORARY LODGING, IN CLASS 43 (U.S. CLS. 100 AND 101).

FIRST USE 7-0-2006; IN COMMERCE 7-0-2006.

THE MARK CONSISTS OF STANDARD CHARACTERS WITHOUT CLAIM TO ANY PARTICULAR FONT, STYLE, SIZE, OR COLOR.

SN 78-761,924, FILED 11-28-2005.

MICHAEL ENGEL, EXAMINING ATTORNEY

**Int. Cls.: 1 and 2**

**Prior U.S. Cls.: 1, 5, 6, 10, 11, 16, 26, and 46**

**United States Patent and Trademark Office**

**Reg. No. 3,506,506**

**Registered Sep. 23, 2008**

**TRADEMARK  
PRINCIPAL REGISTER**

**DESMOLUX**

BAYER AKTIENGESELLSCHAFT (FED REP  
GERMANY JOINT STOCK COMPANY)  
D-51368  
LEVERKUSEN-BAYERWERK, FED REP GERMA-  
NY

FOR: CHEMICALS PREPARATIONS, NAMELY,  
FILTERING MATERIALS FOR VARNISH AND AD-  
HESIVE INDUSTRY USE; CHEMICAL PREPARA-  
TIONS FOR SCIENTIFIC PURPOSES; ADHESIVES  
FOR GENERAL INDUSTRIAL USE; UNPROCES-  
SED ARTIFICIAL RESINS FOR VARNISH AND  
ADHESIVE INDUSTRY USE, IN CLASS 1 (U.S. CLS.  
1, 5, 6, 10, 26 AND 46).

FIRST USE 10-1-2005; IN COMMERCE 10-1-2005.

FOR: VARNISHES; LACQUERS; MORDANTS  
FOR VARNISH AND ADHESIVE INDUSTRY USE,  
IN CLASS 2 (U.S. CLS. 6, 11 AND 16).

FIRST USE 10-1-2005; IN COMMERCE 10-1-2005.

THE MARK CONSISTS OF STANDARD CHAR-  
ACTERS WITHOUT CLAIM TO ANY PARTICULAR  
FONT, STYLE, SIZE, OR COLOR.

OWNER OF U.S. REG. NOS. 1,046,597, 2,300,408,  
AND OTHERS.

"DESMOLUX" APPEARING IN THE MARK HAS  
NO SIGNIFICANCE IN THE RELEVANT TRADE  
OR INDUSTRY OR AS APPLIED TO THE GOODS/  
SERVICES LISTED IN THE APPLICATION, NO  
GEOGRAPHICAL SIGNIFICANCE, NOR ANY  
MEANING IN A FOREIGN LANGUAGE.

SN 78-763,124, FILED 11-30-2005.

JUSTINE D. PARKER, EXAMINING ATTORNEY

**Int. Cl.: 5**

**Prior U.S. Cls.: 6, 18, 44, 46, 51, and 52**

**Reg. No. 3,506,507**

**United States Patent and Trademark Office**

**Registered Sep. 23, 2008**

---

**TRADEMARK  
PRINCIPAL REGISTER**

**SILK TOUCH**

JOHNSON & JOHNSON (NEW JERSEY CORPORATION)  
ONE JOHNSON & JOHNSON PLAZA  
NEW BRUNSWICK, NJ 089337001

THE MARK CONSISTS OF STANDARD CHARACTERS WITHOUT CLAIM TO ANY PARTICULAR FONT, STYLE, SIZE, OR COLOR.

FOR: SANITARY PROTECTION PRODUCTS, NAMELY, TAMPONS, IN CLASS 5 (U.S. CLS. 6, 18, 44, 46, 51 AND 52).

SN 78-764,695, FILED 12-1-2005.

FIRST USE 6-0-2007; IN COMMERCE 6-0-2007.

ROBERT C. CLARK JR., EXAMINING ATTORNEY

**Int. Cl.: 20**

**Prior U.S. Cls.: 2, 13, 22, 25, 32, and 50**

**Reg. No. 3,506,508**

**United States Patent and Trademark Office**

**Registered Sep. 23, 2008**

---

**TRADEMARK  
PRINCIPAL REGISTER**

**SAMPLEONE**

PROMOWORKS, L.L.C. (ILLINOIS LIMITED LIABILITY COMPANY)  
300 N. MARTINGALE ROAD  
SCHAUMBURG, IL 60173

THE MARK CONSISTS OF STANDARD CHARACTERS WITHOUT CLAIM TO ANY PARTICULAR FONT, STYLE, SIZE, OR COLOR.

FOR: POINT OF PURCHASE DISPLAYS INCORPORATING DISPENSERS FOR PROMOTIONAL ITEMS, IN CLASS 20 (U.S. CLS. 2, 13, 22, 25, 32 AND 50).

SN 78-770,300, FILED 12-9-2005.

FIRST USE 5-7-2006; IN COMMERCE 5-7-2006.

JENNIFER DIXON, EXAMINING ATTORNEY



**Int. Cls.: 20 and 24**

**Prior U.S. Cls.: 2, 13, 22, 25, 32, 42, and 50**

**United States Patent and Trademark Office**

**Reg. No. 3,506,509**

**Registered Sep. 23, 2008**

**TRADEMARK  
PRINCIPAL REGISTER**

# ROOM 365

DESIGNSPACE, LLC (NEW YORK LIMITED  
LIABILITY COMPANY)  
7TH FLOOR  
155 6TH AVENUE  
NEW YORK, NY 10013

FOR: DECORATIVE PILLOWS, IN CLASS 20 (U.S.  
CLS. 2, 13, 22, 25, 32 AND 50).

FIRST USE 3-0-2006; IN COMMERCE 3-0-2006.

FOR: BEDDING, NAMELY, BED SHEETS, PIL-  
LOW CASES, COMFORTERS, SHAMS, DUVET COV-  
ERS, FABRIC WINDOW VALANCES, AND

WINDOW DRAPERIES, IN CLASS 24 (U.S. CLS. 42  
AND 50).

FIRST USE 3-0-2006; IN COMMERCE 3-0-2006.

THE MARK CONSISTS OF STANDARD CHAR-  
ACTERS WITHOUT CLAIM TO ANY PARTICULAR  
FONT, STYLE, SIZE, OR COLOR.

SN 78-770,669, FILED 12-9-2005.

BERYL GARDNER, EXAMINING ATTORNEY

**Int. Cl.: 35**

**Prior U.S. Cls.: 100, 101, and 102**

**United States Patent and Trademark Office**

**Reg. No. 3,506,510**

**Registered Sep. 23, 2008**

**SERVICE MARK  
PRINCIPAL REGISTER**

**CATEGORY INFLUENTIALS**

GFK NOP, LLC (DELAWARE LIMITED LIABILITY COMPANY)  
75 NINTH AVENUE  
NEW YORK, NY 10011

FOR: MARKET RESEARCH SERVICES, CONDUCTING BUSINESS AND MARKET RESEARCH SURVEYS, CONDUCTING MARKETING STUDIES, MARKETING AND ADVERTISING CONSULTATION, BUSINESS CONSULTATION, BUSINESS RESEARCH, CONDUCTING PUBLIC OPINION POLLS, STATISTICAL RESEARCH AND CONSULTATION, IN CLASS 35 (U.S. CLS. 100, 101 AND 102).

FIRST USE 7-13-2005; IN COMMERCE 7-13-2005.

THE MARK CONSISTS OF STANDARD CHARACTERS WITHOUT CLAIM TO ANY PARTICULAR FONT, STYLE, SIZE, OR COLOR.

SN 78-774,423, FILED 12-15-2005.

KIMBERLY FRYE, EXAMINING ATTORNEY

**Int. Cls.: 38 and 41**

**Prior U.S. Cls.: 100, 101, 104, and 107**

**United States Patent and Trademark Office**

**Reg. No. 3,506,511**

**Registered Sep. 23, 2008**

**SERVICE MARK  
PRINCIPAL REGISTER**



ACADEMY LEADER, INC. (FLORIDA CORPORATION)  
5106 BLUE HERON DRIVE  
NEW PORT RICHEY, FL 34652

FOR: PODCASTING SERVICES; STREAMING OF AUDIO AND VIDEO MATTER ON THE INTERNET; ELECTRONIC, ELECTRIC AND DIGITAL TRANSMISSION OF VOICE, DATA, IMAGES, SIGNALS AND MESSAGES, IN CLASS 38 (U.S. CLS. 100, 101 AND 104).

FIRST USE 8-3-2006; IN COMMERCE 8-3-2006.

FOR: ENTERTAINMENT SERVICES, NAMELY, PROVIDING A WEBSITE FEATURING PRERECORDED MUSIC, AND PHOTOGRAPHIC, AUDIO, VIDEO AND PROSE PRESENTATION FEATURING CURRENT EVENTS AND NEWS, IN CLASS 41 (U.S. CLS. 100, 101 AND 107).

FIRST USE 8-3-2006; IN COMMERCE 8-3-2006.

SN 78-778,917, FILED 12-22-2005.

JOHN DWYER, EXAMINING ATTORNEY

**Int. Cl.: 10**

**Prior U.S. Cls.: 26, 39, and 44**

**United States Patent and Trademark Office**

**Reg. No. 3,506,512**

**Registered Sep. 23, 2008**

**TRADEMARK  
PRINCIPAL REGISTER**

**Monster Medic**

REED, JAIME (UNITED STATES INDIVIDUAL)  
S96W32925 HICKORYWOOD TRL  
MUKWONAGO, WI 53149

FOR: HEAVY DUTY EMERGENCY CARE PRODUCTS, NAMELY, AMBULANCE COTS, STRETCHERS, STAIR CHAIRS, AIRWAY SUCTION ASPIRATORS, TRAUMA BACKBOARDS, CERVICAL COLLARS, AND PEDIATRIC SPINAL IMMOBILIZATION APPARATUSES, FOR USE BY PRE-HOSPITAL CARE PROFESSIONALS, NAMELY, EMERGENCY MEDICAL TECHNICIANS, FIRE-

FIGHTERS, AND PARAMEDICS, IN CLASS 10 (U.S. CLS. 26, 39 AND 44).

FIRST USE 11-30-2007; IN COMMERCE 11-30-2007.

THE MARK CONSISTS OF STANDARD CHARACTERS WITHOUT CLAIM TO ANY PARTICULAR FONT, STYLE, SIZE, OR COLOR.

SN 78-783,186, FILED 12-30-2005.

LINDA MICKLEBURGH, EXAMINING ATTORNEY

**Int. Cls.: 41 and 43**

**Prior U.S. Cls.: 100, 101, and 107**

**United States Patent and Trademark Office**

**Reg. No. 3,506,513**

**Registered Sep. 23, 2008**

**SERVICE MARK  
PRINCIPAL REGISTER**



INTELLECTUAL RESERVE, INC. (UTAH CORPORATION)  
50 EAST NORTH TEMPLE STREET  
SALT LAKE CITY, UT 84150

FOR: CHARITABLE SERVICES, NAMELY, PROVIDING TRAINING IN THE FIELDS OF MEDICAL SERVICES, AGRICULTURAL PRODUCTION, PERSONAL HYGIENE, BASIC JOB SKILLS, AND LANGUAGES, INCLUDING ENGLISH AS A FOREIGN LANGUAGE, IN CLASS 41 (U.S. CLS. 100, 101 AND 107).

FIRST USE 11-0-1999; IN COMMERCE 11-0-1999.

FOR: CHARITABLE SERVICES, NAMELY, PROVIDING FOOD AND BEDDING TO NEEDY PERSONS, IN CLASS 43 (U.S. CLS. 100 AND 101).

FIRST USE 11-0-1999; IN COMMERCE 11-0-1999.

OWNER OF U.S. REG. NOS. 1,738,742, 2,135,319, AND 2,163,221.

NO CLAIM IS MADE TO THE EXCLUSIVE RIGHT TO USE "CHARITIES", APART FROM THE MARK AS SHOWN.

THE MARK IS COMPRISED OF A FAMILY GROUP SURROUNDED BY A DOUBLE-OVAL CARRIER BEARING THE WORDING "LATTER-DAY SAINT CHARITIES-STRENGTHENING FAMILIES".

SN 78-795,990, FILED 1-20-2006.

BRETT J. GOLDEN, EXAMINING ATTORNEY

**Int. Cls.: 41 and 43**

**Prior U.S. Cls.: 100, 101, and 107**

**United States Patent and Trademark Office**

**Reg. No. 3,506,514**

**Registered Sep. 23, 2008**

**SERVICE MARK  
PRINCIPAL REGISTER**

LATTER-DAY SAINT CHARITIES

INTELLECTUAL RESERVE, INC. (UTAH CORPORATION)  
50 EAST NORTH TEMPLE STREET  
SALT LAKE CITY, UT 84150

FOR: CHARITABLE SERVICES, NAMELY, PROVIDING TRAINING IN THE FIELDS OF MEDICAL SERVICES, AGRICULTURAL PRODUCTION, PERSONAL HYGIENE, BASIC JOB SKILLS, AND LANGUAGES, INCLUDING ENGLISH AS A FOREIGN LANGUAGE, IN CLASS 41 (U.S. CLS. 100, 101 AND 107).

FIRST USE 11-0-1996; IN COMMERCE 11-0-1996.

FOR: CHARITABLE SERVICES, NAMELY, PROVIDING FOOD AND BEDDING TO NEEDY PERSONS, IN CLASS 43 (U.S. CLS. 100 AND 101).

FIRST USE 11-0-1996; IN COMMERCE 11-0-1996.

THE MARK CONSISTS OF STANDARD CHARACTERS WITHOUT CLAIM TO ANY PARTICULAR FONT, STYLE, SIZE, OR COLOR.

OWNER OF U.S. REG. NOS. 1,738,742, 2,135,319, AND 2,163,221.

NO CLAIM IS MADE TO THE EXCLUSIVE RIGHT TO USE "CHARITIES", APART FROM THE MARK AS SHOWN.

SN 78-796,010, FILED 1-20-2006.

BRETT J. GOLDEN, EXAMINING ATTORNEY

**Int. Cls.: 35 and 36**

**Prior U.S. Cls.: 100, 101, and 102**

**United States Patent and Trademark Office**

**Reg. No. 3,506,515**

**Registered Sep. 23, 2008**

**SERVICE MARK  
PRINCIPAL REGISTER**

# SAFE TRANSIT

R. J. AHMANN CO. (MINNESOTA CORPORATION)  
7555 MARKET PLACE DRIVE  
EDEN PRAIRIE, MN 553447813

FOR: BUSINESS MANAGEMENT SERVICES, NAMELY, COST/PRICE ANALYSIS OF SHIPPER AND CARRIER CONTRACTS, IN CLASS 35 (U.S. CLS. 100, 101 AND 102).

FIRST USE 4-30-2008; IN COMMERCE 4-30-2008.

FOR: INSURANCE AGENCY SERVICES IN THE FIELD OF BUSINESS OWNERS POLICIES, NAMELY, LIFE INSURANCE, HEALTH INSURANCE, EMPLOYEE BENEFIT INSURANCE, PROPERTY GENERAL LIABILITY INSURANCE, HIRED AND NON-OWNED AUTOMOBILE LIABILITY INSURANCE, CRIME PROTECTION INSURANCE, ELECTRONIC DATA PROCESSING INSURANCE, BUSINESS AUTO INSURANCE, WORKER'S COMPENSATION INSURANCE, CONTINGENT CARGO INSURANCE, PROFESSIONAL LIABILITY, WAREHOUSE LEGAL LIABILITY INSURANCE, EQUIP-

MENT INSURANCE, UMBRELLA/EXCESS INSURANCE, AND SURETY BOND INSURANCE; INSURANCE CLAIMS ADMINISTRATION; RISK MANAGEMENT CONSULTATION; CONSULTING IN CONNECTION WITH LOSS CONTROL; FINANCIAL ANALYSIS OF SHIPPER AND CARRIER CONTRACTS, IN CLASS 36 (U.S. CLS. 100, 101 AND 102).

FIRST USE 4-30-2008; IN COMMERCE 4-30-2008.

THE MARK CONSISTS OF STANDARD CHARACTERS WITHOUT CLAIM TO ANY PARTICULAR FONT, STYLE, SIZE, OR COLOR.

NO CLAIM IS MADE TO THE EXCLUSIVE RIGHT TO USE "TRANSIT", APART FROM THE MARK AS SHOWN.

SN 78-797,080, FILED 1-23-2006.

KELLY CHOE, EXAMINING ATTORNEY

**Int. Cl.: 11**

**Prior U.S. Cls.: 13, 21, 23, 31, and 34**

**United States Patent and Trademark Office**

**Reg. No. 3,506,516**

**Registered Sep. 23, 2008**

**TRADEMARK  
PRINCIPAL REGISTER**

**BACTERRA**

AMERICAST, INC. (VIRGINIA CORPORATION)  
11352 PRECAST ROAD  
ASHLAND, VA 23005

THE MARK CONSISTS OF STANDARD CHAR-  
ACTERS WITHOUT CLAIM TO ANY PARTICULAR  
FONT, STYLE, SIZE, OR COLOR.

FOR: BIO-FILTER TO REMOVE POLLUTANTS  
AND BACTERIA FROM STORM WATER RUNOFF,  
IN CLASS 11 (U.S. CLS. 13, 21, 23, 31 AND 34).

SN 78-798,018, FILED 1-24-2006.

FIRST USE 2-3-2006; IN COMMERCE 2-28-2008.

KATHRYN COWARD, EXAMINING ATTORNEY



**Int. Cl.: 35**

**Prior U.S. Cls.: 100, 101, and 102**

**United States Patent and Trademark Office**

**Reg. No. 3,506,517**

**Registered Sep. 23, 2008**

**SERVICE MARK  
PRINCIPAL REGISTER**

**ALL THROUGH THE HOUSE**

BATH & BODY WORK BRAND MANAGEMENT,  
INC. (DELAWARE CORPORATION)  
7 LIMITED PARKWAY EAST  
REYNOLDSBURG, OH 43068

FOR: ONLINE, MAIL ORDER AND RETAIL  
STORE SERVICES IN THE FIELD OF PERSONAL  
CARE AND HOME FRAGRANCE PRODUCTS AND  
ACCESSORIES, IN CLASS 35 (U.S. CLS. 100, 101 AND  
102).

FIRST USE 10-31-2006; IN COMMERCE 10-31-2006.

THE MARK CONSISTS OF STANDARD CHAR-  
ACTERS WITHOUT CLAIM TO ANY PARTICULAR  
FONT, STYLE, SIZE, OR COLOR.

SN 78-798,025, FILED 1-24-2006.

DOMINIC FATHY, EXAMINING ATTORNEY

**Int. Cl.: 35**

**Prior U.S. Cls.: 100, 101, and 102**

**United States Patent and Trademark Office**

**Reg. No. 3,506,518**

**Registered Sep. 23, 2008**

**SERVICE MARK  
PRINCIPAL REGISTER**

**FRC SPORT PRO-SHOP IN A BOX**

FIDDLER'S ROCK COMMUNICATIONS, INC.  
(VIRGINIA CORPORATION)  
22446 DAVIS DRIVE SUITE 166  
STERLING, VA 20164

FOR: ON-LINE RETAIL STORE SERVICES, RETAIL STORE SERVICES AND RETAIL OUTLETS FEATURING SPORT AND HEALTH PRODUCTS; DISTRIBUTORSHIP SERVICES IN THE FIELD OF SPORT AND HEALTH PRODUCTS; VENDING MACHINE SERVICES IN THE FIELD OF SPORT AND HEALTH PRODUCTS; PROMOTING THE GOODS OF OTHERS BY DISTRIBUTING ADVERTISING MATERIALS THROUGH A VARIETY OF METHODS, IN CLASS 35 (U.S. CLS. 100, 101 AND 102).

FIRST USE 12-1-2007; IN COMMERCE 12-1-2007.

THE MARK CONSISTS OF STANDARD CHARACTERS WITHOUT CLAIM TO ANY PARTICULAR FONT, STYLE, SIZE, OR COLOR.

OWNER OF U.S. REG. NOS. 1,907,924, 1,909,432, AND 2,740,206.

NO CLAIM IS MADE TO THE EXCLUSIVE RIGHT TO USE "SPORT PRO-SHOP", APART FROM THE MARK AS SHOWN.

SN 78-799,101, FILED 1-25-2006.

BILL DAWE, EXAMINING ATTORNEY

**Int. Cls.: 35 and 36**

**Prior U.S. Cls.: 100, 101, and 102**

**United States Patent and Trademark Office**

**Reg. No. 3,506,519**

**Registered Sep. 23, 2008**

**SERVICE MARK  
PRINCIPAL REGISTER**

**FLATWORLD CAPITAL**

RAJ K. GUPTA (CANADA INDIVIDUAL)  
155 EAST 34TH ST  
SUITE 17P  
NEW YORK, NY 10016

FOR: OUTSOURCING IN THE FIELD OF BUSINESS PROCESS OUTSOURCING, IN CLASS 35 (U.S. CLS. 100, 101 AND 102).

FIRST USE 12-1-2005; IN COMMERCE 12-1-2005.

FOR: ADVICE RELATING TO INVESTMENTS; BANKING; EQUITY CAPITAL INVESTMENT; FUNDS INVESTMENT; INVESTMENT BANKING SERVICES, IN CLASS 36 (U.S. CLS. 100, 101 AND 102).

FIRST USE 12-1-2005; IN COMMERCE 12-1-2005.

THE MARK CONSISTS OF STANDARD CHARACTERS WITHOUT CLAIM TO ANY PARTICULAR FONT, STYLE, SIZE, OR COLOR.

NO CLAIM IS MADE TO THE EXCLUSIVE RIGHT TO USE "CAPITAL", APART FROM THE MARK AS SHOWN.

SN 78-799,673, FILED 1-26-2006.

DANIEL CAPSHAW, EXAMINING ATTORNEY

**Int. Cl.: 42**

**Prior U.S. Cls.: 100 and 101**

**United States Patent and Trademark Office**

**Reg. No. 3,506,520**

**Registered Sep. 23, 2008**

**SERVICE MARK  
PRINCIPAL REGISTER**

**SPG SOLAR**

SPG SOLAR, INC. (CALIFORNIA CORPORATION)  
20 LEVERONI COURT  
NOVATO, CA 94949

FOR: CONSULTING SERVICES RELATED TO EVALUATION OF SITES FOR OPTIMAL PHOTO-VOLTAIC SOLAR MODULES, WHICH CONVERT ELECTRONIC RADIATION TO ELECTRICAL ENERGY, IN CLASS 42 (U.S. CLS. 100 AND 101).

FIRST USE 3-1-2006; IN COMMERCE 3-1-2006.

THE MARK CONSISTS OF STANDARD CHARACTERS WITHOUT CLAIM TO ANY PARTICULAR FONT, STYLE, SIZE, OR COLOR.

NO CLAIM IS MADE TO THE EXCLUSIVE RIGHT TO USE "SOLAR", APART FROM THE MARK AS SHOWN.

SN 78-800,380, FILED 1-26-2006.

MATTHEW PAPPAS, EXAMINING ATTORNEY

**Int. Cls.: 35, 38, and 42**

**Prior U.S. Cls.: 100, 101, 102, and 104**

**United States Patent and Trademark Office**

**Reg. No. 3,506,521**

**Registered Sep. 23, 2008**

**SERVICE MARK  
PRINCIPAL REGISTER**

**READY TO GO SERVERS**

THEPLANET.COM INTERNET SERVICES, INC.  
(DELAWARE CORPORATION)  
315 CAPITOL STREET, SUITE 205  
HOUSTON, TX 77002

FOR: DATA PROCESSING SERVICES, IN CLASS  
35 (U.S. CLS. 100, 101 AND 102).

FIRST USE 7-16-2007; IN COMMERCE 7-16-2007.

FOR: COMPUTER SERVICES, NAMELY, PRO-  
VIDING REMOTE ACCESS TO A TELECOMMUNI-  
CATION NETWORK FOR COMPUTER SERVERS  
HOSTING WEBSITES ON A GLOBAL COMPUTER  
NETWORK, IN CLASS 38 (U.S. CLS. 100, 101 AND  
104).

FIRST USE 7-16-2007; IN COMMERCE 7-16-2007.

FOR: HOSTING THE WEBSITES OF OTHERS ON  
A SERVER FOR A GLOBAL COMPUTER NET-

WORK; TECHNICAL AND CLIENT SUPPORT SER-  
VICES, NAMELY, TROUBLESHOOTING AND  
RESOLUTION OF COMPUTER HARDWARE AND  
SOFTWARE PROBLEMS VIA EMAIL AND POST-  
INGS ON A MULTIPLE USER GLOBAL COMPUTER  
NETWORK, IN CLASS 42 (U.S. CLS. 100 AND 101).

FIRST USE 7-16-2007; IN COMMERCE 7-16-2007.

THE MARK CONSISTS OF STANDARD CHAR-  
ACTERS WITHOUT CLAIM TO ANY PARTICULAR  
FONT, STYLE, SIZE, OR COLOR.

NO CLAIM IS MADE TO THE EXCLUSIVE  
RIGHT TO USE "SERVERS", APART FROM THE  
MARK AS SHOWN.

SN 78-805,915, FILED 2-2-2006.

STEVEN R. FOSTER, EXAMINING ATTORNEY

**Int. Cl.: 40**

**Prior U.S. Cls.: 100, 103, and 106**

**United States Patent and Trademark Office**

**Reg. No. 3,506,522**

**Registered Sep. 23, 2008**

**SERVICE MARK  
PRINCIPAL REGISTER**

**SHALEEVAL**

HALLIBURTON ENERGY SERVICES, INC. (DE-  
LAWARE CORPORATION)  
1-B-121  
2601 BELTLINE ROAD  
CARROLLTON, TX 75006

FOR: OIL AND GAS WELL FRACTURING AND  
STIMULATION SERVICES, NAMELY, FRACTUR-  
ING USING A STABILIZED FLUID SYSTEM, IN  
CLASS 40 (U.S. CLS. 100, 103 AND 106).

FIRST USE 7-31-2005; IN COMMERCE 7-31-2005.

THE MARK CONSISTS OF STANDARD CHAR-  
ACTERS WITHOUT CLAIM TO ANY PARTICULAR  
FONT, STYLE, SIZE, OR COLOR.

SN 78-806,628, FILED 2-3-2006.

MATTHEW MCDOWELL, EXAMINING ATTOR-  
NEY

**Int. Cls.: 25 and 41**

**Prior U.S. Cls.: 22, 39, 100, 101, and 107**

**Reg. No. 3,506,523**

**United States Patent and Trademark Office**

**Registered Sep. 23, 2008**

**TRADEMARK  
SERVICE MARK  
PRINCIPAL REGISTER**

**YOGA ROCKS**

WHOLE NEW WORLD YOGA, LLC (NEW YORK  
LIMITED LIABILITY COMPANY)  
55 CENTER VIEW DRIVE  
UPPER BROOKVILLE, NY 11771

FOR: GOLF SHIRTS; HATS; POLO SHIRTS;  
SHIRTS; SHORT-SLEEVED OR LONG-SLEEVED T-  
SHIRTS; SWEAT SHIRTS; WIND SHIRTS, IN CLASS  
25 (U.S. CLS. 22 AND 39).

FIRST USE 2-6-2006; IN COMMERCE 2-6-2006.

FOR: YOGA INSTRUCTION, IN CLASS 41 (U.S.  
CLS. 100, 101 AND 107).

FIRST USE 2-6-2006; IN COMMERCE 2-6-2006.

THE MARK CONSISTS OF STANDARD CHAR-  
ACTERS WITHOUT CLAIM TO ANY PARTICULAR  
FONT, STYLE, SIZE, OR COLOR.

NO CLAIM IS MADE TO THE EXCLUSIVE  
RIGHT TO USE "YOGA", APART FROM THE  
MARK AS SHOWN.

SN 78-808,009, FILED 2-6-2006.

KELLY MCCOY, EXAMINING ATTORNEY

**Int. Cl.: 25**

**Prior U.S. Cls.: 22 and 39**

**United States Patent and Trademark Office**

**Reg. No. 3,506,524**

**Registered Sep. 23, 2008**

**TRADEMARK  
PRINCIPAL REGISTER**

**WRENCH THIS**

FIX MY HOG, INC. (CONNECTICUT CORPORATION)  
3853 BELMONT AVENUE  
SAN DIEGO, CA 92116

THE MARK CONSISTS OF STANDARD CHARACTERS WITHOUT CLAIM TO ANY PARTICULAR FONT, STYLE, SIZE, OR COLOR.

FOR: CLOTHING, NAMELY, SHIRTS, SWEATSHIRTS, SWEATPANTS AND HEADGEAR, NAMELY, HATS AND KNIT CAPS, IN CLASS 25 (U.S. CLS. 22 AND 39).

SN 78-808,732, FILED 2-7-2006.

FIRST USE 1-20-2006; IN COMMERCE 1-20-2006.

BERNICE MIDDLETON, EXAMINING ATTORNEY



**Int. Cl.: 9**

**Prior U.S. Cls.: 21, 23, 26, 36, and 38**

**Reg. No. 3,506,525**

**United States Patent and Trademark Office**

**Registered Sep. 23, 2008**

**TRADEMARK  
PRINCIPAL REGISTER**

**They play. They learn.  
They achieve!**

HARBOR TOWN GAMES, INC. (NEW YORK  
CORPORATION)  
249 WILCOX ST.  
P.O. BOX 58  
WILSON, NY 14172

THE MARK CONSISTS OF STANDARD CHAR-  
ACTERS WITHOUT CLAIM TO ANY PARTICULAR  
FONT, STYLE, SIZE, OR COLOR.

FOR: INTERACTIVE MULTIMEDIA COMPUTER  
GAME PROGRAM, IN CLASS 9 (U.S. CLS. 21, 23, 26,  
36 AND 38).

SN 78-809,268, FILED 2-7-2006.

FIRST USE 12-15-2005; IN COMMERCE 12-15-2005.

DEBRA LEE, EXAMINING ATTORNEY

**Int. Cls.: 8, 21, and 24**

**Prior U.S. Cls.: 2, 13, 23, 28, 29, 30, 33, 40, 42, 44, and 50**

**Reg. No. 3,506,526**

**United States Patent and Trademark Office**

**Registered Sep. 23, 2008**

**TRADEMARK  
PRINCIPAL REGISTER**

**EAT & DISCOVER**

PLAYTEX PRODUCTS, INC. (DELAWARE CORPORATION)  
300 NYALA FARMS ROAD  
WESTPORT, CT 06880

FOR: INFANTS' AND CHILDREN'S FEEDING AND BEVERAGE PRODUCTS, NAMELY, SPOONS, FORKS, FEEDING KITS CONTAINING ONE OR MORE OF THE FOREGOING GOODS, PACKAGED TOGETHER, IN CLASS 8 (U.S. CLS. 23, 28 AND 44).

FIRST USE 11-0-2006; IN COMMERCE 11-0-2006.

FOR: INFANTS' AND CHILDREN'S FEEDING AND BEVERAGE PRODUCTS, NAMELY, FEEDING BOWLS, PLATES, TRAVEL BOWLS, HOUSEHOLD FOOD AND BEVERAGE CONTAINERS WITH LIDS FOR TRAVELING; FEEDING KITS CONSISTING PRIMARILY OF HOUSEHOLD FOOD AND BEVERAGE CONTAINERS WITH LIDS FOR TRAVELING AND ALSO CONTAINING FEEDING BOWLS, PLATES, TRAVEL BOWLS, FOOD AND BEVERAGE CONTAINERS WITH LIDS FOR TRAVELING, PLACE MATS NOT OF PAPER, SPOONS, FORKS, DRINKING CUPS, SPILL-PROOF CUPS, AND STRAW CUPS, AND MEALTIME TRAYS, PACKAGED TOGETHER; FEEDING KITS CONSISTING

PRIMARILY OF FEEDING BOWLS AND PLATES, AND ALSO CONTAINING FOOD AND BEVERAGE CONTAINERS WITH LIDS FOR TRAVELING, PLACE MATS NOT OF PAPER, SPOONS, FORKS, DRINKING CUPS, SPILL-PROOF CUPS, AND STRAW CUPS, AND MEALTIME TRAYS, PACKAGED TOGETHER, IN CLASS 21 (U.S. CLS. 2, 13, 23, 29, 30, 33, 40 AND 50).

FIRST USE 11-0-2006; IN COMMERCE 11-0-2006.

FOR: INFANTS' AND CHILDREN'S FEEDING AND BEVERAGE PRODUCTS, NAMELY, PLACE MATS NOT OF PAPER, IN CLASS 24 (U.S. CLS. 42 AND 50).

FIRST USE 11-0-2006; IN COMMERCE 11-0-2006.

THE MARK CONSISTS OF STANDARD CHARACTERS WITHOUT CLAIM TO ANY PARTICULAR FONT, STYLE, SIZE, OR COLOR.

SN 78-810,271, FILED 2-8-2006.

DOMINIC FATHY, EXAMINING ATTORNEY

**Int. Cls.: 35, 36, 39, and 42**

**Prior U.S. Cls.: 100, 101, 102, and 105**

**United States Patent and Trademark Office**

**Reg. No. 3,506,527**

**Registered Sep. 23, 2008**

**SERVICE MARK  
PRINCIPAL REGISTER**

# GET THE EDGE

LEADING EDGE AVIATION SOLUTIONS, LLC  
(TEXAS LIMITED LIABILITY COMPANY)  
545 E. JOHN CARPENTER FREEWAY, #950  
IRVING, TX 75062

FOR: BUSINESS AND ADVERTISING SERVICES RELATED TO AVIATION, NAMELY, PROVIDING STRATEGIC BUSINESS PLANNING REGARDING THE AVIATION NEEDS OF OTHERS; CONDUCTING BUSINESS AND MARKET RESEARCH SURVEYS TO ASSIST IN MEETING THE AVIATION NEEDS OF OTHERS; BUSINESS CONSULTATION IN THE AREA OF ASSISTING OTHERS IN THE SELECTION AND PURCHASE OF AIRCRAFT AND FRACTIONAL SHARES OF AIRCRAFT; PROCURING AND EXECUTING CONTRACTS FOR THE PURCHASE AND EXCHANGE OF AIRCRAFT ON BEHALF OF OTHERS; BUSINESS CONSULTATION, NAMELY, ADVISING OTHERS REGARDING AIRCRAFT PROCUREMENT TRANSACTIONS; BUSINESS CONSULTATION, NAMELY, ADVISING OTHERS REGARDING AIRCRAFT LEASING TRANSACTIONS; BUSINESS MANAGEMENT CONSULTATION IN THE AREAS OF ADVISING BUSINESSES ON ESTABLISHING BUSINESS POLICIES, BUSINESS PROCEDURES, STAFFING REQUIREMENTS AND COMPENSATION RECOMMENDATIONS FOR AIRLINE AND CORPORATE FLIGHT DEPARTMENTS; EMPLOYMENT RECRUITING FOR FLIGHT DEPARTMENTS IN AVIATION FIELD, IN CLASS 35 (U.S. CLS. 100, 101 AND 102).

FIRST USE 5-27-2008; IN COMMERCE 5-27-2008.

FOR: AIRCRAFT BROKERAGE SERVICES; AIRCRAFT APPRAISAL SERVICES; AIRCRAFT FINAN-

CIAL VALUATION SERVICES; FINANCIAL CONSULTATION SERVICES, NAMELY, ADVISING OTHERS REGARDING FINANCING AIRCRAFT, IN CLASS 36 (U.S. CLS. 100, 101 AND 102).

FIRST USE 5-27-2008; IN COMMERCE 5-27-2008.

FOR: PROVIDING AIRCRAFT DELIVERY SERVICES FOR THE AVIATION INDUSTRY, IN CLASS 39 (U.S. CLS. 100 AND 105).

FIRST USE 5-27-2008; IN COMMERCE 5-27-2008.

FOR: AIRCRAFT QUALITY ASSURANCE SERVICES; AIRCRAFT INSPECTION SERVICES; MONITORING MANUFACTURING AND REFURBISHMENT OF AIRCRAFT FOR OTHERS, DEVELOPMENT OF STANDARDS AND PRACTICES IN THE AVIATION INDUSTRY RELATING TO AIRCRAFT DESIGN SPECIFICATIONS, PERFORMING FEASIBILITY STUDIES REGARDING PROPOSED AVIATION SOLUTIONS FOR OTHERS, IN CLASS 42 (U.S. CLS. 100 AND 101).

FIRST USE 5-27-2008; IN COMMERCE 5-27-2008.

THE MARK CONSISTS OF STANDARD CHARACTERS WITHOUT CLAIM TO ANY PARTICULAR FONT, STYLE, SIZE, OR COLOR.

SN 78-811,960, FILED 2-10-2006.

CHERYL CLAYTON, EXAMINING ATTORNEY

**Int. Cls.: 36 and 45**

**Prior U.S. Cls.: 100, 101, and 102**

**United States Patent and Trademark Office**

**Reg. No. 3,506,528**

**Registered Sep. 23, 2008**

**SERVICE MARK  
PRINCIPAL REGISTER**

**MEXRETIRE**

MEXRETIRE, LLC (DELAWARE LIMITED LIABILITY COMPANY)  
7 RICHARD STREET  
MEDFORD, MA 02155

FOR: PROVIDING INFORMATION REGARDING REAL ESTATE IN MEXICO; AND REAL ESTATE SERVICES, NAMELY, LISTING, PROCUREMENT AND MANAGEMENT OF REAL ESTATE; AND REAL ESTATE CLOSING SERVICES; AND REAL ESTATE BROKERAGE SERVICES, IN CLASS 36 (U.S. CLS. 100, 101 AND 102).

FIRST USE 3-31-2006; IN COMMERCE 3-31-2006.

FOR: CONCIERGE SERVICES FOR OTHERS COMPRISING MAKING REQUESTED PERSONAL

ARRANGEMENTS AND RESERVATIONS AND PROVIDING CUSTOMER-SPECIFIC INFORMATION TO MEET INDIVIDUAL NEEDS RENDERED TOGETHER IN MEXICO, IN CLASS 45 (U.S. CLS. 100 AND 101).

FIRST USE 3-31-2006; IN COMMERCE 3-31-2006.

THE MARK CONSISTS OF STANDARD CHARACTERS WITHOUT CLAIM TO ANY PARTICULAR FONT, STYLE, SIZE, OR COLOR.

SN 78-812,219, FILED 2-10-2006.

MIDGE BUTLER, EXAMINING ATTORNEY

**Int. Cl.: 36**

**Prior U.S. Cls.: 100, 101, and 102**

**United States Patent and Trademark Office**

**Reg. No. 3,506,529**

**Registered Sep. 23, 2008**

**SERVICE MARK  
PRINCIPAL REGISTER**



FNF INTELLECTUAL PROPERTY HOLDINGS,  
INC. (DELAWARE CORPORATION)  
601 RIVERSIDE AVENUE  
JACKSONVILLE, FL 32204

FOR: UNDERWRITING TITLE INSURANCE, IN  
CLASS 36 (U.S. CLS. 100, 101 AND 102).

FIRST USE 2-0-2006; IN COMMERCE 2-0-2006.

OWNER OF U.S. REG. NOS. 1,305,281, 2,984,492,  
AND OTHERS.

NO CLAIM IS MADE TO THE EXCLUSIVE  
RIGHT TO USE "TITLE GROUP", APART FROM  
THE MARK AS SHOWN.

THE MARK CONSISTS OF (IN PART) THE DE-  
SIGN OF A BUILDING WITHIN A BUILDING.

SEC. 2(F) AS TO "NATIONAL".

SN 78-812,258, FILED 2-10-2006.

IRA J. GOODSaid, EXAMINING ATTORNEY

**Int. Cl.: 18**

**Prior U.S. Cls.: 1, 2, 3, 22, and 41**

**United States Patent and Trademark Office**

**Reg. No. 3,506,530**

**Registered Sep. 23, 2008**

**TRADEMARK  
PRINCIPAL REGISTER**

**KOOKY**

COURAGE INTERNATIONAL, INC. (DELA-  
WARE CORPORATION)  
6049 SLAUSON AVENUE  
CITY OF COMMERCE, CA 90040

THE MARK CONSISTS OF STANDARD CHAR-  
ACTERS WITHOUT CLAIM TO ANY PARTICULAR  
FONT, STYLE, SIZE, OR COLOR.

FOR: TOTE BAGS, DUFFLE BAGS, BACK PACKS,  
BOOK BAGS, BEACH BAGS, HAND BAGS, IN  
CLASS 18 (U.S. CLS. 1, 2, 3, 22 AND 41).

SN 78-812,643, FILED 2-10-2006.

FIRST USE 4-1-2007; IN COMMERCE 4-1-2007.

MIDGE BUTLER, EXAMINING ATTORNEY

**Int. Cl.: 6**

**Prior U.S. Cls.: 2, 12, 13, 14, 23, 25, and 50**

**Reg. No. 3,506,531**

**United States Patent and Trademark Office**

**Registered Sep. 23, 2008**

---

**TRADEMARK  
PRINCIPAL REGISTER**

**KOOKY**

COURAGE INTERNATIONAL, INC. (DELA-  
WARE CORPORATION)  
6049 SLAUSON AVENUE  
CITY OF COMMERCE, CA 90040

THE MARK CONSISTS OF STANDARD CHAR-  
ACTERS WITHOUT CLAIM TO ANY PARTICULAR  
FONT, STYLE, SIZE, OR COLOR.

FOR: GOODS MADE FROM NON-PRECIOUS  
METAL, NAMELY, KEY CHAINS, IN CLASS 6  
(U.S. CLS. 2, 12, 13, 14, 23, 25 AND 50).

SN 78-812,652, FILED 2-10-2006.

FIRST USE 8-30-2004; IN COMMERCE 8-30-2004.

MIDGE BUTLER, EXAMINING ATTORNEY

**Int. Cls.: 9, 42, and 45**

**Prior U.S. Cls.: 21, 23, 26, 36, 38, 100, and 101**

**Reg. No. 3,506,532**

**United States Patent and Trademark Office**

**Registered Sep. 23, 2008**

**TRADEMARK  
SERVICE MARK  
PRINCIPAL REGISTER**

# IDENTRUST

IDENTRUST, INC. (DELAWARE CORPORATION)  
80 BROAD STREET, FIFTH FLOOR  
NEW YORK, NY 10004

FOR: COMPUTER PROGRAMS FOR ISSUING DIGITAL CERTIFICATES FOR AUTHENTICATING USERS FOR ACCESS TO ONLINE SYSTEMS FOR USE IN AN ELECTRONIC TRANSACTION OR COMMUNICATION; SMART CARDS CONTAINING PROGRAMMING, NAMELY, DIGITAL CERTIFICATES, USED TO VERIFY THE IDENTITY OF PARTIES TO AN ELECTRONIC TRANSACTION, IN CLASS 9 (U.S. CLS. 21, 23, 26, 36 AND 38).

FIRST USE 3-31-2006; IN COMMERCE 3-31-2006.

FOR: DIGITAL CERTIFICATION AND SECURITY SERVICES, NAMELY, PROVIDING ENCRYPTION OF DATA; COMPUTER CONSULTATION IN THE FIELD OF NETWORK SECURITY AND AUTHENTICATION OF DIGITAL SIGNATURES IN AN ELECTRONIC TRANSACTION OR COMMUNICATION; DESIGN OF COMPUTER HARDWARE, SOFTWARE, AND SPECIFICATIONS USED FOR NETWORK SECURITY AND AUTHENTICATION OF DIGITAL SIGNATURES AND IDENTITIES IN AN ELECTRONIC TRANSACTION OR COMMUNICATION; TECHNICAL SUPPORT SERVICES, NAMELY, TROUBLESHOOTING OF COMPUTER

HARDWARE AND SOFTWARE PROBLEMS VIA TELEPHONE, EMAIL AND IN PERSON, IN CLASS 42 (U.S. CLS. 100 AND 101).

FIRST USE 3-31-2006; IN COMMERCE 3-31-2006.

FOR: ISSUANCE AND VALIDATION OF DIGITAL CERTIFICATES PROVIDING AUTHENTICATION OF THE SOURCE OF A DIGITAL COMMUNICATION, AUTHENTICATION OF IDENTITY AND/OR OF A DIGITAL SIGNATURE IN AN ELECTRONIC TRANSACTION OR COMMUNICATION, AUTHENTICATION OF IDENTITY FOR PHYSICAL OR LOGICAL ACCESS CONTROL, IN CLASS 45 (U.S. CLS. 100 AND 101).

FIRST USE 3-31-2006; IN COMMERCE 3-31-2006.

THE MARK CONSISTS OF STANDARD CHARACTERS WITHOUT CLAIM TO ANY PARTICULAR FONT, STYLE, SIZE, OR COLOR.

OWNER OF U.S. REG. NOS. 2,313,865, 2,523,114, AND 2,594,962.

SN 78-813,698, FILED 2-13-2006.

TIMOTHY FINNEGAN, EXAMINING ATTORNEY



**Int. Cl.: 35**

**Prior U.S. Cls.: 100, 101, and 102**

**United States Patent and Trademark Office**

**Reg. No. 3,506,533**

**Registered Sep. 23, 2008**

**SERVICE MARK  
PRINCIPAL REGISTER**

**THE REWARDS CARD THAT  
REWARDS YOU FOR LIVING**

VISA INTERNATIONAL SERVICE ASSOCIATION  
(DELAWARE CORPORATION)  
M1-11A  
900 METRO CENTER BOULEVARD  
FOSTER CITY, CA 94404

FOR: PROMOTING THE SALE OF GOODS AND SERVICES OF OTHERS BY MEANS OF ADVERTISEMENTS, COUPONS, DISCOUNTS AND INCENTIVES IN THE NATURE OF REWARD POINTS AND VALUE ADDED OFFERS GENERATED IN CONNECTION WITH THE USE OF PAYMENT CARDS; PROMOTING SPORTS COMPETITIONS AND EVENTS OF OTHERS; PROMOTING CONCERTS AND CULTURAL EVENTS OF OTHERS, IN CLASS 35 (U.S. CLS. 100, 101 AND 102).

FIRST USE 3-1-2006; IN COMMERCE 3-1-2006.

THE MARK CONSISTS OF STANDARD CHARACTERS WITHOUT CLAIM TO ANY PARTICULAR FONT, STYLE, SIZE, OR COLOR.

NO CLAIM IS MADE TO THE EXCLUSIVE RIGHT TO USE "REWARDS CARD", APART FROM THE MARK AS SHOWN.

SN 78-814,377, FILED 2-14-2006.

SUSAN STIGLITZ, EXAMINING ATTORNEY

**Int. Cl.: 44**

**Prior U.S. Cls.: 100 and 101**

**United States Patent and Trademark Office**

**Reg. No. 3,506,534**

**Registered Sep. 23, 2008**

**SERVICE MARK  
PRINCIPAL REGISTER**

**LEADING EDGE**

LEADING EDGE VETERINARY IMAGING, LLC  
(INDIANA CORPORATION)  
10828 E. US HIGHWAY 36  
AVON, IN 46123

THE MARK CONSISTS OF STANDARD CHAR-  
ACTERS WITHOUT CLAIM TO ANY PARTICULAR  
FONT, STYLE, SIZE, OR COLOR.

FOR: VETERINARY SERVICES, IN CLASS 44 (U.S.  
CLS. 100 AND 101).

SN 78-815,086, FILED 2-15-2006.

FIRST USE 10-1-2006; IN COMMERCE 10-1-2006.

AISHA CLARKE, EXAMINING ATTORNEY

**Int. Cl.: 25**

**Prior U.S. Cls.: 22 and 39**

**United States Patent and Trademark Office**

**Reg. No. 3,506,535**

**Registered Sep. 23, 2008**

**TRADEMARK  
PRINCIPAL REGISTER**

**INFINITY WAVE**

MIZUNO USA, INC. (GEORGIA CORPORATION)  
4925 AVALON RIDGE PARKWAY  
ONE JACK CURRAN WAY  
NORCROSS, GA 30071

FOR: ENGINEERED MIDSOLE SOLD AS A COMPONENT OF RUNNING SHOES AND ATHLETIC FOOTWEAR, IN CLASS 25 (U.S. CLS. 22 AND 39).

FIRST USE 5-0-2006; IN COMMERCE 6-0-2006.

THE MARK CONSISTS OF STANDARD CHARACTERS WITHOUT CLAIM TO ANY PARTICULAR FONT, STYLE, SIZE, OR COLOR.

OWNER OF U.S. REG. NOS. 2,865,312, 2,922,837, AND OTHERS.

SN 78-817,294, FILED 2-17-2006.

LINDA LAVACHE, EXAMINING ATTORNEY

**Int. Cl.: 32**

**Prior U.S. Cls.: 45, 46, and 48**

**United States Patent and Trademark Office**

**Reg. No. 3,506,536**

**Registered Sep. 23, 2008**

**TRADEMARK  
PRINCIPAL REGISTER**

**SUAVIDA**

ZING BROTHERS, LLC (UTAH LIMITED LIABILITY COMPANY)  
P.O. BOX 356  
MIDVALE, UT 84047

FOR: NON-ALCOHOLIC FRUIT, RICE AND FLOWER BASED BEVERAGES AND BEVERAGE CONCENTRATES, NAMELY, HORCHATA, TAMARINDO AND JAMAICA, IN CLASS 32 (U.S. CLS. 45, 46 AND 48).

FIRST USE 6-1-2007; IN COMMERCE 10-1-2007.

THE MARK CONSISTS OF STANDARD CHARACTERS WITHOUT CLAIM TO ANY PARTICULAR FONT, STYLE, SIZE, OR COLOR.

SN 78-819,137, FILED 2-20-2006.

KEVIN DINALLO, EXAMINING ATTORNEY

**Int. Cl.: 7**

**Prior U.S. Cls.: 13, 19, 21, 23, 31, 34, and 35**

**Reg. No. 3,506,537**

**United States Patent and Trademark Office**

**Registered Sep. 23, 2008**

---

**TRADEMARK  
PRINCIPAL REGISTER**

**PARAMOUNT**

SIEMENS ENERGY & AUTOMATION, INC. (DE-  
LAWARE CORPORATION)  
1401 NOLAN RYAN EXPRESSWAY  
ARLINGTON, TX 76011

THE MARK CONSISTS OF STANDARD CHAR-  
ACTERS WITHOUT CLAIM TO ANY PARTICULAR  
FONT, STYLE, SIZE, OR COLOR.

FOR: AUTOMATED MAIL SORTING MA-  
CHINES, IN CLASS 7 (U.S. CLS. 13, 19, 21, 23, 31, 34  
AND 35).

SN 78-819,729, FILED 2-21-2006.

FIRST USE 3-31-2006; IN COMMERCE 3-31-2006.

LINDA LAVACHE, EXAMINING ATTORNEY

**Int. Cl.: 5**

**Prior U.S. Cls.: 6, 18, 44, 46, 51, and 52**

**Reg. No. 3,506,538**

**United States Patent and Trademark Office**

**Registered Sep. 23, 2008**

---

**TRADEMARK  
PRINCIPAL REGISTER**

**Mom Made**

MOM MADE FOODS LLC (VIRGINIA LIMITED  
LIABILITY COMPANY)  
107 S. WEST STREET  
SUITE 453  
ALEXANDRIA, VA 22314

THE MARK CONSISTS OF STANDARD CHAR-  
ACTERS WITHOUT CLAIM TO ANY PARTICULAR  
FONT, STYLE, SIZE, OR COLOR.

FOR: BABY FOOD, IN CLASS 5 (U.S. CLS. 6, 18, 44,  
46, 51 AND 52).

SN 78-820,837, FILED 2-22-2006.

FIRST USE 5-1-2006; IN COMMERCE 5-1-2006.

ALICE BENMAMAN, EXAMINING ATTORNEY

**Int. Cl.: 25**

**Prior U.S. Cls.: 22 and 39**

**United States Patent and Trademark Office**

**Reg. No. 3,506,539**

**Registered Sep. 23, 2008**

**TRADEMARK  
PRINCIPAL REGISTER**

**11MANGANG**

HAYWARD, PAUL A. (CANADA INDIVIDUAL)  
3601 EAST BAY DRIVE, #210  
HOLMES BEACH, FL 342172083

THE MARK CONSISTS OF STANDARD CHAR-  
ACTERS WITHOUT CLAIM TO ANY PARTICULAR  
FONT, STYLE, SIZE, OR COLOR.

FOR: ATHLETIC CLOTHING, NAMELY, T-  
SHIRTS, IN CLASS 25 (U.S. CLS. 22 AND 39).

SN 78-822,001, FILED 2-23-2006.

FIRST USE 6-30-2008; IN COMMERCE 6-30-2008.

CHARLOTTE CORWIN, EXAMINING ATTORNEY

**Int. Cl.: 25**

**Prior U.S. Cls.: 22 and 39**

**United States Patent and Trademark Office**

**Reg. No. 3,506,540**

**Registered Sep. 23, 2008**

**TRADEMARK  
PRINCIPAL REGISTER**



HAYWARD, PAUL A. (CANADA INDIVIDUAL)  
3601 EAST BAY DRIVE, #210  
HOLMES BEACH, FL 342172083

THE MARK CONSISTS OF THE REPRESENTATION OF TWO PEOPLE KICKING A BALL.

FOR: ATHLETIC CLOTHING, NAMELY, T-SHIRTS, IN CLASS 25 (U.S. CLS. 22 AND 39).

SN 78-822,021, FILED 2-23-2006.

FIRST USE 6-30-2008; IN COMMERCE 6-30-2008.

CHARLOTTE CORWIN, EXAMINING ATTORNEY



**Int. Cl.: 9**

**Prior U.S. Cls.: 21, 23, 26, 36, and 38**

**United States Patent and Trademark Office**

**Reg. No. 3,506,541**

**Registered Sep. 23, 2008**

**TRADEMARK  
PRINCIPAL REGISTER**



HICKS OIL & HICKSGAS, INC. (INDIANA CORPORATION)  
204 N. ROUTE 54 P.O. BOX 98  
ROBERTS, IL 60962

FOR: EMERGENCY VEHICLES, NAMELY, FIRE AND EMERGENCY SERVICE VEHICLES IN THE NATURE OF FIRE TRUCKS, FIRE TRUCKS FEATURING WATER TANKERS AND FIRST RESPON-

DER FIRE AND EMERGENCY TRUCKS, IN CLASS 9 (U.S. CLS. 21, 23, 26, 36 AND 38).

FIRST USE 5-0-2006; IN COMMERCE 5-0-2006.

SN 78-823,678, FILED 2-26-2006.

RAMONA ORTIGA, EXAMINING ATTORNEY

**Int. Cls.: 9 and 42**

**Prior U.S. Cls.: 21, 23, 26, 36, 38, 100, and 101**

**Reg. No. 3,506,542**

**United States Patent and Trademark Office**

**Registered Sep. 23, 2008**

**TRADEMARK  
SERVICE MARK  
PRINCIPAL REGISTER**

# RA MUSIC

HOWARTH, ALAN STEVEN (UNITED STATES  
INDIVIDUAL)  
4455 COMMONWEALTH AVENUE  
LA CANADA, CA 91011

FOR: COMPUTERS HAVING AUDIO AND VIDEO SOUND CAPABILITIES; COMPUTERS; COMPONENTS OF COMPUTERS AND OTHER DIGITAL DEVICES, NAMELY, COMPUTER HARDWARE AND SOFTWARE USED TO ENHANCE AUDIO AND VIDEO SOUND; COMPUTER SOFTWARE FOR PLAYING AUDIO FILES; COMPUTER SOFTWARE THAT DELIVERS AUDIO SOUND FROM DVDS LOADED INTO A COMPUTER; COMPUTER PROGRAMS USED TO DIGITALLY PROCESS AND ENHANCE THE RECORDING AND PLAYBACK OF AUDIO SOUND, SOUND EFFECTS AND SOUND TRACKS; SOFTWARE USED TO DIGITALLY ENCODE AND DECODE MULTI-CHANNEL SOUND FOR PRE-RECORDED AUDIO DISCS, VIDEO DISCS, LASER DISCS, DVD VIDEO DISCS, AND DVD AUDIO DISCS; COMPUTER PROGRAMS USED FOR GENERATING, PROCESSING, AND PLAYING AUDIO SIGNALS AND SOUNDS; MOUSEPADS; FABRIC CARRYING CASES FOR DVDS AND CDS; DIGITAL SIGNAL PROCESSING CHIPS; INTEGRATED CIRCUITS; DVD VIDEO PLAYERS; DVD AUDIO PLAYERS; SET TOP CABLE BOXES; SATELLITE RECEIVERS; TELEVISION RECEIVERS; DIGITAL TELEVISION RECEIVERS; VIDEO GAME CONSOLES; AUDIO AND VIDEO SURROUND SOUND CONTROLLERS; AUTOMOBILE SOUND SPEAKERS; MULTIMEDIA SPEAKERS; PORTABLE AUDIO EQUIPMENT, NAMELY, CASSETTE PLAYERS AND RECORDERS, AND COMPACT-DISC PLAYERS; CINEMA SOUND PROCESSORS FOR MOTION PICTURE SOUND TRACKS AND CINEMATOGRAPHIC FILMS; VIDEO MONITORS; VIDEO TUNERS; AUDIO AND VIDEO RECORDERS; AUDIO AND VIDEO DISC PLAYERS; AUDIO AND VIDEO DISC DUBBING

DECKS; DVD PLAYERS; CABLE TELEVISION RECEIVERS AND DECODERS; REMOTE CONTROL UNITS FOR CABLE TELEVISION RECEIVERS AND DECODERS; ELECTRONIC BROADCAST SIGNAL PROCESSORS; ELECTRONIC SATELLITE BROADCAST SIGNAL PROCESSORS; AUDIO TAPES RECORDED WITH SIGNALS ENCODED FOR PLAYBACK USING A NOISE REDUCTION SYSTEM; AUDIO AND VIDEO TAPE RECORDERS AND TAPE PLAYERS FOR PORTABLE, NON-PORTABLE OR IN-VEHICLE USE; AUDIO OR VIDEO TAPE RECORDERS OR TAPE PLAYERS IN COMBINATION WITH AT LEAST ONE OF THE FOLLOWING: AMPLIFIER, RECEIVER, RADIO OR TELEVISION TUNER VIDEO CAMERA, RECORD PLAYER, COMPACT DISC PLAYER, VIDEO MONITOR, LOUD SPEAKER; MULTI-CHANNEL SOUND PROCESSORS; AUDIO AND AUDIO-VIDEO AMPLIFIERS AND RECEIVERS; STEREO AUDIO RECEIVERS; COMPUTER PROGRAMS HAVING SOUND GENERATING CAPABILITY; AUDIO AND VIDEO TAPES AND VIDEO DISCS RECORDED WITH ENCODED SIGNALS FOR PLAYBACK USING A NOISE REDUCTION SYSTEM OR SURROUND SOUND DECODER; CINEMATOGRAPHIC FILMS FEATURING FREQUENCY SPECTRUM CONVERSION TO NATURAL HARMONIC FREQUENCIES AND RELATED RESEARCH; ELECTRICAL POWER SUPPLIES; OPTICAL SOUND PROCESSORS FOR MOTION PICTURE SOUND TRACKS AND CINEMATOGRAPHIC FILMS; ELECTRONIC RECORDING/REPRODUCING APPARATUS EMBODYING NOISE REDUCTION CIRCUITS FOR USE IN CONNECTION WITH AUDIO AND VIDEO SIGNALS, NAMELY, MAGNETIC TAPE RECORDERS, CASSETTE RECORDERS, RECORD PLAYERS, RADIO TRANSMITTERS AND RECEIVERS, AND MOTION PICTURE SOUND TRACK RECORDERS; MAGNETIC TAPES, DISCS, AND MOTION PICTURE SOUND TRACKS FEATURING MUSIC AND IMAGES CREATED UTILIZING FRE-

QUENCY SPECTRUM CONVERSION TO NATURAL HARMONIC FREQUENCIES, AND VIDEO RECORDINGS OF ELECTRICAL SIGNALS WHICH HAVE BEEN SUBJECTED TO DYNAMIC RANGE COMPRESSION PRIOR TO RECORDING, IN CLASS 9 (U.S. CLS. 21, 23, 26, 36 AND 38).

FIRST USE 6-15-2006; IN COMMERCE 6-15-2006.

FOR: INFORMATION SERVICES PROVIDED BY MEANS OF A WEBSITE ON A GLOBAL COMPUTER NETWORK FEATURING THE DESIGN OF SOUND REPRODUCTION AND RECORDING EQUIPMENT IN THE CINEMA, PROFESSIONAL, HOME THEATER, MULTI-MEDIA, TELECOMMUNICATIONS

AND COMPUTER NETWORK FIELDS, IN CLASS 42 (U.S. CLS. 100 AND 101).

FIRST USE 6-15-2006; IN COMMERCE 10-15-2007.

THE MARK CONSISTS OF STANDARD CHARACTERS WITHOUT CLAIM TO ANY PARTICULAR FONT, STYLE, SIZE, OR COLOR.

NO CLAIM IS MADE TO THE EXCLUSIVE RIGHT TO USE "MUSIC", APART FROM THE MARK AS SHOWN.

SN 78-824,298, FILED 2-27-2006.

DAVID C. REIHNER, EXAMINING ATTORNEY

**Int. Cl.: 11**

**Prior U.S. Cls.: 13, 21, 23, 31, and 34**

**Reg. No. 3,506,543**

**United States Patent and Trademark Office**

**Registered Sep. 23, 2008**

**TRADEMARK  
PRINCIPAL REGISTER**

**SOLAR BEAR**

FAFCO, INC. (CALIFORNIA CORPORATION)  
435 OTTERSON DRIVE  
CHICO, CA 95928

FIRST USE 5-1-1993; IN COMMERCE 5-1-1993.

FOR: SOLAR HEATING SYSTEMS COMPRISING  
SOLAR COLLECTORS, CONTROLS, VALVES,  
TANKS, FLOW METERS, CIRCULATION PUMPS,  
AND HEAT COLLECTION PANELS, IN CLASS 11  
(U.S. CLS. 13, 21, 23, 31 AND 34).

THE MARK CONSISTS OF STANDARD CHAR-  
ACTERS WITHOUT CLAIM TO ANY PARTICULAR  
FONT, STYLE, SIZE, OR COLOR.

SN 78-825,245, FILED 2-28-2006.

CHERYL CLAYTON, EXAMINING ATTORNEY

**Int. Cl.: 14**

**Prior U.S. Cls.: 2, 27, 28, and 50**

**United States Patent and Trademark Office**

**Reg. No. 3,506,544**

**Registered Sep. 23, 2008**

**TRADEMARK  
PRINCIPAL REGISTER**

**GIFT OF TIME**

SEAH, LLC (FLORIDA LIMITED LIABILITY  
COMPANY)  
820 EAST COCO PLUM CIRCLE  
PLANTATION, FL 33324

THE MARK CONSISTS OF STANDARD CHAR-  
ACTERS WITHOUT CLAIM TO ANY PARTICULAR  
FONT, STYLE, SIZE, OR COLOR.

FOR: WATCHES, IN CLASS 14 (U.S. CLS. 2, 27, 28  
AND 50).

SN 78-825,279, FILED 2-28-2006.

FIRST USE 4-1-2008; IN COMMERCE 4-1-2008.

MICHAEL TANNER, EXAMINING ATTORNEY

**Int. Cl.: 5**

**Prior U.S. Cls.: 6, 18, 44, 46, 51, and 52**

**Reg. No. 3,506,545**

**United States Patent and Trademark Office**

**Registered Sep. 23, 2008**

---

**TRADEMARK  
PRINCIPAL REGISTER**

**ANAVIP**

PHARMASIL, INC. (DELAWARE CORPORATION)  
SUITE E  
110 RED BRANCH ROAD  
COLUMBIA, MD 210452014

THE MARK CONSISTS OF STANDARD CHARACTERS WITHOUT CLAIM TO ANY PARTICULAR FONT, STYLE, SIZE, OR COLOR.

FOR: PHARMACEUTICAL PREPARATIONS FOR THE TREATMENT OF BITES AND STINGS, IN CLASS 5 (U.S. CLS. 6, 18, 44, 46, 51 AND 52).

SN 78-825,625, FILED 2-28-2006.

FIRST USE 2-8-2008; IN COMMERCE 2-8-2008.

RONALD MCMORROW, EXAMINING ATTORNEY

**Int. Cl.: 11**

**Prior U.S. Cls.: 13, 21, 23, 31, and 34**

**United States Patent and Trademark Office**

**Reg. No. 3,506,546**

**Registered Sep. 23, 2008**

**TRADEMARK  
PRINCIPAL REGISTER**

**C<sup>3</sup>**

KOHLER CO. (WISCONSIN CORPORATION)  
444 HIGHLAND DRIVE  
KOHLER, WI 53044

FIRST USE 4-20-2006; IN COMMERCE 4-20-2006.

SN 78-826,517, FILED 3-1-2006.

FOR: TOILET SEATS, IN CLASS 11 (U.S. CLS. 13,  
21, 23, 31 AND 34).

DAVID MILLER, EXAMINING ATTORNEY

**Int. Cl.: 14**

**Prior U.S. Cls.: 2, 27, 28, and 50**

**United States Patent and Trademark Office**

**Reg. No. 3,506,547**

**Registered Sep. 23, 2008**

**TRADEMARK  
PRINCIPAL REGISTER**



STYLE CONSCIENCE (NEW MEXICO PARTNER-  
SHIP)  
450 MAPLE NE  
ALBUQUERQUE, NM 87106

FOR: JEWELRY MADE FROM, OR COATED  
WITH, PRECIOUS METALS AND THEIR ALLOYS  
AND/OR PRECIOUS STONES, NAMELY, PEN-  
DANTS, RINGS, BROACHES, BRACELETS, EARR-  
INGS, AND NECKLACES, IN CLASS 14 (U.S. CLS. 2,  
27, 28 AND 50).

FIRST USE 5-0-2008; IN COMMERCE 5-0-2008.

THE MARK CONSISTS OF TWO HEARTS  
LINKED TOGETHER WHEREIN THE LINES  
FORMING THE FIRST HEART'S LEFT LOWER  
QUADRANT AND SECOND HEART'S RIGHT UP-  
PER QUADRANT EXTEND DOWN TO FORM RIB-  
BON-LIKE TAILS.

SN 78-826,549, FILED 3-1-2006.

MICHAEL ENGEL, EXAMINING ATTORNEY



**Int. Cl.: 30**

**Prior U.S. Cl.: 46**

**United States Patent and Trademark Office**

**Reg. No. 3,506,548**

**Registered Sep. 23, 2008**

**TRADEMARK  
PRINCIPAL REGISTER**

**LOLLIBEAN**

JELLY BELLY CANDY COMPANY (CALIFOR-  
NIA CORPORATION)  
ONE JELLY BELLY LANE  
FAIRFIELD, CA 94533

THE MARK CONSISTS OF STANDARD CHAR-  
ACTERS WITHOUT CLAIM TO ANY PARTICULAR  
FONT, STYLE, SIZE, OR COLOR.

FOR: CANDY, IN CLASS 30 (U.S. CL. 46).

SN 78-826,610, FILED 3-1-2006.

FIRST USE 9-13-2006; IN COMMERCE 9-13-2006.

JENNIFER MARTIN, EXAMINING ATTORNEY

**Int. Cl.: 20**

**Prior U.S. Cls.: 2, 13, 22, 25, 32, and 50**

**Reg. No. 3,506,549**

**United States Patent and Trademark Office**

**Registered Sep. 23, 2008**

**TRADEMARK  
PRINCIPAL REGISTER**

**DOMINION**

HUNTER DOUGLAS, INC. (DELAWARE CORPORATION)  
2 PARK WAY & RT. 17 SOUTH  
UPPER SADDLE RIVER, NJ 074580740

FOR: DRAPERY HARDWARE, NAMELY, TRAVERSE RODS, CURTAIN RINGS, CURTAIN RODS AND POLES, NON-TEXTILE CURTAIN HOLD-BACKS, NON-METAL DRAPERY HARDWARE BRACKETS AND FINIALS, IN CLASS 20 (U.S. CLS. 2, 13, 22, 25, 32 AND 50).

FIRST USE 2-1-2008; IN COMMERCE 3-1-2008.

THE MARK CONSISTS OF STANDARD CHARACTERS WITHOUT CLAIM TO ANY PARTICULAR FONT, STYLE, SIZE, OR COLOR.

SN 78-826,746, FILED 3-1-2006.

KIMBERLY FRYE, EXAMINING ATTORNEY

**Int. Cl.: 19**

**Prior U.S. Cls.: 1, 12, 33, and 50**

**United States Patent and Trademark Office**

**Reg. No. 3,506,550**

**Registered Sep. 23, 2008**

**TRADEMARK  
PRINCIPAL REGISTER**

**ROYAL COURT**

HENGESTONE HOLDINGS, INC. (DELAWARE CORPORATION)

401 THE WEST MALL, SUITE 610

TORONTO, ONTARIO, CANADA M9C 5J5

FOR: PAVING STONES AND RETAINING WALL BLOCKS MADE OF CONCRETE, IN CLASS 19 (U.S. CLS. 1, 12, 33 AND 50).

FIRST USE 3-31-2006; IN COMMERCE 3-31-2006.

THE MARK CONSISTS OF STANDARD CHARACTERS WITHOUT CLAIM TO ANY PARTICULAR FONT, STYLE, SIZE, OR COLOR.

PRIORITY CLAIMED UNDER SEC. 44(D) ON CANADA APPLICATION NO. 1276967, FILED 10-25-2005, REG. NO. TMA673,440, DATED 9-26-2006, EXPIRES 9-26-2021.

SN 78-827,092, FILED 3-2-2006.

ASMAT KHAN, EXAMINING ATTORNEY

**Int. Cls.: 35 and 41**

**Prior U.S. Cls.: 100, 101, 102, and 107**

**United States Patent and Trademark Office**

**Reg. No. 3,506,551**

**Registered Sep. 23, 2008**

**SERVICE MARK  
PRINCIPAL REGISTER**



MENNELLA, MARY JO (UNITED STATES INDIVIDUAL), DBA MUSIC ASSET MANAGEMENT, 4370 TUJUNGA AVENUE, SUITE 320 STUDIO CITY, CA 91604

FOR: BUSINESS MANAGEMENT SERVICES, NAMELY, ACQUISITION CONSULTATION AND ADMINISTRATION; LICENSING AND MARKETING IN THE FIELD OF MUSICAL WORKS AND PERFORMANCES, IN CLASS 35 (U.S. CLS. 100, 101 AND 102).

FIRST USE 6-23-2006; IN COMMERCE 6-23-2006.

FOR: MUSIC PUBLISHING SERVICES; CONSULTING IN THE FIELD OF MUSICAL WORKS AND PERFORMANCES, IN CLASS 41 (U.S. CLS. 100, 101 AND 107).

FIRST USE 6-23-2006; IN COMMERCE 1-16-2007.

NO CLAIM IS MADE TO THE EXCLUSIVE RIGHT TO USE "MUSIC ASSET MANAGEMENT", APART FROM THE MARK AS SHOWN.

SN 78-827,982, FILED 3-2-2006.

DAVID HOFFMAN, EXAMINING ATTORNEY

**Int. Cl.: 9**

**Prior U.S. Cls.: 21, 23, 26, 36, and 38**

**United States Patent and Trademark Office**

**Reg. No. 3,506,552**

**Registered Sep. 23, 2008**

**TRADEMARK  
PRINCIPAL REGISTER**



QUALCOMM INCORPORATED (DELAWARE CORPORATION)  
PATENT & TRADEMARK DEPT.  
5775 MOREHOUSE DRIVE  
SAN DIEGO, CA 921211714

MUNICATION DEVICES, IN CLASS 9 (U.S. CLS. 21, 23, 26, 36 AND 38).

FIRST USE 12-22-2006; IN COMMERCE 12-22-2006.

FOR: SOFTWARE AND HARDWARE, NAMELY, COMPUTER SOFTWARE AND HARDWARE USED TO PROVIDE INFORMATION, INCLUDING LOCATION-BASED INFORMATION, TO WIRELESS COM-

SN 78-827,996, FILED 3-2-2006.

BONNIE LUKEN, EXAMINING ATTORNEY

**Int. Cls.: 29 and 30**

**Prior U.S. Cl.: 46**

**United States Patent and Trademark Office**

**Reg. No. 3,506,553**

**Registered Sep. 23, 2008**

**TRADEMARK  
PRINCIPAL REGISTER**

**YORKMONT VALLEY**

FOODBUY, LLC (DELAWARE LIMITED LIABILITY COMPANY)

11625 RAINWATER DRIVE

500 NORTHWINDS CENTER, SUITE 200

ALPHARETTA, GA 30004

FOR: PORK; TURKEY; INSTANT POTATOES; FRENCH FRIED POTATOES; CHICKEN, BEEF AND BACON BASE, IN CLASS 29 (U.S. CL. 46).

FIRST USE 10-0-2006; IN COMMERCE 10-0-2006.

FOR: GRAVY AND GRAVY CONCENTRATES, IN CLASS 30 (U.S. CL. 46).

FIRST USE 10-0-2007; IN COMMERCE 10-0-2007.

THE MARK CONSISTS OF STANDARD CHARACTERS WITHOUT CLAIM TO ANY PARTICULAR FONT, STYLE, SIZE, OR COLOR.

SN 78-828,451, FILED 3-3-2006.

BRENDAN REGAN, EXAMINING ATTORNEY

**Int. Cls.: 42 and 44**

**Prior U.S. Cls.: 100 and 101**

**United States Patent and Trademark Office**

**Reg. No. 3,506,554**

**Registered Sep. 23, 2008**

**SERVICE MARK  
PRINCIPAL REGISTER**

**QAMI**

REINER, BRUCE I. (UNITED STATES INDIVIDUAL)  
6 GREENLEAF LANE  
SEAFORD, DE 19973

FOR: QUALITY ASSURANCE SERVICES IN THE FIELDS OF MEDICAL RADIOLOGY, MEDICAL IMAGING, AND THERAPEUTIC RADIOLOGY, IN CLASS 42 (U.S. CLS. 100 AND 101).

FIRST USE 0-0-2005; IN COMMERCE 0-0-2005.

FOR: MEDICAL ASSISTANCE CONSULTANCY PROVIDED BY DOCTORS AND OTHER SPECIALIZED MEDICAL PERSONNEL IN CONNECTION

WITH MEDICAL RADIOLOGY SERVICES, MEDICAL IMAGING SERVICES, AND THERAPEUTIC RADIOLOGICAL SERVICES, IN CLASS 44 (U.S. CLS. 100 AND 101).

FIRST USE 0-0-2005; IN COMMERCE 0-0-2005.

THE MARK CONSISTS OF STANDARD CHARACTERS WITHOUT CLAIM TO ANY PARTICULAR FONT, STYLE, SIZE, OR COLOR.

SN 78-828,674, FILED 3-3-2006.

PAUL F. GAST, EXAMINING ATTORNEY

**Int. Cl.: 3**

**Prior U.S. Cls.: 1, 4, 6, 50, 51, and 52**

**United States Patent and Trademark Office**

**Reg. No. 3,506,555**

**Registered Sep. 23, 2008**

**TRADEMARK  
PRINCIPAL REGISTER**

**FORMULASHGRO-XL**

ATHENA COSMETICS, INC. (NEVADA CORPORATION)  
701 NORTH GREEN VALLEY PARKWAY  
SUITE 200  
HENDERSON, NV 89074

THE MARK CONSISTS OF STANDARD CHARACTERS WITHOUT CLAIM TO ANY PARTICULAR FONT, STYLE, SIZE, OR COLOR.

FOR: COSMETIC PREPARATIONS FOR EYE LASHES, IN CLASS 3 (U.S. CLS. 1, 4, 6, 50, 51 AND 52).

SN 78-830,961, FILED 3-7-2006.

FIRST USE 7-8-2008; IN COMMERCE 7-8-2008.

EVELYN BRADLEY, EXAMINING ATTORNEY



**Int. Cl.: 3**

**Prior U.S. Cls.: 1, 4, 6, 50, 51, and 52**

**United States Patent and Trademark Office**

**Reg. No. 3,506,556**

**Registered Sep. 23, 2008**

**TRADEMARK  
PRINCIPAL REGISTER**

**FORMULASHGRO**

ATHENA COSMETICS, INC., A NEVADA CORPORATION (NEVADA CORPORATION)  
701 NORTH GREEN VALLEY PARKWAY  
SUITE 200  
HENDERSON, NV 89074

THE MARK CONSISTS OF STANDARD CHARACTERS WITHOUT CLAIM TO ANY PARTICULAR FONT, STYLE, SIZE, OR COLOR.

FOR: COSMETIC PREPARATIONS FOR EYE LASHES, IN CLASS 3 (U.S. CLS. 1, 4, 6, 50, 51 AND 52).

SN 78-830,981, FILED 3-7-2006.

FIRST USE 6-25-2008; IN COMMERCE 6-25-2008.

EVELYN BRADLEY, EXAMINING ATTORNEY

**Int. Cls.: 37 and 42**

**Prior U.S. Cls.: 100, 101, 103, and 106**

**United States Patent and Trademark Office**

**Reg. No. 3,506,557**

**Registered Sep. 23, 2008**

**SERVICE MARK  
PRINCIPAL REGISTER**

# Solutioneering

HENRY'S AUDIO VISUAL SOLUTIONS, INC.  
(CALIFORNIA CORPORATION)  
STE F  
1582 PARKWAY LOOP  
TUSTIN, CA 92780

FOR: INSTALLATION OF ENTERTAINMENT,  
AUDIO/VISUAL, NETWORKING, AND RELATED  
INTEGRATED SYSTEMS FOR HOME AND BUSI-  
NESS, IN CLASS 37 (U.S. CLS. 100, 103 AND 106).

FIRST USE 4-17-2006; IN COMMERCE 4-17-2006.

FOR: CUSTOM DESIGN AND ENGINEERING OF  
ENTERTAINMENT, AUDIO/VISUAL, NETWORK-

ING, AND RELATED INTEGRATED SYSTEMS  
FOR HOME AND BUSINESS, IN CLASS 42 (U.S.  
CLS. 100 AND 101).

FIRST USE 4-17-2006; IN COMMERCE 4-17-2006.

THE MARK CONSISTS OF STANDARD CHAR-  
ACTERS WITHOUT CLAIM TO ANY PARTICULAR  
FONT, STYLE, SIZE, OR COLOR.

SN 78-831,492, FILED 3-7-2006.

RICHARD WHITE, EXAMINING ATTORNEY

**Int. Cl.: 44**

**Prior U.S. Cls.: 100 and 101**

**United States Patent and Trademark Office**

**Reg. No. 3,506,558**

**Registered Sep. 23, 2008**

**SERVICE MARK  
PRINCIPAL REGISTER**

**IDMPOWER**

SENTILLION, INC. (DELAWARE CORPORATION)  
40 SHATTUCK ROAD  
ANDOVER, MA 01810

THE MARK CONSISTS OF STANDARD CHARACTERS WITHOUT CLAIM TO ANY PARTICULAR FONT, STYLE, SIZE, OR COLOR.

FOR: PROVIDING AN ON-LINE KNOWLEDGE DATABASE IN THE FIELD OF HEALTHCARE, IN CLASS 44 (U.S. CLS. 100 AND 101).

SN 78-832,006, FILED 3-8-2006.

FIRST USE 12-0-2006; IN COMMERCE 12-0-2006.

PAUL CROWLEY, EXAMINING ATTORNEY

**Int. Cl.: 33**

**Prior U.S. Cls.: 47 and 49**

**United States Patent and Trademark Office**

**Reg. No. 3,506,559**

**Registered Sep. 23, 2008**

**TRADEMARK  
PRINCIPAL REGISTER**

**BANTRY BAY**

FONTANNAZ, BERNARD YVES ADRIEN (SWIT-  
ZERLAND INDIVIDUAL)  
PETERSHOF, DEVONVALLEY  
STELLENBOSCH, SOUTH AFRICA 7600

THE MARK CONSISTS OF STANDARD CHAR-  
ACTERS WITHOUT CLAIM TO ANY PARTICULAR  
FONT, STYLE, SIZE, OR COLOR.

FOR: ALCOHOLIC BEVERAGES, NAMELY,  
WINES, IN CLASS 33 (U.S. CLS. 47 AND 49).

SN 78-833,090, FILED 3-9-2006.

FIRST USE 2-6-2008; IN COMMERCE 2-6-2008.

RUDY R. SINGLETON, EXAMINING ATTORNEY

**Int. Cl.: 5**

**Prior U.S. Cls.: 6, 18, 44, 46, 51, and 52**

**United States Patent and Trademark Office**

**Reg. No. 3,506,560**

**Registered Sep. 23, 2008**

**TRADEMARK  
PRINCIPAL REGISTER**

**SLIMSTYX**

NATURAL FACTORS NUTRITIONAL PRODUCTS LTD. (CANADA CORPORATION)  
1550 UNITED BOULEVARD  
COQUITLAM, CANADA V3K 6Y2

FOR: DIETARY AND NUTRITIONAL SUPPLEMENTS; DIETARY DRINK MIX FOR USE AS A MEAL REPLACEMENT; DIETARY FIBER AS AN ADDITIVE FOR FOOD PRODUCTS; DIETARY FOOD SUPPLEMENTS; DIETARY SUPPLEMENTS FOR HUMAN CONSUMPTION; HERBAL SUPPLEMENTS; LECITHIN FOR USE AS A DIETARY SUPPLEMENT; MEAL REPLACEMENT AND DIETARY SUPPLEMENT DRINK MIXES; NUTRACEUTICALS FOR USE AS A DIETARY SUPPLEMENT; VITAMIN AND MINERAL SUPPLEMENTS, IN CLASS 5 (U.S. CLS. 6, 18, 44, 46, 51 AND 52).

FIRST USE 8-15-2006; IN COMMERCE 9-25-2006.

THE MARK CONSISTS OF STANDARD CHARACTERS WITHOUT CLAIM TO ANY PARTICULAR FONT, STYLE, SIZE, OR COLOR.

PRIORITY CLAIMED UNDER SEC. 44(D) ON CANADA APPLICATION NO. 1292929, FILED 3-8-2006.

SN 78-833,470, FILED 3-9-2006.

RONALD MCMORROW, EXAMINING ATTORNEY

**Int. Cls.: 9, 35, 37, 38, and 42**

**Prior U.S. Cls.: 21, 23, 26, 36, 38, 100, 101, 102, 103, 104, and 106**

**Reg. No. 3,506,561**

**United States Patent and Trademark Office**

**Registered Sep. 23, 2008**

**TRADEMARK  
SERVICE MARK  
PRINCIPAL REGISTER**



SMAPPER TECHNOLOGIES GMBH (AUSTRIA GMBH)  
SALURNER STR. 22  
KUFSTEIN, AUSTRIA A-6330

FOR: APPARATUS FOR RECORDING, TRANSMISSION AND REPRODUCTION OF SOUND AND IMAGES, NAMELY, WORD PROCESSORS AND DATA PROCESSORS; TELECOMMUNICATION APPARATUS AND INSTRUMENTS AND THEIR COMPONENTS, NAMELY, COMPUTER PROXY SERVERS, TELEPHONES, SCANNERS, FACSIMILE MACHINES, COMPUTERS, TELEPHONES AND SATELLITES; COMPUTER HARDWARE APPARATUS, SWITCHES AND CONNECTING ELEMENTS FOR USE IN THE MANAGEMENT OF TELECOMMUNICATION NETWORKS, NAMELY, CHANGE-OVER SWITCHES, ROUTERS, COMPUTER NETWORK HUBS, REPEATERS, BANDWIDTH MANAGERS, POWER AND ELECTRIC IDENTIFICATION SWITCHES, PRIORITY SWITCHES AND DIRECTIONAL SWITCHES; COMPUTER HARDWARE; COMPUTER PERIPHERALS; DIGITAL COMMUNICATION NETWORK SWITCHES; APPARATUS AND INSTRUMENTS FOR THE RECORDING, STORAGE, PROCESSING, INTERPRETATION, TRANSMISSION, DISTRIBUTION AND PRESENTATION OF DATA, NAMELY, COMPUTERS, BLANK TAPES FOR STORAGE OF COMPUTER DATA, DISK CONTROLLERS, SCANNERS AND FACSIMILE MACHINES; P R E - R E C O R D E D A N D DOWNLOADABLE COMPUTER PROGRAMS AND COMPUTER SOFTWARE FOR THE AFOREMENTIONED APPLIANCES FOR CONNECTING COMPUTER NETWORK USERS AND GLOBAL COMPUTER NETWORKS, FOR USE IN DATABASE MANAGEMENT, FOR USE AS A SPREADSHEET, FOR WORD PROCESSING, DISTRIBUTION, MANIPULATION AND RELOCATION OF IMAGES,

DATA AND SOUND VIA COMPUTER NETWORKS; COMPUTER HARDWARE AND SOFTWARE FOR THE DISTRIBUTION, MANIPULATION AND RELOCATION OF IMAGES, DATA AND SOUND VIA COMPUTER NETWORKS FOR USE IN THE FIELD OF DATA STORAGE AND HANDLING OF ELECTRONIC DATA; OPTICALLY, ELECTRONICALLY AND MAGNETICALLY RECORDED MANUALS ON COMPUTER MEDIA FOR THE AFOREMENTIONED APPLIANCES SOLD TOGETHER AS A UNIT THEREWITH, IN CLASS 9 (U.S. CLS. 21, 23, 26, 36 AND 38).

FIRST USE 12-9-2004; IN COMMERCE 12-20-2007.

FOR: ELECTRONIC DATA PROCESSING (EDP) CONSULTANCY; COMPILING DATA AND INFORMATION IN THE FIELD OF COMPUTERS IN DATABASES FOR OTHERS, IN CLASS 35 (U.S. CLS. 100, 101 AND 102).

FIRST USE 12-9-2004; IN COMMERCE 1-12-2007.

FOR: INSTALLATION, MAINTENANCE AND REPAIR OF COMPUTER NETWORKS, IN CLASS 37 (U.S. CLS. 100, 103 AND 106).

FIRST USE 12-9-2004; IN COMMERCE 1-12-2007.

FOR: COMMUNICATION BY ELECTRONIC PLATFORMS, NAMELY, COMPUTER TERMINALS, FIBRE-OPTIC NETWORKS AND CELLULAR TELEPHONES; ELECTRONIC DATA INTERCHANGE; TELECOMMUNICATIONS FOR FILE CREATION AND MAINTENANCE AND FOR DOCUMENT AND INFORMATION EXCHANGE, NAMELY, TELECOMMUNICATIONS ROUTING AND JUNCTION SERVICES, PROVIDING FIBER OPTIC NETWORK SERVICES AND TRANSMISSION OF INFORMA-

TION ON OPTICAL TELECOMMUNICATION NETWORKS; COMMUNICATION SERVICES VIA THE INTERNET, LOCAL OPEN AREA NETWORKS, WIDE AREA OPEN NETWORKS, METROPOLITAN AREA OPEN NETWORKS, OPEN WIRELESS NETWORKS, INTRANETS, OPEN FIBRE OPTIC NETWORKS, OPEN TELEPHONE NETWORKS, OPEN MOBILE NETWORKS, AND OPEN NETWORKS, NAMELY, TELECOMMUNICATIONS BY E-MAIL, TRANSMISSION OF DATABASE INFORMATION VIA TELECOMMUNICATIONS NETWORKS AND TRANSFER OF DATA BY TELECOMMUNICATIONS; PROVISION OF TELECOMMUNICATION INFORMATION VIA COMPUTER NETWORKS; TRANSMISSION OF INFORMATION AND DATA VIA COMPUTER NETWORKS; PROVIDING MULTIPLE USER ACCESS TO GLOBAL COMPUTER INFORMATION NETWORKS, ELECTRONIC DATABASES AND COMPUTER DATABASES AND NETWORKS FOR THE TRANSFER AND DISSEMINATION OF A WIDE RANGE OF INFORMATION; PROVIDING REMOTE ACCESS TO THE INTERNET, IN CLASS 38 (U.S. CLS. 100, 101 AND 104).

FIRST USE 12-9-2004; IN COMMERCE 1-12-2007.

FOR: LICENSING OF COMPUTER SOFTWARE; TECHNICAL PROJECT MANAGEMENT IN THE FIELD OF ELECTRONIC DATA PROCESSING; LEASING OF COMPUTER HARDWARE; COMPUTER TIMESHARING; SCIENTIFIC AND TECHNOLOGICAL CONSULTING AND RESEARCH SERVICES RELATING TO COMPUTERS AND TELECOMMUNICATIONS EQUIPMENT AND DESIGN SERVICES RELATING THERETO; INDUSTRIAL DESIGN ANALYSIS AND SCIENTIFIC RESEARCH SERVICES; DESIGN AND DEVELOPMENT OF COMPUTER HARDWARE AND SOFTWARE FOR OTHERS; COMPUTER PROGRAMMING FOR OTHERS; COMPUTER SOFTWARE DEVELOPMENT; LEASING, UPDATING, DEVELOPMENT AND MAINTENANCE OF COMPUTER SOFTWARE FOR OTHERS; PROVIDING TEMPORARY USE OF ON-LINE NON-DOWNLOADABLE SOFTWARE ON DATA NETWORKS FOR USE IN DATABASE MANAGEMENT, FOR USE AS A SPREADSHEET, FOR WORD PROCESSING; COMPUTER ADVISORY SERVICES; COMPUTER ADVISORY SERVICES REGARDING ELECTRONIC DATA PROCESSING; COMPUTER SOFTWARE CONSULTING; COMPUTER SYSTEM ANALYSES; COMPUTER SYSTEM DESIGN FOR OTHERS; DESIGN OF COMPUTER SOFTWARE FOR OTHERS; IMPLEMENTATION OF COMPUTER PROGRAMS ON NETWORKS; INSTALLATION OF COMPUTER PROGRAMS FOR OTHERS; CONFIGURATION OF COMPUTER NETWORKS BY THE USE OF SOFTWARE; CONVERSION OF COMPUTER PROGRAMS AND DATA WITHOUT PHYSICAL MODIFICATION; TECHNICAL COMPUTER PROJECT MANAGEMENT IN

THE FIELD OF ELECTRONIC DATA PROCESSING; RECOVERY OF COMPUTER DATA; CREATING WEBSITES FOR OTHERS; EVALUATION OF COMPUTER SYSTEMS FOR OTHERS FOR TECHNICAL PURPOSES; RESEARCH AND DEVELOPMENT OF COMPUTER HARDWARE AND SOFTWARE; TECHNOLOGICAL SERVICES RELATING TO COMPUTERS, NAMELY, TECHNOLOGICAL CONSULTATION AND TROUBLESHOOTING OF COMPUTER HARDWARE AND SOFTWARE PROBLEMS; LEASING OF COMPUTER SOFTWARE, LEASING COMPUTER DATABASE SERVERS TO THIRD PARTIES; HOSTING THE WEB SITES OF OTHERS ON A COMPUTER SERVER FOR THE GLOBAL COMPUTER NETWORK; SCIENTIFIC AND TECHNOLOGICAL COMPUTER NETWORK RESEARCH SERVICES; COMPUTER HELP LINE SERVICES FOR OTHERS, NAMELY, TROUBLESHOOTING OF COMPUTER HARDWARE AND SOFTWARE PROBLEMS AND INDUSTRIAL PROCESS CONTROL COMPUTER SOFTWARE PROBLEMS; COMPUTER SERVICE, NAMELY, ACTING AS AN APPLICATION SERVICE PROVIDER IN THE FIELD OF KNOWLEDGE MANAGEMENT TO HOST COMPUTER APPLICATION SOFTWARE FOR ELECTRONICALLY STORING DATA IN DATABASES AND RETRIEVING INFORMATION FROM DATABASES; TECHNICAL SUPPORT CONCERNING COMPUTER HARDWARE, COMPUTER SOFTWARE, COMPUTER NETWORKS AND THE INTERNET, NAMELY, TROUBLESHOOTING OF COMPUTER HARDWARE AND SOFTWARE PROBLEMS AND INDUSTRIAL PROCESS CONTROL COMPUTER SOFTWARE PROBLEMS; CREATING INDEXES OF INFORMATION, SITES AND OTHER RESOURCES AVAILABLE ON COMPUTER NETWORKS; DEVELOPMENT OF COMPUTERS AND ONLINE COMPUTER NETWORKS; PROVIDING INFORMATION AND CONSULTING REGARDING THE AFORESAID SERVICES ONLINE OR VIA THE INTERNET AND OPEN COMPUTER NETWORKS; CONSULTANCY, DEVELOPMENT, TESTING, ENGINEERING, ENGINEERING DRAFTING AND SCIENTIFIC AND TECHNOLOGICAL RESEARCH WITH REGARD TO COMPUTERS, COMPUTER NETWORKS, COMPUTER SOFTWARE AND COMPUTER PROGRAMMING, IN CLASS 42 (U.S. CLS. 100 AND 101).

FIRST USE 12-9-2004; IN COMMERCE 1-12-2007.

THE REVERSE STIPPLING IS A FEATURE OF THE MARK.

THE MARK CONSISTS OF A STYLIZED "S".

SN 78-834,923, FILED 3-10-2006.

DAVID YONTEF, EXAMINING ATTORNEY

**Int. Cl.: 16**

**Prior U.S. Cls.: 2, 5, 22, 23, 29, 37, 38, and 50**

**United States Patent and Trademark Office**

**Reg. No. 3,506,562**

**Registered Sep. 23, 2008**

**TRADEMARK  
PRINCIPAL REGISTER**



STAPLES THE OFFICE SUPERSTORE, LLC (DE-  
LAWARE LIMITED LIABILITY COMPANY)  
500 STAPLES DRIVE  
FRAMINGHAM, MA 01702

FIRST USE 1-0-2006; IN COMMERCE 1-0-2006.

OWNER OF U.S. REG. NO. 3,146,564.

FOR: PENS, HIGHLIGHTERS, PADS OF PAPER,  
NOTE PAPER, WRITING PAPER, COPY PAPER,  
LOOSE LEAF PAPER, IN CLASS 16 (U.S. CLS. 2, 5, 22,  
23, 29, 37, 38 AND 50).

SN 78-837,835, FILED 3-15-2006.

ELISSA GARBER KON, EXAMINING ATTORNEY



**Int. Cl.: 11**

**Prior U.S. Cls.: 13, 21, 23, 31, and 34**

**United States Patent and Trademark Office**

**Reg. No. 3,506,563**

**Registered Sep. 23, 2008**

**TRADEMARK  
PRINCIPAL REGISTER**

**MODS**

OKC HOLDING COMPANY, L.L.C. (NEVADA  
LIMITED LIABILITY COMPANY)  
4120 WEST WINDMILL LANE  
SUITE 101  
LAS VEGAS, NV 89139

FOR: BARBECUE ISLANDS AND COMPONENTS  
THEREOF, NAMELY, DOORS, DRAWERS, GRILLS,  
REFRIGERATION UNITS, AND CABINETS, IN  
CLASS 11 (U.S. CLS. 13, 21, 23, 31 AND 34).

FIRST USE 12-0-2004; IN COMMERCE 12-0-2004.

THE MARK CONSISTS OF STANDARD CHAR-  
ACTERS WITHOUT CLAIM TO ANY PARTICULAR  
FONT, STYLE, SIZE, OR COLOR.

SN 78-838,213, FILED 3-15-2006.

ELI HELLMAN, EXAMINING ATTORNEY

**Int. Cls.: 7 and 11**

**Prior U.S. Cls.: 13, 19, 21, 23, 31, 34, and 35**

**United States Patent and Trademark Office**

**Reg. No. 3,506,564**

**Registered Sep. 23, 2008**

**TRADEMARK  
PRINCIPAL REGISTER**

**WING-PLEAT**

KONDOH INDUSTRIES, LTD. (JAPAN CORPORATION)  
SHIN-NIKKO BLDG. 11F  
2-10-1 TORANOMON, MINATO-KU  
TOKYO, JAPAN 105-0001

FOR: AIR FILTERS FOR MECHANICAL PURPOSES, IN CLASS 7 (U.S. CLS. 13, 19, 21, 23, 31, 34 AND 35).

FIRST USE 12-0-2006; IN COMMERCE 12-0-2006.

FOR: AIR FILTERS FOR AIR CONDITIONING UNITS; AIR FILTERS FOR INDUSTRIAL INSTAL-

LATIONS, IN CLASS 11 (U.S. CLS. 13, 21, 23, 31 AND 34).

FIRST USE 12-0-2006; IN COMMERCE 12-0-2006.

THE MARK CONSISTS OF STANDARD CHARACTERS WITHOUT CLAIM TO ANY PARTICULAR FONT, STYLE, SIZE, OR COLOR.

SN 78-839,914, FILED 3-17-2006.

NANCY CLARKE, EXAMINING ATTORNEY

**Int. Cl.: 5**

**Prior U.S. Cls.: 6, 18, 44, 46, 51, and 52**

**United States Patent and Trademark Office**

**Reg. No. 3,506,565**

**Registered Sep. 23, 2008**

**TRADEMARK  
PRINCIPAL REGISTER**

**PROTEOGUARD**

ALLVIVO VASCULAR, INC. (COLORADO CORPORATION)  
SUITE 112  
20914 BAKE PARKWAY  
LAKE FOREST, CA 92688

FOR: MEDICAL PREPARATIONS, NAMELY, BIOCOMPATIBLE SURFACE COATING FOR APPLICATION TO MEDICAL DEVICES AND DRUG DELIVERY SYSTEMS TO PREVENT AN ADVERSE RESPONSE OR MINIMIZE INFLAMMATORY RESPONSE, IN CLASS 5 (U.S. CLS. 6, 18, 44, 46, 51 AND 52).

FIRST USE 4-27-2005; IN COMMERCE 4-27-2005.

THE MARK CONSISTS OF STANDARD CHARACTERS WITHOUT CLAIM TO ANY PARTICULAR FONT, STYLE, SIZE, OR COLOR.

SN 78-840,351, FILED 3-17-2006.

REBECCA POVARCHUK, EXAMINING ATTORNEY

**Int. Cl.: 35**

**Prior U.S. Cls.: 100, 101, and 102**

**United States Patent and Trademark Office**

**Reg. No. 3,506,566**

**Registered Sep. 23, 2008**

**SERVICE MARK  
PRINCIPAL REGISTER**

**EXITCHECK**

CHECKWELL SOLUTIONS CORPORATION (CANADA CORPORATION)  
SUITE 200  
1311 HOWE STREET  
VANCOUVER, CANADA V6Z 2P3

FOR: PERSONNEL SERVICES, NAMELY, DEPARTURE REFERENCES FOR FUTURE EMPLOYMENT, DEPARTURE EXIT INTERVIEW SERVICES OF EMPLOYEES OF OTHER BUSINESSES; AND EMPLOYEE ASSESSMENT SERVICES, NAMELY, TESTING TO DETERMINE EMPLOYMENT SKILLS, IN CLASS 35 (U.S. CLS. 100, 101 AND 102).

FIRST USE 1-1-2006; IN COMMERCE 1-1-2006.

THE MARK CONSISTS OF STANDARD CHARACTERS WITHOUT CLAIM TO ANY PARTICULAR FONT, STYLE, SIZE, OR COLOR.

PRIORITY CLAIMED UNDER SEC. 44(D) ON CANADA APPLICATION NO. 1273641, FILED 9-20-2005, REG. NO. 671573, DATED 8-30-2006, EXPIRES 8-30-2021.

SN 78-840,424, FILED 3-17-2006.

BERNICE MIDDLETON, EXAMINING ATTORNEY

**Int. Cl.: 43**

**Prior U.S. Cls.: 100 and 101**

**United States Patent and Trademark Office**

**Reg. No. 3,506,567**

**Registered Sep. 23, 2008**

**SERVICE MARK  
PRINCIPAL REGISTER**

**RED MANGO**

RELAY INTERNATIONAL CO., LTD. (REPUBLIC  
OF KOREA CORPORATION)  
B1 MARO BUILDING, 203-8 DONGYO-DONG  
MAPO-KU, SEOUL, REPUBLIC OF KOREA 121-819

FOR: RESTAURANT AND CAFE SERVICES, IN  
CLASS 43 (U.S. CLS. 100 AND 101).

FIRST USE 7-0-2007; IN COMMERCE 7-0-2007.

THE MARK CONSISTS OF STANDARD CHAR-  
ACTERS WITHOUT CLAIM TO ANY PARTICULAR  
FONT, STYLE, SIZE, OR COLOR.

OWNER OF REPUBLIC OF KOREA REG. NO.  
0100820, DATED 5-14-2004, EXPIRES 5-14-2014.

SN 78-840,550, FILED 3-17-2006.

CHARISMA HAMPTON, EXAMINING ATTORNEY

**Int. Cl.: 30**

**Prior U.S. Cl.: 46**

**United States Patent and Trademark Office**

**Reg. No. 3,506,568**

**Registered Sep. 23, 2008**

**TRADEMARK  
PRINCIPAL REGISTER**

**PURELY PEACHY**

SARA LEE / DE N.V. (NETHERLANDS COR-  
PORATION)  
VLEUTENSEVAART 100  
3532 AD UTRECHT, NETHERLANDS

NO CLAIM IS MADE TO THE EXCLUSIVE  
RIGHT TO USE "PEACHY", APART FROM THE  
MARK AS SHOWN.

FOR: TEA, IN CLASS 30 (U.S. CL. 46).

FIRST USE 9-30-2006; IN COMMERCE 9-30-2006.

SN 78-841,227, FILED 3-20-2006.

THE MARK CONSISTS OF STANDARD CHAR-  
ACTERS WITHOUT CLAIM TO ANY PARTICULAR  
FONT, STYLE, SIZE, OR COLOR.

DOMINICK J. SALEMI, EXAMINING ATTORNEY

**Int. Cls.: 29 and 30**

**Prior U.S. Cl.: 46**

**United States Patent and Trademark Office**

**Reg. No. 3,506,569**

**Registered Sep. 23, 2008**

**TRADEMARK  
PRINCIPAL REGISTER**

**ROYAL CLASSICS**

THE FEDERATED GROUP, INC. (ILLINOIS CORPORATION)  
3025 WEST SALT CREEK LANE  
ARLINGTON HEIGHTS, IL 60005

FOR: OLIVE OIL, IN CLASS 29 (U.S. CL. 46).

FIRST USE 3-21-2006; IN COMMERCE 8-0-2006.

FOR: CRACKERS; MARINADES; PASTA; RICE;  
SALAD DRESSINGS; SAUCES; SPAGHETTI SAUCE;  
VINEGAR, IN CLASS 30 (U.S. CL. 46).

FIRST USE 3-21-2006; IN COMMERCE 10-0-2006.

THE MARK CONSISTS OF STANDARD CHARACTERS WITHOUT CLAIM TO ANY PARTICULAR FONT, STYLE, SIZE, OR COLOR.

SN 78-841,600, FILED 3-20-2006.

DORITT L. CARROLL, EXAMINING ATTORNEY

**Int. Cls.: 16 and 25**

**Prior U.S. Cls.: 2, 5, 22, 23, 29, 37, 38, 39, and 50**

**United States Patent and Trademark Office**

**Reg. No. 3,506,570**

**Registered Sep. 23, 2008**

**TRADEMARK  
PRINCIPAL REGISTER**

**SIERRA ORO FARM TRAIL**

JOHANSSON, JAMES D. (UNITED STATES IN-  
DIVIDUAL)  
3723 FOOTHILL BLVD.  
OROVILLE, CA 95966

FOR: PRINTED MATERIALS, NAMELY, POST  
CARDS, CALENDARS, MAPS, FOLDERS, BUMPER  
STICKERS, POSTERS, ADDRESS BOOKS, PAPER  
PLACEMATS, AND STATIONERY , IN CLASS 16  
(U.S. CLS. 2, 5, 22, 23, 29, 37, 38 AND 50).

FIRST USE 6-1-2005; IN COMMERCE 6-1-2005.

FOR: CLOTHING, NAMELY, T-SHIRTS, SWEAT-  
SHIRTS, HATS, CAPS, AND JACKETS, IN CLASS 25  
(U.S. CLS. 22 AND 39).

FIRST USE 6-1-2005; IN COMMERCE 6-1-2005.

THE MARK CONSISTS OF STANDARD CHAR-  
ACTERS WITHOUT CLAIM TO ANY PARTICULAR  
FONT, STYLE, SIZE, OR COLOR.

THE ENGLISH TRANSLATION OF THE SPANISH  
WORD "ORO" IN THE MARK IS "GOLD".

SN 78-841,660, FILED 3-20-2006.

CHARISMA HAMPTON, EXAMINING ATTORNEY



**Int. Cl.: 16**

**Prior U.S. Cls.: 2, 5, 22, 23, 29, 37, 38, and 50**

**Reg. No. 3,506,571**

**United States Patent and Trademark Office**

**Registered Sep. 23, 2008**

**TRADEMARK  
PRINCIPAL REGISTER**

# NOTETOTE

MEADWESTVACO CORPORATION (DELAWARE  
CORPORATION)  
MEADWESTVACO CORPORATE CENTER  
11013 WEST BROAD STREET  
GLEN ALLEN, VA 23060

FOR: RING BINDERS AND WIREBOUND NOTE-  
BOOKS FOR SALE IN WHOLESALE AND MASS  
RETAIL CHANNELS OF TRADE AND NOT INTEN-  
DED FOR SPECIAL USE IN THE MUSIC FIELD, IN  
CLASS 16 (U.S. CLS. 2, 5, 22, 23, 29, 37, 38 AND 50).

FIRST USE 6-6-2006; IN COMMERCE 6-6-2006.

THE MARK CONSISTS OF STANDARD CHAR-  
ACTERS WITHOUT CLAIM TO ANY PARTICULAR  
FONT, STYLE, SIZE, OR COLOR.

OWNER OF U.S. REG. NOS. 2,182,188, 3,045,864,  
AND OTHERS.

SN 78-842,899, FILED 3-22-2006.

HANNO RITTNER, EXAMINING ATTORNEY

**Int. Cl.: 14**

**Prior U.S. Cls.: 2, 27, 28, and 50**

**United States Patent and Trademark Office**

**Reg. No. 3,506,572**

**Registered Sep. 23, 2008**

**TRADEMARK  
PRINCIPAL REGISTER**

**HIGH SCHOOL MUSICAL**

DISNEY ENTERPRISES, INC. (DELAWARE CORPORATION)  
500 SOUTH BUENA VISTA STREET  
BURBANK, CA 91521

FOR: ALARM CLOCKS; CLOCKS; EARRINGS; JEWELRY CHAINS; KEY RINGS OF PRECIOUS METAL; PENDANTS; RINGS BEING JEWELRY; WALL CLOCKS; WATCH CHAINS; WATCHES; WRISTWATCHES, IN CLASS 14 (U.S. CLS. 2, 27, 28 AND 50).

FIRST USE 9-0-2007; IN COMMERCE 9-0-2007.

THE MARK CONSISTS OF STANDARD CHARACTERS WITHOUT CLAIM TO ANY PARTICULAR FONT, STYLE, SIZE, OR COLOR.

SN 78-846,789, FILED 3-27-2006.

SAMUEL E. SHARPER JR., EXAMINING ATTORNEY

**Int. Cl.: 25**

**Prior U.S. Cls.: 22 and 39**

**United States Patent and Trademark Office**

**Reg. No. 3,506,573**

**Registered Sep. 23, 2008**

**TRADEMARK  
PRINCIPAL REGISTER**

**HIGH SCHOOL MUSICAL**

DISNEY ENTERPRISES, INC. (DELAWARE CORPORATION)  
500 SOUTH BUENA VISTA STREET  
BURBANK, CA 91521

FOR: BEACH COVER-UPS; BEACHWEAR; BIKINIS; DRESSES; HOSIERY; SANDALS; SWEATERS; SWIMSUITS; WRIST BANDS, IN CLASS 25 (U.S. CLS. 22 AND 39).

FIRST USE 6-17-2008; IN COMMERCE 6-17-2008.

THE MARK CONSISTS OF STANDARD CHARACTERS WITHOUT CLAIM TO ANY PARTICULAR FONT, STYLE, SIZE, OR COLOR.

SN 78-846,811, FILED 3-27-2006.

SAMUEL E. SHARPER JR., EXAMINING ATTORNEY

**Int. Cl.: 41**

**Prior U.S. Cls.: 100, 101, and 107**

**United States Patent and Trademark Office**

**Reg. No. 3,506,574**

**Registered Sep. 23, 2008**

**SERVICE MARK  
PRINCIPAL REGISTER**

**Horse-X**

SAUER, BRIAN (UNITED STATES INDIVIDUAL)  
14306 SKY FROST DRIVE  
DALLAS, TX 75253

THE MARK CONSISTS OF STANDARD CHAR-  
ACTERS WITHOUT CLAIM TO ANY PARTICULAR  
FONT, STYLE, SIZE, OR COLOR.

FOR: ENTERTAINMENT, NAMELY, CONDUCT-  
ING HORSE RACES, IN CLASS 41 (U.S. CLS. 100, 101  
AND 107).

SN 78-847,704, FILED 3-28-2006.

FIRST USE 6-16-2008; IN COMMERCE 6-16-2008.

LINDA POWELL, EXAMINING ATTORNEY

**Int. Cl.: 41**

**Prior U.S. Cls.: 100, 101, and 107**

**United States Patent and Trademark Office**

**Reg. No. 3,506,575**

**Registered Sep. 23, 2008**

**SERVICE MARK  
PRINCIPAL REGISTER**

# Horsecross

SAUER, BRIAN (UNITED STATES INDIVIDUAL)  
14306 SKY FROST DRIVE  
DALLAS, TX 75253

THE MARK CONSISTS OF STANDARD CHAR-  
ACTERS WITHOUT CLAIM TO ANY PARTICULAR  
FONT, STYLE, SIZE, OR COLOR.

FOR: ENTERTAINMENT, NAMELY, CONDUCT-  
ING HORSE RACES, IN CLASS 41 (U.S. CLS. 100, 101  
AND 107).

SN 78-847,714, FILED 3-28-2006.

FIRST USE 6-16-2008; IN COMMERCE 6-16-2008.

LINDA POWELL, EXAMINING ATTORNEY

**Int. Cls.: 16, 35, 38, and 41**

**Prior U.S. Cls.: 2, 5, 22, 23, 29, 37, 38, 50, 100, 101, 102, 104, and 107**

**Reg. No. 3,506,576**

**United States Patent and Trademark Office**

**Registered Sep. 23, 2008**

**TRADEMARK  
SERVICE MARK  
PRINCIPAL REGISTER**



ENTERPRISE BIKES, LLC (COLORADO LIMITED LIABILITY COMPANY)  
#K104  
9888 E. VASSAR DRIVE  
DENVER, CO 80231

FOR: POSTERS, CALENDARS, TRADING CARDS, BOOKS RELATING TO MOTORCYCLES, MAGAZINES RELATING TO MOTORCYCLES, FLYERS AND NEWSLETTERS RELATING TO MOTORCYCLES, NOTEPADS, STICKERS, BUMPER STICKERS, PAPER PENNANTS; PRINTED TICKETS TO MOTORCYCLE RALLIES AND EVENTS; NON-MAGNETICALLY CODED PREPAID PHONE CARDS, PENS AND PENCILS, PENCIL CASES, NOTE PAPER, PICTORIAL PRINTS, PICTURE POSTCARDS, ART PICTURES, STATIONERY, ENVELOPES, PAPER TABLE CLOTHS, PAPER NAPKINS, PAPER PARTY HATS, PAPER PARTY INVITATION CARDS, PAPER GIFT CARDS; PAPER GIFT BAGS, PAPER PARTY DECORATIONS, IN CLASS 16 (U.S. CLS. 2, 5, 22, 23, 29, 37, 38 AND 50).

FIRST USE 7-24-2007; IN COMMERCE 7-24-2007.

FOR: PROMOTING THE GOODS AND SERVICES THROUGH THE ENDORSEMENTS FOR ESTABLISHMENTS AND ORGANIZATIONS WHICH CATER TO MOTORCYCLE OWNERS, RIDERS, AND

ENTHUSIASTS, IN CLASS 35 (U.S. CLS. 100, 101 AND 102).

FIRST USE 7-24-2007; IN COMMERCE 7-24-2007.

FOR: SOCIAL INTERNET FORUMS AND CHAT ROOMS FOR THE TRANSMISSION OF MESSAGES AMONG COMPUTER USERS RELATED TO TOPICS OF INTEREST TO MOTORCYCLE OWNERS, RIDERS, AND ENTHUSIASTS, IN CLASS 38 (U.S. CLS. 100, 101 AND 104).

FIRST USE 7-24-2007; IN COMMERCE 7-24-2007.

FOR: ENTERTAINMENT SERVICES, NAMELY, PROVIDING NEWS AND INFORMATION REGARDING MOTORCYCLE ENTERTAINMENT EXHIBITIONS AND MOTORCYCLE RELATED EVENTS FOR MOTORCYCLE OWNERS, RIDERS, AND ENTHUSIASTS, IN CLASS 41 (U.S. CLS. 100, 101 AND 107).

FIRST USE 7-24-2007; IN COMMERCE 7-24-2007.

SN 78-847,824, FILED 3-28-2006.

KEVIN CORWIN, EXAMINING ATTORNEY

**Int. Cls.: 35 and 41**

**Prior U.S. Cls.: 100, 101, 102, and 107**

**United States Patent and Trademark Office**

**Reg. No. 3,506,577**

**Registered Sep. 23, 2008**

**SERVICE MARK  
PRINCIPAL REGISTER**

**BIKER MARDI GRAS**

EDGEWATER HOTEL CORPORATION (NEVADA CORPORATION)  
6700 VIA AUSTI PARKWAY  
LAS VEGAS, NV 89119

FOR: ARRANGING AND CONDUCTING OF FAIRS AND EXHIBITIONS FOR BUSINESS AND ADVERTISING PURPOSES, IN CLASS 35 (U.S. CLS. 100, 101 AND 102).

FIRST USE 4-26-2006; IN COMMERCE 4-26-2006.

FOR: ENTERTAINMENT IN THE NATURE OF LIVE PERFORMANCES BY MUSICAL GROUPS; ENTERTAINMENT SERVICES, NAMELY, CONDUCTING CONTESTS; ENTERTAINMENT SERVICES, NAMELY, CONDUCTING PARTIES; ENTERTAINMENT SERVICES, NAMELY, PERSONAL APPEARANCES BY A CELEBRITY, IN CLASS 41 (U.S. CLS. 100, 101 AND 107).

NAL APPEARANCES BY A CELEBRITY, IN CLASS 41 (U.S. CLS. 100, 101 AND 107).

FIRST USE 4-26-2006; IN COMMERCE 4-26-2006.

THE MARK CONSISTS OF STANDARD CHARACTERS WITHOUT CLAIM TO ANY PARTICULAR FONT, STYLE, SIZE, OR COLOR.

NO CLAIM IS MADE TO THE EXCLUSIVE RIGHT TO USE "BIKER", APART FROM THE MARK AS SHOWN.

SN 78-849,166, FILED 3-29-2006.

BARNEY CHARLON, EXAMINING ATTORNEY

**Int. Cls.: 6, 18, 20, and 40**

**Prior U.S. Cls.: 1, 2, 3, 12, 13, 14, 22, 23, 25, 32, 41, 50,  
100, 103, and 106**

**Reg. No. 3,506,578**

**United States Patent and Trademark Office**

**Registered Sep. 23, 2008**

**TRADEMARK  
SERVICE MARK  
PRINCIPAL REGISTER**

# KEYPORT

KEYPORT, INC. (NEVADA CORPORATION)  
2880 W. SAHARA AVE., #234  
LAS VEGAS, NV 89102

FOR: METAL KEY BLANKS; METAL KEY FOBS;  
METAL KEY HOLDERS; METAL KEYS FOR  
LOCKS, IN CLASS 6 (U.S. CLS. 2, 12, 13, 14, 23, 25  
AND 50).

FIRST USE 4-30-2007; IN COMMERCE 11-30-2007.

FOR: KEY CASE; KEY CASES, IN CLASS 18 (U.S.  
CLS. 1, 2, 3, 22 AND 41).

FIRST USE 4-30-2007; IN COMMERCE 11-30-2007.

FOR: KEY FOBS, NOT OF METAL; NON-METAL  
KEY HOLDERS, IN CLASS 20 (U.S. CLS. 2, 13, 22, 25,  
32 AND 50).

FIRST USE 4-30-2007; IN COMMERCE 11-30-2007.

FOR: KEY CUTTING; LOCKSMITHING, NAME-  
LY, CUSTOM FABRICATION OF KEYS OR LOCKS,  
IN CLASS 40 (U.S. CLS. 100, 103 AND 106).

FIRST USE 4-30-2007; IN COMMERCE 11-30-2007.

THE MARK CONSISTS OF STANDARD CHAR-  
ACTERS WITHOUT CLAIM TO ANY PARTICULAR  
FONT, STYLE, SIZE, OR COLOR.

SN 78-850,537, FILED 3-30-2006.

DORITT L. CARROLL, EXAMINING ATTORNEY



**Int. Cl.: 33**

**Prior U.S. Cls.: 47 and 49**

**United States Patent and Trademark Office**

**Reg. No. 3,506,579**

**Registered Sep. 23, 2008**

**TRADEMARK  
PRINCIPAL REGISTER**

**MIX! MINGLE! AND BE MERRY!**

DIAGEO NORTH AMERICA, INC. (CONNECTI-  
CUT CORPORATION)  
801 MAIN AVENUE  
NORWALK, CT 06851

THE MARK CONSISTS OF STANDARD CHAR-  
ACTERS WITHOUT CLAIM TO ANY PARTICULAR  
FONT, STYLE, SIZE, OR COLOR.

FOR: ALCOHOL BEVERAGES, NAMELY, DIS-  
TILLED SPIRITS AND WINE, IN CLASS 33 (U.S. CLS.  
47 AND 49).

SN 78-850,541, FILED 3-30-2006.

FIRST USE 11-30-2006; IN COMMERCE 11-30-2006.

DAVID COLLIER, EXAMINING ATTORNEY

**Int. Cl.: 30**

**Prior U.S. Cl.: 46**

**United States Patent and Trademark Office**

**Reg. No. 3,506,580**

**Registered Sep. 23, 2008**

**TRADEMARK  
PRINCIPAL REGISTER**

**BEST IN CLASS**

CHIPURNOI INCORPORATED (NEW YORK  
CORPORATION)  
SHARON-ON-THE-GREEN  
SHARON, CT 06069

THE MARK CONSISTS OF STANDARD CHAR-  
ACTERS WITHOUT CLAIM TO ANY PARTICULAR  
FONT, STYLE, SIZE, OR COLOR.

FOR: CANDY, IN CLASS 30 (U.S. CL. 46).

SN 78-850,838, FILED 3-31-2006.

FIRST USE 3-15-2007; IN COMMERCE 10-23-2007.

H. M. FISHER, EXAMINING ATTORNEY

**Int. Cl.: 5**

**Prior U.S. Cls.: 6, 18, 44, 46, 51, and 52**

**Reg. No. 3,506,581**

**United States Patent and Trademark Office**

**Registered Sep. 23, 2008**

**TRADEMARK  
PRINCIPAL REGISTER**

**SILVERSOL TECHNOLOGY**

AMERICAN SILVER, LLC (UTAH LIMITED LIABILITY COMPANY)  
80 WEST CANYON CREST ROAD  
ALPINE, UT 84004

THE MARK CONSISTS OF STANDARD CHARACTERS WITHOUT CLAIM TO ANY PARTICULAR FONT, STYLE, SIZE, OR COLOR.

FOR: ANTIBIOTICS, NAMELY, NATURAL ANTI-BIOTIC SOLUTIONS FOR INTERNAL AND EXTERNAL USE, IN CLASS 5 (U.S. CLS. 6, 18, 44, 46, 51 AND 52).

SN 78-855,009, FILED 4-5-2006.

FIRST USE 11-30-2007; IN COMMERCE 11-30-2007.

RAUL CORDOVA, EXAMINING ATTORNEY

**Int. Cl.: 5**

**Prior U.S. Cls.: 6, 18, 44, 46, 51, and 52**

**Reg. No. 3,506,582**

**United States Patent and Trademark Office**

**Registered Sep. 23, 2008**

---

**TRADEMARK  
PRINCIPAL REGISTER**

**SILVERSOL TECHNOLOGY**

AMERICAN SILVER, LLC (UTAH LIMITED LIABILITY COMPANY)  
80 WEST CANYON CREST ROAD  
ALPINE, UT 84004

THE MARK CONSISTS OF STANDARD CHARACTERS WITHOUT CLAIM TO ANY PARTICULAR FONT, STYLE, SIZE, OR COLOR.

FOR: HEALTH SUPPLEMENTS, NAMELY, DIETARY SUPPLEMENTS, FOOD SUPPLEMENTS, AND NUTRITIONAL SUPPLEMENTS, IN CLASS 5 (U.S. CLS. 6, 18, 44, 46, 51 AND 52).

SN 78-855,033, FILED 4-5-2006.

FIRST USE 11-30-2007; IN COMMERCE 11-30-2007.

RAUL CORDOVA, EXAMINING ATTORNEY

**Int. Cl.: 35**

**Prior U.S. Cls.: 100, 101, and 102**

**United States Patent and Trademark Office**

**Reg. No. 3,506,583**

**Registered Sep. 23, 2008**

---

**SERVICE MARK  
PRINCIPAL REGISTER**

**FROM CATCH TO KITCHEN**

INTERNATIONAL PACIFIC SEAFOODS, INC.  
(CALIFORNIA CORPORATION)  
2091 RAYMER AVENUE, SUITE C  
FULLERTON, CA 92833

THE MARK CONSISTS OF STANDARD CHAR-  
ACTERS WITHOUT CLAIM TO ANY PARTICULAR  
FONT, STYLE, SIZE, OR COLOR.

FOR: FOOD DISTRIBUTORSHIP SERVICES IN  
THE FIELD OF SEAFOOD PRODUCTS, IN CLASS 35  
(U.S. CLS. 100, 101 AND 102).

SN 78-855,642, FILED 4-6-2006.

FIRST USE 12-0-2006; IN COMMERCE 12-0-2006.

JOHN DWYER, EXAMINING ATTORNEY

**Int. Cls.: 36 and 43**

**Prior U.S. Cls.: 100, 101, and 102**

**United States Patent and Trademark Office**

**Reg. No. 3,506,584**

**Registered Sep. 23, 2008**

**SERVICE MARK  
PRINCIPAL REGISTER**

**KFC FEEDS**

KFC CORPORATION (DELAWARE CORPORATION)  
LEGAL - TRADEMARKS  
1441 GARDINER LANE  
LOUISVILLE, KY 40213

FOR: CHARITABLE SERVICES, NAMELY, PROVIDING FINANCIAL SUPPORT TO TEMPORARY SHELTERS HOUSING VICTIMS OF NATURAL DISASTERS, IN CLASS 36 (U.S. CLS. 100, 101 AND 102).

FIRST USE 9-30-2005; IN COMMERCE 9-30-2005.

FOR: CHARITABLE SERVICES, NAMELY, PROVIDING FOOD TO TEMPORARY SHELTERS HOUSING VICTIMS OF NATURAL DISASTERS;

PROVIDING FOOD TO PERSONS IN NEED, IN CLASS 43 (U.S. CLS. 100 AND 101).

FIRST USE 9-30-2005; IN COMMERCE 9-30-2005.

THE MARK CONSISTS OF STANDARD CHARACTERS WITHOUT CLAIM TO ANY PARTICULAR FONT, STYLE, SIZE, OR COLOR.

OWNER OF U.S. REG. NOS. 1,209,310, 2,729,326, AND OTHERS.

SN 78-858,032, FILED 4-10-2006.

MARK SPARACINO, EXAMINING ATTORNEY

**Int. Cls.: 3 and 5**

**Prior U.S. Cls.: 1, 4, 6, 18, 44, 46, 50, 51, and 52**

**United States Patent and Trademark Office**

**Reg. No. 3,506,585**

**Registered Sep. 23, 2008**

**TRADEMARK  
PRINCIPAL REGISTER**

**B-SURE**

BIRCHWOOD LABORATORIES, INC. (MINNESOTA CORPORATION)  
7900 FULLER ROAD  
EDEN PRAIRIE, MN 55344

FOR: SKIN MOISTURIZERS AND DISPOSABLE WIPES IMPREGNATED WITH CHEMICALS FOR PERSONAL HYGIENE USE; NON-MEDICATED PERINEAL RASH CREAM, IN CLASS 3 (U.S. CLS. 1, 4, 6, 50, 51 AND 52).

FIRST USE 3-5-2007; IN COMMERCE 3-5-2007.

FOR: PRE MOISTENED WITCH HAZEL PADS FOR PERSONAL HYGIENE USE, INCONTINENCE PADS, NAMELY, ANAL LEAKAGE PADS; ANORECTAL SURGERY WOUND DRAINAGE DRESSING; HAND SANITIZER, ANTIMICROBIALS FOR

DERMATOLOGIC USE, NAMELY, ANTIMICROBIAL TOWELETTES AND GELS; MEDICAL CLEANERS FOR SKIN AND WOUNDS; INCONTINENCE PROTECTIVE PADS; ODOR NEUTRALIZING PREPARATIONS FOR USE ON CARPETS, TEXTILES, HARD SURFACES, AND IN THE AIR, IN CLASS 5 (U.S. CLS. 6, 18, 44, 46, 51 AND 52).

FIRST USE 3-5-2007; IN COMMERCE 3-5-2007.

THE MARK CONSISTS OF STANDARD CHARACTERS WITHOUT CLAIM TO ANY PARTICULAR FONT, STYLE, SIZE, OR COLOR.

SN 78-859,120, FILED 4-11-2006.

GILBERT SWIFT, EXAMINING ATTORNEY

**Int. Cl.: 9**

**Prior U.S. Cls.: 21, 23, 26, 36, and 38**

**United States Patent and Trademark Office**

**Reg. No. 3,506,586**

**Registered Sep. 23, 2008**

**TRADEMARK  
PRINCIPAL REGISTER**



SL DELAWARE HOLDINGS, INC. (DELAWARE CORPORATION)  
103 SPRINGER BUILDING  
3411 SILVERSIDE ROAD  
WILMINGTON, DE 19810

FOR: POWER SUPPLY UNITS WHICH CONVERT AC OR DC POWER TO DIRECT ELECTRICAL CURRENT FOR END PRODUCTS; AND ELECTRICAL POWER CONDITIONING AND DISTRIBUTION UNITS, IN CLASS 9 (U.S. CLS. 21, 23, 26, 36 AND 38).

FIRST USE 10-18-2006; IN COMMERCE 10-18-2006.

NO CLAIM IS MADE TO THE EXCLUSIVE RIGHT TO USE "POWER ELECTRONICS", APART FROM THE MARK AS SHOWN.

THE COLOR(S) BLACK AND BLUE IS/ARE CLAIMED AS A FEATURE OF THE MARK.

THE MARK CONSISTS OF THE LETTERS "S" AND "L", A CIRCULAR SWOOSH AND THE TERM "POWER ELECTRONICS". THE COLOR BLUE APPEARS IN THE LETTERS "S" AND "L" AND THE SWOOSH TO THEIR LEFT, AND THE COLOR BLACK APPEARS IN THE WORD "POWER ELECTRONICS".

SN 78-860,768, FILED 4-13-2006.

SANI KHOURI, EXAMINING ATTORNEY



**Int. Cl.: 44**

**Prior U.S. Cls.: 100 and 101**

**United States Patent and Trademark Office**

**Reg. No. 3,506,587**

**Registered Sep. 23, 2008**

**SERVICE MARK  
PRINCIPAL REGISTER**

HARMONIA HEALING ARTS SPA

CSAKY, MATHESY ILONA (UNITED STATES  
INDIVIDUAL)  
205 DRAKES DRUM DRIVE  
BRYN MAWR, PA 19010

FOR: HEALTH SPA SERVICES FOR HEALTH  
AND WELLNESS OF THE BODY AND SPIRIT  
OFFERED AT A HEALTH OR BEAUTY DAY SPA;  
AND HEALTH SPA SERVICES, NAMELY, COSMET-  
IC BODY CARE SERVICES , IN CLASS 44 (U.S. CLS.  
100 AND 101).

FIRST USE 11-0-2006; IN COMMERCE 11-0-2006.

THE MARK CONSISTS OF STANDARD CHAR-  
ACTERS WITHOUT CLAIM TO ANY PARTICULAR  
FONT, STYLE, SIZE, OR COLOR.

NO CLAIM IS MADE TO THE EXCLUSIVE  
RIGHT TO USE "SPA", APART FROM THE MARK  
AS SHOWN.

THE ENGLISH TRANSLATION OF THE WORD  
"HARMONIA" IN THE MARK IS "HARMONY".

SN 78-861,199, FILED 4-13-2006.

DORITT L. CARROLL, EXAMINING ATTORNEY

**Int. Cl.: 38**

**Prior U.S. Cls.: 100, 101, and 104**

**United States Patent and Trademark Office**

**Reg. No. 3,506,588**

**Registered Sep. 23, 2008**

**SERVICE MARK  
PRINCIPAL REGISTER**

# Waterfall Mobile

WATERFALL MOBILE (DELAWARE CORPORATION)  
SUITE 7  
637 NATOMA  
SAN FRANCISCO, CA 94103

FOR: MOBILE MEDIA SERVICE IN THE NATURE OF ELECTRONIC TRANSMISSION OF ENTERTAINMENT MEDIA CONTENT, IN CLASS 38 (U.S. CLS. 100, 101 AND 104).

FIRST USE 8-1-2005; IN COMMERCE 8-1-2005.

THE MARK CONSISTS OF STANDARD CHARACTERS WITHOUT CLAIM TO ANY PARTICULAR FONT, STYLE, SIZE, OR COLOR.

NO CLAIM IS MADE TO THE EXCLUSIVE RIGHT TO USE "MOBILE", APART FROM THE MARK AS SHOWN.

SN 78-861,447, FILED 4-13-2006.

DAVID MILLER, EXAMINING ATTORNEY

**Int. Cl.: 43**

**Prior U.S. Cls.: 100 and 101**

**United States Patent and Trademark Office**

**Reg. No. 3,506,589**

**Registered Sep. 23, 2008**

**SERVICE MARK  
PRINCIPAL REGISTER**



SENGLY SNACKS, CORP. (MASSACHUSETTS CORPORATION)  
55 CHASE AVENUE  
LOWELL, MA 01854

FOR: RESTAURANT SERVICES, IN CLASS 43 (U.S. CLS. 100 AND 101).

FIRST USE 1-4-2006; IN COMMERCE 1-9-2006.

NO CLAIM IS MADE TO THE EXCLUSIVE RIGHT TO USE "EGGROLL CAFE", APART FROM THE MARK AS SHOWN.

THE MARK CONSISTS OF A STYLIZED LETTER "E" AND "C".

SN 78-861,541, FILED 4-14-2006.

JIM RINGLE, EXAMINING ATTORNEY

**Int. Cl.: 16**

**Prior U.S. Cls.: 2, 5, 22, 23, 29, 37, 38, and 50**

**Reg. No. 3,506,590**

**United States Patent and Trademark Office**

**Registered Sep. 23, 2008**

**TRADEMARK  
PRINCIPAL REGISTER**

**PAPYRAMID**

THE JULIE SAVALAS LIVING TRUST (MINNE-  
SOTA TRUST)  
3830 SCHOONER RIDGE  
ALPHARETTA, GA 30005

THE MARK CONSISTS OF STANDARD CHAR-  
ACTERS WITHOUT CLAIM TO ANY PARTICULAR  
FONT, STYLE, SIZE, OR COLOR.

FOR: DOCUMENT HOLDER, IN CLASS 16 (U.S.  
CLS. 2, 5, 22, 23, 29, 37, 38 AND 50).

SN 78-861,799, FILED 4-14-2006.

FIRST USE 1-1-2007; IN COMMERCE 6-17-2008.

KATHY DE JONGE, EXAMINING ATTORNEY

**Int. Cl.: 10**

**Prior U.S. Cls.: 26, 39, and 44**

**United States Patent and Trademark Office**

**Reg. No. 3,506,591**

**Registered Sep. 23, 2008**

**TRADEMARK  
PRINCIPAL REGISTER**

# NAVIGATOR

MEDTRONIC, INC. (MINNESOTA CORPORATION)  
710 MEDTRONIC PARKWAY  
MINNEAPOLIS, MN 554325604

THE MARK CONSISTS OF STANDARD CHARACTERS WITHOUT CLAIM TO ANY PARTICULAR FONT, STYLE, SIZE, OR COLOR.

FOR: MEDICAL DEVICES, NAMELY, SURGICAL DEVICES THAT FACILITATE THE IDENTIFICATION, SEPARATION OR ABLATION OF BIOLOGIC TISSUES, IN CLASS 10 (U.S. CLS. 26, 39 AND 44).

SN 78-861,820, FILED 4-14-2006.

FIRST USE 10-27-2006; IN COMMERCE 10-27-2006.

ROBIN CHOSID, EXAMINING ATTORNEY

**Int. Cl.: 41**

**Prior U.S. Cls.: 100, 101, and 107**

**United States Patent and Trademark Office**

**Reg. No. 3,506,592**

**Registered Sep. 23, 2008**

**SERVICE MARK  
PRINCIPAL REGISTER**

**TURN DINNER TIME INTO  
FAMILY TIME**

DREAM DINNERS, INC. (WASHINGTON COR-  
PORATION)  
P. O. BOX 889  
SNOHOMISH, WA 98291

FOR: EDUCATIONAL AND ENTERTAINMENT  
SERVICES IN THE CULINARY FIELD, NAMELY,  
CONDUCTING CLASSES ON MEAL PLANNING  
AND PREPARATION, NUTRITION, AND THE USE  
OF CULINARY RESOURCES, EQUIPMENT AND  
SUPPLIES, IN CLASS 41 (U.S. CLS. 100, 101 AND 107).

FIRST USE 3-1-2007; IN COMMERCE 3-1-2007.

THE MARK CONSISTS OF STANDARD CHAR-  
ACTERS WITHOUT CLAIM TO ANY PARTICULAR  
FONT, STYLE, SIZE, OR COLOR.

SN 78-862,730, FILED 4-17-2006.

JASON ROTH, EXAMINING ATTORNEY

**Int. Cl.: 41**

**Prior U.S. Cls.: 100, 101, and 107**

**United States Patent and Trademark Office**

**Reg. No. 3,506,593**

**Registered Sep. 23, 2008**

**SERVICE MARK  
PRINCIPAL REGISTER**

**LOS ANGELES ANGELS OF  
ANAHEIM**

ANGELS BASEBALL LP (CALIFORNIA LIMITED PARTNERSHIP)  
2000 GENE AUTRY WAY  
ANAHEIM, CA 92806

FOR: ENTERTAINMENT SERVICE, NAMELY, BASEBALL GAMES, COMPETITIONS, TOURNAMENTS AND EXHIBITIONS RENDERED LIVE AND THROUGH BROADCAST MEDIA INCLUDING TELEVISION, RADIO, SATELLITE, WIRELESS, AUDIO AND VIDEO MEDIA, TELEPHONE, FIBER OPTICS, WI-FI AND OTHER ELECTRONIC MEDIA AND VIA A GLOBAL COMPUTER NETWORK OR A COMMERCIAL ON-LINE SERVICE; INFORMATION SERVICES, NAMELY, PROVIDING INFORMATION IN THE FIELD OF SPORTS, ENTERTAINMENT AND RELATED TOPICS, AND PROVIDING FOR INFORMATIONAL MESSAGES RELATING THERETO; EDUCATIONAL SERVICES IN THE NATURE OF BASEBALL SKILLS PROGRAMS, BASEBALL CAMPS, SEMINARS AND CLINICS OFFERED LIVE ENTERTAINMENT SERVICES, NAMELY, PRODUCTION OF PROGRAMMING BROADCAST VIA TELEVISION, RADIO AND A GLOBAL COMPUTER NETWORK OR A COMMERCIAL ON-LINE SERVICE; ORGANIZING COMMUNITY SPORTING EVENTS; LIVE PERFORMANCES BY COSTUMED CHARACTERS AND PERFORMANCES FEATURING COSTUMED OR CARTOON CHARACTERS EXHIBITED OVER TELEVISION, SATELLITE AND VIDEO MEDIA; PROVIDING FACILITIES FOR SPORTS EVENTS,

TOURNAMENTS, COMPETITIONS, EXHIBITIONS, AND ENTERTAINMENT, INCLUDING PROVIDING SUCH EVENTS FOR PUBLIC EXHIBITION AND TELEVISION AND RADIO BROADCAST AND OTHER MEDIA DISTRIBUTION, AND PROVIDING OTHER CUSTOMARY STADIUM SERVICES, NAMELY, RENTAL OF STADIUM FACILITIES AND PROVIDING FACILITIES FOR STADIUM TOURS AND CONCERTS; ORGANIZING AND CONDUCTING FANTASY SPORTS, SPORTS CONTESTS AND SWEEPSTAKES; FAN CLUBS; PROVIDING ON-LINE NEWSLETTERS IN THE FIELD OF BASEBALL, IN CLASS 41 (U.S. CLS. 100, 101 AND 107).

FIRST USE 1-3-2005; IN COMMERCE 1-3-2005.

THE MARK CONSISTS OF STANDARD CHARACTERS WITHOUT CLAIM TO ANY PARTICULAR FONT, STYLE, SIZE, OR COLOR.

OWNER OF U.S. REG. NOS. 1,646,800, 2,606,782, AND OTHERS.

NO CLAIM IS MADE TO THE EXCLUSIVE RIGHT TO USE "LOS ANGELES" OR "ANAHEIM", APART FROM THE MARK AS SHOWN.

SN 78-863,251, FILED 4-17-2006.

DAVID H. STINE, EXAMINING ATTORNEY

**Int. Cl.: 7**

**Prior U.S. Cls.: 13, 19, 21, 23, 31, 34, and 35**

**Reg. No. 3,506,594**

**United States Patent and Trademark Office**

**Registered Sep. 23, 2008**

**TRADEMARK  
PRINCIPAL REGISTER**

**FURY**

EVOLUTION POWER TOOLS LIMITED (GREAT  
BRITAIN CORPORATION)  
HOLBROOK INDUSTRIAL ESTATE  
EVOLUTION HOUSE, NEW STREET  
SHEFFIELD, ENGLAND S20 3GH

FOR: PORTABLE ELECTRIC/PNEUMATIC POW-  
ER TOOLS, NAMELY, ELECTRIC DRILLS, HAM-  
MER DRILLS, CIRCULAR SAWS, ROUTERS,  
HAMMERS, PERCUSSION DRILLS, HAMMER  
DRILLS, NIBBLERS, POWER STAPLERS, NAIL  
GUNS; AND POWER TOOL ACCESSORIES, NAME-  
LY, CIRCULAR SAW BLADES, DIAMOND SAW  
BLADES, DRILL CHUCKS, DRILL BITS, CUTTING  
TOOLS, SCREWDRIVER BITS, ROUTER BITS,

GRINDING WHEELS, AND GRINDING DISKS  
FOR ALL THE AFORESAID GOODS, IN CLASS 7  
(U.S. CLS. 13, 19, 21, 23, 31, 34 AND 35).

FIRST USE 11-30-2006; IN COMMERCE 6-30-2007.

THE MARK CONSISTS OF STANDARD CHAR-  
ACTERS WITHOUT CLAIM TO ANY PARTICULAR  
FONT, STYLE, SIZE, OR COLOR.

SN 78-863,807, FILED 4-18-2006.

CAROLYN CATALDO, EXAMINING ATTORNEY



**Int. Cl.: 29**

**Prior U.S. Cl.: 46**

**United States Patent and Trademark Office**

**Reg. No. 3,506,595**

**Registered Sep. 23, 2008**

**TRADEMARK  
PRINCIPAL REGISTER**

**OLIO CASA**

CASTELLA IMPORTS, INC. (NEW YORK CORPORATION)  
60 DAVIDS DRIVE  
HAUPPAUGE, NY 11788

FOR: OIL, NAMELY, EDIBLE OIL, OLIVE OIL, VEGETABLE OIL, IN CLASS 29 (U.S. CL. 46).

FIRST USE 8-1-2006; IN COMMERCE 8-1-2006.

THE MARK CONSISTS OF STANDARD CHARACTERS WITHOUT CLAIM TO ANY PARTICULAR FONT, STYLE, SIZE, OR COLOR.

NO CLAIM IS MADE TO THE EXCLUSIVE RIGHT TO USE "OLIO", APART FROM THE MARK AS SHOWN.

THE FOREIGN WORDING "OLIO CASA" IN THE MARK TRANSLATES INTO ENGLISH AS "OIL HOUSE" OR "HOUSE OF OIL".

SN 78-865,669, FILED 4-20-2006.

JULIE GUTTADAURO, EXAMINING ATTORNEY

**Int. Cl.: 39**

**Prior U.S. Cls.: 100 and 105**

**United States Patent and Trademark Office**

**Reg. No. 3,506,596**

**Registered Sep. 23, 2008**

**SERVICE MARK  
PRINCIPAL REGISTER**

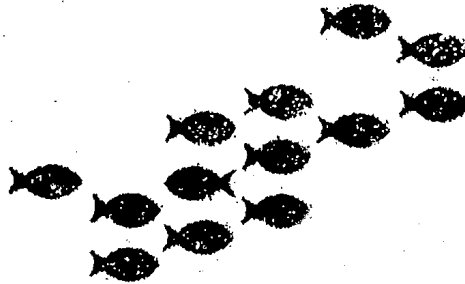

NCL CORPORATION LTD. (BERMUDA CORPORATION)  
7665 CORPORATE CENTER DRIVE  
MIAMI, FL 33126

FOR: ARRANGING OF CRUISES; CRUISE SHIP SERVICES; TRAVEL, EXCURSION AND CRUISE ARRANGEMENT, IN CLASS 39 (U.S. CLS. 100 AND 105).

FIRST USE 6-26-2008; IN COMMERCE 6-26-2008.

THE MARK CONSISTS OF A DIAGONAL SCHOOL OF FISH WITH ONE FISH SWIMMING IN THE OPPOSITION DIRECTION AS THE REST OF THE FISH.

SN 78-866,214, FILED 4-20-2006.

SHARON MEIER, EXAMINING ATTORNEY

**Int. Cl.: 41**

**Prior U.S. Cls.: 100, 101, and 107**

**United States Patent and Trademark Office**

**Reg. No. 3,506,597**

**Registered Sep. 23, 2008**

**SERVICE MARK  
PRINCIPAL REGISTER**

**BUY MEAD. GET REWARDED.**

MEADWESTVACO CORPORATION (DELAWARE  
CORPORATION)  
11013 WEST BROAD STREET  
MEADWESTVACO CORPORATE CENTER  
GLEN ALLEN, VA 23060

FOR: INCENTIVE AWARDS PROGRAM TO PRO-  
MOTE THE SALE OF SCHOOL AND OFFICE PRO-  
DUCTS, IN CLASS 41 (U.S. CLS. 100, 101 AND 107).

FIRST USE 0-0-2006; IN COMMERCE 0-0-2006.

THE MARK CONSISTS OF STANDARD CHAR-  
ACTERS WITHOUT CLAIM TO ANY PARTICULAR  
FONT, STYLE, SIZE, OR COLOR.

OWNER OF U.S. REG. NOS. 1,072,214, 2,162,752,  
AND OTHERS.

SN 78-867,742, FILED 4-24-2006.

ELLEN PERKINS, EXAMINING ATTORNEY

**Int. Cl.: 37**

**Prior U.S. Cls.: 100, 103, and 106**

**United States Patent and Trademark Office**

**Reg. No. 3,506,598**

**Registered Sep. 23, 2008**

**SERVICE MARK  
PRINCIPAL REGISTER**

**READY, SET, RENOVATE!**

HEADLINE MANAGEMENT, INC. (NORTH  
CAROLINA CORPORATION)  
18131 WEST CATAWABA AVENUE  
CORNELIUS, NC 28031

FOR: CONSTRUCTION AND RENOVATION OF  
BUILDINGS; CONSTRUCTION, MAINTENANCE  
AND RENOVATION OF PROPERTY; RENOVA-  
TION IN THE FIELD OF RESIDENTIAL AND  
COMMERCIAL BUILDINGS, IN CLASS 37 (U.S.  
CLS. 100, 103 AND 106).

FIRST USE 9-12-2007; IN COMMERCE 9-12-2007.

THE MARK CONSISTS OF STANDARD CHAR-  
ACTERS WITHOUT CLAIM TO ANY PARTICULAR  
FONT, STYLE, SIZE, OR COLOR.

SN 78-868,987, FILED 4-25-2006.

BRIDGETT SMITH, EXAMINING ATTORNEY

**Int. Cl.: 41**

**Prior U.S. Cls.: 100, 101, and 107**

**United States Patent and Trademark Office**

**Reg. No. 3,506,599**

**Registered Sep. 23, 2008**

**SERVICE MARK  
PRINCIPAL REGISTER**

**BUTLER LEE BOOKS**

MATHESON, MARGARET A. (UNITED STATES  
INDIVIDUAL)  
PO BOX 514  
PORTSMOUTH, RI 028710514

FOR: PUBLICATION OF BOOKS, IN CLASS 41  
(U.S. CLS. 100, 101 AND 107).

FIRST USE 4-28-2006; IN COMMERCE 4-28-2006.

THE MARK CONSISTS OF STANDARD CHAR-  
ACTERS WITHOUT CLAIM TO ANY PARTICULAR  
FONT, STYLE, SIZE, OR COLOR.

NO CLAIM IS MADE TO THE EXCLUSIVE  
RIGHT TO USE "BOOKS", APART FROM THE  
MARK AS SHOWN.

THE NAME IN THE MARK DOES NOT IDENTI-  
FY A LIVING INDIVIDUAL.

SN 78-872,410, FILED 4-28-2006.

DANNEAN HETZEL, EXAMINING ATTORNEY

Int. Cls.: 9, 35, 37, 38, and 42

Prior U.S. Cls.: 21, 23, 26, 36, 38, 100, 101, 102, 103, 104, and 106

Reg. No. 3,506,600

United States Patent and Trademark Office

Registered Sep. 23, 2008

**TRADEMARK  
SERVICE MARK  
PRINCIPAL REGISTER**

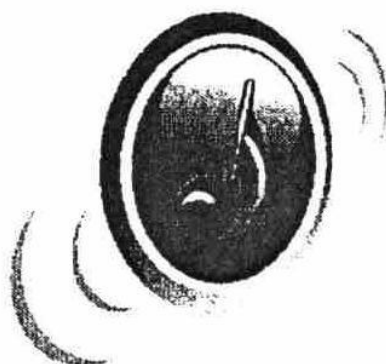

TOUCHTUNES MUSIC CORPORATION (DELAWARE CORPORATION)  
1209 ORANGE ST.  
CORPORATION RUST CENTER  
WILMINGTON, DE 19801

FOR: DIGITAL JUKEBOX INCLUDING COMPUTER HARDWARE AND SOFTWARE FOR DISTRIBUTING, SELECTING AND PLAYING AUDIO AND VIDEO MUSICAL INFORMATION; SATELLITE, WIRE, CABLE OR OPTICAL FIBER TELECOMMUNICATION NETWORK FOR REMOTE DOWNLOADING OF DIGITAL INFORMATION ON A DIGITAL TERMINAL OR DIGITAL JUKEBOX; COMPUTER HARDWARE AND SOFTWARE FOR AUDIO AND VISUAL PLAYBACK FOR KARAOKE PERFORMANCES; AUDIOVISUAL SYSTEM COMPRISING DISKS, SPEAKERS, DIGITAL SOUND BOARDS, DIGITAL TELECOMMUNICATION NETWORK, TELECOMMUNICATION BOARDS, TELECOMMUNICATION MODEM, DIGITAL JUKEBOXES, TOUCH SCREENS AND DISPLAY MONITORS; COMPUTER SOFTWARE FOR STORING, ACCESSING AND TRANSMITTING DIGITAL INFORMATION, NAMELY, MUSIC, MANAGEMENT INFORMATION, STATISTICS, ROYALTY STATEMENTS, ADVERTISEMENTS, SOUNDS, AND VIDEO; COMPUTER PERIPHERALS, NAMELY, JUKEBOXES, REMOTE CONTROL FOR VIDEO OR AUDIO DIGITAL JUKEBOXES, TOUCH

SCREEN, MOUSE, KEYBOARDS AND COMPUTER CABLES, IN CLASS 9 (U.S. CLS. 21, 23, 26, 36 AND 38).

FIRST USE 4-0-2006; IN COMMERCE 5-0-2006.

FOR: ADVERTISING SERVICES, IN CLASS 35 (U.S. CLS. 100, 101 AND 102).

FIRST USE 4-0-2006; IN COMMERCE 5-0-2006.

FOR: REPAIR AND INSTALLATION OF DIGITAL JUKE BOXES AND RELATED ACCESSORIES, NAMELY, COMPUTER HARDWARE AND SOFTWARE, SATELLITE, WIRE, CABLE OR OPTICAL FIBER TELECOMMUNICATION NETWORKS, DISKS, SPEAKERS, DIGITAL SOUND BOARDS, TOUCH SCREENS, DISPLAY MONITORS, MOUSE KEYBOARDS AND COMPUTER CABLES, IN CLASS 37 (U.S. CLS. 100, 103 AND 106).

FIRST USE 4-0-2006; IN COMMERCE 5-0-2006.

FOR: TELECOMMUNICATION SERVICES, NAMELY, TELEPROCESSING ELECTRONIC DATA FOR THE TRANSFER OF AUDIO OR VIDEO DIGITAL INFORMATION, MAINTENANCE INFORMATION FOR REMOTE MAINTENANCE, STATISTICAL INFORMATION, IN CLASS 38 (U.S. CLS. 100, 101 AND 104).

FIRST USE 4-0-2006; IN COMMERCE 5-0-2006.

FOR: REMOTE MAINTENANCE OF COMPUTER SOFTWARE FOR OTHERS VIA A GLOBAL COMPUTER NETWORK; MONITORING SERVICES OF DIGITAL JUKEBOXES AND RELATED SERVICES, NAMELY, SATELLITE, WIRE, CABLE OR OPTICAL FIBER TELECOMMUNICATION NETWORKS, DISKS, SPEAKERS, DIGITAL SOUND BOARDS, TOUCH SCREENS, DISPLAY MONITORS, MOUSE, KEYBOARDS AND COMPUTER CABLES; COMPUTER SERVICES, NAMELY, FACILITATING THE DOWNLOADING OF SONGS, SOFTWARE, AND VIDEOS TO BE EXECUTED ON THE JUKE BOX OR TO ANY ELECTRONIC DEVICE ABLE TO PRODUCE SONG OR VIDEO BY USE OF DIGITAL

INFORMATION, IN CLASS 42 (U.S. CLS. 100 AND 101).

FIRST USE 4-0-2006; IN COMMERCE 5-0-2006.

OWNER OF U.S. REG. NOS. 2,350,643, 2,753,360, AND OTHERS.

THE MARK IS NOT IN COLOR. THE STIPPLING IN THE DRAWING IS FOR SHADING PURPOSES ONLY.

THE MARK CONSISTS OF CLEFT SIGN.

SN 78-877,651, FILED 5-5-2006.

ANNE MADDEN, EXAMINING ATTORNEY

**Int. Cl.: 9**

**Prior U.S. Cls.: 21, 23, 26, 36, and 38**

**United States Patent and Trademark Office**

**Reg. No. 3,506,601**

**Registered Sep. 23, 2008**

**TRADEMARK  
PRINCIPAL REGISTER**



**Fire and Safety Equipment Tracker - FASET**

STRATCOM SYSTEMS, INC. (CALIFORNIA CORPORATION), DBA SIMS SOFTWARE,  
P.O. BOX 607  
SOLANA BEACH, CA 92075

FOR: DATABASE SOFTWARE FOR TRACKING FIRE SAFETY EQUIPMENT AND MATERIALS, IN CLASS 9 (U.S. CLS. 21, 23, 26, 36 AND 38).

FIRST USE 8-21-2006; IN COMMERCE 8-21-2006.

NO CLAIM IS MADE TO THE EXCLUSIVE RIGHT TO USE "FIRE AND SAFETY EQUIPMENT

TRACKER", APART FROM THE MARK AS SHOWN.

THE MARK CONSISTS OF A FIREFIGHTER ICON WITH THE WORDS "FIRE AND SAFETY EQUIPMENT TRACKER - FASET" NEXT TO THE DESIGN.

SN 78-883,943, FILED 5-15-2006.

KAPIL BHANOT, EXAMINING ATTORNEY



**Int. Cls.: 35, 36, and 44**

**Prior U.S. Cls.: 100, 101, and 102**

**United States Patent and Trademark Office**

**Reg. No. 3,506,602**

**Registered Sep. 23, 2008**

**SERVICE MARK  
PRINCIPAL REGISTER**

**BLUE DISTINCTION CENTERS  
FOR SPECIALTY CARE**

BLUE CROSS AND BLUE SHIELD ASSOCIATION  
(ILLINOIS NON-PROFIT CORPORATION)  
6TH FLOOR  
225 NORTH MICHIGAN AVENUE  
CHICAGO, IL 60601

FOR: ASSESSING HEALTHCARE SERVICE PROVIDER PERFORMANCE; PROVIDING SPECIALTY CARE CENTERS, NAMELY, CONDUCTING QUALITY MEASUREMENT, IMPROVEMENT AND ASSURANCE SURVEYS IN HOSPITALS TO DETERMINE SERVICE QUALITY, IN CLASS 35 (U.S. CLS. 100, 101 AND 102).

FIRST USE 12-31-2006; IN COMMERCE 12-31-2006.

FOR: ORGANIZATION AND ADMINISTRATION OF PRE-PAID, PREFERRED PROVIDER ORGANIZATION, HEALTH MAINTENANCE ORGANIZATION, EXCLUSIVE PROVIDER ORGANIZATION AND POINT OF SERVICE HEALTHCARE PLANS, IN CLASS 36 (U.S. CLS. 100, 101 AND 102).

FIRST USE 12-31-2006; IN COMMERCE 12-31-2006.

FOR: HEALTHCARE SERVICES; PROVIDING CENTERS FOR EXCELLENCE PROGRAMS IN THE FIELD OF HEALTHCARE, NAMELY, PROVIDING HEALTH AND MEDICAL CARE INFORMA-

TION TO ENABLE CONSUMERS TO MAKE MORE INFORMED HEALTHCARE DECISIONS IN COLLABORATION WITH HEALTH CARE PROVIDERS TO IMPROVE OUTCOMES AND AFFORDABILITY; PROVIDING CENTERS FOR SPECIALTY HEALTHCARE, NAMELY, BARIATRIC SURGERY AND OBESITY CARE CENTERS, CANCER CARE CENTERS, MEDICAL TRANSPLANT CENTERS, AND CANCER CARE CENTERS, IN CLASS 44 (U.S. CLS. 100 AND 101).

FIRST USE 12-31-2006; IN COMMERCE 12-31-2006.

THE MARK CONSISTS OF STANDARD CHARACTERS WITHOUT CLAIM TO ANY PARTICULAR FONT, STYLE, SIZE, OR COLOR.

OWNER OF U.S. REG. NOS. 554,488, 1,426,942, AND OTHERS.

NO CLAIM IS MADE TO THE EXCLUSIVE RIGHT TO USE "CENTERS FOR SPECIALTY CARE", APART FROM THE MARK AS SHOWN.

SN 78-890,544, FILED 5-23-2006.

MARY ROSSMAN, EXAMINING ATTORNEY

**Int. Cls.: 35, 36, and 44**

**Prior U.S. Cls.: 100, 101, and 102**

**United States Patent and Trademark Office**

**Reg. No. 3,506,603**

**Registered Sep. 23, 2008**

**SERVICE MARK  
PRINCIPAL REGISTER**

**BLUE DISTINCTION CENTERS**

BLUE CROSS AND BLUE SHIELD ASSOCIATION  
(ILLINOIS NON-PROFIT CORPORATION)  
6TH FLOOR  
225 NORTH MICHIGAN AVENUE  
CHICAGO, IL 60601

FOR: ASSESSING HEALTHCARE SERVICE PROVIDER PERFORMANCE; PROVIDING SPECIALTY CARE CENTERS, NAMELY, CONDUCTING QUALITY MEASUREMENT, IMPROVEMENT AND ASSURANCE SURVEYS IN HOSPITALS TO DETERMINE SERVICE QUALITY, IN CLASS 35 (U.S. CLS. 100, 101 AND 102).

FIRST USE 6-30-2006; IN COMMERCE 6-30-2006.

FOR: ORGANIZATION AND ADMINISTRATION OF PRE-PAID, PREFERRED PROVIDER ORGANIZATION, HEALTH MAINTENANCE ORGANIZATION, EXCLUSIVE PROVIDER ORGANIZATION AND POINT OF SERVICE HEALTHCARE PLANS, IN CLASS 36 (U.S. CLS. 100, 101 AND 102).

FIRST USE 6-30-2006; IN COMMERCE 6-30-2006.

FOR: HEALTHCARE SERVICES; PROVIDING CENTERS FOR EXCELLENCE PROGRAMS IN THE FIELD OF HEALTHCARE, NAMELY, PROVIDING HEALTH AND MEDICAL CARE INFORMA-

TION TO ENABLE CONSUMERS TO MAKE MORE INFORMED HEALTHCARE DECISIONS IN COLLABORATION WITH HEALTH CARE PROVIDERS TO IMPROVE OUTCOMES AND AFFORDABILITY; PROVIDING CENTERS FOR SPECIALTY HEALTHCARE, NAMELY, BARIATRIC SURGERY AND OBESITY CARE CENTERS, CANCER CARE CENTERS, MEDICAL TRANSPLANT CENTERS, AND CANCER CARE CENTERS, IN CLASS 44 (U.S. CLS. 100 AND 101).

FIRST USE 6-30-2006; IN COMMERCE 6-30-2006.

THE MARK CONSISTS OF STANDARD CHARACTERS WITHOUT CLAIM TO ANY PARTICULAR FONT, STYLE, SIZE, OR COLOR.

OWNER OF U.S. REG. NOS. 554,488, 1,426,942, AND OTHERS.

NO CLAIM IS MADE TO THE EXCLUSIVE RIGHT TO USE "CENTERS", APART FROM THE MARK AS SHOWN.

SN 78-890,549, FILED 5-23-2006.

MARY ROSSMAN, EXAMINING ATTORNEY

**Int. Cls.: 25 and 41**

**Prior U.S. Cls.: 22, 39, 100, 101, and 107**

**Reg. No. 3,506,604**

**United States Patent and Trademark Office**

**Registered Sep. 23, 2008**

**TRADEMARK  
SERVICE MARK  
PRINCIPAL REGISTER**

# LEADERS CUP

WAKA, LLC (VIRGINIA LIMITED LIABILITY COMPANY)  
3834 BEECH DOWN DRIVE  
CHANTILLY, VA 20151

FOR: CAPS; DRESS SHIRTS; GOLF SHIRTS; HEADBANDS AGAINST SWEATING; HOODS; JERSEYS; KNIT SHIRTS; MANTLES; OPEN-NECKED SHIRTS; PERSPIRATION ABSORBENT UNDERWEAR CLOTHING; POLO SHIRTS; SHIFTS; SHIRTS; SHORT-SLEEVED OR LONG-SLEEVED T-SHIRTS; SHORT-SLEEVED SHIRTS; SHOULDER WRAPS; SPORT SHIRTS; STOCKINGS; SWEAT BANDS; SWEAT PANTS; SWEAT SHIRTS; SWEAT SHORTS; SWEAT SUITS; T-SHIRTS; TOPS; UNDERARM CLOTHING SHIELDS; WIND SHIRTS; WRAPS, IN CLASS 25 (U.S. CLS. 22 AND 39).

FIRST USE 9-1-2006; IN COMMERCE 9-1-2006.

FOR: ENTERTAINMENT IN THE NATURE OF COMPETITIONS IN THE FIELD OF KICKBALL TOURNAMENTS AND GAMES; ENTERTAINMENT IN THE NATURE OF KICKBALL GAMES; ENTERTAINMENT IN THE NATURE OF KICKBALL

TOURNAMENTS; ENTERTAINMENT SERVICES, NAMELY, PROVIDING A WEBSITE FEATURING, PHOTOGRAPHIC, AUDIO, VIDEO AND PROSE PRESENTATIONS FEATURING KICKBALL LEAGUES, GAMES, TOURNAMENTS AND COMPETITIONS; ENTERTAINMENT SERVICES, NAMELY, PARTICIPATION IN KICKBALL TOURNAMENTS, LEAGUES AND COMPETITIONS; PROVIDING FACILITIES FOR KICKBALL TOURNAMENTS, IN CLASS 41 (U.S. CLS. 100, 101 AND 107).

FIRST USE 9-1-2006; IN COMMERCE 9-1-2006.

THE MARK CONSISTS OF STANDARD CHARACTERS WITHOUT CLAIM TO ANY PARTICULAR FONT, STYLE, SIZE, OR COLOR.

NO CLAIM IS MADE TO THE EXCLUSIVE RIGHT TO USE "CUP" IN INTERNATIONAL CLASS 41, APART FROM THE MARK AS SHOWN.

SN 78-893,121, FILED 5-25-2006.

BONNIE LUKEN, EXAMINING ATTORNEY

**Int. Cl.: 43**

**Prior U.S. Cls.: 100 and 101**

**United States Patent and Trademark Office**

**Reg. No. 3,506,605**

**Registered Sep. 23, 2008**

**SERVICE MARK  
PRINCIPAL REGISTER**

**SHIKAGO**

NAK INVESTMENT COMPANY, INC. (ILLINOIS  
CORPORATION)  
190 S. LASALLE ST.  
CHICAGO, IL 60603

THE MARK CONSISTS OF STANDARD CHAR-  
ACTERS WITHOUT CLAIM TO ANY PARTICULAR  
FONT, STYLE, SIZE, OR COLOR.

FOR: RESTAURANT SERVICES, NAMELY, THE  
SERVING OF FOOD AND DRINK IN A RESTAU-  
RANT, IN CLASS 43 (U.S. CLS. 100 AND 101).

SN 78-893,466, FILED 5-25-2006.

FIRST USE 6-26-2007; IN COMMERCE 6-26-2007.

TANYA AMOS, EXAMINING ATTORNEY

**Int. Cl.: 11**

**Prior U.S. Cls.: 13, 21, 23, 31, and 34**

**United States Patent and Trademark Office**

**Reg. No. 3,506,606**

**Registered Sep. 23, 2008**

**TRADEMARK  
PRINCIPAL REGISTER**

**GASMASTER**

FAMA HOLDINGS LTD. (CANADA CORPORATION)  
SUITE 800  
688 WEST HASTINGS STREET  
VANCOUVER, BC, CANADA V6B 1P1

FOR: WATER HEATING SYSTEM, NAMELY, COMBUSTORS, HEAT EXCHANGER, FLUES FOR HEATING BOILERS AND HEATING DAMPERS, AND BOILERS AND PARTS THEREFOR, NAMELY, PIPES AND VALVES, IN CLASS 11 (U.S. CLS. 13, 21, 23, 31 AND 34).

FIRST USE 7-1-1995; IN COMMERCE 7-1-1995.

THE MARK CONSISTS OF STANDARD CHARACTERS WITHOUT CLAIM TO ANY PARTICULAR FONT, STYLE, SIZE, OR COLOR.

PRIORITY CLAIMED UNDER SEC. 44(D) ON CANADA APPLICATION NO. 1281369, FILED 11-30-2005, REG. NO. TMA691,909, DATED 7-12-2007, EXPIRES 7-12-2022.

SN 78-895,241, FILED 5-29-2006.

DAWN FELDMAN, EXAMINING ATTORNEY

**Int. Cl.: 32**

**Prior U.S. Cls.: 45, 46, and 48**

**United States Patent and Trademark Office**

**Reg. No. 3,506,607**

**Registered Sep. 23, 2008**

**TRADEMARK  
PRINCIPAL REGISTER**

**FIRE IT UP**

EXTREME BEVERAGE COMPANY, LLC (TEXAS  
LIMITED LIABILITY COMPANY)  
SUITE 210  
6310 LEMMON AVE  
DALLAS, TX 75209

THE MARK CONSISTS OF STANDARD CHAR-  
ACTERS WITHOUT CLAIM TO ANY PARTICULAR  
FONT, STYLE, SIZE, OR COLOR.

FOR: ENERGY DRINKS, IN CLASS 32 (U.S. CLS.  
45, 46 AND 48).

SN 78-895,546, FILED 5-30-2006.

FIRST USE 12-31-2007; IN COMMERCE 12-31-2007.

JAMES MACFARLANE, EXAMINING ATTORNEY

**Int. Cl.: 9**

**Prior U.S. Cls.: 21, 23, 26, 36, and 38**

**United States Patent and Trademark Office**

**Reg. No. 3,506,608**

**Registered Sep. 23, 2008**

**TRADEMARK  
PRINCIPAL REGISTER**

**GREENBACK JACK**

VIDEO GAMING TECHNOLOGIES (TENNESSEE CORPORATION)  
155 FRANKLIN ROAD, SUITE 255  
BRENTWOOD, TN 37027

FOR: COMPUTER SOFTWARE AND FIRMWARE FOR GAMES OF CHANCE ON ANY COMPUTERIZED PLATFORM, NAMELY, DEDICATED GAMING CONSOLES, VIDEO BASED SLOT MACHINES, REEL BASED SLOT MACHINES, AND VIDEO LOTTERY TERMINALS; GAMING DEVICES, NAMELY, GAMING MACHINES, SLOT MACHINES, BINGO

MACHINES, WITH OR WITHOUT VIDEO OUTPUT, IN CLASS 9 (U.S. CLS. 21, 23, 26, 36 AND 38).

FIRST USE 1-0-2007; IN COMMERCE 1-0-2007.

THE MARK CONSISTS OF STANDARD CHARACTERS WITHOUT CLAIM TO ANY PARTICULAR FONT, STYLE, SIZE, OR COLOR.

SN 78-897,591, FILED 5-31-2006.

SKYE YOUNG, EXAMINING ATTORNEY

**Int. Cl.: 16**

**Prior U.S. Cls.: 2, 5, 22, 23, 29, 37, 38, and 50**

**Reg. No. 3,506,609**

**United States Patent and Trademark Office**

**Registered Sep. 23, 2008**

**TRADEMARK  
PRINCIPAL REGISTER**

# Revive Omaha

SMB ENTERPRISES, L.L.C. (NEBRASKA LIMITED LIABILITY COMPANY)  
12333 CUMING STREET  
OMAHA, NE 68154

FOR: MAGAZINES FEATURING INFORMATION ON LIFE STYLES, IN CLASS 16 (U.S. CLS. 2, 5, 22, 23, 29, 37, 38 AND 50).

FIRST USE 5-7-2008; IN COMMERCE 5-7-2008.

THE MARK CONSISTS OF STANDARD CHARACTERS WITHOUT CLAIM TO ANY PARTICULAR FONT, STYLE, SIZE, OR COLOR.

NO CLAIM IS MADE TO THE EXCLUSIVE RIGHT TO USE "OMAHA", APART FROM THE MARK AS SHOWN.

SN 78-900,482, FILED 6-5-2006.

BRIAN NEVILLE, EXAMINING ATTORNEY



**Int. Cl.: 35**

**Prior U.S. Cls.: 100, 101, and 102**

**United States Patent and Trademark Office**

**Reg. No. 3,506,610**

**Registered Sep. 23, 2008**

**SERVICE MARK  
PRINCIPAL REGISTER**

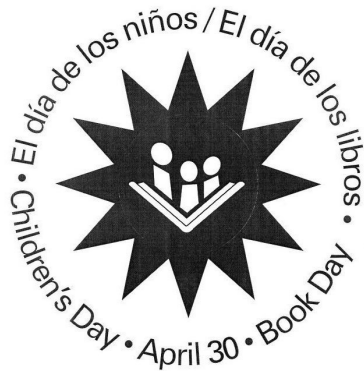

AMERICAN LIBRARY ASSOCIATION (MASSACHUSETTS NON-PROFIT CORPORATION)  
50 EAST HURON  
CHICAGO, IL 606112795

FOR: PROMOTING PUBLIC AWARENESS OF THE NEED FOR LITERACY IN CHILDREN, IN CLASS 35 (U.S. CLS. 100, 101 AND 102).

FIRST USE 1-0-2006; IN COMMERCE 10-0-2007.

NO CLAIM IS MADE TO THE EXCLUSIVE RIGHT TO USE "CHILDREN'S DAY", "BOOK DAY", "EL DIA DE LOS NINOS", "EL DIA DE LOS LIBROS", AND "APRIL 30", APART FROM THE MARK AS SHOWN.

SN 78-901,886, FILED 6-6-2006.

DOMINIC FATHY, EXAMINING ATTORNEY

**Int. Cls.: 5 and 10**

**Prior U.S. Cls.: 6, 18, 26, 39, 44, 46, 51, and 52**

**United States Patent and Trademark Office**

**Reg. No. 3,506,611**

**Registered Sep. 23, 2008**

**TRADEMARK  
PRINCIPAL REGISTER**

# Drugalyzer

VERITEST INTERNATIONAL CORPORATION  
(DELAWARE CORPORATION)  
3009 W. LUPINE AVE.  
PHOENIX, AZ 85028

FOR: TEST STRIPS FOR USE IN ANALYZING  
SALIVA FOR THE PRESENCE OF CONTROLLED  
SUBSTANCES, IN CLASS 5 (U.S. CLS. 6, 18, 44, 46, 51  
AND 52).

FIRST USE 1-21-2008; IN COMMERCE 1-21-2008.

FOR: CONTROLLED SUBSTANCE SALIVA TEST-  
ING UNITS, IN CLASS 10 (U.S. CLS. 26, 39 AND 44).

FIRST USE 1-21-2008; IN COMMERCE 1-21-2008.

THE MARK CONSISTS OF STANDARD CHAR-  
ACTERS WITHOUT CLAIM TO ANY PARTICULAR  
FONT, STYLE, SIZE, OR COLOR.

SN 78-902,149, FILED 6-6-2006.

DORITT L. CARROLL, EXAMINING ATTORNEY

Int. Cl.: 33

Prior U.S. Cls.: 47 and 49

United States Patent and Trademark Office

Reg. No. 3,506,612

Registered Sep. 23, 2008

TRADEMARK  
PRINCIPAL REGISTER



AGAVERA CAMICHINES, S.A. DE C.V. (MEXICO CORPORATION)  
PERIFERICO SUR NO. 8500, TRAMO MORELIA  
CHAPALA, TLAQUEPAQUE, JALISCO  
MEXICO, MEXICO C.P. 4560

FOR: ALCOHOLIC BEVERAGES, NAMELY, TEQUILA, IN CLASS 33 (U.S. CLS. 47 AND 49).

FIRST USE 4-24-2006; IN COMMERCE 4-24-2006.

THE COLOR(S) GOLD, LIGHT GOLD, DARK GOLD, BROWN AND BLACK IS/ARE CLAIMED AS A FEATURE OF THE MARK.

THE MARK CONSISTS OF A FLUTED FLAT GLASS BOTTLE CONTAINING GOLDEN LIQUID WITH A ROUNDED BROWN WOODEN CAP AND A ROUND GOLD LABEL IN THE CENTER WITH THE WORDS "GRAN CENTENARIO LEYENDA" IN

BLACK LETTERING, THE CENTER LABEL ALSO FEATURES AN ANGEL AND CLOUDS DESIGN IN BLACK AND SHADES OF GOLD. THE NECK OF THE BOTTLE IS CLEAR WITH BANDS OF DARK GOLD, LIGHT GOLD AND BLACK AND A CIRCULAR DESIGN IN THE CENTER OF THE BAND FEATURING THE DESIGN OF AN AGAVE PLANT IN SHADES OF GOLD. THE BOTTLE ALSO FEATURES NUMEROUS RIDGES PROJECTING FROM THE CENTER LABEL GIVING THE LOWER PORTION OF THE BOTTLE THE APPEARANCE OF A FLOWER OR SUNBURST.

THE WORDING "GRAN CENTENARIO LEYENDA" IN THE MARK MAY BE TRANSLATED INTO ENGLISH AS GRAND CENTENNIAL LEGEND.

SN 78-902,253, FILED 6-6-2006.

WENDY GOODMAN, EXAMINING ATTORNEY

**Int. Cl.: 9**

**Prior U.S. Cls.: 21, 23, 26, 36, and 38**

**Reg. No. 3,506,613**

**United States Patent and Trademark Office**

**Registered Sep. 23, 2008**

**TRADEMARK  
PRINCIPAL REGISTER**

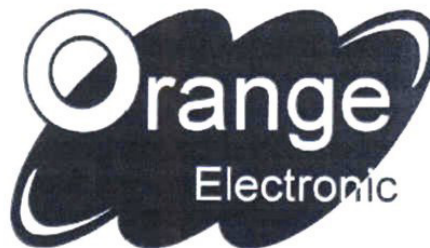

ORANGE ELECTRONIC CO., LTD. (TAIWAN CORPORATION)  
TANZIH TOWNSHIP  
2F, NO. 51, SEC. 1, YATAN RD.  
TAICHUNG COUNTY, TAIWAN 427

FOR: WIRELESS TIRE PRESSURE MONITORING SYSTEMS COMPRISING TIRE PRESSURE GAUGES, COMPUTER HARDWARE; TIRE PRESSURE MONITORING TESTER COMPRISING TIRE PRESSURE GAUGES AND COMPUTER HARDWARE; TIRE PRESSURE GAUGES; PRESSURE GAUGES,

TIRE PRESSURE MONITORING TESTER, IN CLASS 9 (U.S. CLS. 21, 23, 26, 36 AND 38).

FIRST USE 3-15-2006; IN COMMERCE 11-1-2006.

NO CLAIM IS MADE TO THE EXCLUSIVE RIGHT TO USE "ELECTRONIC", APART FROM THE MARK AS SHOWN.

SN 78-903,922, FILED 6-8-2006.

RICHARD WHITE, EXAMINING ATTORNEY

**Int. Cl.: 34**

**Prior U.S. Cls.: 2, 8, 9, and 17**

**United States Patent and Trademark Office**

**Reg. No. 3,506,614**

**Registered Sep. 23, 2008**

**TRADEMARK  
PRINCIPAL REGISTER**

**DREAM TEAM**

MIKE'S CIGARS DISTRIBUTORS, INC. (FLORIDA CORPORATION)  
1030 KANE CONCOURSE  
BAY HARBOR, FL 33154

THE MARK CONSISTS OF STANDARD CHARACTERS WITHOUT CLAIM TO ANY PARTICULAR FONT, STYLE, SIZE, OR COLOR.

FOR: CIGARS, IN CLASS 34 (U.S. CLS. 2, 8, 9 AND 17).

SN 78-904,901, FILED 6-9-2006.

FIRST USE 11-29-2007; IN COMMERCE 11-29-2007.

ELISSA GARBER KON, EXAMINING ATTORNEY

**Int. Cl.: 9**

**Prior U.S. Cls.: 21, 23, 26, 36, and 38**

**United States Patent and Trademark Office**

**Reg. No. 3,506,615**

**Registered Sep. 23, 2008**

**TRADEMARK  
PRINCIPAL REGISTER**

**UMAX**

VEUTRON CORPORATION (TAIWAN CORPORATION)  
8F., NO. 70, SEC. 3  
NANJING E. RD., JHONGSHAN DISTRICT  
TAIPEI CITY, TAIWAN 104

FOR: DESK-TOP COMPUTER, NOTEBOOK COMPUTER, PEN-BASED COMPUTER, PALM COMPUTER, PERSONAL DIGITAL ASSISTANT, DIGITAL CAMERA, COPY MACHINE, CD-ROM DRIVE, IN CLASS 9 (U.S. CLS. 21, 23, 26, 36 AND 38).

FIRST USE 12-1-1998; IN COMMERCE 12-1-1998.

OWNER OF TAIWAN REG. NO. 778571, DATED 4-25-2006, EXPIRES 8-31-2015.

OWNER OF U.S. REG. NO. 1,614,692.

SN 78-905,348, FILED 6-9-2006.

SHARON MEIER, EXAMINING ATTORNEY

**Int. Cl.: 35**

**Prior U.S. Cls.: 100, 101, and 102**

**United States Patent and Trademark Office**

**Reg. No. 3,506,616**

**Registered Sep. 23, 2008**

**SERVICE MARK  
PRINCIPAL REGISTER**

**BLUE DISTINCTION PROVIDER  
MEASUREMENT AND  
IMPROVEMENT PROGRAM**

BLUE CROSS AND BLUE SHIELD ASSOCIATION  
(ILLINOIS NON-PROFIT CORPORATION)  
6TH FLOOR  
225 NORTH MICHIGAN AVENUE  
CHICAGO, IL 60601

FOR: ASSESSING HEALTHCARE SERVICE PROVIDER PERFORMANCE; PROVIDING SPECIALTY CARE CENTERS, NAMELY, CONDUCTING QUALITY MEASUREMENT, IMPROVEMENT AND ASSURANCE SURVEYS IN HOSPITALS TO DETERMINE SERVICE QUALITY, IN CLASS 35 (U.S. CLS. 100, 101 AND 102).

FIRST USE 5-31-2007; IN COMMERCE 5-31-2007.

THE MARK CONSISTS OF STANDARD CHARACTERS WITHOUT CLAIM TO ANY PARTICULAR FONT, STYLE, SIZE, OR COLOR.

OWNER OF U.S. REG. NOS. 554,488, 1,426,942, AND OTHERS.

NO CLAIM IS MADE TO THE EXCLUSIVE RIGHT TO USE "PROVIDER MEASUREMENT AND IMPROVEMENT PROGRAM", APART FROM THE MARK AS SHOWN.

SN 78-906,552, FILED 6-13-2006.

MARY ROSSMAN, EXAMINING ATTORNEY

**Int. Cl.: 44**

**Prior U.S. Cls.: 100 and 101**

**United States Patent and Trademark Office**

**Reg. No. 3,506,617**

**Registered Sep. 23, 2008**

**SERVICE MARK  
PRINCIPAL REGISTER**

**BLUE DISTINCTION PROVIDER  
MEASUREMENT AND  
IMPROVEMENT PROGRAM**

BLUE CROSS AND BLUE SHIELD ASSOCIATION  
(ILLINOIS NON-PROFIT CORPORATION)  
6TH FLOOR  
225 NORTH MICHIGAN AVENUE  
CHICAGO, IL 60601

FOR: PROVIDING CENTERS FOR EXCELLENCE PROGRAMS IN THE FIELD OF HEALTHCARE, NAMELY, PROVIDING HEALTH AND MEDICAL CARE INFORMATION TO ENABLE CONSUMERS TO MAKE MORE INFORMED HEALTHCARE DECISIONS IN COLLABORATION WITH HEALTH CARE PROVIDERS TO IMPROVE OUTCOMES AND AFFORDABILITY, IN CLASS 44 (U.S. CLS. 100 AND 101).

FIRST USE 5-31-2007; IN COMMERCE 5-31-2007.

THE MARK CONSISTS OF STANDARD CHARACTERS WITHOUT CLAIM TO ANY PARTICULAR FONT, STYLE, SIZE, OR COLOR.

OWNER OF U.S. REG. NOS. 554,488, 1,426,942, AND OTHERS.

NO CLAIM IS MADE TO THE EXCLUSIVE RIGHT TO USE "PROVIDER MEASUREMENT AND IMPROVEMENT PROGRAM", APART FROM THE MARK AS SHOWN.

SN 78-906,558, FILED 6-13-2006.

MARY ROSSMAN, EXAMINING ATTORNEY



**Int. Cls.: 41 and 42**

**Prior U.S. Cls.: 100, 101, and 107**

**United States Patent and Trademark Office**

**Reg. No. 3,506,618**

**Registered Sep. 23, 2008**

**SERVICE MARK  
PRINCIPAL REGISTER**

**PAY jr.**

PAYJR, INC. (DELAWARE CORPORATION)  
1760 LANTANA LANE  
FRISCO, TX 75034

FOR: EDUCATIONAL PROGRAMS AND SERVICES, NAMELY, LIVE AND ONLINE CLASSES OR SEMINARS, PROVIDING FINANCIAL EDUCATION TO YOUNG PEOPLE ON MATTERS SUCH AS ENTREPRENEURSHIP, BUDGETING AND FINANCIAL RESPONSIBILITY, IN CLASS 41 (U.S. CLS. 100, 101 AND 107).

FIRST USE 5-1-2006; IN COMMERCE 5-1-2006.

FOR: PROVIDING TEMPORARY USE OF ONLINE, NON-DOWNLOADABLE SOFTWARE FOR

USE IN PROVIDING AN ONLINE DATABASE FOR TRACKING CHORES AND ALLOWANCES OF YOUNG PEOPLE FOR THE PURPOSE OF TEACHING RESPONSIBILITY AND FINANCIAL EDUCATION FOR USE BY YOUNG PEOPLE, IN CLASS 42 (U.S. CLS. 100 AND 101).

FIRST USE 5-1-2006; IN COMMERCE 5-1-2006.

THE MARK CONSISTS OF STANDARD CHARACTERS WITHOUT CLAIM TO ANY PARTICULAR FONT, STYLE, SIZE, OR COLOR.

SN 78-906,832, FILED 6-13-2006.

MELVIN AXILBUND, EXAMINING ATTORNEY

**Int. Cl.: 25**

**Prior U.S. Cls.: 22 and 39**

**United States Patent and Trademark Office**

**Reg. No. 3,506,619**

**Registered Sep. 23, 2008**

**TRADEMARK  
PRINCIPAL REGISTER**



SPANX, INC. (GEORGIA CORPORATION)  
SUITE 105  
3391 PEACHTREE ROAD  
ATLANTA, GA 30326

FOR: WOMEN'S APPAREL, NAMELY, PANTY-  
HOSE, SOCKS, TIGHTS, PANTS, SHIRTS, SKIRTS,  
FOOTLESS PANTYHOSE, FOOTLESS TIGHTS, UN-  
DERWEAR, PANTIES, BODYSUITS AND SLIPS;

SHAPEWEAR, NAMELY, BODY SHAPERS, LEG  
SHAPERS, AND BRAS, IN CLASS 25 (U.S. CLS. 22  
AND 39).

FIRST USE 10-0-2003; IN COMMERCE 10-0-2003.

SN 78-907,539, FILED 6-13-2006.

BENJAMIN ALLEN, EXAMINING ATTORNEY

**Int. Cl.: 3**

**Prior U.S. Cls.: 1, 4, 6, 50, 51, and 52**

**Reg. No. 3,506,620**

**United States Patent and Trademark Office**

**Registered Sep. 23, 2008**

---

**TRADEMARK  
PRINCIPAL REGISTER**

**IF YOU TAKE PRIDE IN YOUR  
RIDE**

FILTHY RICH CAR CARE PRODUCTS, LLC  
(CALIFORNIA LIMITED LIABILITY COMPA-  
NY)  
40-530 KINSALE PLACE  
INDIO, CA 92203

THE MARK CONSISTS OF STANDARD CHAR-  
ACTERS WITHOUT CLAIM TO ANY PARTICULAR  
FONT, STYLE, SIZE, OR COLOR.

FOR: CLEANING SOAPS FOR VEHICLES, IN  
CLASS 3 (U.S. CLS. 1, 4, 6, 50, 51 AND 52).

SN 78-909,576, FILED 6-15-2006.

FIRST USE 5-18-2008; IN COMMERCE 6-1-2008.

CHRIS WELLS, EXAMINING ATTORNEY

**Int. Cl.: 41**

**Prior U.S. Cls.: 100, 101, and 107**

**United States Patent and Trademark Office**

**Reg. No. 3,506,621**

**Registered Sep. 23, 2008**

**SERVICE MARK  
PRINCIPAL REGISTER**

**SMART SPACES INSIDE OUT**

SMART SPACES: INSIDE & OUT, LLC (ARIZONA  
LIMITED LIABILITY COMPANY)  
5555 N 7TH STREET, SUITE 134-144  
PHOENIX, AZ 85014

FOR: ENTERTAINMENT SERVICES NAMELY  
PROVIDING A WEBSITE FEATURING VIDEO PRE-  
SENTATIONS IN THE FIELD OF SUSTAINABLE  
LIVING; PRODUCTION OF VIDEO DISCS AND  
TAPES IN THE FIELD OF SUSTAINABLE LIVING,  
IN CLASS 41 (U.S. CLS. 100, 101 AND 107).

FIRST USE 1-0-2008; IN COMMERCE 1-0-2008.

THE MARK CONSISTS OF STANDARD CHAR-  
ACTERS WITHOUT CLAIM TO ANY PARTICULAR  
FONT, STYLE, SIZE, OR COLOR.

SN 78-909,813, FILED 6-16-2006.

BARBARA RUTLAND, EXAMINING ATTORNEY

**Int. Cl.: 42**

**Prior U.S. Cls.: 100 and 101**

**United States Patent and Trademark Office**

**Reg. No. 3,506,622**

**Registered Sep. 23, 2008**

**SERVICE MARK  
PRINCIPAL REGISTER**

**MYWEBSITEADMIN**

MYEXTENT INC. (UTAH CORPORATION)  
826 E. STATE ROAD, STE. 210  
AMERICAN FORK, UT 84003

FOR: HOSTING THE WEB SITES OF OTHERS ON  
A COMPUTER SERVER FOR A GLOBAL COMPU-  
TER NETWORK, IN CLASS 42 (U.S. CLS. 100 AND  
101).

FIRST USE 2-23-2003; IN COMMERCE 1-20-2005.

THE MARK CONSISTS OF STANDARD CHAR-  
ACTERS WITHOUT CLAIM TO ANY PARTICULAR  
FONT, STYLE, SIZE, OR COLOR.

SN 78-913,768, FILED 6-21-2006.

KATHERINE M. DUBRAY, EXAMINING ATTOR-  
NEY

**Int. Cls.: 38 and 41**

**Prior U.S. Cls.: 100, 101, 104, and 107**

**United States Patent and Trademark Office**

**Reg. No. 3,506,623**

**Registered Sep. 23, 2008**

**SERVICE MARK  
PRINCIPAL REGISTER**

**ECSN**

SCIENTIAE LLC (NEW YORK LIMITED LIABILITY COMPANY)  
SUITE 1100  
48 WALL ST  
NEW YORK, NY 10005

FOR: COMPUTERIZED ONLINE SERVICES, NAMELY, TRANSMISSION OF AND PROVIDING ACCESS TO EDUCATIONAL MATERIALS, NAMELY, DISPLAYS, SLIDES, VIDEO ANIMATIONS, SEMINARS, CLASSES, REPORTS, AND BIBLIOGRAPHIES IN THE MEDICAL FIELD OF THE ENDOCANNABINOID SYSTEM, IN CLASS 38 (U.S. CLS. 100, 101 AND 104).

FIRST USE 7-0-2006; IN COMMERCE 7-0-2006.

FOR: EDUCATIONAL SERVICES, NAMELY, PROVIDING CLASSES AND SEMINARS IN THE MEDICAL FIELD OF THE ENDOCANNABINOID

SYSTEM AND DISTRIBUTING COURSE MATERIALS IN THE NATURE OF REPORTS AND BIBLIOGRAPHIES IN CONNECTION THEREWITH; PROVIDING ONLINE CLASSES AND SEMINARS IN THE MEDICAL FIELD OF THE ENDOCANNABINOID SYSTEM AND DISTRIBUTING COURSE MATERIALS IN THE NATURE OF REPORTS AND BIBLIOGRAPHIES IN CONNECTION THEREWITH, IN CLASS 41 (U.S. CLS. 100, 101 AND 107).

FIRST USE 7-0-2006; IN COMMERCE 7-0-2006.

THE MARK CONSISTS OF STANDARD CHARACTERS WITHOUT CLAIM TO ANY PARTICULAR FONT, STYLE, SIZE, OR COLOR.

SN 78-915,539, FILED 6-23-2006.

JOHN DALIER, EXAMINING ATTORNEY

**Int. Cl.: 35**

**Prior U.S. Cls.: 100, 101, and 102**

**United States Patent and Trademark Office**

**Reg. No. 3,506,624**

**Registered Sep. 23, 2008**

**SERVICE MARK  
PRINCIPAL REGISTER**

**BLUE MOON WORKS INC**

BLUE MOON WORKS, INC. (COLORADO CORPORATION)  
3773 CHERRY CREEK NORTH DR.  
E-985  
DENVER, CO 80209

FOR: ON-LINE ADVERTISING AND MARKETING SERVICES, IN CLASS 35 (U.S. CLS. 100, 101 AND 102).

FIRST USE 3-25-2003; IN COMMERCE 4-30-2007.

THE MARK CONSISTS OF STANDARD CHARACTERS WITHOUT CLAIM TO ANY PARTICULAR FONT, STYLE, SIZE, OR COLOR.

NO CLAIM IS MADE TO THE EXCLUSIVE RIGHT TO USE "INC", APART FROM THE MARK AS SHOWN.

SN 78-918,228, FILED 6-27-2006.

JEFFERY COWARD, EXAMINING ATTORNEY

**Int. Cl.: 10**

**Prior U.S. Cls.: 26, 39, and 44**

**United States Patent and Trademark Office**

**Reg. No. 3,506,625**

**Registered Sep. 23, 2008**

**TRADEMARK  
PRINCIPAL REGISTER**

**BOOMER BRIDGE**

KELLER GROUP INCORPORATED (MISSOURI  
CORPORATION)  
160 LARKIN WILLIAMS IND. CT.  
FENTON, MO 63026

THE MARK CONSISTS OF STANDARD CHAR-  
ACTERS WITHOUT CLAIM TO ANY PARTICULAR  
FONT, STYLE, SIZE, OR COLOR.

FOR: DENTURES; DENTAL BRIDGES; AND  
PROSTHETIC INSTRUMENTS FOR DENTAL PUR-  
POSES, IN CLASS 10 (U.S. CLS. 26, 39 AND 44).

SN 78-918,880, FILED 6-28-2006.

FIRST USE 7-5-2006; IN COMMERCE 7-5-2006.

REGINA DRUMMOND, EXAMINING ATTORNEY



**Int. Cl.: 9**

**Prior U.S. Cls.: 21, 23, 26, 36, and 38**

**United States Patent and Trademark Office**

**Reg. No. 3,506,626**

**Registered Sep. 23, 2008**

**TRADEMARK  
PRINCIPAL REGISTER**

# GOLDEN FAN

VIDEO GAMING TECHNOLOGIES (TENNESSEE CORPORATION)  
155 FRANKLIN ROAD, SUITE 255  
BRENTWOOD, TN 37027

FOR: COMPUTER SOFTWARE AND FIRMWARE FOR GAMES OF CHANCE ON ANY COMPUTERIZED PLATFORM, NAMELY, DEDICATED GAMING CONSOLES, VIDEO BASED SLOT MACHINES, REEL BASED SLOT MACHINES, AND VIDEO LOTTERY TERMINALS; GAMING DEVICES, NAMELY, GAMING MACHINES, SLOT MACHINES, BINGO

MACHINES, WITH OR WITHOUT VIDEO OUTPUT, IN CLASS 9 (U.S. CLS. 21, 23, 26, 36 AND 38).

FIRST USE 9-0-2006; IN COMMERCE 9-0-2006.

THE MARK CONSISTS OF STANDARD CHARACTERS WITHOUT CLAIM TO ANY PARTICULAR FONT, STYLE, SIZE, OR COLOR.

SN 78-920,414, FILED 6-29-2006.

SKYE YOUNG, EXAMINING ATTORNEY

**Int. Cl.: 36**

**Prior U.S. Cls.: 100, 101, and 102**

**United States Patent and Trademark Office**

**Reg. No. 3,506,627**

**Registered Sep. 23, 2008**

**SERVICE MARK  
PRINCIPAL REGISTER**

**SOVEREIGN**

SOVEREIGN BANK (UNITED STATES CHAR-  
TERED BANK)  
1130 BERKSHIRE BLVD.  
WYOMISSING, PA 19610

FOR: BANKING AND RELATED FINANCIAL  
SERVICES, IN CLASS 36 (U.S. CLS. 100, 101 AND 102).

FIRST USE 12-31-1999; IN COMMERCE 12-31-1999.

THE MARK CONSISTS OF STANDARD CHAR-  
ACTERS WITHOUT CLAIM TO ANY PARTICULAR  
FONT, STYLE, SIZE, OR COLOR.

OWNER OF U.S. REG. NOS. 3,092,314 AND  
3,094,970.

SN 78-920,671, FILED 6-30-2006.

APRIL ROACH, EXAMINING ATTORNEY

**Int. Cls.: 35 and 36**

**Prior U.S. Cls.: 100, 101, and 102**

**United States Patent and Trademark Office**

**Reg. No. 3,506,628**

**Registered Sep. 23, 2008**

**SERVICE MARK  
PRINCIPAL REGISTER**

**DYREHAVEN**

DYREHAVEN & ASSOCIATES, LLC (WISCONSIN  
LIMITED LIABILITY COMPANY)

1959 BARRINGTON CIRCLE

SUN PRAIRIE, WI 53590

FOR: BUSINESS CONSULTING SERVICES RELATING TO TRANSACTION INTERMEDIARY SERVICES IN THE FIELD OF SELLING PRODUCTS AND RENDERING SERVICES; MERGER AND ACQUISITION ADVISORY SERVICES AND OTHER CONSULTING SERVICES RELATED TO MERGER AND ACQUISITION ACTIVITY, NAMELY, BUSINESS ADVISORY SERVICES FOR EARLY-STAGE COMPANIES, CONSULTING SERVICES RELATED TO BUSINESS SUCCESSION PLANNING OR THE SALE OF A BUSINESS, IN CLASS 35 (U.S. CLS. 100, 101 AND 102).

FIRST USE 9-10-2005; IN COMMERCE 9-10-2005.

FOR: INVESTMENT BANKING CONSULTING SERVICES; BUSINESS BROKERAGE CONSULTING SERVICES; CONSULTING SERVICES IN THE AREAS OF CAPITAL FORMATION AND PRIVATE INVESTMENT; BUSINESS VALUATION SERVICES, IN CLASS 36 (U.S. CLS. 100, 101 AND 102).

FIRST USE 9-10-2005; IN COMMERCE 6-10-2005.

THE MARK CONSISTS OF STANDARD CHARACTERS WITHOUT CLAIM TO ANY PARTICULAR FONT, STYLE, SIZE, OR COLOR.

THE ENGLISH TRANSLATION OF "DYRE" IS "DEER" AND THE ENGLISH TRANSLATION OF "HAVEN" IS "PARK."

SN 78-923,026, FILED 7-5-2006.

Laurie Mayes, Examining Attorney

**Int. Cls.: 9 and 42**

**Prior U.S. Cls.: 21, 23, 26, 36, 38, 100, and 101**

**United States Patent and Trademark Office**

**Reg. No. 3,506,629**

**Registered Sep. 23, 2008**

**TRADEMARK  
SERVICE MARK  
PRINCIPAL REGISTER**

# USERVUE

TECHSMITH CORPORATION (MICHIGAN CORPORATION)  
2405 WOODLAKE DR.  
OKEMOS, MI 48864

FOR: DOWNLOADABLE COMPUTER SOFTWARE, NAMELY, A REMOTE USABILITY TESTING WEB APPLICATION THAT PROVIDES THE CAPABILITY OF CONDUCTING ONE ON ONE FACILITATED SESSIONS USING A REMOTE FACILITATOR, REMOTE PARTICIPANT AND MULTIPLE OBSERVERS FOR USE IN THE FIELD OF USER TESTING, USER RESEARCH, DESIGN FEEDBACK, AND COLLABORATIVE PROJECTS CONDUCTED BY WEB AND SOFTWARE DEVELOPERS AND USABILITY PROFESSIONALS, IN CLASS 9 (U.S. CLS. 21, 23, 26, 36 AND 38).

FIRST USE 10-3-2006; IN COMMERCE 10-3-2006.

FOR: PROVIDING TEMPORARY USE OF ON LINE NON-DOWNLOADABLE COMPUTER SOFTWARE,

NAMELY, A REMOTE USABILITY TESTING WEB APPLICATION SERVICE THAT PROVIDES THE CAPABILITY OF CONDUCTING ONE ON ONE FACILITATED SESSIONS USING A REMOTE FACILITATOR, REMOTE PARTICIPANT AND MULTIPLE OBSERVERS FOR USE IN THE FIELD OF USER TESTING, USER RESEARCH, DESIGN FEEDBACK, AND COLLABORATIVE PROJECTS CONDUCTED BY WEB AND SOFTWARE DEVELOPERS AND USABILITY PROFESSIONALS, IN CLASS 42 (U.S. CLS. 100 AND 101).

FIRST USE 10-3-2006; IN COMMERCE 10-3-2006.

THE MARK CONSISTS OF STANDARD CHARACTERS WITHOUT CLAIM TO ANY PARTICULAR FONT, STYLE, SIZE, OR COLOR.

SN 78-923,319, FILED 7-6-2006.

THOMAS MANOR, EXAMINING ATTORNEY

**Int. Cl.: 1**

**Prior U.S. Cls.: 1, 5, 6, 10, 26, and 46**

**Reg. No. 3,506,630**

**United States Patent and Trademark Office**

**Registered Sep. 23, 2008**

---

**TRADEMARK  
PRINCIPAL REGISTER**

**NAS**

NA-CHURS PLANT FOOD COMPANY (DELA-  
WARE CORPORATION)  
421 LEADER STREET  
MARION, OH 43302

THE MARK CONSISTS OF STANDARD CHAR-  
ACTERS WITHOUT CLAIM TO ANY PARTICULAR  
FONT, STYLE, SIZE, OR COLOR.

FOR: FERTILIZERS; FERTILIZERS FOR AGRI-  
CULTURAL USE; FERTILIZERS FOR DOMESTIC  
USE, IN CLASS 1 (U.S. CLS. 1, 5, 6, 10, 26 AND 46).

SN 78-923,468, FILED 7-6-2006.

FIRST USE 9-25-2006; IN COMMERCE 9-25-2006.

ELLEN PERKINS, EXAMINING ATTORNEY

**Int. Cls.: 9, 16, 35, 40, 41, and 43**

**Prior U.S. Cls.: 2, 5, 21, 22, 23, 26, 29, 36, 37, 38, 50,  
100, 101, 102, 103, 106, and 107**

**Reg. No. 3,506,631**

**United States Patent and Trademark Office**

**Registered Sep. 23, 2008**

**TRADEMARK  
SERVICE MARK  
PRINCIPAL REGISTER**

**SUPER  TARGET**

TARGET BRANDS, INC. (MINNESOTA CORPORATION)  
TPS-3165  
1000 NICOLLET MALL  
MINNEAPOLIS, MN 55403

FOR: CONSUMER COUPONS DOWNLOADED FROM A GLOBAL COMPUTER NETWORK , IN CLASS 9 (U.S. CLS. 21, 23, 26, 36 AND 38).

FIRST USE 3-0-2006; IN COMMERCE 3-0-2006.

FOR: COUPONS, IN CLASS 16 (U.S. CLS. 2, 5, 22, 23, 29, 37, 38 AND 50).

FIRST USE 3-0-2006; IN COMMERCE 3-0-2006.

FOR: RETAIL AND ONLINE RETAIL GROCERY STORE SERVICES; RETAIL AND ONLINE RETAIL DEPARTMENT STORE SERVICES; RETAIL AND ONLINE RETAIL BAKERY SERVICES; RETAIL AND ONLINE RETAIL DELICATESSEN SERVICES; RETAIL PHARMACY SERVICES; RETAIL OPTICAL SERVICES, NAMELY, RETAIL DISPENSING OF OPTICAL LENSES, IN CLASS 35 (U.S. CLS. 100, 101 AND 102).

FIRST USE 3-0-2006; IN COMMERCE 3-0-2006.

FOR: PHOTO FINISHING SERVICES, IN CLASS 40 (U.S. CLS. 100, 103 AND 106).

FIRST USE 3-0-2006; IN COMMERCE 3-0-2006.

FOR: PHOTOGRAPHY SERVICES, IN CLASS 41 (U.S. CLS. 100, 101 AND 107).

FIRST USE 3-0-2006; IN COMMERCE 3-0-2006.

FOR: RESTAURANT AND SNACK BAR SERVICES; PROVIDING A DATABASE IN THE FIELD OF RECIPES AND COOKING INFORMATION, IN CLASS 43 (U.S. CLS. 100 AND 101).

FIRST USE 3-0-2006; IN COMMERCE 3-0-2006.

OWNER OF U.S. REG. NOS. 2,831,415, 2,839,606, AND OTHERS.

SN 78-923,506, FILED 7-6-2006.

MATTHEW EINSTEIN, EXAMINING ATTORNEY

Int. Cl.: 45

Prior U.S. Cls.: 100 and 101

United States Patent and Trademark Office

Reg. No. 3,506,632

Registered Sep. 23, 2008

**SERVICE MARK  
PRINCIPAL REGISTER**



NEXT DATING, LLC (DELAWARE LIMITED LIABILITY COMPANY)

2525 CHARLESTON ROAD, SUITE 101  
MOUNTAIN VIEW, CA 94043

FOR: COMPUTER SERVICES, NAMELY, PROVIDING INFORMATION REGARDING ON-LINE DATING, SOCIAL INTRODUCTION, AND SOCIAL NETWORKING; INTERNET BASED SOCIAL NETWORKING, INTRODUCTION, AND DATING SERVICES, IN CLASS 45 (U.S. CLS. 100 AND 101).

FIRST USE 12-7-2005; IN COMMERCE 12-7-2005.

THE COLOR(S) BLUE, ORANGE AND WHITE IS/ARE CLAIMED AS A FEATURE OF THE MARK.

THE MARK CONSISTS OF THE WORD "JUST" IN BLUE LETTERING, WITH AN ORANGE DOT OVER THE "J". THE WORD "SAY" IS IN ORANGE LETTERING. THE WORD "HI" IS IN WHITE LETTERING AND IS CONTAINED INSIDE A BLUE CONVERSATIONAL BUBBLE.

SN 78-925,013, FILED 7-7-2006.

STEVEN R. FOSTER, EXAMINING ATTORNEY

**Int. Cl.: 35**

**Prior U.S. Cls.: 100, 101, and 102**

**United States Patent and Trademark Office**

**Reg. No. 3,506,633**

**Registered Sep. 23, 2008**

**SERVICE MARK  
PRINCIPAL REGISTER**

**Nova Worldwide Consulting**

NOVA WORLDWIDE CONSULTING CORPORATION (ILLINOIS CORPORATION)  
SUITE 1406  
121 N. MONROE ST.  
TALLAHASSEE, FL 32301

FOR: CONSULTING SERVICES IN THE FIELD OF MANAGING INTELLECTUAL PROPERTIES; FOREIGN TRADE INFORMATION AND CONSULTATION, IN CLASS 35 (U.S. CLS. 100, 101 AND 102).

FIRST USE 7-13-2008; IN COMMERCE 7-13-2008.

THE MARK CONSISTS OF STANDARD CHARACTERS WITHOUT CLAIM TO ANY PARTICULAR FONT, STYLE, SIZE, OR COLOR.

NO CLAIM IS MADE TO THE EXCLUSIVE RIGHT TO USE "WORLDWIDE CONSULTING", APART FROM THE MARK AS SHOWN.

SN 78-925,129, FILED 7-8-2006.

DOMINICK J. SALEMI, EXAMINING ATTORNEY



**Int. Cls.: 6 and 9**

**Prior U.S. Cls.: 2, 12, 13, 14, 21, 23, 25, 26, 36, 38, and 50**

**Reg. No. 3,506,634**

**United States Patent and Trademark Office**

**Registered Sep. 23, 2008**

**TRADEMARK  
PRINCIPAL REGISTER**

**EJ GROUP**

EAST JORDAN IRON WORKS, INC. (MICHIGAN CORPORATION)  
301 SPRING STREET  
EAST JORDAN, MI 49727

FOR: METAL CASTINGS AND WATER DISTRIBUTION SUPPLIES, NAMELY, MANUALLY OPERATED METAL VALVES, METAL TAPPING SLEEVES AND METAL SERVICE BOXES; METAL BOLLARDS; METAL CONSTRUCTION AND UTILITY CASTS, NAMELY, MANHOLES, MANHOLE COVERS, CATCH BASIN COVERS, CATCH BASIN INLETS, ELEVATED AND BRIDGE DRAIN INLETS, CATCH BASIN TRAPS, CATCH BASIN HOODS, SEWER PIPE GRATES AND COVERS, DITCH GRATES, TRENCH FRAMES AND GRATES, CATCH BASIN CURB INLETS, MANHOLE STEPS, SIGN BASES, TREE GRATES, STOP PLANK GROOVES, LINER PLATES, AND FLAP VALVES; METAL WATER MAIN PIPE FITTINGS; NAMELY, JOINTS, SWIVELS, FLANGES AND ADAPTORS; MANUALLY OPERATED VALVES PRIMARILY OF METAL FOR USE IN WATER AND SEWAGE

SYSTEMS, IN CLASS 6 (U.S. CLS. 2, 12, 13, 14, 23, 25 AND 50).

FIRST USE 6-2-2008; IN COMMERCE 6-2-2008.

FOR: FIRE HYDRANTS, IN CLASS 9 (U.S. CLS. 21, 23, 26, 36 AND 38).

FIRST USE 6-2-2008; IN COMMERCE 6-2-2008.

THE MARK CONSISTS OF STANDARD CHARACTERS WITHOUT CLAIM TO ANY PARTICULAR FONT, STYLE, SIZE, OR COLOR.

NO CLAIM IS MADE TO THE EXCLUSIVE RIGHT TO USE "GROUP", APART FROM THE MARK AS SHOWN.

SN 78-925,343, FILED 7-10-2006.

EVELYN BRADLEY, EXAMINING ATTORNEY

**Int. Cl.: 25**

**Prior U.S. Cls.: 22 and 39**

**United States Patent and Trademark Office**

**Reg. No. 3,506,635**

**Registered Sep. 23, 2008**

**TRADEMARK  
PRINCIPAL REGISTER**

**PSYCHIC TWINS**

JAMISON, TERRY (UNITED STATES INDIVIDUAL)  
13636 VENTURA BOULEVARD, #204  
SHERMAN OAKS, CA 91423 AND  
JAMISON, LINDA (UNITED STATES INDIVIDUAL)  
13636 VENTURA BLVD., #204  
SHERMAN OAKS, CA 91423

FOR: CAPS; CLOTHING, NAMELY, WRAP-AROUNDS; T-SHIRTS; TOPS , IN CLASS 25 (U.S. CLS. 22 AND 39).

FIRST USE 11-23-1994; IN COMMERCE 4-11-2008.

THE MARK CONSISTS OF STANDARD CHARACTERS WITHOUT CLAIM TO ANY PARTICULAR FONT, STYLE, SIZE, OR COLOR.

SN 78-930,185, FILED 7-14-2006.

CYNTHIA SLOAN, EXAMINING ATTORNEY

**Int. Cl.: 38**

**Prior U.S. Cls.: 100, 101, and 104**

**United States Patent and Trademark Office**

**Reg. No. 3,506,636**

**Registered Sep. 23, 2008**

**SERVICE MARK  
PRINCIPAL REGISTER**

**LA BUENISIMA**

VOIP ALLIANCE, L.L.C. (TEXAS LIMITED  
PARTNERSHIP)  
SUITE 702  
200 S. 10TH STREET  
MCALLEN, TX 78501

FOR: TELEPHONE TELECOMMUNICATIONS  
SERVICES PROVIDED VIA PREPAID TELEPHONE  
CALLING CARDS, IN CLASS 38 (U.S. CLS. 100, 101  
AND 104).

FIRST USE 8-12-2004; IN COMMERCE 8-12-2004.

THE MARK CONSISTS OF STANDARD CHAR-  
ACTERS WITHOUT CLAIM TO ANY PARTICULAR  
FONT, STYLE, SIZE, OR COLOR.

THE FOREIGN WORDING IN THE MARK  
TRANSLATES INTO ENGLISH AS "THE ONE BET-  
TER THAN GOOD".

SN 78-930,378, FILED 7-15-2006.

RICHARD A. STRASER, EXAMINING ATTORNEY

**Int. Cl.: 33**

**Prior U.S. Cls.: 47 and 49**

**United States Patent and Trademark Office**

**Reg. No. 3,506,637**

**Registered Sep. 23, 2008**

**TRADEMARK  
PRINCIPAL REGISTER**

**IRISH AT ITS BEST**

THE "OLD BUSHMILLS" DISTILLERY CO. LIM-  
ITED (UNITED KINGDOM CORPORATION)  
BUSHMILLS  
CO. ANTRIM, NORTHERN IRELAND BT57 8XH

THE MARK CONSISTS OF STANDARD CHAR-  
ACTERS WITHOUT CLAIM TO ANY PARTICULAR  
FONT, STYLE, SIZE, OR COLOR.

FOR: ALCOHOLIC BEVERAGES, NAMELY,  
WHISKEY, IN CLASS 33 (U.S. CLS. 47 AND 49).

SN 78-930,982, FILED 7-17-2006.

FIRST USE 12-1-2006; IN COMMERCE 12-1-2006.

ROBERT STRUCK, EXAMINING ATTORNEY

**Int. Cl.: 11**

**Prior U.S. Cls.: 13, 21, 23, 31, and 34**

**United States Patent and Trademark Office**

**Reg. No. 3,506,638**

**Registered Sep. 23, 2008**

**TRADEMARK  
PRINCIPAL REGISTER**

**HEXA**

MIELE, INC. (DELAWARE CORPORATION)  
9 INDEPENDENCE WAY  
PRINCETON, NJ 08540

THE MARK CONSISTS OF STANDARD CHAR-  
ACTERS WITHOUT CLAIM TO ANY PARTICULAR  
FONT, STYLE, SIZE, OR COLOR.

FOR: GRATES MADE OF METAL SOLD AS  
PARTS OF GAS COOKTOPS, IN CLASS 11 (U.S.  
CLS. 13, 21, 23, 31 AND 34).

SN 78-930,993, FILED 7-17-2006.

FIRST USE 12-31-2005; IN COMMERCE 7-31-2006.

AISHA SALEM, EXAMINING ATTORNEY

**Int. Cl.: 25**

**Prior U.S. Cls.: 22 and 39**

**United States Patent and Trademark Office**

**Reg. No. 3,506,639**

**Registered Sep. 23, 2008**

**TRADEMARK  
PRINCIPAL REGISTER**



YANGZHOU TOPARTEX FACTORY CO., LTD  
(CHINA CORPORATION)  
YANGZHOU GUANGLING INDUSTRIAL AREA  
YANGZHOU CITY ECONOMIC DEVELOPMENT  
ZONE  
JIANGSU PROVINCE, CHINA

FOR: SWEATERS; SHIRTS; JUMPERS; TROUSERS; JACKETS; VESTS; SPORTS JERSEYS; T-SHIRTS; BOXER SHORTS; LAYETTES; BATHING TRUNKS; WATERPROOF JACKETS AND PANTS; MASQUERADE COSTUMES; BERETS; CAP VISORS; HEADGEAR, NAMELY, HATS, CAPS; EAR MUFFS;

HAT BANDS; HOSIERY; GLOVES; MITTENS; SHOULDER WRAPS BEING CLOTHING; SCARVES; MANTILLAS; TURBANS; SHOWER CAPS, IN CLASS 25 (U.S. CLS. 22 AND 39).

FIRST USE 3-13-2006; IN COMMERCE 8-24-2006.

THE WORDING "RIOREX" HAS NO MEANING IN A FOREIGN LANGUAGE.

SN 78-934,377, FILED 7-20-2006.

DANNEAN HETZEL, EXAMINING ATTORNEY

**Int. Cl.: 11**

**Prior U.S. Cls.: 13, 21, 23, 31, and 34**

**United States Patent and Trademark Office**

**Reg. No. 3,506,640**

**Registered Sep. 23, 2008**

**TRADEMARK  
PRINCIPAL REGISTER**

**CULINARY ENTERTAINER**

OUTDOOR CHEF INTERNATIONAL LTD.  
(SWITZERLAND CORPORATION)

CH 6030

EBIKON, SWITZERLAND

FOR: GAS BARBECUES, CHARCOAL BARBECUES; BARBECUE ACCESSORIES, NAMELY, CAST-IRON GRIDDLES, COOKING PANS, PIZZA PLATES, WOKS, PIZZA STONES AND FULL-LENGTH COVERS, IN CLASS 11 (U.S. CLS. 13, 21, 23, 31 AND 34).

FIRST USE 4-0-2007; IN COMMERCE 4-0-2007.

THE MARK CONSISTS OF STANDARD CHARACTERS WITHOUT CLAIM TO ANY PARTICULAR FONT, STYLE, SIZE, OR COLOR.

PRIORITY CLAIMED UNDER SEC. 44(D) ON CANADA APPLICATION NO. 1301957, FILED 5-17-2006.

NO CLAIM IS MADE TO THE EXCLUSIVE RIGHT TO USE "CULINARY", APART FROM THE MARK AS SHOWN.

SN 78-934,957, FILED 7-21-2006.

MICHAEL SOUDERS, EXAMINING ATTORNEY

**Int. Cl.: 9**

**Prior U.S. Cls.: 21, 23, 26, 36, and 38**

**United States Patent and Trademark Office**

**Reg. No. 3,506,641**

**Registered Sep. 23, 2008**

**TRADEMARK  
PRINCIPAL REGISTER**

**CommonCents**

HAMPTON, AARON F. (UNITED STATES INDIVIDUAL)  
6008 HEDGECREST PLACE  
CHARLOTTE, NC 28269

FOR: COMPUTER COMMUNICATIONS SOFTWARE TO ALLOW CUSTOMERS TO ACCESS BANK ACCOUNT INFORMATION AND TRANSACT BANK BUSINESS, IN CLASS 9 (U.S. CLS. 21, 23, 26, 36 AND 38).

FIRST USE 8-3-2007; IN COMMERCE 8-3-2007.

THE MARK CONSISTS OF STANDARD CHARACTERS WITHOUT CLAIM TO ANY PARTICULAR FONT, STYLE, SIZE, OR COLOR.

SN 78-936,890, FILED 7-25-2006.

MICHELE SWAIN, EXAMINING ATTORNEY



**Int. Cl.: 16**

**Prior U.S. Cls.: 2, 5, 22, 23, 29, 37, 38, and 50**

**United States Patent and Trademark Office**

**Reg. No. 3,506,642**

**Registered Sep. 23, 2008**

**TRADEMARK  
PRINCIPAL REGISTER**

**NATURE OF CHRISTMAS**

COFFEY, TIMOTHY (UNITED STATES INDIVIDUAL)  
44 LITTLE'S LANE  
HAMPSTEAD, NH 03841

THE MARK CONSISTS OF STANDARD CHARACTERS WITHOUT CLAIM TO ANY PARTICULAR FONT, STYLE, SIZE, OR COLOR.

FOR: PAPER MACHE FIGURINES; PAPER MACHE ORNAMENTS, IN CLASS 16 (U.S. CLS. 2, 5, 22, 23, 29, 37, 38 AND 50).

SN 78-937,785, FILED 7-26-2006.

FIRST USE 7-1-2007; IN COMMERCE 7-1-2007.

MARY ROSSMAN, EXAMINING ATTORNEY

**Int. Cl.: 35**

**Prior U.S. Cls.: 100, 101, and 102**

**United States Patent and Trademark Office**

**Reg. No. 3,506,643**

**Registered Sep. 23, 2008**

---

**SERVICE MARK  
PRINCIPAL REGISTER**

# Link ToAds

WI-FI GUYS, LLC (MINNESOTA LIMITED LIABILITY COMPANY)  
7265 HIGHWAY 1  
FINLAND, MN 55603

THE MARK CONSISTS OF STANDARD CHARACTERS WITHOUT CLAIM TO ANY PARTICULAR FONT, STYLE, SIZE, OR COLOR.

FOR: ADVERTISING SERVICES VIA HIGH SPEED INTERNET NETWORKS, IN CLASS 35 (U.S. CLS. 100, 101 AND 102).

SN 78-939,741, FILED 7-28-2006.

FIRST USE 10-10-2005; IN COMMERCE 10-10-2005.

JILL PRATER, EXAMINING ATTORNEY

Int. Cl.: 29

Prior U.S. Cl.: 46

United States Patent and Trademark Office

Reg. No. 3,506,644

Registered Sep. 23, 2008

TRADEMARK  
PRINCIPAL REGISTER



SIGMA ALIMENTOS, S.A. DE C.V. (MEXICO CORPORATION)  
COLONIA CARRIZALEJO  
AVE. GOMEZ MORIN NO. 1111  
SAN PEDRO GARZA GARCIA, MEXICO 66254

FOR: CHEESE, PROCESSED MEATS, NAMELY, COLD CUTS, HAMS, SAUSAGES, SALAMIS, CHORIZO, PASTRAMI, LOIN, TURKEY BREAST, PIG'S FEET, SLICED BEEF, PORK SAUSAGE, TURKEY SAUSAGE, ROAST BEEF, PEPPERONI AND BACON, YOGURT, IN CLASS 29 (U.S. CL. 46).

FIRST USE 11-0-2006; IN COMMERCE 11-0-2006.

THE COLOR(S) RED AND BLUE IS/ARE CLAIMED AS A FEATURE OF THE MARK.

THE MARK CONSISTS OF THE STYLIZED WORDS "SI SABE" WITH EXCLAMATION POINTS AND A TONGUE; THE COLOR BLUE APPEARS IN THE LANGUAGE "SI SABE" AND IN THE EXCLAMATION POINTS; THE COLOR RED APPEARS IN THE ACCENT OF THE LETTER "I" AND IN THE TONGUE.

THE FOREIGN WORDING IN THE MARK TRANSLATES INTO ENGLISH AS IT DOES TASTE.

SN 78-940,028, FILED 7-28-2006.

LAURIE MAYES, EXAMINING ATTORNEY

**Int. Cl.: 42**

**Prior U.S. Cls.: 100 and 101**

**United States Patent and Trademark Office**

**Reg. No. 3,506,645**

**Registered Sep. 23, 2008**

**SERVICE MARK  
PRINCIPAL REGISTER**

**YOURSTAMPS.COM**

FUJIFILM U.S.A., INC. (NEW YORK CORPORATION)  
200 SUMMIT LAKE DRIVE, 2ND FLOOR  
VALHALLA, NY 10595

FOR: HOSTING A WEBSITE WHICH ALLOWS  
USERS TO UPLOAD PHOTOGRAPHIC IMAGES TO  
CREATE PERSONALIZED POSTAGE STAMPS, IN  
CLASS 42 (U.S. CLS. 100 AND 101).

FIRST USE 1-30-2007; IN COMMERCE 1-30-2007.

THE MARK CONSISTS OF STANDARD CHARACTERS WITHOUT CLAIM TO ANY PARTICULAR FONT, STYLE, SIZE, OR COLOR.

SN 78-940,306, FILED 7-28-2006.

JIM RINGLE, EXAMINING ATTORNEY

**Int. Cls.: 11 and 40**

**Prior U.S. Cls.: 13, 21, 23, 31, 34, 100, 103, and 106**

**United States Patent and Trademark Office**

**Reg. No. 3,506,646**

**Registered Sep. 23, 2008**

**TRADEMARK  
SERVICE MARK  
PRINCIPAL REGISTER**



GROUNDWATER AND ENVIRONMENTAL SERVICES, INC. (PENNSYLVANIA CORPORATION)  
SUITE 500  
440 CREAMERY WAY  
EXTON, PA 193412577

FOR: EQUIPMENT FOR TREATING GROUNDWATER AND SOIL, NAMELY, OZONE, OXYGEN, HYDROGEN PEROXIDE, AND AIR INJECTION UNITS COMPRISED OF DISTRIBUTION LINES, DISTRIBUTION MANIFOLDS, DROP TUBES, WELL SEALS, AND BLOWERS, IN CLASS 11 (U.S. CLS. 13, 21, 23, 31 AND 34).

FIRST USE 12-0-2006; IN COMMERCE 5-12-2008.

FOR: ENVIRONMENTAL REMEDIATION AND TREATMENT SERVICES, NAMELY, SOIL AND WATER TREATMENT SERVICES, IN CLASS 40 (U.S. CLS. 100, 103 AND 106).

FIRST USE 12-0-2006; IN COMMERCE 5-12-2008.

NO CLAIM IS MADE TO THE EXCLUSIVE RIGHT TO USE "SIX-PHASE CHEMICAL OXIDATION", APART FROM THE MARK AS SHOWN.

SN 78-942,022, FILED 8-1-2006.

JENNIFER VASQUEZ, EXAMINING ATTORNEY

**Int. Cls.: 9 and 42**

**Prior U.S. Cls.: 21, 23, 26, 36, 38, 100, and 101**

**United States Patent and Trademark Office**

**Reg. No. 3,506,647**

**Registered Sep. 23, 2008**

**TRADEMARK  
SERVICE MARK  
PRINCIPAL REGISTER**

**TERRAVISION TECHNOLOGIES**

TERRAVISION TECHNOLOGIES, LLC (FLORIDA  
LIMITED LIABILITY COMPANY)

SUITE 1009

45 SKYLINE DR.

LAKE MARY, FL 32746

FOR: COMPUTER APPLICATION SOFTWARE  
FOR MOBILE PHONES; COMPUTER GAME SOFT-  
WARE; COMPUTER SOFTWARE FOR TRACKING  
AND MANAGING AIRCRAFT MAINTENANCE;  
INTERACTIVE MULTIMEDIA COMPUTER GAME  
PROGRAM, IN CLASS 9 (U.S. CLS. 21, 23, 26, 36 AND  
38).

FIRST USE 1-0-2005; IN COMMERCE 1-0-2005.

FOR: COMPUTER SOFTWARE DESIGN FOR  
OTHERS; COMPUTER SOFTWARE DEVELOP-  
MENT, IN CLASS 42 (U.S. CLS. 100 AND 101).

FIRST USE 1-0-2005; IN COMMERCE 1-0-2005.

THE MARK CONSISTS OF STANDARD CHAR-  
ACTERS WITHOUT CLAIM TO ANY PARTICULAR  
FONT, STYLE, SIZE, OR COLOR.

NO CLAIM IS MADE TO THE EXCLUSIVE  
RIGHT TO USE "TECHNOLOGIES", APART FROM  
THE MARK AS SHOWN.

SN 78-942,392, FILED 8-1-2006.

HEATHER THOMPSON, EXAMINING ATTORNEY

**Int. Cl.: 5**

**Prior U.S. Cls.: 6, 18, 44, 46, 51, and 52**

**Reg. No. 3,506,648**

**United States Patent and Trademark Office**

**Registered Sep. 23, 2008**

---

**TRADEMARK  
PRINCIPAL REGISTER**

**PULMICORT**

ASTRAZENECA AB (SWEDEN CORPORATION)  
VASTRA MALAREHAMNEN 9  
SODERTALJE, SWEDEN SE-151 85

FOR: PHARMACEUTICAL PREPARATIONS FOR  
THE TREATMENT OF RESPIRATORY DISEASES,  
IN CLASS 5 (U.S. CLS. 6, 18, 44, 46, 51 AND 52).

FIRST USE 10-31-2000; IN COMMERCE 10-31-2000.

THE MARK CONSISTS OF STANDARD CHAR-  
ACTERS WITHOUT CLAIM TO ANY PARTICULAR  
FONT, STYLE, SIZE, OR COLOR.

OWNER OF U.S. REG. NOS. 1,912,691, 2,502,318,  
AND 3,079,539.

SN 78-942,523, FILED 8-1-2006.

DEIRDRE ROBERTSON, EXAMINING ATTORNEY

Int. Cl.: 25

Prior U.S. Cls.: 22 and 39

United States Patent and Trademark Office

Reg. No. 3,506,649

Registered Sep. 23, 2008

TRADEMARK  
PRINCIPAL REGISTER



VIEW POINT INTERNATIONAL CORP. (CALI-  
FORNIA CORPORATION)  
4030 MOORPARK AVENUE  
SUITE 250  
SAN JOSE, CA 95117

FOR: JAPANESE STYLE SOCKS (TABI COVERS),  
IN CLASS 25 (U.S. CLS. 22 AND 39).

FIRST USE 11-15-2006; IN COMMERCE 6-1-2007.

NO CLAIM IS MADE TO THE EXCLUSIVE  
RIGHT TO USE "TABI SOCKS", APART FROM  
THE MARK AS SHOWN.

THE COLOR(S) BLACK AND RED IS/ARE  
CLAIMED AS A FEATURE OF THE MARK.

THE MARK CONSISTS OF THE WORD "TABBI-  
SOCKS" ABOVE A BLACK INK STROKE WITH THE  
LETTERS "BB" APPEARING IN RED AND THE  
COLOR BLACK APPEARING IN THE REMAINDER  
OF THE MARK.

SN 78-943,578, FILED 8-2-2006.

HOWARD B. LEVINE, EXAMINING ATTORNEY



**Int. Cl.: 41**

**Prior U.S. Cls.: 100, 101, and 107**

**United States Patent and Trademark Office**

**Reg. No. 3,506,650**

**Registered Sep. 23, 2008**

**SERVICE MARK  
PRINCIPAL REGISTER**



BEAULIEU GROUP, LLC (GEORGIA LIMITED  
LIABILITY COMPANY)  
1502 CORONET DRIVE  
DALTON, GA 30720

FIRST USE 1-0-2006; IN COMMERCE 1-0-2006.

OWNER OF U.S. REG. NO. 2,911,344.

FOR: TRAINING SERVICES IN THE FIELD OF  
INSTALLATION OF RESIDENTIAL AND COM-  
MERCIAL CARPET, IN CLASS 41 (U.S. CLS. 100,  
101 AND 107).

SN 78-944,363, FILED 8-3-2006.

MARCIE MILONE, EXAMINING ATTORNEY

**Int. Cls.: 35 and 37**

**Prior U.S. Cls.: 100, 101, 102, 103, and 106**

**United States Patent and Trademark Office**

**Reg. No. 3,506,651**

**Registered Sep. 23, 2008**

**SERVICE MARK  
PRINCIPAL REGISTER**



BELLA PORTA LLC (NEW YORK LIMITED LIABILITY COMPANY)  
92 FRONT STREET  
HEMPSTEAD, NY 11550

FOR: RETAIL STORES FEATURING DOORS AND ACCESSORIES, IN CLASS 35 (U.S. CLS. 100, 101 AND 102).

FIRST USE 5-15-2006; IN COMMERCE 5-15-2006.

FOR: INSTALLATION OF DOORS AND ACCESSORIES, IN CLASS 37 (U.S. CLS. 100, 103 AND 106).

FIRST USE 5-15-2006; IN COMMERCE 5-15-2006.

THE COLOR(S) RED, WHITE IS/ARE CLAIMED AS A FEATURE OF THE MARK.

THE MARK CONSISTS OF A RED RECTANGLE WITH A WHITE BORDER CENTERED WITHIN ANOTHER RED RECTANGLE. THE WORD "BELLAPORTA" IS HANDWRITTEN IN WHITE IN A CURSIVE STYLE WITH A ROUGH BRUSH STROKE INSIDE THE RECTANGLE. ON THE LEFT-HAND SIDE OF "BELLAPORTA" IS A WHITE STYLIZED VERTICAL LINE AND WHITE DOOR HANDLE.

THE ENGLISH TRANSLATION OF THE WORD "BELLAPORTA" IN THE MARK IS BEAUTIFUL DOOR.

SN 78-947,124, FILED 8-8-2006.

CAROLYN CATALDO, EXAMINING ATTORNEY

Int. Cl.: 35

Prior U.S. Cls.: 100, 101, and 102

United States Patent and Trademark Office

Reg. No. 3,506,652

Registered Sep. 23, 2008

**SERVICE MARK  
PRINCIPAL REGISTER**



SAUERBIER, ALBERT J. (UNITED STATES IN-  
DIVIDUAL)

1543 WINDAMERE LANE

NAPLES, FL 34119

FOR: ELECTRICAL COST DATA ESTIMATING  
OF ELECTRICAL CONTRACTING WORK; PRO-  
VIDING DATABASES ONLINE FEATURING ELEC-  
TRICAL COST DATA FOR USE IN ELECTRICAL  
CONTRACTING WORK ESTIMATING, IN CLASS 35  
(U.S. CLS. 100, 101 AND 102).

FIRST USE 7-1-2006; IN COMMERCE 1-1-2007.

NO CLAIM IS MADE TO THE EXCLUSIVE  
RIGHT TO USE "E-COST", APART FROM THE  
MARK AS SHOWN.

THE COLOR(S) YELLOW, BLUE, AND BLACK IS/  
ARE CLAIMED AS A FEATURE OF THE MARK.

THE MARK CONSISTS OF A YELLOW LIGHT-  
NING BOLT OUTLINED IN BLACK. THE LETTERS  
OF THE WORDING "E-COST" ARE BLUE.

SN 78-947,899, FILED 8-8-2006.

HANNO RITTNER, EXAMINING ATTORNEY

**Int. Cl.: 18**

**Prior U.S. Cls.: 1, 2, 3, 22, and 41**

**United States Patent and Trademark Office**

**Reg. No. 3,506,653**

**Registered Sep. 23, 2008**

**TRADEMARK  
PRINCIPAL REGISTER**

**STONZ**

STONE MOUNTAIN ACCESSORIES, INC.  
(GEORGIA CORPORATION)  
SUITE 728  
10 WEST 33RD STREET  
NEW YORK, NY 10001

FOR: ATHLETIC BAGS; BACKPACKS; HAND-  
BAGS; LEATHER HANDBAGS; PURSES; TOTE  
BAGS; WALLETS, IN CLASS 18 (U.S. CLS. 1, 2, 3, 22  
AND 41).

FIRST USE 10-0-2006; IN COMMERCE 10-0-2006.

THE MARK CONSISTS OF STANDARD CHAR-  
ACTERS WITHOUT CLAIM TO ANY PARTICULAR  
FONT, STYLE, SIZE, OR COLOR.

OWNER OF U.S. REG. NOS. 1,667,647, 2,588,945,  
AND OTHERS.

SN 78-948,217, FILED 8-9-2006.

AISHA SALEM, EXAMINING ATTORNEY

**Int. Cl.: 29**

**Prior U.S. Cl.: 46**

**United States Patent and Trademark Office**

**Reg. No. 3,506,654**

**Registered Sep. 23, 2008**

**TRADEMARK  
PRINCIPAL REGISTER**

**SPOON HUGGING TEXTURE**

YOPLAIT MARQUES INTERNATIONALES  
(FRANCE CORPORATION)  
170 BIS, BOULEVARD DU MONTPARNASSE  
75014 PARIS, FRANCE

THE MARK CONSISTS OF STANDARD CHAR-  
ACTERS WITHOUT CLAIM TO ANY PARTICULAR  
FONT, STYLE, SIZE, OR COLOR.

FOR: DAIRY PRODUCTS EXCLUDING ICE  
CREAM, ICE MILK, AND FROZEN YOGURT, IN  
CLASS 29 (U.S. CL. 46).

SN 78-948,448, FILED 8-9-2006.

FIRST USE 0-0-2004; IN COMMERCE 0-0-2004.

SHANNON TWOHIG, EXAMINING ATTORNEY

**Int. Cls.: 25 and 41**

**Prior U.S. Cls.: 22, 39, 100, 101, and 107**

**Reg. No. 3,506,655**

**United States Patent and Trademark Office**

**Registered Sep. 23, 2008**

**TRADEMARK  
SERVICE MARK  
PRINCIPAL REGISTER**

**LADIES LINKS FORE GOLF**

MARTIN, HELEN (UNITED STATES INDIVIDUAL)  
4 FIELDWAY DRIVE  
STUART, FL 34996

FOR: GOLF APPAREL, NAMELY, SHIRTS AND VISORS, IN CLASS 25 (U.S. CLS. 22 AND 39).

FIRST USE 3-15-2006; IN COMMERCE 11-15-2007.

FOR: PROVIDING A WEBSITE THROUGH WHICH GOLFERS LOCATE GOLF INSTRUCTION INFORMATION AND INFORMATION ABOUT GOLF COURSES AND GOLF TOURNAMENTS; ENTERTAINMENT IN THE NATURE OF GOLF

TOURNAMENTS; AND WORKSHOPS AND SEMINARS IN THE FIELD OF GOLF, IN CLASS 41 (U.S. CLS. 100, 101 AND 107).

FIRST USE 3-15-2006; IN COMMERCE 11-15-2007.

THE MARK CONSISTS OF STANDARD CHARACTERS WITHOUT CLAIM TO ANY PARTICULAR FONT, STYLE, SIZE, OR COLOR.

SN 78-949,304, FILED 8-10-2006.

DAVID MILLER, EXAMINING ATTORNEY

**Int. Cl.: 9**

**Prior U.S. Cls.: 21, 23, 26, 36, and 38**

**United States Patent and Trademark Office**

**Reg. No. 3,506,656**

**Registered Sep. 23, 2008**

**TRADEMARK  
PRINCIPAL REGISTER**

**MAX RAVE**

MAX RAVE, LLC (DELAWARE LIMITED LIABILITY COMPANY)  
2761 FRUITLAND AVE.  
VERNON, CA 90058

FOR: EYE GLASSES, CASES FOR EYE GLASSES, FRAMES FOR EYE GLASSES, SUN GLASSES, CASES FOR SUN GLASSES, FRAMES FOR SUN GLASSES, IN CLASS 9 (U.S. CLS. 21, 23, 26, 36 AND 38).

FIRST USE 6-18-2007; IN COMMERCE 6-18-2007.

THE MARK CONSISTS OF STANDARD CHARACTERS WITHOUT CLAIM TO ANY PARTICULAR FONT, STYLE, SIZE, OR COLOR.

SN 78-950,690, FILED 8-11-2006.

SKYE YOUNG, EXAMINING ATTORNEY

**Int. Cl.: 3**

**Prior U.S. Cls.: 1, 4, 6, 50, 51, and 52**

**United States Patent and Trademark Office**

**Reg. No. 3,506,657**

**Registered Sep. 23, 2008**

**TRADEMARK  
PRINCIPAL REGISTER**

**COLOR GLOW**

FNC MEDICAL CORPORATION (CALIFORNIA  
CORPORATION)  
6000 LELAND STREET  
VENTURA, CA 93003

THE MARK CONSISTS OF STANDARD CHAR-  
ACTERS WITHOUT CLAIM TO ANY PARTICULAR  
FONT, STYLE, SIZE, OR COLOR.

FOR: FOAMING SOLUTION FOR CLEANING  
THE COATS, MANES AND TAILS OF HORSES, IN  
CLASS 3 (U.S. CLS. 1, 4, 6, 50, 51 AND 52).

SN 78-952,735, FILED 8-15-2006.

FIRST USE 4-0-2006; IN COMMERCE 4-0-2006.

HENRY S. ZAK, EXAMINING ATTORNEY



**Int. Cl.: 3**

**Prior U.S. Cls.: 1, 4, 6, 50, 51, and 52**

**United States Patent and Trademark Office**

**Reg. No. 3,506,658**

**Registered Sep. 23, 2008**

**TRADEMARK  
PRINCIPAL REGISTER**

**KRUD KLEANER**

FNC MEDICAL CORPORATION (CALIFORNIA  
CORPORATION)  
6000 LELAND STREET  
VENTURA, CA 93003

THE MARK CONSISTS OF STANDARD CHAR-  
ACTERS WITHOUT CLAIM TO ANY PARTICULAR  
FONT, STYLE, SIZE, OR COLOR.

FOR: SOIL RELEASE CLEANING PREPARA-  
TIONS, IN CLASS 3 (U.S. CLS. 1, 4, 6, 50, 51 AND 52).

SN 78-952,758, FILED 8-15-2006.

FIRST USE 4-0-2006; IN COMMERCE 4-0-2006.

HENRY S. ZAK, EXAMINING ATTORNEY

**Int. Cl.: 25**

**Prior U.S. Cls.: 22 and 39**

**United States Patent and Trademark Office**

**Reg. No. 3,506,659**

**Registered Sep. 23, 2008**

**TRADEMARK  
PRINCIPAL REGISTER**

**ENHANCE YOUR LOOK**

VANITY FAIR, INC. (DELAWARE CORPORATION)  
LEGAL DEPARTMENT  
ONE FRUIT OF THE LOOM DRIVE  
BOWLING GREEN, KY 42103

FOR: LINGERIE, IN CLASS 25 (U.S. CLS. 22 AND 39).

FIRST USE 1-6-2006; IN COMMERCE 1-6-2006.

THE MARK CONSISTS OF STANDARD CHARACTERS WITHOUT CLAIM TO ANY PARTICULAR FONT, STYLE, SIZE, OR COLOR.

OWNER OF U.S. REG. NO. 806,773.

SN 78-952,977, FILED 8-16-2006.

JANICE KIM, EXAMINING ATTORNEY

**Int. Cls.: 6, 9, 12, 18, and 28**

**Prior U.S. Cls.: 1, 2, 3, 12, 13, 14, 19, 21, 22, 23, 25, 26,  
31, 35, 36, 38, 41, 44, and 50**

**Reg. No. 3,506,660**

**United States Patent and Trademark Office**

**Registered Sep. 23, 2008**

**TRADEMARK  
PRINCIPAL REGISTER**



OCELOT ENGINEERING, INC. (CALIFORNIA CORPORATION)  
555 SOUTH H STREET  
SAN BERNARDINO, CA 92410

FOR: METAL RAMPS FOR MOTORCYCLES, IN CLASS 6 (U.S. CLS. 2, 12, 13, 14, 23, 25 AND 50).

FIRST USE 6-13-2008; IN COMMERCE 6-13-2008.

FOR: MOTORCYCLE HELMETS; PROTECTIVE CLOTHING, NAMELY, MOTORCYCLE JERSEYS AND PANTS; PROTECTIVE MOTORCYCLE BOOTS, AND PROTECTIVE MOTORCYCLE GLOVES, IN CLASS 9 (U.S. CLS. 21, 23, 26, 36 AND 38).

FIRST USE 6-13-2008; IN COMMERCE 6-13-2008.

FOR: MOTORCYCLE STANDS, IN CLASS 12 (U.S. CLS. 19, 21, 23, 31, 35 AND 44).

FIRST USE 6-13-2008; IN COMMERCE 6-13-2008.

FOR: SHOE AND GARMENT BAGS FOR TRAVEL, LUGGAGE FOR TRAVEL; SHOE AND GARMENT BOXES FOR TRAVEL NOT OF PAPER OR CARDBOARD, IN CLASS 18 (U.S. CLS. 1, 2, 3, 22 AND 41).

FIRST USE 6-13-2008; IN COMMERCE 6-13-2008.

FOR: SHOULDER, ARM, AND BODY PROTECTIVE PADS, PADDING, AND GUARDS FOR MOTORCYCLE RIDING AND RACING, MOTORCYCLE BODY PROTECTORS, IN CLASS 28 (U.S. CLS. 22, 23, 38 AND 50).

FIRST USE 6-13-2008; IN COMMERCE 6-13-2008.

THE MARK CONSISTS OF A STYLIZED DRAWING OF A CAT'S PAW PRINT, SURROUNDED BY A CIRCLE.

SN 78-953,577, FILED 8-16-2006.

ROBIN MITTLER, EXAMINING ATTORNEY

**Int. Cl.: 16**

**Prior U.S. Cls.: 2, 5, 22, 23, 29, 37, 38, and 50**

**Reg. No. 3,506,661**

**United States Patent and Trademark Office**

**Registered Sep. 23, 2008**

**TRADEMARK  
PRINCIPAL REGISTER**

**TUSKY**

GREENBERG, KENNETH R. (UNITED STATES  
INDIVIDUAL)  
1733 HUTCHINSON LANE  
SILVER SPRING, MD 20906

THE MARK CONSISTS OF STANDARD CHAR-  
ACTERS WITHOUT CLAIM TO ANY PARTICULAR  
FONT, STYLE, SIZE, OR COLOR.

FOR: SERIES OF FICTION BOOKS, IN CLASS 16  
(U.S. CLS. 2, 5, 22, 23, 29, 37, 38 AND 50).

SN 78-954,344, FILED 8-17-2006.

FIRST USE 5-1-1991; IN COMMERCE 5-1-1991.

MICHELE SWAIN, EXAMINING ATTORNEY

Int. Cls.: 9 and 41

Prior U.S. Cls.: 21, 23, 26, 36, 38, 100, 101, and 107

United States Patent and Trademark Office

Reg. No. 3,506,662

Registered Sep. 23, 2008

TRADEMARK  
SERVICE MARK  
PRINCIPAL REGISTER

**WALKER**  
*D i g i t a l*  
G A M I N G ♠ L L C

WALKER DIGITAL GAMING, LLC (DELAWARE  
LIMITED LIABILITY COMPANY)  
2 HIGH RIDGE PARK  
STAMFORD, CT 06905

FOR: GAMING MACHINES, NAMELY, DEVICES WHICH ACCEPT A WAGER OR AN INDICATION OF A WAGER, AS WELL AS COMPONENTS THEREFOR, NAMELY, CONTROLLERS, DISPLAYS, BUTTON PANELS, BOLSTERS, ELECTRICAL WIRING, AND COMPUTER HARDWARE AND SOFTWARE ASSOCIATED THEREWITH; MACHINES MACHINES FOR PLAYING CARD GAMES, NAMELY, VIDEO POKER MACHINES; MACHINES; COIN, CASHLESS TICKET OR TOKEN-OPERATED SLOT MACHINES FROM WHICH MONEY CAN BE WON, IN CLASS 9 (U.S. CLS. 21, 23, 26, 36 AND 38).

FIRST USE 7-11-2007; IN COMMERCE 7-11-2007.

FOR: CONSULTING SERVICES IN THE FIELD OF GAMING, ENTERTAINMENT AND AMUSEMENT MACHINES AND APPARATUS, IN CLASS 41 (U.S. CLS. 100, 101 AND 107).

FIRST USE 3-23-2008; IN COMMERCE 3-23-2008.

NO CLAIM IS MADE TO THE EXCLUSIVE RIGHT TO USE "DIGITAL GAMING" AND "LLC", APART FROM THE MARK AS SHOWN.

SN 78-956,189, FILED 8-21-2006.

MELVIN AXILBUND, EXAMINING ATTORNEY

**Int. Cl.: 42**

**Prior U.S. Cls.: 100 and 101**

**United States Patent and Trademark Office**

**Reg. No. 3,506,663**

**Registered Sep. 23, 2008**

**SERVICE MARK  
PRINCIPAL REGISTER**

**WE EXPLAIN THINGS BETTER**

BLUE GRAVITY, INC. (ILLINOIS CORPORATION), DBA AVIATOR HOSTING,  
13008 S. MEADE AVE.  
PALOS HEIGHTS, IL 60463

THE MARK CONSISTS OF STANDARD CHARACTERS WITHOUT CLAIM TO ANY PARTICULAR FONT, STYLE, SIZE, OR COLOR.

FOR: WEB SITE HOSTING AND DESIGN SERVICES, IN CLASS 42 (U.S. CLS. 100 AND 101).

SN 78-956,654, FILED 8-21-2006.

FIRST USE 7-3-2008; IN COMMERCE 7-3-2008.

DAVID TAYLOR, EXAMINING ATTORNEY

**Int. Cl.: 36**

**Prior U.S. Cls.: 100, 101, and 102**

**United States Patent and Trademark Office**

**Reg. No. 3,506,664**

**Registered Sep. 23, 2008**

---

**SERVICE MARK  
PRINCIPAL REGISTER**

**IRAAA**

NABERS, JEFFREY (UNITED STATES INDIVIDUAL)  
P.O. BOX 50605  
MYRTLE BEACH, SC 29579

THE MARK CONSISTS OF STANDARD CHARACTERS WITHOUT CLAIM TO ANY PARTICULAR FONT, STYLE, SIZE, OR COLOR.

FOR: FINANCIAL SERVICES, NAMELY, PLANNING, MANAGEMENT, AND CONSULTATION OF RETIREMENT PLANS, IN CLASS 36 (U.S. CLS. 100, 101 AND 102).

SN 78-957,647, FILED 8-22-2006.

FIRST USE 10-1-2005; IN COMMERCE 10-1-2005.

DANIEL CAPSHAW, EXAMINING ATTORNEY

**Int. Cl.: 16**

**Prior U.S. Cls.: 2, 5, 22, 23, 29, 37, 38, and 50**

**Reg. No. 3,506,665**

**United States Patent and Trademark Office**

**Registered Sep. 23, 2008**

**TRADEMARK  
PRINCIPAL REGISTER**

**WOWZEE**

WOWZEE WORKS, LLC (NEVADA LIMITED  
LIABILITY COMPANY)  
2217 GREEN MOUNTAIN CT.  
LAS VEGAS, NV 89135

THE MARK CONSISTS OF STANDARD CHAR-  
ACTERS WITHOUT CLAIM TO ANY PARTICULAR  
FONT, STYLE, SIZE, OR COLOR.

FOR: CHILDREN'S BOOKS, IN CLASS 16 (U.S.  
CLS. 2, 5, 22, 23, 29, 37, 38 AND 50).

SN 78-958,498, FILED 8-23-2006.

FIRST USE 1-28-2008; IN COMMERCE 1-28-2008.

JOHN GARTNER, EXAMINING ATTORNEY



**Int. Cl.: 16**

**Prior U.S. Cls.: 2, 5, 22, 23, 29, 37, 38, and 50**

**United States Patent and Trademark Office**

**Reg. No. 3,506,666**

**Registered Sep. 23, 2008**

**TRADEMARK  
PRINCIPAL REGISTER**



DATAWORKS, LLC (COLORADO LIMITED LIABILITY COMPANY)  
4550 SOUTH WINDERMERE STREET  
ENGLEWOOD, CO 80110

FOR: LOG BOOKS, DESKTOP PLANNERS, PERSONAL PLANNERS, WAIT-LIST NOTE PADS, TIP-SHARE LOG BOOKS, TRAINER'S LOG BOOKS, EMPLOYEE HISTORY LOG BOOKS, CAR RENTAL LOG BOOKS, CALL-AHEAD SEATING LOG BOOKS, DEPOSIT LOG BOOKS, RESERVATION BOOKS, TRI-FOLD NOTE CARDS FOR RECORD-

ING INFORMATION, IN CLASS 16 (U.S. CLS. 2, 5, 22, 23, 29, 37, 38 AND 50).

FIRST USE 7-24-2008; IN COMMERCE 7-24-2008.

OWNER OF U.S. REG. NOS. 2,291,009 AND 3,100,193.

SN 78-959,308, FILED 8-24-2006.

ROBERT STRUCK, EXAMINING ATTORNEY

**Int. Cl.: 7**

**Prior U.S. Cls.: 13, 19, 21, 23, 31, 34, and 35**

**United States Patent and Trademark Office**

**Reg. No. 3,506,667**

**Registered Sep. 23, 2008**

**TRADEMARK  
PRINCIPAL REGISTER**

**SNAPDECK**

DUREX PRODUCTS, INC. (WISCONSIN CORPORATION)  
112 FIRST AVENUE WEST  
LUCK, WI 54853

FOR: MACHINE PARTS, NAMELY, MODULAR SCREEN PANELS, SUPPORT FRAMES AND PARTS FOR USE ON MINING MATERIAL SORTING MACHINES, IN CLASS 7 (U.S. CLS. 13, 19, 21, 23, 31, 34 AND 35).

FIRST USE 4-4-2008; IN COMMERCE 4-4-2008.

THE MARK CONSISTS OF STANDARD CHARACTERS WITHOUT CLAIM TO ANY PARTICULAR FONT, STYLE, SIZE, OR COLOR.

SN 78-959,480, FILED 8-24-2006.

MARK T. MULLEN, EXAMINING ATTORNEY

**Int. Cl.: 29**

**Prior U.S. Cl.: 46**

**United States Patent and Trademark Office**

**Reg. No. 3,506,668**

**Registered Sep. 23, 2008**

**TRADEMARK  
PRINCIPAL REGISTER**

**HEART OF ENGLAND**

DAIRY CREST LIMITED (UNITED KINGDOM  
CORPORATION)  
CLAYGATE HOUSE, LITTLEWORTH ROAD  
ESHER, SURREY, UNITED KINGDOM KT10 9PN

FOR: CHEESE, IN CLASS 29 (U.S. CL. 46).

FIRST USE 1-0-2006; IN COMMERCE 1-0-2006.

THE MARK CONSISTS OF STANDARD CHAR-  
ACTERS WITHOUT CLAIM TO ANY PARTICULAR  
FONT, STYLE, SIZE, OR COLOR.

SN 78-960,180, FILED 8-24-2006.

RICHARD WHITE, EXAMINING ATTORNEY

**Int. Cl.: 35**

**Prior U.S. Cls.: 100, 101, and 102**

**United States Patent and Trademark Office**

**Reg. No. 3,506,669**

**Registered Sep. 23, 2008**

**SERVICE MARK  
PRINCIPAL REGISTER**



ELEMENT 79 PARTNERS LLC (DELAWARE  
LIMITED LIABILITY COMPANY)  
SUITE 3300  
200 EAST RANDOLPH DRIVE  
CHICAGO, IL 60601

FOR: ADVERTISING AGENCY SERVICES; MAR-  
KETING; AND PROMOTION SERVICES FOR OTH-  
ERS IN THE NATURE OF SPORTS EVENT  
MARKETING AND SPONSORSHIPS; BUSINESS  
MARKETING CONSULTING IN THE FIELD OF  
SPORTS, SPORT EVENT MARKETING AND SPON-  
SORSHIPS; MARKET RESEARCH SERVICES;  
BRAND DEVELOPMENT AND BRAND CONSULT-  
ING SERVICES, IN CLASS 35 (U.S. CLS. 100, 101 AND  
102).

FIRST USE 11-30-2006; IN COMMERCE 11-30-2006.

OWNER OF U.S. REG. NO. 2,828,347.

NO CLAIM IS MADE TO THE EXCLUSIVE  
RIGHT TO USE "SPORTS", APART FROM THE  
MARK AS SHOWN.

THE MARK CONSISTS OF THE NUMBER 79  
IMPRINTED ABOVE "AU" AND "SPORTS".

SN 78-960,278, FILED 8-25-2006.

KELLY CHOE, EXAMINING ATTORNEY

**Int. Cl.: 25**

**Prior U.S. Cls.: 22 and 39**

**United States Patent and Trademark Office**

**Reg. No. 3,506,670**

**Registered Sep. 23, 2008**

**TRADEMARK  
PRINCIPAL REGISTER**

**BREEZE THROUGH LIFE**

SHONEBARGER, DENNIS (UNITED STATES INDIVIDUAL)  
1036 HARROW  
TOLEDO, OH 43615 AND  
SORGE, PATRICIA B. (UNITED STATES INDIVIDUAL)  
1036 HARROW  
TOLEDO, OH 43615

FOR: T-SHIRTS; TANK TOPS, IN CLASS 25 (U.S. CLS. 22 AND 39).

FIRST USE 6-1-2007; IN COMMERCE 6-1-2007.

THE MARK CONSISTS OF STANDARD CHARACTERS WITHOUT CLAIM TO ANY PARTICULAR FONT, STYLE, SIZE, OR COLOR.

SN 78-960,573, FILED 8-25-2006.

KATHRYN COWARD, EXAMINING ATTORNEY

**Int. Cl.: 44**

**Prior U.S. Cls.: 100 and 101**

**United States Patent and Trademark Office**

**Reg. No. 3,506,671**

**Registered Sep. 23, 2008**

**SERVICE MARK  
PRINCIPAL REGISTER**



MASSAGE RETREAT, LLC (MINNESOTA LIMITED LIABILITY COMPANY)  
200 SOUTH 6TH STREET  
1100 US BANK PLAZA  
MINNEAPOLIS, MN 554021400

FOR: MASSAGE, IN CLASS 44 (U.S. CLS. 100 AND 101).

FIRST USE 5-1-2007; IN COMMERCE 6-5-2008.

NO CLAIM IS MADE TO THE EXCLUSIVE RIGHT TO USE "MASSAGE RETREAT", APART FROM THE MARK AS SHOWN.

THE COLOR(S) BLACK, YELLOW AND ORANGE IS/ARE CLAIMED AS A FEATURE OF THE MARK.

THE COLOR BLACK APPEARS IN THE TEXT LETTERING "MASSAGE RETREAT"; THE COLORS YELLOW AND ORANGE APPEAR IN THE GRASS LIKE BLADES THAT APPEAR TO THE LEFT OF THE TEXT LETTERING.

SN 78-961,328, FILED 8-27-2006.

JORDAN BAKER, EXAMINING ATTORNEY

**Int. Cl.: 41**

**Prior U.S. Cls.: 100, 101, and 107**

**United States Patent and Trademark Office**

**Reg. No. 3,506,672**

**Registered Sep. 23, 2008**

**SERVICE MARK  
PRINCIPAL REGISTER**

**FIT FAMILIES - HEALTHY  
COMMUNITIES**

PEAK FITNESS, LLC (MASSACHUSETTS LIMITED PARTNERSHIP)  
70 JACONET STREET  
NEWTON, MA 02464

FOR: ARRANGING AND CONDUCTING ATHLETIC COMPETITIONS; BALLET SCHOOLS; BASEBALL CAMPS; BASKETBALL CAMPS; CHILDREN'S ENTERTAINMENT AND AMUSEMENT CENTERS, NAMELY, INTERACTIVE PLAY AREAS; DANCE EVENTS; DANCE INSTRUCTION; DANCE SCHOOLS; DANCE STUDIOS; ENTERTAINMENT SERVICES, NAMELY, CONDUCTING PARTIES; GYMNASIUMS; HEALTH CLUB SERVICES, NAMELY PROVIDING INSTRUCTION AND EQUIPMENT IN THE FIELD OF PHYSICAL EXERCISE; MARTIAL ARTS INSTRUCTION; OPERATING OF MARTIAL ARTS' SCHOOLS; OPERATION OF SPORTS CAMPS; ORGANIZATION OF DANCING EVENTS; PERSONAL TRAINER SERVICES; PERSONAL TRAINING SERVICES, NAMELY, STRENGTH AND CONDITIONING TRAINING; PHYSICAL EDUCATION SERVICES; PHYSICAL FITNESS CONSULTATION; PHYSICAL FITNESS INSTRUCTION;

PRODUCTION OF VIDEO CASSETTES; PRODUCTION OF VIDEO DISCS FOR OTHERS; PROVIDING A WEBSITE FEATURING SPORTING INFORMATION; PROVIDING GYMNASIUMS; PROVIDING GYMNASIUMS; PROVIDING INFORMATION IN THE FIELD OF EXERCISE TRAINING; PROVIDING RECREATIONAL AREAS IN THE NATURE OF CHILDREN'S PLAY AREAS; PROVIDING SPORTS FACILITIES; PROVIDING SPORTS INFORMATION BY MEANS OF TELEPHONE PRE-RECORDED MESSAGES; SOCCER CAMPS; SPORT CAMPS; SUMMER CAMPS; YOGA INSTRUCTION, IN CLASS 41 (U.S. CLS. 100, 101 AND 107).

FIRST USE 1-13-2008; IN COMMERCE 1-13-2008.

THE MARK CONSISTS OF STANDARD CHARACTERS WITHOUT CLAIM TO ANY PARTICULAR FONT, STYLE, SIZE, OR COLOR.

SN 78-961,471, FILED 8-28-2006.

JAMES MACFARLANE, EXAMINING ATTORNEY

**Int. Cl.: 36**

**Prior U.S. Cls.: 100, 101, and 102**

**United States Patent and Trademark Office**

**Reg. No. 3,506,673**

**Registered Sep. 23, 2008**

**SERVICE MARK  
PRINCIPAL REGISTER**

PROSAVER PLUS FIXED ANNUITY

PROTECTIVE LIFE INSURANCE COMPANY  
(TENNESSEE CORPORATION)  
2801 HIGHWAY 280 SOUTH  
BIRMINGHAM, AL 35223

OWNER OF U.S. REG. NO. 1,559,247.

FOR: LIFE INSURANCE SERVICES, NAMELY,  
UNDERWRITING ANNUITIES, IN CLASS 36 (U.S.  
CLS. 100, 101 AND 102).

NO CLAIM IS MADE TO THE EXCLUSIVE  
RIGHT TO USE "FIXED ANNUITY", APART FROM  
THE MARK AS SHOWN.

FIRST USE 8-31-2007; IN COMMERCE 8-31-2007.

SN 78-962,591, FILED 8-29-2006.

THE MARK CONSISTS OF STANDARD CHAR-  
ACTERS WITHOUT CLAIM TO ANY PARTICULAR  
FONT, STYLE, SIZE, OR COLOR.

DANIEL BRODY, EXAMINING ATTORNEY



**Int. Cls.: 9 and 41**

**Prior U.S. Cls.: 21, 23, 26, 36, 38, 100, 101, and 107**

**United States Patent and Trademark Office**

**Reg. No. 3,506,674**

**Registered Sep. 23, 2008**

**TRADEMARK  
SERVICE MARK  
PRINCIPAL REGISTER**



WMS GAMING INC. (DELAWARE CORPORATION)  
800 SOUTH NORTHPOINT BOULEVARD  
WAUKEGAN, IL 60085

FOR: GAMING MACHINES THAT GENERATE OR DISPLAY WAGER OUTCOMES AND GAMING SOFTWARE THAT GENERATES OR DISPLAYS WAGER OUTCOMES OF GAMING MACHINES, IN CLASS 9 (U.S. CLS. 21, 23, 26, 36 AND 38).

FIRST USE 11-14-2006; IN COMMERCE 11-14-2006.

FOR: EDUCATION SERVICES, NAMELY, PROVIDING CLASSES AND INFORMATION IN THE FIELD OF GAMING MACHINES THAT GENERATE OR DISPLAY WAGER OUTCOMES AND GAMING SOFTWARE THAT GENERATES OR DISPLAYS

WAGER OUTCOMES; ENTERTAINMENT SERVICES, NAMELY, PROVIDING FOR CONSUMER PLAY OF GAMING MACHINES THAT GENERATE OR DISPLAY WAGER OUTCOMES AND GAMING SOFTWARE THAT GENERATES OR DISPLAYS WAGER OUTCOMES, IN CLASS 41 (U.S. CLS. 100, 101 AND 107).

FIRST USE 11-13-2006; IN COMMERCE 11-13-2006.

OWNER OF U.S. REG. NOS. 2,341,453 AND 2,695,864.

SN 78-962,914, FILED 8-29-2006.

MIDGE BUTLER, EXAMINING ATTORNEY

**Int. Cl.: 9**

**Prior U.S. Cls.: 21, 23, 26, 36, and 38**

**United States Patent and Trademark Office**

**Reg. No. 3,506,675**

**Registered Sep. 23, 2008**

**TRADEMARK  
PRINCIPAL REGISTER**

**SMART CORRAL**

CARTTRONICS, LLC (CALIFORNIA LIMITED  
LIABILITY COMPANY)  
12310 WORLD TRADE DRIVE  
SAN DIEGO, CA 92128

FOR: SHOPPING CART IDENTIFICATION AND  
RETURN SYSTEM COMPRISED OF IDENTIFICA-  
TION TAGS; ELECTRONIC SENSORS; ELECTRO-  
MAGNETIC, MAGNETIC AND OPTICAL  
READERS; COMPUTER SOFTWARE AND COMPU-  
TER HARDWARE FOR MONITORING THE LOCA-  
TION, MOVEMENT AND RETURN OF SHOPPING  
CARTS, FOR REWARDING THE RETURN OF  
SHOPPING CARTS WITH CREDITS OR INCEN-  
TIVES, AND FOR ALLOWING THE USE OF CUS-  
TOMER LOYALTY PROGRAMS, IN CLASS 9 (U.S.  
CLS. 21, 23, 26, 36 AND 38).

FIRST USE 5-6-2007; IN COMMERCE 5-6-2007.

THE MARK CONSISTS OF STANDARD CHAR-  
ACTERS WITHOUT CLAIM TO ANY PARTICULAR  
FONT, STYLE, SIZE, OR COLOR.

NO CLAIM IS MADE TO THE EXCLUSIVE  
RIGHT TO USE "SMART" , APART FROM THE  
MARK AS SHOWN.

SN 78-965,547, FILED 8-31-2006.

ALICE BENMAMAN, EXAMINING ATTORNEY

**Int. Cls.: 8 and 21**

**Prior U.S. Cls.: 2, 13, 23, 28, 29, 30, 33, 40, 44, and 50**

**Reg. No. 3,506,676**

**United States Patent and Trademark Office**

**Registered Sep. 23, 2008**

**TRADEMARK  
PRINCIPAL REGISTER**

**STEEL - FUNCTION**

STEEL-FUNCTION ASIA (H.K.) LIMITED (HONG KONG CORPORATION)  
UNIT 3, 12TH FLOOR, STAR CENTRE  
NO. 443-451 CASTLE PEAK ROAD, KWAI CHUNG  
NEW TERRITORIES, HONG KONG

FOR: HOUSEHOLD UTENSILS IN THE NATURE OF HAND TOOLS, NAMELY, CAN OPENERS, CAN PIERCERS, CAN TAPPERS, FORKS, HAND-OPERATED FOOD SLICERS, NON-ELECTRIC FRUIT AND VEGETABLE PEELERS, PIZZA CUTTERS, HAND-OPERATED FOOD CHOPPERS, KNIVES, GRAPEFRUIT SEGMENTORS, KNIFE SHARPENERS, GARLIC SKIN REMOVERS, APPLE WEDGERS, TOMATO CORERS, NUT CRACKERS NOT MADE OF PRECIOUS METAL, AND ICE PICKS, IN CLASS 8 (U.S. CLS. 23, 28 AND 44).

FIRST USE 7-0-1992; IN COMMERCE 5-1-2008.

FOR: HOUSEHOLD AND KITCHEN CONTAINERS NOT OF PRECIOUS METAL; HAND-OPERATED HOUSEHOLD AND KITCHEN UTENSILS, NAMELY, LEMON ZESTERS, COOKIE CUTTERS, GRATERS, SIEVES, COOKING STRAINERS, TURNERS, TURNING SHOVELS, POT AND PAN SCRAPERS, ROLLING PINS, SPATULAS, WHISKS, SKIMMERS, POTATO MASHERS, FOOD SERVERS, SLOTTED SPOONS, BASTING SPOONS, PERFORATED SPOONS, KITCHEN AND SERVING LADLES, SERVING FORKS, SERVING TONGS, BOTTLE

OPENERS, JAR OPENERS, CORKSCREWS, BUTTER CURLERS AND SPREADERS, FLOUR DUSTERS, PASTRY WHEELS, PASTRY PRESS, PASTRY BRUSHES, PASTRY BLENDERS, PASTRY SERVING TOOLS, NAMELY, SERVING BOWLS, SERVING DISHES, SERVING TRAYS, SERVING FORKS AND SERVING TONGS, ICE-CREAM SCOOPS, ICE-CREAM SPADES, GARLIC PRESS, COCKTAIL JIGGERS, SANDWICH HOLDERS, TOAST HOLDERS, NON-ELECTRIC FRUIT JUICERS, LEMON SQUEEZERS, FRUIT BALLERS AND DECORATORS, EGG PIERCERS, FUNNELS, SALT AND PEPPER SETS, SALAD DRESSING SHAKERS, SALAD DISHES, CORN SHEWERS, ICING SETS, COOKIE CUTTERS, MIXING BOWLS, MIXING CUPS AND MIXING SPOONS, SCRAPERS FOR HOUSEHOLD PURPOSES, STIRRERS FOR BEVERAGES, COCKTAIL SWORD PICKS, ICING SYRINGES, COASTERS NOT MADE OF PAPER OR LINEN, FLASKS, TEA STRAINERS, SIFTERS, CUTTING BOARDS, ICE CUBE TRAYS, BOTTLE POURING SPOUTS FOR HOUSEHOLD USE, GLASS BOTTLE STOPPERS, TRIVETS, BOWLS, PANS, IN CLASS 21 (U.S. CLS. 2, 13, 23, 29, 30, 33, 40 AND 50).

FIRST USE 7-0-1992; IN COMMERCE 5-1-2008.

SN 78-966,042, FILED 9-1-2006.

Laurie Kaufman, Examining Attorney

**Int. Cl.: 16**

**Prior U.S. Cls.: 2, 5, 22, 23, 29, 37, 38, and 50**

**Reg. No. 3,506,677**

**United States Patent and Trademark Office**

**Registered Sep. 23, 2008**

---

**TRADEMARK  
PRINCIPAL REGISTER**

**WOWZEE WORLD**

WOWZEE WORKS, LLC (NEVADA LIMITED  
LIABILITY COMPANY)  
2217 GREEN MOUNTAIN CT.  
LAS VEGAS, NV 89135

THE MARK CONSISTS OF STANDARD CHAR-  
ACTERS WITHOUT CLAIM TO ANY PARTICULAR  
FONT, STYLE, SIZE, OR COLOR.

FOR: CHILDREN'S BOOKS, IN CLASS 16 (U.S.  
CLS. 2, 5, 22, 23, 29, 37, 38 AND 50).

SN 78-966,354, FILED 9-1-2006.

FIRST USE 1-28-2008; IN COMMERCE 1-28-2008.

JOHN GARTNER, EXAMINING ATTORNEY

**Int. Cl.: 33**

**Prior U.S. Cls.: 47 and 49**

**United States Patent and Trademark Office**

**Reg. No. 3,506,678**

**Registered Sep. 23, 2008**

**TRADEMARK  
PRINCIPAL REGISTER**

**SCULPTERRA**

FRANKEL REVOCABLE TRUST (CALIFORNIA  
TRUST)  
5125 LINNE ROAD  
PASO ROBLES, CA 93446

THE MARK CONSISTS OF STANDARD CHAR-  
ACTERS WITHOUT CLAIM TO ANY PARTICULAR  
FONT, STYLE, SIZE, OR COLOR.

FOR: WINE, IN CLASS 33 (U.S. CLS. 47 AND 49).

SN 78-966,569, FILED 9-2-2006.

FIRST USE 6-13-2007; IN COMMERCE 12-23-2007.

ZHALEH DELANEY, EXAMINING ATTORNEY

**Int. Cl.: 14**

**Prior U.S. Cls.: 2, 27, 28, and 50**

**United States Patent and Trademark Office**

**Reg. No. 3,506,679**

**Registered Sep. 23, 2008**

**TRADEMARK  
PRINCIPAL REGISTER**

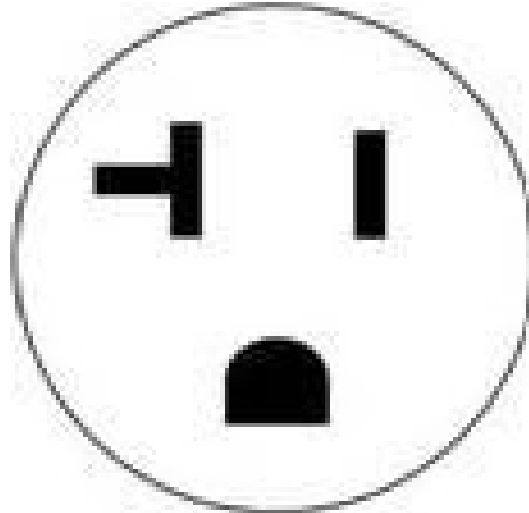

SOCKETOME, LLC (ILLINOIS LIMITED LIABILITY COMPANY)  
4250 N. MARINE DRIVE #932  
CHICAGO, IL 60613

FIRST USE 12-1-2005; IN COMMERCE 10-1-2006.

SN 78-967,750, FILED 9-6-2006.

FOR: JEWELRY, IN CLASS 14 (U.S. CLS. 2, 27, 28 AND 50).

RENEE SERVANCE, EXAMINING ATTORNEY

**Int. Cl.: 9**

**Prior U.S. Cls.: 21, 23, 26, 36, and 38**

**United States Patent and Trademark Office**

**Reg. No. 3,506,680**

**Registered Sep. 23, 2008**

**TRADEMARK  
PRINCIPAL REGISTER**

**PACKETASSURE**

DNE TECHNOLOGIES, INC. (DELAWARE CORPORATION)  
50 BARNES PARK NORTH  
WALLINGFORD, CT 06492

FOR: ACCESS DEVICES FOR WIRELESS AND SATELLITE RADIO TRANSMISSION, NAMELY, MULTIPLEXERS WITH QUALITY OF SERVICE AND CONNECTION ACCESS CONTROL, IN CLASS 9 (U.S. CLS. 21, 23, 26, 36 AND 38).

FIRST USE 8-1-2008; IN COMMERCE 8-1-2008.

THE MARK CONSISTS OF STANDARD CHARACTERS WITHOUT CLAIM TO ANY PARTICULAR FONT, STYLE, SIZE, OR COLOR.

SN 78-967,758, FILED 9-6-2006.

KATHERINE CHANG, EXAMINING ATTORNEY

**Int. Cl.: 41**

**Prior U.S. Cls.: 100, 101, and 107**

**United States Patent and Trademark Office**

**Reg. No. 3,506,681**

**Registered Sep. 23, 2008**

**SERVICE MARK  
PRINCIPAL REGISTER**



**AFRICENTIALS**

Deeply Rooted For Living, For Learning, For Life

AFRICENTIALS CORPORATION (ILLINOIS  
CORPORATION)  
1302 WISCONSIN STREET  
JOLIET, IL 60432

FOR: EDUCATION SERVICES, NAMELY, PRO-  
VIDING WORKSHOPS, LECTURES AND SEMI-  
NARS IN THE FIELD OF AFRICAN AMERICAN  
RACIAL IDENTITY, IN CLASS 41 (U.S. CLS. 100, 101  
AND 107).

FIRST USE 3-15-2007; IN COMMERCE 3-15-2007.

NO CLAIM IS MADE TO THE EXCLUSIVE  
RIGHT TO USE THE PICTORIAL REPRESENTA-  
TION OF AFRICA, APART FROM THE MARK AS  
SHOWN.

SN 78-968,406, FILED 9-6-2006.

REBECCA EISINGER, EXAMINING ATTORNEY



**Int. Cl.: 41**

**Prior U.S. Cls.: 100, 101, and 107**

**United States Patent and Trademark Office**

**Reg. No. 3,506,682**

**Registered Sep. 23, 2008**

**SERVICE MARK  
PRINCIPAL REGISTER**

**AFRICENTIALS**

AFRICENTIALS CORPORATION (ILLINOIS  
CORPORATION)  
1302 WISCONSIN STREET  
JOLIET, IL 60432

FOR: EDUCATION SERVICES, NAMELY, PRO-  
VIDING WORKSHOPS, LECTURES AND SEMI-  
NARS IN THE FIELD OF AFRICAN AMERICAN  
RACIAL IDENTITY, IN CLASS 41 (U.S. CLS. 100, 101  
AND 107).

FIRST USE 4-23-2007; IN COMMERCE 4-23-2007.

THE MARK CONSISTS OF STANDARD CHAR-  
ACTERS WITHOUT CLAIM TO ANY PARTICULAR  
FONT, STYLE, SIZE, OR COLOR.

SN 78-968,419, FILED 9-6-2006.

REBECCA EISINGER, EXAMINING ATTORNEY

**Int. Cl.: 16**

**Prior U.S. Cls.: 2, 5, 22, 23, 29, 37, 38, and 50**

**Reg. No. 3,506,683**

**United States Patent and Trademark Office**

**Registered Sep. 23, 2008**

**TRADEMARK  
PRINCIPAL REGISTER**

**PAPA ROWE**

WOWZEE WORKS, LLC (NEVADA LIMITED  
LIABILITY COMPANY)  
2217 GREEN MOUNTAIN CT.  
LAS VEGAS, NV 89135

THE MARK CONSISTS OF STANDARD CHAR-  
ACTERS WITHOUT CLAIM TO ANY PARTICULAR  
FONT, STYLE, SIZE, OR COLOR.

FOR: CHILDREN'S BOOKS, IN CLASS 16 (U.S.  
CLS. 2, 5, 22, 23, 29, 37, 38 AND 50).

SN 78-969,465, FILED 9-7-2006.

FIRST USE 1-28-2008; IN COMMERCE 1-28-2008.

JOHN GARTNER, EXAMINING ATTORNEY

**Int. Cl.: 9**

**Prior U.S. Cls.: 21, 23, 26, 36, and 38**

**United States Patent and Trademark Office**

**Reg. No. 3,506,684**

**Registered Sep. 23, 2008**

**TRADEMARK  
PRINCIPAL REGISTER**

**ZLIVE**

DPI, INC. (DELAWARE CORPORATION)  
900 N. 23RD STREET  
ST. LOUIS, MO 63106

FOR: CONSUMER AUDIO AND VIDEO ELECTRONIC PRODUCTS, NAMELY, PHONOGRAPHS, COMPACT DISC PLAYERS, AUDIO AND VIDEO RECEIVERS, AUDIO AND VIDEO AMPLIFIERS, WALKIE-TALKIES, AUDIO SPEAKERS, HEADPHONES, MICROPHONES, AUDIOTAPE CASSETTE PLAYERS AND RECORDERS, AUDIOTAPE DUAL CASSETTE RECORDERS, AUDIO GRAPHIC EQUALIZERS, REMOTE CONTROL UNITS FOR RADIOS, AUDIOTAPE CASSETTE PLAYERS, VIDEOTAPE CASSETTE PLAYERS, DVD PLAYERS, MP3 PLAYERS AND MP3 RECORDERS, TELEVISIONS, VIDEO CASSETTE PLAYERS, RECORDERS, AND REWINDERS; RADIOS; RADIO ANTENNAS;

TELEPHONES; TELEPHONE EQUIPMENT, NAMELY, CALLER IDENTIFICATION BOXES; CITIZEN BAND RADIO TRANSCEIVERS; ELECTRONIC PERSONAL COMMUNICATION DEVICE, NAMELY, TWO-WAY RADIO FOR USE ON SPECIFIED FREQUENCY WAVES FOR COMMUNICATIONS BETWEEN FAMILIES OR SMALL GROUPS, IN CLASS 9 (U.S. CLS. 21, 23, 26, 36 AND 38).

FIRST USE 6-19-2008; IN COMMERCE 6-19-2008.

THE MARK CONSISTS OF STANDARD CHARACTERS WITHOUT CLAIM TO ANY PARTICULAR FONT, STYLE, SIZE, OR COLOR.

SN 78-969,785, FILED 9-8-2006.

NAAKWAMA ANKRAH, EXAMINING ATTORNEY

**Int. Cls.: 9 and 42**

**Prior U.S. Cls.: 21, 23, 26, 36, 38, 100, and 101**

**United States Patent and Trademark Office**

**Reg. No. 3,506,685**

**Registered Sep. 23, 2008**

**TRADEMARK  
SERVICE MARK  
PRINCIPAL REGISTER**

games4you

GAMES4YOU LLC (NEVADA LIMITED LIABILITY COMPANY)  
7830 E. GELDING DRIVE, SUITE #400  
SCOTTSDALE, AZ 85260

FOR: GAMING MACHINES, IN CLASS 9 (U.S. CLS. 21, 23, 26, 36 AND 38).

FIRST USE 4-17-2008; IN COMMERCE 4-17-2008.

FOR: PRODUCT DESIGN AND DEVELOPMENT FOR OTHERS IN THE FIELD OF GAMING AND RECREATION, NAMELY, OF MECHANICAL GAMING EQUIPMENT, ELECTROMECHANICAL GAM-

ING EQUIPMENT, ELECTRONIC GAMING EQUIPMENT AND GAMES FOR GAMING MACHINES, IN CLASS 42 (U.S. CLS. 100 AND 101).

FIRST USE 8-28-2007; IN COMMERCE 8-28-2007.

THE MARK CONSISTS OF STANDARD CHARACTERS WITHOUT CLAIM TO ANY PARTICULAR FONT, STYLE, SIZE, OR COLOR.

SN 78-969,997, FILED 9-8-2006.

ESTHER A. BORSUK, EXAMINING ATTORNEY

**Int. Cl.: 16**

**Prior U.S. Cls.: 2, 5, 22, 23, 29, 37, 38, and 50**

**United States Patent and Trademark Office**

**Reg. No. 3,506,686**

**Registered Sep. 23, 2008**

**TRADEMARK  
PRINCIPAL REGISTER**

**Innovative Teachers'  
Companion**

ITC PUBLICATIONS PTY LTD (AUSTRALIA  
CORPORATION)  
PO BOX 2640  
TOOWOOMBA, QUEENSLAND, AUSTRALIA 4350

FOR: STATIONERY, DIARIES, PRINTED IN-  
STRUCTIONAL AND TEACHING MATERIAL IN  
THE FIELD OF EDUCATION, AND TEACHER AND  
CLASSROOM DAILY PLANNERS IN THE FIELD  
OF EDUCATION, IN CLASS 16 (U.S. CLS. 2, 5, 22, 23,  
29, 37, 38 AND 50).

FIRST USE 8-0-2006; IN COMMERCE 5-0-2007.

THE MARK CONSISTS OF STANDARD CHAR-  
ACTERS WITHOUT CLAIM TO ANY PARTICULAR  
FONT, STYLE, SIZE, OR COLOR.

PRIORITY CLAIMED UNDER SEC. 44(D) ON  
AUSTRALIA APPLICATION NO. 1130370, FILED 8-  
18-2006, REG. NO. 1130370, DATED 8-18-2006, EX-  
PIRES 8-18-2016.

SN 78-970,959, FILED 9-11-2006.

ANDREA SAUNDERS, EXAMINING ATTORNEY

**Int. Cl.: 11**

**Prior U.S. Cls.: 13, 21, 23, 31, and 34**

**Reg. No. 3,506,687**

**United States Patent and Trademark Office**

**Registered Sep. 23, 2008**

---

**TRADEMARK  
PRINCIPAL REGISTER**

**PURELOCK**

AMMM PATENT HOLDINGS, LLC (MISSOURI  
LIMITED LIABILITY COMPANY)  
1033 CORPORATE SQUARE DRIVE  
ST. LOUIS, MO 63132

THE MARK CONSISTS OF STANDARD CHAR-  
ACTERS WITHOUT CLAIM TO ANY PARTICULAR  
FONT, STYLE, SIZE, OR COLOR.

FOR: CONVERSION DEVICES, NAMELY, ADAP-  
TERS TO RETROFIT EXISTING WATER COOLERS  
TO DISPENSE BAGGED FLUIDS, IN CLASS 11 (U.S.  
CLS. 13, 21, 23, 31 AND 34).

SN 78-971,199, FILED 9-11-2006.

FIRST USE 8-0-2007; IN COMMERCE 8-0-2007.

TINA KUAN, EXAMINING ATTORNEY

**Int. Cl.: 9**

**Prior U.S. Cls.: 21, 23, 26, 36, and 38**

**Reg. No. 3,506,688**

**United States Patent and Trademark Office**

**Registered Sep. 23, 2008**

**TRADEMARK  
PRINCIPAL REGISTER**

# FASTLANE

PLX TECHNOLOGY, INC. (CALIFORNIA CORPORATION)  
870 MAUDE AVENUE  
SUNNYVALE, CA 94085

FOR: COMPUTER HARDWARE, NAMELY, COMPUTER AND SILICON CHIPS AND INTEGRATED CIRCUITS, AND INSTRUCTIONAL MANUALS SOLD AS A UNIT; COMPUTER REFERENCE DESIGN KITS, CONSISTING OF COMPUTER HARDWARE FOR USE WITH CD-ROMS FEATURING INFORMATION ABOUT USAGE AND COMPATIBILITY OF CIRCUIT BOARDS AND CHIPS; COMPUTER REFERENCE DESIGN CIRCUIT BOARDS AND INSTRUCTIONAL MANUALS SOLD AS A UNIT, ALL FOR USE IN THE FIELD OF CIRCUIT BOARD AND COMPUTER CHIP DESIGN; COMPUTER REFERENCE DESIGN KITS CONSISTING OF SILICON CHIPS; COMPUTER REFERENCE DESIGN CIRCUIT BOARDS AND CD-ROMS CON-

TAINING SET-UP DRIVERS AND ELECTRONIC COPIES OF INSTRUCTIONAL MANUALS SOLD AS A UNIT FOR DESIGN AND DEVELOPMENT WITHIN A COMPUTER OR EMBEDDED SYSTEM; COMPUTER UTILITY PROGRAMS FOR USE IN DEVELOPMENT, DESIGN, AND IMPLEMENTATION OF PERIPHERAL CONNECT INTERFACE SILICON DEVICES, IN CLASS 9 (U.S. CLS. 21, 23, 26, 36 AND 38).

FIRST USE 11-0-1995; IN COMMERCE 11-0-1995.

THE MARK CONSISTS OF STANDARD CHARACTERS WITHOUT CLAIM TO ANY PARTICULAR FONT, STYLE, SIZE, OR COLOR.

SN 78-972,688, FILED 9-12-2006.

LINDSEY RUBIN, EXAMINING ATTORNEY

Int. Cl.: 41

Prior U.S. Cls.: 100, 101, and 107

**United States Patent and Trademark Office**

**Reg. No. 3,506,689**

Registered Sep. 23, 2008

**SERVICE MARK  
PRINCIPAL REGISTER**

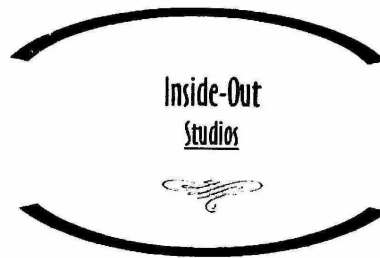

HOFFMAN, TERRA (UNITED STATES INDIVIDUAL)  
9955 SAND KEY SREET  
LAS VEGAS, NV 89178

NO CLAIM IS MADE TO THE EXCLUSIVE RIGHT TO USE "STUDIOS", APART FROM THE MARK AS SHOWN.

FOR: YOGA/PILATES INSTRUCTION, IN CLASS 41 (U.S. CLS. 100, 101 AND 107).

SN 78-973,110, FILED 9-13-2006.

FIRST USE 10-24-2007; IN COMMERCE 10-24-2007.

TANYA AMOS, EXAMINING ATTORNEY



**Int. Cl.: 41**

**Prior U.S. Cls.: 100, 101, and 107**

**United States Patent and Trademark Office**

**Reg. No. 3,506,690**

**Registered Sep. 23, 2008**

**SERVICE MARK  
PRINCIPAL REGISTER**

**SOUL OF A MAN**

BLACK ENTERTAINMENT TELEVISION LLC  
(D.C. LIMITED LIABILITY COMPANY)  
LEGAL AFFAIRS  
ONE BET PLAZA, 1235 W STREET, N.E.  
WASHINGTON, DC 20018

FOR: ENTERTAINMENT SERVICES, NAMELY,  
PROVIDING AN ONGOING REALITY-BASED TEL-  
EVISION PROGRAM VIA TELEVISION, CABLE,  
WIRELESS AND THE INTERNET, IN CLASS 41  
(U.S. CLS. 100, 101 AND 107).

FIRST USE 7-12-2006; IN COMMERCE 7-12-2006.

THE MARK CONSISTS OF STANDARD CHAR-  
ACTERS WITHOUT CLAIM TO ANY PARTICULAR  
FONT, STYLE, SIZE, OR COLOR.

SN 78-974,145, FILED 9-14-2006.

CYNTHIA SLOAN, EXAMINING ATTORNEY

**Int. Cl.: 9**

**Prior U.S. Cls.: 21, 23, 26, 36, and 38**

**United States Patent and Trademark Office**

**Reg. No. 3,506,691**

**Registered Sep. 23, 2008**

**TRADEMARK  
PRINCIPAL REGISTER**

**CRUSHER**

BENSAID, PHILLIP (UNITED STATES INDIVIDUAL)  
655 CLAYTON ST.  
SAN FRANCISCO, CA 94117 AND  
DEJESUS, ERIC (PHILIPPINES INDIVIDUAL)  
APT. 5  
330 FILLMORE ST.  
SAN FRANCISCO, CA 94117

FOR: COMPUTER SOFTWARE THAT ENABLES  
USERS TO CREATE AND PUBLISH CUSTOMIZABLE  
WEB PAGES AND INVITE OTHERS TO

COLLABORATIVELY ADD TO THEM, IN CLASS 9  
(U.S. CLS. 21, 23, 26, 36 AND 38).

FIRST USE 3-1-2007; IN COMMERCE 5-1-2007.

THE MARK CONSISTS OF STANDARD CHARACTERS  
WITHOUT CLAIM TO ANY PARTICULAR FONT,  
STYLE, SIZE, OR COLOR.

SN 78-974,622, FILED 9-14-2006.

RICHARD A. STRASER, EXAMINING ATTORNEY

**Int. Cl.: 41**

**Prior U.S. Cls.: 100, 101, and 107**

**United States Patent and Trademark Office**

**Reg. No. 3,506,692**

**Registered Sep. 23, 2008**

**SERVICE MARK  
PRINCIPAL REGISTER**

**LEADING CAUSES OF LIFE**

GUNDERSON, GARY R. (UNITED STATES IN-  
DIVIDUAL)  
SUITE 700 - LEGAL DEPARTMENT  
1211 UNION AVENUE  
MEMPHIS, TN 38104

FOR: INSTRUCTION IN THE FIELD OF MENTAL  
HEALTH AND MENTAL WELLNESS; TRAINING  
SEMINARS IN THE FIELD OF MENTAL HEALTH  
AND MENTAL WELLNESS; CONDUCTING WORK-  
SHOPS AND SEMINARS IN MENTAL HEALTH  
AND MENTAL WELLNESS, IN CLASS 41 (U.S. CLS.  
100, 101 AND 107).

FIRST USE 10-14-2006; IN COMMERCE 10-14-2006.

THE MARK CONSISTS OF STANDARD CHAR-  
ACTERS WITHOUT CLAIM TO ANY PARTICULAR  
FONT, STYLE, SIZE, OR COLOR.

SN 78-974,706, FILED 9-14-2006.

ROBIN CHOSID, EXAMINING ATTORNEY

**Int. Cl.: 16**

**Prior U.S. Cls.: 2, 5, 22, 23, 29, 37, 38, and 50**

**Reg. No. 3,506,693**

**United States Patent and Trademark Office**

**Registered Sep. 23, 2008**

**TRADEMARK  
PRINCIPAL REGISTER**

**LIVE LARGE**

CIM/H&H RETAIL, LP (CALIFORNIA LIMITED  
PARTNERSHIP)  
SUITE 900  
6922 HOLLYWOOD BOULEVARD  
LOS ANGELES, CA 90028

THE MARK CONSISTS OF STANDARD CHAR-  
ACTERS WITHOUT CLAIM TO ANY PARTICULAR  
FONT, STYLE, SIZE, OR COLOR.

FOR: PRINTED MATTER AND PAPER GOODS,  
NAMELY, POST CARDS, AND POSTERS, IN CLASS  
16 (U.S. CLS. 2, 5, 22, 23, 29, 37, 38 AND 50).

SN 78-976,742, FILED 5-11-2005.

FIRST USE 8-3-2005; IN COMMERCE 2-0-2006.

ANNE E. GUSTASON, EXAMINING ATTORNEY

**Int. Cl.: 10**

**Prior U.S. Cls.: 26, 39, and 44**

**United States Patent and Trademark Office**

**Reg. No. 3,506,694**

**Registered Sep. 23, 2008**

**TRADEMARK  
PRINCIPAL REGISTER**

LEARN HOW TO SMILE AGAIN.

ALIGN TECHNOLOGY, INC. (DELAWARE CORPORATION)  
881 MARTIN AVENUE  
SANTA CLARA, CA 95050

THE MARK CONSISTS OF STANDARD CHARACTERS WITHOUT CLAIM TO ANY PARTICULAR FONT, STYLE, SIZE, OR COLOR.

FOR: DENTAL APPARATUS, NAMELY, PLASTIC ORTHODONTIC APPLIANCE, IN CLASS 10 (U.S. CLS. 26, 39 AND 44).

SN 78-977,341, FILED 7-13-2005.

FIRST USE 4-17-2007; IN COMMERCE 4-17-2007.

DAVID H. STINE, EXAMINING ATTORNEY

**Int. Cl.: 21**

**Prior U.S. Cls.: 2, 13, 23, 29, 30, 33, 40, and 50**

**United States Patent and Trademark Office**

**Reg. No. 3,506,695**

**Registered Sep. 23, 2008**

**TRADEMARK  
PRINCIPAL REGISTER**



LARRY H. MILLER BASEBALL, INC. (UTAH CORPORATION)  
9350 SOUTH 150 EAST, SUITE 100  
SANDY, UT 84070

FOR: BASEBALL FAN BEVERAGE CONTAINERS, NAMELY, CUPS, SOLD EXCLUSIVELY THROUGH APPLICANT'S BASEBALL STADIUM, BASEBALL TEAM WEBSITE, AND SPECIALTY RETAIL OUTLETS FEATURING SPORTS FAN PRO-

DUCTS, IN CLASS 21 (U.S. CLS. 2, 13, 23, 29, 30, 33, 40 AND 50).

FIRST USE 10-27-2005; IN COMMERCE 10-27-2005.

THE MARK CONSISTS OF "BEES" LOGO.

SN 78-977,899, FILED 10-26-2005.

CAROLYN CATALDO, EXAMINING ATTORNEY

**Int. Cl.: 41**

**Prior U.S. Cls.: 100, 101, and 107**

**Reg. No. 3,506,696**

**United States Patent and Trademark Office**

**Registered Sep. 23, 2008**

**SERVICE MARK  
PRINCIPAL REGISTER**

**WCL**

NORRIS, CARLOS RAY (UNITED STATES INDIVIDUAL)  
C/O MICHAEL S. FORSHEY, PATTON BOGGS LLP  
2001 ROSS AVE., #3000  
DALLAS, TX 75201

FOR: ENTERTAINMENT, EDUCATION AND INFORMATION SERVICES, NAMELY, ORGANIZATION AND PRODUCTION OF MARTIAL ARTS TOURNAMENTS, COMPETITIONS AND EXHIBITIONS RENDERED LIVE, THROUGH BROADCAST MEDIA INCLUDING TELEVISION AND RADIO, AND VIA THE INTERNET; PRODUCTION OF TELEVISION PROGRAMS, CD'S AND DVDS RELATING TO MARTIAL ARTS TOURNAMENTS, COMPETITIONS, EXHIBITIONS AND TRAINING; PROVIDING INFORMATION AND ORGANIZING

SPORTS EVENTS IN THE FIELD OF MARTIAL ARTS AND RELATED TOPICS TO MARTIAL ARTS, SUCH AS KICKBOXING AND SPORTS AND PHYSICAL TRAINING AND CONDITIONING, IN CLASS 41 (U.S. CLS. 100, 101 AND 107).

FIRST USE 9-0-2005; IN COMMERCE 9-0-2005.

THE MARK CONSISTS OF STANDARD CHARACTERS WITHOUT CLAIM TO ANY PARTICULAR FONT, STYLE, SIZE, OR COLOR.

SN 78-980,189, FILED 4-29-2005.

TAMARA FRAZIER, EXAMINING ATTORNEY

**Int. Cl.: 25**

**Prior U.S. Cls.: 22 and 39**

**United States Patent and Trademark Office**

**Reg. No. 3,506,697**

**Registered Sep. 23, 2008**

**TRADEMARK  
PRINCIPAL REGISTER**

**THE ROW**

DUALSTAR ENTERTAINMENT GROUP, LLC  
(CALIFORNIA LIMITED LIABILITY COMPAN-  
NY)  
3760 ROBERTSON BOULEVARD  
CULVER CITY, CA 90232

FOR: CLOTHING, NAMELY, TOPS, BOTTOMS,  
SKIRTS, PANTS, JACKETS, TANK TOPS, T-SHIRTS,  
SWEATERS, AND BELTS, IN CLASS 25 (U.S. CLS. 22  
AND 39).

FIRST USE 9-0-2006; IN COMMERCE 11-0-2006.

THE MARK CONSISTS OF STANDARD CHAR-  
ACTERS WITHOUT CLAIM TO ANY PARTICULAR  
FONT, STYLE, SIZE, OR COLOR.

SN 78-980,321, FILED 11-23-2005.

DAWN HAN, EXAMINING ATTORNEY



**Int. Cl.: 35**

**Prior U.S. Cls.: 100, 101, and 102**

**United States Patent and Trademark Office**

**Reg. No. 3,506,698**

**Registered Sep. 23, 2008**

**SERVICE MARK  
PRINCIPAL REGISTER**

**AVOX SYSTEMS**

AVOX SYSTEMS INC. (DELAWARE CORPORATION)  
225 ERIE STREET  
LANCASTER, NY 14086

OWNER OF U.S. REG. NOS. 982,305, 2,516,696,  
AND 2,521,919.

FOR: WHOLESALE DISTRIBUTORSHIP SERVICES FEATURING AVIATION OXYGEN EQUIPMENT, IN CLASS 35 (U.S. CLS. 100, 101 AND 102).

NO CLAIM IS MADE TO THE EXCLUSIVE RIGHT TO USE "SYSTEMS", APART FROM THE MARK AS SHOWN.

FIRST USE 1-4-2008; IN COMMERCE 1-4-2008.

SN 78-980,324, FILED 9-2-2004.

THE MARK CONSISTS OF STANDARD CHARACTERS WITHOUT CLAIM TO ANY PARTICULAR FONT, STYLE, SIZE, OR COLOR.

SAIMA MAKHDOOM, EXAMINING ATTORNEY

**Int. Cls.: 7 and 11**

**Prior U.S. Cls.: 13, 19, 21, 23, 31, 34, and 35**

**United States Patent and Trademark Office**

**Reg. No. 3,506,699**

**Registered Sep. 23, 2008**

**TRADEMARK  
PRINCIPAL REGISTER**

**EDENPURE**

SUAREZ CORPORATION INDUSTRIES (OHIO  
CORPORATION)  
7800 WHIPPLE AVENUE NW  
NORTH CANTON, OH 44720

FOR: VACUUM CLEANERS, IN CLASS 7 (U.S.  
CLS. 13, 19, 21, 23, 31, 34 AND 35).

FIRST USE 3-31-2006; IN COMMERCE 3-31-2006.

FOR: ELECTRIC SPACE HEATERS, IN CLASS 11  
(U.S. CLS. 13, 21, 23, 31 AND 34).

FIRST USE 10-31-2004; IN COMMERCE 10-31-2004.

THE MARK CONSISTS OF STANDARD CHAR-  
ACTERS WITHOUT CLAIM TO ANY PARTICULAR  
FONT, STYLE, SIZE, OR COLOR.

SN 78-980,374, FILED 3-14-2005.

JAMES STEIN, EXAMINING ATTORNEY

**Int. Cls.: 6 and 22**

**Prior U.S. Cls.: 1, 2, 7, 12, 13, 14, 19, 22, 23, 25, 42, and 50**

**United States Patent and Trademark Office**

**Reg. No. 3,506,700**

**Registered Sep. 23, 2008**

**TRADEMARK  
PRINCIPAL REGISTER**



ADVANCE MERCHANDISING COMPANY, INC.  
(VIRGINIA CORPORATION)  
5673 AIRPORT ROAD  
ROANOKE, VA 24012

FOR: LOAD CONTROL MATERIALS, NAMELY, METAL UNIVERSAL ANCHOR POINTS, RATCHET TIEDOWNS OF METAL, CAMBUCKLE TIEDOWNS OF METAL, IN CLASS 6 (U.S. CLS. 2, 12, 13, 14, 23, 25 AND 50).

FIRST USE 5-1-2008; IN COMMERCE 5-1-2008.

FOR: LOAD CONTROL MATERIALS, NAMELY, VEHICLE TOWING ROPE, TOWING STRAPS, BUN-GEE CORDS, TARPAULINS, TARPAULIN STRAPS

AND METAL LASHING STRAPS WITH BUCKLES, IN CLASS 22 (U.S. CLS. 1, 2, 7, 19, 22, 42 AND 50).

FIRST USE 5-1-2008; IN COMMERCE 5-1-2008.

NO CLAIM IS MADE TO THE EXCLUSIVE RIGHT TO USE "CARGO", APART FROM THE MARK AS SHOWN.

THE STIPLING IS FOR SHADING PURPOSES ONLY.

SN 78-980,411, FILED 5-13-2005.

SONYA STEPHENS, EXAMINING ATTORNEY

**Int. Cl.: 36**

**Prior U.S. Cls.: 100, 101, and 102**

**United States Patent and Trademark Office**

**Reg. No. 3,506,701**

**Registered Sep. 23, 2008**

**SERVICE MARK  
PRINCIPAL REGISTER**



GRUPO FAMSA, S.A. DE C.V. (MEXICO CORPORATION)

AV. PINO SUAREZ 1202 NTE., ZONA CENTRO

C.P. 64000

MONTEREY, N.L., MEXICO

FOR: CREDIT CARD SERVICES, NAMELY, PROVIDING CREDIT TO CUSTOMERS OF APPLICANT'S RETAIL STORE, IN CLASS 36 (U.S. CLS. 100, 101 AND 102).

FIRST USE 12-0-2005; IN COMMERCE 12-0-2005.

OWNER OF U.S. REG. NOS. 2,698,662 AND 3,011,676.

NO CLAIM IS MADE TO THE EXCLUSIVE RIGHT TO USE "GRAN CREDITO", APART FROM THE MARK AS SHOWN.

THE FOREIGN WORDING IN THE MARK TRANSLATES INTO ENGLISH AS GREAT CREDIT.

SN 78-980,457, FILED 11-29-2005.

ANDREA SAUNDERS, EXAMINING ATTORNEY

**Int. Cl.: 35**

**Prior U.S. Cls.: 100, 101, and 102**

**United States Patent and Trademark Office**

**Reg. No. 3,506,702**

**Registered Sep. 23, 2008**

**SERVICE MARK  
PRINCIPAL REGISTER**

**BORGHESE**

BORGHESE TRADEMARKS INC. (DELAWARE CORPORATION)  
ONE COMMERCE CENTER  
12TH AND ORANGE STREET, SUITE 713  
WILMINGTON, DE 19801

FOR: RETAIL MAIL ORDER SERVICES AND COMPUTERIZED ONLINE ORDERING VIA A COMPUTER NETWORK IN THE FIELD OF CONSUMER GOODS AND SERVICES; AND RETAIL STORE SERVICES IN THE FIELD OF COSMETICS, FRAGRANCES, SKIN CARE PREPARATIONS, HAIR CARE PREPARATIONS, SOAPS, NAIL CARE PRODUCTS, SUNGLASSES, MASSAGE OILS, ESSENTIAL OILS, BATH AND SHOWER OIL AND GELS, DEODORANT, PERSONAL CARE AND

GROOMING ITEMS, TRAVEL CASES, CLEANING PREPARATIONS, AROMA THERAPIES, ATOMIZERS, SPRAY BOTTLES, SPA ACCESSORIES, GIFT NOVELTIES, IN CLASS 35 (U.S. CLS. 100, 101 AND 102).

FIRST USE 5-3-1996; IN COMMERCE 5-3-1996.

THE ENGLISH TRANSLATION OF "BORGHESE" IS "MIDDLE CLASS".

SN 78-980,468, FILED 2-21-2001.

SAMUEL E. SHARPER JR., EXAMINING ATTORNEY

**Int. Cl.: 9**

**Prior U.S. Cls.: 21, 23, 26, 36, and 38**

**United States Patent and Trademark Office**

**Reg. No. 3,506,703**

**Registered Sep. 23, 2008**

**TRADEMARK  
PRINCIPAL REGISTER**

**PRESS YOUR LUCK**

FREMANTLEMEDIA OPERATIONS B.V. (NETHERLANDS CORPORATION)  
MEDIA CENTRE, 4TH FLOOR, SUMATRALAAN 45  
1217 GP HILVERSUM, NETHERLANDS

FOR: COMPUTER GAME EQUIPMENT CONTAINING MEMORY DEVICES, NAMELY, DISCS; INTERACTIVE VIDEO GAME PROGRAMS, IN CLASS 9 (U.S. CLS. 21, 23, 26, 36 AND 38).

FIRST USE 9-0-2007; IN COMMERCE 9-0-2007.

THE MARK CONSISTS OF STANDARD CHARACTERS WITHOUT CLAIM TO ANY PARTICULAR FONT, STYLE, SIZE, OR COLOR.

OWNER OF U.S. REG. NOS. 2,666,877, 2,795,333, AND 2,863,025.

SN 78-980,491, FILED 12-8-2005.

MATTHEW PAPPAS, EXAMINING ATTORNEY

**Int. Cl.: 16**

**Prior U.S. Cls.: 2, 5, 22, 23, 29, 37, 38, and 50**

**Reg. No. 3,506,704**

**United States Patent and Trademark Office**

**Registered Sep. 23, 2008**

---

**TRADEMARK  
PRINCIPAL REGISTER**

**IQ**

ACCO BRANDS CORPORATION (DELAWARE  
CORPORATION)  
300 TOWER PARKWAY  
LINCOLNSHIRE, IL 60069

THE MARK CONSISTS OF STANDARD CHAR-  
ACTERS WITHOUT CLAIM TO ANY PARTICULAR  
FONT, STYLE, SIZE, OR COLOR.

FOR: DRY ERASE BOARDS, BULLETIN  
BOARDS, CHALK BOARDS, MARKERS, ERASERS,  
BOARD HOLDERS AND PARTS THEREOF, IN  
CLASS 16 (U.S. CLS. 2, 5, 22, 23, 29, 37, 38 AND 50).

SN 78-980,513, FILED 3-28-2006.

FIRST USE 9-30-2006; IN COMMERCE 9-30-2006.

MARILYN IZZI, EXAMINING ATTORNEY

**Int. Cls.: 35, 38, and 42**

**Prior U.S. Cls.: 100, 101, 102, and 104**

**United States Patent and Trademark Office**

**Reg. No. 3,506,705**

**Registered Sep. 23, 2008**

**SERVICE MARK  
PRINCIPAL REGISTER**

**SIRCLE**

NET VISIBILITY, INC. (CALIFORNIA CORPORATION)  
20241 BIRCH STREET SUITE 201  
NEWPORT BEACH, CA 92660

FOR: ADVERTISING AND INFORMATION DISTRIBUTION SERVICES, NAMELY, PROVIDING CLASSIFIED ADVERTISING SPACE VIA THE GLOBAL COMPUTER NETWORK; PROMOTING THE GOODS AND SERVICES OF OTHERS OVER THE INTERNET; PROVIDING ON-LINE COMPUTER DATABASES AND ON-LINE SEARCHABLE DATABASES FEATURING CLASSIFIED LISTINGS AND WANT ADS, IN CLASS 35 (U.S. CLS. 100, 101 AND 102).

FIRST USE 7-16-2008; IN COMMERCE 7-16-2008.

FOR: PROVIDING ON-LINE CHAT ROOMS AND ELECTRONIC BULLETIN BOARDS FOR TRANSMISSION OF MESSAGES AMONG USERS IN THE FIELD OF GENERAL INTEREST; PROVIDING EMAIL AND INSTANT MESSAGING SERVICES, IN CLASS 38 (U.S. CLS. 100, 101 AND 104).

FIRST USE 7-16-2008; IN COMMERCE 7-16-2008.

FOR: COMPUTER SERVICES, NAMELY, HOSTING ONLINE WEB FACILITIES FOR OTHERS FOR ORGANIZING AND CONDUCTING ONLINE MEETINGS, GATHERINGS, AND INTERACTIVE DISCUSSIONS; AND COMPUTER SERVICES IN THE NATURE OF CUSTOMIZED WEB PAGES FEATURING USER-DEFINED INFORMATION, PERSONAL PROFILES AND INFORMATION, IN CLASS 42 (U.S. CLS. 100 AND 101).

FIRST USE 7-16-2008; IN COMMERCE 7-16-2008.

THE MARK CONSISTS OF STANDARD CHARACTERS WITHOUT CLAIM TO ANY PARTICULAR FONT, STYLE, SIZE, OR COLOR.

SN 78-980,516, FILED 5-31-2006.

BRIAN PINO, EXAMINING ATTORNEY



**Int. Cl.: 41**

**Prior U.S. Cls.: 100, 101, and 107**

**United States Patent and Trademark Office**

**Reg. No. 3,506,706**

**Registered Sep. 23, 2008**

**SERVICE MARK  
SUPPLEMENTAL REGISTER**

**WORLD MUSIC AND DANCE HALL OF FAME**

ROY, HAROLD VAN (UNITED STATES INDIVIDUAL)  
1450 N. SANTE FE AVENUE  
SUITE C299  
VISTA, CA 92083

FOR: EXHIBITIONS FOR MUSIC AND DANCE HISTORY, IN THE NATURE OF THE VARIETY OF MUSIC AND DANCES OF THE WORLD, IN CLASS 41 (U.S. CLS. 100, 101 AND 107).

FIRST USE 11-5-2007; IN COMMERCE 5-12-2008.

THE MARK CONSISTS OF STANDARD CHARACTERS WITHOUT CLAIM TO ANY PARTICULAR FONT, STYLE, SIZE, OR COLOR.

NO CLAIM IS MADE TO THE EXCLUSIVE RIGHT TO USE "HALL OF FAME", APART FROM THE MARK AS SHOWN.

SER. NO. 76-645,552, FILED P.R. 8-25-2005; AM. S.R. 7-29-2008.

MARLENE BELL, EXAMINING ATTORNEY

Int. Cl.: 3

Prior U.S. Cls.: 1, 4, 6, 50, 51, and 52

United States Patent and Trademark Office

Reg. No. 3,506,707

Registered Sep. 23, 2008

TRADEMARK  
SUPPLEMENTAL REGISTER

Olive **ESSENCE**

ABESERA, JACKLYNN (UNITED STATES INDIVIDUAL)  
348 NORTH SPAULDING AVENUE  
LOS ANGELES, CA 90036

FOR: NON-MEDICATED SKIN CARE PRODUCTS, NAMELY, SKIN TONERS, MOISTURIZERS AND CLEANSERS; FACIAL MASKS; BODY LOTION AND CREAM; FACIAL AND BODY SCRUBS; BLEACHING CREAM; SUN SCREEN; SELF-TANNING CREAM; ESSENTIAL OILS FOR USE BY COSMETICIANS; SKIN, BODY AND FACIAL CREAM DERIVED FROM GLYCOLIC ACID AND FRUIT ACID; AND MINERAL SALT EXFOLIANT, IN CLASS 3 (U.S. CLS. 1, 4, 6, 50, 51 AND 52).

FIRST USE 2-1-2008; IN COMMERCE 2-1-2008.

THE MARK CONSISTS OF THE WORD "OLIVE" WITH THE WORD "ESSENCE" IN CAPITAL LETTERS ABOVE THE "E" IN "OLIVE" AS SHOWN IN THE DRAWING.

SER. NO. 76-672,146, FILED P.R. 2-2-2007; AM. S.R. 8-4-2008.

NORA BUCHANAN WILL, EXAMINING ATTORNEY

**Int. Cls.: 9 and 44**

**Prior U.S. Cls.: 21, 23, 26, 36, 38, 100, and 101**

**United States Patent and Trademark Office**

**Reg. No. 3,506,708**

**Registered Sep. 23, 2008**

**TRADEMARK  
SERVICE MARK  
SUPPLEMENTAL REGISTER**

**eCattleMatings.com**

BULL'S EYE SOLUTIONS, LLC (TEXAS LIMITED  
LIABILITY CORPORATION)  
16550 JONES MALTSBERGER ROAD  
SAN ANTONIO, TX 782472803

FOR: COMPUTER PROGRAMS FOR USE IN  
CATTLE BREEDING WHICH ALLOWS USERS TO  
IDENTIFY MATINGS , IN CLASS 9 (U.S. CLS. 21, 23,  
26, 36 AND 38).

FIRST USE 12-31-2005; IN COMMERCE 12-31-2005.

FOR: CATTLE BREEDING SERVICES, IN CLASS  
44 (U.S. CLS. 100 AND 101).

FIRST USE 12-31-2005; IN COMMERCE 12-31-2005.

THE MARK CONSISTS OF STANDARD CHAR-  
ACTERS WITHOUT CLAIM TO ANY PARTICULAR  
FONT, STYLE, SIZE, OR COLOR.

OWNER OF U.S. REG. NO. 3,214,175.

SER. NO. 76-673,641, FILED P.R. 3-6-2007; AM. S.R.  
8-14-2008.

GEOFFREY FOSDICK, EXAMINING ATTORNEY

Int. Cl.: 38

Prior U.S. Cls.: 100, 101, and 104

United States Patent and Trademark Office

Reg. No. 3,506,709

Registered Sep. 23, 2008

SERVICE MARK  
SUPPLEMENTAL REGISTER

*SwingLifeStyle*

DASHBOARDHOSTING, INC. (FLORIDA CORPORATION)  
P.O. BOX 9896  
CORAL SPRINGS, FL 33075

FOR: COMMUNICATION SERVICES BY COMPUTER TERMINALS, NAMELY, PROVIDING ON-LINE FACILITIES FOR REAL-TIME INTERACTION WITH OTHER COMPUTER USERS CONCERNING

ADULT THEMES, DATING AND SWINGER LIFESTYLES, IN CLASS 38 (U.S. CLS. 100, 101 AND 104).

FIRST USE 10-7-2001; IN COMMERCE 10-7-2001.

SER. NO. 76-682,929, FILED P.R. 10-15-2007; AM. S.R. 7-25-2008.

AISHA CLARKE, EXAMINING ATTORNEY

**Int. Cl.: 21**

**Prior U.S. Cls.: 2, 13, 23, 29, 30, 33, 40, and 50**

**Reg. No. 3,506,710**

**United States Patent and Trademark Office**

**Registered Sep. 23, 2008**

**TRADEMARK  
SUPPLEMENTAL REGISTER**



FITZ AND FLOYD, INC. (DELAWARE CORPORATION)  
501 CORPORATE DRIVE  
LEWISVILLE, TX 75057

FOR: HOUSEWARES, NOT OF PRECIOUS METAL, NAMELY, DINNERWARE, DINNER PLATES, SALAD PLATES, CUPS, SAUCERS, MUGS, BOWLS, SERVING PLATTERS, SERVING BOWLS, TUREENS, SUGAR BOWLS, COVERED BUTTER DISHES, CREAM PITCHERS, TEAPOTS, COCOA POTS, GRAVY BOATS, PITCHERS, SALT AND PEPPER SHAKERS, TEA BAG CADDY, CUP AND SAUCER SETS, SERVING TRAYS, AND SERVING

DISHES FOR CONDIMENTS, PICKLES, AND OLIVES, IN CLASS 21 (U.S. CLS. 2, 13, 23, 29, 30, 33, 40 AND 50).

FIRST USE 1-3-2007; IN COMMERCE 1-3-2007.

NO CLAIM IS MADE TO THE EXCLUSIVE RIGHT TO USE "PORCELAIN", APART FROM THE MARK AS SHOWN.

SER. NO. 77-024,107, FILED P.R. 10-18-2006; AM. S.R. 4-22-2008.

JILL PRATER, EXAMINING ATTORNEY

**Int. Cls.: 11 and 17**

**Prior U.S. Cls.: 1, 5, 12, 13, 21, 23, 31, 34, 35, and 50**

**United States Patent and Trademark Office**

**Reg. No. 3,506,711**

**Registered Sep. 23, 2008**

**TRADEMARK  
SUPPLEMENTAL REGISTER**

**MARLEY**

MARLEY (U.K.) LIMITED (UNITED KINGDOM CORPORATION)  
1 SUFFOLK WAY  
SEVENOAKS, KENT, UNITED KINGDOM TN131SD

UNIONS, CHANNEL STRIP ANGLES, BARREL SLIP COLLARS, NUTS AND BOLTS FOR USE THEREWITH, SYSTEMS COMPRISING THESE PARTS, IN CLASS 11 (U.S. CLS. 13, 21, 23, 31 AND 34).

FOR: PLUMBING FITTINGS FOR WASTE AND OVERFLOW INSTALLATIONS AND INSTALLATIONS FOR SANITARY PURPOSES AND PARTS THEREOF, NAMELY, PIPE SOCKETS, SLIP COUPLINGS, COUPLINGS, TRIPLE SOCKETS, MULTI-BRANCH SOCKETS, MULTI-BRANCH ACCESS CAPS, COLLAR-BOSS BRANCHES, BOSS BRANCHES, STRAP-ON BOSSES, BOSS CONNECTORS, CONCENTRIC SOCKET PLUS SPLASH REDUCERS, REDUCERS, ECCENTRIC REDUCERS, ACCESS CAPS, ACCESS CAP AND PRESSURE PLUGS, PVC ADAPTORS, CAST IRON ADAPTORS, AUTOMATIC AIR ADMITTANCE VALVES, DUCT PIPES, LONG RADIUS DUCT BENDS, GRILLE CONNECTORS, WALL GRILLES, FLEXIBLE DUCTS, COWLS/VENT TERMINALS, VENT TERMINALS, WEATHERING COLLARS, BARREL CLIP COLLARS, DRIVE-IN SPIKE AND BACK PLATES, WC SEAL AND RETAINING CAPS, FLANGES, FLOOR OUTLETS, TRAPPED FLOOR GULLEYS, STAINLESS STEEL TILE GRID AND COVER PLATES, FIRE SLEEVES, VENT TERMINALS, VENT SLATE CAPS, FEMALE IRON ADAPTORS, MALE IRON ADAPTORS, CAULKING BUSHES, CAPS AND LININGS, MULTI-FIT STRAIGHT TANK CONNECTORS, TUBULAR SWIVEL TRAPS, BOTTLE TRAPS, MONITOR ANTI-SIPHON BOTTLE TRAPS, LOW INLET TUBULAR BATH TRAPS, SHALLOW BATH TRAPS, LOW LEVEL BATH TRAPS, RUNNING TUBULAR SWIVEL TRAPS, INLET HEIGHT ADJUSTERS, WASHING MACHINE TEES, UNIVERSAL TRAP BENDS, BATH OVERFLOW OUTLETS, BATH OVERFLOW MANIFOLDS, SNAP CAPS, PIPE BRACKETS, SINGLE SUPPORT BRACKETS, CHANNEL BRACKETS, DOUBLE SUPPORT BASE PLATES, CHANNEL STRIPS, SINGLE SUPPORT BASE PLATES, ANGLE CLEATS, CHANNEL STRIP

FOR: PLASTIC PIPES FOR PLUMBING PURPOSES, WASTE AND OVERFLOW INSTALLATIONS AND INSTALLATIONS FOR SANITARY PURPOSES AND PARTS AND FITTINGS THEREFOR, NAMELY, O-RINGS, T-RINGS, UNIVERSAL T-SEALS, PIPES, THIN WALL DUCT PIPES, ADJUSTABLE BEND PIPES, SHORT RADIUS BEND PIPES, EAVES OFFSET BEND PIPES, PLAIN EQUAL BRANCH PIPES, FIVE BOSS BRANCH PIPES, KNUCKLE BEND PIPES, EQUAL BRANCH PIPES, ADJUSTABLE BRANCH PIPES, UNEQUAL BRANCH PIPES, DOUBLE BRANCH PIPES, MULTI-BRANCH PIPES, ACCESS PIPES, RIDGE VENT CONNECTORS, WC CONNECTORS, BENT WC CONNECTORS, STRAIGHT WC CONNECTORS, ADJUSTABLE WC BENDS, ADJUSTABLE SPIGOT BENDS, STRAIGHT CONNECTORS, BENT CONNECTORS, EXPANSION COUPLINGS/COPPER ADAPTORS, BENT BOSS CONNECTORS, TEES, CROSS TEES, SOCKET REDUCERS, MULTI-FIT WASTE CONNECTORS, WASHING MACHINE PIPE KITS, FLEXIBLE OVERFLOW PIPES, PLASTIC PIPES AND PIPE FITTINGS, PIPE JOINT SEALANT; PLASTIC IN THE FORM OF TUBES FOR USE IN UNDERGROUND DRAINAGE SYSTEMS, SOIL AND WASTE SYSTEMS AND RAINWATER SYSTEMS, NAMELY, PIPES, PERFORATED PIPES, COUPLINGS, REPAIR/SLIP COUPLINGS, PIPE SOCKETS, TRIPLE SOCKETS, SHORT RADIUS BENDS, LONG RADIUS BENDS, ADJUSTABLE BENDS, PLAIN EQUAL BRANCHES, PLAIN UNEQUAL BRANCHES, ACCESS PIPES, ACCESS BENDS, ACCESS BRANCHES, ACCESS DOUBLE BRANCHES, LEVEL INVERT REDUCERS, REDUCERS, ADAPTORS, STRAIGHT CHAMBER BASES, DOUBLE BRANCH CHAMBER BASES, BOTTOM OUTLET CHAMBERS, STRAIGHT CHANNELS, SLIPPER BENDS, LONG RADIUS CHANNEL

BENDS, BOSS BRANCHES, BOSS CONNECTORS,  
STRAIGHT COUPLINGS, BENDS, IN CLASS 17 (U.S.  
CLS. 1, 5, 12, 13, 35 AND 50).

THE MARK CONSISTS OF STANDARD CHAR-  
ACTERS WITHOUT CLAIM TO ANY PARTICULAR  
FONT, STYLE, SIZE, OR COLOR.

OWNER OF UNITED KINGDOM REG. NO.  
2143053, DATED 5-1-1998, RENEWED AS REG. NO.  
2143053, DATED 8-26-2007, EXPIRES 8-26-2017.

OWNER OF U.S. REG. NOS. 925,011, 2,186,508,  
AND 2,638,858.

SER. NO. 77-031,153, FILED P.R. 10-27-2006; AM.  
S.R. 7-19-2008.

BENJAMIN OKEKE, EXAMINING ATTORNEY

**Int. Cls.: 9, 41, and 42**

**Prior U.S. Cls.: 21, 23, 26, 36, 38, 100, 101, and 107**

**United States Patent and Trademark Office**

**Reg. No. 3,506,712**

**Registered Sep. 23, 2008**

**TRADEMARK  
SERVICE MARK  
SUPPLEMENTAL REGISTER**

**ROCK DEFORMATION RESEARCH**

ROCK DEFORMATION RESEARCH LIMITED  
(UNITED KINGDOM CORPORATION)  
UNIVERSITY OF LEEDS  
11-84 EC STONER BLDG, FINANCIAL SERVICES  
LEEDS, WEST YORKSHIRE, UNITED KINGDOM  
LS29JT

FOR: COMPUTER SOFTWARE, NAMELY, COMPUTER SOFTWARE FOR THE INTERPRETATION AND ANALYSIS OF GEOPHYSICAL AND GEOLOGICAL SEISMIC SURVEY DATA AND/OR DATA GENERATED FROM ACTIVE CORE SAMPLES, IN CLASS 9 (U.S. CLS. 21, 23, 26, 36 AND 38).

FIRST USE 8-2-2006; IN COMMERCE 8-2-2006.

FOR: EDUCATION SERVICES, NAMELY, PROVIDING LECTURES, CLASSES, SEMINARS, WORKSHOPS AND REPORTS DISTRIBUTED IN CONNECTION THEREWITH IN THE FIELDS OF STRUCTURAL GEOLOGY, FAULT SEAL, SEISMIC INTERPRETATION, PETROPHYSICAL ANALYSIS, UNCERTAINTY ANALYSIS FOR THE ACADEMIC AND FOR THE EXPLORATION AND PRODUCTION AREAS OF THE MINERALS, HYDROCARBON INDUSTRY; EDUCATION AND TRAINING SERVICES, NAMELY, PROVIDING LECTURES, CLASSES, SEMINARS, WORKSHOPS AND REPORTS DISTRIBUTED IN CONNECTION THEREWITH RELATING TO GEOPHYSICAL AND GEOLOGICAL SURVEYS AND IN RELATION TO THE INTERPRETATION AND ANALYSIS OF GEOPHYSICAL AND GEOLOGICAL SURVEY DATA,

GEOPHYSICAL AND GEOLOGICAL SURVEYING, IN CLASS 41 (U.S. CLS. 100, 101 AND 107).

FIRST USE 8-2-2006; IN COMMERCE 8-2-2006.

FOR: CONSULTATION SERVICES RELATING TO GEOPHYSICAL AND GEOLOGICAL SURVEYS AND IN RELATION TO THE INTERPRETATION AND ANALYSIS OF GEOPHYSICAL AND GEOLOGICAL SURVEY DATA; INTERPRETATION AND ANALYSIS OF GEOPHYSICAL AND GEOLOGICAL SURVEY DATA; GEOPHYSICAL AND GEOLOGICAL SURVEYING; GEOPHYSICAL AND GEOLOGICAL SERVICES, NAMELY, STRUCTURAL GEOLOGY, FAULT SEAL, SEISMIC INTERPRETATION, PETROPHYSICAL ANALYSIS, GEOLOGICAL RESEARCH, UNCERTAINTY ANALYSIS FOR THE ACADEMIC, MINERALS, HYDROCARBON INDUSTRY, IN CLASS 42 (U.S. CLS. 100 AND 101).

FIRST USE 8-2-2006; IN COMMERCE 8-2-2006.

THE MARK CONSISTS OF STANDARD CHARACTERS WITHOUT CLAIM TO ANY PARTICULAR FONT, STYLE, SIZE, OR COLOR.

NO CLAIM IS MADE TO THE EXCLUSIVE RIGHT TO USE "RESEARCH", APART FROM THE MARK AS SHOWN.

SER. NO. 77-061,160, FILED P.R. 12-11-2006; AM. S.R. 5-1-2008.

MARGARET POWER, EXAMINING ATTORNEY



**Int. Cl.: 10**

**Prior U.S. Cls.: 26, 39, and 44**

**United States Patent and Trademark Office**

**Reg. No. 3,506,713**

**Registered Sep. 23, 2008**

**TRADEMARK  
SUPPLEMENTAL REGISTER**

**E2E**

EVALVE, INC. (DELAWARE CORPORATION)  
4045 CAMPBELL AVENUE  
MENLO PARK, CA 94025

THE MARK CONSISTS OF STANDARD CHAR-  
ACTERS WITHOUT CLAIM TO ANY PARTICULAR  
FONT, STYLE, SIZE, OR COLOR.

FOR: MEDICAL DEVICES FOR ENDOVASCU-  
LAR AND PERCUTANEOUS PROCEDURES,  
NAMELY, VASCULAR CLIPS, IN CLASS 10 (U.S.  
CLS. 26, 39 AND 44).

SER. NO. 77-071,818, FILED P.R. 12-27-2006; AM.  
S.R. 7-24-2008.

FIRST USE 12-20-2006; IN COMMERCE 12-20-2006.

SAIMA MAKHDOOM, EXAMINING ATTORNEY

**Int. Cl.: 36**

**Prior U.S. Cls.: 100, 101, and 102**

**United States Patent and Trademark Office**

**Reg. No. 3,506,714**

**Registered Sep. 23, 2008**

**SERVICE MARK  
SUPPLEMENTAL REGISTER**

LUNG HEALTH ADVOCACY GROUP

LUNG HEALTH ADVOCACY GROUP, INC.  
(NEW YORK CORPORATION)

16 COURT STREET, SUITE 3301

BROOKLYN, NY 11201

FOR: CHARITABLE FUND RAISING, IN CLASS  
36 (U.S. CLS. 100, 101 AND 102).

FIRST USE 6-26-2008; IN COMMERCE 6-26-2008.

THE MARK CONSISTS OF STANDARD CHARACTERS WITHOUT CLAIM TO ANY PARTICULAR FONT, STYLE, SIZE, OR COLOR.

NO CLAIM IS MADE TO THE EXCLUSIVE RIGHT TO USE "ADVOCACY GROUP", APART FROM THE MARK AS SHOWN.

SER. NO. 77-078,113, FILED P.R. 1-8-2007; AM. S.R. 7-8-2008.

MICHAEL WEBSTER, EXAMINING ATTORNEY

**Int. Cl.: 18**

**Prior U.S. Cls.: 1, 2, 3, 22, and 41**

**United States Patent and Trademark Office**

**Reg. No. 3,506,715**

**Registered Sep. 23, 2008**

**TRADEMARK  
SUPPLEMENTAL REGISTER**

**ZENRAY**

ZENRAY SPA PRODUCTS, INC. (CAYMAN ISLANDS CORPORATION)  
P.O. BOX 30955 KY1-1204  
GRAND CAYMAN, CAYMAN ISLANDS

THE MARK CONSISTS OF STANDARD CHARACTERS WITHOUT CLAIM TO ANY PARTICULAR FONT, STYLE, SIZE, OR COLOR.

FOR: TOTE BAGS, IN CLASS 18 (U.S. CLS. 1, 2, 3, 22 AND 41).

SER. NO. 77-085,513, FILED P.R. 1-18-2007; AM. S.R. 6-2-2008.

FIRST USE 10-19-2007; IN COMMERCE 10-19-2007.

GEORGE LORENZO, EXAMINING ATTORNEY

**Int. Cl.: 35**

**Prior U.S. Cls.: 100, 101, and 102**

**United States Patent and Trademark Office**

**Reg. No. 3,506,716**

**Registered Sep. 23, 2008**

**SERVICE MARK  
SUPPLEMENTAL REGISTER**

**SAFE BUILDING SOLUTIONS**

MITCHELL, PACE & ASSOCIATES, INC. (WIS-  
CONSIN CORPORATION)  
W292 S4498 HILLSIDE ROAD  
WAUKESHA, WI 53189

FOR: RETAIL STORE SERVICES, MAIL ORDER  
SERVICES AND ONLINE COMPUTERIZED RETAIL  
SERVICES ALL FEATURING ENVIRONMENTAL  
FRIENDLY BUILDING MATERIALS, NAMELY,  
PAINTS, STAINS, CLEANERS, FLOORING AND  
RELATED HOUSEHOLD PRODUCTS, IN CLASS 35  
(U.S. CLS. 100, 101 AND 102).

FIRST USE 8-2-1996; IN COMMERCE 8-2-1996.

THE MARK CONSISTS OF STANDARD CHAR-  
ACTERS WITHOUT CLAIM TO ANY PARTICULAR  
FONT, STYLE, SIZE, OR COLOR.

NO CLAIM IS MADE TO THE EXCLUSIVE  
RIGHT TO USE "SOLUTIONS", APART FROM  
THE MARK AS SHOWN.

SER. NO. 77-086,347, FILED P.R. 1-19-2007; AM. S.R.  
7-9-2008.

LESLEY LAMOTHE, EXAMINING ATTORNEY

**Int. Cl.: 5**

**Prior U.S. Cls.: 6, 18, 44, 46, 51, and 52**

**United States Patent and Trademark Office**

**Reg. No. 3,506,717**

**Registered Sep. 23, 2008**

**TRADEMARK  
SUPPLEMENTAL REGISTER**

**BEAR GRUB**

PRODUCERS RICE MILL, INC. (ARKANSAS  
CORPORATION)  
P. O. BOX 461  
STUTT GART, AR 72160

FOR: FEED SUPPLEMENT WITH ATTRAC-  
TANTS FOR BEARS, IN CLASS 5 (U.S. CLS. 6, 18,  
44, 46, 51 AND 52).

FIRST USE 6-2-2008; IN COMMERCE 6-2-2008.

THE MARK CONSISTS OF STANDARD CHAR-  
ACTERS WITHOUT CLAIM TO ANY PARTICULAR  
FONT, STYLE, SIZE, OR COLOR.

SER. NO. 77-093,164, FILED P.R. 1-29-2007; AM. S.R.  
8-8-2008.

ESTHER A. BORSUK, EXAMINING ATTORNEY

**Int. Cl.: 9**

**Prior U.S. Cls.: 21, 23, 26, 36, and 38**

**United States Patent and Trademark Office**

**Reg. No. 3,506,718**

**Registered Sep. 23, 2008**

**TRADEMARK  
SUPPLEMENTAL REGISTER**

**CROSSCHECK**

PUBLISHERS INTERNATIONAL LINKING ASSOCIATION, INC. (NEW YORK CORPORATION)  
40 SALEM STREET  
LYNNFIELD, MA 01940

FOR: COMPUTER SOFTWARE FOR USE BY PUBLISHERS, OTHERS IN THE PUBLISHING INDUSTRY AND LIBRARIES, TO CREATE, MAINTAIN, UPDATE AND ACCESS AN ELECTRONIC SEARCHABLE DATABASE USED TO DETERMINE IF SCHOLARLY WRITTEN WORKS HAVE BEEN PREVIOUSLY PUBLISHED BY OTHERS AND, IF SO, WHEN, BY WHOM, IN WHAT FORMAT AND WHETHER THEY HAVE BEEN PUBLISHED IN WHOLE OR IN PART, IN CLASS 9 (U.S. CLS. 21, 23, 26, 36 AND 38).

FIRST USE 6-19-2008; IN COMMERCE 6-19-2008.

THE MARK CONSISTS OF STANDARD CHARACTERS WITHOUT CLAIM TO ANY PARTICULAR FONT, STYLE, SIZE, OR COLOR.

OWNER OF U.S. REG. NOS. 2,542,451, 2,628,946, AND 2,628,947.

SER. NO. 77-102,660, FILED P.R. 2-8-2007; AM. S.R. 6-30-2008.

KELLY MCCOY, EXAMINING ATTORNEY

**Int. Cl.: 44**

**Prior U.S. Cls.: 100 and 101**

**United States Patent and Trademark Office**

**Reg. No. 3,506,719**

**Registered Sep. 23, 2008**

**SERVICE MARK  
SUPPLEMENTAL REGISTER**

**THE DENTAL BUILDING**

L.M. WEINFELD D.D.S., LTD. (ILLINOIS CORPORATION)

9839 SOUTHWEST HIGHWAY

OAK LAWN, IL 60453

FOR: DENTIST SERVICES, IN CLASS 44 (U.S. CLS. 100 AND 101).

FIRST USE 12-24-1949; IN COMMERCE 12-24-1949.

THE MARK CONSISTS OF STANDARD CHARACTERS WITHOUT CLAIM TO ANY PARTICULAR FONT, STYLE, SIZE, OR COLOR.

NO CLAIM IS MADE TO THE EXCLUSIVE RIGHT TO USE "DENTAL", APART FROM THE MARK AS SHOWN.

SER. NO. 77-103,078, FILED P.R. 2-8-2007; AM. S.R. 8-13-2008.

ANGELA GAW, EXAMINING ATTORNEY

**Int. Cl.: 41**

**Prior U.S. Cls.: 100, 101, and 107**

**United States Patent and Trademark Office**

**Reg. No. 3,506,720**

**Registered Sep. 23, 2008**

**SERVICE MARK  
SUPPLEMENTAL REGISTER**

**PHARMACEUTICAL  
MARKETING COMPLIANCE  
CONGRESS**

CBI RESEARCH INC (MASSACHUSETTS COR-  
PORATION)  
500 WEST CUMMINGS PARK SUITE 5100  
WOBURN, MA 01801

FOR: ARRANGING OF EXHIBITIONS, SEMI-  
NARS AND CONFERENCES, IN CLASS 41 (U.S.  
CLS. 100, 101 AND 107).

FIRST USE 7-1-2003; IN COMMERCE 8-1-2003.

THE MARK CONSISTS OF STANDARD CHAR-  
ACTERS WITHOUT CLAIM TO ANY PARTICULAR  
FONT, STYLE, SIZE, OR COLOR.

NO CLAIM IS MADE TO THE EXCLUSIVE  
RIGHT TO USE "CONGRESS", APART FROM THE  
MARK AS SHOWN.

SER. NO. 77-103,652, FILED P.R. 2-9-2007; AM. S.R.  
7-1-2008.

MARTHA FROMM, EXAMINING ATTORNEY



**Int. Cl.: 9**

**Prior U.S. Cls.: 21, 23, 26, 36, and 38**

**United States Patent and Trademark Office**

**Reg. No. 3,506,721**

**Registered Sep. 23, 2008**

**TRADEMARK  
SUPPLEMENTAL REGISTER**

**IPVIDEOXML**

PUGLIESE, ANTHONY V III (UNITED STATES  
INDIVIDUAL)  
101 NE 2ND AVENUE  
DELRAY BEACH, FL 33444

FOR: COMPUTER SOFTWARE, NAMELY, SOFTWARE FOR USE IN OPERATING IP VIDEO CAMERAS AND FOR MANAGING IP VIDEO CAMERA SURVEILLANCE SYSTEMS, WEB CAMERA SYSTEMS, POINT OF SALE SYSTEMS AND RADIO FREQUENCY-BASED IDENTIFICATION SYSTEMS, AND INSTRUCTION MANUALS SOLD AS A UNIT THEREWITH; COMPUTER SOFTWARE DEVELOPMENT TOOLS AND INSTRUCTION MANUALS

SOLD AS A UNIT THEREWITH, IN CLASS 9 (U.S. CLS. 21, 23, 26, 36 AND 38).

FIRST USE 10-0-2007; IN COMMERCE 10-0-2007.

THE MARK CONSISTS OF STANDARD CHARACTERS WITHOUT CLAIM TO ANY PARTICULAR FONT, STYLE, SIZE, OR COLOR.

SER. NO. 77-108,710, FILED P.R. 2-15-2007; AM. S.R. 7-18-2008.

FRANK LATTUCA, EXAMINING ATTORNEY

**Int. Cl.: 7**

**Prior U.S. Cls.: 13, 19, 21, 23, 31, 34, and 35**

**United States Patent and Trademark Office**

**Reg. No. 3,506,722**

**Registered Sep. 23, 2008**

**TRADEMARK  
SUPPLEMENTAL REGISTER**

**DIAGONAL SCREENS**

ANDRITZ INC. (DELAWARE CORPORATION)  
13 PRUYN'S ISLAND DRIVE  
GLENS FALLS, NY 128013686

FOR: PULP AND PAPER PROCESSING APPARA-  
TUS AND EQUIPMENT, NAMELY, DIGESTERS,  
DIGESTING MACHINES, AND PARTS THEREFOR,  
IN CLASS 7 (U.S. CLS. 13, 19, 21, 23, 31, 34 AND 35).

FIRST USE 3-0-2007; IN COMMERCE 3-0-2007.

THE MARK CONSISTS OF STANDARD CHAR-  
ACTERS WITHOUT CLAIM TO ANY PARTICULAR  
FONT, STYLE, SIZE, OR COLOR.

SER. NO. 77-124,917, FILED P.R. 3-7-2007; AM. S.R.  
7-15-2008.

KATHERINE M. DUBRAY, EXAMINING ATTOR-  
NEY

**Int. Cl.: 11**

**Prior U.S. Cls.: 13, 21, 23, 31, and 34**

**United States Patent and Trademark Office**

**Reg. No. 3,506,723**

**Registered Sep. 23, 2008**

**TRADEMARK  
SUPPLEMENTAL REGISTER**

# Premier Aire

HOFFMAN, JOHN (UNITED STATES INDIVIDUAL)

20306 ADRIANA PLACE

SANTA CLARA, CA 91351

FOR: REGISTERS, GRILLES AND DIFFUSERS AND DEVICES, NAMELY, DAMPERS ALL FOR THE USE IN RESIDENTIAL, OR COMMERCIAL BUILDINGS FOR THE DISTRIBUTION OF SUPPLY AND RETURN AIR IN CONDITIONED SPACES, IN CLASS 11 (U.S. CLS. 13, 21, 23, 31 AND 34).

FIRST USE 9-30-2006; IN COMMERCE 9-30-2006.

THE MARK CONSISTS OF STANDARD CHARACTERS WITHOUT CLAIM TO ANY PARTICULAR FONT, STYLE, SIZE, OR COLOR.

NO CLAIM IS MADE TO THE EXCLUSIVE RIGHT TO USE "AIRE", APART FROM THE MARK AS SHOWN.

THE FOREIGN WORDING IN THE MARK TRANSLATES INTO ENGLISH AS AIR.

SER. NO. 77-130,127, FILED P.R. 3-13-2007; AM. S.R. 7-21-2008.

RUDY R. SINGLETON, EXAMINING ATTORNEY

**Int. Cls.: 35, 36, and 37**

**Prior U.S. Cls.: 100, 101, 102, 103, and 106**

**United States Patent and Trademark Office**

**Reg. No. 3,506,724**

**Registered Sep. 23, 2008**

**SERVICE MARK  
SUPPLEMENTAL REGISTER**

**Diversified Capital  
Management, Inc.**

INGRAM ENTITIES, INC. (GEORGIA CORPORATION)  
5400 BOWMAN RD.  
MACON, GA 31210

FOR: REAL ESTATE ADVERTISING SERVICES,  
IN CLASS 35 (U.S. CLS. 100, 101 AND 102).

FIRST USE 2-4-2007; IN COMMERCE 2-4-2007.

FOR: ASSESSMENT AND MANAGEMENT OF REAL ESTATE; EVALUATION OF REAL PROPERTY; FINANCIAL VALUATION OF PERSONAL PROPERTY AND REAL ESTATE; LEASING OF REAL ESTATE; REAL ESTATE ACQUISITION SERVICES; REAL ESTATE CONSULTATION; REAL ESTATE INVESTMENT; REAL ESTATE MANAGEMENT; REAL ESTATE MANAGEMENT CONSULTATION; REAL ESTATE PROCUREMENT FOR OTHERS; REAL ESTATE VALUATION SERVICES; REAL ESTATE VALUATIONS, IN CLASS 36 (U.S. CLS. 100, 101 AND 102).

FIRST USE 2-4-2007; IN COMMERCE 2-4-2007.

FOR: REAL ESTATE DEVELOPMENT; REAL ESTATE SITE SELECTION, IN CLASS 37 (U.S. CLS. 100, 103 AND 106).

FIRST USE 2-4-2007; IN COMMERCE 2-4-2007.

THE MARK CONSISTS OF STANDARD CHARACTERS WITHOUT CLAIM TO ANY PARTICULAR FONT, STYLE, SIZE, OR COLOR.

NO CLAIM IS MADE TO THE EXCLUSIVE RIGHT TO USE "INC.", APART FROM THE MARK AS SHOWN.

SER. NO. 77-130,412, FILED P.R. 3-14-2007; AM. S.R. 12-27-2007.

TIMOTHY FINNEGAN, EXAMINING ATTORNEY

**Int. Cls.: 9 and 16**

**Prior U.S. Cls.: 2, 5, 21, 22, 23, 26, 29, 36, 37, 38, and 50**

**United States Patent and Trademark Office**

**Reg. No. 3,506,725**

**Registered Sep. 23, 2008**

**TRADEMARK  
SUPPLEMENTAL REGISTER**

**CREATIVE LEARNING IN  
COSMETOLOGY**

CERTIFIED LEARNING IN COSMETOLOGY,  
INC. (PENNSYLVANIA CORPORATION)  
396 POTTSVILLE-ST. CLAIR HIGHWAY  
POTTSVILLE, PA 17901

FOR: PRERECORDED CD ROMS FEATURING  
TEACHING CONTENT, TEXTBOOKS AND TEA-  
CHERS MANUALS IN THE FIELDS OF COSME-  
TOLOGY, HAIRCUTTING, HAIR DESIGNING,  
HAIR CHEMISTRY, HAIR COLORING, NAILS, MA-  
KEUP AND PEOPLE SKILLS, IN CLASS 9 (U.S. CLS.  
21, 23, 26, 36 AND 38).

FIRST USE 6-0-2008; IN COMMERCE 7-7-2008.

FOR: PRINTED MATERIALS, NAMELY, TEXT-  
BOOKS, TEACHERS MANUALS, AND CERTIFICA-  
TION TESTS IN THE FIELDS OF COSMETOLOGY,

HAIRCUTTING, HAIR DESIGNING, HAIR CHEM-  
ISTRY, HAIR COLORING, NAILS, MAKEUP AND  
PEOPLE SKILLS, IN CLASS 16 (U.S. CLS. 2, 5, 22, 23,  
29, 37, 38 AND 50).

FIRST USE 2-1-2007; IN COMMERCE 2-1-2007.

THE MARK CONSISTS OF STANDARD CHAR-  
ACTERS WITHOUT CLAIM TO ANY PARTICULAR  
FONT, STYLE, SIZE, OR COLOR.

OWNER OF U.S. REG. NO. 2,730,956.

SER. NO. 77-146,343, FILED P.R. 4-2-2007; AM. S.R.  
8-14-2008.

STEVEN JACKSON, EXAMINING ATTORNEY

**Int. Cl.: 9**

**Prior U.S. Cls.: 21, 23, 26, 36, and 38**

**United States Patent and Trademark Office**

**Reg. No. 3,506,726**

**Registered Sep. 23, 2008**

**TRADEMARK  
SUPPLEMENTAL REGISTER**

**TRACKLEAVE**

RECORDABLES, INC. (ILLINOIS CORPORATION)  
825 EDGEWATER PARKWAY  
WAUCONDA, IL 60067

FOR: COMPUTER SOFTWARE, NAMELY, AN APPLICATION ALLOWING MONITORING, INPUTTING, MANAGING AND REPORTING INFORMATION AND ISSUES PERTAINING TO THE FAMILY MEDICAL LEAVE ACT, SHORT AND LONG TERM DISABILITY, PERFORMING APPRAISALS, TIME AND ATTENDANCE, AND COBRA HEALTH BEN-

EFITS ADMINISTRATION, IN INTERNATIONAL CLASS 9, IN CLASS 9 (U.S. CLS. 21, 23, 26, 36 AND 38).

FIRST USE 6-30-2007; IN COMMERCE 6-30-2007.

THE MARK CONSISTS OF STANDARD CHARACTERS WITHOUT CLAIM TO ANY PARTICULAR FONT, STYLE, SIZE, OR COLOR.

SER. NO. 77-151,821, FILED P.R. 4-9-2007; AM. S.R. 8-13-2008.

GEOFFREY FOSDICK, EXAMINING ATTORNEY

**Int. Cl.: 42**

**Prior U.S. Cls.: 100 and 101**

**United States Patent and Trademark Office**

**Reg. No. 3,506,727**

**Registered Sep. 23, 2008**

**SERVICE MARK  
SUPPLEMENTAL REGISTER**

**ON-LINE VOLUME RENDERING**

BIO-SIM CORPORATION (DELAWARE CORPORATION)  
SUITE 179  
439 N. 6TH AVENUE  
TUCSON, AZ 85705

FOR: PROVIDING TEMPORARY USE OF NON-DOWNLOADABLE COMPUTER SOFTWARE FOR COMBINING AND MANIPULATING IMAGES TO DISPLAY THEM IN THREE-DIMENSIONAL VIEWS OVER COMPUTER NETWORKS, INTRANETS, AND THE INTERNET, IN CLASS 42 (U.S. CLS. 100 AND 101).

FIRST USE 8-12-2008; IN COMMERCE 8-12-2008.

THE MARK CONSISTS OF STANDARD CHARACTERS WITHOUT CLAIM TO ANY PARTICULAR FONT, STYLE, SIZE, OR COLOR.

SER. NO. 77-152,238, FILED P.R. 4-9-2007; AM. S.R. 8-12-2008.

DEIRDRE ROBERTSON, EXAMINING ATTORNEY

**Int. Cl.: 12**

**Prior U.S. Cls.: 19, 21, 23, 31, 35, and 44**

**United States Patent and Trademark Office**

**Reg. No. 3,506,728**

**Registered Sep. 23, 2008**

**TRADEMARK  
SUPPLEMENTAL REGISTER**

**#1 PHYSICIAN APPROVED**

PRIDE MOBILITY PRODUCTS CORPORATION  
(PENNSYLVANIA CORPORATION)  
182 SUSQUEHANNA AVENUE  
EXETER, PA 18643

THE MARK CONSISTS OF STANDARD CHAR-  
ACTERS WITHOUT CLAIM TO ANY PARTICULAR  
FONT, STYLE, SIZE, OR COLOR.

FOR: MOTORIZED WHEELCHAIRS FOR PERSONAL  
MOBILITY USE BY HANDICAPPED AND  
DISABLED PERSONS, IN CLASS 12 (U.S. CLS. 19,  
21, 23, 31, 35 AND 44).

SER. NO. 77-153,255, FILED P.R. 4-10-2007; AM. S.R.  
7-31-2008.

FIRST USE 3-31-2007; IN COMMERCE 3-31-2007.

DANIEL CAPSHAW, EXAMINING ATTORNEY



**Int. Cl.: 1**

**Prior U.S. Cls.: 1, 5, 6, 10, 26, and 46**

**United States Patent and Trademark Office**

**Reg. No. 3,506,729**

**Registered Sep. 23, 2008**

**TRADEMARK  
SUPPLEMENTAL REGISTER**

**FūL**

SIMPLE ENERGY SOLUTIONS, INC. (NEW  
YORK CORPORATION)  
89 CLAY PIT ROAD  
SAG HARBOR, NY 11963

FOR: CHEMICAL FUEL ADDITIVES FOR IN-  
CREASING THE EFFICIENCY AND ENHANCING  
THE PERFORMANCE OF COMBUSTION ENGINE  
FUELS, IN CLASS 1 (U.S. CLS. 1, 5, 6, 10, 26 AND 46).

FIRST USE 7-1-2007; IN COMMERCE 7-1-2007.

THE MARK CONSISTS OF THE LETTER "U"  
INCLUDES A LINE OVER THE SAME.

SER. NO. 77-161,513, FILED P.R. 4-20-2007; AM. S.R.  
6-16-2008.

CHRIS DONINGER, EXAMINING ATTORNEY

**Int. Cl.: 27**

**Prior U.S. Cls.: 19, 20, 37, 42, and 50**

**United States Patent and Trademark Office**

**Reg. No. 3,506,730**

**Registered Sep. 23, 2008**

**TRADEMARK  
SUPPLEMENTAL REGISTER**

**K9Grass**

FOREVERLAWN, INC. (FLORIDA CORPORATION)  
4500 BOGAN RD. NE  
ALBUQUERQUE, NM 87109

FOR: ARTIFICIAL TURF, IN CLASS 27 (U.S. CLS. 19, 20, 37, 42 AND 50).

FIRST USE 10-1-2005; IN COMMERCE 10-1-2005.

THE MARK CONSISTS OF STANDARD CHARACTERS WITHOUT CLAIM TO ANY PARTICULAR FONT, STYLE, SIZE, OR COLOR.

SER. NO. 77-169,031, FILED P.R. 4-30-2007; AM. S.R. 2-12-2008.

BILL DAWE, EXAMINING ATTORNEY

Int. Cl.: 16

Prior U.S. Cls.: 2, 5, 22, 23, 29, 37, 38, and 50

United States Patent and Trademark Office

Reg. No. 3,506,731

Registered Sep. 23, 2008

TRADEMARK  
SUPPLEMENTAL REGISTER



EVERSIO, INC. (WASHINGTON CORPORATION), DBA SUSTAINABLE GROUP, INC.,  
844 NW 49TH STREET  
SEATTLE, WA 98107

FOR: OFFICE SUPPLIES, NAMELY, BINDERS, IN  
CLASS 16 (U.S. CLS. 2, 5, 22, 23, 29, 37, 38 AND 50).

FIRST USE 4-23-2006; IN COMMERCE 4-23-2006.

THE COLOR(S) GREEN AND BLACK IS/ARE  
CLAIMED AS A FEATURE OF THE MARK.

THE MARK CONSISTS OF THE WORDS "SUSTAINABLE" AND "GROUP" ALONG WITH A RECYCLING SYMBOL. THE COLOR BLACK APPEARS IN THE WORD "SUSTAINABLE", AS OUTLINE FOR THE RECYCLING SYMBOL AND OUTLINING FOR THE WORDING "GROUP"; THE COLOR GREEN APPEARS IN THE RECYCLING SYMBOL AND THE WORD "GROUP".

SER. NO. 77-198,931, FILED P.R. 6-6-2007; AM. S.R. 7-22-2008.

ADA HAN, EXAMINING ATTORNEY

Int. Cl.: 11

Prior U.S. Cls.: 13, 21, 23, 31, and 34

United States Patent and Trademark Office

Reg. No. 3,506,732

Registered Sep. 23, 2008

TRADEMARK  
SUPPLEMENTAL REGISTER

HI-FLOW

AMCOL INTERNATIONAL CORPORATION (DE-  
LAWARE CORPORATION)  
1500 WEST SHURE DRIVE  
ARLINGTON HEIGHTS, IL 60004

FOR: WATER TREATMENT EQUIPMENT, FIL-  
TRATION MEDIA IN THE NATURE OF WATER  
FILTERING UNIT FOR COMMERCIAL AND IN-  
DUSTRIAL USE IN THE REMOVAL OF CRUDE OIL  
FROM AQUEOUS STREAMS, IN CLASS 11 (U.S.  
CLS. 13, 21, 23, 31 AND 34).

FIRST USE 1-0-2007; IN COMMERCE 1-0-2007.

THE MARK CONSISTS OF STANDARD CHAR-  
ACTERS WITHOUT CLAIM TO ANY PARTICULAR  
FONT, STYLE, SIZE, OR COLOR.

SER. NO. 77-206,949, FILED P.R. 6-15-2007; AM. S.R.  
6-23-2008.

SEAN CROWLEY, EXAMINING ATTORNEY

**Int. Cl.: 42**

**Prior U.S. Cls.: 100 and 101**

**United States Patent and Trademark Office**

**Reg. No. 3,506,733**

**Registered Sep. 23, 2008**

**SERVICE MARK  
SUPPLEMENTAL REGISTER**

**NEW THERAPIES FROM  
DISCOVERY IN MOLECULAR  
NEUROSCIENCE**

ERNEST GALLO CLINIC AND RESEARCH CENTER (CALIFORNIA CORPORATION)  
UNIVERSITY OF CALIFORNIA SAN FRANCISCO  
5858 HORTON STREET, SUITE 200  
EMERYVILLE, CA 94608

FOR: BIOMEDICAL RESEARCH, IN CLASS 42  
(U.S. CLS. 100 AND 101).

FIRST USE 1-0-2008; IN COMMERCE 1-0-2008.

THE MARK CONSISTS OF STANDARD CHARACTERS WITHOUT CLAIM TO ANY PARTICULAR FONT, STYLE, SIZE, OR COLOR.

SER. NO. 77-219,363, FILED P.R. 6-29-2007; AM. S.R. 6-10-2008.

MICHAEL WEBSTER, EXAMINING ATTORNEY

**Int. Cl.: 45**

**Prior U.S. Cls.: 100 and 101**

**United States Patent and Trademark Office**

**Reg. No. 3,506,734**

**Registered Sep. 23, 2008**

**SERVICE MARK  
SUPPLEMENTAL REGISTER**

**Juris Clerks**

JURISCLERKS, INC. (UTAH CORPORATION)  
6621 TROUT CREEK COURT  
PARK CITY, UT 84098

FOR: LEGAL DOCUMENT PREPARATION AND  
RESEARCH SERVICES FOR ATTORNEYS; LEGAL  
SERVICES; LITIGATION SUPPORT SERVICES, IN  
CLASS 45 (U.S. CLS. 100 AND 101).

FIRST USE 7-9-2007; IN COMMERCE 7-9-2007.

THE MARK CONSISTS OF STANDARD CHAR-  
ACTERS WITHOUT CLAIM TO ANY PARTICULAR  
FONT, STYLE, SIZE, OR COLOR.

SER. NO. 77-229,696, FILED P.R. 7-13-2007; AM. S.R.  
1-5-2008.

PRISCILLA MILTON, EXAMINING ATTORNEY

**Int. Cls.: 41 and 42**

**Prior U.S. Cls.: 100, 101, and 107**

**United States Patent and Trademark Office**

**Reg. No. 3,506,735**

**Registered Sep. 23, 2008**

**SERVICE MARK  
SUPPLEMENTAL REGISTER**

**ONETOONE**

APPLE INC. (CALIFORNIA CORPORATION)  
1 INFINITE LOOP  
CUPERTINO, CA 95014

FOR: EDUCATION AND TRAINING SERVICES, NAMELY, PERSONAL INSTRUCTION AND CONDUCTING CLASSES, WORKSHOPS, CONFERENCES AND SEMINARS IN THE FIELD OF COMPUTERS, COMPUTER SOFTWARE, ONLINE SERVICES, INFORMATION TECHNOLOGY, INTERNET WEBSITE DESIGN, VIDEO PRODUCTS AND CONSUMER ELECTRONICS; COMPUTER EDUCATION TRAINING SERVICES; TRAINING IN THE USE AND OPERATION OF COMPUTERS AND COMPUTER SOFTWARE; PROVIDING INFORMATION IN THE FIELD OF EDUCATION AND ENTERTAINMENT VIA THE INTERNET, IN CLASS 41 (U.S. CLS. 100, 101 AND 107).

FIRST USE 5-2-2007; IN COMMERCE 5-2-2007.

FOR: TECHNICAL SUPPORT SERVICES, NAMELY, PROVIDING ASSISTANCE AND ADVICE RELATING TO THE CONFIGURATION AND OPERATION OF COMPUTER SOFTWARE AND CONSUMER ELECTRONICS; MAINTENANCE OF COMPUTER SOFTWARE; CONSULTING SERVICES

IN THE FIELD OF COMPUTER SOFTWARE; TECHNICAL CONSULTING IN THE FIELD OF CONSUMER ELECTRONICS; COMPUTER DIAGNOSTIC SERVICES; INSTALLATION OF COMPUTER SOFTWARE; UPDATING OF COMPUTER SOFTWARE; MAINTENANCE OF COMPUTER SOFTWARE; COMPUTER CONSULTATION SERVICES; CONSULTING SERVICES IN THE FIELD OF SELECTION, IMPLEMENTATION AND USE OF COMPUTER HARDWARE AND SOFTWARE SYSTEMS FOR OTHERS; COMPUTER DATA RECOVERY, IN CLASS 42 (U.S. CLS. 100 AND 101).

FIRST USE 5-2-2007; IN COMMERCE 5-2-2007.

THE MARK CONSISTS OF STANDARD CHARACTERS WITHOUT CLAIM TO ANY PARTICULAR FONT, STYLE, SIZE, OR COLOR.

PRIORITY CLAIMED UNDER SEC. 44(D) ON TRINIDAD/TOBAGO APPLICATION NO. 38298, FILED 3-21-2007.

SER. NO. 77-234,844, FILED P.R. 7-20-2007; AM. S.R. 8-13-2008.

APRIL ROACH, EXAMINING ATTORNEY

**Int. Cl.: 5**

**Prior U.S. Cls.: 6, 18, 44, 46, 51, and 52**

**United States Patent and Trademark Office**

**Reg. No. 3,506,736**

**Registered Sep. 23, 2008**

**TRADEMARK  
SUPPLEMENTAL REGISTER**

# 4Weight Control

GENESIS TODAY, INC. (TEXAS CORPORATION)  
JACKIE WEIGEL  
14101 W. HWY. 290, BLDG. 1900  
AUSTIN, TX 78737

FOR: DIETARY AND NUTRITIONAL SUPPLEMENTS, IN CLASS 5 (U.S. CLS. 6, 18, 44, 46, 51 AND 52).

FIRST USE 8-1-2005; IN COMMERCE 8-1-2005.

THE MARK CONSISTS OF STANDARD CHARACTERS WITHOUT CLAIM TO ANY PARTICULAR FONT, STYLE, SIZE, OR COLOR.

OWNER OF U.S. REG. NO. 3,257,226.

SER. NO. 77-249,250, FILED P.R. 8-7-2007; AM. S.R. 7-31-2008.

ESTHER BELENKER, EXAMINING ATTORNEY



**Int. Cl.: 37**

**Prior U.S. Cls.: 100, 103, and 106**

**United States Patent and Trademark Office**

**Reg. No. 3,506,737**

**Registered Sep. 23, 2008**

**SERVICE MARK  
SUPPLEMENTAL REGISTER**

**DOWNEAST ENERGY & BUILDING  
SUPPLY**

DOWNEAST ENERGY CORP. (MAINE COR-  
PORATION)

18 SPRING STREET

BRUNSWICK, ME 04011

FOR: FURNACE INSTALLATION AND REPAIR,  
IN CLASS 37 (U.S. CLS. 100, 103 AND 106).

FIRST USE 12-31-2006; IN COMMERCE 12-31-2006.

THE MARK CONSISTS OF STANDARD CHAR-  
ACTERS WITHOUT CLAIM TO ANY PARTICULAR  
FONT, STYLE, SIZE, OR COLOR.

NO CLAIM IS MADE TO THE EXCLUSIVE  
RIGHT TO USE "ENERGY & BUILDING SUPPLY",  
APART FROM THE MARK AS SHOWN.

SER. NO. 77-253,735, FILED P.R. 8-13-2007; AM. S.R.  
7-29-2008.

ESTHER A. BORSUK, EXAMINING ATTORNEY

Int. Cl.: 25

Prior U.S. Cls.: 22 and 39

United States Patent and Trademark Office

Reg. No. 3,506,738

Registered Sep. 23, 2008

TRADEMARK  
SUPPLEMENTAL REGISTER



WILSON, STEVE (UNITED STATES INDIVIDUAL)  
29386 NORTH 108TH PLACE  
SCOTTSDALE, AZ 85262

FOR: JACKETS; SPORTS JACKETS; GOLF SHIRTS; SPORT SHIRTS; SPORTS SHIRTS; SPORTS SHIRTS WITH SHORT SLEEVES; T-SHIRTS; TEE SHIRTS; PANTS; SHORT-SLEEVED OR LONG-SLEEVED T-SHIRTS; SHORT-SLEEVED SHIRTS; ATHLETIC SHOES; BASEBALL SHOES; CLEATS

FOR ATTACHMENT TO SPORTS SHOES; FOOTBALL SHOES; RUNNING SHOES; SOCCER SHOES; TRACK AND FIELD SHOES, IN CLASS 25 (U.S. CLS. 22 AND 39).

FIRST USE 12-1-2006; IN COMMERCE 7-1-2007.

SER. NO. 77-256,362, FILED P.R. 8-15-2007; AM. S.R. 8-12-2008.

KATHERINE CHANG, EXAMINING ATTORNEY

**Int. Cl.: 41**

**Prior U.S. Cls.: 100, 101, and 107**

**United States Patent and Trademark Office**

**Reg. No. 3,506,739**

**Registered Sep. 23, 2008**

**SERVICE MARK  
SUPPLEMENTAL REGISTER**

## Experience Education

CLASSROOM WITH A VIEW, INC. (ALASKA  
NON-PROFIT CORPORATION)  
PO BOX 783  
TALKEETNA, AK 99676

FOR: PROVIDING EXPERIENTIAL, ACADEMIC  
COURSES OF INSTRUCTION AT THE HIGH  
SCHOOL LEVEL, IN CLASS 41 (U.S. CLS. 100, 101  
AND 107).

FIRST USE 3-10-2007; IN COMMERCE 6-2-2007.

THE MARK CONSISTS OF STANDARD CHAR-  
ACTERS WITHOUT CLAIM TO ANY PARTICULAR  
FONT, STYLE, SIZE, OR COLOR.

NO CLAIM IS MADE TO THE EXCLUSIVE  
RIGHT TO USE "EDUCATION", APART FROM  
THE MARK AS SHOWN.

SER. NO. 77-265,643, FILED P.R. 8-28-2007; AM. S.R.  
8-1-2008.

SIMON TENG, EXAMINING ATTORNEY

**Int. Cls.: 35 and 36**

**Prior U.S. Cls.: 100, 101, and 102**

**United States Patent and Trademark Office**

**Reg. No. 3,506,740**

**Registered Sep. 23, 2008**

**SERVICE MARK  
SUPPLEMENTAL REGISTER**

**BUYTXFORECLOSURES.COM**

BUYTXFORECLOSURES, LLC (TEXAS LIMITED LIABILITY COMPANY)  
SUITE 800  
18400 VON KARMAN AVENUE  
IRVINE, CA 92612

FOR: INVESTMENT PROPERTY AND LAND AUCTION AND AUCTION SERVICES, NAMELY, REAL ESTATE AUCTIONS, ARRANGING AND CONDUCTING AUCTIONS IN THE FIELD OF REAL ESTATE, IN CLASS 35 (U.S. CLS. 100, 101 AND 102).

FIRST USE 6-19-2008; IN COMMERCE 6-19-2008.

FOR: INVESTMENT PROPERTY ACQUISITION, NAMELY, REAL ESTATE ACQUISITION SERVICES, REAL PROPERTY ACQUISITION AND CONSUMER FINANCING TO FACILITATE HOME OWNERSHIP; REAL LAND ACQUISITION, NAME-

LY, REAL ESTATE ACQUISITION SERVICES, REAL PROPERTY ACQUISITION AND CONSUMER FINANCING TO FACILITATE LAND OWNERSHIP; WHOLESALE LAND AND INVESTMENT PROPERTY ACQUISITION, NAMELY, REAL ESTATE ACQUISITION SERVICES, REAL PROPERTY ACQUISITION AND CONSUMER FINANCING TO FACILITATE HOME OWNERSHIP, IN CLASS 36 (U.S. CLS. 100, 101 AND 102).

FIRST USE 6-19-2008; IN COMMERCE 6-19-2008.

THE MARK CONSISTS OF STANDARD CHARACTERS WITHOUT CLAIM TO ANY PARTICULAR FONT, STYLE, SIZE, OR COLOR.

SER. NO. 77-266,719, FILED P.R. 8-28-2007; AM. S.R. 8-14-2008.

MICHAEL TANNER, EXAMINING ATTORNEY

**Int. Cl.: 41**

**Prior U.S. Cls.: 100, 101, and 107**

**United States Patent and Trademark Office**

**Reg. No. 3,506,741**

**Registered Sep. 23, 2008**

**SERVICE MARK  
SUPPLEMENTAL REGISTER**

**TEENAEROBIX**

GARZA, RAYNALDO (UNITED STATES INDIVIDUAL)  
14 MONARCH BAY PLAZA, SUITE 475  
MONARCH BEACH, CA 92629

FOR: ENTERTAINMENT SERVICES, NAMELY, LIVE EXERCISE AND HEALTH AND FITNESS PERFORMANCES AND EVENTS; ENTERTAINMENT SERVICES, NAMELY, AN ONGOING SHOW IN THE FIELD OF HEALTH, SINGING, DANCING, HUMOR, MAGIC, FASHION AND VARIETY, BROADCAST OVER TELEVISION, SATELLITE, THE INTERNET, AUDIO AND VIDEO MEDIA FOR USE BY HEALTH AND FITNESS CENTERS, SCHOOLS, AND FOR PERSONAL USE; EDUCATIONAL SERVICES, NAMELY, A CONTINUING EDUCATIONAL PROGRAM IN THE FIELD OF HEALTH, SINGING, DANCING, HUMOR, MAGIC,

FASHION AND VARIETY BROADCAST OVER TELEVISION, SATELLITE, THE INTERNET, AUDIO AND VIDEO MEDIA FOR USE BY HEALTH AND FITNESS CENTERS AND SCHOOLS, AND FOR PERSONAL USE, IN CLASS 41 (U.S. CLS. 100, 101 AND 107).

FIRST USE 9-13-2003; IN COMMERCE 10-18-2007.

THE MARK CONSISTS OF STANDARD CHARACTERS WITHOUT CLAIM TO ANY PARTICULAR FONT, STYLE, SIZE, OR COLOR.

SER. NO. 77-271,453, FILED P.R. 9-4-2007; AM. S.R. 6-12-2008.

SUSAN RICHARDS, EXAMINING ATTORNEY

**Int. Cl.: 35**

**Prior U.S. Cls.: 100, 101, and 102**

**United States Patent and Trademark Office**

**Reg. No. 3,506,742**

**Registered Sep. 23, 2008**

**SERVICE MARK  
SUPPLEMENTAL REGISTER**

# Ionic Spa

MERIDIAN LIFEFORCE INC (CANADA CORPORATION)  
3 GREYSTONE WALK DRIVE, SUITE 2230  
SCARBOROUGH, CANADA M1K5J4

FOR: ON-LINE RETAIL STORE SERVICES FEATURING HYDROTHERAPY EQUIPMENT AND PRODUCTS, NAMELY, BATHS AND PATCHES FOR CLEANSING BODY PARTS, WATER TREATMENT SYSTEMS, AND SKIN HYDRATING PRODUCTS, IN CLASS 35 (U.S. CLS. 100, 101 AND 102).

FIRST USE 7-30-2004; IN COMMERCE 7-30-2004.

THE MARK CONSISTS OF STANDARD CHARACTERS WITHOUT CLAIM TO ANY PARTICULAR FONT, STYLE, SIZE, OR COLOR.

SER. NO. 77-274,771, FILED P.R. 9-7-2007; AM. S.R. 8-12-2008.

KARANENDRA S. CHHINA, EXAMINING ATTORNEY

**Int. Cl.: 25**

**Prior U.S. Cls.: 22 and 39**

**United States Patent and Trademark Office**

**Reg. No. 3,506,743**

**Registered Sep. 23, 2008**

**TRADEMARK  
SUPPLEMENTAL REGISTER**

**GEL-KUSHON**

ASICS CORPORATION (JAPAN CORPORATION)  
1-1 MINATOJIMA-NAKAMACHI 7-CHOME  
CHUO-KU, KOBE, JAPAN 650-8555

OWNER OF U.S. REG. NOS. 1,877,669, 2,878,124,  
AND OTHERS.

FOR: FOOTWEAR, IN CLASS 25 (U.S. CLS. 22 AND  
39).

SER. NO. 77-282,137, FILED P.R. 9-18-2007; AM. S.R.  
8-6-2008.

FIRST USE 5-30-2008; IN COMMERCE 5-30-2008.

THE MARK CONSISTS OF STANDARD CHAR-  
ACTERS WITHOUT CLAIM TO ANY PARTICULAR  
FONT, STYLE, SIZE, OR COLOR.

SAMUEL E. SHARPER JR., EXAMINING ATTOR-  
NEY

**Int. Cl.: 26**

**Prior U.S. Cls.: 37, 39, 40, 42, and 50**

**Reg. No. 3,506,744**

**United States Patent and Trademark Office**

**Registered Sep. 23, 2008**

**TRADEMARK  
SUPPLEMENTAL REGISTER**

**FASHION & HAIR LOSS  
SOLUTIONS FOR TODAY'S WOMAN**

DE NOVO HAIR, LLC (ILLINOIS LIMITED LIABILITY COMPANY)  
P.O. BOX 08374  
CHICAGO, IL 60608

THE MARK CONSISTS OF STANDARD CHARACTERS WITHOUT CLAIM TO ANY PARTICULAR FONT, STYLE, SIZE, OR COLOR.

FOR: HAIR PRODUCTS AND ACCESSORIES, NAMELY, WOMEN'S WIGS, WOMEN'S BRAIDS AND WOMEN'S HAIR EXTENSIONS, IN CLASS 26 (U.S. CLS. 37, 39, 40, 42 AND 50).

SER. NO. 77-283,650, FILED P.R. 9-19-2007; AM. S.R. 8-12-2008.

FIRST USE 2-1-2007; IN COMMERCE 2-1-2007.

BARBARA A. GOLD, EXAMINING ATTORNEY



**Int. Cl.: 35**

**Prior U.S. Cls.: 100, 101, and 102**

**United States Patent and Trademark Office**

**Reg. No. 3,506,745**

**Registered Sep. 23, 2008**

**SERVICE MARK  
SUPPLEMENTAL REGISTER**

**the CardzStore**

MERIDIAN MEDIA GROUP, INC. (DELAWARE  
CORPORATION)  
223 WEST ERIE STREET, SUITE 4E  
CHICAGO, IL 60610

FOR: COMPUTERIZED ON-LINE RETAIL STORE  
SERVICES IN THE FIELD OF GREETING CARDS,  
MAGAZINES, IN CLASS 35 (U.S. CLS. 100, 101 AND  
102).

FIRST USE 8-1-2007; IN COMMERCE 8-1-2007.

THE MARK CONSISTS OF STANDARD CHAR-  
ACTERS WITHOUT CLAIM TO ANY PARTICULAR  
FONT, STYLE, SIZE, OR COLOR.

SER. NO. 77-284,170, FILED P.R. 9-20-2007; AM. S.R.  
8-11-2008.

BARBARA A. GOLD, EXAMINING ATTORNEY

**Int. Cl.: 38**

**Prior U.S. Cls.: 100, 101, and 104**

**United States Patent and Trademark Office**

**Reg. No. 3,506,746**

**Registered Sep. 23, 2008**

**SERVICE MARK  
SUPPLEMENTAL REGISTER**

**WORLD HEALTH NET TV**

MEDICAL DEVELOPMENT MANAGEMENT,  
INC. (ILLINOIS CORPORATION)  
1510 WEST MONTANA STREET  
CHICAGO, IL 60614

FOR: STREAMING OF AUDIO/VIDEO OR ELECTRONIC PRINT MATERIAL ON THE INTERNET RELATED TO ANTI-AGING MEDICINE, MEDICAL EDUCATION, HEALTH, FITNESS, NUTRITION AND PERSONAL IMPROVEMENT, SPORTS MEDICINE, BIOTECHNOLOGY REGENERATIVE MEDICINE AND ANTI-AGING MEDICAL PRODUCTS AND/OR TECHNOLOGY RELATED THEREOF; TRANSMISSION OF INTERACTIVE AUDIO AND VIDEO SERVICES, NAMELY, TELEVISION PROGRAMS, SOUND AND VISION, SHORT MESSAGES, AUDIO PROGRAMS, VIDEO PROGRAMS, MULTIMEDIA PRESENTATIONS VIA SATELLITE OR INTERACTIVE MULTIMEDIA RELATING TO ANTI-AGING MEDICINE, MEDICAL EDUCATION,

HEALTH, FITNESS, NUTRITION AND PERSONAL IMPROVEMENT, SPORTS MEDICINE, BIOTECHNOLOGY REGENERATIVE MEDICINE AND ANTI-AGING MEDICAL PRODUCTS AND/OR TECHNOLOGY, IN CLASS 38 (U.S. CLS. 100, 101 AND 104).

FIRST USE 8-30-2007; IN COMMERCE 8-30-2007.

THE MARK CONSISTS OF STANDARD CHARACTERS WITHOUT CLAIM TO ANY PARTICULAR FONT, STYLE, SIZE, OR COLOR.

NO CLAIM IS MADE TO THE EXCLUSIVE RIGHT TO USE "NET TV", APART FROM THE MARK AS SHOWN.

SER. NO. 77-285,290, FILED P.R. 9-21-2007; AM. S.R. 5-16-2008.

KATHERINE STOIDES, EXAMINING ATTORNEY

**Int. Cl.: 9**

**Prior U.S. Cls.: 21, 23, 26, 36, and 38**

**United States Patent and Trademark Office**

**Reg. No. 3,506,747**

**Registered Sep. 23, 2008**

**TRADEMARK  
SUPPLEMENTAL REGISTER**

**HOLIDAY DASHBOARD**

PARADYSZ MATERA CO., INC. (NEW YORK CORPORATION)

5 HANOVER SQUARE

NEW YORK, NY 10004

FOR: SOFTWARE FOR TRACKING AND FORECASTING RETAIL SALES DURING THE HOLIDAY SEASON, IN CLASS 9 (U.S. CLS. 21, 23, 26, 36 AND 38).

FIRST USE 10-30-2007; IN COMMERCE 10-30-2007.

THE MARK CONSISTS OF STANDARD CHARACTERS WITHOUT CLAIM TO ANY PARTICULAR FONT, STYLE, SIZE, OR COLOR.

NO CLAIM IS MADE TO THE EXCLUSIVE RIGHT TO USE "DASHBOARD", APART FROM THE MARK AS SHOWN.

SER. NO. 77-286,803, FILED P.R. 9-24-2007; AM. S.R. 7-10-2008.

JUSTINE D. PARKER, EXAMINING ATTORNEY

**Int. Cl.: 10**

**Prior U.S. Cls.: 26, 39, and 44**

**United States Patent and Trademark Office**

**Reg. No. 3,506,748**

**Registered Sep. 23, 2008**

**TRADEMARK  
SUPPLEMENTAL REGISTER**

**SMARTBOLUS**

TENXSYS INC. (IDAHO CORPORATION)  
408 SOUTH EAGLE ROAD, SUITE 201  
EAGLE, ID 83616

FIRST USE 2-12-2008; IN COMMERCE 2-12-2008.

FOR: ELECTRONIC TELEMTRY DEVICES FOR  
MEDICAL USE, NAMELY, FOR MONITORING,  
COLLECTING AND COMMUNICATING HEALTH,  
TEMPERATURE, ESTRUS, MOTION, EATING AND  
DRINKING PATTERNS, AND PHYSIOLOGIC  
DATA CONCERNING COWS, IN CLASS 10 (U.S.  
CLS. 26, 39 AND 44).

THE MARK CONSISTS OF STANDARD CHAR-  
ACTERS WITHOUT CLAIM TO ANY PARTICULAR  
FONT, STYLE, SIZE, OR COLOR.

SER. NO. 77-291,205, FILED P.R. 9-28-2007; AM. S.R.  
7-7-2008.

COLLEEN DOMBROW, EXAMINING ATTORNEY

**Int. Cl.: 38**

**Prior U.S. Cls.: 100, 101, and 104**

**United States Patent and Trademark Office**

**Reg. No. 3,506,749**

**Registered Sep. 23, 2008**

**SERVICE MARK  
SUPPLEMENTAL REGISTER**

# EFOOTAGE

EFOOTAGE, LLC (CALIFORNIA LIMITED LIABILITY COMPANY)  
87 N. RAYMOND AVE. STE 850  
PASADENA, CA 91103

FOR: STREAMING OF AUDIO MATERIAL ON THE INTERNET; STREAMING OF VIDEO MATERIAL ON THE INTERNET, IN CLASS 38 (U.S. CLS. 100, 101 AND 104).

FIRST USE 12-1-1998; IN COMMERCE 12-1-1998.

THE MARK CONSISTS OF STANDARD CHARACTERS WITHOUT CLAIM TO ANY PARTICULAR FONT, STYLE, SIZE, OR COLOR.

OWNER OF U.S. REG. NO. 2,326,902.

SER. NO. 77-296,812, FILED P.R. 10-5-2007; AM. S.R. 7-27-2008.

GENE MACIOL, EXAMINING ATTORNEY

**Int. Cl.: 41**

**Prior U.S. Cls.: 100, 101, and 107**

**United States Patent and Trademark Office**

**Reg. No. 3,506,750**

**Registered Sep. 23, 2008**

**SERVICE MARK  
SUPPLEMENTAL REGISTER**

# EFOOTAGE

EFOOTAGE, LLC (CALIFORNIA LIMITED LIABILITY COMPANY)  
87 N. RAYMOND AVE. STE 850  
PASADENA, CA 91103

FOR: FILM DISTRIBUTION; FILM EDITING; FILM MASTERING SERVICES; VIDEO EDITING; VIDEO MASTERING SERVICES; VIDEO TAPE EDITING; PRODUCTION OF VIDEO AND CREATION OF VISUAL EFFECTS FOR OTHERS FOR USE IN DVDS, TELEVISION PROGRAMS AND ON WEBSITES; PRODUCTION OF VIDEO DISCS AND TAPES; RENTAL OF FILMS; DIGITAL VIDEO, AUDIO, AND MULTIMEDIA PUBLISHING SERVICES; MULTIMEDIA ENTERTAINMENT SERVICES IN THE NATURE OF RECORDING, PRODUCTION AND POST-PRODUCTION SERVICES IN THE

FIELDS OF MUSIC, VIDEO, AND FILMS; POST-PRODUCTION EDITING SERVICES IN THE FIELD OF MUSIC, VIDEOS AND FILMS, IN CLASS 41 (U.S. CLS. 100, 101 AND 107).

FIRST USE 12-1-1998; IN COMMERCE 12-1-1998.

THE MARK CONSISTS OF STANDARD CHARACTERS WITHOUT CLAIM TO ANY PARTICULAR FONT, STYLE, SIZE, OR COLOR.

OWNER OF U.S. REG. NO. 2,326,902.

SER. NO. 77-296,814, FILED P.R. 10-5-2007; AM. S.R. 7-25-2008.

GENE MACIOL, EXAMINING ATTORNEY

**Int. Cl.: 36**

**Prior U.S. Cls.: 100, 101, and 102**

**United States Patent and Trademark Office**

**Reg. No. 3,506,751**

**Registered Sep. 23, 2008**

**SERVICE MARK  
SUPPLEMENTAL REGISTER**

**DISASTER RECOVERY PLAN**

ACE LIMITED (CAYMAN ISLANDS CORPORATION)  
17 WOODBOURNE AVENUE  
ACE GLOBAL HEADQUARTERS  
HAMILTON, BERMUDA 08

FOR: INSURANCE SERVICES IN THE FIELD OF  
PROPERTY AND CASUALTY INSURANCE, IN  
CLASS 36 (U.S. CLS. 100, 101 AND 102).

FIRST USE 2-16-2007; IN COMMERCE 2-16-2007.

THE MARK CONSISTS OF STANDARD CHARACTERS WITHOUT CLAIM TO ANY PARTICULAR FONT, STYLE, SIZE, OR COLOR.

NO CLAIM IS MADE TO THE EXCLUSIVE RIGHT TO USE "PLAN", APART FROM THE MARK AS SHOWN.

SER. NO. 77-298,565, FILED P.R. 10-8-2007; AM. S.R. 5-21-2008.

SUZANNE BLANE, EXAMINING ATTORNEY

**Int. Cls.: 35 and 36**

**Prior U.S. Cls.: 100, 101, and 102**

**United States Patent and Trademark Office**

**Reg. No. 3,506,752**

**Registered Sep. 23, 2008**

**SERVICE MARK  
SUPPLEMENTAL REGISTER**

**PETRO CAPITAL**

PETRO CAPITAL HOLDINGS LLC (TEXAS LIMITED LIABILITY COMPANY)  
3838 OAK LAWN AVE., SUITE 1775  
DALLAS, TX 75219

FOR: BUSINESS ACQUISITION AND MERGER ADVISORY SERVICES RELATING TO ALL AREAS OF ENERGY AND ENERGY RELATED COMPANIES, IN CLASS 35 (U.S. CLS. 100, 101 AND 102).

FIRST USE 10-9-2007; IN COMMERCE 10-9-2007.

FOR: FINANCIAL VALUATIONS, FINANCIAL ADVISORY SERVICES, PRINCIPAL INVESTMENT ADVISORY SERVICES, AND MERCHANT BANKING SERVICES, ALL RELATING TO ALL AREAS OF ENERGY AND ENERGY RELATED COMPANIES AND THEIR CAPITAL STRUCTURES; BROKER-DEALER SERVICES, NAMELY, SECURITIES BROKERAGE IN THE FIELDS OF DEBT, PREFERRED AND COMMON EQUITY, OVERRIDES, NAMELY, OVERRIDING ROYALTY INTERESTS, WARRANTS, AND DERIVATIVE FINANCIAL IN-

STRUMENTS, AND OTHER YIELD ENHANCING AND REAL PROPERTY INSTRUMENTS, NAMELY, NET PROFITS INTERESTS AND RELATED INTERESTS, ALL RELATING TO ALL AREAS OF ENERGY AND ENERGY RELATED COMPANIES AND THEIR CAPITAL STRUCTURES; INVESTMENT ADVICE; INVESTMENT ADVISORY SERVICES, IN CLASS 36 (U.S. CLS. 100, 101 AND 102).

FIRST USE 10-9-2007; IN COMMERCE 10-9-2007.

THE MARK CONSISTS OF STANDARD CHARACTERS WITHOUT CLAIM TO ANY PARTICULAR FONT, STYLE, SIZE, OR COLOR.

NO CLAIM IS MADE TO THE EXCLUSIVE RIGHT TO USE "CAPITAL", APART FROM THE MARK AS SHOWN.

SER. NO. 77-299,540, FILED P.R. 10-9-2007; AM. S.R. 7-9-2008.

STEVEN R. FOSTER, EXAMINING ATTORNEY



**Int. Cls.: 35, 42, and 45**

**Prior U.S. Cls.: 100, 101, and 102**

**United States Patent and Trademark Office**

**Reg. No. 3,506,753**

**Registered Sep. 23, 2008**

**SERVICE MARK  
SUPPLEMENTAL REGISTER**

**DISCOUNTPERMIT.COM**

ACCUSESS ENVIRONMENTAL, INC. (LOUISIANA CORPORATION)  
P.O. BOX 886  
BATON ROUGE, LA 70821

FOR: ON-LINE RETAIL STORE SERVICES FEATURING EROSION CONTROL PRODUCTS, NAMELY, EROSION CONTROL FABRIC, EROSION CONTROL FENCING, AND EROSION CONTROL MATS , IN CLASS 35 (U.S. CLS. 100, 101 AND 102).

FIRST USE 8-31-2007; IN COMMERCE 8-31-2007.

FOR: CONSULTING SERVICES IN THE FIELD OF ENVIRONMENTAL COMPLIANCE AND PLANNING, IN CLASS 42 (U.S. CLS. 100 AND 101).

FIRST USE 8-31-2007; IN COMMERCE 8-31-2007.

FOR: PERMITTING, NAMELY, OBTAINING ENVIRONMENTAL PERMITS FOR DEVELOPMENT PROJECTS, IN CLASS 45 (U.S. CLS. 100 AND 101).

FIRST USE 8-31-2007; IN COMMERCE 8-31-2007.

THE MARK CONSISTS OF STANDARD CHARACTERS WITHOUT CLAIM TO ANY PARTICULAR FONT, STYLE, SIZE, OR COLOR.

SER. NO. 77-299,860, FILED P.R. 10-9-2007; AM. S.R. 7-23-2008.

MYRIAH HABEEB, EXAMINING ATTORNEY

**Int. Cl.: 41**

**Prior U.S. Cls.: 100, 101, and 107**

**United States Patent and Trademark Office**

**Reg. No. 3,506,754**

**Registered Sep. 23, 2008**

**SERVICE MARK  
SUPPLEMENTAL REGISTER**

**RADIO AND WIRELESS  
SYMPOSIUM**

THE INSTITUTE OF ELECTRICAL AND ELECTRONICS ENGINEERS, INC. (NEW YORK CORPORATION), DBA IEEE,  
445 HOES LANE  
PISCATAWAY, NJ 08855

FOR: ORGANIZATION OF CONFERENCES AND SYMPOSIA IN THE FIELD OF RADIO, WIRELESS AND RADIO FREQUENCY TECHNOLOGY, IN CLASS 41 (U.S. CLS. 100, 101 AND 107).

FIRST USE 10-20-2004; IN COMMERCE 10-20-2004.

THE MARK CONSISTS OF STANDARD CHARACTERS WITHOUT CLAIM TO ANY PARTICULAR FONT, STYLE, SIZE, OR COLOR.

NO CLAIM IS MADE TO THE EXCLUSIVE RIGHT TO USE "SYMPOSIUM", APART FROM THE MARK AS SHOWN.

SER. NO. 77-302,510, FILED P.R. 10-12-2007; AM. S.R. 7-24-2008.

JERI J. FICKES, EXAMINING ATTORNEY

**Int. Cl.: 36**

**Prior U.S. Cls.: 100, 101, and 102**

**United States Patent and Trademark Office**

**Reg. No. 3,506,755**

**Registered Sep. 23, 2008**

**SERVICE MARK  
SUPPLEMENTAL REGISTER**

**WIKI WEALTH**

DURANT, DAVID T. (UNITED STATES INDIVIDUAL)  
802 ENNIS DR  
ORANGE PARK, FL 32073

FOR: PROVIDING INFORMATION AND ADVICE IN THE FIELD OF FINANCE, FINANCIAL INVESTMENTS, FINANCIAL VALUATIONS, AND THE FINANCIAL ASPECTS OF RETIREMENT; FINANCIAL PORTFOLIO ANALYSIS SERVICES; PROVIDING ON-LINE FINANCIAL CALCULATORS, IN CLASS 36 (U.S. CLS. 100, 101 AND 102).

FIRST USE 0-0-2005; IN COMMERCE 0-0-2005.

THE MARK CONSISTS OF STANDARD CHARACTERS WITHOUT CLAIM TO ANY PARTICULAR FONT, STYLE, SIZE, OR COLOR.

SER. NO. 77-304,794, FILED P.R. 10-16-2007; AM. S.R. 7-28-2008.

TRACY WHITTAKER-BROWN, EXAMINING ATTORNEY

**Int. Cl.: 19**

**Prior U.S. Cls.: 1, 12, 33, and 50**

**United States Patent and Trademark Office**

**Reg. No. 3,506,756**

**Registered Sep. 23, 2008**

**TRADEMARK  
SUPPLEMENTAL REGISTER**

**PEST PROOF WITHOUT  
PESTICIDES**

R. H. TAMLYN & SONS, L.P. (TEXAS LIMITED  
PARTNERSHIP)  
13623 PIKE ROAD  
STAFFORD, TX 77477

THE MARK CONSISTS OF STANDARD CHAR-  
ACTERS WITHOUT CLAIM TO ANY PARTICULAR  
FONT, STYLE, SIZE, OR COLOR.

FOR: NON-METALLIC BUILDING MATERIALS,  
NAMELY PLASTIC WEEPHOLE COVERS, IN CLASS  
19 (U.S. CLS. 1, 12, 33 AND 50).

SER. NO. 77-305,772, FILED P.R. 10-17-2007; AM.  
S.R. 6-30-2008.

FIRST USE 11-14-2007; IN COMMERCE 11-14-2007.

JESSICA FATHY, EXAMINING ATTORNEY

**Int. Cl.: 40**

**Prior U.S. Cls.: 100, 103, and 106**

**United States Patent and Trademark Office**

**Reg. No. 3,506,757**

**Registered Sep. 23, 2008**

**SERVICE MARK  
SUPPLEMENTAL REGISTER**

**LOW-RISK NUCLEAR WASTE  
FORMS**

ANSTO INC. (DELAWARE CORPORATION)  
P.O. BOX 2006  
IDAHO FALLS, ID 834032006

FOR: NUCLEAR WASTE TREATMENT SERVICES, IN CLASS 40 (U.S. CLS. 100, 103 AND 106).

FIRST USE 2-0-2005; IN COMMERCE 2-0-2005.

THE MARK CONSISTS OF STANDARD CHARACTERS WITHOUT CLAIM TO ANY PARTICULAR FONT, STYLE, SIZE, OR COLOR.

NO CLAIM IS MADE TO THE EXCLUSIVE RIGHT TO USE "NUCLEAR WASTE FORMS", APART FROM THE MARK AS SHOWN.

SER. NO. 77-306,372, FILED P.R. 10-17-2007; AM. S.R. 7-30-2008.

JASON LOTT, EXAMINING ATTORNEY

**Int. Cl.: 35**

**Prior U.S. Cls.: 100, 101, and 102**

**United States Patent and Trademark Office**

**Reg. No. 3,506,758**

**Registered Sep. 23, 2008**

**SERVICE MARK  
SUPPLEMENTAL REGISTER**

**MEDICAL BENEFITS PLAN  
SCORECARD**

THE CHELKO CONSULTING GROUP, LLC  
(OHIO LIMITED LIABILITY COMPANY)  
SUITE 201  
27500 DETROIT ROAD  
WESTLAKE, OH 44145

FOR: BUSINESS SERVICES, NAMELY, TRACK-  
ING, COMPARING AND MONITORING EMPLOY-  
EE COST ITEMS FOR OTHERS, IN CLASS 35 (U.S.  
CLS. 100, 101 AND 102).

FIRST USE 9-12-2006; IN COMMERCE 9-12-2006.

THE MARK CONSISTS OF STANDARD CHAR-  
ACTERS WITHOUT CLAIM TO ANY PARTICULAR  
FONT, STYLE, SIZE, OR COLOR.

SER. NO. 77-306,570, FILED P.R. 10-17-2007; AM.  
S.R. 8-12-2008.

SUSAN STIGLITZ, EXAMINING ATTORNEY

**Int. Cl.: 40**

**Prior U.S. Cls.: 100, 103, and 106**

**United States Patent and Trademark Office**

**Reg. No. 3,506,759**

**Registered Sep. 23, 2008**

**SERVICE MARK  
SUPPLEMENTAL REGISTER**

**LOW-RISK NUCLEAR WASTE  
FORMS**

ANSTO INC. (DELAWARE CORPORATION)

P. O. BOX 2006

IDAHO FALLS, ID 834032006

FOR: TECHNICAL CONSULTATION SERVICES  
IN THE FIELD OF NUCLEAR WASTE TREAT-  
MENT, IN CLASS 40 (U.S. CLS. 100, 103 AND 106).

FIRST USE 2-0-2005; IN COMMERCE 2-0-2005.

THE MARK CONSISTS OF STANDARD CHAR-  
ACTERS WITHOUT CLAIM TO ANY PARTICULAR  
FONT, STYLE, SIZE, OR COLOR.

NO CLAIM IS MADE TO THE EXCLUSIVE  
RIGHT TO USE "NUCLEAR WASTE FORMS",  
APART FROM THE MARK AS SHOWN.

SER. NO. 77-307,150, FILED P.R. 10-18-2007; AM.  
S.R. 7-30-2008.

JASON LOTT, EXAMINING ATTORNEY

**Int. Cl.: 16**

**Prior U.S. Cls.: 2, 5, 22, 23, 29, 37, 38, and 50**

**Reg. No. 3,506,760**

**United States Patent and Trademark Office**

**Registered Sep. 23, 2008**

**TRADEMARK  
SUPPLEMENTAL REGISTER**

# The Dancer's Deck

THIBODEAU, KYRA D P (UNITED STATES INDIVIDUAL)

7582 LAS VEGAS BLVD SOUTH, #346  
LAS VEGAS, NV 891231060 AND

PARKER, LISA NICOLE THIBODEAU (UNITED STATES INDIVIDUAL)

7582 LAS VEGAS BLVD SOUTH, #346  
LAS VEGAS, NV 891231060

FOR: EDUCATIONAL PUBLICATIONS, NAME-  
LY, EDUCATIONAL LEARNING CARDS AND  
FLASH CARDS IN THE FIELD OF DANCE IN-  
STRUCTION, IN CLASS 16 (U.S. CLS. 2, 5, 22, 23, 29,  
37, 38 AND 50).

FIRST USE 1-8-2008; IN COMMERCE 4-5-2008.

THE MARK CONSISTS OF STANDARD CHAR-  
ACTERS WITHOUT CLAIM TO ANY PARTICULAR  
FONT, STYLE, SIZE, OR COLOR.

NO CLAIM IS MADE TO THE EXCLUSIVE  
RIGHT TO USE "DECK", APART FROM THE  
MARK AS SHOWN.

SER. NO. 77-309,409, FILED P.R. 10-21-2007; AM.  
S.R. 8-15-2008.

TOBY BULLOFF, EXAMINING ATTORNEY



**Int. Cl.: 9**

**Prior U.S. Cls.: 21, 23, 26, 36, and 38**

**United States Patent and Trademark Office**

**Reg. No. 3,506,761**

**Registered Sep. 23, 2008**

**TRADEMARK  
SUPPLEMENTAL REGISTER**

# HELIX ARRAY

TARA LABS, INC. (OREGON CORPORATION)  
550 CLOVER LANE  
ASHLAND, OR 97520

FOR: CABLE CONNECTORS; CABLES AND FIBRES FOR THE TRANSMISSION OF SOUNDS AND IMAGES; CABLES FOR ELECTRICAL AND OPTICAL SIGNAL TRANSMISSION SYSTEMS; CABLES FOR ELECTRICAL OR OPTICAL SIGNAL TRANSMISSION; CABLES FOR OPTICAL SIGNAL TRANSMISSION; COAXIAL CABLES; COAXIAL CABLES INCORPORATING FILTERS; CONNECTING ELECTRICAL CABLES; CONNECTION CABLES; ELECTRIC CABLES; ELECTRIC WIRE AND CABLE; ELECTRIC WIRES AND CABLES; ELECTRICAL CABLES; ELECTRICAL CABLES FOR USE IN CONNECTIONS; ELECTRONIC CABLES; EXTENSION CABLES; FIBER OPTIC CABLES; GUITAR CABLES;

MICROPHONE CABLES; OPTICAL CABLES; OPTICAL FIBER CABLES; POWER CABLES; STEREO CABLES; TELECOMMUNICATION CABLES; TELECOMMUNICATIONS CABLES; THREADED CABLE CONNECTORS OF METAL, IN CLASS 9 (U.S. CLS. 21, 23, 26, 36 AND 38).

FIRST USE 1-0-1988; IN COMMERCE 1-0-1988.

THE MARK CONSISTS OF STANDARD CHARACTERS WITHOUT CLAIM TO ANY PARTICULAR FONT, STYLE, SIZE, OR COLOR.

SER. NO. 77-311,512, FILED P.R. 10-23-2007; AM. S.R. 7-12-2008.

DAVID TAYLOR, EXAMINING ATTORNEY

**Int. Cls.: 35 and 41**

**Prior U.S. Cls.: 100, 101, 102, and 107**

**United States Patent and Trademark Office**

**Reg. No. 3,506,762**

**Registered Sep. 23, 2008**

**SERVICE MARK  
SUPPLEMENTAL REGISTER**

# THE LEAGUE

COMMUNITY LEAGUE, INC. (NEW JERSEY CORPORATION)  
35 JAMES STREET  
NEWARK, NJ 071022016

FOR: CHARITABLE SERVICES, NAMELY, ORGANIZING SCHOOL AGE CHILDREN TO UNDERTAKE COMMUNITY SERVICE PROJECTS, IN CLASS 35 (U.S. CLS. 100, 101 AND 102).

FIRST USE 4-30-2007; IN COMMERCE 6-30-2007.

FOR: EDUCATION SERVICES, NAMELY, PROVIDING PROGRAMS THAT PROMOTE COMMU-

NITY SERVICE TO SCHOOL AGE CHILDREN, IN CLASS 41 (U.S. CLS. 100, 101 AND 107).

FIRST USE 4-30-2007; IN COMMERCE 6-30-2007.

THE MARK CONSISTS OF STANDARD CHARACTERS WITHOUT CLAIM TO ANY PARTICULAR FONT, STYLE, SIZE, OR COLOR.

SER. NO. 77-312,377, FILED P.R. 10-24-2007; AM. S.R. 8-1-2008.

DANIEL CAPSHAW, EXAMINING ATTORNEY

**Int. Cl.: 35**

**Prior U.S. Cls.: 100, 101, and 102**

**United States Patent and Trademark Office**

**Reg. No. 3,506,763**

**Registered Sep. 23, 2008**

**SERVICE MARK  
SUPPLEMENTAL REGISTER**

**ELECTRICAL INDUSTRIES**

ELECTRICAL INDUSTRIES (MICHIGAN CORPORATION)

5641 SCHAEFER RD

DEARBORN, MI 48126

FOR: WHOLESALE DISTRIBUTORSHIP SERVICES FEATURING ELECTRICAL SUPPLIES, IN CLASS 35 (U.S. CLS. 100, 101 AND 102).

FIRST USE 8-21-2007; IN COMMERCE 8-21-2007.

THE MARK CONSISTS OF STANDARD CHARACTERS WITHOUT CLAIM TO ANY PARTICULAR FONT, STYLE, SIZE, OR COLOR.

NO CLAIM IS MADE TO THE EXCLUSIVE RIGHT TO USE "INDUSTRIES", APART FROM THE MARK AS SHOWN.

SER. NO. 77-313,076, FILED P.R. 10-25-2007; AM. S.R. 8-14-2008.

DAWN FELDMAN, EXAMINING ATTORNEY

**Int. Cl.: 28**

**Prior U.S. Cls.: 22, 23, 38, and 50**

**United States Patent and Trademark Office**

**Reg. No. 3,506,764**

**Registered Sep. 23, 2008**

**TRADEMARK  
SUPPLEMENTAL REGISTER**

**Doggy Tug**

DOGGY TUG, INC. (TEXAS CORPORATION)  
5017 BRIAR TREE DRIVE  
DALLAS, TX 75248

FOR: DOG TOYS, IN CLASS 28 (U.S. CLS. 22, 23, 38  
AND 50).

FIRST USE 12-15-2007; IN COMMERCE 12-15-2007.

THE MARK CONSISTS OF STANDARD CHAR-  
ACTERS WITHOUT CLAIM TO ANY PARTICULAR  
FONT, STYLE, SIZE, OR COLOR.

NO CLAIM IS MADE TO THE EXCLUSIVE  
RIGHT TO USE "TUG", APART FROM THE MARK  
AS SHOWN.

SER. NO. 77-313,397, FILED P.R. 10-25-2007; AM.  
S.R. 8-1-2008.

MARY ROSSMAN, EXAMINING ATTORNEY

**Int. Cl.: 11**

**Prior U.S. Cls.: 13, 21, 23, 31, and 34**

**United States Patent and Trademark Office**

**Reg. No. 3,506,765**

**Registered Sep. 23, 2008**

**TRADEMARK  
SUPPLEMENTAL REGISTER**

# Midili

HOMER TLC, INC. (DELAWARE CORPORATION)  
1404 SOCIETY DRIVE  
CLAYMONT, DE 19703

THE MARK CONSISTS OF STANDARD CHARACTERS WITHOUT CLAIM TO ANY PARTICULAR FONT, STYLE, SIZE, OR COLOR.

FOR: CEILING FANS; ELECTRIC LIGHTING FIXTURES, IN CLASS 11 (U.S. CLS. 13, 21, 23, 31 AND 34).

SER. NO. 77-313,699, FILED P.R. 10-25-2007; AM. S.R. 8-7-2008.

FIRST USE 1-0-2008; IN COMMERCE 1-0-2008.

MELVIN AXILBUND, EXAMINING ATTORNEY

**Int. Cl.: 43**

**Prior U.S. Cls.: 100 and 101**

**United States Patent and Trademark Office**

**Reg. No. 3,506,766**

**Registered Sep. 23, 2008**

**SERVICE MARK  
SUPPLEMENTAL REGISTER**

# MacAllisters

RONNEY ENTERPRISES, INC. (FLORIDA CORPORATION), DBA DOING BUSINESS AS MACALLISTERS GRILL & TAVERN,  
8110 LAKEWOOD MAIN STREET  
BRADENTON, FL 34202

FOR: CAFE-RESTAURANTS; PROVISION OF FOOD AND DRINK IN RESTAURANTS; RESTAURANTS, IN CLASS 43 (U.S. CLS. 100 AND 101).

FIRST USE 7-1-2007; IN COMMERCE 7-1-2007.

THE MARK CONSISTS OF STANDARD CHARACTERS WITHOUT CLAIM TO ANY PARTICULAR FONT, STYLE, SIZE, OR COLOR.

SER. NO. 77-314,427, FILED P.R. 10-26-2007; AM. S.R. 8-1-2008.

SUSAN LESLIE DUBOIS, EXAMINING ATTORNEY

**Int. Cl.: 35**

**Prior U.S. Cls.: 100, 101, and 102**

**United States Patent and Trademark Office**

**Reg. No. 3,506,767**

**Registered Sep. 23, 2008**

**SERVICE MARK  
SUPPLEMENTAL REGISTER**

# CEOmeetings

CEOMEETINGS (MARYLAND LIMITED LIABILITY COMPANY)  
1421 CLARKVIEW ROAD, SUITE 208  
BALTIMORE, MD 21209

FOR: ONLINE BUSINESS MEETING SERVICES, NAMELY, PLANNING, SCHEDULING, AND COORDINATING BUSINESS MEETINGS, AND COLLECTING AND DISSEMINATING INFORMATION FOR ESTABLISHING AND FACILITATING BUSINESS MEETINGS, IN CLASS 35 (U.S. CLS. 100, 101 AND 102).

FIRST USE 11-27-2007; IN COMMERCE 11-27-2007.

THE MARK CONSISTS OF STANDARD CHARACTERS WITHOUT CLAIM TO ANY PARTICULAR FONT, STYLE, SIZE, OR COLOR.

SER. NO. 77-315,930, FILED P.R. 10-29-2007; AM. S.R. 8-6-2008.

JORDAN BAKER, EXAMINING ATTORNEY

**Int. Cl.: 14**

**Prior U.S. Cls.: 2, 27, 28, and 50**

**United States Patent and Trademark Office**

**Reg. No. 3,506,768**

**Registered Sep. 23, 2008**

**TRADEMARK  
SUPPLEMENTAL REGISTER**

**America's Trusted Coin  
Source**

JOHN MABEN RARE COINS, INC. (FLORIDA  
CORPORATION)  
5565 BROADCAST CT  
SARASOTA, FL 34240

FOR: COLLECTIBLE COINS; COMMEMORATIVE  
COINS; MONETARY COIN SETS FOR COLLECT-  
ING PURPOSES; NON-MONETARY COINS, IN  
CLASS 14 (U.S. CLS. 2, 27, 28 AND 50).

FIRST USE 5-6-2008; IN COMMERCE 5-6-2008.

THE MARK CONSISTS OF STANDARD CHAR-  
ACTERS WITHOUT CLAIM TO ANY PARTICULAR  
FONT, STYLE, SIZE, OR COLOR.

NO CLAIM IS MADE TO THE EXCLUSIVE  
RIGHT TO USE "COIN", APART FROM THE MARK  
AS SHOWN.

SER. NO. 77-318,963, FILED P.R. 11-1-2007; AM. S.R.  
8-6-2008.

REBECCA GILBERT, EXAMINING ATTORNEY



**Int. Cl.: 28**

**Prior U.S. Cls.: 22, 23, 38, and 50**

**United States Patent and Trademark Office**

**Reg. No. 3,506,769**

**Registered Sep. 23, 2008**

**TRADEMARK  
SUPPLEMENTAL REGISTER**

# Hunter Safety Pants

HAJARI KHOSRO B. (UNITED STATES INDIVIDUAL), DBA TREE APRON INC.,  
WWW.TREEAPRON.COM  
3353 GRASSGLAN PLACE  
WESLEY CHAPEL, FL 33544

FOR: HARNESSSES FOR SPORTS PURPOSES,  
NAMELY, SAFETY HARNESSSES FOR HUNTERS,  
IN CLASS 28 (U.S. CLS. 22, 23, 38 AND 50).

FIRST USE 11-8-2007; IN COMMERCE 4-25-2008.

THE MARK CONSISTS OF STANDARD CHARACTERS WITHOUT CLAIM TO ANY PARTICULAR FONT, STYLE, SIZE, OR COLOR.

NO CLAIM IS MADE TO THE EXCLUSIVE RIGHT TO USE "SAFETY PANTS", APART FROM THE MARK AS SHOWN.

SER. NO. 77-324,565, FILED P.R. 11-8-2007; AM. S.R. 8-8-2008.

KATHY DE JONGE, EXAMINING ATTORNEY

**Int. Cls.: 35 and 36**

**Prior U.S. Cls.: 100, 101, and 102**

**United States Patent and Trademark Office**

**Reg. No. 3,506,770**

**Registered Sep. 23, 2008**

**SERVICE MARK  
SUPPLEMENTAL REGISTER**

**CATHOLIC LOYALTY**

HELP WORLDWIDE, INC (DELAWARE CORPORATION)  
24254 MAIN STREET  
NEWHALL, CA 91321

FOR: MANAGING AND ADMINISTERING A PRIVATE BRANDED CUSTOMER LOYALTY PROGRAM AIMED AT PROMOTING AND REWARDING LOYALTY AND CATHOLIC AWARENESS THROUGH THE DISTRIBUTION AND ADMINISTRATION OF PRIVILEGED USER CARDS, IN CLASS 35 (U.S. CLS. 100, 101 AND 102).

FIRST USE 3-1-2007; IN COMMERCE 4-11-2007.

FOR: PROVIDING REBATES AT PARTICIPATING ESTABLISHMENTS THROUGH THE USE OF A LOYALTY MEMBERSHIP CARD; PROVIDING

CHARITABLE FUND RAISING SERVICES, NAME-  
LY, BY PROVIDING MEMBERS OF ITS LOYALTY  
PROGRAM WITH THE INFORMATION AND OP-  
PORTUNITY TO MAKE MONETARY DONATIONS  
TO CATHOLIC CHARITIES AND INSTITUTIONS,  
IN CLASS 36 (U.S. CLS. 100, 101 AND 102).

FIRST USE 3-1-2007; IN COMMERCE 9-1-2007.

THE MARK CONSISTS OF STANDARD CHAR-  
ACTERS WITHOUT CLAIM TO ANY PARTICULAR  
FONT, STYLE, SIZE, OR COLOR.

SER. NO. 77-324,810, FILED P.R. 11-8-2007; AM. S.R.  
7-29-2008.

LINDA ORNDORFF, EXAMINING ATTORNEY

Int. Cl.: 25

Prior U.S. Cls.: 22 and 39

United States Patent and Trademark Office

Reg. No. 3,506,771

Registered Sep. 23, 2008

**TRADEMARK  
SUPPLEMENTAL REGISTER**

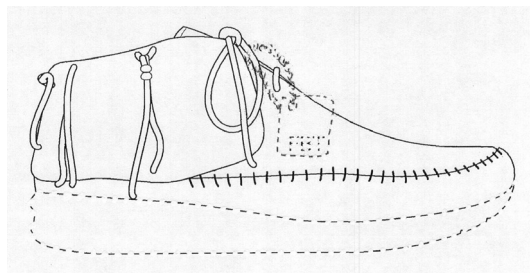

CUBISM, INC. (JAPAN CORPORATION)  
HIGASHIYAMA, MEGURO-KU  
OSAWA BUILDING, 3-3-10  
TOKYO, JAPAN

FOR: SHOES, IN CLASS 25 (U.S. CLS. 22 AND 39).

FIRST USE 4-1-2005; IN COMMERCE 4-1-2005.

THE MARK CONSISTS OF THE DESIGN OF A SHOE, WHEREBY NO CLAIM IS MADE TO THE SOLE OF THE SHOE OR THE HANG TAG HANGING FROM THE LACES AND TONGUE AREA. THE

SHOE IS MOCCASIN-STYLE WITH DECORATIVE STITCHING AROUND THE SIDES AND TOE AREA. THERE ARE DECORATIVE LACES HANGING FROM THE SIDES AND BACK OF THE SHOE, AND SOME OF THE LACES HAVE TWO PLASTIC BEADS KNOTTED AT THE TOP. THE LACES HANG ALMOST TO THE TOP OF THE SOLE, ALONG A DECORATIVE LEATHER FLAP.

SER. NO. 77-329,392, FILED P.R. 11-14-2007; AM. S.R. 8-11-2008.

TOBY BULLOFF, EXAMINING ATTORNEY

**Int. Cl.: 36**

**Prior U.S. Cls.: 100, 101, and 102**

**United States Patent and Trademark Office**

**Reg. No. 3,506,772**

**Registered Sep. 23, 2008**

**SERVICE MARK  
SUPPLEMENTAL REGISTER**

**ECONDISC**

FEDERAL RESERVE BANK OF ST. LOUIS (UNI-  
TED STATES FEDERALLY CHARTERED  
CORPORATION)  
P.O. BOX 442  
ST. LOUIS, MO 631660442

FOR: PROVIDING AN INTERACTIVE WEBSITE  
FOR CONDUCTING RESEARCH IN THE FIELD OF  
ECONOMICS, FINANCE, BANKING, AND THE  
FEDERAL RESERVE SYSTEM , IN CLASS 36 (U.S.  
CLS. 100, 101 AND 102).

FIRST USE 11-1-2007; IN COMMERCE 11-1-2007.

THE MARK CONSISTS OF STANDARD CHAR-  
ACTERS WITHOUT CLAIM TO ANY PARTICULAR  
FONT, STYLE, SIZE, OR COLOR.

SER. NO. 77-341,456, FILED P.R. 11-30-2007; AM.  
S.R. 7-22-2008.

KATHRYN COWARD, EXAMINING ATTORNEY

**Int. Cl.: 30**

**Prior U.S. Cl.: 46**

**United States Patent and Trademark Office**

**Reg. No. 3,506,773**

**Registered Sep. 23, 2008**

**TRADEMARK  
SUPPLEMENTAL REGISTER**

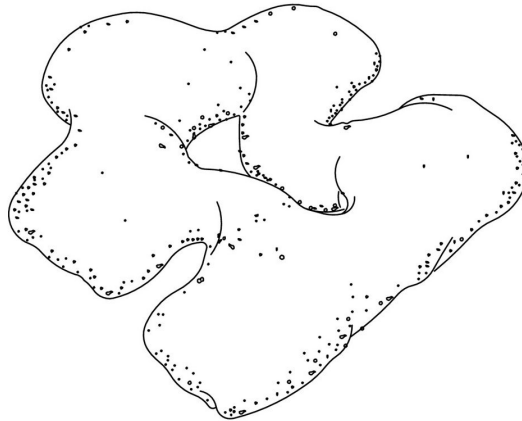

THE BACHMAN COMPANY (PENNSYLVANIA  
CORPORATION)  
ONE PARK PLAZA  
WYOMISSING, PA 19610

THE MARK CONSISTS OF A CONFIGURATION  
OF THE GOODS IN THE SHAPE OF A JIGSAW  
PUZZLE.

FOR: PRETZELS, IN CLASS 30 (U.S. CL. 46).

SER. NO. 77-343,788, FILED P.R. 12-4-2007; AM. S.R.  
6-9-2008.

FIRST USE 2-25-2008; IN COMMERCE 2-25-2008.

THE STIPPLING IS A FEATURE OF THE MARK.

EVELYN BRADLEY, EXAMINING ATTORNEY

**Int. Cl.: 41**

**Prior U.S. Cls.: 100, 101, and 107**

**United States Patent and Trademark Office**

**Reg. No. 3,506,774**

**Registered Sep. 23, 2008**

**SERVICE MARK  
SUPPLEMENTAL REGISTER**

**AMERICA'S BEST DANCE CREW**

WARNER BROS. ENTERTAINMENT INC. (DE-  
LAWARE CORPORATION)  
4000 WARNER BOULEVARD  
BURBANK, CA 91522

FOR: ENTERTAINMENT SERVICES IN THE  
NATURE OF LIVE-ACTION, COMEDY AND DRA-  
MA TELEVISION SERIES; PRODUCTION OF LIVE-  
ACTION, COMEDY AND DRAMA TELEVISION  
SERIES; PROVIDING NEWS ABOUT CURRENT  
EVENTS AND ENTERTAINMENT, AND INFOR-  
MATION RELATED TO EDUCATION AND CUL-  
TURAL EVENTS, VIA A GLOBAL COMPUTER  
NETWORK; AND PROVIDING INFORMATION  
FOR AND ACTUAL ENTERTAINMENT VIA AN

ELECTRONIC GLOBAL COMMUNICATIONS NET-  
WORK IN THE NATURE OF LIVE-ACTION, COME-  
DY AND DRAMA PROGRAMS, IN CLASS 41 (U.S.  
CLS. 100, 101 AND 107).

FIRST USE 1-26-2008; IN COMMERCE 1-26-2008.

THE MARK CONSISTS OF STANDARD CHAR-  
ACTERS WITHOUT CLAIM TO ANY PARTICULAR  
FONT, STYLE, SIZE, OR COLOR.

SER. NO. 77-346,181, FILED P.R. 12-6-2007; AM. S.R.  
7-21-2008.

PAUL CROWLEY, EXAMINING ATTORNEY

**Int. Cl.: 16**

**Prior U.S. Cls.: 2, 5, 22, 23, 29, 37, 38, and 50**

**United States Patent and Trademark Office**

**Reg. No. 3,506,775**

**Registered Sep. 23, 2008**

**TRADEMARK  
SUPPLEMENTAL REGISTER**

**TEAM EMOTIONAL AND SOCIAL  
INTELLIGENCE SURVEY**

COLLABORATIVE GROWTH, L.L.C. (COLORADO LIMITED LIABILITY COMPANY)

P.O. BOX 17509

GOLDEN, CO 80402

FOR: BUSINESS FORMS, NAMELY, TEAM AND TEAM MEMBER PERFORMANCE SURVEYS, IN CLASS 16 (U.S. CLS. 2, 5, 22, 23, 29, 37, 38 AND 50).

FIRST USE 11-22-2006; IN COMMERCE 11-22-2006.

THE MARK CONSISTS OF STANDARD CHARACTERS WITHOUT CLAIM TO ANY PARTICULAR FONT, STYLE, SIZE, OR COLOR.

NO CLAIM IS MADE TO THE EXCLUSIVE RIGHT TO USE "SURVEY", APART FROM THE MARK AS SHOWN.

SER. NO. 77-347,332, FILED P.R. 12-8-2007; AM. S.R. 8-10-2008.

CARRIE GENOVESE, EXAMINING ATTORNEY

**Int. Cl.: 25**

**Prior U.S. Cls.: 22 and 39**

**United States Patent and Trademark Office**

**Reg. No. 3,506,776**

**Registered Sep. 23, 2008**

**TRADEMARK  
SUPPLEMENTAL REGISTER**

**Lotus Clothing Company**

WOODS, HEIDI, AS PARENT OF MINOR,  
WOODS III, CHARLES A. (UNITED STATES  
INDIVIDUAL)  
1157 KILBERY AVE  
NORTH AURORA, IL 60542

FOR: KNIT SHIRTS; PIQUE SHIRTS; RUGBY  
SHIRTS; SHIRTS; SHORT-SLEEVED OR LONG-  
SLEEVED T-SHIRTS; SHORT-SLEEVED SHIRTS;  
SLEEP SHIRTS; SPORT SHIRTS; SPORTS SHIRTS;  
SWEAT SHIRTS; YOGA SHIRTS, IN CLASS 25 (U.S.  
CLS. 22 AND 39).

FIRST USE 6-1-2007; IN COMMERCE 6-1-2007.

THE MARK CONSISTS OF STANDARD CHAR-  
ACTERS WITHOUT CLAIM TO ANY PARTICULAR  
FONT, STYLE, SIZE, OR COLOR.

NO CLAIM IS MADE TO THE EXCLUSIVE  
RIGHT TO USE "CLOTHING COMPANY", APART  
FROM THE MARK AS SHOWN.

SER. NO. 77-352,929, FILED 12-14-2007.

BRIAN CALLAGHAN, EXAMINING ATTORNEY



**Int. Cl.: 41**

**Prior U.S. Cls.: 100, 101, and 107**

**United States Patent and Trademark Office**

**Reg. No. 3,506,777**

**Registered Sep. 23, 2008**

**SERVICE MARK  
SUPPLEMENTAL REGISTER**

**MILLION**  
  
**BINGO**

STATION CASINOS, INC. (NEVADA CORPORATION)  
1505 S. PAVILION CENTER DRIVE  
LAS VEGAS, NV 89135

FOR: ENTERTAINMENT IN THE NATURE OF  
CASINO SERVICES, IN CLASS 41 (U.S. CLS. 100, 101  
AND 107).

FIRST USE 1-1-2008; IN COMMERCE 1-1-2008.

NO CLAIM IS MADE TO THE EXCLUSIVE  
RIGHT TO USE "BINGO", APART FROM THE  
MARK AS SHOWN.

THE MARK CONSISTS OF THE WORD "MIL-  
LION" UNDERLINED WITH THE WORD "BINGO"  
BELOW FEATURING THE DOLLAR SIGN CHAR-  
ACTER "\$" SUPERIMPOSED WITH A CIRCLE  
AROUND IT.

SER. NO. 77-359,121, FILED P.R. 12-24-2007; AM.  
S.R. 7-29-2008.

MICHAEL SOUDERS, EXAMINING ATTORNEY

**Int. Cls.: 35 and 41**

**Prior U.S. Cls.: 100, 101, 102, and 107**

**United States Patent and Trademark Office**

**Reg. No. 3,506,778**

**Registered Sep. 23, 2008**

**SERVICE MARK  
SUPPLEMENTAL REGISTER**

**HEINEMANN**

GEBR. HEINEMANN KG (FED REP GERMANY  
KOMMANDITGESELLSCHAFT (KG))  
MAGDEBURGER STRASSE 3  
20457 HAMBURG, FED REP GERMANY

FOR: RETAIL STORE SERVICES FEATURING  
TOBACCO PRODUCTS, COSMETICS AND PER-  
FUMERY, ALCOHOLIC BEVERAGES, CLOTHING,  
CLOTHING ACCESSORIES, GIFT ARTICLES, LIFE-  
STYLE ACCESSORIES AND TOYS, IN CLASS 35  
(U.S. CLS. 100, 101 AND 102).

FOR: ENTERTAINMENT TICKET AGENCY SER-  
VICES, IN CLASS 41 (U.S. CLS. 100, 101 AND 107).

THE MARK CONSISTS OF STANDARD CHAR-  
ACTERS WITHOUT CLAIM TO ANY PARTICULAR  
FONT, STYLE, SIZE, OR COLOR.

OWNER OF ERPN CMNTY TM OFC REG. NO.  
005215868, DATED 5-21-2007, EXPIRES 7-24-2016.

OWNER OF ERPN CMNTY TM OFC REG. NO.  
005215868, DATED 5-21-2007, EXPIRES 7-24-2016.

SER. NO. 77-399,591, FILED P.R. 2-18-2008; AM. S.R.  
8-12-2008.

CURTIS FRENCH, EXAMINING ATTORNEY

**Int. Cl.: 35**

**Prior U.S. Cls.: 100, 101, and 102**

**United States Patent and Trademark Office**

**Reg. No. 3,506,779**

**Registered Sep. 23, 2008**

**SERVICE MARK  
SUPPLEMENTAL REGISTER**

**Securing America's  
Critical Infrastructure**

INFRASTRUCTURE SECURITY, INC. (TEXAS CORPORATION)  
747 NORTH SHEPHERD, SUITE 800  
HOUSTON, TX 77007

FOR: CONSULTANCY SERVICES REGARDING BUSINESS STRATEGIES, BEING IN PARTICULAR COMMERCIAL ASSISTANCE RELATING TO SYSTEM IMPLEMENTATION AND SYSTEM INTEGRATION, AND MANAGEMENT AND BUSINESS CONSULTING SERVICES IN THE FIELD OF CRITICAL INFRASTRUCTURE, IN CLASS 35 (U.S. CLS. 100, 101 AND 102).

FIRST USE 6-15-2006; IN COMMERCE 6-15-2006.

THE MARK CONSISTS OF STANDARD CHARACTERS WITHOUT CLAIM TO ANY PARTICULAR FONT, STYLE, SIZE, OR COLOR.

SER. NO. 77-401,635, FILED 2-20-2008.

JENNIFER DIXON, EXAMINING ATTORNEY

**Int. Cl.: 35**

**Prior U.S. Cls.: 100, 101, and 102**

**United States Patent and Trademark Office**

**Reg. No. 3,506,780**

**Registered Sep. 23, 2008**

**SERVICE MARK  
SUPPLEMENTAL REGISTER**

**Securing Critical  
Infrastructure Worldwide**

INFRASTRUCTURE SECURITY, INC. (TEXAS CORPORATION)  
747 NORTH SHEPHERD, SUITE 800  
HOUSTON, TX 77007

FOR: CONSULTANCY SERVICES REGARDING BUSINESS STRATEGIES, BEING IN PARTICULAR COMMERCIAL ASSISTANCE RELATING TO SYSTEM IMPLEMENTATION AND SYSTEM INTEGRATION, MANAGEMENT, AND BUSINESS CONSULTING SERVICES IN THE FIELD OF WORLDWIDE CRITICAL INFRASTRUCTURE, IN CLASS 35 (U.S. CLS. 100, 101 AND 102).

FIRST USE 6-15-2006; IN COMMERCE 6-15-2006.

THE MARK CONSISTS OF STANDARD CHARACTERS WITHOUT CLAIM TO ANY PARTICULAR FONT, STYLE, SIZE, OR COLOR.

SER. NO. 77-401,690, FILED 2-20-2008.

JENNIFER DIXON, EXAMINING ATTORNEY

**Int. Cl.: 25**

**Prior U.S. Cls.: 22 and 39**

**United States Patent and Trademark Office**

**Reg. No. 3,506,781**

**Registered Sep. 23, 2008**

**TRADEMARK  
SUPPLEMENTAL REGISTER**

**SYNIKAL HARDWEAR**

THE LUIS AND ALEXIS CHAVEZ PARTNER-  
SHIP (CALIFORNIA PARTNERSHIP), DBA  
SYNIKAL HARDWEAR,  
5150 N. BISHOP AVE  
FRESNO, CA 93723

FOR: CLOTHING, NAMELY, HATS, BELTS FOR  
PANTS, PANTS, SHORTS, SHORT SETS, CAPRI  
PANTS, T-SHIRTS, TANK TOPS, THONG PANTIES,  
PANTIES, MEN'S UNDERWEAR, WOMEN'S UN-  
DERWEAR; YOUTH CLOTHING, CHILDREN'S  
CLOTHES, AND INFANT CLOTHES, NAMELY,  
ONE PIECE CLOTHING, T-SHIRTS, INFANT  
PANTS, CLOTH BIBS, INFANT HATS, INFANT  
SOCKS; CLOTHING, NAMELY, JERSEYS, BEANIES,  
SKULL CAPS, A-SHIRTS, SOCKS, TENNIS SHOES,

MITTENS, SCARVES, HOODED SWEATSHIRT,  
SWEAT SHIRTS, SWEATERS, POLO SHIRTS, LONG  
SLEEVE SHIRTS, JACKETS, WIND RESISTANT  
JACKET, BOARD SHORTS, IN CLASS 25 (U.S. CLS.  
22 AND 39).

FIRST USE 5-8-2007; IN COMMERCE 6-1-2007.

THE MARK CONSISTS OF STANDARD CHAR-  
ACTERS WITHOUT CLAIM TO ANY PARTICULAR  
FONT, STYLE, SIZE, OR COLOR.

SER. NO. 77-410,664, FILED 3-2-2008.

ZACHARY BELLO, EXAMINING ATTORNEY

**Int. Cl.: 35**

**Prior U.S. Cls.: 100, 101, and 102**

**United States Patent and Trademark Office**

**Reg. No. 3,506,782**

**Registered Sep. 23, 2008**

**SERVICE MARK  
SUPPLEMENTAL REGISTER**

**office locator**

OFFICE LOCATOR INC. (FLORIDA CORPORATION)

#121A  
1919 VAN BUREN ST.  
HOLLYWOOD, FL 33020

FOR: MATCHING CONSUMERS WITH REAL ESTATE PROFESSIONALS IN THE FIELD OF REAL ESTATE SERVICES VIA COMPUTER NETWORK, IN CLASS 35 (U.S. CLS. 100, 101 AND 102).

FIRST USE 9-1-2007; IN COMMERCE 9-1-2007.

THE MARK CONSISTS OF STANDARD CHARACTERS WITHOUT CLAIM TO ANY PARTICULAR FONT, STYLE, SIZE, OR COLOR.

SER. NO. 77-414,711, FILED P.R. 3-6-2008; AM. S.R. 7-21-2008.

TRACY WHITTAKER-BROWN, EXAMINING ATTORNEY

**Int. Cl.: 35**

**Prior U.S. Cls.: 100, 101, and 102**

**United States Patent and Trademark Office**

**Reg. No. 3,506,783**

**Registered Sep. 23, 2008**

**SERVICE MARK  
SUPPLEMENTAL REGISTER**

**Carmel Valley Art  
Association**

ALIOTTI, SHELLEY A. (UNITED STATES INDIVIDUAL)  
13766 CENTER STREET  
CARMEL VALLEY, CA 93924

FOR: ART GALLERY AND ASSOCIATION SERVICES, NAMELY, PROMOTING THE INTERESTS OF ARTISTS, IN CLASS 35 (U.S. CLS. 100, 101 AND 102).

FIRST USE 8-11-2006; IN COMMERCE 8-11-2006.

THE MARK CONSISTS OF STANDARD CHARACTERS WITHOUT CLAIM TO ANY PARTICULAR FONT, STYLE, SIZE, OR COLOR.

NO CLAIM IS MADE TO THE EXCLUSIVE RIGHT TO USE "ART ASSOCIATION", APART FROM THE MARK AS SHOWN.

SER. NO. 77-415,341, FILED P.R. 3-6-2008; AM. S.R. 7-22-2008.

MARTHA FROMM, EXAMINING ATTORNEY

**Int. Cl.: 31**

**Prior U.S. Cls.: 1 and 46**

**United States Patent and Trademark Office**

**Reg. No. 3,506,784**

**Registered Sep. 23, 2008**

**TRADEMARK  
SUPPLEMENTAL REGISTER**

**K9 JERKY**

KAREN KU (UNITED STATES INDIVIDUAL),  
DBA K9 JERKY,  
216 S. 5TH AVE.,  
MONROVIA, CA 91016

FOR: DOG TREATS, IN CLASS 31 (U.S. CLS. 1  
AND 46).

FIRST USE 9-1-2007; IN COMMERCE 9-1-2007.

THE MARK CONSISTS OF STANDARD CHAR-  
ACTERS WITHOUT CLAIM TO ANY PARTICULAR  
FONT, STYLE, SIZE, OR COLOR.

NO CLAIM IS MADE TO THE EXCLUSIVE  
RIGHT TO USE "JERKY", APART FROM THE  
MARK AS SHOWN.

SER. NO. 77-415,661, FILED 3-7-2008.

BARBARA A. GOLD, EXAMINING ATTORNEY



**Int. Cl.: 41**

**Prior U.S. Cls.: 100, 101, and 107**

**United States Patent and Trademark Office**

**Reg. No. 3,506,785**

**Registered Sep. 23, 2008**

**SERVICE MARK  
SUPPLEMENTAL REGISTER**

**BACHELOR PARTY**

TWENTIETH CENTURY FOX FILM CORPORATION (DELAWARE CORPORATION)  
10201 WEST PICO BOULEVARD  
LOS ANGELES, CA 90035

FOR: PRODUCTION AND DISTRIBUTION OF MOTION PICTURE FILMS; PROVIDING ON-LINE INFORMATION IN THE FIELD OF MOTION PICTURE FILM AND VIDEO ENTERTAINMENT VIA A GLOBAL COMMUNICATIONS NETWORK, IN CLASS 41 (U.S. CLS. 100, 101 AND 107).

FIRST USE 6-29-1984; IN COMMERCE 6-29-1984.

THE MARK CONSISTS OF STANDARD CHARACTERS WITHOUT CLAIM TO ANY PARTICULAR FONT, STYLE, SIZE, OR COLOR.

OWNER OF U.S. REG. NO. 3,469,924.

SER. NO. 77-427,538, FILED P.R. 3-20-2008; AM. S.R. 6-30-2008.

SUSAN RICHARDS, EXAMINING ATTORNEY

Int. Cl.: 29

Prior U.S. Cl.: 46

United States Patent and Trademark Office

Reg. No. 3,506,786

Registered Sep. 23, 2008

TRADEMARK  
SUPPLEMENTAL REGISTER



VAN ECUADOR SEA FOODS, INC. (NEW YORK CORPORATION)  
445 PARK AVENUE, 9TH FLOOR  
NEW YORK, NY 10022

FOR: SARDINES, IN CLASS 29 (U.S. CL. 46).

FIRST USE 11-0-2007; IN COMMERCE 11-0-2007.

OWNER OF U.S. REG. NO. 3,387,141.

NO CLAIM IS MADE TO THE EXCLUSIVE RIGHT TO USE "SARDINA" AND "SARDINAS EN SALSA DE TOMATE", APART FROM THE MARK AS SHOWN.

THE COLOR(S) BLUE, WHITE AND BROWN IS/ ARE CLAIMED AS A FEATURE OF THE MARK.

THE MARK CONSISTS OF THE STYLIZED WORDING SARDINA ECUADOR IN WHITE LETTERING WITH DARK BLUE OUTLINING UNDERNEATH WHICH APPEARS A BROWN BAR CONTAINING THE WORDING SARDINAS EN SALSA DE TOMATE WHICH APPEARS IN DARK BLUE LETTERING".

THE FOREIGN WORDING IN THE MARK TRANSLATES INTO ENGLISH AS SARDINE AND SARDINES IN TOMATO SAUCE.

SER. NO. 77-427,960, FILED P.R. 3-21-2008; AM. S.R. 8-13-2008.

ERIN FALK, EXAMINING ATTORNEY

**Int. Cl.: 33**

**Prior U.S. Cls.: 47 and 49**

**United States Patent and Trademark Office**

**Reg. No. 3,506,787**

**Registered Sep. 23, 2008**

**TRADEMARK  
SUPPLEMENTAL REGISTER**

**SAN ANDREAS**

BLACK RIDGE WINERY LLC (CALIFORNIA  
LIMITED LIABILITY COMPANY)  
18550 BLACK ROAD  
LOS GATOS, CA 95033

FOR: RED WINE; TABLE WINES; WHITE WINE;  
WINE; WINES, IN CLASS 33 (U.S. CLS. 47 AND 49).

FIRST USE 3-1-2008; IN COMMERCE 3-1-2008.

THE MARK CONSISTS OF STANDARD CHAR-  
ACTERS WITHOUT CLAIM TO ANY PARTICULAR  
FONT, STYLE, SIZE, OR COLOR.

SER. NO. 77-430,061, FILED P.R. 3-24-2008; AM. S.R.  
8-11-2008.

ELLEN PERKINS, EXAMINING ATTORNEY

**Int. Cl.: 35**

**Prior U.S. Cls.: 100, 101, and 102**

**United States Patent and Trademark Office**

**Reg. No. 3,506,788**

**Registered Sep. 23, 2008**

**SERVICE MARK  
SUPPLEMENTAL REGISTER**

**PlaceToRent.com**

PLACETORENT.COM, INC. (NEVADA CORPORATION)  
SUITE 400  
8200 WILSHIRE BLVD.  
BEVERLY HILLS, CA 90211

FOR: ADVERTISING SERVICES, NAMELY, PROVIDING INFORMATION AS TO THE AVAILABILITY OF APARTMENTS FOR RENT OR PURCHASE, IN CLASS 35 (U.S. CLS. 100, 101 AND 102).

FIRST USE 5-26-2006; IN COMMERCE 5-26-2006.

THE MARK CONSISTS OF STANDARD CHARACTERS WITHOUT CLAIM TO ANY PARTICULAR FONT, STYLE, SIZE, OR COLOR.

SER. NO. 77-432,531, FILED P.R. 3-26-2008; AM. S.R. 7-21-2008.

JASON TURNER, EXAMINING ATTORNEY

**Int. Cl.: 9**

**Prior U.S. Cls.: 21, 23, 26, 36, and 38**

**United States Patent and Trademark Office**

**Reg. No. 3,506,789**

**Registered Sep. 23, 2008**

**TRADEMARK  
SUPPLEMENTAL REGISTER**

**EPAD**

GREAT LAKES AIR SYSTEMS (MICHIGAN CORPORATION)  
1238 ANDERSON COURT  
CLAWSON, MI 48017

THE MARK CONSISTS OF STANDARD CHARACTERS WITHOUT CLAIM TO ANY PARTICULAR FONT, STYLE, SIZE, OR COLOR.

FOR: ELECTRONIC CONTROL PANELS FOR INDUSTRIAL AIR FILTRATION MACHINES, IN CLASS 9 (U.S. CLS. 21, 23, 26, 36 AND 38).

SER. NO. 77-432,584, FILED P.R. 3-26-2008; AM. S.R. 8-12-2008.

FIRST USE 8-18-2007; IN COMMERCE 8-18-2007.

BARBARA GAYNOR, EXAMINING ATTORNEY

**Int. Cl.: 35**

**Prior U.S. Cls.: 100, 101, and 102**

**United States Patent and Trademark Office**

**Reg. No. 3,506,790**

**Registered Sep. 23, 2008**

**SERVICE MARK  
SUPPLEMENTAL REGISTER**

**Orange County  
Resource Guide.com**

WELCOME EXPRESS, INC. (CALIFORNIA CORPORATION)

647 CAMINO DE LOS MARES 108-100  
SAN CLEMENTE, CA 92673

FOR: PROVIDING AN ON-LINE COMMERCIAL INFORMATION DIRECTORY ON THE INTERNET; PROVIDING AN ONLINE DIRECTORY INFORMATION SERVICE FEATURING INFORMATION REGARDING LOCAL BUSINESSES, ORGANIZATIONS, AND EMPLOYMENT OPPORTUNITIES; PROVIDING ON-LINE DIRECTORY INFORMATION SERVICES ALSO FEATURING HYPERLINKS TO OTHER WEB SITES; SHOPPERS' GUIDE INFORMATION; ADVERTISING AND ADVERTISEMENT SERVICES; ADVERTISING AND COMMERCIAL INFORMATION SERVICES, VIA THE INTERNET; ADVERTISING AND MARKETING; ADVERTISING AND PROMOTIONAL SERVICES; ADVERTISING SERVICES; ADVERTISING, MARKETING AND PROMOTION SERVICES; INTERNET ADVERTISING SERVICES; PROVIDING SPACE AT A WEB SITE FOR THE ADVERTISE-

MENT OF THE GOODS AND SERVICES OF OTHERS, IN CLASS 35 (U.S. CLS. 100, 101 AND 102).

FIRST USE 9-0-2007; IN COMMERCE 9-0-2007.

NO CLAIM IS MADE TO THE EXCLUSIVE RIGHT TO USE "RESOURCE GUIDE.COM", APART FROM THE MARK AS SHOWN.

THE COLOR(S) BLACK AND ORANGE IS/ARE CLAIMED AS A FEATURE OF THE MARK.

THE MARK CONSISTS OF THE TWO WORDS "ORANGE COUNTY" IN BLACK LETTERING FOLLOWED BY THE TWO WORDS "RESOURCE GUIDE" IN ORANGE LETTERING AND THE PHRASE ".COM" IN BLACK LETTERING WHICH IS CONNECTED TO THE WORD "GUIDE" .

SER. NO. 77-433,647, FILED P.R. 3-27-2008; AM. S.R. 7-21-2008.

KIMBERLY FRYE, EXAMINING ATTORNEY

**Int. Cl.: 41**

**Prior U.S. Cls.: 100, 101, and 107**

**United States Patent and Trademark Office**

**Reg. No. 3,506,791**

**Registered Sep. 23, 2008**

**SERVICE MARK  
SUPPLEMENTAL REGISTER**

**THE TEXAS RALLY**

MACE, DAVID (UNITED STATES INDIVIDUAL)  
PO BOX 435  
DAMON, TX 77430

FOR: ENTERTAINMENT SERVICES, IN THE  
NATURE OF A MOTORCYCLE RALLY, IN CLASS  
41 (U.S. CLS. 100, 101 AND 107).

FIRST USE 0-0-2006; IN COMMERCE 0-0-2006.

THE MARK CONSISTS OF STANDARD CHAR-  
ACTERS WITHOUT CLAIM TO ANY PARTICULAR  
FONT, STYLE, SIZE, OR COLOR.

NO CLAIM IS MADE TO THE EXCLUSIVE  
RIGHT TO USE "RALLY", APART FROM THE  
MARK AS SHOWN.

SER. NO. 77-436,020, FILED P.R. 3-31-2008; AM. S.R.  
8-5-2008.

NICHOLAS COLEMAN, EXAMINING ATTORNEY

**Int. Cl.: 41**

**Prior U.S. Cls.: 100, 101, and 107**

**United States Patent and Trademark Office**

**Reg. No. 3,506,792**

**Registered Sep. 23, 2008**

**SERVICE MARK  
SUPPLEMENTAL REGISTER**

**Positive Dog Parenting**

TRIPP, SUSAN (UNITED STATES INDIVIDUAL)  
15340 PASTRANA DRIVE  
LA MIRADA, CA 90638

FOR: EDUCATION SERVICES, NAMELY, PROVIDING ON-LINE TRAINING IN THE FORM OF EMAIL COURSES IN THE FIELD OF PET BEHAVIOR; EDUCATION SERVICES, NAMELY, PROVIDING A WEB SITE FEATURING INFORMATIONAL VIDEOS AND PHOTOGRAPHIC, AUDIO, VIDEO, AND PROSE PRESENTATIONS, ALL IN THE FIELD OF PET TRAINING AND PET BEHAVIOR AS

RELATING TO PET TRAINING, IN CLASS 41 (U.S. CLS. 100, 101 AND 107).

FIRST USE 9-1-2003; IN COMMERCE 1-1-2004.

THE MARK CONSISTS OF STANDARD CHARACTERS WITHOUT CLAIM TO ANY PARTICULAR FONT, STYLE, SIZE, OR COLOR.

SER. NO. 77-437,969, FILED P.R. 4-2-2008; AM. S.R. 7-7-2008.

ADA HAN, EXAMINING ATTORNEY



**Int. Cl.: 41**

**Prior U.S. Cls.: 100, 101, and 107**

**United States Patent and Trademark Office**

**Reg. No. 3,506,793**

**Registered Sep. 23, 2008**

**SERVICE MARK  
SUPPLEMENTAL REGISTER**

**NO CUSSING CLUB**

HATCH, BRENT (UNITED STATES INDIVIDUAL)  
1135 DIAMOND AVENUE  
SOUTH PASADENA, CA 91030

FOR: SOCIAL CLUB SERVICES, NAMELY, ORGANIZING EVENTS AND ACTIVITIES FOR CLUB MEMBERS, SUCH ACTIVITIES BASED ON A THEME OF ENCOURAGING INDIVIDUALS NOT TO CURSE, SWEAR OR USE BAD LANGUAGE; SOCIAL CLUB SERVICES, NAMELY, ARRANGING, ORGANIZING, AND HOSTING SOCIAL EVENTS, GET-TOGETHERS, AND PARTIES FOR CLUB MEMBERS, IN CLASS 41 (U.S. CLS. 100, 101 AND 107).

FIRST USE 6-1-2007; IN COMMERCE 6-1-2007.

THE MARK CONSISTS OF STANDARD CHARACTERS WITHOUT CLAIM TO ANY PARTICULAR FONT, STYLE, SIZE, OR COLOR.

NO CLAIM IS MADE TO THE EXCLUSIVE RIGHT TO USE "CLUB", APART FROM THE MARK AS SHOWN.

SER. NO. 77-443,151, FILED P.R. 4-8-2008; AM. S.R. 7-25-2008.

ALICE BENMAMAN, EXAMINING ATTORNEY

**Int. Cl.: 9**

**Prior U.S. Cls.: 21, 23, 26, 36, and 38**

**United States Patent and Trademark Office**

**Reg. No. 3,506,794**

**Registered Sep. 23, 2008**

**TRADEMARK  
SUPPLEMENTAL REGISTER**

**Digital Streaming Digest**

AMERICAN MEDIA SERVICES INTERACTIVE,  
LLC (SOUTH CAROLINA LIMITED LIABILITY  
COMPANY)

# 202

1311 CHUCK DAWLEY BLVD.  
MT. PLEASANT, SC 29464

FOR: DOWNLOADABLE ELECTRONIC NEWS-  
LETTERS IN THE FIELD OF RADIO AND INTER-  
NET BROADCASTING, IN CLASS 9 (U.S. CLS. 21, 23,  
26, 36 AND 38).

FIRST USE 4-1-2007; IN COMMERCE 4-1-2007.

THE MARK CONSISTS OF STANDARD CHAR-  
ACTERS WITHOUT CLAIM TO ANY PARTICULAR  
FONT, STYLE, SIZE, OR COLOR.

NO CLAIM IS MADE TO THE EXCLUSIVE  
RIGHT TO USE "DIGEST", APART FROM THE  
MARK AS SHOWN.

SER. NO. 77-444,243, FILED P.R. 4-9-2008; AM. S.R.  
8-8-2008.

NICHOLAS COLEMAN, EXAMINING ATTORNEY

**Int. Cl.: 9**

**Prior U.S. Cls.: 21, 23, 26, 36, and 38**

**United States Patent and Trademark Office**

**Reg. No. 3,506,795**

**Registered Sep. 23, 2008**

**TRADEMARK  
SUPPLEMENTAL REGISTER**

# MedDemo

POLYGLOT SYSTEMS, INC (DELAWARE CORPORATION)  
SUITE 101  
2000 AERIAL CENTER PARKWAY  
MORRISVILLE, NC 27560

FOR: COMPUTER HARDWARE AND COMPUTER SOFTWARE PROGRAMS FOR THE INTEGRATION OF TEXT, AUDIO, GRAPHICS, STILL IMAGES AND MOVING PICTURES INTO AN INTERACTIVE DELIVERY FOR MULTIMEDIA APPLICATIONS, IN CLASS 9 (U.S. CLS. 21, 23, 26, 36 AND 38).

FIRST USE 11-1-2005; IN COMMERCE 11-1-2005.

THE MARK CONSISTS OF STANDARD CHARACTERS WITHOUT CLAIM TO ANY PARTICULAR FONT, STYLE, SIZE, OR COLOR.

SER. NO. 77-447,565, FILED P.R. 4-14-2008; AM. S.R. 8-11-2008.

SAMUEL E. SHARPER JR., EXAMINING ATTORNEY

**Int. Cl.: 16**

**Prior U.S. Cls.: 2, 5, 22, 23, 29, 37, 38, and 50**

**United States Patent and Trademark Office**

**Reg. No. 3,506,796**

**Registered Sep. 23, 2008**

**TRADEMARK  
SUPPLEMENTAL REGISTER**

**ECO-FRIENDLY**

GREAT AMERICAN MARKETING, INC. (CALI-  
FORNIA CORPORATION)  
29145 THE OLD ROAD  
VALENCIA, CA 91355

FOR: PAINT BRUSHES, IN CLASS 16 (U.S. CLS. 2,  
5, 22, 23, 29, 37, 38 AND 50).

FIRST USE 4-24-2008; IN COMMERCE 4-24-2008.

THE MARK CONSISTS OF STANDARD CHAR-  
ACTERS WITHOUT CLAIM TO ANY PARTICULAR  
FONT, STYLE, SIZE, OR COLOR.

SER. NO. 77-448,013, FILED P.R. 4-14-2008; AM. S.R.  
8-14-2008.

ALICE SUE CARRUTHERS, EXAMINING ATTOR-  
NEY

Int. Cl.: 25

Prior U.S. Cls.: 22 and 39

United States Patent and Trademark Office

Reg. No. 3,506,797

Registered Sep. 23, 2008

TRADEMARK  
SUPPLEMENTAL REGISTER



FOSTER, NORMAN (UNITED STATES INDIVIDUAL)  
2207 EAST 87TH STREET  
CHICAGO, IL 60617

FOR: CLOTHING, IN CLASS 25 (U.S. CLS. 22 AND 39).

FIRST USE 4-5-2008; IN COMMERCE 4-5-2008.

THE COLOR(S) RED, YELLOW, GREEN AND BLACK IS/ARE CLAIMED AS A FEATURE OF THE MARK.

THE MARK CONSISTS OF TWO "S"-SHAPED LETTERS HAVING THREE CURVED LANES IN

BLACK, THE LANES BEING DIVIDED BY TWO CURVED YELLOW DASHED LINES OF VARYING THICKNESS. THE MARK ALSO INCLUDES TWO "T" LETTERS THAT HAVE A STOPLIGHT DESIGN, (I.E., A RED LIGHT, A YELLOW LIGHT, AND A GREEN LIGHT VERTICALLY ALIGNED WITHIN THE "T"). THE MARK ALSO INCLUDES FIVE RED RAYS, THREE RED RAYS EXTENDING UPWARD AND TWO RED RAYS EXTENDING DOWNWARD FROM THE RED LIGHT IN THE TWO "T" LETTERS. THE OTHER LETTERS IN THE MARK ARE STYLIZED.

SER. NO. 77-448,491, FILED P.R. 4-15-2008; AM. S.R. 8-14-2008.

HEATHER SAPP, EXAMINING ATTORNEY

**Int. Cl.: 16**

**Prior U.S. Cls.: 2, 5, 22, 23, 29, 37, 38, and 50**

**United States Patent and Trademark Office**

**Reg. No. 3,506,798**

**Registered Sep. 23, 2008**

**TRADEMARK  
SUPPLEMENTAL REGISTER**

**PERFORMANCE ANALYSIS RECORD**

STERLING CREEK SOFTWARE (INDIANA LIMITED LIABILITY COMPANY), DBA LINX-TRACKER,  
5881 E. 82ND STREET, STE. 105  
INDIANAPOLIS, IN 46250

FOR: SCORE SHEETS AND PRINTED FORMS USED TO TRACK INFORMATION RELATED TO GOLF SKILLS AND THE GAME OF GOLF , IN CLASS 16 (U.S. CLS. 2, 5, 22, 23, 29, 37, 38 AND 50).

FIRST USE 2-5-2007; IN COMMERCE 2-5-2007.

THE MARK CONSISTS OF STANDARD CHARACTERS WITHOUT CLAIM TO ANY PARTICULAR FONT, STYLE, SIZE, OR COLOR.

SER. NO. 77-451,706, FILED P.R. 4-18-2008; AM. S.R. 8-8-2008.

DAVID YONTEF, EXAMINING ATTORNEY

**Int. Cl.: 35**

**Prior U.S. Cls.: 100, 101, and 102**

**United States Patent and Trademark Office**

**Reg. No. 3,506,799**

**Registered Sep. 23, 2008**

**SERVICE MARK  
SUPPLEMENTAL REGISTER**

**THE NORTH CAROLINA  
CONFERENCE FOR WOMEN**

TRIBBLE CREATIVE GROUP, INC. (NORTH  
CAROLINA CORPORATION)  
SUITE 202  
129 WEST TRADE STREET  
CHARLOTTE, NC 28202

FOR: ARRANGING AND CONDUCTING A BUSI-  
NESS CONFERENCE FOR WOMEN, IN CLASS 35  
(U.S. CLS. 100, 101 AND 102).

FIRST USE 7-0-2005; IN COMMERCE 10-0-2005.

THE MARK CONSISTS OF STANDARD CHAR-  
ACTERS WITHOUT CLAIM TO ANY PARTICULAR  
FONT, STYLE, SIZE, OR COLOR.

NO CLAIM IS MADE TO THE EXCLUSIVE  
RIGHT TO USE "CONFERENCE FOR WOMEN",  
APART FROM THE MARK AS SHOWN.

SER. NO. 77-452,002, FILED 4-18-2008.

KIMBERLY FRYE, EXAMINING ATTORNEY

**Int. Cl.: 25**

**Prior U.S. Cls.: 22 and 39**

**United States Patent and Trademark Office**

**Reg. No. 3,506,800**

**Registered Sep. 23, 2008**

**TRADEMARK  
SUPPLEMENTAL REGISTER**

**Express Your Life**

CAMP II, W. HUNTER (UNITED STATES INDIVIDUAL)  
511 SAINT JOHNS AVENUE  
GREEN COVE SPRINGS, FL 32043

FOR: GOLF SHIRTS; HATS; HOODED SWEAT SHIRTS; NIGHT SHIRTS; PANTS; PIQUE SHIRTS; POLO SHIRTS; SHORT-SLEEVED OR LONG-SLEEVED T-SHIRTS; SHORTS; TANK TOPS; YOGA SHIRTS, IN CLASS 25 (U.S. CLS. 22 AND 39).

FIRST USE 6-15-2008; IN COMMERCE 6-20-2008.

THE MARK CONSISTS OF STANDARD CHARACTERS WITHOUT CLAIM TO ANY PARTICULAR FONT, STYLE, SIZE, OR COLOR.

SER. NO. 77-454,306, FILED P.R. 4-22-2008; AM. S.R. 7-15-2008.

BRIAN CALLAGHAN, EXAMINING ATTORNEY



**Int. Cl.: 35**

**Prior U.S. Cls.: 100, 101, and 102**

**United States Patent and Trademark Office**

**Reg. No. 3,506,801**

**Registered Sep. 23, 2008**

---

**SERVICE MARK  
SUPPLEMENTAL REGISTER**

**RACKING DIRECT**

LOGIFLO PROCESS CORPORATION (CANADA  
CORPORATION)  
40 CRAIGHURST AVENUE  
TORONTO, CANADA M4R1J8

THE MARK CONSISTS OF STANDARD CHAR-  
ACTERS WITHOUT CLAIM TO ANY PARTICULAR  
FONT, STYLE, SIZE, OR COLOR.

FOR: DISTRIBUTORSHIPS IN THE FIELD OF  
PALLET RACKING AND SHELVING, IN CLASS 35  
(U.S. CLS. 100, 101 AND 102).

SER. NO. 77-454,977, FILED 4-22-2008.

FIRST USE 12-21-2007; IN COMMERCE 12-21-2007.

JENNY PARK, EXAMINING ATTORNEY

**Int. Cl.: 41**

**Prior U.S. Cls.: 100, 101, and 107**

**United States Patent and Trademark Office**

**Reg. No. 3,506,802**

**Registered Sep. 23, 2008**

**SERVICE MARK  
SUPPLEMENTAL REGISTER**

**OMAHA BOOT CAMP**

CAIN, COREY A. (UNITED STATES INDIVIDUAL)  
5537 NORTH 160TH AVENUE  
OMAHA, NE 68116

FOR: PHYSICAL FITNESS TRAINING SERVICES,  
IN CLASS 41 (U.S. CLS. 100, 101 AND 107).

FIRST USE 6-1-2005; IN COMMERCE 4-23-2008.

THE MARK CONSISTS OF STANDARD CHARACTERS WITHOUT CLAIM TO ANY PARTICULAR FONT, STYLE, SIZE, OR COLOR.

SER. NO. 77-457,293, FILED P.R. 4-24-2008; AM. S.R. 8-12-2008.

DAVID YONTEF, EXAMINING ATTORNEY

**Int. Cl.: 31**

**Prior U.S. Cls.: 1 and 46**

**United States Patent and Trademark Office**

**Reg. No. 3,506,803**

**Registered Sep. 23, 2008**

**TRADEMARK  
SUPPLEMENTAL REGISTER**

**GROUND CONTROL**

LITTLE PRINCE OF OREGON NURSERY, INC.  
(OREGON CORPORATION)  
15868 NE EILERS RD.  
AURORA, OR 97002

FOR: LIVE PLANTS, IN CLASS 31 (U.S. CLS. 1  
AND 46).

FIRST USE 8-19-1997; IN COMMERCE 8-19-1997.

THE MARK CONSISTS OF STANDARD CHAR-  
ACTERS WITHOUT CLAIM TO ANY PARTICULAR  
FONT, STYLE, SIZE, OR COLOR.

OWNER OF U.S. REG. NO. 2,582,093.

SER. NO. 77-459,939, FILED P.R. 4-28-2008; AM. S.R.  
8-12-2008.

IRA J. GOODSID, EXAMINING ATTORNEY

**Int. Cl.: 44**

**Prior U.S. Cls.: 100 and 101**

**United States Patent and Trademark Office**

**Reg. No. 3,506,804**

**Registered Sep. 23, 2008**

**SERVICE MARK  
SUPPLEMENTAL REGISTER**

**Medical Wellness  
Association**

CHRISTOPHER E. BREULEUX (UNITED STATES  
INDIVIDUAL)  
3518 ACACIA DRIVE  
SUGAR LAND, TX 77479

FOR: CONSULTING SERVICES IN THE FIELD OF MENTAL HEALTH AND WELLNESS; COUNSELING SERVICES IN THE FIELDS OF HEALTH, NUTRITION AND LIFESTYLE WELLNESS; HEALTH CARE SERVICES, NAMELY, WELLNESS PROGRAMS; PROVIDING A WEB SITE FEATURING INFORMATION IN THE FIELD OF MENTAL HEALTH AND WELLNESS; PROVIDING ASSISTANCE, FITNESS EVALUATION AND CONSULTATION TO CORPORATE CLIENTS TO HELP THEIR EMPLOYEES MAKE HEALTH, WELLNESS AND NUTRITIONAL CHANGES IN THEIR DAILY LIVING TO IMPROVE HEALTH; PROVIDING ASSISTANCE, FITNESS EVALUATION AND CONSULTATION TO INDIVIDUALS TO HELP THEM MAKE HEALTH, WELLNESS AND NUTRITIONAL CHANGES IN THEIR DAILY LIVING TO

IMPROVE HEALTH; PROVIDING WELLNESS SERVICES, NAMELY, PERSONAL ASSESSMENTS, PERSONALIZED ROUTINES, MAINTENANCE SCHEDULES, AND COUNSELING, IN CLASS 44 (U.S. CLS. 100 AND 101).

FIRST USE 1-15-2001; IN COMMERCE 2-10-2002.

THE MARK CONSISTS OF STANDARD CHARACTERS WITHOUT CLAIM TO ANY PARTICULAR FONT, STYLE, SIZE, OR COLOR.

NO CLAIM IS MADE TO THE EXCLUSIVE RIGHT TO USE "WELLNESS ASSOCIATION", APART FROM THE MARK AS SHOWN.

SER. NO. 77-460,662, FILED P.R. 4-29-2008; AM. S.R. 4-29-2008.

REBECCA POVARCHUK, EXAMINING ATTORNEY

**Int. Cl.: 10**

**Prior U.S. Cls.: 26, 39, and 44**

**United States Patent and Trademark Office**

**Reg. No. 3,506,805**

**Registered Sep. 23, 2008**

**TRADEMARK  
SUPPLEMENTAL REGISTER**

# Pocket Vibe

ZHEN DISTRIBUTION, INC. (NEVADA CORPORATION), DBA ZHEN GLOBAL CORPORATION,  
12345 LAKE CITY WAY NE #289  
SEATTLE, WA 98125

FOR: ADULT SEXUAL AIDS, NAMELY, VIBRATORS AND THERAPEUTIC MASSAGERS, NAMELY, ELECTRIC MASSAGING APPARATUS FOR PERSONAL USE; ELECTRIC MESSAGE APPARATUS FOR HOUSEHOLD USE; ELECTRIC MESSAGE APPLIANCES, NAMELY, ELECTRIC VIBRATING MASSAGER; MESSAGE APPARATUS; MESSAGE APPARATUS AND INSTRUMENTS; MASSAGING APPARATUS FOR PERSONAL USE, IN CLASS 10 (U.S. CLS. 26, 39 AND 44).

FIRST USE 1-1-2005; IN COMMERCE 1-1-2008.

THE MARK CONSISTS OF STANDARD CHARACTERS WITHOUT CLAIM TO ANY PARTICULAR FONT, STYLE, SIZE, OR COLOR.

NO CLAIM IS MADE TO THE EXCLUSIVE RIGHT TO USE "POCKET", APART FROM THE MARK AS SHOWN.

SER. NO. 77-467,412, FILED P.R. 5-6-2008; AM. S.R. 8-20-2008.

WILLIAM ROSSMAN, EXAMINING ATTORNEY

Int. Cl.: 25

Prior U.S. Cls.: 22 and 39

United States Patent and Trademark Office

Reg. No. 3,506,806

Registered Sep. 23, 2008

**TRADEMARK  
SUPPLEMENTAL REGISTER**

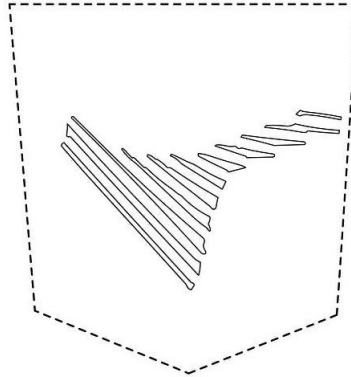

JOE'S JEANS SUBSIDIARY, INC. (DELAWARE CORPORATION)  
5901 EASTERN AVENUE  
COMMERCE, CA 90040

FOR: JEANS; PANTS; DENIMS, IN CLASS 25 (U.S. CLS. 22 AND 39).

FIRST USE 8-16-2006; IN COMMERCE 8-16-2006.

THE MARK CONSISTS OF A STITCHING DESIGN ON THE BACK POCKET OF PANTS. THE LINES ON THE POCKET REPRESENT STITCHING.

THE STITCHING CONSISTS OF A SERIES OF DIAGONAL LINES THAT FORM A CURVED SHAPE ON THE BACK POCKET OF PANTS. THE SHAPE OF THE POCKET IS REPRESENTED BY BROKEN LINES AND IS NOT PART OF THE MARK BUT ONLY SERVES TO SHOW THE POSITION OF THE MARK.

SER. NO. 77-476,190, FILED P.R. 5-16-2008; AM. S.R. 8-7-2008.

TANYA AMOS, EXAMINING ATTORNEY

Int. Cl.: 25

Prior U.S. Cls.: 22 and 39

United States Patent and Trademark Office

Reg. No. 3,506,807

Registered Sep. 23, 2008

TRADEMARK  
SUPPLEMENTAL REGISTER

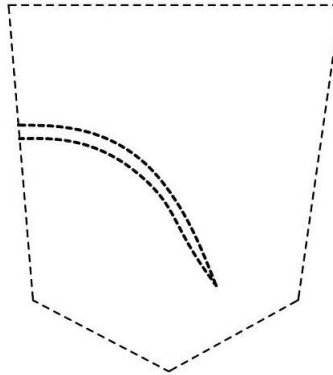

JOE'S JEANS SUBSIDIARY, INC. (DELAWARE CORPORATION)  
5901 EASTERN AVENUE  
COMMERCE, CA 90040

FOR: JEANS; PANTS; DENIMS, IN CLASS 25 (U.S. CLS. 22 AND 39).

FIRST USE 1-11-2006; IN COMMERCE 1-11-2006.

THE MARK CONSISTS OF A STITCHING DESIGN ON THE BACK POCKETS OF PANTS. THE LINES ON THE POCKET REPRESENT STITCHING. THE SHAPE OF THE POCKET ITSELF IS NOT CLAIMED AS A FEATURE OF THE MARK.

SER. NO. 77-476,191, FILED P.R. 5-16-2008; AM. S.R. 8-7-2008.

TANYA AMOS, EXAMINING ATTORNEY

Int. Cl.: 25

Prior U.S. Cls.: 22 and 39

United States Patent and Trademark Office

Reg. No. 3,506,808

Registered Sep. 23, 2008

**TRADEMARK  
SUPPLEMENTAL REGISTER**

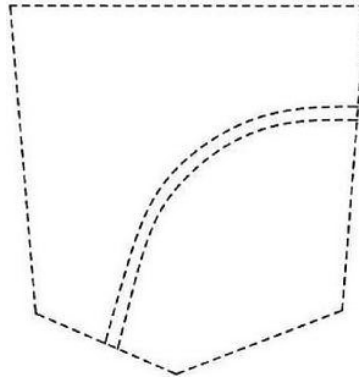

JOE'S JEANS SUBSIDIARY, INC. (DELAWARE CORPORATION)  
5901 EASTERN AVENUE  
COMMERCE, CA 90040

FOR: JEANS; PANTS; DENIMS, IN CLASS 25 (U.S. CLS. 22 AND 39).

FIRST USE 2-28-2008; IN COMMERCE 2-28-2008.

THE MARK CONSISTS OF A STITCHING DESIGN ON THE BACK POCKETS OF PANTS. THE DESIGN IS THE STITCHING OF TWO CURVED

LINES, ONE DIRECTLY ABOVE THE OTHER ON THE BACK POCKET OF JEANS. THE LINES ON THE POCKET REPRESENT STITCHING. THE SHAPE OF THE POCKET IS REPRESENTED BY BROKEN LINES AND IS NOT PART OF THE MARK BUT ONLY SERVES TO SHOW THE POSITION OF THE MARK.

SER. NO. 77-476,192, FILED P.R. 5-16-2008; AM. S.R. 8-7-2008.

TANYA AMOS, EXAMINING ATTORNEY



Int. Cl.: 25

Prior U.S. Cls.: 22 and 39

United States Patent and Trademark Office

Reg. No. 3,506,809

Registered Sep. 23, 2008

**TRADEMARK  
SUPPLEMENTAL REGISTER**

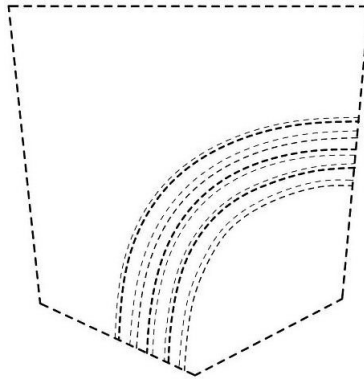

JOE'S JEANS SUBSIDIARY, INC. (DELAWARE CORPORATION)  
5901 EASTERN AVENUE  
COMMERCE, CA 90040

FOR: JEANS; PANTS; DENIMS, IN CLASS 25 (U.S. CLS. 22 AND 39).

FIRST USE 2-26-2008; IN COMMERCE 2-26-2008.

THE MARK CONSISTS OF A STITCHING DESIGN ON THE BACK POCKETS OF PANTS. THE STITCHING DESIGN CONSISTS OF MULTIPLE

CURVED LINES FORMING A RAINBOW SHAPE ON THE BACK OF THE POCKET. THE LINES ON THE POCKET REPRESENT STITCHING. THE SHAPE OF THE POCKET IS REPRESENTED BY BROKEN LINES AND IS NOT PART OF THE MARK BUT ONLY SERVES TO SHOW THE POSITION OF THE MARK.

SER. NO. 77-476,195, FILED P.R. 5-16-2008; AM. S.R. 8-7-2008.

TANYA AMOS, EXAMINING ATTORNEY

Int. Cl.: 25

Prior U.S. Cls.: 22 and 39

United States Patent and Trademark Office

Reg. No. 3,506,810

Registered Sep. 23, 2008

TRADEMARK  
SUPPLEMENTAL REGISTER

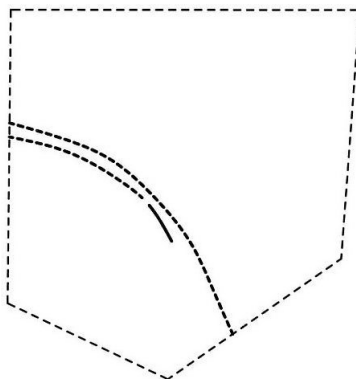

JOE'S JEANS SUBSIDIARY, INC. (DELAWARE CORPORATION)  
5901 EASTERN AVENUE  
COMMERCE, CA 90040

FOR: JEANS; PANTS; DENIMS, IN CLASS 25 (U.S. CLS. 22 AND 39).

FIRST USE 2-26-2008; IN COMMERCE 2-26-2008.

THE MARK CONSISTS OF A STITCHING DESIGN ON THE BACK POCKETS OF PANTS. THE STITCHING CONSISTS OF TWO CURVED LINES.

THE SECOND CURVED LINE IS DIRECTLY BELOW THE FIRST CURVED LINE BUT NOT AS LONG. THE LINES ON THE POCKET REPRESENT STITCHING. THE SHAPE OF THE POCKET IS REPRESENTED BY BROKEN LINES AND IS NOT PART OF THE MARK BUT ONLY SERVES TO SHOW THE POSITION OF THE MARK.

SER. NO. 77-476,196, FILED P.R. 5-16-2008; AM. S.R. 8-7-2008.

TANYA AMOS, EXAMINING ATTORNEY

**Int. Cls.: 12, 16, and 25**

**Prior U.S. Cls.: 2, 5, 19, 21, 22, 23, 29, 31, 35, 37, 38,  
39, 44, and 50**

**Reg. No. 3,506,811**

**United States Patent and Trademark Office**

**Registered Sep. 23, 2008**

**TRADEMARK  
SUPPLEMENTAL REGISTER**

**LOW AND LOADED**

VERNETTI, ROBERT F. (UNITED STATES INDIVIDUAL)  
15040 SEPTO STREET  
MISSION HILLS, CA 91345

FOR: AUTOMOBILE ACCESSORIES, NAMELY, LICENSE PLATE FRAMES, IN CLASS 12 (U.S. CLS. 19, 21, 23, 31, 35 AND 44).

FIRST USE 6-1-2007; IN COMMERCE 6-1-2007.

FOR: AUTOMOBILE ACCESSORIES, NAMELY, BUMPER DECALS, IN CLASS 16 (U.S. CLS. 2, 5, 22, 23, 29, 37, 38 AND 50).

FIRST USE 6-1-2007; IN COMMERCE 6-1-2007.

FOR: CLOTHING, NAMELY, SHIRTS AND T-SHIRTS, IN CLASS 25 (U.S. CLS. 22 AND 39).

FIRST USE 6-1-2007; IN COMMERCE 6-1-2007.

THE MARK CONSISTS OF STANDARD CHARACTERS WITHOUT CLAIM TO ANY PARTICULAR FONT, STYLE, SIZE, OR COLOR.

SER. NO. 78-572,620, FILED P.R. 2-22-2005; AM. S.R. 7-23-2008.

ANNE FARRELL, EXAMINING ATTORNEY

**Int. Cl.: 30**

**Prior U.S. Cl.: 46**

**United States Patent and Trademark Office**

**Reg. No. 3,506,812**

**Registered Sep. 23, 2008**

**TRADEMARK  
SUPPLEMENTAL REGISTER**

**ARTISAN MILL**

FLOWERS BAKERIES BRANDS, INC. (DELA-  
WARE CORPORATION)  
1105 NORTH MARKET STREET  
WILMINGTON, DE 19899

FOR: BREAD, IN CLASS 30 (U.S. CL. 46).

FIRST USE 9-26-2005; IN COMMERCE 9-26-2005.

THE MARK CONSISTS OF STANDARD CHAR-  
ACTERS WITHOUT CLAIM TO ANY PARTICULAR  
FONT, STYLE, SIZE, OR COLOR.

NO CLAIM IS MADE TO THE EXCLUSIVE  
RIGHT TO USE "ARTISAN", APART FROM THE  
MARK AS SHOWN.

SER. NO. 78-667,602, FILED P.R. 7-11-2005; AM. S.R.  
5-21-2008.

EDWARD NELSON, EXAMINING ATTORNEY

Int. Cl.: 41

Prior U.S. Cls.: 100, 101, and 107

**United States Patent and Trademark Office**

**Reg. No. 3,506,813**

Registered Sep. 23, 2008

**SERVICE MARK  
SUPPLEMENTAL REGISTER**

**Invest Ed**

OKLAHOMA DEPARTMENT OF SECURITIES  
(OKLAHOMA STATE AGENCY)  
SUITE 860, FIRST NATIONAL CENTER  
120 N. ROBINSON  
OKLAHOMA CITY, OK 73102

FOR: EDUCATIONAL SERVICES, NAMELY  
CONDUCTING PROGRAMS IN THE FIELD OF  
INVESTMENT LITERACY EDUCATION, IN CLASS  
41 (U.S. CLS. 100, 101 AND 107).

FIRST USE 9-0-2005; IN COMMERCE 9-0-2005.

NO CLAIM IS MADE TO THE EXCLUSIVE  
RIGHT TO USE "ED", APART FROM THE MARK  
AS SHOWN.

THE MARK CONSISTS OF THE WORDS "INVEST  
ED" IN STYLIZED LETTERS.

SER. NO. 78-698,689, FILED P.R. 8-23-2005; AM. S.R.  
3-3-2008.

LINDA ESTRADA, EXAMINING ATTORNEY

**Int. Cls.: 18 and 25**

**Prior U.S. Cls.: 1, 2, 3, 22, 39, and 41**

**United States Patent and Trademark Office**

**Reg. No. 3,506,814**

**Registered Sep. 23, 2008**

**TRADEMARK  
SUPPLEMENTAL REGISTER**

**ALLARD**

A. ALLARD BOUTIQUE DE MEGEVE (FRANCE CORPORATION)  
148 PLACE DE L'EGLISE  
MEGEVE, FRANCE 74120

FOR: LEATHER AND IMITATIONS OF LEATHER; ANIMAL SKINS, HIDES, TRUNKS AND TRAVELING BAGS, UMBRELLAS, PARASOLS AND WALKING STICKS; WHIPS, HARNESS AND SADDLERY; LEATHER GOODS OR GOODS MADE OF IMITATIONS OF LEATHER, NAMELY, PURSES, CARD HOLDERS, CHECK HOLDERS, WALLETS, GLOVES AND BELTS; HANDBAGS, RUCKSACKS, TRAVELING BAGS, SPORTS BAGS, SCHOOLBAGS, LEASHES AND COLLARS FOR DOGS, IN CLASS 18 (U.S. CLS. 1, 2, 3, 22 AND 41).

FOR: CLOTHING, NAMELY, TROUSERS, SHIRTS, JACKETS, COATS, PULLOVERS, SKIRTS,

DRESSES, ANORAKS; SHOES, SPORTS SHOES, HEADWEAR; SPORTS CLOTHES OTHER THAN FOR DIVING, NAMELY, SKI WEAR, SKI BOOTS; HEAD SCARVES, SCARVES, SHAWLS, TIES, CAPS, SOCKS, BRACES, NAMELY, SUSPENDERS, SLIPPERS, GLOVES, BELTS, BATH ROBES, IN CLASS 25 (U.S. CLS. 22 AND 39).

THE MARK CONSISTS OF STANDARD CHARACTERS WITHOUT CLAIM TO ANY PARTICULAR FONT, STYLE, SIZE, OR COLOR.

OWNER OF FRANCE REG. NO. 98765518, DATED 12-16-1998, EXPIRES 12-15-2008.

SER. NO. 78-767,383, FILED P.R. 12-6-2005; AM. S.R. 3-31-2008.

CAROLYN CATALDO, EXAMINING ATTORNEY

**Int. Cl.: 11**

**Prior U.S. Cls.: 13, 21, 23, 31, and 34**

**United States Patent and Trademark Office**

**Reg. No. 3,506,815**

**Registered Sep. 23, 2008**

**TRADEMARK  
SUPPLEMENTAL REGISTER**

**SLIMLAMP**

FEELUX CO., LTD. (REPUBLIC OF KOREA  
CORPORATION)  
624-8, SEOKWOO-RI, KWANGJEOK-MYUN, YANGJ  
U-KUN;  
KYONGGI-DO, REPUBLIC OF KOREA

FOR: LIGHTING APPARATUS, NAMELY, ELEC-  
TRIC LAMPS, FLUORESCENT LAMPS, COMPACT  
FLUORESCENT LAMPS, FREE STANDING ELEC-  
TRIC LAMPS, DECORATIVE ELECTRIC LAMPS,  
ELECTRIC LIGHTING FIXTURES AND FLUORES-  
CENT LAMP TUBES, IN CLASS 11 (U.S. CLS. 13, 21,  
23, 31 AND 34).

FIRST USE 1-15-2000; IN COMMERCE 1-15-2000.

THE MARK CONSISTS OF STANDARD CHAR-  
ACTERS WITHOUT CLAIM TO ANY PARTICULAR  
FONT, STYLE, SIZE, OR COLOR.

SER. NO. 78-786,953, FILED P.R. 1-6-2006; AM. S.R.  
12-4-2007.

KATHERINE STOIDES, EXAMINING ATTORNEY

**Int. Cl.: 14**

**Prior U.S. Cls.: 2, 27, 28, and 50**

**United States Patent and Trademark Office**

**Reg. No. 3,506,816**

**Registered Sep. 23, 2008**

**TRADEMARK  
SUPPLEMENTAL REGISTER**

# BEAD SHOP

WESTRIM, INC. (DELAWARE CORPORATION)  
7855 HAYVENHURST AVENUE  
VAN NUYS, CA 91406

FOR: JEWELRY, IMITATION JEWELRY AND COSTUME JEWELRY AND PARTS THEREOF, NAMELY, WOOD BEADS, CLAY BEADS, METAL BEADS, PLASTIC BEADS, GLASS BEADS, STRINGS OF BEADS, PEARLS, RHINESTONES, DECORATIVE CHAIN, RING CASTINGS, PIN CASTINGS, MINIATURE ANIMAL AND FISH FIGURINES MADE OF PRECIOUS METALS; ORNAMENTAL PINS; JEWELRY BRACELETS; CHARMS; JEWELRY CHAINS; EAR CLIPS; TIE CLIPS; EARRINGS; FIGURES OF PRECIOUS METALS; JEWELRY BOXES MADE OF PRECIOUS METAL; NECKLACES; PENDANTS; RINGS BEING JEWELRY; SCULPTURES OF PRECIOUS METALS; KEY FOBS OF PRECIOUS

METAL; AND JEWELRY FINDINGS, IN CLASS 14 (U.S. CLS. 2, 27, 28 AND 50).

FIRST USE 5-15-2003; IN COMMERCE 5-15-2003.

THE MARK CONSISTS OF STANDARD CHARACTERS WITHOUT CLAIM TO ANY PARTICULAR FONT, STYLE, SIZE, OR COLOR.

NO CLAIM IS MADE TO THE EXCLUSIVE RIGHT TO USE "BEAD", APART FROM THE MARK AS SHOWN.

SER. NO. 78-834,808, FILED P.R. 3-10-2006; AM. S.R. 5-27-2008.

KAREN K. BUSH, EXAMINING ATTORNEY



**Int. Cls.: 9, 16, 35, and 39**

**Prior U.S. Cls.: 2, 5, 21, 22, 23, 26, 29, 36, 37, 38, 50,  
100, 101, 102, and 105**

**Reg. No. 3,506,817**

**United States Patent and Trademark Office**

**Registered Sep. 23, 2008**

**TRADEMARK  
SERVICE MARK  
SUPPLEMENTAL REGISTER**

**SUPPORTS INTENSITY SCALE**

AMERICAN ASSOCIATION ON INTELLECTUAL  
AND DEVELOPMENTAL DISABILITIES  
(PENNSYLVANIA CORPORATION)  
444 NORTH CAPITOL STREET, N.W.  
SUITE 846  
WASHINGTON, DC 20001

FOR: ELECTRONIC SCORING PROGRAMS RE-  
CORDED ON CD FOR USE IN SCORING TESTS  
AND ASSESSMENTS IN THE FIELD OF MENTAL  
RETARDATION AND RELATED DEVELOPMEN-  
TAL DISABILITIES, IN CLASS 9 (U.S. CLS. 21, 23, 26,  
36 AND 38).

FIRST USE 9-0-2005; IN COMMERCE 9-0-2005.

FOR: PRINTED MATTER, NAMELY, BOOKS,  
BROCHURES, ASSESSMENT INSTRUMENTS AND  
ACCOMPANYING EDUCATIONAL MANUALS,  
PRINTED FORMS, REPORTS, AND GUIDES IN  
THE FIELD OF MENTAL RETARDATION AND  
RELATED DEVELOPMENTAL DISABILITIES, IN  
CLASS 16 (U.S. CLS. 2, 5, 22, 23, 29, 37, 38 AND 50).

FIRST USE 12-0-2003; IN COMMERCE 12-0-2003.

FOR: BUSINESS AND DATA MANAGEMENT,  
NAMELY, THE COLLECTION, ANALYSIS AND  
REPORTING OF INFORMATION AND DATA RE-

LATED TO THE MEASUREMENT OF SUPPORT  
NEEDS FOR PEOPLE WITH INTELLECTUAL AND  
DEVELOPMENTAL DISABILITIES, IN CLASS 35  
(U.S. CLS. 100, 101 AND 102).

FIRST USE 10-0-2005; IN COMMERCE 10-0-2005.

FOR: STORAGE AND RETRIEVAL OF INFOR-  
MATION AND DATA RELATED TO THE MEA-  
SUREMENTS OF SUPPORT NEEDS FOR PEOPLE  
WITH INTELLECTUAL AND DEVELOPMENTAL  
DISABILITIES, IN CLASS 39 (U.S. CLS. 100 AND 105).

FIRST USE 11-0-2005; IN COMMERCE 11-0-2005.

THE MARK CONSISTS OF STANDARD CHAR-  
ACTERS WITHOUT CLAIM TO ANY PARTICULAR  
FONT, STYLE, SIZE, OR COLOR.

NO CLAIM IS MADE TO THE EXCLUSIVE  
RIGHT TO USE "SCALE", APART FROM THE  
MARK AS SHOWN.

SER. NO. 78-858,378, FILED P.R. 4-10-2006; AM. S.R.  
12-18-2007.

DANIEL CAPSHAW, EXAMINING ATTORNEY

**Int. Cl.: 9**

**Prior U.S. Cls.: 21, 23, 26, 36, and 38**

**United States Patent and Trademark Office**

**Reg. No. 3,506,818**

**Registered Sep. 23, 2008**

**TRADEMARK  
SUPPLEMENTAL REGISTER**

**WIDE ANGLE DIAL**

PROPARTS LLC (MARYLAND LIMITED LIABILITY COMPANY)

1100 WILSO DRIVE

BALTIMORE, MD 21223

FOR: TACHOMETERS, IN CLASS 9 (U.S. CLS. 21, 23, 26, 36 AND 38).

FIRST USE 11-6-2007; IN COMMERCE 11-6-2007.

THE MARK CONSISTS OF STANDARD CHARACTERS WITHOUT CLAIM TO ANY PARTICULAR FONT, STYLE, SIZE, OR COLOR.

NO CLAIM IS MADE TO THE EXCLUSIVE RIGHT TO USE "DIAL", APART FROM THE MARK AS SHOWN.

SER. NO. 78-911,068, FILED P.R. 6-19-2006; AM. S.R. 7-31-2008.

SANDRA MANIOS, EXAMINING ATTORNEY

**Int. Cl.: 16**

**Prior U.S. Cls.: 2, 5, 22, 23, 29, 37, 38, and 50**

**United States Patent and Trademark Office**

**Reg. No. 3,506,819**

**Registered Sep. 23, 2008**

**TRADEMARK  
SUPPLEMENTAL REGISTER**

# Fair Game

THE NEW YORK TIMES COMPANY (NEW  
YORK CORPORATION)  
229 WEST 43RD STREET  
NEW YORK, NY 10036

FOR: COLUMNS ON THE SUBJECT OF BUSI-  
NESS AND FINANCE, IN CLASS 16 (U.S. CLS. 2, 5, 22,  
23, 29, 37, 38 AND 50).

FIRST USE 9-24-2006; IN COMMERCE 9-24-2006.

THE MARK CONSISTS OF STANDARD CHAR-  
ACTERS WITHOUT CLAIM TO ANY PARTICULAR  
FONT, STYLE, SIZE, OR COLOR.

SER. NO. 78-950,065, FILED P.R. 8-11-2006; AM. S.R.  
2-28-2008.

TRACY WHITTAKER-BROWN, EXAMINING AT-  
TORNEY

**Int. Cl.: 36**

**Prior U.S. Cls.: 100, 101, and 102**

**United States Patent and Trademark Office**

**Reg. No. 3,506,820**

**Registered Sep. 23, 2008**

**SERVICE MARK  
SUPPLEMENTAL REGISTER**

**FRONT RANGE VILLAGE**

FRONT RANGE RETAIL COMPANY, LLC (DE-  
LAWARE LIMITED LIABILITY COMPANY)  
2222 ARLINGTON AVENUE  
BIRMINGHAM, AL 35205

FOR: SHOPPING CENTER SERVICES, NAMELY,  
LEASING AND MANAGEMENT OF SHOPPING  
CENTER SPACE; OFFICE BUILDING SERVICES,  
NAMELY, LEASING AND MANAGEMENT OF OF-  
FICE BUILDING SPACE; AND PROVIDING INFOR-  
MATION ON MANAGING AND LEASING OF  
REAL ESTATE VIA A WEBSITE, IN CLASS 36 (U.S.  
CLS. 100, 101 AND 102).

FIRST USE 10-15-2005; IN COMMERCE 10-15-2005.

THE MARK CONSISTS OF STANDARD CHAR-  
ACTERS WITHOUT CLAIM TO ANY PARTICULAR  
FONT, STYLE, SIZE, OR COLOR.

NO CLAIM IS MADE TO THE EXCLUSIVE  
RIGHT TO USE "VILLAGE", APART FROM THE  
MARK AS SHOWN.

SER. NO. 78-960,203, FILED P.R. 8-24-2006; AM. S.R.  
5-9-2008.

ELI HELLMAN, EXAMINING ATTORNEY