

# PAONIA, CO MINE RESCUE CONTEST - 2004

## 3rd LEFT

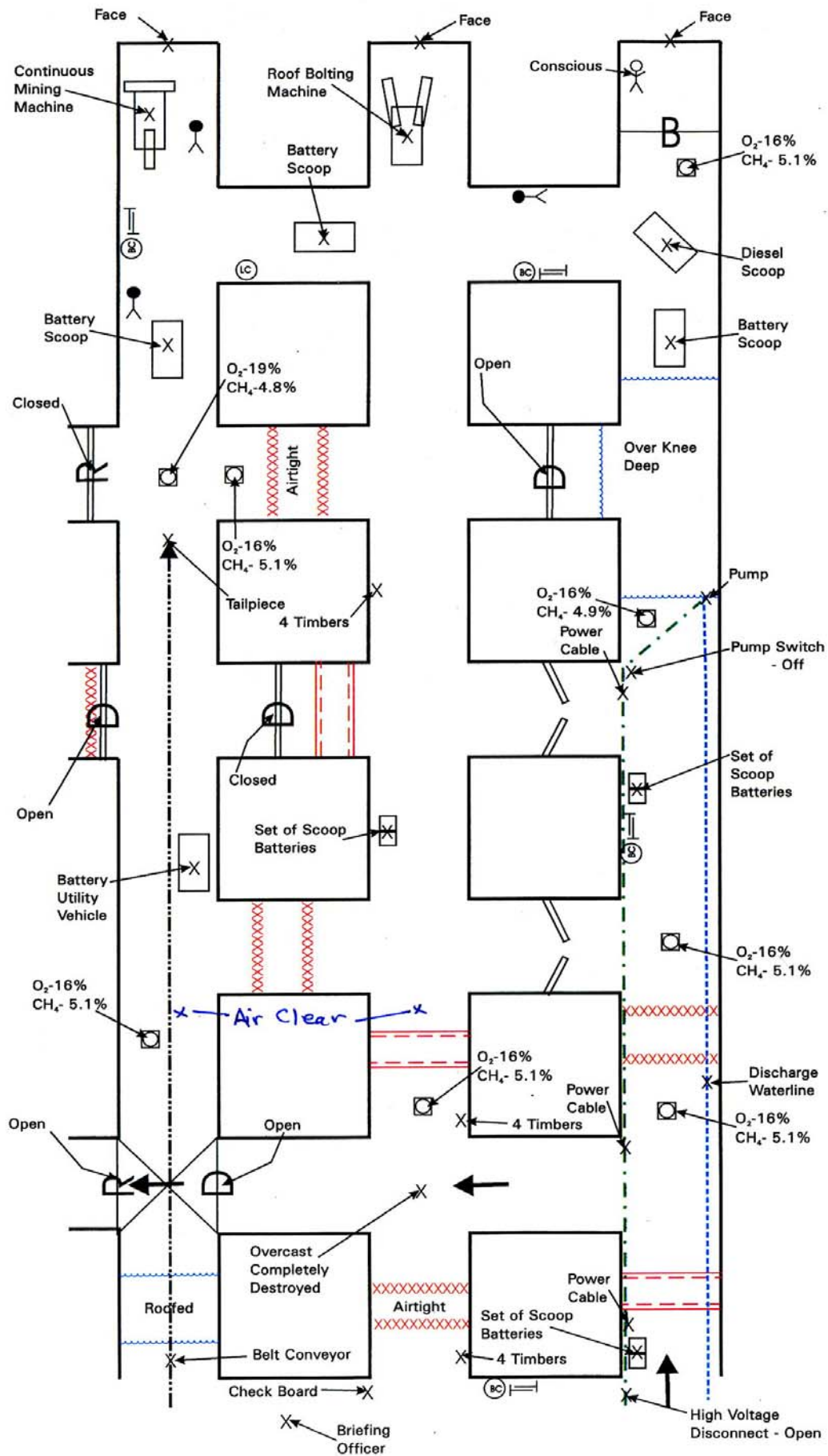

# VENTILATION PRIOR

Note: For ventilation prior to incident, all regulators were open and all doors were closed. Area explored by other teams is shown and conditions found are noted

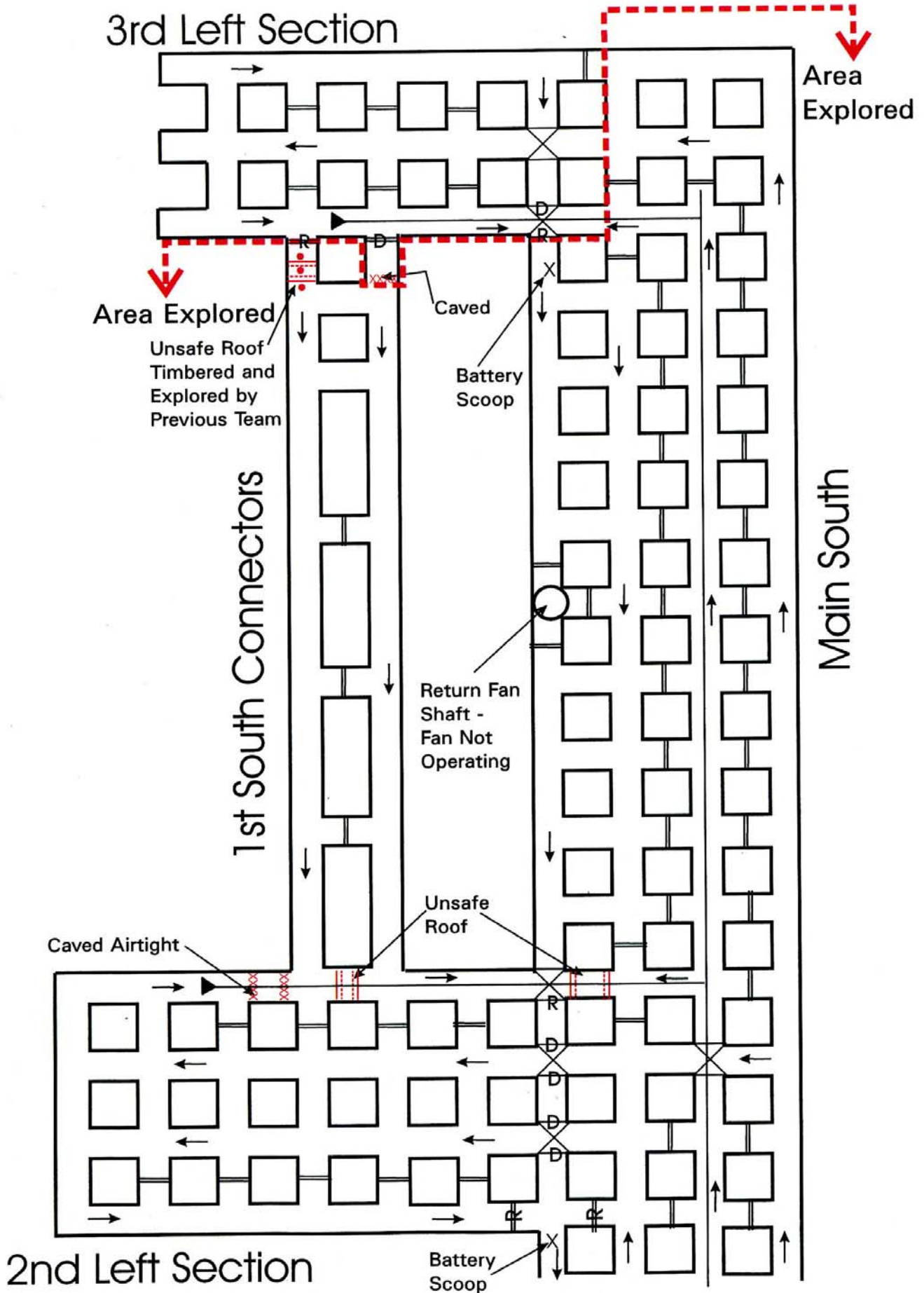

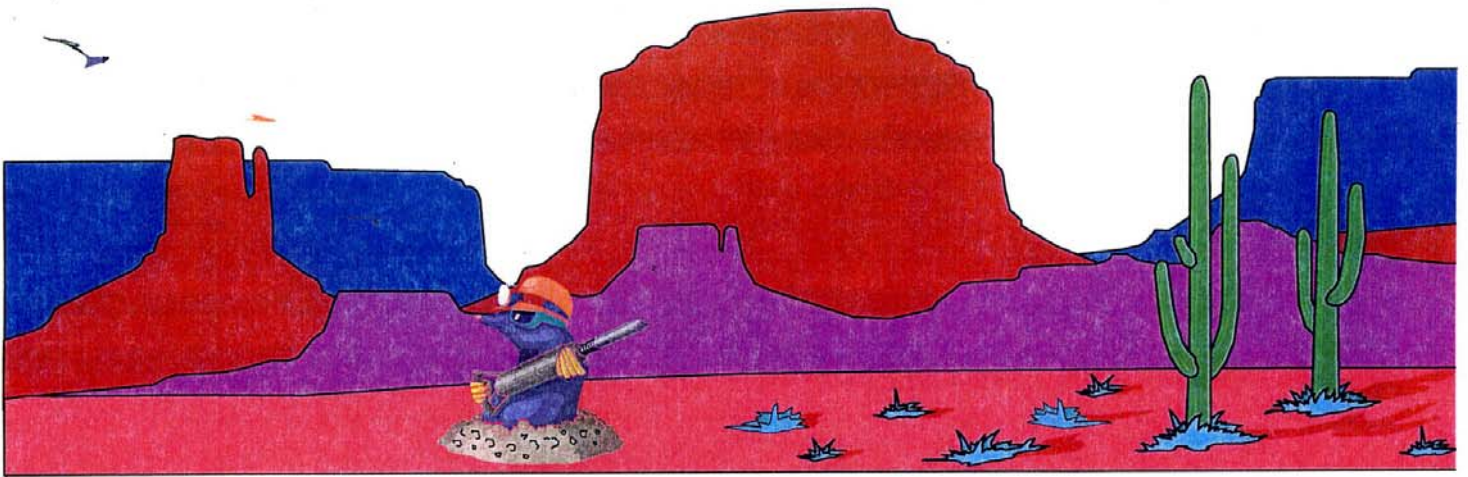

I am \_\_\_\_\_, superintendent of the Red Sands Mine. The mine operates two development sections and one longwall section, three shifts per day, seven days per week. The mine is currently being ventilated by one exhaust fan, but we have just completed installing a 2<sup>nd</sup> return fan shaft in the No. 1 entry of Main South. This second fan can be used if needed. The mine fan is operating and is guarded. The mine liberates approximately 12 million cubic feet of methane in 24 hours.

The 7:00 a.m. day shift crew, consisting of four miners, was assigned to do maintenance work in the 3<sup>rd</sup> Left development section. At approximately 9:30 a.m., the outside conspec attendant reported that there was an increase in carbon monoxide and methane levels. The return fan also went into alarm for a short period of time. The conspec attendant attempted to contact the four miners in the 3<sup>rd</sup> Left section but has been unsuccessful. The other sections and outby miners were notified and have evacuated the mine.

Mine rescue team members and adjacent mine rescue teams were immediately notified of the incident. Teams have explored the Main South area of the mine, including the 2<sup>nd</sup> Left development section, and the 1<sup>st</sup> South connectors up to the 3<sup>rd</sup> Left regulator. (See the prior ventilation map for areas that have already been explored.) At this point, the team had to retreat due to several apparatus alarms indicating low oxygen. Prior to exiting the 1<sup>st</sup> South connectors, the team closed the return regulator as per instructions by the surface personnel.

**The other mine rescue teams explored the Main South entries toward the 3<sup>rd</sup> Left development section, at which point, they encountered water and unsafe roof. The teams established a fresh-air base between the No. 1 and No. 2 entries of the 3<sup>rd</sup> Left section.**

**The Command Center reported that the teams encountered water, roof falls and unsafe roof during their exploration, which is documented on the map that will be provided to your team.**

**Fully equipped and properly trained mine rescue teams are available as backup to assist you while you are in by the fresh air base. You may request assistance from them through the superintendent.**

**The mine maps are up-to-date and will be provided to you when you are ready to proceed.**

**Good Luck!**





- Explore all areas of the mine, if it can be done safely.
- Account for all missing persons.

**Good Luck!**

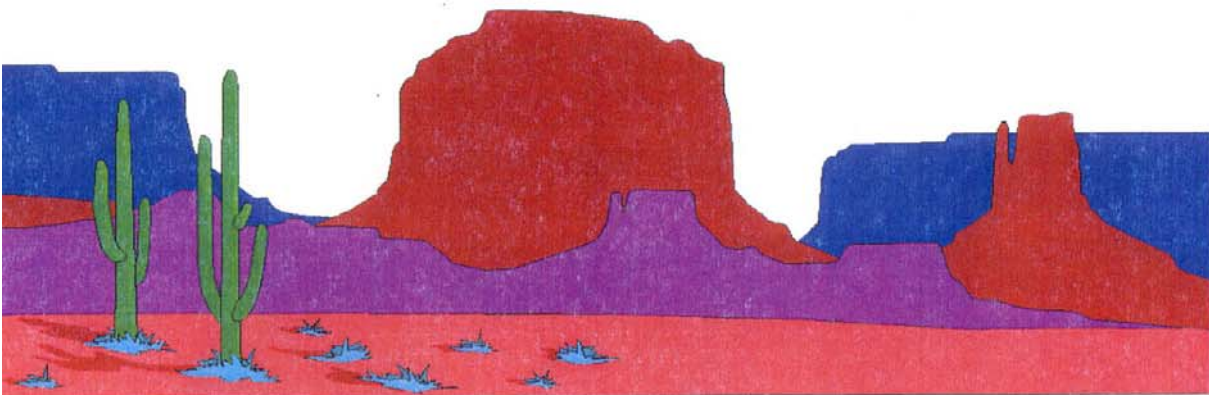

**PROBLEM**



**HELP!  
GET ME OUT!**

**I'm in good air.  
I have solid roof,  
face and ribs  
behind me.**

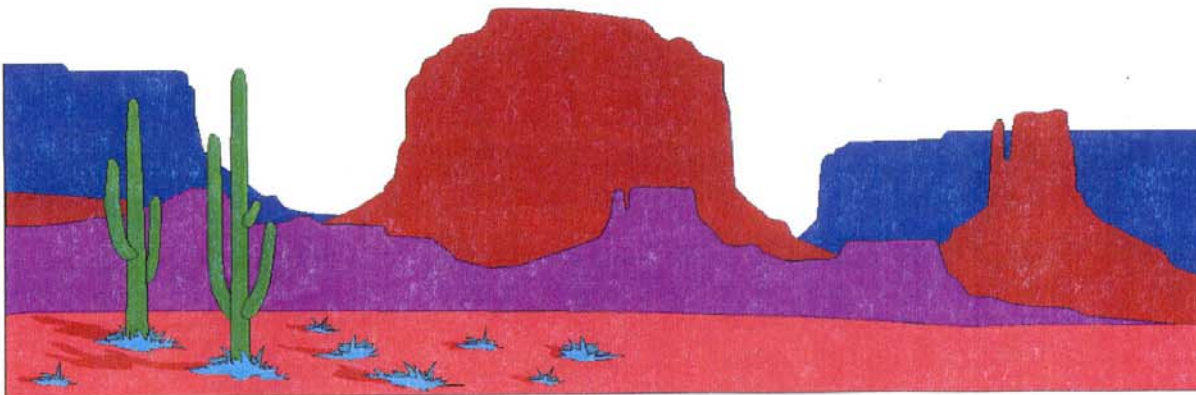

**PATIENT STATEMENT**

# PAONIA, CO MINE RESCUE CONTEST - 2004

## 3rd LEFT VENT CHANGE

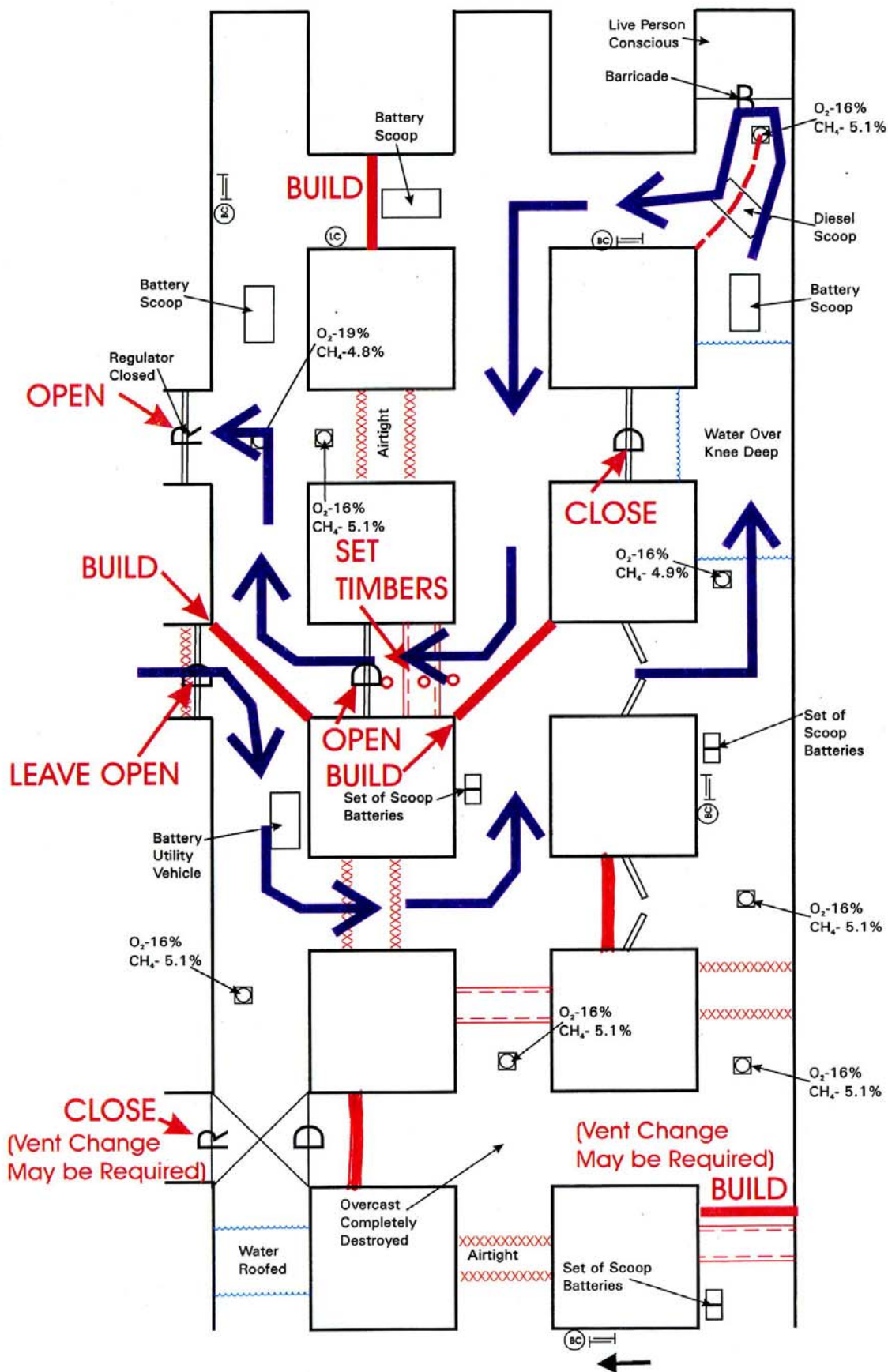

# VENTILATION CHANGES

## 3rd Left Section

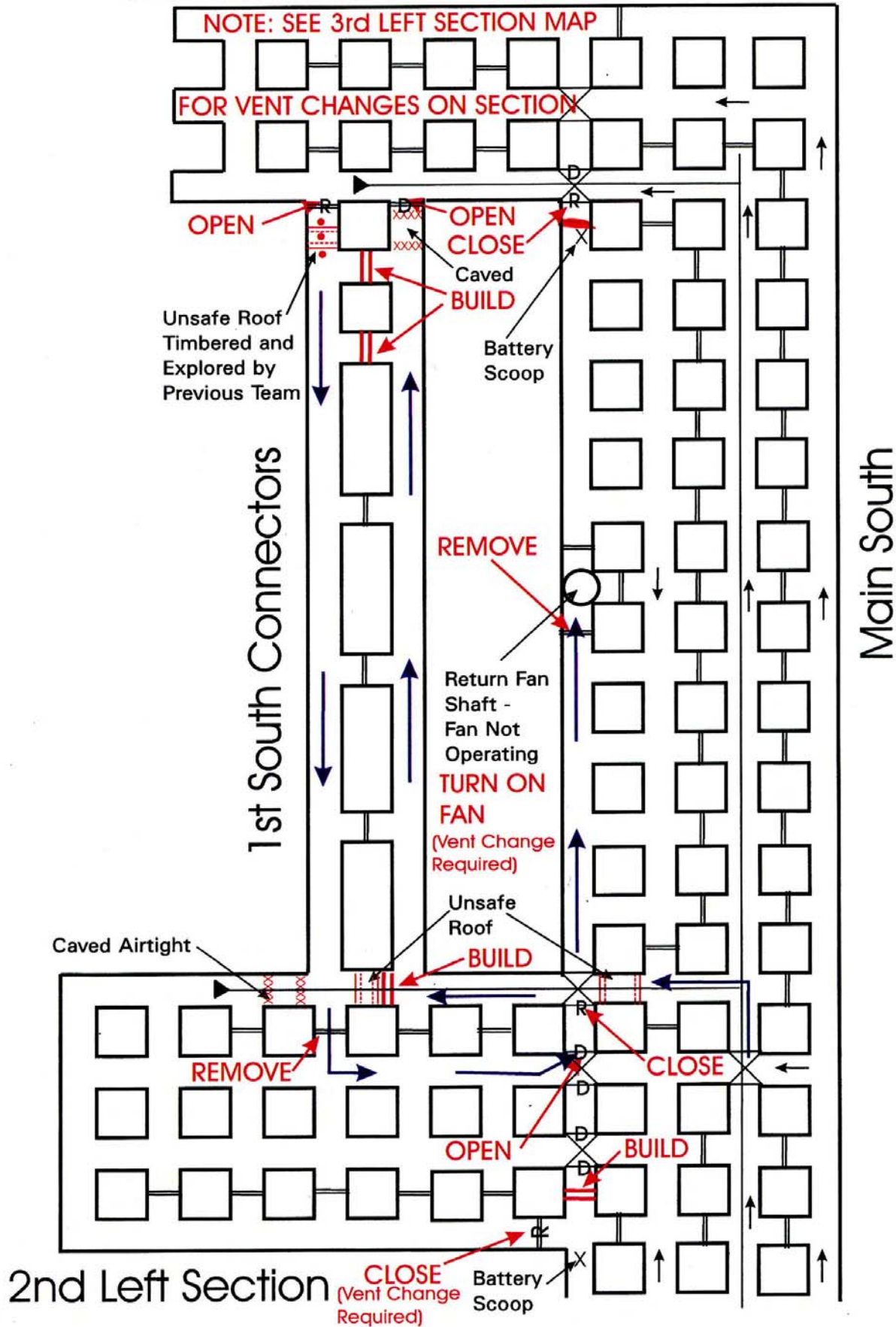



# PAONIA, CO MINE RESCUE CONTEST - 2004

## 3rd LEFT

## JUDGES MAP

INDEX	
RR	- ROOF & RIB TEST
RRF	- ROOF, RIB & FACE TEST
▲	- DATE & INITIALS
GT	- GAS TESTS FOR CO, O2 & CH4

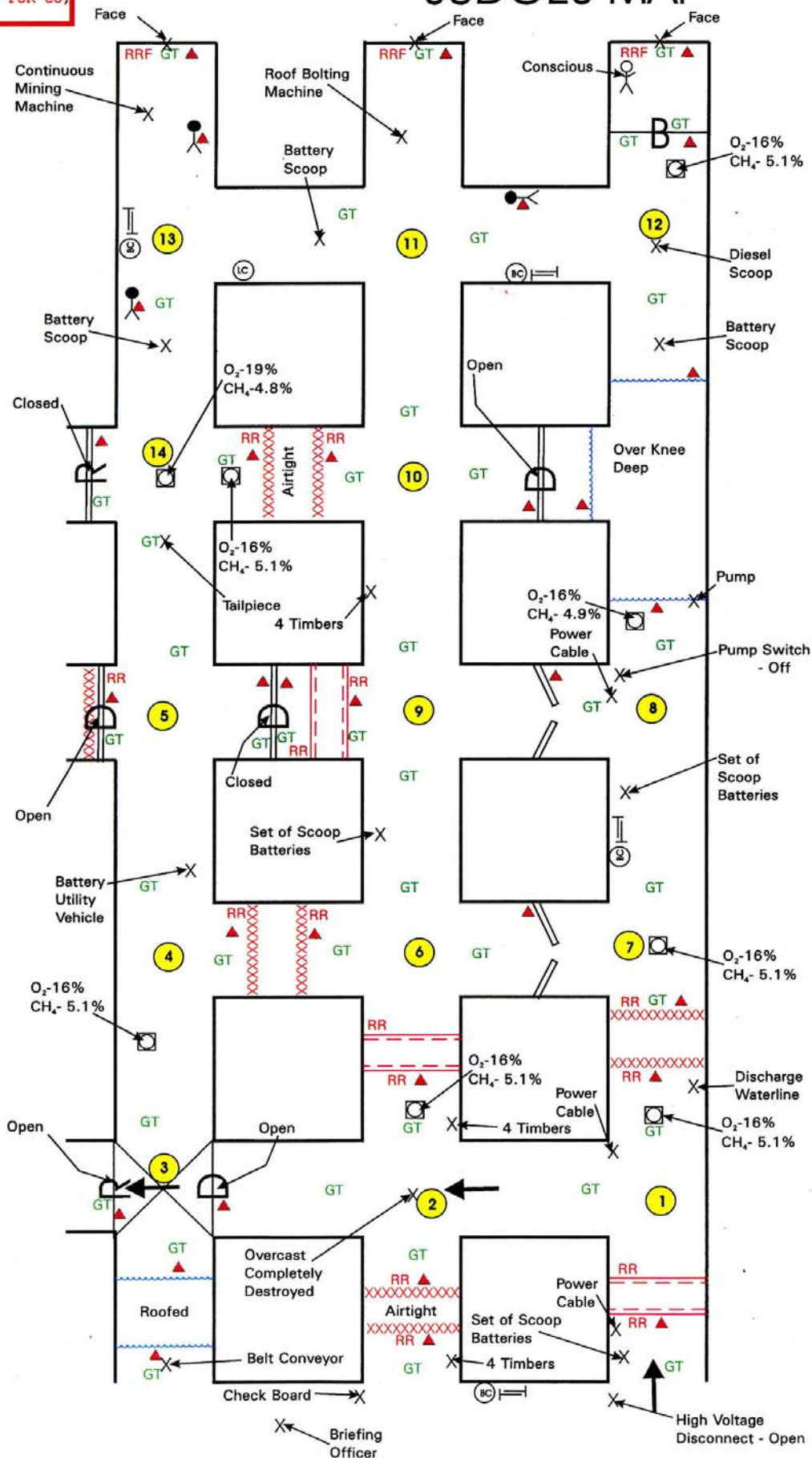

# PAONIA, CO MINE RESCUE CONTEST - 2004

## 3rd LEFT

## JUDGES WORK MAP

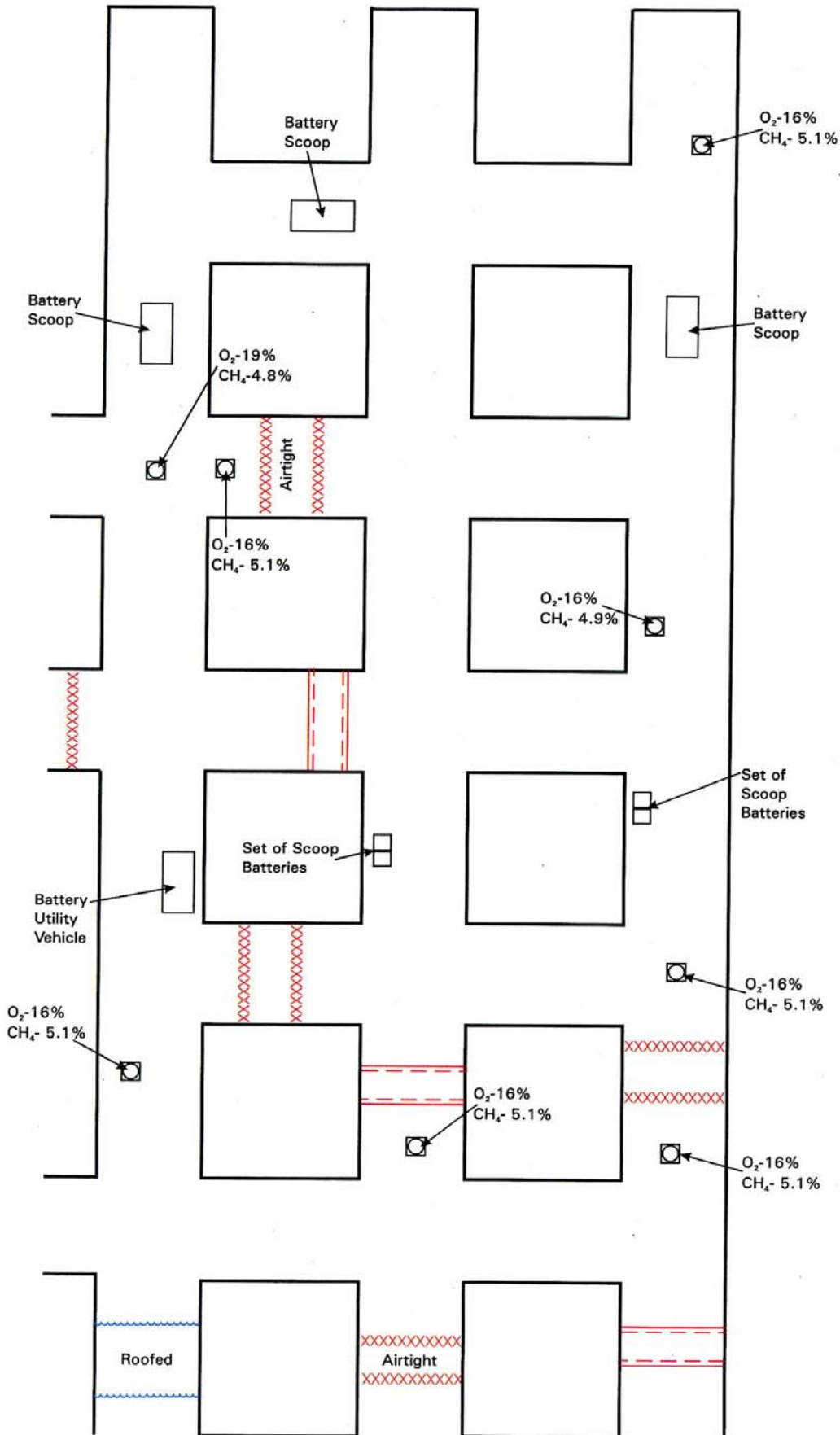

# PAONIA, CO MINE RESCUE CONTEST - 2004

## 3rd LEFT

## JUDGES VENT. / FINAL MAP

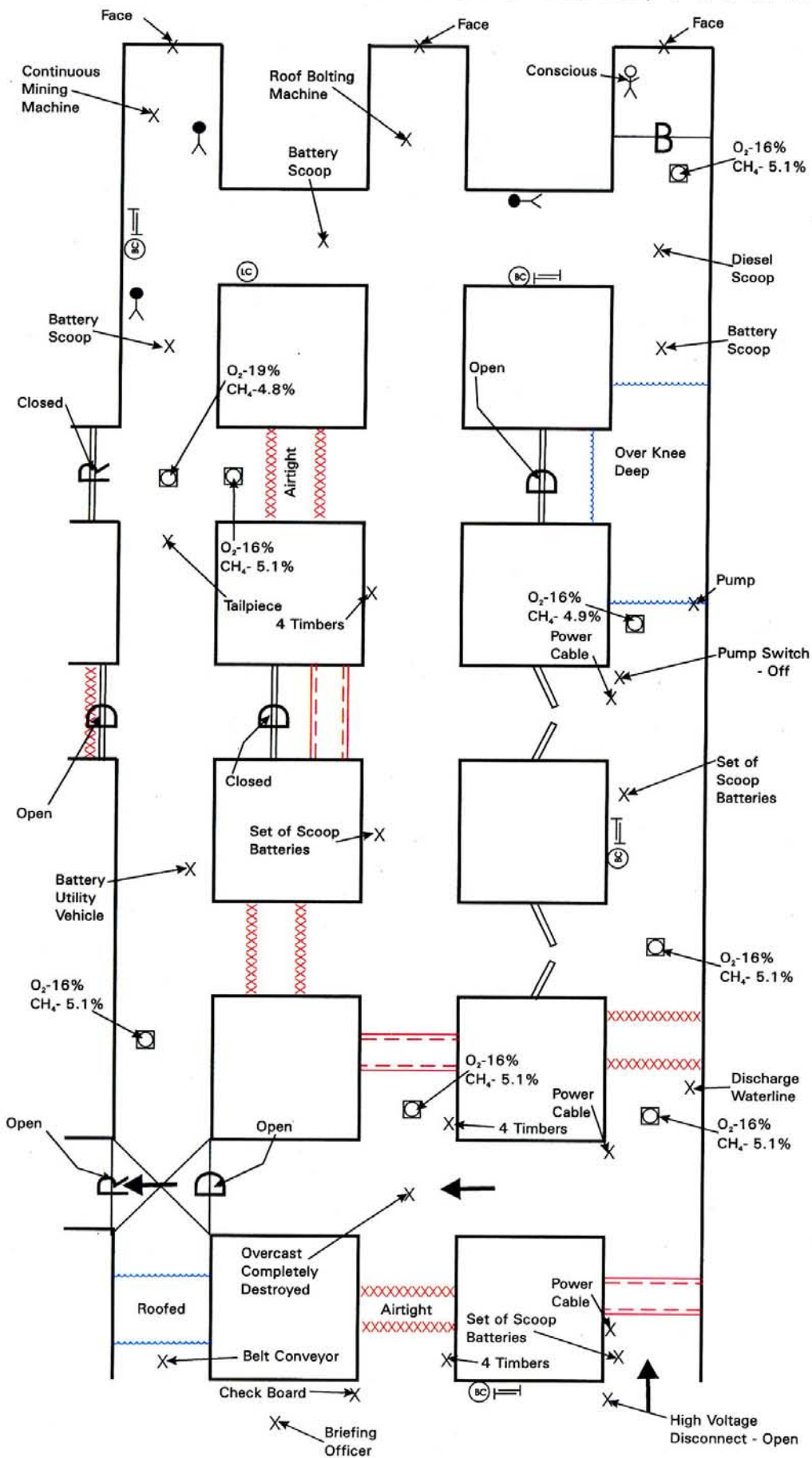

# PAONIA, CO MINE RESCUE CONTEST - 2004

## 3rd LEFT

## JUDGES MAP

INDEX	
RR	- ROOF & RIB TEST
RRF	- ROOF, RIB & FACE TEST
▲	- DATE & INITIALS
GT	- GAS TESTS FOR CO, O <sub>2</sub> & CH <sub>4</sub>

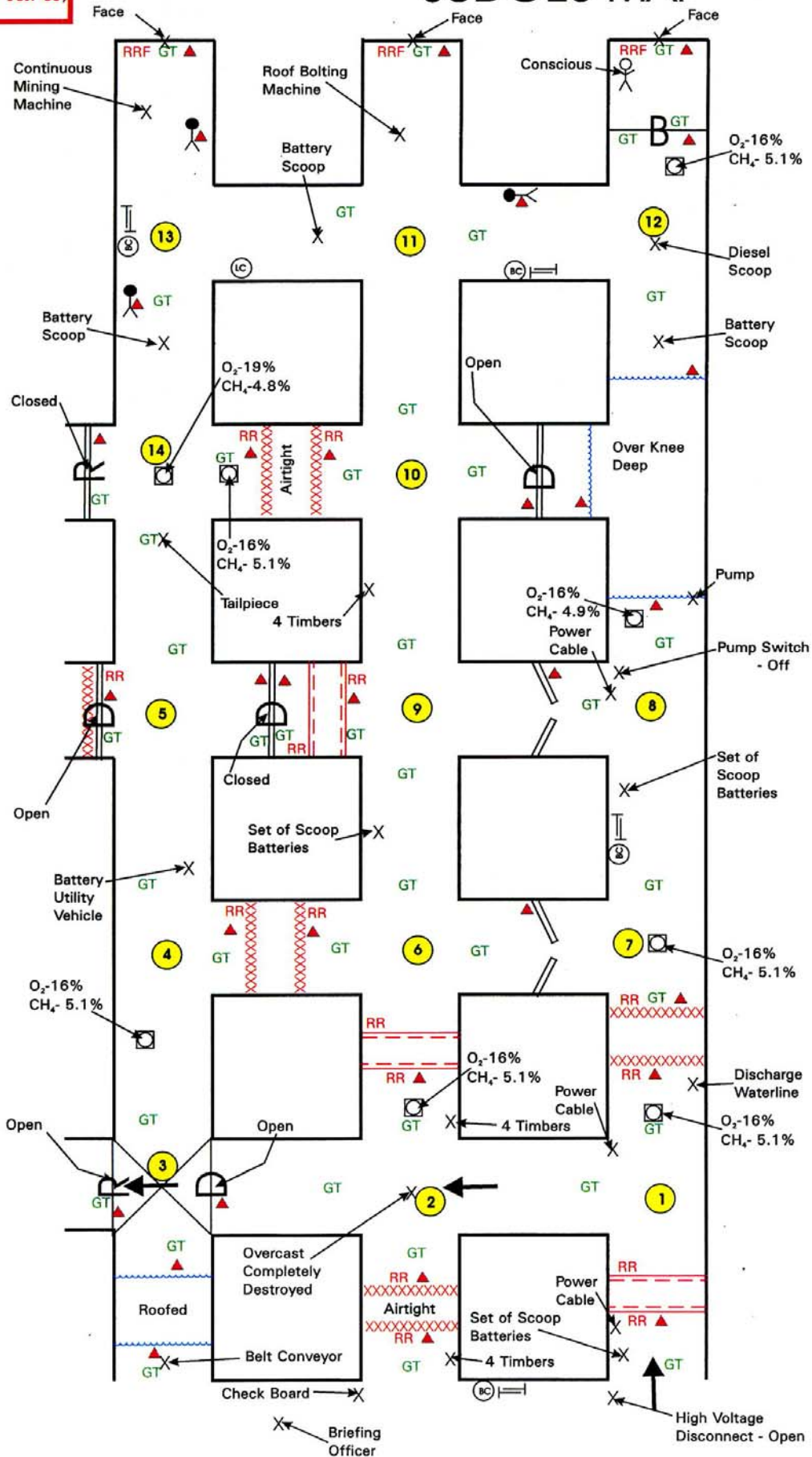

# PAONIA, CO MINE RESCUE CONTEST - 2004

## 3rd LEFT

## JUDGES WORK MAP

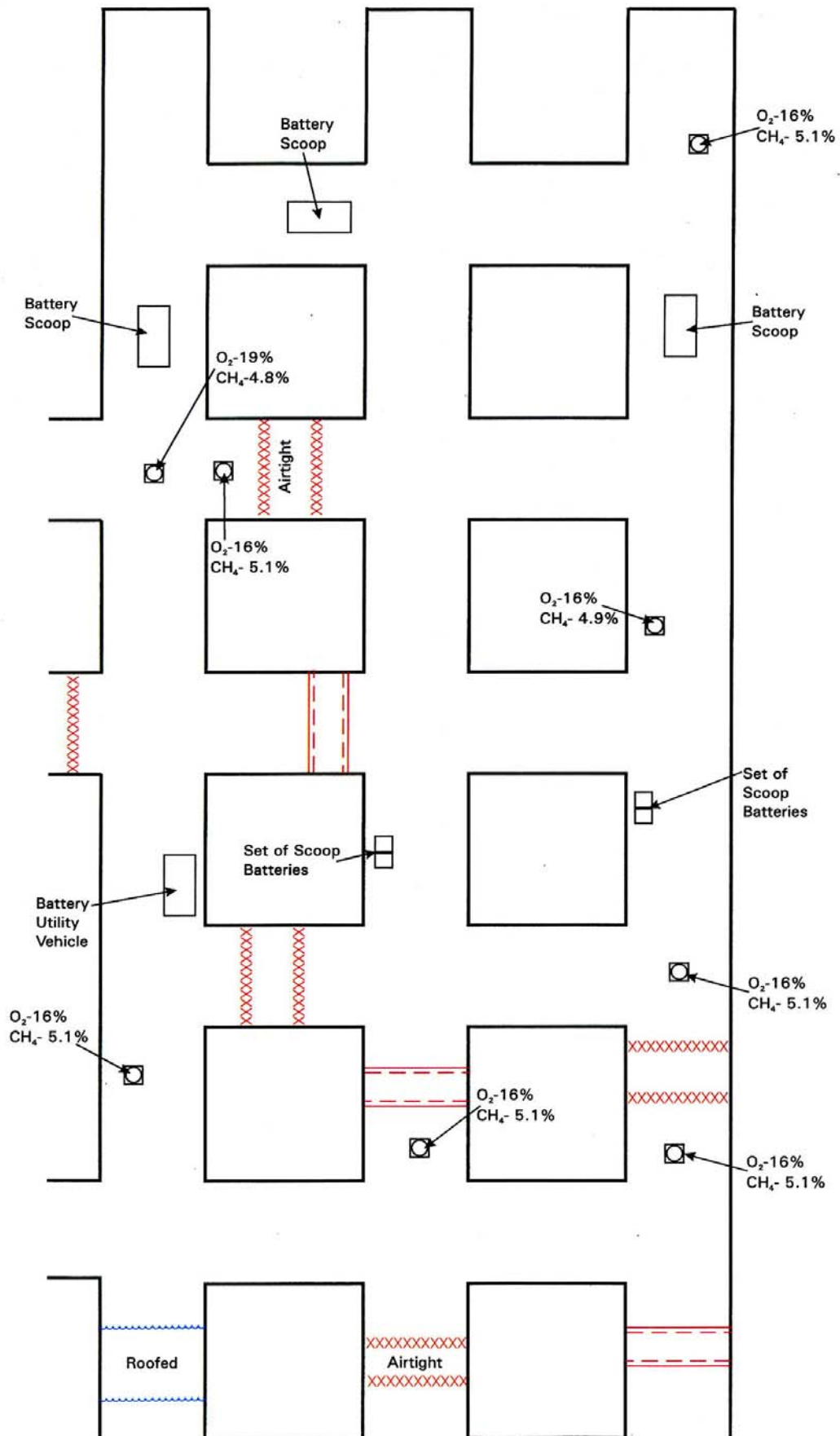

# PAONIA, CO MINE RESCUE CONTEST - 2004

## 3rd LEFT

## JUDGES VENT. / FINAL MAP

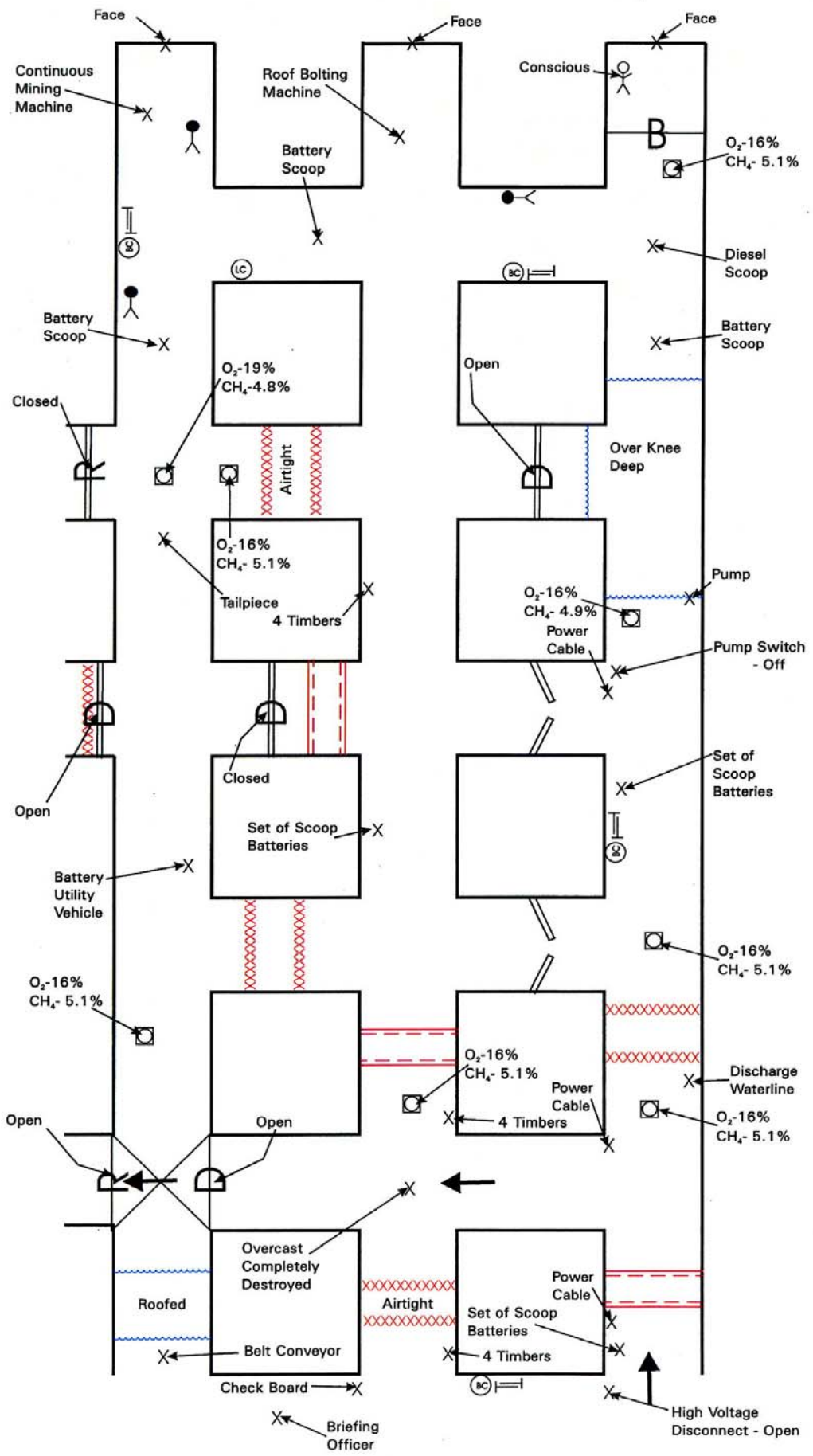

# PAONIA, CO MINE RESCUE CONTEST - 2004

## 3rd LEFT PLACARD LOCATIONS

